

JUNE 1974 • 75 CENTS



A HARCOURT BRACE JOVANOVIH PUBLICATION

ELECTRONIC TECHNICIAN/DEALER

WORLD'S LARGEST TV-RADIO SERVICE & SALES CIRCULATION

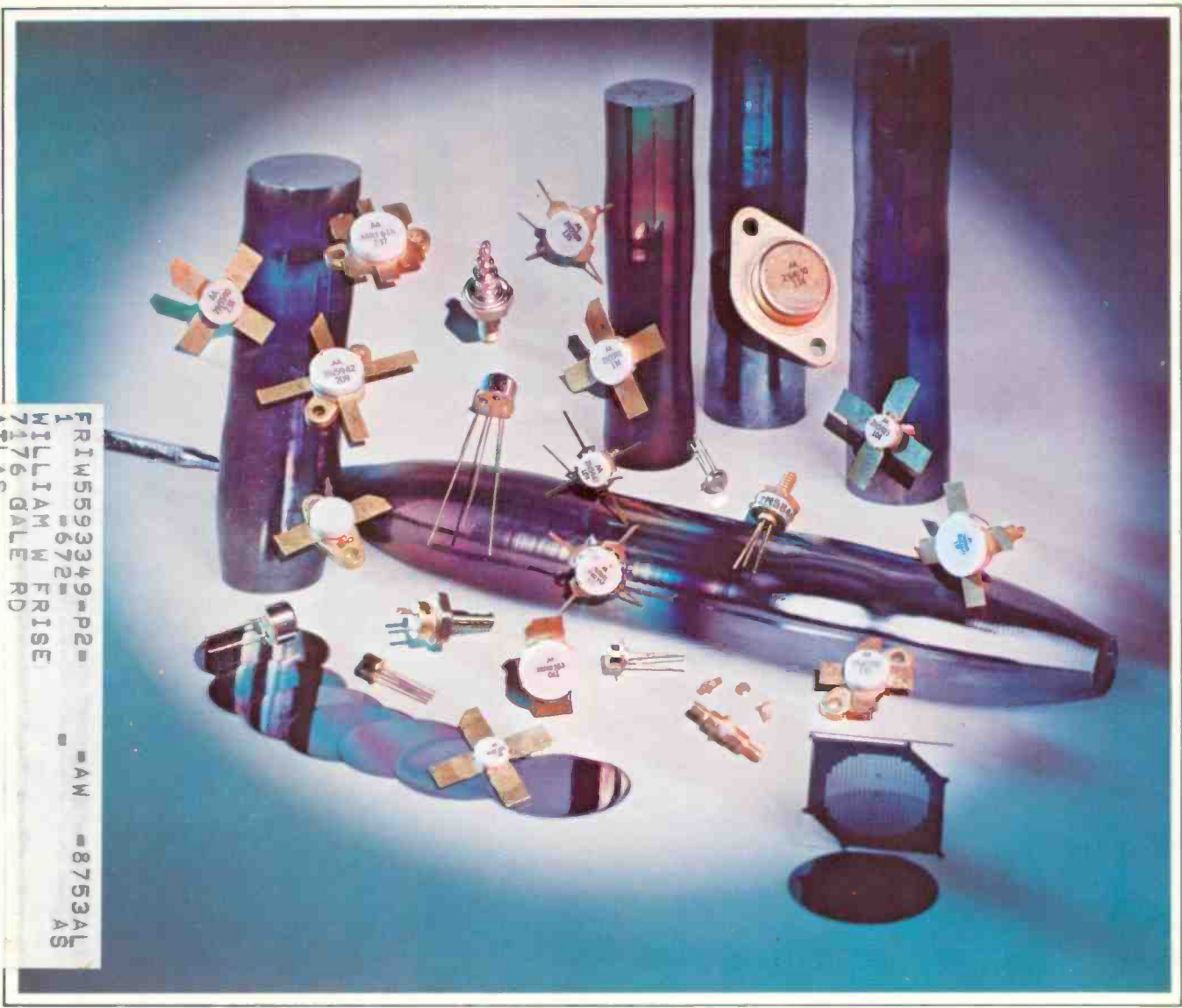

FRIM5593349-P2-
WILLIAM W FRISE
7176 GALE RD
ATLAS
MI 48411

Testing Bipolar Transistors
Speakers For Commercial Audio
Stereo Audio Measurements

PTS ELECTRONICS

Precision Tuner Service

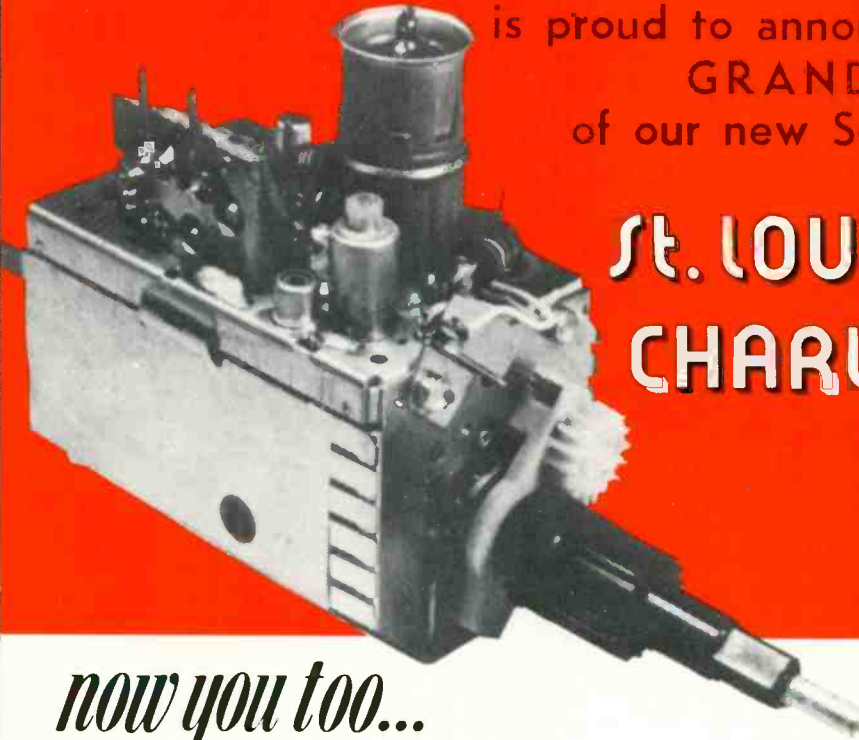

is proud to announce the
GRAND OPENING
of our new Service Centers in

ST. LOUIS, MO.

CHARLOTTE, N.C.



HOME OFFICE—INDIANA:
5233 S. HWY. 37
BLOOMINGTON, INO. 47401
TEL. 812, 824-9331

CALIFORNIA—NORTH:
4611 AUBURN BLVD.
SACRAMENTO, CALIF. 95841
TEL. 916, 482-6220

CALIFORNIA—SOUTH:
5111 UNIVERSITY AVE
SAN DIEGO, CALIF. 92105
TEL. 714, 280-7070

COLORADO:
4958 ALLISON ST.
ARVADA, COLO. 80001
TEL. 303, 423-7080

FLORIDA:
1918 BLANDING BLVD.
JACKSONVILLE, FLA. 32210
TEL. 904, 389-9952

INDIANA:
5233 S. HWY. 37
BLOOMINGTON, INO. 47401
TEL. 812, 824-9331

KANSAS:
3116 MERRIAM LNE.
KANSAS CITY, KANSAS 66100
TEL. 913, 831-1222

LOUISIANA:
2914 WYTCWOOD DR.
METAIRIE, LOUISIANA 70033
TEL. 504, 885-2349

MARYLAND:
1105 SPRING ST.
SILVER SPRING, MD. 20910
TEL. 301, 565-0025

MASSACHUSETTS:
191 CHESTNUT ST.
SPRINGFIELD, MASS. 01103
TEL. 413, 734-2737

MINNESOTA:
815 WEST LAKE ST.
MINNEAPOLIS, MINN. 55408
TEL. 612, 824-2333

MISSOURI:
8456 PAGE BLVD.
ST. LOUIS, MO. 63130
TEL. 314, 428-1299

NEW YORK:
993 SYCAMORE ST.
BUFFALO, N.Y. 14212
TEL. 716, 891-4935

N.Y. CITY—NEW JERSEY:
158 MARKET ST.
E. PATERSON, N.J. 07407
TEL. 201, 791-6380

NORTH CAROLINA:
724 SIEGLE AVE.
CHARLOTTE, N.C. 28205
TEL. 704, 332-8007

OHIO:
5682 STATE RD.
CLEVELAND, OHIO 44134
TEL. 216, 845-4480

OKLAHOMA:
3007 N. MAY
OKLAHOMA CITY, OKLA. 73106
TEL. 405, 947-2013

OREGON:
5220 N.E. SANOVY BLVD.
PORTLAND, OREGON 97213
TEL. 503, 282-9636

PENNSYLVANIA—EAST:
1921 S. 70TH ST.
PHILADELPHIA, PA. 19142
TEL. 215, 724-0999

PENNSYLVANIA—WEST:
257 RIVERVIEW AVE. W.
PITTSBURGH, PA. 15202
TEL. 412, 761-7648

TEXAS—NORTH:
MOPAC LANE
LONGVIEW, TEX. 75601
TEL. 214, 753-4334

TEXAS—EAST:
4324-26 TELEPHONE RD.
HOUSTON, TEX. 77032
TEL. 713, 644-6793

now you too...

...get **Fast 8 hr. Service!**

\$9⁹⁵

1 YEAR GUARANTEE

ALL PTS BRANCHES are wholly owned subsidiaries of PTS ELECTRONICS, INC: (NO FRANCHISES!) and report directly to the Home Office in Bloomington, Indiana. Only this way can we guarantee the same quality—PRECISION TUNER SERVICE—that made PTS the leader in this field. PTS is proud to be the only tuner service to publish a **TUNER REPLACEMENT PARTS CATALOG**. (New 4th Edition; over 100 pages of tuner blow-ups. Tuner—antenna coil—and shaft replacement guides available for \$2.00.)

WE OFFER MORE.

SERVICE IS EVERYTHING WITH US.

WE ARE DYNAMIC AND FAST.

TRUSTWORTHY.

YOU AND US—A TRUE PARTNERSHIP.



PTS ELECTRONICS, INC. is recommended by more TV manufacturers and overhauls more tuners than all other tuner services combined!

Color • Black & White • Transistor
• Tubes • Varactor • Detent UHF
All Makes

VHF, UHF	\$ 9.95
UV-COMBO	16.95
IF-SUBCHASSIS	12.50

Major parts and shipping charged at cost. (Dealer net!)
over 4000 exact tuner replacements available for \$14.95 up (new or rebuilt)

PTS-NUMBER ONE

AND STILL TRYING HARDER!

(NOT A FRANCHISE COMPANY)

... for more details circle 120 on Reader Service Card

Now you can get "XR" glass tubes in our economy line.

You know the EIA guidelines. Replace like with like.

That used to mean that all you could offer in "XR" glass tubes were the all-new, more expensive types.

Now, Sylvania has changed all that.

We've added 19 of the "XR" glass types to our Color Screen 85 economy line, and another 5 types to our medium price Color Bright 85® RE line. You can tell them by the

"V" designation in the type number. For example 23 VANP22. And of course, you've got all types in our Color Bright 85® "XR" new tube replacement line.

Three lines to offer. Three prices to offer.

That should eliminate a lot of your customer's inhibitions.

Electronic Components Group, GTE Sylvania, 100 First Avenue, Waltham, Mass. 02154

Another first from the leader

GTE SYLVANIA

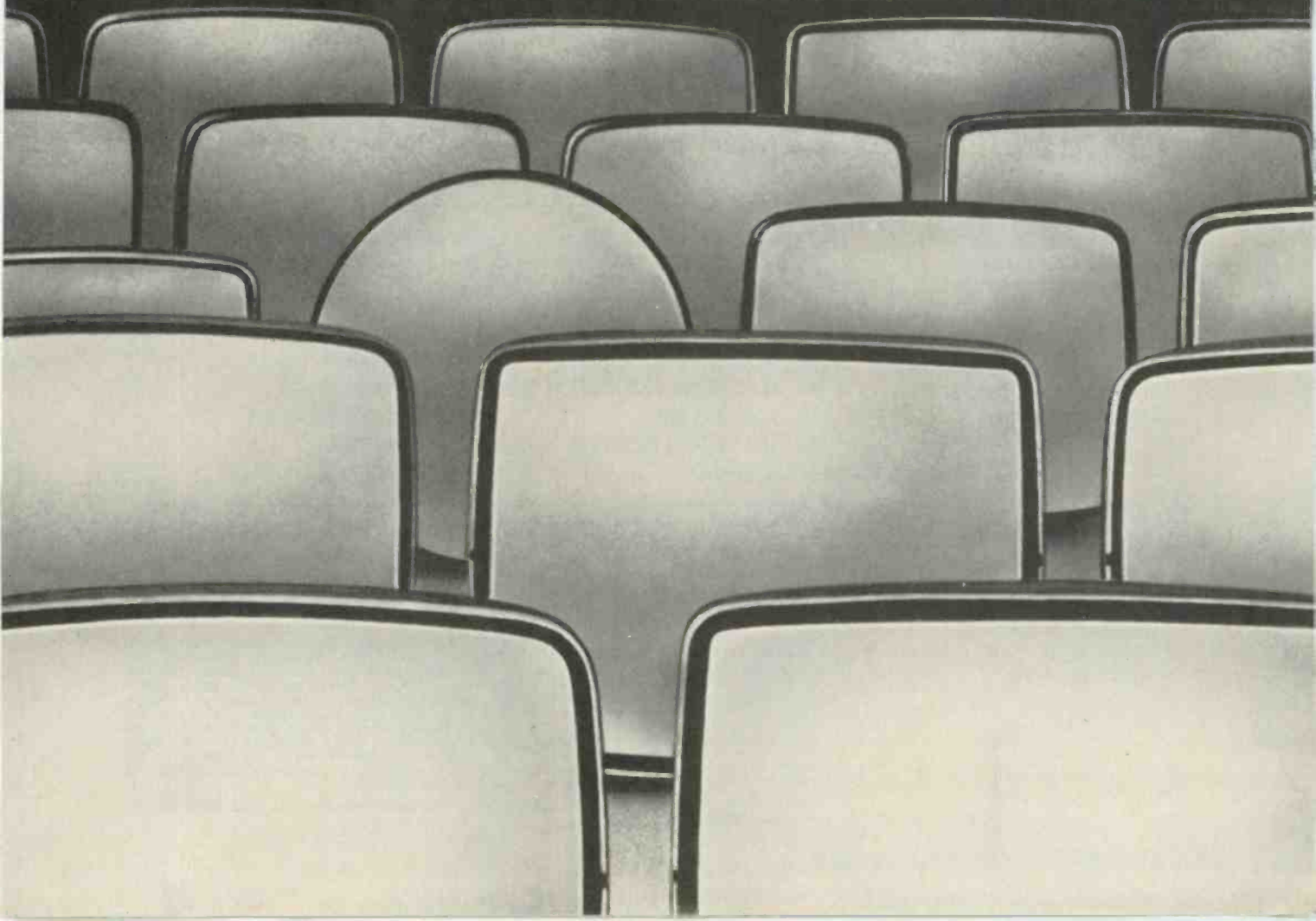

ELECTRONIC TECHNICIAN/DEALER

JUNE 1974 • VOLUME 96 NUMBER 6

J. W. PHIPPS
Editor
1 East First Street
Duluth, Minn. 55802
(218) 727-8511

ALFRED A. MENEGUS
Publisher
757 Third Avenue
New York, N.Y. 10017
(212) 572-4839

TOM GRENEY
Publishing Director

JOSEPH ZAUHAR
Managing Editor

DEBRA BOOTH
Production Manager

JOHN PASZAK
Graphic Design

LILLIE PEARSON
Circulation Fulfillment

GENE BAILEY
Manager, Reader Services

MANAGERS

DAVE HAGELIN
43 East Ohio Street
Chicago, Ill. 60611
(312) 467-0670

CHUCK CUMMINGS
Ad Space South/West
613 North O'Connor
Irving, Texas 75060
(214) 253-8678

KEN JORDAN
DONALD D. HOUSTON
1901 West 8th Street
Los Angeles, Calif. 90057
(213) 483-8530

CHARLES S. HARRISON
CY JOBSON
57 Post Street
San Francisco, Calif. 94104
(415) 392-6794

ROBERT UPTON
Tokyo, Japan
C.P.O., Box 1717

FEATURES

18 **TEKLAB REPORT—GTE Sylvania Color TV Chassis E06—Part 2**

The chroma, horizontal and vertical sync, video and convergence circuits are covered in this second of a two-part analysis of Sylvania's new small-screen, nonmodular, solid-state color TV chassis. By Joseph Zauhar.

24 **TECH BOOK DIGEST—Stereo Audio Measurements**

How to measure the power output, frequency response, audio input sensitivity, total harmonic distortion and channel separation of stereo amplifiers. Reprinted from **FM STEREO/QUAD RECEIVER SERVICING MANUAL** by Joseph J. Carr, TAB BOOKS, 1974.

30 **SELECTING SPEAKERS FOR COMMERCIAL AUDIO SYSTEMS**

How the three basic types of speakers should be used and how to determine what types are needed for a particular installation, plus a look at how the speaker requirements for a typical installation were determined. By Jack Hobbs.

38 **TEST INSTRUMENT REPORT—B&K Precision Model 282 Digital Multimeter**

Block diagram analysis plus step-by-step procedures for using this new 3½-digit multimeter to measure resistances and AC and DC voltages and currents. By J. W. Phipps.

42 **MODERN SERVICING TECHNIQUES—Bipolar Transistors—What Every Good Technician Should Know About Them**

A practical examination of the characteristics of bipolar transistors with which the technician should be concerned, and how to test them. By B. B. Dee. (Cover photo courtesy of Motorola Semiconductor Products, Inc.)

TEKFAX—Airline Model GAI-12914B, General Electric Ch. 19QA, Sylvania Ch. B10-19 and Ch. D19-10, and Trav-ler Ch. T9H1-1A.

DEPARTMENTS

- | | |
|----------------------------------|-----------------------|
| 6 NEWS OF THE INDUSTRY | 48 TECHNICAL DIGEST |
| 12 ELECTRONIC ASSOCIATION DIGEST | 49 NEW PRODUCTS |
| 14 READER'S AID | 56 DEALER SHOWCASE |
| 17 TECHNICAL LITERATURE | 60 ADVERTISERS' INDEX |
| 47 COLORFAX | 61 READER SERVICE |



A HARCOURT BRACE JOVANOVIICH PUBLICATION

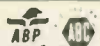

HARCOURT BRACE JOVANOVIICH PUBLICATIONS: James Millholland, Jr., Chairman; Robert L. Edgell, President; Lars Fladmark, Senior Vice President; Richard Moeller, Treasurer; John G. Reynolds, Vice President; Thomas Greney, Vice President; Ezra Pincus, Vice President; Bruce B. Howat, Vice President; James Gherna, Vice President.

ELECTRONIC TECHNICIAN/DEALER is published monthly by Harcourt Brace Jovanovich Publications. Corporate Offices: 757 Third Avenue, New York, New York 10017. Advertising Offices: 43 East Ohio Street, Chicago, Illinois 60611 and 757 Third Avenue, New York, New York 10017. Editorial, Accounting, Ad Production and Circulation Offices: 1 East First Street Duluth, Minnesota 55802. Subscription rates: One year \$6, two years \$10, three years \$13, in the United States and Canada. Other countries: one year \$15, two years \$24, three years \$30. Single copies: 75¢ in the U.S. and Canada; all other countries \$2. Second class postage paid at Duluth, Minnesota 55806 and at additional mailing offices. Copyright © 1974 by Harcourt Brace Jovanovich, Inc. All rights reserved. No part of this publication may be reproduced or transmitted in any form or by any means, electronic or mechanical, including photocopy, recording, or any information storage and retrieval system, without permission in writing from the publisher.

POSTMASTER: Send form 3579 to ELECTRONIC TECHNICIAN/DEALER, P.O. Box 6016, Duluth, Minnesota 55806.

while the guy down the street complains about how tough alignments are...I do them!

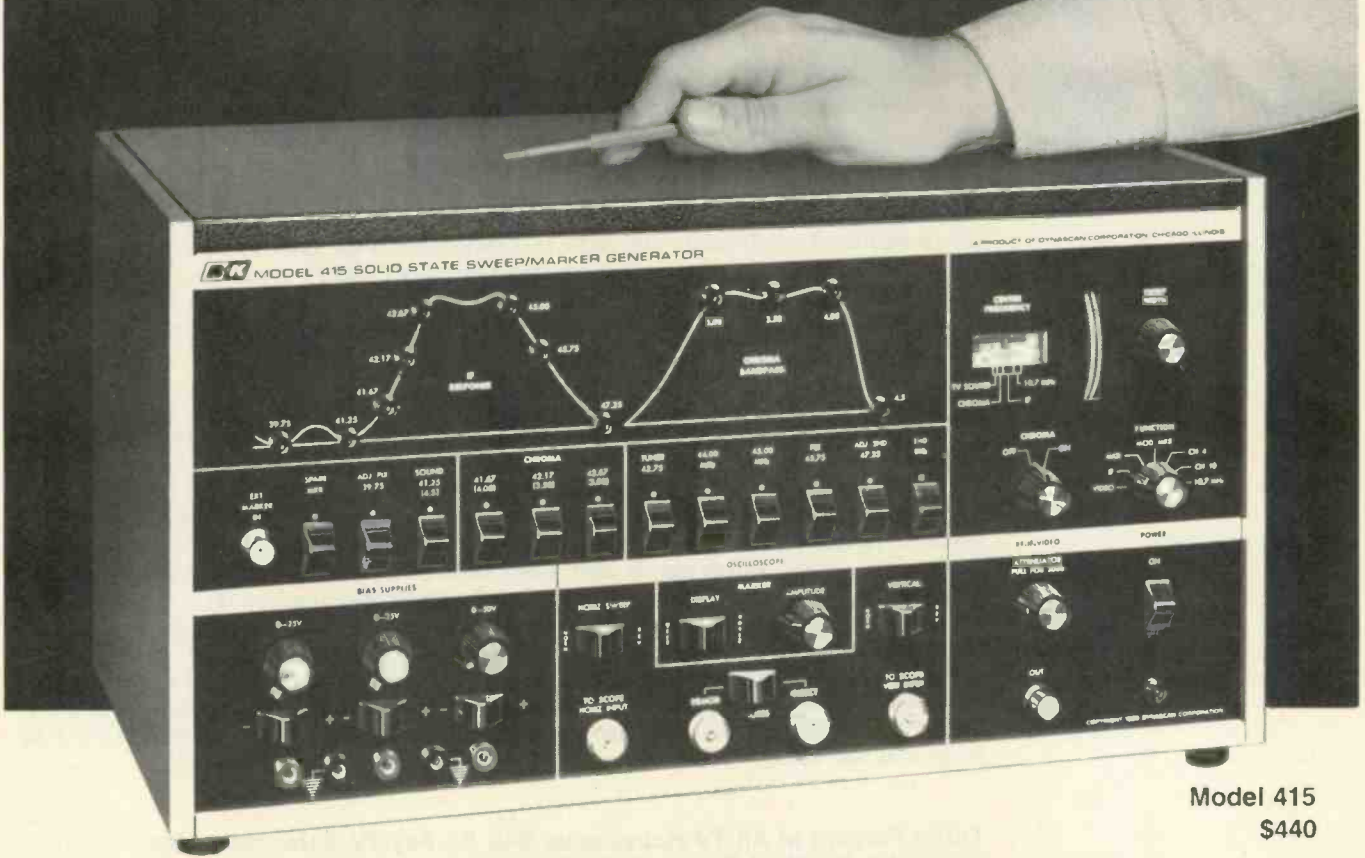

Model 415
\$440

I used to hook up a separate sweep generator, marker generator, marker adder and bias supply, hope that everything was properly calibrated and adjusted, and pray that the alignment would hold after I disconnected the cables draped all over the bench.

I didn't do it very often.

Now, in the time it used to take me just to set up, I can almost complete an alignment. And I'm confident the set will perform as well as it possibly can. My customers notice, too. That's the difference B&K's 415 Solid-State Sweep/Marker Generator made.

Setup is no problem. After I connect the 415's outputs to my scope (there's even low-frequency compensation to eliminate pattern errors), I connect its RF outputs (channel 4 or 10) to the antenna terminals or mixer test point, the direct probe to the video detector test point (or anywhere else after the video detector diode) and the demodulator probe to the bandpass amplifier output.

They're all clip-on connections, and the 415 comes with all the accessories I need. Once I've made the initial signal and bias hookups, there's nothing else to connect or reconnect. All intercabling changes and generator functions are controlled from the front panel. There's even a 15,750Hz filter to eliminate disabling

the set's horizontal output section.

Shaping the waveform is easy, because the 415 has 10 crystal-controlled IF markers, each of which lights up on the front-panel waveform diagram as it is used. Markers can be shown either vertically or horizontally on the scope trace. There's a 100kHz modulated marker that makes nulling the traps so easy it's almost automatic. And three low-impedance, reversible-polarity bias supplies—two, 0-25VDC; one, 0-50VDC.

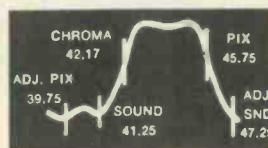

Vertical Markers

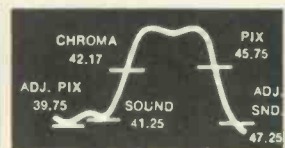

Markers Tilted Horizontally

Every step is easy to understand, too, thanks to the comprehensive manual.

Since I have nothing to sell but my time, I have to make the most profitable use of it I can. That's why I have a B&K 415.

In stock now at your local distributor or write Dynascan.



1801 W. Belle Plaine Ave. • Chicago, IL 60613 • Phone (312) 327-7270

Complete Line of Analog and Digital Multimeters, Oscilloscopes, Signal Generators, Semiconductor Testers, Power Supplies, Probes, Tube Testers and Substitution Boxes.

... for more details circle 102 on Reader Service Card

NEWS OF THE INDUSTRY

More Independent Retailers Honor Bank Credit Cards, Pay Higher Service Fees

The percentage of independent retailers honoring bank credit cards has increased 50 percent during the past three years, according to data compiled through the continuous field survey conducted by the National Federation of Independent Business (NFIB).

In January, 1971, NFIB data gathered during the previous year revealed that 30 percent of independent retailers were accepting bank credit cards for payment of purchases. By January of this year, the percentage had increased to 45.6 percent.

The comparative data also indicates that independent retailers are paying a higher discount, or service fee, to banks for this service. In January, 1971, 58 percent were paying from three to five percent of the purchase amounts. Current data indicates that the percentage of retailers paying this service fee range has jumped to 85.2 percent. In addition, 2.4 percent of retailers report they are being discounted six percent on bank credit card sales.

Only 25 percent of the service establishments responding to the NFIB survey report that they honor bank credit cards, and those that do pay about the same service fee as retailers.

Promoters of bank credit cards claim that a customer using a credit card is more likely to buy a higher quality or price of merchandise than if he or she pays in cash. Of those retailers who report to the NFIB that they accept credit cards, 33.9 percent say they are upgrading sales.

RCA Discrete Four-Channel FM Stereo Broadcast System Demonstrated

RCA's new four-channel discrete FM stereo broadcast system, which transmits four separate audio signals simultaneously, was demonstrated publicly for the first time at the National Association of Broadcasters Convention in Houston, Texas, March 17-20.

The new system, which also is compatible with existing two-channel and monophonic receivers, employs an FM transmitter equipped with RCA's standard BTS-1 stereo generators modified for four-channel capability plus a turntable, tape deck, audio console and receiver, all designed for the four-channel format.

After the demonstration, the system was turned over to the National Quadraphonic Radio Committee of the Electronic Industries Association, which will study and field test the RCA system and other systems proposed for quadraphonic broadcasting in the FM band, and will report its findings to the Federal Communications Commission.

Thirty Percent of All TV Households Will Be Pay TV Subscribers by 1985 Says Stanford Research Institute

A study conducted by Stanford Research Institute (SRI) predicts that by 1976 1.5 million TV households will be pay TV subscribers and that by 1985 this figure will surpass 25 million. These predictions are included in one volume of a seven-volume SRI examination of the outlook for CATV.

The study also predicts that pay TV will be delivered to American households both by over-the-air and CATV systems, and will permit CATV to expand profitably into market areas not considered viable today. According to the SRI study, although CATV will dominate pay TV within 10 years because of its multi-channel capability, the projected growth of pay TV will not have a serious impact on commercial over-the-air TV because of FCC limitation of pay TV to small-audience programming and the fact that the price of pay TV subscription will itself limit the amount of time viewers will watch pay TV.

U.S. Justice Department Delays Sale of Motorola TV to Panasonic

The proposed sale of Motorola Inc.'s home television receiver business to Matsushita Electric Industrial Co., Ltd., parent company of Panasonic, was extended to May 28 in response to a request by the U.S. Department of Justice, which, at publishing time, was reviewing the status of the acquisition under U.S. antitrust laws. The purchase agreement was signed on March 22, 1974.

The Justice Department asked Motorola, in late April, to use the 30-day postponement period to make a "good faith" effort to find another qualified buyer who is capable of continuing to operate the business as "a viable competitive entity."

According to a report in the April 24 issue of *The Wall Street Journal*, Senator Birch Bayh (D., Ind.) early in April complained to the Justice Department that the proposed sale could harm the Indiana-based Magnavox Co. and other U.S. TV manufacturers.

The Department of Justice stated at press time that if at the end of the 30-day postponement it is satisfied that the sale of Motorola to Matsushita is the only means of retaining Motorola's TV business as a viable competitive entity, it would not sue to prevent the sale.

Sale of Philco-Ford Consumer Electronics to White Called Off

Philco-Ford Corporation and White Consolidated Industries, Inc., have announced that they have mutually agreed to end negotiation of a sales agreement under which White Consolidated would have purchased the Philco-Ford home entertainment electronic products marketing operation and two Philco-Ford manufacturing plants.

Commenting on the announcement, T. C. Page, president of Philco-Ford, said, "Throughout our negotiations with White Consolidated, Philco-Ford has continued the product planning and sales programs we deemed essential to maintain a strong position for Philco-Ford products in the marketplace."

Philco-Ford introduced its 1975 home entertainment product lines to its field sales organization and its 100 top retailers at the Flamingo Hilton Hotel in Las Vegas on June 1.

PTS Electronics Adds Three New Tuner Servicing Branches

PTS Electronics, Inc., Indiana-based tuner repair company, recently announced the opening of new tuner repair branches in St. Louis, Missouri (8465 Page Blvd.), Birmingham, Alabama (524 Thirty-Second St.), and Charlotte, North Carolina (724 Siegle Ave.).

Sylvania Service Company Opens Branch to Serve Greater Hartford, Conn. Area

Sylvania Service Company, Inc., which provides service on home entertainment products manufactured by GTE Sylvania, Inc., has opened a service center at 77 Grossmere Ave. in West Hartford, Conn.

The new service center will serve an area which includes the Connecticut communities of Hartford, New Haven, Waterbury, Torrington, Middletown and Willimantic, and Springfield, Northampton and Amherst in Mass.

Sylvania Service Company was founded seven years ago and presently serves about 500,000 customers, mostly along the East Coast. In addition to in-home service, it also provides factory repair of color TV, black-and-white TV and audio products for individual consumers and dealers, and specializes in the installation and maintenance of MATV, security and closed-circuit TV systems for business, industry and institutions.

Hickok Re-Enters Service Test Instrument Market

Hickok Electrical Instrument Co., Inc., recently announced its intention to re-enter the service test instrument market and, at press time, already has introduced five new service-oriented test instruments.

A few years ago the company was an active marketer in the service field but then decided to concentrate on the industrial test instrument market.

New Federal Law Ups Minimum Hourly Wage to \$2.00

A bill which amends the Fair Labor Standards Act of 1938 was signed into law by the President in April. One of the amendments of the new bill increased the minimum wage of non-farm workers covered before 1966 to \$2 an hour on May 1 of this year and provides for further increases to \$2.10 an hour on January 1, 1975, and to \$2.30 an hour on January 1, 1976.

Employees covered by these new hourly rates generally include those engaged in or producing goods for interstate or foreign commerce. Also covered are hourly employees of retail or service enterprises with annual gross sales volumes of at least \$1 million and \$250,000 annual inflow of interstate goods.

The new amendments contain several provisions which affect youth employment, including one provision which permits retail and service enterprises to hire up to four full-time students at 85 percent of the minimum wage without obtaining certification from the Labor Department.

continued on page 8

NEWS OF THE INDUSTRY

continued from page 7

EIA Publishes Consumer Electronic Statistics

More than 96 percent of the nation's homes have at least one television receiver, and at least half of American TV homes now have more than one set. Portables and table models represented 65.6 percent of the color TV market in 1973. More than 96 percent of monochrome TV receivers sold last year were portables or table models.

These and many other sales and production statistics about virtually every type of consumer electronic product are included in the Electronic Industries Association's *1974 Consumer Electronics Annual Review*, a 52-page compilation which is now available for 50 cents from the Consumer Electronics Group, Electronic Industries Association, 2001 Eye Street, N.W., Washington, D.C. 20006.

Teledyne Packard Bell 1975 Line 100 Percent Solid-State

Teledyne Packard Bell has announced that its entire 1975 line of TV and audio products will be 100 percent solid-state.

Higher Volume Needed During Inflation, But Does Not Guarantee Bigger Net Profits

The effects of continuing inflation are being felt by independent retailers, according to the National Federation of Independent Business (NFIB). Statistics compiled from information gathered through the continuous survey of the NFIB reveal that, of the independent retailers responding during the 1st quarter of this year, only 27.5 percent reported a higher dollar volume, and of this group, only 24.1 percent said their net profit has increased.

Zenith Announces Increased TV Sales for First Quarter

Increased unit sales of color television during the first quarter of 1974 have been announced by Zenith. The increased sales by Zenith during a period when the industry as a whole experienced a downturn has reportedly enabled Zenith to achieve a significant increase in its share of the color television market.

Zenith also has reported new records in unit sales and increased market shares of black-and-white television and console and modular stereo instruments.

Griffiths to Market Replacement Picture Tubes under Magnavox Label

Griffiths Electronics, Inc., has entered into an agreement with Magnavox under the terms of which Griffiths is now the sole distributor of replacement TV picture tubes marketed under the "Magnavox" label. Griffiths will remanufacture the picture tubes and will pay Magnavox a "modest" royalty fee for use of the Magnavox label.

In addition to replacement TV picture tubes, Griffiths also manufactures electron gun mount assemblies for black-and-white and color TV picture tubes and other electronic components in facilities in Tucson, Arizona; Nogales, Mexico; Jacksonville, Florida; Atlanta, Georgia; and Dallas, Texas. The firm is based in Jacksonville.

Potpourri . . .

The products lines of two Northrop Corporation subsidiaries, *The Hallicrafters Co.* and *Wilcox Electric, Inc.*, have been integrated into one product line. . . . The third annual meeting of the *Zenith Radio Corporation Technicians' Advisory Council* was held in Chicago April 8-9. The Council, which consists of 16 independent service technicians from all sections of the U.S., spent two days discussing service, parts, product development, quality assurance and other service-oriented topics with Zenith executives involved in product planning, quality, reliability and servicing of the company's consumer electronics products. . . . *Pioneer Electronics of America* has announced that it will appoint a Service Advisory Council to help "uncover and hopefully cure those difficulties the average independent repair firm experiences in working with complex products that are manufactured thousands of miles away." The Council will be appointed and will hold its first meeting in late May or early June and thereafter will meet at least semi-annually, in addition to providing individual input on a monthly basis. ■

4 GOOD REASONS WHY YOU SHOULD BUY YOUR VOM FROM "THE BIG T"

1 TUCKER SELLS THE WORLD'S FINEST VOM - The Weston 660 series VOM are completely drop-proofed, custom ruggedized with self-storing carrying handle, pluggable circuit boards, external calibration and the highest quality components. Six models to choose from, all temperature compensated.

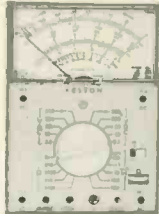

MODEL 660

2 YOU CAN TRADE-UP at a later date - or use your surplus instruments as trade-ins.



Model 666 VOM Solid-state circuit tester designed specifically for semiconductor circuit trouble shooting.

3 IT'S EASY. At Tucker one letter or phone call (on our special toll-free number) allows you to complete the deal. You can use your Bank Americard, Master Charge or American Express. Tucker will ship on P.O.'s, M.O., checks or COD.



4 IT'S SAFE. If for any reason you change your mind within 30 days, return your purchase and get your money back. This guarantee does not affect the normal WESTON guarantee of quality.

OPTIONS

Protective meter flap\$4.50
Leather Carrying Case\$19.50



DC HIGH-VOLTAGE PROBE extends voltage range as high as 50KV. OPTIONAL \$23.75

RANGES FOR 660, 661, 662, 663: DC Millivolts 0-250; AC/DC volts 0-2, 5/10/50/250/500/1000/5000; VAC output 0-2.5/10/50 and 250; DC microamps 0-50; DC Millamps 0-1/10/100/500; DC Amps 0-10; Ohms Rx1 (0-2K) 20Ω center, Rx10 (0-20K) 200Ω center, Rx100 (0-200K) 2000Ω center, Rx1000 (0-2 Meg) 20KΩ center and Rx10K (0-20 Meg) 200KΩ center; dB scales -10 to +10/+2 to +22/+16 to +36/+30 to +50/+36 to +56,



RF PROBE allows measurements to 50 MHz. OPTIONAL \$19.50

PRICES:

660 (2% DC & 3% AC accuracy)	\$ 68.00
661 (1% DC & 2% AC accuracy)	\$ 76.50
662 (overload protection version of 660)	\$101.50
663 (overload protection version of 661)	\$110.00
666 (VOM solid state circuit tester)	\$139.00

Send your Check, M.O., Bank Americard No., Master Charge No., American Express No. to the address below. Add \$2.75 for shipping. Residents of California, New Jersey, Illinois and Texas add 5% sales tax. Call or write for your Free Weston 660 series brochure.



TUCKER
ELECTRONICS · COMPANY

P.O. Box No. 1050
Garland, Texas 75040

FOR RUSH ORDERS CALL TOLL-FREE 800-527-4642 (In Texas call 214-348-8800)

... for more details circle 132 on Reader Service Card

Five ways Zenith brightens your

1 All-new elegance in 25" diagonal Chromacolor II consoles.

This year, the Zeniths in our most popular screen size should be more popular than ever.

Because this year, the 25" diagonal Chromacolor II consoles come in 23 elegant new models.

In a full range of styles to satisfy the most discriminating customer. And all in the customers' choice of fine grained finishes.

The Reynolds, model F4732P

2 Bold new styling in 23" diagonal Chromacolor II consoles.

For 1975, the 23" diagonal Chromacolor II consoles are all new. Every one.

And there are six bold new models to choose from. With exciting styling that covers everything from traditional to contemporary.

To give you a 23" line that should sell like nothing you ever saw before. Or sold before.

The Ribera, model F455C



color TV sales picture in 1975.

3 America's best-selling line of portable and table color TV.

The best-sellers are back again.

With an expanded line of Chromacolor II 17" and 19" diagonal portables and table models.

In a full range of styles and pricing points. Plus the feature options you need to clinch the sale: Space Command® remote control, electronic channel selection, Chromatic® rebutton tuning, advanced styling.

And more.

The Braque, model F4039W



The Matisse, model F3860W (with swivel base)

4 Plus a whole new market: Zenith's new 19" Decorator Compact Consoles.

For people who want a fine-furniture console but don't have room for a big console.

Introducing Zenith Decorator Compact Consoles Real 19" diagonal Chromacolor II consoles that are up to 8" narrower and 6" slimmer front-to-back than comparably styled 25" consoles.

So they fit into apartments, small spaces and other locations where a regular console won't. But they still have all the style and craftsmanship of our full-sized models.

Decorator Compact Consoles. In six beautiful new styles. For people who don't have room for a big console.

The Avanti, model F4082X

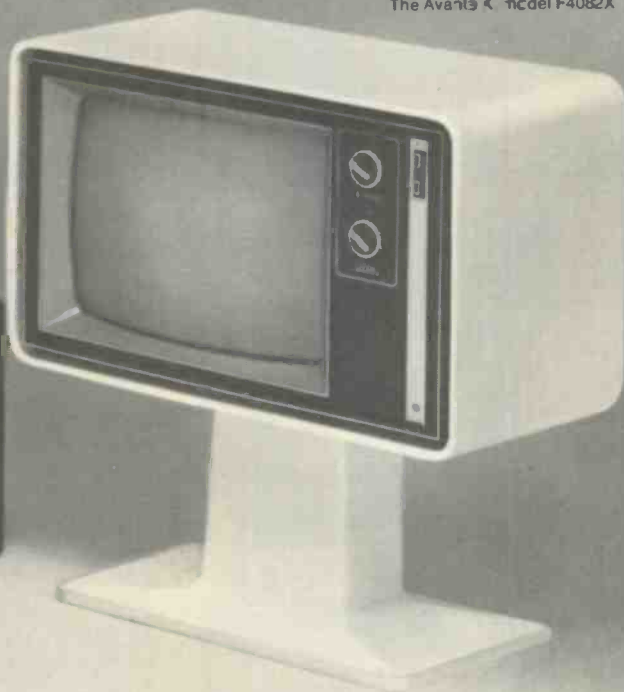

5 And all backed by the best-selling features of Chromacolor II.

This year, your customers are going to be more value-conscious than ever. Which means there's never been a better time to sell the proven quality and dependability of Zenith Chromacolor II.*

It's features like these that move customers. And color TV's.

Patented Power Sentry protection.

A Zenith first. Regulates the

power, to guard the chassis and picture tube while it helps keep the picture sharp under varying household voltage conditions. Actually improves picture tube life. And enables Chromacolor II sets to perform on less energy.

100% solid-state chassis.

Zenith's most powerful chassis. It delivers cleaner, more

naturally brilliant colors. And solid-state design means years of cool, dependable operation. amazing contrast and detail.

Brilliant Chromacolor picture.

From Zenith's patented Chromacolor picture tube that set a new standard in color TV picture quality. Bright, sharp, vivid, with

*For the third straight year, a nationwide survey of independent TV service technicians has named Zenith, by more than 2 to 1 over the next best brand, as the color TV needing fewest repairs. The same survey rated Zenith as the highest-quality color TV, as the one with the best picture, and as the one service technicians would buy for themselves today.

ZENITH
SOLID STATE
CHROMACOLOR II

The quality goes in before the name goes on.®

Heath is out to make the counter as commonplace as the VTVM



the \$169.95*, IB-1100
30 MHz, 5-digit kit-form
counter

the \$225.00*, SM-118A
30 MHz, 6-digit
assembled autoranging
counter

the \$229.95*, IB-1101
100 MHz, 5-digit kit-form
counter

the \$299.95*, IB-1102
120 MHz, 8-digit kit-form
counter

the \$325.00*, SM-128A
110 MHz, 7-digit
assembled autoranging
counter

the \$379.95*, IB-1103
180 MHz, 8-digit kit-form
counter

the \$395.00*, SM-128B
110 MHz, 7-digit,
assembled high stability,
autoranging counter

the \$495.00*, SM-110A
200 MHz, 7-digit,
assembled counter

the \$625.00*, SM-110B
200 MHz, 7-digit,
assembled high stability,
programmable counter

the \$795.00*, SM-110C
600 MHz, 7-digit,
assembled high stability,
programmable counter

HEATH

Schlumberger

Heath Company
Dept. 24-6
Benton Harbor, MI 49022

- Please send latest Heathkit catalog.
- Please send latest assembled instruments catalog.
- Enclosed is \$_____ plus shipping.
Please send model(s)_____

Name _____

Address _____

City _____ State _____ Zip _____

*Mall order prices; F.O.B. factory.

TE-307

ELECTRONIC ASSOCIATION DIGEST

Information about the activities of national, state and local associations of electronic servicers, dealers and manufacturers. Material for publication in this department should be addressed to: Service Association Digest, ET/D, 1 East First St., Duluth, Minn. 55802.

Colorado Association Assists BBB in "Bugged" Set Investigation of Denver "Free Service Call" Advertisers

The Colorado Professional Electronics Association (CPEA) in March of this year assisted the Rocky Mountain Better Business Bureau (BBB) in an "investigation" of consumer electronic service businesses in the metropolitan Denver area which offer free service calls in their advertisements.

According to a report in the April issue of *Holine*, the official publication of the CPEA, the Rocky Mountain BBB requested the association to assist it in the investigation. Acting on the request, the president and vice president of CPEA helped the BBB prepare two television receivers for use in the investigation. One set was equipped with a defective tube which produced loss of color and the other set was equipped with a number of other defects. In addition, all parts in the sets were marked so that they later could be identified.

The BBB then placed the "bugged" TV receivers in homes in the Denver area and requested servicing of them from several servicers, including some who advertised free service calls. After being repaired by a servicer from whom service was requested by the BBB, the repairs were evaluated and the sets then restored to their original "bugged" condition, for servicing by another BBB-selected servicer.

The results of this "investigation," which were published in the *Denver Post*, reportedly showed that the total costs of repairs by the firms who advertised free service calls were generally higher than those performed by servicers who did not advertise free service calls.

According to the CPEA report, the Rocky Mountain BBB has labeled the advertising of free service calls a "bait and switch" technique and has turned over the records of the investigation to the Colorado Department of Consumer Affairs, for use in determining whether or not the free-service-call advertisers should be prosecuted.

NESDA Michigan Affiliate Elects New Officers

The Michigan Television Service Association, an affiliate of the National Electronic Service Dealers Association (NESDA), has elected the following new officers: Stewart Leightner, CET, president; Thomas McDonald, CET, vice president; Larry Radley, treasurer; and Al Moskal, executive secretary.

AEM Exploring Merger with EIA Distributor Products Division

The National Board of Directors of the Association of Electronic Manufacturers, Inc., (AEM) in April unanimously voted to begin exploration of a possible merger with the Distributor Division of the Electronic Industries Association (EIA).

ISCET Chapter Formed in Houston

A chapter of the International Society of Certified Electronics Technicians (ISCET) was established in Houston, Texas, in March. Officers of the new ISCET Chapter are: Louis Macko, CET, Chairman; Charles Thompson, CET, vice president; Herbert Bell, CET, secretary; and Charles Domingo, CET, treasurer. ■

... for more details circle 111 on Reader Service Card

BOTTOMS UP



Start saving the gray bottom flaps with the GE monogram from GE entertainment receiving tube cartons. They're worth valuable awards to independent service dealers and technicians in a fabulous gift bonanza program from General Electric.

The gift list includes some 43 items ranging from sporting equipment to home appliances, from diamond jewelry to distinctive luggage, from globes and books to calculators and Attend-a-Phones. It even includes the much prized Polaroid SX-70 camera and American Experience week-end vacations at any one of 101 prestigious resorts.

BOTTOMS UP!!! Redeem your flaps by November 30, 1974. Full details at your authorized distributor.

TUBE PRODUCTS DEPARTMENT
GENERAL ELECTRIC COMPANY
OWENSBORO, KENTUCKY 42301

GENERAL  ELECTRIC

THE ONLY COLOR SET YOU SHOULD TINKER WITH



It takes more than tools to be a TV service technician. It requires know-how, especially with a color TV set. Some "do-it-yourselfers" actually do more harm than good . . . and wind up paying more money for repairs or adjustments than they would have if they called their local TV technician at that first sign of trouble. So don't play with that color set. Tinkering can be dangerous as well as expensive. Call your independent TV technician for safety as well as satisfaction.

**THIS MESSAGE WAS PREPARED BY SPRAGUE PRODUCTS COMPANY,
DISTRIBUTORS' SUPPLY SUBSIDIARY OF SPRAGUE ELECTRIC COMPANY, NORTH ADAMS, MASSACHUSETTS FOR . . .
YOUR INDEPENDENT TV-RADIO SERVICE DEALER**

PUT THIS BUSINESS-BUILDING TRAFFIC-STOPPER ON YOUR SHOP WALL OR IN YOUR WINDOW

See your Sprague Distributor for window-size blow-ups of this message. Or, send 25¢ to Sprague Products Co., 65 Marshall St., North Adams, Mass. 01247 to cover handling and mailing costs. Just ask for Poster RP-42.

SPRAGUE
THE MARK OF RELIABILITY

THE BROAD-LINE PRODUCER OF ELECTRONIC PARTS

. . . for more details circle 126 on Reader Service Card

READERS' AID

Space contributed to help serve the personal needs of our readers.

For Sale

A large amount of obsolete Delco auto radio parts, including volume controls, vibrator transformers, output transformers, wonder bar motors and relays. Please write needs.

GARY C. DAGENBARDT, CET
Hickory Electronics
P.O. Box 2728
Hickory, N.C. 28601

Large inventory of new industrial grade, receiving and special purpose tubes. Will accept best offer for one or all. Please write for listing.

K. R. BURNS
1398 E. 7200 So.
Salt Lake City, Utah 84121

I am closing my shop and would like to sell everything as a unit. Please write for details.

CHUCK ANDERSON
7303 Oliver Smith Drive
Des Moines, Ia. 50322

Quality test equipment, tubes and electronic parts. Please write for listing.

GARY PROBST
336 West Church St.
Lock Haven, Pa. 17745

Business for Sale

Complete service business with Zenith franchise. Good service area with plenty of work.

E. W. KRETCHMAR
Box 10
Medford, Okla. 73759

Wanted

A new or used schematic, owner's manual, and power transformer for a Roberts (Akai) 720A reel-to-reel recorder. The transformer has an Akai Part No. RP-102.

HAL LEARNARD
Box 333
Washburn, Maine 04786

Schematic for a 12-in. Japanese made TV set, brand name "Bradford," Chassis No. 32.

C. CABEZAS
928 Glenwood Ave.
Sebring, Fla. 33870

Good used color generator, modern tube checker, solid-state FET VOM

(battery type), low voltage power supply with amp and volt meters and solid-state engine analyzer.
ARENDS RADIO & TV SERVICE
 102 N. Webster
 Shenandoah, Ia. 51601

Service data on Rider Chanalyst made for AM radio servicing by RCA. Stock No. 162-C.
SULLIVAN ELECTRONICS
 P.O. Box 1667
 Summerside Prince Edward Island
 Canada Zip CIN 2V5

Adapters for a Superior Model 82A Tube Tester.
C. PEDZIWIATR
 3233 N. Cermak
 Chicago, Ill. 60623

The names and address of manufacturers selling picture tube rebuilding machines.
C. ORDONEZ
 149 W. 26th St.
 Bayonne, N.J. 07002

A copy of Sam's Photofact No. 12. Must contain schematic for a Philco-Ford Model 46-1213.
RODERICK O. WILSON
 P.O. Box 93
 Cadysville, N.Y. 12918

Jerrold Model 727 Field Strength Meter. Please state price and condition.
E. KRETCHMAR
 Box 10
 Medford, Okla. 73759

Schematic and updated tube chart needed for Reliance Tube Tester.
TONY SANTANGELO
 352 Kensington Rd. South
 Garden City So, N.Y. 11530

I have a new unused copy of Tek-fax 110 and will trade for a clean copy of Tekfax 109 or 111.
P. L. STRUSE
 Box 85
 Leonardville, Ks. 66449

Schematic for a Trommes Hi-Fi Amplifier Model 61PG.
ANDREW FOOT
 2480 Benny Crescent #403
 Montreal, Canada H4B 2R1

Instruction Manual for a Precision Model E-200C Signal Generator.
VREGH GODOSHIAN
 1512 Vine St.
 Saginaw, Mich. 48602 ■

Our little "3-incher" is bigger than anybody's!

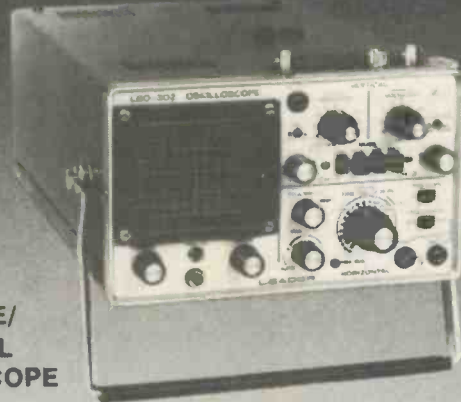

**LBO-302
 3" DUAL TRACE/
 DUAL CHANNEL
 TRIGGERED SCOPE**

\$699.⁹⁵
 With accessories

Conquer the test bench squeeze! Obtain lab-grade quality! Here's solid state accuracy plus push-button convenience for trig. & auto. sweep & "free run" momentary function. • 10MHz b'width • 10mVp-p/div to 5Vp-p/div Vert. Sen-

sitivity, 9 steps. • Sep. or simult. sweep display, ch 1 & 2 - alt., chopped, algebra added and X-Y vector. • Sweep range from 1μs/div (0.2μs w/5X mag) to 0.2s/div, 17 steps. • Polarity inversion on ch 2. • 4 3/4"H, 10 lbs.

LEADER
 INSTRUMENTS CORP.

151 Dupont St., Plainview, L.I., N.Y. 11803 (516) 822-9300

"Put us to the test!"

... for more details circle 115 on Reader Service Card

"Associate" with Success!

THE INVESTMENT IS \$40,000 TO \$75,000. THE RETURN IS AS UNLIMITED AS YOU MAKE IT!



You're the boss with a Lafayette Radio Electronics Associate store and you're in business in a big way. You sell a complete line of fast-moving electronics products with a proven record of success and almost unlimited growth! You're acknowledged as No. 1 nationwide in the CB 2-way radio field and way out front with the latest and the best new four-channel stereo equipment. You're backed by professional advertising, expert merchandising and over 50 years of experience in setting up and operating retail establishments. Over 377 successful business people operate and enjoy Lafayette Associate stores right now. Grow with us in a money-making adventure!

Write: R. Laub • Vice-President

Lafayette Radio
 Electronics Corp.
 111 Jericho Turnpike
 Syosset, N.Y. 11791
 Phone: 516-921-7700

Lafayette ASSOCIATE STORE
 Listen to us, you can't go wrong.

... for more details circle 114 on Reader Service Card

The Dodge Tradesman Van: The things that make it so easy to buy are the things that make it so easy to sell.

A passenger compartment with wide, moulded foam seats and an attractive dash panel with easy-to-read instruments that make you feel as if you're riding in a car.

Our dependable Dodge engines. Today, your choice begins with our famous 225 Slant Six (smallest displacement engine offered in any American van) and continues with two V8 engine options for more power, if you need it.

An Electronic Ignition System that gives you a virtually maintenance-free ignition system. (All you change are spark plugs.) And gives you quick, easy starts on cold days, too.

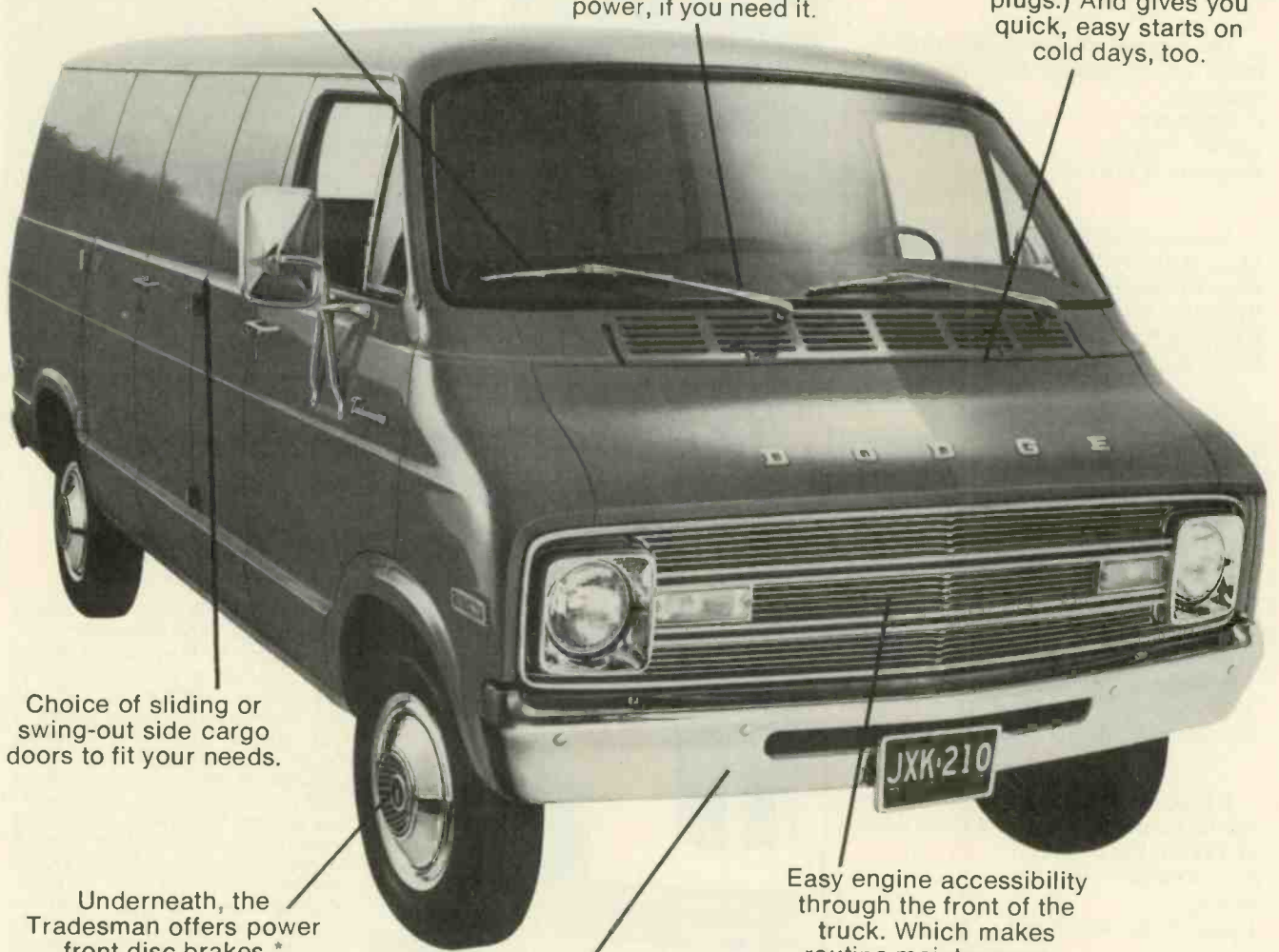

Choice of sliding or swing-out side cargo doors to fit your needs.

Underneath, the Tradesman offers power front disc brakes,* independent front coil suspension, and a heavy galvanized coating on body parts most exposed to moisture, road salt, etc.

*Standard on B200 and B300 models.

Dodge gives you the widest choice in van sizes. There are eight models on two wheelbases—including the Dodge Maxivan, the biggest van in the field.

Easy engine accessibility through the front of the truck. Which makes routine maintenance—and bigger jobs, too—as easy as you'll find on any van.



Enjoy the excitement of the Baseball Playoffs, World Series, and AFC Football, brought to you by Dodge on NBC-TV. See your local paper for time and station.



EXTRA CARE
IN ENGINEERING
MAKES A DIFFERENCE.
**DODGE TRUCKS.
DEPEND ON 'EM.**

... for more details circle 105 on Reader Service Card

TECHNICAL LITERATURE

Storage Racks

A completely new rack catalog is available which presents technical information on the bulk storage and pallet rack. The bulk storage rack, which is completely compatible with Uniflex Clip-Type shelving, is intended for large, bulky items. The new line of pallet rack is intended for use with powered equipment. Bernard Franklin Co., 4424 Paul Street, Philadelphia, Pa. 19124.

Inventory Control Books

Completely updated distributor and dealer inventory control books are now available. The books provide the most comprehensive account of what electronic products are available, what's in demand, what's in inventory, what's needed and what's selling. They provide a minute-by-minute account of how an electronic parts business is doing. Order ET #1560 for dealer inventory and ET #1559 for the distributor inventory book. GTE-Sylvania, Advertising Services Center, 70 Empire Drive, West Seneca, N.Y. 14224.

Instrument Cathode Ray Tubes

A new catalog providing complete data on instrument cathode ray tubes from one to seven inches in diameter is now available. This sixteen-page brochure, STC904, covers specifications including: electrical and physical characteristics; maximum ratings; typical operation; phosphor characteristics; socketing, basing, and shielding requirements; mounting and operating considerations; and safety precautions. RCA Commercial Engineering, Harrison, N.J. 07029.

Sound Systems

A 90-page illustrated handbook described as the company's "best selling aid" for sound sales personnel is now available. The A.E.S.S. handbook consists of a series of specially prepared application and technical sheets in a loose-leaf binder, with provisions for future supplements. It furnishes tips on the selection of amplifiers, speakers, intercoms and other equipment plus installation techniques. It is designed to help even a novice salesman to recommend, with confidence, components for a wide variety of sound installations. Price \$3.95. Bogen Division/Lear Siegler, Inc., P.O. Box 500, Paramus, N.J. 07652. ■

DC to
10 MHz,
10 mV/cm
sensitivity
5" CRT

Simpson

Model 455
5" SCOPE
\$310

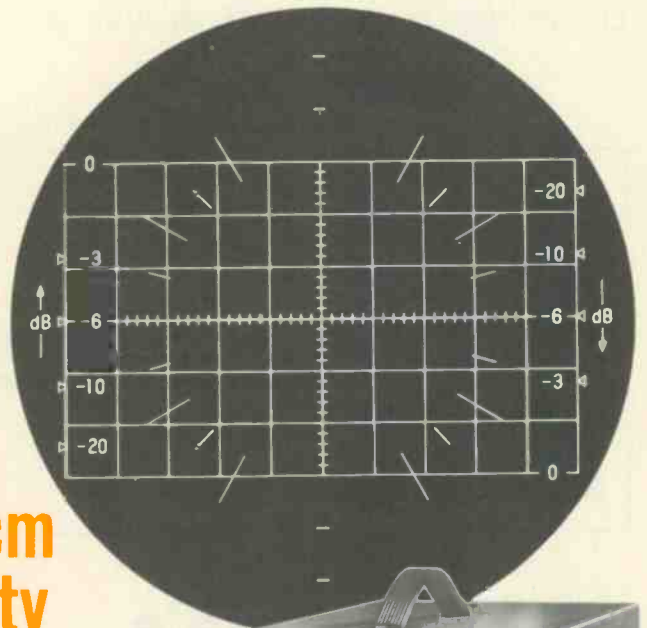

- Direct input for vector display
- Sensitivity: vertical, 10 mV/cm to 5 V/cm; horizontal, 300 mV/cm.
- 9-step calibrated and compensated vertical attenuator
- Accepts standard scope cameras and viewing hoods
- Low-parallax, high-contrast, calibrated graticule
- 1 kHz square wave calibration signal
- High linearity sweep with retrace blanking—separate 7875 Hz position for TV work
- 120 or 240 VAC operation, 50 or 60 Hz
- Fold-in support for incline viewing
- Size: 10 $\frac{3}{8}$ " H x 8" W x 16 $\frac{1}{2}$ " D
- Low-capacitance 10:1 probe available

SEE YOUR ELECTRONICS DISTRIBUTOR OR WRITE FOR CATALOG 4300

Simpson
INSTRUMENTS THAT STAY ACCURATE

SIMPSON ELECTRIC CO.

853 Dundee Avenue, Elgin, Illinois 60120
(312) 695-1121 • CABLE: SIMELCO • TELEX: 72-2416
IN CANADA: Bach-Simpson, Ltd., London, Ontario
IN ENGLAND: Bach-Simpson (U.K.) Limited, Wadebridge, Cornwall
IN INDIA: Ruttonsha-Simpson Private, Ltd., Vikhroll, Bombay

... for more details circle 125 on Reader Service Card

KATY INDUSTRIES





TEKLAB REPORT

by Joseph Zauhar

GTE Sylvania's E06-2 Color TV Chassis- Part 2

An analysis of this manufacturer's new small-screen, all-solid-state, nonmodular, tilt-out chassis with plug-in semiconductors and a new in-line picture tube

IN PART 1

■ Coverage of the E06-2 chassis in **TEKLAB REPORT** began last month with an analysis of the general features of the 13-inch color TV receiver (Model CA4115W) in which this new chassis is used. These include an in-line picture tube, which simplifies convergence, and GT-Matic self-adjusting circuits, which have eliminated the need for some customer controls and have made it possible to put most of the remaining customer controls inside a lockable compartment on the top rear of the cabinet.

Also described last month were the many features of this new chassis which make servicing easier when and if it is required. Included among these serviceability features are the tilt-out design of the main chassis, plug-in transistors, integrated circuits and chassis cables and connections, and easy-to-read road-mapping and identification of circuits and components on the single,

large circuit board of the main chassis.

Circuit analysis of the E06-2 chassis began last month with descriptions of the operation of the regulated power supply, the pin-cushion circuits, the horizontal scan and high-voltage system and the damper circuits. The analysis will continue this month, with descriptions of the operation of the chroma processing system, the horizontal and vertical sync and sweep system, the video detection and amplification circuitry and the convergence system. Separate schematic diagrams of these circuits are included in this **TEKLAB REPORT**. A complete schematic diagram of the E06-2 chassis was published last month in **TEKFAX** (Schematic No. 1526).

IN PART 2

Chroma Signal Processing System

The three basic blocks used to recover and process the chroma

signal are: 1) the chroma processing integrated circuit, IC600, and the 3.58MHz amplifier transistor Q604 (Figure 1); 2) the chroma AGC detector, Q600, and transistor Q602 (Figure 1); 3) demodulator integrated circuit IC602 and the matrix amplifier (Figure 2).

The chroma AGC circuit is a GT-Matic feature and uses two transistors: Q600, a chroma amplifier and Q602, a peak detector which detects the amplitude of the chroma circuit and feeds the resultant central voltage through time-constant filter to pin 3 of IC600.

The chroma demodulator, IC602, receives two CW signals phased about 90 degrees apart: R-Y phase, to pin 6; B-Y phase, to pin 7. The chroma signal is coupled into pin 4, and synchronous detection recovers the -(R-Y) and -(B-Y) color difference signal. Matrixing in IC602 between -(R-Y) and -(B-Y) is used to recover the -(G-Y) signal.

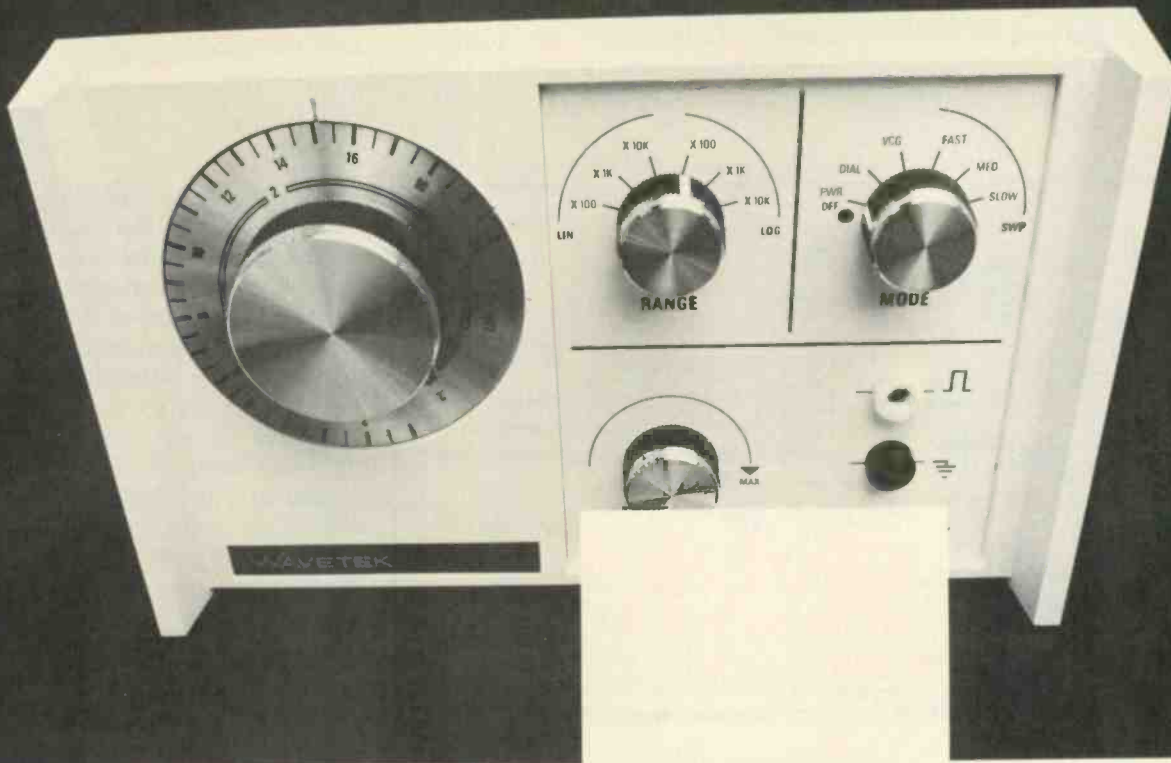

**This Model 30
portable function generator
goes from
2 Hz to 200 kHz with
sines, squares, triangles,
and linear
or log sweeps.**

**And it goes for
\$149.⁹⁵**



WAVETEK®

P.O. Box 651, San Diego, Calif. 92112
TWX 910-335-2007, Tel. (714) 279-2200

... for more details circle 133 on Reader Service Card

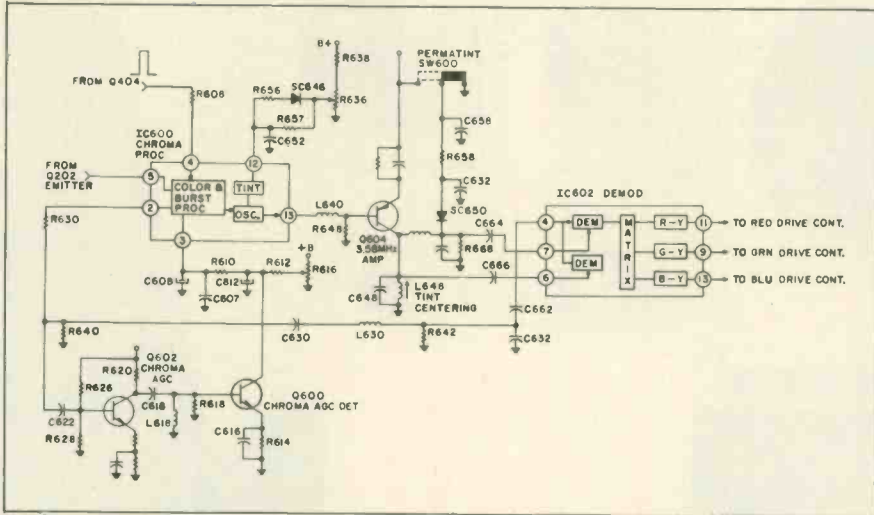
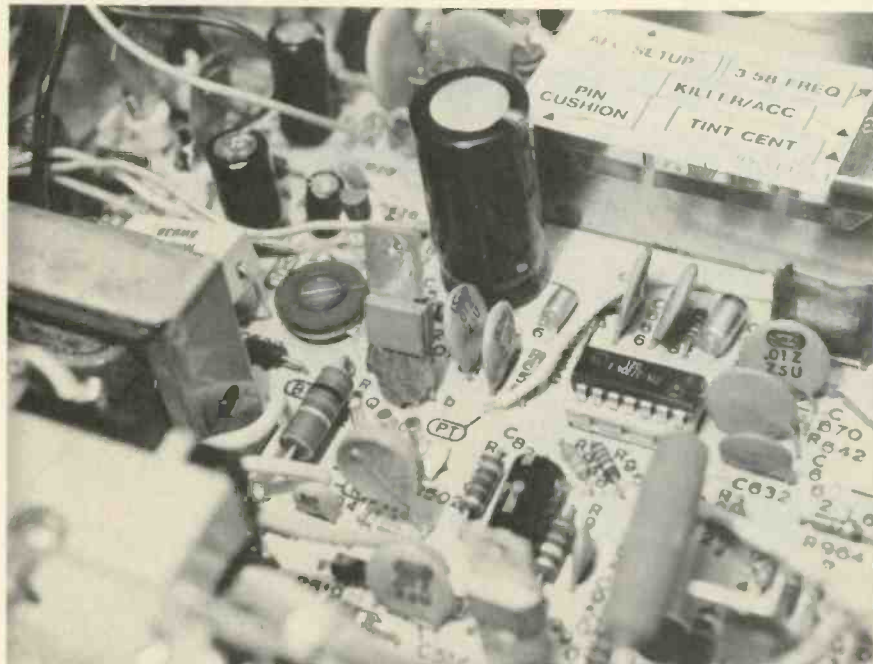

Fig. 1—Simplified schematic diagram of the chroma processor, demodulator and chroma AGC circuits. Courtesy of GTE Sylvania.



The integrated circuits and transistors in the E06-2 chassis plug into sockets for easy replacement, if required. Also, increased use of IC's reduce the number of components on the board, making component identification and removal easier.

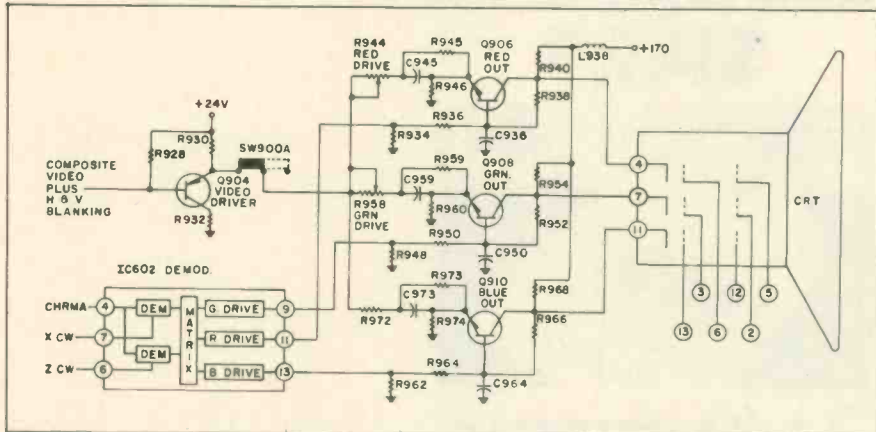

Fig. 2—Schematic diagram of the R, G, and B amplifiers, demodulator and video-output circuits. Courtesy of Sylvania.

These negative-going color-difference signals drive the bases of the R, G and B color amplifiers, while the positive phase monochrome signal drives the emitters of the R, G and B amplifier. The monochrome component in the color-difference signals cancels across the base-emitter junctions of the color amplifiers. The remaining R, G and B color signals are amplified in the collectors of the color amplifiers and are then applied to the CRT R, G and B cathodes.

AFC and 31.5-KHz Clock

The noise immunity, frequency stability and wide pull-in range of integrated circuit IC400 (Figures 3 and 4) have eliminated the need for a customer *horizontal hold* control. The horizontal frequency coil, L418, can be adjusted by the service technician, but in most cases it should not require adjustment, because of the stability of the integrated circuit. The noise protection, sync separation and phase comparison circuits make possible horizontal and vertical phase and frequency lock by either standard or nonstandard sync signals.

The phase after 31.5-KHz clock signal is locked to the phase of the horizontal sync signal by a comparator circuit. The relative phase of the 15.75-Hz sawtooth waveform and the horizontal sync is compared. The control voltage produced by any phase difference is used to control the clock timing or phase by increasing or decreasing the clock's frequency in relation to the sync-sawtooth phase error.

Pulses from the flyback are shaped by the horizontal blanker, Q404, and are then fed to pin 8 of IC400. Transistor Q20 amplifies this pulse and inverts its polarity and then feeds it to terminal 7 of IC400. Capacitor C422, connected to pin 7, integrates the pulse into a sawtooth waveform, which then is applied to the bases of the phase comparator transistors, Q24 and Q25, for comparison with station sync pulses.

The positive-going sync pulses are separated from the composite video signal by zener diode ZD2 and transistors Q21 and Q28. The sync pulses are amplified by transistor

Q23 and then coupled to the emitters of the phase comparator transistors, Q24 and Q25.

The frequency of the clock (oscillator) is 31.5-KHz, and is established by adjustable coil L418 and capacitor C418 (Figure 4). AFC voltage is applied to transistor Q35 (Figure 3), which is part of the clock. Transistor Q37 feeds the oscillator signal to transistor Q34, a dual collector transistor that couples the 31.5-KHz clock pulse through transistor Q33 to pin 15 of IC400.

When the sawtooth waveform from the clock circuit and the sync pulse are in phase, no correction voltage is developed, and the 31.5-KHz clock timing circuit requires no charge. However, when the frequency of the sawtooth is lower than that of the clock, the sync pulse rides down the sawtooth slope, reducing the differential amplifier's forward bias, which, in turn, increases the frequency of the clock until the sawtooth and sync pulse are once again in phase.

Countdown Integrated Circuit

The horizontal and vertical countdown chip, IC300, consists of six sections: A) A single flip-flop that divides the clock input by two, for a 15.75-KHz horizontal drive signal; B) A 10 flip-flop array that divides the clock input by 525, for a 60-Hz drive signal; C) A composite sync processor, for checking the vertical sync pulse for the presence of equalizing pulses; D) A vertical sync processor, for clocking the vertical drive pulse when the noninterlaced signals produced by inexpensive or nonstandard sync cameras are encountered; E) A comparator circuit that produces mode-switching logic; F) A vertical-drive waveform generator that produces a vertical drive pulse.

These six sections, together with the circuitry of IC400, function a synchronized scan system (Figure 4) that produces stable horizontal and vertical sync during both interlaced and noninterlaced signal conditions.

Block "D" and "E" are the logic circuits that determine the appropriate vertical sync operating mode. The composite sync is sampled by the composite sync processor, Block

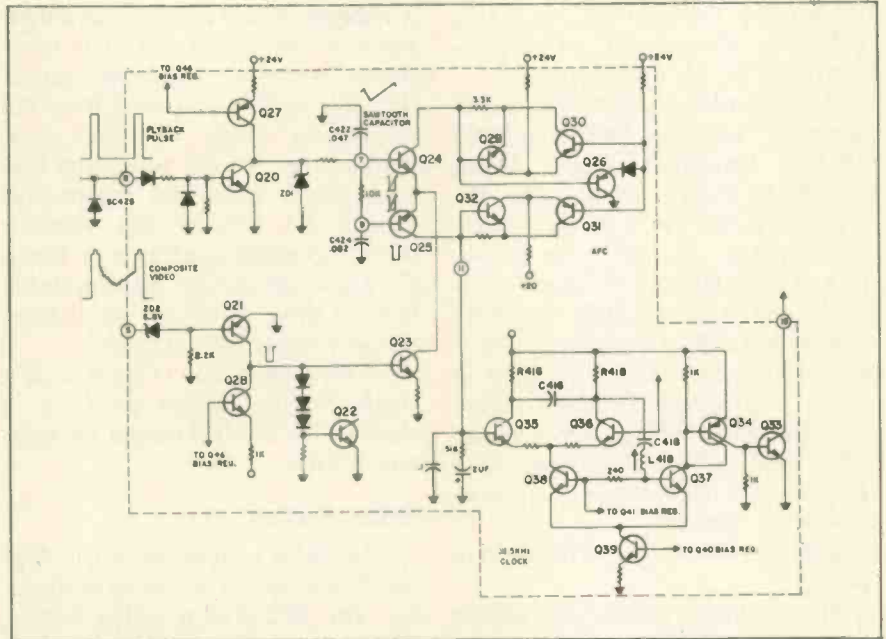
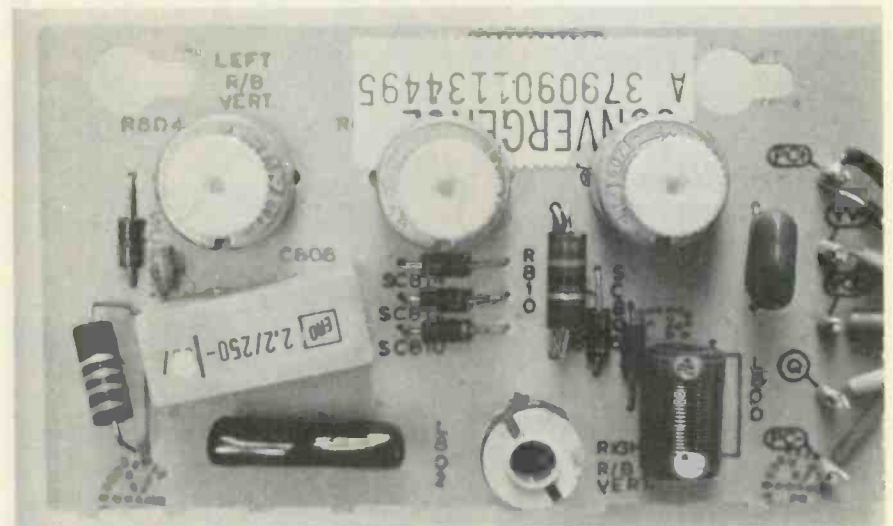

Fig. 3—Integrated circuit IC400 contains the AFC and the 31.5-KHz clock circuits. Courtesy of Sylvania.



Because only the vertical lines on the CRT screen require convergence, the E06-2 chassis uses a less complicated convergence board and convergence procedure.

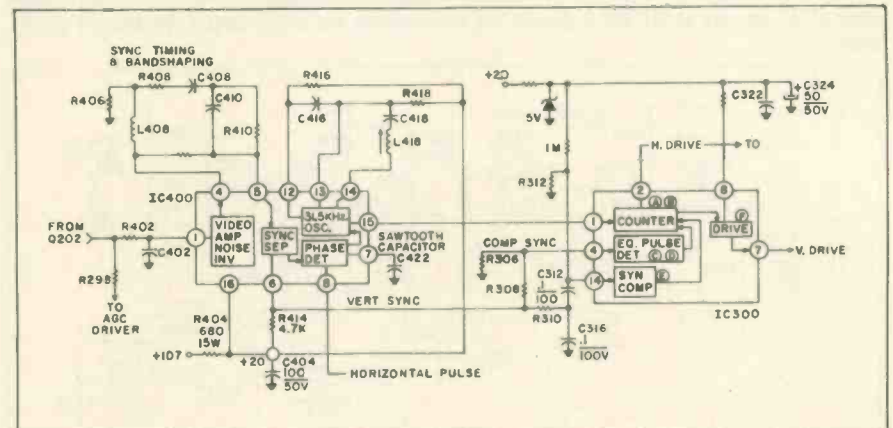

Fig. 4—The noise immunity, sync separation, AFC, 31.500 oscillator and the horizontal and vertical divider circuits. Courtesy of Sylvania.

D, for the presence of equalizing pulses, to determine if the signal is interlaced or not interlaced.

The presence of equalizing pulses normally indicates an interlaced (E.I.A. Standard) signal. When equalizing pulses are present, the logic circuits switch to the countdown mode, in which the phase-locked 31.5-KHz clock signal is divided down to produce a 60-Hz square wave. This dividing action is accomplished by the 10 flip-flops in Block B (Figure 4), which create an interlaced vertical drive pulse. The "clocked" 60-Hz square-wave pulse is then fed to the vertical-drive waveform generator in Block F, which produces a vertical-drive pulse.

If equalizing pulses are absent during several consecutive frames,

it indicates that a noninterlaced sync signal is being received. The composite sync processor then causes the logic circuits to switch from the countdown mode to direct synchronization, during which the vertical pulses from the comparator (Block E) "clock" the vertical-drive waveform generator in Block F, again producing an interlaced vertical drive pulse for application to the vertical scan system.

Block A in IC300 (Figure 4) is a single flip-flop which produces a clocked 15.75-MHz output for horizontal drive.

Video System

The video system, shown in Figure 5, consists of a low-level detector (in IC202); a video buffer, Q202; a video amplifier, Q902; a

video driver, Q904; plus R, G and B amplifiers, Q906, Q908 and Q910 which are shown in Figure 4. The brightness limiter transistor, Q900, controls the DC level in the video channel.

A negative-going video composite signal is developed in the low-level detector (in IC202). This signal passes through a 4.5-MHz trap, L244, to remove the 4.5-MHz signal developed in the video detectors by the heterodyning of the IF picture carrier with the IF sound carrier. The video buffer stage, Q202, is an emitter follower, which matches the output impedance of the detector with the input of the video channel. The signal developed in the emitter circuit of the buffer stage, Q202, is coupled through the *contrast* control to the base of the video amplifier, Q902.

The *contrast* control, R906, is part of a voltage divider network. R902 and R904 are used to minimize brightness variations when the contrast control is readjusted. Capacitor C906 is connected across the contrast control from the high side to the wiper. This 220-pf capacitor permits high-frequency video to bypass the contrast control to prevent changes in video response when the contrast control is readjusted.

The wiper of the contrast control is connected to an RC network—R912, R914 and C912—which, together with the brightness control, establish the DC level of the video system.

Video peaking or depeaking is accomplished by feeding the video signal through a peaking switch connected to an RC coupling network. In the maximum peaking position, the switch shorts out R913 and C913, feeding maximum high-frequency video to the base of transistor Q902. In the center, or medium peaking position, the impedance of R913 and C913 rolls off the higher video frequencies fed to Q902. In the minimum peaking position, the switch parallels C914 to C915, increasing the bypass capacitance, which, in turn rolls off additional upper frequency response.

The compensated video signal is fed to the base of Q902. A horizontal blanking pulse is applied through diode SC924, to the emitter of

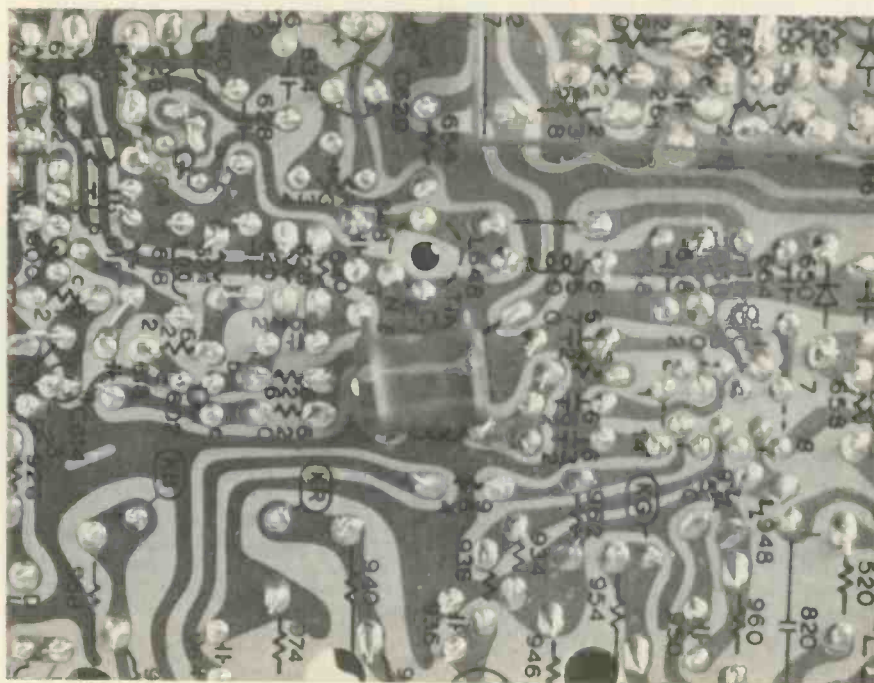

Q902, cutting off the video amplifier during retrace.

The base circuit of Q902 is DC controlled by the brightness limiter stage, Q900. The brightness limiter operates as a common base stage, with the input developed across resistor R996. Current from the high-voltage tripler flows to ground through this resistor from the low side of the high-voltage winding of the flyback. This action puts the emitter of Q900 below ground potential when the tripler current increases. The emitter of Q900 becomes more negative as beam current increases until, finally, Q900 turns on. During conduction of Q900, the lower impedance across it pulls the base of Q902 closer to a ground potential, reducing its conduction. This, in turn, increases the collector voltage of Q902, which decreases the gain of Q904, a PNP transistor. Reduced conduction of Q904 causes its emitter voltage to swing more positive. The increase in emitter voltage is coupled to the picture tube cathodes through the R, G, and B amplifiers, lowering the beam current through the picture tube.

The R, G, and B amplifiers (Figure 2) perform two functions: 1) Matrixing of the chroma monochrome signal across their respective emitter-base junctions; 2) Amplification of the color signal in their respective collectors, which, in turn, drive the picture tube cathodes.

A positive-going vertical blanking pulse is applied to the base of the video driven through pulsing diode SC926. This positive-going pulse is obtained from the vertical driver, IC302.

Quadrapole Convergence

The in-line picture tube used in this television receiver simplifies the setup adjustments because it requires a less complicated dynamic convergence system. This is attributable, in part, to more precise CRT gun alignment. Only the beams from the red and blue guns on the sides, are aligned during the dynamic convergence procedure. The beam from green gun, in the middle, remains stationary.

The new 13VAHP22 shorter neck picture tube allows the elimina-

tion of the pole pieces and the necessary convergence energy is coupled into the yoke through the quadrapole winding in the yoke. The quadrapole windings (Figure 6) are four separate but interconnected windings positioned 90 degrees apart which create four magnetic poles when energized by convergence current. This effect is split into two parts: the common mode and the differential effect. The common mode affects all the guns equally, causing an increase in horizontal scan. It also effectively reduces vertical scan, improving top and bottom pincushioning.

The horizontal waveform signal fed to the quadrapole windings is developed in a manner very similar to that of the method used to develop the waveform in a conventional

chassis. A horizontal pulse from the flyback is integrated twice, producing a parabolic current in the quadrapole circuit. The Right R/B vertical convergence coil, L802, controls the parabola amplitude, while the Left R/B vertical convergence control, R802, controls the tilt.

The vertical convergence circuit used in this chassis, shown in Figure 6, is quite different from a conventional type. The complete circuit is placed in series with the vertical yoke coils. Diodes SC806, SC808, SC810 and SC812 are connected in a bridge configuration, with controls R808 and R184 forming a current divider which energizes the quadrapole windings, Coil L800 is an isolation inductor which separates the horizontal- and vertical-rate sweep signals. ■

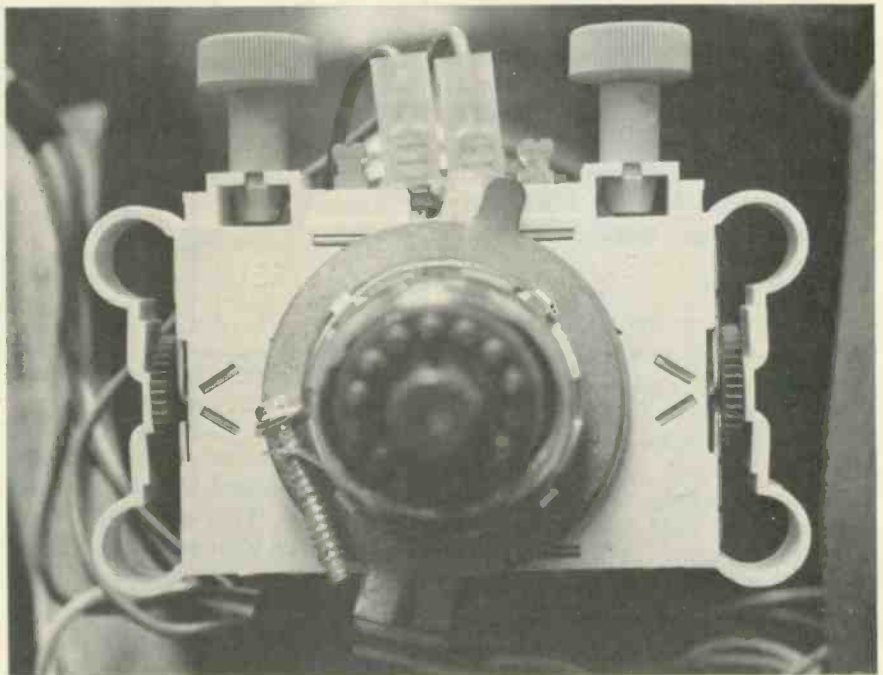

The inline gun system permits a less complicated dynamic convergence system. Only the beams of the red and blue guns require alignment.

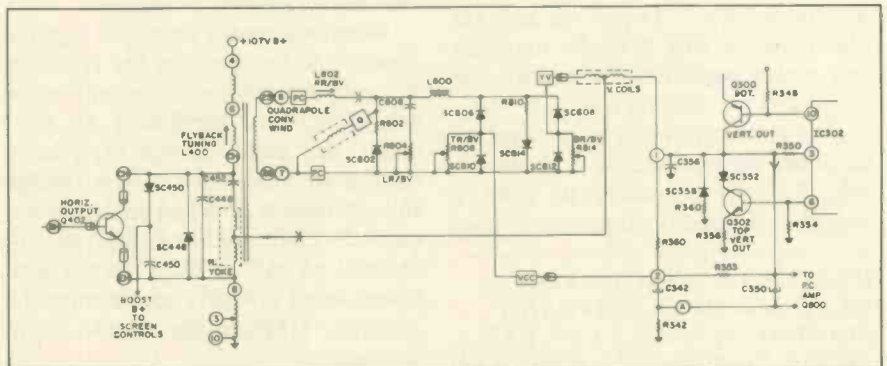

Fig. 6—The vertical convergence circuit used is quite different from a conventional type because it is placed in series with the vertical yoke coils. Courtesy of GTE Sylvania.

TECH BOOK DIGEST

Material in this department is condensed from a single chapter of a recently introduced TAB book, by permission of TAB BOOKS, Blue Ridge Summit, Pa. 17214

Stereo Audio Measurements

Occasionally, it is necessary for the service technician to make certain measurements on FM stereo receivers. Specific checks and tests are used to uncover defects, to verify the condition of a receiver prior to delivery to a customer, or to check performance on customer demand. Therefore, it is incumbent on the service technician to be able to make these measurements in an accurate and proper manner.

Power Output

The *output power* is one of the most frequently misquoted, cursed, discussed, and abused high-fidelity power amplifier ratings. Contributing to the confusion is the fact that there are several methods for determining amplifier output power, and they all yield vastly different numerical results. The particular method used seems to be related to exactly what the measurer is trying to prove. The confusion and chaos is so great that some technicians are quoting "so many watts IYL." The abbreviation "IYL" means "If You're Lucky." There are several qualifications that must be made in any power measurement before the result can be rationalized.

The test setup for a wide range of amplifier measurements is shown in Fig. 1. It is necessary to have a source of audio frequency sine

(From Chapter 8, FM STEREO/QUAD RECEIVER SERVICING MANUAL, by Joseph J. Carr, TAB BOOKS, Copyright 1974. A review of the complete book follows this article.)

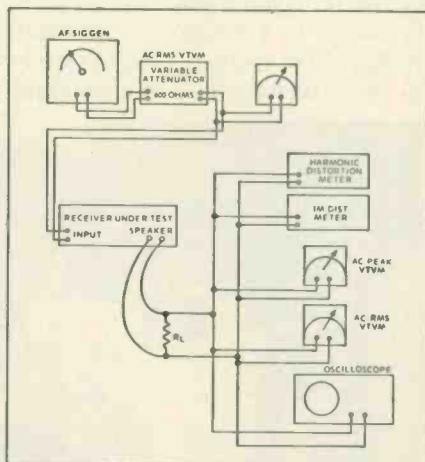

Fig. 1—Bench setup for general measurements.

waves with a distortion figure at least one order of magnitude better than that offered by the amplifier being tested. If the amplifier is rated at 1 percent total harmonic distortion (THD), the audio oscillator must have less than 0.1 percent THD. Because of the extremely low levels of THD offered by modern stereo equipment, the technician must equip himself with only the best audio sources available.

Whatever audio source is chosen, there must be a means for reducing the output to a level that will properly drive most amplifiers. In most cases, the audio source includes a calibrated attenuator. Even though the attenuator is billed as being accurately calibrated, it is desirable to include an AC VTVM in the amplifier input circuitry to measure the absolute RMS value of the input sine wave.

The output of the amplifier is loaded with a "dummy" speaker, an

8-ohm noninductive resistor of an appropriate power level. Considering the claims of many modern receivers, it seems like a 10W dummy load is the minimum acceptable, while a 100W load is at least highly desirable. Mounting a 50 or 100W resistor of appropriate design to a heatsink or in an oil bath effectively increases its apparent power rating.

Few noninductive resistors are wirebound. The cross-sectional diameter of the wire element in the resistor is one primary factor in determining a resistor's suitability as a dummy load. The current developed by the amplifier must not exceed the current capability of the wire. The resistors encased in a flanged metal housing are preferable because of the power rating increase realized by mounting it to a finned metal power transistor heatsink and by forced air cooling with one of the newer types of "whisper fans."

The audio test equipment is connected in parallel across the dummy load (Fig. 1). Of particular use are: a total harmonic distortion analyzer, an intermodulation distortion analyzer, an RMS AC VTVM, a peak-reading AC VTVM, and an oscilloscope. It is more efficient to provide a bank of switches so that the instruments can be connected into the circuit at will. Another switch can also be provided to replace the dummy load with a real speaker system. This arrangement can result in an extremely efficient test bench. If appropriate, another switch can be provided to transfer the entire collection of test instruments to the opposite channel. Do not, however, include the dummy load in the transfer operation. Each channel should have its own load, regardless of where the instruments are connected.

To make the power test, turn the volume control on the amplifier to maximum and apply a signal of an appropriate voltage level from the audio generator. Turn the signal up until the rated THD figure is reached. If the specifications claim that the power rating was measured at 1000 Hz and 1 percent THD, turn the input voltage up until the 1 percent THD figure is reached. At this point, measure the RMS AC

We're making it our business to make your business easier.

General Electric's STC program. It takes the 'Tough' out of 'Tough Dog' service.



S. stands for our new Symptom Repair Manual. It was created for you by GE to deal with the most common faults. It lists a variety of symptoms. And then tells you what to check and in what order.

T. stands for our Troubleshooting Flow Charts. If a particular problem was not found by using the Symptom Repair Manual, these charts will take you through a logical sequence of checks to locate the faults.

C. stands for time-consuming Circuit Analysis. If you follow the 'S' and 'T', in most cases you will never have to get to 'C.' With these two service aids you can quickly diagnose 95% of all General Electric TV service problems. Using them will save you time, money and aggravation. And needless to say, they'll help you generate a lot of good will and build your reputation for fast, reliable service.

The Symptom Repair Manual is available for a \$1.00 handling charge. To receive your copy or details of GE service subscription plans, write "Dutch" Meyer, GE Television Receiver Products Department, Portsmouth, Va. 23705; or call collect (804) 484-3521.



**STC. A service technician's
best friend.**

GENERAL  ELECTRIC

voltage across the dummy load. The power output of the amplifier is equal to:

$$\text{Power} = \frac{(\text{RMS voltage})^2}{(\text{resistance of dummy load})}$$

The dummy resistance in most cases is 8-10 ohms.

Peak power, a rating preferred by some manufacturers because it tends to make their equipment look more powerful in the eyes of the less sophisticated buyer, is obtained from the equation:

$$P = \frac{(E \cos FT)^2}{R_L}$$

Where P is the peak audio power output in watts, E is the peak voltage of the output sine wave as measured on the peak AC VTVM or oscilloscope, F is the test frequency, and T is the time in seconds for each cycle.

If any particular power level is stated, it must be qualified by the level of harmonic distortion and by the number of channels operating from a common power supply. It is common to find amplifiers rated with only one of the two channels driven to full output at a time. If the specification sheet calls an amplifier capable of producing 50W per channel, but the power supply can only deliver a total of 80W, it would be more honest to label the amplifier as a 40W per channel unit, not 50W. Unfortunately, pressures of the marketplace often dictate that the single-channel power be advertised to keep from having a "less scrupulous" competitor scoop the sales potential due to his allegedly more powerful product.

If the total harmonic distortion level is not stated in the advertising, it may be that the specified output power cannot be achieved at normal THD levels. An amplifier that can produce only 20W at 1 percent THD may well be able to produce upwards of 50W with a THD of 5 percent instead of 1 percent. It is less than honest to use the 5 percent figure unless it is so stated. In this author's opinion, a THD of 5 percent, considering the state of the art, does not qualify an amplifier as "high fidelity." In fact, 5 percent THD is rather low "fidelity."

Another consideration, in a few cases, is the length of time an amplifier can sustain its so-called rated

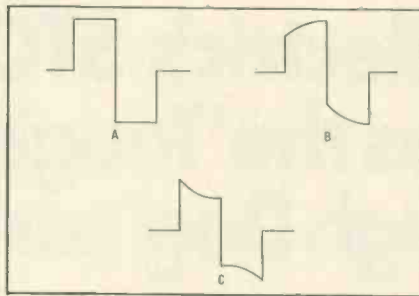

Fig. 2—Square waves indicate the frequency response of an amplifier. Waveform B shows a loss of high frequencies, and C indicates a low-frequency loss.

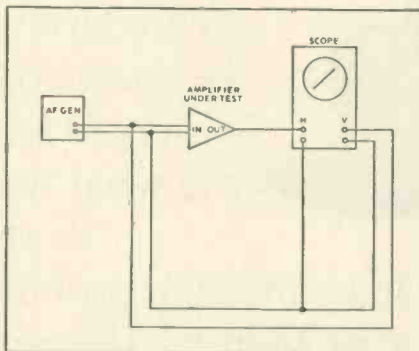

Fig. 4—Harmonic distortion test setup using an oscilloscope.

power level. If that time is for only a fraction of a second, the power rating is meaningless. Most quality high-fidelity receivers will operate up to five minutes at full power. Power level comparisons must be made at the same frequency, at the same THD figure, and with the same number of channels driven. You will notice that many modern amplifiers fall down when power is measured with all channels (two or four) driven to the maximum level simultaneously. This is because the power supply capability becomes significant under these conditions.

Frequency Response

The test setup used for power output measurements can also be used to make a step-by-step check of amplifier frequency response. Start at 1 kHz with the amplifier producing either full rated output or 1W, or whatever power level the manufacturer intended, with a THD figure at or less than 1 percent. Use the RMS signal voltage output under these specified conditions as the 0 db reference level. Check the output voltage level at least every octave (an octave is a two-to-one frequency spread; 100 Hz is one octave above

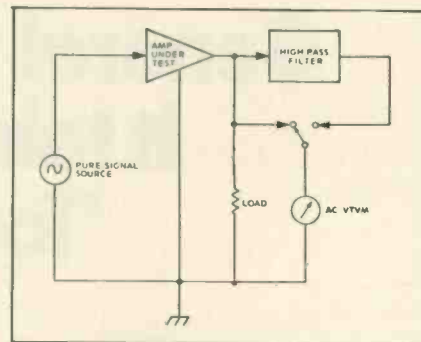

Fig. 3—Harmonic distortion analyzer test setup.

500 Hz and one octave below 2000 Hz) and preferably more often. This must be done while maintaining a constant signal input voltage level. The resultant output voltages can be used as the data to construct a frequency response curve calibrated in either absolute voltage terms or in relative decibels related to the 1000 Hz figure.

If quantitative information is not required, the square-wave method offers a quick and convenient method of measuring frequency response. A square wave is fed to the input of the amplifier being tested. It must be noted that since the input waveform is not sinusoidal, the AC VTVM is of limited usefulness during this test. It is necessary to use an oscilloscope to determine proper input and output voltage levels.

One property of a perfect square wave is that it contains many harmonics and subharmonics of the fundamental frequency. The rule of thumb usually stated is that a square wave will indicate the frequency response of an amplifier over a range of from one tenth to ten times the fundamental frequency. A 1 kHz square wave, therefore, can be used to rough check the response from 100 Hz to 10 kHz. A 5 kHz square wave is good for response checks up to 50 kHz. It must be noted, however, that the use of too high a fundamental frequency may tend to give apparently erroneous results due to the amplifier's normal rolloff at higher than audio frequencies. An amplifier flat to 20 kHz may be downgraded because of a poor waveform in a square-wave test if the input frequency is over 2 kHz. This isn't critical, but it can cause problems.

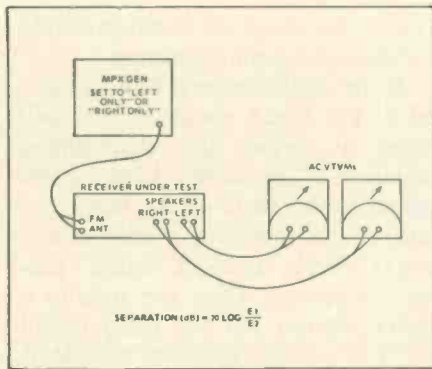

Fig. 5—Stereo channel-separation test setup.

A normal square wave is shown in Fig. 2A. In Fig. 2B, we see what happens to the waveshape if it passes through an amplifier or other circuit that attenuates the high-frequency components. You'll see this waveform if an amplifier has poor high-frequency response. If the waveform in Fig. 2C is present, we can assume that the low-frequency response of the amplifier is affected. Of course, if the wrong frequency is chosen for the fundamental, either of the two apparent defects might show up. For example, if the input frequency is 10 kHz or more, expect a high degree of high-frequency attenuation.

Audio Input Sensitivity

The bench test setup in Fig. 1 can also be used to check the input sensitivity of an amplifier. The sensitivity is the RMS level input signal required to produce either the full-rated output or a certain specified output power. If the amplifier is rated to produce, say, 20W with a 250 mv input signal at 1000 Hz, we may properly say that the amplifier has a 0.25v sensitivity. All inputs should be compared at the same output power level, and the THD at this power level should be no more than 1 percent or the manufacturer's specified level if less than 1 percent.

Another valid test might be to rate an amplifier's sensitivity at an output power of 1W. The input sensitivity ratings of two different amplifiers can be compared by the proportion:

$$\frac{V1}{V2} = \left(\frac{P1}{P2} \right)^{1/2}$$

Total Harmonic Distortion (THD)

The basic test setup in Fig. 3 is

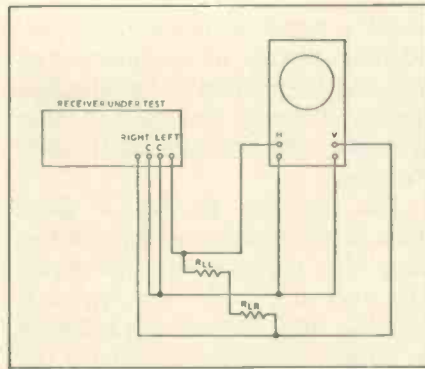

Fig. 6—"X-Y" scope separation test setup.

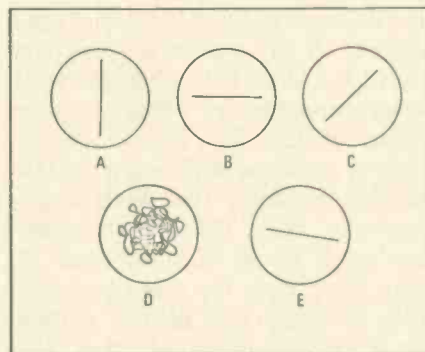

Fig. 7—Waveforms encountered during the test setup in Fig. 6. See text.

used to measure total harmonic distortion in an audio amplifier system. An RMS AC VTVM is used to measure the output signal voltage of the amplifier under test. After this measurement is taken, the signal is fed through a high-pass filter that attenuates the fundamental while permitting the harmonics to pass. The voltmeter is then used to measure the RMS value of the remaining signal. This is the harmonic content. If the test set is arranged so that the output of the amplifier drives the meter to exactly full scale, we can make the voltmeter read in percentage THD. We do this by adjusting the fundamental signal level so that the meter reads exactly full scale. When we switch in the high-pass filter, the reading represents only the harmonics. If the meter scale is calibrated in percentage, the THD is indicated directly.

Another means of making a quick check of the THD is outlined in Fig. 4. In this method, we use an oscilloscope and an audio generator. The output of the audio generator is fed to both the amplifier input and the vertical input of the oscilloscope. The output of the amplifier is fed to the horizontal input of the oscillo-

scope. The scope input controls are adjusted to bring the trace on the screen in a viewable manner. The result will be a relatively straight line that indicates both THD and relative phase shift. In the case of THD, it is the curvature of the line which is of interest. If the output of the amplifier is identical to the input (zero THD, an impossible but approachable situation) the trace line will be absolutely straight. The existence of harmonic distortion will cause the tips of the line to bend, one way or the other. The angle of the line relative to the baseline will give phase-shift information.

Channel Separation

In all stereo amplifiers and receivers, there is a certain amount of signal crossover from one channel to another; that is, a small amount of the signal in the right channel will appear in the left channel output and vice versa. In a real amplifier, the only way to eliminate this problem altogether is to completely isolate the circuitry of the two channels. This also means separate power supplies and separate cabinets. Of course, all of this effort would amount to nothing, since no perfect stereo program material is available.

The degree of separation, or lack of it, can be measured. Since it is indicated by relative RMS signal voltage levels, we can express the relationship in decibels. The most common procedure is to connect the equipment as shown in Fig. 5. In the case of an amplifier, you would use an audio generator in place of the FM stereo multiplex generator and would feed the input to only one of the two channels. The two RMS AC meters indicate the signal voltage output for each channel. The separation is equal to:

Separation (dB) = $20 \log \frac{E_{\text{channel 1}}}{E_{\text{channel 2}}}$
 where channel 1 is the channel to which the input signal is being delivered and channel two is the channel that is supposedly dead.

Some specialized test systems built by audio servicers for their own use include but a single meter. These systems have a level control so that the reading of the live channel can be adjusted to deflect the AC VTVM to exactly full scale. A

switch is provided to transfer the meter to the quiet channel. The meter scale is calibrated in decibels so that the arithmetic is performed automatically in the process of the measurement.

In cases where you want to measure or adjust the separation offered by the stereo decoder section of an FM stereo receiver, it is necessary to use a multiplex generator. Some generators allow direct connection to the decoder input via a composite output cable or jack. This author prefers to use a system where the composite signal modulates the output of an FM signal generator. The generator output is connected to the receiver's antenna input circuit, which allows you to check the entire receiver at once. This is advisable because some FM IF amplifier problems can cause a loss of separation, and in some receivers it is possible to over-attenuate the pilot signal in the RC network present in most FM stereo decoder input section. The FM multiplex generator should be of the type that can produce a "right only" or "left only" composite modulated by a 1000 Hz audio tone.

The test setup for a relatively unknown method of measuring channel separation is shown in Fig. 6. With this method, it is also necessary to use either a real "X-Y" oscilloscope or a regular scope with the vertical and horizontal input sensitivities equalized. It is important that equal voltages applied to the two inputs cause equal deflection in both directions. In other words, if a 0.1v RMS signal to the vertical amplifier causes a 1 centimeter deflection, the same signal applied to the horizontal input should also cause a 1 centimeter deflection in the opposite plane. If the signal is fed to both inputs simultaneously, the trace will be deflected in both planes an equal amount, resulting in a straight line positioned at a 45 degree angle. This test is less valid if the scope isn't calibrated.

The electrical requirements of the oscilloscope are not high. In fact, some technicians who use this system have found that almost any oscilloscope is suitable. Many shops still have an old audio response recurrent sweep oscilloscope stuffed

under a bench someplace. A considerable savings in troubleshooting time can be realized if the scope is connected across the speaker lines as shown at all times during troubleshooting.

The drawings in Fig. 7 show some of the traces you may find in using this measurement technique. The trace at Fig. 7A will appear if only the right channel is producing an output. If the left channel is the "live" channel, you will see the trace in Fig. 7B. In these two traces we see the result of perfect channel separation. If a monaural program source is fed to both channels with equal amplitude, we will see a trace similar to Fig. 7C. The 45 degree angle of the trace with respect to the baseline indicates that both scope inputs are being fed with the same amount of signal. In most cases of poor separation, the trace is something between one of the perfect traces and the monaural trace. The less than perfect stereo trace will appear at some angle other than 45 degrees.

The above traces will appear with either a sine-wave input to an audio amplifier or sine-wave modulation of an FM stereo signal generator. In the trace of Fig. 7D, we see the trace to be expected when tuned to a station with good stereo separation. This type of trace has been described as a "mess of very angry snakes" or a "plate of spaghetti that doesn't want to be eaten." It is continuously in motion as long as there is modulation present.

This scope is extremely useful in aligning certain IC stereo decoders. In those sets, the 38 kHz signal is of such a low amplitude that normal alignment by the peaking method is almost impossible. With this method of alignment, we need only adjust the 38 kHz transformer while the receiver is tuned to an FM signal generator output signal that is modulated on only one channel. Tune the slug of the 38 kHz coil until the trace lies as close to one axis as possible. Be sure, of course, that it is the proper axis. In most receivers employing the Motorola designed FM stereo decoder IC, it is possible to completely reverse the stereo channels by reversing the phasing of that 38 kHz coil. If you adjust the

coil as described, the receiver should exhibit maximum separation.

If the oscilloscope is left connected to the bench speakers, you will have a means for determining whether a "no stereo lamp" complaint is the fault of the lamp circuit or the receiver's multiplex circuitry. If the "mess of snakes" pattern is present when you tune to a stereo station but the lamp is not lit, it is evident that the trouble is in the lamp or its associated circuitry. On the other hand, if the trace is missing or if one of the monaural traces is present instead, look in either the FM receiver circuits or the multiplex decoder circuits. ■

TECH BOOK REVIEW

Title: FM Stereo/Quad Receiver Servicing Manual (TAB BOOK No. 660)

Author: Joseph J. Carr

Price: \$7.95 Hardbound

\$4.95 Paperback

Published: January, 1974

Size: 192 pages, 130 illustrations

For the technician looking for the latest information on the newest multichannel FM receivers, this highly informative new book more than fills the bill. It is intensely thorough, quite extensive in scope, and easy to understand, even for beginning technicians. There are no "holes"; the simply written text covers every phase of receiver servicing and adjustment—including information on the revolutionary digital tuner!

It is an extremely useful and much needed book in a field where the technician has little really factual up-to-date service information. This is especially true in the areas of quadraphonic reproduction, which receives extensive coverage in this volume. All the currently popular quad systems—CBS, Electro-Voice, RCA, and Sansui—are discussed in great depth. The explanations of the encoding and decoding techniques used in each system are presented in a down-to-earth manner, so that even the beginning technician will have little trouble understanding the two operations.

Nothing is assumed on the part of the reader. Each receiver section is

continued on page 55

RCA introduces the "easy way" to buy test equipment.

RCA's new Easy Payment Plan makes it possible for you to own . . . *immediately*, any of the electronic instruments shown in the table below for just a small down payment and only four additional easy payments.

No interest . . . no special charges to worry about. Just meet your local participating Distributor's credit criteria.

So check off the instruments you need and visit your nearest participating RCA Electronic Instruments Distributor. Or write to RCA Electronic Instruments, 415 S. Fifth St., Harrison, N.J. 07029. A distributor will contact you. He'll show you the quick and easy way to own the best in RCA test equipment.

But hurry. This great offer ends on July 31, 1974.

<p>Model WO-33B New "super" portable 3" Oscilloscope \$229.00 \$71.00 Down</p>			<p>Model WO-535A Triggered sweep DC to 10 MHz 5" Oscilloscope \$349.00 \$104.00 Down</p>
<p>Model WO-505A DC to 10 MHz 5" Oscilloscope \$329.00 \$101.00 Down</p>			<p>Model WV-510A Master VoltOhmyst® \$135.00 \$40.00 Down</p>
<p>Model WV-98C Senior VoltOhmyst® \$99.95 \$30.00 Down</p>			<p>Model WV-500B Portable Solid-State VoltOhmyst® \$99.95 \$30.00 Down</p>
<p>Model WV-532A Relay-protected VOM \$99.95 \$30.00 Down</p>			<p>Model WA-504B/44D Audio Sine/Square-wave Generator \$109.50 \$36.00 Down</p>
<p>Model WR-514A TV Sweep Chanalyst \$380.00 \$114.00 Down</p>			<p>Model WR-515A Master Chro-Bar Generator \$189.00 \$56.00 Down</p>
<p>Model WR-538A Super Chro-Bar Generator \$129.95 \$39.00 Down</p>			<p>Model WT-333A Picture Tube Tester/Rejuvenator with "SIMUL-TEST" \$189.00 \$56.00 Down</p>
<p>Model WT-524A Dynamic Transistor/FET Tester \$159.00 \$47.00 Down</p>			<p>Model WP-702A Dual Output DC Power Supply \$99.00 \$30.00 Down</p>

ALL PRICES SHOWN ARE OPTIONAL WITH DISTRIBUTOR

TRADEMARK(S)® REGISTERED
MARCA(S) REGISTRADA(S)

Specialists demand the best tools of their trade.

RCA Electronic Instruments

. . . for more details circle 123 on Reader Service Card

Selecting Speakers for Commercial Audio Systems

A review of the three basic types of commercial speakers, plus a look at how the speakers were selected and placed in one system. by Jack Hobbs

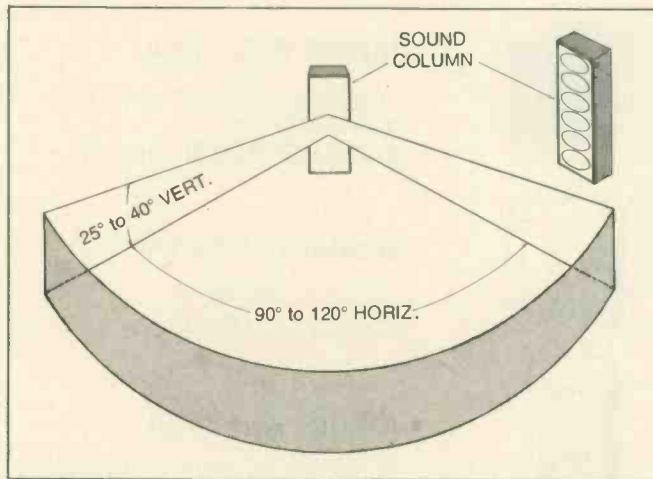
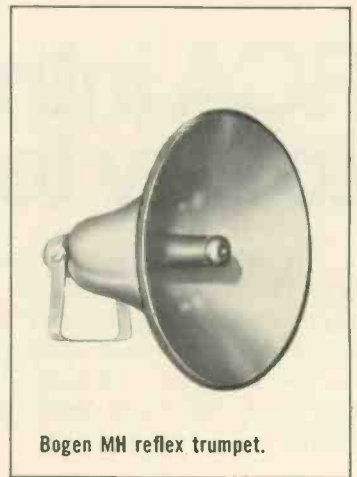

Fig. 1—Approximate angular dispersion range of column-type speaker.

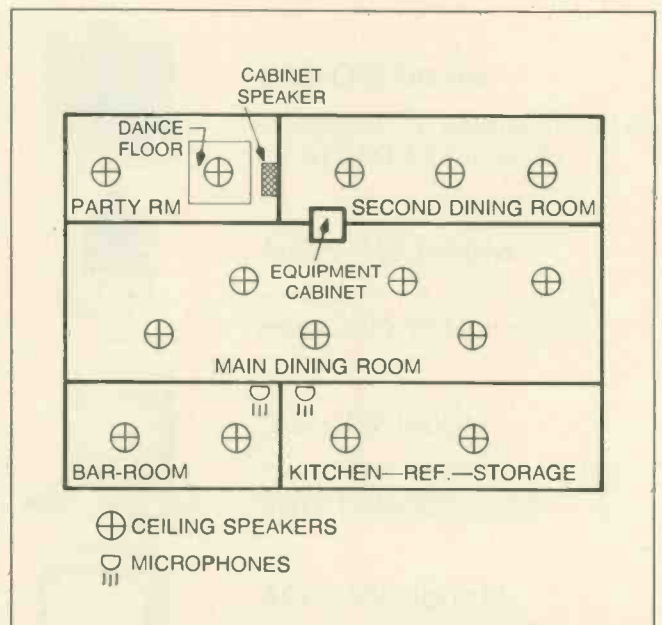

Fig. 2—Simplified floor-ceiling plan of remodeled restaurant showing approximate location of audio equipment closet, 15 speakers and two microphones.

■ During the past decade, many millions of dollars have been garnered by commercial audio specialists, TV/radio/audio service dealers and technicians who have diversified or expanded into this area of the electronics field. Some of these installations have been made in hotel dining rooms, clubs, churches, auditoriums, school rooms, factories, restaurants, shops, department stores, bars and cocktail lounges, shopping centers, sports arenas, funeral homes and parlors, and even parking lots, to mention only a few. Each installation required a careful initial survey before proper speakers could be selected. And it should be mentioned here that some of these installations were audio/visual — including closed-circuit TV (CCTV) in addition to

audio equipment.

It is not possible in one brief article to cover all factors involved in selecting proper speakers for a variety of commercial audio installations. And most every installation must be "tailor-made." We can, however, confine ourselves to basic fundamentals which apply to a rather wide variety of installations and come up with valuable information which is considered essentially "typical." It is assumed, of course, that we are not about to select speakers for a job we have contracted for which is beyond both the technical and financial capabilities of our particular operation. In that event, no amount of technical information, however detailed, can help us. Once again, we'll stick to basic fundamentals.

BASIC SPEAKER TYPES

Before we can even step into an audio installation location to select speakers, we need to know, among other things, details regarding the various kinds of speakers available. Each of these speaker types have characteristics which produce specific results under a variety of conditions.

In almost any installation, we may be concerned with one or more of three basic speaker types: 1) A number of different individual cone-type speakers — plus special cone- or reflex-type arrays called "sound columns" or "line radiators"; 2) a number of

"compression"- or "pressure-driver" types and 3) panel-type speakers. We will not discuss the thin-line, panel-type speakers here.

Cone-Type Speakers

For high-fidelity audio reproduction, three or four specially designed cone speakers may be used which includes a "woofer," or low-frequency reproducer, a mid-range frequency reproducer, an intermediate high range and a "tweeter" (high range). (When three instead of four speakers are used in this arrangement, the intermediate high-range unit is not employed.) These are usual-



Atlas Sound series AP-30 paging/talkback speakers have watts/impedance switch.



Fanon HDA-30T multi-tap paging horn.

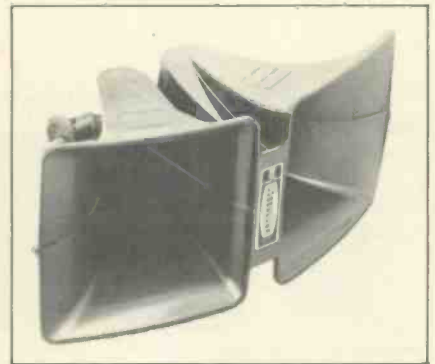

University model Cobreflex wide-angle horn.

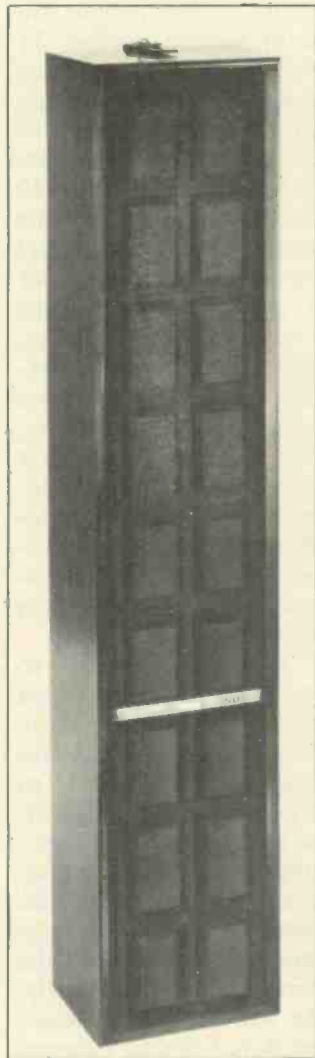

Fanon model FSC-75 sound column handles 75 watts power.

ly mounted on a wooden baffle-board and housed in a wooden cabinet. When cone-types are used in most ordinary commercial systems for background music, paging and public address (PA) functions, they are usually of the mid-range, low- to medium-powered types.

In practice, cone-type

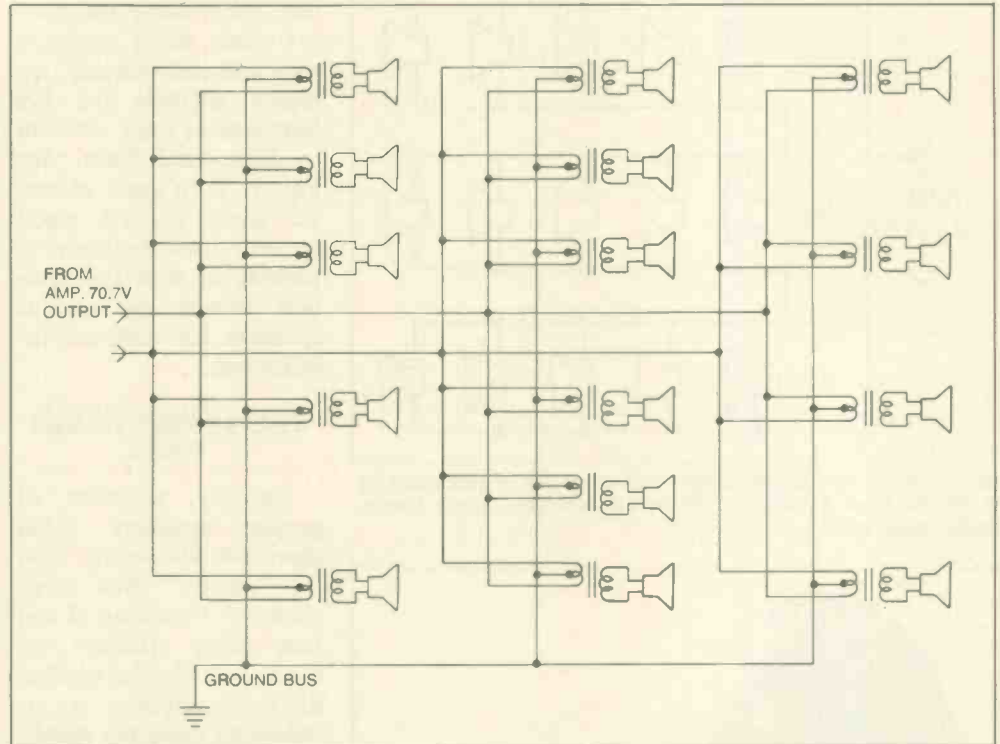

Fig. 3—Hook-up of 15 speakers employing 70.7-V constant-voltage system with grounded center-tapped-primary matching transformers.

speakers are mounted in ceilings, in corner cabinets, or hung relatively high on walls in high-ceilinged rooms—usually baffled in slightly tilting or downward-sloping cabinets. Cone-type speakers are not normally used in high-powered commercial installations of the PA type. There are also combination cone/pressure-driver type coaxial speakers which provide rather wide frequency response.

Pressure-Driver Speakers

Pressure-driver type speakers essentially are of two main configurations: directional and radial, re-

flex trumpets, sometimes called projectors. These are designed for uniform 360-degree dispersion under moderate ambient noise conditions and where *speech intelligibility* is more important than music fidelity. These radial-reflex units, however, are also designed to have certain type-characteristics to fit particular needs. The other reflex-type trumpet is designed for wide-angle audio dispersion, with emphasis obtained in either the horizontal or vertical areas by rotating the horn 90 degrees. Normal dispersion in the horizontal mode is around 120 degrees, and 60 degrees in

the vertical mode. These units are sometimes stacked in arrays and clusters for wide-angle or in-depth dispersion. Other speaker types in this group include high-powered pressure-driver trumpets and combination paging and talk-back speakers.

Columnar Speakers

The columnar or its variation, the "line-radiator," is also a specialized speaker. Depending on its length, internal speaker unit sizes and the number of speakers arranged in the array—including "shaping-networks" and other special arrangements—audio dispersion in the verti-

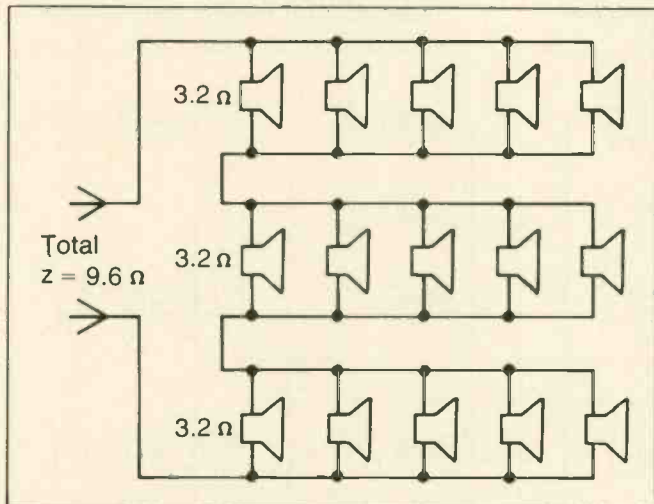
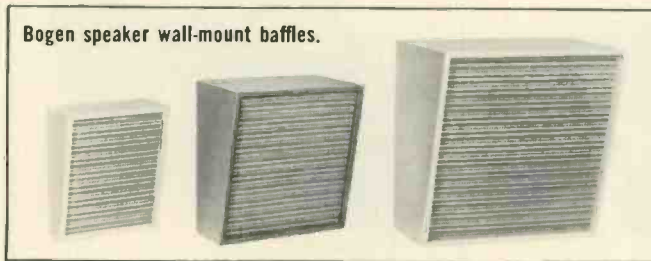
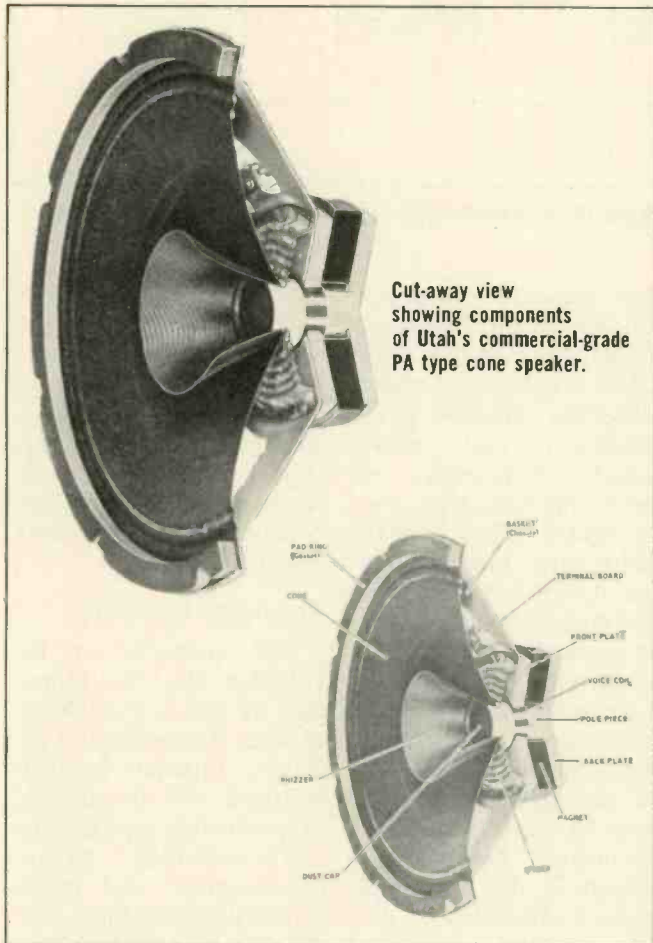

Fig. 4—Fifteen speakers of 16-ohms each connected in series/parallel to provide direct matching to 10-ohm transformerless output transistorized audio amplifier.



cal area varies from about 16 to 40 degrees, and from 90 to 120 degrees in the horizontal area when mounted vertically. When the column is mounted horizontally, the dispersion angles are reversed. These speakers have an effective throw from approximately 50 feet to 200 feet (depending on power) and, when properly mounted and "aimed," are highly effective for PA functions in some medium to large-sized halls. See Fig. 1. To a great extent, we must depend upon speaker manufacturers to provide us with specification details on various speakers for different installations.

THE SURVEY COMES FIRST

Actually, selection of proper speakers takes place simultaneously with the "survey." And when we know what kind of and how many speakers we need, we'll also know what kind of amplifier is required to drive the speakers. This fact will become more obvious as we proceed. Make no bones about it, with the possible exception of selecting a pair of low-wattage speakers for mounting at one end or side of a 10-foot by 12-foot doctor's or dentist's waiting room for an FM stereo or continuous tape background music system, every commercial audio installation will require much more than a "five minute look around" the location. Let's look at one job a service-dealer ran into.

A TYPICAL INSTALLATION

The Installation Area

The owner of an old restaurant which had been

in his family for three generations decided to remodel, expand and redecorate his establishment, including the construction of a new 20-foot by 100-foot addition to the building. The planned total floor space would be about 7000 square feet, a total of 84,000 cubic feet. This would be divided into five main rooms as follows: 1) The main (old) dining room, 30 feet by 100 feet; 2) the bar-room (old) 20 feet by 40 feet; 3) a special party room (new) 20 feet by 40 feet, to include tables and a small 12 feet by 12 feet dance floor; 4) a second dining room (new), 20 feet by 60 feet; and 5) the kitchen, refrigeration, storage area (old), 28 feet by 60 feet. (See Fig. 2.) The party room and the second dining areas, as previously indicated, were new additions to the original restaurant, bar and kitchen areas.

The owner wished to provide the entire area with background music, customer paging facilities and audio dispatching to waitresses from the kitchen and also from the beverage-bar table/service area. Additionally, he wanted "canned" dance music provided in the party room. Incidentally, the number of waitresses employed during different hours of the day varied from 5 up to a maximum of 11 during the lunch- and dinner-hour peaks. The establishment was open from 10 a.m. to 2 a.m.—employing two 8-hour shifts.

One Survey out of Innumerable Possibilities

The TV/radio/audio service dealer who con-

continued on page 58

No other 10 MHz oscilloscope gives you all this for \$475

The TELEQUIPMENT D61 is a low priced 10 MHz dual trace oscilloscope with sweep rates up to 100 ns/div. It is ideally suited for students, technicians, and hobbyists.

Operating Ease. Front panel controls are engineered for instant recognition. Line or

frame displays are selected automatically in the TV trigger position. And, chopped or alternate modes are determined automatically to optimize display clarity.

Bright, stable viewing.

Stable waveforms, displayed on an 8 x 10 cm crt, are easy to view, even under unfavorable ambient light conditions. Two identical input channels simplify generation of X-Y displays. This is particularly useful in analysis of vector patterns.

Application versatility.

Because of its X-Y capability, the D61 simplifies alignment and troubleshooting of color television sets. Its performance equals or exceeds the requirements for servicing audio equipment, pocket calculators, public safety control, alarm, and communications systems, microwave ovens, digital clocks, and similar consumer electronic products.

Compact, portable.

Fully transistorized, and weighing only 15 pounds, the D61 occupies only 6.3 inches of bench width. It's easy to transport and use in confined working areas.

Tektronix reliability.

TELEQUIPMENT products carry the well-known Tektronix warranty and are marketed and supported by the Tektronix organization.

**Automatic triggering.
TV Frame
and line triggering.
Dual-trace, X-Y
and vector modes.**

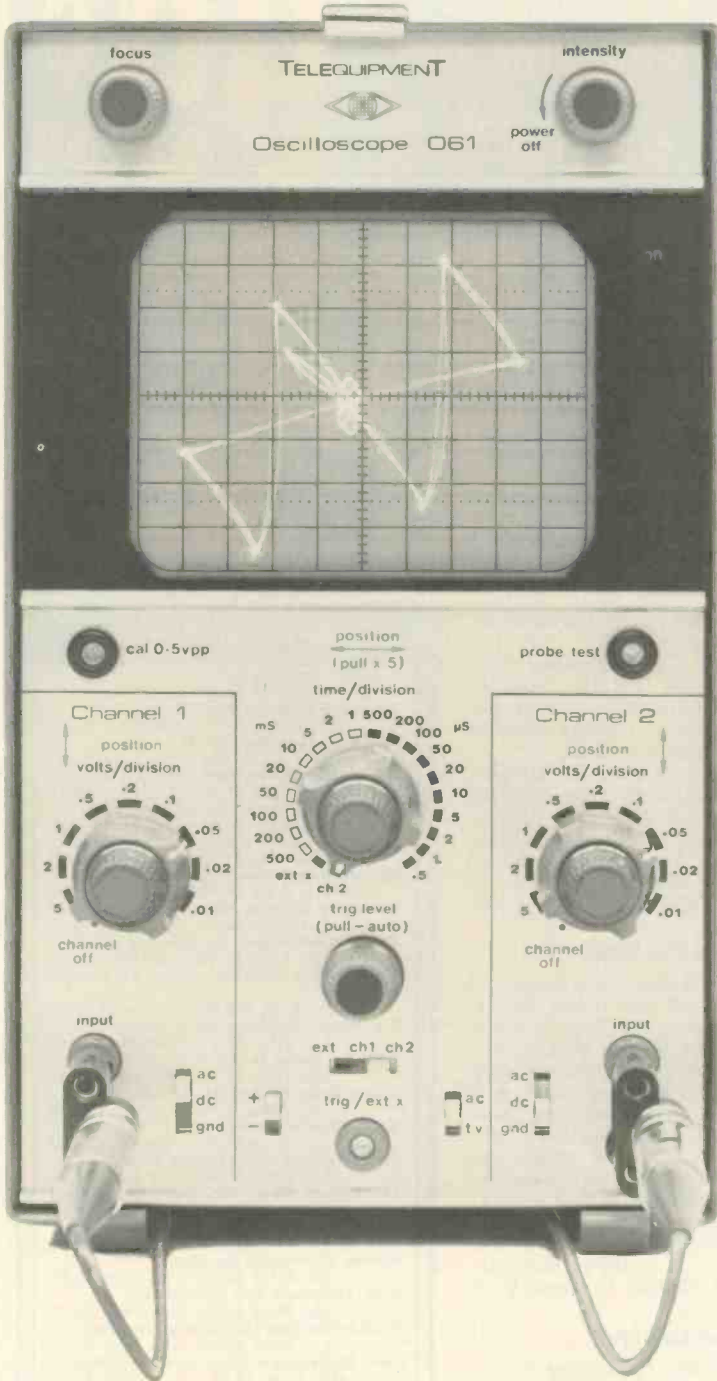

Send me the D61 Spec Sheet and Telequipment catalog.

Have your field engineer call to arrange a demonstration.

Tektronix, Inc., P.O. Box 500, Beaverton, Oregon 97005

Name _____

Title _____ Telephone No. _____

Company _____

Address _____

City _____ State _____ Zip _____



TEKTRONIX®

committed to
technical excellence

... for more details circle 129 on Reader Service Card

An Extraordinary Offer

to introduce you to the benefits of Membership in

ELECTRONICS BOOK CLUB

for a limited time only you can obtain

ANY 3 OF THESE UNIQUE BOOKS . . . yours for only **99¢** each
(Combined List Price \$40.85) Club Membership . . . with Trial

May we send you your choice of any three books on the facing page as part of an unusual offer of a Trial Membership in Electronics Book Club?

Here are quality hardbound volumes, each especially designed to help you increase your know-how, earning power, and enjoyment of electronics.

These handsome, hardbound books are indicative of the many other fine offerings made to Members . . . important books to read and keep . . . volumes with your specialized interests in mind.

Whatever your interest in electronics—radio and TV servicing, audio and hi-fi, industrial electronics, communications, engineering—you will find Electronics Book Club will help you.

With the Club providing you with top quality books, you may broaden your knowledge and skills to build your income and increase your understanding of electronics, too.

How You Profit From Club Membership

This special offer is just a sample of the help and generous savings the Club offers you. For here is a Club devoted exclusively to seeking out only those titles of direct interest to you. Membership in the Club offers you several advantages.

1. Charter Bonus: Take any three of the books shown . . . plus the FREE Bonus book worth \$7.95 (combined values to \$40.85) for only 99¢ each with your Trial Membership.

2. Guaranteed Savings: The Club guarantees to save you 15% to 75% on all books offered.

3. Continuing Bonus: If you continue after this trial Membership, you will earn a Dividend Certificate for every book you purchase. Three Certificates, plus payment of the nominal sum of \$1.99, will entitle you to a valuable Book Dividend which you may choose from a special list provided members.

4. Wide Selection: Members are annually offered over 50 authoritative books on all phases of electronics.

5. Bonus Books: If you continue in the Club after fulfilling your Trial Membership, you will receive a Bonus Dividend Certificate with each addi-

SPECIAL FREE BONUS

. . . if you act now!

Yes, if you fill in and mail the Membership Application card today, you'll also get this Bonus Book, FREE!

TV TROUBLESHOOTER'S HANDBOOK

Revised Second Edition

A completely updated quick-reference source for solutions to hundreds of tough-dog troubles.

Regular List Price \$7.95

tional Club Selection you purchase. For the small charge of only \$1.99, plus three (3) Certificates, you may select a book of your choice from a special list of quality books periodically sent to Members.

6. Prevents You From Missing New Books: The Club's FREE monthly News gives you advance notice of important new books . . . books vital to your continued advancement.

This extraordinary offer is intended to prove to you, through your own experience, that these very real advantages can be yours . . . that it is possible to keep up with the literature published in your areas of interest . . . and to save substantially while so doing.

How the Club Works

Forthcoming selections are described in the FREE monthly Club News. Thus, you are among the first to know about, and to own if you desire, significant new books. You choose only the main or alternate selection you want (or advise if you wish no book at all) by means of a handy form and return envelope enclosed with the News. As part of your Trial Membership, you need purchase as few as four books during the coming 12 months. You would probably buy at least this many anyway . . . without the substantial savings offered through Club Membership.

Limited Time Offer!

Here, then, is an interesting opportunity to enroll on a trial basis . . . to prove to yourself, in a short time, the advantages of belonging to Electronics Book Club. We urge you, if this unique offer is appealing, to act

promptly, for we've reserved only a limited number of books for new Members.

To start your Membership on these attractive terms, simply fill out and mail the postage-paid airmail card today. You will receive the three books of your choice for 10-day inspection. SEND NO MONEY! If you are not delighted, return them within 10 days and your Trial Membership will be cancelled without cost or obligation. Electronics Book Club, Blue Ridge Summit, Pa. 17214.

Typical Savings Offered Club Members on Recent Selections

Cassette Tape Recorders	List Price \$7.95; Club Price \$4.95
Introduction to Medical Electronics	List Price \$9.95; Club Price \$6.95
MATV Systems Handbook	List Price \$7.95; Club Price \$4.95
Pictorial Guide to Color TV Cir. Troubles	List Price \$7.95; Club Price \$4.95
10-Min. Test Tech. for PC Servicing	List Price \$7.95; Club Price \$4.95
Understanding & Using the Oscilloscope	List Price \$7.95; Club Price \$4.95
How to Repair Small Gasoline Engines	List Price \$8.95; Club Price \$4.95
Miniature Projects for Elect. Hobbyists	List Price \$6.95; Club Price \$3.95
Acoustic Techniques for Home & Studio	List Price \$7.95; Club Price \$4.95
Svc'ng. New Modular Color TV Recvrs. (2 Vols.)	List Price \$15.90; Club Price \$7.95
Everyman's Guide to Auto Maintenance	List Price \$7.95; Club Price \$4.95
Pictorial Guide to CB Radio Inst./Repair	List Price \$7.95; Club Price \$4.95
Zenith Color TV Service Manual—Vol. 3	List Price \$7.95; Club Price \$4.95
Mobile Radio Handbook	List Price \$7.95; Club Price \$4.95
Understanding & Using the VOM & EVM	List Price \$7.95; Club Price \$4.95
125 Typical Elect. Cir. Anal. & Repaired	List Price \$7.95; Club Price \$4.95
Jap. Radio/Rec./Tape Player Serv. Man.	List Price \$7.95; Club Price \$4.95
Marine Electronics Handbook	List Price \$7.95; Club Price \$4.95
Basic Electronic Test Procedures	List Price \$9.95; Club Price \$6.95
Troubleshooting Solid-State Amplifiers	List Price \$7.95; Club Price \$4.95
How to Repair Musical Inst. Amplifiers	List Price \$8.95; Club Price \$5.95
Kwik-Fix™ TV Service Manual	List Price \$8.95; Club Price \$5.95
How to Build Solid-State Audio Circuits	List Price \$8.95; Club Price \$5.95

SEND NO MONEY! Simply fill in and mail postage-paid Airmail card today!

How to Use Color TV Test Instruments



Here's an opportunity to close whatever gaps there are in your ability to use modern, up-to-date equipment designed specifically to save you time and money. You'll quickly grasp the author's common-sense approach to using the right instruments, thereby getting the most out of your investment in test gear. You'll improve your ability to use an oscilloscope, color bar generator, alignment generators, vectorscope, TV Analyst and sine, square-wave generators. The author also has included a description of his "curve tracer." With this simple scope attachment, you can rapidly assess the condition of diodes, transistors—even ICs—in or out of the circuit. 256 pps., over 230 illus. Hardbound. List Price \$7.95 • Order No. 577

Installing Hi-Fi Systems



The world of high fidelity doesn't stop with the purchase of equipment. This book explores the many aspects of in-the-home music reproduction, from acoustical considerations to structural requirements. Now in its fourth printing, this timeless and ever-popular guidebook has helped thousands to achieve studio quality sound at home. Includes details on building your own hi-fi furniture, setting up a sound room, eliminating interference and hum, how best to route wires and interconnecting cables, speakers, and speaker enclosures (with information on how to build your own), and much more. Tells all you need to know. 224 pps., 153 illus. Hardbound. List Price \$8.95 • Order No. 86

Radio & Television: Principles & Applications



A complete electronics library in a single volume! From raw ac and dc fundamentals to advanced hi-fi short-wave, and TV theory, the complete spectrum of electronics is covered in depth. Prepared in Great Britain, this book amounts to a full course in electronics—and it's written in extremely readable language. It starts with a description of the manner in which current flows, progresses to wave generation, electron activity in tubes and transistors, and then into the more advanced principles of electronics, its practical applications. Includes comparative descriptions of U.S. and British standards. 400 pps., 286 illus. Hardbound. List Price \$8.95 • Order No. 296

Fire & Theft Security Systems



A handy guidebook on the selection, installation, and general maintenance of home and business security devices and systems. Describes many newly introduced systems from simple door and window switches to ultra-sensitive microwave sensing systems. There's also a wealth of information for those who would like to get into sales, installation, and maintenance services—how to design the most effective and economical installation for any situation. And, you'll know where to find the components needed for fire and theft protection, because the equipment section includes data on a myriad of devices, with most of the principal suppliers represented. 176 pps., over 100 illus. Hardbound. List Price \$7.95 • Order No. 556

How to Solve Solid-State Circuit Troubles



A troubleshooter's "dreambook"—complete with 161 circuit descriptions and step-by-step troubleshooting procedures—for who occasionally or regularly services solid-state entertainment equipment of any kind—TV receivers, AM-FM radios (including auto radios), tape recorders, record players, etc. Very probably the most complete work of its kind ever published, it will serve as an excellent reference and study guide for those desiring to learn more about solid-state circuits and how they work. Hobbyists and experimentalists alike can use it to design and build complex solid-state circuits. 304 pps., 5 1/2 x 8 1/2. 161 illus. Hardbound. List Price \$8.95 • Order No. 624

Small Appliance Repair Guide



Learn to repair dozens of small household appliances with the use of this authoritative, low-cost handbook. Profusely illustrated, the text tells how to find the cause of trouble in minutes, and how to go about making the required repairs. You'll also pick up helpful hints on disassembly, one of the really "tricky" aspects of many appliance repair jobs. General troubleshooting procedures are explained to familiarize you with the techniques of appliance repair. Succeeding chapters deal with thermostats, skillets, sauce pans, irons, toasters, coffee makers, blankets, mixers, knives, deep fryers, hair dryers, electric shavers, and small motors found in countless appliances. 11 Chapters, 224 pps. Over 150 illus. Appendix and Index. List Price \$7.95 • Order No. 515

Electronic Circuit Design Handbook



New Fourth Edition—A brand-new, enlarged edition of the ever popular circuit designer's "cookbook" now containing over 600 proven circuits, for all types of functions, selected from thousands on the basis of originality and practical application. Now you can have, at your fingertips, this carefully planned reference source of tried and tested circuits. Selected on the basis of their usefulness, this detailed compilation of practical design data is the answer to the need for an organized gathering of proved circuits—both basic and advanced designs that can easily serve as stepping stones to almost any kind of circuit you might want to build. 416 pps., 19 big sections, over 600 illus. 8 1/2" x 11". List Price \$17.95 • Order No. T-101

Dictionary of Electronics



You'll find this huge volume extremely useful in whatever connection you have with electronics. This dictionary of electronics defines most all of the electronic terms you will run across in your everyday reading—from alpha particles through zoom lens terms you need and use most often, including those found in radio, TV, communications, radar, electronic instrumentation, broadcasting, industrial electronics, etc. It provides full, complete and easily-understandable explanations of thousands of specific electronics terms such as transistors, acoustic feedback, alpha particles, beat oscillator, final anode, electrostatic lens, nonlinear resistance, etc. 420 pps., 487 illustrations. Hardbound. List Price \$8.95 • Order No. 300

The Fascinating World of Radio Communications



Covers the romance of short-wave listening, DXing, specialized bands such as the Coast Guard, radio amateurs, the broadcast band, foreign broadcasts, etc. It also delves into the fascinating developments of radio pioneers—Tesla, Loomis, Volta, Galvani—and shows how their discoveries worked to bring us radio as it is today. Also described are the interesting installations of the National Bureau of Standards, plus WWV services used by industries, citizens and even governments all over the world. Citizen's Band? You bet—and how to get your license, what to look for in CB, and how to pick a CB receiver. 176 pps., illus. List Price \$6.95 • Order No. 586

Sylvania Monochrome TV Service Manual



Complete service, alignment, parts and schematic data for all Sylvania black-and-white sets introduced during the last 5 years—from the A01 through B14, and 372 through 578 chassis. Contains everything you need including techniques for setup, preliminary adjustments, tuner alignment, and repair and system alignments. Also, included are the latest factory-recommended modifications to help you eliminate "bugs." 19 complete schematic diagrams are printed on big double foldout sheets with waveform illustrations. 196 pps., 8 1/2 x 11", including 36-page schematic foldout section; and complete parts list for all chassis. Leatherette cover. List Price \$7.95 • Order No. 599

Practical Color TV Servicing Techniques



This brand-new updated and expanded second edition contains troubleshooting guidelines and case histories on the latest solid-state receivers, including a 4-color section with 32 trouble-symptom photos and a foldout section with 6 complete TV receiver schematics. Now included are service tips and techniques on RCA, Motorola and Zenith solid-state chassis, plus a host of case histories and current data on G.E. chassis. In fact, each of the 12 chapters is filled with information applicable to virtually any brand of color TV receiver, enabling you to solve tough-dog troubles quickly. 404 pps., 250 illus. Hardbound. List Price \$8.95 • Order No. 436

Amateur Radio General-Class License Study Guide



A new and unique text—the only one entirely devoted to the subject—for anyone who wants to pass the FCC General-Class exam successfully. Each question is dealt with individually, and the answers are explained in depth at a level that can be easily understood by relatively inexperienced readers. Even if you have no interest in "ham" radio, you'll find the content of this well-written text is an excellent source of information of value to anyone in electronics. Pertinent facts are grouped into palatable, easy-to-assimilate doses, and the conversational style keeps the material fresh and interesting from the first page to the last. 320 pps. Hardbound. List Price \$9.95 • Order No. 551

Reliable Electronic Assembly Production



Here is one of those rare books which successfully bridges the gap between design and production technologies, thereby providing guidelines for choosing the best design to achieve the least expensive and most reliable product. The content provides information on material and methods employed in mass production, giving the designer in-depth knowledge of the broad range of processes he should consider in evolving a final product concept. Not only does the content define the best materials for each given application, and detail the best choice for fabricating but it also points out incompatibilities which may arise between design and production. 208 pages. Hardbound. List Price \$12.95 • Order No. 287

Practical Electronic Servicing Techniques



Here is a new and unique handbook that will sharpen your electronics troubleshooting ability. Yes, you can learn to whip those tough dogs and prepare yourself for any electronic gear that comes your way with the "inside" information presented in this handbook. You'll be surprised how simple and logical the professional techniques really are. Begins with an analysis of what troubleshooting really is; to condition your thinking (which is part of the secret), the author begins with the analysis of troubleshooting logic; then he tells you how to think like a tough-dog expert. Also logical service approaches to DC circuits, tube circuits, and transistor circuits. 256 pps., 136 illus. Hardbound. List Price \$7.95 • Order No. 547

Transistor Projects for Hobbyists & Students



If building useful electronic gadgets and projects turns you on, your imagination will be triggered into conduction the moment you pick up this book. Build all sorts of devices with ICs, LASERS, transistors, Triacs, Diacs, Triacs, and integrated circuits. The first section offers suggestions for building or breadboarding these circuits. Sections 2 through 4 describe a wide range of devices for your car, home, office, or wherever electronics can serve you. Section 5 describes Triacs and how to use them in a variety of circuits for switching and control functions. Section 6 is devoted to integrated-circuit projects. 192 pps. Over 100 illus. Hardbound. List Price \$7.95 • Order No. 542

Hi-Fi for the Enthusiast

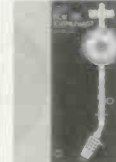

Expert practical guidance for the audiophile who wants to achieve first-class reproduction from radio, tape or records. Content is truly unique—main emphasis is on the efficient selection, assembly and use of modern commercial hi-fi units, modules and construction kits; you will be able to build a system that both suits individual needs, and gives a high standard of reproduction at an economical price. Room acoustics, amplifiers, pickups and loudspeakers, links with visual sources such as TV, film and slides, are dealt with in detail. Technicians, too, will find this book packed with invaluable advice, practical, book written by a hi-fi professional. 176 pps., 42 illus. Hardbound. List Price \$6.95 • Order No. 596

AN EXTRAORDINARY OFFER...

... for more details circle 103 on Reader Service Card

TEST INSTRUMENT REPORT

Descriptions and specifications of the products included in this department are provided by the manufacturers. For additional information, circle the corresponding numbers on the Reader Service Card in this issue.

B&K Precision Model 282 Digital Multimeter

by J. W. Phipps

■ The B&K Precision Model 282 Digital Multimeter is a compact, light-weight test instrument designed to measure resistance and DC and AC voltages and currents. As revealed by the accompanying list of specifications, the Model 282 is capable of measuring all of the levels of voltages, currents and resistances normally encountered in the servicing of home entertainment and most communications electronic products, with the exception of the focus and picture tube anode voltages in television receivers. And it is capable of measuring them with accuracies which exceed those of most high-quality service-type analog-readout FET VOM's. Equally significant, it offers the speed and precise readout inherent in digital displays.

BLOCK DIAGRAM ANALYSIS

A simplified block diagram of the Model 282 is shown here. Input for all measurements, except current levels exceeding 199.9 mA, is through the (+) and (-) jacks on the front panel of the instrument. To measure current levels exceeding 199.9 mA, one of the two prongs of the test lead assembly is inserted into the jack labeled 1A, as described in the operating procedures section.

For AC and DC voltage measurements, the FUNCTION switch routes the input voltage through a precision series attenuator network, the resistance value of which is determined by the setting of the RANGE

switch. The full-scale voltage developed across the attenuator network in each voltage position of the range switch is a nominal 1 volt.

For AC and DC current measurements, the FUNCTION switch routes the input current through a set of four precision shunt resistors. The number of resistors shunted across the input is determined by the RANGE switch. The current through the resistor(s) develops a nominal 100 mV at full scale of each of the four current ranges.

For resistance measurements, the input is connected to a constant-current source, which develops across the unknown resistance a voltage which is proportional to the value of the resistance.

All inputs are applied to the buffer amplifier, which consists of a balanced dual FET follower and an operational amplifier. The function of the buffer amplifier for AC and DC voltage and resistance measurements is to provide impedance matching between the input circuits and the absolute valve circuit which follows it. For AC and DC current measurements, the buffer amplifier also provides a gain of 10.

The absolute valve circuit provides full-wave rectification of the output of the buffer amplifier and converts the input voltage into a current which charges the integrator capacitor of the analog-to-digital converter. The absolute valve circuit eliminates the need for a sepa-

rate rectifier converter circuit for converting AC to DC before application to the analog-to-digital (A-D) converter.

The analog-to-digital converter is a modified integrator type which converts the analog input into a series of pulses whose average repetition rate during the sampling period is proportional to the true average of whatever electrical quantity is being measured. (This method of analog-to-digital conversion is generally conceded to be more accurate than pure "ramp" type conversion systems.)

The pulses produced by the analog-to-digital converter during each sampling period are gated into the counter circuitry of the logic section by a timer circuit which is controlled by a sample from the AC line. The remaining circuitry of the digital logic section stores and decodes the output of the counter circuitry. The decoded digital information then is used to drive the display section, which consists of a three-section, 7-bar Sperry display for the last three digits, and a single-section, 4-bar Sperry display, for the first digit and negative polarity indicator. (Positive polarity is implied by the absence of a negative sign display.)

The polarity indicating section consists of a transistor amplifier which, when the FUNCTION switch is in the DCV position, fires the negative sign bar of the polarity indicator display.



B&K Precision Model 282 Digital Multimeter. For more information about this instrument, circle 900 on the Reader Service Card.



Close-up view of the Model 282 digital multimeter. Note the brightness and clarity of the readout and the simple, clearly labeled operating controls.

The decimal points of the Sperry displays are activated by the RANGE switch.

OPERATING PROCEDURES FOR TYPICAL MEASUREMENTS

Test Probe Connections

For all measurements except current levels exceeding 199.9 mA, the dual-pin plug of the test probe is inserted so that the (+) pin is in the (+) jack and the (-) pin is inserted in the COM jack. For measurement of current levels exceeding 199.9 mA, the (+) pin is inserted in the 1A jack.

The probe supplied with the Model 282 is equipped with a 100K-ohm isolating resistor which can be switched in and out of the input circuit. The isolating resistor should be switched into the input circuit when DC measurements are made in high-impedance or high-frequency circuits, to isolate the cable and input circuit capacitance of the Model 282 from the circuit in which measurements are being performed. This added series resistance reduces the capacitive loading which otherwise would affect the accuracy of the measurement. When the isolating resistor is switched in, a reading error of -1 percent is introduced because the 100K of resistance is placed in series with the internal 10M-ohm divider of the Model 282 (1/100 of the input voltage is dropped across the isolating resistor). If this error is considered sig-

nificant, the observed reading can be mentally increased by multiplying it by 1 percent (.01).

Interpreting the Readout

The digital readout of the Model 282 produces up to four numbers plus a minus (-) sign, which is activated when the DC voltage or current being measured has a negative polarity. The display also is equipped with a decimal point, which automatically changes position when the RANGE switch is changed from one range to another, to indicate the decimal fractions of whatever unit is being measured. For example, if the FUNCTION switch is in either the ACV or DCV positions, the numbers to the right of the decimal point indicate decimal fractions of a volt. If the FUNCTION switch is in either the DCA (DC current), ACA (AC current) or OHMS position, the numbers to the right of the decimal point indicate decimal fractions of whatever unit of measure corresponding to the quantity being measured is indicated by the RANGE switch. For example, if the FUNCTION switch is in the OHMS position and the RANGE switch is in the position labeled 10/V/MA/K, all numbers to the right of the decimal point indicate decimal fractions of K ohms. A reading of 12.55 would be interpreted as 12 K ohms plus 55/100 of a K ohm, or, in more precise terms, 12,550 ohms.

An accompanying table illustrates the digital readouts for the various

combinations of the five measuring positions of the FUNCTION switch and the six positions of RANGE switch. This table also illustrates that the Model 282 is capable of reading up to twice the full scale range indicated by the RANGE switch. In digital meter terminology this is called *overrange*, and in the case of the Model 282, is 100 percent overrange. For example, in the table note that the Model 282 can read out up to 1.999V in the O-IV position of the RANGE switch, or twice the full scale range indicated by that position of the RANGE switch.

If the quantity being measured exceeds the 100-percent overrange capability of the Model 282 in any position of the RANGE switch, the automatic *overrange indication* feature of the Model 282 will be activated, causing the second, third and fourth digits (from the left of the display) to be turned off and leaving on only the first, or "1", digit. (Actually this automatic feature should properly be called an *over 100 percent overrange* indication, because it is not activated until the input quantity exceeds 100 percent of the full scale capability of the particular range being used.) When this condition occurs, the RANGE switch should be moved to the next *higher* range position.

Step-by-step procedures for operating the Model 282 are outlined in the following paragraphs, to provide you a better understanding of the speed and ease with which voltage, current and resistance measurements can be made with a well designed digital multimeter.

DC Voltage Measurements

- 1) The FUNCTION switch is set to the DCV position. The 100K-ohm resistor in the test probe should be switched out unless required to provide isolation when measuring DC voltages in a high-frequency or high-impedance circuit.
- 2) Connect the clip on the common test lead to the tip of the probe and zero the instrument by turning the ZERO control until the MINUS sign just lights or flickers and a zero reading is obtained. (Note that the instrument can differentiate between a "minus zero" and a "plus zero.")
- 3) Set the RANGE switch as required for the voltage amplitude to be measured. If the approximate amplitude of the voltage is not known, set the

RANGE switch to the *highest* position and reduce the settings as required to obtain a reading.

4) Connect the negative clip lead of the test probe to the common (ground) point of the chassis or equipment in which the measurements are to be performed.

5) Touch the tip of the probe to the voltage point to be measured. If the polarity is negative, the polarity sensing circuit will be energized and the voltage reading displayed will be preceded by a minus (-) sign. If the amplitude of the DC voltage measured is greater than twice that of the range selected, the overrange condition will be indicated by turn off of all digits except the first digit on the left, which will read "1."

AC Voltage Measurements

1) Place the FUNCTION switch in the ACV position.

2) Set the probe switch to the DIRECT position.

3) Set the RANGE switch to the desired voltage range. If in doubt about the actual voltage amplitude to be measured, always use the *highest* voltage range for the first measurement and adjust the RANGE switch as required to obtain a satisfactory readout. If a voltage greater than twice that indicated on the RANGE switch is being measured the overrange condition will be indicated, as described previously for DC voltage measurements. When this occurs, a *higher* voltage range must be selected.

Resistance Measurements

Before attempting in-circuit resistance measurements, be sure that the equipment in which the measurements are to be made is turned off and that all capacitors in the circuit are discharged. Once these conditions have been met, resistance measurements can be performed in the following manner:

1) Set the FUNCTION switch to the OHM position.

2) Set the probe switch to the DIRECT position.

3) Set the RANGE switch to the desired position. Connect the test leads across the resistance to be measured.

4) If the resistance value being measured exceeds twice the value of the range selected, the overrange circuitry is energized, causing the first digit to remain on and the second, third, and fourth to remain off.

When this occurs, select a *higher* range.

DC Current Measurements

When making either DC or AC current measurements, be sure the leads of the Model 282 are connected in *series* with the load of the circuit in which the measurements are to be made. Connecting the leads of the Model 282 in parallel with the voltage source might cause a current overload of sufficient magnitude to damage the voltage source. Also, always begin current measurements with the RANGE switch of the

Model 282 in the *highest* range position and then reduce the range to obtain a satisfactory reading.

1) Before connecting the leads of the Model 282 to the circuit in which current is to be measured, turn off all power to the circuit. Then connect the leads of the Model 282 to the circuit in one of the two following methods:

a) When inserting the test leads of the multimeter on the *positive* side of the power source which connects to the load, connect the *positive* lead of the test probe assembly at the *voltage* source and connect

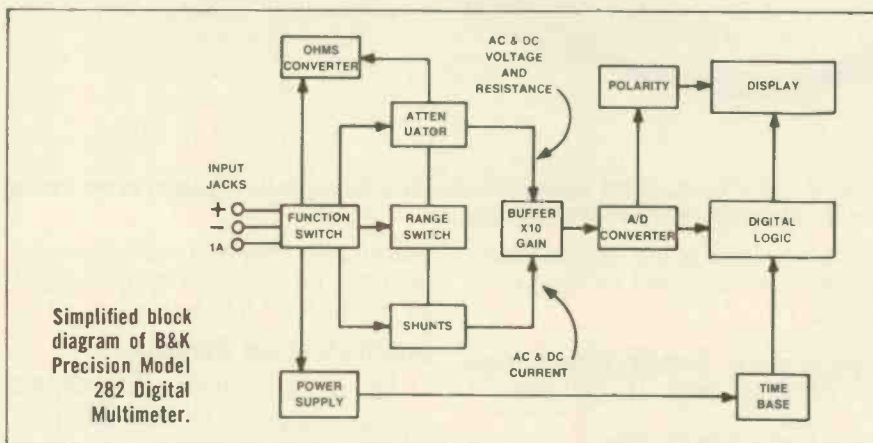

Measurement Functions, Switch Positions, Probe Lead Connections & Readouts, B&K Precision Model 282 Digital Multimeter

To Measure	Set Function Switch	Set Range Switch	Connect (+) Lead	Digital Display	
				Full Scale	100% Overrange
DC VOLTS	DCV	1 V	(+) Jack	1.000	1.999
		10 V	(+) Jack	10.00	19.99
		100 V	(+) Jack	100.0	199.9
		1000 V	(+) Jack	1000.	1500.
AC VOLTS	ACV	1 V	(+) Jack	1.000	1.999
		10 V	(+) Jack	10.00	19.99
		100 V	(+) Jack	100.0	199.9
		1000 V	(+) Jack	1000.	1000.
DC CURRENT	DCA	1 mA	(+) Jack	1.000	1.999
		10 mA	(+) Jack	10.00	19.99
		100 mA	(+) Jack	100.0	199.9
		1000 mA	1 A	1000.	1999.
AC CURRENT	ACA	1 mA	(+) Jack	1.000	1.999
		10 mA	(+) Jack	10.00	19.99
		100 mA	(+) Jack	100.0	199.9
		1000 mA	1 A	1000.	1999.
OHMS	OHMS	100 Ω	(+) Jack	100.0	199.9
		1 KΩ	(+) Jack	1.000	1.999
		10 KΩ	(+) Jack	10.00	19.99
		100 KΩ	(+) Jack	100.0	199.9
		1000 KΩ	(+) Jack	1000.	1999.
		10 MΩ	(+) Jack	10.00	19.99

the *negative* lead to the *load*.

b) When inserting the multimeter between the *negative* power source terminal and the *load*, connect the *negative* (black) test lead to the *negative* voltage terminal and connect the *positive* (red) lead to the *load*.

After the Model 282 has been connected as described previously, power can be reapplied to the circuit and you can proceed to Step 2. 2) Place the FUNCTION switch in the DCA position.

3) Set the probe switch to the DIRECT position.

4) Rotate the RANGE switch to the desired current range position. Always set the range switch to the *highest* position if the amplitude of the current to be measured is not known.

5) If the polarity of the current being measured is negative, the polarity sensing circuit will be energized, and the current value displayed will be preceded by a minus (-) sign. If the magnitude of the current being measured exceeds

twice the amount indicated on the RANGE switch position selected, the overrange circuitry will be energized, causing the first digit to remain on and the second, third and fourth digits to remain off. When this occurs, *immediately* remove power from the circuit under test and select a *higher* current range before proceeding.

6) When using 1A current range, the (+) tip of the test probe assembly must be connected to the 1A jack.

AC Current Measurements

The precautions and circuit connections described for DC current measurements also apply to AC current measurements. After making the required connections, AC current measurements can be performed in the following manner:

1) Set the FUNCTION switch to the ACA position.

2) Set the probe switch to the DIRECT position.

3) Set the RANGE switch to the desired position. If in doubt about the

magnitude of the current to be measured, again use the *highest* current range and then adjust the RANGE switch as required to obtain a satisfactory reading.

CONCLUSION

The B&K Precision Model 282 Digital Multimeter seemingly has been designed and priced with home entertainment and communications electronic technicians in mind, although its measuring functions, ranges and accuracies also should make it attractive to any type of electronic technician who is willing to pay the relatively few extra dollars difference between the cost of it and a high-quality, service-type FET VOM. The few extra dollars spent for a digital multimeter with the characteristics of the Model 282 are a cheap price to pay for the added speed, ease and accuracy with which such an instrument permits you to make the measurements which probably represent at least 75 percent of your diagnostic effort. ■

SPECIFICATIONS B&K Precision Model 282 Digital Multimeter

AC VOLTAGE

(Average reading circuitry calibrated to read RMS value of pure sine wave)

Ranges: 0—1,000, 10.00, 100.0, 1000 volts RMS
Overrange: 100 percent, to 1,999, 19.99, 199.9, 1000 volts RMS*
Maximum AC Input: 1000V RMS or 1500 volts peak.
Accuracy: ±1 percent of reading, ±1 digit, 1, 10, 100 V ranges.
±1.5 percent of reading, ±1 digit, 1000 V range.
Frequency Response: ±1 percent accuracy: 50Hz to 1000Hz on 1, 10 and 100 V range.
±1.5 percent accuracy: 50Hz to 1000Hz on 1000 V range.
±.5 dB: 1000Hz to 10kHz on 1 and 10 V ranges.
±1.0 dB: 1000Hz to 10kHz on 100 V range.
±1.0 dB: 1000Hz to 2000Hz on 1000 V range.
Input Impedance: 10 megohms.
Overrange Indication: If the input voltage exceeds 200 percent of full scale, the first digit ("1") will remain on and the second, third and fourth digits will be turned off.

DC VOLTAGE

Ranges: ±0—1,000, 10.00, 100.0, 1000 volts.
Overrange: 100 percent to ± 1,999, 19.99, 199.9, 1500 volts
Maximum DC Input: 1500 volts DC or DC plus AC peak.
Accuracy: ±.5 percent of reading, ±1 digit, 1, 10, 100 volt range.
±1 percent of reading, ±1 digit, 1000V range.
Input Impedance: 10 megohms.
Polarity Indication: Automatic, minus sign shown, with plus sign implied.
Overrange Indication: If the input voltage exceeds 200 percent of full scale, the first digit ("1") will remain on and the second, third, and fourth digits will be turned off.

DC CURRENT

Ranges: 0—1,000mA, 10.00mA, 100.0mA, 1000mA.
Voltage Drop (Measured at Instrument Terminals): 100mV, at full range.
Overrange: 100 percent, to 1,999, 19.99, 199.9 and 1999mA.
Accuracy: ±1 percent of reading, ±1 digit, 1, 10, and 100mA range.
±1.5 percent of reading, ±1 digit, 1000mA range.
Polarity Indication: If a DC current of negative polarity is applied to the input, the minus sign will light. The plus sign is implied.
Overrange Indication: If the input current exceeds 200 percent of full scale, the first digit ("1") will remain on and the second, third, and fourth digits will be turned off.

AC CURRENT

Ranges: 0—1,000, 10.0, 100.0, 1000mA.
Voltage Drop (Measured at Instrument Terminals): 100mV RMS at full range.
Overrange: 100 percent, to 1,999, 19.99, 199.9 and 1999mA.
Accuracy: ±1.5 percent of reading, ±1 digit, 1, 10, and 100mA range.
±2 percent of reading, ±1 digit, 1000mA range.
Frequency Response: 50Hz to 1000Hz at stated accuracy.
Overrange Indication: If the input current exceeds 200 percent of full scale, the first digit ("1") will remain on and the second, third, and fourth digits will be turned off.

RESISTANCE

Ranges: 0—100.0 ohms; 1,000, 10,00, 100.0, 1000Kohms; 10,000 megohms.
Overrange: 100 percent, to 199.9 ohms, 1,999, 19.99, 199.9 1900 Kohms; 19.99 megohms.
Accuracy: ±1 percent of reading, ±1 digit, 100 ohm to 1000Kohm ranges.
±2 percent of reading, ±1 digit, 10 megohms range.

Maximum Test Currents:	100ohm	10mA
	1Kohm	1mA
	10Kohm	100µA
	100Kohm	10µA
	1000Kohm	1µA
	10Mohm	100nA

CIRCUIT PROTECTION

DC Volts, AC Volts: Diode protection together with series current limiting resistance.
DC and AC Current: Fuse and diode protection on all ranges except 1000mA.
Ohms Ranges: Internal to ±250V DC or DC plus AC peak, 100 ohm range limited to +100V DC—250V DC or 250V AC peak.

POWER SOURCE: 117VAC, 60Hz.

ACCESSORIES (Included): One test probe assembly, PR-21.
Instruction manual with schematic and parts list.
DIMENSIONS: 3½" x 7" x 9".
WEIGHT: 5 lbs.
PRICE: \$199.95.

Bipolar Transistors— What Every Good Technician Should Know About Replacing Them

by B. B. Dee

■ The bipolar transistor is a two-junction device (as differentiated from unipolar devices, such as FETs) and is available in many electrical and physical variations. This leads to terms such as *mesa*, *Planar*, *epitaxial*, *drift* and others in the technical literature covering bipolar transistors. It is not really necessary, for service purposes, to understand these technical terms. Instead, it is more meaningful for the technician to be able to understand the terms used in transistor specifications. Such terms are discussed in the following paragraphs, to help the technician make suitable substitutions.

Collector Voltage

When a transistor in some relatively noncritical application such as a simple audio amplifier fails, it is apparent that a substitute device with a suitable collector voltage rating must be selected. Assuming that the technician knows the applied voltage, as in a 12-volt auto radio, where the small-signal stages have 14 or less volts applied (twice that for devices using transformers or inductive loads), it would seem a simple matter to pick such a device. That is not so. There are four common methods of specifying collector voltage ratings: V_{CB} , V_{CEO} , V_{CER} and V_{CES} .

V_{CB} is the voltage between collector and base with the emitter lead open, and is really only the diode voltage between collector and base with no transistor (gain) effect pos-

sible. This is not a realistic definition of collector voltage from the service standpoint, and is usually a higher figure that the device can actually tolerate when connected as a transistor.

V_{CEO} , on the other hand, is tested in the normal transistor connection, but with the base open, which is the worst possible condition the transistor can be tested under. This voltage rating is useful and can be depended upon at reasonable transistor temperatures. (These figures usually are specified at 25 degrees Centigrade, which is room temperature. Significantly different operating temperatures have some modifying effect.)

V_{CER} is tested with a low-value resistor connected between base and emitter, and is used with power transistors which are often used in

that manner. It is similar in voltage to V_{CES} , which is the same test performed with a short between base and emitter. These two specifications provide useful information for switching and other specialized uses, but are of little use to the serviceman.

The reason for the differences in these voltage ratings on the same transistor can be understood by examining Fig. 1. V_{CB} is the point at which *substantial* leakage indicates the reverse biased collector-base junction is about to break down. V_{CEO} is markedly lower, since even the *smallest* collector-base leakage must then flow through the base-emitter junction in order to return to the negative battery terminal, and, of course, *any* current flowing through the base-emitter junction is amplified just as if it were an input

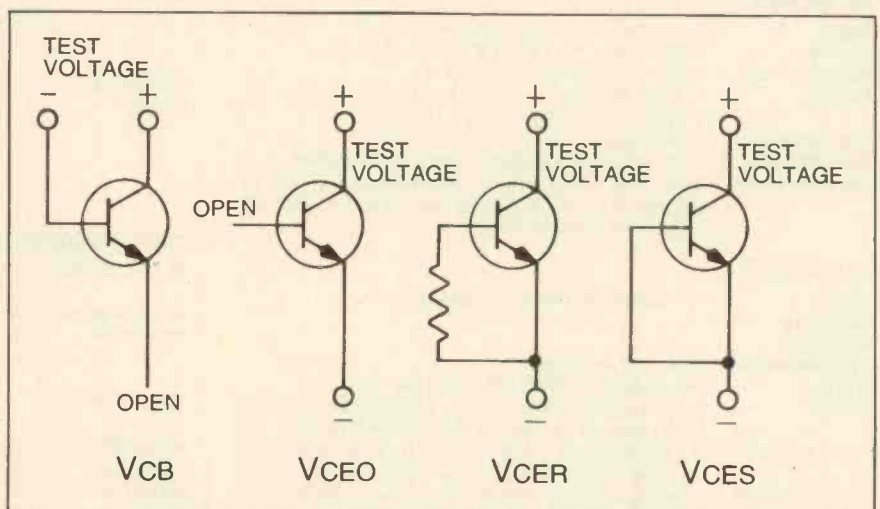

Fig. 1—Four common methods of specifying collector voltage ratings.

current (signal). Thus at the smallest sign of collector junction leakage, the transistor amplifies that leakage causing a heavy collector current to flow.

Because transistor cost is markedly affected by voltage rating, the service shop can make substantial savings by careful selection of semiconductors available at low prices from several reputable manufacturers. In general, the "replacement series" transistors offered by the same manufacturers cost several times as much as O.E.M. devices because they are marketed by a separate department and must include the added advertising, handling and other costs involved in marketing them.

Reverse Breakdown Voltage

An often overlooked factor in transistor substitution is BV_{EBO} , or breakdown voltage, base to emitter, with the collector open. This is the reverse breakdown voltage of the emitter-base junction, which occurs

with large input signals. With the commonly encountered silicon NPN transistor, this can be as low as four volts or as high as seven. With older type PNP transistors, it was even higher. (It is assumed that the technician is aware of the difference between germanium, silicon, NPN and PNP devices and is making his substitutions accordingly.)

Power Dissipation

Another area where various ratings differ considerably is in dissipation. It *cannot* be assumed that a transistor rated at 100 volts and 10 amperes (maximums) can be run at both maximums simultaneously. That would be a power input of 1 kilowatt. Accordingly, there are at least three means of indicating the true power dissipating ability. (Power dissipated is the difference between the input power and the useful output of the transistor, and appears in the form of heat inside the package.)

One method rates maximum power dissipated, P_D , at a specified case temperature, T_c , with a derating factor that tells you how much power must be reduced at correspondingly higher case temperatures. This takes into effect the cooling afforded by external heat sinks and other means. Another rating method gives P_D at an *ambient* (surrounding air)

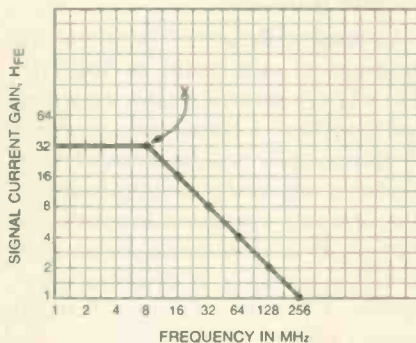

Fig. 2—Chart which shows the relationship of signal current gain (H_{fe}) and frequency of a particular high-frequency bipolar transistor. The frequency at which the signal current gain drops to 1 is the Gain-Bandwidth Product of the transistor.

4 Money-saving reasons to buy EICO's Solid State Test Equipment.



EICO 242 FET-TVOM. Peak-to-peak measurements of AC volts and milliamps. 6½" meter. 7 non-skip ranges. High input Impedance. Low 1 volt scale. DC/AC Multi-Probe. AC or battery operated. Kit \$84.95, Wired \$119.95

EICO 330 RF Signal Generator. 5 bands cover a range from 100 kHz to 54 MHz. Calibrated modulation adjustment control. 400 Hz audio output. Provision for modulating RF with internal or external signal source. Kit \$69.95, Wired \$109.95

EICO 379 Sine/Square Wave Generator. Simultaneous sine and square wave outputs. Covers 20 Hz to MHz in five ranges. Low distortion sultzer feedback circuit. Square wave rise time better than 0.1 microseconds. Kit \$79.95, Wired \$119.95

EICO TR-410 Triggered Sweep Scope. 100% solid state. DC to 10MHz bandwidth. Sweep synchronized gate output. Z-Axis input. Use as vectorscope for color TV servicing. One probe for direct and 10:1 measurements. Wired \$429.95

FREE 32 PAGE EICO CATALOG

For latest catalog on Eico Solid State Test Equipment, Automotive and Hobby Electronics, Burglar-Fire Alarm Systems, Stereo, and name of nearest EICO Distributor, check reader service card or send 25¢ for fast first class mail service.

EICO, 283 Malta Street, Brooklyn, N.Y. 11207



Is there an ice cream maker in your tube caddy?

There could be. We award one for 345 "Wal-tham" address tabs from Sylvania entertainment receiving tube boxes. Other awards range from table lighters to a weekend holiday at a famous resort. Write for an award catalog

or ask your distributor. Who knows what's in your tube caddy right now?

Sylvania SAV-A-TAB program, Sylvania Award Hq., P.O. Box 1000, Fenton, Mo. 63026.



temperature, T_A , usually 25 degrees C., with derating for higher ambient temperatures. If the transistor is equipped with a heat sink this latter power spec is more difficult to use. However, two transistors rated with these two different specs might not have similar power handling abilities at all, so when selecting replacements be sure to use similar ratings.

Current Gain

Current gain, called *Beta*, can be specified at some value of DC current (H_{FE}) or some value of signal current (H_{fo}). These two methods of rating gain can be considerably different, especially at high frequencies. An RF transistor may have a gain of 40 at 100 MHz, but a gain of 120 at some specified DC level of current. Obviously, H_{FE} is not useful in such cases.

Gain—Bandwidth Product

While on the subject of high-frequency devices, it is important to note the Gain-Bandwidth Product, F_T . This is the frequency at which the signal gain falls to a value of one. If you examine Figure 2, it can be seen that the current gain is halved each time the frequency is doubled, once the "knee" of the curve (point X) is passed. F_T is very useful in several ways: First, if we know F_T , we can work backwards to estimate gain at lower frequencies, knowing that gain is reduced by a factor of two for every octave of frequency. Thus, if F_T is 200 MHz, it would be reasonable to assume that the gain is 2 at 100 MHz and 4 at 50 MHz.

You can now see why transistors with F_T ratings of 700 to 900 MHz are used in VHF tuners even though the tuner does not operate at these high frequencies. The noise figure, which is the figure of merit of the ratio signal level to noise level, is reduced as the frequency increases past point X and gain decreases. Therefore, it is also advisable, from the noise standpoint, to use a transistor with as high an F_T as possible, compared to the actual frequency of operation. Noise Figure NF is given in decibels, abbreviated "DB", and as far as the service technician is concerned, the lower the NF the better

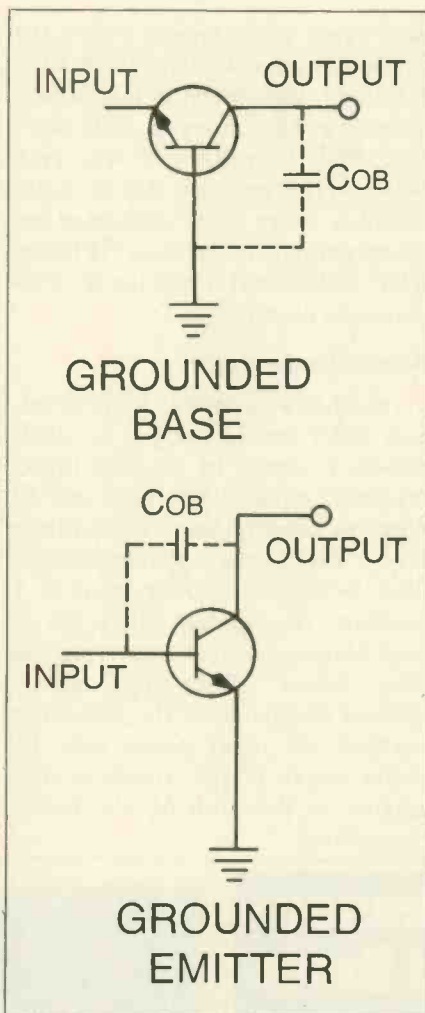

Fig. 3—In the grounded base configuration, C_{ob} is the output capacitance of the transistor. In the grounded emitter configuration, C_{ob} becomes the input-to-output feedback capacitance of the circuit and is effectively multiplied by the voltage gain of the stage.

when comparing devices. Again, it should be noted that changing the operating current changes the gain and the noise figure; consequently be sure that both transistors being compared are rated at the same current. If two transistors rated at different currents are being compared, the one with the lowest NF at the current nearest the actual operating current is the best. Transistors are available with low noise figures at audio frequencies for audio preamplifier use, while others are tested at VHF or even UHF for tuner use. The test frequency is always specified for noise figures, so look for it.

Output Capacitance

C_{ob} , frequently called "output capacitance," is given for transistors specified for IF or RF use. This is a

misleading label, as can be seen in Figure 3. C_{ob} is the output capacitance measured in the *grounded base configuration* (which corresponds to grounded grid operation in vacuum tube applications). It is really, in large part, the collector-to-base capacitance. When the transistor is used in the common emitter configuration, C_{ob} becomes the input-to-input feedback capacitance, which can cause oscillation. Further, its actual capacitance is effectively multiplied by the voltage gain of the stage as far as input capacitance is concerned. This is known as the "Miller Effect" and can be studied under that title in most good text books. This makes it impossible to properly tune the input circuit during alignment if C_{ob} is much different from that of the original transistor. This is a good point to remember when oscillations or alignment problems develop after a defective IF transistor in a TV set has been changed.

Because of the Miller Effect, as previously mentioned, C_{ob} is multiplied by the actual voltage gain of the stage. Therefore, if the gain varies, the input capacitance also varies, which accounts, in part, for why response curves change when the AGC level changes. Because of this, set manufacturers specify the AGC level at which alignment should be made.

AGC Considerations

At this point it might be well to mention that there are several methods of developing and applying AGC to IF stages in solid-state equipment. If the AGC voltage turns off the IF stages, the gain falls as the transistors approach cutoff. This is called the "starvation" method of AGC, and works only with transistors which have the necessary gain characteristics for this use. Some transistors maintain their gain right down to microamperes of collector current, and do not perform well with this type of AGC application.

Other systems turn the transistor fully on to the point of saturation. AGC systems also have to have transistors suited for that type of use. If not, clipping and distortion can become a severe problem, causing

harmonic generation and cross-modulation and intermodulation effects.

In integrated circuit amplifiers, the AGC capability is designed in by means of added transistors, usually in the form of balanced amplifiers, and there is little the service technician can do beyond replacing the entire IC.

In some CATV amplifiers, AGC is accomplished by means of varactors, which are used in balanced bridge circuits. When the bridge is balanced to a null, there is little output; with the bridge unbalanced, there is a substantial output. The bridge input is the desired signal, while one or more arms of the bridge are varactors biased with the AGC level. In this manner, AGC level affects the bridge balance and, consequently, the bridge output. This is mentioned because the TV technician may be required to service such equipment, and if not made aware of this type of AGC, would certainly be baffled.

If, at this point, some of our experienced technicians feel that semi-

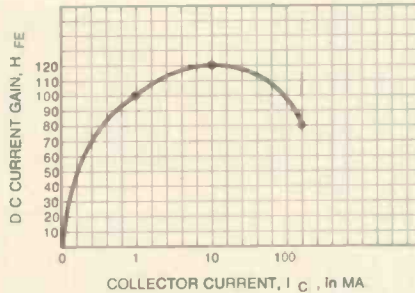

Fig. 4—Graph which illustrates the nonlinear DC current gain (H_{FE}) of a transistor intended for switching functions. Such nonlinearity makes the transistor unsuitable for audio and video amplification functions.

conductors are complicated, it might be well to point out that we had these problems in the 1930's, for Miller effect existed with vacuum tubes. As a matter of fact, since thermionic tubes operate with a voltage input and a current output, it was necessary to invent the term " G_m ", or "mutual conductance" in order to get around this "apples input versus oranges output." At least the bipolar transistor is a simple current amplifier, with current in and current out.

Linearity

There are some other characteristics of transistors that do not appear on data sheets, but which are only implied by the classification of the device. For example, a "switching" transistor may have good current gain, H_{FE} , may have suitable capability and an F_T of 300 MHz, but be totally unsuited as an audio or video amplifier. The reason lies in the "linearity," or lack of linearity, of the device. Referring to Figure 4, the variation of current gain as the current varies from zero up towards the maximum is clearly shown in graphical form for easy visualization. Note that current gain falls markedly as zero current is approached and as peak current is approached, which occurs at about 10 milliamperes for the transistor being examined. What is significant is that the top of the curve is not flat, or "linear," for much of the current range. This is adequate for a switch, which need only be on or off for logic purposes. But if the transistor is used for audio amplification it

THERE IS A SHORTAGE OF TWO-WAY TECHNICIANS



In public safety services the life and safety of people depends upon the operation of the radio.

EMPLOYMENT OPPORTUNITIES NATIONWIDE

Here's the Answer!

A TWO-WAY RADIO HOME STUDY COURSE

COMPLETE 40 LESSON TWO-WAY RADIO COURSE FOR ONLY \$275.00

Check Here for Veterans' Information

MTI

MOTOROLA TRAINING INSTITUTE

COLLEGE HILL ROAD, SUMMERDALE, PENNSYLVANIA 17093

... for more details circle 117 on Reader Service Card



Is there a grandfather clock in your tube caddy?

There could be. We award one for 345 "Waltham" address tabs from Sylvania entertainment receiving tube boxes. Other awards range from table lighters to a weekend holiday at a famous resort. Write for an award catalog

or ask your distributor. Who knows what's in your tube caddy right now?

Sylvania SAV-A-TAB program, Sylvania Award Hq., P.O. Box 1000, Fenton, Mo. 63026.

GTE SYLVANIA

causes flattening of the tops and bottoms of sine waves, which are the maximum and minimum current points, because of lack of gain at those points. And, in a video amplifier, sync information lies in one of those regions, depending on whether the video stage is sync inverting or non-inverting.

Transistors which are intended for amplifier use are designed for linearity, to prevent the distortions mentioned previously, and as a result they cost more. It is true that many switching transistors are quite linear, and have been successfully used by experimenters and amateurs, especially as mixers and oscillators, in which linearity is not so important. But for the professional service technician who has to be right the first time or face a recall, it is not advisable to save a few pennies by using the wrong device.

Power Transistor Considerations

Power transistors of different types have different internal semiconductor designs. But there are differences also in the mechanical mounting of the semiconductor chip which affect the heat transfer between the junction itself and the case in which it is enclosed. No amount of heat sinking or cooling of the case can keep junction temperatures down if the heat cannot be transferred efficiently from the junction to the case. That is why the power dissipation, P_D , was discussed earlier. It is quite likely that in substituting one device for another the junction operating temperature, T_j , normally in the range of 125 to 175 degrees C, may be exceeded. If this happens, the device will lose its ability to function as a semiconductor, and might be destroyed. This can be caused by several factors: if the thermal path between junction and case transfers heat less efficiently out of the junction into the case; if the replacement has a higher H_{VF} , it will draw more collector current, and heating will increase; if the device has greater losses, such as too low an F_T in the case of switching devices, these losses cause additional heat. The failure mode may not be an immediate catastrophic one, but may occur several weeks later. This

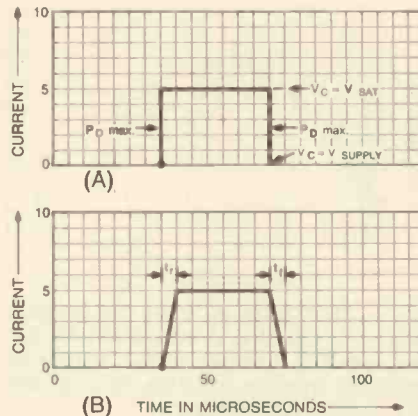

Fig. 5—Graphs illustrating the collector current and voltage waveform produced by a theoretically perfect switching transistor (B). As explained in the text, the increased switching time of the practical transistor increased the amount of average power dissipated by the transistor. As switching time increases, so does the average power dissipated.

is so because the severe heating causes a great change in temperature from nonoperating to operating conditions, and the temperature cycling causes mechanical fatigue which destroys hermetic seals, hard solder joints between the chip and its mounting, etc. The lesson here is that a few minutes spent in thoughtful transistor selection prevents problems later on.

Switching Transistors

Switching transistors are appearing in more color TV sets and communications equipment. They are used to generate not only sweeps but also various voltages used as power sources in the equipment, and it is important that the technician become aware of the problems involved in the use of semiconductors in such circuits. Previously, such transistors were largely limited to use in automatic solid-state ignition systems and DC to AC conversion.

Let us assume that we have a TV sweep frequency switch operating at close to 16 KHz. The period of a half wave is about 35 microseconds. Assuming that we have a 50% duty cycle, the collector current and voltage of the *theoretical* switch would appear as in Figure 5A. If the switch is turned fully on (saturated), the current is limited by the load, and, as in the case of a simple electrical switch, the voltage across the switch is close to zero. What small voltage exists across the switch is produced

by the switch resistance multiplied by the current flowing through it. This is called *saturation voltage* and is abbreviated V_{SAT} , as shown in Figure 5A. When the switch is turned off, or open, the current falls to nearly zero, with only leakage currents remaining. At that moment, the voltage across the open switch becomes the full applied supply voltage, as across any open switch. The significant thing is to remember that when current is high, voltage is low, and vice versa. Thus, because power is the product of current and voltage, power dissipated in the switch is low except for the tiny fraction of time it takes for the switch to change state, and is highest at the point marked " P_D max." Because this time is very short, the *average* power is also small.

Now examine Figure 5B. This is more like a transistor switching waveform, and has rise time, t_r , and fall time, t_f , each considerably longer than the instantaneous theoretically perfect switch of Figure 5A. Because the switching intervals are relatively appreciable, power is applied for longer periods, and the dissipation increases sharply. Rise and fall times are the result of both emitter-base junction delays and collector-base junction delays. These delay times were discussed in the first article of this series, which covered diodes. (Switching times and F_T are intimately related.) The saturation voltage, V_{SAT} , can also be significant in high-current, linear amplifiers. If the saturation voltage is high, the wave shape can never "bottom" near the zero axis when viewed on an oscilloscope. Thus, the maximum voltage swing is reduced, with a marked reduction in power output, or, put another way, distortion will be high if full-rated power output is attempted. This is another parameter to be considered when substituting not only switching devices, but any high-power transistor.

Accurate Substitution

All of the parameter specifications discussed in the preceding paragraphs, taken one at a time, are easily understood, and should be intelligently evaluated by the service technician each time he has to select a replacement bipolar transistor. ■

COLORFAX

The material used in this section is selected from information supplied through the cooperation of the respective manufacturers or their agencies.

MAGNAVOX

Color TV Chassis T989—Remote Control UHF AGC Improved

The T989 chassis employing the six-function remote control and digital readout features may exhibit overload symptoms on strong UHF signals. This condition can be

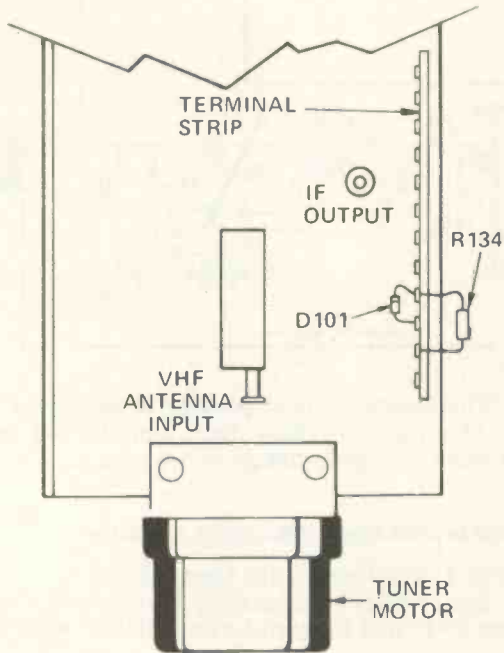

corrected by changing resistor R134 from 150 K, $\frac{1}{2}$ w to 270 K, $\frac{1}{2}$ w. The change increases the RF, AGC voltage applied to the UHF, RF amplifier in the 340236-1 UHF varactor tuner. Resistor R134 is physically located on a terminal strip on top of the 21-channel detent tuner, as shown in illustration.

Color TV Chassis T989—8-Function Remote Control

Certain stereo theatre models, such as the CD4971 console and the CD4987 Armoires, utilize the T989 chassis with the No. 704078—8-function remote-control system. In cases where the TV chassis is returned to the shop for repair, a special procedure must be followed in order to power the chassis on the bench. First, connect a jumper between pins 1 and 2 on the 6-pin Molex plug that connects to the radio chassis. Next, use a wedge to hold the contacts of relay 202 closed. The chassis may now be operated in the normal manner. Be sure to remove the jumper and the wedge when repairs have been completed.

Universal Video Output Module Part No. 703552-4

A new video output module, Part No. 703552-4, is now available which is a universal replacement for the 612032-1, 612032-101, 703552-1, and 703552-2 modules used in the T981, T982, and T987 chassis, and the 612032-1, 612032-101, and 703552-3 modules used in the T989 chassis. A DRIVE control, R8, is mounted on the new

module and must be set correctly for the chassis in which the module is installed.

When this new module is placed in a T989 chassis, R8 should be set to its maximum clockwise (minimum resistance) position. (The control is not needed in the T989 chassis and the fully clockwise position effectively takes the control out of the circuit.) White balance adjustments should be performed as outlined in Magnavox Service Manual No. 7343.

Early T981, T982, and T987 chassis used "DRIVE" controls to set the low-light color temperature of the picture tube. These DRIVE controls were actually DC BIAS adjustments and were re-named "Background" controls in later chassis versions. Control R8 on the new modules serves to control the amount of signal applied to each picture tube cathode, to provide correct high-light tracking.

When the universal module is installed in a T981, T982, or T987 chassis, R8 should be turned maximum clockwise and white balance adjustments performed in accordance with the service manual procedure. The brightness control should be turned up and down to check color temperature at both high-light and low-light conditions. The old drive (BACKGROUND) controls on the rear apron should be adjusted for proper gray scale at low brightness settings, and R8 should be adjusted for proper gray scale at high brightness settings. ■

Comments from our readers are always welcome.

Address your letters to:

J. W. Phipps, Editor
Electronic Technician/Dealer
1 East First Street
Duluth, Minnesota 55802.

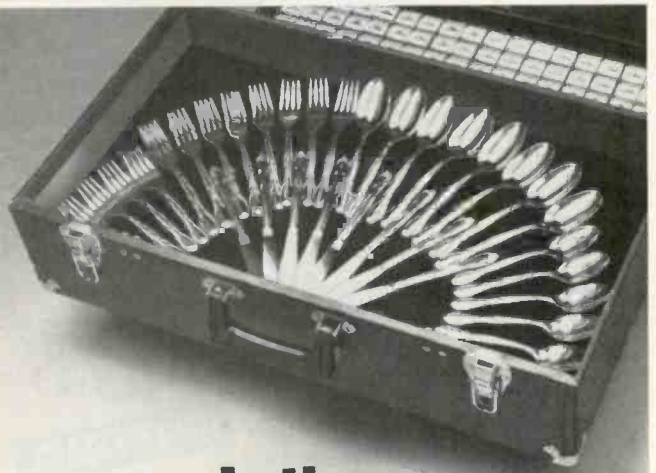

Is there a dinner service in your tube caddy?

There could be. We award one for 345 "Wal-tham" address tabs from Sylvania entertainment receiving tube boxes. Other awards range from table lighters to a weekend holiday at a famous resort. Write for an award catalog

or ask your distributor. Who knows what's in your tube caddy right now?

Sylvania SAV-A-TAB program, Sylvania Award Hq., P.O. Box 1000, Fenton, Mo. 63026.

GTE SYLVANIA

NEW PRODUCTS

Descriptions and specifications of the products included in this department are provided by the manufacturers. For additional information, circle the corresponding numbers on the Reader Service Card in this issue.

SOLDERING IRON TIP CLEANER 700

Cleans by inserting and withdrawing the iron tip

A new concept for the cleaning of soldering iron tips from Solder Removal Co., called Re-Tip, cleans old and new tips alike by simply inserting and withdrawing the hot tip. There is no wiping or rubbing required and no



sponges to keep wet. The cleaner removes oxides and contaminants, keeping the tips clean and uniformly

tinned. There are no abrasives used of any kind, preventing damage to the surface of the tips caused by scratching or chipping of the plating. The tip cleaner will effectively clean any style or shape tip up to 1/4 inch in diameter. It features a non-skid base and an economical replaceable cartridge which may be used as a hand-held or pocket model.

CONTACT CLEANER 701

Eliminates disassembly of equipment for cleaning

CRC Chemicals Inc. introduces a contact cleaner with a penetrating spray which evaporates rapidly, leaving precision parts grease free. The cleaner is best utilized for removal of light contaminants—dust, lint, atmospheric oils, moisture, or fingerprint oils. In-place cleaning can now be substituted for vapor degreasing or ultrasonic cleaning. In this way, disassembly and reassembly of equipment is avoided. Because it has no flash or fire points, the



cleaner is nonconductive, noncorrosive, and nonstaining to metals.

DIGITAL MULTIMETER 702

Includes 24 ranges with 1μv sensitivity

California Instruments has added another low cost digital multimeter—a full autoranging model that offers



24 ranges, 1μv sensitivity and 0.004% basic accuracy in an 8 lb bench system. Measurement capabilities of the Model DMM-51 Digital Multimeter include five DC voltage ranges from .1v to 1000v and five DC ratio ranges from .100000:10 to 1000.00:10 full scale. Optional accessories are available to extend the voltage and resistance measurements. Sensitivity is 1μv on everything but the AC ranges, which deliver 10μv sensitivity. Over-range is specified at 20%, useable to 30%. Fully automatic polarity and

WINEGARD AMPLIFIED PRODUCTS PROVEN IN OVER 1,000,000 INSTALLATIONS.

CASE IN POINT: WINEGARD SOLID-STATE BOOSTER-COUPPLERS.



For quality and dependability in booster-couplers, look to Winegard. You know they're good. Because our solid-state, booster-couplers deliver the best TV/FM reception and the best reliability in the industry today. Winegard booster-couplers come in a wide choice of models so each TV system can be "customized" for perfect reception. You can

amplify signals for up to four TV receivers or outlets.

- 75 and 300 ohm models
- 2 to 4 set capability
- solid-state circuitry
- lightning protection diode
- three wire ground cord
- rugged commercial quality steel cabinet

Best TV products for Best TV reception

WINEGARD
TELEVISION SYSTEMS

Winegard Company • 3000 Kirkwood Street • Burlington, Iowa 52601

... for more details circle 136 on Reader Service Card

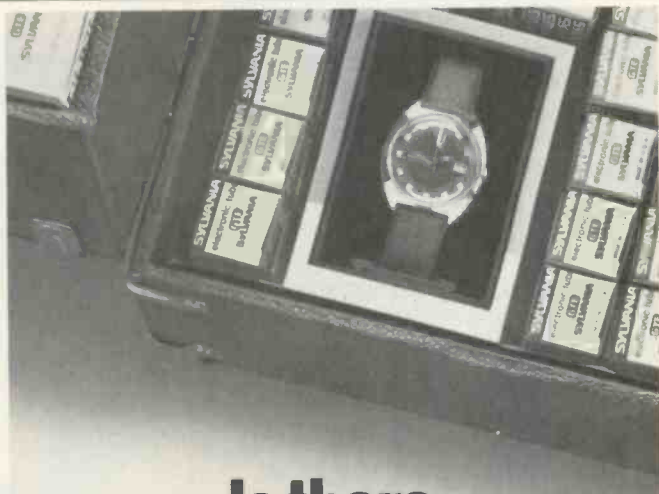

Is there a calendar watch in your tube caddy?

There could be. We award one for 240 "Waltham" address tabs from Sylvania entertainment receiving tube boxes. Other awards range from table lighters to a weekend holiday at a famous resort. Write for an award catalog

or ask your distributor. Who knows what's in your tube caddy right now?

Sylvania SAV-A-TAB program, Sylvania Award Hq., P.O. Box 1000, Fenton, Mo. 63026.

GTE SYLVANIA

World's best Multimeter

93 Ranges. $\pm 1.5\%$ Basic Accuracy.
100M Ω Impedance. FET Input.
Frequencies to 1GHz



MASTERANGER[®]

gives you 61 built-in ranges with $\pm 1.5\%$ accuracy or better:

- 0-1.5mV to 0-1500V AC & DC
- 0-0.15 μ A to 0-1.5A AC & DC
- 0-10k Ω to 0-10,000M Ω , output <24mV
- -60dBm to +60dBm in 10dBm steps
- Galvanometer & Null Detection

32 additional ranges with optional accessories:

- 0-1.5kV to 0-50kV AC & DC @ $\pm 1.5\%$ acc.
- 0-5V to 0-1500V AC (P-P) @ $\pm 1.5\%$ acc.
- 0-1.5V to 0-500V RF & VSWR @ $\pm 5\%$ acc.
- 0-5A to 0-150A AC & DC @ $\pm 5\%$ acc.
- -150 $^{\circ}$ C to +500 $^{\circ}$ C in 5 ranges @ $\pm 1.5\%$ acc.

More ranges, better accuracy than Triplett, HP, and others. Send now for brochure and address of local sales office.

\$245. MONEY BACK if not satisfied for any reason in first 30 days



Durable
INTERNATIONAL, INC.
Instrument Division

3-01 Twenty-Seventh Ave.,
Long Island City, N.Y. 11102 (212) 726-1200

... for more details circle 107 on Reader Service Card

50 | ELECTRONIC TECHNICIAN/DEALER, JUNE 1974

zero set are provided. Range selection for any function is automatic or it can be easily controlled using the front panel pushbuttons. For true readings, the basic accuracy is 0.004%. Easy-reading gas discharge displays are used to minimize human reading errors. Other basic specifications include 3½ readings per second with 66dB noise rejection. The unit provides greater than 140dB common mode rejection. Price is \$795.

ANTENNA

703

Incorporates a new corner reflector and UHF driver

JFD Electronics Corp., announces the production of a new series of VHF/UHF/FM antennas. The antennas, known as the LPV-UC Color Best, combine the patented log periodic de-

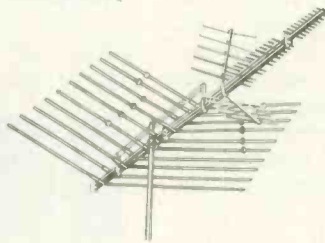

sign with a new corner reflector and

UHF driver. Capacitor-coupled dipoles and an electronically integrated, high-gain corner reflector capture more signal, providing higher front-to-back and front-to-side signal ratios. Other features include: a staggered multi-element phased driver, triple square crossarm construction, and gold colored alodized aluminum finish to protect the antenna. An all-band VHF/UHF/FM splitter is included with each of the seven area-engineered models: Model LPV-UC180 (far fringe), LPV-UC150 (fringe), LPV-UC120 (near fringe), UPV-UC90 (suburban-fringe), LPV-UC60 (suburban), LPV-UC40 (local-suburban), LPV-UC30 (local).

OSCILLOSCOPE

704

Includes many automatic functions to increase speed and accuracy of measurements

Lectrotech, Inc., announces two new oscilloscopes, the Model TO-55, a single-trace instrument and the Model TO-60 shown in picture, a dual-trace instrument. The oscilloscopes include many automatic functions which increase the speed and accuracy of measurements. Some of the automatic features include astigmatism and automatic selection of TV vertical and TV horizontal triggering. The vertical sen-

Look what \$450 buys!



New 2 MHz sweep function generator

It's the only one at that price... Systron-Donner's Model 411 sweep function generator. Check these features: **Frequency** in 6 decade ranges from 0.02 Hz to 2 MHz—Dial accuracy 2% of full scale typical—**Waveform outputs:** sine, square, triangle, ramp and a T₂L compatible sync pulse square wave. **Plus:** Model 411 is the only low cost sweep function generator which allows the operator to set the upper frequency limit to dial accuracy. **Contact:** your nearest Scientific Devices office or Systron-Donner at 10 Systron Drive, Concord, CA 94518. For immediate details call our Quick Reaction line (415) 682-6471 collect.

SYSTRON  DONNER

... for more details circle 127 on Reader Service Card

sitivity of both instruments has been increased to 10 mv/cm. The oscilloscope's vertical bandwidth is 10 MHz while the dual-trace Model TO-60 has

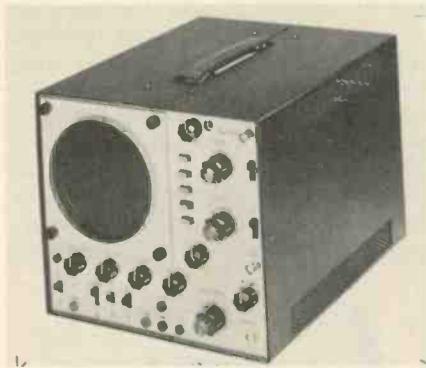

a 15 MHz system. All switching is done in the 1-2-5 step sequence to provide maximum resolution on all ranges. The unit provides five operating modes for the dual-trace vertical amplifier. These include independent operation of each channel plus dual-trace "alternate" and dual-trace "chopped" and the "sum" of each channel.

MOBILE CB ANTENNA 705

Features fold-down construction, with unique swivel action on lower mast

The Antenna Specialists Co. announces the development of a new series of antenna systems called "Super Can II" and "Super Can III" which are designed for increased CB range. The overall antenna height is 77 inches, but is easily folded down for overhead obstruction clearance. A positive locking sleeve holds the antenna securely upright when in operation, yet unlocks in seconds for fold-down. The sleeve, of heavy-duty material, was specially designed to eliminate the problems of rust, corrosion, or sand interfering with the operation. Also featured is a unique swivel action on the lower mast which permits simple line up of the antenna to the vehicle when folded. Both antennas use a heavy-duty type coil which is guaranteed not to burn out and is designed to run cooler, with less transmitted power lost in coil heating. Above the coil is a stainless steel whip and special collet locking nut designed for quick, easy adjustment of the antenna to peak efficiency and lowest VSWR. Price is \$34.95.

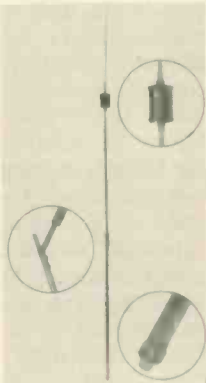

These new IR devices make replacing Zenith Semiconductors a local buy... everywhere!



Now you can buy International Rectifier's "Guaranteed" replacements for the most popular Zenith semiconductors right at your local IR distributor. Besides cutting days from the usual ordering-shipping cycle, they're priced locally too — more than competitive with the Zenith pricing structure.

Like everyone, we recognize Zenith's equipment is top quality, and we're not about to compromise their name, or ours. We analyzed circuits and devices for five months before we guaranteed that IR's devices will match, and meet or exceed Zenith's electrical and physical parameters in all applications.

Right now you can pick up a kit* of 23 IR semiconductors, and save an additional 10%.

Add it all up: Local availability. Local price. Guaranteed IR replacements for Zenith semiconductors. You can't lose.

*13-Transistors; 5-ICs; 3-Rectifiers; 1-Diode; 1-Crystal.

INTERNATIONAL RECTIFIER

Semiconductor Division



233 Kansas Street, El Segundo, California 90245, Phone (213) 678-6281

... for more details circle 112 on Reader Service Card

new!
FINCO[®]
 '80 Series
 COLOR SPECTRUM™
 TV/FM ANTENNAS



Capture the TRUE
 COLOR...

VHF-UHF-FM

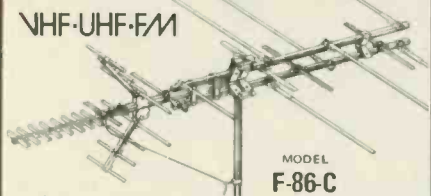

MODEL
 F-86-C

- MODEL F-89-C
 54 Elements VHF-UHF-FM
 CX-F-89-C (75 OHM)
- MODEL F-88-C
 47 Elements VHF-UHF-FM
 CX-F-88-C (75 OHM)
- MODEL F-87-C
 33 Elements VHF-UHF-FM
 CX-F-87-C (75 OHM)
- MODEL F-86-C
 27 Elements VHF-UHF-FM
 CX-F-86-C (75 OHM)
- MODEL F-85-C
 21 Elements VHF-UHF-FM
 CX-F-85-C (75 OHM)

VHF-FM

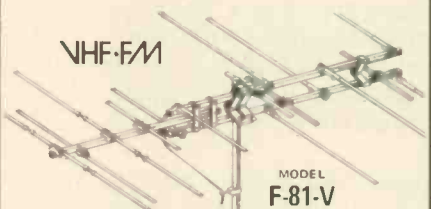

MODEL
 F-81-V

- MODEL F-84-V
 34 Elements VHF-FM
 CX-F-84-V (75 OHM)
- MODEL F-83-V
 28 Elements VHF-FM
 CX-F-83-V (75 OHM)
- MODEL F-82-V
 20 Elements VHF-FM
 CX-F-82-V (75 OHM)
- MODEL F-81-V
 14 Elements VHF-FM
 CX-F-81-V (75 OHM)

Write for Catalog No. 20-658, Dept. ETD-6-74

The FINNEY Co.
 34 West Interstate Street
 Bedford, Ohio 44146

... for more details circle 109 on Reader Service Card

CAPACITOR MOUNT ADAPTERS 706

Mounts twist-type electrolytic capacitors on printed boards

A new servicing aid from Sprague Products Co. makes it possible to mount Sprague Type TVL Twist-Lok electrolytic capacitors on printed wiring boards, to replace O.E.M. types having special terminals. The type PC-8



adapters are easily secured to the capacitor lugs and terminals to make a neat, permanent installation. The adapters are packaged eight to a reusable, clear plastic box along with complete installation instructions.

TUNER CLEANING PADS 707

Keeps contacts polished and lubricated

PTS Electronics, Inc., announces a new tuner oriented product, PTS Tuner Pads. These high quality, prelubricated pads are cello packed, 12 per card.



Press on installation. The pads keep contacts polished and lubricated with the same lubricant used by all major manufacturers.

UHF PREAMPLIFIERS 708

Single-channel, ultra-low noise with guaranteed noise figures

Mast-mounted, ultra-low-noise UHF preamplifiers are added to Blonder-Tongue's SCMA ultra-low-noise preamplifier line. They exhibit gain of

23.5 to 25.0 dB and flat response. Noise figures are typically 3.5 dB, ±1 dB; but actual, guaranteed noise figures for the channel in question are etched on each unit's case, together with the channel number. Designed for mast or tower mounting to prevent noise or interference pickup by long leads, each unit is mounted in a die-cast aluminum case designed for "U"-bolt mounting. Operating temperature range is from -40° F to +140° F, and all parts are lightning protected to 18 kv. Output connection is through standard 75-ohm, .412-inch aluminum

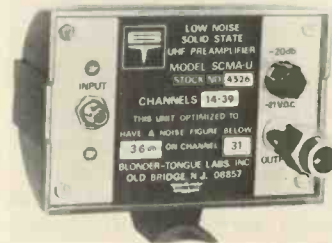

cable output connector. In addition, a standard 75-ohm, F-type, backmatched test jack output permits the unit's performance to be checked without interrupting service. Price is \$292.18.

OSCILLOSCOPE 709

Dual trace, lightweight, and a bandwidth of DC to 10 MHz

Jermyn introduces the "Scopex 4D-10" oscilloscope, a high performance, easy-to-use, dual-trace instrument. The manufacturer's specifications are as follows: Dual-trace display at 'A' channel. Sensitivity 10 mv per centimeter and a bandwidth of DC to 10 MHz. All solid-state circuitry including MOS technology for reliability and minimal drift. Direct calibration on volts/cm and time/cm for direct and consistent measuring accuracy. Triggering is accomplished by one control operating both level and polarity. In the absence of a trigger signal, the "bright line auto" will free run and thus a display is always present unless deactivated, and a beam locate button will position a lost trace (or both)

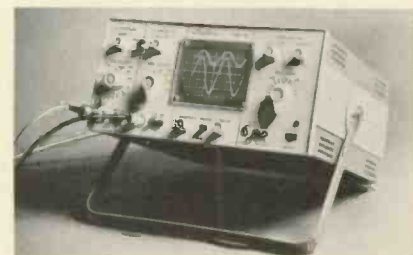

when operated. All other controls are pushbutton and include alternate/chop, external trigger and AC/DC coupling. The instrument is said to be

accurate to (± 5 percent), and easy to view. Lightweight 17 pounds, and the price is \$450.00.

PARTS CHEST 710

Keeps part inventory readily visible and accessible

Inventory can be kept readily visible and accessible in the AMP Parts Chest by AMP Special Industries. Four drawers, each 18 inches by 12 inches by 3 inches, slide out easily to reveal scooped compartments for tools and parts.



They can be removed for easy loading and carrying. Card frames on each drawer assure quick identification of contents. Made of heavy-duty, welded steel, the chest measures 20 inches long, 14½ inches high and 15¾ inches deep. Its balanced construction allows full extension of a completely loaded drawer without tipping over.

AUDIO SWEEP/FUNCTION GENERATOR 711

Hand-size miniature unit weighs less than 1½ pounds

Designed for audio service work, this hand-size, impact resistant generator weighs less than 1½ pounds, and with its battery power supply it

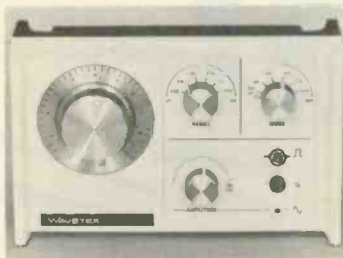

can be operated anywhere with complete line isolation. The Wavetek, Model 30, features 2 Hz to 200 KHz simultaneous sine, square and triangle waveforms plus sweep. Automatic sweep mode gives a frequency change of 1000:1, either logarithmically or linearly. Full voltage control of the

NOW



Original Replacement Parts

for

Radio ■ Stereo ■ Television

All Out-of-Warranty Replacement Components

Available from your local
J. W. Miller Distributor



Sanyo National Representative

BELL INDUSTRIES / J. W. Miller Division

19070 REYES AVENUE • P.O. BOX 5825 • COMPTON, CALIFORNIA 90224

... for more details circle 101 on Reader Service Card

FREE catalog of
BUSINESS FORMS
for TV and appliance dealers

Featuring ... SERVICE ORDERS
SALES SLIPS
STATEMENTS
PURCHASE ORDERS, ETC.

printed on **NCR Paper***

Provides clean, clear copies without
carbons—nothing to insert, tear out
or throw away.

... **LOW PRICES ... 6 DAY SERVICE**

* A reg. T.M. of National Cash Register Co.

Mall to: New England Business Service, Inc., P.O. Box 500, Townsend, Ma. 01469

Yes, please mail me your FREE catalog of business forms.

Name _____
Street _____
City, State, Zip _____

ETD-6

... for more details circle 119 on Reader Service Card

ideal, all-around iron

BY
Weller®



FOR ELECTRONIC SOLDERING

Model WP-25. Popular 25-watt, pencil-type iron for general purpose work. Handy size: 7 $\frac{7}{8}$ " long. Lightweight: 1 $\frac{3}{4}$ oz. Comfortable to hold. Perfect for crowded areas. Easily stored. Long-life, double-coated, $\frac{3}{16}$ " screwdriver tip quickly changed to other available styles and sizes. Rugged stainless steel barrel. Use with or without optional, mounted or free-standing bench stand PH-25.

Ask your local distributor or write...

**Weller-Xcelite
Electronics Division**



The Cooper Group

P. O. BOX 728,
APEX, NORTH CAROLINA 27502

generator requires only 0 to 1 v, either DC, for programming discrete frequencies, or AC, for FM operation. The sine wave output is variable up to 1 v rms. A recharger is available, and can be used for unlimited line operation. Price is \$149.95.

SEMICONDUCTOR CURVE TRACER 712

*Permits scope display
of operating parameters*

Used with an oscilloscope, the Heathkit, Model IT-1121 Semiconductor Curve Tracer displays operating parameters of virtually all types of semiconductors such as bipolar transistors, diodes, SCRs, triacs, FETs, etc. Extra leads are provided for tests of larger devices or for in-circuit tests.



The instrument is a valuable aid in selecting devices for specific applications or for sorting, inspecting and testing. It is particularly useful in identifying unknown semiconductors. All major controls are stepped in a 1, 2, 5 sequence for maximum parameter resolution. Price is \$89.95.

DISTORTION ANALYZER 713

*A frequency range of
from 5 Hz to 600 Hz*

Tucker Electronics Co., announces a small size, full capability, all solid-state distortion analyzer. The new Model 510A features a full frequency



range from 5 Hz to 600 Hz, 40:1 push-pull frequency tuning for quick balancing, an input range attenuator that expands each range, preventing amplifier saturation. In addition to

PROFESSIONAL NUTDRIVERS

BY **Xcelite®**

exactly what you need

LARGEST SELECTION ANYWHERE

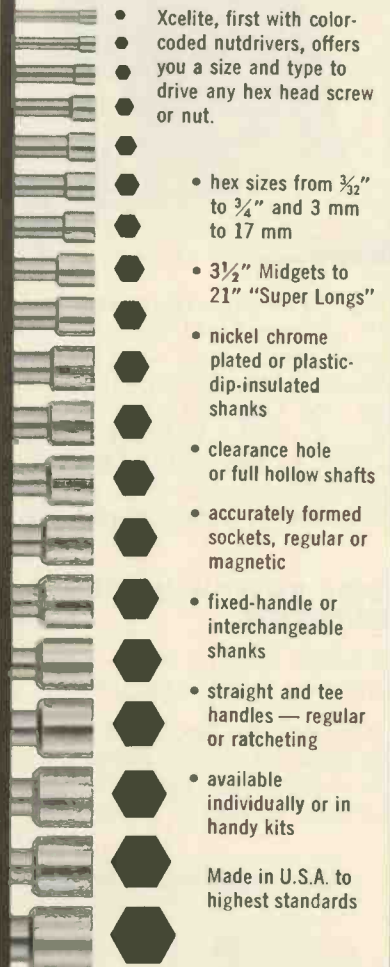

- Xcelite, first with color-coded nutdrivers, offers you a size and type to drive any hex head screw or nut.
- hex sizes from $\frac{3}{32}$ " to $\frac{3}{4}$ " and 3 mm to 17 mm
- 3 $\frac{1}{2}$ " Midgets to 21" "Super Longs"
- nickel chrome plated or plastic-dip-insulated shanks
- clearance hole or full hollow shafts
- accurately formed sockets, regular or magnetic
- fixed-handle or interchangeable shanks
- straight and tee handles — regular or ratcheting
- available individually or in handy kits
- Made in U.S.A. to highest standards

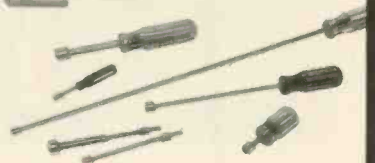

Ask your local distributor or write...

**Weller-Xcelite
Electronics Division**



The Cooper Group

ORCHARD PARK, N. Y. 14127

taking up less room on the test bench, the unit fits neatly into a half-rack, allowing side-by-side mounting with other instruments. An optional external AM detector is available. The unit measures 8 inches by 5¼ inches. Price is \$595.00. ■

TECH BOOK DIGEST...

continued from page 28

explored in sufficient detail to completely enlighten the beginner and to refresh the memory of those seasoned vets who have at least a speaking acquaintanceship with the basics.

The audio section is covered first, beginning with a review of the basic circuits, plus the bias, feedback, and protection methods used in modern stereo receivers. Included also are function controls, preamplifiers, audio IC op-amps, tone control techniques, and equalization. The discussion on IF and RF circuits delves into detectors and demodulation, including the new phase-locked loop method; IF systems; tuner circuits, including mixers, RF amplifiers, and local oscillators—and a voltage-tuned front end; automatic frequency controls, mute circuits, etc.

Later chapters detail a host of receiver performance measurements. Among them are power output, frequency response, input sensitivity, harmonic distortion, channel separation, and signal-to-noise ratio. Also, to assist the technician in setting up an FM receiver servicing facility, the author suggests a full complement of equipment; each unit is evaluated for its importance in the servicing function versus the cost.

An entire chapter is devoted to the absolute latest—the digital tuner. The reader will acquire an understanding of its phase-locked loop front end tuning, IF and detector, stereo decoder, and mute system. Included are actual, complete schematics of this newest addition to the field. In fact, the entire book is liberally illustrated with many useful schematics and other data.

CONTENTS: Power Amplifier and Driver Circuits—Control Amplifiers and Preamps—RF and Detector Circuits—Two- and Four-Channel Systems—AM Receiver Circuits—Control Circuits and Antennas—Power Supply Circuits—Stereo Measurements—Test Equipment for Stereo Servicing—Digital FM Service Tuner. ■

TUN-O-POWER RESTORES TUNERS!



Take a really bad tuner. The contacts are so dirty you have to wiggle the knob to pull in a channel.

Remove the tuner cover and spray in TUN-O-POWER. Rotate the tuner a couple of times. Then stand back and admire the results.

The tuner contacts are not just clean, they're shined to a high luster. And they're coated with a long lasting lubricant that makes detent action smooth as silk.

TUN-O-POWER is available from your Chemtronics Distributor.

Try it. You'll love it.

 **CHEMTRONICS**
INCORPORATED
1260 RALPH AVE., BROOKLYN, N.Y. 11236
Our business is improving yours.

... for more details circle 104 on Reader Service Card

JUNE 1974, ELECTRONIC TECHNICIAN/DEALER | 55

SERVICE NEW 110° COLOR and 90° IN-LINE TV CHASSIS



With the NEW
TeleMatic

110° COLOR ACCESSORY KIT!

PA-222
KIT
CONTAINS:

ONLY
\$25⁰⁰



CR-280
C.R.T. BRIGHTENER



CR-115
REPLACEMENT SOCKET



CR-90-110
TUBE TEST ADAPTOR



CR-110-90
CHASSIS SERVICE ADAPTOR



CR-110
SERVICE EXTENSION

AVAILABLE INDIVIDUALLY

FREE Reference Charts.

TeleMatic
Brooklyn, N.Y. 11207

DEALER SHOWCASE

Descriptions and specifications of the products included in this department are provided by the manufacturers. For additional information, circle the corresponding numbers on the Reader Service Card in this issue.

HEADPHONES

714

Combines comfort
with 20Hz-20kHz frequency response

GC Electronics' Open Air Headphones, The Marquis, Cat. No. 30-5205, features cushioned earpieces, fully adjustable padded headband, 8-ohm impedance and a 20Hz to 20kHz



frequency response. It matches all amplifiers with output from 4- through 16-ohm, has a power handling capacity of 250m watts and sensitivity of 110dB/0.4v.

4-CHANNEL/STEREO AMPLIFIER

715

Moderately priced and rated
at 70 w continuous power

The Marantz Co. is adding a moderately-priced console amplifier to its line of Stereo 2 + Quadradial 4 components. The Model 4070 amplifier is rated at 70 watts total continuous power and more than 15 watts per channel in the Quadradial mode. The total harmonic distortion rated power is 0.5 percent. In addition, pre-out/main-in facilities are provided on the rear panel, allowing the preamplifier

section and the output amplifiers to be used independently. Four-channel facilities on the amplifier includes a decoder pocket on the bottom panel, which accommodates an optional SQ-decoder or any advance in 4-channel

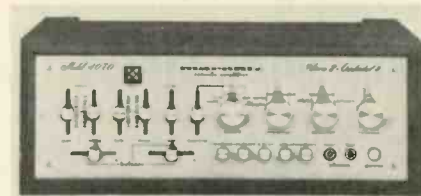

matrix technology. Built into the amplifier is a synthesizer that derives 4-channel sound from both ordinary stereo and matrix-encoded sources. The unit also incorporates facilities to accommodate a discrete demodulator for reproducing 4-channel sound from CD-4 discrete discs and discrete tape sources. Price is \$299.95.

AUTO CASSETTE PLAYER

716

Allows easy cartridge
insertion while driving

Audiovox Corp. announces a new AM/FM stereo in-dash radio with built-in cassette player for autos. This newest model C984 features fast-forward, adjustable shafts for easy in-dash installation, FM local-distant control, AM/FM selector with indicator lights, and



slide-rule dial scale. The cassette loading mechanism allows easy cartridge insertion even while driving and the pushbutton cassette ejector facilitates removal. The unit measures 7 inches wide by 2½ inches high by 6⅞ inches deep. Price is \$179.95.

CORNELL ELECTRONICS COMPANY

4213 N. UNIVERSITY AVE. SAN DIEGO CALIF. 92105

THE ORIGINAL
HOME OF

Same Low Price
East or West Coast!

- ★ Bargain Tools
- ★ Transistor Tester
- ★ Technician's Library

SPECIAL
OFFER

ON ALL ORDERS
OVER \$10.00

25¢
PER TUBE
(NO LIMIT)

FROM THIS LIST
6AG5 6CB6
6AU6 6J6
6AX4 6SN7

36¢
PER TUBE
UNLESS OTHERWISE PRICED
100 TUBES OR MORE
33¢ PER TUBE

ONE YEAR
GUARANTEE

INDIVIDUALLY
BOXED

5 DAY MONEY
BACK OFFER

LAB TESTED USED

SEND FOR FREE
NEW 48 PAGE
COLOR CATALOG

- ★ Dumont Picture Tubes
- ★ Diodes—Transistors—Kits
- ★ Tube Cartons

Your Order FREE if Not Shipped in 24 Hours

Lighted "clam shell" display showing the inside view

An eye-catching counter-top display that lets customers see, touch and operate RCA's Mini-State TV Antenna before they buy, gives maximum selling exposure to this new miniaturized antenna system for home or apartment. The colorful display tells the complete story and occupies little more than two feet of counterspace.



This merchandising piece, MLU-1606, comes with a clear plastic window that is inserted between the top and bottom halves of the radome. A bulb in the top half lights the interior of the colorful "clam shell" so that prospective customers can see the antenna rotate as they operate the hand-held remote control.

RECORDING TAPE ERASER 718

Completely erases all tapes of up to 1/2 inch size

Nortronics Co. Inc., Model QM-211, bulk tape eraser generates a 60-Hz magnetic field which will completely erase prerecorded reels, cassettes and 8-track cartridges of up to 1/2 inch tape width. The unit features a sensi-



tive Microswitch that is activated with fingertip pressure and is deactivated as soon as the eraser is put down. This

continued on page 59

When the big name companies fail you, come to the solid state of Workman.



It happens. Boy, does it ever happen.

Well, next time call Workman. Off-the-shelf delivery and prompt, attentive service has been our stock in trade for years.

And our new WEP semi-conductor line is going to carry on the tradition. It's got a few other things going for it too:

The packaging does a lot of work for you—cross-referenced to all major lines right on the face of the card. The back of the card has basing diagram and full specifications with symbol and ratings.

About 200 WEP numbers offer one-for-one replacement against competitive lines and our complete cross referencing enables them to replace up to 1000 numbers in other lines.

The whole line is fully warranted and we've designed it to make life as easy as possible for you.

Which is a pretty good reason for not waiting for someone else to flop before you call us.

After all, things are complicated enough today.

Workman. Your first second resource for replacement components.

Workman Electronic Products, Inc. Box 3828, Sarasota, Florida 33578
A subsidiary of IPM Technology, Inc.

... for more details circle 138 on Reader Service Card

Selecting Speakers . . .

continued from page 32

tracted for the audio work, prior to the beginning of the expansion and remodeling, walked through the main dining room, bar and kitchen areas with the audio technician carrying an audio-level (sometimes called a noise-level or sound-level) meter during the lunch hour, the dinner hour and again one morning just prior to opening time. Background noise-level readings were made at 10 spots in the three different areas during three different times—or a total of 30 readings.

The following day, under similar conditions, the two men went through the same three areas with a so-called "portable" audio amplifier, tape player and one 10-W, baffled 8-inch speaker mounted atop a four-legged partly telescoping structure. The speaker was arranged to point downward. This amplifier contained a 70.7-V output transformer and a small matching transformer mounted on the speaker. The 10-W portable amplifier was designed by the audio technician so the output could be varied in calibrated steps from a minimum of one watt to a 10-W maximum—in one-watt increments. (This equipment, while transistorized, was not really portable, because it was powered by 117VAC, and the long extension cord had to be moved frequently from one outlet to another.)

The service-dealer had been previously informed that the 25-foot high ceilings in the old original area were to be lowered to about 12 feet. The ceilings of the two new areas would be constructed at the same height. The speaker "quad-pod" was adjusted to about 11 feet

and the two men were making an occasional sound-pressure-level (SPL) measurement directly beneath the speaker at approximately 8 feet; but more important, one man also walked around the speaker in a circular area, approximating 10 feet from the speaker, to test audio *intelligibility* with his ears. Audio output to the speaker was varied from one or two watts from time to time up to the maximum of 10W. All data, with qualifying remarks, were listed on a substantial survey sheet.

Three days after the survey was completed, and based on all the data accumulated, the audio technician and service-dealer concluded that 15 five-watt, ceiling-mounted cone speakers would cover the entire area satisfactorily. (See Fig. 2.) Spacing of the speakers, with respect to the walls and to each other, was an important consideration. (Note that no survey was ever made in the new areas.)

Prior to the beginning of construction and remodeling, plans were made to construct a closet-sized room about 5 feet x 6 feet at a point only 15 feet from the center of the building between the main and second dining rooms. (See Fig. 2.) Because it had already been decided to provide an additional 10-W amplifier and a separate, automatic, continuous tape player and cabinet-type speaker for the party room, this closet would house two amplifiers and two automatic tape players. The main solid-state amplifier selected was rated at 80-W RMS output.

All cabling for this layout was farmed out to electrical subcontractors,

and consisted of size 14 plastic-insulated wire run in rigid conduit. Fifteen parallel tap-offs, terminated in "female" polarized outlets, were arranged in the ceilings at specified points. This arrangement was calculated to facilitate speaker phasing, the responsibility for which was assumed by the electricians. Matching transformer primaries were provided with polarized "male" plugs. Likewise, all transformer primaries were center tapped and grounded. Two separate, shielded microphone cables were run from their respective input points to the equipment closet. A simplified hook-up of the 15 speakers is shown in Fig. 3. Finally, a separate line-pair was run from the equipment closet to the party-room for the cabinet, which housed three cone-type, ten-watt speakers—woofer, mid-range and tweeter—and also the necessary inductive and capacitive crossover networks for woofer and tweeter. This speaker was fed direct from the low-impedance output of the 10-W solid-state transformerless amplifier.

After connecting all equipment, no problems were encountered when the system went into operation. Some acoustical feedback was noted at the service-bar microphone and the wattage on the speaker nearest the microphone was reduced by changing to a 2-W tap on the matching transformer secondary. Both microphone input levels were adjusted considerably higher for customer paging and waitress dispatching than for tape-player background music input. A few weeks later, a 10-W "T" pad was mounted on the

back of the party-room cabinet speaker, to provide on-the-spot flexibility of audio-level adjustment.

THE CHOICE IS YOURS

Some audio specialists and technicians would probably argue that the aforementioned hypothetical installation was "too involved and over elaborate," or "too expensive," or the customer was "taken for a ride," or the "service/dealer short-changed himself." Naturally, various alternatives were considered by the service/dealer and his audio technician. And they even discussed this with the customer.

Admittedly, by present space-age standards and current state-of-the-art techniques in commercial audio reinforcement and distribution, the aforementioned installation is inefficient, wasteful and expensive. But then, the approach is on a par with the system employed by most of us who insist on getting our normal supply of protein by eating thick, juicy steaks. Eating soy beans would be much more efficient, less wasteful and less expensive.

By employing 15 speakers of 16 impedance each and connecting them as shown in Fig. 4, we could have driven them all directly from the 10-ohm output of a transformerless transistorized amplifier and saved the cost of 15 CV (constant-voltage) transformers, plus the cost of the amplifier output transformer. And this direct-drive system is at least 15 or 20 percent more efficient power-wise. Still, each method offers advantages and disadvantages.

The choice is yours. ■

continued from page 57

function provides a unique safeguard that prevents burnout by accidentally leaving the eraser in the ON position. The easy-to-hold housing is made of unbreakable Cyclocac. Other features include a coiled power cord and detailed instructions for proper use.

SPEAKERS 719

Can be used for indoor or outdoor applications

Sound West Inc. offers handsome round, square and octagonal shape white plastic "Extraspeakers" for indoor and outdoor use. Colorful sculp-

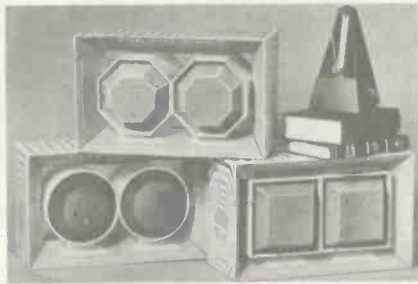

tured foam grilles lift-out for easy cleaning and come in choice of moss green, sea blue, rust, black, white and desert gold colors. Packaged two to a carton. The speaker measures 6 inches wide and 7 inches high and long. Price is \$15.95.

PORTABLE RADIO 720

Covers 10 bands, AC/DC operated

This solid-state General Electric Model P4970 portable radio covers UHF Public Service, VHF Public Service-hi, VHF Public Service-lo, Aircraft or Shortwave (has 2 SW bands for easier tuning) as well as FM



and AM. Push a button for Citizen Band or continuous U.S. government weather broadcasts in many U.S. cities. Operates on six "D" batteries or AC, with built-in power cord. It has a 5-inch dynamic speaker, squelch control, eight IF tuned circuits, vernier tuning,

and a solid-state chassis. The cabinet measures 13 by 9 3/8 by 4 inches. Price is \$99.95. ■

**For More Information about
DEALER SHOWCASE Products
Circle Appropriate Box on
Reader Service Card.**

**NATION-WIDE
TUBE & TRANSISTOR CO.**

OUR 21st MAIL ORDER YEAR

**ORIGINATORS
OF**

30¢

Tubes

\$27 per 100
Some Slightly Higher

**ORDER NOW
From This
Sample Listing**

3A3	6EA7
4BZ6	6FQ7
5CG8	6GF7
5U4	6GH8
6AH4	6HB7
6AU6	6JH6
6AY3	12AT7
6BZ6	12BE6
6CG8	12FX5
6DQ6	15KY8
6DT6	25L6
6DW4	35Z4

100's of Types Available at 30¢ Each!

DISCOUNT TRANSISTORS
(Sylvania & RCA Types)

ECG 128	...69¢ Ea.	— 10 for \$6
ECG 152	...59¢ Ea.	— 10 for \$5
SK 3004	...59¢ Ea.	— 10 for \$5
SK 3010	...59¢ Ea.	— 10 for \$5
SK 3018	...59¢ Ea.	— 10 for \$5
SK 3019	...59¢ Ea.	— 10 for \$5
2N 3054	...69¢ Ea.	— 10 for \$6
2N 3055	...79¢ Ea.	— 10 for \$7

FREE! TUBE CADDY With Every Order Of \$99 Or More From 30¢ Tube Listing Or Our Discount Transistors — Valued At \$19.95

All tubes & transistors individually boxed, branded, code dated, guaranteed 1 year. 5 day money back offer. All tubes & transistors shipped immediately, prepaid.

SEND FOR FREE COMPLETE LIST!
Magazine Special (1 Month Only) POCKET SIZE TUBE TESTER

3 socket tester checks continuity for every tube incl. picture tube. Has long test leads for printed circuits. Only \$4.99 each, prepaid.

TUNER REPAIR
Any Tuner Rebuilt \$8.99

VHF or UHF
All parts included. Tubes, transistors, nuvists extra. Send only \$8.99 plus \$1 shipping. Repaired tuner will be returned prepaid along with job sheet and shipping labels for future repairs. Mutilated tuners will be replaced at discount prices. All repairs guaranteed for 1 year!

SOLID-STATE REPAIR
Radios (home or auto), stereos, cassettes, 8-tracks, B&W transistor TV's, etc. Sample Repair Charge: AM Radio, \$3.95 plus parts, 8-Track Stereo, \$9.95 plus parts. B&W TV (transistor), \$12.95 plus parts. Wrap units carefully. Send all broken parts. List nature of complaint. **SEND NO MONEY!** Repaired units will be returned COD. All repairs guaranteed 3 months. Send for free job sheet & shipping labels!

**NATION-WIDE
TUBE & TRANSISTOR CO.**

1275 Stuyvesant Ave., Union, N.J. 07083
Tel: (201) 688-1414 Dept. ET4

... for more details circle 118 on Reader Service Card

GOOD TOOLS!

15 Watt Miniature Plug-In Soldering Iron

ORYX — the tiny iron for service work, lab, production. Needs no transformer, weighs only an ounce plus cord. Heats so quickly — reaches 725°F in about a minute. Light weight, small size let you work all day without fatigue. Just the thing for tiny components, delicate circuits, working in close quarters. Many replaceable tips.

Controlled-Temperature Soldering Iron

ORYX Model 50 iron affords close control of temperature, from 400 to 750° F. 50-watt element gives fast heat, quick recovery from heavy joint loads. Temperature adjustable while iron is on. Ideal for semiconductors, delicate components that can't be damaged by heat. Many replaceable tips, in various shapes, sizes.

20 - 70 Power Microscope

Pocket-size 20 to 70 power 'scope gives you a close-up view of circuitry, components, tiny metal or plastic parts, the surfaces of mirrors, metals, glass... wherever you are in the field, in the lab, at the work bench, in the home. Comes with tripod legs, pen light, zipper case.

Write today for **FREE CATALOG!** Electronic Tools & Test Instruments

TEL-66

ORYX TELVAC TEVAC INSTRUMENT COMPANY 14694 RAYMER STREET VAN NUYS, CALIF. 91405

... for more details circle 116 on Reader Service Card

SPRAY AWAY THE RACKET.

Squeak. Whine. Whirr. Pss! Silence. Quietrol did it again. Silenced those moving T.V. parts, with one squirt from the handy spray pack. Cleaned away dirt, dust, and crud. Without damaging anything... in any black and white or color set. Silence is golden. So is Quietrol.

Also available in bottles, and the new Silicone—"Siltron."

Product of
QUIETROLE COMPANY
Spartanburg, South Carolina

... for more details circle 122 on Reader Service Card

READERS SERVICE INDEX

ADVERTISER'S INDEX

101	Bell Industries	53
102	B&K Division, Dynascan Corp.	5
103	Book Club—Tab Books	34-37
104	Chemtronics	55
105	Chrysler Dodge	16
106	Cornell Electronics	56
107	Durable International	50
108	Eico Electronic Instruments Co.	43
109	Finney Company	52
110	Fordham Radio Supply	60
	General Electric Product Service	25
	General Electric Tube Division	13
	GTE Sylvania Consumer	
	Renewal	3, 43, 45, 47, 49
111	Heath Company	12
112	International Rectifier	51
113	Jensen Tools	60
114	Lafayette Radio Electronics Corp.	15
115	Leader Instruments	15
116	Mitchell-Telvac	59
117	Motorola Training Institute	45
118	Nationwide	59
119	NCR	53
120	PTS Electronics Inc.	Cover 2
121	Qualitone, Inc.	60
122	Quietrole	59
123	RCA Electronic Instruments Div.	29
124	Sadelco	60
125	Simpson	17
126	Sprague Products Co.	14
127	Systron Donner	50

128	Systems Electronics	48
129	Tektronix, Inc.	33
130	Telematic Division, UXL Corp.	56
131	Triplett Corporation	Cover 4
132	Tucker	9
133	Wavetek	19
134	Weller Xcelite	54
135	Weller Xcelite	54
136	Winegard Company	49
137	Winegard Company	Cover 3
138	Workman	57
139	Zenith Radio Corporation	10-11

NEW PRODUCTS

700	Soldering Iron Tip Cleaner	49
701	Contact Cleaner	49
702	Digital Multimeter	49
703	Antenna	50
704	Oscilloscope	50
705	Mobile CB Antenna	51
706	Capacitor Mount Adapter	52
707	Tuner Cleaner Pads	52
708	UHF Preamplifiers	52
709	Oscilloscope	52
710	Parts Chest	53
711	Audio Sweep/Function Generator	53
712	Semiconductor Curve Tracer	54
713	Distortion Analyzer	54
714	Headphones	56
715	4-Channel/Stereo Amplifier	56
716	Auto Cassette Player	56
717	TV Antenna Display	57
718	Recording Tape Eraser	57
719	Speakers	59
720	Portable Radio	59

TEST INSTRUMENT

900	B&K Precision Model 282	
	Digital Multimeter	38

DISCOUNT TEST EQUIPMENT SPECIALISTS

B&K HICKOK
SENCORE RCA
EICO Leader

COMPLETE LINE OF ELECTRONIC SUPPLIES

ICC/Mullard & Raytheon Tubes
Telematic Test Rigs

FREE CATALOG
QUOTATIONS ON REQUEST

FORDHAM
Radio Supply Co., Inc.

558 Morris Ave., Bronx, N.Y. 10451
Tel: (212) 585-0330

... for more details circle 110 on Reader Service Card

FREE CATALOG

HARD-TO-FIND PRECISION TOOLS

Lists more than 2000 items—pliers, tweezers, wire strippers, vacuum systems, relay tools, optical equipment, tool kits and cases. Also includes ten pages of useful "Tool Tips" to aid in tool selection.

JENSEN TOOLS
4117 N. 44th Street, Phoenix, Ariz. 85018

... for more details circle 113 on Reader Service Card

IEC-MULLARD



88¢

MINIMUM 10

POPULAR 6GH8

ORDER No. X1114

SEND CHECK WITH
ORDER - WE PAY
SHIPPING CHARGE

FREE BIG WHOLESALE CATALOG

with thousands of money-saving audio and electronic parts and accessories.

FREE

QUALITONE INDUSTRIES, INC.
17 Columbus Avenue, Tuckahoe, N. Y. 10707
Please send FREE Catalog to:

Name _____
Address _____
City _____ State/Zip _____

... for more details circle 121 on Reader Service Card

MOVING?

Send your new address and a complete address label from one of your recent issues to:

Circulation Fulfillment
Electronic Technician/Dealer
P.O. Box 6016
Duluth, Minn. 55806



"Would you believe the man who fixed our set last time absolutely refused to make a service call?"

SADELCO FS719B! Offers the Best!



SINGLE INPUT
LHF/VHF/FM

BUILT-IN
SPEAKER

Finest in Its Class

- Features
- Accuracy
- Price

For the name of your local distributor, contact:

SADELCO, INC.
299 Park Ave.
Weehawken, N.J. 07087
201 866-0912

• THE LARGEST MANUFACTURER OF TELEVISION FIELD STRENGTH METERS IN THE U.S.A. •

... for more details circle 124 on Reader Service Card

READER SERVICE INFORMATION CARD 6-74

This card is usable until September 1, 1974.

For more information on products or services mentioned in this issue, simply circle the appropriate numbers below, type or print your name and address, apply postage, and drop in the mail.

ADVERTISED PRODUCTS

101	109	117	125	133	141	149
102	110	118	126	134	142	150
103	111	119	127	135	143	151
104	112	120	128	136	144	152
105	113	121	129	137	145	153
106	114	122	130	138	146	154
107	115	123	131	139	147	155
108	116	124	132	140	148	156

TEST INSTRUMENTS

900	908	916
901	909	917
902	910	918
903	911	919
904	912	920
905	913	921
906	914	922
907	915	923

NEW PRODUCTS

700	708	716	724	732	740
701	709	717	725	733	741
702	710	718	726	734	742
703	711	719	727	735	743
704	712	720	728	736	744
705	713	721	729	737	745
706	714	722	730	738	746
707	715	723	731	739	747

NAME _____ POSITION _____

COMPANY _____ STREET _____

CITY _____ STATE _____ ZIP CODE _____

Please describe your type of business or industry _____

Your signature _____

PLACE
STAMP
HERE

Reader Service Department

ELECTRONIC TECHNICIAN/DEALER

POST OFFICE BOX 6016, DULUTH, MINNESOTA 55806

For those countries outside the U.S., please apply appropriate postage before mailing

ELECTRONIC TECHNICIAN/DEALER • TEKFAK 111 VOLUME 11

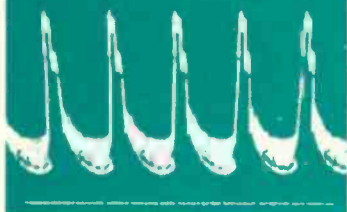

PERSONAL SUBSCRIPTION CARD

GET A FREE BONUS WITH YOUR PERSONAL
SUBSCRIPTION TO ELECTRONIC TECHNICIAN/DEALER!

- 3 Years \$13 2 Years \$10 1 Year \$6*
 Payment Enclosed Bill Me

*BONUS: With a 2 or 3 year subscription, you receive both TEKFAK 111 and the COLOR TV GUIDEBOOK free! If you are subscribing for 1 year, please indicate your choice of either: TEKFAK 111 COLOR TV GUIDEBOOK

PLEASE CHECK BELOW:

1. In the TV, Radio and other consumer products fields, is your firm

PRIMARILY a: (please check most descriptive item)

- Retailer with service department Industrial electronics service firm
 Service/repair firm with some retail Manufacturer Service manager
 Service/repair firm with no retail Other (please describe) Service repairman or other employee

2. Title (please check one)

Owner, manager, buyer, other executive

Service manager

Service repairman or other employee



NAME _____ STREET _____

FIRM _____ TITLE _____

CITY _____ STATE _____ ZIP _____

If you are renewing your subscription, check here and attach your address label. If you renew your subscription for 2 to 3 years, you are still eligible to receive your free bonus.

Circle
the
Reader
Service
numbers
of those
items of
interest
to you.

GET
MORE
FACTS

Your own
personal
copy
for
only
pennies
per issue

PLACE
STAMP
HERE

Reader Service Department

ELECTRONIC TECHNICIAN/DEALER

POST OFFICE BOX 6016, DULUTH, MINNESOTA 55806

GET MORE FACTS

READER SERVICE INFORMATION CARD 6-74

This card is usable until September 1, 1974.

For more information on products or services mentioned in this issue, simply circle the appropriate numbers below, type or print your name and address, apply postage, and drop in the mail.

ADVERTISED PRODUCTS

101	109	117	125	133	141	149
102	110	118	126	134	142	150
103	111	119	127	135	143	151
104	112	120	128	136	144	152
105	113	121	129	137	145	153
106	114	122	130	138	146	154
107	115	123	131	139	147	155
108	116	124	132	140	148	156

TEST INSTRUMENTS

900	908	916
901	909	917
902	910	918
903	911	919
904	912	920
905	913	921
906	914	922
907	915	923

NEW PRODUCTS

700	708	716	724	732	740
701	709	717	725	733	741
702	710	718	726	734	742
703	711	719	727	735	743
704	712	720	728	736	744
705	713	721	729	737	745
706	714	722	730	738	746
707	715	723	731	739	747

NAME _____ POSITION _____

COMPANY _____ STREET _____

CITY _____ STATE _____ ZIP CODE _____

Please describe your type of business or industry _____

Your signature _____

Circle the Reader Service numbers of those items of interest to you.

BUSINESS REPLY MAIL

NO POSTAGE STAMP NECESSARY IF MAILED IN THE UNITED STATES

FIRST CLASS

PERMIT NO. 665

DULUTH, MINNESOTA

POSTAGE WILL BE PAID BY

Circulation Department

ELECTRONIC TECHNICIAN/DEALER

POST OFFICE BOX 6016, DULUTH, MINNESOTA 55806

Your own personal copy for only pennies per issue

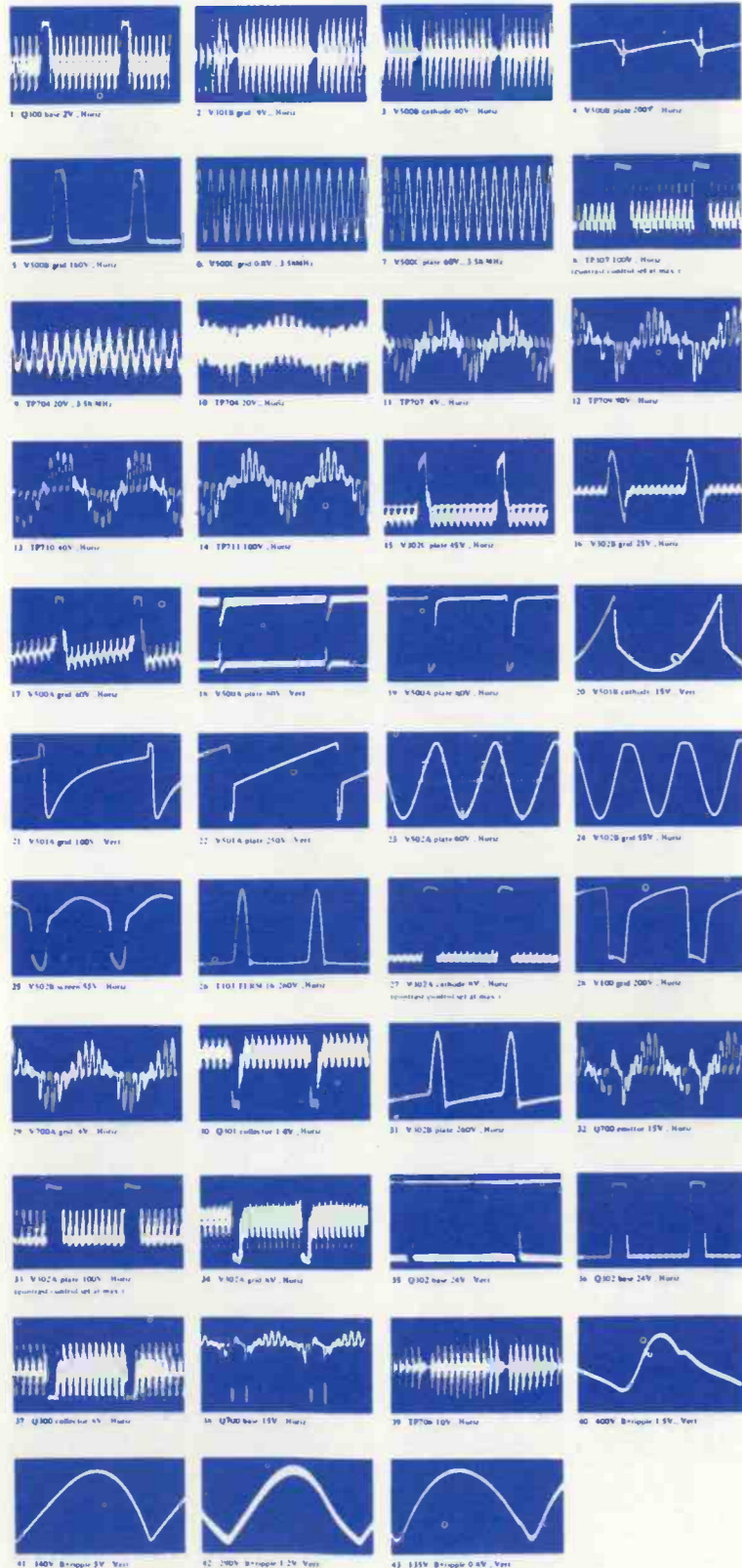

SYMBOL	DESCRIPTION	AIRLINE PART NO.
C106A	150 μ f, 250v, electrolytic	67A15-412
C106B	200 μ f, 350v, electrolytic	
C106C	100 μ f, 175v, electrolytic	
C106D	100 μ f, 150v, electrolytic	
C107A	100 μ f, 175v, electrolytic	
C107B	80 μ f, 150v, electrolytic	67A15-511
C107C	50 μ f, 150v, electrolytic	
R112	voltage divider, focus	61A71-1
RV101,102	VDR	61A46-13
RV500	varistor	61A65-1
R115	control, focus 130M	75A108-8
R116	control, high voltage adjust, 5M	75A135-48
R124	control, contrast 350 Ω	75A140-3
R125	control, brightness, 100K	75A140-13
R126	control, color, 500 Ω	75A140-22
R127	control, tint, 50K	75A140-23
R128	control, volume, ON/OFF, 1M	75A189-3
R129	control, vert hold, 750K	75A135-46
L101	filter choke	74A31-1
L106	deflection yoke assembly	94A379-10
L201	coil, quadrature (inc. C206)	72A366-1
L306	coil, 4.5MHz trap	72A367-1
L501	coil, horiz hold	94A351-2
T100	x-former, power	80A116-3
T101	x-former, pix filament	80A119-1
T102	x-former, vert. output	79A153-4
T103	x-former, horiz. output	79A164-3
T104	x-former, audio output	79A88-7
T200	x-former, 4.5MHz, sound driver	72A303-17
T700	x-former, chroma take-off	72A368-1
T701	x-former, chroma bandpass	72A358-1
M100	voltage tripler	93A91-1
IC401	integrated circuit	56A1-1
CB100	circuit breaker, 2.6a	84A17-15
F100	fuse, .7a	84A28-13
	tuner, UHF	94A396-3
	tuner, VHF	94A423-1

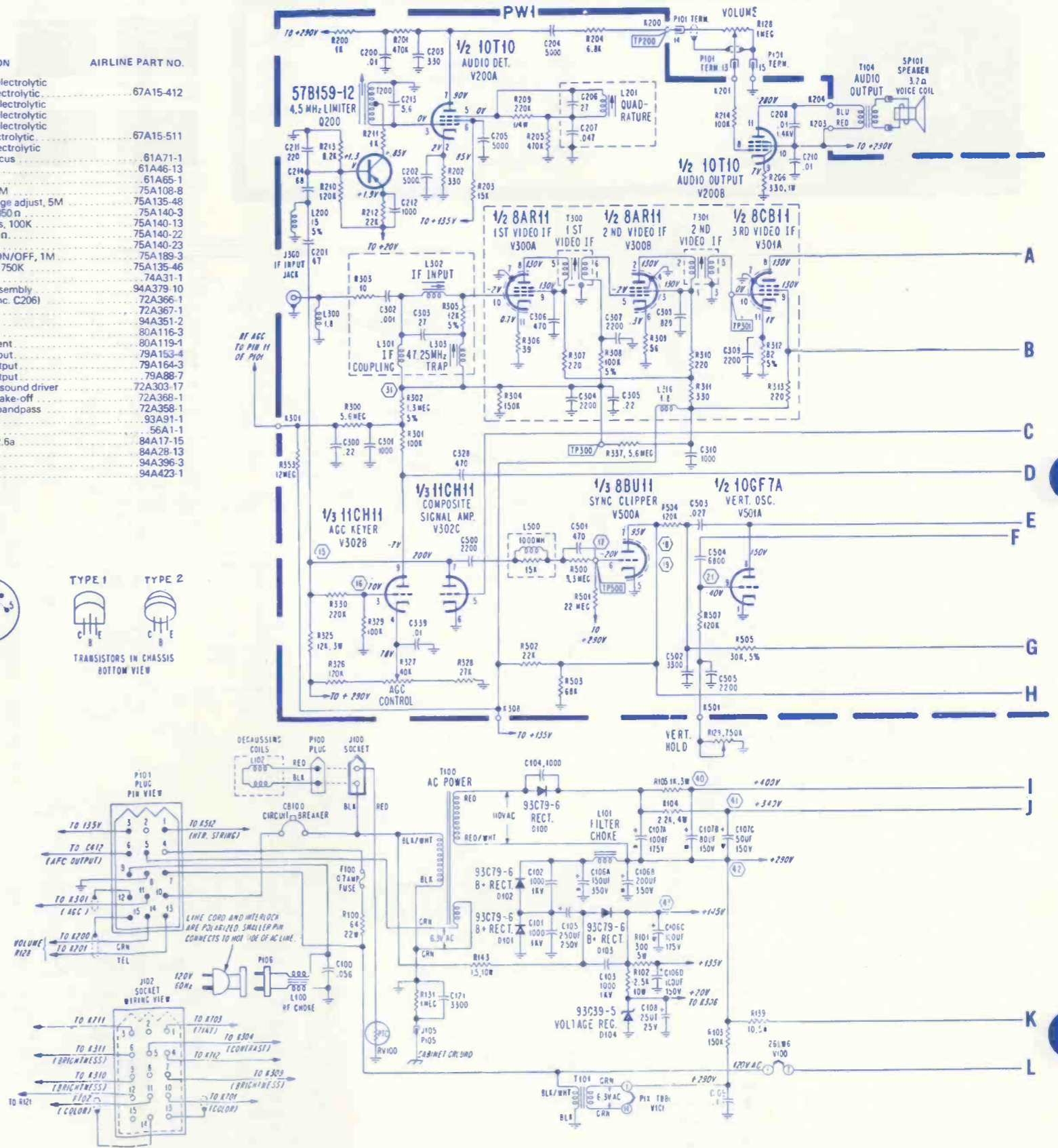
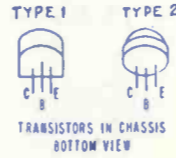
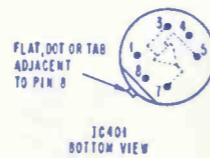

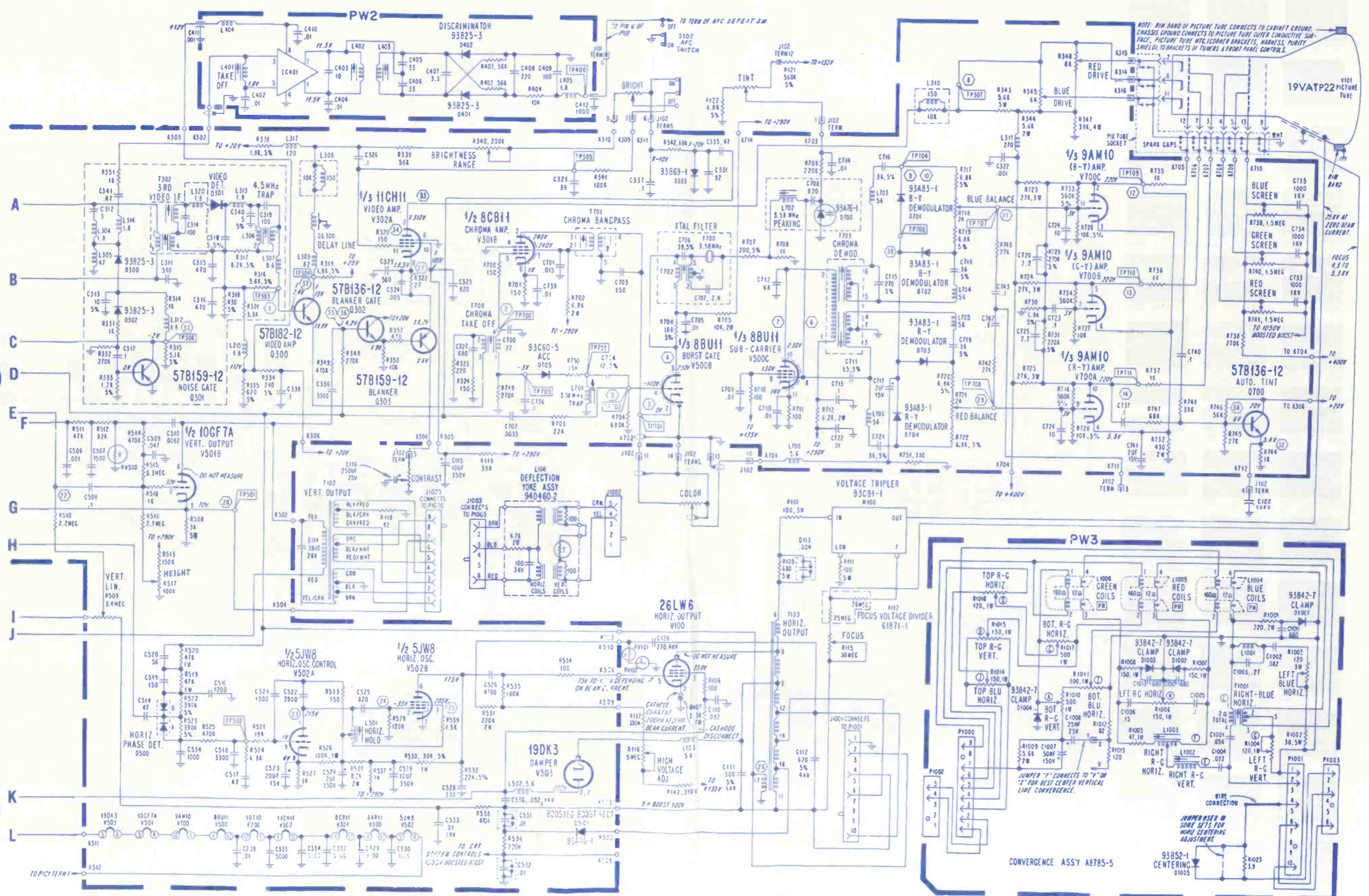

1532

SYLVANIA

Color-TV Chassis
D19-10

JUNE • 1974

ELECTRONIC TECHNICIAN/DEALER **TEKFAK**

COMPLETE MANUFACTURERS' CIRCUIT DIAGRAMS
AND TECHNICAL INFORMATION FOR 5 NEW SETS

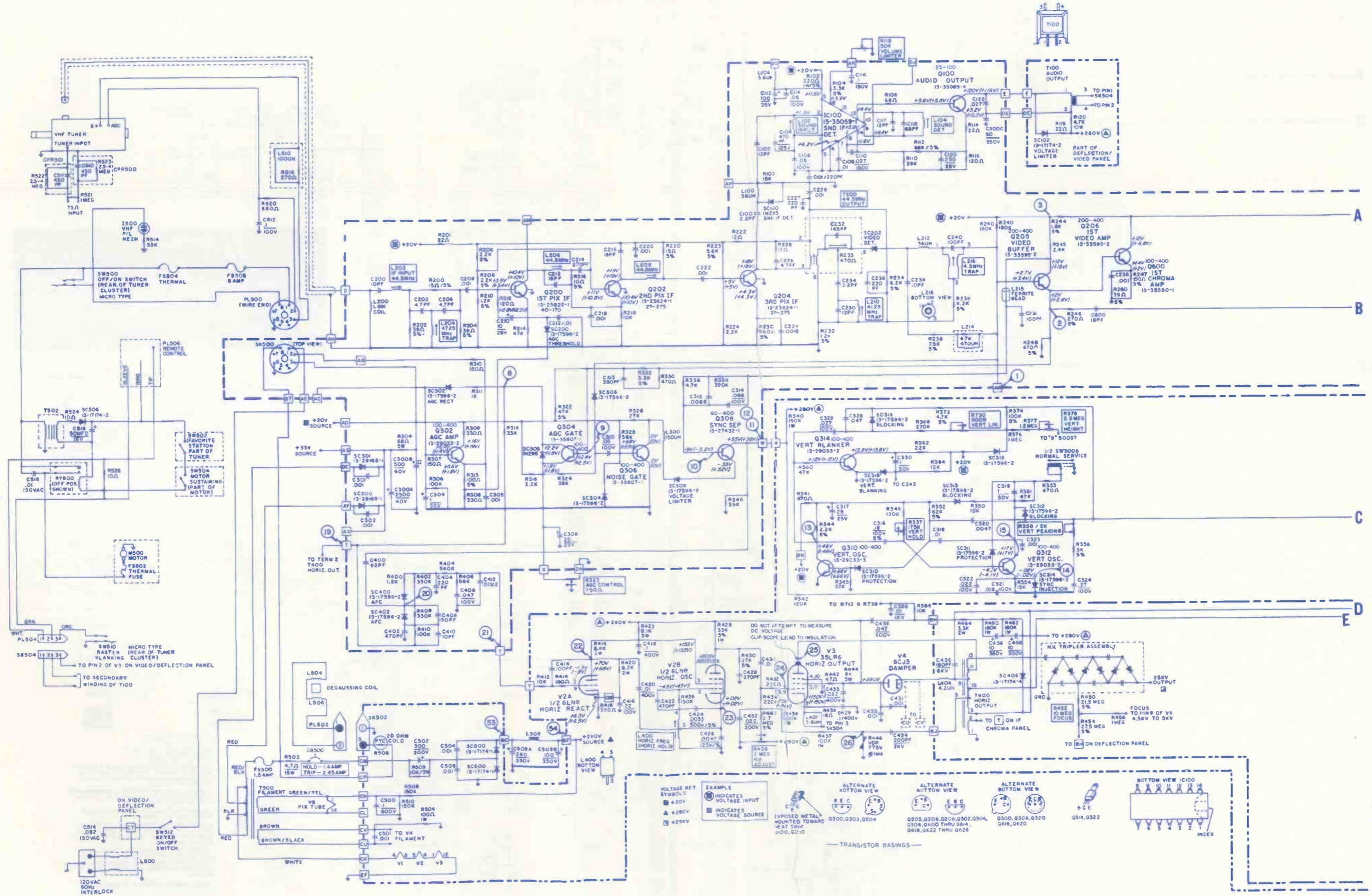
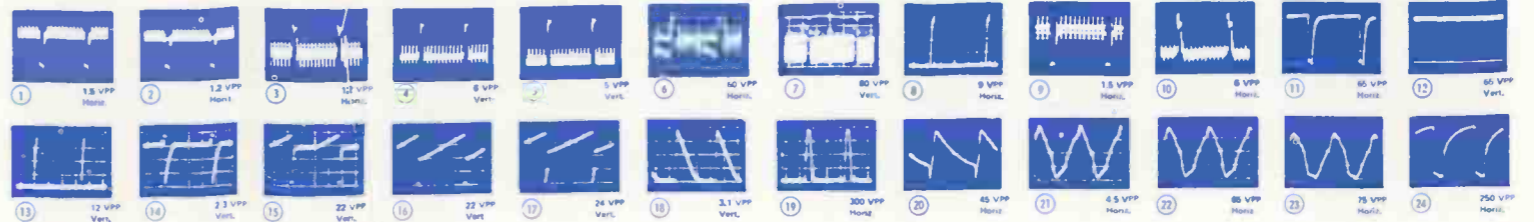

MODEL CHART

MODEL	COLOR	TUNER	CHASSIS
T12P800	BLACK	VHF 94A363-1	T9H1-1A
T12P817	WALNUT	UHF 94A361-1	

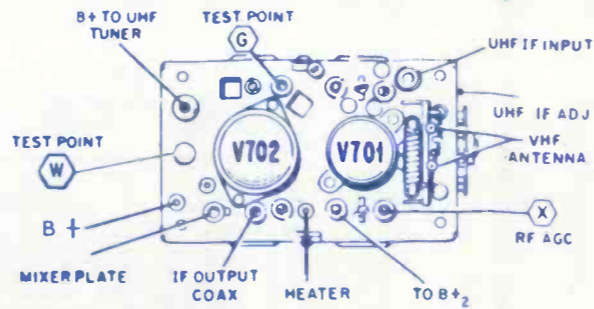

TOP DRAWING OF VHF TUNER

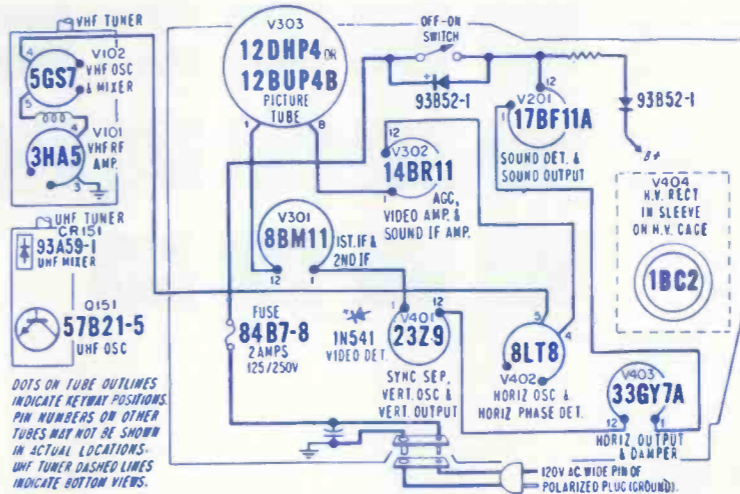

TUBE LOCATION CHART

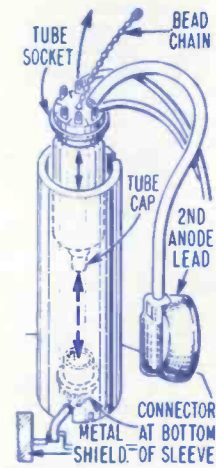

HIGH VOLTAGE RECTIFIER HOUSING

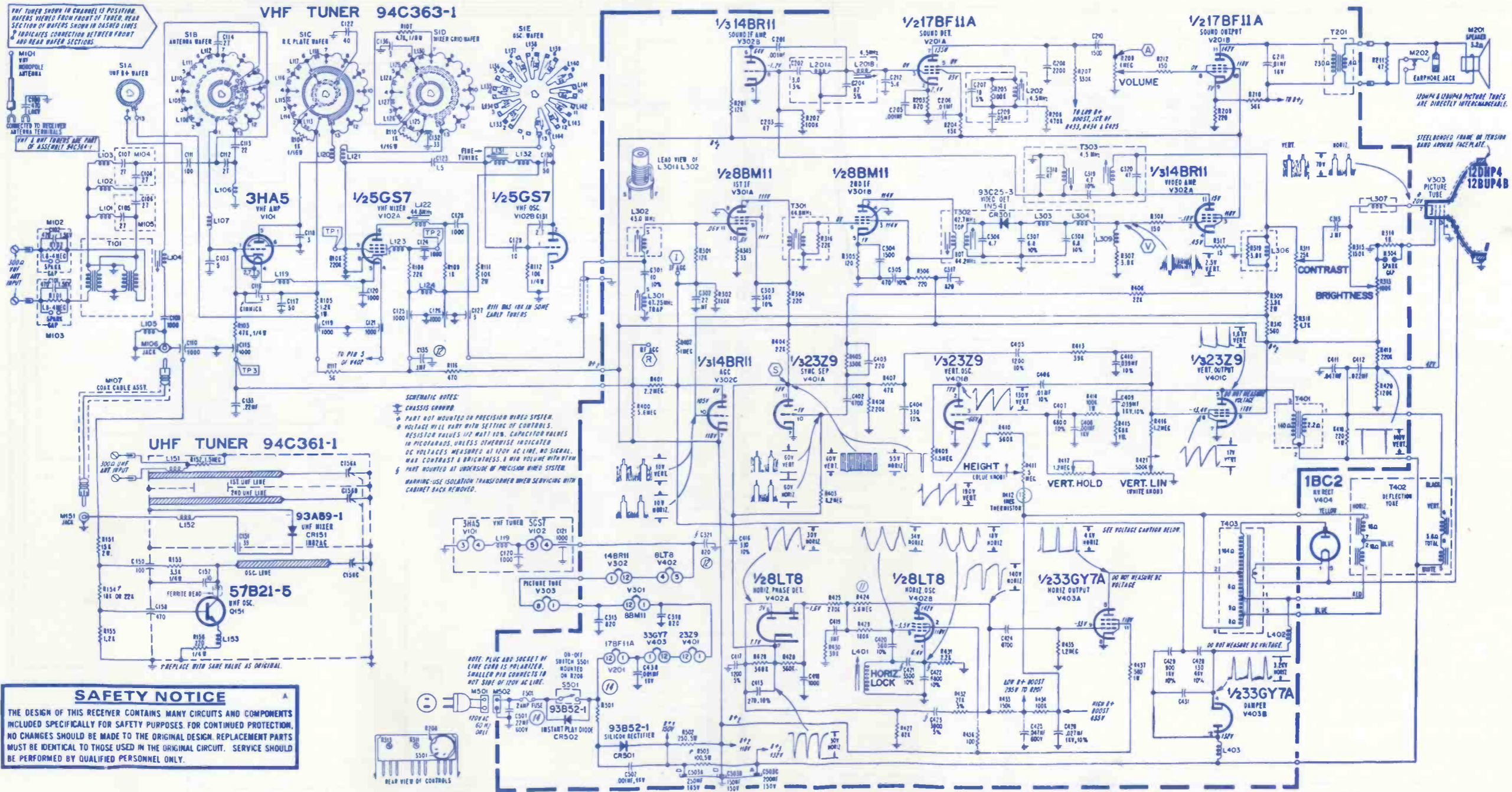

SAFETY NOTICE
THE DESIGN OF THIS RECEIVER CONTAINS MANY CIRCUITS AND COMPONENTS INCLUDED SPECIFICALLY FOR SAFETY PURPOSES. FOR CONTINUED PROTECTION, NO CHANGES SHOULD BE MADE TO THE ORIGINAL DESIGN. REPLACEMENT PARTS MUST BE IDENTICAL TO THOSE USED IN THE ORIGINAL CIRCUIT. SERVICE SHOULD BE PERFORMED BY QUALIFIED PERSONNEL ONLY.

SCHEMATIC NOTES:
CHASSIS GROUND
PART NOT MOUNTED OR PRECISION WIRING SYSTEM.
VOLTAGE WILL VARY WITH SETTING OF CONTROLS.
RESISTOR VALUES 1/2 WATT 10%. CAPACITOR VALUES IN MICROFARADS, UNLESS OTHERWISE INDICATED.
DC VOLTAGES MEASURED AT 120V AC LINE, NO SIGNAL, MAX CONTRAST & BRIGHTNESS, & HIGH VOLUME WITH BFTW.
PART MOUNTED AT UNDERSIDE OF PRECISION WIRING SYSTEM.
WARNING: USE ISOLATION TRANSFORMER WHEN SERVICING WITH CABINET BACK REMOVED.

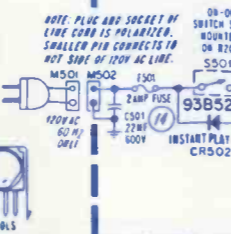

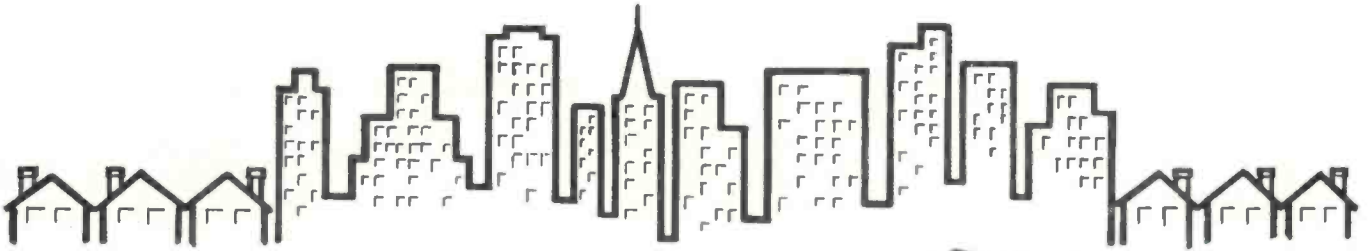

Announcing the WINEGARD METRO-LINE TV-FM DISTRIBUTION AMPLIFIERS

...the first high input,
high output, low-cost
MATV system amplifiers
for strong signal areas

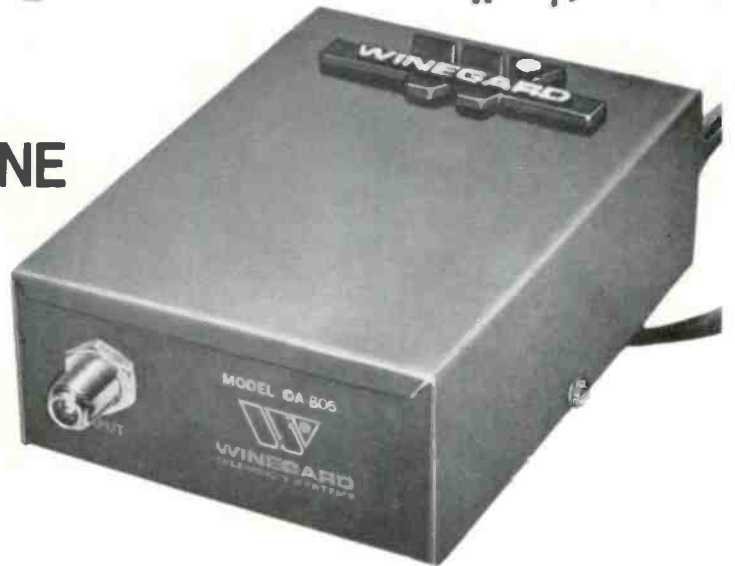

Winegard's new Metro-Line amplifiers are specifically engineered to accommodate strong signals and eliminate overload economically and efficiently. Because they have the same commercial quality construction and circuitry as the DA-830, DA-825B and DA-851, they are ideal for home, hotel, apartment and office building systems.

Check these other important performance features:

- High output capability makes a Metro-Line your best db buy
- High input solves distortion and overload problems common in strong signal areas
- Lightning protection diode
- 82 channel models have separate VHF and UHF amplifier stages
- Extended band pass (54 to 300MHz) includes mid and super band coverage making Metro-Line approved for CATV use
- Eliminates multiple outlet charge for extra sets or MATV systems on cable TV
- UL listed
- Easy for any competent TV service dealer to install
- Choose from 3 VHF-FM and 2 VHF-UHF-FM models; suggested list prices from \$30.85 to \$47.30

		DA-203	DA-205	DA-215	DA-803	DA-805
OUTPUT PER CHANNEL*	VHF	46dbmv	46dbmv	53dbmv	43dbmv	45dbmv
	UHF	NA	NA	NA	35dbmv	35dbmv
INPUT PER CHANNEL*	VHF	31dbmv	31dbmv	40dbmv	31dbmv	31dbmv
	UHF	NA	NA	NA	26dbmv	26dbmv
GAIN	VHF	15db	15db	13db	12db	14db
	UHF	NA	NA	NA	9db	9db
IMPEDANCE		300 ohm	75 ohm	75 ohm	300 ohm	75 ohm
Bandpass	VHF	54 to 300MHz	54 to 300MHz	54 to 300MHz	54 to 300MHz	54 to 300MHz
	UHF	NA	NA	NA	470 to 810MHz	470 to 810MHz
NOISE FIGURE	VHF	4.2db	3.3db	4.8db	4.3 db	3.3db
	UHF	NA	NA	NA	10.0db	7.3db
POWER REQUIREMENTS		117VAC, 60Hz, 2.3 watts	117VAC, 60Hz, 2.3 watts	117VAC, 60Hz, 2.3 watts	117VAC, 60Hz, 3.5 watts	117VAC, 60Hz, 3.5 watts

*7 channels VHF, 5 channels UHF 0.5% Cross Modulation

For additional information and sample system layouts, request New Product Bulletin No. 24.



WINEGARD TELEVISION SYSTEMS
Winegard Company / 3000 Kirkwood Street
Burlington, Iowa 52601

... for more details circle 137 on Reader Service Card

The reader that can stay on, and on, and on. The 603.

The price of the Model 603 V-O-M is only \$173.

The one V-O-M you can forget about forgetting to turn off. The incredible Model 603 FET V-O-M with exclusive Triplett Micro-Power™ draws only 10 uA, can stay on indefinitely without impairing performance. Ideal wherever frequent test changes, interruptions, distractions—or gremlins—keep your V-O-M working when you're not.

Truly outstanding features:

1. Exclusive Triplett Micro-Power (TMP™) provides battery life in excess of a year for carbon batteries with unit left on continuously 24-hours a day.
2. Low-Power Ohms (LPΩ™)—6 ranges with 70 mV power source for in-circuit measurements without damage to components.
3. FET V-O-M with Patented Auto-Polarity—convenient and time-saving, always reads up scale.

Accurately measures electric and electronic circuits on production lines, in quality testing, during maintenance, in service shops and on calls, in the laboratory or classroom, in the field.

One range selector switch operates the unit. One probe handles all functions—AC, DC, MA, Ohms—and a simplified scale utilizes only 4 arcs for all 44 ranges. The Low Power Ohm circuit permits fast circuit measurements without biasing semiconductor device junctions. The

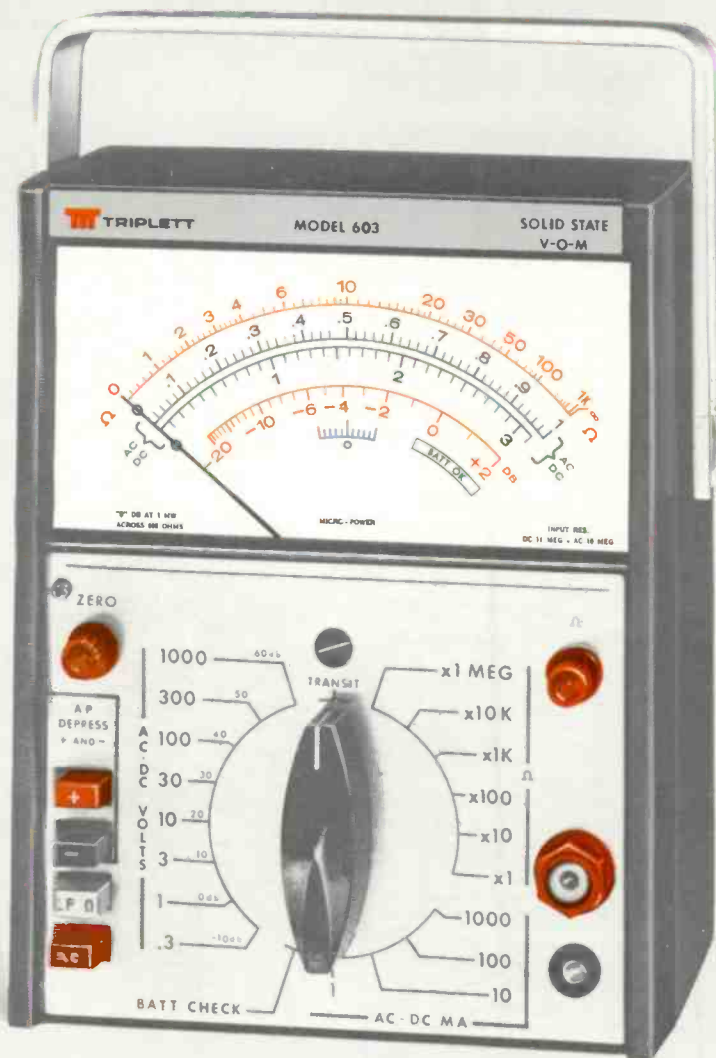

Model 603 also has a unique, Patented Auto-Polarity circuit: push a button, measure either plus or minus voltages without switching leads. Make very fast voltage checks where polarity is known or doesn't matter.

For more information or a free demonstration, call your Triplett distributor or sales representative.

For the name of the representative nearest you, dial toll free (800) 645-9200. New York State, call collect (516) 294-0990. Triplett Corporation, Bluffton, Ohio 45817.

TRIPLETT
ALL YOU'LL EVER NEED IN V-O-M'S.

Triplett. The easy readers.

... for more details circle 131 on Reader Service Card