

# ELECTRONIC TECHNICIAN/DEALER

WORLD'S LARGEST TV-RADIO SERVICE

*Detailed Schedule  
of Next Month's Joint  
National Convention*

*Skitch's Restaurant Goes CCTV*

*Magnavox's 1500 DTI Receiver*

*Another Step Forward*



FRIM3347465M2AZ 8722693AJ1  
WILLIAM W FRISE AS  
7176 GALE RD  
ATLAS MI 48411  
XX

# Leader

The more  
you see  
...The more  
you believe.

## LBO-505 DUAL CHANNEL/ DUAL TRACE 5" OSCILLOSCOPE

Outduals them all! Solid state accuracy, performance. Has triggered & auto sweep; AC or DC coupling per channel; 15MHz bandwidth; 100nanosec/cm max. speed (10Xmag.); 10MVp-p/cm vert. sensitivity; cont. scale illumination w/front panel control; Sep. or simult. display of 2 signals to compare input-and-output, for color, B&W, audio & more. Checks gain, loss, distortion, phase shift, freq. Complete with probes, adapters, leads.

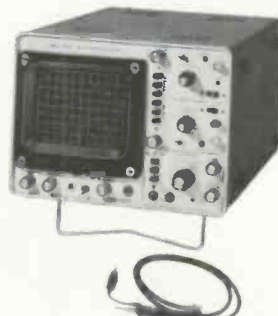

\$559.95

## LTC-905 CURVE TRACER

Test Transistor, Triac, SCR, Diode, FET & MOSFET quality... In-or-out of circuit, with precise voltage or current steps. Has exclusive, variable h'z't'l length adjustment to 100V sweep. Places entire h'z't'l trace on all scope faces. Sweep Voltage is 8 steps selectable. An all IC timesaver that checks for opens, shorts, leakages. Complete with special probes and leads.



\$119.95

## LSG-231 FM MULTIPLEX/ STEREO GENERATOR

Solid state stability that has no equal for Multiplex testing and service. Compact, easy to use. Checks separation, balance, alignment. 19KHz pilot signal freq. has  $\pm 2$ Hz accuracy. The 1KHz audio signal freq. has  $\pm 1\%$  accuracy. Signal separation is 50dB. 0-3Vrms output, cont. variable. It's so accurate you may not want to use a scope! With handy tilt-stand.

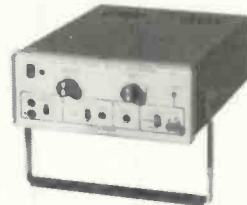

\$229.95

## LSB-41 RC SUBSTITUTION BOX

The quick, easy way to obtain resistor and capacitor values. No more "scrounging" through small parts bins, no more struggles with unmarked or illegible color coding. Has 24 EIA standard, 10%, 1W resistor subs, from 10 $\Omega$  to 10M $\Omega$ . Selects any of 22 standard capacitor subs. Lightweight, compact.

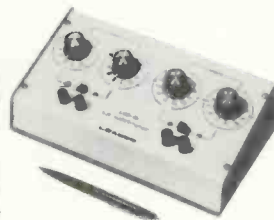

\$59.95



Send for your copy of the new 1972-73 Leader catalog. Features new "Leadership" performance products & accessories unmatched in every way.

The more you see...  
the more you believe.

# Leader

INSTRUMENTS CORP.

37 · 27 Twenty-Seventh Street,

Long Island City, N.Y. 11101 (212) 729-7410

GROUP  
**239**

SCHEMATIC NO.

SCHEMATIC NO.

ADMIRAL TV Chassis NA10-1A ..... 1429

MAGNAVOX TV Chassis T960 Series ..... 1425

AIRLINE Color-TV Model GEN-12442A ..... 1426

ZENITH Color-TV Chassis 19DC20 ..... 1428

EMERSON Color-TV Chassis 5K1675-2-3 ..... 1427

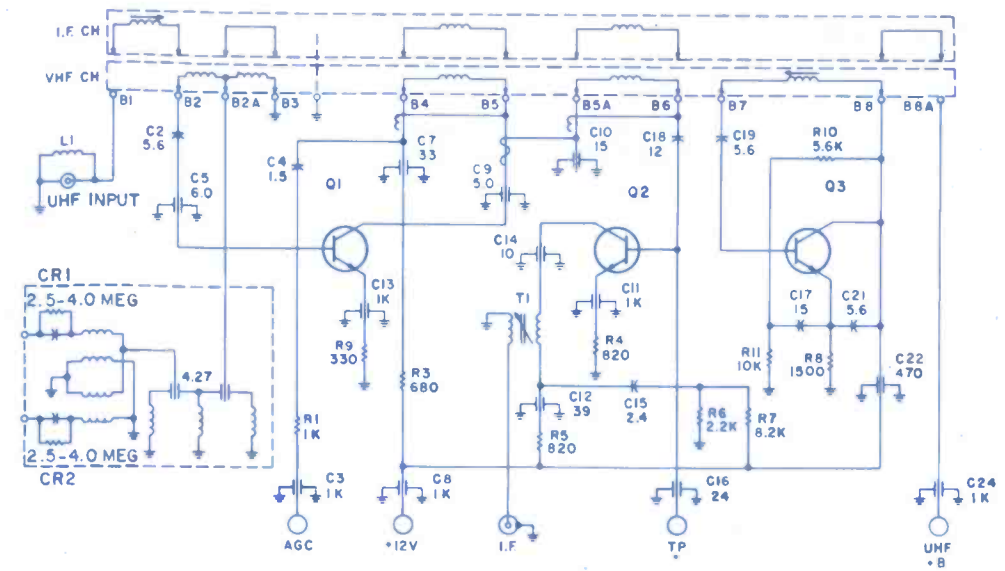

- NOTES:  
UNLESS OTHERWISE SPECIFIED
1. ALL CAPACITORS ARE 500V.
  2. ALL CAPACITORS ARE 20%.
  3. ALL CAPACITORS WITH VALUES OF LESS THAN 1 ARE IN MFD.
  4. ALL CAPACITORS WITH VALUES GREATER THAN 1 ARE IN PF.
  5. ALL ELECTROLYTICS ARE IN MFD.
  6. ALL RESISTORS ARE 1/2 WATT, 10%.
  7. VOLTAGES MEASURED WITH VTVM FROM POINT SHOWN TO GROUND. MEASUREMENTS TAKEN WITH NO SIGNAL INPUT, VOLUME CONTROL AT MINIMUM, NORMAL CONTRAST AND BRIGHTNESS SETTINGS, AND 120V AC POWER.

- ▲ COMPONENT MOUNTED COPPER SIDE OF BOARD.
- EP EARLY PRODUCTION.
- LP LATE PRODUCTION.
- \* DEPENDENT ON CONTROL SETTINGS.

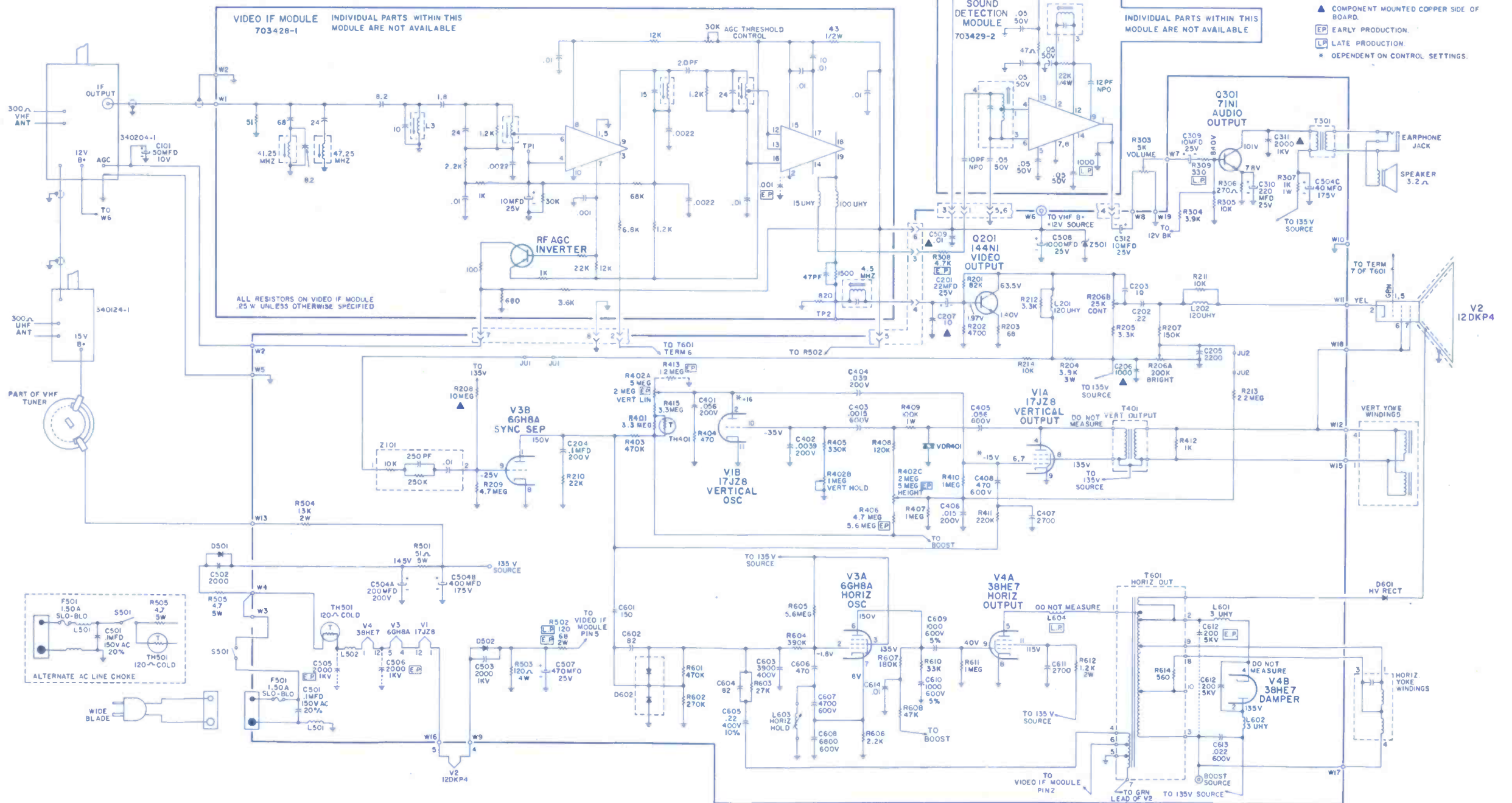

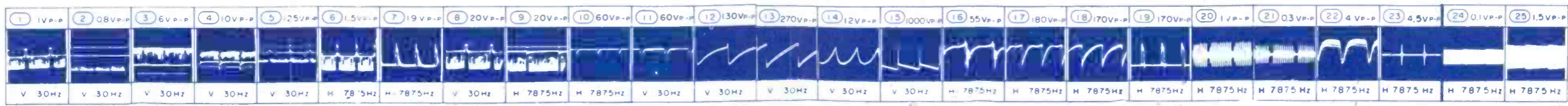
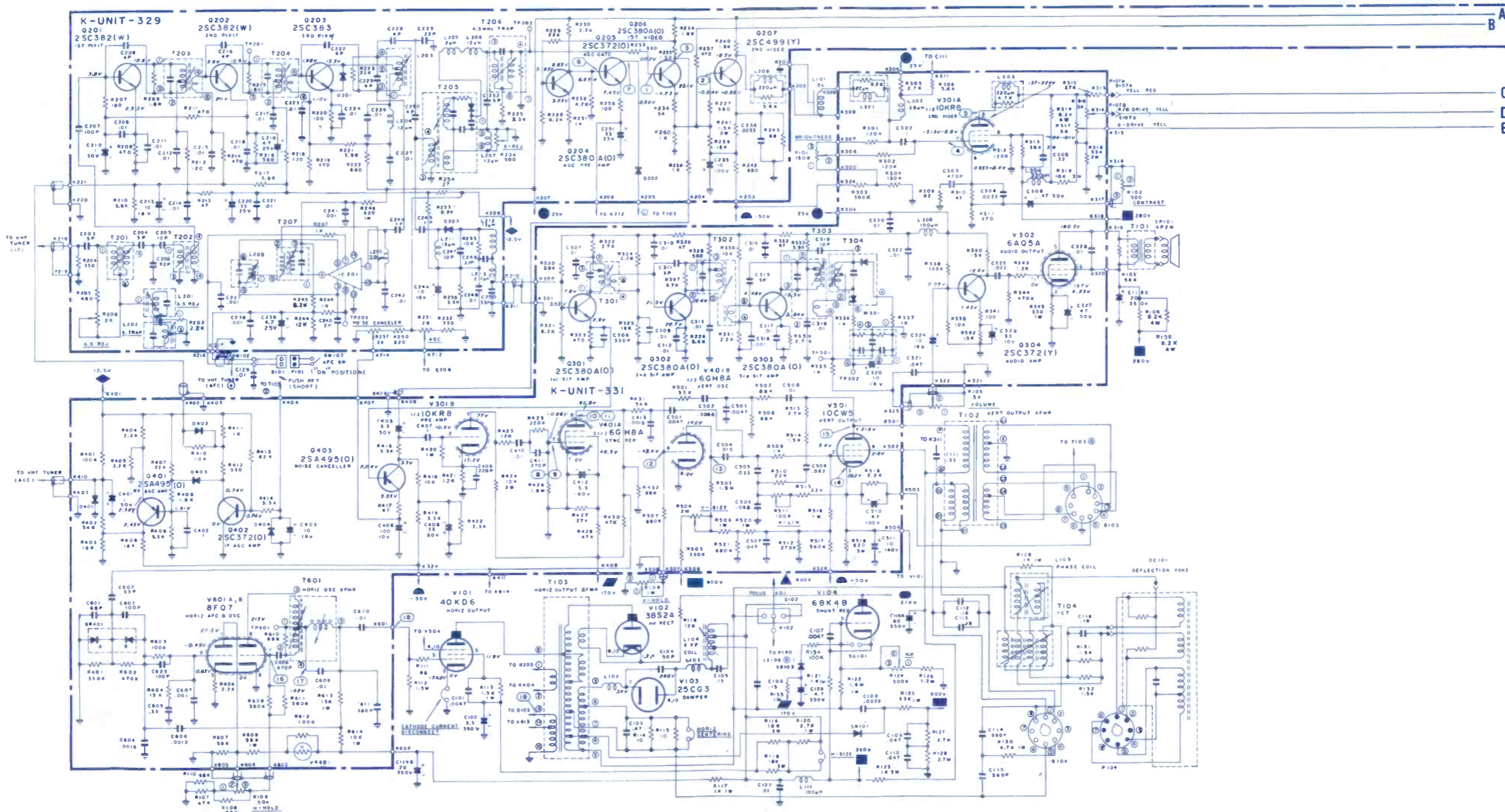

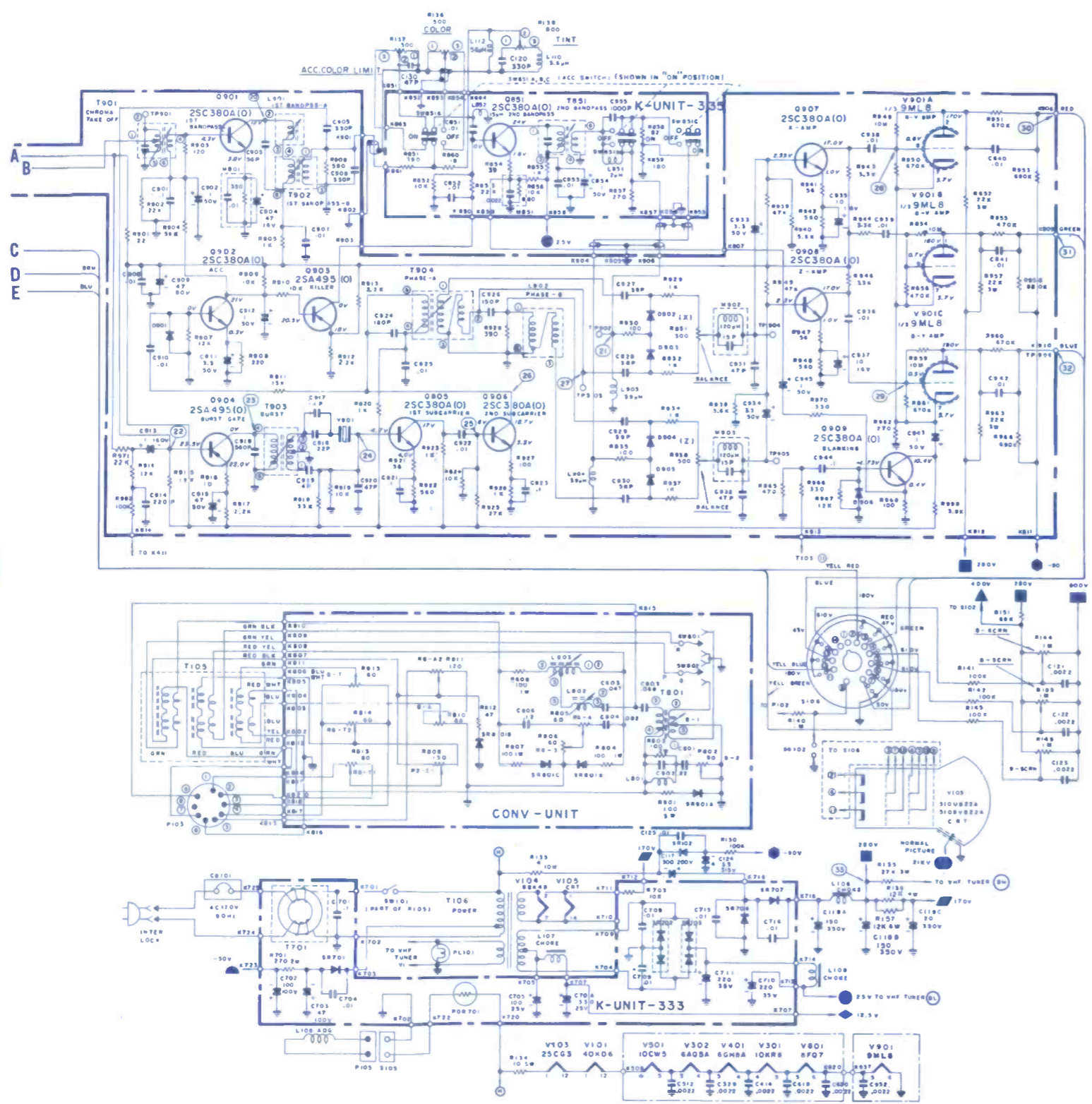

SYMBOL	DESCRIPTION	AIRLINE PART NO.	DESCRIPTION	AIRLINE PART NO.	
C119A,B	60/20/20/20 μf, @350v		L209	coil, discriminator	TV61866
C,D	electrolytic	TV32452	T101	x-former, sound output	TV11239
R101	150K, brite control	TV25264	T102	x-former, vert output	TV11297
R102	500Ω, contrast control	TV25354	T103	x-former, horiz output	TV11345
R105	5K, volume control	TV25342	T106	x-former, power	TV11275
SW101	w/on-off switch	TV25342	T206	x-former, 4.5MHz trap	TV62513
R106	1M, vert hold control	TV25460	T301	x-former, sound take off	TV62471
R109	50K, horiz hold control	TV25363	T601	x-former, horiz osc	TV62334
R124	500K, HV adjust	TV25269	T851	x-former, 2nd bandpass	TV62620
R137	500Ω, ACC color limit control	TV25461	T901	x-former, chroma takeoff	TV62621
R224	500Ω, sound reject	TV25348	T903	x-former, burst	TV62623
R316	5K, green red drive		M101	capistor	TV34685
R317	5K, blue drive		M301	capistor	TV34107
R504	2M, vert size	TV25349	M851	capistor	TV34121
R511	100K, vert lin		M901	capistor	TV34122
R257	2K, noise canceller control	TV25463	M902	capistor	TV34123
L104	coil, horiz efficiency	TV61673	M903	capistor	TV34123
L202	coil, sound trap	TV61658	1C201	Integ circuit, AFC	TV24993
			VR601	varistor	TV24238
				tuner, VHF	TV35375
			DC101	yoke deflect (DC-115U)	TV61908

**CHASSIS LAYOUT**

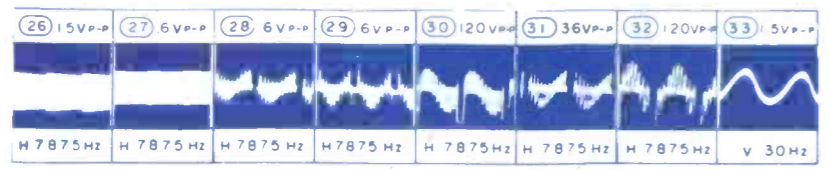
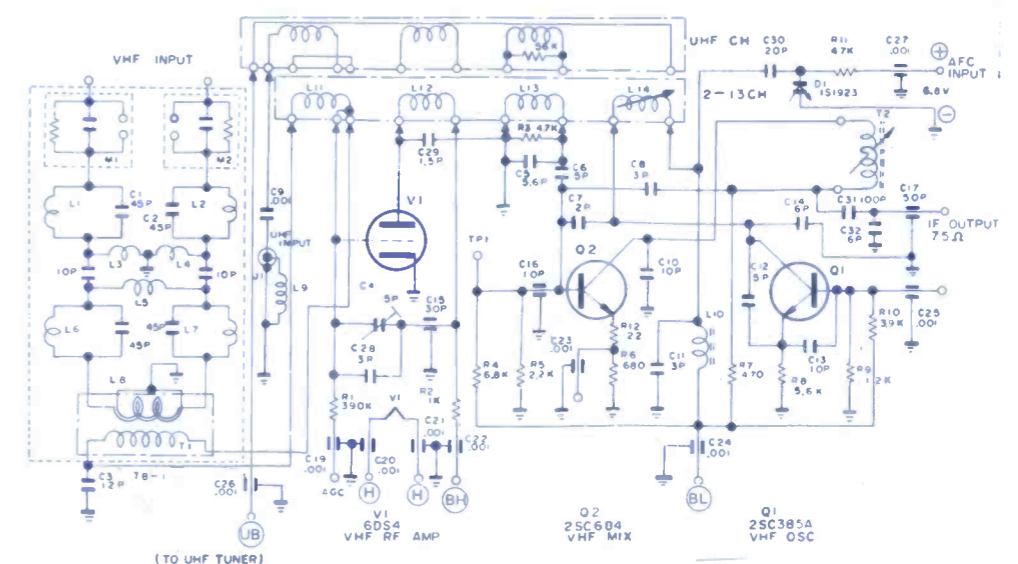
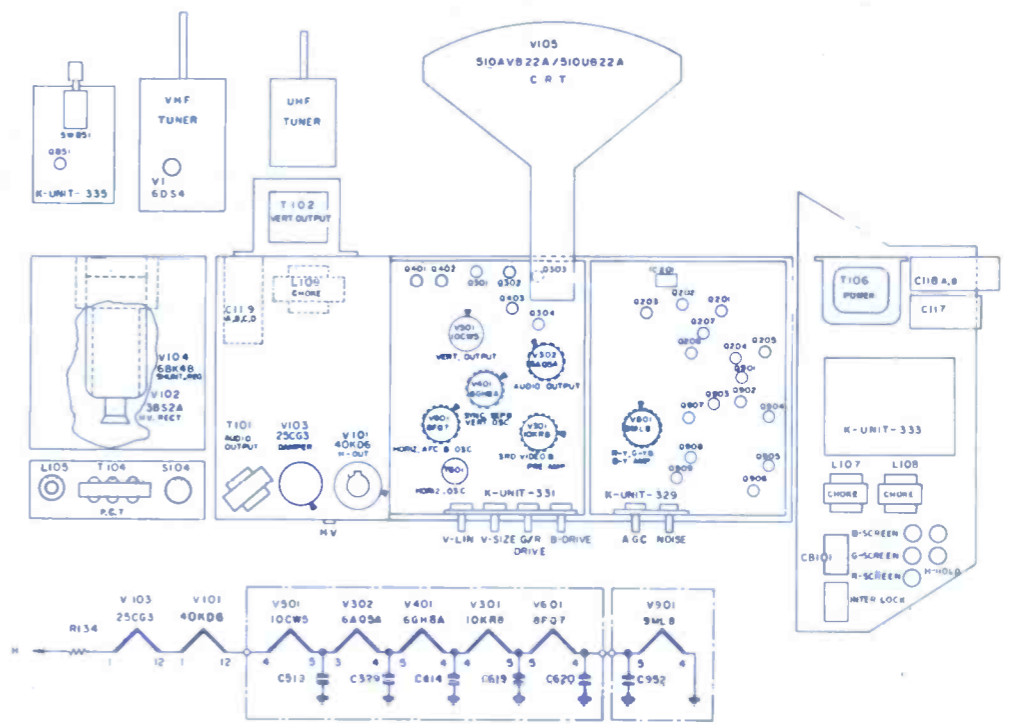

VOLTAGE SYMBOL LEGEND

BB	90V	B3	25V
B F	400V	B4	12.5V
B 1	280V	B5	-50V
B 2	170V	B6	-90V

**RUN CHANGES**

- 17 PWS500 circuitry changed to standardize with other models. See other schematic for sets stamped RUN 16 or lower.
- 18 V502 color demodulator circuit changed to increase color output.
- 19 No service significance.

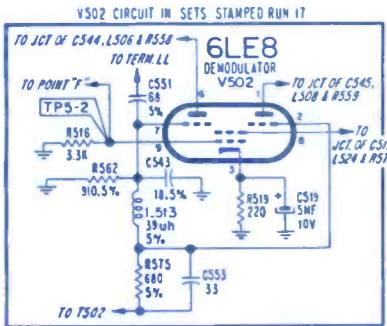

**SCHEMATIC NOTES**

RESISTOR VALUES 1/2 WATT, 10% CAPACITOR VALUES IN MICROFARADS UNLESS OTHERWISE INDICATED. SEE SEPARATE SCHEMATIC FOR VHF-UHF TUNERS AND CONTROL CIRCUITRY.

VOLTAGES MEASURED WITH VTVM AT 120 VOLTS AC LINE TO PREVENT LOADING IN CRITICAL STAGES; USE A 47K 1/2W ISOLATING RESISTOR AT END OF TEST PROBE.

1) VOLTAGE READINGS SHOWN IN BRACKETS TAKEN WITH COLOR SIGNAL, VOLTAGE READING TAKEN WITHOUT SIGNAL, TUNER SET AT UNUSED CHANNEL.

2) INDICATES VOLTAGE READINGS TAKEN WITH BRIGHTNESS CONTROL AT MINIMUM ROTATION (FULLY CW.) VOLTAGES IN VIDEO CIRCUITRY WILL VARY WITH VIDEO CONTENT OF PICTURE BEING RECEIVED. VOLTAGES SHOWN ARE TYPICAL READING.

3) INDICATES VOLTAGE READINGS TAKEN WITH BRIGHTNESS CONTROL AT MAXIMUM ROTATION (FULLY CCW, BUT BELOW BLOOMING).

4) INDICATES VOLTAGE WILL VARY WITH SETTING OF CONTROLS.

5) PARTS MOUNTED ON BOTTOM OF PRECISION WIRED SYSTEM.

6) PART MOUNTED ON CHASSIS OR OTHER ASSEMBLY.

7) CHASSIS GROUND.

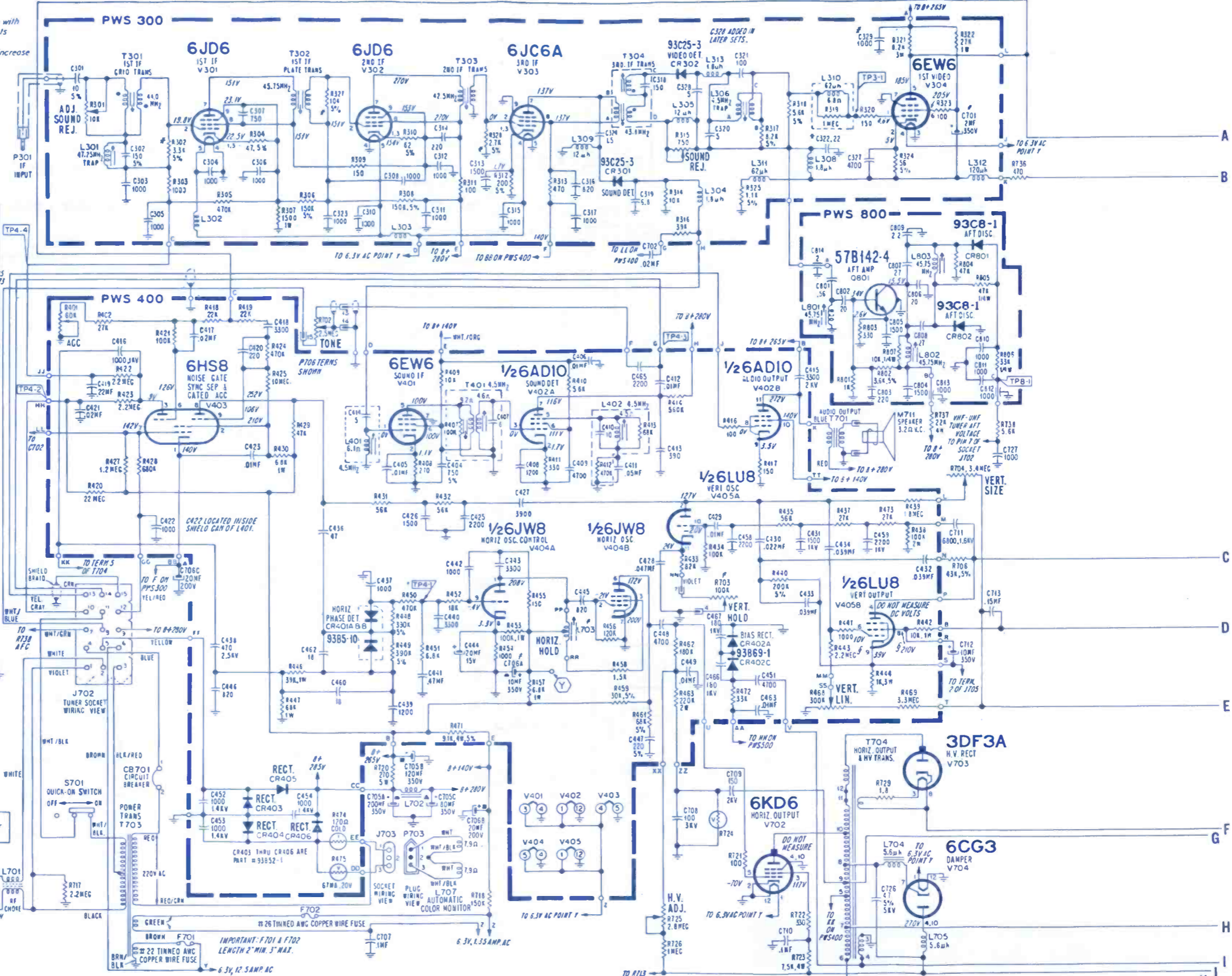
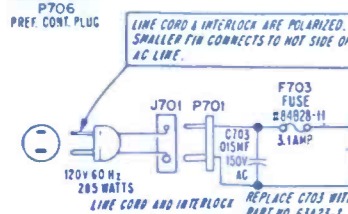
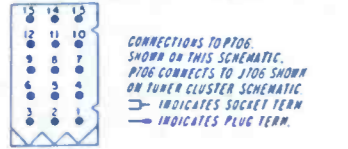
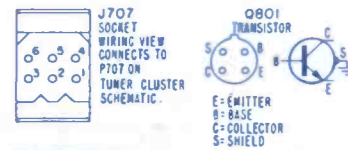



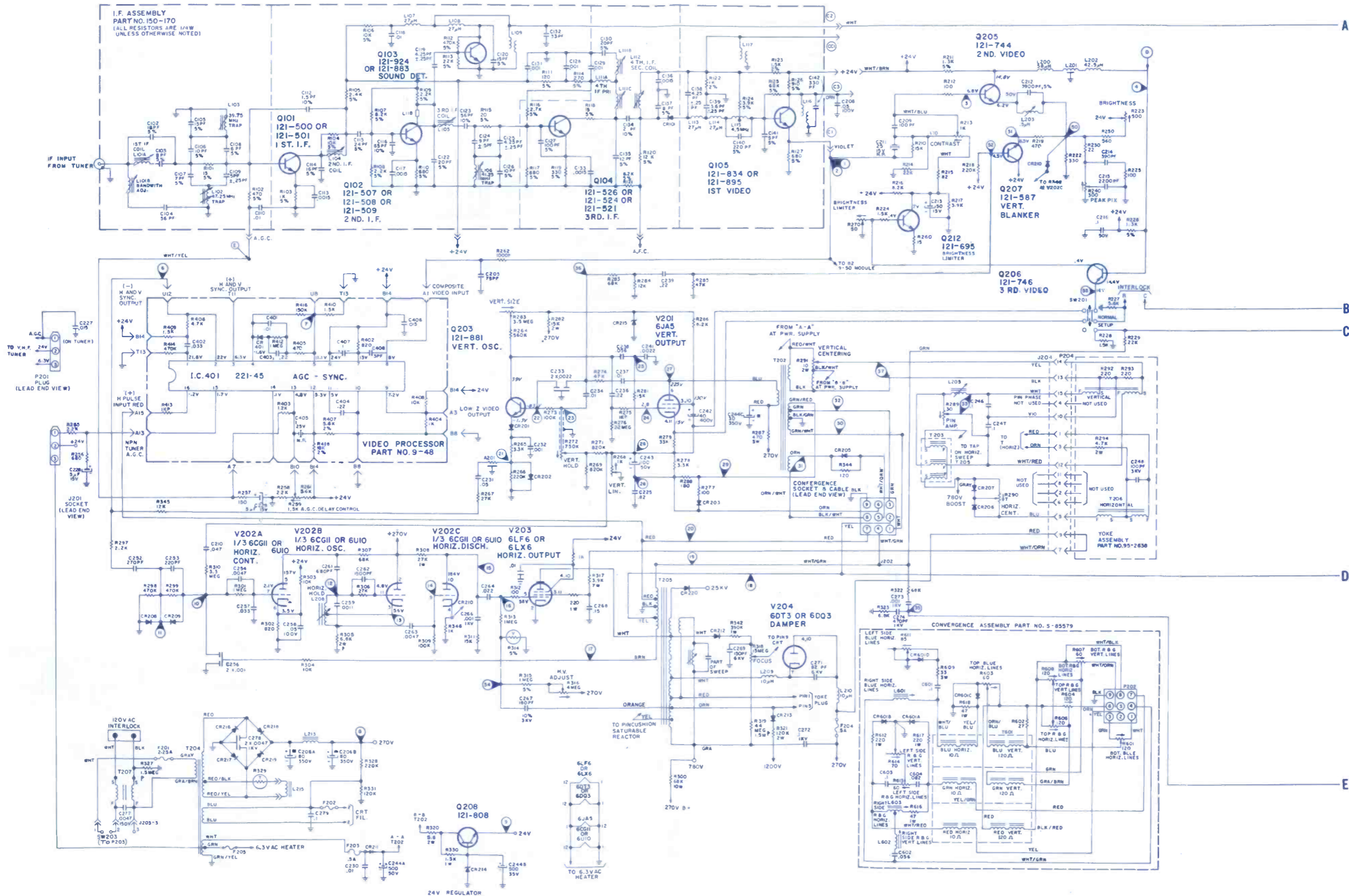



**ZENITH  
Color-TV Chassis  
19DC20**

SYMBOL DESCRIPTION ZENITH PART NO.

C206A	—80µf, electrolytic cap, 350v	22-6073
C206B	—80µf, electrolytic cap, 350v	22-6073
C206C	—15µf, electrolytic cap, 350v	22-6073
R203	—20K, volume control	63-8609
R208	—voltage dependent resistor	63-5440
R213	—1K, contrast control	63-9193
R220	—voltage dependent resistor	63-9184
R223	—500Ω, brightness control	63-9192
R240	—300Ω, peak plx control	63-9119
R259	—1.5K, AGC delay control	63-9177
R263	—3.5M, vert size control	63-9115
R268	—1K, vert lin control	63-9066
R270	—50Ω, brightness limiter	63-8989
R272	—750K, vert hold control	63-9194
R290	—70Ω, horiz centering	63-8474
R291	—10Ω, vert center control 2w	63-7009
R295	—25K, CTA control	63-9117
R296	—500Ω, color level control	63-9308
R314	—voltage dependent resistor	63-8688
R316	—4M, high volt adjust	63-9004
R318	—15M, focus control	63-8709
R326	—200Ω, tint control	63-9133
R329	—thermistor	63-8687
L101A	—1st IF coil	95-2941
L102	—47.25MHz, trap coil	20-3409

L103	—39.75MHz, trap coil	20-3145
L115	—4.5MHz trap coil	95-2947
L201	—delay line	S-91505
L203	—3.58MHz trap coil	20-1838
L208	—horiz osc coil	S-56877
L213	—filter choke	95-2917
T201	—audio output xformer	95-2854
T202	—vert output xformer	95-2983
T203	—saturable reactor	95-3004
T204	—power xformer	95-2970
T206	—deflect yoke assembly	95-2638
A201	—integrator unit	87-4
F201	—2.25a, bel-fuse	138-92
F202	—heater fuse link	91-2061
F203	—5a, bel-fuse	138-84
F204	—5a, bel-fuse	138-84
F205	—heater fuse link	91-2061
CR212	—focus diode	212-85

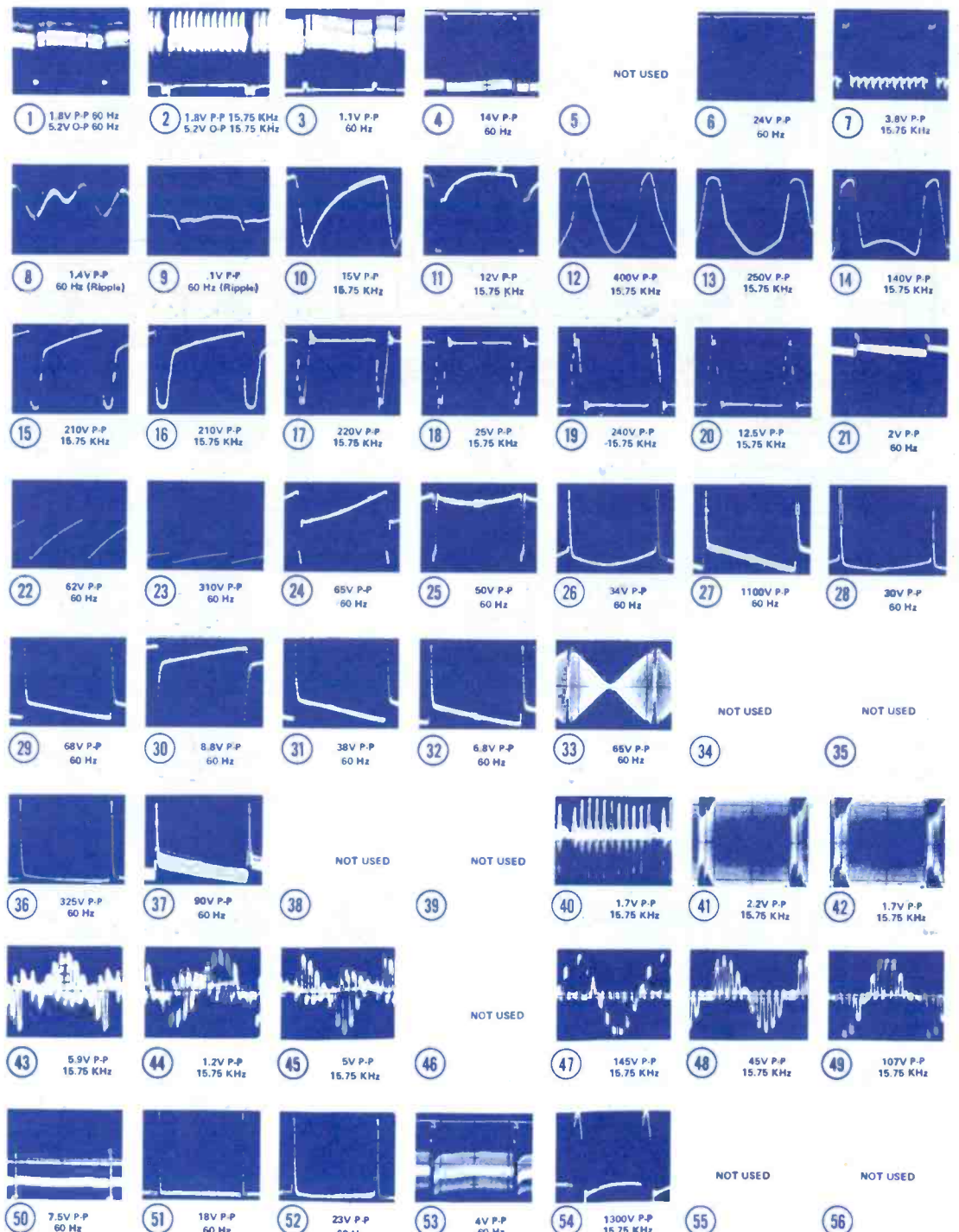
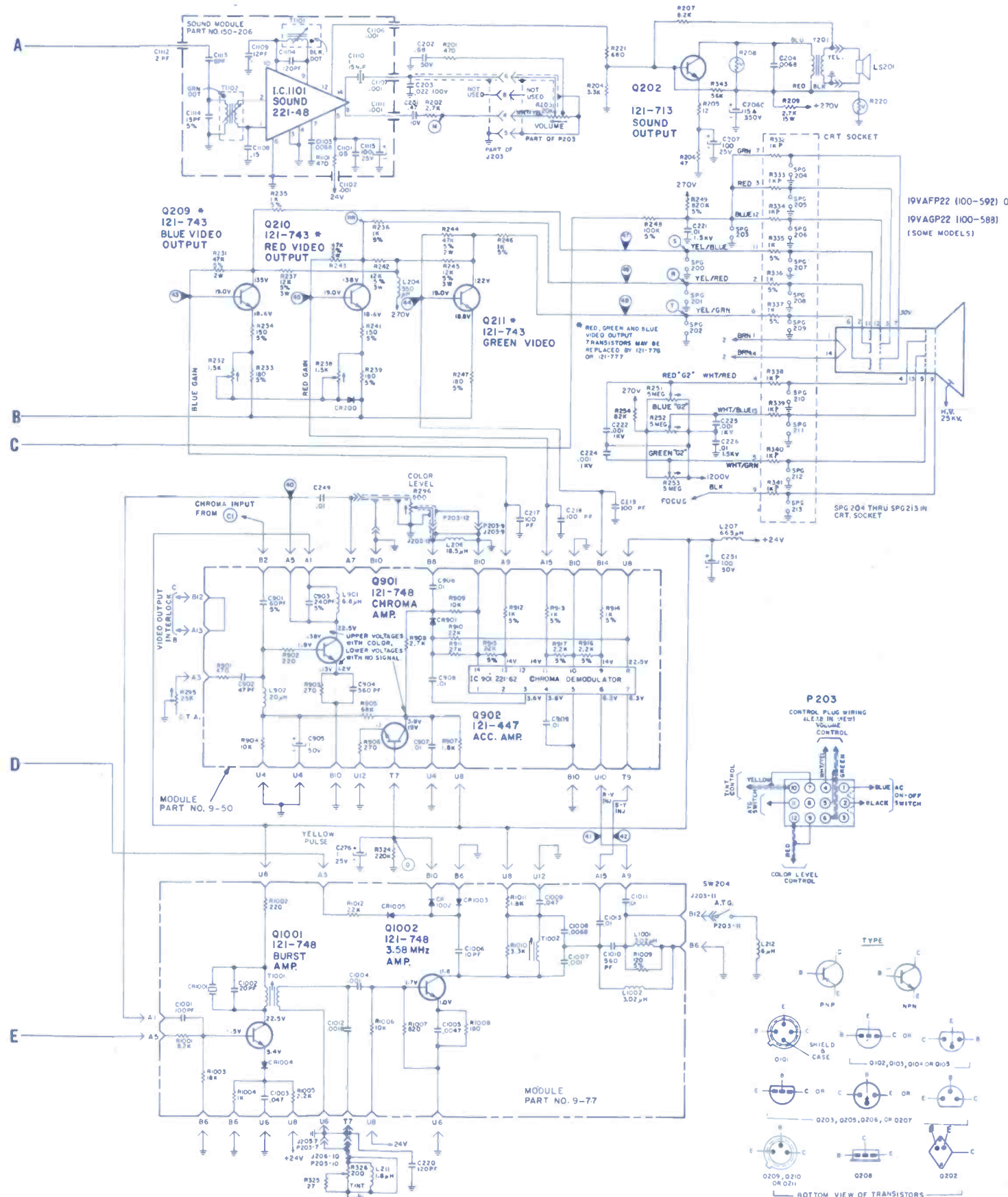

SYMBOL	DESCRIPTION	ADMIRAL PART NO.
R801	10K, volume control	2075A89-146
R802	1K, contrast control	2075A89-148
R803	500K, brite control	2075A89-147
R804	30K, vert hold control	2075A89-162
R805	20K, vert lin control	2079A2-7
R806	20K, vert height	2079A2-2
R807	20K, horiz frequency	2079A2-5
R808	20K, horiz hold control	2079A2-6
R809	2M, focus control	2079A2-5
R810	3K, bias control	2084A1-2
R811	1K, AGC control	2094A2-3
R812	300K, sub-brite control	2094A1-3

TH-1	thermistor	2061A45-63
TH-2	thermistor	2061A45-63
L101	bandpass coil	2073A72-131
L103	sound trap coil 41.25MHz	2072A254-298
L106	4.5MHz trap coil	2073A72-134
L107	trap coil	2073A72-131
L110	horiz stabilizer coil	2079A2-7
L120	deflection yoke	2073A3-2
S1F1	sound takeoff xformer	2072A254-306
T101	horiz osc xformer	2079A2-6
T102	horiz output xformer	2079A2-5
	fuse 0.75	2084A1-2
	UHF tuner	2094A2-3
	VHF tuner	2094A1-3

ELECTRONIC TECHNICIAN/DEALER is published monthly by HARCOURT BRACE JOVANOVICH PUBLICATIONS, INC., 1 East First St., Duluth, Minn. 55802. Subscription rates: One year \$6, two years \$10, three years \$13, in the United States and Canada. Other countries: One year \$15, two years \$24, three years \$30. Single copies 75¢ in the United States, and \$2 in other countries. Second class postage paid at Dansville, New York and at additional mailing offices. Copyright 1972 by HARCOURT BRACE JOVANOVICH PUBLICATIONS, INC. POSTMASTER: Send Form 3579 to ELECTRONIC TECHNICIAN/DEALER, HARCOURT BRACE JOVANOVICH PUBLICATIONS, INC., 1 East First St., Duluth, Minn. 55802.

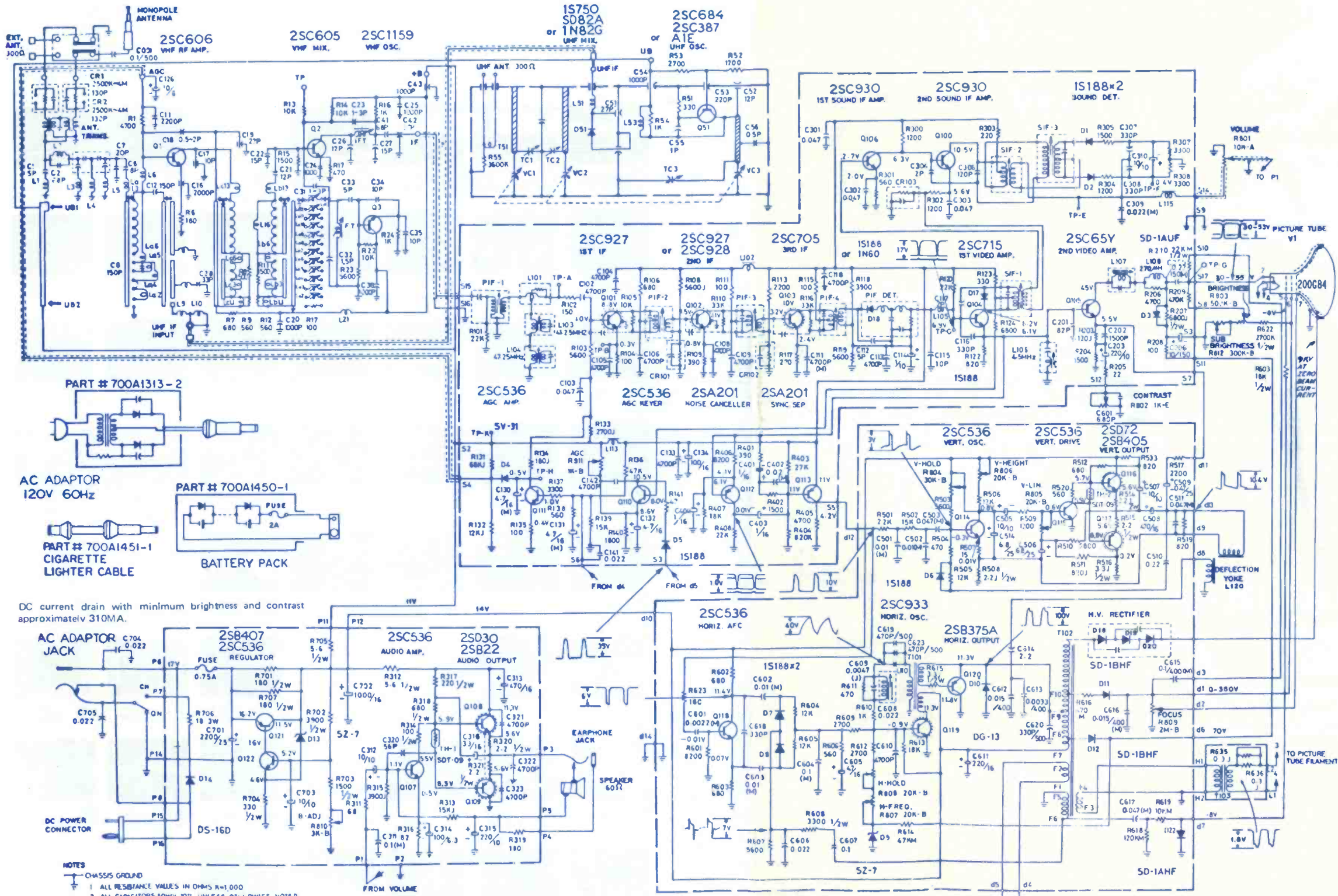

DC current drain with minimum brightness and contrast approximately 310mA.

- NOTES
1. ALL RESISTANCE VALUES IN OHMS, K=1,000
  2. ALL CAPACITORS 50% W, 10% UNLESS OTHERWISE NOTED
  3. ALL RESISTORS 1/4W, 10% UNLESS OTHERWISE NOTED
  4. UNLESS OTHERWISE NOTED IN SCHEMATIC, ALL CAPACITORS LESS THAN 1 ARE REPRESENTED IN  $\mu$
  5. DC VOLTAGES MEASURED AT 120V AC LINE

# TV TUNER SERVICE

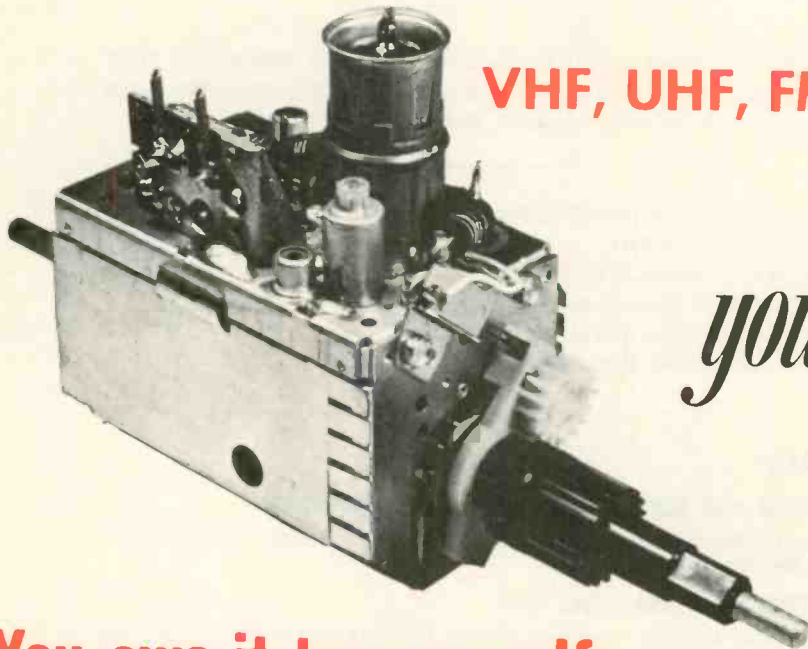

VHF, UHF, FM or IF-Subchassis. . .

. . . All Makes

*you get...*

*Fast 8 hr. Service!*

**You owe it to yourself**

to try P.T.S. We are the fastest growing, oldest and now the largest tuner service company in the world. Here is what you get:

1. Fastest Service — 8 hr. — in and out the same day. Overnight transit to one of our six plants, for parts, tuners or IF-modules.
2. All tuners cleaned inside and out, repaired, realigned and air tested.
3. On IF-modules all stages checked, all traps set with high calibre test equipment.
4. Fine Quality! Your customers are satisfied and you are, not bothered with returning your units for rework!
5. Lower Cost! Up to \$5.50 less than other tuner companies!
6. Friendly, helpful personalized service!

**1 YEAR GUARANTEE**



FIRST TO OFFER 365-DAY GUARANTEE!  
COLOR—BLACK & WHITE—TRANSISTOR TUNERS—ALL MAKES  
GUARANTEED COLOR ALIGNMENT—NO ADDITIONAL CHARGE

**We offer you finer, faster...**

VHF-UHF-FM	<b>\$ 9.95</b>
UV-COMBO	<b>\$16.95</b>
IF-MODULE	<b>\$12.50</b>

Major Parts charged at Net Price

**CUSTOMIZED REPLACEMENTS AVAILABLE  
FOR \$12.95 UP (NEW OR REBUILT)**

**Precision**

**Tuner Service**



**LIKE TO DO IT YOURSELF?**

PTS makes all tuner parts available to you.

Send one dollar (redeemable) for our

**TUNER REPLACEMENT GUIDE AND PARTS CATALOG**

- 60 pages of top information
- Blow-up of all tuners
- Largest exact tuner replacement guide
- Antenna Coil Replacement Guide
- Multi-fit Replacement Tuner Shaft Guide

For fastest service, send faulty unit with tubes, shields and all broken parts to:

**PTS ELECTRONICS, INC.**

HOME OFFICE—P. O. Box 272—Bloomington, Ind. 47401 Tel. 812/824-9331  
EAST— P. O. Box 3189—Springfield, Mass. 01103 Tel. 413/734-2737  
WEST COAST— P. O. Box 41354—Sacramento, Calif. 95841 Tel. 916/482-6220  
MOUNTAIN— P. O. Box 4145—Denver, Colo. 80204 Tel. 303/244-2818  
SOUTHWEST— P. O. Box 7332—Longview, Tex. 75601 Tel. 214/753-4334  
SOUTHEAST— P. O. Box 6771—Jacksonville, Fla. 32205 Tel. 904/389-9952

... for more details circle 124 on Reader Service Card

# ELECTRONIC TECHNICIAN/DEALER

JULY 1972 • VOLUME 94 NUMBER 7

## PHILLIP DAHLEN, C.E.T.

Editor  
1 East First Street  
Duluth, Minn. 55802  
(218) 727-8511

## ALFRED A. MENEGUS

Publisher  
757 Third Avenue  
New York, N.Y. 10017  
(212) 572-4839

## TOM GRENEY

Publishing Director

## JOSEPH ZAUHAR

Managing Editor

## BERNICE GEISERT

Associate Editor

## GAYNELLE DAVIDSON

Production Manager

## JOHN PASZAK

Graphic Design

## LILLIE PEARSON

Circulation Fulfillment

## JOHN KESSLER

Manager, Reader Services

## MANAGERS

### JIM SMITH, C.E.T.

43 East Ohio Street  
Chicago, Ill. 60611  
(312) 467-0670

### CHUCK CUMMINGS

Ad Space South/West  
613 North O'Connor  
Irving, Texas 75060  
(214) 253-8678

### KEN JORDAN

DONALD D. HOUSTON  
1901 West 8th Street  
Los Angeles, Calif. 90057  
(213) 483-8530

### CHARLES S. HARRISON

CY JOBSON  
57 Post Street  
San Francisco, Calif. 94104  
(415) 392-6794

### ROBERT UPTON

Tokyo, Japan  
C.P.O., Box 1717

The man behind the camera on this month's cover should look familiar—he's Skitch Henderson, famed composer-conductor-pianist and owner of the CCTV equipped restaurant described in the article beginning on page 39. Photo courtesy of Panasonic.

- 
- 3 TEKFAQ: Up-to-date schematics for easier servicing.
  - 23 EDITORIAL: Those That Dare.
  - 24 NEWS: Events of interest to our industry.
  - 29 LETTERS: Pertinent comments concerning past issues.
  - 32 READER'S AID: What you need or have for sale.
  - 34 NEW AND NOTEWORTHY: Merchandise of special interest.
- 

## FEATURES

### 25 PROGRAM AND SCHEDULE FOR 1972 JOINT CONVENTION

A complete listing of the many, many activities that will warrant your coming with us to New Orleans next month.

### 39 SKITCH'S RESTAURANT GOES CCTV

With security problems increasingly plaguing New York City restaurants, Mr. Henderson recently installed a CCTV system in his popular Daly's Dandelion bistro.

### 40 MAGNAVOX'S MODEL 1500 DTI RECEIVER

A look at one of the coming generation of AM/FM receivers that digitally indicated the tuned frequency.

### 47 ANOTHER STEP FORWARD

Tequipment's Model D67 scope is used to observe signals within a color-TV set not apparent with a conventional triggered-sweep scope.

### 51 SUCCESSFUL ADVERTISING

Comments concerning a very impressive advertisement that a service dealer placed in a weekly paper.

### 56 TEST INSTRUMENT REPORT

Reviewing specifications for Simpson's Model 460 Digital Volt-Ohm-Milliammeter.

- 
- 58 COLORFAX: Tips for easier color-TV set repair.
  - 60 TECHNICAL DIGEST: Hints and shortcuts for more effective servicing.
  - 62 DEALER SHOWCASE: These items may increase your sales revenue.
  - 65 NEW PRODUCTS: Instruments and components to make your job easier.
  - 67 TECHNICAL LITERATURE: Informative material that you may need.
  - 69 BOOK REVIEWS: Our appraisal of recent publications.
  - 70 ADVERTISER'S INDEX: Manufacturers concerned about you.
  - 71 READER'S SERVICE: A source of additional information.
- 



A HARCOURT BRACE JOVANOVIICH PUBLICATION



HARCOURT BRACE JOVANOVIICH PUBLICATIONS: James Milholland, Jr., Chairman; Robert L. Edgell, President; Lars Fladmark, Senior Vice President; Richard Moeller, Treasurer; John G. Reynolds, Vice President; Thomas Greney, Vice President; Ezra Pincus, Vice President; Bruce B. Howat, Vice President; James Gherna, Vice President.

ELECTRONIC TECHNICIAN/DEALER is published monthly by Harcourt Brace Jovanovich Publications. Corporate Offices: 757 Third Avenue, New York, New York 10017. Advertising Offices: 43 East Ohio Street, Chicago, Illinois 60611 and 757 Third Avenue, New York, New York 10017. Editorial, Accounting, Ad Production and Circulation Offices: 1 East First Street, Duluth, Minnesota 55802. Subscription rates: One year \$6, two years \$10, three years \$13, in the United States and Canada. Other countries: one year \$15, two years \$24, three years \$30. Single copies: 75¢ in the U.S. and Canada; all other countries \$2. Second class postage paid at Duluth, Minnesota 55806 and additional mailing offices. Copyright © 1972 by Harcourt Brace Jovanovich, Inc.

POSTMASTER: Send form 3579 to ELECTRONIC TECHNICIAN/DEALER, P.O. Box 6016, Duluth, Minnesota 55806.

# Look for the PTC *Please The Customer* Semiconductor Mart at your Mallory Distributor's.

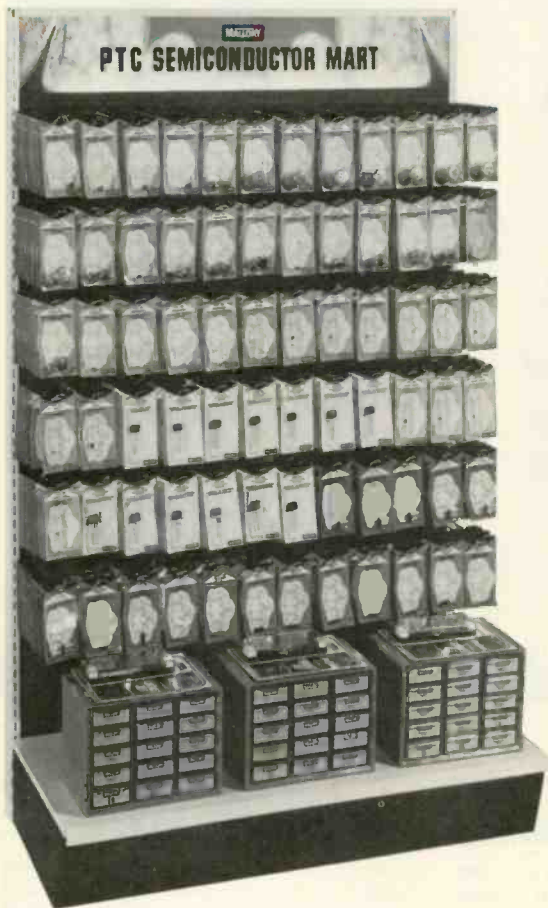

**THE SEMICONDUCTOR MART.** Here's the quick, easy way to get the replacements you need. It's the best assortment of the hottest semiconductors around. Transistors, diodes, multiple diode packages, zener diodes and integrated circuits included.



**THE FAMOUS MALLOBIN WAREHOUSE.**  
With the semiconductors most needed by service technicians.



**FREE** copies of the very latest cross-referenced Semiconductor Product Guide.

Clear, concise product data on the packages makes your choice easy. And Mallory quality, versatility, and dependability make every choice a good one.

## You know what you need. Now you know where to find it.

**MALLORY**

**MALLORY DISTRIBUTOR PRODUCTS COMPANY**

a division of P. R. MALLORY & CO. INC.

Box 1284, Indianapolis, Indiana 46206; Telephone: 317-636-5353

... for more details circle 119 on Reader Service Card

# Now, for 4.1¢ a day - have complete Zenith facts at your fingertips!



## DIRECT FROM ZENITH: Up-to-date information for technicians!

All the information you need to service any Zenith product: color TV, B&W TV, radio, stereo, tape players/recorders, and record players. All from one convenient, dependable source, Zenith... all for you to keep in compact, durable binders in one handy place.

Zenith will send you:

### 1. SERVICE MANUALS

Regular mailings with everything you need to know about new Zenith products or modification of existing circuits. Complete with charts, diagrams, exploded views, photographs and other helpful information for easier servicing.

### 2. "TECH TOPICS"

Twelve monthly technical bulletins with latest news about circuitry changes and improvements, short cuts in service and other valuable information, all designed to help you work more effectively and faster.

MAIL THE COUPON WITH YOUR CHECK TODAY

TO: ZENITH RADIO CORPORATION  
Attention: Service Dept. A  
1900 N. Austin, Chicago, Illinois 60639

- 1973 Service Manuals, including  
12 monthly copies of "Tech Topics" and two  
durable binders for the publications. \$19.95 per year
- 1973 Service Manuals, including 12 monthly  
copies of "Tech Topics." \$14.95 per year
- Durable binders only \$ 2.95 each

Check or money order enclosed for \$ \_\_\_\_\_

Name \_\_\_\_\_

Address \_\_\_\_\_

City \_\_\_\_\_ State \_\_\_\_\_ Zip \_\_\_\_\_

**ZENITH**  
The quality goes in  
before the name goes on

**Those That Dare**

Monday morning, prior to the opening of the NEW/COM Show in Las Vegas, Morris L. Finneburgh, Sr., E.H.F., delivered the keynote address to the Electronic Distributor's



Research Institute. The theme of his speech was, "The Tripod Story." We had been advised that this was a conservative audience, one not accustomed to standing ovations—yet M.L. did it again—an enthusiastic standing ovation.

Expounding upon the tripod theory, M.L. explained that, "in geometry we learn that it takes three points to make a plane. That's why a three-legged table is more stable, although manufacturers continue to produce wobbly four-legged ones." Comparing this analogy to the electronics industry, he added: "Manufacturers cannot do without capable distributors or good service dealers. Neither can distributors live without good manufacturers; and service dealers must have good distributors and manufacturers. The problems of each are interrelated."

He continued by indicating that although the virtues of the manufacturers are well known (product research and planning, product productivity and quality), the manufacturers also suffer from a number of weaknesses. They design a product beyond its functional need, provide unreasonably long warranties, offer too many discounts for volume orders, use the "free goods" technique and press for large distributor orders. They have an increasing interest in a one-step sales policy (discount stores, private labels, company-owned outlets, etc.) and demonstrate a distressing lack of interest in the problem of "parts availability," resulting in a loss of the company image. Both the distributor and service dealer must combat and correct these policies—the EDR! being a front runner in such an effort!

Although the value of the distributor is unquestioned, he too frequently succumbs to most of the manufacturer's pressure and has a tendency to be a "stocking warehouse" rather than a merchandising business. He fails to hold sufficient educational seminars with the service dealers, shows too little interest in service dealers, and (in some areas) has a bad retail over the counter policy. All distributors should separate their wholesale and retail operations! The distributor shows a lack of interest in local, state and national service association activities and goes for the manufacturer's "free goods" concepts rather than using the discount money for effective advertising and sales promotion. It is important that he stick with recognized, reputable products, take a firm stand concerning parts availability, and reduce inventories to improve his cash flow.

The service dealer suffers from lethargy . . . a lack of professional image . . . a lack of coordinated effort. He fails to heed the adverse warnings of manufacturers, distributors, service association leaders and the trade papers. He fails to properly sell **expert professional service** or to support his best suppliers . . . capitulating to **free goods** . . . so-called "bargains" . . . usually purchasing any brand for a "price" or a "deal." As a whole, he sees no advantage in affiliating with the local, state or national professional associations.

The Bureau of Labor forecasts a need for an additional 20,000 expert TV and radio technicians by 1980! Thus the NEA, NATESA, NARDA, and state service associations in California, New York, Texas, Kansas, Illinois, Connecticut, Massachusetts, Iowa . . . and others . . . must be **supported and guided by all manufacturers and distributors. SERVICE MUST GROW UP AND IMPROVE!** This must be done through industry cooperation as well as through their own efforts.

I presume all of this sounds like an impossible task! Not so!!

The worthy can do it! The unworthy won't even try!

Here is your ammunition!

The difference between success and failure is not necessarily the difference between intelligence and stupidity! Usually the difference lies merely in hard work, sincerity of purpose, dedication, and planned preparation to meet your problems.

We are always in a hurry! But don't hurry too fast. Take time to **work** . . . it is the price of success. Take time to **think** . . . it is the source of power. Take time to **play** . . . it is the secret of youth—recharging "working batteries." Take time to **read** . . . it is the foundation of knowledge. Take time to **worship** . . . it is the highway of reverence and self-respect. Take time to **laugh** . . . it helps with life's problems and heartaches. Take time to **love** . . . it is the gift closest to God. Take time to **dream** . . . it hitches your soul to the stars and creates ambition. Take time to **sing** . . . it helps to carry life's load. And above all else . . . take time to **plan** . . . it is the secret of being able to have time for the other nine suggestions!

If we wish to die in the cold-blooded jungle of business competition, then: Don't look . . . we might see. Don't listen . . . we might hear. Don't think . . . we might learn. Don't make a decision . . . we might be wrong. Don't walk . . . we might stumble. Don't run . . . we might fall. Don't speak up . . . some idiot might not like it! Don't live . . . we might die.

Our collective business objective (yours and mine) is to do the best possible job of meeting our responsibilities. Free enterprise is a blessing which allows us to study . . . to learn . . . and to fight for every dollar's worth of business profit potential. If you and I fail to get our share or even more than our share, then it is our fault as each of us holds within himself the key to success, independence and security. In the end, only fools believe in luck, wise men in deeds alone.

M. L. concluded his speech by saying: "To be able to work at the things you

*continued on page 68*

# NEWS OF THE INDUSTRY

## Considerable Interest Continues Concerning ISCET and the Exam

This issue came out too early to permit us to include a report concerning the number of people tested on June 15th at the many testing sites across the nation. However, based on the inquiries that we have received and the response to the first national test day a few months ago, we are certain that again a great number of people have taken and passed the examination.

As we have seen in the Letters to the Editor Column, there has been a great deal of concern on the part of electronic technicians regarding the CET Examination. Some fear it is too hard, others that it is too easy, and still others that it will either help or hinder state licensing.

The best place to make your feelings known (whether you care to join a trade association or not), meet many of the association members, officers and executives—plus those that are actually assembling the CET Examinations—is at the Joint Convention next month in New Orleans. They will *all* be there! Take your summer vacation in New Orleans this year, learn firsthand what the associations are doing, and take this opportunity to express *your own* feelings!

This month we are running the fifth in a series of quizzes representative of the types of questions found in the CET Examination.

### Section V

#### Electronic Components and Circuits

1. The power supply in Fig. 1 employs a (half wave/full wave) rectifier circuit?
2. In Fig. 1, regulated voltage B1 has the same value as the zener voltage of diode D3. (True/False)
3. What is capacitor C3 used for in Fig. 1?
4. In Fig. 1, TR1 is a silicon, NPN transistor. (True/False)

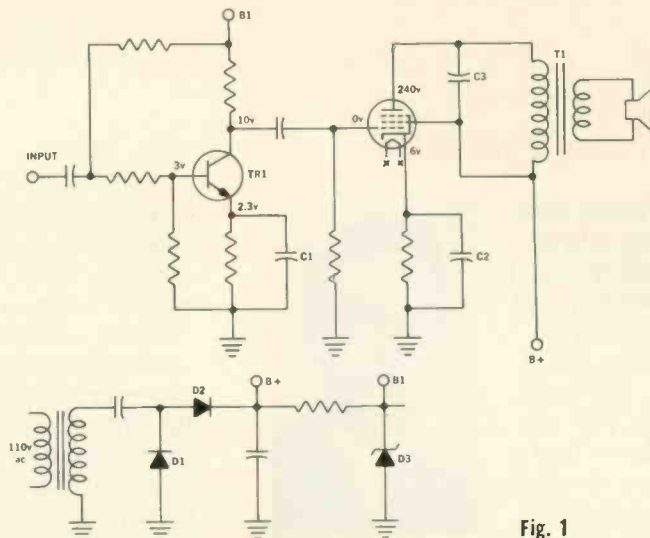

Fig. 1

5. The circuit in Fig. 2 is an FET amplifier. (True/False)

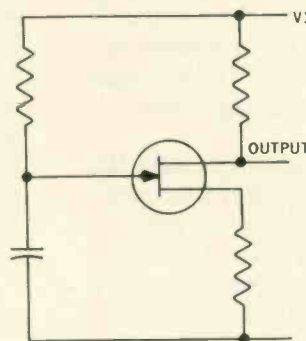

Fig. 2

#### Explanations

1. The rectifier circuit is a half-wave doubler.
2. The zener voltage is the value of voltage at which the

*continued on page 26*

Mail to: **ROGER A. DROST—JOINT CONVENTION COORDINATOR**  
**502 PECAN STREET, SULPHUR, LOUISIANA 70663**

I/We will attend the NATESA-NEA-ISCET-ETA Louisiana Joint Convention, August 9-13, New Orleans.

Enclosed is my/our check in amount of \$ \_\_\_\_\_ for \_\_\_\_\_ persons @ \$15.00\* per person.

Registration Fee covers admission to all general meetings, seminars, Friday and Saturday breakfast, lunch and dinner, Saturday cocktail hour, Sunday breakfast. Does not include Business Management School† or National Electronics Service Conference‡. Other meals and functions will be Dutch, unless later specified.

Please prepare Convention Packets for the following, who will accompany me:

Name \_\_\_\_\_ Street \_\_\_\_\_ City \_\_\_\_\_ Zip \_\_\_\_\_

Name \_\_\_\_\_ Street \_\_\_\_\_ City \_\_\_\_\_ Zip \_\_\_\_\_

Name \_\_\_\_\_ Street \_\_\_\_\_ City \_\_\_\_\_ Zip \_\_\_\_\_

Signed: \_\_\_\_\_ Street \_\_\_\_\_ City \_\_\_\_\_ Zip \_\_\_\_\_

SEND HOTEL ROOM RESERVATION CARDS

\* Registration Fee for Children same as Adults.

† For Information on Business Management School write to:

NEA—1309 W. Market Street, Indianapolis, Indiana 46222

‡ For Information on National Electronics Service Conference write to:

NATESA—5906 S. Troy Street, Chicago, Illinois 60629



# program and schedule for 1972 joint convention

The Jung Hotel, 1500 Canal St., New Orleans, La.

## Monday and Tuesday—August 7 and 8

Vacationing families and "Early Bird" arrivals get together with old friends for sight-seeing, tour of the Vieux Carre, eating in world famous restaurants, driving across the world's longest bridge (Lake Pontchartrain Causeway), drinking cajun coffee and eating French donuts at the French Market Coffee House. Paint-the-town and have a grand time, all on your own.

## Wednesday—August 9

8:00 a.m. Breakfast  
Registration in Joint Convention Foyer—Sixth Floor near Trade Show Exhibit area

9:00 a.m. Early arrivals' sight-seeing tours and other programs to be developed as pre-registration dictates

10:00 a.m. Electronic Industry Council Meeting. Ron Crow, Chairman (Project TRIP and all other subjects of interest for discussion by representatives of associations involved in virtually every phase of electronic entertainment)  
CET Tests—ISCET

Noon Luncheon

5:00 p.m.—6:00 p.m. Registration for NEA Business Management School—Sixth floor near Trade Show Exhibit area

6:00 p.m. Dinner

8:00 p.m. Early arriving committee chairmen meet to finalize past year's reports and convention arrangements  
Singing Fun—Hospitality Room

## Thursday—August 10

8:00 a.m. Breakfast  
Registration begins for convention and Business Management School in Joint Convention Foyer—Sixth Floor near Trade Show

9:00 a.m.—2:00 p.m. NEA-NATESA "Open" Golf Tournament, Gene Dicker, Chairman

9:00 a.m.—11:30 a.m. NEA Business Management School "1973 and Electronic Service . . . at a Profit" presented by Les Nesvik, CET, President of the Indiana Electronic Service Assn. and Service Manager of Wholesale TV Service (an audio-visual presentation developed by IESA and a major manufacturer). ELECTRONIC SERVICING will distribute 52-page booklet of past business management articles  
Association Publication Editors' Seminars directed by Phillip Dahlen, Editor of ELECTRONIC TECHNICIAN DEALER (a discussion of all subjects that will help make state trade association publications even better)

10:00 a.m. Coffee Break\*

12:15 p.m. Luncheon

1:15 p.m.—2:15 p.m. NEA Business Management School, "A Natural for Electronics Service Business . . . The Burglar Alarm" presented by Larry Steckler, Editor of RADIO ELECTRONICS

1:15 p.m.—3:30 p.m. Association Publication Editors' Seminars continued

2:15 p.m. Coffee Break\*

2:30 p.m.—4:00 p.m. NEA Business Management School, "Stabilize Your Service Business Through Sales of Service Contracts" presented by Sid Baker of RCA Service Co.

4:30 p.m. Coffee Break\*

5:00 p.m. Convention Official Call to Order

5:15 p.m. Keynote Address:  
Leo Shumavon, President of NATESA  
Norris Browne, CET, President of NEA

6:00 p.m. Dinner

8:00 p.m. NATESA Executive Council Meeting  
NEA Executive Committee Meeting  
M&M Business Forms Bowling Tournament, Pete Fabbri, Chairman  
All Hospitality Rooms open—attendance awards drawn there instead of at main functions

8:00 p.m.—11:00 p.m. CET Tests—ISCET

## Friday—August 11

8:00 a.m. ETA of Louisiana breakfast sponsored by RCA  
Registration in Joint Convention Foyer—Sixth Floor near Trade Show Exhibit area

9:00 a.m. NEA Business Management School, "How to Make Money with Your Financial Reports" presented by Robert Bond, president of the Texas

Electronic Assn. and owner of Bond's TV in Austin, Texas  
Electronic Trade Show opens in Sixth Floor Terrace Suites  
Hospitality Room for teens and sub-teens sponsored by the Finney Co. and supervised by ETA of Greater New Orleans

9:15 a.m. NATESA Executive Council Meeting  
NEA Board of Directors Meeting  
Technical Seminars—ISCET (Don Pogue of Magnavox describes the digital tuning system featured in this issue of ELECTRONIC TECHNICIAN/DEALER)

10:15 a.m. Coffee Break\*

10:30 a.m. NEA Business Management School, Roundtable—questions and answers  
Technical Seminars—ISCET (Technical representative of Motorola describes the low-voltage power supply featured in the January 1972 issue of ELECTRONIC TECHNICIAN/DEALER)

Noon NEA Luncheon sponsored by Magnavox

1:30 p.m.—5:30 p.m. National Electronic Service Conference sponsored by NATESA (A chance for you and all other electronic technicians and service dealers to get together and discuss with manufacturers the many problems that should be resolved to make your work more efficient)

1:30 p.m. Electronic Trade Show Opens

3:00 p.m. Coffee Break\*

3:30 p.m. Electronic Trade Show Visitation Hour

6:00 p.m. Cocktail Hour sponsored by Howard W. Sams & Co.

7:00 p.m. NATESA Dinner sponsored by Zenith Radio Corp.

8:30 p.m.—10:00 p.m. ISCET Annual Meeting and election of officers

8:30 p.m. All Hospitality Rooms open, attendance awards drawn

9:00 p.m. A night in "Old New Orleans" directed by ETA of Louisiana

## Saturday—August 12

8:00 a.m. ISCET Breakfast sponsored by Sylvania and featuring a film on Hawaii  
Registration in Joint Convention Foyer—Sixth Floor near Trade Show

9:00 a.m. NATESA Annual Corporation Meeting  
NEA Annual Corporation Meeting  
Hospitality Room for teens and sub-teens sponsored by The Finney Co. and supervised by ETA of Greater New Orleans

9:00 a.m.—Noon Electronic Trade Show

9:15 a.m. ISCET Technical Mini-Sessions: Tape-deck servicing; Transistor testing and servicing; Testing stereo and Hi-Fi systems to specifications; Alignment—IF, Color and AFPC; Scope usage; CET Test review; Effective reading; Effective writing; Others  
Symposium for Licensed Board Executives

10:30 a.m. Coffee Break\*

Noon Hall of Fame Banquet sponsored by Ampex Electronic Corp.; Morris L. Finneburgh, Sr., E.H.F., Keynote Speaker; Doh Martin, Editor of ELECTRONIC SERVICE DEALER, Master of Ceremonies

1:30 p.m. NATESA election of officers  
NEA election of officers

1:30 p.m.—2:30 p.m. ISCET Technical Mini-Sessions continued

1:30 p.m.—4:00 p.m. CET Tests—ISCET

1:30 p.m.—6:00 p.m. Electronic Trade Show

2:30 p.m. Coffee Break\*

3:00 p.m. Drawing of prizes at Trade Show for those that register prior to July 10th

4:00 p.m.—6:00 p.m. Louisiana State Radio & TV Technicians' board meeting (open meeting)

6:00 p.m. Cocktail Hour sponsored by Howard W. Sams & Co.

7:00 p.m. ETA of Louisiana Fais-Do-Do Banquet and dance to sun-up sponsored by General Electric

## Sunday—August 13

8:00 a.m. Louisiana State Radio and TV Technicians' Board meeting

9:00 a.m. NATESA Breakfast

10:00 a.m. ISCET Annual Meeting continued. Meeting of all state association presidents (presidents only, please)  
NATESA Annual Corporation Meeting continued  
NEA Annual Corporation Meeting continued  
ETA of Louisiana Meeting

Noon—2:00 p.m. Planning Meeting for new NATESA Executive Council  
Planning Meeting for NEA Board of Directors

3:00 p.m. Adjournment for all and check-out time

\*Coffee Breaks are sponsored by The Finney Co.

**New and only  
from EICO...  
The Professional Home  
Protection everyone can  
Install and Afford!**

## EICO FC-100 SECURITY CONTROL CENTER

- Start your custom Burglar/Hold-up/Fire Alarm System with the FC-100.
- Add on Sensors, Alarms and Accessories to suit your own needs.
- "Do-it-Yourself" Installers Handbook included.
- No technical knowledge needed-No soldering.
- Ideal for Apartment, Home and certain Commercial Installations.
- 100% Professional in Design, Reliability, Performance.

The FC-100 is an extremely flexible home protection device. It has been designed for use with all types of intruder and fire sensors. The alarm activating circuits accommodate burglar alarm bells, separate fire horns, as well as various combinations of fire and burglar alarm bells and horns. A Remote Station Control with signal lights (EICO A-65) can be installed at any number of locations to show that all doors and windows are closed and the alarm system is ready to be "armed." The simple circuit uses only two wires. For maximum safety, the fire alarm circuits are always on and cannot be turned off accidentally.



The EICO FC-100 Security Control Center is powered by a 117 VAC Power Supply (EICO A-75) which supplies 6 volts DC for operating the system. Space is provided for an optional standard 6 volt lantern

battery for standby/emergency operation. In the event of an electrical power failure, the battery automatically supplies the power to keep the alarm system activated.

Each circuit in the EICO FC-100 has its own independent set of screw terminals that allow installation by someone unfamiliar with electrical wiring.

Model FC-100 **\$69.95**

## EICO SS-500 BURGLAR/HOLD-UP/FIRE ALARM SYSTEM

- Systems "HEART" is the EICO FC-100 Security Control Center.
- Additional Sensors, Alarms, Accessories may be added any time to meet future needs.
- "Do-it-Yourself" Installers Handbook included.

A basic home Burglar/Hold-Up/Fire Alarm Systems which combines a high reliability alarm control center with detectors, alarm accessories and an alarm bell.

The SS-500 system is supplied with the following: A-75 Power Supply; SA-25 8" Alarm Bell; A-45 Entrance Key-Switch with "system-on" signal light; A-65 remote station control with signal lights; SD-20 Fire Sensors; SD-10, Door/Window Contact Switches; SD-50 Tamper Switches; SD-40 Door Cords; A-35 Emergency Buttons; A-95 Installers Handbook; A-105 "Home Protected" Decals and 250 feet of hook-up wire. Additional remote stations, entrance key switches, alarm bells, signal horns as well as fire, smoke, intruder, freeze-up and water flooding detectors, are available as optional accessories.

Model SS-500 **\$129.95**

### "Do-it Yourself" HOME SECURITY HANDBOOK

A comprehensive 40-page Homeowners Handbook which includes a wealth of information on professional home security as well as comprehensive installation procedures in clear non-technical language.

A-95 Handbook **\$2.95**

THIS  
BOOK MAKES  
IT  
POSSIBLE



## FREE 32 PAGE EICO CATALOG

For latest catalog on EICO Burglar/Fire Alarm Systems, Environmental Lighting, Test Instruments, Stereo, EICOCRAFT Projects, and name of nearest EICO Distributor, check Reader Service Card or send 25¢ for First Class mail service.

EICO, 283 Malta Street, Brooklyn, New York 11207



... for more details circle 110 on Reader Service Card

## NEWS...

continued from page 24

zener breaks down in the reverse bias direction. The circuit operates in that region, therefore B1 has the same value as the zener voltage.

3. Parasitic noise suppression.
4. TR1 is a silicon, NPN transistor. The symbol (direction of the arrow) indicates that it is NPN, and the emitter-to-base bias being 0.7v indicates that the transistor is made of silicon.
5. Fig. 2 represents a free-running oscillator utilizing a uni-junction transistor. The answer is False.



On May 6, 1972, the Joint Convention Committee met at the Jung Hotel in New Orleans for the purpose of finalizing plans and approving the program of activities for the NATESA-NEA-ISCET-ETA Louisiana Joint Convention, which will be staged in New Orleans, La., on August 9-13. Committee members representing NATESA for this meeting were, from left to right: Nolan Boone, NATESA Convention Chairman and Trade Show Chairman for the Joint Convention; Tom Easum, Treasurer of NATESA; Leo Shumavon, NATESA president; and representing NEA—Roger Drost, Coordinator for the Joint Convention. Also representing NATESA is Stan Brohn, not shown. Approval of the program of activities (printed on page 25) now makes it possible for all of the associations involved to complete their plans and programs for this "greatest-of-all" conventions.

## Statewide Council Formed To Administer Self-Regulation

Several of the most representative electronic and appliance service associations throughout the state of New York have formed a state council called the Electronic & Appliance Service Associations Council (EASAC). Charter members include the Association of Home Appliance Service Companies; Service Managers Association; Television Electronic Service Association of Suffolk County; and Television Service Association of Northeastern New York, Inc.

The purpose, aims and objectives of the council include joint activity on industry problems within the state of New York, education of government and the public, establishment of an industry code of ethics, legislative activity, and dissemination of trade and industry information.

Council members have been active with the legislature and the attorney general's office in the area of consumer protection. In addition, they have been cooperating with the Better Business Bureaus, Chambers of Commerce, and other consumer-oriented groups.

continued on page 61

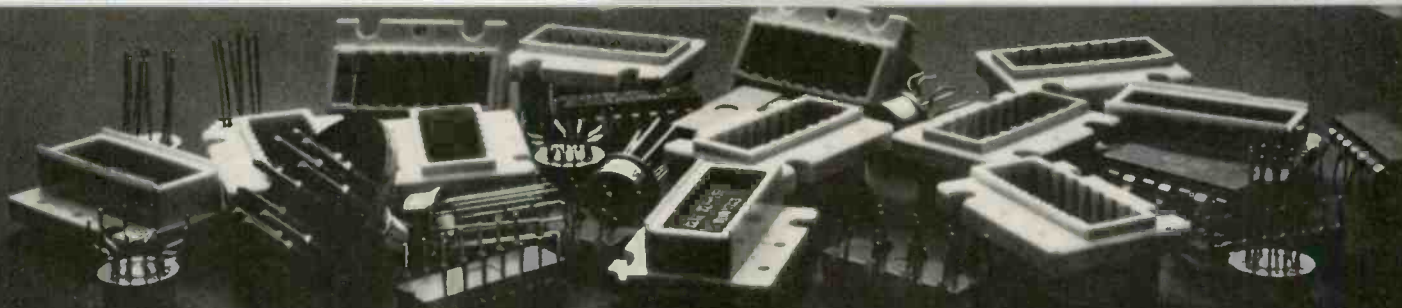

## Our 28 ICs replace...

To Be Replaced	ECG Replacement	To Be Replaced	ECG Replacement
CA3057	727	1M3028A	724
CA3053	724	1M3028B	724
CA3065	712	1M3053	724
CA3070	714	1M3065	712
CA3071	715	MC1303L	725
CA3072	713	MC1303P	718
CA3075	723	MC1304P	720
DM-11	709	MC1304PQ	720
DM-14	718	MC1305P	720
DM-24	719	MC1305PQ	722
DM-26	721	MC1307P	722
DM-30	721	MC1307PQ	704
EX4053	722	MC1314G	707
FF274	715	MC1328G	713
FL274	712	MC1328P	713
GE-IC2	712	MC1328PQ	708
GE-IC3	705A	MC1357P	713
GE-IC4	714	MC1358P	703A
GE-IC5	713	MFC6010	708
GE-IC6	715	N5111	

## and hundreds more.

Integrated circuits are still pretty new in TV and stereo equipment.

But Sylvania's ECG Semiconductor program really has those applications pinned down.

Today, just 28 of our ICs will replace over 300 type numbers.

We don't do it by magic, or by offering an "almost as good" replacement.

We do it by assigning our own part number to just one high quality IC that can be used to replace dozens of others.

And to make it easy for you,

we've put together a replacement guide that tells you which of our ICs to use where.

Your customer won't know that you're not carrying 300 different ICs.

All he'll know is that you fixed his set fast, and fixed it right.

The fact that you only needed 28 IC replacements is your secret.

And ours.

In servicing, that can be the secret of success.

Sylvania Electronic Components, Waltham, Mass. 02154.

**GTE SYLVANIA**

# 7

# NEW RATINGS (in 1000, 1600, and 2000V) ADDED

## to world's broadest line of dipped tubulars!

# SPRAGUE DIFILM® ORANGE DROP® CAPACITORS



- Designed to provide the electronics industry with compact capacitors with outstanding dependability under conditions of high heat and humidity.
- Dual dielectric—combines the best features of both polyester film and special capacitor tissue.
- Impregnated with HCX<sup>®</sup>, an exclusive Sprague synthetic hydrocarbon material which fills every void in the paper, every pinhole in the film before it poly-

- merizes, resulting in a solid, rock-hard capacitor section.
- Double dipped in bright orange epoxy resin for moisture and mechanical protection.
- Leakproof—because impregnant is solid, there is no oil to leak, no wax to drip.
- Designed for operation at temperatures to +125 C.
- Capacitance tolerance, ±10%.

μF	D. x L.	Sprague Products Cat. No.	μF	D. x L.	Sprague Products Cat. No.	μF	D. x L.	Sprague Products Cat. No.
<b>200 VOLTS D-C</b>			<b>600 VOLTS D-C (cont.)</b>			<b>1000 VOLTS D-C (cont.)</b>		
.02	29/64 x 15/16	2PS-S20	.005	29/64 x 3/4	6PS-D50	.022	3/64 x 1 3/8	10PS-S22
.022	29/64 x 15/16	2PS-S22	.0056	17/32 x 3/4	6PS-D56	.033	1 1/2 x 1 3/8	10PS-S33
.047	33/64 x 15/16	2PS-S47	.006	17/32 x 3/4	6PS-D60	*.039	43/64 x 1 3/8	10PS-S39
.05	33/64 x 15/16	2PS-S50	.0068	15/32 x 3/4	6PS-D68	.047	43/64 x 1 3/8	10PS-S47
.1	35/64 x 1 1/4	2PS-P10	.0075	17/32 x 3/4	6PS-D75	*.056	47/64 x 1 11/16	10PS-S56
.15	5/8 x 1 1/4	2PS-P15	.008	29/64 x 15/16	6PS-D80	.068	47/64 x 1 11/16	10PS-S68
.2	43/64 x 1 3/8	2PS-P20	.0082	29/64 x 15/16	6PS-D82	*.082	49/64 x 1 11/16	10PS-S82
.22	43/64 x 1 3/8	2PS-P22	.01	29/64 x 15/16	6PS-S10	.1	49/64 x 1 11/16	10PS-P10
.25	43/64 x 1 3/8	2PS-P25	.012	31/64 x 15/16	6PS-S12	<b>1600 VOLTS D-C</b>		
.33	11/16 x 1 11/16	2PS-P33	.015	31/64 x 15/16	6PS-S15	.0005	1/2 x 7/8	16PS-T50
.47	49/64 x 1 11/16	2PS-P47	.02	35/64 x 15/16	6PS-S20	.001	13/32 x 7/8	16PS-D10
.5	49/64 x 1 11/16	2PS-P50	.022	35/64 x 15/16	6PS-S22	.0015	7/16 x 7/8	16PS-D15
<b>400 VOLTS D-C</b>			.025	35/64 x 15/16	6PS-S25	.002	1/2 x 7/8	16PS-D20
.01	15/32 x 3/4	4PS-S10	.027	17/32 x 1 1/4	6PS-S27	.0022	1/2 x 7/8	16PS-D22
.015	31/64 x 3/4	4PS-S15	.03	17/32 x 1 1/4	6PS-S30	.003	7/16 x 1 1/8	16PS-D30
.02	31/64 x 15/16	4PS-S20	.033	17/32 x 1 1/4	6PS-S33	.0033	7/16 x 1 1/8	16PS-D33
.022	31/64 x 15/16	4PS-S22	.035	17/32 x 1 1/4	6PS-S35	*.0039	31/64 x 1 1/8	16PS-D39
.025	31/64 x 15/16	4PS-S25	.039	19/32 x 1 1/4	6PS-S39	.004	31/64 x 1 1/8	16PS-D40
.03	17/32 x 15/16	4PS-S30	.04	19/32 x 1 1/4	6PS-S40	.0047	31/64 x 1 1/8	16PS-D47
.033	17/32 x 15/16	4PS-S33	.047	19/32 x 1 1/4	6PS-S47	.005	31/64 x 1 1/8	16PS-D50
.04	35/64 x 1 1/4	4PS-S40	.05	19/32 x 1 1/4	6PS-S50	.006	17/32 x 1 1/8	16PS-D60
.047	35/64 x 1 1/4	4PS-S47	.056	41/64 x 1 1/4	6PS-S56	.0068	17/32 x 1 1/8	16PS-D68
.05	35/64 x 1 1/4	4PS-S50	.06	41/64 x 1 1/4	6PS-S60	.007	17/32 x 1 1/8	16PS-D70
.056	37/64 x 1 1/4	4PS-S56	.068	41/64 x 1 1/4	6PS-S68	.0075	17/32 x 1 1/8	16PS-D75
.068	37/64 x 1 1/4	4PS-S68	.075	41/64 x 1 1/4	6PS-S75	.008	5/8 x 1 1/32	16PS-D80
.075	37/64 x 1 1/4	4PS-S75	.082	11/16 x 1 3/8	6PS-S82	.01	5/8 x 1 1/32	16PS-S10
.1	41/64 x 1 1/4	4PS-P10	.1	11/16 x 1 3/8	6PS-P10	.015	21/32 x 1 1/8	16PS-S15
.15	43/64 x 1 3/8	4PS-P15	.15	47/64 x 1 11/16	6PS-P15	*.018	3/4 x 1 1/8	16PS-S18
.2	43/64 x 1 3/8	4PS-P20	.2	27/32 x 1 11/16	6PS-P20	.02	3/4 x 1 1/8	16PS-S20
.22	43/64 x 1 11/16	4PS-P22	.22	27/32 x 1 11/16	6PS-P22	.022	3/4 x 1 1/8	16PS-S22
.25	43/64 x 1 11/16	4PS-P25	.25	27/32 x 1 11/16	6PS-P25	.03	3/4 x 1 3/8	16PS-S30
<b>600 VOLTS D-C</b>			.33	59/64 x 1 11/16	6PS-P33	.033	3/4 x 1 3/8	16PS-S33
.001	25/64 x 3/4	6PS-D10	.47	1 1/64 x 1 11/16	6PS-P47	.04	27/32 x 1 3/8	16PS-S40
.0012	25/64 x 3/4	6PS-D12	<b>1000 VOLTS D-C</b>			.047	27/32 x 1 3/8	16PS-S47
.0015	25/64 x 3/4	6PS-D15	.001	25/64 x 3/4	10PS-D10	.05	27/32 x 1 3/8	16PS-S50
.0018	25/64 x 3/4	6PS-D18	.0015	13/32 x 3/4	10PS-D15	<b>2000 VOLTS D-C</b>		
.002	25/64 x 3/4	6PS-D20	.002	7/16 x 3/4	10PS-D20	.001	3/8 x 1 1/4	20PS-D10
.0022	25/64 x 3/4	6PS-D22	.0022	7/16 x 3/4	10PS-D22	.0015	27/64 x 1 1/8	20PS-D15
.0025	25/64 x 3/4	6PS-D25	.003	7/16 x 3/4	10PS-D30	.0022	15/32 x 1 1/8	20PS-D22
.0027	25/64 x 3/4	6PS-D27	.0033	7/16 x 15/16	10PS-D33	.0033	33/64 x 1 1/8	20PS-D33
.003	25/64 x 3/4	6PS-D30	.004	15/32 x 15/16	10PS-D40	.0047	1/2 x 1 1/8	20PS-D47
.0033	25/64 x 3/4	6PS-D33	.0047	15/32 x 15/16	10PS-D47	.0056	37/64 x 1 3/8	20PS-D56
.0039	29/64 x 3/4	6PS-D39	.005	15/32 x 15/16	10PS-D50	.0068	37/64 x 1 3/8	20PS-D68
.004	29/64 x 3/4	6PS-D40	.0068	31/64 x 15/16	10PS-D68	*.0082	39/64 x 1 3/8	20PS-D82
.0047	29/64 x 3/4	6PS-D47	.01	35/64 x 15/16	10PS-S10	*.027	51/64 x 1 11/16	20PS-S27
			.015	17/32 x 1 1/4	10PS-S15			

\*New rating



MEMBER

For information on Sprague's broad line of components for the service trade, get Catalog C-620 from your Sprague Distributor or write to Sprague Products Co. 65 Marshall St., North Adams, Mass. 01247

**THE BROAD-LINE PRODUCER OF ELECTRONIC PARTS**



# LETTERS

Reader comments concerning past feature articles, Editor's Memos, previous reader responses or other subjects of interest to the industry.

## The CET Exam

There has been a considerable amount of discussion concerning the amount of theory vs. practical knowledge required for passing the CET Exam. I would like to explain that the exam is weighed so as to place emphasis on the practical aspects of troubleshooting and circuit analysis. Here is a list of the 12 sections that make up the associate/journeyman test for consumer electronics:

Section	Title	Number of Questions	
I	Basic Mathematics	5	ASSOCIATE TEST
II	DC Circuits	5	
III	AC Circuits	5	
IV	Transistors and Semiconductors	10	
V	Electronic Components and Circuits	10	
VI	Instruments	10	
VII	Tests and Measurements	15	
VIII	Troubleshooting and Network Analysis	15	
Total			125
IX	Antennas and Transmission Lines	10	JOURNEYMAN TEST
X	AM, FM, Audio and Monochrome Television	15	
XI	Color Television	15	
XII	Troubleshooting Consumer Electronics Equipment	10	
Total			

There are only five questions (out of a total of 125 questions) devoted to mathematics. Sections I, II and III comprise the basic theory part of the exam, while the other sections contain questions on both theory and practical applications. In other words, you could miss every question in the first three sections and still pass the test. (A grade of 75 percent is required.)

It is difficult to imagine an experienced technician missing every question in the first three sections since they include questions on color code, tolerance, power ratings and filters. If the experienced technician can answer a few of these questions—and he *should* be able to—then the first three sections of the test do not carry enough importance to worry about. Incidentally, all of the questions in the CET Exam are multiple-choice type.

It may be true that many experienced technicians have been out of school for years, but I seriously doubt if this would have any effect on their ability to pass the test. The fact that a technician is out of school does not mean that he has stopped studying.

He reads ELECTRONIC TECHNICIAN/DEALER and other technical magazines, he attends technical seminars, he attends upgrading courses presented by manufacturers, he subscribes to TECHNI-TIPS, he reads instruction manuals and technical advertisements, he reads technical books and he exchanges information with his co-workers and the members of his local, state and national associations. In fact, a good technician may be spending more time studying in these ways than he did when he was in school.

In all of the types of study just described, the technician learns theory as well as practical applications. This is what makes him a professional.

Sections IV through XII contain a balance between theory and practical applications. The test is revised several times each year, and CET's are asked to participate in each revision. They submit questions and they evaluate proposed questions. Every question and every suggestion is given serious consideration.

J. A. "SAM" WILSON, CET  
SECRETARY—ISCET

## For Safety Sake

For the sake of safety, I refer to the front cover of the December 1971 issue.

In 1956, just after I graduated from the Pacific College of Radio and TV (now Western College of Electronics), I learned the hard way that you do not have a safe bench when you have any ground strap or receptacles on the leading edge to make a ground return when the technician leans against it.

One of the technicians working along side me, at a bench similar to the one on the front cover, came very close to ending his career when he leaned against the receptacles and accidentally touched boot-strap voltage.

Granted, ready access to ac power makes the job easier. But when you use this type of bench, you may be gambling with your life.

MARVIN NOLAN

## Pleased with February Editor's Memo

Elated—indeed! Or as the firefly remarked, after a trip through the electric fan, I am de-lighted—no end with your excellent editorial in the February 1972 issue of ELECTRONIC TECHNICIAN / DEALER, "Professional Associations."

Of all your previously well expressed editorials, this one should stand as a masterpiece with every electronic as-

*continued on next page*

# Telematic

PROFESSIONAL COLOR TV SERVICE EQUIPMENT

## ECONO JIG Color Test Jig



\$49.95 Net  
less tube

- Complete with all components and cables.
- Durable metal cabinet.
- Professional equipment for rapid servicing.

## ADAPT-ALLS Yoke Convergence Adaptors



- To service all sets with any test jig.
- FREE: Write for cross-reference listing thousands of sets.

## TRANSVERTERS Service Solid State TV



- On any make test jig with simple plug-in Transverter.

## MOLEX CUSTOM CABLE KIT Make all combinations of Molex Cables

CR-596 contains:

- Assortment of Molex Plugs and sockets.
- 18 wires, contacts attached.
- Extractor tool.

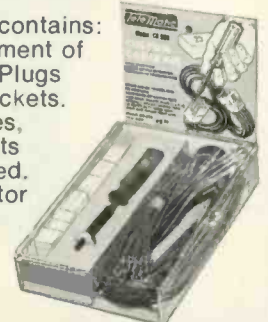

TELEMATIC DIV., UXL CORP.  
2245 PITKIN AVE., BKLYN., N. Y. 11207

... for more details circle 127 on Reader Service Card

## LETTERS...

continued from page 29

sociation leader—local, state or national—in his efforts in obtaining new members. I am taking the liberty of adding this page as another valuable tool to my own sales brochure. And should you send me another dozen or so copies, to be similarly used by local leaders, I would assume permission for this use granted.

Please inform those people who read your editorial and may not have found a reason to belong, that: Your space and other restrictions allowed

only a mere scratching of the surface, and that the benefits from association membership are limited only by the scope of and dedication to their own particular goals. Many dealers have attributed to association membership a \$1,000.00 and more increase in annual net income. The electronic service industry is probably "low man in the piddle-puddle" where professional association membership is concerned. Just ask your druggist, florist, electrician, plumber, dentist, doctor, teacher, engineer, city manager and yea, even the dog catcher and garbage collectors. We are independent and don't need to associate? Warn them of the

high cost of association membership—it may be as much as they spend for bowling or cigarettes!

So much for elaboration on your fine effort in our behalf. Keep up the good work.

JULIUS RAMEY, PRESIDENT  
TSA OF OHIO

### Opposes CET Exam

Here is my opinion of the letters in ET/D's April issue by Charles Morris and William Hartman concerning the CET exam:

Here you have two technicians in different boats. Being a serviceman, you'll find me riding in Morris' boat. Like him, I learned regular electronics at night school and later at radio school. From there on I successfully taught myself the servicing of transistor radios up to color-TV sets. During my 36 years of servicing, I have found little use for the technical theory learned in school.

What I am getting at is that Hartman's letter lets a person know that he wields an intelligent technical/mathematical pen. He may be able to lay everything out with directions on paper, but can he use the test instruments and tools then to repair the trouble as well as Morris or I?

Technical theory is good as far as reading and studying is concerned, but in electronic servicing you cannot rely on the book. I say this because for many a time I have repaired TV sets with my own tricks (without damaging or overloading other circuits) and improved the receiver. I am not afraid to say this for I have sold several of these ideas to other electronic magazines.

This is a case where the saying, "the pen is stronger than the sword," is not true.

PETER LEGON

### And Why Not Theory?

I would like to direct one brief comment to those "technicians" who ask if there is any need for electronic theory in the Electronic Service Industry. What would these same "technicians" think of the competency of the Civil Engineer who said, "Oh, I don't need math, physics or surveying, I just build my bridges and they work"? Or the MD who might say, "I don't have to know much about pathology or anesthesiology, I'm a surgeon"?

I also have one brief comment for ET/D. Keep up the good work.

DON F. REYNOLDS, CET

## How listening to servicemen made the world's best electronic chemicals even better.

While we're proud of all the R&D we do, some of our best ideas come from the many servicemen who use our products.

Take our newest "first"—**Adjusta-Spray**. Its continuously-variable valve system lets you dial any spray intensity you want. We developed it because different jobs (and different servicemen) require different spray intensities: light for pinpoint cleaning and lubrication without overspray; medium for average jobs; and heavy, to blast away stubborn dirt.

**Adjusta-Spray** has it all. And it's fully compatible with extender tubes, to give you the **exact spray** you want, exactly **where** you want it. **Adjusta-Spray** is available on the world's most popular electronic chemicals: our **TUN-O-BRITE** cleaner/polisher/lubricant and **TUN-O-FOAM** cleaner/lubricant—both at your distributor's now. They're even more of a value, because there's no increase in price. How's that for making a good thing even better?



**CHEMTRONICS**  
INCORPORATED

1260 RALPH AVE., BROOKLYN, N.Y. 11236

Our business is improving yours.

... for more details circle 105 on Reader Service Card

## Why RCA XL-100's can be a quick fix:

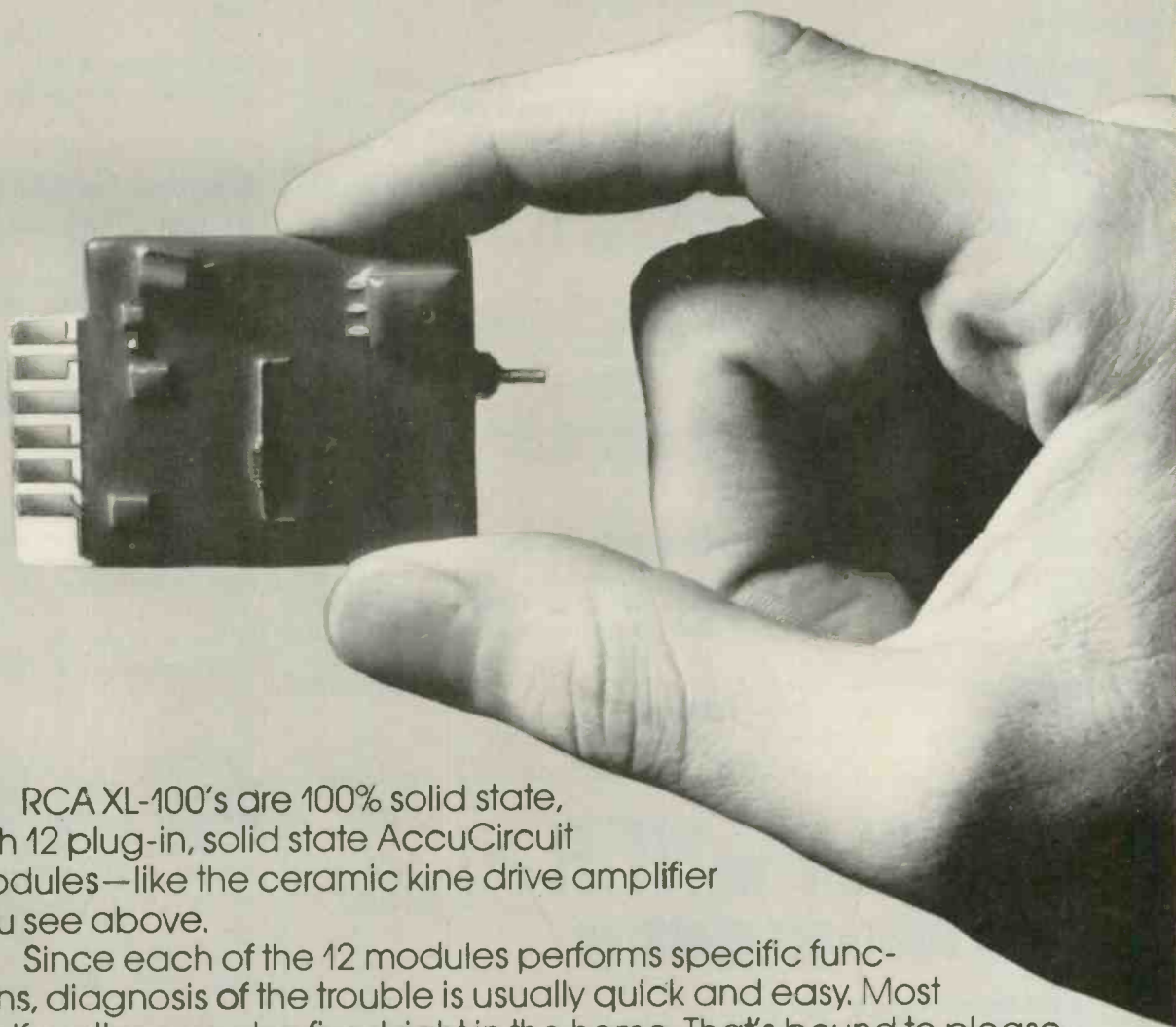

RCA XL-100's are 100% solid state, with 12 plug-in, solid state AccuCircuit modules—like the ceramic kine drive amplifier you see above.

Since each of the 12 modules performs specific functions, diagnosis of the trouble is usually quick and easy. Most malfunctions can be fixed right in the home. That's bound to please your customer.

So when it comes to servicing RCA solid state color, XL-100's let you make more house calls—in a lot less time!

And you won't waste so much time hauling sets back and forth to the shop.

Something else: Whether you're servicing an XL-100 console, table model or portable, most modules are interchangeable, function for function. That will make your life easier, and you won't have to worry about stocking a large parts inventory.

RCA XL-100. It's already got a great reputation. It could even add to yours.

**RCA** **XL-100**   
100% Solid State AccuColor

## READERS' AID

Space contributed to help serve the personal needs of you, our readers.

### For Sale

I have a TV sales and service shop for sale—franchised Zenith dealer. It is a one man operation grossing over \$55,000 per year. The store is in town and the home is on three acres four miles from the store. All must go for one price. Everything is ready to move into.

JIM'S TV

232 W. Howard St.  
Live Oak, Fla.

For sale to the best offer are Riders Trouble Shooter Manuals No. 4 through No. 23 (No. 13 is missing), plus a No. 4 Riders TV manual.

J. C. SEAY

Seay Radio & TV  
1748 Ross Clark Circle S. E.  
Dothan, Ala. 36301

I am retiring and would like to sell my home with a 24 ft by 24 ft TV shop attached. The TV shop is the only one

in town, and the closest competitor is 10 miles away. Also, I have more than 500 ET/D TEKFAK Schematics for sale.

DICK JACKSON

P.O. Box 373  
Kingston, Okla. 73439

I have a small plant for the rebuilding of picture tubes that I am willing to sell at a fraction of the value. Details provided upon request.

MIGUEL C. DI PIERRI

213 Palm Ave.  
Hiialeah, Fla. 33010

I have the following for sale: antique radio tubes and Riders radio and TV manuals at reasonable prices.

G. C. GOODWIN

Goodwin Radio Shop  
Rankin, Ill. 60960

### Magazines Wanted

I am interested in locating back issues of ELECTRONIC TECHNICIAN/DEALER, particularly from 1960 on. I am willing to pay a fair price for them.

PAUL E. NYMAN

108 West St.  
West Hatfield, Mass. 01088

### Conflict of Interest Sale

Due to the recent promotion to the position of service manager for a national firm, I can no longer do service work on the side. Therefore, I am offering various test instruments for sale.

GLENN FESSENDEN

1701 Burnham Road  
Fort Smith, Ark. 72901

### Schematic Needed

I need a schematic for a Precise scope, Model 300-C. If possible, a complete assembly manual would help greatly. The Model 300-C is a triggered scope.

DAILIS MELBARDE

644 Washington St.  
Hackettstown, N.J. 07840

I would like to secure a schematic for a Corsair II ship-to-shore radio manufactured by Hudson American Corp., New York City.

JACK COBELDICK

42 South Bridge St.  
Poughkeepsie, N.Y. 12601

I'm in need of a schematic for RCA Magic Eye radio Model 811K. RCA indicates the prints are no longer available, and Sam's do not go back that far. I will gladly pay the cost of having a copy sent to me.

ALAN NASELSKY

137 Wilshire Ct.  
Elyria, Ohio 44035

### Information Requested

We have in for service, a Collaro record changer (part of a large system) that needs repair. I recall seeing that make of changer as far back as 1953, but today I can learn nothing about who distributed it in the U.S. I believe that it is a British product. Anything that anyone can tell us will be appreciated.

ALEXANDER BELL

Xan Instrumatics  
P.O. Box 358  
Beaufort, N.C. 28516

### Sams Requested

We are looking for a set of Sams folders going back 5 to 10 years.

B. C. BOYKIN

Applied Electronics & Power  
4620 York Road  
Baltimore, Md. 21212

## SALES SLIP on NCR Paper\* with PORTABLE REGISTER

... provides instant copies of every transaction on-the-spot, without carbons.

Compact, lightweight, easy-to-operate ... just write up sale ... release Sales Slip, pull out and detach ... next form is in place, ready-to-use.

NCR paper adds efficiency to your business. Saves time and money by eliminating the need to adjust, replace or throw away messy, dirty carbon paper. This modern system is business-like yet not expensive. Sales Slips priced as low as \$9.95 ... in quantities of 250 printed with your heading.

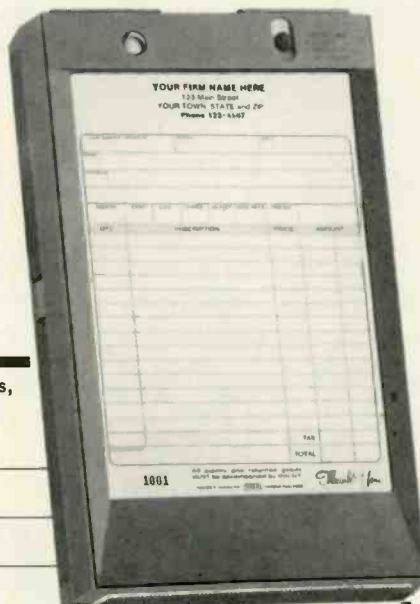

Please rush more information on Sales Slips, and catalog of other time-saving forms.

Name \_\_\_\_\_

Street \_\_\_\_\_

City, State & Zip \_\_\_\_\_

Your line of business \_\_\_\_\_



Mall to: New England Business Service, Inc.  
P.O. Box 500, Dept. 235, Townsend, Mass. 01469

\*NCR PAPER—A REGISTERED TRADEMARK of NATIONAL CASH REGISTER COMPANY

... for more details circle 122 on Reader Service Card



# Introducing the expensive dual-trace scope that doesn't cost a lot.

The B&K Precision Model 1470.

A solid-state 5-inch scope that combines dual-trace triggered sweep with vectorscope capability.

Our DC to 10 MHz bandwidth with 10 mV/cm sensitivity makes the 1470 exceptionally versatile. And its TV-H and TV-V positions are a special plus.

Dual-trace lets you observe input and output wave forms simultaneously in the same circuit. And 16-position triggered sweep, from 1 sec/cm to 0.2sec/cm, lets you sync them instantly.

On the other hand, you might prefer our Model 1465 single-trace, triggered-sweep scope at \$359.95. It has many of the same features and our patented CALI-BRAIN® automatic voltage readout system.

Everything about our scopes is expensive — except their price.

For complete technical data, call your local B&K distributor. Or write Dynascan Corporation.

Very good equipment  
at a very good price. **B&K**

Product of Dynascan Corporation  
1801 West Belle Plaine Avenue, Chicago, Illinois 60613

# \$499<sup>95</sup>

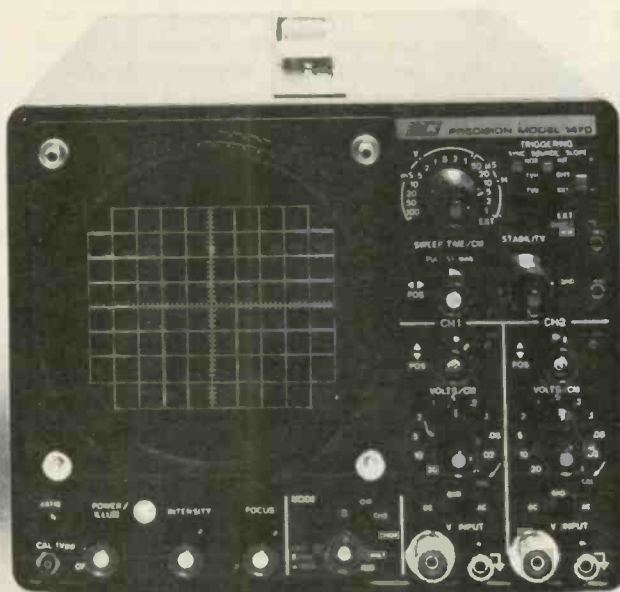

## NEW AND NOTEWORTHY

For additional information on products described in this section, circle the numbers on Reader Service Card. Requests will be handled promptly.

FOR MORE NEW PRODUCTS  
SEE PAGE 62

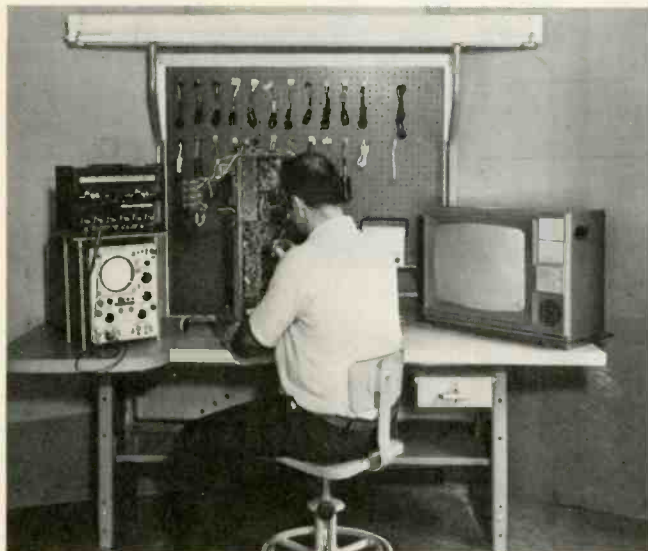

### REPAIR SERVICING BENCH 700

*Increases comfort  
and job efficiency*

The conveniences of this new color-TV repair servicing bench include almost shadowless lighting, master indicating 15 amp fused/switch package, clutter proof peg board storage of meters, tools and test cables—all within arms reach. Also included are eight grounded 110v convenient outlets and 2160 sq in. of work top area. Optional items to increase efficiency include swivel posture chair, locked drawers, locking 360° turntable, lower storage shelf that attaches to adjustable leg supports, and a solder-iron holster for locating the soldering iron away from the target top work area. Specifications are as follows: supplied knocked down—assemble and set-up in 35 sq. ft. Height is 82 in. Length approximately 84 in. Depth is approximately 30 in. The net weight is 175 lb with gross weight of 185 lb. Alden Systems Co., Inc.

### TEST CLIP 701

*Simplifies attaching probes for  
testing integrated circuits*

A test clip, called DIP CLIP, has been designed to facilitate the testing of 14 or 16 lead dual in-line integrated circuit packages and provide elevated test points to which test probes can be easily attached for hands-free testing. The test clip, Model 3916, works like a spring-loaded clothes pin—squeeze the top together to open contact jaws, then position clip over DIP leads and release. Spring tension provides positive electrical connection. Test points feature staggered design to provide clearance between probes attached to both rows.

Pomona Electronics Co., Inc.

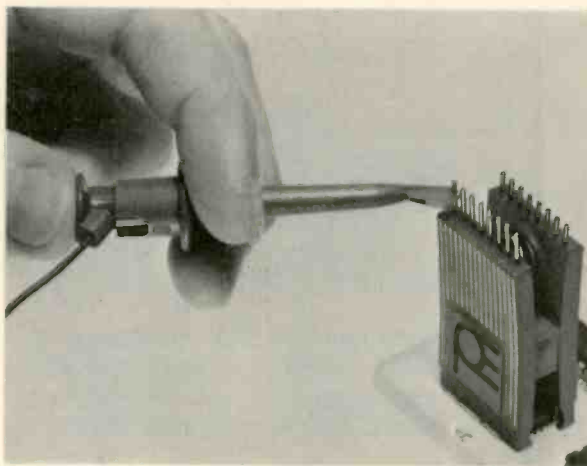

### CHEK-A-COLOR TEST JIG 702

*Designed for testing solid-state,  
hybrid or tube-type receivers*

Called Chek-A-Color, the test jig is designed to test solid-state, hybrid or tube-type receivers. The Model CK1500X is housed in a reinforced plastic cabinet 15-in. deep, 20-in. wide, 16-in. high and weighs 34 lb. The picture tube provides 14-in. of viewable screen area and is equipped with dual circuits for the testing of high and low focus-voltage receivers. Sixty-one adapters and extensions, which plug directly into the unit's front panel, give the instrument the

capability of testing more than 5,000 chassis sold under 42 brand names. The following accessories are included as standard equipment: A solid-state yoke programmer which provides a range of impedances with front-panel switching to closely match deflection systems in both solid-state and tube-type receivers; a 3.4-in. high voltage meter for monitoring anode voltage from 0 to 34kv; a 4-in. speaker to provide audio signals from the chassis being monitored; and a comprehensive setup manual referencing adapters and extensions for servicing different brands and models. Suggested list price: \$239.15. GTE Sylvania Inc.

# You can earn more money if you get a Government FCC License

...and here's our famous **CIE Warranty** that you will get your License if you study with us at home

NOT SATISFIED with your present income? The most practical thing you can do about it is add to your Electronics know-how, pass the FCC exam and get your Government License.

The demand for licensed men is enormous. Today there are over a million licensed broadcast installations and mobile transmitters on the air, and the number is growing constantly. And according to Federal Law, no one is permitted to operate or service such equipment without a Government FCC License or without being under the direct supervision of a licensed operator.

This has resulted in a gold mine of new business for licensed service technicians. A typical mobile radio service contract pays an average of about \$100 a month. It's possible for one trained technician to maintain eight to ten such mobile systems. Some men cover as many as fifteen systems, each with perhaps a dozen units.

## Opportunities in Plants

And there are other exciting opportunities in the aerospace industry, electronics manufacturing, telephone companies, and plants operated by electronic automation. Inside includ-



**Matt Stuczynski, Senior Transmitter Operator, Radio Station WBOE:** "I give CIE credit for my First Class Commercial FCC License. Even though I had only six weeks of high school algebra, CIE's lessons made Electronics easy. I now have a good job in studio operation, transmitting, proof of performance, equipment servicing... and am on my way up."



**Thomas E. Miller, Jr., Engineer, Indiana Bell Telephone Company:** "I completed my CIE course and passed my FCC exam while in the Navy. On my discharge, I was swamped with job offers from all over the country. My only problem was to pick the best one, and I did—engineer with Indiana Bell Telephone. CIE made the difference between just a job and a management position."

Cleveland Institute of Electronics

## WARRANTY

### OF SUCCESS IN OBTAINING A GOVERNMENT FCC LICENSE

A Cleveland Institute of Electronics FCC License course will quickly prepare you for a Government FCC License. If you don't pass the FCC exam after completing your course, CIE will refund all your tuition. You get an FCC License...or your money back!

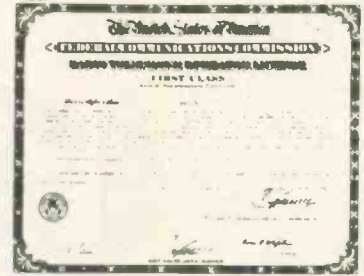

trial plants like these, it's the licensed technician who is always considered first for promotion and in-plant training programs. The reason is simple. Passing the Federal Government's FCC exam and getting your License is widely accepted proof that you know the fundamentals of Electronics.

So why doesn't everybody who "tinkers" with electronic components get an FCC License and start cleaning up?

The answer: it's not that simple. The Government's licensing exam is tough. In fact, an average of two out of every three men who take the FCC exam fail.

There is one way, however, of being pretty certain that you will pass the FCC exam. That's to take one of the FCC home study courses offered by the Cleveland Institute of Electronics.

CIE courses are so effective that better than 9 out of every 10 CIE gradu-

ates who take the exam pass it. That's why we can afford to back our courses with the iron-clad Warranty shown above: you get your FCC License or your money back.

### Mail Coupon for Two Free Books

Want to know more? Send the coupon below for free copies of our school catalog, "How To Succeed In Electronics," describing opportunities in Electronics, together with our special booklet, "How To Get A Commercial FCC License." If coupon has been removed, just send your name and address to us.

### ENROLL UNDER NEW G.I. BILL

All CIE courses are available under the new G.I. Bill. If you served on active duty since January 31, 1955, or are in service now, check box in coupon for G.I. Bill information.

**CIE** Cleveland Institute of Electronics  
1776 East 17th Street, Cleveland, Ohio 44114

Cleveland Institute of Electronics

1776 E. 17th St., Cleveland, Ohio 44114

Please send me without cost or obligation:

1. Your 40-page book "How To Succeed In Electronics" describing the job opportunities in Electronics today and how your courses can prepare me for them.

2. Your book "How To Get A Commercial FCC License."

Name \_\_\_\_\_ Age \_\_\_\_\_  
(Please Print)

Address \_\_\_\_\_

City \_\_\_\_\_

State \_\_\_\_\_ Zip \_\_\_\_\_

Check here for G.I. Bill information

Accredited Member National Home Study Council  
A Leader in Electronics Training... Since 1934

ET-63

... for more details circle 106 on Reader Service Card



# Skitch's Restaurant Goes CCTV

Famed composer-conductor-pianist, Lyle Russel Cedric "Skitch" Henderson has orchestrated his restaurant enterprises with the same dedication, discipline and creativity that he has brought to his many and varied musical activities

■ Today, at 53 years of age, Skitch Henderson leads a highly active, diversified and rewarding "double life." Now conductor of the Tulsa Symphony Orchestra, and guest conductor with the Montreal Symphony, the maestro is "on the go" all year, heeding the call of his favorite muse at festivals and concert halls, then hustling back to New York City to supervise his substantial restaurant holdings.

Noting that security problems are increasingly plaguing New York City restaurants, Mr. Henderson recently installed a Panasonic closed-circuit TV/video-playback system in his popular Daly's Dandelion

bistro. With his Panasonic mini-CCTV system (containing three cameras, video tape recorder/playback and monitor), Skitch can sit in his upstairs office and "watch the store," monitoring employee operations and customer traffic.

Although the three video cameras have been placed rather inconspicuously around the restaurant, they can be seen by everyone—employees as well as diners. And while there have been very few gripes from Daly's patrons, Skitch had to admit that a couple of customers have been bothered.

"As a matter of fact, early one evening, while I was working up-



Skitch Henderson observing video-taped restaurant activity on the TV monitor.

stairs in my office, and was looking at a crowded dinner scene on the monitor, one irate diner stormed in and vehemently objected to his being on camera," recalled Skitch. "However, I'll put up with an occasional customer beef—and, so far, it's the only one we've ever had—because of the CCTV systems' many benefits; we've really tightened up Daly's security," Skitch added.

Mr. Henderson makes a practice of running his tape recorder in its time-lapse mode all night. The time-lapse video recorder can accommodate up to 48 hours on a single tape that can be played back in only 40 minutes. Since what's on the tape can lead to a burglar or hold-up man's identification and arrest, it is a strong crime deterrent. Prior to the video equipment's installation, Daly's had been held up three times. Since the system has been in operation, the restaurant appears to have "hold-up protection."

Although would-be crooks are understandably camera shy, it is apparent that Daly's 56 employees do not object to being "televised," and it certainly doesn't appear to have hurt employee efficiency. As for Skitch's customers, since they're still jamming the place from luncheon to well into the evening, they obviously see nothing wrong in a noted TV personality using TV as a tool to turn an extremely successful restaurant into an even more efficient operation.

So pleased is Skitch with Daly's CCTV security set up that he is giving serious consideration to installing similar systems in his two other

*continued on page 68*



In the upper right we note a CCTV camera observing activity just outside Skitch Henderson's Daly's Dandelion bistro.



Magnavox's Model 1500 DTI receiver with speakers. This system is designed to produce 150w of IHF music power.

## Magnavox's Model 1500 DTI Receiver

by Phillip Dahlen

Uses digital tuning  
for more convenient station selection

■ If there is anything annoying, it is trying to tune in a specific distant station when the numbers on the tuning dial are 100kHz or more apart—so far apart that one must listen for the eventual call-letter announcement of several stations before the desired one can be identified. Such problems do not exist with Magnavox's Model 1500 DTI Receiver, designed to tune the AM Broadcast Band to the nearest 1kHz and the FM Broadcast Band to the nearest 100kHz. This would certainly seem to be an adequate degree of precision since the AM stations in this country are separated by 10kHz, while the FM stations are separated by 200kHz.

But just how accurately can one tune this receiver? We decided to find out, and to assist us we used our copy of a book obtained from Magnavox with the receiver—NORTH AMERICAN AM-FM

RADIO STATION GUIDE published by Howard W. Sams & Co. This book provides a listing of all AM and FM stations according to both geographical location and assigned frequency.

Starting out at the low-frequency end of the AM band, the first station that we received was a local Duluth station—WEBC at 560kHz. The relative strength of this signal prevented us from hearing any lower-frequency stations or immediately adjacent higher-frequency stations.

Announced call letters confirmed that the second station received was WOW of Omaha, Nebr., precisely at the 590kHz indicated by the receiver. Another frequency gap then resulted from the relatively strong signal of Duluth's KDAL at 610 kHz.

With still additional tuning we received WSM of Nashville, Tenn.

at 650kHz; WMAQ of Chicago, Ill. at 670kHz; and KFEQ of St. Joseph, Mo. at 680kHz—all confirmed by station announcements.

Skipping to some of the higher frequencies, we received announcements from WHAM of Rochester, N.Y. at 1180kHz; WOWO of Ft. Wayne, Ind. at 1190 kHz and WOAI of San Antonio, Texas at 1200kHz. With each station coming in precisely at the frequency specified, we saw no need to spend more time DX'ing the AM Broadcast Band with the receiver's built-in antenna.

The FM antenna terminals were coupled to the roof antenna, and we were able to tune in relatively distant FM stations—the call letters again indicating that we were precisely on frequency.

Some readers may instinctively object to the claim that the digital circuitry indicates AM station frequencies to the nearest 1kHz. After all, the effective carrier frequency is modified by the audio signal transmitted. Thus the station actually radiates over a range of frequencies. We are not, however, faced with such a theoretical problem. The digital circuitry used does not measure the frequency of the signal received. It instead indicates the frequency at which the receiver is tuned. This is done by measuring the frequency of the receiver's RF converter oscillator, and subtracting from this digital measurement a number that is slightly offset of the IF frequencies—454.5kHz for AM and 10.65 MHz for FM.

Although this receiver does contain many interesting circuits, this article concentrates only on the function of the digital tuning indicator circuitry, which contains 21 integrated circuits and 31 discrete transistors. The AM and FM oscillators within the tuner circuitry (Fig. 2) generate the initial signal that is processed by this digital tuning indicator circuitry (Fig. 1), a block diagram of this signal processing appearing in Fig. 3.

The FM oscillator signal (obtained from coil L107—Fig. 2) is fed through a coaxial cable and capacitor to the base of transistor Q101 (Fig. 1). This transistor, plus transistors Q102 and Q103, func-

tion as a high-frequency amplifier (also shown in upper left portion of Fig. 3) to provide enough signal to drive the first divider integrated circuit (IC-1). This amplifier is broadbanded to accommodate the range of frequencies produced by the FM oscillator (98.2MHz to 119.2MHz), and two diodes (D101 and D102) are used to "square up" the resulting waveform prior to its being fed to the frequency divider.

The first frequency divider (IC-1) divides the oscillator frequency by two, the second frequency divider (IC-2) performing the same function. The resulting signal then receives additional amplification by transistor Q104 prior to being fed to IC-3, which divides the signal frequency by five. Integrated circuit IC-4 also divides the signal frequency by five. Thus if a 100 MHz oscillator signal is present at the collector of transistor Q103, it will result in a 1MHz signal being applied to the base of transistor Q106.

The AM oscillator signal (obtained from the emitter of transistor Q202—Fig. 2) is fed through a coaxial cable, coil and capacitors to the base of transistor Q105, where it is amplified for further processing. The transistor must be able to accommodate the range of frequencies produced by the AM oscillator (990kHz to 2075kHz). This range of signals plus the FM oscillator signal, which has been reduced to a frequency range of 982kHz to 1192kHz, must also be handled by the second portion of the low-frequency amplifier (transistor Q106). Only one signal or the other passes through the amplifier—depending upon the position of the receiver's band switch. Through the remaining circuitry the AM and FM oscillator signals are handled in the same manner.

Frequency counters function by counting the number of cycles that occur during a predetermined interval of time. If functioning for a full second, this circuitry would count a million cycles when a 1MHz signal is applied. However, for this receiver the counting circuitry was designed for counting during 10ms (0.01 sec) intervals, thus per-

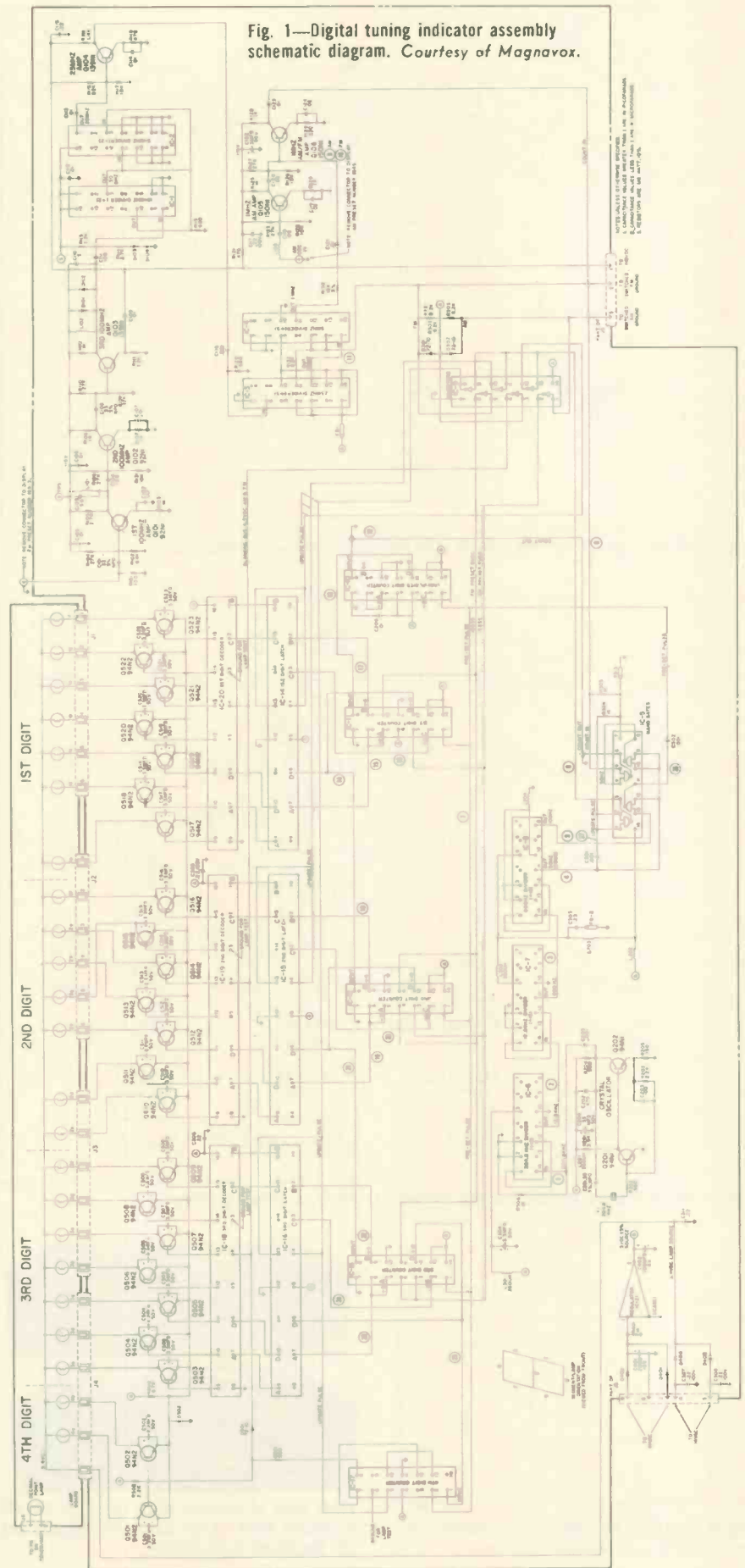

Fig. 1—Digital tuning indicator assembly schematic diagram. Courtesy of Magnavox.

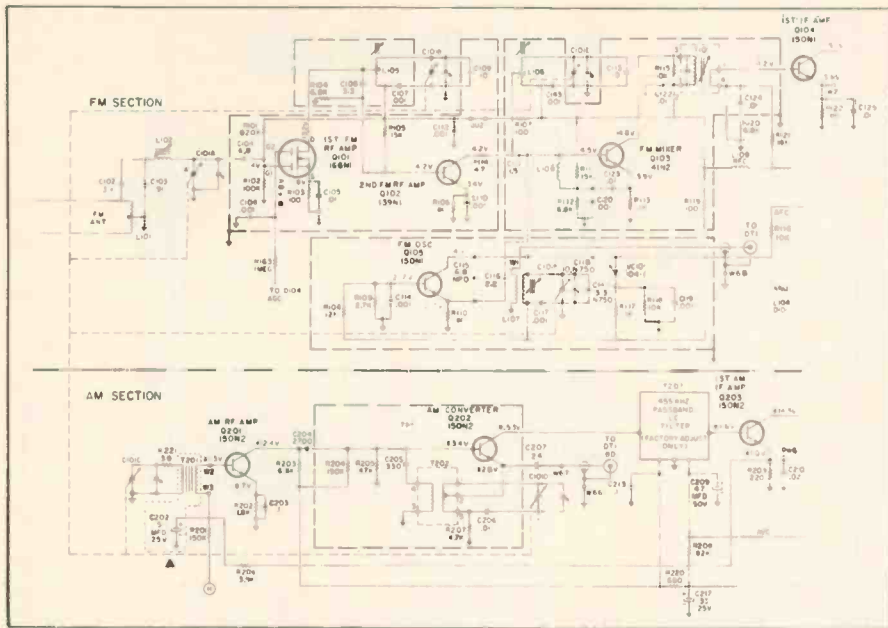

Fig. 2—Front stages of the AM and FM tuner section. Courtesy of Magnavox.

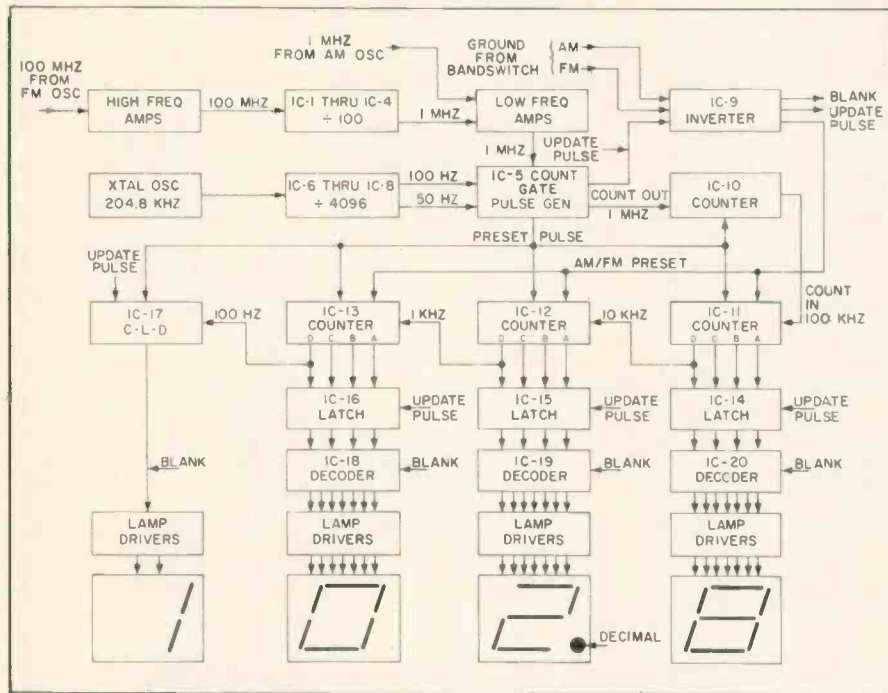

Fig. 3—Block diagram of digital tuning indicator assembly. Courtesy of Magnavox.

Decimal	Binary Coded Decimal				
	Outputs	D	C	B	A
0		0	0	0	0
1		0	0	0	1
2		0	0	1	0
3		0	0	1	1
4		0	1	0	0
5		0	1	0	1
6		0	1	1	0
7		0	1	1	1
8		1	0	0	0
9		1	0	0	1

Fig. 4—Decimal to binary coded decimal conversion table. Courtesy of Magnavox.



Front view of receiver when tuned to the AM Broadcast Band (above) and when tuned to the FM Broadcast Band (below).

mitting this circuitry to count to 10,000 during each time interval when a 1MHz signal is applied.

Since the count gate signal that turns ON or OFF the frequency counter circuitry is not synchronized with the applied signal to be counted, different segments of the applied signal will appear while the counting circuitry is functioning, and the circuitry may therefore indicate an uncertainty—sometimes indicating the presence of 10,000 cycles and sometimes indicating the presence of 10,001 cycles during a 10ms time interval when a 1MHz signal is applied. However, by dividing this count by 10 before obtaining a digital reading, this factor is in effect eliminated. We then get a reading of 1000 with the application of a 1MHz signal. The band-switch can be used to see that this figure is presented in the proper manner (100.0MHz or 1000kHz) depending upon whether the FM oscillator signal or the AM oscillator signal is used.

The 10ms signal for determining the time interval is derived from the 204.8kHz crystal oscillator circuit (crystal X1 and transistors Q201 and Q202, Fig. 1). Integrated circuit IC-6 divides this frequency by 16 to obtain a 12.8kHz signal, which is then fed to IC-7 and divided by 16 to obtain an 800Hz signal, which is then fed to IC-8, divided by 8 to obtain a 100Hz signal and divided again by two to obtain a 50Hz signal.

Both the 100Hz and 50Hz square-wave signals are fed to the Nand Gate integrated circuit (IC-5), and during the 10ms that the 50Hz square wave is negative, this gate permits the oscillator signal from the low-frequency amplifier to pass through to the first decade counter circuit (IC-10). It (IC-10) merely divides the frequency of the applied signal by 10 (to eliminate the element of uncertainty described previously in the article) and then passes the resulting signal on to the first-digit decade counter (IC-11). This integrated circuit (IC-11), in turn, divides the applied signal frequency by 10 and passes the resulting signal on to the second-digit decade counter (IC-



12), which divides the frequency by 10 and applies the resulting signal to the third-digit decade counter (IC-13), it in turn dividing the signal frequency by 10 and passing it on to the fourth-digit counter (IC-17).

At the end of the 50Hz square-wave's negative half cycle (10ms), the gate of IC-5 stops conducting the signal from the low-frequency amplifier to the decade counters (IC-10, 11, 12 and 13) and counting stops. The binary output of each decade counter (a table of binary numbers is included in Fig. 4) then corresponds to the total number of cycles counted—this binary count having increased as the cycles were counted.

As the 50Hz square wave switches from its negative to its positive half cycle, the resulting positive pulse passes through capacitor C301, producing a  $1\mu\text{s}$  "update" pulse that is amplified in integrated circuit IC-5 and then fed to three separate inverter amplifiers in integrated circuit IC-9 before being applied to the three digital latch (memory) integrated circuits (IC-14, 15 and 16) and the fourth-digit counter circuit (IC-17). These memory circuits, and the memory portion of the fourth-digit counting circuit, store the previous binary count for continual application to the decoding and output stages (thus permitting a continual visual display—eliminating the flashing of numbers that would otherwise occur if the visual output circuitry were to display the frequency as it was counted). Upon receiving the  $1\mu\text{s}$  update pulse, these memory circuits are updated with the current binary-coded count. This occurs so rapidly that no flashing of numbers is apparent.

Once the new frequency count has been transferred to the memory circuitry for continued display, the counting circuitry can be reset during the remaining portion of the 10ms positive 50Hz half cycle. This function is activated by a pre-set signal that is produced 5ms after the positive half cycle of the 50Hz square wave began. The pre-set signal is obtained from the Nand Gates integrated circuit (IC-5),

which is *designed to conduct* the 5ms negative half cycle of 100Hz signal—but only during the presence of the positive half cycle of the 50Hz signal. (The 50Hz signal and the 100Hz signal maintain a fixed phase relationship since they are both produced by the same frequency divider circuitry, IC-8.) The resulting negative pulse passes through capacitor C302 and is applied to all five decade counting integrated circuits (IC-10, 11, 12, 13 and 17).

Earlier in the article it was indicated that the frequency counter circuitry actually counts the AM or FM oscillator frequency; and to determine the frequency of the station received, 454.5kHz must be subtracted from the AM oscillator frequency and 10.65MHz must be

subtracted from the FM oscillator frequency. By subtracting the number 454.5 from 10,000.0, we obtain 9545.5; and by subtracting 10.65 from 1000.00 we obtain 989.35. The counting circuitry can begin at these numbers and then count up to the oscillator frequency—obtaining the same results as if this circuitry started at zero, counted up to the oscillator frequency, and then had the number approximating the IF frequency subtracted from the total count. (Example: Suppose the AM oscillator frequency is 1660.7kHz. Then,  $1660.7\text{kHz} + 9545.5\text{kHz} = 11206.2\text{kHz}$ . We then see the number 1206kHz appearing digitally on the front panel of the receiver—there being no digital readout circuitry to indicate the numerals



View of receiver with front panel removed.

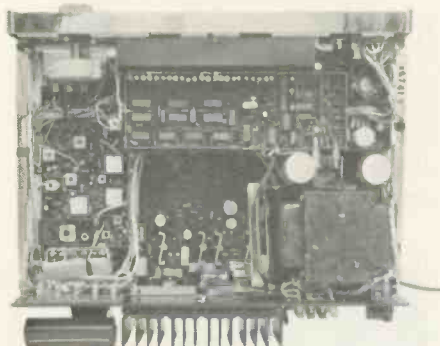

Top view of receiver with digital tuning indicator circuitry in place.

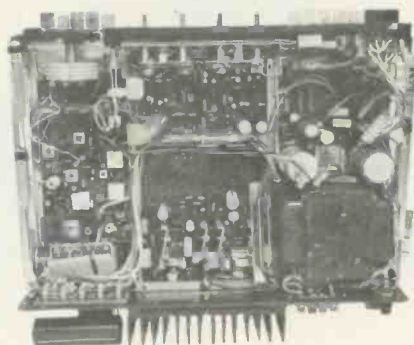

Top view of receiver with digital tuning indicator circuitry removed.



Rear view of tuning indicator lamp assembly.

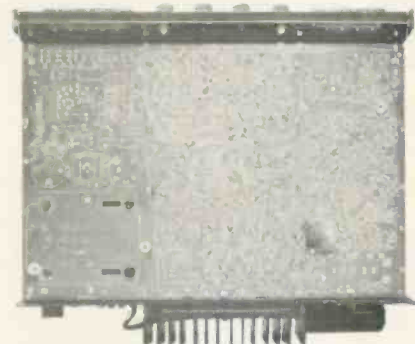

Bottom view of receiver with cover removed.



Rear view of receiver.

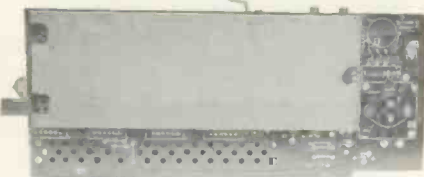

Bottom view of digital tuning indicator circuitry.



Top view of digital tuning indicator circuitry with lamp assembly removed.

omitted from the total.)

The fourth-digit integrated circuit (IC-17) need not display any number greater than "1," since no frequency can be received requiring a larger numeral (the maximum AM frequency received is 1620kHz and the maximum FM frequency received is 108.5MHz). Therefore, IC-17 is designed to count only between "0" and "1"—no display occurring for the "0," there being a display only for the "1." For this reason, a numeral "1" is substituted for the "9" when pre-setting the counter. Thus the number 15455 is added to the counting circuitry prior to counting the AM oscillator frequency, and the number 18935 is added to the counting circuitry prior to counting the FM oscillator frequency. Since the first and last digits of the two numbers are the same, the AM/FM bandswitch need only switch between the numbers 545 and 893.

Counting circuit IC-10 is wired to begin counting at "5" when the pre-set pulse is applied, while counting circuit IC-17 is wired to begin

counting at "1" with the application of that pulse. When the bandswitch is in the AM position, the resulting grounded lead causes inverter IC-9 to provide a 5v dc pre-set voltage for starting IC-11 at "5," IC-12 at "4" and IC-13 at "5," upon the application of the pre-set pulse. And when the bandswitch is in the FM position, the resulting ground lead causes inverter IC-9 to provide a 5v dc pre-set voltage for starting IC-11 at "3," IC-12 at "9" and IC-13 at "8," upon the application of the pre-set pulse.

Grounding either the AM or FM bandswitch lead also results in nearly grounding Pin 3 of inverter IC-9. (Diodes D301 and 302 are used in this circuit so that the grounding of either the AM or FM bandswitch lead will not result in the other lead also being grounded.) During the time that such a nearly grounded condition does occur (during AM or FM reception), 4.5v dc is applied to the digital decoder. With the presence of such a voltage, the decoders will produce a digital display, while in the absence of such a voltage (when the receiver is in its PHONO or AUXILIARY mode), the decoder does not produce a digital display and the panel digital display area appears black.

The first digital, second digital and third digital decoders (IC20, 19 and 18) contain memory converter circuitry for translating the binary coded numbers into coded signals for lighting the appropriate segments of the display area to form the corresponding numerals. These numeral-segment voltages are amplified by one transistor for each incandescent lamp driver.

Integrated circuit IC-17 has but one output, the "1." When a "1" is present in the fourth-digit position, IC-17 turns ON transistors Q501 and Q502, which in turn drive the two corresponding lamps to produce a numeral "1." When at lower counts there is no "1" in the fourth-digit position, these driver transistors remain OFF and the entire digital display for that position remains dark.

During AM or FM reception, the decoder circuitry appears to continuously drive the lamp-driver transistors and the lamps seem to continually indicate the frequency received—the decoder circuitry being OFF only 1μs once every 20ms, at which time it is again switched to either the same binary coded number or a new number. This is such a short time OFF that there is no

*continued on page 68*

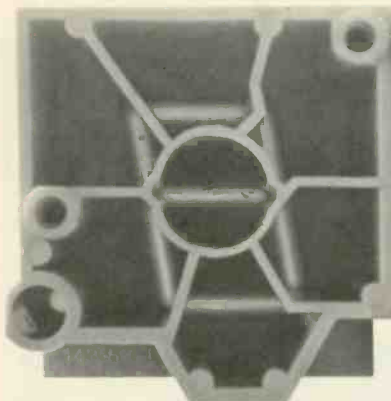
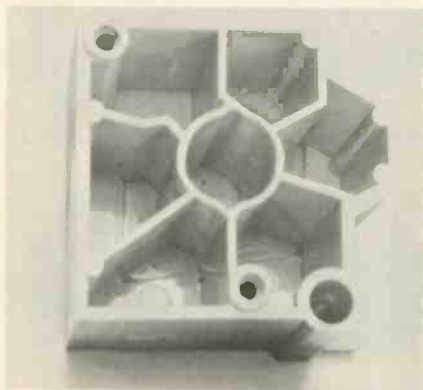

Two views of the plastic housing through which the lamps glow to produce numerals "0" through "9" and the decimal point.

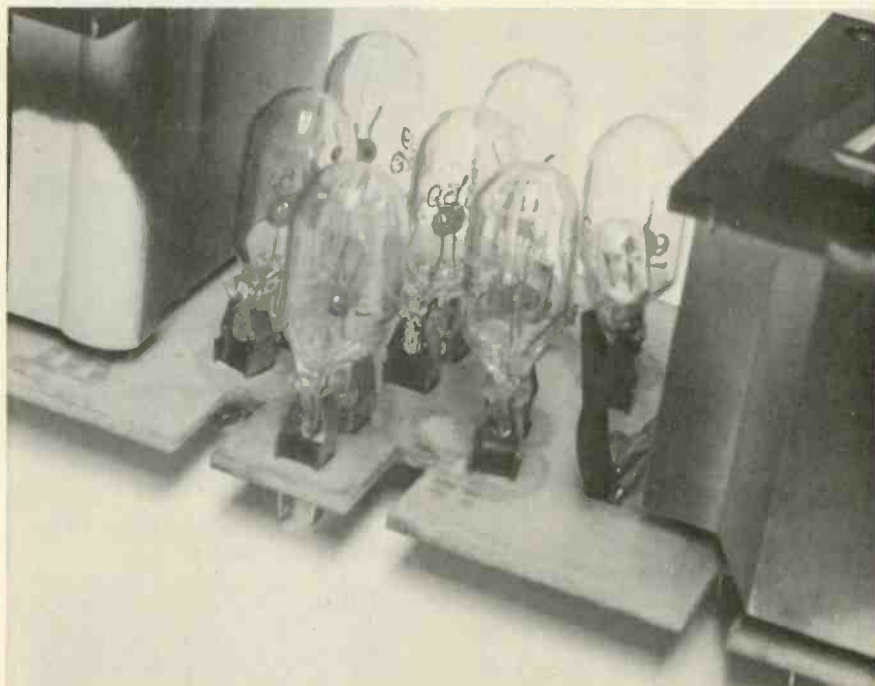

Seven lamps used in tuning indicator lamp assembly to form various segments of a numeral display, plus an additional lamp for the decimal point.

# Weller.

## The fastest gun in town.



**Fast heat-up.** The Weller® Automatic Glue Gun heats up nearly three times faster than the other gun. And an indicator/work light tells when it's ready. Your customers get hot glue instead of getting hot under the collar.

**Fast gluing.** Our Gun is slim, well-balanced and good-looking. There's no awkward trigger to squeeze because glue feeds automatically. There's no mess because our tip is dripless. And in recent tests, we found that Weller glue sticks bond better than any other glue sticks around.

**Fast selling.** Dealers everywhere are discovering that our glue gun really moves. It's easy to promote because our 50/50 Co-op program supplies you with everything you need. And with Weller, you sell a kit, not just a gun. A complete kit (gun, glue, caulk, instruction book, stand and carrying case) that won an award for excellence in package design.

### Quick! Join the Group.

The Cooper Group is Crescent, Lufkin and Weller. Top-name, top-profit products that are backed by strong consumer advertising and publicity campaigns, our Certified Dealer Program and modern merchandising techniques.

If you're looking for the fastest profits in town, contact your distributor, or The Cooper Group, P.O. Box 728, Apex, No. Carolina 27502.

The  
30 second  
Glue  
Weller  
Automatic  
Glue Gun Kit



**The Cooper Group**  
CRESCENT · LUFKIN · WELLER



## Now Ford gives you a choice of swinging or sliding doors.

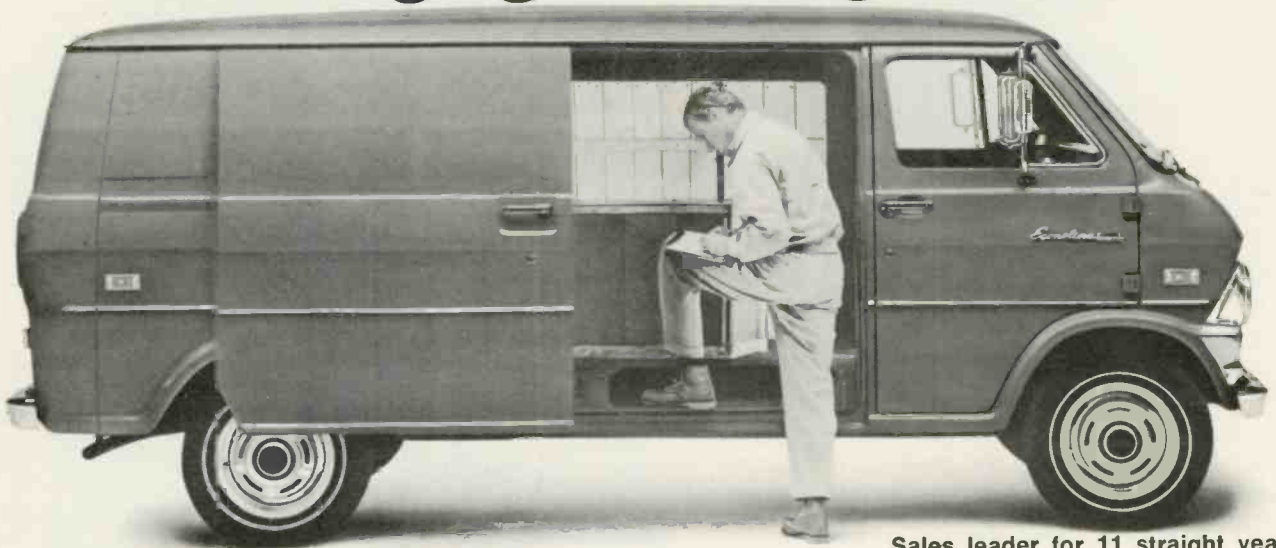

Only Ford vans have so many better ideas that make vans easier to drive, to service, to use.

New Econoline Vans now offer you a choice of conventional swinging doors or a new gliding side door for cargo handling in cramped alleys and beside loading docks. Three separate tracks, at top, bottom and center, give bridge-like support for solid, smooth, one-hand operation, tight seal.



**Shorter outside, easier to park.** Compared to other makes with similar loadspace, Econoline Vans have significantly less overall length. This means easier parking and better maneuverability in city-delivery operations—time saved on every trip.

**Strong, Twin-I-Beam Independent Front Suspension—**Ford's exclusive design smooths the going for both load and driver. Two forged steel I-beam axles provide strength and durability; wide wheel stance means stability in cross winds.

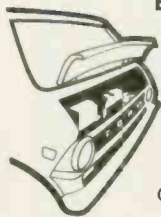

**Wider at top for built-ins.** Body sides are more vertical, wider apart at top than other vans. Built-in units fit better and leave more aisle.



**Biggest payload.** E-300 Series hauls

... for more details circle 114 on Reader Service Card

Sales leader for 11 straight years.

over two tons of payload; 4,285-lbs. to be exact—biggest of any van.

**Engine clear forward.** In Ford's clear-deck design, engine is forward—all the way out of cargo area. Over 8½ ft. clear floor space behind driver's seat... over 10 ft. in the SuperVan. Driver can easily step from seat into rear cargo area.

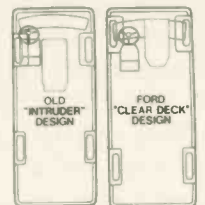

# FORD ECONOLINE VANS



# Another Step Forward

by Phillip Dahlen

New scope shows TV waveforms never obtained with conventional triggered-sweep scopes

■ Each year the electronic circuitry that we must service becomes increasingly sophisticated and precise. In the field of audio we are now servicing receivers that have specifications more stringent than the best test instruments that we were recently using. And with higher quality color-TV transmissions, plus more precise TV-set circuitry, here again we require more sophisticated test instruments than we have been using.

Recently we received Telequipment's Model D67 scope (Fig. 1), a new instrument that clearly displays TV signal waveforms that we have never been able to observe in the ELECTRONIC TECHNICIAN/DEALER lab before—many of these waveforms being displayed with the aid of the instrument's delayed-sweep circuitry.

When using this instrument as a conventional single-trace, triggered-sweep scope, we connected a low-capacity probe to the CRT blue-grid terminal of the TV set under test and observed the waveforms produced as the scope operated at

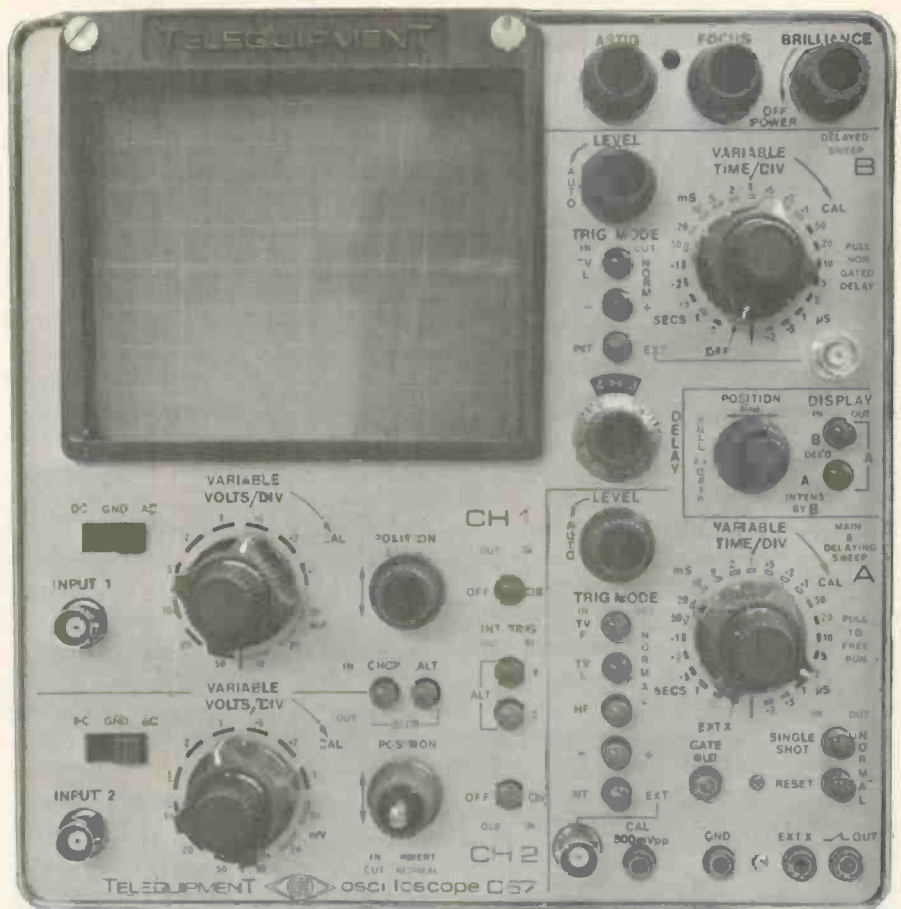

Fig. 1—Telequipment's Model D67 scope clearly displays TV signal waveforms that we have never been able to observe in the ELECTRONIC TECHNICIAN/DEALER lab before.

a multiple of the TV set's vertical-sweep rate—two virtually complete, conventional vertical fields being apparent (Fig. 2). Then switching to a multiple of the TV set's horizontal sweep rate, we observed three TV horizontal-sweep traces (Fig. 3)—or at least the conventional patterns that we assume to be these three traces. Actually, each of these three is an average of several hundred *different* TV horizontal-sweep traces—the blanking pulses appearing uniform, while the video infor-

mation appears as but a smear.

While still using this instrument as but a high-quality, conventional, triggered-sweep scope—still connected to the same video terminals in the TV set—the scope sweep rate was adjusted so that we could see an expanded view of the original TV vertical-sweep waveform (Fig. 4)—the fine sawtoothed pattern observed at the right being a few of the many hundred TV horizontal traces present in a single TV vertical trace. By expanding this wave-

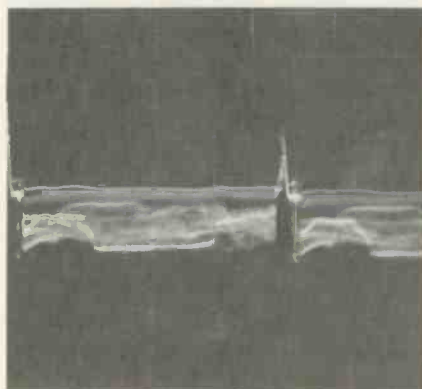

Fig. 2—Two virtually complete TV vertical-sweep traces produced with merely the triggered-sweep scope circuitry.

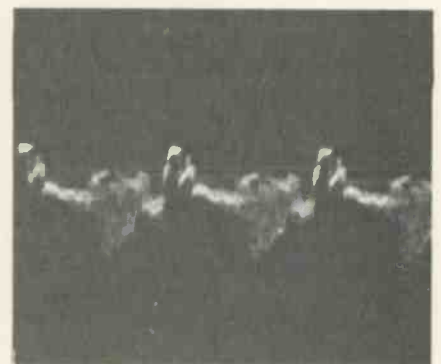

Fig. 3—Using merely the triggered-sweep scope circuitry to obtain what might normally be considered three TV horizontal-sweep traces.

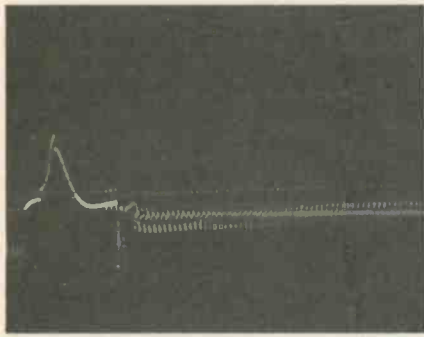

Fig. 4—Using merely the triggered-sweep scope circuitry to obtain a more expanded view of the TV vertical-sweep trace.

form even further, we began to be able to observe two test signals that are transmitted with programs from the three major TV networks (Fig. 5), but which are not present on locally originated programs. Still additional scope sweep expansion

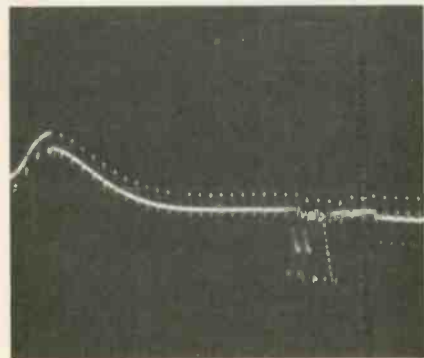

Fig. 5—TV network test signals begin to become apparent with a further expansion of the TV vertical-sweep trace.

showed these two test signals better (Fig. 6)—although they could not be well defined with but conventional triggered-sweep scope circuitry.

For all scope traces observed thus far, the delayed sweep circuitry has been turned OFF. However, the use of this additional circuitry permits the observation of

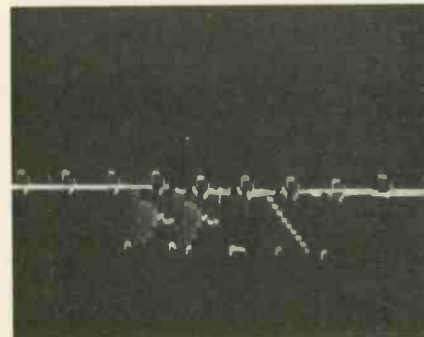

Fig. 6—Even with greater sweep expansion, these test signals cannot be clearly defined using but conventional trigger-sweep scope circuitry.

waveforms that cannot be produced by conventional triggered-sweep scopes. The "DELAYED SWEEP B" control determines how large a portion of the initial scope trace will be expanded the full width of the CRT for more detailed viewing. If the sweep B time base selected is half that of the sweep A time base (that used for determining the sweep rates observed thus far), then sweep B will show half the originally observed waveform. By properly adjusting the brilliance of the scope trace, and pressing the "A INTENS BY B" button, we see that a portion of the waveform observed appears brighter than the balance of the waveform (Fig. 7). Adjusting the delay control moves this brighter segment to the left or right, so that it includes different portions of the observed TV vertical-sweep waveform.

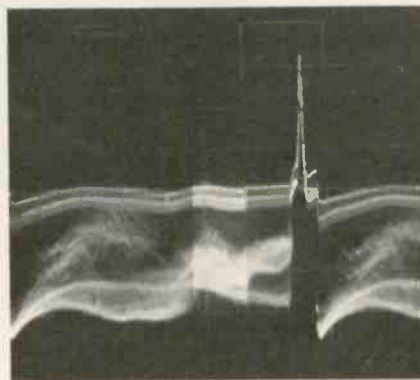

Fig. 7—The brighter portion of this waveform represents the portion of the TV vertical-sweep signal that would be expanded to cover the entire scope screen if we pressed the instrument's "B DEL'D" button.

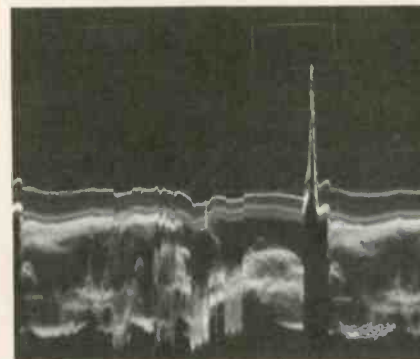

Fig. 8—Reducing the sweep B time base reduces the portion of the TV vertical-sweep signal selected for additional expansion.

A further reduction in the sweep B time base narrows the portion of the waveform seen brighter. In Fig. 8 it appears as but a single bright vertical line at approximately the cen-

ter of the scope trace. By pressing the "B DEL'D" button, this bright vertical "line" is expanded across the entire CRT, and we see a single TV horizontal-sweep signal (Fig. 9)—appearing quite unlike the TV horizontal-sweep signals previously observed in Fig. 3. Single TV hori-

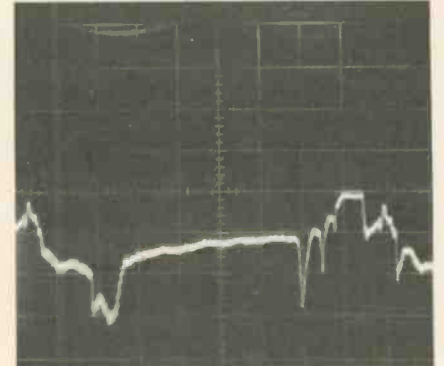

Fig. 9—The single TV horizontal-sweep signal expanded from the TV vertical-sweep signal shown in the previous photograph.

zontal-sweep signals may appear a little more familiar when seen in a group (Fig. 10). But whatever the number viewed, they may at first glance seem strange—the video information appearing less complex than what we expected after having seen previous scope traces made by

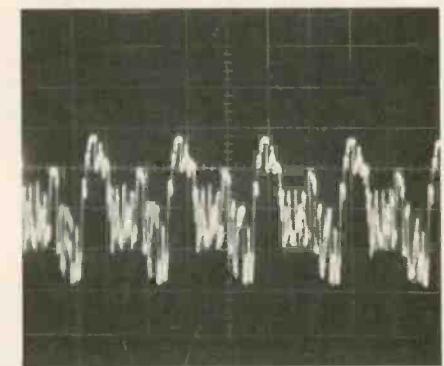

Fig. 10—A group of five single TV horizontal-sweep signals obtained with the use of the delayed-sweep circuitry.

overlapping many TV horizontal-sweep signals—bright spots in the TV picture appearing as but a few discrete negative peaks. Upon using the maximum sweep rates available, plus the "times-five" expanded scale and extra vertical gain, it is even possible to note the 3.58MHz color burst signal following one of the horizontal blanking pulses (Fig. 11). This signal was severely attenuated by the TV set prior to the output stage observed.

Earlier in the article we made

reference to the testing signals carried by the national TV networks and observed by better conventional triggered-sweep scopes. In the corresponding photograph (Fig. 6), we could see some sort of double image of these signals. This apparent signal doubling was due to

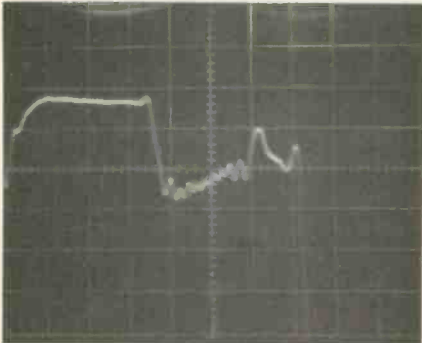

Fig. 11—The 3.58MHz color-burst signal following one of the horizontal blanking pulses can be clearly observed by increasing the scope's horizontal sweep with the "X5 GAIN" switch and using delayed-sweep circuitry.

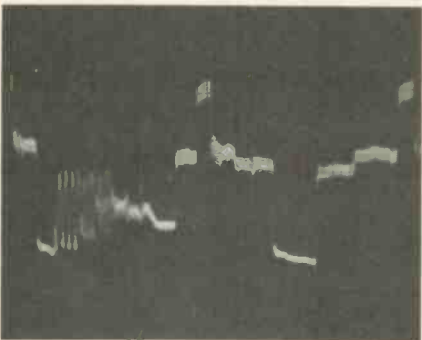

Fig. 12—In one of the alternate frames of the TV picture, the multiburst signal is not followed by the modulated staircase signal.

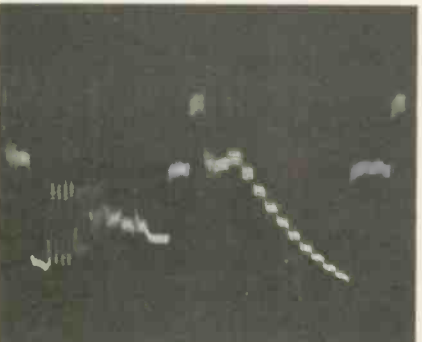

Fig. 13—In the other of the alternate frames of the TV picture, the multiburst signal is followed by the modulated staircase signal.

the fact that these signals are transmitted differently in alternate frames of the TV picture. In one frame we observe with this scope merely the multiburst test signal (Fig. 12), while in the next frame the multiburst test signal is followed by a

modulated staircase signal (Fig. 13), the following TV-picture frame being like the first.

It is possible to use this scope to select at will either of these test signal combinations (Fig. 12 or 13) by first depressing the "A INTENS BY B" button, and then using the scope as a standard triggered-sweep scope to show two TV-set vertical scans (Fig. 7)—delayed sweep rate B being adjusted for the number of TV horizontal-sweep signals wanted (Fig. 8). The DELAY control can then be adjusted to select the particular TV horizontal-sweep signals wanted. [As may have been noted in one of the earlier photographs (such as Fig. 4), the test signals wanted occur shortly after the vertical blanking pulse—the pair of test signals occurring after one blanking pulse and the single test signal occurring after the other blanking pulse. These test signals can also be seen on a TV set as a series of dashes near the top of the picture.] Upon pressing the "B DEL'D" button, only those selected TV horizontal-sweep traces appear across the screen. But even after pressing this button, additional adjustments of the delayed sweep rate and DELAY controls can be made for changing the number of TV horizontal-sweep traces observed and switching to adjacent TV horizontal-sweep traces.

Two trigger sync controls are also included on the scope. In this instance, the first is used to synchronize the scope to the pair of TV vertical-sweep traces selected, and the second to synchronize the scope to the TV horizontal-sweep traces obtained from the vertical traces.

By using these controls, it is possible to obtain a stable trace of the 3.58MHz modulated staircase signal (Fig. 14), which the TV stations use for testing gray scale. You can use this signal when servicing to make certain that the TV set's video amplifier is not saturating the video signal, eliminating some of the dark grays or light grays from the picture. The more linear this staircase, the more uniform the final gray scale of the TV set under test. This can be a very helpful test

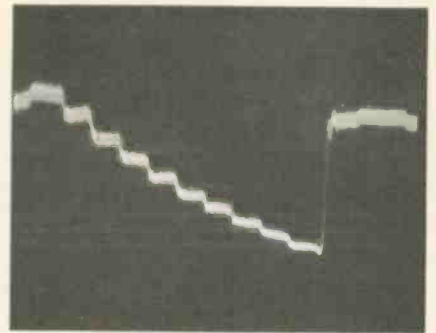

Fig. 14—By using the scope's delayed-sweep circuitry, we are able to obtain a stable trace of the 3.58MHz modulated staircase signal—a helpful service aid for checking gray scale.

signal, more precisely calibrated than any similar signal produced by any generator locally available for our use.

The multiburst signal (more precisely called Vertical Interval Test Signals—VITS) can be clearly obtained from either frame of the TV picture (Fig. 15). The initial four cycles of this multiburst are a 0.5 MHz signal, the next seven cycles are a 1.5MHz signal, the following 10 cycles are a 2.0MHz signal—followed by a burst of 2.9MHz signals, a burst of 3.6MHz signals and finally a burst of 4.2MHz signals.

Although only the first three of the six test bursts can be clearly seen at this stage within the particu-

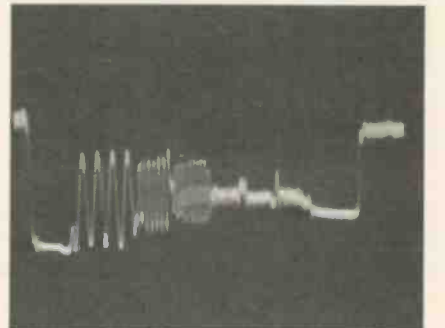

Fig. 15—The scope's delayed-sweep circuitry can also be used to obtain a stable trace of the Vertical Interval Test Signals—another aid for adjusting anything from antenna systems to video amplifiers.

lar TV set under test, more precise tuning and alignment of this TV set would allow more of these signals to become apparent. The better the antenna system, the better the adjustment of the tuner, the more accurate the alignment of the IF circuits and the better the frequency response of the video amplifiers, the

more uniform the amplitude of these six test bursts. Thus, this multiburst signal can be used for adjusting everything from the antenna on through to the picture tube.

How many of you have tried to use your scope to measure the video signal delay through a delay coil in a TV set being serviced? Such measurements simply are not possible with a conventional scope. However, we were able to make such measurements using the VITS signal received with a network TV program. This was done by using the instrument as a dual-trace scope, while at the same time taking advantage of the delayed-sweep circuitry.

In Fig. 16, we see the pair of test signals as they enter the delay coil (upper trace) and a similar pair of test signals as they leave the delay

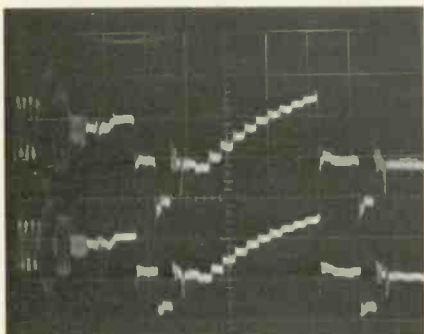

Fig. 16—The test signals before (upper trace) and after (lower trace) they pass through the color-TV set's delay coil. Note the slight phase shift due to the delaying action of the coil.

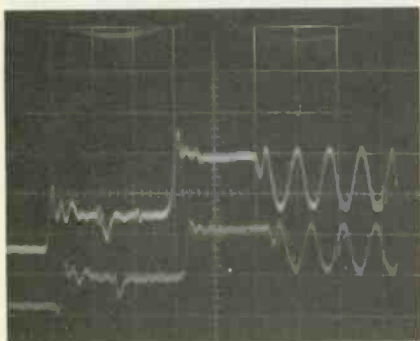

Fig. 17—By noting the apparent phase shift of the 0.5MHz signal as it passes through the color-TV set's delay coil, we are able to determine that there has been a signal delay of approximately  $1\mu\text{s}$ .

coil (lower trace). Since the time interval between these test signals is precisely regulated and the scope is synchronized to the first pair of signals, then the second pair of signals are shown in proper phase relationship with the first. Nothing is lost by having the scope alternately trace the two signal inputs.

By expanding these scope traces even further, we are able to note the phase relationship of the 0.5MHz signal entering the delay coil with that of the 0.5MHz signal leaving it (Fig. 17). Since we know the frequency of this test signal, we also know the amount of time corresponding to one wavelength of the signal:  $T = \frac{1}{f} = \frac{1}{0.5 \times 10^6 \text{Hz}} = 2 \times 10^{-6} \text{ sec}$  or  $2\mu\text{s}$ . The signal leaving the delay coil was delayed by just slightly less than half a wavelength. Thus the delay through the coil was just slightly less than  $1\mu\text{s}$ —an interval of time precisely measured by the scope using a time standard generated by the TV network in cooperation with the National Bureau of Standards. There are virtually no test signals otherwise available to the average electronic technician that are as precise as these.

Plans call for the future use of single horizontal TV traces as carriers for the transmission of time information and even codes for generating words across the TV picture in a customer's TV set, so that the deaf can read the dialogue that occurs on network programs. How will you service such new applications without being able to observe the horizontal TV traces upon which

this information will be transmitted?

Space has permitted us to mention but a few of the many applications possible with this extremely versatile instrument. Some additional information concerning this scope was reported in New and Noteworthy on Page 30 of our September 1971 issue.

This is the only scope that we have used with a trace so bright that when operated without the delay sweep you need to either turn down the BRILLIANCE control or wear sun glasses. In fact, the extreme brightness of its CRT enabled us to successfully complete another experiment that we have never even attempted before—the actual reproduction of a TV picture on the scope CRT by applying the appropriate signals to the scope's horizontal, vertical and Z-axis inputs. Note the photograph in our free ad this month supporting the joint trade association convention in New Orleans in August. That picture is for real! ■

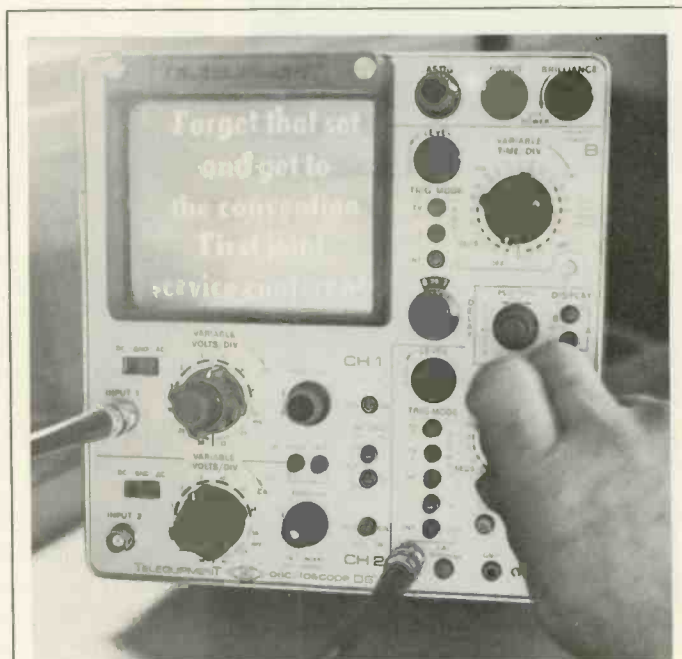

No fooling—the D67 scope described this month actually displayed this video information. And no fooling—whether a service dealer or electronic technician, a believer in associations or not—it should be worth your time and money to attend the joint convention next month in New Orleans.



# Successful Advertising

by Phillip Dahlen

Present an image that will sell

■ A recent issue of the CLOQUET BILLBOARD contained an advertisement that really caught our eye—running 9 $\frac{7}{8}$  in. from top to bottom. In fact, we were so impressed with this ad that we obtained Jack Carter's authorization to reproduce it here as an example of good advertising.

From the wording of this ad, you would assume that all of Jack's customers buy from him because of the good service that they can expect from his shop. (As service dealers, this is one of our strongest selling points!) It would seem as though this is only natural, so if you haven't realized this in the past, now is the time to buy from Jack and see for yourself.

But wait, a shop that stresses quality service must charge *more!* Why not buy that TV set from some discount store and then let Jack fix it if something happens later? He'll probably still provide good service, and it might initially save us a small bundle.

Not so says Jack, and he backs his words with money—offering to pay the difference if you can buy it elsewhere for less. Note, however, that he requests that customers seeking such a refund supply him with the complete dated ad page offering the product for less. The price and model number must, of course, be included. Without such supporting evidence, a salesman in some discount store could—upon loosing a sale—claim that he would have sold an unadvertised item for less, not really intending to do so. Also, too frequently potential customers fail to realize that the discount store may

be selling an older or stripped-down model, as opposed to the quality product that the service dealer has for sale.

In granting us authorization to re-print this ad, Jack reported that it did prove effective, providing a good customer response. ■

## *An Open Letter to Our Customers*

*So often we have heard that people in Cloquet and the surrounding area buy from us because of the service we offer our customers after the sale. They have indicated that they pay more to buy locally because of the service afforded them after the sale by Carter's TV and Appliance.*

*It is not true that people pay more locally than what they could have purchased the product elsewhere. To prove this point, Carter's TV and Appliance will publicly guarantee to you, our valued customers, that you do not pay more to buy locally just to be assured of service after the sale. If you buy an appliance or television set from us and within 10 days after the purchase find the same item advertised at a lower price elsewhere, we will refund to you the difference in price.*

*We must insist, however, that you bring the complete page with the advertisement and dateline showing the item with the model number and advertised price. We take great pride by insisting that we will not be undersold and this is our way of proving it to you.*

*We, at Carter's, appreciate your business and look forward to serving you for your appliance and television needs. Thank you.*

Sincerely yours,

**Jack Carter, Manager**  
Carter's TV & Appliance  
Cloquet, Minn.

# An Extraordinary Offer

to introduce you to the benefits of Membership in

## ELECTRONICS BOOK CLUB

for a limited time only you can obtain

ANY **3** OF THESE UNIQUE BOOKS . . . yours for only **99¢** each  
...with Trial Club Membership (Combined List Price \$33.85)

May we send you your choice of many three books on the facing page as part of an unusual offer of a Trial Membership in Electronics Book Club?

Here are quality hardbound volumes, each especially designed to help you increase your know-how, earning power, and enjoyment of electronics.

These handsome, hardbound books are indicative of the many other fine offerings made to Members . . . important books to read and keep . . . volumes with your specialized interests in mind.

Whatever your interest in electronics—radio and TV servicing, audio and hi-fi, industrial electronics, communications, engineering—you will find that Electronics Book Club will help you.

With the Club providing you with top quality books, you may broaden your knowledge and skills to build your income and increase your understanding of electronics, too.

### How You Profit From Club Membership

This special offer is just a sample of the help and generous savings the Club offers you. For here is a Club devoted exclusively to seeking out only those titles of direct interest to you. Membership in the Club offers you several advantages.

- 1. Charter Bonus:** Take any three of the books shown (combined values up to \$33.85) for only 99¢ each with your Trial Membership.
- 2. Guaranteed Savings:** The Club guarantees to save you 15% to 75% on all books offered.
- 3. Continuing Bonus:** If you continue after this trial Membership, you will earn a Dividend Certificate for every book you purchase. Three Certificates, plus payment of the nominal sum of \$1.99, will entitle you to a valuable Book Dividend which you may choose from a special list provided members.
- 4. Wide Selection:** Members are annually offered over 50 authoritative books on all phases of electronics.
- 5. Bonus Books:** If you continue in the Club after fulfilling your Trial Membership, you will receive a Bonus Dividend Certificate with each addi-

### SPECIAL FREE BONUS

. . . if you act now!

Yes, if you fill in and mail the membership application card today, you'll also get this Bonus Book, FREE!

#### TV TROUBLESHOOTER'S HANDBOOK Revised Second Edition

A completely updated quick-reference source for solutions to hundreds of tough-dog troubles.  
Regular List Price \$7.95

tional Club Selection you purchase. For the small charge of only \$1.99, plus three (3) Certificates, you may select a book of your choice from a special list of quality books periodically sent to Members.

**6. Prevents You From Missing New Books:** The Club's FREE monthly *News* gives you advance notice of important new books . . . books vital to your continued advancement.

This extraordinary offer is intended to prove to you, through your own experience, that these very real advantages can be yours . . . that it is possible to keep up with the literature published in your areas of interest . . . and to save substantially while so doing.

### How the Club Works

Forthcoming selections are described in the FREE monthly *Club News*. Thus, you are among the first to know about, and to own if you desire, significant new books. You choose only the main or alternate selection you want (or advise if you wish no book at all) by means of a handy form and return envelope enclosed with the *News*. As part of your Trial Membership, you need purchase as few as four books during the coming 12 months. You would probably buy at least this many anyway . . . without the substantial savings offered through Club Membership.

### Limited Time Offer!

Here, then, is an interesting opportunity to enroll on a trial basis . . . to prove to yourself, in a short time, the advantages of belonging to Electronics Book Club. We urge you, if this unique offer is appealing, to act

promptly, for we've reserved only a limited number of books for new Members.

To start your Membership on these attractive terms, simply fill out and mail the postage-paid airmail card today. You will receive the three books of your choice for 10-day inspection. **SEND NO MONEY!** If you are not delighted, return them within 10 days and your Trial Membership will be cancelled without cost or obligation. Electronics Book Club, Blue Ridge Summit, Pa. 17214.

### Typical Savings Offered Club Members on Recent Selections

Commercial FCC License Handbook	List Price \$8.95; Club Price \$5.95
RCA Color TV Service Manual—Vol. 2	List Price \$7.95; Club Price \$4.95
Citizens Band Radio Service Manual	List Price \$7.95; Club Price \$4.95
How to Use Color TV Test Instruments	List Price \$7.95; Club Price \$4.95
FET Applications Handbook	List Price \$14.95; Club Price \$9.95
Fire & Theft Security Systems	List Price \$7.95; Club Price \$3.95
Modern Radio Repair Techniques	List Price \$7.95; Club Price \$4.95
Beginner's Guide to Computer Programming	List Price \$9.95; Club Price \$6.95
199 Electronic Test & Alignment Techniques	List Price \$7.95; Club Price \$4.95
Zenith Color TV Service Manual—Vol. 2	List Price \$7.95; Club Price \$4.95
Transistor Projects for Hobbyists & Students	List Price \$7.95; Club Price \$4.95
Electronic Musical Instruments	List Price \$7.95; Club Price \$4.95
Electronic Designer's Handbook	List Price \$9.95; Club Price \$5.95
Dictionary of Electronics	List Price \$6.95; Club Price \$5.50
Computer Circuits & How They Work	List Price \$7.95; Club Price \$4.95
Japanese Color TV Service Manual	List Price \$7.95; Club Price \$4.95
Solid-State Circuit Design & Operation	List Price \$9.95; Club Price \$7.95
How to Read Electronic Circuit Diagrams	List Price \$7.95; Club Price \$3.95
Electronic Test & Measurement Handbook	List Price \$7.95; Club Price \$4.95
Computer Technician's Handbook	List Price \$10.95; Club Price \$7.95
125 One-Transistor Projects	List Price \$7.95; Club Price \$4.95
Servicing Modern Hi-Fi Stereo Systems	List Price \$7.95; Club Price \$4.95

# SEND NO MONEY!

 Simply fill in and mail postage-paid Airmail card today!

## Color TV Trouble Factbook

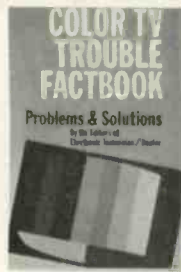

Here's a complete guide to color TV troubles and solutions, arranged by make and model, a low-cost, all-in-one reference handbook every TV service technician should own. The information it contains may easily save you hours of time repairing a "tough-dog" color TV. Included are details concerning repetitive troubles, field-factory

changes, new and unusual circuits and descriptions of how they work, special adjustment procedures and other such pertinent service information. The content is arranged by brand names, covering every major make of color TV receiver produced in the past several years. Models and chassis covered are arranged in alpha-numerical order. 176-pps. Hardbound.

List Price \$6.95

Order No. 519

## Basic Electronics Problems Solved

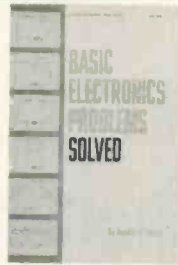

Here are easy step-by-step solutions to basic electronics problems in a convenient one-stop source dealing with both solid-state and tube-type circuits. The content not only presents a detailed explanation of each point, but also provides many actual examples on how to work out problems. Then, to firmly fix the information in your mind,

there are numerous example problems for you to solve; answers to these are included in one Appendix, and worked out solutions in another. Covers DC circuits, AC circuits, powers of ten, semiconductors, power supplies, and receiver circuits. A final chapter shows how to use a slide rule to speed calculations. 192 pps., over 100 illus. Hardbound.

List Price \$7.95

Order No. 530

## 199 TV Tough-Dog Problems Solved

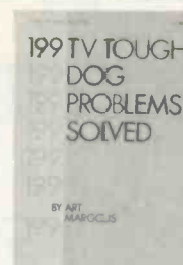

Here is a master collection of actual case-history solutions—answers to the most challenging tough-dog TV problems on both color and B & W sets—covering all popular makes from Admiral to Zenith. This new book is organized so that you can quickly find the solution to particular problems—toughies that required the best efforts of top

technicians to solve. To enable you to find information relative to a particular problem in a specific set, a cross-reference of troubles by brand name and chassis is included. The content is organized into trouble symptom sections. Several different circuits are included; thus, the information provided will apply to similar circuits in other models. 256 pps., 199 illus. Hardbound.

List Price \$7.95

Order No. 559

## Philco Color TV Service Manual



An all-in-one service guide for Philco color sets, with 12 complete schematic diagrams for chassis 15M90/91 to 20QT88. Here in one manual is complete service data for all the color models produced by Philco and Philco Ford (thru 1970), from the all-tube to the latest hybrid solid-state chassis, including the small-screen portable

Model T5062WA. The unique 36-page foldout section contains 12 complete schematic diagrams, representing all the chassis covered. The profusely illustrated text delves into each section (video, chroma, vertical, horizontal, etc.), and points out specific problems based on the author's extensive experience. Included are complete alignment and setup instructions, detailed in step-by-step form. 160 pps., plus 36-page schematic foldout section. Long-life vinyl cover.

List Price \$7.95

Order No. 522

## 101 TV Troubles: From Symptom to Repair

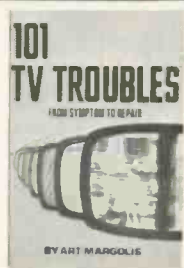

An invaluable "cause and cure" guide to the practical, easy solution for virtually any TV trouble—color or B&W. All you do is analyze what you see and hear, look up the symptoms in the book, and follow the clear and simple steps to a speedy trouble cure. To show how and why certain troubles occur in specific types of circuits, schematics and other illustrations are included for every major manufacturer—Admiral to Zenith.

TV troubles are broken down into five basic categories: Brightness, Contrast, Sweep, Color, and Sound. Each category lists specific troubles relating to that symptom. For example, under "Contrast" are 22 causes of actual picture problems. With the categorized trouble list and index, you can quickly and easily find the exact symptom—and the trouble cure—for virtually any TV circuit defect you might encounter. 224 pps. Hardbound.

List Price \$7.95

Order No. 507

## TV, Radio, Hi-Fi Hints & Kinks



If you want to get the best performance out of consumer electronics equipment, you'll find this to be the most informative and useful handbook ever published. Over 150 ideas suggest ways to customize and add accessories to any equipment setup—how to connect single and multiple accessory speakers, how to add remote controls to

TV's, radios, hi-fi systems, how to connect microphones, etc. Also includes many tips on hi-fi equipment, CB and 2-way radio equipment, antenna systems, remote monitoring techniques, intercoms, a wireless baby sitter, telephone amplifier, moisture, fire and other alarm accessories for any existing amplifier. 256 pps., over 150 illustrations. Hardbound.

List Price \$7.95

Order No. 561

## CB Radio Operator's Guide

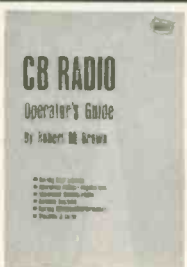

An all-in-one handbook on Citizens Band radio, and how to make the best use of available equipment. Tells you everything you must know to get on the air, with complete details on what you can and can't do right down to the "nitty gritty" rules and regulations! What's more, you receive expert advice on the type of equipment to buy,

and how to get the best performance out of your "system." The information contained in this book will save you time and money in short order! With this one book, you can become an expert on CB Radio, and how to use the service most successfully. You'll learn about antenna systems, including how they are used in CB. 224 pps. Hardbound.

List Price \$7.95

Order No. 499

## How To Fix Transistor Radios & Printed Circuits



Here it is! Just off the press—a completely updated, revised edition of Leonard Lane's best-selling classic on transistor radio repair. In addition to extensive enrichment of the first edition, the author brings FETs, zener diodes, FM radios—in fact, everything related to the current state of the art—into the picture. Here's the perfect

reference and guide for electronic technicians who need to understand and repair semiconductor circuits efficiently. For those interested in transistor physics, fundamentals are emphasized in the first two chapters. The real "meat" begins in Chapter 3 which will thoroughly familiarize you with amplifier fundamentals, basic circuit configurations, biasing, FETs, JFETs, and IGFETs. The next two chapters will acquaint you with RF and IF amplifiers. 256 pps., over 150 illus., 12 Chapters.

List Price \$7.95

Order No. 504

## Electronic Circuit Design Handbook



New Fourth Edition—A brand-new, enlarged edition of the ever popular circuit designer's "cookbook," now containing over 600 proven circuits, for all types of functions, selected from thousands on the basis of originality and practical application. Now you can have, at your fingertips, this carefully-planned reference source of tried and

tested circuits. Selected from thousands submitted by distinguished engineers, these "thought-starters" are a collection of original circuits selected on the basis of their usefulness. This detailed compilation of practical design data is the answer to the need for an organized gathering of proved circuits . . . both basic and advanced designs that can easily serve as stepping stones to almost any kind of circuit you might want to build. 384 pps., 19 big sections, over 600 illus., 8 1/2" x 11".

List Price \$17.95

Order No. T-101

# AN EXTRAORDINARY OFFER...

... for more details circle 104 on Reader Service Card

JULY 1972, ELECTRONIC TECHNICIAN/DEALER | 55

## TEST INSTRUMENT REPORT

# Simpson's Model 460 Digital Volt-Ohm-Milliammeter

by Phillip Dahlen

Provides both analog and digital readout with each scale used

■ In many of our previous test instrument reports we have stressed the fact that many of the newer electronic circuits to be serviced require that we make voltage, resistance and current measurements to a much higher degree of accuracy than is possible with conventional meter movements—one simply cannot read the meter scale, even a mirrored scale, accurately enough to obtain the high resolution required. It is for this reason that digital meter systems

are becoming a must for effective servicing.

There have been occasions, particularly when we first began using digital meters in the ELECTRONIC TECHNICIAN/DEALER lab, when we felt inclined to question the measurements obtained. On some occasions we wondered if the zero reading obtained was due to the absence of any voltage, or the presence of an above scale voltage for which the last few digits were zero. We simply had a



Simpson's Model 460 Digital Volt-Ohm-Milliammeter. For more details, circle 900 on the Reader Service Card.

little problem adjusting from analog to digital readings.

Such problems do not occur with Simpson's new Model 460 Digital Volt-Ohm-Milliammeter, for it provides *both* digital and analog readings. The digital readout goes from 0 to 1999 and includes an overload indicator, while the analog readout has 0 to 200 scale markings.

Manufacturer technical specifications for this instrument include the following:

### DC Voltage

Range	Maximum Indication	Input Impedance	Overload Protection
200mv	199.9mv	100M	350v
2v	1.999v	1000M	350v
20v	19.99v	10M	1000v
200v	199.9v	10M	1000v
°1000v	°	10M	1000v

°Instrument rating on 1000v range is 1000v maximum.

Accuracy: From +10°C to +40°C: ±0.1% of reading ±1 digit.

Input bias current: 7na maximum at reference conditions.

Resolution: 100µv.

Full-range step response (to rated accuracy): 2sec.

Normal mode rejection: 35dB minimum at 60Hz.

Common mode rejection: 80dB minimum with 1K unbalance at 60Hz.

### Resistance

Range	Maximum Indication	Test Current	Overload Protection
200Ω	199.9Ω	1ma	250v rms
2K	1.999K	100µa	250v rms
20K	19.99K	10µa	250v rms
200K	199.9K	10µa	250v rms
2000K	1999 K	1µa	250v rms
20M	19.99M	100na	250v rms

Accuracy: From +10°C to +40°C: ±0.5% of reading ±1 digit except on the 20M range, which is ±1% of reading ±1 digit.

Resolution: 0.1Ω.

Temperature coefficient: From 0°C to +55°C: ±(0.5% of reading +0.1 digit)/°C.

Full range step response (to rated accuracy): 2sec on Ω and K ranges, 6sec on 10M range and 10sec on 20M range.

### AC RMS Voltage

Range	Maximum Indication	Input Impedance	Overload Protection
200mv	199.9mv	1M at 150pf	250v
2v	1.999v	1M at 150pf	250v

Range	Maximum Indication	Input Impedance	Overload Protection
20v	19.99v	1M at 150pf	600v
200v	199.9v	1M at 150pf	600v
°1000v	°	1M at 150pf	600v

°Instrument rating on 1000v range is 600v rms (or equivalent peak to peak) maximum.

Accuracy: From +10°C to +40°C: ±0.5% of reading ±1 digit, 40Hz to 10kHz; ±1.0% of reading ±1 digit, 10kHz to 20kHz.

Resolution: 100µv.

Full-range step response (to rated accuracy): 5sec.

Temperature coefficient: From 0°C to +55°C: ±(0.05% of reading +0.1 digit)/°C, 40Hz to 10kHz; ±(0.1% of reading +0.2 digits)/°C, 10kHz to 20kHz.

### DC Current

Range	Maximum Indication	Voltage Drop	Overload Protection
200µa	199.9µa	100mv	3a
2ma	1.999ma	100mv	3a
20ma	19.99ma	100mv	3a
200ma	199.9ma	100mv	3a
1000ma	1999 ma	100mv	3a

°Based on a numerical indication of 1000.

Accuracy: From +10°C to +40°C: ±0.2% of reading ±1 digit, except on the 1000ma range, which is ±0.5% of reading ±1 digit.

Resolution: 100na.

### AC RMS Current (40Hz to 10kHz)

Range	Maximum Indication	Voltage Drop	Overload Protection
200µa	199.9µa	100mv	3a
2ma	1.999ma	100mv	3a
20ma	19.99ma	100mv	3a
200ma	199.9ma	100mv	3a
1000ma	1999 ma	100mv	3a

°Based on a numerical indication of 1000.

Accuracy: From +10°C to +40°C: ±0.7% of reading ±1 digit, except on the 1000ma range, which is ±1.0% of reading ±1 digit.

Resolution: 100na.

# GREATEST TV Schematic Bargain EVER Offered

## NOW-Complete TV Schematics for less than 5¢ each

**COLOR TV**  
Covers ALL  
Color Sets  
1960 - 1968

**BLACK & WHITE**  
Coverage for  
23 U.S. Brands  
1965 - 1968

### TV TECH / MATICS - 8 Giant Volumes

Cover 99% of Color TV-4 Years B&W!

Here are FABULOUS savings on nationally-known TV schematic and service data. Here is everything you need to fill your vital service data needs for TV model years 1965 through 1968 . . . plus COLOR TV coverage from 1960 through 1968! What it amounts to is a low, low cost of less than \$9.00 per year for your TV service data . . . with an extra 5 years of Color TV coverage thrown in for good measure! Compare that with the over \$100 a year you may now be paying for comparable information.

### SERVICE DATA FOR MORE THAN 20 BRANDS

TV TECH/MATICS is the ideal Service Data package for today's modern technician. It includes complete schematic diagrams and vital servicing data for every TV receiver produced by more than 20 leading American Manufacturers for 1965, 1966, 1967, and 1968. All diagrams and servicing details are completely authentic, based on information provided by the original equipment manufacturers. Each year's coverage is permanently bound into two convenient-to-use volumes which open flat to 11" x 29½", ready to provide you with instant service data at your workbench. Some of the diagrams are as large as 58" x 22".

### EASY TO USE

TV TECH/MATICS is easy to use. Brand names are arranged alphabetically by model year. No more hunting through several file drawers to find the schematic you need! And at the special low price, think of the savings you will enjoy on your schematic needs . . . think of the time you'll save by having the schematics you need right at your fingertips in handy, permanently-bound form!

TV TECH/MATICS is the ideal way to cut down your schematic expenses, and to enjoy the convenience of having all your data needs right at your fingertips.

**8 BIG Volumes**  
**Regular Price \$79.60**  
**...NOW YOURS**  
**for only \$34.95**

### HERE'S WHAT YOU GET

You receive 8 BIG volumes in all, two for each year from 1965 through 1968. Included is a clearly detailed and annotated TV schematic diagram for each specific model. You also get complete replacement parts lists, alignment instructions, tube and component location diagrams, plus key waveforms and voltage readings . . . all the information you need to service over 90% of the TV receivers you'll encounter!

### STREAMLINED AND CONVENIENT

All the information for a given model is contained on two facing sheets. The special bound-leaf format allows pages to lie flat when open. Each volume is organized alphabetically by manufacturer, then numerically by model number. In addition, a handy Chassis/Model Finder is bound into each volume. Regular list price for each year's coverage — 2 BIG volumes — is \$19.90. All 8 volumes normally sell for \$79.60. Your price is ONLY \$34.95 . . . a savings of nearly \$45.00!

### MONEY-BACK GUARANTEE

You MUST be satisfied that TV TECH/MATICS is the greatest bargain in TV Schematics ever offered. Order at our risk for FREE 10-day examination. Prove to yourself they are worth many times the price. You can return them in 10 days for full refund or cancellation of invoice. No need to send money. But, the supply is limited, so fill-in and mail the NO-RISK coupon today to obtain these time-saving, money-making manuals.

### -CONTENTS-

#### CONTENTS 1965 MODELS

Covers all 1965 models for: Admiral, Airline, Andrea, Coronado, Curtis Mathes, Dumont, Electrohme, Emerson, Firestone, General Electric, Magnavox, Motorola, Muntz, Olympic, Packard-Bell, Philco, RCA Victor, Sears-Silvertone, Setchell-Carlson, Sylvania, Truetone, Westinghouse, and Zenith . . . plus all color sets 1960-1965, at no extra cost!  
PUBLISHER'S LIST PRICE . . . \$19.90

#### CONTENTS 1966 MODELS

Covers all 1966 color and B & W models of: Admiral, Airline, Andrea, Coronado, Curtis Mathes, Dumont, Emerson, General Electric, Hoffman, Magnavox, Motorola, Olympic, Packard-Bell, Philco, RCA Victor, Sears-Silvertone, Setchell-Carlson, Sonora, Sylvania, Truetone, Westinghouse, and Zenith.  
PUBLISHER'S LIST PRICE . . . \$19.90

#### CONTENTS 1967 MODELS

Covers all 1967 color and B & W models of: Admiral, Airline, Andrea, Coronado, Curtis Mathes, Dumont, Emerson, General Electric, Hoffman, Magnavox, Motorola, Olympic, Packard-Bell, Philco-Ford, RCA Victor, Sears-Silvertone, Setchell-Carlson, Truetone, Westinghouse, and Zenith.  
PUBLISHER'S LIST PRICE . . . \$19.90

#### CONTENTS 1968 MODELS

Covers all 1968 color and B & W models for: Admiral, Airline, Andrea, Coronado, Curtis Mathes, Dumont, Emerson, General Electric, Hoffman, Magnavox, Motorola, Olympic, Packard-Bell, Philco-Ford, RCA Victor, Sears-Silvertone, Setchell-Carlson, Sonora, Sylvania, Truetone, Westinghouse, and Zenith.  
PUBLISHER'S LIST PRICE . . . \$19.90



LARGE PAGES contain complete circuit schematics, replacement parts lists, alignment instructions critical part locations, important waveforms and voltage readings.

### NO RISK COUPON—MAIL TODAY

TAB Books, Blue Ridge Summit, Pa. 17214

- I enclose \$34.95 for which please send me your complete 8-Volume Tech/Matics Schematic offer postage prepaid.  
 Please invoice me for \$34.95 plus postage. Same return privileges.

Name .....  
Company .....  
Address .....  
City ..... State ..... Zip .....

(Paid orders shipped prepaid. Pa. resident add 6% Sales Tax. Outside USA 10% extra.)

ET-72

for more details circle 103 on Reader Service Card

# COLORFAX

The material used in this section is selected from information supplied through the cooperation of the respective manufacturers or their agencies.

## ADMIRAL

Color-TV Chassis K16 Series—Color-Monitor Circuit

The color-monitor function of the color-TV K16 chassis is obtained by widening the demodulation angle to increase the fleshtone range.

The angle of demodulation is produced by a 39 $\mu$ h coil, L513, in conjunction with a 910 $\Omega$  resistor, R562, and capacitance to ground. This capacitance to ground consists

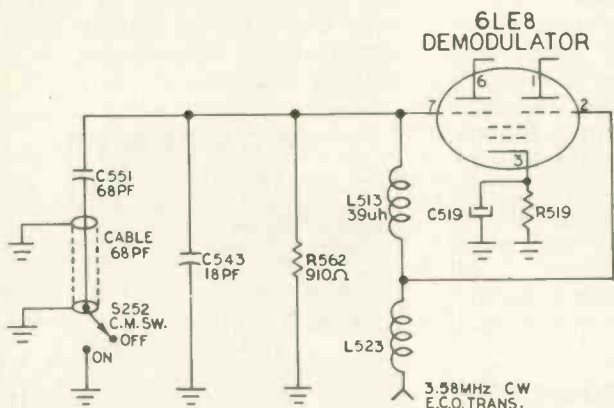

principally of the following: A 18pf capacitor C543 and a 68pf capacitor C551 in series with the known capacitance of a coaxial cable connected between the COLOR-MONITOR switch and C551. The length of cable used provides a capacitance value of 68pf.

The shield of the coaxial cable is grounded and the COLOR-MONITOR switch either grounds or ungrounds the center conductor (i.e., C551). When the color monitor is OFF, the total capacitance to ground is 52pf, corresponding to a demodulation angle of about 90°. This demodulation angle provides a range of about 20° for acceptable flesh tones.

When the color monitor is ON, the capacitance to ground totals 86pf. This additional capacitance adds about 15° to

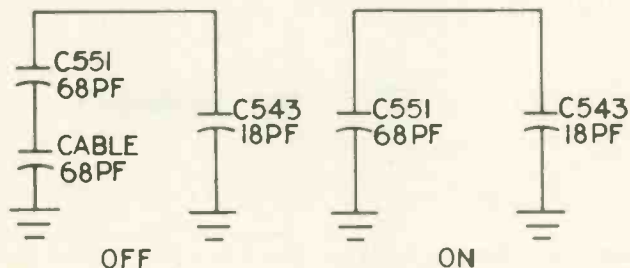

each side of the normal demodulation angle, increasing it to about 120°, which provides a fleshtone range of about 70°.

## MAGNAVOX

Convergence and Screen Purity Problems

Problems associated with convergence and screen purity frequently result from inadequate degaussing of all metal near the picture tube. Any magnetized metal near the pic-

ture tube can affect the landing points of the beams on the screen. And because of this, all metal other than permanent magnets that are purposely located near the picture tube must be completely demagnetized. Some TV sets use a metal back cover or a metal picture tube cup attached to the back cover. Although frequently the back is not attached to the instrument at the time the TV set is degaussed, the metal back or picture tube cup also must be completely degaussed to prevent its having any influence on purity. Each time a TV set is degaussed, be sure that any metal portion of the back cover is also thoroughly degaussed.

## RCA SALES CORP.

Color-TV Chassis CTC22/41,42,43—Damper Diodes

For maximum reliability of the solid-state damper diode, as employed in these chassis, it is advisable to use two devices in parallel when replacement is required.

Damper diodes are supplied by two vendors, the black plastic barrel portion of one is slightly larger than the other. Always use two of the same configuration.

RCA Parts and Accessories will be packaging, under Stock No. 135320, two diodes which are the same as those previously supplied except they will have leads attached to either end. Installation instructions will be included. Single diodes (without leads) Stock No. 120818, will not be available.

When installing the diodes, wrap the diode leads together and solder, making a good mechanical and electrical bond. Keep leads as short as possible, clipping off any excess. Space diodes approximately 1/8 in. apart for easier installation. Then install the diodes as shown in the appropriate illustration.

Relatively high differences in potential exist between the damper diode terminals and other components in the immediate area. These components include capacitors, the

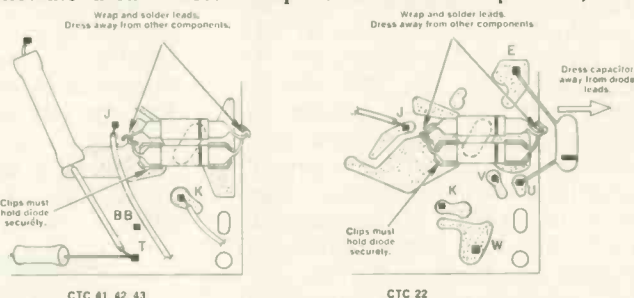

metal chassis, board terminal stakes and associated leads, and printed circuitry on the PW400 board itself as well as adjacent boards. Be sure the diode leads are dressed well away from these components. Make certain the mounting clips hold the diodes securely in position after proper lead dress has been established.

Color-TV Chassis CTC46 Series—Troubleshooting Focus Symptoms

The symptom of "poor" or "no focus" may be caused by a shorted or leaky spark gap on the focus lead. This spark gap is an integral part of the picture tube socket. The socket for this chassis is stocked by Parts and Accessories as a complete unit, including leads, under Stock No. 135506.

The following procedure may be helpful in isolating focus symptoms:

With the TV set power OFF, disconnect the picture tube socket ground strap from its ground connection and connect a high-voltage meter between the picture-tube-socket ground strap and ground. Turn the TV set ON. Caution: If

the focus lead spark gap is shorted, 5kv to 6kv can be present on the picture tube socket ground strap when the strap is ungrounded. Operate the TV set in this mode only long enough to perform the check.

If this check verifies that the socket is not shorted, replace the ground strap and check the voltage quadrupler. It can be assumed that the voltage quadrupler is functioning if 5kv to 6kv is measured between Pin F of the quadrupler and ground.

The next step is to confirm proper focus control operation. The focus voltage at the picture tube socket should vary between about 4kv and 6kv while rotating the FOCUS control.

#### Color-TV Chassis CTC44/46/47/49/54—High-Voltage Quadrupler Interchangeability

The CTC49 quadrupler (Stock No. 132634) can be used as a direct replacement for the CTC44,46,47,54 quadrupler

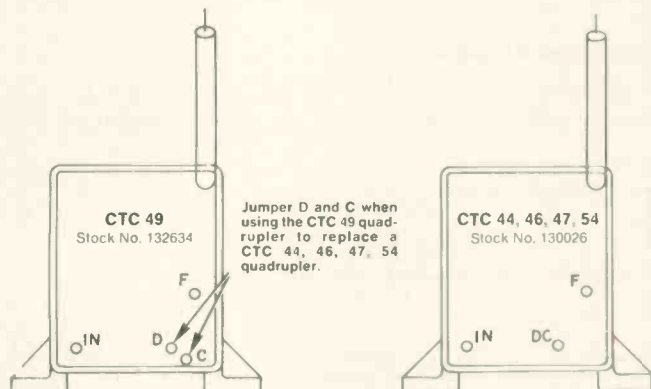

(Stock No. 130026) by jumpering quadrupler terminals D and C together and using that point for the DC connection. Stock No. 130026 cannot be used in the CTC49 chassis.

#### Color-TV Chassis CTC36—Unstable Vertical Sweep

Loss of vertical sweep in this chassis, when no sync input is present (i.e., during channel changes, when the tuner is on an inactive channel, etc.), may be the result of an off-tolerance vertical oscillator transistor, Q501.

To test for this condition: First turn instrument OFF. Then disable the sync input to transistor Q501 by moving

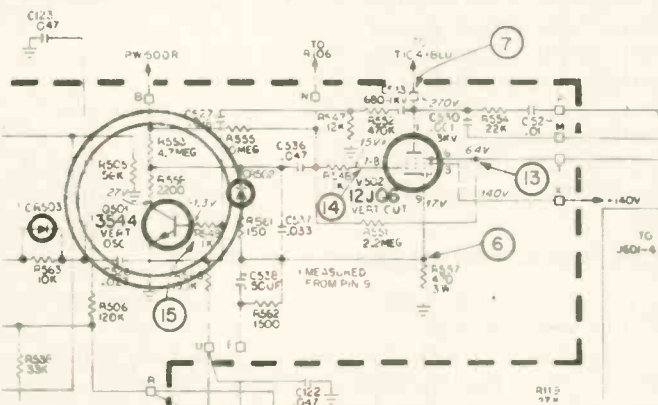

the service switch to the RASTER position and turn the TV set ON again.

No vertical sweep (oscillator does not restart) under these conditions indicates the possibility of an off-tolerance transistor (Q501). Output components (such as tube V502 and/or cathode resistor R557) may be damaged if the instrument has been operated any length of time without the vertical oscillator running.

# Free Heathkit Catalog



## Build your own test equipment and save!

Your free Heathkit catalog describes the entire Heathkit test equipment line — meters, scopes, counters, generators, everything you need to make your business easier, more profitable. Send for it.

### NEW Heathkit 8-Digit Calculator — \$129.95\*



Feature for feature, the new Heathkit Desktop Electronic Calculator is your best buy. It adds, subtracts, multiplies, divides, in chain or mixed functions, and includes use of a constant. Floating or selectable decimal position. Overflow and plus or minus indicators. Overflow protection of 8 most significant figures. Clear display key permits removal of last entry without losing problem. Bright, red, 1/2" 7-segment display tubes. Dependable American LSI circuitry. Standard keyboard configuration. Operates on 120 or 240 VAC. Black & white cabinet, 3 1/2" x 6" x 10 1/4" d. Kit IC-2008, 11 lbs.

### NEW Heathkit Solid-State FET VOM — \$79.95\*

This new dual FET portable multimeter has lab-grade accuracy, high (10 megohm) impedance input, and the ranges you really need... at a price you can easily afford. 9 DCV and ACV ranges from 0.1 to 1000 V. at ±2% accuracy. 6 DC and AC current ranges from 10 microamps. to 1 amp. 7 resistance ranges, x1 (10 ohm center) to x1 Megohm. 9 dB ranges, -40 to +62. 1% precision metal-film dividers. 4 1/2", 100 uA ruggedized taut-band meter, diode and fuse protected. Battery check switch provided. Kit IM-104, less batteries, 4 lbs.

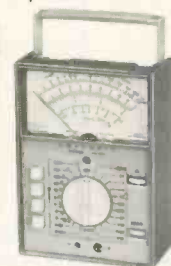

### NEW Heathkit 8-Digit 120 MHz Counter \$349.95\*



Measures 1 Hz to over 120 MHz. Overrange, gate, and two range indicators. Preassembled TCXO time base. 1 megohm FET input. Automatic triggering level. Sensitivity 125 mV or less to 120 MHz. ECL logic. Builds in 15 hours. Kit IB-1102, 12 lbs.

### NEW Heathkit Digital Multimeter \$229.95\*



3 1/2 digits. 100 uV to 1000 VDC, 5 ranges; 100 uV to 500 VAC, 5 ranges; 10 current ranges, 100 nanoamps. to 2 amps, AC & DC; 6 resistance ranges, 0.1 ohm to 20 megs. 10 megohm or higher input. Overload protected. Calibrator inc. Kit IM-102, 9 lbs.

### Send for FREE Catalog

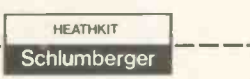

HEATH COMPANY, Dept. 24-7  
Benton Harbor, Michigan 49022

Please send FREE Heathkit Catalog.

Enclosed is \$ \_\_\_\_\_, plus shipping.  
Please send model (s) \_\_\_\_\_

Name \_\_\_\_\_

Address \_\_\_\_\_

City \_\_\_\_\_ State \_\_\_\_\_ Zip \_\_\_\_\_

\*Mail order prices; F.O.B. factory.  
Prices & specifications subject to change without notice. TE-269

... for more details circle 115 on Reader Service Card

# TECHNICAL DIGEST

The material used in this section is selected from information supplied through the cooperation of the respective manufacturers or their agencies.

## WESTINGHOUSE

### Quadrix Four-Channel Sound

At a live performance, whether symphony or "rock," you hear sounds coming from all directions—directly from the performers, and by reverberant reflection from walls and ceiling of the concert hall. Before stereo, high-fidelity sound systems lacked realism because the sound all came from one speaker location. Stereo added an element of realism by spreading the sound sources out in front of you. Four-channel creates concert hall realism by surrounding you with sound sources.

### "Discrete" Four-Channel Sound

In the concert hall, sound coming from four directions is picked up by four microphones (or equivalent), and the

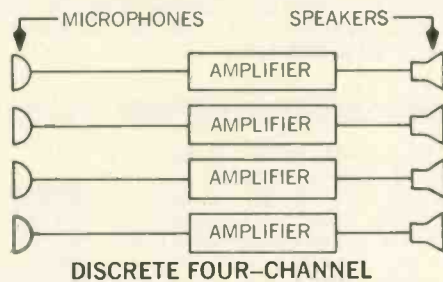

four signals are amplified and fed to four speakers. "Discrete" four-channel material is available on reel-to-reel and four-channel eight-track tape.

### "Matrixed" Four-Channel Sound

Before recording, or broadcasting by FM stereo radio, the signals from the four microphones are combined into

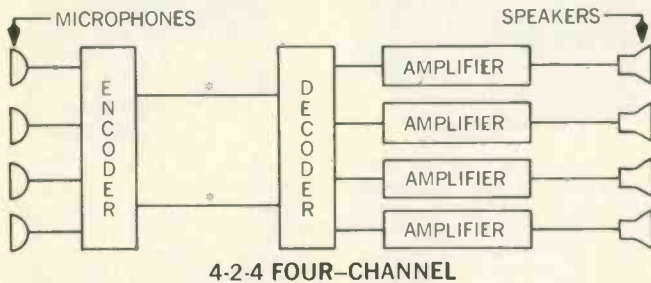

two signals by an encoding matrix (encoder). In the consumer's equipment a matching decoder converts the two signals into the original four signals, with some compromise of separation between them. The signals are usually amplified by four amplifiers and fed to four speakers. These systems are frequently called 4-2-4 systems, because they start with four channels, convert to two, and convert back again to four channels.

### Quadrix Four-Channel Sound

Quadrix is a simplified matrix system. The Quadrix decoder is placed after the amplifier, instead of before it,

so that only two amplifiers are required, instead of four. The cost and size is reduced, and installation and operation

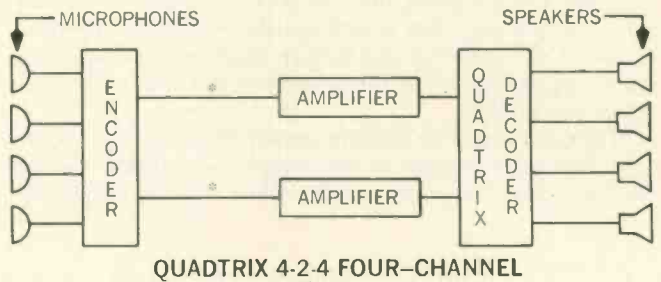

are simplified. The normal stereo amplifiers are used. The Quadrix unit decodes any compatibly matrixed four-channel recording or FM broadcast (Electrovoice, Sansui, Dynaco) systems.

### Quadrix Four-Dimensional Sound

When stereo records, tape or FM stereo broadcasts are played with the same Quadrix system, two additional de-

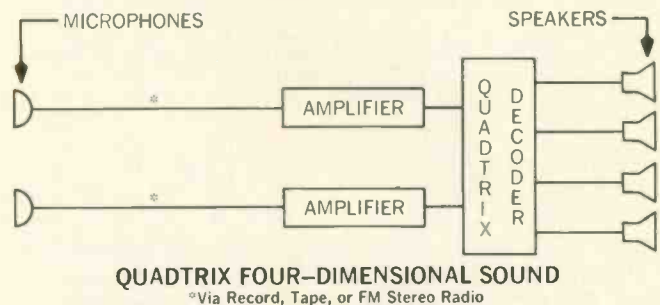

rived sound signals are produced, and fed to the rear speakers. A concert hall ambience is added, surrounding you with sound, and giving essentially the same feeling of realism produced by four-channel sources.

### Radio Models RPA5035A, RPA5040A—Weak and Fuzzy Sound

Normally, when a technician hears some sound from the speaker, he doesn't suspect the speaker but looks in other parts of the circuit for the trouble. He assumes that the speaker is okay, but in these models, which use a 40Ω speaker, some sound can be heard even though the speaker winding is open.

Check the speaker for continuity, if it is open replace it with Westinghouse Part No. 690V110H14.

### Radio Models RS21P08A, RS11P28A—Hum and Distortion

Hum and distortion may be caused by capacitors C20 or C21 changing in value.

Replace C21 and C23 with new capacitors, Part No. 690V051H50. Part No. 690V051H50 is an alternate capacitor used to replace Part No. 690V034H39.

### Radio Model RG13S68C—No AM Reception

This was an unusual case, which appeared to be a bad AM oscillator coil, L8, but this was not the part that was bad; the trouble was a shorted MB oscillator coil, L7.

Replace the MB oscillator coil, L7, Part No. 690V-086H34.



## NEWS...

*continued from page 26*

Any associations or trade groups interested in membership in the council may contact TSA of Northeastern N.Y., Inc., 514 Second St., Albany, N.Y. 12206.



Representatives of the affiliated New York State associations meeting for the statewide council.

### Missouri Electronic Service Assn. Holds Its Annual Convention

The Missouri Electronic Service Assn. met at the Holiday Inn East in Columbia on Saturday and Sunday, May 6-7. During the two days, over 30 men and women registered for the meeting. Regular business was transacted on Saturday, and on Sunday seminars were held on solid-state testing and on "How to Price Your Service for Profit." A film on collections was shown, and a contract signed with a nationwide collection agency. This company has a record well above average for collections. Its services will be available to all MESA members.

The following were elected to serve for the next year as officers of MESA: President, Leonard Thompson of Joplin; Vice-President, Benton Linder, CET, of Springfield; Treasurer, George Oviatt, CET, of Joplin; Secretary, Leonard Jacob of St. Louis; Sergeant-at-Arms, James Stutes of St. Ann; Executive Vice-President, Vincent J. Lutz, CET, of St. Louis; and four directors: Robert Chenoweth, CET, of Trenton; Larry Vance of Rolla; David Bauman, Jr., of Huntsville and David Watsen of Neosho. Doyle Taber is the Immediate Past President.

### Jerrold Announces 18 Technical Schools

TV technicians, distributor personnel, antenna installers, MATV system installers and engineering contractors all over the country are invited to attend, free of charge, one of the eighteen MATV technical training schools being conducted by Jerrold Electronics in 1972. Each of the school sessions takes two days, and two different courses are offered—a basic course for people with some background in electronics and antenna theory, but little or no MATV experience, and an advanced course for people with extensive experience in planning and installing MATV systems.

Readers interested in attending any of these schools can contact their local Jerrold representative or Jerrold Electronics, DSD, P.O. Box A, 401 Walnut St., Philadelphia, Pa. (215) 925-9870.

# YOUR SUCCESS STORY!

You as a TV serviceman must have the necessary equipment to make repairs. A volt meter, oscilloscope, various generators, and etc. BUT, you cannot rebuild the picture tube! Why not investigate this opportunity. Being in the service business, you should take advantage of any piece of equipment that would be helpful to you. You should have your own picture tube rebuilding unit! You could rebuild any picture tube, be it black and white or color or 20mm, etc. ANY PICTURE TUBE! You could build the finest quality tube available. This tube would have the finest contrast and color definition. The building of the picture tube has been developed into a simplified process. It is easier to rebuild a picture tube than to repair the circuit on the average television set. We can offer you the most revolutionized compact unit on the market today. This unit will only require 4 x 8 ft. of space. The unit will not hinder your present business. While a picture tube is being processed, you will still be able to do your bench repairs or make service calls. Why not have your own tube rebuilding plant? Why not be a distributor? In some areas, the picture tube must be shipped and as a result, you must wait quite a period of time for the picture tube. With your own rebuilding unit, you could immediately rebuild the old tube and return it to the customer within a matter of hours!

Can you imagine rebuilding only four color tubes per day? You sell these tubes for \$60.00 each. Your total cost to rebuild these tubes would be \$7.00 each. This leaves a \$53.00 profit on each tube. This leaves you a net profit for the day of \$212.00. Not a bad day's pay. Let's cut this figure by one half. Build only two color tubes per day. Your net profit would be \$106.00 per day. Work a five day week. Your earnings would be \$530.00. Sound fantastic? Facts are facts!

Lakeside Industries invites you to visit our showrooms in Chicago. You will see the most revolutionized rebuilding unit of our modern times. You will see the unit in operation. You will see the picture tube it can rebuild. You will be amazed at the quality of the finished product.

The operation of the rebuilding unit is so simple that we can train you in a matter of hours. Upon your visit to our showrooms, and at the end of the day, you will have the knowledge and know-how to operate this fine equipment and be able to rebuild any picture tube, be it black and white or color.

Equipment to operate your TV service business is necessary. Your own picture tube rebuilding plant should also be an absolute must. Why not realize all the profits instead of buying your picture tubes at costly prices.

For further information please write to

## LAKESIDE INDUSTRIES,

3520 W. FULLERTON AVE., CHICAGO, ILLINOIS 60647

PHONE: (312) 342-3399

P.S. No salesman will call.

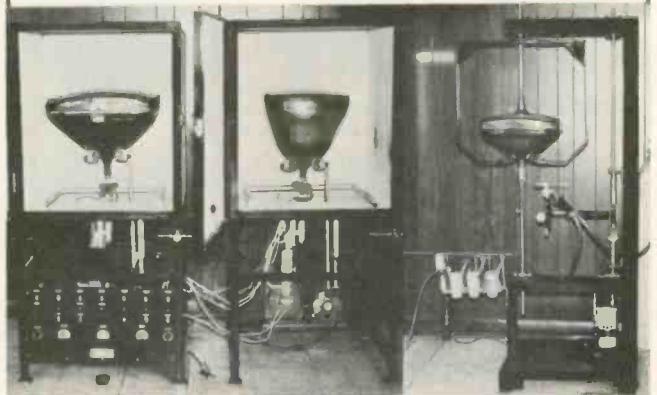

... for more details circle 116 on Reader Service Card

## DEALER SHOWCASE

For additional information on products described in this section, circle the numbers on Reader Service Card. Requests will be handled promptly.

### BULK ERASER 703

*Provides precise amount of magnetic flux*

The QM-210 Bulk Eraser is reportedly designed to provide the precise amount of magnetic flux required to effectively erase recorded tapes in



seconds. The hand-held unit features a momentary switch built into its

handle and is supplied with an ac cord for 110 to 120vac, 50 to 60Hz operation. Nortronics Co., Inc.

### HEADPHONES 704

*Reproduces sound over a wide range*

The SHP-1 stereo headphone set is complete with an 8-ft cord and standard three-circuit plug. User-comfort is assured due to the padded-cushion rests. The unit reportedly reproduces



sound over a wide audio range with high quality and smooth frequency. Price: \$14.95. Duotone Company, Inc.

3¾ ips. The tape is driven by a center capstan, with automatic reverse for 2-channel stereo operation. The QT-6600 can supply 4-track 4-channel stereo, 4-track 2-channel stereo or 4-track 1-channel monaural, utilizing a reel size up to 7 in.—at tape speeds of either 3¾ or 7½ ips. The unit is equipped with a master control for recording plus individual level controls for each channel for recording and playback. Two meters are used to indicate sound level of the front left and right speakers and 2 meters are used for the rear left and right speakers. Other features include single-hand loading, pause lever (for momentarily stopping tape motion during recording or playback), a 4-digit tape counter with reset buttons, two headphone jacks for front and rear sound, and a choice of either horizontal or vertical operation. Price: \$599.95. U.S. Pioneer Electronics Corp.

### AUTOTRANSFORMER 706

*Designed to reduce excessive line voltage supplied to homes*

The Model TVSD-1 is a new step-down autotransformer designed to reduce excessive line voltage supplied to homes, and thereby relieve the undue stresses placed on electronic equipment such as TV sets and hi-fi



components. It reportedly reduces line voltage by 10% and its 350va rating will handle all size TV sets. Installation is simple—plug it into the wall and then plug the TV power cord into the TVSD-1. Measuring 2½-in. high by 2¼-in. wide by 2 5/16-in. deep, the unit may be mounted in any position on the back of the cabinet or any convenient location. A line cord and plug are provided for input and a receptacle for output. Price: \$6.17 dealer net, \$10.29 list. Essex International, Inc.

### QUADRAPHONIC STEREO TAPE DECK 705

*Capable of recording and playback of four-channel sound*

The QT-6600 Model quadraphonic stereo tape deck is reportedly designed to permit the recording and playback of 4-channel sound. Specifications indicate wow and flutter of 0.12% or



less measured at 7½ ips, less than 0.20% at 3¾ ips, with a signal-to-noise of better than 55dB. The preamplifier has a frequency response of 30Hz to 20kHz at 7½ ips or 30Hz to 13kHz at

### CASSETTE UNIT 707

*Provides extra sensitive record and playback*

The Model 6310 portable player/recorder features Automatic-Stop and built-in condenser mike. Automatic-Stop electronically stops the motor

# DESIGNS OF THE NEW SHAPE OF SOUND TOMORROW



COMPLETE CATALOG AVAILABLE.  
CALL YOUR WELTRON DISTRIBUTOR TODAY!  
or write or call direct:

## Weltron<sup>®</sup> COMPANY

514 East Peabody Street, Durham, N.C. 27702  
919-682-0333

... for more details circle 129 on Reader Service Card

when the tape has reached its end, thereby preventing excess wear and assuring the user of longer and more dependable operating life. The condenser mike permits recording without the use of the remote control mike. It is said to be extremely sensitive and picks up everything within a 10 ft radius, making it useful in conference and group recordings where an external mike proves impractical. The new cassette player/recorder is said to provide extra sensitive record and playback with an ac bias record system and integrated circuitry. A built-in automatic loudness control is also included. A cassette viewing window serves to alert the user as to how much

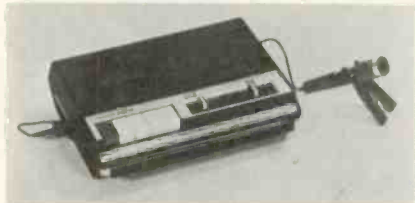

tape has been expended. The unit operates on ac current with an accessory line cord or 4 C-size cells. It is housed in a high impact, wood grained finish plastic cabinet with retractable carrying handle. Suggested list price: \$64.95. Channel Master.

## TRANSCIVER

708

*Features hands-off receive capability*

A completely self-contained VHF-UHF, integral helmet-mounted FM transceiver, the ComRad system, has an FM transmitter and receiver, power pack, speaker, microphone, and an-



tenna all contained within a lightweight polycarbonate fire helmet. The transceiver features "hands-off" receive capability and simple push-to-talk transmit capability. Samson Communications Corp.

## FM TRANSMITTER

709

*Has a transmitting range of 300 ft*

The Remota is a compact, battery-powered FM transmitter that reportedly enables any amplifier (for phono-

graph or tape recorder) to broadcast to any FM radio (portable or otherwise) in the owner's house or grounds. The unit has a transmitting range of

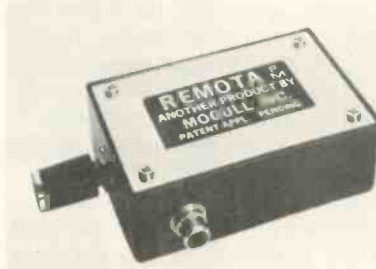

300 ft. The transmitter can be installed by plugging it into a headphone jack, speaker output or line output of the amplifier (for turntable or tape deck). The broadcast frequency of the transmitter is pre-set to a blank spot on the radio band, however it can be adjusted to transmit on any desired frequency within the band by use of a trimmer capacitor. Suggested retail price is \$24.95. Mogull, Inc.

## FOUR-CHANNEL CONVERTER

*Power bandwidth is 25Hz to 40kHz* **710**

The Model QS100 four-channel converter combines a synthesizer, a

matrix decoder, two channels of power amplification and a complete set of controls and accessory circuits for 2- and 4-channel stereo performance. The synthesizer reportedly can detect the non-direct ambient information that already exists in most two-channel stereo recordings and broadcasts, processing these signals for rear-channel presentation to produce a four-channel effect. The decoder is said to recover and reproduce the four original channels of any compatibly matrixed four-channel recording or FM broadcast. In the decoder mode, the unit's original phase-shift network design prevents the sound dropouts



and confused or lost sound-source localization that plague many matrixed systems. The phase modulators are also operative to implement and sustain the live sound field effect. The *continued on next page*

## Low Cost Blue Lateral and Purity Assembly

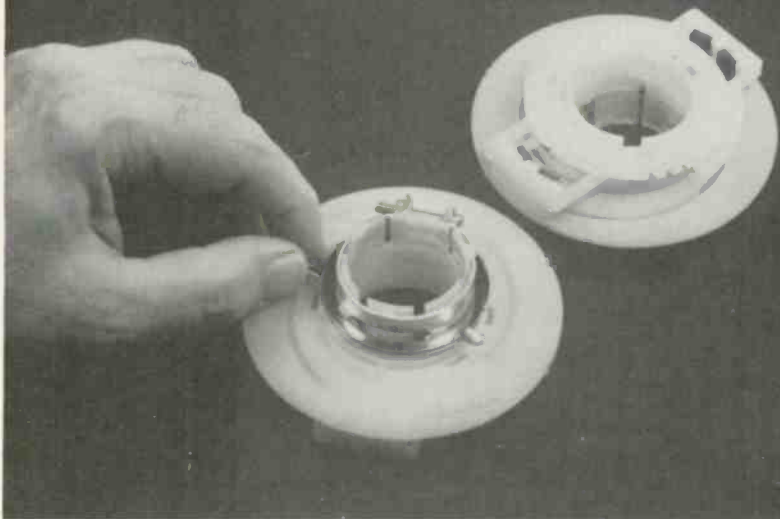

New low cost single-unit blue lateral and purity assembly No. 7605 replaces similar assemblies on any size rectangular color picture tube with a triangular dot pattern.

List \$5.50. Dealer Net \$3.30; available from distributors' stocks.



Write for 92-page Coil Replacement Guide 172.

**J.W. MILLER COMPANY**

19070 REYES AVE. ■ P.O. BOX 5825 ■ COMPTON, CA. 90224

... for more details circle 120 on Reader Service Card

## The Best Performing UHF Converters!

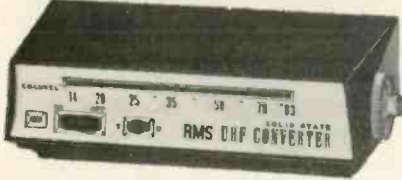

RMS model CR-300. 2-transistor, solid-state. Built-in Amplifier provides 27 dB gain. Has accurately calibrated UHF dial Indicator, UHF and VHF antenna selector switch, on-off switch, pilot light indicator. Suggested retail: \$39.95.



RMS model CR-2TW. 2-transistor, solid-state. Provides 12 dB gain. Has on-off switch, UHF/VHF antenna selector and UHF tuning control. Low suggested retail: \$27.95.

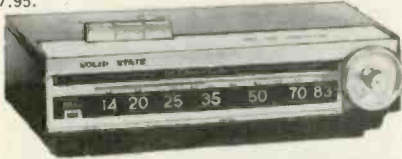

RMS model CR-880. 3-transistors, 2 diodes, solid-state. Powerful Amplifier provides 30 dB gain. Brings in clear UHF reception in areas where other Converters and UHF tuners of TV sets cannot. Features Local/Distant Switch, push-button controls, accurate UHF dial indicator, pilot light. Suggested retail: \$49.95.

Write for Catalog and Price—

### RMS ELECTRONICS, INC.

50 Antin Place, Bronx, N.Y. 10462  
Tel. (212) 892-6700

... for more details circle 125 on Reader Service Card

## PROVEN IMPORTANT DEVELOPMENT FOR TV SERVICING

(OVER 250,000 SOLD)

### SANS-A-FUSE®

FITS IN SAME  
SOCKET AS CHEMICAL  
OR AMP FUSE

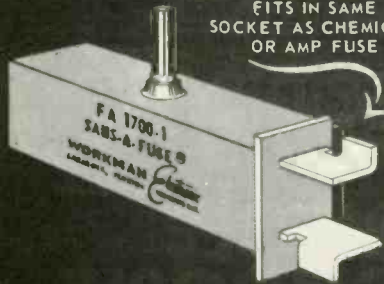

### 14 COLOR CODED CIRCUIT BREAKER REPLACEMENTS FOR CHEMICAL OR AMP FUSE

SAVES TIME AND FUSES  
WHEN LOCATING SHORTS  
IN TELEVISION CIRCUITS

DEVELOPED AND  
MANUFACTURED BY

**WORKMAN**  
Subsidiary of IPM TECHNOLOGY, INC.  
BOX 3828 SARASOTA, FLA. 33578

*Electronic*  
PRODUCTS, INC.

... for more details circle 130 on Reader Service Card

## DEALER SHOWCASE...

*continued from page 63*

amplifier section features 50w of total IHF music power at 4Ω (18w per channel of continuous power at 4Ω; 15w per channel of continuous power at 8Ω) for driving the rear channels. Power bandwidth is 25Hz to 40kHz; frequency response at normal listening levels is 20Hz to 50kHz ±1dB; total harmonic distortion at rated output is less than 0.8%; and intermodulation distortion at rated output is less than 1%. Price: \$214.95. Sansui Electronics Corp.

### STEREOPHONE 711

*Can be used for stereo  
or monaural listening*

The Model KO-747 stereophone reportedly has a VOLUME control in each earcup which allows the wearer to make fine adjustments in both level and balance without returning to the receiver or amplifier control center. The stereo-monaural feature in this unit gives the listener one set of stereophones for use with stereo hi-fi or with monaural sources. The model has an extendable stainless steel headband with self-adjusting, pivoting yokes,



which conforms to any head size for comfortable wearing. It is available in a two-tone brown: light brown earcups and headband cover with dark brown fluid-filled, washable ear cushions. The set delivers a frequency response from 30Hz to 20kHz. Price: \$45.00. Koss Corp.

### ENDLESS CASSETTES 712

*Available in three  
message lengths*

The continuous play, endless-loop tape cassettes are reportedly available in 3 basic message lengths. The EC-1 offers 1 min of record/play time, the EC-3 runs for 3 min and the EC-6 for 6 min. Special construction prevents

damage caused by accidentally activating the recorder's reverse mode while endless-loop devices are in position. An automatic brake is engaged whenever the cassette is out of the



recorder, locking the tape supply in position and preventing fouling. Special tape backing and magnetic coating are used to assure long cassette life. Wow and flutter are said to be minimal. TDK Electronics Corp.

### SSB/CW TRANSCEIVER 713

*Self-contained for fixed,  
portable and mobile use*

A completely self-contained SSB/CW transceiver, the FPM-300, is compactly designed with modular construction techniques for effective and reliable service in fixed, portable and mobile use. The transceiver provides the user an extended VFO range (600kHz) with full frequency coverage (80 through 10 meters) allowing the unit to be used in a wider range of applications. It features low power drain and is rated at 250w PEP input power on SSB with selectable upper and lower sideband—CW input power is 180w. The transceiver has glass epoxy printed circuit board construction for greater reliability and features solid-state devices throughout. Test



points are included on each of the modular boards to facilitate maintenance. Its device complement includes 10 FET's, 20 junction diodes, 3 bridge rectifiers, 3 integrated circuits, 6 zener regulators, 8 hot-carrier diodes, 18 bipolar transistors, plus 2 vacuum tubes used in the driver and amplifier stages. The unit is housed in a grey and black finished steel cabinet with elevated front support rests. Priced at \$595.00, the FPM-300 is 5½-in. by 12-in. by 11-in. in size and weighs 25 lb. The Hallicrafters Co.

## NEW PRODUCTS

For additional information on products described in this section, circle the numbers on Reader Service Card. Requests will be handled promptly.

### FIBER OPTICS KIT 714

*Includes wide assortment of optical supplies*

The Model OP8080 is a kit of plastic fiber optic materials, which includes 264 ft of mono fiber in four sizes (0.010-in., 0.020-in., 0.030-in. and 0.045-in.), 9 ft of jacketed light



guides in three sizes from 0.087-in. to 0.152-in., a four-channel light head, a low voltage power source, bulbs, eyelets and adhesive/end-treat compound. A manual provided with the kit contains information on fiber optics technology, appropriate data and engineering details and suggested uses. Price of kit: \$23.95. International Rectifier Corp.

### TAPE EDITING KIT 715

*For use with Audio and Video tape*

A complete editing kit for use with 0.150m audio tape (KS-1) and a kit for use with 1/2-in. video tape (KV-3.5) are now available. An important ingredient in the tape splicing system



are the Editab replacement splicing tabs. The new, improved tabs are

available in 3 types: XC-1, splicing tabs for 1/4-in. tape; CX-2, 1/4-in. metalized splicing tabs for automatic reverse and/or automatic stop on machines equipped for metal-foil sensing; and CX-3, 0.150m splicing tabs for cassette tapes. Complete Editall splicing and editing kits include patented Editall block, a supply of the appropriate Editab splicing tabs, instruction booklet, demagnetized cutting blade and grease marking pencil. Elpa Marketing Industries, Inc.

### FUNCTION GENERATOR 716

*Offers nine modes of operation*

The Model 5200 function generator offers nine modes of operation for a wide variety of options. Functions include separate waveform and ramp outputs, pulse, sweep and burst modes, and external voltage control of the main output frequency. In external and sweep modes, the frequency range extends from 0.00003Hz to 3MHz. Maximum main output is 20v p-p open circuit, or 10v across a 50Ω load; maximum ramp output is 10v peak with a 200Ω source impedance. An auxiliary square wave is also provided. In the pulse mode, it is possible to produce pulses as narrow as 200nsec at repetitious rates anywhere between 100kHz and 0.1Hz. A manual or external trigger gives one shot performance of either a single cycle of a waveform or a single frequency sweep. The

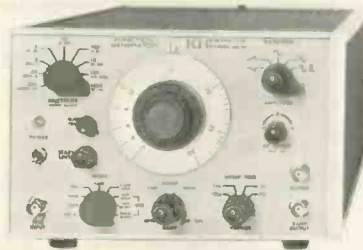

start level between triggered functions is fully adjustable. Output dc level is adjustable  $\pm 5v$ . Both ramp and main output amplitude are fully adjustable by means of infinite resolution controls. Price: \$495.00. Krohn-Hite Corp.

### TRANSISTOR AND COMPONENT TESTER 717

*Designed to eliminate desoldering components for test purposes*

The transistor and component tester has been designed to eliminate the step of desoldering components for test purposes. The tester is connected to a scope, and a pair of test probes are

*continued on next page*

## SERVICE MASTER HANDIEST HANDFUL of service tools

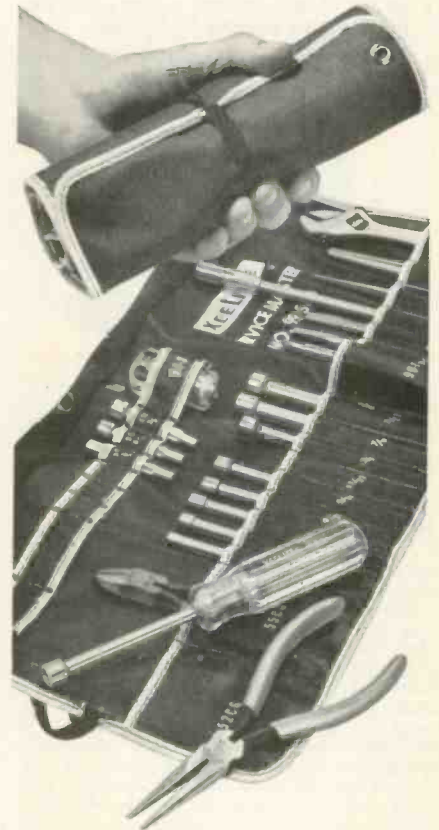

23 essential tools at your fingertips in this lightweight (only 2 3/4 lbs.), compact, easy-to-carry, roll-up kit. Contains long nose plier, diagonal plier, adjustable wrench, regular and stubby plastic handles with these interchangeable blades: 9 regular and 3 stubby nutdriver, 2 slotted and 1 Phillips screwdriver, 2 reamer, 1 extension. Eyelets in plastic-coated canvas case permit wall hanging. New elastic loop secures roll, eliminates need for tying.

### many optional accessories:

Junior and Tee handles... Additional nutdriver, Phillips & slotted screwdriver, and extension blade sizes... Allen hex type, Bristol multiple spline, Frearson, Scrufox, and clutch head blades... Awl/Scriber... Chuck adaptors to use blades in spiral ratchet drivers.

WRITE FOR CATALOG 166

# XCELITE

XCELITE, INC. 14 Bank St., Orchard Park, N.Y. 14127  
In Canada contact Charles W. Pointon, Ltd.

... for more details circle 131 on Reader Service Card  
JULY 1972, ELECTRONIC TECHNICIAN/DEALER | 65

# SOLVE YOUR DRIVE BELT PROBLEMS IN MINUTES

## with ONEIDA'S all new DRIVE BELT KITS

- Eliminates "Down Time" on special and foreign belts.
- No need to stock replacement belts; makes any size in minutes.
- No molds or complicated vulcanizing processes to follow.
- No special skill required, cutting guide, cutting tools and adhesive all included.
- Special Insta-Weld® adhesive makes replacement belts as strong as or stronger than originals for lasting repairs.



- ORK-1 Round Rubber Drive Belt Kit** ..... \$19.95
- ORK-2 Flat and Square Rubber Drive Belt Kit** ... \$19.95
- ORK-3 "O" Ring Kit** ..... \$19.95

Get up to five times your investment back in belt sales. Each of these kits will make from 80-100 dollars or more in rubber drive belts. Included with the kit is the special cutting guide, razor blade, Special Insta-Weld® adhesive, a large quantity of rubber stock and easy-to-follow directions. Nothing has been left out. Packed in an attractive, handy, plastic box that fits into the tube caddy or on the bench. Now, you can replace over 90% of the belts found on tape recorders, phonographs and cassette recorders, both foreign and domestic, right on the spot. Check with your distributor now. If he doesn't stock them, ask him to order them for you today.

### PERMABOND ADHESIVE POWER WITH ONEIDA'S Insta-Weld®

*Makes Space Age Bonds*

**Great for: Rubber • Plastic • Metal • Ceramics • Glass • Etc.**

Insta-Weld® is new, not epoxy, nothing you have heard of before. There is no mixing, just apply and hold parts together. Just seconds are all that is required for a bond stronger than anything you could ever get before. One drop supports 2,000 pounds per square inch.

Now make economical repairs that were never before possible. Extremely economical, up to 132 bonds per tube.

**NEW INSTA-WELD®**  
only \$2.00 per 2-gram tube

**oneida** ELECTRONIC MFG., INC.  
MEADVILLE, PENNA. 16335

... for more details circle 123 on Reader Service Card

## NEW PRODUCTS...

*continued from page 65*  
used to contact component terminals. Graphic symbols on the face of the tester show scope patterns for each good component. The tester checks

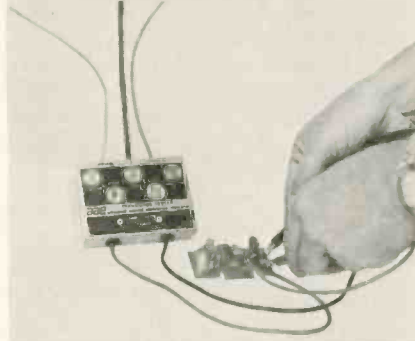

transistors, capacitors (including electrolytic) and resistors. Suggested retail price: \$29.95. Advanced Applied Electronics.

### PLIERS AND CUTTER 718

*With specially designed joint to prevent spring disengagement*

A 6-in. long-nose plier with side cutter and a 6-in. diagonal cutter, both with spring actuated handles, have just been introduced. A specially designed box joint prevents the handles from spreading too far and thus avoids spring disengagement.



Other features of both new pliers include high luster polished steel finish, hand honed, specially hardened, mated cutting edges and blue dipped plastic grips. Channellock, Inc.

### PENETRANT-LUBRICANT 719

*Resists collection of dirt and abrasive particles*

Sprayon No. 711 Penetrant-Lubricant, Corrosion Inhibitor, Demoliturant is a new product which reportedly displaces moisture and offers dielectric properties when applied to

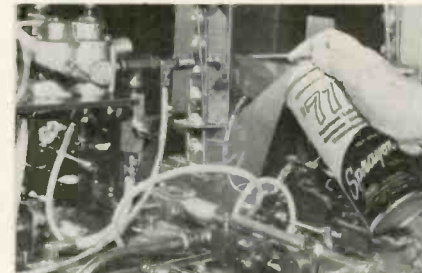

electrical connectors, circuitry and relays. It leaves an invisible barrier which resists the collection of dirt and abrasive particles on delicate close

tolerance surfaces, while it lubricates and protects against corrosion attack. The lubricant reportedly contains no silicone and is harmless to plastic, rubber, fabric and painted surfaces. Sprayon Products, Inc.

### SCOPE

720

*Has sweep speeds to 5nsec per division*

From dc to 75MHz, the Model 4100 scope has 5mv/division sensitivity at full bandwidth. This scope has sweep speeds to 5nsec per division, and fully comprehensive time-base facilities are incorporated. The 8 by 10 cm

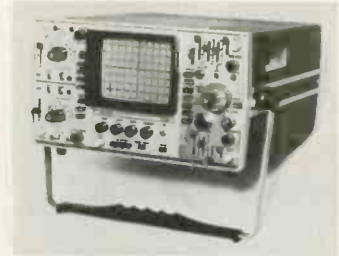

CRT features high brightness for easy and accurate viewing. Plug-in semi-conductors and modular printed-circuit cards contribute to ease of service and calibration. Price: \$1825.00. Raytheon Co.

### HAND EPOXY-REMOVER 721

*Removes tenacious materials from hands*

Deepox is a new compound, designed to safely remove tenacious materials from the hands. It is specifically formulated to remove such materials as epoxy, phenolic resins, polyesters, adhesives, varnish, airplane dope, curing agents, enamel, ink, and dyes. Deepox reportedly contains no toxic or explosive solvents, which frequently lead to adverse reactions such as chafing and dermatitis. Having a viscosity similar to cold cream, the product is a pinkish color and contains no caustics or scouring abrasives. Starnetics Co.

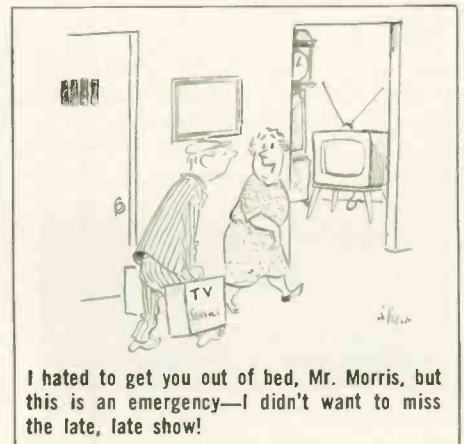

I hated to get you out of bed, Mr. Morris, but this is an emergency—I didn't want to miss the late, late show!

## TECHNICAL LITERATURE

### Simplified MATV Layouts

A set of 16 easily understood block diagrams of typical MATV signal distribution systems are available which include: school systems (with and without locally originated channels), plus UHF/VHF distribution systems for single and multiple story apartment buildings, trailer parks, TV dealer display rooms and small garden apartment complexes. Special attention is given to headend design for both single, broadband amplified systems and individually amplified channelized systems. Equipment types are specified. Although the advisability of using them in a particular location depends on local conditions, they provide an excellent reference for the MATV installer. Blonder-Tongue Laboratories, 1 Jake Brown Rd., Old Bridge, N.J. 08857.

### TV Catalog

The 1972 Chromacolor Catalog is an attractive full color 32-page booklet containing screen sizes, customized tuning, remote control, chassis and cabinetry. Several pages are devoted to the different styles of TV sets available. Zenith Radio Corp., 1900 N. Austin Ave., Chicago, Ill. 60639

### Professional Products Catalog

A 20-page catalog has been published describing a line of microphone and circuitry products for broadcasting, recording, motion pictures, and professional sound reinforcement. Included are illustrations and technical specifications, extensive discussions of microphone types and microphone selection. Shure Brothers Inc., 222 Hartrey Ave., Evanston, Ill. 60204.

### Knob Catalog

An 8-page catalog offers descriptions of hand-crafted machined aluminum control knobs. Also represented is an expanded line of plastic knobs, all with spun aluminum inlay tops. The complete machined aluminum knob series listed include straight knurls, fluted knurls, diamond knurls, standards, skirted concentrics as well as knobs made to establish your separate identity. Alcocnob Div., Alco Electronic Products, Inc., P.O. Box 1348, Lawrence, Mass. 01842.

### Test Instrument Brochure

A 6-page, two-color brochure features four new portable, battery-operated, FET Volt-Ohm-Milliammeters and accessories to fit the exacting test requirements of electrical circuit applications. Three hole punched for easy reference, the catalog describes the Model 801, Model 310-FET hand size VOM, and Models 601 and 602 FET VOMs. Triplet Corp., Marketing Dept., Bluffton, Ohio 45817.

### Audio Controls Brochure

A new 4-page brochure describes the manufacturer's complete line of linear and rotary motion audio attenuators. Both linear and audio taper characteristic curves are offered. MystR, Waters' proprietary low noise resistance element is described. Specifications, outline drawings and operating characteristic curves are included. Waters Mfg., Inc., Boston Post Road, Wayland, Mass. 01778.

### Transistor Sockets & Hardware Supplement

An eight-page supplement introduces a new line of standardized transistor sockets, insulators and mounting hardware for use with plastic silicon and hybrid power transistors. Material and construction are fully described and include detailed drawings and illustrations. Keystone Electronics Corp., 49 Bleecker St., New York, N.Y. 10012.

### TV Parts Cross-Reference Guide

The new 64-page color- and b/w-TV parts replacement guide lists over 500 transformer and deflection components for 200 TV manufacturers and provides the TV technician with replacement data for over 14,000 original parts. A separate section covers a line of flybacks, deflection yokes, vertical outputs, filter chokes, power and output transformers. Essex International, Inc., Controls Div., Stancor Products, 3501 W. Addison St., Chicago, Ill. 60618.

### Encapsulating Compound

New product literature covering silicone semiconductor encapsulating compound, MC-507, includes product description, typical compound processing and physical data, and molded physical and electrical properties. General Electric Co., Silicone Products Dept., Waterford, N.Y. 12188.



## Find Out How Selling the DeltAlert Home Alarm System Makes a Secure P & L Statement

Make money in the expanding home alarm market by selling DeltAlert, the reliable, sophisticated ultrasonic system that assures customer satisfaction. Priced right so you can forget about call-backs, it carries the kind of margin that makes it all worth while. No big cash tie-up in inventory... you order as necessary (experience shows consistent, fast reorders from dealers).

Find out how the DeltAlert and DeltaHorn accessories are your sure boost to profits.

Send for complete information now.  
"Delta Products, One Of America's  
Finest Names In Electronics"



**DELTA PRODUCTS, INC.**

P.O. BOX 1147 • GRAND JUNCTION COLORADO 81501  
PHONE (303) 242-9000

DEPT. ETD

... for more details circle 108 on Reader Service Card

## 'No-Noise' Products Work Like Magic!

For Color  
and B/W

### SUPER - LUBE

Concentrated formula for heavy duty jobs. Foams away corrosion, dirt, oxidation and polishes all tuners without drift or detuning. Avoid call-backs.

"No-Noise" products are guaranteed non-flammable, no carbon tet, non-toxic, safe for plastics.

### Volume Control & Contact Restorer

Cleans, lubricates, restores volume controls, push button assemblies, band switches, relays and other electrical contacts.

Manufacturers of These Other Famous "NO-NOISE" Products:  
Tuner-Tonic · EC-44 · Super Spray Bath  
Frigid-Air · Tape-Reco Head Cleaner

Often imitated but never duplicated  
**ELECTRONIC CHEMICAL CORP.**

813 Communipaw Avenue Jersey City, N. J. 07304

... for more details circle 111 on Reader Service Card

## Save Time on PC Board Repairs!



Melted solder disappears up hollow tip into tube

### The ENDECO Desoldering Iron Removes Soldered Components in seconds... without damage!

Endeco melts solder; removes last trace by vacuum. Leaves terminals and mounting holes clean. Resolders PC boards better than regular iron. One-hand operation. Temperature controlled for continuous use. Standard tip furnished, 5 other tip sizes. Pays for itself. \$20.65 net. Smaller size available. See your distributor or write:



**ENTERPRISE  
DEVELOPMENT  
CORPORATION**

5127 E. 65th · Indianapolis, Ind. 46220

... for more details circle 112 on Reader Service Card  
68 | ELECTRONIC TECHNICIAN/DEALER, JULY 1972

## SKITCH'S ...

continued from page 39

highly successful dining salons—the Wooden Horse on the island of St. Thomas, V.I., and the Bird and Bottle in New York City.

"When I get back from doing the Vancouver music festival, and a series of special broadcasts for the CBC Symphonic Society, I'll take a closer look at CCTV situations in our other restaurants," says the busy, bearded maestro.

It is all part of Mr. Henderson's colorful, dual career. While his ear is tuned in on Dvorak or Gershwin (his prize-winning RCA *Porgy and Bess* recording with Leontyne Price is an enduring achievement); his eye (with the help of CCTV), is zeroed in on the constant action at his flourishing restaurant enterprises. ■

## MAGNAVOX ...

continued from page 44

flickering of the incandescent read-out lamps.

The decimal point, kHz and MHz lamps are controlled directly by the bandswitch, the kHz lamp being turned ON when the switch is in the AM position and the MHz and decimal point lamps being turned ON when the switch is in the FM position.

Serviceability was apparently an important factor in the design of the digital tuning indicator assembly. This entire assembly can easily be removed from the balance of the receiver merely by disconnecting a couple of plugs and removing a few screws. The entire lamp assembly is also easily unplugged from the tuning indicator assembly—all but one lamp in this sub-assembly also being socketed. The extensive use of integrated circuit sockets permits their substitution or replacement without having to solder their many leads.

This article has dealt almost exclusively with the sensitivity of this receiver, its tuning accuracy and the digital readout circuitry. However, these features alone do not make a good receiver. Using the massive speakers provided by Magnavox with this receiver, we noted a tremendous audio frequency response—the tonal qualities being excellent!

Even at very low volume levels, the sound was very clear and easily heard. No distortion or apparent overloading was heard as high as we turned the VOLUME control. However, with the VOLUME control turned up to nearly midrange, the sound level produced was so great that although not distorted, we feared for our ears, the windows or some other portion of the building—anything that might not withstand so great an audio level. ■

## EDITOR'S MEMO ...

continued from page 23

love, or for those you love, is to turn work into pleasure and duty into privilege. When we love our work, it is not work, it is life. This alone is sufficient reason for there being an Electronic Distributors Research Institute!"

Later that afternoon I heard Ben Frankenstein, who is with the Telematic Div. of U.X.L. Corp., comment that "M. L. is not only the Champion of Independent Service, he's the Champion of the Independent Manufacturer."

Unfortunately, our industry has very few such champions. Too few people are ready to dedicate themselves openly to the cause of Independent Service. Continuing this theme, next month's editorial is entitled, "And Those That Don't."

*Phillip Dahlen*

## HIRE THEM FIRST



FOR FURTHER INFORMATION REGARDING  
**THE TRAINING AND EMPLOYMENT  
OF OUR NATION'S WOUNDED**  
Please Contact: THE 52 ASSOCIATION, INC. 147 East 50th Street  
New York, N.Y. 10022 212-750-1855  
A Non-profit, Private-Not-for-Profit Organization  
Founded in 1945 and Dedicated to The Pledge That

"THE WOUNDED SHALL NEVER BE FORGOTTEN"



## BOOK REVIEWS

**UNDERSTANDING SOLID-STATE ELECTRONICS** developed and published by the Texas Instruments Learning Center, 242 pages, paperback, \$2.95.

Although we all know of books that have been made into movies, few movies have been made into books, and even fewer videotape programs into technical books. Yet, this book is actually adapted from a full 12-hour videotape course, which is also available for purchase.

This self-teaching course in basic semiconductor theory is also unusual in the manner in which the material is organized. Instead of beginning immediately with the composition of semiconductor components, it precedes that section with such subjects as AND Gate Truth Tables, how logic gates work, and adding binary numbers—subject matter of extreme importance for servicing some of the newer digital circuitry found in consumer electronic products. And yet, they claim that the most sophisticated arithmetic encountered in this book is only fourth grade level.

The following chapters are included in this book: "What Electricity Does in Every Electrical System"; "Basic Circuit Functions in the System"; "How Circuits Make Decisions"; "Relating Semiconductors to Systems"; "Diodes: What They Do and How They Work"; "Diode Performance and Specifications"; "Transistors: How They Work and How They Are Made"; "The PNP Transistor and Transistor Specifications"; "Thyristors and Optoelectronics"; "Introduction to Integrated Circuits"; "Digital Integrated Circuits"; and "MOS and Linear Integrated Circuits."

Each of these chapters is preceded by a glossary of related terms and followed by a short quiz—the answers being provided at the end of the book.

The book appears to be well written, and we are certain that it would be very helpful for one just beginning to enter the field of electronics.

**BASIC MATHEMATICS FOR ELECTRICITY AND ELECTRONICS** by Bertrand B. Singer, published by McGraw-Hill Book Co., 640 pages, hardbound \$9.95.

This book, well illustrated in two colors, slowly develops the electronic theory related to the circuitry that would be serviced in consumer electronic products, and then extends this theory to practical mathematical problems. Sample problems are solved in a

very simple step-by-step procedure so that they can be clearly understood.

Since it is not possible to obtain service data on all products serviced, we feel that this book is a must since it will help you to better understand such circuitry and perform the necessary calculations for determining what unlisted components are required to return the circuit to its proper operating condition. Practical experience is great when you are servicing familiar circuitry. Information gained from this book will help prepare you for servicing the circuits with which you are not familiar.

**STUDY GUIDE FOR CET EXAMINATIONS** by J. A. Wilson, CET, and Dick Glass, CET, published by Howard W. Sams, 272 pages, paperback, \$5.95

Although we have begun printing in our news section a series of questions and answers that will help electronic technicians prepare for the CET examination, it will be nearly a year before that series is completed. We recommend this book for those interested in preparing more rapidly for the examination.

The first chapter of this book gives some information concerning the development of the CET examination, the professional association supporting it, certification, eligibility, information concerning the way in which certain questions are asked and suggestions on how to use the book.

Other chapters cover such subjects as, "The Television Signal," "Antennas and Transmission Lines," "Electronic Components," "Transistors and Other Semiconductor Devices," "Basic Mathematics and Circuit Analysis," "Monochrome Television Circuits," "Color Television Circuits," "The Synchronizing Circuits," and "AGC, Power Supplies, and Waveform Analysis."

Each chapter goes into detail concerning practical circuit function, using clearly drawn illustrations. These chapters then conclude with a short quiz, testing your understanding of the information presented.

The last chapter is a 34-page test reviewing the contents of the book—the answers to these questions also being provided. If you do well with this material, and have adequate practical experience, then you should have no difficulty passing the examination.

Whether you plan on taking the CET examination, have already passed the CET examination, or have no interest in the CET program, we are certain that you will find this book a very valuable resource reference book—the two-page index directing you to almost any subject in which you might be seeking additional information.

## DISCOUNT PRICES TEST EQUIPMENT



**SENCORE**

Test Equipment of Other Manufacturers also Available

Catalog & Prices on Request

**FORDHAM** Radio Supply Company, Inc.



265 E. 149 Street, Bronx, N.Y.  
Tel: (212) 585-0330

**RCA**

**DISTRIBUTORS OF ELECTRONIC SUPPLIES**

... for more details circle 113 on Reader Service Card

<b>MOST VERSATILE Stereo Theatre TRUCK DEVELOPED!</b>	<b>FURNITURE PADD</b>		5.50
		21.50	<b>CONSOLE TV COVER</b>
	522.00	<b>YEATS PLATFORM DOLLY</b>	

FREE illustrated brochure

YEATS APPLIANCE DOLLY SALES CO.  
1307 W. FOND DU LAC AVE.  
MILWAUKEE, WIS. 53205

... for more details circle 132 on Reader Service Card

**FREE ALARM CATALOG**

64 PAGES FILLED WITH 380 BURGLAR AND FIRE ALARM PRODUCTS FOR INSTALLERS AND ELECTRONIC TECHNICIANS. INCLUDES RADAR, INFRARED, CONTROLS, HARD-TO-FIND PARTS, AND 6 PAGES OF APPLICATION NOTES.



**mountain west alarm**  
4215 n. 16th st., phoenix, az. 85016

... for more details circle 121 on Reader Service Card

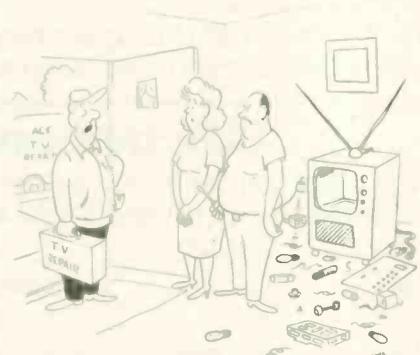

Okay, if you'll sweep it up I'll take it in to the shop!

**NEW!**

# INSTANT CONTACT CLEANER



NO RESIDUE • NON-FLAMMABLE  
NON-TOXIC • NON-CONDUCTOR

A CHEMICALLY PURE CLEANING AGENT  
WITH:

- 1. SELECTIVE CLEANING POWER** — removes greases, oils, dirt and organic soils with no effect on the article being cleaned.
- 2. EXCELLENT PENETRATING AND WETTING ACTION** — its high density and low surface tension permits maximum penetration of most minute crevices where its superior wetting action then cleans even most difficult materials.
- 3. PURITY** — evaporates completely — leaves **NO** residue.
- 4. SAFETY** — Non-explosive, non-flammable, non-toxic.
- 5. STABILITY** — does not react chemically with other materials.

Available in 7 & 16 oz. aerosols with "Snorkel Tubes"

SEND FOR  
FREE SAMPLE

## LPS RESEARCH LABORATORIES, INC.

2050 COTNER AVENUE, LOS ANGELES, CALIFORNIA 90025  
PHONE: (213) 478-0095

... for more details circle 118 on Reader Service Card

## Why pay an answering service when you can own your own?



Dictaphone has a machine to make sure you never lose another cent through a missed phone call or a garbled message. In fact, we have a whole line of them.

They're called Ansafones. You can buy one outright or possibly lease it for about what you're paying your answering service now. And it works for you 24 hours a day, 7 days a week.

For a free brochure describing how much an Ansafone can help you, mail this coupon now.

### ▶ Dictaphone

Box L-7-24, 120 Old Post Road, Rye, New York 10580

Please send me full details of the Ansafone line.

Name \_\_\_\_\_

Company \_\_\_\_\_ Phone \_\_\_\_\_

Address \_\_\_\_\_

City \_\_\_\_\_ State \_\_\_\_\_ Zip Code \_\_\_\_\_

Ansafone and Dictaphone are registered trademarks of Dictaphone Corp.

... for more details circle 109 on Reader Service Card

## READERS SERVICE INDEX

### ADVERTISER'S INDEX

101	Amperex Electronic Corp.	38
102	B&K Div., Dynascan Corp.	33
103	Book Club-Schematics	57
104	Book Club-Tab Books	52-55
105	Chemtronics, Inc.	30
106	Cleveland Institute of Electronics	35-37
107	Cooper Industries, Inc. Weller Div.	45
108	Delta Products, Inc.	67
109	Dictaphone	70
110	Eico Electronic Instruments Co., Inc.	26
111	Electronic Chemical Corp.	68
112	Enterprise Development Corp.	68
113	Fordham Radio Supply Co., Inc.	69
114	Ford Marketing Corp. GTE Sylvania, Electronic Components	27, 3rd Cover
115	Heath Company, The	59
116	Lakeside Industries	61
117	Leader Instruments Corporation	2nd Cover
118	LPS Research Labs	70
119	Mallory Distributor Products Co.	21
120	J. W. Miller Company	63
121	Mountain West Alarm Supply Co.	69
122	NCR Paper-Appleton Papers, Inc.	32
122	New England Business Service, Inc.	32
123	Oneida Electronic Mfg. Inc.	66
124	Precision Tuner Service RCA Consumer Electronics	19 31
125	RMS Electronics, Inc.	64
126	Sprague Products Company	28
127	Telematic Div., UXL Corp.	29
128	Triplett Corporation	4th Cover
129	Weltron Co., Inc.	62
130	Workman Electronic Products, Inc.	64
131	Xcelite Incorporated	65
132	Yeats Appliance Dolly Sales Co. Zenith Radio Corporation	69 22

### NEW PRODUCTS

700	Repair Servicing Bench	34
701	Test Clip	34
702	Chek-A-Color Test Jig	34
703	Bulk Eraser	62
704	Headphones	62
705	Quadraphonic Stereo Tape Deck	62
706	Autotransformer	62
707	Cassette Unit	62
708	Transceiver	63
709	FM Transmitter	63
710	Four-Channel Converter	63
711	Stereophone	64
712	Endless Cassettes	64
713	SSB/CW Transceiver	64
714	Fiber Optics Kit	65
715	Tape Editing Kit	65
716	Function Generator	65
717	Transistor and Component Tester	65
718	Pliers and Cutter	66
719	Penetrant-Lubricant	66
720	Scope	66
721	Hand Epoxy-Remover	66

### TEST INSTRUMENT

900	Simpson's Model 460 Volt-Ohm-Milliammeter	56
-----	-------------------------------------------	----



## How to stay in shape without getting your wallet out of shape.

We've shaped up a plan that lets you mix business with pleasure.

The program is simple: You buy Sylvania receiving tubes, you get merchandise award points. When you have enough points, you just pick out what you want from the catalog that Sylvania's distributors will be glad to give you. (Ask him for the "Take Stock with GTE Sylvania" book.)

To keep you in shape, there are things like golf or fishing equipment and shop tools. And if whittling is your sport, there's even a knife for that.

If you'd rather keep your wife in good shape there are pages of kitchen and household equipment that will make her workload a lot lighter.

Or if you are interested in really living the good life, there is everything from clothing to cameras.

And then there are the Sylvania color television sets. They take a lot of points, but they deliver a lot of picture.

Buying Sylvania receiving tubes can keep your business in good shape.

And if you buy enough Sylvania tubes, you can keep the whole family in shape.

But, we have to warn you, your wallet will get a lot fatter.

Sylvania Electronic Components, 100 First Avenue, Waltham, Mass. 02154.

**GTE SYLVANIA**



