

# ELECTRONIC TECHNICIAN

SEPTEMBER 1963

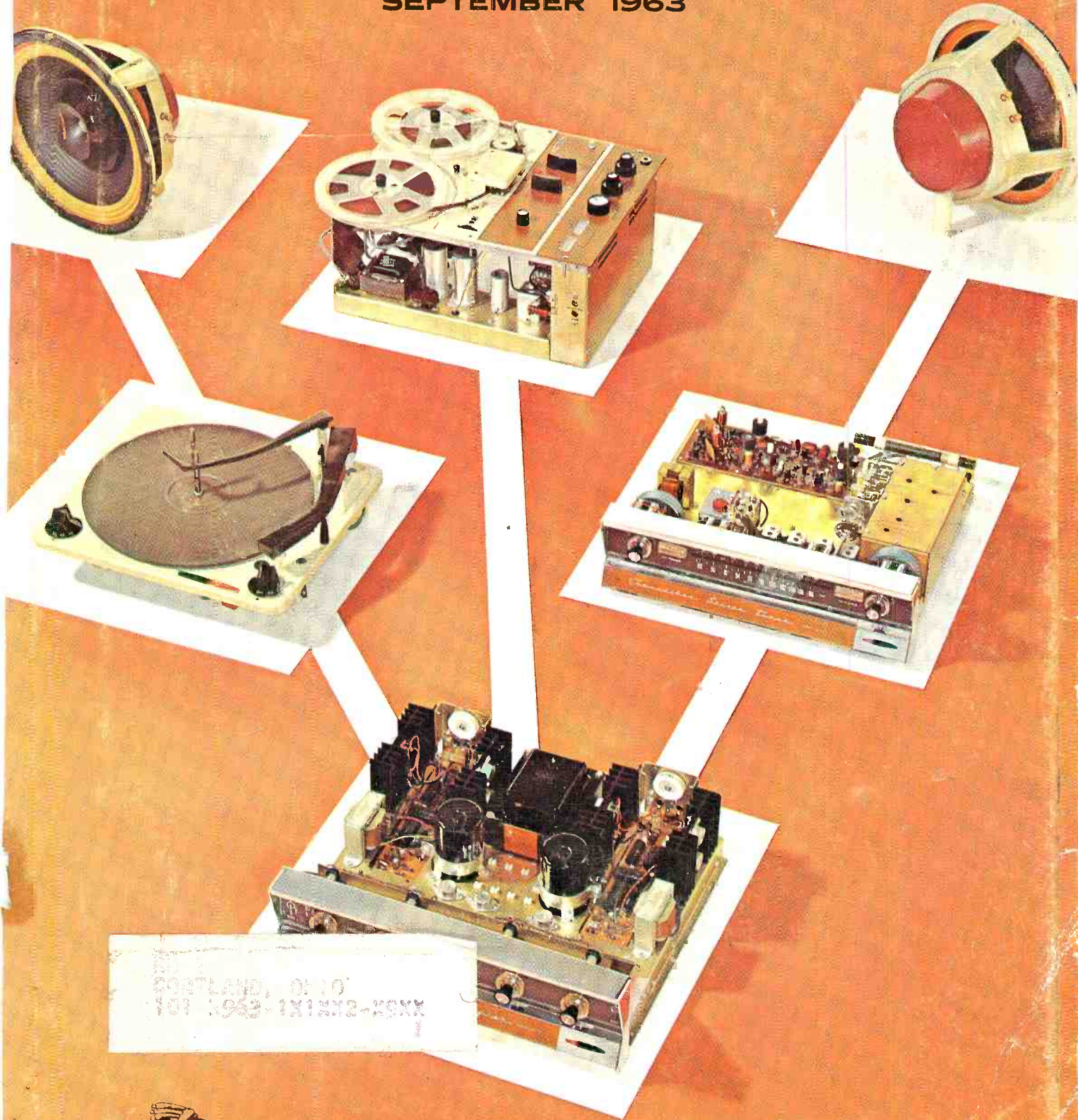

CORLAND, OHIO  
101-2963-1X1X2-KSKX



STEREO '64



# FREE!

Your Own AMF Bowling Ball ...  
or any of over 30 Wonderful Gifts in

## PHILCO'S

# Fall Fiesta

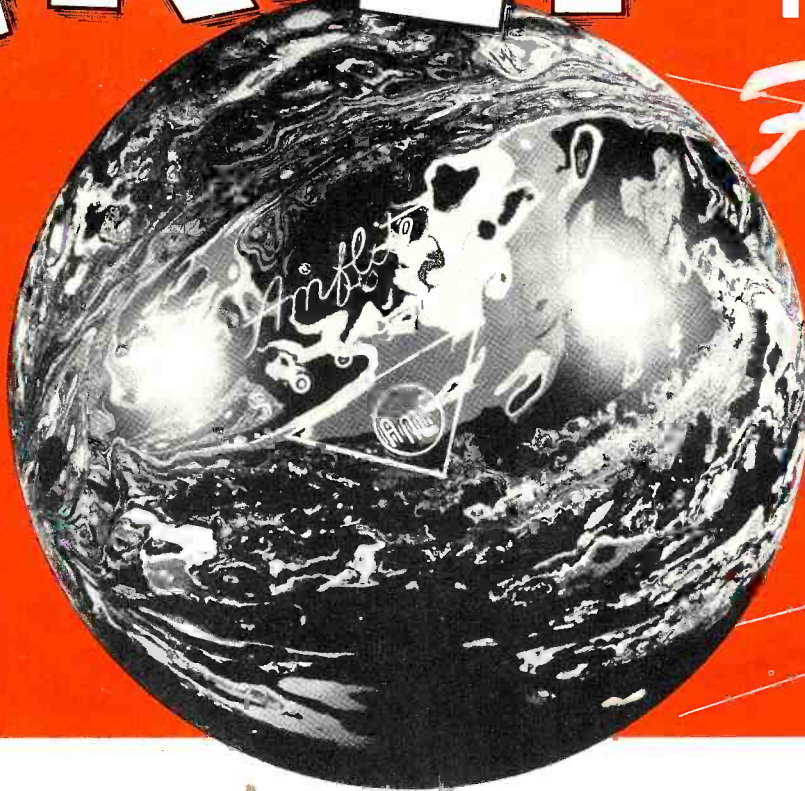

AMFLITE Bowling Ball ... for men, women or youngsters. YOURS FREE with purchases of only \$375!

Your choice of scores of wonderful gifts FREE with your purchases of Philco Parts, Accessories and Tubes included in Philco's Fall Fiesta Catalog! Big savings ... as well as wonderful gifts, just in time for Fall and Christmas. Get Your Philco Fall Fiesta Catalog NOW ... see your Philco distributor ... stock up on parts and accessories you need ... AND GET THE GIFTS YOU WANT, TOO!

**ALL THESE  
OTHER WONDERFUL GIFTS ... YOURS FREE**  
with your purchases of  
Philco Fall Fiesta Catalog Merchandise

FREE with your purchases  
of merchandise worth

AMF Rugger Bowling Bag	\$125
Daisy CO <sub>2</sub> Gas Operated Pistol	\$225
AMF Roadmaster Hawk Bicycle	\$700
Bridal-Trousseau Doll Set	\$110
Famous Lionel Train Set	\$200
Daisy Thundercap Tank	\$ 55
Men's Million Miler Luggage	
One Suiter	\$400
Two Suiter	\$450
Three Suiter	\$500
Attache Case	\$275
Ladies' Million Miler Luggage	
16" Hat Box	\$250
21" Overnighter	\$275
26" Pullman Case	\$450
Ladies' Orion Sweater	\$135
Ladies' Antron Cardigan Sweater	\$175
Ladies' Suburban Coat	\$350
Men's Melton Loden Coat	\$350
Men's Imported Rain Coat	\$350
Men's OuterJac	\$175
Men's Lambs Wool Cardigan	\$175
Men's Runabout Nylon Coat	\$350
Weather Trio (Instruments)	\$130
Outdoor Thermometer	\$ 15
Stanley Ratchet Driver Set	\$ 65
Oneida Dinner Ware	\$350
Oneida Stainless Flatware	\$450
8 Piece Cutlery Set	\$130
Hamilton Cosco Table and Chair Set	\$550



Luxurious  
**MINK and Cashmere Ladies'  
Sweater by Dalton**

**YOURS FREE** with purchases of only  
\$1300 of Philco Fall Fiesta Catalog  
merchandise.



Famous  
**SCHICK TRAVEL-ALL**

(Shaver, pre-shave, after-shave and  
grooming kit in handsome travel case.)

**YOURS FREE** with purchases of only  
\$225 of Philco Fall Fiesta Catalog  
merchandise.

GET YOUR FREE Fall Fiesta Gifts NOW ... See Your PHILCO Distributor Today



PARTS & SERVICE OPERATIONS

# PHILCO

A SUBSIDIARY OF *Ford Motor Company*

... for more details circle 43 on post card

Prices effective January 1, 1963

Tarzian offers  
**FAST, DEPENDABLE  
TUNER REPAIR  
SERVICE (ALL  
MAKES)**

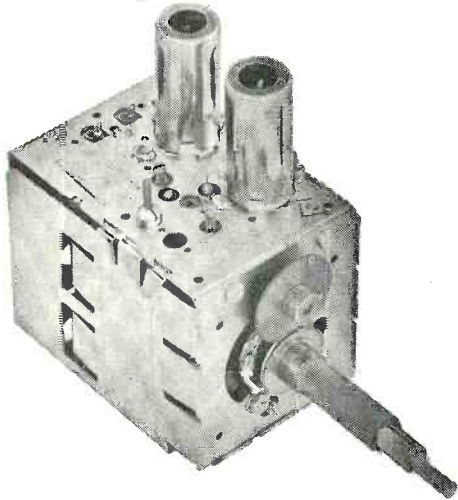

It just makes sense that a manufacturer of tuners should be better-qualified, better-equipped to offer the most dependable tuner repair and overhaul service.

Sarkes Tarzian, Inc. pioneer in the tuner business, maintains two complete, well-equipped Factory Service Centers—assisted by Engineering personnel—and staffed by specialized technicians who handle **ONLY** tuner repairs on **ALL** makes and models.

Tarzian-made tuners received one day will be repaired and shipped out the next. Allow a little more time for service on other than Tarzian-made tuners.

Tarzian offers a 12-month guarantee against defective workmanship and parts failure due to normal usage. And, compare our cost of \$9.50 and \$15 for UV combinations. There is absolutely no additional, hidden charge, for **ANY** parts except tubes. You pay shipping costs. Replacements on tuners beyond practical repair are available at low cost.

Ⓢ Tarzian-made tuners are identified by this stamping.

When inquiring about service on other tuners, always give TV make, chassis and Model number. All tuners repaired on approved, open accounts. Check with your local distributor for Sarkes Tarzian replacement tuners, replacement parts, or repair service.

 **SARKES TARZIAN, INC.**  
*Bloomington, Indiana*

MANUFACTURERS OF TUNERS . . . SEMICONDUCTORS . . . AIR TRIMMERS . . . FM RADIOS . . . AM/FM RADIOS . . . AUDIO TAPE . . . BROADCAST EQUIPMENT

**ONLY**  
**\$9.50**  
**INCLUDING**

**ALL PARTS**  
**(except tubes)**  
**and LABOR**

**24-HOUR SERVICE**  
**1-YEAR WARRANTY**

**TWO SERVICE CENTERS  
TO SERVE YOU BETTER**

**See your distributor, or use the  
address nearest you for fast fac-  
tory repair service**

537 South Walnut St.  
Bloomington, Indiana  
Tel: 332-6055

10654 Magnolia Blvd.  
North Hollywood, Calif.  
Tel: 769-2720



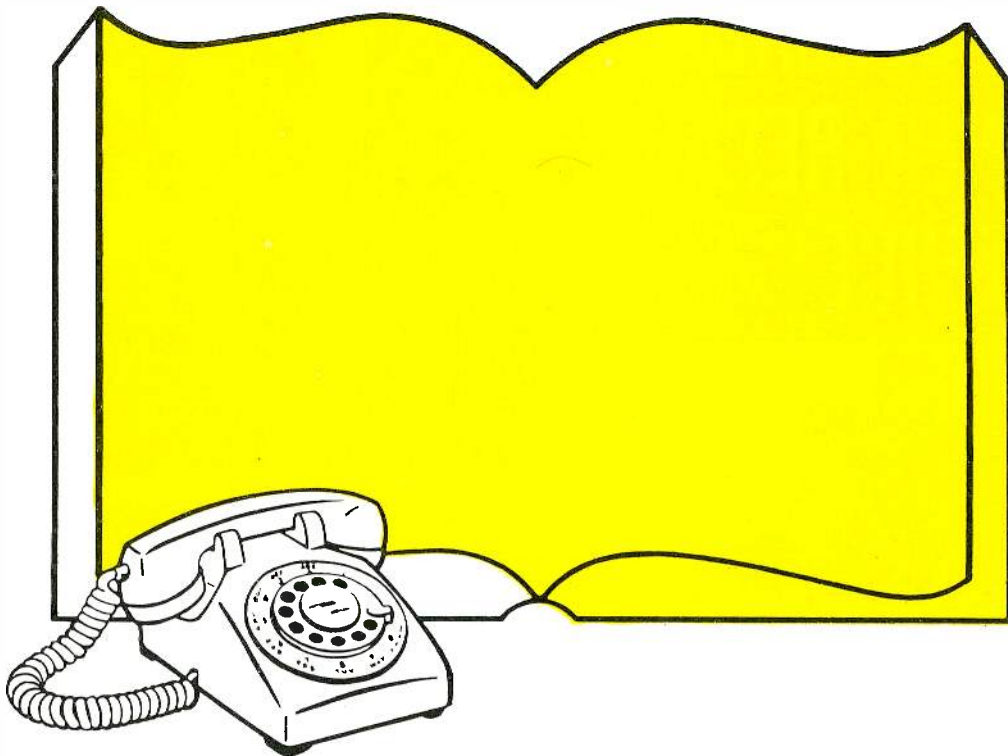

**This is one of the hardest-working  
signs in America.  
Is it working for you?**

IF NOT, CALL YOUR YELLOW PAGES MAN - FIND HIM IN THE YELLOW PAGES UNDER: **ADVERTISING - DIRECTORY & GUIDE.**

- - - for more details circle 10 on post card  
ELECTRONIC TECHNICIAN



**WORLD'S LARGEST  
ELECTRONIC TRADE  
CIRCULATION**

# ELECTRONIC TECHNICIAN

SEPTEMBER • 1963

Vol. 78 • No. 3

RON KIPP Publisher  
VICTOR L. BELL Editor  
JACK HOBBS Managing Editor  
WARREN CREWS Technical Editor  
ALEX ORR Assistant Editor  
DOUGLAS HEDIN Associate Editor  
EARL HINTZ Production Manager  
MAGGIE KANE Advertising Production  
JIM GHERNA Art Director  
JERRY WHITTLESEY Circulation Mgr.  
ETHEL NASH Circulation Fulfillment



**OJIBWAY PRESS, Inc.**

Ojibway Building  
Duluth 2, Minn.

AREA CODE 218 727-8511

**Sales Offices:**

**NEW YORK:** Ran Kipp, 480 Lexington Ave., New York 17, N.Y. AREA CODE 212 TN 7-0011

**CHICAGO:** William Klusack, 221 N. LaSalle St., Chicago 1, Ill. AREA CODE 312 CE 6-1600

**CLEVELAND:** Arnold T. Suhart, 6207 Norman Lane, Cleveland, Ohio AREA CODE 216 YE 2-6666

**LOS ANGELES:** Boyd B. Garrigan, 1145 W. Sixth St., Los Angeles 17, Calif. AREA CODE 213 HU 2-2838



Copyright 1963 by Ojibway Press, Inc., Duluth 2, Minn. Reproduction and reprinting prohibited except by written authorization of the publication. Subscription price: \$5 for 1 year, \$8 for 2 years, \$10 for 3 years. Foreign, \$9 for 1 year, \$14 for 2 years, and \$18 for 3 years. If you have a change of address or a question about your subscription, write: ELECTRONIC TECHNICIAN, Circulation Department, Ojibway Building, Duluth 2, Minnesota. BE SURE TO SEND ALONG THE ADDRESS LABEL FROM YOUR MOST RECENT ISSUE.

## COVER

The cover photo this month was furnished by Heathkit. A glance makes it obvious that amplifiers and turntables do not make a stereo system. Sales and service on both wired and kit equipment is big business—some dealers have even gone completely out of TV in an attempt to corner a market in a given town or area. The items shown on the cover are: Heath's transistorized amplifier AA-21; its companion tuner, AJ-43; tape deck AD-22; Changer AD-92 and two 12 in. Heathkit speakers.

## CONTENTS

Letters to the Editor .....	24
Editor's Viewpoint .....	33
<i>The Same Old Story</i>	
Good Store Image is Basic .....	34
<i>Cliff Iverson tells how one shop has created an image which pulls in stereo customers for everything from kits to custom installations.</i>	
Understanding Stereo Multiplex Equipment .....	36
<i>The operation of both matrix and time division demodulators are explained by L. V. Winston.</i>	
Troubleshooting Preamplifiers .....	40
<i>Understanding tone control circuits used in modern preamps is the key to easy repair according to author Eino Niemi.</i>	
Improving Sound in Decorator Packages .....	42
<i>A photo preview of what's coming in package stereo.</i>	
Sound Slender Style .....	44
<i>The trend in thin speakers—what it means to you.</i>	
Finishing the Kit .....	45
<i>When the kit builder turns on his newly built kit and finds that it doesn't work it's time for the technician to make his services available. Here's what you'll need to know.</i>	
Eliminate That Hum! .....	46
<i>John Holmes reviews procedures to locate and correct all types of hum in Hi Fi equipment.</i>	
Converting 40 and 50 cps Phonographs .....	48
<i>Some of the problems the technician encounters when converting foreign equipment is described by Granville L. Frichette.</i>	
Multiplex Generator Aids in Tuner Demonstration .....	49
<i>How one technician uses his stereo generator to demonstrate stereo tuners to service customers.</i>	
Multipath Problems in FM Stereo .....	50
<i>Harlen H. Winters tells how to detect and correct multipath problems in FM stereo installations.</i>	
Tuners Better, Especially Up Front .....	52
<i>Fringe areas stereo is no longer impossible with new tuner designs.</i>	
Manufacturer and Product Stereo Directory .....	60
The Effect of Stylus Polish on Record Wear .....	84
<i>A Sonotone engineer describes the various types of styli and tells about their effect on records.</i>	

## DEPARTMENTS

'Tough Dogs' .....	56	News of the Industry .....	82
Shop Hints .....	58	Free Literature .....	87
New Books .....	68	Advertisers Index .....	90
New Products .....		76	

## TEKFAX ..... 16 PAGES OF LATEST SCHEMATICS

ADMIRAL: Color TV Chassis 24A2, UA2, B2, UB2, C2, UC2, D2, UD2, UE2—Run 10

GENERAL ELECTRIC: Radio Model P970A

PERMA-POWER: Remote Control System Models G230, 1, 2 Receiver, Models G340, 50 Transmitter

MATSUSHITA: Motional Feedback Amplifier MF800

TELECTRO (Emerson): Tape Recorder-Radio Model 215

ZENITH: Transistor Radio Model Royal 490, Chassis 7KT45Z1



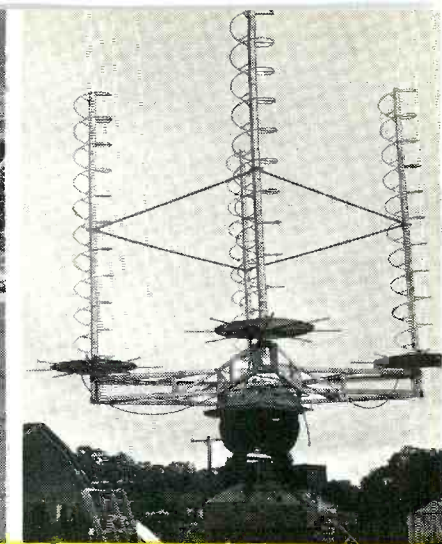
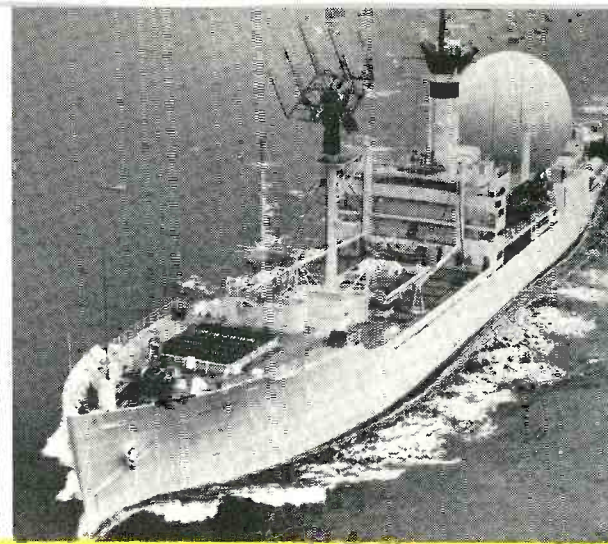
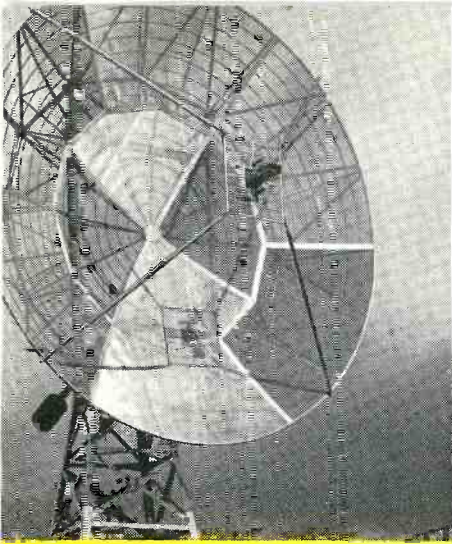

**THE SAME ENGINEERING, SAME PLANT THAT  
PRODUCES AMERICA'S GREATEST SATELLITE-  
TRACKING AND TELEMETRY STATIONS, HAS CREATED**

*the revolutionary new*

**PARALOG**

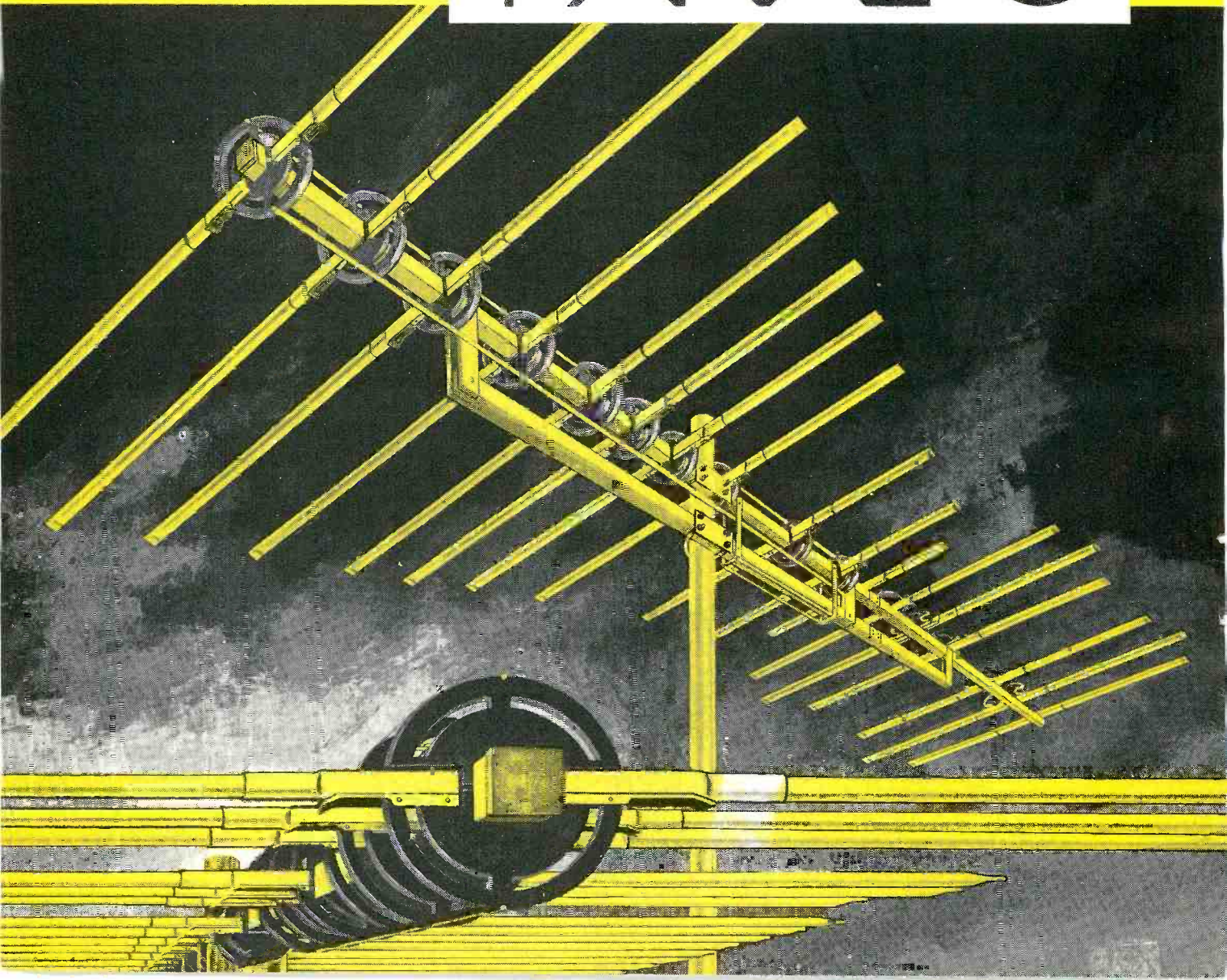





# PARALOG

## TV/FM ANTENNA

... Unparalleled performance because it has **ALL 4**:

- **HIGH GAIN**
- **EXTREMELY LOW VSWR**
- **HIGH FRONT-TO-BACK RATIO**
- **RUGGED CONSTRUCTION**

HERE IT IS—the space-age TV/FM antenna from the only manufacturer with actual space-age experience!

From the laboratories of Jerrold-TACO, designers of powerful satellite-tracking and space-telemetry antenna arrays for the U. S. Government, comes the all-new PARALOG, first home TV/FM antenna truly based on the log-periodic principle with a unique parasitic-element system for maximum all-channel gain.

Exclusive Cyclocac insulating mounts on PARALOG antennas assure constant impedance under all weather conditions, and eliminate the troublesome and unsatisfactory cross-feed systems of other antennas. Cyclocac, tough enough to be used for timber-splitting wedges and golf-club heads, makes each insulating mount a *strong point* on the PARALOG. Look at all these features:

### PARALOG FEED SYSTEM

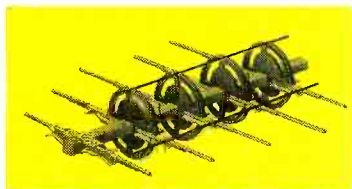

### OTHER FEED SYSTEMS

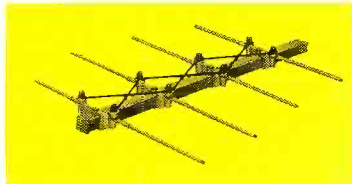

### SELF-CLEANING WEDGE-SNAP LOCKS

eliminate dipole-junction noise, can't loosen to cause vibration snow. Wind vibration merely serves to tighten wedge further into dipole.

**CYCOLAC INSULATORS** and radically-new impedance-stabilizing phase correctors eliminate the poor criss-cross transmission-line characteristics of other antennas.

### UNIFORM STRONG FORWARD LOBE

is maintained throughout high and low bands. Left: 69 mc (mid-channel 4); right: 195 mc (mid-channel 10). Lobe patterns for each channel equal or surpass these.

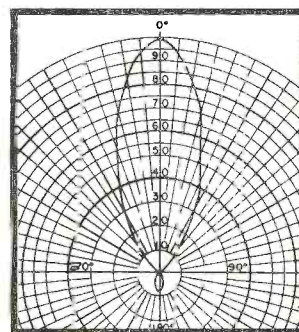
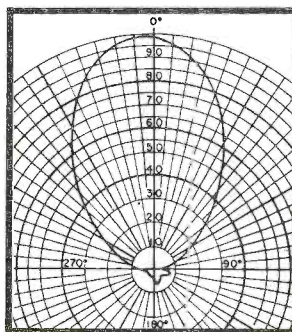

4 Electronic Models feature  
NEW TWIN-TRANSISTOR

### SUPER POWERMATE

Best gain/overload capability in the industry—brings in distant stations without overloading from nearby signals.



### 14 MODELS, UNSURPASSED FOR EVERY RECEPTION NEED

Seven non-amplified and four electronic PARALOGs for TV and FM, plus three special FM-stereo models, give you a line prepared to meet any reception condition at distances up to 200 miles.

#### ELECTRONIC MODELS

JTP-130S—List \$94.95    JTP-190S—List \$114.95  
JTP-160S—List \$104.95    JTP-220S—List \$124.95

#### FM STEREO MODELS

FMJTP-8—List \$29.95    FMJTP-10—List \$39.95  
FMJTP-16—List \$59.95

See your Jerrold-TACO distributor now, or write Jerrold Electronics, Philadelphia 32, Pa.

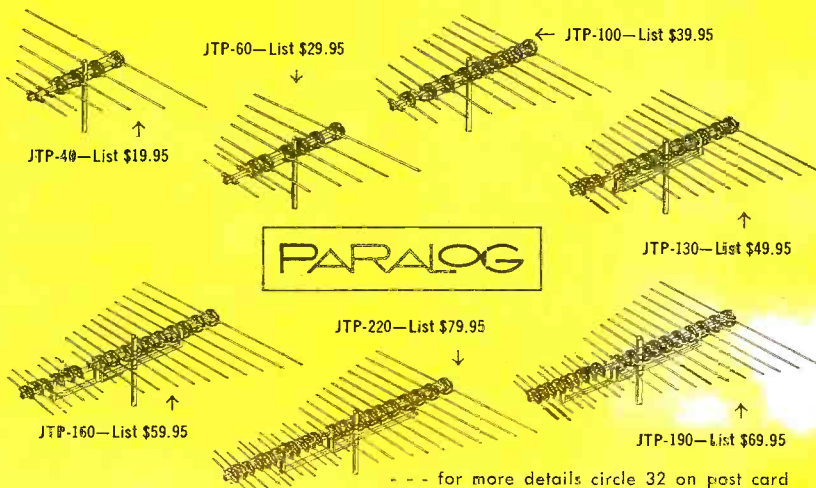

- JTP-60—List \$29.95
- JTP-100—List \$39.95
- JTP-40—List \$19.95
- JTP-130—List \$49.95
- JTP-220—List \$79.95
- JTP-160—List \$59.95
- JTP-190—List \$69.95

... for more details circle 32 on post card

TELEVISION F. M. RADIO

**CROSSWAY TELEVISION - RADIO**  
SALES - SERVICE

ANBURY ROAD, HILTON, CONN.

Customer's Order No. \_\_\_\_\_ Date \_\_\_\_\_ 196\_\_  
M. Cash

Address: \_\_\_\_\_

SOLD BY CASH C. O. D. CHARGE ON ACCT. NOSE. PAID OUT RETO.

QUAN.	DESCRIPTION	PRICE	AMOUNT
2	5U45B		4 20
1	6CD66A		5 75
1	6AF4A		4 -
	Label		5 -

Rec'd by \_\_\_\_\_ Tax \_\_\_\_\_

No. 002062 ALL claims and returned goods MUST be accompanied by this bill 1964

**Now, put more profit in this  
with this!**

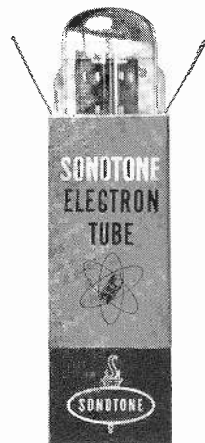

## NEW SONOTONE VALUE LINE

How much of that figure called "total" is profit? Depends on the cost of the tubes. That's why the new Sonotone Value Line puts more profit into that bill; they cost much less! They're top quality, first-line tubes, too. Every one is thoroughly tested to meet Sonotone's rigid quality standards—no more extra callbacks. And Sonotone makes sure you can enjoy these

extra profits on all calls. The Value Line includes all the popular home entertainment types—the ones you're most likely to need. So ask your distributor for the Sonotone Value Line. Start making bigger profits tomorrow. Now your distributor has two great Sonotone lines—the new Value Line and the well regarded Premium Line.

SONOTONE CORPORATION • ELECTRONIC APPLICATIONS DIVISION • ELMSFORD, N. Y.  
Cartridges • Speakers • Tape Heads • Microphones • Electron Tubes • Batteries • Hearing Aids • Headphones

- - - for more details circle 50 on post card

## LETTERS TO THE EDITOR

### Article in Error

Publishing only partial schematics of circuits, which is necessary in most cases because of space considerations, can lead to much confusion and head scratching. A case in point is the partial schematic in Fig. 2, page 40 of the April issue on Servicing Radios. Since both transistors are shown as PNP types (one of which may not actually be such) it would take more than a Philadelphia technically minded lawyer, I'm afraid, to interpret the schematic correctly. Note that the top transistor has its emitter connected to ground through a resistor. Since the symbol is shown as PNP we must assume that ground is positive. If that is so, then the lower transistor also shown as PNP and connected to negative must be incorrectly marked or connected, especially since you have the lower collector going to ground, which would be positive on the basis of the first assumption. Complete analysis of this is impossible with full certainty since you have left the top collector and lower base high and dry so we can't see to which end of the battery these are connected, thus dissipating a possible pair of clues to the answer to this mystery. Also, the top transistor emitter resistor can't be doing much since it would be shorted out by the extremely low resistance of the s.w. oscillator coil. Unless, of course, you have left out a coupling capacitor from the top emitter to the s.w. oscillator coil winding. Studying this circuit further, it appears to me that if the lower transistor were symbolized as an NPN transistor, all questions about the correctness of this schematic would vanish into thin air.

Your own comments on this apparent discrepancy will be awaited with interest.

M. G. GOLDBERG

St. Paul, Minn.

• There are several errors in the partial schematic in Fig. 2, page 40. The first, the collector and the emitter are reversed; second, a connection should be shown at the junction of the two resistors, the capa-



# WHY

## risk your reputation with "just-as-good" capacitors?

When you pay little or no attention to quality in tubular replacement capacitors, you leave yourself wide open for criticism of your work . . . you risk your reputation . . . you stand to lose customers. It just doesn't pay to take a chance on capacitors with unknown or debatable performance records when it's so easy to get guaranteed dependable tubulars from your Sprague distributor!

## There's no "maybe" with these 2 great SPRAGUE DIFILM® TUBULARS!

The ultimate in tubular capacitor construction. Dual dielectric . . . polyester film and special capacitor tissue . . . combines the best features of both. Impregnated with HCX®, an exclusive Sprague synthetic hydrocarbon material which fills every void in the paper, every pinhole in the plastic film *before it solidifies*, resulting in a rock-hard capacitor section . . . there's no oil to leak, no wax to drip.



**DIFILM® BLACK BEAUTY®**  
Molded Tubular Capacitors

The world's most humidity-resistant molded capacitors. Tough, protective outer case of non-flammable molded phenolic . . . cannot be damaged in handling or installation. Designed for 105°C operation with *no voltage derating* . . . will withstand the hottest temperatures to be found in any TV or radio set, even in the most humid climates.



**DIFILM® ORANGE DROP®**  
Dipped Tubular Capacitors

A "must" for applications where only radial-lead capacitors will fit . . . the perfect replacement for dipped capacitors now used in many leading TV sets. Double-dipped in rugged epoxy resin for positive protection against extreme heat and humidity. No other dipped tubular capacitor can match Sprague Orange Drops!

For complete listings, get your copy of Catalog C-615 from your Sprague distributor, or write to Sprague Products Company, 65 Marshall Street, North Adams, Massachusetts.



WORLD'S LARGEST MANUFACTURER OF CAPACITORS

# NEW SECO MODEL 107B TUBE TESTER SPEEDS REPAIRS, DETECTS SLEEPERS

● 8 sockets wired to 14 lever type pin selectors for testing tubes circuit by circuit!

● 40 prewired sockets accommodating 63 basic arrangements for testing thousands of popular tube types with no set-up data required!



**FOOLPROOF READINGS**—all test information reads on one meter and one scale! Eliminates errors that can be made reading off closely packed multiple scales. Wide sweep increases accuracy of readings.

**3 COMPREHENSIVE TESTS** find tube faults that slip by other testers that cost much more. Pull out more "sleepers" on your first try—save time and call-backs.

- **GRID CIRCUIT TEST** makes up to 11 simultaneous checks for leaks, shorts and grid emission—indicates "hard to find faults" that conventional short tests pass by.

- **DYNAMIC MUTUAL CONDUCTANCE TEST** indicates relative transconductance—incorporates gas error test.

- **CATHODE EMISSION TEST** provides the best method for testing pulse amplifier, power output and damper type tubes.

Readings can be made for element identification and analysis of elements for shorts. A "life" test checks for allowable drop in mutual conductance or emission current under reduced heater supply conditions. The exclusive Grid Circuit Test above is a test originated and patented by Seco.

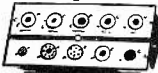

**PLUG-IN-SOCKET CHASSIS** is easily replaced or interchanged to accommodate the widest possible range of tubes. In addition to 8 sockets, panel has 3 pin straighteners for 4 most popular types. Inexpensive and easy to keep up to date as new tubes appear. Plug in chassis can be customized at low cost to fit your needs.

**WIDE RANGE** of tube types tested includes all modern TV, radio, industrial and foreign tubes using the following sockets—seven pin, nine pin, octal, loctal, novar, nuvistor, compactron, magnoval and ten pin. Special circuit for low voltage hybrid types. Complete set-up data book is included—pages covering new tubes that appear are mailed periodically to all registered owners at no charge.

ALWAYS UP TO DATE

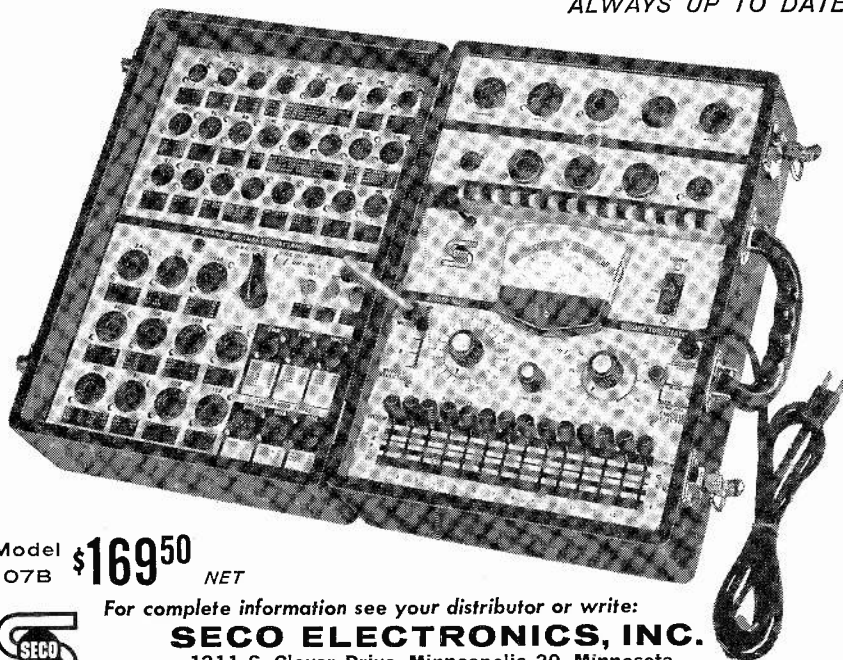

Model 107B \$169<sup>50</sup> NET



For complete information see your distributor or write:

**SECO ELECTRONICS, INC.**  
1211 S. Clover Drive, Minneapolis 20, Minnesota  
A DIVISION OF DI-ACRO CORPORATION

— for more details circle 47 on post card

## LETTERS TO THE EDITOR

citor and the base of the lower transistor; third, the series resistor-capacitor from the base of the lower transistor is not connected to the BC-SW switch.

Finally, a capacitor should be inserted in the lead between the upper transistor emitter and the junction of the capacitor connected to the lower transistor emitter; that gives some function back to the emitter resistor you were worried about. — Ed.

### We Bow

I have become greatly dependent upon your magazine and have introduced it to friends who have since applied for their subscriptions. Your magazine and more especially the circuit diagrams included therewith have saved me numerous dollars.

I will continue to boast of your magazine to all my friends who are in the electronic business. I know they will feel that the first two or three times they use the data compiled in your magazine, this alone will pay the subscription. Heretofore, I paid \$2.50 for similar information through (another source).

Also, be sure to notify me in plenty of time when my subscription is about to run out so I may renew it without missing any copies.

JOHN F. HOFFMAN  
Fort Devens, Mass.

### For Pros

In the past few years, I've been subscribing to various electronic publications which I thought had merit in the electronics field. But I just wasted my money on these publications, because they had no "meat" for the technician in which his trade is dependent upon for a living. Apparently most of the so-called electronic magazines are mostly theorized and not reduced to practice. However, I did see your publication a few years ago at an electronic school which I attended and was very much pleased with the "meat" contents on TV, In-



**As you read this ad . . .**

**A Finco Engineer is designing**

**A "special area" TV Antenna**

**Finco has produced 3,152 already**

**Each one is the best in its area**

**Want proof?**

**See your Finco distributor**

**Or write us.**

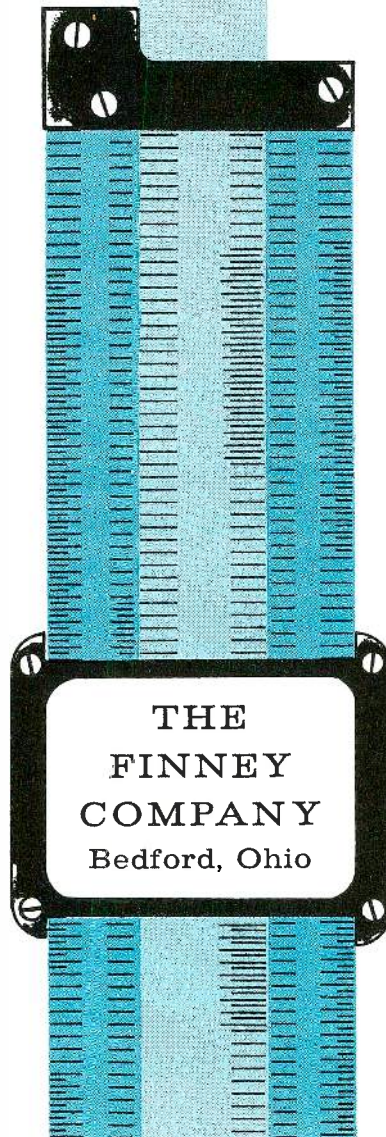

--- for more details circle 61 on post card

# Only Sylvania receiving tubes

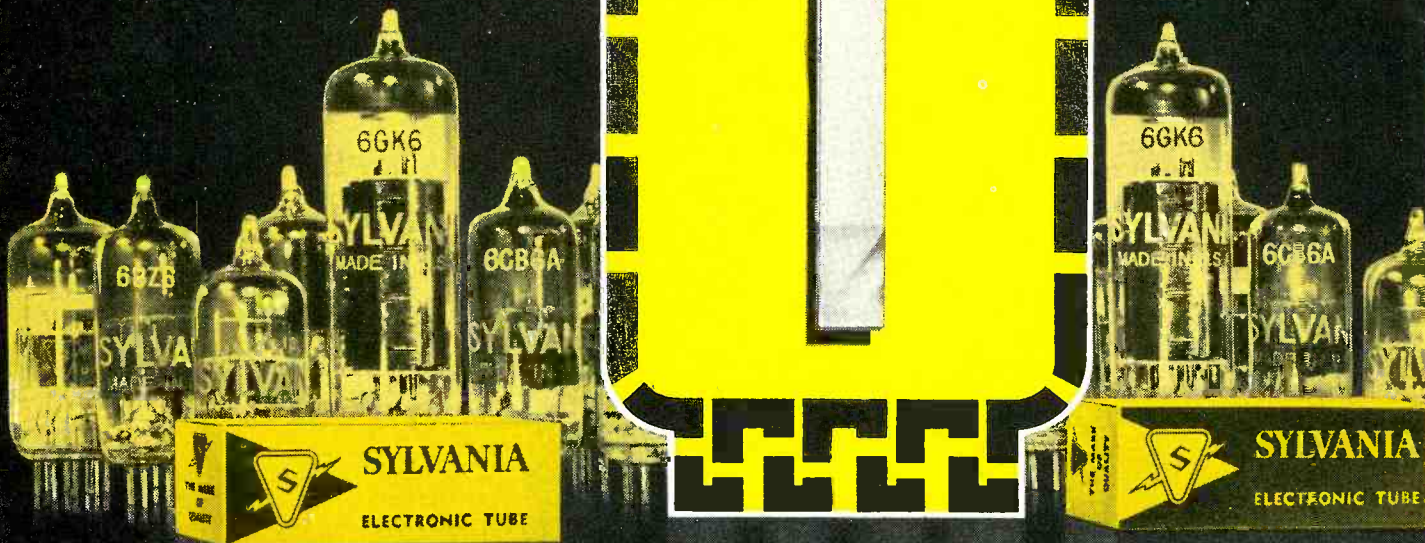
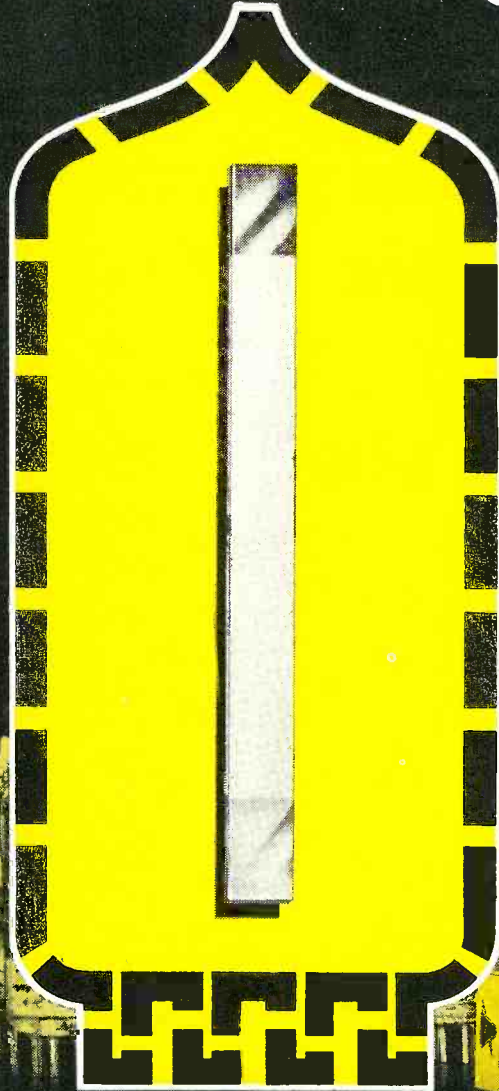

## LIFE-BOOST\* CATHODE...a big bonus in tube quality

Sylvania's exclusive LIFE-BOOST Cathode is putting new life into tubes—and sales. This latest evidence of Sylvania leadership in tube technology offers benefits you can really sell: it virtually eliminates performance slump, a major cause of profit-stealing callbacks. Besides stability, it produces significantly better tube life and uniformity. 90 types already have LIFE-BOOST, with more on the way...and it's being heavily promoted in national magazines and by mail. \*Trademark

New edition of Sylvania Technical Manual. Valuable 632-page dealer reference lists data on over 2,000 tube types, is fully indexed and tabbed for quick reference. Free supplementary data service to keep your manual current. Price \$3.00 through your Sylvania Distributor.





# give you these 2 big bonuses:



## **S&H GREEN STAMPS...with the Service 'n Save Plan**

Here's another big reason to go with Sylvania. S&H Green Stamps, exclusive with participating Sylvania Distributors, are given free to dealers with the purchase of Sylvania receiving tubes. They add up fast, especially when they're combined with stamps from the grocer and other merchants who give S&H Green Stamps. And the family can select gifts from a 144-page S&H Catalog full of everything from home furnishings to furs.

**GO WITH SYLVANIA—TO PROFIT!**

# SYLVANIA

SUBSIDIARY OF  
**GENERAL TELEPHONE & ELECTRONICS**





# make extra dollars with your scope

An oscilloscope gives a visual picture of what is happening in a circuit, something no other test instrument can do. This very feature makes a good scope a money maker for your shop. It saves you time, analyzes those intermittent faults, and makes routine servicing easier than ever. Once you start using a scope regularly you'll never be without one.

You've pulled a set with a buzz in the sound. Is it 60-cycle hum or 60-cycle buzz? A quick look with the scope and you'll know. You'll either see a 60-cycle sinewave caused by heater-cathode leakage or there'll be a vertical deflection sawtooth probably resulting from a defective bypass capacitor.

If alignment required? A scope is a must. Set it up along with your EICO post injection sweep generator, and you have only to adjust transformer and sound trap slugs to finish the job. Same thing for setting up the 4.5-mc sound takeoff network.

Losing the signal somewhere in the video circuits? Hook up the scope and see where it's going astray. There's a good chance you'll spot the bad component at the same time.

But when you go to buy a scope, what do you look for? Large screen, high sensitivity, frequency response, attenuators, synchronization, calibrator? All of these are important and are included in the design of any professional scope intended for the service technician.

**Large screen:** You can get by with 3 inches, but take the 5-inch screen of the EICO 460. Get a close look at what's happening. It's got an edge lit calibrated bezel too. **High sensitivity:** The 460's vertical amplifier delivers 25 mv per cm. All you'll ever need and more. **Frequency response:** EICO makes it flat from dc to 4.5 mc

in the 460. Ideal for color and black and white as well as industrial production and research, audio testing and experimenting. **Attenuators:** The vertical attenuator in the EICO 460 is a 4-step frequency compensated network. Can't beat this kind of design. **Sync:** Any signal reaching the screen is fully synced — automatically. And for special purposes you can inject your own external sync signal. **Calibration:** Accurate peak-to-peak voltage calibrator is built right into the 460.

All this adds up to the top scope for TV service. You can get it as a kit for \$89.95 or completely wired for \$129.50.

If you don't need so elaborate an instrument, take a careful look at the 427 dc to 1 mc scope or the new 3" General Purpose scope, the EICO 430 (kit, \$65.95; wired, \$99.95). The new 430 does everything bigger and more expensive scopes do. Vert amp/flat from 2 c to 500 kc, —6 db at 1mc. Sensitivity 25 mv/cm. Horiz amp. flat from 2 c to 300 kc. Sensitivity .25 V/cm. Flat face 3" tube; mu-metal shield eliminates effects of external fields.

There are plenty of accessories for EICO scopes too. An Electronic Switch to put two different signals on the scope screen at the same time (EICO 488; kit, \$23.95; wired, \$39.95). Voltage Calibrator for the less expensive 427 and 430 (EICO 495; kit, \$12.95; wired, \$17.95). Three accessory probes-demodulator, direct and low capacitance types.

Whether it's scopes, tube testers or VTVM's you get the best for less with EICO. Save money by building your instruments from kits, or buy them factory-wired at a substantial savings. See your distributor. Write for complete 28 page catalog. Dept. ET-9 *Add 5% in west*

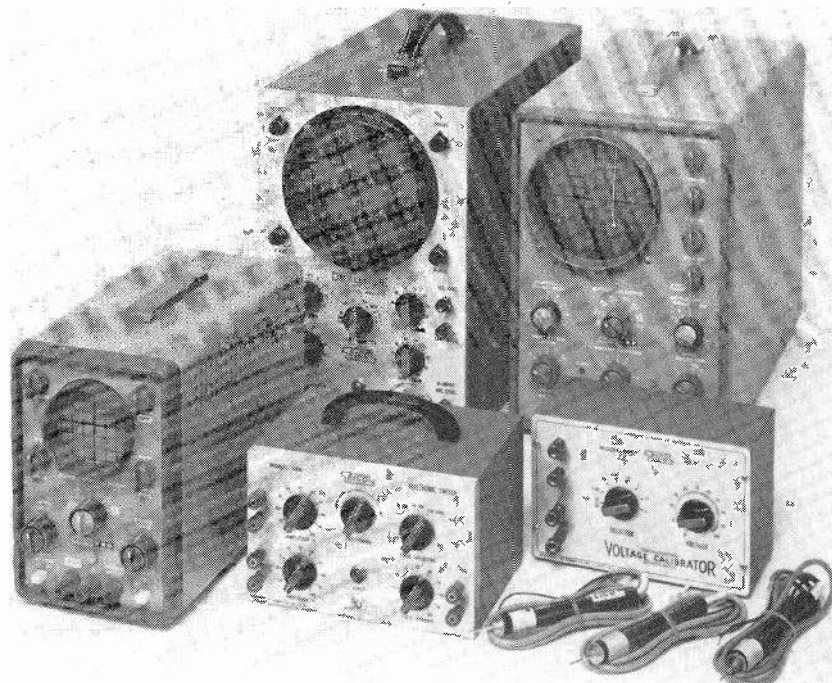

**EICO**

EICO ELECTRONIC INSTRUMENT CO. INC., 3300 Northern Blvd, L. I. C. 1, N. Y.

EXPORT: ROBURN AGENCIES INC., 431 GREENWICH ST., N. Y. 13, N. Y.

- - - for more details circle 23 on post card

## LETTERS TO THE EDITOR

dustrial Electronics, Auto Radio, etc.

I do hope your publication will always be confined to the electronics trade and that it won't be sold to any Tom, Dick and Harry or on newstands.

M. R. DALESSANDRO

Farrell, Pa.

● *Unless Tom, Dick and Harry are professionals, they're out of luck.—Ed.*

### Notice

... As manufacturers of the Ampli-Vox Roving Rostrum, we are always happy to see publicity about portable public address systems. I would like to point out, however, that the term Roving Rostrum is our registered trade name for a battery operated portable address system; and therefore should not be used generally to describe all such products as in "Afraid Is a Dirty Word," July ET.

NORMAN A. ACKERMAN  
Perma-Power Co.

Chicago, Ill.

### May Tube Article

My article entitled "Why So Many New Tubes" which was published in your May issue contained an error. The last sentence on page 49 should read: "The true hot capacity will be more under most operating conditions or approximately 30 per cent greater than the cold capacitance value."

The error came about because of a misinterpretation of data. The hot capacity can appear to be less than the cold capacity under a certain type of circuit operation, but in the context of the article it must be a greater capacity.

ARTHUR OVERSTROM

Westinghouse Electric Corp.  
Bath, N. Y.

### Commendations

... You are publishing a terrific magazine and I heartily recommend it for any technician.

JOSEPH A. KUSNERAK  
Cleveland, Ohio



# From RCA Victor—another big advance in Space-Age Sealed Circuitry

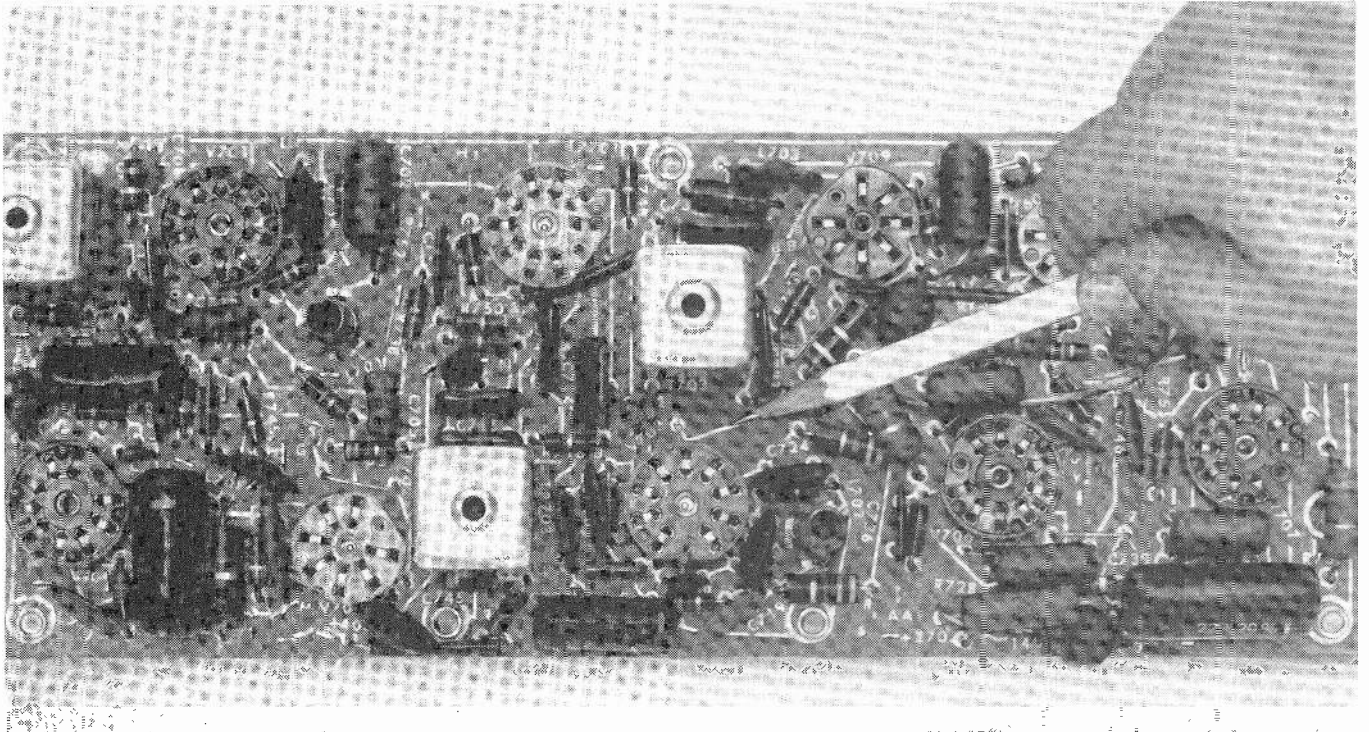

RCA Victor Color TV Chroma Circuitry

You can see at a glance how new streamlined “road-mapping”  
makes servicing faster, easier, surer than ever before

Pictured above is the “new look” in RCA Space Age Sealed Circuitry . . . the new precision-crafted boards that you’ll see in *all* 1964 New Vista Color and in most RCA Victor black-and-white television sets for 1964.

This new schematic diagram “road-mapping” consists of *straight white lines* that run *directly* from *point-to-point*. No confusion, no difficult paths. And the extra space gained has been used

to make the label markings larger. You can see and trace the circuits at a glance.

Here again RCA Victor has made a vitally important contribution to easier, faster and more accurate servicing. It is part of our continuing research program to offer the utmost in reliability with Space Age Sealed Circuitry.

See Walt Disney’s “Wonderful World of Color,”  
Sundays, NBC-TV Network



The Most Trusted Name in Electronics

Tmk(s)®

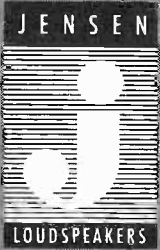

# MR. SERVICE DEALER: MAKE AN EXTRA 12½% ON YOUR REPLACEMENT SPEAKER PURCHASES!

12½% EXTRA is a big deal! It's three times savings account interest . . . twice the yield of good bonds . . . more than the final net profit of many a business enterprise!

Worth while? You bet! And it's easy. Every time you install a JENSEN Viking replacement speaker you make not 40%, but 45% profit plus your labor charge. There's no extra cost to the customer—official list prices are very competitive . . . you benefit from a built-in better profit structure.

Quality? Of course. You and your customer know that the JENSEN label is synonymous with the best in hi-fi . . . with equipment on every fighting ship . . . major commercial aircraft . . . wherever the finest is important.

Can you afford not to use JENSEN Viking replacement speakers? Better see your distributor soon! (Write for Data Sheet 170.)

## NOW NEW OVALS!

All the popular oval sizes and impedances are now available in the new JENSEN Viking series of replacement and general purpose loudspeakers. You get them at the right prices . . . and best profit margin!

Nom. Size	Model No.	Magnet Wt. Oz.	Imped. Ohms	List Price
3	3K7	.68	3.2	\$ 3.80
3½	35K7	.68	3.2	3.80
4	4K5	.53	3.2	2.90
4	4K7	.68	3.2	3.55
5	5K5	.53	3.2	3.25
5	5K7	.68	3.2	3.85
5½	525K7	.68	3.2	4.35
6	6K7	.68	3.2	4.35
7	7W3	1.00	3.2	6.55
7	7J9	1.47	3.2	6.65
8	8W3	1.00	3.2	5.85
8	8J9	1.47	3.2	6.90
10	10J10	1.73	3.2	9.00
12	12J10	1.73	3.2	10.50
3x5	3X5K5	.53	3.2	4.10
4x6	4X5K7	.68	3.2	4.80
4x8	4X3W9	1.00	8-10	6.00
4x10	4X10W9	1.00	8-10	6.50
5x7	5X7W3	1.00	3.2	5.35
5x7	5X7W9	1.00	8-10	5.35
5x7	57J9	1.47	3.2	5.40
6x9	6X9W3	1.00	3.2	5.95
6x9	6X9W9	1.00	8-10	5.95
6x9	69J9	1.47	3.2	6.40

JENSEN MANUFACTURING COMPANY/DIVISION OF THE JENSEN CORPORATION, 6150 SOUTH WASHINGTON AVENUE, CHICAGO 38, ILLINOIS  
Canada: Radio Speakers of Canada, Ltd., Toronto; Argentina: MCOA, S.A., Buenos Aires; Mexico: Papattel, S.A., Naucalpan, Mexico



## EDITOR'S VIEWPOINT

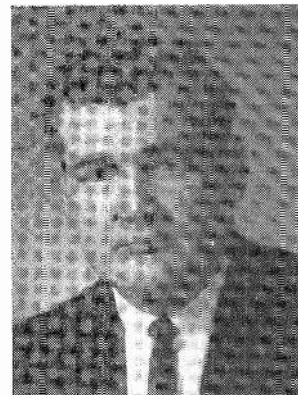

### The Same Old Story

Servicing Hi Fi equipment is big business. Some of you obviously think it's too big; or perhaps too little. Consequently, a Hi Fi owner who has a set which doesn't sound just right can have considerable trouble finding out what is wrong with it. Contrary to distorted facts from certain quarters, getting a Hi Fi set repaired properly is not easy. Most of you have met an auto mechanic, I'm sure, who will change your spark plugs but that's all. Hence you can sympathize with the Hi Fi customer who gets the brush-off when a technician tells him he'll check the tubes but that's all.

It just doesn't make sense. Here are people begging to get an expensive piece of equipment properly serviced. Service which you can justifiably charge a good price for and you say "no." But you'll work on a TV set that's ready to fall apart and take a beating on the bill. Wake up! You'll need some special equipment, sure, but it will pay for itself in short order if you make it known that you are a Hi Fi expert. And if you don't know enough about it by now, perhaps you should forget about it after all.

Bringing up the garage mechanic makes me think about an experience I had the other day when I was visiting a TV shop. The phone rang and the ensuing conversation had all the earmarks, from what I could hear, of an irate customer talking to his TV technician. Only the situation was turned around. The technician was talking to his auto mechanic and he suddenly became one of the mechanic's problems:

"Oh, you got it fixed, huh? How much is the damage? . . . \$165? . . . Now wait a minute. You said it would cost about \$65 . . . Well are you charging me for pulling the engine twice? . . . Well if just that one little part was bad how come you put in the rest? . . . I don't care. I can't see how all those parts could go bad at once. How about the factory — don't they have a "make good;" sounds like it's something that goes wrong on all of these models? . . . I

understand that, but you had to pull the engine out anyway. Are you sure you didn't use the book and charge me for that and then use the book and charge me separately for pulling the engine again? I mean if you had to take the engine out, for one job and did another while you were in there you shouldn't charge me for pulling the engine twice."

This went on for a full ten minutes. I don't know the outcome; perhaps the technician had a legitimate complaint. But the similarity between this conversation and so many I've overheard when a technician was talking to a TV-Hi Fi owner seemed almost overwhelming: "No sir, it would have worked all right with just one tube, but the others were weak and would have gone bad soon anyway — putting them in now is the least expensive way out. Not only that, we just can't guarantee our work if we don't put the set into top condition."

But you know how it goes — as long as you're on the giving end. I think the most amazing part is not the effort we put into educating the customer about the cost and problems in repairing a piece of electronic equipment but the screams we put up when someone in another trade tries to educate us. If each one of you would think about the other side of the story, no matter how unrealistic it sounds, before you blow your top you might better understand the misgivings of the next customer you have to "handle." Remember, your customer probably understands far less about the TV or Hi Fi than you do about automobiles.

*Vic Beale*



*How one successful TV-service dealer  
is laying the foundation for  
future growth to avoid stagnation  
and possible business failure*

## **Good Store Image Is Basic**

*by Cliff Tuerson*

■ Mindful that his advertising and promotional program—selling techniques and service department—are the “bread and butter” elements of his daily merchandising effort, Norm Rozak, president of Rozak Bros., Highland Park, Ill., groups all these activities in a planned program to create a good store image for bigger future sales.

### **Store Image**

“We are constantly aware in our effort to produce daily, weekly or monthly sales that we must pay the rent, meet our payroll and other expenses,” he said. “But, we are always looking to future years and we firmly believe that the future will produce more plentiful rewards if we make a major effort to build a strong store image.

“What produces a good store image is not always easily defined,” he continued, “but it is a combination of every day attention to meeting the customer’s needs so that he is well satisfied, plus service ‘beyond the call of duty,’ and promotions which make lasting impressions.”

Perhaps no place is a dealer more vulnerable than in his service department. It is in this area that customers may be handled in such a way that they leave the store angry and vow never to set foot in the store again. And this can pyramid.

In pointing out examples on “how-to” and “how-not-to” handle service customers, Norm cites two

actual experiences in his own shop.

One customer picking up a repaired TV set asked, “What is the charge?” The serviceman answered directly, “\$40.” The customer’s reaction (in the presence of four other customers) was extremely embarrassing and certainly did not contribute to a good store image.

In contrast, when another customer served by Norm asked what the repair bill was, he first explained what was wrong with the unit and gave details on the number of tubes replaced and repair of a short, in addition to explaining that preventive maintenance had been performed on the set to insure a longer operating interval. Then he said the repairs came to \$45.

“She may not have liked to pay \$45 for repairs,” Norm pointed out, “but few do. However, she did feel satisfied that we had rendered good service and quietly paid the bill without a scene.”

### **Promotion**

Mr. Rozak firmly believes that service calls can be used advantageously to implant a good store image. In the above instance, he feels that the customer has the right to know what and how much work was performed and is thus made aware that the cost is reasonable.

Citing an instance where an expensive custom installation developed into four additional jobs, Norm pointed out that the importance he and his crew paid to every detail on the original job created such

a good image that the customer became “a walking-and-talking promotion man for our company.”

For the spectacular promotion to gain image and customers, the firm promoted its own Hi-Fi show, renting the local Elks Club headquarters and displaying some \$50,000 worth of Hi Fi equipment sent in by manufacturers. Some 5000 area inhabitants attended the show during its three-day run. About \$1500 worth of merchandise was given away in gifts.

“We didn’t make a sale at the show,” Norm reports, “but, boy did we up our image and that is worth dollars to me.”

A future promotion contemplates a manufacturer bringing in a lot of expensive test gear along with three top flight engineers who will test any amplifier of any brand name and give the set owner a response curve.

Off and on, Norm has a high school girl in the show room window or on the floor demonstrating how easy it is to build component kits. Incidentally, the teen-ager is a big part of Norm’s plans to build a strong image for his store.

During the current year, Norm designed an eight page flyer which was used as a stuffer in 11 local weekly newspapers. Combined circulation of these newspapers is 100,000. In addition, he is using the same flyer as a mailing piece. Norm is making plans to send these flyers out about four times each year.





Rozak store front in Highland Park, Ill.



High school girl demonstrates ease of building Hi-Fi kits.

### It Pays Off

Doing a total annual sales of \$250,000, Norm breaks this up as 25 percent from the servicing department, 37½ percent from TV and 37½ percent from Hi-Fi and stereo. The Hi-Fi business, he says, is more profitable than the other two.

He also disclosed that the firm is increasing the number of "big custom jobs." These range from \$600 to \$5000. This, he emphasized, has been very rewarding in providing references and increasing store recognition.

Philosophically, Norm points out, "If you don't have a direction where you're going, it is difficult to gain success. Business becomes drab and affects all personnel."

Each year, Norm sets the sales goal for the following year and hasn't missed once. He predicts that

*Continued on page 88*

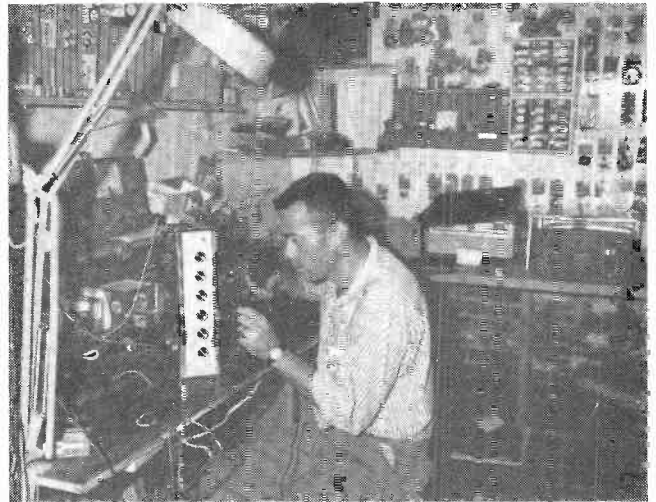

Dick Roberts, one of three service technicians, is service manager of Rozak company.



Home TV/Hi-Fi installation in closet.



One of many home Hi-Fi installations designed by Rozaks.

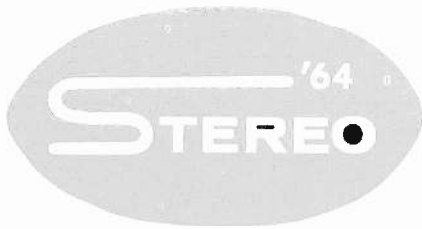

*A discussion of signals and alignment problems with troubleshooting tips*

## **Understanding and Servicing Stereo**

---

■ Servicing stereo multiplex equipment is different than servicing most home entertainment equipment. When a part is replaced in the multiplex unit, it almost invariably will require realignment. In fact, alignment is one of the best ways to locate trouble in this equipment. Certainly it is not wise to simply listen to a multiplex unit to determine whether or not it is working properly. Of course, many obvious symptoms can be readily diagnosed by listening tests. The steps necessary for proper alignment will invariably lead to the trouble in less obvious cases.

Alignment instructions for all instruments are too varied to be detailed here. The best method is to learn all you can about multiplex in general so it can be applied to any unit you might encounter.

### **The Multiplex Signal**

Multiplex is a method of transmission whereby two or more signals can be sent in a single transmission. This is accomplished by

coding each signal before transmission so they can be separated at the receiver.

In stereo multiplex, the signals being transmitted are left (L) channel audio signals picked up from a microphone on the left and right (R) channel audio signals picked up from a microphone on the right. These signals are then coded, transmitted, decoded and reproduced at the respective right and left speakers of the receiver.

To accomplish this, the RF carrier is FM modulated with a mixture of the left and right channels (called the sum or  $L + R$  signal). This is transmitted in a normal fashion (as though picked up by a single microphone) and can be received with a monophonic tuner.

For stereo reception, however, the carrier is also FM modulated with a 38 kc signal. This is called the 38 kc subcarrier. The subcarrier carries the L information and has been AM modulated by this audio information. In order to fully understand how this is accomplished,

let's digress and discuss sideband modulation.

Using the 38 kc subcarrier frequency, as an example, and drawing on our fundamental electronics knowledge, we can show that there are actually three distinct RF frequencies plus the modulating frequency involved when one frequency is used to modulate a second frequency. Just as there are four frequencies present when an incoming radio signal is mixed with a local oscillator signal in a radio.

For illustration, let's assume that the 38 kc subcarrier is being AM modulated with a 1000 cycle audio signal. The result is the original 38 kc signal (now AM modulated with the 1000 cycle signal), the sum of the signals, 39 kc, and the difference of the signals, 37 kc are both modulated with the 1 kc signal. The sum and difference frequencies actually contain all the information that the modulated carrier contains. These frequencies are called the upper and lower sidebands respectively.



# Multiplex Equipment

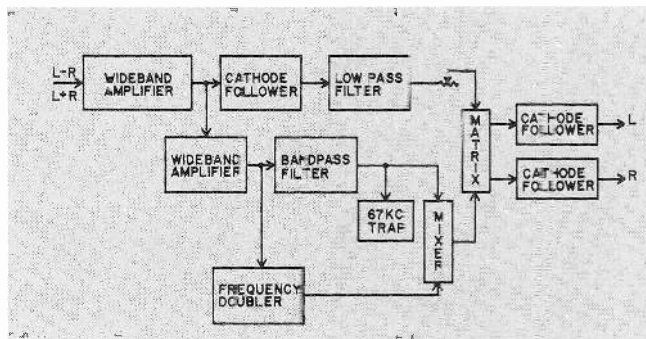

Fig. 1—Functional block diagram of a stereo multiplex decoder.

by L. V. Winston

In FM stereo multiplexing, only the sidebands are transmitted; the main carrier is suppressed. Of course, you can see that when the full audio range is used to modulate the subcarrier, the sideband on either side of 38 kc would be twice as wide as the audio range. In FM stereo the lower sideband extends from 23 kc to 38 kc and the upper from 38 kc to 53 kc when a full 15 kc audio is impressed on the subcarrier.

At the receiver end, it is necessary to reconstruct the L and R signals. But to accomplish this, a 38 kc signal with the exact phase of the original must be used. Since this signal is suppressed at the transmitter, it must be obtained in another manner. To obtain this reference, a 19 kc pilot frequency is also transmitted in the main carrier; exactly half the subcarrier frequency. In fact, the original 38 kc subcarrier is in most cases developed by a frequency doubled to obtain the exact reference needed to decode the stereo signal.

Thus far we have used 0 to 15 kc for standard broadcast audio frequencies, the 19 kc area for a reference pilot signal, and 23 kc to 37.950 kc and 38.050 kc to 53 kc for sideband signals to develop the stereo signal. Since the FM signal band width is 75 kc, we still have a band of frequencies above 53 kc that can be used. These frequencies are, therefore, set aside to be used for broadcast background music by FM stations and is called SCA (Subsidiary Communications Authority). This band is removed a little further from the upper sideband so no interference can take place; the SCA band is located from 60 to 67 kc.

## The Multiplex Receiver

We need only be concerned with the circuits directly affecting the decoding of the multiplex signal or adapters which are employed to convert standard tuners to receive stereo. A functional diagram of the multiplex decoder in a stereo tuner is shown in Fig. 1.

The multiplex information for the decoder circuitry is obtained at the detector output in the normal configuration of the stereo tuner. Information at this point includes the 19 kc pilot, as well as the L and R information. It should be understood that the stereo information is actually an L-R signal in the sidebands and L+R in the normal monophonic area. The reason for transmitting the stereo information in this manner involves the compatibility of monophonic receiver for stereo signals.

The first part of all multiplex decoders is a sideband amplifier to boost all frequencies in the composite frequency equally. Some type of matching device, usually a cathode follower, is then used to feed a low pass filter which passes only L+R. Often a single coil and capacitor constitutes the low pass filter.

The total signal is fed to another wideband amplifier; since this signal is filtered considerably, it must have additional amplification. After

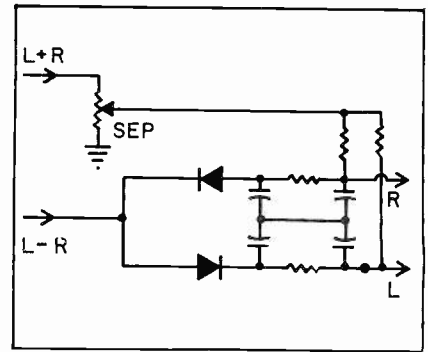

Fig. 2—Typical matrixing network found in most receivers.

amplification, the signal is fed to a keyed oscillator where the 19 kc is used to drive a frequency doubler to obtain the 38 kc reinsertion frequency. The addition usually takes place through a common load resistor of the amplifier and the frequency doubler.

A 67 kc trap is also often included at this point to eliminate the possibility of SCA signals passing through the system. This filter has a higher degree of attention than any other in the adapter.

### Demodulation

At this point both L-R and L + R signals are available; a matrixing network separates the two signals back to the original L and R channels so they can be applied to left and right audio amplifiers.

A typical matrixing network where the signals are derived is shown in Fig. 2.

Another modulator system called the time division method now being employed does not use the reinsertion principle to separate the L and R signals. In this system the composite signal is amplified and applied directly to a pair of diodes which are polarized in opposite directions. If no other voltages were applied to the diodes, a positive rectified signal would be present at the output of one jack and a negative rectified voltage would be present at the other.

A 38 kc voltage is developed, however, in the same manner used

in the matrixing system and is applied to the diodes. This voltage switches the diodes so that each diode is gated on when its respective left or right signal is present. This system is shown in Fig. 3.

It may be difficult to tell at a glance whether a particular circuit is employing a matrix type demodulation or a switching type. Some matrixing systems employ four diodes as do some switching types. Don't let yourself be caught trying to identify what circuit type is employed in a particular receiver without analyzing the circuitry involved.

You should note when troubleshooting any of these circuits, that a right or left signal will also be found, greatly attenuated at the opposite channel. The actual amount of separation depends on the particular unit but a good minimum figure is 18 db.

Now, let's look at some troubleshooting tips that will get you out of the woods before you completely misalign the receiver trying to find the trouble.

### Before Alignment

Poor separation will be the most frequent single complaint you will hear from your customers — and the most difficult to deal with. There are many reasons for this problem — ranging all the way from poor original program material or station difficulties to improper adjustments of the customer controls. At any rate, several points should be

analyzed prior to “tearing” into the unit with a generator and soldering iron in hand:

1. Check the setting of all controls to be sure one or more aren't in the mono position. Often a control is also included on the adapter chassis. Although this would cause a complete loss of stereo reproduction, the customer may complain only of poor separation since differences in each side of the speaker system may resemble stereo with little separation.
2. If an adapter is employed, check all the connections between the tuner and the adapter.
3. Listen closely for motorboating; when present, this indicates that the local oscillator is not locking to the 19 kc pilot frequency. Since the oscillator is operating, however, it is usually only a symptom of poor alignment.
4. The effect that audio which should be coming from one channel is continually moving toward the other channel is usually caused by multipath problems and is a separate story in itself. (See *Stereo FM Antenna* article on page 50 this issue. — Ed.)
5. Poor stereo after warm up is a common complaint with systems which have been converted with adapters. This is purely a case of drift which was not objectionable on older tuners but is most objectionable during stereo programing. There is no cure except to reset the dial after sufficient warm up. Newer



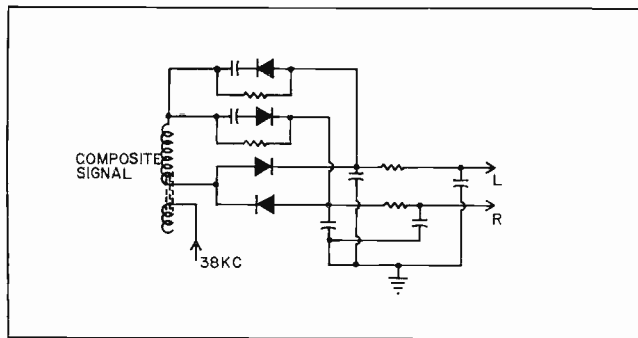

Fig. 3—Demodulating system used in time division multiplex decoders.

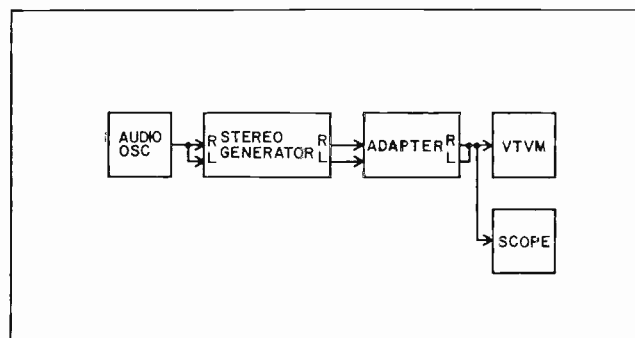

Fig. 4—Equipment set up for multiplex alignment of either type decoder.

## Stereo Multiplex Equipment Continued

tuners designed for stereo have been made with a great deal more stability and are rarely a problem.

6. As with any other type electronic equipment, the tubes should be checked first; substitution is preferred. This will eliminate the majority of problems that seem too baffling for analysis.

After having reached the point where the unit must be disassembled before proceeding, there are a few more checks to make before alignment is begun.

1. Thoroughly inspect the unit for signs of overheated components and bad connections.

2. Make quick checks on the diodes, coils and other components easily checked with an ohmmeter to establish if they are completely open or shorted. Do not relieve suspicion of these units permanently, however; a more complete check may be in order after further troubleshooting.

3. SCA interference may sometimes be most easily eliminated by careful adjustment of the SCA trap to the center range of minimum interference.

### Alignment

Alignment without a stereo generator is not recommended, but if absolutely necessary or for expediency in the field, the procedure is outlined here.

1. Tune the receiver carefully to a station broadcasting a stereo signal. Make sure this is a stereo signal; it would be wise to check

with the station to be sure if possible.

2. Turn the separation control to its minimum position. If a separation control is not available, ground out the L+R signal in the unit. (Note: This is not possible in switch type circuits.)

3. Turn the 19 kc oscillator slug until maximum sound is present at both speakers.

4. Adjust the channel separation control for maximum separation (or remove ground connected in step 2.).

5. Peak other adjustments to produce the effect for which they are functioning. That is, 67 kc trap for minimum SCA interference. This adjustment may be aided by injecting a modulated 67 kc signal into the unit and adjusting the trap for minimum output.

Alignment by using a stereo signal generator is more precise and will invariably gain better results. Specific instructions for alignment should be determined by the instruction manual for the test set.

A diagram of the setup required is shown in Fig. 4. Certain specifications will be necessary in equipment used with the multiplex generator for the alignment. The VTVM should have at least a 10 mv full range scale; and the audio oscillator should be capable of at least 2.0 v output in the SCA frequency range. A standard oscilloscope may be used for the alignment if the horizontal and vertical

amplifiers have no phase shift (within two degrees) or have 180 degree phase shift within two degrees.

Observe standard test setup procedures making sure grounds are tight and allowing the equipment to warm up 15 or 20 minutes. Set the test equipment controls according to the manufacturers' instructions. This usually involves setting the proper left and right signal amplitudes, the proper amount of deviation, etc. Follow the tuner manufacturer's recommendations for alignment. This involves setting the SCA traps, adjusting the 19 kc and 38 kc circuits and setting the instrument for maximum separation.

Rough channel separation measurements can often be accomplished by using the scope as an indicator and feeding a left only or right only signal through the unit while adjusting separation for minimum output on the opposite channel. The difference in amplitude between the right and left channel outputs — with only one input — (either right or left) is the unit's separation. This is most often given in db's. A standard meter calibrated in db can be used for this test.

The amount of stereo FM work you can do will depend on several factors. Obviously, if stereo multiplex is not being broadcast in your area, this will be the limiting factor. But the most important factor in other areas is making the public aware that you are a qualified technician. ■



# TROUBLESHOOTING PREAMPLIFIERS

'Tone' control circuits are technicians' biggest headache

by Eino Niemi

Technicians who are competent and fearless when servicing radios, TV or power amplifiers often find themselves shuddering when it becomes necessary to "operate" on a preamp. Boost and cut circuits, equalization and relatively small signals seem to be too much for them. But the principles for amplification and electron flow are the same and knowledge of the "tone" circuit with a few troubleshooting tips will make you qualified to service most Hi Fi preamps.

Some preamplifiers are separate and incorporate their own power supply; others take power from the main amplifier or are incorporated with the power amp to form an in-

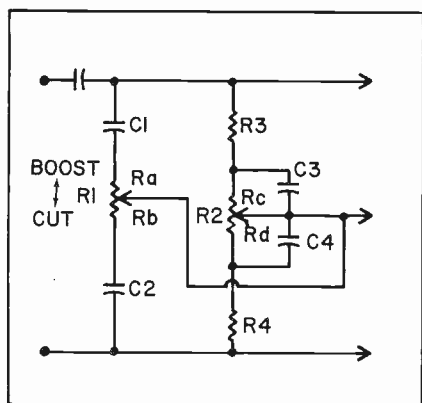

Fig. 1—Losser tone control circuit employed in PA equipment is still used in many Hi Fi preamplifiers.

tegrated unit. When it comes to finding hum, motorboating, distortion or just plain silence, however, one is just about as easy to repair as the other.

### Getting Started

Isolating the problem to the pre-amp is, in most cases, relatively easy. For example, hum can be isolated by simply shorting the output

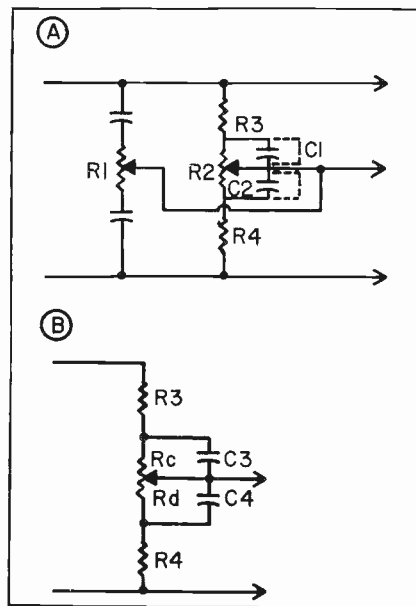

Fig. 2 (A)—Treble portion of the losser tone circuit shows that part of bass circuitry is also employed. (B)—Bass circuitry stripped of treble components.

of the preamp to ground while observing a meter indication at the power amplifier's output and separately at the input. A dead system can be checked out by injecting a signal into the power amp with your finger (and into the preamp — with the volume turned down). Distortion too, can be checked out in this manner: First select a different program source; in many cases it is possible to select a source which is simply switched in the preamp such as a tuner. Of course, if distortion is still present under these conditions, the trouble is most likely not the preamplifier. Because of the switching possible in most preamps, it can be a convenient aid to troubleshooting. Before any meter work is begun, all switches should be turned to various combinations and the effect noted. If no difference is noted in the symptom, the problem can be considered to be uncommon with the switching circuitry.

Particularly in cases where hum is a problem, the interconnections should be carefully checked. Use an ohmmeter and check for continuity and shorts in both the center conductor and the shield. It should be noted, however, that in some cases, it is desirable to disconnect one end of some shields to prevent ground loops. (See "Eliminate That Hum" on page 46 of this issue.—Ed.)

Troubleshooting preamp circuitry is actually easier than the power amplifier in many instances because the industry has standardized much of the circuitry. The biggest problem you will probably encoun-

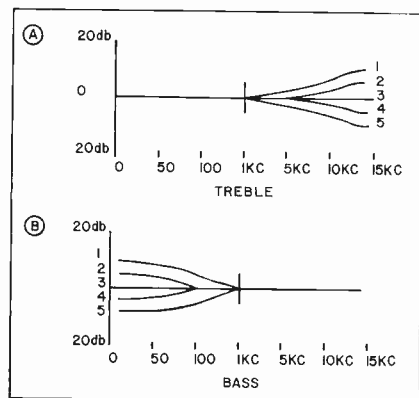

Fig. 3 (A)—Treble boost and cut shown in 1, 2, 3, order: maximum boost, intermediate boost, flat, intermediate cut and maximum cut. (B)—Bass boost and cut in the same order.



ter will be tracing switch connections and replacing hard to reach components on the control panel. When replacing components in Hi Fi equipment, care should be exercised to see that the replacement is positioned exactly as the original. Replacement components which are oversized and do not permit exact positioning should not be used.

Exceptions are found when it becomes necessary to reposition components to reduce hum or eliminate feedback problems. If this is the case, a complete check of the unit should be made to determine that the response or some other specification has not been changed.

### Bass and Treble Circuits

Two basic types of tone control circuits are used in Hi Fi amplifiers; Losser and Baxendall or feedback type. Both are based on the fact that a capacitor will pass more high frequencies than low. Let's examine each of these two circuits to see how they operate.

The Losser circuit is essentially a voltage divider and is shown in Fig. 1. Without the capacitors you will note that the treble control is "floating" and the bass control would simply act as a "volume control." Capacitors are added to the circuit to make it frequency sensitive. The actual range of control is determined by the size of the capacitors and resistors.

To more clearly illustrate the action of these controls, the components affecting each circuit are shown separately in Fig. 2. Note that the bass control is shown in the treble circuit but that it becomes ineffec-

tive because capacitors C1 and C2 become shorts at frequencies affecting the treble circuit. Only R3 and R4 need be of concern.

To understand the operation of the treble control consider the treble control turned to full cut so the Rb is equal to zero. Resistor R4 is then shunted by C2 and the output at very high frequencies. Thus very little high frequency will appear at the output. At middle range frequencies, C2 partially shunts R4 and some of the signal appears at the output. At lower frequencies, C2 does not affect the signal and the entire signal is felt at the output.

When the treble control is turned so a smaller cut takes place, Rb reduces the shunting effect of C2 and a proportionately smaller cut is incurred.

In the maximum boost position, Ra is equal to zero and C1 shunts R3. Thus, the parallel impedance of C1-R3 will be small at high frequencies and less at middle and low frequencies and larger high frequency signal will appear across R4 than a middle or low frequency signal.

Typical curves for treble and bass boost and cut are shown in Fig. 3.

The boost and cut with the losser type circuit are accomplished with a mid and high frequency cut or boost respectively which gives an apparent and effective change in the bass.

Again referring to Fig. 2B and the bass portion of the circuit consider the bass control in the maximum boost position. In this position C3 is shorted and Rd is maximum. At high and middle range frequencies, C4 and Rd which by passes and attenuates these frequencies at the output. This is effective by a bass boost. Different settings of R2 change the amount of effect that C4 exerts. The total boost is controlled by the size of R4.

A bass cut is achieved turning the control to eliminate or reduce Rd, thus shunting C4. High frequency signals pass through C3 limited only by R3. Reducing the setting of the bass cut allows C4 to become somewhat effective, thus limiting the total effect produced by C3.

Trouble in either the bass or treble circuits of losser controlled types can almost always be attributed to faulty capacitors.

The most frequently employed feedback type tone control circuit is the Baxendall circuit. Others are usually only variations and will not be discussed here. The Baxendall feedback tone control circuit is shown in Fig. 4.

The Baxendall circuit works on the principle that when a signal is passed through a capacitor, lower frequencies are attenuated. The combination of capacitors and resistors determine whether this will be a bass boost or a treble cut.

Capacitor C4 is the feedback capacitor for both the treble and bass control. The exact path the feedback takes is not easily determined and depends to a large extent on the bass control setting and treble controls. The possible paths for various control settings are from the plate through C4, R3, R2, R1, the left portion of R5, through C3 and to the grid; from the plate through C4, through the right half of R5, and through C3 to grid; from the plate through C4, R2, C2, R4, and to the grid; from the plate through C4, R2, C1, R4 and to the grid. Additionally, of course, there are several possible combinations of the above.

The treble action in this circuit is primarily dependent on the treble control's position and the value of C3. In the treble boost setting of the control, high frequencies are passed from the input through R5 and C3 to the grid—since C3 is elective, the high frequencies are favored.

To cut the treble, the control is rotated toward the end connected to C4. Thus, the output of the tube is fed back through C3 where high frequencies are passed back to the grid to degenerate the treble signal.

The low frequencies are boosted and cut by employing the same principle as used in the treble circuit. Low frequencies are passed through the control when it is set to the boost position, but are countered by out of phase signals when set to the cut position.

Like the losser circuits, Baxendall tone compensation network trouble can usually be traced to faulty coupling capacitors. It is obvious that the sneak circuits involved in tone control networks makes it imperative to

*Continued on page 88*

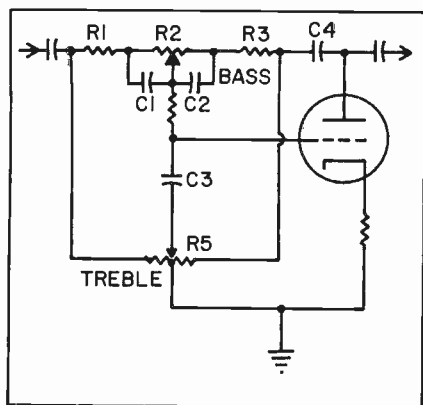
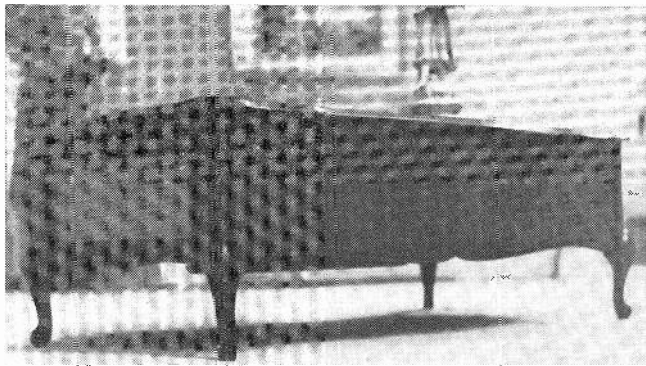

Fig. 4—The Baxendall tone circuit showing feedback path for treble and bass control.

## IMPROVED SOUND IN

■ Packaged stereo manufacturers are becoming so style conscious that the consumer may one day treat his stereo like he does his car, trading it in every year on a newer model with a more elaborate grill.

It's still, what's under the hood that counts, but so long as manufacturers continue to strive for per-



Dorsett Electronics' stereo table is available in four models, each with or without AM/FM. Cherry wood, hard rock maple and black walnut finishes. \$209 to \$289.

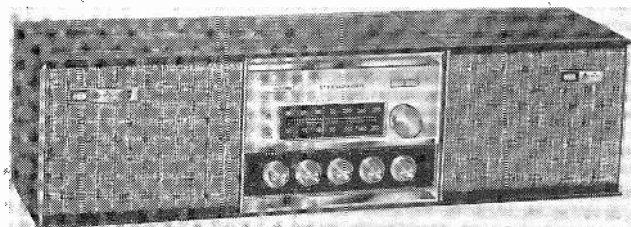

Arvin Industries' AM/FM stereo radio Model 32R98 has 6-inch speakers housed in a walnut cabinet.

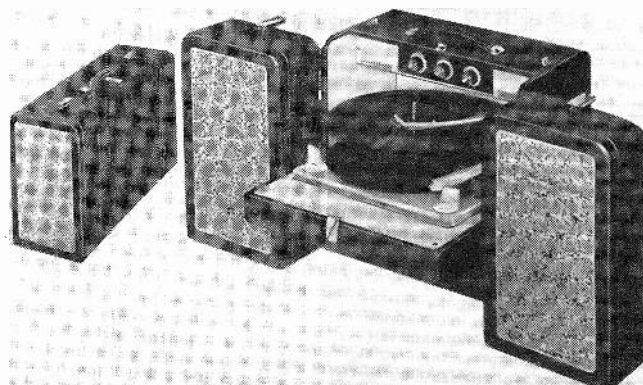

Audiola Corporation's Concertone, Model 550, Swing-a-Matic stereo hi-fidelity 8-speaker system plays all records and all speeds.

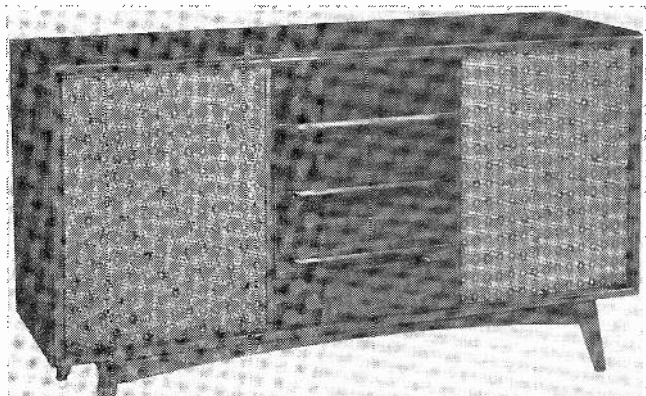

Setchell-Carlson's Model RP640 features a 4-speed stereo record changer, AM/FM radio and FM/Multiplex.

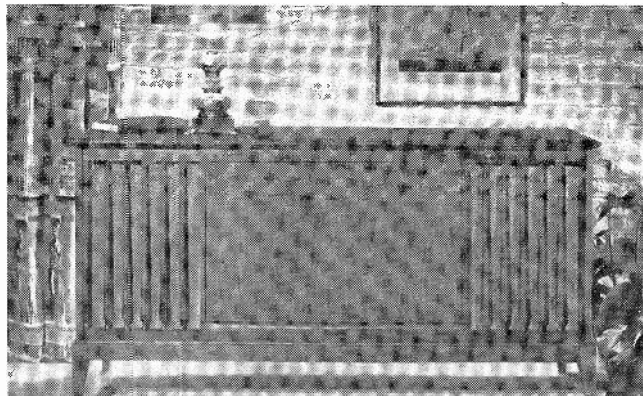

Sparton's Southgate, Model 14N5-P, stereo comes in walnut. It has two 10-in. wide range speakers and two 3-1/2 in. tweeters. \$625.



# DECORATOR PACKAGES

fection in sound reproduction, we can only applaud their efforts to make their units stylish pieces of furniture.

This is, of course, only a representative sampling of the models available. If you wish additional information on a particular line or item, contact the manufacturer. ■

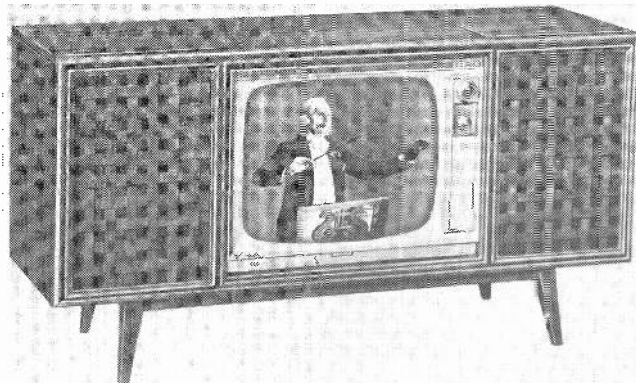

Zenith's Strandberg, Model ML2786W combines a stereo FM radio, conventional AM/FM radio, 23-in. television and a hi-fidelity record playing system.

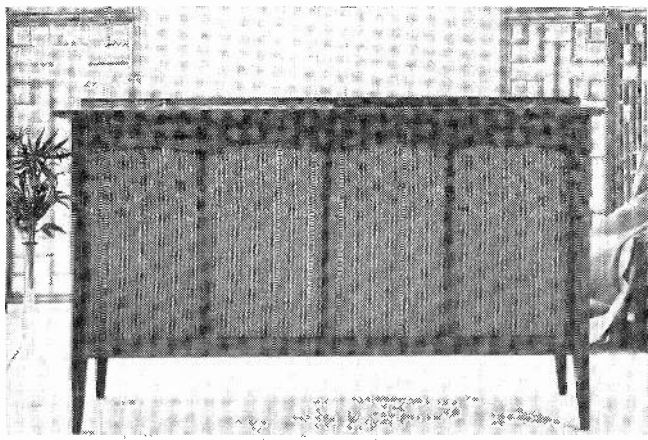

Westinghouse's transistor stereo console, Model M1350, is in walnut. It has AM-FM, built-in FM stereo and a 7-speaker sound system.

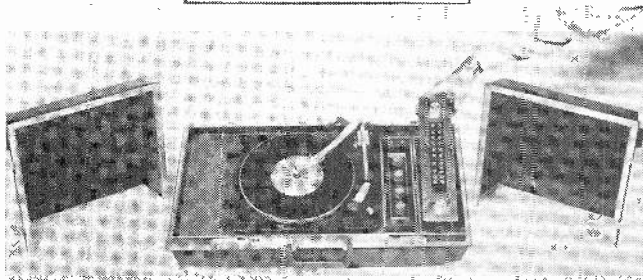
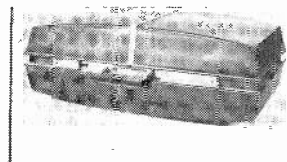

Pilot Radio Corporation's solid-state portable stereo phonograph comes enclosed in a custom-designed airplane-type case. \$199.

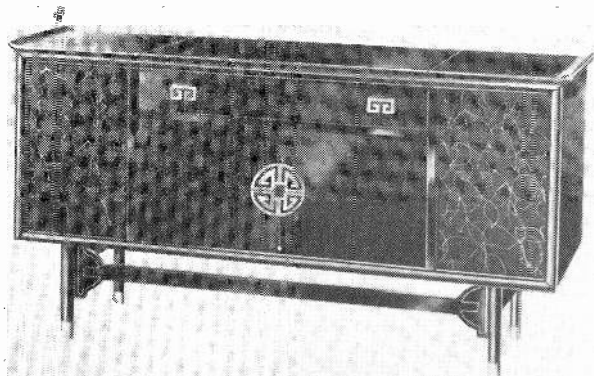

Olympic's Orientale, Model 1938, stereo hi-fidelity radio-phonograph console is ebony-finished hardwood accented with metal trim.

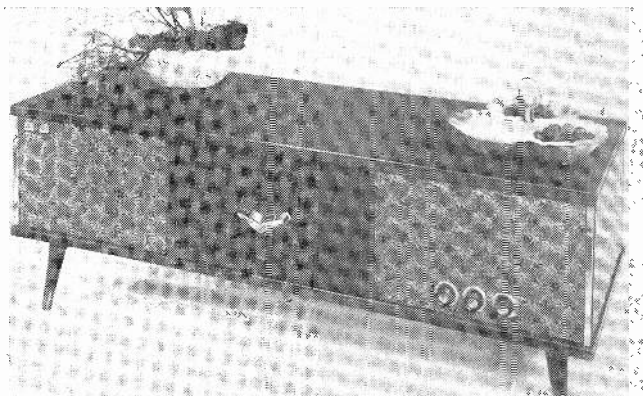

Boetsch Brothers' Birch phonograph line features this cocktail table, Model CTS 363. The walnut unit has two Alnico V speakers.

Audio Dynamics' ADC-18 speaker system measures 40 x 17 x 12-1/2 in. \$250.

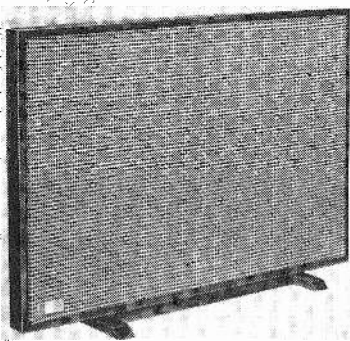
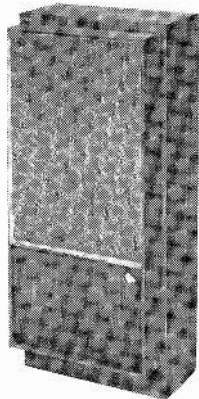

University Loudspeakers' Tri-Planar has two panel radiators and a tweeter. 15 x 23 x 1-3/4 in.

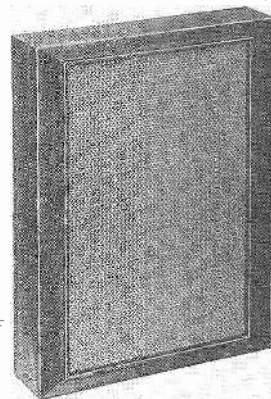

Heathkit "Profile" slim-trim three-way speaker system in bass reflex cabinet. Includes crossover network.

## SOUND, SLENDER- STYLE



Eico Electronic Instrument Company's Model HFS-10 employs two 6-1/2 in. speakers. 12 x 18 x 5-1/4 in. \$29.95

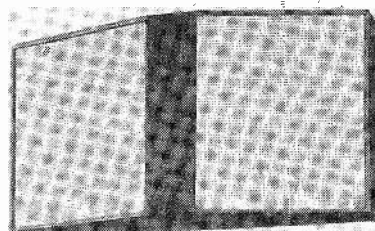

Utah Electronics Corporation's Model TP88 has two 8-in. speakers. 10 x 20 x 4 in. Mahogany, blonde or walnut finishes. \$33.-85.

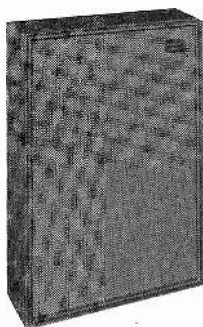

Electro-Voice's Regina 200 utilizes a 10-in. woofer, 800-cycle crossover and a TC8 5-in. cone. 24 3/8 x 16 3/8 x 5 5/8. \$89.50.

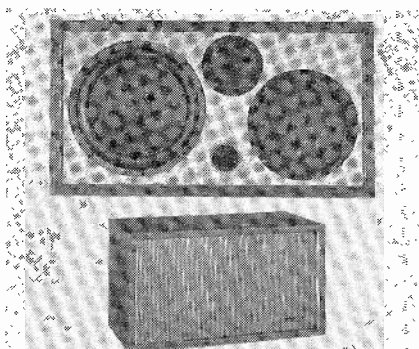

Sherwood's Berkshire, Model SR2 comes with walnut, birch and fir cabinets. 24 x 13 x 9 1/2 in. \$89.50 to \$99.50.

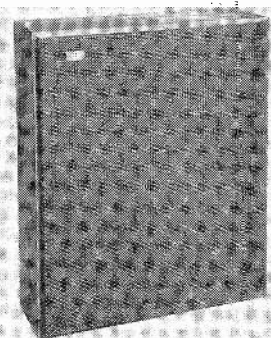

Fisher's Model KS-2 features a 12-in. bass speaker, a 5-in. butyl-coated midrange speaker and a 3-in. cone-type high frequency speaker. 25 x 20 x 6 1/2 in.

■ Here is a brief "teaser" sampling of the many new thin-line speaker models. Most everyone, the consumer, the technician and the manufacturer, is enthusiastic about the thin-lines. Steady advancing technology has made it possible to combine slender beauty, moderate prices and good sound, and these stylish new models can only advance the thin-line's already bright future.

There are, nevertheless, those who are less than effervescent about the thin-line trend. A letter asking more information on thin-line mod-

els brought this response from Robert L. Moers, general manager of Klipsch and Associates Inc:

"Your letter of 1 July received here with horror. We feel rather strongly about trying to make a little machine do a big machine's job. It takes a locomotive to pull the train . . . The 'compacts' were enough to the audio art and the 'thin-lines' are even worse. One cannot force function to conform to shape. Function must dictate shape and size. Have you ever seen a thin-line grand piano or airplane?"

"So many frauds have been perpetuated on the public for so long by self-appointed experts and 'anything for a buck hucksters' that it is a wonder John Q hasn't stopped buying.

"Needless to say, we do not manufacture a 'tin-line' speaker. The idea of a small cone frantically flailing away in a minute enclosure revolts us."

None-the-less, they're fair game for profits whether you like them or not!



You can turn 'do it yourself' into a profit by telling the world that you are qualified and willing to . . .

## . . . **FINISH THE KIT**

■ The boom in stereo kit building is one aspect of electronic do-it-yourself that can be profitable for electronic technicians. Many technicians have been selling kits for several years and find them a profitable product to stock. Some enterprising technicians use free time on the bench to build kits for sale. Since a skilled technician can assemble a kit much faster than an amateur, particularly after building several of the same kind, you can recover more than your normal bench charge.

With all their alertness to these kit profits, most technicians are overlooking the profits in salvaging their customer's mistakes. For many technicians the prospect of working on equipment mangled by amateur builders is too frightening. As a result they refuse to touch partially built kits or charge prohibitive "penalty" fees.

This is short sighted and costly. In the first place kits are probably the easiest to work on equipment you can find, and in the second place you are going to charge your standard hourly rate anyhow.

Kit service is composed of two main types — periodic maintenance and salvaging botched construction. The repair of kits that have failed with time is similar to that for factory built hardware and covered elsewhere in this issue. Just remember on any kit you should be suspicious of the quality of construction — particularly solder joints.

But what to do about the panic stricken and embarrassed customer whose new kit won't work?

First be considerate of the customer — he is emotionally involved. He has just failed at what the ads say is a simple task — the customer is not apt to see much humor in the situation. Once the customer is willing to trust you with his broken pet, what do you do first? The answer

is to get hold of the kit construction manual. Why? Because this is the most complete and easy to use service guide you are likely to find. While manuals, like kits themselves vary from manufacturer to manufacturer, they typically contain a great deal of helpful information. Usually there will be a small troubleshooting guide describing a few symptoms and their most probable cause. Obviously, these should be checked first. If no luck, then check the wiring.

When checking the wiring, you can do it the hard way, using the circuit diagram, or you can use the special information in the manual. In order to guide their unskilled builders, kit manufacturers provide large, detailed photographs or drawings showing the location of each wire and component. Comparing these with the actual hardware, should cause errors to stand out like a "sore thumb."

In the event that no wiring errors are apparent, the construction manual is still valuable. It will contain test point voltages and troubleshooting suggestions. While the well equipped shop can solve the problem without following these suggestions, the kit manufacturer, the firm that knows most about the equipment, has designed them to speed troubleshooting.

There is one customer error that you cannot economically repair — acid core solder. A few kit manufacturers include solder just to eliminate this corrosive menace and all warn against it. Even so, a few people insist on using "uncle Jake's old solder" on \$200 worth of electronics. The ugly part of the acid flux is that you don't notice it until it is destroying the equipment. Initially, it works as well or better than rosin. But current flowing through the joints causes electrochemical action that rapidly can

destroy construction materials.

Assuming that the connections are good, that all the components are in place and that the parts are not obviously damaged, what next? By following the manufacturers' advice, we have probably localized the problem to a single section. Now we test the components and proceed as in any other troubleshooting effort.

Always when working on a kit, keep in mind that it is the product of unskilled labor. You may be able to solder to a printed circuit board or a transistor with a 250 gun without damage but the amateur can't. (What's worse, while you won't take the chance, the amateur will.)

What are some of the common errors you may encounter other than bad solder joints and omitted wiring or components? Next in line of probability are excess wires causing shorts, components with reversed polarity and components that have been interchanged.

Of course, sometimes there really is not a problem after all, just an apprehensive customer who won't try the set because he had parts left over. Several kits allow an option or two. For example a choice of equalization on a preamp auxiliary input. This is fine and it increases the unit's capabilities. Unfortunately, it also means that there are components left over after the kit is finished. So before you wildly start searching a place to put that extra capacitor, read the instructions.

Except for the rare cases when components are defective, the customer gets into trouble because he does not read the instruction book. For all your specialized knowledge and skill, you too can get into trouble if you disregard the manufacturers' instructions. The *instruction manual is the most important part of any kit.* ■

■ Many skilled stereo, Hi Fi and audio technicians know that hum can be a formidable problem at times. And they also know that a thorough knowledge of hum-sources is a necessary aid to rapid and profitable repair.

Hum can originate in B+ supply circuits. It can come from ac and rectified ac tube heater supplies—becoming exceptionally troublesome in preamplifier stages.

Cathode-to-heater tube shorts and leakage are major hum causes. Inadequate or improper shielding in low level high impedance circuits is an invitation to hum.

Hum can be coupled from power transformers and chokes to pickups and recorder heads. And one particularly difficult-to-locate hum source is the "ground loop," especially where the Hi Fi system is composed of individual component units. A closely related ground loop hum problem is caused by wiring unbalance (in relation to ground) from microphones and pickups.

A few other causes of hum include open grounds, improper circuit lead dress, improper speaker-lead dress in relation to power supply components and ac power lines, improperly bypassed tube cathodes or defective cathode bypass capacitors, defective grid resistors in amplifiers and open feedback loops. Hum in Hi Fi systems is confined

to 60 or 120 cps (except in rare circumstances when a higher harmonic of 120 cps may be encountered).

#### Diagnosing Hum Sources

Most experienced Hi Fi technicians have "pet" procedures for diagnosing and isolating hum. And differences of opinion exist regarding methods. Procedures may include "cut-and-try" steps—shunting power supply electrolytics and bypass capacitors; substituting tubes and resistors. Some technicians consider hum a "side effect" and begin by checking voltage—after substituting tubes and adjusting balance controls. Others begin with scope observations—after substituting tubes and checking the balance control or output tube matching.

A sensitive ac-calibrated scope can monitor and measure hum amplitude at most points in a Hi Fi system—and indicate if the frequency is 60 or 120 cps. Approximate location of the hum source in the equipment can be quickly determined by scope observations of hum amplitude variations at different points in component circuitry. Knowing the hum frequency helps in preliminary diagnosis. Tube cathode-heater leakage or shorts, in ac heater powered sets, for example, is always 60 cps. And the hum from a defective filter system in an

*Learn to diagnose sources  
for profitable repair*

# **ELIMINATE THAT HUM**

*by John Holmes*



otherwise properly operating full-wave preamp tube heater rectifier can only be 120 cps under normal conditions (See Fig. 1). The hum frequency from a defective fullwave B+ rectifier filter is 120 cps—and 60 cps from a halfwave rectifier filter. But 60 cps hum can originate in fullwave rectifiers too if one diode is defective and inoperative. In this event, rectifier output voltage will measure low.

Whatever procedure may be used to isolate a hum source, it is obvious that tubes should be checked first for cathode-heater leakage or shorts. And this should be followed by checking the output amplifier's balance control and hum pot balance when it is employed. If the amplifier has no balance control, then check the output tubes to see if both draw the same dc plate current (within 10 to 15 percent) when identical screen voltage and cathode bias voltage are applied to each tube. A similar approach is necessary with each push-pull stereo output stage.

#### Ground Loop Problem

Ground loop hum is always at power line frequency—60 cps. Induced currents from power transformers, chokes, etc., always flow through equipment chassis. When chassis are used as a return for 60 cps power circuits—ground loops can develop unless precautions are

taken. This is a problem of equipment design engineers primarily. And it seldom develops as a problem in well designed integrated equipment *e x c e p t* accidentally. When separate components are used, however, especially separate preamps, it may become a problem. An above-ground ac difference may exist between individual units. Remember, a voltage drop, however small, (See Fig. 2) between one chassis ac ground point and another or between separate chassis, may cause a troublesome ground loop—with ac current being injected into the input signal.

All individual unit ground leads should run to a single buss (made of #18 or larger stranded copper) which is grounded at only one point on the chassis. And the chassis of all separate units should be bussed together and grounded at a common point for all units. A similar approach should be taken with pickup and tape head leads to preamps. In some cases, the record changer base and drive motor frame may need to be integrated into the common buss ground. Four-terminal stereo cartridges and insulated two-conductor shielded lead for each channel can eliminate ground loops in this area. When grounds on stereo cartridges are separate (one ground for each channel) hum is eliminated here. If both grounds are

common, connected internally or externally, a cabling system as shown in Fig. 3 should be used. The shield of only one cable is connected to be the cartridge ground terminal. Shields of both cartridge cables are connected to the preamp chassis ground.

#### Tunable and Fixed Hum

As every radio technician knows, when hum persists over the entire tuning range of a receiver, the hum is being injected into the receiver's audio frequency stages. If the hum comes through only when a station is tuned in, it is being injected through the RF section. This is called *modulation hum* and is a point for apprentice Hi Fi technicians to remember when checking hum problems in modern AM/FM receiver components.

Nothing should be left to chance when checking for hum in home audio equipment. If parts are replaced, make sure all lead dress is exactly the same as the original—particularly volume and tone control leads.

Hum is probably the most annoying "interference" Hi Fi listeners will experience. So check tube and cable shields for inadequate or open grounds. Watch for open grid circuits, high resistance joints and don't forget to readjust that preamp hum-bucking control. ■

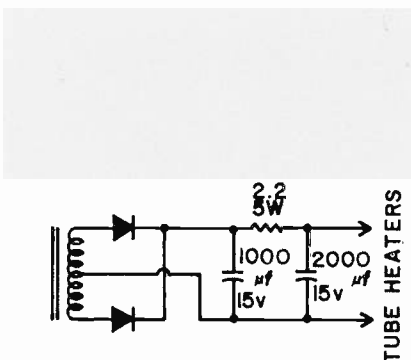

Fig. 1—Fullwave dc heater supply used for audio tubes in some Hi Fi preamplifiers.

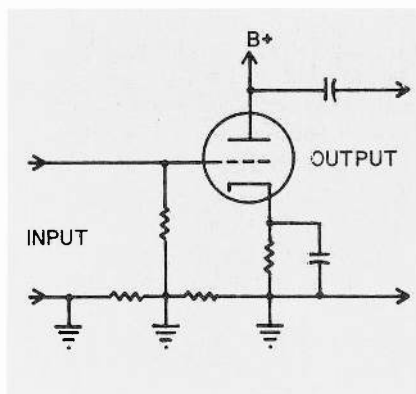

Fig. 2—Minute voltage drops across resistors and separate ground points can cause ground loop hum.

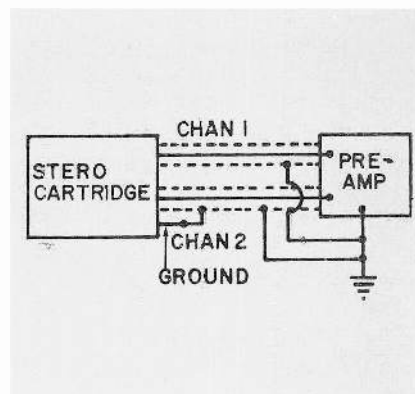

Fig. 3—One cable shield is connected to internal or external ground of 3-terminal stereo cartridge. Both shields are connected to common ground of preamplifier.



Are you missing service opportunities by not converting foreign equipment? Here are some tips that may help you land some new customers

## Converting 40 & 50 cps Phonographs

by Granville L. Frichette

■ A gentleman recently returned from England brought in a phonograph with the complaint of unusually fast speeds. This unit is equipped with a Collaro 456 changer which is also English. Since England utilizes 50 cps line frequency, I felt that this would be but a few minutes work involving two interchangeable motor pulleys. I had the owner leave the phonograph, explaining I would order the pulley and call him in a few days.

I looked up the part number in the tech library and ordered it. A few days later the part arrived. In order to check one pulley against the other, I selected a stobe card with both 50 and 60 cps patterns on it and started checking out the turntable speeds. I was really set back when I found there was only a minor difference in speed, both around the 50 cps pattern. Although the pulleys were color coded differently, they were obviously meant for the same frequency. In this case, 50 cps.

Feeling a little less certain of the problem but that I was still on the right track, I began to look into it a little more thoroughly. Sure enough, Collaro in particular and possibly other foreign manufacturers provide several motor pulleys to take care of about every line variation. In this case, Collaro makes 40, 50 and 60 cps pulleys all of

which are interchangeable. For each of these basic line frequencies they make four grades of pulleys which are color coded. In order of increasing pulley size, they are:

- Red: extra small grade**
- Green: small grade**
- Blue: large grade**
- Yellow: extra large grade**

Consistent minor variations around a basic frequency of 60 cps will call for one of the grades shown above for exact turntable speed. In this particular case I found that the blue pulley for 60 cps was the proper one for our area, which runs about 59.75 cps by a freq-meter.

The matter of line frequency variations is rapidly becoming important to the electronic technician, no matter what his specialty. It is inevitable that much foreign equipment designed for operation at a different frequency will drift back to the States. By the same token there will be times when a good customer is going abroad and wants his favorite piece of hi-fi gear or the children's trains converted before they depart.

Most of the equipment sold to the general public is production run material. By American tradition it is manufactured by good engineering standards, with a reasonable margin above minimum specifications. As

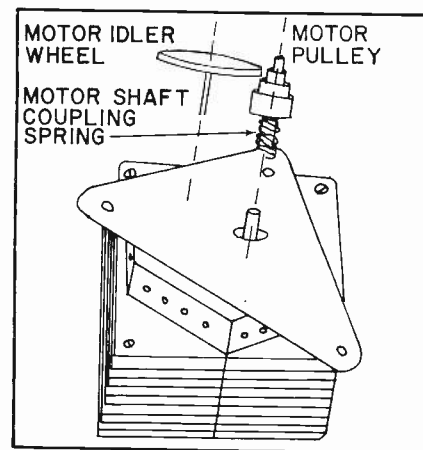

Interchangeable motor pulleys on some record changers provide a means for correcting line frequency variations. The motor must be rated to withstand the various frequencies, however.

with motors or transformers, one can usually apply intermittent overloads of about 10 or 15 percent without fear of damage. By the same standards, it is unreasonable to expect a manufacturer of production run material to provide a margin for a very small percentage of use not called for in his design.

With a given wire size, a decrease in the applied frequency to a motor or transformer will also decrease the inductive reactance and overheating will result. Depending upon how much the frequency is decreased or how the windings are designed, a minimum usable frequency will be met. It is unusual to find a frequency sensitive motor which can be used at 25, 50, and 60 cps. Common enough, though not always readily available, is the 50-60 cps motor or transformer.

Motor speed will always be affected when used on different frequencies even if the motor is designed to withstand multiple frequencies. In the case of clock or timer motors, the only cure is replacement. A 50 cps clock used on 60 cps will gain 10 minutes an hour. Devices using belts and pulleys may be speeded up or slowed by changing pulley diameter.

There are occasional sleepers hidden behind the usual ac/dc device. The clock radio is an excellent example. The selenium rectifier, ser-

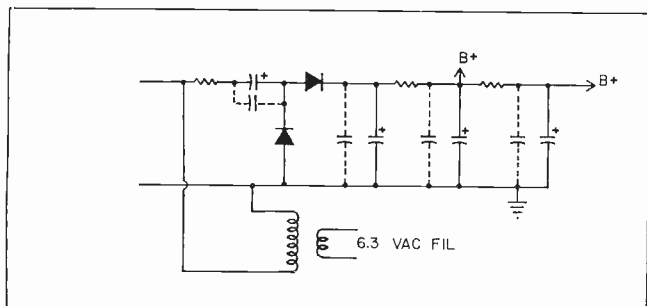

A typical TV power supply converted to 25 cps by paralleling the filter capacitors with values 50 to 100% higher and substituting the 60 cps filament transformer with a 25 cps replacement. (See Dominion Electrochrome ET Tekfax 509).

ies-string type radio is commonly known as universal. Put a 60 cps clock in the case with it and a problem is present. Used on 25 cps, the clock motor will burn to a crisp in a matter of about 10 minutes. This is notwithstanding the fact that the manufacturer takes care to make the 60-cps-only notation on the case and chassis. It's amazing the number of people who never read or

don't comprehend the notice. Disconnecting the clock winding and rewiring the switch through the radio will restore this to service until a 25 cps clock can be obtained; or a 60 cps clock if being returned to service in the States.

Some television and hi-fi equipment is designed for 50-60 cps use. Often it is not. There is little, if any, for use of 25-40-50-60 cps.

While 60 cps only units can be used intermittently on 50 cps, the transformers will overheat some. A 50-60 cps TV used on 25 cps will not last 30 minutes. Again, don't expect a customer to understand the variations and consequences. Conversions can be quick and inexpensive, time consuming and expensive, completely impractical or occasionally unnecessary.

An otherwise ac/dc set with parallel filaments off a filament transformer can be converted to a lower frequency simply by replacing the transformer. Sometimes additional filtering in the B+ supply will be necessary to take care of the slower ripple. I've found that paralleling the filter condensers by 50 or 100% is satisfactory. Some times the portable TV does not have the space available for the increased size of the transformer. There is little, if anything, that can be done about that. In consoles, if the chassis is cramped, the larger transformer can be mounted elsewhere in the cabinet and leads run into the chassis. ■

## MULTIPLEX GENERATOR Aids in Tuner Demonstration

*Satisfy tuner customers with  
simple demonstration after repairs*

■ Technicians are frequently called upon to service equipment which is difficult or impossible to demonstrate after repairs are complete. Stereo tuners are among these units. And here is where a piece of test equipment comes to the rescue: the multiplex signal generator.

Although this instrument has a place in every Hi Fi repair shop, technicians sometimes find its use hard to justify when perhaps no more than one out of 10 units will need to be connected to it. There is a way to convince yourself of its value and prove to your customers

that they have picked the right shop for stereo tuner repairs, however.

### Multiplex Generator Broadcasts

Most multiplex generators put out a signal identical to that broadcast by stereo FM stations. Often, however, a stereo signal is not being broadcast or is a poor quality signal in terms of separation. On the other hand, the multiplex generator can put out a good stereo signal any time you need one.

All that is needed is a good stereo demonstration record, a Hi Fi system and the generator. The output

of the record player is connected to the multiplex generator's modulation input according to manufacturer's instructions, and the generator's output is connected to the tuner's antenna terminals. The tuner is connected to the Hi Fi system in the conventional manner.

When the customer comes in to the shop to pick up his tuner, you can offer him a demonstration as good as any he will find on the air. Show him the connection to the tuner — explain your guarantee and you'll have a permanent satisfied Hi Fi customer. ■

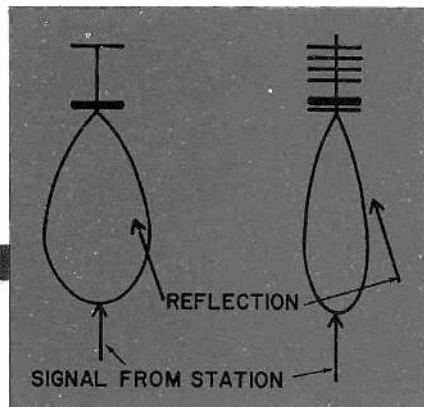

Fig. 1—The effect of a reflection on a narrow lobe pattern and one with a broad lobe antenna pattern.

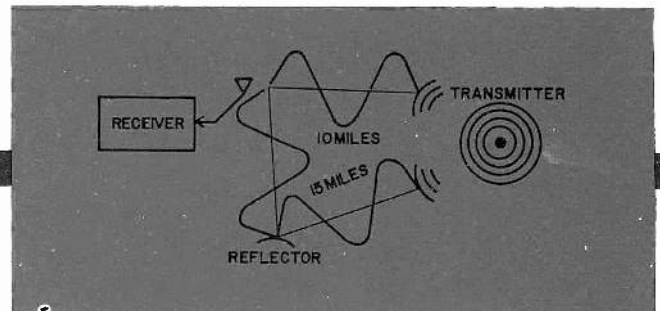

Fig. 2—Signals arriving completely out of phase with each other can cause strength reduction and complete loss of stereo effect.

■ Is an external antenna needed for every multiple installation? This is perhaps the most frequently asked question relating to FM multiplex. The most frequently given answer is yes. The fact that a built-in antenna is supplied with a set does not mean a receiver is capable of stereo reception. Although they do work on most monophonic signals when near a station and even though they may operate satisfactorily on stereo signals, they are not satisfactory for many semifringe installations.

A good antenna is essential for stereo in areas where monophonic reception is borderline with a simple antenna, since a higher field strength is required for the same audio quality below the full limiting level of the receiver. This results from the lower percentage of the RF signal energy containing audio information and increases the effective background noise. The actual effective signal difference is about 20 db.

#### Problems

In the average system the decrease in signal to noise ratio is taken for granted (that is, that the manufacturer has done what he can) and concentration is directed to the antenna as most practical cor-

rective measure. Several different antenna types are available for FM or TV/FM installations, but before you decide what antenna type to install, you should take certain facts into consideration. Special considerations are necessary for multiplex because stereo can be destroyed by reflections or other multipath signals. In some locations, therefore, it is wise to use a highly directive antenna. When stations are located in more than one direction from the tuner site, it may even be necessary to install an antenna which can be mechanically or electrically rotated.

Multipath — analogous to ghosts seen on TV — distort audio reception too. In fact, one good way to determine the possibility of multipath distortion in stereo equipment is by connecting the TV set to the FM antenna and observe a picture from a station in the general direction as the FM station.

While it is debated whether or not a listener can detect phase shift at certain frequencies, it can be shown that phase shift in stereo can electronically degrade or completely obliterate the stereo effect.

#### Phase Shift

It has been determined that a 3

degree phase shift between the original 38 kc subcarrier and the reconstructed subcarrier will limit the separation to 30 db. But let's see how much greater phase shifts are possible with only normal reflections which might be encountered in any installation. A signal traveling through a normal propagation medium has elapsed time of .186272  $\mu$ sec per mile. While an RF signal traveling straight to the antenna requires a specific length of time depending on the distance traveled. A signal traveling from a reflection, however, reaches the receiver later; the actual time difference depending on the difference in the distance. If the difference is 2 miles, for example, the elapsed time would be 0.372544 sec. Although this may seem like a very small and immaterial amount, the amount of phase shift caused by this and large distances can cause very noticeable changes in the reproduction of stereo reproduction.

Taking a common distance from which a reflection might occur, say an additional 5 miles, let's examine the phase shift between the original 38 kc signal and the reproduced signal in the decoder. Of course, the further the receiver is from the tran-



*Microsecond delays from reflections  
may defeat stereo or cause audio "drift"*

## **Multipath Problems in FM Stereo Reception**

*by Harlan H. Winters*

smitting station, the better chance a normal antenna would have to receive reflections. With the straight signal traveling say 15 miles then, and the reflection traveling 20 miles, a difference of  $5 \times 0.186272 \mu\text{sec}$  or  $0.931060 \mu\text{sec}$  exists between the arrival times.

Since the pilot frequency determines the reconstructed subcarrier phase, we will base our calculations on the phase change in reference to its wavelength which is 9.83 miles (by dividing frequency into velocity). To simplify, we can call this 10 miles. Since our reflected signal is traveling five additional miles or half a wave length, we can see that the two signals reaching the receiver will be about 180 degrees out of phase. This is shown graphically in Fig. 1. At first, with such an out-of-phase condition, it may appear that no signal would reach the frequency doubler in the decoder. This is not true, however, since the reflected signal is usually weaker than the straight signal because it is greatly attenuated.

A problem such as this would cause poor lock-in ability of the frequency doubler and at times would cause the stereo effect to "change" sides from time to time and perhaps

cause motorboating from loss of sync.

Lesser reflections can at times be even more troublesome. The addition of the two signals creating another phase between the straight signal and the reflected, as a resultant, which is slightly greater in amplitude and averages the two phases. Although this would in itself not be conducive to true stereo, the greater problem is the change which take place in the two signals from atmospheric effects. These changes cause variations in the sound which should be coming from one speaker, making it appear that the sound is moving between the two speakers.

While *multipath* is most pronounced when it is caused by hills and man-made structures, it can also occur when both the transmitter and the receiver are located on flat ground with level ground between the two. This is possible when the signal is bounced off the ionosphere and the ground alternately. The effect of this is usually much less pronounced because the signal strength is greatly decreased. Also the effect is not constant since the ionosphere is not too predictable within the FM frequency range.

A diagram showing the effect two

different antennas have on the received signal is shown in Fig. 2.

Often an existing TV antenna can be employed with a coupler to feed the FM tuner. The antenna's specifications should be kept clearly in mind, however. Broad response pattern types should be avoided; and weak signal areas should have an antenna with a good FM response: Some TV antennas have very poor response in the FM range although they frequently perform satisfactorily in strong signal areas.

In very strong TV signal areas, the TV signal may cause interference by saturating the limiter or causing images over the entire FM band.

Remember too that even though stereo may not be broadcast at this time by a certain station in all probability it will be in the near future. With this in mind you can instruct your customer that a return trip to modify the installation would add greatly to the overall cost compared to making the installation suitable for the foreseeable future at the normal installation time. This makes you more money now and assures you a satisfied customer for whatever the future brings in the way of more FM stereo transmissions. ■

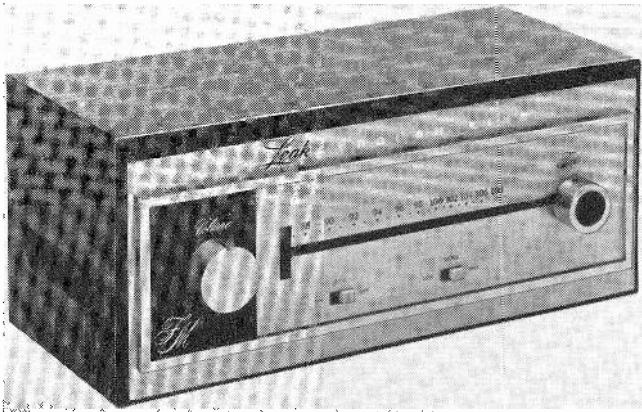

Econa's Leak Trough-Line FM tuner employs a tuning indicator. \$149.

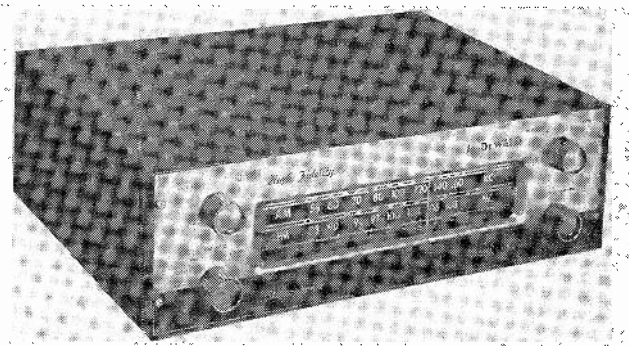

DeWald's Model S-1103A AM/FM stereo-multiplex tuner comes in a brown cabinet with brass and broken face plate.

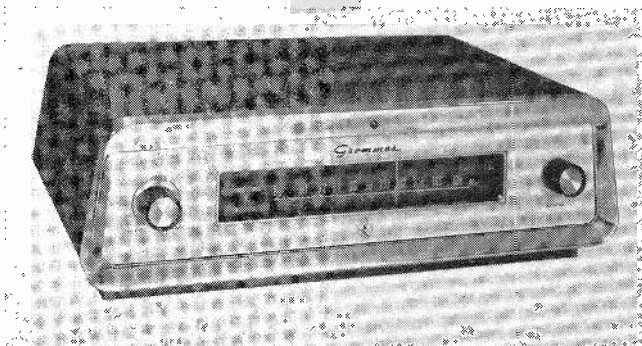

Grommes' Model 101M FM multiplex stereo tuner has "Magic Bar" tuning. Cabinet has charcoal or silver finish.

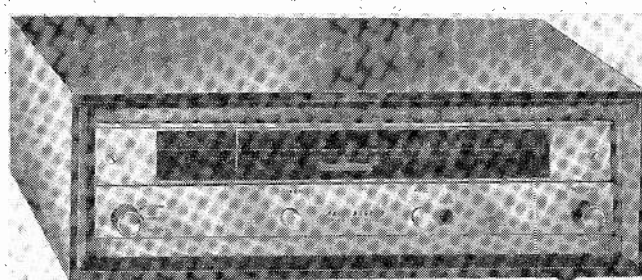

Paco's Model ST-55 FM wideband tuner is powered by 10 tubes. Kit \$69.95. Semi-kit \$79.95. Factory wired \$99.95.

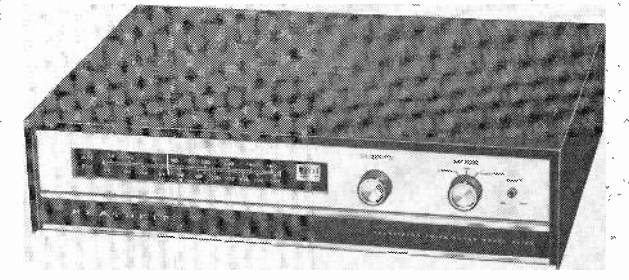

Heathkit's Model AJ-33 transistor AM/FM tuner has a walnut cabinet and gold-anodized aluminum front panel. Kit \$99.95.

## TUNERS BETTER, ESPECIALLY UP FRONT

■ Continued refinements that enable better performance and more sophisticated stereo mean that the tuner buyer is getting more for his money when he purchases current models.

If it is really what's up front that counts, the new tuners rate especially high. It is up to the techni-

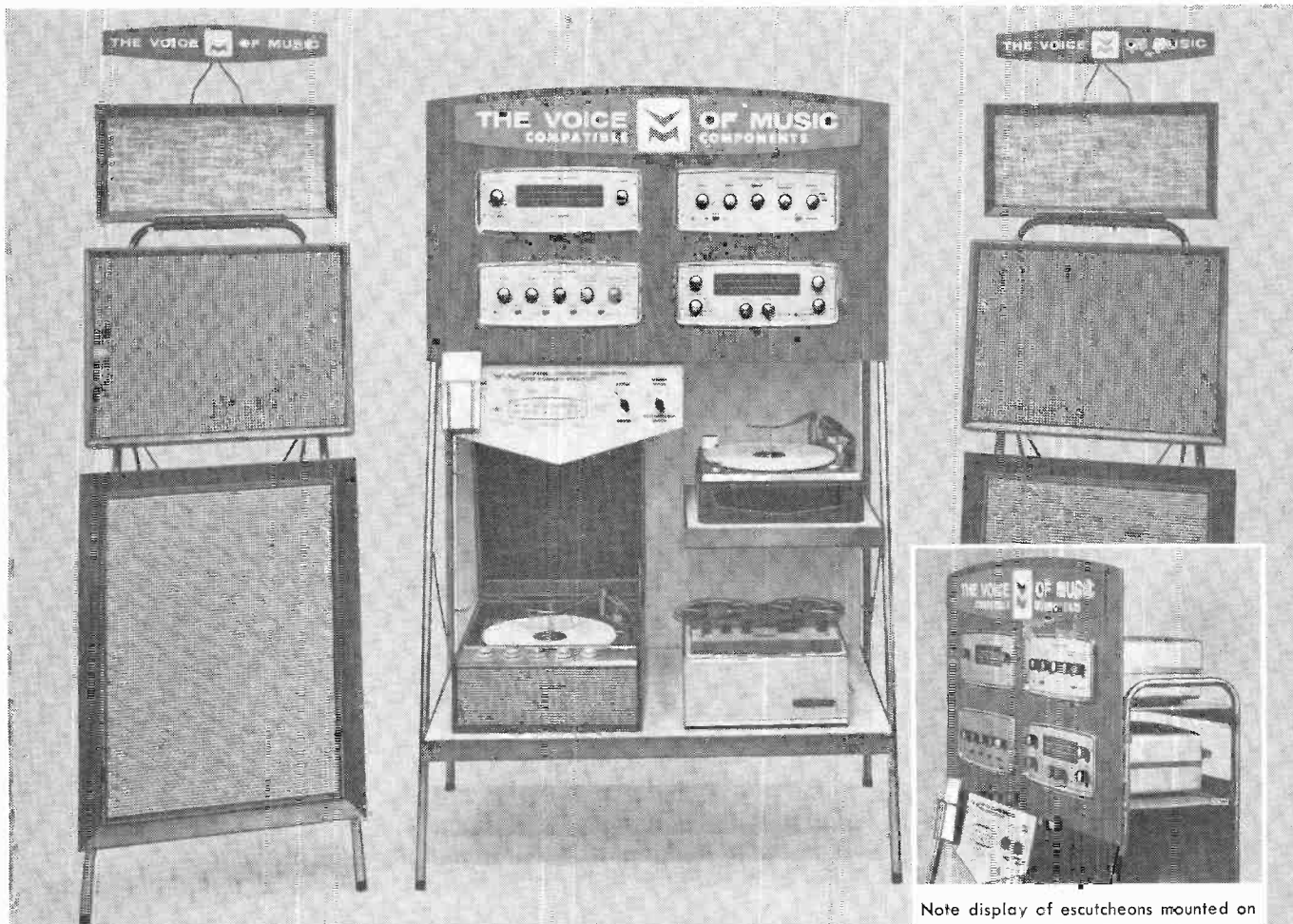

Note display of escutcheons mounted on wainut facing, with control switches below

## **COMPATIBLE COMPONENTS DISPLAY DEMONSTRATION CENTER OFFERS MORE WAYS TO Make MORE Sales... BIGGER Sales**

While almost everybody else **promises** more profits with their line, V·M *delivers the special tools you need to build better profits.*

**FOR EXAMPLE:** this new display-demonstrator contains 15 separate V·M high-fidelity compatible components, has a big, bright header to gain attention, yet fits conveniently in minimum store space. Complete connections provided so you can demonstrate three complete VOICE OF MUSIC component hook-ups, and play each component series through any of three separate dual speaker systems.

**All you or your salesman does is turn a switch to select component combinations.** The sound does the selling! Prospects *hear* the difference in systems, realize at once why a few extra dollars more in an

amplifier or speaker or radio tuner is money well spent! By assisting selling people to trade up, their personal effectiveness is increased.

The new V·M display-demonstrator is available when you order components to stock it. Included in this component selection are the following items: Model 1428 amplifier; 1465-2 radio tuner; 1448 amplifier; 1467 tuner-amplifier combination; 1470 tape recorder deck; 1475 base; 1573 record changer; 1438 base; 1466 changer-amplifier combination; 2 Model "32" speakers; 2 Model "42" speakers; 2 Model "62" speakers.

**ORDER TODAY!**  
 Your V·M distributor can provide full details.

**THE VOICE  OF MUSIC®**

V·M CORPORATION • BENTON HARBOR, MICHIGAN • RECORD CHANGERS, PHONOGRAPHS, TAPE RECORDERS AND HIGH FIDELITY COMPONENTS

- - - for more details circle 56 on post card



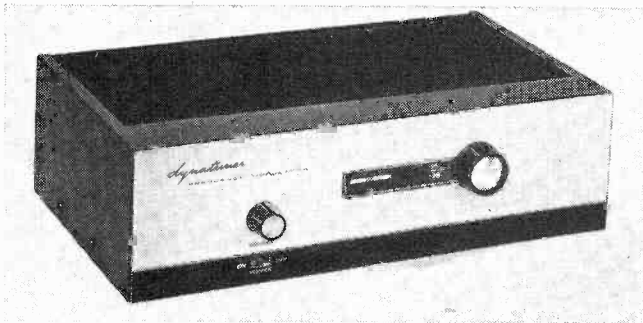

Dynaco's FM-1 is a wide-band mono FM tuner which has provision for internal addition of the FMX-3 stereo multiplex integrator which converts the tuner to fully automatic stereo operation.

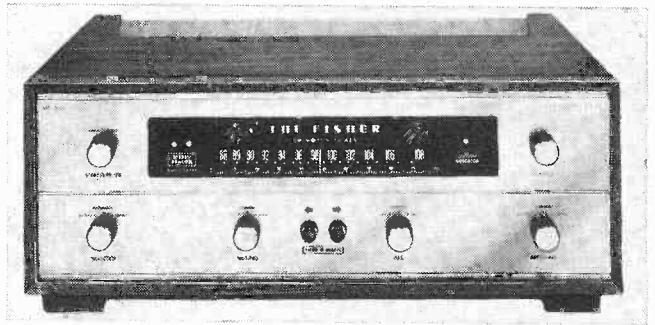

Fisher's MF-300 tuner is available in both wireless and cable models. It features five IF stages, two Nuvistors and four tuned circuits utilizing a 4-gang tuning capacitor.

## TUNERS Continued

cian to sell the customer on the unit's performance and for fringe areas. The use of gold and silver-plated circuitry is especially valuable.

Designers are trying hard to make the tuners compliment the appearance of the equipment they will be used with.

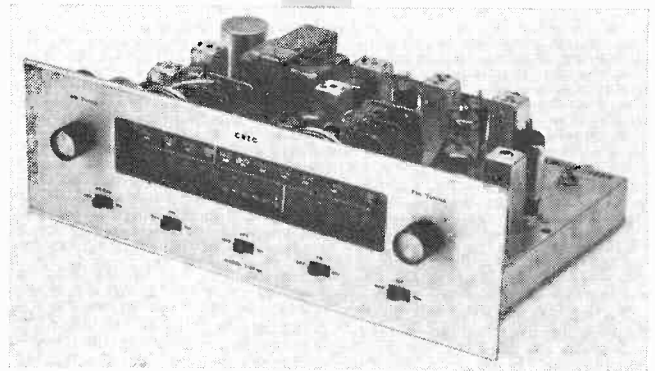

Eico's Model ST97 FM multiplex stereo tuner is available in the semi-kit at \$99.95 or wired at \$149.95.

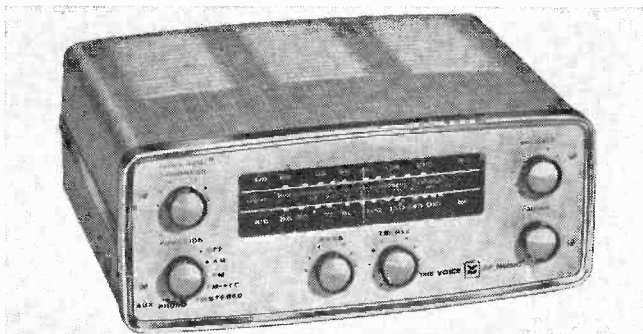

Voice of Music's Model 1267 stereo hi-fidelity AM/FM tuner-amplifier has a stereo indicator light.

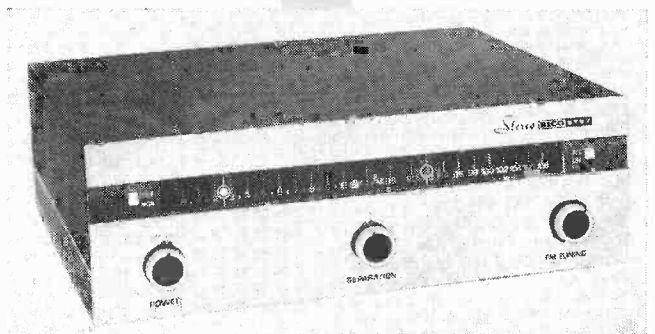

Eric's Model 3157 AM/FM stereo-multiplex tuner features beam switching demodulation.

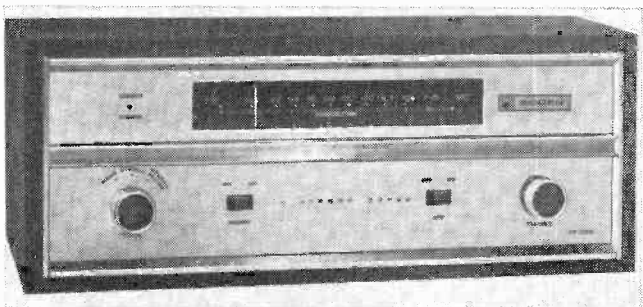

Bogen's TP250 FM stereo tuner comes in a walnut enclosure and features the Stereo-Minder indicator. \$159.95.



Scott's Model 333B AM/FM stereo tuner features a 2-megacycle wide band detector and a 3-gang tuning capacitor.

# STEREO



## Let RCA equip you with EVERYTHING YOU NEED FOR STEREO SERVICING

RCA—entertainment leader of the world—now offers you a complete set of test instruments to put you in the stereo servicing business. And now's the time to get in because it's growing bigger and more profitable by the day.

### A. NEW! RCA WR-51A FM STEREO SIGNAL SIMULATOR

Generates signals necessary to service and maintain stereo multiplex FM receivers and adaptors. Generates... Choice of 4 FM signals—Left Stereo, Right Stereo, Special Phase Test, Monaural FM • Choice of 8 sine-wave frequencies (400 cps, 1Kc, 5Kc, 19Kc, 28Kc, 38Kc, 48Kc, 67Kc) available separately or for modulating FM signals • 100 Mc carrier tuneable  $\pm 0.8$  Mc to permit selection of a quiet point in the FM band • 19 Kc subcarrier, crystal-controlled within  $\pm 2$  cps • 100 Mc sweep signal adjustable from 0-750 Kc at 60 cps rate • Choice of 3 composite stereo output signals—Left Stereo, Right Stereo, Special Phase Test • Choice of 3 sine-wave frequencies for composite stereo

signals • Crystal controlled markers for receiver if and rf alignment • Zero-center meter for checking the balance of stereo amplifier output. **\$249.50\***

### B. RCA WA-44C AUDIO GENERATOR

Generates sine-wave and square-wave signals over range of 20 to 200,000 cps to test audio systems. Can be used to measure intermodulation distortion, frequency response, input and output impedance, speaker resonance, transient response and phase shifts. Less than 0.25% total harmonic distortion over range of 30 to 15,000 cps. **\$98.50\***

### C. RCA W0-91A 5" OSCILLOSCOPE

A high-performance, wide-band 'scope—serves as a visual VTVM. Choice of wide band (4.5 Mc—0.053-volt rms/inch sensitivity)

or narrow, high-sensitivity band (1.5 Mc—0.018-volt rms/inch sensitivity). New 2-stage sync separator provides solid lock-in on composite TV signals. **\$249.50\***

### D. RCA WV-98C SENIOR VOLTOHMYST®

For direct reading of peak-to-peak voltages of complex waveforms, rms values of sine-waves, DC voltages, and resistance. Accuracy: 3% full-scale on both AC and DC, with less than 1% tracking error. Color-coded scales differentiate peak-to-peak from rms readings. New 0.5 volt full scale DC range for use with low-voltage transistor circuits.  $6\frac{1}{2}$ " meter. **\$79.50\***

### E. RCA WV-76A AC VTVM

Measures voltages down to 0.001 volt. Decibel scale for measure-

ments from -40 to +40 db. Built-in amplifier which may be used separately as a preamplifier. Typical applications include: frequency response tests of preamplifiers, power amplifiers and tone control circuits, signal tracing; measurements of audio level, power level and gain; amplifier balancing applications and general audio voltage measurements. **\$79.95\***

### F. RCA WG-360A STEREO PHASE CHECKER

A quick, simple, positive way to check phase alignment of low and mid-range speakers in stereo systems. Completely "sound-powered". Snag-proof recessed grille design. For use with a VOM, VTVM, or oscilloscope. **\$14.95\***

See Them all at your Authorized RCA Electronic Instrument Distributor  
RCA Electronic Components and Devices, Harrison, N. J.

\*User price (optional)



The Most Trusted Name in Electronics

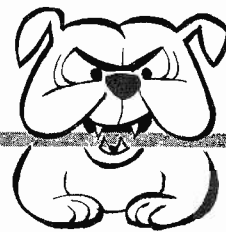

## Difficult Service Jobs Described by Readers

### Filter Alteration

Recently, a 1954 Philco split chassis (D181 and RF181) set needed a new CRT and the job was routinely handled in the home. The customer marvelled at the tremen-

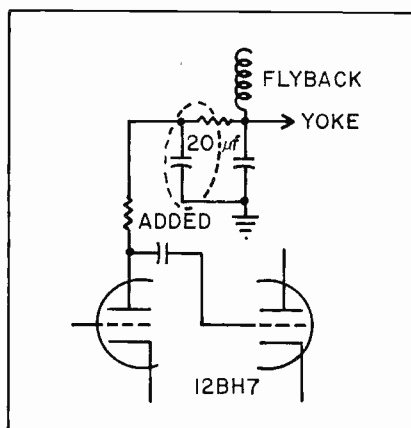

Added filter serves as decoupling capacitor to eliminate horizontal sawtooth 'humps' which caused vertical 'jitter.'

dous increase in brightness, but one slight flaw in the picture became apparent that was not noticed before: a bad vertical jitter made the picture look like an old movie.

Naturally I tried substituting the sync amp and separator tubes as well as the vertical oscillator and output tubes but the bounce remained. I informed the customer that a bench job was in order.

With the chassis on the bench I proceeded to scope the sync circuit. Much to my surprise, the waveforms were very close to book values in shape, amplitude and stability all the way to the grid of the multivibrator. Still the vertical hold control required a safecracker's touch to stop the jitter.

From past experience, I decided to substitute parts in the vertical integrator circuit. This hunch did not pay off. Next I disabled the retrace

elimination network to see the retrace lines; they were pairing.

Now I was getting someplace. It had been quite a while since I battled an interlace problem. The reference book library had bailed me out before so I read up a little on interlace problems.

They mentioned ripple on the B+ lines to the sync circuits. I scoped these and found them pure dc. I decided to scope the vertical oscillator. Turning the scope frequency to horizontal displayed a series of humps. Moving the probe to the other end of the plate load resistor revealed the same humps. Tacking in a 20  $\mu\text{f}$  capacitor locked in the retrace lines rock solid.

I restored the retrace network and viewed a picture that was interlaced precisely. Just for curiosity I cut the capacitor in and out and saw the terrific change in the bounce; the resulting improvement in picture resolution was well worth the effort. —*Bob Ciszak, Buffalo, N. Y.*

### New Tubes Won't Work

An Olympic Model 21BC10 was brought into the shop recently with no picture. When checking the set, we found the high voltage measured only 5000 v. Replacing the 1B3 with another 1B3 did not cure the trouble, in fact with any of several new rectifiers the high voltage was zero. All voltages, including boost voltages in the horizontal circuit were checked and found normal. The socket of the 1B3 was loosened and turned upside down, and upon inspection, it was found that the high voltage take-off was from pin 8 through a 3.3 ohm re-

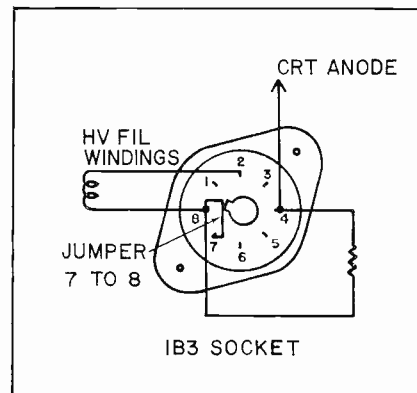

A jumper from tube socket terminals 7 and 8 was necessary before a new 1B3 would work in this Olympic TV set.

sistor to pin 4 where the anode lead was connected.

Pins 7 and 8 were measured on the 1B3 itself and was found to have a high resistance reading. The pins 7 to 8 on a new tube were found to have no continuity at all.

The older tube manuals call out pins 7 and 8 as internal connections but the newer manuals call out 7 and 8 as limited connections which seems to indicate that the tubes now manufactured most likely will not have the internal connections.

The set was obviously repaired by connecting a jumper between terminals 7 and 8 on the tube socket. —*Harvey P. Rubien, Rochester, N. Y.*

### TOUGH DOGS WANTED

\$10.00 paid for acceptable items. Use drawings to illustrate whenever necessary. A rough sketch will do. Photographs are desirable. Unacceptable items will be returned if accompanied by a stamped envelope. Send your entries to "Tough Dog" Editor, ELECTRONIC TECHNICIAN, 1 East First St., Duluth 2, Minnesota.



# Find it and Fix it in 1/2 the time!

EASILY SOLVES "TOUGH DOGS"... INTERMITTENTS... ANY TV TROUBLE



## **B&K** MODEL 1076 TELEVISION ANALYST BLACK & WHITE AND COLOR

**By Easy Point-to-Point Signal Injection, You see the Trouble on the TV Screen and Correct it—Twice as Fast and Easy!**

Simplified technique stops lost hours never recovered on "tough dogs", intermittents, and general TV troubleshooting. This one instrument, with its complete, accurate diagnosis, enables any serviceman to cut servicing time in half... service more TV sets in less time... satisfy more customers... and make more money.

With the Analyst, you inject your own TV signals at any time, at any point, while you watch the generated test pattern on the picture tube of the television set itself. This makes it quick and easy to isolate, pinpoint, and correct TV trouble in any stage throughout the video, audio, r.f., i.f., sync and sweep sections of black & white and color television sets—including intermittents. No external scope or waveform interpretation is needed. Checks any and all circuits—solves any performance problem. Gives you today's most valuable instrument in TV servicing—proved by thousands of professional servicemen everywhere.

Available on Budget Terms. As low as \$30.00 down.

Net, \$329.95

### SIMPLIFIES COLOR TV SERVICING, TOO

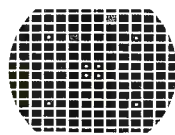

Enables you to troubleshoot and signal trace color circuits in color TV sets, or facilitate installation.



Generates white dot, crosshatch and color bar patterns on the TV screen for color TV convergence adjustments.



Generates full color rainbow display and color bar pattern to test color sync circuits, check range of hue control, align color demodulators. Demonstrates to customers correct color values.

### Time-Saving, Money-Making Instruments Used by Professional Servicemen Everywhere



Model 960 Transistor Radio Analyst



Model 360 V O Matic Automatic VOM



Model 375 Dynamatic Automatic VTVM



Model 700 Dyna-Quik Tube Tester

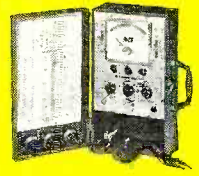

Model 445 CRT Rejuvenator Tester

See Your B&K Distributor or Write for Catalog AP 21-T



**B & K MANUFACTURING CO.**

Division of DYNASCAN CORPORATION

1801 W. BELLE PLAINE AVE. • CHICAGO 13, ILL.

Canada: Atlas Radio Corp., 50 Wingold, Toronto 19, Ont.

# SHOP HINTS

TIPS FOR HOME AND BENCH SERVICE

## Fuse Identification

When it is important to know the size of a blown fuse with difficult-to-read markings, rub a little white or yellow chalk over the fuse; wipe off the excess and the lettering will stand out clearly.—*Harry J. Miller, Sarasota, Fla.*

## Resistor Storage

I have solved the resistor storage problem with a 12 drawer cabinet for all values. The drawers are labeled 10, 12, 15, 18, 22, 27, 33, 39, 47, 56, 68 and 82. Resistors are then stored according to the first two digits of their value and finding the correct one is merely a matter of picking out the correct last color for the multiplier. This, of course, works only for the shop with a small stock, but I have found it most successful.—*E. D. Standish, Frankford, Ont.*

## TV Truck

An old sick power mower makes an excellent and cheap hand truck for moving TV sets from shop to service truck and vice versa. Remove the engine and accumulated dirt and grease. Mount a 3/4" plywood platform about a foot above the original chassis. Pad it with an old comforter, burlap bags, or something similar. Eliminates most of the aching backs connected with lugging the one-eyed monsters. —*Dennis Crisp, Howard Kansas*

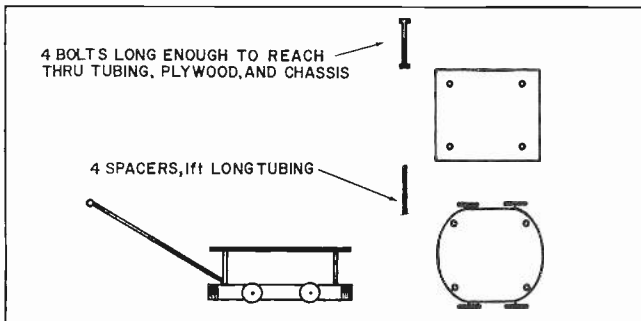

Old power mower carriage converts into hand truck for TV sets.

## Capacitor Replacement

Technicians often find bad capacitors in ac-dc radios with their markings missing. This presents some-

CAPACITOR APPLICATION	CAPACITANCE IN $\mu f$
A F COUPLING	0.01 TO 0.25
A F BYPASS	0.25 TO 1.
DECOUPLING CAPACITORS	1. TO 10.
GRID LEAK DETECTORS	0.00025
R F COUPLING	0.0001
R F BYPASSES	0.1 TO 0.25
I F BYPASSES	0.1 TO 0.25

Capacitor sizes can be easily determined in most radios with the aid of this chart.

thing of a problem if no service diagram is available. However, the accompanying chart will simplify capacitor replacement for virtually all radio applications.—*Noble C. Travis, Sheridan, Ky.*

## Changer Template

I was called on to make a custom installation of a record changer that had no mounting board or template to cut one with. I solved this problem with a cardboard box. I picked out a box that had a sturdy bottom, placed the box upside down and placed the changer on the box. Then I made a rough sketch around the motor and changer mechanism, leaving a place for the changer hold down screws and the cushion

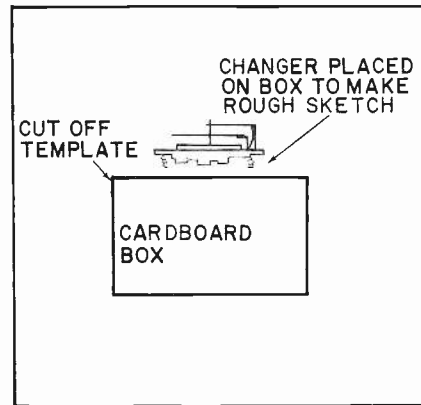

Cardboard template for changers made from box.

springs. I then cut out the outline with a pocket knife, inserted the changer and trimmed the hole for a good fit. Cutting the sides of the box away yielded a good template for cutting the mounting board.—*Robert W. Willey, Emporia, Kan.*

## Convergence Aid

I have found that a surplus-type periscope aids in convergence adjustments. Simply place the periscope against the face of the tube and you can look from the top or side of the set. A periscope suitable for this work can be purchased at Army surplus stores for about \$2. I am using an M6 tank periscope which I picked up at a nearby surplus store.—*Ted Morton, Granite Quarry, N. C.*

## SHOP HINTS WANTED

\$3 to \$10 for acceptable items. Use drawings to illustrate whenever necessary. A rough sketch will do. Unacceptable items will be returned if accompanied by a stamped envelope. Send your entries to Shop Hints Editor, ELECTRONIC TECHNICIAN, Ojibway Building, Duluth 2, Minn. The hints published in this column have not necessarily been tried by ELECTRONIC TECHNICIAN editors and are the ideas of the individual writers.





## There's more profit in your hands with ITT tubes

Yes, you can pocket extra profit when you stock ITT receiving tubes . . . with full confidence that you are giving your customers the finest replacement tubes money can buy.

Your customers will appreciate it, too, because they know ITT's international

reputation for quality and leadership in electronics.

ITT can provide this "extra value" of finest quality at higher profit margins because ITT products are available from 154 factories and laboratories in 24 countries. Brands without these world-

wide resources cannot offer you these advantages.

Ask your local distributor about ITT tubes. He'll give you *extra profit* details.

ITT Distributor Products Division, International Telephone and Telegraph Corporation, Box 99, Lodi, New Jersey.

# ITT



# MANUFACTURER AND PRODUCT STEREO DIRECTORY

Amplifiers, 1-channel ..... amp-1  
 Amplifiers, 2-channel ..... amp-2  
 Amplifier-preamplifiers  
 integrated, stereo ..... amp-pre  
 Antennas, FM ..... ant  
 Arms ..... arm  
 Cartridges, stereo phono ..... car  
 Changers ..... cha  
 Control Units, stereo ..... cont  
 Conversion Kits, stereo phono conv-p  
 Conversion Kits, stereo  
 tape recorder ..... conv-t  
 Enclosures & Cabinets ..... enc  
 Headphones ..... hed  
 Microphones ..... mik  
 Needles ..... need  
 Phono Systems, accessories phon-acc  
 Phono Systems, stereo,  
 complete ..... phon-sys  
 Preamplifiers, 1-channel ..... pre-1  
 Preamplifiers, 2-channel ..... pre-2  
 Records, stereo ..... rec  
 Speakers & Speaker Systems ..... spk  
 Tape, blank ..... tap  
 Tape, prerecorded stereo ..... tap-pr  
 Tape Recorder Accessories ..... Tap-acc  
 Tape Recorder Heads,  
 stereo ..... tap-hed  
 Tape Recorders or Decks,  
 stereo ..... tap-rec  
 Tuners & Receivers, AM or  
 FM Mono ..... tun-1  
 Tuners & Receivers,  
 multiplex equipped ..... tun-2  
 Tuner multiplex adapters ..... tun-ad  
 Turntables ..... tur  
 Kit form ..... K  
 Wired ..... W

**Acoustic Research, Inc.**, 24 Thorndike St., Cambridge 41, Mass.—spk; tur  
**Aldshir Mfg. Co., Inc.**, 111 Lake Ave., Tuckahoe, N. Y.—car; need; diamond retipping; 35 RPM spindle adap.  
**Allied Radio Corp.**, 100 N. Western Ave., Chicago 80, Ill.—amp-1; amp-2; amp-pre; hed; phon-acc; phon-sys; pre-1; pre-2; spk; tun-1; tun-2; tun-ad; K; W  
**Altec Lansing Corp.**, 1515 S. Manchester Ave., Anaheim, Calif.—amp-1; amp-2; amp-pre; enc; mik; pre-1; pre-2; spk; tun-1; tun-2; tun-ad  
**Amelux Electronics Corp.**, 33 W. 42nd St., New York 36, N. Y.—tap-acc; tap-hed; tap-rec  
**American Concertone, Inc.**, Div. of Astro-Science Corp., 9449 W. Jefferson Blvd., Culver City, Calif.—tap-acc; tap-hed; tap-rec  
**American Microphone Mfg. Co.**, 1st & George Sts, Galien, Mich.—car; mik  
**Ampex Corp.**, 401 Broadway, Red-

wood City, Calif.—conv-t; mik; spk; tap; tap-pr; tap-acc; tap-rec  
**Argos Products Co., Inc.**, 600 S. Sycamore St., Genoa, Ill.—enc; spk  
**Astatic Corp.**, Harbor & Jackson, Conneaut, Ohio—arm; car; hed; mik; need; tap; W  
**Atlas Sound Corp.**, 1419-51 39th St., Brooklyn 18, N. Y.—spk  
**Audio Devices, Inc.**, 444 Madison Ave., New York 22, N. Y.—need; tap; discs-recording blanks  
**Audio Dynamics Corp.**, Pickett District Rd., New Milford, Conn.—arm; car; spk; stylus assemblies; record cleaning device  
**Audio Originals**, 474 S. Meridian, Indianapolis 25, Ind.—enc  
**Audiotex Mfg.**, 400 S. Wyman St. Rockford, Ill.—ant; tap-acc; record accessories  
**Bel Canto Stereophonic Recordings Div.**, Thompson Ramo Wooldridge, 6325 Huntley Rd., Columbus 24, Ohio—amp-1; amp-2; amp-pre; conv-t; pre-2; tap-pr; tap-rec; tun-1; tun-2; tun-ad  
**Bell Sound Div.**, Thompson Ramo Wooldridge Inc., 6325 Huntley Rd., Columbus 24, Ohio—amp-pre; hed; mik; tap-pr; tap-acc; tap-rec; tun-2; tun-ad  
**Benjamin Electronic Sound Corp.**, 80 Swalm St., Westbury, N. Y.—car; cha; need; tap-rec; tur  
**Blonder-Tongue**, 9 Alling St., Newark 2, N. J.—r-f preamplifiers  
**Bozak Mfg. Co.**, 587 Connecticut Ave., S. Norwalk, Conn.—enc; spk  
**British Industries Corp.**, 80 Shore Rd., Port Washington, N. Y.—cha; conv-p; spk; tur  
**Burgess Battery Co.**, Magnetic Tape Div., Freeport, Ill.—tap  
**Cabinart Acoustical Dev. Corp.**, 35 Geyer St., Haledon, N. J.—spk  
**Calbest Electronics Co.**, 4801 Exposition Blvd., Los Angeles 16, Calif.—amp-1; amp-2; amp-pre; tun-1; tun-2; tun-ad; W  
**CBS Laboratories**, Research Dr., Stamford, Conn.—rec  
**Channel Master Corp.**, Ellenville, N. Y.—amp-2; ant; spk; tur  
**Cleveland Electronics, Inc.**, 1974 E. 61st St., Cleveland 3, Ohio—spk  
**Clevite Corp.**, 232 Forbes Rd., Bedford, Ohio—hed  
**Crosby Electronics**, 135 Eileen Way, Syosset, L. I., N. Y.—tun-2; tun-ad; W  
**"Crown" International**, a sub. of International Radio & Electronics Corp., 1718 W. Mishawaka Rd., Elkhart, Ind.—amp-1; amp-2; amp-pre; pre-1;

pre-2; tap-acc; tap-rec  
**CTS of Paduca, Inc.**, 1500 North 8th Street, Paduca, Kentucky.  
**Daystrom Products Corp.**, Box 167, St. Joseph, Mich.—amp-1; amp-2; amp-pre; cha; spk; tun-1; tun-2; tun-ad; K; W  
**Duotone Co. Inc.**, Locust St., Keyport, N. J.—car; need; phon-acc; tap  
**Dynaco Inc.**, 3912 Powelton Ave., Ave., Philadelphia 4, Pa. — amp-1; amp-2; amp-pre; arm; car; cont; mik; pre-1; pre-2; tun-1; tun-2; tun-ad; K; W  
**Eastman Kodak Co.**, 343 State St. Rochester 4, N. Y.—tap  
**Eico Electronic Instrument Co., Inc.**, 3300 Northern Blvd., Long Island City 1, N. Y.—amp-1; amp-2; amp-pre; cont; pre-1; pre-2; spk; tap-rec; tun-1; tun-2; tun-ad; K; W  
**Electron Enterprises, Inc.**, 6727 W. Stanley Ave., Berwyn, Ill.—amp-1; amp-2; amp-pre; enc; phon-sys; tun-1; W  
**Electronic Applications, Inc.**, 80 Danbury Rd., Wilton, Conn.—hed; mik; W  
**Electro-Voice, Inc.**, Cecil & Carroll Sts., Buchanan, Mich.—car; enc; mik; need; spk  
**Elpa Marketing Industries, Inc.**, Atlantic & Thorens Aves., New Hyde Park, N. Y.—arm; car; cha; tur; record cleaning equip.  
**Emerson Radio Inc.**, 680 5th Ave., New York, N. Y.—tap-rec; W  
**Empire Scientific Corp.**, 845 Stewart Ave., Garden City, N. Y.—arm; car; tur  
**Ercona Corp.**, 16 W. 46th St., New York 36, N. Y.—amp-1; amp-2; cont; mik; pre-1; pre-2; spk; tap-acc; tap-hed; tap-rec; tun-1; tun-2; W  
**Eric Electronics**, 1823 Colorado Ave., Santa Monica, Calif.—amp-1; amp-2; amp-pre; tun-1; tun-2; tun-ad; W  
**Euphonics Corp.**, Box 233, Guaynabo, Puerto Rico—car; mik; need  
**Fairchild Recording Equipment Corp.**, 10-40 45th Ave., Long Island City 1, N. Y.—ant; arm; car; tur; dynamic expansion device  
**Ferrodynamics Corp.**, Gregg St. & Rt. 17, Lodi, N. J.—tap; tap-acc  
**Fidelitone, Inc.**, 6415 N. Ravenswood Ave., Chicago 26, Ill.—need; phon-acc; tap  
**Finney Co.**, 34 W. Interstate, Bedford, Ohio—ant; RF amplifiers; FM antenna couplers  
**Fisher Berkeley Corp.** (Ektacom), 1475 Powell St., Emeryville 8, Calif.—amp-1; W  
**Frazier Inc.**, 2649 Brenner Dr., Mail:



**This cabinet is yours free ... when you order these 1964 radio parts**

Order the parts you need to service the Delco radios in all the 1964 General Motors cars—and get a good looking cabinet to boot. Plan on using this cabinet often because the parts you get with this package are the fastest movers. And to help make sure you never run out of them, you'll also get a handy inventory control card. All this is yours

when you order Part No. 1964 from your United Delco representative. Supply of cabinets is limited, so call him today!

**Delco Radio** automotive radio service parts are distributed nationally through **United Delco**.

DELCO RADIO, Division of General Motors, Kokomo, Indiana.

simply say **Delco**



# SARKES TARZIAN Silicon Rectifiers

*are first choice among service technicians (according to a nation-wide poll) for the third year in a row*



Tarzian 400V and 600V "F" Series units in handy Ten-Paks, Doubler Replacement Kits, and in bulk

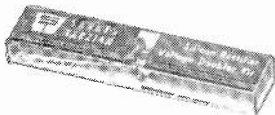

Tarzian 400V and 600V "H" Series units in handy Ten-Paks, Doubler Replacement Kits, and in bulk



## Preference high! Here's why:

- ★ They are immediately available from distributors throughout the nation
- ★ They are "handy-packed" in the quantities and sizes you need most
- ★ Their proven quality and dependability eliminates callbacks that waste your time and profits

A free Tarzian "Replacement Line" catalog is yours for the asking. It's your guide to replacement rectifiers with competitive prices, unsurpassed performance.

Write or call your nearest Tarzian distributor, or:

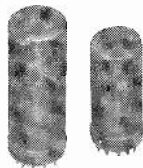

Tarzian's nine standard tube replacement rectifiers replace over 95% of all vacuum tube rectifiers

Tarzian M-500 and M-150 units in Conversion Kits and in bulk



Tarzian's four "condensed stack" selenium rectifiers fit small-size, high-efficiency applications

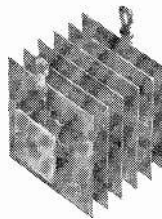

P. O. Box 20302, Dallas 20, Tex.—enc; spk; W  
**GC Electronics Co.**, Div. of Textron Electronics Inc., 400 S. Wyman St., Rockford, Ill.—ant; mik  
**Garrard**; See British Industries Corp.  
**General Electric Co.**, Audio Products Dept., 2200 N. 22nd St., Decatur, Ill.—amp-pre; car; need; spk; tun-ad  
**Glaser-Steers**, A Div. of Ametek, Inc., 155 Oraton St., Newark, N. J.—cha  
**Gotham Audio Corp.**, 2 W. 46th St., New York 36, N. Y.—arm; car; mik; tur  
**Grado Laboratories Inc.**, 4614 7th Ave., Brooklyn 20, N. Y.—arm; car; phon-acc  
**Gray Research & Development Co., Inc.**, P. O. Box 12, Elmwood 10, Conn.—conv-p; tur; arm; broadcast record equalizers  
**Harman-Kardon, Inc.**, 55 Ames Ct., Plainview, N. Y.—amp-2; amp-pre; cont; conv-p; enc; pre-2; tun-1; tun-2; tun-ad; K; W  
**Hartley Products Co.**, 519 E. 162nd St., New York 51, N. Y.—spk  
**Heath Co.**, Benton Harbor, Mich.—amp-1; amp-2; amp-pre; car; cha; cont; enc; hed; phon-sys; pre-2; spk; tap-rec; tun-1; tun-2; tun-ad; tur  
**Jensen Industries**, 7333 W. Harrison St., Forest Park, Ill.—car; need  
**Jensen Mfg. Co.**, 6601 S. Laramie Ave., Chicago 30, Ill.—hed; spk  
**Jerrold Electronics Corp.**, 15th & Le-High Ave., Philadelphia 32, Pa.—pre-1; pre-2; tun-2; tun-ad; W  
**Karg Laboratories, Inc.**, 162 Fly Ave., S. Norwalk, Conn.—amp-2; amp-pre; pre-2; tun-1; tun-2; tun-ad; K; W  
**Karlson Associates Inc.**, 433 Hempstead Ave., W. Hempstead, L. I., N. Y.—enc; phon-sys; spk; K; W  
**KLH Research & Development Corp.**, 30 Cross St., Cambridge 39, Mass.—phon-sys; spk; tun-1; tun-2  
**Klipsch & Assoc. Inc.**, Box 96, Hope Ark.—enc; spk; W  
**Lafayette Radio Electronics Corp.**, 111 Jericho Turnpike, Syosset, L. I., N. Y.—amp-1; amp-2; amp-pre; cont; enc; hed; mik; phon-acc; phon-sys; pre-2; spk; tap-acc; tap-hed; tap-rec; tun-1; tun-2; tun-ad; tur  
**Lansing Sound Inc.**, James B., 3249 Casitas Ave., Los Angeles 39, Calif.—amp-2; pre-2; spk  
**Lear Siegler, Inc.**, Bogen Communications Div., P. O. Box 500, Paramus, N. J.—amp-1; amp-2; amp-pre; arm; enc; pre-1; pre-2; tap-acc; tap-hed; tap-rec; tun-1; tun-2; tun-ad; tur; W  
**McIntosh Laboratories, Inc.**, 2 Chambers St., Binghamton, N. Y.—amp-1  
**Marantz Co.**, 25-14 Broadway, Astoria, L. I., N. Y.—amp-1; amp-2; pre-1; pre-2; W  
**Michigan Magnetics Inc.**, W. 3rd St., Vermontville, Mich.—tap-hed  
**Minnesota Mining & Mfg. Co.**, Magnetic Products Div., 2501 Hudson



## SARKES TARZIAN, Inc.

World's Leading Manufacturers of TV and FM Tuners • Closed Circuit TV Systems • Broadcast Equipment • Air Trimmers • FM Radios • Magnetic Recording Tape • Semiconductor Devices

SEMICONDUCTOR DIVISION • BLOOMINGTON, INDIANA

Canadian Licensee: Marsland Engineering Limited • 350 Weber Street North, Waterloo, Ontario

- - - for more details circle 45 on post card



# Centralab

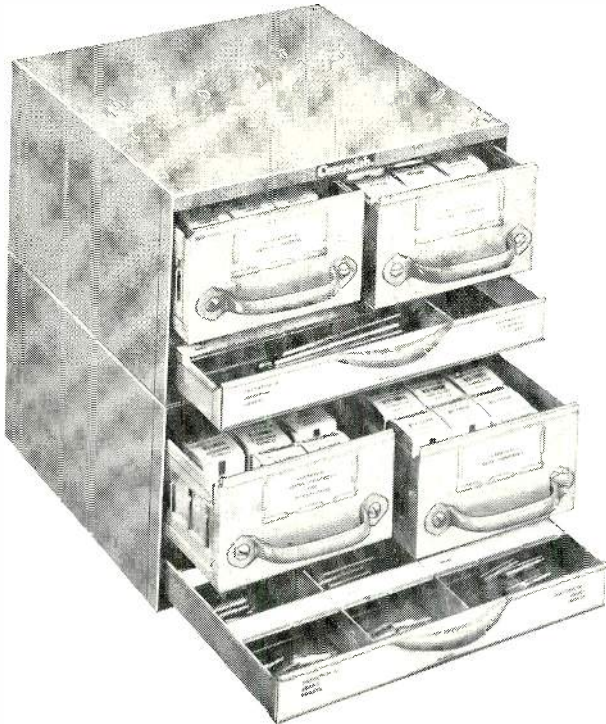

## BRAND NEW CENTRALAB FASTATCH II® FRK-200 KIT WITH EXACT REPLACEMENT SHAFTS

## Makes Control Replacement A SNAP!

- Centralab's new FRK-200 kit gives you the most convenient, most versatile, and simplest system for control replacement.
- Since it includes 13 sizes of exact replacement shafts, shaft cutting is eliminated on *all* the popular dual concentric controls and on almost 60% of all dual controls.
- The Fastatch II® Control System is a snap to use. Single and dual concentrics snap together without tools! Shafts plug in and are permanently locked. Assembled units can't loosen—shafts can't pull out.

### JUST CHECK THESE EXCLUSIVE FEATURES:

1. Just one control system for dual concentric or single controls.
2. Universal terminals.
3. Plug-in, permanently locking shafts.
4. Rotary or push-pull (snap-on) line switches attach to both front and rear controls.

The FRK-200 kit is contained in two stacking Equipto steel cabinets with plenty of extra space for expansion. *All* your control needs, including push-pull, are at your finger tips.

### THE FRK-200 KIT CONTAINS:

- |                                       |  |
|---------------------------------------|--|
| 35 Exact Front Shafts (7 sizes)       | 9 Assorted Rear Controls                                     |
| 30 Exact Rear Shafts (6 sizes)        | 40 Assorted Universal Shafts for Single and Dual Concentrics |
| 5 Universal Push-Pull Shafts (1 size) | 5 SPST on/off Switches                                       |
| 5 Push-Pull Line Switches             | 2 DPST on/off Switches                                       |
| 5 Twist-Tab Adapter Plates            | 1 DP on/off Switch   |
| 2 3-Drawer Equipto Cabinets           | Complete with current cross-reference guides.                |
| 27 Assorted Front Controls            |  |

Dealer Net \$72.50

Less Credit for your old controls!



THE ELECTRONICS DIVISION OF GLOBE-UNION INC.

902I East Keefe Avenue • Milwaukee 1, Wisconsin

TWX: 414-731-8731

In Canada: Centralab Canada Ltd., P. O. Box 400, Ajax, Ontario

- - - for more details circle 19 on post card

**IT'S A FIRST!**

# Gator-Probe

*a new development in test leads*

- Adjustable Length Probe
- Swivel Jawed Clips
- Probe-to-Tip Insulation
- No Moving Parts in Circuit
- Changeable Thread-in Tips
- ONE Pair for ALL Jobs

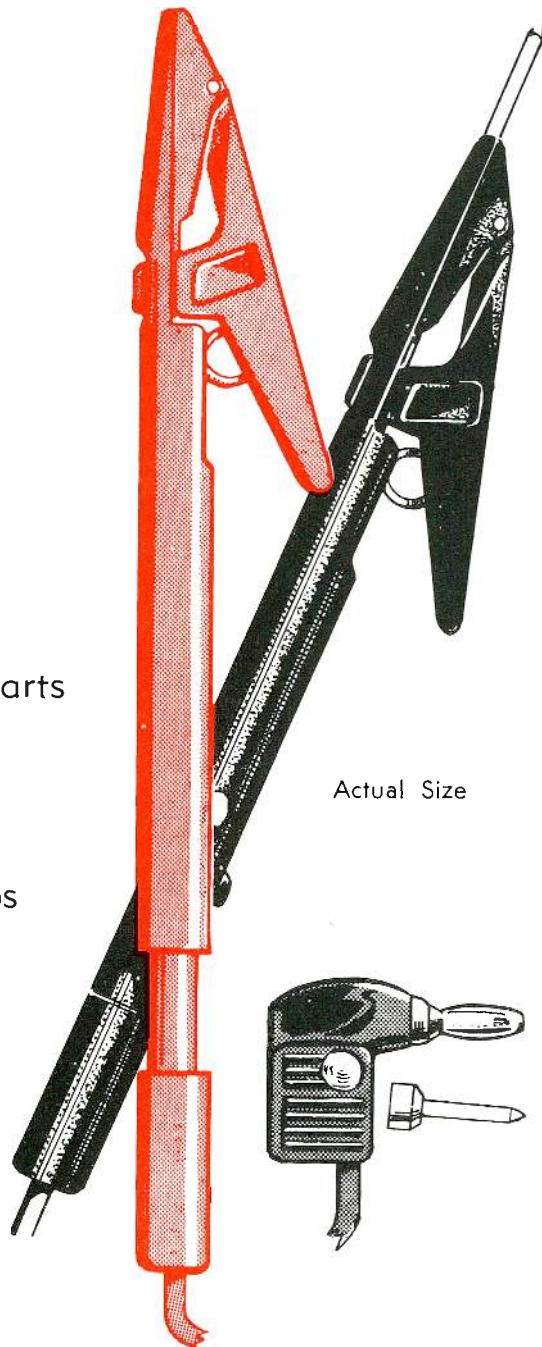

**SEE YOUR  
DISTRIBUTOR**

## Gator-Probe Corporation

HOLLISTER, CALIFORNIA

A Subsidiary of HOLEX Incorporated

Rd., St. Paul 19, Minn.—spk; tap-acc; tap-rec

**Monarch Electronics International, Inc.**, 7035 Laurel Canyon Blvd., N. Hollywood, Calif.—amp-1; amp-2; arm; car; cont; hed; mik; pre-1; spk; tap; tap-acc; tun-1; tun-2; tun-ad; tur; W

**Motorola, Inc.**, Consumer Products Div., 9401 W. Grand Ave., Franklin Park, Ill.—phon-sys

**Neshaminy Electronic Corp.**, 382 Easton Rd., Neshaminy, Pa.—rec

**Newcomb Electronics Corp.**, 6824 Lexington Ave., Hollywood 28, Calif.—amp-1; amp-2; tap-rec

**North American Philips Co.**, Hi Fi Products Div., 230 Duffy Ave., Hicksville, L. I., N. Y.—car; cha; mik; spk; tap-rec; tur; W

**Nortronics Co., Inc.**, 8101 W. 10th Ave. N., Minneapolis, Minn.—conv-t; pre-1; tap-acc; tap-hed

**Oaktron**, Monroe, Wis.—spk

**Olson Electronics Inc.**, 260 S. Forge St., Akron, Ohio—amp-1; amp-2; amp-pre; ant; arm; enc; hed; mik; phon-sys; pre-1; pre-2; spk; tap-acc; tun-1; tun-2; tun-ad

**Oxford Components**, Div. of Oxford Electric Corp., 3911-29 S. Michigan Ave., Chicago 53, Ill.—spk

**Paco Electronics Co.**, 70-31 84th St., Glendale 27, N. Y.—amp-pre; spk; tun-1; tun-2; tun-ad; K; W

**Pentron Corp.**, 777 S. Tripp Ave., Chicago 24, Ill.—tap-rec

**Philco Corp.**, C & Tioga Sts., Philadelphia 34, Pa.—phon-sys

**Philmore Mfg. Co., Inc.**, 130-01 Jamaica Ave., Richmond Hill 18, N. Y.—amp-2; arm; car; hed; tun-ad; K; W

**Pickering & Co., Inc.**, Sunnyside Blvd., Plainview, L. I., N. Y.—arm; car; need; tur; K

**Qualitone Industries Inc.**, 102 Columbus Ave., Tuckahoe, N. Y.—amp-1; amp-2; amp-pre; arm; car; mik; need; pre-1; tap-acc

**Quam-Nichols Co.**, 234 E. Marquette Rd., Chicago 37, Ill.—spk

**Radio Corp. of America**, Electron Tube Div., 415 S. 5th, Harrison, N. J.—amp-1; mik; spk; tap; tap-pr; tap-acc; tun-2; tur; test equipment; W

**Reeves Soundcraft**, Div. of Reeves Industries, Inc., Great Pasture Rd., Danbury, Conn.—tap

**Reiter Co., F.**, 3340 Bonnie Hill Dr., Hollywood 28, Calif.—tap-acc

**Revere Camera Co.**, 320 E. 21st St., Chicago 16, Ill.—tap-acc; tap-rec

**Roberts Electronics, Inc.**, 5920 Bowcroft St., Los Angeles 16, Calif.—spk; tap; tap-acc; tap-rec

**Robins Industries Corp.**, 15-58 127th St., Flushing 56, N. Y.—cont; phon-acc; tap-acc; tap-hed; tun-ad; audio controls & switches; tape splicers; head demagnetizers; bulk erasers; patch cords; cable; assemblies; adaptors

... for more details circle 24 on post card



equip yourself  
for professional  
stereo/hi-fi service  
with **HEATHKITS**

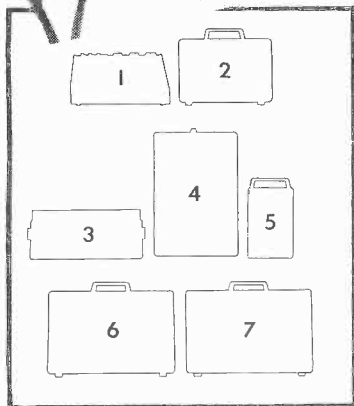
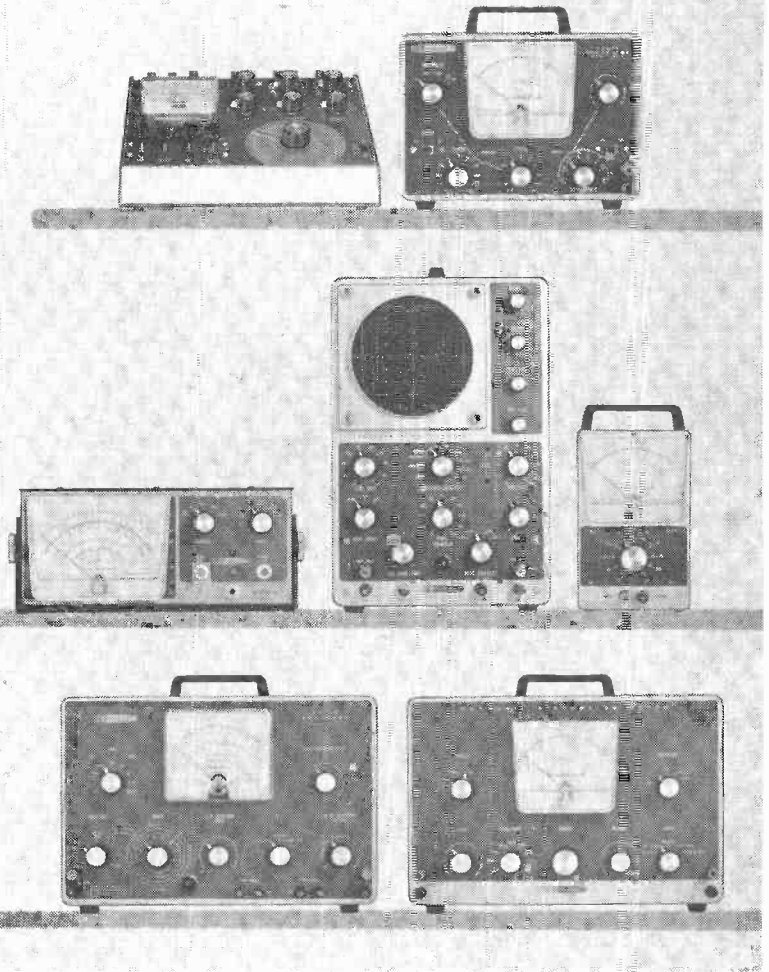

Complete lab above consists of:

1. Heathkit IM-30 Deluxe Transistor Tester, \$54.88. 2. Heathkit IG-72 Audio Generator, \$41.95. 3. Heathkit IM-13 Deluxe Service Bench VTVM, \$32.95. 4. Heathkit IO-12 "Extra-Duty" Wide Band 5" Oscilloscope, \$76.95. 5. Heathkit IM-21 Laboratory AC VTVM, \$33.95. 6. Heathkit IM-22 Audio Analyzer, \$96.95. 7. Heathkit IM-12 Harmonic Distortion Meter, \$54.95.

**The test set-up above can be yours for no money down,  
and as low as \$27 per month!**

Heathkit, world-leader in kit-form electronics, makes it possible for you to enter the profitable field of Audio and High Fidelity servicing with a minimum investment in test instrument facilities! Equip now with the outstanding selection of service instruments shown above for complete audio and hi-fi servicing... all units are professionally designed for years of dependable trouble-free performance, with all the latest design and operational features for maximum versatility and convenience. Best of all, you save up to 50% or more by doing the easy assembly yourself!

Heathkit test equipment is widely acclaimed by service technicians everywhere across the nation for their excellent quality, versatile performance, and conservatively rated specifications... features that emphasize their high value and assure you of top service facilities at all times. Order your complete Heathkit service lab now and see why so many technicians have come to rely on Heath for professional quality at lowest cost.



HEATH COMPANY, Benton Harbor 24, Mich. 49023

Please send free 1964 Heathkit catalog.

Enclosed is \$ \_\_\_\_\_ plus postage.  
Please send models \_\_\_\_\_

NAME \_\_\_\_\_

ADDRESS \_\_\_\_\_

CITY \_\_\_\_\_ STATE \_\_\_\_\_

--- for more details circle 27 on post card

**HEATHKIT-1964**

**SEND FOR FREE 1964 HEATHKIT CATALOG**  
Gives full description and specifications of units above, plus 245 others in Test, Amateur Radio, Hi-Fi, Marine, Educational and General Hobby fields of interest. Send for your free copy today and get the complete story on money-saving Heathkits.



# FOR THE NATIONAL ELECTRONIC CONFERENCE IN CHICAGO

(OCT. 28-30)

Imperial Inn offers you added fun in the way of a swimming pool, Health Club (with sun and steam rooms, Swedish massage, bar), and that smash hit, the Frustration Room.

For details, phone 427-6969 or write for brochure.



Your host, Don Miller, former pro-footballer

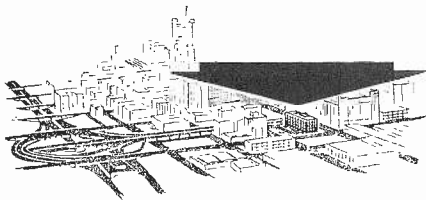

All roads lead to DOWNTOWN CHICAGO'S

## IMPERIAL INN

at the hub of Chicago's great expressway system

Easy to reach from everywhere . . . close to the city's business and night life . . . Chicago's most convenient motor hotel is also its newest and most luxurious. Plan now to stay at the glamorous Imperial Inn. Great for sales meetings, too.

### Enjoy superb service:

- 201 sumptuous guest rooms and suites
- Famous Royal Hearth restaurant/Kings Taverne/Coffee house
- Health club and Roof-top pool
- Free transportation to and from your convention center
- Free parking/TV/Hi-Fi radio/Ice cubes
- Home of the "Frustration Room"
- Facilities for sales meetings, banquets and receptions.



Congress Expressway at Canal Street  
Chicago 7, Illinois  
Telephone 427-6969



--- for more details circle 28 on post card

**Rockbar Corp.**, 650 Halstead Ave., Mamaroneck, N. Y.—spk  
**Sarkes Tarzian Inc.**, E. Hillside Dr., Bloomington, Ind.—tap  
**Scott, Inc., H. H.**, 111 Powdermill Rd., Maynard, Mass.—amp-2; amp-pre; arm; car; cont; pre-2; spk; tun-1; tun-2; tun-ad; K; W  
**Sherwood Electronic Laboratories, Inc.**, 4300 N. California Ave., Chicago 18, Ill.—amp-1; amp-2; amp-pre; spk; tun-1; tun-2; tun-ad; MX indicator light; W  
**Shure Brothers, Inc.**, 222 Hartrey, Evanston, Ill.—arm; car; mik; need; phon-acc; pre-1; pre-2  
**Smith Laboratories, Inc., A. Bernard**, 2969 Ludlow Rd., Cleveland 20, Ohio—car; mik; need; pre-2; photoelectric cartridge & acc; W  
**Sonitron Corp.**, Saw Mill River Rd., Elmsford, N. Y.—arm; car; hed; mik; need; spk; tap-hed  
**Stanford International**, 569 Laurel St., San Carlos, Calif.—mik  
**Stromberg-Carlson Corp.**, 1400 N. Goodman St., Rochester, N. Y.—amp-2; spk; tun-2  
**Superex Electronics Corp.**, 4-6 Radford Pl., Yonkers, N. Y.—hed; phon-acc; tap-acc  
**Superscope Ind.**, 8150 Vineland Ave., Sun Valley, Calif.—amp-1; hed; mik; tap-acc; tap-rec; W  
**Switchcraft, Inc.**, 5555 N. Elston Ave., Chicago 30, Ill.—phase switches; molded cable assemblies; headphone replacement cord; transistorized 2-channel microphone mixers; monaural 4-channel microphone mixers, speaker selector switches, adapters; line volume controls  
**Tandberg of America, Inc.**, 8 3rd Ave., Pelham, N. Y.—hed; spk; mik tap-acc; tap-rec  
**Tannoy (America) Ltd.**, P. O. Box 177, E. Norwich 47, N. Y.—enc; spk;  
**Telecraft Electronics Corp.**, 55 Milbar Blvd., Farmingdale, L. I., N. Y.—amp-1; amp-2; amp-pre; conv-p; pre-1; tun-2; tun-ad; K; W  
**Telefunken (American Elite Inc.)** 48-50 34th St., Long Island City 1, N. Y.—amp-1; mik; phon-sys; pre-1; pre-2; spk; tap; tap-acc; tap-rec; tun-1; tun-2; Hi Fi Consoles; W  
**Telex Inc.**, 3054 Excelsior Blvd., Minneapolis 16, Minn.—hed and accessories  
**Trusonic Inc.**, 389 N. Fair Oaks Ave., Pasadena, Calif.—enc; mik; spk;  
**Turner Co.**, 909 17th St., N.E., Cedar Rapids, Iowa—mik; W  
**University Loudspeakers**, 9500 W. Reno, Oklahoma City, Okla.—mik; spk;  
**Utah Electronics Corp.**, 1124 E. Franklin St., Huntington, Ind.—enc; spk  
**Vidaire Electronics Mfg. Corp.**, 365 Babylon Turnpike, Roosevelt, N. Y.

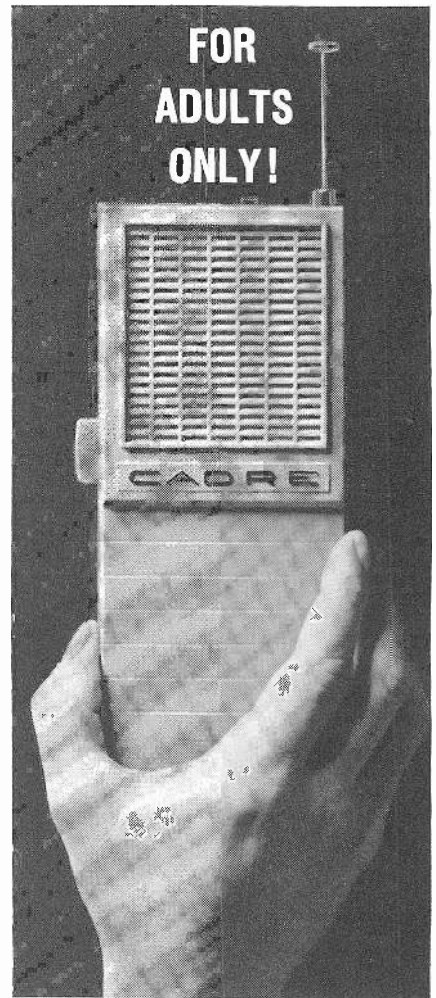

## FOR ADULTS ONLY!

### NEW CADRE C-75 CB TRANSCEIVER

The new Cadre C-75 1.5-watt, 2-channel transceiver is 15 times too powerful for youngsters (under 18 years of age) to operate, according to FCC regulations. Clearly, it's not a toy. It's designed for serious CBers who need 'big set' performance that can be used anywhere.

The new C-75, weighing less than 2 lbs; provides clear, reliable 2-way communications up to 5 miles and more. All solid state design creates an extremely rugged transceiver to absorb rough handling, stays on frequency. Two crystal-controlled channels spell perfect communications contact everytime. Sensitive superhet receiver (1 $\mu$ v for 10 db S/N ratio) brings in signals in poor reception areas. Powerful transmitter has one watt output to the antenna. Adjustable squelch silences receiver during standby. AGC assures proper listening level. In a word, the C-75 has all the features you'd look for in a quality full size CB unit.

The C-75 has all the portable conveniences you'd want, too: operates on alkaline or mercury penlite cells (8-hour rechargeable nickel-cadmium battery available); earphone and antenna jacks; built-in retractable antenna; jack for base operation while recharging.

Use the Cadre C-75 anywhere in the field, for vehicle, office, boat or plane. Use it constantly too, because its all-transistor modular circuit (11 transistors and 2 diodes) is virtually maintenance free. \$109.95. Recharger and 2 nickel-cadmium batteries \$31.85.

Cadre also offers a complete line of 5-watt all transistor transceivers and accessories. See your Cadre distributor or write

**CADRE INDUSTRIES CORP.**  
 COMMERCIAL PRODUCT DIVISION  ENDICOTT, NEW YORK  AREA CODE 607, 748-3373. **Canada:** Tri-Tel Assoc., Ltd., 81 Sheppard Ave. W., Willowdale, Ont. **Export:** Morhan Exporting, 458 B'way, N. Y. 13, N. Y.

--- for more details circle 18 on post card

ELECTRONIC TECHNICIAN

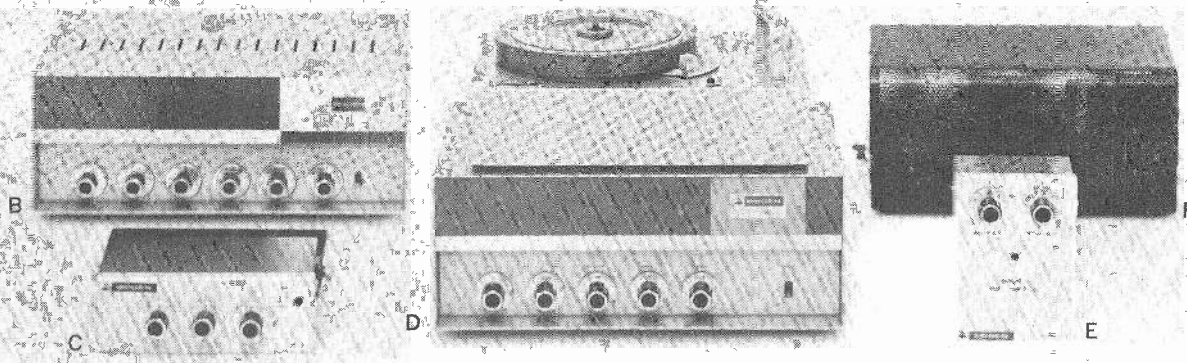

**Bogen stays number one in P. A. after 30 years by designing new products for new needs.**

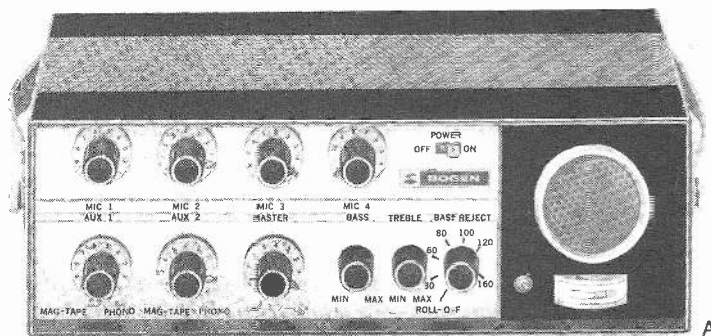

**Case in point:  
six new amplifiers to widen your sales  
opportunities, strengthen your profit potential.**

BOGEN's all-new, all-transistorized MTX30 P.A. amplifier (illustration 'A') is the latest addition to the deluxe Flex-Pak series. This uniquely versatile 30 watt amplifier sets new standards in reliability and flexibility.

**Some of its important features:** Continuous operation at full output even at  $-30^{\circ}$  C or  $+65^{\circ}$  C temperature • Low power consumption, reduced heat • 13 inputs, 6 of which may be mixed and faded simultaneously • 4 of 6 mic. inputs convert to low impedance with plug-in transformers • 32 transistors, 2 silicon diodes eliminate recurrent tube failures • Six unique push-pull controls instantly select wide or limited response for each channel (via variable, calibrated notch filter) to meet all acoustical conditions • Full 30 watt output at less than 2% distortion, peak power 50 watts • Optional monitor speaker and output meter (as illustrated), locking plate, remote and precedence control, rack panel.

**Other Profit Producers from BOGEN include:**

- B.** New MU70 . . . 70 watt Amplifier
- C.** New BT35 . . . 35 watt Transistor Mobile Amplifier
- D.** New CHB20 . . . 20 watt Challenger Amplifier (shown with phono-top)
- E.** New BT20 . . . 20 watt Transistor Mobile Amplifier
- F.** New MT30 . . . Transistor Booster Amplifier

LEAR SIEGLER, INC.  **BOGEN COMMUNICATIONS DIVISION**  
PARAMUS, NEW JERSEY

Please send me detailed literature on the following:  
P.A. Line (including new MTX30)  Intercoms   
Portable Transcription Players

Name \_\_\_\_\_

Address \_\_\_\_\_

City \_\_\_\_\_ State \_\_\_\_\_

ET-9

**BOGEN**

Sound products for communications and entertainment for over 30 years

... for more details circle 16 on post card

# now there are 3 time & tool-saving double duty sets

New PS88 all-screwdriver set rounds out Xcelite's popular, compact convertible tool set line. Handy midgets do double duty when slipped into remarkable hollow "piggyback" torque amplifier handle which provides the grip, reach and power of standard drivers. Each set in a slim, trim, see-thru plastic pocket case, also usable as bench stand.

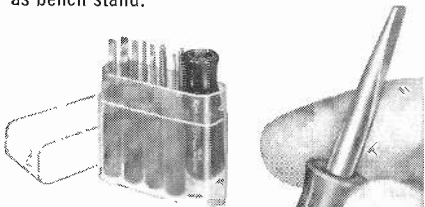

PS88

5 slot tip,  
3 Phillips screwdrivers



PS120

10 color  
coded nutdrivers

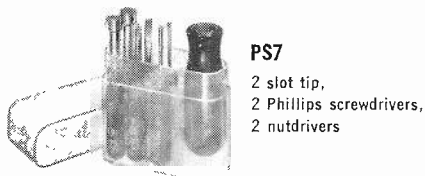

PS7

2 slot tip,  
2 Phillips screwdrivers,  
2 nutdrivers

WRITE FOR CATALOG SHEET N563



XCELITE, INC., 14 Bank St., Orchard Park, N.Y., U.S.A.  
Canada: Charles W. Pointon, Ltd., Toronto, Ont.

for more details circle 60 on post card

—amp-2; arm; car; cha; phon-acc; spk; tap-rec; tur; L-pads; switching panels

**Viking of Minneapolis, Inc.**, 9600 Aldrich Ave. S., Minneapolis, Minn.

—amp-1; amp-2; amp-pre; pre-1; pre-2; tap-pr; tap-acc; tap-rec; tape cartridges; tape cartridge handles; W

**V-M Corp.**, 305 Territorial Rd., Benton Harbor, Mich.—amp-pre; cha; phon-sys; spk; tap-rec- tun-ad; tur; W

**Waters Conley Co., Inc.**, 645 N. Michigan Ave., Chicago 11, Ill.—phon-sys; tun-2; W

**Webcor, Inc.**, 5626 W. Bloomingdale Ave., Chicago 39, Ill.—cha; phon-sys; tap-rec

**Weathers Industries**, Div. of Teleprompter Corp., 66 E. Gloucester Pike, Barrington, N. J.—arm; car; spk

**Westinghouse Electric Corp.**, High Fidelity Products, Metuchen, N. J.—phon-sys

**Westminster Recording Co., Inc.**, 1501 Broadway, New York 36, N. Y.—rec

**Zenith Radio Corp.**, 6001 Dickens Ave., Chicago 39, Ill.—phon-sys

## NEW BOOKS

**TROUBLESHOOTING WITH THE VOM AND VTVM.** By Robert G. Middleton. Published by Howard W. Sams & Co., Inc., Indianapolis, Ind. Soft cover, 160 pages. \$2.50.

This is the finest book Middleton has turned out in some time. After his first few books, many of his attempts seemed to have been marketed on the merits of his early books. It appears that he's back in business now, however, with what we think is the best technicians' book on VOM and VTVM use available. The subject is well covered and well illustrated. Typical chapters cover meter operation, signal tracing in RF, IF and video amplifiers, sync section testing, AFC, horizontal testing, vertical testing and AGC troubles. We think there are tips here for even the most experienced technician.

**IF YOU CHANGE YOUR ADDRESS**  
Notify us at 1 East First Street, Duluth 2, Minn. Please include the address label from a recent issue and allow 6 weeks for the change.

# ALL TAPE HEADS WEAR OUT! HERE'S HOW AND WHY!

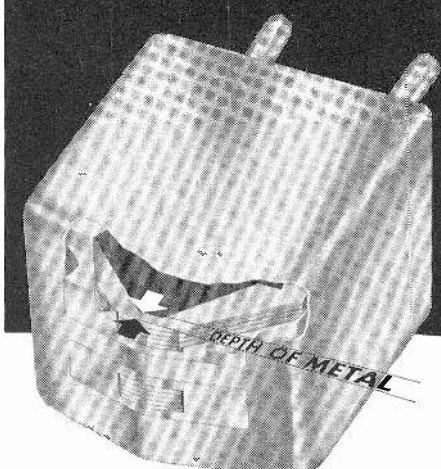

## Magnetic tape itself is the real cause of head wear!

The abrasive action of tape as it passes over the head face gradually wears away the *depth of metal* left on a new head after final polishing (see above). Because wear is nearly always uneven, craters or ripples are also formed on the face as wear progresses, thus making it impossible to achieve good contact between the head gap and the all-important signal recorded on the tape. The severe high frequency losses and erratic output resulting from poor tape-to-gap contact are very annoying to the ear. Head wear should NOT be permitted to reach this point — much less go beyond it to the limit where the gap actually begins to open up.

By replacing the worn head with a new Nortronic professional type of laminated tape head you will obtain improved high frequency response over the original head, plus the added feature of longer life since laminated heads have 50% more depth of metal at the gap. Nortronic manufactures both laminated and solid-core heads, but recommends the use of the laminated types for up-grading of your customer's recorder.

## CHECK into the profit-packed Nortronic Tape Head Replacement Program NOW!

This new program offers you the opportunity to get in on the ground floor . . . Replacement of worn tape heads is profitable — is easy — is ever-growing in demand. If your local representatives can't help you — write Thor Johnson, Distributor Sales Manager.

*"Music sounds best on Tape —  
Tape Sounds Best  
with Nortronic Heads"*

**Nortronic**

8133 10th Ave., N.  
Minneapolis 27, Minn.

for more details circle 40 on post card  
ELECTRONIC TECHNICIAN





**YOU'D HAVE TO STOCK ALL THESE**

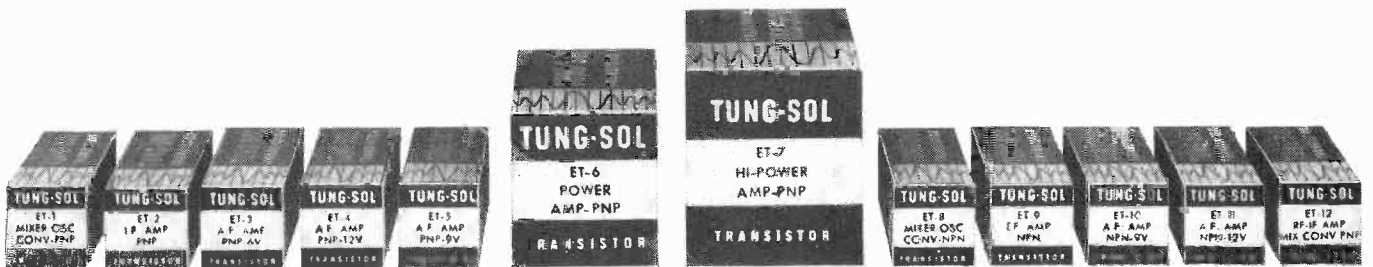

**IF IT WEREN'T FOR THESE**

Yes, if you had to stock an original part for every transistor in some radio set, you'd have hundreds upon hundreds of numbers on your shelves. But, the Tung-Sol ET transistor line cuts your inventory to just twelve numbers. That's all you need to service all the popular transistor radios.

Each ET transistor replaces scores of older types. Altogether more than several hundred. The packages are marked to show the type of service for which each transistor was designed. Selection of the proper type is easier—more accurate and the job is done quicker.

Tung-Sol ET transistors are made to original equipment standards. They're the same high quality that have made Tung-Sol a leading supplier of tubes and semiconductors. Tung-Sol Electric Inc., Newark 4, N.J.

Low power PNP	Medium power PNP	High power PNP	Low power NPN
ET1 Mixer/oscillator/ converter	ET6 AF power amplifier	ET7 AF high power amplifier	ET8 Mixer/oscillator/ converter
ET2 IF amplifier			ET9 IF amplifier
ET3 AF amplifier 6v.			ET10 AF amplifier 9v.
ET4 AF amplifier 12v.			ET11 AF amplifier 12v.
ET5 AF amplifier 9v.			
ET12 RF-IF amplifier Mixer/converter			



TELL YOUR SUPPLIER YOU'D RATHER HAVE



**TUNG-SOL**  
ET TRANSISTORS



... for more details circle 54 on post card

## NEW PRODUCTS

### CB TRANSCEIVER

200

A citizen's band transceiver, designated the CB-Six, has been specifically designed for commercial and industrial citizen's band communications. The unit features six crystal controlled channels for receive and transmit, and a built-in power supply which operates from 12 vdc and 117 vac for mobile or base station use.

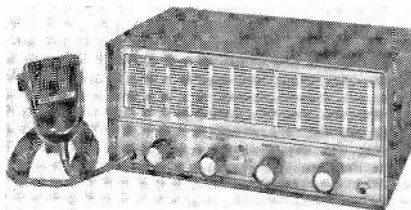

The receiver is a dual conversion superheterodyne employing a 262 kc IF ( $\pm 8$  kc bandwidth at 60 db points). A  $\pm 3$  kc vernier tuning control for the receiver section permits peak tuning while preserving crystal stability.

Standard equipment includes a ceramic microphone, crystals for one channel, a mobile mounting bracket, and ac and dc power cables. Hammarlund Manufacturing Co.

### TAPE REEL

201

A new sound tape reel, which is said to literally thread itself, will be introduced during the 1963 fall-winter season.

The new reel reportedly elimi-



nates the fumbling, all-fingers method of threading reels which has made it difficult for women and children to use tape recorders.

The new reel is threaded by laying the tape between the flanges near the hub. The tape winds automatically around the hub. It also unwinds freely and easily off the reel. Minnesota Mining & Mfg. Co.

# NEW DEEP FRINGE TV ANTENNAS

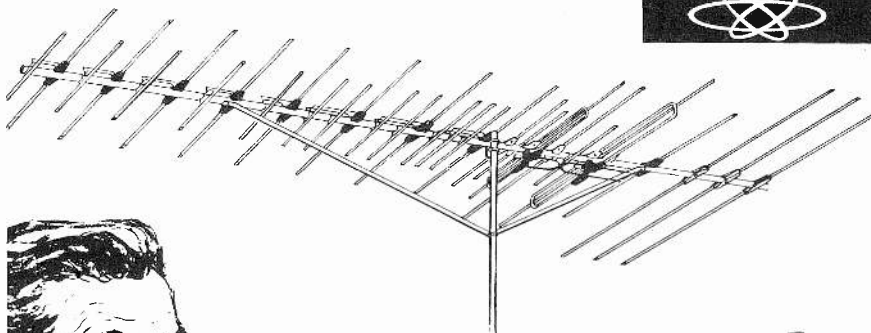
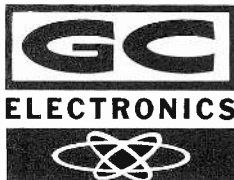

FOR OUTSTANDING COLOR OR  
BLACK and WHITE TV RECEPTION!

## GC COLORMAGIC line

NOW—GC Electronics enables you to offer your customers the finest in long range color and black and white TV reception!

**COLORMAGIC**—the new Leader in the field; the televising series designed for the customer who expects and deserves the finest in color and black and white TV viewing!

### IT ALL ADDS UP:

The Colormagic series insures brighter, clearer viewing on more channels over a larger reception area. GC's engineering research developments have created an almost perfect 300 ohm impedance match—VSWR 1.5 to 1 maximum.

Installation is a "snap". GC's solid-sembled construction permits quick, easy installation—rigid-lock elements snap securely into place. The entire series is built for long-life, trouble-free service. GC's exclusive Gold-Guard anodizing process also makes the Colormagic series the best protected all-weather line available.

**COLORMAGIC**—GC's all-new "prestige line"—the ultimate in pure color and black and white TV reception . . . Ask your distributor about this new profit package today!

Write for full particulars today to:

**GC ELECTRONICS** Division of Tectron Electronics, Inc.  
400 S. Wyman St., Rockford, Ill., U.S.A.

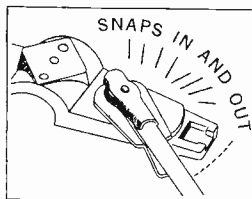

Quick assembly components—dependable, long lasting, all rigid-lock elements snap securely into place.

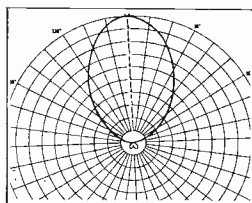

Extremely excellent front-to-back ratio  
Pencil-point directivity drives out co channel interference.

--- for more details circle 25 on post card

### RECORD CLEANER

202

The new, manual "Parastat" is reported to bring old records back to life and protect new records. The

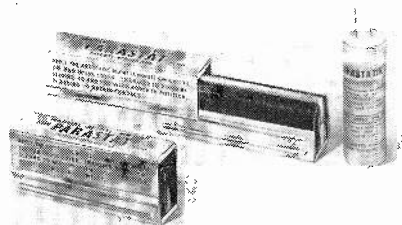

Parastat's bristles and detergent remove accumulated dust, grit and residue and allegedly restore lost fidelity and reveal hidden tone. The brush is made of pure nylon bristle. Price is \$15.00. Elpa Marketing Industries, Inc.

### DEPTH SOUNDER

203

A depth sounder with a built-in engine noise rejection feature has been introduced. The unit was developed particularly for inshore and inland waterways cruising in either fresh or salt water.

The JBL Energizer/Transducer raises audio reproduction to a degree of perfection and precision never before available to the home listener. You hear music re-created in all its detail, rich and splendid, life size, without hum or distortion. The Energizer/Transducer sets new standards for fully controlled bass, completely realistic mid-range, immaculate highs, and transient reproduction without equal.

An Energizer/Transducer has its own source of power: the Energizer. The Energizer is exactly matched to the specific loudspeaker-and-enclosure system in which it is used. Energizer and transducer are engineered as a unit. Given a flat, pure signal from a preamplifier, the Energizer/Transducer delivers sound that is perfectly flat and pure — an exact replica

# NOW! ALL ARE AVAILABLE SELF- ENERGIZED

— with exactly the right amount of damping at all frequencies. No other home high fidelity equipment can give you these results.

The JBL Energizer is a stereophonic all-solid-state device of scientific-instrument quality. Devoid of microphonics, generating negligible heat, it can be mounted within an acoustical enclosure. All JBL loudspeaker systems are available as Energizer/Transducers. The JBL loudspeaker system you now own can be made into an Energizer/Transducer. When ordering your matched Energizer, you need only provide your Audio Specialist with the complete model number of your system. Write for your free copy of the new Energizer/Transducer six-page brochure.

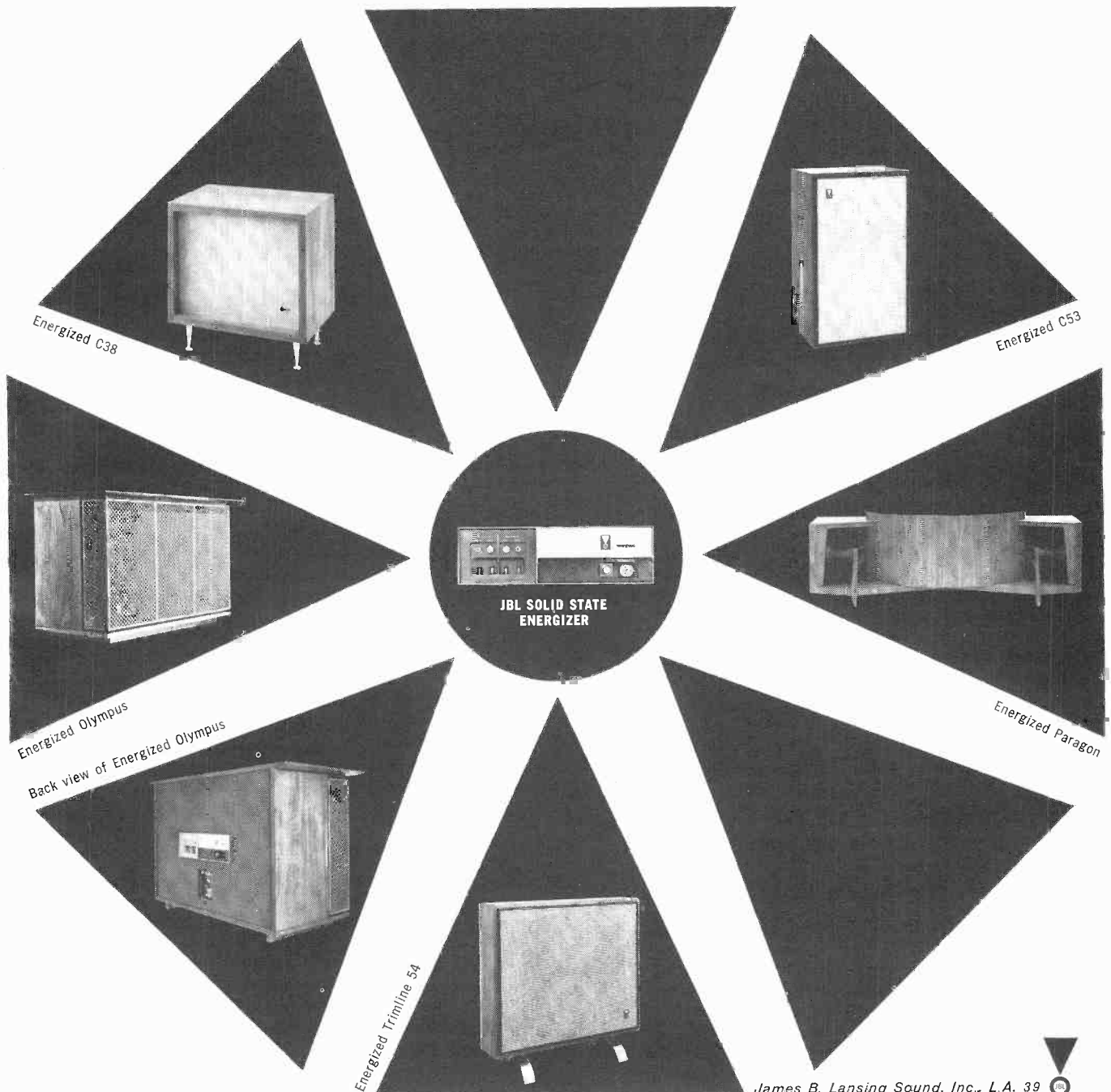

James B. Lansing Sound, Inc., L.A. 39

... for more details circle 35 on post card



## NEW PRODUCTS

The DE-720 Fathometer depth sounder has a calibrated six-inch dial with markings at every foot to indicate depths to 60 ft. Sufficient power has been designed into the unit to provide second-revolution readings beyond 60 ft., according to the manufacturer.

It is housed in a single-control, high-impact corrosion-proof plastic

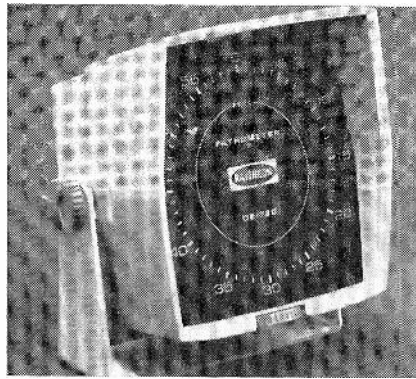

case provided with an aluminum yoke to permit tilting for easy viewing. \$130. Raytheon Co.

### FM STEREO RECEIVER 204

Featured in the new S-3000 V FM stereo receiver are a zero-center tuning meter, which reads "zero" when the receiver is tuned to the center of the FM channel, and a stereo indicator which lights when a stereo broadcast is being received.

The S-3000 V is rated at 1.8  $\mu$ V sensitivity (IHF) for -30 db noise and distortion. A 2.4 db capture effect eliminates background noise, and FM interchannel hush suppresses between-station noise

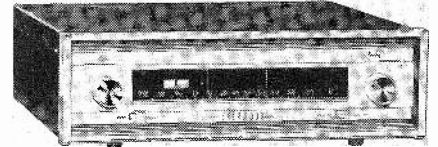

when tuning. The receiver has an 8-in. dial scale. Price, less case, is \$165.00. Optional leatherette case is \$7.50. Sherwood Electronic Laboratories, Inc.

### FM RECEIVER 205

An FM receiver is announced for monitoring business, police, fire, taxi, trucking and mobile telephone frequencies.

Called the Duo-Band it receives both the low band (30-50 Mc) and



the high band (152-174 Mc). It features a dual-conversion superhet circuit, squelch, tuned RF stage, crystal-controlled second oscillator and is temperature-compensated for control of drift according to the manufacturer.

The unit is housed in a chrome steel cabinet measuring 5½ by 3 by 8¼ in. It operates from 110-120 v, 60 cycle ac. \$164.95. Utica Communications Corp.

### RF DIP OSCILLATOR 206

A portable transistorized Radio Frequency Dip Oscillator called "Little Dipper" is now available. It performs all the functions of a grid dip oscillator, an absorption wave-meter and, with its built-in audio modulation, a signal generator

For



**TV PICTURES**  
and brighter  
customer smiles...

*the TU·BRITE sparkles with  
a NEW LOOK!*



Handsomely packaged for instant acceptance, and color-coded by base type for instant selection, the TU-BRITE gives new life to fading picture tubes in an instant.

No worries about wrong voltages, either. With Tu-Brite, *if the base is right, the boost is right.* Model C-202 brightens duodecal base picture tubes; Model C-212 brightens 110° button base CRT's; and Model C-222 handles 110° shell bases. Make sure you have them all in stock! Write for Perma-Power's free Britener Selector Chart, your guide to the base type of every picture tube now in the field.



Compact colorful display rack attracts attention, stimulates sales.

--- for more details circle 42 on post card

**Perma-Power** COMPANY

5740 North Tripp Avenue • Chicago 46, Illinois  
Phone 539-7171 (Area 312)

# 3 GREAT NEW SCOTT AMPLIFIERS

## POWERHOUSE

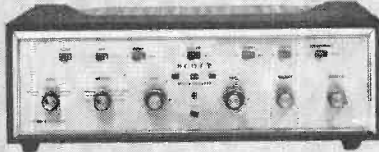

**New 299D 80-Watt Stereo Amplifier**

This best-selling stereo amplifier, top-rated by all leading consumer testing organizations, is now better than ever. New luxury features include: direct connection for powered center channel and extension speakers, speaker switch for private listening, new switching for choice of five low level inputs, non-magnetic electrolytic aluminum chassis, exclusive Scott Balance Left/Balance Right level balancing system, and massive output transformers. Behind the handsome panel, with its easy-grip knobs, is a lifetime of trouble-free performance and power to spare. \$229.95

## TOP PERFORMER

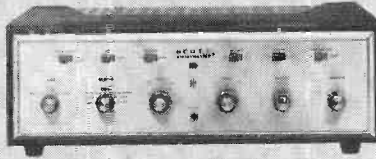

**New 222D 50-Watt Stereo Amplifier**

There's a new look to the ever-popular 222 series . . . and new performance, too. Massive transformers deliver enough power to drive even the most inefficient speaker systems . . . and the 222D gives you power in the low frequencies, where it's really needed. This value-packed performer incorporates a center channel speaker connection without the need for an additional amplifier, speaker switch for private listening, front panel switch for selection of phono or tape deck. Build a quality music system around this most versatile, feature-filled amplifier. \$179.95

## MODEST COST



**New 200B 30-Watt Stereo Amplifier**

Scott performance and looks at a budget price! Oversize transformers give full power in the critical bass range . . . power enough to drive low efficiency speakers to full room level. The new 200B has features you'd never expect to find at this price: stereo headphone output on front panel, dual tone controls, tape monitor, and a handsome, massive panel and knobs. Scott gives you all the controls and power you'll ever need at a price not much higher than you would pay for ordinary equipment without Scott quality. \$139.95

## How to select the right one for your system

### FEATURES

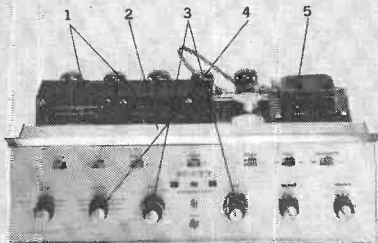

#### Wide Range of Features and Controls

1. Oversized output transformers for full bass response.
2. Non-magnetic electrolytic aluminum chassis for cool operation and lowest hum.
3. Dual tone controls for maximum adjustment of any program material
4. Exclusive Scott balancing method for perfect stereo regardless of speakers or program material.
5. Conservatively designed power-supply assures years of trouble-free enjoyment.

### SPECIFICATIONS

	299D	222D	200B
Power per channel (IHF) watts	40/40	25/25	15/15
Power band (cps)	19-25,000	19-25,000	25-15,000
Hum Level (db)	-80	-80	-70
Tape Monitor	Yes	Yes	Yes
Dual Tone Controls	Yes	Yes	Yes
Stereo Headphone Output	Yes	Yes	Yes
Low Level Inputs	2	2	1
High Level Inputs	3	3	2

### WANT MORE INFORMATION?

Mail this coupon for complete information on all the great new Scott components and kits.

H. H. Scott, Inc. Dept.  
111 Powdermill Road  
Maynard, Mass.

Send me complete information on the new 1964 Scott line of stereo components & kits.

Name . . . . .  
Address . . . . .  
City . . . . . Zone . . . . . State . . . . .

Include names of interested friends, and we'll send them duplicate materials.

**SCOTT®**  
Export: Morhan Exporting Corp., 458 Broadway, N.Y.C.  
Canada: Atlas Radio Corp., 50 Wingold Ave., Toronto  
All prices slightly higher west of Rockies. Accessory cases extra.

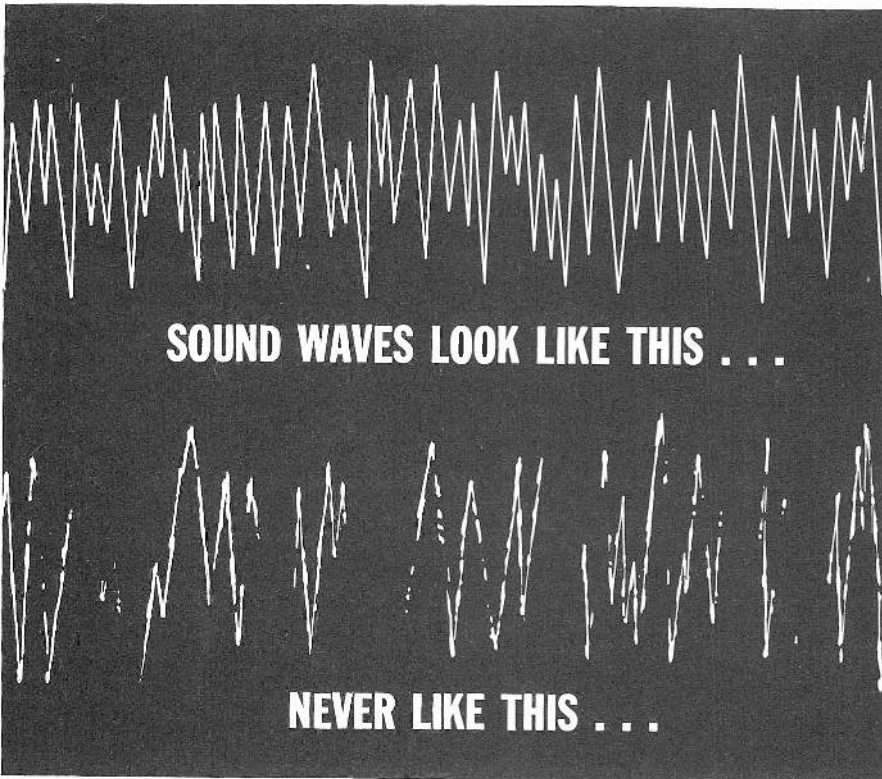

## WHEN YOU USE KESTER SOLDER

Kester "44" Resin Core or Kester "Resin-Five" solder gives solid connections that insure a permanent and constant electrical contact under all operating conditions. Why? Because "44" and "Resin-Five", just like all other Kester Solder products, are made from

pure metals necessary for perfect soldering. They also contain an activated non-corrosive, non-conductive Flux—designed specifically for electrical soldering. Ask your jobber for solder of superior quality—Kester "44" Resin Core or Kester "Resin-Five" Solder!

# KESTER SOLDER

## KESTER SOLDER COMPANY

4238 Wrightwood Avenue • Chicago, Illinois 60639  
 Newark 5, New Jersey • Anaheim, California • Brantford, Ontario, Canada  
**Over 64 years manufacturing quality solders and fluxes**

--- for more details circle 33 on post card

## MOVING?

**Be sure to let us know your new address at least 6 weeks in advance. And please enclose a complete address label from one of your recent issues.**

## ELECTRONIC TECHNICIAN

1 East First Street      Duluth 2, Minnesota      RA 7-8511

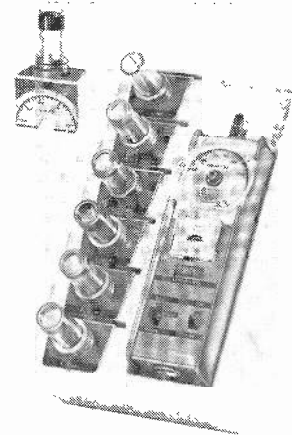

for field use, according to the manufacturer.

The unit employs a stabilized MADT Transistor RF oscillator covering 2 to 230 Mc; 7 coils, each carrying its own scale; a 1 kc audio oscillator for modulation and a dc amplifier and meter for detecting the dip. It is said to have  $\pm 3\%$  accuracy. Waters Manufacturing, Inc.

### OEM UHF TV CONVERTER 207

The new Series U UHF TV tuner, for use in original equipment manufacturers' receivers, has an average noise figure of 9 db, low drift, and low microphonics. The mfr. says that the compact units, which are designed for easy mounting and long life, will fit all receivers using the standard 43 Mc IF.

Model U uses a 6DZ4 oscillator tube and a silicon diode mixer. For UHF converter manufacturers, a Model UC is available. The tuners are designed to be used with direct drive or with planetary drive using single speed or dual speeds. Other

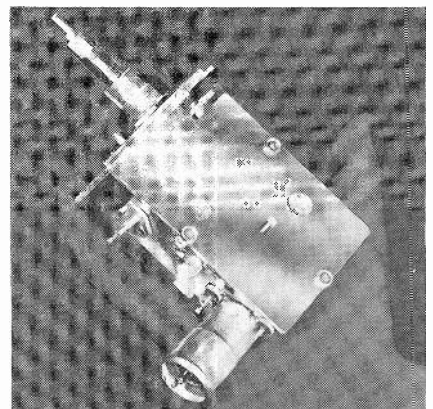



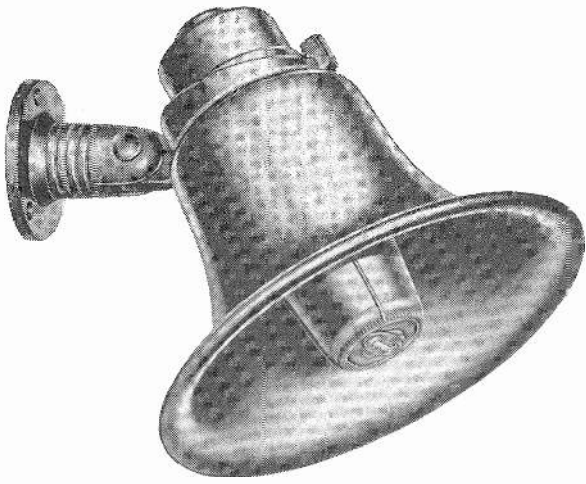

**“in this corner—  
and still the world’s champion—  
the University MIL-A.”**

And the champ in *any* corner (or wherever else you install it). It’s the world’s best-selling paging loudspeaker—outselling the closest competitor ten to one! Reason? The MIL-A out-performs them all—a fact you can easily prove to yourself. Do you realize, for example, that competitive makes require almost three times the power to obtain the same level produced by the University MIL-A? For installation ease and convenience, University’s exclusive patented Omni-Lok bracket directs the speaker in any plane. One hand locks it in position with a twist of the wrist. No loose hardware—no two handed adjustments! 7.5 watts continuous duty. 350-13,000 cps. 25-watt Model IB-A Paging Speaker offers the same outstanding features. For catalog describing the industry’s most complete line of P.A. speakers, write Desk **E9**,



**UNIVERSITY LOUDSPEAKERS**

Division of Ling-Temco-Vought, Oklahoma City, Oklahoma

- - - for more details circle 55 on post card

## NEW PRODUCTS

drive ratios are available. A single nut potentiometer type threaded bushing permits rapid mounting of the tuners in assembly.

Type U over-all dimensions are approximately 1.66 in. wide by 3.64 in. long by 4.07 in. high, including the tube. A transistor Model UT is now being tooled and will be introduced soon. Standard Kollsman Industries, Inc.

## UHF CONVERTERS 208

Two all-channel UHF converters, the Super-Vista for weak-signal areas and the Vista for strong signal areas, are "top-of-the-set" converters having an all-channel frequency range of 470 to 890 Mc (Channels 14 to 83).

Both models reportedly feature 12 second warm-up time and no-drift circuitry. When the converter is turned on in the morning, it is said to need no adjustment onto the frequency the night before.

The Super-Vista (Model SVC-560) gain is reportedly 8-12 db

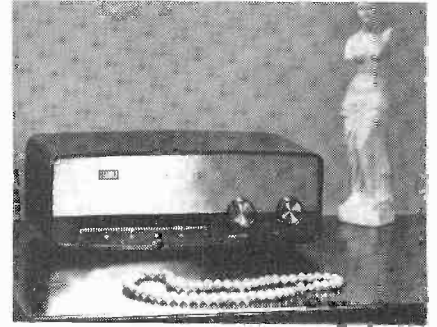

over the entire UHF band and the circuitry includes a transistor, nuvistor and a silicon crystal diode. The oscillator is a 6DV4 nuvistor. The noise figure for both Super-Vista and Vista is reported to be 13.5 db at 470 Mc, 13.9 db at 600 Mc, and 14.2 db at 890 Mc. Input and output impedance is 300 ohms. Jerrold Electronics Corp.



- Tests TV and Radio Tubes —both old and new
- Tests all Novars
- Tests Nuvistors, 10-pin Tubes, and 12-pin Compactrons
- Tests Voltage Regulators, Thyratrons, Auto Radio Hybrid Tubes, European Hi-Fi Tubes, and Many Industrial Types

## B&K PROFESSIONAL QUALITY AT LOW COST

### Model 600 Compact Portable Dyna-Quik Makes Tube Testing Quick, Accurate, Profitable!

It's amazing how quickly you can accurately check out tubes on every call—sell more replacements, and make more money—with this up-to-date, low-cost professional quality tube tester.

Checks for all shorts, grid emission, leakage, and gas. Checks each section of multi-section tubes separately. Checks tube capability under simulated load conditions. Rejects bad tubes, not good tubes. Quickly reveals tube condition, saves customers, stops call backs, increases servicing profit.

Exclusive adjustable grid emission test. Sensitivity to over 100 megohms. Phosphor-bronze socket contacts.

Complete tube listing in handy reference index. Handsome, sturdy leatherette-covered carry-case.

Size 8½" x 11" x 4½". Net, \$74.95

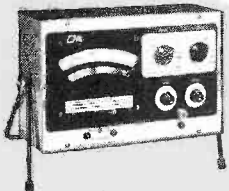

QUICK, DIRECT, ERROR-FREE  
READINGS WITHOUT MULTIPLYING

Model 375  
VTVM  
Net, \$89.95

Model 360  
VO Matic  
Net, \$59.95



## HANDI-TESTER 209

This appliance-battery-utility tester was designed as a broad-utility test instrument. It employs a D'-Arsonval meter movement.

The rated accuracy of the 800 a



movement is said to be  $\pm 2\%$ . Ranges are: volts (ac or dc): 0-15, -150, -300; amps (ac or dc): 0-15; watts (ac or dc): 0-1,500; resistance: 0-2,000 ohms; Neon leakage test: 0-5 megohms.

The tester weighs only 1¼ lb. and comes complete with test leads and instruction manual. Available in kit form, \$12.95 or wired and tested, \$15.95. Electronic Measurements Corp.

## TURNTABLE-CHANGER 210

The Thorens TD-224 "Masterpiece" is said to be the world's first turntable and automatic record

See Your B&K  
Distributor  
or Write for  
Catalog  
AP21-T



## B & K MANUFACTURING CO.

Division of DYNASCAN CORPORATION  
1801 W. BELLE PLAINE · CHICAGO 13, ILL.  
Canada: Atlas Radio Corp., 50 Wingold, Toronto 19, Ont.  
Export: Empire Exporters, 253 Broadway, New York 7, U.S.A.

- - - for more details circle 15 on post card

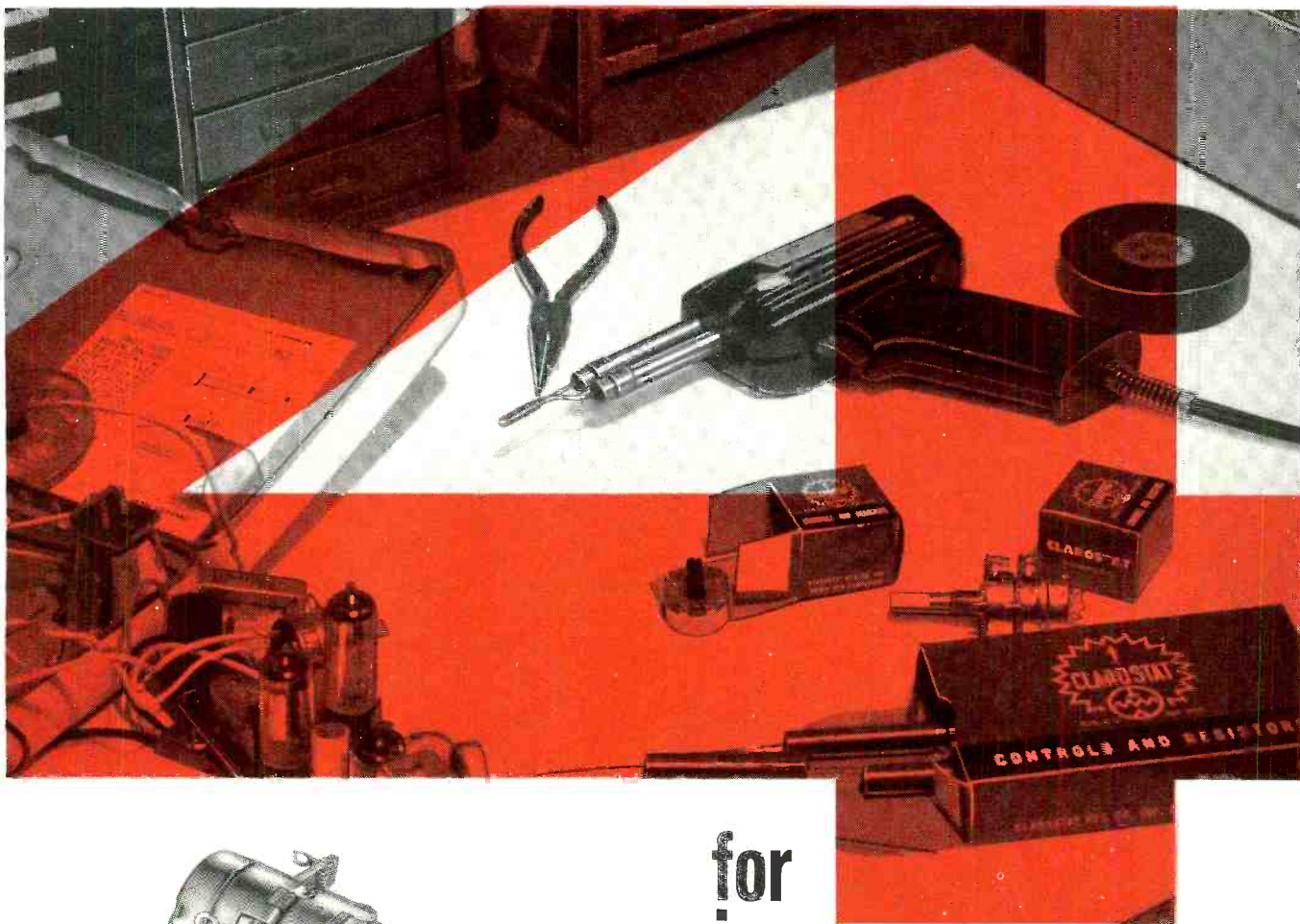

**for  
service**

**CLAROSTAT POTENTIOMETERS  
ARE RIGHT  
FOR EVERY SERVICING NEED**

For all your television, radio, Hi-Fi, stereo, and sound system control needs, Clarostat has the appropriate potentiometer. Clarostat replacement potentiometers are the same fine quality that has made them first choice with the most critical equipment manufacturers.

**RTV exact replacement controls ready for installation right from the carton.**

**Standard wire-wound and composition controls for all popular requirements.**

**Series DA field assembled duals for balanced functions in audio and stereo.**

**Uni-Tite field assembled dual concentrics go together quickly and easily.**



*Get complete details from your Clarostat Distributor, or write . . .*

**DISTRIBUTOR SALES DIVISION**



**CLAROSTAT**

CLAROSTAT MFG. CO., INC. DOVER, NEW HAMPSHIRE



# Winegard

## Dealer of the month



### DEL'S TV and Radio

DUBUQUE, IOWA

Winegard congratulates Del Pillard on 10 years of successful operation... and his distributor, Electronic Associates, Dubuque.

With two full time men to help him, Del Pillard handles an average of 90 antenna calls per month, in addition to TV and radio servicing and sales. This includes antenna installation for television, FM and 2-way radios, and everything from repair of antennas, lead-ins, and rotors, to erection of towers. Located in a hilly, rugged area, he's run into just about every type of reception and installation problem since he started in business in 1952.

"We have been using Winegard antennas and equipment for many years", says Mr. Pillard. "Of course, when new antennas are brought out we try them and compare them with Winegard antennas for performance, construction and ease of installation. We still rate Winegard tops. In our hilly fringe area Winegard does the job."

 **Winegard**  
ANTENNA SYSTEMS

D3019-9 Kirkwood • Burlington, Iowa  
- - - for more details circle 59 on post card

## NEW PRODUCTS



changer combination. The TD-224 plays records individually yet changes records automatically by means of a record feed-in arm. Record stacking is completely eliminated on the turntable. Other features include a built-in record cleaning device and an illuminated stroboscope, visible throughout the playing cycle. The TD-224 is said to be the only record changer which can properly utilize the finest professional cartridges, with the highest lateral and vertical compliances. Specifications reportedly exceed NAB standards. Thorens.

### TUBE-TOTING TESTER 211

The "Caddy Pack Tester," Model 88TC, has space for carrying more than 200 tubes to the job. The test

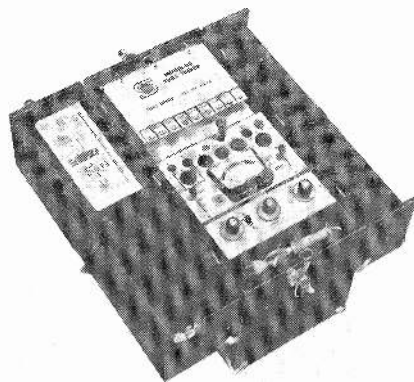

section of the caddy pack is an adaptation of the Model 88 tester. The meter reads grid emission and all common leakage and short faults in one step. Filament continuity and open elements are also indicated as well as cathode emission in a special low impedance circuit. Grid circuit and tube merit test scales show tube faults on a single, burn-out-proof meter. The "Caddy Pack Tester" is unconditionally guaranteed by the mfr. to be up-to-date for

# FREE

## WIRE STRIPPER

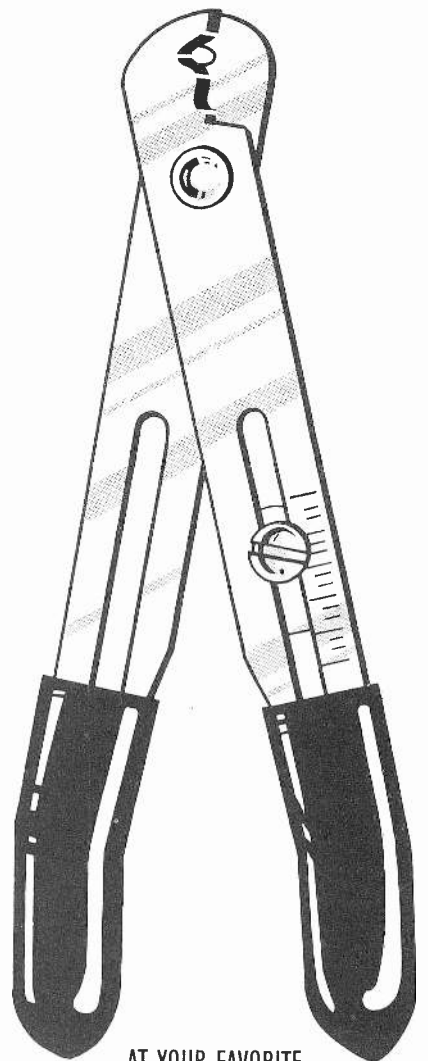

AT YOUR FAVORITE  
ELECTRONIC PARTS JOBBER

**WITH BRITENER 10 PAK**  
FOR ALL TYPES OF PICTURE TUBES



10 Universal Britener Pak \$13.40 Value

PLUS FREE  
WIRE STRIPPER... **Only \$11.95**



**ANTRONIC CORPORATION**  
2712 W. Montrose Ave., Chicago, Ill.

- - - for more details circle 11 on post card  
ELECTRONIC TECHNICIAN

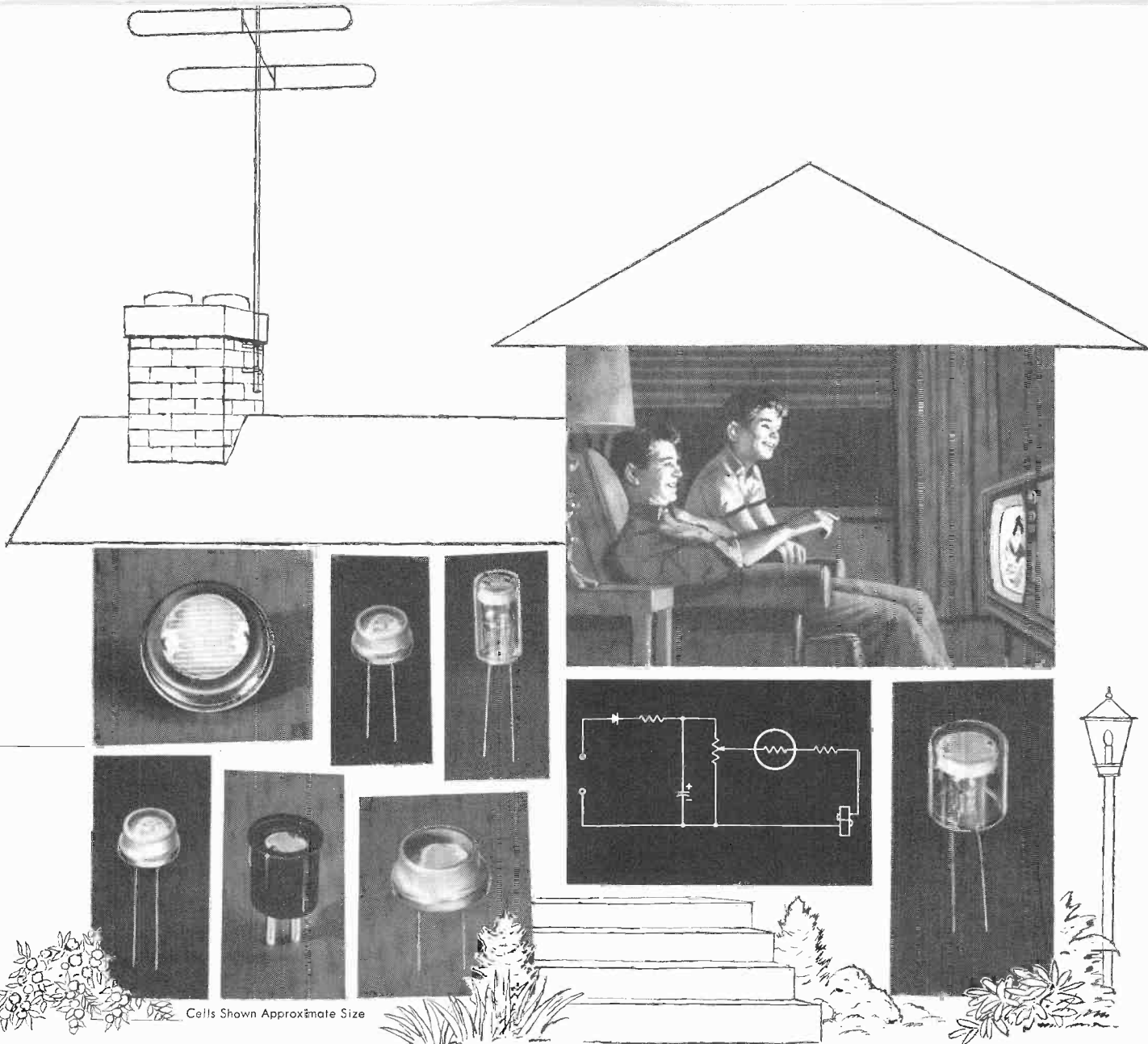

Cells Shown Approximate Size

# RCA PHOTOCELLS

An extremely wide choice for design or replacement

The RCA family of Photoconductive, Photojunction and Photovoltaic Cells is designed to provide a wide choice in electrical ratings, cell size and shape. It includes both glass and glass-metal types.

RCA's cadmium-sulfide Photoconductive Cell line is the widest in the industry.

Each RCA Photocell type meets the most exacting specifications and environmental demands... is characterized by high sensitivity, reliability, and long life.

RCA Photocells are in use in a wide range of light-operated control, switching, and measurement applications... have been adopted as a standard component by many leading manufacturers of business machines and home

appliances. RCA Photoconductive Cells are the sensor element in automatic door openers, pilot-flame monitors in home heating systems, light flashers, storage level indicators, home, industrial and municipal automatic lighting controls. RCA Photojunction Cells are used extensively for sound pick-up from film, and rapid reading of punched tape and cards. RCA Photovoltaic Cells find use in the direct conversion of solar power into electrical power and in light measuring units.

For proven reliability and performance, plus widest selection, specify and use RCA Photocells. For detailed information, the booklet, "Photocells and Circuits," ICE-261, is available from your RCA INDUSTRIAL TUBE DISTRIBUTOR.

Commercial Cadmium Sulfide Photocells									
RCA Type	Volts DC or Peak AC	Power Dissipation Watts		Photo-current (ma)	Volts	Illumination Foot Candles	Photocurrent (ma)		
		Contin-uous	Demand*				Min.	Max.	
4403	250	0.3	0.75	50	50	1	7	16	
4404	690	0.3	0.75	50	50	1	2.5	5	
4448	600	0.3	0.75	50	50	1	1.5	4	
4453	600	0.3	0.75	50	50	1	3	7	
7163	600	0.3	0.75	50	50	1	1	3	
4423	250	0.2	—	20	50	1	1.5	4	
4424	110	0.2	—	50	12	1	3.6	14.5	
4425	110	0.2	—	50	12	1	3.6	14.5	
502500	250	0.2	—	20	12	1	0.24	0.80	
4402	200	0.05	—	5	12	10	1.6	—	
4413	100	0.05	—	5	12	10	1.0	2.75	
7412	200	0.05	—	1	12	1	0.065	0.275	
7536	200	0.05	—	1	12	1	0.065	0.275	
6694A	150	0.03	—	—	90	30	0.057	0.65	

\*The demand rating may be utilized for a period of 20 minutes each time twice every 24 hours.

For name and address of your local RCA Industrial Tube Distributor write or call your nearest RCA Distributor Products Sales Office

- NEW YORK, N. Y.: 36 W. 49th St., Murray Hill 9-7200
- NEEDHAM HEIGHTS 24, MASS.: 80 "A" St., Hillcrest 4-8480
- WASHINGTON 6, D. C.: 1725 "K" St., S.W., Federal 7-8500
- ATLANTA, GA.: 134 Peachtree St., N.W., Jackson 4-7703
- CLEVELAND, OHIO: 1621 Euclid Ave., Chery 1-3450
- CHICAGO, ILL.: Merchandise Mart, 467-5900
- DALLAS 7, TEXAS: 7901 Carpenter Freeway, MEIrose 1-3050
- KANSAS CITY 14, MO.: 7711 State Line, EMerson 1-6462
- LOS ANGELES 22, CAL.: 6801 E. Washington Blvd., RAYmond 3-8361



The Most Trusted Name in Electronics

**AKTRON**

hi-fi  
classic

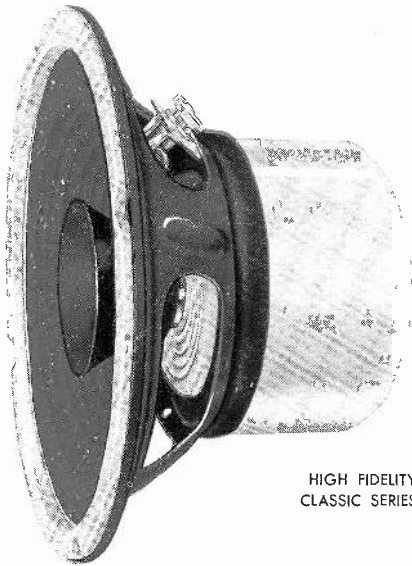

HIGH FIDELITY  
CLASSIC SERIES

- 10 oz. Magnet
- 1 1/4" aluminum voice coils

What a combination! Big 10.10 ounce magnet and 1 1/4 inch aluminum voice coil! Handles up to 20 watts of program material! Excellent woofer characteristics combined with a perfectly matched twin cone complete a truly exceptional full range high fidelity speaker for superior listening performance. Handsome chrome dust cover distinguishes this classic from ordinary speakers. Available in 8 and 12 inch round sizes.

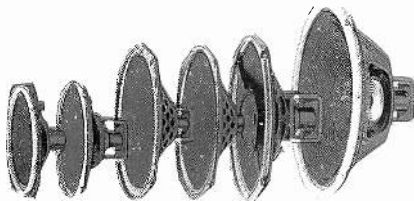

Write Today For FREE Catalog — "The Blueprint To Better Sound."

**AKTRON**  
INDUSTRIES, INC.  
MONROE • WISCONSIN

- - - for more details circle 41 on post card

**NEW PRODUCTS**

all receiving tubes, including the new novars, nuvistors, 10-pin types, compactrons and magnovals. The case measures 9 1/2 x 15 1/2 x 19 1/2 in. It opens from the center, providing two enclosed storage areas on the sides and a large area below the tester. Seco Electronics, Inc.

**VHF ANTENNA 212**

A new line of antennas combining log periodic principles and innovative modular parasitic element systems, is claimed to produce an unamplified TV antenna gain of up to 16 db. Eleven VHF-TV antenna models are available: seven are non-amplified types (gain to 16 db), and four are electronically amplified (transistorized antenna-mounted preamplifier) with a gain up to 28 db. Three FM antennas are also offered, featuring a gain of up to 12 db. "Cyclac" plastic insulating mounts do away with the familiar criss-cross affairs interconnecting

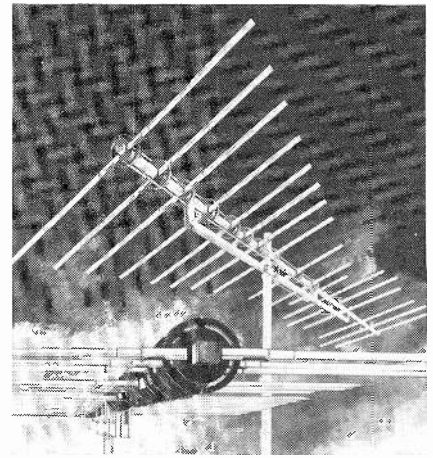

the dipoles. These insulators perform the transposed interconnections without crossing the transmission line conductors. It is said that impedance remains constant and line losses due to reflections are negligible. Jerrold Electronics Corp.

**FOR MORE INFORMATION . . .**  
CIRCLE THE NUMBER ON THE READER SERVICE POST CARD LOCATED AFTER PAGE 90.

**SAFE!**  
FOR NYLON SHAFTS AND PLASTICS IN TUNERS!

**50¢ OFF**  
DEALER NET  
8 oz. spray can with 6" steel needle.

SUPER 100 . . . is a fast drying cleaner and lubricant that is excellent for TV tuners. It cleans contacts sparkling clean and evaporates quickly leaving a lubricated coating.

Dealer Net . . . \$2.25  
**Introductory Offer . . . \$1.75**  
Cat. No. 100-8

**INJECTORALL COMPANY**  
BROOKLYN 14, NEW YORK

- - - for more details circle 29 on post card  
ELECTRONIC TECHNICIAN





© 1963 VOLKSWAGEN OF AMERICA, INC.

## When do the tires give up?

Some owners never find out.  
We advertise 35,000 miles to a set.  
Some get closer to 60,000.

You can safely expect 15,000 miles  
more than you get with a regular truck.

The tires on a VW aren't loaded down  
with heavy fenders, frame, or hood.

We weld our truck into one solid hunk  
to make it light and solid.

This takes nearly a half ton off the  
tires. (Which is also one half ton you  
don't buy gas for.)

Even our engine saves you weight.

It's made of aluminum-magnesium  
alloy. (Lighter and stronger than alumi-  
num itself.)

And you never need water or anti-  
freeze. So you don't even have to haul

a radiator.

When you load the Volkswagen, the  
cargo sits in the middle because the  
engine's in back.

The tires share the load equally.



Even at that, though, some  
VWs won't get 35,000 miles.  
A lot depends on the roads.  
We don't build those.

- - - for more details circle 57 on post card

TO HELP MAKE FUSE HANDLING MORE PROFITABLE...

# BUSS VISUAL- PAK

ANOTHER BUSS FIRST



CLEAR PLASTIC BOX,  
THERE'S NO NEED  
TO OPEN  
TO SEE HOW MANY  
FUSES ARE  
IN IT

- BUSS fuse 5-in clear plastic box—let's you check fuses in each box at a glance... guards against running short on needed fuses.
- Size and style of fuses printed in large type on lid of box makes it easier to pick out fuses you want.
- Box fits all fuse display stands and channels.

# BUSS

PIONEERING NEW  
DEVELOPMENTS IN  
ELECTRICAL PROTECTION  
SINCE 1914

BUSSMANN MFG. DIVISION, McGraw-Edison Co., St. Louis 7, Mo.

... for more details circle 17 on post card

Corp. of America, ITT and Sylvania (subsidiary of General Telephone & Electronics).

A few of the other companies included in the "top 100" are American Telephone & Telegraph Co., Bendix, IBM, General Motors, Eastman Kodak, Sperry Rand, Western Electric, Union Carbide, General Dynamics, and Minnesota Mining and Mfg.

Sixty-seven of these companies have paid dividends each year for at least the last 25 years, and 11 have returned cash dividends every year since 1900.

### Report on Pay TV

"The first year of Subscription TV operation has been encouraging and enlightening," said Thomas F. O'Neil, Chairman of the Board of the General Tire & Rubber Co., in a report concerning the country's only pay-TV project, now being run on a three-year trial basis in Hartford, Conn., by RKO General Phonovision Co., a General Tire subsidiary. Zenith Radio Corp. developed the system and produced the technical equipment used in the test which began on-the-air operations June 29, 1962.

Mr. O'Neal said further, "Although it is still too early to provide us with complete conclusions as to the future of Subscription TV, the experiment has already shown that we are meeting a public need, that program expenditures are consistent and the disconnections due either to dissatisfaction on the part of subscribers or delinquency in payment are remarkably low."

## BUSS: the complete line of fuses



### Profit Ratios Up

The annual Cost of Doing Business survey, conducted for the National Appliance & Radio-TV Dealers Association (NARDA) in 1962 by Richard E. Snyder, its economic analyst, showed that television is the biggest single item for appliance dealers.

According to the report, the gross margin of retailers in 1962 was 28 per cent, and an improved net operating profit ratio was reported by NARDA members for 1962 as compared with 1961.

The study indicated that firms offering "merchandise plus service" had an average net operating profit ratio of 1.14 in 1962 compared with a 0.4 per cent profit ratio in 1961.

### "Top 100" Club

Six of the 100 largest non-financial corporations in the United States are involved in a production and merchandising of television, radio, and similar equipment. Some of the other "top 100" companies are involved in other areas of the electronics business.

The six most active corporations, in the order of sales reported for 1962, are: Philco (div. of Ford Motor Co.), General Electric, Westinghouse, Radio

### FUSETRON dual-element fuses time-delay type

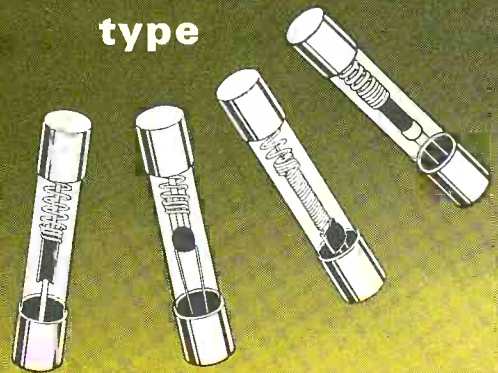

"Slow blowing" fuses for circuits where harmless surges occur. These fuses prevent needless outages by safely holding starting currents or surges, — yet they provide safe, positive protection against short-circuits or continued overloads.

# BUSS

Write for BUSS  
Bulletin SFB.

BUSSMANN MFG. DIVISION, McGraw-Edison Co., St. Louis 7, Mo.

... for more details circle 17 on post card



TO HELP MAKE FUSE HANDLING MORE PROFITABLE

# BUSS VISUAL- PAK

ANOTHER BUSS FIRST



**CLEAR PLASTIC BOX,  
THERE'S NO NEED  
TO OPEN  
TO SEE HOW MANY  
FUSES ARE  
IN IT**

- BUSS fuse 5-in clear plastic box—let's you check fuses in each box at a glance... guards against running short on needed fuses.
- Size and style of fuses printed in large type on lid of box makes it easier to pick out fuses you want.
- Box fits all fuse display stands and channels.

# BUSS

PIONEERING NEW  
DEVELOPMENTS IN  
ELECTRICAL PROTECTION  
SINCE 1914

BUSSMANN MFG. DIVISION, McGraw-Edison Co., St. Louis 7, Mo.

--- for more details circle 17 on post card

tions of production, multiple recording, splicing and editing.

## Loudspeaker Technology Stagnant?

Addressing some 100 representatives of most of the nation's 51 loudspeaker firms at a recent meeting, Marvin L. Bruckner, section chairman of the Electronic Industries Association Loudspeaker and Loudspeaker Parts Section, cited the fact that there have been no significant contributions to technological progress of the speaker industry in several decades.

"Although the electronics industry is still in its infancy, the loudspeaker segment has been content to be an ostrich-like hanger-on to the main course of its expansion. We have been content to be dependent on the research and development of others—content to live on the crumbs of the tables of others," Mr. Bruckner, sales manager of Oxford Electric Corp., Chicago, asserted.

He attributed the lack of a major research and development effort on the "natural inertia" of most loudspeaker manufacturers and "their emphasis on attempting to keep up with their competitors by mere duplication of products or attempting to maintain their status in the industry.

The section planned to continue its search for a technical foundation on which to base loudspeaker innovations—the establishment of generally accepted standard methods for measuring the quality of sound and, accordingly, the quality of loudspeakers.

## of unquestioned high quality

Mr. O'Neil emphasized that the purpose of the Hartford experiment is not to get the greatest possible number of subscribers—a goal both unwarranted and unnecessary during the test period—but rather to maintain a large enough sample "to develop data for our own purposes and for the information of the Federal Communications Commission in its eventual evaluation of the entire subject of pay television."

### Zenith Enters Antenna Business

Zenith Sales Corp. announces its entry into the antenna business with a line of TV and FM antennas, including hardware and accessories, for outdoor and indoor use. Announcement was made by L. C. Truesdell, Zenith Sales Corp. president.

Outdoor antennas in the line include a series of harmonically resonant, all-channel log-periodic type antennas ranging from a 4-element array for local use to a 17-element array for fringe locations.

### Burgess Announces New "Test Tape"

Burgess Battery Co., Magnetic Tape Div., announces a "Test tape," which is claimed to enable the average recordist to check, test and time his recorder without elaborate test gear. Included on the tape are descrip-

## Let BUSS Fuses Help Protect Your PROFITS

To make sure BUSS fuses will operate as intended under all service conditions, each and every BUSS fuse is individually tested in a sensitive electronic device.

This is your assurance that when you sell or install BUSS fuses, you are safeguarded against complaints, call-backs and adjustments that might result from faulty fuses and eat away your profit.

It is just good business  
to sell fuses the BUSS way.

# BUSS

Write for BUSS  
Bulletin SFB.

BUSSMANN MFG. DIVISION, McGraw-Edison Co., St. Louis 7, Mo.

--- for more details circle 17 on post card



**NOW!** A 2-Set Coupler  
for fringe areas...

# Winegard's

**NEW Transistorized TV-FM  
2-Set Color-Coupler has no  
signal loss... (Actually gives a  
signal boost of over 7 DB)**

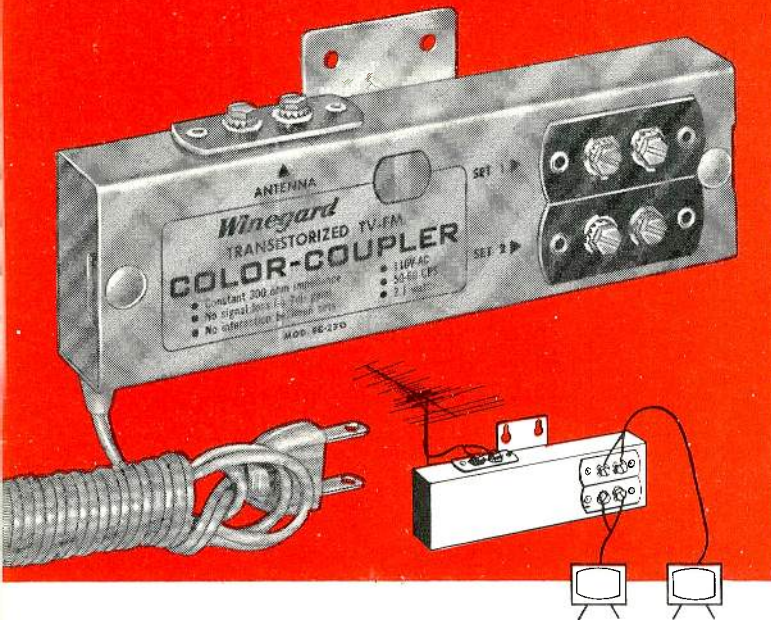

*Now even in fringe and weak signal areas, you can run two sets from one antenna without loss or any interference between sets!*

The Winegard Transistor Color-Coupler (Model EC-230) has linear frequency response across both TV and FM bands. Isolation between sets 15 DB, with exact match into 300 ohms. This means *No Smear, No line ghosts, No picture degradation, No interference between sets!* Works perfectly with Color and FM as well as black and white. Works with signals from 25 microvolts to 45,000 microvolts. 300 ohm input, two 300 ohm outputs—no-strip terminals. \$17.95 list.



Write for complete specifications or ask your distributor.

# Winegard

ANTENNA SYSTEMS

3019-9 Kirkwood, Burlington, Iowa

... for more details circle 58 on post card

## Results of Sty- on Record

Semi-polished and unpolished  
styli show 10 db noise  
increase after 30 plays

by Paul M. Adler

Sonotone Corp.

■ Three classes of diamond stylus finish, "polished," "semi-polished" and "unpolished," have been tested and evaluated for noise producing effects on records.

Measurement results and listening tests show the "semi-polished" stone to be inferior and capable of producing an objectionable average-noise level increase of 10 db on record's quiet groove after 30 plays.

It is indicated that employment of the "semi-polished" stylus will degrade phonograph cartridge quality. It is conceivable that cartridges with semi-polished stones can be used with lower quality record players but not with high class units. Considerable additional testing and data-accumulation will be required, however, before it is safe to use anything but a "polished" diamond.

Investigation of stylus finish-effect on record wear, and the consequent effect on record noise, signal level, and distortion, was motivated by the need for more realistic judgement of stylus quality than existing visual inspection methods.

Sample diamond styli were divided into three general classifications. Group A was identified as "well polished," Group B was called "semi-polished," and Group C was called "unpolished." The procedure followed in polishing these tips, as described by N. H. Dieter, Jr., is indicated in Chart I.

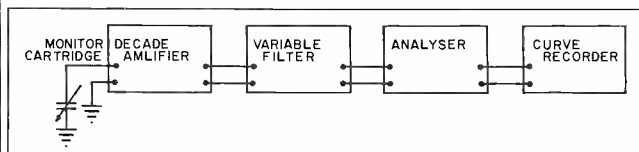

Fig. 1—Keithley decade amplifier is adjusted for 20 db gain. Krohn-Hite variable bandpass filter adjusted for low cut-off frequency of 200 cps and high cut-off of 200 kc. General Radio sound and vibration analyser adjusted for narrow band sweep filter. Sound apparatus curve recorder adjusted for 9 in./min chart speed.

# Ius Polish Wear

## Test and Evaluation

Data was recorded as noise level versus the number of plays on an unmodulated groove record. The record was played 60 times and readings were taken at 10-day intervals. Two styli from each of the three sample groups were tested. A separate unmodulated groove record was used for each stylus tested.

"Wear" cycling of the record was performed with the tone arm adjusted for 7 g vertical load. The specific stylus investigated was installed in the cartridge and checked for proper alignment. Noise level of the unmodulated grooves of a standard test record was evaluated by using the monitor system shown in Fig. 1.

Listening tests were performed to determine if the record-noise levels caused by the stylus were of sufficient magnitude to become annoying to a listener. This was accomplished by setting the standard listening setup gain to a "normal" program listening level. The low level passages of a record, having a wide variety of recorded levels, could be just comfortably heard. The worn test record (after 60 plays with a particular test stylus) was then substituted for audio evaluation. These listening tests were also correlated with the objective measurements.

## Result and Conclusions

Average noise levels of the three stylus groups show that the "semi-polished" and "unpolished" stones are inferior to the well-polished units. Noise level increased by about 10 db. Also apparent is evidence that there is no significant difference between the noise levels produced by styli from Group B and those from Group C. Listening tests confirmed this data.

Noise level measurements as a function of record wear indicates

Why did Sherwood zero-in on the problem of tuning accuracy?

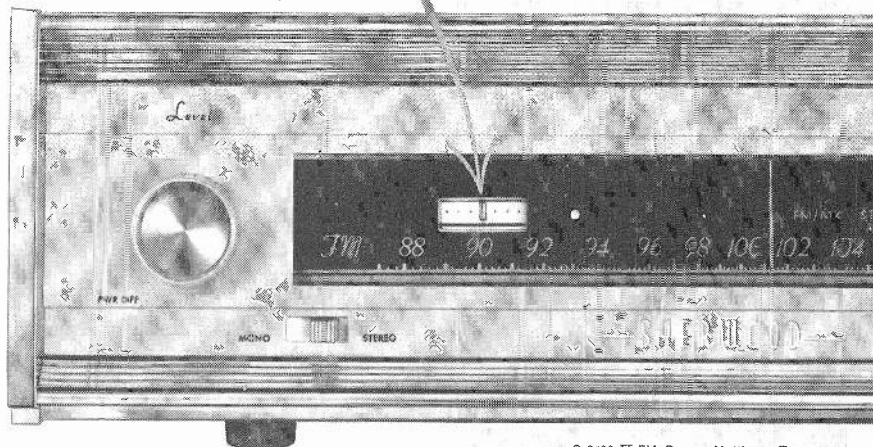

S-3000 V FM Stereo Multiplex Tuner with professional zero-centered tuning meter and Stereo Indicator Light.

It takes wider bands to broadcast the multiple information for stereo FM multiplex, and the most precise "dead-on-center" tuning to receive it... with maximum stereo separation and minimum distortion.

This is why in the new S-3000 V Tuner, Sherwood engineers incorporated a professional zero-centered tuning meter. Superior to tuning eyes, better than peak meters, it uses the same D'Arsonval meter needed to design, align and test FM tuner circuits. When the meter reads "zero"... you're right on. No guesswork. No maybe's.

Gain three tuning advantages

- Tune accurately, the first time.
- Tune low-power Class "A" stations interspaced between more powerful broadcasts.
- Tune with professional surety.

Added value features of the S-3000 V

- Stereo Indicator Light: identifies stereo broadcasts.
- Superb sensitivity: 1.8 $\mu$ v (IHF) for -30db. noise and distortion.
- No background noise: pace setting 2.4db. capture effect.
- FM Interchannel Hush: suppresses between-station noises.
- Flywheel tuning: smooth as silk.
- 20% longer dial scales: professional accuracy.
- Price: \$165.00. (Leatherette case optional at \$7.50)

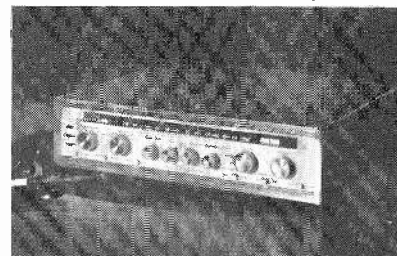

New S-8000 III FM Stereo MX Receiver. Combines above tuner features with an 80-watt stereo amplifier. Price: \$319.50. (Leatherette case optional at \$9.50)

Price slightly higher in the Far West.

*Sherwood*  
HIGH FIDELITY  
Stereo Receivers • Tuners  
Amplifiers • Stereo Indicator Lights  
Speaker Systems • Contemporary Cabinetry

For complete information write Sherwood Electronic Laboratories, Inc., 4300 North California Ave., Chicago 18, Ill.

... for more details circle 49 on post card

# TV TUNERS\* REBUILT OR EXCHANGED

ALL TYPES

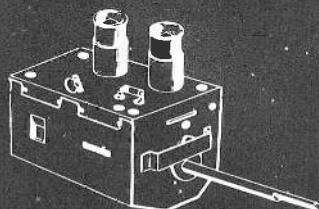

**\$9.95** including parts and labor  
(broken parts at our cost)

- Normally shipped same day received
- 90 day full guarantee
- U/V combinations \$17.95

FREE—!! Mailing carton sent to you on request

Phone REpublic 3-9189

**L. A. TUNER EXCHANGE**

4611 West Jefferson Blvd.  
Los Angeles 16, California

... for more details circle 34 on post card

# Troubleshoot, repair receivers and transmitters faster



- Two great volumes cover all phases of radio receiver servicing.
- Detailed coverage on transmitter servicing.
- Practical repair techniques as they would be done at the workbench.

There are other books that cover the subject of radio receiver repair. Some also cover transmitter servicing. But none of them make it easier to apply your knowledge of radio circuitry to the maintenance and repair of defective equipment. These books show you how to use the best and fastest approach to circuit troubleshooting and repair. Valuable to both newcomer and veteran, the text provides practical servicing procedures for both radios and transmitters. By a combination of dramatic illustrations and down-to-earth description, you are brought as close as possible to actual workbench conditions.

## HIGHLIGHTS OF BASIC RADIO REPAIR

**VOLUME I TEST INSTRUMENTS** — Reveals the construction of the various radio servicing test instruments providing an understanding for both better use and maintenance.

**COMPONENTS** — Discusses often-ignored facts such as general replacement vs. exact replacement components, tolerances, working voltages, values, etc.

**SERVICING PROCEDURES** — Outlines methods of approach in servicing to make repairs in the fastest possible way.

**SUPERHETERODYNE RECEIVERS** — Treats each stage of a receiver in the same order most likely to be followed during actual servicing.

**SERVICING PORTABLE RECEIVERS** — Discusses circuits and problems peculiar to portable receivers, including 3-way portables.

**SERVICING AUTOMOBILE RECEIVERS** — Details this neglected but lucrative field. Includes such special circuits as the "signal-seeker".

**VOLUME II SERVICING FM RECEIVERS** — Includes a discussion of antenna requirements as well as complete coverage of the various detector circuits.

**TRANSISTOR RECEIVERS** — Covers best methods to service transistor receivers: transistor handling and testing; servicing printed circuits and transistor receiver circuits; hybrid auto radios.

**SERVICING TRANSMITTERS** — Discusses transmitter symptoms and checks before covering individual stages. Details servicing FM and single sideband circuits.

#233—2 vol. soft cover set, \$5.30; #233H, 2 vol. in one cloth binding, \$5.95.

## EXCELLENT COMPANION VOLUME

**BASIC RADIO** by Marvin Tepper — 6 vol. pictured-text course makes it easy for you to master the theory and circuitry of radio communications equipment. 6 vol. soft cover, \$13.85. 6 vols. in cloth, \$14.85.

Rider books are available at electronic parts distributors, bookstores or use coupon.

## ORDER TODAY—10-DAY APPROVAL

**JOHN F. RIDER PUBLISHER, INC.**  
A division of Hayden Publishing Co., Inc.  
850 Third Avenue, New York 22, N.Y.

Please send following books for 10-day examination. Within 10-days of receipt, I shall remit payment, plus postage, or return books without obligation.

- BASIC RADIO REPAIR 2 vols. soft cover, \$5.30
- 2 vols. cloth, \$5.95
- BASIC RADIO 6 vols. soft cover, \$13.85
- 6 vols. cloth, \$14.85

Name \_\_\_\_\_

Address \_\_\_\_\_

City \_\_\_\_\_ Zone \_\_\_\_\_ State \_\_\_\_\_





Payment enclosed—Rider pays postage.

— for more details circle 44 on post card

that audible deterioration of record quality may be expected when styli of the semi-polished or unpolished classifications are used. This increase in noise level was noticeable after 20 plays with the semi-polished styli. After 60 plays, however, the increase in noise level caused by the semi-polished styli and that caused by the unpolished styli were approximately equal. Listening tests performed substantiated results of electrical measurements.

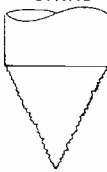
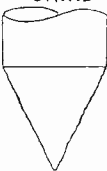
It was concluded that employment of the "semi-polished" stylus will degrade phonograph cartridge quality. ■

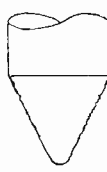
**CHART I**  
**DESCRIPTION OF CLASSIFICATIONS OF STYLUS POLISH**

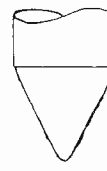
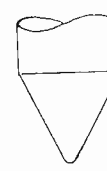
<p>1. <b>ROUGH GRIND</b></p>  <p>2. <b>FINE GRIND</b></p>  <p>3A. <b>RADIUS</b></p>  <p>4A. <b>POLISH</b></p> 	<p>1A. <b>ROUGH GRIND</b></p>  <p>3. <b>RADIUS</b></p>  <p>4. <b>POLISH</b></p> 
---	--

**STEPS**

1,2,3,4,  
1A,3A,4A  
1,2,3

**CLASSIFICATION**

A. POLISHED  
B. SEMI-POLISHED  
C. UNPOLISHED

# TV TIPS FROM TRIAD

NO. 22 IN A SERIES

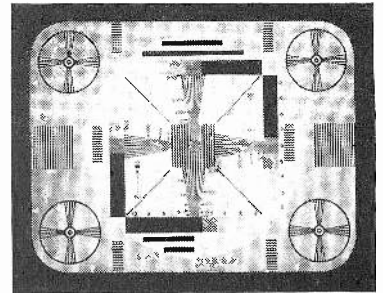

Bill, the Senior PTM, pushed his chair away from the bench with finality. He had just finished wiring a new Triad hi-fi output transformer into a vintage audio amplifier. "Well, that's that," he informed his assistant, Joe.

Apprising the new, grey Triad S-156A gleaming in the durable period piece, Joe remarked, "What is this? Give the people more for their money week?"

Bill deftly grabbed the cue. "Old stuff with us. As you know, the frequency-limiting factor in most audio amplifiers is the output transformer. Too often the small, original part does not have enough iron and copper to prevent saturation. Also, the primary current capability is insufficient. Result—overheating and failure. Unfortunately, the customer never enjoys the full frequency range the rest of the amplifier and equipment can produce because of the output transformer bottleneck."

Bill warmed into the second part of his oratory. "New materials such as grain-oriented steel, improved processing, and latest construction techniques in winding and stacking add up to greatly improved products nowadays. They enhance listening quality so much the customer immediately notices the improvement."

"And there are other advantages," said Bill, reaching his finale. "The primary impedance can be matched closely to the new output tubes. Tapped secondary impedances of 4, 8, or 16 ohms are available to drive the newer high-impedance voice coils if the customer wishes to upgrade his speaker system. And the circuitry can be easily changed to screen-tap operation. Naturally, since you are saving the customer lots of money by making his old amplifier perform as well as many new models for only a modest investment, he will be happy to compensate you fairly."

"You've convinced me," concurred Joe, "No one ever loses by giving a customer more for his money!"

**MORAL:** Overwhelm your customers with value beyond the call of duty. See your nearest Triad Distributor, or write for our latest Replacement Catalog TV 63/64. It lists a complete range of audio outputs from 2 to 100 watts for every purpose. Triad Distributor Division, 305 North Briant Street, Huntington, Indiana.

A DIVISION OF LITTON INDUSTRIES 

— for more details circle 53 on post card

ELECTRONIC TECHNICIAN



**BUYING GUIDE 300**

A new, illustrated catalog of packaged electronic and electrical products covers packaged solderless terminals and connectors, hardware, tube sockets and terminal strips. It also lists replacement speakers for Japanese transistor radios. Net prices are given throughout. All solderless terminals are shown actual size. Waldom Electronics, Inc.

**COMPONENT CATALOG 301**

A new eight-page catalog lists components for cooling and retention of electron tubes and semiconductor devices. The catalog contains part numbers, descriptions and photos for over 200 standard heat-dissipating electron tube shields and accessories and a complete line of heat dissipators for transistor and diode thermal control. Heat dissipators listed are designed for all types of semiconductors and meet milliwatt-to-high-power dissipation requirements. International Electronic Research Corp.

**TRANSFORMER CHART 302**

This single-page, card-stock output transformer chart lists the proper transformer to use with 260 different audio tubes for audio amplifier construction or for replacement purposes. The chart is arranged by tube numbers and lists applicable operating characteristics and, in most cases, two or more transformers, in order to give a choice of mounting styles. Where a specific tube can be used under a variety of operating characteristics, separate transformers are listed for each application. Stancor Electronics, Inc.

**COIL GUIDE 303**

This guide contains over 664,000 listings of more than 1150 different components—in 31 separate categories for TV and 17 different categories for home and auto radios.

The guide contains cross references between original - manufacturer and catalog part numbers, list and net prices, TV special service notes, a TV model index, and a TV chassis index.

The guide is bound in a three-ring

Available from all authorized ARCO distributors

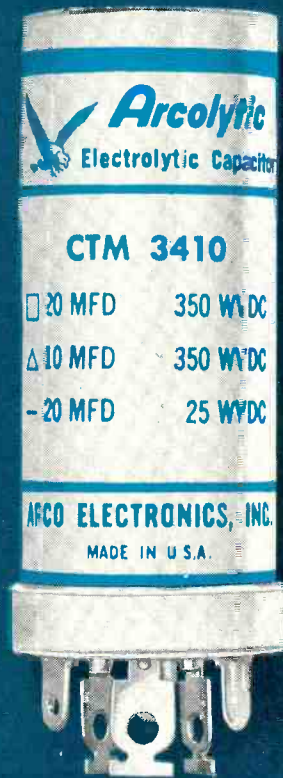

**Arcolytic®**

**1401 Values... The largest selection of exact replacement twist-mount & tubular electrolytics**

■ 99.99% high purity aluminum foil electrolytics at no extra cost! ■ Choose from stock any single, dual, triple or quadruple capacitance - voltage combination for replacement in television, radio, and other electronic equipment ■ Made to withstand high ripple and high surge voltages ■ Designed for 85°C high temperature operation ■ Greater shelf and operating life because only premium grade ingredients are used ■ Built and tested to meet EIA Specification RS-154 ■ Individually packaged with mounting plates for your convenience ■ Unconditionally Guaranteed.

**ARCO** electronics inc. ELECTROLYTIC DIVISION  
 Community Drive, Great Neck, New York • HUnter 7-0500  
 Branches: Dallas 7 Los Angeles 35

Anyone  
can install  
a MOSLEY  
TV-FM Antenna  
System !!

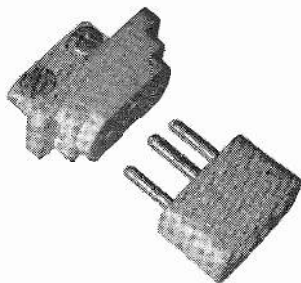

## Mosley FG-1PK

Here is a TV/FM receptacle designed to make every room a family room. Mosley engineered to fit popular interchangeable type electrical plates and straps. Now the AC and TV/FM outlets can be matched to fit any room decor. Convenient - Set can easily be moved for enjoyment in other rooms. Mosley FG-1PK combines efficiency with neatness and ease of installation in one compact outlet. Comes complete with mating polarized 303 plug. Available in brown and ivory to match interchangeable plates.

MOSLEY FG-1PK List \$ .99

MOSLEY HAS A COMPLETE LINE  
OF TV/FM ACCESSORIES  
DESIGNED AND ENGINEERED TO  
PROVIDE BETTER TV/FM  
RECEPTION THROUGH A BETTER  
INSTALLATION!

**FREE**  **FREE**

Please send me your catalog containing the complete line of TV/FM installation accessories.

Name .....

Address .....

City/State .....

**Mosley**  
*Electronics Inc.*

4610 N. Lindbergh Bridgeton Mo.

--- for more details circle 37 on post card

## FREE LITERATURE

notebook so that the updating information, which is mailed to the holder of the guide when changes are necessary, may be inserted easily. Thordarson-Meissner.

### TINY TOOL CATALOG 304

This new eight-page catalog, giving a complete description of a line of tiny tool sets, is designed for easy filing or placement in a three ring binder. The catalog features descriptions of the entire line plus an "action" photo of several products. Moody Machine Products Co., Inc.

### ... GOOD STORE IMAGE

(Continued from page 35)

within three years, Rozak Bros. will have a stable business of one half million dollars with more emphasis on Hi Fi, Stereo and TV. The firm has doubled its sales in the last three years over the previous two years.

Norm is associated in business with his brother, Irving, the latter in charge of a factory operation owned by both which produces technical service aid equipment, head phones, tape recordings for language laboratories, and a number of other electronic equipment. The business originally started as a service shop in 1950 in nearby Highwood.

"Let me make a dollar or two, but give me a barrel-ful of good store image aong with it and I'll make out just real good," Norm concludes.

### ... PREAMPLIFIERS

(Continued from page 41)

remove one end of a capacitor when testing.

Checking the response of the various circuits is quite simple and need not be detailed here. The amount of boost and cut for bass and treble is measured at 50 and 15,000 cps respectively in relation to the signal at 1000 cps.

Standard troubleshooting procedures can be employed throughout the remainder of the amplifier. Particular attention should be devoted to replacement components used, however, to avoid upsetting the response.

ERSIN  
**Multicore**  
5-CORE SOLDER  
WORLD'S FINEST  
BIC ENDORSED QUALITY

Multicore Sales Corp. Port Washington, NY

For information, write Department MM553  
--- for more details circle 38 on post card

**NEW YORK'S**  
*exciting East Side Hotel*  
comfort, convenience, luxury at reasonable rates ... from \$8.85 single, \$11.85 double, including TV and air-conditioning ... plus free swimming in Olympic pool on premises. Special family, week-end and group rates ... Convenient to 5th Avenue, Grand Central Station, Air Line Terminals, Mid-Town Business Appointments ... All good reasons for wide acceptance by business and pleasure travelers

the *Shelton Towers*  
Hotel  
Lexington Avenue  
48th to 49th Streets  
TEL: PLaza 5-4000  
**YEAR 'ROUND POOL**

--- for more details circle 48 on post card  
ELECTRONIC TECHNICIAN

# ADVERTISERS INDEX

American Telephone & Telegraph Company .....	20
Antronic Corporation .....	78
Arco Electronics .....	87
Arrow Fastener Company, Inc. ....	89
B & K Manufacturing Company .....	57
B & K Manufacturing Company .....	76
Bogen Communications Division .....	67
Bussmann Manufacturing Company .....	82-83
Cadre Industries Corporation .....	66
Centralab, Electronics Div. of Globe-Union, Inc. ....	63
Clerostat Manufacturing Company .....	77
DAVCO Specialties .....	90
Delco Radio Division .....	61
EICO Electronic Instrument Co., Inc. ....	30
Finney .....	27
Gator-Probe Corporation .....	64
GC Electronics .....	70
Hallmark Instruments .....	89
Heath Company .....	65
Imperial Inn .....	66
Injectorall Company .....	80
ITT Distributor Products Div. ....	59
Jensen Manufacturing Company .....	32
Jerrold Electronics .....	22-23

## ARROW Staple Gun Tackers

SAVE YOU TIME AND MONEY!

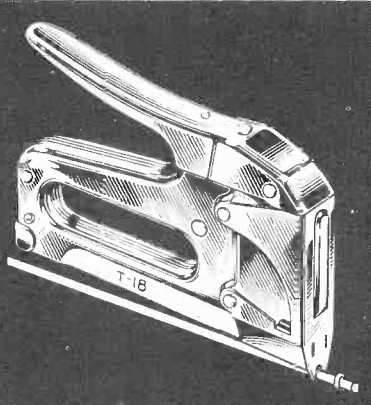

### SAFE!

Can't damage wire because staples automatically stop at right height! Won't even break 1/4" hollow glass tubing.

### FAST!

Proved by test 10 times faster than old hammer method. Saves you 70% in fatigue and efficiency . . . saves many dollars.

### HOLDS!

New staples get tremendous holding power from tack points that spread to lock into wood!

Tapered striking edge gets into tight corners!

MODEL T-18 — For wires 3/16" and less in diameter. Loads (85) T-18 staples with 3/16" crown, divergent-pointed, of .050 wire in 3/8" leg length.

MODEL T-25 — For wires up to 1/4" in diameter. Loads (85) T-25 staples with 1/4" crown, wedge or divergent-pointed, of .050 wire in 9/32", 3/8", 7/16" and 9/16" leg lengths.

- All-steel construction with chrome finish.
- Jam-proof patented mechanism for trouble-free operation.

Write for catalog and information.

**ARROW FASTENER COMPANY, INC.**

One Junius Street • Brooklyn 12, N. Y.

--- for more details circle 13 on post card

## "TORQUE WRENCH" MANUAL

SENT UPON REQUEST



Formulas  
Applications  
Engineering Data  
Screw Torque Data  
Adapter Problems  
General Principles

**PAT STURTEVANT CO.**  
**ADDISON QUALITY ILLINOIS**

Manufacturers of over 85% of the torque wrenches used in industry

--- for more details circle 52 on post card

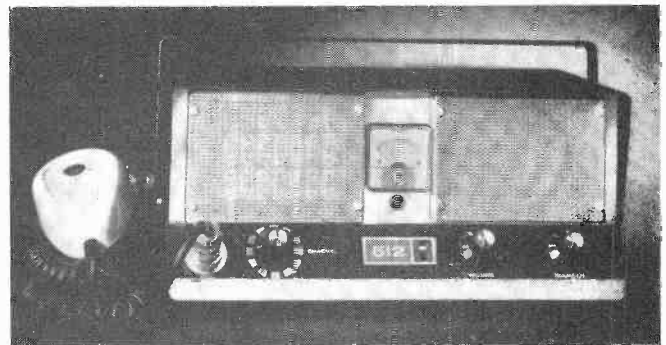

List Price \$149.50

## HALLMARK 512

UNEXCELLED IN PERFORMANCE, STYLING AND RUGGED RELIABILITY!

Today's best selling CB from Hallmark features dual-power, 12 channel crystal-controlled, push to talk operation. Sensitivity better than 0.3µv for 10 db S/N ratio. Selectivity better than 30db. RF power over 3.2 watts. Audio power 3 watts. Top-quality components in rugged hand-wired chassis. 26.965 to 27.255 mc. High-level modulation, improved low-noise front end. "S" meter and neon modulation indicator standard.

### NOW FROM HALLMARK! NEWEST ADVANCE IN IMPROVED MULTI-PURPOSE TRANSCEIVER TESTERS!

Price \$ 49.50

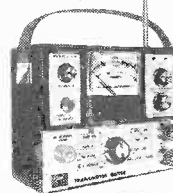

A precision instrument designed to assist the technician in installation and servicing of low power transceivers. Measures: RF power (absolute) 0-5 w.; 0-120% amplitude modulation; VSWR; Produces a 100mw carrier (with or without amplitude modulation of a 1000 cps tone) for checking receivers; Use as a field strength meter.



**HALLMARK INSTRUMENTS**  
6612 DENTON DRIVE, DALLAS 35, TEXAS

--- for more details circle 26 on post card



**Mercury** offers you the **GREATEST VALUE**  
in **TUBE TESTERS**

**TOP QUALITY • SPEED • ACCURACY • LOW PRICES**  
*...sell more tubes — earn more money*

a true **DYNAMIC MUTUAL CONDUCTANCE TUBE TESTER**  
for only **\$79.95** Net

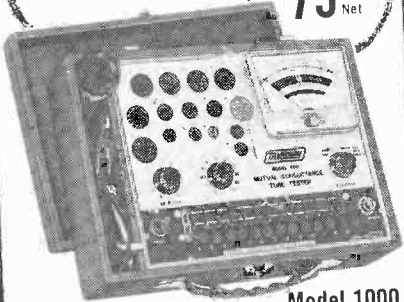

**Model 1000**  
**MUTUAL CONDUCTANCE TUBE TESTER**

Tests for true dynamic mutual conductance (Gm)

Tests for shorts and leakage between any tube elements

Tests for gas and grid emission... sensitivity over 100 megohms

Tests picture tubes

Here, for the first time is a true dynamic mutual conductance tube tester to sell for less than a hundred dollars... in fact it bears a price tag of only \$79.95... truly, one of the greatest values in test equipment to come your way in a long time.

Size: 14x9½x4¾"

**Model 1100 TUBE TESTER**

... an outstanding tester—yet amazingly low in price!

Tests for shorts and leakage

Tests for dynamic cathode emission

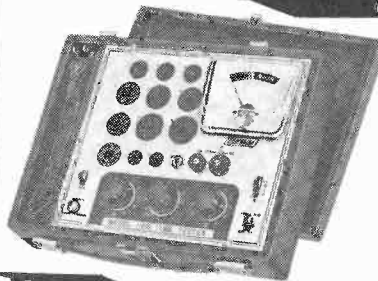

Tests for grid leakage

Tests for gas content

**\$39.50** Net

Size: only 10¼x8¼x3¼"

Here is the answer to technicians who seek a dependable, professional performing tube tester at a minimum cost. The Model 1100 has a range of operation that will outperform many, more expensive testers. It boasts an exclusive meter bridge circuit, found only in more expensive testers. Conveniently compact in size—a whale of a money-maker.

**ALL MERCURY Tube Testers have these features:**

- Also test the new tube types including Novars, Nuvistors, Compactrons, new 10-pin tubes as well as battery type tubes, auto radio hybrid tubes, voltage regulators, foreign and hi-fi tubes, thyatrons and most industrial tube types.
- Check each section of multi-section tubes separately
- Handsome, two-tone long lasting etched aluminum panel
- Housed in sturdy carrying case with handsome leatherette finish.

**Model 1200**  
**MUTUAL CONDUCTANCE TUBE TESTER**

Tests for true dynamic mutual conductance (Gm)

Tests for shorts and leakage between any tube elements

Tests for gas and grid emission... sensitivity over 100 megohms

**\$119.95** Net

Here is a deluxe dynamic mutual conductance tube tester with a unique push-button set-up method that can be compared with the ease of selecting a record on a juke box. Push buttons provide complete flexibility in accommodating all present and new tube types and basing arrangements. The Model 1200 is the most versatile tube tester available today.

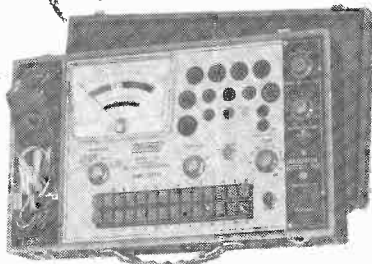

**Deluxe**  
**Dynamic Mutual Conductance Tube Tester with FAST PUSH BUTTON SETTINGS**

**TREMENDOUS VALUE!**

Also tests black and white and color picture tubes.

Also tests transistors.

Also tests batteries under load

Size: 18¼x10¼x4¾"

See your electronics parts distributor or write for complete Mercury catalog

**Mercury** **ELECTRONICS CORPORATION**

manufacturers of quality electronic products

111 Roosevelt Avenue, Mineola, New York

EXPORT: EMEC Inc., 127 Grace St., Plainview, N. Y.

... for more details circle 36 on post card

Kester Solder Company	74
L. A. Tuner Exchange	85
James Lansing Sound, Inc.	71
Mercury Electronics Corporation	90
Mosley Electronics Inc.	88
Multicore Sales Corporation	88
North American Philips Company 3rd Cover	
Nortronics, Inc.	68
Oaktron Industries, Inc.	80
Perma-Power Company	72
Philco Corporation	2nd Cover
Radio Corporation of America	
RCA Electronic Components and Devices	55, 79, 4th Cover
RCA Sales Corporation	31
John F. Rider Publisher	86
Sarkes Tarzian Semiconductor Div.	62
Sarkes Tarzian Tuner Service Div.	19
H. H. Scott, Inc.	73
Seco Electronics, Inc.	26
Shelton Towers Hotel	88
Sherwood Electronic Laboratories, Inc.	85
Sonofone Corporation	24
Sprague Products Company	25
P. A. Sturtevant Company	89
Sylvania Electric Products	28-29
TACO — (See Jerrold Electronic Corp.)	22-23
Triad Distributor Division	86
Tung-Sol Electric Inc.	69
University Loudspeakers	75
V-M Corporation	53
Volkswagen of America	81
Winegard Company	84
Winegard Company	78
Xcelite, Inc.	68

**\$2 EXTRA PROFIT \$2**  
ON EACH  
**TV SERVICE CALL**

While the back's off the set, end your customer's problems with too loud, insulting commercials — Install "SOUND OFF"—New Remote Control that cuts commercials ALL the way off — leaves picture unchanged! An exclusive 3 wire circuit CANNOT HARM THE SET like 2 wire imitations. 25 ft. special cable fits any normal room. Complete instructions for 2 minute installation. Order your supply of "SOUND OFF!" today. Technician's net — \$2.95 ea. or \$14.95 for 6 POSTPAID.

**DAVCO SPECIALTIES**

DEPT. ET-1

BOX 2253 PIO NONO STN.

MACON, GEORGIA

... for more details circle 21 on post card

ELECTRONIC TECHNICIAN

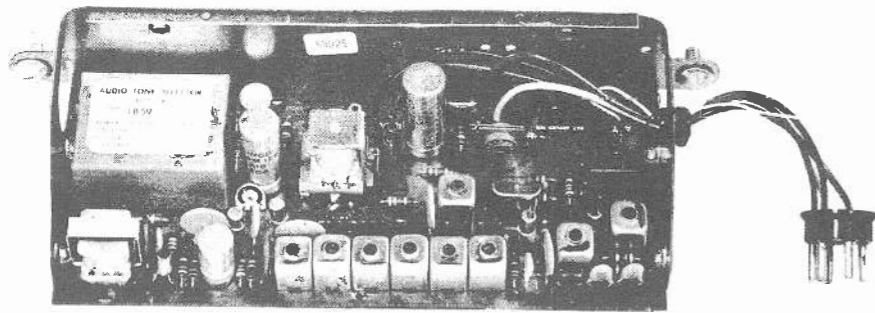

# ELECTRONIC TECHNICIAN TEKFAX

# 806

COMPLETE MANUFACTURERS' CIRCUIT DIAGRAMS  
AND TECHNICAL INFORMATION FOR SIX NEW SETS

**PERMA-POWER**  
Remote Control System  
Models G230, 1,  
2 Receiver,  
Models G340, 50  
Transmitter

- Antenna not fully extended, wire broken within insulation or loose connection on circuit board pin.
- Receiver Plug disconnected from (or loose in) Socket
- Receiver Plug wires broken, disconnected or loose on circuit board pins.
- Selector Channel not firmly connected on board.

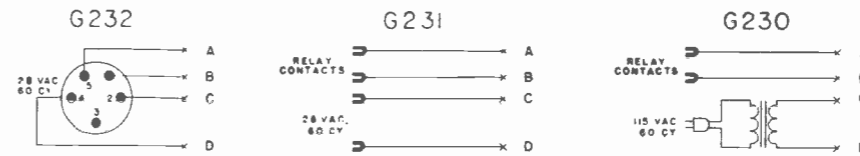

## PORTABLE TRANSMITTER CHECKLIST

September 1963

- Battery properly installed and plugged in.
- Weak battery. Measure at least 7 volts when operating.
- Location in automobile. Try operation from outside of automobile and without Mounting Bracket to check.
- Code number same as Receiver.

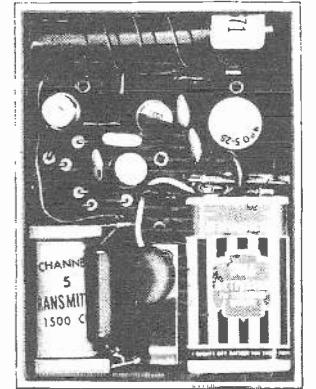

## WIRED-IN TRANSMITTER CHECKLIST

- Power Cord improperly connected to automobile supply (see diagram in housing cover for selecting proper battery voltage and polarity).
- Broken Power Cord wire, or defective jumper cable. Test for continuity or shorts.
- Defective push-button - short the 2 wires connected to push-button together, to check.
- Automobile radio antenna connected and radio antenna extended at least 2 feet.
- Mounting bracket connected to metal of automobile to make battery ground connection.
- Code number same as Receiver.

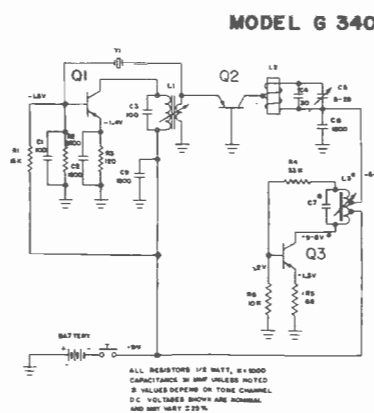
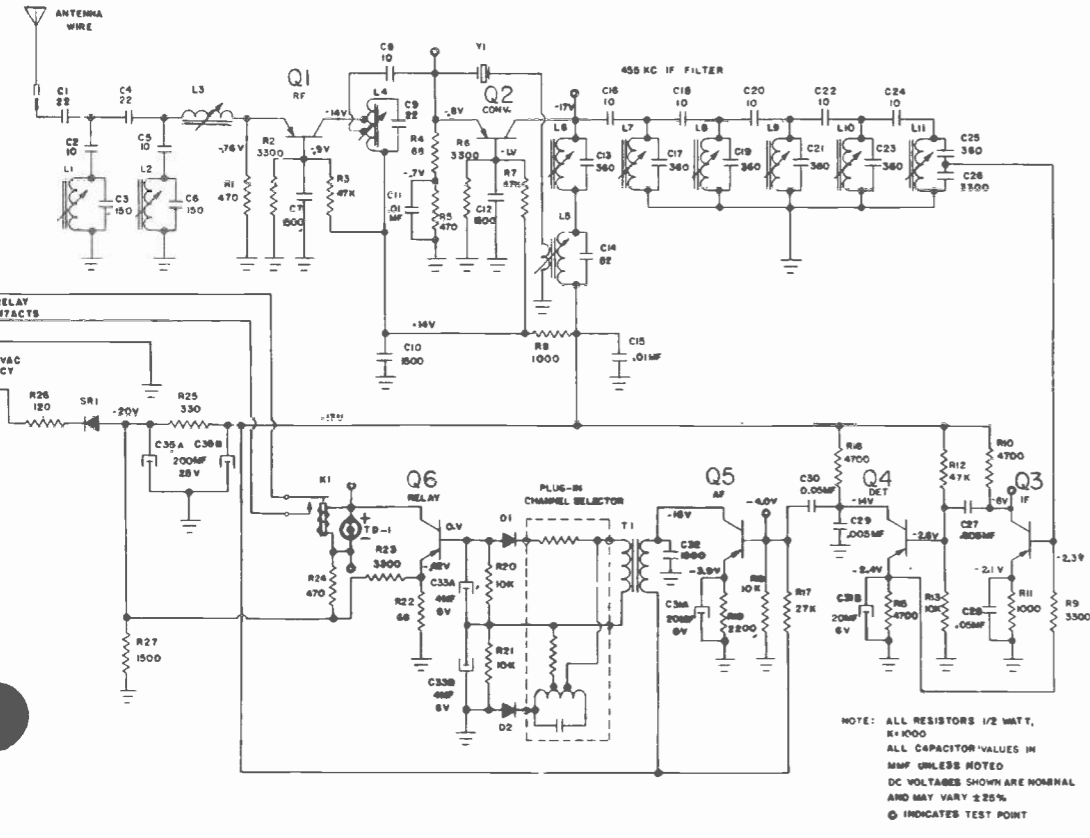
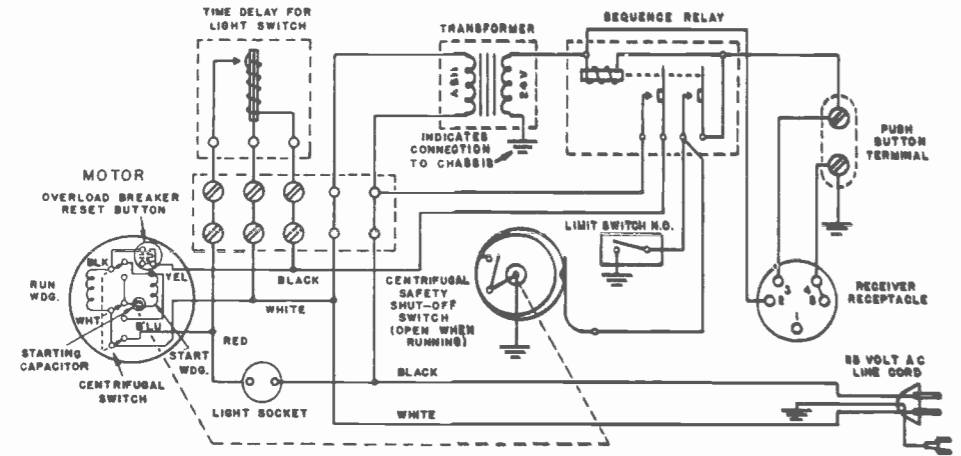
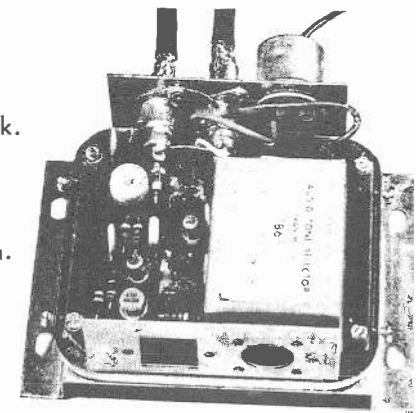

CIRCUIT SYMBOL	PART NUMBER	PART NUMBER
R1	15,000 Ohm ± 10% 1/2 Watt	26112
R2	3,300 Ohm ± 10% 1/2 Watt	1842
R3	120 Ohm ± 10% 1/2 Watt	1847
R4	33,000 Ohm ± 10% 1/2 Watt	26114
R5	48 Ohm ± 10% 1/2 Watt	
R6	10,000 Ohm ± 10% 1/2 Watt	
CL1, CL2	100 MMF 5% Mica	
CL3, CL4, CL5	150 MMF GAY CURRENT OHM	
C1	50 MMF ± 20% Mica	26112
C2	50 MMF Transistor	1842
C3	30 MMF Transistor	1847
L1	Output Coil Assembly	1842
L2	Driver Coil Assembly	1847
L3, L7	Tune Coil Assembly (Identical Channel)	26112
Q1, Q2	Transistor	26112
Q3	Transistor	26112
Q4	Transistor	26112
Y1	Crystal, Quartz	A-3342
		B-3343
		C-3344
		D-3345
		E-3346
		F-3347
		1848
Battery	Radio	1824
	Supplies	208
	Excess	218
	R.C.A.	9322
	Trans	5764417
	PARTS NOT SHOWN	
	Case & Clip Assembly	1899
	Control Switch Assembly	18100
	Battery Connector	2346

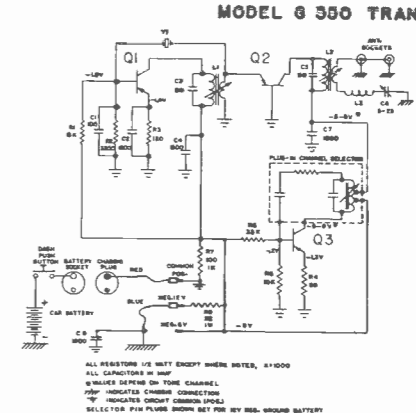

CIRCUIT SYMBOL	PART NUMBER	PART NUMBER
R1	15,000 Ohm ± 10% 1/2 Watt	26112
R2	3,300 Ohm ± 10% 1/2 Watt	1842
R3	120 Ohm ± 10% 1/2 Watt	1847
R4	33,000 Ohm ± 10% 1/2 Watt	26114
R5	48 Ohm ± 10% 1/2 Watt	
R6	10,000 Ohm ± 10% 1/2 Watt	
CL1, CL2	100 MMF 5% Mica	
CL3, CL4, CL5	150 MMF GAY CURRENT OHM	
C1	50 MMF ± 20% Mica	26112
C2	50 MMF Transistor	1842
C3	30 MMF Transistor	1847
L1	Output Coil Assembly	1842
L2	Driver Coil Assembly	1847
L3, L7	Tune Coil Assembly (Identical Channel)	26112
Q1, Q2	Transistor	26112
Q3	Transistor	26112
Y1	Crystal, Quartz	A-3342
		B-3343
		C-3344
		D-3345
		E-3346
		F-3347
		1848
Battery	Radio	1824
	Supplies	208
	Excess	218
	R.C.A.	9322
	Trans	5764417
	PARTS NOT SHOWN	
	Case & Clip Assembly	1899
	Control Switch Assembly	18100
	Battery Connector	2346

# 807

**TELECTRO  
(Emerson)**

Tape Recorder -  
Radio  
Model 215

**ELECTRONIC TECHNICIAN**

# TEKFAK

COMPLETE MANUFACTURERS' CIRCUIT DIAGRAMS  
AND TECHNICAL INFORMATION FOR SIX NEW SETS

September 1963

COMPONENT LAYOUT FM RADIO VIEW A (TOP)

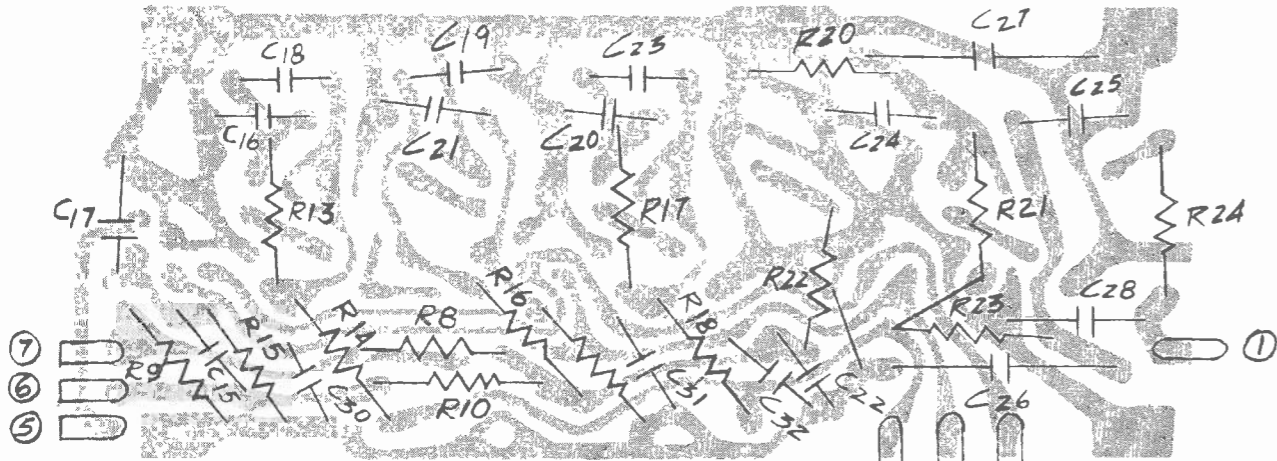

COMPONENT LAYOUT AMP, VIEW A (TOP)

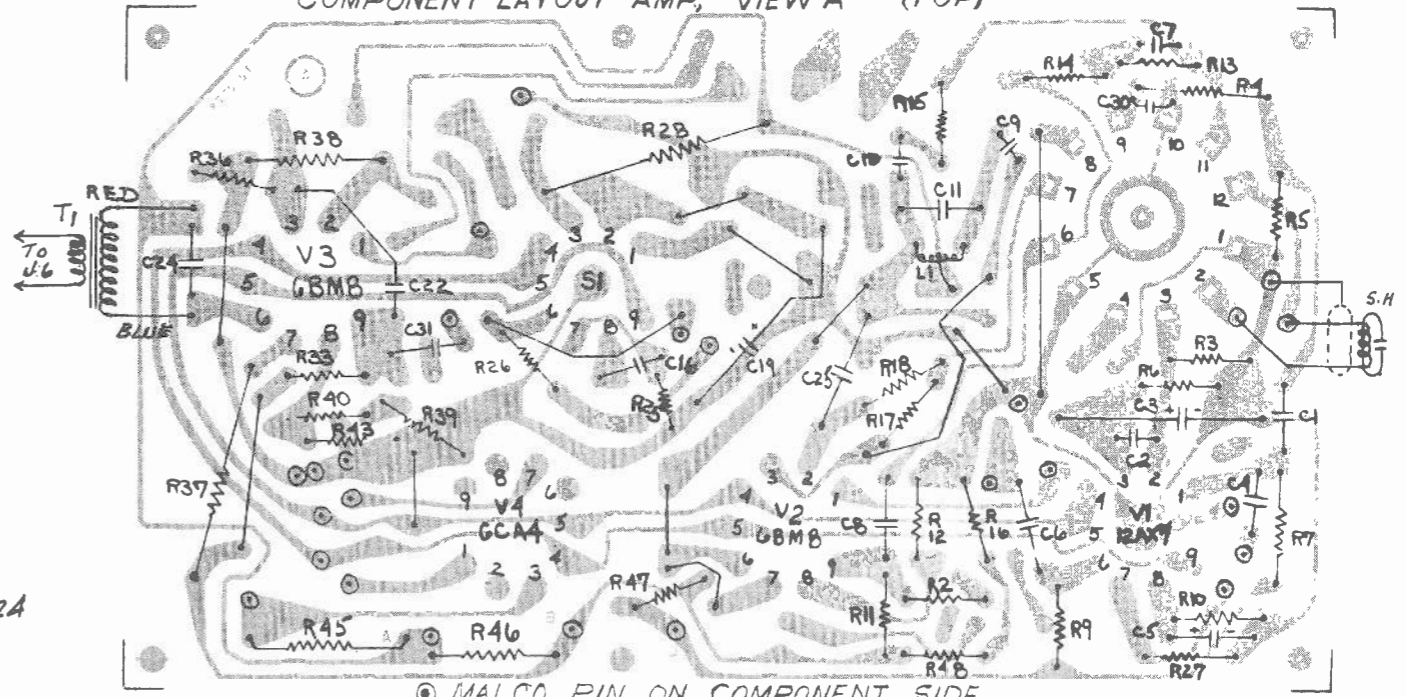

© MALCO PIN ON COMPONENT SIDE

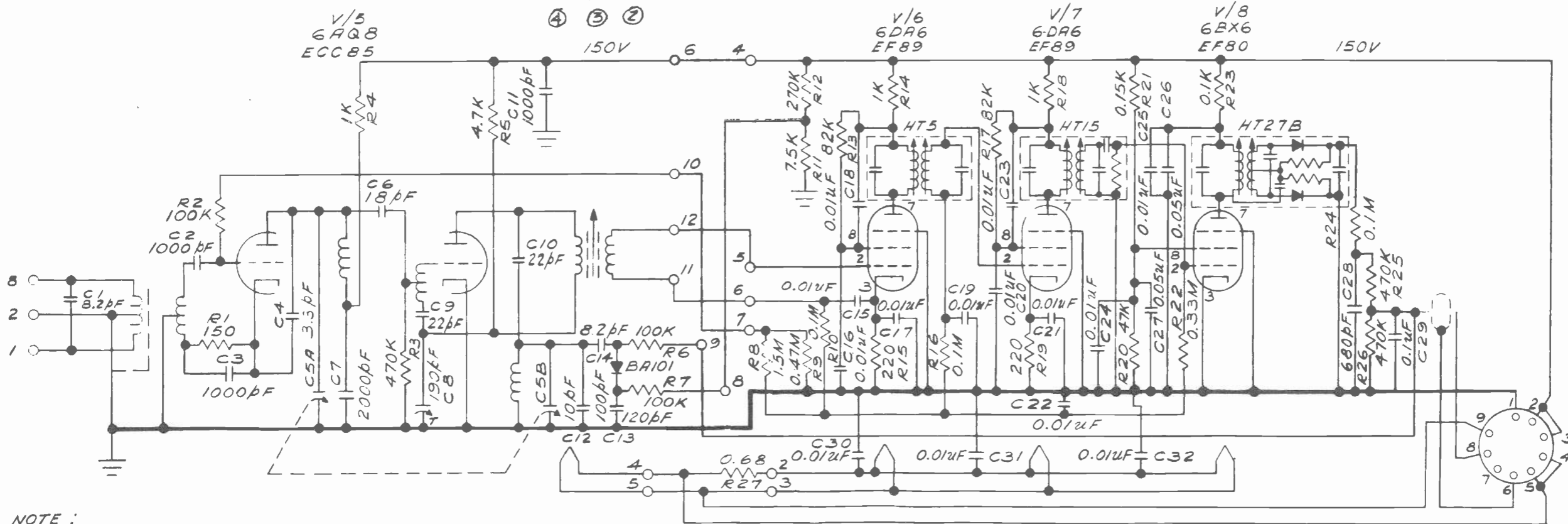

- NOTE:
1. ALL RESISTORS IN OHMS 1/2 WATT UNLESS OTHERWISE SPECIFIED.
  2. ALL VOLTAGES INDICATED ARE D.C.
  3. ALL D.C. VOLTAGES TO GROUND IN PLAYBACK AND NO SIGNAL APPLIED.
  4. D.C. VOLTAGES TAKEN WITH VTVM 11 MEGOHMS INPUT
  5. POSSIBLE VARIATION IN VOLTAGE AND RESISTANCE MEASUREMENTS ±20%

REF	TUBE	1	2	3	4	5	6	7	8	9
V6	EF89/6DA6		0.4	0.9				143	54	
V7	EF89/6DA6		0.4	0.9				143	54	
V8	EF80/6BX6		0.5					70	30	



REF	TUBE	1	2	3	4	5	6	7	8	9
V1	ECC83/12AX7	234.2K*	1K	2.2K	0	0	114.2K*	59.4K	2.2K	.145Ω
V2	ECL82/6BM8	143K	—	—	0	.145Ω	270Ω*	270Ω*	1.5K	51.2K*
V3	ECL82/6BM8	143K	330Ω	470K	.145Ω	0	700Ω*	6.4K*	1.36K	224.2K*
V4	EZ81/6CA4	150Ω	∞	—	.145Ω	0	∞	150Ω	∞	∞
S1	POWER TUNER	0	4.25K*	∞	.145Ω	.145Ω	0	∞	∞	0

**TELECTRO (Emerson)**  
Tape Recorder-Radio  
Model 215

**ELECTRONIC TECHNICIAN**

**TEKFAX**

**807**

September 1963

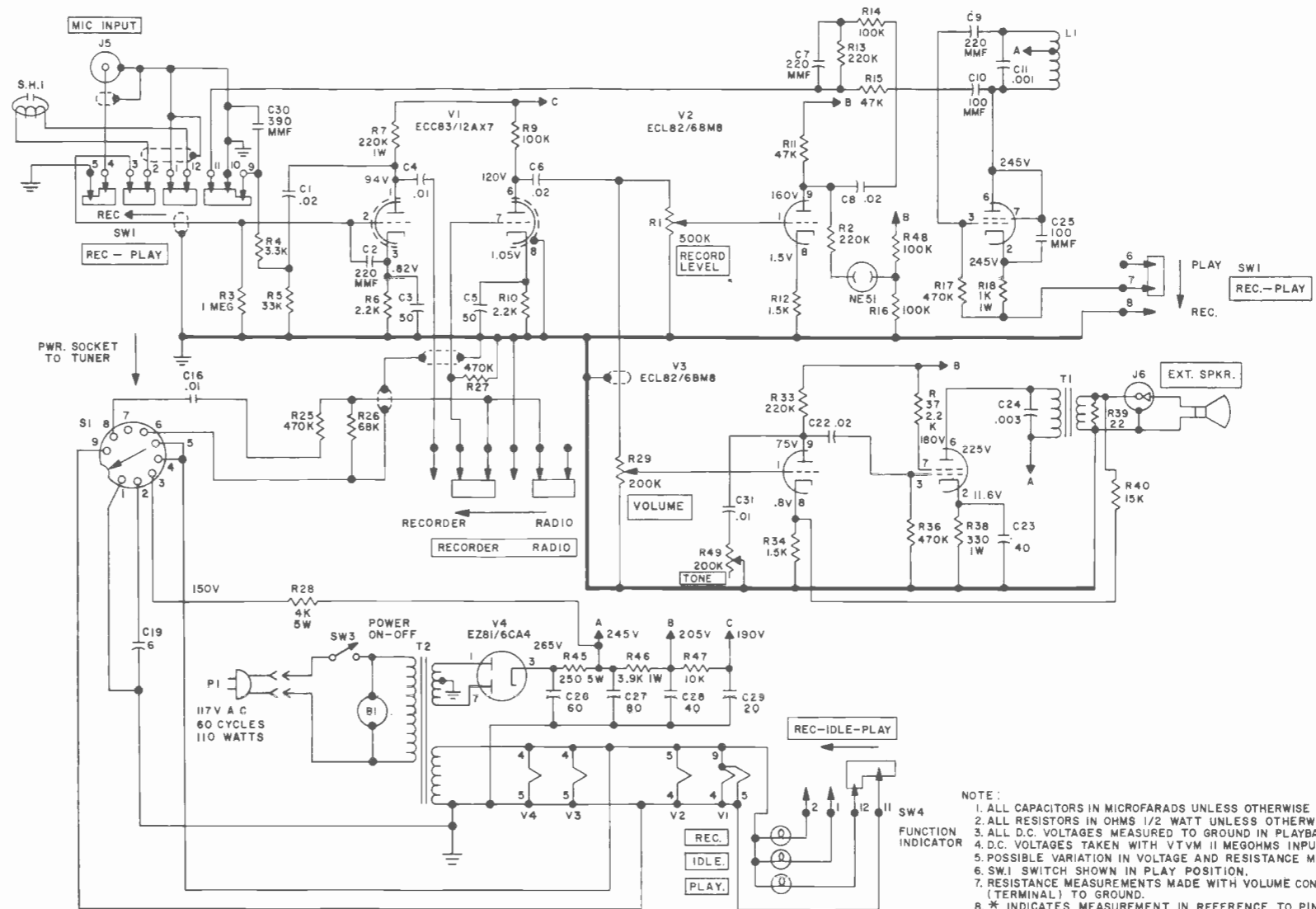

- NOTE:
1. ALL CAPACITORS IN MICROFARADS UNLESS OTHERWISE SPECIFIED.
  2. ALL RESISTORS IN OHMS 1/2 WATT UNLESS OTHERWISE SPECIFIED.
  3. ALL D.C. VOLTAGES MEASURED TO GROUND IN PLAYBACK & NO SIGNAL APPLIED.
  4. D.C. VOLTAGES TAKEN WITH VTVM II MEGOHMS INPUT.
  5. POSSIBLE VARIATION IN VOLTAGE AND RESISTANCE MEASUREMENT ±20%.
  6. SW1 SWITCH SHOWN IN PLAY POSITION.
  7. RESISTANCE MEASUREMENTS MADE WITH VOLUME CONTROL FULLY C.W. FROM PIN (TERMINAL) TO GROUND.
  8. \* INDICATES MEASUREMENT IN REFERENCE TO PIN 7 OF V3.
  9. SW4-FUNCTION INDICATOR SHOWN IN PLAY POSITION.

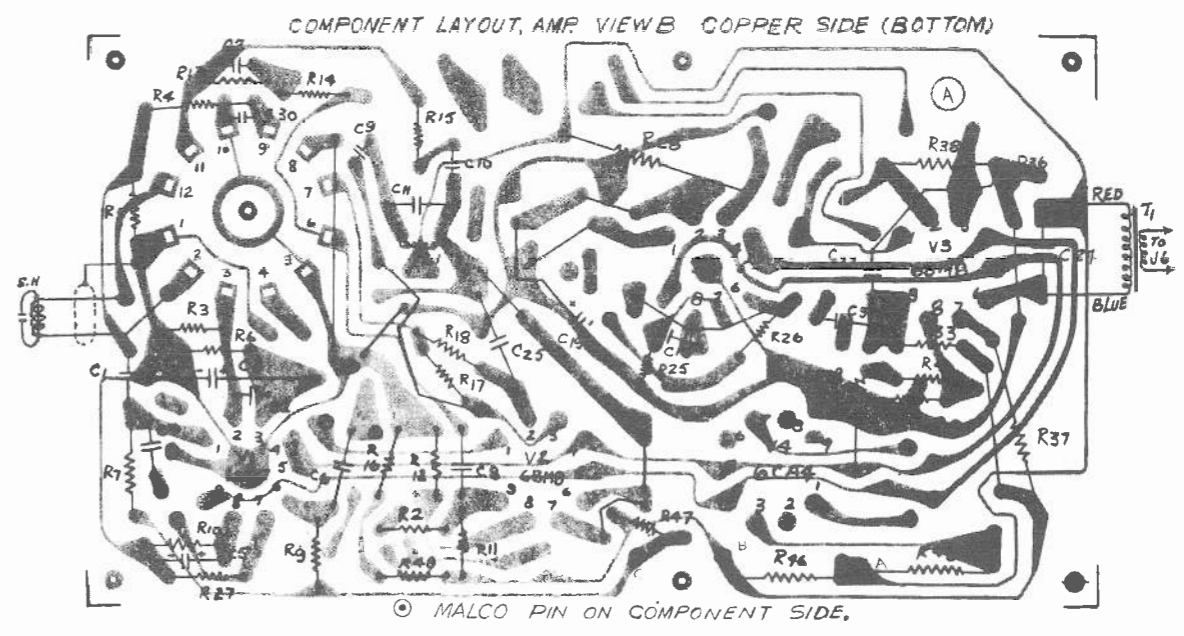
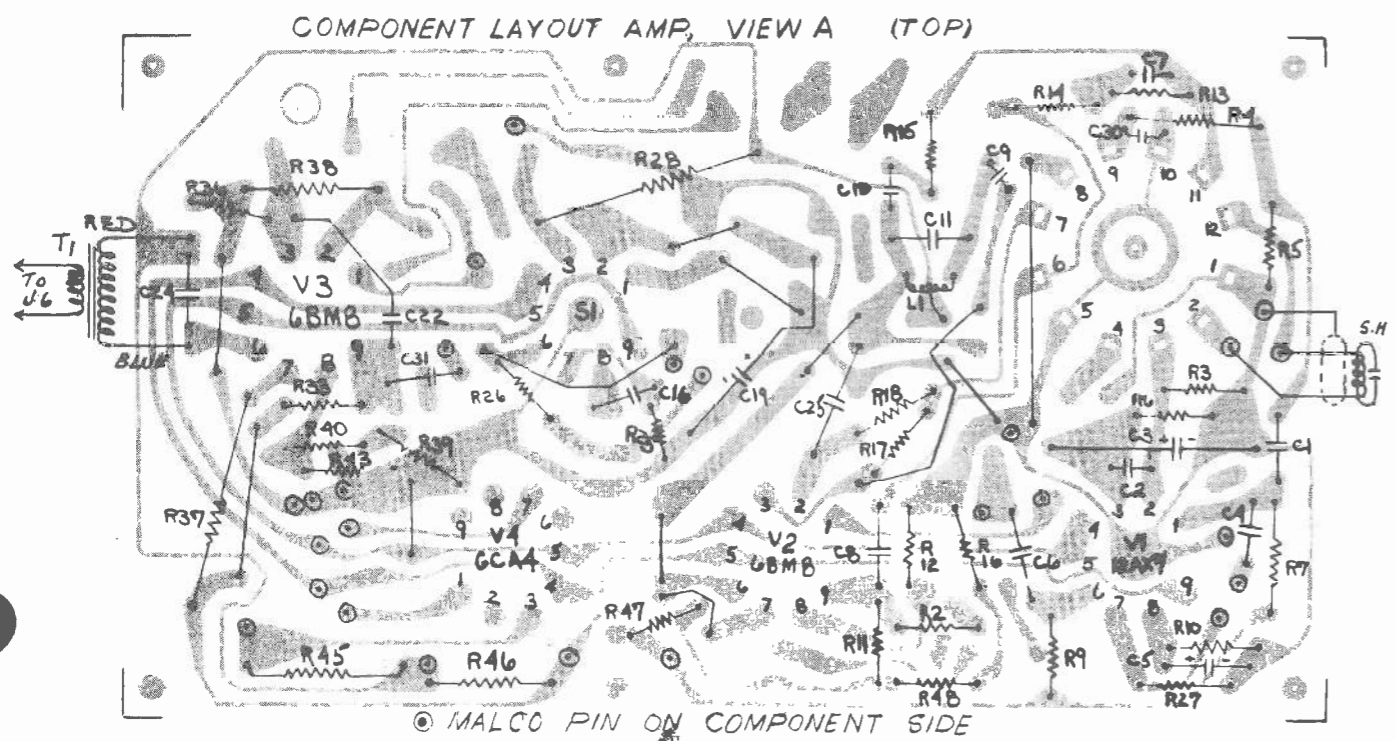

# 808

# ELECTRONIC TECHNICIAN TEKFAK

COMPLETE MANUFACTURERS' CIRCUIT DIAGRAMS  
AND TECHNICAL INFORMATION FOR SIX NEW SETS

**ADMIRAL**  
Color TV Chassis  
24A2, UA2, B2,  
UB2, C2, UC2, D2,  
UD2, UE2—Run 10

September 1963

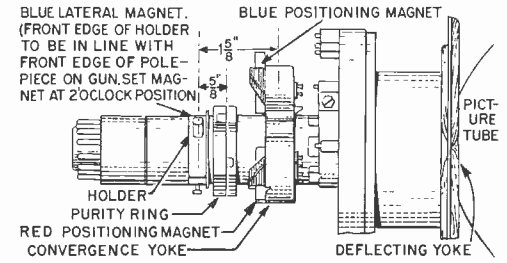
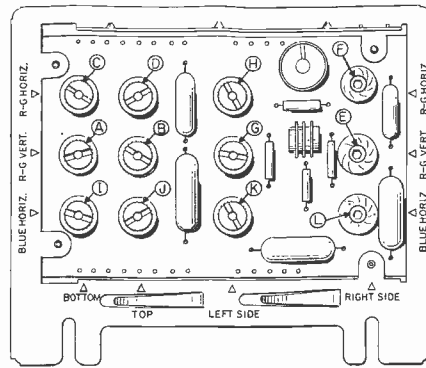
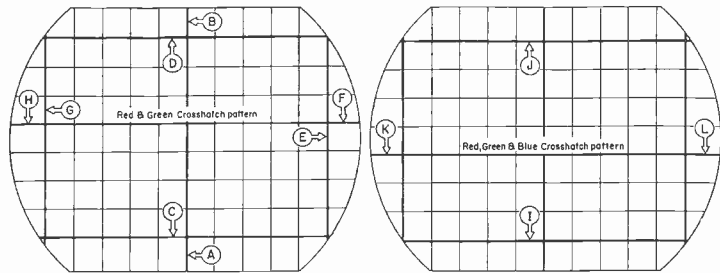

Tuner

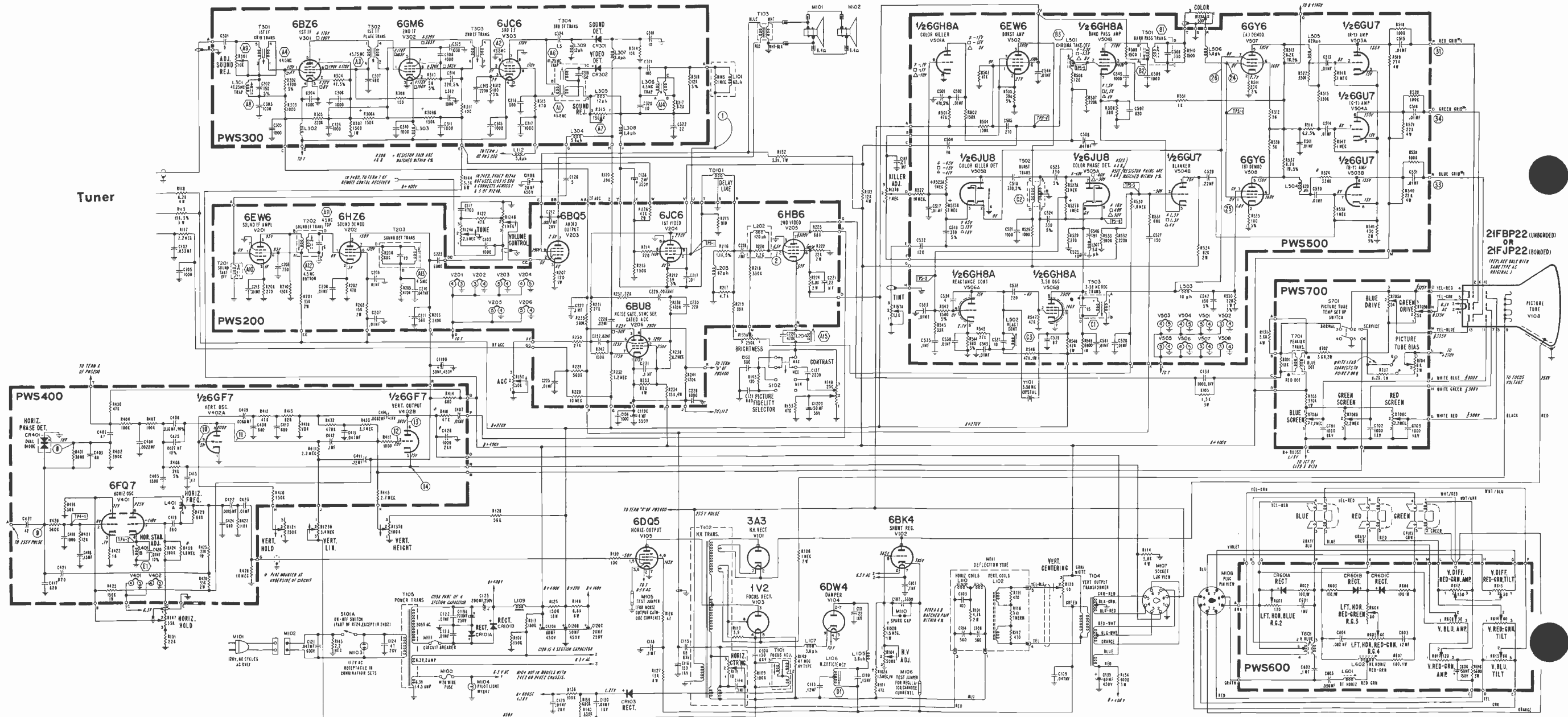

# VHF TUNER 94E228-1,2 OR 3

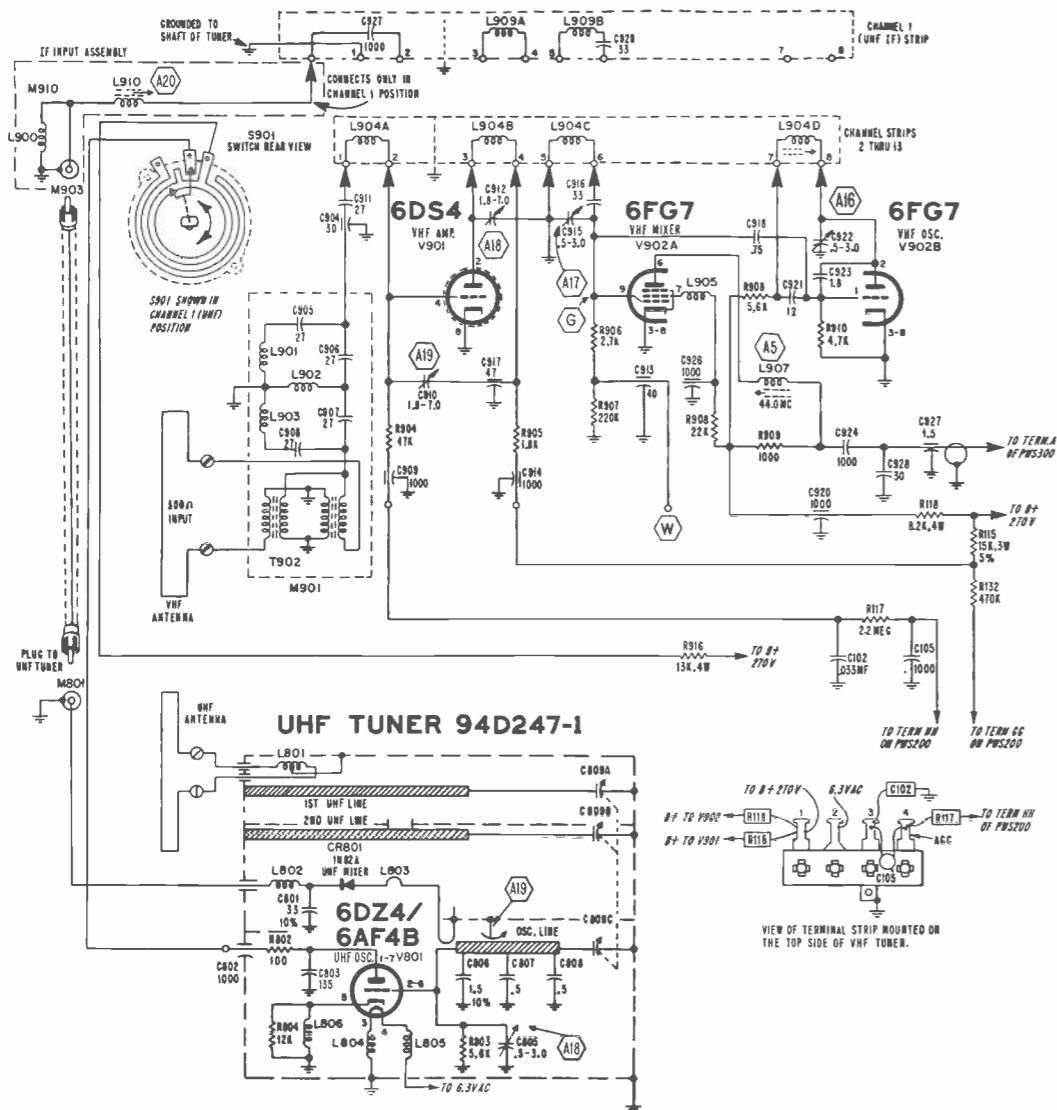

## UHF TUNER 94D247-1

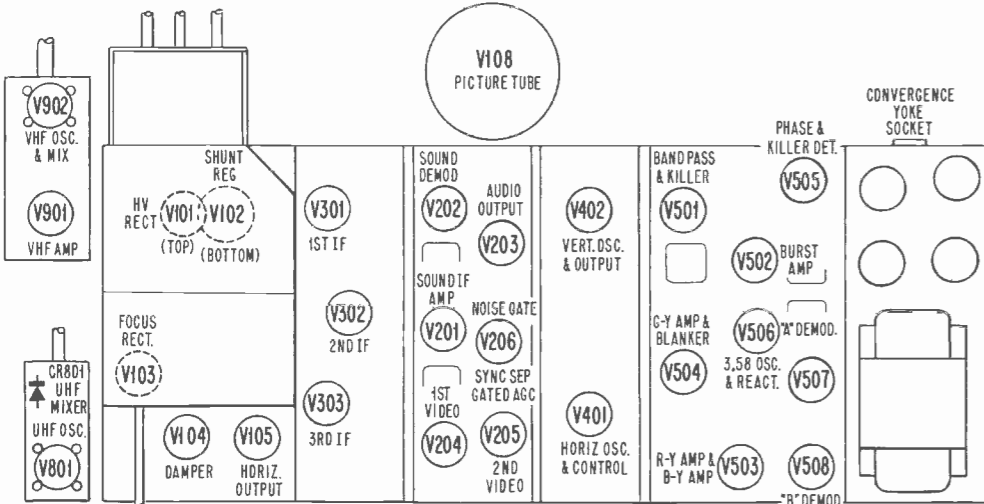
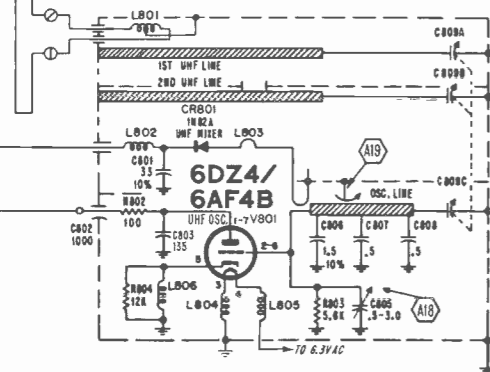

TUBE LOCATIONS

**ADMIRAL**  
Color TV Chassis  
24A2, UA2, B2, UB2, C2,  
UC2, D2, UD2, UE2  
— Run 10

**ELECTRONIC TECHNICIAN**  
**TEKFAX**  
**808**

September 1963

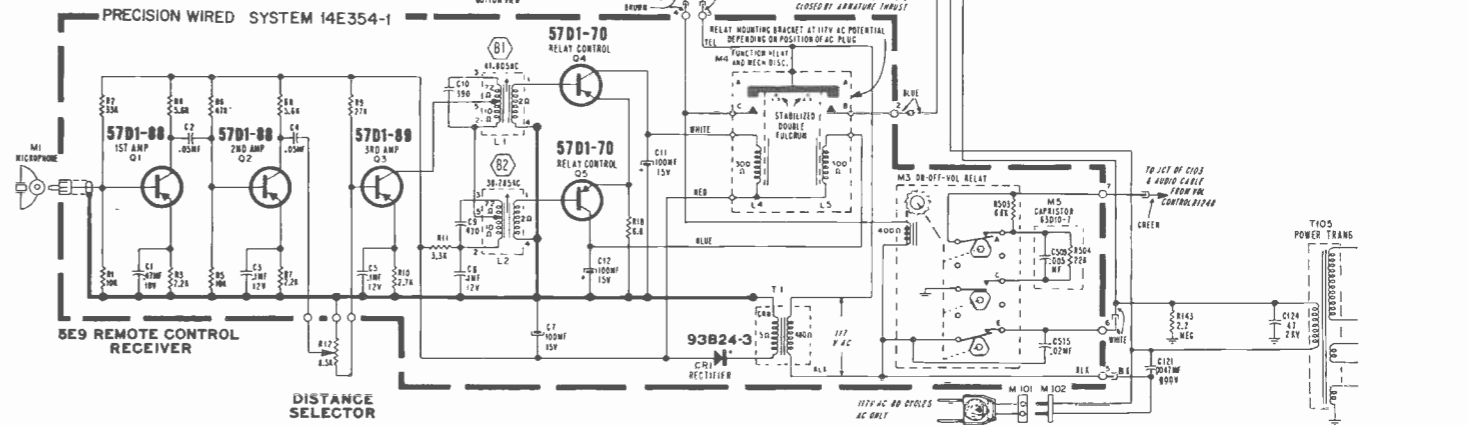

### VOLTAGES

Line Voltage: 117 Volts.  
Channel Selector on unused channel. Contrast control fully clockwise. Do not disturb Horizontal Hold control. Antenna disconnected and terminals shorted. DC voltages measured with VTVM between tube socket and chassis, unless otherwise indicated. For other voltage information, see notes on schematic.

### VOLTAGE WARNING

Exercise normal high voltage precautions when servicing receiver power supply and deflection circuits.  
Pulsed high voltage is present at various points of the power supply and deflection system. Use suitable test equipment at these points.

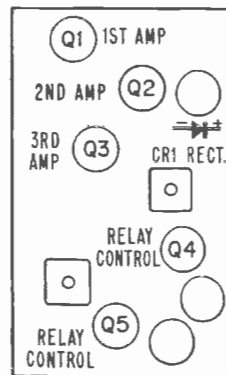

Remote Control Receiver

### CHASSIS NOTES

Test Points: Test point (TP) numbers and connection terminal letters appear on chassis and on schematic. Note: Test point prefix TP2—indicates that test point is located on Precision Wired System PWS200, TP5—is on PWS500, etc. B+ Circuit Breaker: B+ supply of this receiver is equipped with a thermal type circuit breaker having a manual reset button. Allow a few minutes for circuit breaker to cool before pressing the reset button.  
Heater Fuse: A one inch length of number 26 gauge bare annealed copper wire is used. Fuse wire is located at underside of chassis.

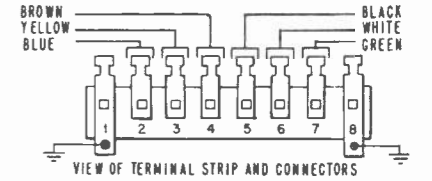

NOTE: COLORS OF CONNECTORS CORRESPOND TO COLORS OF TERMINALS ON STRIP

## VHF TUNER 94E228-1 OR -2

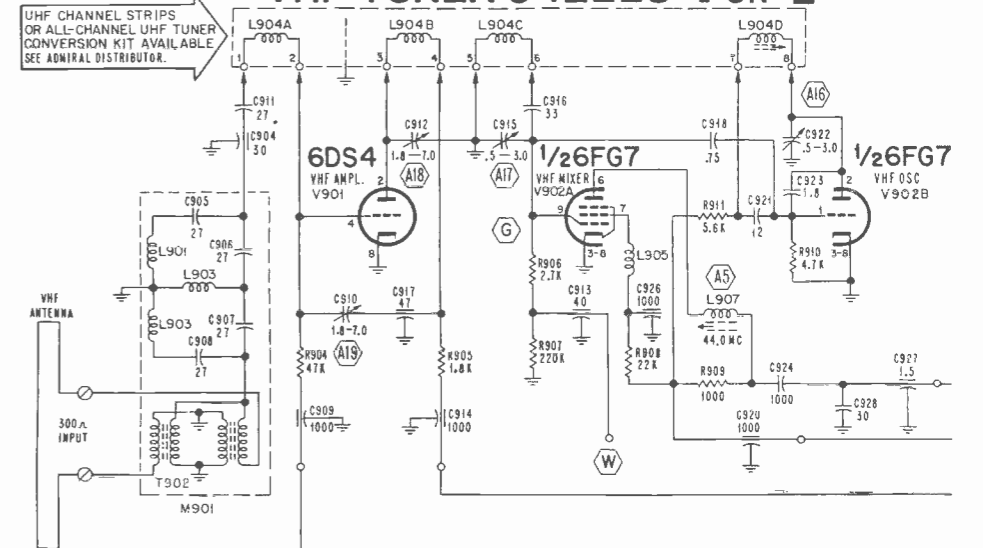

### TUBE AND SEMI-CONDUCTOR COMPLEMENT

- |                          |                    |                 |
|--------------------------|--------------------|-----------------|
| V101—3A3                 | V303—6JC6          | CR1—93B24-3     |
| V102—6BK4                | V401—6FQ7          | CR101A} 93C30-2 |
| V103—1V2                 | V402—6GF7          | CR101B}         |
| V104—6DW4                | V501—6GH8A         | CR103—93C40-1   |
| V105—6DQ5                | V502—6EW6          | CR301—93C8-1    |
| +V108—21FJP22 or 21FBP22 | V503—6GU7          | CR302—93C8-1    |
| V201—6EW6                | V504—6GU7          | CR401—93B5-6    |
| V202—6HZ6                | V505—6JU8          | CR601A}         |
| V203—6BQ5                | V506—6GH8A         | CR601B} 93C1-20 |
| V204—6JC6                | V507—6GY6          | CR601C}         |
| V205—6HB8                | V508—6GY6          | Q1, Q2—57D1-88  |
| V206—6BU8                | V801—6DZ4 or 6AF4B | Q3—57D1-89      |
| V301—6BZ6                | V901—6DS4          | Q4, Q5—57D1-70  |
| V302—6GM6                | V902—6FG7          |                 |

† Replace only with exact same type as original.



# 809

# ELECTRONIC TECHNICIAN TEKFAK

COMPLETE MANUFACTURERS' CIRCUIT DIAGRAMS  
AND TECHNICAL INFORMATION FOR SIX NEW SETS

GENERAL  
ELECTRIC  
Radio  
Model P970A

September 1963

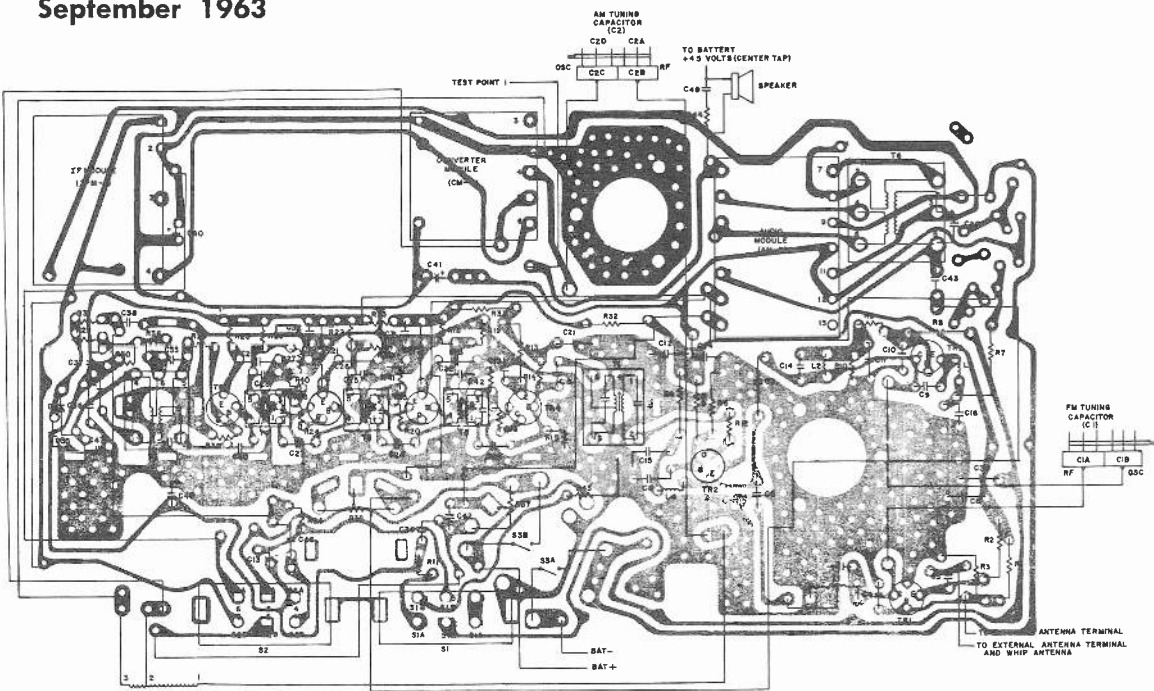
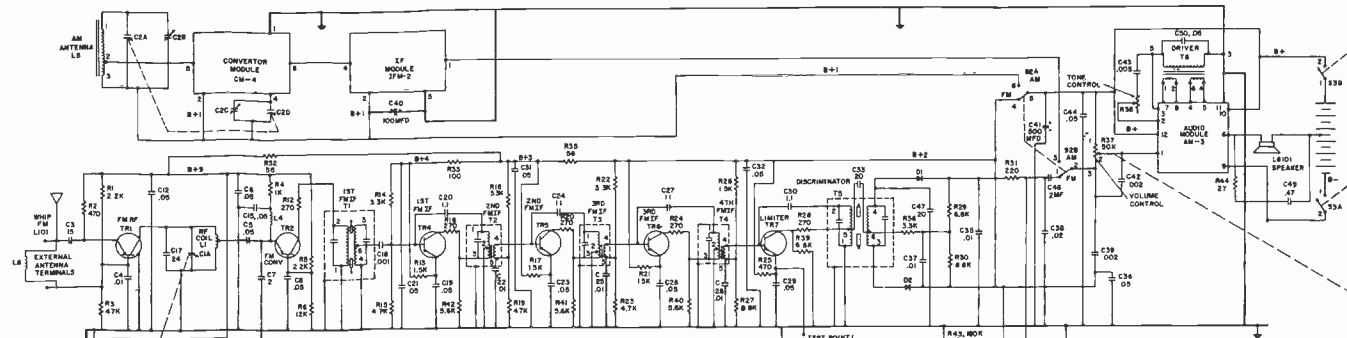

COMPONENT WIRING DIAGRAM

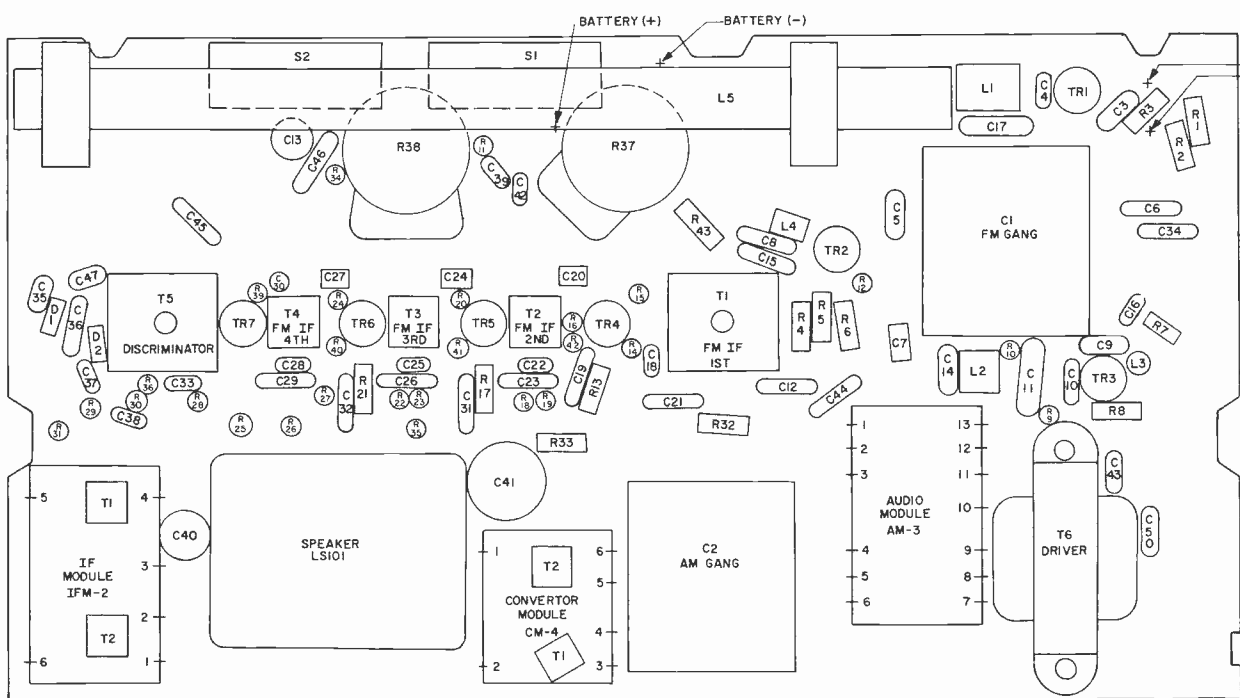

VOLTAGE MEASUREMENTS WITH RESPECT TO GROUND (NO SIGNAL)

TRIM "ENTER" TEST POINT

TRIM	FM	AM	FM	AM	FM	AM
TR1	5.9	0	3.4	0	0	0
TR2	5.2	0	4.8	0	0	0
TR3	4.5	0	4.3	0	3.4	0
TR4	5.4	0	3.1	0	2	0
TR5	3.8	0	3.1	0	2.8	0
TR6	2.8	0	3.2	0	3	0
TR7	3.0	0	3.2	0	2.8	0

AT PIN 3 OF VOLUME CONTROL DC VOLTAGE SHOULD VARY WITH RETURNING OF STRONG INPUT SIGNAL FROM 4.5V TO 6.8V

PIN	FM	AM
1	0	7.3
2	0	7.4
3	0	7.4
4	0	7.3
5	0	0
6	0	0

CURRENT DRAW (NO SIGNAL)

FM	AM
3.4mA	23mA

VOLTAGE FM AM

B+	FM	AM
B+	6	7.4
B-	0	7.4
B2	6	0
B3	5.4	0
B4	5.2	0
B5	5	0

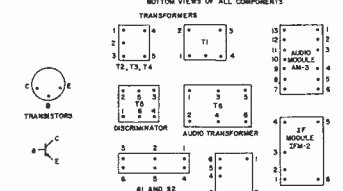

CM-4

PIN	FM	AM
1	3.2	3.2
2	7.2	7.2
3	7.2	7.2
4	1.8	1.2
5	7	7
6	7.5	7.5
7	3	3
8	3	3
9	-1.2	-1.2
10	8.0	7.4
11	0	0
12	6.0	7.4
13	7	7

AM-3

PIN	FM	AM
1	0	7.4
2	0	7.4
3	0	7.4
4	0	7.3
5	0	0
6	0	0

NOTES:

- UNLESS OTHERWISE NOTED - CAPACITORS MORE THAN 1 MUF CAPACITORS LESS THAN 1 MUF RESISTORS - 1% WATT, 1/4W-1000
- VOLTAGES ARE POSITIVE WITH RESPECT TO GROUND UNDER NO SIGNAL CONDITIONS AND VOLUME CONTROL MINIMUM UNLESS OTHERWISE INDICATED
- REPLACE TRANSISTORS BY CATALOG NUMBER AS LISTED IN THE PARTS LIST
- SWITCHES SHOWN IN FM POSITION
- WHEN TR1 IS RS3885 RB IS 22K AND R11 IS 27K WHEN TR1 IS RS2888 RB IS 12K AND R11 IS 22K WHEN TR1 IS RS3885 RB IS 18K AND R11 IS 22K

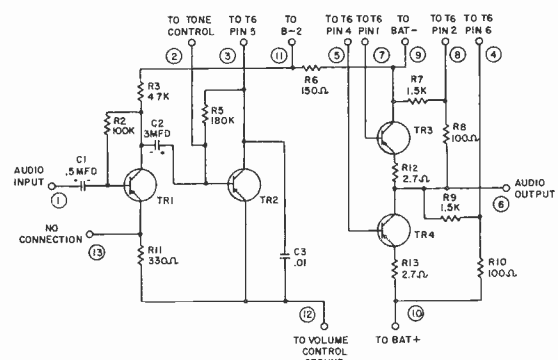
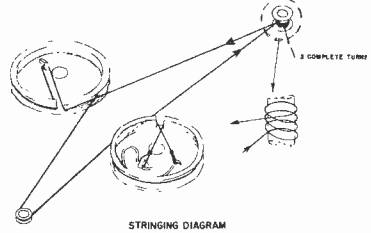

AUDIO MODULE (AM-3)

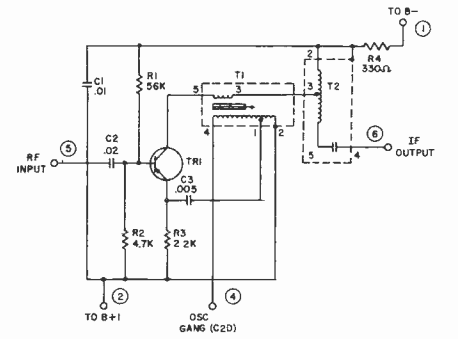

CONVERTER MODULE (CM-4)

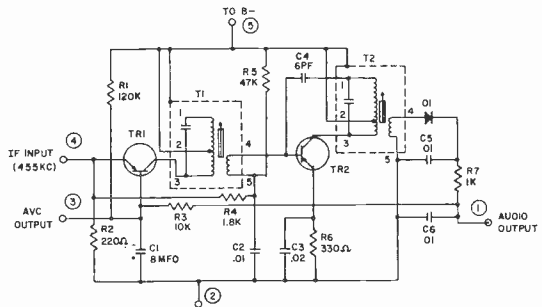
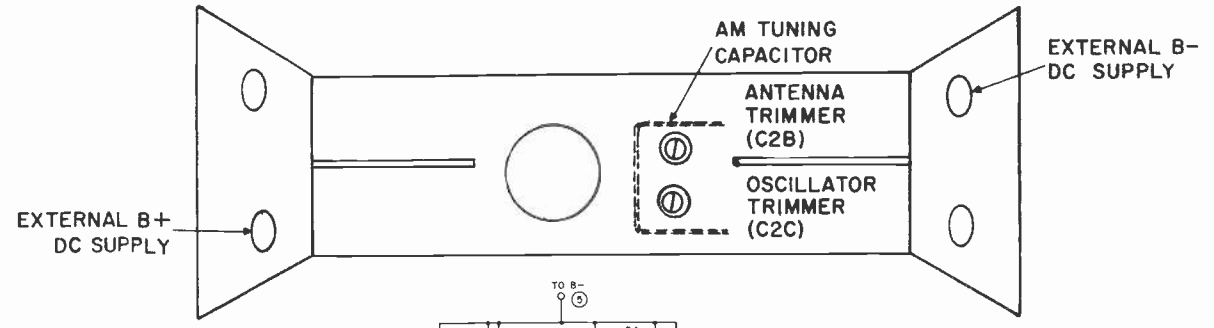

IF MODULE (IFM-2)

CHART 2. FM ALIGNMENT

Step	Signal Generator	Generator Setting	Tuning Gang	VTVM Connection	Adjustment	Notes
1	Couple output to C1A Couple ground to tuning gang	10.7 MC AM Modulated 80% or less	Open	TP1 Emitter of TR7 Use 1.5 AC Scale	T4, T3, T2, T1 for max. gain	Keep gen. out- put level as low as possible. S1 and S2 in FM position
2	Same	Same	Open	Same	T5 (bottom slug) for slight null	Same
3	Same	Same	Open	S2B-2	T5 (top slug) for sharp null	Same
4	Repeat all steps					
5	* Couple output and ground to FM antenna terminals	108.25 MC Unmodulated	Open	S2B-2	Adjust coils of L1 and L2 for best null in noise level.	If FM modulation is avail- able, make all adjustments for max. gain in steps 5 - 7  Use weakest possible signal
6	Same	87.75 MC Unmodulated	Closed	S2B-2	Adjust coils of C1B and C1A for best null in noise level.	
7	Same	98 MC Unmodulated	98 MC	S2B-2	Adjust coils of L1 for best null in noise level.	
8	Recheck steps 5 - 7					

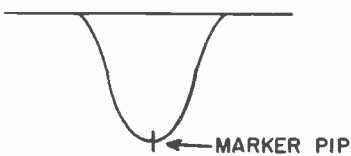

FIGURE 1

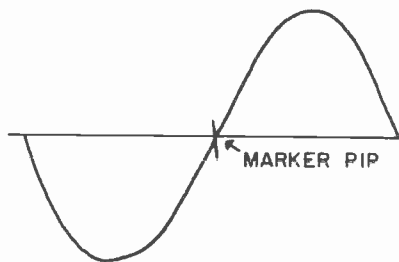

FIGURE 2

September 1963

CHART 3. AM ALIGNMENT

Step	Signal Generator	Generator Setting	Tuning Gang	Connect Scope or Output Meter	Adjustments
1	Radiate Output to L5	455 KC Modulated 400 cycles at 30%	Open	Voice Coil	T2 of CM4 and T1, T2, of IFM-2 for max.
2	Repeat step 1				
3	Radiate Output to L5	1630 KC	Open	Voice Coil	Oscillator trimmer C2C for max.
4	Same	580 KC	580 KC	Voice Coil	AM Oscillator T1 of CM4 while rocking gang.
5	Same	1400 KC	1400 KC	Voice Coil	Peak Antenna trimmer C2B while rocking gang
6	Repeat steps 1 - 5 as necessary				

\*DC Isolate both input antenna terminals with .05 mfd, 200 volts capacitor.

# ELECTRONIC TECHNICIAN TEKFAX

COMPLETE MANUFACTURERS' CIRCUIT DIAGRAMS  
AND TECHNICAL INFORMATION FOR SIX NEW SETS

# 810

**MATSUSHITA**  
Motional Feedback  
Amplifier  
MF800

September 1963

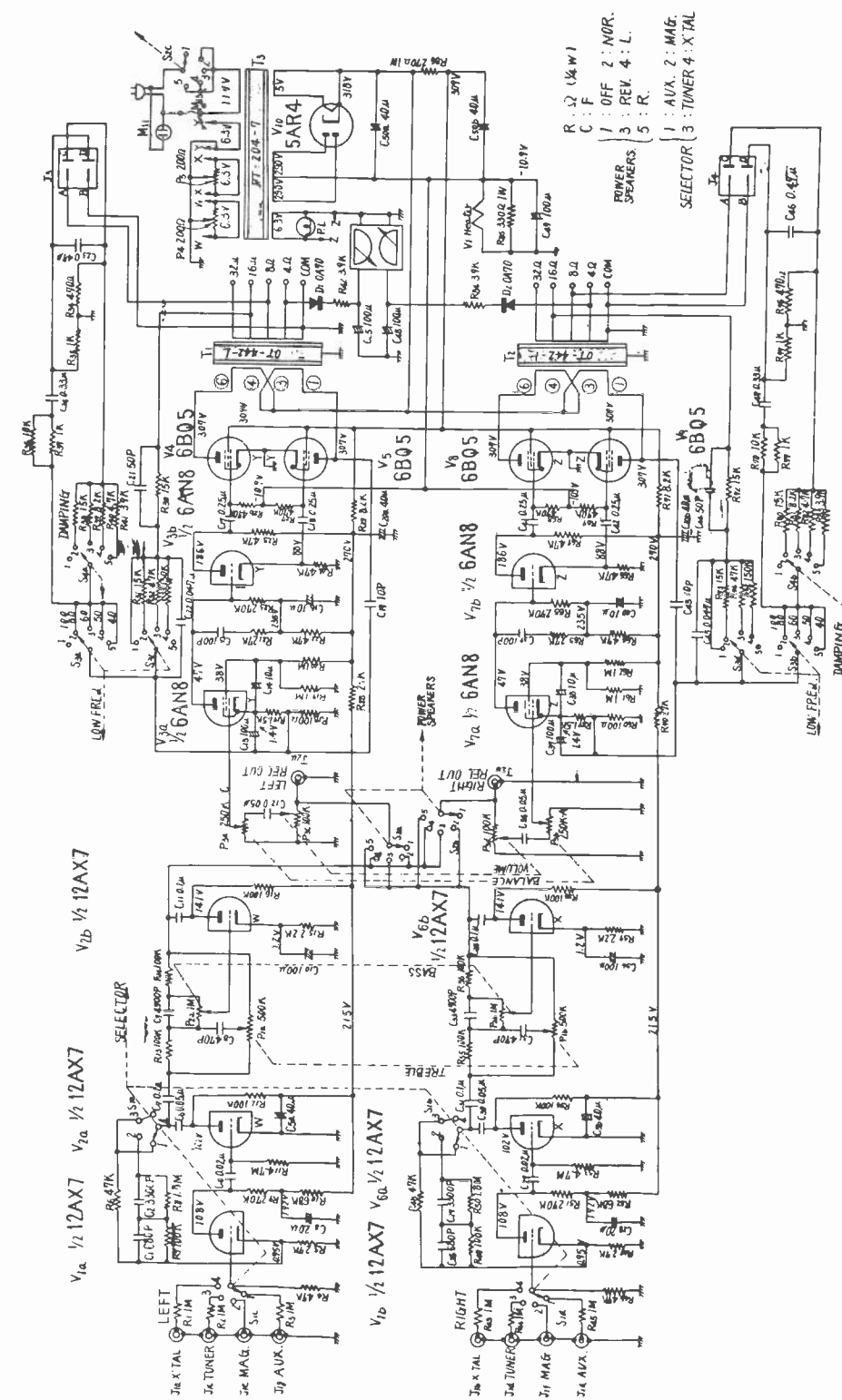







A.

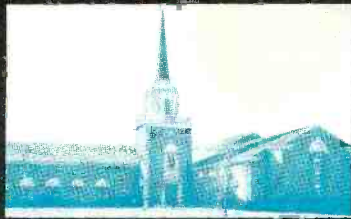

B.



C.



D.



E.

# They turned to Norelco...

## and here's why:

Take the case of (A) Independence Hall, Philadelphia. To tell the "cradle of liberty" story to thousands of visitors, Norelco developed an outdoor sound-and-light spectacle utilizing Norelco equipment... Or look at (B) Parleys Stake House, Salt Lake City, where, for precision of speech reproduction, the answer was a Norelco sound system of microphones, amplifiers and sound columns... (C) The State Department, Washington, wanted the same simultaneous interpreting equipment that Philips installed in NATO Headquarters in Paris. They got it with the Norelco multi-channel system... In (D) Sts. Peter and Paul Cathedral, Philadelphia, the prob-

lem of difficult acoustics in a high-vaulted area was solved with a columnar speaker arrangement... And for the (E) House of Representatives, State Capitol, Denver, the answer again was Norelco microphones, amplifiers and speakers... These, just a handful of the Norelco sound systems in operation, indicate the wide range of equipment and experience available from Norelco—and from no other manufacturer. For full details, check Sweet's File—or write to Dept. ET-9, North American Philips Company, Inc., Commercial Sound Department, High Fidelity Products Division, 100 East 42nd Street, New York 17, New York.

IN CANADA AND THROUGHOUT THE FREE WORLD, NORELCO IS KNOWN AS THE 'PHILIPS'.

### Norelco® Sound Systems

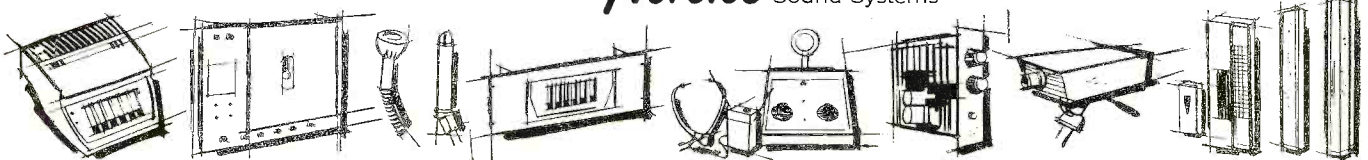

- - - for more details circle 39 on post card





## TRAP FOR FAULTY PICTURE TUBES

### RCA Guards Against Callbacks 26 Ways

Under the watchful eyes of trained inspectors, RCA Silverama® Picture Tubes are carefully scrutinized for screen quality and focus.

All Silverama replacement picture tubes as well as those destined for original equipment undergo a battery of 26 automated tests. These include: warm-up, emission, gas, leakage, electron-gun performance, and other critical factors that can spell the difference between long-term performance or costly callback. Tubes failing a single test are automatically tagged and rejected. In addition to automatic testing, every tube lot leaving the RCA plant has been sampled by Quality Control.

Nothing is left to chance; part by part, inside and out, from base to faceplate the quality of each tube has been carefully controlled and assured prior to assembly. Even the Silverama envelope is carefully inspected prior to re-use, and is internally scrubbed, buffed, and restored to the peak of its optical capabilities. Result: a superior picture tube, an RCA Silverama. Make it your next installation choice.

RCA ELECTRONIC COMPONENTS AND DEVICES, HARRISON, N. J.



**CARRY EACH SILVERAMA FACTORY-FRESH INTO YOUR CUSTOMER'S HOME.** New Foam-Lined RCA Picture Tube Tote Bag makes scratched, marked, or scuffed faceplates a thing of the past. Makes carrying both easier and safer. Two sizes: one for 16" to 19" tubes, one for 20" to 24" tubes.

**SEE YOUR AUTHORIZED RCA PICTURE TUBE DISTRIBUTOR FOR DETAILS**



**The Most Trusted Name in Electronics**