

# ELECTRONIC TECHNICIAN / DEALER

WORLD'S LARGEST TV-RADIO SERVICE & SALES CIRCULATION

OCTOBER 1969  A HARBRACE PUBLICATION



ORDER 2513072X871AD 8625  
HARRIS  
SIDE A/E  
TV CT  
31212

TEKLAB REPORT ON ADMIRAL  
SPECIAL TV ROUNDUP FOR 1970  
THE CAT GAME



# The first and only solid-state test equipment guaranteed for 5 years.

Now EICO, because of its emphasis on *reliability* in engineering and manufacture, offers the industry this breakthrough.

EICO's new line of solid-state test equipment comes with an unprecedented 5-year guarantee of performance and workmanship. (Send

for full details of this EICO 5-year GUARANTEE on factory-assembled instruments.)

Additional advanced features include: new functional design, new color-coordinated esthetics, new PC construction, new easier-to-build kit designs.

## New EICO Solid-State Test Equipment



### EICO 240 Solid-State FET-VOM \$49.94 kit, \$69.95 wired.

One all-purpose DC/AC OHMS Uniprobe®. Reads 0.01V to 1 KV (to 30 KV with optional HVP probe). 7 non-skip ranges, in 10 dB steps. AC or battery operated. RMS & DCV: 0-1, 3, 10, 30, 100, 300, 1000V P-P ACV: 0-2.8, 8.5, 28, 85, 280, 850, 2800V. Input Z: DC, 11 M $\Omega$ ; AC, 1 M $\Omega$ . Response 25 Hz to 2 MHz (to 250 MHz with optional RF probe). Ohmmeter reads 0.2 to 1 M $\Omega$  in 7 ranges. 4 1/2" 200  $\mu$ A movement. HWD: 8 1/2", 5 3/4", 5", 6 lbs.

### EICO 242 Solid-State FET-TVOM \$59.95 kit, \$79.95 wired.

All the versatility of the EICO 240 plus: AC/DC Milliammeter, 1 ma to 1000 ma in 7 non-skip ranges; single all-purpose DC/AC-Ohms — MA Uniprobe®; and large 6 1/2" 200  $\mu$ A meter movement.

### EICO 150 Solid-State Signal Tracer \$49.94 kit, \$69.95 wired.

Multi-purpose troubleshooter for TV/FM/AM & Audio Equipment. Independent RF Audio inputs. Speaker and meter output indicators. 400 mW continuous power output. Substitution amplifier, output transformer, speaker. Input for rated output: 1 mV RF, 63 mV audio.

Hum 60 dB below 400 mW, 105-132 VAC, 50/60 Hz, 5VA. HWD: 7 1/2", 8 1/2", 5", 6 lbs.

### EICO 330 Solid-State RF Signal Generator. \$59.95 kit, \$79.95 wired.

5 fundamental bands 100 kHz to 54 MHz. Vernier control 0-100%. Output 300,000  $\mu$ V into 50-Ohm load. External signal modulation or internal 400 Hz, 0 to 100%. 105-132 VAC, 50/60 Hz, 1.7 VA. HWD: 7 1/2", 8 1/2", 5", 5 lbs.

### EICO 379 Solid-State Sine/Square Wave Generator. \$54.95 kit, \$74.95 wired.

5 sine wave and 4 square wave bands. Low distortion Sultzer feedback FET circuit. Sine: 20 Hz to 2 MHz; 0-7.5V rms into hi-Z; 0-6.5V into 600 ohms Max. distortion 0.25%. Square: 20 Hz to 200 kHz; 0-10V p-p into hi-Z, pos. direction, zero ground. Rise time at 20 kHz less than 0.1  $\mu$  sec. 105-132 VAC, 50/60 Hz, 10VA. HWD: 7 1/2", 8 1/2", 8 1/2", 9 lbs.

## New EICO High Performance Instruments

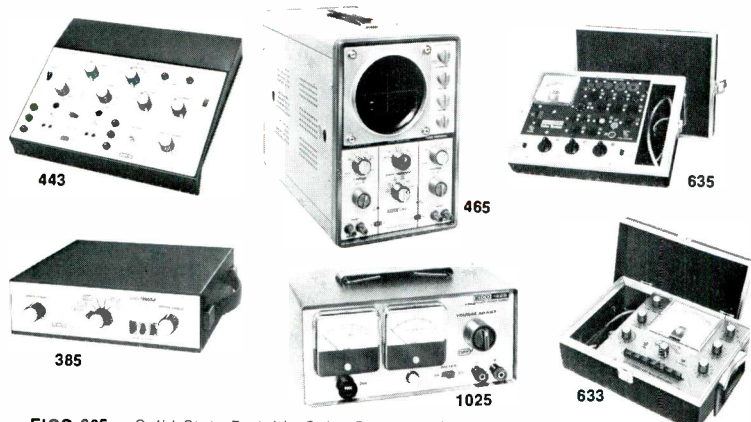

- EICO 385 — Solid-State Portable Color Generator \$79.95 Kit, \$109.95 Wireo.
- EICO 465 — Wideband Vectorscope/Oscilloscope \$179.95 Kit, \$249.95 Wired.
- EICO 1025 — Solid-State Power Supply \$34.95 Kit, \$49.95 Wired.
- EICO 443 — Semiconductor Curve Tracer \$69.95 Kit, \$99.95 Wired
- EICO 633 — CRT Tester & Rejuvenator \$69.95 Kit, \$99.95 Wired
- EICO 635 — Portable Tube Tester \$44.95 Kit, \$69.95 Wired.

## New EICO Probes for the Pros

### Hi-Voltage Probe HVP-5, Wired \$19.95.

Convenient built-in voltmeter. Barrier sections isolate HV tip from handle and meter. Measures up to 30 KV. Lightweight, compact.

### Solid-State Signal Injector Probe PSI-1, Kit \$5.95, Wired \$9.95.

Pen-size, 1-ounce, self-powered signal generator. Frequency range from 1kHz to 30MHz, with harmonics. Clip it to your pocket — ideal for signal tracing in the field.

### Solid-State Signal Tracer Probe PST-2, Kit \$19.95, Wired \$29.95.

Flashlight-size, 2.2oz, self-powered Hi-gain amplifier, 50Hz to 200MHz with demod tip. Input Z: 3500 $\Omega$ , 35K $\Omega$ , 350K $\Omega$ ; Output: 0.3 p-p volts. Noise —45dB. Distortion <5% Complete with earphone, all probe tips, AA battery, pocket clip.

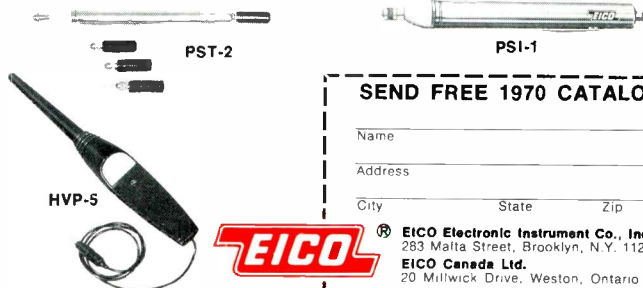

SEND FREE 1970 CATALOG

Name \_\_\_\_\_  
Address \_\_\_\_\_  
City \_\_\_\_\_ State \_\_\_\_\_ Zip \_\_\_\_\_



EICO Electronic Instrument Co., Inc.  
283 Malta Street, Brooklyn, N.Y. 11207  
EICO Canada Ltd.  
20 Millwick Drive, Weston, Ontario



# OVERHAUL

# \$9.75

## GUARANTEED for 1 Year

### OVERHAUL \$9.75 • REPLACEMENT TUNERS...\$10.45

Nine-seventy-five buys you a complete tuner overhaul—including parts (except tubes or transistors)—and *absolutely no hidden charges*. All makes, color or black and white. UV combos only \$15.

Guaranteed means a full 12-month warranty against defective workmanship and parts failure due to normal usage. That's 9 months to a year better than others. And it's backed up by the only tuner repair service authorized and supervised by the world's largest tuner manufacturer—Sarkes Tarzian, Inc.

Four conveniently located service centers assure speedy in-and-out service. All tuners thoroughly cleaned, inside and out... needed repairs made... all channels aligned to factory specs, then rushed back to you. They look—and perform—like new.

SEND ORDERS FOR UNIVERSAL AND CUSTOMIZED REPLACEMENT TUNERS TO OUR OFFICE IN INDIANAPOLIS.

Prefer a universal replacement? Sarkes Tarzian will give you a universal replacement for only \$10.45. This price is the same for all models. The tuner is a new tuner designed and built specifically by Sarkes Tarzian for this purpose. It has memory fine tuning—UHF plug-in for 82 channel sets—universal mounting—hi-gain—lo-noise.

#### ORDER TUNERS BY PART NUMBER, AS FOLLOWS:

Part #	Intermediate Frequency	AF Amp Tube	Osc. Tube	Mixer Heater
MFT-1	41.25 mc Sound 45.75 mc Video	6GK5	6LJ8	Parallel 6.3V
MFT-2	41.25 mc Sound 45.75 mc Video	3GK5	5LJ8	Series 450 MA
MFT-3	41.25 mc Sound 45.75 mc Video	2GK5	5CG8	Series 600 MA

Prefer a customized replacement tuner? The price will be \$18.25. Send us the original tuner for comparison purposes, also TV make, chassis and model numbers.



#### TUNER SERVICE CORPORATION FACTORY-SUPERVISED TUNER SERVICE

<b>MIDWEST</b>	817 N. PENNSYLVANIA ST., Indianapolis, Indiana (Home Office)	TEL: 317-632-3493
<b>EAST</b>	547-49 TONNELE AVE., Jersey City, New Jersey	TEL: 201-792-3730
<b>SOUTH-EAST</b>	938 GORDON ST., S. W., Atlanta, Georgia	TEL: 404-758-2232
<b>WEST</b>	SARKES TARZIAN, Inc. TUNER SERVICE DIVISION 10654 MAGNOLIA BLVD., North Hollywood, California	TEL: 213-769-2720

WATCH FOR NEW CENTERS UNDER DEVELOPMENT

... for more details circle 147 on Reader Service Card



## Our hot ones are the last to go.

The last thing you need is to be called back a day or two after you've replaced the sweep or high voltage tubes in somebody's color TV.

But, they're usually the first to go. Because they get so hot.

So we figured out how to cool them. Now, they last a lot longer.

Take our 6JE6C/6LQ6, for example. It's the horizontal deflection tube that takes such a beating when the set gets hot.

Well, we've given it special patented radiator fins that first absorb the heat and then radiate it out of the tube.

Now it runs cooler and lasts longer. Same for our 6JS6C.

Or take our 6BK4C/6EL4A. That's the shunt regulator that eliminates runaway high voltage. We gave this one a whole new anode and shield design to improve heat transfer and stability.

Now it also runs cooler and lasts longer.

Or take our 3A3B high voltage rectifier. This one's got leaded glass for added protection. And it lasts longer too.

So next time you have to replace any of the hot ones, just cool it. You'll both last longer.

**SYLVANIA**  
GENERAL TELEPHONE & ELECTRONICS



**HUGH "SCOTTY" WALLACE**  
Publisher

**PAUL DORWEILER**  
Editor

**JOSEPH ZAUHAR**  
Technical Editor

**DONNA BUTLER**  
Production Editor

**BOB ANDRESEN**  
Graphic Design

**LILLIE PEARSON**  
Circulation Fulfillment

**JOHN KESSLER**  
Manager, Reader Services

**BERNICE GEISERT**  
Advertising Production

#### OFFICES

757 Third Avenue  
New York, N.Y. 10017  
Phone: (212) 572-4800

43 East Ohio St.  
Chicago, Ill. 60611  
Phone: (312) 467-0670  
Telex: 02-53549

1901 West 8th Street  
Los Angeles, Calif. 90057  
Phone: (213) 483-8530

Harbrace Building  
Duluth, Minn. 55802  
Phone: (218) 727-8511  
Telex: 02-94417

#### MANAGERS

**HUGH "SCOTTY" WALLACE**  
Chicago: (312) 467-0670

**DEAN GREENER**  
Chicago: (312) 467-0670

**ALFRED A. MENEGUS**  
New York: (212) 686-2200

**DONALD D. HOUSTON**  
Los Angeles: (213) 483-8530

**ROBERT UPTON**  
Tokyo, Japan  
I.P.O., Box 5056

#### HARBRACE PUBLICATIONS, INC.

**JAMES MILHOLLAND, JR**  
Chairman of the Board

**JOHN B. GELLATLY**  
President

**RICHARD MOELLER**  
Treasurer

**LARS FLADMARK**  
Senior Vice President

**HARRY RAMALEY**  
Vice President

**JAMES GHERNA**  
Art Director

**WILLIAM SWAIN**  
Director of Marketing Services

**DOUG HEDIN**  
Ad Production Manager

# ELECTRONIC TECHNICIAN / DEALER

WORLDS LARGEST ELECTRONIC TRADE CIRCULATION

OCTOBER 1969 • VOL. 90 NO. 4

## 41 TEKLAB REPORT ON ADMIRAL

Electronic Technician/Dealer's lab technicians present a complete circuit description of Admiral's new 12in. hybrid color portable, Model 2017A with specifications and diagrams.

## 46 THE CAT GAME

Games may not be your thing, but you will find CAT—short for Circuit Analysis and Troubleshooting—interesting, fun reading, and best of all, full of practical service information.

## 50 SPECIAL ROUNDUP 1970 TV

Part one of this two-month preview presents the latest in television equipment for 1970 including specifications and information on new circuit designs.

## 55 ELECTROLYTICS ARE DIFFERENT

This article is must reading as it discusses electrolytic service replacement, what goes into making an electrolytic and what is meant by wide-range tolerance.

## 59 TESTLAB REPORT

Our lab technicians this month take a close look at Leader's new scope, Model LBO-535, and the Model 162 Transistor/FET tester from B&K.

26 EDITOR'S MEMO

28 LETTERS TO THE EDITOR

34 TECHNICAL DIGEST

64 DEALER SHOWCASE

68 COLORFAX

74 NEW PRODUCTS

81 NEWS OF THE INDUSTRY

87 CATALOGS AND BULLETINS

98 AD INDEX

#### COVER

The test instruments used by today's TV-radio technicians are becoming more and more sophisticated, complex and necessary.

#### TEKFAX • 16 PAGES OF THE LATEST SCHEMATICS • Group 206

AIRLINE: TV Model GEN-11460A

GENERAL ELECTRIC: TV Chassis T-5

MAGNAVOX: Color TV Chassis T940

MOTOROLA: TV Chassis TS-465

OLYMPIC: Color TV Chassis CT400

PHILCO-FORD: TV Chassis 20V35



**HARBRACE PUBLICATIONS, INC.**

A subsidiary of Harcourt, Brace & World, Inc.

ELECTRONIC TECHNICIAN/DEALER is published monthly by Electronics Technician, Inc., a subsidiary of Harbrace Publications, Inc. Corporate Offices: 757 Third Avenue, New York, New York 10017. Advertising Offices: 43 East Ohio Street, Chicago, Illinois 60611 and 757 Third Avenue, New York, New York 10017. Editorial, Accounting and Circulation Offices: Harbrace Building, Duluth, Minnesota 55802. Subscription rates: One year \$5, two years \$8, three years \$10, in the United States and Canada. Other countries: one year \$9, two years \$14, three years \$18. Single copies 75¢ in the U.S. and Canada; all other countries: \$2. Second class postage paid at Dansville, New York 14437 and at additional mailing offices. Copyright 1969 by Electronics Technician, Inc.

POSTMASTER: Send form 3579 to ELECTRONIC TECHNICIAN/DEALER, Harbrace Building, Duluth, Minnesota 55802.

**“When we started our business,  
we picked the Yellow Pages as our  
only source of advertising.”**

“Our business started out as a wholesale operation. So we chose the Yellow Pages as our single source of advertising,” says Ken Champlin, general manager of Radio Supply and Engineering Co., Inc., Detroit, Michigan. “The Yellow Pages was a must. It was the best way we could make contact with people and let them know who we were. Now we have two branch locations. And the Yellow Pages helps our customers keep track of



us. When they look through the listings for electronic equipment, they recognize us immediately. Naturally we're the ones they call. We've grown a lot since we

started out. The Yellow Pages has really helped us.”



***An effective  
way to build  
business.***



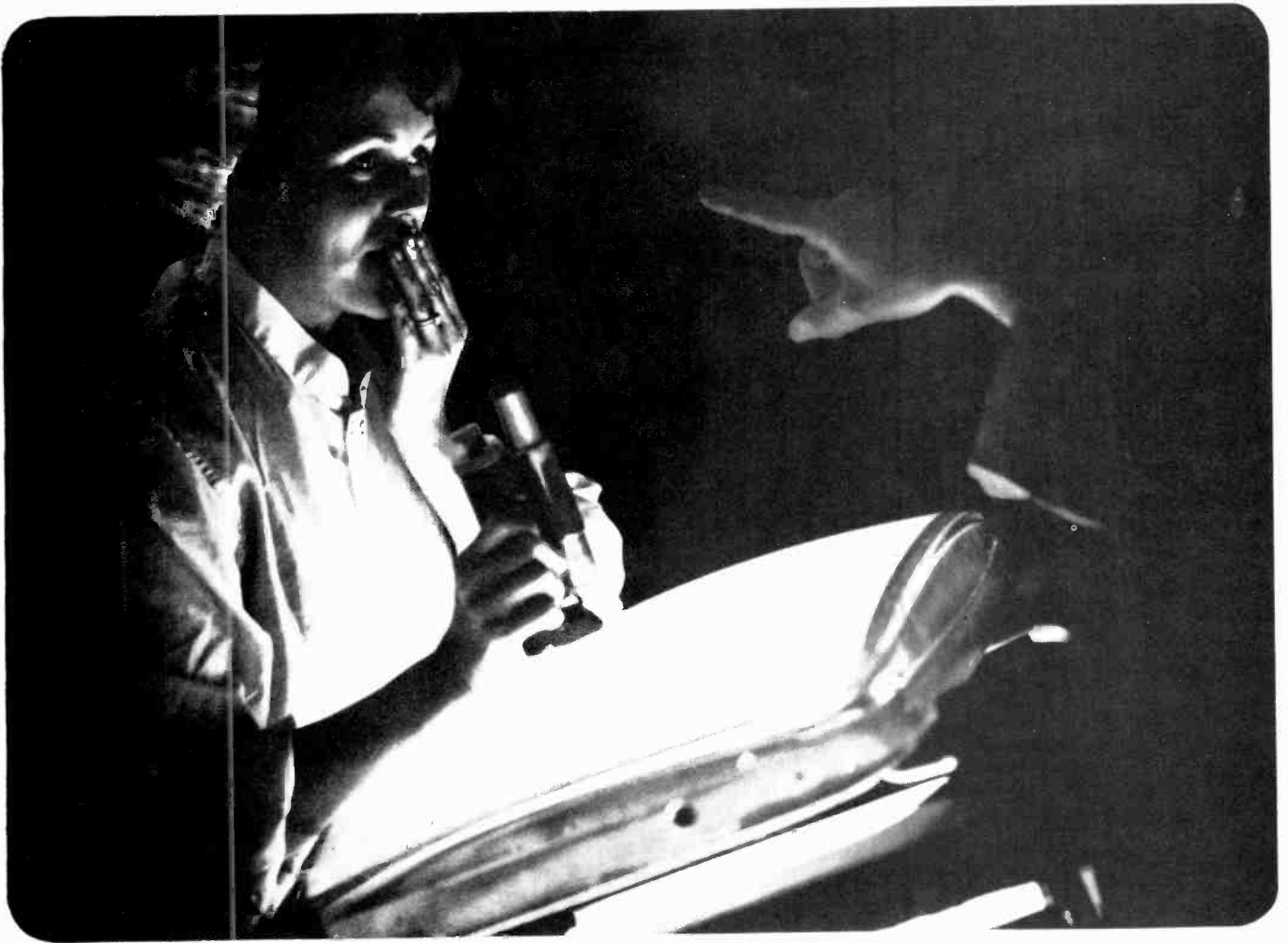

## Just one little mistake... and you're washed up!

That's the way it is at Channel Master.

If a color picture tube's screen doesn't pass precision inspection in 1-2-3 order...green, blue, and red...it's sent back for a complete acid wash-up.

We'll start all over again.

Even our new extra bright gadolinium rare earth phosphors at \$120 a pound go right down the drain when a color screen isn't up to standard.

Regardless of cost, we protect Channel Master's

reputation for producing Color CRTs that equal or exceed industry standards.

That's just one of the reasons why you find Channel Master CRTs in some of today's finest new color sets. It's also why you can point with pride to the Channel Master name on replacement color tubes.

Call your Channel Master Distributor. He's your complete Picture Tube Headquarters.

**At Channel Master YOUR Reputation is OUR Business.**

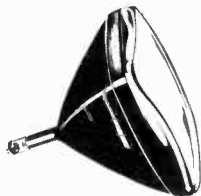

# **CHANNEL MASTER®**

DIVISION OF AVNET, INC., ELLENVILLE, NEW YORK 12428

... for more details circle 111 on Reader Service Card



# NEW AND NOTEWORTHY

## TRANSISTOR/DIODE CURVE TRACER 700

*Obtain direct readout of semi-conductor characteristics on an oscilloscope*

Introduced is the Model 443 transistor-diode curve tracer making it possible to obtain direct readout of semi-conductor characteristics on a general-purpose oscilloscope. Diode and rectifier characteristics that can be displayed include forward voltage, forward current, reverse current and peak inverse voltage. Transistor tests include those for  $h_{FE}$ ,  $h_{OE}$ ,  $ICEO$ ,  $V_{CE}$  (sat) and  $BVC_{BO}$ . Beta can be read directly from the controls on the front panel. A special matching switch allows you to compare or match sets of transistors. The unit features all silicon solid-state printed circuit board construction and dual transformers for isolation and safety. Other features of the curve



tracer include a flashing light to indicate presence of high voltage on the diode test terminals, built-in oscilloscope voltage calibrators and terminals for connecting external test sockets. The price in kit form is \$69.95 and factory-wired, \$99.95. Eico.



## FM RECEIVERS 701

*Compact and easily installed*

Announced is the Model FR-105 FM monitor receiver with a frequency range of 150-175MHz. It is reportedly a good unit for police, fire and other municipal defense or federal departments. The unit is compact employing solid-state circuitry and glass epoxy circuit boards. Other features include: dual purpose transistorized power supply dual limiter and Foster Seely discriminator, quadruple tuned RF stage, plug-in channel crystals, 2X6in. speaker with moisture resistant cone and 1 1/2w audio output. Specifications: Frequency range: FR104 25-50MHz. FR105 150-175MHz. Maximum frequency separation: FR104  $\pm 1$ MHz, FR105  $\pm 3.5$ MHz. Sensitivity: FR104 0.3uv 20db quieting, FR105 0.3 $\mu$ v 20db quieting. Squelch sensitivity: 0.18uv minimum. Selectivity: 6db  $\pm 6$ kHz, 60db  $\pm 3$ kHz. Modulation acceptance:  $\pm 5$ kHz. Audio output: 1.5w into 4.0 $\Omega$ . Power consumption: 4.4w @ 13.8vdc, 17.5w @ 117vdc. Dimensions 6 7/8W x 2 5/8H x 8 1/2in.D. Weight: 3 lb 8oz. Price \$140. Crystals are \$5 each. Sonar.

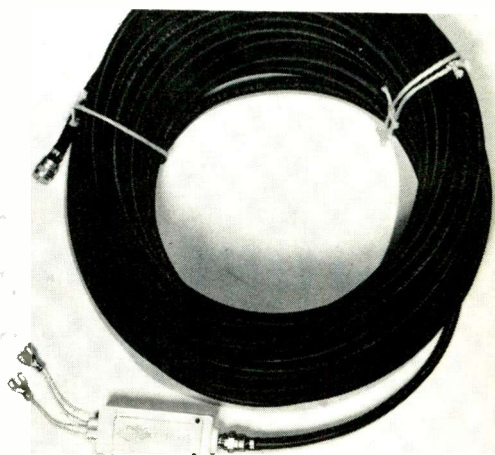

## COAXIAL TV LEAD-IN 702

*Matching transformers included for conversion*

Introduced is a line of coaxial TV lead-in cable to supplement a broad range of twin lead antenna wire. The coax is manufactured in both 59/U 20 AWG and 82 channel 18 AWG with standard F-59 crimped connectors on both ends. Both cable configurations have a foam polyethylene core and black PVC jacket, offering excellent electrical characteristics. Matching transformers are also supplied for converting 300 $\Omega$  antenna systems to 75 $\Omega$  installations. Cable lengths of 50, 75 and 100ft are available and all come in packaged units with installation directions on package. Phalo.

**FOR MORE  
NEW PRODUCTS SEE  
PAGES 64 & 74**



# Heavyweight solder guns were hot news 30 years ago.

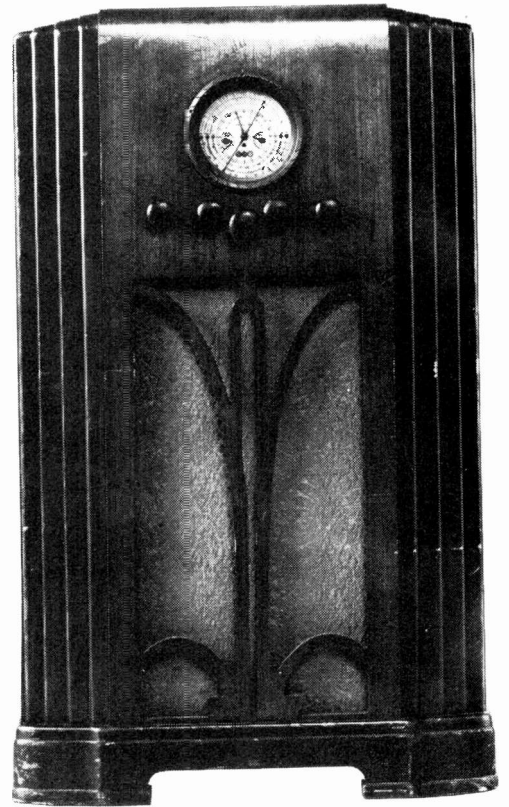

## Now for a look at today's lighter news...

a featherlight solder gun for the delicate, dense micro-circuitry of the '70's. The new Ungar Solid State Solder Gun. Under five ounces. No dead-weight transformer.

To assure you damage-free soldering of IC's and FET's, the tip is "electrically-isolated"—no current leakage.

And, three different interchangeable micro-tips are included. You simply thread them on and off—no need to remove or replace heat cartridge. At a flip of the dual-heat selector switch, you have your choice of a safe 500° or 900°F tip temperature range.

So drop the heavy artillery. Ungar's got the solder gun (#6760) for the solid state age. Fast. Safe. Economical. Under 5 oz.

Call your nearest Ungar distributor or dealer now.  
Or write directly for information.



WEIGHS LESS THAN 5 OZ.



Division of Eldon Industries, Inc., Dept. A2-1  
Compton, California 90220

IN THE AGE OF SOLID STATE, UNGAR OUTGUNS THE HEAVYWEIGHTS.

... for more details circle 141 on Reader Service Card

# the new Gold Rush

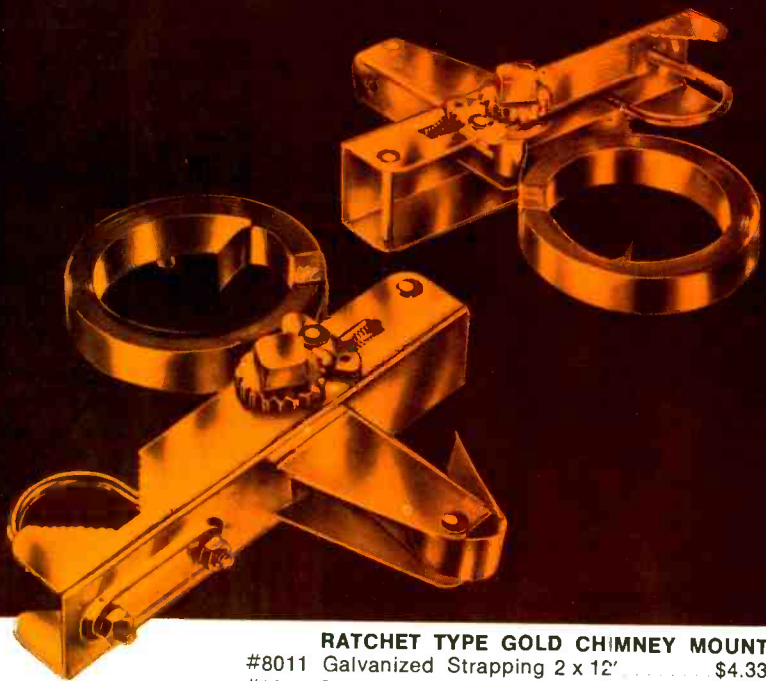

**RATCHET TYPE GOLD CHIMNEY MOUNT**  
 #8011 Galvanized Strapping 2 x 12' ..... \$4.33  
 #8013 Stainless Steel 2 x 12' ..... \$5.18

## There's Profit In Gold

**1. GOLD RATCHET MOUNT** — New gold finish — first available on the market. New heavy gauge — non-strip ratchet features. Here is the quality constructed two-bracket chimney mount designed to give maximum service in high wind, seasonal storms, adverse weather conditions. **2. GOLD TRIPOD TOWERS** — Boxed — contains 6 lag screws supplied with self-adhesive weather patch, 1¼" tubing. **3. GOLD CHIMNEY MOUNTS** — Both Snap-in chimney mounts and GC-Telco "Y" Mounts are heavier gauge metal with new design. GC chimney mounts are strengthened at the stress point. Buy with confidence from the world's largest basic manufacturer of television hardware... you'll make your job easier, faster, and more profitable... more satisfying to your customer.

**GOLD TRI-POD  
TOWER ANTENNA  
BASES**



#9146 3' ..... \$5.86  
 #9145 5' ..... \$9.28

**HEAVY DUTY  
GOLD SNAP-IN  
CHIMNEY MOUNTS**

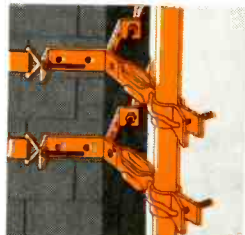

#8646 Galvanized  
Strapping ..... \$3.09  
 2 x 12'  
 #8946 Stainless  
Steel ..... \$4.46  
 2 x 12'

**GC-TELCO GOLD  
CHIMNEY "Y"  
MOUNTS**

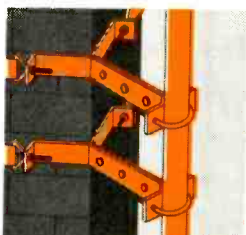

#8616 Galvanized  
Strapping ..... \$3.85  
 2 x 12'  
 #9031 Stainless  
Steel ..... \$5.03  
 2 x 12'



**GC ELECTRONICS**  
 MAIN PLANT: ROCKFORD, ILL. U.S.A.  
 A DIVISION OF HYDROMETALS, INC.



### TV Gyps

The frustrating fact that some people still believe they can get something for nothing leads me to comment on the so-called "crooked TV man." We surely can't kid ourselves that they do not exist.

It hurts, however, when well-read national magazines exploit the practices and bare the "evidence" of a few unethical TV service technicians without giving the real facts or even bothering to cite the irresponsible deeds of these men. A neighbor recently asked if all TV service technicians were "crooked" and how could one be sure he was getting what he paid for. When you consider the number of people who fall for the gimmick ads claiming "free" or almost free color TV service calls, it's easy to see how some of these people get taken to the cleaners. No legitimate service business, regardless of size, can profit from "free" service calls unless the costs are made up in parts and labor as they would have to be in these cases.

As individuals, we can't go out and educate the country as to the facts, but we can do something. We can support the associations concerned with our problems. We can speak with a louder voice if we harmonize - and with a lot less individual effort. And best of all we will be heard. One technician or even a dozen in a medium sized city would be as well off trying to solder transistors with a blow torch as to try to eliminate the public's attitude of "infection by association" bred by a very few unethical "service technicians." Do your own thing, but remember, it's a rare one who gets more than he gives. By the way, if you are interested in joining an association or in becoming a licensed technician, write to Richard Glass, N.E.A., 7046 Doris Dr., Indianapolis, Inc., 46224 or Frank Moch, NAT-ESA, 5906 S. Troy St., Chicago, Ill. 60629.



*Paul A. Horvick*



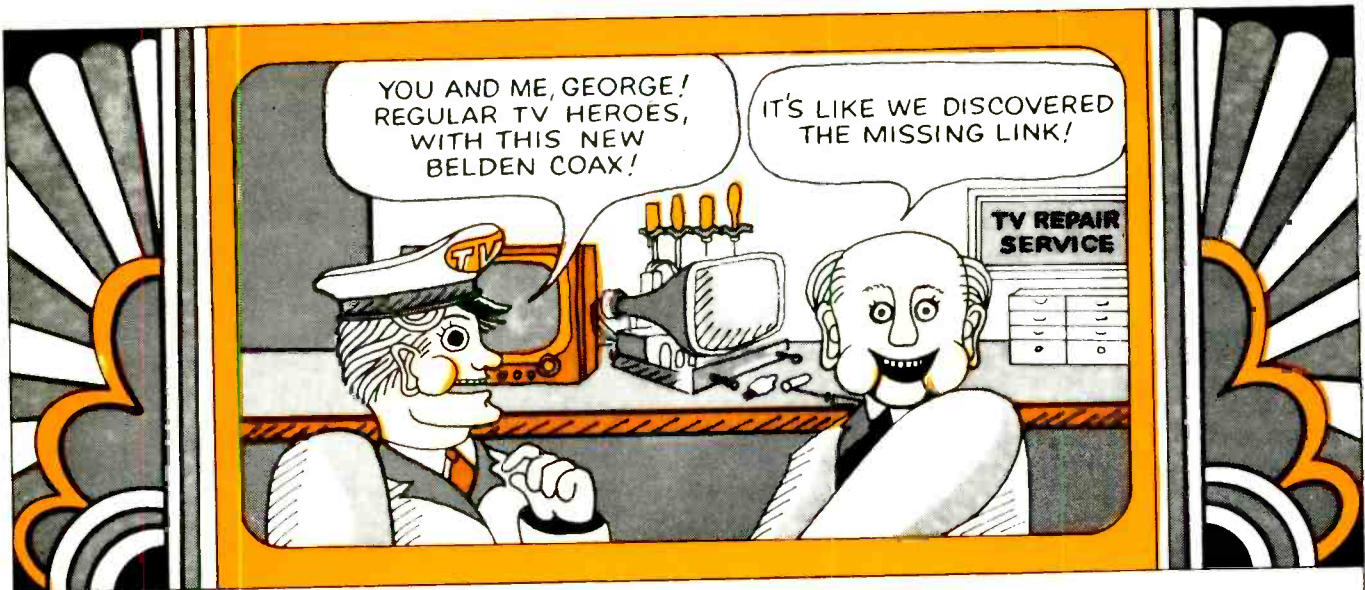

**Jacket**

Black all-weather PVC .030 nominal wall with a .242" nominal O.D.

**Dielectric**

Low loss cellular polyethylene, .180" nominal O.D.

**Conductor**

18 AWG solid, annealed, bare copper.

**8228 BELDEN DUOFOIL**

**Drain Wires**

4-28 AWG solid tinned copperweld conductors applied spirally and positioned uniformly around the circumference of the shield.

**Shield**

Belden DUOFOIL 100% shield is a polyester film with aluminum lamination on both outside surfaces.

THE MISSING LINK TO PERFECT VHF AND UHF COLOR AND B/W RECEPTION

**BELDEN 8228 DUOFOIL®**

75 OHM COAXIAL CABLE • 100% SHIELDED • 100% SWEEP TESTED



For MATV distribution systems, DUOFOIL is the finest coax yet. Its low loss, 100% shielding keeps B/W and color VHF and UHF signals pure. Apartment dwellers, hotel and motel tenants, etc.—even in congested areas—get sharp, clear reception. Its small diameter provides extra space savings in conduit installations.

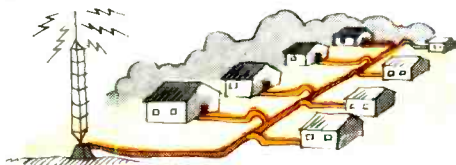

Is CATV coming into your area? DUOFOIL is the perfect underground drop cable. Its exceptional flexibility and moisture resistance assures extra-long service life, and preserves the impedance values of the cable design.

**LOW, LOW ATTENUATION**

Nom. Attenuation per 100'	
mc	db
50	1.5
100	2.1
200	3.1
300	3.8
400	4.5
500	5.0
600	5.5
700	6.0
800	6.5
900	6.9

Available in 100, 500 and 1000 ft. spools. See your local Belden Distributor for full details or to order. For a copy of the reprint article, "Electronic Cable," write: Belden Corporation, P.O. Box 5070-A, Chicago, Illinois 60680.

Don't forget to ask them what else needs fixing?



B-5-8

... for more details circle 106 on Reader Service Card

# Dyna-flex\*

the only practical probe  
for testing  
transistors in circuits.

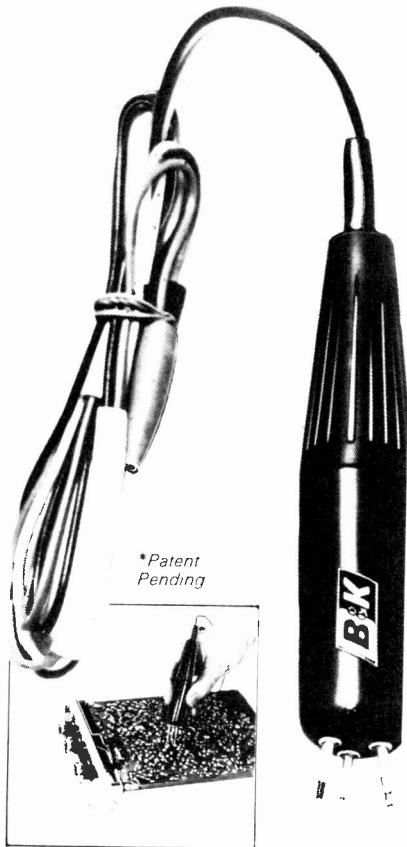

Throw away your alligator clips! Dyna-flex, the world's first and only 3-point probe, makes instant test connections to transistors in printed boards. Easy to use, the Dyna-flex probes are spring-mounted on ball joints. Allow you to adjust to any spacing 1/32" to 5/8", using only one hand. Dyna-flex eliminates costly unsoldering; can be used to make temporary component substitutions on printed wiring boards. Each point is color-coded for fast, easy identification. Dyna-flex—another engineering breakthrough from B&K.

Model FP-3, \$12.95 user net



B&K Division of Dynascan Corporation  
1801 W. Belle Meade Avenue, Lincoln, Illinois 60613  
Where Electronic Innovation Is A Way Of Life

... for more details circle 105 on Reader Service Card

ET/D

## LETTERS TO THE EDITOR

### Obsolete Test Instruments

Some time ago I purchased a B&K Model 700 tube tester. This is advertised as a mutual conductance tester costing \$189.50. I believe this to be inaccurate as the lower half of the tester appears to be strictly emission tests. The grid lead does absolutely nothing. Also, the relative control settings would indicate an emission tester rather than dynamic. My supplier insisted it was dynamic even after I complained. I feel there are many areas of the electronic test instrument field that need investigation including their rapid obsolescence and the reduced warranty time to a ridiculous 90 days. I would be pleased to hear if other technicians have had similar problems.

E. K. McNEILL

12530 "B" Hawthorne Blvd.  
Hawthorne, Calif. 90250

### Wants TV Shop

I would like to purchase an established one-man TV servicing business that has growth potential. I prefer the southeastern Florida area but would accept the Gulf coast. I would prefer a snapshot with the first letter.

D. MIHYCHUK

755 Giasson St.  
Seven Islands, Que.

### Letters Pay Off

About a month ago, I received a very fine letter from Marvin L. Thall, product services manager of Jerrold Electronics Corp. Enclosed was a copy of the firm's catalog soon to be released.

Here's the story. Back in September '67 ET/D, a series of articles (Antennas--Sans Bafflegab and Bushwa) began. The first article was good but I wrote in and offered some words of criticism in regard to the antenna business. One of the major complaints was the lack of adequate data on all brands of antenna equipment which prevented us from applying them to best effect. Some of the things suggested were adequate gain figures for all channels and *calibrated* polar graphs.

Because of that letter, the new Jerrold catalog does just that!

It would seem, therefore, that your

magazine is widely read and not just by electronic technician-dealers. Also, it would appear that it does do some good to speak your piece where it will be heard. Some people do listen and show concern for our problems.

This is a business in which all too often the little man is over-run, expediency is the criterion of performance and the quick dollar is the main objective—but not always!

I'd like to see an editorial urging all electronic technician-dealers to say what they feel strongly about and let the chips fall as they may. Maybe if enough men agitate strongly enough we can direct the course of our business so as to benefit all of us. My letter was published over a year ago and I had forgotten it. But it had results beyond my expectations.

FRANCIS C. WOLVEN

RFD 2, Box 144  
Saugerties, N.Y. 12477

### Defective Parts

I recently had occasion to replace the yoke on a Zenith Chassis No. 14N33Z television receiver. The yoke recommended by available information was a Thordarson Y-105.

The Y-105 was purchased from a local electronics parts supply house, and, on inspection, it was revealed that construction of the unit left much to be desired. The plastic material from the base or shield, on which was mounted the centering assembly, was very soft and distorted completely out of shape, a definite indication of the poorest sort of manufacture, either in specifications or poor assembly. Further, on connecting the yoke in the chassis, it did not operate satisfactorily. Vertical controls were not properly responsive and the width control had no effect whatever. In addition, a thermistor which was a part of the original yoke and supplying voltage to the vertical size control, was not included. There was no practical way to install the thermistor in the Y-105, although I connected it temporarily for a bench test.

With replacement parts such as this made available to the trade it is no wonder that so many of us are rated "jack-legs," and cited for turning out work that is unsatisfactory to the customer.

It is suggested that this matter be investigated and that the proper steps be taken to correct it.

GEORGE W. THOMPSON

2039 Mount St., Box 162  
Orange Park, Fla. 32073

# Sprague makes the best components on Earth

**(Now they're on the moon, too!)**

More than 53,000 Sprague components flew in the Apollo 11, many of which landed on the moon with Lunar Excursion Module EAGLE.

A high degree of reliability is also built into the Sprague capacitors, resistors, and transistors you use in TV-radio service work.

For complete listings of Sprague components for the service trade, get Catalog C-619 from your Sprague Distributor, or write to:  
Sprague Products Company, 65 Marshall Street,  
North Adams, Massachusetts 01247



**THE BROAD-LINE PRODUCER OF ELECTRONIC PARTS**

**SPRAGUE®**  
THE MARK OF RELIABILITY

'Sprague' and '®' are registered trademarks of the Sprague Electric Co.

... for more details circle 139 on Reader Service Card



**Readers' Aid**

Have been enlightened by your excellent magazine for a number of years now. Just keep up the good work.

We have an 8in. Delmonico TV receiver on the bench requiring a new flyback-transformer, Part #A-30174A. Have written to Delmonico Int'l Corp. in Maspeth, N.Y., several weeks ago, but no reply.

Would any of your loyal readers

know where parts might be obtained for this set? It's a Model #8PV-47U. If parts for these imports are not to be made available in this country, the customer should be so advised prior to purchase and told that these are "throw-away" receivers.

R.P. FROHWERK

4330 S.E. Woodward St.  
Portland, Ore. 97206

As a subscriber, I enjoy your magazine very much. The data comes in mighty handy.

I have a problem and hope that your

readers may be able to help me. I need an original or substitute tube for a Grundig model 4570U/ST stereo FM receiver. I can find no data or listing whatsoever for the EAF-801 tube. I need the information or the tube.

I will gladly pay for any efforts a reader undertakes in this regard and will certainly appreciate it.

M.W. JEWETT

RFD 5  
Schenectady, N.Y. 12306

I have in the shop a Japanese made 8in. television set, Model 8T61A. I need a schematic, service data and the name of a parts supplier. The only information available so far is that it was distributed through the American Mercantile Co. of Seattle, Wash., but it is not listed in the Seattle directory of the telephone company. Any assistance offered will be appreciated.

One of my chief activities is the rebuilding and refinishing of antique radios dating back to the 1920s. I have Riders manuals through volume 16 and would be interested in purchasing the rest of them with an index volume, or the complete set if reasonable.

BURNIE WATKINS

147 S.E. Freeman Dr.  
Corvallis, Ore. 97330

I need a schematic for a NATCO 16mm sound motion picture projector Model 3015 manufactured in Chicago. The company went out of business 20 years ago. I will be glad to defray the cost of any reader who can loan or sell me the schematic.

JOHN L. LATIMER

Star Trailer Park  
Bradenton, Fla. 33505

*Our thanks to the many readers who have sent us compliments. We sincerely appreciate them as well as requests for information. However, to expedite an answer to your letter, we suggest that you print your name and address on the letter itself.....Ed*

**ERRATUM**

The "Selling CCTV" feature in the August issue of ELECTRONIC TECHNICIAN/DEALER (page 46) showed several CCTV units. The camera on page 47 was incorrectly identified as an Amperex Model CC-6007. It should say Ampex Model CC-6007. The videotape recorder on page 50 should be an Ampex Model VR-5100.

# One company dominates the sound column field...

## ARGOS.

*And you reap the profits! Why?* Because as an Argos TSSD (Total Sound System Distributor), you have the tools to do the job right, starting with the product itself. Argos "Sound Directors" are not just boxfuls of speakers. Each is a carefully engineered sound system designed to do a specific job, with models for voice reinforcement, background music, hi-fidelity, big rooms, little rooms, indoors or out. They're also easy to install and aim with Argos' exclusive Speedy Mounting Clips and Focus Gauge.

Fifteen minutes with our booklet, "Sound Solutions to Sound Problems with Sound Columns," will help you solve 95% of the speaker system problems that come your way. But it takes more than even this to be the industry's leading sound column people. Let us show you the rest. Write today.

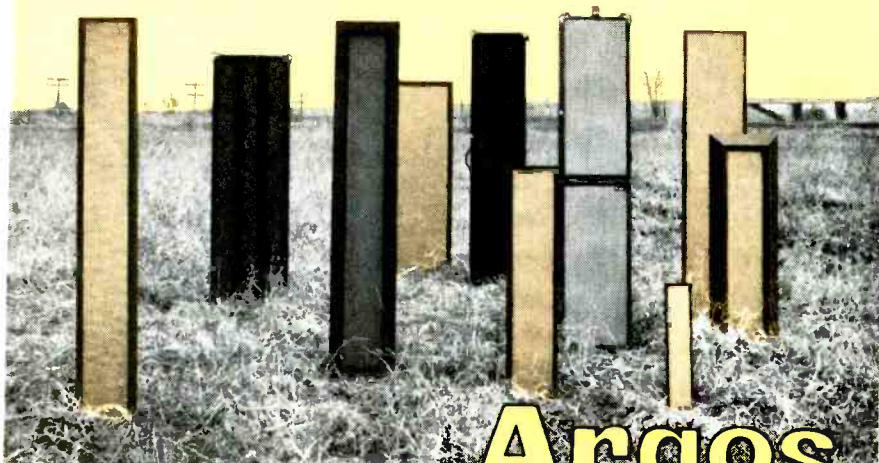

**Argos**  
PRODUCTS COMPANY  
600 South Sycamore Street  
Genoa, Illinois 60135

See the "Block Buster" Display Deal at the N.E.W. Show Booth C119

# Engineered for outstanding reception— Zenith outdoor antennas for Color TV!

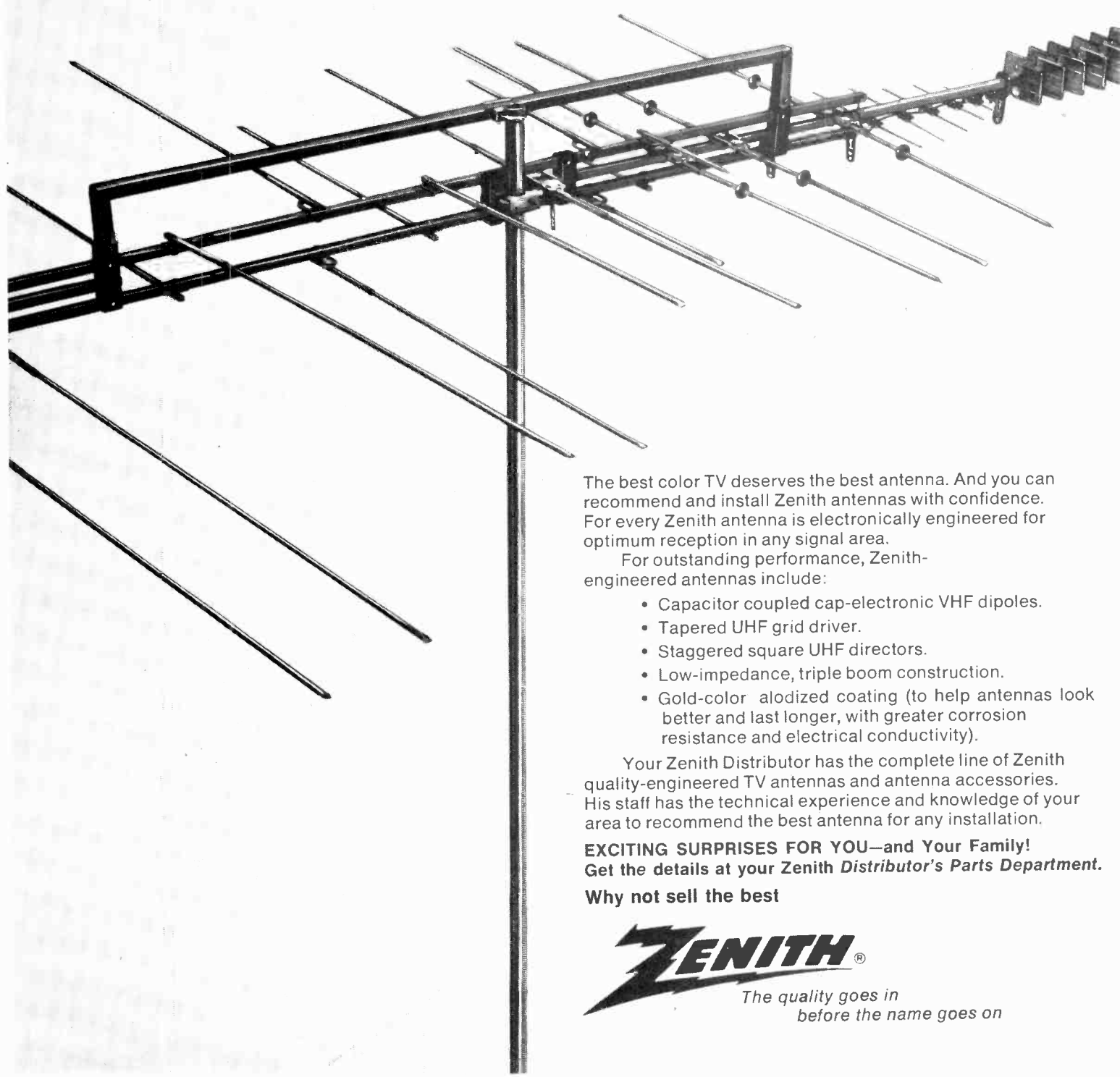

The best color TV deserves the best antenna. And you can recommend and install Zenith antennas with confidence. For every Zenith antenna is electronically engineered for optimum reception in any signal area.

For outstanding performance, Zenith-engineered antennas include:

- Capacitor coupled cap-electronic VHF dipoles.
- Tapered UHF grid driver.
- Staggered square UHF directors.
- Low-impedance, triple boom construction.
- Gold-color alodized coating (to help antennas look better and last longer, with greater corrosion resistance and electrical conductivity).

Your Zenith Distributor has the complete line of Zenith quality-engineered TV antennas and antenna accessories. His staff has the technical experience and knowledge of your area to recommend the best antenna for any installation.

**EXCITING SURPRISES FOR YOU—and Your Family!**  
Get the details at your Zenith *Distributor's Parts Department*.

**Why not sell the best**

**ZENITH<sup>®</sup>**

*The quality goes in  
before the name goes on*

# The only complete

# SWEEP & MARKER GENERATOR

\$395.00

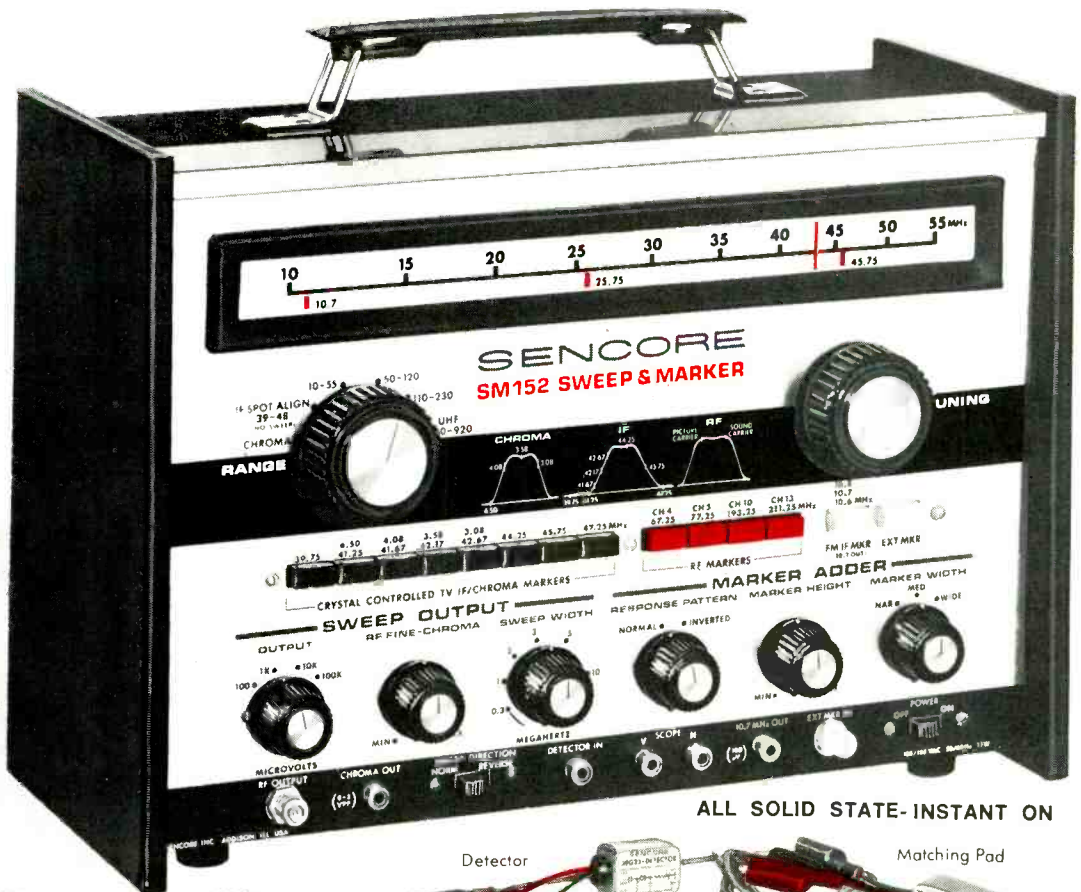

ALL SOLID STATE-INSTANT ON



## FREE WITH YOUR SWEEP AND MARKER:

80 full color reproductions direct from Sencore technical training film clearly depicts alignment from beginning to end using SM152. Pictures are numbered so you can review a section at a time if you are in trouble. 35 minute LP record direct from film clearly leads you all the way. Also packed with each SM152. Numbers are announced for each picture so you can review a section when necessary.

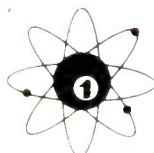
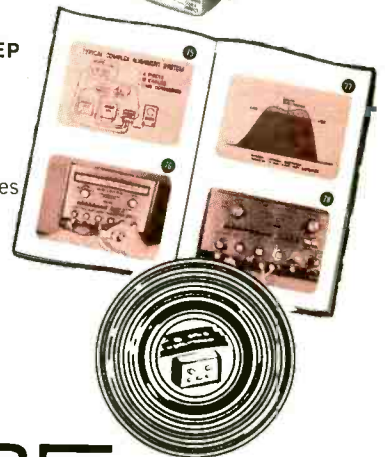

# SENCORE

NO. 1 MANUFACTURER OF ELECTRONIC MAINTENANCE EQUIPMENT

426 SOUTH WESTGATE DRIVE, ADDISON, ILLINOIS 60101



# ONLY GENERATOR THAT GIVES YOU A COMPLETE IF, CHROMA, ALL CHANNEL VHF, UHF AND FM ALIGNMENT SIGNALS IN ONE UNIT

## complete IF SWEEP AND CRYSTAL CONTROLLED MARKERS

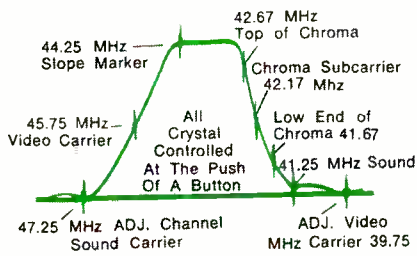

View the complete IF response curve with full 15 MHz sweep width (competition has only 12 MHz, restricting view on RF and some solid state receivers that have extra traps). Press one or all of the crystal controlled marker push buttons without upsetting response curve. Post injection is used all the way to prevent overloading the TV receiver. Crystal markers are provided for all critical check points as shown on the response curve. Also sweeps 20 MHz IFs as found on older sets and new import color sets. Major competition does not cover these frequencies. Special spot align position converts the sweep generator to a regular signal generator for spot alignment or dipping odd traps. Only Sencore goes all the way.

Note that Sencore has a base line giving you a reference to zero. Competitive models do not.

## complete CHROMA SWEEP AND CRYSTAL CONTROLLED CHROMA MARKER

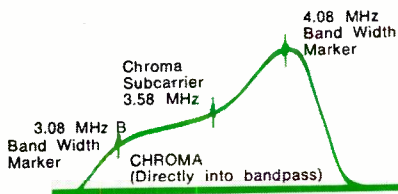

You can inject the chroma signal directly into the chroma amplifiers as shown here or through the IF amplifiers for a flat response. You are equipped to follow manufacturer's recommendation either way. Injection directly into the chroma amplifiers is a must for fast trouble shooting of color circuits.

## complete ALIGNMENT SIGNALS FOR VHF TUNER OR OVERALL ALIGNMENT

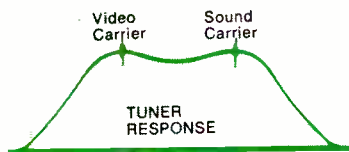

The SM152 sweeps all of the VHF channels for complete tuner check from channel 2 through 13. Competitive models sweep only two VHF channels. Push button markers are provided for channels 4, 5, 10 and 13 for both the video carrier and the sound carrier. The second low and high channels are available in case you have a station operating on the same channel . . . which will cause the patterns to be upset. You want to align on an unused channel and check it on the channel in operation for best results. Only Sencore goes all the way.

## complete UHF SWEEP FROM CHANNEL 14 THROUGH 82



After completely aligning a TV set, you'll want a complete check on the UHF tuner to be sure that it is operating on all channels. Markers aren't necessary as you just view the RF or over-all curve to see that the curve looks the same as the VHF and output remains reasonably constant. Only Sencore has UHF output; all new tuners are required to cover all UHF channels and you will come up short if you own any other alignment generator than the SM152. A UHF sweep generally costs hundreds of dollars more.

## complete FM SWEEP AND CRYSTAL CONTROLLED MARKERS

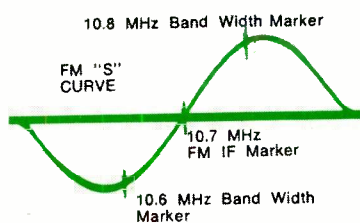

You won't be stopped with just TV alignment. You can align the IF amplifiers of the FM receivers with the 10.7 MHz crystal for maximum as indicated in service manuals. Then, throw on the scope and sweep the amplifiers and view the "S" curve if you have stereo. Two markers, 100 KHz above and below the 10.7 MHz mark the limits of the curve for good stereo. You can align the front end of the receiver too. Competitive units cover only the IFs and you find the job only half done.

There are other features too numerous to mention that makes the Sencore SM152 the most complete sweep and marker generator on the market. Ultra linear sweep from 10 MHz to 920 MHz, exclusive calibrated sweep width that is constant on all channels

and RF calibrated output for circuit trouble shooting are only a few of the things that places the SM152 in a class by itself. Dare compare and you'll see your distributor today for a good look at the SM152.

... for more details circle 135 on Reader Service Card

The material used in this section is selected from information supplied through the cooperation of the respective manufacturers or their agencies.

## ADMIRAL

### Bench Setup for Alignment

One of the recent changes suggested in radio and TV service manuals is the bench equipment setup shown. A permanent setup such as this will save you time.

Alternate equipment may be substituted, provided that

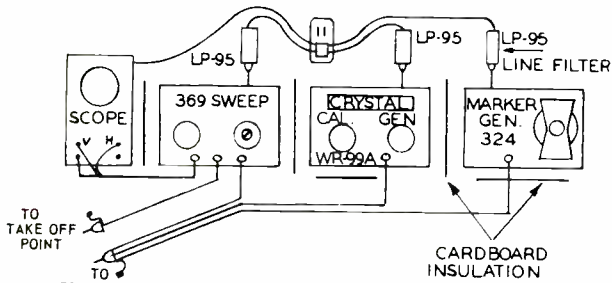

TELEVISION EQUIPMENT SETUP

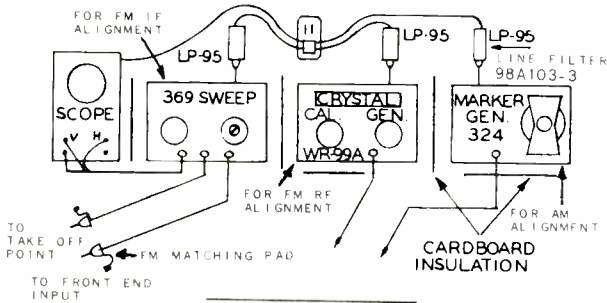

RADIO EQUIPMENT SETUP

you know it is reliable, stable and capable of doing the job. This same setup is used for both television and radio with alternate sets of cables.

Correct termination of the equipment is mandatory for maximum transfer of signal without inducing distortion. Some equipment is designed with an output impedance of 90 Ω; some with 50 Ω. Consult the equipment instruction booklet for the correct value. The coaxial cable from the equipment must have approximately the same impedance as the equipment output and the matching network must be correct for the cable impedance. The recent manuals show networks for both types of equipment. We suggest using RG58A/U coaxial cable for 50 Ω impedance and RG62A/U coaxial cable for 90 Ω because the stranded wire used in these cables provides greater flexibility.

## GENERAL ELECTRIC

### TV Chassis S-2, P-1 and P-2—Intermittent Audio

The small, green, .047μf capacitors used in the audio circuits of S-2, P-1 and P-2 chassis receivers may cause complaints of intermittent audio. In S-2 chassis receivers, these capacitors are designated C309, and in P-1 and P-2 chassis receivers, they are designated C304 and C310.

If C309 (S-2 chassis) or C310 (P-1 and P-2 chassis) opens, audio is lost, sync buzz becomes pronounced and off channel white noise is normal. There is very little effect on the audio quality when these capacitors are shorted.

In P-1 and P-2 chassis receivers an open C304 causes reduced audio, sync buzz and no white noise when the tun-

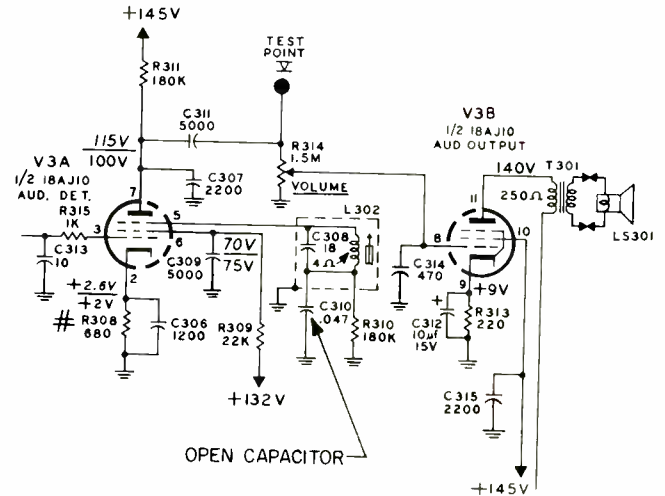

er is switched to an unused channel. A shorted C304 upsets the bias of Q301 and causes loss of audio.

## PHILCO-FORD

### Hi Fi Amplifier Chassis R20—Production Run Change

Run Number 2—Resistors AR14A and AR15A have been inserted in series with the ground connected lug of the associated bias controls AR14 and AR15 as shown in the illustration.

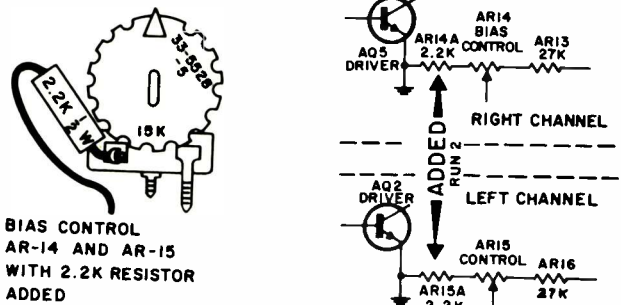

tration. Run Number 2A—An equivalent stop was added to body of pot as a 2.2K stop in place of the resistors.

This change prevents the possible danger of damage to the associated push-pull output transistors should extreme and rapid rocking of the control adjustment arm take place during bias adjustment.

If and when service is being rendered on the first production, Run #1, R20 amp chassis, it is strongly suggested that the two bias pots, AR14 and AR15, be removed and reinstalled with a 2.2K added so that this protective improvement will be incorporated. CAUTION: Use care in soldering resistors to bias control ground terminal to prevent solder flux from running up into the control.

### Hi Fi Amplifier Chassis R20ST Tuner—Hum On Multiplex Operation

Should there be noticeable hum interference when the R20ST tuner is receiving FM stereo and the hum disappears when the Stereo/Monaural switch is placed in no aural position, the following change may be applied.

Disconnect the orange multiplex B+ lead from terminal M3 on the amplifier PW panel and relocate to the opposite side of R4A (330Ω).

Think of it  
as a  
gift box!



Open here to select your gifts!



# tubes in this famous box!

t points!

12. Tripoley® Game Set  
95 gift points



15. Super Spirograph®  
160 gift points



18. GE Toast-R-Oven  
825 gift points



13. Swinging Doll  
200 gift points



17. GE Deluxe Blender  
1,115 gift points



4. European  
Cheese Assortment  
100 gift points



11. Paint By Number Set  
110 gift points



19. GE Automatic Griddle  
715 gift points



14. Sandlot Slugger®  
170 gift points



Steak Package



7. Imported Cheese &  
Cocktail Set  
240 gift points

21. GE Buffet Skillet  
665 gift points





# Great gifts cost you nothing with

GE Tube purchases earn gift



8. Imported Gourmet Snack Basket  
280 gift points



6. Imported Ham Buffet  
215 gift points



9. Complete Spice Rack  
195 gift points



10. Kenner Easy Bake C  
305 gift points



5. International Sweets®  
160 gift points



20. GE Deluxe Coffeemaker  
495 gift points

16. GE Cassette Recorder  
990 gift points



1. \$15 Prime Steak Package  
by Pfaelzer  
485 gift points

2. \$20 Prime S  
by Pfaelzer  
645 gift poi



3. Complete Turkey Dinner  
or \$25 Prime Steak Package  
by Pfaelze-  
805 gift points



# Ask your participating General Electric Tube Distributor for the tubes in the Gourmet Gift Holiday box.

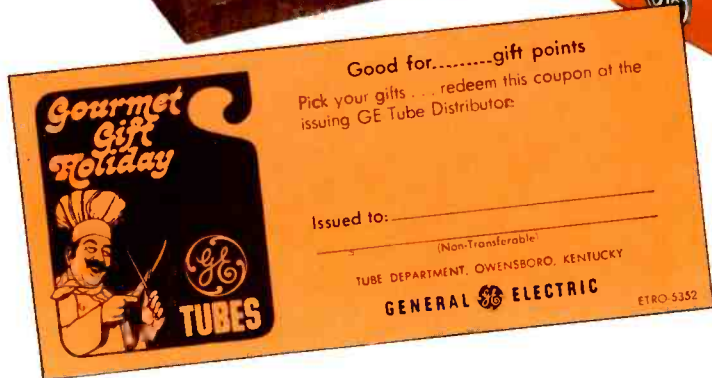

Start saving gift points today.  
Get great gifts for your family  
that will cost you nothing with  
the purchase of GE Tubes.

TUBE DEPARTMENT  
OWENSBORO, KENTUCKY

GENERAL  ELECTRIC



# Weller®

## makes dependable soldering the easiest part of servicing.

Weller has done more than anyone else to simplify soldering. Weller innovations began with the soldering gun. And they've continued ever since. With the development of new tools and advanced features.

All designed to give dependable, noise-free soldered connections quickly, efficiently and easily. Is there any wonder why more service technicians use Weller than any other soldering tools?



### Weller Dual Heat Soldering Guns

Preferred by technicians for their unmatched benefits. Tip heats instantly when trigger is pulled. Two trigger positions permit instant switching to low or high heat. Low heat prevents damage to sensitive components, yet high heat is there when you need it. Gun also offers high soldering efficiency, long-life copper tip, spotlight, perfect balance and maximum operating comfort.

#### 3 Dual Heat Models

- Model 8200 100/140 watts
- Model D-440 145/210 watts
- Model D-550 240/325 watts

### Weller 25-watt Technician's Iron

Industrial rated. Weighs only 1¾ ounces. Delivers tip temperatures to 860°F. Cool, impact resistant handle. Recovers heat rapidly. Model W-PS with 1/16" tip.



### New Weller TEMPMATIC®

### Temperature Controlled Soldering Tool

Combines all the advantages of a light-weight pencil iron, a fast heating soldering gun and tip temperature control. Ideal for heat sensitive work, yet it handles heavy-duty jobs with speed. Weighs only 7 ounces. Reaches full heat in 10 seconds. Exclusive interchangeable Powerhead contains Weller's temperature control system. Gives maximum component protection, eliminates frequent tip changes and filing.

MODEL GT-7A comes with 700°F 3/16" chisel point Powerhead

MODEL GT-6B comes with 600°F 1/8" conical point Powerhead

### MARKSMAN Soldering Irons



Model No.	Watts/120V	Weight
SP-23	25	1¾ oz.
SP-40	40	2 oz.
SP-80	80	4 oz.
SP-120	120	10 oz.
SP-175	175	16 oz.

Ideal for deep chassis work, the caddy, and on-the-job soldering. Marksman irons outperform all others of their size and weight. All models feature stainless steel barrel and replaceable tip.

# Weller®

WELLER ELECTRIC CORP., Easton, Pa.

WORLD LEADER IN SOLDERING TOOLS

**JFD is ready!... 20 million homes are ready!...  
Get ready... get set... go with new**

# **JFD** Home Entertainment Program Center Kits

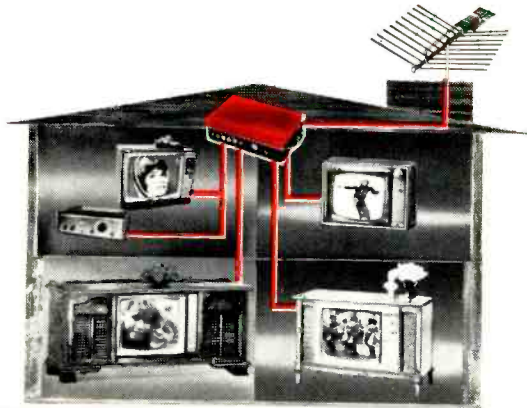

- ★ Provide up to 4 TV sets with *different* programs — from 1 antenna.
- ★ Beautifully packaged in *full-color carry-home* display carton.
- ★ Distribution amplifier powerful enough to drive up to 12 sets — with additional splitters.

Whether you install it yourself or sell it over-the-counter, the unique JFD Home Entertainment Program Center Kit gets you in on the ground floor of a lucrative new untapped market — 20 million households with two or more sets that can use a distribution system.

**Make every home an entertainment center!**

**Thousands of old home owners, new home owners, contractors, and builders in your area are ready-to-buy prospects for (4) JFD Program Center Kits**

**Easy to sell!  
Easy to install!**

SEE YOUR DISTRIBUTOR  
OR WRITE FOR OUR PROMOTION KIT



**JFD ELECTRONICS CORP.**

SUBSIDIARY OF BIKER-MAXSON CORP.

15 AVENUE AT 62 STREET, BROOKLYN, NEW YORK 11219

JFD INTERNATIONAL, 2200 SHAMES DRIVE, WESTBURY, N.Y. 11590 / JFD CANADA LTD., ONTARIO, CANADA

JFD DE VENEZUELA, S.A., AVENIDA LOS HATUICOS 125-97, MARACAIBO, VENEZUELA

© 1969 JFD



**ET/D** TEKLAB REPORT

# A Technician Views Admiral's Model 2017P Color TV

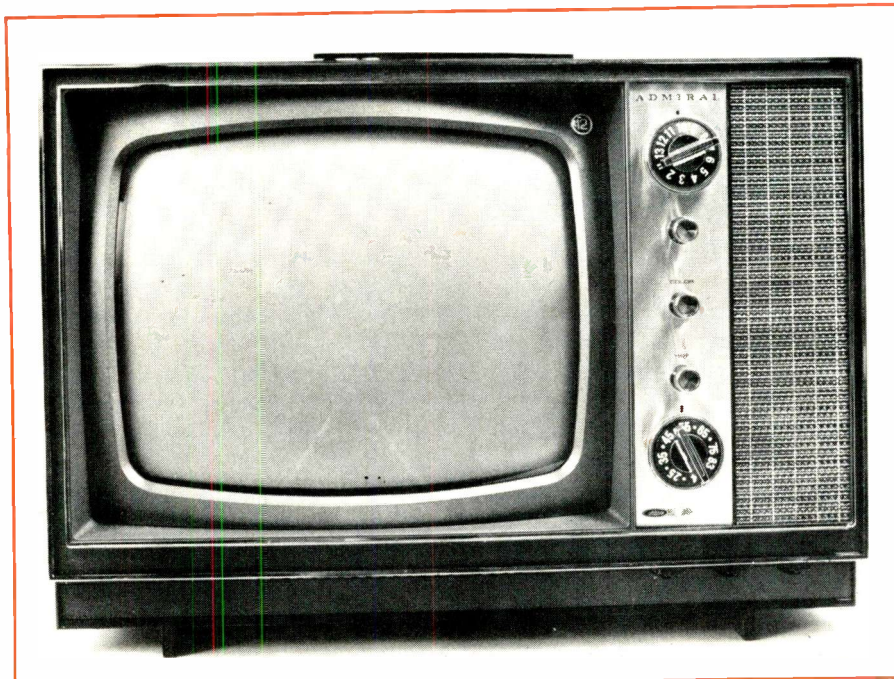

Admiral Model 2017P portable color TV set.

You cannot troubleshoot and properly repair these circuits unless you have a thorough knowledge of their function

■ Keeping pace with the increasing demand for a lightweight, compact television, Admiral introduced the 12in. diagonal measurement color television.

The portable is reportedly the first color set of this size produced in the United States and the new size CRT is developed by Admiral engineers and produced by the company's tube division in Chicago.

The television receiver includes a transformer-powered 22kv chassis that employs 49 solid-state devices such as transistors and diodes in 80 percent of the circuitry.

The signal processing circuits such as the tuner assembly, three-stage amplifier, low voltage power supply and color amplifier are all transistorized.

This set carries the company's three-year replacement warranty on the color CRT, and the etched copper circuit panels, excluding attached components, are warranted to be free from defects for five years.

After reading the news release on this portable, we ordered the Model 2017P portable color set for this Teklab report, which will cover some of the important features and circuits of this set.

The chassis employed is hybrid, meaning it incorporates both tubes and transistors: 26 transistors, 24 diodes and 7 tubes, which are used in the heavier power stages. The solid-state stages are confined to one circuit.

Most of the service on this chassis can be accomplished by re-





Rear view of chassis showing service controls.

filament and as heater in the automatic degaussing switch SH75, A full-wave rectifier, CRD84 and CRD85, supplies 25v B + for the tube circuits, with a separate half-wave rectifier CRH68 supplying 112v for the audio stage. Both the 112 and 295v supplies and the degaussing circuits are protected with a circuit breaker. The 25v supply is protected by 1/2a "plug-in" fuse.

A line choke TH12 prevents generated RF frequencies in the chassis from circulating in the power line. Also, RF frequencies that might be present on the power line are blocked from entering the chassis.

### VIDEO IF SYSTEM

The video IF shown in Fig. 1 has three stages using NPN transistors. The mixer stage in the VHF tuner, Q52, is coupled to the IF input by a plug-in coax cable. This stage is tuned by LV22 which positions to the 42.17MHz at 50 percent on the curve. The impedance is matched to that of the cable and 1st IF transistor Q1.

The first IF transistor is coupled to the cable by CA1 and LA2. LA2 positions 45.75MHz at 50 percent on the other side of the curve. LA2 and LV22 are mutually coupled producing a wide band-pass.

There are two 41.25MHz and one 47.25MHz sound traps which, in addition to suppressing interference, account for most of the selectivity in the IF stages. The 47.25MHz trap consisting of LA5, CA3, CA4 and resistor RA6 is very effective. Equal voltages, but 180deg out-of-phase at 47.25MHz, are on the base of Q1. One voltage is supplied across resistor RA6 and the other by CA3, LA5 and CA4. These cancel out the 47.25MHz adjacent channel sound. LA9 is a loosely coupled 41.25MHz series resonant trap, improving skirt selectivity and providing better fine tuning. AGC control on the IF section is obtained by applying forward AGC to Q1 base.

The collector of Q1 is connected to the base of Q2 by dividing the

moving the four chassis bolts through the bottom of the cabinet and pulling the chassis part way out. Lead lengths are sufficient to operate with the chassis removed from the cabinet and setting on the high voltage cage. When the chassis is operated in this manner, a heavy ground braid strap should be connected between the CRT mounting strap and metal chassis.

To monitor the horizontal output current, simply remove the cathode fuse and measure the current across the terminals with a 500ma current meter.

The purity adjustment on this set is simplified; slide the service switch to the purity position and a clear raster can be viewed to make the adjustment if necessary. The picture tube guns are mounted with the blue gun down in the CRT and the neck components are positioned accordingly.

If the tuner and chassis are removed, the tuner may be conveniently stored for local transportation by sliding the front mounting bracket of the tuner into the two holes in the front of the HV assembly.

Looking at the chassis, there are two etched circuit boards, one with tube circuits, the other

with transistor circuits. Close inspection will reveal a new system of board component identification.

These boards are divided into zones by heavy white lines. Each zone is identified by a large white letter and each component on the board within the zone is assigned a number.

To identify a component, look at the number printed beside it, add the zone letter and the appropriate symbol letter and you have something like RA27 for a resistor in zone A or LC4 for a coil in zone C. This is the way it appears in the schematic diagram. Going from the schematic to the board for RA27, look in zone A for 27.

The test points are clearly identified on both sides of the board.

The following are a few of the important circuits employed in this chassis. Other color circuits can be found in the January 1969 Colorfax section of ELECTRONIC TECHNICIAN/DEALER.

### POWER SUPPLY

A transformer provides 25v for the transistor circuits and it has a 6.3v filament winding which is used for the picture tube

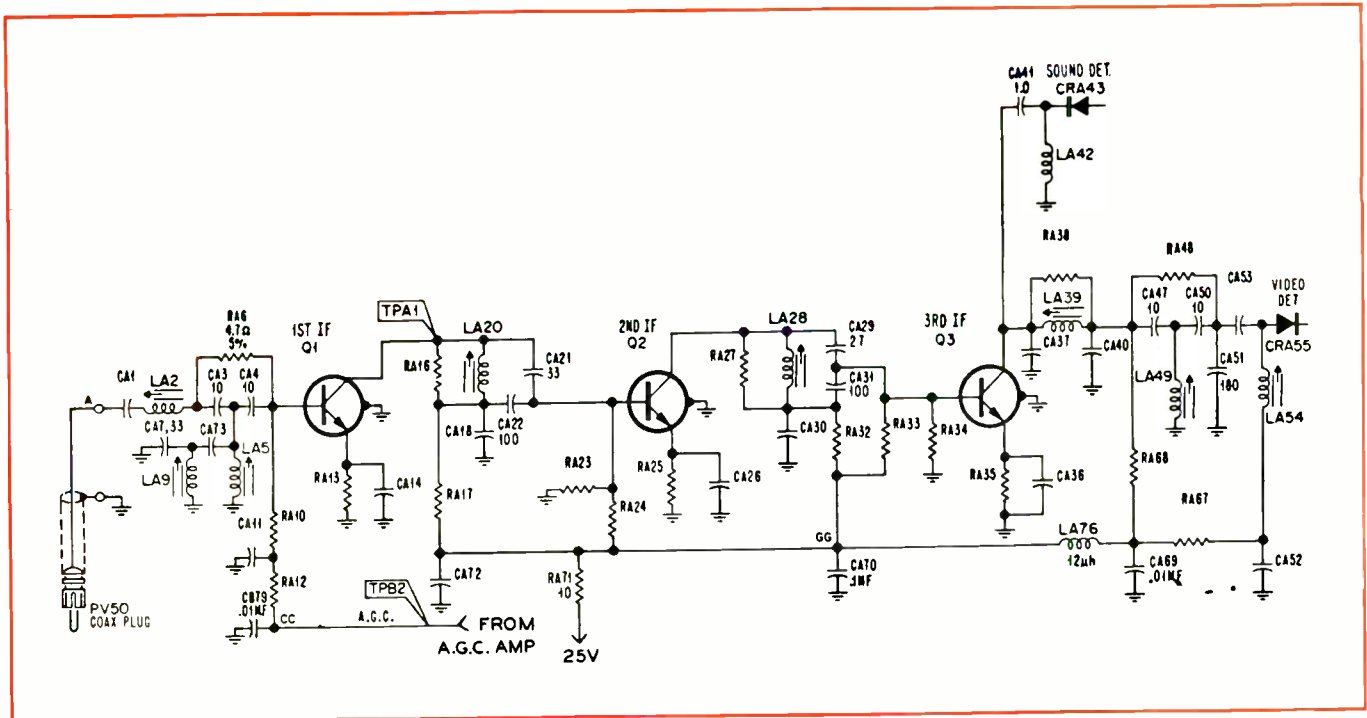

Fig. 1--Schematic of the transistorized video IF system.

voltage across LA20 through series capacitors, CA21 and CA22. The junction of the two capacitors provides an impedance match to Q2's base. LA20 is tuned to 43.8MHz, the IF passband center. Q2 is coupled to Q3 in a similar manner, the divider capacitors being CA29 and CA31. LA28 is also adjusted to obtain maximum gain at 43.8MHz.

Sound take-off is at the collector of Q3 prior to sound trapping. The IF signal passes through an output link which is similar to the IF input link from the tuner. LA39 and LA54 are the two tuned coils. A highly selective 41.25MHz sound trap, LA49, is located between these two tuned circuits. The IF signal is delivered to the video detector CRA55 across LA54.

### 1ST VIDEO AMPLIFIER

Operating as a grounded emitter circuit, transistor Q10 (1st video amplifier) provides an amplified composite video signal at the collector. See Fig. 2. The polarity of the signal at the collector is negative and fed to the sync separator stage Q11 and to the 2nd video amplifier through the delay line (DLH49).

The positive video is taken

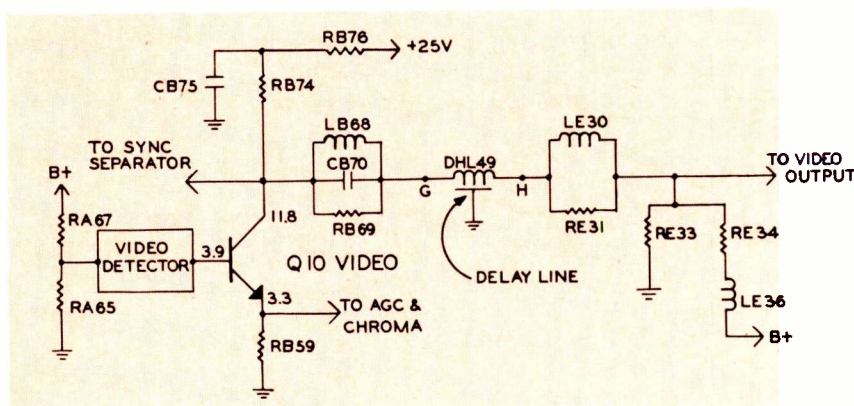
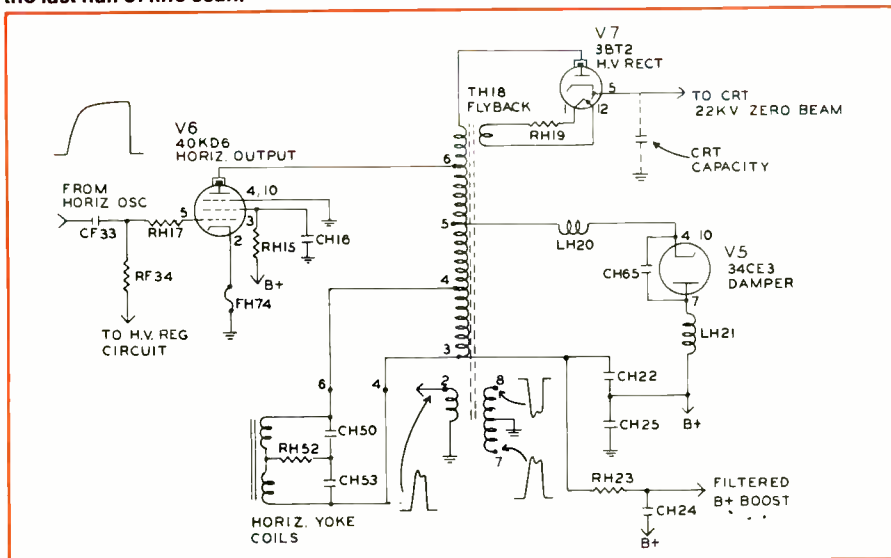

Fig. 2--The 1st video IF amplifier circuit.

Fig. 3--The horizontal output circuits functions as a controlled switch, operating during the last half of line scan.





from the emitter and fed to the AGC gate and the chroma section.

Operating as a common collector, positive video is supplied by the emitter to the AGC gate and the chroma section.

### HORIZONTAL OUTPUT SYSTEM

The horizontal output stage functions as a controlled switch, operating during the last half of line scan. Drive pulses draw electrons into coupling capacitor CF33 through grid rectification, resulting in a high negative grid voltage. See Fig. 3. (This grid voltage is supplemented by the scan regulator system.) The horizontal output system is cut off about half the time and driven heavily during the other half.

When the output tube conducts, heavy current flows through the flyback windings, primarily from the boost voltage charge stored in CH22. At the end of the line scan, the output tube stops conducting and the flyback coil field collapses. This collapse produces the flyback pulse. This pulse is stepped up by the high voltage windings and rectified by V7 to become the high voltage for the CRT. The CRT internal aluminizing and external dag coating form the filter capacitor for this rectifier. The flyback magnetic field is used to supply filament current to the rectifier. As this collapsing magnetic field swings into its negative half-cycle, the damper tube becomes forward biased and strong damper current flows. At this time the damper take-off point is attempting to reach ac ground potential instead of CH22. The yoke current will begin to increase and in the same direction as the output tube conducts. The damper will then cause the beam to sweep across the first half of the line. At the same time, CH22 is charging up to the boost level. The dampened flyback field will produce an output which will be added to the B+. This boost is filtered and used to supply the picture

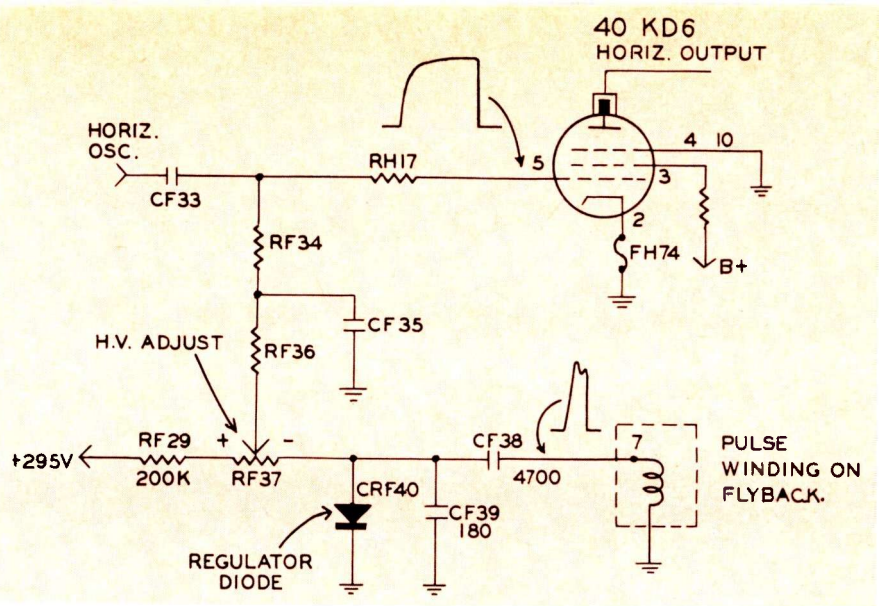

Fig. 4--The set employs a simplified and highly reliable pulse feedback HV regulator system.

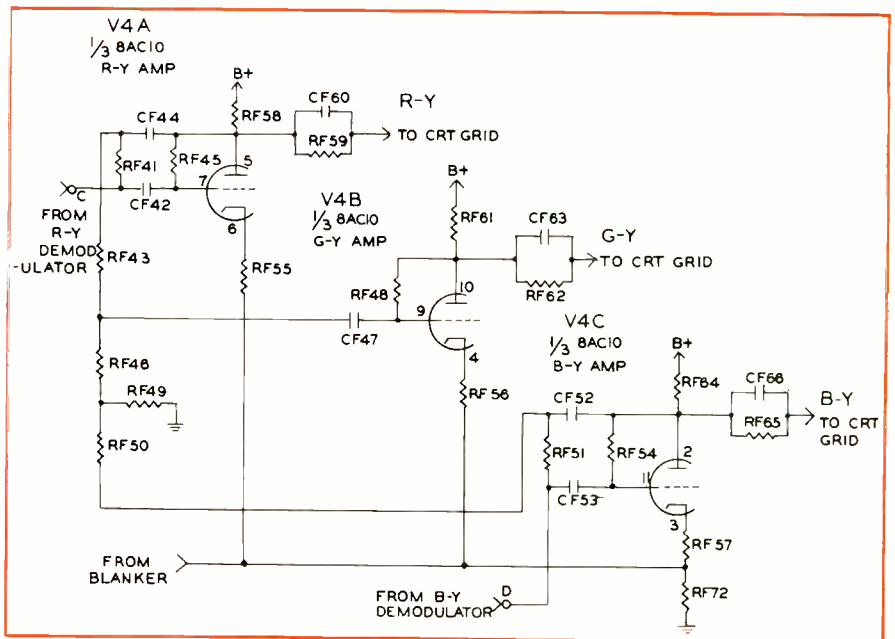

Fig. 5--An 8AC10 triode tube serves as the color difference amplifiers for the demodulator signals.

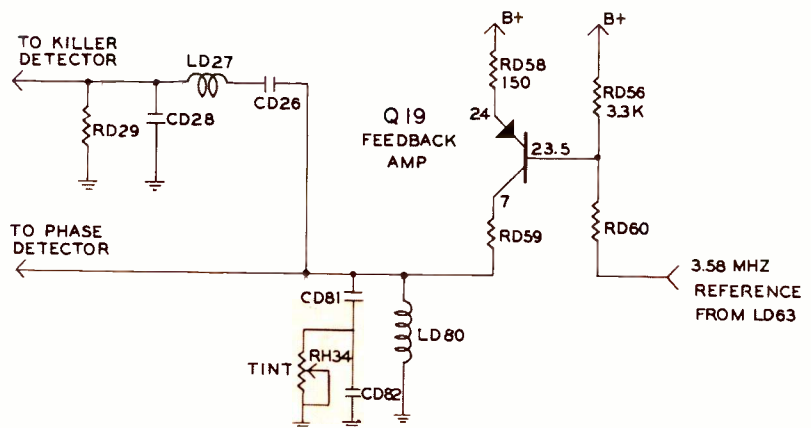
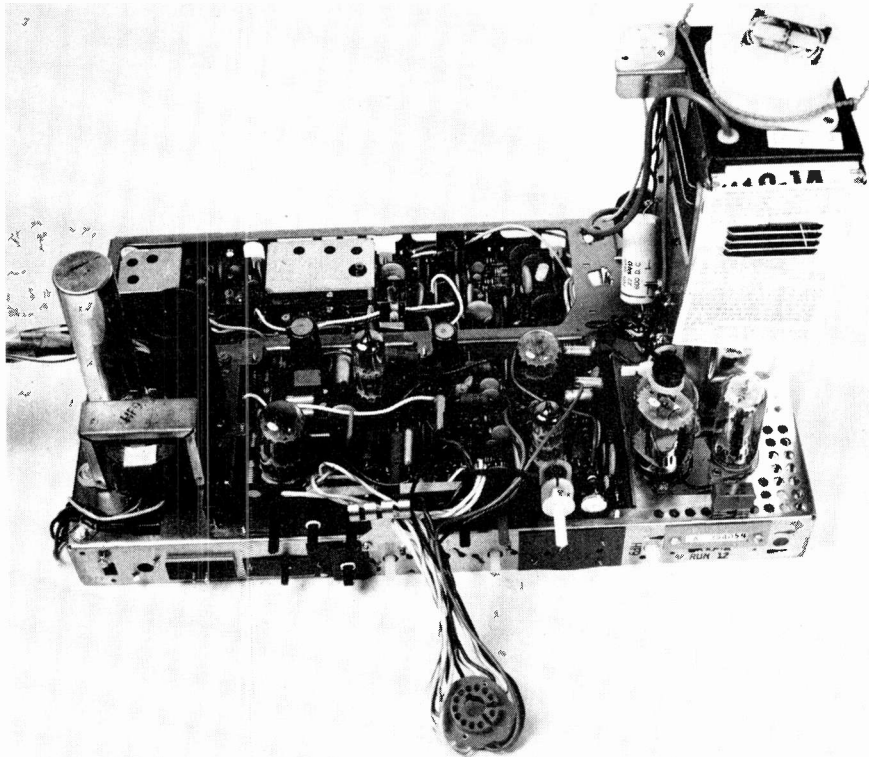

Fig. 6--Schematic of the 3.58MHz reference feedback system.



Top view of chassis with the solid-state circuits confined to a separate circuit.

tube screen voltage, the vertical oscillator plate and the vertical output bias. A fuse in the horizontal output cathode circuit will open if some malfunction should cause excessive current. This fuse is also a convenient means of disabling the horizontal output system. Just take it out. The deflection yoke operates as a parasite and also contributes to the mutual inductance of the system.

### HIGH VOLTAGE REGULATOR

A simplified and highly reliable pulse feedback regulation system, shown in Fig. 4, is employed in this chassis. Regulation is accomplished by varying the bias on the horizontal output control grid and in turn, the conduction of the tube to produce more or less high voltage.

The normal negative bias which is developed on the grid results from the positive drive signal from the horizontal oscillator. Electrons are drawn from the cathode to the grid circuit and charge capacitor CF33. When the drive cuts off the output tube, the charge on CF33 discharges through RF34 and RF36, producing a (bias) negative voltage on the grid. The HV regulator circuit supplements this bias

to maintain HV proper regulation.

A positive pulse is fed back to the regulator diode CRF40 from the pulse winding on the flyback. The rectified pulse produces a negative dc voltage at the HV control RF37. The other side of the control connects to the 295v B + through RF29. By adjusting the control, we can electrically add or subtract from the negative bias on the control grid of the output tube.

As the brightness control is advanced, the conduction of the CRT increases as does the current flow in the flyback and the HV rectifier tube. This increased loading on the flyback reduces the amplitude of the pulse produced resulting in less negative voltage being produced at the regulator diode. Therefore, the supplementary bias changes. Since there is less negative bias in this case, the horizontal output tube increases in conduction to bring the high voltage back up to its original level.

A reverse condition exists when the brightness is reduced. The flyback load decreases, increasing the rectified negative voltage to the output grid and the tube conducts less bringing the high voltage back to its original level.

### COLOR DIFFERENCE AMPLIFIERS

Tube V4 is a three-section triode serving as a difference amplifier for the demodulator signals. The -(R-Y) (cyan) signal is amplified and inverted to become R-Y (red) color difference signal. Similarly -(B-Y) (yellow) is amplified and inverted to become B-Y (blue) color difference signal. The green matrix circuit consisting of RF43, RF46, RF49 and RF50 forms -(G-Y) from B-Y and R-Y. After inversion, -(G-Y) becomes the G-Y (green) color difference signal. Each signal is amplified and applied to the red, blue and green picture tube grids as shown in Fig. 5.

It is desirable to turn off the color difference amplifier during the horizontal retrace time to accomplish horizontal blanking. Transistor Q15 supplies the blanking signal. A negative blanking signal is fed to each difference cathode. This blanking signal causes heavy conduction through the triodes and places a high level pulse at the picture tube grids. This results in saturation of the tube and reduced plate voltage. This reduction of plate voltage is seen as the blanking pulse. Blanking will drive the picture tube into cutoff. CF42, CF47 and CF53 are unable to maintain sufficient bias provided by the blanking action. This causes some signal detection and in turn, dc restoration to the picture tube.

### 3.58MHZ REFERENCE FEEDBACK SYSTEM

Q19, 3.58MHz reference feedback amp, called a "buffer" on the schematic diagram, Fig. 6, supplies a 3.58MHz reference signal for the color detector diodes.

The 3.58MHz sinewave signal from LD63 is connected to the base of Q19 for amplification. RH34 (tint control), CD81 and CD82 across LC89 alter the phase of the collector signal, which will eventually be used to control demodulation as the tint control is varied. LD27 and its associated components restore the phase of the reference signal which is fed to the killer detector. ■



# The CAT Game

Playing games may not be up your alley, but this one (Circuit Analysis and Troubleshooting — CAT), in the form of a quiz with complete explanations of circuit problems, will help you turn those 'tough dogs' into routine service jobs

■ There are many common sense approaches to various circuit problems; some are better than others. But all have a common goal—quick and effective repair. As a somewhat different approach to learning, here is a quiz based on circuit problems in a B/W television set shown schematically on the opposite page. Following the quiz are complete answers explaining the particular circuit and its operating characteristics with a defective component(s). How do you rate? Score five points for each correct answer: 90 to 100 is excellent; 75 to 90 is good; 60 to 75 is fair. Less than 60 means you should brush up on your circuit theory and troubleshooting.

1. Off-channel, there is no raster. With a station tuned in, there is an extremely dark picture but sound is normal.
  - (a) C182 is open (in the horizontal output circuit)
  - (b) open heater is V115 (horizontal phase detector)
  - (c) C184 is open (across horizontal yoke coils)
  - (d) C165 is shorted (in the vertical retrace blanking circuit)
2. There is no raster and no sound. The dc voltage at the control grid of V105 and V106 (1st and 2nd picture IF) reads -30v!
  - (a) the primary winding of sound take-off transformer T106 is open

- (b) R126 is open (in the V106 cathode circuit)
  - (c) C127A is shorted (in the V106 screen-grid circuit)
  - (d) C118 is open (in the IF AGC line)
3. Although remaining locked-in, the picture bends and pulls horizontally. The pulling varies with changes in picture content. Sound is normal.
    - (a) C175 is leaky (in the horizontal AFC filter circuit)
    - (b) C153 is leaky (in the sync separator grid circuit)
    - (c) C158 is open (in the cathode circuit of phase splitter V108B)
    - (d) C152 is shorted (in the sync separator input circuit)
  4. If C149 shorts (5000pf capacitor, below the tuner block), which symptom will be observed?
    - (a) picture snowy, sound normal
    - (b) no picture, no sound, raster normal
    - (c) no sound, no raster
    - (d) weak sound, washed out picture (low contrast)
  5. Which capacitor is the "boost-capacitor" in this set?
    - (a) C182
    - (b) C183
    - (c) C184
    - (d) C185
  6. Which symptom will likely occur if C186 opens (across

half of horizontal yoke winding)?

- (a) no raster
  - (b) trapezoidal raster (key-stone-shaped raster)
  - (c) vertical white bars and slight ripple in the scanning lines, on left side of raster
  - (d) raster lacks width and suffers from a slight horizontal foldover on the right side
7. If R176 (in the plate circuit of the vertical oscillator) increases in value to three times its normal resistance (i.e., 4.5M),
    - (a) there will be a severe vertical foldover at the bottom of the raster
    - (b) the vertical size of the raster will be excessive
    - (c) the raster will lack height
    - (d) there will be only a bright horizontal line across the center of the screen
  8. If the 6AL5 phase detector tube fails in such a way that one of its diodes becomes completely dead while the other half continues to operate normally, the following symptom will result:
    - (a) no raster
    - (b) picture slipping sideways
    - (c) picture breaking up into many diagonal lines
    - (d) picture waving, i.e., pulling horizontally
  9. There is no raster and the plate of the horizontal output tube is glowing red. The most likely fault is:
    - (a) C182 shorted
    - (b) R202 open
    - (c) C183 shorted
    - (d) C181 open
  10. What is the purpose of the C152-R163 network in the

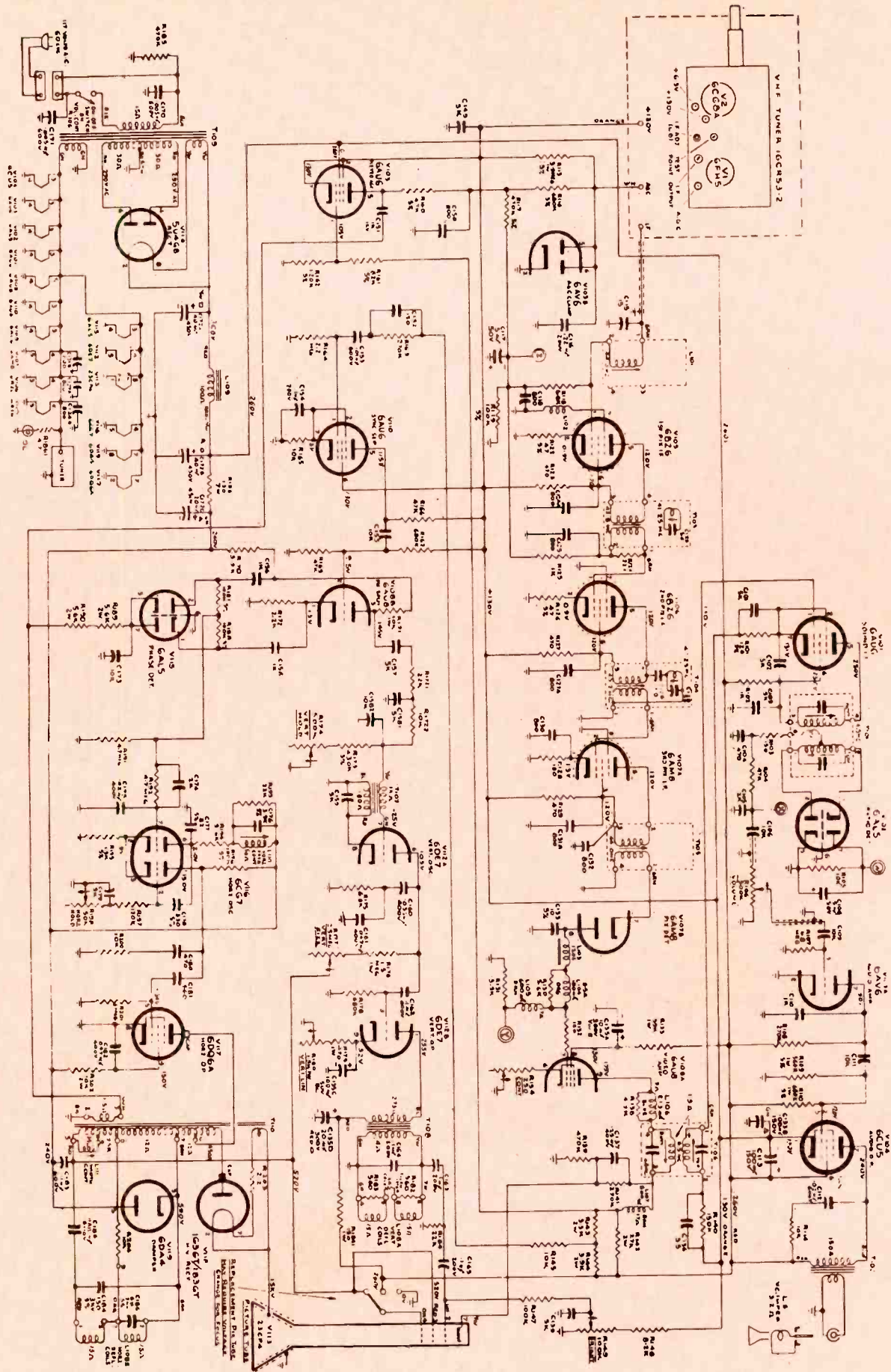

## CAT Game...

- grid circuit of the sync separator?
- (a) to produce grid-leak bias
  - (b) to make the sync separator more immune to noise pulses
  - (c) to give the 6AU6 tube sharp cutoff characteristics
  - (d) to boost the high-frequency components of the composite video signal applied to the V110 control grid
11. With the receiver tuned to a local station, excessive snow in the picture is likely caused by:
    - (a) a weak 1st IF amplifier tube (V105)
    - (b) a defective 6AV6 AGC clamp tube
    - (c) R116 increasing in resistance
    - (d) R115 increasing in resistance
  12. The picture shrinks vertically, mostly from the bottom. Normal vertical hold is retained. The most likely fault is:
    - (a) C160 leaky
    - (b) C159 shorted
    - (c) C135C leaky
    - (d) C162 open
  13. Off-channel the raster is normal. With the signal tuned in, only black and white horizontal bars appear on the screen accompanied by a high-pitch squeal in the sound.
    - (a) L102 is shorted (in the 1st picture IF circuit)
    - (b) C130 is shorted (in the 3rd picture IF circuit)
    - (c) C117 is open (in the AGC line)
    - (d) C118 is shorted (in the AGC line)
  14. The raster shrinks in width (by about 1 inch in both sides)
    - (a) The width coil is open
    - (b) C182 is open (in the horizontal output circuit)
    - (c) The resistance of R201 has decreased to 500K (horizontal output circuit)
    - (d) R204 is open (in the fly-back transformer circuit)
  15. Which of the following faults in the horizontal AFC/oscillator circuit will cause the picture to slip sideways (no horiz. synchronization)?
    - (a) C174 open
    - (b) C175 shorted
    - (c) C177 shorted
    - (d) C176 shorted
  16. If C135D opens (in the vertical output circuit), there will be:
    - (a) no raster (only a bright line at the center of the screen)
    - (b) a non-linear vertical sweep (top of pix stretched, bottom shrunk)
    - (c) a horizontal bend in the picture
    - (d) no vertical sync (picture rolling vertically)
  17. With the receiver tuned to a normal-strength signal, what symptom will result from a shorted C154 (in the sync separator circuit)?
    - (a) the picture will roll vertically
    - (b) the picture will slip sideways or break into diagonal lines
    - (c) there will be neither horizontal nor vertical synchronization
    - (d) there will be no noticeable effect
  18. If the resistance of R109 (in the audio output circuit) drops from its normal value of 560K down to 220K, which symptom will be observed?
    - (a) weak sound, normal picture
    - (b) no sound, normal picture
    - (c) no sound, no picture
    - (d) weak sound with washed-out picture (low contrast)
  19. If C151 opens (in the AGC keyer circuit), there will be:
    - (a) no sound, no picture, raster normal
    - (b) no raster with a channel tuned in; normal raster off-channel.
    - (c) picture dim and negative with buzz in the sound on a normal signal; raster normal off-channel
    - (d) picture normal, but inter-carrier buzz in the sound
  20. What effect will be produced by an open C135C (vertical output circuit)?
    - (a) vertical deflection non-linear and picture height reduced considerably
    - (b) picture will roll vertically
    - (c) no picture (only a bright horizontal line in center of screen)
    - (d) the vertical blanking bar will lock-in at approximately the center of the screen (picture split in two)
- Answers:
1. (d) In this set, the plate of the video amplifier is dc coupled to the CRT cathode, placing the latter at a high positive dc level. The CRT control grid must therefore receive a relatively high positive voltage from the brightness control for proper bias. With C165 shorted, the CRT grid voltage is drastically reduced due to the voltage-divider action of R147 and R184. CRT bias becomes excessive and the raster blacks out.
  2. (a) With the primary open, no plate current can flow in the



video amplifier circuit. Therefore, no voltage drop across the video amplifier's plate load resistance. The dc voltage at the junction of R142 and R143 rises to the full B + value (approx. 260v) and places an excessively high positive bias on the control grid of V109 (AGC keyer). The latter conducts excessively during plate keying pulses, developing excessive AGC voltage (-30v) which naturally cuts off the IF tubes; hence no picture and no sound. Furthermore, excessive positive voltage is dc coupled from the video amplifier plate load circuit to the CRT cathode, biasing the CRT to cutoff; hence no raster. (Note: advancing the brightness control to maximum will restore a dim raster).

3. (b) With C153 leaky, sync separator grid leak bias is reduced. With insufficient bias, the separator allows some picture information to appear along with the sync in its plate circuit (this would show clearly on an oscilloscope). With "picture in the sync," picture pulling is inevitable. A severe case of leakage would also cause vertical rolling of the picture.

4. (c) With C149 shorted, the 130v B + line is shorted to ground, killing the IF's and many other circuits. In addition, with no 130v potential applied to the brightness control, the CRT is biased to cutoff. (Note: the 6CU5 audio output tube would probably "glow" for a while and then burn out due to the short in its cathode circuit.)

5. (b) In receivers featuring an autotransformer type of flyback, the boost capacitor is always located between the bottom of the flyback transformer winding and the B + line, as is C183 in this set.

6. (c) C186 is necessary to balance the yoke capacitance and reduce "crosstalk" between horizontal and vertical coils in the yoke.

7. (c) R176 is in series with the height control. Increasing its resistance is effectively the

same as increasing the resistance of the height control, i.e., reducing the vertical size of the raster.

8. (a) With a serious unbalance in the phase detector, an excessive AFC correction voltage is applied to the horizontal oscillator. This results not only in the wrong oscillator frequency, but also in a slow retrace in the horizontal sawtooth. This in turn causes a serious drop in the back e.m.f. voltage developed at the plate of the horizontal output tube during flyback and consequently, a drastically reduced high voltage from the 1B3 (usually only a few kilovolts, insufficient to produce a raster).

9. (d) With coupling capacitor C181 open there would be no drive to the horizontal output tube and no grid-leak bias. Without bias, the output tube would conduct excessively, exceeding its maximum plate dissipation rating.

10. (b) The short time constant of the R163-C152 network prevents excessive grid-leak bias from developing across R164 when high-amplitude noise pulses accompany the video signal. Without this noise filter, the long time constant of C153-R164 would retain the excessive bias and V110 would remain cut off for a relatively long time resulting in poor or no sync in the presence of noise interference.

11. (d) If the resistance of R115 increases substantially, the lower amount of positive voltage from the + 130v line will be insufficient to reduce the negative AGC voltage to the tuner. This will lower the RF amplifier gain and result in a poor signal-to-noise ratio (snow).

12. (a) With C160 leaking, the plate voltage of the vertical oscillator cannot rise to its proper peak value near the end of the vertical trace and this will cause the picture to shrink from the bottom.

13. (c) With this electrolytic filter capacitor open, oscillations occur in the IF system due to

mutual coupling between stages via the common impedance of the AGC line.

14. (b) With the screen bypass capacitor open, degeneration occurs in the horizontal output amplifier. This loss of gain causes a reduction in the amplitude of the horizontal deflection signal.

15. (b) With C175 shorted, the dc correction voltage produced by the phase detector is shorted to ground and allows the horizontal oscillator to become free-running.

16. (c) C135D forms a decoupling network with R1841. With the capacitor open, mutual coupling can now occur between the vertical output and the horizontal sweep and sync circuits. The 60-cycle voltage getting in the horizontal sync then causes a horizontal bend in the picture.

17. (d) No noticeable effect will occur because additional grid-leak bias voltage will automatically be produced, making up for the lack of cathode bias voltage when C154 shorts. Thus the operating point (bias) of the sync separator tube remains essentially unaltered and normal sync separation is preserved.

18. (d) This set features a "stacked B+" arrangement where in the B + voltage of 130v for the picture IF amplifiers (and for a few other circuits as well) is obtained from the cathode of the audio output tube. With R109 low in value, the R109-R110 voltage-divider ratio is upset and reduces the positive voltage on the 6CU5 to increase the B + voltage available as its cathode goes down. Low B + to the picture IF's causes a washed out picture (low contrast) along with weak sound.

19. (c) With C151 open, no keying pulses are applied to the AGC keyer plate, hence no AGC voltage is produced. Excessive RF and IF gain causes overloading in the IF's.

20. (a) With C135C open, degeneration occurs in the vertical output amplifier which affects the linearity and amplitude of the vertical deflection waveform. ■

# What You Can Expect in 1970 Television Sets

Module solid-state circuits, brighter picture tubes, more small screen portables

More solid-state circuits are being employed in new television receivers and other electronic instruments which account for a 10 percent decline of U.S. factory sales of receiver tubes. Factory sales reached 71 million units during the first quarter of 1969 as reported by Electronic Industries Assn.

Color TV picture tubes sales were up 9.4 percent to reach 2.8 million units during January-May 1969.

Admiral's new line of color television receivers is again highlighted by a three-year replacement warranty on picture tubes.

General Electric introduces a hybrid color television receiver employing an 18in. (diagonal measurement) delta gun picture tube and a new lightweight (60 lb) chassis.

The Automatic Frequency Control circuit has been used for several years by Magnavox. Automatic Chroma Control is provided by a new improved ACC circuit and the Automatic Tint control is an exclusive feature just introduced.

Motorola introduces a "Quasar" color TV set with the "works in the drawer" built in a horizon-

tal mechanical configuration and sliding out the back of the cabinet for fast and easy service.

Philco-Ford introduces the company's first 14in. (102sq in.) portable color set employing a 15NP22 picture tube.

Service technicians will welcome some of the following features which make servicing easier.

## ADMIRAL

Admiral's line of color television receivers is highlighted again by a three-year replacement warranty on picture tubes, Instant Play, Automatic Fine Tuning and seven-button wireless remote control.

The line is comprised of 52 models which includes the recently introduced 12, 14, 16in. portables which have solid-state devices in 80 percent of the circuitry.

The seven-button wireless remote control has a separate on/off volume control. The volume button allows the viewer to preset and change the volume to any of four levels.

Basic features in the color line include a 25,500v chassis, 3-stage IF amplifier, automatic degaussing, two-speed transistorized UHF tuner and super scope VHF

tuner with preset fine tuning.

The important new circuits employed in the basic K10 series of chassis are reviewed in this month's Teklab Report.

A new solid-state 9in. B/W portable television receiver, the first all-transistor set, is offered by Admiral.

The 12 lb Travel Mate (9P400) has a chassis which employs 26 transistors and 18 diodes. The set can be played anywhere by using an optional 12v power pack and charger.

Additional features include Instant Play, built-in sun shield, built-in jack with earphone and an interior-exterior antenna switch. The portable has 42sq in. of viewing area, gated AGC, unitized channel selectors, 3-stage IF amplifier, monopole antenna and front-mounted speaker.

Eight new big screen B/W television receivers featuring 20,000v chassis with solid-state signal circuits are included in the new line.

## GENERAL ELECTRIC

Included in the new series of color television receivers is the C-1 chassis with an 18in. diagonal measurement CRT and a lightweight (60 lb) chassis. The delta gun CRT designated 19HXP22 employs rare earth phosphors and integral implosion protection.

Each model features a high-impact polystyrene cabinet with front mounted 4in. speaker. Additional features available on some models are: a retractable VHF dipole antenna, Insta-Color operation, AFC and slide rule UHF tuning.

All customer controls are located at the front of the receiver except for the FOCUS and HORIZONTAL HOLD control which are located at the rear of the chassis.

Eleven transistors and 13 tubes

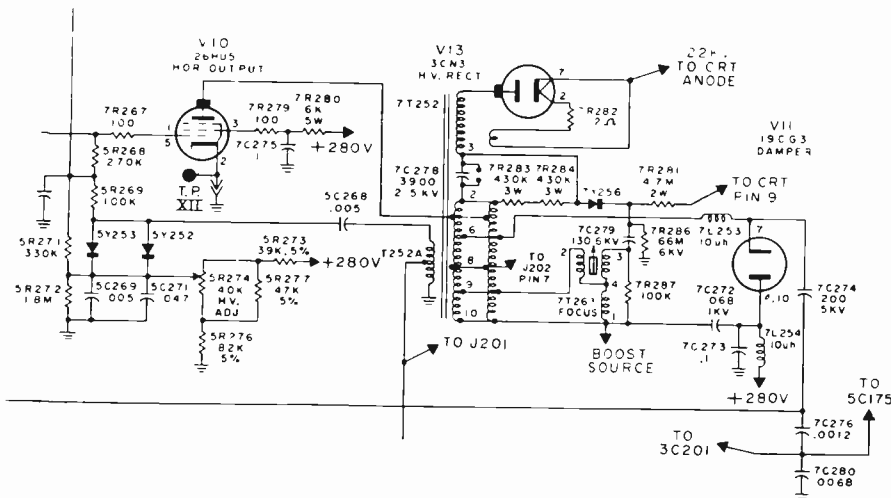

Fig. 1—High voltage in General Electric's C-1 color chassis is regulated by automatically controlling the grid voltage of the horizontal output tube.

## and extended CRT warranties highlight the television line for the coming year

are employed in this chassis and the tube filaments are series-connected to the ac line.

The video amplifier, AGC keyer, sync separator and horizontal oscillator are transistorized circuits.

A removable sliding panel allows easy access to the copper side of the circuit boards.

High voltage in this chassis is regulated by automatically controlling the grid voltage of the horizontal output tube shown in Fig. 1. This system is more efficient than a shunt regulation system because all of the current generated is used by the CRT.

A pulse from the high voltage transformer is coupled to regulator diodes 5Y252 and 5Y253 through capacitor 5C268. The amplitude of this pulse varies with the high voltage. An increase in pulse amplitude would indicate an increase in high voltage. This pulse causes the diodes to conduct, charging 5C268, the diode end becoming negative.

The amount of charge on 5C268 is determined by the pulse amplitude and the dc voltage level applied to the diode cathodes. This dc level is variable by means of the HIGH VOLTAGE ADJUST control, which is part of a resistive voltage divider network connected between the 280v source and chassis ground.

Between pulses, 5C268 discharges through 5R269, 5R271, 5R274 and 5R276. The negative voltage developed is applied to the horizontal output tube grid through 5R268.

Since there would be no high voltage regulation without the diode action, two parallel diodes are used as a safeguard. One diode will maintain regulation even if the other should become open.

Each time the receiver is serviced, the regulation system should be checked for proper operation. Measure the high volt-

age while varying the control setting. If the voltage can be set to the proper value, and varies with different HIGH VOLTAGE ADJUST control settings, the system is operating properly.

The H-3 color chassis series uses an inline gun 10in. (diagonal measurement) CRT. This chassis is an update of the H-2 chassis. New features include: rocker bar on/off switch, slide type volume controls and regulated high voltage.

Also introduced is the T-5 chassis which is an all solid-state chassis containing 26 transistors. This 9in. monochrome television receiver operates on 120vac or 12vdc power capabilities and Insta-View operation when connected to 120vac.

### MAGNAVOX

Magnavox recently introduced two new color chassis: the T936 and the T924.

The T936 chassis is designed for use in 15in. portable color TV models. Eight receiving tubes are used in this chassis (primary in the power stages) and the small-signal stages employ transistors. The tube portion of the chassis is similar to those used in the T924 chassis. The tube filaments are connected in series and one side of the ac line is connected to the chassis. The circuits which have been transistorized include the tuners, the IF's, AGC and portions of the video stages, sync, chroma and vertical sweep. An integrated circuit (IC) is used in the audio circuit.

Most of the components are mounted on two circuit boards. One board is used for solid-state circuits and the tube circuits are mounted on the second board.

Solid-state devices require low operating voltages so the power supply must supply a wider range of output voltage. Two 18v and one 36v source is provided

for operation of the solid-state circuits.

The following are a few of the features worthy of note. The sound is taken from the output of the second IF and has its own 40MHz amplifier. The chroma output stage, rather than the bandpass amplifier, is controlled by the color killer. The color killer is not keyed by a horizontal pulse, but is directly controlled by the 3.58MHz oscillator.

The shunt regulator is eliminated in the high voltage section and regulation is accomplished by a pulse regulator circuit which controls the conduction of the horizontal output stage.

The T940 chassis is used in high-end console and stereo theatre instruments. Several physical and electrical improvements are employed in this chassis that enhance performance and serviceability.

The tuner mounting has been modified to include a new power supply board making components more accessible and eliminating many of the terminal stripes that were located in various parts of the chassis.

The high voltage control is located on the video control board along with a new CHROMATONE control. The control has been added to the chromatone circuit to provide more accurate adjustment of sepia tones. The control is active only when the CHROMATONE switch is "on."

The 1V2 focus rectifier tube has been replaced with a solid-state rectifier. The stick type diode fits in a special holder mounted to the side of the HV cage.

A 6MU8 tube is used as the sync amp and video amp replacing the 6LM8. The new tube has better linearity, more gain and is not prone to "slump."

The new Automatic Tint Control circuit (ATC) shown in Fig. 2, senses fleshtone errors and automatically corrects them to the desired hue. The ATC cir-



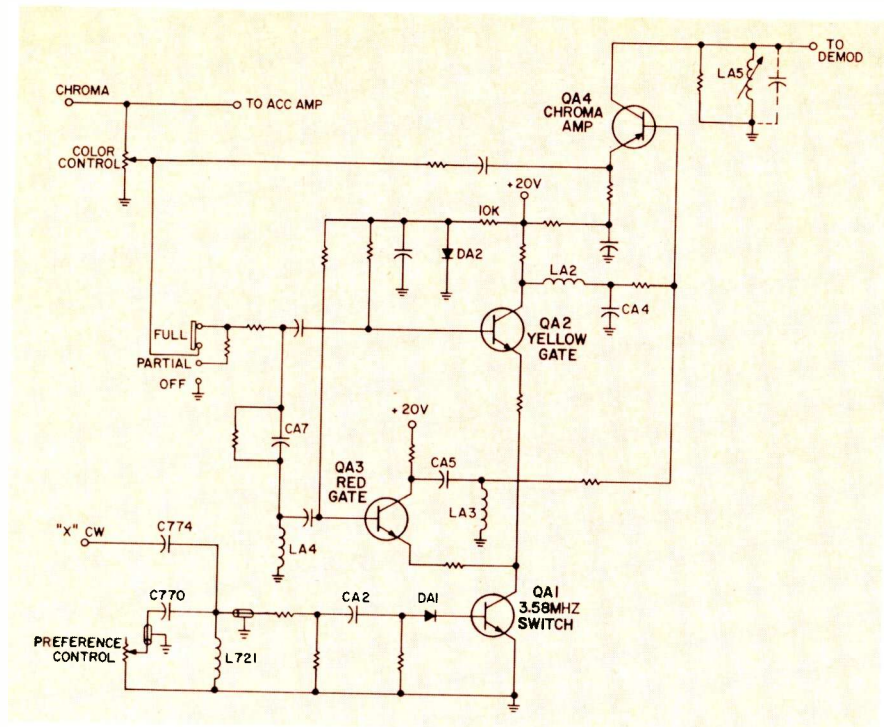

**Fig. 2—The new Automatic Tint Control (ATC) circuit employed in the Magnavox T940 color chassis, senses fleshtone errors and automatically corrects them to the desired hue.**

circuit is located in a metal box attached to the tuner mounting assembly. The circuit employs one switch and one control. The ATC switch is located on the front control panel and has three positions—OFF, PARTIAL and FULL correction. The FULL position is used when variations of fleshtones are extreme; the PARTIAL position is used when only minor correction is needed. A potentiometer called the PREFERENCE control is located on the secondary control panel. The setting of the PREFERENCE control determines the hue of fleshtones produced after correction by the ATC. The control allows the customer to set fleshtones to personal liking; more red or green may be added as desired.

The ATC circuit is inserted between the bandpass amplifier and the color demodulators. The chroma signal, prior to demodulation, is a 3.58MHz sine wave which changes amplitude and phase in accordance with the saturation and hue of the transmitted scene. This signal is coupled to a chroma amplifier. A

3.58MHz correction signal is also applied to the chroma amplifier and combined with the original chroma. The output signal applied to the demodulators is the resultant of the two input signals and is phase corrected for variation in fleshtones.

The Automatic Color Control (ACC) circuit, shown in Fig. 3 functions to minimize large variations

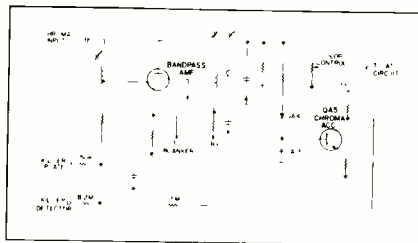

**Fig. 3—The Automatic Color Control (ACC) circuit functions to minimize large variations in chroma amplitude so that frequent adjustment of the color control becomes unnecessary in the Magnavox T940 color chassis.**

in chroma amplitude so that frequent adjustment of the COLOR control becomes unnecessary. Control is accomplished by changing the gain of the bandpass amplifier with a dc voltage. The ACC circuit employed in the T940 chas-

sis uses two signals to develop the control voltage—the burst signal and the chroma signal. An increase in either one or both of these signals causes a negative-going voltage to be applied to the control grid of the band-pass amplifier to reduce gain. A reduction of either signal causes the gain of the amplifier to increase.

## MOTOROLA

The "Quasar" color television enters the new product line with price reductions.

Highlighting the color line is model WT675F with the chassis built in a horizontal mechanical configuration and sliding out the back of the cabinet for fast and easy service as shown in photo Fig. 4.

Also, the 20in. diagonal receiver has a roll-cart, automatic fine tuning, solid-state high voltage rectifier, lighted dials and a vinyl clad metal cabinet.

The 14in. diagonal portable color TV sets appear with redesigned cabinets and lower manufacturers suggested list prices.

An ac line regulator, shown in Fig. 5, enters the line in the deluxe "Quasar" solid-state 23in. model. The regulator provides a constant 105vac to the TV over a wide range of ac voltages.

All 23in. diagonal tube chassis console color sets employ the "Fastback" chassis which slides out the back of the cabinet for faster and easier service.

An expanded assortment of small screen portables include the introduction of a 14in. diagonal "true rectangular" series, additional 12in. diagonal and new designs.

The "works in a drawer" chassis design is also adapted to new 12in. and 14in. diagonal B/W portable TV sets.

## PHILCO-FORD

The new color television line features the company's first 14in. portable, three new 18in. portables and a number of consoles in popular furniture styles at each major price level.

A number of changes have

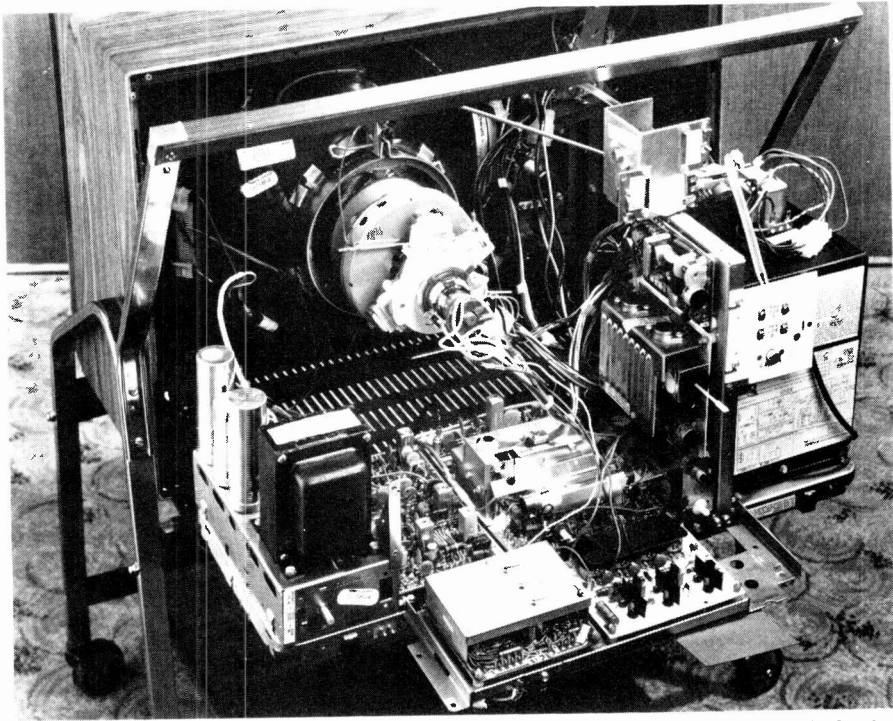

Fig. 4--The "works in a drawer" modular chassis Quasar color TV by Motorola in the 20in. diagonal screen size slides out the back for ease of service. Release of two spring clips permits the drawer to be pulled out. All modular panels plug in from the top.

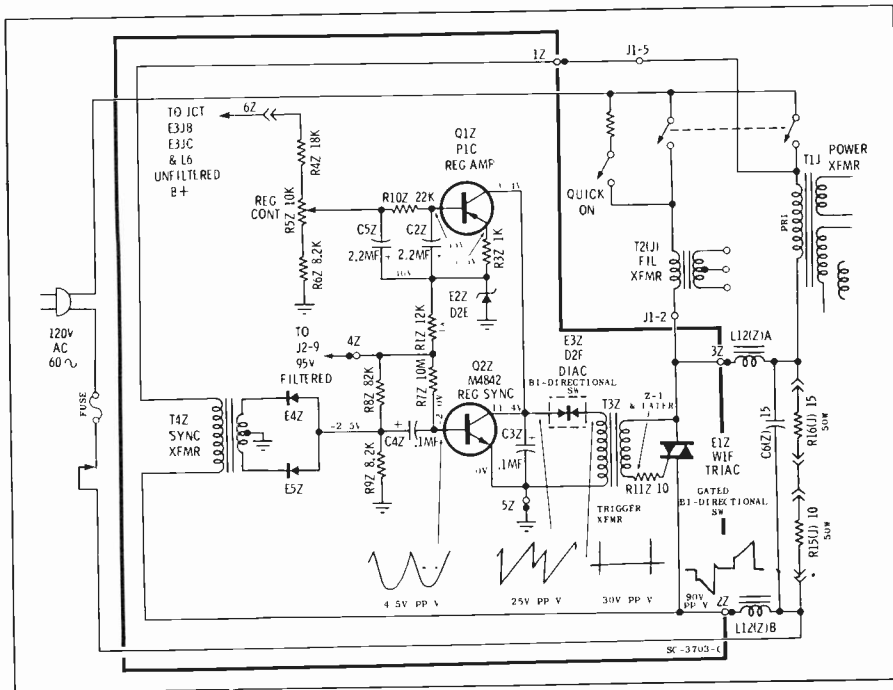

Fig. 5--Schematic of Motorola's ac line regulator which provides a constant output voltage, even though the input voltage changes.

been made in the 20QT90 chassis which is the basic 20QT87 chassis with the same type of tuner and control instrumentation.

Although the basic component configuration and circuit operation are similar to the previously

used grounded AGC panels, there are four new features on the VIF panel.

As part of the 1st VIF transformer (L10), a 41.25MHz absorption type accompanying sound trap has been employed to improve

ACC sound rejection during color casts and to eliminate 920kHz beat.

A 39.75MHz trap L4A has been added between the output (anode side) of the 2nd detector diode through RF choke L4 and the primary side of the 4.5MHz trap L8. This trap has been added to improve rejection of adjacent picture interference.

A thermistor (RT1) has been added (across resistor R14, 2.2k) to one arm of VR2, the AGC distribution control. The thermistor compensates for variations in transistor parameters because of changes in ambient temperature. The AGC bias may tend to drift, but with the thermistor in the circuit the bias remains fixed regardless of variations in temperature.

A new transformer circuit is employed in conjunction with some minor circuit changes to the HV regulator circuitry to provide better and more stable HV regulation.

The change consists of removing the 4.2K, 7w in the screen of the 6KD6 horizontal output tube and changing the screen B + supply from 275v (as used in earlier hybrid chassis) to 170v. An additional decoupling network has been added to the power supply to develop the 170v source. Also, one side of the bias varistor (RV100) is now returned to ground, rather than to the transformer.

The 19FT60 chassis is designated as a 14in. (102 sq in.) receiver employing a 15NP22 kincode CRT. The 15NP22 CRT, although electrically similar to larger rectangular tubes, operates with the blue gun down rather than up, as used in other conventional rectangular tubes.

The 19FT60 is a hot chassis and employs a power supply consisting of a half wave doubler to develop a 290v and 140v source. The 100 and 20v supplies are developed from half wave rectifiers. The 20v source is regulated by an active filter transistor (Q200). Operation of the active filter is quite similar to the active filter used in the transistor Hi Fi chassis. The 20v source is accom-

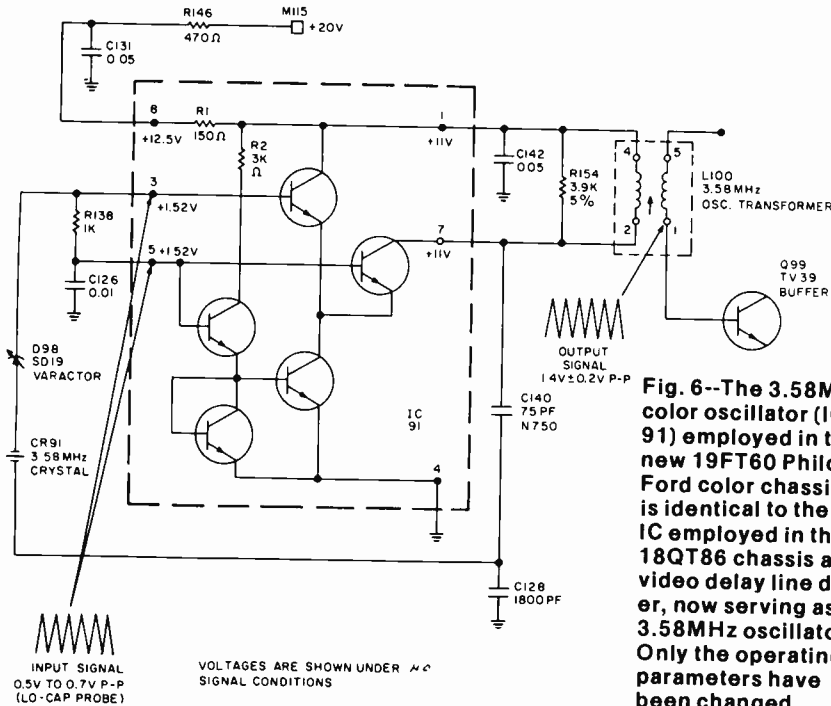

**Fig. 6--The 3.58MHz color oscillator (IC-91) employed in the new 19FT60 Philco-Ford color chassis is identical to the IC employed in the 18QT86 chassis as video delay line driver, now serving as a 3.58MHz oscillator. Only the operating parameters have been changed.**

plished by a control (3K) VR200 in the collector of the active filter and mounted on the chassis top.

Automatic degaussing in this chassis is accomplished by a new type circuit using a positor. Although performing the same basic operation as in previous hybrid chassis, it has a new type mode of operation during warmup.

As you will note in the schematic, this system does not require a varistor and the positor (RT200) is marked PTC (Positive Temperature Coefficient). When this circuit is switched on, the positor is at its minimum resistance and the full ac potential is applied to the degaussing coil. As the temperature across the positor rises, the resistance also rises until such time when the positor reaches its maximum resistance, causing the full ac potential to drop across the thermistor with no ac flowing through the degaussing coil, shutting off the system.

The chroma panel is all new and all transistorized with the exception of two tubes. A 12GN7 (V92) for video output and a single tube (V91), a 6ML8 triple triode, are used as color difference amplifiers supplying the B-Y, R-Y and G-Y signals to the control grids of the CRT. The chroma panel contains an IC (Integrated Circuit) IC91 used as a 3.58MHz

color osc in the 19FT60 chassis.

In the 19FT60 the sound circuitry is part of the chroma panel; in the previous chassis the sound circuits were part of the deflection panel. All sound circuitry with the exception of the audio output transistor is mounted on the panel. The audio output transistor (Q201), an HR106, is heat sink-mounted directly on the top of the chassis sub base.

This chassis contains a red drive control in addition to the blue and green drive controls. The red drive is employed because of the higher efficient red phosphor used in the 15NP22 and 19GWP22 CRT's. To achieve a more uniform white balance, the red drive control was required.

The horizontal output tube used in this chassis is a 6JS6A, the HV rectifier a 3AW2 and the damper a 6CG3. Biasing of the horizontal output tube remains basically the same as earlier hybrid chassis.

A completely new mode of focus control is incorporated in this chassis. It requires no control, coil or focus rectifier, only a simple bleeder network and jumper link because of the closer gun structure in the 15NP22 CRT. The 15NP22 is known as an Einzel lens or Einzel focus CRT.

Next month we will review more important features in new sets for 1970. ■



# Electrolytics Are Different

Don't get hung up on capacitors--especially when it comes to replacing an electrolytic. A better understanding of these components can save you valuable time

■ Most technicians can do a competent repair job when they need to replace a defective capacitor. Once the faulty capacitor is located, the technician replaces it. But many technicians also believe that a circuit will not operate if a capacitor is replaced with anything other than one having exactly the same ratings. This idea seems to have special significance for electrolytics. Often an exact replacement is not readily available and set repair is delayed waiting for parts.

Actually, this idea is a carry-over from the "old days" when wet electrolytics were liquid-filled and shelf life dried them up. So when it came time to use one of these capacitors, it had to be "re-formed" or reconditioned. This meant applying a voltage and slowly raising it to the capacitor's rated value. However, today's modern electrolytics are not liquid; they are paste.

What has this to do with the technician's problem of obtaining an exact replacement? Just this. In the past 15 years, more than 25,000 filter capacitors with different ratings and sizes have been manufactured. It is almost impossible for anyone to stock a full line of exact replacements for these. So the technician who needs a capacitor that is not readily available must first understand what his needs are and what this means in terms of capacitor ratings. Most of us learned a few basics about capacitors and less about what goes into making a capacitor with certain ratings.

## TWO FAMILIES

Capacitors can be grouped into two families: electrolytics and electrostatics. In other words, everything that is not an electrolytic is an electrostatic. We all know that a capacitor is used to store electrons.

We learned that when two conductors are separated by a dielectric (oil, paper, air, etc.) with a potential difference existing between them, we have capacitance--the property of storing electrons.

An electrolytic capacitor normally has two plates, an anode and a cathode, which are separated by a porous substance impregnated with conductive

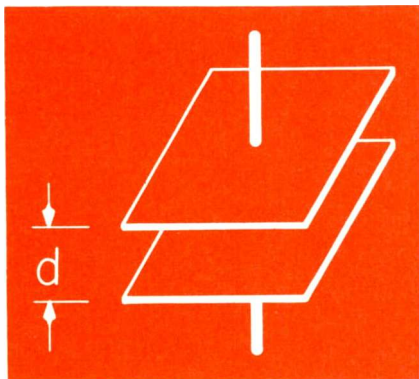

Fig. 1--When conductors are parallel flat plates separated by dielectric sheets, the capacitance (neglecting fringe effects) is  $C = \frac{0.224KAN}{d} \times 10^{-6}$ .

liquid. An aluminum electrolytic has an anode covered with aluminum oxide. This oxide is the dielectric across which the electrical charge is stored. So the capacitance is determined by how much of the surface area of the anode is covered by aluminum oxide and in contact with

the electrolyte. The cathode has little effect on capacitance except in special cases which will be discussed later. The dielectric of an electrolytic capacitor is a thin oxide film, only a few millionths of an inch. Referring to Fig. 1, we note that in a capacitor with parallel flat plates, capacitance,  $C = \frac{0.224KAN}{d} \times 10^{-6}$ . C is in microfarads, K is the dielectric constant, A is the area of one of the conductors in square inches, N is the number of dielectric sheets used in parallel, and d is the distance between conductors in inches. If the distance between conducting plates is very small, as it is in electrolytics, a large capacity can be obtained in a small volume.

As we learned from our basic electronic training, the total capacitance of capacitors in parallel is found by adding their individual capacities.  $CT = C1 + C2 + C3$ . But remember, when capacitors are connected in parallel, the voltage rating of the combination is only as great as the lowest voltage rating of any one of the capacitors. If a 25v, 50v and 75v capacitor are parallel connected, the voltage rating of this group would be 25v.

Capacitors in series are combined like resistors in parallel.

$$CT = \frac{1}{\frac{1}{C1} + \frac{1}{C2} + \frac{1}{C3}} \text{ mfd.}$$

For two capacitors in series,

$$CT = \frac{C1 \times C2}{C1 + C2}$$

Using this formula as an example, if  $C1 = 8\mu\text{fd}$ ,  $C2 = 20\mu\text{fd}$  and  $C3 = 40\mu\text{fd}$ , we find

$$CT = \frac{1}{\frac{1}{8} + \frac{1}{20} + \frac{1}{40}} = \frac{1}{\frac{5}{40} + \frac{2}{40} + \frac{1}{40}} = \frac{1}{\frac{8}{40}} = 5\mu\text{fd.}$$

## CHARACTERISTICS

Two factors that affect capacitance are temperature and frequency. Electrolytics lose much of their effectiveness at low temperatures. This is because the resistance of the electrolyte in-

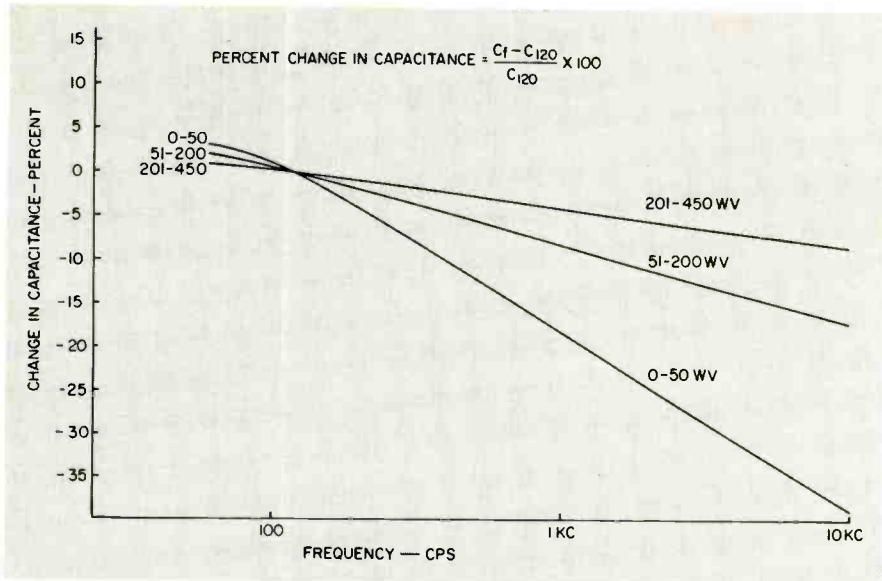

Fig. 2--This graph shows the approximate change in capacitance with frequency.

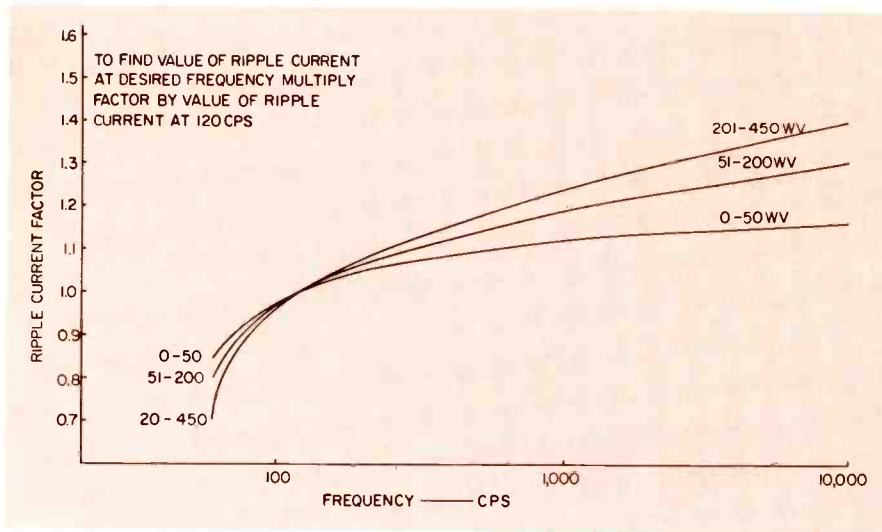

Fig. 3--Shows ripple current factor vs frequency.

creases. So if the capacitor is to be used at low temperatures, the electrolyte has to be made for this type of operation. As the temperature is increased, the capacitance increases.

A nominal value of capacitance is usually specified at 120Hz. As the frequency increases, the effective capacitance decreases. As shown in Fig. 2, the variation in capacitance is also a function of the rated dc voltage. In other words, low voltage capacitors will have a greater amount of decrease than capacitors rated at higher voltages.

Another very important measure of the *quality* of an electrolytic capacitor is the amount

of the dc leakage current. This current is a function of the materials used and their purity. It is also a function of the thickness of the oxide film, the compatibility of the oxide film with the electrolyte, the applied voltage, area of the foil and the temperature. As temperature increases, the leakage current increases which further increases capacitor heating and this in turn further increases leakage current. This is an accumulative effect and could cause thermal runaway and eventual failure of the capacitor. Therefore, a low value of leakage current over the temperature range of operation is necessary.

Ripple current is another factor to be considered, especially in applications where ac is impressed on a dc voltage such as in power supply filtering. The watts dissipated in a capacitor is the sum of the heat generated because of *ripple* current and *leakage* current. Electrolytic capacitor manufacturers usually publish ripple current ratings for a frequency of 120Hz. These values are selected to obtain the best compromise between long operating life and the maximum possible heating ratings. The maximum temperature at which the capacitor can safely operate is a function of the ambient temperature in which the capacitor is located, the heat which is radiated or conducted to the capacitor, the internal heating and the conductor size. The graph shown in Fig. 3 may be used to determine the ripple current ratings at frequencies other than 120Hz. The peak voltage which may be applied is equal to the dc plus the peak of the ac.

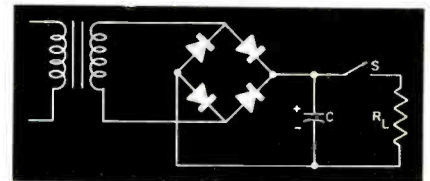

Fig. 4--Typical full wave single phase bridge rectifier operating on a 60Hz input.

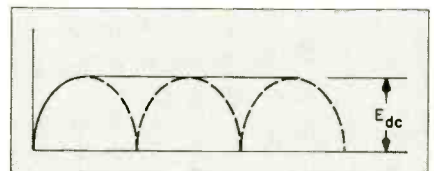

Fig. 5--The rectifier voltage is a constant dc as long as the load switch remains open.

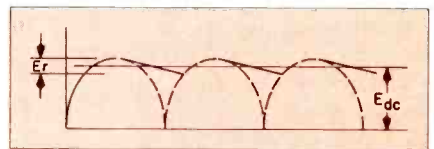

Fig. 6--When the load switch in Fig. 4 is closed, the capacitor supplies load voltage and current between successive rectifier input peaks. As the capacitor discharges, its terminal voltage drops by the amount ER creating ripple voltage.

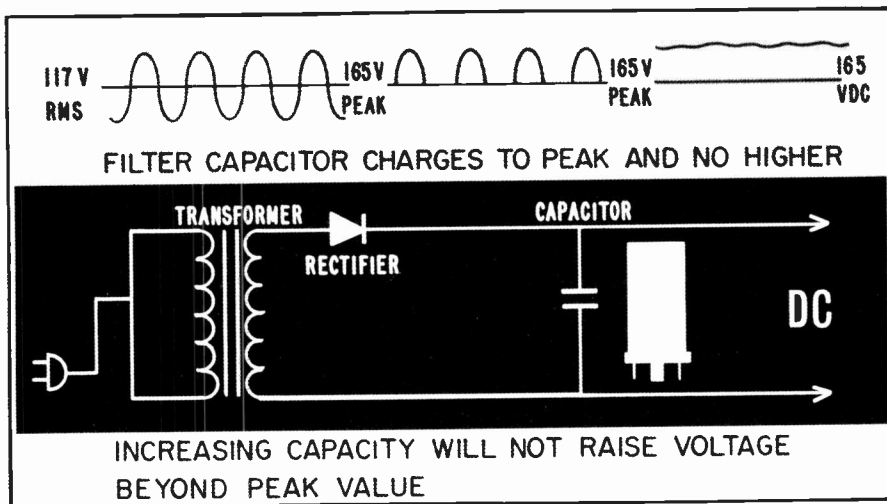

Fig. 7--The filter capacitor charges to peak and no higher. Increasing capacity will not raise the voltage beyond the peak value.

## FILTER CAPACITOR APPLICATIONS

A typical filter capacitor application is shown in Fig. 4. This is a single phase full wave bridge rectifier supplied from a 60Hz sinusoidal input. If the switch to the resistive load is open, the capacitor (C) will be charged to peak voltage. This is the transformer maximum voltage during the first 1/240 second and it will hold its charge, maintaining a constant dc voltage across its terminals. There will be no significant ac ripple voltage under these conditions as shown in Fig. 5.

However, conditions change when the load switch is closed. The capacitor will be charged to the peak voltage during the first 1/240 second as before, but after the rectifier voltage reaches the maximum value and begins to decrease, the capacitor voltage remains higher than the rectifier voltage. The capacitor must now supply load voltage and current until the rectifier voltage is again equal to, or greater than, the capacitor voltage. How fast the capacitor voltage drops during the time it is supplying the load voltage depends on the size of the load. The rms value of the "triangular wave" shown in Fig. 6 is independent of the slopes or lengths of the straight lines and depends only on the peak

values. To calculate this rms value,  $E_{rms} = \frac{E_r}{\sqrt{3}}$ . When the load switch in Fig. 4 is closed, the capacitor supplies load voltage and current between successive rectifier input peaks. As the capacitor discharges, its terminal voltage drops by the amount  $E_r$ , creating ripple voltage. The voltage drop  $E_r$  is proportional to load current and is decreased when the filter capacitor is increased in capacity.

## TYPES OF ELECTROLYTICS

There are generally three types of electrolytics: polar, semipolar and nonpolar. Polar capacitors have an oxide film on only one foil or electrode which is the anode. The other foil is plain and unformed. If a ripple voltage is applied, an oxide film will form on the cathode foil during the negative slope of the ripple voltage and result in a decrease in effective capacitance. One way to look at this type of capacitor is to consider it as two capacitances in series, one between the anode and the electrolyte and one between the electrolyte and the cathode. This type of capacitor is suitable only where the applied voltage is dc. During manufacture, etching the cathode foil increases the cathode capacitance and delays the decrease in capacitance caused by ripple current. The maximum amount of ac ripple which can be safely applied

is specified by manufacturers. Ripple current values are listed for various temperatures. If in a given application the ambient temperature is less than rated, additional ripple current can be allowed.

Semipolar capacitors are similar to polar units except that a thin oxide film has been formed on the cathode foil. These capacitors are used where some dc potential less than rated voltage may be applied in the reverse direction. They may also be used where the ripple current requirements are greater than a polar capacitor could withstand. Generally, the rms voltage drop across a semipolar capacitor should not be over 10 percent of the applied dc voltage.

Nonpolar capacitors have equal thicknesses of oxide film on both the anode and cathode. They are used in dc circuits where the full rated voltage may be applied across the capacitor in either direction for extended periods. When the ripple voltage is a large portion of the total applied voltage, nonpolar capacitors are often used. They may also be used in ac circuits when the rated ac voltage is to be applied for limited periods of time. At lower voltage ratings, they may be used for longer periods of time.

## CAPACITOR REPLACEMENT

Now that we have a fair idea of what the ratings in a capacitor mean, we can plug these facts into component replacement needs in servicing. The illustration in Fig. 7 shows a simplified half wave power supply using a diode rectifier and a filter capacitor. The filter capacitor will charge to the peak value and no higher. Likewise, increasing the capacity of the filter will not raise the voltage beyond the peak value. When it is necessary to replace a filter capacitor and an exact replacement cannot be found, use a capacitor higher in value. As the diagram of Fig. 8 illustrates, the bigger the capacitor, the better the filtering.



## ELECTROLYTICS...

Electrolytics are used in circuits where tolerance is normally not needed. The EIA standard tolerances indicate the voltage range of electrolytics in which capacity can vary and still be acceptable. To borrow from the EIA standard, it states in section 3.4.5: The tolerance from nominal rated capacitance shall be:

Rated DC Voltage	Capacitance Tolerance
From 3 to 50v, inclusive.....	-10% to +150%
From 51 to 350v, inclusive.....	-10% to +100%
From 351 to 450v, inclusive.....	-10% to +50%

The diagram in Fig. 9 shows three capacitors. All have the same capacitance and voltage rating, all measure different actual capacities-yet, all are within tolerance. Consequently, one electrolytic capacitor can be used to replace many as shown in Fig. 10. Wide-range capacitors can reduce the number of replacement capacitors the service-dealer has to stock. Wouldn't it be great if the industry could come up with a few wide-range tubes and transistors to replace the hundreds of types we now have! ■

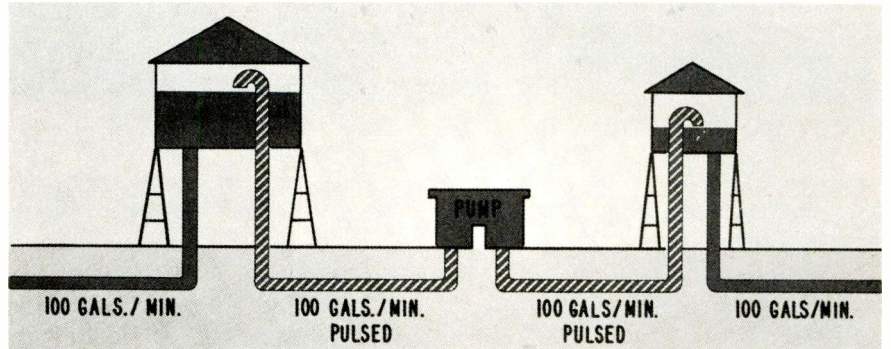

Fig. 8--Electrolytics are used in circuits where tolerance is not needed.

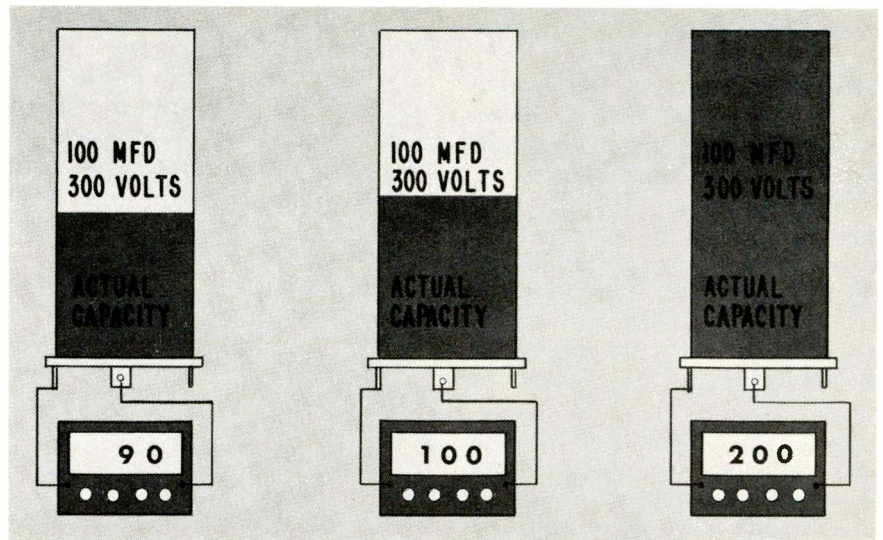

Fig. 9--These capacitors all measure different values, yet all are within tolerance.

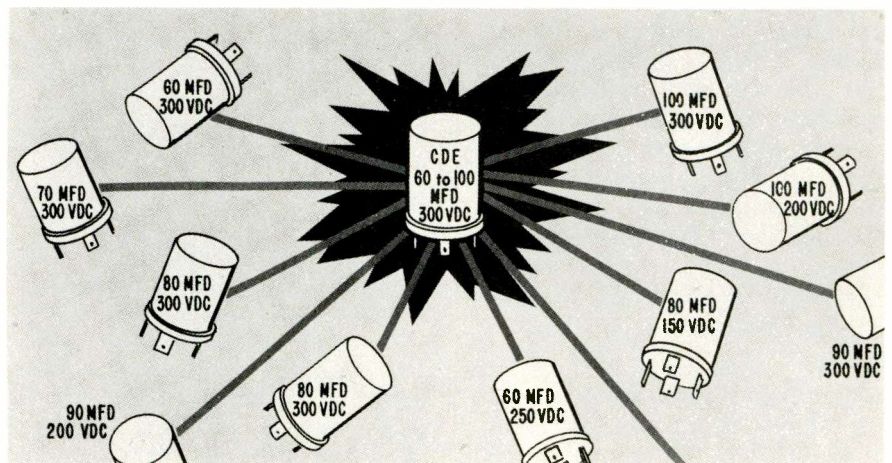

Fig. 10. Wide range tolerance means one electrolytic can replace many.



# B&K Model 162 Transistor/FET Tester

A combination tester is designed to provide a quick analysis of conventional (bipolar) and the new field effect transistors both in-circuit and out-of-circuit using the same basic procedure

■ We were anxious to check out the B&K Model 162 and after taking the tester from the box, we looked for the instruction manual. It turned out to be a booklet made like a fly-chart with hangers to fit on the back of the tester. The instruction booklet is worth mentioning because it goes into detail explaining transistors, how to test them, how they can be identified and how to determine an NPN from a PNP. Other data in the booklet indicates nor-

mal readings for various transistor categories. It provides the same information for FET's. The tester itself is small, light weight and battery operated (the batteries are included). It uses three 1.5v "D" cells. The unit measures 9in. wide, 7 1/4in. high and 4in. deep with a pocket in the back for the test leads and manual. The front panel has all of the operating controls including plug-in sockets for transistors and FET's. Test leads,

of course, are provided for in-circuit tests. The circuit diagram shows the switching arrangement for the various test listing switch positions and functions. We tried the unit on several transistors and a couple of FET's. The tester has a "balancing" circuit feature which is used for balancing out the circuit impedances when making in-circuit beta tests. Some of the other transistor testers *continued on page 83*

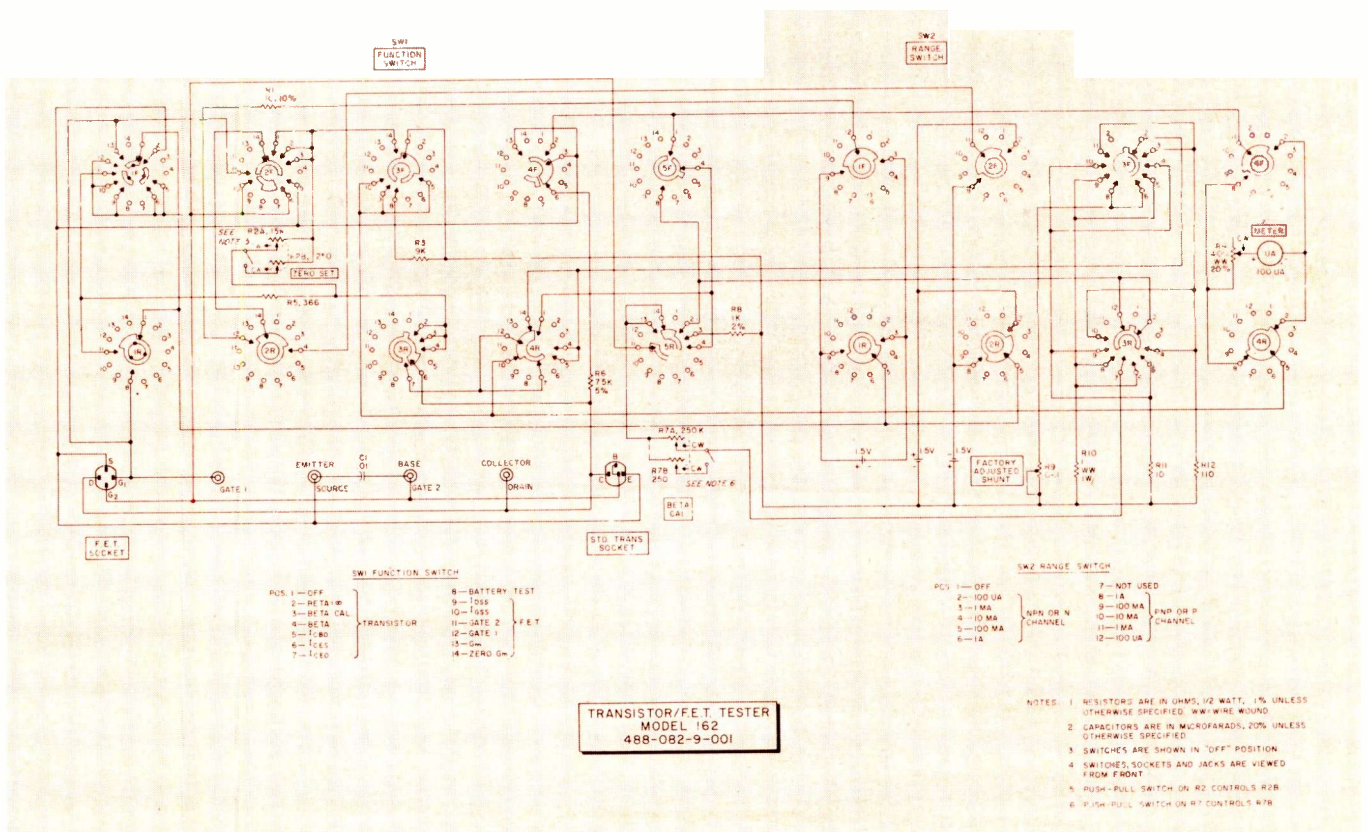

Model 162 schematic diagram showing switch positions and their functions.

## Leader Model LBO-53B Oscilloscope/Vectorscope

■ Although regarded by some as a complicated device, the oscilloscope when properly applied and fully understood can be a most useful and time-saving instrument available. You will find this especially true when servicing color television receivers with the vectorscope offered in this instrument.

After reading the news release and specifications of this imported oscilloscope we ordered one for review.

The features available and the price of this scope make it ideal for the small shop service bench or for industrial purposes.

This instrument is a compact general purpose oscilloscope and vectorscope having wide-band (DC to 10MHz) and high sensitivity (10mv P-P/cm) characteristics. Hybrid circuitry using both transistors and electron tubes has been employed for economy and reliability in operation.

A 1X2B HV rectifier tube is used in the HV supply, two 6AW8A tubes in the horizontal amplifier and two 12BY7 tubes are employed in the vertical amplifier circuit.

The chassis is very well constructed and circuit boards are employed in a good portion of the chassis.

Other important features include: DC amplifiers for vertical and horizontal inputs, highly linear wide sweep range with automatic synchronization, vector pattern display for color TV circuits and FET input stages for stable operation.

The input control and jacks for the vector pattern display are located on the back subpanel. The scope graticule is replaced with a graticule with the angular marking by removing the four thumbscrews on the CRT hood when a vector pattern is displayed.

The vertical amplifier circuit is the hybrid type consisting of an input stage employing the paraphase circuit which includes transistors Q209 and Q212. From the input circuits, the pushpull signal is fed to a direct coupled three-stage transistorized circuit with transistors Q201 and Q206. The output from the final stage is fed to the deflection amplifier tube V202 and V203. Peaking coils are connected in the plate circuits for extending the frequency range up to 10MHz. (V201 is not used.)

The gain control VR203 is the frequency compensated emitter circuit of Q201, and Q202 adjusts the signal level to the following stage with Q203 and Q204. A "padding" resistor R222 is included which limits the adjusting range within the linear characteristics, precluding the zero output condition.

The vertical spot positioning control in the emitter circuit of Q205 and Q206 varies the grid bias voltage on V202 and V203 which in turn will vary the dc voltage to produce the required static deflection.

In the input FET circuit, control VR201 is used to compensate the gate currents and control VR202 is used for balancing the characteristics necessary for dc input operation.

For the amplitude calibration, a voltage of 0.05vP-P at the line frequency is derived from a divider circuit supplied with 3.1v supplied from one-half of the heater winding.

The input stage of the horizontal amplifier is a cathode follower tube V301A with the gain control VR302 in the cathode circuit. The signal is then direct-coupled to the paraphase circuit consisting of tube V301A and V301B.

The pushpull output is applied to the horizontal deflection plates of the CRT at the pins 10 and 9 respectively.

For the proper spot centering, V302A is used for the dc balancing. The dc grid bias is set by the adjustment of VR301 and is not affected by the position of the gain control VR302. The spot positioning along the horizontal axis is done by adjusting the dc grid bias for V302B with VR303.

When the dc voltage is applied, the base potential of Q403 is in a conducting state. At the same time, C404 will be charged through the low resistance R412. When capacitor C411 is fully charged through Q403, the collector current flow will stop. This will cause the collector current in Q401 to flow and the voltage drop in R404 will put Q403 in a non-conducting state. During the interval when Q403 is off, C411 will discharge through VR402 and D402 to the potential of C416 in the bootstrap circuit of Q404. After C11 has been discharged, the charging cycle is repeated. For the different sweep ranges, capacitors C411-C415 provide the best switching action for the charge-discharge cycling.

In the bootstrap circuit, a large capacitor, 20 $\mu$ f (C416) is connected through Q404 to provide a positive feedback. This results in a sawtooth output waveform voltage with a high degree of linearity. Since the discharge effect is utilized, it is necessary to reverse the phase for the proper sweep action and this is done in the Q405 circuit.

The sweep frequency is synchronized with the input signal in the following manner.

It will be noted that there are two emitter followers, Q207 and Q208, connected to the outputs of the vertical deflection ampli-



You can't afford to be without the oscilloscope, with the features and price offered in this instrument

fiers V202 and V203 respectively. These emitter followers derive their signals at relatively high level and their polarities depend on the displayed waveforms. The sync signal polarity, positive or minus, is applied to a voltage limiter made up of R401, C401 and D401 to prevent excessive control and then fed to the amplifier Q402 in the base circuit of the sawtooth generator Q403. Thus any signal whose amplitude exceeds a minimum practical display height will automatically synchronize the sweep frequency.

A single transformer PT101 is used for supplying the power to the rectifier systems and the heaters of the electron tubes. The dc power section is composed of three main rectified sources.

**SPECIFICATIONS.** Vertical axis: Deflection sensitivity, 10mv P-P/cm or better. Bandwidth, at -3db; DC: to 10MHz; AC: 2Hz to 10MHz. Input impedance, 1M, 35pf in shunt. Input control, X1, X10, X100, X1000, and fine adjuster. Calibration voltage, 0.05vP-P at line frequency. Horizontal axis: Deflection sensitivity, 300mv P-P/cm or better. Bandwidth, at -3db; DC: to 500kHz; AC: 2Hz to 500kHz. Input impedance, 1M, 50pf in shunt. Input control, X1, X10 and fine adjuster. Sweep Circuit: Frequency range, 1Hz to 200kHz in six steps; H-TV at 15.75kHz/2. Synchronization, INT + & -, EXT and LINE. Phasing control, 0-140deg variable for line frequency. Power supply: 100, 115 or 230v as specified; 50/60Hz; 85va approx. Size and weight: 10 3/8(H) x 8(W) x 16 1/2(D) in.; 24 lb 11kg. Accessories furnished: Low capacitance probe, 10: 1 ratio (LPB-IZ), terminal adapter, vectorscope scale. Price \$229. ■

Leader Model LBO-53B  
oscilloscope/  
vectorscope.

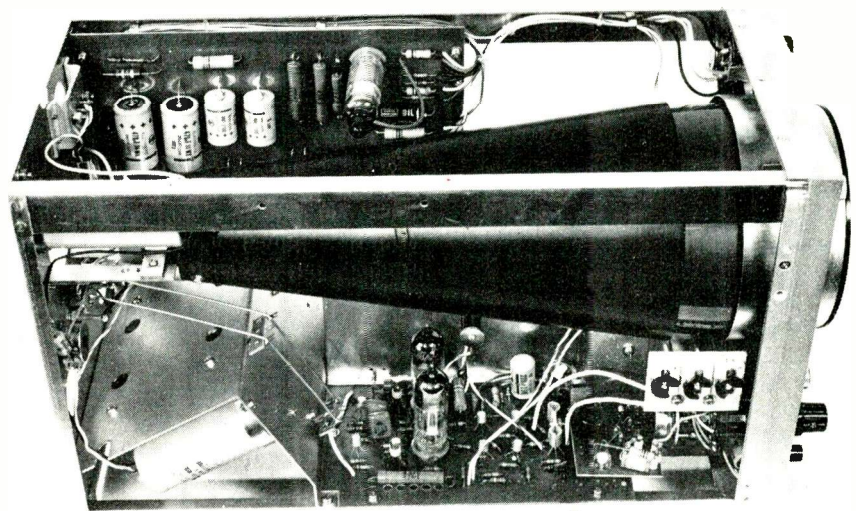

Interior view showing circuit boards, shielded CRT and controls.  
Simplified block diagram of the Leader oscilloscope.

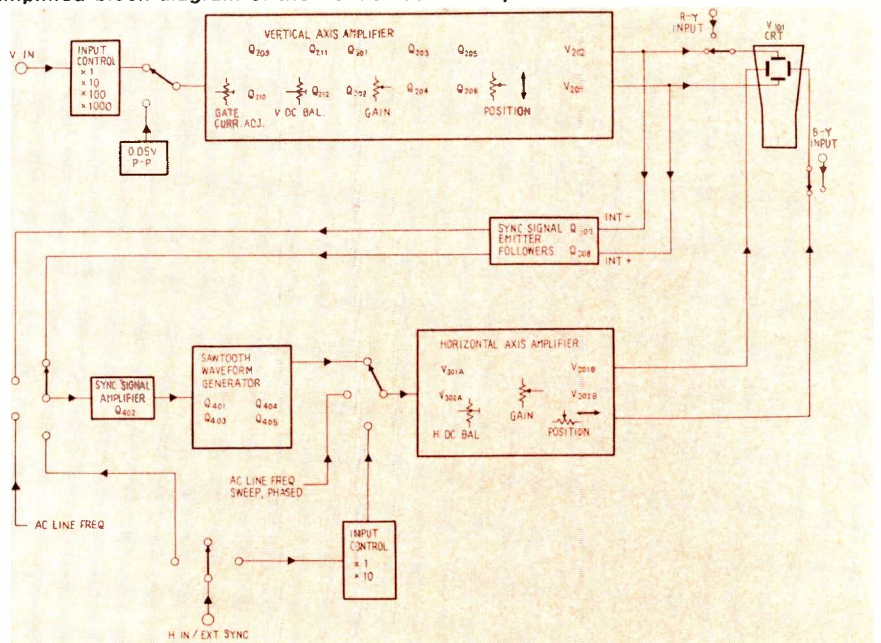

# NOW—Color-Coded Schematics for 1500 TV Sets . . . at an Unbelievable 1.3¢ Per Set!

Yes, now you can speed-repair 1500 popular TV receivers for just about 1¢ each . . . with the service-man-proved COLOR-CODED TV COLORGRAMS.

If you've heard about TV Colorgrams, then you know they were a real bargain at their original total price of \$102.50. Now, at this special price of only \$19.95, they're almost a steal.

## What are TV COLORGRAMS?

They're amazing new color-coded charts that help you isolate TV receiver difficulties and with less effort than you ever dreamed possible. Each COLORGRAM chart is clearly color-coded to show signal-flow, continuity, test points, and voltages. The entire ground conductor is shown in its own distinctive color. Every component in the circuit is clearly identified, and its relationship to other components made readily recognizable. COLORGRAM charts let you concentrate on that small portion of the set most likely to be the cause of the trouble. There's no time wasted working back and forth between schematic and set looking for test points . . . wading through superfluous information . . . identifying components incorrectly. With COLORGRAMS, everything is there, before your eyes, and very often looking just as it does in the set.

## What does a TV COLORGRAM Service-Pak include?

Everything you need to service a whole series of TV sets!

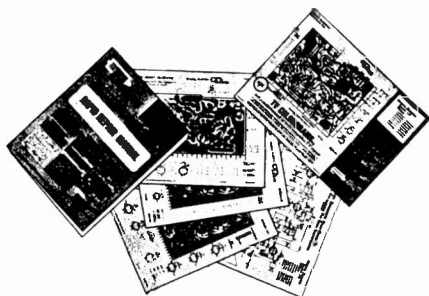

Typical COLORGRAMS SERVICE-PAK sold for \$1.95. You get 50 such PAKS . . . plus 148-page Index . . . for only \$19.95!

First of all, the Pak includes COLORGRAM charts for IF, Video, Audio, Vertical and Horizontal (showing sync and sweep circuits), B+ distribution and AGC circuits. You use the Video chart if you have a Video problem, the Audio chart if you have an Audio problem, etc.

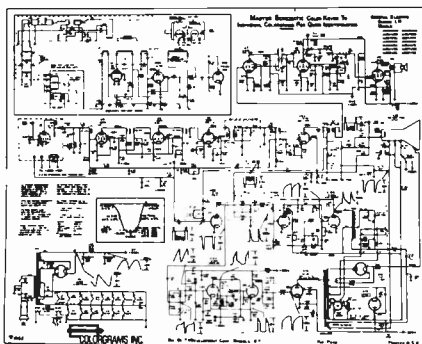

Easy to read complete master schematic is color-keyed to the colors used in the Colorgram Charts.

Second, the Pak includes color-keyed master schematic providing an overall view of the receiver circuit. It shows the Tuner, IF, Video, Audio, Vertical and Horizontal sections, color-keyed to the colors used in individual COLORGRAM charts. It also shows test points, waveforms, voltage, resistance, capacitance, practical alignment data, etc.

## CONTENTS

ADMIRAL	(25 CHASSIS, 179 MODELS)
EMERSON	(24 CHASSIS, 100 MODELS)
G. E.	(9 CHASSIS, 332 MODELS)
MAGNAVOX	(1 CHASSIS, 27 MODELS)
MOTOROLA	(8 CHASSIS, 63 MODELS)
PHILCO	(24 CHASSIS, 122 MODELS)
R. C. A.	(125 CHASSIS, 539 MODELS)
WSTGHSE.	(27 CHASSIS, 183 MODELS)

Third, the Pak includes a Rapid Repair Manual that is an effective guide to the use of the COLORGRAM System. It contains original manufacturer's service notes, special instructions, circuit modifications, parts list, and parts numbers. Other practical service data in the Guide are a Pictorial Tube and Component Location Chart, and a Tube Failure Guide.

## What do I get for my money?

50 complete Service-Paks . . . each Pak containing data on approximately 30 TV sets. PLUS, as an added bonus,

we'll include the 148-page MASTER-INDEX and Cross Reference Replacement Parts Guide which lists all 1500 TV sets you can quickly repair with TV COLORGRAMS. It describes the black-and-white receivers of Admiral, Emerson, General Electric, Magnavox, Motorola, Philco, RCA, and Westinghouse. These receivers are cross-referenced (by IBM data-processing) to nine replacement parts manufacturers . . . Aerovox, Centralab, Clorostat, G. C., Merit, Stancor, Thordarsan, Triad, and TVD, covering over 25,000 parts listings. This INDEX gives you the newest, fastest, clear-

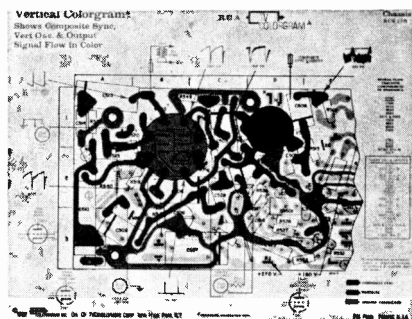

Each Colorgram chart is color-coded to show signal flow and continuity—just like a road map!

est, most practical approach to obtaining the correct replacement part in a hurry.

## MONEY-BACK GUARANTEE

So sure are we that the data in these invaluable Service-Paks will save you time and money we're offering them on a guaranteed money-back basis. Order at our risk for FREE 10-day examination. Put the data in these schematic-packed guides to work for you for 10 days. If they don't prove to be worth several times their cost, return them and we'll refund the full purchase price, or cancel the invoice. Simply fill in and mail the NO-RISK coupon below, to obtain these time-saving, money-making manuals.

## NO RISK COUPON — MAIL TODAY

TAB Books, Blue Ridge Summit, Pa. 17214

- I enclose \$19.95 for which please send me your complete 50-Package Colorgrams Schematic offer postage prepaid.
- Please invoice me for \$19.95 plus postage. Same return privileges.

Name .....

Company .....

Address .....

City ..... State ..... Zip .....

(Paid orders shipped prepaid. Pa. resident add 6% Sales Tax. Outside USA 10% extra.)

ET59



# smooth

**RCA WP-700A, 702A, 703A and 704A** constant voltage dc power supplies are all solid-state. A negative feedback circuit maintains constant output voltage with low ripple—regardless of varying line. In fact, at rated load, these supplies are so smooth that “they hardly cause a ripple.”

They are versatile bench-type units—ideally suited for use in circuit design, servicing, industrial, and educational applications.

Output voltage of the WP-700A and WP-702A is continuously adjustable from 0 to 20 volts at current levels up to 200 mA.

Output voltage of the WP-703A is continuously adjustable from 0 to 20 volts at current levels up to 500 mA.

Output voltage of the WP-704A is continuously adjustable from 0 to 40 volts at current levels up to 250 mA.

All four power supplies have built-in electronic short-circuit protection—and a front panel overload-indicator that signals approach to maximum rated current level.

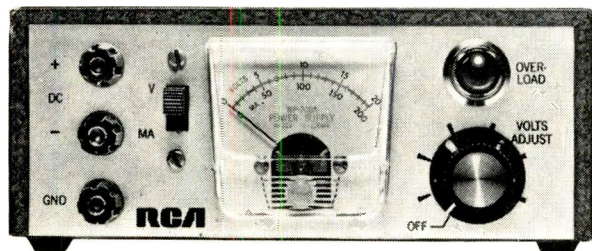

**WP-700A:** \$40.00\* (five or more) \$48.00\* (less than five)

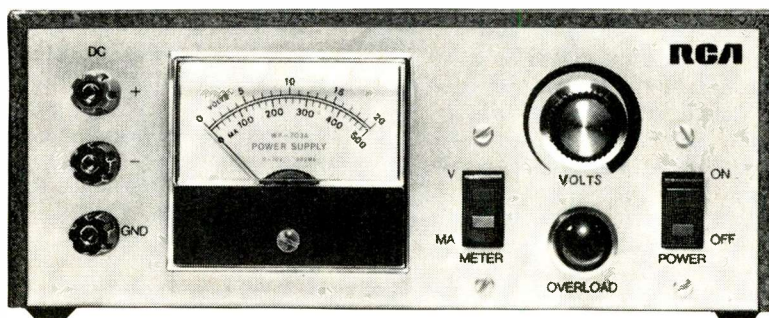

**WP-703A:** \$49.00\* (five or more) \$58.00\* (less than five)

**WP-704A:** \$49.00\* (five or more) \$58.00\* (less than five)

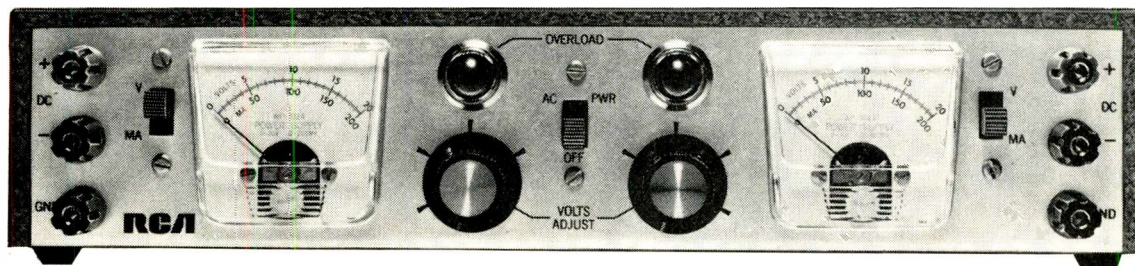

\*Optional Distributor Resale Price.

**WP-702A:** Siamese Twins of WP-700A, but electrically isolated \$73.00\* (five or more) \$87.00\* (less than five)

For further information write: RCA Electronic Components, Commercial Engineering, Department J-205W, Harrison, N.J. 07029.

Look to RCA for instruments to test/measure/view/monitor/generate

... for more details circle 134 on Reader Service Card





# DEALER SHOWCASE

For additional information on products described in this section, circle the numbers on Reader Service Card. Requests will be handled promptly.

## SOUND COLUMN 703

*Tested to withstand high and low temperature*

Introduced is a new weatherproof sound column which is constructed of solid 3/4in. redwood. Known as

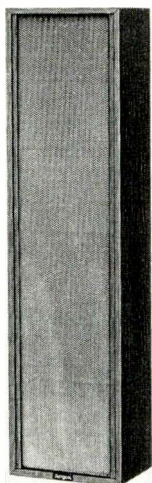

the SD-1062 "Sound Director," this column is claimed tested to withstand high and low temperature extremes and actual emersion in water. The sound column minimizes feedback because of its focused sound characteristic. The unit is electronically glued with 100 percent waterproof adhesive and its louvered, anodized aluminum grille is backed with a double plastic moisture barrier. Six special 6in. speakers with waterproof cones and aluminum bobbin voice coils have a frequency response from 50 to 15,000Hz. The mounting hardware has a heavy-duty weatherproof plating and two-way action permitting horizontal and vertical rotation for focusing. Vertical projection angle is 30deg and horizontal the projection angle is 130deg typical. Power capacity is 60w and the impedance is 16Ω. The unit measures 44 high x 11 1/2 wide x 7 1/2in. deep. Argos.

## CAPACITOR CENTER 704

*72 electrolytics satisfy all replacement demands*

A capacitor replacement center is introduced. As a result of a study, a Re-Place capacitor system was developed which includes a complete stock of all wide-range twist-prong,



tubular and miniature aluminum electrolytic, dipped paper-Mylar, dipped mica, ceramic disc and wax-filled capacitors in use in the replacement market today. The entire assortment is housed in a 2 x 5ft merchandising center designed for self-service. Adequate backup stock and an easy re-order system is included in the center. The capacitor center reportedly cuts down the over-all capacitor stock required. The twist-prong line contains 248 different units and provides only 72 tubular aluminum electrolytics to satisfy all replacement demands. Cornell-Dubilier.

## VHF-FM RADIO 705

*Solid-state design with superhet circuit*

Introduced is a radio designed for monitoring emergency messages or for the fun of listening-in. The hand-



held portable radio is offered in two models to cover VHF-FM frequencies of 27 to 50MHz and 146 to 175MHz. Depending on frequencies used in specific areas, the monitor will tune police, fire, civil defense, utilities, radio-telephone, U.S. Weather Bureau, railroad, cab, radio-dispatched vehicles and various other service bands. The design is solid-state for instant operation with a modern superhet circuit for dependable performance. Each unit has a self-contained 2 3/5in. speaker, a built-in swivel telescoping antenna with provision for an external antenna and earphone jack. There is provision for a 110vac adapter available separately for home operation. Size is 6 x 3 1/8 x 1 1/8in. Price \$17.95. Allied.

## TAPE CASSETTE 706

*Color-coded transparent cassette cases*

A 30min tape cassette reportedly ideal for "tape-spondence" and other short-term recording needs, is intro-



duced. The cassette line, which includes 60, 90 and 120min cassettes, is now offered in easy-to-recognize color-coded transparent plastic cases; C-30, clear; C-60, green; C-90, orange; and C-120, blue. All cassettes in the series offer low noise tape construction for improved fidelity. The cassette will be offered in a file album for \$2.25 suggested list, or a post office-approved mailer for \$2.35. 3M.

## STEREO RECEIVER 707

*Field effect transistorized front end*

An all-silicon transistor AM/FM multiplex stereo receiver, Model SX-770, is introduced. The tuning scale

# Meet the number one swinger!

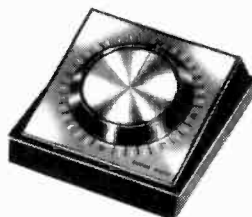

More antennas swing with Channel Master's Automatic Colorotor than any other automatic rotator in the country. That just goes to show that dealers and customers know a winner when they see one.

And everybody has been seeing a lot more rotator sales since color came into the picture. Color set owners usually want the best and research has proved that ghosting can be substantially reduced by a rotator even when all stations are in one direction!

Channel Master's Automatic Colorotor is the ultimate in convenience and performance! Aims the antenna within **one degree** of precise transmitter location—impossible to knock out of alignment by reversing direction. Built-in thrust bearing provides friction-free rotations under heavy loads. Resynchronizes smoothly and automatically merely by rotating the antenna.

Ask about Channel Master's unique dealer profit protection policy and instant replacement warranty!

***CHANNEL MASTER***  
Color-Engineered Antennas and Accessories

... for more details circle 146 on Reader Service Card



**Put this E-V  
needle/cartridge  
display next to  
your cash register  
...it insures  
good fortune!**

Put this handsome merchandiser with its stock of E-V literature on your counter. You've just taken the first step toward bigger phono needle & cartridge sales.

Now, take the second step. Let your E-V distributor help you fill it with the best-selling needles & cartridges in town.



Best-selling because the Electro-Voice computer prepares accurate, up-to-date popularity lists for your guidance. Easy-selling because all E-V needles and cartridges meet or exceed original equipment specifications for quality.

Your Electro-Voice distributor has the broadest line of exact-replacement phono parts in the business. Needles, cartridges, wheels and belts. Plus a merchandiser deal that helps you sell them. Start your good fortune today at your nearby E-V distributor's!

ELECTRO-VOICE, INC., Dept. 10977  
663 Cecil St., Buchanan, Michigan 49107

**Electro-Voice**  
A SUBSIDIARY OF GULTON INDUSTRIES, INC.

## ET/D DEALER SHOWCASE

is illuminated in blue, with an all-black front panel and housed in an oiled walnut cabinet. The unit has 70w audio output power (IHF rating at  $4\Omega$ ) with



reportedly less than 0.8 percent at full output at 1kHz of harmonic distortion. It features a field effect transistorized front end and an integrated circuit IF section. The receiver has an IHF usable sensitivity of  $1.8\mu\text{V}$ , an image rejection of 60db at 98MHz and a signal-to-noise ratio of 70db (IHF rating). There are output terminals and jacks for speakers, stereo headphones, a tape recording/playback jack as well as a simultaneous tape recording jack equipped with a tape monitor switch. Price \$249.95. Pioneer.

### SPEAKER 708

*Hi Fi or bi-directional  
paging capabilities*

Introduced is a lightweight, thin-line plastic loudspeaker. The Poly-Sonic employs a speaker with a weather-proof plastic enclosure adapting it



to outdoor as well as indoor use. It may be used for Hi Fi music or for bi-directional paging. Weighing less than 4 lb, the speaker is easily carried. It measures  $16\frac{1}{4} \times 13\frac{3}{4}$  in. with a depth of less than 2 in. Power capability is 20w peak with an input impedance of  $8\Omega$ . Suggested retail price is \$19.95. ERA.

### CB TRANSCEIVER 709

*Transmits and receives  
all 23 channels*

A 23-channel, hand-held CB transceiver is introduced. The "Fanfare 23" is reportedly capable of transmit-

ting and receiving on all 23 CB channels. The unit reportedly has full 5w power with an effective inland range of 10 miles, depending on terrain. The

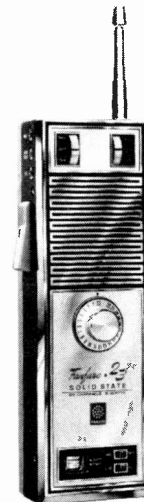

solid-state unit weighs less than 5 lb with a  $2\frac{3}{4}$  in. PM dynamic speaker. All crystals are included for all channels. The unit is equipped with jacks for public address systems, external earphone/speaker, antenna, microphone and power connection. Accessories are available which extend the versatility of the unit. These include a solid-state transformer-regulated ac power supply recharger which makes it possible to use it as a base station. Additional accessories include a cigaret lighter adaptor cord for operation on 12v auto lighter, external power pack for "D" cells, an external antenna adaptor and a leather carrying case. The receiver has  $0.25\mu\text{V}$  sensitivity and measures  $3\frac{3}{8} \times 11\frac{1}{8} \times 2\frac{1}{2}$  in. D. Fanon.

### TRANSISTOR TESTER 710

*Requires no leads  
or alligator clips*

A battery-operated transistor tester is introduced. The unit tests unknown or identified transistors for NPN or PNP

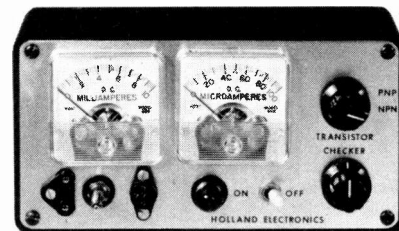

configurations, shorts, opens and gain. The Model TT285 contains two high-accuracy, easily seen  $1\frac{5}{8}$  in. square ammeters, 0-100 $\mu\text{A}$  base current and 0-10ma collector current. The unit measures  $2\frac{1}{2} \times 5\frac{7}{8} \times 3\frac{1}{8}$  in. Self-contained in its plastic case, the instrument requires no lead wires. Price \$65. Holland.



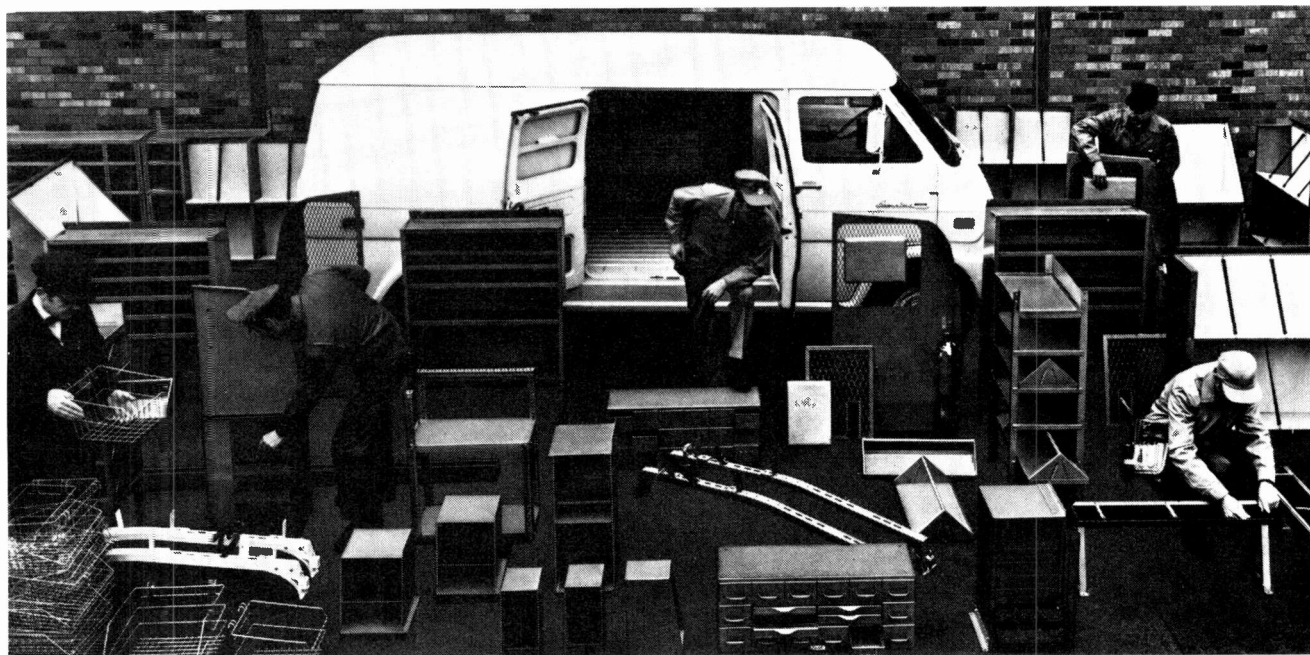

## Perfect fit: Econoline Van custom-designed to your job.

### CUSTOM-DESIGN YOUR VAN

Your job may call for a one-of-its-kind van. You can get it in an Econoline, and all from one place—from your Ford Dealer.

Sound impossible? Not for the man with better ideas. Your Ford Dealer can custom-design the Econoline's interior into *your* kind of efficient working space, and it comes to you *ready for work*.

### WIDE CHOICE OF MODULAR UNITS

Econoline modular units (like those shown above) are the answer. Components include: racks, adjustable shelf units, drawer units, cabinets, bins (both padded and plain), padded trays, tote trays, hanging baskets, book compartments, storage boxes, partitions, padded siderails, padded floor, equipment holders, ladder racks, and many more.

These are not just parts and pieces, but a system of Econoline-engineered units designed to fit and work together. Constructed of heavy gauge steel with gray enamel finish, they bolt to floor and/or body pillars to become permanent yet movable parts of the van. Traveling showcase or workshop—you name it and it's yours with the Ford Econoline.

### BETTER IDEAS EASE YOUR WORK

However you design your van, you have all of Econoline's basic better ideas going for you. Convenient outside front service center for quick-checking engine and related parts. Driver "walk-through" for easy access to the load compartment. More clear floorspace by 23% than any other van. Wide 5½-ft. stance for stability, yet a sharp 40-ft. turning diameter for maneuverability. And, of course, exclusive Twin-I-Beam independent front suspension for great durability, easy handling, low maintenance, long tire life.

Because it is the one-of-its-kind van, you see more and more Econolines on all kinds of jobs. See how much more an Econoline Van can do for you—see your Ford Dealer.

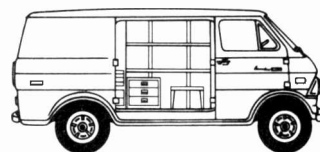

Radio, TV, Appliance Repair

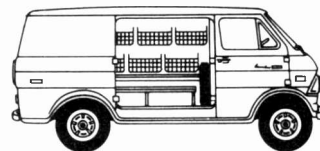

General Utility

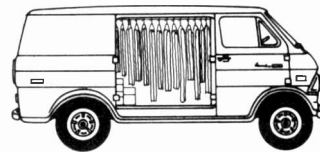

Laundry and Dry Cleaning

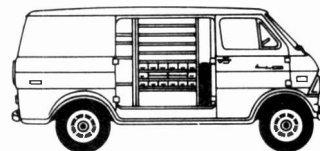

Vending Repair

# FORD ECONOLINE VANS



... for more details circle 116 on Reader Service Card



# COLORFAX

The material used in this section is selected from information supplied through the cooperation of the respective manufacturers' or their agencies.

## ADMIRAL

### Color TV Chassis 4K10—Automatic Degaussing Circuit

The degaussing coils in the 4K10 chassis are automatically "turned off" as the picture comes on by two special thermistor units: RE70 (61C52-1) and RE71 (61C53-2). Thermistor RE70 has a positive temperature coefficient; its resis-

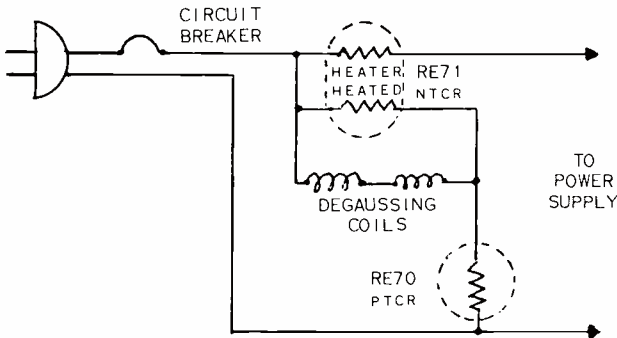

tance increases as its temperature increases. RE71 has a negative temperature coefficient; its resistance decreases as its temperature increases. RE71 is actually two NTC thermistors thermally connected so the heat generated by current flowing through one heats the other, causing the resistance of the heated unit to decrease.

When the set is first switched on, RE70 has low resistance, allowing high current to flow through the degaussing coils. As RE70 heats up and its resistance increases, the current through the coils decreases. At the same time, but at a slower rate, the RE71 unit in the power supply circuit is heating the unit connected across the coils, lowering its resistance and shunting the current around the coils.

The combination of decreased resistance in parallel with the coils and increased resistance in series with them effectively stops current flow through the degaussing coils as the picture comes on.

### Color TV Chassis 4K10—Color TV High Voltage Tubes

Well over a year ago, Admiral announced new HV rectifier and shunt regulator tubes and specified that they were to be used exclusively as field replacements for earlier types. The 3BT2 HV rectifier must always be used to replace the 3AT2 and 3BS2 types. In the same manner, the 6EL4 shunt regulator must always be used to replace the earlier 6BK4, 6BK4A and 6BK4B regulators.

## GENERAL ELECTRIC

### Color TV Chassis H-3—Adjusting High Voltage

The set should be allowed to warm up for 20 minutes or more before the final high voltage adjustment is completed. Reduce the brightness to minimum and adjust the HIGH VOLTAGE SET control to produce 17.2kv at second anode

with 120v line input. Increase line voltage to 130v and make sure the second anode potential does not exceed 17.8kv.

### Color TV Chassis C-1—Modification To Improve Degaussing Action

Inadequate degaussing action in some C-1 chassis receivers has been attributed to the charge remaining in electrolytic capacitor 2C405 when the receiver is switched off.

In current C-1 chassis production, a 100K, 1/2w carbon resistor has been added in parallel with 2C405 to provide

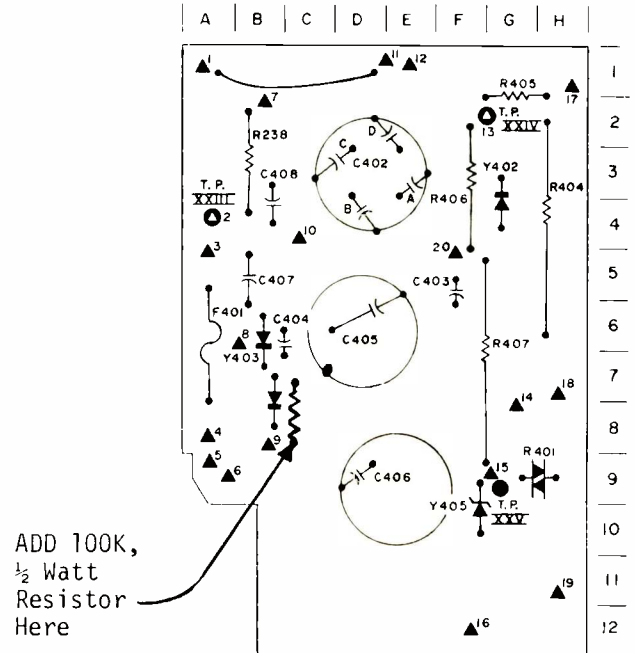

a discharge path to ground. Receivers bearing Serial No. 5D4 and higher are equipped with this resistor. It is physically located adjacent to rectifier Y404 on the power supply board.

To improve set performance, it is recommended that you add this resistor to any early production C-1 chassis when serviced.

### Color TV Chassis G-1—HV Voltage Transformer Squeal

There have been some complaints of high voltage transformer fundamental frequency squeal in G-1 chassis receivers. Current production receivers (EN433 and higher) are being manufactured with an increased HVT core air gap.

The air gap is controlled by special paper tape between the core halves. Originally, one thickness of tape was used to create this air gap. Now, two thicknesses of tape are used to create a 15 mil gap. The proper tape is Scotch Brand No. 280, which is available from your General Electric parts distributor under catalog number EP60X9.

To modify an early production receiver, dismantle the HVT and remove the original air gap tape from the core halves. There may be some versions with black plastic electrical tape used as pads between the core and high voltage cage. Remove these pieces of tape also. Use four pieces of new tape approximately 1 1/2 in. long. Attach tape to both ends of both core halves as shown in the drawing. Be careful that the tape does not wrinkle or have foreign material stuck to it, as this air gap dimension is critical.

The second part of the modification is the elimination of the pincushion correction circuit. Remove the brass screws securing the pincushion transformer assembly to the HVT cage and clip the transformer winding leads close to the terminal board. Discard the pincushion transformer, but salvage the terminal board and insulating strip. Securely mount the terminal board and the fish paper insulator

# We carry your shipments to 24,999 other places, too!

Greyhound Package Express serves more places than you can imagine...over 25,000 of them—large and small, in 48 states throughout the USA. And we love small shipments. Can we drop something off for you? It's there in hours and costs you less when you ship by GPX.

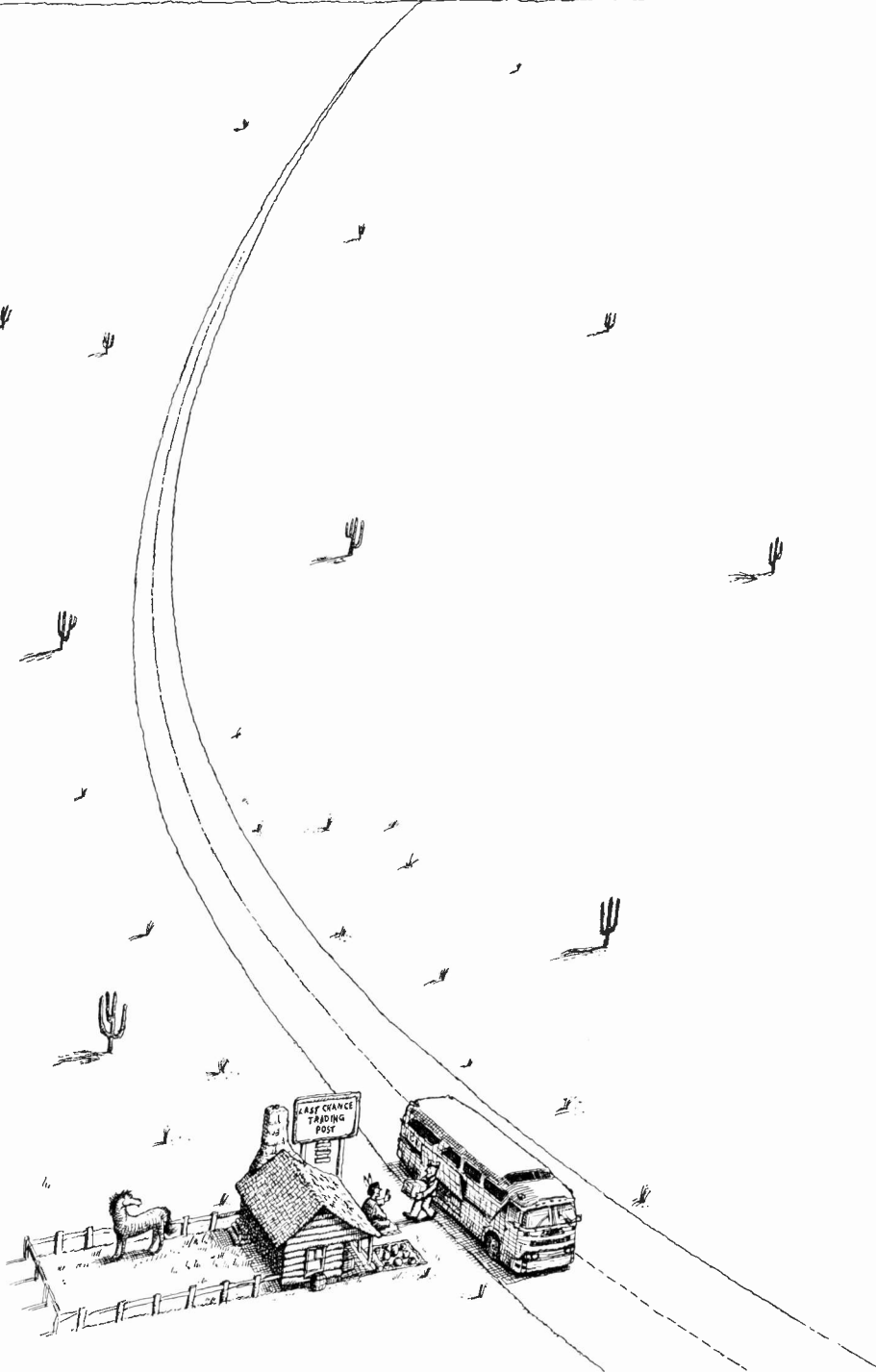

For Example	Buses Daily	Running Time	10 lbs.	30 lbs.	50 lbs.
Atlanta— Birmingham	9	3 hrs. 30 min.	\$2.05	\$2.60	\$3.40
Houston— Ft. Worth	4	6 hrs. 00 min.	1.90	2.40	3.00
Portland— Eugene	17	1 hr. 55 min.	1.30	1.70	2.20

Other low rates up to 100 pounds. Lot shipments, too. For complete information call Greyhound, or write Greyhound Package Express, Dept. 53-J, 10 South Riverside Plaza, Chicago, Illinois 60606.

... for more details circle 120 on Reader Service Card





# ET/D COLORFAX

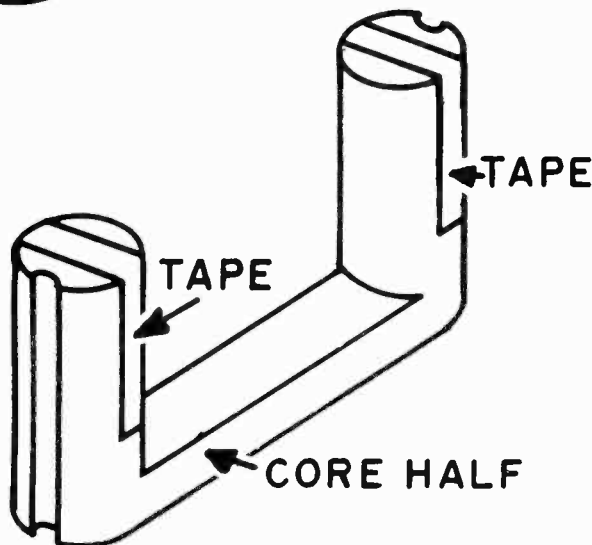

in the space formerly occupied by the transformer, using the same brass screws. Cut off any excess length of the screws. To restore continuity in the vertical yoke circuit, the green lead on the pincushion transformer terminal strip has to be moved one terminal to the rear which is a common ground point. This procedure leaves C275 (3 $\mu$ f) and R275 (22  $\Omega$ ) out of the circuit on the power supply board. They can be left on the board or removed at your discretion.

To insure proper performance of the set, it is essential that both steps of this procedure are performed. Eliminating the pincushion transformer will not adversely affect

receiver performance, but will decrease the load on the horizontal output tube resulting in cooler operation and increased reliability.

Apply power to the receiver and reset the high voltage to 21kv at zero beam current (minimum brightness) with a line voltage of 120 vac.

Be sure to perform the safety check as specified in your G chassis service manual after reassembling the receiver.

## OLYMPIC

### Color TV Model CT-910—Service Hints

Symptom: Intermittent tuner operation. Correction: Check R-10 (10K-1w) resistor. This resistor is easily accessible from the inside of tuner. It is the mixer-plate load resistor.

Symptom: Restricted focus range. Correction: Check R-808 (68M) focus rectifier load resistor for a possible change in value.

Symptom: Vertical linearity control improvement. Correction: There may be an improvement by changing R-241 (120K) resistor to 68K.

Symptom: Poor vertical retrace suppression. Correction: Check and replace, if necessary, C420 (.05 $\mu$ f) capacitor which may have leakage.

Symptom: Excessive brightness and weak color. Correction: Check resistor R608 (15K); it may be "open." It is located on Pin 8 of V18.

### Color TV Model CTC-30—Service Hints

Symptom: Poor color killer action. Correction: Check that C-170, a .01 $\mu$ f disc capacitor, is wired as shown in the sketch which is in accordance with the schematic in the ser-

## NEW COAX LINE SPLITTER

For UHF/VHF  
Color/B&W TV



The Mosley M-22 two set, and M-24 four set 75 ohm coax splitters for color TV/FM Stereo distribution systems. High inter-set isolation, low insertion loss. Models may be combined to provide any number of lines for larger amplified systems.

Solderless. Easy installation.



Write Dept. 159A for FREE detailed brochure.

**Mosley Electronics, Inc.** 4610 N. Lindbergh Blvd.,  
Bridgeton Missouri 63042

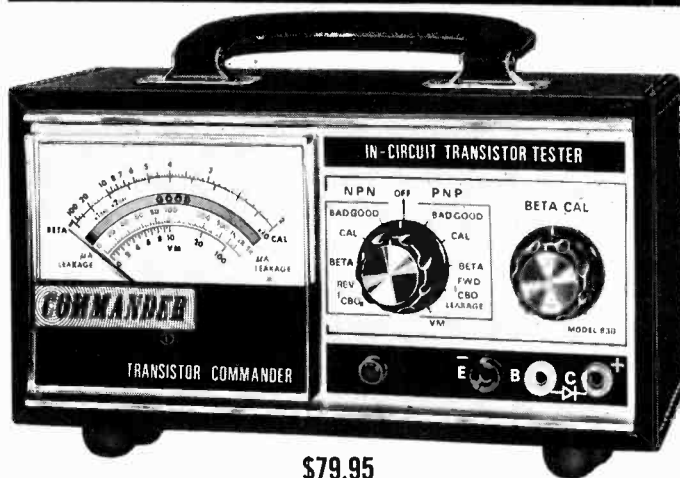

\$79.95

### LOWEST COST FET TESTER

- Tests FET's For Gm (UMHOS)
- Tests Transistors For AC Beta
- Obsolescence Proof
- No Charts Needed

### Full Line of Test Equipment

- 830-Transistor Tester
- 840-Field Strength Meter
- 857-CRT Tester/Rejuvenator
- 865-Color Bar Generator
- 880-Stereo Test System
- 870-FET Volt-Ohm Meter

133 N. Jefferson, Chicago 60606 312-346-2841

... for more details circle 130 on Reader Service Card

... for more details circle 113 on Reader Service Card

# a new Deluxe line

# RCA

## Spray Chemicals

### A new exciting selection of RCA Deluxe Electronic Spray Chemicals

RCA Parts and Accessories presents a new line of Deluxe Electronic Spray Chemicals branded with the RCA name . . . the name electronic service technicians rely on for quality and dependability.

A complete selection of "most needed" chemicals—cleaners, coolers, lubricants, insulators, protectors—top quality sprays designed to meet the demands of service technicians in TV/radio/record player/tape recorder repair—plus additional applications in computer, office machine, industrial and broadcast servicing.

RCA Deluxe Electronic Spray Chemicals . . . the work saving, profit making line.

*See other side for complete specifications.*



# RCA Spray Chemicals

Color Code	Stock Number and Description	Advantages	Recommended Use
	SC100 Deluxe Color Tuner Cleaner-Lubricant 8 ozs.	Safe for plastics Non flammable Non-toxic Driftless Will not detune	Use RCA Deluxe Color Tuner Cleaner-Lubricant on all Color and Black and White tuners. Specially compounded to leave no residue that will affect operation of high performance tuners. Will not cause tuner to drift, detune or oscillate.
	SC101 Deluxe Heavy Duty Control Cleaner and Lubricant 8 ozs.	Safe for plastics Long lasting protection	Use RCA Deluxe Control Cleaner and Lubricant on all low power carbon composition and wire wound potentiometers and rheostats including all types of radio and television controls.
	SC102 Deluxe Circuit Chiller 16 ozs.	Instant chilling power Tracks down intermittents fast	RCA Deluxe Circuit Chiller is an instant cooling spray; an excellent trouble shooting aid when the trouble is intermittent and difficult to locate. Faulty components such as capacitors, resistors, semiconductors and oxidized junctions can be readily located with RCA Deluxe Circuit Chiller.
	SC103 Deluxe Red Corona Spray 8 ozs.	Economical Fast drying Long lasting Provides tough permanent film	RCA Deluxe Red Corona Spray stops arcing and corona discharge.
	SC104 Deluxe Acrylic Spray 16 ozs.	Tough clear acrylic coating Protects against tarnish and oxidation	RCA Deluxe Acrylic Spray is used on antennas, drawings, polished metal surfaces, and electrical connections.
	SC105 Deluxe Multi Purpose Lubricant 8 ozs.	High quality lubricating oil Extra penetrating power	Use RCA Deluxe Multi Purpose Lubricant for computers, tape recorders, instruments, office machines, record changers, small motors, all moving parts, loosening rusted screws, and loosening "frozen" TV yokes.
	SC106 Deluxe Relay and Contact Cleaner 16 ozs.	Safe for plastics Non flammable No residue Can be used while circuitry is in operation	Use RCA Deluxe Relay and Contact Cleaner for missile components, cleaning contacts, switches, controls, radio tuning capacitors, phono motors, gears and slide mechanisms; printed circuit boards, remote control actuators and other electromechanical devices. Also flush away dirt from negatives, transparencies and movie film. Safe for all types of film base. Used as universal "White Room" cleaner.
	SC107 Deluxe Audio/Video Tape and Head Cleaner 16 ozs.	Cleans, protects, cuts wow, flutter and squeal Extends tape life	For use on audio/video tape and heads.
	SC108 Deluxe Anti-Static Record Spray 6 ozs.	Cleans, protects Safe for all records <i>Free record cloth.</i>	Use RCA Deluxe Anti-Static Record Spray to clean and protect all types of records.

**RCA** Parts and Accessories



*Continued from page 70*

vice manual. A few early production units may have been shipped with one leg of C-170 wired incorrectly.

**ZENITH**

**Color TV Chassis 14A9C51—HV 'Hold Down' Circuit**

The purpose of this circuit is to limit the maximum high voltage under conditions of misadjustment of the HV adjust control or circuit malfunction.

Under normal conditions where the high voltage is at 25kv and the 6HV5 regulator tube is functioning properly, current will be drawn through the diode in its cathode circuit. The positive voltage at the cathode (approximately 390v B+) will be reflected to the high side of the VDR through the 1.5M resistor. The pulse appearing at the lower winding of the sweep transformer will cause the 120pf capacitor to assume a charge through the VDR. However, the positive B+ voltage at the same point (high side of the VDR) will be sufficiently high to cancel the "negative" charge on the capacitor. Thus, nearly zero voltage will appear at this junction.

The control grid of the horizontal output tube is returned to ground through the 4.7M and 1.5M resistors and the VDR.

Thus, since zero volts appears at the high side of the VDR, this point is essentially at ground potential. The bias (drive

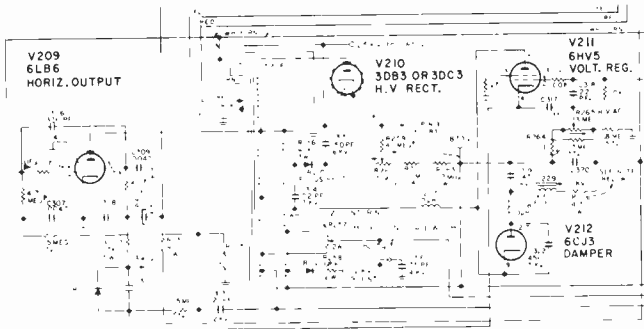

voltage) for the horizontal output tube is achieved in the conventional manner (grid current flow charging the coupling capacitor).

Should the circuit malfunction where the high voltage tends to increase, the pulse amplitude coupled to the 120pf capacitor will also increase. This will cause a greater charge on the capacitor and produce an amount of negative voltage at the high side of the VDR which will overcome the positive voltage to some degree. The resulting negative voltage will in turn be reflected to the grid of the horizontal output tube preventing the high voltage from rising to excessive limits.

Should the cathode of the 6HV5 open, the tube would be non-conducting. The diode in the cathode circuit would also be nonconducting (blocked state) and B+ would be absent from its anode and from the high side of the VDR. Thus, the full "negative" charge on the 120pf capacitor (having no B+ voltage to overcome) would be reflected to the control grid of the horizontal output tube. This voltage value may be in excess of negative 100v which would decrease high voltage to less than 20kv.

Therefore, should the regulation malfunction, the HV hold-down circuit prevents the high voltage from rising to excessive limits.

It should be noted that in the 14A9C51 the VDR circuit functions as a protective device, whereas in the 12A10C15 chassis similar circuitry incorporating a VDR is actually used for regulation.

# NEW Heathkit® Solid-State Color Bar—Dot Generator

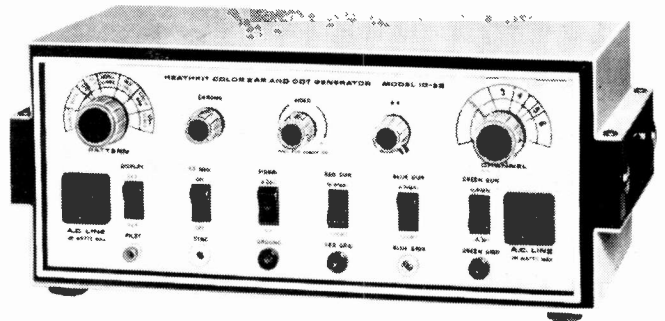

**Kit IG-28  
Only \$79.95\***

**Advanced Integrated Circuitry  
Delivers 12 Patterns Plus  
Clear Raster ... No Divider  
Chain Adjustment ... No  
Flicker, Bounce or Jitter**

- All solid-state construction using Integrated Circuitry
- No divider chain adjustments
- Stable pattern display — no flicker, bounce or jitter
- Produces 12 patterns plus clear raster
- Instant switch selection of all functions
- Exclusive 3x3 display plus standard 9x9 display of all patterns
- Horizontal lines only one raster thick for added accuracy
- Variable front panel tuning for channels 2 through 6
- Variable front panel positive and negative video output
- Front panel negative going sync output
- Two handy AC outlets on front panel
- Built-in gun shorting circuit with lead piercing connectors
- Front panel switchable crystal controlled sound carrier
- Copper-banded transformer to reduce stray fields
- Safe three-wire line cord
- Fast, easy construction with two circuit boards and two wiring harnesses

**Advanced Design.** The new Heathkit IG-28 is one of the most stable, versatile Color and B&W TV service instruments available. In addition to the exclusive Heath "3 x 3" display of patterns illustrated, it also produces the familiar 9 x 9 displays ... plus a clear raster for adjusting purity without upsetting the AGC. Fifteen J-K Flip-Flops count down from a crystal controlled oscillator to eliminate divider chain instability and adjustment.

**Time-Saving Versatility ...** gives you front panel tuning for channels 2 thru 6 ... front panel variable plus and minus video output ... front panel sync output ... two convenient AC outlets ... built-in gun shorting circuits and grid jacks ... vectorscope capability ... crystal controlled sound carrier ... banded transformer to eliminate stray fields ... zener-regulated power supply ... safe three-wire line cord ... fast circuit board-wiring harness assembly. For the versatility you couldn't get before ... put the new IG-28 on your bench now.

**Kit IG-28, 8 lbs. .... \$79.95\***

**Standard  
9x9 Displays  
plus  
Exclusive  
Heath  
"3 x 3" Display**

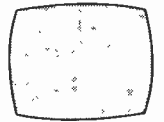

3x3 Dot

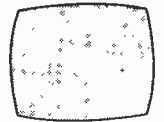

3x3 Cross Hatch

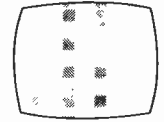

3x3 Shading

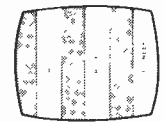

3x3 Color Bars

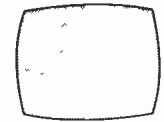

3x3 Vertical

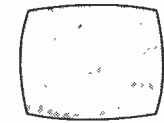

3x3 Horizontal

**HEATH COMPANY, Dept. 24-67**  
Benton Harbor, Michigan 49022

Please send my FREE 1969 Heathkit Catalog.  
 Enclosed is \$ \_\_\_\_\_ plus shipping.

Please send model (s) \_\_\_\_\_

Name \_\_\_\_\_

Address \_\_\_\_\_

City \_\_\_\_\_ State \_\_\_\_\_ Zip \_\_\_\_\_

Prices & specifications subject to change without notice.  
\*Mail order prices; F.O.B. factory.

TE-200

... for more details circle 121 on Reader Service Card

For additional information on products described in this section, circle the numbers on Reader Service Card. Requests will be handled promptly.

### OSCILLOSCOPE/VECTOR- 711 SCOPE

10MHz bandwidth  
with triggered sweep

Announced is a new, high-performance, wideband, triggered sweep 5in. oscilloscope/vectorscope. The Model

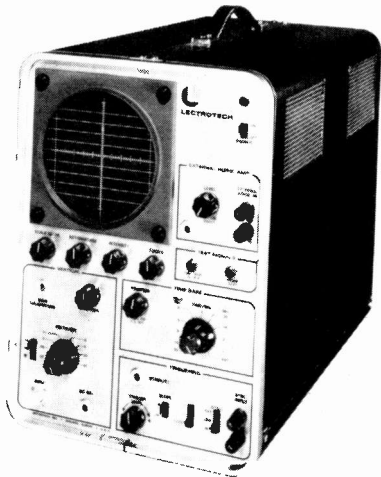

TO-50 is recommended for TV servicing, production testing and other industrial applications in communications, engineering labs—wherever a stable, calibrated scope display is required. Features include 10MHz bandwidth; dc amplifiers to eliminate pattern bounce, permit viewing ac and dc simultaneously; calibrated vertical attenuator and horizontal time base; automatic sync mode; TV sync selector; vectorscope input for color TV servicing; external horizontal amplifier; 60 Hz horizontal sweep with phasing control; edge—lit calibrated scale; compatibility with all sweep generators; all solid-state (tube-protected input). Size is 14 1/8H, 10 1/4W, 16 1/2in.D; weight is 23 lb. Net price \$329.50. Lectrotech.

### CB ANTENNA

Control circuitry permits  
omni-directional scanning

Announced is a sector-phased electronic beam antenna known as "The Scanner," with increased versatility through the incorporation of new control circuitry permitting omni-directional, instantaneous 360deg scanning. The effect is achieved through an additional switch position on the control

box located at the transceiver. In this position, the antenna works omni-directionally with a claimed 2.5db gain in all directions. In this "locator" mode, the operator may search and identify

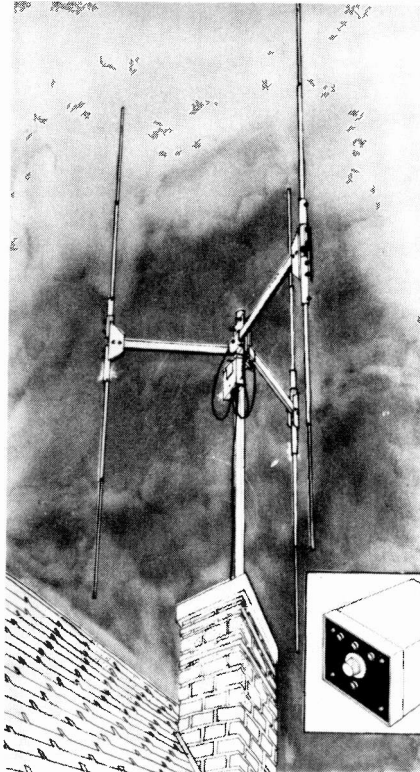

desired mobile or base stations and then switch electronically to the appropriate directional sector in which the antenna operates as an electronic beam. In the beam mode the antenna, identified as Model MR119 "Super Scanner," delivers a 7.75db forward gain with a front-to-back ratio of 23db, reducing interference and extraneous signals from the back side and increasing directional range. The beam effect is achieved electronically, no mechanical rotor is needed and the desired directionality can be achieved instantaneously by switching, says the firm. Weight 17 lb. Price \$79.95. Antenna Specialists.

### TAPE HEAD CLEANER 713

May be sprayed on running  
tape without affecting operation

A head cleaner designed to meet the needs of cassette tape recorders is introduced. The cleaner can be used

for conventional reel-to-reel tape recorders. The aerosol reportedly preserves tapes and improves fidelity by removing all dirt, film and oxide that accumulates on tape recorder heads. A 6in. extender tube enables the user to direct a jet stream of cleaner into hard to reach areas. The cleaner



is said to be non-toxic, non-flammable and non-conductive and will not harm soft plastic tape recorder parts. The cleaner, guaranteed safe for all tapes, will not mar the finish of any cassette or reel to reel tape recorder and can be sprayed on running tape without affecting the operation of the recorder, says the firm. The cleaner contains no abrasives to cause tape head wear. Model THC-6 Tape Head Cleaner is sold in a 6oz spray can. Chemtronics.

### TWO-WAY FM RADIO 714

Board exchange program  
simplifies maintenance

Introduced is a line of solid-state two-way FM mobile radios. Frequency ranges are 25-35, 35-50, 406-420 and



# ANALYSE THYSELF

So you can analyse fast and simple with the *B&K Model 162 FET/Transistor Tester* with features nobody else has.

**TESTS EVERYTHING:** Diodes. Bipolars. FETs. Unijunctions. SCR'S and Triacs.

**HIGHER CURRENT CAPABILITIES:** Up to 1 ampere. You need this for power transistors and FETs.

**THREE TRANSISTOR LEAKAGE TEST:** Icbo-Iceo-Ices. Finds failures missed by other transistor testers. Especially "avalanche mode breakdown" failures, common in horizontal output or other power stages.

**CORRECT BETA READING:** From 1-5000.

**SPECIAL BALANCING CIRCUIT:** Permits balancing-out as low as 6 ohm circuit impedance for in-circuit test.

**FRONT PANEL SOCKETS:** For bipolar and FET transistors. Especially useful for FET test. Minimizes damage due to static charges.

**SEPARATE CHECKS:** Checks Gate 1 and Gate 2 of dual gate FETs separately.

**PROGRAMMED INSTRUCTION GUIDE:** Provides instruction on Go-no-Go conditions for Beta and Leakage.

But, the new *B&K 162* doesn't just have the features nobody else has. It has *all* the features they have, too. And has them better.

Which means all the other transistor and field effect transistor testers are obsolete.

So, if you didn't just get stuck with somebody else's outdated unit, go see a good analyst. Ours. At your nearest B&K distributor.

See B&K . . . you'll be better in your field.

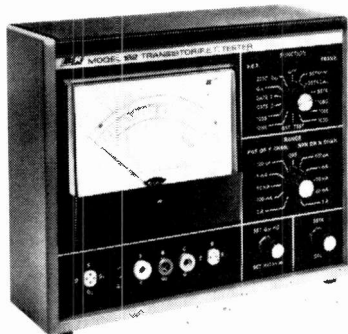

Price: \$99.95

B&K puts an end to test equipment. We've developed Silent Partners.



Product of DYNASCAN CORPORATION  
1801 W. Belle Plaine Chicago, Illinois 60613

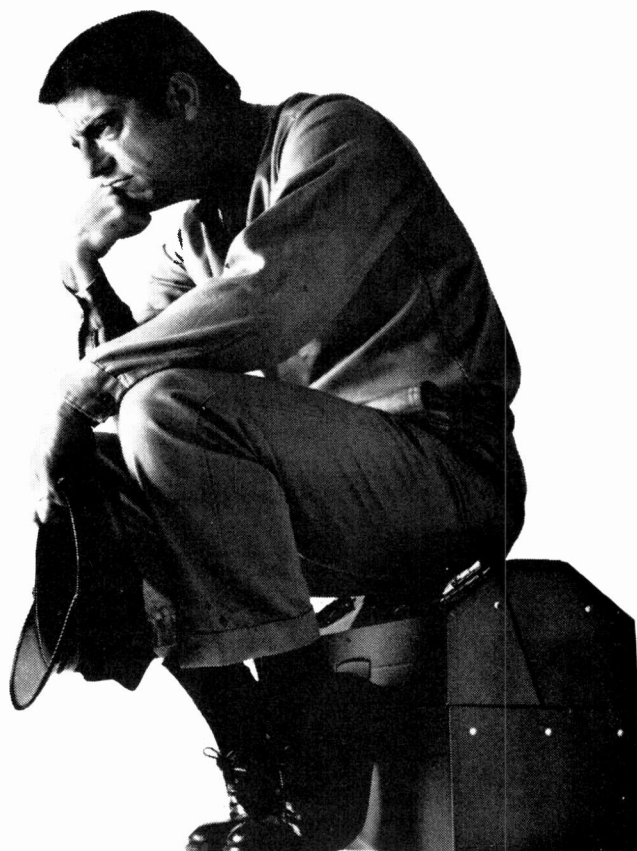

. . . for more details circle 104 on Reader Service Card



## ET/D NEW PRODUCTS

450-470MHz. Plug-in modular circuits are used throughout, interconnected by means of a main cable harness. No soldering or unsoldering is required and polarized plugs eliminate the possibility of misconnections. A board exchange program is said to simplify maintenance to the point where there is very little downtime and a reduced need for standby sets by large system users. The set is driven directly from the vehicle battery with applied voltage held to within 1 percent by the voltage regulator. The Series 80 is extremely compact and the desk-mounted control units are only 6 5/8in. wide x 2 5/8in. high. Trunk mount radio units are less than 3 1/2in. high when installed. DC control of channel switching, squelch and volume is used to eliminate troublesome relays, motors and long shielded lines. It also helps to cut down on power consumption. The output transistors are also protected against burn-out if the antenna is accidentally broken or shorted to ground. Other features of the radio include: built-in test sockets for use with plug-in test meter; integral push buttons for "net" and "transmit," and optional electronic

tone squelch (ETS). The latter is also fully solid-state, doing away with mechanical reeds which are vulnerable to shock and vibration. The low-impedance, controlled-reluctance element is sealed against dust and moisture and is spring-mounted to protect it from shock and vibration. Accessories available include a 5in. speaker which can also be obtained with a 10w amplifier for high noise conditions; telephone handset; and exterior horn speaker. Kaar.

### POWER SUPPLY 715

**Fuse protected against short circuits**

Introduced is the Model 1025 power supply, a versatile all-transistor power source with built-in meters to provide continuous monitoring of both output current and voltage. Output volt-



EICO Model 1025 Solid State Power Supply

### TRANSISTOR/FET TESTER 716

**Provides in-or out-of-circuit readings**

Announced is the availability of a portable Model TF17 in- or out-of-circuit tester. Performing the same

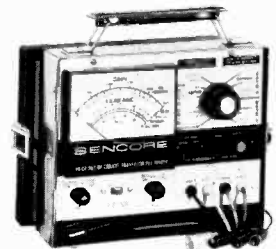

functions as the company's Model TF 151, the unit is smaller, more compact and features a new, improved mechanical layout. The instrument tests regu-

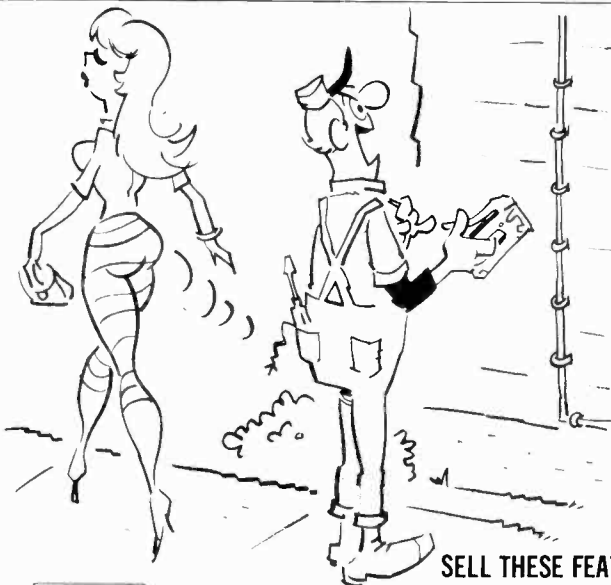

# MMMMMM!

## "now there's a snug fit!"

No loose, sagging wires... no sloppy, unsightly installations... because Arrow's specially pre-formed ROUND CROWN staples are shaped just right, to hug tight... for neater, snugger-fitting wiring jobs!

SELL THESE FEATURES FOR SAFER, FASTER AND MORE EFFICIENT FASTENING with

## ARROW® Low Voltage Wire STAPLE GUNS

- Built-in GROOVED GUIDE positions wire to insure proper staple envelopment.
- GROOVED DRIVING BLADE automatically halts round crown staple at safe height over wire to prevent damage or short circuits!

Model T-18 — For fastening wires up to 3/16" in diameter.

Model T-25 — For fastening wires up to 1/4" in diameter.

ARROW FASTENER COMPANY, INC.

271 Mayhill Street, Saddle Brook, N. J. 07663

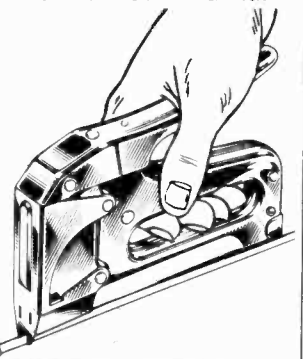

Krylon® Crystal Clear is standard equipment for all installation and service work. It prevents many of the causes of picture

fading and high voltage losses and keeps lead-in connections tight. It's the repairman's handiest repairman.



Borden Chemical, Division of Borden Inc



# radio-tv repairman

... for more details circle 110 on Reader Service Card

# You never saw a scope like this for twice \$229.

Leader's five-inch LBO-53B has a bandwidth running from DC to 10MHz. (About twice the bandwidth of any other scope in the same price range.)

Its sensitivity rating is 10 mv/cm or better. (About half-again the sensitivity of any other scope in the same price range.)

It has FET vertical and horizontal inputs, directly coupled with push-pull amplifiers for no-distortion display. (You won't find that on any other scope

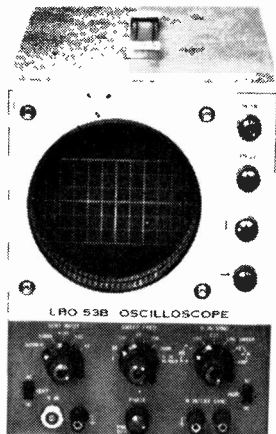

for the money.)

It's the perfect test companion for Leader's LCG-388 color bar generator. The only one that's perfectly stable, the instant you turn it on.

The LBO-53B: only \$229, and now you know what we mean about never seeing a scope like it for twice the price.

At your distributor's, along with the LCG-388 and other Leader test instruments. For the distributor nearest you, just drop a line or call.

## Seeing is believing.

### LEADER INSTRUMENTS CORP.

24-20 Jackson Avenue, Long Island City, N. Y. 11101 (212) 729-7411

... for more details circle 126 on Reader Service Card

## Solve Color Register Problems... Use Miller 7604 Blue Lateral & Purity Assembly on any American Rectangular Color Picture Tube

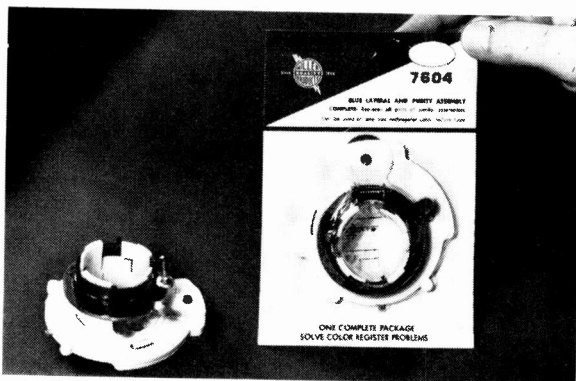

Now register blue, red and green beams simultaneously.

A single wheel rotates two magnetic rings in opposite directions to provide blue lateral convergence. Purity correction is accomplished by individual adjustment of the two purity rings. The magnets compensate for mis-registration up to .005" in any direction.

Dealer Net Each: \$3.96: Available from distributors' stocks. Write for your copy of Cross Reference Bulletin 1069



### J.W. MILLER COMPANY

19070 REYES AVE. ■ P.O. BOX 5825 ■ COMPTON, CALIF. 90224  
See your local distributor for the full line of RF and IF coils, chokes and transformers

... for more details circle 129 on Reader Service Card

lar transistors in or out of circuit for AC beta, and out of circuit for  $I_{cbo}$  leakage. By flipping the front-mounted function switch, it tests all FETs—MOS, dual gate and new enhancement types—in or out of circuit for gain, and out of circuit for leakage. It also provides an increased current check for high power transistors, with a special test for critical RF transistors. The instrument is housed in a vinyl-clad steel and brushed aluminum case with lead compartment and removable cover. Included is a special reference book listing over 12,000 transistors and FETs with all information needed for testing them. The compact transistor FET tester can be carried to service solid-state equipment on the job. Score.

### CB ANTENNA Swaged tubing reduces wind vibration

717

Announced is a three-element beam antenna for Citizens Band Radio. The Paragon Beam (Model PA-311) takes its basic design from the Model AD-

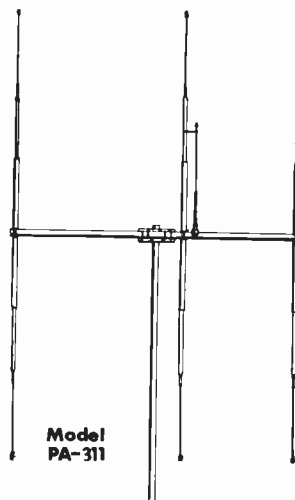

311. It features a three-piece boom and balanced elements with swaged tubing to reduce vibration in the wind. Its improved gamma matching system includes a molded gamma base and connector for greater convenience and durability. Specifications: Electrical—Forward Gain: 8db compared to reference dipole; 10.1db over isotropic source. Front-to-back ratio: 24db. SWR: 1.5/1 or better. Type of match: Gamma. Feed point impedance: 52Ω nominal. Radiation: uni-directional. Mechanical—Maximum element length: 19ft 2 1/2in. Boom length: 12ft. Assembled weight: 11 lb. Net Price \$46.65. Mosley.



# POWERFUL

One \$100 Winegard Color-Wedge equals the performance of twelve ten-element yagis!

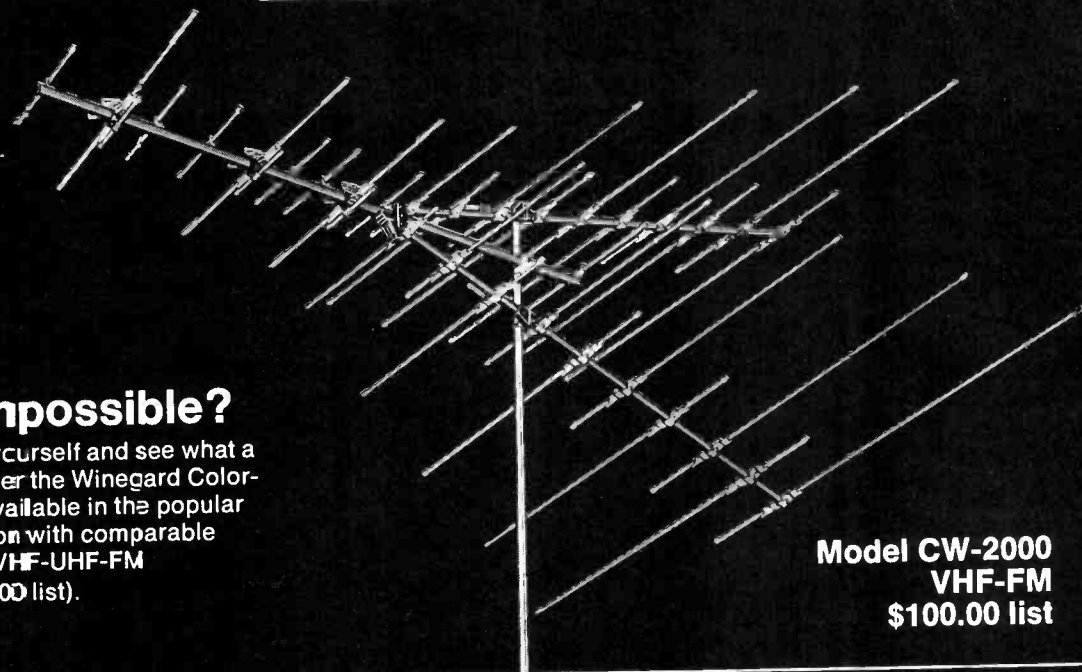

## Sound impossible?

Then try one for yourself and see what a powerful performer the Winegard Color-Wedge is. Also available in the popular 82-channel version with comparable performance on VHF-UHF-FM (CW-1000, \$100.00 list).

Model CW-2000  
VHF-FM  
\$100.00 list

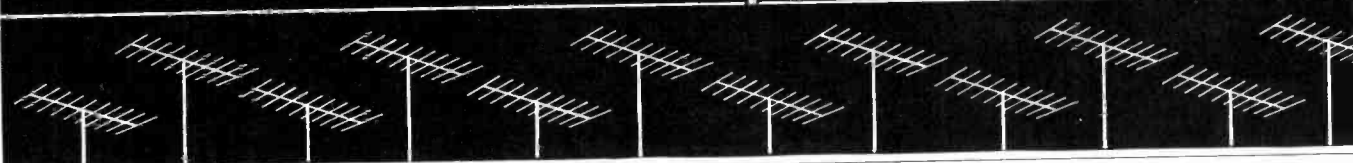

### example A: CHECK DB GAIN

Channel	CW-2000	10-Elem. Yagi
2	7.2	7.8
4	7.2	7.6
6	7.4	8.0
7	12.2	10.8
10	11.4	11.0
13	12.0	11.5

### example B: CHECK DIRECTIVITY

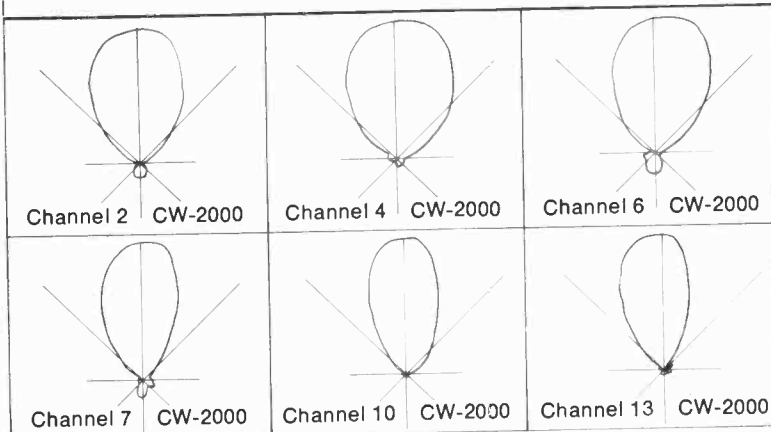

### example C: CHECK FRONT-TO-BACK RATIO

CW-2000	CH. 2	CH. 4	CH. 6	CH. 7	CH. 10	CH. 13
DB	22	26	17	20	35	30



WINEGARD COMPANY • 3019-6 KIRKWOOD STREET  
BURLINGTON, IOWA 52601

SEE YOUR WINEGARD DISTRIBUTOR AND WRITE FOR FACT-FINDER #284

... for more details circle 143 on Reader Service Card

Now With  
Solid State Circuitry &  
Rechargeable Batteries

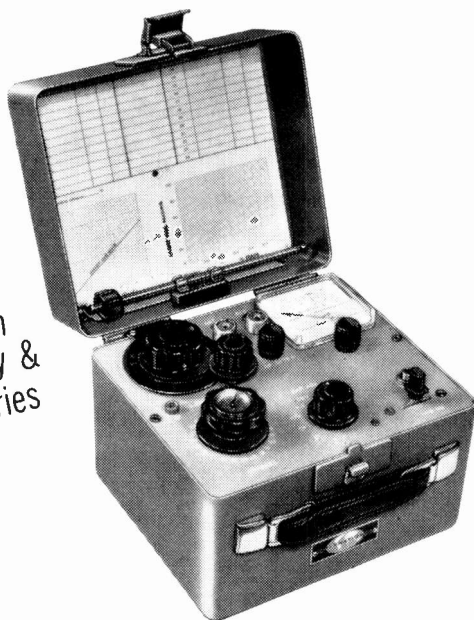

# ICM FM-2400C frequency meter...

- Completely Portable
- Tests Predetermined Frequencies  
25 MHz - 500 MHz

The **FM-2400C** provides an accurate standard frequency signal for testing and adjustment of mobile transmitters and receivers at predetermined frequencies between 25 and 500 MHz. Up to 24 crystals may be inserted into the meter. The frequencies can be those of the radio frequency channels of operation, and/or of the intermediate frequencies of the receivers between 5 MHz and 40 MHz. Frequency stability (standard)  $\pm .001\%$  from  $\pm 32^\circ$  to  $\pm 122^\circ$ F. Frequency stability with built-in thermometer, calibrated crystals and tempera-

ture corrected charts, .00025% from  $\pm 25^\circ$ F to  $\pm 125^\circ$ F. (.000125% special 450 MHz crystals available)

FM 2400C (Meter Only).....	\$445.00
RF Crystals	
Hi Band.....	\$24.00 ea.
Lo Band.....	15.00 ea.
IF Crystals.....	8.00 ea.

Write for free catalog.



**CRYSTAL MFG. CO., INC.**  
10 NO. LEE • OKLA. CITY, OKLA. 73102

... for more details circle 123 on Reader Service Card

## ET/D NEW PRODUCTS

### COLOR BAR GENERATOR 718

Plug-in computer style  
PC boards

Introduced is the Model LCG-390 color bar generator, compact, solid-state instrument featuring built-in



stability provided by the binary counters and gates employed in the logic circuitry. The patterns generated by this unit reportedly remain stationary and show no signs of flicker, regardless of temperature extremes, line voltage conditions or transmitter signals. Five basic patterns are displayed: (1) gated rainbow color bars, (2) R-Y, B-Y & -(R-Y) color bars, (3) dots, (4) cross hatch and (5) single cross centered on raster. Gun killers are provided for convergence adjustments. The unit has plug-in computer style PC boards and a fully regulated dc power supply. Measurements are 2 1/8H x 5 7/8W x 7 3/4 in.D and weighs 2.9 lb. Price \$119.50. Leader.

### AGC MODULES 719

Field effect transistors and  
ICs for head end systems

A series of single channel solid-state AGC modules for all UHF and VHF channels is introduced. The automat-

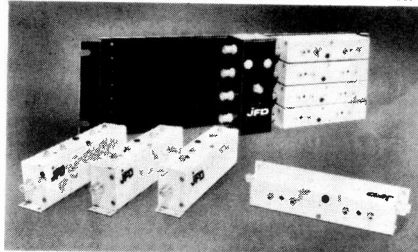

ic gain control units can be used to improve TV reception in any MATV or CATV head end. They reportedly maintain constant output ( $\pm 1.0$ db) with input signal voltage variations as large as 20db and up to 25db gain. Completely self-contained, the new AGC units can be used with broadband or single channel amplifiers and antennas. They provide amplification of weak channels and antenna mixing, as well as automatic gain control and can be used individually as AGC strip amplifiers, providing 25db gain with up to 50dbmv output. There are 82 AGC modules. Price \$75. JFD.

continued on page 94

ELECTRONIC TECHNICIAN/DEALER

**Precision Tuner Purchases  
Valley TV Tuner**

Precision Tuner Service, of Bloomington, Ind., has announced the recent purchase of Valley TV Tuner Service, formerly located in Canoga Park, Calif. All physical assets involved will be transferred to the present West Coast facility, located at 2325 Waldorf Drive, Turlock, Calif. Roland Nobis, president and owner of Precision Tuner, stated that this acquisition, in addition to the Bloomington, Ind. home office plant, and the Southern operations in Longview, Tex., now offers greater service for the Western portion of the country, and follows the company's expansion plans. Another plant was opened in Miami, Fla.

**Swain To Manage Zenith's  
Employee Induction Program**

Zenith Radio Corp. announced the promotion of Gerald L. Swain to manager of Zenith's new employee induction program.

Swain has been with Zenith since January 1968 as a supervisory development specialist. He helped implement Zenith's "Supervisory Development Program" and was instrumental in designing and coordinating Zenith's "Pre-Foremanship Training Program" set up to discover and develop employees with supervisory potential.

**Wanted by the FBI**

The Federal Bureau of Investigation is seeking information on the whereabouts of Howard I. Sands. Sands has been employed in the past as a television technician and as an electronics engineer on both domestic and overseas assignments.

**Sands**

On March 30, 1966, a Federal Grand Jury at Grand Rapids, Mich., returned an indictment charging Sands with a violation of Section 2312, Title 18, United States Code, for having allegedly on or about June 16, 1965, transported a stolen 1963 Ford Econoline truck from Norfolk, Va., to Kalamazoo, Mich., knowing the motor vehicle to have been stolen.

On June 18, 1965, Sands rented an ivory-colored 1965 Plymouth Valiant, four-door sedan, Vehicle Identification Number 1352539450, from a car rental agency in Kalamazoo, Mich. The Valiant was not returned by Sands and has not been located to date.

Sands is a white male, born Jan. 11, 1918, at Grand Junction, Mich., is 5 ft 9 1/2 in. tall, weighs 133 lb, has gray hair, blue eyes, a ruddy complexion, is slender built and has Social Security Number 370-12-7552.

If you have any information concerning this individual, please notify the nearest office of the Federal Bureau of Investigation, whose telephone number may be located on the first page of your local telephone directory.

**Mallory Purchases a Manufacturing  
Operation of Honeywell**

P. R. Mallory & Co. of Indianapolis, Ind., has announced the purchase of a manufacturing operation of Honeywell,

You're making money in electronics now.  
**RCA Offers 4 Ways to Make More.**  
Study at home...set your own pace.  
RCA Institutes has an easy approach  
to bring you bigger earnings.

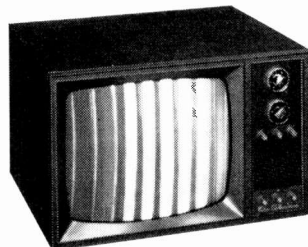
**COLOR TV:**

During this course you'll perform over 50 experiments—and receive all parts and instructions to build your own color TV.

The cost of the Color TV Kit is included in the tuition—in both the beginner's program and the advanced course in color TV servicing. (Picture tube optional)

Course is based on the latest receiver circuitry and equipment.

**SOLID STATE  
TECHNOLOGY**

New courses include the latest findings and techniques in this field. Information you must have if you are to service the multitude of solid state instruments and devices used in TV, Digital, and Communications equipment.

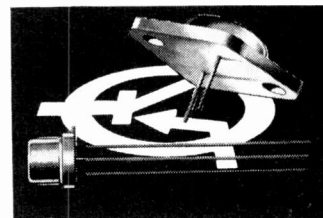
**FCC LICENSE TRAINING:**

Choose the course for the FCC License you want: third, second or first phone. If you need basic training first, apply for the complete License Training Program. Get your License—or your money back.

**CATV TRAINING:**

You'll receive two comprehensive lessons, covering the practical phases of CATV systems in either the Television Servicing or Communications courses.

Licensed by New York State Education Department. Approved for Veterans. Accredited Member National Home Study Council.

**RCA**

MAIL THE COUPON NOW FOR COMPLETE INFORMATION.

RCA INSTITUTES, Inc., Dept. ET-09  
320 West 31st Street, N.Y., N.Y. 10001

Please rush me FREE illustrated catalog. I understand that I am under no obligation, and that no salesman will call.

Name \_\_\_\_\_ Age \_\_\_\_\_  
(please print)

Address \_\_\_\_\_

City \_\_\_\_\_

State \_\_\_\_\_ ZIP \_\_\_\_\_

... for more details circle 133 on Reader Service Card



**AT LAST .... solid state triggered sweep, wide-band at a price you can afford!**

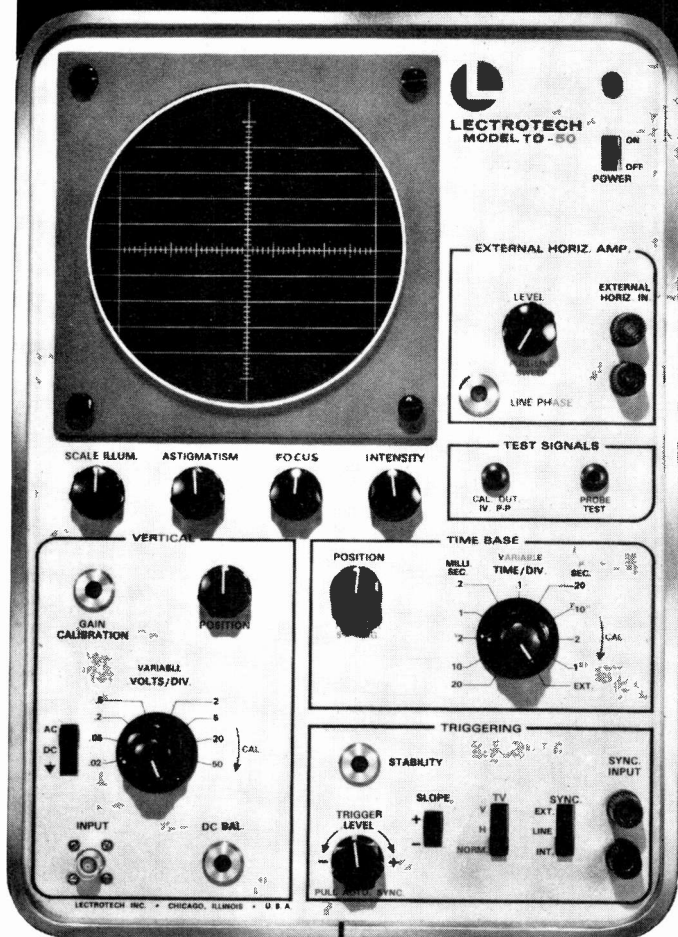

Made in U.S.A.

## 5" oscilloscope / vectorscope

**Triggered Sweep:** Easy to use. Positive sync results in absolute stability of patterns.

**Solid State:** For reliability and performance.

**Wide Band:** 10 MHz—for increased use in all servicing, industrial and educational applications.

**D.C. Amplifiers:** Eliminates pattern bounce. Permits viewing A.C. signals and D.C. level simultaneously. Use as a sensitive D.C. voltmeter.

plus . . . Calibrated vertical attenuator. • Calibrated horizontal time base. • Automatic sync mode. • TV sync selector. • Vectorscope input for color TV servicing. • External horizontal amplifier. • 60 cycle horizontal sweep (sine wave) with phasing control. Compatible with all sweep generators. • Edge lit calibrated scale. • All solid state (tube protected input).

**ONE YEAR WARRANTY**

**TO-50—oscilloscope / vectorscope . . . . . Net 329<sup>50</sup>**

See your distributor or write Dept. ET-10



**LECTROTECH, INC.**

4529 North Kedzie Avenue • Chicago, Illinois 60625

. . . for more details circle 127 on Reader Service Card

**ET/D**

**NEWS**

**OF THE INDUSTRY**

Inc., of Minneapolis, Minn., that produces a family of electronic audible signal devices. Terms of the cash transaction were not disclosed.

Charles A. Barnes, president of the Indianapolis firm, said that Mallory has been marketing the series of devices, trademarked Sonalert, for three years under an arrangement with Honeywell. He said Sonalert sales have reached forecasted levels and that the acquisition is expected to result in an increased sales volume. Mallory's original arrangement for the product was with the former Computer Control Co., now the Computer Control Div. of Honeywell.

The Sonalert operation will be moved from Honeywell's Computer Control Div. facility in Peterborough, N.H. to a plant of the Mallory Capacitor Co., a division of the parent firm, in Huntsville, Ala. The device will continue to be marketed in the United States through the nationwide distributor sales outlets of the Mallory Distributor Products Co., another Mallory division, and to overseas markets by Mallory export sales and its international companies. The unit will be marketed to industrial concerns through the sales operations of the Mallory Capacitor Co.

### EIA Will Continue Sponsorship Of Consumer Electronics Show

The Executive Committee of the Electronic Industries Assn. Consumer Products Div. voted to continue ownership and sponsorship of the Consumer Electronics Show.

The committee met in special session in Chicago to decide on the future of the show which the EIA Div. has sponsored for the past three years.

The show will be held June 28-July 1, 1970, at the Americana and New York Hilton hotels in New York City.

It is also being scheduled for June 1971 at Chicago's McCormick Place.

### June Color TV and Phonograph Sales Up Over 1968

Distributor sales of color television sets to dealers were up 8.9 percent and phonographs were up 6.8 percent during June 1969, as compared with sales during the same month the year before, the Electronic Industries Assn.'s marketing services department reported.

In June 427,491 sets were sold to dealers, compared with 392,635 sets the same month last year, EIA reported. Color TV sales to dealers were 2,533,694 sets for the first six months, 9.4 percent ahead of the 2,316,718 sets sold in the same period in 1968.

Monochrome TV sales in June, at 417,010 sets were down 11.2 percent from the 469,522 sets sold in the same month last year. Total TV sales to dealers in June declined 2.1 percent from the 862,157 sets sold in June 1968; however, year-to-date sales remained 1.7 percent ahead of the same period in 1968.

Phonograph sales increased in both portable and table and console categories, registering 6.3 percent and 7.8 percent increase, respectively. Over-all phonograph sales increased 6.8 percent in June over the same month last year and now stand 2.9 percent ahead on a year-to-date basis.

Total radio sales to dealers for June dropped 15.4 percent over June 1968, bringing the year-to-date total 4.4 percent behind the same period last year.

## B & K . . .

*continued from page 59*

have a similar feature, but the 162 specifications indicate that this unit will balance out the effects of other components to as low as  $6\Omega$ . Beta can be read from 1 to 5000 and GM to 50,000.

The 162 provides for three leakage tests rather than one or two. These are  $I_{cbo}$ ,  $I_{ces}$  and  $I_{ceo}$ . All three checks are useful when testing power transistors for avalanche breakdown since a power transistor could test normal with only the beta and  $I_{cbo}$  test. Leakage tests are made on a go-no-go basis. Normal allowable leakage is in the na range so any leakage reading on the  $100\mu a$  scale is considered evidence of a defective device. The unit is relatively easy to operate and except for battery replacement, there is nothing in the circuit that should cause the technician a maintenance problem. Safety circuits are provided to protect the instrument from internal damage caused by improper lead connection. ■



B&K Model 162 dynamic transistor analyst.

## Zenith "Royal Crest" Tubes... with unrivaled dependability

Zenith "Royal Crest" replacement circuit tubes are engineered to the same exacting standards as original Zenith circuit tubes in new sets. With the same unrivaled dependability and "new set" performance.

Zenith "Royal Crest" circuit tubes are life-tested under actual operating conditions for more than 1,500,000 hours every month!

The "Royal Crest" line is broad and comprehensive. Over 900 different types, all built to Zenith rigid quality standards.

Insist on Zenith quality. Choose Zenith's "Royal Crest" circuit tubes and assure customer satisfaction.

**EXCITING SURPRISES FOR YOU—and your family!**  
Get the details at your Zenith Distributor's Parts Department.

Why not sell the best

**ZENITH**  
®

The quality goes in  
before the name goes on



# ALL NEW!

*NRI learn-by-doing training in*

## ADVANCED COLOR TV

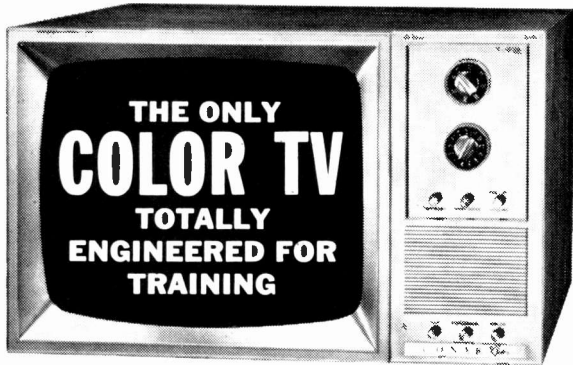

- **Build your own custom color set in 5 training stages**
- **50 designed-for-learning color circuit experiments**
- **Programmed with 18 "bite-size" lesson texts**

A comprehensive training plan for the man who already has a knowledge of monochrome circuits and wants to quickly add Color TV servicing to his skills. DEFINITELY NOT FOR BEGINNERS. It picks up where most other courses leave off—giving you "hands on" experience as you build the only custom Color TV set engineered for training. You gain a professional understanding of all color circuits through logical demonstrations never before presented. The end product is your own quality receiver.

### TRAIN WITH THE LEADER

This NRI course — like all NRI training — is an outgrowth of more than 50 years experience training men for Electronics. NRI has simplified, organized and dramatized home-study training to make it easy, practical, entertaining. You train with your hands as well as your head, acquiring the equivalent of months of on-the-job experience. Demand for Color TV Service Technicians is great and growing. Cash in on the color boom. Train with NRI—oldest and largest school of its kind. Mail coupon. No obligation. No salesman will call. NATIONAL RADIO INSTITUTE, Color TV Div., Washington, D.C. 20016.

### MAIL FOR FREE CATALOG



**NATIONAL RADIO INSTITUTE**  
Color TV Division  
Washington, D.C. 20016 42-109

Send me complete information on NRI new Advanced Color TV Training. (No salesman will call)

Name \_\_\_\_\_ Age \_\_\_\_\_

Address \_\_\_\_\_

City \_\_\_\_\_ State \_\_\_\_\_ Zip \_\_\_\_\_

ACCREDITED MEMBER NATIONAL HOME STUDY COUNCIL



## NEWS OF THE INDUSTRY

### Admiral First Half Earnings Increase

Admiral Corp. reported a continuation of improved sales and earnings in the first half of 1969.

Ross D. Siragusa, Jr., president of the television-appliance manufacturer, pointed out that the company's additional consumer business in the second quarter and the first half more than offset the sales volume of the government electronics division which is included in the 1968 figures. This division was sold in March 1969. The 1969 earnings do not include the profit from the sale of the government division and other related items.

The Admiral official said that consolidated sales for the first six months were \$189,798,150, compared with \$187,852,561 in the same period last year.

Profits before taxes were \$6,245,426, which compares with a loss of \$1,264,547 in the first half of 1968.

Profits after taxes were \$3,285,426, or 64 cents per share, while a loss of \$559,492 was reported a year ago.

Second quarter sales were \$90,448,313, compared with \$92,493,066 in the 1968 quarter. Excluding government division sales, 1968 volume was \$83,481,309.

Pretax earnings in the quarter were \$2,283,522, contrasted with a loss of \$939,440 last year. After provision for taxes, earnings were \$1,236,470 or 24 cents per share, compared with a deficit of \$483,545.

### Computerized Electrical System For Tomorrow's Automobiles

A revolutionary, Computerized Energy Distribution and Automated Control System (CEDAC) which will replace automotive electrical circuitry and related equipment was unveiled by Essex International, Inc.

Advantages of the system include increased reliability, easier trouble diagnosis, simple part replacement, increased design flexibility, better assembly procedures, and improved safety with more driver convenience.

Simultaneously, Essex announced collateral development of a diagnostic computer which interrogates the CEDAC System, isolating maintenance problems in seconds; and the firm's entry into high volume production of low cost integrated circuits, which are part of the system.

Paul W. O'Malley, Essex President, said these developments, stemming from a research and development program conducted by Essex-sponsored scientists and engineers at Mellon Institute of Carnegie-Mellon University and coordinated with major automotive manufacturers, will eventually lead to automatically controlled operations in vehicles.

"Since the time of the 'Model T,' a maze of hundreds of individual wires and connections has been added to perform electrical functions and operate devices in the automobile. The result is an effective, but complex electrical system which grew through necessity.

Now, for the first time, an entire electrical power, energy distribution and automated control system has been designed as an integral unit."

"While the system is now a reality," O'Malley said, "I expect that it will take several years for it to be totally integrated into production automobiles which change only gradually."



The control system contains a digital central computer the size of a match box. It is connected to a single energy distribution and control harness which is routed throughout the vehicle to sensors and actuators about the size of nail-heads. The new system concept, which employs electronic signal information, along with electric and pneumatic power, virtually does away with the automotive electrical system as it is known today by eliminating most of the terminal connectors and electrical wires.

No moving parts are involved in the computer or sensors and they can be installed anywhere in the vehicle, facilitating automotive design, assembly procedure and reliability. Together, they have the capability of controlling more than 1,000 separate functions as demand for additional safety and driver convenience increases.

A CEDAC prototype, now installed in an operating vehicle, features a driver-operated master control-display panel that transmits a signal to the central computer which, in turn, commands one or more of 18 automotive functions to perform.

These include safety power door locks which automatically lock at a predetermined speed, windshield washers operated by fluidics, and electronically controlled power windows.

Also, safety lighting is provided at the four corners of the car for dual intensity turn signals, hazard warning, and braking illumination; lamp outage warning for all exterior lighting is included; and electronically controlled locking and unlocking of all doors from the exterior is provided from the driver's door key position.

Growth potential is provided for future inclusion of climate control, braking, high current, anti-skid, power assist, fuel injection, transmission and ignition sub-systems. In addition, a digital display panel can be incorporated which, on command from the driver, will provide instantaneous readout of speed, engine revolutions per minute, oil pressure, fuel level, time, engine and car temperature, lamp outage warning and other information. Adding these functions will be accomplished by programming the central computer and installing appropriate sensors and actuators.

The external diagnostic computer will enable an unskilled mechanic to check out the onboard computer, sensors, and actuators by connecting to the system at any point. He will obtain an instantaneous readout of the location of any system failure. Most repairs will be accomplished by simply plugging in a new low cost replacement module.

At the same time as it interrogates CEDAC, the external diagnostic computer will automatically reorder parts from the factory, and provide inventory control and diagnostic studies for the manufacturer, all of which will reduce warranty costs.

"A pilot line will begin manufacturing components for the system this fall in Pittsburgh, Pa.," O'Malley said. "By 1978,

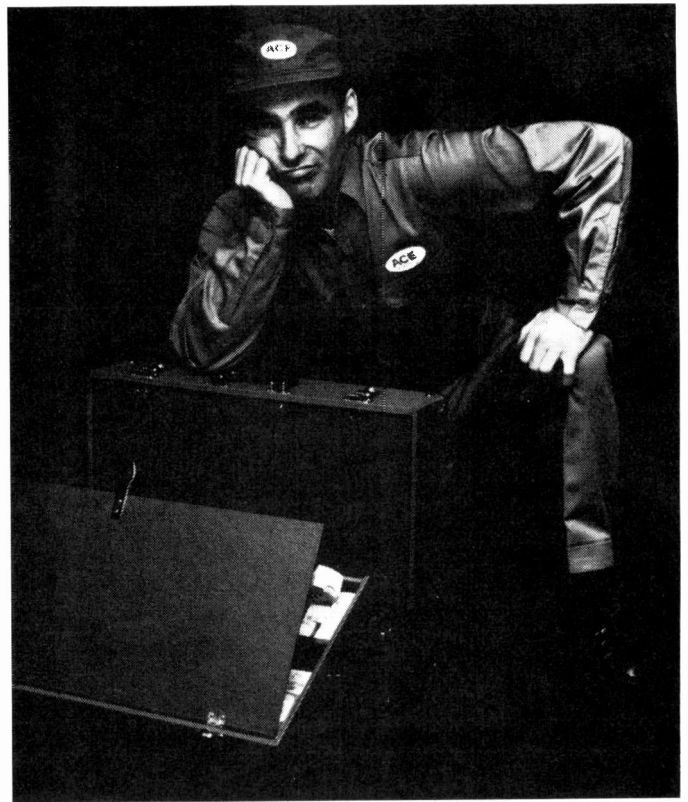

## Bugged about never having the right replacement lamp?

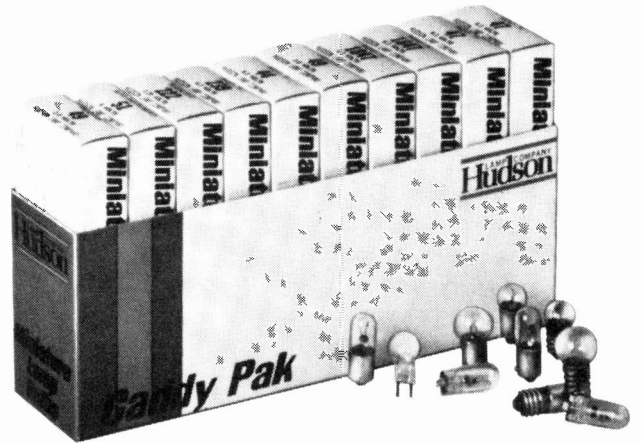

## Hudson's New "Caddy-Pak" puts them right at your fingertips.

Now there's a replacement kit of miniature lamps packed just like replacement tubes. Hudson's "Caddy-Pak" — available in four assorted packages of eight to ten types — a total of 100 miniature lamps of those types proven in day-to-day experience to be the most needed in servicing all makes of television and radio sets.

The "Caddy-Pak" is convenient and handy for in-shop repairs — and is especially useful for house calls. Makes it easy for your jobber to keep you well supplied, too.

So take in a supply of first-quality, made in U.S.A., miniature lamps in a Hudson "Caddy-Pak". Save yourself time, frustration — and money. Ask your jobber about the "Caddy-Pak" today.



Hudson Lamp Company, 528 Elm Street, Kearny, New Jersey 07032. Telephone: (201) 997-1850

... for more details circle 122 on Reader Service Card

## FREE CATALOG

Lists over 1700 hard-to-find tools used by electronic technicians, instrument mechanics, engineers, and scientists. Included are many types of pliers, tweezers, wrenches, soldering irons, wire strippers, relay tools, watchmakers tools, drills, precision grinders, files, optical equipment, lighting, vacuum systems, tool cases, and tool kits. Included also are a solder section and four pages of useful "Tool Tips" with valuable data on fasteners, color coding, drift and metal gauges, insulation facts, and tool selection.



**JENSEN TOOLS and ALLOYS**  
4117 N. 44th Street, Phoenix, Arizona 85018

... for more details circle 124 on Reader Service Card

Speedy solutions to servicing problems  
from **LECTROTECH**



ONE YEAR  
WARRANTY

## TT-250 Transistor Analyzer

**GOOD/BAD TRANSISTOR TESTING IN OR OUT OF CIRCUIT**

Now—positive Good/Bad in-circuit and out-of-circuit testing. Also tests diodes and rectifiers. In-circuit testing measures dynamic AC gain. No transistor leads to unsolder or disconnect. Out-of-circuit testing measures transistor Beta on 2 scales: 0 to 250 and 0 to 500. Automatic biasing . . . no calibration required. PNP or NPN determined immediately. The TT-250 measures transistor leakage (I<sub>cbo</sub>) directly in micro-amperes and, for diodes and rectifiers measures reverse leakage and forward conduction directly to determine front-to-back ratio. Simple Good/Bad test instantly determines condition of power transistors. Panel has Power Transistor Socket. Measures leakage current of transistor electrolytics at test voltage of 6 volts. Size 10½" x 7" x 4". Wt. 5½ lbs. **NET \$87<sup>50</sup>**

For Color and  
Black & White



ONE YEAR  
WARRANTY

## CRT-100 Picture Tube Analyzer

Features line voltage adjustment to insure all tube voltages are correct regardless of line voltage. Critical Grid-to-Cathode Leakage is read on sensitive meter for greatest accuracy. Leakage in all other elements indicated on neon lamp. Tests all black and white and all color tubes for leakage, shorts and emissions and tests each color gun separately to a standard set of test conditions. With variable G-2 voltage, each grid is normalized to a reference cut-off voltage. This method, used by tube manufacturers, simulates tube performance in color receiver. Rejuvenates, removes shorts from picture tubes for increased brightness and tube life. Life expectancy test predicts remaining useful life of all type picture tubes. Complete with Plug-in Type Test Cables and Set-up Chart. **NET \$89<sup>50</sup>**

See your distributor or write Dept. ET-10.

**LECTROTECH, INC.**

4529 N. Kedzie Ave., Chicago, Illinois 60625

... for more details circle 128 on Reader Service Card

**ET/D**

**NEWS  
OF THE INDUSTRY**

volume is expected to increase annually to 400 million integrated circuits, 200 million power transistors and 100 million fluidic devices."

He estimated Essex automotive product potential annual sales of \$550,000,000 in 1978 compared to \$142,000,000 last year. Total annual sales in 1968 were \$426,000,000.

"A systems approach to research, development and production has been commonplace in aerospace technology for many years," O'Malley said. "Essex has selected the most advanced technologies in the aerospace and computer industries for application to a complete energy distribution and automated control system. CEDAC is also applicable to the appliance, mobile home, construction and industrial controls industries."

### Sylvania Introduces Brighter Color TV Picture Tube

Sylvania Electric Products Inc. announced a series of new color television picture tubes described as being "substantially brighter than the company's former lines and, in addition, providing the best contrast of any tube introduced to date by Sylvania". Sylvania is a subsidiary of General Telephone and Electronics Corporation.

The new tubes are being offered to color television set manufacturers at existing prices.

George Konkol, Senior Vice President, Sylvania Electronic Components, said that in a color television set, "the two chief factors that provide an optimum picture are a precise balance of brightness level and contrast. In a color picture—particularly under high ambient light levels—high contrast is necessary to prevent picture 'washout'. The new tube provides this precise balance of brightness and contrast".

The new tubes have a completely new phosphor system including a newly developed "deep red" yttrium oxide rare earth phosphor plus brighter green and blue phosphors. Sylvania introduced its first rare earth color tubes in 1964. In February, 1968, the company introduced its second generation of rare earth color tubes that were 23 to 69 per cent brighter than existing color tubes at that time.

The new brighter, high-contrast Sylvania tubes in 22 and 25-inch versions, have been made available to color TV set manufacturers for the past several months, Konkol said.

**M O V I N G ?**

Be sure to let us know  
your new address.

Please enclose  
a complete address label  
from one of your recent issues.



cluded in the publication are antennas, preamps, amplifiers, AGC units, filters, mixers, tapoffs, matching transformers, splitters, FM converters, traps, coaxial cable, connectors and terminators. JFD.

**Electronic Kits 400**

A new 1970 catalog, featuring a selection of electronic kits, is available. The 116-page catalog illustrates over 300 kits for every budget and interest. Heath.

**Solid-State VOM 401**

A two-page technical bulletin featuring battery-operated, handsized, all-solid-state volt-ohm-milliammeter (Model 310-FET) with field effect transistorized circuitry, 10M input resistance on all dc voltage ranges and sensitivity 10 times greater than conventional bench type VTVM, is offered. The three-hole-punched technical bulletin also provides a complete listing of all electrical and mechanical features. Triplett.

**Electronics Directory 402**

A 16-page directory of U.S. offices of Japanese electronic manufacturers is available to help American companies locate sources for electronic products and parts. Among the companies listed in the directory are manufacturers of: consumer electronic products, Hi Fi sets and components, auto radios and tape players, communications systems, electronic computers, electronic measuring and indicating equipment, radar equipment, automatic control systems, biophysiological electronic systems, transformers, relays, coils, capacitors and other electronic devices and components. The directory may be obtained by enclosing a 6-cent stamped, self-addressed #10 envelope with each request for the publication. Requests should be addressed to: Electronic Manufacturers' Directory, Japan Light Machinery Information Center, 437 Fifth Ave., New York, N.Y. 10016.

**Instrument Rentals 403**

A 42-page catalog bulletin GEC-1551C, listing more than 200 new items, gives the monthly rates and ordering information for a wide variety of analytical instruments, electro-mechanical measuring devices and electrical and electronic instrumentation available for rental. Technicians are available to operate the rental instruments or to conduct electro-mechanical measurements on site. General Electric.

**MATV Antenna Systems 404**

A 16-page guide to master antenna TV system products is available. In-

**General Catalog 405**

A new edition of a general catalog is available. Illustrations and drawings reportedly have been reworked for better legibility and in several cases schematics have been enlarged to make them more readable. Mallobins and integrated circuits were added to the catalog. MTV capacitors are now listed by complete part number. TIM and TAC tantalums have more comprehensive coverage, CSR capacitors include the "P" level, tantalum foils show ratings per recent MIL specs, wire-wound controls are more clearly indicated, timer ordering information has been simplified and current Sonalert data is included. Mallory.

**Switches and Keyboards 406**

A 20-page catalog features an expanded line of miniature electronic switches and keyboard assemblies. The toggle switches have five complete lines that include the 5a Standard Series, 6a Series, waterproof series, 15/32in. bushing series, and locking toggle series. SPDT, DPDT, 3PDT and 4PDT configurations are available in each group. An illuminated push-button switch features easy lamp removal without the use of tools. Reed actuated keyboard assemblies are available in four standard stock models. ALCO.

**Service Manuals 407**

A new series of service manuals to cover servicing and adjustment of all popular makes of television sets is available. The first new volume C-69 will cover 1969 sets and will follow the format of the monochrome TV manuals previously issued. \$4. Supreme Publications.

**Chemicals 408**

An eight page catalog of chemical products for the electronic service industry is issued. The catalog covers tuner sprays, contact and control cleaners, insulating sprays, lubricants, circuit coolers and a variety of other servicing aids. Featured in the catalog are the following new items: Tun-o-Foam, a foaming tuner lubricant/cleaner; an Tape Head Cleaner, an aerosol spray designed for cassette tape recorders; Mask-N-Glas cleaner/polisher; Tun-o-Wash, a tuner degreaser, and Super Frost Aid, which locates thermal intermittents quickly. The new catalog is available free to distributors and TV technicians upon request. Chemtronics.

# compact sets

## SPEED DRIVING OF BRISTOL AND ALLEN HEX TYPE SCREWS



No. 99PS-60 Pristol Multiple Spline Type Screwdriver Set

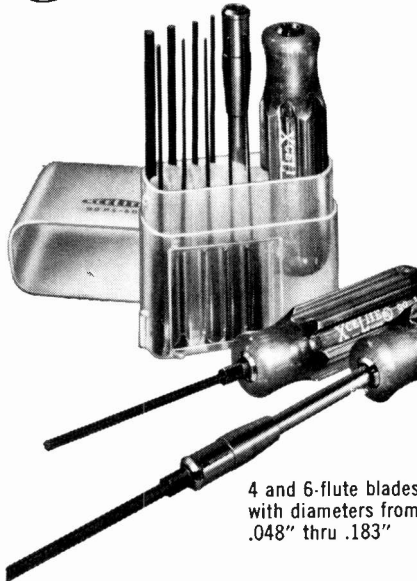

4 and 6-flute blades with diameters from .048" thru .183"



No. 99PS-40 Allen Hex Type Screwdriver Set



Hex diameters from .050" thru 3/16"

Compact, interchangeable blade, Xcelite sets permit quick selection of the right tool for the job. With greater reach than conventional keys, these handy blade and handle combinations make it easier to get at deep set or awkwardly placed socket screws, simplify close quarter work.

Each set contains 9 precision formed, alloy steel, 4" blades; 4" extension; shockproof, breakproof, amber plastic (UL) handle with exclusive, positive locking device.

Sturdy, see-thru plastic cases fit pocket, have flat bases for use as bench stands.

WRITE FOR BULLETIN N365



XCELITE, INC., 14 Bank St., Orchard Park, N.Y. 14127  
In Canada contact Charles W. Pointon, Ltd.

... for more details circle 145, on Reader Service Card



# An Extraordinary Offer

to introduce you to the benefits of Membership in  
**ELECTRONIC TECHNICIAN'S BOOK CLUB**

for a limited time only you can obtain

**ALL 3** OF THESE UNIQUE BOOKS . . . yours for only **\$199**  
... with Trial Club Membership  
(Combined List Price \$19.85)

May we send you these three unique servicing handbooks as part of an unusual offer of a Trial Membership in Electronic Technician's Book Club?

### Popular Tube & Transistor Substitution Guide

NOW—the most-needed substitution data for both tubes and transistors all in one handy, brand-new volume! No longer do you have to refer to one substitution manual for tubes and another for transistors—everything is here in one quick-reference guide. Designed to fit into your tube caddy or on your workbench, this guide lists 99% of the tubes and transistors you'll ever need to replace. Moreover, only readily-available and comparably-priced substitutes are listed—no longer do you have to search through lists of tubes and transistors you'll rarely see in use, or search through pages of irrelevant material to find a substitute.

This brand-new volume contains 8 Big Sections—four devoted to tubes and four to transistors. Section 1 provides you with a cross-reference of popular American receiving tubes, listing substitutes which have similar or superior characteristics and which require no mechanical changes or circuit modifications. In each case the best substitute is listed separately from others you may use. Section 2 lists substitutes for popular tube types found in commercial and industrial equipment. American substitutes for popular foreign types are presented in Section 3, while Section 4 includes base diagrams keyed to the tube listings in each section.

The transistor portion begins with Section 5, which contains a complete listing of popular American types and the most readily-available, popularly-priced substitutes. Section 6 lists American substitutes for the most often encountered foreign transistors. Section 7 is a listing of general-purpose replacements for popular original equipment types. Section 8 includes base diagrams which are keyed to the original type listings.

You'll find this guide to be one of the most practical everyday aids you've ever used. It will enable you to repair many sets for which replacement tubes and transistors are not available. 160 pps., 8 Sections. Long-life, flexible simulated leather cover for lasting convenience.

### TV Servicing Guidebook: Problems & Solutions

Here's a new book for professional

TV Service Technicians—a benchman's handbook detailing shop-proven service procedures which will pinpoint ALL TV circuit troubles—monochrome and color!

Calling upon his many years of on-the-job experience, the author describes 30 separate troubleshooting approaches, each predicated on specific symptoms, to help you nail down any TV problem quickly . . . eliminate waste motion—cut troubleshooting time to the bone. The author has categorized all TV troubles—both color and B & W—according to 62 classic symptoms. He then describes the servicing procedures proved most successful in his shops. And you won't have to wade through page after page of dreary theory discussions to get the information you want. The text—illustrated with over 100 schematics and photos—gets to the point quickly, excluding extraneous theory and unrelated facts and figures.

Chapter 1 details initial setup procedures for color TV receivers, including gray-scale tracking, color screen adjustments, purity, degaussing, convergence, etc. Chapter 2 is devoted exclusively to color problems—no Y signal; no color; excessive red, green, or blue; incorrect colors; pastels; "confetti"; "worms"; etc. An entire chapter is devoted to the CRT and its trouble symptoms. To eliminate unnecessary replacement, many repairs are suggested. Chapter 4 lists seven video troubles, what causes them, and tells how to correct them. Chapter 5 analyzes the 13 basic high voltage faults, including flyback, yoke, and the oscillator circuits. Horizontal and vertical deflection circuits are explored for defects in Chapter 6. Chapter 7 exposes elusive sync and AGC troubles, from sync takeoff to integrator and AFC circuits. Chapters 8 and 9 encompass troubles peculiar to sound and power supply circuits.

In all, there isn't a TV trouble you won't be able to cure with the information presented in this book. 176 pps.; over 100 illustrations, including numerous waveform photos; 9 Chapters. Hardbound.

### Semiconductors From A to Z

All you need to know about the entire range of transistors and semiconductors used today. Written in language anyone can understand, this book explains how various semiconductor devices work and how they are used, with complete descriptions of all the

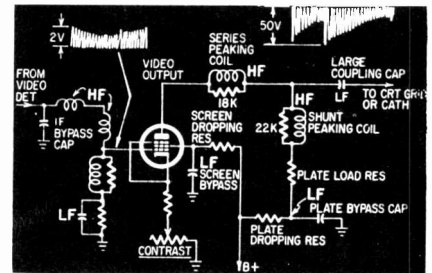

Literally scores of easy-to-use schematic diagrams are contained in all these new books. (Example shown greatly reduced in size)

common and unique circuits used in modern technology. With the wealth of knowledge incorporated in this book you'll be eminently qualified to service any type of solid-state equipment.

The content begins with a review of how basic semiconductors work, including types and function, how a transistor conveys a signal, transistor biasing and self-biasing techniques, effects of temperature on operation, factors limiting transistor frequency response, etc. Succeeding chapters delve into the mystical arena of field-effect transistors by explaining the differences between FETs and regular transistors. You'll understand junction FET applications, frequency response, temperature effects, and the treatment given depletion-type and enhancement-type MOS FETs in the most down-to-earth explanation you'll ever find.

Considerable attention is given to integrated circuit applications—variable-current and constant-current sources, unbalanced differential amplifiers, IC applications in FM and TV receivers, TV sound circuits, discriminator circuits, and cascade amplifier networks. The use of varicaps is also covered, as well as unijunction transistors, field-effect diodes, zener diodes, SCR diodes, 4-layer diodes, diacs, and triacs. The final chapters deal with constant current and voltage regulating systems and DC-to-AC-to-DC converters. Hardbound.

*Popular Tube & Transistor Substitution Guide*, *TV Servicing Guidebook*, and *Semiconductors From A to Z* are handsome, hardbound books, indicative of the many other fine offerings made to Members . . . important books to read and keep . . . volumes with your specialized interests in mind.

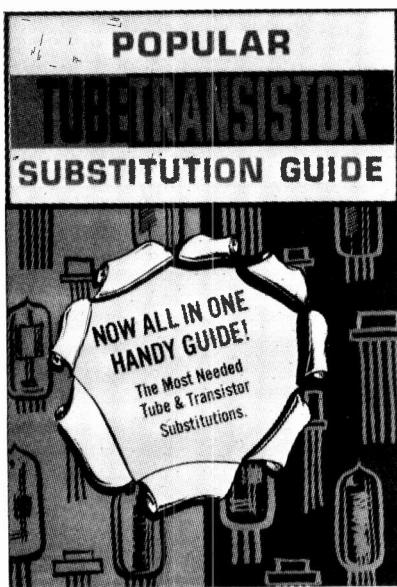

- BRAND-NEW & Original
- Covers BOTH Tubes & Transistors
- Long-Life Vinyl Cover
- Lists U.S. & Foreign Types

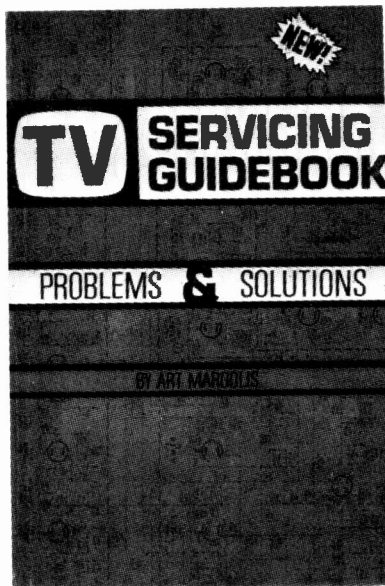

- 176 pages • over 100 illus.
- Scores of waveform photos
- Covers both B & W and Color
- Unique step-by-step guide

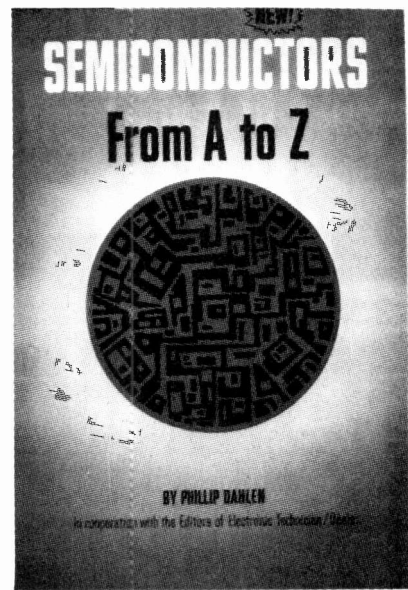

- 256 pages • over 300 illus.
- Permanent Hardbound Volume
- 26 Fact-Filled Chapters
- Practical & down-to-earth

### How You Profit From Club Membership

This is just a sample of the help and generous savings the Club offers you. For here is a Club devoted exclusively to seeking out only those titles of interest to you as an electronic technician (no hobby or "fringe" books are offered). Membership in the Club offers you several advantages:

**1. Charter Bonus.** *Popular Tube & Transistor Substitution Guide*, *TV Servicing Guidebook*, and *Semiconductors From A to Z* carry a publisher's retail price of \$19.85. But they can be yours for only \$1.99 with your Trial Membership.

**2. Continuous Savings:** The Club guarantees to save you 15% to 75% on the books you need.

**3. Editorial Advisory Services:** The Club's Editorial Advisory Board selects *only* the important books of direct interest to you.

**4. Wide Selection:** Members are annually offered over 50 of the authoritative books on all phases of electronic servicing. The Club makes it a point to offer new books, along with standard classics . . . lists books from *all* publishers—not just one or two.

**5. Prevents You From Missing New Books:** The Club's FREE monthly *News* gives you advance notice of important new books . . . books vital to your continued professional advancement.

This extraordinary offer is intended to prove to you, through your own experience, that these very real advantages can be yours . . . that it is possible

to keep up with the professional literature published in your specific area of interest . . . and to save substantially while so doing.

### How the Club Works

Forthcoming selections are described in the FREE monthly *Club News*. Thus, you are among the first to know about, and to own if you desire, significant books. You choose only the main or alternate selection you want (or advise if you wish no book at all) by means of a handy form and return envelope enclosed with the *News*. As part of your Trial Membership, you need purchase as few as four books during the coming 12 months. You would probably buy at least this many anyway . . . without the substantial savings offered through Club Membership.

### Limited Time Offer!

Here, then, is an interesting opportunity to enroll on a trial basis . . . to prove to yourself, in a short time, the advantages of belonging to the only Book Club devoted *exclusively* to electronic servicing. We urge you, if this unique offer is appealing, to act promptly, for we've reserved only a limited number of Handbooks for new Members.

To start your Membership on these attractive terms, simply fill out and mail the postage-paid Airmail card today. You will receive *Popular Tube & Transistor Substitution Guide*, *TV Servicing Guidebook*, and *Semiconductors From A to Z* for FREE 10-day inspection. SEND NO MONEY! If you are not delighted with these quality hardbound books, return them within 10 days and your Trial Membership will be cancelled without cost or obligation. Electronic Technician's Book Club, Blue Ridge Summit, Pa. 17214.

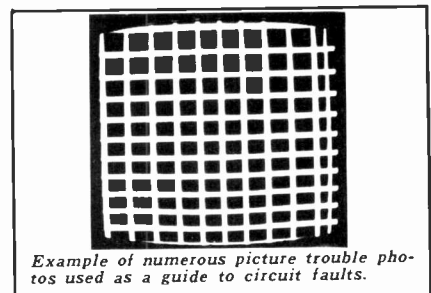

Example of numerous picture trouble photos used as a guide to circuit faults.

Typical Savings Offered Club Members on Recent Selections	
RCA Color TV Service Manual	List Price \$7.95; Club Price \$4.95
Electronics Reference Data Book	List Price \$7.95; Club Price \$4.95
Digital Computer Analysis	List Price \$10.95; Club Price \$7.95
How To Test Almost Everything Electronic	List Price \$5.65; Club Price \$3.95
How to Use Your VOM, VTVM & Scope	List Price \$6.95; Club Price \$4.95
Modern Electronic Troubleshooting	List Price \$7.95; Club Price \$4.95
Installing Hi-Fi Systems	List Price \$7.95; Club Price \$4.95
Electronic Circuit Design Handbook	List Price \$14.95; Club Price \$7.95
Repairing Home Audio Systems	List Price \$7.95; Club Price \$6.50
FET Applications Handbook	List Price \$12.95; Club Price \$7.95
Handbook of Semiconductor Circuits	List Price \$7.95; Club Price \$4.95
Pinpoint TV Troubles in 10 Minutes	List Price \$6.95; Club Price \$4.95
Easy Way To Service Radios	List Price \$6.95; Club Price \$3.95
Practical Color TV Servicing Techniques	List Price \$7.95; Club Price \$4.95
On the Color TV Service Bench	List Price \$6.95; Club Price \$4.95
Transistor Circuit Guidebook	List Price \$6.95; Club Price \$4.95
Mathematics for Electronics	List Price \$10.95; Club Price \$7.95
Transistor Projects	List Price \$5.95; Club Price \$2.95
Radio Operating Questions & Answers	List Price \$9.25; Club Price \$7.95
Electronic Musical Instruments	List Price \$10.00; Club Price \$7.95

**SEND NO MONEY!** Simply fill in and mail postage-paid Airmail card today!

Who needs a tuner wash? Save your money and use

# QUIETROLE

The product that cleans while it lubricates. Zero effect on capacity and resistance. Harmless to plastics and metals. Keeps color and black and white on the beam. Non-flammable.



manufactured by  
**QUIETROLE CO.**  
Spartanburg, South Carolina

... for more details circle 131 on Reader Service Card

## SOLVE YOUR TV REPAIR PROBLEMS WITH TV TECH AID

A monthly TV publication of actual repairs, and troubles encountered in OUR business. The information will be gathered from technicians, field reps, and all the leading manufacturers.

TV TECH AID will present up to 40 different trouble shooting cases each month. Each manufacturer will have its own page.

Each symptom will have a clearly marked schematic of the particular faulty stage. The faulty components, and corrections will be listed to aid in repair. No guess work.

It will contain current models, older models, circuit changes and modifications on various models as they occur.

The days of "Trial and Substitution" are over.

Time means money. Don't forfeit those valuable profits.

ONE repair is worth more than four times the investment.

Each monthly issue will contain a series of timely sheets and the cost to you is only \$7.95 for a full year's subscription.

TV TECH AID  
P.O. BOX 603  
KINGS PARK, L. I.  
NEW YORK 11754

ENCLOSED IS A CHECK OR M.O. FOR \$7.95. PLEASE SEND 12 ISSUES OF TV TECH AID TO:

NAME .....  
ADDRESS .....  
CITY .....  
STATE ..... ZIP .....

... for more details circle 140 on Reader Service Card

**ET/D**

## CATALOGS & BULLETINS

### Power Outlet Boxes 409

A 16-page catalog describing a complete line of prewired power outlet boxes is available. The catalog provides information on more than 400 standard models and illustrates nearly 150 of them. Included in the catalog are a variety of multiple prewired power outlet boxes for industry, institutional, school and home laboratory use. Waber.

### International System of Units 410

An 88-page booklet, which serves as an introduction to the International (IS) System of Units, is offered. The book provides discussion, definitions, conversion factors and slide-rule settings regarding the new system of units arrived at by the International Committee on Weights and Measures. The initial steps for implementing this new system in the United States have already been taken. This book, designed for the technical community, will serve as a reference and guide during the transition from the old to the new measurement system. Cubic Corp.

### Cabinet Kits 411

A four-page bulletin describing a line of custom cabinets is available. The cabinets, which are delivered unassembled, consist of six panels and 12 vise-grip slides. The panels are made of vinyl-clad steel, 26 gauge, and are available either in walnut wood-grain or black leather style, with the front panel either brushed brass or chrome. A table gives sizes, descriptions and prices of the cabinets. Beltronix.

### Antennas 412

A 28-page publication, entitled "Selecting Proper Antenna Systems To Meet Communications Requirements," is available. The illustrated manual is a basic guide to selection of the optimum type of antenna for both base and mobile installation. Relative antenna efficiency, effective height, receiver sensitivity and selectivity, and transmitter power are among the factors discussed and charted. Additional sections cover the effects of transmission loss and antenna gain. Antenna Specialists.

### Stereo Systems 413

A brochure describing the wide range of compact stereo systems for 1970 is available. This fully illustrated

## ATR PRODUCTS FOR MODERN LIVING



### ATR UNIVERSAL INVERTERS

A.C. Household Electricity Anywhere . . . in your car, boat or plane!  
To Operate • Tape Recorders • TV Sets • Dictating Machines • Radios • Public Address Systems • Electric Shavers • Record Players • Food Mixers • and Emergency Lighting.  
NET 12U-RHG (12 V.) 175-200 W. Sh. Wt. 27 lbs. 79.66  
28U-RHG (28 V.) 150-175 W. Sh. Wt. 27 lbs. 96.66

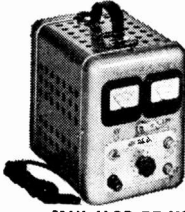

### ATR "A" Battery ELIMINATOR

For Demonstrating and Testing Auto Radios—TRANSISTOR or VIBRATOR OPERATED!  
Designed for testing D.C. Electrical Apparatus on Regular A.C. Lines.  
MAY ALSO BE USED AS A BATTERY CHARGER  
MODEL 610C-ELIF . . . 6 volts at 10 amps. or 12 volts at 6 amps. Shipping weight 22 lbs.  
USER NET PRICE . . . . . \$59.92

### ATR AUTO RADIO and COMMUNICATION

### LONGER-LIFE VIBRATORS



"The Best by Test!"  
**ATR ELECTRONICS, INC.**  
Quality Products Since 1931  
St. Paul, Minnesota 55101—U.S.A.

... for more details circle 103 on Reader Service Card

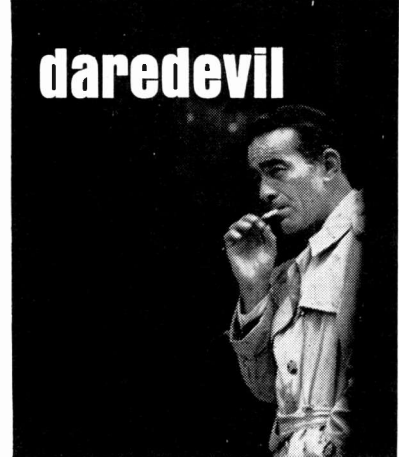

Doesn't think of himself as the reckless type at all. But he goes on taking the *big* risk. Clings to a habit which causes 100 deaths every day from lung cancer and which contributes to many, many more from coronary artery and respiratory diseases. Studies show that the death rate from lung cancer alone for cigarette smokers (one-pack-a-day or more) is 10 times higher than for nonsmokers. Nobody says it's easy to stop. But living *that* dangerously often winds up in not living at all.

**american cancer society**  
THIS SPACE CONTRIBUTED BY THE PUBLISHER



guide may be used as an aid in choosing the compact stereo appropriate to individual requirements. Featured are complete descriptions of all compact systems and options, including clearly worded reasons for choosing one particular model over another. Complete specifications and retail prices are included. Scott.

### Microphones 414

A 20-page microphone catalog is available. Illustrations, descriptions and specifications are also given for some 50 other models in the microphone line. The catalog also includes a microphone selector guide to assist the user in determining the microphone that best meets the requirements of a given application. Replacement microphone cartridges and accessories are also listed. Astatic.

### Coaxial Cable Connectors 415

Individual connectors, sockets and switches and a new line of 10 coaxial cable/connector assemblies are described in an 18-page general line catalog. Designated GL-2, the two-color publication also features new sections on the company's 131 Series precision and 5116 Series Subminax RF connectors. Also included are tube sockets, relay sockets, test jacks, tip jacks, microphone connectors, home and industrial type ac plugs and receptacles plus coaxial connectors and switches. Photographs, line drawings, electrical characteristics and mechanical specifications are provided for each. Amphenol.

### Microwave 416

A 12-page catalog No. 70A, describing a line of microwave transmitters, receivers and components is available. The catalog contains detailed specifications on over 300 individual models of microwave FM transmitters, receivers, mixer preamp, linear and log amplifiers, discriminators, filters and multipliers. Two pages describe and illustrate FM microwave relay equipment including air-to-air and air-to-ground relay links and portable and fixed ground stations. Photos and technical specifications describe the various models and their combinations. RHG Electronics.

### Tools 417

A 16-page catalog of small tools for the communication, telephone and electronic industries is issued. Illustrations and dimensions of the line of tools include in the catalog cover items such as adjuster tools, kits for numbering and lettering and for adjusting relays, contact burnishers, spring tension gauges, thickness gauges, cable and wire tools, special wrenches and screwdrivers. Neuses.

# 3 GUN SALUTE

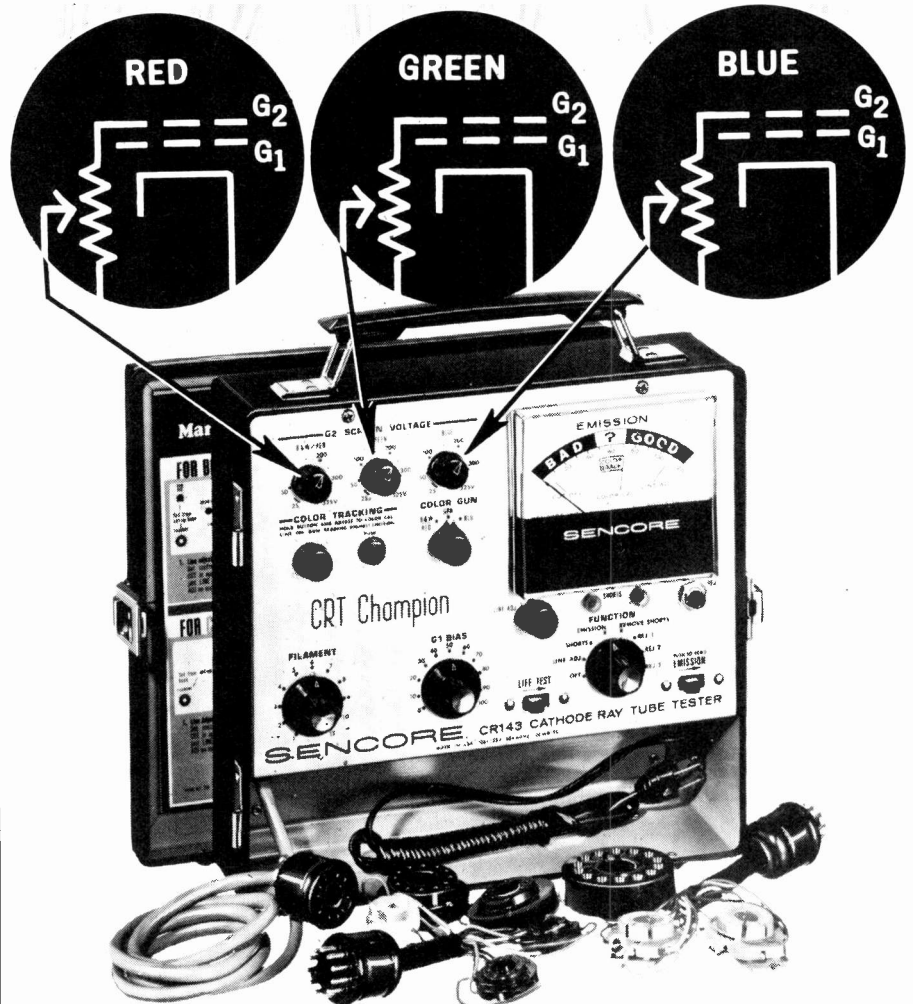

Only the Sencore CRT Champion has three gun control . . . Just like the color TV set.

Only Sencore has automatic color tracking to make your job easier.

Only Sencore has the simplified instructions in the cover so that you can analyze any color CRT tube in seconds. Just flip the "Color Gun" switch from red to green to blue (after setting the three G2 controls) and the CR143 Champion will tell you if the tube has adequate emission and if it will track in the TV set.

Why don't you salute the Sencore Champion today by marching in and asking your distributor to try one. You won't bring it back because it is 100 percent.

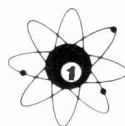

## SENCORE

NO. 1 MANUFACTURER OF ELECTRONIC MAINTENANCE EQUIPMENT  
426 SOUTH WESTGATE DRIVE, ADDISON, ILLINOIS 60101

... for more details circle 136 on Reader Service Card

## ET/D NEW PRODUCTS

continued from page 80

### COLOR TUBE BRIGHTENERS 720

*Plastic construction assures longer life*

Two color tube brightener models completely enclosed in plastic are introduced. They are designed to restore performance to color TV sets having

picture tubes which have become dull and show loss of contrast quality. Brighteners increase tube brilliance by stepping up the electron emission. Installation is reportedly simple. No

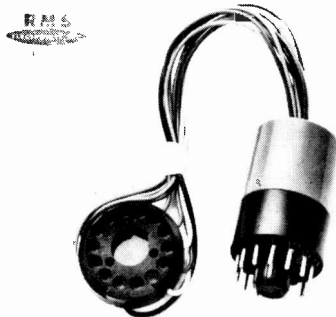

switching or complicated wiring is required; the unit is simply plugged in between the color tube and the tube socket. Available brighteners include the CTB-70 for use with 70deg button base picture tubes and the CTB-90 for 90deg button base picture tubes. Suggested retail price for either model is \$8.95. RMS.

### COLOR BAR/PATTERN GENERATOR 721

*Employs computer-type integrated circuitry*

Introduced is a solid-state color bar-pattern generator, Model IG-28, employing computer-type integrated circuitry to produce 12 patterns and

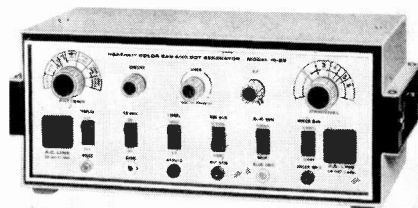

FIGURE 11  
Color Bar & Pattern Generator  
Model IG-28

a clear raster. The generator produces the six standard 9 x 9 patterns...dots, cross hatch, shading bars, color bars, vertical lines and horizontal lines...and in addition also displays these same patterns in the 3 x 3 format. A clear raster is also available for adjusting purity without upsetting the AGC. The use of 15 J-K flip-flops that count down from a crystal-controlled master oscillator eliminates flicker, bounce and jitter in the display and provides a divider chain network that is claimed to never need adjustment. A number of convenience features have been incorporated in the generator: variable front panel tuning for channels 2 through 6, front panel variable plus and minus video output, front panel sync output, two front panel ac convenience outlets, built-in gun short-

ing circuits and grid jacks, vectorscope capability, front panel switchable crystal-controlled sound carrier, a copper-banded transformer to eliminate stray fields, zener-regulated power supply and three-wire line cord. The generator is styled in beige and brown. Kit assembly is facilitated by the use of two circuit boards and two pre-cut and stripped wiring harnesses. The kit version, IG-28, sells for \$79.95; a factory-wired and tested model, the GW-28, is also available for \$114.95. Heath.

### FUSES

722

*Values are in large easy-to-read print*

Introduced is the common 3AG fuse with new easy-to-read values. Available in the popular values of 1/2,

HERE IS A FUSE.....

YOU CAN READ!



1 1/2, 2, 3 1/2 and 5a, they are conveniently merchandised in a two-pack display card. These fuses are especially made in Japan. Workman.

### ALARM SYSTEM 723

*Produces high frequency silent sound waves*

Introduced is an intrusion alarm system designed to provide 24-hour silent protection for homes, offices, factories, trailers and boats. The sys-

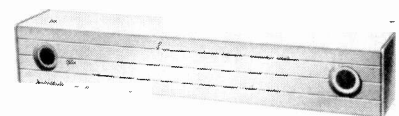

tem operates on the principle of sending high frequency (silent) sound waves: when the sound path is broken by an intruder, a signal triggers a shrieking siren, light or notifies law enforcement agencies automatically. The system, designated model 7350, can be expanded to provide emergency or hazardous environment warnings such as heat, fire, smoke or water detection through remotely placed sensors. All controls are located on the rear panel of the unit or can be remotely controlled with the addition of accessory kits. Installation by the user can be accomplished in minutes. The control mechanism is so small that it can be placed unnoticed from intruders. Its size measures only 14 x 2 x 2in. and it weighs less than 5 lb. Price \$99.95. James.

## GOOD BETTER BEST



*the foamy white stuff that cleans and polishes and lubes*

WORKMAN Electronic  
SARASOTA, FLORIDA PRODUCTS, INC.

... for more details circle 144 on Reader Service Card

## Electronics Technicians: Earn Your DEGREE

If you have at least one year of full-time experience as an electronics technician, you can earn your Associate Degree in Electronics by correspondence plus two weeks of review and examination at the School. This degree is accredited by the Accrediting Commission of the National Home Study Council. Get complete details in our free catalog. Write:

Dept. T

Grantham School of Engineering  
1505 N. Western Ave.  
Hollywood, California 90027

... for more details circle 118 on Reader Service Card

**ANTENNA TRIPODS**

724

*Tilt-up feature facilitates installation*

Three gold tripods are introduced in 2-, 3- and 5ft sizes. Each of the tripods is available in an attractive gold

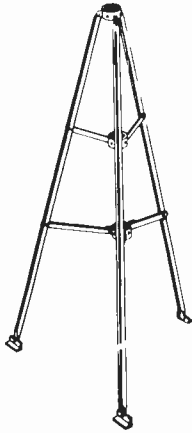

baked enamel finish and is supplied with six lag screws and three tar patches for sealing and mounting holes. The 3- and 5ft towers feature heavy-duty 1 1/4in. diameter legs and the original tilt-up feature to facilitate antenna installation. GC Electronics.

**WIRELESS MICROPHONE 725**

*Operates through any FM radio up to 200ft*

A wireless microphone is introduced offering performance with full fidelity reportedly at a low price. The Mod-



el WX-127 is a high quality, precision-engineered instrument which operates through any FM radio located up to 200ft away. The wireless microphone conforms to all FCC requirements. It is reportedly static-free and will not "drift." Small and lightweight, the dimensions are 4 3/4 x

# NOW - CHECK ALL TRANSISTORS IN OR OUT OF CIRCUIT ...

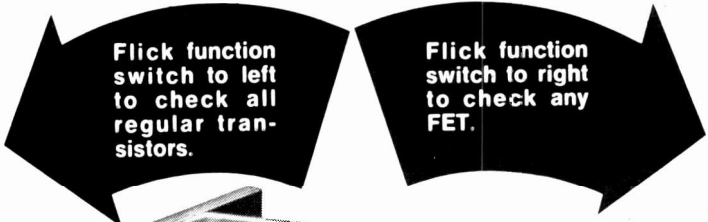

... plus the new **FIELD EFFECT TRANSISTORS** too!

You won't be stopped when you run into the new FETs that are wired into the latest hi-fi, newest TV receivers and nearly every other new device coming on the market. For the very first time, you can check them all, in or out of circuit. The TF151 works every time using tried and proven signal injection techniques. New, improved tests on special RF transistors and the latest high power transistors, mean that the TF151 is the only up-to-date transistor tester on the market. A new, exclusive setup book in rear compartment guides you to every test for over 12,000 transistors and FETs. The book is not needed for general service troubleshooting. Regular transistors are checked for beta gain and I<sub>CO</sub> leakage. FETs are checked for transconductance and I<sub>gss</sub> leakage. **only \$129<sup>50</sup>**

**NEW SENCORE TF17** compact in and out of circuit transistor FET tester. Same as TF151 except in new Sencore Handi case and with 4-1/2" meter. ... \$109.50

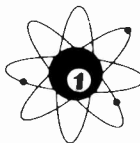

**SENCORE**  
NO. 1 MANUFACTURER OF ELECTRONIC MAINTENANCE EQUIPMENT

426 SOUTH WESTGATE DRIVE, ADDISON, ILLINOIS 60101  
... for more details circle 137 on Reader Service Card



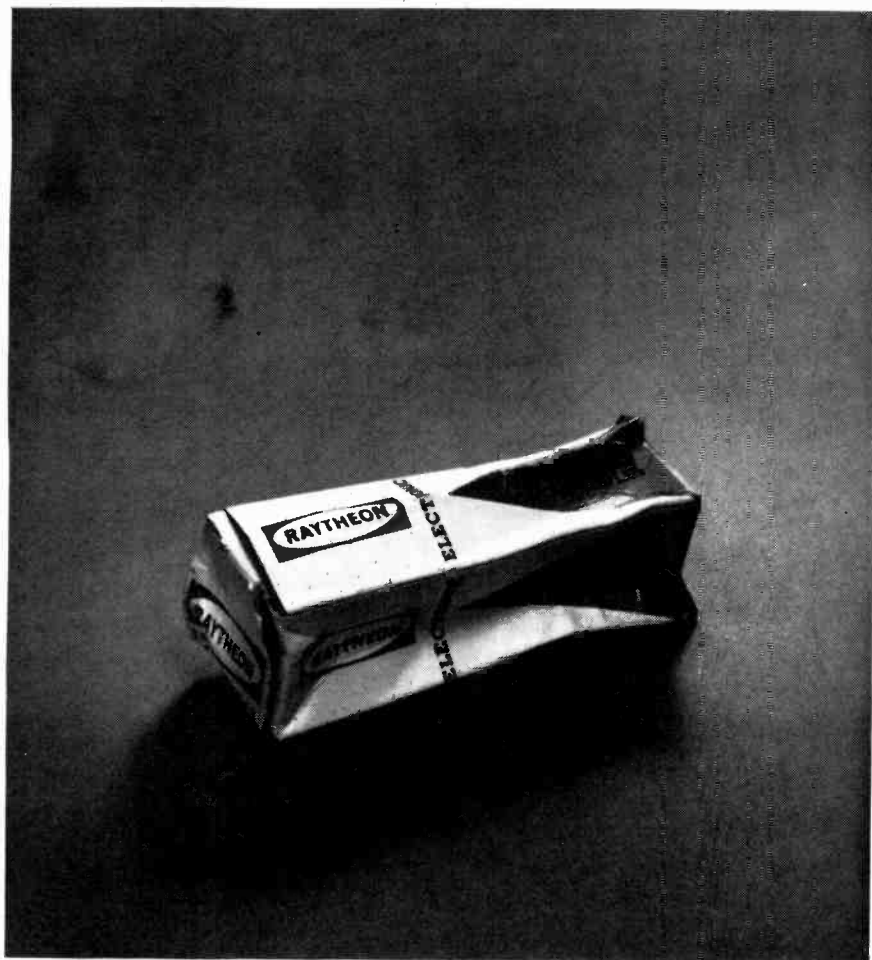

## A dud in 500 million?

Now and then, our big competitors knock us—because they'd like to have our share of your business. But they can't knock our product.

Because Raytheon receiving tubes are universally regarded as the most reliable in the industry. Ever since we produced the first vacuum tube, we've made them to just one specification: the highest quality standards.

All of our tubes have to shape up—to pass rigid electrical and mechanical performance checks.

That's why you rarely find a "dud" among the more than 500 million Raytheon receiving tubes we've made. It's also why you get fewer call-backs...earn greater customer satisfaction with your work...while

making more profit per tube. And it's the reason why Raytheon is the leading independent tube manufacturer serving the independent service dealer today.

Like to know more? Ask your distributor why he gets fewer Raytheon returns than with any other brand...and about his latest deal for you.

*Raytheon Company, Receiving Tube Operation, Fourth Avenue, Burlington, Massachusetts 01803.*



Remember to ask  
"WHAT ELSE NEEDS FIXING?"

... for more details circle 132 on Reader Service Card

## ET/D NEW PRODUCTS

1 x 1 in. and the unit weighs only 3 1/2oz. It is powered by two mercury cells and includes on/off switch. A buffer amplifier prevents instability. Price \$17.50. Mura.

### ELECTROLYTIC CAPACITORS

Capacitor kit with 726  
values to 10,000 $\mu$ f

To meet increasing replacement demands for low voltage, high capacity electrolytic tubular capacitors,

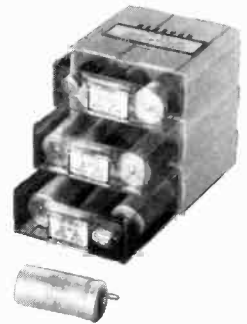

a series of kits is introduced. The kit promotion is called "Top Drawer" and features a plastic drawer with an interlocking feature enabling the user to assemble several of these drawers vertically or horizontally. Each drawer offers an assortment of electrolytic capacitors in 15-, 25- and 50v ratings at capacities to 10,000 $\mu$ f. The electrolytic capacitors are sheathed in a heat shrinkable PVC yellow tubing for maximum environmental protection. Aerovox.

**At home, in your spare time.  
Prepare For Your**

## F. C. C. LICENSE

and for higher pay and greater prestige.

We teach you electronics from the beginning, and then how to pass F.C.C. license examinations for your 3rd, 2nd, and 1st class radio-telephone license—all by home study. This training is approved under the G.I. Bill. For details, write:

**Dept. T**  
**Pathfinder School of Electronics**  
1509 N. Western Ave.  
Hollywood, California 90027

... for more details circle 119 on Reader Service Card

ELECTRONIC TECHNICIAN/DEALER

## BNC UHF CONNECTORS 727

*Corrosion resistant and withstand 2500° F temperatures*

The industry's broadest line of popular BNC and UHF RF connector configurations with tarnish-free, corrosion-resistant surface plating is introduced. Included in the new RF connectors are the 18 most popular coax

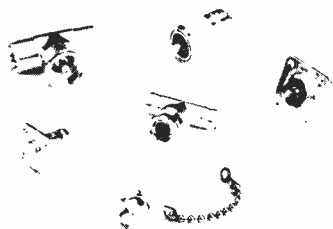

configurations. These include: (1) UG-1094 BNC bulkhead receptacle, (2) UG-88 BNC plug, (3) UG-260 BNC plug, (4) UG-657 BNC bulkhead receptacle, (5) UG-625 BNC bulkhead receptacle, (6) UG-290 BNC panel receptacle, (7) CW-123A BNC cap and chain, (8) UG-88B BNC plug, (9) UG-88C BNC plug, (10) UG-260A BNC plug, (11) UG-260B BNC bulkhead receptacle, (12) UG-260D BNC plug, (13) UG-625B BNC bulkhead receptacle, (14) UG-290A BNC panel receptacle, (15) UG-914 BNC panel receptacle, (15) UG-914 BNC straight adapter, (16) UG-274 BNC tee adapter, (17) UG-492A BNC bulkhead adapter and (18) Amphenol No. 31-759 BNC grounding lug. Designed for 50Ω impedance lines, they can be used to 500v peak through 10,000MHz. All other numbers are available on special order. New UHF Astroplate offerings include: (1) PL-259 UHF plug, (2) SO-239 UHF panel receptacle, (3) UG-176 UHF reducing adapter, (4) UG-175 UHF reducing adapter, (5) UG-363 UHF bulkhead adapter, (6) PL-258 UHF straight adapter, (7) M-358 UHF tee adapter, (8) Amphenol No. 83-877 UHF double male adapter, (9) Amphenol No. 83-878 UHF single hole mounting receptacle, (10) UG-646 UHF angle adapter, (11) PL-259A UHF plug for smaller coaxial cables, (12) PL-259 UHF plug with Teflon insert. All UHF connectors meet government specifications, exhibit non-constant impedances, are rated at 500v peak and can be effectively used through 300MHz. All other numbers are available on special order. The new connectors withstand exceptionally high temperatures (melting point of 2600F) that far exceed those of silver. Solderability performance meets MIL-Spec QQ-S 365. Amphenol.

**FAR  
SUPERIOR  
TO  
ANY  
VTVM  
OR  
VOM**

**--and  
for  
less  
money  
only  
\$69.95**



## NEW FIELD EFFECT MULTIMETER

Here is the revolutionary new approach to circuit testing, the solid state Sencore FIELD EFFECT METER. This FE14 combines the advantages of a VTVM and the portability and versatility of a VOM into a single low-cost instrument. This is all made possible by the use of the new space age field effect transistor that is instant in action but operates like a vacuum tube in loading characteristics. Compare the features of the FIELD EFFECT METER to your VTVM or VOM.

**Minimum circuit loading — 15 megohm input impedance on DC is better than a VTVM and up to 750 times better than a 20,000 ohm per volt VOM — 10 megohm input impedance on AC is 20 times better than a standard VTVM. The FIELD EFFECT METER is constant on all ranges, not like a VOM that changes loading with each range.**

**Seven AC peak-to-peak ranges with frequency response to 10MHz. Seven zero center scales down to 0.5 volt. Five ohmmeter ranges to 1000 megohms. DC current measurements to 1 ampere. Full meter and circuit protection. Mirrored scale. Low current drain on batteries — less than 2 milliamps. Built-in battery check. Unbreakable all-steel vinyl clad case. Optional Hi-Voltage probe adds 3KV, 10KV and 30KV ranges with minimum circuit loading for greatest accuracy in the industry... \$9.95.**

### FE16 HI-ACCURACY FIELD EFFECT METER.

All of above features, plus unmatched accuracy — 1.5% on DC, 3% on AC. High-style meter, knobs, and special meter-tilting handle. **\$84.50.**

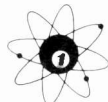

**SENCORE**

NO. 1 MANUFACTURER OF ELECTRONIC MAINTENANCE EQUIPMENT

426 SOUTH WESTGATE DRIVE, ADDISON, ILLINOIS 60101

... for more details circle 138 on Reader Service Card



TOF-8  
239 Dealer Net

**“After 20 years fixing TV sets, I’ve finally found a tuner spray that really works!”**

“I’ve tried them all” says Herb Gruen, owner of Gruen TV Service, Brooklyn, New York. “But most of them were more trouble than they were worth. A lot of tuner sprays cause detuning. Some do a pretty good job of cleaning, but don’t have enough body to provide real lubrication. The “thick stuff” dries out and gunks up in a couple of months, and I have a callback on my hands.”

“But this new TUN-O-FOAM is something else. It’s thick, but it foams into the tightest places. It doesn’t detune. It makes the tuner turn smooth as silk and it clears up snow due to poor contacts.”

“Best of all, TUN-O-FOAM doesn’t dry out. It works so well that now... for the first time in my life... I’m automatically cleaning and lubricating the tuner of every chassis I service. AND AFTER MORE THAN FOUR MONTHS AND HUNDREDS OF TUNERS I HAVEN’T HAD A SINGLE CALLBACK DUE TO TUNER TROUBLES.”

“In fact, on the few sets where I’ve had to make a callback for some other reason, I’ve made it a point to flip the tuner a few times and in every case it was still turning as smoothly as when it left my shop.”

Before Chemtronics releases a product, we field-test it thoroughly through a panel of expert TV technicians. Herb Gruen was one of the men chosen to test TUN-O-FOAM. His report was so enthusiastic that you’ll soon be seeing TUN-O-FOAM on your favorite distributor’s shelf. Try it. You’ll be amazed at the difference between TUN-O-FOAM and all previous tuner sprays. For detailed information on how TUN-O-FOAM works, write:



1260 RALPH AVENUE  
BROOKLYN, N.Y. 11236  
FOR EXPORT: ROBURN AGENCIES INC., N.Y., N.Y. 10013

IN CANADA:  
PERFECT MANUFACTURING LTD.,  
MONTREAL 9, CA.

... for more details circle 112 on Reader Service Card

American Telephone and Telegraph Co.	22
Argos Products Co.	30
Arrow Fastener Co.	76
ATR Electronics	92
B & K Div., Dynascan	28, 75
Belden Corp.	27
Berns Mfg. Co.	92
Book Club-Tab Books	62, 88-91
Borden Chemical Co.	77
Channellmaster Corp.	23, 65
Chemtronics, Inc.	98
Commander Electronics	70
C.R.T. Equipment Co.	3rd Cover
EICO Electronic Instruments Co.	2nd Cover
Electro-Voice, Inc.	66
Ford Motor Company, Econoline Van Div.	67
GC Electronics Co.	26
General Electric Co., Receiving Tubes	35-38
Grantham School of Engineering	94, 96
Greyhound Lines, Inc.	69
Heath Co.	73
Hudson Lamp Co.	85
International Crystal Mfg. Co.	80
Jensen Tools & Alloys	85
JFD Electronic Corp.	40
Leader Instruments Corp.	78
Lectrotech, Inc.	82, 86
Miller Co., J. W.	78
Mosley Electronics, Inc.	70
National Radio Institute	84
Quietrol Co.	92
Raytheon Co., Rec. Tube Operation	96
RCA Electronic Components, Entertainment Tubes	4th Cover
RCA Institutes	81
RCA Parts & Accessories	71-72
RCA Electronic Components, Test Equipment	63
Scencore, Inc.	32-33, 93, 95, 97
Sprague Products Co.	29
Sylvania Electric Products	20
Tuner Service Corp.	19
TV Tech Aid	92
Ungar Division of Eldon Industries	25
Weller Electric Corp.	39
Winegard Co.	79
Workman Electronic Products, Inc.	94
Xcelite, Inc.	87
Zenith Radio Corp.	31, 83



# THE PROFIT-MAKER!



- REBUILDS ANY SIZE ROUND OR RECTANGULAR COLOR PICTURE TUBES . . . AVERAGE COST PER TUBE \$7.80
- REBUILDS ANY SIZE BLACK AND WHITE PICTURE TUBE . . . AVERAGE COST PER TUBE \$1.80
- FREE INSTALLATION AND TRAINING ANYWHERE IN THE CONTINENTAL U.S.A.
- FREE SUPPLIES FOR REBUILDING YOUR FIRST 50 PICTURE TUBES

- EXTREMELY EASY TO OPERATE
- INCLUDES LAMINATING AND DELAMINATING EQUIPMENT FOR REBUILDING BLACK AND WHITE AND COLOR BONDED-FACE PICTURE TUBES.
- INCLUDES ALL TOOLS FOR REBUILDING ROUND AND RECTANGULAR COLOR PICTURE TUBES
- INCLUDES ALL TOOLS FOR REBUILDING BLACK AND WHITE PICTURE TUBES

## CRT COLOR CHAMPION

CRT COLOR CHAMPION . . . \$2,875.00

Mail Coupon To

C.R.T. Equipment Company, Inc.  
2740 Old Lebanon Road  
Nashville, Tennessee 37214

Telephone (615) 883-0215

Name \_\_\_\_\_  
Firm Name \_\_\_\_\_  
Address \_\_\_\_\_  
City \_\_\_\_\_  
State \_\_\_\_\_

COMING YOUR WAY FOR CHRISTMAS '69 RCA'S

# TOY CARNIVAL

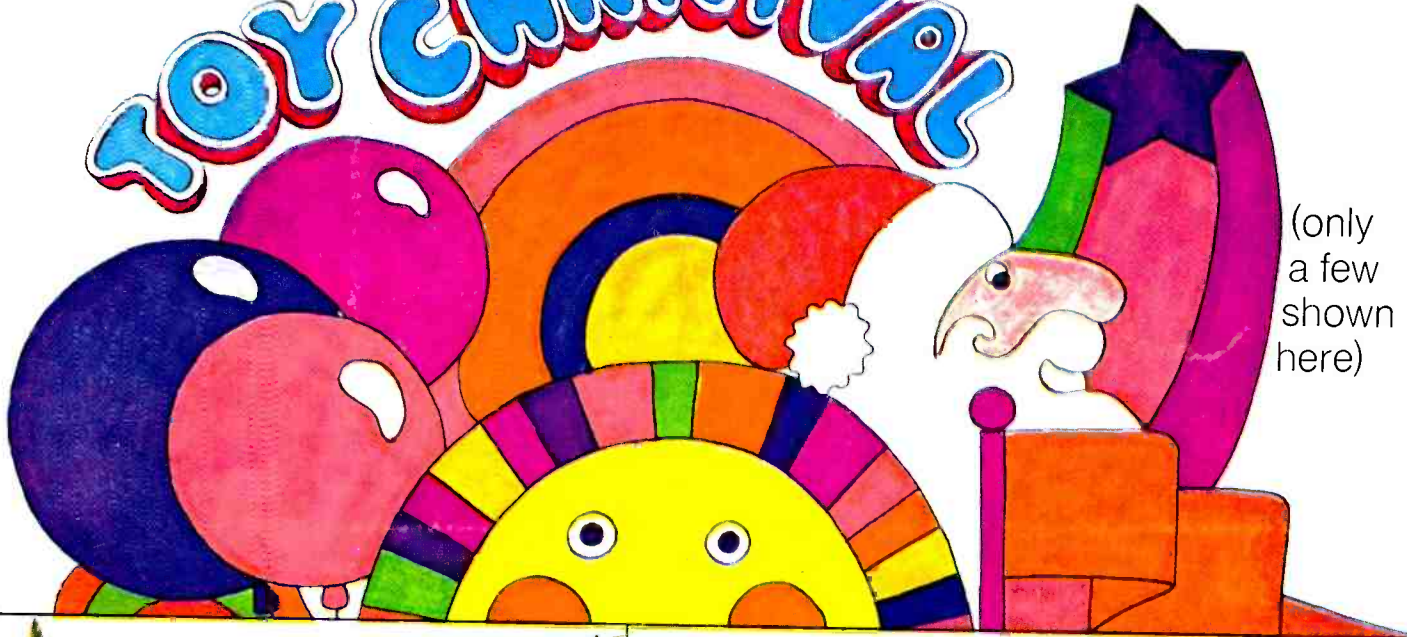

(only a few shown here)

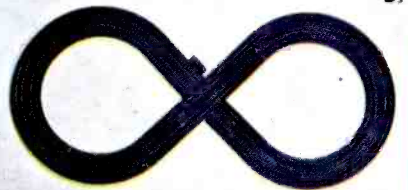

\* 17 wondrous toys (only a few shown here) to light up the eyes of children of all ages!  
 \* available with purchases of RCA Entertainment Receiving Tubes and Picture Tubes from your local participating RCA Tube Distributor.



- A. HUFFY BOY'S BICYCLE "DRAG-STER III"—TC-2044—3 speeds
- B. ATLAS N-GAUGE READY-TO-RUN TRAIN SET—TC-69364—complete
- C. PLUSH DOG—TC-2262—cute-as-a-button beagle type
- D. ATLAS ROAD RACING-SET—TC-1202—complete with power supply
- E. PARKER "QUBIC" GAME—TC-400—3-dimensional Tic-Tac-Toe
- F. COLLECTOR'S SET AMERICAN SPACE PROGRAM BY REVELL—TC-1839—3 ready-to-assemble models
- G. HORSMAN "BABY BUTTERCUP" DOLL—TC-5301—drinks and wets
- H. MIGHTY-TONKA DUMP TRUCK—TC-3900—a kid can ride it
- I. HORSMAN "BABY TWEAKS"—TC-2570—18" tall, she "coos"

See your local RCA Tube Distributor for details

N.J. 07029