

# ELECTRONIC TECHNICIAN / DEALER

WORLD'S LARGEST TV-RADIO SERVICE & SALES CIRCULATION

AUGUST 1969  A HARBRACE PUBLICATION



FRISEW10812392N869AD3A117966B  
WILLIAM W FRISE  
7176 GALE RD  
ATLAS MI

48411

SELLING CCTV

POST MARKER SWEEP ALIGNMENT

# Outstanding Values from the Nation's Largest CCTV Supplier

## GE VIDEO TAPE RECORDERS

(built by Sony for General Electric)

**50% OFF**  
REGULAR GE PRICE

ONLY

**\$397<sup>50</sup>**



**COMPATIBLE WITH ALL SONY 1/2" VIDEO TAPE RECORDERS INCLUDING BATTERY OPERATED PORTABLES**

GBC spent half a million dollars to bring you this once-in-a-lifetime close-out price on quality video tape recorders. GE sold thousands of these units at \$795. Now, you can buy them for under \$400. You actually get a video *and* audio tape recorder for the price you'd expect to pay for a good audio tape recorder!

You can use your video tape recorder for educational TV, training, instruction, presentations, advertising, or instant home movies. Simple to operate, it tapes programs picked up by TV cameras or off-the-air, and plays them back through a standard TV monitor. Brand new, **FULLY GUARANTEED**, in original factory cartons. Order today, while they last.

**NEW! WEATHERPROOF CAMERA**



This is a top quality camera built right into a rugged, enamel plated aircraft aluminum housing. Completely weatherproof, it accepts any lens, including a remote controlled zoom lens. Light enough to be used with any standard mount. Full year warranty. Only **\$495<sup>00</sup>**

## VIDICONS

**TOP QUALITY AT LOW, LOW PRICES.**



The quality: brand-new Hitachi, fully guaranteed in factory-sealed cartons.

The price: (distributor cost)

Hitachi 7735-A vidicon .....	<b>\$34.50</b>
Toshiba 7038-H vidicon .....	<b>\$29.50</b>
Hitachi separate mesh vidicon 8507 .....	<b>\$74.50</b>
Hitachi 7262—replacement for Sony and Panasonic .....	<b>\$34.50</b>

All vidicons sold in lots of 5 (10% more for lesser quantities)



**WHEN YOU NEED IT, WE GOT IT!**

GBC maintains a huge inventory of TV cameras, viewfinders, monitors and accessories of all kinds. Whatever you want, we probably have in stock right now.

**WRITE FOR THE FREE GBC ENCYCLOPEDIA OF CCTV**

**TERMS:** Check with order — FREE delivery.  
COD — 25% deposit, shipped F.O.B. N.Y.C.



**GBC Closed Circuit TV Corp.**

74 Fifth Avenue, New York, N.Y. 10011 / Phone: (212) 989-4433

...for more details circle 111 on postcard



AUGUST • 1969

**19KT40B CHASSIS  
TRANSISTOR VOLTAGES**

	E	B	C
Q1	1.2V	1.9V	19V
Q2	1.9V	2.55V	20V
Q3	2V	2.6V	17V
Q4	19V	20V	1.2V
Q5	20V	16.5V	24V
Q6	4.6V	5.2V	11V
Q41	0V	-4.7V	37V
Q91	11.5V	12.5V	16V
Q92	7.2V	7.9V	10.8V
Q93	4V	4.7V	17.5V
Q94	0V	.55V	2.7V
Q95	2.8V	0V	36V
Q96	.3V	.95V	19V
Q97	.45V	-1.0V	22V
Q98	2.1V	2.6V	22V
Q99	.9V	1.5V	19V
Q100	1.5V	1.55V	12V
Q101	1.5V	1.55V	12V
Q102	.6V	.55V	22.5V
Q103	.6V	-.8V	8.2V
Q200	23V	15V	26V
Q201	.65V	1.2V	98V

SYMBOL	DESCRIPTION	PHILCO-FORD PART NO.
C204	200-20-50µ/200wv, 150µ/350wv	30-2618-11
C207	500-500-100µ/50wv	30-2618-10
C211	250µ/15wv, bright control	30-2611-12
CB200	power ac	42-1236-6
D41	SD7, horiz phase det	34-8057-13
D98	SD19, 3.58MHz osc	34-8054-19
D300A-D	selen, conv rect	34-8058-2
IC91	3.58MHz osc	46-5002-4
J202	def yoke	41-4385-3
L2	2nd video IF	32-4935-1
L4	40MHz choke	32-4837-1
L6	4.5MHz trap	32-4869-2
L9	video det	32-4762-13
L10	RF AGC	32-4762-3
L13	41.25MHz trap	32-4762-23
L16	1st video IF pole	32-4652-79
L41	horiz hold	32-4891-2
L91	sound interstage	32-4936-2
L92	sound take-off	32-4936-1
L93	sound det	32-4928-1
L94	tint control	32-4942-1
L96	chroma take-off	32-4878-3
L100	3.58MHz osc	32-4932-1
L101	680µh, "X" demod coil	32-4762-14
L103	demod driver	32-4930-1
L105	100µh, delay driver out	32-4762-4
L107	270µh video out	32-4762-9
L108	180µh, video out plate	32-4762-7
DL91	delay line	32-4839-3
R223	170-30M, focus bleed	33-1383-1
RT200	degaussing	33-1376-6
RV55	horiz bias	33-1379-2
RV200	degaussing	33-1379-8
VR1	3K, RF AGC emit	33-5628-7
VR2	750 Ω sound reject	33-5628-3
VR41A-C	1.5M, CRT screens	33-5595-20
VR91	blu, grn, red CRT drive	33-5632-1
VR92	4.7K, color killer	33-5628-6
VR93	250K, CRT bias	33-5628-12
VR201	10M, focus	33-5631-10
VR202	25K, volume	33-5634-4
VR203	1.2K, tint	33-5623-20
VR204	100 Ω contrast	33-5631-12
VR205	500 Ω bright	33-5631-9
VR206	A-vert, hold, B-color	33-5636-6
AOT	audio output	32-10097-1
FC	filter choke	32-10095-1
HOT	horiz output	32-10111-1
PT	power	32-10110-1
VOT	vert output	32-10117-1
	chroma assy., w/comp	38-10177-7

PIN NO.	V41	V42	V91	V92	V200	V201
	6JZ8	6BL8	6ML8	12GN7	6JS6	6CG3
1	0V	84V	185V	26V	FIL	FIL
2	88V	-36V	153V	24V	0V	-
3	0V	145V	183V	0V	110V	-
4	278V	FIL	FIL	FIL	0V	295V
5	0	FIL	FIL	FIL	-59V	-
6	58V	172V	0	FIL	-	-
7	58V	.17V	2.5V	248V	-	DO NOT MEASURE
8	282V	4.3V	.35V	145V	-	-
9	93V	.15V	.3V	0V	-59V	-
10	-19V	-	-	-	0V	295V
11	0V	-	-	-	110V	-
12	0V	-	-	-	FIL	FIL

**19KT40B CHASSIS  
TUBE VOLTAGES**

Resistance measurements of transistors in circuit (power off).

All measurements are in ohms and taken with a B & K Model 175 VTVM with an allowable tolerance of ±20%.

**TRANSISTOR MEASUREMENTS (USE X100 SCALE)**

	Coll. to Gnd.		Emit. to Gnd.		Base to Gnd.		Coll. to Emit. (-) (+)		Coll. to Base (-) (+)		Base to Emit. (+) (-)	
	+	-	+	-	-	+	+	-	+	-	-	+
Q1	920		220		1350		(820) 1.2K		(1K) 1.6K		(1K) 1.6K	
Q2	740		440		5K		(840) 1.4K		(1.2K) 6K		(1K) 5.2K	
Q3	560		125		1.7K		(700) 700		(950) 2.2K		(950) 2K	
Q4	1050		460		1150		(900) 3K		(900) 1.2K		(2.2K) 1.2K	
Q5	INF		1.2K		1.2K		(2.4K) INF		(INF) 780		(840) 1.9K	
Q6	1.3K		270		3.8K		(1.3K) 700		(5K) 800		(800) 4.2K	
Q41	30K		0		INF		(25K) 25K		(INF) 760		(850) INF	
Q91	1400		2K		560		(3.5K) 2K		(850) 1600		(900) 2.6K	
Q92	700		800		1150		(1500) 1500		(900) 1700		(940) 2K	
Q93	1.1K		300		2K		(1350) 1450		(800) 3K		(800) 2.3K	
Q94	2.2K		100		50K		(50K) 2.3K		(850) 50K		(820) 45K	
Q95	18K		12K		9K		(15K) 7K		(800) 20K		(800) 20K	
Q96	1200		80		3.8K		(850) 1280		(1100) 5K		(1070) 4K	
Q97	1.4K		2.4K		INF		(4K) 5K		(760) INF		(850) INF	
Q98	750		6.5K		40K		(7.5K) 1.7K		(850) 50K		(880) 50K	
Q99	500		70		960		(580) 580		(750) 1400		(820) 1K	
Q100	3.8K		500		1420		(2.1K) 4.2K		(610) 5K		(2K) 680	
Q101	4K		540		1400		(4.5K) 2.2K		(630) 5.5K		(700) 2K	
Q102	1400		180		9K		(1500) 1600		(920) 12K		(960) 10K	
Q103	2200		70		7K		(1850) 2200		(700) 9.5K		(740) 7K	
Q200	1K		280		1250		(260) 650		(500) 680		(550) 1.4K	
Q201	900		10		10K		(2.8K) 10K		(600) 20K		(700) 10K	

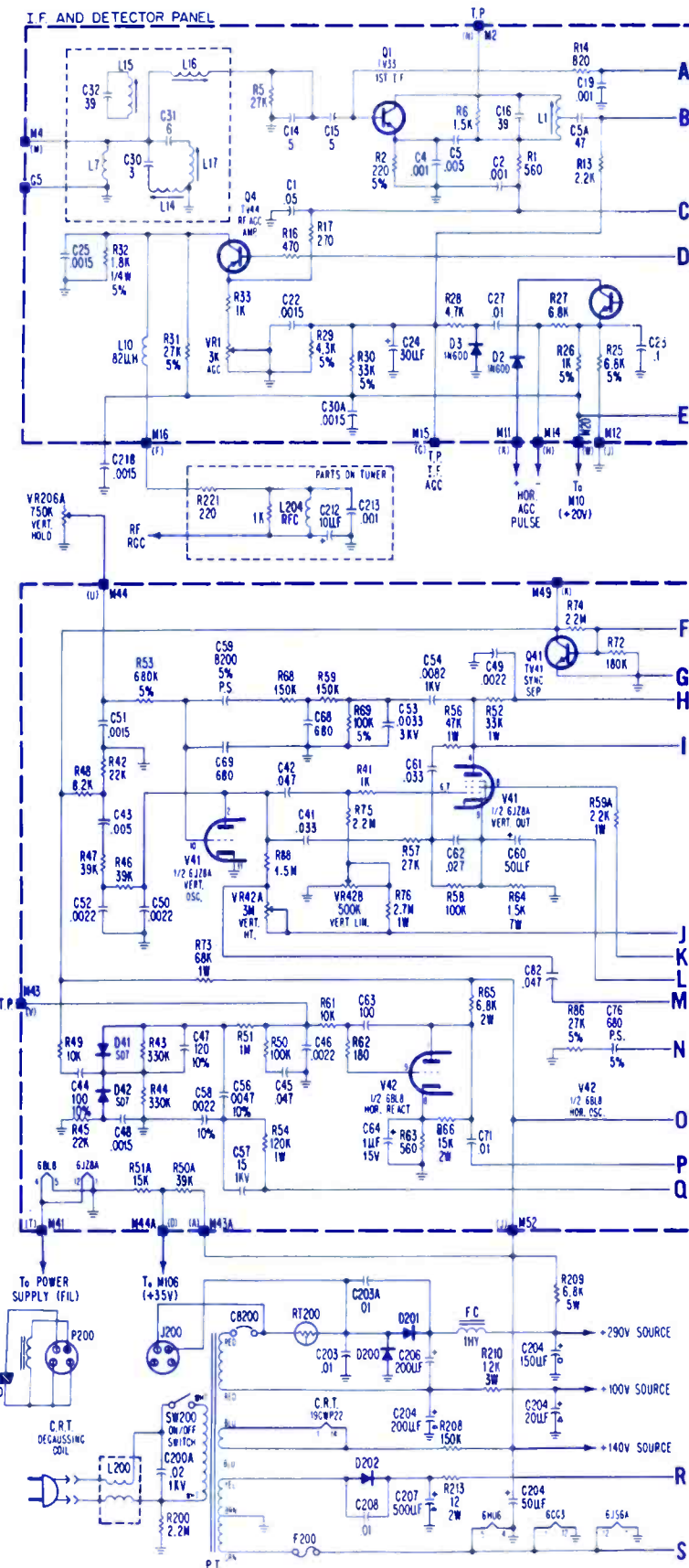



AUGUST • 1969

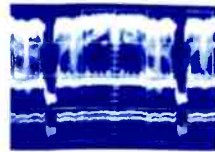

1 2 VPP Vert.

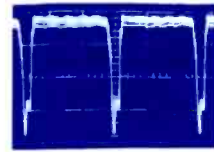

2 18 VPP Horiz.

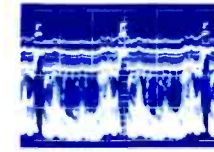

3 8 VPP Vert.

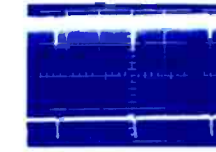

4 50 VPP Vert.

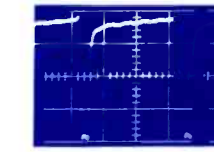

5 50 VPP Horiz.

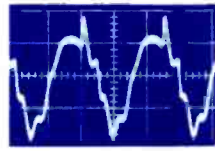

13 60 VPP Horiz.

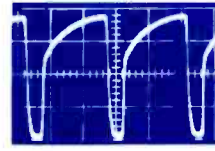

14 192 VPP Horiz.

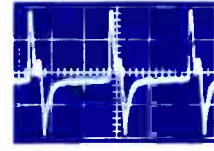

15 192 VPP Horiz.

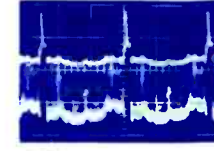

16 75 VPP Vert.

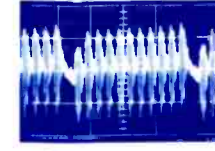

17 \* .62 VPP Horiz.

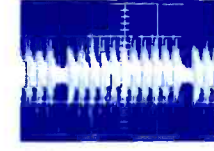

18 \* 4 VPP Horiz.

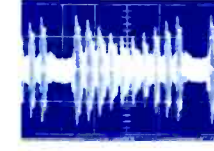

19 \* 5 VPP Horiz.

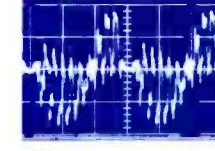

20 \* 14 VPP Horiz.

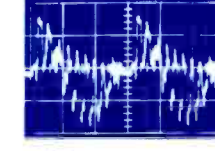

21 \* 14 VPP Horiz.

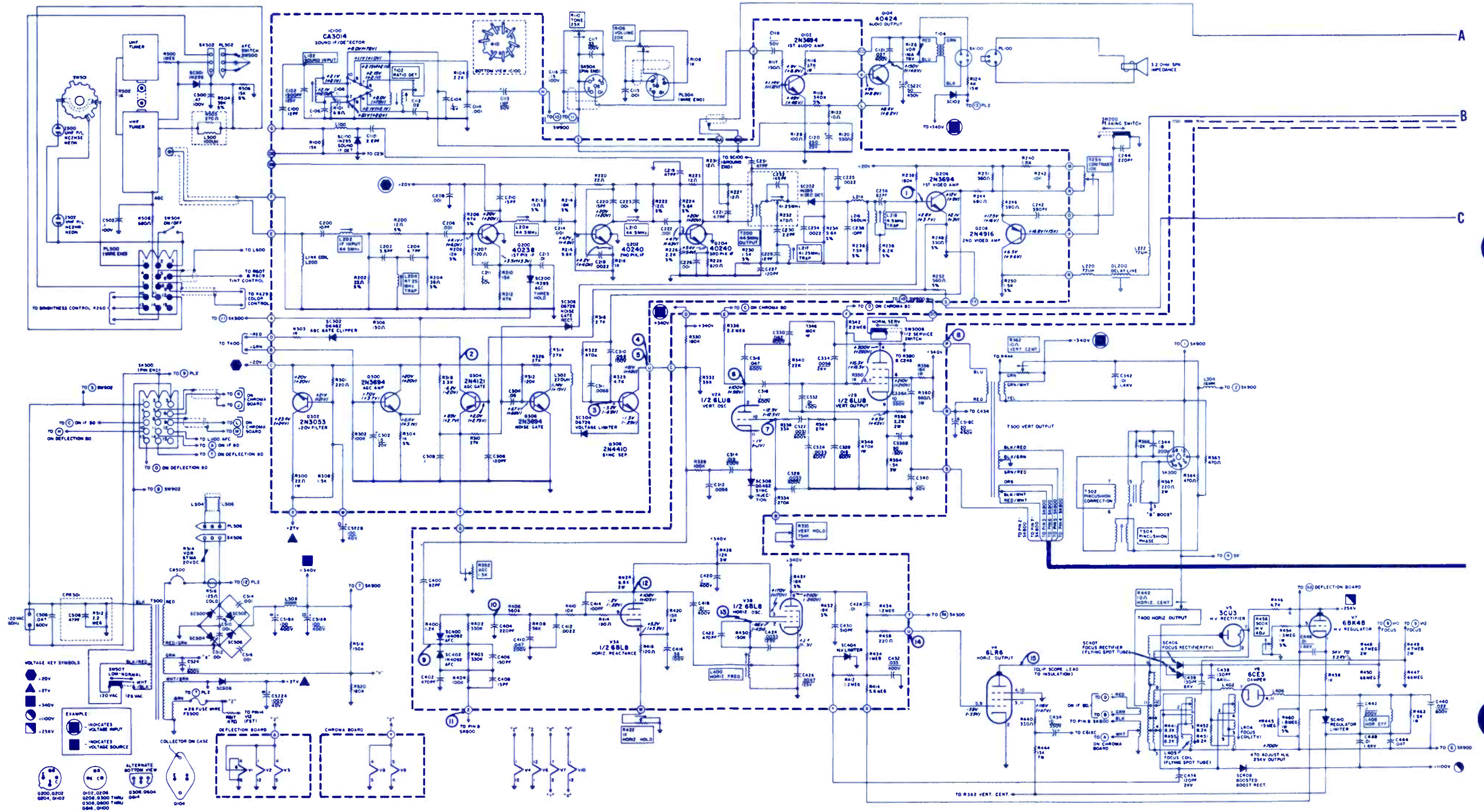

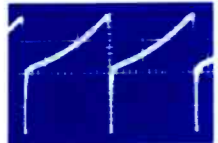

6 100 VPP Vert.

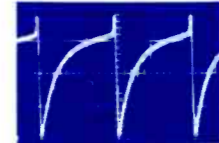

7 40 VPP Vert.

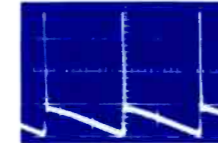

8 1300 VPP Vert.

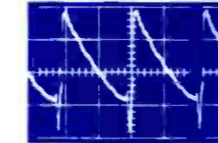

9 30 VPP Horiz.

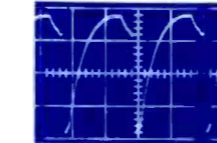

10 78 VPP Horiz.

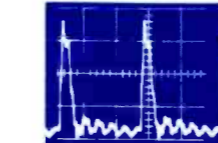

11 220 VPP Horiz.

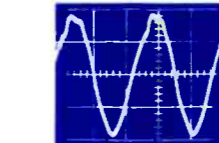

12 45 VPP Horiz.

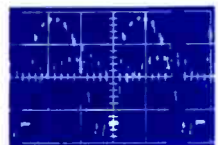

22 \* 138 VPP Horiz.

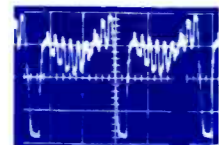

23 \* 93 VPP Horiz.

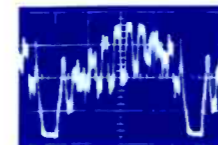

24 \* 120 VPP Horiz.

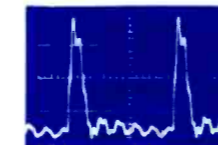

25 \* 20 VPP Horiz.

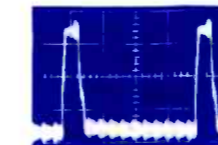

26 \* 3.5 VPP Horiz.

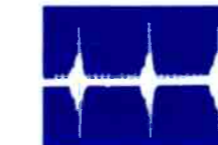

27 \* 19 VPP Horiz.

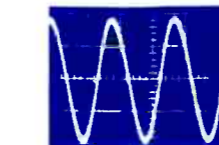

28 \* 13 VPP Horiz.

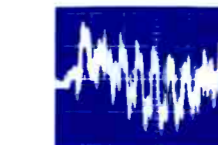

29 \* 11 VPP Horiz.

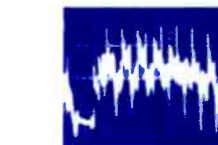

30 \* 4 VPP Horiz.

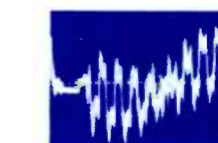

31 \* 12.5 VPP Horiz.

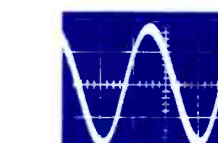

32 \* 20 VPP 3.58MHz

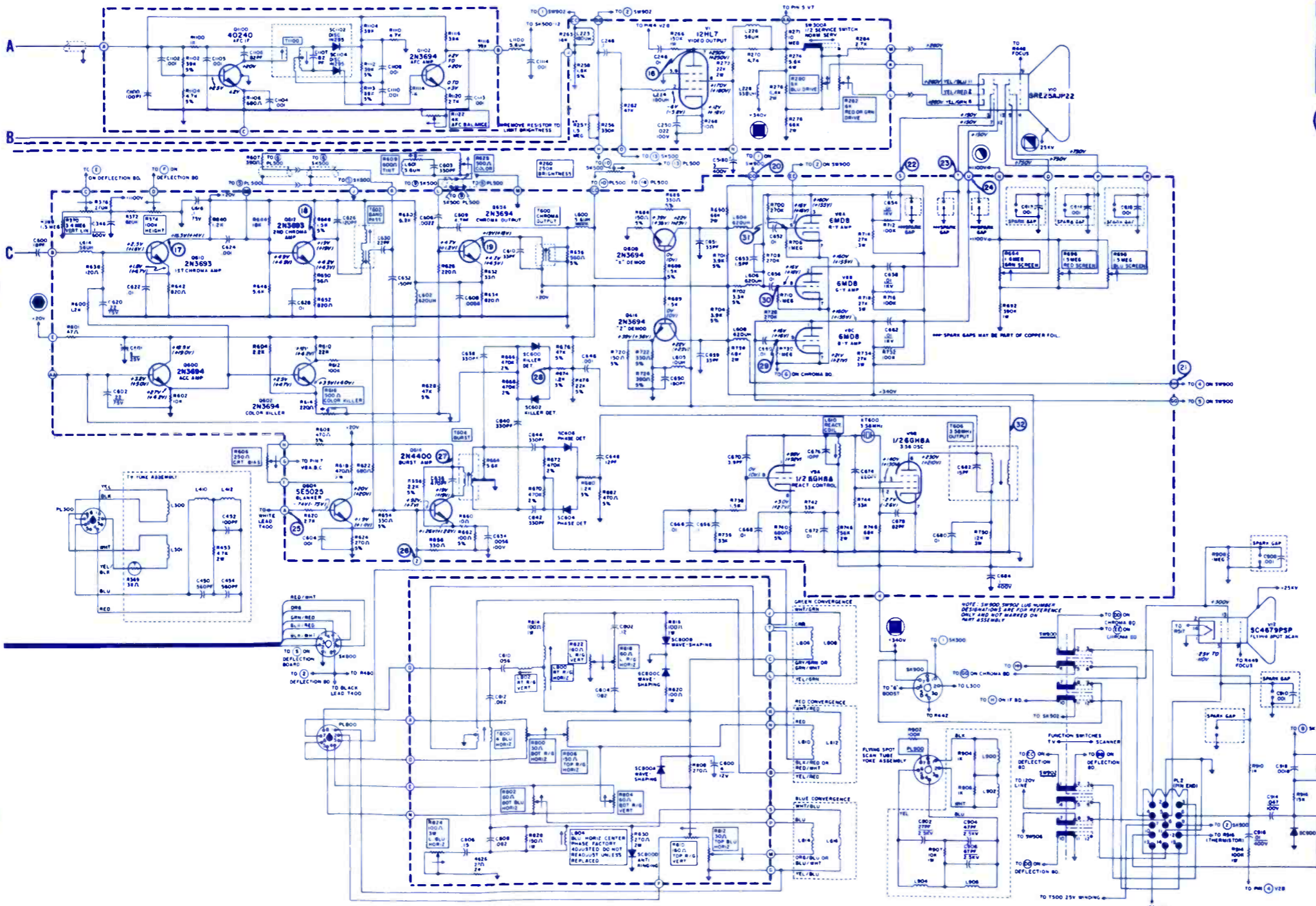

SYMBOL	DESCRIPTION	SYLVANIA PART NO.
C336	--2 sec elect	41-27344-1
C336A	--2 sec 10/350v	41-27344-1
C336B	--2 sec 50/150v	41-27344-1
C518	--4 sec elect	41-27418-1
C518A	--4 sec 100/400v	41-27418-1
C518B	--4 sec 100/400v	41-27418-1
C518C	--4 sec 200/450v	41-27418-1
C518D	--4 sec 3/400v	41-27418-1
C522	--3 sec elect	41-27421-1
C522A	--3 sec 1000/40v	41-27421-1
C522B	--3 sec 100/40v	41-27421-1
C522C	--3 sec 50/450v	41-27421-1
R106	--20K vol	37-23479-32
R110	--25K tone	37-27242-8
R126	--VDR1MA 76v	38-15257-18
R254	--10K contrast	37-27242-13
R260	--250K bright	37-15536-10
R280	--6K blu dr	37-11632-15
R335	--750K vert hold	37-27242-6
R352	--1.5K AGC	37-11632-1
R362	--10 vert cent	37-16021-17
R369	--38 therm	
R370	--3.4M vert lin	37-11632-19
R374	--100K height cont	37-11632-19
R422	--1K horiz hold	37-27242-12
R442	--10 horiz center	37-17539-3
R458	--500K H.V. adj	37-16020-27
R514	--VDR 67ma 20vdc	38-17072-1
R518	--therm 120 Ω cold	38-17071-1
R606	--250 CRT bias	37-16020-30
R616	--500 color killer	37-11632-19
R629	--500 color killer	
R694	--1.5M grn scr cont	37-11632-20
R1122	--4K afc bal	37-14567-7
L100	--coil tweet 36μh	50-16103-46
L102	--sound input	67-23832-2
L200	--link coil	50-23828-1
L218	--4.5MHz trap	50-16238-5
L400	--horiz freq	50-23508-1
L404	--foc coil (TV)	50-27845-1
L406	--choke	50-92043-1
L408	--horiz eff	50-23507-1
L610	--react coil	50-16185-3
T102	--ratio det	57-23547-1
T104	--audio output	56-16018-8
T200	--IF output	57-23831-1
T300	--vert output	56-17559-6
T302	--pincushion corr.	50-23485-1
T304	--horiz output	50-27415-1
T500	--power transf.	55-27691-1
T600	--chroma output	50-27407-1
T602	--bandpass	50-27405-1
T604	--burst	50-27406-1
T606	--3.58MHz output	50-27549-1
T800	--RT blu horiz	50-16248-9
T1100	--AFC	57-23581-1
CB500	--cir brkr	29-23918-1
CPR200	--capristor 47PF/2.2M	32-11448-4
DL200	--delay line	32-16108-2

SYMBOL	DESCRIPTION	AIRLINE PART NO.
C708	---150 $\mu$ f @ 200v elect	TV3284
C711A,B,C,D	---120 $\mu$ f/80 $\mu$ f/20 $\mu$ f/10 $\mu$ f @ 350v elect	TV3285
R622	---100K, 2w, 10w, oxide film	CD1410
R705,R706	---3K, 4w, 10%, oxide film	TV23275
R709A,B	---10 $\Omega$ 15w/15 $\Omega$ , 5w, special	TV23177
R711	---1.8 $\Omega$ , 17w, special	TV23178
R313, SW-701	---1M, pot, on-off vol w/switch (9V-160UL)	TV24320
R520A	---1M, pot, vert size	TV25165
R520B	---1M, pot vert lin	TV25165
R520C	---50K pot horiz hold	TV25165

R714A	---250K pot vert hold	TV25166
R714B	---100K pot AGC	TV25166
R714C	---1M pot vert hold Assy (8V-061)	TV25166
R715	---20K pot contrast (8V-007)	TV2572
L201	---coil 47.25MHz trap (2TIF-487)	TV62248
L202	---coil filter (2TL-970)	TV61474
L204	---coil peak (CL-151)	TV61601
L301	---coil sound det (TIF-544)	TV62254
L601	---coil horiz hold (TL-97)	TV61373
L603	---coil horiz lin (TL-96)	TV61337
L702	---coil peak (CL-561)	TV61622
L703	---coil peak (HL-821K)	TV61639
T201	---50.25MHz trap (TIF-302)	TV62288
T202	---xformer, 2nd pic IF (TIF-343)	TV62300

T301	---xformer, sound IF (TIF-378)	TV62341
T302	---xformer, audio output (7T-182)	TV11262
T501	---xformer, vert output (8T-191)	TV11770
T601	---xformer, horiz output (8T-642)	TV11225
T701	---xformer, 4.5MHz trap (2TIF-491)	TV62252
T702	---xformer, power choke (9T-188)	TV1161
M501	---capristor (PRC-302)	TV3455
M701	---capristor (PRC-366)	TV3465
D601	---dual diode (SELEN-38)	TV24190
SR701,SR702	---rectifier (SI-RECT-48)	TV24191
F701	---fuse, 2A	*315002
	tuner, VHF (NTB-7U2G)	TV35185
	tuner, UHF (UT6-2U2)	TV35148
	yoke, def Assy	TV61617

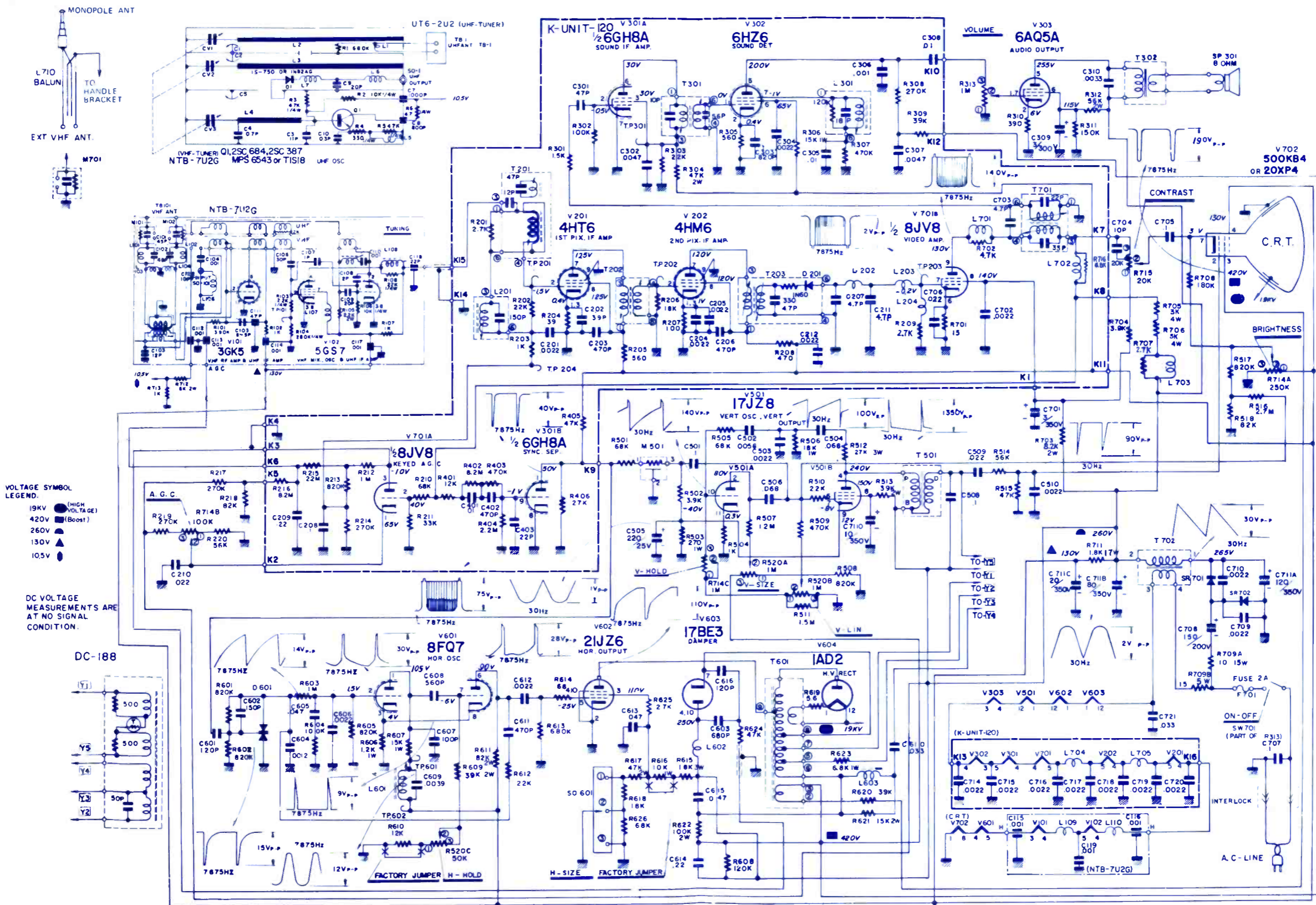



SYMBOL	DESCRIPTION	OLYMPIC PART NO.
VR101	500K, vol, power on-off	PTJ33392
VR102	500K, picture	PTJ33393
VR103	100K, bright	PTJ60483
VR104	1M, vert hold	PTJ60486
VR201A	500K, vert height	PTJ61586
VR201B	500K, vert lin	PTJ61586
VR105	1M, horiz hold	PTJ60486
C103	250µ, +200µ, +50µ, 200v	COJ33413
C220	100µ, 6.3v	COJ60319
C231	150pf ± 5%	
T101	speaker output	TRJ33387

TRJ60103	
TRJ60105	
TRJ60314	
TRJ60320	
TRJ60315	
TRJ60315	
TRJ60322	
TRJ33241	
CLJ60479	
CLJ33385	
CLJ61374	
CLJ60471	

L203	coil, inductor, 5.6µh
L204	coil, inductor, 47µh
L205	coil, inductor, 180µh
L206	coil, inductor, 270µh
L208	coil, horiz freq
L209	coil, choke, 10µh
L210	coil, choke
S101	rec silicon
F101	fuse, 1.9a
D203	diode, 1N60 tuner VHF
	tuner UHF

CLJ60472	
CLJ60473	
CLJ60474	
CLJ60475	
CLJ33390	
CLJ60477	
CLJ60484	
RFJ31363	
INJ60034	
CLJ61375	
CLJ61376	

NOTE:

- ALL CARBON FILM RESISTOR (RD) VALUES IN OHMS ± 10% TOLERANCE 1/2 WATT UNLESS OTHERWISE NOTED.
- ALL CARBON COMPOSITION RESISTOR (RC) VALUES IN OHMS ± 20% TOLERANCE 1/2 WATT UNLESS OTHERWISE NOTED.
- ALL MICA AND PAPER CONDENSERS: 20% TOLERANCE UNLESS OTHERWISE NOTED.
- ALL CERAMIC CONDENSERS (MARK DISC TYPE) VALUES IN MICRO-MICRO FARADS ± 10% TOLERANCE UNLESS OTHERWISE NOTED.
- ALL VOLTAGES MEASURED BETWEEN POINTS INDICATED AND CHASSIS USING AN ELECTRONIC VOLTMETER. ALL VOLTAGE READINGS ± 15% WITH INCOMING SIGNAL AND WITH PICTURE CONTROL SET TO PRODUCE 60 VOLTS PEAK TO PEAK AT KINESCOPE.
- \*\* MARK TEMP. COEFFICIENT.

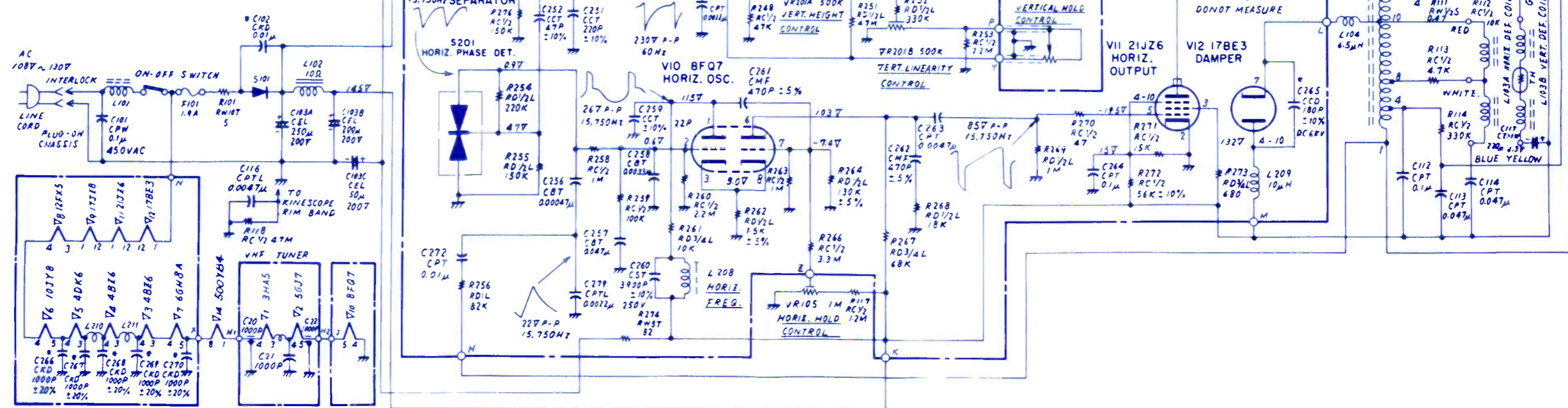
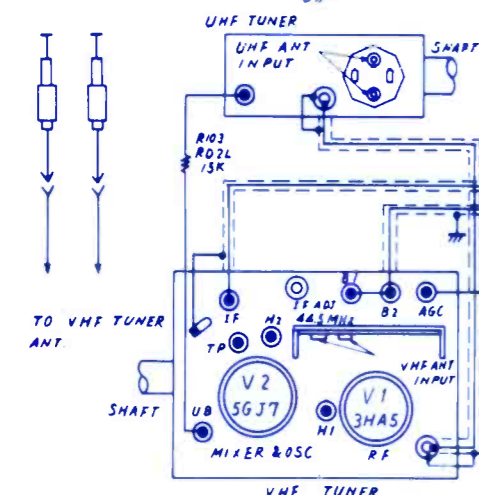

COMPLETE MANUFACTURERS' CIRCUIT DIAGRAMS  
AND TECHNICAL INFORMATION FOR 6 NEW SETS

AUGUST • 1969

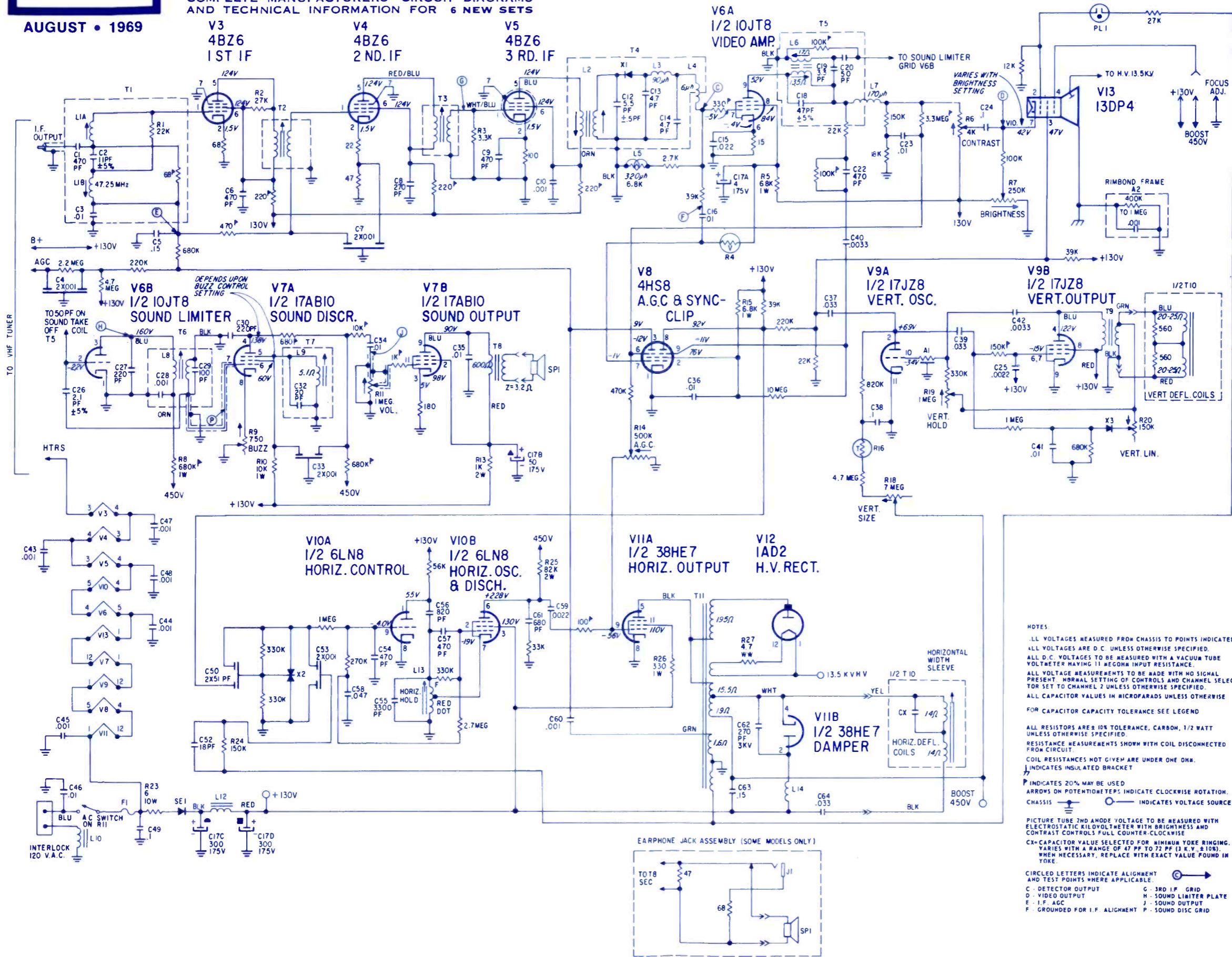

NOTES:

- ALL VOLTAGES MEASURED FROM CHASSIS TO POINTS INDICATED.
- ALL VOLTAGES ARE D.C. UNLESS OTHERWISE SPECIFIED.
- ALL D.C. VOLTAGES TO BE MEASURED WITH A VACUUM TUBE VOLTMETER HAVING 11 MEGOHM INPUT RESISTANCE.
- ALL VOLTAGE MEASUREMENTS TO BE MADE WITH NO SIGNAL PRESENT. NORMAL SETTING OF CONTROLS AND CHANNEL SELECTOR SET TO CHANNEL 2 UNLESS OTHERWISE SPECIFIED.
- ALL CAPACITOR VALUES IN MICROPARADS UNLESS OTHERWISE SPECIFIED.
- FOR CAPACITOR CAPACITY TOLERANCE SEE LEGEND.
- ALL RESISTORS ARE ± 10% TOLERANCE, CARBON, 1/2 WATT UNLESS OTHERWISE SPECIFIED.
- RESISTANCE MEASUREMENTS SHOWN WITH COIL DISCONNECTED FROM CIRCUIT.
- COIL RESISTANCES NOT GIVEN ARE UNDER ONE OHM.
- INDICATES INSULATED BRACKET
- P INDICATES 20% MAY BE USED
- ARROWS ON POTENTIOMETERS INDICATE CLOCKWISE ROTATION.
- CHASSIS
- INDICATES VOLTAGE SOURCE.
- PICTURE TUBE 2ND ANODE VOLTAGE TO BE MEASURED WITH ELECTROSTATIC KILVOYLMETER WITH BRIGHTNESS AND CONTRAST CONTROLS FULL COUNTER-CLOCKWISE
- CX - CAPACITOR VALUE SELECTED FOR MINIMUM YOKE RINGING. VARIES WITH A RANGE OF 47 PF TO 72 PF (3 K.V. ± 10%). WHEN NECESSARY, REPLACE WITH EXACT VALUE FOUND IN YOKE.
- CIRCLED LETTERS INDICATE ALIGNMENT AND TEST POINTS WHERE APPLICABLE.
- C - DETECTOR OUTPUT
- D - VIDEO OUTPUT
- E - I.F. AGC
- F - GROUNDED FOR I.F. ALIGNMENT
- G - 3RD I.F. GRID
- H - SOUND LIMITER PLATE
- J - SOUND OUTPUT
- P - SOUND DISC GRID



# OVERHAUL

# \$975

## GUARANTEED for 1 Year

### OVERHAUL \$9.75 • REPLACEMENT TUNERS...\$10.45

Nine-seventy-five buys you a complete tuner overhaul—including parts (except tubes or transistors)—and *absolutely no hidden charges*. All makes, color or black and white. UV combos only \$15.

Guaranteed means a full 12-month warranty against defective workmanship and parts failure due to normal usage. That's 9 months to a year better than others. And it's backed up by the only tuner repair service authorized and supervised by the world's largest tuner manufacturer—Sarkes Tarzian, Inc.

Four conveniently located service centers assure speedy in-and-out service. All tuners thoroughly cleaned, inside and out . . . needed repairs made . . . all channels aligned to factory specs, then rushed back to you. They look—and perform—like new.

SEND ORDERS FOR UNIVERSAL AND CUSTOMIZED REPLACEMENT TUNERS TO OUR OFFICE IN INDIANAPOLIS.

Prefer a universal replacement? Sarkes Tarzian will give you a universal replacement for only \$10.45. This price is the same for all models. The tuner is a new tuner designed and built specifically by Sarkes Tarzian for this purpose. It has memory fine tuning—UHF plug-in for 82 channel sets—universal mounting—hi-gain—lo-noise.

#### ORDER TUNERS BY PART NUMBER, AS FOLLOWS:

Part #	Intermediate Frequency	AF Amp Tube	Osc. Mixer Tube	Heater
MFT-1	41.25 mc Sound 45.75 mc Video	6GK5	6LJ8	Parallel 6.3V
MFT-2	41.25 mc Sound 45.75 mc Video	3GK5	5LJ8	Series 450 MA
MFT-3	41.25 mc Sound 45.75 mc Video	2GK5	5CG8	Series 600 MA

Prefer a customized replacement tuner? The price will be \$18.25. Send us the original tuner for comparison purposes, also TV make, chassis and model numbers.



#### TUNER SERVICE CORPORATION FACTORY-SUPERVISED TUNER SERVICE

- MIDWEST** ..... 817 N. PENNSYLVANIA ST., Indianapolis, Indiana ..... TEL: 317-632-3493  
(Home Office)
- EAST** ..... 547-49 TONNELE AVE., Jersey City, New Jersey ..... TEL: 201-792-3730
- SOUTH-EAST** ..... 938 GORDON ST., S. W., Atlanta, Georgia ..... TEL: 404-758-2232
- WEST** ..... SARKES TARZIAN, Inc. TUNER SERVICE DIVISION  
 10654 MAGNOLIA BLVD., North Hollywood, California ..... TEL: 213-769-2720

WATCH FOR NEW CENTERS UNDER DEVELOPMENT

...for more details circle 128 on postcard

**Unless you are an advanced CBer,  
you probably can't use Johnson's  
new solid state Messenger 124**



**New Messenger 124 full-function, 23-channel base station. \$289<sup>95</sup>**  
(less mike)

*If you're an operator with a purpose . . . consider this, the most sophisticated of all Johnson 27 MHz base stations . . . from the largest and most experienced of all manufacturers of citizens and industrial two-way radio.*

To the advanced CB operator, the Messenger 124 means complete mastery of the equipment—a degree of control and measurement that permits, for the first time, full utilization of all the enormous power, hairline selectivity, sensitivity and noise suppression of which the incomparable Johnson circuitry is capable.

Whatever your requirement, the Messenger 124 offers a new experience in base station performance.

#### Features

- $\pm 3$  kHz Delta fine tuning
- Adjustable microphone gain with modulation adjustment to 100%
- 2½" four-way professional meter, measures SWR, output, % modulation and receive
- 4.3 MHz crystal filter for unequalled selectivity
- Built-in speech compression
- Panel-controlled, series-type threshold noise limiter
- Built-in tone control
- Built-in 117 VAC/12 VDC power supply
- 14 tuned circuits
- FET for superior gain
- Dual conversion receiver

**E. F. JOHNSON COMPANY**

Waseca, Minnesota 56093



...for more details circle 114 on postcard

ELECTRONIC TECHNICIAN/DEALER

**HUGH "SCOTTY" WALLACE**  
Publisher

**PAUL DORWEILER**  
Editor

**JOSEPH ZAUHAR**  
Technical Editor

**MORTON WARNOW**  
Field Editor

**DONNA BUTLER**  
Production Editor

**BOB ANDRESEN**  
Graphic Design

**LILLIE PEARSON**  
Circulation Fulfillment

**JOHN KESSLER**  
Manager, Reader Services

**BERNICE GEISERT**  
Advertising Production

#### OFFICES

71 Vanderbilt Ave.  
New York, N.Y. 10017  
Phone: (212) 686-2200  
Telex: 01-26286

43 East Ohio St.  
Chicago, Ill. 60611  
Phone: (312) 467-0670  
Telex: 02-53549

1901 West 8th Street  
Los Angeles, Calif. 90057  
Phone: (213) 483-8530

Harbrace Building  
Duluth, Minn. 55802  
Phone: (218) 727-8511  
Telex: 02-94417

#### MARKETING REPRESENTATIVES

**HUGH "SCOTTY" WALLACE**  
Chicago: (312) 467-0670

**DEAN GREENER**  
Chicago: (312) 467-0670

**ALFRED A. MENEGUS**  
New York: (212) 686-2200

**DONALD D. HOUSTON**  
Los Angeles: (213) 483-8530

**ROBERT UPTON**  
Tokyo, Japan  
I.P.O., Box 5056

#### HARBACE PUBLICATIONS, INC.

**JAMES MILHOLLAND, JR.**  
Chairman of the Board

**JOHN B. GELLATLY**  
President

**RICHARD MOELLER**  
Treasurer

**LARS FLADMARK**  
Senior Vice President

**HARRY RAMALEY**  
Vice President

**BEN MARSH**  
Vice President

**JAMES GHERNA**  
Art Director

**WILLIAM SWAIN**  
Director of Marketing Services

**DOUG HEDIN**  
Ad Production Manager

# ELECTRONIC TECHNICIAN / DEALER

WORLDS LARGEST ELECTRONIC TRADE CIRCULATION

AUGUST 1969 • VOL. 90 NO. 2

## 35 TEKLAB REPORT ON SEARS SILVERTONE

Our analysis this month discusses the new Silvertone 18 in. Color TV, Model 9168. The report will be given in a two part series as it explains individual circuits with appropriate diagrams and schematics.

## 40 POSTMARKER SWEEP ALIGNMENT

Part two of this timely service article outlines actual alignment procedures using various types of sweep/marker generators complete with waveforms and test equipment set up diagrams

## 46 SELLING CCTV

Service-dealers and technicians breaking into the CCTV market will find this series of special interest as it outlines not only applications, but also provides useful information on procedures that educational institutions follow to purchase equipment of this type

## 51 TESTLAB REPORT ON B&K 415

The versatility and nature of an instrument such as the B&K 415 Sweep/Marker generator makes it necessary to spend the entire testlab report on it this month which describes the unit's features, operation, advantages and disadvantages

22 EDITOR'S MEMO

26 LETTERS TO THE EDITOR

29 BOOK REVIEWS

32 TECHNICAL DIGEST

54 DEALER SHOWCASE

58 COLORFAX

62 NEW PRODUCTS

66 NEWS OF THE INDUSTRY

69 CATALOGS AND BULLETINS

74 AD INDEX

#### COVER

Two-way radio goes everywhere, even in the Northwoods, as depicted by the charming young lady on this month's cover.

#### TEKFAX • 16 PAGES OF THE LATEST SCHEMATICS • GROUP 204

ADMIRAL: TV Chassis TK2-1A

AIRLINE: TV Model GEN-13160A

OLYMPIC: TV Chassis 9P90/9P91

PHILCO-FORD: Color TV Chassis 19KT40B

SYLVANIA: Color TV Chassis D13-2

ZENITH: TV Chassis 13Y16,Z



**HARBACE PUBLICATIONS, INC.**

A subsidiary of Harcourt, Brace & World, Inc.

ELECTRONIC TECHNICIAN/DEALER is published monthly by Harbrace Publications, Inc., Harbrace Building, Duluth, Minnesota 55802, a subsidiary of Harcourt, Brace & World, Inc. Subscription rates: One year \$5, two years \$8, three years \$10, in the United States and Canada. Other countries: One year \$9, two years \$14, three years \$18. Single copies 75¢ in the United States and Canada; all other countries: \$2.00. Second class postage paid at Dansville, New York, and at additional mailing offices. Copyright 1969 by Harbrace Publications, Inc.

POSTMASTER: Send Form 3579 to ELECTRONIC TECHNICIAN/DEALER, Harbrace Building, Duluth, Minnesota 55802.

# 3 GUN SALUTE

**ET/D** EDITOR'S MEMO

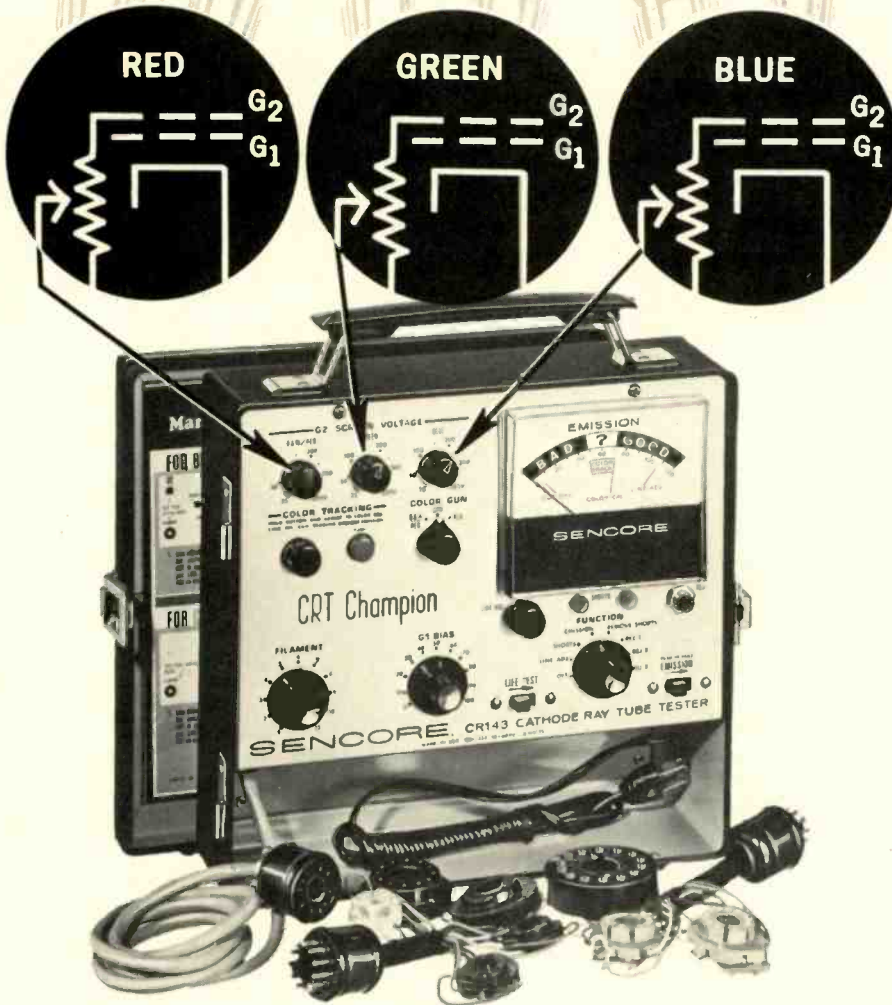

**Only the Sencore CRT Champion** has three gun control . . . Just like the color TV set.

**Only Sencore** has automatic color tracking to make your job easier.

**Only Sencore** has the simplified instructions in the cover so that you can analyze any color CRT tube in seconds. Just flip the "Color Gun" switch from red to green to blue (after setting the three G2 controls) and the CR143 Champion will tell you if the tube has adequate emission and if it will track in the TV set.

Why don't you salute the Sencore Champion today by marching in and asking your distributor to try one. You won't bring it back because it is 100 percent.

## INCREASING INTEREST HAUNTS SMALL BUSINESS

A little item close to all our hearts is the rising prime interest rate. The researchers of the National Federation of Independent Business feel that the latest boost to 8 1/2 percent could effect the survival of many independent business firms and may even result in increased unemployment.

At the time of their report, the national average was at 7.5 percent; 8.1 percent was the going rate on the Pacific Coast. Based on these rates the national average bank rate to independent business may be slightly over 9 percent and just over 10 percent on the Pacific Coast. But the increase of the prime rate, the interest charged to the wealthy borrowers, from 7.5 to 8.5 percent presents a whole new ball game. If this rate is held, the Federation's researchers say independent firms will be paying close to 10.5 percent on the national average and 12 percent in the Pacific States for bank loans. This will be the highest rate since the end of the Civil War when gold was bringing over \$280 per ounce.

While many businesses will not be able to keep up inventories, in some states they probably won't be able to operate at all. Even more serious is the employment outlook for the working man. A summary in FORTUNE magazine shows that there are an estimated 76,000,000 people employed. About 45,000,000 people work for smaller firms which depend on lending capital to operate unless they have access to public money through the stock market.

So what does it all mean? It could mean that unless Congress takes a closer look at what makes our national money system tick, you could end up working for one of the corporate giants-or in the unemployment line.



*Paul A. Howie*



**SENCORE**

NO. 1 MANUFACTURER OF ELECTRONIC MAINTENANCE EQUIPMENT  
426 SOUTH WESTGATE DRIVE, ADDISON, ILLINOIS 60101

...for more details circle 126 on postcard

ELECTRONIC TECHNICIAN/DEALER

**“When we started our business,  
we picked the Yellow Pages as our  
only source of advertising.”**

“Our business started out as a wholesale operation. So we chose the Yellow Pages as our single source of advertising,” says Ken Champlin, general manager of Radio Supply and Engineering Co., Inc., Detroit, Michigan. “The Yellow Pages was a must. It was the best way we could

make contact with people and let them know who we were. Now we have two branch locations. And the Yellow Pages helps our customers keep track of

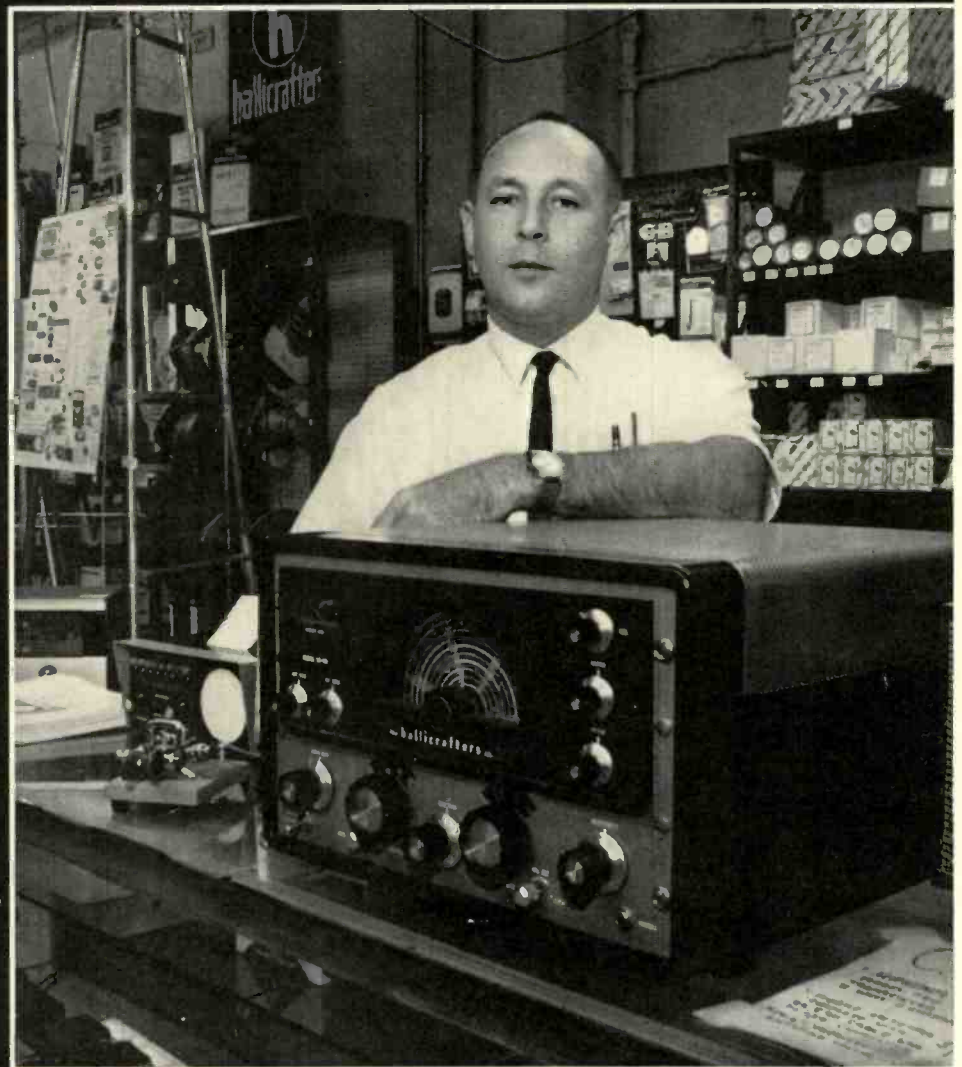

us. When they look through the listings for electronic equipment, they recognize us immediately. Naturally we're the ones they call. We've grown a lot since we

started out. The Yellow Pages has really helped us.”



***An effective  
way to build  
business.***

## AC VOLTMETER PLUG-IN 700

*Down to 10 $\mu$ v with 0.1 percent accuracy*

An ac voltmeter plug-in, the DP130, is introduced. The new plug-in, when used with any main frame DMS3200 digital measuring system, provides digital display of ac voltage measurements over a wide range of level and frequency. AC measurements down to 10 $\mu$ v and as high as 1kv are possible with the unit and with a claimed accuracy specification of  $\pm 0.1$  percent of reading  $\pm 1$  digit. The plug-in may be used for measurements over a wide frequency range of 22Hz to 1.0MHz. Accuracy of 0.1 percent is maintained over the range of 22Hz to 100kHz and with but a slight reduction up to 1MHz. The unit is designed to provide RMS readings when measuring sine wave ac signals; however, it will accept and display indications of the RMS value of square and triangular waveform inputs as well if specified correction factors are applied to such measurements. Loading errors are minimized by the high input impedance of 100M shunted by approximately 25pf on all ranges. Stability is assured by ultra-stable voltage dividers and a precision temperature compensated zener diode reference. Its basic design uses a dual slope, self-zeroing integration technique. Input circuitry is protected from damage by excessively high voltage and a built-in filter, selected by a front panel switch, providing additional noise rejection during low frequency measurements. Price \$375. Hickok.



**TAPE RECORDER-PLAYER 701**  
*Automatic recording level  
 and push-button keyboard*

A portable cassette tape recorder-player, the first of such products to be marketed by the company is introduced. The Model CT100W operates from house current or with four "C" cell batteries. A six push-button keyboard places all functions at the fingertips--cassette up, rewind, stop, play, fast forward and record. The unit has an automatic recording level. It is finished with walnut grain sides, black top and white keyboard. It measures 2 1/8 in. high, 5 1/4 in. wide, 10 in. deep and weighs 5 lbs. Included with the recorder is a microphone and a listening earphone which turns off the speaker automatically when inserted, also, the earphone may be used as a monitor while making recordings. A leatherette carrying case is included. List price is \$69.95. Sylvania.

**FOR MORE  
 NEW PRODUCTS  
 SEE PAGES 54 AND 62**



# This little part plays a big role in radio.

This box gives you top revues.



The transistor is no bit player when it comes to radio performance. That's why Delco transistors are manufactured under controlled conditions that assure high reliability. And why they're thoroughly tested before being placed in the familiar blue and black box.

Delco Radio engineers are leaders in auto radio design and transistor technology.

Delco radios are original equipment on over half of the cars on the road.

That United Delco box is your guarantee of genuine OEM

quality replacement parts. And just 12 Delco transistors replace over 7,500 other types.

Doesn't it make good sense to stock the best?

Remember these facts when you re-order. And remember, too, that your United Delco supplier handles the most recognized name in the parts business.

Next time you think little, think big. Think Delco.

DELCO RADIO, Div. of General Motors, Kokomo, Ind.



MARK OF EXCELLENCE



...for more details circle 110 on postcard

**ET/D****LETTERS  
TO THE EDITOR****finger-  
tip avail-  
ability****AEROVOX  
HAS EVERY  
EXACT  
REPLACEMENT  
TWIST PRONG AFH  
ELECTROLYTIC**

Why fool with "jerry-rigged" electrolytics when there's an Aerovox exact replacement to give you the right rating and the right size? Aerovox actually stocks all twist prong AFH electrolytics—this means off-the-shelf availability...not "we'll build it for you if you order it" delivery.

Available in singles, doubles, triples and quads, these popular types are now manufactured in new values for filter bypass applications in color TV as well as radio, black and white TV and amplifier equipment. Many values are now being used for industrial applications.

Aerovox AFH Twist Prong Electrolytics feature ruggedized prongs and mounting terminals, high purity aluminum foil construction, improved moisture resistant seal and 85°C operation. Here is the quality you need to protect your professional reputation.

Go to your Aerovox Distributor for a perfect electrolytic fit—he will deliver exactly what you want in less time than it takes to tell. Ask him for the new Aerovox Servicemen's Catalog #SE-567 or ask us. We'll be happy to send one your way.



**AEROVOX**  
Hi-Q  
**AEROVOX**  
CORPORATION  
DISTRIBUTOR SALES, New Bedford, Mass. 02741

Visit AEROVOX  
at WESCON SHOW, BOOTH NOS.: 4409 & 4410  
...for more details circle 101 on postcard

**Still in the Running**

I am renewing my subscription and also asking for some advice. I have some antennas patented, and although I was very athletic in the Army in 1933, we all get it sooner or later. I am by no means an invalid, but I am retired and broke. I would like to market my antennas which I have spent at least 30,000 hours developing. Perhaps you or your readers can help.

GRADY L. TEAGUE

22354 Ave. 152  
Porterville, Calif. 93257

**NEA Certification**

I have been a reader of **ELECTRONIC TECHNICIAN/DEALER** for many years and all I can say is keep up the good work. However, I would appreciate a little information on how to get a National Electronics Assn. certificate. I know it involves an examination, and there was an article some time back about obtaining an electronic technician engineers certificate. I want to be a number one man in the service business and I don't want to have to tell what I know. I want people to see for themselves.

LAWRENCE J. ROSE

Mill Hill Rd.  
Wellfleet, Mass. 02667

**Reader's Aid**

Perhaps one of your readers can help me locate a schematic for an Atwater-Kent receiver, Model 60C. A few years ago I had excellent response from your readers in a similar situation.

ROBERT G. SPACHMAN

109 S. 5th St.  
Saudeston, Pa. 18964

I would welcome any help obtaining a schematic for a battery eliminator made by ATR. I have written the company repeatedly to no avail. The unit is an ATR rectifier power supply G20C-ELIR.

WOODROW EMERTON, JR.  
448 Brackett Rd.  
Rye, N.H. 03870

**Old Photofacts**

After noting the large number of requests for schematics in your Let-

ters to the Editor column, I would like to make available to any one interested, a copy of Sam's Photofacts for any particular schematic from 1948 to 1960.

MAYO ELECTRONICS  
ERNEST G. MAYO

172 N. Walnut St.  
Kahoka, Mo. 63445

**Used Equipment Sale**

I have been a satisfied subscriber to **ELECTRONIC TECHNICIAN/DEALER** for a number of years and found it most helpful. However, I am now out of the part-time service business and wonder if any of your readers would be interested in purchasing the following equipment: Heathkit IG-62 color bar generator, IT-11 capacity tester, Devry 5 in. scope and VTVM combination, Mercury 100 tube tester, B&K CRT tester and a caddy of tubes.

MELVIN OLSON

941 Gail Ave.  
Neenah, Wis. 54946

**'Amen'**

ET/D's particular slant and format makes it the only national publication the technician and small dealer has available to satisfy his interest in what is going on in the industry nationwide.

While your Technical Digest and Colorfax features help many a technician over the hump on factory goofs that are squeezing the small dealer's dollar margin, your editorials from time to time focus on problems that concern every one connected with the industry.

Your editorial in the April 1969 issue is one I personally say "Amen" to! If the typical Wisconsin dealer, whom you quoted regarding the 50 percent defective merchandise, must repair sets before he can sell them represents business as usual in our particular segment of the electronics industry, our EIA spokesmen must be getting near the head of the line for their turn in the congressional hot seat!

It might be fair to ask if most dealers are responding to this problem of "new junk" by hiring extra technicians to make it saleable? It might be pertinent to point out that there are still American companies whose distributors assume responsibility for a properly operating product when ordered and delivered to a retailer.

H. NEUMAN

Walport, Ore.

**USE ZIP CODE**



advertising contributed for the public good

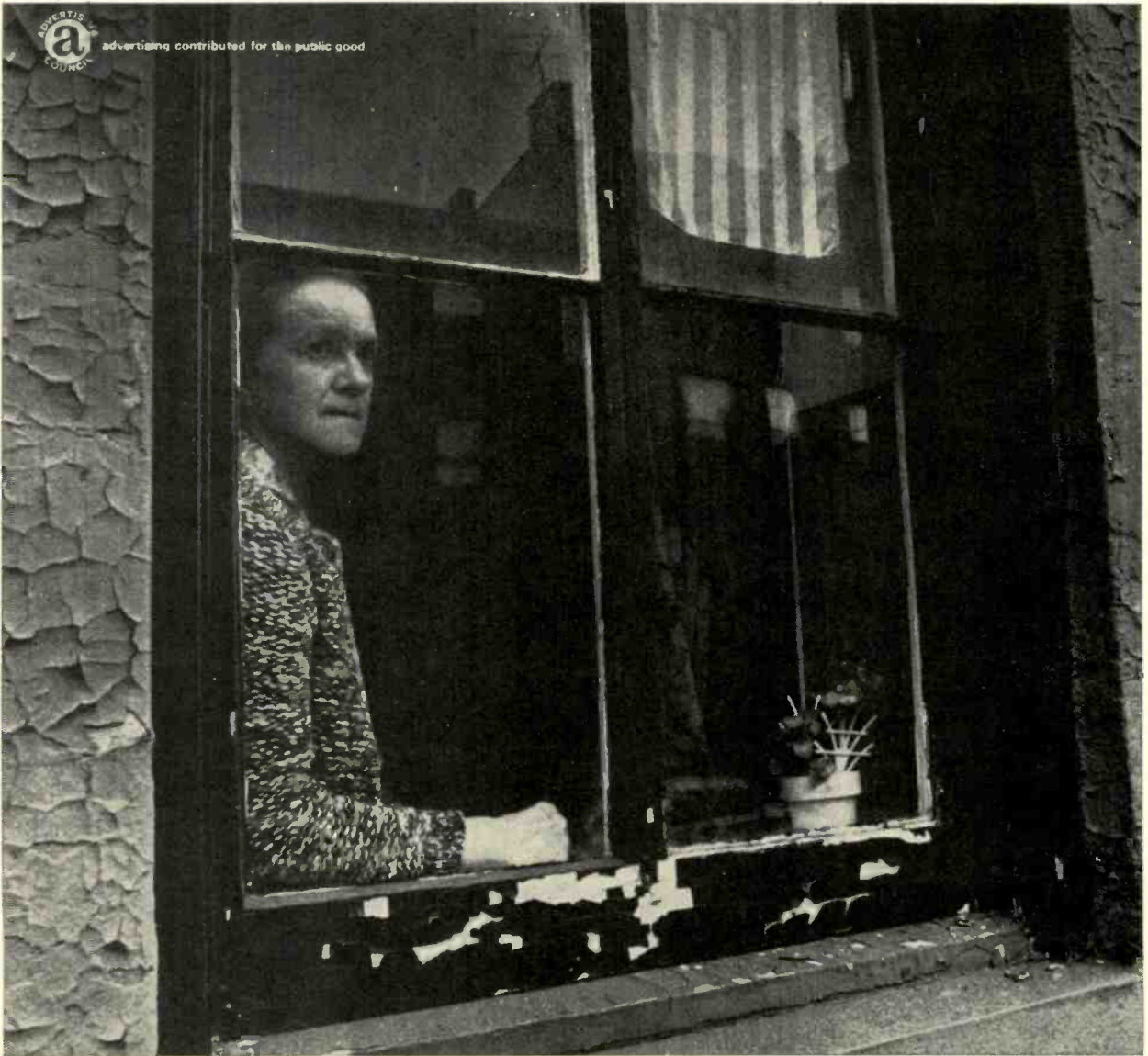

## Pride, fear, and confusion are stopping 5 million disabled from getting the help they need.

Five million disabled people are in need of our help. And we can't find them. Either they don't know where to go for help or they won't go.

Some are disabled physically. Others mentally. Some are living in

the past. Others, disabled from birth, have no past.

But most, with proper guidance and medical aid, could be living instead of existing. They could be learning to take care of themselves. They could be taught interesting

jobs. They could be getting more out of life than they're getting.

So if you're disabled (or concerned about someone who is), write to us for help.

You've got nothing to lose but your disability.



## What's stopping you!

Write: Help, Box 1200, Washington, D.C. 20013

# If you think rising tuition costs are paying for college education

you're  $\frac{2}{3}$  wrong.

Tuition, rising though it is, covers only about  $\frac{1}{3}$  of what it takes to educate a student today.

And costs are multiplying. Colleges are girding themselves now for the undergraduate influx that could mean 10 million students by 1977.

The new dorms, laboratories, libraries and faculty salaries to sustain this learning population must be paid for. This could lead to a financial crisis, unless we—individuals and business—give education its rightful priority in the American scene.

If you think it's important, you'll prove yourself 100% right by sending a contribution to a college.

**Give to the college of your choice.**

Advertising contributed for the public good.



**THE OSCILLOSCOPE**, by George Zwick, published by TAB Books, Inc., 256 pages, 170 illustrations. \$7.95 hardbound, \$4.95 paperback.

This book is a revised third edition and includes information on the latest scopes. There are eight chapters, most of them quite thorough, especially the chapters on typical oscilloscopes, alignment, scope techniques, measurements and experiments. The text includes many good backup diagrams and photos for each chapter. The first chapter describes the various waveforms such as dc waves, sinewaves and trapezoidal. The second chapter gets into the scope CRT itself, mainly discussing deflection systems. From the third chapter on, the text covers scope types, their uses and actual application. This includes information on the latest triggered sweeps, dual-trace and also discusses electronic switches for multi-waveform display. Since the scope is one of the technician's most important service tools, especially in today's color sets, he should know all he can about its use. For the large amount of information this book provides, it is a bargain reference source for any service technician's library.

**CONTROL SYSTEMS FOR TECHNICIANS**, by G. T. Bryan, published by Hart Publishing Co., 238 pages, 6 x 9 1/4. \$12.50 hardbound.

The 12 chapters of this book explain the many types of control systems used in industrial electronic applications and is written to help technicians understand their operations. It is not a servicing guide. The book discusses control system components such as photo electric cells, tachometers, strain gauges, thermo couples and electromagnetic flowmeters. Other chapters deal with closed loop systems, amplifiers, valves, motors, remote transmission, position control systems, speed control and process control. The book is well written and illustrated. It does not get into heavy formulas. At the end of each chapter is a quiz which the reader can use to check his grasp of the important subjects. Answers are provided at the back of the book along with a four section appendix providing instrumentation symbols, conversion factors and graphs. The technician involved in industrial electronic control systems will find this book a useful source of reference.

# You never saw a scope like this for twice \$229.

Leader's five-inch LBO-53B has a bandwidth running from DC to 10MHz. (About twice the bandwidth of any other scope in the same price range.)

Its sensitivity rating is 10 mv/cm or better. (About half-again the sensitivity of any other scope in the same price range.)

It has FET vertical and horizontal inputs, directly coupled with push-pull amplifiers for no-distortion display. (You won't find that on any other scope

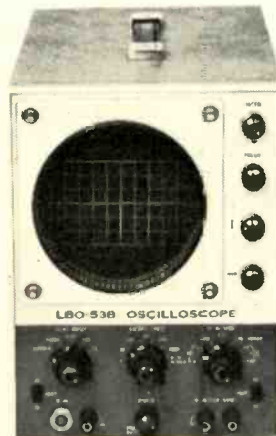

for the money.)

It's the perfect test companion for Leader's LCG-388 color bar generator. The only one that's perfectly stable, the instant you turn it on.

The LBO-53B: only \$229, and now you know what we mean about never seeing a scope like it for twice the price.

At your distributor's, along with the LCG-388 and other Leader test instruments. For the distributor nearest you, just drop a line or call.

## Seeing is believing.

**LEADER INSTRUMENTS CORP.**

24-20 Jackson Avenue, Long Island City, N. Y. 11101 (212) 729-7411

... for more details circle 116 on postcard

## Solve Color Register Problems... Use Miller 7604 Blue Lateral & Purity Assembly on any American Rectangular Color Picture Tube

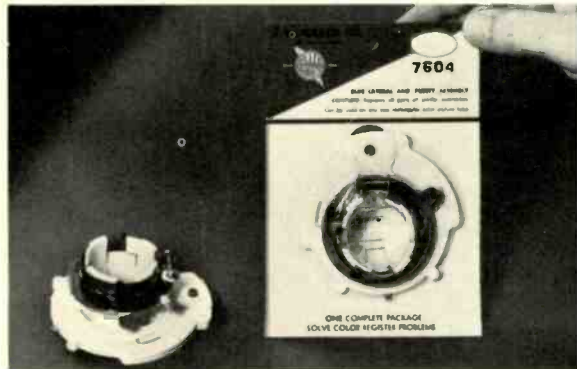

Now register blue, red and green beams simultaneously.

A single wheel rotates two magnetic rings in opposite directions to provide blue lateral convergence. Purity correction is accomplished by individual adjustment of the two purity rings. The magnets compensate for mis-registration up to .005" in any direction.

Dealer Net Each: \$3.96: Available from distributors' stocks. Write for your copy of Cross Reference Bulletin 1069



**J.W. MILLER COMPANY**

19070 REYES AVE. • P.O. BOX 5825 • COMPTON, CALIF. 90224

See your local distributor for the full line of RF and IF coils, chokes and transformers

# FANTASTIC INTRODUCTORY SPECIALS!

3 New Motorola HEP  
Transistor Replacement Kits

**Revolutionary!** These new kits are the first of a *computer-planned* series designed to provide you with replacement semiconductors to *do the job right*...with devices to satisfy the fast moving and most often needed applications.

"Universal" replacement devices just don't fill the bill any more for many applications. With more and more consumer products using semiconductors...with many of these products becoming increasingly complex...closer tolerances are needed in more and more applications. Our computers have selected the *right* devices for the *right* jobs!

And we're bringing these kits to you at the *right* prices!

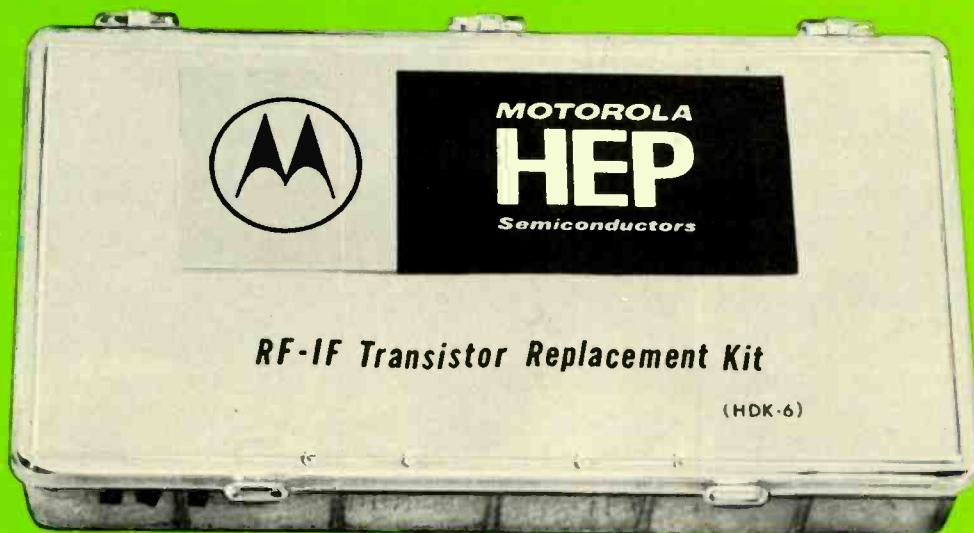

**HDK-6... RF-IF 12 HEP** types (26 units) programmed to replace 3,794 original equipment types plus several "universal" device numbers. Doesn't cover everything, just the major portion of your IF and RF out-of-warranty replacement needs!

REGULARLY \$32.68  
**SPECIAL INTRODUCTORY PRICE**  
**\$23.95**



**HDK-7...FOREIGN** Replacements for foreign semiconductors are hard to find...but not with this kit! 12 types (22 units). Covers over 5,700 device types, including most of nearly 2,000 Japanese type numbers. In fact, they'll replace 83% of the foreign types listed in our Cross Reference Guide. Quantities of each type are programmed to give you more of what you need most.

REGULARLY \$27.35  
**SPECIAL INTRODUCTORY PRICE**  
**\$19.95**



**HDK-8...RF-IF/AUDIO/FOREIGN** Computer-programmed to give you the best replacements for today's complex RF-IF and foreign applications plus an excellent selection of the most popular audio devices. 47 units — 23 HEP types — covering the specific numbers you need *most*. No odd-balls to gather dust. Replaces over 10,000 specific type numbers.

REGULARLY \$60.09  
**SPECIAL INTRODUCTORY PRICE**  
**\$39.95**

**Get in touch with your HEP distributor now!**  
**These special introductory prices are in effect**  
**only while his on-hand inventory lasts!**

**GET HAPPY! GET HEP! FROM MOTOROLA!**

**MOTOROLA HEP SEMICONDUCTORS**

P. O. Box 20924 / Phoenix, Arizona 85034



...for more details circle 122 on postcard

The material used in this section is selected from information supplied through the cooperation of the respective manufacturers or their agencies.

## ADMIRAL

### Radio Chassis 15B4--Power Tuning Circuit Description

The radio can be viewed as a conventional AM-FM unit with an accessory power tuning or searching package. During normal operation B+ is disconnected completely from the power tuning section.

The power tuning section itself is divided into two basic sections: control and operate. The control section, when activated, samples the IF signals, amplifies them and con-

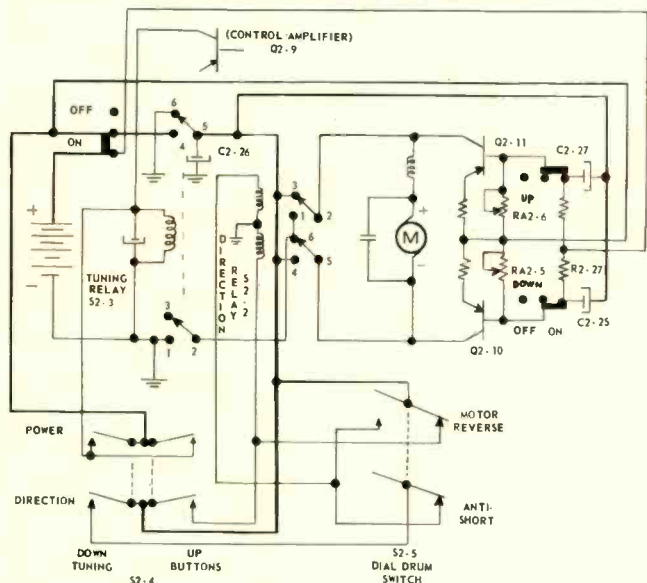

controls a power tuning relay S2-3. FM-IF sampling is achieved at the second FM-IF collector of transistor Q4, while AM sampling is achieved at transformer T1-4. In the control section, the FM-IF signal receives additional gain through transistors Q2-6 and Q2-7. Assume the power tuning up or down button has been pressed. Transistor Q2-7 is maintained at a controlled bias by threshold controls, RA2-3 or RA2-4. IF signals will be amplified and presented to control detector CR2-1. This diode is in the bias circuit of Q2-8, which has been forward biased during power tuning by the forward contact potential voltage of forward biased diode CR2-2. When CR2-1 detects a signal, a reverse-going bias will be presented to Q2-8, turning it off. This amplified turn-off signal will also turn off Q2-9, the relay driver transistor. The relay will release and the motor will stop on station. Transistors Q208 and Q209 draw current only when two conditions are simultaneously present: (a) Power tuning from B5 B-; (b) When no signal (or oscillation) is being detected by CR2-1.

The relay S2-3 has four sets of contacts which control various parts of the radio (only two circuits are shown). With normal reception on station these are:

1. Unmuting the radio by connecting the audio drive to the input audio amplifier through 11-12;
2. Opening the ground to the motor circuits through 2-3;
3. Feeding the AFC control through 7, 8, 9;
4. Disconnecting the B+ from the power tuning and grounding the disconnected line through 5-6. During the power tuning these contacts are respectively:

(a) Muting the radio by disconnecting the audio system through 10-11;

(b) Grounding the motor circuits through 1-2;

(c) Disabling the AFC control voltage. (The AFC diode is biased by a connection through the floating ratio detector, the AFC diode is reconnected to a secondary B+ line at C2-3 to avoid detuning.);

(d) Supplying B+ to the power tuning section and power tuning motor through 4-5.

The operation section has a dc drive motor controlled by the direction relay S2-2, and the dial drum direction sensing switch S2-5 or push buttons. Since it is a dc motor, merely reversing the power leads will reverse rotation. The direction relay S2-2 has several unusual characteristics. It has two coils connected opposite each other. Secondly, it has a permeable core. Once the direction switch S2-4 or power tune up or down button has been pressed, the pulse of current through that respective coil will operate the contacts and will magnetize the core. The direction relay then acts as a double-pole-double-throw switch; the contacts stay in their last position until the core is magnetized opposite from the other coil.

The relay S2-3 applies B+ to the entire power tuning section only during power tuning. Thus, the search motor is controlled by S2-3 relay B+ contacts.

Assume the system is in the standby position, the radio playing and the power tuning section is at rest. The customer presses one of the push buttons on S2-4 and the tuning relay S2-3 is energized. Immediately, contacts 4-5 on S2-3 apply power tune B+ to the control amplifier and motor circuits. The motor circuit ground is obtained by S2-3 contacts 1-2. If the direction is different from the last operation, direction contacts on S2-4 will cause S2-2 to operate before the motor, thus reversing its direction.

When the relay driver transistor Q2-9 located in the electronic control section stops conducting, this indicates that a station has been found. Since the customer's finger has been removed from S2-4, the power tune relay S2-3 will open and the motor power will stop. In the process, however, C2-26 is quickly discharged by S2-3 contacts 5-6, and that side of the motor circuit formerly connected to B+ is again connected. The B+ side of the motor circuit is left open through S2-3 contacts 2-3. It is at this point, that the "stop-error" transistors come into play. Keep in mind that the entire operation takes place in a matter of seconds. When the power tune operation started, B+ was applied to the motor circuits, stop-error timing capacitors S2-25 and C2-27 had B+ applied to their negative sides. Since the positive sides were connected to the main power source, they were charged. When the tuning action ended with the opening of S2-3 and the grounding of the motor B+ side of the supply, the negative sides of these stop timing capacitors were grounded. This amounts to moving them in a less positive or more negative direction. This change-of-charge appears as a negative pulse on the stop timing transistor bases, causing them to conduct heavily. How long they will conduct in milliseconds is determined by the RC time constant of the base circuit and this is adjusted through RA2-5 and RA2-6. Heavy current caused by the low collector resistance flows in both Q2-10 and Q2-11. Depending upon the direction switching of S2-2, one transistor's current will flow directly from S2-3 ground at contacts 5-6 through that transistor to emitter B+, completely external to the motor. Since S2-3 contacts 5-6 are reversed from normal in the stop mode, the motor would tend to turn in the op-



posite direction. However, this is not possible because of the current limiting of the stop transistor emitter resistors and inertia of the motor. Braking action occurs due to the motor acting as a dc generator while coasting, and the opposite braking current being passed through it to buck or null it out.

It is interesting to note the extra contacts necessary on S2-1 push switch in the stop error transistor circuits. If the radio were turned off without the extra contacts, the battery would be discharged through the timing controls. After the radio is turned off, C2-25 and C2-27 are bled off by R2-27 and R2-28. This is necessary to prevent erratic motor movement when turning the unit on by unpredictable conduction of Q2-10 and/or Q2-11.

A local-distant switch controls the AM and FM sensitivity of the radio and thus sensitivity of the power tuning unit. The radio is approximately 15 times more sensitive in distant position.

## EMERSON

### Amateur Radio or FM Station Interference

We are all familiar with channel 2 amateur band interference which is resolved by using an effective hi-pass filter connected in the antenna lead-in. For optimum results the hi-pass filter should be connected as close as possible

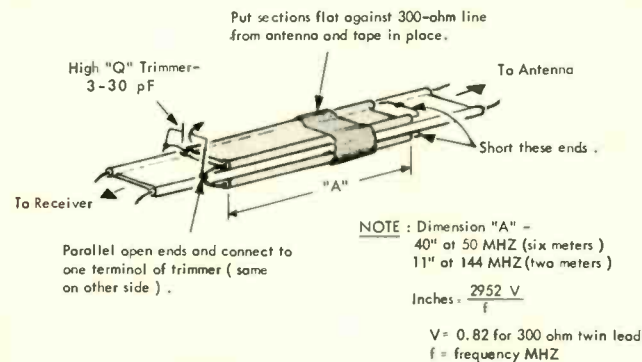

to the tuner antenna input terminals. Picture interference can also be the result of an FM station and again FM traps installed at the tuner antenna input terminals are effective. A tuning stub trap as shown in the illustration is very effective in minimizing picture interference especially when caused by a strong ham or FM station located in proximity to the TV receiver.

Note: (1) Slide trap along lead-in until most effective position is found. Tape in place (scotch tape, etc.). (2) The actual physical length required will be less than that calculated because of the loading effects of capacitance at the open ends. Reduce length 1/2 in. at a time until capacitor tunes through interference.

## CORRECTION

The "Color Bar Generator Survey" which appeared in the July issue of ET/D had a couple of omissions. With red cheeks and egg on face, we humbly admit our error.

On page 48, the question regarding color bar generator patterns was not fully answered. It should also have indicated that the Heath IG-28 unit, in addition to the standard 10 bar pattern, provides 12 other patterns including the usual 9 x 9 patterns plus a series of 3 x 3 patterns and a 3-bar pattern which are unique.

The article was continued on page 78 with an answer to the question concerning the use of IC circuits. This answer should also have indicated that the Heath IG-28 *does* use IC circuits extensively (10) which has resulted in reduced size, improved stability, greater reliability and slightly higher cost.

# NEW Heathkit® Solid-State Color Bar — Dot Generator



Kit IG-28  
Only \$79.95\*

**Advanced Integrated Circuitry  
Delivers 12 Patterns Plus  
Clear Raster ... No Divider  
Chain Adjustment ... No  
Flicker, Bounce or Jitter**

Standard  
9x9 Displays  
plus

Exclusive  
Heath  
"3 x 3" Display



3x3 Dot



3x3 Cross Hatch



3x3 Shading



3x3 Color Bars



3x3 Vertical

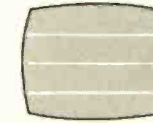

3x3 Horizontal

- All solid-state construction using Integrated Circuitry
- No divider chain adjustments
- Stable pattern display — no flicker, bounce or jitter
- Produces 12 patterns plus clear raster
- Instant switch selection of all functions
- Exclusive 3x3 display plus standard 9x9 display of all patterns
- Horizontal lines only one raster thick for added accuracy
- Variable front panel tuning for channels 2 through 6
- Variable front panel positive and negative video output
- Front panel negative going sync output
- Two handy AC outlets on front panel
- Built-in gun shorting circuit with lead piercing connectors
- Front panel switchable crystal controlled sound carrier
- Copper-banded transformer to reduce stray fields
- Safe three-wire line cord
- Fast, easy construction with two circuit boards and two wiring harnesses

**Advanced Design.** The new Heathkit IG-28 is one of the most stable, versatile Color and B&W TV service instruments available. In addition to the exclusive Heath "3 x 3" display of patterns illustrated, it also produces the familiar 9 x 9 displays . . . plus a clear raster for adjusting purity without upsetting the AGC. Fifteen J-K Flip-Flops count down from a crystal controlled oscillator to eliminate divider chain instability and adjustment.

**Time-Saving Versatility . . .** gives you front panel tuning for channels 2 thru 6 . . . front panel variable plus and minus video output . . . front panel sync output . . . two convenient AC outlets . . . built-in gun shorting circuits and grid jacks . . . vectorscope capability . . . crystal controlled sound carrier . . . banded transformer to eliminate stray fields . . . zener-regulated power supply . . . safe three-wire line cord . . . fast circuit board-wiring harness assembly. For the versatility you couldn't get before . . . put the new IG-28 on your bench now.

Kit IG-28, 8 lbs. . . . . \$79.95\*

HEATH COMPANY, Dept. 24-18  
Benton Harbor, Michigan 49022



Please send my FREE 1969 Heathkit Catalog.

Enclosed is \$ \_\_\_\_\_ plus shipping.

Please send model (s) \_\_\_\_\_

Name \_\_\_\_\_

Address \_\_\_\_\_

City \_\_\_\_\_ State \_\_\_\_\_ Zip \_\_\_\_\_

Prices & specifications subject to change without notice.

\*Mail order prices; F.O.B. factory.

TE-200

...for more details circle 113 on postcard

# Play hard...



## but play it safe!

Boating can be great fun. It's a great way to promote family togetherness. But sure as fate it's going to happen — the inevitable problem on the water that could turn into a nightmare. Unless, of course, your boat is equipped with citizens 2-way radio to close the distance between you and help instantly when trouble comes.

More than three million citizens radios are now used in boats, automobiles, farm vehicles, homes, marinas and campers. To these Americans, citizens 2-way radio has become a marvelous everyday convenience and a vital communications link. And it costs less than a new set of tires for the family car.

### **PUBLIC SAFETY COMMITTEE**

Citizens Radio Service Section 2001 Eye Street, N.W. Washington, D.C. 20006



**ELECTRONIC  
INDUSTRIES  
ASSOCIATION**

# Sears Silvertone Model 4168 Portable Color TV

Review the circuits employed in this portable;  
they compare with the deluxe large set

■ Total television sales in the first quarter of 1969 reached 3,363,695 sets compared with 2,796,074 sets in the same period of 1968. Color television's share reached 1,604,962 sets according to Electronic Industries Assn.'s marketing service department.

The portable color television set is taking an increasing percentage of total color set sales probably because of their lower cost and the fact that many people now want a second set.

With the portable color set being so popular we decided to make a Testlab Report on the Sears Silvertone Model 4168

color portable manufactured in the United States by Warwick Electronics, Inc.

The cabinet is attractively styled with all the customer controls conveniently located on the front panel. This set employs a CHROMIX control not normally included on most sets. The CHROMIX control affects the color tone of the picture for either B/W or color reception. When the entire viewing screen has an overall monochrome color tone ranging from blue to yellowish green, you may not be viewing a color program, but a B/W program with the CHROMIX control set to either side of its neutral position. The control is normally left in the neutral position for a B/W picture. We didn't like the fine tuning and channel selector knob arrangement because the customer may have a tendency to grip both knobs when changing channels, thus making readjustment of the fine tuning necessary.

We found this chassis fairly easy to service. After removing the cabinet back the chassis was removed by loosening two screws, then pulling it back. We did have a little difficulty removing the tuner assembly, but in most cases, tuner removal is not necessary

Sears Silvertone Model 4168 portable color TV.

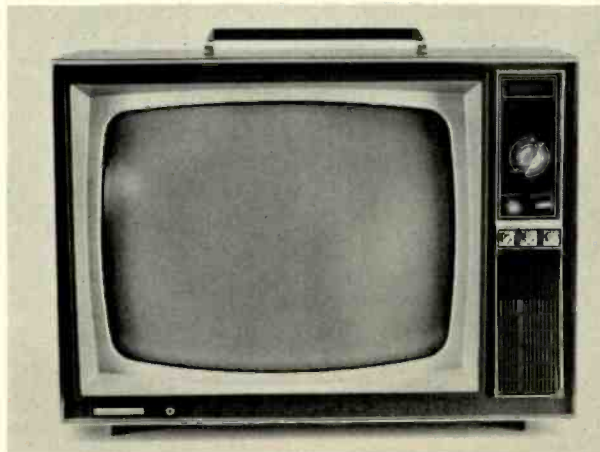



because of long chassis leads. The circuit board is road-mapped for easy identification of components. Testpoints for adjustments and alignment are also clearly marked.

The video IF consisting of two stages of amplification provided an excellent and stable picture. We did not check the set for fringe signal operation, but the use of high gain frame grid tubes and improved circuitry appears to be satisfactory.

The 528.72940 low B+ chassis is similar to previous chassis 528.72900. It employs a regulated 26kv high voltage supply, 90 degree scan angle, two-stage IF, keyed AGC, auto-shift memory fine tuning, an instant start circuit and automatic chroma control. The chassis contains 24 tubes (including CRT), 20 diodes, three transistors, and one integrated circuit. There are five printed circuit boards: (1) Convergence, (2) Deflection, (3) Chroma, (4) IF and (5) AFC. The power supply is transformerless, using silicon rectifiers. A special feature on this chassis is the addition of an AFC circuit.

This low cost portable has practically all the features found on the big deluxe set such as: the CHROMIX control, AFC, keyed AGC, instant start circuit, automatic chroma control and automatic degaussing.

The following are some of the circuits that we feel are new and important.

#### LOW VOLTAGE POWER SUPPLY

AC and dc supply voltages needed for proper operation of the circuits originate in the low voltage power supply.

The low voltage dc power supply shown in Fig. 1 is a conventional half wave voltage doubler circuit using two silicon rectifiers. Four different B+ potentials are available through the use of suitable voltage dropping resistors. Two additional voltage supply sources are not shown in the illustration. B- boost is developed in the damper circuit. The 50C5, audio output tube and its circuitry

are used as a voltage divider between B+3 and ground. The cathode of this tube is B+1, a regulated 150v source. A circuit breaker in series with the hot side of the ac line provides necessary overload protection.

Tube filaments, with the exception of the CRT, are arranged in three separate series paths. Each path contains tubes with similar current requirements. Line voltage is applied directly to two series strings. The line voltage is rectified (D200) and powers the other filament path. Using the negative half cycle prevents the filament from acting as an anode and reduces cathode to filament leakage possibilities. A separate transformer provides 6.3v for the CRT filaments and pilot lamp. The filament winding is at B+ potential to prevent heater to cathode arc-over in the CRT by reducing the voltage potential between the elements.

#### HORIZONTAL OUTPUT AND HIGH VOLTAGE

The voltages and currents required to provide horizontal deflection, focus, high voltage and B boost are developed in the horizontal output and high voltage stages.

The sawtooth waveform output of the horizontal oscillator is coupled to the horizontal output tube (V11) shown in Fig. 2. This tube increases the voltage level and applies it to the horizontal deflection coils through the high voltage transformer. The damper tube (V12) removes unwanted oscillations and develops B boost voltages. High voltage pulses produced by autotransformer action are rectified by the high voltage rectifier, V13. The high voltage developed is applied to the CRT second anode and a voltage divider circuit which provides an adjustable focus voltage for the CRT.

To maintain a constant high voltage potential as the average CRT beam current varies, requires some regulation. In this circuit, capacitor C120 charges through VDR R111 and high volt-

age adjustment control R112 on each high voltage pulse. The amount of charge depends upon pulse amplitude and the total resistance in the charging path. The VDR resistance will vary in reverse proportion to the flyback pulse amplitude and then increase in value during trace time when the pulse is not present. The slow discharge of C120 during trace time creates a dc voltage which alters the grid potential of V11. Any grid voltage changes alter the horizontal output tube gain and help maintain a constant high voltage output. Altering the V11 bias to adjust high voltage will also affect picture width. Optimum width at normal brightness is achieved when the high voltage has been adjusted for 26kv at zero CRT beam current.

Two additional windings on the high voltage transformer provide pulses for AGC blanking, burst, color killer and horizontal dynamic convergence. A short across R119 provides a means of altering horizontal centering. When the short is removed, the picture will move to the right by about 1/4in.

Only top and bottom pincushion correction is required for 18in. rectangular CRT. Both amplitude and phase adjustments are provided for pincushion corrections using R121 and L120.

#### COLOR OSCILLATOR AND REACTANCE TUBE

The color oscillator shown in Fig. 3 is a crystal controlled oscillator which generates a 3.58MHz CW sinewave voltage output. The reactance tube and its circuitry control the frequency of the oscillator by acting upon the input capacitance of the oscillator circuit. Controlling the conduction of the reactance tube permits phase as well as frequency control of the oscillator.

Frequency of the tuned plate oscillator is adjustable within a narrow range above and below 3.58MHz by reactance coil L490. A crystal is employed to insure consistent frequency stability. Output signals from the oscillator plate circuit are used for

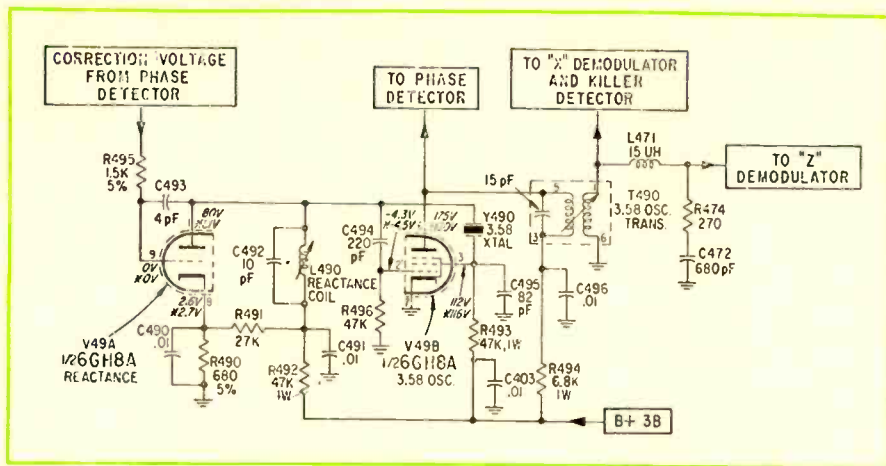

Fig. 3--Schematic of the color oscillator and reactance tube circuit.

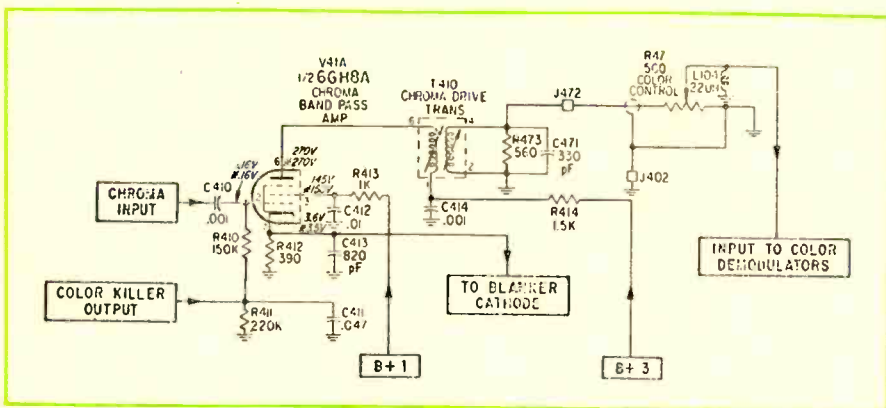

Fig. 4--The chroma bandpass amplifier circuit.

## Sears Silvertone ...

comparison with incoming station burst information in the phase detector. Any slight difference in frequency or phase of the two signals results in a correction voltage to the reactance tube input circuit. This voltage corrects the oscillator phase to coincide with burst phase. CW 3.58 MHz signals from the secondary of the oscillator plate transformer are applied to the suppressor grid of each demodulator tube. The signals at each demodulator, although of the same frequency, are of different phase angles. The signal phase shift through the plate transformer, which resonates at 3.58MHz, approaches 90deg. The oscillator signal to the "X" demodulator and the killer detector are therefore nearly 90deg out of phase with burst. The phase shift of this signal across L471 also approaches 90deg. The oscillator signal to the "Z" demod-

ulator is therefore almost 180deg out of phase with burst.

## CHROMA BANDPASS AMPLIFIER

The chroma amplifier shown in Fig.4, is a narrow band circuit which selects and amplifies only that portion of the composite video response containing the chrominance information. Chrominance information is contained in the video response one-half MHz above and below the color subcarrier frequency of 3.58MHz. Amplification occurs only during horizontal trace time whenever chrominance information is being received.

Chrominance information from the plate circuit of the 1st video amplifier is applied to the control grid of the bandpass amplifier. The plate transformer, tuned to the desired frequencies, determines the bandpass of the amplifier and couples these signals to the COLOR control. The adjustable signal amplitude from the arm of the control is then applied to the demodulator inputs.

The bandpass amplifier must be cut off during the burst cycle to prevent unwanted signals from reaching the demodulators and picture tube during this period. Cutoff is accomplished through the use of a common cathode resistor for the bandpass and blanker tubes. Because the blanker tube grid receives a positive flyback pulse during retrace time, increased tube current will develop a positive pulse on R412, the common cathode resistor, of sufficient amplitude to cut off the bandpass amplifier. Since the burst cycle occurs during retrace time, burst is effectively blocked from passing through the bandpass amplifier.

The bandpass amplifier is cut off during monochrome reception by a negative voltage applied to the control grid developed in the plate circuit of the color killer tube. Permitting the amplifier to function during B/W reception would result in color snow appearing on the screen unless the color control was turned to minimum.

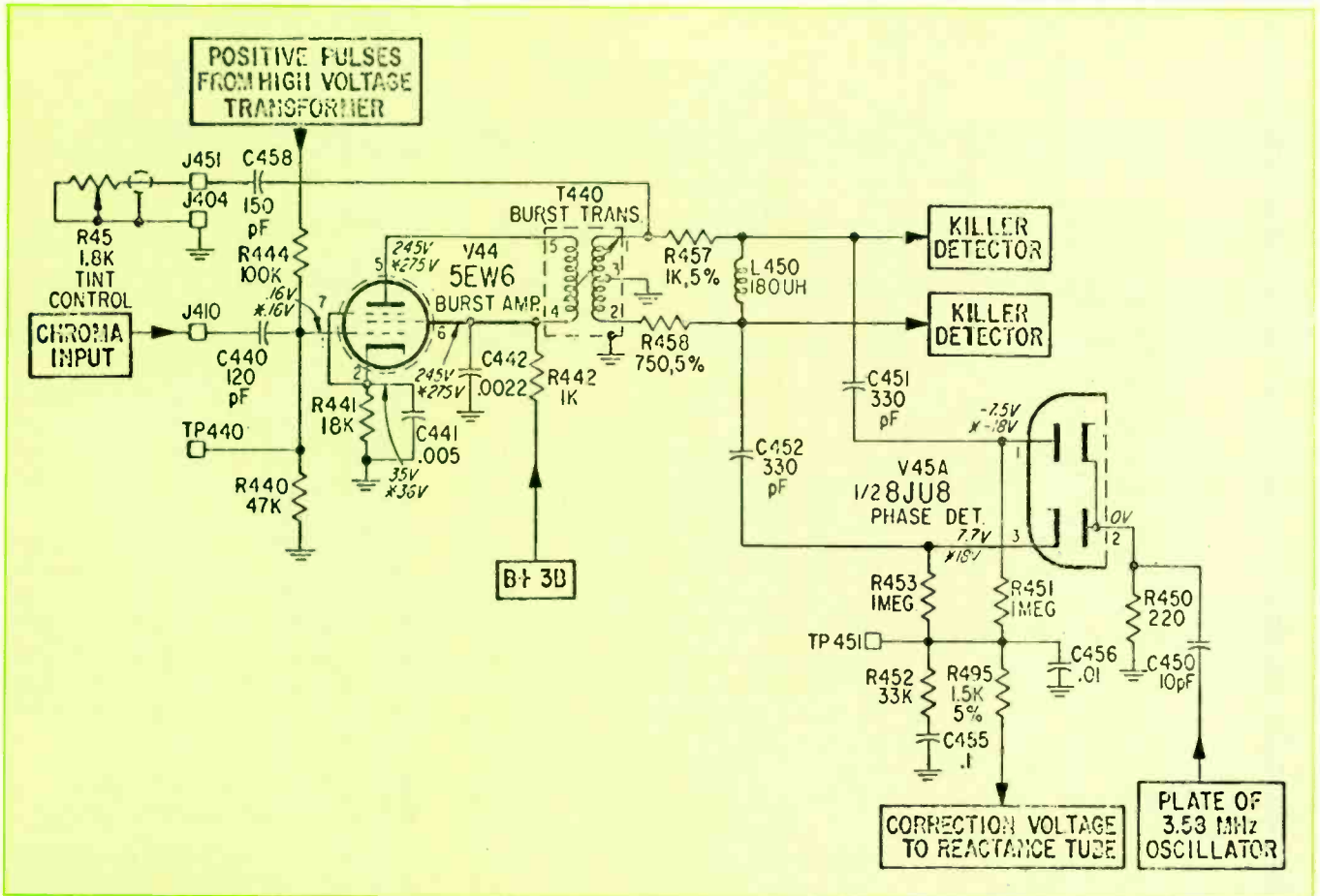

Fig. 5--Schematic of the color sync circuit. The output of the burst amplifier consists of a gated 3.58MHz burst signal with burst occurring at the horizontal rate.

## COLOR SYNC

A sample of the station 3.58MHz oscillator is transmitted as a "burst signal" during horizontal retrace time. The burst amplifier extracts the burst signal from the other chrominance information and compares it with the receiver color oscillator. Any difference in the frequency or phase of the receiver oscillator and burst results in a corrective voltage to the reactance tube. This voltage corrects the oscillator to conform with burst frequency and phase, provided, of course, the frequency differences are minor.

All chroma information is coupled to the burst amplifier control grid shown in Fig. 5. The tube is normally biased to cutoff and is turned on only by positive pulses from the high voltage transformer, also applied to the control grid. These pulses occur during re-

trace time and permit burst signal amplification. This is the only chrominance information at the control grid during this interval.

The output of the burst amplifier consists of a gated 3.58MHz burst signal with burst occurring at the horizontal rate. The burst signal is developed across the primary of the burst transformer, T440, and then coupled to the center tapped secondary where two burst signals (180deg out of phase) are developed. The two opposite phase burst signals are coupled to the phase detector (V54A) where they are compared with the output of the receiver 3.58MHz oscillator. Should the 3.58MHz oscillator tend to change phase or frequency slightly, a dc voltage is developed at the junction of the matched resistors between the two diodes. The dc voltage thus developed

is coupled to the reactance tube. This will alter the 3.58MHz oscillator so it will conform to the frequency and phase of the 3.58 MHz oscillator signal from the station.

The ultimate goal of all the chassis circuits, except the sound section, is to provide operating voltages and currents for the CRT. The CRT converts these voltages and currents into light variations which the eye interprets as B/W or color pictures.

Next month we will continue with the review of other important color circuits and AFC which monitors the video IF and when the frequency is not correct, it provides correction voltage to a control device in the VHF or UHF tuners. This circuit is not normally found on many portable color sets and therefore, should be of interest. ■

# Post Marker Color TV Sweep Alignment

Sweep/marker generators are simple to use, but often made difficult by improper setup and not following the manufacturer's alignment procedure

■ In the June 1969 issue of *ELECTRONIC TECHNICIAN/DEALER* we reviewed the features of the post marker generator, the response curve, alignment hints and precautions.

We will now review the various alignment procedures. Before we get into the actual applications, general background information should be reviewed to acquaint the technician with existing methods and to point out certain specific points which are important in alignment. This information is not always emphasized in alignment procedures or manufacturer's data.

## LOCALIZING ALIGNMENT PROBLEMS

The IF amplifiers of the television receiver are the most critical amplifiers in the set. Most of the variations of the over-all response curve will be the result of changes in the IF amplifiers. Tube capacity differs and when a tube is replaced in the IF, the response curve will change.

Examine the output of the video detector as well as the output of the chroma bandpass amplifier and determine which of the circuits is misaligned. If the IF response curve is satisfactory as compared to the manufacturer's waveforms and if the chroma response curve at the same time is seriously misaligned, it is reasonable to assume that the misalignment is confined to the chroma circuits only. If the IF response curve as viewed at the video detector shows signs of severe misalignment and if the chroma response curve is also misaligned,

the problem lies with the IF alignment portion of the receiver and could possibly include the chroma portions. If a separate sweep alignment of the chroma circuits is outlined in the test procedure, this will immediately give the condition of chroma alignment. If a separate video sweep alignment of the chroma circuits is not provided, the most effective way to localize the problem is first to restore the IF portion of the television receiver to proper alignment condition and then recheck the chroma section of the receiver. If only the IF portion of the receiver has been misaligned or is in need of alignment, the realignment of the IF section will correct both the IF response and the chroma response or the chroma section will require only a touch-up alignment.

When performing adjustments in the chroma circuits, particularly the bandpass amplifier transformer, the signal level at the video detector is usually specified by the manufacturer. Most alignment procedures specify that the level of signal injected at the mixer test point be adjusted so that a certain dc voltage is obtained at the video detector test point. This level is set by using the VTVM to monitor the dc level at the video detector while adjusting the signal level applied to the mixer input. With proper bias levels set in the IF and chroma circuits as specified by the manufacturer, no further adjustment of signal levels should be required to produce the proper chroma level in the chroma portions of the television receiver. Some

procedures require the input level be adjusted to produce a specified peak-to-peak waveform at the chroma circuit test point, this usually being the output of the bandpass amplifier.

Determine from the manufacturer's procedure whether alignment of the IF section is performed by injecting the sweep signal at the antenna (RF sweep) or at the mixer (IF sweep). The advantage of alignment by injecting at the mixer test point is that the fine tuning control of the tuner is no longer a consideration. Tuner bias is then set at a cut-off value to prevent interference from local television channels.

## RECORDING ALIGNMENT REFERENCE INFORMATION

As the user accumulates alignment experience on the television receivers of various manufacturers, he will recognize that many similarities exist among the various procedures. Certain marker and reference frequencies are continually repeated through alignment procedures. In addition, the user should analyze each alignment procedure with reference to the circuit schematic. He should also make brief notes on new sets which he encounters. These notes at the minimum should identify the various tuned circuits in the IF strip and also note which markers are observed while adjusting the various tuned circuits. Bias points and injection and monitoring test points should also be noted. Pitfalls should be logged to be avoided in the future.

If this procedure is maintained over a period of time, the user will soon begin to recognize the similarities in IF design with respect to frequency and gain distribution. This procedure will not only save the technician some time, but will prove to be more accurate.



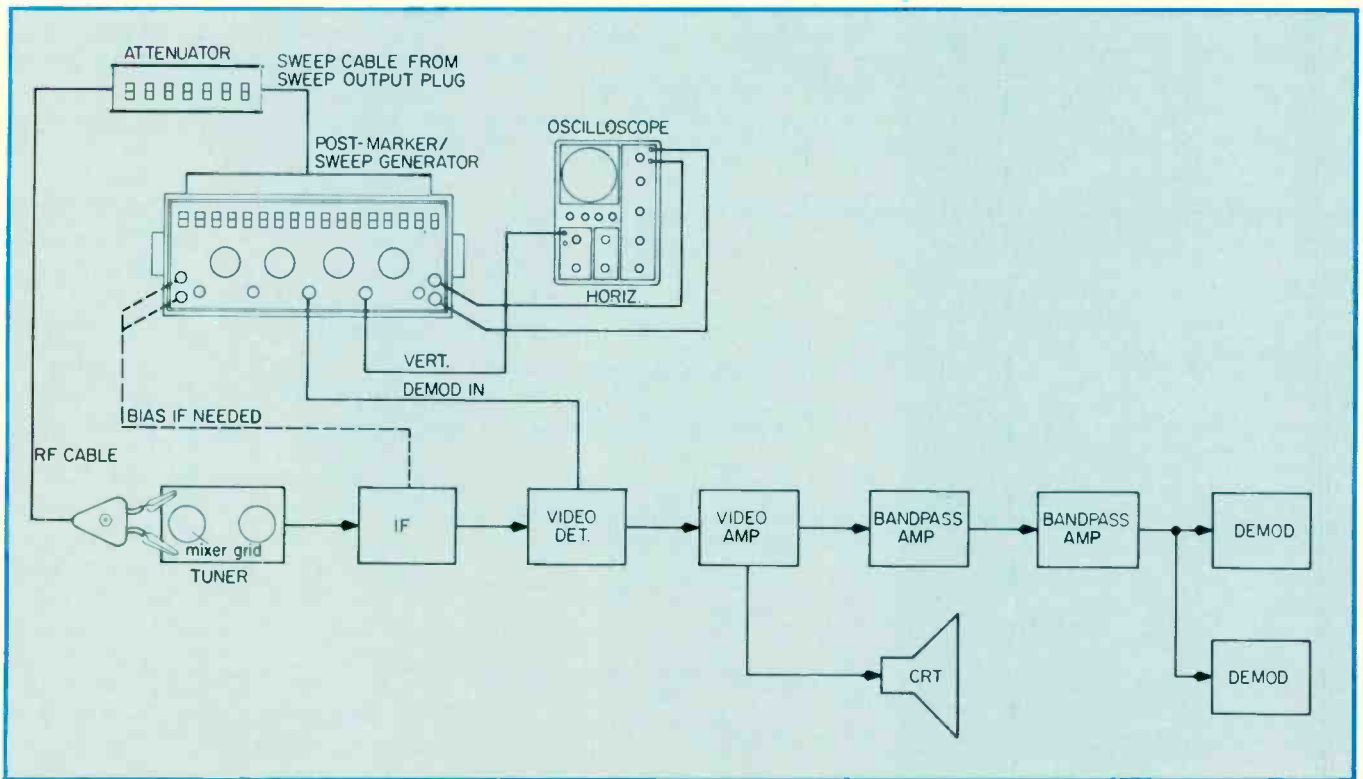

Fig. 1--TV IF alignment setup employing Heathkit Model IG-57 TV post marker sweep generator.

## TV IF ALIGNMENT

Follow the manufacturer's instructions very carefully. If the alignment instructions do not indicate a specific setting for the channel selector, turn the selector to the highest unused VHF channel. In very strong signal areas, it may be necessary to disable the VHF oscillator to prevent station interference during alignment. Be sure all alignment equipment and the TV set are at normal operating temperature.

Refer to Fig. 1 for the following steps: Connect the generator, attenuator and oscilloscope together and connect the generator and attenuator to the TV set as shown.

If bias voltage is called for, connect the bias leads to the proper point on the TV set. Connect a voltmeter across the bias binding

posts and adjust this voltage to the value specified by the manufacturer. Either positive or negative voltage may be applied by reversing the connections of the bias leads.

Place both of the attenuator 20db rocker switches to the IN position for 40db of attenuation.

Set the oscilloscope vertical attenuator and vertical gain control to near maximum sensitivity.

Turn the sweep range switch to the IF position. Turn on the TV set and allow it to reach normal operating temperature.

The trace shown in Fig. 2 is a typical over-all IF waveform for most TV set IF circuits. You will not obtain this waveform if the IF circuits in the color TV set you are testing are out of adjustment. However, you should obtain a trace with the 42.17, 42.75, 45.00 and 45.75MHz markers

in the left-to-right sequence as shown.

Turn on the 45.00MHz marker and place the BLANKING switch in the OFF position.

Adjust the SWEEP CENTER control and locate this marker.

Adjust the PHASE control and superimpose both markers; then place the BLANKING switch in the ON position.

Turn on the required marker switches. If the TV set IF circuits are correctly aligned, the markers should appear as shown in Fig. 2A.

If the IF circuits are far out of adjustment, you may have to inject the signal into the last IF stage; then work toward the IF input. The output from the generator (trace and marker controls) should be increased when the signal is injected into the last IF stage because there will be very little IF amplifica-

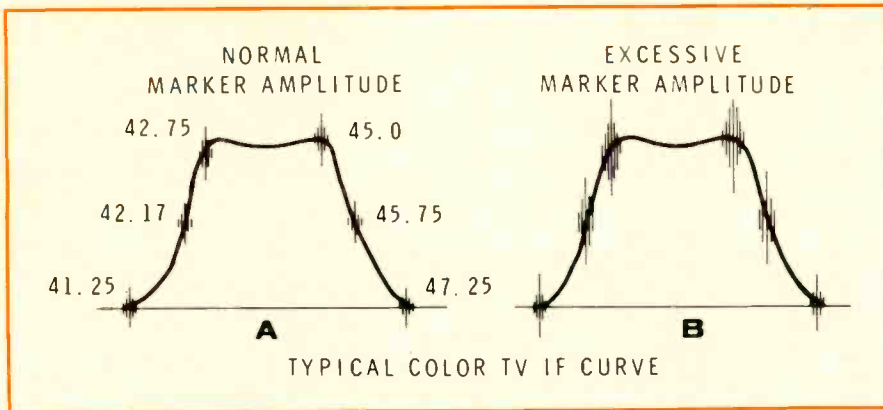

Fig. 2--Typical over-all IF waveform for most TV set IF circuits.

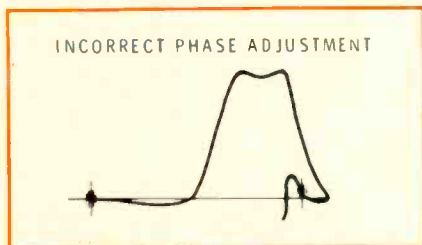

Fig. 3--The IF curve with the phase incorrectly adjusted.

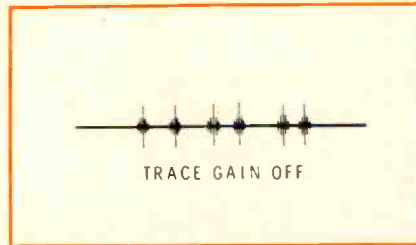

Fig. 4--When the trace control is turned fully counterclockwise only the markers show.

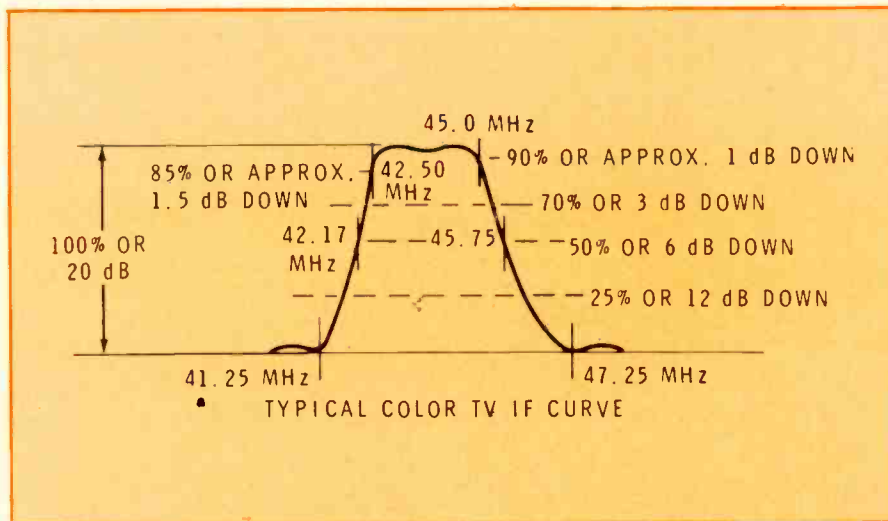
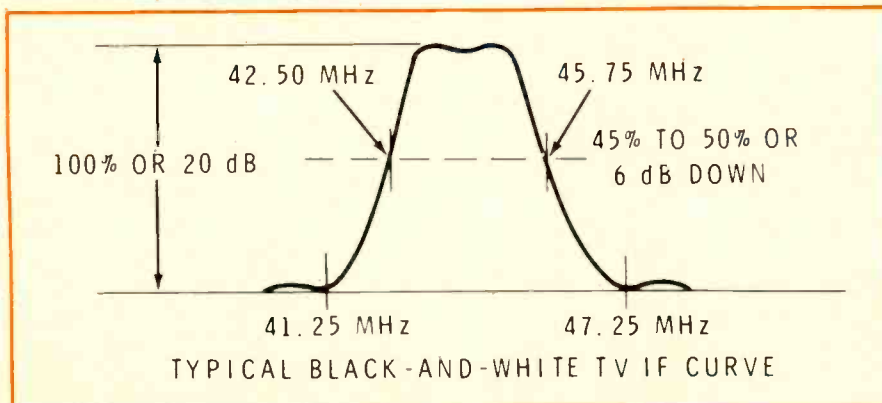

Fig. 5--A typical TV response curve with markers indicated in both db and percentage.

Fig. 6--Typical B/W TV IF response curve.



tion. The output must be decreased as the signal injection point is moved back toward the input of the IF circuits. An over-all IF check and adjustment should be performed after the stage-by-stage adjustments have been made.

Now perform the IF alignment procedure as detailed in the manufacturer's alignment instructions.

Fig. 2 through 3 show normal and incorrect IF curves. Fig. 2A shows a normal IF curve with proper size markers. Fig. 2B shows a normal IF curve with excessive marker amplitude. Fig. 3 shows an IF curve with the phase adjusted incorrectly. Fig. 4 shows only markers with the TRACE control turned fully counterclockwise.

Some set manufacturers specify the position of the marker frequencies as so many "db down," or as a percentage of full trace size. Fig. 5 shows a typical color TV IF response curve with markers indicated by both db and percentage.

A typical black-and-white TV IF response curve is shown in Fig. 6. Note the IF bandwidth, which is usually specified as the point at which the response is 6db down from maximum, is greater for color TV than it is for B/W TV.

For the color set, the 6db points are at 42.17MHz and 45.75MHz; the difference being 3.58MHz, which is the color bandwidth. For the B/W set, the 6db points are 42.50MHz and 45.75MHz; the difference being 3.25 MHz, which is the B/W bandwidth (for a high quality set).

Proper bandwidth is necessary for correct picture detail. A too-narrow bandwidth will cause picture smear and loss of detail. A too-wide bandwidth will produce a grainy, herring-bone picture with possible ringing and a greater chance of adjacent channel interference.

### CHROMA BANDPASS ALIGNMENT THROUGH THE IF

Color signal information is amplified unequally as it passes

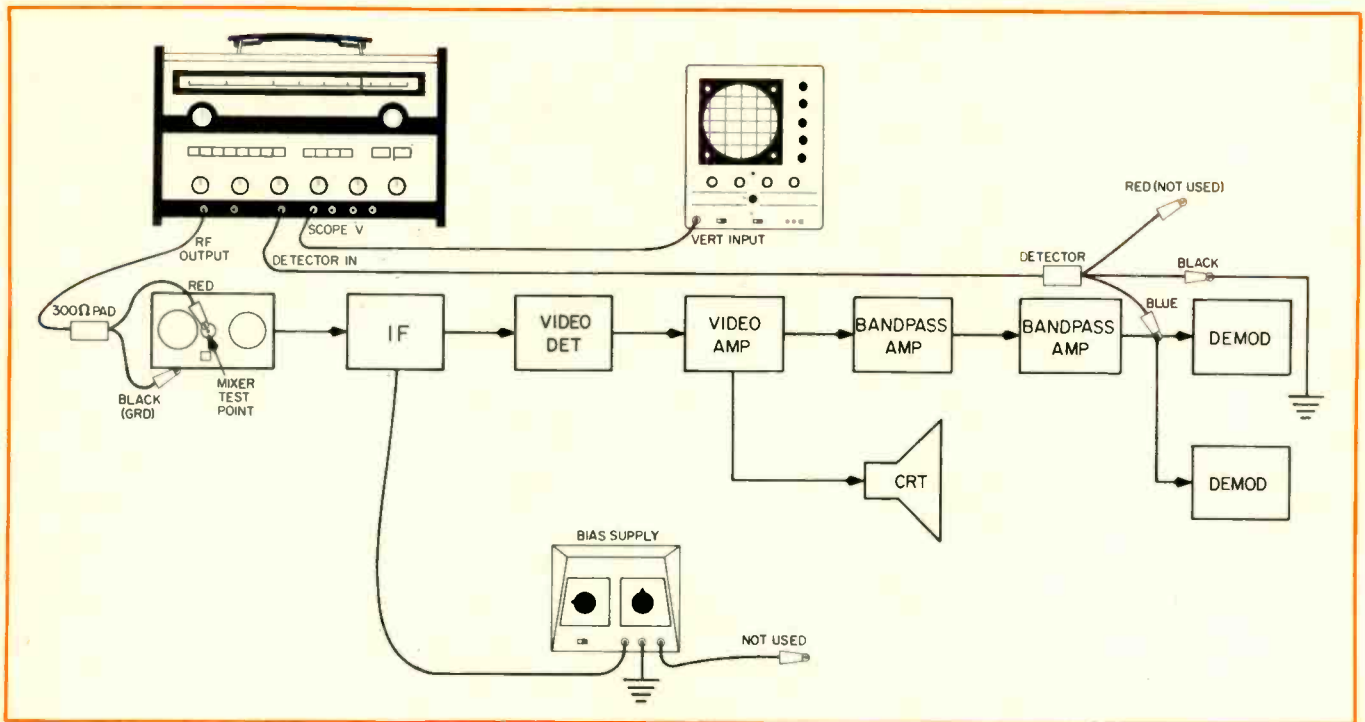

Fig. 7--Bandpass alignment through the video IF employing the Sencore Model SM152 sweep and marker generator.

through the IF amplifier, because the color subcarrier is at the 50 percent point on the response curve skirt. The bandpass amplifier must make up for this condition by amplifying the color signal information unequally in the opposite direction, so that the net effect is equal amplification of the entire color signal. The only way that the bandpass amplifier can be aligned easily is to feed a special signal through the IF and observe the bandpass response at the output of the bandpass amplifier, as shown in Fig. 7. The generator provides this necessary signal when the range switch is set to the chroma position. It is very important that the IF response is aligned first, because good alignment of the bandpass amplifier depends on proper IF alignment.

After the IF has been aligned or checked, simply turn the range switch to the chroma position and connect the blue lead of the detector probe to the output of the bandpass amplifier and you are set to check out and align the chroma section of the receiver. Frequency and sweep width are

preset in the chroma position.

1. Connect the matching pad to the tuner test point or capacity couple to the mixer tube.

2. Connect the blue lead of the detector probe to the output of the bandpass amplifier, or to the cathode of one of the demodulators.

3. Connect a bias supply to the IF AGC test point. A positive voltage is needed if the set is solid-state, and a negative voltage for a tube set. In some cases, the manufacturer will tell you to ground out the AGC test point in a tube receiver. This also will hold true for the chroma alignment.

4. Disable the tuner by placing it between channels or switching to UHF if it is not equipped with a UHF tuner.

5. Set the RF output on the generator as you would for IF alignment. A 2v peak-to-peak response curve is normal with most sets. If you are working on a Zenith receiver, it should have at least a 4 to 6v peak-to-peak response curve for the best alignment.

6. The scope vertical input should now be connected to the scope

V jack on the generator and the scope set to line for a 60Hz sweep, or use the scope H signal from the generator. Adjust the scope controls for a proper trace.

The best procedure for alignment of the chroma is to follow the manufacturer's service procedure. The over-all curve should appear as shown in Fig. 8. Note that the 3.08 and 4.08 markers should be equally spaced and appear at the 80 percent points on the curve. In many sets, an automatic 3.58 marker will appear on the curve because of the 3.58 crystal in the set.

In most cases, the chroma take-off coil is peaked at 3.58MHz for maximum gain while the second and third transformers will affect the 3.08 and 4.08 marker positions on the curve respectively. This will not always hold true, so check the manufacturer's literature for their recommended procedure when aligning the chroma bandpass amplifier.

#### ALIGNMENT OF AFT CIRCUITS

The automatic fine tuning alignment can be performed upon com-

pletion of the IF alignment procedure with no changes in setup connections as shown in Fig. 9 other than connecting the direct cable of the marker/sweep generator to the AFT test point and placing the PROBES switch in the DIRECT position.

The P-P spacing of the discriminator "S"-curve is usually about 1MHz, so that at full IF sweep the discriminator curve will appear compressed as shown in Fig. 10. Adjust the sweep width and center frequency as required to increase the size of the discriminator "S"-curve as shown in Fig. 11. Only the pix (45.75MHz) marker should be used for this section.

In the alignment of various AFT circuits, marker frequencies of 45.25MHz and 46.25MHz are sometimes used as specified to locate the peaks of the AFT discriminator curve during the alignment process. Because these frequencies or any other frequencies required for AFT alignment

are not standard, it is not likely that crystal-controlled markers are readily available at these frequencies. Normally it would be necessary to use an external variable frequency marker generator to locate the peaks of the

AFT "S"-curve. When using the generator for AFT alignment, all that is required is that the 100 kHz marker switch be placed in the ON position. This generates a continuous string of markers having 100kHz separations and

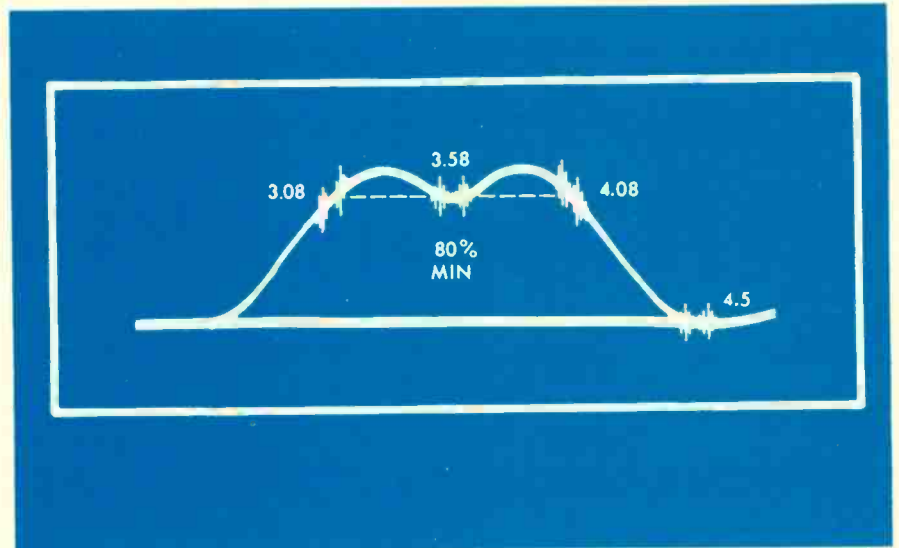
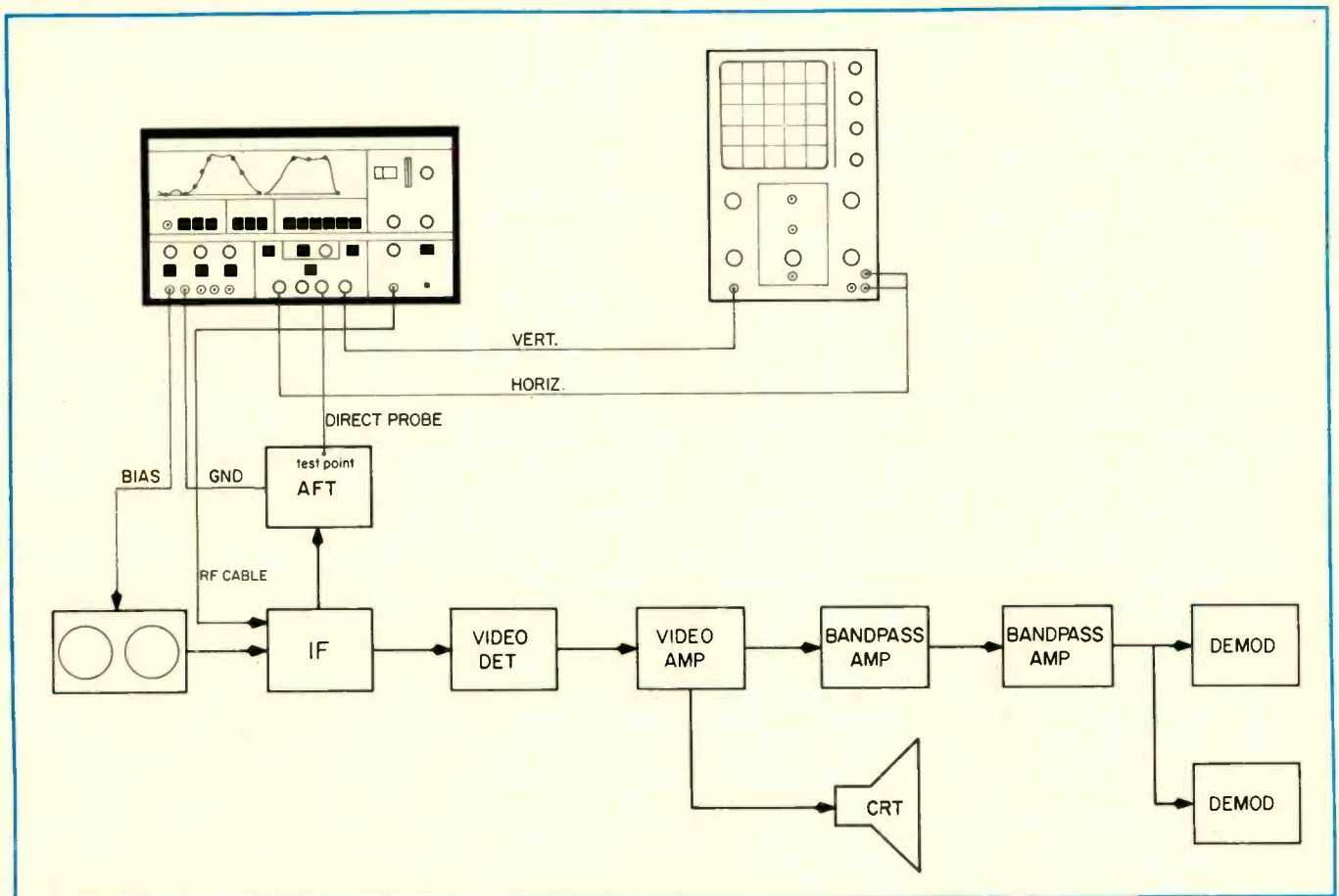

Fig. 8--The over-all chroma bandpass curve through the IF.

Fig. 9--AFT circuit alignment setup employing the B&K Model 415 marker sweep generator.



extending over 1M in each direction from the pix carrier marker as shown in Fig. 12. This enables the operator to set the discriminator adjustments as outlined in any procedure by counting in increments of 100kHz in either

direction from the pix carrier.

Shown in Fig. 12 is the method for determining the various frequency points of the AFT discriminator curve. The distance between each marker is 100kHz as indicated and the method of counting in either direction from the pix (45.75) carrier is shown. For example, with a discriminator bandwidth of 1MHz ( $45.75\text{MHz} \pm 0.5\text{MHz}$ ) the discriminator adjustment is performed so that the fifth 100kHz marker on each side of the pix marker falls on each peak of the discriminator curve.

With the calibration provided by superimposing the 100kHz markers on the AFT discriminator curve, perform the AFT circuit alignment as indicated by the manufacturer.

Most manufacturers recommend disconnecting the AFT output to the tuner when performing AFT alignment.

After the discriminator has been aligned, the exact discriminator cross-over is obtained by injecting a 45.75MHz carrier at the signal injection point. The dc output voltage of the AFT circuit is then checked at the AFT test point using a VTVM. This is performed when using the 415 by placing the FUNCTION switch in the MKR position and turning on the PIX (45.75) marker (all other markers OFF).

The RF cable of the Model 415 remains connected to the IF sweep injection point. The required voltage is then obtained by performing the specified adjustments.

Upon completion of the AFT alignment, perform the AFT check specified by the manufacturer. This involves connecting the television receiver to an external antenna and disabling the AFT and adjusting the fine tuning manually for best picture and sound with minimum sound interference in the picture. The AFT feature of the TV receiver is then activated and the "pull-in" effect is observed. The amount of pull-in should be unnoticeable if the AFC circuits are properly aligned according to the specifications of the manufacturer. ■

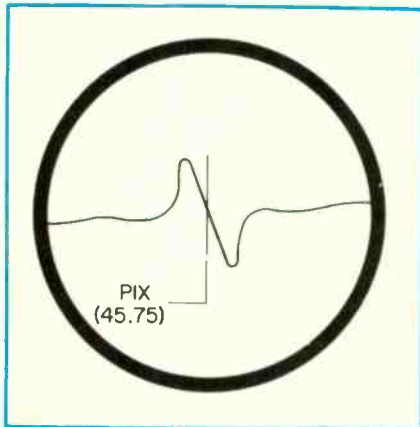

Fig. 10--"S" curve presentation using wide IF sweep.

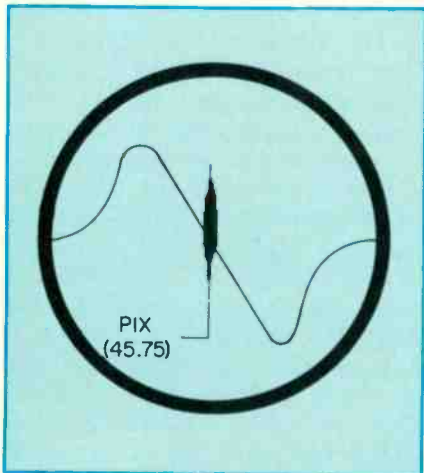
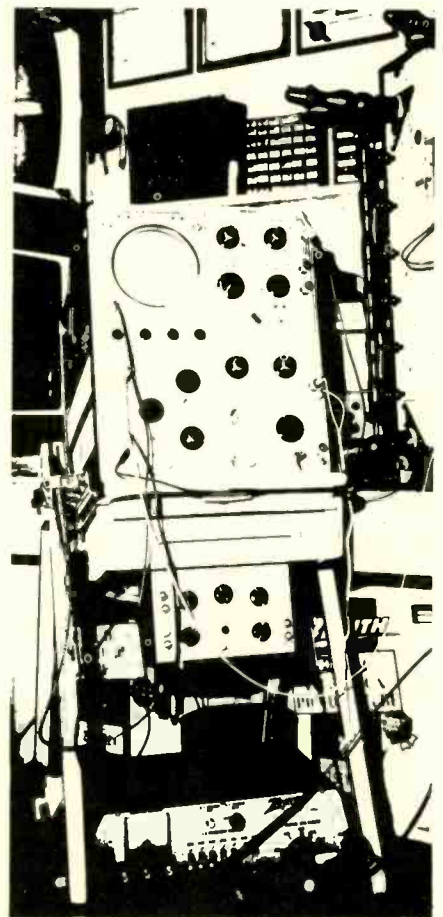
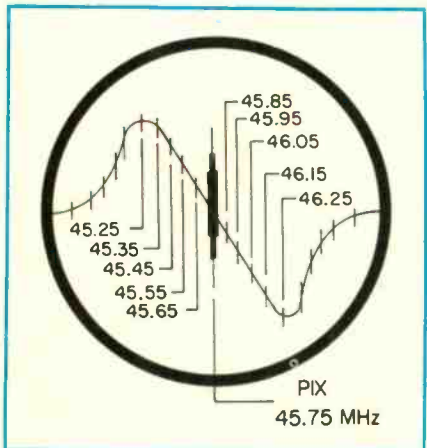

Fig. 11--"S" curve at reduced IF sweep.

Fig. 12--Using 100kHz markers to determine frequency separation of discriminator peaks.



## Part One

# Selling CCTV

Many TV service-dealers thinking of CCTV as a profitable business sideline are often not in a position to evaluate first-hand the many applications CCTV has in education and industry

■ Remember the first television receiver you saw? No, not the first time you watched a program on television, but the first time a TV receiver found its way to your work-bench?

That may be ancient history, but now we have crept toward another era in the field of electronics, that has literally caught us napping. This new "monster" is in the form of the equipment in use all over the country. It's called CCTV or CLOSED CIRCUIT TELEVISION.

One surprising fact is that many service shops and dealers are ignoring CCTV as if it didn't exist. It reminds us of the old-time radio man who said he wasn't going to bother learning television repair simply because it was just a fad. Or the service technician who said, "I'm not going to bother learning about transistors and SCRs because it won't be worth the effort."

We all know that TV and solid-state devices are here to stay--and so is CCTV. Those that get in on the ground-floor of the CCTV business are those who will be in a position to bring in a lot of extra business. The purpose of this series on CCTV is intended to point out some of the practical applications of CCTV, what it can mean to technicians and dealers, and how to properly prepare yourself for a place in the CCTV market.

### APPLICATIONS

Industry is going for CCTV in a big way. Corporations are using it to watch critical areas in the manufacturing process, keeping an eye on the till; that is to say, "watch-dogging" the tellers cages in banks, watching over safes during evening and other "off" hours, surveying company parking lots, and any number of other watch-dog jobs that would have normally required a large staff of security people. With CCTV, one man can watch a number of areas without leaving his row of video monitors. The applications are unlimited.

Education is the largest single user of CCTV and its related

personnel. Television cameras, video-tape recorders and CCTV monitors are now to be seen in virtually every school district, every college or school of higher education, and most schools concerned with vocational education in the country. You weren't aware of this? It's not surprising. Not because we tend to bury our heads in the sand, but because additions of this type are not widely publicized by the schools. There is no particular reason for this because schools are proud of the fact that they're involved in something that is very up to date.

What are the schools doing with all this fancy, newfangled, technical hardware? Let's talk first of the uses in elementary and secondary schools.

One of the prime uses is the video-tape recordings of programs put on the air by area ETV (Educational Television) stations. There are many such stations in the country, and their function, among others, is to supply programming to the member schools. (Schools pay a "subscription fee" to the station, and this allows the schools to make use of programs beamed at the elementary and secondary schools in the district in question. For more data on this, contact your area ETV station.)

Many of the programs aimed at the classroom are broadcast at a time when the class in question is not in session. This means the school without CCTV gear has two options: change the time the particular class meets in order to "catch" the program, or not use the program at all. These ETV presentations are generally excellent and missing the presentation means missing something which can be quite important to the students.

Schools equipped with CCTV gear don't have any problems at all. They simply record the program with the aid of a TV tuner and a video-tape recorder and play the program back at the time the class normally meets. (Part two of this series will explain the ways and means of video-tape recording.)



Sony's Model VCK-2400 CCTV camera with a DVK-2400 video tape recording system operates on battery or ac power.



Satchell Carlson's Model 9M902 monochrome TV monitor, with 172 sq in. of viewable picture area, features plug-in circuits and full power transformer operation.



Amperex Model CC-6007 general purpose CCTV camera for monitoring or surveillance is compact and light weight.

Another use for CCTV equipment in the schools is an area called "micro-teaching," which means teaching a *short* lesson to a *small* group of students. It is generally done in "in-service" programs of enrichment for teachers who have been teaching for some time. Here's how it works:

The teacher prepares a short lesson which makes use of one particular skill such as "positive-reinforcement." This short lesson is presented to a group of about five students. The whole process is recorded on video-tape. The lesson length varies from 5 to 20 minutes. After the lesson

is finished, the teacher views his presentation in another room and evaluates the effectiveness of the presentation. The person conducting the in-service session usually views the tape at the same time and also prepares an evaluation. The next step is for the teacher and evaluator to discuss the presentation and come up with "good" and "bad" points which are to be kept in mind when the procedure is repeated.

The next session is called a "re-teach" session. This time, the teacher should be able to improve on those points which didn't

work too well during the first session. The entire procedure is repeated as many as three times in order to take full advantage of the situation.

The discussion of this particular area might be a bit boring, but the idea is to give you the opportunity to become as completely aware of the process as possible so that when you approach an administrator with "sales" in mind, you won't "come-off" sounding as though you have no idea of the uses of CCTV in the school. So far we have only scratched the surface on the uses for a CCTV system. There are many more, but we will describe only a few of the major ones. You will undoubtedly find others as you investigate the market in your particular area.

#### IMAGE MAGNIFICATION

The name suggests the use: the camera and monitor magnify an item or demonstration so that the entire class can see at the same time. This application has not been taken too seriously by many schools at this time, probably because no one has pointed out this use to the teachers and administrators. Many teachers think the only thing they can do is record programs and play them back to the class.

Simply explain that a biology teacher can point the camera at a specimen on the lab table and the monitor TV set at the students. Then everybody can see the teacher dissect the frog at the same time without crowding around the lab table. (Fig. 1)

With a little care, the camera can be "aimed" down the barrel of a microscope, and the school doesn't need to invest thousands of dollars in additional microscopes.

The key to the whole thing is in using imagination. You'll never know what you've missed if you don't experiment a bit. You can see the potential here. The school administrator is going to be hounded by the teachers until he gets enough cameras and monitors to satisfy the image-magnification need. Why video-tape everything when there are

## CCTV...

so many other uses for the camera and monitor?

Let's touch on some of the areas that use not only the camera and monitor, but also the video-tape recorder. Remember, we are still talking about uses for CCTV in elementary and secondary schools.

We've mentioned the recording of ETV programs for later replay. What about recording practice sessions of the basketball team? It would give them the chance to better themselves by seeing their mistakes "first-hand" and would save the coach a lot of needless repetition.

In higher education, lectures can be video-taped ahead of time so that a professor can be gone all day for a meeting. The students can watch the lecture on the classroom monitor and gain almost as much as if the professor had been right in the room. One disadvantage is that questions have to wait until the next day when the professor returns.

Another possible use for CCTV in the college would be for the professor who has a class of 500 students who meet in three different sections. It usually means that he has to give the same lecture three times each day. Why not record it? This way, he would give the lecture only once and also would have a little extra time to spend helping students, counseling, etc.

### SAMPLE SYSTEMS

In this section we'll deal with the general makeup of CCTV hardware, how it can be connected to perform different jobs, and what complications you might run into in these various applications.

As we mentioned, image magnification is an important application. For example, an electronics plant could use it for taking a closer look at a circuitboard assembly process where aspiring "assemblers" are to be trained in a specific operation. In this

case, a camera would be trained on the circuitboard assembly process, and the output of the camera would be connected to a television monitor (receiver). All personnel to be trained would be able to see the process at the same time, resulting in a considerable savings in training time.

In this system, either the video or RF output of the camera could be used. Most industrial CCTV cameras have both outputs available on the rear apron of the camera. The video output should be used where possible since the resolution is generally much better. When the RF output is used, the resolution (focus) is limited by both the modulator in the camera, and the RF circuits of the receiver.

In addition, some receivers are equipped with both RF and video inputs. Since the advent of CCTV, many manufacturers have come out with a line of receivers specifically designed for the CCTV market. Not only are they equipped with video and RF input jacks; they're also available with external audio input circuits for "public-address" functions. A microphone can be attached to this input allowing a large group to see and hear the presentation simultaneously.

Another item available on many of the newer CCTV receivers is a video output jack. This allows for connection to the video output section of the receiver, just past the point where demodulation takes place. Such a set is often referred to as a "jeeped" receiver.

A "jeeped" receiver can be connected to a video-tape recorder for recording programs sent out by the local open-circuit TV stations. An audio output is also available on these same receivers so that both audio and video can be recorded.

Receivers of this type generally include a function switch which allows various uses of the receiver without the need for making connection changes. One can switch video and RF input quite readily.

As cited earlier, a CCTV sys-

tem could be connected to a microscope. This would find application in both education and industry. Many manufacturers put out a line of adapters which allow direct connection of microscope and camera. The camera output would be fed to a monitor to allow group viewing of a slide in the microscope. Many schools and scientific firms may not have this adapter, but this does *not* mean they're unable to take advantage of CCTV microscopy. A camera designed for other uses can be aimed down the barrel of a microscope and, with a little care, the CCTV image achieved in this manner is entirely acceptable. The area of concern in this type of pickup is getting the eyepiece of the microscope and the lens of the camera in good focus, as one is directly dependent upon the other. The key here is to "juggle" until you get the right combination. Don't be discouraged if you can't get it to work right away; be patient. It does work but it takes some precision.

### OBSERVATION SYSTEMS

Sample "observation-systems" are numerous. The first is the most simple; one camera, one monitor. This has already been dealt with in previous examples.

The next would be a single camera-multiple monitor installation as shown in Fig. 2. The most simple to deal with is one in which the video output of the camera is used. The CCTV cameras generally have an output impedance of approximately  $75 \Omega$ . This must be load-terminated to prevent an "over-driven" condition. Without proper termination, the picture from the camera has a tendency to "bloom" with too much contrast.

Connection is quite simple when dealing with CCTV designed receivers. The video output of the camera is connected to the first input jack of the monitor and the second jack is used to feed the first input of the next monitor. (See Fig. 2) The last monitor in the string is terminated in  $75 \Omega$ . The most direct method



of doing this is to install a  $68\Omega$ ,  $1/2w$ , 10 percent fixed carbon resistor in a mating connector. Mark the connector "T" for termination. This will prevent its getting pulled out of the tool box as a "fresh-unused" connector. It's a good idea to have about six connectors of this type around. They're about as necessary as a screwdriver in CCTV service and installation work. Make up both BNC and UHF connectors for termination purposes. The  $68\Omega$  value is close enough for all practical purposes and is common at most wholesalers.

Some receivers have a switch

near the video input jacks which is marked 75 OHMS and OFF; others have marked the switch TERM and HI-Z. In the first case, 75 OHMS means that in this position, the input is terminated internally. You can feed to the next monitor with the switch in this position. In the OFF position you can continue the signal to the next monitor. In the second example, the TERM position means that the unit is internally terminated. The HI-Z, or high impedance position, is the position used when feeding signal through to another monitor.

Don't underestimate the im-

portance of impedance matching. Proper matching spells the difference between a good and poor signal in video terms as much as it does in audio. The manufacturer will list the impedances in the "specifications" section of the operation manual. Very seldom will you find a television pickup unit that uses other than  $75\Omega$  as the source impedance, but check anyway.

Obtaining a good picture means more than matching impedances. Explaining this will mean going into a bit of photography. All cameras have lenses. Most lenses have a variable f-stop ring, and

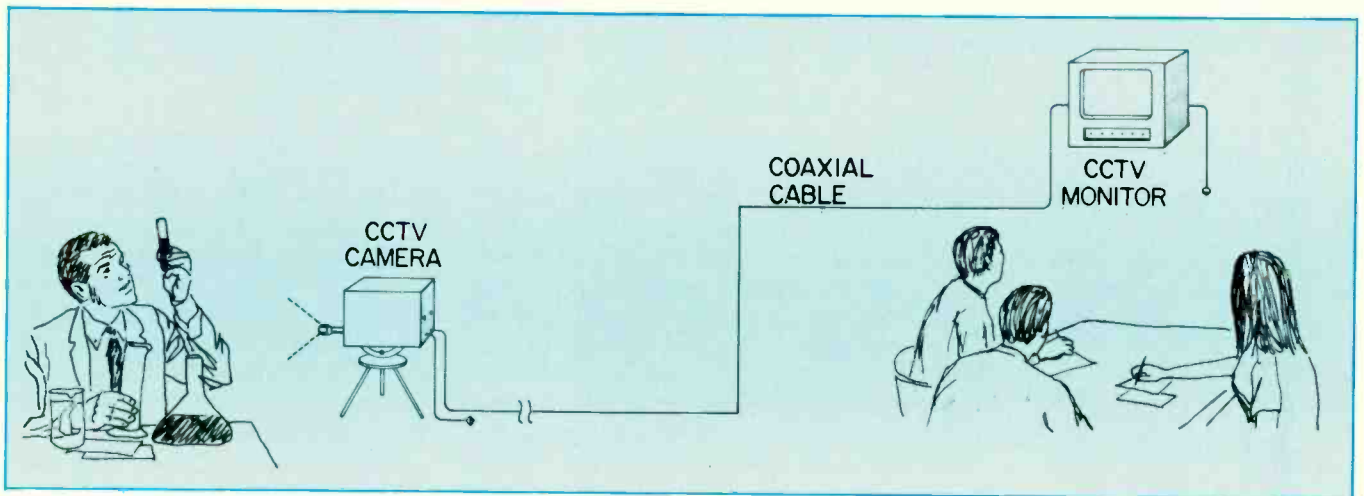

Fig. 1--A typical single camera-monitor CCTV system for training.

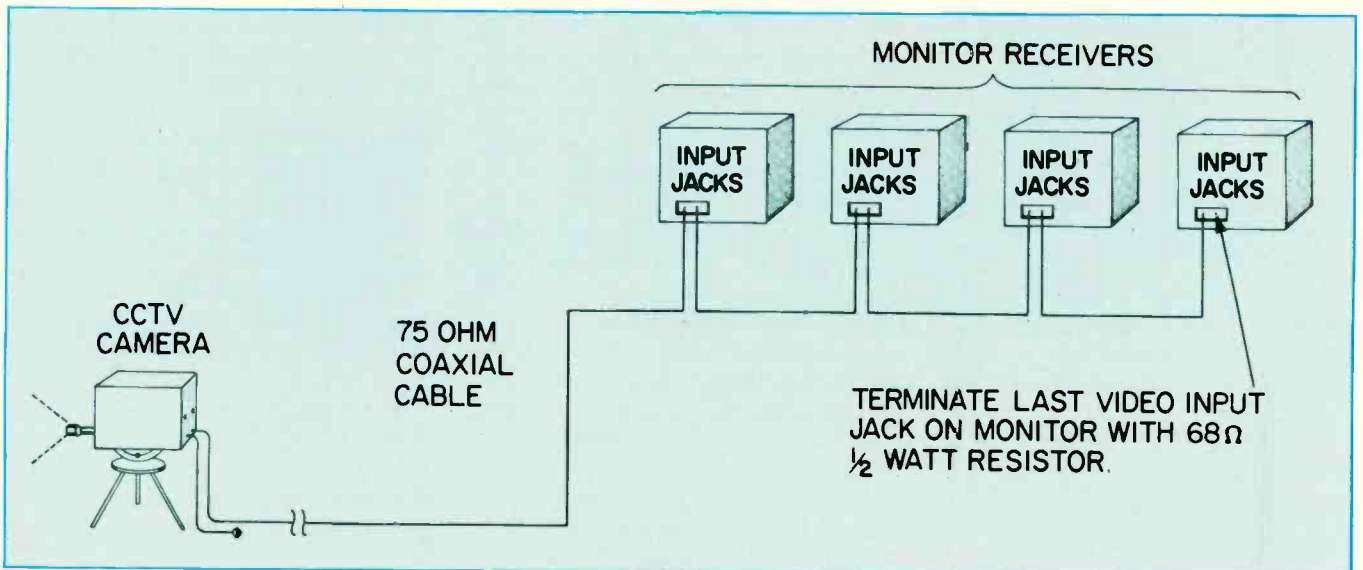

Fig. 2--A single camera connected to multiple monitor receivers, uses the video input jacks on the monitor for "looping" or "feed-through." The last monitor in the string is terminated with the proper impedance to prevent an "over-driven" condition.



Amperex Model VR-5100 portable videotape recorder for CCTV systems.



GE Model TE-23 solid-state camera features all components on single etched circuitboard.

all have a variable focus ring. The f-stop ring varies the opening of the lens iris. The smaller the f-number, the larger the lens opening. In a room which has

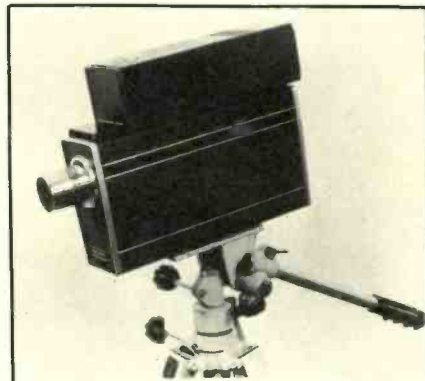

Sony's solid-state CCTV camera, Model DXC-2000A shown with optional viewfinder, features internal crystal-controlled sync generator.

Diamond Electronics transistorized vidicon camera, Model ST-1.



normal lighting, approximately 30 footcandles, an f-opening of about 1.9 would be needed in order to obtain a good picture. Outdoors, on a bright sunny day, an opening of f-16 to f-22 would be needed. One method of determining the f-stop is to look at the picture monitor and set the f-stop ring for the "best picture." Another would be to look at the signal level with an oscilloscope and set the f-stop to the point where a peak-to-peak reading of 1v is obtained. Most CCTV systems in industry do not have a "scope" on hand for constant monitoring of levels, so the "best picture" method is commonly used.

The other ring, variable focus, is used to get the sharpest picture. Rotate the ring until the picture is as crisp as possible. When a camera has been subjected to rough usage, the vidicon tube, or pickup tube, can sometimes become dislodged in its carriage; in this event, follow the manufacturer's instructions for moving the vidicon until good focus is possible once again. This process involves loosening the screws which clamp the vidicon in po-

sition to allow back-and-forth movement of the tube.

By the way, the vidicon is the only tube in most CCTV cameras today. All other components are solid-state, so a good understanding of solid-state devices is mandatory when it comes to servicing these units.

A third type of observation system would be one containing more than one camera and more than one monitor. One example would be three cameras feeding three monitors, but since it would be assumed that each camera would feed each monitor separately, this is in essence, a single camera-single monitor system. We will talk about three cameras which are feeding a series-string of monitors.

For example, a bank has a monitor receiver at a guard post, one at the office of the bank president and one in the administration conference room. The guard has a switching unit in front of him which allows selection of any of three cameras. He can select any one of the three cameras to feed all of the monitors.

This type of system is quite

*continued on page 73*



B&K Model 415 solid-state sweep/marker generator

## B&K Model 415 Sweep/Marker Generator

The built-in features of this instrument will simplify alignment and accomplish the job with speed and accuracy

for more details  
circle 900 on postcard

■ Before the introduction of the sweep marker generator a number of separate instruments were employed to perform sweep alignment. These instruments included a sweep generator furnishing the video, IF and RF sweep. Usually more than one generator was required and a marker generator capable of furnishing reference markers. If this generator was tunable, it was capable of furnishing one reference marker at a time, then the calibration accuracy was questionable. Also some alignment procedures called for the applications of up to three bias voltages simultaneously.

Now the sweep/marker generator combines the function of four separate instruments in one unit and provides everything needed for alignment except a scope and a VTVM.

Recently we unpacked the B&K Model 415 sweep/marker generator for Testlab evaluation.

The instrument has a modern looking front panel with trim to match other instruments in its line.

Visual reproductions of alignment curves and marker indicators on the front panel provide constant reference for scope waveforms. You can select any or all markers with crystal-controlled accuracy. The marker lights on the front panel show which marker or markers you are using and where they should be on the curve. If the markers fall on a slope they can be tilted for easy identification.

If service or adjustments should be needed, the top cover is hinged and opens exposing the complete circuit board without removing a screw as shown in photo.

The instrument has three bias supplies, two of which have a range from 0-25v and the third 0-50v eliminating separate bias supplies.

Another feature which impressed us is the 15kHz built-in filter reducing any horizontal frequency "grass" which eliminates any need to disable high voltage during alignment. This feature alone can save time. The 415 operating manual explains this and other circuits. It should be thoroughly read

## 415 MARKER/SWEEPER GENERATOR SPECIFICATIONS

Outputs available (selected by Function Switch at single output jack): a. Video Sweep, b. IF Sweep, c. Markers, Unmodulated, d. Modulated Markers, e. CH 4 RF Sweep, f. CH 10 RF Sweep, g. 10.7MHz Sweep

Sweep Width: a. IF, CH 4, CH 10 — less than 1MHz to over 10MHz b. 10.7 — less than 200kHz to over 2MHz c. Video — less than 1MHz to over 6MHz

Sweep Frequency Coverage (Sweep plus center frequency Adjustment): a. IF—35-50MHz, b. CH 4—56.5-71.5MHz, c. CH 10—182.5-196.5MHz d. 8MHz to 12MHz

Sweep Frequency Rate: 60/SEC

Output Levels across 75  $\Omega$  (Nominal): a. IF—0.3v, b. RF—50K $\mu$ v c. Markers—0.15v d. Video—1.5vP-P e. 10.7—0.3v

RF Attenuator Range: 60db

Output Impedances: 75 $\Omega$  or 300 $\Omega$ . Desired impedance is selected by switch on RF cable terminating pad.

Crystal — Controlled Markers: IF (10 Standard Frequencies) (Post Injection System) a. 39.75MHz (ADJ PIX) b. 41.25MHz (SOUND) c. 41.67MHz (CHROMA) d. 42.17MHz (CHROMA CARRIER) e. 42.67MHz (CHROMA) f. 42.75MHz g. 44.00MHz h. 45.00MHz i. 45.75MHz (PIX) j. 47.25MHz (ADJ. SND)

*CHANNEL 4, CHANNEL 10*

Because of the marker generation system, the RF equivalents of all RF markers are available on Channel 4 and Channel 10.

*CUSTOMER OPTION*

A spare marker oscillator circuit is provided for the customers option. The circuit can be adjusted to accept any third overtone crystal in the 35MHz to 50MHz range.

*10.7MHz*

A 10.7MHz crystal marker oscillator is automatically energized when 10.7MHz sweep is selected.

Additional marker provisions: *External Marker Input*

External markers can be used in combination with the internal IF or 10.7MHz markers.

*100kHz MARKERS*

A continuous string of markers having 100kHz separations can be superimposed on any of the IF markers or the 10.7MHz marker. This enables the operator to interpolate frequencies to either side of a crystal controlled marker in 100kHz increments. This feature is valuable in 10.7MHz IF and discriminator alignment as well as in alignment of automatic fine tuning discriminators in television receivers.

Bias Supplies: 2 each  $\pm 0.25$ vdc (750 $\Omega$  Max Impedance).  
1  $\pm 0.50$ vdc (2.5K $\Omega$  Max Impedance).

Controls: a. 12 ON/OFF Marker Switches b. 3 Bias Voltage Adjustments c. 3 Bias Polarity Switches d. NORM-REV Horizontal Sweep Switch e. NORM-REV Vertical Display Switch f. MARKER AMPLITUDE Control g. Marker VERT/HORIZ Display — selects either vertical or horizontal orientation of markers. h. SWEEP WIDTH Control for IF, CH4, CH10, Video, and 10.7MHz Sweeps. i. Center Frequency Control for all Sweep Outputs. j. CHROMA ON/OFF Switch k. FUNCTION Switch l. RF-IF-VIDEO ATTENUATOR Continuous Output Level Adjustment of all Outputs. m. PROBES Selector Switch — Selects either the Direct Probe Output or the Demodulator Probe Output. n. POWER SWITCH

**B&K 415...**

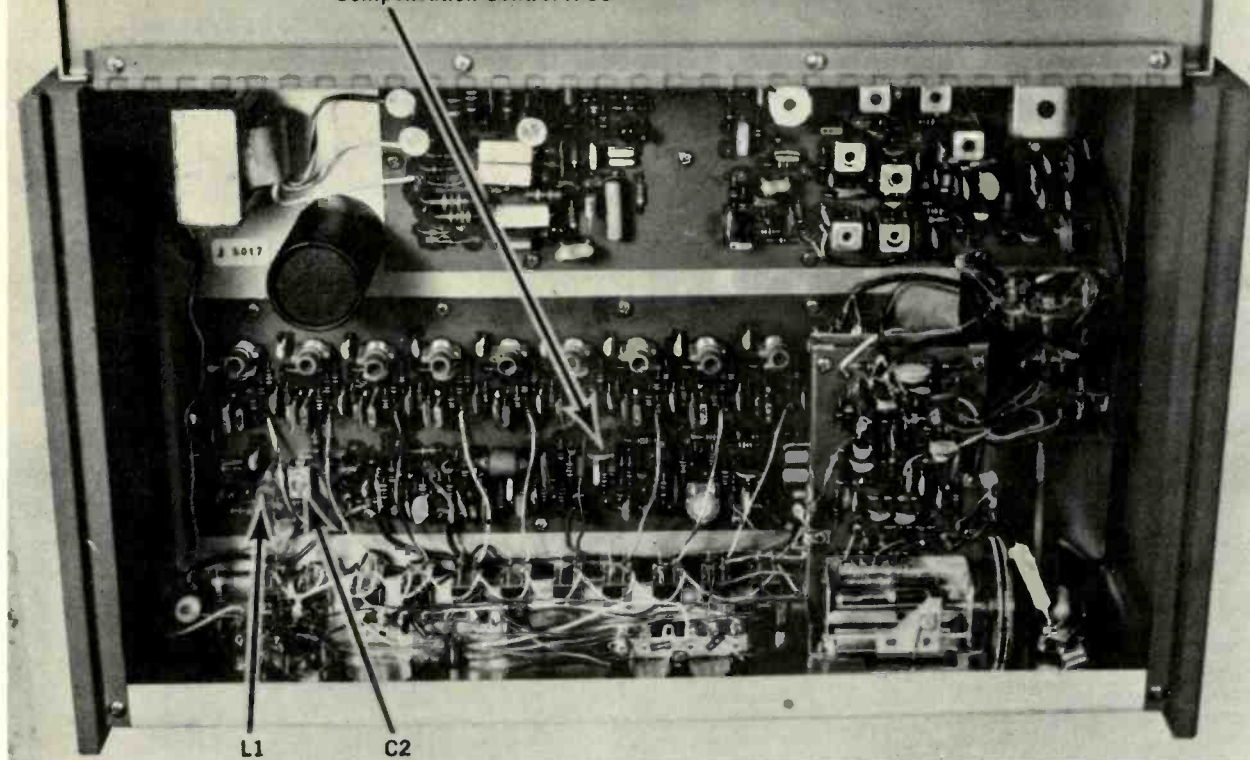

Adjustments and components are accessible by opening the top cover of the instrument.

before alignment is attempted. It is almost a complete course which takes you step-by-step through the alignment process.

All accessories are provided including the RF demodulator probe, a direct cable with built-in isolating resistor and an RF cable with built-in terminations which can be quickly selected by a switch.

If you are using an oscilloscope having poor low frequency response in conjunction with the generator, erroneous tilt will be introduced into the response patterns. This is a function of the oscilloscope itself rather than the television receiver which is being aligned. This instrument has an internal adjustment which is used when required to compensate for poor low frequency response of the oscilloscope. The frequency compensation adjustment (R-99) is located on the printed circuit board inside the unit and is accessible by opening the top cover of the unit. The location of this control is shown in photo. Normally, when no compensation is required, this control is set to the extreme left position as viewed from the front of the unit. The most effective way to perform a compensa-

tion adjustment is to first obtain an IF response curve on the oscilloscope. Once the response curve has been obtained, switch the horizontal sweep of selector of oscilloscope to an internally generated sweep position and use a low sweep rate so that several IF response curves are repeated on the oscilloscope trace.

Another feature we liked is the 100kHz marker function which provides a useful method of determining frequencies other than the exact crystal-controlled marker frequencies provided. When the 100kHz MKR switch is turned on, a string of markers with 100kHz separations is superimposed on the standard marker. A crystal reference marker must first be selected; the 100kHz markers cannot be generated unless used in conjunction with a reference marker in IF range. Because the 100kHz modulation is added to every marker which is being displayed, it should be used with only one marker at a time. First, establish the direction of increasing sweep frequency by using several markers if necessary, and then to maintain convention, adjust the HORIZ SWEEP switch as required to set increasing frequency from left to right on the

oscilloscope. Then, using only the reference marker in the frequency region of interest, turn on the 100kHz markers and reduce sweep width as desired to display the desired sweep range. This feature is extremely useful in the alignment of automatic fine tuning circuits.

This instrument has an oscillator stage which is energized by the spare MRK switch. The primary purpose of this stage is to provide an additional crystal-controlled marker oscillator for sets which require a special alignment frequency such as trap frequencies of 35.25MHz and 38.75MHz.

The oscillator circuit will accept a third overtone crystal in the 35MHz to 50MHz range. Crystal pin receptacles are provided accepting the plug-in crystal and other types of crystals must be wired into the circuit. For best frequency correlation, the crystal frequency should be specified with 32pf load capacitance. A trimmer capacitor C2 is used for rough frequency adjustment and a tunable inductor coil, L1, is used for the final oscillator.

Additional uses can be found for the sweep marker as you become increasingly familiar with its features and its operation. ■



# DEALER SHOWCASE

For additional information on products described in this section, circle the numbers on Reader Service Card. Requests will be handled promptly

## TV ANTENNA ACCESSORIES 702

*Entire TV antenna accessory line in blister-packed display cards*

Introduced are blister-packed self-merchandising display cards for packaging an entire TV antenna accessory line. The new display packages are



expected to increase distributor volume on these products by stimulating impulse sales. The new packaging can be used to conveniently set up both dealer and distributor point-of-purchase displays. Each card is slotted for standard pegboard mounting. Available in four color display packs are more than a hundred types of popular JFD items, including matching transformers, wall plates, switches, filters, traps, couplers, splitters, lightning arresters and a full line of mounting hardware. JFD.

## WIRE AND CABLE CENTER 703

*Features quick turnover items in handy rack display*

A self-service wire and cable center designed to build impulse sales volume is announced. Customized to reflect local consumer preferences, each center will feature quick turnover items selected from a line of 139 style-line bubble-pack wire and cable products. Also available is a promotional self-service rack merchandiser for counter, island or wall display. The prepackaged line includes appli-



ance and extension cords; TV antenna lead-in wire and rotor cable; shielded and unshielded connecting cable for Hi Fi and other electronic equipment; hookup wire and magnet wire; and heat shrinkable insulating tubing. Belden.

## POLICE-PUBLIC SERVICE BAND RECEIVERS 704

*All models include standard AM band*

Announced is a line of solid-state portable public service band communications receivers including a low band model, a high band model, and a dual high and low band receiver. All three models incorporate the standard AM broadcast band. The new dual public service band receiver, Model 6252A, covers the 30-50MHz low band and the 147-174MHz high band, incorporating three separate tuner and con-



verter circuits with four IF stages for maximum sensitivity, selectivity and best signal-to-noise ratio. The low band unit, Model 6254, covers the 30-50MHz public service band, while the high band unit, Model 6251, covers the 147-174MHz range with the coastal weather frequency indicated on the dial. These two receivers also employ separate tuner sections and four stages of IF amplification in addition to an RF stage on the public service band. Power is battery or ac using an optional adap-

ter. Each radio incorporates variable squelch and is supplied with an external antenna connecting cable for mobile use with standard car antennas. All three models have write-on log panels to record most used frequencies. Dual Band Model 6252A carries a suggested list price of \$59.95, Low Band Model 6254 and High Band Model 6251 are both \$35.95. Channel Master.

## CB ANTENNA 705

*Requires only 2sq ft of floor space*

Announced is the DB-69 antenna display and CB equipment dealers can now merchandise up to 40 skin-packed antennas plus accessories in just 2 sq ft of floor space. The metal display provides maximum versatil-

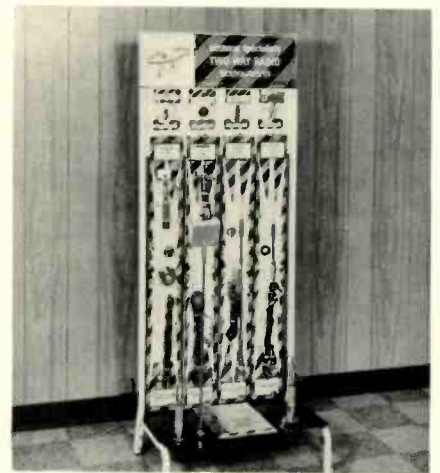

ity with both front and back merchandise display panels and the attractive two-side header. The unit can also be used against a wall or aisle end. Placement anywhere within the store is practical because the 5ft height can't block the view of other items. Antenna Specialists.

## STEREO UNIT 706

*Can be used as a room divider or furniture piece*

A vertical designed stereo unit which also may be used as a room divider or accent furniture piece is introduced. The Model CS25W is constructed of

aluminum poles and walnut veneer cabinetry. It is 68in. high, 22in. wide and 16 1/2in. deep. The upper portion of the console houses an AM/FM tuner and amplifier. Concealed be-



neath this section are miniature spot lights which cast a glow through the plate glass shelves below. The lights also illuminate the Garrard custom deluxe automatic record changer in the lower portion. The unit also has a 10-button control panel and the stereo unit delivers 240w of peak music power. Sylvania.

## CAR STEREO REVERBERATION SYSTEM 707

*Solid-state unit mounts under the dash*

A solid-state stereo reverberation system which adds a new dimension in sound to any car stereo tape player or stereo-FM radio is announced. The reverb unit mixes the sound from each

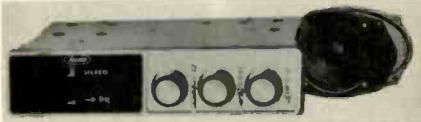

stereo channel and delays it through the rear speaker. The "hole in the middle" is filled with reverberation for a full sound effect. A solid-state (all-transistor) circuit is used and control selections are provided with front panel operation which include VOLUME, BALANCE and REVERB. Pilot lights indicate "on" and "stereo." The reverb unit is 8in. wide, 1 3/4in. high and 5 3/4in. deep and mounts under the dash. The front panel is styled with grained chrome and polished chrome edges. A 6in. round speaker on a 6 x 9in. adapter board with a chrome grille is supplied for rear mounting. It operates from the 12vdc car battery. Price \$29.95. Allied.

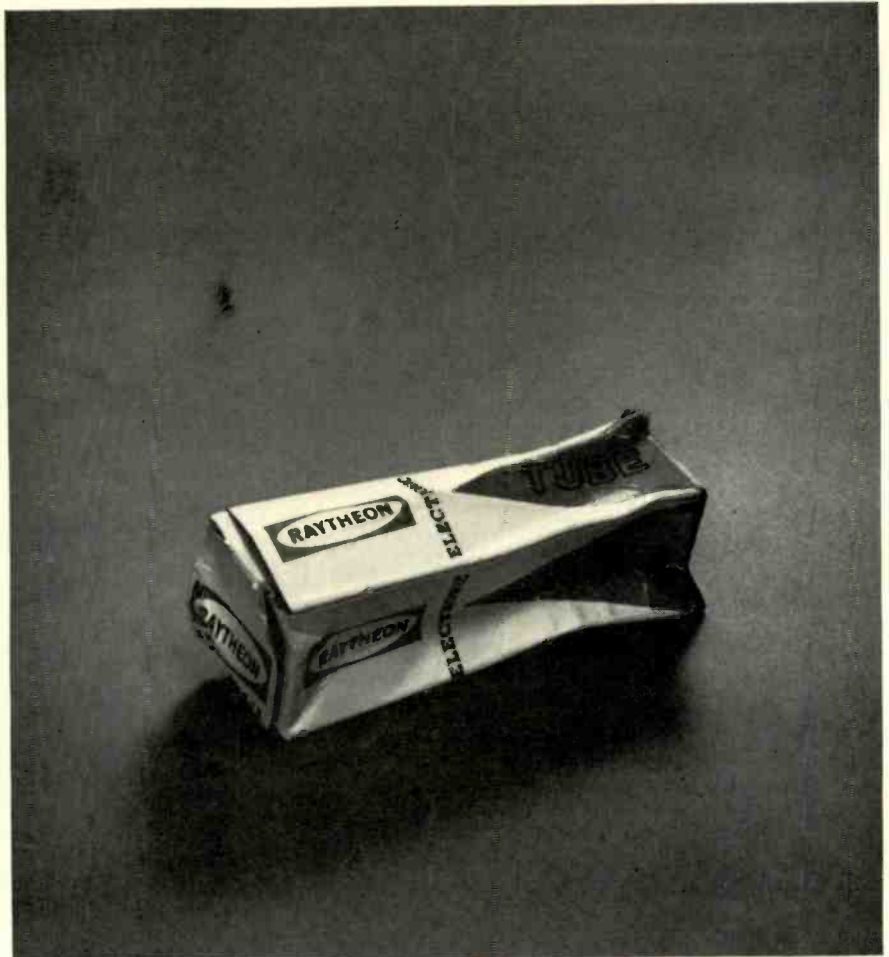

## A dud in 500 million?

Now and then, our big competitors knock us—because they'd like to have our share of your business. But they can't knock our product.

Because Raytheon receiving tubes are universally regarded as the most reliable in the industry. Ever since we produced the first vacuum tube, we've made them to just one specification: the highest quality standards.

All of our tubes have to shape up—to pass rigid electrical and mechanical performance checks.

That's why you rarely find a "dud" among the more than 500 million Raytheon receiving tubes we've made. It's also why you get fewer call-backs...earn greater customer satisfaction with your work...while

making more profit per tube. And it's the reason why Raytheon is the leading independent tube manufacturer serving the independent service dealer today.

Like to know more? Ask your distributor why he gets fewer Raytheon returns than with any other brand...and about his latest deal for you.

Raytheon Company, Receiving Tube Operation, Fourth Avenue, Burlington, Massachusetts 01803.

**RAYTHEON**

Remember to ask  
"WHAT ELSE NEEDS FIXING?"

...for more details circle 125 on postcard

**TELEPHONE INTERCOM 708**  
*Transmitting distance up to one mile*

Announced is a two-way telephone intercom system featuring automatic dialing. It is available in two models for 10 or 20 station operation. The transmitting distance is up to one mile with the parallel wiring designed for simple installations. The unit has stan-



dard telephone construction, measures 8 5/8 x 9 x 5in. The system handles private conversations, conference calls and also allows multiple call operation. Telephone is gray and is supplied with a 4-conductor PVC spiral cord. Alco.

# Stockbroker, Sr.



**B&K 707  
 Tube Analyzer**

Telling customers what or what not to invest in is part of your business. Take tube sales, for example. When it comes to tube sales today, it's not enough just to be a good salesman. Many customers have to be *shown* that tube replacement is necessary. That's where the Stockbroker comes in. It's the "Silent Partner" that actually *shows* your customer the need for new replacement tubes.

The B&K 707 professional tube analyzer is designed to make tube checking a simple, routine job. It can handle both color and black-and-white TV tubes, radio tubes, nuvistors, novars, both types of 10-pin tubes, 12-pin compactrons, European hi-fi tubes, voltage regulators, and just about every industrial tube on the market.

It combines the best of two types of tube analysis. The multiple-socket section is an accurate, dynamic

mutual conductance tube checker which makes tube analysis a fast, easy operation. It features exclusive B&K patented automatic line voltage compensation. And it's four times less time-consuming than using multiple switch-type testers.

The switch section of the 707 provides obsolescence protection on your investment. Tubes which may not be analyzed on the multiple-socket section may be analyzed with precision accuracy in this emission section (which produces current loads to simulate actual operating conditions).

**B&K Tube Analyzer  
 Model 707. Net: \$199.95**

**For more information on how the Stockbroker can encourage clients to buy your stock, write to:**

*B&K Division of Dynascan Corp.  
 1801 W. Belle Plaine  
 Chicago, Illinois 60613*

**B&K puts an end to test equipment.  
 We've developed Silent Partners.**



...for more details circle 104 on postcard

**RECEIVER SYSTEM 709**  
*A choice of 75 or 300 Ω solves antenna to tuner mismatch*

Announced is the KR-44 stereo receiver with its own duo of matched and mated speakers. The receiver is said to deliver 48w of music power at 8 Ω, accommodating phonograph, tape recorder, auxiliary and two pairs of stereo speakers plus center channel output. The FM/AM tuner section features 2 FET's, 3-gang tuning

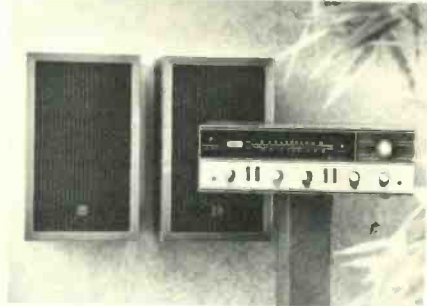

condenser and 2 IC, IF circuits. A choice of either 75 or 300Ω antenna input solves the problem of antenna-to-tuner mismatch. The 6 1/2in. woofer and 3in. cone-type tweeter produce a claimed frequency response between 50 and 20,000Hz, with an impedance of 8 Ω. The speakers are housed in oiled walnut cabinets and the receiver matches in a simulated-walnut case. The price of \$239.95 includes cabinet-ry. Kenwood.

**TELEVISION 710**  
*Sliding control levers for fingertip adjustment*

A digital clock feature with a compact 9in. B/W TV is introduced. The Model AN-409T features sliding control levers for fingertip adjustment

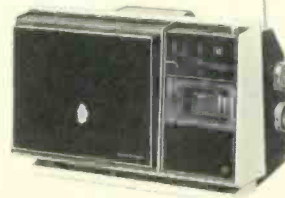

of VOLUME, CONTRAST AND BRIGHTNESS. A special sleep timer may be set to turn the TV set off automatically after 3 1/2 hours. The digital clock's white numerals are illuminated by a red neon lamp. The clock is powered by a synchronous motor. A carrying handle is molded into the grey, black and white cabinet. A detachable tinted screen cuts reflections. Other features include set and forget tuning, Speed-O-Vision for instant on/off sound and picture, and earphones for privacy. Suggested retail price is \$125. Panasonic.



# POWERFUL

One \$100 Winegard Color-Wedge equals the performance of twelve ten-element yagis!

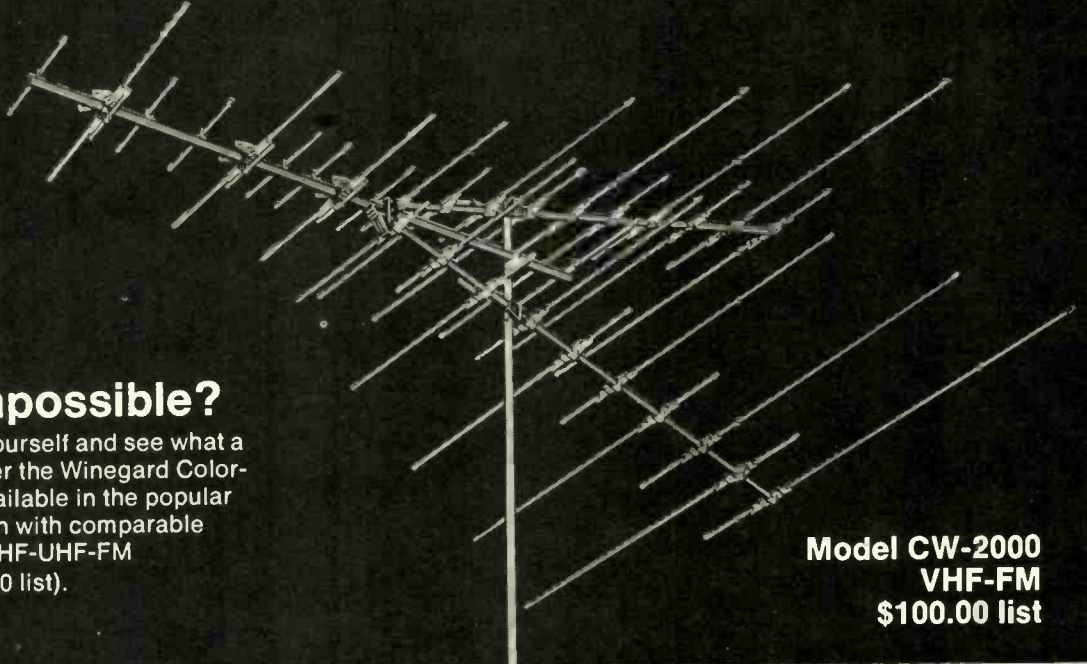

## Sound impossible?

Then try one for yourself and see what a powerful performer the Winegard Color-Wedge is. Also available in the popular 82-channel version with comparable performance on VHF-UHF-FM (CW-1000, \$100.00 list).

Model CW-2000  
VHF-FM  
\$100.00 list

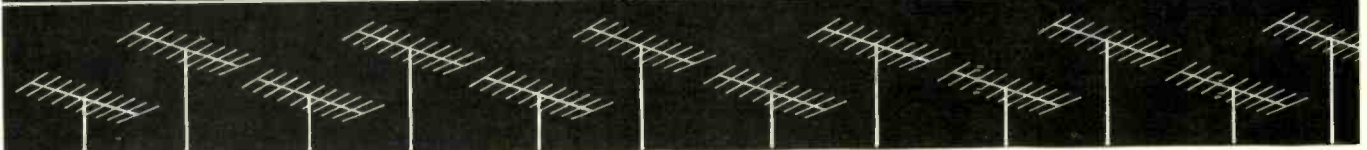

**example A:**  
CHECK DB GAIN

Channel	CW-2000	10-Elem. Yagi
2	7.2	7.8
4	7.2	7.6
6	7.4	8.0
7	12.2	10.8
10	11.4	11.0
13	12.0	11.5

**example B:**  
CHECK DIRECTIVITY

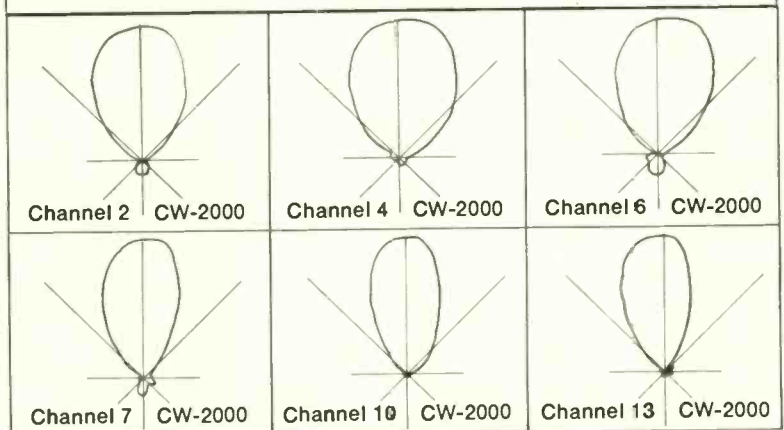

**example C:**  
CHECK FRONT-TO-BACK RATIO

CW-2000	CH. 2	CH. 4	CH. 6	CH. 7	CH. 10	CH. 13
DB	22	26	17	20	35	30



WINEGARD COMPANY • 3019-5 KIRKWOOD STREET  
BURLINGTON, IOWA 52601

SEE YOUR WINEGARD DISTRIBUTOR AND WRITE FOR FACT-FINDER #284

...for more details circle 131 on postcard



# COLORFAX

The material used in this section is selected from information supplied through the cooperation of the respective manufacturers' or their agencies.

## OLYMPIC

### Color Model CT-400 Chassis—Service Hints

Symptom: Knob "wobbling" on the tint control. Correction: Remove knob, add sleeve (bushing), manufacturer part #PP36137 and reinstall knob. It is recommended that when sleeve is installed on the tint control knob, it is also added to the color control knob, so that both have the same "feel." Symptom: High pitch sound that appears to come from the horizontal output transformer. Correction: We found this to be a frequency of  $1/2 \times 15750\text{Hz} = 7875\text{Hz}$ , which is one-half the horizontal sweep frequency. In some sets the high voltage cage door is resonant to this frequency. Dampening with a piece of tape around the door's edge and tightening screws around cage area should correct this "sing." Symptom: Critical vertical hold, accompanied by some high-voltage arcing in the picture. Correction: Make sure that the CRT's aquadag coating makes contact with grounding wire finger from the CRT harness. There should be two spring contactors. Symptom: 60Hz sync buss audible when volume is turned

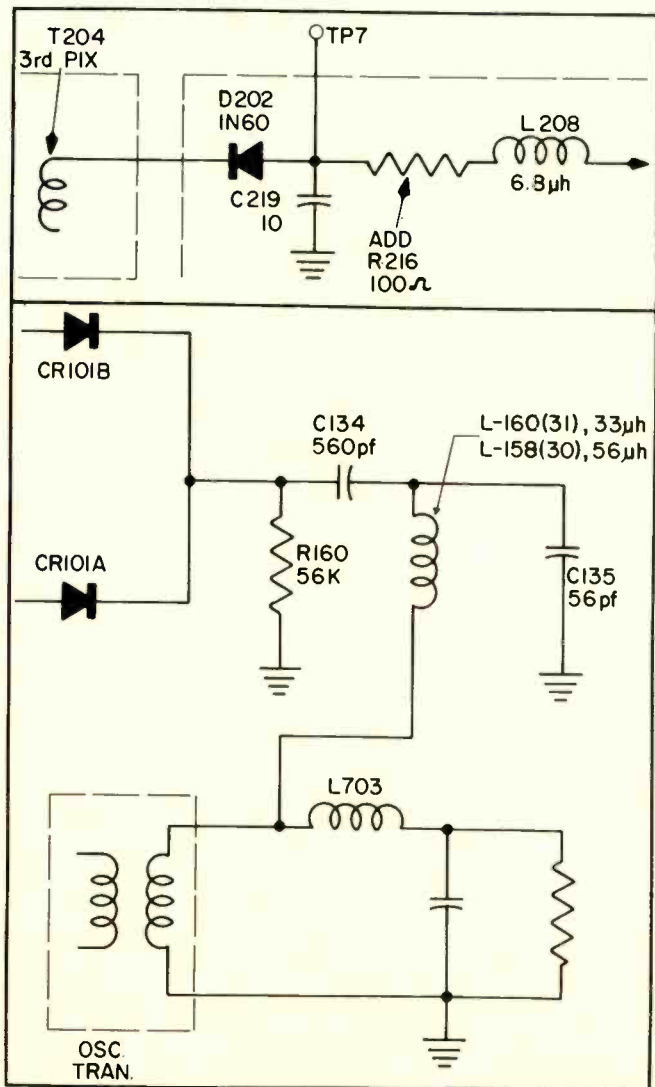

way down. Correction: Ground low side of volume control to control mounting bracket. Symptom: Beat pattern on screen when viewing Channel 3 with indoor dipole antenna. Correction: Add a  $100\ \Omega$  resistor, as shown on the diagram. This should be helpful in most areas. Symptom: Horizontal frequency drift over a period of time during the first one-half hour of operation. Correction: Replace C267, a  $.0033\ \mu\text{f}$  500v capacitor with a polystyrene type  $.0039\ \mu\text{f}$  500v; its location is between the horizontal oscillator coil and horizontal oscillator tube.

There is an error on the schematic, CTC-30/31, which was supplied with the initial group of production models. This error was not in the wiring of the chassis: (a) Components R-160 (56K) and C134 (560pf) in the ACC circuits of CTC-30 and 31 should be interchanged. (b) Takeoff to ACC on CTC-30 was shown on wrong side of phase shift coil. Proper connections are shown.

## PHILCO-FORD

### Color TV Chassis 18QT85/18MT70— Failure of Blue and Green Drive Control

The problem of an all-red or excessive red raster may be due to an open blue or green drive control (VR36).

Engineering evaluation has shown that the blue or green drive control can open if arcing appeared between the copper circuitry connecting the drive control and B+.

Late production of the subject chassis incorporates a phys-

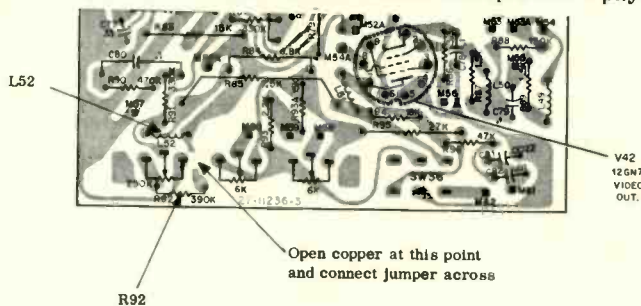

ical copper change in the area of the blue and green drive controls to prevent arcing and afford additional protection from future failure of the controls. This improvement does not affect the blue and green circuits electrically.

In those instances where a set is removed for replacement of the control or for servicing other than the control, the following change should be made to protect the control from future failure (refer to drawing).

(1) Open the copper strip connecting coil L52 and resistor R92 (390K). (2) Connect an insulated jumper between coil L52 and resistor R92 (390K).

## RCA VICTOR

### Servicing Direct-Coupled Circuitry

Technicians are being required to service more and more equipment that employ direct-coupled transistor stages. This type of coupling is simple and transistors readily adapt to it. Many service technicians first encountered direct-coupled stages in portable radio audio output circuitry. Next came complete direct-coupled amplifiers for stereo instruments. Now, with the advent of transistorized television, even more direct-coupled circuits are being used.

In the direct-coupled circuit shown, resistor R3 served as both the collector load resistor for transistor Q1 and the bias resistor for transistor Q2. Resistor RL is the output load of the amplifier. If another stage were added, RL would serve the same function as R3—collector load for



**There are some parts of the U.S.A.  
where you can't ship by  
Greyhound Package Express**

**(...but not many!)**

GPX does go to 25,000 cities, towns and villages in the U.S.A. every day.

Can we drop something off for you?

It's there in hours and costs you less, when you ship by Greyhound Package Express.



For Example	Buses		Running Time	10 lbs.	30 lbs.	50 lbs.
	Daily					
BOSTON— New York	30		4 hrs. 15 min.	\$2.30	\$2.90	\$3.60
LOS ANGELES— OAKLAND	9		8 hrs. 50 min.	1.90	2.55	3.30
DALLAS— SAN ANTONIO	12		5 hrs. 30 min.	1.90	2.40	3.00

Other low rates up to 100 pounds. Lot shipments, too. For complete information call Greyhound, or write Greyhound Package Express, Dept. 53-H, 10 South Riverside Plaza, Chicago, Illinois 60606.



...for more details circle 112 on postcard

Q2 and bias supply for the added stage. Resistors R1 and R2 enhance circuit stability by providing a feedback path. Stability is of prime consideration in direct-coupled stages since temperature-caused bias variations in one stage will be amplified by all following stages resulting in temperature instability. This is often a limiting factor to the number of stages that can be direct-coupled.

Servicing direct-coupled stages requires a technique that is somewhat different from those used to troubleshoot R-C

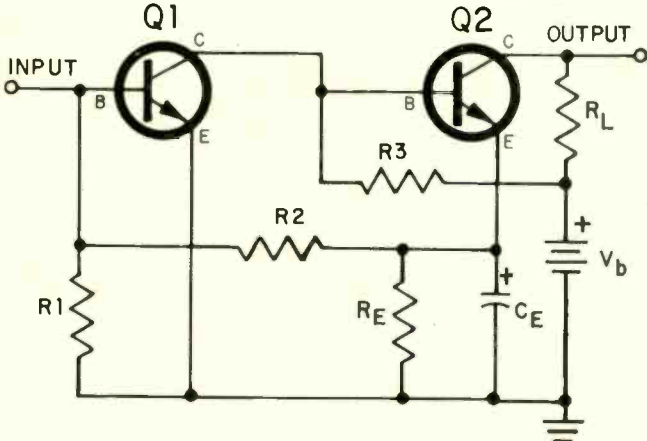

or transformer-coupled stages. A different approach is needed since each stage is dependent on the preceding stage for bias. If several stages are direct-coupled, a defect causing incorrect operation of one will affect the bias of the next, and therefore all succeeding stages. Normal signal injection/tracing techniques cannot completely isolate the trouble in

this type of circuit.

The actual troubleshooting technique involves checking individual transistor element bias potentials. Start at the output stage of the circuit and check back through each stage to the input of the circuitry involved. Each reading is noted (write it down if necessary), then compared to both the expected normal reading and to the readings taken at

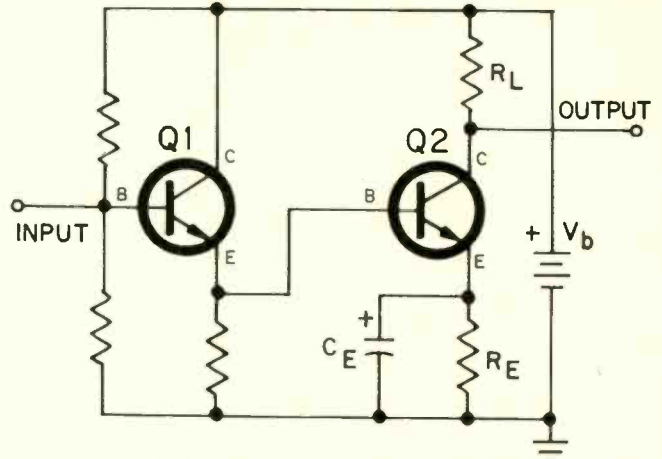

other points in the circuit. The starting point for troubleshooting circuitry would be to measure the voltage drop across RL to determine the operating condition of Q2. Little drop (or no drop) would indicate non-conduction, while heavy conduction would cause a large drop. In either case, it is necessary to measure the bias potentials on Q1 to determine whether the trouble is actually in the circuitry of Q2, or caused by incorrect bias supplied to Q2 (as a result of Q1 circuit defects). As an example: if tests indicate Q2 is conducting heavily, the cause could be Q2 emitter-to-collector leakage; however, the symptom would be similar if a defective Q1 did supply excessive bias to

# Zenith "Royal Crest" Tubes... with unrivaled dependability

Zenith "Royal Crest" replacement circuit tubes are engineered to the same exacting standards as original Zenith circuit tubes in new sets. With the same unrivaled dependability and "new set" performance.

Zenith "Royal Crest" circuit tubes are life-tested under actual operating conditions for more than 1,500,000 hours every month!

The "Royal Crest" line is broad and comprehensive. Over 900 different types, all built to Zenith rigid quality standards.

Insist on Zenith quality. Choose Zenith's "Royal Crest" circuit tubes and assure customer satisfaction.

**EXCITING SURPRISES FOR YOU—and your family!**  
Get the details at your Zenith Distributor's Parts Department.

Why not sell the best



The quality goes in  
before the name goes on



the base of Q2. The defect can be isolated to a particular stage by checking bias potentials of all transistors in the circuit (starting at the output), and comparing these readings to the normal expected potentials and to each other. Other methods of direct coupling may be encountered as shown in illustration. The servicing technique described in this article is also applicable to this and most other direct-coupled circuits.

Don't overlook the possibility of a defect in one stage supplying excessive bias to one or more succeeding stages, thereby causing other devices to fail. Some circuit designs have built-in current limiting to prevent subsequent device failure; in other designs, multiple device failure is quite possible. Remember, however, a logical analysis of all the dc bias potentials in a circuit will greatly simplify the troubleshooting procedure—regardless of the circuit configuration.

## SYLVANIA

Color TV Chassis D12/D13—Local Oscillator Stabilization on 54-23857-3 Tuner

To stabilize local shift with line voltage, a 27v B+ oscillator frequency source is connected from positive side of C522 to pin 4 of SK500. From pin 4 to PL500 the 27v B+ is

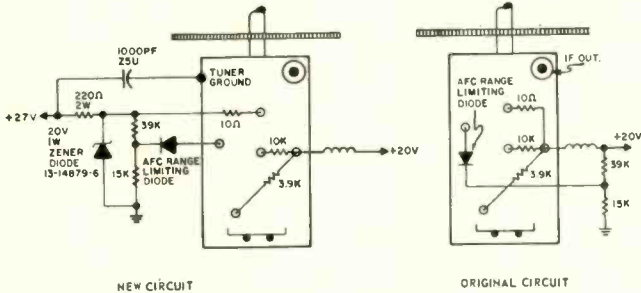

wired to the tuner through the circuit shown.

To correct for local oscillation radiation problems, a 1000pf-Z5U capacitor has been added from the + 27v side of a 220 Ω 2w resistor to tuner ground.

## WESTINGHOUSE

Color TV Chassis V8001—CRT Circuit

A feature of this new CRT is the blue gun down operation. This simply means that the CRT is mounted in the cabinet with the blue gun downward (toward the chassis). Similarly, the convergence yoke assembly must be

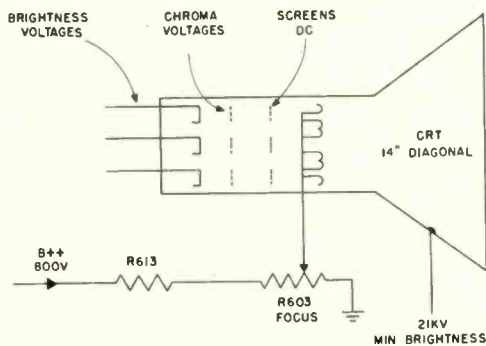

mounted on the neck of the CRT with the blue yoke assembly down over the blue gun of the CRT as shown.

This new 14in. CRT uses a 6.3v, 900ma heater which is supplied from a separate filament transformer.

If the focus control is adjusted from one extreme to an

*continued on page 71*

# Speedy solutions to servicing problems from LECTROTECH



ONE YEAR WARRANTY

## TT-250 Transistor Analyzer

GOOD/BAD TRANSISTOR TESTING IN OR OUT OF CIRCUIT

Now—positive Good/Bad in-circuit and out-of-circuit testing. Also tests diodes and rectifiers. In-circuit testing measures dynamic AC gain. No transistor leads to unsolder or disconnect. Out-of-circuit testing measures transistor Beta on 2 scales: 0 to 250 and 0 to 500. Automatic biasing . . . no calibration required. PNP or NPN determined immediately. The TT-250 measures transistor leakage ( $I_{cbo}$ ) directly in micro-amperes and, for diodes and rectifiers measures reverse leakage and forward conduction directly to determine front-to-back ratio. Simple Good/Bad test instantly determines condition of power transistors. Panel has Power Transistor Socket. Measures leakage current of transistor electrolytics at test voltage of 6 volts. Size 10½" x 7" x 4". Wt. 5½ lbs. NET \$87<sup>50</sup>

For Color and Black & White



ONE YEAR WARRANTY

## CRT-100 Picture Tube Analyzer

Features line voltage adjustment to insure all tube voltages are correct regardless of line voltage. Critical Grid-to-Cathode Leakage is read on sensitive meter for greatest accuracy. Leakage in all other elements indicated on neon lamp. Tests all black and white and all color tubes for leakage, shorts and emissions and tests each color gun separately to a standard set of test conditions. With variable G-2 voltage, each grid is normalized to a reference cut-off voltage. This method, used by tube manufacturers, simulates tube performance in color receiver. Rejuvenates, removes shorts from picture tubes for increased brightness and tube life. Life expectancy test predicts remaining useful life of all type picture tubes. Complete with Plug-in Type Test Cables and Set-up Chart. NET \$89<sup>50</sup>



See your distributor or write DEPT. ET-8  
**LECTROTECH, INC.**

4529 N. Kedzie Ave., Chicago, Illinois 60625

...for more details circle 117 on postcard

ET/D

## NEW PRODUCTS

For additional information on products described in this section, circle the numbers on Reader Service Card. Requests will be handled promptly.

### SWEEP/MARKER GENERATOR

*Four separate instruments 711  
combined into one unit*

A Model 415 sweep/marker generator, a new approach to TV alignment problems, is introduced. Built-in features reportedly simplify the oper-



ation and make the alignment with utmost speed and accuracy. The generator is all solid-state with dual gate-MOS FETS. It combines the functions of four separate instruments in one and reportedly provides everything needed for alignment except a scope and a VTVM. Sweep frequencies, marker frequencies, bias supplies and the connectors are included. Visual reproduction of alignment curves and marker indicators on the front panel provide constant reference for scope waveforms. You can select any or all markers with crystal-controlled accuracy. They can all be used simultaneously--post injection insures no curve distortion. Marker lights show which marker or markers you are using and where they should appear on the curve. If the markers fall on a slope, they can be tilted for easy identification. The unit provides crystal-controlled RF channels 4 and 10. Three bias supplies provide self-contained bias for tuner, IF and chroma sections. The bias sup-

ply can be employed on transistor and tube sets with safety. Electronic sweep provides maximum linearity and reliability. Output can be compensated for use with scopes that may have linearity deficiencies at low frequencies. A 15kHz filter eliminates the need to disable high voltage during alignment. Unity gain eliminates intermediate connecting steps for calibration purposes. Polarity reverse and sweep direction reverse allow matching to any scope or television receiver. Electronic circuit eliminates need to disable horizontal sweep which could cause waveform change by variance of load on B+ section. Provides 10.7MHz sweep for FM, 4.5MHz for TV audio. Available outputs: Sweep chroma and band-pass, and TV-IF and FM-IF. Output impedance 72Ω; 300Ω for RF output to antenna; 10 IF markers, standard crystal controlled. The instrument also includes 100KHz markers to align new automatic fine tuning discriminators. Additional marker oscillator (optional) will accept crystal in the 35 to 50MHz range. Instruction manual is furnished, which takes you step-by-step through the alignment process. Net price is \$349.95. B&K.

### GLASS AND PLASTIC CLEANER

*Polishing agent and an 712  
antistatic formula*

An improved version of the Mask-N-Glas cleaner is introduced. The formula has more cleaning power, a pol-



ishing agent and an antistatic action. It is made specifically for TV technicians to clean picture tubes and masks. The cleaner reportedly can be used for all plastics, including recorder and phone cases. It is packaged in a convenient 8oz. aerosol can, and the cap contains a lint-free, soft cleaning cloth. The cleaner is available through distributors in 8oz. cans for \$1.79. Chemtronics.

### TRANSISTOR CHECKER 713

*Special section performs  
function of signal tracer*

Introduced is a multifunction instrument used for both in-circuit and out-of-circuit transistor testing. Beta and Icco of transistors as well as diode



quality may be determined. A special section of the instrument performs the function of a signal tracer for both AF and RF applications. This section is made up of an oscillator, signal injector, RF/AF detector probe and a high gain transistorized audio amplifier with a small loudspeaker for

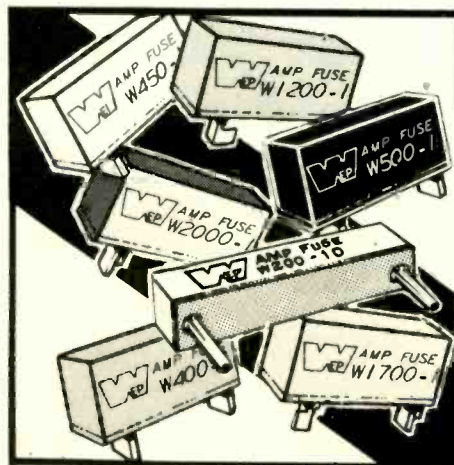

## AMP FUSES

Reliable protective fusing device. COLOR CODED for easy replacement of original manufacturer's parts.

Listed in Howard Sams' Photographs and Counterfacts.

FREE vest pocket cross reference booklet indicating correct Workman part numbers to manufacturer's part numbers.

Ask for #X58

**WORKMAN** *Electronic* PRODUCTS, INC.  
BOX 3878 SARASOTA, FLA. 33578  
TELEPHONE: Area Code 813 955-4242

...for more details circle 132 on postcard

audible indication. The instrument is useful for general troubleshooting and electronic servicing in the laboratory as well as in the field. Convenient dc voltage and current ranges add to the utility of the device. The unit is battery powered. Specifications: Ranges-transistor Beta 0-100 and 0-200 + or - 10% fsd; Icco 0-1ma, + or - 10% fsd. Voltage 0-20v dc 1kv. Current 0-50ma dc. Signal tracer-output 100mw; gain-90db. Tracer probe-Impedance: AF 100K; RF 50K. Signal injector-1kHz and harmonics. Accessories-seven test leads furnished. Priced at \$69. Leader.

**75Ω SPLITTER MIXER 714**  
*Designed for high inter-set isolation and low insertion loss*

Introduced are the M-22 and M-24 splitter/mixer for color/B&W TV/FM-stereo reception in large or small dis-



tribution systems. The units are easily installed with solderless crimp-on ferrules. The M-22 two-set splitter divides on 75Ω VHF/FM line into two 75Ω outputs. It is claimed to have a low insertion loss with high 12db isolation and an SWR of 1.2. Three crimp-on ferrules to provide connections are supplied with the unit. The M-24 four-set splitter divides one 75Ω VHF/FM line into four 75Ω outputs. Low insertion loss with high 18db isolation and an SWR of 1.5 is claimed. Five solderless crimp-on ferrules are supplied. Both models may be combined to provide any number of lines for larger amplified systems. Mosley.

**LOW VOLTAGE SUPPLY 715**  
*Equipped with a remote sensing feature*

Announced is the addition of a 1-30v, regulated, current-limiting solid-

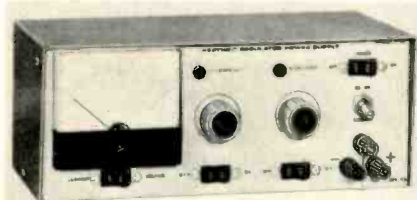

state power supply Model IP-28 to the firm's test equipment line. The power supply has a number of features

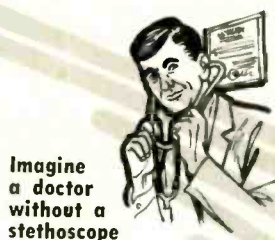

Imagine a doctor without a stethoscope



Imagine an engineer without a slide rule

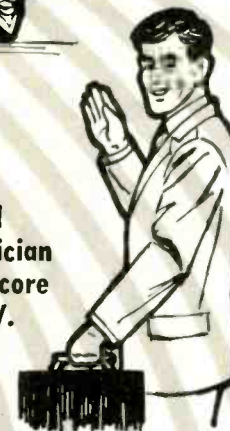

Imagine a professional service technician without a Sencore Mighty Mite V.



# STANDARD OF A PROFESSIONAL!

The Mighty Mite has become the standard of the industry with over 50,000 used daily by competent professional servicemen from coast to coast. The Mighty Mite checks them all; tubes large and small . . . and it checks them critically too. 100 megohm grid leakage sensitivity, individual tube element shorts test and cathode emission test at full rated current make the Mighty Mite really tough. It's tough on tube tests, tough in appearance with vinyl case and cover, and mighty tough on competition. But, it's not tough on your pocketbook at only

See your Sencore distributor today.  
 He has the TC142 Mighty Mite in stock. **\$84.50**



**SENCORE**  
 NO. 1 MANUFACTURER OF ELECTRONIC MAINTENANCE EQUIPMENT  
 426 SOUTH WESTGATE DRIVE, ADDISON, ILLINOIS 60101

...for more details circle 127 on postcard

# now...a better way to drive and adjust hex socket screws

## ...IN PRECISION WORK

With the tools in this new, compact convertible screwdriver set, you can turn all types of hex socket screws ... in all types of locations ... faster, easier than with conventional keys.

Handy midgets are ideal for such delicate, precision work as assembly and servicing of instruments and controls. Remarkable "piggyback" torque amplifier handle adds grip, reach, and power needed for other applications, lets you do more jobs with fewer tools.



### PS-89 SET

8 midgets (hex size .028" thru 1/8") plus hollow, "piggyback" handle. Slim, trim, see-thru plastic case fits pocket or tool box, doubles as bench stand.



### REQUEST COMPLETE HAND TOOL CATALOG

which includes information on other Xcelite Compact Sets, too — slot tip/ Phillips/Scrulox® screwdrivers, nutdrivers, and combinations.

# XCELITE®

Nationwide availability through local distributor

XCELITE, INC., 14 Bank St., Orchard Park, N. Y. 14127  
In Canada contact Charles W. Pointon, Ltd.

...for more details circle 133 on postcard

## ET/D NEW PRODUCTS

that would make it attractive to servicemen, experimenters or anyone who works with solid-state circuitry. It will deliver up to 30vdc at 1a maximum load with less than 50mv variation without using the sensing terminals. For critical circuits where the voltage drop across the supply leads is an important consideration, the power supply is equipped with a remote sensing feature that reduces the voltage variation at the load to less than 20mv. A front panel rocker switch selects either 1-10vdc or 1-30vdc range and the output is continuously variable. Variable current limiting in two switch-selected ranges from 10-100ma or 10ma-1a is also included to protect the load. A 3 1/2in. meter can be switched to read either voltage or current, and two pilot lamps indicate which function is being monitored. For extra convenience, a dc ON/STANDBY switch on the front removes voltage from the load for making circuit changes without having to disconnect leads. For special applications, external ac and dc programming terminals are provided on the rear panel. The power supply is styled in beige and brown. Priced at \$47.50 in kit form. Heath.

## 716 AC CURRENT LEAKAGE TESTER

*All ranges protected if accidentally subjected to line voltage*

Introduced is Model 229 current leakage tester designed for testing 120vac appliances and electrical equip-

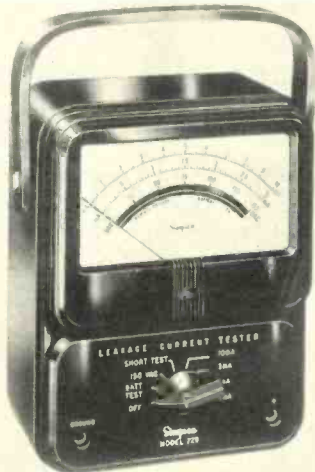

ment. Performance approximates the normal perception curve to within  $\pm 1.0$ db and will measure the leakage currents as small as 5 $\mu$ a. Operation is simple and all ranges are protected from damage if accidentally

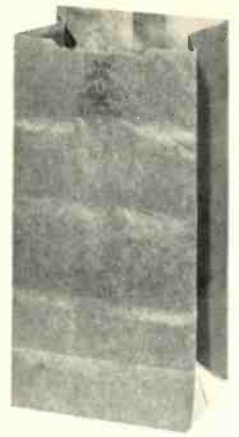

# THEIR BULK PACK



# OURS!

 Pick up this handful of best-selling needles from your Electro-Voice distributor, and you get a handsome display carton free.

And if you want more, ask about our permanent phono needle/cartridge merchandiser, wall banners, literature, and the best cross-reference catalog in the industry.

We don't just make the most complete line of needles and cartridges, we also help you sell ... help you profit. Insist on Electro-Voice. From the parts distributor with more than parts to offer!

ELECTRO-VOICE, INC., Dept. 897T  
663 Cecil Street, Buchanan, Michigan 49107

# Electro-Voice®

A SUBSIDIARY OF GULTON INDUSTRIES, INC.



subjected to line voltage. Ranges include ac current: 0-0.3; 1; 3; 10ma and ac voltage from 0 to 150v. Simpson.

## FREQUENCY CALIBRATOR 717

*Generates frequencies from 100kHz to 500kHz*

Introduced is an instrument for radio frequency calibration. The solid-state S1315A frequency calibrator generates a spectrum of frequencies

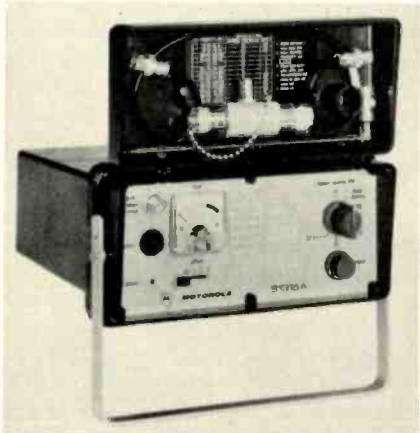

from 100kHz to 500MHz selected by the position of the channel switch. This spectrum of frequencies includes all assigned frequencies within the band selected by the channel switch. The transmitter frequency beats against the frequencies generated by the instrument and produces a zero beat with the correct frequency when properly adjusted. Since no tuning is required, the unit is said to be fast and foolproof. Featuring fast warmup, the unit is claimed to be accurate to 0.00001% in 3min. Stability and accuracy are assured with a daily drift rate of better than 0.000002%. Weighing 7 lb, the unit is a compact portable unit. Battery or optional ac line operation makes the unit versatile and ideal for field use. Battery-operated units are powered by nine standard "D" cells. The spectrum of frequencies generated for calibration purposes cover mobile and aircraft bands. Raw crystals and other fundamental frequency devices can also be checked with this unit. Motorola.

## AUDIO/COLOR ORGANS 718

*Changes brightness and color with mood and intensity of music*

Announced is a family of kit and factory-wired equipment that adds a new dimension to music. The family consists of a color organ that changes brightness and color with the mood and intensity of music, an electronic strobe that flashes in time with music,

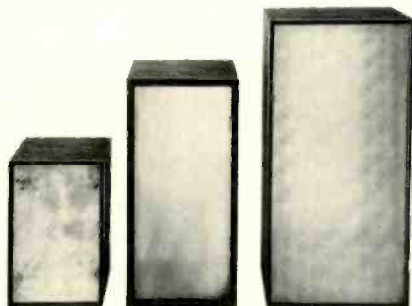

a light display box that is controlled by thermal relays and an audio/visual translator that allows you to build your own special lighting effects. The unit employs special low-voltage, high-intensity lights to achieve effects. The light boxes come in three and four channel models. Each channel responds to a different portion of the audio spectrum. Colored lamps in each channel change in brightness with the variations in the sound intensity within its frequency range. Every combination of musical instruments produces its own distinct multicolored pattern. The color organs can be connected to any 3.2 to 50Ω audio line without affecting the operation of the music system. Eico.

## TAPE ERASER 719

*Can be hand-held or used as table model*

Introduced is a new dual-purpose tape eraser that is compact and can be easily held by hand or used as a table model. The eraser also can be



used for cassette recorders. As a table model, the unit is claimed the only type available with a reel post. The tape reel is placed on the post and rotated. Hand-held, the eraser is passed over the tape reel in a circular motion. The Model No. 30-140 carries a suggested list price of \$18.30. GC Electronics.

For more information on these  
NEW PRODUCTS  
See page 75  
READERS SERVICE



## dream factory!

### "Invent" a whole new sound system . . . fast 'n easy . . . with new BELL P/A MODULAR AMPS

Bell P/A's "stacking" principle gives you *unusual design flexibility*. Place up to 8 input modules in different positions . . . get thousands of possible input configurations.

FET's are located up front for true Hi Z input (or bal. lo Z with trans.). *Units have 20, 45, 90 or 200-watt output (RMS ratings)!* All silicon solid state design.

Exclusive, fully automatic output circuit protection (with signal light) saves time, labor, components . . . eliminates guesswork. *See your local electronics distributor, or send for full specs.*

**BELL** pia  
professional appeal

BELL P/A PRODUCTS CORPORATION  
1209 North Fifth St., Columbus, Ohio 43201

...for more details circle 105 on postcard

### Tomorrow's Color TV Set Today

The color television set of tomorrow is here today. RCA's new "Two Thousand" model, which the company plans to produce this year in a limited quantity of 2000 units at a suggested retail price of \$2000 was shown for the first time in New York during the Consumer Electronics Show at the Americana.

With the "Two Thousand" model,

RCA ushered in a new era in color TV design, according to B. S. Durant, division vice president and general manager, RCA Consumer Electronics Div.

The new set, he told RCA distributors, incorporates a computer-like tuner that permits instantaneous and silent channel selection; an all solid-state chassis that makes possible instant on-and-off capability, and a recently announced 23 in. (diagonal) color picture tube capable of producing a picture more than twice as bright as previous big screen sets.

"The 'Two Thousand' not only is a great stride forward technically, but

the styling is spectacular," Durant said. "A truly striking appearance is achieved by the set's white end pieces, sculptured base, rosewood top and black translucent doors which slide into the cabinet."

Heart of the electronic system--which has no moving parts--is a diode-switched tuner controlled with digital logic circuits similar to those used in today's computer. Desired VHF channel selection is easily programmed into the electronic system by the viewer merely by adjusting buttons behind the control panel door, making any station instantly available by the push of a button on the hand-held remote unit. Previously, remote controlled systems stopped briefly at each possible station.

By taking advantage of the inherent speed of computer type electronic circuitry--which eliminates the motors and other moving mechanical parts in previous systems--the new RCA tuner can change pictures virtually as fast as the human eye can shift from one scene to another, Durant said.

The hand-held remote unit also permits the viewer to electronically control the color level, tint and volume, he added. This is done by memory modules receiving commands from the remote system.

VHF channel switching involves an electronic counter. The system uses four integrated circuits--a counter, a control "gate" and two decoder "drivers." All these are quite similar to devices employed in modern computers. The new design has eliminated four of the five motors used in conventional remote control on color receivers.

### Johnson Sales for May Hit Near Record Level

Order input at its Waseca plant for the month of May was the second highest in history for the E. F. Johnson Co., Minnesota-based manufacturers of two-way radio equipment and electronic components, Trav Marshall, vice president of marketing, announced.

May business totaled \$1,698,705, an increase of 48 percent over the same month a year ago. Year to date orders were \$7,458,250, up 36 percent from last year. Shipments for the year showed an increase of 31 percent through the end of May, reflecting the best first five months in the company's history. Sales for June are expected to continue

Comments from our readers are always welcome.

Address your letter to:  
The Editors  
Electronic Technician  
Harbrace Building  
Duluth, Minn. 55802

## FIX IT FAST WITH MICROFLAME



Perfect Gift. Ideal for workshop or lab. Perfect for electrical, electronic repair and wiring. The do-it-yourselfer's dream!



A must for every home workshop. Microflame is designed to handle most light-weight welding jobs. It's a proven, professional miniature welding torch. Completely self-contained, this patented torch produces 5000° F pin-point accurate flame. Operates on miniature oxygen and LP Gas cylinders. No wires or connections needed. Make your workshop complete! Microflame is the ideal gift for birthdays, Xmas, every special occasion. Only \$19.95 (with oxygen and LP Gas) Deluxe Kit \$29.95 (with oxygen, LP Gas and accessories).

● FREE BROCHURE



### MICROFLAME, INC.

7800 Computer Avenue, Dept. ETD  
Minneapolis, Minnesota 55424  
Area 612 927-5681

...for more details circle 120 on postcard

at near record levels, according to Marshall.

The Johnson Co. operates subsidiaries at Coral Gables, Fla., and Houston, Tex. It also showed healthy increases over the last year.

### Color TV Sales for April Up 21.4 Percent

Distributor sales of color television sets to dealers were up 21.4 percent during April 1969, as compared with sales during the same month the year before, the Electronic Industries Assn.'s Marketing Services Dept. reported.

In April, 321,702 sets were sold to dealers, compared with 264,929 the same month last year, EIA reported. Color TV sales to dealers were 1,849,919 sets for the year to date, 14.3 percent ahead of the 1,618,454 sets sold in the same period in 1968.

Monochrome TV sales in April, at 336,757 sets, were almost identical to the 336,799 number sold in the same month last year. Total TV sales to dealers in April rose 9.4 percent from April 1968 and year-to-date sales remained 5.6 percent ahead of the same period in 1968.

FM/AM or FM radio sales for April were 259,407 units, up 36.5 percent over the 189,982 units sold in April 1968, and 7.2 percent ahead of the 1968 sales for the four-month reporting period. AM radio sales for April were down 11.2 percent from the same month last year.

In other major consumer electronic categories, automobile radio sales declined 2.8 percent on a year-to-date comparison. Phonograph sales increased in both portable and table and console categories, and registered a 3.4 percent increase over-all, in April 1969 over April 1968, according to EIA Marketing Services Dept.

### NAB Releases 1968 Figures On TV Station Revenues

The National Assn. of Broadcasters reported today that its annual survey shows that the profit margin of the median television station increased 1.72 percent last year on a 7.8 percent increase in revenues.

The report, based on revenue and expense figures submitted by stations in the nationwide survey, shows that the median station made a \$288,400 profit before taxes last year, or a 19.86 percent return of its revenue. This compares with \$244,300 or 18.14 percent pre-tax profit in 1967.

Other highlights of the report:

The median station had total revenues of \$1,452,000 last year, compared with \$1,346,000 in the previous year, an increase of 7.8 percent.

Its expenses last year amounted to \$1,163,600 compared with \$1,102,300 in 1966.

Responding stations expect a further increase in revenues next year averaging 7.2 percent.

The median station's time sales totaled \$1,577,700, compared with \$1,456,200 in 1968, and included \$358,100 from networks, \$645,300 national and regional, and \$574,300 from local advertisers.

Administrative and general expenses of the median station amounted to \$425,900, followed closely by program costs of \$418,900. These compared, respectively, with \$382,500 and \$404,500 in 1967.

Data from the reports was compiled by NAB's Dept. of Broadcast Management.

#### MOVING?

Be sure to let us know  
your new address

# Weller® simplifies soldering



### New TEMPMATIC® Temperature Controlled Soldering Tool

Combines all the advantages of a pencil iron, a fast heating soldering gun, and tip temperature control. Exclusive removable Powerhead contains Weller's temperature control system. Protects components even in the most delicate work situations. Tool weighs 7 oz. Use it for light or heavy duty soldering. Model GT-7A has 700°F.  $\frac{3}{16}$ " chisel point Powerhead. Model GT-6B has 600°F.  $\frac{1}{8}$ " conical point Powerhead.



### The original Dual Heat Guns

Fast heating. Long-life tips. Exclusive trigger-controlled dual heat. High soldering efficiency. Spotlight. 3 models from 100/140 watts to 240/325 watts.



### Dependable MARKSMAN Irons

They outperform other irons of their size and weight. Long-reach stainless steel barrels. Replaceable tips. 5 models from 25 watts to 175 watts.



### Weller 25-watt Iron for intricate work

Industrial rated. Weighs  $1\frac{3}{4}$  oz. Delivers tip temperatures to 860°F. Cool, impact-resistant handle. Model W-PS with  $\frac{1}{16}$ " tip.

# Weller®

WELLER ELECTRIC CORP., Easton, Pa.  
WORLD LEADER IN SOLDERING TOOLS

...for more details circle 130 on postcard

### Larger Selection of TV Programs To Be Offered

The selection of television programs offered in the near future may change dramatically. Viewers may be able to switch between a cricket match in London, a bull fight in Barcelona, a road race in Monte Carlo, an opera in Rome—all actually happening at that time.

It will be made possible with new television broadcast equipment available from Andersen Laboratories of Bloomfield, Conn. The equipment is being produced in a program named "Argonaut," alluding to adventure associated with foreign viewing. The equipment will allow U.S. broadcasters to receive European programs by satellite and to rebroadcast them instantly. This is not possible at the present time because the European TV systems are different from the U.S. system. An American set picture is composed of bright lines running from left to right. There are 525 raster lines on any American screen, while there are 625 in most European systems. U.S. sets can only receive the 525 line signals which are broadcast in the United States.

"Argonaut" equipment being produced by Andersen and installed in network facilities will convert the 625 line video into 525 line video and immediately rebroadcast it for U.S. viewing.

There are three methods by which foreign programs can be shown in the United States. Networks can send crews and equipment to Europe to televise and send the signal back by satellite, but this is prohibitively expensive for all but the most major events such as the Olympics. The second method requires the use of camera type equipment to view the 625 line screen of a TV receiver tuned to a foreign program and rebroadcast it in 525 lines "as is." The quality of the picture is greatly diminished, however. The third method is to film the program and send it to the United States for processing and broadcast. This imposes a delay.

With Argonaut, U.S. broadcasters will be able to stay home and select any program broadcast in Europe and beamed to a satellite circling the Earth. They will receive the signal which has traveled from Europe to the satellite and downward to the United States.

### Expansion Program Announced by Essex

A major expansion program involving the construction of two new California warehouses by Essex International, Inc., Fort Wayne, Ind., is announced by William T. Hopkins, vice president and general manager of the firm's controls division.

Construction began April 1 on the two buildings, one of which is in Los Angeles and the other in San Francisco.

Hopkins indicated the new Essex structures will have an in-depth stock of the complete line of Stancor products, including transformers, chokes and yokes. The products are used as replacement or original equipment components for radios, televisions and other communication equipment.

The Essex divisions which will be utilizing the Los Angeles warehouse are the controls division (Stancor products), the IWI Div. (including IWI/Steveco products), industrial wire products division and the firm's automotive parts group. This warehouse will service southern California.

The San Francisco warehouse, servicing central California, will be used by the controls division (Stancor

products), the IWI Div. and the automotive parts group. Both buildings are scheduled for completion in early August.

Representing an expenditure of approximately \$250,000 for building costs alone, the Los Angeles warehouse building program calls for the erection of a single-story structure containing 40,000sq ft of warehousing space. According to Hopkins, the entire tract of land has an area of 80,000sq ft, providing Essex with ample parking facilities and eventual warehouse expansion capabilities.

Construction costs of the 36,360sq ft on-floor building in San Francisco will be approximately \$300,000. The warehouse will have three semi-truck loading docks as well as a railroad siding with automated loading and unloading facilities.

### Matsushita Electric Develops New Method for Tape Duplication

Engineers at Matsushita Electric Industrial Co. Ltd. of Japan announced a breakthrough in the time required to duplicate computer and B/W and color video tapes. It is claimed to be possible to duplicate a one-hour video tape in only two minutes. Previously, it took one full hour to accomplish the same purpose. The MEI process, which is reportedly some 30 times faster than conventional methods, is achieved with an almost negligible loss in detail. This is the first successful application of the contact printing method being applied to video tape duplication.

In the past, contact printing was considered to be extremely difficult because of frequent slippage between the master and the slave tape. Imperfect contact often occurred between the master and the slave tape because of trapped air. Both of these problems consistently caused the duplicated picture to be out of focus.

In the Matsushita system, the master and slave tapes are wound tightly onto one reel in alternating layers at an extremely high speed. Because a special pressure roller is used, air cannot be trapped between the tapes. After the tapes are fully wound, a magnetic field is applied to the wound reel. There is reportedly no possibility of slippage. To complete the process, the tapes are rapidly rewound back onto their respective original reels. According to the engineers, conventional video tape can be used for the slave tapes. The master tape, however, has a mirror-image recorded pattern and should, therefore, be recorded on a special video tape recorder.

### 3M Offers New Video Tape

A new 2in. magnetic video recording tape designed to eliminate the problems of windowing and cinching, scratching, capstan slippage and dust-generated dropouts has been announced by 3M Co. of St. Paul, Minn. To be known as "Scotch" brand 400, the product reportedly employs a revolutionary approach to the manufacture of quadruplex video tape for the professional market. The tape is virtually scratch resistant and claimed to essentially eliminate the problem of redeposit on the tape surface that causes dropouts.

According to the announcement, "It is now possible to ship 7200 foot lengths with normal machine wind tensions without fear of windows, creases or cinching. This means it is possible for a syndicator to place an entire 90-minute program on a single roll and eliminate the tape waste and added expense of shipping the program on two 60-minute reels."

**Miniature Lamps 400**

A four-page catalog lists a line of miniature lamps and panel assemblies. Neon T-1 3/8in. subminiature lamps with a choice of short bare leads or 10in. insulated leads are described for individual lamp use or as part of a panel assembly. Other neon lamp assemblies include the BN Series with three types of lenses, compact, long or square. Miniature incandescent T-1 lamps are available in a variety of styles including round domed lamp assemblies and cylindrical shapes. The BFK-1 replaceable lamp assemblies feature a simple lamp replacement advantage for easy removal. A detailed listing of 110v neon light indicators using NE2H high intensity lamps are included with a choice of eight lens styles. Alco.

**Antennas 401**

Five antenna catalogs are now available. Each describes the line of A/S antennas designed for use by a particular market. These compact catalogs reportedly make it easier for distributors and users to select the proper antenna for every communications application. The markets covered are: amateur ("ham"); aviation; citizens two-way radio; marine and monitor applications. Antenna Specialists.

**Integrated Circuits 402**

An 86-page illustrated catalog describing integrated circuits is available. Typical characteristics as well as logics and schematics are given for the 200 and 930 Series of DTL circuits; the Ray I, II, III Series of TTL circuits; and complex and linear circuits. Raytheon.

**Lever Switches 403**

An eight-page catalog describing a complete line of quality lever type switches is available. This comprehensive engineering guide has complete specifications on lever switch types, mountings, switching capacity, operating characteristics and construction. The catalog describes the new Series 41000 "LT" switch which is a highly reliable, compact telephone type requiring only 2 1/8in. behind-panel depth. It features a specially designed damping block for reduced contact bounce, and a "U" shaped frame for added stability even under maxi-

mum spring loads. A "can't cheat" detent guide prevents accidental actuator bypass of a switching position. Other varieties of lever switches listed include the "Lev-R" switch for miniaturized applications or the Series 12000 type used when behind-panel space is critical. Simplified, one-hole mounting coupled with unusual switching flexibility is offered with "Tele-ver" switch series. Switchcraft.

**Semi Conductors 404**

A 90-page catalog giving complete specifications on all Hughes semiconductors is now available. The catalog covers both monolithic circuits and discrete device. Hughes.

**FET Transistors 405**

A 12-page booklet on FET design ideas is available. This booklet was developed as a "thought-starter" for designers employing field-effect transistors in their circuits. The bulletin describes how to properly bias FETs and provides 20 examples of FET usage in a wide range of applications. A complete listing of FET application reports currently available is included along with ordering instructions. Short-form data on TI's standard field-effect transistors is also furnished. Texas Instruments.

**Electrical Wire and Cable 406**

A 64-page up-to-date catalog of electrical wires and cables is available. The catalog describes the materials, construction and applications of a range of wires including those for appliances, buildings, fixtures, machine tools and telephones as well as power control and welding cable. ITT.

**RF Power Measurement Instruments 407**

A four-page short form catalog lists nearly all the coaxial load resistors, absorption wattmeters and directional wattmeters stocked. The feature product is a new series of miniature insertion wattmeters for maintenance of communications systems. In addition to basic performance specifications and prices, the catalog also describes related custom-built accessories such as coaxial filters. A list of regional offices and overseas representatives is included. Bird.

**Desoldering Iron 408**

A brochure describing a desoldering iron is announced. It describes the advantages of the iron and its use on printed circuit boards for removing

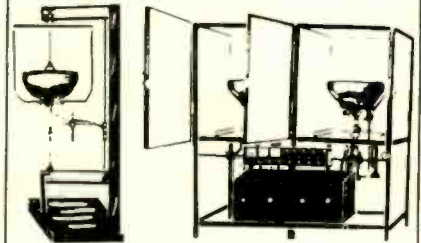
**REBUILD  
YOUR OWN  
PICTURE TUBES?**

With Lakeside Industries precision equipment, you can rebuild any picture tube!

**EASY TO OPERATE!**

Requires only 4 x 8 ft. of space.  
Your cost to rebuild black and white—\$1.50.

Your cost to rebuild Color—\$5.80.

For complete details, mail coupon.

**LAKESIDE INDUSTRIES**

5233 N. Clark St.  
Chicago, Ill. 60640  
Phone: 312-271-3399

- Free demonstration appointment  
 Send me more information

Name .....

Address .....

City .....

State .....

...for more details circle 115 on postcard

**SOLVE YOUR TV REPAIR  
PROBLEMS WITH  
TV TECH AID**

A monthly TV publication of actual repairs, and troubles encountered in OUR business. The information will be gathered from technicians, field reps, and all the leading manufacturers.

TV TECH AID will present up to 40 different trouble shooting cases each month. Each manufacturer will have its own page.

Each symptom will have a clearly marked schematic of the particular faulty stage. The faulty components, and corrections will be listed to aid in repair. No guess work.

It will contain current models, older models, circuit changes and modifications on various models as they occur.

The days of "Trial and Substitution" are over.

Time means money. Don't forfeit those valuable profits.

ONE repair is worth more than four times the investment.

Each monthly issue will contain a series of timely sheets and the cost to you is only \$7.95 for a full year's subscription.

TV TECH AID  
P.O. BOX 603  
KINGS PARK, L. I.  
NEW YORK 11754

ENCLOSED IS A CHECK OR M.O. FOR \$7.95. PLEASE SEND 12 ISSUES OF TV TECH AID TO:

NAME .....

ADDRESS .....

CITY .....

STATE .....

ZIP .....

...for more details circle 129 on postcard

**AMAZING BERN'S** PERFECT PIN CRIMPER

### Picture-Tube Repair Tool

Also for—5U4, 6SN7, 6BQ6, etc.

Eliminates that hard soldering job

only \$1.69 each

A MUST for round color pic tubes

PT-1 3/32" PIN

Fix loose pin connections in seconds. Pays for itself in time saved on first job. Less than 3" long. Carry it in your pocket.

Patented

Intermittent operation of picture tubes and other tubes due to defective solder connections easily corrected. Provides solid electrical connections, can also be used as channel-selector wrench and screwdriver. Pin keeps its original form. A 3-in-1 tool.

**3 MODELS ELIMINATE SOLDERING**

Makes Solid Electrical Connections

### Phono Pin-Plug Crimper

Slip wire in "pin plug," insert in tool, and squeeze... job is done.

AU-2 1/8" PIN

C-Rings 3 for 5¢

Use end of tool to push on C-ring for ground connection.

Ant. plugs, hi-fi, multiple plugs, public address, radio and TV tubes, radar, speakers, and loop connections. Many, many more uses.

Model LC-3 for 5/32" pin diameter

At your parts distributor, or write us

**BERN'S** MANUFACTURING CO.  
P. O. BOX 237  
WASHINGTON, MICH. 48094

...for more details circle 106 on postcard

Did your mother take you for your last checkup?



What is it about grownups? Don't they know annual checkups are the first line of defense against cancer? It's nice to find out you're as healthy as you feel. See your doctor. You'll find peace of mind beats lollipops any day! Help yourself with a checkup. And others with a check.

American Cancer Society

THIS SPACE CONTRIBUTED BY THE PUBLISHER

## ET/D CATALOGS & BULLETINS

ICs, transistors, diodes and other components. It also illustrates available replacement tips, complete kits and prices. Endeco.

409

### Advertising Promotion Ideas

A new business service designed to help retailers get better results from their advertising and promotion efforts is introduced. Fully illustrated and detailed, the quarterly reports show ads, mailers, stunts, etc., retailers anywhere can easily and inexpensively adapt to their own profitable use. Ad Arts.

410

### Sound Entertainment Products

A pocket-size color line folder illustrates and describes the company's full line of sound entertainment products—reel-to-reel portable and stereo tape recorders, portable and stereo cassette recorders, mobile stereo cartridge systems, home stereo cartridge players and tape recording accessories. Craig.

411

### Semiconductors

As a result of continued expansion, a second volume of the Technical Data Handbook is available. The new volume will be sent automatically to existing handbook holders. The complete handbook covers thyristors, bridges, firing circuits, solid-state regulators, rectifier diodes, reference diodes, integrated circuits, signal diodes, Hall devices, microwave diodes and application notes. AEI.

College tuition covers only about 1/3 the cost of a college education. Help supply the other 2/3.

**GIVE TO THE COLLEGE OF YOUR CHOICE.**



advertising contributed for the public good



AID TO HIGHER EDUCATION CAMPAIGN

USE ZIP CODE

## ATR PRODUCTS FOR MODERN LIVING



### ATR UNIVERSAL INVERTERS

A.C. Household Electricity Anywhere... in your car, boat or plane!

To Operate • Tape Recorders • TV Sets • Dictating Machines • Radios • Public Address Systems • Electric Shavers • Record Players • Food Mixers • and Emergency Lighting.

NET 12U-RHG (12 V.) 175-200 W. Sh. Wt. 27 lbs. 79.66  
28U-RHG (28 V.) 150-175 W. Sh. Wt. 27 lbs. 96.66



### ATR "A" Battery ELIMINATOR

For Demonstrating and Testing Auto Radios—TRANSISTOR or VIBRATOR OPERATED!

Designed for testing D.C. Electrical Apparatus on Regular A.C. Lines.

MAY ALSO BE USED AS A BATTERY CHARGER  
MODEL 610C-ELIF... 6 volts at 10 amps. or 12 volts at 6 amps. Shipping weight 22 lbs.

USER NET PRICE \$59.62

### ATR AUTO RADIO and COMMUNICATION

### LONGER-LIFE VIBRATORS

"The Best by Test!"



### ATR ELECTRONICS, INC.

Quality Products Since 1931

St. Paul, Minnesota 55101—U.S.A.

...for more details circle 103 on postcard

Who needs a tuner wash? Save your money and use

**QUIETROLE**

The product that cleans while it lubricates. Zero effect on capacity and resistance. Harmless to plastics and metals. Keeps color and black and white on the beam. Non-flammable.



manufactured by  
**QUIETROLE CO.**  
Spartanburg, South Carolina

...for more details circle 124 on postcard

ELECTRONIC TECHNICIAN/DEALER

*continued from page 61*

other, do not be alarmed to see a very slight change in focus which is a characteristic of this system.

The 14in. diagonal color CRT has a new focus system called the Einzel lens. The Einzel lens is the same system used in all B/W CRT's. Therefore, problems which have occurred previously in focus diodes, etc., have been virtually eliminated.

Picture tubes used in present-day TV receivers may be

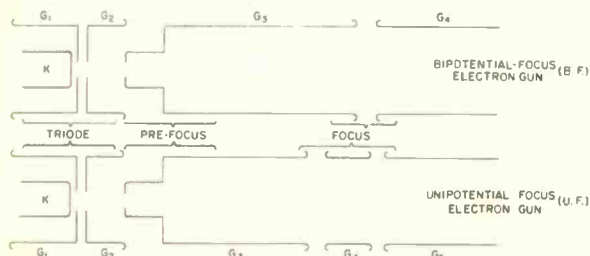

classified into two types characterized by the focusing method used. One type uses a "bi-potential" focusing lens and the other uses a "unipotential" or "Einzel" focusing lens.

Shown in diagram is the Einzel method. The focus voltage of 800v is actually boosted B+ and is independent of the high voltage. This is not true of the bi-potential method which used a percentage of the high voltage as the focusing voltage. The advantages of the Einzel lens (unipotential) gun compared to that of the bi-potential gun are as follows:

- (1) The CRT maintains sharp focus even with large variations of the high voltage.
- (2) The Einzel lens eliminates the need for extensive focus circuits.
- (3) Secondary variable high voltage supply is not needed for focusing.
- (4) Relatively flat focus characteristics minimizes need for focus voltage adjustments.
- (5) There is no high focus voltage connected to the stem lead through the CRT base eliminating leakage or arcing.

The main difference between the two gun types is in the operation of the focus electrode, G3 in the BF gun, and G4 in the UF gun. In the BF gun, G3 is connected to a variable secondary high voltage supply of 3 to 6Kv. Focusing in the BF gun is very sensitive to the G4-G3 voltage ratio variations. In the UF gun, G4 is connected either to ground or to a variable low voltage supply, -250 to +800v, or to fixed low voltage taps. Focusing in the UF gun is relatively insensitive to variations in the G4-G5 voltage ratio.

Most present-day monochrome picture tubes use the unipotential gun design. However, because of the higher voltages used in color sets, only a few of the smaller color tubes are unipotential.

**For more details  
on New Products  
see page 75  
Readers Service**

**"IT'S GOOD BUSINESS  
TO HIRE THE HANDICAPPED."**

**ISN'T THAT A GREAT IDEA, SNOOPY?**



THE PRESIDENT'S COMMITTEE ON EMPLOYMENT  
OF THE HANDICAPPED, WASHINGTON, D. C.

**NEW! Mercury 4000**

**FIELD EFFECT METER  
VOLT-OHM MILLIAMMETER**



- .300 V. FULL SCALE DC
- LARGE 6" METER
- AC and BATTERY OPERATED
- HIGH IMPEDANCE (11 MEG DC)
- 5 DC CURRENT RANGES

This precision engineered test instrument combines features and quality only available in higher priced equipment.

- NO WARM UP! • NO DRIFT!
- NO STABILITY-UPSETTING INTERNAL HEAT!
- ISOLATION FROM AC LINE!

**\$7995 WIRED**

**SPECIFICATIONS**

**DC VOLTS** — 8 Ranges: 0 to 0.3, 1, 3, 10, 30, 100, 300, 1000 volts  
• Accuracy: ±3% of F.S. • Input Resistance: 11 Megohms.

**AC VOLTS** — 7 Ranges: 0 to 1, 3, 10, 30, 100, 300, 1000 volts  
• Frequency response: 10 Hz to 1 MHz 1± Db. • Accuracy: ±5% of F.S.  
• Input Impedance: 2 Megohms shunted by 30 pf thru probe.

**RESISTANCE** — 7 Ranges: 10 ohms Center Scale. x1, x10, x100, x1K, x10K, x100K, x1 Megohm • From 0.2 ohm through 1000 Megohms  
• Accuracy: ±3% of max. angular displacement.

**CURRENT** — 5 Ranges: 0 to 0.3, 1, 10, 100, 1000 milliamperes D.C.  
Voltage Drop: 240 Millivolts. • Meter Movement: Full-View 6 inch, 200 Microampere Meter. Diode protected • Battery Test: Indicates battery condition directly on meter. • Power requirements: Line Operation . . . 115V 50/60 Hz, 3W, 1.5V "D" Cell. Battery Operation . . . 9V NEDA #1604, 1.5V "D" Cell. • Dimensions . . . 7 1/2" x 6 1/2" x 4". • Weight 3 Lbs. • Accessories . . . Comb. AC-OHMS/DC Probe.

ALL MERCURY TEST EQUIPMENT GUARANTEED FOR ONE FULL YEAR!

**MERCURY ELECTRONICS CORPORATION**  
315 ROSLYN ROAD • MINEOLA, N. Y. 11501 • (516) 742-5400

...for more details circle 118 on postcard

ELECTRONIC TECHNICIAN'S BOOK CLUB INVITES YOU AS PART OF TRIAL MEMBERSHIP TO  
**Take This Brand-New Book for only 99¢**

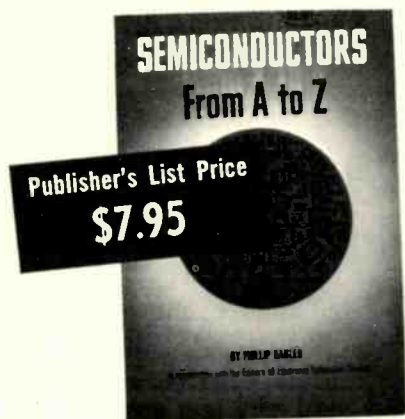

yours for only **99¢**

with Trial Membership in  
 Electronic Technician's Book Club.

May we send you this unique new book as part of an unusual offer of a Trial Membership in Electronic Technician's Book Club?

Now you can have, at your fingertips, this brand new, up-to-date 256-page working guidebook on all types of semiconductors.

This handsome, hardbound book is indicative of the many other fine offerings made to Members . . . important books to read and keep . . . volumes with your specialized interests in mind.

**How the Club Works**

Forthcoming selections are described in the FREE monthly *Club News*. Thus, you are among the first to know about, and to own if you desire, significant books. You choose only the main or alternate selection you wish (or advise if you want no book at all) by means of a handy form enclosed with the *News*. As part of your Trial Membership, you need purchase as few as four books during the coming 12 months. You would probably buy at least this many anyway . . . without the substantial savings offered through Club Membership.

**How You Profit From Club Membership**

This is just a sample of the help and generous savings the Club offers you. For here is a Club devoted exclusively to seeking out only those titles of interest to you as an electronic technician. Membership in the Club offers you several advantages:

1. **Charter Savings:** *Semiconductors From A to Z* carries a retail price of \$7.95. But it can be yours for only 99¢ with your Trial Membership.
2. **Continuous Savings:** The Club guarantees to save you 15% to 75% on all books offered through the *Club News*.
3. **Wide Selection:** Members are annually offered well over 50 of the new and authoritative books on electronic servicing.

**Limited Time Offer!**

Here, then is an interesting opportunity to enroll on a trial basis . . . to prove to yourself, in a short time, the advantages of belonging to Electronic Technician's Book Club.

To start your Membership on these attractive terms, simply fill out and mail the Postpaid Trial Membership Coupon today. **SEND NO MONEY!** If you are not delighted with the book, return it within 10 days and your Trial Membership will be cancelled without cost or obligation. We take all the risk.

**SEMICONDUCTORS FROM A TO Z** contains all you need to know about the entire range of transistors and semiconductors used today. Written in language anyone can understand, this book explains how various semiconductor devices work and how they are used, with complete descriptions of all the common and unique circuits used in modern technology. With the wealth of knowledge incorporated in this book, you'll be eminently qualified to service any type of solid-state equipment.

The content begins with a review of how basic semiconductors work, including types and function, how a transistor conveys a signal, transistor biasing and self-biasing techniques, effects of temperature on operation, factors limiting transistor frequency response, etc. Succeeding chapters delve into the mystical arena of field-effect transistors by explaining the differences between FETs and regular transistors. You'll understand junction FET applications, frequency response, temperature effects, and the treatment given depletion-type and enhancement-type MOS FETs in the most down-to-earth explanation you'll ever find.

Considerable attention is given to integrated circuit applications—variable-current and constant-current sources, unbalanced differential amplifiers, IC applications in FM and TV receivers, TV sound circuits, discriminator circuits, and cascade amplifier networks. The use of varicaps is also covered, as well as unijunction transistors, field-effect diodes, zener diodes, SCR diodes, 4-layer diodes, diacs, and triacs. The final chapters deal with constant current and voltage regulating systems and DC-to-AC-to-DC converters.

**CONTENTS:** What Is a Semiconductor? — Semiconductor Characteristics — Determining Semiconductor Characteristics — Frequency Limitations — Field-Effect Transistors — MOS FETs — The Tunnel Diode — Tunnel Diode Applications — Integrated Circuits — IC Balanced Differential Amplifier — IC Applications in FM Circuits — IC Applications in TV — IC TV Sound Circuits — IC Time Constants & Cascade Amplifiers — The Varicap — Varicap Applications — Review of Capacitor & Coil Impedances — Photo-Sensitive and Photo-Emissive Devices — FET Light-Sensitive Devices — Principles of Optics — Optic-Electronic Couplers — Semiconductors for Power Supplies — Constant-Voltage Transformer — Power Conversion — Filter & Regulators. Index.

FIRST CLASS  
 Permit No. 9  
 Blue Ridge Summit, Pa.

BUSINESS REPLY MAIL  
 No Postage Stamp Necessary If Mailed in The United States

Postage Will Be Paid By

**ELECTRONIC TECHNICIAN'S BOOK CLUB**

Monterey & Pinola Ave's.  
 Blue Ridge Summit, Pa. 17214

DO NOT CUT HERE ↑ JUST FOLD OVER, SEAL AND MAIL—NO STAMP OR ENVELOPE NECESSARY

**Send No Money! Simply fill in and mail Trial Membership Coupon Today!**

**ELECTRONIC TECHNICIAN'S BOOK CLUB, Blue Ridge Summit, Pa. 17214**

Please open my Trial Membership in Electronic Technician's Book Club and send me a copy of *Semiconductors From A to Z* (billing me only 99¢ plus a few cents postage and mailing expense). If not delighted, I may return the book within 10 days and owe nothing. Otherwise, to complete my Trial Membership, I agree to purchase at least four additional monthly selections or alternates during the next 12 months. I have the right to cancel my membership anytime after purchasing these four books.

Name \_\_\_\_\_ Phone No. \_\_\_\_\_  
 Address \_\_\_\_\_  
 City \_\_\_\_\_ State \_\_\_\_\_ Zip \_\_\_\_\_  
 Company \_\_\_\_\_

(The Club assumes postage on all prepaid orders. Foreign and Canadian prices 10% higher.)  
**THIS ENTIRE FOLD-OVER COUPON FORMS A NO-POSTAGE-REQUIRED BUSINESS REPLY ENVELOPE**



# CCTV...

*continued from page 50*  
 easy to handle. Each camera is connected to the switcher input and terminated whether in-use, or in-standby. By pressing a button, the operator (the guard in this case) can determine which camera is to be "on-the-air." Switchers for this purpose are available commercially or you can build one yourself. Commercial switchers come in a variety of types and styles with the physical layout and price the two most common determiners of the unit for the job.

Switchers may allow for as few as two inputs or as many inputs as you wish. They come in all styles, ranging from slope-front, desktop models, to custom units for whatever configuration is needed. Some use conventional on-off switches, some use reed relays and others use vertical-interval switching techniques, to name a few. The latter units are generally found in commercial television station control rooms. There is no prac-

tical limit to switcher capabilities other than the amount of capital the user wants to invest.

Remote control systems are also available which allow control of such functions as lens f-stop, "zooming" of lenses, panning of the camera, and tilt. There are even units which will operate a "windshield wiper" on cameras used where moisture is a problem.

Two definitions will be of help here. "Panning" a camera means swiveling on a horizontal plane; "tilting" is pivoting up and down.

Many times, a customer finds it necessary to mount a camera in a position where it would be impossible for a person to stand at the camera and move it from one scene to another. In this case, a fixed lens could be attached to the camera and the camera could be mounted on a remote-control pan-and-tilt unit. The controller can then take care of all camera movement from an observation booth or a room which is located some distance from the camera.

A fixed lens will not allow close-

up as well as wide-angle photography without physically moving the camera. This is where the "zoom" lens comes in. The zoom lens allows a variety of shots, from close-up to wide-angle without any change in physical location of the camera. An example here might be the bank we mentioned earlier. A camera mounted high on the wall of the bank, and the guard has remote control of pan, tilt and zoom. With this setup, he gets a birds-eye view of the bank with no trouble at all.

If a camera were to be used in a hospital operating room, regulations would require an explosion-proof housing. These are also available commercially. There are housings which allow the use of CCTV cameras in under-water locations and even radiation-proof housings. There is really no limit to the possibilities for the use of CCTV gear. (Part two of this series will discuss studio systems, lighting, video tape recording, distribution systems and servicing.) ■



## LOWEST COST FET TESTER

- Tests FET's For Gm (UMHOS)
- Tests Transistors For AC Beta
- Obsolescence Proof
- No Charts Needed

## Full Line of Test Equipment

- 830-Transistor Tester
- 840-Field Strength Meter
- 857-CRT Tester/Rejuvenator
- 865-Color Bar Generator
- 880-Stereo Test System
- 870-FET Volt-Ohm Meter

133 N. Jefferson, Chicago 60606 312-346-2841

...for more details circle 108 on postcard

## COMPONENT FIESTA!

FEATURING A COMPLETE LINE OF

## RADIO and ELECTRONIC COMPONENTS

THERE'S BIG DOINGS AT METROPOLITAN SUPPLY!

We have a \$250,000 Inventory of Brand New Current Production Components... Including Many Leading Brand Names.

They Are Yours at a Fraction of OEM List Price  
 For Example:

100,000 FERRITE ANTENNAS .....	18 cents each
15,000 WESTCLOCK ELECTRIC TIMERS .....	\$1.60 each
31,000 VOLUME CONTROLS .....	24 cents each
1,000 STEREO PRE-WIRED AM-FM AMPLIFIERS .....	\$16.00 each

MANY OTHER COMPONENTS INCLUDING

- AM-FM TUNERS
- SWITCHES
- SPEAKERS
- KNOBS
- CAPACITORS
- IF TRANSFORMERS
- RECTIFIERS
- VARIABLE CONDENSERS

Components for Consumer and Industrial Equipment Makers

Write, Wire or Phone

**Metropolitan Supply Co.**

Division of Metropolitan Overseas Supply Corp.  
 468 Park Avenue South, New York, N.Y. 10016

(212) MU6-2120



...for more details circle 119 on postcard



TOF-8  
239 Dealer Net

**“After 20 years fixing TV sets, I’ve finally found a tuner spray that really works!”**

“I’ve tried them all” says Herb Gruen, owner of Gruen TV Service, Brooklyn, New York. “But most of them were more trouble than they were worth. A lot of tuner sprays cause detuning. Some do a pretty good job of cleaning, but don’t have enough body to provide real lubrication. The “thick stuff” dries out and gunks up in a couple of months, and I have a callback on my hands.”

“But this new TUN-O-FOAM is something else. It’s thick, but it foams into the tightest places. It doesn’t detune. It makes the tuner turn smooth as silk and it clears up snow due to poor contacts.”

“Best of all, TUN-O-FOAM doesn’t dry out. It works so well that now... for the first time in my life... I’m automatically cleaning and lubricating the tuner of every chassis I service. AND AFTER MORE THAN FOUR MONTHS AND HUNDREDS OF TUNERS I HAVEN’T HAD A SINGLE CALLBACK DUE TO TUNER TROUBLES.”

“In fact, on the few sets where I’ve had to make a callback for some other reason, I’ve made it a point to flip the tuner a few times and in every case it was still turning as smoothly as when it left my shop.”

Before Chemtronics releases a product, we field-test it thoroughly through a panel of expert TV technicians. Herb Gruen was one of the men chosen to test TUN-O-FOAM. His report was so enthusiastic that you’ll soon be seeing TUN-O-FOAM on your favorite distributor’s shelf. Try it. You’ll be amazed at the difference between TUN-O-FOAM and all previous tuner sprays. For detailed information on how TUN-O-FOAM works, write:



1260 RALPH AVENUE  
BROOKLYN, N.Y. 11236  
FOR EXPORT: ROBURN AGENCIES INC., N.Y., N.Y. 10013

IN CANADA:  
PERFECT MANUFACTURING LTD.,  
MONTREAL 9, CA.

...for more details circle 107 on postcard

Aerovox Corp. ....	26
American Telephone & Telegraph Co. ....	23
ATR Electronics ....	70
B&K Div. Dynascan Corp. ....	56
Bell P/A Products Corp. ....	65
Berns Mfg. Co. ....	70
Book Club—Tab Book ....	72
Chemtronics, Inc. ....	74
Commander Electronics ....	73
C.R.T. Equipment Co. ....	3rd Cover
Delco Radio Div. ....	25
GBC Close Circuit Corp. ....	2nd Cover
Electro-Voice ....	64
Greyhound Lines, Inc. ....	59
Heath Co., The ....	33
Johnson Co., E. F. ....	20
Lakeside Industries. ....	69
Leader Instruments Corp. ....	29
Lectrotech, Inc. ....	61
Mercury Electronics Corp. ....	71
Metropolitan Supply Co. ....	73
Microflame ....	66
Miller Co, J. W. ....	29
Motorola HEP. ....	30,31
Quietrole ....	70
Raytheon Co. ....	55
Radio Corporation of America RCA Electronic Components & Devices ....	4th Cover
Sencore, Inc. ....	22, 63
Tuner Service Corp. ....	19
T.V. Tech Aid ....	69
Weller Electric Corp. ....	67
Winegard Co. ....	57
Workman Electronic Products Inc. ....	62
Xcelite, Inc. ....	64
Zenith Radio Corp. ....	60

# THE PROFIT-MAKER!



- REBUILDS ANY SIZE ROUND OR RECTANGULAR COLOR PICTURE TUBES . . . AVERAGE COST PER TUBE \$7.80
- REBUILDS ANY SIZE BLACK AND WHITE PICTURE TUBE . . . AVERAGE COST PER TUBE \$1.80
- FREE INSTALLATION AND TRAINING ANYWHERE IN THE CONTINENTAL U.S.A.
- FREE SUPPLIES FOR REBUILDING YOUR FIRST 50 PICTURE TUBES

- EXTREMELY EASY TO OPERATE
- INCLUDES LAMINATING AND DELAMINATING EQUIPMENT FOR REBUILDING BLACK AND WHITE AND COLOR BONDED-FACE PICTURE TUBES.
- INCLUDES ALL TOOLS FOR REBUILDING ROUND AND RECTANGULAR COLOR PICTURE TUBES
- INCLUDES ALL TOOLS FOR REBUILDING BLACK AND WHITE PICTURE TUBES

## CRT COLOR CHAMPION

CRT COLOR CHAMPION . . . \$2,875.00

Mail Coupon Today for FREE CATALOG

C.R.T. Equipment Company, Inc.  
2740 Old Lebanon Road  
Nashville, Tennessee 37214

Telephone (615) 883-0215

\_\_\_\_\_ (Please Print) \_\_\_\_\_

Name \_\_\_\_\_

Firm Name \_\_\_\_\_

Address \_\_\_\_\_

City \_\_\_\_\_

State \_\_\_\_\_ Zip \_\_\_\_\_

...for more details circle 109 on postcard

# How do you “install” confidence when you install an RCA color picture tube?



The surest way to compliment a customer is to agree with his opinion. This is pretty easy to do when it comes to deciding which brand of replacement color picture tube to install in his set.

Here both set owner and service technician agree—and by a wide margin—on RCA! And for one very good reason: RCA's reputation... for experience, quality, and proven performance... over the years. More years than anyone else in the business.

Place your confidence in the company that perfected the color TV system in use today. Introduced more technical innovations than any other company. Stays on top of the state-of-the-art not just in technology, but in tube sizes as well.

Whether it's an all-new RCA HI-LITE or the popular priced quality rebuilt RCA Colorama—when you recommend RCA—you'll not only flatter your customer, you'll also be protecting your own hard-earned service reputation. That's because RCA picture tubes are designed to protect the biggest reputation in the COLOR TV industry.

RCA Electronic Components, Harrison, N.J.

# **RCA**