

ELECTRONIC TECHNICIAN

WORLD'S LARGEST ELECTRONIC TRADE CIRCULATION



OCTOBER 1967

FRISEW10812392N869AA3A17966B
WILLIAM W FRISE
7176 GALE RD
ATLAS MI
48411

1968 Color TV Circuits

Test Instruments For Color

Tape recorders

Beginning: Dealer Fax

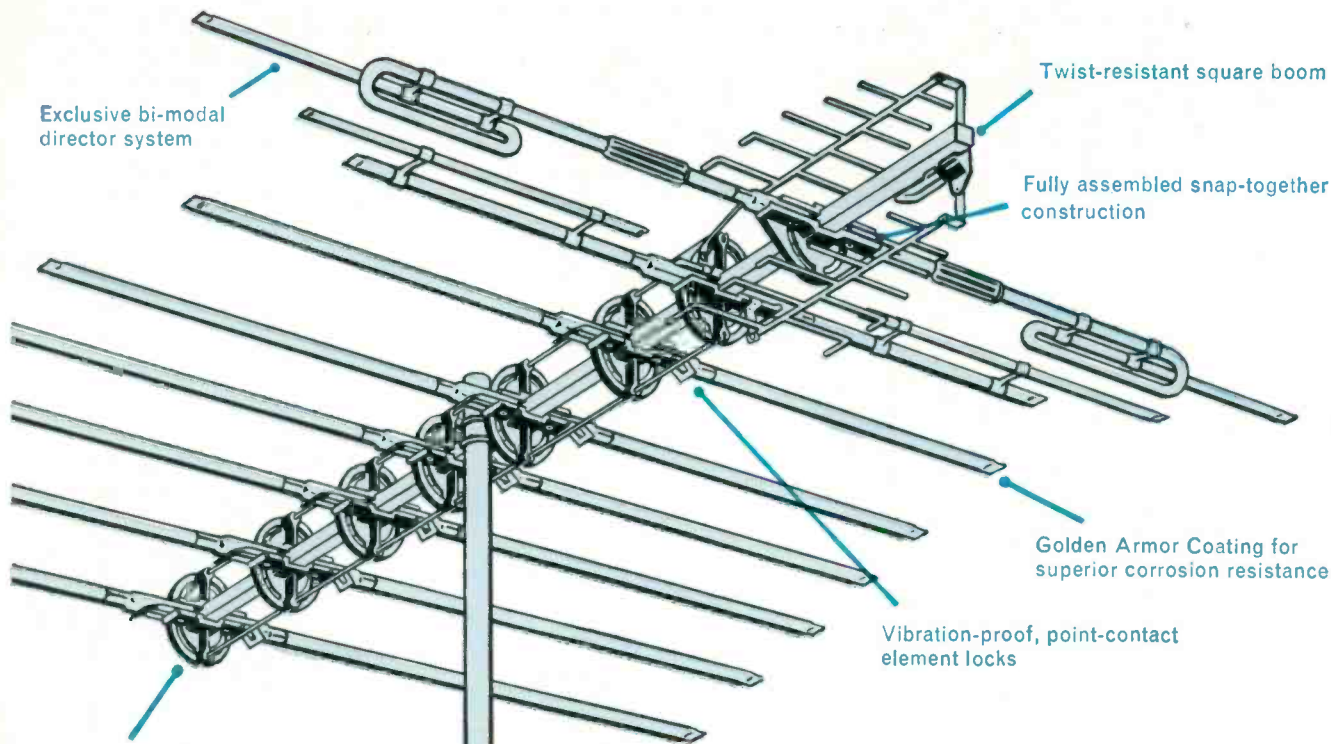

82-channel signal grabber

The Jerrold VUfinder® Antenna. The first 300-ohm UHF-VHF-FM antenna designed—from the ground up—for uncompromising color and black-and-white excellence across the entire TV spectrum. Models available for metropolitan to deepest fringe areas.

- Sharp directivity eliminates color ghosts
- Flat response (± 1 db per channel) for optimum color fidelity
- Exclusive bi-modal director system for extra gain

VUfinders are easy to put together, can't possibly fall apart. The quality that's built in stays in. Quickly convertible to 75-ohm Color-axial performance. VUfinders come in 5 models. Each is supplied with a UHF/VHF frequency splitter. And the list prices range from \$17.95 to \$79.95. There's no better performance per dollar than this—anywhere.

For the most efficient 300-ohm signal grabber in Jerrold's Spectrum '67, see your Jerrold Distributor *today* about the Jerrold VUfinder antenna.

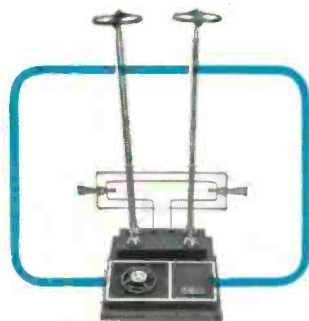

Indoor antennas



Home pre-amplifiers



Distribution equipment



*Focusing on one thing...
better reception*

... for more details circle 101 on postcard

ELECTRONIC TECHNICIAN

TEKFAX

COMPLETE MANUFACTURER'S CIRCUIT DIAGRAMS
AND TECHNICAL INFORMATION FOR 6 NEW SETS

1111

MAGNAVOX
TV Chassis
T925 Series

OCTOBER • 1967

GROUP
182

SCHEMATIC NO.

SCHEMATIC NO.

CANADIAN GENERAL ELECTRIC... 1112
TV Chassis M687

RCA VICTOR... 1116
TV Chassis KCS157 Series

MAGNAVOX... 1111
TV Chassis T925 Series

SILVERTONE... 1114
Color TV Chassis 528-72280,81,82

PHILCO... 1113
TV Model Q1054

SYLVANIA... 1115
Color TV Chassis D07-1,-2

VHF TUNER SCHEMATIC

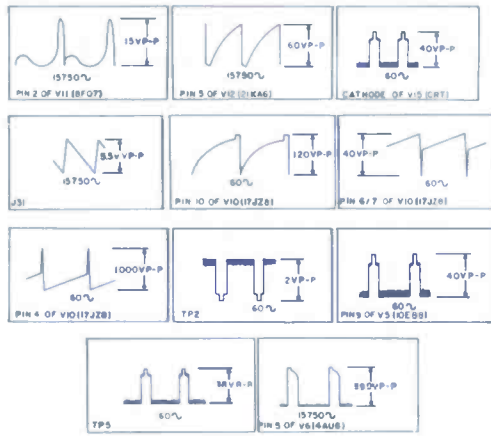
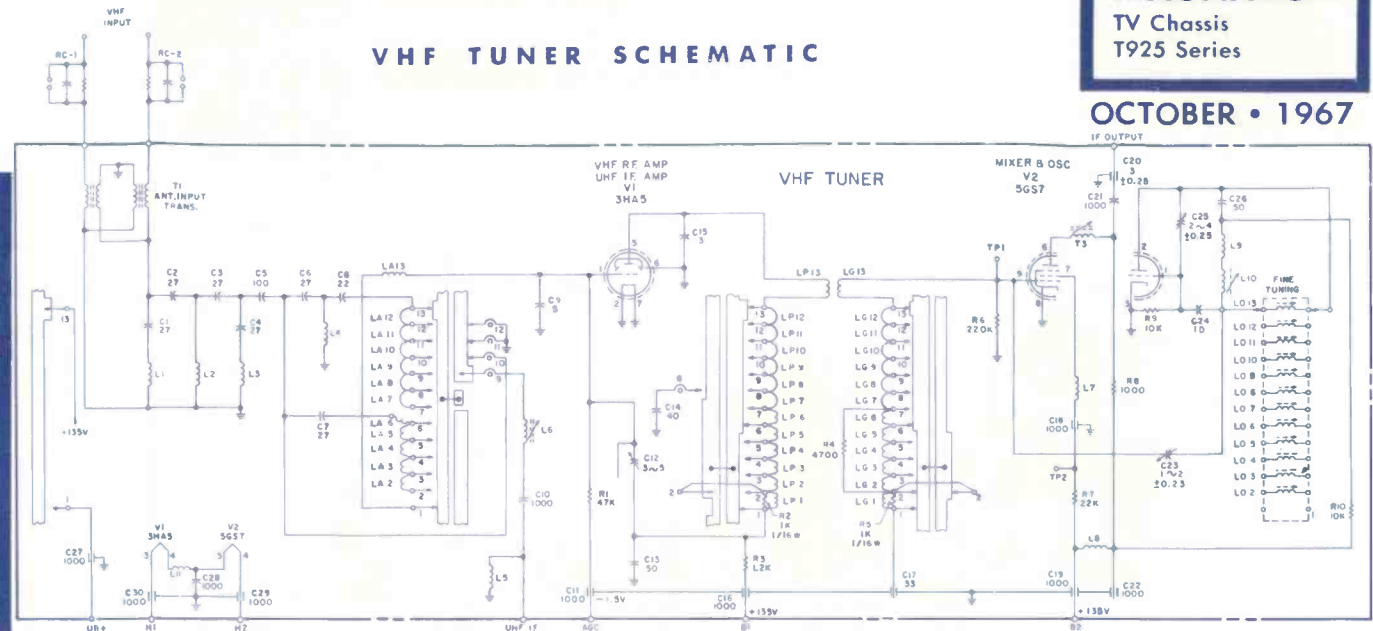

NOTES: UNLESS OTHERWISE SPECIFIED,
1. CAPACITANCE VALUES OF 1 AND LESS ARE IN MICROFARADS.
2. CAPACITANCE VALUES GREATER THAN 1 ARE IN PICOFARADS.
3. VOLTAGES MEASURED WITH NO SIGNAL, CONTRAST CONTROL SET TO MAXIMUM, AND LINE VOLTAGE 120 VAC.

SYMBOL	DESCRIPTION	MAGNAVOX SERVICE PART NO.
CH601	ac Line Choke	320148-2
L201A	Tweet Choke	361050-23
L201B	Tweet Choke	361050-22
L202	180µH Peaking Coil	361050-24
L203	390µH Peaking Coil	361050-25
L204	390µH Peaking Coil	361050-25
L501	Horiz Stabilizing Coil	361129-2
L502	Damper Plate Coil	361050-27
L503	Filter Choke	361050-20
L602	Line Choke	361050-21
T201	Video IF Input Coil & 47.25 MHz Trap	361049-31
T202	1st Video IF xformer & 41.25 MHz Trap	361049-32
T203	2nd Video IF xformer	361049-33
T204	4.5MHz Trap	361049-34
T301	4.5MHz Sound Take-Off Coil	361049-36
T302	4.5MHz Sound IF xformer	361049-37
T303	Quadrature Coil	361049-35
T304	Audio Output xformer	320144-2
T401	Vertical Output xformer	320147-2
I501	Horiz Output xformer	361048-4
	Deflection Yoke	361047-3
	VHF Antenna input xformer	361049-38
C410	Oil Filled, 0.22µF 1 kv	250319-317
C517	Ceramic, 100pF 4.2kv	250497-59
C519	Ceramic, 200pF 4.2 kv	250497-62
C603	Electrolytic, 200µF 250V	270075-5
C604	Electrolytic, 20µF 200V	270074-20
Controls		
VR1	500K Volume W/AC Switch	220192-15
VR2	100K Bright	220192-17
VR3	700Ω Contrast	220192-16
VR4	1M Vertical Hold	220192-18
VR5	100K Horiz. Range	220191-4
VR6	1M Vertical Height	220191-4
VR7	500K Vertical Linearity	220191-4
VR8	50K Horiz. Hold	220191-4
Miscellaneous		
	Fuse, 2 amp, 125v	180865-1200
FR601	Fusible Resistor, 2.5Ω 10w	240076-39
K401	Vertical Blanking Pac	250499-7
	VHF Tuner	340135-1
	UHF Tuner	340136-1

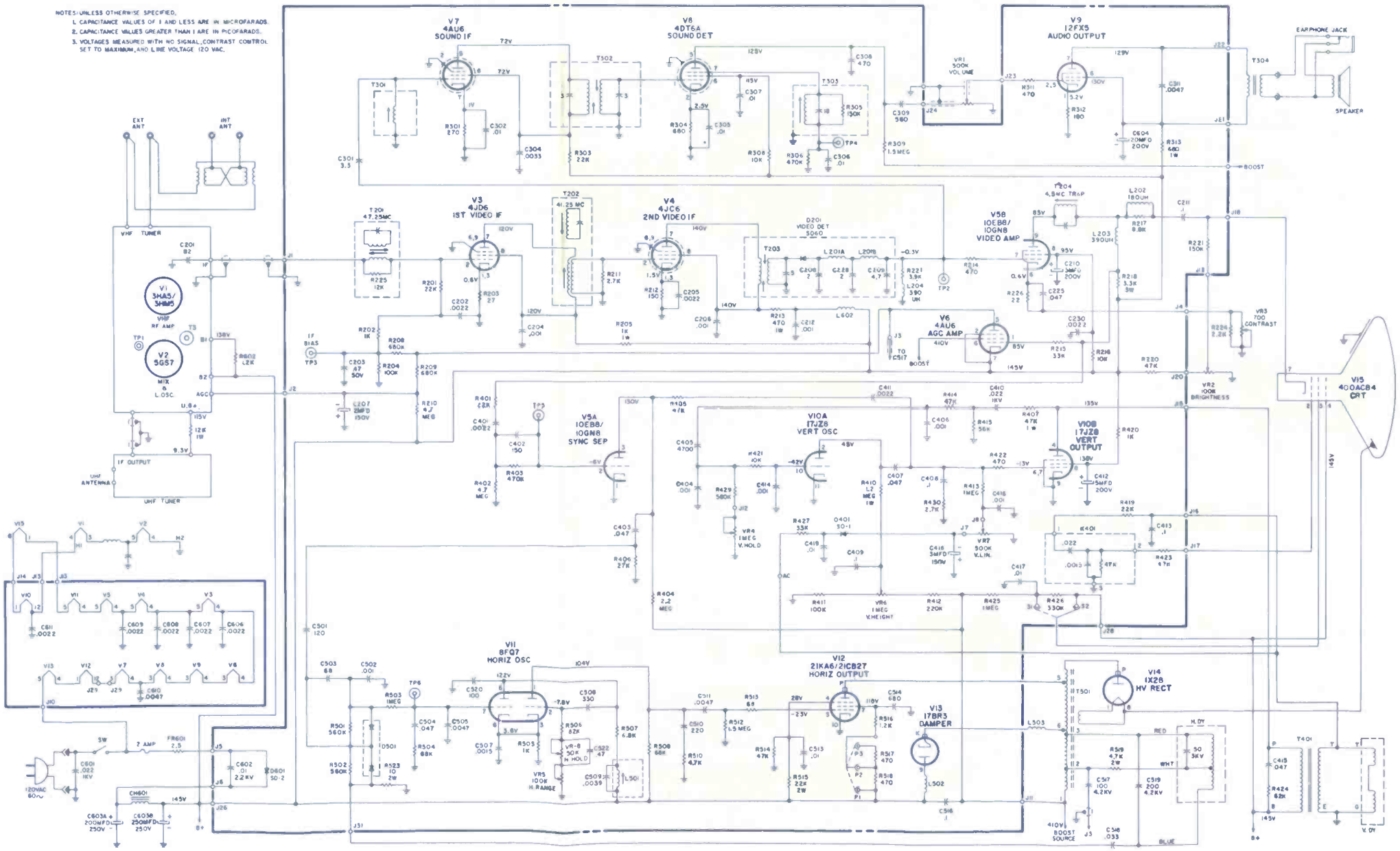

COMPLETE MANUFACTURERS' CIRCUIT DIAGRAMS AND TECHNICAL INFORMATION FOR 6 NEW SETS

OCTOBER • 1967

SYMBOL	DESCRIPTION	CANADIAN GENERAL ELECTRIC PART NO.
C204	Capacitor-paper .0047µf 10% 1kv	R5684
C264	capacitor-paper .1µf 1kv	R6745
C402A,B,C,D	capacitor-elect 250µf 165v	
	200µf 160v 10µf 150v 5µf 160v	R7440
L150	coil-link trap	R6735
L151	coil-1st IF grid	R6736
L152	coil-video det primary	R6738
L154	coil-video sec assy	R6738
L155,6	coil-choke 390µh	R4944
L157	coil-choke 300µh	R7446
L158	coil-choke 10µh	R7445

L159	coil-choke 36.2µh	R6731
L160	coil-link trap	R6824
L251	coil-horz osc	R7448
L252,L253	coil-choke 10µh	R7994
L301A,B	coil-4.5MHz/s interstage	R8201
L302	coil-quad	R7001
L401	coil-filter reactor	R7451
L402	coil-filament choke 100µh	R8567
L255	coil-width	R7009
L201,L254	yoke deflection	R7434

R207	control-vert lin 2M	R6995
R214	control-height 500K	R6996
R269	thermistor 150K	R7442
F401	fuse 1.75a	R7573
	cup high voltage socket mount	R7008
T301	xformer audio O.P.	R6851
T151	xformer 1st IF plate	R7572
T154	xformer audio take-off trap	R8568
T251	xformer horiz output	R7575
T201	xformer vert output	R8570

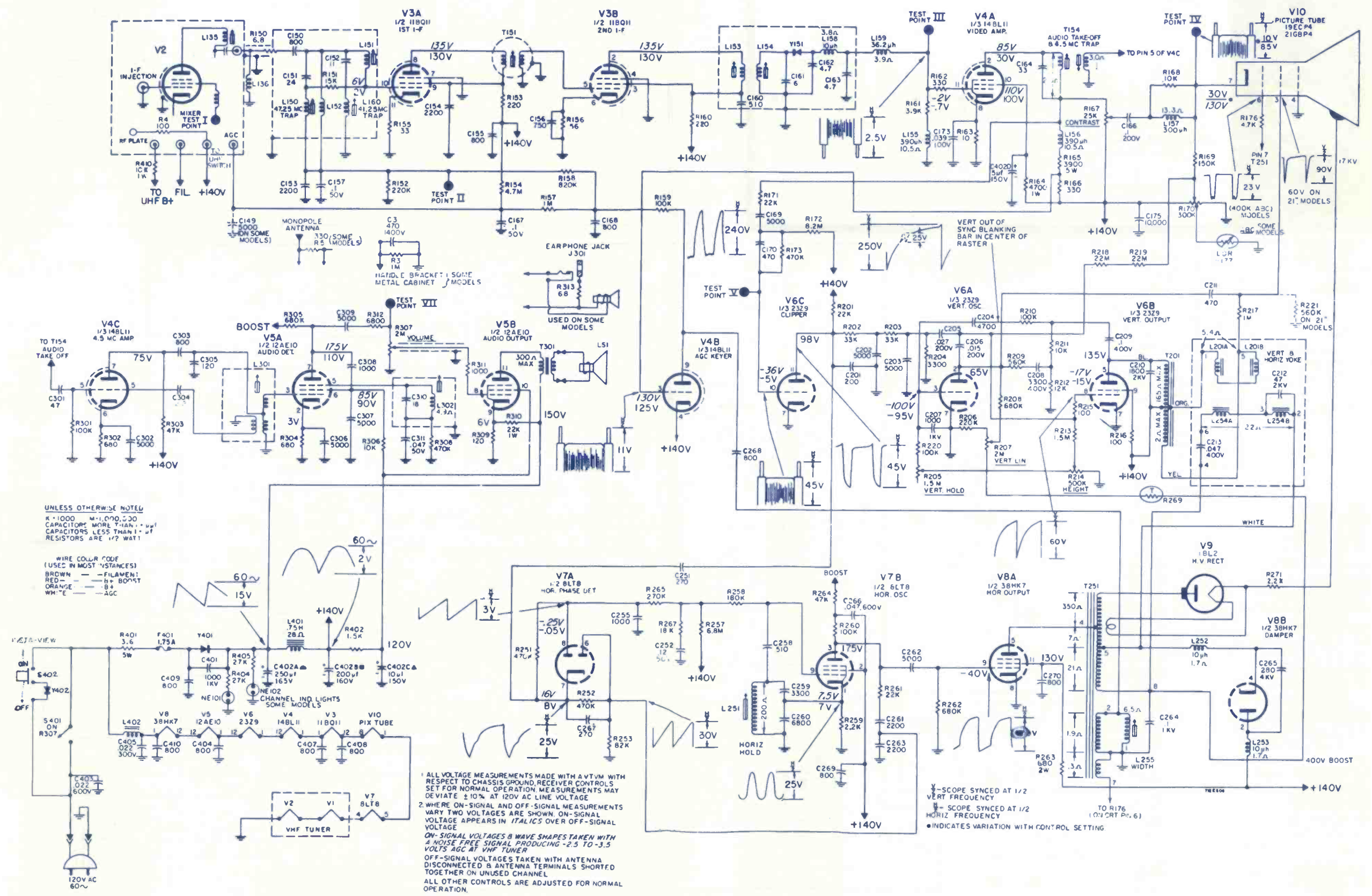

UNLESS OTHERWISE NOTED
 K = 1000 M = 1,000,000
 CAPACITORS MORE THAN 1 µf
 CAPACITORS LESS THAN 1 µf
 RESISTORS ARE 1/2 WATT

WIRE COLOR CODE
 (USED IN MOST INSTANCES)
 BROWN — FILAMENT
 RED — B+ BOOST
 ORANGE — B+
 WHITE — AGC

1. ALL VOLTAGE MEASUREMENTS MADE WITH A VTVM WITH RESPECT TO CHASSIS GROUND. RECEIVER CONTROLS SET FOR NORMAL OPERATION. MEASUREMENTS MAY DEVIATE ±10% AT 120V AC LINE VOLTAGE.
 2. WHERE ON-SIGNAL AND OFF-SIGNAL MEASUREMENTS VARY TWO VOLTAGES ARE SHOWN. ON-SIGNAL VOLTAGE APPEARS IN ITALICS OVER OFF-SIGNAL VOLTAGE.
 ON-SIGNAL VOLTAGES & WAVE SHAPES TAKEN WITH 4 NOISE FREE SIGNAL PRODUCING -2.5 TO -3.5 VOLTS AGC AT VHF TUNER.
 OFF-SIGNAL VOLTAGES TAKEN WITH ANTENNA DISCONNECTED & ANTENNA TERMINALS SHORTED TOGETHER ON UNUSED CHANNEL.
 ALL OTHER CONTROLS ARE ADJUSTED FOR NORMAL OPERATION.

— SCOPE SYNCED AT 1/2 VERT FREQUENCY
 — SCOPE SYNCED AT 1/2 HORIZ FREQUENCY
 ● INDICATES VARIATION WITH CONTROL SETTING

SYMBOL	DESCRIPTION	PHILCO SERVICE PART NO.
C601	2000µf/15v filter	320-0279
C609	1500p/1.4kv Fuses	
F1	5a	45-2656-51
F2	2a	45-2656-65
J301	Earphone	328-0300
L1	43.5MHz trap assy	229-1054-2
L2	Balun coil	229-1054-3
L201	47.25MHz trap	229-1054-28
L202	41.25MHz trap	229-1054-29
L203	39.75MHz trap	229-1054-30
L204	Video def choke	229-1054-31
L206	Video def	322-0407
L207	4.5MHz trap	229-1054-32
L208	220mh peaking	229-1054-33
L401	Horiz stab	322-0412
L402	Yoke defl	328-0301
L501	Vert defl choke	322-0418
L601	Power choke	229-1054-83
L602	Filter coil	229-1054-79
L603	Filter coil	229-1054-79
R226	Control, contr. & bright	229-1054-78
R234	Control AGC	323-0164
R318	5K control volume	323-0171
R406	Control horiz. hold	
	(Part of R502)	323-0173
R407	82K control horiz. freq.	323-0169
R426	100K control, bright	229-1054-9
R502	Control vert. hold	
	(Part of R406)	323-1073
R506	1001Ω, control vert. lin.	323-0169
R507	Control vert. size	323-0170
R513	Control vert. bias	323-0167
	Switches	
S601	Power on/off	422-0053
S602	Power on/off	Part of S601
S603	Operate/charge	229-1054-76
	Transformers	
T1	Ant. Matching Coil	229-1054-60
T201	Input VIF	229-1054-24
T202	1st VIF	229-1054-25
T203	2nd VIF	229-1054-25
T204	3rd VIF	229-1054-26
T301	Sound IF	322-0401
T302	Rotary Detector	322-0402
T303	Audio Input	229-1054-27
T401	Horiz. Osc.	322-0413
T402	Horiz. Drive	322-0414
T403	Horiz. Linearity	322-0413
T404	Horiz. output	229-1054-1
T501	Vert. Osc.	322-0415
T601	Power	229-1054-84
	THERMISTORS	
TH501	D330 vert. osc.	323-0163
TH502	D220 vert. out. base	323-0127
	VARISTORS	
VR401	VY3 horiz. osc. base IF & AF Perma-ekt. panel w/comp. IDK29 HV rect. Tuner UHF Tuner VHF	323-0166
		229-1054-22
		29-0001
		328-0299
		328-0298



OSCILLOSCOPE WAVEFORM PATTERNS
 These waveforms were taken with the receiver adjusted for an approximate peak-to-peak output of .55 volts at the video detector. Voltage readings taken with the raster just filling screen and all controls set for normal picture viewing. The voltages given are approximate peak-to-peak values. The frequencies shown are those of the waveforms—not the sweep rate of the oscilloscope. All readings were taken with a Model PS-127 Sencore Oscilloscope.

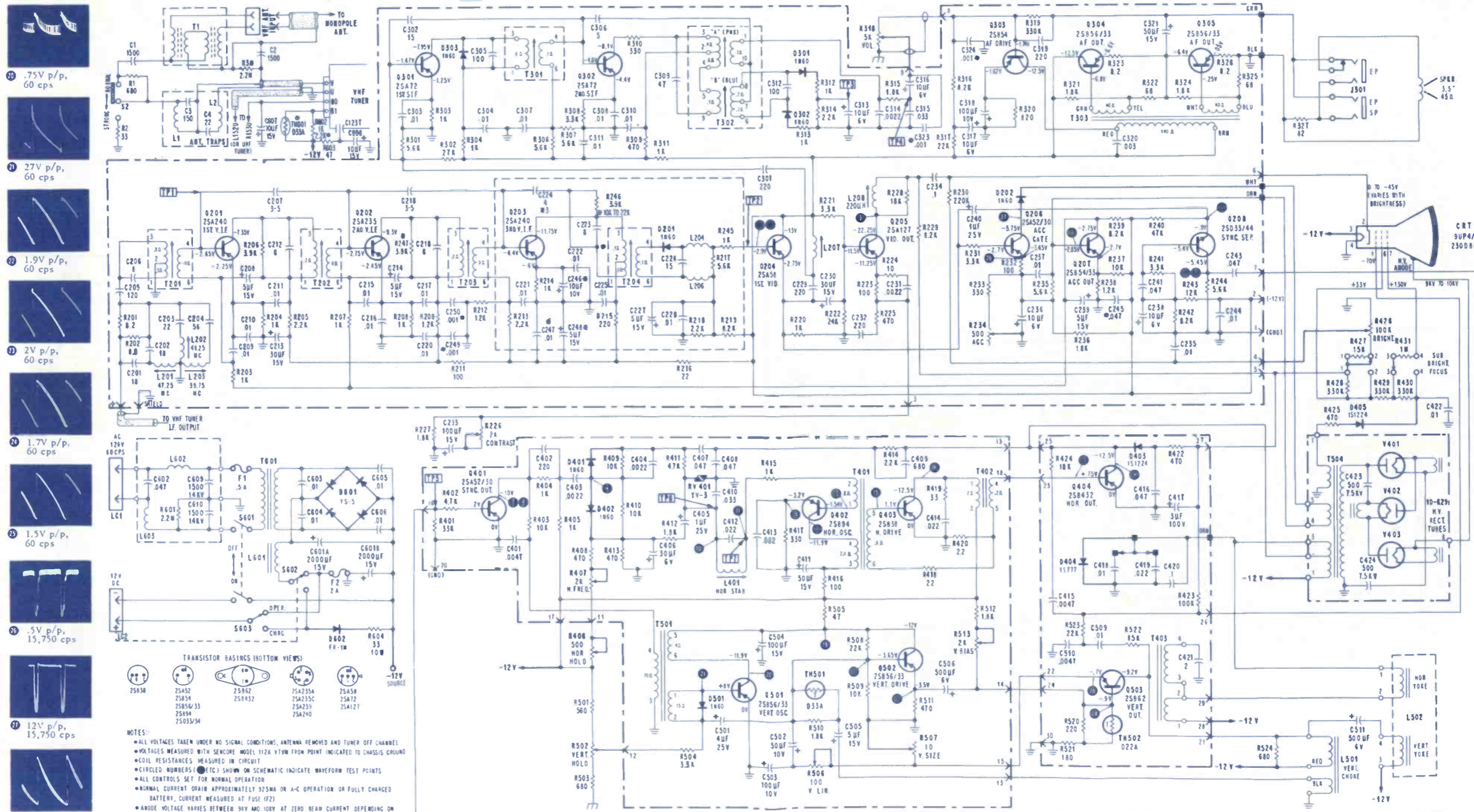
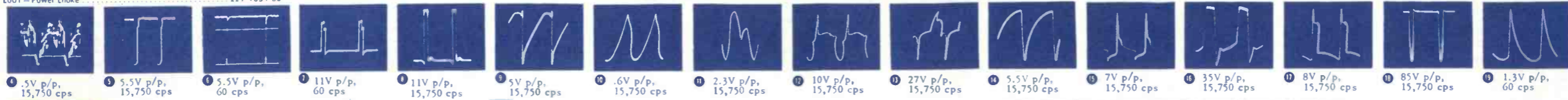

TRANSISTOR BASINGS (BOTTOM VIEWS)

25830	25A52	25862	25A235A	25A58
	25854	258432	25A235C	25A72
	25856/33		25A239	25A127
	25894		25A240	
	25833/34			

NOTES:
 • ALL VOLTAGES TAKEN UNDER NO SIGNAL CONDITIONS, ANTENNA REMOVED AND TUNER OFF CHANNEL
 • VOLTAGES MEASURED WITH SENCORE MODEL 112A VTVM FROM POINT INDICATED TO CHASSIS GROUND
 • COIL RESISTANCES MEASURED IN CIRCUIT
 • CIRCLED NUMBERS (●) SHOWN ON SCHEMATIC INDICATE WAVEFORM TEST POINTS
 • ALL CONTROLS SET FOR NORMAL OPERATION
 • NORMAL CURRENT DRAIN APPROXIMATELY 325MA ON A-C OPERATION OR FULLY CHARGED BATTERY, CURRENT MEASURED AT FUSE (F2)
 • ANODE VOLTAGE VARIES BETWEEN 8KV AND 10KV AT ZERO BEAM CURRENT DEPENDING ON THE TYPE OF VOLTMETER AND HIGH VOLTAGE PROBE USED
 • LATER PRODUCTION COMPONENTS ADD OR VALUE CHANGES ARE MARKED WITH AN ASTERISK (*)

OCTOBER • 1967

SYMBOL	DESCRIPTION	SILVERTONE NO.
C101	- Elec 200/175v	18-64-2
C102A,B,C	- Elec 25µf 350v (A) 400 of 350v (B) 80µf 350v (C)	18-105-3
C103A,B,C	- Elec 300µf 200v (A) 250µf 350v (B) 100µf 350v (C)	18-106-3
C120	- Disc 110pf 4 v N1500	20-653-0
R4	- Thermistor	61-94-1
CR14	- Control Chromix 1M	24-799
CR21	- Control Bright 1M	24-930
CR23	- Control Horiz Hold 10K	24-893
CR37	- Control on/off Volume 250K	24-966
CR45	- Control Tint 1.8K	24-988
CR47	- Control Color 500Ω	24-958
CR48	- Control Contrast 150Ω	24-983
CR49	- Control Vert Hold 1.5Ω	24-1033
R100	- 4.5Ω 10w WW	61-191-0
R101	- 2.2Ω 10w	61-323-0
R102	- 70Ω 5w Dep Oxide	68-70051
R108	- Thermistor (120Ω cold)	61-78-1
R111	- Varistor	61-87-1
CR112	- Control, High Voltage (Adjust)	24-951
CR121	- Control Pincushion Corrector 10KΩ	24-821
CR131	- Control Focus 15M	24-830
CR134	- Control w.v. Vert Cent 10Ω	24-547
CR160	- Control Red Screen 2M	24-957
CR161	- Control Green Screen 3M	24-956
CR162	- Control Blue Screen 2M	24-957
R200	- Varistor	61-91-1
R201	- 300Ω 10w W.W. 5% (Chassis 72281, 72282 only)	61-299-0
CR217	- Control 2.5Ω (Vert Height)	24-832
CR223	- Control 100K (Vert. Lin.)	24-897
CR227	- Control 750K (Drive Adj.)	24-902
R228	- Varistor	61-95-1
CR239	- Control 50K +30% (Horiz. Freq)	24-926
R303	- 13.5Ω 4w W.W.	61-270-0
R319	- 6.8Ω 3w Dep Oxide	68-68231
CR326	- Control 20K 41.25MHz Trap	24-987
R385	- 5.6K 5w W.W.	61-299-0
CR397	- Control 50K (AGC)	24-833
CR403	- Control Brite Limit 2.5M	24-976
CR417	- Control 1M (Color Killer)	24-981
CR435	- Drive Control (Blue)	24-976
R451, R453	- 1M (matched pair)	63-10501
R455, R456	- 1M (matched pair)	63-10501
R480	- 3.9K 7w Dep Oxide	68-39271
R510	- 60Ω 3w W.W.	24-880
T101	- xformer (Audio Output)	80-246-1
T102	- xformer (Vert Output)	80-42-2

T103	- xformer (Horiz Output)	80-76-3
T104	- xformer (Filament)	80-19-5
T105	- xformer (Pincushion)	80-15-7
T311	- Coil 1st I.F.	10-72-3
T321	- Coil 2nd I.F.	10-73-3
T331	- Coil, Chroma Take Off	10-109-3
T351	- Coil, Sound I.F.	10-66-3
T352	- Coil Ratio Detector	10-328-1
T410	- xformer Chromo Drive	10-268-1
T440	- Coil Burst Phase	10-250-1
T490	- Coil 3.58 Oscillator xformer	10-258-1
T501	- Coil Blue Horizontal	10-101-5
L14	- Yoke Deflection	80-67-4
L101	- Choke Filter	80-51-6
L102,L103	- Choke, Line Radiation	10-149-1
L116,L117	- Coil degaussing (Top)	10-98-5
L120	- Coil Pincushion	10-125-5
L140	- Coil Peaking 100µh	10-337-1
L230	- Coil Horiz Stabilizer	10-34-5
L315	- Choke, Filament	10-156-1
L322	- Coil 41.25MHz Trap	10-101-3
L323	- Coil 4.5MHz Trap	10-68-3
L324	- Coil Tweet 12µh	10-65-1
L331	- Coil Peaking 60µh	10-341-1
L351	- Coil Peaking 23.5µh	10-333-1
L430,L463,L470	- Coil Peaking 620µh	10-339-1
L472	- Coil Peaking 5.6µh	10-272-1
L483	- Coil Peaking 560µh	10-316-1
L501	- Coil Horiz Convergence	10-126-5
L502	- Coil Vert Convergence	10-102-5
D321,D322	- Diode Germanium (Detector)	86-10-1
D371,D372	- Diode Germanium (Ratio Detector)	86-15-1
Y490	- Crystal	33-8-3
Q31	- Noise Gate	86-161-2
CB101	- Circuit Breaker (3.5a)	43-33-2
TD331	- Delay Line	23-22-2

NOTES:

- RESISTANCE IS SHOWN IN OHMS K=1000, MEG=1,000,000.
- ALL RESISTORS ARE 1/2 WATT, UNLESS OTHERWISE NOTED
- CAPACITANCE VALUES ARE MFD, UNLESS OTHERWISE NOTED
- VOLTAGES READ WITH "VTVM" FROM POINT INDICATED TO CHASSIS GROUND, NO SIGNAL INPUT. ANTENNA SHORTED TOGETHER BUT NOT TO GROUND, LINE VOLTAGE 120 V.A.C.
- CHROMA VOLTAGES WERE TAKEN WITH AIR SIGNAL
- * THESE VOLTAGES MEASURED DURING COLOR RECEPTION
- ↑ READING WILL VARY DEPENDING ON KILLER CONTROL SETTING.
- NUMBERS WITHIN CIRCLES, SQUARES & HALF MOON REFER TO WAVEFORM NUMBERS.

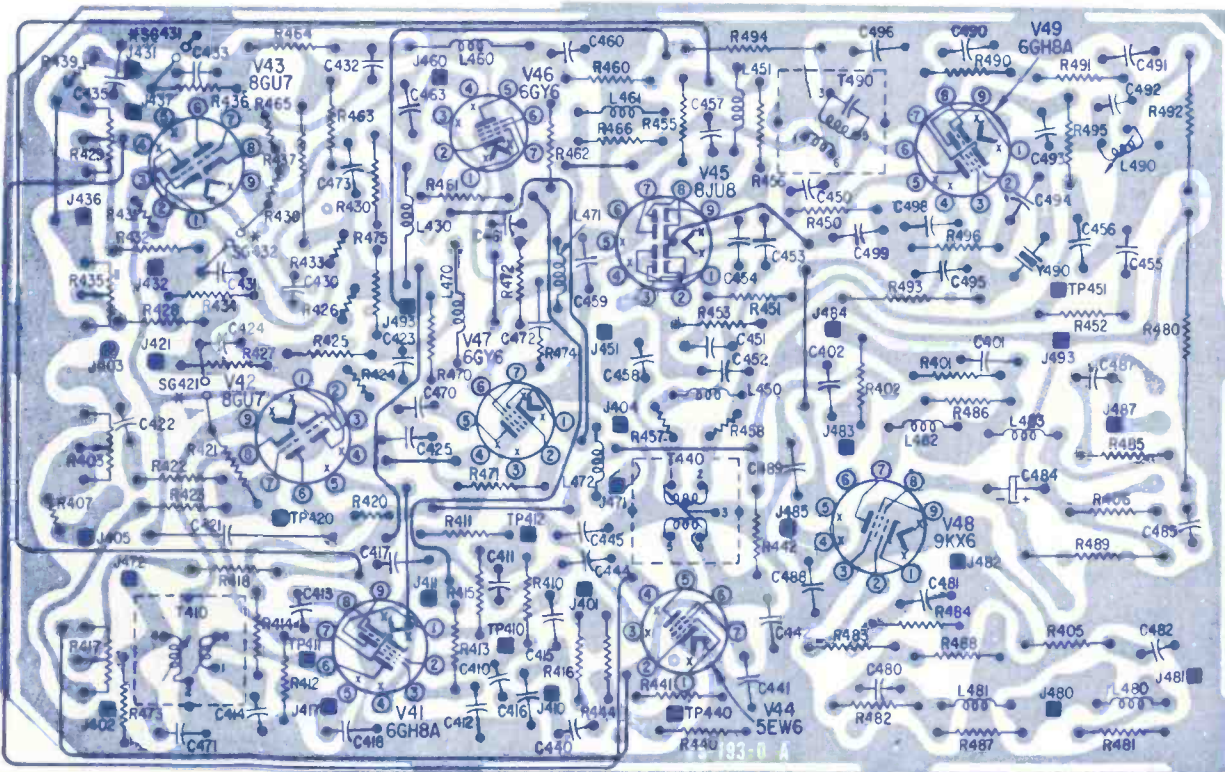

- NOTES:
- WIRING DIAGRAM SHOWN FROM CIRCUIT SIDE OF BOARD.
 - SOLID LINES INDICATE WIRE JUMPERS
 - (*) COMPONENTS MARKED WITH ASTERISK ARE LOCATED ON CIRCUIT SIDE OF BOARD.

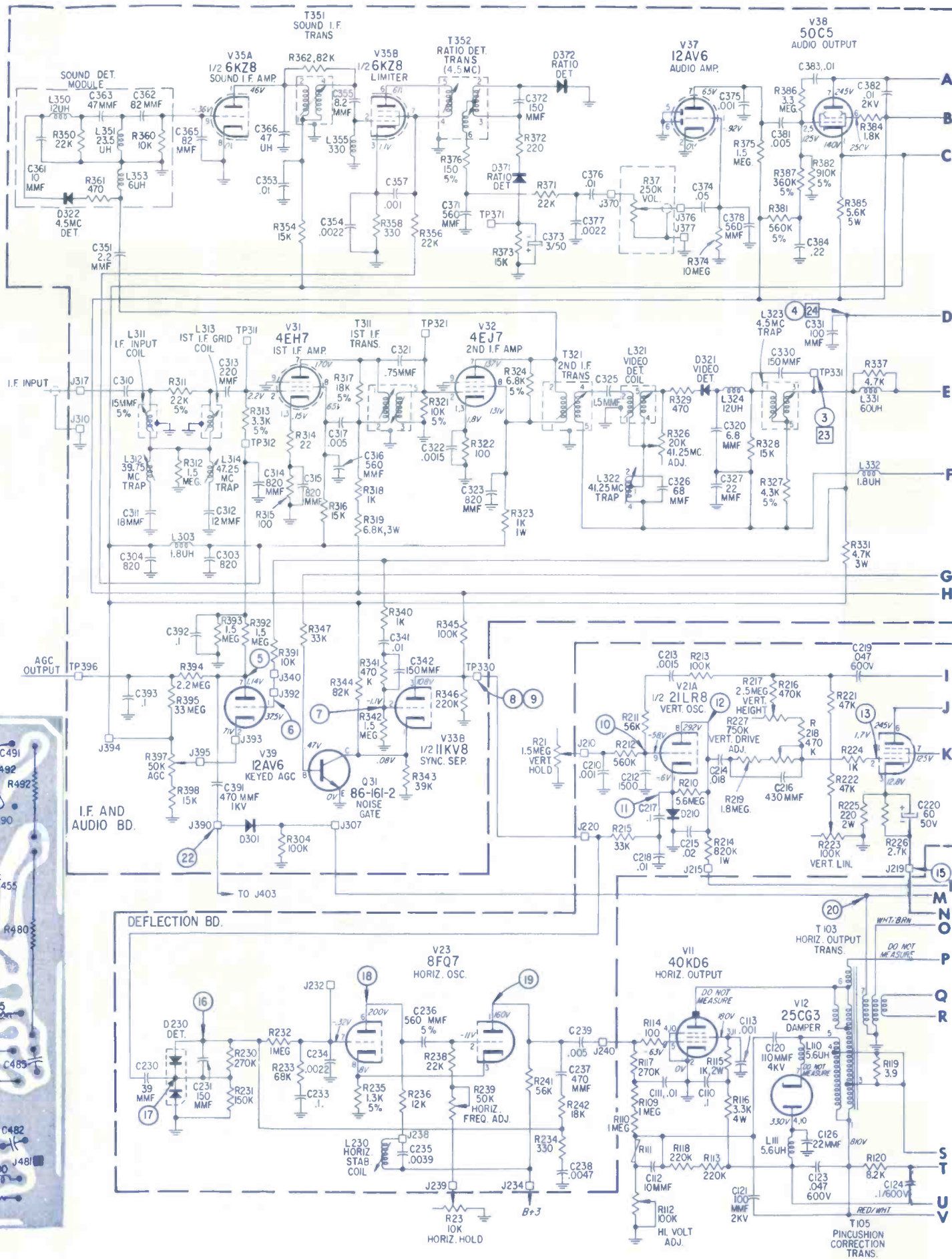

ELECTRONIC TECHNICIAN
OCTOBER • 1967

COMPLETE MANUFACTURERS' CIRCUIT DIAGRAMS
AND TECHNICAL INFORMATION FOR

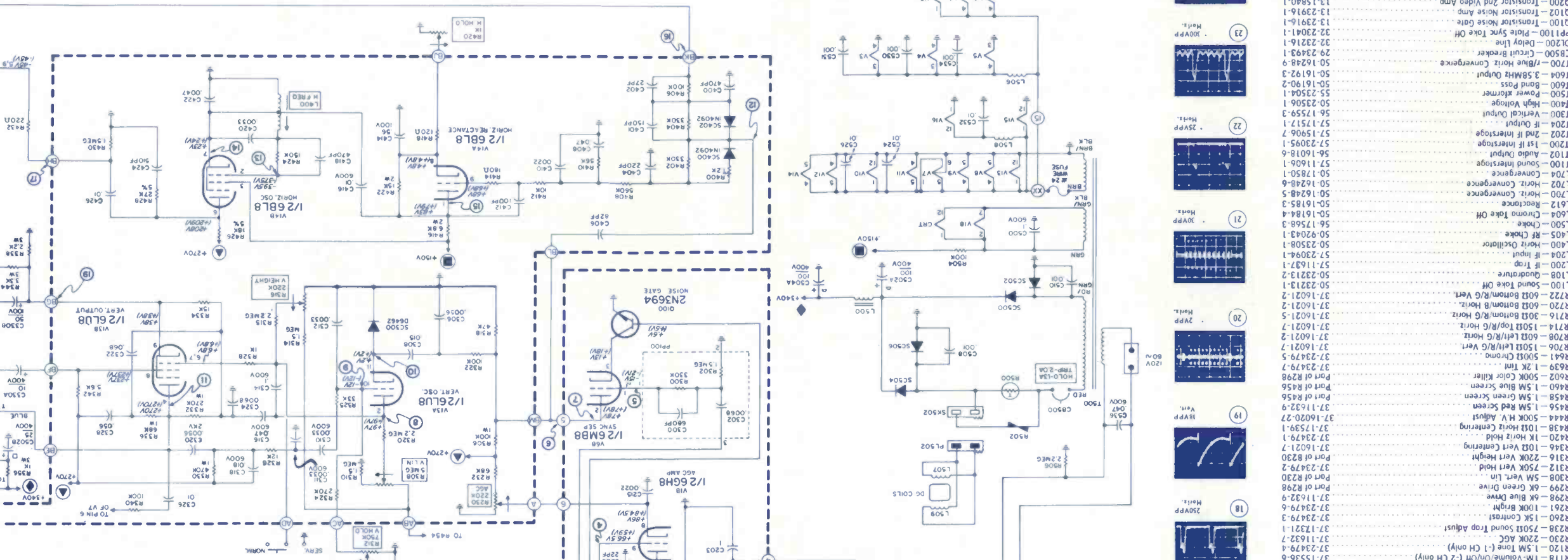
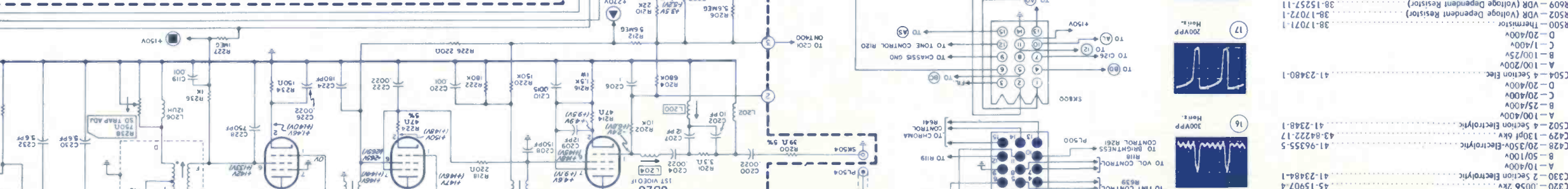
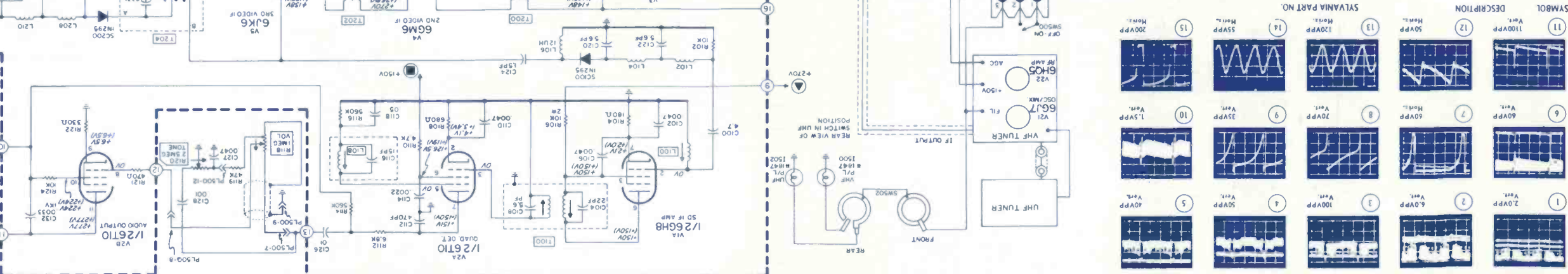
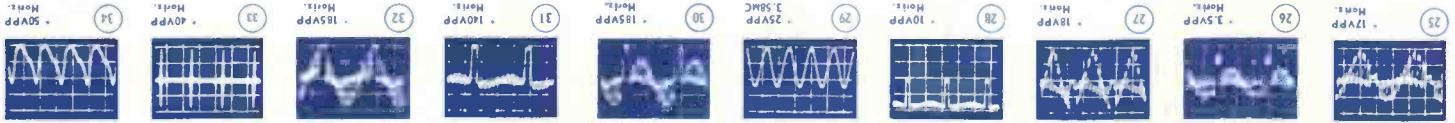

SYMBOL DESCRIPTION

11	110VPP	Vert.	110VPP
12	50VPP	Horiz.	50VPP
13	120VPP	Horiz.	120VPP
14	55VPP	Horiz.	55VPP
15	200VPP	Horiz.	200VPP
16	300VPP	Horiz.	300VPP
17	200VPP	Horiz.	200VPP
18	250VPP	Horiz.	250VPP
19	18VPP	Vert.	18VPP
20	2VPP	Horiz.	2VPP
21	30VPP	Horiz.	30VPP
22	25VPP	Horiz.	25VPP
23	300VPP	Horiz.	300VPP
24	38VPP	Horiz.	38VPP

SYLVANIA PART NO.

C320	0056 2K
C330	2 Section Electrolytic
A10/400V	
C428	20/35V-Electrolytic
C429	130P 6V
43	8A22-17
C502	4 Section Electrolytic
A100/400V	
C504	4 Section Elec.
D	20/400V
A	100/25V
B	100/25V
C	20/400V
D	20/400V
B	25/400V
C	20/400V
A	100/400V
C320	0056 2K
C330	2 Section Electrolytic
A10/400V	
C428	20/35V-Electrolytic
C429	130P 6V
43	8A22-17
C502	4 Section Electrolytic
A100/400V	
C504	4 Section Elec.
D	20/400V
A	100/25V
B	100/25V
C	20/400V
D	20/400V
B	25/400V
C	20/400V
A	100/400V
R502	Thermistor
R503	VDR (Voltage Dependent Resistor)
R504	38-1707-1
R505	38-1525-11
R118	1M Volume/On/Off (-1 CH only)
R119	1M Volume/On/Off (-2 CH only)
R170	1.5M Tone (-1 CH only)
R220	220K AGC
R228	50K Sound Trap Adjust
R260	15K Control
R261	100K Bright
R268	6K Blue Drive
R298	6K Green Drive
R308	5M Vert. Lin
R312	750K Vert. Hold
R316	220K Vert. Height
R346	10K Vert. Centering
R420	1K Horiz. Hold
R438	10K Horiz. Centering
R444	500K H.V. Adjust
R456	1.5M Red Screen
R458	1.5M Green Screen
R460	1.5M Blue Screen
R692	50K Color Killer
R693	1.5M
R706	1.5M L/R/G Vert.
R707	1.5M L/R/G Horiz.
R714	50K L/R/G Horiz.
R716	30K L/R/G Horiz.
R717	30K Bottom/R/G Horiz.
R722	60K Bottom/R/G Horiz.
R723	60K Bottom/R/G Vert.
L108	Sound Take Off
L110	50/2313-1
L200	IF Trap
L204	IF Trap
L205	571149-1
L206	50/2313-2
L207	50/2313-1
L208	50/2313-1
L209	50/2313-1
L210	50/2313-1
L211	50/2313-1
L212	50/2313-1
L213	50/2313-1
L214	50/2313-1
L215	50/2313-1
L216	50/2313-1
L217	50/2313-1
L218	50/2313-1
L219	50/2313-1
L220	50/2313-1
L221	50/2313-1
L222	50/2313-1
L223	50/2313-1
L224	50/2313-1
L225	50/2313-1
L226	50/2313-1
L227	50/2313-1
L228	50/2313-1
L229	50/2313-1
L230	50/2313-1
L231	50/2313-1
L232	50/2313-1
L233	50/2313-1
L234	50/2313-1
L235	50/2313-1
L236	50/2313-1
L237	50/2313-1
L238	50/2313-1
L239	50/2313-1
L240	50/2313-1
L241	50/2313-1
L242	50/2313-1
L243	50/2313-1
L244	50/2313-1
L245	50/2313-1
L246	50/2313-1
L247	50/2313-1
L248	50/2313-1
L249	50/2313-1
L250	50/2313-1
L251	50/2313-1
L252	50/2313-1
L253	50/2313-1
L254	50/2313-1
L255	50/2313-1
L256	50/2313-1
L257	50/2313-1
L258	50/2313-1
L259	50/2313-1
L260	50/2313-1
L261	50/2313-1
L262	50/2313-1
L263	50/2313-1
L264	50/2313-1
L265	50/2313-1
L266	50/2313-1
L267	50/2313-1
L268	50/2313-1
L269	50/2313-1
L270	50/2313-1
L271	50/2313-1
L272	50/2313-1
L273	50/2313-1
L274	50/2313-1
L275	50/2313-1
L276	50/2313-1
L277	50/2313-1
L278	50/2313-1
L279	50/2313-1
L280	50/2313-1
L281	50/2313-1
L282	50/2313-1
L283	50/2313-1
L284	50/2313-1
L285	50/2313-1
L286	50/2313-1
L287	50/2313-1
L288	50/2313-1
L289	50/2313-1
L290	50/2313-1
L291	50/2313-1
L292	50/2313-1
L293	50/2313-1
L294	50/2313-1
L295	50/2313-1
L296	50/2313-1
L297	50/2313-1
L298	50/2313-1
L299	50/2313-1
L300	50/2313-1
L301	50/2313-1
L302	50/2313-1
L303	50/2313-1
L304	50/2313-1
L305	50/2313-1
L306	50/2313-1
L307	50/2313-1
L308	50/2313-1
L309	50/2313-1
L310	50/2313-1
L311	50/2313-1
L312	50/2313-1
L313	50/2313-1
L314	50/2313-1
L315	50/2313-1
L316	50/2313-1
L317	50/2313-1
L318	50/2313-1
L319	50/2313-1
L320	50/2313-1
L321	50/2313-1
L322	50/2313-1
L323	50/2313-1
L324	50/2313-1
L325	50/2313-1
L326	50/2313-1
L327	50/2313-1
L328	50/2313-1
L329	50/2313-1
L330	50/2313-1
L331	50/2313-1
L332	50/2313-1
L333	50/2313-1
L334	50/2313-1
L335	50/2313-1
L336	50/2313-1
L337	50/2313-1
L338	50/2313-1
L339	50/2313-1
L340	50/2313-1
L341	50/2313-1
L342	50/2313-1
L343	50/2313-1
L344	50/2313-1
L345	50/2313-1
L346	50/2313-1
L347	50/2313-1
L348	50/2313-1
L349	50/2313-1
L350	50/2313-1
L351	50/2313-1
L352	50/2313-1
L353	50/2313-1
L354	50/2313-1
L355	50/2313-1
L356	50/2313-1
L357	50/2313-1
L358	50/2313-1
L359	50/2313-1
L360	50/2313-1
L361	50/2313-1
L362	50/2313-1
L363	50/2313-1
L364	50/2313-1
L365	50/2313-1
L366	50/2313-1
L367	50/2313-1
L368	50/2313-1
L369	50/2313-1
L370	50/2313-1
L371	50/2313-1
L372	50/2313-1
L373	50/2313-1
L374	50/2313-1
L375	50/2313-1
L376	50/2313-1
L377	50/2313-1
L378	50/2313-1
L379	50/2313-1
L380	50/2313-1
L381	50/2313-1
L382	50/2313-1
L383	50/2313-1
L384	50/2313-1
L385	50/2313-1
L386	50/2313-1
L387	50/2313-1
L388	50/2313-1
L389	50/2313-1
L390	50/2313-1
L391	50/2313-1
L392	50/2313-1
L393	50/2313-1
L394	50/2313-1
L395	50/2313-1
L396	50/2313-1
L397	50/2313-1
L398	50/2313-1
L399	50/2313-1
L400	50/2313-1
L401	50/2313-1
L402	50/2313-1
L403	50/2313-1
L404	50/2313-1
L405	50/2313-1
L406	50/2313-1
L407	50/2313-1
L408	50/2313-1
L409	50/2313-1
L410	50/2313-1
L411	50/2313-1
L412	50/2313-1
L413	50/2313-1
L414	50/2313-1
L415	50/2313-1
L416	50/2313-1
L417	50/2313-1
L418	50/2313-1
L419	50/2313-1
L420	50/2313-1
L421	50/2313-1
L422	50/2313-1
L423	50/2313-1
L424	50/2313-1
L425	50/2313-1
L426	50/2313-1
L427	50/2313-1
L428	50/2313-1
L429	50/2313-1
L430	50/2313-1
L431	50/2313-1
L432	50/2313-1
L433	50/2313-1
L434	50/2313-1
L435	50/2313-1
L436	50/2313-1
L437	50/2313-1
L438	50/2313-1
L439	50/2313-1
L440	50/2313-1
L441	50/2313-1
L442	50/2313-1
L443	50/2313-1
L444	50/2313-1
L445	50/2313-1
L446	50/2313-1
L447	50/2313-1
L448	50/2313-1
L449	50/2313-1
L450	50/2313-1
L451	50/2313-1
L452	50/2313-1
L453	50/2313-1
L454	50/2313-1
L455	50/2313-1
L456	50/2313-1
L457	50/2313-1
L458	50/2313-1
L459	50/2313-1
L460	50/2313-1
L461	50/2313-1
L462	50/2313-1
L463	50/2313-1
L464	50/2313-1
L465	50/2313-1
L466	50/2313-1
L467	50/2313-1
L468	50/2313-1
L469	50/2313-1
L470	50/2313-1
L471	50/2313-1
L472	50/2313-1
L473	50/2313-1
L474	50/2313-1
L475	50/2313-1
L476	50/2313-1
L477	50/2313-1
L478	50/2313-1
L479	50/2313-1
L480	50/2313-1
L481	50/2313-1
L482	50/2313-1
L483	50/2313-1
L484	50/2313-1
L485	50/2313-1
L486	50/2313-1
L487	50/2313-1
L488	50/2313-1
L489	50/2313-1
L490	50/2313-1
L491	50/2313-1
L492	50/2313-1
L493	50/2313-1
L494	50/2313-1
L495	50/2313-1
L496	50/2313-1
L497	50/2313-1
L498	50/2313-1
L499	50/2313-1
L500	50/2313-1
L501	50/2313-1
L502	50/2313-1
L503	50/2313-1
L504	50/2313-1
L505	50/2313-1
L506	50/2313-1
L507	50/2313-1
L508	50/2313-1
L509	50/2313-1
L510	50/2313-1
L511	50/2313-1
L512	50/2313-1
L513	50/2313-1
L514	50/2313-1
L515	50/2313-1
L516	50/2313-1
L517	50/2313-1
L518	50/2313-1
L519	50/2313-1
L520	50/2313-1
L521	50/2313-1
L522	50/2313-1
L523	50/2313-1
L524	50/2313-1
L525	50/2313-1
L526	50/2313-1
L527	50/2313-1
L528	50/2313-1
L529	50/2313-1
L530	50/2313-1
L531	50/2313-1
L532	50/2313-1
L533	50/2313-1
L534	50/2313-1
L535	50/2313-1
L536	50/2313-1
L537	50/2313-1
L538	50/2313-1
L539	50/2313-1
L540	50/2313-1
L541	50/2313-1
L542	50/2313-1
L543	50/2313-1
L544	50/2313-1
L545	50/2313-1
L546	50/2313-1
L547	50/2313-1
L548	50/2313-1
L549	50/2313-1
L550	50/2313-1
L551	50/2313-1
L552	50/2313-1
L553	50/2313-1
L554	50/2313-1
L555	50/2313-1
L556	50/2313-1
L557	50/2313-1
L558	50/2313-1
L559	50/2313-1
L560	50/2313-1
L561	50/2313-1
L562	50/2313-1
L563	50/2313-1
L564	50/2313-1
L565	50/2313-1
L566	50/2313-1
L567	50/2313-1
L568	50/2313-1
L569	50/2313-1
L570	50/2313-1
L571	50/2313-1
L572	50/2313-1
L573	50/2313-1
L574	50/2313-1
L575	50/2313-1
L576	50/2313-1
L577	50/2313-

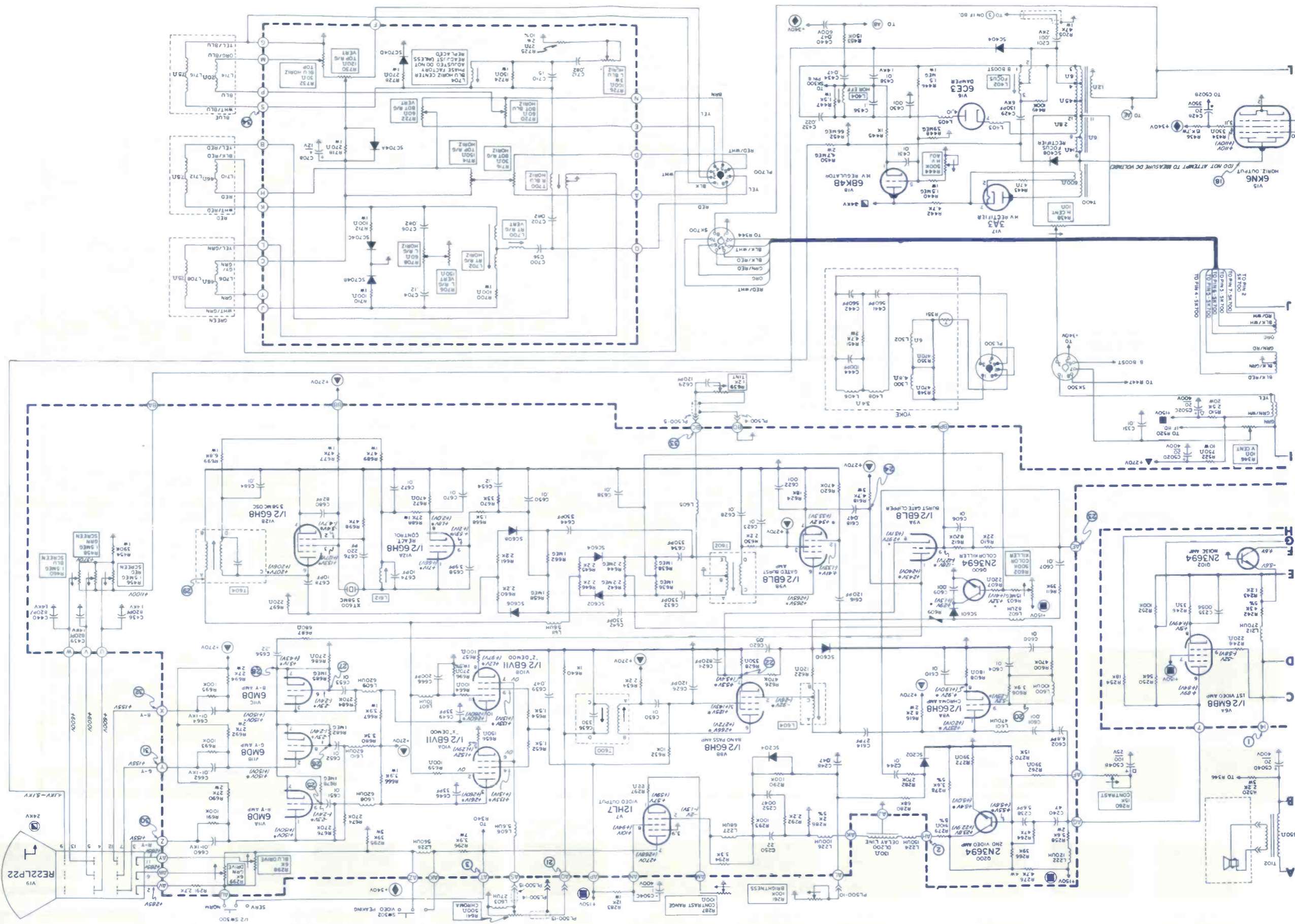

SYLVANIA Color TV Chassis D07-1,-2



\$975

EFFECTIVE 8/1/67

GUARANTEED

Nine-seventy-five buys you a complete tuner overhaul—including parts (except tubes or transistors)—and absolutely no hidden charges. All makes, color or black and white. UV combos only \$15.

Guaranteed means a full 12-month warranty against defective workmanship and parts failure due to normal usage. That's 9 months to a year better than others. And it's backed up by the only tuner repair service authorized and supervised by the world's largest tuner manufacturer—Sarkes Tarzian, Inc.

Four conveniently located service centers assure speedy in-and-out service. All tuners thoroughly cleaned, inside and out . . . needed repairs made . . . all channels aligned to factory specs, then rushed back to you. They look—and perform—like new.

Prefer a replacement? Sarkes Tarzian universal replacements are only \$10.45, customized replacements \$18.25. Shipped same day order received. Order custom tuners by TV make, chassis, and model number. Order universal replacement by part number:

Part #	Intermediate Frequency	AF Amp Tube	Osc. Mixer Tube	Heater
MFT-1	41.25 mc Sound 45.75 mc Video	6GK5	6LJ8	Parallel 6.3V
MFT-2	41.25 mc Sound 45.75 mc Video	3GK5	5LJ8	Series 450 MA
MFT-3	41.25 mc Sound 45.75 mc Video	2GK5	5CG8	Series 600 MA

Genuine Sarkes Tarzian universal replacement tuners with Memory Fine Tuning—UHF Plug In for 82-channel sets—Pre-set line tuning—13-position detent—Hi gain—Lo noise—Universal mounting

FOR FASTEST SERVICE, SEND FAULTY TUNER WITH TV MAKE, CHASSIS, AND MODEL NUMBER, TO TUNER SERVICE CENTER NEAREST YOU



TUNER SERVICE CORPORATION FACTORY-SUPERVISED TUNER SERVICE

MIDWEST817 N. PENNSYLVANIA ST., Indianapolis, IndianaTEL: 317-632-3493
 EAST547-49 TONNELE AVE., Jersey City, New JerseyTEL: 201-792-3730
 SOUTH-EAST . . .938 GORDON ST., S. W., Atlanta, GeorgiaTEL: 404-758-2232
 WESTSARKES TARZIAN, Inc. TUNER SERVICE DIVISION
 10654 MAGNOLIA BLVD., North Hollywood, CaliforniaTEL: 213-769-2720

ISOLATE ANY SWEEP PROBLEM IN SECONDS COLOR OR B/W

NEW!



INADEQUATE WIDTH

**ALL NEW SENCORE
SS137**

SWEEP CIRCUIT ANALYZER



Sweep circuit defects cause the toughest dogs, especially with color. Simplify them in seconds with the All New Sencore Sweep Circuit Analyzer. The only complete Sweep Circuit Analyzer available. The SS137 trouble shoots each and every stage in both the vertical and horizontal sweep sections of the receiver, by either signal injection or direct substitution of the entire stage. Using tried and proven methods, the Sencore SS137 takes the sweat out of sweep circuit trouble shooting. All tests are with the set on, dynamically in the circuit . . . to insure the most reliable and accurate check on each component.

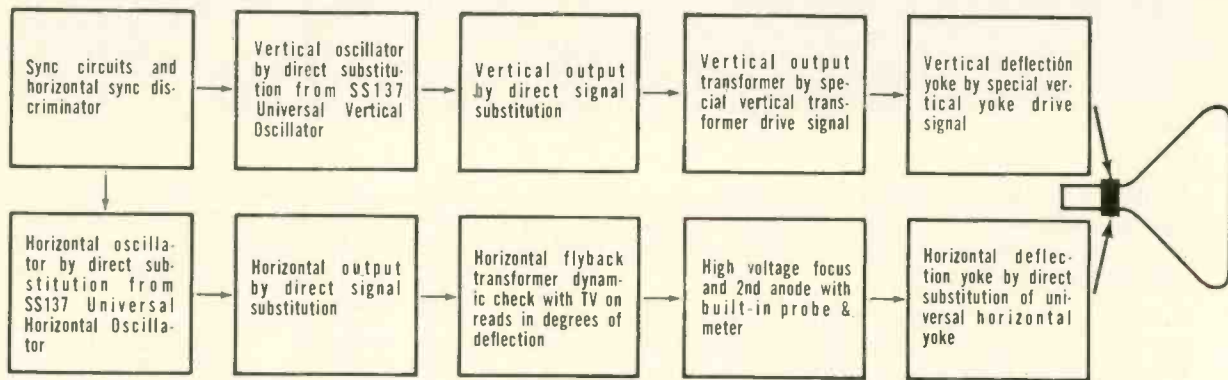

In addition, a built-in VTVM and milli-ampere meter to back you up when setting regulator currents and measuring current through the horizontal output stage. Measures AC peak to peak and DC voltages up to 1000 volts. There is even a clip-on high voltage probe and a meter circuit for measuring and monitoring the second anode up to 30,000 volts in two ranges at the flick of a switch. An absolute MUST for color.

**ALL
FOR
ONLY
\$94⁵⁰**

PLUS — These Special Sencore Extras

- Glass mirror in the lid to setup linearity and height adjustments.
- Removable hinged cover that can be left right on the unit for protection to and from the job.
- All steel construction for maximum durability.

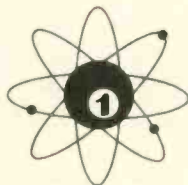

See America's most complete line of professional test instruments — at your Distributor now.

SENCORE

NO. 1 MANUFACTURER OF ELECTRONIC MAINTENANCE EQUIPMENT
426 SOUTH WESTGATE DRIVE, ADDISON, ILLINOIS 60101

... for more details circle 138 on postcard
ELECTRONIC TECHNICIAN

ELECTRONIC TECHNICIAN

WORLDS LARGEST ELECTRONIC TRADE CIRCULATION

OCTOBER 1967 • VOL. 86, NO. 4

RON KIPP
Publisher

JACK HOBBS
Managing Editor

JOSEPH ZAUHAR
Technical Editor

PHILLIP DAHLEN
Associate Editor

RICHARD CLAYTON
Field Editor

MARTIN PADLEY
Field Editor

BARBARA BURNSON
Production Editor

KEN McSHANE
Art Editor

RUTH GELINEAU
Circulation Manager

JOHN KESSLER
Manager, Reader Services

MAGGIE KANE
Advertising Production

GENERAL OFFICES
OJIBWAY PRESS, INC.
Ojibway Building
Duluth, Minn. 55802
Phone: (218) 727-8511
Telex: 029-4417

MARSHALL REINIG
President

GREG BLODGETT
Treasurer

DEAN MYHRAN
Executive Vice President

JOE WOLKING
Vice President, Marketing

BEN MARSH
Vice President, Editorial

HARRY RAMALEY
Vice President, Production

LARS FLADMARK
Circulation Director

JAMES GHERNA
Art Director

WARREN BODIN
Ad Production Supervisor

NEW YORK OFFICES
71 Vanderbilt Ave.
New York, N.Y. 10017
Phone: (212) 686-2200

ROBERT EDGELL
Senior Vice President

RICHARD C. REINHARDT
Vice President

DON GENOAR
Manager, New York Office

CHICAGO OFFICES
43 East Ohio Street
Chicago, Illinois 60611
Phone: (312) 467-0670
Telex: 02-53549

TOM GRENEY
Vice President

DOROTHY BOLAN
Manager, Chicago Office

MARKETING REPRESENTATIVES

New York: (212) 686-2200
RON KIPP

Chicago: (312) 467-0670
ED KELLY

39 WHAT'S NEW IN 1968 COLOR TV?

Learn all about the new circuit innovations you'll discover in the 1968 color sets

44 COMMON COLOR PROBLEMS

An expert bench technician tells how you can boil down most older color set problems into about ten categories

47 TAPE RECORDERS, TAPE DECKS, AND CARTRIDGE PLAYERS

Part one of an in-depth article series will cover this equipment from "soup to nuts"

50 SEMICONDUCTORS FROM A TO Z

The fifteenth article in this continuing series covers "varicaps" — those variable capacitance diodes which are being used to tune various types of electronic circuits

56 UNIQUE TEST INSTRUMENTS FOR COLOR TV SERVICING

This article covers two unique instruments used for speeding color TV servicing

60 GOOD SERVICE PROMOTES STEADY SALES GROWTH

Read how one service-dealer is making his business hum

62 WHO'S SELLING WHAT — WHERE AND HOW?

Short sketches of service-dealer operations and how they are promoting sales and service

22 LETTERS TO THE EDITOR

28 EDITOR'S MEMO

30 TECHNICAL DIGEST

60 DEALER FAX

66 COLORFAX

74 NEW PRODUCTS

82 NEWS OF THE INDUSTRY

90 BOOK REVIEWS

94 CATALOGS & BULLETINS

96 ADVERTISERS' INDEX

97 READER SERVICE CARD

COVER:

As solid-state technology continues to shrink electronic circuitry, our photographers develop new techniques for enlarging it. Our cover shows a 1½ inch section of the chroma panel "S" used in Motorola's transistorized color receiver. The small section from the panel is enlarged approximately five times.

TEKFAX • 16 PAGES OF THE LATEST SCHEMATICS • Group 182

AIRLINE: TV Model GEN-11768A

MAGNAVOX: TV Chassis T925 Series

PHILCO: TV Model Q1054

RCA VICTOR: TV Chassis KCS157 Series

SILVERTONE: Color TV Chassis 528.72280,81,82

SYLVANIA: Color TV Chassis DO7-1,-2

OJIBWAY PRESS, INC.



ELECTRONIC TECHNICIAN is published monthly by Ojibway Press, Inc. Subscription Rates: One year \$5.00, Two years \$8.00, three years \$10.00 in United States and Canada. Other Countries: One Year \$9.00, two years \$14.00, three years \$18.00. Single Copies, 60¢. Second Class postage paid at Waseca, Minnesota and at additional mailing offices. Copyright 1967 by Ojibway Press, Inc. POSTMASTER: Send form 3579 to ELECTRONIC TECHNICIAN, Ojibway Building, Duluth, Minnesota 55802.

**"I was TROUBLE-SHOOTING
in the DARK**

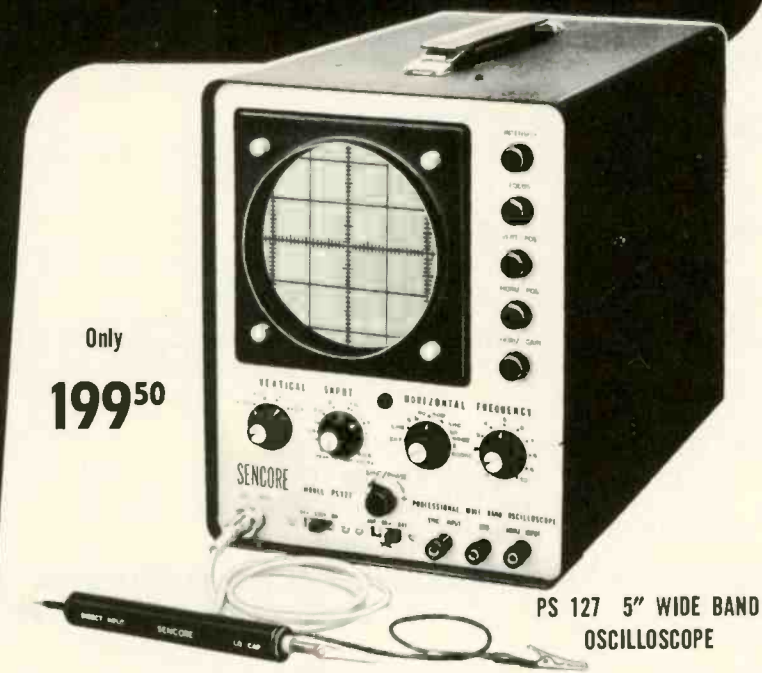

PS 127 5" WIDE BAND
OSCILLOSCOPE

Technicians everywhere are talking about the PS127 5" Wide Band Oscilloscope. Try one and you, too, will send us comments like these—

"So easy to use! With my Sencore scope I can read high or low frequency signals without band switching. As easy to use as a voltmeter."—R. L., Portland, Ore.

"I've only had my PS127 a couple of months, but it's more than paid for itself already with the extra jobs I've been able to handle."—S. O., New Orleans, La.

"With the direct peak-to-peak readout I can compare voltage readings to those on the schematic without wasting valuable time setting up my scope with comparison voltages."—J. M. F., Plymouth, Michigan.

"Those Sencore exclusives really sold me, like the extra 500KC Horizontal Sweep range and the free high voltage probe."—D. N., Brooklyn, N.Y.

You'd expect a wide band scope of this quality to cost at least double."—W. L., Chicago, Ill.

"With the PS127, I find I can trouble-shoot those tough ones twice as fast as before—especially color TV."—F. C., Burlingame, Calif.

"Once I compared the specs, I knew Sencore had the best buy in scopes. We now have three PS127's in our shop."—J. S., Ft. Lauderdale, Fla.

SPECIFICATIONS

Vert. Freq. Resp. 10 CPS to 4.5 MC \pm 1 db, — 3 db @ 6.2 MC • Rise Time .055 Microseconds • Vert. Sens. .017 Volts RMS/inch • Horiz. Freq. Resp. 10 CPS to 650 KC • Horiz. Sens. .6 Volts RMS/inch • Horiz. Sweep Ranges (10% overlap) 5 to 50 CPS, 50 to 500 CPS, 500 CPS to 5 KC, 5 to 50 KC, 50 to 500 KC • Input Impedance 2.7 megohms shunted by 99 MMF, 27 megohms shunted by 9 MMF thru low-cap. jack • High Voltage Probe 5000 Volts Max. • Dimensions 12"x9"x15½", Wt. 25 lbs. • Price Complete \$199.50



NO. 1 MANUFACTURER OF ELECTRONIC MAINTENANCE EQUIPMENT

SENCORE

426 SOUTH WESTGATE DRIVE, ADDISON, ILLINOIS 60101

... for more details circle 139 on postcard

LETTERS TO THE EDITOR

Replacing OZ4s

If anyone is interested, an OZ4 rectifier can be replaced with a top-hat silicon rectifier. I not only found the change to be more efficient but there was also a lot less noise. An OZ4 can produce a lot of hum or hash in a car radio if all leads are not shielded. The top-hat rectifier eliminates the need for some of this shielding.

WILLIAM E. PROCTOR
Berrysburg, Pa.

Color Problem

Perhaps this may help some other ET readers.

A Motorola Color set, WTS907, had a short raster (up about 8in. at the bottom) and none of the controls and no vertical tube replacements would help. Changed the silicon rectifier (X5) on the convergence board and solved the problem.

ROY RANDALL
Hobe Sound, Fla.

A New Subscriber

I am a new subscriber who understands the tremendous value of your magazine and began with a three-year subscription. I need a schematic and operators manual for an Anchor CRT tester/rejuvenator, model T401 and also operators manual for a Heathkit Visual-Aural Signal Tracer, model T3. Can any reader help me?

WALLACE F. PETERSON
Box 248
Thompson, Conn. 06277

A Helping Hand

I have noticed frequent letters from readers who are in need of service information on Hi Fi and stereo equipment of European manufacture. I will, as far as time permits, assist anyone who sends specific symptoms and as much other info as possible along with a stamped self-addressed envelope.

EARL K. KIRKPATRICK
Delta Electronics
2042 Ft. Benning Road
Columbus, Ga. 31903

• Because ET is published only for professionals, it does not run a "clinic" or engage in the amateurish game of "remote troubleshooting" which is a very dangerous endeavor at best. Articles in ET adequately cover practical problems which its readers confront

continued on page 24

SOME SHOP OWNERS DO MORE BUSINESS THAN OTHERS BY DOING BASIC THINGS LIKE THESE:

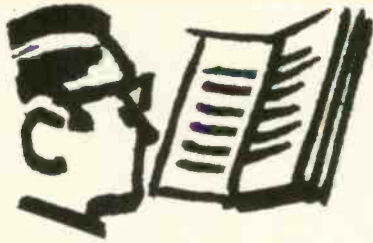

1 Reading what's new in leading technical magazines.



2 Keeping their trucks ready to roll at a moment's notice.



3 Arranging to have their phones answered promptly.

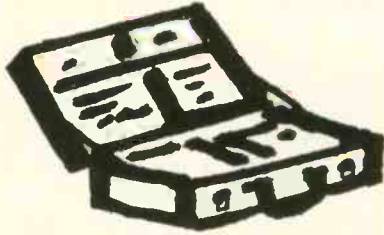

4 Making sure their caddies are organized and properly stocked.



5 Keeping accurate track of their time on each job.



6 Smiling . . . often . . . both on and off the job.



DIFILM® ORANGE DROP® . . .
The world's finest
radial-lead capacitor

DIFILM® BLACK BEAUTY® . . .
Ultimate in molded tubulars

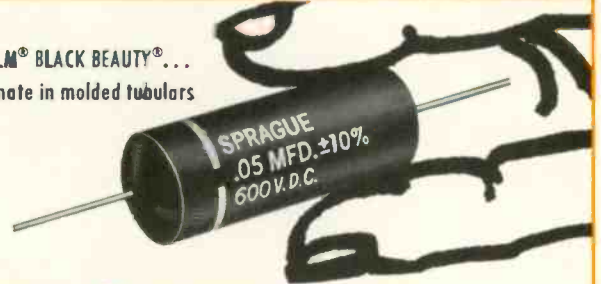

7 INSTALLING SPRAGUE DIFILM® CAPACITORS

These two great Sprague capacitors are expressly made for men who are in the TV service business to do business . . . as it should be done. Both feature the ultimate in tubular capacitor construction to keep you out of call-back trouble:

- Dual dielectric . . . combine best properties of both polyester film and special capacitor tissue.
- Impregnated with HCX® to provide rock-hard capacitor section.
- Because impregnant is solid, there's no oil to leak, no wax to drip.
- Designed for 105° C (220° F) operation without voltage derating.

DIFILM® ORANGE DROP® Dipped Tubular Capacitors

A "must" for applications where only radial-lead capacitors will fit. Perfect replacements for dipped capacitors used in most leading TV sets. No other dipped tubular capacitors can match them. Double-dipped in rugged epoxy resin for positive protection against extreme heat and humidity.

DIFILM® BLACK BEAUTY® Molded Tubular Capacitors

World's most humidity-resistant molded capacitors. Feature tough, protective outer case of non-flammable molded phenolic . . . which cannot be damaged in handling or installation. Will withstand the hottest temperatures of any radio or TV set . . . even in the hottest, most humid climates.

For complete listings, ask your Sprague distributor for Catalog C-617, or write to Sprague Products Company, 65 Marshall Street, North Adams, Massachusetts 01247.

**DON'T FORGET TO ASK YOUR CUSTOMERS
"WHAT ELSE NEEDS FIXING?"**



... for more details circle 144 on postcard

Introducing Winegard's

color★line 82

the finest
TV antenna
lead wire yet!

coaxial
cable
pack

NOT JUST VHF!
NOT JUST UHF!

But the first and only 1-piece, molded
82-channel coax system—complete with
its own VHF-UHF band separator!

... actually lets you convert any antenna into the lowest loss
coaxial system available, without special transformers,
connectors and tools.

Look at the features you get only with Color-line 82

- 1 All-band 82-channel transformer** (VHF-UHF-FM) permanently molded onto cable—no connector needed—completely weatherproof! Includes soft drawn copper antenna leads permanently molded into transformer case.
- 2 Sensational new ultra-low-loss, foam-filled coax cable** specially designed and factory sweep-tested for channels 2 to 83. Temperature tested to -55°C . Tough, yet flexible vinyl jacket is easy to work with and won't deteriorate in any weather. Color-line 82 is completely shielded to shut out interference.
- 3 No loss VHF-UHF Band Separator** attaches to set and separates VHF and UHF signals coming from antenna to set. Can be used with 82-channel set or with straight VHF set.

 **Winegard**
ANTENNA SYSTEMS

WINEGARD COMPANY • 3000 KIRKWOOD STREET • BURLINGTON, IOWA 52601

© Copyright 1967, Winegard Company, Burlington, Iowa

... for more details circle 146 on postcard



NOTHING ELSE
TO BUY!

- Completely self-contained
- Ready-to-install

LETTERS TO THE EDITOR

continued from page 22

from day to day — even including much refresher material in electronic theory for both the professional and the apprentice. But many ET readers are sometimes confronted with the problem of finding information which the editors could not possibly locate if they worked 24 hours a day. In these cases, readers frequently volunteer to help other readers. Thanks, Earl. — Ed.

Tuning Indicator Tubes

Regarding Rudolf Natoli's need for a UM80, I have two on hand and he can have one. I am an ET subscriber and I like the good work of the whole staff. Keep it up on servicing.

BEN C. PROTASIO

Automotive Electrical Services

PO Box 1114

Agana, Guam 96910

Pleased

It was a pleasure to read your Editor's Memo in the June issue regarding the NEA resolution on the terms supplied to service technicians. We have been receiving favorable response to this resolution from many segments of the industry. I am sure that your editorial will do much to help the service industry upgrade itself by using proper terminology.

I would like to thank ELECTRONIC TECHNICIAN for publishing this resolution where it will be read by so many.

NEA has been accused of passing resolutions at the drop of a hat, but it is our way of taking a stand and making our feelings known on the various subjects that affect our industry.

I will see that you are put on our mailing list to receive copies of all the resolutions we adopt and if you think they have merit, you may want to pass them on through your fine magazine.

JOHN BETZ,
NEA President

211 West 18th
Waterloo, Iowa 50702

CRT Size Confusion

If we can correctly interpret news reports, then the sizes of CRTs have been determined by glassmakers to designate one pattern from another in their line of work. It appears the figures selected are quite adequate for

continued on page 26

The package carrier that never sleeps

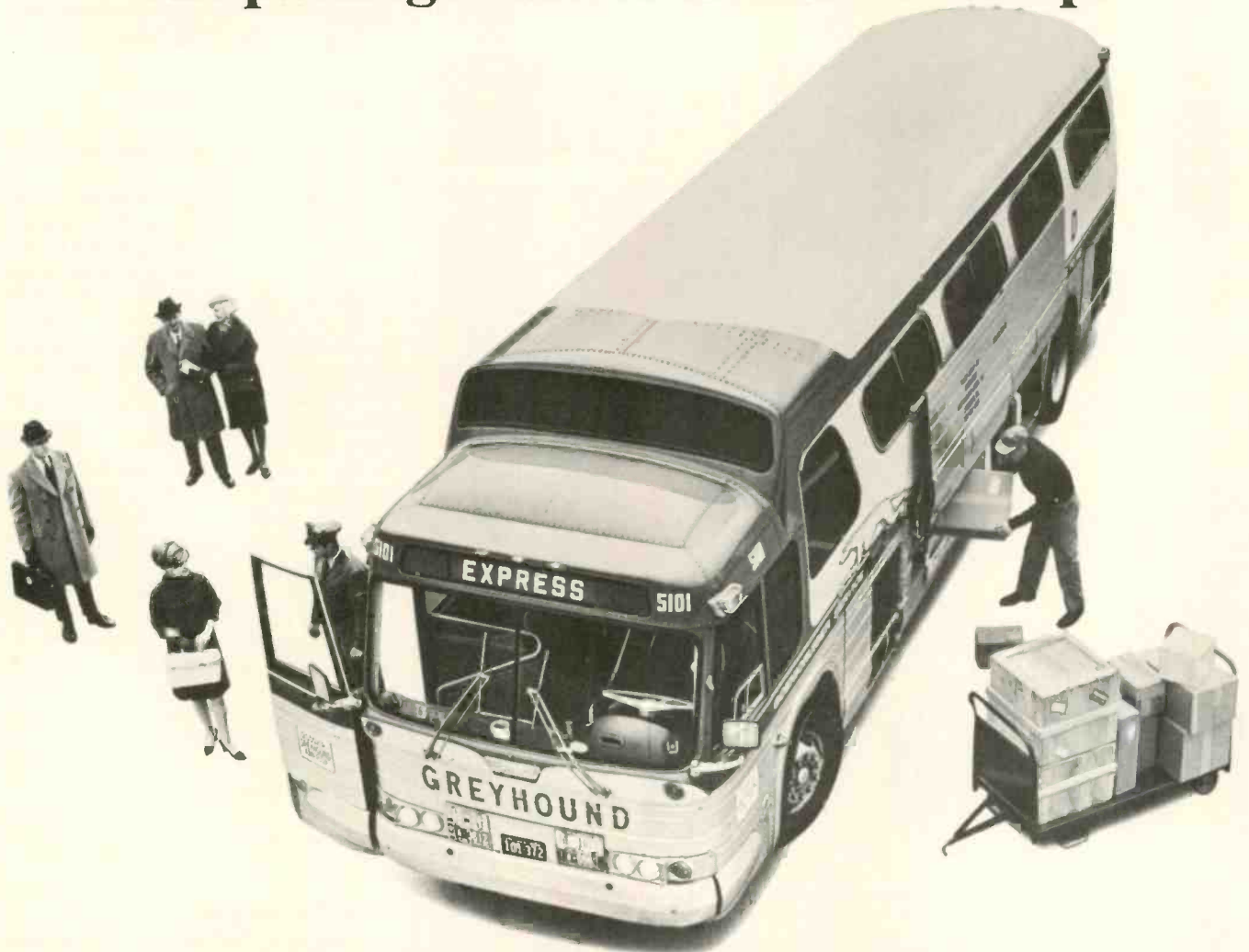

Your packages go 24 hours a day, 365 days a year, by Greyhound Package Express

Greyhound Package Express is the wide-awake way to get your packages *where* you want them. Ship anytime 'round the clock, days, nights, weekends, and holidays, too! Your packages can go wherever Greyhound goes, and Greyhound goes just about everywhere in the U.S.A. When you ship by GPX,

your packages travel on fast, frequent "people" schedules, aboard regular Greyhound buses, serving more than 25,000 cities, towns and villages. Very often, packages shipped by GPX get where you want them in a matter of hours. Sometimes even faster than if you shipped them by air. Before you

make your next shipment, remember GPX. Ship C.O.D., Collect, Prepaid, or open a Charge Account. Extra savings on lot shipments also available. For information on service, rates and routes, call Greyhound or write: Greyhound Package Express, Dept. 53-J, 10 South Riverside Plaza, Chicago, Ill. 60606.

It's there in hours and costs you less

For Example:	Buses Daily:	Running Time:	20 lbs.	30 lbs.	40 lbs.
Boston New York	28	4 hrs. 15 min.	\$2.20	\$2.60	\$2.90
Los Angeles San Francisco	22	9 hrs. 15 min.	2.10	2.45	2.80
Pittsburgh Cleveland	12	2 hrs. 45 min.	2.00	2.25	2.65
Indianapolis Chicago	10	4 hrs.	2.10	2.45	2.85

*Other low rates up to 100 lbs. Lot shipments, too.



One of a series of messages depicting another growing service of The Greyhound Corporation.

... for more details circle 118 on postcard



has
everything
in

phono drives

Look to GC-Walsco for the largest, most versatile "one source" selection of quality parts to meet any phono drive service need.

Choose from idler and drive wheels, pressure rollers, turret drives, pulleys, fabric belts, flat and round rubber belts . . . all made to precise original equipment specifications from the finest materials available assuring you and your customers of top performance, maximum service life.

All parts are available individually, or in convenient pre-packed assortments, together with handy cross-reference Walsco wall charts to facilitate your selection.

Specify GC-Walsco . . . and you get the finest!

Write for your Giant **FREE GC Catalog** today . . . over 12,000 items including TV Hardware, Phono Drives, Chemicals, Alignment Tools, Audio, Hi-Fi, Stereo & Tape Recorder Accessories, Nuts & Bolts, Plugs & Jacks, Service Aids, and Resistive Devices.



*only GC gives you
everything in electronics.
..... for almost 40 years!*

GC ELECTRONICS COMPANY

400 South Wyman Street
Rockford, Illinois 61101

A DIVISION OF HYDROMETALS, INC.



Phono Drive
Assortment Kit
Cat. No. 1408-02



2" O.D. Idler Wheel
Cat. No. 1432-S



Round Rubber Belt
Cat. No. 1410-54



Turret Drives
Cat. No. 1465
Cat. No. 1466
Cat. No. 1467



Fabric Drive Belt
Cat. No. 1409-04



Idler Pulley
Cat. No. 1453



LETTERS TO THE EDITOR

continued from page 24

both design and replacement practice of TV picture tubes.

No small amount of confusion and irritation has been caused to prospective buyers of TV receivers, due to the fact that while one group of receiver manufacturers refer to their CRT sizes in square-inch terms, another group favors a scaled-down diagonal face measurement mode. The latter conforms to practices recently made mandatory by an FTC ruling concerning a diagonal connotation.

For many years the lumber industry has referred to terms convenient to its use such as two-by-fours (2x4s); denoting inch measurements which have received consumer acceptance, but are not in fact the true sizes received by the consumer.

Since a discrepancy exists between actual sizes delivered and the sizes denoted, it would appear an injustice prevails. An oversight on the part of receiver manufacturers could be a reason for not rebelling against the recent ruling by the FTC.

FLOYD N. STRONG

Chardon, Ohio

TEKFAK Available

Am out of the business. Will sell my TEKFAK which begin from June 1962.

JAMES H. FLICKINGN

PO Box 137
Holt, Calif. 95234

A Zipperoo

The Zip Code given for the Sprague Products Co. on Page 84 of your June issue is not correct. The correct Post Office Zip Code for North Adams is 01247. As you can note from this letterhead, the Zip Code at one time was 01248 but this has since been changed.

Incidentally, the label on which my checking copy comes and which carries the identification "Chert S 009 81081X" has the Zip Code for North Adams as 02147. Apparently someone transposed two digits in key-punching.

SIDNEY L. CHERTOK, Manager
Advertising and Sales Promotion
Sprague Products Co.
North Adams, Mass. 02147

•Note to all service-dealers: Correct this in your "Technician's Directory."
— Ed.

... for more details circle 116 on postcard

Getting a hernia and not getting paid for it?

Switch to Elmenco dipped Mylar®-paper capacitors and you won't have to worry about call-backs, lost profits, broken reputations or broken anything else.

The only ordinary thing about them is their price. You get capacitors that meet the requirements of high-reliability computer and missile systems. You get capacitors that hold their rating at 125°C continuous operation. Yet you get them at TV set prices.

Elmenco dipped Mylar-paper capacitors come in just about any value you need from .001 mfd to 1.0 mfd. And just about any TV rated voltage you need, too, from 100V through 1600V.

Ask your Authorized Arco Distributor to put them on your next order. Without fail.

Tell him you're counting on his support.

(While you're at it, ask about other Elmenco types: padders and trimmers; high voltage dipped micas.)

Arco Electronics

A Division of Loral Corporation
Community Drive, Great Neck, N. Y. /
Arlington, Texas / Elk Grove Village,
Illinois / Pasadena, Menlo Park, California.

® OUPONT TRADEMARK.

... for more details circle 104 on postcard



The Model 6000 Modular Frequency Meter will measure frequencies 10 KHz to 600 MHz with .000125% accuracy. Special plug-in modules allow the instrument to be used as an audio frequency meter from 500 Hz to 20 KHz full scale and in addition to be used as a dc voltmeter (10,000 ohms/volt).

The wide variety of plug-in oscillator accessories and range modules makes the Model 6000 adaptable to a number of jobs in the field and in the laboratory. Portable, battery operated with rechargeable batteries.

Model 6000 with 601A charger, less plug-in modules.....\$195.00

INTERNATIONAL MODEL 6000 FREQUENCY METER

measures frequencies 10 khz to 600 mhz with accuracy as close as .000125%



Range Modules (Mixers)
\$25.00 to \$45.00 each

Oscillator Modules
(Crystal Controlled For
Frequency Measurement)
\$30.00 to \$90.00 each

Special Modules
Audio Frequency.....\$45.00
DC Voltmeter..... 25.00

where
accuracy
counts!

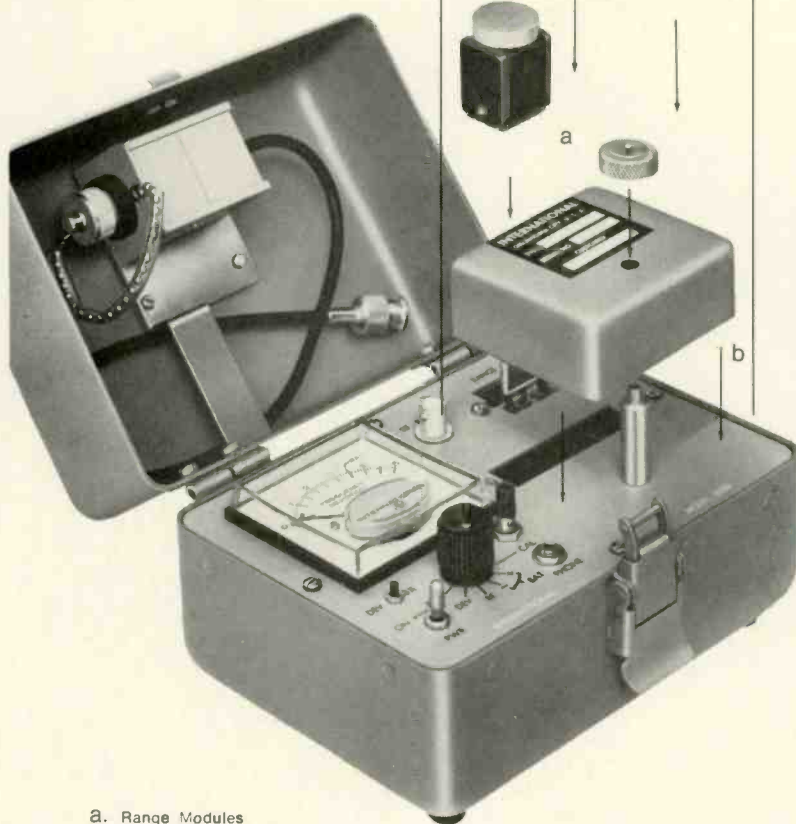

- a. Range Modules
- b. Oscillator Modules

For complete information
write International today.



CRYSTAL MFG. CO., INC.
10 NO. LEE • OKLA. CITY, OKLA. 73102

... for more details circle 120 on postcard

EDITOR'S MEMO

Unalterable Change

To botch-up an old cliché, "nothing is more sure, more absolute, more unalterable than change itself." But change frequently has a tough time with natural human inertia. People have a natural affinity for soft-bottomed chairs.

ELECTRONIC TECHNICIAN has been fortunate in this respect, however. Although it does not believe in change just for the sake of change, it does believe in keeping up with the times. We don't sit on our "fannies" until progress demands a ton of TNT to move us. The magazine tolerates the status-quo only so long as it can produce results. Hence, many changes have been made over the years so the magazine could live up to its unequivocal purpose: "To provide the most up-to-date, practical technical and business information available for the service-dealers and technicians who work in the home-entertainment area of the electronics field."

And it has further been made clear that this coverage is concentrated in the sub-areas of color TV, radio, Hi Fi, two-way audio and radio communications and solid-state technology. Additional coverage is directed to service-dealers and technicians who have diversified into or who now specialize in certain electronic equipment used in business, industry, education and medical science. This additional coverage includes public address, video tape recording, medical electronic equipment, closed-circuit TV and other types of audio and audio-visual systems.

While the main editorial concentration in ET is technical — in the equipment installation and maintenance area — it also concentrates emphatically on the "how to" aspects of business management and merchandising.

The latest change to be made in ET will become obvious in this issue. The DEALER FAX section which begins on page 60 will be expanded and made more useful in the months to come. And the plans which have already been projected for 1968 will include expanded coverage in the technical area which we believe will prove even more helpful to the service-dealers and technicians in this country.

Yes, we live in a changing world. Let's try to keep up with it and avoid the inevitable catastrophe which will result if we allow ourselves to be left behind.

Yours FREE with purchase of any RCA 21" color picture tube!

In RCA's "VOLUMES OF VALUE" Program.

*Except test tubes.

LIFE Science Library

SPECIAL OFFER ON



COLOR PICTURE TUBES



Choice of 24 Volumes LIFE Science Library

- | | |
|----------|--------------------|
| Flight | Sound and Hearing |
| Ships | Health and Disease |
| Time | Man and Space |
| Wheels | Giant Molecules |
| The Cell | Drugs |
| The Body | The Scientist |
| The Mind | The Planets |
| Matter | The Engineer |
| Energy | The Physician |
| Growth | Food and Nutrition |
| Water | Mathematics |
| Weather | Machines |

Any two LIFE Science Library books

Earn a gift that not only enriches the mind but one that will become a valued family possession. Choose from the 24 volumes of this nationally advertised library.

Each hardbound Life Science Library book comprises about 200 pages, 35,000 words of text, and hundreds of drawings, photographs, charts and diagrams, many of them in full color. Size is 8½ by 11 inches. The Library is beautifully matched and will bring to your family an ever-ready source of lively and concise information on virtually every scientific subject.

ASK YOUR AUTHORIZED RCA COLOR PICTURE TUBE DISTRIBUTOR FOR THE DETAILS! OFFER GOOD TILL JANUARY 31, 1968.



Or your choice of a Van Heusen® shirt

A huge selection of colors and styles for both men and ladies. All are Vanopress™—the permanently pressed shirt that never needs ironing. A 20-page catalog to choose from.

RCA Electronic Components and Devices, Harrison, N. J.



The Most Trusted Name in Electronics

TUNE IN ON THE PERRY COMO HOLIDAY SPECIAL IN COLOR ON NBC-TV. THURSDAY, NOVEMBER 30, 7:30 - 8:30 P.M., E.S.T.

RCA TEST EQUIPMENT FALL COUPON CARNIVAL

Clip the coupons—take them to your participating RCA Test Equipment Distributor any time between now and October 31st. Take advantage of RCA's BIG Fall offer—*discounts on every test instrument listed!*

(Only one coupon will be accepted per instrument)



RCA Electronic Components and Devices, Harrison, N. J.

The Most Trusted Name in Electronics

PICK YOUR RCA INSTRUMENTS—ACT NOW!

\$10.00

TOWARD PURCHASE OF
3" OSCILLOSCOPE WO-33A



Mr. Distributor: Refer to RCA Fall Festival Announcement. Void where prohibited, taxed or restricted. Cash value 1/20g. Offer expires October 31, 1967.

\$3.00

TOWARD PURCHASE OF
WV-38A V.O.M.



Mr. Distributor: Refer to RCA Fall Festival Announcement. Void where prohibited, taxed or restricted. Cash value 1/20g. Offer expires October 31, 1967.

\$10.00

TOWARD PURCHASE OF
WA-44C SINE/SQUARE WAVE
AUDIO SIGNAL GENERATOR



Mr. Distributor: Refer to RCA Fall Festival Announcement. Void where prohibited, taxed or restricted. Cash value 1/20g. Offer expires October 31, 1967.

\$3.00

TOWARD PURCHASE OF
WR-50B RF SIGNAL
GENERATOR

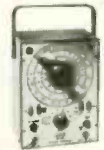

Mr. Distributor: Refer to RCA Fall Festival Announcement. Void where prohibited, taxed or restricted. Cash value 1/20g. Offer expires October 31, 1967.

\$25.00

TOWARD PURCHASE OF
WR-64B COLOR BAR /DOT/
CROSSHATCH GENERATOR



Mr. Distributor: Refer to RCA Fall Festival Announcement. Void where prohibited, taxed or restricted. Cash value 1/20g. Offer expires October 31, 1967.

\$20.00

TOWARD PURCHASE OF
WR-69A TV-FM
SWEEP GENERATOR



Mr. Distributor: Refer to RCA Fall Festival Announcement. Void where prohibited, taxed or restricted. Cash value 1/20g. Offer expires October 31, 1967.

\$5.00

TOWARD PURCHASE OF
WR-70A RF-IF-VF
MARKER-ADDER



Mr. Distributor: Refer to RCA Fall Festival Announcement. Void where prohibited, taxed or restricted. Cash value 1/20g. Offer expires October 31, 1967.

\$3.00

TOWARD PURCHASE OF
WV-77E VOLTOHMYST®



Mr. Distributor: Refer to RCA Fall Festival Announcement. Void where prohibited, taxed or restricted. Cash value 1/20g. Offer expires October 31, 1967.

\$14.00

TOWARD PURCHASE OF
WO-91B 5" OSCILLOSCOPE



Mr. Distributor: Refer to RCA Fall Festival Announcement. Void where prohibited, taxed or restricted. Cash value 1/20g. Offer expires October 31, 1967.

\$20.00

TOWARD PURCHASE OF
WR-99A MARKER-GENERATOR



Mr. Distributor: Refer to RCA Fall Festival Announcement. Void where prohibited, taxed or restricted. Cash value 1/20g. Offer expires October 31, 1967.

\$10.00

TOWARD PURCHASE OF
WT-115A COLOR PICTURE
TUBE TESTER



Mr. Distributor: Refer to RCA Fall Festival Announcement. Void where prohibited, taxed or restricted. Cash value 1/20g. Offer expires October 31, 1967.

**ALSO
SAVE ON
RCA
KITS!**

\$5.00

TOWARD PURCHASE OF
WO-33A(K) 3" SCOPE KIT

Mr. Distributor: Refer to RCA Fall Festival Announcement. Void where prohibited, taxed or restricted. Cash value 1/20g. Offer expires October 31, 1967.

\$2.50

TOWARD PURCHASE OF
WV-38A(K) V.O.M.

Mr. Distributor: Refer to RCA Fall Festival Announcement. Void where prohibited, taxed or restricted. Cash value 1/20g. Offer expires October 31, 1967.

\$4.50

TOWARD PURCHASE OF
WR-50B(K) RF SIGNAL
GENERATOR KIT

Mr. Distributor: Refer to RCA Fall Festival Announcement. Void where prohibited, taxed or restricted. Cash value 1/20g. Offer expires October 31, 1967.

\$2.50





TOWARD PURCHASE OF
WV-77E(K) VOLTOHMYST

Mr. Distributor: Refer to RCA Fall Festival Announcement. Void where prohibited, taxed or restricted. Cash value 1/20g. Offer expires October 31, 1967.

TUNE IN ON THE PERRY COMO HOLIDAY SPECIAL IN COLOR ON NBC-TV. THURSDAY, NOVEMBER 30, 7:30 - 8:30 P.M., E.S.T.

4 ways to increase your income

RCA Institutes, Inc. offers these four comprehensive home study courses especially designed to help build your income immediately!

 <p>COLOR TV Add profitable color TV to your skills with this home training course, newly revised to include information on the latest techniques, receiver circuitry and equipment. Train under the direction of RCA Institutes... experts in Color TV home study training.</p>	 <p>TRANSISTORS You get the necessary background for semiconductor technology including characteristics of tunnel diodes, rectifiers and other solid state devices. Transistor trainer also available.</p>
 <p>AUTOMATION ELECTRONICS Trains you for the many applications of automation electronics in industry and government including Photoelectronics, Digital Computer Techniques, Synchros and Servomechanisms, Automatic Control Systems, and many more!</p>	 <p>MOBILE COMMUNICATIONS Trains you to service and maintain 2-way radio communications on land, sea, and air! Gives you the technical foundation for space communications!</p>

Take advantage of RCA's Liberal Tuition Plan. You only pay for lessons you order; and have no long-term obligations. Licensed by New York State Education Department. Approved for Veterans.

RCA INSTITUTES, INC.

A Service of Radio Corporation of America
350 West Fourth Street, New York, N. Y. 10014



The Most Trusted Name in Electronics

SEND THIS COUPON NOW FOR COMPLETE FREE INFORMATION

RCA INSTITUTES, INC. Home Study School, Dept. ET-07
350 West Fourth Street, N. Y., N. Y. 10014

Without obligation, rush me free information on the following RCA Home Training Course: COLOR TV TRANSISTORS MOBILE COMMUNICATIONS AUTOMATION ELECTRONICS

Name _____ Age _____

Address _____

City _____ Zone _____ State _____

TECHNICAL DIGEST

continued from page 30

brightness and contrast for normal operation under normal viewing conditions. Cover the LDR window and note if the picture brightness decreases. If it does, the LDR is functioning correctly. If not, check the resistance of the LDR unit and check to see if the unit is properly connected to the circuit.

In chassis employing the LDR, a 400 Ω brightness potentiometer is used instead of the usual 300 Ω pot. The LDR is connected in parallel with a portion of the bright-

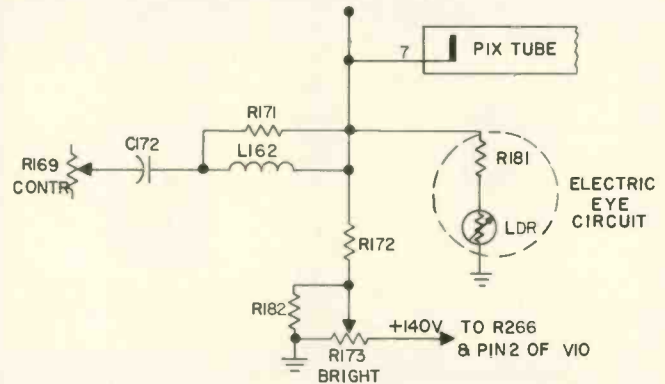

ness control through a tap on the pot. When the amount of illumination striking the LDR decreases (as the room darkens), the resistance of the LDR increases. The increased resistance raises the CRT cathode voltage with respect to ground, thereby increasing the potential difference between cathode and control grid of the CRT. The grid becomes more negative since it is connected to ground through the horizontal blanking winding of T251. Thus current flow is decreased, with lower brightness on CRT.

In the M664 chassis, the LDR is effectively placed in parallel with the brightness control. Again, when the amount of illumination striking the LDR decreases, the resistance of the LDR increases. The increased resistance raises the CRT cathode voltage and reduces brightness.

Color TV 25in. Models — New CRT Type

Presently there are two types of 25in. color tubes used; the only differences are as follows:

Characteristics	25AP22A	25SP22
Heater current	.8a	1.3a
G1 cut off at 440 G2	-95 to -190	-75 to -167v
Over-all length	20.924 \pm .375	21.123 \pm .375

Both tubes are interchangeable with only one small modification — R124 .08 Ω 3w resistor should be bypassed by a piece of buss wire when you use the 25SP22. The buss wire is removed if you replace a 25SP22 with a 25AP22A. The resistor is located under the chassis near the power transformer.

AM, FM, FM Stereo Tuner Model M671 — Change in T12

The inductance of coil T12 on the M671 chassis has been changed from 58mh to 61mh. The 58mh version is

continued on page 34

This part speaks for the whole radio.



This box speaks well of you.



To the listener, the speaker is the most important part of the radio. Reason enough that it be of the highest quality and reliability. And when it says Delco on the box you can be certain you've got it: genuine OEM quality.

Delco Radio Parts are designed by engineers who specialize in automotive radios. Delco Radio speakers, for example, provide greater efficiency and sensitivity per ounce of magnet than any other speakers built. And since nearly half the cars on the road

have Delco Radios as original equipment, you are assured of a vast pre-sold market.

Doesn't it make sense to stock the best for your customers?

They know Delco's reputation. So, the next time you reorder, remember your United Delco Supplier. He handles the most widely advertised, merchandised and recognized name in the parts business.

Why not let Delco Radio speakers say something nice about you?

Delco Radio, Division of General Motors, Kokomo, Indiana.



MARK OF EXCELLENCE

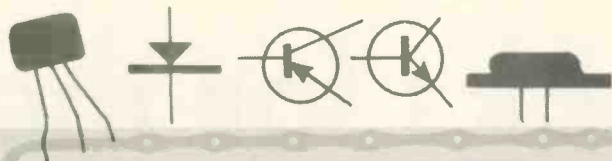

TEST TRANSISTORS IN SECONDS in circuit

TR139
8950



Also check all transistors, diodes, and rectifiers out of circuit for true AC beta and I_{cbo} leakage.

Your best answer for solid state servicing, production line testing, quality control and design.

Sencore has developed a new, dynamic in-circuit transistor tester that really works—the TR139—that lets you check any transistor or diode in-circuit without disconnecting a single lead. Nothing could be simpler, quicker or more accurate. Also checks all transistors, diodes and rectifiers out of circuit.

BETA MEASUREMENTS—Beta is the all-important gain factor of a transistor; compares to the gm of a tube. The Sencore TR139 actually measures the ratio of signal on the base to that on the collector. This ratio of signal in to signal out is true AC beta.

ICBO MEASUREMENTS—The TR139 also gives you the leakage current (I_{cbo}) of any transistor in microamps directly on the meter.

DIODE TESTS—Checks both rectifiers and diodes either in or out of the circuit. Measures the actual front to back conduction in micro-amps.

COMPLETE PROTECTION—A special circuit protects even the most delicate transistors and diodes, even if the leads are accidentally hooked up to the wrong terminals.

NO SET-UP BOOK—Just hook up any unknown transistor to the TR139 and it will read true AC beta and I_{cbo} leakage. Determines PNP or NPN types at the flick of a switch.

Compare to laboratory testers costing much more. . . . \$89.50

See America's Most Complete Line of Professional Test Instruments — At Your Distributor Now.



NO. 1 MANUFACTURER OF ELECTRONIC MAINTENANCE EQUIPMENT

SENCORE

426 SOUTH WESTGATE DRIVE, ADDISON, ILLINOIS 60101

... for more details circle 140 on postcard

TECHNICAL DIGEST

continued from page 32

identified with a white dot, the 61mh with a yellow dot. This dot is located on the coil form between pin 1 and 5.

To compensate for this revision, the shunting capacitor, C65, has been changed from 1200pf to 1000pf.

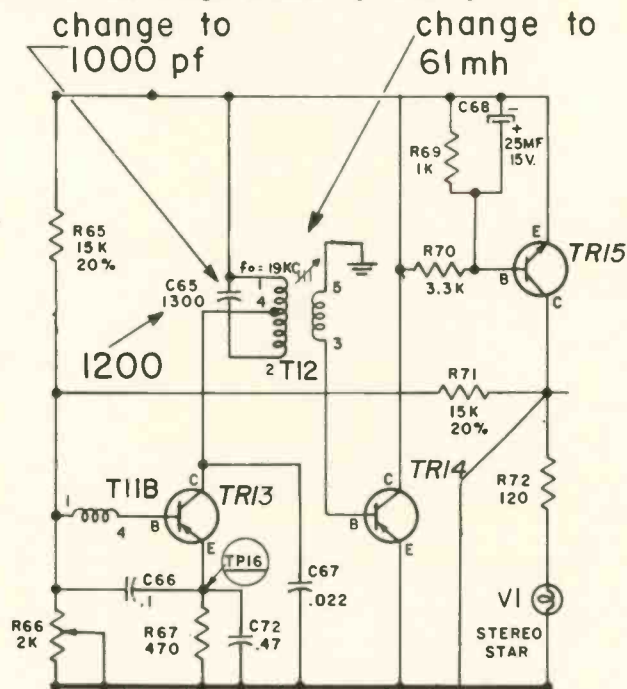

Renewal parts is stocking only the "white dot" at this time. Therefore, if a "yellow dot" is replaced with the "white dot" (Cat. EJR7878), C65 must be changed.

MAGNAVOX

Stereo Theatres — Remote Shut-Off Delay

Stereo theatre models equipped with remote control display a delay of approximately 2s in TV remote shut-off. When the TV picture does not disappear immediately after the set is switched off by the remote transmitter, some customers question the operation of the set. It should be explained that this delay is normal and intended to avoid unnecessary switching on and off of the TV chassis as the volume is adjusted by remote.

The delay results because the ac to the TV chassis is controlled by a relay which is actuated by the B+ supply in the radio chassis. The stepper relay is triggered by the remote signal and when it reaches the OFF position, it interrupts the ac supply to the radio chassis. Because the radio chassis B+ decays gradually there is resultant delay of about 2s before the TV is switched off.

Take advantage of the handy mail-order card in this magazine. If you would like information about the products listed on this card, return it to us and we will see to it that you receive the literature that you desire.

ELECTRONIC TECHNICIAN

Ojibway Building

Duluth, Minn. 55802

Just detach and mail
this postpaid card 

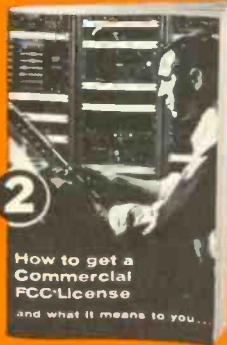
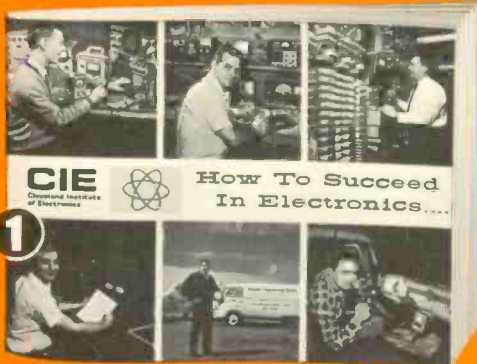

Find out how to
**PREPARE AT
HOME FOR A
HIGH-PAY JOB**

and how to
**GET AN
FCC LICENSE
OR YOUR
MONEY BACK**

Readers of **ELECTRONIC TECHNICIAN**:

**Get 2 FREE BOOKS
that can change your life**

CIE

Cleveland Institute of Electronics
1776 East 17th Street, Cleveland, Ohio 44114

Please send me without cost or obligation:

1 Your 40-page book "How To Succeed in Electronics" describing the job opportunities in Electronics today, and how your courses can prepare me for them.

2 Your book on "How To Get A Commercial FCC License."

I am especially interested in:

- Electronics Technology Electronic Communications
 First Class FCC License Industrial Electronics
 Broadcast Engineering Advanced Engineering

Name _____
(please print)

Address _____

City _____

State _____ Zip _____ Age _____

Check here for G. I. Bill information



Accredited Member National Home Study Council
A Leader in Electronics Training... Since 1934

ET-32

CIE'S FAMOUS WARRANTY:

**You get a
Government
FCC License
... or Your
Money Back!**

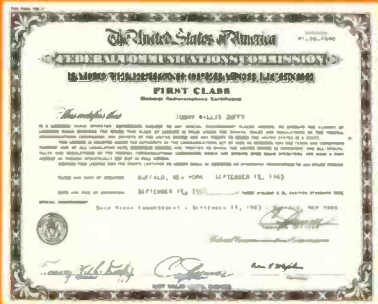

For free details, fill out other side of postpaid card, detach, and mail

If card has been removed, write Cleveland Institute of Electronics, 1776 East 17th St., Cleveland, Ohio 44114

BUSINESS REPLY MAIL

No Postage Stamp Necessary if Mailed in the United States

POSTAGE WILL BE PAID BY:

Cleveland Institute of Electronics

1776 East 17th Street

Cleveland, Ohio 44114

FIRST CLASS

PERMIT NO. 8685

CLEVELAND, OHIO

How to get into

One of today's hottest money-making fields —servicing 2-way radios!

More than 5 million two-way transmitters have skyrocketed the demand for service men and field, system, and R&D engineers. Topnotch licensed experts can earn \$12,000 a year or more. You can be your own boss, build your own company. And you don't need a college education to break in.

HOW WOULD YOU LIKE to start collecting your share of the big money being made in electronics today? To start earning \$5 to \$7 an hour... \$200 to \$300 a week... \$10,000 to \$15,000 a year?

Your best bet today, especially if you don't have a college education, is probably in the field of two-way radio.

Two-way radio is booming. Today there are more than five million two-way transmitters for police cars, fire trucks, taxis, planes, etc. and Citizen's Band uses—and the number is growing at the rate of 80,000 new transmitters per month.

This wildfire boom presents a solid gold opportunity for trained two-way radio service experts. Many of them are earning \$5,000 to \$10,000 a year more than the average radio-TV repair man.

Why You'll Earn Top Pay

One reason is that the U.S. Government doesn't permit anyone to service two-way radio systems unless he is licensed by the FCC (Federal Communications Commission). And there simply aren't enough licensed electronics experts to go around.

Another reason two-way radio men earn so much more than radio-TV service men is that they are needed more often and more desperately. A two-way radio user *must* keep those transmitters operating at all times, and *must* have them checked at regular intervals by licensed personnel to meet FCC requirements.

This means that the licensed experts can "write their own ticket" when it comes to earnings. Some work by the hour and usually charge at least \$5.00 per hour, \$7.50 on evenings and Sundays, plus travel expenses. Others charge each customer a monthly retainer fee, such as \$20 a month for a base station and \$7.50 for each mobile station. A survey showed that one man can easily maintain at least 15 base stations and 85 mobiles. This would add up to at least \$12,000 a year.

Be Your Own Boss

There are other advantages too. You can become your own boss—work by yourself or gradually build your own fully staffed service company. Instead of being chained to a workbench, machine or desk, you'll move around, see lots of action, rub shoulders with important police and fire officials and business executives who depend on two-way radio for their daily operations.

How to Get Started

How do you break into the ranks of the big-money earners in two-way radio? This is probably the best way:



He's flying high. Before he got his CIE training and FCC License, Ed Dulaney's only professional skill was as a commercial pilot engaged in crop dusting. Today he has his own two-way radio company, with seven full-time employees. "I am much better off financially, and really enjoy my work," he says. "I found my electronics lessons thorough and easy to understand. The CIE course was the best investment I ever made."

1. Without quitting your present job, learn enough about electronics fundamentals to pass the Government FCC Exam and get your FCC License.
2. Then get a job in a two-way radio service shop and "learn the ropes" of the business. All CIE students can use our free employment service.
3. As soon as you've earned a reputation as an expert, there are several ways you can go. You can move *out* and start signing up and servicing your own customers. You might become a franchised service representative of a big manufacturer and then start getting into two-way radio sales, where one sales contract might net you \$5,000. Or you may be invited to move *up* into a high-prestige salaried job with one of the major manufacturers.

The first step—mastering the fundamentals of electronics in your spare time and getting an FCC License—can be easier than you think.

Cleveland Institute of Electronics has been successfully teaching electronics by mail for over thirty years. Right at home, in your spare time, you learn electronics step by step. Our AUTO-PROGRAMMED™ lessons and coaching by expert instructors make everything clear and easy, even for men who thought they were "poor learners." You'll learn not only the fundamentals that apply to all electronics design and servicing, but also the specific procedures for installing, troubleshooting, and maintaining two-way mobile equipment.

Get Your FCC License... or Your Money Back!

By the time you've finished your CIE course, you'll be able to pass the FCC License Exam with ease. Better than nine out of ten CIE-

trained men pass the FCC Exam, even though two out of three non-CIE men fail. This startling record of achievement makes possible our famous FCC Warranty: you'll be able to pass the FCC Exam upon completion of your course or your tuition will be refunded in full.

Find out more about how to get ahead in all fields of Electronics, including two-way radio. Mail the bound-in postpaid card for two FREE books. If the card is missing, simply fill out and mail the coupon provided below.

ENROLL UNDER NEW G.I. BILL

All CIE courses are available under the new G.I. Bill. If you served on active duty since January 31, 1955, or are in service now, check box in coupon for G.I. Bill information.

Cleveland Institute of Electronics
1776 E. 17th St., Cleveland, Ohio 44114

Please send me without cost or obligation:

1. Your 40-page book "How To Succeed In Electronics" describing the job opportunities in Electronics today, and how your courses can prepare me for them.
2. Your book on "How To Get A Commercial FCC License."

Name _____
(Please Print)

Address _____

City _____

State _____ Zip _____

Occupation _____ Age _____

Check here for G.I. Bill information

Accredited Member National Home Study Council

ET-33

CIE

Cleveland Institute of Electronics

1776 E. 17th St., Dept. ET-33, Cleveland, Ohio 44114

COLOR GENERATORS

FOR EVERY NEED

**4 reasons why Sencore is your best buy
in professional test instruments**

1

LOBOY CG10

America's lowest priced professional quality standard color bar generator. All solid state. Battery powered for maximum portability,

\$89.50



2

LOBOY CG12

AC operated version of the CG10. Also has 4.5 MHz crystal controlled signal for fine tuning adjustment.

\$109.50



3

COLOR KING CG141

Absolute stability assured by exclusive "Temp Control" and new timer circuitry. All standard patterns, plus new movable single dot and single cross. Analyzing features too.

\$149.95



4

COLOR ANALYZER CA122B

The complete analyzer for color and B&W—far more than just a color generator. Has variable RF and IF outputs, composite video, chroma, and horizontal and vertical sync pulses.

\$187.50



Whatever the need, Sencore has the color generator that is just right for you. Each has the built-in quality you expect from Sencore. Each has standard RCA licensed color bar patterns.

Each is triple tested for guaranteed accuracy. Each is steel encased with chrome panel. See your distributor for more reasons why Sencore is your best buy, always.



SENCORE

NO. 1 MANUFACTURER OF ELECTRONIC MAINTENANCE EQUIPMENT
426 SOUTH WESTGATE DRIVE, ADDISON, ILLINOIS 60101

WHAT'S NEW

in **1968**

COLOR TV

Integrated circuits and more transistorized circuits will highlight the new color line for the coming year

■ More solid-state, more integrated circuit applications and a larger variety of color CRT sizes highlight the 1968 color TV line.

It should be noted that U.S. manufacturers sold \$64.3 million worth of semiconductor integrated circuits during the first four months of 1967, increasing by 52 percent from sales of \$42.2 million during this period last year, according to estimates released by the Electronic Industries Ass'n. (EIA).

Motorola developed a solid-state color TV set with 10 removable panels for easier servicing, in its top-of-the-line model.

One-third of Sylvania's previously tubed circuitry has been transistorized and uses integrated circuits.

Most 1968 color TV models will employ automatic fine tuning (AFT), tuning indicators, instant play and automatic chroma control.

ADMIRAL

Admiral will employ a new circuit on the H10 series chassis to adjust automatically the 1st chroma bandpass amplifier gain, providing a relatively constant chroma level at the CRT grids.

Fig. 1 — Automatic saturation circuit used in Admiral H10 series chassis.

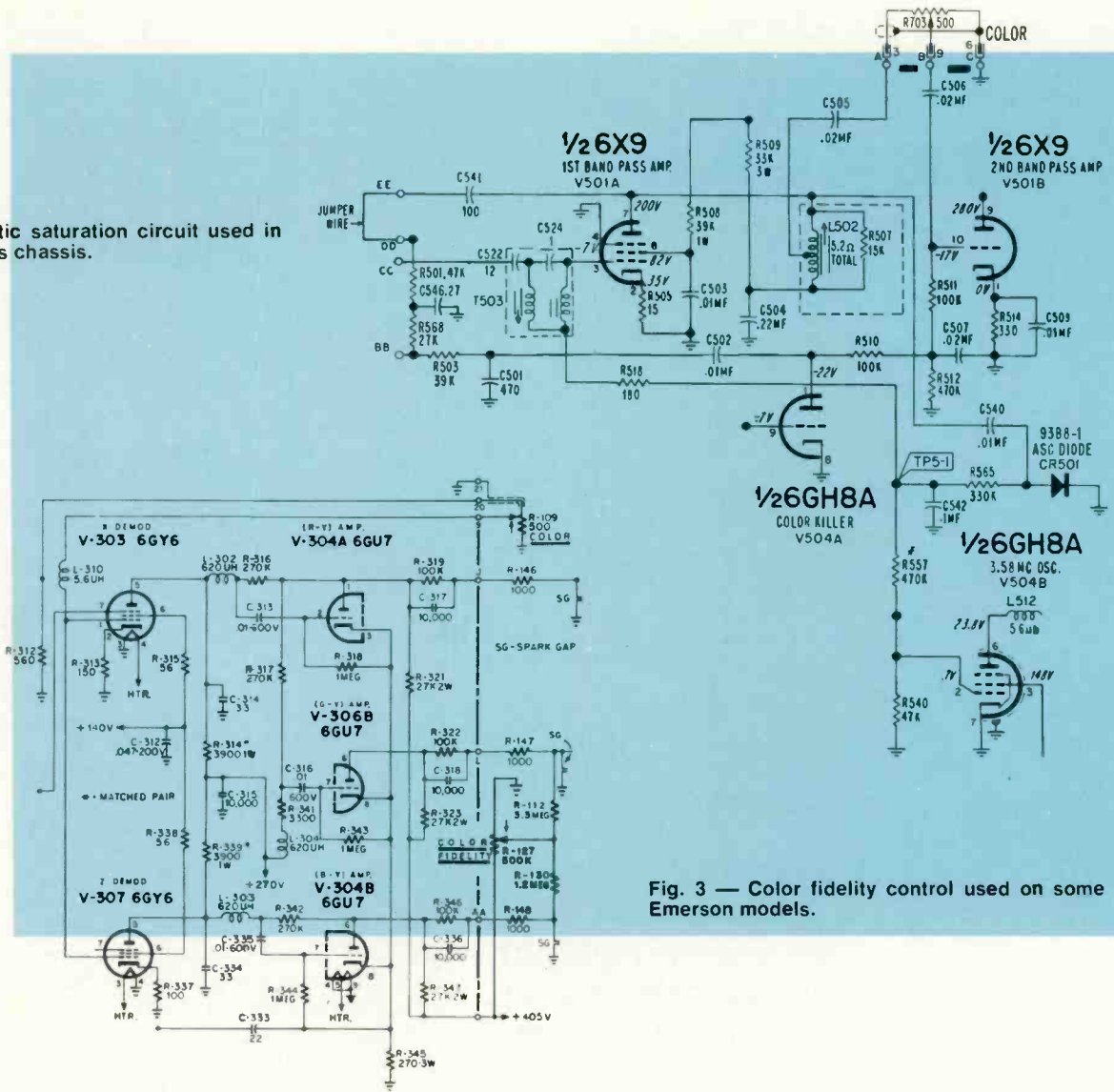

Fig. 3 — Color fidelity control used on some Emerson models.

Automatic saturation circuit (ASC) diode detection (CR501) is determined by the amount of chroma information at V501A bandpass amp plate (see Fig. 1). The chroma information between 3 and 4MHz is at a much higher level than the accompanying luminance information at this point. To prevent excessive color in scenes having only a small amount of color, a burst referenced dc voltage limits the amount of maximum gain of V501A. CR501 conducts on the positive half of the chroma signal and the rectified dc signal is filtered by R565 and C542. R557 and C542 filters the dc from the chroma oscillator. The resulting varying dc correction voltage appears at the V501A grid through R518 and T503. The cor-

rection voltage will cause the gain of V501A to increase when the chroma level decreases, or decrease when the chroma level increases. Monitoring the bandpass amp grid with a VTVM will show about -1.5v with low chroma signal and -3.5v with high chroma level signal.

Another feature in models using the 4H12, 6H10 and 9H10 chassis is "instant play." The power transformer has a special primary winding, only a part of which is used during normal operation (see Fig. 2). When the ON/OFF volume switch is pushed to the OFF position, the ac line is connected across the entire primary, thus reducing the voltage and current in the secondary. At the same time, the B+ and dial light

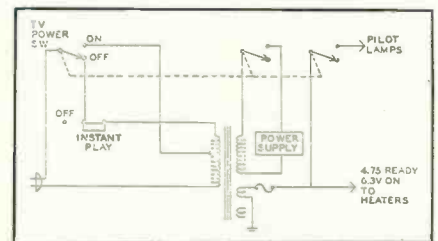

Fig. 2 — Admiral's "Instant Play" used in the 4H12, 6H10 and 9H10 chassis.

circuits are opened — leaving only the tube heater circuit in operation at the reduced voltage and current.

A separate switch in the ac line is located at the back of the cabinet so the set can be switched off completely.

The Admiral 4H12 color TV chassis employs an automatic frequency control system which completes the fine tuning once the

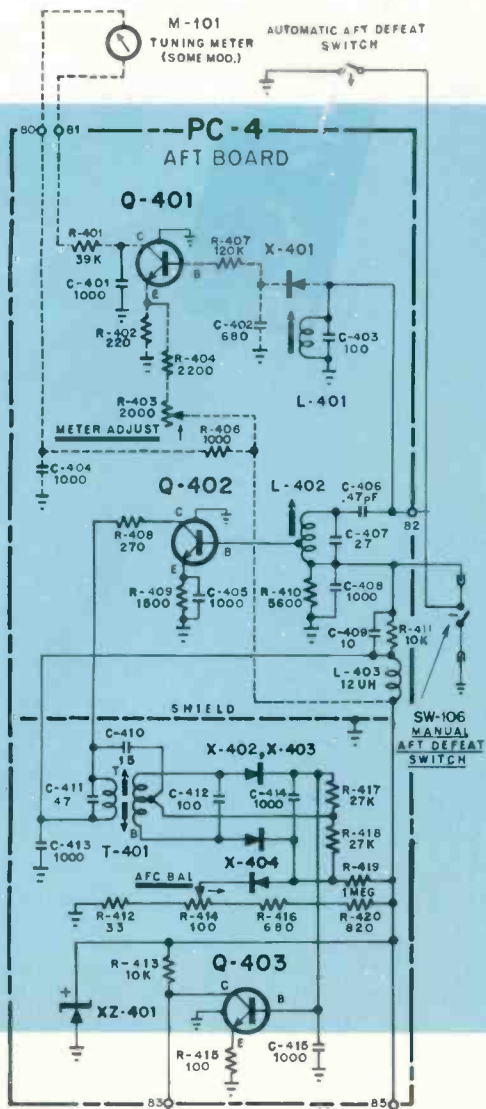

Fig. 4 — Emerson's AFT circuit employing a manual as well as an automatic defeat switch.

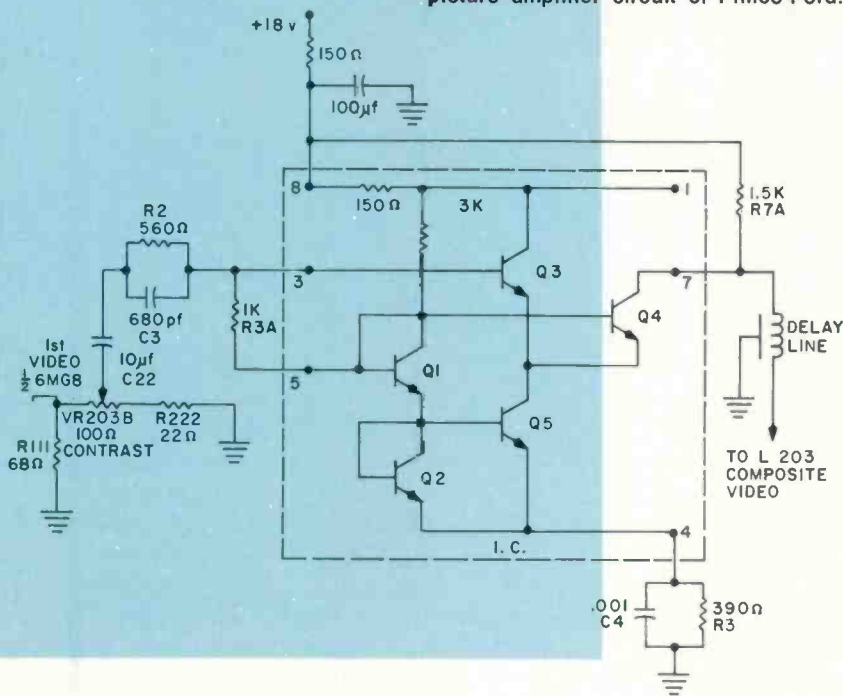

Fig. 5 — Integrated circuit used in the picture amplifier circuit of Philco-Ford.

customer has "roughed it in." Its operation is similar to the AFC used on FM tuners.

EMERSON

The Emerson line is the largest ever, consisting of models in all price and CRT size categories, from low cost leader-models to the deluxe top of the line which is now called the DuMont custom series by Emerson.

Some of the features will include "quick-on," timer, AFT and ACC.

A new video peaking control allows the customer to adjust the picture from very sharp to soft to suit his individual taste. In the extreme soft position, the effects of snow on extremely weak signals are reduced. The color fidelity control (Fig. 3),

which is used on some models, allows the customer to make a very fine setting of gray scale. The AFT circuitry (Fig. 4) employs a manual defeat switch as well as an automatic defeat switch every time the "Perm-Lok" (permanent fine tuning control) is adjusted. This allows the customer to tune the picture as accurately as possible before the automatic fine tuning (AFT) circuits take over. In certain areas, the defeat switch would permit tuning in a stronger B/W picture as well as a color picture by positioning the video carrier higher up on the response curve.

MOTOROLA

The Motorola color line for 1968 includes a solid-state chassis in the

top-of-the-line models. The chassis has ten removable panels for easier servicing and uses an integrated circuit in the audio panel. The only tube in the circuit is a 3BN2 HV rectifier.

Part one of a two-part article covering this one-of-a-kind set appeared in the September 1967 issue of ELECTRONIC TECHNICIAN.

PACKARD BELL

The new 1968 color TV models of this manufacturer are basically the same as last year.

An import color TV model, CRQ312, has been added to the line. A 90deg deflection, tri-gun CRT with 176 sq in. of viewing area will be used. Other features will include automatic degaussing,

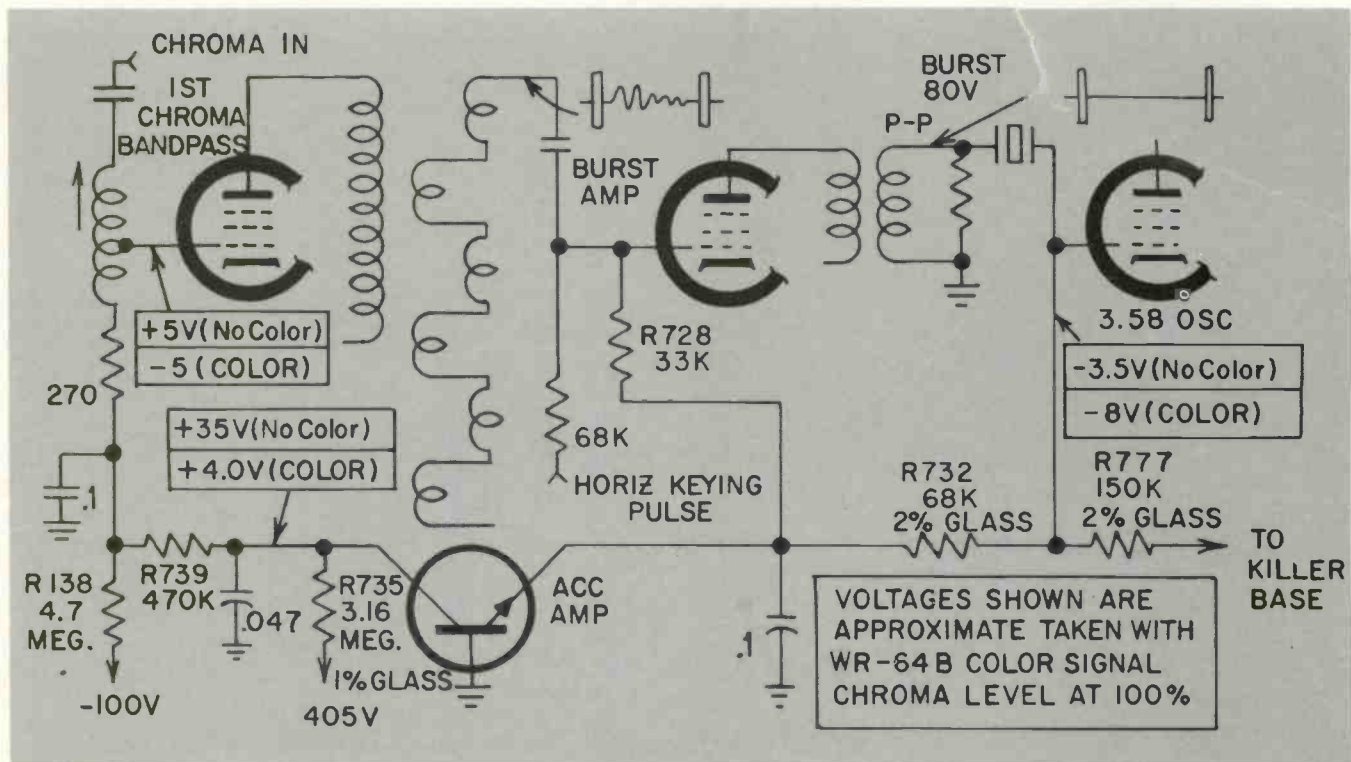

Fig. 6 — Simplified schematic of transistorized automatic chroma control used in the RCA Victor CTC31 series chassis.

hand wiring of major circuits, front mounted speaker, up-front controls and a new "set-and-forget" fine tuning.

PHILCO-FORD

The 1968 color line has a wider over-all selection — 37 compared to 32 previously. A 267 sq in. set, quoted at \$229.95, is said to be the lowest suggested retail price in the company's history.

Integrated circuitry will be used in a color TV set, and a color TV/radio/phonograph home-theater combination has ICs in the picture amplifier circuits as shown in Fig. 5. All color sets are fully transistorized from the tuner through the IF amplifier stages.

RCA VICTOR

The chassis used in the 1968 RCA Victor color line are in many respects similar to last year's chassis (with the exception of the CTC-22). Specific new color chassis in the '68 line, introduced in June, include the CTC27, -28, -30, -31 and -35. The CTC22 color chassis introduced in March will be continued.

The complete color TV line will employ a new family of rectangular "Hi-Lite" color CRTs with a new red phosphor. The tubes offer an improvement over earlier color picture tubes.

The new red phosphor achieves a unity-current ratio — equal beam current from each electron gun.

Three drive controls — red, green and blue — are used in the new line and because of the new red phosphor CRT, it is possible for the blue phosphor to be less efficient than red or green. Previously, only red or green could be the least efficient.

The new line features several refinements to improve reliability in the horizontal sweep circuits. Changes are found in the horizontal oscillator, output, damper and efficiency circuits.

A new damper tube type 6CL3 will be employed in the CTC35, CTC30 and CTC28 series chassis. It is said that the tube offers increased damper efficiency over the 6DW4. As a result of this increased efficiency, screen dissipation of the 6JE6 horizontal output tube is re-

duced. This is done by increasing the 6JE6 screen resistance from 13K to 15K.

All new color chassis will employ an improved horizontal efficiency coil. This coil employs a new core which reduces the possibility of saturation and its resulting effect on 6JE6 cathode current. The efficiency coil tuning capacitors will be physically located next to the efficiency coil.

Increased horizontal grid drive is accomplished by supplying the horizontal oscillator plate from the B+ boost line, in addition to its regular B+ feed from the 450v supply.

This provides for an additional 20 to 30 volts increase in oscillator plate voltage which in turn increases the amplitude of the waveform applied to the grid of the output tube.

The CTC30 is the top-of-the-line, three IF, chassis featuring automatic chroma control, automatic fine tuning (AFT) and all channel motorized, detented channel selection. Integrated circuits are employed in the audio and AFT sections. This chassis is physically and electrically similar to the 1967

Common **COLOR** Problems

Here are ten common problems and their causes — one could 'clear the road' for the set now on your bench

■ It has been estimated that about 80 percent of the color chassis now coming into service-dealer shops have the same basic electronic circuitry. Consequently, the problems in these chassis are often identical. And even those chassis using a radically different physical layout are often electronically similar and plagued by the same problems.

Although some of the problems that develop in these sets are "easy" to solve, others are downright tricky. But in either case, even the pro may have difficulty finding his way around the schematic or the chassis.

This is a "checklist" composed of common problems which arise in today's color receivers. The problems here are not those which *could* cause certain trouble symptom but those which do cause these symptoms every day in service shops everywhere. They are problems which frequently cause even the pro to tear his hair.

If the chassis which has you stumped does not have the typical physical configuration, check the schematic. Chances are good that the circuitry is the same and with only a little more effort you can pin-point the faulty part.

Tubes are not considered as a possible trouble here since it is assumed that all technicians understand that tubes can cause almost any conceivable trouble and that tubes have already been substituted with known-good tubes.

Color Only — Screen Blank On Monochrome

This is one which can cause technicians to waste a lot of time unless they are on-the-ball. In this case, it is easy to overlook the fact that the screen is not blank all the time — color programs do come through when the color control is advanced!

Although this fault can be caused by an open or short almost anywhere in the video circuit beyond the color takeoff point, the most common cause is an open delay line. Fortunately, an open delay line is easy to check out: simply jump it with a clip lead. Most delay lines have only three leads and one is grounded. Short the two that are not grounded together. If the delay line is open, the picture should appear *almost* normal when jumpered (see Fig. 1).

Delay lines can often be repaired since they are simply a single layer coil. Opens usually occur at or near terminals. The grounded terminal is connected to a cylinder of copper foil on which the coil is wound.

Poor Focus — No Focus Control

When the focus on a color set is poor but can be varied, it means that the CRT is bad or that the focus voltage is incorrect. It usually means the latter. When there is no control over focus, generally the focus voltage is nonexistent or is not reaching the CRT focus grids.

Focus voltage circuits are almost always the same and are quite simple (see Fig. 2). The pulse voltage at the horizontal output plate is simply passed through a transformer (the "focus coil"), rectified (sometimes a selenium stick, sometimes a tube), filtered with a 130pf capacitor and applied to the CRT focus grid.

If you suspect there's no focus voltage, give a light tug on the black wire to the CRT socket. There's a good possibility that the lead is loose and will pull out. Then all you have to do is replace the socket. If the lead doesn't pull out, try a continuity check just to be sure.

If the socket is good, then other checks are in order. First on the list should be a voltage check. You should measure about 5kv at the output end of the rectifier. Other problems in this area usually leave burned components so they aren't difficult to track down.

One caution: Don't try to measure the front-to-back resistance on the selenium focus rectifier. This unit is actually a stack of selenium cells and the front resistance is about the same as the back. A good "sniff" will usually tell you more about seleniums.

Insufficient Height and Width— Little or No Sync

Just as in B/W sets, this symptom is a clue that something is wrong in the B+ circuitry. And,

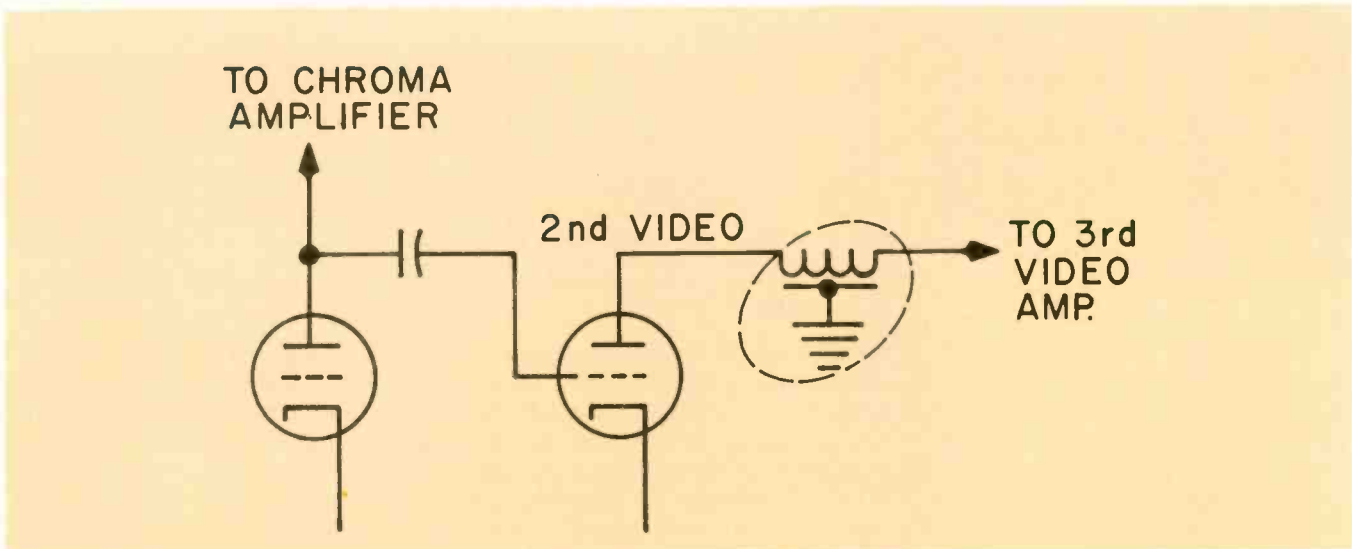

Fig. 1 — Simplified circuit of delay line.

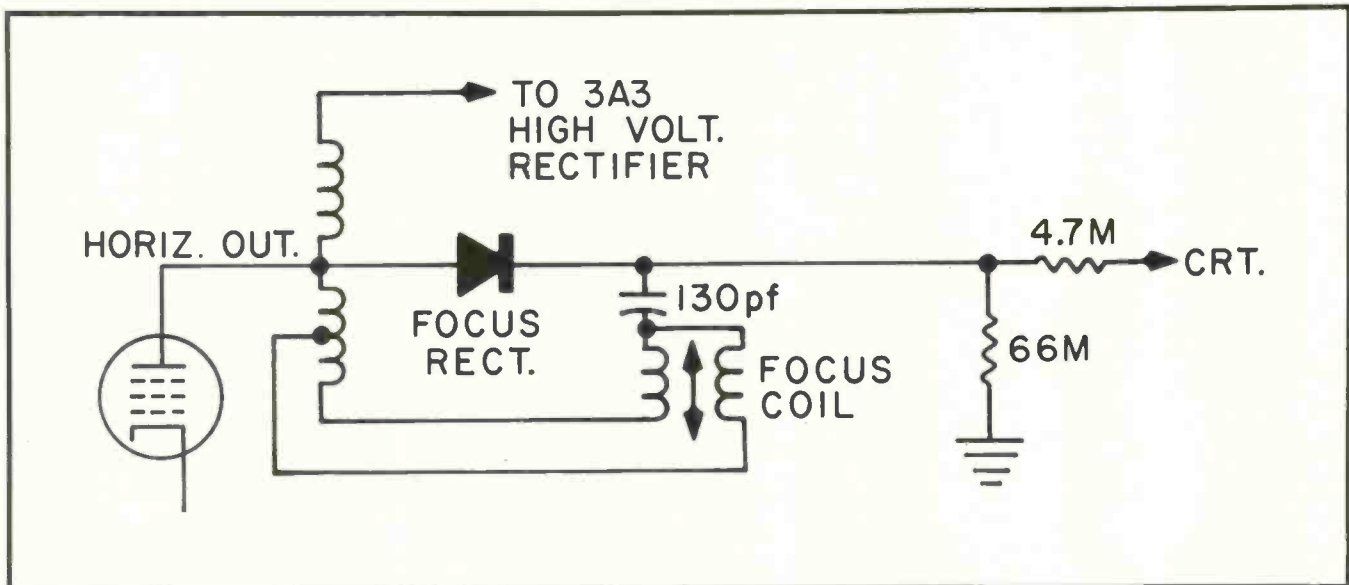

Fig. 2 — Typical focus-voltage circuit.

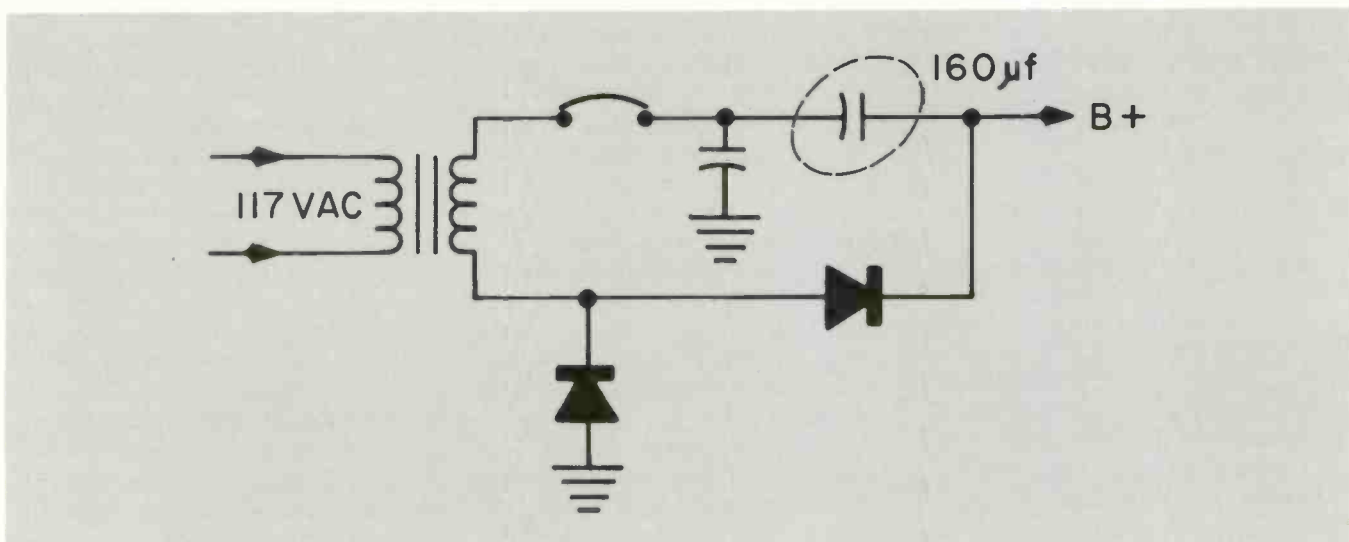

Fig. 3 — Schematic of typical power supply circuit.

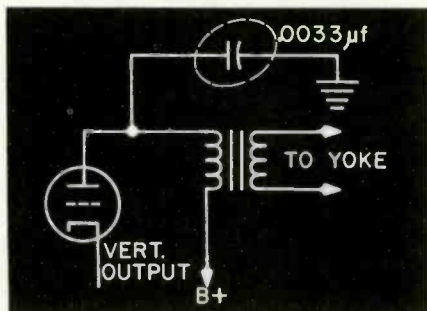

Fig. 4 — When the 0.0033µf capacitor shorts the circuit breaker will trip.

as in B/W sets, the offending part is almost always the voltage doubling capacitor. In the typical color set this is a single-unit "can" rated at 160µf, 250vdc (see Fig. 3).

A capacitor of this type is used to bridge a suspected capacitor to confirm if it is open. Shorts rarely develop and they will open the circuit breaker when they do.

If the voltage doubler is completely open, the set will not function. A few quick voltage measurements will lead you to the faulty part and the same bridging technique will prove it. If you're looking for the screen to come to life or the speaker to sound off when the suspected capacitor is bridged, be sure the volume control is turned up and the brightness and screen controls are set to their normal positions.

To make sure the suspected capacitor is at fault, monitor the voltage while bridging the suspected component. Also, the set may have more than one faulty component.

No High Voltage—Burned Smell

When the flyback transformer overheats, it may be obvious or it may not be. It's not exactly an industry joke that every color TV manufacturer has, at some time or other, been embarrassed by being called in to "put out" a fire in one of its TV sets.

The demands placed on a color set flyback are great and the toll this demand takes is great.

Latest models often have the flyback "tire" made of silicon which does not burn under normal conditions. If you suspect the flyback has burned, feel the "tire" gently (when the set is switched off). If you feel a "crunchiness" underneath, peel the silicon back slightly. If the flyback is burned, it will become obvious.

Of course, all bad flybacks don't look bad nor are all bad-looking

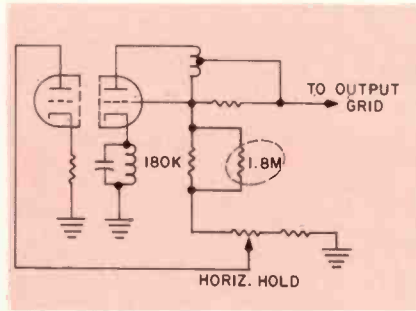

Fig. 5 — When the 1.8M resistor drifts out of tolerance the horizontal hold control will sync the oscillator on the extreme edge of its range.

flybacks faulty. A few drops of wax which have dripped from a transformer are sometimes normal and are known as "tearing" (as in crying). When it is necessary to replace a flyback be sure the high voltage cup and associated wiring are in good shape. All tubes in the horizontal and high voltage section should also be replaced since any one of these parts could *intermit* and cause flyback failure. Heat may have damaged selenium focus rectifiers in extreme cases and these should also be replaced.

Circuit Breaker Trips

There can be many causes for a circuit breaker to trip open — either immediately or after the set has operated normally for a few seconds or a few minutes. Common causes in our typical set, however, are fewer.

If the circuit breaker trips as soon as the set is switched on, the most likely suspect is one of the B+ diodes. No need to disconnect the diodes — a quick check with the ohmmeter will determine if a short exists or not. Make sure you check the diode both ways.

Another common cause is the 0.0033µf, 1.6kv capacitor used in the vertical B+ section (see Fig. 4). This, too, sometimes goes off with a flourish and the convergence wiring may have to be replaced in the area of the capacitor and the resistor feeding the vertical circuit.

The slow-tripping circuit breaker is the toughest to troubleshoot because you have little time to take voltage readings. More often than not, a resistance reading will not be conclusive.

If the horizontal output tube begins to turn red, the trouble may be in the tube, the high voltage rectifier or the horizontal oscillator. A quick output tube grid voltage

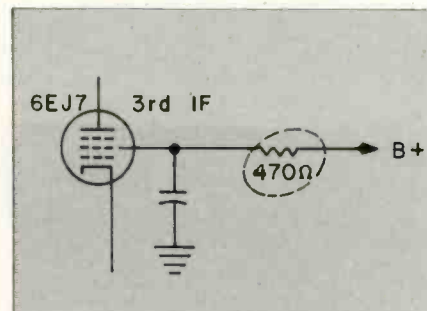

Fig. 6 — When the 6EJ7 shorts the 470Ω resistor will usually burn up.

check should tell you where to begin. The voltage should be about -45 to -55v. A less negative voltage usually indicates oscillator trouble.

Another frequent offender, and last on many technician's list, is the circuit breaker itself. The only safe way to check it is to substitute.

Quickies

Poor sound, no sync? Check the sound/sync detector diode.

Very light picture with interference-like lines? Check the picture diode.

Horizontal hold control locks at one end? Locate the 1.8M resistor on the bottom of the board in the horizontal circuit (see Fig. 5). Replace resistor — remove or add resistance as necessary to center control. Readjust the sinewave coil when you're through with this one.

Horizontal hold tends to lock-out when adjusting? Several manufacturers have added a 0.1µf capacitor across the 0.03µf capacitor on the tuner AGC line. This capacitor is located right on top of the tuner.

There is still no substitute for the thorough visual inspection. Although the raster-only malfunction causes some technicians to shirk at what could be wrong, the commonest cause is pretty obvious.

The 6EJ7 often shorts out and takes a 470Ω resistor with it (see Fig. 6). By "craning" your neck properly, this resistor can be viewed alongside its IF can. If the resistor is burned, use a long-nose plier and finish it off by crushing. You can then jumper the stubs on the bottom side of the board.

Another, but less common cause of the raster-only syndrome is a B+ dropping resistor on the tuner. This is sometimes obvious but more often obvious only by the clear, snow-free raster that presents itself. ■

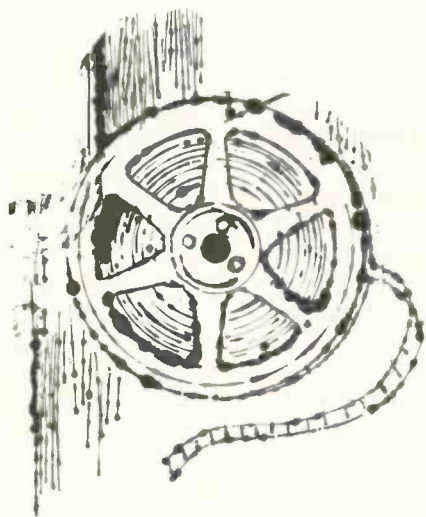

Tape Recorders Tape Decks and Cartridge Players

Part One of a Series

Learn how to get your share of this steadily expanding market

■ Despite the growing-pains suffered by tape recorders, tape decks and cartridge players, the business is steadily expanding and it is estimated that total sales will be near 5 million units in 1967 (including foreign made recorders). Although many of these units will rank in the "toy" class because of their low initial cost (less than \$50) — hardly worth bothering with in the repair shop unless delayed service and "assembly line" repair methods are employed — an increasingly larger number of quality units are being sold.

Since tape recorders moved from recording studios and broadcasting stations into many areas of our society, including the home, industry, business and education, sales have grown steadily.

Selling and maintaining this equipment is worth the effort if you take the necessary measures to turn out expert, quality work and build the business. At the same time, the service-dealer who can do this can also build the sales end into a profitable department in his home-entertainment electronic equipment business. Other service-dealers have done it and so can you.

Understanding the Basic Tape Recorder

Because tape recorders, like

phonographs, are electromechanical, you have to develop a special facility for both mechanical and electronic work. But more than in phonographs, radios and TVs, many mechanical defects in tape recorders will show up as electronic trouble symptoms. At the same time, many trouble symptoms can also be caused by either mechanical or electronic defects. For example, an old or misaligned record/playback (R/P) head — mechanical faults — can cause poor high-frequency response and low output level. At the same time, these symptoms can also be caused by the record-bias being too high — an electronic fault.

Be this as it may, we will divide tape recorders into two sections — the electronic and the mechanical. And we will refer to the over-all mechanical section as the "tape transport." Chances are, you will have more trouble with the mechanical section than with the electronic section.

The electronic components of a simple tape recorder are shown in the block diagram of Fig. 1. But it should be emphasized at this point that when a tape recorder has only one R/P amplifier, a single section R/P head and a single section erase head, it is a *monophonic* unit — not a "monaural" unit. (Monaural literally means "one-eared" and is a

meaningless definition used even by some manufacturers to describe single-channel audio.)

Before discussing stereophonic tape recording and reproducing

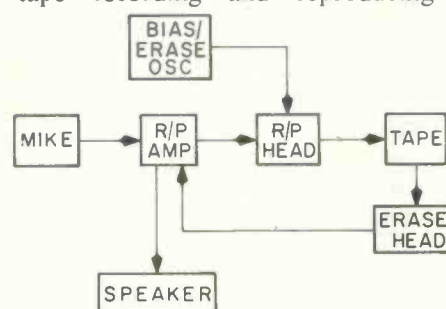

Fig. 1 — Block diagram of a simple tape recorder.

equipment in general, we will first cover basic principles from the monophonic viewpoint.

Record-Playback and Erase Heads

Erase and R/P heads are essentially electromagnets. And from the technician's viewpoint, R/P and erase heads will probably be two very important components in the typical tape recorder — mono or stereo. On the typical home or general-use tape recorder we are concerned with a combination R/P head and a single section erase head. The heads may be mounted together in one shell or mounted separately. Commercial grade equipment will usual-

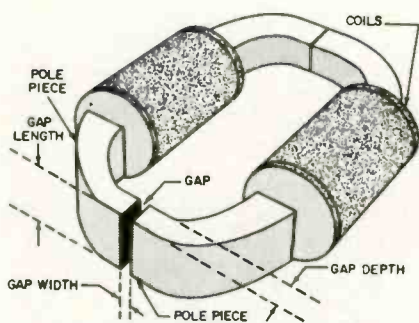

Fig. 2 — Typical "ring" type, double-pole R/P head. Courtesy Ampex.

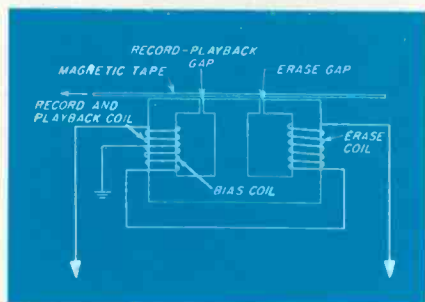

Fig. 3 — R/P Head with three-leg laminated core having two gaps — one for R/P and one for erase.

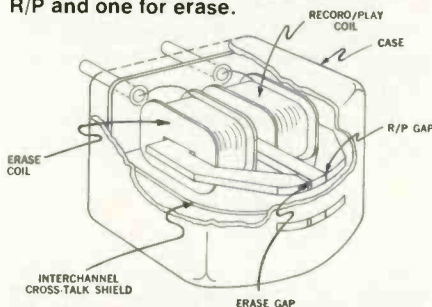

Fig. 4 — Cutaway view of a section of an R/P head which uses the three-leg concept. It is designed for 8-track stereo. Courtesy Nortronics.

ly have separate record, play-back and erase heads.

Because tape-head structures are designed in various shapes and configurations, we will not go into details regarding various designs. We are primarily concerned here with basic electromechanical functions, troubleshooting and maintenance techniques. Details will be covered only when they aid maintenance and repair procedures.

A typical "ring" type double-pole R/P head is shown in Fig. 2. The quality of heads varies and a high quality head may use thin pieces of magnetically "soft" metal to form a laminated core, around which the coils are wound. Laminating reduces electrical losses in the core.

Another type combination head uses a three-leg laminated core having two gaps — the R/P gap and

erase gap. This basic arrangement is shown in Fig. 3.

The R/P coil is wound over one leg of the core and the erase coil is wound on another leg. Note that bias voltage is supplied to the erase coil, part of which is wound on the same core-leg used for the R/P coil — hence bias is also supplied to this coil during the recording process. The blank third leg of the core serves a common magnetic path.

On those commercial grade recorders which use a separate playback head, a double-pole core is frequently used and the two windings are generally connected in series to cancel stray hum pickup. But when a double-pole core is used for a combination R/P head, the two windings are usually connected in parallel to obtain higher current-carrying capabilities while recording.

Because the record process calls for a different width headgap than the gap width used in the playback process — to obtain best results in each case — the combination monophonic R/P head is a compromise arrangement, since one gap is involved in both record and playback.

A combination R/P head with erase and R/P gaps interlocked on a three-leg core is shown in Fig. 4. This head is designed for 8-track stereo operation.

The Preliminary Service Approach

As every experienced service-dealer and technician knows, the least expensive approach to over-all electromechanical equipment servicing involves preventive maintenance concepts. But the public does not adjust normally to this concept. The average tape recorder owner waits until the equipment breaks down and stops functioning in some apparent way before asking for service.

The public has to be sold on the idea of preventive maintenance. At any rate, when a tape recorder comes in for any type of repair, the repair estimate must include a certain amount of preventive maintenance. Otherwise, you will have dissatisfied customers and you'll find it impossible to establish a solid repu-

tation for providing high-quality service work.

You can generally arrive at a close estimate, including preventive maintenance work, by removing the head cover and inspecting the tape transport. One such arrangement as seen under the head is shown in Fig. 5. Of course, variations of this arrangement exist.

Inspect and determine the condition of tape guides, pressure pads, capstan, pressure roller and the heads. Observe how dirty the various components are. Ask the customer how many hours the equipment has operated since it was last cleaned and lubricated. On most equipment, heads will need cleaning and demagnetizing after about 15 or 20 hours of use. Heads pick up residual magnetism while they are being used. This normally decreases frequency response at the high end and increases noise and harmonic distortion.

Also observe how much the heads and various moving parts are worn. Inspect the head-gaps with a good magnifying glass. If the heads are worn perceptibly or the gaps have widened, you may have to include head replacements in your estimate. If the heads are not worn and the gaps look OK, but the recorder's output is distorted and noisy, you may have to demagnetize the heads.

We will go into greater detail regarding servicing and replacing R/P and erase heads in a forthcoming article. In the meantime, let's begin digging into one important electronic circuit used in tape recorders.

Bias-Erase Oscillators

Undesirable hysteresis effects that develop when a magnetizing force is applied to a magnetic material (the iron oxide deposited on the dull side of magnetic tape) creates a need for corrective measures. The magnetization of the oxide does not increase in a linear manner. To obtain undistorted output in magnetic recording, a supersonic bias voltage is added to the audio voltage which is applied to the head during the recording process. The amplitude of this voltage is about 10 times the average audio voltage. The frequency of this supersonic voltage is also im-

portant from the designer's viewpoint. It may range upward to 100kHz or more.

It would not prove helpful, from the troubleshooting viewpoint, to cover biasing theory in detail. Suffice it to say that the bias/erase oscillator performs two separate functions during recording: It drives the erase head to eliminate previous recordings from the tape and it biases the recording head to compensate for the non-linear tape response. If we used no bias on the recording head, we would get harmonic and intermodulation distortion on playback. The erase/bias oscillator does not function on playback.

The simplified schematic of an electron tube bias/erase oscillator which is used in the Westinghouse H22RS and H24RS monophonic tape recorders is shown in Fig. 6. This is a balanced, plate-coupled multivibrator having a parallel-resonant output circuit. The circuit, in effect, operates as push-pull. The LC circuit composed of L1, C3, 4 and 5, establishes a frequency near 60kHz. C4 and 5 serve as feedback capacitors and if either of these capacitors fails, the oscillator fails.

Bias failures to the record section of the R/P head and erase-head signal failures can occur because of improper operation of the erase/bias oscillator, defects in the heads or defects in the coupling circuits between the oscillator and the heads. Failure of the oscillator can cause a complete loss of both bias and erase signals or erratic and intermittent record bias and erase signals. When the oscillator fails, of course, previous recordings will not be erased.

Most tape recorders made today use solid-state components. The schematic of a transistorized bias oscillator circuit is shown in Fig. 7. The oscillator functions at a frequency of 35kHz and furnishes bias to the R/P head when the switch is in the RECORD position. C23, a 0.001 μ f capacitor, couples the 35kHz voltage to the R/P head. A dc bias of -9v is applied to the erase head when the R/P switch is in the RECORD position.

A forthcoming article will cover problems of tape recorder troubleshooting and repair. ■

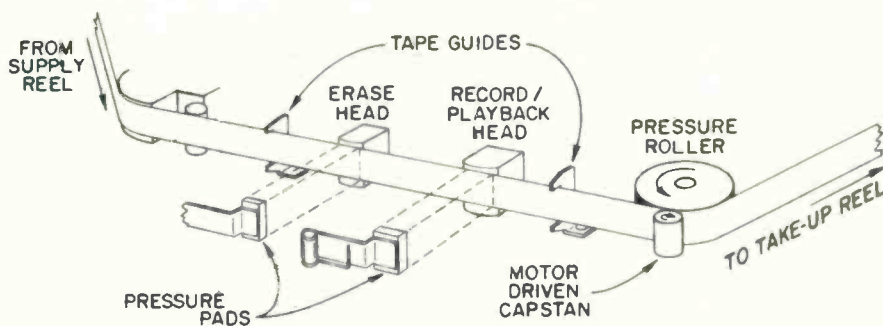

Fig. 5 — Tape transport section of a tape recorder. Courtesy Westinghouse.

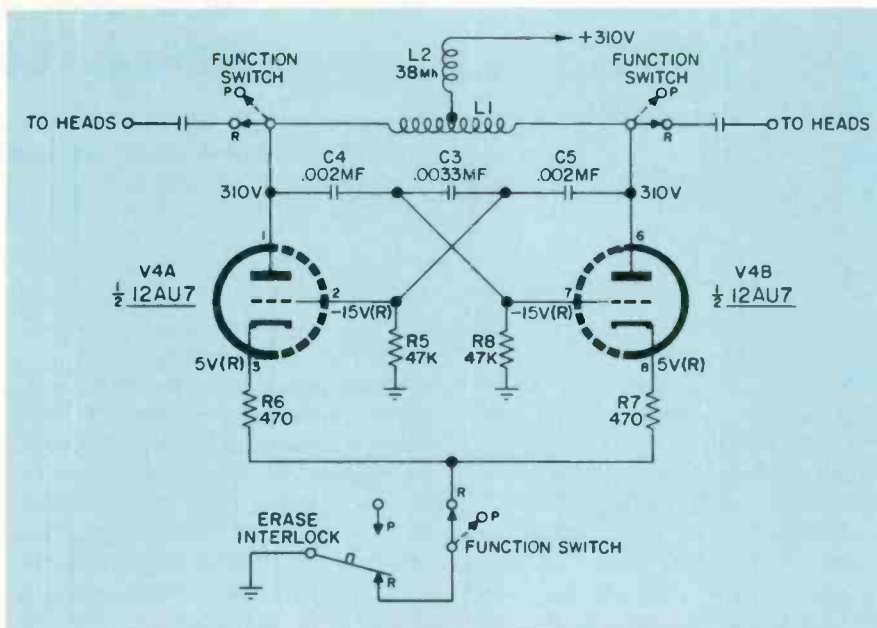

Fig. 6 — Schematic of plate-coupled multivibrator bias/erase oscillator used in Westinghouse tape recorders H22RS and H24RS.

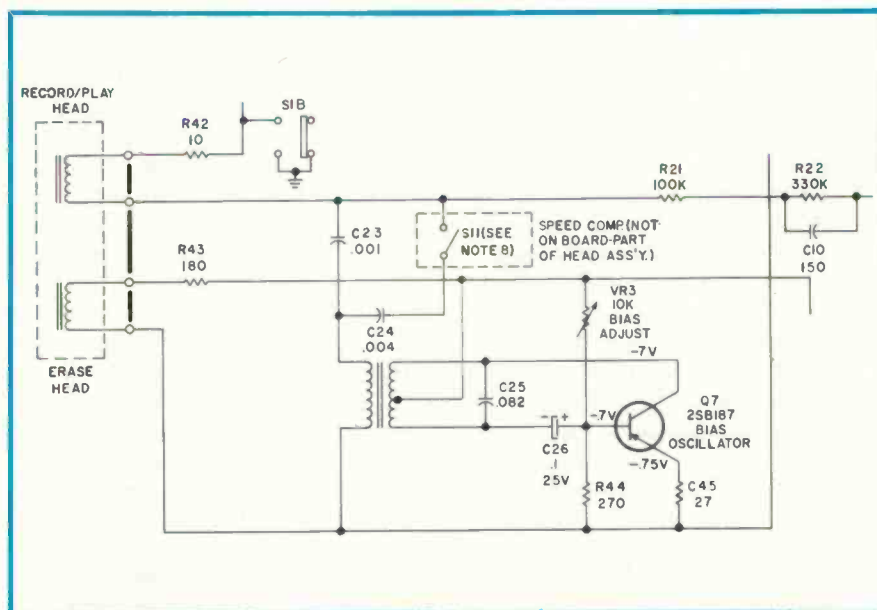

Fig. 7 — Transistorized bias oscillator used in Magnavox TR107M tape recorder.

Semiconductors

Technicians who understand how diodes can be used for tuning

The Fifteenth Article in a Continuing Series

■ Previous articles in this series describe how diodes are used to rectify alternating currents, supply temperature compensating bias voltages and amplify signals. Still another type of diode is gaining prominence in the electronics industry. Voltage-variable capacitance diodes, varicaps, have been used in the past for microwave tuning (as varactors) and in some FM and TV AFC circuits. With recent improvements, these diodes can now substitute for mechanical variable capacitors to tune AM and FM radios.

General Capacitor Characteristics

The basic principles of nonvariable capacitors also apply to varicaps. These principles may be merely a review for experienced technicians.

The study of capacitor time constants in the September 1967 article of this series indicated that electrons enter or leave a capacitor as the potential drop across it changes. The number of electrons that enter or leave the two portions of the capacitor is dependent on the ac potential across the capacitor and the value of the capacitor.

The material that separates the

two portions of some capacitors virtually prohibits the flow of electrons between the two portions of the capacitor. Although electrons are not flowing from one capacitor lead to the other, the concentration of electrons in one portion of the capacitor increases when a negative potential is applied to it, and the concentration of electrons in the other portion of the capacitor decreases when a positive potential is applied to it. When an ac voltage is applied to the capacitor, the potential across each side of the capacitor alternates between negative and positive, and electrons enter and leave each side of the capacitor. This results in an alternating current flow in the two capacitor leads.

Since, in some capacitors, virtually no electrons pass from one portion of the capacitor to the other, virtually no current can pass from one capacitor lead to the other. After the capacitor has been charged or discharged, virtually no current will flow through its leads. In the process of charging and discharging, however, electrons enter and leave the two portions of the capacitor. The resulting current flow through the capacitor leads is not from one capacitor lead to the other, but

between the capacitor leads and the portions of the capacitor gaining and losing electrons.

The ac potential applied across a capacitor results in ac currents through the capacitor leads. This ac current only appears to flow between the two leads, and no dc current flows between the leads of a capacitor that contains a perfect insulator between its two portions.

The apparent ability of a capacitor to conduct an ac current increases with the frequency of the ac voltage applied across it and is expressed in terms of the capacitor's reactance

$$(I \approx \frac{X}{X_C}).$$

This relationship is illustrated in Fig. 11 on page 51 of the November 1966 article and is shown in the equation

$$X_C = \frac{1}{2\pi fC}.$$

The material separating the two portions of a capacitor is usually not nearly a perfect insulator, and some electrons may pass through it. These capacitors experience a "leakage" of electrons and some current may "leak" through capacitors at frequencies from dc up. The amount of current resulting from the capaci-

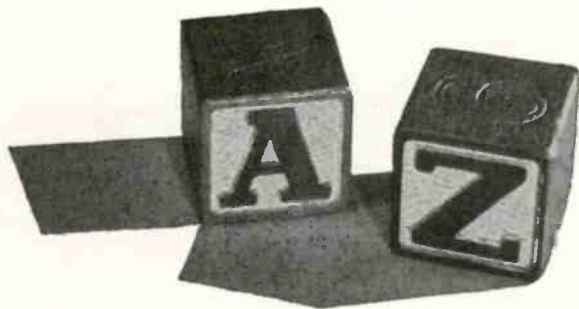

from A to Z

circuits are better prepared to service receivers of the future.

tor's leakage, unlike the current resulting from the capacitor's reactance, is not dependent on the frequency of the ac voltage applied to the capacitor. It depends instead on the composition and quality of the capacitor.

If a manufacturer increases the resistance (R_p) of the material that is used to separate the two portions of a capacitor, he reduces the leakage current. This resistance (R_p) has the same effect as a resistor connected in parallel with the capacitor. By reducing the leakage current, the manufacturer produces a higher quality (Q_p) capacitor, since the capacitor's reactance is then a greater factor in determining the total current conducted. This quality factor (Q_p) can be calculated if the leakage resistance (R_p) and capacitor reactance (X_c) is known

$$(Q_p = \frac{R_p}{X_c}).$$

The two portions of the capacitor that gain and lose electrons, the leads connected to them and the connections all resist the flow of electrons. They have the same effect as a resistor (R_s) connected in series with the capacitor. This resistance (R_s) reduces the ac current that results from the capacitor's re-

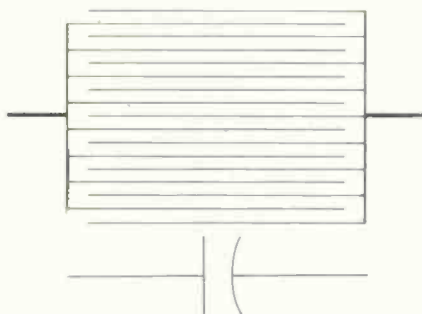

Fig. 1 — The basic structure of most capacitors (above) and a conventional diagram of a capacitor (below).

actance (X_c), and by reducing the resistance the manufacturer produces a higher quality (Q_s) capacitor. This quality factor (Q_s) can be calculated if the effective series resistance (R_s) and the capacitor reactance (X_c) is known

$$(Q_s = \frac{X_c}{R_s}).$$

The over-all quality (Q) of a capacitor is reduced by both its leakage resistance (R_p) being too low and its effective series resistance (R_s) being too large. This over-all quality factor (Q) must, therefore, be less than the two quality factors (Q_p and Q_s) already calculated

$$(\frac{1}{Q} = \frac{1}{Q_p} + \frac{1}{Q_s} = \frac{X_c}{R_p} + \frac{R_s}{X_c}),$$

but equally dependent on both.

The over-all quality factor (Q) of a capacitor depends on the relationship of the capacitor's leakage resistance (R_p) and effective series resistance (R_s) with its reactance (X_c). This factor (Q) changes as the capacitor's reactance (X_c) changes with the frequency of the applied ac voltage

$$(X_c = \frac{1}{2\pi f C}).$$

Most circuit applications require capacitors with loaded Q 's exceeding 20 and often 100 or more. The low unloaded Q 's of the previously available voltage-variable capacitors limited the application of these components.

Most capacitors basically resemble the one shown as the top illustration in Fig. 1. The lower illustration in that figure is, of course, a conventional diagram of a capacitor. The ground side (right side) is the same for both.

Capacitors are constructed so that the maximum area of the conductive surfaces attached to their two leads are exposed to one another. The capacitor functions by gaining and losing electrons in these surfaces. The greater the number of surfaces and the greater the area of these surfaces, the more electrons they can

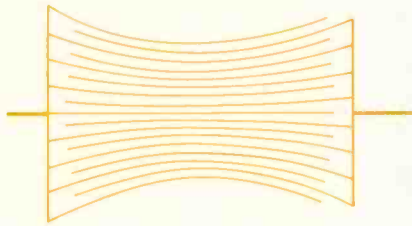

Fig. 2 — Reducing the spacing between the surfaces in a capacitor increases the capacitance.



Fig. 3 — Reducing the area of each set of surfaces, adjacent to another set, reduces the capacitance.

gain or lose and the greater the value of the capacitor.

The capacitor shown in Fig. 1 contains 32 surfaces exposed to one another. Only the bottom surface of the material represented by the top line is exposed to another surface and only the top surface of the material represented by the bottom line is exposed to another surface, while both surfaces of the material represented by the other lines are exposed to other surfaces.

The right side of the capacitor shown in Fig. 1 is the ground side since the outer material connected to the right side shields the material connected to the left side.

As you may know, unlike electrical charges attract each other just as unlike magnetic poles attract each other. As one set of surfaces loses electrons, when a voltage is applied across a capacitor, its charge becomes more positive — the charge of the remaining protons contained in the atoms of material that the conductive surfaces are made of. The excess electrons in the other set of surfaces have a negative charge and are attracted by the surfaces containing the positive charge. The greater the attraction of electrons for the positive surface, the more electrons the negative surface can contain.

Each proton in an atom has a positive charge virtually equal to the negative charge of an electron. If the proton's positive charge is attracting excess electrons on the negative surface, the proton has less energy to attract electrons on its own positive surface. The greater the proton's attraction for the negative surface, the more electrons the positive surface can lose.

When the negative surfaces are close to the positive surfaces, their unlike charges have a greater attraction toward one another than when the negative and positive surfaces are further apart. The spacing of the conductive surfaces, like their surface areas, is a factor that determines their capacitance.

The capacitance of some capacitors, such as mica trimmer capacitors, is changed by increasing or reducing the spacing between the two sets of surfaces. When this spacing is reduced (Fig. 2), the component's capacitance increases.

In some other capacitors, like the mechanical ones generally used to tune AM or FM radios, the spacing of the two sets of surfaces remains the same while the area of each set, adjacent to the other set, is increased or decreased. When the area of adjacent surfaces is reduced (Fig. 3), the capacitance is also reduced.

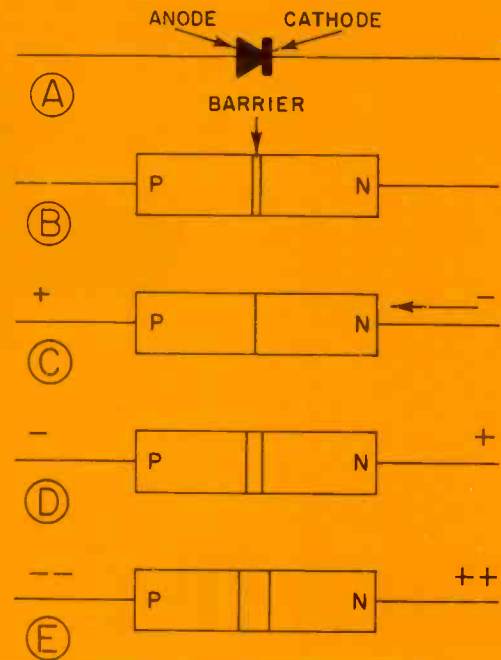

Fig. 4(A) — A diode's anode contains P-type material while its cathode contains N-type material. (B) — The junction of P- and N-type material forms a barrier blocking the flow of electrons. (C) — Current will flow through a diode when its cathode is more negative than its anode. (D) — The junction resists the flow of current when the anode is more negative than the cathode. (E) — The barrier becomes greater as the reverse bias increases.

As has been indicated, the resistance of the material separating the charged surfaces in a capacitor determines the amount of "leakage" in the capacitor and its quality (Q_p and Q). The separating material also affects its capacitance.

Just as a magnet's ability to attract objects varies with the material its field must travel through, the attractive force of unlike electrical charges varies with the material this force must travel through. The material that separates the two sets of charged surfaces in a capacitor is called the dielectric. The dielectric's ability to transmit the attractive force of unlike charges is called the dielectric constant. The dielectric constant of air or a vacuum is 1.0, paper is 4.0, pyrex glass is 4.2, clear indian mica is 7.5, aluminum oxide is 10.0 and tantalum oxide is 11.0.

The value of a capacitor can be calculated using the factors that have been described in the equation

$$C = 2.235 \frac{KA}{d} (N - 1) 10^{-11},$$

where:

- C = capacitance in Farads
- K = dielectric constant
- A = average area of effective surfaces (described with Fig. 3)
- d = distance between plates
- N = number of surfaces exposed to one another (described with Fig. 1)

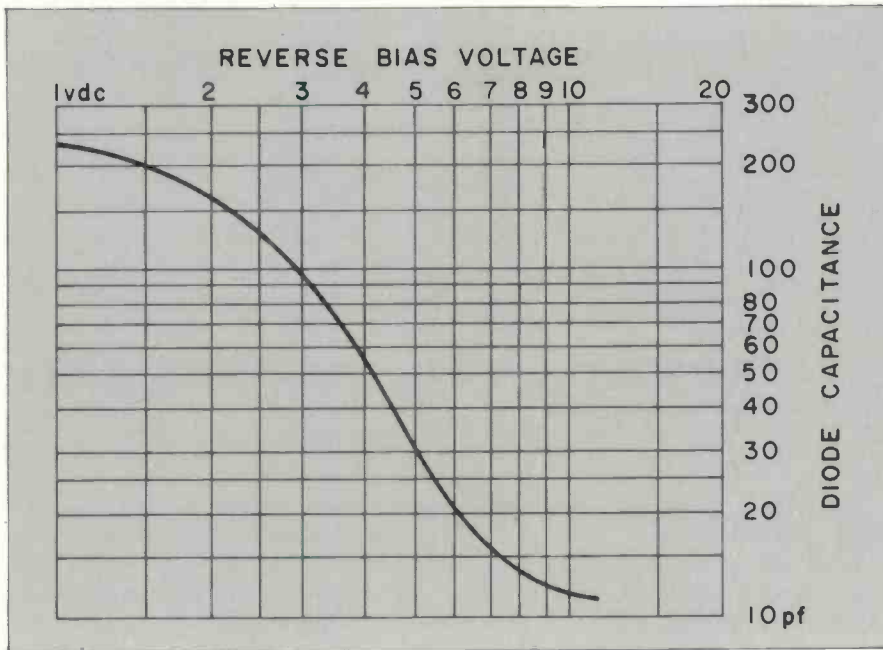

Fig. 5 — The relationship between reverse bias voltage and capacitance in a voltage-variable capacitance diode recently developed for tuning AM radios. Courtesy of Motorola.

Diode Capacitors

The P-type material in a diode's anode (Fig. 4A) forms a junction with the N-type material in its cathode. This junction of P- and N-type material normally resists the flow of electrons (Fig. 4B). As first described with Fig. 3 on page 61 of the August 1966 article and then described in more detail with Fig. 13 in the August 1967 article of this series, a diode will conduct current (Fig. 4C) when a negative voltage is applied to its cathode and a positive voltage is applied to its anode. When a positive voltage is applied to its cathode and a negative voltage is applied to its anode, the junction of P- and N-type material has a relatively high resistance and functions as a barrier to current flow (Fig. 4D). The greater the amount of this reverse bias, the greater the barrier developed (Fig. 4E).

The P- and N-type material forms the two portions of the voltage-variable capacitance diode that gain or lose electrons. When the diode is reverse biased (its anode more negative than its cathode) a barrier separates the two portions of the diode. Like the capacitors described earlier in this article, the ac current then flowing through the

diode's leads is basically the result of electrons gained or lost in the P- and N-type portions of the diode, rather than the result of an ac current "leaking" between the two portions of the diode.

As the reverse bias is increased, the barrier between the two portions of the diode becomes greater and the diode's capacitance is reduced. As the reverse bias is reduced, the bias barrier becomes smaller and the diode's capacitance increases. This relationship between diode capacitance and reverse bias voltage is shown in Fig. 5 for a voltage-variable capacitance diode recently developed for tuning AM radios. Two of these diodes are shown (Fig. 6) next to a two-stage mechanical tuning capacitor they replace.

Voltage-Current Phases

A review of voltage-current phase relationships may help some technicians understand the application of voltage-variable capacitance diodes in resonant circuits for tuning receivers.

A relationship between electron flow (current) and the voltage across a capacitor was described in the September 1967 article of this series. The circuit shown in Fig. 7 is used to explain this relationship in

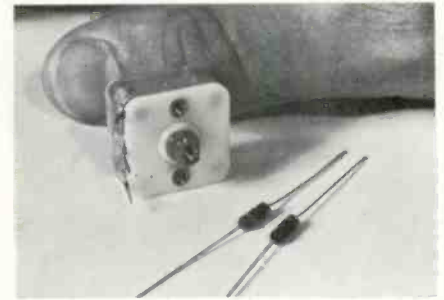

Fig. 6 — Tuning diodes are compared to a miniature mechanical tuning capacitor they can replace.

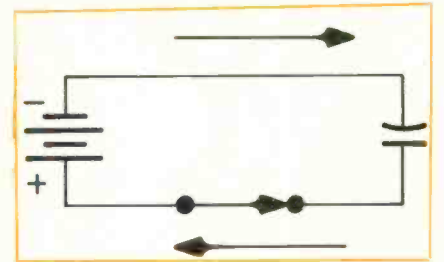

Fig. 7 — The greatest dc current flows through a capacitor when the switch is first closed.

greater detail. When the switch is closed in the circuit, electrons flow from one portion of the capacitor to the battery and from the battery to the other portion of the capacitor. The largest current (electron flow) occurs just after the switch is closed, before the voltage first appears across the capacitor. The smallest current occurs as the voltage across the capacitor becomes as large as the voltage across the battery. This voltage-current relationship is shown in Fig. 8.

Sinewaves were described with Fig. 7 and 8 in the August 1967 article. There the various portions of a sinewave were compared with the angles of a rotating line. The height of a rotating line increases and decreases more rapidly when it is nearly horizontal than when it is nearly vertical up or down. Sinewave voltages change more rapidly

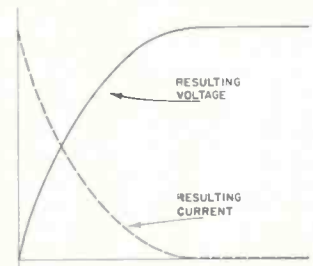

Fig. 8 — The voltage-current relationship that occurs when a dc voltage is applied across a capacitor.

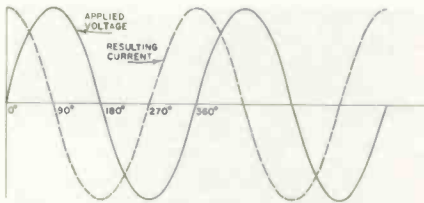

Fig. 9 — The voltage-current relationship that occurs when an ac voltage is applied across a capacitor.

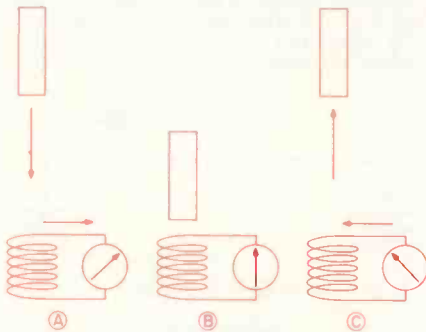

Fig. 10 (A) — A current is induced when a permanent magnet approaches one end of a coil (B) — No current is induced when the magnet remains stationary near the coil (C) — A current is induced in the opposite direction when the permanent magnet moves away from the coil.

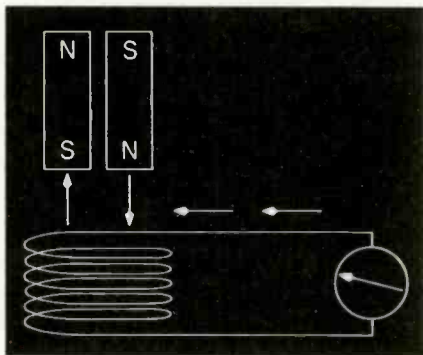

Fig. 11 — The same current is induced when the north pole of a magnet approaches a coil as when the south pole of a magnet is moved away from that end of the coil.

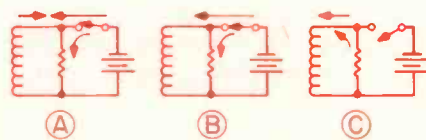

Fig. 12 (A) — When the switch is first closed, an induced current impedes any current flow from the battery through the coil. (B) — Once the coil's magnetic field has reached its maximum strength, no current is induced through the coil to impede any current from the battery through the coil. (C) — When the switch is opened, an induced current flows through the coil in the same direction as the battery current.

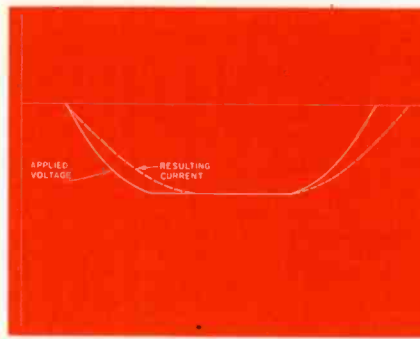

Fig. 13 — The negative current lags behind the increase and decrease in negative voltage.

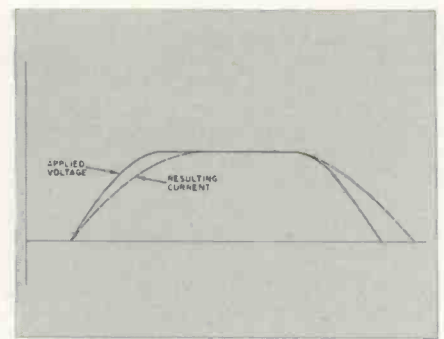

Fig. 14 — The positive current lags behind the increase and decrease in positive voltage.

at around 0 and 270deg than they do around 90 and 270deg.

When an ac voltage, resembling a sine wave, is applied across a capacitor, the voltage alternates between positive and negative. The slowest change in voltage occurs when portions of the capacitor are at nearly the maximum positive or negative voltage (90 or 270deg) and the fastest change occurs at the lower voltages or when portions of the capacitor shift between positive and negative polarities (0 and 180deg).

In Fig. 9 we see that as the voltage in one portion of a capacitor becomes positive (0 to 90deg), that portion of the capacitor loses electrons and a current flows out of the connecting lead. As it becomes less positive and then negative (90 to 270deg), electrons return through the lead. Electrons again reverse their direction and flow out of the connecting lead as this portion of the capacitor becomes less negative and then positive (270 to 360deg).

Since the greatest change in voltage occurs when the voltage shifts between positive and negative, the maximum flow of electrons (current) out of the capacitor lead (the same lead described in the preceding paragraph) occurs at 0 and 360deg, while the maximum flow of electrons into the lead occurs at 180deg.

Coil Impedances

Resonant circuits are equally dependent on the impedance of capacitors and the impedance of coils. Unless the impedance of coils and their related voltage-current phase relationships are clearly understood, the function of voltage-variable

capacitance diodes, as well as mechanical diodes, are beyond the scope of the average technician. Although coils are not semiconductors, a review of their function is important for a clear understanding of semiconductor circuits.

The function of coils in electronic circuits is dependent on the magnetic fields they produce. Similar magnetic fields can be produced by a permanent magnet.

When a permanent magnet approaches the end of a coil (Fig. 10A), it induces a current through the coil's windings, and one end of the coil becomes more negative than the other. While the magnet remains stationary near the coil (Fig. 10B), no current is induced in the coil. As the magnet moves away from the coil (Fig. 10C), a current is again induced through the coil's winding. This current, however, flows in a direction opposite that of the current induced by the approaching magnet, and the coil's other lead is now more negative.

When the south pole of a magnet moves away from a coil (Fig. 11), the induced current flows through the coil in the same direction as a current induced when the north pole of a magnet approaches the coil.

The circuits shown in Fig. 12 help explain the function of a coil. When the switch is first closed (Fig. 12A), an electrical current flows through both the coil and the resistor connected in parallel with it. As the current begins to flow through the coil, it produces a magnetic field in the coil corresponding to a permanent magnet approaching the coil. Just as an approaching permanent magnet induces a current in the

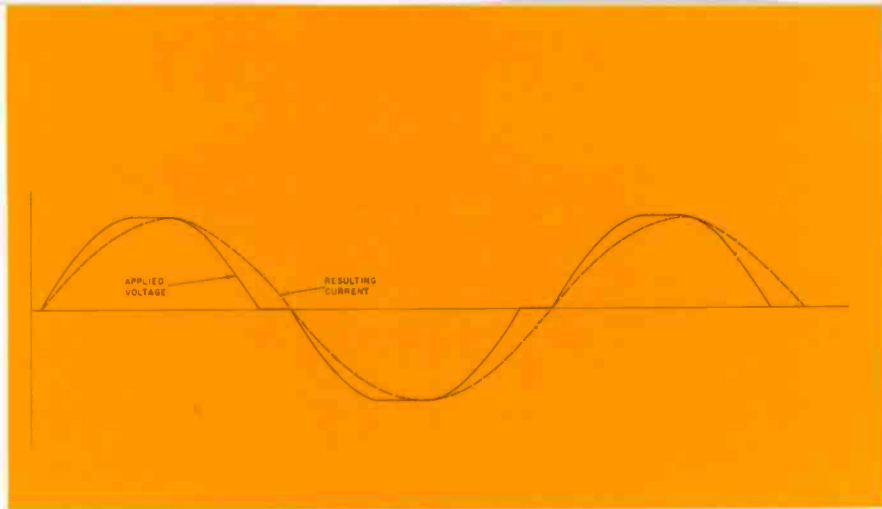

Fig. 15 — As a dc voltage is switched between positive and negative, the resulting current lags behind the voltage.

coil, the increasing magnetic field induces a current opposing the current from the battery.

Once the magnetic field has attained its maximum strength and ceases to increase (Fig. 12B), it, like a permanent magnet remaining stationary near a coil, no longer induces a current. The maximum amount of current can then flow from the battery through the coil.

When the switch is opened (Fig. 12C), no voltage from the battery is applied across the coil and the magnetic field decreases. Just as a receding permanent magnet induces a current through a coil, the depleting field also induces a current through the coil, which flows through the resistor. The current now induced flows in a direction opposite that of the current previously induced. The induced current flows in the same direction as the current that had been flowing from the battery.

The increasing negative current (Fig. 13) in the circuit described lags behind the increasing negative voltage, and the decreasing negative current lags behind the decreasing negative voltage. If the polarity of the battery is reversed in the circuit (Fig. 12), the increasing positive current (Fig. 14) lags behind the increasing positive voltage and the decreasing positive current lags behind the decreasing positive voltage.

By combining the curves shown in Fig. 13 and 14 we see the current that results when a positive voltage is applied to the circuit, until the maximum positive current flows through the coil (Fig. 14); the voltage drops to zero, until the cur-

rent ceases to flow through the coil; a negative voltage is applied, until the maximum negative current flows through the coil; etc. The positive and negative changes in current always lag behind the positive and negative changes in voltage.

If the permanent magnet shown in Fig. 10 approaches the coil and departs from it at a more rapid rate, the induced current becomes greater. As indicated earlier in this article, sinewave voltages do not change at a uniform rate. With an ac sinewave voltage applied across a coil, there is a more rapid change in the magnetic field when the applied voltage changes polarity than when the voltage reaches its maximum positive or negative value. The coil's induced current is therefore the greatest, further impeding or enhancing the current from the power source (Fig. 16), when the applied voltage changes polarity. Measurements indicate that when an ac voltage is applied across a coil, the current always lags 90deg behind the voltage.

When comparing the voltage-current phase relationship for a capacitor (Fig. 9) with the voltage-current phase relationship for a coil (Fig. 16), we see that in a capacitor the current leads the voltage 90deg while in a coil the voltage leads the current 90deg. The greatest amount of ac current passes through the capacitor's leads and the coil as the applied voltage changes polarity.

The amount of ac current flowing through a coil is dependent on the coil's reactance

$$(I \approx \frac{V}{X_L}),$$

just as the amount of apparent ac

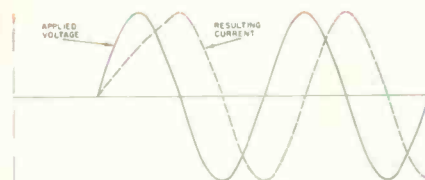

Fig. 16 — When an ac voltage is applied across a coil, the current lags 90deg behind the voltage.

current through a capacitor is dependent on the capacitor's reactance

$$(I \approx \frac{V}{X_C}).$$

Although a capacitor appears to have less resistance to ac currents at higher frequencies, a coil's resistance to ac currents increases as the applied voltages and magnetic field fluctuate at higher frequencies. The coil's reactance can be calculated with the equation $X_L = 2\pi fL$, where L is the inductance of the coil.

The coil's inductance (L) is dependent on the magnetic field it produces. The greater the field's concentration, the greater the coil's inductance and the smaller the ac current it will conduct.

An iron core can concentrate a magnetic field more than an air core can. Iron has a greater permeability (μ) than air. The greater a core's permeability, the greater the coil's resistance to ac currents.

The strength of a magnetic field also depends on the core's cross-sectional area (A), the number of turns of wire (N) around the core and the coil's length (l). When the core's area (A) is expressed in square inches and its length (l) in inches, we can use this data to calculate the coil's inductance (L) in henries,

$$L = \frac{\mu N^2 A 10^{-8}}{l}$$

The next article in this series will describe the operation of series-resonant and parallel-resonant circuits, and show how varicaps can be used to vary the resonant frequency of the parallel-resonant circuits used to tune receivers. ■

Use specialized testers to
troubleshoot and align color sets
faster and more accurately

Unique Test Instruments for Color TV Servicing

■ About 10 years ago, Bob Middleton demonstrated some magic techniques for aligning and troubleshooting color TV sets by using an oscilloscope and rainbow generator (*ELECTRONIC TECHNICIAN* August 1957). Since then, a more convenient, compact scope/generator combination instrument has been designed and manufactured which employs the principles outlined by Mr. Middleton.

The Vectorscope

The Lectrotech, Model V7 color generator and vectorscope combination can provide a highly significant amount of practical data, in a single waveform display, regarding chroma circuit operation. The vectorscope is a hybrid — electron tube/solid-state instrument. In addition to the vectorscope display, the instrument also provides five normal crosshatch, dot, vertical line, horizontal line and color bar patterns. The instrument's RF output is tuned for channel 4 at the factory but it is also adjustable to either channel 3 or channel 5. It has a self-contained CRT, internally connected to receive and reproduce the color signal on the CRT's face. And the screen of the CRT is marked to indicate where the individual color signals should appear. Any variation from these markings, of course, indicates troubles in the color section.

As described by Bob Middleton in the previously mentioned article which was written 10 years ago, the vectorscope screen shows the phase of each color bar with respect to the burst signal — including the important R-Y and B-Y signals. Thus, the hue range control can be accurately centered and the demodulator alignment can be checked or adjusted to provide equality between the red and blue amplifier gain. In effect,

complete information regarding the performance of the color circuits can be obtained.

The color signals, R-Y and B-Y, are applied at a 90deg angle to the deflection plates. The R-Y signal falls at the top of the vectorscope screen when the hue control is correctly set and the B-Y signal falls at 90deg (3 o'clock) when the color demodulator is properly adjusted. G-Y is automatically developed on the scope screen because of the natural matrixing of the B-Y and R-Y signals which takes place within the tube and produces green on the color set screen. Then, a signal which is part R-Y and part B-Y — for example, a magenta signal — appears between the red and blue signals because both the B-Y and R-Y voltages act upon it. This holds true of all the 10 bars — each bar is displayed on the vectorscope in its proper order and phase angle. The vectorscope principle, because it conforms totally with compatible color TV basics, is perhaps the most logical approach to color TV troubleshooting and alignment.

Perhaps it would be helpful at this point to reiterate: The G-Y voltages on the color set's CRT grid are not used to produce the vectorscope pattern.

It may also prove helpful to point out that the rainbow generator in this instrument is a crystal controlled oscillator which operates at the normal frequency of 3.563795MHz — and provides the color signal. The color TV receiver being checked automatically phase-locks on this signal during the horizontal blanking period. Since the receiver's oscillator frequency is normally 3.579545MHz, you will recall that the difference between this frequency and that of the rainbow generator used in the vectorscope is 15.75kHz — which, of course, is the set's scanning frequency. Since phase-lock occurs at the beginning of each horizontal



Lectrotech Model V7 vectorscope.

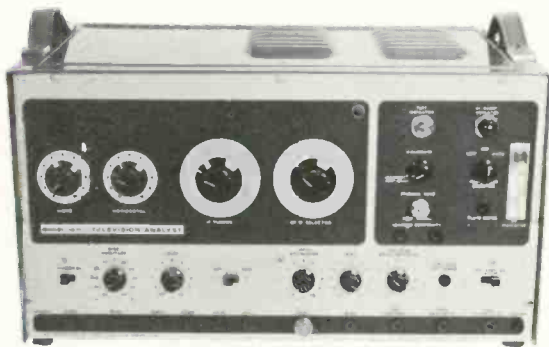

B&K Model 1076 television Analyst.

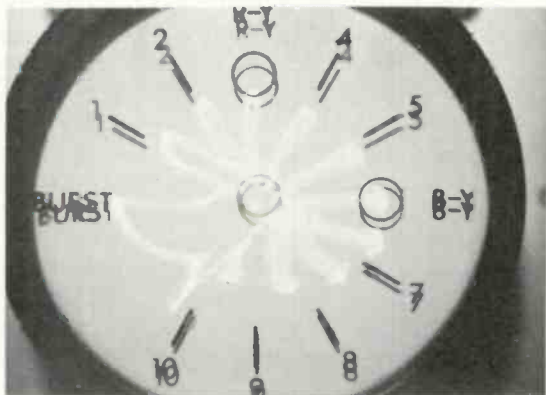

Fig. 1 — Correct vector display from a Zenith color circuit.

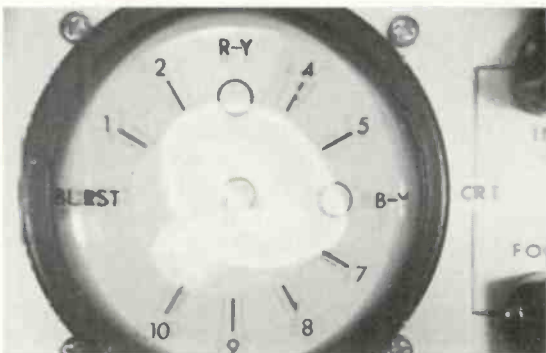

Fig. 2 — Vector display showing all colors present but out of color sync.

line, the offset color signal “appears” to the receiver as a color signal which undergoes a phase change of 360-deg during each horizontal scanning period.

For some time now, ET’s editor/technicians have been using the vectorscope on a Zenith color chassis (a 20X1C38 chassis) to simulate various practical problems which may arise at any moment during the technicians normal working day.

Vector display photographs taken directly from the model V7 CRT in ET’s TEKLAB are shown in Figs. 1 through 4. A Zenith color chassis 20X1C38 was used to simulate the troubles shown.

The vector pattern may vary slightly from set to set, particularly between different brands — but the specific areas of importance on the vector patterns are the ends of the vectors which must be placed into the center circle of the graph on the face of the instrument’s CRT by adjusting the horizontal and vertical controls on the front of the V7.

Vectors on RCA sets all have approximately the same length. This is not true of Motorola and Zenith sets. The R-Y vector on Motorola is longer than the B-Y vector, while Zenith is just opposite, as shown in the following vector display patterns.

A correct vector display is shown in Fig. 1, with the ends of the vectors dropping into the R-Y and B-Y circles and the 3rd bar is in the middle of the R-Y circle. The 6th bar should occur within the confines of the B-Y circle or lie along a line connecting the B-Y circle to the center.

The vector display showing all colors present, but out of sync, is shown in Fig. 2. The rotating vector which appears as a solid mass of green results when there is no color sync.

TEST INSTRUMENTS...

If the receiver does not have enough color gain — all the vectors reduced by the same amount — then the trouble is in a stage common to all colors as shown in Fig. 3.

If the bandpass amplifier is in need of alignment, the vector pattern crosses over on itself and again opens into a loop — this also indicates poor color amplifier alignment. This condition is shown in Fig. 4.

The Analyst

The B&K TV Analyst is a flying spot scanner video signal generator coupled with an RF transmitter. Many of the circuits used in this instrument are familiar to service technicians because they are similar to those used in most TV sets today.

Loss of color, weak color or distorted color can occur in the RF or IF sections of a receiver as well as in chroma circuits. The Analyst is useful in quickly troubleshooting these symptoms since either the RF or IF signal may be modulated with the rainbow color signal which is injected into the RF or IF stage to localize the fault.

A chroma signal is also available and may be injected directly into the video detector, video amplifier, bandpass amplifier or to the grids of low level demodulators. These checks localize phase errors by showing the wrong sequence of color.

Phase errors arise in the chroma, or in the IF section. It is possible for the RF section or video section to cause phase errors, but not common. If you inject the chroma signal into the bandpass amplifier and get a normal color pattern, the next step is to inject an IF signal modulated with chroma information at the input of the IF amplifier.

When a phase error is found in the latter check, it is indicated that the IF amplifier is in need of proper alignment.

By referring to Fig. 5, you will see the vector display of the color information that can be obtained for a phase shift of any given number of degrees. For example, 60deg represents a $+(I)$ signal. A 90deg phase shift represents $+(R-Y)$. And 180deg represents $+(B-Y)$ and a $+300deg$ represents $(G-Y)$. To change a color rainbow signal to a color bar signal, we electronically blank out with the 189kHz oscillator those portions of the rainbow display that we do not want and allow the portion of the rainbow that we do want to come through. You will note there are ten light intervals and nine dark intervals equally spaced. Each bright interval or bar, represents a color phase shift of 30deg and is so placed to give the colors as indicated in Fig. 6. You will note, for example, the 2nd bar is indicated as orange and its color corresponds to $+(I)$ since it is 60deg from the reference signal. The 6th bar, for example, is a blue color and corresponds to $+(B-Y)$ since it is 180deg from reference signal. The color pattern will be extremely useful in servicing color TV receivers since it will enable you to check the range of the hue control and will provide a simple method of color demodulator alignment.

Since most of the color TV receivers in use today demodulate a $+(R-Y)$ and a $+(B-Y)$ signal, the following demodulator alignment will refer to this condition only.

Connect the TV Analyst to the receiver under test and set up and adjust for a proper picture on the TV receiver. Be sure the horizontal frequency of the generator is adjusted to the correct frequency. Turn the color signal on and insert the R-Y, B-Y slide into the

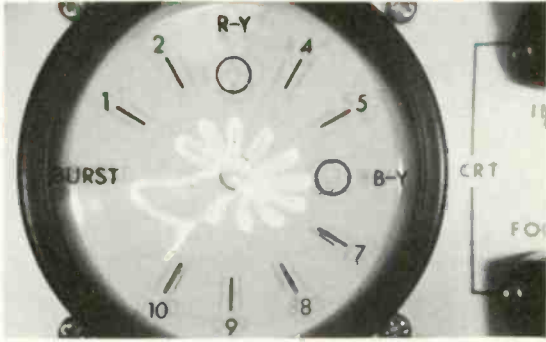

Fig. 3 — Vector showing receiver lacking color gain.

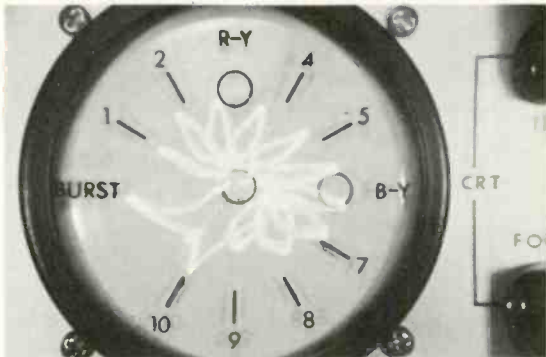

Fig. 4 — Vector showing bandpass amplifier out of alignment.

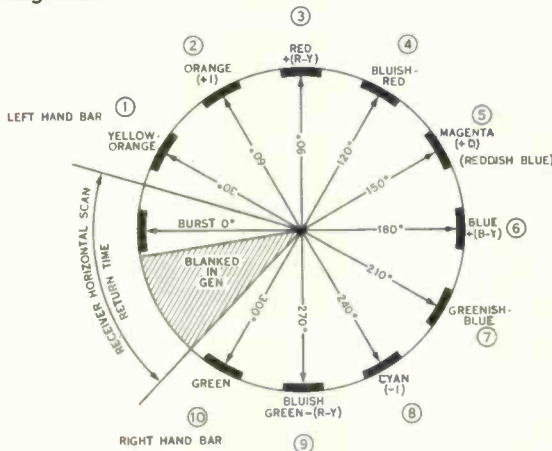

Fig. 5 — Color vector diagram showing relative phase relations of color signals. Shaded area represents duration of horizontal sync pulse.

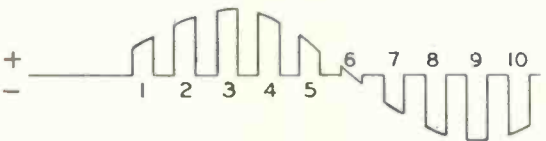

Fig. 7 — R-Y demodulator output as seen on scope.

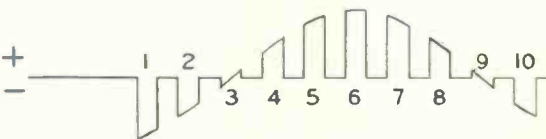

Fig. 8 — B-Y demodulator output as seen on scope.

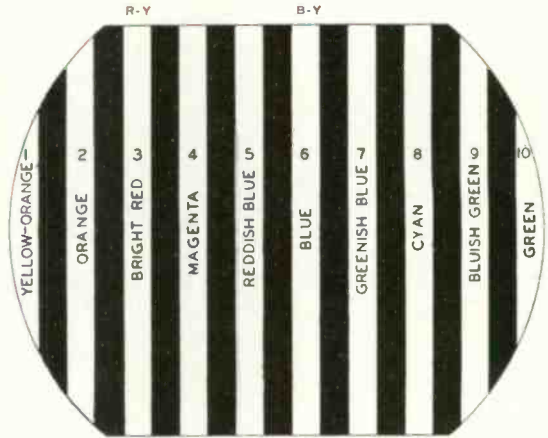

Fig. 6 — Color pattern showing each bar, the number and its color.

Analyst. Adjust the video control on the generator to get good reproduction of the bars and adjust chroma and hue controls for the proper color signal level so the color bars occur in the proper sequence as shown in Fig. 6. If the color bars do not fall into the proper sequence, the coarse adjustment of the hue range located inside the receiver will center the range of the hue control. At this point it is well to indicate that the horizontal width of the receiver under test should be reduced to ten bars.

We know the output of the $+(R-Y)$ demodulator, if properly adjusted, should have zero $+(B-Y)$ output and the output of the $+(B-Y)$ demodulator should have zero output of $+(R-Y)$ signal.

Since our color bar pattern has both a $+(R-Y)$ signal which is the 3rd bar and a $+(B-Y)$ signal which is the 6th bar, we can use these signals to check and align color demodulators.

Connect a scope of adequate bandwidth to the output of the $+(R-Y)$ demodulator. You will see a waveform similar to that shown in Fig. 7. This is viewed at a 15.75kHz sweep on the scope. The 6th bar which is $+(B-Y)$ should be at zero amplitude as (shown in Fig. 7). If this condition is not met, set the hue control to its center position and adjust the coarse hue control adjustment which is located within the TV receiver so that the 6th bar is at zero amplitude. Now connect the scope to the output of the $+(B-Y)$ demodulator and adjust the quadrature transformer driving the $+(B-Y)$ demodulator so the 3rd bar which is $+(R-Y)$ is at zero amplitude (Fig. 8).

The color demodulators are now properly aligned so no $+(R-Y)$ signal gets through the $+(B-Y)$ demodulator and also no $(B-Y)$ signal gets through the $+(R-Y)$ demodulator. ■

Good Service Promotes Steady

Service-dealer operation shuns discount business and technician

■ When Grant and Grant, 586 Bank Lane, Lake Forest, Ill., took over the radio repair department of a retail operation on Western Avenue in 1947, they bought a lot of "service goodwill" which has helped it grow steadily over the years. In the beginning its annual gross was around \$50,000. But business has increased with neighborhood growth.

By 1957, business had expanded to such an extent that the father-and-son team decided to open another store in Highland Park. The new operation was an immediate success, partly because of a promotional deal involving personal appearances of recording stars, including Homer and Jethro, Pearl Eddie and Tommie Leonetti. Phonograph record sales spurted and people began buying phonographs and Hi Fi equipment, and this added impetus to the store's business growth.

"But, when color TV began to boom," the senior Mr. Grant says, "we ran into a problem. We needed better antennas on the store roof to provide higher gain for good color TV reception from Chicago. And the landlord wouldn't let us put the kind of antennas we needed on the roof. So we moved to another location a few blocks down the street. We were able to put up adequate antennas at our present location on Bank Lane."

Today, the Grants employ five people in Lake Forest, three in

Highland Park and last year's gross was around a quarter million dollars. Eighty percent of this came from sales and about 20 percent came from service operations.

Advertising and Sales Promotion

"We spend between \$5000 and \$6000 a year on newspaper ads around Christmas time," the senior Mr. Grant says. And this covers an area extending south to Wilmet and west to Northbrook.

"Our records indicate that our old customers repeat steadily," Mr. Grant declares. "And besides, because of our past customer relations efforts in the direction of top-level service, we obtain a lot of new customers through word-of-mouth advertising.

"We do have some competition from discount houses that moved into nearby communities recently," he admits. "With large-volume, low-overhead sales, these stores are able to undercut us on color TV sets. But they can't compete with us on service."

Mr. Grant points out that he could compete with the discount houses if he had enough technicians.

"But if we went out to get the discount business we would have to give good service on the sets. And with the present shortage of service technicians, we'd probably get into trouble. We're servicing all the sets we can handle right now."

Mr. Grant indicates, even if the

company wanted to expand its operations and push sales upward, it would be difficult to hire additional technicians to handle the service on any large increase in color sales.

Mr. Grant understands that the apprentice training programs now under way throughout the country will eventually help solve this problem and make it possible for small and medium-sized service-dealer operations to continue expansion at a higher rate.

The senior Mr. and Mrs. Grant handle sales in the Lake Forest store while their son operates the Highland Park store. Mr. Grant handles the payroll and accounting for both stores.

Service Setup

The service shop is located in the basement of the Lake Forest store and any service originating in the Highland Park store is processed in the Lake Forest shop. This store is open to the public 44 hours a week while the Highland Park store is open 52 hours weekly. The service manager, with 25 years' industry experience, is in charge of service for the areas served by both stores and he, with another technician, concentrate mainly on home calls.

A part-time technician, who is also an electronic technician First Class at the s.s. Great Lakes Training Center, also helps with service work. There's one benchman that works in the shop all the time.



Front of Lake Forest Store.



Technician working in shop at Lake Forest store.

Sales Growth

shortage slows expansion of color TV sales

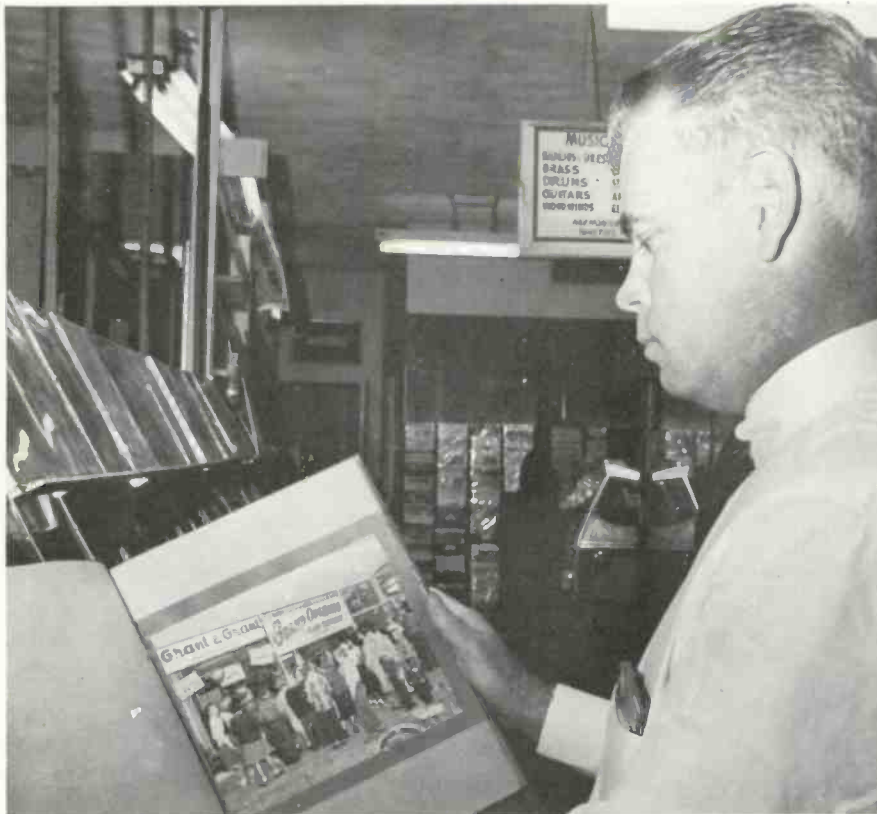

Young Mr. Grant looks over photo album covering promotion using recording stars.



Salesman demonstrates TV set in sales room.



Senior Mr. Grant takes telephone call from customer.

Mr. Grant says that solid-state equipment is a lot harder to service than tube equipment, and most of it has to be done in the shop.

"We average around 125 house calls a month and repair 50 or 60 portable radios, about 10 home

radios and about 20 to 25 Hi Fi units and tape recorders. We also sell and install 8-track cartridge players for cars."

Mr. Grant estimates that color sets are replacing B/W sets at the rate of about 75 percent in his area. ■

Thousands of small-to medium-sized service-dealer operations are boosting sales by giving the public better service and paying commissions to house-call technicians who provide leads and close sales

WHO'S SELLING

■ Figures released by the Electronic Industries Ass'n. (EIA) reveal that the consumers of this country spent over \$6.5 billion for electronic equipment in 1966 — including TVs, phonographs, radios, Hi Fi equipment and antennas. This doesn't include electronic replacement parts nor equipment bought by industry and government. The entire bundle amounted to over \$20.2 billion!

But \$6.5 billion is a lot of "clams," too.

And who do you think sold all this equipment to the purse-powered public? The discount houses? The hardware stores? The home-furnishing stores? Or the drug chains? Not by a long shot!

Dick Weber of Weber's Television in Pasadena, Calif., says he sold \$300,000 worth of it last year. And this figure includes \$90,000 for services which he sold to *keep the equipment sold*. This is something the discount houses and the hardware stores and the home furnishing stores and the drug chains can't do. And Mr. Weber makes no bones about the fact that service is the bedrock on which sales rest.

"We once leaned in the direction of a 'chain operation,'" Mr. Weber says. "But we closed the second store we had opened and decided to maintain a 'personal business' relationship with the public."

According to Dick Weber, this idea paid off. His business has shown a steady increase of more than 15 percent annually during the past few years. Mr. Weber has been running this business for the past 15 years — he's no fly-by-night, quick-buck operator.

Now Weber's has one store in South Pasadena, concentrating on service within a 5-mile radius.

About seven years ago Dick Weber went exclusive on one brand of TV, selecting a top brand after considering the possibilities carefully.

"That's the best single business decision I ever made," he says.

"First, we got to know the product thoroughly and

WHAT, WHERE AND HOW?

became experts on the product in our territory. Then, according to our agreement, the distributor won't place the line with others in our territory as long as we do the sales job for them."

Except for service advertising in the yellow pages, Weber's does not presently do any advertising. Discount prices, he says, seem to be the only thing that get any newspaper attention in his hotly competitive area and he doesn't intend to take that road.

"One thing we've found important in building a personal identity is free telephone advice. In this respect, being a service technician is something like being a doctor. People want to be reassured. Most people understand less about their TV and Hi Fi equipment than they do about their own bodies. When something goes wrong, they need expert consultation.

"Telephone consultation keeps our customers from coming down to the shop or prevents our having to make a useless service call.

"Another way we build our image is not to write out a job ticket every time a radio is brought in. We average about 15 customers each day who bring in a radio that's not working. In more than 20 percent of the cases the radios need only batteries or a tube or some small adjustment. We fix them right in front of the customer at no charge for labor.

"A little free radio repair and service advice brings in the big repair jobs and boosts sales. We've had customers so impressed with this that they've come back and bought a color TV from us. If you take care of their little problems, chances are they'll purchase their major home-entertainment items from you."

Tom Carmichael, TV and stereo manager of Balcom & Vauhan, Seattle, Wash., grossed over \$750,000 in TV and stereo sales and service last year.

"I believe our sales figures strongly indicate that the specialty dealer can compete effectively with leading department stores and quality home furnishers who have

previously had more or less a corner on selling TV and stereo as both home decor and entertainment," Mr. Carmichael says.

This reminds us that not all change is taking place in technology alone. Merchandising is no longer in the "hot-shot" area. The "ma" and "pa" operations are growing up.

"It's our experience that the small- to medium-sized dealer has a considerable advantage since the general public believes the small dealer will give better personal attention and follow-up on service after a sale than will department stores and home furnishing stores," he emphasizes.

Gearing to the booming TV market begins with a strong advertising campaign, Mr. Carmichael believes. The follow-through depends on the proper kind of sales setup — and the bedrock of this merchandising struc-



Byron Napper's Hampton TV Service in St. Louis is typical of the tens of thousands of "mama" and "papa" service-based TV-radio sales organizations that have grown up in recent years.

WHO'S SELLING WHAT, WHERE AND HOW?

ture rests on the quality of service rendered by the shop.

To bring in the traffic, Mr. Carmichael budgets approximately 3 percent of gross sales to advertising. The company is a one-brand dealer and uses co-op advertising exclusively — which gives a fat budget for presenting color and stereo equipment to the public.

A full-page ad goes in the Sunday TV supplement of Seattle's leading newspaper every week. Approximately half of this is on color TV and half on color TV stereo "theaters." Four column wide by 10in. deep ads are also used in both local daily newspapers for a mid-week exposure — increasing to three ads a week during the fall selling season.

Selling color TV is fundamentally no different from selling B/W, Mr. Carmichael emphasizes, but color TV offers a prime opportunity to upgrade the market. The company's sales technique is to stress furniture, tone and picture, in that order. The demonstration begins by showing the top of the line.

"The basis of salesmanship is product knowledge, including some knowledge of competitive lines," Mr. Carmichael points out, "and then an orderly demonstration procedure."

"The majority of our sales are running in the \$300 to \$750 price bracket," he says. "With the color TV stereo theater hitting around 30 percent of the sales, I believe we're doing a considerable job in upgrading the home entertainment market.

"Like most dealers, we think there are too many models and too much inventory required, even in a one-line dealership. But the market is on the boom and we must have the broadest possible selection to close the sales. The dealer who gets his color customers now is laying the foundation for increased service and sales in the future."

Over in St. Louis, Mo., owner Byron Napper of Hampton Radio and TV Service believes that selling color is the best way for his service-based business to thrive.

"Don't get me wrong," he says. "I realize that the biggest profit dollar for me is in the service end. But the swing to color sales increases your chances of making more regular service customers."

Although sales-oriented, this operation is service-based. Service accounts for about 60 percent of gross, which was somewhat above \$100,000 last year.

Fast, priority service keeps Hampton color TV owners happy. "Color always gets priority over B/W service here," Mr. Napper says. "We make every effort to get the ailing set in proper operation the same day, even if the customer has a second B/W set."

Mr. Napper, like many other service-dealers, offers incentive pay to his technicians who furnish leads and close sales on home-entertainment equipment.

A technician gets 15 percent commission on any sales he makes whether in the home or on the sales floor.

Hampton has a color-oriented sales floor — a daytime-viewing booth has been made especially for color TV viewing. Located in a dramatic spot at a corner of the salesroom facing the entrance, this is simply constructed of colorful drapes and a small platform on which the set is placed. When open, as it usually is, the booth spotlights the color set. When closed simply by a tug on the drapes, it shuts out almost all light — to provide good viewing.

The advertising budget of Hampton is heavily influenced by the emphasis on color. Amount and type of advertising is decided by the color situation. Most is co-op and runs about 5 percent of gross sales.

Hampton is also one of the largest car radio and cartridge tape installation and repair shops in St. Louis.

The outside Hampton technician is an excellent customer relations man. He keeps tabs on work flow in the shop and tells any customer when to expect delivery on a set which is in the shop for repair. His promise is usually one to two days, but if it's a big job, he says, "We'll call you." Hampton religiously follows a policy of never promising what it can't deliver. ■

we looked into your future, then created the "little corporal," a most remarkable CRT tester.

B & K has done it again . . . put you a "jump ahead" by looking into your future . . . your problems, *your* needs. This is the "Little Corporal," the CRT Rejuvenator and Checker, designed to provide maximum obsolescence protection by providing continuously variable voltages for all CRT elements. You can make the most accurate possible tests, even on future CRT types, because the heater

voltage is metered and is continuously variable from 0 to 13 volts with any tube heater current. And, using the required adaptors, you can test and correct all tube, transistor or integrated circuit black and white and color picture TV tube troubles (including GE 11" color and imported color tubes) in a few minutes . . . in the home or on the bench . . . without removing tubes from the TV set.

You can give new life to weak or inoperative picture tubes—prove to your customers their need for new tubes.

The "Little Corporal," another product of B & K electronic innovation, carries the B & K Professional Servicing Equipment emblem, your assurance . . . your customers' assurance . . . that you use the finest equipment made.

Model #465, Net: \$89.95.



A Division of
Dynascan Corporation
1801 W. Belle Plaine
Chicago, Illinois 60613

Export: Empire Exporters, Inc.
123 Grand Street
New York, N.Y., 10013
Made in U.S.A.



A Division of Dynascan
Where Electronic Innovation
Is A Way of Life

... for more details circle 106 on postcard



COLORFAX

Westinghouse Introduces 'On Screen Tuning Bar' Feature

Proper fine tuning of the local oscillator in a color television is as important and much more critical, than for monochrome receivers. The reason being that all color information can be lost if the fine tuning is misadjusted. Therefore, some means of indicating proper fine tuning for color, as well as for B/W reception, would be an aid to the viewer.

This method employs the CRT screen as the indicating device. The presentation is to display the degree of mistuning, to show the necessary direction of adjustment for correction and to indicate when correct tuning has been achieved. See screen illustration.

The object is to display two vertical lines on the CRT screen when the viewer desires to check or adjust the fine tuning. The lines are superimposed with the received picture and provides simultaneous viewing of picture quality and fine tuning indication. A switch is provided so the viewer can remove the vertical lines when he completes the adjustment.

One of the lines is stationary and acts as a reference. The other line is movable with fine tuning adjustment and can move to either side of the reference line. Correct fine tuning is

indicated when the lines coincide. The direction of mistuning is indicated by the position of the movable line with respect to the stationary line. Also, the degree of mistuning is indicated by the spacing between the two lines. The larger the spacing, the greater is the degree of mistuning.

The circuits responsible for developing the two dark vertical lines on the CRT are shown in the block diagram. These circuits will provide two sets of gating pulses sufficient to cut off the video amplifier for approximately 1 or 2 μ s. This results in two dark vertical lines appearing on the screen of the CRT. Two dc voltages are also developed to control the pulse forming circuits.

One voltage, referred to as the reference voltage, is developed across a voltage dividing network consisting of resistors, R921, R922 and R923. This voltage develops the stationary or reference line. The other voltage, referred to as the control voltage, can be varied by adjusting the fine tuning control. This voltage develops the movable vertical line.

The circuits to be described, except for the video gate circuit, are combined on one small separate PC board and attached to the main color TV chassis. Three sources of voltage are required for the added circuits.

Two of the voltage sources are obtained directly from the chassis power supply. The third source is developed in the cathode circuit of the audio section.

A push-on/off type switch, located on the control panel, is provided to activate or deactivate the multicircuits so the generated lines on the CRT screen can be turned on/off. The control signal portions of the circuitry are continuously activated. The reason for this is, if these transistors were switched off there would be detrimental loading on the video circuitry of the main chassis and also the possibility of harmonic generation (tweet) in the slope detector portion.

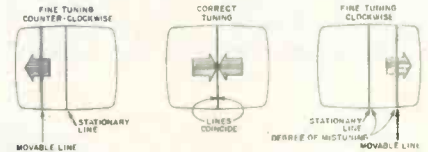

The lines are generated in a time-sharing system in which the reference line is generated during one picture field and the movable line is generated during the next field. The required signals needed to generate the lines are a series of narrow video gating pulses of about 1 or 2 μ s duration and synchronized to the horizontal scan rate. These video gating pulses as shown in waveshape "A", are sent to the grid of the video amplifier, cutting the amplifier off. Diode X203 acts as a closed gate during these pulses allowing them to be applied to the grid. At the same time, diode X204 acts as an open gate, preventing any video information from arriving on the grid of the video amplifier.

The 1 or 2 μ s video gating pulses are generated in the monostable multivibrator. This circuit consists of a pair of transistors, Q907 and Q908.

The pulses necessary to operate the monostable multivibrator are shaped by the differentiator, as shown in waveshape "B". The input to the differentiator is provided by the comparator.

The comparator is also a monostable multivibrator and its purpose is to provide trigger pulses (waveshape "C") to the differentiator.

The timing of these trigger pulses, in reference to the horizontal retrace pulses, (waveshape "D") will determine the position of the generated line on the CRT.

The name comparator is chosen because the circuit essentially compares the level of an input voltage to the level of an internally generated saw tooth voltage, to determine when the multivibrator will change state.

The purpose of this circuit is to allow the comparator to monitor two

continued from page 68

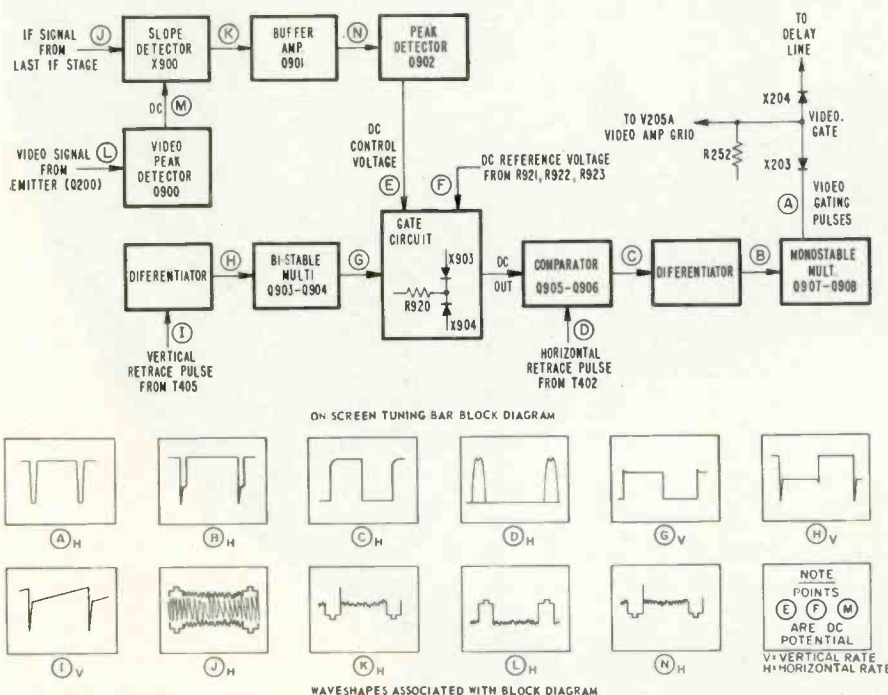

GET AN FCC LICENSE OR YOUR MONEY BACK

NRI MONEY-BACK AGREEMENT

The NRI Communications Course you select will qualify you for a First Class Commercial Radiotelephone License issued by the Federal Communications Commission. If you fail to pass the FCC examination for this License after successfully completing your NRI course, we will, on request, refund in full the tuition you have paid. This agreement is valid for the period of your active student membership and for six months after completion of your course.

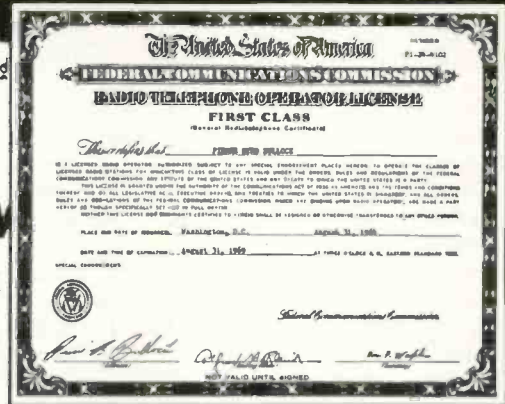

**NATIONAL RADIO INSTITUTE
WASHINGTON, D.C.**

TAKE YOUR PICK OF 5 NRI COMMUNICATIONS TRAINING PLANS

Find out *now* how quickly and easily you can earn your FCC License by training at home in spare time the NRI way. NRI offers you a choice of five training plans, all including preparation for FCC License exams, all carrying the NRI money-back agreement. In addition to FCC License preparation by itself, NRI courses range from Complete Communications—which includes the only professional lab equipment designed exclusively to give you the priceless ingredient of experience—to specialized courses in Mobile Communications, Aviation Communications and Marine Communications.

87% OF NRI GRADUATES PASS THEIR FCC EXAMS

The NRI method of FCC training is so complete, so up-to-date, that the record of success among graduates who take FCC exams is outstanding. Men with absolutely no training or experience in Electronics have completed the NRI course in as little as 10 months. A Technician, or man with some background in the field, can cut that time in half. And because NRI has a greater enrollment than any other school of its type, FCC training costs you less than comparable courses offered by other schools. Compare. You'll find—as have thousands of others—that you get more for your money from NRI. More value, more solid experience so essential to careers in the fast moving, rapidly growing field of Communications.

APPROVED UNDER GI BILL

If you served since January 31, 1955, or are in service, check GI line in coupon.



NATIONAL RADIO INSTITUTE
Over 50 years of leadership
in Electronics training

TRAIN WITH THE LEADER

NRI, the oldest and largest school of its kind, has been a pioneer in the development of home-study training methods, including the learn-by-doing, experience approach to learning. Get full details about FCC License courses and other NRI training plans. Mail the coupon. No obligation. No salesman will call. NATIONAL RADIO INSTITUTE, Electronics Division, Washington, D.C. 20016.

MAIL COUPON FOR FREE CATALOG

NATIONAL RADIO INSTITUTE 14-107
Electronics Div., Washington, D.C. 20016

Please send me complete information about FCC License training and other NRI courses as checked below. (No salesman will call.)

- | | |
|--|--|
| <input type="checkbox"/> Complete Communications | <input type="checkbox"/> Math for Electronics |
| <input type="checkbox"/> FCC License | <input type="checkbox"/> TV-Radio Servicing (with color) |
| <input type="checkbox"/> Aviation Communications | <input type="checkbox"/> Advanced Color TV |
| <input type="checkbox"/> Marine Communications | <input type="checkbox"/> Industrial Electronics |
| <input type="checkbox"/> Mobile Communications | <input type="checkbox"/> Basic Electronics |
| | <input type="checkbox"/> Electronics for Automation |
| | <input type="checkbox"/> Electrical Appliance Repair |

CHECK FOR FACTS ON NEW GI BILL

Name _____ Age _____

Address _____

City _____ State _____ Zip _____

ACCREDITED MEMBER
NATIONAL HOME STUDY COUNCIL



... for more details circle 129 on postcard



continued from page 66

different signals in a particular time sharing mode. During the first time period (one picture field) the gate presents to the comparator a reference voltage (point "F"). During the next field the gate presents to the comparator a control voltage (point "E"), which is a function of the fine tuning. The gate has two diodes and a suitable biasing scheme to provide the switching of either signal. These diode switches are controlled from a bistable multivibrator.

The bistable multivibrator changes state on each vertical pulse so the switching rate of each gate signal is 30Hz. The vertical retrace pulse from transformer T405, shown in waveshape "I", is shaped into a usable pulse by the differentiator (waveshape "H") and passed onto the bistable multivibrator.

An IF signal is taken from the last IF stage (waveshape "J") and sent to the slope detector.

The slope detector has the responsibility of converting frequency variations into voltage variations. As the

fine tuning is varied, the IF picture carrier moves higher or lower in frequency, resulting in a varying output voltage from the slope detector.

This signal is then detected and filtered, resulting in a negative going video signal of about 3v P-P.

The video peak detector is used to compensate for signal level changes at the last IF stage. If the compensation were not used, the dc control voltage would not only be a function of the IF picture carrier frequency, but also of its amplitude. For strong moderate received signals the AGC system of the receiver maintains the IF picture carrier level relatively constant at the input to the slope detector. However, for received signals below the threshold of operation of the AGC system, the IF picture level will decrease and so will the dc control voltage. To compensate for this, the level of IF picture carrier is monitored by taking the video signal from the emitter of the first video amplifier, Q200, and sending it to the video peak detector (waveshape "L"). The video peak detector dc output voltage (Point "M") is then added in opposite polarity to the slope detector output. Relatively good tracking is achieved so the dc control voltage remains constant at correct tuning for strong to zero received signals.

The buffer is needed to isolate the peak detector from the slope detector, otherwise there would be loading on the tuned circuit of the slope detector. The output of the buffer amplifier is shown in waveshape "N".

Following the buffer amplifier is a peak detector for the video signal developed by the slope detector. The output of the peak detector is a dc potential at Point "E".

Field Adjustment of AFC Circuit In Admiral 4H12 Color Chassis

1. Remove cabinet back and power with cheater cord.
2. Properly adjust preset fine tuning for each active VHF channel. (Fine tune until you observe familiar "diamond" pattern color/sound beat, then back off until pattern just disappears. This is the only correct fine tuning point.)
3. Turn on AFC — if AFC is not properly adjusted, receiver will detune, do not try to retune.
4. The AFC subassembly is located below the chassis, between power transformer and IF strip. However, adjustments can be made from top of chassis through adjustment holes in chassis pan. Secondary coil L803 is the AFC coil having a yellow form.

continued on page 70

Why not sell the best

**3 ZENITH
WAVEMAGNET®
INDOOR TV ANTENNAS**
built to the quality
standards of Zenith
original parts

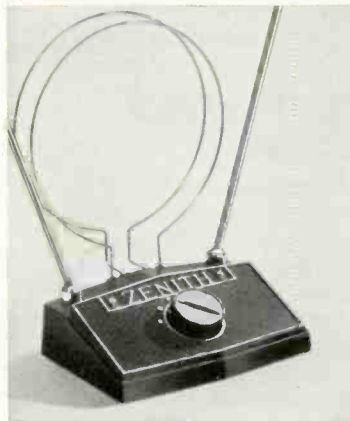

**DELUXE
ALL-CHANNEL**
Part No. 973-56
Two full-size UHF
loops develop high
front-to-back ratios
equal to many
outdoor antennas.



**ECONOMY
ALL-CHANNEL**
Part No. 973-55



VHF ONLY
Part No. 973-58

Zenith has designed these Wavemagnet antennas for sensitive reception in color or B/W. Fully adjustable telescopic dipoles. Six-position selector switch for top performance on each channel. Handsome molded base of high-impact styrene. Individually packaged for effective sales display. Order now from your Zenith distributor.



... for more details circle 148 on postcard

Industry Demanded - only Sencore delivered

AN ALL NEW IMPROVED COLOR CRT TEST



**Simple - Fast - Accurate • Automatic Color Tracking!
No Time-Wasting Logging and Computing!**

CRT manufacturers, set manufacturers, distributors, technicians — all demanded a better CRT tester than any available. This is it — the new Sencore CHAMPION — a winner on every count.

Separate G2 screen grid controls, just like the color circuit itself, enable you to set up each color gun, then **automatically** compare it with the others for tracking — exactly according to industry standards. **This check is important when claiming credit for a defective color CRT.** No time consuming logging of each color gun reading at every setting of the G2 control like competitive models. It's automatic with the CR143 Champion.

The CHAMPION also makes all the standard color and black and white CRT tests — shorts, emission, and life tests. Its Line Adjust control assures exceptional accuracy. Its exclusive three step Automatic Rejuvenation Circuit lets you save many a faulty black and white tube or equalize gun currents in color tubes.

The all-new CHAMPION is equipped with plug-in sockets for fast testing and easy updating. Rugged vinyl-clad steel case has spacious lead compartment.

For a sure thing, put your money on the champion — the Sencore CR143 CHAMPION.



**CR143
CHAMPION**

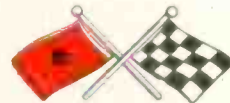

\$99.50



SENCORE

NO. 1 MANUFACTURER OF ELECTRONIC MAINTENANCE EQUIPMENT
426 SOUTH WESTGATE DRIVE, ADDISON, ILLINOIS 60101



COLORFAX

continued from page 68

5. Adjust L803 slightly (no more than 1/8 turn) until detuning ceases. Do not adjust any other coil in this area. If AFC will not respond with this slight adjustment, do not attempt further adjustment — repair is indicated. If L803 is not severely misadjusted it will be easy to restore proper operation when the trouble is found and repaired.

6. Check operation of AFC on UHF channels, if any, in a similar manner (tune with AFC off — turning AFC on should not detune). It may be necessary to compromise L803 adjustment slightly between VHF and UHF.

Warranty Returns of Philco 'P' and 'Q' Line Color-TV Horizontal Output Transformers

Engineering evaluation of a large percentage of horizontal output transformers returned in warranty has shown that those tested were good and had no defects. Technicians have been

returning the transformers because of wax drippings which appear on the base of the transformers. These wax drippings are normal and are caused by heat generated by the transformer.

An excess amount of wax drippings may be more apparent on "Q" line transformers because they have been double-impregnated with wax. Therefore, any transformers that are suspected of being bad, should be checked to ascertain if they are bad.

The following checks should be made:

1. Using a VOM or VTVM check for open windings, making sure the dc resistance of the windings agree with the schematic.

2. Although a VOM or VTVM will not indicate one shorted turn, a shorted turn can be found by using a flyback tester or a B&K Analyst.

3. Check the two 430K resistors (R218 and R219) which are mounted on the transformer. Also, check the 0.0027 μ f, 2.5kv capacitor (C210) mounted on the transformer. The resistors and capacitors are replaceable and are carried by the accessory division under the following part numbers. 430K resistor 33-1363-145 0.0027 μ f, 2.5kv capacitor 30-4712-2

Increasing Chroma Gain on Canadian G-E M678/M679 Color Chassis

There may be instances, in some locations, where additional chroma gain is desirable.

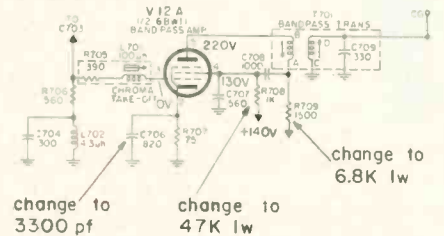

The following modification has been developed which provides considerable additional chroma gain.

1. Change bandpass V12A cathode bypass capacitor, C706, 820pf to a 3300pf (ET22X127).

2. Change bandpass V12A screen resistor, R708 1K to 47K, 1w.

3. Change bandpass V12A plate resistor, R709 1.5K to 6.8K, 1w.

4. Connect dc supply to R708 from 140v to 270vdc. This can be accomplished by connecting the supply end of R708 to the supply end of R724 (junction of R724 and R709) on top of the board.

5. Make certain the CRT leads to pins 3, 7 and 12 are dressed vertically from the board. Excess length should be dressed forward underneath the yoke.

This is not intended as an instruction to rework sets, but is to be used as a cure if this complaint is encountered.

NO MORE GUESSWORK!

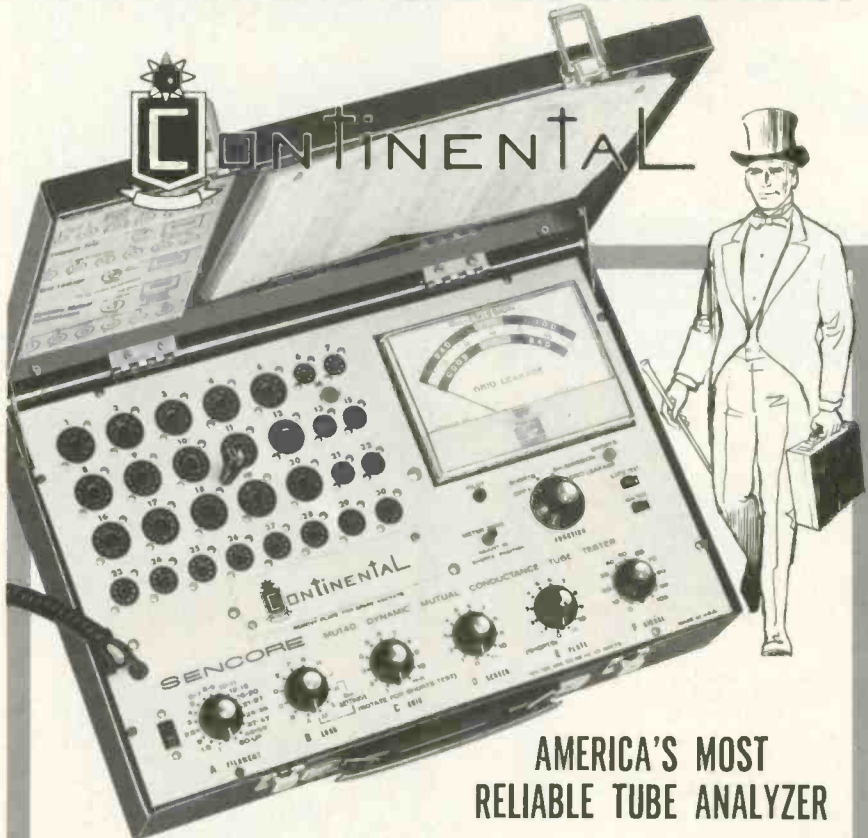

AMERICA'S MOST RELIABLE TUBE ANALYZER

You don't need three guesses to tell if a tube is bad — or why. With the new Sencore MU140 Continental, you know. Right now. And you simply can't go wrong. Because it's a complete tube analyzer for 4-way testing — true mutual conductance (using exclusive 5000 hertz square wave), full cathode emission, 100 megohm grid leakage, and internal shorts. Tests all tubes, including foreign — over 3000 in all. Obsolescent-proof, too — with "new socket" panel, and controls so standard the switch numbers correspond to the pin numbers in any tube manual.

If it's reliability you want — for years to come — you need the Continental. It's the best way to be sure —

for only
\$179⁵⁰

See America's most complete line of professional test instruments — at your Distributor now.

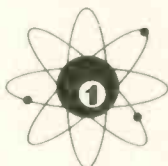

SENCORE

NO. 1 MANUFACTURER OF ELECTRONIC MAINTENANCE EQUIPMENT

426 SOUTH WESTGATE DRIVE, ADDISON, ILLINOIS 60101

... for more details circle 143 on postcard

Alliance Tenna-Rotor®

REDUCES COLOR SET RETURNS

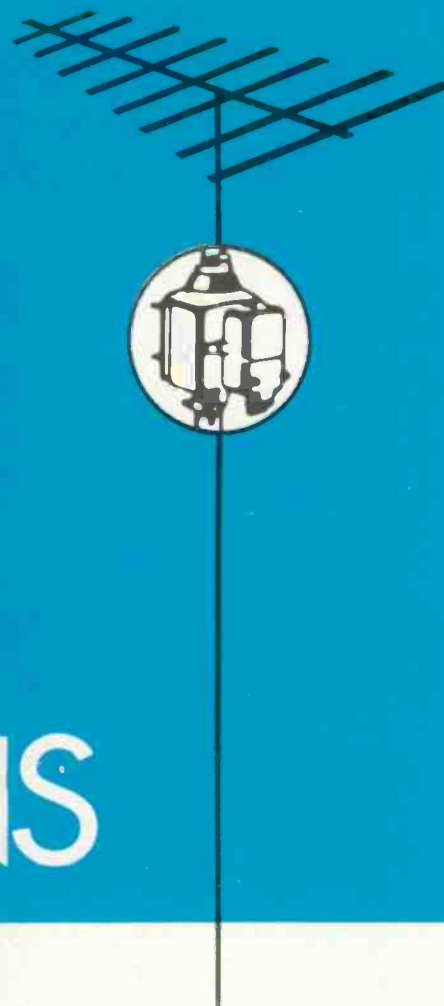

- CUT COSTLY CALL BACKS
- KEEP CUSTOMERS SATISFIED
- EARN MORE PROFITS

Since color reception is so critical, it is important to have an Alliance Tenna-Rotor and proper antenna to eliminate color ghosts, snow, and other interference. With an Alliance Tenna-Rotor, your customers will enjoy improved Color TV reception, and you'll be backed by the nationwide Alliance Service, Advertising and Merchandising Program. There are four attractive models to choose from. Let us tell you how to take advantage of this program.

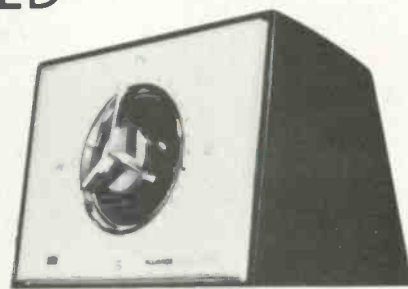

"TV's better Color-Getter"



the **ALLIANCE** Manufacturing Company Inc.

(Subsidiary of Consolidated Electronics Industries Corp.) **ALLIANCE, OHIO**

Maker of famous Alliance Genie® Automatic Garage Door Opener System

ET-10

... for more details circle 102 on postcard



SYLVANIA

SYLVANIA
RADIO
TV
SERVICE

BRIGHT
GUY

Are you eligible for the Bright Guy Awards?

It's easy to get them—and to get all the business they'll bring you. New customers. More sales. More money.

The Bright Guy Awards is the big program Sylvania's running this year to boost your sales.

Your Sylvania distributor can put your name and address in TV Guide in your own area. These Sylvania ads will call you "the brightest serviceman in town"—and tell people in your town why they should call you.



You'll get into the Yellow Pages, too, under the heading "TV Service and Repairs."

Once again this year you'll be eligible for over



one hundred valuable, interesting SMB-Bright Guy gifts, just for buying the Sylvania TV replacement parts you normally buy anyway.

And you'll get window displays proclaiming you "the brightest"—the TV serviceman everyone's reading about.

You're eligible for the Bright Guy Awards just by buying Sylvania's famous *color bright 85*[®] color picture tube. And our other picture tubes, and our receiving tubes. So see your Sylvania distributor.

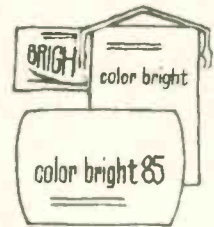

Sylvania Electronic Tube Division,
Electronic Components Group, Seneca
Falls, New York 13148.

SYLVANIA
SUBSIDIARY OF
GENERAL TELEPHONE & ELECTRONICS **GTE**

NEW PRODUCTS

For additional information on products described in this section, circle the numbers on Reader Service Card. Requests will be handled promptly

Substitution Box 700

Announced is a resistor-capacitor substitution box that is reportedly designed to offer 684 combinations of



capacitors, resistors, or the two in series or parallel with each other. The box measures 7 1/8 x 5 x 3 1/2 in. Olson.

All-Wave Stereo Receiver 701

A 30w IHF, all-transistor receiver is designed to cover the 185 to 400kHz longwave band, 550kHz to 1.6MHz standard AM broadcast band and the 2 to 4MHz, 5.9 to 10.2MHz and 11.4 to 18.2MHz shortwave bands plus the 88 to 108MHz FM/FM-stereo broadcast band. An illuminated rotary-drum band selector shows only the band selected. A BFO is provided for code and single sideband reception. Specifications indicate that the receiver



can accommodate ceramic or magnetic phono cartridges, tape or auxiliary equipment inputs and will easily drive most 8 Ω speaker systems. Price \$269.95. Hallicrafters.

Paging System 702

A paging system is designed to enable a calling party to use a remote location telephone in a company's phone system to call a paging unit rather than having all calls encoded from a central keyboard encoder location. The system reportedly op-



erates through dial telephones connected with a "Dial 9"-type switchboard through an applique unit furnished by the telephone company. Specifications indicate that the radio paging system can handle up to 400 individual receivers. E. F. Johnson.

Field-Strength Meter 703

Announced is a solid-state field-strength meter designed primarily to serve the CATV field. It reportedly comes with an illuminated meter and can operate from self-contained rechargeable batteries or 110vac. Specifications indicate that it can cover TV



channel 2 through FM and channel 7 through 13, has a 1.5db maximum error, 75 Ω "F" type input connector, four nearly linear db scales that range from -30dbmv to +60dbmv, 55db adjacent channel rejection and a 32MHz IF. The manufacturer indicates that the instrument comes in a leather carrying case that measures 4 1/4 x 6 1/2 x 7 in. and weighs 5 1/8 lb. Price \$330. Vikoa.

CB Transceiver 704

A 23 channel CB two-way radio reportedly contains 18 transistors plus three integrated circuits. Specifica-

tions indicate that it features dual conversion, a mechanical filter, variable squelch and automatic noise limiter.



It is designed to operate from 12vdc with either positive or negative ground and measures 2 3/8 x 6 1/4 x 8 in. Price \$189.95. Lafayette.

Film Resistors 705

A series of metal film resistors is announced that is rated at 1/4w at 70°C and 1/8w at 125°C. Specifications indicate that the change in resistance after 1000 hours load life is less

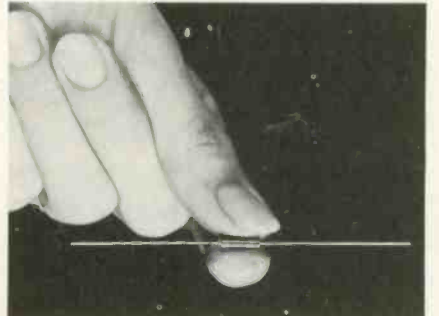

than $\pm 0.5\%$. They reportedly have a 100PPM/°C temperature coefficient. Mallory.

Soldering Iron Tips 706

Announced is a soldering iron tip that is reportedly iron plated to increase service life. Specifications indi-



cate that the core of the tip is made of high purity copper. The manufacturer says that the tips are being made in 1/8, 3/32, 3/16 and 1/4 in. diameters to fit all plug type pencil soldering irons. Plato.

**New low cost.
 New ease of operation.
 No waiting. No warm-up.
 No adjustments.
 Brightest patterns in the industry.**



The **B&K** 1242 Color Generator is all business\$!

There's nothing else like it. The all-new B&K 1242 represents the highest state of the art today. Go ahead and compare it; it's unique.

Unsurpassable solid-state circuits make antiquated heating elements unnecessary. The 1242 works instantly in all service

environments—no waiting, no warm-up, no adjustments. Other units have up to 3 times as many front panel controls. For ease of operation, the 1242 has just two: color level and selector switch. It provides dots, crosshatch, horizontal or vertical lines, and color bars. And these are the sharpest, brightest patterns in the industry.

The 1242 handles easily, too. It's the smallest, lightest-weight color generator! Rugged, too; it's all steel, with storage

space for leads. It's transformer powered and complete with leads. Calls take less time and you make more money, because you can go from a cold or hot truck into a home and get right to work.

On every count, the new B&K 1242 is amazing. In time saved, it will pay for itself in just a few weeks—especially at this low price: **\$99.95**

B&K Division of Dynascan Corporation
 1801 W. Belle Plaine • Chicago, Illinois 60613

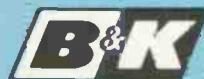

Where Electronic Innovation Is A Way Of Life
 Made in U.S.A.

... for more details circle 107 on postcard

NEW PRODUCTS

Mounting Clamps 707

Announced are two mounting clamps with integral threaded stud for mounting wire bundles against a struc-



ture. One mounting clamp reportedly has a 1/4-28 thread and the other a 10-32 thread. Specifications indicate that they have a 3/16 to 3/2 in. bundle range and are 13.3 in. long and 0.3 in. wide. Thomas & Betts.

Oscilloscope 708

Announced is a miniature scope designed to operate for limited periods from dry batteries or automobile batteries. Specifications indicate that it

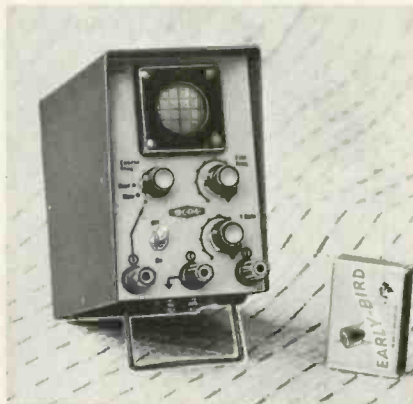

has a 1v/cm vertical sensitivity, 10v/cm horizontal sensitivity, 17μsec/cm to 133msec/cm time base speed in two ranges and 10Hz to 50kHz bandwidth. It reportedly has a 3.1 x 4.6 x 5.8 in. cabinet. Ikonra.

Stereo Receiver 709

An FM receiver reportedly contains 2 RF stages with five tuned circuits for selectivity and sensitivity in the front end, plus a 4-stage double-tuned

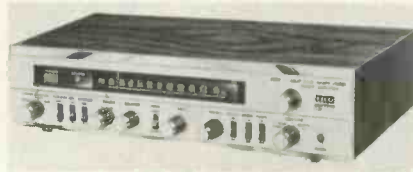

IF for interference rejection. Specifications indicate that the receiver provides 70 to 50w of IHF power respectively with 4 or 8 speakers. Kit price \$159.95. Eico.

CRT Transformers 710

Announced is a color CRT isolation transformer designed to correct for color CRT filament-to-cathode shorts



and restore the B/W picture information lost. It can be plugged in between the color tube and socket. List price \$11.95. Perma Power.

Power Supply 711

A transistorized zener-reference regulated power supply reportedly has a continuously variable output between 0.5 and 25v at currents to 200ma. Specifications indicate that the 4 1/2 x 2 1/2 x 4 in. power supply *continued on page 78*

ASSURES EXCELLENT TV PICTURE QUALITY

NEW PERFO 8-0 PERFORATED TV ANTENNA WIRE

COLOR TV - UHF - VHF

Check these outstanding features of the new PERFO 8-0:

- Greatly reduces signal loss
- All purpose—ideal for 82-channel use
- Full 20-gauge copper conductors
- Virtually unaffected by moisture
- Greater flexibility for easy installation
- Less wind resistance

J.S.C. offers this lightweight, inexpensive TV antenna wire for top quality, reliable reception anywhere. Open air spaces between conductors insure low signal loss, maximum signal transfer. Available in 500-foot spools and 50, 75 and 100 foot packaged coils.



For more details, call your local J.S.C. distributor or contact us directly.

JERSEY SPECIALTY CO., INC.

P.O. Box 235, Wayne, N. J. 07470
201-694-6200



... for more details circle 122 on postcard

ELECTRONIC TECHNICIAN

The book they open just to read the ads.

If you want to be sure your business
customers read your advertising,
try putting some of it in this book.

When a businessman
settles back with a good
Yellow Pages, he's not
looking for entertainment.



349

PHONO CARTRIDGES!

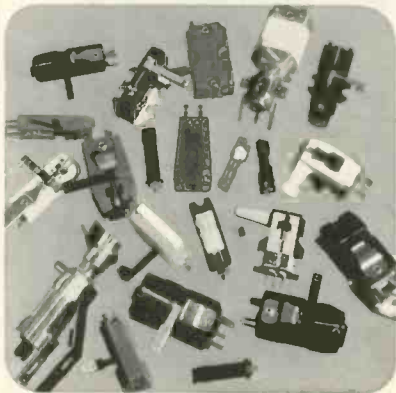

459

PHONO NEEDLES!



NEW! PHONO AND TAPE RECORDER WHEELS, DRIVES, BELTS!

(E-V) That's how many models are listed in the current Electro-Voice phono needle and cartridge catalogs. With more being added as you need them.

No other single source offers such variety—all built to the highest industry standards. All are exact replacements that install quickly, to give your customers "like new" performance—or better!

Electro-Voice models are listed in your Photofact files, or ask your E-V distributor for free copies of the E-V catalogs. It's your guarantee of complete customer satisfaction!

ELECTRO-VOICE, INC., Dept. 1077T
663 Cecil Street, Buchanan, Michigan 49107

Electro-Voice
SETTING NEW STANDARDS IN SOUND

... for more details circle 114 on postcard

NEW PRODUCTS

continued from page 76



provides better than 100mv load regulation, and less than 2mv of ripple and noise at full load. Price \$34.95. Viking.

Rotary Switch 712

Announced is a 45deg angle of throw switch designed to carry 10a continuously with a maximum contact

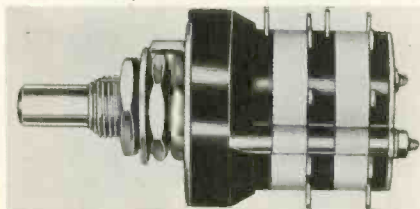

temperature rise of 20°C. Specifications indicate that the rotary switch's contact resistance is 0.005 Ω, increasing to a maximum of 0.020 Ω after 25,000 cycles of operation. Prices range from \$7.70 to \$17.50, depending on the number of poles and decks. Grayhill.

Desoldering Iron Tips 713

Two tips have been designed to increase the line of replaceable tips for desoldering irons. The tips are in the intermediate size range and reportedly come with 0.046 and 0.067in. open-



ings. Specifications indicate that the tips fit over heads or around connections to vacuum off all solder, leaving terminals and mounting holes clean. Enterprise.

impedance mismatch problems?

When most voice coil impedances were either 3.2 ohms or 8 ohms, speaker replacement was relatively simple. Then came transistor sets, and equipment without output transformers, and now voice coil impedances range all over the map.

It's important to remember that a mismatched impedance in a speaker replacement will almost surely create problems... from a loss of volume to a blown transistor.

Quam... and only Quam... helps you avoid these problems these three ways:

1. WIDE CHOICE—As Photofacts/Counterfacts participants, we know in advance what voice coil impedance the new equipment will require, so we generally have the right speaker in our comprehensive line *when you need it.*

2. VERSATILE SPEAKERS—Quam *multi-tap speakers* offer a choice of impedances in a single unit. Available in all the sizes you need for automotive replacement, Quam multi-taps handle 10, 20, or 40 ohm applications.

3. SPECIAL SERVICE—Just in case you run across an oddball, we offer this convenient exclusive: *any Quam speaker can be supplied with any voice coil impedance, only \$1.00 extra, list price.*



QUAM

THE QUALITY LINE
FOR EVERY SPEAKER NEED

QUAM-NICHOLS COMPANY

234 East Marquette Road • Chicago, Illinois 60637

... for more details circle 134 on postcard

ELECTRONIC TECHNICIAN

If you're looking for trouble,

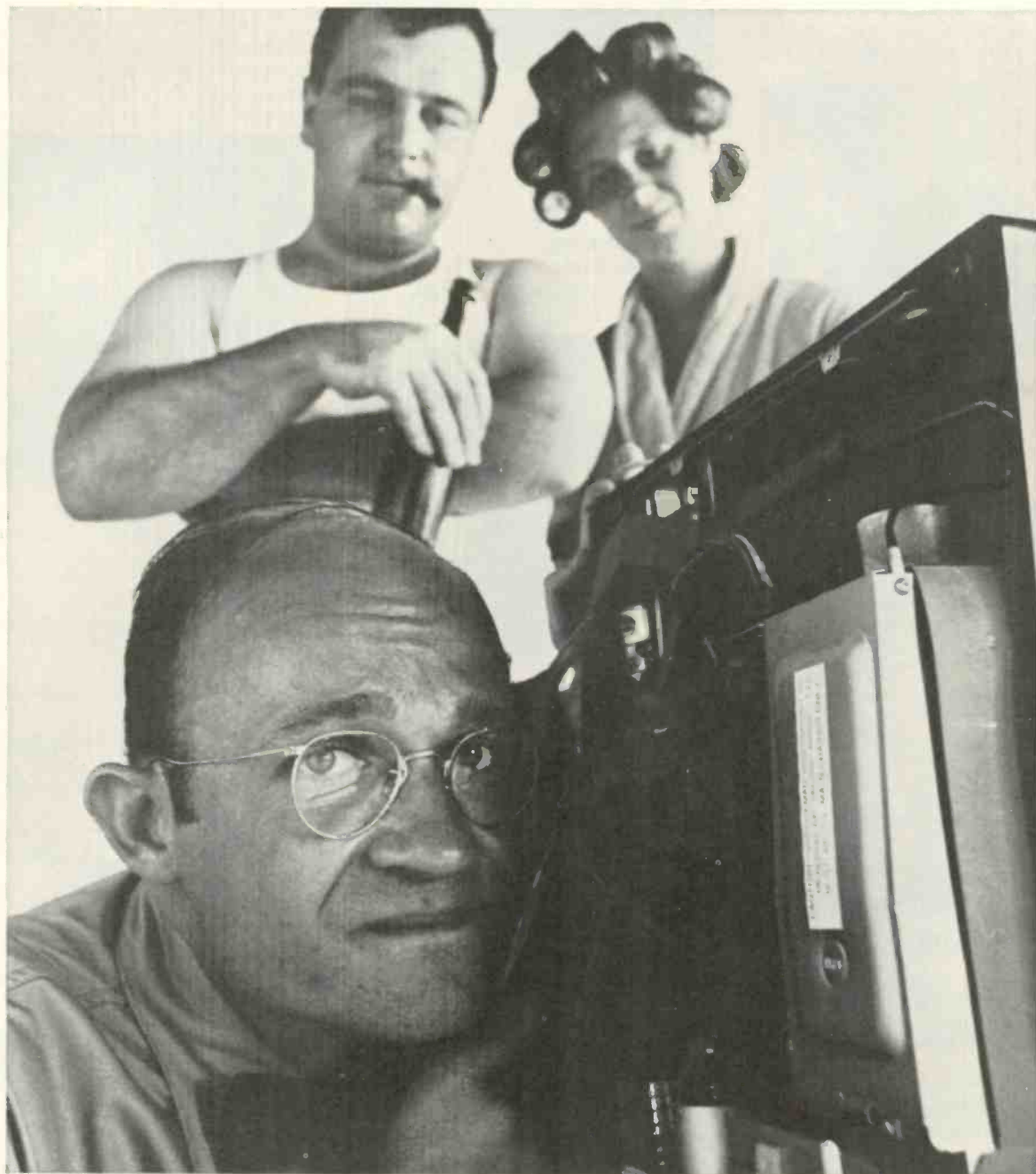

you'll find it fast.

That's what Amphenol test equipment is all about. The CRT Commander. The Milivolt Commander. The Signal Commander. The Color Commander. The Stereo Commander. They're all time savers. With them you can test any TV, radio or stereo set. They let you find trouble, fix it, then get out of there. See your Amphenol distributor. Or write us direct. Amphenol Corporation, Department PF-107, 2875 South 25th Avenue, Broadview, Illinois 60153.



CRT



Milivolt



Stereo



Color



Signal



AMPHENOL

for more details circle 103 on postcard

NEW PRODUCTS

Cutting Plier 714

A stainless steel diagonal plier has been developed for full-flush cutting at points where wires emerge from

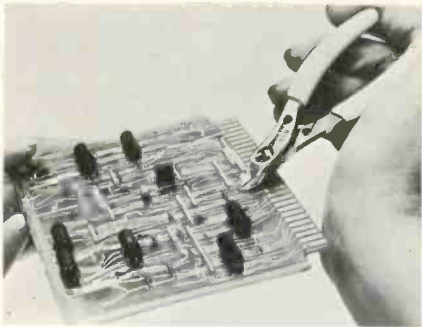

circuit boards and in other component wiring applications. List price \$15. Crescent.

Wireformer 715

Announced is a wireformer designed to bend, straighten and cut any size wire up to 5/32in. diameter in steel, copper, aluminum, cold rolled rod and coat hanger wire. All parts of the wireformer are reportedly made of

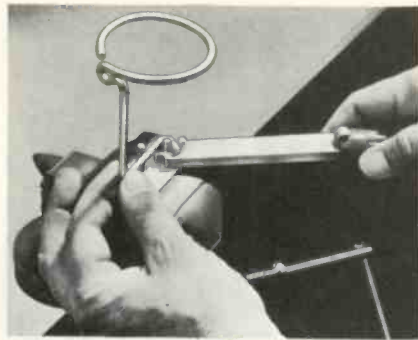

cold rolled steel and case-hardened. Price \$3.98. Winkemulder.

Cable Harness 716

A cable harness is announced that reportedly requires no special tools and permits "on-the-spot" wiring

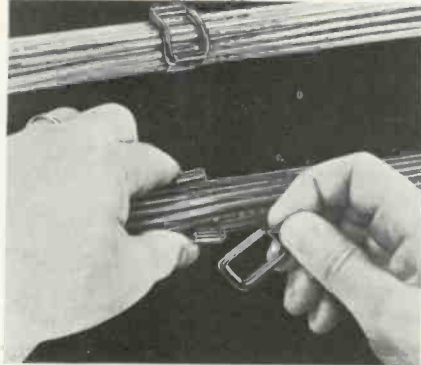

changes when necessary. Specifications indicate that it can withstand a temperature range of approximately -76° to 212°F. Electrovert.

Wire Markers 717

A line of clip-on markers has been designed for applications where identification is required after electrical connections have been made. These markers can reportedly be removed

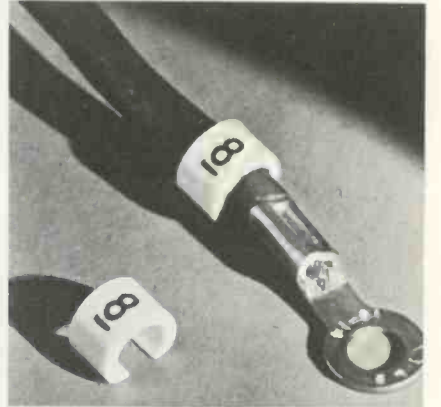

for recoding without breaking the terminal connection. The manufacturer indicates that they are made in an assortment of colors; come with numerical, letter or electrical symbols; and fit 0.080 to 0.570in. wire and cables. Electrovert.

ARE YOU CASHING-IN ON THE PROFITABLE 2-WAY RADIO SERVICE BUSINESS?

- ★ Motorola will train you for this rewarding, elite profession
- ★ Send for our FREE EVALUATION EXAM. Prove to yourself that you are ready to learn FM 2-way radio servicing.

Opportunities in 2-way radio servicing are virtually unlimited. ■ Just one of the hundreds of successful Motorola Service Stations writes, "we would be pleased to interview any graduate of your school that has received some training in 2-way radio maintenance. We are an established firm, 10 years old, with a promise of expansion governed by our ability to obtain competent technicians." ■ Get all the facts today. There is no obligation and no salesman will call.

MOTOROLA TRAINING INSTITUTE
4545 West Augusta Blvd. • Chicago 51, Illinois • Dept. AEH741

- Send me FREE entrance exam.
- Send full details on Home Study Course on FM 2-way Radio Servicing
- Send me details on how you can help me prepare for an FCC License.

Name _____ Occupation _____
 Address _____
 City _____ Zone _____ State _____

SAVES your back... SAVES your time...

47"

YEATS SHORTY DOLLY

for RADIO and TV

just 47 inches high for STATION WAGONS and PANEL PICK-UPS

FOLDING PLATFORM
15 1/4" x 24 1/2" top. Snaps on or off. (Platform only) \$11.95

YEATS Model No. 5
Height 47" Weight 32 lbs.

Designed for TV, radio and appliance men who make deliveries by station wagon or panel truck... the short 47 inch length saves detaching the set for loading into the "wagon" or pick up. Tough, yet featherlight aluminum alloy frame has padded felt front, fast (30 second) web strap ratchet fastener and two endless rubber belt step glides. New folding platform attachment, at left, saves your back handling large TV chassis or table models. Call your YEATS dealer or write direct today!

FURNITURE PAD

"Everlast" COVER AND PADS

YEATS semi fitted covers are made of tough water repellent fabric with adjustable web straps and soft, scratchless white flannel liners. All shapes and sizes — Write

YEATS APPLIANCE DOLLY SALES COMPANY
1313 W. Fond du Lac Avenue • Milwaukee, Wis.

NEW

FINCO®

COLOR SPECTRUM™ ANTENNAS

are "signal customized"
for better color reception...



"the ANTENNA that captures the RAINBOW"

FINCO has developed the Color Spectrum Series of antennas — "Signal Customized" — to exactly fit the requirements of any given area.

There is a model scientifically designed and engineered for your area.

Check this chart for the FINCO "Signal Customized" Antenna best suited for your area.

STRENGTH OF UHF SIGNAL AT RECEIVING ANTENNA LOCATION ▼	Strength of VHF Signal at Receiving Antenna Location				
	NO VHF ▼	VHF SIGNAL STRONG ▼	VHF SIGNAL MODERATE ▼	VHF SIGNAL WEAK ▼	VHF SIGNAL VERY WEAK ▼
NO UHF →		 CS-V3 \$10.95	 CS-V5 \$17.50 CS-V7 \$24.95	 CS-V10 \$35.95	 CS-V15 \$48.50 CS-V18 \$56.50
UHF SIGNAL STRONG →	 CS-U1 \$9.95	 CS-A1 \$18.95	 CS-B1 \$29.95	 CS-C1 \$43.95	 CS-C1 \$43.95
UHF SIGNAL WEAK →	 CS-U2 \$14.95	 CS-A2 \$22.95	 CS-B3 \$49.95	 CS-C3 \$59.95	 CS-D3 \$69.95
UHF SIGNAL VERY WEAK →	 CS-U3 \$21.95	 CS-A3 \$30.95	 CS-B3 \$49.95	 CS-C3 \$59.95	 CS-D3 \$69.95



NOTE: In addition to the regular 300 ohm models (above), each model is available in a 75 ohm coaxial cable downlead where this type of installation is preferable. These models, designated "XCS", each come complete with a compact behind-the-set 75 ohm to 300 ohm balun-splitter to match the antenna system to the proper set terminals.

THE FINNEY COMPANY

34 West Interstate Street • Dept. 110 • Bedford, Ohio 44146

... for more details circle 115 on postcard

**MOST
VERSATILE**

TRIPLET



**MODEL
850
\$89.00**

**MODEL 850
ELECTRONIC VOLT-OHMMETER
IS BEST FOR YOU**

FACTS MAKE FEATURES:

- 1** Long 7" easy-to-read scale.
- 2** .5 D.C. volt range for transistor circuits.
- 3** HIGH STABILITY. Meter connected in cathode circuit of 12AU7.

High Input Impedance (11 MEGOHMS) and wide Frequency Ranges give this extremely versatile Electronic Volt-Ohmmeter considerable advantage in the measurement of DC voltages, AC RMS and Peak-to-Peak voltages. It measures directly the Peak-to-Peak values of high-frequency complex wave forms and RMS values of sine waves on separate scales.

ADDED PROTECTION. Meter is shorted out in OFF position for greater damping, meter safety during transit, electrically protected against accidental overload. ZERO CENTER mark for FM discriminator alignment, plus other galvanometer measurements.

New pencil thin test probe used for all functions: DC, AC, and ohms. No need to change cables. Beautifully styled case for professional appearance and functional utility, 7⁵/₈" x 6⁷/₁₆" x 3³/₄".

Carrying handle can be used as a tester stand to place the tester at 25° angle for ease in reading.

Frequencies to 250 MC may be measured with auxiliary Diode Probe, \$8.50 extra. DC voltages to 50 KV may be measured with auxiliary High Voltage Probe. \$24.00 extra.

TRIPLET ELECTRICAL INSTRUMENT COMPANY, BLUFFTON, OHIO

... for more details circle 145 on postcard

NEWS OF THE INDUSTRY

**Audio Devices Joins Magnecord
In Promoting Magnetic Tape**

Audio Devices announces a special promotion to introduce 8¹/₄-in. reels of magnetic tape.

Designed for all transports capable of using reels larger than 7in., the reel reportedly contains 2400ft of 1-mil Milar — enough to provide a full hour of uninterrupted recording at 7¹/₂ ips or two hours at 3³/₄ ips.

Through a joint promotion, owners of Magnecord tape recorders are being invited to purchase a reel of the tape at \$1 off the regular retail price. The discount is allowed only on the initial order and upon presentation to the dealer of either the promotion mailing or discount card now being included with the latest Magnecord tape recorders.

**Electronic Industries Assn.
Recommends Highway Channel**

The Citizens Band Section of the Electronic Industries Assn. has sent a recommendation to the Federal Communications Commission suggesting "that through cooperative industry effort channel 9, provided in the CB radio frequency, be reserved primarily for obtaining emergency assistance by the operators of equipment within this service."

The section pointed out that the use of channel 9 would provide a communications link between motorists equipped with two-way CB radio and sources of information and assistance across the country.

**Premium Program Offered
To TV Service-Dealers**





















A new premium program offers TV service-dealers their choice of a permanently pressed Van Heusen shirt or two "Life Science Library" books with the purchase of any replacement-type RCA 21-in. color TV picture tube. The 24 books available cover topics that include mathematics, machines, the body, flight, the engineer and man and space.

To qualify for his premium, all a dealer need do is complete the registration section of the warranty card as well as indicate his gift selection on the "Volumes of Value" coupon. Both the card and coupon must be mailed to RCA at the address shown on the warranty registration postcard. The program has already begun and is expected to continue until Jan. 31, 1968.

As part of this color TV tube promotion program, RCA will also launch an extensive network-TV advertising program. A new 60sec commercial, featuring Dave Garroway, will be scheduled for American League professional football telecasts.



20 ways to break the exact replacement capacitor habit:

 CAPACITOR XC1-8	 CAPACITOR XC1-18	 CAPACITOR XC1-19	 CAPACITOR XC1-19.2
 CAPACITOR XC1-21	 CAPACITOR XC2-1.1	 CAPACITOR XC2-26	 CAPACITOR XC2-36.1
 CAPACITOR XC3-45	 CAPACITOR XC4-4.2	 CAPACITOR XC4-5.1	 CAPACITOR XC4-6.1
 CAPACITOR XC4-9.1	 CAPACITOR XC4-10.2	 CAPACITOR XC4-55.1	 CAPACITOR XC4-63.1
 CAPACITOR XC4-68.1	 CAPACITOR XC4-68.2	 CAPACITOR XC4-70.1	 CAPACITOR XC4-80

Stock only 20 General Electric Service-Designed replacement capacitors and meet over 70% of your replacement needs.

Use General Electric extended-range replacement capacitors. Just 20 General Electric Service-Designed replacement units will meet over 70% of all TV can style needs!

"Extended-range" means that fewer General Electric types are needed to meet your requirements. Every GE aluminum capacitor meets not just one, but a range of capacitance and voltage requirements. And, to make selection easier, the application range of every General Electric capacitor is shown clearly on the unit, and on the carton.

You can quickly see, for example, that the GE capacitor rated 50-60 mfd up to 450 VDC will replace any unit between

50 and 60 mfd at any voltage up to 450 VDC. You save time and money in making replacements because General Electric capacitors are Service-Designed with you in mind!

Your local GE electronics distributor carries a complete line of replacement capacitors from General Electric, a leader in supplying capacitors to the radio and television industry. Call him today for full details.

430-31

GENERAL ELECTRIC



Call your GE distributor now for a special offer on replacement capacitors for COLOR TV!

It's a Treasure Chest loaded with 12 of the most popular General Electric replacement capacitors for COLOR TV! Your distributor's offering it at a special low, low price. And to make it more appealing, you get an Xcelite® nut driver set with each Treasure Chest. Don't delay, call today! Offer is limited.





... for more details circle 117 on postcard

COMPLETE TUNER OVERHAUL

995

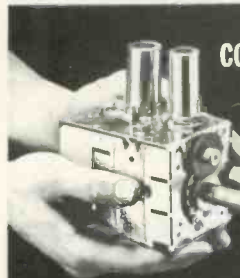
ALL LABOR AND PARTS
(EXCEPT TUBES & TRANSISTORS)*

COLOR TUNERS **GUARANTEED COLOR ALIGNMENT — NO ADDITIONAL CHARGE**

Simply send us the defective tuner complete; include tubes, shield cover and any damaged parts with model number and complaint. Your tuner will be expertly overhauled and returned promptly, performance restored, aligned to original standards and warranted for 90 days.

UV combination tuner must be single chassis type; dismantle tandem UHF and VHF tuners and send in the defective unit only.

Exact Replacements are available for tuners unfit for overhaul. As low as \$12.95 exchange. (Replacements are new or rebuilt.)

And remember—for over a decade Castle has been the leader in this specialized field . . . your assurance of the best in TV tuner overhauling.

CASTLE
TV TUNER SERVICE, INC.

5713 N. Western Ave., Chicago 45, Illinois
41-92 Vernon Blvd., Long Island City 1, N. Y.

For service in Canada write to Chicago or use reader service card in this magazine.
*Major parts are charged extra in Canada.

... for more details circle 110 on postcard

NEWS OF THE INDUSTRY

Hugo Gernsback, Inventor, Author, Publisher Dies

Hugo Gernsback, pioneer in electronic invention, author, publisher and called the father of modern science-fiction, died on Saturday, Aug. 19. He was 83 years old and resided in New York City.

Mr. Gernsback sponsored New York's first TV broadcast in 1928. He was editor-in-chief of the monthly magazine RADIO-ELECTRONICS and editor-in-chief and publisher of the magazine SEXOLOGY. At his death Mr. Gernsback held 80 scientific patents.

His improved dry battery invention brought Mr. Gernsback to New York from his native Luxembourg in 1904. There in 1925 he founded radio station WRNY and three years later, with the help of Pilot Radio Corp. engineers, started TV broadcasts. Postage-stamp-size images were received on crude scanners owned by 2000 amateurs in the New York area.

Mr. Gernsback is widely credited with having written the first true science-fiction story, published in

1911, and with coining the term itself. In this story he accurately predicted radar, microfilm, stainless steel and numerous other now commonplace things, even including night baseball. In his honor, science-fiction writing awards are called "Hugos."

Mr. Gernsback's family said that his body would be given to the Cornell University Medical School for scientific purposes.

FTC Initiates Regulation Regarding Transistor Count

The Federal Trade Commission has announced that it has initiated proceedings for the adoption of a trade regulation rule governing the count of transistors in radios.

The proposed rule would make it unfair competition to count transistors that perform a function other than the usual detection and amplification of radio signals. Transistors performing auxiliary functions could not be included.

The commission said it initiated this proceeding because it has reason to believe that with the present emphasis on the number of transistors both in advertising and labeling a substantial portion of the purchasing public believes that the greater the number of transistors in a radio the greater its sensitivity and audio output. The report made no reference to any customer concern for the voltage or signal stability additional transistors might provide.

Interested parties may present their views by writing in duplicate to the Chief, Div. of Trade Regulation Rules, Bureau of Industry Guidance, Federal Trade Commission, Pennsylvania Ave. at Sixth St. N.W., Washington, D.C. 20580, not later than Nov. 3, 1967.

First Color-TV Sets Manufactured in Latin America

Philco S.A. de C.V., Philco-Ford Corp.'s electronic subsidiary in Mexico City, has begun marketing the first line of color-TV sets manufactured in Latin America.

The three models offered are of contemporary Mexican design and feature wood veneers and a polyester finish. Their prices range from 11,795 pesos (\$944.78) to 11,295 pesos (\$904.73). These prices are approximately 17 percent above those for comparable U.S. made color-TV sets.

The Mexican Broadcasting Co. has begun scheduling a total of 7 to 8 hours of color telecasts a week and is expected to increase this to 16 hours a week by the end of 1967 in preparation for the 1968 Olympic Games in Mexico City.

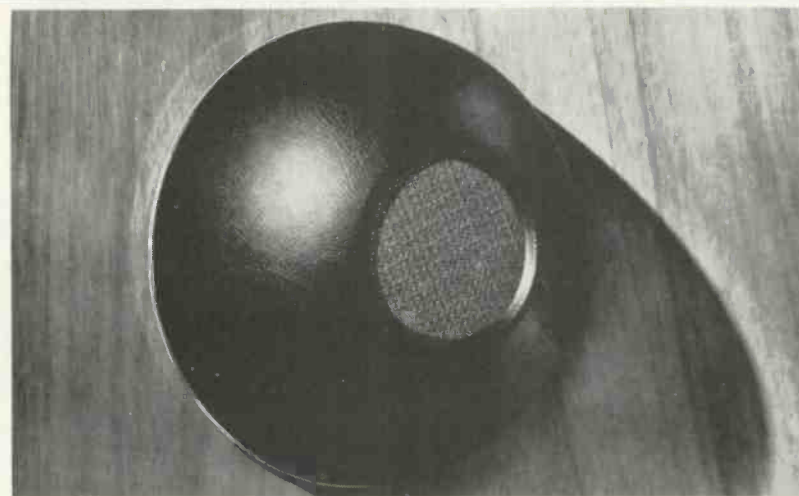

THE FIRST NEW IDEA IN A SPEAKER ENCLOSURE COMBINATION IN 20 YEARS

REDUCES YOUR COST
REDUCES INSTALLATION TIME
INCREASES YOUR PROFIT

For complete information,
send for Brochure #673.

OAKTRON INDUSTRIES, INC.
Monroe, Wisconsin 53566



... for more details circle 132 on postcard

New **B&K** Dynamic Transistor Analyst

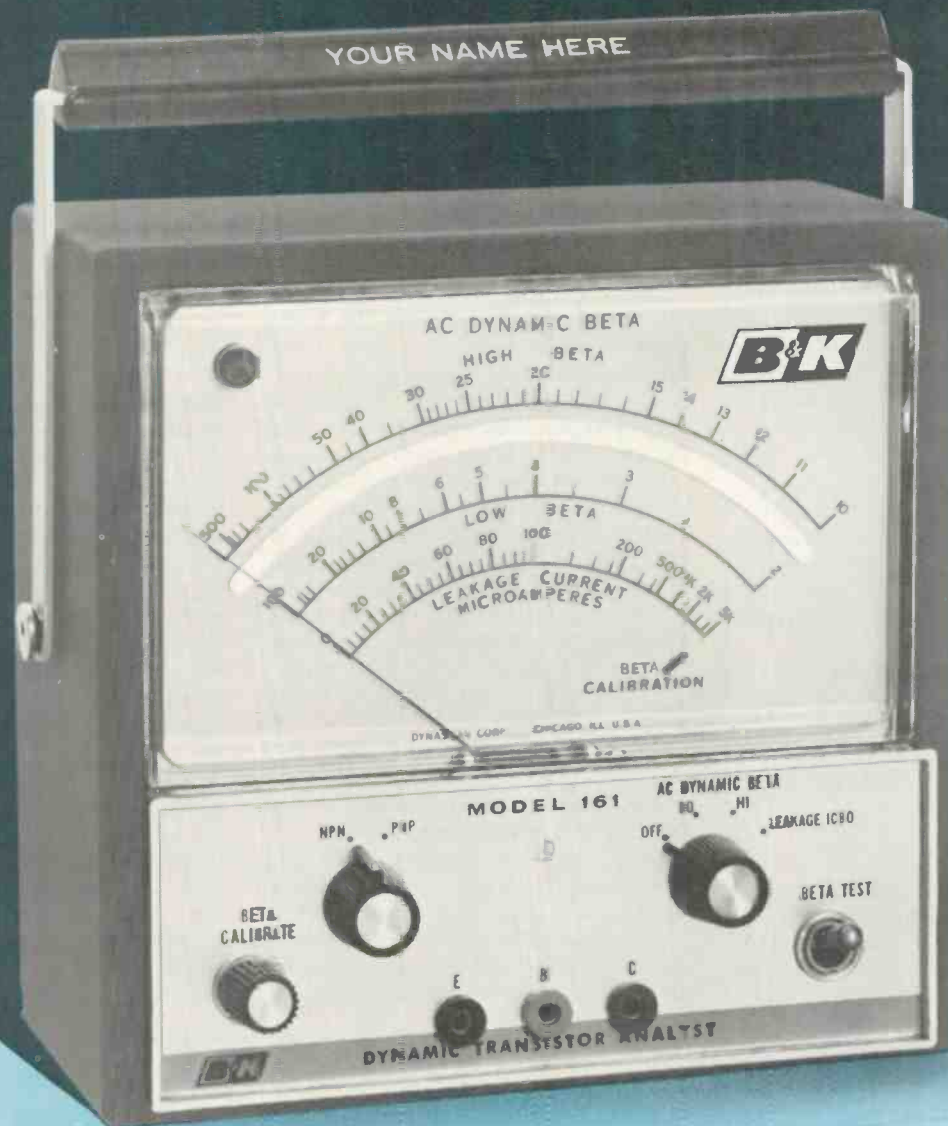

Simple to operate... fast... safe to use. In-Circuit Transistor Tester. Personalized for professional pride.

B&K ends the mystery, fears and misunderstanding surrounding transistor servicing, application and theory. With every Model 161 Transistor Analyst, you get *two free reference manuals*: the new edition of Howard W. Sams' Transistor Specification Handbook, plus the all-new, years-ahead B&K Basic Course on Transistors — everything you need to know to test and service unfamiliar solid-state sets. You get ahead of your competition and stay ahead of the market.

The new B&K 161 means fast, accurate, *in-circuit* testing of transistors for AC Beta. With the same simple procedures, the 161 makes out-of-circuit tests, too, including I_{cbo} (current leakage) and front-to-back conduction of diodes and rectifiers. There's no chance of damaging transistors or components; special circuitry protects all parts, even if leads are connected incorrectly. The huge 7" mirrored meter insures accurate readings on three separate scales. Two ranges check AC Beta: 2 to 100; 10 to 500. For leakage tests, I_{cbo}

range is 0 to 5000 microamps on an expanded scale for better readability. A flick of the switch checks polarity. It's so simple, you don't need any set-up book.

To stay ahead of the game, get the B&K Model 161 with a scuff-proof case and the two exclusive B&K Transistor reference manuals. A complete transistor service package with all leads included and your personalized name plate — for only \$89.95.

B&K Division of Dynascan Corporation
1801 W. Belle Plaine • Chicago, Illinois 60613
Made in U.S.A.

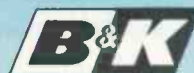

Where Electronic Innovation Is A Way Of Life
... for more details circle 108 on postcard

RCA Expands into Common Market

RCA Colore S.p.A. has been formed in Italy to manufacture and sell color-TV picture tubes in the European Common Market.

Several European countries are expected to begin color-TV broadcasting before the end of this year, including West Germany, Great Britain, France, Monaco, Spain and the Netherlands.

"RCA's expansion program is based on our belief that color TV will develop in Europe along the same lines as in the United States, where color is already a major growth industry. Sales of color sets in the United States alone have increased from around 400,000 sets in 1962 to almost 5 million sets in 1966," Robert Sarnoff, RCA president, said.

Mr. Sarnoff forecast color sales in Great Britain and Western Europe at approximately 300,000 sets in 1968, rising to nearly one million in 1970, two million in 1972 and nearly 3.5 million by 1975.

Elpa Marketing Industries Appoints California Reps

David H. Ross Co. is selected to represent the Tape Products Div. of Elpa Marketing Industries. The products handled include ReVox tape recorders, Beyer microphones and Edital tape splicing equipment.

Channel Master To Supply Training Films

The Channel Master Co. has made arrangements to supply educational films for the training projects of the National Electronic Assn's., Inc. Apprenticeship upgrading classes and local association training groups are ad-

vised by the association to use these films.

The free training film library includes regular product information plus films on antenna theory, CRT building processes, rotators, transmission lines and other topics directly related to the electronics service industry.

TV System Can Broadcast Printed Copy into Homes

An experimental system that can broadcast printed copy into the home along with standard TV programming is ready for on-the-air testing by RCA.

Dr. James Hillier, vice president of RCA Laboratories, said the system has the potential to bring about a dramatic advance in home information services by making it possible to print information of a newsworthy nature right in the living room or elsewhere in the home without affecting the TV program also transmitted on the same channel. He emphasized, however, that it will be a few years before an operating system might be available to the public.

Astatic Files Patent Infringement Suit

The Astatic Corp. of Conneaut, Ohio, has filed a suit for patent infringement against Rivertone Co.; U. S. Electroton, Inc.; American Phonoton, Inc.; and William Adamson. The suit, a civil action, was filed in the U.S. District Court for the southern district of N. Y. It alleged that the defendants have violated Astatic's patent rights by the sale of certain phonograph styli and pickup cartridges under the "Rivertone" label.

Astatic owns a number of U. S. patents and alleges that seven of them are being infringed by Rivertone. Astatic's complaint seeks an injunction against future sales and an accounting and assessment of treble damages against the defendants.

New Tabulations Indicate Shift in Semiconductor Sales

New statistics compiled by the Electronic Industries Assn. indicate a 26.9 percent drop in germanium transistor dollar sales and a 7 percent drop in silicon transistor dollar sales during the first five months this year as com-

pared to last year. Despite the lower total quantity of semiconductors produced and the lower average value of these components, the accompanying table indicates that the increased use of integrated circuits has offset any dollar losses, and there has actually been a \$6,321,000 increase.

FACTORY SALES OF SEMICONDUCTORS

Description	First Five Months 1966			First Five Months 1967		
	Units	Dollars	Average Value	Units	Dollars	Average Value
Germanium Transistors	163,774,000	73,024,000	.45	124,985,000	53,359,000	.43
Silicon Transistors	171,420,000	111,957,000	.65	184,798,000	104,147,000	.56
Dual Transistors	1,214,000	9,734,000	8.02	1,950,000	10,983,000	5.63
Field Effect Transistors	617,000	2,809,000	4.55	1,785,000	4,899,000	2.74
Digital Integrated Circuits	8,715,000	42,470,000	4.87	18,731,000	63,509,000	3.39
Analog Integrated Circuits	571,000	10,192,000	17.85	2,567,000	19,610,000	7.67
Total	346,311,000	250,186,000	.72	334,816,000	256,507,000	.77

COLOR

GET A *Better* PICTURE
FROM ANY SET

WITH A
KAY-TOWNES
Colorphase
COMBINATION ANTENNA

ALL 82 Channels FM!

CPC 33, 27, 24, 18, 12

KAY-TOWNES ANTENNA CO., P.O. Box 593, Rome, Georgia 30162

KING OF THE
FRINGE AREAS



CPC-33G

WITH FREE
BAND SPLITTER

... for more details circle 124 on postcard

ELECTRONIC TECHNICIAN

The '10 Most Wanted' Receiving Tubes

A list of the "10 most wanted" entertainment receiving tubes in the electronic-parts-distribution market is compiled by the G-E tube department. Statistics are based on industry sales to distributors.

The most popular types are: 5U4GB/5AS4A, 50C5, 6CB6A/6CF6 6DW4B 6JE6A 6AQ5A 6HG5 6DQ6B/6DM4A, 35W4, 6AX4GTB and 6BQ7A/6BZ7.

Conversion Factors Listed On Free Wall Chart

Precision Equipment Co. has published a wall chart of conversion factors. This reference table is designed



to help electronic technicians locate factors occasionally used, but which seem to slip our minds. Included are common conversions such as inches to centimeters, watts to horsepower and other conversions that are difficult to locate in reference manuals.

This free wall chart can be obtained by writing Precision Equipment Co., 4409G Ravenswood Ave., Chicago, Ill. 60640.

Ling-Temco-Vought May Acquire Allis-Chalmers in Transaction

Ling - Temco - Vought, Inc. has made a proposed tender offer to acquire all the outstanding common and preferred stock of Allis-Chalmers Manufacturing Co. for cash and an exchange of LTV securities in a transaction that could total some \$590 million.

Arista Introduces Exact Replacements For Japanese Phonos

Artista Enterprises announces the introduction of 14 exact-replacement Japanese phonograph cartridges for many brands including Singer, Lloyd, Mastercraft, Channel Master and G-E "Show & Tell." They reportedly already market a line of over 650 exact-replacement phonograph cartridges.

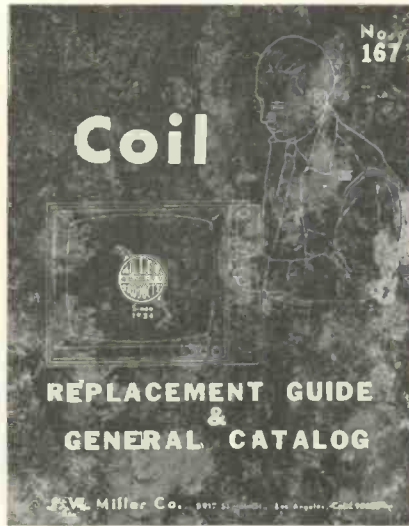

NEW Coil Catalog & Replacement Directory No. 167

New 148-page catalog gives specifications and prices for the industry's most complete line of RF and IF coils. Replacement directory cross references exact replacement coils for all known black-and-white and color TV sets, home radios and car radios.

For your free copy, call on your local distributor or write directly to:



J. W. MILLER COMPANY

5917 SO. MAIN STREET • LOS ANGELES, CALIFORNIA 90003

SEE YOUR LOCAL DISTRIBUTOR FOR THE FULL LINE OF RF AND IF COILS, CHOKES, FILTERS AND TRANSFORMERS.

... for more details circle 126 on postcard

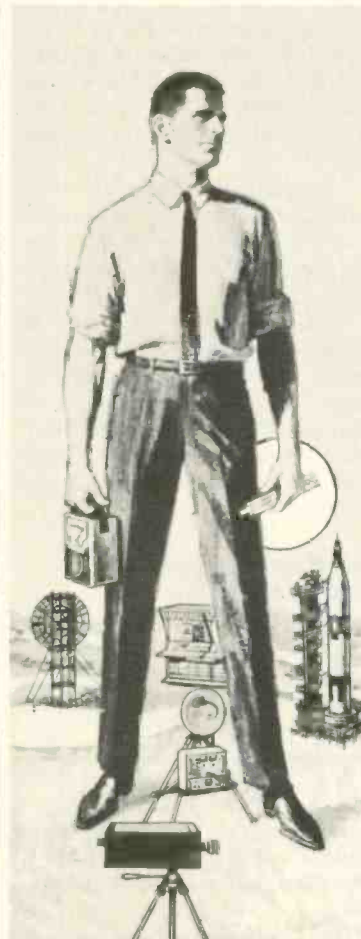

Portable "computer" for electronics men.

WANT FAST ANSWERS to math and electronics problems? Now, compute them in a flash with this new Electronics Slide Rule.

Calculate resonant frequencies, solve inductive or capacitive reactance problems, find reciprocals for resistance formulas, locate decimal points—all in just seconds, without pencil and paper.

Whiz through regular math problems, too: multiplication, division, square roots, logarithms, even trigonometric functions.

Sturdy 12-inch, all-metal slide rule comes complete with handsome leather carrying case—plus 4-lesson instruction course. Deliberately priced low as our way of making friends with electronics men. **FREE** booklet gives full details. Mail coupon below today.

Mail Coupon for FREE Booklet

CIE Cleveland Institute of Electronics
1778 East 17th Street, Cleveland, Ohio 44114

Please send me, without charge or obligation, your booklet describing the Electronics Slide Rule and 4-lesson instruction course. Also free if I act at once—a handy, pocket-sized Electronics Data Guide.

Name _____ (Please Print)

Address _____

City _____ State _____ ZIP _____

Accredited Member National Home Study Council
A Leader in Electronics Training... Since 1934 ET-119

... for more details circle 113 on postcard

Listen!

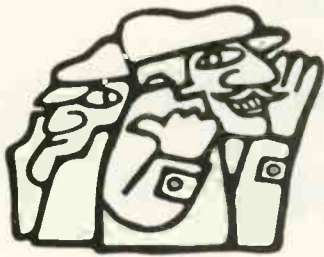

The right connections can save you money!

... every time you make a connection with Jensen's 8-inch Commercial Sound loudspeakers. The exclusive KWIKON® instant connectors and a pre-attached transformer save better than 50¢ per unit in installation cost! That's the built-in savings you get with Jensen.

For example, with the Jensen K-950 coaxial loudspeaker you need only half as many units to deliver smooth, dynamic sound. The K-950's 110° coverage angle and exceptional frequency range provide approximately twice the coverage area of an average 8-inch speaker.

There are 40 different Commercial Sound 8-inch loudspeaker models to choose from ... your right connection to save money.

Jensen

Jensen Manufacturing Division, The Muter Company,
6601 South Laramie Avenue, Chicago, Illinois 60638.

... for more details circle 121 on postcard

NEWS OF THE INDUSTRY

Free Barbecue Grill Designed to Generate Sales

An attention-getting new battery display from Mallory uses a free barbecue grill to attract customers and generate impulse sales.



Two free batteries power the spit to spin an action display sign. A battery assortment is displayed in a colorful carton that fits into the grill.

Two free batteries power the spit to spin an action display sign. A battery assortment is displayed in a colorful carton that fits into the grill.

G-E Offers Programed Instruction in Transistors

A three-volume, programed-instruction (self-teaching) course is being offered by the General Electric Co. to help technicians learn the sophisticated skills and techniques needed for transistor-circuit troubleshooting.

The programed instruction is based on learning bits of information at a time instead of large chunks, and learning these bits in a logical, carefully planned sequence.

G-E indicates that a group of technicians were tested on the subject of transistorized circuits, and the average score was 23.4 percent. After spending an average of seven hours with the programed instructions, their post-study scores reportedly averaged 96.8 percent.

ITT and Rayonier Discuss Possible Association

International Telephone and Telegraph Corp. and Rayonier, Inc. have announced that discussions are under way leading to the possible association of Rayonier with the ITT System.

MOVING?

Be sure to let us know your new address. Please enclose a complete address label from one of your recent issues.

NEW! from SECO

"IN - CIRCUIT" CURRENT CHECKER

Eliminates most common cause of "callbacks" (unstable focus, shrinking pictures, etc.)! Should pay for itself on next months' calls alone!



Nothing else like the HC-8 available! Tune horizontal drive and linearity for "dip"—and in seconds—you've got best possible focus, width and stability at minimum cathode current. Makes convergence adjustments faster, easier—longer lasting!

Especially useful on color TV where a slight misadjustment of horizontal linearity or efficiency coils drives cathode currents sky high! 5 pre-wired sockets for all popular horizontal output tubes lets you plug into circuit fast—no clipping or unsoldering of leads! **\$34.50** Net

ASK YOUR DISTRIBUTOR
or write for full details.

SECO
SECO ELECTRONICS CORP.
1003 Second St. So. • Hopkins, Minn. 55343

... for more details circle 137 on postcard

ELECTRONIC TECHNICIAN



"I like the results . . .

. . . when I install the JFD Color Laser," comments Elmer Whitmore, Hill's Antenna Service, Saginaw, Michigan, who has made over 13,000 antenna installations in the 14 years he has been in business.

"That's a real good color picture! is what I like to hear after I put up a new antenna because to me a pleased customer is like money in the bank. So I don't take chances—I install JFD Color Lasers for top color pictures.

"I like the way the Color Lasers work on all the VHF and UHF stations here. They rig up fast and give us better results in the form of precise color and ghost-free images."

Elmer Whitmore prefers JFD engineered-for-color Color Lasers, like many other professional antenna installers, for best possible performance.

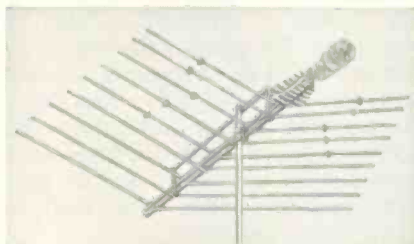

BRILLIANT COLOR — flat (frequency independent) response across each channel, free from suck-outs or roll-offs. Keeps colors vivid and alive.

PATENTED W-I-D-E BAND LOG PERIODIC DESIGN — the most efficient ever developed — provides higher gain, better signal-to-noise ratios, needle-sharp directivity. Eleven patents cover its revolutionary space-age design.

MORE DRIVEN ELEMENTS. Harmonically resonant capacitor coupled design makes dual-function elements work on both VHF and UHF frequencies. *Entire* antenna (not just part of it as in other log periodic imitations) responds on every channel.

LUSTROUS, ELECTRICALLY CONDUCTIVE GOLD ALODIZING promotes signal transfer, protects against corrosion, enhances appearance.

PROFESSIONAL ANTENNA INSTALLERS KNOW —

The Best Antenna for Color TV is The Color Laser by

JFD®

Now at your JFD distributor!

JFD ELECTRONICS CO.

15th Avenue at 62nd Street, Brooklyn, N.Y. 11219

JFD International, 64-14 Woodside Ave., Woodside, N.Y. 11377 JFD Canada, Ltd., Ontario, Canada

JFD de Venezuela, S.A., Avenida Los Haticos 125-97, Maracaibo, Venezuela

LICENSED UNDER ONE OR MORE OF U.S. PATENTS 2,958,081; 2,985,879; 3,011,168; 3,108,280; 3,150,376; 3,210,767. RE. 25,740 AND ADDITIONAL PATENTS PENDING IN U.S.A. AND CANADA. PRODUCED BY JFD ELECTRONICS CO. UNDER EXCLUSIVE LICENSE FROM THE UNIVERSITY OF ILLINOIS FOUNDATION. LICENSED UNDER ONE OR MORE OF U.S. PATENTS 2,954,287 AND 3,015,821 AND ADDITIONAL PATENTS PENDING

. . . for more details circle 123 on postcard

FOR BIGGER PROFITS make **QUIETROLE** your silent partner!



QUIETROLE is the quality lubricant-cleaner that silences noisy radio, TV, (black and white, color too) and instrument controls. Works as silent partner to save time, build added income for you.

Harmless to plastics or metals... is non-conductive, non-corrosive, non-flammable. Zero effect on capacity and resistance. Leader for over 20 years.

- Mark II for tuners
- Spray Pack for controls and switches
- Silitron for general use

manufactured by



QUIETROLE COMPANY
Spartanburg, South Carolina

... for more details circle 135 on postcard

We offer You nothing but finer, faster, Precision Tuner Service!... (Period)



VHF-UHF
\$7.95

+parts & shpg.

Why pay for parts you don't need? Mail coupon now for free information!
PRECISION TUNER SERVICE
... one of the OLDEST and LARGEST TV tuner repair firms in the world!
Box 272E Bloomington Indiana 47401

Firm _____
Name _____
Title _____
Address _____
City _____ St. _____ Zip _____

... for more details circle 133 on postcard

BOOK REVIEWS

TRANSFORMERS FOR ELECTRONIC CIRCUITS. By Nathan R. Grossner. Published by McGraw-Hill Book Co., 336 pages, hard cover. \$14.

The characteristics of nearly linear transformers are described in this book to assist the reader in applying the proper transformer to the proper electronic circuit. The author assumes that the reader has an understanding of trigonometry, but uses graphs to help simplify calculations. The book ranges from a discussion of transformer weaknesses (where we learn that many failures result from defects that accumulate during storage and installation — usually becoming apparent in the first 10 to 20 hours of operation) to a study of the tail oscillations that occur in pulse transformers. This book may be of interest to the advanced technician who wonders why special cores or windings are selected for the circuits where they are used.

FIELD EFFECT TRANSISTOR PROJECTS. Written and published by the Semiconductor Products Div. of Motorola, Inc., 96 pages, soft cover. \$1.

In the first chapter there are one and one-half pages of basic FET theory and two pages of related-term definitions. Components and good construction techniques are illustrated in the second chapter. The balance of the book describes circuits, their operation and construction. These projects include a vibrato circuit for musical instruments, audio mixer, timer, crystal oscillator, preamplifier and dc voltmeter. The construction check list resembles those frequently accompanying electronic kits. This book should be of interest to the apprentice technician who needs to learn basic construction techniques and to inexperienced technicians who wish to learn more about FETs.

A COMMON SENSE APPROACH TO SMALL BUSINESS ANALYSIS. Compiled and edited by Jerry I. Reitman. Published by Business and Financial Publications, 84 pages, soft cover. \$4.95.

At first glance most service-dealers may feel this book does not apply to them — it may appear more appropriate for a small owner-manager factory. A large portion of the material, however, can be applied to the needs

continued on page 92

simplest
top
quality
modular
amplifier
system

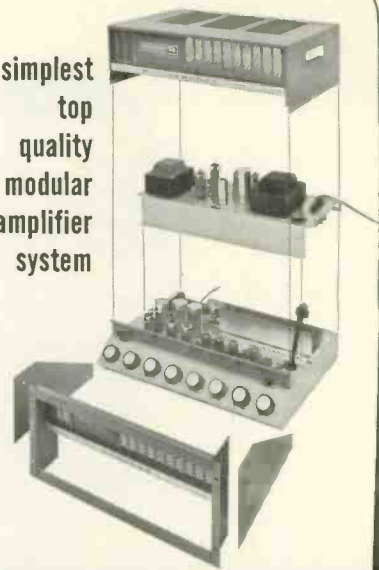

NEWCOMB
TOP QUALITY CUSTOM **K**

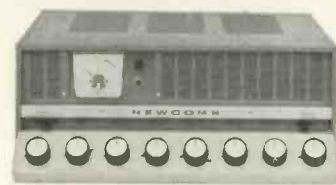

Newcomb's finest, the Custom K Series is the climax of 30 years devoted to developing and producing the very best public address amplifiers. You quickly and simply get the combination of channels and power you need. A power output module is dropped into either a front-end or booster chassis. Two electrical plug-in connections; no soldering. Put a cover over the top or insert the chassis in a rack mount. You can plug in a transistorized VU meter accessory which has a sensitivity control and monitor jack for crystal headphones. The 4-channel models have provisions for a remote control accessory. There are 3 power amplifier modules: 40, 60, and 125 watts, and a power supply when you want to use a front end as a mixer-preamplifier only. There are three preamplifier modules: 3, 4, and 5 channels, and a chassis for making a booster amplifier out of any of the output modules. All in all, only 14 components permit 70 combinations. Performance is superb. Frequency response is ± 1 db 20-20,000 cps; distortion is extremely low. Custom K amplifiers run remarkably cool. Easy-to-trace, easy-to-service vacuum tube construction is used throughout. Colors are soft shades of gray-green. Write for Catalog K-15.

NEWCOMB AUDIO PRODUCTS CO., Dept. ET-10
12881 Bradley Ave.
Sylmar, California 91342

... for more details circle 131 on postcard

ELECTRONIC TECHNICIAN

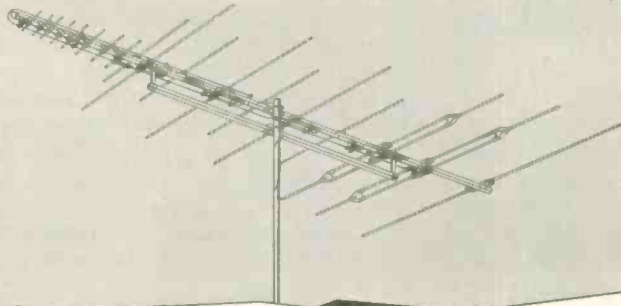

**3-Way Combination
FREE SPACE STANDING WAVE
MAGNETIC ANTENNA**

*ZEROS IN
YOUR SIGNAL—*

**Discriminates Between
Desired Signal and
Unwanted Noise!**

Here is an antenna with the unique ability to discriminate between the desired signal and unwanted noise! A complete absence of minor lobes and an extremely high front to back ratio are characteristics of these antennas. This is made possible by the development of the Free Space Standing Wave Magnetic Drive Antenna system (F.S.M.). The outstanding electrical qualities, combined with the simplified mechanical construction of this system yields a total performance package unparalleled in today's market. 4 models, 60-inch to 180-inch boom, all modestly priced.

UNEXCELLED!

UHF — VHF — FM — COLOR

INVESTIGATE NOW!

S&A Electronics Inc.

Manufacturers of the TARGET ANTENNA

**204 West Florence Street
Toledo, Ohio 43605**

... for more details circle 136 on postcard

**If You're Still Using
A V.T.V.M.
It's Time To Change
... Go Solid-State!**

**(A)
Kit
IM-16
\$44.95**



**(B)
Kit
IM-25
\$80.00
Wired
IMW-25
\$115.00**

**These New Heathkit® Solid-State Meters
Feature State-Of-The-Art Performance
At Prices You Can Afford**

- Modern, stable, long-life solid-state circuitry
- New low-voltage ranges to accurately analyze modern transistor circuits
- Full capability to go "out on the job" . . . instant selection of internal battery power or 120/240 v. 50-60 Hz AC operation
- Exceptional accuracy . . . 3% on DC volts, plus a large, easy-to-read 6" meter face
- High impedance F.E.T. input for minimum circuit loading

(A) New! Deluxe Solid-State Volt-Ohm Meter
Features 8 DC and 8 AC voltage ranges from 0.5 v to 1500 v full scale; 7 ohmmeter ranges (10 ohms center scale) x1, x10, x100, x1k, x10k, x100k, & x1 megohm; 11 megohm input on DC ranges; 1 megohm on AC ranges; internal battery or 120/240 v 50-60 Hz AC power for portable or "in shop" use; large readable-across-the-bench 6" meter; separate switches for individual functions; single test probe for all measurements; modern, stable solid-state circuit-board construction.
Kit IM-16, 10 lbs. \$44.95

(B) New! Deluxe Solid-State Volt-Ohm-Milliammeter
All silicon transistors plus FET's. Features 9 AC and 9 DC voltage ranges from 150 mV to 1500 volts full scale; 7 ohmmeter ranges (10 ohms center scale) x1, x10, x100, x1k, x10k, x100k, & x1 megohm; 11 current ranges from 15 uA to 1.5 Amperes full scale; 11 megohm input on DC voltage ranges; 10 megohm input on AC voltage ranges; internal battery power or 120/240 v 50-60 Hz AC power for maximum versatility; easily readable 6" meter face; ±3% accuracy on DC volts; ±4% on DC current; ±5% accuracy on AC voltage and current; separate range switches "human engineered" for efficiency in actual use; modern circuit board construction; all solid-state components; easy to assemble.
Kit IM-25, 10 lbs. \$80.00
Wired IMW-25, 10 lbs. \$115.00



HEATH COMPANY, Dept. 24-10
Benton Harbor, Mich. 49022
In Canada, Daystrom Ltd.

- Please send my FREE 1968 Heathkit Catalog.
 Enclosed is \$ _____, plus postage.
Please send model(s) _____

Name _____

Address _____

City _____ State _____ Zip _____

Prices & Specifications subject to change without notice. TE-165

... for more details circle 119 on postcard

MOVING?

Be sure to let us know your new address at least 6 weeks in advance. And please enclose a complete address label from one of your recent issues.

ELECTRONIC TECHNICIAN

Ojibway Bldg.
Duluth, Minn. 55802
727-8511

BOOK REVIEWS

of all shops that sell and repair electronic equipment. Included are helpful hints for maintaining stock, suggestions for developing useful ideas to improve a company, and several self-check lists are discussed which will help the owner-manager see if business has actually improved and what is needed to make the business even better. This book should be of value to any service-dealer operation, whether large or small.

ELECTRICAL CHARACTERISTICS OF TRANSISTORS. By Robert L. Pritchard. Published by McGraw-Hill Book Co., 737 pages, hard cover. \$19.50.

The author, presently Professor of Electrical Engineering at Stanford University, goes into great detail describing the valence electron characteristics of semiconductor materials, the fabrication of transistors and their electrical characteristics. The book contains a portion of the periodic table to illustrate the atomic relationship of elements used in transistors;

equations to describe the drift of electrons and holes; illustrations showing the various methods of fabricating P-N junctions; a description of how an ideal transistor differs from a pair of diodes; and graphs, equivalent circuits and equations to describe a wide range of transistor ac and dc characteristics. A 69-page bibliography lists additional sources of transistor information. This book may be of interest to advanced electronic engineering students and engineers who are concerned with a detailed study of transistors.

BROADCAST ANTENNA SYSTEMS HANDBOOK. By Harry Etkin, John Battison, Ward Yelverton, Herman Gihring and M. S. Siukola. Published by Tab Books, 160 pages, soft cover. \$7.95.

Tables, charts and equations are used in describing the design and radiation of AM, FM and TV transmitting antennas. Many references are made to relevant FCC regulations. This book should be of interest to technicians who are engaged in the design of commercial broadcast antennas, particularly the last portion of the book, which includes a detailed description of recent FM dual polarization studies.

Why not sell the best

ZENITH TUBES built to the quality standards of Zenith original parts

"Royal Crest" Circuit Tubes

More than 875 tubes—a full line with the same quality as original Zenith equipment. Get Zenith tubes for greater dependability and finer performance.

Order all genuine Zenith replacement parts and accessories from your Zenith distributor.



TV Picture Tubes

For color TV, B&W TV or special purposes. A complete Zenith line of more than 200 tubes built for greater reliability, longer life.

Zenith B&W replacement picture tubes are made only from new parts and materials except for the glass envelope in some tubes which, prior to reuse, is inspected and tested to the same high standard as a new envelope. Some color picture tubes contain used material which, prior to reuse, is carefully inspected to meet Zenith's high quality standards.

ZENITH®
The quality goes in before the name goes on

... for more details circle 149 on postcard

ELECTRONIC TECHNICIAN

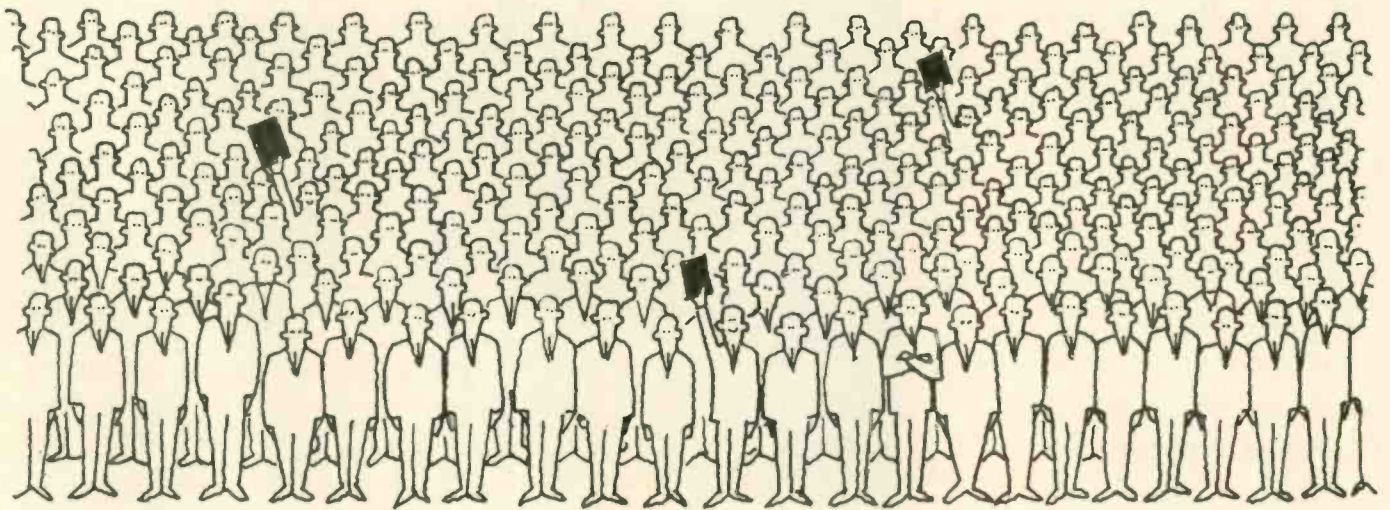

No, 4693 isn't a very large circulation.

But in the 2 billion dollar fur raising industry there are only about 5000 participants. And 4693 paid ABC subscribers in a 5000 universe must be some kind of a record. These people who are tremendously important to many suppliers depend on AMERICAN FUR BREEDER for our complete, concise and convenient cover-

age of their industry. So, we approach this magazine—one of our smallest in circulation—with the same skill and vitality we do our 26 other business publications. And we always will. That skill and vitality is what has made 4693 important people depend on AMERICAN FUR BREEDER and our growing company.

OJIBWAY PRESS, inc.

Ojibway Building, Duluth, Minn. 55802

Satisfying the need to know . . . with 27 publications in 13 industries.



ELECTRONIC TECHNICIAN • DRIVE-IN MANAGEMENT • DRIVE-IN MANAGEMENT GUIDEBOOK • HOSPITAL & NURSING HOME FOOD MANAGEMENT • SCHOOL & COLLEGE FOOD MANAGEMENT • PLANT & BUSINESS FOOD MANAGEMENT • KITCHEN PLANNING • GAS AGE • GAS APPLIANCE MERCHANDISING
 • LP-GAS • INDUSTRIAL GAS • BROWN'S DIRECTORY • PAPER SALES • THE PAPER YEAR BOOK • CONVENTION NEWS • MODERN CONVERTER • HEARING DEALER • HOSIERY & UNDERWEAR • OFFICE PRODUCTS DEALER • OP CONVENTION DAILY • AMERICAN FUR BREEDER • MEAT • SPONSOR • FLOORING • RSI (ROOFING, SIDING & INSULATION) • BAKERS WEEKLY • BISCUIT & CRACKER BAKER

GREATEST Breakthrough IN COLOR TV SERVICING



NO.
CL-8

NON-DRIFT COLOR TV TUNER CLEANER

TEST AFTER TEST HAS PROVEN
COLOR-LUBE

- To clean better
- To be safe on plastics used in TV sets
- Non-flammable
- To cause no drifting

\$2³⁹



Another First

SUPER FROST AID

Cools Faster • Leaves
No Liquid Residue
SUPER FROST AID is a faster
circuit freezer designed to
locate intermittent compon-
ents without leaving a
liquid residue.

No. 1550

CHEMTRONICS

BROOKLYN

N. Y. 11236

... for more details circle 111 on postcard

ADVERTISERS' INDEX

Alliance Mfg. Co.	71
American Telephone & Telegraph Co.	77
Amperex Electronic Corp.	3rd Cover
Amphenol Corp.	79
Arco Electronics	27
Arrow Fastener Co.	96
B&K Div., Dynascan Corp. ...	65, 75, 85, 96
Castle TV Tuner Service	84
Chemtronics, Inc.	96
Cleveland Institute of Electronics	35-37, 87
Delco Radio Div., General Motors Corp.	33
Electro-Voice, Inc.	78
Finney Co., The	81
GC Electronics Co.	26
General Electric Co.	83
Greyhound Lines, Inc.	25
Heath Co.	91
International Crystal Mfg. Co.	28
Jensen Mfg. Div., The Muter Co.	88
Jerrold Electronics Corp.	2nd Cover
Jersey Specialty Co.	76
JFD Electronics Corp.	89
Kay-Townes Antenna Co.	86
Lectrotech, Inc.	95
Miller Co., J. W.	87
Mosley Electronics, Inc.	94
Motorola Training Institute	80
National Radio Institute	67, 95
Newcomb Audio Products Co.	90
Oaktron Industries	84
Precision Tuner Service	90
Quam-Nichols Co.	78
Quietrole Co.	90
Radio Corp. of America RCA Electronic Components & Devices ..	4th Cover, 29, 31
RCA Institutes, Inc.	32
S&A Electronics, Inc.	91
Seco Electronics Corp.	88
Sencore, Inc.	20, 22, 34, 38, 69, 70
Sprague Products Co.	23
Sylvania Electric Products, Inc.	72-73
Triplet Electrical Instrument Co.	82
Tuner Service Corp.	19
Winegard Co.	24
Yeats Appliance Dolly Sales Corp.	80
Zenith Sales Corp.	68, 92

for PROFITABLE,
TIME-**SAVING**
SERVICING

OF: Black & White TV
Color TV

AM and FM, Tube or
Transistor Home, Portable
and Auto Radios

Communications
equipment &
Home
Appliances

Hi-Fi
Components

B & K PROFESSIONAL TEST EQUIPMENT

WITH SIGNAL INJECTION AND IN-AND-OUT OF CIRCUIT
MEASURING TECHNIQUES

Send today for your free copy of Catalog AP22

B&K
DIVISION OF
DYNASCAN

DS-602

1801 WEST BELLE PLAINE AVENUE, CHICAGO, ILL. 60613
Telephone: (312) 327-7270 • Cable Address: BANDKCO-
Made in U.S.A.

... for more details circle 109 on postcard



AUTOMATIC STAPLE GUNS

For Fastening Any
Inside or Outside

Wire Up to 1/2" in Diameter

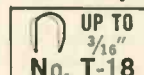

No. T-18

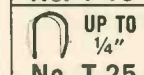

No. T-25



No. T-75

- Telephone wire
 - Intercom wire
 - Bell wire
 - Thermostat wire
 - Radiant heating wire
 - Hi-Fi, Radio & TV wires
- Tapered striking edge
gets into close corners!

Available in:
Brown, Ivory, Beige,
Monel, Bronze, Natural

ARROW FASTENER COMPANY, INC.

Saddle Brook, N.J. 07663

... for more details circle 105 on postcard

ELECTRONIC TECHNICIAN

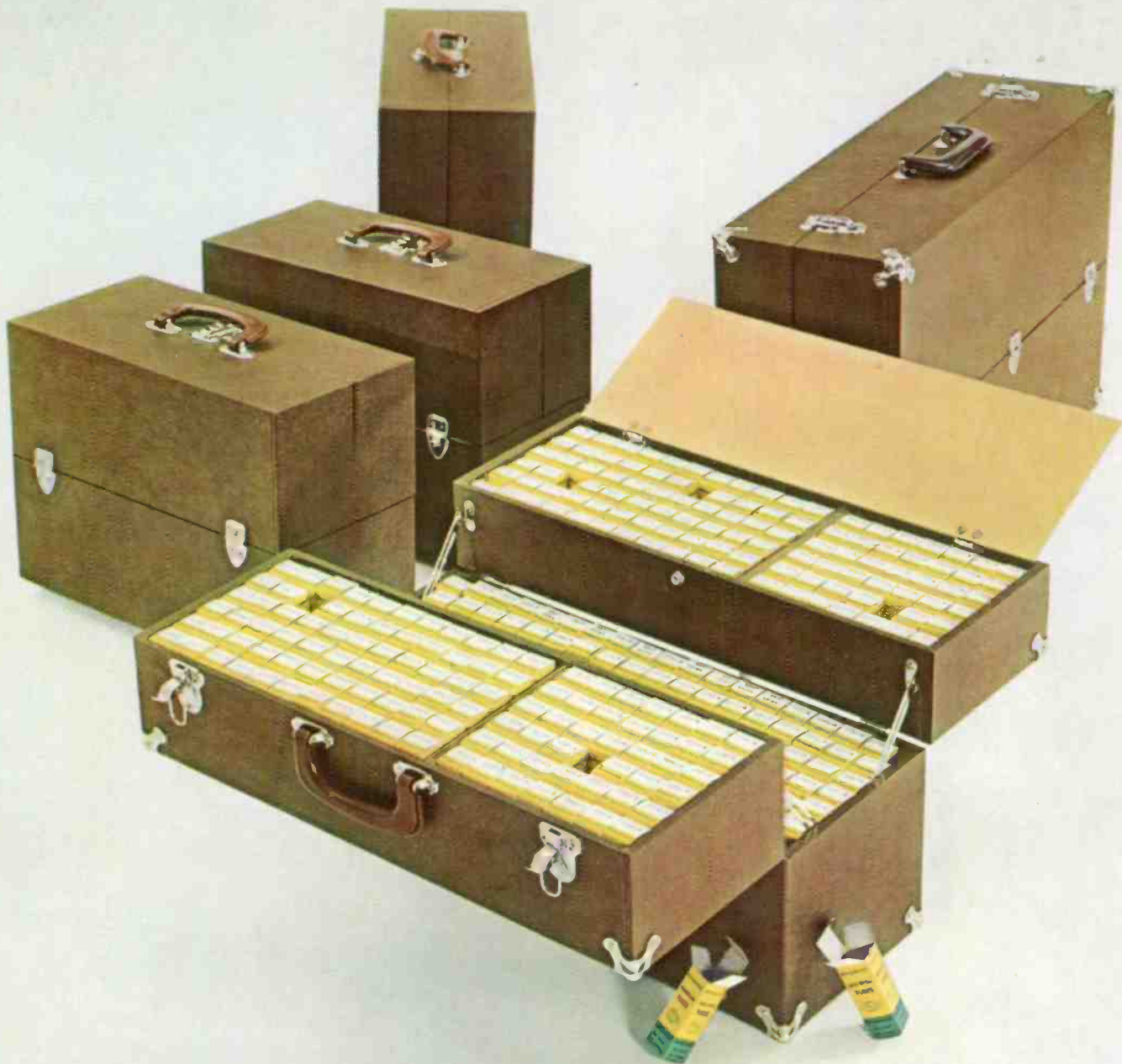

One out of every five
professional servicemen
has switched to Amperex
TV replacement tubes

It takes a lot of quality to change the buying habits of 20% of the most knowledgeable technicians in the business. These servicemen are following the pattern set by the leading TV manufacturers, who are designing more and more of their quality lines around tubes originated by Amperex. The Amperex line of popular types is expanding all the time. Look for the green and yellow cartons at your distributor's or write: Amperex Electronic Corp., Hicksville, L. I., N.Y. 11802.



Amperex

TOMORROW'S THINKING IN TODAY'S PRODUCTS

Get on board RCA's Gift-Time Special for 71 valuable prizes

FREE with your purchases of RCA receiving tubes

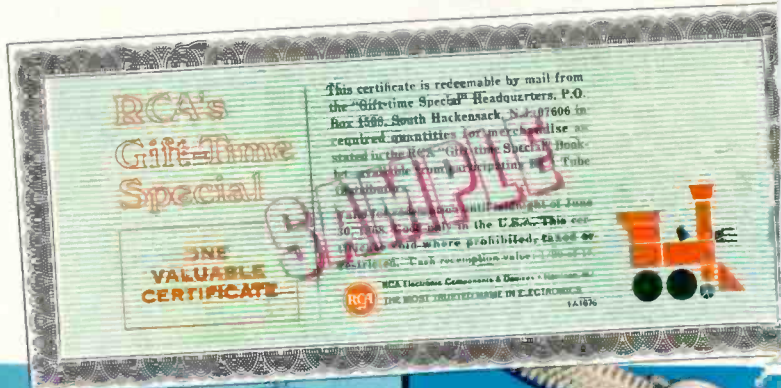

RCA's "Gift-time Special" certificates bring you great premiums for Christmas gift giving for the entire family. These valuable certificates are FREE WITH YOUR PURCHASES OF RCA RECEIVING TUBES from your participating RCA Tube Distributor. (Optional with RCA Tube Distributors.)

1. Argus Electromatic Slide Viewer. 51-126. 43 Cert. 2. Polaroid 215 Color-Pack Camera. 51-170. 155 Cert. 3. Polaroid Flash Sun Attachment. 51-174. 22 Cert. 4. Toastmaster "Sovereign" Automatic Toaster. 35-80. 51 Cert. 5. Rival Slimline Electric Knife. 35-141. 33 Cert. 6. West Bend 8-Cup Automatic Aluminum Perculator. 35-73. 27 Cert. 7. Man's Elgin "Armaca" 17-jewel Watch. 53-80. 61 Cert. 8. Longines-Wittnauer Man's Watch. 53-11. 146 Cert. 9. Hickock Man's Alligator Belt. 20-765. 36 Cert. 10. Sterling Silver Candlesticks. 52-25. 15 Cert. 11. Star Rogers and Bros. Silverplate "Starlight" by The International Silver Company. 52-45. 37 Cert. 12. Oneida 4 pc. "Paul Revere" Coffee Service. 52-46. 81 Cert. 13. Sterling Silver Salt and Pepper Shakers. 52-26. 15 Cert. 14. Sterling Silver and Crystal Cake Plate. 52-75. 17 Cert. 15. Reed and Barton Color-Glazed "Paul

Revere" Bowl. 52-96. 29 Cert. 16. Man's Alligator Raincoat. 20-568. 103 Cert. 17. Lady's Alligator Raincoat. 20-571. 103 Cert. 18. Lady's Twin-Pearl Ring. 49-147. 39 Cert. 19. Lady's Linde Star Ring. 49-149. 105 Cert. 20. Hamilton "Loralie" Lady's Watch. 53-65. 133 Cert. 21. "Buddy L" Aerial Ladder Fire Engine. 48-90. 18 Cert. 22. Toddler's "Tiger Trike". 47-51. 16 Cert. 23. "Buddy L" Sit N Ride Truck. 48-207. 19 Cert. 24. "Kiss Me" Doll. 48-137. 13 Cert. 25. Cosco Doll High Chair. 48-43. 10 Cert. 26. "Drink and Wet" Doll and Cradle. 48-139. 13 Cert.

AND THESE ARE JUST A FEW OF THE 71 EXCITING GIFT PREMIUMS AVAILABLE! Get RCA "Gift-time Special" certificates FREE with your purchases of RCA receiving tubes from your participating RCA Tube Distributor.

RCA Electronic Components and Devices, Harrison, N.J.



The Most Trusted Name in Electronics