

ELECTRONIC TECHNICIAN

WORLD'S LARGEST ELECTRONIC TRADE CIRCULATION



APRIL 1967



ANTENNA ROTATORS / MODERN AGC CIRCUITS

29 108

New Jerrold Colorpeak™ VHF Antenna weathers any reception problem

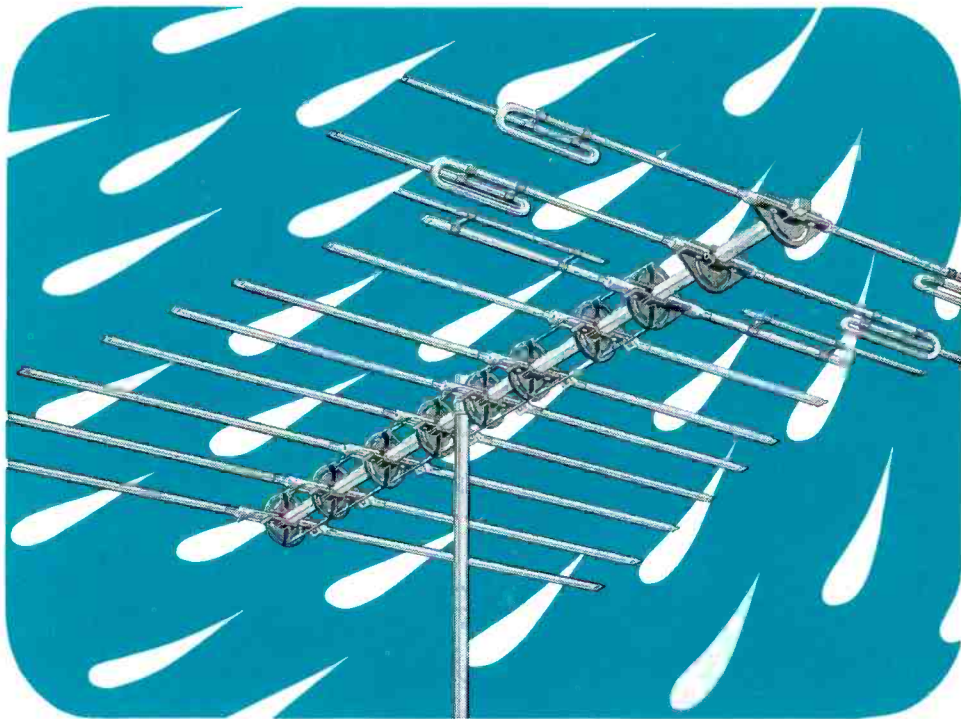

Here's one outdoor antenna that stays put—even in a howling storm. The new Jerrold Colorpeak 300-ohm VHF-FM Antenna.

Colorpeak is a high gain antenna with unusual flatness across the entire VHF-FM band. It picks up strong, clear signals—even in difficult reception areas—because of its excellent front-to-back ratio. And it's built as rugged as a tank.

Vibration-proof point-contact element locks, corrosion-resistant Golden Armor Coating and tough Cyclac insulators make each insulating mount a strong point. No shorting out because of icing. No wavering image as wind whips through the antenna. No flimsy criss-cross conductors for transfer of the signal. Jerrold Colorpeak quality construction sees to all that.

Jerrold Colorpeak antennas,

like Jerrold VUfinder, Paralog Plus and Pathfinder antennas, assemble faster than any other antenna made today. All parts snap into place—anywhere—on the ground or on the roof. For hook-up ease, Colorpeak lead connections are made close to the mast.

For more details on the Jerrold Colorpeak antenna, see your Jerrold distributor.

JERROLD®

Focusing on one thing—
better reception.

... for more details circle 101 on postcard

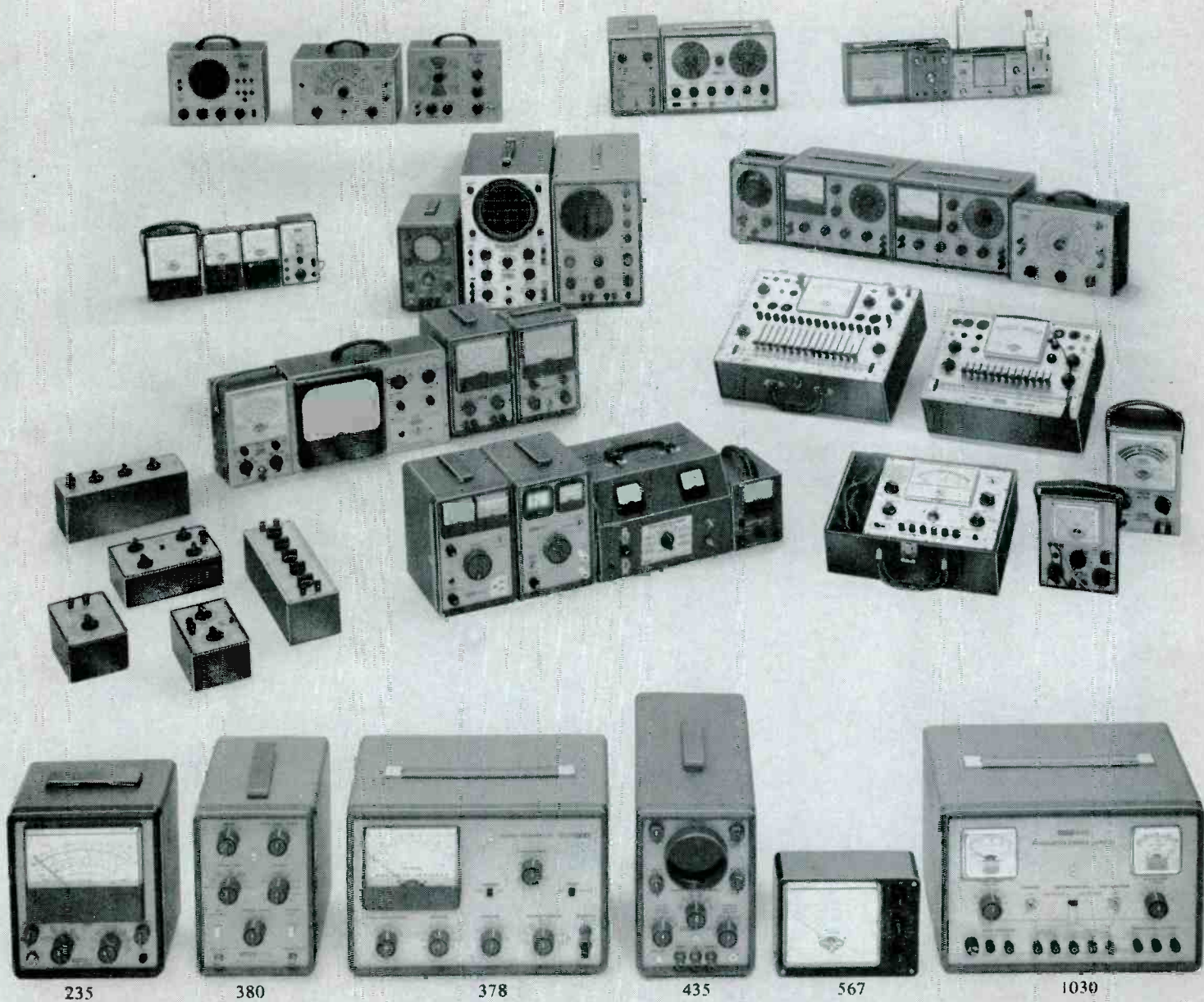

The Professionals

The reason EICO's line is the industry's most comprehensive (100 to choose from!) is because each instrument serves a specific group of professional needs. You name the requirement—from a resistance box to a VTVM, from a signal tracer to a scope, from a tube tester to a color TV generator, etc., you can depend on EICO to give you the best professional value. Compare these latest (foreground) professional instruments at your neighborhood electronics distributor. You judge who knows your needs best — and serves your needs with the best values!



21 years of service to the Professional Serviceman.
Laboratory precision at lowest cost.

1967 Guidebook to Professional Test Equipment AVAILABLE FREE TO PROFESSIONAL SERVICE TECHNICIANS

EICO Electronic Instrument Co., Inc. 131-01 39th Avenue, Flushing, N. Y. 11352
ET-5

Please send further data on New EICO instruments below:

- #235 Professional VTVM. Measures to 0.01V for transistor servicing. Large 6" meter. 8DC ranges 0.5V to 1500V. 7 AC P-P ranges to 4200V. 7 AC RMS ranges to 1500V. 7 ohms ranges to 100M Ω . Response 30Hz to 3MHz \pm 1 db. Kit \$49.95 Wired \$64.95
- #380 Solid-State NTSC Color Generator. The first serviceman-priced. True NTSC Generator. Extremely compact weighs only 4 lbs. \$169.00 Wired Only.
- #1030 Regulated Power Supply. 0-150V @ 2ma, 0-400V up to 150ma, all to 1/2 of 1% Ripple 3mV. 6.3V & 12.6V, @ 3A. Kit \$59.95 Wired \$99.95
- #435 Direct-Coupled DC-4. 5MHz Scope. Outperforms 5" scopes 3 times its size. Kit \$99.95 Wired \$149.95
- #567 Professional V-O-M. Measures to 0.005VDC. 7DC ranges to 5KV (20,000 Ω /V). 5 DC ranges to 10A. 5db ranges. 3R ranges to 20 Meg. Kit \$34.95 Wired \$44.95
- #378 Near-Distortionless Audio Generator. 0.1% 20-20,000Hz Switch selection of frequencies from 1Hz to 110KHz. Kit \$49.94 Wired \$69.95

NAME _____

ADDRESS _____

CITY _____ STATE _____ ZIP _____

... for more details circle 111 on postcard

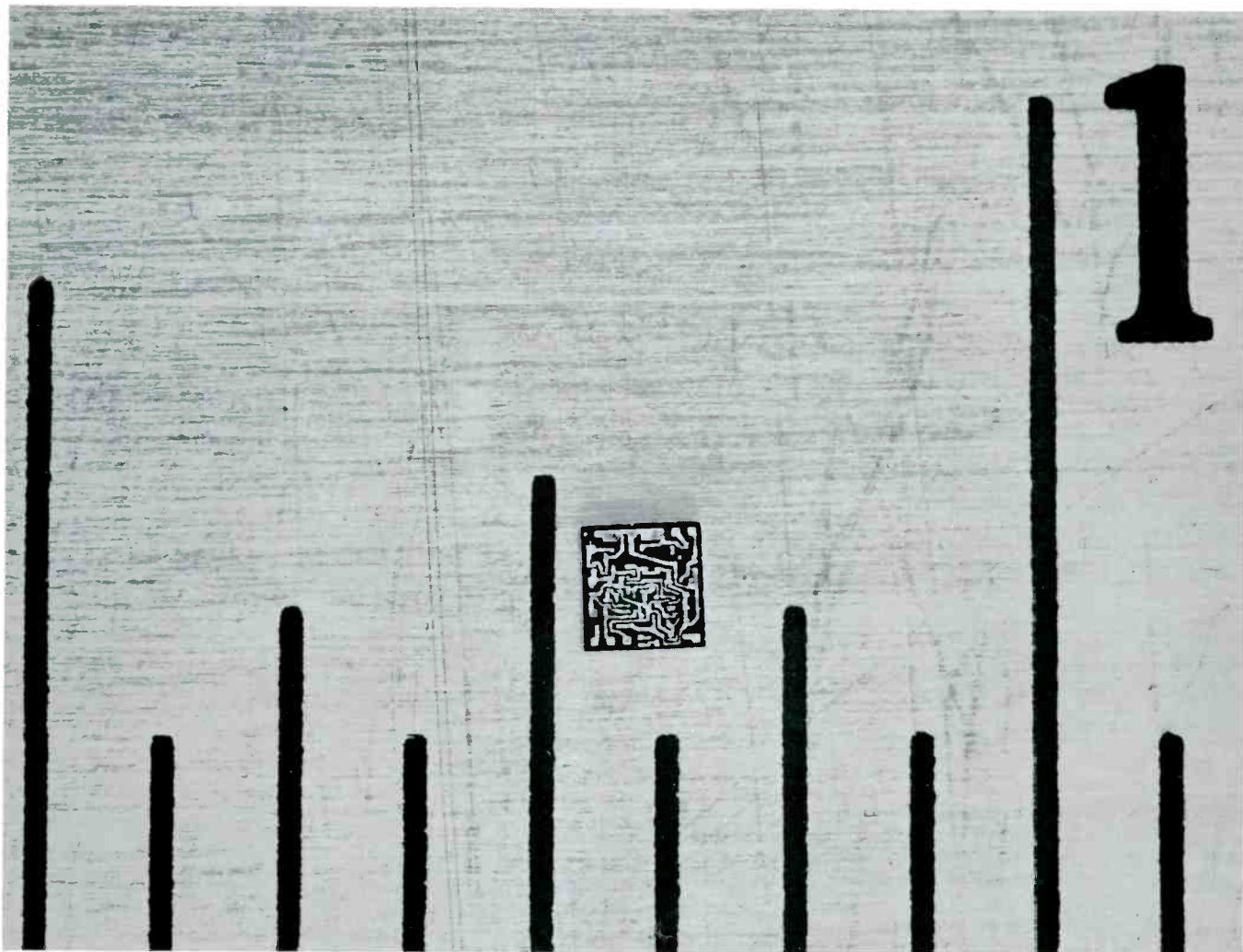

**At 1/20th of an
inch square it's
the biggest thing
in electronics**

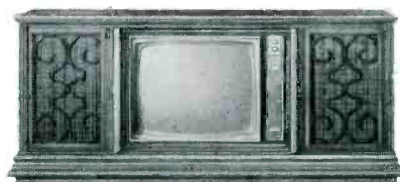

(And RCA Victor is using it now)

RCA Victor was first to use integrated circuits in home entertainment products. Why? Because the integrated circuit is the most reliable circuit ever made for a consumer product. It's made in a room continuously cleansed of microscopic particles • Computer-controlled tests assure that it functions properly • Each is firmly mounted and connected to leads by ultrasonic bonding to enhance reliability (and that's what helps you sell). See your RCA Victor distributor today.



The Most Trusted Name
in Electronics

ELECTRONIC TECHNICIAN

WORLD'S LARGEST ELECTRONIC TRADE CIRCULATION

APRIL 1967
VOL. 85, NO. 4

RON KIPP Publisher
JACK HOBBS Managing Editor
JOSEPH ZAUHAR Technical Editor
PHILLIP DAHLEN Associate Editor
DONALD GRANT Assistant Editor
RICHARD CLAYTON Field Editor
JUDITH BERINI Editorial Production
KEN McSHANE Artist
MAGGIE KANE Advertising Production
RUTH GELINEAU Circulation Fulfillment

OJIBWAY PRESS, Inc.

Ojibway Building, Duluth, Minn. 55802
AREA CODE 218 727-8511

PUBLICATIONS DIVISION:

ROBERT EDGELL President
BEN MARSH Editorial Director
HARRY RAMALEY Production Director
JIM GHERNA Art Director
LARS FLADMARK Circulation Director
WARREN BODIN Ad Production Supervisor

Sales Offices:

NEW YORK: Ron Kipp, 25 W. 45 St.
New York, N.Y. 10036
AREA CODE 212 581-4200

CHICAGO: Jack Daniels, 43 E. Ohio St.
Chicago, Ill. 60601
AREA CODE 312 467-0670



Copyright 1967 by Ojibway Press, Inc., Duluth, Minn. 55802. Reproduction and reprinting prohibited except by written authorization of the publication. Subscription price: \$5 for 1 year, \$8 for 2 years, \$10 for 3 years. Pan American and Foreign, \$9 for 1 year, \$14 for 2 years, and \$18 for 3 years.

If you have a change of address or a question about your subscription, write: ELECTRONIC TECHNICIAN, Circulation Department, Ojibway Building, Duluth, Minnesota 55802. BE SURE TO SEND ALONG THE ADDRESS LABEL FROM YOUR MOST RECENT ISSUE. Second class postage at Waseca, Minnesota and at additional mailing offices.

POSTMASTER: Send notification form 3579 to ELECTRONIC TECHNICIAN, Ojibway Building, Duluth, Minnesota 55802.

Cover

ET's editor-technicians are busy these days checking out the latest color TV circuitry and exploring new troubleshooting techniques to help you make repairs and adjustments rapidly and more accurately.

FEATURES

- A Technician Looks At G-E's 'Porta-Color' TV Receiver** 53
Part two of this article covers color demodulation and difference-amplifier circuitry and trouble symptoms
- Repairing Antenna Rotators** 58
Read this article and learn how to make more money in this area of our business
- Semiconductors from A to Z** 63
Part 9 of a continuing series which brings us into the area of integrated circuitry
- Understanding Modern AGC Circuits** 68
The first article of an in-depth series will help you understand these circuits better and how to repair them faster
- Servicing Closed-Circuit TV Equipment** 71
The first article in another series which many readers have asked for

DEPARTMENTS

Letters to the Editor	22	News of the Industry	94
Editor's Memo	30	Catalogs & Bulletins	98
Technical Digest	32	Book Reviews	100
Colorfax	76	Advertisers Index	102
New Products	82	Reader Service	103

TEKFAX — 16 PAGES OF THE LATEST SCHEMATICS

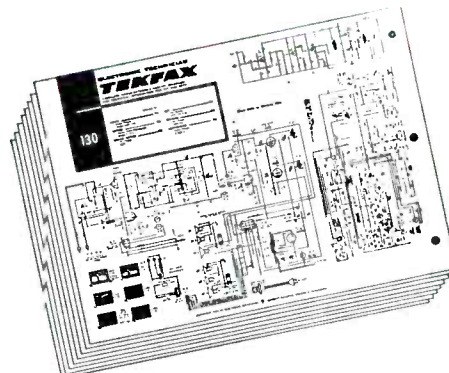

- Group 176 April • 1967
- ADMIRAL: TV Chassis G5, 2G5, 3G5, 5G5, 7G5, 9G5
- GENERAL ELECTRIC: TV Chassis DD
- MAGNAVOX: TV Chassis T923 Series
- OLYMPIC: Color TV Chassis CTC 19/21 Series
- PHILCO-FORD: TV Chassis 17NT45
- TRUETONE: TV Model 2DC1605
- ZENITH: TV Chassis 14N27

LETTERS TO THE EDITOR

Needs Info

I need an instruction manual and schematic for a Pyramid capacitor/resistor analyzer, type CRA-1. Can any reader help?

MAX OWENSBY

Northridge, Calif.

From NEA

I have noted three letters to the editor concerning interest in national service-dealer associations. More important, however, were the comments made by NEA state leaders regarding the first published inquiry (Oct. ET Letters to the Editor) at the November 12/13 board of directors meeting held here in Indianapolis. This certainly attests to the good readership your magazine has.

As I scanned the December letters, however, I had to come to the conclusion, despite what we consider to be dynamic programs (apprenticeship training under a U.S. Labor Dept. promotional prime contract; the trade's first national certified electronic technician

program for TV technicians and a public relations program to help improve the less-than-desirable present image), that we appear to be doing a lousy job of keeping this professional trade informed regarding what the national associations are doing and what the trade itself hopes to do to bring about better conditions. Certainly, between now and our February 11/12 board meeting in Cincinnati, some effort will be expended to try and do a better job to solve the problem which ET unveils.

Also, let me take this moment to let you know that I am no longer president of NEA. At our August convention new officers were elected. The new NEA president is Mr. John Betz, 211 W. 18th St., Waterloo, Iowa.

We have been subscribers to ET for several years and find it very enjoyable. Thanks for your time and interest.

DICK GLASS

Director of Training, NEA
5302 W. 10th St.
Indianapolis, Ind. 46224

• *ET has received very few letters from readers who were not aware of the existence of the two national service-dealer/technician trade organizations. We do receive hundreds of in-*

quiries regarding the addresses of the two national organizations which we answer directly. The addresses were published at this time in an effort to reduce somewhat our heavy letter-answering load. — Ed.

ED Meter

Please help me locate a schematic and parts list for an Electronic Designs Model 100 VTVM.

FELIX BARAZANA

H. Veracruz, Ver.
Mexico

• *Can any reader help? — Ed.*

Got the Info

Thanks for printing my letter in the November 1966 issue of ET. I received letters from two national service-dealer and technicians' associations. Your magazine is the best in the field.

MARVIN E. POOLEY

Mitchell, S.D.

Technician Shortage

I operate a TV sales and service business here. For the past five years it has been almost impossible to secure a competent bench technician. At present, I have been without a bench technician since September, 1966. I have advertised in all the local papers and the NEW YORK TIMES without success. I am curious as to whether this is a nationwide condition. I am also open to suggestions as to how to secure competent help.

VINCENT P. DELZIO

Daltone T.V. Service

361A Mamaroneck Ave.
White Plains, N.Y.

• *The shortage of qualified technicians appears to be generally nationwide — with some areas more critical than others. This state of affairs has come about over a long period of time for various reasons — primarily because of flaws in our educational system. Some technicians have avoided the problem by carrying out a continuing program of apprentice in-shop training. Some service-dealers are now "stealing" qualified technicians from other areas by offering higher salaries and other benefits like many large manufacturers are doing to obtain skilled engineers.—Ed.*

Saja Tape Recorder

I am looking for service data and source of parts for Saja export tape recorders. Can any reader help me?

GLENN SEATON

Cleveland, Ohio

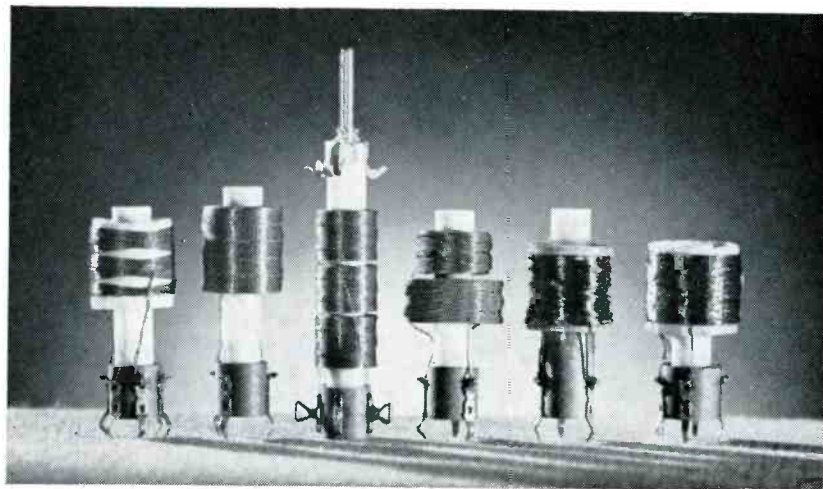

Exact Replacement Sweep Circuit Coils for More than 25 Color TV Manufacturers

Color TV exact replacements for focus, convergence and sweep circuit coils are now available for sets made by manufacturers such as RCA • Philco • Westinghouse • Muntz • Motorola. Installation instructions and diagrams are included.

Write today for Color TV Coil Cross Reference Guide.



J. W. MILLER COMPANY

5917 SO. MAIN STREET • LOS ANGELES, CALIFORNIA 90003

SEE YOUR LOCAL DISTRIBUTOR FOR FULL LINE OF RF & IF COILS, CHOKES, FILTERS & TRANSFORMERS.

... for more details circle 124 on postcard

KWIKETTE* Soldering Aids available these NEW ways...



Packet of 10
for 29¢



Package of 100
for \$2.79

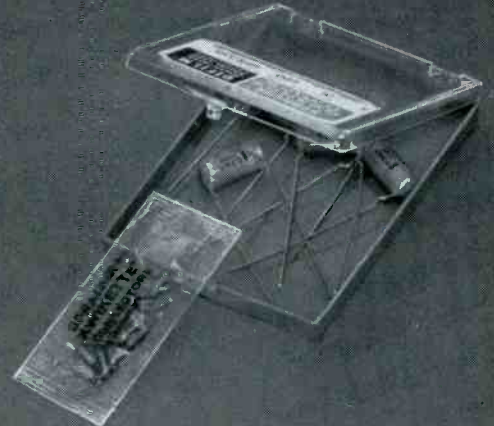

With all Sprague pre-packaged wire-lead service-type capacitors at no extra cost to you!



7x
actual
size

WIRE
FLUX
SOLDER

NOW...YOU CAN SAVE TIME, TROUBLE, AND \$\$\$\$ ON MORE SOLDERING JOBS

This is it: the revolutionary KWIKETTE that speeds component replacement . . . and practically lets you do "in-circuit" parts testing. This unique soldering aid is not just another wire spring connector. It features a Copperweld wire inner core, an intermediate layer of flux, and an outer jacket of solder . . . all you need is heat!

You can now buy KWIKETTES from your Sprague distributor in packages of 10 and 100. You'll also find them included with all Sprague pre-packaged wire-lead service-type capacitors . . . at no extra cost to you.

★Trademark

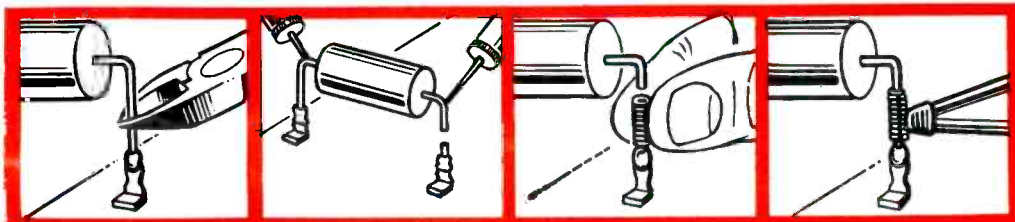

SLIP LEAD...

TEST...

SLIP ON KWIKETTE...

APPLY HEAT!

If you haven't tried KWIKETTES yet, do it now. They're the biggest boon to the service technician since the soldering gun!

**DON'T FORGET TO ASK YOUR CUSTOMERS
"WHAT ELSE NEEDS FIXING?"**



... for more details circle 136 on postcard

FIX'EM FAST!

FIX'EM RIGHT!

WITH

JENSEN

EXACT REPLACEMENT

PHONO NEEDLES

PHONO CARTRIDGES

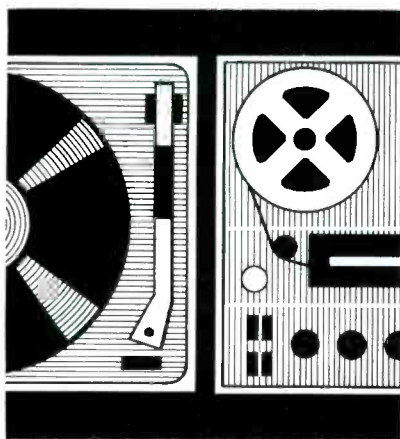

TAPE RECORDER AND PHONO DRIVE WHEELS, IDLERS, PULLEYS, BELTS, TIRES

Complete line, top quality,
all available at your
friendly Jensen
distributor's. Ask him
for your set of Jensen
catalogs, today!



JENSEN

INDUSTRIES DIVISION

ELECTRO-VOICE, INC., Dept. 478T,
663 Cecil Street, Buchanan, Michigan 49107

... for more details circle 119 on postcard

LETTERS

TO THE EDITOR

German Radio

Can anyone give me information about a German transistor radio, Schaub-Lorenz? Where can I get parts for this radio? If it is an import, perhaps the company has a service center in this country. Have received ELECTRONIC TECHNICIAN for one year and the TEKFAK have already saved me more than the cost of a subscription to the magazine.

WILLIAM KELLER

Phoenixville, Pa.

Wants More Stereo and CB

Have been reading ET for four years and I think it is a very good magazine. Let's have more articles on Hi Fi stereo and CB radio.

KEN SCHULTENBURG, SR.

Niagara Falls, N.Y.

• We have more articles planned on both subjects.—Ed.

EMC Tube Tester

Have been a subscriber and reader of your excellent magazine for a number of years and have gained untold knowledge from the many fine articles. If any reader has a schematic for an EMC tube tester, model 206, I would appreciate knowing if I can obtain a copy. Have written the manufacturer and was advised that the schematic is no longer available.

ROBERT L. WILEY

Lula, Ga.

Cash On The Line

Enclosed is my check for \$10 to renew my subscription to your fine, informative magazine for the next 3 years. I would especially like to congratulate you on your fine choice of TEKFAK in the past six issues. I had several of these new sets in for repair before any other form of technical information was available.

R. H. OSWALD

Manitowoc, Wis.

One Man Shop

You have had some fine articles on larger TV shop operations — how about a piece about the one-man TV shop? I operate on a low budget, fewer service calls — miles apart and have to fix everything from lamp cords to color TVs. Some advice on how

to work more efficiently would be very much appreciated.

R. GREENE

Topsfield, Mass.

• See the report of a one-man marine electronics operation in the January 1967 issue. The TV-radio service-dealer operations we have reported on thus far have been modest operations — not large operations. In many areas the one-man TV-radio shop is fast disappearing. Although there are ways of working more efficient, the one-man operation is limited in efficiency. A lot of one-man operations are merging into two, three or more single operations and our information is they are making more money, working less hours — eating and living better. We suppose, in some thinly populated areas, however, the one-man shop will be with us for a long time.—Ed.

Hickok Tube Tester

We have schematics and parts lists in our files as follows: 1 page schematic (has resistor and capacitor values specified). 2 pages parts list (for model 550 which is the same as 450 except with addition of a VOM). Reproductions available at 50¢ a page.

SCOTT INSTRUMENT LAB

2222 Broadway

San Diego, Calif. 92102

Needs Schematic and Alignment Data

I need a schematic and alignment data for a Commercial Trades Institute Chicago, Ill. model TV321. Also need a pulley for Tonemaster model TM-200-BKG serial U7898. Also need schematic and parts list.

D. A. STESZEWSKI

South Bend, Ind.

Kept Well Informed

I'd like to take this opportunity to express my compliments on your fine magazine. ET has kept me well informed of the constantly changing developments in the field and your color articles are just the greatest.

EDWARD WEBER

New York

Dwell Tachometer

If John Holloman of Kensington, Md. has been unable to obtain a circuit diagram of the Accurate Instruments Co. dwell-tachometer, model AT162, I can furnish him with a factory schematic.

MATTHEW GAREY

Long Beach, Calif.

continued on page 98



Thrifty-paks are back!

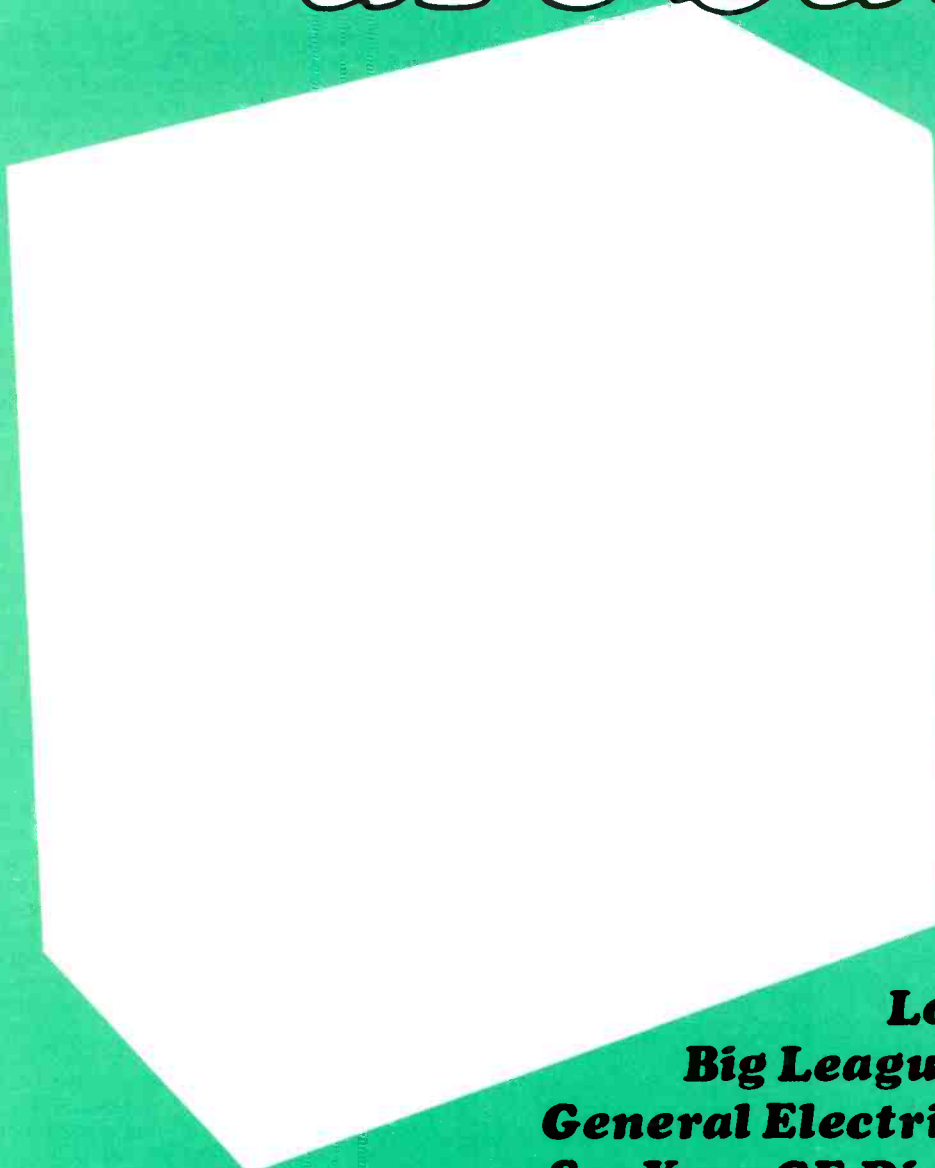

**Look for
Big League Specials* on
General Electric Color Tubes.
See Your GE Distributor Now.**

**All specials available at the option of your GE distributor.*

TUBE DEPARTMENT
GENERAL  ELECTRIC

288-06A

... for more details circle 116 on postcard

Take BOTH These Brand-

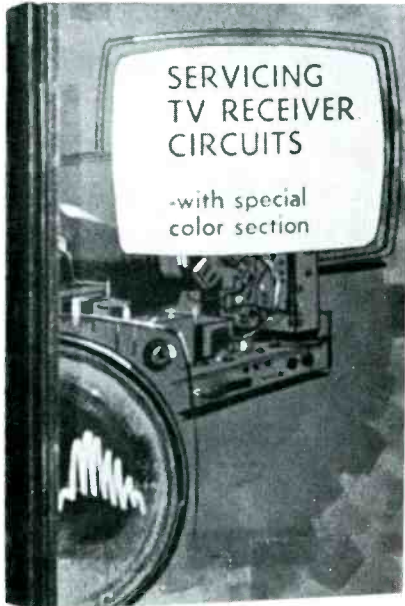

- 224 pages
- Special Color Section
- 34 FACT-FILLED Chapters
- Permanent, Hardboard Volume

PARTIAL LIST OF CONTENTS

SERVICING TV RECEIVER CIRCUITS — with Special Color Section, contains 224 pages — 34 BIG Chapters of the type of practical servicing data every TV service technician should have — expert troubleshooting techniques and solutions to the most complex circuit problems. Contains step-by-step approaches to locating and correcting defects in every section of the receiver — from tuner to picture tube, from power supply to audio output. Contains complete analyses of TV circuit troubles and solutions for sweep and sync problems, AGC malfunctions, RF and IF faults, sound and audio trouble, power supply defects, etc.

- Color Television Basics
- Basic Color TV Circuitry
- Understanding Chroma Circuitry
- Details of Color Sync Circuitry
- Details of Color Demodulation
- Blanking and Gating in Color Sets
- Color TV High-Voltage Circuits
- Color TV Servicing Equipment
- Chroma Circuit Servicing I
- Chroma Circuit Servicing II
- Color Sync and Demodulator Servicing
- Obtaining Proper Scope Waveforms
- Automatic Degaussing Circuitry
- General Color Servicing Tips
- Servicing the Horizontal Section
- Servicing the Vertical Section
- Adjusting Color Convergence
- Using Logic to Diagnose Troubles
- Developing a Methodical Approach
- Troubleshooting Sync Circuits
- Vertical Sweep Servicing Tips
- Troubleshooting Noise Circuits
- Troubleshooting AFC Circuits
- Troubleshooting Synchronizing Circuits
- Troubleshooting Multivibrators
- Troubleshooting Horizontal Sweep
- Selecting Yoke Replacements
- Solving HV Flyback Problems
- Troubleshooting B+ Circuits
- Servicing Sound and Audio Circuits
- Eliminating Unwanted Oscillations
- Understanding Transistor Circuits I
- Understanding Transistor Circuits II
- Servicing Transistor TV Circuits

An Extraordinary

Accept BOTH these

May we send you these two unique time-savers as part of an unusual offer of a Trial Membership in Electronic Technician's Book Club?

Servicing TV Receiver Circuits

Now you can have, at your fingertips, this carefully-planned, comprehensive handbook which contains the TV service data *most needed* for troubleshooting both monochrome and color receivers.

Selected by the Editorial Staff of "Electronic Technician," this brand-new volume contains just the kind of practical, down-to-earth information you can use in your everyday service work. The material—written by nearly a dozen of the leading experts in the field—is based on articles which originally appeared in "Electronic Technician." Edited and arranged to provide a quick and easy reference, emphasis has been placed on the *practical* information you can use in home or at the service bench.

Detailed, Practical Help

This detailed compilation of practical help is the answer to the need for an organized gathering of proven troubles and cures that will help you locate and correct the most elusive TV circuit faults. This practical information will help you solve your daily servicing problems . . . will save you hours of time and effort. These accurate and clear servicing descriptions are supplemented by scores of easy-to-follow schematic diagrams and illustrations.

While no one book is a cure-all for TV troubles, *Servicing TV Receiver Circuits* comes about as close as you can get. Every chapter follows the time-proven methods of experienced troubleshooters—analyzing circuit performance and applying logical and efficient test procedures. Numerous example troubles are cited to help you solve "tough-dog" problems.

Special Color Section

More than half the content is devoted to color, and includes the practical background theory needed to troubleshoot and repair today's complex color TV receivers. A full 10 Chapters are devoted to step-by-step color TV servicing techniques, complete with test procedures, waveform photos, and trouble-correction techniques. While experience is the best teacher, an occasional re-reading of a Chapter or two when you're faced with a "tough-dog" set will make this book invaluable to you in servicing TV receivers.

BOTH these unique books
(Combined List Price \$13.90)

yours for only **\$1.79**
... with Trial Membership in the Club

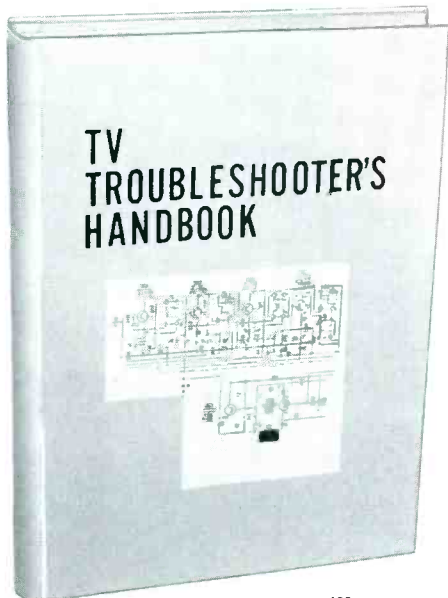

- 192 pages
- Special Color Sections
- Permanent, Hardboard Volume
- Over 350 solutions to "tough dog" problems
- Over 125 schematic diagrams & illustrations

Partial List of Contents

TV TROUBLESHOOTER'S HANDBOOK contains over 350 proven servicing items describing "tough dog" problems and their solutions. For ease of use, these helpful trouble cures are arranged by manufacturer & model number. And, a special section concentrates on color set servicing.

These tried and tested troubleshooting aids constitute a vital reference source of servicing techniques and will help make your own work easier and more effective. Circuit faults and solutions are included for these manufacturers:

B&W SETS	EMERSON-DUMONT
RCA VICTOR	GAMBLE
GEN. ELECTRIC	SKOGMO
PHILCO	
SYLVANIA	COLOR SETS
WESTINGHOUSE	RCA VICTOR
MAGNAVOX	SYLVANIA
MOTOROLA	GEN. ELECTRIC
ZENITH	ZENITH
ADMIRAL	PHILCO
EMERSON	MAGNAVOX
CURTIS-MATHES	MOTOROLA
HALLI	OLYMPIC
CRAFTERS	SETCHELL
CORONADO	CARLSON
TRUETONE	WESTINGHOUSE
SYMPHONIC	ADMIRAL
SILVERTONE	

New Books For Only \$1⁷⁹

Offer...introducing the benefits of Electronic Technician's Book Club
invaluable NEW Servicing Handbooks for only \$1.79 . . . with trial Club Membership

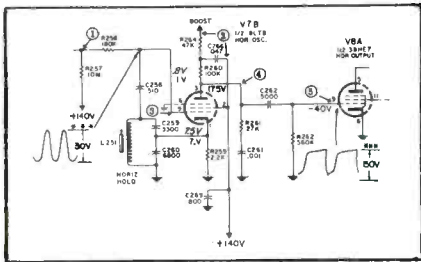

Literally scores of easy-to-use schematic diagrams are contained in both these new books. (Example shown greatly reduced in size)

TV Troubleshooter's Handbook

Here are helpful techniques which are a complete digest of late-model TV receiver troubles and cures, compiled strictly on the basis of their usefulness to you!

This practical compilation of servicing help contains data on new and unusual circuits and descriptions of how they work, field and factory changes, recurring defects, etc.

These accurate and clear servicing descriptions are supplemented by over 175 easy-to-follow schematic diagrams and illustrations. For ease of use, all troubles have been logically organized by manufacturer and model number.

A Special Section on color TV describes recurring defects and cures, and includes service hints for troubleshooting chroma circuits, short cuts for making convergence adjustments, descriptions of new circuits, etc.

Assembled for the first time in book form, *Servicing TV Receiver Circuits* and *TV Troubleshooter's Handbook* are handsome, hardbound books, indicative of the many other fine offerings made to Members . . . important books to read and keep . . . volumes with your specialized interests in mind.

How You Profit From Club Membership

This is just a sample of the help and generous savings the Club offers you. For here is a Club devoted exclusively to seeking out only those titles of interest to you as an electronic technician (no hobby or "fringe" books are offered). Membership in the Club offers you several advantages:

1. Charter Bonus: *Servicing TV Receiver Circuits* and *TV Troubleshooter's Hand-*

book carry publisher's retail price of \$13.90. But they can be yours for only \$1.79 with your Trial Membership.

2. Continuous Savings: The Club guarantees to save you 15% to 75% on the books you need.

3. Editorial Advisory Services: The Club's Editorial Advisory Board selects *only* the important books of direct interest to you.

4. Wide Selection: Members are annually offered over 50 of the authoritative books on all phases of electronic servicing. The Club makes it a point to offer new books, along with standard classics . . . lists books from *all* publishers — not just one or two.

5. Prevents You From Missing New Books: The Club's FREE monthly *News* gives you advance notice of important new books . . . books vital to your continued professional advancement.

This extraordinary offer is intended to prove to you, through your own experience, that these very real advantages can be yours . . . that it *is* possible to keep up with the professional literature published in your specific area of interest . . . and to save substantially while so doing.

How the Club Works

Forthcoming selections are described in the FREE monthly *Club News*. Thus, you are among the first to know about, and to own if you desire, significant books. You choose only the main or alternate selection you want (or advise if you wish no book at all) by means of a handy form and return envelope enclosed with the *News*. As part of your Trial Membership, you need purchase as few as four books during the coming 12 months. You would probably buy at least this many anyway . . . without the substantial savings offered through Club Membership.

Limited Time Offer!

Here, then, is an interesting opportunity to enroll on a trial basis . . . to prove to yourself, in a short time, the advantages of belonging to the only Book Club devoted *exclusively* to electronic servicing. We urge you, if this unique offer is appealing, to act promptly, for we've reserved only a limited number of Handbooks for new Members.



Typical Savings Offered Club Members on Recent Selections

Transistors: Principles & Applications,	Pub. pr. \$6.95, Club pr. \$3.95
Basic Television,	Pub. pr. \$11.95, Club pr. \$8.95
Practical Oscilloscope Handbook,	Pub. pr. \$6.95, Club pr. \$4.95
CATV System Engineering,	Pub. pr. \$12.95, Club pr. \$7.95
TV Troubleshooting & Repair,	Pub. pr. \$6.95, Club pr. \$3.95
10-Minute Test Techniques for Electronic Servicing,	Pub. pr. \$6.95, Club pr. \$3.95
Advanced Servicing Techniques, Vol. 1,	Pub. pr. \$8.25, Club pr. \$5.95
Repairing Home Audio Systems,	Pub. pr. \$7.25, Club pr. \$5.95
Reference Data for Radio Engineers,	Pub. pr. \$6.00, Club pr. \$5.00
Fundamentals of Transistors,	Pub. pr. \$12.00, Club pr. \$9.95
Basic Mathematics for Electronics,	Pub. pr. \$10.75, Club pr. \$8.50
Principles of Applied Electronics,	Pub. pr. \$7.50, Club pr. \$6.50
Technical Television,	Pub. pr. \$14.65, Club pr. \$5.95
Profitable Television Troubleshooting,	Pub. pr. \$7.95, Club pr. \$5.95
Electronic Troubleshooting,	Pub. pr. \$12.50, Club pr. \$9.95
Color Television Fundamentals,	Pub. pr. \$10.95, Club pr. \$7.95
Advanced Servicing Techniques, Vol. 2,	Pub. pr. \$5.95, Club pr. \$4.75
TV Technatics '65 (2 Vols.),	Pub. pr. \$19.90, Club pr. \$13.50
TV Technatics '66 (2 Vols.),	Pub. pr. \$19.90, Club pr. \$13.50
Basic Radio Repair,	Pub. pr. \$5.95, Club pr. \$4.75

To start your Membership on these attractive terms, simply fill out and mail the postage-paid Airmail card today. You will receive *Servicing TV Receiver Circuits* and *TV Troubleshooter's Handbook* for 10-day inspection. SEND NO MONEY! If you are not delighted with these quality hardbound books, return them within 10 days and your Trial Membership will be cancelled without cost or obligation. Electronic Technician's Book Club, Drawer D, Thurmont, Md. 21788.

SEND NO MONEY!

Simply fill in and mail postage-paid Airmail card today!

... for more details circle 144 on postcard

SEE YOUR ELECTRONICS PARTS DISTRIBUTOR:

Weller® for every soldering job

Pencil Soldering Irons by Weller



"Marksman" Kit with pencil soldering iron; screwdriver, cone and chisel tips; handy soldering aid and a supply of solder. **\$444** list
Model SP-23K.



"Marksman" Iron at popular price. Stainless-steel long-reach barrel. 1/8" replaceable tip. Maximum tip temperature, 750°F. **\$298** list
Model SP-23.



Weller Iron is industrial rated, highly efficient. Does work of bigger irons. Only 7 7/8" long including the tip. 25 watts. 115 volts. **\$520** list
Model WP-S.

Temperature Controlled Soldering Unit

For universal hobby soldering, including heavy-duty metal work. Temperature control is in the tip. Interchangeable tips give a choice of 500°F, 600°F, 700°F and 800°F controlled temperatures. Operates on 24 volts. Complete with 3/16" 700°F tip and 60 watt, 120 volt, 50/60 cycle power unit with soldering pencil stand and tip cleaning sponge attached. **\$2600** list
Model W-TCP.



Dual Heat Soldering Guns

100/140 Watts. Two trigger positions let you switch instantly to high or low heat to suit the job. Tip heats instantly and spotlight comes on when trigger is pulled. Tip has exceptionally long reach. **\$695** list
Model 8200.

145/210 Watts. A professional model with all Weller gun features: instant heat, dual heat, spotlights. **\$995** list
Model D-440.

240/325 Watts. Heavy-duty model with all Weller gun features: instant heat, dual heat, spotlights. **\$1095** list
Model D-550.



Dual Heat Soldering Gun Kit

Includes Weller 100/140 watt dual heat gun, 3 soldering tips, tip-changing wrench, soldering aid, flux brush, supply of solder . . . all in a colorful utility case of break-proof plastic. **\$895** list
Model 8200PK.



Heavy-Duty Soldering Gun Kit

Features Weller 240/325 watt dual heat gun; tips for soldering, cutting and smoothing; tip-changing wrench; solder; metal-tone utility case of break-proof plastic. **\$1295** list
Model D-550PK.



Utility Grade Solder On Hang Cards 5 feet of 40/60 alloy solder in each pack. Acid core, AC-40. **39¢** list
Rosin core, RC-40.



Superior Grade Solder In Dispenser Tubes 10 feet of 60/40 alloy rosin-core solder in each tube. **59¢** list
Number RC-60.

EDITOR'S MEMO

'Formula Kick'

Some people are always looking for sure things, absolute solutions to problems — formulas, or panaceas, that fit every situation that may arise in the world.

And there are some other people who never worry about problems. They are too busy finding solutions. In fact, they deal primarily with solutions that have no problems. Like the politician, for example, who thinks he can mold a higher order of human moral fiber by passing a special law.

The old bull-whip is often the politician's idea of a formula to the orderly process of human evolution. His formula may be a solution to some existing problem, but it certainly doesn't fit *this* problem. Almost every grammar-school child today knows that you can't legislate human morals.

Nor do we believe that the primary ills of our industry can be eliminated by licensing laws. We believe the self-cleaning, self-governing, self-certifying process supported by some of the service-dealer associations in this country will do the job faster and more effectively.

This solution is not a formula. It is a basic theory that has guided mankind up the ladder of progress since the day when the first two cave-men ceased to be rugged individualists, pooled their two clubs, and chased edible meat together.

It is a tested process which grows with the needs of the hour—it can be quickly revised, improved and amended to meet the inevitable changes that are now taking place and will continue to take place in a fast-changing world.

It is a method that will receive the maximum support of the largest possible number of those concerned — because it is *their* solution to their problem — a problem which they are more aware of and more sincerely concerned with than anyone else. What do the politicians know about our problems? What do they care about them?

We cannot afford to have our energies diverted up muddy jungle streams by twentieth-century snake doctors and pseudo-metaphysicians who have axes to grind.

Coming technological changes will soon need all our energies. We have no time to waste on panaceas. Let's get no time to waste on panaceas. Let's get off the "formula kick."

WELLER ELECTRIC CORPORATION, Easton, Pa.
WORLD LEADER IN SOLDERING TECHNOLOGY

... for more details circle 140 on postcard

Will the coming age of solid state TV catch you half ready?

Not if you take advantage of our new
"Professional Technician Program." Read on
and see how Motorola's "PTP" can help.

Home entertainment products are changing—fast. There's more transistorization . . . and more advanced solid state technology each year. This means great opportunity for service organizations that keep abreast, because, well-informed technicians will be in even greater demand than they are now.

Motorola can help your service department be well prepared.

We have recently increased our staff of field technical personnel. It is their job to help provide you with Technical information for your men and to give some of the training your men will need to cope with this rapidly changing industry.

Each of our technicians has

had extensive, practical consumer experience. They know their business—from your side of the fence. The training will be done *right in your place of business*. It will provide a valuable adjunct to the large-scale training meetings held by Motorola Regional Service Managers &

Motorola Distributors. Two hours will be spent in formal training. The remainder of the day will be spent working with your men *on your work* to give information—and to help find ways to make more profitable and productive use of service time.

Get full information on availability of this training for your shop. Just call your Motorola Distributor.

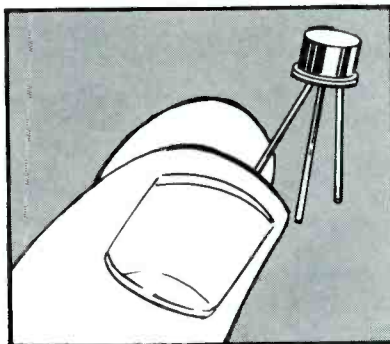

 **MOTOROLA**

... for more details circle 125 on postcard

TECHNICAL DIGEST

ADMIRAL

TV Model TKE-3011—Audio Output Tube Replacement

The new educational TV receiver TKE3011 will use a 6BY11 audio output tube to obtain the specified 3w (EIA standard) audio output. At present the tube is only available from Admiral distributors.

Emergency replacements can be made with the 6BF11 tube used in current entertainment type sets. The output will be sharply reduced, to about 1w, which could be unsatisfactory for classroom use.

If you are called on to service any of these educational TV sets, be sure you have this tube on hand.

GENERAL ELECTRIC

TB Chassis—Audio Distortion

Audio distortion, resembling a "raspy" speaker, has been reported from some areas. This has been traced to crossover distortion occurring in Q15 and Q16 because of component tolerance buildup.

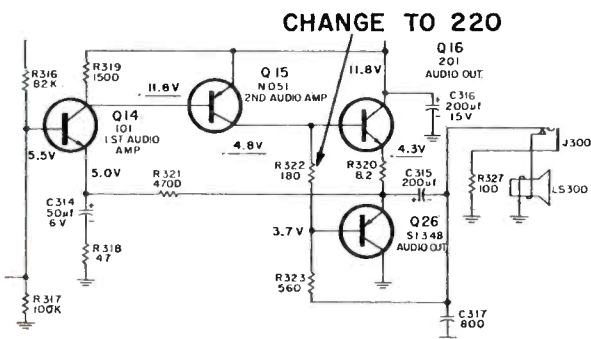

The correction is to replace R322 $180\Omega \pm 10\%$ with a $220\Omega \pm 10\%$ $\frac{1}{2}w$ resistor. If a 10% tolerance resistor is not readily available, select the proper value using an accurate ohmmeter.

Do not increase the value of R322 over 240 Ω or the ratings of the output transistors will be exceeded.

OLYMPIC

TV Chassis NCP, NDP—Horizontal Oscillator Modification

The NCP and NDP chassis employ an 8FQ7 tube as a horizontal oscillator which has a wide range of dynamic operation.

When a replacement of this tube is required, the new tube may throw the horizontal frequency out of control range. This may also happen if the tube or components in the circuit age.

Compensation in the horizontal oscillator circuit was required in the past. Varying the value of R149 and R151 resistors, was good for the immediate tube change, but not a permanent cure.

Modification has been made on the horizontal circuit to employ an additional control, not available before. The control allows setting of the horizontal hold control to its mid-position under all conditions encountered with various 8FQ7 tubes, when the horizontal sweep circuit is adjusted as follows:

Allow a two minute warm-up, tune in a station.

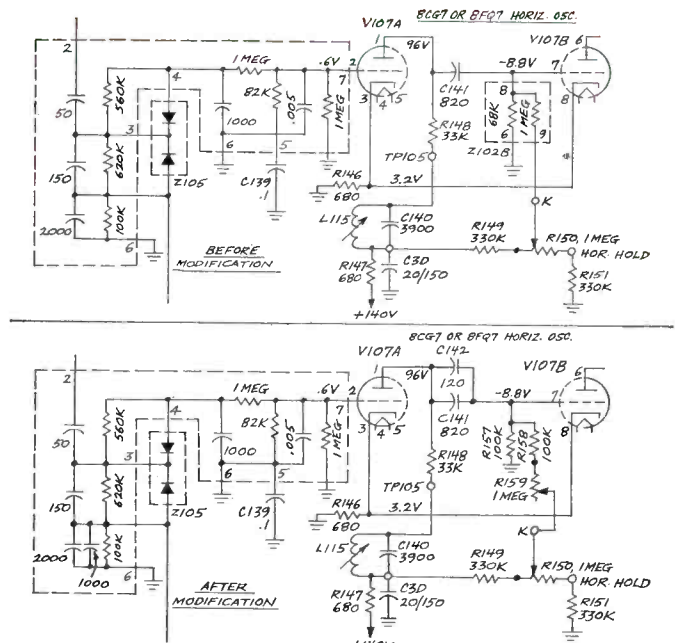

Short out the horizontal frequency coil (L115), by jumping TP-105 tie point to the -140v terminal.

Connect a clip lead from TP-104 to ground, to disable the horizontal sync input.

Adjust the horizontal hold control to mid-position, adjust the new control until the picture is near locked-in.

Remove jumper from L115 and adjust L115 until picture is in sync. Remove clip lead from TP-104 and ground allowing station sync signal to reach the horizontal circuits.

In production this control will be labeled "H. BAL." (horizontal balance), and will be located directly above and on the same plate as the horizontal hold control.

The control and its associated circuit can be added in the field, by installation of modification kit PP35557, which has installation instructions enclosed.

The kit is available at \$2.50 list, and consists of the following parts:

- | | |
|-------------------------------|----------------------------|
| 1 Potentiometer | 1M $\frac{1}{2}w \pm 30\%$ |
| 2 Resistors | 100K $\frac{1}{2}w$ |
| 1 Capacitor | 120pf N1500 |
| 1 Capacitor | 1000pf 1kv $\pm 20\%$ |
| 1 Terminal strip, double lug, | stand-off |

PHILCO-FORD

High Fidelity Console Models N-P-Q Line—Noisy Loudness Controls

If static or noisy audio is heard through the speaker system on the mentioned models, when the metal control knob is touched, juggled, or rotated, use a compression spring over the control shaft between the knob and control bushing to provide an improved ground between the knob and control shaft.

To reduce or minimize the condition proceed as follows:

1. Remove metal loudness control knob.
2. Place spring over shaft.
3. Replace loudness control knob.

Suggested spring Part #28-14692-1 or equivalent.



RCA
 Transistors
 Rectifiers
 Integrated
 Circuits
 For
**EXPERIMENTERS
 HOBBYISTS
 HAMS
 and
 TECHNICIANS**

LOOK FOR THIS
 DISPLAY AT YOUR
 RCA DISTRIBUTOR

Here displayed on the RCA Solid-State Center is the RCA SK-Series Transistors, Rectifiers, and Integrated Circuits; the new RCA 3N128 MOS Field-Effect Transistor; RCA's 40214 Silicon Stud Rectifier; and three RCA Experimenter's Kits. This new Solid-State Center, in addition to its host of devices, also includes technical literature to support the devices right on the rack. It's the "one-stop" answer to the solid-state needs of experimenter, hobbyist, ham, or the replacement requirements of the service technician.

All devices and kits are packaged in easily identifiable see-through packs for your convenience. Included with each device is broad performance data or specific ratings and characteristics where applicable.

RCA Solid-State Center Includes:

- RCA Experimenter's Kits. Three kits enable you to build a light dimmer or any one of 14 different circuits for dozens of applications around the house.
- RCA SK-Series "Top-of-the-Line" Devices: 17 Transistors, 2 Rectifiers, and 2 Integrated Circuits, for exper-

imenter or replacement use.

- RCA Technical Manuals. Four manuals include: RCA Experimenter's Manual, RCA Transistor Manual, RCA Linear Integrated Circuits Fundamentals Manual, and RCA Tunnel Diode Manual.
- RCA Solid-State Replacement Guide. Lists all RCA SK-Series "Top-of-the-Line" Transistors, Rectifiers, and Integrated Circuits and the more than 7,300 types which they replace.

Keep RCA Experimenter's Kits and the RCA SK-Series in mind when you're shopping for solid-state devices. Look for the RCA Solid-State Center. Now at your RCA Distributor. Do it today!

RCA Electronic Components and Devices, Harrison, N.J



The Most Trusted Name in Electronics

... for more details circle 133 on postcard

Color them green

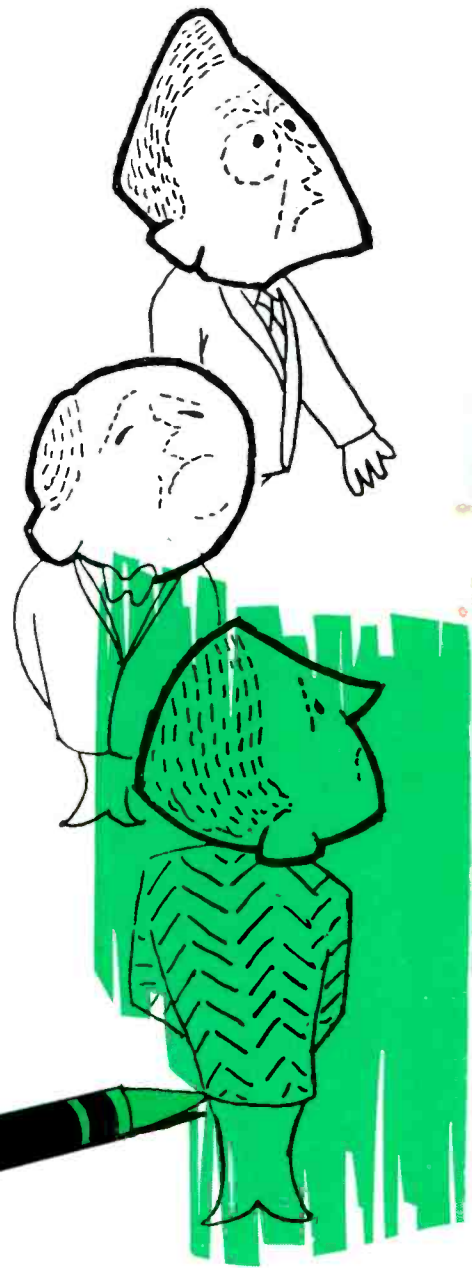

Channel Master's Crossfire Antenna Series has

...More dealers prefer Channel Master to any other brand (2 to 1 by survey of leading trade magazine).

...More have been sold (and are still being sold) than any other antenna in the history of television. And dealer acceptance is still growing.

...More dealers bought Crossfire antennas in January and February than in any previous first two month period.

No wonder other antenna manufacturers try so hard to re-work their own designs along the famous Channel Master

Crossfire lines.

But it just can't be done.

Legally, the Crossfire series is protected by five U.S. patents or patents pending.

And, in terms of mechanical and electronic design, the Crossfire series maintains a standard that has never been equalled.

Take mechanical design, for instance. Crossfire antennas have weathered six tough winters, verifying structural superiority originally proven in wind tunnel tests at the University of Miami hurricane test labs. Channel Master dealers ...who have just recorded the biggest

first-two-months Crossfire sales in history...can tell you many of those antennas went up to replace less rugged makes that couldn't take the winter storms.

Most, of course, were teamed up with new set sales to meet the critical demands of color reception. Because, when it comes to electronics, Channel Master Crossfire Series antennas set the industry pace for clean, crisp color as well as outstanding black and white and FM Stereo.

In seven VHF models of Color Crossfires, electronic leadership takes the form of Proportional Energy Absorption

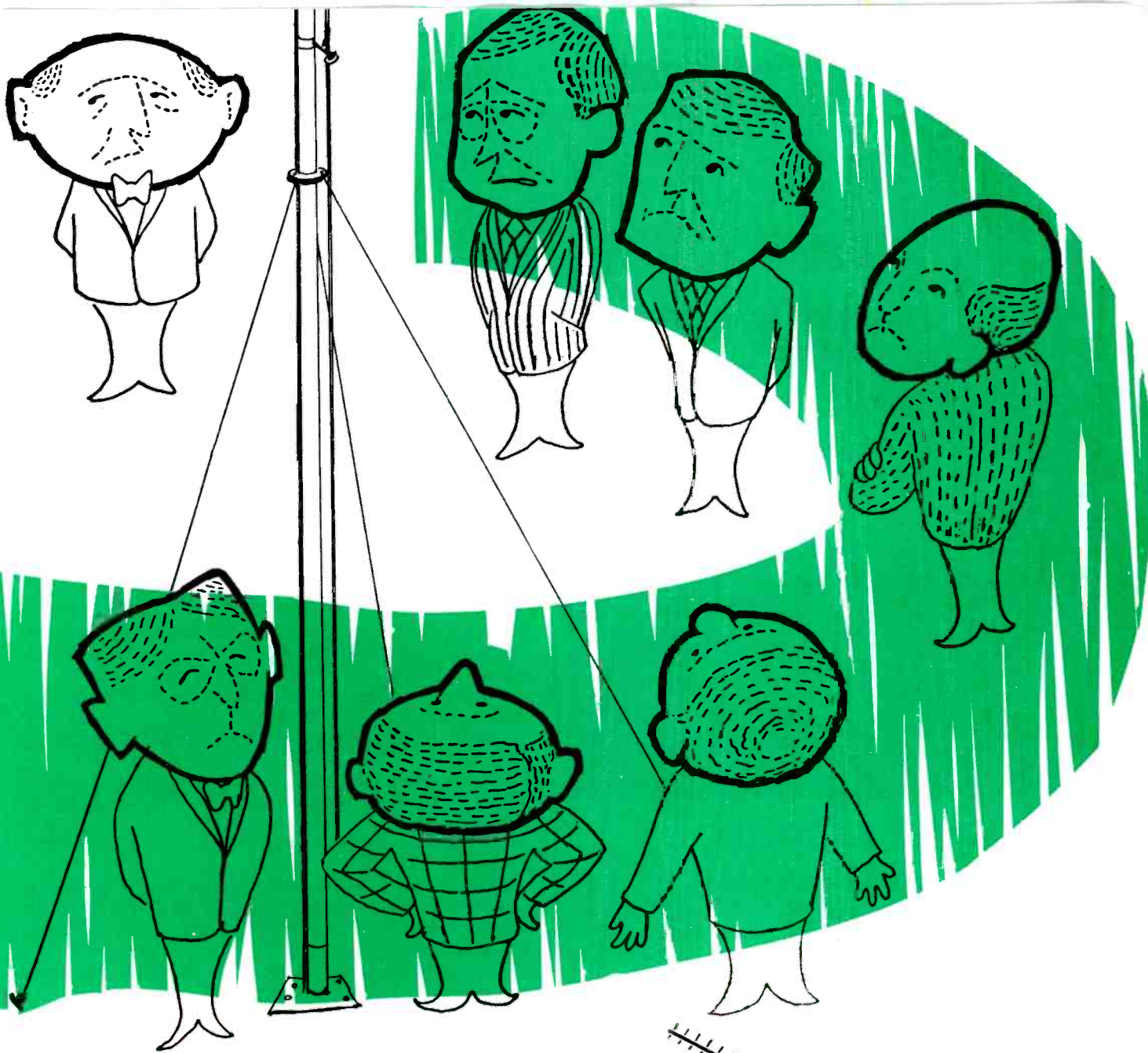

our competition green with envy.

and gain-boosting Tri-Band Directors. Then there are the 82-channel Ultradyne Crossfires...6 of them...with the most advanced, self-coupling, UHF section ever developed, plus all the Color Crossfire features. Finally, the Coloray group provides television's first electronic ghost-killing service in an 82-channel model and two VHF/FM models. All are finished with Channel Master's famous golden E.P.C....the coating that has been adopted by the military

because of its weather protection.

Channel Master dealers know green is the color of envious competition. But they also know green is the color that lines their cash drawers when they meet the critical demands of Color head on with Channel Master Crossfire Antennas. Only Channel Master gives dealers full profit...then protects that profit from mail order and discounter inroads.

Color your cash drawer green. Call your Channel Master Distributor.

Ultradyne Crossfire
Model 3634-G

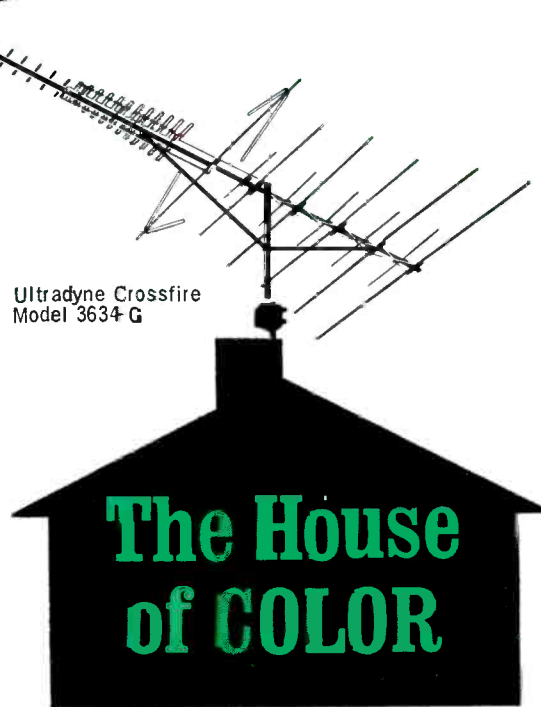

CHANNEL MASTER®

ELLENVILLE, N.Y.

© 1967 Channel Master Corp.

... for more details circle 109 on postcard

NEW! Portable Instruments For School or Lab

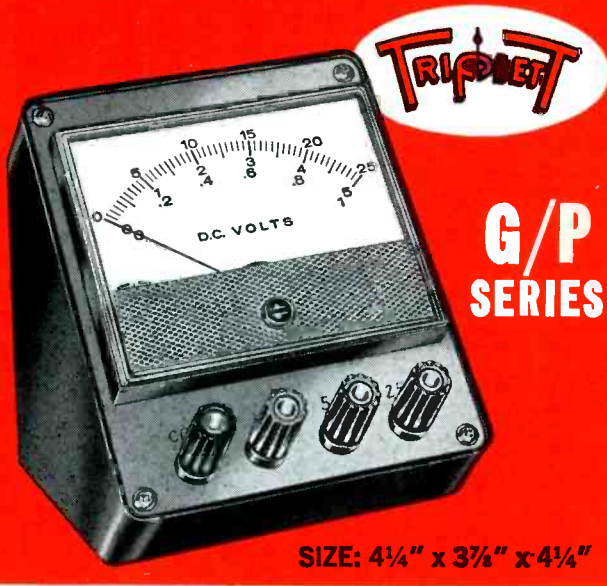

SIZE: 4¼" x 3⅞" x 4¼"

FACTS MAKE FEATURES:

- 1** Wide clear view plastic meter, with Bar-Ring DC movements.
- 2** Overload protection on all models. (Diodes on DC, Fused AC)
- 3** Unbreakable molded black plastic cases with aluminum panels.

- 51 Standard ranges available in 22 units.
- ±2% accuracy on DC and AC Iron Vane Type.
- ±3% accuracy on AC Rectifier Type and Ohms.
- Wide clear view plastic panel instrument.
- Bar-Ring construction in DC movements assures self-shielding.
- Five-way binding posts.
- Knife-edge pointers.
- Diodes protect against instantaneous overloads on DC movements.
- AC movements are fuse protected.
- Unbreakable black molded plastic case.

Now you can make all types of electrical measurements right in your own lab or shop set-up with these economically priced portable instruments. Rugged case and movement construction safeguards against rough handling. Overload protection of all models guards against electrical damage from misuse.

These instruments are of the highest quality and contain the craftsmanship of more than 60 years of instrument manufacturing. The G/P Series are perfect for complete shop set-up . . . breadboard wiring devices . . . supplement limited training devices . . . production line checking . . . professional lab use.

TRIPLETT ELECTRICAL INSTRUMENT CO., BLUFFTON, OHIO

. . . for more details circle 138 on postcard

TECHNICAL DIGEST

PHILCO-FORD

SS-45 and SS-45, Code 126 Extension Speakers—Converting 3-Prong Plug to Common Phono Plug

The SS-45 extension speaker was early-production used with "P" line high fidelity merchandise. The connector on the end of the extension cable uses a regular single prong phono plug.

The SS-45 Code 126 extension speaker is later-production used with high power output "Q" line high fidelity merchandise. The connector on the end of the extension cable is a special 3-prong plug to match the associated

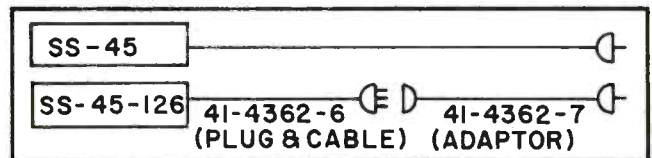

extension speaker socket on "Q" line 300w models which has sufficient power output to damage the smaller speaker assembly, SS-36.

When used with "P" line and lower power "Q" line models.

SS-45 is already equipped with proper single prong plug.

SS-45, Code 126 has an adaptor plug #41-4362-7 packed in shipping carton with speaker assembly (Converts 3-prong to common phono plug).

When used with high power "Q" line models (Q-1799, 1795 and 1793).

SS-45 needs a 3-prong plug instead of a single prong plug the assembly comes equipped with. There is no adapter available, so to use the early production SS45 you must do the following:

Install a 3-prong plug (#54-4878) on end of the extension cable, or, replace extension cable and plug assembly with #41-4362-6.

GENERAL ELECTRIC

Tape Recorder Model TP1100B—Bias Oscillator Transistor and Record Lamp Failure

When there is an absence of bias and erase voltage and the record lamp does not light, the following condition may exist:

The bias and erase oscillator transistor Q9 (EA1135) developed a collector-to-emitter short, causing full power supply voltage of 21.5v to appear across the record lamp. The record lamp will glow very brightly for a short period before the filament opens.

When this trouble occurs, replace bias/erase oscillator transistor Q9 and record lamp.

If one junction of Q9 should open preventing Q9 from conducting, the symptom would be as stated here, however, it would not be necessary to replace the record lamp bulb.

PHILCO-FORD

TV Chassis 17JT41, 17LT43, 17NT45—Run Change Information

17NT45 Run #2 Panel and 17JT41, 17LT43 Run #7 Panel.

TECHNICAL DIGEST

IF 150K CHANGE
TO 390K

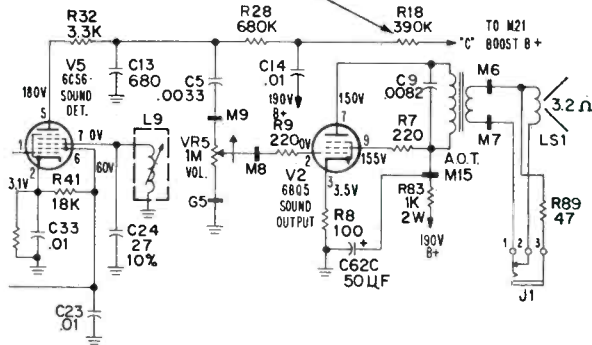

To improve hum rejection in the audio output stage, resistor R18 in the audio detector plate has been changed from 150K to 390K.

17NT45 Run #2 panel will be identified by a red dot on the panel.

17JT41 and 17LT43 run #7 panels will be identified by a violet dot on the panel.

How To Tighten Grille Cloth

From time to time we have had requests for informa-

tion on how to repair the grille cloth that sags on one corner possibly because of moisture or temperature conditions in the home. The following is a suggested procedure which can be used to tighten this sagging cloth.

A. For plastic grille cloth or combination plastic and cotton grille cloth.

1. At a distance of approximately 10in., pass a heat lamp (250w) back and forth across the affected area of the cloth until it tightens.

CAUTION: Do not allow the heat to concentrate in one area too long as the material will scorch.

B. For cotton grille cloth.

1. Mix in a container 1 part water and 1 part Isopropyl
2. Place mixture in an atomizer.
3. Dampen affected area with atomizer.

(If an atomizer is not available, the cloth may be dampened by flicking the mixture on the cloth with a small brush).

4. Use a heat lamp to dry the cloth.

(Use the same procedure as outlined for plastic grille cloths). If sagging is still present after drying, repeat the dampening and drying process.

Courtesy service training department, Magnavox.

Old Schematics

Supreme Publications offers to send promptly by mail most radio schematics for \$1 each which go back to the 1930's. Try them: Supreme Publications, 1760 Balsam Rd., Highland Park, Ill.

BE SUSPICIOUS

DON'T WAVER

IF IT SAYS BELFUSE...YOU CAN TRUST IT

**NO MATTER WHAT ELSE
YOU SEE OR HEAR
YOU RUN A RISK
IF YOU DON'T SEE**

"BELFUSE"

**THE ONLY CHEMICAL FUSE
USED BY
LEADING
SET MANUFACTURERS**

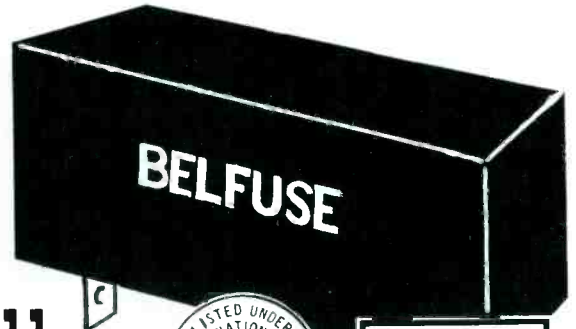

**"BELFUSE" ..
supplied exclusively by**

GC ELECTRONICS Division of Hydrometals, Inc.
MAIN PLANT: ROCKFORD, ILLINOIS, U.S.A.
HICKSVILLE, L.I., N.Y. LOS ANGELES, CALIF.

... for more details circle 115 on postcard
... for more details circle 141 on postcard →

Winegard Introduces Super Compact Total Design Electronic SUPER COLORTRONS

Five 82-Channel Models
Four VHF/FM Models
Three UHF Models

...so revolutionary in design and concept,
they have 7 patents and patents pending

82-Channel Super Colortron
Model SC-82; \$54.95

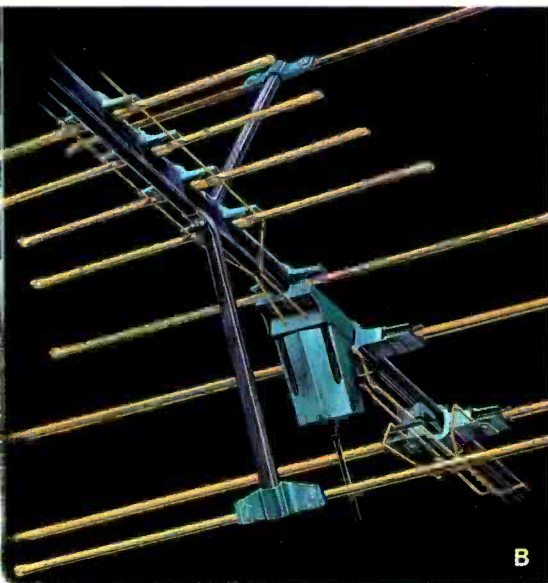
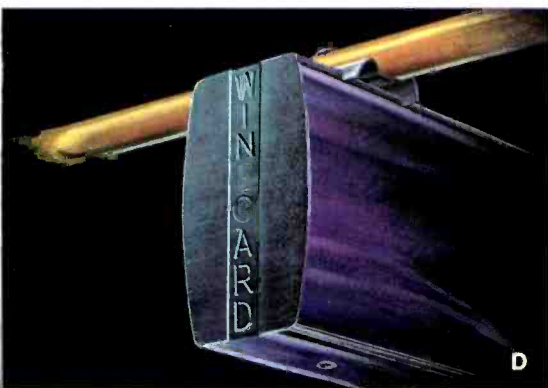

The World's First Total Design Antennas

New antennas come and go. But there's never been an antenna like the amazing Winegard Super Colortron. 12 models in all—totally designed with more exclusive electronic, construction and performance features than all other antennas combined. It's taken us a while to create and develop and perfect the Super Colortron. But it was worth the time. See for yourself. Read about the Super Colortron's exclusive features. Then call your Winegard distributor. Or write for full color, 8-page brochure.

(A) Total Design

Cartridge Pre-Amps:

Exclusive solid state, instant-loading cartridge pre-amps drop into totally enclosed, weatherproof cartridge housing at point of signal interception. Models for 82-channel (VHF-UHF) antennas, VHF only, UHF only—plus a color spectrum filter. Custom-match the Super Colortron to any reception requirements.

Total Design

Impedance Correlators:

Exclusive impedance correlators (2 patents pending) automatically increase 75 ohm driven elements to 300 ohms to provide 100% signal transfer from antenna to set. Enables antenna to be 20% more compact!

(B) Total Design

Vertical Resonant Reflectors:

Exclusive UHF vertical resonant reflectors achieve highest realizable gain on channels 14-83 because of exceptionally large vertical capture area. More UHF gain than any other 82-channel antenna design.

Total Design

Electro-Lens Director System:

Exclusive patented Electro-Lens system (U.S. Patent 2,700,105; Canada 511,984) absorbs entire signal and focuses it directly onto the driven elements to give Super Colortrons pinpoint directivity.

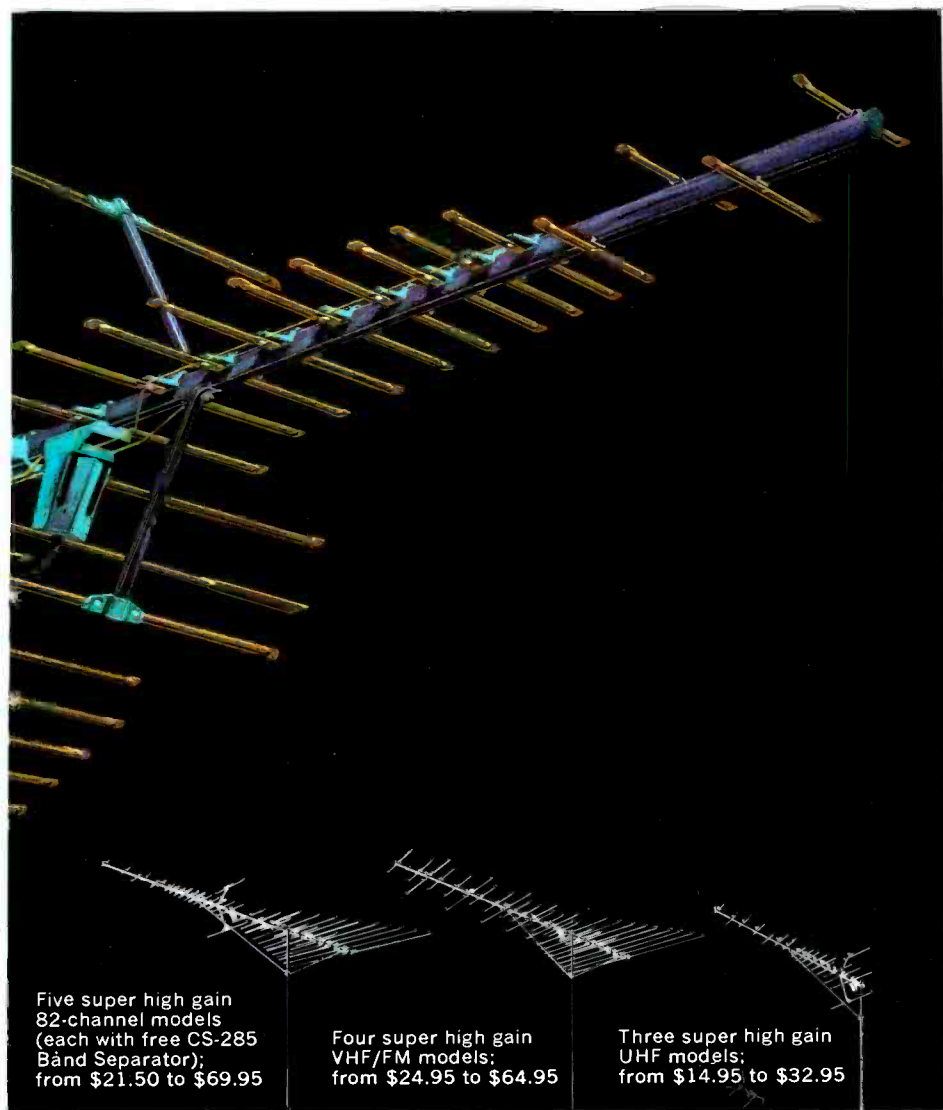

Five super high gain
82-channel models
(each with free CS-285
Band Separator);
from \$21.50 to \$69.95

Four super high gain
VHF/FM models;
from \$24.95 to \$64.95

Three super high gain
UHF models;
from \$14.95 to \$32.95

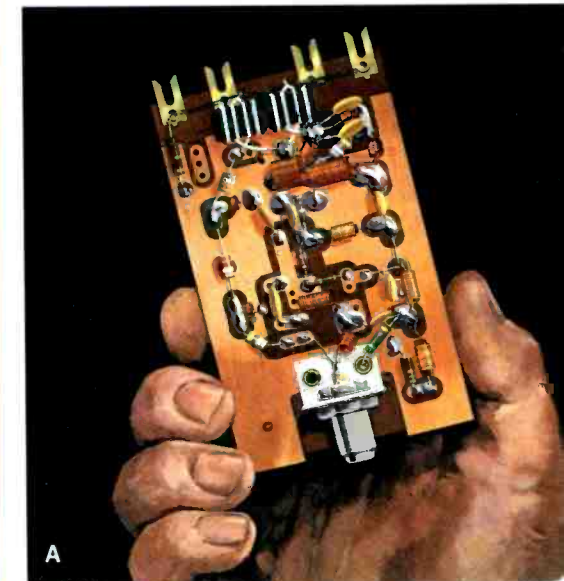
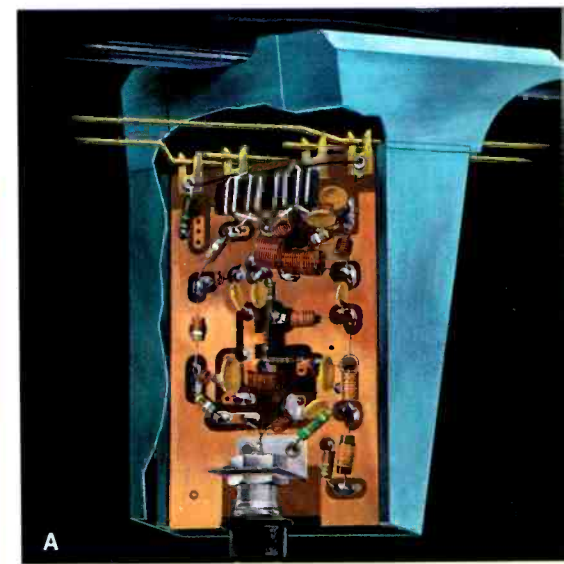
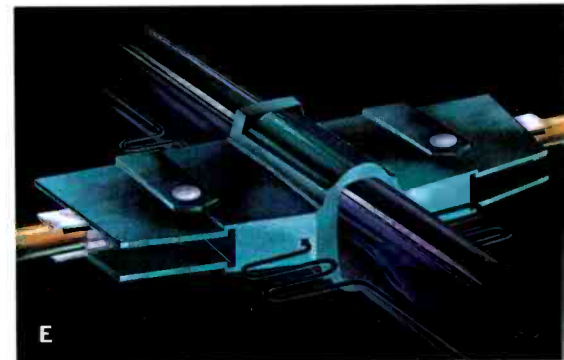
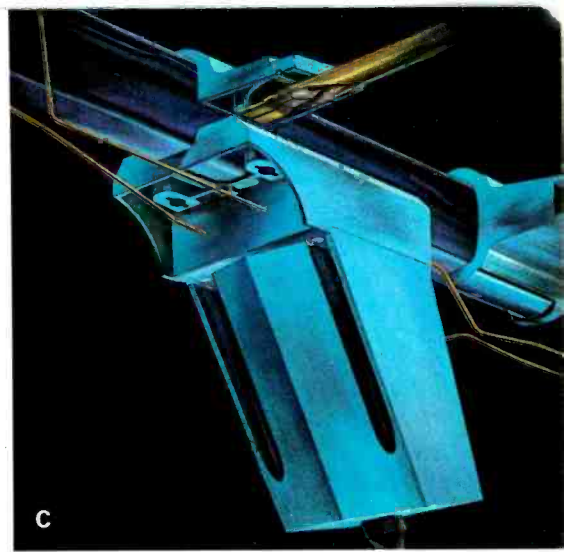

Total Design FM Control Element:

Exclusive FM element provides high gain on FM bands—and enables you to attenuate FM bands in areas where strong FM signals interfere with TV reception.

(C) Total Design Cartridge Housing:

Exclusive housing is an integral part of Super Colortron—built-in and permanent. Completely weatherproofed to protect solid state cartridge pre-amps and connections.

(D) Total Design Ellipsoidal Boom:

Exclusive boom is the first aluminum tubing shape engineered especially for antenna use. Proved far stronger than any other existing boom design.

(E) Total Design Wrap-Around Insulators:

Exclusive low loss dielectric insulators completely encapsulate and weatherproof elements and correlators at point of electrical contact. Hi-impact polystyrene. Provide perfect alignment of elements and eliminate sagging and loosening.

Total Design High Tensile Aluminum Elements:

Exclusive aluminum alloy has PSI rating of 38,000 as compared to 27,000 PSI for alloys used in other antennas. More than 49% stronger—and 29% more resistant to bend and wind distortion.

Total Design Wrap-Around Mast Clamp:

Exclusive mast clamp has 4 pair of locking jaws (not just 2) to automatically align antenna on mast and for greater strength and durability. Requires only one U bolt.

Total Design Gold Anodizing: Exclusive Gold Anodizing is the only permanent gold finish used on any antenna—the only positive protection against corrosion and fading.

Total Design Assembly: Exclusive construction makes the Super Colortron truly easy-to-install—unfolds in seconds—completely factory pre-assembled.



Winegard
ANTENNA SYSTEMS

WINEGARD COMPANY, 3000 KIRKWOOD STREET, BURLINGTON, IOWA 52601

Why is a Vectorscope essential for Color TV servicing?

- 1 Check and align demodulators to any angle . . . 90°, 105°, 115° . . . accurately and quickly. No guesswork. New color sets no longer demodulate at 90°. Only with a Vectorscope can these odd angles be determined for those hard-to-get skin tones.
- 2 Check and align bandpass-amplifier circuits. Eliminate weak color and smeared color with proper alignment. No other equipment required. Only a V7 Vectorscope does this.
- 3 Pinpoint troubles to a specific color circuit. Each stage in a TV set contributes a definite characteristic to the vector pattern. An improper vector pattern localizes the trouble to the particular circuit affecting either vector amplitude, vector angle or vector shape. Only a V7 Vectorscope does this.



EXCLUSIVE FEATURES:

Color Vectorscope: Until now, available only in \$1500 testers designed for broadcast use. Accurately measures color demodulation to check R-Y and B-Y, for color phase and amplitude. A must for total color and those hard-to-get skin tones. **Self-Calibrating.** Adjust timing circuit without external test equipment. **Dial-A-Line.** Adjust horizontal line to any width from 1-4 lines. **Solid State Reliability** in timer and signal circuits. **Plus:** All Crosshatch, Dots, Vertical only, Horizontal only and Keyed Rainbow Patterns. RF at channels 3, 4 or 5. Video Output (Pos. and Neg. adjustable) for signal injection trouble-shooting. Red-Blue-Green Gun. Killer. All transistor and timer circuits are voltage-regulated to operate under wide line voltage ranges. Lightweight, compact—only 8¼x7½x12½". **NET 189⁵⁰**

ONE YEAR WARRANTY

V6-B New, improved complete color bar generator with all the features of the V7 except the Vectorscope. Only **99.50**

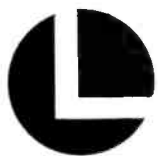

For the full story, see your distributor or write for literature.
Dept. ET-4
LECTROTECH, INC.
1221 W. Devon Ave., Chicago, Ill. 60626

. . . for more details circle 122 on postcard

Dual VC Speaker Solves Stereo Extension Problem

■ How many times have you been asked by a stereo customer to install an extension speaker to his den or outdoor patio? Most customers want this to be an inexpensive project and do not want two speakers nor care for the stereo sound effect.

If you tap off one speaker of the stereo, you may unbalance the output, and you do not have the total audio reproduced from the extension speaker.

This problem can be solved with a dual voice coil speaker that is designed for multi-impedance matching of transistor auto radios. The Quam Nichols Co., for example, makes a 5- x 7-in. speaker, model 57A2MT,

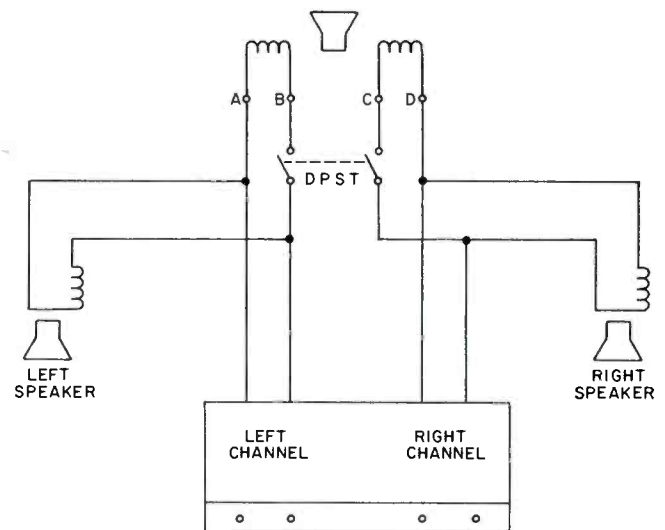

or equivalent that mounts nicely in an 8-in. speaker baffle. These speakers have a dual VC of 20Ω impedance for each coil.

One of the voice coils is connected to the right channel stereo speaker and the other one to the left channel output. This hook-up will not cause any cross talk or distortion.

These speakers will match very well the 8 to 16Ω transformer output type amplifiers. They also work equally well with direct feed transistor amplifiers having a 20 to 40Ω impedance output.

The only precaution is to have proper phasing of the two coils. To do this, listen to the audio output while you reverse the leads of terminals A and B or C and D until maximum output is obtained.

This set-up produces good quality audio output and cuts the cost in half for the installation. ■

Stockroom on wheels!

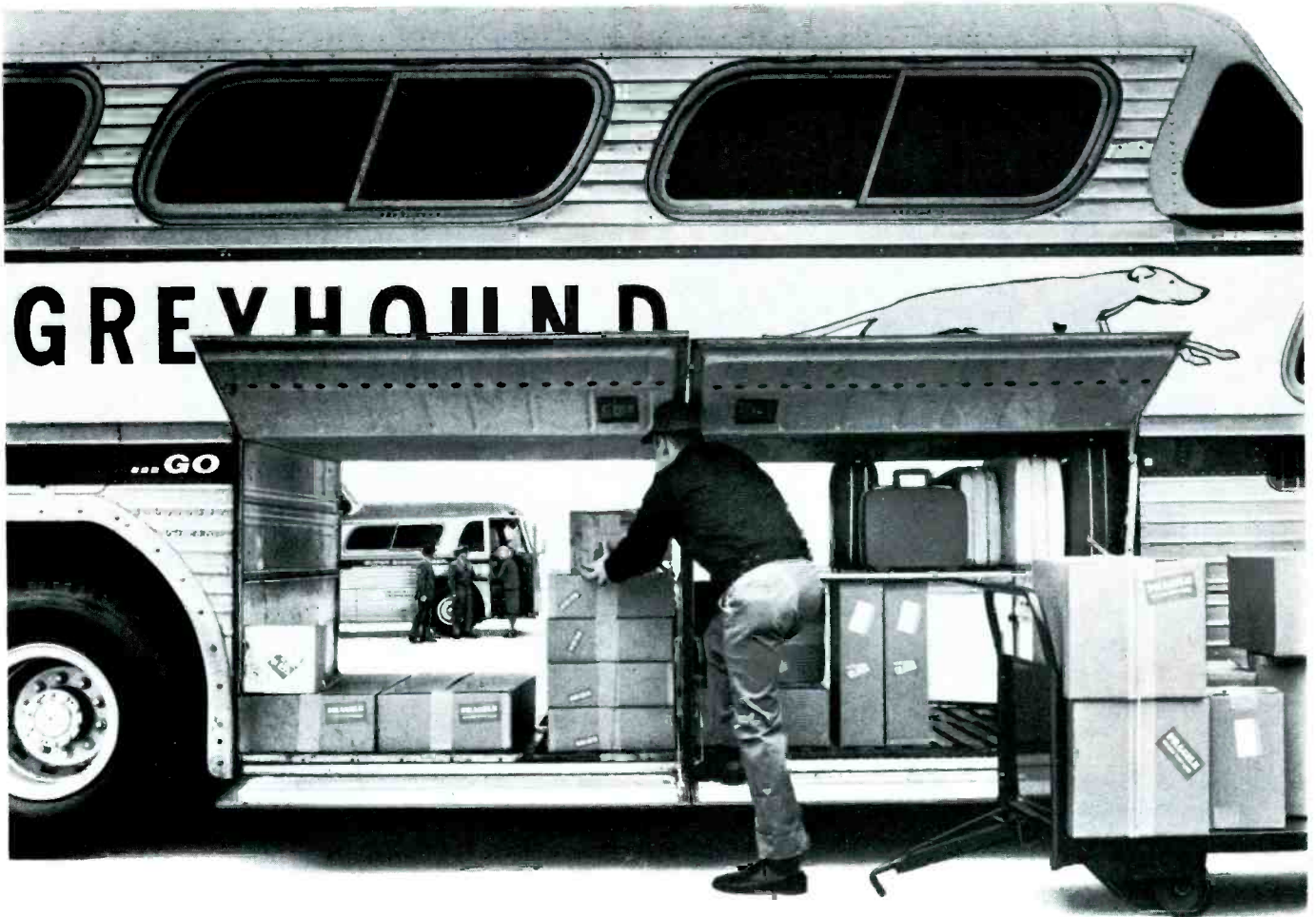

Your stockroom is as big as a catalog and as near as a Greyhound bus, when you specify Greyhound Package Express

Greyhound Package Express puts a warehouse at your fingertips. Gives you easy access to more different kinds of items than your shelf space could possibly accommodate. No matter what your customer wants—if it's in a catalog, you can get it for him fast by GPX. Your profits are boosted by a wider

choice of merchandise...while your capital investment is kept to a minimum. GPX shipments travel on regular Greyhound buses, running on fast, frequent passenger schedules. Very often, you get what your customers need in a matter of hours. Specify GPX for round-the-clock service. 7 days a week,

24 hours a day. Weekends and holidays, too! Choice of C.O.D., Collect, Pre-paid, or GPX Charge Account. For complete information about service, rates and routes, call Greyhound, or write: Greyhound Package Express, Dept. 53-D, 10 South Riverside Plaza, Chicago, Illinois 60606.

It's there in hours and costs you less

For Example	Buses Daily	Running Time	20 lbs.	30 lbs.	40 lbs.*
BOSTON— NEW YORK	28	4 hrs. 15 mins.	\$2.20	\$2.60	\$2.90
LOS ANGELES— SAN FRANCISCO	22	9 hrs. 15 mins.	2.10	2.45	2.80
PITTSBURGH— CLEVELAND	12	2 hrs. 45 mins.	2.00	2.25	2.65
INDIANAPOLIS— CHICAGO	10	4 hrs.	2.10	2.45	2.85

*Other low rates up to 100 lbs. Lot shipments, too.



One of a series of messages depicting another growing service of The Greyhound Corporation.

... for more details circle 117 on postcard

RCA brings you a marvelous array of prizes for

THE GREAT OUTDOORS

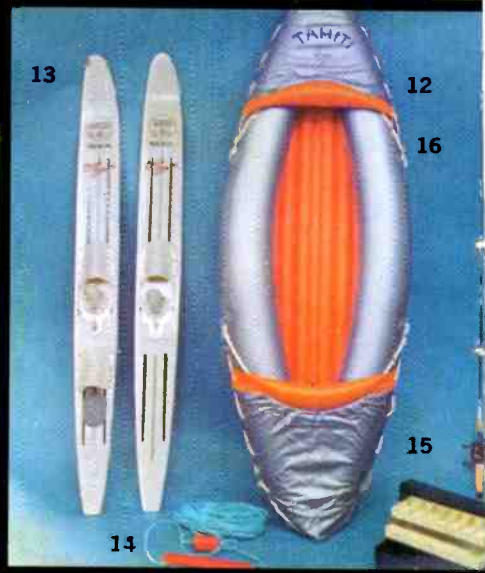

RCA's GREAT OUTDOORS

ONE VALUABLE CERTIFICATE

This certificate is redeemable by mail from "Great Outdoors," Headquarters, P.O. Box 1908, South Hackensack, N. J. 07606 in required quantities for merchandise as stated in the RCA "Great Outdoors" booklet—available from participating RCA Tube Distributors.

Valid for redemption until midnight of September 30, 1967. Good only in the U.S.A. This certificate void where prohibited, taxed or restricted. Cash redemption value: 1/20 of 1¢.

RCA ELECTRONIC COMPONENTS AND DEVICES CORPORATION, NEW JERSEY

RCA THE MOST TRUSTED NAME IN ELECTRONICS

1A1652



RADIOTRON

ELECTRON TUBE

THE MOST TRUSTED NAME IN ELECTRONICS

- 1. 30-42 Skil Portable Electric Saw. 76 Cert.
- 2. 30-45 Black and Decker Drill Kit. 46 Cert.
- 3. 30-90 Thor 4 1/2" Bench Grinder. 55 Cert.
- 4. 30-85 Skil 1/4" Variable-Speed Drill. 53 Cert.
- 5. 30-20 Wen Sabre Saw. 53 Cert.
- 6. 32-324 Atlantic "Comparto" Golf Bag. 62 Cert.

- 7. 32-89 Spalding "Jerry Barber" Golf Woods. 56 Cert.
- 8. 32-91 Spalding "Jerry Barber" Golf Irons. 94 Cert.
- 32-356 Set of 3 Bobby Nichols "Grand Slam" Golf Woods. 107 Cert. Not illustrated.
- 32-357 Set of 5 Bobby Nichols "Grand Slam" Golf Irons. 119 Cert. Not illustrated.
- 9. 32-319 Wilson "Flag-Hi" Golf Balls. 25 Cert.
- 10. 32-344 Wilson "Tom Gola" Basketball. 18 Cert.
- 11. 32-123 Vicki Double Table Tennis Set. 13 Cert.
- 12. 32-336 "Tahiti" One-Man Boat. 124 Cert.
- 13. 32-251 Lund Combination Water Skis. 73 Cert.
- 14. 32-369 Allan Marine 75' Ski Tow Rope. 13 Cert.
- 15. 32-339 Union Steel Two-Tray Plastic Tackle Box. 10 Cert.
- 16. 32-253 Zebco Rod and Reel Combination. 26 Cert.

- 17. 20-328 Jack Nicklaus Golf Jacket. 42 Cert.
- 18. 20-593 Arrow "PinHi" Golf Shirt. 17 Cert.
- 19. 20-588 Hickok Dacron-Cotton Golf Slacks. Unpleated. 33 Cert.
- 19. 20-589 Hickok Dacron-Cotton Golf Slacks. Pleated. 33 Cert.
- 20. 31-30 Central 20" Lawn Spreader. 32 Cert.
- 21. 31-21 Wiss Hedge Shears. 12 Cert.
- 22. 31-51 Village Blacksmith Precision Lopping Shears. 9 Cert.
- 23. 31-28 Air Capital Power Mower. 141 Cert.
- 24. 31-18 Melnor Oscillating Lawn Sprinkler. 14 Cert.
- 25. 31-61 Skil Hedge-Trimmer. 63 Cert.
- 26. 45-135 Crestline Portable Folding Brazier. 27 Cert.
- 27. 46-63 Hamilton-Skotch Kooler. 19 Cert.
- 28. 31-22 Melnor Roll 'N Reel Sprinkler. 49 Cert.
- 29. 31-24 Reinforced Garden Hose. 13 Cert.
- 30. 46-120 Shott Contoured Aluminum and Webb Chair. 24 Cert.
- 31. 46-119 Shott Aluminum and Web Chaise. 40 Cert.



17

18

19



20

21

22



23

24

25



26

27



41

42



28

29



30

31



39

40

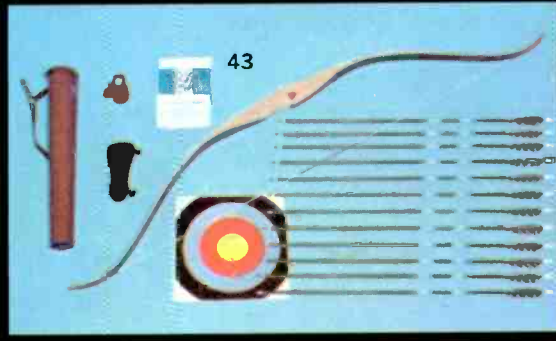

43



44



45

46



58

59

60

61



57

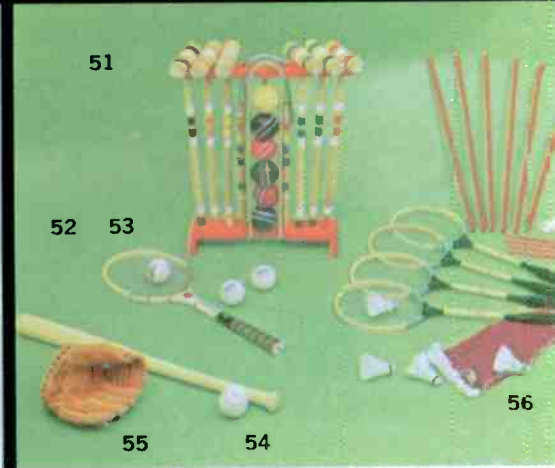

51

52

53

55

54

56

- 32. 46-141 Bunting Aluminum Ball-Glide Chair. 95 Cert.
- 46-142 Bunting Aluminum Spring Base Chair. 95 Cert. Not illustrated.
- 33. 32-272 Schrade Utility Knife. 8 Cert.
- 34. 32-230 Gold Medal Yacht Chair. 38 Cert.
- 35. 46-65 Macon Folding Garden Umbrella. 57 Cert.
- 36. 46-64 Hampden Steel Umbrella Table. 42 Cert.
- 37. 20-343 Man's Puritan Ban-Ion Knit Shirt. 30 Cert.
- 38. 20-596 Arrow Decton Plainsman Short-Sleeve Sport Shirt. 14 Cert.
- 39. 20-591 Breier Suede Blouse-Jacket. 102 Cert.
- 40. 20-344 Puritan Imported Alpaca Cardigan. 69 Cert.
- 41. 51-46 Hawkeye Standard "8" Movie Camera. 62 Cert.
- 42. 51-123 Kodak Instamatic Super "8" Camera. 120 Cert.
- 43. 32-362 Shakespeare Deluxe Archery Set. 81 Cert.
- 44. 51-45 Vicki Field Glasses. 21 Cert.

- 45. 43-38 Men's Samsonite 21" Companion Case. 65 Cert.
- 46. 43-39 Men's Samsonite "Silhouette" Luggage Two-Suiter. 107 Cert.
- 47. 32-349 Wilson Ranger Adult-Size Sleeping Bag. 57 Cert.
- Samsonite "Silhouette" Luggage For Women. Specially designed for jet-age travel.
- 48. 43-37 26" Pullman. Dover White. 107 Cert.
- 48. 43-36 26" Pullman. Oxford Grey. 107 Cert.
- 49. 43-33 15" Beauty Case. Dover White. 61 Cert.
- 49. 43-32 15" Beauty Case. Oxford Grey. 61 Cert.
- 50. 43-35 21" O'Nite Case. Dover White. 65 Cert.
- 50. 43-34 21" O'Nite Case. Oxford Grey. 65 Cert.

- 51. 32-70 South Bend 6-Player Croquet Set. 26 Cert.
- 52. 32-279 Spalding Pancho Gonzales Tennis Racket. 18 Cert.
- 53. 32-286 3 Dunlop Tennis Balls. 6 Cert.
- 54. 32-75 George Young Baseball and Bat Set. 8 Cert.
- 55. 32-148 Rawling Mickey Mantle Fielder's Glove. 26 Cert.
- 56. 32-125 Vicki Double Badminton Set. 26 Cert.
- 57. 46-149 Full-Smoker Patio Wagon. 77 Cert.
- 58. 32-271 12-Pc. Camp Cookware Set. 22 Cert.
- 59. 46-49 Hamilton-Skotch "Cold-Flyte" Gallon Jug. 12 Cert.
- 60. 46-46 Hampden Picnic Table with Benches. 89 Cert.
- 61. 46-127 Thermos Outing Kit. 28 Cert.

Get RCA "Great Outdoors" Certificates FREE with your purchases of RCA Entertainment Receiving Tubes from your local participating RCA Tube Distributor!



Electronic Components and Devices, Harrison, N.J.
THE MOST TRUSTED NAME IN ELECTRONICS

Precision Apparatus

introduces 3 new models; now a complete line of quality test equipment for service technicians

For over 30 years, professionals in industry, service, laboratory and educational fields have relied on Precision Apparatus Test Equipment. Today, through the experience and marketing know-how of Dynascan Corporation, Precision Apparatus offers even greater reliability and performance—maximum versatility—in all applications. By every standard, they are the hallmark of quality in test equipment.

NEW! A MUST FOR COLOR TV ALIGNMENT

MODEL E-410C—SWEEP GENERATOR AND MARKER ADDER



Wide range, frequency modulated signal source combined with Marker Adder circuitry designed for the alignment of color TV, FM and other high frequency wide-band receivers and circuits. Solves marker visibility and overloading problems. Furnished with a 4.5 mc crystal and 5 output cables. \$169.95

NEW! MODEL B-12—REGULATED POWER SUPPLY



A reliable source of variable, regulated DC plate voltages, and bias plus AC filament voltages . . . with exclusive 6.3 VAC and 12.6 VAC supply. Perfect for service bench and circuit development, it offers regulated DC voltages from 0 to 400 volts, and a bias supply from 0 to -150 volts. Each output is variable throughout its range. Rugged, double-jewelled, D'Arsonval meters mounted on the front panel. \$99.95

NEW! MODEL B-10—BATTERY ELIMINATOR & CHARGER



Twice the filtering provides .15% ripple! Designed to meet rigid, low-ripple output requirements of modern transistorized automobile radios and other electronic equipment of 6 and 12 volt ratings. Does not require additional investment for external filter adapters. Functions as an efficient, reliable battery charger with special high-current output at separately labeled terminals. \$59.95

ES-550B WIDE-BAND OSCILLOSCOPE—

Rugged, dependable performance. Automatic horizontal sweep synchronization. Wide-band 5 mHz vertical amplifier. Extra-high 10 Mv RMS/inch sensitivity allows measurement as low as 2 Mv. Wide-band vertical amplifier. \$279.95



E-310 SINE & SQUARE WAVE GENERATOR—

Only moderate cost, low distortion generator with both sine and square-wave coverage from 5 Hz to 600 KHz. Pre-aged tubes provide long-term stability. Over 7' of logarithmic scales for more accurate settings. \$199.95



E-200C MULTI-BAND SIGNAL GENERATOR—

Unique! AVC substitution voltage system permits, accurate alignment. Over 7' of etched dial scale from 88 KHz to 440 mHz with FM and TV band channels indicated. Each unit individually hand-calibrated on all bands. \$119.95



120 VOLT-OHM-MILLIAMMETER— 2% DC accuracy. Exclusive extra-low ohm scale for accurate readings to 0.1 ohm, extremely important for solid state measurements. Mirrored scale. Solid state protected meter movement. Transit meter movement protection. \$51.95



V75 VACUUM TUBE VOLTMETER— Special built-in battery eliminator assures ohm-meter accuracy. Rugged uni-probe speeds operation. Special calibration on 1.5 VAC and 5 VAC scales assures maximum accuracy. \$59.95



120M VOLT-OHM-MILLIAMMETER— Offers all of the convenience features of the 120 plus the extremely high accuracy of 1½% on DC and 3% on AC. \$61.95

P **PRECISION APPARATUS**
hallmark of quality in test equipment

Tube supplement information now available for all Precision and Paco Tube Testers.

Division of Dynascan Corporation
1801 W. Belle Plaine Avenue
Chicago, Illinois 60613

Where Electronic Innovation Is A Way Of Life

... for more details circle 130 on postcard
ELECTRONIC TECHNICIAN

A Technician Looks At G-E's 'Porta-Color' TV Receiver

**TEKLAB
REPORT**

Understand this unique small-screen
color receiver — it's different

Part Two of a Series

■ Last month we covered some important details of this unusual color receiver — including the horizontal in-line three gun CRT and the relatively simple methods used for obtaining purity and convergence.

We will now explore the color demodulation circuits, the color difference amplifiers and review some chroma circuit trouble symptoms that may be encountered and their causes.

Color Demodulation Circuits

The 3.58MHz sideband information and reference burst signal are taken from the composite video, at the amplifier cathode circuit by a chroma take-off transformer. The 3.5MHz signal across the primary is coupled to the grid of a conventional bandpass amplifier by the slug-tuned secondary of the chroma take-off transformer. The output of the bandpass amplifier is transformer coupled to the burst gate cathode by a double-tuned chroma amp transformer. The secondary of this transformer is connected in shunt with the chroma gain control, providing a take-off point for chroma

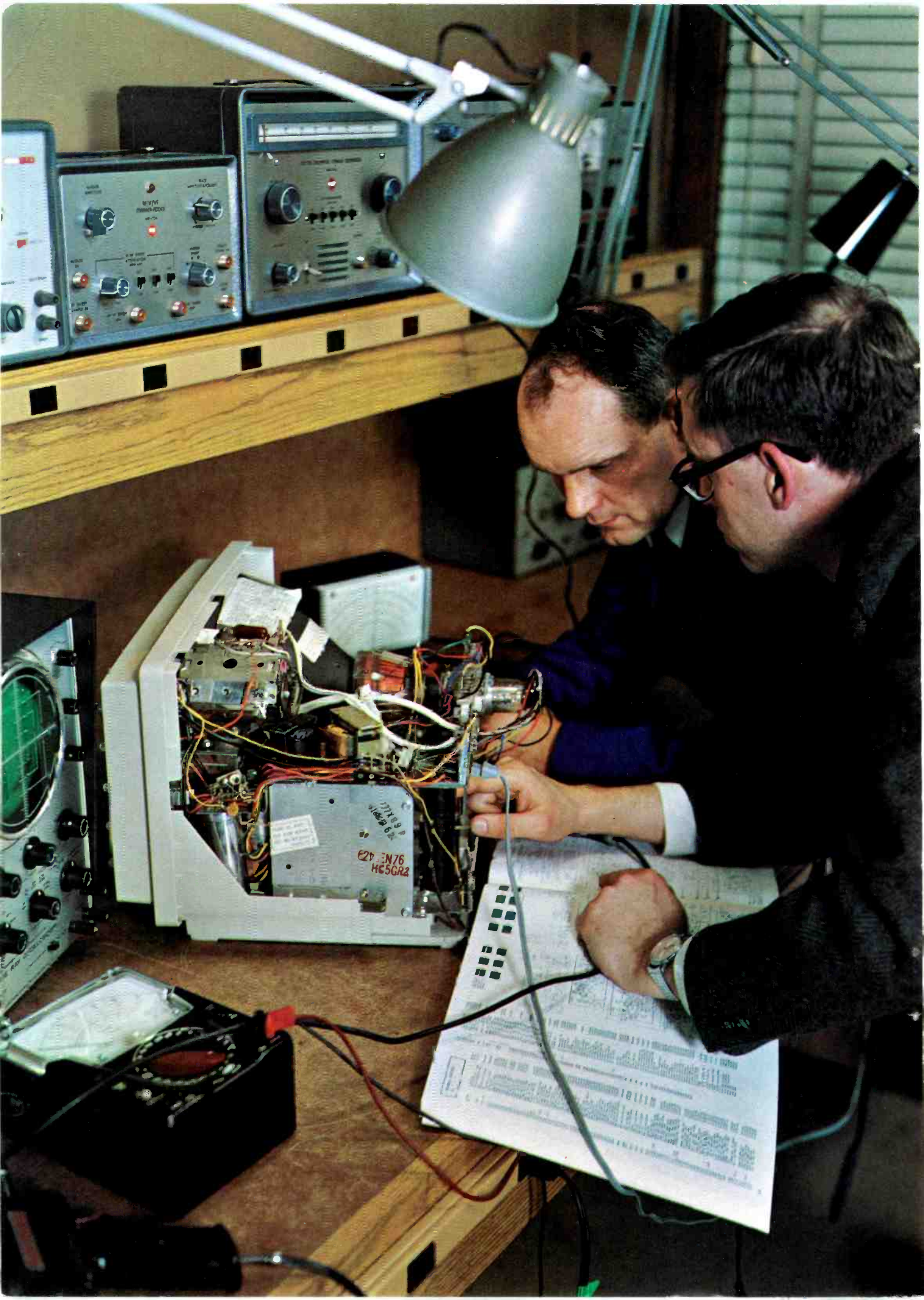

'Porta-Color'

information. During retrace, a pulse from the horizontal output transformer is shaped and coupled to the burst gate tube grid, to gate the tube on and thus extract the burst or reference signal.

A 3.58MHz series resonant trap is connected between grid and ground — the burst-gate part of the tube — thus, with respect to 3.58MHz, the gate tube is functioning as a grounded-grid amplifier with its plate circuit tuned by the primary of the crystal filter transformer for maximum output at 3.58MHz. The burst signal, which is mainly capacitively coupled to the bifilar wound secondary of the crystal filter transformer by a 39pf capacitor, excites the high Q resonant crystal circuit into a sinewave oscillation that results in a 3.58MHz wavetrain.

If the 3.58MHz crystal is defective or the crystal filter transformer is not properly adjusted, the 3.5MHz oscillator will be out of sync, as shown in Fig. 1.

The reference amp part of the tube also limits the 3.5MHz wavetrain signal to produce a sinewave of almost constant amplitude in the primary winding of the chroma demodulator transformer.

The tint control, transformer and a 12pf capacitor tune the chroma demodulator transformer primary. If the transformer is improperly adjusted, the hue or color phase will be incorrect (as shown in the bar pattern of Fig. 2).

A 90deg shift from reference burst appears in the primary of the chroma demodulator transformer. The 3.58MHz carrier in the transformer primary shifted 90deg from burst, is inductively coupled to both secondary windings of the transformer. They in turn supply subcarrier information to the synchronous detector diodes. The R-Y

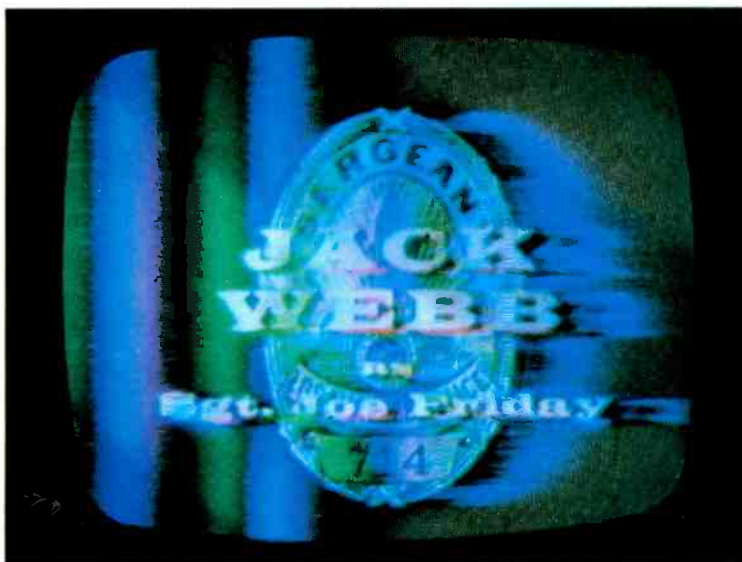
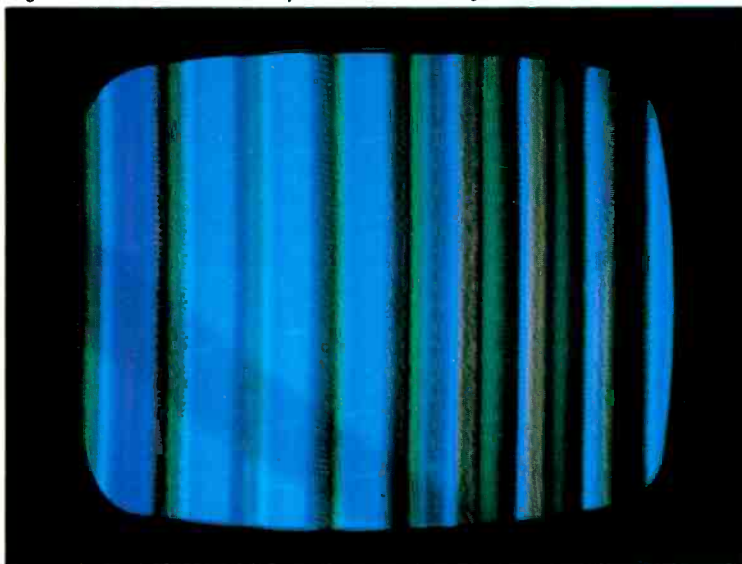

Fig. 1—Defective 3.58MHz crystal throws oscillator out of frequency as indicated by color-bar-pattern.

Fig. 2—Incorrect hue caused by a defect or misalignment in the AFPC circuits.



Technical editor Joe Zauhar and associate editor Philip Dahlen look over the G-E Porta-Color receiver's insides in a corner of ET's TEKLAB.

'Porta-Color'

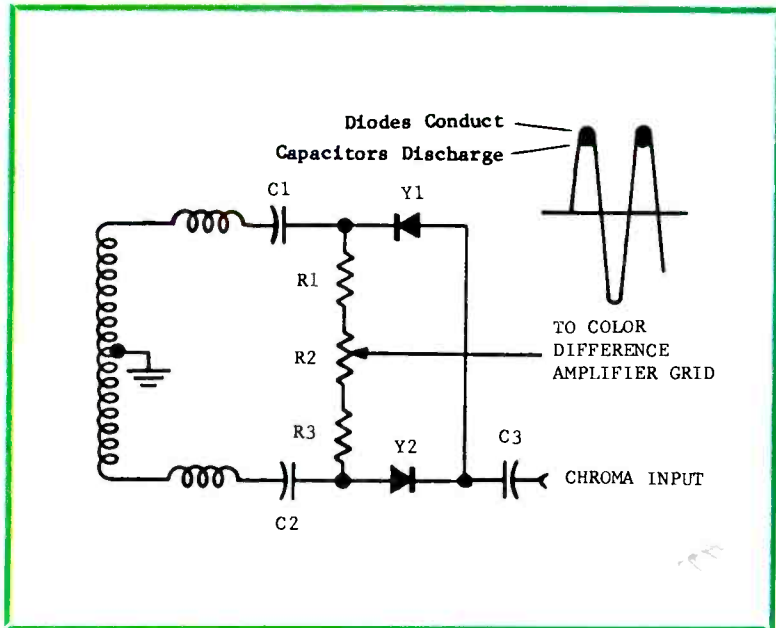

Fig. 3—Simplified circuit of balanced-diode synchronous detectors.

secondary of the chroma demodulator is tightly coupled to the primary, therefore the subcarrier phase for this winding follows that of the primary, while the B-Y secondary is loosely coupled and is separately tuned to produce the necessary phase shift between the two subcarriers. The two subcarriers, essentially in quadrature, are coupled to the synchronous detector diodes.

The synchronous detectors are balanced diode types (see Fig. 3). Each of the two

detectors has a balancing potentiometer to produce zero dc volts from the output of the detectors so that the presence or absence of the carrier has no effect at the grids of the color difference amplifiers. Although the limiting action of the reference amplifier produces a sinewave carrier with a fairly constant amplitude, some variations in amplitude might exist. Balancing out the carrier at the output of the synchronous detectors provides gray scale stability by maintaining a given potential at the grid of the color difference amplifiers whether or not the subcarrier is present. As shown in Fig. 4, diode Y502 opened and caused a blue screen.

The reference signal from the secondary winding is fed to the series connected diodes through C1 and C2, while the chrominance signal from the cathode circuit of the burst gate is connected in parallel with the anode and cathode of Y1 and Y2, respectively. Each diode is functioning as a peak detector. In the absence of chroma information, capacitors C1 and C2 are charged to the peak value of the reference signal and with the diodes cut off, both capacitors discharge in series across series resistors R1, R2 and R3. Further diode conduction then occurs only at the peaks of the reference signals.

Diode Y1 conducts when a negative signal is present at its cathode from the secondary of the transformer. At the same instant, a positive signal is presented at the other end of the transformer secondary and diode Y2 conducts in the opposite direction to diode Y1. This conduction of equal but opposite currents produces zero output at the center of the balancing potentiometer, R2.

When the diodes are conducting, the chrominance signal is detected by each diode. Diode Y1 develops a positive voltage which is proportional to the sum of the chroma and in phase reference signal. Diode

Y2 develops a negative voltage which is proportional to the sum of the chroma and the 180deg out of phase reference signal.

Color Difference Amplifiers

The three triodes used for the color difference amplifiers are contained in a 6AC10 compactron. Besides performing the function of amplifying the demodulated chroma information, the color difference amplifiers are part of the biasing network in the CRT control grid circuits. The plate of each amplifier is connected to the junction of two series connected resistors which are in turn placed between B+ and the respective CRT control grid. Since the cathode of each amplifier is returned to ground through small value resistors, each amplifier becomes one leg of a bleeder network (see Fig. 5). This provides a level of bias for the control grids of each of the three CRT guns which may be made to change by conduction of the color difference amplifiers. In a quiescent state the picture tube grid bias remains constant. The chroma output from the color difference amplifiers is coupled to the picture tube control grids by the RC networks in the color difference amplifiers' plate circuit.

The detected chroma information from the R-Y synchronous detector is dc coupled to the R-Y color difference amplifier grid, and in like manner, the B-Y chroma information is coupled to the B-Y amplifier. The G-Y signal is derived by matrixing in the common cathode circuit and appears in the G-Y amplifier plate circuit. The G-Y amplifier operates as a grounded grid amplifier with a capacitor serving as ac grid return to ground.

The final article in this series will cover the horizontal oscillator and phase detector circuits, horizontal deflection and HV, plus other important circuits of this receiver. ■



Fig. 4—Blue screen caused by open synchronous detector diode, Y502.

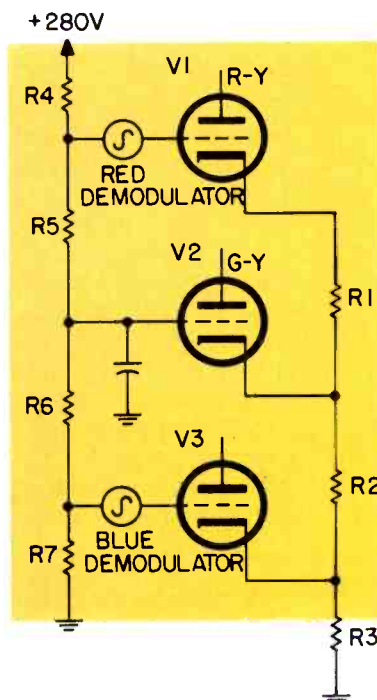

Fig. 5—Simplified schematic of color difference amplifiers.

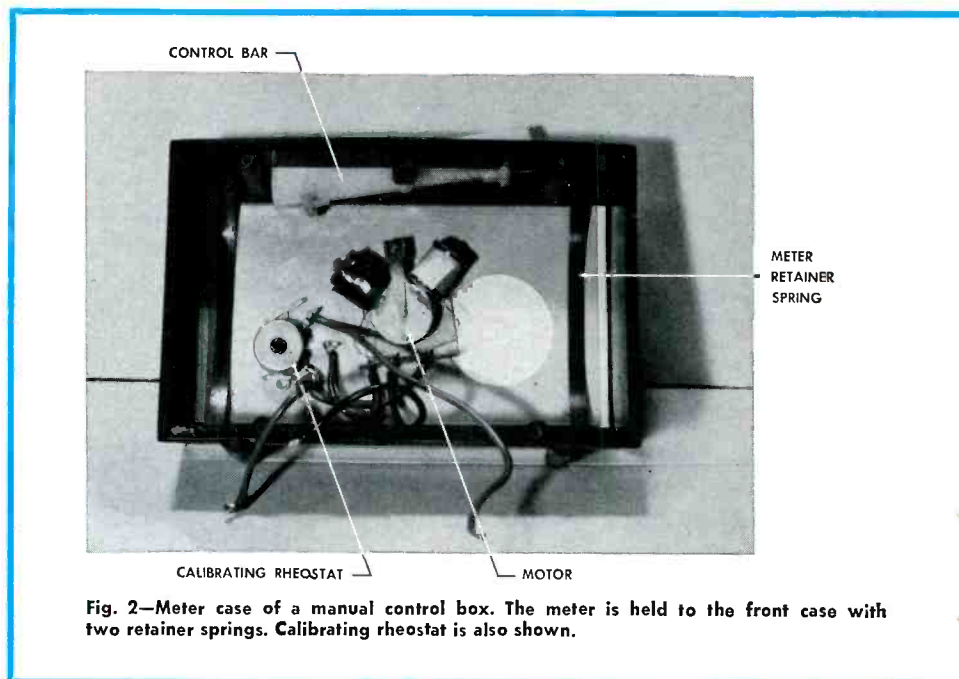

Fig. 2—Meter case of a manual control box. The meter is held to the front case with two retainer springs. Calibrating rheostat is also shown.

Repairing Antenna

Lightning, winter winds and ice place heavy strain on antenna rotators and open the way for repairs and new business

■ Repairing antenna rotators is easy — if you know how they are designed and operate and you have the mechanical ability. And, in addition to the added income you will receive from rotator maintenance, there's a lot of potential cash waiting in new rotator sales and new fringe area antenna installations.

We normally come into contact with three types of antenna rotators. 1) A manual unit in which the operator must hold the direction lever down until the desired antenna orientation is obtained; 2) The automatic rotator in which the desired direction can be selected and the motor will follow and stop at this point; 3) A transistorized or semi-automatic rotator which is synchronized and has a greater degree of accuracy. Transistors and two separate motors are used in these rotators.

Rotator Operation

It will prove extremely helpful to understand how these rotators function.

The manual rotator has the least number of parts and is simple to operate. When the direction switch

is pushed down to one side, 117vac is applied to the primary of the rotator's power transformer. At the same time, other contacts on the

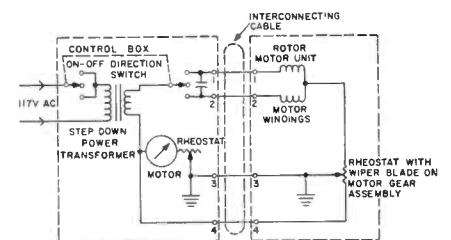

Fig. 1—Wiring diagram of Cornell-Dubilier manual rotator.

direction switch make contact with one leg of the motor winding. Press down on the right side and the motor will turn clockwise. Press down on the left and the motor will turn counter-clockwise. The direction switch simply transfers the voltage to one motor winding and then to the other winding—reversing the field and direction of rotation (see Fig. 1).

Correct direction of the rotator motor is indicated with a wirewound rheostat, which turns with the rotator shaft. A wire connects to this rheostat and also to the indicating meter inside the control box. A correct meter reading can be ob-

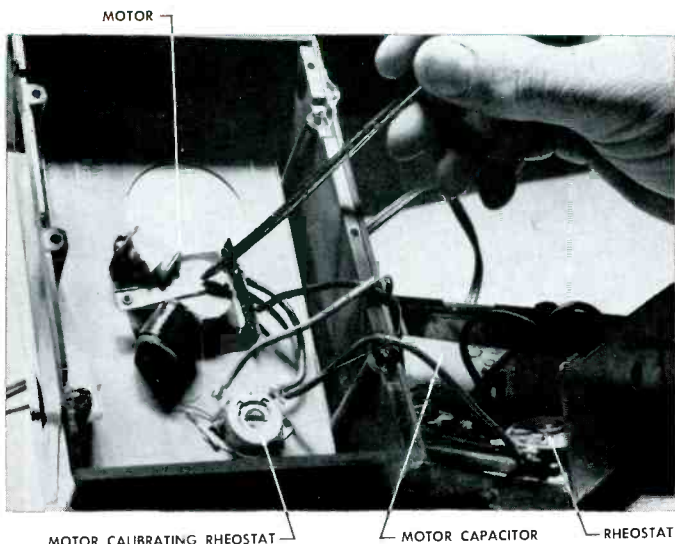

Fig. 4—Various components located inside an Alliance T12 control box.

Rotators

tained by adjusting a small rheostat in the control box (see Fig. 2).

An automatic rotator stops at a pre-set point on the dial. The operator turns the direction knob and leaves it set at a specific direction. Then the rotator motor will turn, stopping at this point on

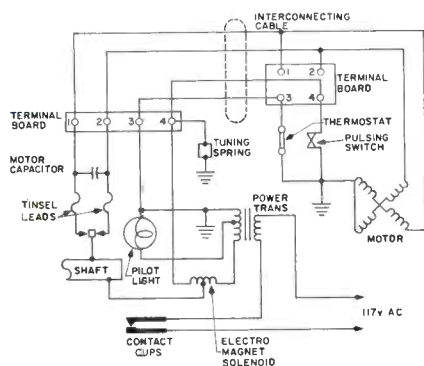

Fig. 3—Schematic of Alliance automatic rotator U-83.

the direction dial. The automatic rotator is constructed the same as a manual rotator but has a pulsing solenoid, pulsing switch, transistor control or with two separate motors. The wiring diagram of a typical automatic rotator is shown in Fig. 3.

The direction indicator knob is turned to the desired location and left there. When the ac switch is

turned to the ON position, the primary and secondary voltages are applied to the correct motor windings. A pulsing switch in the motor unit will trip the pulsing solenoid in the control box pulling the ratchet assembly around to the desired location against a stop indent and the off/on switch will shut the unit off.

Manual Rotator Construction

This rotator consists of a control box, antenna motor and interconnecting wires. There are five basic components to any manual rotator control box.

1. Motor-direction indicator
2. Power step-down transformer
3. Direction switch
4. Motor capacitor
5. Rheostat

All front panel meters will indicate the direction the antenna is turning or the point where it has stopped. The power transformer is a step-down type, delivering about 29 to 35acv under no-load. While in operation, the operating voltage is around 30v.

To reverse the motor, a direction switch is tied to one end of the secondary winding of the power

Fig. 6—Automatic control box which burned while resting out of sync.



transformer, switching to each separate motor winding. The motor will turn in either direction but the direction switch must be held in position so that contacts will be made. If the direction switch is not engaged, the rotator motor will stop. A motor capacitor is switched into the two motor windings at the instant of changing direction.

In the control box shown in Fig. 4, a rheostat is shorted to ground with a moving contact switch-indicating antenna direction.

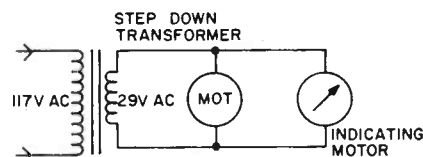

Fig. 5—Diagram of Channel Master model 9520 rotator showing parallel wiring.

In the unit diagramed in Fig. 5, the meter location is paralleled by the motor and step-down transformer. If the meter fails in any way, the rotator will still turn.

This unit has a five conductor cable instead of the regular four wire cable. Three wires are used for the motor circuit. Two wires

Antennas . . .

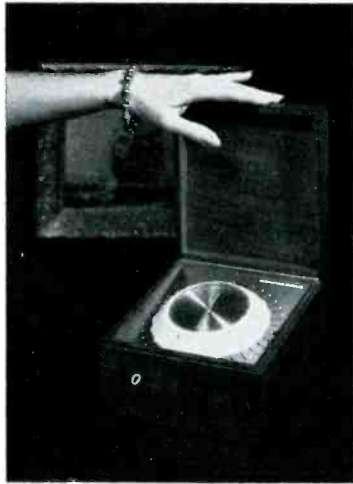

Fig. 7—Channel Master model 9516A automatic rotator.

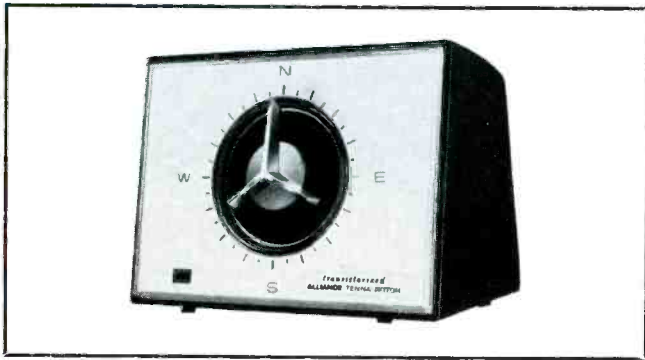

Fig. 8—Alliance model C-225 transistorized antenna rotator.

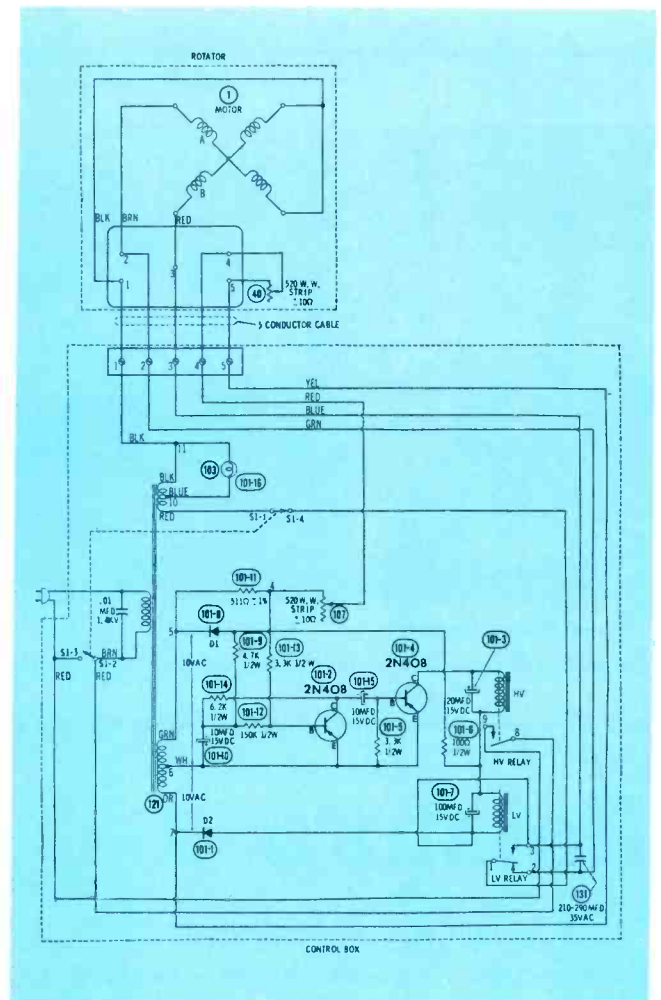

Fig. 9—Schematic of Alliance C-225 rotator.

are used for the rheostat which is part of the meter circuit. One extra wire makes it possible for the meter rheostat to be operated on a separate circuit. Since the two circuits are independent, smoother meter operation and greater meter direction accuracy is said to be possible.

Automatic Control Box

The automatic control box consists of six basic parts.

1. Rotating-knob indicator assembly
2. Pulsing-relay contacts
3. Pulsing solenoid
4. Step-down power transformer
5. Motor capacitor
6. One or two pilot lamps

To start an automatic rotator, the indicator switching assembly is rotated and left set on the desired direction. The switching assembly has start and stop contacts with switching contacts for reversed direction. When the starting contact is made, the rotator motor will turn—sending a voltage pulse to the

pulsing relay in the control box. The pulsing solenoid relay pulls the indicator switching assembly stops but is out of step with the antenna motor. If left in this position, the power transformer and switching point will become hot and burn. The automatic rotator should never be allowed to remain operating when the indicating lights are on (see Fig. 6). Simply flip the tripping lever located underneath the control box until the two units are synchronized.

Excessive damage can result if the automatic pulsing relay jumps out of sync, or step, with the antenna motor. This condition is noted when the indicator lights remain on. Actually, the indicator switching assembly stops but is out of step with the antenna motor. If left in this position, the power transformer and switching point will become hot and burn. The automatic rotator should never be allowed to remain operating when the indicating lights are on (see Fig. 6). Simply flip the tripping lever located underneath the control box until the two units are synchronized.

Generally, the antenna motor will get out of step with the pulsing relay when the operator pushes the lever for one direction and then suddenly reverses direction. To get

most automatic rotators back in step, it is best to turn the indicator knob to north, or the end of rotation. Now let the indicator hand stop and trigger the trip lever of the relay until the lights go out. Reverse the direction of the rotator to the other end of rotation and both motor and control box should be in sync.

To synchronize the automatic rotator shown in Fig. 7, which has two separate motors, turn the control box knob to north position. Select the closest clockwise or counter-clockwise direction to north. When the dial has revolved and finally halts in the indicated top position, the automatic rotator is synchronized. Now reverse the direction and check the control box indication with that of the antenna on the roof.

Most step-down power transformer and motor capacitors are the same as those used in the manual models. One or two dial lights are used on automatic rotators and will

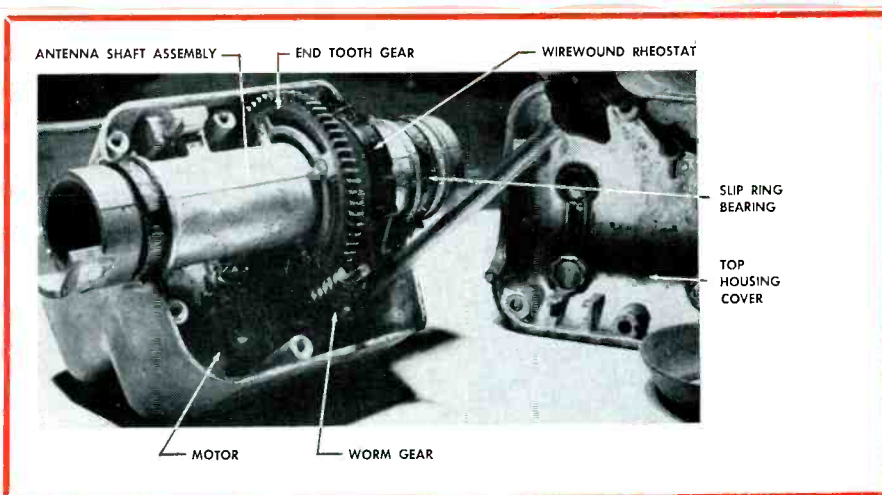

Fig. 10—Inside a manual rotator. Notice the wirewound rheostat at the far end and also the worm gear that drives the antenna shaft assembly.

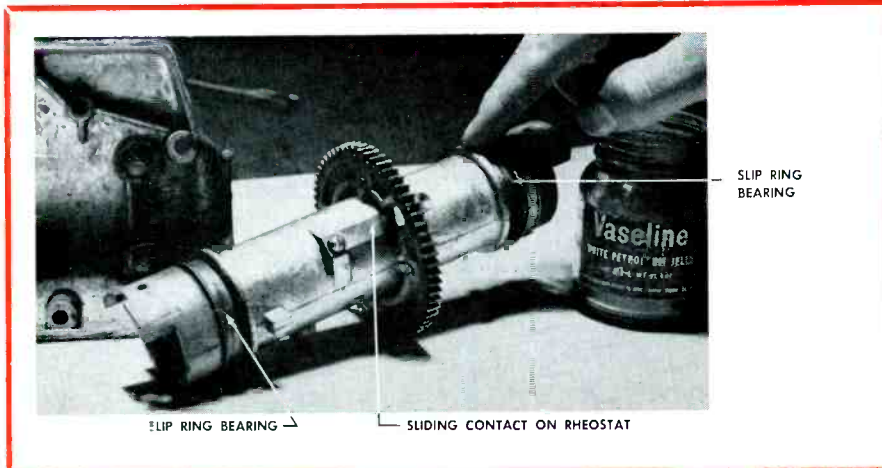

Fig. 11—Remove all sticky grease with a brush and cleaning fluid and lubricate slip-rings and bearings with petrolatum.

go out when the motor stops.

The automatic transistorized unit shown in Fig. 8 has a bridge circuit and a phase selective solid-state switching circuit which is said to provide exact antenna positioning. The circuit is shown in Fig. 9.

Rotator Motor Assembly

The manual motor housing consists of a small, low voltage ac motor, end, or worm gear, reduction gear and metal housing assembly. Speed reduction of the small motor is accomplished with end and worm gear assembly. A rheostat wiping blade is bolted to the main antenna shaft assembly indicating direction of the antenna.

In all motor models a braking or stop-slide action is accomplished. The automatic models use a contact switching assembly to trigger the pulsing solenoid in the control box. A tripping cam on the motor shaft assembly strikes the pulsing contact switch twice on each rotation of the small motor. Each time the contact

switch is tripped, the pulsing solenoid pulls the control direction assembly around one notch.

Checking Manual Control Box and Motor Housing

To quickly determine why a rotator will not turn, substitute a new control box or check with a continuity checker. The ohmmeter or any lamp-type continuity tester will indicate grounds, open interconnecting cables or poor connections. When suspecting a defective control box, substitute a new one. Always check the control box and continuity of the interconnecting cable before removing the rotator motor from the mast.

If a new control box is not handy, go directly to the motor capacitor located in the control box. Shunt a rotator capacitor across the leads of the original one. A defective capacitor will cause slow, sluggish rotation or no rotation. Dried out motor capacitors result in most control box failures.

On the rotator shown in Fig. 1, the ac step-down power transformer potential is 35acv, without the rotator motor connected. Check the ac voltage reading on terminals 3 and 4. The ac voltage may vary from 29 to 35acv on most manual and automatic rotators. Under working loads, the potential drops about 5v.

Check, clean and spray all switching terminal contacts. Bad switching controls will first show up as an intermittent dial light or no antenna rotation. Burned switching contacts will cause the rotator to be erratic or become intermittent in operation. Signs of excessive arcing of switching points will flash across the TV screen while the rotator is in motion. This condition can also arise on automatic rotators when the main contacts in the detent body assembly are improperly adjusted.

If the direction meter does not indicate, check for a bad meter, open motor rheostat, broken cable wire or open rheostat in the control box. Most manual meters will have a resistance of around 70Ω . Generally, when the rheostat in the motor housing opens, the meter will not read and, of course, the motor will not turn. This only applies to rotators with meter, rheostat and power transformer operating in series. The small rheostat in the manual control box will vary in resistance from 100 to 150Ω . See Chart I for manual rotator troubles.

All wires should show continuity on a manual rotator. The fourth wire on the automatic pulsing motor will show open unless the pulsing switch is making contact.

Generally, the removal of four bolts will allow the motor assembly to come apart (see Fig. 10). In the motor housing used with the control box shown in Fig. 4, a rheostat wiping blade turns with the antenna shaft assembly. One leg of the rheostat goes via the interconnecting cables of terminal four to terminal four on the manual control box. This conductor goes to the indicating meter which shows antenna direction. If the rheostat becomes worn and opens, the motor will stop and no meter indication will be noted. When dirt or grease

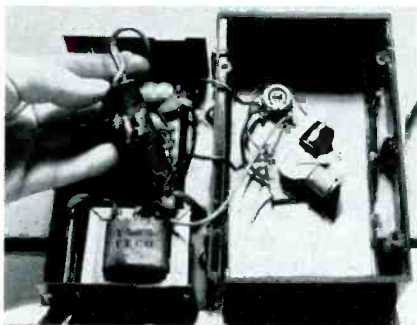

Fig. 12—Motor capacitor with a hole blown in it when the control box was hit by lightning.

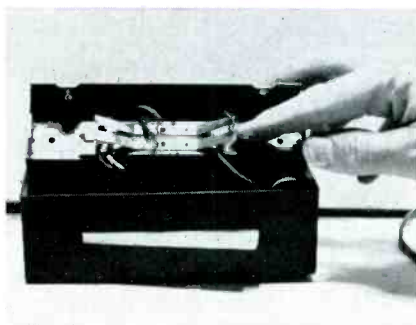

Fig. 13—Another control box hit by lightning shows burned marks on the ac contact switch blades.

CHART I
FOR MANUAL ROTATORS

Rotator fails to operate when control lever is pushed.	Check and shunt the capacitor. Check primary switch, directional switch and interconnecting cable. Substitute a new control box to see if the trouble is in motor or control box.
	Check motor to see if it has a broken gear.
Meter indicator will not move.	Check the resistance of meter, and meter rheostat for open. Check contact spring for good contact of rheostat in motor unit. Check meter return wire.
Rotator operates slowly or sluggishly.	Change the capacitor. Check hookup of interconnecting cable. Check length of cable.

FOR AUTOMATIC ROTATORS

Rotator fails to operate when turned to desired direction.	If motor is not turning, check tripping lever. Check capacitor. Check input contacts to make sure they are closed. Check cables. Check contact switch in rotator unit for proper operation.
Light fails to come on.	Out of sync. Trigger trip level until in sync. Input controls not adjusted properly.
Rotator operates slowly or sluggishly.	Change the capacitor. Check the cable. Check length of cable.
Light fails to come on.	Bad lamp. Bad socket. Bad connection to transformer.
Solenoid buzzes.	Check armature setting on bracket. Check pawl clearance.
Rotator does not go full 360deg.	Stripped gears. Teeth out of end gear. Cable wrapped too tightly around rotator and mast.

accumulates on the rheostat or wiping blade, an erratic reading will appear on the indicating meter.

Broken teeth from end gears or dry bearings can prevent the rotator from turning. It is also possible that the rotator will only turn a few degrees and then stop. Under excessive wind storms and using large antenna bays, a few teeth are frequently whipped from the end gear assembly. Dry slip ring bearings will cause the rotator to bind and drag. Use a paint brush dipped in gasoline or special cleaning fluids (not carbon tetrachloride), and clean the bearings. Apply petroleum jelly or proper consistency grease on the slip rings and bearings (see Fig. 11).

Trouble Cases

In the unit shown in Fig. 4, the rotator would not turn or show an indication on the meter. The motor capacitor was shunted and a continuity check made. An open was noted on terminal four from the motor housing. The rotator cable was checked and showed continuity. An open rheostat in the meter circuit of the motor housing was found to be worn and several wires were corroded. The trouble was a bent wiper blade not making contact with the rheostat winding.

Another rotator would not move the antenna, only the control box would hum. Substituting a new control box did not solve the problem and the motor housing was removed from the roof. A grounded field winding of the small ac motor would only let the motor hum. A new ac motor restored the rotator. Lightning damage suffered by another control box is shown in Fig. 12 and 13.

One rotator would rock back and forth or oscillate. By substituting a new control box, the trouble was located. After digging into the defective control box, a 2N408 transistor was found to have emitter-to-collector leakage.

Valuable information on maintaining antenna rotators is available in rotator manufacturers' service manuals. Most rotator components are available at wholesale parts distributors or from the rotator manufacturer. ■

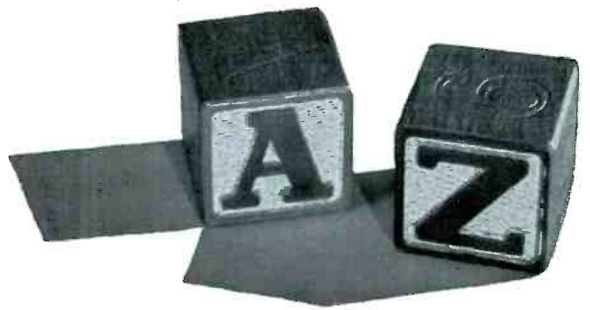

Semiconductors from A to Z

Understand basic integrated circuits before they become widely used in home entertainment equipment



■ This series of articles has included descriptions of regular transistors, FET's, MOS' and tunnel diodes. Another device that is becoming increasingly important in semiconductor radios, TV sets and special equipment is the integrated circuit. This device must also be understood by the technician if he is to remain efficient in his field as technology advances.

Silicon chips, smaller than a dime (Fig. 1) can now be "grown" with an assortment of electronic components. Although some integrated circuits are currently being made with plug-in bases, they are so reliable that many are wired directly into larger circuits. One manufacturer indicates that when some of their integrated circuits are operated between 25 and 30°C (around room temperature) in an oscillator circuit, they experience a failure rate equal to 0.001 percent per 1000 hours. This is equivalent to running 263,000 integrated circuits for a year without experiencing a single failure. A TV manufacturer indicates that the integrated circuit used in their sets is the least likely component to fail.

One integrated circuit (Fig. 2), sold as part No. CA3005 by an

Fig. 1—Approximately 135 usable circuits have been formed on a silicon wafer not much larger than a dime. The relative size of a complete integrated circuit unit is shown on the face of a dime. Courtesy of Motorola.

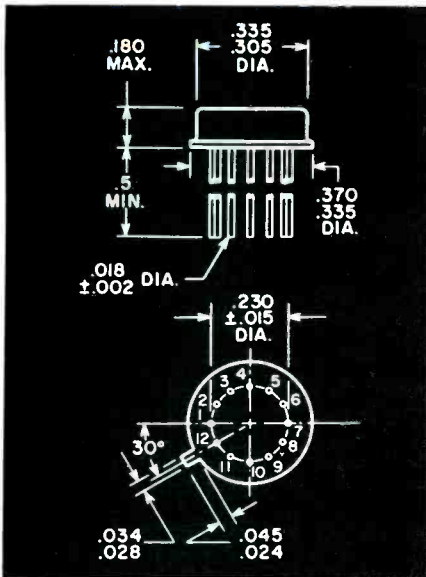

Fig. 2—The dimensions of an integrated circuit sold by an electronics supply company for \$2.80. Courtesy of RCA.

electronics supply company for \$2.80, is commonly used as an RF amplifier. According to the manufacturer, this amplifier has an RF, IF, and video frequency capability, with a frequency response ranging from dc to 100MHz. It has a balanced differential amplifier circuit having a controlled constant-current source, and it can be used as a cascode amplifier.

The function of this integrated circuit can be more readily explained by first comparing a variable-current-source amplifier with a constant-current-source amplifier and then comparing an unbalanced differential amplifier circuit with a balanced differential amplifier circuit.

A Variable-Current-Source Amplifier

The variable-current-source am-

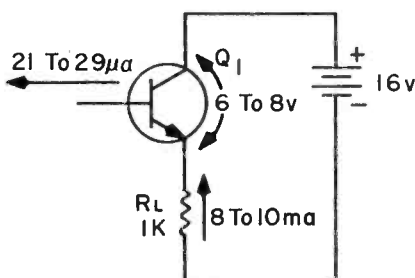

Fig. 3—A variable-current-source amplifier circuit.

plifier circuit (Fig. 3) is similar to the transistor circuit shown in Fig. 2, page 64, of the SEMICONDUCTORS FROM A TO Z article in the October, 1966, issue of ELECTRONIC TECHNICIAN. The only difference is that the collector resistor (R_C) and emitter resistor (R_E) are combined as a single load resistor (R_L) in the emitter portion of the circuit (Fig. 3). The transistor in this circuit has the same characteristic curve as that shown in Fig. 3 of the forementioned article.

If the transistor could conduct sufficient current to cause the voltage drop across the load resistor to equal the voltage source, there would be no collector-to-emitter voltage. The maximum collector current (I_C) would be the amount of current then passing through the load resistance.

(When $C_{CE} = 0$, $I_C = \frac{V_{CC}}{R_L}$.) Since

the circuit contains a 1K load resistance and a 16v source, 16ma of current is required for these conditions.

If the base of the transistor could cut off the collector current completely, no voltage drop would exist across the load resistor and the collector-to-emitter voltage would equal the voltage source. (When $I_C = 0$, $V_{CE} = V_{CC} = 16v$.)

Using the points determined in the two preceding paragraphs, the circuit's load line can be drawn on the transistor's characteristic curve (Fig. 4). From this load line we see that when the base current (I_B) fluctuates between 21 and 29 μ a, the transistor's collector-to-emitter voltage (V_{CE}) fluctuates between 6 and 8v, and the current flowing through the load resistor (R_L) fluctuates between 8 and 10 ma. (The characteristic curve indicates that this is a fluctuation in collector current rather than a fluctuation in emitter current. The actual emitter current, as explained in the September, 1966, article SEMICONDUCTORS FROM A TO Z, varies from 8ma + 21 μ a to 10ma + 29 μ a — the collector current plus the base current — or from 8.021 to 10.029ma.) For all practical purposes, there is no need for this degree of accuracy, and we can merely refer to the collector current as the current flowing

through the load resistor R_L in Fig. 3. We see that a variable amount of current is able to flow from the voltage source (V_{CC}), and that is the reason the circuit has been referred to as a variable-current-source amplifier.

A Constant-Current-Source Amplifier

A second transistor (Q_2) is used to regulate the current in the constant current source amplifier circuit (Fig. 5). Resistors R_1 and R_2

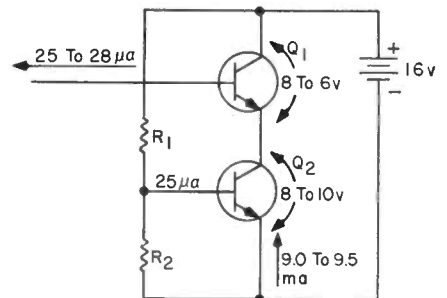

Fig. 5—A constant-current-source amplifier circuit.

are used as a voltage divider to provide this transistor with 25 μ a of base current (I_B). From the transistor's characteristic curve (Fig. 6), we see that the transistor's collector current (I_C) is almost solely dependent on the transistor's base current (I_B) and nearly independent of variations in its collector-to-emitter voltage (V_{CE}). When this particular transistor experiences a constant 25 μ a base current, and the collector-to-emitter voltage is varied from 8 to 10v, the collector current varies only from 9.0 to 9.5ma—remaining nearly constant.

The other transistor (Q_1) in this circuit (Fig. 5) is used to vary the collector-to-emitter voltage of the nearly constant current transistor (Q_2). Since the circuit contains a 16v source of voltage (V_{CC}), the collector-to-emitter voltage in transistor Q_1 must vary from 6 to 8v to cause the collector-to-emitter voltage in transistor Q_2 to vary from 10 to 8v ($16v - 6v = 10v$, $16v - 8v = 8v$.) When the collector-to-emitter voltage of transistor Q_1 is 6v, the collector-to-emitter voltage of transistor Q_2 is 10v, and transistor Q_2 conducts 9.5ma of current. Since

transistor Q_1 is connected in series with transistor Q_2 , 9.5ma of current must pass through it as well. When the collector-to-emitter voltage of transistor Q_1 is 8v, the collector-to-emitter voltage of transistor Q_2 is 8v, and transistors Q_1 and Q_2 conduct 9.0ma of current. Lines have been drawn on the characteristic curve (Fig. 7) of transistor Q_1 to indicate that when it's collector-to-emitter voltage (V_{CE}) varies between 6 and 8v, the collector current (I_c) varies between 9.5 and 9.0ma. By drawing a line through the two points representing these voltage-current combinations, the effective load line can be drawn for the circuit (Fig. 5) containing transistor Q_1 . From the effective load line we see that the base current (I_B) must vary between 25 and 28.5 μ a to cause the transistor's emitter voltage to vary between 6 and 8v. In this circuit (Fig. 5), a 3.5 μ a variation in base current results in a 2v change in collector-to-emitter voltage, while in the circuit discussed earlier (Fig. 3), the same transistor required an 8 μ a variation in base current to produce the 2v change in collector-to-emitter voltage.

If the effective load line (Fig. 7) for the nearly constant current circuit (Fig. 5) could be extended to both coordinates, we would see that

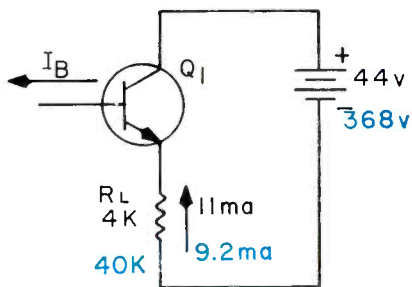

Fig. 8—An equivalent to the constant-current-source amplifier circuit.

it would indicate a maximum current of 11ma and a maximum potential of 44v. The conditions experienced by transistor Q_1 are nearly the same as those it would experience in a circuit (Fig. 8) containing a 44v source and a 4K load resistor. The effective load line, obviously, cannot extend over this range of conditions. In this circuit (Fig. 5), the collector-to-emitter voltage of transistor Q_1 cannot be greater than

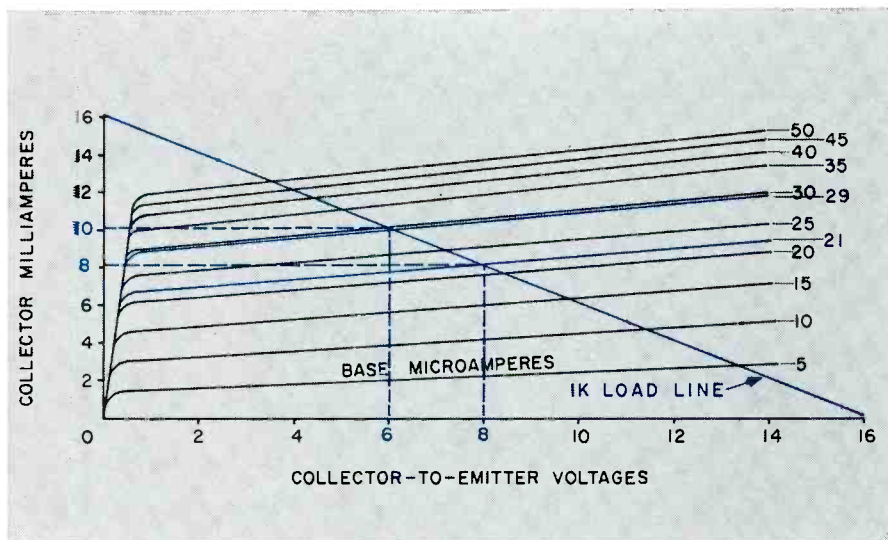

Fig. 4—The load line of the variable-current-source amplifier circuit.

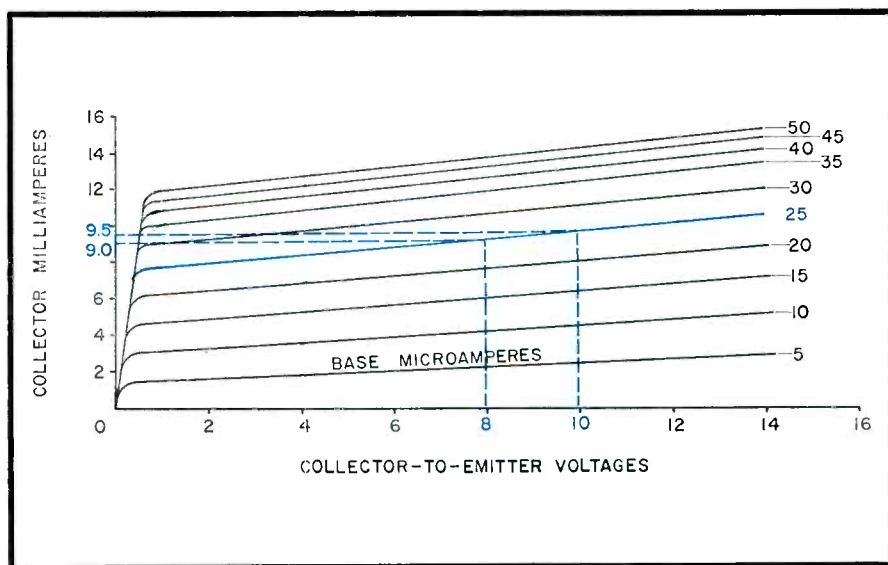

Fig. 6—The characteristic curve of the current regulating transistor.

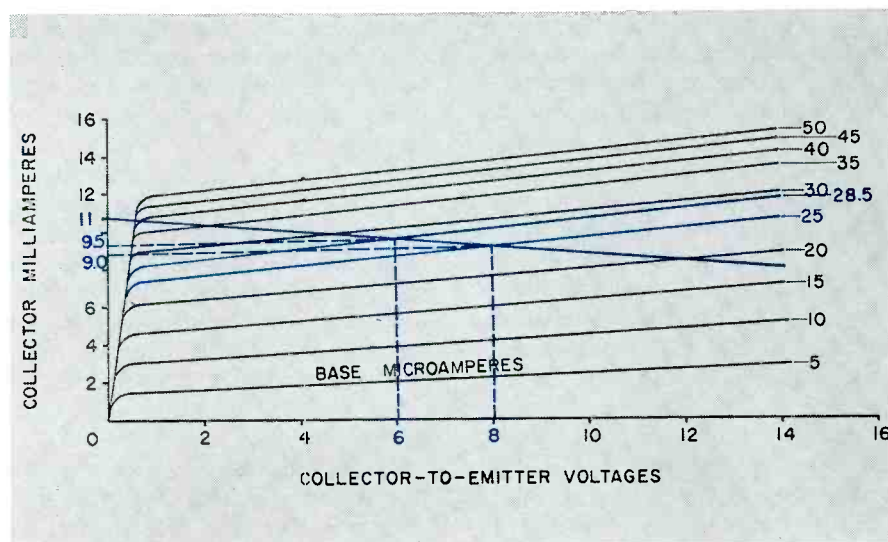

Fig. 7—The effective load line of the constant-current-source amplifier circuit.

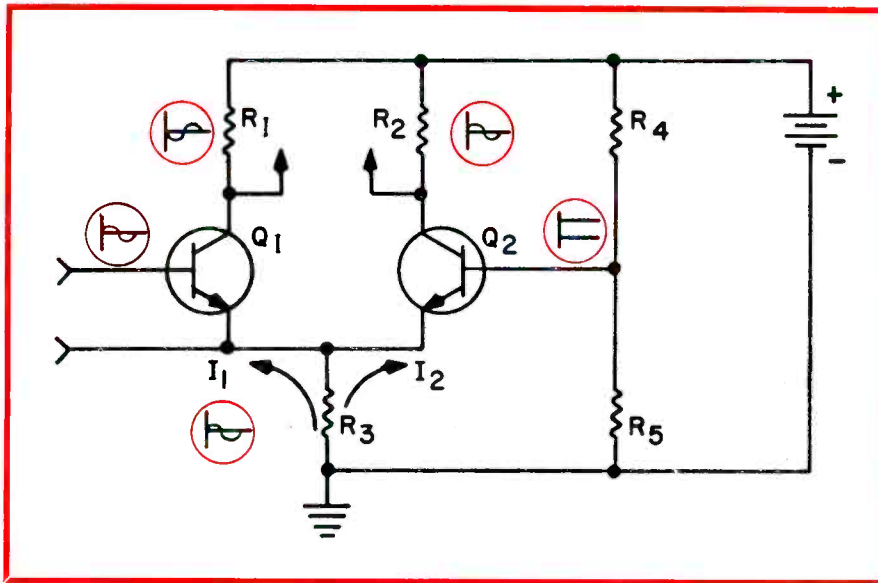

Fig. 9—An unbalanced differential amplifier circuit.

the actual 16v source. As the collector-to-emitter voltage in transistor Q_1 exceeds 15v, the collector-to-emitter voltage in transistor Q_2 becomes less than 1v, and there is a sharp decrease in the amount of current passing through the transistor and circuit.

Suppose we were able to substitute another transistor, for the current regulating transistor Q_2 in the circuit (Fig. 5), that was able to regulate the current 10 times as effectively as before. When the collector-to-emitter voltage in this transistor changes from 8 to 10v, the collector current changes from 9.00 to 9.05ma. Under these new conditions transistor Q_1 conducts 9.05ma when the collector-to-emitter potential is 6v, and it conducts 9.00ma when the collector-to-emitter potential is 8v. If these new points were plotted on the transistor's characteristic curve, we would see that the maximum current conducted in the circuit would be 9.2ma and that there would be an effective potential of 368v. These conditions experienced by transistor Q_1 are nearly the same as those it would experience in a circuit (Fig. 8) containing a 368v supply and a 40K load resistor. The transistor would probably require less than a $\frac{1}{2}\mu\text{a}$ signal to produce a change of 2v.

An Unbalanced Differential Amplifier

A high percentage of the linear integrated circuits currently available make use of differential amplification. The two transistors (Q_1 and Q_2) in a simplified differential amplifier circuit (Fig 9) have separate collector resistors (R_1 and R_2) but a common emitter resistor (R_3). When the base of the first transistor (Q_1) is made more positive with respect to its emitter, the transistor is more forward biased — the collector current will increase and the collector-to-emitter voltage is reduced. As more current flows through the emitter resistor (R_3), the emitters of both transistors become more positive with respect to ground.

The base of the second transistor (Q_2) is biased by two resistors (R_4 and R_5) in a voltage divider. Since the base current is only a small portion of the current passing through the voltage divider, the base remains at a nearly constant voltage with respect to ground.

As the first transistor (Q_1) conducts more current and the emitters of both transistors become more positive with respect to ground, the emitter of the second transistor (Q_2) also becomes more positive with

respect to the base — the base remaining at a nearly constant voltage above ground.

Since the base of the second transistor is less positive with respect to the emitter, the transistor (Q_2) is less forward biased and conducts less current.

When the base of the first transistor (Q_1) is made less positive with respect to the emitter, the transistor is less forward biased, and its collector current decreases as its collector-to-emitter voltage increases. As less current flows through the emitter resistor (R_3), the emitters of both transistors become less positive with respect to ground. While being less positive with respect to ground, the emitter of the second transistor is also less positive with respect to the base — which still remains at a nearly constant potential with respect to ground. Since its base has become more positive with respect to its emitter, the second transistor is now more forward biased and conducts more current.

When the emitter current in the first transistor increases, the emitter current in the second transistor decreases. Since the voltage drop in the common emitter resistor is the sum of the voltage drops caused by the two transistors [$V_{\text{emitter}} = (I_1 + I_2) R_3$ or $I_1 R_3 + I_2 R_3$], the amplitude of the emitter signal is reduced by the two opposing changes in current.

As the first transistor's collector current (I_1) increases, the second transistor's collector current (I_2) decreases, and when the first transistor conducts less current, the second transistor conducts more current. As a result of this situation, the voltage drop across one collector resistor ($I_1 R_1$) increases as the voltage drop across the other collector resistor ($I_2 R_2$) decreases and vice-versa. Since the signal present on one collector resistor is present in inverted form on the other collector resistor, the signal applied to the base of the first transistor results in a push-pull signal at the circuit's output.

There is no way of biasing the two transistors in this circuit so that the change in current across one collector resistor is equal to the change in current across the other

collector resistor. It is the change in emitter voltage that produces the signal in the second transistor. If the signal current of one transistor is equal to the alternate signal current of the other transistor, no signal voltage can be developed across the emitter resistor (When $\Delta I_1 = -\Delta I_2$, $\Delta V_{emitter} = \Delta I_1 R_3 + \Delta I_2 R_3 = \Delta I_1 R_3 - \Delta I_1 R_3 = 0$).

We can more easily compare the currents flowing through the two transistors (Q_1 and Q_2) by applying values to the differential amplifier circuit (Fig. 10). By changing the forward bias of the first transistor (Q_1), the voltage drop across its collector resistor (R_1) varies from about 1 to 4v, and the voltage drop across the common emitter resistor (R_3) varies from 8 to 10v. The voltage drop across the first transistor (V_1) must, therefore, vary from 7 to 2v [$16v - (1v + 8v) = 7v$, and $16v - (4v \times 10v) = 2v$].

The change in the voltage drop across the common emitter resistor changes the bias of the second transistor (Q_2), and as a result of this change, the voltage drop across its collector resistor (R_2) varies from 4 to 1v. The voltage drop across the second transistor must, therefore, vary from 4 to 5v [$16v - (4v + 8v) = 4v$, and $16v - (1v + 10v) = 5v$].

Since the voltage drop across the 1K common emitter resistor (R_3) varies from 8 to 10v, the current (I_3) flowing through this resistor must vary from 8 to 10 ma

$$\left[\frac{8v}{1000\Omega} = 0.008a = 8ma, \text{ and } \frac{10v}{1000\Omega} = 0.010a = 10ma \right]$$
 Since this resistance (R_3) is in series with both transistors (Q_1 and Q_2), the current passing through the resistor must equal the total of the currents passing through the two transistors ($I_3 = I_1 + I_2$).

If the same amount of current could alternately flow through both transistors, and each transistor had collector resistors (R_1 and R_2) of equal value, the voltage drops across the two resistors would be equal at alternate intervals of time. (If I_1 could equal I_2 and $R_1 = R_2$, then $I_1 R_1$ would equal $I_2 R_2$).

When the forward bias of the first

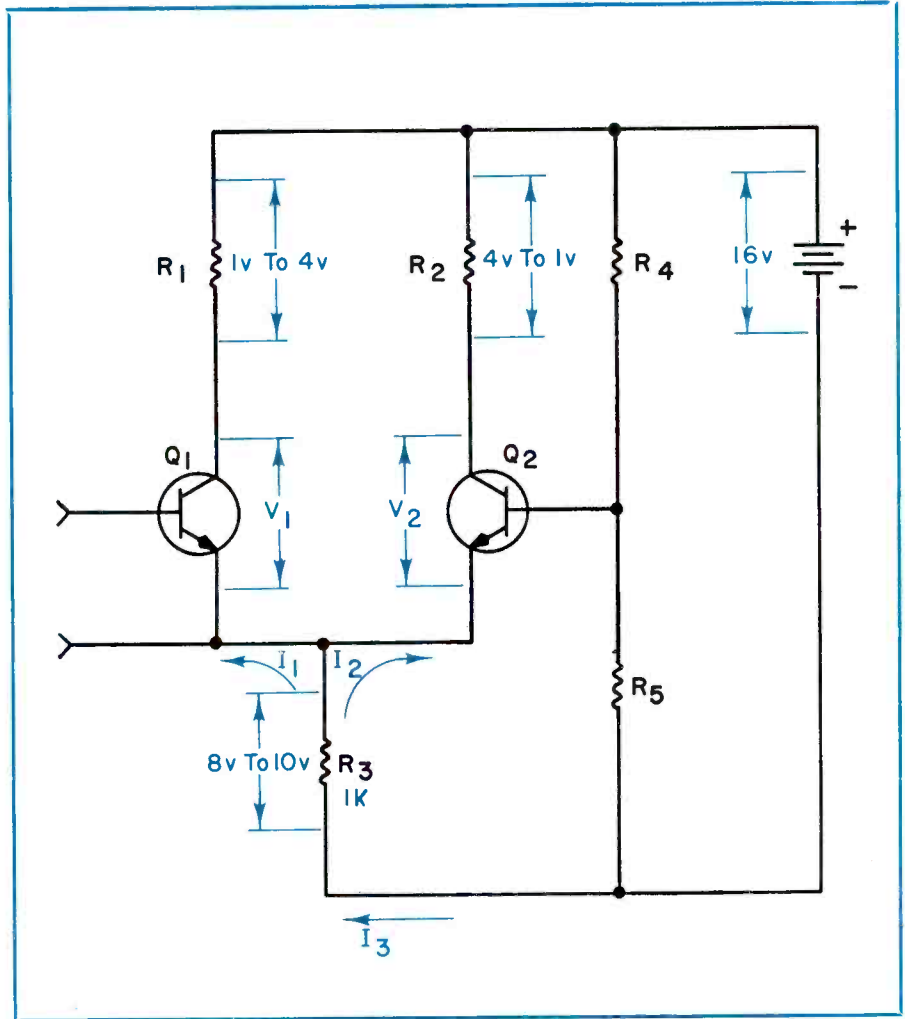

Fig. 10—Voltages present in the unbalanced differential amplifier circuit.

transistor (Q_1) results in a 7v collector-to-emitter potential, the transistor conducts sufficient current to produce an 8v drop across the common emitter resistor (R_3). Under these conditions, 8ma of current passes through this resistor and is the total current passing through the two transistors.

When the two collector resistors (R_1 and R_2) are of equal value, the voltage drop across one is four times that across the other, and 1/5th of the total current passes through one resistor while the remaining 4/5ths of the total current passes through the other resistor. The first transistor must, therefore, be biased to conduct 1.6ma while the second transistor must be biased to conduct 6.40ma ($1/5 \times 8.00ma = 1.60ma$, and $4/5 \times 8.00ma = 6.40ma$).

When the forward bias of the first transistor results in a 2v collector-to-emitter voltage, the tran-

sistor conducts sufficient current to produce a 10v drop across the common emitter resistor. Under these conditions, the common emitter resistor conducts 10ma. Since there is four times as much voltage drop, this time, across the first collector resistor than there is across the second collector resistor, 4/5ths of the current (8.00ma) must now flow through the first transistor and only 1/5th of the current (2.00ma) through the second transistor ($4/5 \times 10.00ma = 8.00ma$, and $1/5 \times 10.00ma = 2.00ma$).

1v	4v		
1.60ma	6.40ma	8.00ma	8v
2.00ma	8.00ma	10.00ma	10v

From these calculations we see that the current flowing through the first transistor fluctuates from
continued on page 101

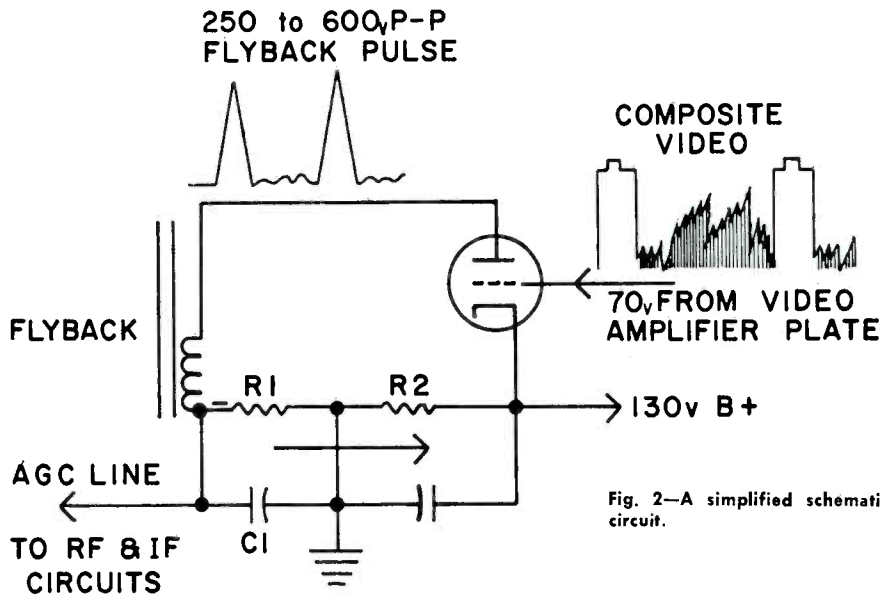

Fig. 2—A simplified schematic of a basic keyed AGC circuit.

UNDERSTANDING MODERN

You cannot troubleshoot and properly repair present-day keyed AGC circuits unless

Part 1 of a Series

■ Every well trained and experienced technician already knows that TV receiver AGC systems, on both B/W and color sets, are designed to develop a dc voltage that varies with the *strength* of the video signals being received. And this voltage is used to maintain the signal strength of the RF and video IF stages at a constant level — to prevent picture and sound fluctuations.

We also know that the simple AGC systems used in older TV sets had many inadequacies. For one thing, the time constant of the circuits were slow and reacted "sluggishly" to signal variations. And noise pulses of various kinds, plus "ghosts" caused by passing airplanes, created unstable signals.

"Keyed," or "gated" AGC circuits provide many improvements over earlier systems. The keyed system is referenced to a portion of the signal, the horizontal sync pulse tips, which does not vary as a function of video information. Thus, it is a more accurate reference. The dc AGC voltage varies with the amplitude of the received horizontal

sync pulse. In other words, more AGC voltage is developed on black scenes and less AGC voltage is developed on lighter scenes.

Because *time* is your most valuable asset, you can make more money when you repair more sets within a given time. Since most of your time is used in troubleshooting — in isolating defective components — your primary need is to reduce troubleshooting time.

To save time in troubleshooting AGC systems, you'll need to know every detail about how these circuits operate. You will also need to develop new, more efficient techniques to speed servicing and repair. Before we explore practical AGC circuits, however, it may prove helpful to remind ourselves, briefly, of the basic principles of keyed AGC.

Basic Principles

Look at the simplified block diagram in Fig. 1. Note that a stage, known as the "AGC keyer," is used. In some sets this stage may be a combination AGC, sync clipper, or separator and noise suppressor.

And, in modern solid-state circuits, still another stage, the AGC amplifier, is frequently a common addition.

Older AGC systems took the AGC control voltage from the video detector but in modern systems, the control, or bias voltage, is taken from the "keyer." A composite signal from the video amplifier is, in effect, "mixed" with a pulse which is taken from a winding on the horizontal output transformer, to produce the AGC voltage. It is important to remember, however, that the system functions only on the upper, or highest amplitude portion, of the horizontal sync pulses.

It is sometimes helpful to think of the typical AGC keyer in general terms — a system that uses two fast-acting "switches" which always function simultaneously (when the receiver is properly synced). The plate/cathode circuit of the keyer tube serves as one switch and the grid/plate circuit serves as the other switch. The first switch is actuated by positive-going horizontal pulses taken from the flyback transformer

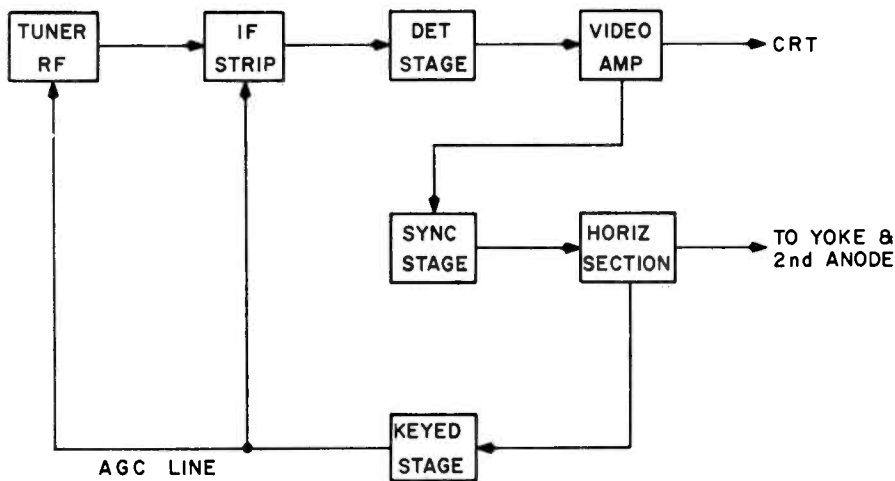

Fig. 1—Simplified block diagram of a TV, showing AGC keyer.

AGC CIRCUITS

you have a thorough knowledge of their functions

and the second switch is actuated by positive-going horizontal sync pulses from the composite video signal. Let's look at a simplified circuit and see how the two simultaneously-operating "switches" function.

Take a look at the simplified schematic shown in Fig. 2. Note that a sharp positive-going horizontal pulse, having an amplitude that may vary in different keyer designs from 250v and upward, is taken from a winding on the flyback transformer and applied across the plate/cathode circuit of the keyer tube. This section of the tube acts like a diode rectifier and the tube will conduct on each horizontal pulse. R1 and R2 act as the diode load. Note that no B+ voltage is applied to the keyer tube plate.

The current waveform through resistors R1 and R2 is a series of sharp spikes at a frequency of 15.75kHz — the horizontal sweep rate. Note, also, that the resistors are grounded at their connecting points. The arrow shows the direction of current flow through the resistors. Observe, too, that the un-

grounded end of R1 is *more negative* than the grounded end. This plate/cathode network is the first "switch" in the keyer,

The grid of the keyer tube is connected directly to the video amplifier plate. Under no-signal conditions this particular keyer tube's grid is approximately 70v, the same as the supply voltage to the video amplifier tube's plate. Because the keyer tube cathode is connected to the 130v supply, the tube's grid is then -60v with respect to the cathode. The keyer tube, under these conditions, is cut off and cannot conduct.

When a positive-going composite video signal having a horizontal pulse amplitude of approximately 60v is on the plate of the video amplifier, the -60v bias on the keyer grid is balanced out and the tube conducts. This action takes place only in the blacker-than-black signal region — at the tips of the horizontal sync pulses. This is the tube's second "switch."

At the instant the keyer tube conducts, it develops a negative voltage

across R1. This can occur, of course, only if both "switches" are closed simultaneously — when the keyer plate is made positive by the flyback pulse and the positive voltage on the grid is increased by the horizontal sync pulse.

Strong received signals will make the keyer grid more positive — creating higher negative pulses across R1. C1 filters the ac from the negative pulses and they are then fed to the AGC bus. The actual design of keyed AGC circuits vary, but all serve the same purpose. Now, let's take a look at some actual circuits and see how they operate.

Typical AGC Circuits

We'll begin with an older chassis and work up to the more modern circuits — including solid-state systems.

The keyed AGC circuit shown in Fig. 3, using a 6AU6 tube, is employed in a Westinghouse V2417 chassis. The tube's screen grid is connected to a 270v B+ source. The cathode has about 155v, obtained through the action of resistors R300, 302 and the AGC level control, R301. The level control is set to provide this voltage. The control grid is dc coupled to the plate circuit of the video amplifier which makes it 100v positive. The 100v on the control grid and 165v on the cathode, places the grid at -65v with respect to the cathode. The tube, of course, is cut off under these conditions.

When the tube's plate receives a capacitively-coupled 600v P-P positive-going pulse from the flyback at the same time that the grid receives a 100v P-P positive-going composite video signal, the keyer tube conducts. When the tube conducts, the pulse-coupling capacitor becomes charged as shown in Fig. 3. When the tube cuts off, the capacitor discharges through resistors R205 and R208 to ground — producing a negative voltage drop. This potential is about -45v but is reduced to a lower voltage which varies between 1 to 5v through drops which take place in R203, 204, 205 and 208. Current flowing from the capacitor through R205 and R208 to ground, opposes current produced by the 270v

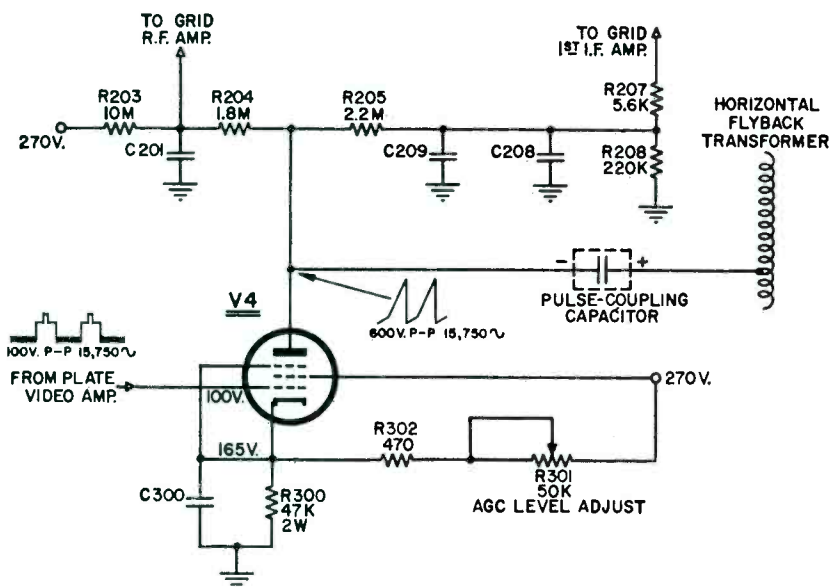

Fig. 3—Keyed AGC circuit in Westinghouse V2417 chassis.

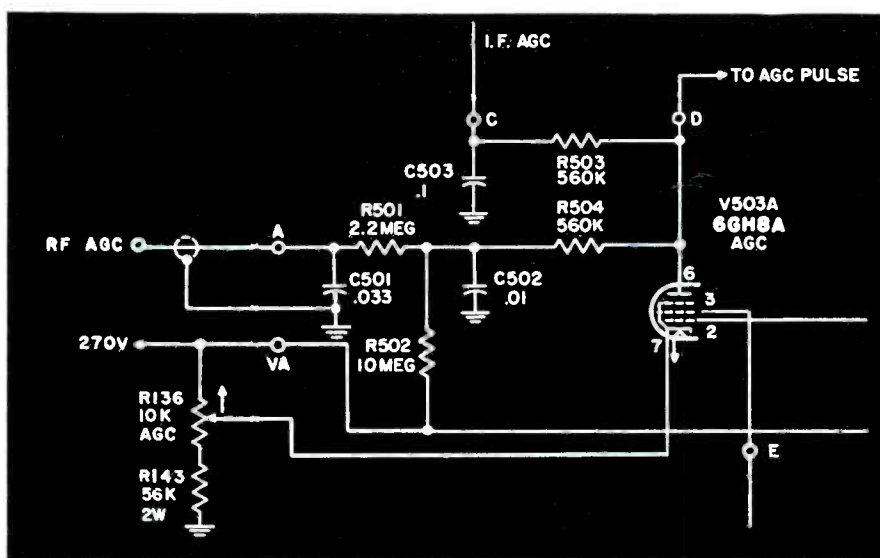

Fig. 4—Keyed AGC system used in the Magnavox T904 color chassis.

across the resistors and the resultant voltage drop across these resistors is the low dc AGC voltage which varies with the incoming signals.

The AGC control in this circuit is used primarily to compensate for variations in AGC circuit component tolerances and to set AGC action at the optimum point for average incoming signal levels. The resistor, R302, limits the amount of positive voltage to the tube's cathode when the control is set to minimum. Under normal conditions, the

AGC control is set to provide about $-65v$ bias between the control grid and cathode. Capacitors C201, 208 and 209 filter the $15.75kHz$ ac from the AGC voltage. It should be noted in practice that the pulse-coupling capacitor in this particular chassis is a 5-in.-long piece of shielded cable.

Once again, as previously indicated, AGC bias — a negative voltage — varies in proportion to the amount of current flowing from the AGC tube. And this current is likewise proportional to the incom-

ing signal amplitude. A strong video signal at the grid of the AGC tube will cause it to conduct more heavily and the larger current will produce a larger negative voltage in the AGC bus. This increased negative voltage will decrease the RF and IF gain. The 1st and 2nd IF grids in this chassis are AGC controlled.

It is interesting to note that the AGC bias circuit to the tuner is designed to apply a somewhat lower voltage to the RF tube grid than that applied to the two IF tube grids. The RF bias is inactive at this lower voltage and begins to function only when the incoming signal becomes stronger. In effect, the RF AGC bias is "delayed." Now we'll look at a more modern keyed AGC circuit.

The schematic in Fig. 4 shows a keyed AGC system used in the Magnavox T904 color chassis. We'll only review the circuit operation briefly.

The pentode section of a 6GH8 tube has its control grid dc coupled to the sync amplifier plate which places a certain amount of B+ on the keyer grid. The cathode of the tube is connected through the 10K AGC control (R136) which places B+ on the cathode. Under normal conditions, the voltage on the cathode will be higher than that on the grid — biasing the tube well below cutoff. The signal on the tube's grid is a positive-going composite video signal. The tube is so biased that it conducts only on the horizontal sync signals. At the instant a sync pulse appears on the grid, a high positive pulse from a winding on the horizontal output transformer is applied to the plate through a 68pf, N150-type, coupling capacitor. The tube conducts at this instant — creating negative AGC bias proportional to the signal strength.

This review of a few keyed AGC circuit functions should give us a fair idea of how modern circuits operate. Forthcoming articles will explore a few other keyed AGC circuits, including transistorized types. Troubleshooting procedures, including the analysis of trouble symptoms, will also be detailed in forthcoming articles. ■

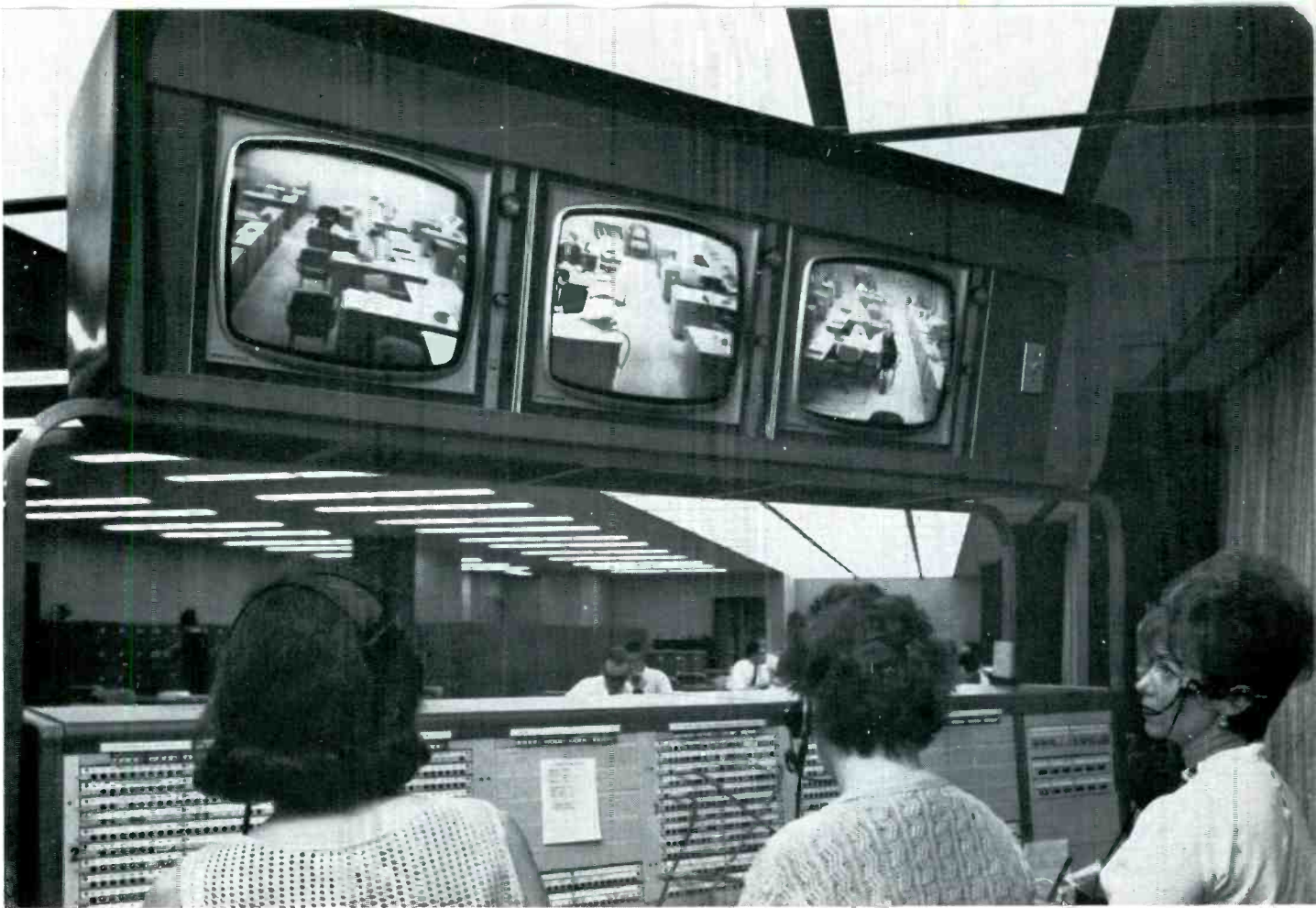

Telephone operators at Bethlehem Steel use CC-TV office monitoring system to route calls to sales personnel. Equipment furnished by Sylvania.

Servicing Closed-Circuit TV Equipment

Learn the 'ropes' in this area of the electronics field and increase your earning ability

Part 1 of A Series

■ A substantial number of **ELECTRONIC TECHNICIAN** readers have moved into the business of servicing CC-TV equipment as a diversified sideline and some have become specialists. In many cases, CC-TV is now employed within integrated setups — audio-visual communications systems. (See the article "Striking It Rich in Audio and Visual Communications," *ET* September 1966.) Some specialists design and install custom audio-visual systems to fit particular needs — in addition to servicing equipment already installed.

Closed-Circuit TV is widely used today in schools and colleges, indus-

trial manufacturing plants, retail stores, security systems, hospitals and in many other areas. And it is showing continuous growth. It can be said unequivocally that this area of the electronics field is indeed promising.

General Technical Considerations

To effectively maintain closed-circuit TV systems, technicians should have a good knowledge of theory involved. While some basic knowledge is compatible with that which every TV technician now has, much additional specialized knowledge is required for CC-TV.

You will, for example, learn that

two basic camera types are in general use: the vidicon and orthicon type cameras. And, in recent years, high resolution cameras have been developed which produce pictures three times as sharp as home-type TV receivers.

You will also need to know what equipment is being used and keep up with technological developments in this area, as with home entertainment equipment, because the techniques involved in maintenance are constantly changing.

Cameras are designed for harsh environmental conditions. Those used in this area generally contain only the video pick-up tube, hori-

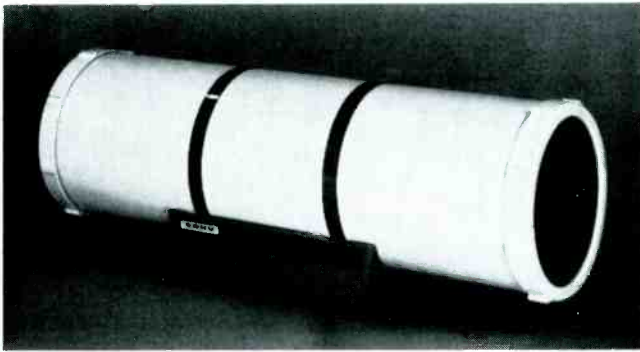

Fig. 1—Cameras designed for rough environmental conditions usually contain only the video pick-up tube, horizontal deflection circuit and preamplifier in a sealed housing.

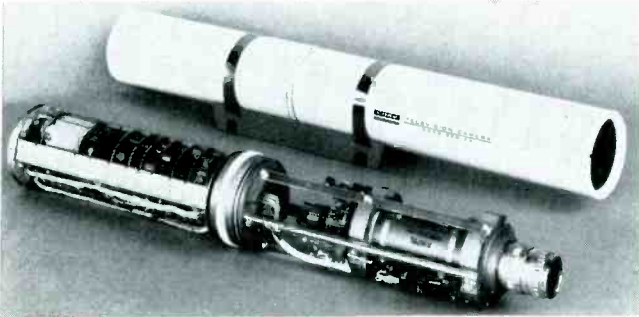

Fig. 3—Miniaturized power supply, synchronizing generator, vertical deflection and amplifier circuits in a sealed housing which is used on an environmental-resistant camera head.

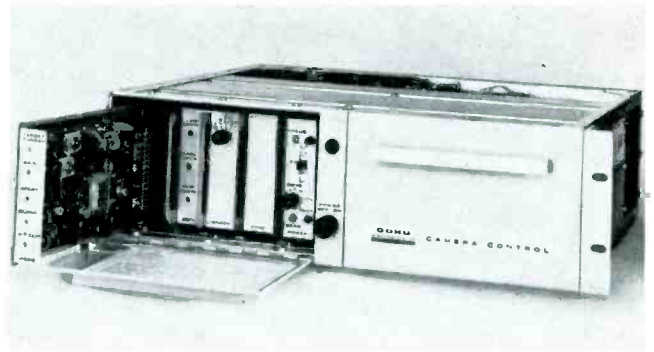

Fig. 2—Separate unit used with remote package shown in Fig. 1 is normally located in a permanent interior spot.

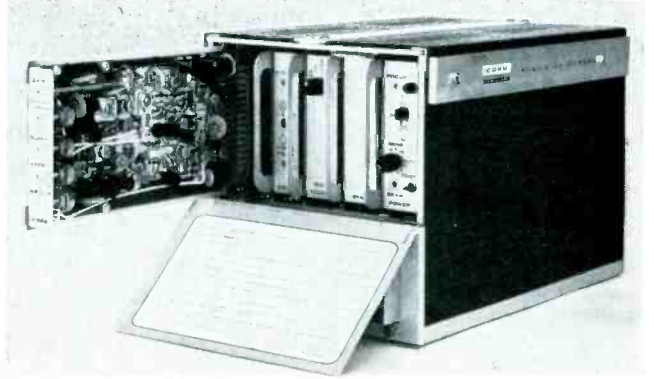

Fig. 4—Single unit "self-contained" camera for interior use.

zontal deflection circuit and preamplifier — all in a sealed housing (see Fig. 1). All other camera circuit assemblies, including those containing controls for alignment and other functions, are contained in a separate unit which is normally located in a permanent interior spot (see Fig. 2).

Where a separate camera control is not used, a miniaturized power supply, synchronizing generator, vertical deflection and amplifier circuits are in a sealed housing and attached to an environment-resistant camera head (Fig. 3). This single-unit camera, frequently referred to as a "self-contained," camera, is also constructed for interior use and is usually larger (see Fig. 4).

Most of the equipment being designed and manufactured today is solid-state and mounted on etched circuit boards. The etched boards are frequently treated with a compound to prevent trouble caused by dust, corrosion, etc. Some boards are encapsulated, or potted, in a non-conductive material to prevent trouble caused by extreme environmental conditions.

You will come into contact with

a wide variety of products capable of satisfying almost any need. Some of this equipment, like that shown in Fig. 5, is completely solid-state and has plug-in modules. Available modules are designed so the service-dealer can put together a variety of custom units to satisfy most needs.

This particular equipment is designed to have a video passband of either 15 or 30MHz, having resolutions up to 1100 lines and a variety of horizontal scan rates and other features. Integrated circuitry, of course, is already making its way into modern CC-TV cameras. Now let's get a little closer to some important basic considerations regarding this equipment.

The Vidicon Tube

About 90 percent of the equipment used in the areas previously mentioned are built around the vidicon tube. And this tube requires considerable care.

A cross-sectional view of a vidicon tube's structure is shown in Fig. 6. It is probably the weakest and most costly link in the CC-TV equipment chain.

Some installations require orthicon type equipment because of its greater sensitivity and ability to operate at lower light levels. It should be understood, however, that each type of equipment has its own advantages and disadvantages.

The standard-type vidicon tube is about 1in. in diameter and 6in. long. The tube base has an electron gun which functions the same as a gun in a B/W TV. The gun's beam is usually deflected electromagnetically with a yoke similar to that used on a TV receiver — although some equipment uses electrostatic deflection.

A photoconductive layer, called the "target," is deposited on the vidicon's faceplate. When this target is lighted the vidicon conducts. The target layer is an insulator when the vidicon is in darkness. An exaggerated drawing of the target is shown in Fig. 7.

Since a fast moving beam is used to sweep the target surface, scan failure can cause the target to be burned in the same way as sweep failure can cause the phosphor or burn on the inside face-plate of a TV CRT.



Fig. 5—One-piece and two-piece CC-TV camera systems by General Precision's GPL Division feature solid-state circuitry and plug-in modular construction.

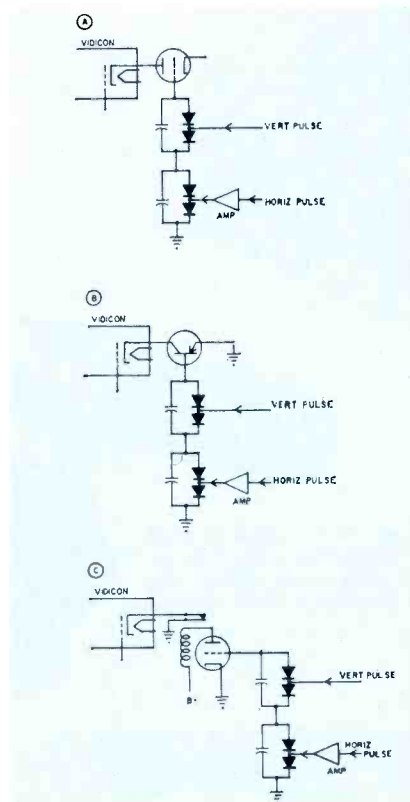

Fig. 8—Three circuits used to protect the vidicon tube. (A)—System which uses rectified positive pulses to keep triode tube "gated" on. (B)—Positive dc keeps transistor gated on. (C)—Relay is kept energized by positive voltage which keeps triode conducting.

All vidicon cameras have a protective circuit to prevent damage to the costly vidicon if the horizontal or vertical sweep fails. The protective circuit cuts off the vidicon beam when a scan failure occurs. Three systems used for vidicon protection are shown in Fig. 8.

Vidicon maintenance consists primarily of routine face-plate cleaning. The same type of tissue and liquid cleaner recommended for optical lenses is used. This is very important since a build-up of foreign substances on the vidicon face will reduce light transmission which in turn can shorten tube life because of the necessity of "overdriving" to maintain picture brightness.

Some important points in vidicon care are as follows:

1. Do not allow direct sunlight to fall on the target area of the vidicon.
2. Do not focus the camera on a spot or flood light.
3. Do not operate the camera with a low light level for any length of time — even if picture quality appears good. This will reduce vidicon life.
4. Do not rotate the vidicon in

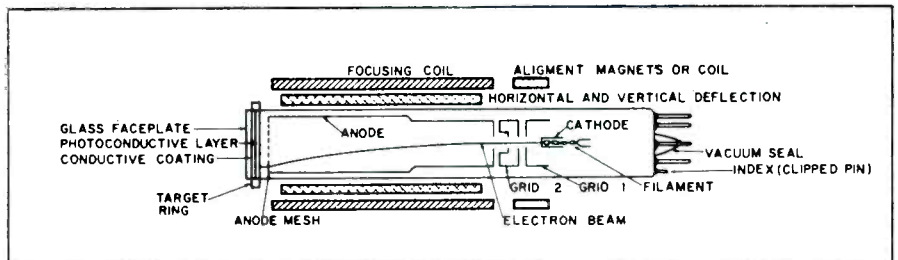

Fig. 6—Cross-sectional view of a vidicon tube's structure.

the deflection yoke from the position set at the factory.

5. Always cap the lens when the camera is not in use and if the lens mount is removed, make sure to cap it.

Sweep Circuits

Sweep circuits used in CC-TV equipment are basically similar to those used in B/W TVs.

In cameras which are completely housed in one case, cathode follower circuits are frequently used to drive the deflection yoke. In those cameras having separate control units, sweep circuits are frequently contained in the control unit housing. In these situations, because of the cable run length, transformer coupling may be used.

Some vidicon equipment uses

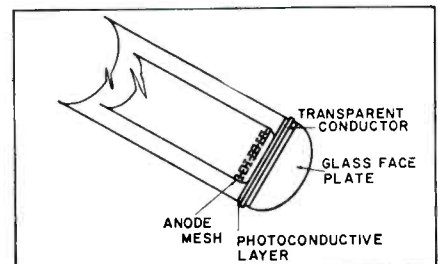

Fig. 7—Relative position of materials used to form the target on a vidicon tube.

electrostatic deflection, similar to that used on most oscilloscopes, and a simple sweep generator is plate-coupled directly to the vidicon deflection elements.

It should be noted that the sync signals for the video output usually originate with the camera sweep circuits. Some cameras have a crystal oscillator which drives the sweep



Blonder-Tongue CC-TV camera provides 800 lines resolution.



Two-piece Sylvania CC-TV camera designed to withstand extreme shock, vibration and noise. Sealed camera head contains only 10 percent of system's circuitry.



Librarian keeps tabs on activities in public rooms and in other sections at the library.



CC-TV camera by Channel Master Corp.



Two CC-TV cameras by Diamond Electronics are solid-state.

output tube for horizontal deflection with dividers to count down to the vertical frequency so an interlaced signal is obtained.

Some camera systems use a free-running horizontal oscillator and tie the vertical oscillator to the 60Hz line frequency.

Some systems feed the sync separately through coaxial cable to synchronize the monitor. If the signal is not used to sync the monitor through the composite video, it is used for "blanking" during the sweep retrace. The blanking signal is applied directly to an active element in the camera tube to cut off the video during retrace.

Normal output for a CC-TV camera is about 1v. If the system uses a composite output signal, one with the sync signal included in the video, the sync signal will be somewhat greater than 1v.

In composite systems the sync may be added in a number of ways. In many cases the sweep outputs are coupled independently to the video amplifier. Since the horizontal sync is usually weaker, it is frequently applied one stage ahead of the vertical sync. The sync may be applied to the cathode, screen or mixed and applied to the grid of a video tube.

Since the CC-TV output signal is fed through a coaxial cable, the output of the video amplifier must match the impedance of the cable. This is usually 75Ω.

The CC-TV system has a number of controls similar to those on a regular TV receiver. These include width, vertical size, vertical linearity and focus. Additionally, there are blanking controls to determine the amount of blanking injected into the video signal, a beam control, to determine the beam current in the vidicon and a target control, to adjust the potential on the vidicon's photoconductive surface.

Control adjustment is sometimes critical and misadjustment can shorten a vidicon tube's life. Too much beam current, for example, will shorten the life of the vidicon. And it will sometimes cause retrace lines or picture smear.

A forthcoming article on this subject will explore some installation and maintenance problems. ■

locate defective capacitors in-circuit

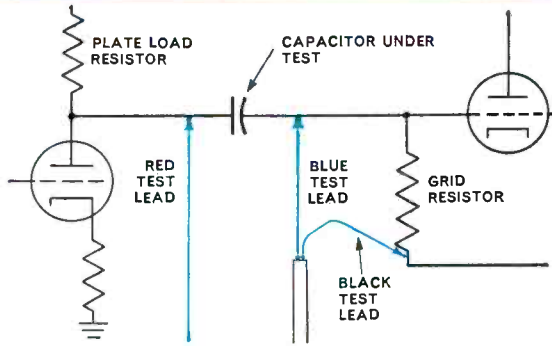

3-LEAD LEAKAGE TEST: One test lead is connected to the plate side of the capacitor and the ground lead to the grid leak return on the other side of the capacitor, and the meter is zeroed. The third test lead is then connected to the grid side of the capacitor and the meter scale shows the leakage directly in megohms.

The B & K model 801 capacitor analyst **really works** without unsoldering or altering circuitry

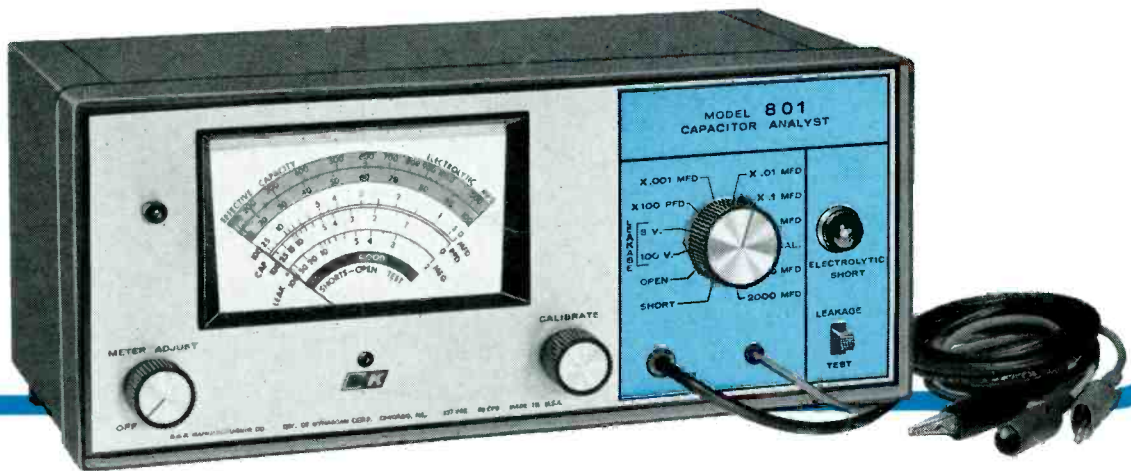

Both in-circuit and out-of-circuit capacitor testing can be done quickly and accurately with the new B & K Model 801 Capacitor Analyst. Foil, mica, general purpose and temperature compensating ceramic, and electrolytic capacitors can be accurately tested for leakage, capacitance, opens, and shorts.

Leakage can be determined in-circuit. The unique B & K 3-lead method permits a degree of accuracy not possible with any 2-lead tester. For normal circuits defective capacitors can be located immediately.

Open capacitors with values as low as 25 pF are easily located with the sensitive high-frequency-signal and resonant- $\frac{1}{4}$ -wave-transmission-line method.

Electrolytic capacitors are tested with a circuit that accurately measures their effective capacitance. Their inherent characteristics of variable equivalent series resistance and internal parallel resistance are automatically accounted for. Only one capacitor lead need be disconnected. The capacitor is charged and then discharged under load. High peak load currents up to 2 amperes ensure testing to in-circuit conditions. Unlike with other testers, capacitor can not be deformed by a reverse polarity voltage. The actual power transferred to a load is measured and the capacitance is read directly from the meter scale for immediate replacement decisions.

All these tests and short tests too are performed with the one set of test leads which is included with the instrument.

Here's the capacitor analyst that really works: B&K Model 801 quickly pays for itself with reduced shop time. Net \$109⁹⁵

See your B & K distributor or write for catalog AP-22.



A DIVISION OF DYNASCAN CORPORATION

1801 W. Belle Plaine, Chicago, Illinois 60613

WHERE ELECTRONIC INNOVATION IS A WAY OF LIFE

Canada: Atlas Radio Corp., 50 Wingold, Toronto 19, Ont. Export: Empire Exporters, 123 Grand St., New York 13, U.S.A.



COLORFAX

Sylvania's DO6 Color Chassis

The new chassis is similar to the DO5 color chassis and has many features of the DO2 shown here. It employs a power transformer, shunt type high voltage regulation and pin-cushion correction at the raster top and bottom. The pincushion correction circuit uses a passive transformer and is slug adjusted.

Chroma circuits are very similar to the DO5 chassis, "X" and "Z" demodulation is used to drive the color difference amplifiers. Matrixing in the cathode and grid circuits provide drive for the G-Y amplifier.

In the video amplifier circuit the pentode-triode (10JT8) used in the DO5 has been replaced by a 6HL7 pentode and the triode section (color killer) is now transistor Q600, an SE1002/2N3694 type.

An additional refinement has been made in the noise gate circuit. Transistor (Q102) has been added to provide greater bias amplification.

This bias is used to cut off the

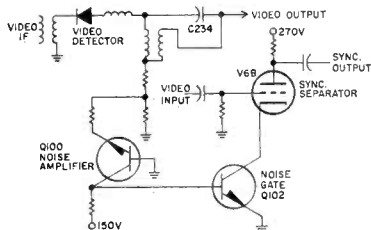

sync separator stage and prevent noise pulses from affecting the scanning oscillators. (See schematic above.)

The brightness and contrast levels are set by adjusting the contrast range control. A spike flyback pulse is rectified by SC204 to provide a negative

dc source for biasing the final video amplifier. This sets the amplifier conduction level and, by dc coupling, the CRT cathode potential. This bias is further adjusted by signal level regardless of average video level variations. To prevent loss of gray scale range caused by changes in average video level, dc restoration is required.

The horizontal AFC circuit in the DO6 is similar to traditional AFC used in color subcarrier frequency control. A diode phase detector is used to compare oscillator and horizontal sync pulse frequency to provide a correction voltage. This voltage controls the reactive current conduction of a reactance tube. The reactance tube is paralleled with a portion of the oscillator tank circuit to provide oscillator control as shown below.

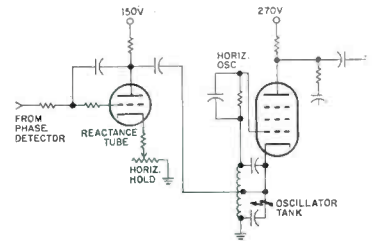

At the grid of the video output stage, dc restoration is accomplished by the clamping diode, SC204. This diode clamps at about the blanking level to provide fixed bias for the video output stage.

Replacing Rubber Bushings on Admiral Color TV Tuning Motor

If the motor will not disengage to permit manual tuning on power tuned Admiral color TV sets using the 91C76-1 tuning motor the condition can be caused by the following: On early production sets the bushings may become warped by oil or heat, preventing the motor from pulling far enough out to disengage. The bushings should be replaced with part No. 91C76-52. The bushings are specially treated to prevent recurrence of this condition.

Color Sync and Brightness Problems on Sylvania's DO1, DO2

Intermittent color sync problems have been found in several DO1 and DO2 chassis caused by a cold solder

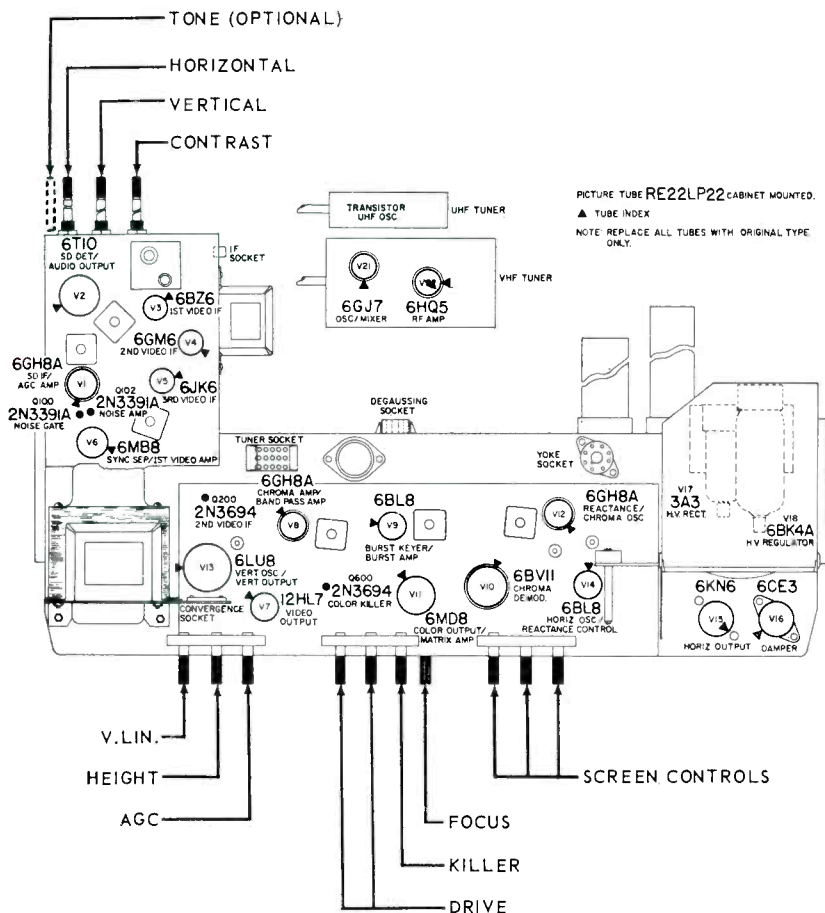

DO6 CHASSIS LAYOUT

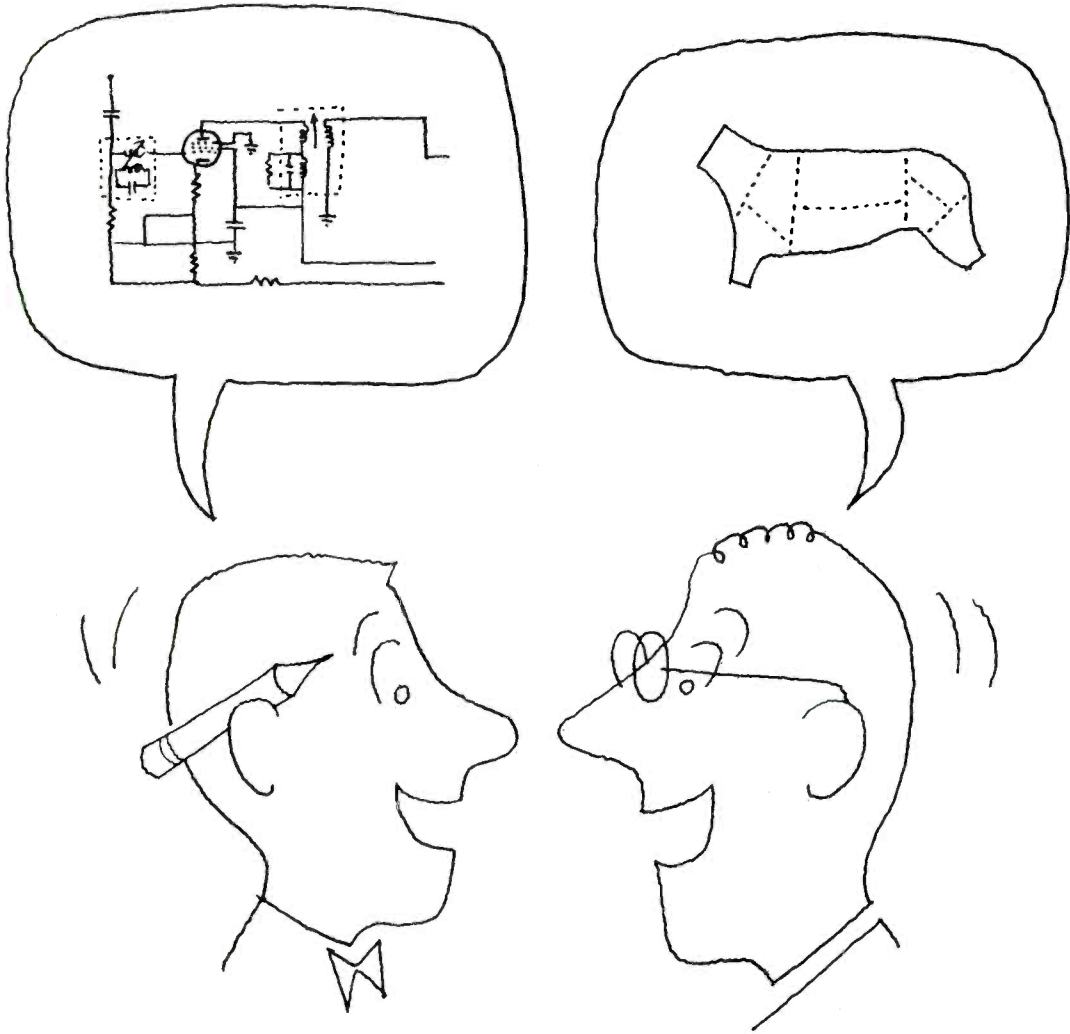

Our editors don't speak the same language.

What can you expect when they serve 11 industries that have about as much in common as an electronic technician and a meat packer? But there are from 5000 to 85,000 people who understand each one of them, and they're the people who count — their readers. Our editors speak the language of their readers — and

fluently. On the job the only things they have in common are mutual pride in our rapidly growing company and the facilities and editorial opportunities that our kind of company makes available to them. That's the way we like it. What they talk about on the golf course is their business.

OJIBWAY PRESS, inc.

Satisfying the need to know . . . with 23 publications in 11 industries.



ELECTRONIC TECHNICIAN • DRIVE-IN MANAGEMENT • DRIVE-IN MANAGEMENT GUIDEBOOK • HOSPITAL & NURSING HOME FOOD MANAGEMENT • SCHOOL & COLLEGE FOOD MANAGEMENT • PLANT & BUSINESS FOOD MANAGEMENT • KITCHEN PLANNING • GAS AGE • GAS APPLIANCE MERCHANDISING • LP-GAS • INDUSTRIAL GAS • BROWN'S DIRECTORY • PAPER SALES • THE PAPER YEAR BOOK • CONVENTION NEWS • MODERN CONVERTER • HEARING DEALER • HOSIERY & UNDERWEAR • OFFICE PRODUCTS DEALER • OP CONVENTION DAILY • AMERICAN FUR BREEDER • MEAT • SPONSOR



joint. This connection is found on the ground side of the flyback AFC

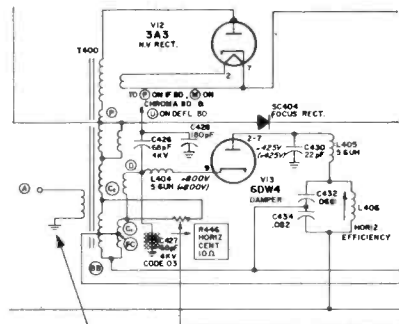

HEAT CONNECTION

REPLACE CAPACITOR

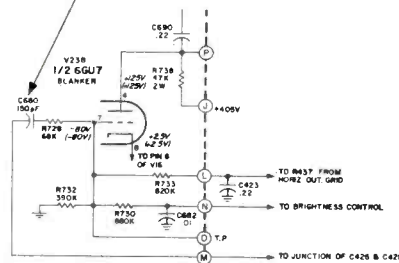

WHAT'S SO GREAT ABOUT OAKTRON SPEAKERS ?

SUPPLYING ALMOST EVERY MAJOR MANUFACTURER OF RADIOS AND TV, OAKTRON HAS ONE OF THE WIDEST RANGES OF SPEAKERS ON THE MARKET.

THE DISTINCTIVE BLUE SPEAKERS FROM OAKTRON ALL HAVE TRUE ALUMINUM VOICE COILS

ALUMINUM VOICE COILS ELIMINATE WARPAGE FROM HUMIDITY AND OVERLOAD HEAT. YOU GET INCREASED SENSITIVITY AND LONGER LIFE. BETTER QUALITY MEANS BETTER RELIABILITY. BEST OF ALL, THEY COST NO MORE THAN PLAIN SPEAKERS. CHECK YOUR LOCAL DISTRIBUTOR FOR COMPLETE DETAILS OR WRITE

YOUR BLUEPRINT TO BETTER SOUND
OAKTRON
INDUSTRIES, INC.
MONROE, WISCONSIN

transformer winding. Re-heat the joint and if there's smoke, there's rosin.

An intermittent opening of C680 in the blunker tube grid circuit, V23B, will cause the brightness to change. Replacement of the 150pf capacitor with a new component will correct the trouble.

RCA Victor CTC16X Chassis HV Rectifier Substitution

Reports reveal tube type 3A3A is being substituted for type 3CA3 in the CTC16X chassis without circuit modification. The 3A3A is a greatly improved tube type designed for better reliability in the high voltage section. Therefore, the 3A3A is a recommended replacement for the 3CA3, if a 3.3Ω resistor is placed in series with the filament lead.

Some replacement tubes, will be double-branded-labeled 3A3A/3CA3. These tubes should, however, be considered as type 3A3A when used in a CTC16X chassis, requiring the addition of the filament resistor.

Installation of the resistor can be made at the rectifier socket without removing the chassis.

Relocate black filament lead from pin 2 to pin 4, connect resistor from pin 2 to pin 4.

... for more details circle 129 on postcard

This **Remington** PREMIER PORTABLE TYPEWRITER

FREE



**WHEN YOU BUY THIS RCA WR-64B
COLOR BAR/DOT/CROSSHATCH
GENERATOR...THE ESSENTIAL
COLOR TV TEST INSTRUMENT**

Here's a deal you can't afford to miss! A FREE Remington portable typewriter—yours when you purchase the most essential color-TV test instrument—the RCA WR-64B!

Just imagine how handy your new typewriter will be—in the shop or at home. You'll use it almost as much as you use the RCA WR-64B—standard of the color TV servicing industry.

Here's how to get your FREE Remington Typewriter. Shipping carton empty card plus the gold label from the RCA Test Equipment Dept. for your new RCA color bar generator to RCA Test Equipment Headquarters, Bldg. 17-2, Harrison, N. J. We will ship your new Remington portable typewriter to you direct, freight prepaid. But remember—this offer covers only equipment purchased between February 1, 1967 and May 15th, 1967. To allow for postal delay, we will honor cards postmarked up to May 31st.

Plan NOW to take advantage of this BIG offer—a FREE Remington portable typewriter with your purchase of an RCA WR-64B color bar/dot/crosshatch generator.



The standard of the Color-TV Servicing Industry. Generates all necessary test patterns—color bars, crosshatch, dots plus sound-carrier. **Only \$189.50***

*Optional Distributor resale price. All prices subject to change without notice. Price may be slightly higher in Alaska, Hawaii, and the West.

Ask to see it at Your Authorized
RCA Test Equipment Distributor

RCA Electronic Components and Devices, Harrison, N. J.



The Most Trusted Name in Electronics

NEW PRODUCTS

For additional information on any products in this section, circle the numbers on Reader Service Card. Requests will be handled promptly.

VTVM 700

A new VTVM is introduced that has a 1/2 v transistor servicing range. Both P-P and RMS voltages are read on separate scales in 7 overlapping



ranges with a rated frequency response of 30Hz to 3MHz. Its 11M input is designed for negligible loading in dc measurements from 0.01 to 1.5kv in 8 overlapping ranges. EICO.

Phillips Screw Launcher 701

A launcher tool for starting Phillips screws is an addition to a line of screw launchers. Available in four

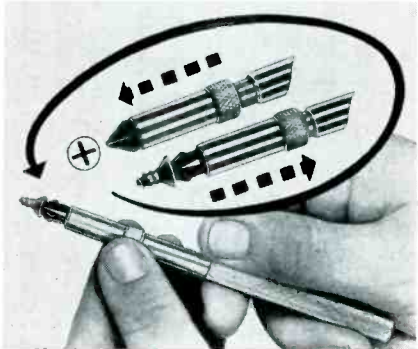

lengths — 3, 5, 7 and 9in. — the screw launcher is designed to grip and start cross-slot screws. Prices from \$1.75 to \$2.20. Vaco.

Two-Way Radio 702

A 120w, FM, two-way, mobile radio is announced that is designed to operate on six channels in the 148 to 174MHz band. The transceiver employs solid-state circuitry throughout, except in the final RF power ampli-

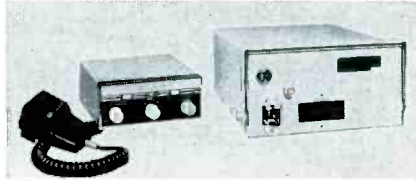

fier stage of the transmitter where an "instant-heat" tube is used. Specifications indicate that spurious emissions are down more than -85db and distortion is less than 4%. The transmitter-receiver unit is designed for trunk mounting and is only 15 x 9 1/8 x 4 1/2 in. The unit weighs only 15 lb. A remote control unit is provided with volume, channel selection and squelch controls. Kaar.

Illuminated Magnifier 703

An illuminated magnifier is announced that reportedly provides 48



sq in. free of distortion or aberration. Included in the unit are two high-intensity flood lights for uniform, concentrated illumination, and a panoramic arm. The arm consists of a vertical mounting post and base with jointed arm that extends to 19in. Techni-Tool.

PA Lecterns 704

A series of roll-about and table model lecterns are introduced for schools, hotels, conference halls, etc. They contain dual mounted speaker columns that may reportedly be individually oriented both vertically and horizontally to meet audience configuration and the physical shape of the location. The model shown weighs

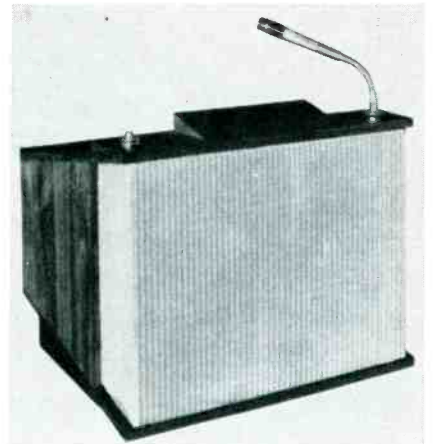

70 lb, measures 19 x 26 x 21 in. and is designed to rest on any table. Temple Sound.

Dual-Channel CB Transceivers 705

A matched pair of dual-channel, unlicensed, CB walkie talkies has a 10 transistor superheterodyne circuit that



includes an RF Stage. The units operate on eight 1.5v penlight cells. List price for pair is \$84.95. Channel Master.

Radio Analyzer 706

A solid-state instrument is announced for servicing and troubleshooting all types of AM and FM radios. The instrument combines "sig-

nal injection," "signal detection" and a power supply source in a single portable instrument. The generator output includes 1kHz audio and RF over the range of 240kHz to 1750kHz plus 10.7MHz FM IF, for "injection-type" service work. "Signal tracer" circuitry incorporates a light-

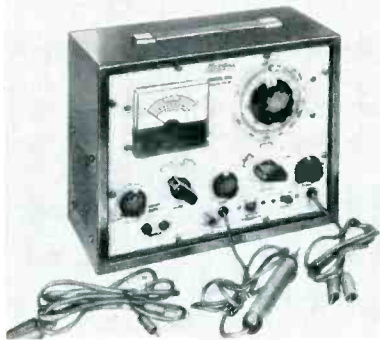

loading probe along with a tuneable amplifier covering 240kHz to 1.75MHz and a built-in audio amplifier and speaker. Price \$149.50. Hickok.

Bench Lamp 707

A bench lamp is designed to provide both fluorescent and incandescent light. It comes with a double-wall re-



flector hood with ventilating louvers for air cooling, and either a standard 26-in. arm or an extra long 33-in. arm. Price \$28.10. Acme Lite Products.

Universal Tool 708

A new universal terminal attaching tool can reportedly be used to attach both insulated and non-insulated ter-



minals to wire from 22 to 10 AWG. It is also designed to strip wire from

10 to 22 AWG, cut wire and cut all bolts ranging from 1/4 to 5/8 in diameter. Price \$5.99. Aerovox.

Color Generator 709

A solid state, color generator featuring a movable single dot and single vertical and horizontal line patterns is announced. Its automatic timer heating element is thermostatically controlled to maintain a minimum operating temperature of 80°F. All adjustments are located on the front panel under the hinged pattern strip,

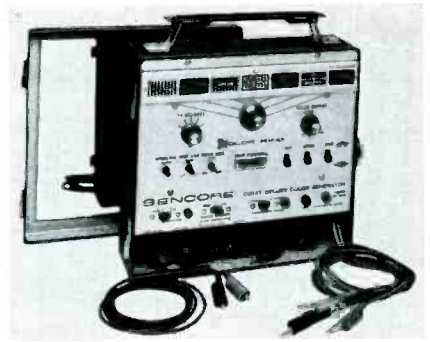

for readily accessible fine adjustment of each channel, timer controls or dot size. Price \$149.95. Sencore.

How to break into the big money servicing 2-way radios!

How would you like to start collecting your share of the big money being made in electronics today? To start earning \$5 to \$7 an hour... \$200 to \$300 a week... \$10,000 to \$15,000 a year?

Your best bet today, especially if you don't have a college education, is probably in the field of two-way radio.

Two-way radio is booming. Today there are more than five million two-way transmitters for police cars, fire trucks, taxis, planes, etc. and Citizen's Band uses—and the number is growing at the rate of 80,000 new transmitters per month.

This wildfire boom presents a solid gold opportunity for trained two-way radio service experts. Most of them are earning \$5,000 to \$10,000 a year more than the average radio-TV repair man.

Why You'll Earn Top Pay

One reason is that the U.S. doesn't permit anyone to service two-way radio systems unless he is licensed by the FCC (Federal Communications Commission). And there aren't enough licensed electronics experts to go around.

Another reason two-way radio men earn so much more than radio-TV service men is that they are needed more often and more desperately. A two-way radio user must keep those transmitters operating at all times, and must have them checked at regular intervals by licensed personnel to meet FCC requirements.

This means that the available licensed experts can "write their own ticket" when it comes to earnings. Some work by the hour and usually charge at least \$5.00 per hour, \$7.50 on evenings and Sundays, plus travel expenses. Others charge each customer a monthly retainer fee, such as \$20 a month for a base station and \$7.50 for each mobile station. A survey showed that one man can easily maintain at least 15 base stations and 85 mobiles. This would add up to at least \$12,000 a year.

How to Get Started

How do you break into the ranks of the big-money earners in two-way radio? This is probably the best way:

1. Without quitting your present job, learn enough about electronics fundamentals to pass the Government FCC Exam and get your Commercial FCC License. Then start getting practical experience in servicing two-way radio systems in your area.

2. As soon as you've earned a reputation as an expert, there are several ways you can go. You can add mobile radio maintenance to the present services offered by your shop, or start your

own separate mobile radio business. You might become a franchised service representative of a big manufacturer and then start getting into two-way radio sales, where one sales contract might net you \$5,000. Or you may be invited to move up into a high-prestige salaried job with one of the major manufacturers.

The first step—mastering the fundamentals of electronics in your spare time and getting your FCC License—can be easier than you think.

Cleveland Institute of Electronics has been successfully teaching electronics by mail for over thirty years. Right at home, in your spare time, you learn electronics step by step. Our AUTO-PROGRAMMED™ lessons and coaching by expert instructors make everything clear and easy, even for men who thought they were "poor learners." You'll learn not only the fundamentals that apply to all electronics design and servicing, but also the specific procedures for installing, troubleshooting, and maintaining two-way mobile equipment.

Your FCC License... or Your Money Back!

By the time you've finished your CIE course, you'll be able to pass the FCC License Exam with ease. Better than nine out of ten CIE-trained men are able to pass the FCC Exam, even though two out of three non-CIE men fail. This startling record of achievement makes possible our famous FCC License Warranty: you'll pass the FCC Exam upon completion of your course or your tuition will be refunded in full.

Find out more. Mail coupon for two FREE books, "How To Succeed In Electronics" and "How To Get A Commercial FCC License."

CIE

Cleveland Institute of Electronics

1776 E. 17th St., Dept. ET-28 Cleveland, Ohio 44114

Cleveland Institute of Electronics

1776 E. 17th St., Cleveland, Ohio 44114

Please send me without cost or obligation:

1. Your 40-page book "How To Succeed In Electronics" describing the job opportunities in Electronics today, and how your courses can prepare me for them.

2. Your book on "How To Get A Commercial FCC License."

Name _____ Age _____
(please print)

Address _____

City _____

State _____ Zip _____

Check here for G.I. Bill information.

Accredited Member National Home Study Council. ET-28

ENROLL UNDER NEW G.I. BILL

All CIE courses are available under the new G.I. Bill. If you served on active duty since January 31, 1955, or are in service now, check box in coupon for G.I. Bill information.



SCORE with
SPRA KLEEN
ELECTRONIC CONTACT & CONTROL CLEANER



SPRA-KLEEN eliminates noise due to dust, dirt and corrosion on electrical contacts the easy way. Just spray onto the contact or control for a quick efficient job. No need to dismantle the chassis to get at the parts when you use Sprakleen. Spray extension included.

FREE GIFT COUPONS
on GC Aerosol Chemicals

GC ELECTRONICS
 400 S. Wyman Street Rockford, Ill. 61101
 ... for more details circle 114 on postcard

NEW PRODUCTS

Tape Package 710

A line of magnetic tape is to be distributed in individual plastic containers. The containers are reportedly



made of high-impact molded plastic, with an inner plastic box to guard the tape against dust and dirt. Compu-tron.

Butterfly Clamp 711

A butterfly clamp is designed to hold two cables side by side. In installations, the nylon clamp is fastened in place with two screws and

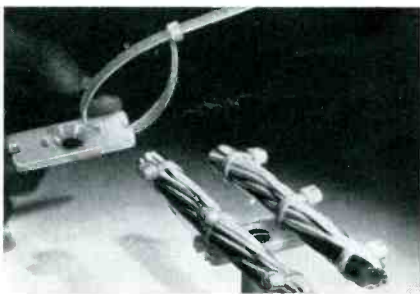

two ties are inserted in the slots in the clamp. The wire bundles are then positioned and the ties are fastened around each wire bundle. Either self locking or twist locking ties may be used. Thomas & Betts.

Cartridge-Tape Deck 712

Announced is a cartridge-tape deck for background music and special programs in commercial and business establishments. It reportedly uses a specially designed, two-hour, no-rewind cartridge that provides continuous service without tape tangles,



tension loss or tape edge fatigue. The cartridge slides in from the front and all controls, including fuse change, are on the front panel so that the unit can be operated from any confined location. The unit has a rated frequency response of 50Hz to 7.5kHz. Bell.

AM/FM Tuner 713

Announced is an AM/FM Tuner that is designed to provide a background music source for any commer-

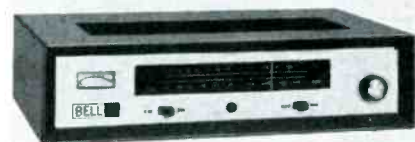

cial-sound system. The circuitry is completely transistorized and designed to handle strong input signals. Specifications indicate an FM sensitivity of $3\mu\text{v}$ with 200kHz band width and an AM sensitivity of $10\mu\text{v}$ with 8kHz band width. Bell.

Remote Control Switch 714

A wireless remote control switch is announced that is designed to turn electrical equipment ON and OFF with



a battery powered transmitter. The unit will reportedly operate over a range of 40ft, and specifications indicate that the relay in the receiver has a contact rating of 7.5amp. Euphonics.

Telephone-Type Handset 715

A close-talking, dynamic-microphone-type handset has been designed



for environments of high-ambient noise and reverberant acoustics. Specifications indicate that the microphone has a frequency response of 70Hz to 5kHz and that the noise discrimination averages 15db. The output impedance is 150/250 Ω . Altec Lansing.

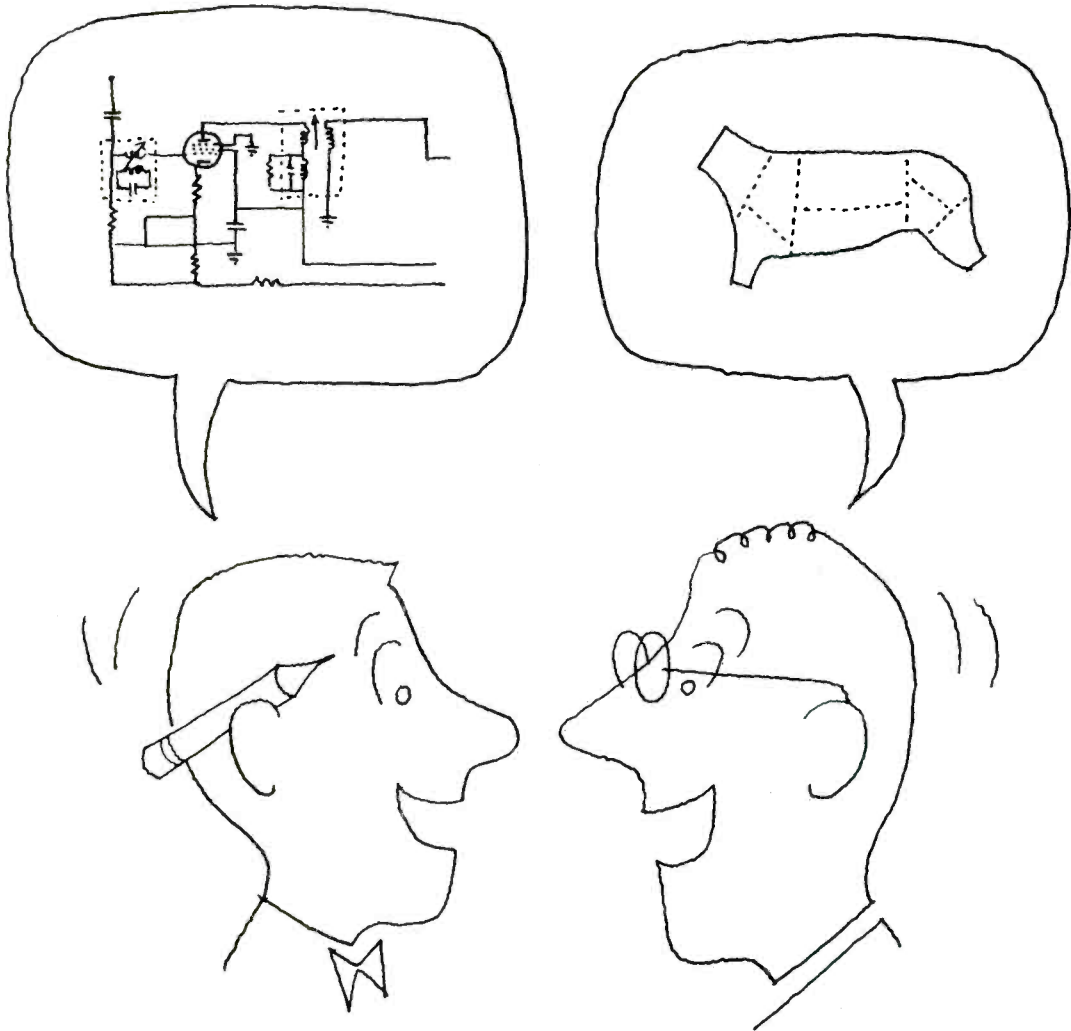

Our editors don't speak the same language.

What can you expect when they serve 11 industries that have about as much in common as an electronic technician and a meat packer? But there are from 5000 to 85,000 people who understand each one of them, and they're the people who count — their readers. Our editors speak the language of their readers — and

fluently. On the job the only things they have in common are mutual pride in our rapidly growing company and the facilities and editorial opportunities that our kind of company makes available to them. That's the way we like it. What they talk about on the golf course is their business.

OJIBWAY PRESS, inc.

Satisfying the need to know . . . with 23 publications in 11 industries.



ELECTRONIC TECHNICIAN • DRIVE-IN MANAGEMENT • DRIVE-IN MANAGEMENT GUIDEBOOK • HOSPITAL & NURSING HOME FOOD MANAGEMENT • SCHOOL & COLLEGE FOOD MANAGEMENT • PLANT & BUSINESS FOOD MANAGEMENT • KITCHEN PLANNING • GAS AGE • GAS APPLIANCE MERCHANDISING • LP-GAS • INDUSTRIAL GAS • BROWN'S DIRECTORY • PAPER SALES • THE PAPER YEAR BOOK • CONVENTION NEWS • MODERN CONVERTER • HEARING DEALER • HOSIERY & UNDERWEAR • OFFICE PRODUCTS DEALER • OP CONVENTION DAILY • AMERICAN FUR BREEDER • MEAT • SPONSOR



joint. This connection is found on the ground side of the flyback AFC

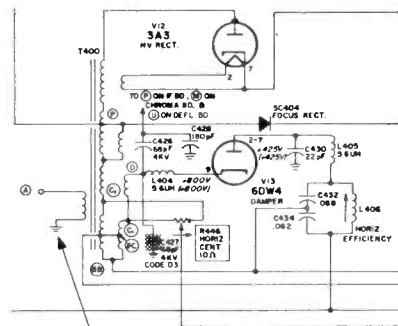

HEAT CONNECTION

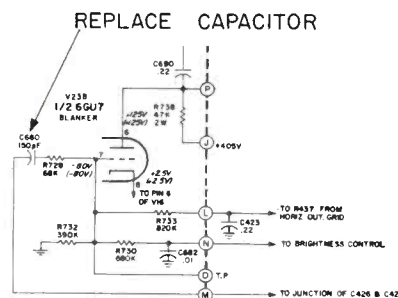

REPLACE CAPACITOR

transformer winding. Re-heat the joint and if there's smoke, there's rosin.

An intermittent opening of C680 in the blanker tube grid circuit, V23B, will cause the brightness to change. Replacement of the 150pf capacitor with a new component will correct the trouble.

RCA Victor CTC16X Chassis HV Rectifier Substitution

Reports reveal tube type 3A3A is being substituted for type 3CA3 in the CTC16X chassis without circuit modification. The 3A3A is a greatly improved tube type designed for better reliability in the high voltage section. Therefore, the 3A3A is a recommended replacement for the 3CA3, if a 3.3Ω resistor is placed in series with the filament lead.

Some replacement tubes, will be double-branded-labeled 3A3A/3CA3. These tubes should, however, be considered as type 3A3A when used in a CTC16X chassis, requiring the addition of the filament resistor.

Installation of the resistor can be made at the rectifier socket without removing the chassis.

Relocate black filament lead from pin 2 to pin 4, connect resistor from pin 2 to pin 4.

WHAT'S SO GREAT ABOUT OAKTRON SPEAKERS



SUPPLYING ALMOST EVERY MAJOR MANUFACTURER OF RADIOS AND TV, OAKTRON HAS ONE OF THE WIDEST RANGES OF SPEAKERS ON THE MARKET.

THE DISTINCTIVE BLUE SPEAKERS FROM OAKTRON ALL HAVE TRUE ALUMINUM VOICE COILS

ALUMINUM VOICE COILS ELIMINATE WARPAGE FROM HUMIDITY AND OVERLOAD HEAT. YOU GET INCREASED SENSITIVITY AND LONGER LIFE. BETTER QUALITY MEANS BETTER RELIABILITY. BEST OF ALL, THEY COST NO MORE THAN PLAIN SPEAKERS. CHECK YOUR LOCAL DISTRIBUTOR FOR COMPLETE DETAILS OR WRITE

YOUR BLUEPRINT TO BETTER SOUND
OAKTRON
INDUSTRIES, INC.
MONROE, WISCONSIN

... for more details circle 129 on postcard

install ALLIANCE Tenna-Rotor®...now

*Profit now with world-famous
Tenna-Rotors.®*

**You'll sell more than ever before.
And they're twice as easy to sell!**

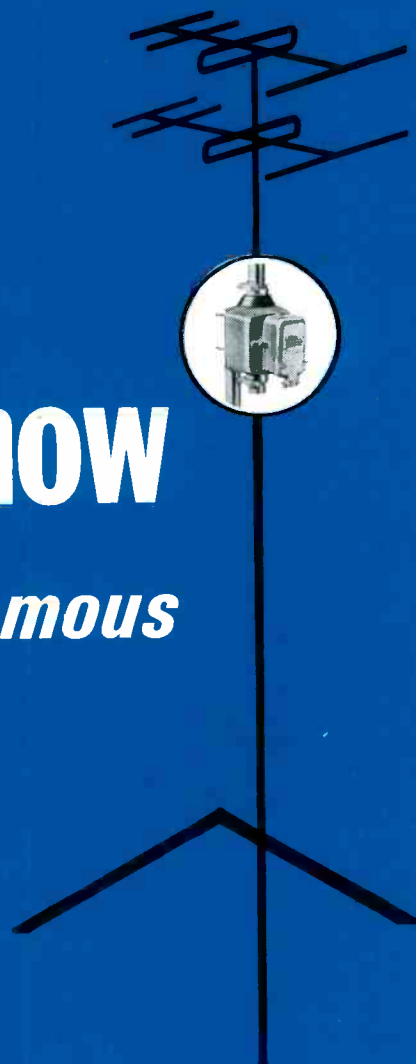

In-store demonstrations sell on sight! Hook up a Tenna-Rotor . . . Every color set needs one . . . Then, watch their faces light up when you turn the dial and they see a beautiful color picture. Switch to black & white or FM Stereo. Same result: Tenna-Rotor pulls 'em in sharp, clear, bright and strong!



Install the world famous Alliance Tenna-Rotor®

"TV's Better Color Getter"



The **ALLIANCE** Manufacturing Company, Inc.
(Subsidiary of Consolidated Electronics Industries Corp.) **ALLIANCE, OHIO**
Maker of GENIE® Garage Door Openers

ET-4

CIRCUIT ANALYZERS



PS 127—Wide Band 5" Oscilloscope with direct reading P to P volts. **\$199.50**



SM 112E — Combination VTVM-VOM with automatic scale indication. **\$89.95**

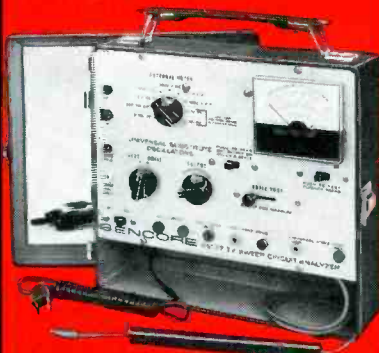

SS 137—Sweep Circuit Analyzer for both black & white and color TV. **\$79.50**



FS 134—Field Strength Meter covers all VHF and UHF channels plus FM. **\$199.50**

PICTURE TUBE TESTERS & REJ.



CR 143—CRT Champion Deluxe CRT checker and rejuvenator. A must for accurate color CRT testing. **\$99.50**



CR 13—CRT Cadet: CRT checker and rejuvenator. Easy to set-up; fast to use. **\$79.95**

NEW for 1967

the most complete line of quality time-saving test instruments by

SENCORE

NO. 1 MANUFACTURER OF ELECTRONIC MAINTENANCE EQUIPMENT

Here's the big SENCORE line-up for '67. All new, all improved. Each instrument is the finest in the field, designed, engineered and built to save time, make you money. Every instrument is

COLOR GENERATORS



CG 10 — Lo Boy Standard Color Bar Generator — battery operated. **\$89.95**



CG 12 — Lo Boy Standard Color Bar Generator — AC operated and 4.5 mc tuning crystal. **\$109.95**



CG 141—Color King Standard Color Bar Generator with exclusive TEMP CONTROL for absolute stability. **\$149.95**



CA 122B—Deluxe Color Circuit Analyzer for black & white and color. **\$187.50**

triple tested for guaranteed accuracy. Compact, portable, rugged. All steel encased. Priced right — check and compare. SENCORE ... your best buy, always.

TRANSISTOR TESTING



TR 139—In-Circuit, Out of Circuit Transistor Tester **\$89.50** that works every time.



TR 115—Out of Circuit Transistor Tester. Easy to use. **\$24.95**



BE 124—Battery Eliminator for fast repair of transistor radios. **\$24.95**

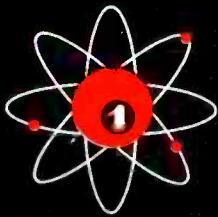

MULTIPLEX



MX 129—Deluxe Multiplex Generator for fast repair of FM Stereo receivers. **\$169.50**



MX 11—Channelizer FM Stereo Multiplex Generator simplifies stereo servicing. **\$99.50**

SUBSTITUTION

RC 144—Handy 36 Resistor-Capacitor substitution unit—lower than the cost of **\$14.95** the parts.



RC 145—Handy 53 Resistor, Capacitor and Electrolytic substitution with full protection. **\$34.95**



RC 146—Handy 75. Resistors, Capacitors, Electrolytics, Power Resistors, and Universal Silicon and Selenium Rectifiers at your fingertips. **\$44.95**



TUBE TESTERS

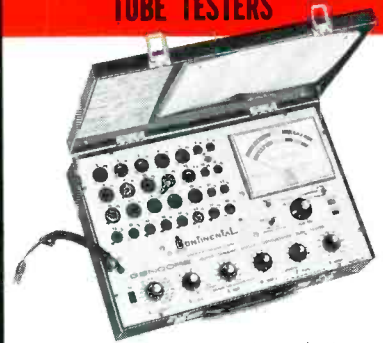

MU 140 Continental Mutual Conductance Tube Tester—also speedy Mighty Mite tester with first three controls. **\$179.50**



TC 131—Semi-Automatic Tube Tester for you or your customer. Easy to operate—sensitive. **\$99.50**



TC 142—New Mighty Mite V speed and sensitive in home or shop tube tester. **\$74.50**

FC 123—Filament Checker: A must for series string filament testing. **\$3.95**



BE 113—Dual TV Bias Supply. Two 0 to 20 volts DC supplies for alignment or AGC trouble shooting. **\$12.75**



FREE
SEND
FOR NEW 1967
SENCORE
CATALOG

SENCORE, INC. 426 S. Westgate Dr., Addison, Ill. 60101

Please rush me your FREE 1967 catalog, showing all your new instruments.

NAME _____ (Please print)

ADDRESS _____

CITY _____ STATE _____ ZIP _____

... for more details circle 134 on postcard

NEW PRODUCTS

Wire Marking Kit 716

A pocket-size book of wire markers for on-the-job use is announced. It features 10 flip-strip dispenser cards

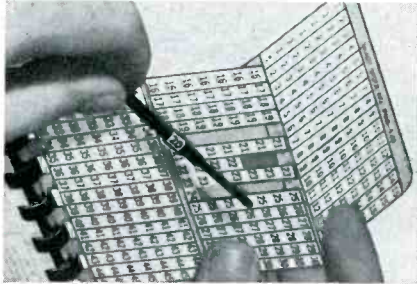

of self-sticking markers for around-the-wire identification. The kit reportedly contains up to 450 wire markers and matching terminal markers. Price \$2.50. Brady.

Voice-Actuated Switch 717

A voice-actuated switch is announced that is designed to convert four current tape recorder models to sound-switched machines, creating a broad line of voice-actuated recorders.

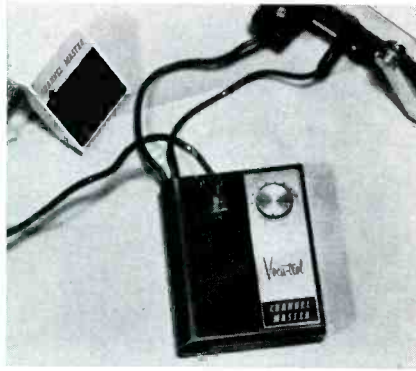

The new unit is connected between the recorder's remote microphone input and the normal microphone. A variable sensitivity adjustment is provided to pre-set the sound-activation level. A three second delay circuit prevents shut-off during normal pauses such as occur in dictation. List price \$12.95. Channel Master.

FM Stereo Tuner 718

Announced is a solid-state,

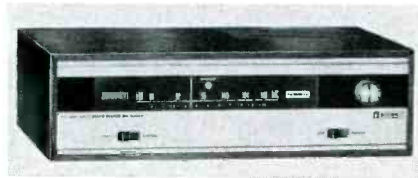

FM/stereo FM tuner with a reported sensitivity of 1.5mv for 20db quieting. Specifications indicate that it has an image rejection of over 90db, a 55db signal-to-noise ratio, less than 1 percent distortion and a frequency response of 50Hz to 15kHz \pm 1.5db. Price without cabinet \$89.95. Allied.

CB Transceiver 719

A new 23-channel, solid-state CB transceiver is introduced that measures 5 $\frac{3}{4}$ x 6 $\frac{1}{4}$ x 1 $\frac{7}{8}$ in. Crystals are reportedly supplied for all 23 channels,

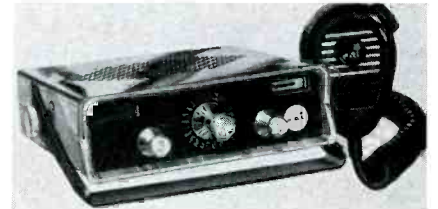

and the transceiver comes complete with microphone, illuminated S meter, illuminated channel selector and modulation indicator. Courier.

For more information on these
NEW PRODUCTS
See pages 103 & 104
READERS SERVICE

Helps stop ghosts!

Zenith Quality Wavemagnet® Indoor TV Antenna

Designed for finest all-channel (2 to 83) reception in color or B&W. Special network provides stepped-up basic dipole impedance, resulting in lower voltage standing wave ratio than ordinary VHF indoor antennas . . . cuts down snow, reflections and ghosts. Two full-size UHF loops, one behind the other, develop an unusually high front-to-back ratio (equal to that in many outdoor antennas), remarkably reducing ghosts and man-made interference. Order as Part Number 973-56 from your Zenith distributor!

*Built to the quality standards
of Zenith original parts*

ZENITH

The quality goes in before the name goes on

Want to catch all the action this year?

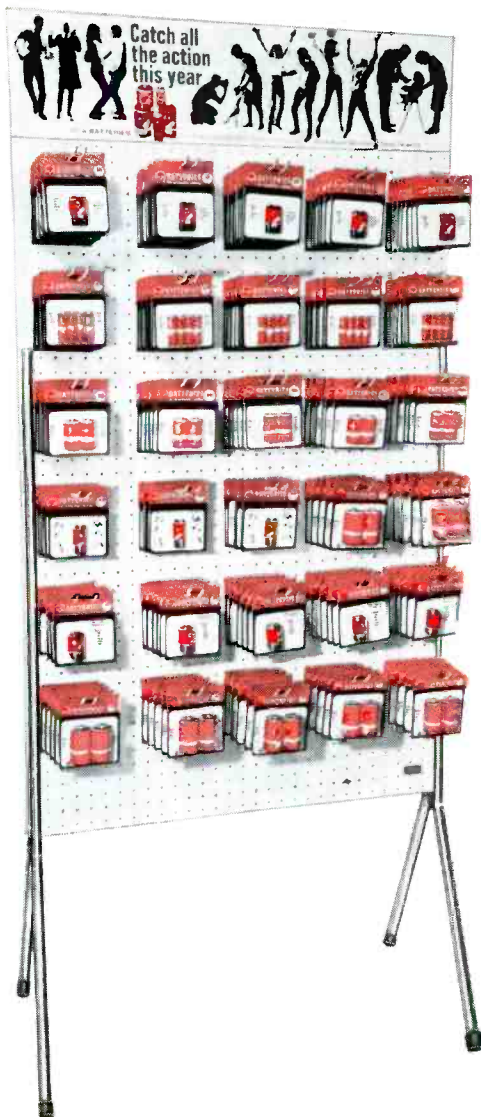

1P1279
Full-Line Blister-Pack
Pegboard Floor Display

You'll catch all the battery action you can handle with RCA's new floor merchandiser. For greater sales appeal, greater self-service, better inventory control, and reduced handling of products, you can't beat this Full-Line Blister Pack Floor Display.

Designed to hold a full complement of RCA blister pack batteries (up to 180 blister packs), this attention-demanding unit measures 72" high by 31" wide. And the attractive "Catch All The Action" header will stop them in their tracks!

So contact your RCA Battery Distributor and find out how easily you can catch all the battery action this year... and the profits that go with it!

RCA Electronic Components & Devices, Harrison, N.J.



The Most Trusted Name in Electronics

NEW PRODUCTS

Color TV Coils 720

Exact-replacement, sweep-circuit coils for color-TV sets are introduced. The focus, convergence and sweep-

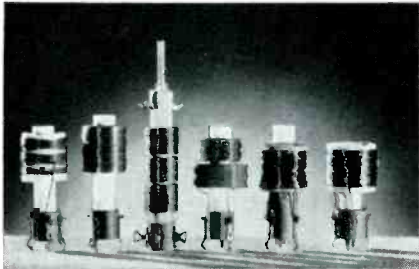

circuit coils reportedly are directly interchangeable with the original coils in color-TV sets made by five manufacturers. J. W. Miller.

Routing Clamps 721

Announced are routing clamps for temporarily routing wires or clamping permanent wiring. The clamps can be used for control wiring in panels and are reportedly completely reusable. They are locked closed by slots that are designed to permit reopening at will without damaging the clamp.

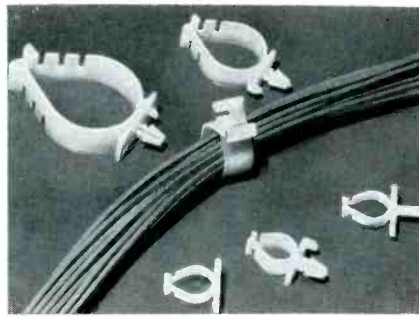

Specifications indicate that they can be locked in either of three positions to permit adjustability for varying diameters. The clamps are fabricated of nylon and are available in four basic sizes of 1/2, 1, 1 1/2 and 2 in. diameters. Thomas & Betts.

31 Channel Transceiver 722

Announced is a 31-channel transceiver that includes all 23 CB channels plus 8 additional part-15 channels that can be used to monitor short range walkie-talkie communications. The

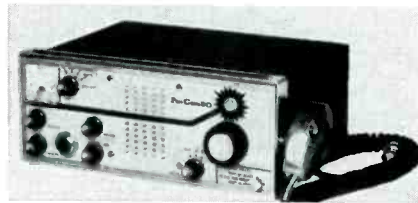

receiver is a dual-conversion super-heterodyne with a Nuvistor RF amplifier and mixer stages for a rated 0.15µv sensitivity at 10db S/N. Price \$329.50. Polytronics.

Square Wave Generator 723

An all solid-state, squarewave generator reportedly produces clean squarewaves over a wide frequency range from 1Hz to 10MHz. Accord-



ing to specifications the squarewave rise and fall times are less than 5 percent and jitter is less than 0.2 percent of the waveform period at any repetition rate. The new squarewave generator weighs only 9 lb. Price \$375. Hewlett-Packard.

Tone Caller 724

A transistorized private tone caller is introduced that reportedly uses ceramic and resonant-tuning-fork circuitry instead of conventional reed



relays. The unit features 9-transistor, 2-diode circuitry; push-button switches for standby, normal, call and reset; a volume control and indicator light. Size: 1 7/16 x 4 x 5 3/4 in. Price \$34.95. Lafayette.

Power Rheostat-Potentiometers 725

A line of power rheostat-potentiometers is introduced that features

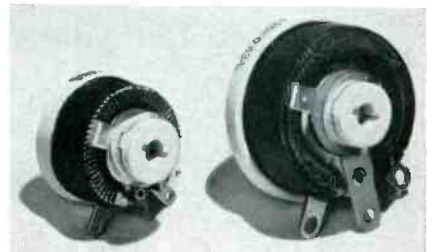

ceramic construction (core, base, hub). Stocked in all popular resistance values of 5K and 10K for 25 and 50w sizes respectively, the units are reportedly directly interchangeable with

NEW FROM INJECTORALL



HERE'S PROOF!

PROOF that "SUPER 100" tuner cleaner is BETTER!

Tested by a leading independent laboratory against competitive products!

	SUPER 100	A	B	C
CLEANING	Excellent	Good	Fair	Fair
LUBRICATION	Good	Fair	Fair	Poor
PLASTIC ATTACK	None	None	None	None
FLAMMABILITY	None	None	None	None
CONDUCTIVITY	None	None	Slight	Slight
ANTI-STATIC PROTECTION	Excellent	Fair	Poor	Poor
DRIFT	None	Slight	Yes	Yes



SUPER 100 TUNER CLEANER . . . for COLOR and Black and White TV tuners
6 oz. spray can with INJECTORALL steel needle
CAT. NO. 100-6 net \$1.95

Buy it at your Electronic Parts Dealer.
For free catalog on the complete line, write to:

INJECTORALL ELECTRONICS CORP. • Great Neck, N. Y. 11024

. . . for more details circle 118 on postcard

those of other major manufacturers. Ward Leonard.

FM Stereo Antennas 726

A series of FM antennas is designed to overcome the critical db loss in

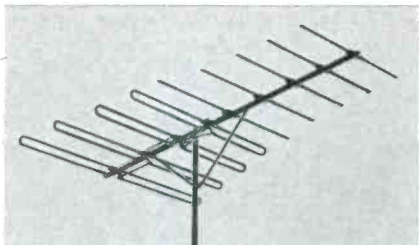

multiplex reception which tends to limit fringe area listeners to monophonic reception only. \$14.95 to \$29.95. Channel Master.

Nylon Cable Clamps 727

A line of nylon cable clamps offers molded-in, self-aligning ribs designed

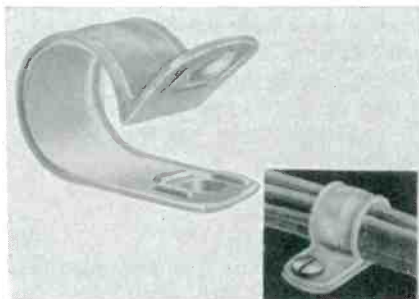

to permit easier installation and better locking action. These clips are made in black or natural nylon and come in three sizes, $\frac{3}{8}$, $\frac{5}{16}$, and $\frac{1}{2}$ in. Weckesser.

Wide-Band Oscilloscope 728

A 5-in wide-band oscilloscope is introduced for audio and TV servicing. The specifications include a vertical



response to 5MHz with 10mv RMS/cm sensitivity, a two stage push-pull vertical amplifier plus cathode-follower input and a squarewave tilt for true display of complex waveform. Price net, \$134.95. Precise.



In the Replacement Cartridge Business

LOOK-ALIKES ARE NOT ENOUGH!

Only PERFORM-ALIKES and FIT-ALIKES will do! Everyone gets skinned when the resemblance is only skin deep!

Astatic has stayed FIRST BY FAR in the cartridge field for more than three decades by supplying EVERY TYPE OF CARTRIDGE needed, WHEN needed, and with EXACT DUPLICATE FIT and SUPERIOR PERFORMANCE.

It's the No. 1 formula for cartridge business success offered ONLY by the No. 1 cartridge manufacturer - Astatic.



THE ASTATIC CORPORATION

Conneaut, Ohio 44030 U. S. A.

In Canada: Canadian Astatic Ltd., Toronto, Ontario • Export Sales: Roburn Agencies, Inc., 431 Greenwich Street, New York, New York 10013, U. S. A.

THE PIONEERS AND THE PACESETTERS OF QUALITY SOUND REPRODUCTION

... for more details circle 104 on postcard

Impedance mismatch problems?

When most voice coil impedances were either 3.2 ohms or 8 ohms, speaker replacement was relatively simple. Then came transistor sets, and equipment without output transformers, and now voice coil impedances range all over the map.

It's important to remember that a mismatched impedance in a speaker replacement will almost surely create problems... from a loss of volume to a blown transistor.

Quam... and only Quam... helps you avoid these problems these three ways:

1. WIDE CHOICE—As Photofacts/Counterfacts participants, we know in advance what voice coil impedance the new equipment will require, so we generally have the right speaker in our comprehensive line *when you need it.*

2. VERSATILE SPEAKERS—Quam *multi-tap speakers* offer a choice of impedances in a single unit. Available in all the sizes you need for automotive replacement, Quam multi-taps handle 10, 20, or 40 ohm applications.

3. SPECIAL SERVICE—Just in case you run across an oddball, we offer this convenient exclusive: *any Quam speaker can be supplied with any voice coil impedance, only \$1.00 extra, list price.*



QUAM

THE QUALITY LINE
FOR EVERY SPEAKER NEED

QUAM-NICHOLS COMPANY

234 East Marquette Road • Chicago, Illinois 60637

... for more details circle 131 on postcard

NEW PRODUCTS

Electronics Pliers 729

A new line of electronics pliers features a copper-alloy bearing on a wheel or shaft to eliminate steel-

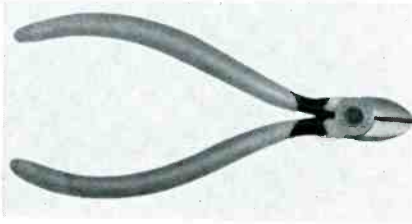

against-steel friction. The copper-colored rivet is readily visible on both faces of the tool for easy identification. Diamond Tool.

Ten-Band Radio 730

A solid-state, 10-band, portable radio is introduced that features a padded vinyl case with swing-out doors. The radio covers the following reception bands: FM (88-108MHz) with automatic frequency control, long



wave for beacon use, marine-short wave (1.8-5.2MHz), standard broadcast (AM) with tuning meter (540-1600kHz) and six short wave bands. Separate whip antennas are provided for FM and SW reception. Price \$150. G-E.

Coaxial Cable Clip Leads 731

A series of "Breakouts," designed to convert standard coaxial cable to test cables, is announced. These units are supplied in eight models, with either BNC, UHF, TNC, or type "N" receptacle at one end, and a choice of alligator or minigator clips at the other end. By connecting the proper breakout receptacle to a correspond-

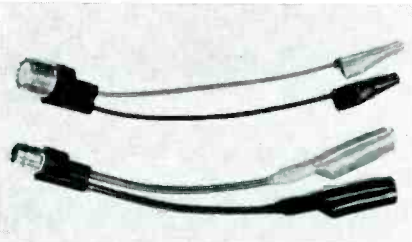

ing cable plug, any standard coaxial cable becomes a test cable equipped with clip leads. Pomona.

Record Spray 732

A record spray is introduced, which is reportedly safe on all phonograph



records, including the old shellac types. According to the release, the spray cleans and lubricates the records with a fine silicone film that prevents static build up. The lubricant is designed to prolong record life by reducing wear of the grooves. Colman.

CB Walkie-Talkie 733

Announced is a 3w, two channel, CB walkie-talkie that reportedly contains 11 transistors and is powered by



rechargeable nickel-cadmium batteries. The sealed Speaker/Mike transducer is designed to be impervious to weather or humidity. Price \$129.50. Polytronics.

For more information on these
NEW PRODUCTS
See pages 103 & 104
READERS SERVICE

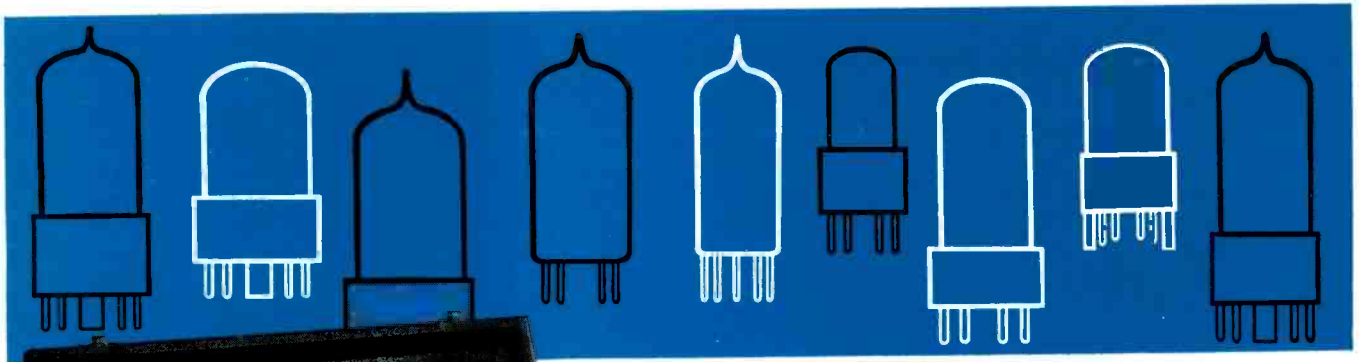

*New design for color
...and all other!*

**QUICK-CHECKS
MORE COLOR
TV TUBES
WITH
Gm* ACCURACY**

**Makes test under actual
set-operating conditions*

NEW B&K model 707 DYNAMIC MUTUAL CONDUCTANCE TUBE TESTER *with obsolescence protection*

You're always ahead with B&K. The new "707" gives you the famous B&K professional tube-testing speed and efficiency—plus the ability to test more color TV tubes with Gm* accuracy.

Provides multiple-socket section to quick-check most of the TV and radio tube types the *true dynamic mutual conductance way**—plus simplified switch section to check other tube types in Dyna-Jet emission circuit. Also includes provision for future new sockets.

You can quickly check all the tubes in the set, detect hard-to-locate weak tubes that need replacement... sell more tubes, save call-backs, and make more profit. *Makes test under set-operating conditions.* Checks each section of multi-section tubes separately. Checks for all shorts, grid emission, leakage, and gas. Makes quick "life" test. Exclusive adjustable grid emission test provides sensitivity to over 100 megohms. *Quickly pays for itself.* Net, \$189.95

Tests:

New and old TV and Radio Tubes. Tests Nuvistors, Novars, 10-pin tubes, 12-pin Compactrons, European Hi-Fi tubes, Voltage Regulators, and Most Industrial types.

See your B&K Distributor or Write for Catalog AP22-R

NEW TUBE INFORMATION SERVICE

Keep your tube tester up-to-date. Subscribe now to tube information service, available every 3 months.

Canada: Atlas Radio Corp., 50 Wingold, Toronto 19, Ont.



A DIVISION OF DYNASCAN CORPORATION

1801 W. Belle Plaine, Chicago, Illinois 60613

WHERE ELECTRONIC INNOVATION IS A WAY OF LIFE

Export: Empire Exporters, 123 Grand St., N.Y. 10013 U.S.A.

... for more details circle 106 on postcard

NEWS OF THE INDUSTRY

Capitol Records Will License 4-Track Cartridges With Selections from Its Catalog

Capitol Records, Inc., has announced that it will license the manufacture and distribution of 4-track, stereo-tape cartridges containing selections from the Capitol catalog. This is a departure from previously-stated policy of confining their tape-cartridge product to 8-track.

According to Capitol Record's President, Alan Livingston, "Large quantities of 4-track cartridges illegally dubbed from recordings are now being sold throughout the nation. It is estimated that the number of bootlegged 4-track cartridges may be equivalent to the number that would be sold if Capitol itself released such a product.

A \$1 reduction in the total price of most Capitol 8-track single cartridges was also reported by the company. The price reduction is reportedly in response to prevailing marketing conditions and competitive price levels.

ITT and ABC Assail Dept. Of Justice Merger Evidence

International Telephone and Telegraph Corp. and the American Broadcasting Cos., have charged that the Dept. of Justice's new evidence in opposition to the merger of the two communications companies is "glaringly insufficient, for the most part irrelevant" and in many respects "seriously misrepresented."

The charges were contained in a joint filing by ITT and ABC with the Federal Communications Commission in response to the Justice Dept.'s petition to the FCC to reconsider the merger situation.

ITT's and ABC's joint filing declared that the department, in its plea for reconsideration by the FCC, through the medium of full hearing, failed to prove its contentions in all six areas raised by the department. These were: potential entry of ITT into network operation, the CATV issue, the merger's possible effect on technological innovations, the issue of fusion of diverse communications interests, the issue of reciprocity and the issue of ABC's financial needs.

To refute the Justice Dept.'s claims of possible fusion of adverse communications interests, the petition says that ABC's interest in cheaper domestic rates continues with no conflicts since ITT is not a domestic carrier, and that the proposed merger would, in fact, strengthen ABC's bargaining power with AT&T.

EIA Reveals Official Statistics for 1966

Final tabulation of December distributor sales by the Electronic Industries Assn's. Marketing Services Depts. confirms industry estimates of sales records in all major product categories.

During 1966 color TV showed a gain of 71.2 percent over 1965 while there was a 13.4 percent decrease in the sales of B/W TV sets.

Table, clock and portable home AM radios managed a gain of 2.4 percent while all home FM radio sales were up 19.9 percent. The auto radio trend was just the reverse with an 8.1 percent decrease in sales during 1966.

SAVES
your back...

SAVES
your time...

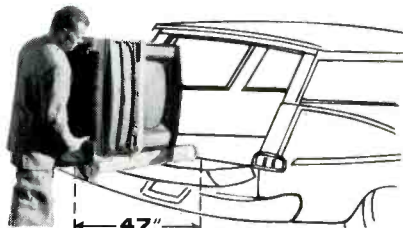

YEATS

SHORTY DOLLY
for
RADIO and TV

just 47 inches high for STATION WAGONS
and PANEL PICK-UPS

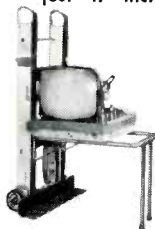

FOLDING PLATFORM
15 1/4" x 24 1/2" top.
Snaps on or off.
(Platform only)
\$11.95

Designed for TV, radio and appliance men who make deliveries by station wagon or panel truck... the short 47 inch length saves detaching the set for loading into the "wagon" or pick up. Tough, yet featherlight aluminum alloy frame has padded felt front, fast (30 second) web strap ratchet fastener and two endless rubber belt step glides. New folding platform attachment, at left, saves your back handling large TV chassis or table models. Call your YEATS dealer or write direct today!

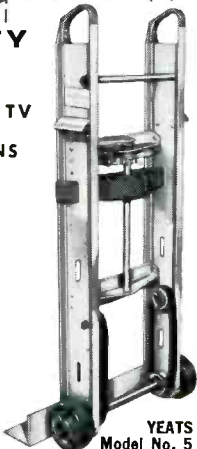

YEATS
Model No. 5
Height 47"
Weight 32 lbs.



FURNITURE PAD

"Everlast" COVER AND PADS

YEATS semi fitted covers are made of tough water repellent fabric with adjustable web straps and soft, scratchless white flannel liners. All shapes and sizes — Write



TV COVER

YEATS

APPLIANCE DOLLY SALES COMPANY

1313 W. Fond du Lac Avenue • Milwaukee, Wis.

"TORQUE WRENCH" MANUAL

SENT
UPON REQUEST

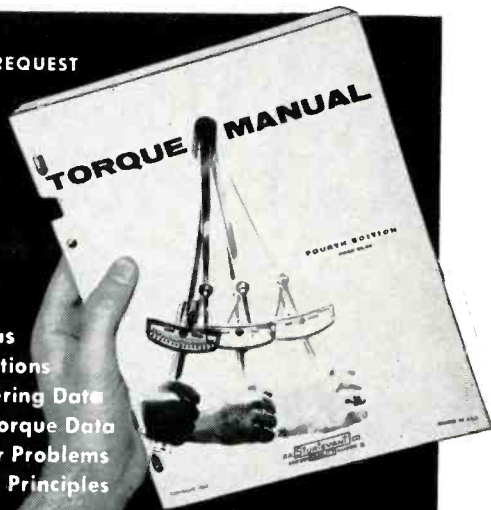

Formulas
Applications
Engineering Data
Screw Torque Data
Adapter Problems
General Principles

P.A. STURTEVANT CO.
ADDISON QUALITY ILLINOIS

Manufacturers of over 85% of
the torque wrenches used in industry

... for more details circle 142 on postcard

... for more details circle 137 on postcard
ELECTRONIC TECHNICIAN

Portable and table phonographs showed a 6.5 percent increase while console phonograph sales were up 4.9 percent for the year.

All of these items listed in the news release accounted for \$44,449,023 in sales during 1966.

RCA Announces 20w Overlay Transistor For Marine Communications Equipment

A high-power, RF-amplifier for marine communications equipment in the 2 to 3MHz frequency band is announced by RCA Electronic Components and Devices.

This amplifier uses a 20w overlay transistor, operating from a 13v power supply, that is primarily intended for marine communications equipment as a Class B and C, RF-amplifier for medium frequency service with amplitude modulation.

Specifications indicate that the transistor exhibits a typical gain-bandwidth product of 100MHz at 3-amp and produces an output of 20w minimum with a 1w RF-power input at 2.5MHz. It is an epitaxial, silicon, NPN overlay emitter electrode type transistor.

Snowbound Factory and Office Workers Cheered With Cool Music

While thousands of Kalamazoo, Mich., workers were forced to remain at their places of employment during a 26-hour storm that deposited 27in. of snow last January, they were cheered with a special selection of music. They heard such musical selections as HOW LONG HAS THIS BEEN GOING ON?, LOOK FOR THE SILVER LINING, IN THE COOL, COOL OF THE EVENING and SPRING WILL BE A LITTLE LATE THIS YEAR.

James White, general manager of the Fetzer-Muzak franchise operation, a subsidiary of WKZO-TV and WKZO Radio, said that his office had received hundreds of telephone calls for his company to continue the unusual musical selections.

React Publishes New List Of Emergency Radio Teams

A pocket size folder listing the locations and membership of 1185 Radio Emergency Associated Citizens Teams (REACT) throughout the western hemisphere has been published by the organization's National Headquarters at Chicago.

Sponsored as a public service by The Hallicrafters Co., REACT comprises volunteer groups of CB radio owners organized on a local basis to provide their communities with emergency two-way radio communications for all types of local emergencies and disasters.

It is estimated that since its inception, the four-year-old organization has rendered assistance in over 1,200,000 situations requiring emergency aid or road information. Nearly 72 percent of these emergencies involved motor vehicles and nearly a third of these involved accidents.

REACT pioneered the move several years ago to establish channel nine in the citizens radio spectrum unofficially as the "emergency" frequency, which has been universally accepted by CB'ers. REACT teams monitor channel nine 24 hours a day. A motorist equipped with CB equipment may call "REACT control" in over a thousand communities on channel nine. The chances are very good that his call will be received by a REACT mobile or base station and whatever assistance is required will usually be dispatched quickly.

Blank Continuous-Loop-Tape Cartridges Now Marketed

The introduction of blank 4- and 8-track, continuous-loop-tape cartridges for the consumer market has been announced by Audio Devices, Inc. The new blank cartridges are reportedly designed to fit both home and automobile playback and recording systems according to Herman Kornbrodt, Audio Devices vice president.

"While the market for unrecorded, continuous-loop cartridges is modest at this time, a survey we have made indicates that loaded blanks will represent a substantial portion of the cartridge market in the future," Mr. Kornbrodt said.

Currently there are two continuous-loop cartridge systems being sold that record as well as playback — the Roberts 1725-8L and Muntz. In addition, two other firms — Lear-Jet Corp. and Pioneer — have announced intentions to produce systems that will record.

G-E Announces Miniature Filamentary Diode With Recessed Anode Connector

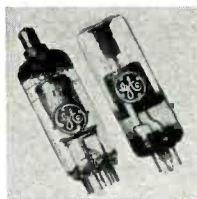

minimum.

The 1BL2, a miniature filamentary diode with a recessed anode connector, has been announced by the General Electric Tube Dept. The recessed-connector feature reportedly reduces space requirements and allows the use of a lower-cost anode connector, holding corona to a mini-

In developing the recessed anode feature, a cantilever technique was employed, with the anode connector supported by the tube glass. This eliminated the need for a mica-disk support, and the overall result is a 18kv rating with a greater safety factor than the 1X2B tube.

GETS ALL 82 CHANNELS + FM!

UHF-VHF

FULL **COLOR** OR
BLACK AND WHITE RECEPTION

FREE UHF-VHF BAND SPLITTER

KAY-TOWNES

Colorphase

COMBINATION ANTENNA



KAY-TOWNES

AFFILIATED ONLY WITH FINE PERFORMANCE

QUALITY ENDORSED

SATISFIED USERS ANTENNA SYSTEM

CPC 27, 24, 12

KAY-TOWNES Antenna Co. 1511 Dean Ave., Rome, Ga. 30162

... for more details circle 121 on postcard

Littelfuse Develops Degaussing Switch



An automatic operating degaussing switch, that is designed to eliminate annoying picture blurs and color distortions in color-tv sets, has been developed by Littelfuse, Inc.

With the degaussing switch, each time the set is turned ON, the degaussing coils in the receiver circuitry are automatically energized to wipe off the residual magnetism on the shields, restore true color definition and eliminate blurs. The degaussing action reportedly occurs in a matter of seconds.

Motorola Prepares for New FCC Requirements For 450 to 470MHz Radio Equipment

Motorola communications division has announced the availability of new 450 to 470MHz radio equipment that meets the split channel requirements recently announced by the FCC.

These new rulings, built around 25kHz channel spacing rather than 50kHz spacing, will make operational changes necessary for present owners of UHF radio equipment and will eventually make additional channels available for more radio users.

The new requirements include: the reduction of deviation to ± 5 kHz by June 1, 1967; the use of full split channel

equipment for all stations authorized after Nov. 1, 1967; and the conversion of all existing stations to full split channel requirements by Nov. 1, 1967.

New Motorola base stations will reportedly include a modification and a ± 0.0002 percent channel element to provide better than the 0.00025 percent frequency stability required by the FCC.

Plectron Corp.'s President and Sales Manager Fatally Injured

Mr. Arlyn H. Collins, president, and Mr. John R. Mayberry, sales manager, of the Plectron Corp. were fatally injured in a plane accident February 24, 1967. The management of Plectron, although deeply saddened by the loss of these two executives, wishes to assure their customers and suppliers that Plectron will continue to strive for the kind of service that was established by Mr. Collins.

Integrated Circuit Sales Climb

The Electronic Industries Assoc. reports that U.S. manufacturers sold \$148 million worth of semiconductor integrated circuits during 1966.

With a 40 percent decline in the average value of IC's during 1966, the unit sales have climbed 210 percent to reach a 29.4 million total last year.

Digital IC's currently comprise more than 90 percent of the unit volume and about 80 percent of the dollar volume of the total semiconductor IC business. This represents only a very moderate decline of digital IC's share of the total unit and dollar volumes during 1965.

Sales of analog IC's reached 2.3 million units valued at \$31 million during 1966, up 303 percent and 115 percent, respectively, from the unit and dollar sales during 1965. Average value declined from \$25.06 to \$13.37.

INSTANT SPEED



Means time saving assembly and servicing of mechanical, electrical or electronic components. VACO Nut Drivers eliminate fumbling and lost time... reach into hard-to-get-at places. Precision made in 30 sizes and lengths. Available in shelf displays, boxed sets, or handy roll up service kits. Unconditionally Guaranteed. See your VACO representative or distributor today!

VACO PLUS FEATURES

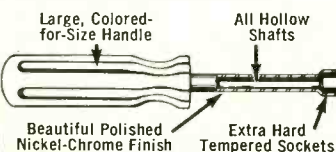

VACO®

The most powerful name in hand tools... terminals
VACO PRODUCTS COMPANY
 510 N. Dearborn, Chicago, Ill. 60610

... for more details circle 139 on postcard



NOW ...

a convenient, sturdy binder for your ELECTRONIC TECHNICIAN Schematics!

Here's a sturdy book binder designed specifically for technicians who want to file away the ELECTRONIC TECHNICIAN Tekfax schematics for easy reference.

KING-SIZED 11" x 15". Your schematics lay flat, no folding necessary.

EASY TO USE Just press back the special spring clamp and slip your new schematics into place. No holes to punch.

STURDY Handsome, reinforced binding. Tough duty fabric cover.

ORDER TODAY — USE THIS CONVENIENT FORM

ELECTRONIC TECHNICIAN

DEPT. B-B OJIBWAY BUILDING, DULUTH 2, MINNESOTA

Please Rush Me.....Schematic Binders at \$4.95 each

I am enclosing \$.....

Name

Company Name

Street Address

City Zone..... State

EIA Supports National Commission's Objectives on Product Safety

The Electronic Industries Assn.'s Consumer Products Div. has endorsed the objectives of the proposed National Commission on Product Safety.

In written testimony submitted to the Consumer Subcommittee of the Senate Commerce Commission, which has been holding hearings on the administration-backed-commission, the CPD went on to detail EIA's and the industry's efforts in consumer safety.

The CPD listed 10 examples of the Safety Committee's work with Underwriters' Laboratories. The list includes the reduction of leakage current standards from 15ma in 1946 to the present level of 2.5ma, the widespread use of interlock switches, the use of special fuses, improvement of CRT tubes to eliminate implosions, the setting of standards for plastic material enclosing hazardous equipment and the use of circuit breakers.

Another potential risk factor cited by the Consumer Products Div. has been the growing popularity of portable, miniaturized models of all consumer electronic products. This development has greatly increased the amount of physical contact between user and instrument and consequently multiplied potential hazards.

The fact that the "statistical likelihood" of greatly increased electronically induced injuries has not taken place was attributed in the report to the work of the Safety Committee and the individual manufacturers to protect the consumer.

RCA Announces Mobile Radio Contract With California Highway Patrol

A \$680,000 contract to supply 834 solid-state, 50MHz,

mobile radios for installation in California Highway Patrol vehicles has been announced by RCA.

A custom-designed control head will fulfill the Highway Patrol requirements for switching among the four transmitting and two receiving frequencies used in the communications system.

The control head will carry color dot identification of the frequency bands, with one color indicating a state frequency and a county frequency, making the available channels instantly identifiable to the police officer using the radio.

A single tone selector will permit the mobile radio user to key a "repeater" transmitter to automatically rebroadcast the message. This provides communications service when the vehicle is in mountainous or otherwise difficult terrain for radio signals.

Regency's Complete Line Placed on the Road

Every one of Regency's products has been placed in a "rolling stock" display called the "Regency Communications Caravan."

The display unit is a Dodge Motor Home with the interior customized to show working models of the company's line of CB transceivers, monitorradios, tone alerting systems and aircraft communications equipment.

In addition, sample models of military products are put into the display. Included in this category is a Morse code read-out device that the U. S. Army has called the "world's smallest computer."

The caravan is equipped with four antennas for two-way communications in the 30 to 50MHz and 152 to 174MHz bands as well as aircraft frequencies.

GAS WELDING TORCH

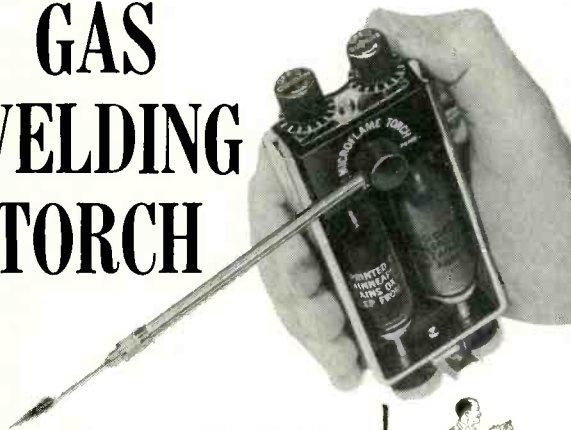

Uses **OXYGEN** and **LP GAS**

- Completely self-contained.
- Produces 5000° pin-point flame.
- Welds, brazes, solders.
- Hundreds of lightweight uses.
- Suggested list — \$19.95.

GET COMPLETE DETAILS AT MOST INDUSTRIAL DISTRIBUTORS, OR WRITE TO MICROFLAME, INC.



MICROFLAME, INC.
7800 COMPUTER AVENUE
MINNEAPOLIS, MINNESOTA 55424

be confident with

colson

MOBILE SHELF TRUCKS

VERSATILE

"WAREHOUSE ON WHEELS"

All-purpose, adjustable shelf wire truck. Selection of 36 models. 3-4-5 or 6 shelves. Chrome finish.

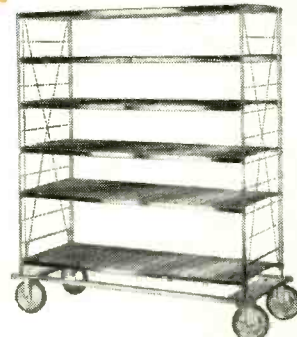

Send for folder of 36 models and accessories.

Prices start at
\$95³⁰
F.O.B.
Chicago.



THE COLSON CORPORATION

39 S. La Salle St., Chicago, Ill. 60603, Dept. ET-4

Finest quality on wheels — Since 1885

... for more details circle 123 on postcard

... for more details circle 110 on postcard

TECHNICIAN MANAGERS

and

TRAINEES

Positions available for qualified technicians to manage and staff attractive Norelco Service Centers currently planned for Los Angeles, Kansas City, Dallas, San Francisco and other Metropolitan areas planned for the coming months.

If you have experience in the repair of such consumer appliances as Tape Recorders, Transistor Radios and Shavers, the personality for consumer contact, and can manage a business, write indicating salary requirements to:

MARTIN G. WOLFERT
NORTH AMERICAN PHILIPS Co., Inc.
100 E. 42 St., New York, N.Y. 10017

Norelco[®]

An Equal Opportunity Employer

... for more details circle 127 on postcard

MOVING?

Be sure to let us know your new address. Please enclose a complete address label from one of your recent issues.

POWER
NEW
POWER

FROM

FINCO

Model 65-3 VHF-TV ANTENNA AMPLIFIER

improves reception of WEAK VHF-TV signals in FRINGE AREAS even where strong local TV or FM signals are present. **AMPLIFIES UP TO 7 TIMES** for Better Color and B/W

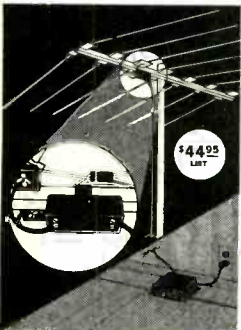

Model 65-3 VHF-TV ANTENNA AMPLIFIER

Let Finco solve your Color and B & W reception problems. Write for complete information, schematics and specifications. Form #20-357.

THE FINNEY COMPANY

34 West Interstate St., Dept. 110, Bedford, Ohio

... for more details circle 113 on postcard

CATALOGS AND BULLETINS

Tools 400

A six-page flyer lists an assortment of electronics tools including spring adjusters, gages, burnishers, wrench sets, pliers and clamps. Jonard Industries.

Scissors, Shears, Snips 401

A 16-page catalog lists forceps, wire and electronic filament cutters, rubber shears and many other scissors for industrial, commercial and home use. Compton.

Test Instruments 402

A palm-sized VOM is featured in a 16-page test instrument brochure. Also included are VTVMs, scopes, a recording VOM, general purpose micro-testers and temperature measuring instruments. Simpson.

Mobile CB Antennas 403

A data sheet describes three CB antennas designed to be mounted by two small set screws on the underside of the trunk lid. Also shown are adapters for mounting in the same manner 3/8-in. snap-in antennas or antenna bases normally requiring a 3/4-in. hole. Antenna Specialists.

Electronic Components 404

Every electronic component stocked by a manufacturer's distributors are reportedly illustrated in a 25-page catalog. Included are plugs, jacks, switches, connectors, molded cable assemblies, adapters and audio accessories. Switchcraft.

Tape Recorder 405

A flash-light-battery powered, 4-lb, portable tape recorder, that reportedly has a good enough frequency response to be used for music, is described in a data sheet. Channel Master.

Wireless Microphone 406

A data sheet describes an FM, wireless microphone with a reported frequency range of from 90 to 106 ±2MHz. Specifications indicate that this unit measures only 3 1/4 x 2 1/2 x 1 in. and operates from a 9v battery. Channel Master.

Multi-Band Radios 407

Two multi-band, portable, solid-state radios, one a six-band model and the other a four-band model, are described in two data sheets. Both radios include FM and AM bands and operate on batteries or an ac-

cessory ac adapter-charger. Channel Master.

Transformers 408

A 34-page catalog lists an expanded line of transformers and toroids for commercial/industrial constructions. Included are charts, graphs, schematics and notes describing transformer specifications. Microtran Co.

Power Drills 409

A four-page, three-color catalog describes nine new electric 1/4-, 3/8- and 1/2-in. power drills with a "machine-gun" auxiliary handle. These drills reportedly feature double-reduction gear trains and self-aligning bearings. Wen.

FM Antennas 410

An eight-page bulletin describes a line of FM antennas with drawings of the antennas and characteristic curves comparing decibel responses over various frequencies. Rotators, boosters, band separators and set couplers are also included. Channel Master.

Phonograph Cartridges 411

A total of 6600 cartridge listings are cross-referenced in a 28-page manual. The first listing cross references the manufacturer's cartridges with other cartridges on the market, while the second listing cross references the manufacturer's cartridges with the phonographs that they reportedly will fit. Sonotone.

Potentiometers and Resistors 412

A 32-page, illustrated catalog contains engineering drawings and descriptions of a line of potentiometers, field-assembled controls, power rheostats and resistors. Clarostat.

LETTERS TO THE EDITOR

continued from page 24

'Flash' Schematic

Can any ET reader help me locate a schematic for a PCA X-100 or X-200 electronic flash? It was made in Belgium by Photronic Corp. of America and I understand the company is no longer in business.

A. ALTRO

Hartsdale, N.Y.

Organ Schematic

I enjoy reading ELECTRONIC TECHNICIAN because you seem to have plenty of solutions to a variety of

problems. Here's my problem: I need a schematic for a Bradford (2 manual, 13 pedal) electronic organ. Can any reader help me? Write via ET.

ROY LARRICK

Streetsboro, Ohio

Problems—But No Solutions

I enjoyed reading the article "The Growing Pains of CB Radio," in the January 1967 issue of *ELECTRONIC TECHNICIAN*. It covered the problems very good but didn't give any answers on how to solve the problems. We have used CB for over a year and it is an excellent tool when we can use

it but instead of the situation getting better, it is worse . . . May I suggest that the FCC could appoint one or two responsible people on a part-time basis in each locality who could monitor and report rule violators and then the FCC could do something about them. Also, if the violators know that they are being reported, this alone would stop a lot of violations . . . You failed to touch on the problem of skip which under the present set up is something we have to live with but it is still annoying. I would like to suggest that if the channels were divided on an east, central and west

basis this would help everyone. For example, channels 1, 4, 7, 10, 13, 16 and 19 could be restricted to the eastern area; channels 2, 5, 8, 11, 14, 17 and 20 to the central area; channels 3, 6, 9, 12, 15, 18 and 21 to the western area and the two other channels 22 and 23 could be used in all areas or one more channel could be added. This would not only help clear up the skip problem but also adjacent channel interference. Sure, this would cut back the number of channels available in each area, but I have never heard of all 23 channels being used at the same time and it would be much better to wait 2 or 3 minutes for the channel and be able to use it than not be able to use it at all. Perhaps if you could get your readers to write to their congressmen something would be done about this.

N. N. JONES

Lebanon, Ind.

• *As you know, ET is devoted entirely to the technical and business welfare of its readers. And before problems can be solved, it is necessary to know precisely what the problems are. We called attention to some of these problems but the nature of the problems are such that solutions must be found primarily by the FCC—although legitimate CB users, like yourself, can surely contribute to the solutions by reporting violations to the FCC. Once again, we would like to point out that the problems are being made more difficult to solve primarily because of the "within-the-law" activities of "near-sighted, quick-buck" forces whose actions indicate that they care little or nothing about the future of CB as a useful citizens communications medium.—Ed.*

Home Study

Where can I get a list of accredited private home study schools?

JIM BRADY

New York, N.Y.

• *A directory of these schools is available from the National Home Study Council, 1601 18th St., N.W. Washington, D.C. 20009.—Ed.*

Transistor Tip

Many technicians often mistakenly assume that because a transistor is new or unused, it is in good condition. Transistors — especially the bargain-priced imported types — are sometimes defective or have poor amplification capabilities. To be on the safe side, I always check untried transistors on a transistor tester.

ROBERT APPEL

Newark, N.J.

How to make connections

And influence your customers



A quick spray with Krylon Crystal Clear Spray Coating will give your electrical connections a hard, waterproof connection that seals. And lasts.

The connection won't dry out. Crack. Or rust.

So thanks to Krylon Crystal Clear Spray, many of the causes of picture

fading and high voltage section losses can be prevented.

(Which should keep your customers happy.)

Krylon Crystal Clear...standard equipment for all TV/Radio installation and repair work.



... for more details circle 107 on postcard

TECHNICIANS

Can you . . .

Repair an electric shaver?

or

Install Medical X-Ray equipment?

or

Service CCTV systems?

or

Manage a Service Center?

We seek trained and experienced technicians for a variety of assignments in various metropolitan areas.

If you want an opportunity to grow with a major manufacturer, write indicating preferred location and current salary to:

MARTIN G. WOLFERT
NORTH AMERICAN PHILIPS CO., Inc.
100 E. 42 St., New York, N.Y. 10017

Norelco®

An Equal Opportunity Employer

. . . for more details circle 128 on postcard

MOVING?

Be sure to let us know your new address. Please enclose a complete address label from one of your recent issues.



AUTOMATIC STAPLE GUNS

For Fastening Any
Inside or Outside

Wire Up to 1/2" in Diameter

UP TO
3/16"
No. T-18

- Telephone wire
 - Intercom wire
 - Bell wire
 - Thermostat wire
 - Radiant heating wire
 - Hi-Fi, Radio & TV wires
- Tapered striking edge gets into close corners!

UP TO
1/4"
No. T-25

Available in:
Brown, Ivory, Beige,
Monel, Bronze, Natural

UP TO
1/2"
No. T-75

ARROW FASTENER COMPANY, INC.

1 JUNIUS STREET - BROOKLYN 12, N. Y.

. . . for more details circle 103 on postcard

BOOK REVIEWS

DESIGNING TRANSISTOR IF AMPLIFIERS. By *W. Th. Hetterscheid*. Published by *Philips Technical Library*, 346 pages, hard cover. \$11.25.

Many factors that must be considered when designing IF amplifiers for radio, TV and radar receivers are discussed in this book. Some of these include transistor parameters, automatic gain controls and deviations from nominal conditions. Theories of design are developed into practical circuits with the aid of graphs and charts. This book would be of value to design engineers who already have a good background in electronics.

USING YOUR TAPE RECORDER. By *Harold D. Weiler*. Published by *Allied Radio*, 96 pages, soft cover.

Many people almost automatically assume that when any electronics supplier publishes a book about electronic equipment, the book will merely describe their line of merchandise. Although a couple of pictures of Allied equipment are included in the book, the book does not discuss any specific line of equipment. The author assumes that the reader has had only a limited experience with tape recorders and no understanding of sound. The nature of sound and the frequency range of musical instruments are described to familiarize the reader with what will be recorded. The proper use of microphones, phonograph records and tuners for making home recordings are discussed. Sections of the book describe tape surfaces, sound effects, proper editing and the addition of sound to slides and movies. This book should be of value to anyone who has a tape recorder capable of pleasing sound reproduction, whatever the reader's level of experience. It has potential value to service-dealers as a promotional piece for tape recorder customers and prospects.

THE SEMICONDUCTOR DATA BOOK, 2nd edition. By *Motorola Semiconductor Products Inc.*, 1536 pages, hard cover.

The characteristics of silicon zener diodes, silicon rectifiers, silicon rectifier assemblies, thyristors and trigger diodes, power transistors, germanium milliwatt transistors, switching and general purpose transistors, RF transistors, FETs, dual transistors, dual diodes, field-effect current limiters, varactors, digital and linear integrated

circuits, along with related hardware, are described in this handbook. The book contains a numerical and alphabetical index of semiconductors. Each section assigned to a particular type of semiconductor is preceded by a listing of semiconductors according to characteristics. Characteristic curves are provided for many semiconductors. A special section near the end of the book contains additional semiconductors too recently included to be among the others. Although not all semiconductors are listed, there is such a large volume of them and this book would be of value to circuit designers.

THIN-FILM AND SEMICONDUCTOR INTEGRATED CIRCUITRY. By *John Doyle*. Published by *McGraw-Hill Book Co.*, 314 pages, hard cover. \$6.95.

The technology of fabricating thin-film and integrated circuits is discussed in interesting detail. The author discusses the equipment used to lay out the circuit design and reduce it by as much as 500X; cathode sputtering and evaporation techniques used for thin-film deposition; using a quartz-crystal to monitor the thickness of the film being deposited; the epitaxial growth of the quartz wafer; and the use of scanning electron microscopy for heating portions of the circuit, observing the surface of the circuit and seeing voltage levels of 0.5v in the integrated circuit, on the face of a CRT. Thin-film cryotrons as superconductive cryogenic switching devices, magnetic film memory cores and photon-coupled amplifiers were included as special components in integrated circuits. Despite the apparent complexity of the material covered in this book, the reader will find that, even if his knowledge of chemistry and mathematics is rather limited, he will be able to understand the major portion of the book. Although the book does not tell how integrated circuits are used as components in other circuits, it does discuss the internal function of several practical integrated circuits. It is of little value to practicing technicians in our industry but may be of interest to those who look forward to new areas of the electronics field.

ELECTRONIC TESTING. Compiled and edited by *L. L. Farkas*. Published by *McGraw-Hill*, 316 pages, hard cover. \$12.

The function and electronic testing of a wide assortment of systems, including receivers and transmitters, inertial-guidance platforms, and analog and digital computers, are dis-

cussed. The author assumes that the reader has a good background in electronics, and block diagrams are frequently used to illustrate portions of circuits and components. Some simplified circuits are also shown. Such a wide scope of material is covered that the depth of each description is rather limited. The book may be of interest to any reader with a good science background who wishes to broaden the scope of his knowledge.

BEST'S SAFETY-MAINTENANCE DIRECTORY. Edited by Harry Armand, Ralph Eames and Kendrick Taylor. Published by Alfred M. Best Co., 772 pages, hard cover. \$10.

The editors prepared this book more as a directory, as indicated by the title, than as a text. There are, however, quite a number of safety articles, mostly written by the staff of various industrial concerns, that may be of interest to managements in other industries. Most of these safety problems, however, would not be encountered by the average electronic technician. The major portion of the book contains directories listing sources of safety equipment, which are supplemented with ads from about 190 companies who manufacture various types of safety equipment.

DATA PROCESSING FOR THE SMALL BUSINESS. By Byron L. Carter. Published by Macfadden-Bartell Corp., 190 pages, soft cover, 95 cents.

The time is near when even small TV repair shops, in order to maintain a competitive stance, must decide whether their bookkeeping, inventory and over-all business check-up and control is to be handled manually or with the data processing techniques used by others in their field. This book tells how even the cash register can be used to print paper tapes that are read directly by a computer in a data processing center. With this process, even salaries and bank loans can be tabulated as part of a bookkeeping process that takes only a few minutes of the computer's time. The author indicates that payrolls, customer billing and other more complicated services can also be handled by the computer center at an additional cost. The book shows how such programs have worked for other small businesses and how an analysis has shown weak points in their profit-picture that could be corrected. This book may be of interest to progressive small business men who have not yet considered using data processing systems in their businesses.

Semiconductors . . .

continued from page 67

1.60 to 8.00ma while the current flowing through the second transistor fluctuates from 2.00 to 6.40ma.

Thus, we see that there is a 6.40ma change in current flowing through the first transistor while there is only a 4.40ma change in current flowing through the second transistor. This agrees with the earlier statement that the signal current through the first transistor must be greater than the signal current through the second transistor. Since this unbalanced condition does exist, the voltage drops across the two resistors are not quite equal at alternate intervals of time. If the value of each collector resistor is 550Ω , the voltage across the first transistor's collector resistor (R_1) will actually vary from 0.88 to 4.40v rather than the desired 1 to 4v fluctuation, while the voltage across the second transistor's collector resistor will actually vary from 3.52 to 1.10v rather than the desired 4 to 1v fluctuation ($1.6\text{ma} \times 550\Omega = 0.016\text{a} \times 550\Omega = 0.88\text{v}$, and $8\text{ma} \times 550\Omega = 4.4\text{v}$, etc.).

When the voltage drops across the common emitter resistor (R_3) varies from 8 to 10v while the voltage drop across the first transistor's collector resistor (R_1) varies from 0.88 to 4.40v, the voltage drop across the first transistor (V_1) must actually vary from 7.12 to 1.60v [$16.00\text{v} - (8.00\text{v} + 0.88\text{v}) = 7.12\text{v}$, and $16.00\text{v} - (10.00\text{v} + 4.40\text{v}) = 1.60\text{v}$]. With the corresponding 3.52 to 1.10v fluctuation in voltage drop across the second transistor's collector resistor (R_2), the voltage drop across the second transistor must actually vary from 4.48 to 4.90v [$16.00\text{v} - (8.00\text{v} + 3.52\text{v}) = 4.48\text{v}$, and $16.00\text{v} - (10.00\text{v} + 1.10\text{v}) = 4.90\text{v}$].

By substituting voltages, we have seen that the differential amplifier circuit (Fig. 10) is unbalanced. A forthcoming article will show how a current regulating transistor can be used to make this differential amplifier virtually balanced. The balanced differential amplifier circuit will then help us understand an FM tuner currently on the market. ■

simplest
top
quality
modular
amplifier
system

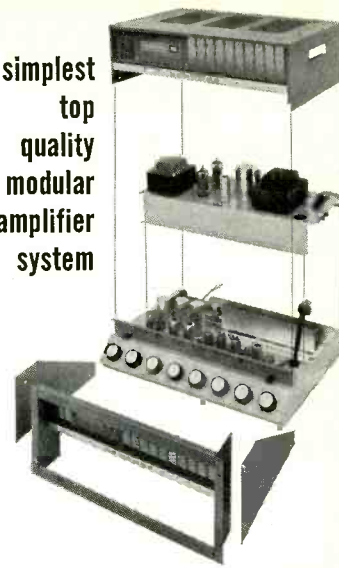

NEWCOMB
TOP QUALITY CUSTOM **K**



Newcomb's finest, the Custom K Series is the climax of 30 years devoted to developing and producing the very best public address amplifiers. You quickly and simply get the combination of channels and power you need. A power output module is dropped into either a front-end or booster chassis. Two electrical plug-in connections; no soldering. Put a cover over the top or insert the chassis in a rack mount. You can plug in a transistorized VU meter accessory which has a sensitivity control and monitor jack for crystal headphones. The 4-channel models have provisions for a remote control accessory. There are 3 power amplifier modules: 40, 60, and 125 watts, and a power supply when you want to use a front end as a mixer-preamplifier only. There are three preamplifier modules: 3, 4, and 5 channels, and a chassis for making a booster amplifier out of any of the output modules. All in all, only 14 components permit 70 combinations. Performance is superb. Frequency response is ± 1 db 20-20,000 cps; distortion is extremely low. Custom K amplifiers run remarkably cool. Easy-to-trace, easy-to-service vacuum tube construction is used throughout. Colors are soft shades of gray-green. Write for Catalog K-15.

NEWCOMB AUDIO PRODUCTS CO., Dept. ET-4
12881 Bradley Ave.
Sylmar, California 91342

... for more details circle 126 on postcard

COMPLETE TUNER OVERHAUL

995

ALL LABOR AND PARTS (EXCEPT TUBES & TRANSISTORS)*



VHF UHF COLOR U-V TRANSISTOR

COLOR TUNERS GUARANTEED ALIGNMENT — NO ADDITIONAL CHARGE COLOR — NO CHARGE

Simply send us the defective tuner complete; include tubes, shield cover and any damaged parts with model number and complaint. Your tuner will be expertly overhauled and returned promptly, performance restored, aligned to original standards and warranted for 90 days. UV combination tuner must be single chassis type; dismantle tandem UHF and VHF tuners and send in the defective unit only. Exact Replacements are available for tuners unfit for overhaul. As low as \$12.95 exchange. (Replacements are new or rebuilt.) And remember—for over a decade Castle has been the leader in this specialized field . . . your assurance of the best in TV tuner overhauling.

CASTLE
TV TUNER SERVICE, INC.

5713 N. Western Ave., Chicago 45, Illinois
41-92 Vernon Blvd., Long Island City 1, N. Y.

For service in Canada write to Chicago or use reader service card in this magazine.
*Major parts are charged extra in Canada.

... for more details circle 108 on postcard

ADVERTISERS INDEX

Alliance Mfg. Co. 85

Amperex Electronic Corp. 3rd Cover

Arrow Fastener Co. 100

Astatic Corp. 91

B & K Div., Dynascan Corp. 75, 93

Borden Chemicals, Krylon Div. 99

Castle TV Tuner Service 102

Channel Master Corp. 34-35

Cleveland Institute of Electronics 83

Colson Corp. 97

EICO Electronic Instruments, Co. 19

ELECTRONIC TECHNICIAN
Book Club 26-29

Finney Co. 98, 102

GC Electronics Co. 45, 84

General Electric Co. 25

Greyhound Corp. 49

Injectorall Electronics Corp. 90

Jensen Industries Div., Electro-Voice, Inc. 24

Jerrold Electronics Corp. 2nd Cover

Kay-Townes Antenna Co. 95

Lectrotech, Inc. 48

Microflame, Inc. 97

Miller Co., J. W. 22

Motorola, Inc. 31

Newcomb Audio Products Co. 101

North American Philips Co. 98, 100

Oaktron Industries, Inc. 80

Precision Apparatus Div., Dynascan Corp. 52

Quam-Nichols Co. 92

Quietrole Co. 102

Radio Corp. of America
RCA Electronics Components & Devices 4th Cover, 33, 50-51, 81, 89
RCA Sales Corp. 20

Sencore, Inc. 86-87

Sonotone Corp. 102

Sprague Products Co. 23

Sturtevant Co., P. A. 94

Sylvania Electric Products, Inc. 37-44

Triplett Electrical Instrument Co. 36

Vaco Products Co. 96

Weller Electric Corp. 30

Winegard Co. 46-47

Yeats Appliance Dolly Sales Co. 94

Zenith Sales Corp. 88

FINCO
"has 'em both!"



Model #65-1 \$2995 list
Model #65-2 \$3995 list

BOOSTER COUPLERS FOR 300 OR 75 OHM
For Deluxe Home or Commercial Use

Now available for either 75 OHM CO-AX or 300 OHM operation . . . you can't beat the price, quality and performance of Finco's famous 2-tube, 4-set VHF or FM Distribution Amplifiers. Finco challenges 'em all! Equip either model with Finco low loss splitters (#3001 or #3003) and you can drive up to 16 sets in a master antenna system!

All Finco Products Are Engineered for Color!



Dept. 110

THE FINNEY COMPANY
34 West Interstate Street, Bedford, Ohio

... for more details circle 112 on postcard

Our policies are your best insurance:



Sonotone has been the reliable, quality name in replacement phono cartridges since 1947. We've made and sold 20 million of them. When you service with Sonotone cartridges, you can be assured you are servicing with the best. *We'll stake our name on that.*

REPLACE WITH SONOTONE CARTRIDGES. There's a complete line for immediate replacement of virtually every cartridge in use today. Prove it to yourself — fill out and mail coupon TODAY for your free copy of Sonotone's 1967 "computer-programmed" cartridge replacement manual.

Send today for complete information: Sonotone Corporation, Dept. 107 Elmsford, New York 10523

Just fill out and mail this coupon for your free copy of Sonotone's 1967 "computer-programmed" cartridge replacement manual.

YOUR NAME _____
ADDRESS _____
CITY _____
STATE _____ ZIP _____

... for more details circle 135 on postcard

QUIETROLE
built its reputation
with black & white TV
AND is
extending it even
further with
color TV!



- Lubricates as it cleans
- Non-inflammable . . . Non-conductive . . . Non-corrosive
- Nearly 20 years of acknowledged superiority
- Easy spray or dropper application
- Harmless to plastics & metal — zero effects on capacity & resistance — "for color & black & white".

Quietrole is recognized by manufacturers and servicemen alike as the leading lubricant/cleaner for noisy controls in radios and TV alike. Mark-II for tuners . . . Spray-Pack for controls and switches . . . Silitron for general use.

At Your Distributor . . . Ask for Quietrole by Name.



manufactured by
QUIETROLE CO.
Spartanburg, South Carolina

... for more details circle 132 on postcard

... for more details circle 102 on postcard →

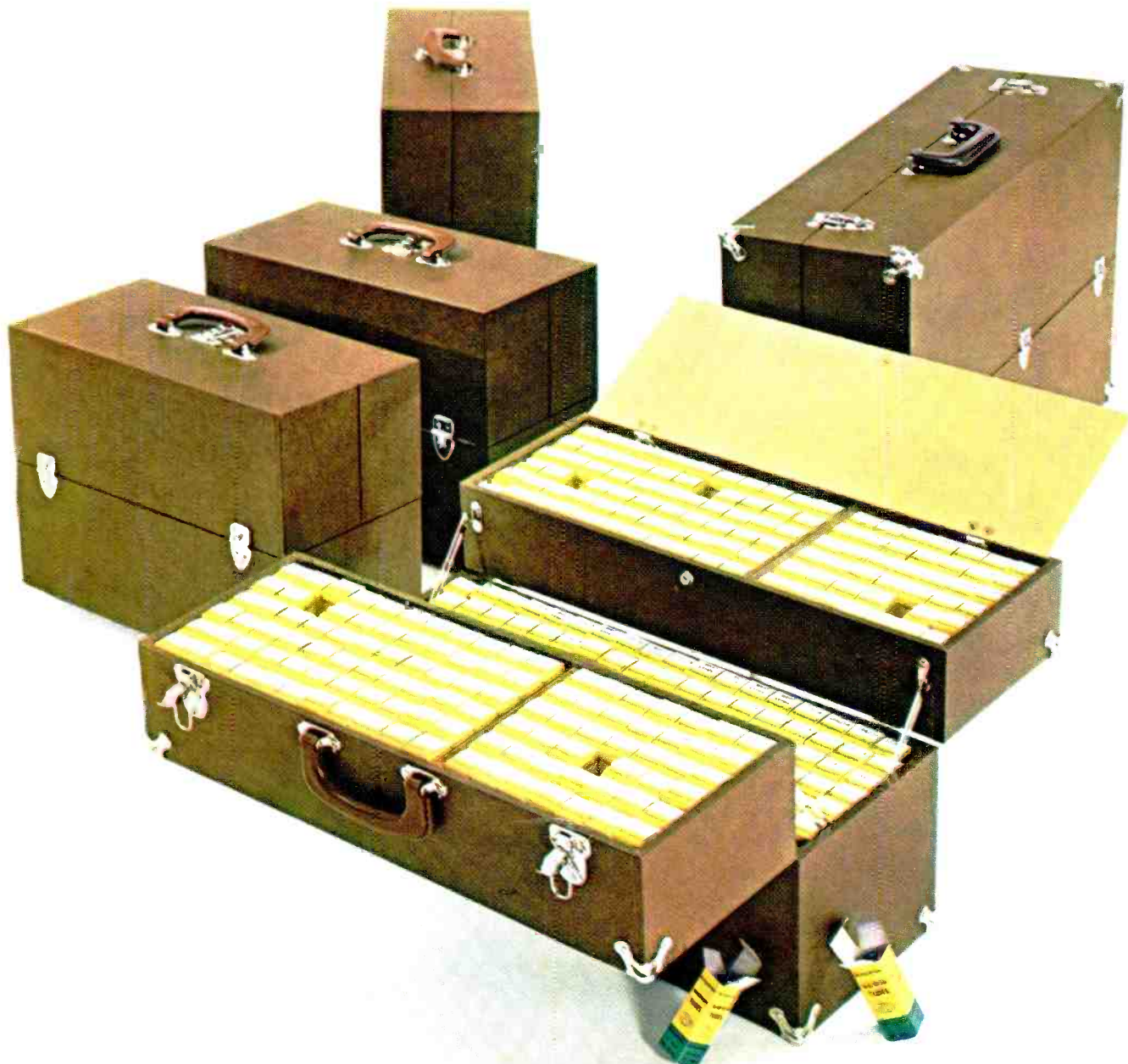

**One out of every five
professional servicemen
has switched to Amperex
TV replacement tubes**

It takes a lot of quality to change the buying habits of 20% of the most knowledgeable technicians in the business. These servicemen are following the pattern set by the leading TV manufacturers, who are designing more and more of their quality lines around tubes originated by Amperex. The Amperex line of popular types is expanding all the time. Look for the green and yellow cartons at your distributor's or write: Amperex Electronic Corp., Hicksville, L. I., N.Y. 11802.



Amperex

TOMORROW'S THINKING IN TODAY'S PRODUCTS



How else but with RCA HI-LITE color picture tubes
 can you bring today's color to your customers?

Your service reputation is the cornerstone of your business. That's why there's no room to compromise with quality in the components you install.

RCA HI-LITE picture tubes enable you to offer your customers TODAY'S COLOR... incorporating the latest technology of the world's most experienced picture tube manufacturer. They're the same tubes that go into today's original equipment sets.

RCA's new Perma-Chrome process for rectangular picture tubes, for example, means locked-in color purity from the moment the picture comes on. Faster servicing for you. Added customer satisfaction.

Install an RCA HI-LITE and you literally "up-date" your customer's set while, at the same time, enhancing your service reputation.

RCA Electronic Components and Devices, Harrison, N. J.



The Most Trusted Name in Electronics