

ELECTRONIC TECHNICIAN

WORLD'S LARGEST ELECTRONIC TRADE CIRCULATION



AUGUST 1964

- The Color Demodulator
- Color High-voltage Systems
- Simplified Convergence



IN THE UPPER MIDWEST TOO, SERVICEMEN AGREE:

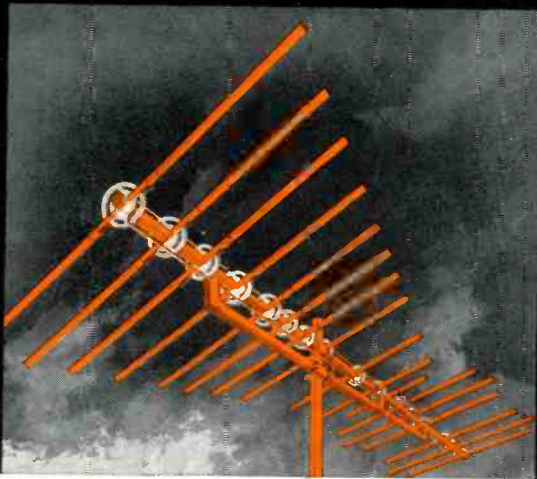

JERROLD PARALOG IS THE GREATEST!

Still the raves come in! TV service dealers all over the country keep switching wholeheartedly to Jerrold-Taco PARALOG antennas.

These dealers in Minnesota and North Dakota have gone 100% Paralog after putting it to the test under the roughest reception and weather conditions. And they've found that Paralog goes up easiest, stays

up without callbacks, and delivers by far the best pictures on all channels.

How about you? Have you tried the Jerrold-Taco Paralog side-by-side with its nearest competition? If not, see for yourself what's made the Paralog line the selling sensation in TV antennas.



**HARRY PFLAUM, HAUGNERS
TV & RADIO, DEVILS LAKE, N. D.**

"Every time we put up a Paralog antenna we create a satisfied customer. We are pleased with the construction and ease of installation of Paralog, and its terrific set performance."



**LOUIS ALLERY,
ROY'S RADIO & TV, ROLLA, N. D.**

"In our part of North Dakota we need the best-constructed and best-performing antenna made. Paralog is all of this and then some. And installation is easy because of factory preassembly."

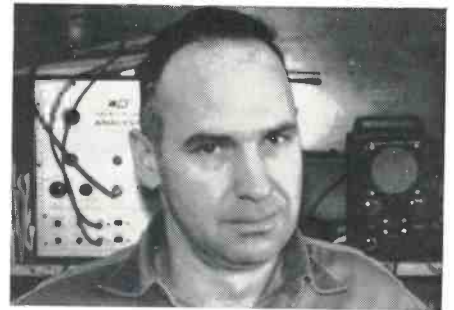

**ED JOCHIM, NESTORS
RADIO & TV, LANGDON, N. D.**

"Paralog withstands the terrific ice and wind problems we have here in Langdon, where other antennas have failed. We also like the ease and speed of installation."



**EUGENE DOLL,
DOLL'S TV, PERHAM, MINN.**

"Business has been terrific on Paralogs in our territory. And no wonder. Everybody who buys a Paralog is happy with the reception. We've gone to Paralog 100%."



**LAWRENCE DARGUS,
DARGUS RADIO & TV, WARREN, MINN.**

"Paralog antennas really perform well here in northern Minnesota—better than any other we've tried. And they're built rugged to withstand our rough winters."

For complete information, write

**DISTRIBUTOR SALES DIVISION,
JERROLD ELECTRONICS,
PHILADELPHIA, PA. 19132**



COMPLETE MANUFACTURERS' CIRCUIT DIAGRAMS AND TECHNICAL INFORMATION FOR SEVEN NEW SETS

Schematics No.

DELCO Opel Kadett Auto Radio Model 980886	864	PHILCO Transistor Portable Radio Model NT-600	867
EMERSON Color TV Chroma Board Chassis 120642-43	870	RCA Portable Record Changer Chassis RS-206-A	868
GENERAL ELECTRIC "FY" Color Chassis	866	SONORA TV Chassis 1194-194	869
KORTING Tape Recorder Models MT 2233, 2243	865		



COMPLETE MANUFACTURERS' CIRCUIT DIAGRAMS AND TECHNICAL INFORMATION FOR SEVEN NEW SETS

SIGNAL INJECTION

ISLAND NO.	LOCATION	OUTPUT
33	Base of DS-501	Weak
32	Base of Audio Driver (AF-2)	Louder
27	Base of Audio Amplifier (AF-1)	Very Loud
22	Audio Detector	Weak
16	Base of I.F. Amp.	Weak
9	Base of Converter	Louder
1	Base of R.F. Amplifier	Loud

August 1964

Delco
Opel Kadett Auto
Radio
Model 980886

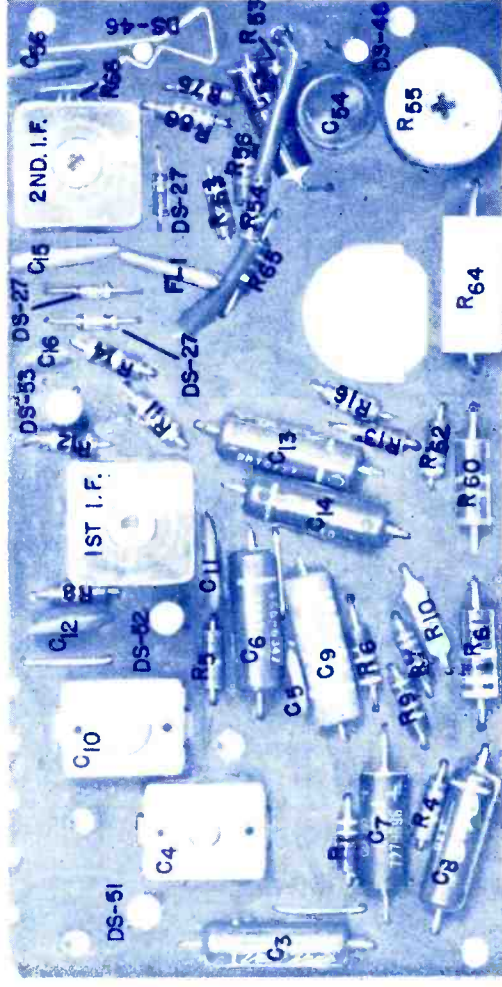
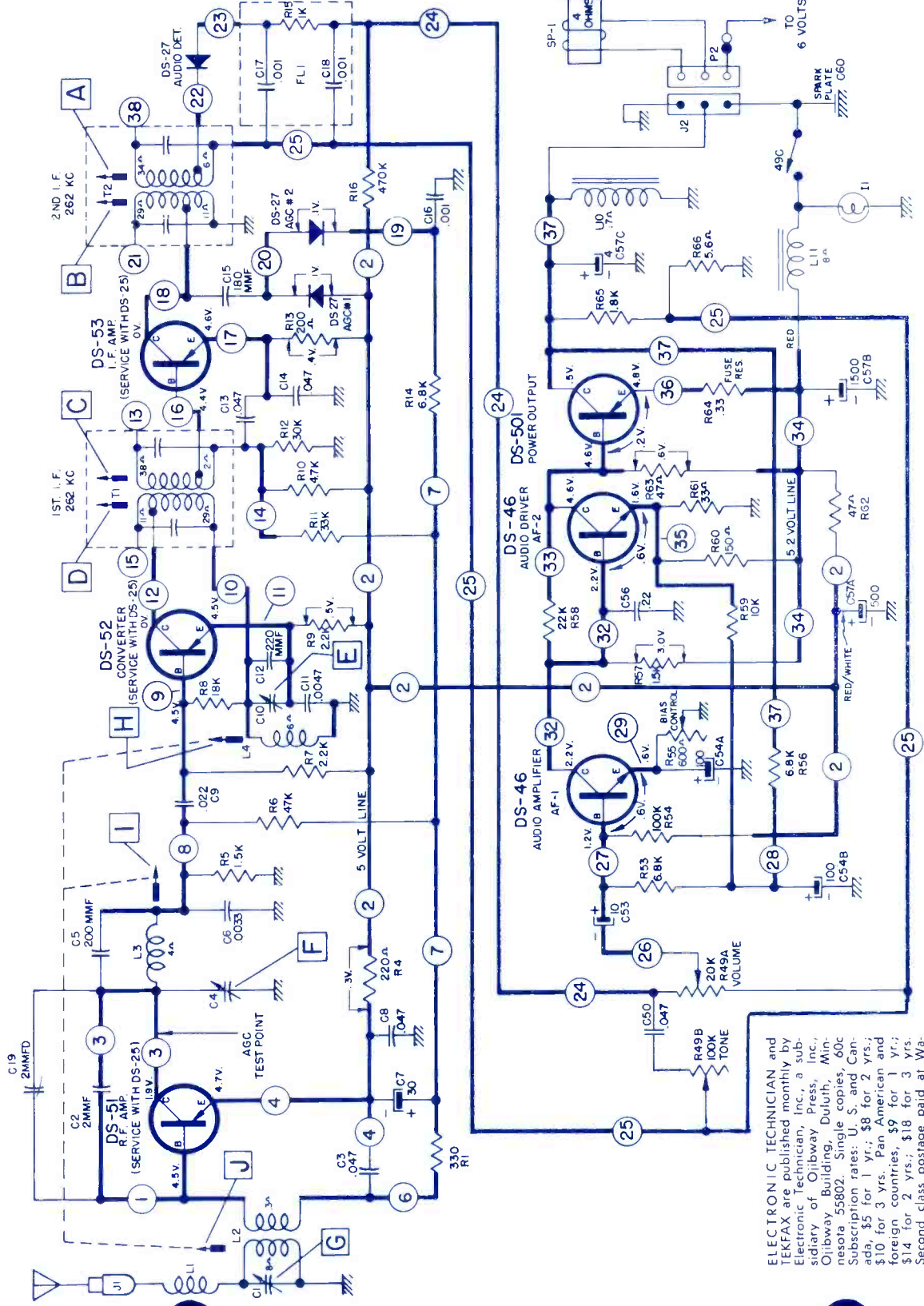

CIRCUIT BOARD
(COMPONENT VIEW)

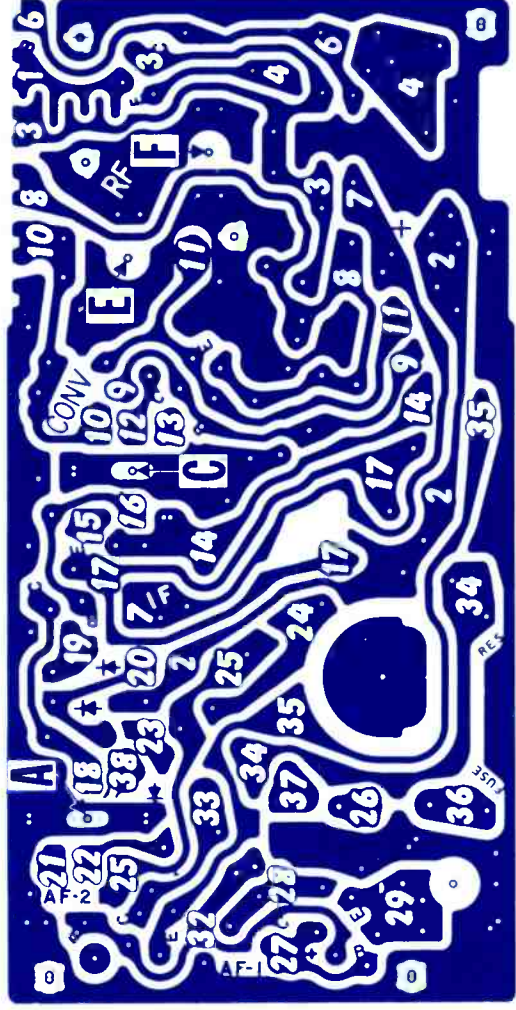

CIRCUIT BOARD
(CIRCUIT VIEW)

ELECTRONIC TECHNICIAN and TEKFAK are published monthly by Electronic Technician, Inc., a subsidiary of Ojibway Publishing, Duluth, Minnesota 55802. Single copies, 60c. Subscription rates: U. S. and Canada, \$5 for 1 yr.; \$8 for 2 yrs.; \$10 for 3 yrs. Pan American and foreign countries, \$9 for 1 yr.; \$14 for 2 yrs.; \$18 for 3 yrs. Second class postage paid at Waseca, Minn. and at additional mailing offices. POSTMASTER: Send notification form 3579 to ELECTRONIC TECHNICIAN, Ojibway Publishing, Duluth, Minnesota 55802.

865

Korting
Tape Recorder
Models MT 2233,
2243

August 1964

ELECTRONIC TECHNICIAN

TEKTRAX

COMPLETE MANUFACTURER'S CIRCUIT DIAGRAMS
AND TECHNICAL INFORMATION FOR SEVEN NEW SETS

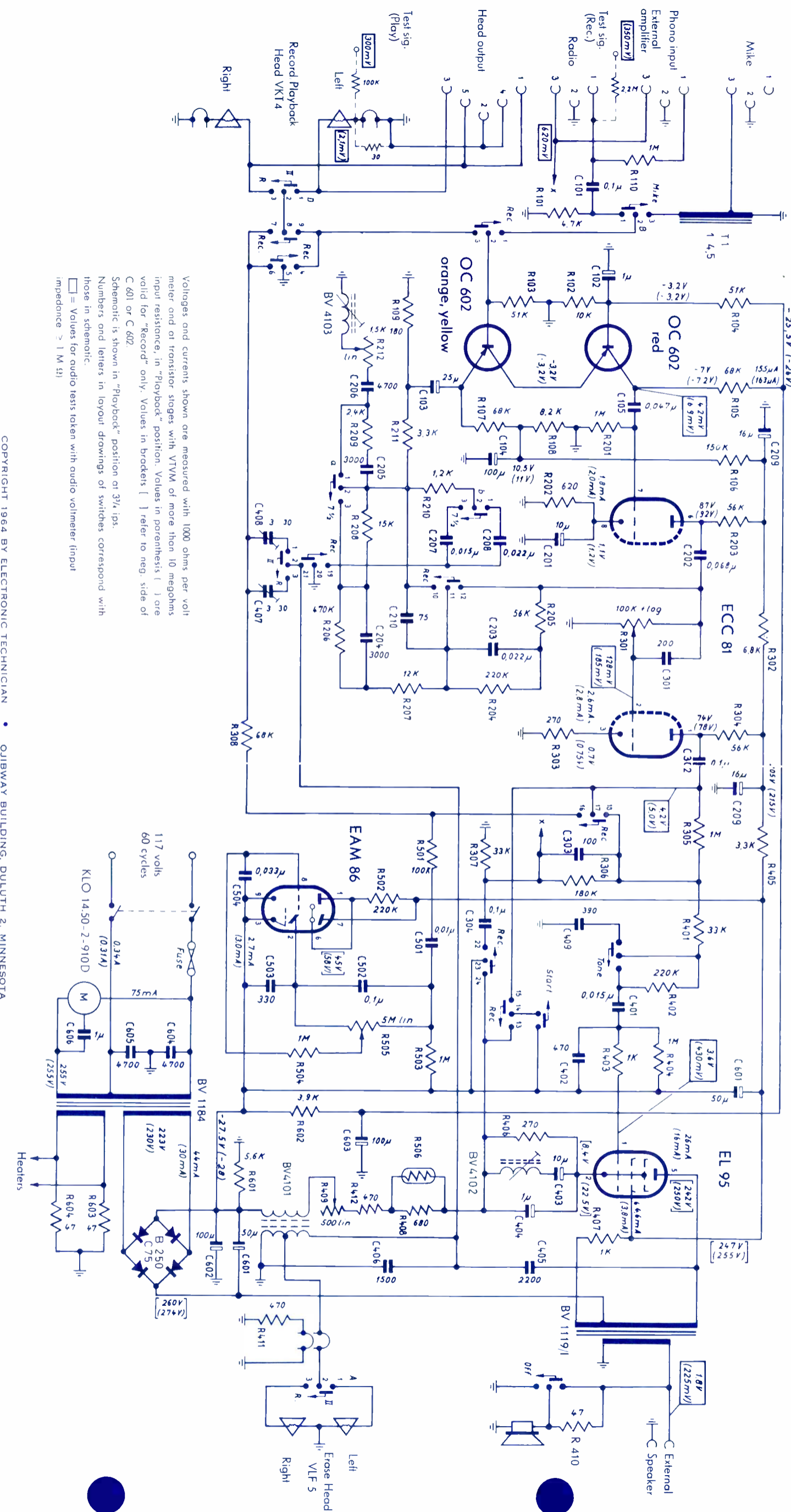
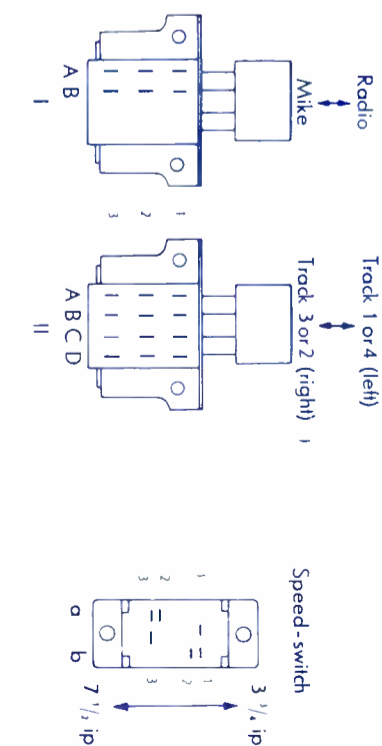
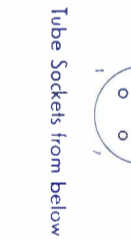
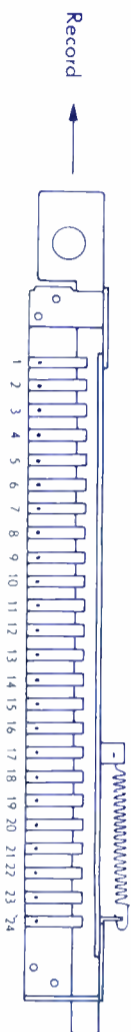

Voltages and currents shown are measured with 1000 ohms per volt meter and at transistor stages with VTVM of more than 10 megohms input resistance, in "Playback" position. Values in parenthesis () are valid for "Record" only. Values in brackets [] refer to neg. side of C 601 or C 602.

Schematic is shown in "Playback" position at 3 1/4 ips.

Numbers and letters in layout drawings of switches correspond with those in schematic.

[] = Values for audio tests taken with audio voltmeter (input impedance > 1 M Ω)

ELECTRONIC TECHNICIAN

TEKFAK

866

COMPLETE MANUFACTURERS' CIRCUIT DIAGRAMS
AND TECHNICAL INFORMATION FOR SEVEN NEW SETS

General Electric
"FY" Chassis

August 1964

More Data on Reverse Side

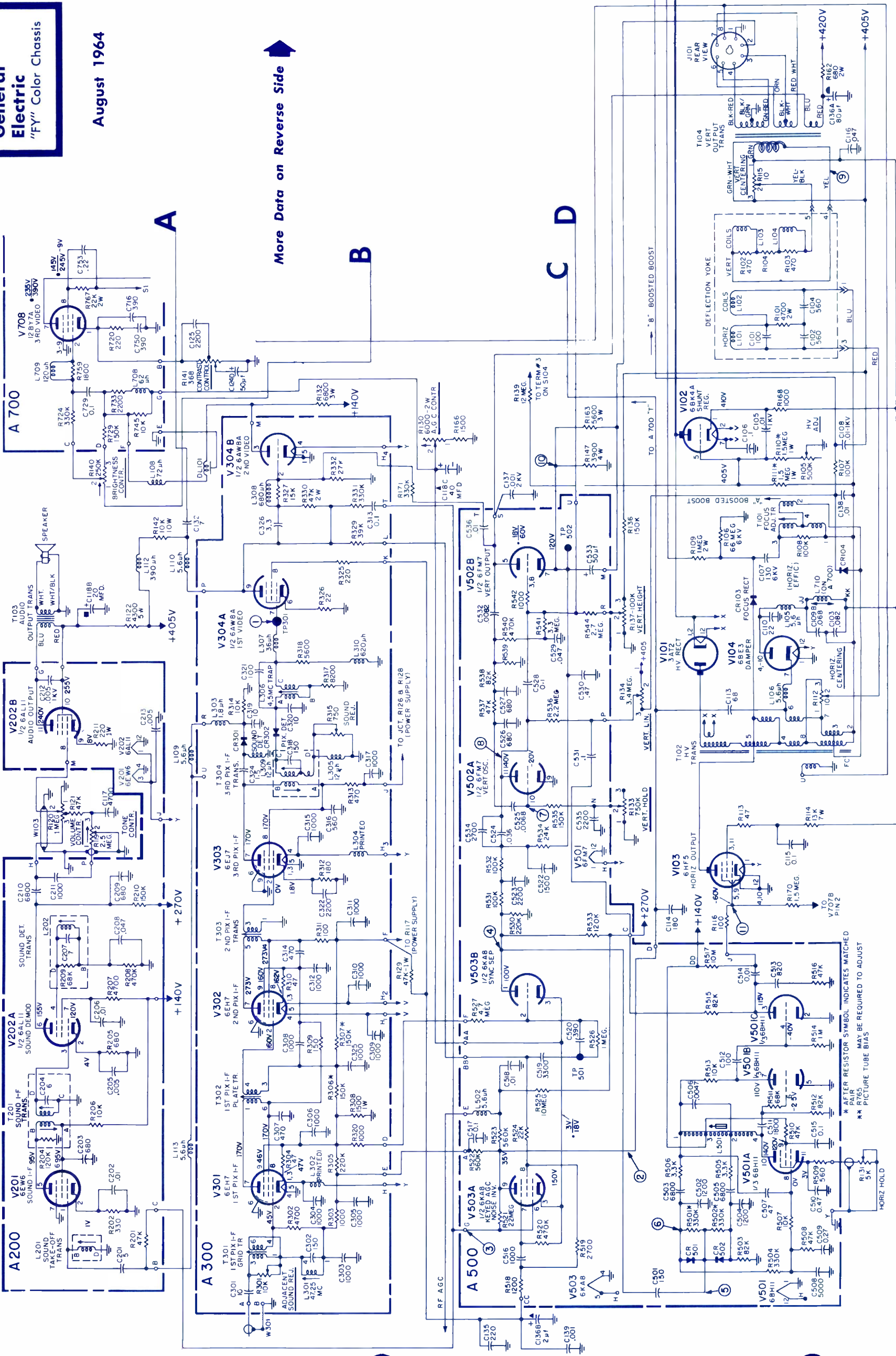

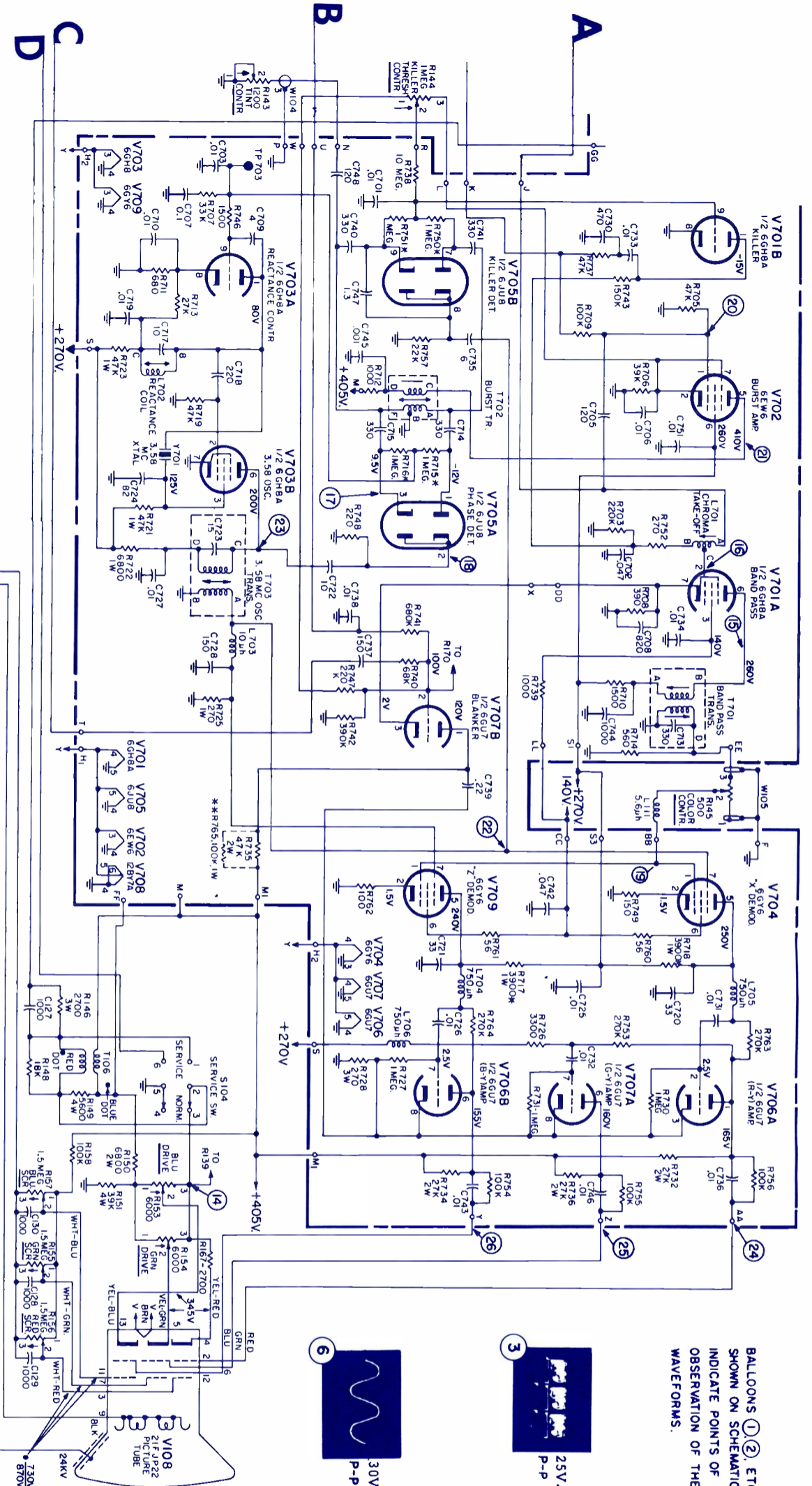

BALLOONS ① ②, ETC., SHOWN ON SCHEMATIC INDICATE POINTS OF OBSERVATION OF THE WAVEFORMS.

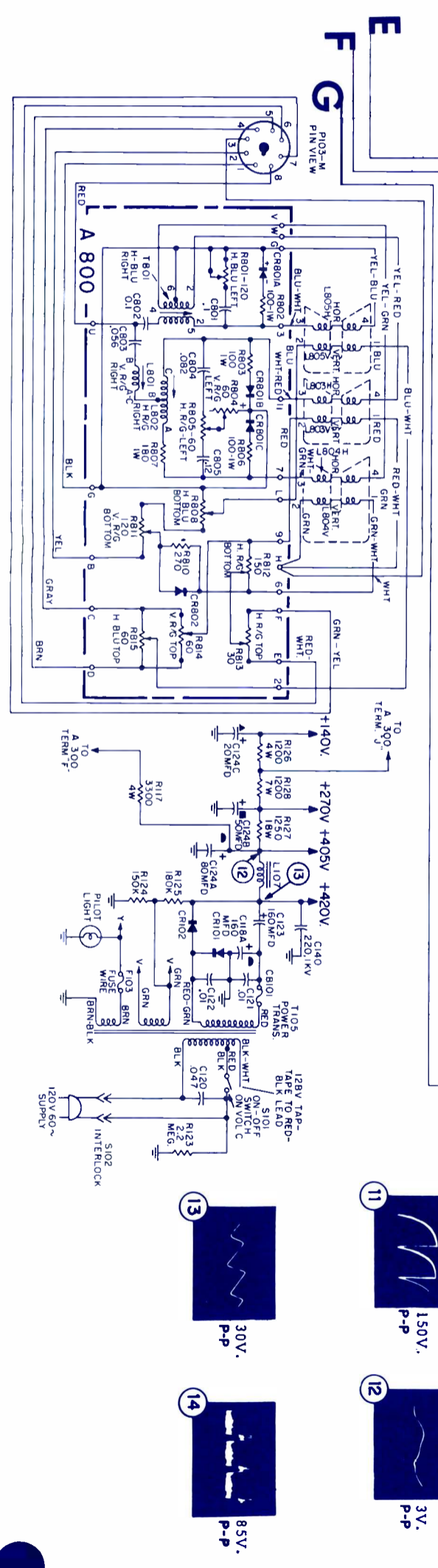
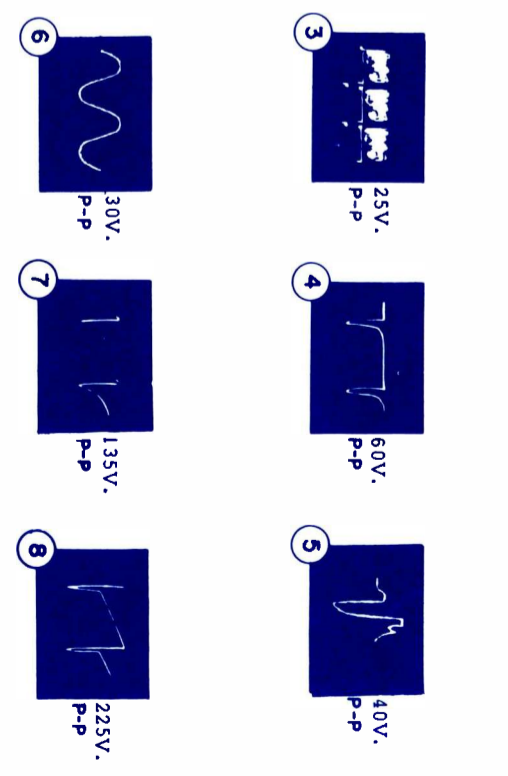

General Electric
"Fly" Color Chassis
ELECTRONIC
TEKFAX
TECHNICIAN
866

More Data on Reverse Side

August 1964

COMPLETE MANUFACTURERS' CIRCUIT DIAGRAMS AND TECHNICAL INFORMATION FOR SEVEN NEW SETS

Philco
Transistor Portable
Radio
Model NT-600

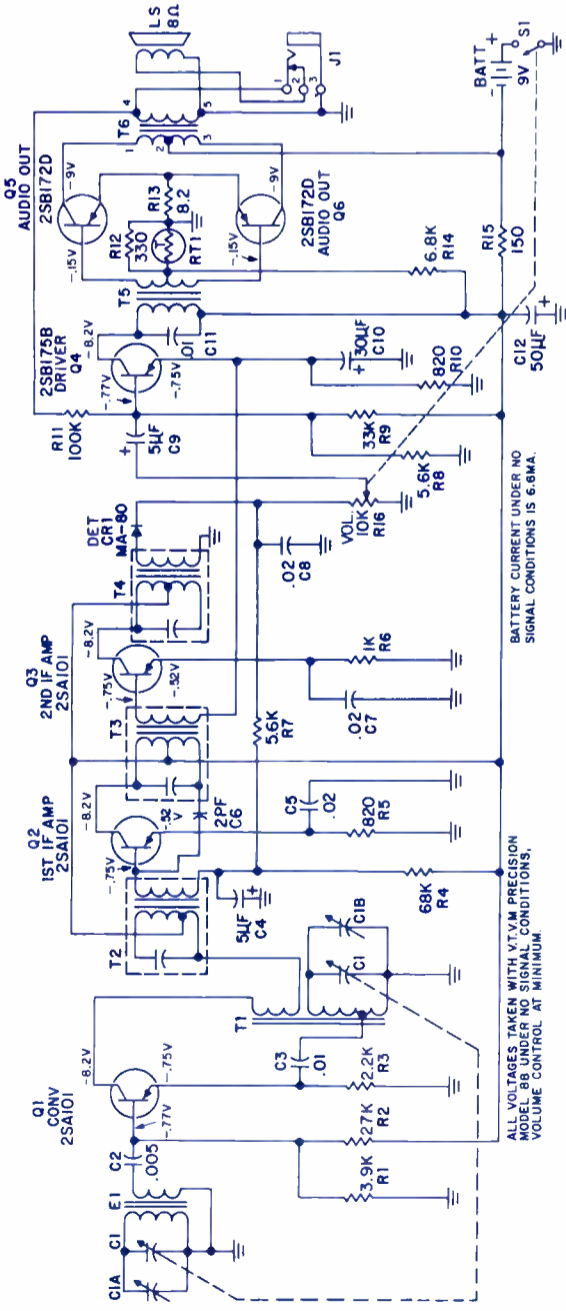

ALL VOLTAGES TAKEN WITH VTVM PRECISION
MODES UNDER NO SIGNAL CONDITIONS.
VOLUME CONTROL AT MINIMUM.

BATTERY CURRENT UNDER NO
SIGNAL CONDITIONS IS 6.8MA.

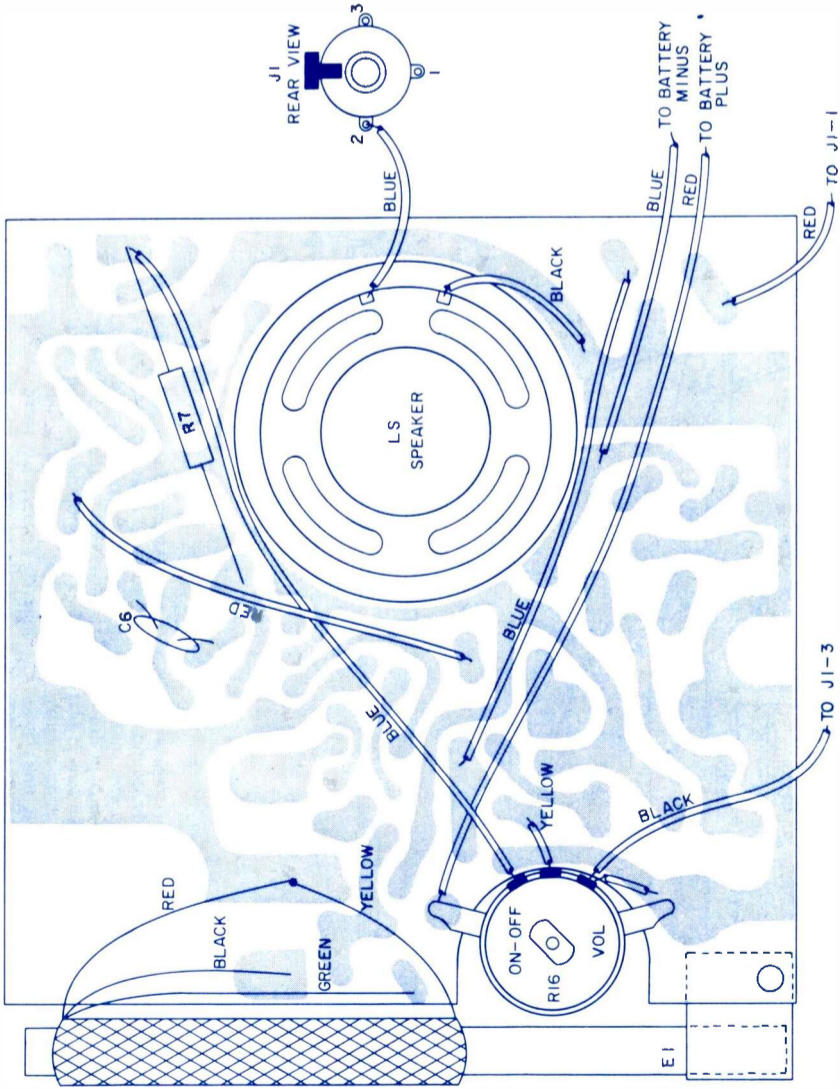
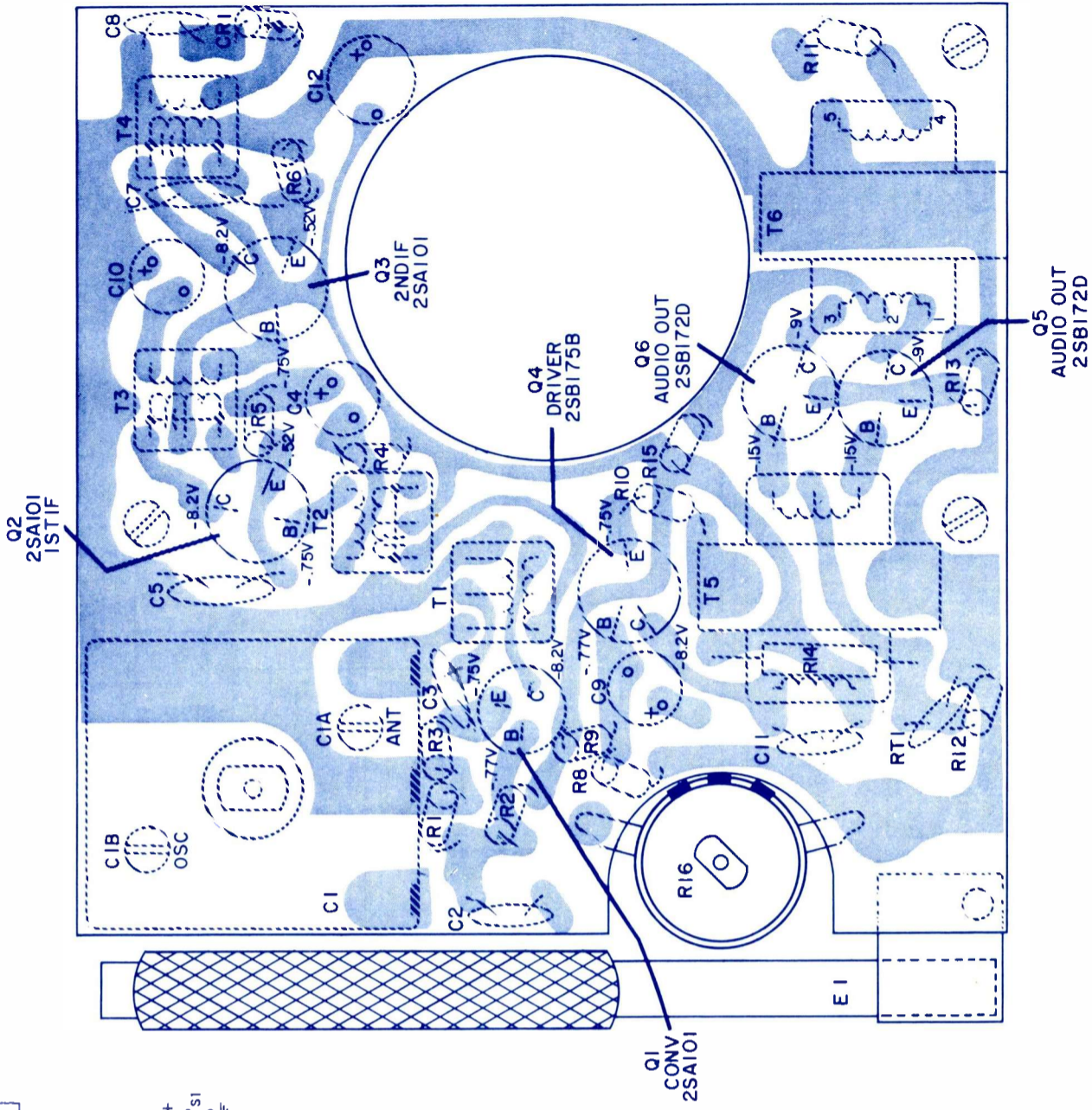

NOTE: WHEN REPLACING BATTERY, NEW BATTERY MAY READ SEVERAL TENTHS OF A VOLT HIGHER THAN ORIGINAL BATTERY. THEREFORE, VOLTAGES MAY READ SLIGHTLY HIGHER THAN THOSE INDICATED ON BASE LAYOUT.

868

RCA
Portable Record
Changer
Chassis RS-206-A

ELECTRONIC TECHNICIAN TEKTRAX

COMPLETE MANUFACTURERS' CIRCUIT DIAGRAMS
AND TECHNICAL INFORMATION FOR SEVEN NEW SETS

August 1964

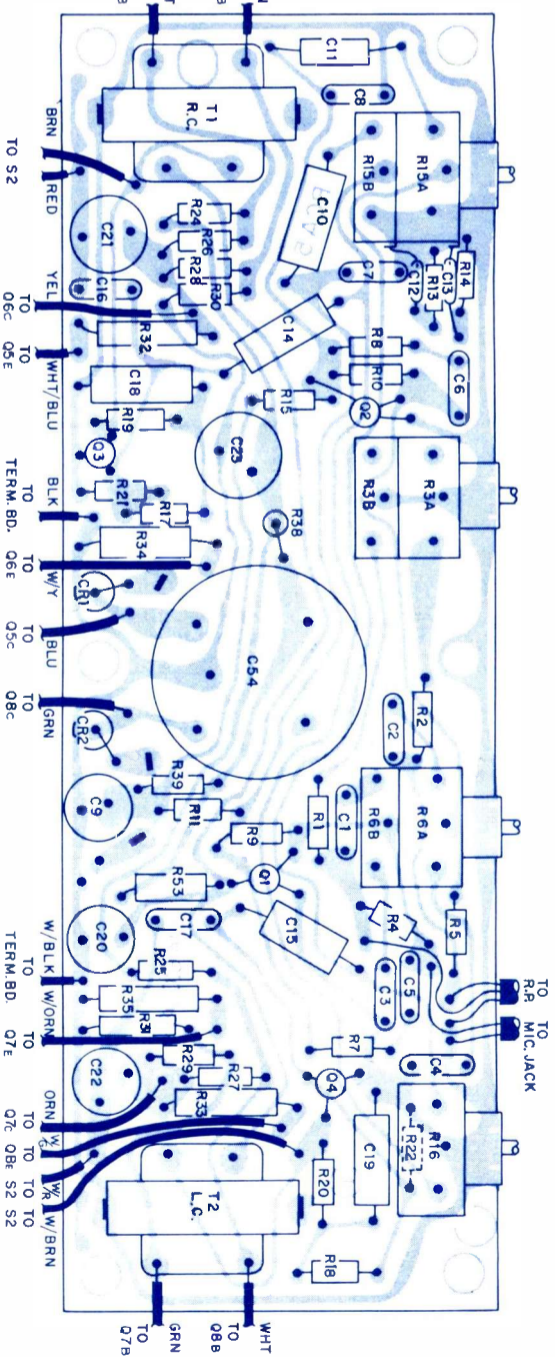
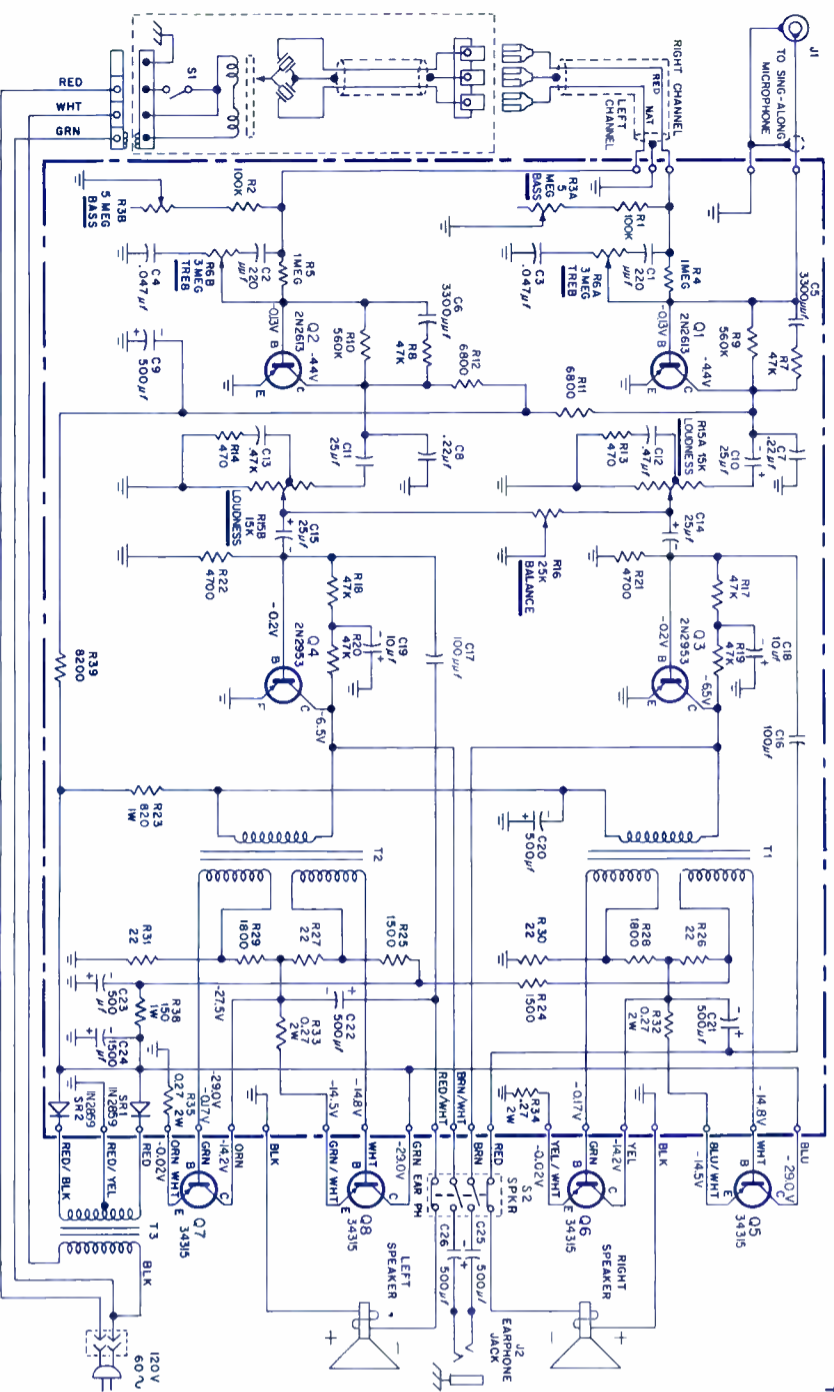

CHASSIS REMOVAL

- The top of the record changer compartment comprises the complete chassis. It rests on and is secured to a ledge at the front and is held by screws at the rear. The recommended procedure for its removal is as follows:
1. Remove knobs.
 2. Open small access panel as described in "Access to Chassis."
 3. Position two (2) holes in access panel over screws holding power cord interlock.
 4. Remove two (2) *machine screws* holding interlock.
 5. Pull record changer drawer down.
 6. If it is not desired to remove chassis completely, omit Steps 6 and 7.
 7. Unscrew two (2) bolts securing record changer in drawer.
 8. Lift mat of turntable and reach bolts through access holes in turntable, one at front and one at rear.) **DO NOT ATTEMPT TO REMOVE RECORD CHANGER DRAWER.**
 9. Lift up changer and disconnect cables.
 10. Remove four (4) *plated screws* holding front of chassis to horizontal ledge located inside of compartment at front of compartment, from holding clips.
 11. Remove wires, running down each back corner of compartment, from holding clips.
 12. Remove four (4) *paired screws* holding rear of chassis to rear of instrument—just below the access panel. (Hold chassis top of compartment—prevent its falling.)
 13. Chassis may then be lowered and removed.
 14. Disconnect speaker cables from transformers and lift chassis out of case.

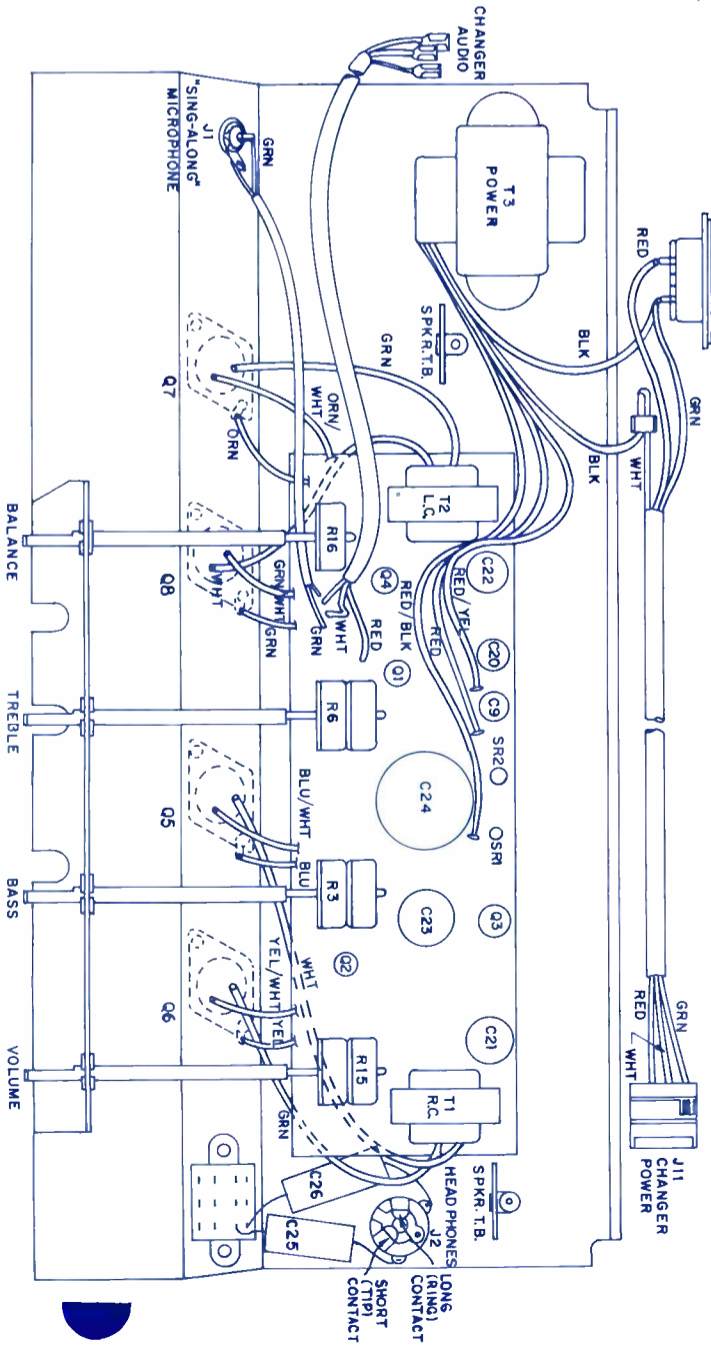
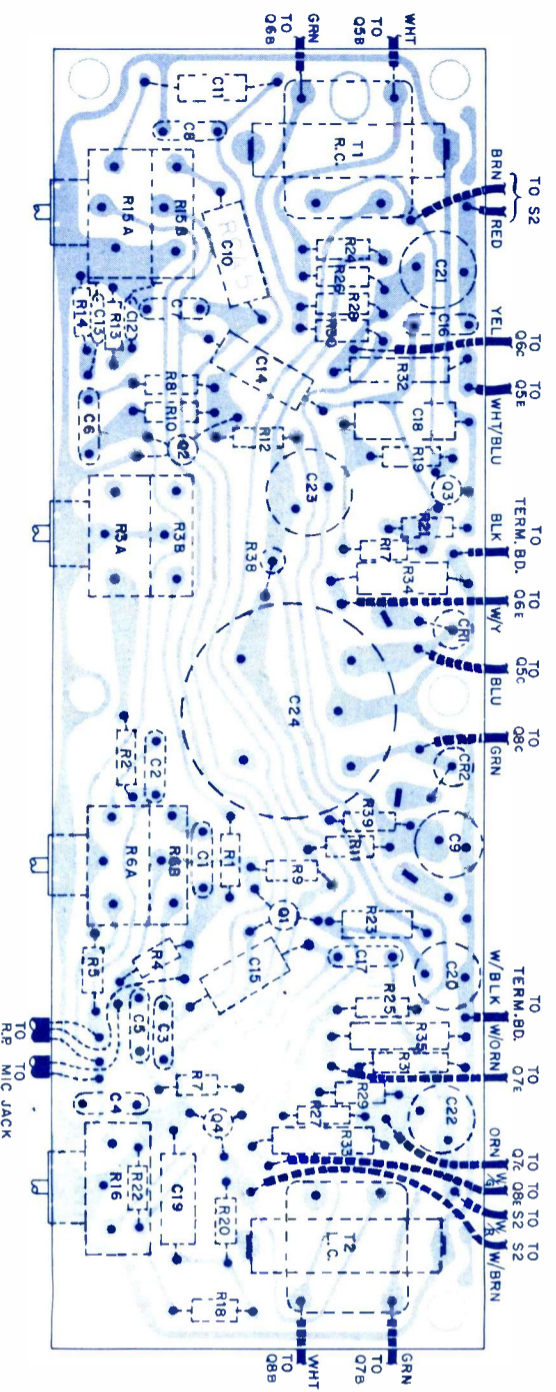

870

Emerson
Color TV Chroma
Board
Chassis 120642-43

ELECTRONIC TECHNICIAN TEKTRAX

COMPLETE MANUFACTURER'S CIRCUIT DIAGRAMS
AND TECHNICAL INFORMATION FOR SEVEN NEW SETS

COLOR AFPC ALIGNMENT

August 1964

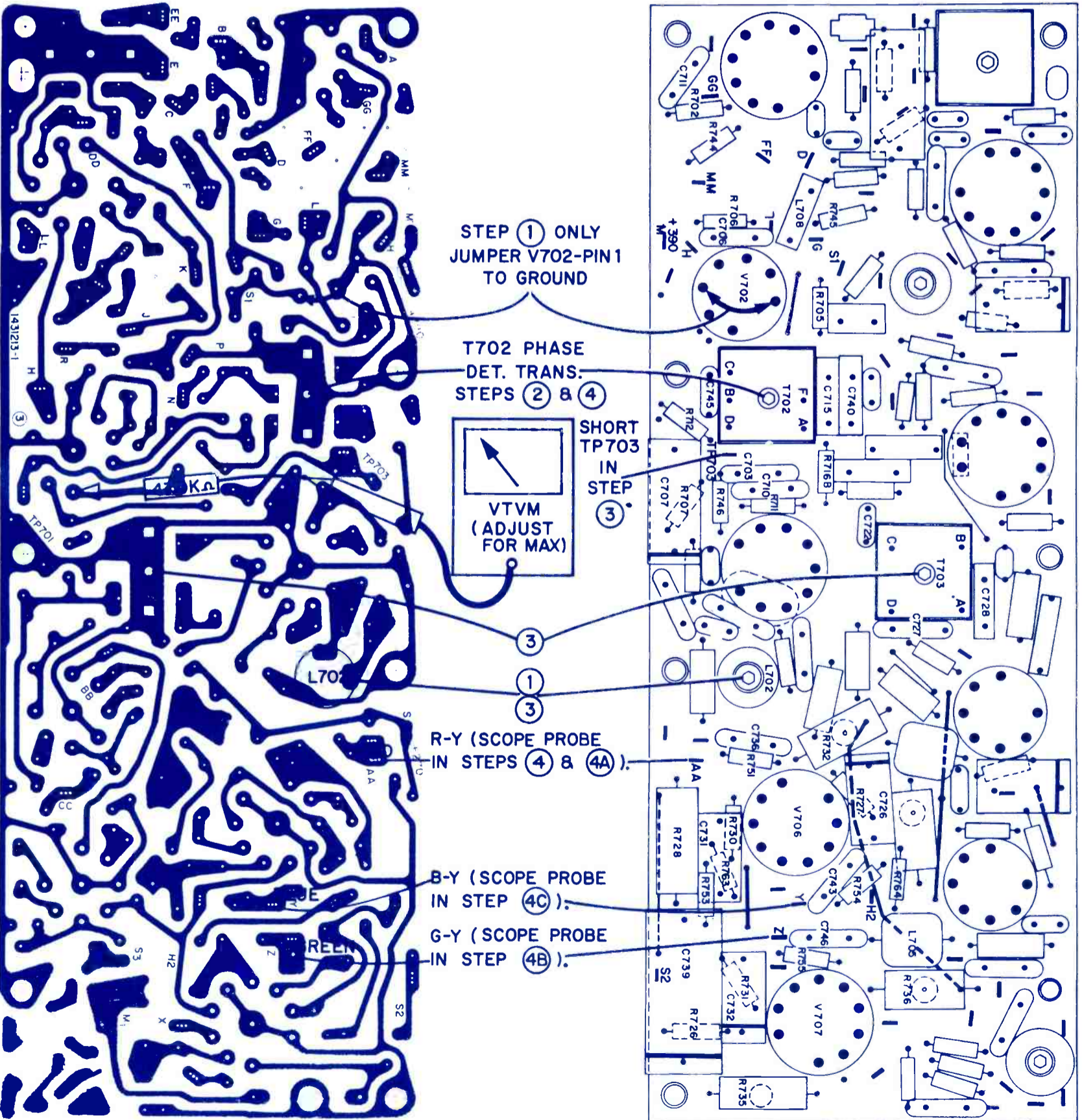
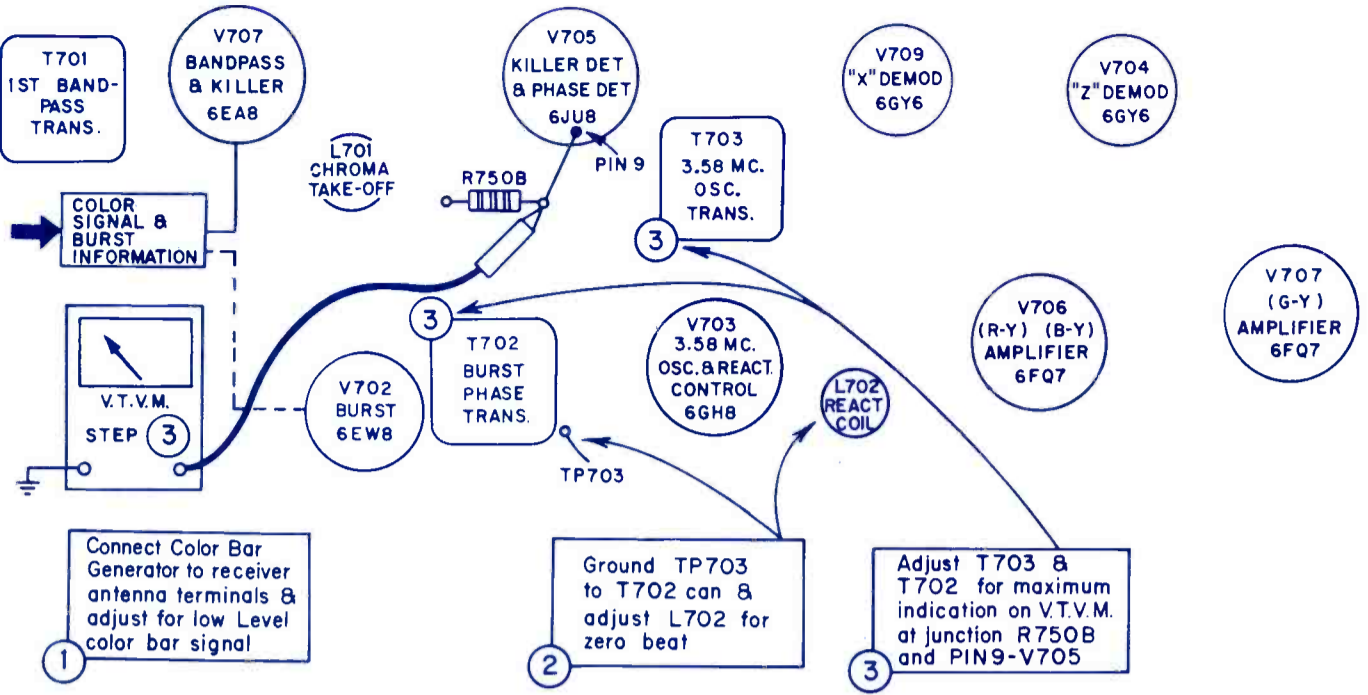

NEW . . . JUST \$119.50 FOR A COMPLETE COLOR BAR GENERATOR WITH EXCLUSIVE SECO STABILITY!

- 15-second warmup for your convenience
- Day-long performance without variation
- Simple sync control—just vertical and horizontal hold
- Work-a-day ruggedness—crystal controlled in heavy metal case

JUST IN TIME FOR THE BIG BOOM IN COLOR TV!

Cash in on the bigger volume coming from the new lower cost color TV's. Here are two color bar generators built to take the toughest use in truck or shop. Fast hookup—just clip on two antenna leads. Foolproof crystal controlled color bars. Fast warm up. Highly stable, after just 15 seconds and all day long—speeds work in home or at bench. Factory set to Channel 3 and can be tuned to Channels 2 or 4. Steel case. See your electronic supply dealer or write for information.



MODEL 990



MODEL 980

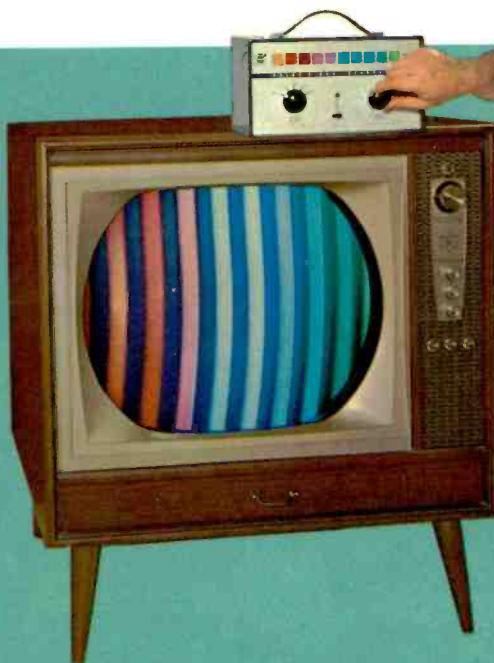

MODEL 980 does everything you need to set up a color TV set

- **KEYED COLOR BARS** for aligning and trouble shooting color circuitry—10 standard bars.
- **DOT PATTERN** for DC or static convergence—54 dots.
- **CROSSHATCH** for dynamic convergence, overscan and linearity adjustments—6 horizontal bars, 9 vertical bars.
- **VERTICAL BARS** for adjusting dynamic horizontal convergence controls—9 vertical bars.
- **HORIZONTAL BARS** for adjusting dynamic vertical convergence controls—6 horizontal bars.

ONLY \$119.50 net

MODEL 990 gives you all the deluxe features!

- **ALL** the tests of the Model 980—with these extra advantages—
- **COLOR GUN KILLER** to actuate any combination of guns.
- **RAINBOW COLOR PATTERN** to supplement keyed color bar tests.
- **VARIABLE DOT PATTERN** with 54 or 144 dots of adjustable size.
- **VARIABLE CROSSHATCH** with 6 or 16 horizontal bars.
- **VARIABLE HORIZONTAL BARS** with 6 or 18 lines.
- **GREY RASTER** for tests required on older sets.

ONLY \$149.50 net



SECO ELECTRONICS, INC.

1211 S. CLOVER DRIVE • MINNEAPOLIS, MINNESOTA 55420
A DIVISION OF DI-ACRO CORPORATION

... for more details circle 35 on post card

SECO also manufactures a full line of tube testers—see back of this page.

SECO'S patented Grid Circuit Test detects "hard to find" tube faults

GRID CIRCUIT TEST makes up to 11 simultaneous checks
for leaks, shorts and grid emission

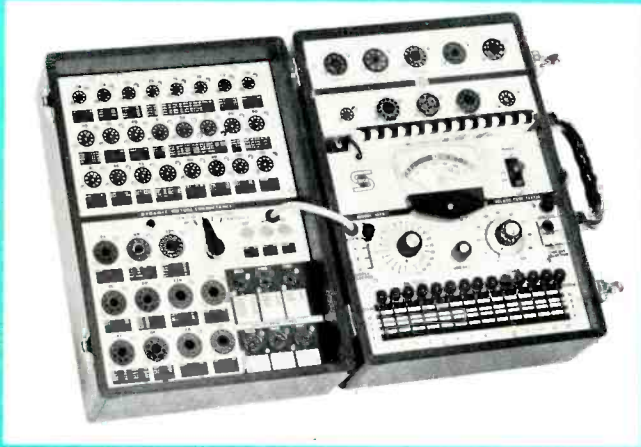

MODEL 107B FEATURES "NO-SET-UP" TESTING

40 prewired sockets accommodate 63 basic pin arrangements for testing all modern TV, radio, industrial and foreign tubes. Also included is a plug-in chassis with 8 sockets wired to 14 lever type pin selectors for testing tubes circuit by circuit. To eliminate errors in reading, all information reads on *one* meter and *one* scale. Three comprehensive tests—Grid Circuit Test, Dynamic Mutual Conductance Test and Cathode Emission Test. Model 107B is always up to date—data book pages covering new tubes are mailed periodically to registered owners. **ONLY \$189.50 net.**

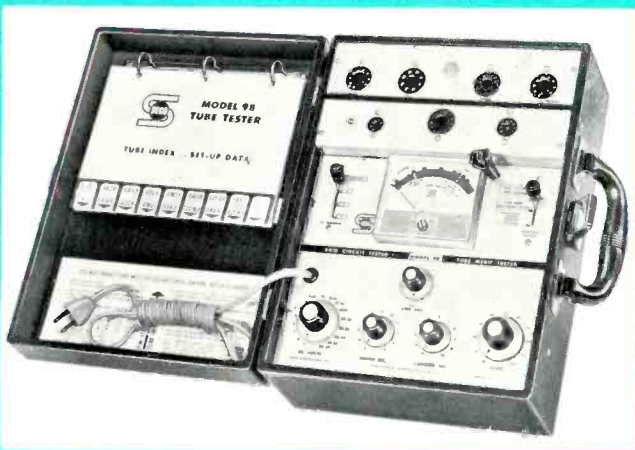

MODEL 98 FEATURES PICTURE TUBE TEST

Tests over 400 cathode ray picture tubes including 110° deflection types—has 12-pin picture tube socket. Also has replaceable plug-in chassis for receiving tubes—guaranteed up-to-date including novars, nuvistors, 10-pin types, compactrons and magnovals. This chassis can be replaced for new tubes or customized for special uses. Dial controls isolate or transpose tube circuits and select test current—Grid Circuit Test, Tube Merit Test and Heater Current Test. Removeable cover holds speed-indexed tube data cards, pin straighteners and condensed operating instructions. **ONLY \$99.50 net.**

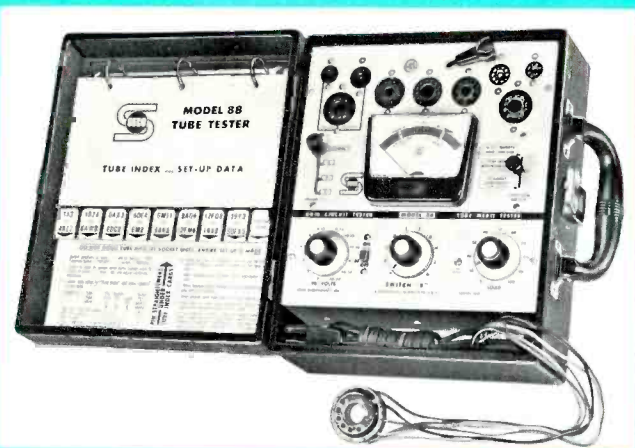

MODEL 88—COMPLETE TESTER AT LOW COST

Performs the same picture tube test as Model 98. Tests all receiving tubes including novars, nuvistors, 10-pin types, compactrons and magnovals. Grid Circuit Test, Tube Merit Test and Filament Continuity Test—you can find cathode emission, leaks, shorts, grid emission, gas error, filament continuity and cathode-to-heater emission. Stationary receiving tube chassis. Unit comes complete with speed-indexed setup data, pin straighteners and 12-pin picture tube socket on a 3-foot cable. **ONLY \$74.50 net.**

See two new color bar generators on front of this page. For complete information on Seco test equipment, see your electronic supply distributor or write:

 **SECO ELECTRONICS, INC.**

1211 S. CLOVER DRIVE • MINNEAPOLIS, MINNESOTA 55420
A DIVISION OF DI-ACRO CORPORATION

... for more details circle 35 on post card

AUGUST 1964
VOL. 80 NO. 2

ELECTRONIC TECHNICIAN

WORLD'S LARGEST ELECTRONIC TRADE CIRCULATION

RON KIPP Publisher
JACK HOBBS Managing Editor
DOUGLAS HEDIN Industrial Editor
DONALD HEDMAN Assistant Editor
ALEX ORR Assistant Editor
EARL HINTZ Production Manager
MAGGIE KANE Advertising Production
JIM GHERNA Art Director
JOE WOLKING Circulation Mgr.
DONNA GEARY Circulation Fulfillment



AN OJIBWAY
PUBLICATION

OJIBWAY PRESS, Inc.

Ojibway Building
Duluth, Minn.
55802

AREA CODE 218 727-8511

Sales Offices:

NEW YORK: Ron Kipp, 555 Fifth Ave.,
New York, N.Y. 10017
AREA CODE 212 MU7-8080

CHICAGO: William Klusack, 221 N.
LaSalle St., Chicago, Ill. 60601
AREA CODE 312 CE 6-1600

CLEVELAND: Arnold T. Suhart, 6207
Norman Lane, Cleveland, Ohio 44124
AREA CODE 216 YE 2-6666

LOS ANGELES: Boyd B. Garrigan, 1655
Beverly Blvd., Los Angeles, Calif.
90026

AREA CODE 213 MA8-8556

SAN FRANCISCO: Stearns Ellis, 260
Kearny St., Room 206, San Francisco,
Calif. 94108

AREA CODE 415 GA1-0593



Copyright 1964 by Ojibway Press, Inc.,
Duluth, Minn. 55802. Reproduction and re-
printing prohibited except by written
authorization of the publication. Subscription
price: \$5 for 1 year, \$8 for 2 years,
\$10 for 3 years. Foreign, \$9 for 1 year,
\$14 for 2 years, and \$18 for 3 years.
If you have a change of address or a ques-
tion about your subscription, write: ELEC-
TRONIC TECHNICIAN, Circulation Depart-
ment, Ojibway Building, Duluth, Minnesota.
55802. BE SURE TO SEND ALONG THE AD-
DRESS LABEL FROM YOUR MOST RECENT
ISSUE.

COVER:

Our cover this month was photographed at Sylvania's Home & Commercial Electronics Division plant in Batavia, N.Y. A technician is examining the phosphor on a Color Bright 85 CRT.

FEATURES

A Technician Views the Synchronous Color Demodulator	39
<i>Reg Bartlett tells you how to eliminate service headaches in the 'heart' of color TVs</i>	
Tinyvision—Color and Black-and-White	41
<i>Tells of recent developments in battery-operated 'toters'</i>	
Change That Color CRT Fast!	42
<i>Homer Davidson presents a step-by-step photo story that shows how to eliminate haphazard motions when replacing a color CRT</i>	
The One-Gun Chromatron	45
<i>About a color tube that may make color TV sets less expensive</i>	
Color High Voltage Systems	46
<i>John Holmes tells how to keep your color customers happy by eliminating sloppy technical practices</i>	
Simplified Color Convergence	49
<i>Bob Dunn reveals five easy steps for avoiding adjustment pitfalls</i>	
Color Trouble	52
<i>Joe Hayes continues with his popular 'Bob' and 'Scoot' series</i>	
Closed-Circuit TV Grows Up	54
<i>John Haskell points up the money-making opportunities in closed-circuit TV</i>	
Your Credit Policy Can Make or Break You	56
<i>Harold Ashe shows that 'collection is the proof of an effective credit policy'</i>	
INDUSTRIAL ELECTRONICS Section	63

DEPARTMENTS

Letters to the Editor	24	New Products	74
Editors Memo	32	Sync on Business	95
Technical Digest	35	Industry News	98
'Tough Dogs'	58	New Literature	100
Shop Hints	60	Coming Events	100
Advertisers Index	100		

TEKFAX 16 PAGES OF LATEST SCHEMATICS

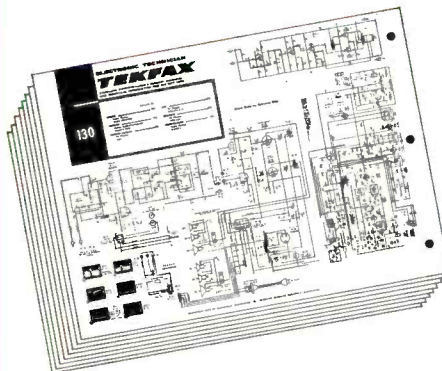

DELCO: Opel Kadett Auto Radio, Model 980886

EMERSON: Color TV Chroma Board, Chassis 120642-43

GENERAL ELECTRIC: 'FY' Color Chassis

KORTING: Tape Recorder, Models MT2233, 2243

PHILCO: Transistor Portable Radio, Model NT-600

RCA: Portable Record Changer, Chassis RS-206-A

SONORA: TV Chassis 1194-194

Available Now

RCA Victor Color TV

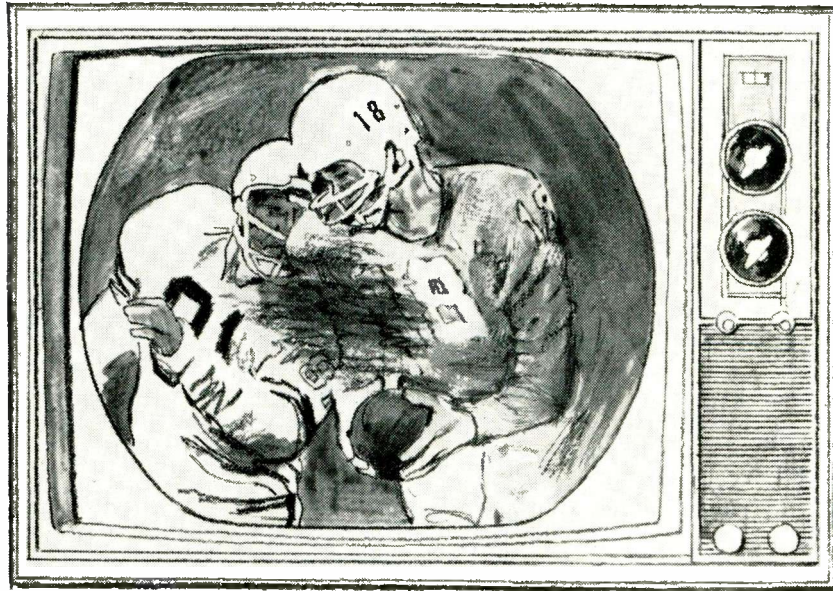

Magnetism can cause impurities...

in the color picture—and unwanted color areas in the black and white picture. In the home, as you know, magnetic distortions may be caused by moving the set in relation to the earth's magnetic field or they can sometimes be caused by nearby electric appliances.

To “cancel” the magnetism and restore natural color...

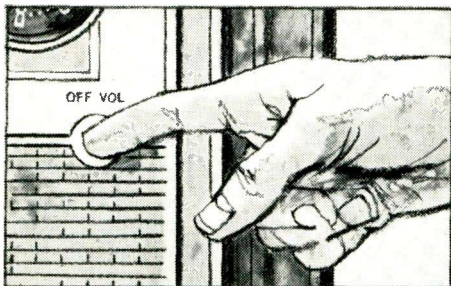

simply turn off the set, let it cool 4 or 5 minutes, then turn it back on. That's all—no more need for a separate degaussing coil! The RCA Victor Automatic Color Purifier acts *every time the set is turned on* from a cool start. Color is bright, sharp, true—free of impurities caused by magnetism. The RCA Victor Automatic Color Purifier also removes unwanted color areas from the black and white picture. Here's another major “first” from RCA Victor that can give you a profitable advantage in extra sales . . . and in service savings!

degausses itself!

Gives you 3 big advantages!

1

Floor models always ready for best color picture!

Ever lost a sale because your floor demonstrator needed degaussing? The RCA Victor Automatic Color Purifier cleans up that problem . . . helps make the sale easier for you. And with a swivel or caster model, you can quickly demonstrate how color TV can now be moved about without worry of magnetic distortion!

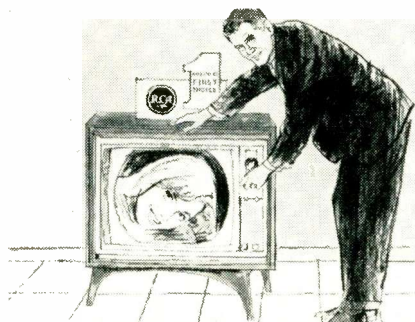

2

Faster, easier setup in customer's home!

The RCA Victor Automatic Color Purifier eliminates the need for you to perform time-consuming degaussing when you deliver the new Mark 10 color TV set. This makes setup faster, easier . . . freeing you for more profitable TV servicing. The Automatic Color Purifier is standard on all Mark 10 models except the price leaders.

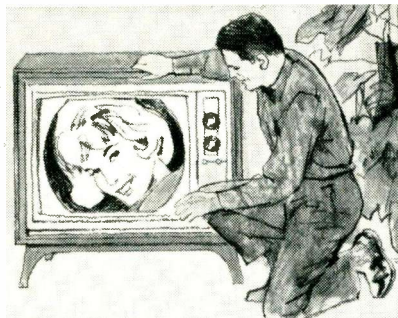

3

Reduces unprofitable callbacks!

The RCA Victor Automatic Color Purifier will end those degaussing "nuisance" calls that can eat up service time and profits. They're a nuisance to customers, too! Increased customer satisfaction is sure to follow from this new RCA Victor "first"—and remember, a satisfied customer is very often your best salesman.

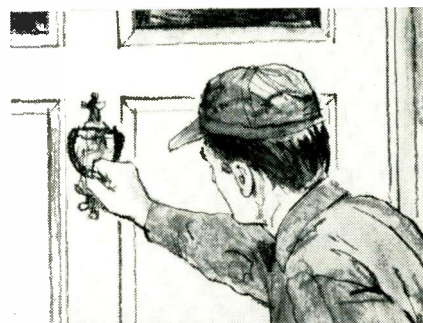

Make sure you get your share of the big Color TV sales forecast for '65...get with RCA Victor!



The Most Trusted Name in Television

Tmk(s)®

SEE THE RCA COLOR TV CENTER AT THE WORLD'S FAIR

Weller® for all soldering

Dual Heat Soldering Guns

Weller dual heat soldering guns give time-saving instant heat. Two trigger positions let you switch to low heat, for soldering near heat-sensitive components, or high heat when needed. Spotlight illuminates work. Three models available.

100/140 watts—Model 8200—\$5.95 list

145/210 watts—Model D-440—\$9.95 list

240/325 watts—Model D-550—\$10.95 list

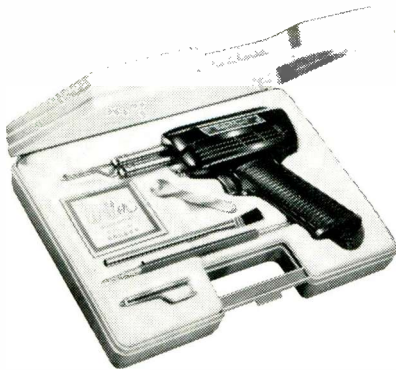

Soldering Gun Kits

"Expert" Kit (shown) includes 100/140 watt gun, 3 soldering tips, tip wrench, flux brush, soldering aid and solder in a plastic utility case. Model 8200PK—\$8.95 list.

Heavy-Duty Kit features 240/325 watt gun; soldering, cutting and smoothing tips; tip-changing wrench; solder; plastic utility case. Model D-550PK—\$12.95 list.



"Pencil" Soldering Iron

For miniature type soldering. A 25 watt, 115 volt soldering pencil that's small and lightweight. So efficient it does the work of irons that are much heavier and require much higher wattage. Rapid recovery. Cool handle. Complete with 3/16" screwdriver tip and cord set. Model WP—\$5.20 list.

Temperature-Controlled Low-Voltage Soldering Pencils



Temperature control of this new Weller soldering pencil is in the tip. Interchangeable tips give a choice of 500°F, 600°F, or 700°F controlled temperatures. Operates on 24 volts. Small, lightweight, highly efficient. Complete with 3/16" 700°F tip and 60 watt, 120 volt, 50/60 cycle power unit with stand for soldering pencil attached. Model W-TCP—\$26.00 list.

Also available: a soldering pencil controlled by thermistor and SCR (silicon controlled rectifier) circuit. It gives a choice of controlled temperatures between 200°F and 450°F. Highly efficient. Model W-TCP-2.

AT YOUR ELECTRONIC PARTS DISTRIBUTOR

WELLER ELECTRIC CORP., Easton, Pa.

WORLD LEADER IN SOLDERING TECHNOLOGY

In Canada: Grant Brothers Sales Co., 18 Hook Ave., Toronto 9; A. C. Simmonds & Sons, 100 Merton St., Toronto 7.
In Europe: Weller Elektro-Werkzeuge G.m.b.H., 7122 Besigheim Am Neckar (Postfach 140), West Germany.

- - - for more details circle 43 on post card

LETTERS TO THE EDITOR

What's the Delay?

Long time ago I requested certain information regarding components mentioned in an article on VTVM improvements written by H. O. Smith of Western Electric and published on page 43 of ELECTRONIC TECHNICIAN's November 1963 issue. What goes? You so busy getting out the best magazine in the business you don't have time to give out a little extra info?

GEORGE LANGDON
New York, N.Y.

• We have received a substantial number of letters requesting similar information. Two formal requests for this information to responsible persons have to this date produced no desired information. Suggest a little more patience with the ivory towers.—Ed.

Biz is Biz

Have read with considerable interest, the article "Ten Tight Money Tips for You," by Mr. Larston D. Farrar, in the November 1963 issue.

From reading his article, we feel that Mr. Farrar must have considerable practical experience with small business and we would appreciate it if you could send us a list of books or pamphlets which he has written concerning small business, particularly retail.

It appears to us that most of the articles written about the retail and service business are wordy and not too knowledgeable and we are hap-



"I don't know why I never thought of it before."

WHY bother with makeshift twist-prong capacitor replacements?

When you substitute capacitor sizes and ratings, you leave yourself wide open for criticism of your work . . . you risk your reputation . . . you stand to lose customers. It just doesn't pay to use makeshifts when it's so easy to get the exact replacement from your Sprague distributor!

Get the right SIZE,
right RATING every time
with improved

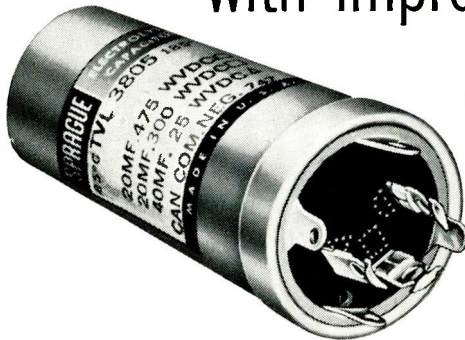

SPRAGUE TWIST-LOK[®] CAPACITORS!

1,863 different capacitors to choose from!

The industry's most complete selection of twist-prong capacitors, bar none. Greater reliability, too. Exclusive Sprague cover design provides a leak-proof seal which permits capacitors to withstand higher ripple currents.

GET YOUR COPY of Sprague's comprehensive Electrolytic Capacitor Replacement Manual K-107 from your Sprague Distributor, or write Sprague Products Co., 65 Marshall St., North Adams, Massachusetts.



WORLD'S LARGEST MANUFACTURER OF CAPACITORS

Sensational
Performance!

New
small size!

Hand wired
modular
construction!

HALLMARK 1250



suggested list
\$169.50

Get on the profit line with the "hottest" CB going — the new Hallmark 1250!

Hand wired top performance and reliability in a size so compact (only 4"x6 1/4"x10") it fits any vehicle. Built like a 15 watt unit, the new full wave silicon bridge easily provides the power for maximum output and modulation. A dual powered, 12 channel, crystal-controlled unit, the 1250 has 0.3 μ v sensitivity and 45 db selectivity. Other features include electronic switching, ferrite speaker and sturdy snaps for easy access to crystal sockets and chassis.

SPECIAL OPTION! Model 1250 X — with plug-in transistorized power supply! \$189.50, suggested list.

Write for information on the complete Hallmark line!

Hallmark 512. 12 channel CB.

Hallmark 3000. FCC type accepted 30 watt transceiver for business service.

Transceiver Tester. Battery powered, crystal-controlled signal generator.

Power Supply. Transistorized plug-in to replace vibrator power supply.

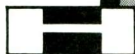

HALLMARK INSTRUMENTS

2620 Freewood Dr. P. O. 10941 Dallas 20, Texas FL 7-0184

- - - for more details circle 22 on post card

LETTERS TO THE EDITOR

py to see your magazine with several interesting business articles lately.

GORDON MCINTOSH
Crysler, Ontario, Canada

• We know that Mr. Farrar has written one book but we are not in possession of full details.— Ed.

Glow, Gentlemen, Glow

I want to tell a little story that should cause the TV-radio receiver manufacturers to glow with pride in their products.

By now the country knows of the devastating flood which recently struck Montana. Fortunately, very few lives were lost (20 known dead and 13 presumed so), but property damage is still being revised upward.

During this period many TV and radio receivers remained under water for four days, some of them trundled along in the sweeping flood currents.

If any kind of pattern was evident, it involved burned-out power transformers and frozen phono motors—while flybacks and yokes were rarely damaged. Some IF transformers were damaged only to the extent they needed slight re-tuning. TV tuners, some completely packed with mud, were simply washed out with cold water from a garden hose and dried in the sun or under a heat lamp. Those of the incremental type were generously sprayed with tuner spray, and the turret types were cleaned with a soft eraser and lubricated with small

quantities of contact "dope." Very few required further servicing.

Receivers requiring new parts—capacitors, resistors, tubes, etc.—were obviously in various stages of decay before the flood. There were, of course, a few comedies-of-error—some sets were ruined by being plugged into outlets before they were dried out. In one instance, a TV receiver exploded with such force that it knocked plaster off the wall.

Cases of autos considered a total loss had radios that came through without serious damage. Where household furniture fell apart from soaking, radios, obviously tossed about like flotsam, played normally after drying out. Wooden console cabinets came through in amazingly good shape. The veneer did not even peel, and grill cloth seldom had to be replaced.

Even speakers, although completely soaked and the cones impacted with mud and silt, showed few ill effects after proper cleaning and drying. Controls, in most instances, needed only a generous "shot" of tuner spray to get them going again.

Hand-wired and printed circuits withstood the onslaught of water equally well.

So, gentlemen, take your bows. We believed it when you claimed parts were impregnated against humidity, but who thought you'd done the job so well that entire receivers could be dunked for almost a week without serious damage? Montana technicians now have a more knowledgeable respect for your consumer products.

JAY SHANE

Great Falls, Montana

Unschool'd Typewriter

I've read with much interest the article "Estimate or Guesstimate" by Reg Bartlett in May ET. The problems expounded certainly exist. Writer Bartlett, unwittingly exposed another problem not referenced in his article. See Table III. So, when presenting a bill to the customer, how does one talk his way out of incorrect mathematics, to wit, minor bench service (1.0 x \$6.00 = \$6.50) and a total which is cockeyed (\$25.25)? Could it be maybe the editor's typewriter needs an overhaul? I find ET most helpful, but would enjoy more articles on Hi Fi

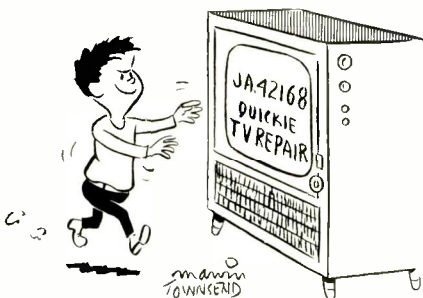

"Now children, before we twist all the little buttons on our TV set like we showed you — let's be sure we remember this telephone number to tell mommy."

TUNER REPAIRS

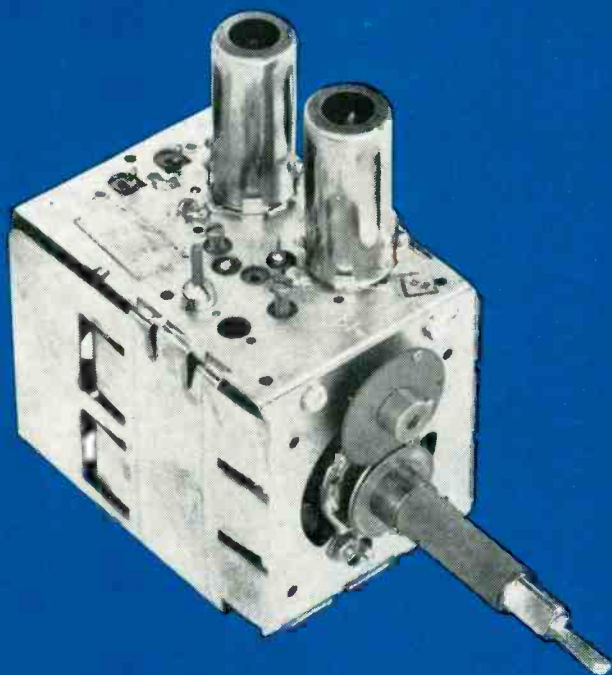

\$9.50

FOR COMPLETE OVERHAUL

**Includes ALL parts (except tubes)
ALL labor on ALL makes**

**24-HOUR SERVICE with
FULL YEAR WARRANTY**

Sarkes Tarzian, Inc., largest manufacturer of TV and FM tuners, maintains two completely-equipped Service Centers to serve YOU. Both centers are staffed by well-trained technicians in this specialized field and are assisted by engineering personnel to assure you of FAST, DEPENDABLE service.

Ⓢ Tarzian-made tuners—identified by this stamping—received one day will be repaired and shipped out the next. A little more time may be required on other makes. Every channel is checked and re-aligned per manufacturer's specifications, not just the channels which might exist in any given area.

You get a 12-month guarantee against defective workmanship and parts failure due to normal usage. Cost to you is only \$9.50 and \$15 for UV combinations, including all labor and parts except tubes. No additional costs. No hidden charges. All tuners repaired on approved, open accounts. You pay shipping. Replacements on tuners beyond practical repair are available at low cost.

When inquiring about service on other than Tarzian-made tuners, always send TV make, chassis and Model number. Check with your local distributor for Sarkes Tarzian replacement tuners, parts, or repair service. Or, use the address nearest you for fast factory repair service.



SARKES TARZIAN, INC.
TUNER SERVICE DIVISION

See your distributor, or use the address nearest you

537 South Walnut St.,
Bloomington, Indiana
Tel: 332-6055

10654 Magnolia Blvd.,
North Hollywood, Calif.
Tel: 769-2720

Manufacturers of Tuners . . . Semiconductors . . . Air Trimmers . . . FM Radios . . . AM-FM Radios . . . Audio Tape . . . Broadcast Equipment

TV-RADIO SERVICE
 tubes 
YOUR NAME HERE

ETR 1290

TV-RADIO SERVICE
 
ELECTRONICS

ETR 1566

TV-RADIO SERVICE
 tubes 

ETR 1569

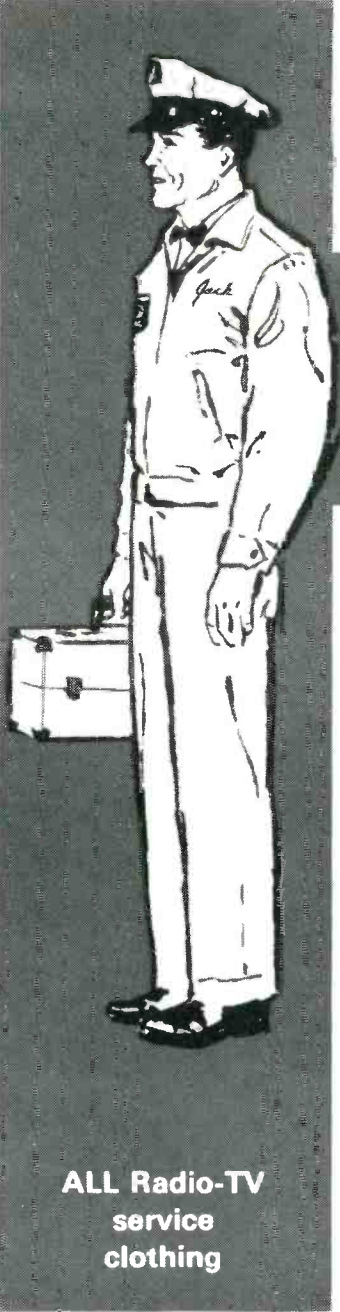

ALL Radio-TV service clothing

PATTERN-PERFECT PICTURE SERVICE?
GENERAL ELECTRIC
 best tubes for your set 
ETR 3287

TV-RADIO SERVICE

ETR 1291

ELECTRONICS
TV-RADIO SERVICE

ETR 1564

Electronic tube

ETR 3288

TV-RADIO SERVICE
 
ETR 1565

TV-RADIO SERVICE

ETR 1568

TV-RADIO SERVICE
 tubes 
YOUR MESSAGE HERE
ETR 1556

G-E FIX-UP, DRESS-UP

Be "Best Dressed" at half the catalog price!

The better your shop looks, the better is the outlook for business. Customers prefer to do business at a shop that has a neat, "careful" look. It gives them confidence in your work. But time and use *can* and *do* affect appearance.

It may be just that time—when your outdoor signs are looking a bit under the weather, or perhaps you could use a display clock or thermometer to functionally dress up your shop. Need a new service hat or jacket?

For a limited time, General Electric is sponsoring a "Fix-up, Dress-up" campaign to make you, the dealer, "best dressed" at half price. Choose from over 25 items, including signs and display materials, clocks and thermometers, and a complete selection of wearing apparel—hats, shirts, pants, caps, jackets—ALL AT 1/2 THEIR CATALOG PRICE. All special-priced display and clothing items may be obtained on a cash basis by mail or directly from your distributor with the purchase of G-E tubes.

CHOOSE FROM THESE ITEMS:

ETR 1290	SIGN, outdoor, illum., 2 face, 24" x 48"
ETR 1566	SIGN, nameplate, outdoor, 2 face, 48" x 36"
ETR 1565	SIGN, flange, outdoor, 2 face, 15" x 12"
ETR 1564	SIGN, tack-on, outdoor, 14" x 42"
ETR 1556	SIGN, indoor, with changeable letter kit (37" x 14")
ETR 1291	CLOCK, indoor, illum., 16" dia.
ETR 1568	THERMOMETER, indoor/outdoor, 12" dia.
ETR 1569	BACKDROP, corrugated, 36" x 24" (2 per carton)
ETR 3288	TUBE CARTON, giant, 7 1/8" x 17 5/8"
ETR 3287	DECAL, 1 side, back stick, 16" x 12"

Catalog Price	Special Price
\$168.75	\$84.37
27.00	13.50
2.25	1.13
2.70	1.35
27.50	13.75
14.95	7.48
5.95	2.98
2.00	1.00
.35	.18
.25	.13

AND

You may use form ETR 1499B for ordering *any* radio-TV service clothing at half price. Obtain this form from your local distributor or complete and mail the coupon below. Please check the box requesting ETR 1499B.

**Send To: General Electric Co., Dept. B
3800 N. Milwaukee Ave.
Chicago, Illinois 60641**

Name _____

Address _____

City _____ Zone _____ State _____

I enclose \$_____ in check or money order for the following half-price items, including applicable local and/or state sales/use taxes:

- | | |
|-----------------------------------|-----------------------------------|
| <input type="checkbox"/> ETR 1290 | <input type="checkbox"/> ETR 1291 |
| <input type="checkbox"/> ETR 1566 | <input type="checkbox"/> ETR 1568 |
| <input type="checkbox"/> ETR 1565 | <input type="checkbox"/> ETR 1569 |
| <input type="checkbox"/> ETR 1564 | <input type="checkbox"/> ETR 3288 |
| <input type="checkbox"/> ETR 1556 | <input type="checkbox"/> ETR 3287 |

Please send me service clothing order form ETR 1499B.

Progress Is Our Most Important Product

GENERAL  ELECTRIC

--- for more details circle 20 on post card



EVERYTHING IN A NUTSHELL

... Viking your source from beginning to end. Manufacturers of the Rainbow series of 59U and all featured mainline cables. Plus a complete line of taps, amplifiers, wall plates, connectors and every component to successfully and profitably install a small or large system. Specializing in all phases of the closed circuit industry. We plan, design, layout and supply everything you need. Viking is your one shop for every phase of Master Antenna, Educational and Instructional Television System Equipment and cable. For a look at what's in our nutshell drop a line on a company letterhead and we will do the rest.

Be smart like a squirrel, put all your nuts in one basket.



VIKING



Call Us Collect

400 NINTH STREET
HOBOKEN, NEW JERSEY

NEW YORK: (212) WH 3-5793
HOBOKEN: (201) OL 6-2020

LETTERS TO THE EDITOR

& stereo subjects. TEKFAK is an invaluable reference, but I would like to see some schematics of Grundig equipment, particularly Tape machines of late production—providing, of course, that they make this information available for publication.

WILLIAM R. PARKS
Duarte, Calif.

• *Just carted that typewriter back to school for a PhD in math. Its MA is a little obsolescent in this Jet Age.—Ed.*

... In looking through the May issue of ET I couldn't help but notice several things which appear to be errors and which would certainly confuse the reader. In Table III on page 63 you show "minor bench service (1 x 6.00) total \$6.50 which you must agree is poor multiplication! Furthermore, you show the total at the bottom as \$24.75 when it should be \$25.25 if you use the figures shown, or \$24.75 if you use the correct figure of \$6.00 instead of \$6.50 for the minor bench service....

M. G. GOLDBERG
St. Paul, Minn.

• *See above.—Ed.*



... Well what'ya know, ... I was just about to tear up your customer file card. ..."

WHY SHOP
 ALL OVER TOWN
 USE THIS **ONE** 
 RECTIFIER KIT FOR
 ALL THESE MAKES
 OF **COLOR TV**

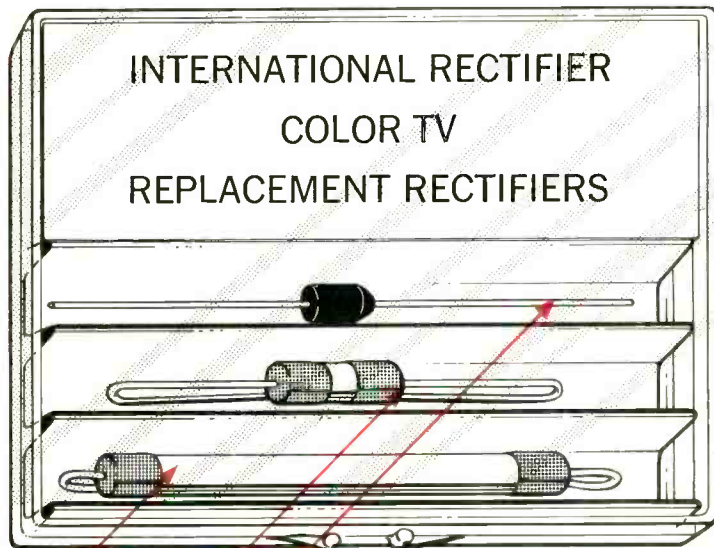

KIT INCLUDES:

- One #61-8969 Focus Rectifier 6500 PIV
- One #61-8968 Voltage Booster Rectifier 800 PIV
- One #5A6-D Silicon Rectifier 600 PIV 1,000 ma
- One Cross Reference Chart

Manufacturer	INTERNATIONAL RECTIFIER CATALOG NUMBERS			Replaces Any Low Voltage Power Supply
	61-8969 REPLACES	61-8968 REPLACES	5A6-D REPLACES	
RCA	113397	113391		
MAGNAVOX	B530096-1	C530097-3		
ZENITH	212-48	---		
PHILCO	34-8053-2	34-8056-1		
EMERSON	817123	817124		
PACKARD BELL	72110	72111		
SETCHELL CARLSON	FR1033	---		
WARWICK (Sears Roebuck)	86-44-3	86-45-3		
WELLS GARDNER (Muntz TV)	B66X0035-001	B66X0036-001		
MOTOROLA	48D66653A05	48D66653A03		
SYLVANIA	16106-1	16105-3		
OLYMPIC	RF32103-1	RF32102-3		
HEATH	12429 (57-36)	---		

Just ONE source to contact—your local International Rectifier distributor. Spend less time ordering from many sources—carry a smaller parts inventory—have fewer delays on repair jobs... Standardize on International Rectifier replacement rectifiers for color TV.

SPECIAL INTRODUCTORY OFFER
 by your local International Rectifier Distributor.
 One International Rectifier Color TV Replacement Rectifier Kit #K-896, a \$4.40 value for \$4.00
WITH THIS COUPON.

This offer expires September 30, 1964.

40¢ **40¢**

THIS COUPON WORTH 40¢

One #K-896 International Rectifier Color TV Replacement Rectifier Kit.

Regular Dealer Net	\$4.40
Save 40¢ with This Coupon	.40
SPECIAL INTRODUCTORY OFFER	\$4.00

Offer Expires September 30, 1964

Redeem at your local International Rectifier distributor.

40¢ **40¢**

 **INTERNATIONAL RECTIFIER**

233 KANSAS STREET, EL SEGUNDO, CALIFORNIA

--- for more details circle 24 on post card

"Here it is. An all channel UHF amplifier."

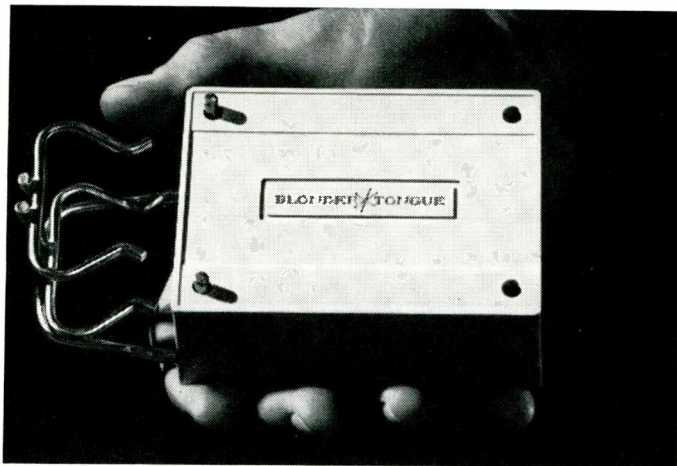

"So what?"

"So, Bob, it's the world's first two transistor UHF amplifier."

"Big deal."

"Gives twice the gain of those one transistor jobs."

"Go on, Harry. Go on."

"It's the first to deliver peak performance on all UHF channels."

"So what does it all mean to me?"

"Cleans up fuzzy pictures, brings in distant signals sharp and clear."

"Now you're really talking."

"Remote power supply, Miracle Mount for instant mounting, 300 ohm stripless screws."

"I'm sold. What's it called?"

"The Blonder-Tongue Able - U2. Only \$44.95* at your TV dealer."

"Did you say Blonder-Tongue? Great! I can use it with my Blonder-Tongue Golden Dart UHF antenna."

"Hey, Charlie! Here it is. An all-channel UHF amplifier!"

"So what?"

*list

Blonder-Tongue Laboratories,
9 Alling St., Newark 2, New Jersey



- - - for more details circle 15 on post card

EDITORS' MEMO

Time to Sell 'Gum'

Some of us have shied away from selling and servicing color TV. We have made color TV complicated in the eyes of many prospective customers.

Our attitudes at times have indicated that an ordinary mortal needed at least a BSEE degree and perhaps a pilot's license as qualifications for adjusting the front controls on a color TV set. Most of us now realize this was a mistake. And now people don't believe this fable any more. Yet, there's quite a few hold-outs left.

It is said that William Wrigley, Jr. once gave packages of gum to his distributors as premiums for buying his soap products. Later, the demand for his gum became greater than the demand for his "lathering" products. Did he continue to sell soap? As everyone knows, he saw the shadows of future events—switched to the gum business and made millions.

It is not likely that a Wrigley success story will be written about some of our contemporary service-dealer hold-outs. Their "phono needles" are still stuck in the same old soap-opera groove. The old—now obviously mad—"no-go-color" refrain plays on.

The "Wrigley's" among us have long since taken on color. And now it appears likely—under normal economic conditions and within a reasonable length of time—color TV sales will surpass B/W sales.

A famous alibi for failure is "too little, too late." But it's not yet too late for the stragglers to get into color. The pot has just begun to boil. What you will see in the next few years will startle you—when compared to the past. But *too little action* right now will leave you in a weakened competitive position. Besides, since this is an "election year," you won't get another opportunity like this in a long time—if ever.

If your needle is still scraping along in the same old cross-cut soap-opera groove—change the record—and play a color-song before it is too late. The demand is switching fast from "soap" to color-striped "gum".

It used to take 2 men to pull
a color TV set into the shop...



BUT NO MORE

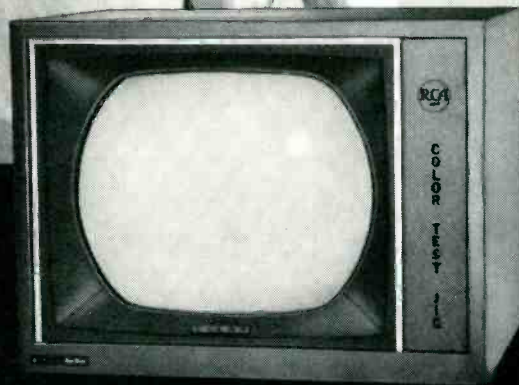

RCA COLOR TV TEST JIG

Cuts your manhours on Color-TV home service calls

Here is a real "must" for anyone servicing or planning to service color TV sets.

No longer must you send two men to a customer's home to pull in his entire color set. Now, one man can simply remove the chassis and bring it back to your shop for testing, troubleshooting and alignment in your RCA Color TV Test Jig.

Look at some of the extra advantages built into this money-saving unit:

- **Minimizes costly damage claims.** Pulling chassis eliminates possibility of scratching or damaging a customer's cabinet when transporting it to and from his home.
- **Saves time.** Eliminates need to reconverge a customer's set when chassis is returned. Convergence control panel on Test Jig provides static and dynamic convergence for CTC-10, 11, 12 and 15 chassis.
- **Versatile.** Can be used with CTC-4, 5, 7, 9, 10, 11, 12 and 15 chassis.
- **Safe.** Supplied with factory-installed safety glass and kine mask.
- **Complete components kit,** supplied with unit, provides all necessary service components and instructions for installing RCA Color Picture Tube.
- **Professional appearance.** Finish matches that of your other RCA test instruments.

The RCA Color TV Test Jig is available through your Authorized RCA Parts and Accessories Distributor. See him this week to find out how this versatile instrument can help you capitalize on the growing Color TV servicing market.

For information on where you may obtain the RCA Color Test Jig, and for additional specifications, fill out and mail the coupon below.

RCA PARTS AND ACCESSORIES, CAMDEN, N. J.



The Most Trusted Name in Electronics

RCA Parts and Accessories
P.O. Box 654, Camden, New Jersey

Please send me full specifications on the RCA Color TV Test Jig, Stock No. 11A1015A, and the name of the nearest distributor where I may obtain it.

Name _____

Company or Service Shop _____

Address _____

City _____ Zone _____ State _____



MALLORY

Tips for Technicians

Mallory Distributor Products Company
 P.O. Box 1558, Indianapolis, Ind. 46206
 a division of P. R. Mallory & Co. Inc.

How to choose and use replacement controls

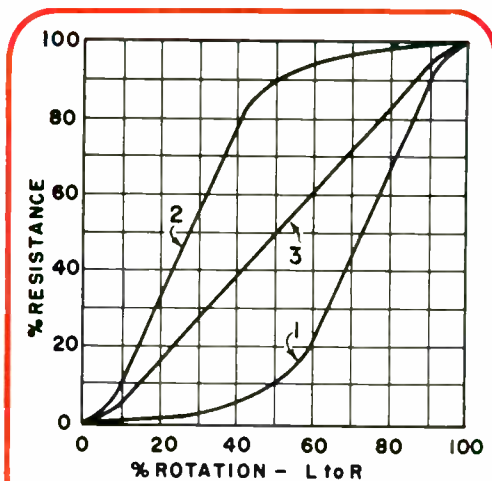

1—Audio taper. 2—Reverse taper. 3—Linear taper.

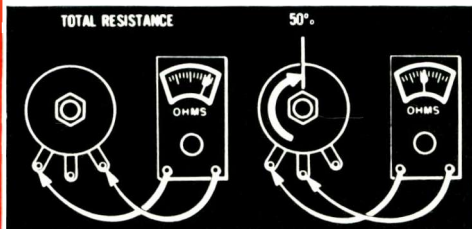

Using ohmmeter to check control taper

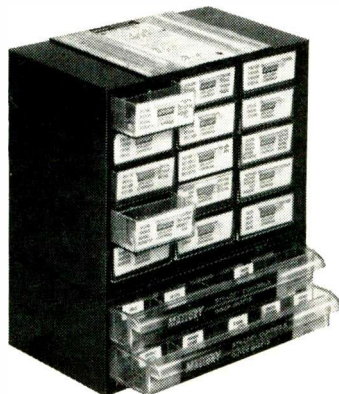

STA-LOC technician kit

There's more to replacing a volume control, "pot", or trimmer than simply selecting the proper value in ohms and watts. Naturally you *need* the proper value, but you also need the correct *taper* or the circuit won't perform properly.

What's taper? Briefly, it's the way resistance changes as you rotate the shaft. There are three basic tapers normally used which match the needs of different kinds of circuits. The chart shows how each of the three works.

Audio taper (often called left hand logarithmic by people who like big words) gives you a small increase in resistance at the beginning of shaft rotation and a faster increase toward the end (clockwise rotation). This matches the response of the human ear and is the reason audio tapers are generally used in volume controls and similar shunt circuits.

Linear taper is just that. Resistance change is exactly proportional to shaft rotation. All standard wire-wound controls have linear tapers. Carbon controls with linear tapers are commonly used in tone controls, sweep controls and other straight voltage-division uses.

Reverse taper (right hand logarithmic) is the opposite of an audio taper. You'll get a big change in resistance in the first half of shaft rotation and very little in the last half. This taper is used with cathode voltage controls such as TV contrast and many bias voltage controls.

In the Mallory STA-LOC® control system, it's easy to remember which taper is which. Linear controls end with "L", and audio with "A", and reverse with "R".

You can check which taper is used in an unknown control by connecting an ohmmeter as shown in the drawing.

First, measure total resistance. Then turn the shaft to 50% of rotation. If resistance is 50% of total, you have a linear taper. If it is 10% to 20% of total you have an audio taper. If it is around 80% of total you have a reverse taper.

To be sure you have the exact control when you need it, ask your Mallory distributor to show you one of the STA-LOC technician kits. With a STA-LOC kit you can make exact on-the-spot replacements of any of literally *thousands* of single, dual, push-pull, tandem, or clutch controls. Pieces snap together and *stay* together. STA-LOC kits are sensibly priced and are real money-makers and time-savers. See your Mallory distributor for everything you need in controls, capacitors, batteries, switches, resistors, and semiconductors.

- - - for more details circle 29 on post card
 ELECTRONIC TECHNICIAN

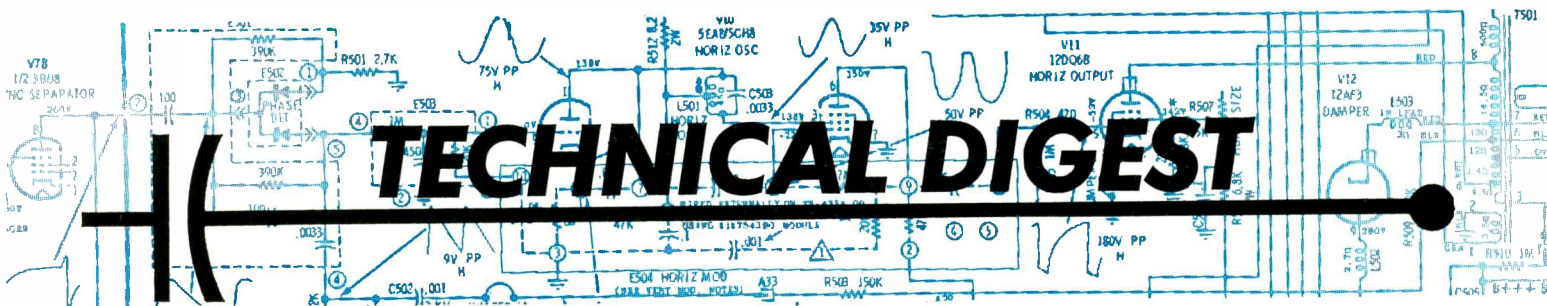

G-E

TV "FY" Color Chassis—Horizontal Interference During Alignment

Interference from the horizontal sweep circuits of the receiver may appear on the scope responses during alignment procedures, making it difficult to observe a clearly defined trace. To avoid such interference, it is important that the horizontal circuits be disabled during alignment of the IF, RF and Video sections of the receiver.

The horizontal circuits in these receivers should be disabled in the following manner: Open the jumper grounding the cathode of the horizontal output tube V105. Connect a 2000Ω 100-w resistor from the +405-v buss to ground, to load the B+ supply by an amount equivalent to the horizontal circuit load.

If interference is encountered from the vertical deflection circuits during alignment, switch the "Normal/Service" switch on the rear of the chassis to the "Service" position.

RCA

TV Color Chassis CTC15—Blue Lateral Magnet

Adjustment of the three magnets on the convergence assembly causes the red and green dots to shift diagonally and the blue dot to shift vertically. To

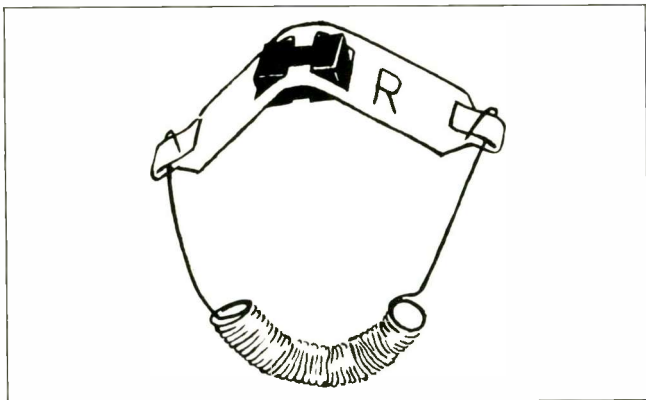

Blue lateral magnet used on RCA CTC15 color TV.

achieve center convergence, additional lateral motion must be imparted to the blue dot by means of another magnet. The configuration of the blue lateral magnet

varies with the chassis series in which it is used. In some earlier color sets, this magnet influences all three dots in a lateral direction, hence giving rise to the term, "lateral" magnet. In the CTC15, this magnet affects only the blue dot and can be referred to as a blue lateral magnet.

This new blue lateral magnet is oriented directly above the blue pole section of the gun assembly. Its exclusive, tighter control of the blue dot helps the technician lighten his setup task.

SYLVANIA

All 21 in. 70 deg glass shadow-mask CRTs—Color Purity

The deflection yoke should be moved back on the CRT neck toward the convergence assembly until the neck shadow appears. At this point it is necessary to

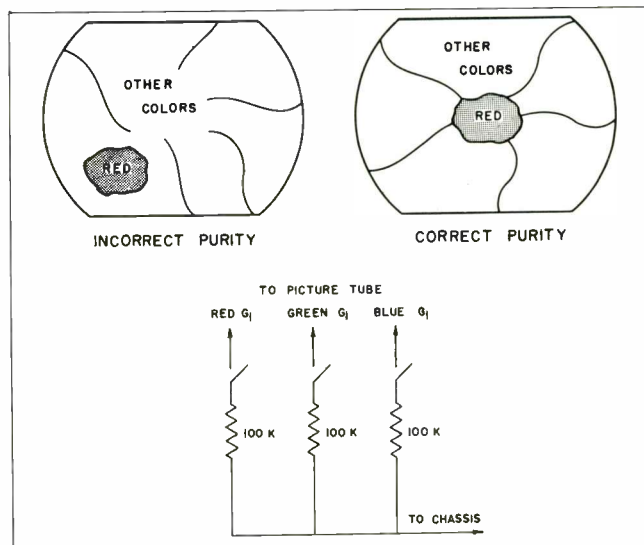

The red field is employed for purity setup because it shows up incorrect beam landing. Three 100 K resistors and switches can be used to control any gun.

have only the red gun operating. The green and blue guns can be biased off by shunting 100,000 Ω between the No. 1 grids of the CRT and the chassis. A suitable switching circuit that can be used to control any gun is shown here.

For good purity is is necessary for the red, green and blue beams to land in the center of their respective dots. In general, when the red beam lands correctly,

TECHNICAL DIGEST

the green and blue beams are also landing correctly. The red field is used for purity setup since it shows up incorrect beam landing better than either the green or blue field.

The purity magnet, located between the convergence assembly and the blue lateral magnet, functions on a color tube exactly like the picture centering magnet on a monochrome tube. The strength of the purity field is changed by separating the tabs on the two flat rings. The direction of the field can be changed by rotating the two rings together. The action of the purity magnet is followed more easily if the two rings are rotated together.

The purity magnet centers the beams correctly as they pass through the center of deflection of the yoke. The beams are then deflected and pass through the aperture mask at the angle necessary to land at the center of the correct dots.

The red beam is landing correctly when the uniform red area is moved to the center of the picture tube screen as shown in the drawing.

WESTINGHOUSE

All Tape Recorders—Troubleshooting With the Record-Play Switch

Intelligent and efficient troubleshooting of any electronic equipment requires a plan. The plan provides a way to isolate the trouble to progressively smaller sections of the equipment.

The switch connections in a tape recorder provide a built-in way to break the unit into small sections. Any failure can be isolated by determining which sections operate only in RECORD, which operate only in PLAY, and which sections operate in both functions. The switch contacts are also convenient points for signal injection and for scope readings.

Because the amplifier section is used for both recording and playback (see diagram), a failure in the amplifier section would show up in both PLAY and RECORD. Because the bias/erase oscillator operates

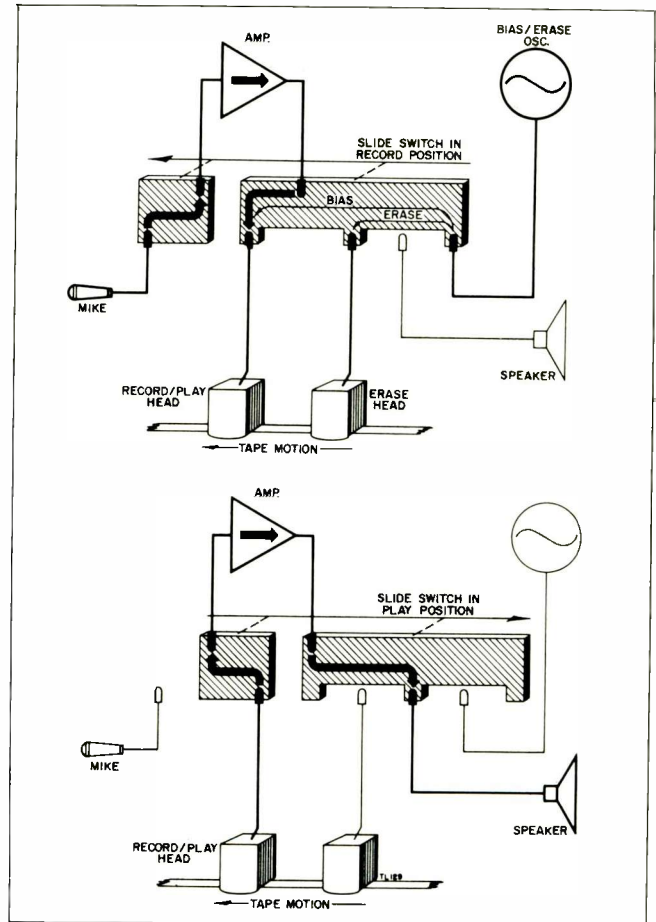

By studying the switching arrangement in tape recorders, technicians can use the record-play switch arrangement as a built-in troubleshooting aid. Failures can be isolated by determining which sections operate only in RECORD, which operate in PLAY, and which sections operate in both functions.

only during RECORD, a failure in that circuit would show up when a tape is being played back. A failure in the power supply would cause trouble in both PLAY and RECORD. The switches are always a possible source of trouble because they may get dirty over a period of time.

A failure that affects RECORD, but not PLAY, is possible. This would show up during playback of a tape that was recorded on the same machine. But, it would not show up during playback of "pre-recorded" tape, or tape which had been previously recorded on a different machine.

SUBSCRIPTION SERVICE CHANGE OF ADDRESS

Please include your ELECTRONIC TECHNICIAN address label to insure prompt service whenever you write us about your subscription.

Mail to: ELECTRONIC TECHNICIAN Subscription Service Dept.
Ojibway Building, Duluth, Minnesota 55802.

To subscribe: mail this form with your payment, and check:
() new subscription () Renew my present subscription

Subscription rates: in the United States:
1 year, \$5.00; 2 years, \$8.00; 3 years, \$10.00.
Subscription rates for all other countries available on request.

ATTACH LABEL HERE

If you're moving, please let us know five weeks before changing your address. Place your magazine address label here, print your new address below. If you have a question about your subscription, place your magazine address label here and clip this form to your letter.

name _____

your job title or position _____

address _____

city _____

state _____

zip code _____

Can you afford to guess

AT SWEEP, SYNC OR HIGH VOLTAGE TROUBLES?

WHEN IT'S SO EASY TO WALK THE TROUBLE
RIGHT OUT OF THESE TIME CONSUMING
CIRCUITS STEP BY STEP.....



SYNC. CIR.
& H. SYNC.
DISCRIM.

VERT.
OSC.

VERT.
OUTPUT

VERT.
OUTPUT
XFORMER

VERT.
DEFLEC.
YOKE

HORIZ.
OSC.

HORIZ.
OUTPUT

HORIZ.
FLYBACK
XFORMER

2nd ANODE
VOLTAGE
CIRCUIT

HORIZ.
DEFLEC.
YOKE

NEW, IMPROVED SENCORE SWEEP CIRCUIT ANALYZER MODEL SS117

How many times do you ask, "Why do I take so long finding that sweep trouble?" How often have you wondered whether weak horizontal sync was caused by defective sync circuit, horizontal oscillator, or sync discriminator? Can you quickly isolate inadequate width or low 2nd anode voltage to the oscillator, output, flyback transformer, or yoke? How many times have you changed a good yoke by mistake?

The SS117 will pinpoint troubles like these in minutes with tried and proven signal injection, plus yoke substitution for dynamic in-circuit tests. Error proof push button testing enables you to make all tests from the top of the chassis without removal from cabinet for maximum speed and profit on every job.

Here are the checks the SS117 makes . . .

- Horizontal Oscillator: Checked by substituting 15,750 variable output universal oscillator from SS117. Signal can be injected at any spot from horizontal output grid to horizontal oscillator to determine defective component.
- Horizontal Output Stage: Checked by reliable cathode current and screen voltage checks made with adapter socket and two push buttons.
- Horizontal Output Transformer: Checked for power transfer in circuit and read as good or bad on meter.
- Horizontal Deflection Yoke: Checked by direct substitution with adjustable universal yoke on SS117.

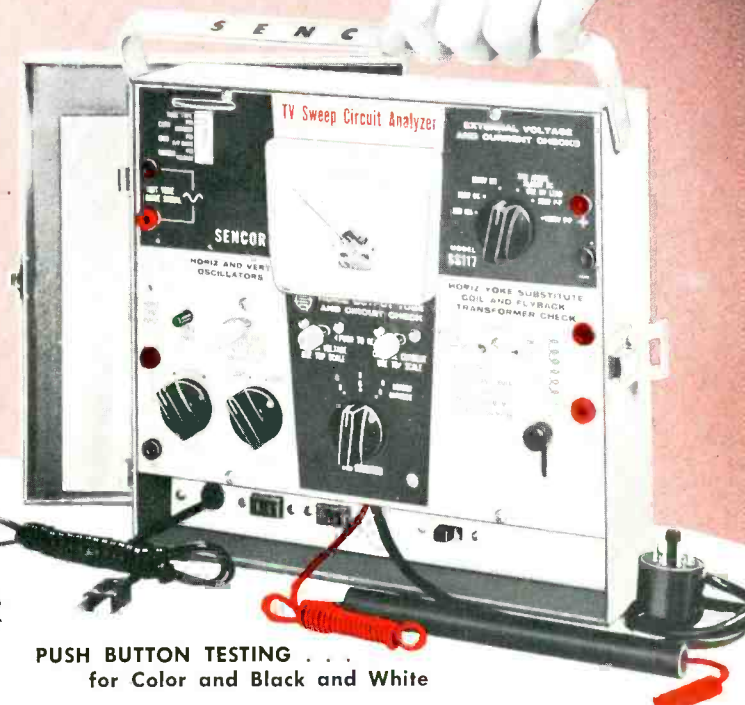

PUSH BUTTON TESTING . . .
for Color and Black and White

- Vertical Oscillator: Checked by substituting 60 cycle synchronized oscillator.
- Vertical Output Transformer: By simple signal injection for full height on picture tube.
- Vertical Deflection Yoke: By signal substitution for full height on picture tube.
- Sync Stages: Checked by synchronizing triggered horizontal SS117 oscillator from any stage. If oscillator synchronizes, sync is O.K.
- 2nd Anode Voltage: A new dynamic check using simulated picture tube load. C.R.T. does not need to be operating for current tests. No interpretations—read direct from 0 to 30 KV.
- External Circuit Measurements: By applying from 0 to 1000 volts AC or DC to external meter jacks. Meter will read DC or peak-to-peak volts. 0 to 300 milliamp scale also provided for measuring horizontal fuse current.
- New features include: Large 0 to 300 microamp meter for minimum circuit loading; all-steel carrying case with full mirror in adjustable cover; two 115 volt AC outlets in cable compartment.

Size: 10¼" x 9¼" x 3½". Wt. 10 lbs.

Model SS117

Dealer Net **\$89⁵⁰**



Sencore Sam says . . . How can you miss . . .

EACH PACKAGED UNIT CONTAINS:

- An Easy to Follow Instruction Book Especially Prepared and Edited by H. W. Sams.
- A complete 33 RPM, 10 inch Permanent Record on "How to Simplify Sweep Circuit Trouble Shooting."

SEE YOUR AUTHORIZED SENCORE DISTRIBUTOR

--- for more details circle 36 on post card

SENCORE

ADDISON, ILLINOIS

EICO's complete new color TV lab for the pro

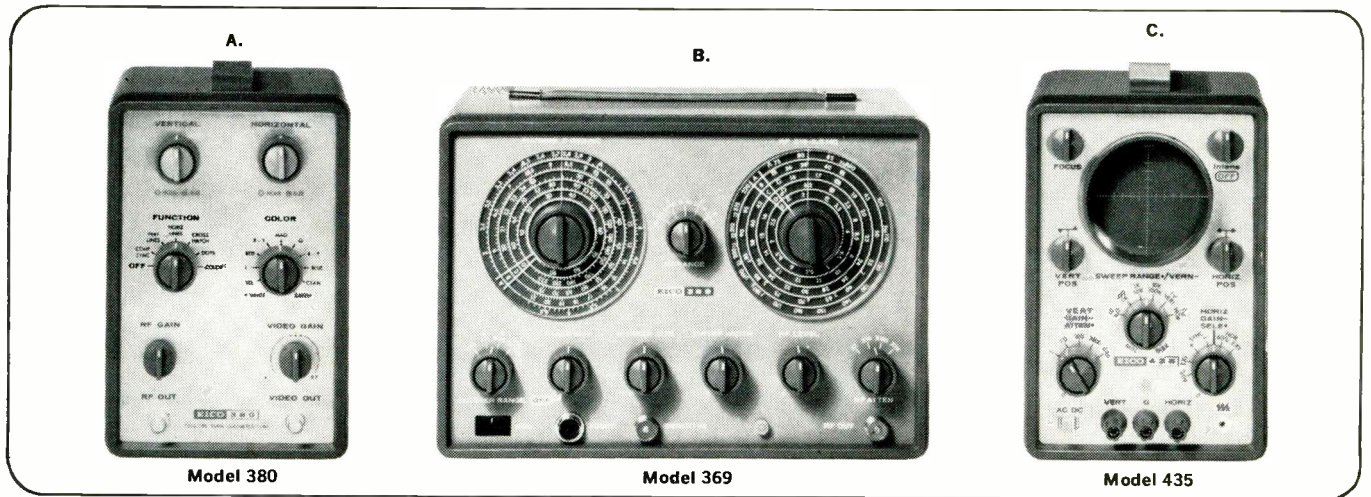

Color TV servicing is a job for professionals—and Eico's new color TV test equipment is designed to their requirements. Professional service engineers can't afford to waste time on apparent set troubles caused by make-shift, inaccurate test signals, or on test equipment that is inherently difficult to use or incapable of fast, accurate determinations. Critical professionals know they can depend on EICO for accuracy, reliability, and laboratory standard performance. Moreover, EICO has now successfully reduced equipment size while improving performance, to permit convenient on-location servicing. No wonder the pros choose EICO!

PROFESSIONAL PERFORMANCE IN COLOR TV TEST INSTRUMENTS/ (A) MODEL 380 SOLID STATE N.T.S.C. STANDARD COLOR SIGNAL & DOT-BAR GENERATOR (PAT. PEND.) Entirely unique in both providing completely standard 100% fully saturated N.T.S.C. color signals, including both chrominance and luminance signals exactly as specified, and in being completely transistorized. Color burst is precisely gated and delayed according to N.T.S.C. standards, and phase angles are permanently established by taps on a linearly distributed delay line, so that no adjustments are ever required. Use of saturated transistor for switching and delay provides square "clean" waveforms without significant overshoots or ringing for excellent signal definition. The design of the 380 is an absolute protection against obsolescence, and assures the professional service engineer that apparent set trouble is not caused by a non-standard test signal. In addition to generating 11 different color signals, one at a time, for hue and demodulator adjustments, the Model 380 generates dots, crosshatch, horizontal lines, and vertical lines for convergence and linearity adjustments. Both video and RF outputs are provided, with gain controls. Three crystal-controlled oscillators are employed for color burst and color information, convergence and sync signals, and RF output on TV channel 3 (exchangeable for TV channel 4). Entirely stable and inherently rugged by solid state design, the Model 380 is also outstandingly compact and weighs only 4 lbs. SIZE (HWD): 8½ x 5¼ x 6¾ inches. Kit \$129.95. Wired \$169.95.

(B) MODEL 369 TV-FM SWEEP & POST-INJECTION MARKER GENERATOR (CRYSTAL-CALIBRATED) For easiest, fastest visual alignment of color or B&W TV, and FM receiver RF & IF circuits. Five sweep ranges from 3-220 mc and four marker ranges from 2-225 mc, plus a crystal marker oscillator that turns on when a crystal is plugged into the panel socket (4.5 mc crystal supplied for TV sound alignment). Controllable inductor sweep circuit is purely electronic and has no mechanical parts to wear out. Retrace blanking, and a 3-stage AGC circuit that keeps the amplitude of the swept signal even when the widest sweep width of 20 mc is used. With the 369, circuit response is not affected by markers and markers are not affected by traps in the circuit. Only the sweep signal is applied to the circuit under test. A demodulator cable picks up the output signal and feeds the demodulated signal to a mixer stage in the 369 where the markers are added, then the combined signal is led to a 'scope. Separate trace size and marker size controls can be used independently. SIZE (HWD): 8½ x 12½ x 7½ inches. Kit \$89.95. Wired \$139.95.

(C) MODEL 435 DC WIDEBAND 3" OSCILLOSCOPE You'll be able to complete many more color or B&W TV service calls on location if you can take your 'scope with you. EICO's 435 is really portable (½ the size of conventional 5" scopes) and fully equipped to do the job. Quality equal to or better than the finest 5" TV service scopes is achieved with a far sharper, brighter trace on a flat-face CRT. Direct-coupled, push-pull V amplifier, with 4-pos. frequency-compensated decade attenuator has no low frequency phase shift, and is flat from DC-4.5mc (+1, -3db). Far more accurate p-p voltage measurements than ever before with a Zener diode-controlled

square wave calibrating voltage, and an edge-lit calibration grid. Easier to use for TV servicing with pre-set TV-V and TV-H positions in addition to 4 sweep ranges, automatic sync limiter and amplifier, and full retrace blanking. Amazingly easy to build because of professional interior packaging that has eliminated crowding and permits easy access to any component. SIZE (HWD): 8½ x 5¼ x 12½ inches. Kit \$99.95. Wired \$149.95.

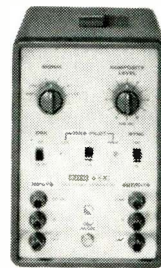

ONE MORE MATCHING INSTRUMENT EQUIPS YOU FOR FM STEREO SERVICING MODEL 342 FM MULTIPLEX SIGNAL GENERATOR. The EICO Model 342 is a compact, efficient instrument essential for test or alignment of the multiplex circuits of FM Multiplex Stereo tuners, receivers, and radios. FM Stereo is a field as fast-growing as color TV, and a multiplex generator is an absolute must for getting a share of the increasingly important and profitable service business. The circuitry of the Model 342 is of the design lab quality needed for restoring original performance quality to the costliest equipment, but the controls have been simplified for fast, uncomplicated operation. With it, you can quickly measure and adjust channel separation and balance, or the input level needed for synchronization or switch-over to stereo operation. The Model 342 provides signals as perfect as those available from generators costing many hundreds of dollars. It provides both a controlled amplitude composite audio output for direct signal injection beyond the detector into a multiplex section, and the same signal modulating an FM RF carrier at about 100mc (adjustable) with controlled deviation ± 75kc (100% modulation) for connection directly to the antenna terminals. Either a built-in 1kc oscillator (below 0.3% distortion) or an external audio oscillator may be used to provide the left only, right only, difference, or sum signals. The 19kc pilot signal is crystal controlled and may be switched on or off independently of the composite signal. The signal may be obtained without audio information and only the 19kc pilot injected. An oscilloscope sync output is provided, with a choice of either 19kc sync or internal 1kc/external oscillator sync. In addition, an input is provided for connecting an external audio oscillator to provide an SCA signal when required. Another important and valuable feature of the Model 342 is dual inputs and amplifiers for a stereo source to permit FM MULTIPLEX STEREO demonstrations to customers when there are no stereo programs being broadcast. Modern compactron tubes are used to obtain a lightweight, compact package that is easily portable. SIZE (HWD): 8½ x 5¼ x 12½ inches. Kit \$119.95. Wired \$179.95.

Visit the EICO exhibit in the Pavilion of American Interiors at the World's Fair.

EICO

ET 6

EICO Electronic Instrument Co., Inc.
131-01 39th Avenue, Flushing, N.Y. 11352

Please send 1964 Catalog

Name _____

Address _____

City _____ Zone _____ State _____

--- for more details circle 18 on post card

ELECTRONIC TECHNICIAN



ELECTRONIC TECHNICIAN
AUGUST 1964

A large red line diagram forms a rectangular frame around the central text. On the left side, a small vertical rectangle has an arrow pointing to a larger vertical rectangle. At the top and bottom right corners of the frame, there are circles containing a horizontal dashed line.

A Technician Views the Synchronous Color Demodulator

**Eliminate service headaches
by knowing how the 'heart'
of a color TV receiver operates**

by Reg Bartlett

■ Much has been written about color TV receiver circuits. Color and B/W circuit similarities and differences have been adequately explored. But one circuit—the color demodulator—cannot be compared with other TV circuits, and until color TV came along, nothing exactly comparable was used in consumer electronics equipment. The color demodulator is the heart of a color TV receiver and a knowledge of its operational theory will pay dividends to alert technicians. This is a simplified approach to this important circuit.

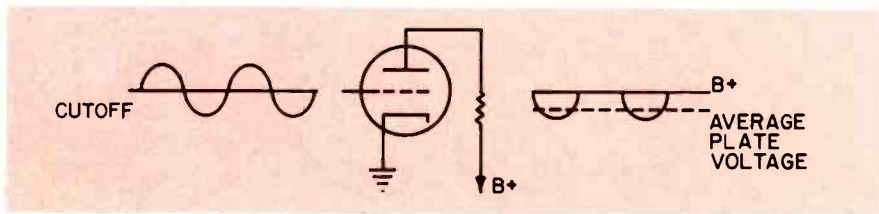

Fig. 1—A simple triode detector with sine wave input has output voltage as shown here.

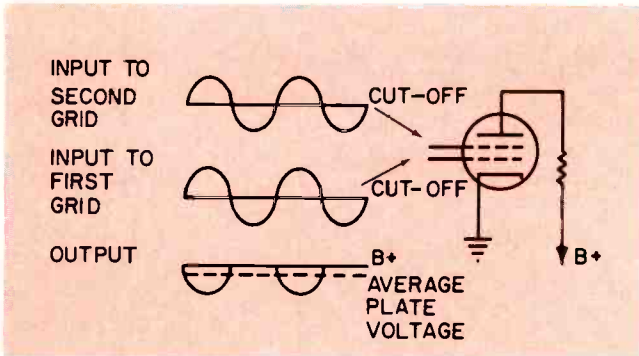

Fig. 2 — Two in-phase signals applied to dual grid tube and resultant plate voltage variations.

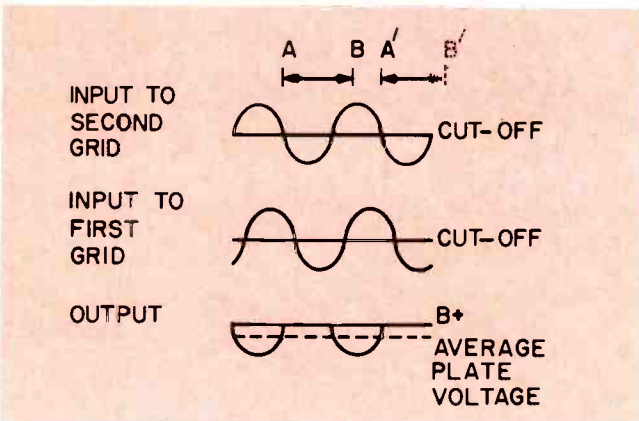

Fig. 3 — Dual-grid inputs 45 deg out-of-phase and resultant average plate voltage.

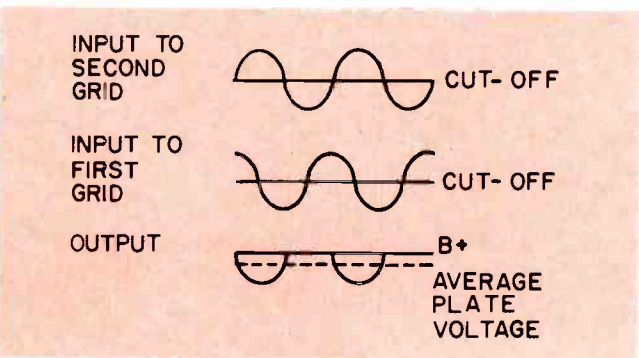

Fig. 4—Grid inputs 90 deg out-of-phase and resultant average plate voltage.

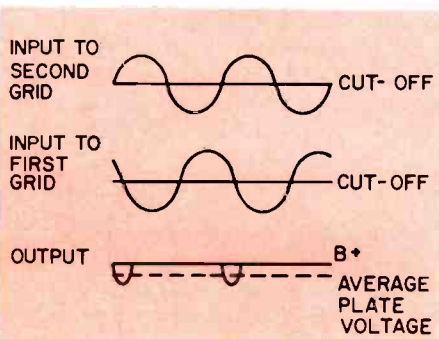

Fig. 5—Inputs 135 deg out-of-phase.

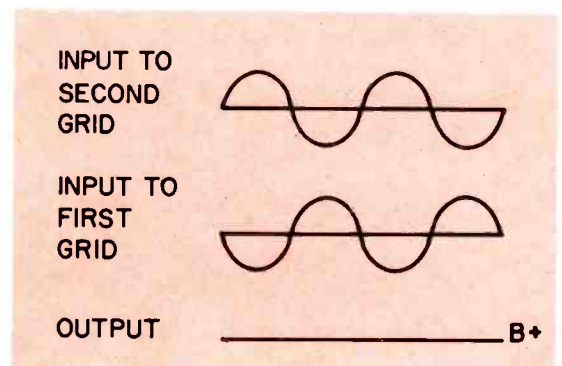

Fig. 6—Inputs 180 deg out-of-phase give no output.

It is assumed that you are thoroughly familiar with the National Television System Committee's (NTSC) color TV signal standards. It is also taken for granted that you know how the "Y" (luminance, monochrome or brightness) signal and the "I" (saturation) and "Q" (hue) components of the chrominance signal are derived and telecast from the transmitter. And we can begin by refreshing our memories of demodulation fundamentals.

Demodulation Fundamentals

A triode electron tube having a sine wave input is shown in Fig. 1. If the tube's grid is biased to cut-off, only the positive half cycles of the input signal will cause the tube to conduct and the plate voltage to change as indicated. This, of course, is an example of the traditional detection (demodulation) system with which all trained technicians are familiar.

Now look at Fig. 2 and you will see a tube with two control grids—both capable of being biased to cut off the tube's current flow. The same input signal is applied to both grids and the signals are in phase. In this case, both grids must be positive for the tube to conduct, and since the signals are in phase, the resultant plate voltage variation is much like that shown in Fig. 1.

As shown in Fig. 3, the input to grid 1 has now been shifted 45 deg out of phase with respect to the signal on grid number 2. Since both grids must be positive for conduction to take place, no change occurs in the plate voltage during periods of the cycle A to B and A' to B'. This is true because during these periods one or the other of the grids is negative. The resultant plate voltage variation is

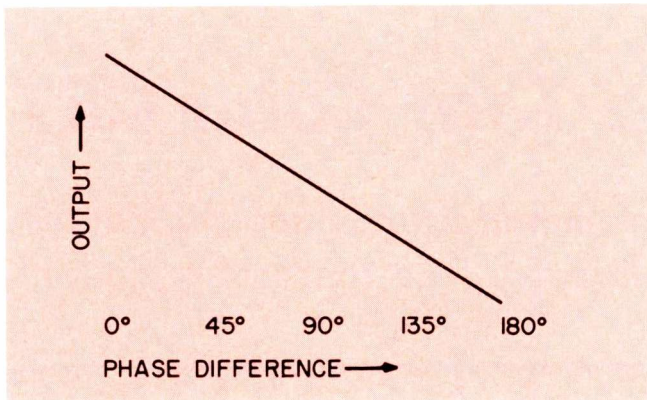

Fig. 7—Output plotted against phase difference between two grid signals.

a little lower in amplitude and of shorter duration than when the inputs were in phase, consequently the average plate voltage is lower.

Conditions that prevail as the inputs are moved to 90 deg and 135 deg out-of-phase respectively, are shown in Fig. 4 and 5. It can be clearly seen that the phase difference increases as the average plate

voltage variation (or output) decreases. Finally, as shown in Fig. 6, when the inputs are 180 deg out-of-phase, no output occurs. A graph plotting output against phase difference is shown in Fig. 7.

Now let's see how these simple demodulation principles compare with the practical functions of a color TV demodulator.

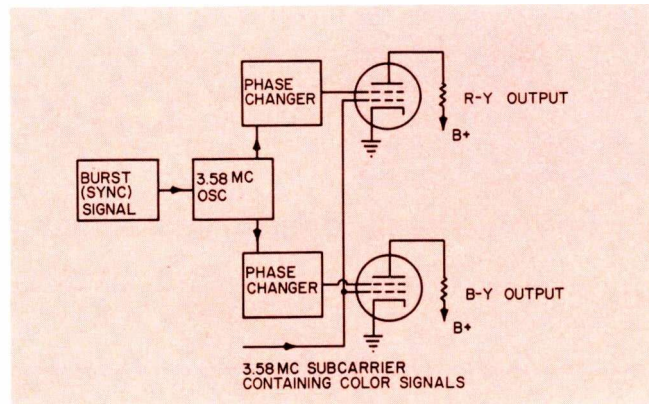

Fig. 8—Block diagram showing how R-Y and B-Y signals are obtained.

The Color TV Modulator

Without oversimplifying, we can say that the 3.58 Mc subcarrier brings the color information to the demodulators in the form of two out-of-phase signals. Both signals, of course, have a fixed phase relationship to the 3.58 Mc subcarrier

Continued on page 90

TINYVISION . . .

Color And Black-And-White

Color portables are now on the way

■ Shortly after the Japanese manufacturer, Mitsubishi Electric, announced its tinyvision (6-in.) console color set, reportedly the world's first color tinyvision, rumors flew thick and fast from Japan and the U. S. regarding a transistorized VHF/UHF Chromatron color portable being developed. The Mitsubishi Electric color set uses three 6-in. single-gun tubes, as previously reported here.

Almost before this smoke had cleared away, Yaou Electric announced a 9-in. transistorized job. Nippon Columbia was reported at work on an 11-in. shadow mask CRT with 70 deg deflection. And Toshiba was said to be developing a small-screen Chromatron. Sony has been working on both a large screen and small screen Chromatron and reportedly will have a portable color set sometime in early '65 or before.

Here at home more tinyvision color-phosphor was glowing. Talk of a home-baked color portable continued unabated. RCA was talking about a smaller-than-21-in. screen color set. As mentioned elsewhere in this issue, both Raytheon and General Electronics were rumored to be "thinking about" asking Paramount for a license to manufacture the Chromatron—in small-screen sizes. But reliable information indicated that the transistorized color portable was "just around" a rather long corner. It was believed that the first domestic-made color portable would be in the 8-to-16-in. size and have a Chromatron tube — which isn't being produced here yet.

B/W Tinyvision

Something more substantial was cooking in the B/W portable area, however. Preliminary smoke-signals

indicated that Zenith, Emerson, Westinghouse, Olympic, Admiral and others were planning to get in the tinyvision market-van. At this writing both G-E and Philco are

Continued on page 90



G-E's transistorized portable weighs 13 lb and operates on either 110-v ac house current or 12-v battery.



Change That Color CRT

Follow these organized steps, check manufacturers specific details, and avoid haphazard, time-consuming motions

Fig. 1—Determine if the color CRT is defective before you change it. Check it out on a good color-tube tester.

Fig. 2—Remove front panel knobs, disconnect antenna, remove set's back.

Fig. 3—Discharge high voltage lead and disconnect from CRT.

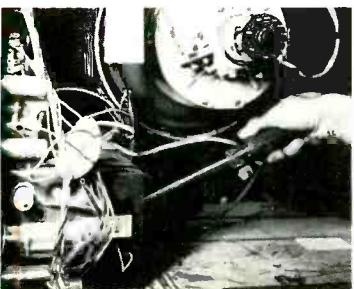

Fig. 4—Unplug CRT base socket, yoke wires, remove speaker wires, remove plug on convergence yoke and board assembly and disconnect antenna terminal board from chassis (exact operations depend on type and make of color set).

Fig. 5—Remove chassis.

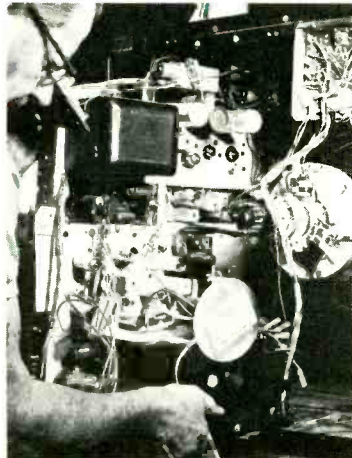
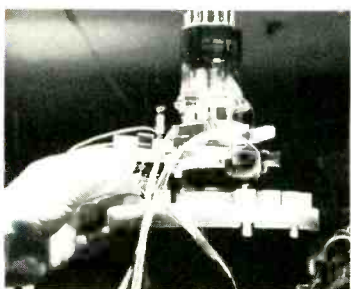
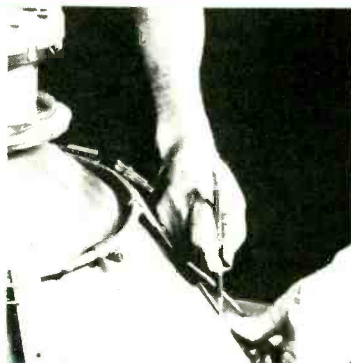
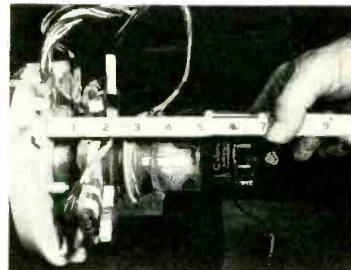

Fig. 6—Measure exact location and position of components on CRT neck (yoke, convergence assembly, purity magnet, blue lateral magnet) and note carefully. Place heavy quilted padding on bench or floor and tilt cabinet forward until the front rests on soft padding.

Fig. 7—Mark position of strapping for reference, remove nuts holding mounting brackets and remove CRT from cabinet.

Fig. 8—Place CRT face down on another quilted pad. Remove lateral beam magnet, purity magnet and convergence yoke.



FAST!

by Homer Davidson

All other factors being equal, the difference between a successful and unsuccessful service-dealer operation is almost always determined by work methods. Under similar conditions, the degree of success achieved by every successful operation is proportional to work-method efficiency. And the technician who can do comparable jobs in the shortest time will inevitably end up with most of the marbles.

Here, in a few photos and words, is our procedure for removing a defective 3-gun color CRT and replacing it with a new one in the shortest possible time. You should fill in minor brand-name procedure variations and details by checking the specific manufacturer's original service instructions.

Fig. 9—Remove deflection yoke and CRT mounting harness and transfer harness to the new CRT.

Fig. 10—Remove high voltage plastic from around CRT face.

Fig. 11—Remove plastic wrap (this may not be on newer sets).

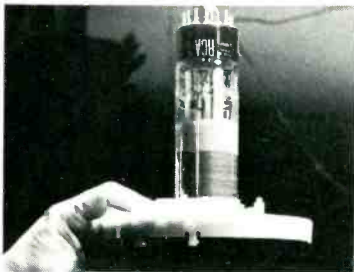

Fig. 12—Wipe off new tube face with lint-free cloth and place plastic wrap-around on new CRT.

Fig. 13—Replace deflection yoke and snug up screw. The yoke may have to be moved backward and forward to clear up the purity.

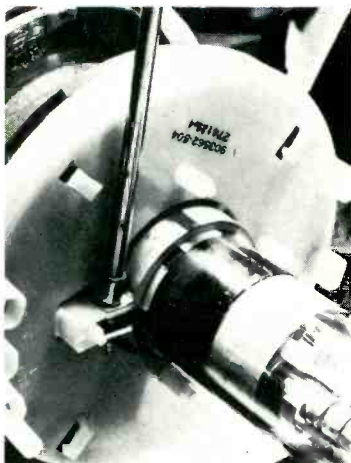
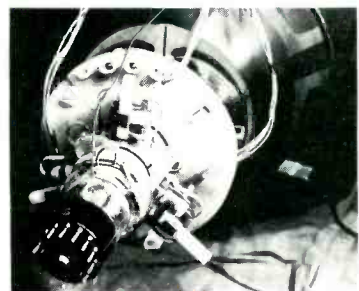
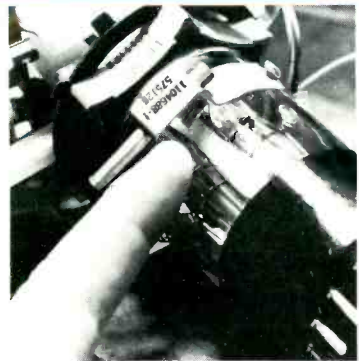
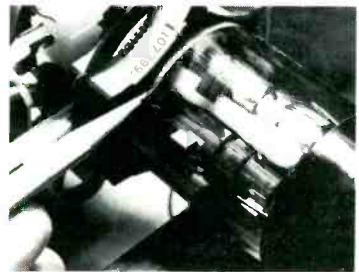

Fig. 14—Mount convergence yoke assembly and purity ring. Pencil points to red ring on CRT for purity ring setting.

Fig. 15—Set blue lateral magnet at edge of blue pole pieces. Clean safety glass on set.

Fig. 16—Place CRT in cabinet with blue gun assembly and blue convergence assembly pointing to the top of the cabinet. The wires going to the blue gun convergence assembly are blue and those to the red and green assembly are also color-matched.





Change That Color CRT FAST

Continued

Fig. 17—Tilt cabinet back to its normal position and snug up nuts on CRT mounting brackets.

Fig. 18—Check front to see if lint or rubber edges are showing.

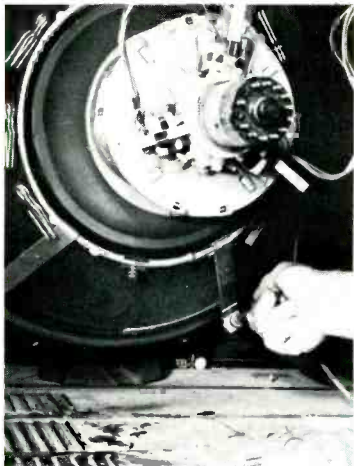

Fig. 19—Reconnect high voltage lead and resistor to CRT anode. Replace chassis in cabinet.

Fig. 20—Reconnect all plugs and wires.

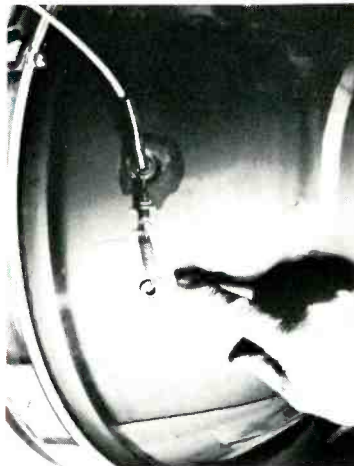
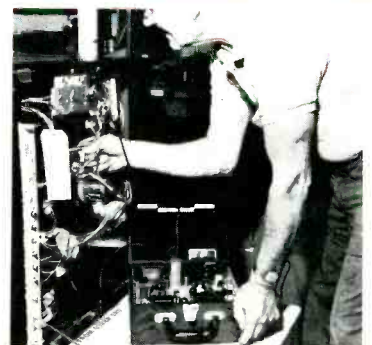
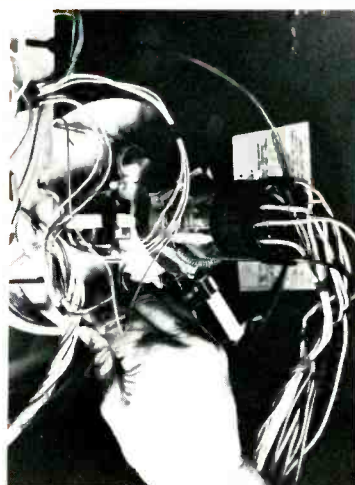
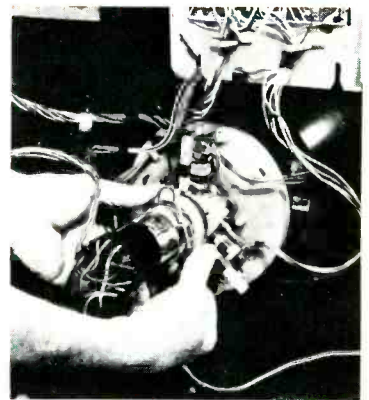
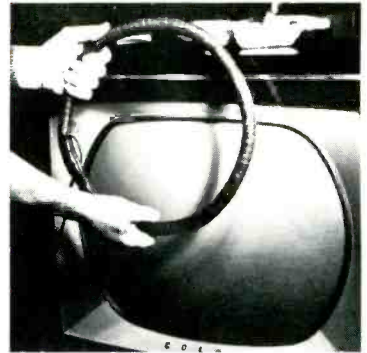

Fig. 21—'Fire-up' the set and de-gauss the CRT. Go around and around and then circle the coil away from the screen. (Some new sets do not require this.)

Fig. 22—Refine purity ring. If this doesn't clear up the screen, move deflection yoke back and forth.

Fig. 23—Warm up the dot-bar generator. Converge the red and green guns first. Short out the blue gun through a 100 K Ω resistor. Then converge the red and blue guns by refining the convergence magnets. After complete convergence, set up the black and white adjustments.



The One-Gun Chromatron

Lawrence tube may make substantial reduction in cost of color sets

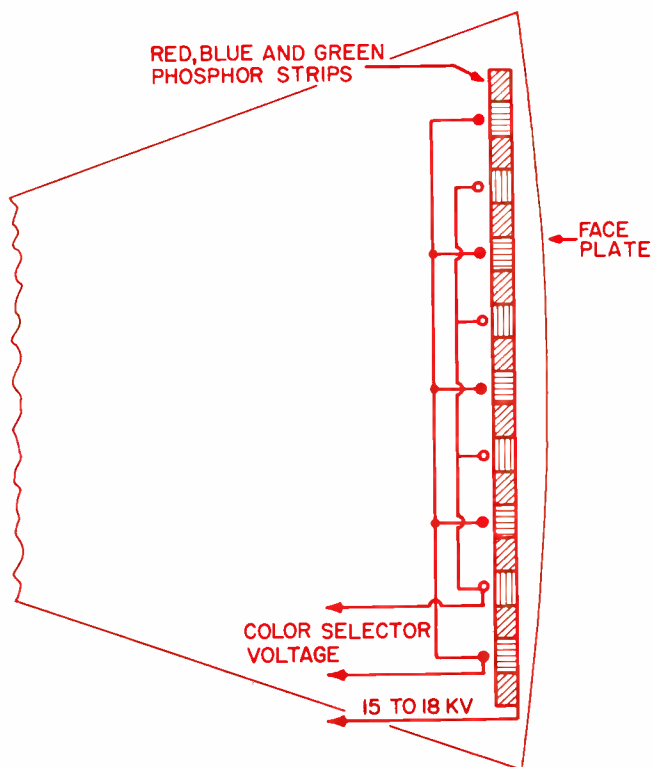

Cross-sectional drawing of Chromatron, single-gun color tube.

set will be in U. S. show windows by Christmas. Others feel it won't arrive until early '65. In any event, it may pay us to briefly refresh our memories about the Chromatron.

The Lawrence Chromatron

The literature is full of information regarding experiments with one-gun CRTs. Bond, Nicoll and More; Herold, Law, Weimer and Lafferty—to mention only a few—have reported on these researches, experiments and developments in detail. We will discuss only the Chromatron briefly and in a simplified way.

The obviously outstanding difference between the Chromatron and the conventional 3-gun color tube is the chromatron's single electron gun. The gun can be a regular electro-magnetic focus type. A regular deflection yoke can be used. It isn't necessary to converge three electron beams so they can pass simultaneously through tiny holes in a shadow mask, and then bulls-eye their respective red, blue and green phosphor dots. The Chromatron principle is beam switching—an electron-lense focusing system.

As shown in the cross-sectional drawing, instead of clustered groups of red, blue and green phosphor dots, thin strips of red, blue and green phosphor are alternately placed horizontally on the metalized back surface of a viewing screen mounted on the inside surface of the CRT's face plate. Behind this screen is placed two sets of color selection "grids" (red and blue) which run parallel to the red and blue phosphor strips. The single electron beam is directed to pass straight between these grids (when no voltage difference exists between them), and strike the green phosphor strip. By varying the potential between the two grids, the electron beam can be deflected to either the red or the blue phosphor strip.

A sine wave voltage at the 3.58 Mc subcarrier frequency is applied to the red and blue selection grids and causes the electron beam to "wobble" vertically as it sweeps horizontally—striking the proper colored strip in accordance with color information being modulated and supplied by the CRT's control grid.

The color grids operate with approximately 4.5 kv. From 15 to 18 kv is applied to the aluminized backing of the phosphor strips. This HV does not

Continued on page 92

■ We frequently forget the growth-history of things we take for granted and enjoy today. Take color TV for example.

The three-gun color picture tube is not a device that suddenly appeared at the end of a magic wand one bright, spring morning in a dew-sparkling everglade. It represents a lot of earthy research and experimental and financial "blood, toil, tears and sweat"—to quote from Winston Churchill's famous wartime House of Commons' speech.

And the single-gun Lawrence Chromatron color tube wasn't suddenly "yanked up" either. It "grow'd" like Stowe's Topsy—through 10 years of research—nourished on substantial portions of deep-green "cabbage". Yet the Chromatron has been buried, along with the CBS Colortron, more times than Fleming's "valve"—which we know is still very much alive today as a widely used rectifier and detector. And Lawrence's Chromatron appears to be very much alive, too.

Word came from Japan quite some time ago that a color TV set, with a single gun 17 in. viewing-area Chromatron, was being developed. It was also said that Sony had obtained a license to make the tube. Now comes next-door word that Raytheon and General Electronics Corp. are both dickering with Paramount Pictures, owners of the tube, for licenses to produce Chromatron color TV CRTs. It was also said that other companies were negotiating to manufacture the Chromatron.

Some crystal-ballers say that a Chromatron TV



Color High Voltage

Keep your customers happy by eliminating sloppy technical practices and make money doing it

by John Holmes

■ "Color, a big ticket product, which can and should be the most profitable electronic item you handle, is being displayed on many retail floors with no more care and thought than a tinyvision black and white set on which you might make a buck or two, if you're lucky."

Thus spoke the representative of a color TV set manufacturer recently. And he called careful attention to a few sloppy technical practices that TV-radio technicians and service-dealers must understand and correct if they are to get and keep their share of the color TV business.

Two things are now crystal clear about color TV: 1) Transmitting and receiving equipment has been developed and refined to a relatively high level; 2) color TV receivers will give a high degree of customer satisfaction when properly installed and adjusted by qualified technicians. And some of the sloppy technical practices that get by on B/W will lose you customers and money in color. Take a quick look at the high voltage section of a color TV set, for example.

You cannot produce satisfactory color pictures—like you can B/W—if the anode and focus voltages of a color set are out of tolerance, if components are defective or controls are improperly adjusted. You can't even make convergence adjustments properly. You can't get the kind of color on the set's screen that is being telecast from the studio. And if you don't, your custom-

er or sales prospect will be looking elsewhere for a technician or service-dealer. But you can solve this problem if you spend a little time studying the HV sections of color sets.

Color Set HV

It isn't necessary at this late date to itemize all the reasons why we need a good HV supply on a color TV. Suffice it to remind ourselves that more power—about five times as much compared to that needed for B/W—is necessary for efficient reproduction of color programs. And the three electron beams from three guns have to be pretty sharp to sweep back and forth—alternately registering in unison through a million-or-so very small holes in the CRT's shadow mask. This makes sharp focus necessary. And the HV must have better regulation than on B/W-only sets. In fact, it must be well regulated to optimize picture size, convergence and focus.

You already know that the load current on a HV supply varies widely with variations in brightness levels on the CRT screen—from very bright to very dark scenes. This variation in load makes the voltage go up and down on ordinary TV HV supplies. But the voltage amplitude on color sets must be kept within narrow limits to maintain constant picture size and convergence.

Shunt Regulator

Let's dig briefly into one type of

voltage regulator on a typical color set. First, however, we will take a look at a simplified shunt regulator schematic as shown in Fig. 1. Note that the regulator tube is shunted across the CRT high voltage with its plate connected to the CRT anode supply. Note, too, that the regulator's cathode is connected to +390 v and the triode regulator's grid is connected to a pot in the B+ boost supply. The pot is used to set the high voltage level at the required point. How does this arrangement work?

The B+ boost voltage will vary with the amount of current being drawn by the CRT from the HV supply. If the CRT draws more current, B+ boost voltage goes down and the grid of the regulator triode becomes more negative—reducing the regulator current. If the CRT draws less current, B+ boost voltage goes up, causing the regulator current to increase. It can be seen, then, that the total current and, hence, the voltage remain practically the same during CRT load variations.

Let's look at this briefly from a slightly different viewpoint but one which adds up to the same thing. A simplified high voltage regulator circuit schematic is shown in Fig. 2. Power from the flyback transformer is rectified by a 3A3 tube. A 6BK4 shunt regulator tube is used. Remember, the 6BK4 is connected in parallel across the high voltage output and it regulates by presenting a constant load to the high voltage

Systems

Fig. 1 — Simplified schematic of a shunt regulator. Courtesy of RCA.

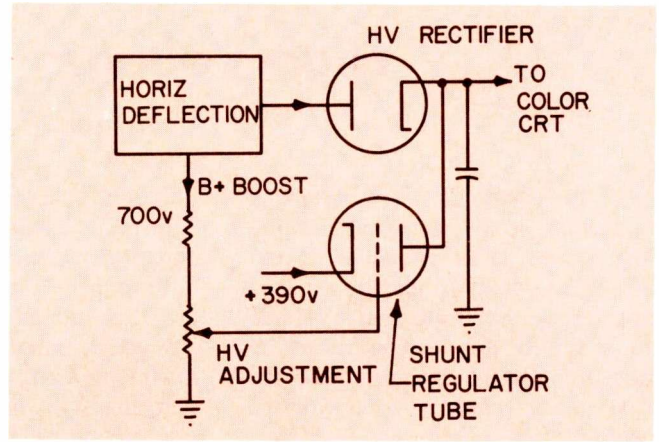
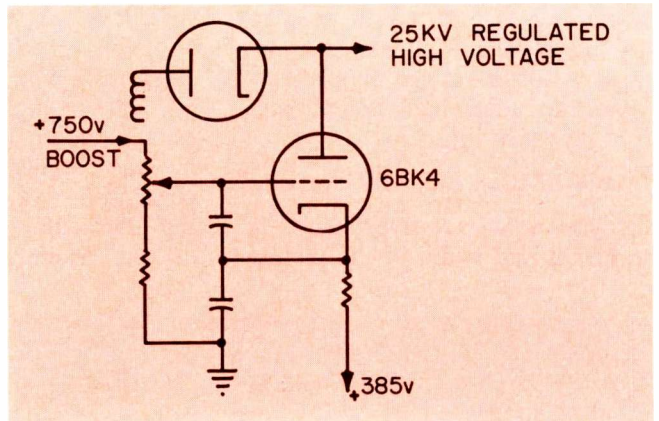

Fig. 2 — Simplified HV rectifier and regulator circuit. Courtesy of Motorola.



supply. The CRT is connected across the high voltage supply also and represents a variable load—depending on where the brightness control is set. The CRT draws more current as the brightness control is advanced. If the circuit did not have a regulator, a large drop would occur across the supply impedance. When the circuit has a regulator, the current remains constant—no matter how much current the CRT draws (up to a certain point). In operation, the 6BK4 regulator tube will be drawing no current when the CRT has maximum brightness and the tube will be drawing maximum current when the CRT is cut off. And the current through the supply impedance remains constant—flowing either through the regulator tube or the CRT. Since the load on the high voltage supply is constant, the output voltage will also be constant—under varying brightness levels. But the shunt regulator is not the only system used to establish stable high voltage.

Automatic Bias Control

One regulated high voltage system employs a pulse from the flyback which varies the bias on the horizontal output tube, in turn regulating the high voltage. A simplified schematic is shown in Fig. 3.

The grid resistance in the horizontal output tube is divided and a diode connected as shown in the schematic. A 300 v positive-going pulse is coupled to the diode's anode, and a variable B+ supply is

connected to the diode's cathode. This closed loop feedback regulator system works as follows: As the CRT's current demand increases, the load on the high voltage transformer increases, reducing the amplitude of the output voltage to the 3A3 HV rectifier. This causes the positive 300 v flyback pulse to the regulator diode to be reduced in

amplitude. Less negative voltage appears on the horizontal output tube grid and more power is supplied into the flyback system, meeting the high voltage current demands.

Focus Voltage

In addition to the stabilized HV necessary for the CRT anode, a

Fig. 3—Schematic of closed loop feedback system that regulates HV by varying bias on the HO tube. Courtesy of Motorola.

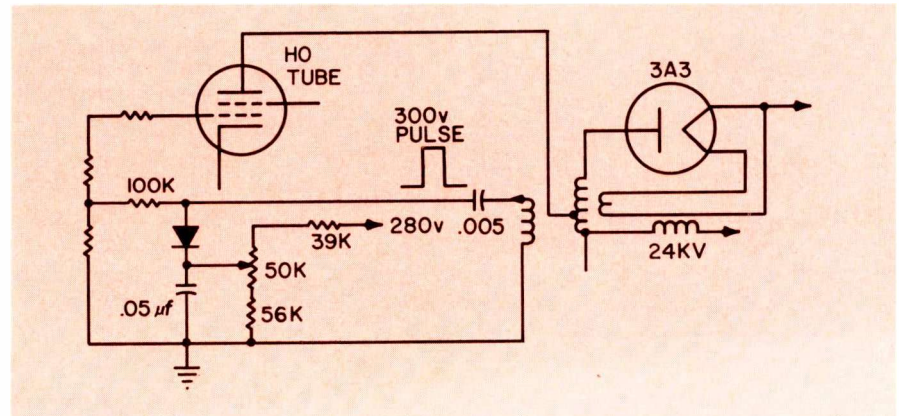

High Voltage

Continued

stable but manually variable focus voltage must be supplied to the electrostatic focus elements of the CRT guns. Some high voltage systems have a separate focus-voltage tap on the flyback which goes to the anode of a solid-state diode or the plate of a separate focus-voltage rectifier tube (1V2, 1AU2, etc.), as shown in Fig. 4. A focus-adjust transformer or pot may be used to vary this voltage. A simplified drawing of a focus voltage supply employing an adjustment potentiometer is shown in Fig. 5.

Troubleshooting Color HV Systems

If you note excessive change in the height and width of the picture

(blooming) when the brightness control is advanced, if corona discharge or arcing appears in the high voltage cage or elsewhere, chances are the voltage regulator tube has stopped conducting. Insert a 0-1 ma meter in the regulator cathode. Current will be around 700-800 microamperes if the tube is conducting in a normal manner. If the current is very low, regulation will be poor. If the current runs up close to 1 ma, you will probably not have enough high voltage. The exact amount of current drawn by the regulator under various conditions will be determined by the particular circuit and type of set. Manufacturers' schematics

and service literature should be carefully consulted.

The most likely cause of poor focus is a defective focus voltage rectifier tube, if used. Use a VTVM with high voltage probe and check it. Check the manufacturer's exact specifications on this. Specifications will probably call for 4.3 to 5.3 kv. If insufficient voltage is present after substituting a known-good tube, check associated circuit components.

When adjusting the focus transformer or potentiometer the brightness and contrast controls should be set as near the proper viewing level as possible. In general, the control should be adjusted to give maximum overall definition of fine picture detail. And it goes without saying that a VTVM with a high voltage probe handling up to 30 kv is necessary for making over-all HV and focus voltage measurements. Extreme caution should be observed with these voltages.

An off-value resistor in the grid circuit of the 6BK4 voltage regulator, a tube element short, cathode-to-heater or grid-to-cathode short, or a shorted capacitor which normally appears across the shunt regulator grid and cathode, can cause HV problems.

Focus potentiometers sometimes become pitted—causing intermittent or varying focus conditions. And if a new control also becomes pitted, you'd better check the circuit for a leaking bypass capacitor in the focus circuit. These pitted pots should be replaced. No effort should be made to clean them as is done with volume and other low current carrying controls. ■

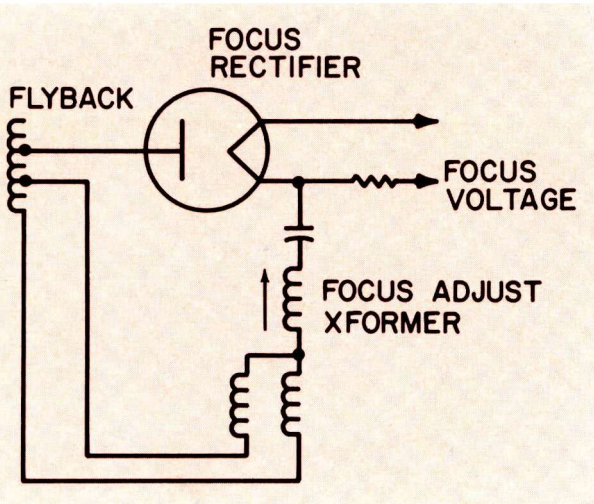

Fig. 4—Focus rectifier tube circuit showing focus-adjust transformer.

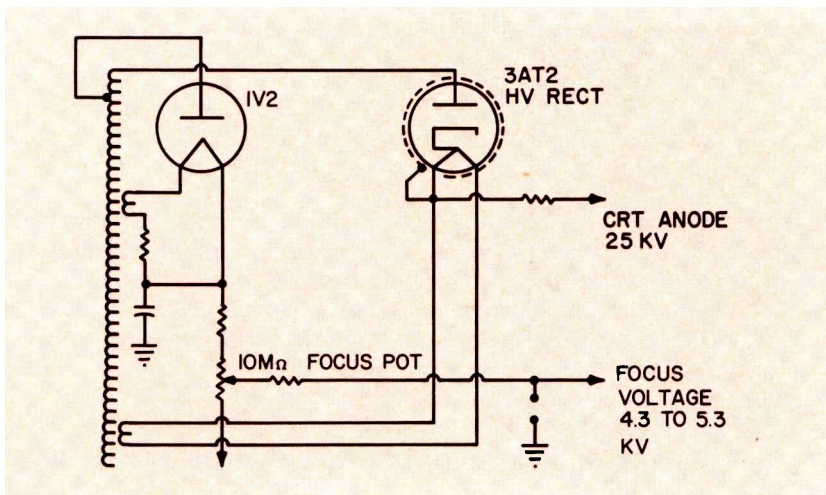
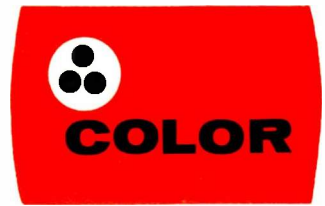

Fig. 5 — Simplified drawing of focus voltage supply using an adjustment potentiometer. Courtesy of Zenith.



Avoid adjustment pitfalls by following the five simple steps outlined here

Simplified COLOR CONVERGENCE



by Bob Dunn

B & K Manufacturing Co.
Division of Dynascan Corp.

■ Probably the most troublesome single problem that plagues service technicians in color TV is convergence. Although it may be difficult for the inexperienced, it may also be relatively simple once a systematic procedure is adopted and followed.

It is important for technicians to understand what they are attempting to accomplish by convergence. For this reason, let's remind ourselves how a three gun color tube produces black-and-white pictures.

The color CRT produces three separate and distinct images on the face of the tube, one each of red, green and blue. By "superimposing" one color exactly on the other two, complete convergence can be accomplished and a true black and white picture can be viewed.

Actually, we cannot really superimpose one color on top of another. We really do not superimpose, but light up the adjacent red, green and blue dots.

We will recall that mixing the three primaries—red, green and blue—in the relationship of 59 per-

cent red plus 30 percent green and 11 percent blue will produce white. The actual picture is not white, but appears so to the eye. The white, if examined closely, is composed of a series of red, green and blue dots. Because of the small size of the dots, the eye sees a combination of the three that appears white to the eye.

Preliminary Steps

Before attempting to converge the 3-gun color tube, it is important to make the following checks or adjustments. If any of these are out of tolerance, it could affect convergence and possibly make convergence impossible. It is suggested that manufacturers' procedures and recommendations be observed when making any adjustment on a color receiver.

- a) Check and adjust high voltage if necessary
- b) Check and adjust focus voltage if required
- c) Adjust background and screen controls
- d) Adjust vertical size and linearity controls

e) Adjust centering controls

In other words, the receiver must be adjusted to produce a good black and white picture (at this point we can ignore color fringing of the whites). The picture should be in good focus, of proper size, and of good linearity. It is entirely possible that these controls and adjustments will need very little attention. But make necessary adjustments before proceeding.

Correct placement of components on the neck of the CRT is essential for optimum convergence. The proper position of the convergence assembly, purity ring, and blue lateral magnet is shown in Fig. 1. The dimensions given are for glass tubes and are not necessarily correct for metal types or the new 23 in. rectangular types. Check the position of the convergence assembly, being especially careful of the lateral position as well as making sure the assembly is aligned squarely over the proper color of guns. This is extremely important. (See Fig. 2). The yoke position is not necessarily correct since it must later be moved for purity adjustments.

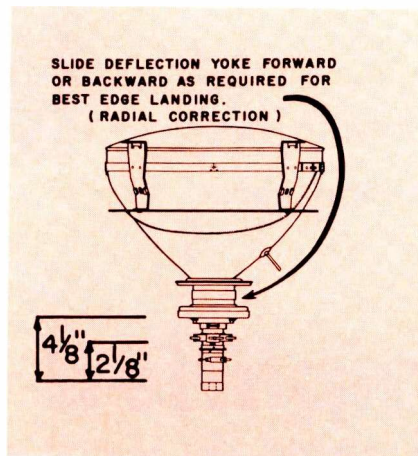

Fig. 1—Proper position of the convergence assembly, purity ring and blue lateral magnet for round glass color CRTs.

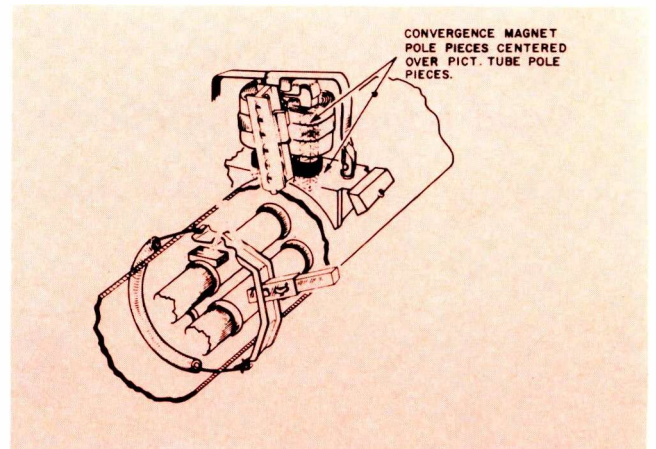

Fig. 2—Make sure the lateral position of the convergence assembly is true.

Simplified Color

Purity Adjustment

This is the first actual step in convergence. What we must do is align the red gun so its beam strikes only the red phosphor dots on the face of the CRT. The blue and green beams should then strike only the blue and green dots respectively.

Before checking purity, it is wise to set static or center convergence; if this is off too far, it may not be possible to achieve good red purity.

Technicians will be able to do a better all-around job if a small-dot generator is used for static convergence. A dot-crosshatch generator capable of producing a dot and horizontal line of only one scanning line in height would be ideal. A large dot, or a dot that has a tendency to bloom (enlarge with high brightness), may cause improper center or static adjustment which can, in turn, prevent good dynamic or edge convergence. It is advisable to view the receiver in a darkened room to permit a considerably lower setting of the TV receiver's brightness and contrast controls.

After initial static convergence, we can now accurately check purity. This is done by either reducing the

screen controls of the blue and green guns, or preferably by using a gun killer, leaving only the red gun in operation. This should produce a uniform red in all areas of the screen.

Degaussing

Because of the iron material in the shadow mask or aperture plate, it is necessary to demagnetize the color CRT. (Two manufacturers have announced automatic degaussing in their new models; each time the set is turned off, the color picture tube is demagnetized.) The degaussing coil should be moved around the entire area of the screen for a period of 20 to 30 sec and then moved away from the tube 5 to 6 ft.

Rotate the coil at a right angle to the front of the CRT before turning off coil power. (Note: On metal tubes, the rim magnets must be moved into their keepers to prevent these magnets from being permanently demagnetized.)

The screen should now be free of magnetism and a pure uniformly red screen should be present. If not, move the yoke toward the rear of the CRT until a small circle of red appears in the center of the

screen. Adjust the purity rings to obtain pure red in the center area. A low-powered microscope may be used to make certain the entire area of the red phosphor is being lighted (see Fig. 3). Then slide the yoke forward until the entire screen is free from yoke shadow and is uniformly red. Some manufacturers suggest that purity on blue and green screens should be checked at this point. No adjustments are provided for the purity of these screens, however.

The gun killer or screen controls should now be rotated back to their normal position and static convergence reset. Movement of purity rings will necessitate readjustment of static magnets. After static convergence is reset very carefully, we are ready to start dynamic or edge convergence.

Dynamic Convergence

Step One: Vertical Convergence. Turn the pattern selector on the dot-crosshatch generator to vertical lines; disable the CRT's blue gun, either by gun killer or adjustment of screen control; adjust the controls on the dynamic convergence board until the center vertical line is converged over its entire length,

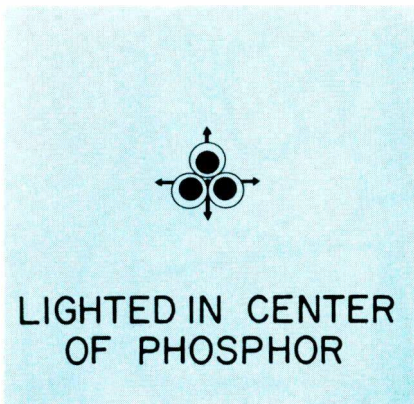

Fig. 3—Adjust purity rings to obtain pure red in the center area. Use a low-powered microscope to make certain the entire area of the red phosphor is being lighted.

Convergence

Continued

red and green only. (See typical controls used at this point as shown in Figs. 4 & 5.) Turn on blue so all three are operating again. Now determine that blue is converged on the center red-green vertical line.

Step Two: Horizontal Convergence. Turn pattern selector to horizontal lines and again disable the blue gun. The top and bottom lines, red and green only, should now be converged, paying strict attention to the center two-thirds of these lines. Refer frequently to proper controls in manufacturer's service instructions. Blue again should be made operable and converged on the top and bottom red-green lines.

Step Three: Vertical. Turn selector switch on generator to cross-hatch and converge vertical lines along the sides of the screen. It is advisable to use the second line from the edge instead of the extreme lines.

Step Four: Horizontal. Using horizontal lines, kill green and red guns. Now adjust blue to produce a straight horizontal line across the center of the CRT.

Step Five: Horizontal. Use cross-

Fig. 4—Vertical convergence controls.

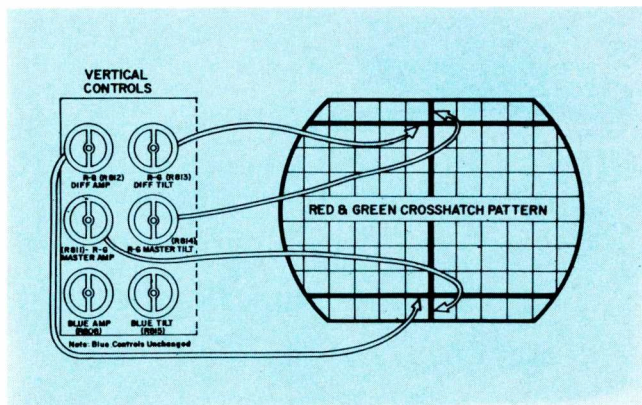
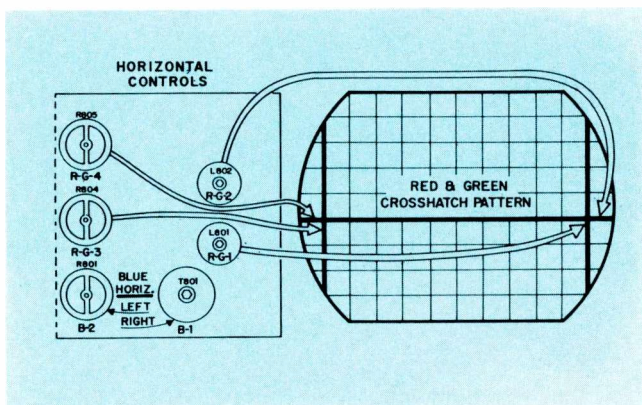

Fig. 5 — Horizontal convergence controls.



hatch and make all three guns operative again. Adjust horizontal lines along extreme left and right using the center horizontal line to converge red and green on the blue line used in Step Four.

At this point it is advisable to quickly run through the five steps again and do minor touch-ups. You should have achieved convergence of about 80 to 90 percent. This amount is considered to be average by most manufacturers. It should be understood that 100 percent convergence is next to impossible and the wise technician will not try to obtain 100 percent. Undoubtedly, the most difficult part of convergence is knowing when to leave well enough alone. A lot of wasted time and shattered nerves can be traced to attempts at perfection.

A slight amount of color infringement can be expected. This 10 to 20 percent color infringement is hardly noticeable and certainly is not objectionable at normal viewing distance.

Although the foregoing procedure

will not be applicable in all receivers, it will be valid in more than 70 percent of present day sets. In other cases, a recommended procedure is supplied or is easily obtainable from the manufacturer.

Remember the Customer

Customers should be instructed on proper use of the controls and fringing should be explained. They should also be cautioned about the use of electrical appliances in close proximity to a color receiver. For example, turning off a vacuum cleaner close to the color CRT may cause the tube to become magnetized, causing impurities and mis-convergence. The once taboo moving of a color receiver from one side of the room to the other or even to another room is now permissible and rarely causes the receiver to require readjustment—except in rare cases.

Alert technicians will take the time to learn and avoid the pitfalls of convergence. *Illustrations: Courtesy of RCA.* ■



Bob's repair tips help Scoot hurdle the color barrier

COLOR TROUBLE

by Joseph Hayes

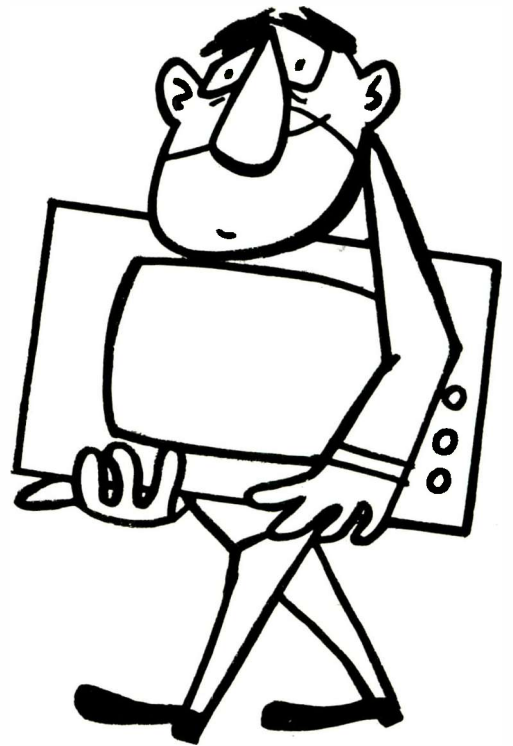

■ Scoot was busy checking tubes from a small table radio. He found a bad 35W4 and replaced it; the sound blared in and he put the radio out of the way on a shelf to "cook" with the volume turned down. Bob was working at the far end of the same bench on a tape recorder. He was 'snowed' with color sets and tape recorders today and couldn't discuss "vertical lines" with Scoot.

"There's a couple of color chassis sitting over there you can start on next," Bob said, pointing in the general area of five or six sets lined up neatly dividing the service department and the showroom. Bob believed in showing his service department off as well as his display room.

"Which one do you want first?"

"Start on the RCA, Bob answered. "If you get stuck on that one, start on the Zenith."

Scoot read the tag tied to the RCA chassis "Sound and pix overload with passing traffic, people and airplanes."

"Sounds like AGC trouble," Scoot announced.

"Don't get your mind in a rut, Scoot. The last time you did that you got lost in the wrong area of

the set for at least two hours."

Scoot systematically checked all the tubes. He replaced a tuner tube that showed leakage and the IF tube that barely gave an emission indication on the tester. He slid the chassis over to the color test jig and began connecting the cables. "I'll bet that's got it," Scoot mumbled. But Bob walked toward the chemical rack for tape head cleaner and ignored him. Scoot flipped the switch and waited for the set to warm up.

"Look at that," Scoot said. "A perfect . . ." But before he could finish, the picture twisted grotesquely and the sound flared up and died to a buzz and a whisper.

Scoot reached for a VTVM without further comment and started checking voltages around the AGC amplifier. He made light pencil notations of voltages on the schematic so they could be erased later. This also speeded up Bob's work when he had to bail Scoot out of trouble. The set was playing normally now and all the voltages were close to those called for on the manufacturer's service sheets. He substituted the 6KA8 AGC and sync tube and touched the antenna lead terminals. The set overloaded as it did before.

Scoot picked up a scope probe and looked at the schematic absent mindedly. "Keying voltage on the plate reads 600 v," he mused. He connected the ground clip and placed the probe to the tube's plate. "Umm . . . close enough—just short of 600 v."

He moved the probe to the control grid and penciled "20 v" on the schematic.

"I give up, Bob."

"OK," Bob said, walking over to Scoot. "What's the problem?"

"Well, I'm just stuck." He showed Bob his notations on the schematic and explained that he didn't know where to look next.

Bob looked at the screen, touched the antenna terminals and tried adjusting the AGC control. He then turned the vertical hold slightly and the picture lost sync.

"The vertical hold is a little soft, isn't it, Scoot?" You should always check the action of other controls to see if they're normal. If they're not, you may find the trouble without further looking.

"Don't tell me you've got a clue already?"

"No, not yet. Did you check the waveform at the screen grid of the AGC tube?"

"No, I've never found anything out that way. If the voltage is OK, the tube conducts all right and everything works like it should. Isn't that right?"

"As a matter of fact, it isn't," Bob said. "If the manufacturer goes to the trouble of putting a waveform on the schematic it must be meaningful. It really doesn't take that much time to check it out anyway."

Bob touched the scope probe to the 6KA8 screen grid.

"Look. The specs call for 11 v, P-P. What do you see?"

"About 19 or 20 v," Scoot calculated.

"Yep, and what do you see in this circuit that would let that signal be too high?"

Scoot traced around the schematic with his pencil eraser.

"There's a 2 μ f job tied to the grid through 2.7 and 1.2 K resistors. I suppose that could cause a problem if it opened up."

"It sure could. I'll give odds that's exactly what's wrong with it, too." Bob clipped one capacitor lead from the PC board. "If this unit's bad, the set should work better without it."

"Now let's have a look." Bob touched the antenna lead terminals with two fingers and the picture wavered but was more stable than before. "There's your problem—replace the 2 μ f capacitor."

"What about the vertical?" Scoot asked. "You might just as well check that while you're here."

"You put that new capacitor in, Scoot, and I think you'll find the vertical problem cleared up, too. That capacitor has been causing problems in these sets since the CTC 5s. Sometimes it shows up as AGC trouble and sometimes as

vertical sync trouble, but sooner or later they all come down with it. There's no reason you couldn't have found that yourself, Scoot. All you needed to do was use the information you had available in front of you.

"By the way, Scoot, that same capacitor can cause a host of other problems, including weak color. If you don't have AGC or sync trouble, it doesn't mean that the 2 μ f unit is good."

"OK, Bob, you don't have to rub it in. I'll get this one together and let it cook. I'll have that Zenith out of the way before you get that tape recorder finished."

Scoot checked out the CTC 10 and set it aside. He made a few cable changes and hooked up the Zenith set. The tag on this one read "Severe piecrusting."

"Oh, no—these horizontal things really throw me, Bob. Don't you want to take this one yourself?"

"You're approaching it with the wrong attitude, Scoot. Just think a little and you can whip it."

Scoot checked the tubes almost mechanically. No problems here, the set was only 6 months old. He sat and reasoned a minute and then connected the scope to the AFC tube grid. He got a distorted sine wave at about 800 or 1000 cps.

"Looks like the AFC circuit is hunting," he announced.

"Sounds logical, Scoot. Now all you have to do is find out why."

Bob was no help at all. The least he could do was hint, Scoot thought. He studied the schematic again and

checked voltages around the AFC tube.

"Let's see," he muttered, "this dual diode rectifies the sync pulse and a pulse from the flyback. The difference is then applied to the horizontal oscillator tube changing its bias and oscillating frequency. The sync pulse is amplified by the HORIZONTAL CONTROL and fed to the oscillator to zero it in. Now, if a filter is open somewhere . . ."

Bob laughed at Scoot's muttering.

"A filter could let the ripple from the rectifier get through and change the oscillator at some regular rate. That would cause piecrusting."

He snipped one end of the .022 capacitor (Fig. 1) and checked it with an ohmmeter. It read about 2 M Ω . He chuckled to himself at finding the problem so easily. Without saying anything to Bob he installed a new capacitor and fired the set up. It came in out of horizontal sync. Adjusting the horizontal sync control straightened it out. The piecrusting was gone.

"How's that for fixing one in a hurry?" Scoot asked.

"Not bad, if it's really done. Set it up good and see what it looks like. By the way, a 680 pf capacitor in that circuit (Fig. 1) gives a lot of trouble, too. The indication is a very critical horizontal hold. To check it, ground the control tube plate momentarily. If the oscillator frequency goes way off, the capacitor is open."

Scoot had been working while

Continued on page 92

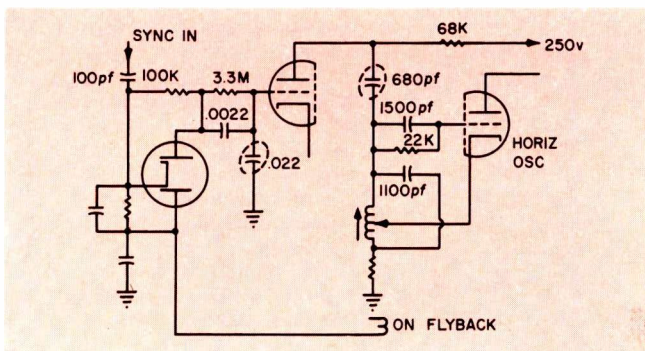
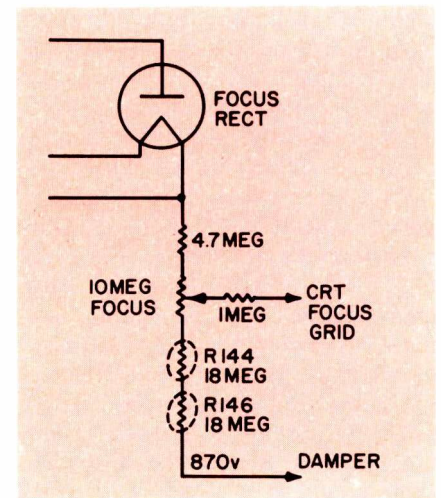

Fig. 2—Bob disconnected the wire between R144 and R146 and measured each resistor with a VOM. "There you are," he said to Scoot. "Both of these units are way out of tolerance." They measured 12 M Ω instead of 18 M Ω .

Fig. 1—He snipped one end of the 0.022 capacitor and checked it with an ohmmeter. It read about 2 M Ω .



Expanding industrial, business and educational usage opens way for exceptional money-making opportunities for service-dealers and technicians

CLOSED-CIRCUIT

by John Haskell

■ CC-TV is much more today than the exotic "eyes" of a robot that handles radioactive materials, a show-window merchandising device or fashion-show novelty. It is now earning its salt as a "shirt-sleeve" industrial tool in hard-core basic industry, business, finance and education. It has grown up and become top-watchdog of the electronic Space Age.

Equipment Characteristics

Closed-circuit television is *TV intercommunication*. In the same way that voice intercoms connect offices, CC-TV transmits instantaneous visual information from point-to-point in business offices, banks, stores, industrial plants, classrooms, hospitals, missile launching pads and research labs.

Pictures of any number of diverse operations can be brought to widely separated locations or to a centralized point. Private, low-cost cable circuits connect the camera to the camera control unit and the camera control unit to the monitor. And no government license is necessary for a CC-TV system.

Compact, rugged, low-cost TV cameras and camera control units are available with quality picture monitors. The monitors can be operated at considerable distances from the camera location with ordinary cable. Greater distances are possible when broad-band microwave radio or special common-carrier channels are employed.

Compact all-weather cameras now available generally operate over temperature ranges from -22 to 160°F. Explosion-proof cameras observe machines, pumps and industrial equipment in volatile atmospheres. Monitors with 5 to 27 in. screens are available. These are built for table or rack-mounting, pedestal or overhead suspension mounting.

Remote control facilities enable operation of at least 10 camera functions from monitor locations—including zoom lens operation, pan and tilt movement and power on/off switching. This flexibility aids in adapting CC-TV to many useful applications.

Production savings which may run into many thousands of dollars, are possible with CC-TV. A minimum number of operators are required to observe critical functions throughout a plant from one central location.

Airline, railroad and trucking industries are using CC-TV to keep costs at a minimum. Manual methods of posting airline, bus or railroad arrivals and departures at many points in a station are costly—CC-TV can pick up, transmit and display the information from a single source to many locations throughout terminals at minimum expense.

Typical Applications

In isolated pumping stations on a cross-country pipe-line, for example, CC-TV monitors line pressure, fuel level for the power equipment, or outside temperatures. Readings are sent by TV so the control station operator can observe actual operating conditions at the remote location.

CC-TV is used to observe industrial operations and provide a visual presentation in a different location. TV monitors watch railroad yards, steel furnaces, gas, coal or oil-fired boiler flames, or scan restricted areas.

Typical of the many CC-TV uses is a monitor for watching dangerous high-voltage from a safe distance. Remote control protects operators from possible radiation injury while viewing the high-energy particles at work.

Waterproof cameras allow remote

observation of underwater objects and activities. They are used in constructing or evaluating pier conditions, dock pilings and underwater moorings for buoys or ships; to evaluate damage and ship hull repair; to monitor underwater drilling operations; for diver training and for fish studies. These systems consist of an underwater housing and TV camera, a camera control unit, a TV monitor, waterproof cable for connecting the TV camera to the camera control unit, and coaxial cable for connecting the camera control unit to the monitor. The camera, including lens iris and focus is completely controlled by the camera control unit. Housings are available for use by divers or for mounting in a permanent, fixed position for continuous monitoring. Special lighting equipment is available for night viewing or at great depths where ambient light is low.

A list of broad-area CC-TV applications are shown in Table I.

The Opportunity

Perhaps the most important factor which makes CC-TV a once-in-a-lifetime opportunity for service-dealers and technicians is its ability to reduce costs. This is a never-ending, strong selling point.

Table I

1. Centralized record viewing
2. Display
3. Education and in-plant training
4. Expanding student facilities
5. Material Handling
6. Merchandising
7. Production Control
9. Property Protection
10. Remote observation
11. Surveillance
12. Traffic control
13. Viewing dangerous operations
14. Work coordination

TV GROWS UP



CC-TV "scooter" at the Pioneer Bank & Trust Company, Shreveport, La., moves on tracks in front of the bank's files and sends pictures to monitors at key locations in the main and branch banks. Teller, bank official, or customer sees requested information on one of the many monitors used throughout the system.

And you will do well to look around, discover *how*, it can save a prospective customer money, show him how, sell and install and then service the equipment. An incomplete but representative list of CC-TV equipment manufacturers appears in Table II. ■

Table II

Blonder-Tangue Labs., Inc.
9 Ailing St.
Newark, N. J.

Cohu Electronics, Inc.
Kin Tel Division
Box 623
San Diego, Calif.

Diamond Electronics
Box 415
Lancaster, Ohio

General Electric Co.
Industrial Sales Operation
Sect. 998-75
Schenectady, N. Y.

G P L Division
General Precision, Inc.
63 Bedford Rd.
Pleasantville, N. Y.

ITT Industrial Laboratories Div.
3700 E. Pontiac St.
Fort Wayne, Ind.

Lear Siegler
714 N. Broakhurst
Anaheim, Calif.

Ling-Temco-Vaught, Inc.
Box 5003
Dallas, Texas

Motorola Comm. & Electronics
4501 W. Augusta Blvd.
Chicago 51, Ill.

Radio Corp. of America
Broadcast & Comm. Prods. Div.
Front & Cooper Sts.
Camden, N. J.

Sylvania Electric Products, Inc.
Home & Commercial Electronics Div.
700 Ellicott St.
Batavia, N. Y.

Thompson-Ramo-Wooldridge
Dage Div.
455 Sheridan
Michigan City, Ind.

Zenith Radio Corp.
6001 Dickens Ave.
Chicago, Ill.

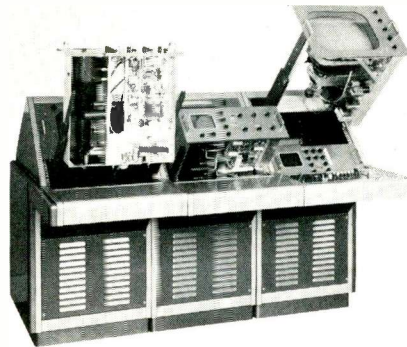

Much of the equipment is service-engineered with fold-out, tilt-out, pull-out chassis. Monitor console, courtesy of Dage.

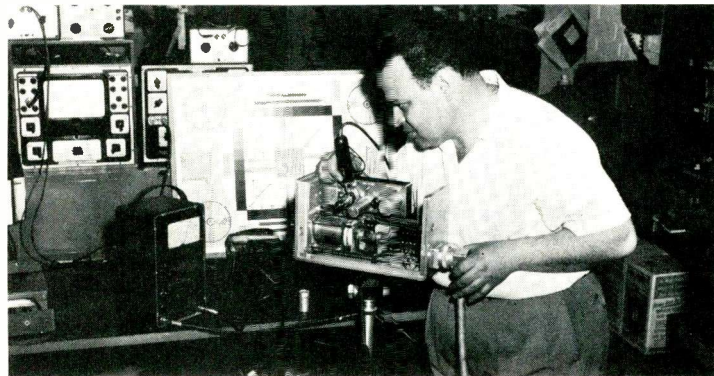

Technician in CC-TV service shop uses standard test pattern to check out cameras and monitors.

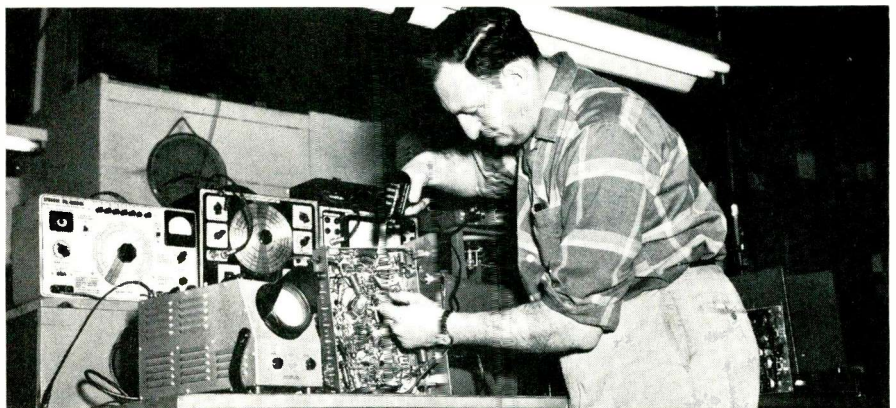

Most TV-radio service-dealers and technicians have the capability and knowledge to install and service CC-TV equipment.

Collection is the proof
of the effectiveness
of your credit policy

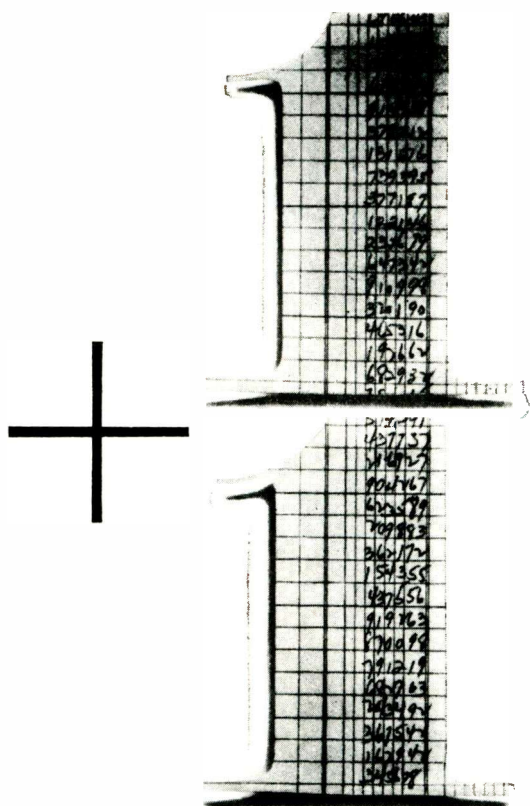

■ It is all too easy to enter a sale or service charge on the books—but it is not always as simple to collect. This truth about accounts receivable should be kept uppermost in mind at all times when granting so-called accommodation credit. Nevertheless, a good many service shop owners continue to grant easy credit to undeserving customers with dubious records for honoring their obligations, and to those who are chronically “slow” reaching for their check books. This is especially true in smaller communities where credit is widespread.

At the end of only a few years in business, an unwary shop owner may have accounts receivable (many aging and uncollectible), totaling more than its best year's net earnings. These uncollected—if not uncollectible—accounts sharply depress a shop owner's earnings. In addition, these accounts deprive the owner of needed working capital. With the passage of years, and the cumulative effect of uncollected accounts, the owner may conceivably be in a worse financial bind.

Possible Credit Costs

A fact every TV-radio, Hi Fi shop owner should keep in mind—even when a delinquent account is finally collected—is the period of time during which you have not had the use of the money involved in the account. This time represents an additional cost to you in one form or another. If the cost is high enough, because long delinquent, it may wipe out all original profit and result in a loss on the products sold or services performed.

Cramped for cash, a shop owner may be obliged

**YOUR CREDIT POLICY CAN MAKE
OR BREAK YOU**

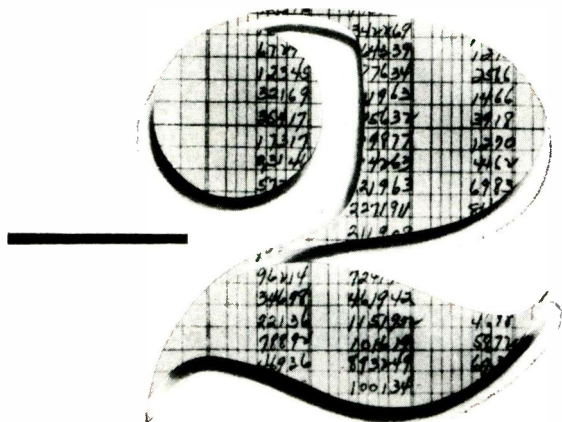

PART II (Conclusion)
by Harold J. Ashe

to resort to a bank loan on which a certain amount of interest is paid. At this point you are in the unenviable position of rewarding your delinquent debtors, indirectly of course, for not honoring their bills. You pay a premium on their delinquency. Because they don't pay, you must borrow! And, because they do not make timely payment, you must forego your profit, if any, on the products sold or work performed. This is the final indignity. You are in business, at least it is hoped you are, for a profit; yet "heel-dragging" customers deny you a profit, along with an outlay in labor, materials and overhead, material bills and other expenses.

Just what do past due accounts receivable cost a shop owner? This is difficult to calculate because no two service-dealer organizations may be in identical situations. The most favorably situated shop owner pays something, however, for the questionable privilege of carrying delinquent accounts. The cost to a less favored shop owner may be prohibitive and explain the plight of many who eventually meet with a committee of creditors weary of carrying the shop owner year after year.

Assume that all delinquent accounts receivable are good, and eventually will be collected. (That takes a lot of assuming, incidentally.) Every month an account receivable remains uncollected it costs a creditor money and reduces his original profit.

Some shop owners get in such a critical situation that they cannot borrow money from their bank, while carrying an excess of accounts receivable. What then? They must pass their cash discounts. At this point, accounts receivable are not costing them the moderate

6 percent a bank might charge if a loan were available. They are paying 24 percent or more annually in the cash discounts not taken because customers have the use of funds needed for discounting. It's as simple as that.

How does this shape up? Suppose a service-dealer is making 10 percent on his capital, above a good salary for himself. The lost discount earnings because of lack of cash is running at a rate of 2.4 times that of overall earnings on capital. If a substantial part of total annual volume is reflected in chronically delinquent accounts payable, net earnings otherwise available may be sharply reduced because of this inability to take discounts offered by the trade.

Actually, as every shop owner knows, accounts receivable become uncollectible with the passage of time. Therefore, let's explore the probable real cost of delinquent accounts a little further to see just what the real cost is. Assume that past due accounts become uncollectible at the rate of two percent of value each month. (This is a conservative assumption.) Further assume 6 percent cost of a bank loan to offset failure to collect such accounts. Finally, assume that in some situations a bank loan is not available and a monthly two percent cash discount offered by suppliers must be passed up for lack of cash, thanks to uncollected accounts.

It can be seen from studying Table I and II here that allowing accounts receivable to go uncollected month after month is prohibitive and can become a primary cause for failure. Loss of profit can result from tolerating easy, easy credit which remains uncollected on books month after month. ■

TABLE I

MONTHLY COST OF DELINQUENT ACCOUNTS RECEIVABLE
(With Bank Loan)

Delinquent Accounts	factor* Bad debt	Cost 6% Bank Loan	Monthly Total Cost
\$ 250	\$ 5.00	\$1.25	\$ 6.25
500	10.00	2.50	12.50
1,000	20.00	5.00	25.00

* Arbitrarily assumes 2 per cent of delinquent accounts become bad debts each month.

TABLE II

MONTHLY COST OF DELINQUENT ACCOUNTS RECEIVABLE
(Loss of cash discount)

Delinquent Accounts	Factor Bad Debt	Lost 2%* Discount	Monthly Total Cost
\$ 250	\$ 5.00	\$ 5.00	\$10.00
500	10.00	10.00	20.00
1,000	20.00	20.00	40.00

* Assumes entire amount of funds tied up in accounts receivable could be employed in cash discounting.

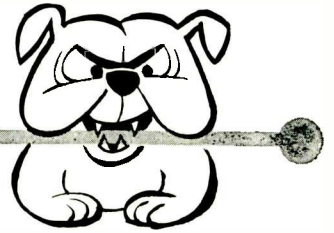

Difficult Service Jobs Described by Readers

PC Network Dilemma

A Philco, Chassis 8H25 was brought into the shop with the rather vague comment that "it quits in the middle of the programs." A bench check showed weak sound, the bottom of the raster would shrink without any apparent loss of vertical lock and eventually it would drift out of horizontal lock.

All the tubes checked good on a tube tester except for the HO tube which arced when vibrated by tapping. A check of the sound alignment showed the top interstage transformer slug was broken. The bottom slug began moving only with great effort and then moved freely. The slugs appeared to have been frozen by heat. Since heat was the key to this set's problems, I placed a hot soldering gun tip momentarily on one of the leads of a 0.0068 μf capacitor connected from pin 6 of the 10DE7 vertical osc to ground.

Now the picture began to shrink at the bottom immediately. A heat lamp was used to warm up the components in the vicinity of the horizontal osc tube. This was followed by a spray of freeze mist which pinpointed the horizontal osc RC network. I pulled the circuit board and replaced the sound interstage transformer, the 0.0068 μf capacitor the horizontal osc RC network and for good measure, the phase comparing network. After all I did not want to have to pull that circuit board oftener than I had to! The circuit board was replaced, the sound aligned, a new 12DQ6 added and the back was replaced for a check.

The sound was improved, the

picture did not appear to be drifting out of horizontal lock, but after a while the set drifted out of vertical lock! The heat lamp and freeze mist this time pointed to the vertical feedback RC network. Since this part was not in my stock, I decided to fabricate it out of molded tubular capacitors and $\frac{1}{2}$ -w resistors.

The circuit board was now pulled for the second time to install this unit. I might add that it is no longer my practice to clip off the old units and splice the new units to the old leads to save the bother of pulling the circuit board. I have found a number of bad solder joints on circuit boards where parts have been replaced in this manner.

The back was replaced and the set again warmed up. Much to my disgust it did not seem to be much improved. This time the heat lamp and freeze mist pinpointed the vertical integrator network. A similar unit was fabricated out of individual parts in the same fashion as the vertical feedback network. Now the picture stayed locked in vertically. *Arnold E. Nemmers, Dell Rapids, South Dakota.*

Resistor 'Run-Around'

I ran into a problem several weeks ago that I think may interest other technicians. It was a Westinghouse TV chassis (V-2346).

The complaint was severe tearing and excessive snow after the set was on for about a minute. I replaced all tubes. The new 5BT8 (keyed AGC and AFC) took care of the pulling, but the snow was still present. Monitoring the RF AGC voltage showed that it built up con-

siderably although the IF AGC seemed pretty much unaffected.

It was discovered, then, in spraying the components around the base of the RF amp with circuit cooler that the snow would disappear for awhile but would then gradually build back up. This screamed "tuner trouble," but after checking everything possible the trouble was still there. Reluctantly I went back to the main chassis and started checking. All voltages were well within tolerance and the wave-shapes seemed good—that is, all I thought pertinent to AGC. Then I checked all the components in the AGC system, but to no avail. Now grasping for straws, I sprayed the printed circuit board in the vicinity of the AGC components. Lo and behold, about three times out of ten the snow cleared up. Now bear in mind that I really put the cooler to it because I felt sure it was a thermal problem of some type, even though I couldn't localize it. I then checked, luckily, the filament voltage of the 5BT8 and it read 6-v, whereas it should have been 4.7. Further checking revealed the filament dropping resistor to be 20 Ω where it should have been 59 Ω . Replacing it cured the trouble.—*Gary G. Backen, Dover-Foxcraft, Maine.*

TOUGH DOGS WANTED

\$10.00 paid for acceptable items. Use drawings to illustrate whenever necessary. A rough sketch will do. Photographs are desirable. Unacceptable items will be returned if accompanied by a stamped envelope. Send your entries to "Tough Dog" Editor, ELECTRONIC TECHNICIAN, 1 East First St., Duluth, Minnesota 55802.

NOW

*convergence and color adjustments
are easier, faster, more accurate!*

NEW B&K MODEL 1240 LOW PRICED PORTABLE COLOR GENERATOR

with crystal-controlled keyed rainbow color display!

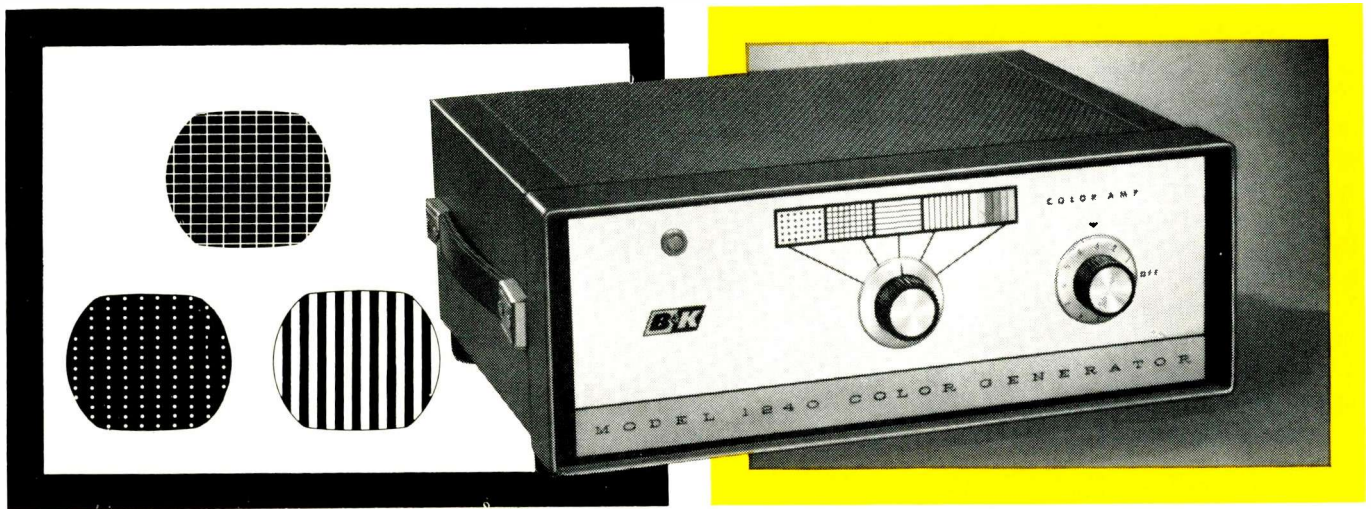

Thinnest Horizontal Lines! Smallest Visible Dots!
(Just one raster scanning line thick)

**Simplifies In-Home (or Shop)
Color TV Set-Up and Servicing**

only
\$134⁹⁵_{NET}

You're the color TV expert when you use the "1240." You have the advantage of B&K quality—with features not available before at such surprisingly low cost.

Provides crystal-controlled keyed rainbow color display on TV screen to test color sync circuits, range of hue control, and align color demodulators. Shows ability of TV receiver to display color values.

Provides dot pattern, crosshatch, horizontal and vertical lines. Highly stable crystal-controlled count circuit with small-step count assures greater reliability and stability of color, dots, and lines. All horizontal lines and

dots are just one raster scanning line thick. Lines begin off-screen and end off-screen, with no break in line. Dot brightness is adjustable with easily accessible control. Chroma Level Control simplifies color sync trouble-shooting.

Operates on channels 3, 4, and 5, and adjustable without removing cabinet. No connection inside TV set is needed. Power transformer operated and line isolated to prevent shock hazards. Operates reliably on 105-125 VAC, 60 cps. (Color Gun Killer is available as optional accessory.) Extreme lightness and portability (9 lbs.) make it ideal for in-home servicing.



*See it at your B&K Distributor
or Write for Bulletin AP21-T*

B & K MANUFACTURING CO.
DIVISION OF **DYNASCAN CORPORATION**
1801W. BELLE PLAINE AVE. • CHICAGO, ILL. 60613
Canada: Atlas Radio Corp., 50 Wingold, Toronto 19, Ont.
Export: Empire Exporters, 123 Grand St., New York 13, U.S.A.

- - - for more details circle 13 on post card

SHOP HINTS

TIPS FOR HOME AND BENCH SERVICE

Backward Saw

If you're using a hacksaw to cut tubular mast sections or any kind of thinwall pipe or tubing, reverse

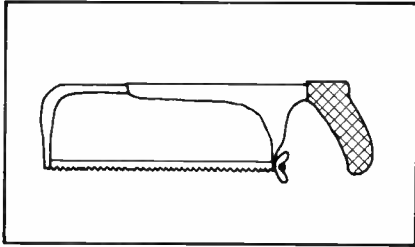

Reverse blade in hacksaw when sawing thinwall tubing.

the blade so the teeth of the saw point toward the handle, or use the entire saw in reverse. Then the sawblade won't snag on the tubing or chatter or break, no matter how fine or coarse its teeth are.—*Harry J. Miller, Sarasota, Fla.*

Cap/Connection Extensions

When using current checker on horizontal output tubes, I find many plate cap leads will not reach the

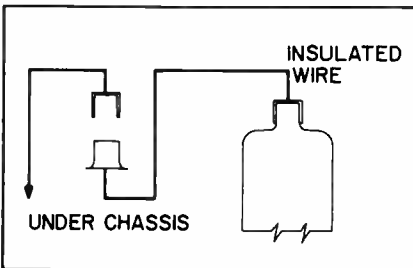

Insulated-wire extension leads are convenient when using current-reading adapter under horizontal output tubes.

plate connection on tubes when the adapter raises the tube. I made up two extension leads with a small plate cap and old tube connector on one lead and a large plate cap and old tube connector on the other lead. *C. J. Barnes, Toledo, Ohio.*

TV Jig

In the occasional TV set requiring work or measurements beneath the chassis with CRT, speaker, etc.

hooked up, and the jumper cables won't reach or for some other reason it is more convenient to work with the chassis in normal position inside the cabinet, I pull the chassis, remove the louvered metal plate or screen from the wooden base, then saw out the center under where the chassis mounts—using the dust as a guide and leaving about an inch extra wood on each side. (I use a sabre saw for this.) Then, after mounting the chassis with a couple of its bolts, I turn the set on its side on my bench, using a piece of rug material to cushion and protect the finish of the cabinet. Now I can make whatever measurements necessary with the power connected. After the repair is completed, the metal plate is again installed beneath the chassis for safety. *F. M. Burton, Grand View, Idaho.*

Mast Substitute

When you have a fast, top-rate antenna job to do and can't obtain the proper mast in a hurry, try the hardware store for a light gage, aluminum ladder. The one shown here has been in use over four months now. It replaced a number of antennas of various types that have failed to withstand high winds, etc.—*Samuel H. Miller, Philadelphia, Penn.*

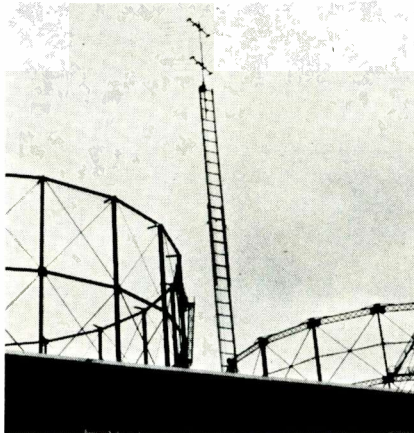

Aluminum extension ladder used as antenna mast.

Another Spare Hand

Any pair of pliers you have makes a third hand when you need one, if you wrap a heavy rubber band around the handles so the resulting pressure forces the jaws to close on the objects to be held. *H. Muller, Danboro, Penn.*

Twin Lead Stripper

A handy tool for stripping insulation off twin lead wire is the conventional kitchen-type potato-peeling knife. It cuts the inner plastic insulation with one slice and doesn't gouge into the wire. *H. Josephs, Gardenville, Pa.*

Phono Motor Speed-Up

When normal replacement of drive pulleys and belts does not supply sufficient speed to a turntable, take off the motor and clean the shafts at the points where they ride on the bearings. Use a very fine sandpaper gently on these shaft surfaces to clean off gum deposits and when necessary carefully flush away the grit with a light oil. The same procedure may be used on drive pulleys and other shafts. Lubricate according to the manufacturers specifications. The slightest drag on the synchronous motor will be reflected as a slow turntable. —*Virgil W. Zieg, Fremont, Neb.*

SHOP HINTS WANTED

\$3 to \$10 for acceptable items. Use drawings to illustrate whenever necessary. A rough sketch will do. Unacceptable items will be returned if accompanied by a stamped envelope. Send your entries to Shop Hints Editor, ELECTRONIC TECHNICIAN, Ojibway Building, Duluth, Minn. 55802. The hints published in this column have not necessarily been tried by ELECTRONIC TECHNICIAN editors and are the ideas of the individual writers.

G-E value analysis
will help you stretch the
dollars you spend on
electronic
components



A QUICK
VALUE ANALYSIS PROCEDURE FOR

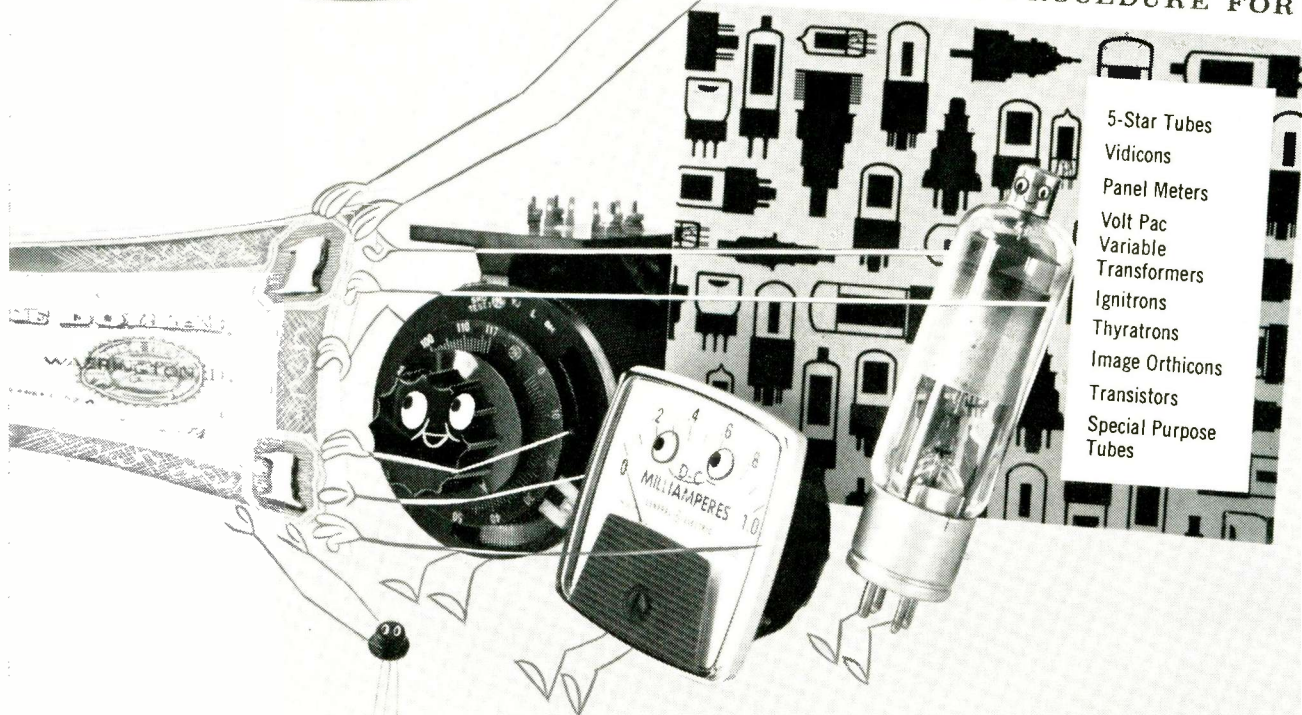

- 5-Star Tubes
- Vidicons
- Panel Meters
- Volt Pac
- Variable Transformers
- Ignitrons
- Thyratrons
- Image Orthicons
- Transistors
- Special Purpose Tubes

Unless you're already using G-E components, chances are excellent you can get more mileage out of your electronic components' dollar. Without the facts, a lower list price is hard to resist. It's *top performance per dollar* that counts... and that's what you get with G-E electronic components.

You can prove this for yourself by getting G-E's free value analysis information. It will not only

help you unscramble all the confusing claims and definitions but will allow you to compare, *accurately*, the benefits of G-E components with competing brands.

See your authorized G-E Industrial Electronic Components Distributor and make the comparison today. See him also for details on how to get your personalized, walnut, desk-top nameplate.



Progress Is Our Most Important Product

GENERAL  ELECTRIC

--- for more details circle 21 on post card
INDUSTRIAL ELECTRONICS SECTION

■ INDUSTRIAL ELECTRONICS

SECTION

CONTENTS

Repairing and Troubleshooting

Xenon Lamp Devices64

Conclusion of practical instructions for servicing arc lamp circuitry

Carbon Monoxide Alarm66

A plant safety device that weighs only 3 pounds

Adjustable Speed Control for AC Motors Features Simplified Solid-State Electronics67

Look Up—Move Up68

Tells how to achieve professional recognition through engineering technician certification

Checking Power Transformers With a Tube Checker70

Industrial New Products72

Ultrasonic Leak Detector73

AUGUST • 1964 • VOL. 80 • NO. 2

Repairing and Troubleshooting Xenon Lamp Devices

*Although they come in many sizes and shapes,
most xenon lamp units are a lot alike*

by Reginald W. Neale

PART II (conclusion)

■ When checking xenon arc lamp circuitry, if the supply voltage is OK but there isn't any sputtering even with a new lamp, the starter circuit may be faulty. Some rigs have a separate starter, on its own chassis. Minimum ignition voltages cover a range from 15 kv for small, low-pressure lamps, to 50 kv for large, high-pressure lamps. Don't attempt to measure the ignition voltage, of course, unless you have special equipment.

Here's how the starter works. Transformer T1, Fig. 1, is a conventional type except for its high leakage reactance. It steps up the supply voltage to several kv and applies it to spark gap Y1. The voltage across the spark gap oscillates very rapidly, producing broadband RF modulated at 120 cps. The RF portion of this voltage resonates across the series circuit of C5 and T2's primary. T2 steps up the RF voltage by a factor of three or more and applies it to the lamp. C2 bypasses the low side of T2 to ground for RF.

T2 is a large-diameter, air-core coil and is wound with very heavy wire because it must carry full arc current. The primary winding usually has a dozen or so turns, and the secondary has two to five times as many. Although the unit shown in Fig. 1 is an autotransformer, some starters use a transformer with isolated primary and

secondary. The entire assembly is generously insulated. Both the primary tap and the secondary lead should be dressed away from any nearby metal structures.

If you have a voltmeter which can read 50 kv of RF, you can measure the starting voltage directly; otherwise, it's cut and try, substitute and eliminate.

Check out the simple elements first. The TV doorknob types, C5 and C6, seldom fail, and the spark gap width shouldn't be terribly critical (the best operating point is a little narrower than the point where it refuses to spark at all).

Look carefully for sparks occurring in places where they shouldn't be—breaking through insulation, etc.—because the noise from the spark gap is loud enough to mask out the sound of what would otherwise be a very obvious short.

A neon lamp probe can be used to test for the simple presence of high voltage at the lamp, or an arc can momentarily be drawn. Of course, no quantitative measurements result from these tests.

Troubleshooting the Power Supply

If a new lamp sputters but refuses to start, the trouble is almost certain to be in the arc supply rather than the starting circuit, the arc goes out after being momentarily ignited simply because the in-

ternal impedance of the arc supply is too high.

There are several causes of this problem. The most obvious is a loose or high-resistance joint in the supply. If they all check out OK, however, then check the ballast.

Some very low-power lamps use a resistive ballast, but the more efficient reactive ballast is most common. An oscilloscope can help confirm the diagnosis of a defective ballast. Connect the scope input across the output of the arc supply, but *not* across the lamp terminals, where it would be exposed to starting voltage. Watch out for power supplies whose outputs are not isolated from the 115-v line, such as the one in Fig. 1. A scope with a differential input should be used in this case. Check to see whether the starter is in series with the positive or negative lamp lead.

The scope will probably exhibit a waveform like the one in Fig. 2. The "hash" is caused by RF voltage from the starter circuit radiating directly into the scope and test leads. The occasional half-cycles which appear to be chopped are instants when the arc forms but lasts only a few milliseconds. Fig. 3 shows the corresponding waveform for an operating lamp. Only when the arc persists during most of a half-cycle will it be able to re-form at the beginning of the next one.

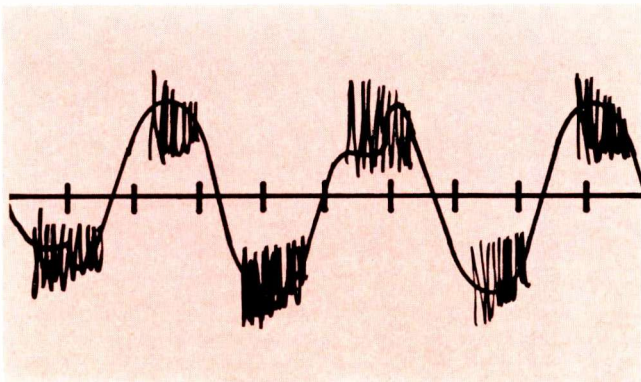

Fig. 2—Output voltage of xenon arc power supply with defective ballast, as observed on oscilloscope.

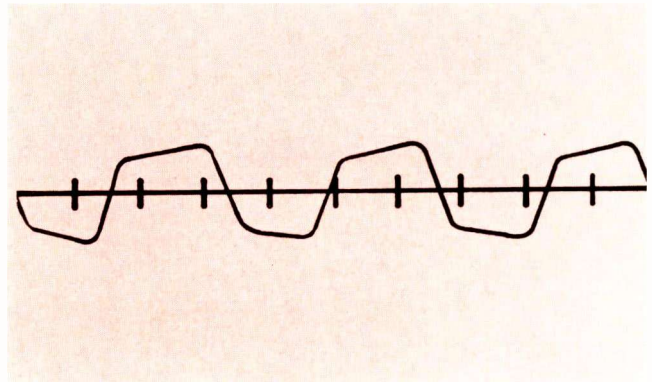

Fig. 3—Output voltage of xenon arc power supply during normal operation.

Another useful check on the arc supply is to load it with a power resistor. Calculate the resistance, R , of the arc from

$$R = \frac{(22 \text{ v})^2}{\text{Lamp Watts}}$$

Connect a resistor of the calculated value across the lamp-supply terminals. An ammeter in series with the low-potential side of the resistor will show whether the supply is delivering the proper amount of current. Be sure to use a resistor in the same wattage range as the lamp.

What to Expect

Here are a couple of case histories, which are not guaranteed to be typical.

Unit 1 was a model 505 "Puls-arc," made by American Speedlight Corporation (Fig. 4). It is a 150-w lamp used for microscope illumination and has an accessory circuit which briefly pulses the lamp to a higher level for making photomicrographic exposures. The major part of the circuit is shown in Fig. 1. The lamp had become too jittery for routine use, and the operator replaced it with a new one. The new lamp, however, wouldn't start.

In the shop, the lamphouse cover was removed, and it was discovered

that the top lamp lead had pulled loose from its terminal and was resting against the side of the metal lamphouse. This was repaired, but still no sputtering occurred when the start button was pushed. The arc supply voltage checked normal, and a neon probe showed that there was some high voltage at the lamp.

Components in the starter circuit were checked one by one, and it was determined that C3 and C4 (Fig. 1) were defective (probably because of the lamp lead shorting against the case).

Unit 2 was a custom-built, 1-kw rig in a high-intensity spectrograph. Ballast and starter unit,

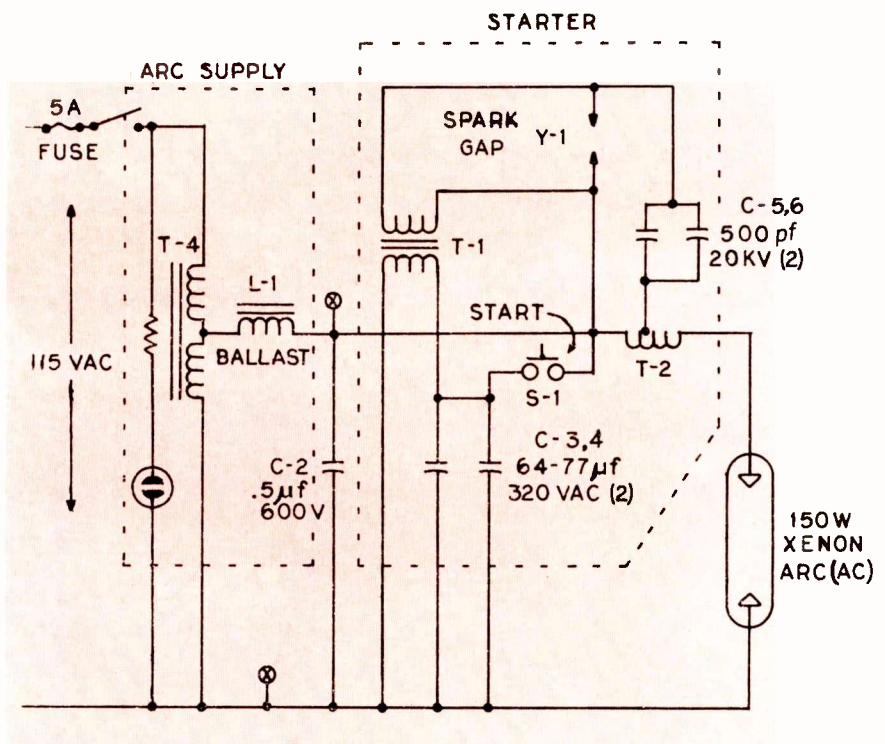

Fig. 1—Schematic of typical low- or medium-power xenon arc power supply and starter.

Xenon Lamp Devices

Continued



Fig. 4—This 150-w xenon lamp is used for microscope illumination and has an accessory which briefly pulses the lamp to a higher level for making photomicrographic exposures. Most of its circuitry is shown in Fig. 1.

again similar to Fig. 1, had been purchased separately and packed into a wooden case inside the instrument. The lamp had become increasingly harder to start. It sputtered nicely, but the arc wouldn't form no matter how long the starter was energized. The scope showed a trace like Fig. 2. Although 1 kw divided by 22 v equals 45 amp, the supply would deliver only about 12 amp, even into a short-circuited load. A new ballast cured the trouble.

When the old ballast was removed, it was discovered that one of the bolts holding the laminations together had broken, probably because of the severe vibration normal for a unit this large. The broken bolt had allowed the core to slide very slightly out of shape, increasing its air gap and drastically reducing the available current. If this

had been noticed initially, the unit probably could have been back in service within a couple of hours.

The PXA Lamp

One type of XA lamp that hasn't been mentioned yet is the pulsed-xenon-arc (PXA) lamp. In size and shape, the PXA lamp resembles a fluorescent lamp. Its long, extended source is an advantage in many uses of high-intensity lamps, it starts instantly, with the flip of a switch, and it can be operated in any position. On the debit side, the lamps have a shorter life and require a more elaborate power supply than the ordinary XA lamp. Other characteristics are similar to the XA lamp, but its strobe effect is much more pronounced because a saturable-reactor switching circuit in the power supply delivers the current in 1-ms bursts during

each half cycle of the line supply.

An Opportunity Knocks

XA lamps are used in sizes from 150 - w microscope illuminators through 5-kw projection lamps, to 50-kw floodlights. Some other typical applications are step-and-repeat machines for making printed circuits, production of lithographic plates, fabric fadeability testing, office copying machines and studio lighting setups. The graphic arts industry is one of the largest customers for this equipment.

There are thousands of XA lamp devices in plants all over the country. If you're the type of electronic technician who enjoys the challenge of working with something different, this equipment represents a very promising area for expanding your know-how and money-making possibilities. ■

Carbon Monoxide Alarm

*Plant safety device
weighs three pounds*

■ An American-made Carbon Monoxide Detector and Alarm, costing less than \$100 and weighing less than 3 pounds, is said to be simple, reliable and maintenance-free. Licensed by E. I. du Pont De Nemours & Co., it will be
Continued on page 70



Adjustable Speed Control for AC Motors Features Simplified Solid-State Electronics

■ An adjustable, compact solid-state ac motor speed control designed for precise control of ac motors over a wide range of stepless speeds (without using feedback loops), allows ac motors in sizes from 1 to 100 hp to be used in many applications where the more expensive and difficult-to-maintain dc motors were the only previous choice.

One of the basic benefits claimed for the new drive is its ability to maintain accuracy at any set point, whether controlling a single motor or a whole group of motors. For many applications, such as textile, paper converting, machine tools, steel or metal rolling, etc., this accurate speed control is very important in maintaining the quality of the finished product.

Design Characteristics

Design simplicity eliminates the normal logic system, which in some drives may use many more components. The design flexibility allows the addition of many other control features such as threading, jogging, reversing, controlled acceleration, dynamic braking, tachometer follower control, ratio control, and instrumentation to any specific requirements.

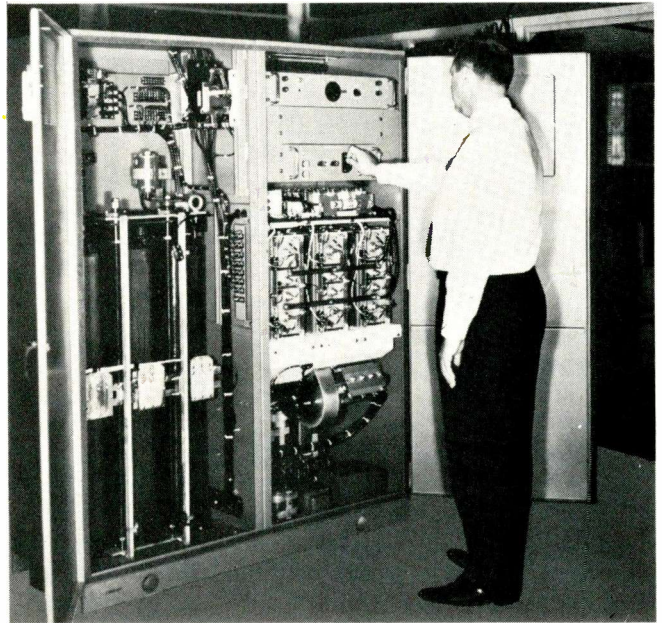

Borg-Warner's solid-state ac adjustable speed motor control comes in sizes from 10 to 100 kva. The unit requires no feedback loops, and it maintains precise speed control (reportedly ± 0.05 percent of any given set point) of individual or groups of ac motors.

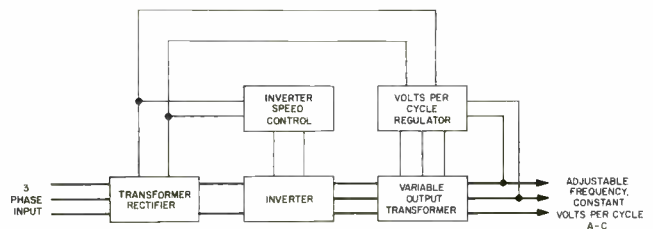

Basic block diagram of solid-state motor speed control.

Operation

The unit called "Accuspede," converts 220, 440 or 550 v, 3-phase, 60-cps ac power through a dc rectifier and power inverter, to adjustable-frequency ac power. An electronic oscillator provides precise frequency control within ± 0.05 percent of a set point over a 6:1 or 12:1 range.

The use of solid-state components is said to make the drive virtually troublefree. Should maintenance become necessary, all component parts are easily accessible and are simple to plug in or replace. The solid-state components and packaging techniques used result in a drive that requires very little floor space. Sizes are available from 10 to 100 kva.

Static inverters as used in this unit have been marketed since 1958, and the solid-state, adjustable speed control has been in field use since 1961. ■

■ Are you certified? If you are interested in advancing your career you should learn more about the Institute for the Certification of Engineering Technicians (ICET), sponsored by the National Society of Professional Engineers. The ICET exists to: (1) raise the standards of engineering technicians, (2) determine the competency of engineering technicians who apply for certification, and (3) award certificates to qualified technicians and maintain a registry of these technicians.

Certification usually raises the professional status of technicians and can bring promotions, raises and more responsible positions. A more basic benefit is greater recognition for the growing group of individuals classified as "engineering technicians."

By definition, engineering technicians perform duties at a specific technical level (see the definition of an engineering technician). They are vital members of this country's scientific-engineering manpower team, and the ICET is finally bringing them the recognition they deserve.

The engineering technician is the middleman in the engineering

team. On one side is the graduate scientist or engineer, while on the other is the skilled craftsman. The technician puts the theoretical ideas of the scientist or engineer into a practical form—he helps develop, test and apply their ideas and creations, and at the same time may supervise the craftsmen who actually build the devices or equipment. Because of his unique position, the technician must be familiar with the practices and tools of the craftsmen and at the same time know the mathematics and scientific principles that are the tools of the engineer. Draftsmen, technicians in charge of maintenance and repair of complex equipment, production line testers, and laboratory development assistants all may be classed as engineering technicians.

How to Apply for Certification

A look at the requirements will help you to decide which grade of certification you qualify for. There are three grades of certified technicians: Junior Engineering Technician, Engineering Technician, and Senior Engineering Technician.

To become a Junior Engineering Technician, you should have two years of work experience or be a

graduate of a technical school accredited by the Engineers' Council for Professional Development (ECPD). Endorsement by a professional engineer or equivalent is required.

Five additional years of satisfactory experience plus meeting requirements for Junior Engineering Technician will qualify you for certification in the Engineering Technician grade. You must also be at least 25 years old, and you may be required to pass an examination. Two professional engineers, or their equivalent, familiar with your work, must endorse you.

As an applicant for certification as a Senior Engineering Technician you must meet all the requirements of the two lower grades and have an additional ten years experience. The minimum age limit for this grade is 35. Three professional engineers (or their equivalent) must approve you for this grade.

When you apply for certification, your education, experience and references will be checked and you may be required to take an examination. If the institute concludes that your qualifications are satisfactory, they will award you a certificate in the appropriate grade.

LOOK UP - MOVE UP

Achieve professional
recognition through
engineering technician
certification

by
Louis E. Frenzel, Jr., EE



Although the certification program is still in its infancy, over 2000 technicians have already been certified.

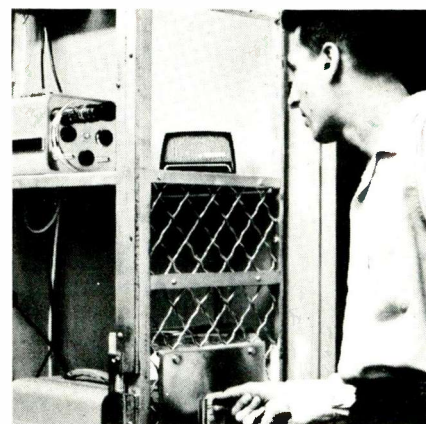

The technician puts the theoretical ideas of the scientist or engineer into a practical form developing testing and evaluating.

Recognition for Technicians

By becoming certified, you demonstrate that you have a specific level of education, experience and competency. Since certification is strictly voluntary, employers recognize that you are seeking to improve yourself when you make application. Thus, certification is an incentive for self-improvement.

The country's need for good technicians is great—greater perhaps than its need for engineers, for when the engineer's more routine and less theoretical responsibilities are assumed by a technician, the engineer has more time to pursue activities for which he was trained. In fact, it has been found that a technician is better prepared than the engineer to handle the more practical duties, and already much design work is done by technicians rather than engineers. ICET certification now emphasizes the technician's capabilities and thus brings him even more advanced technical recognition.

Although the certification program is still in its infancy, over 2000 technicians have already been certified. As more technicians become certified, the advantages of

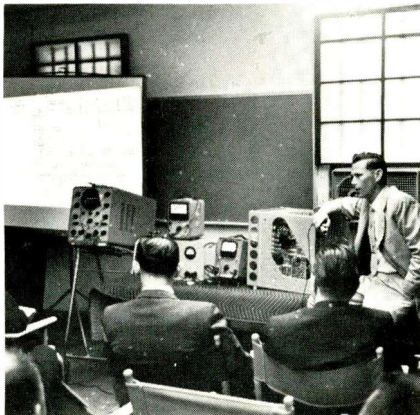

It has been found that a technician is better prepared than the engineer to handle the more practical duties, and already much design work is done by technicians rather than engineers.

"An engineering technician is one whose education and experience qualify him to work in those areas of engineering which require the application of established scientific and engineering knowledge and methods, combined with technical skills, in the support of engineering or scientific activities toward the accomplishment of engineering objectives."

... definition of an engineering technician, Engineers' Council for Professional Development

certification are becoming increasingly apparent. And the increase in the number of certifications is increasing the demand for certified technicians.

Application materials and further information about how you can become a certified engineering technician are available, free, by writing to: "Engineering Certification," ELECTRONIC TECHNICIAN, Ojibway Bldg., Duluth, Minn. 55802. ■

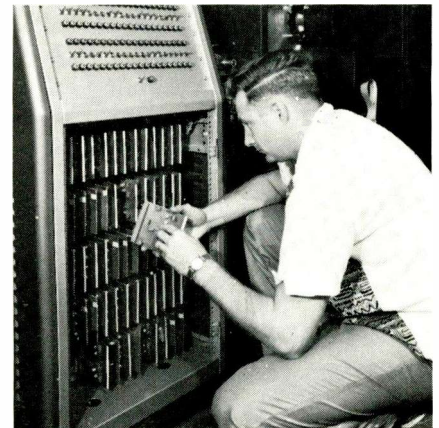

Certification usually raises the professional status of technicians and can bring promotions, raises and more responsible positions.



Because of his unique position, the technician must be familiar with the practices and tools of the craftsman and at the same time know the mathematics and scientific principles that are the tools of the engineer.



Technicians are vital members of this country's scientific-engineering manpower team, and the ICET is finally bringing them the recognition they deserve.

Carbon Monoxide Alarm

Continued on page 66

offered by Union Industrial Equipment Co. of Port Chester, New York. Called the UniCo Sentinel II Alarm, it is designed to protect personnel in industrial and chemical plants, mills, mines, warehouses and garages from the harmful and sometimes fatal effects of carbon monoxide exposure.

The instrument uses an ingenious, simple analytical technique which eliminates maintenance problems, makes it highly reliable, and permits it to be offered at a price well within the reach of all potential industrial users. It will detect carbon monoxide and sound an alarm if the concentration exceeds

100 parts per million, the maximum allowable concentration permitted by government agencies for eight-hour exposures of industrial personnel. At this level its rapid response will give the user ample time to take preventive action before personnel can suffer injury from carbon monoxide. At higher concentrations of carbon monoxide, the instrument responds even more rapidly.

Readily portable, the compact 5 x 4 x 3 in. instrument, powered by 110 vac, can also be used in garages, service stations, or state auto testing stations for detecting leaking and faulty mufflers. Its versatility may be increased by an

accessory remote control head which makes it possible to sample distant areas, the announcement said.

It was reported that major advantages of the device include simplicity of operation, operation by untrained personnel, elimination of elaborate calibrations and easy sensor element replacement. The automatic alarm feature is particularly important in the detection of carbon monoxide, which can affect the judgment and reactions of personnel before its presence is realized. A dc automatic battery pack is available as an accessory, making the unit completely portable, as well as providing standby dc power in the event of failure. Dc power is supplied by rechargeable batteries. An automatic trickle charger is built into the circuitry.

Other models are designed for use in motor vehicles, as well as in private homes. ■

CHECKING POWER TRANSFORMERS WITH A TUBE CHECKER

*Determine output of unidentified power transformer windings
by using a simple-to-construct adapter*

by George Oberto

■ Did you ever run into a power transformer whose proper lead or terminal connections were unknown? The most common way of identifying the windings is to connect 117 v to the primary and measure the secondary winding output voltages. It can be dangerous to wire up such a transformer in this way, however, especially if the manufacturer used nonstandard color code or if the lead colors have faded. Although the windings of small transformers can sometimes be identified by use of an ohmmeter, this technique is unreliable at best. A simple and much better approach is to use the variable filament voltage part of your tube checker to

identify the transformer windings.

Make up an adapter plug that will fit the standard octal socket, and connect leads to pin 2 and 7. Set the tube checker for a 6V6 tube, plug in the adapter, and connect the two leads from the adapter to what you think is the primary winding of the transformer. Next measure the voltage on the other windings. If you get little or no voltage reading, gradually increase the tube-checker filament voltage one step at a time. If the readings are "normal" at full line voltage, you should be able to identify the windings. Although "normal" voltages vary considerably, they typically are: 110 to 120 v for primary, 5 v for

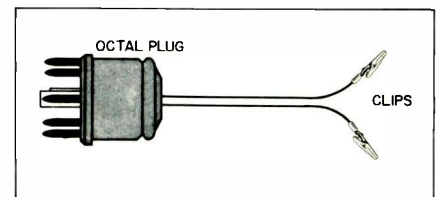

rectifier filament and 500 vCT for high voltages. The tube checker also can be used to determine the turns ratio of all type transformers in the audio and power-line class by measuring the voltages on the various windings. For added safety, if the tube checker is not equipped with a fuse, a 3-amp fuse should be wired in series with one of the adapter leads. ■

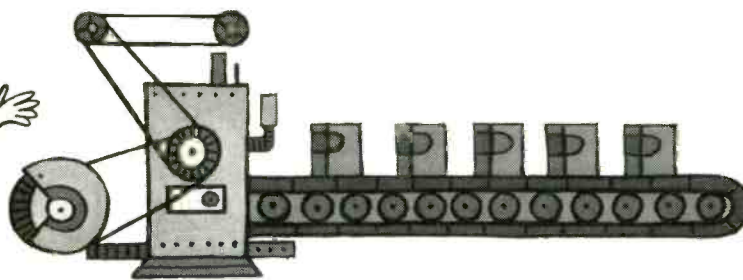

Put photoconductors to work...

new Sylvania kit shows you how

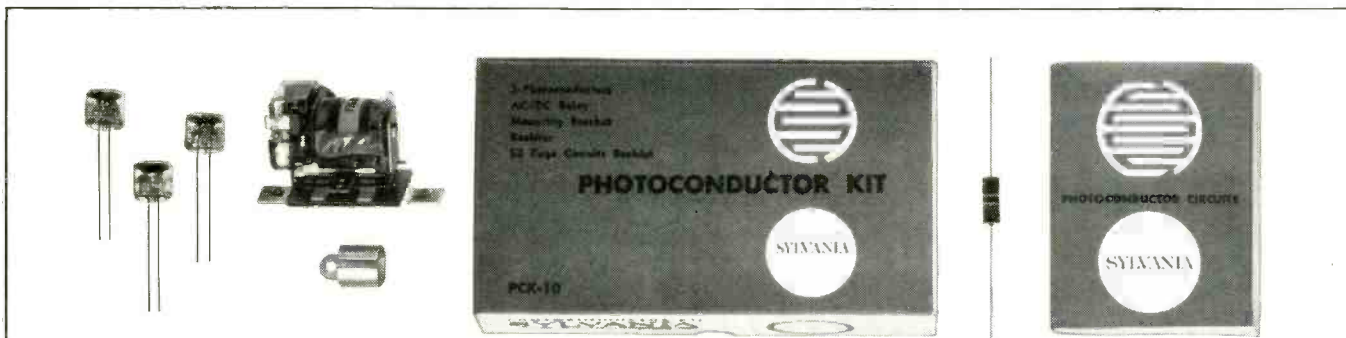

The information contained herein is supplied without assuming any responsibility for its use, from a patent viewpoint or otherwise, and no license under Sylvania's patent rights is granted thereby either expressly or by implication.

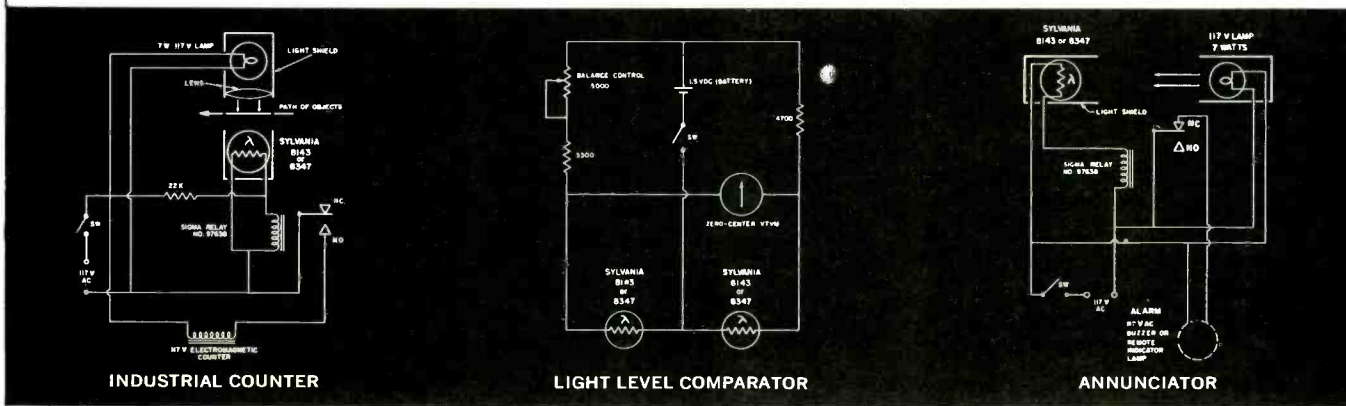

Count containers on a conveyor...compare materials by their light reflectivity...increase safety with a machine light-beam alarm...just a few of the many ways you can put light to work, using the new Sylvania Photoconductor Kit.

This kit contains 3 Sylvania photoconductors, one Sigma AC/DC relay, a 22,000-ohm 1-watt resistor, a mounting

bracket, and a 52-page booklet that details many ways the components can be used for measurement and control. It has all the basic parts for your own experimental setup, to help you discover how practical Sylvania photoconductors are. Individual photocells may then be obtained from your distributor.

The Sylvania Photoconductor Kit

PCK-10 is available now from Sylvania Electronic Distributors everywhere, for less than you would pay for the component parts. Or send \$9.95 (plus 50 cents handling charge) to Dept. PCK-10, Sylvania Electric Products Inc., 1025 Westminster Drive, Williamsport, Pa., and we'll send you the kit postpaid.

Mention this publication.

SYLVANIA

SUBSIDIARY OF
GENERAL TELEPHONE & ELECTRONICS



now there are 3 time & tool-saving double duty sets

New PS88 all-screwdriver set rounds out Xcelite's popular, compact convertible tool set line. Handy midgets do double duty when slipped into remarkable hollow "piggyback" torque amplifier handle which provides the grip, reach and power of standard drivers. Each set in a slim, trim, see-thru plastic pocket case, also usable as bench stand.



PS88

5 slot tip,
3 Phillips screwdrivers

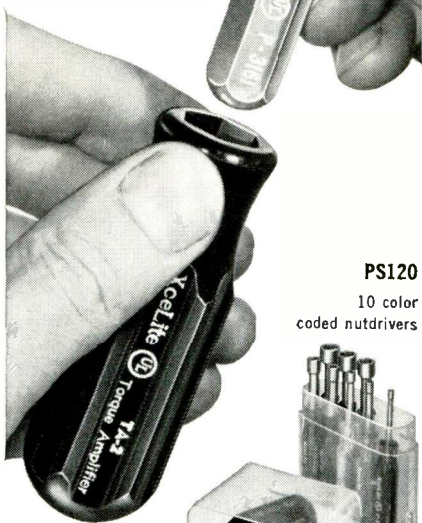

PS120

10 color
coded nutdrivers



PS7

2 slot tip,
2 Phillips screwdrivers,
2 nutdrivers

WRITE FOR CATALOG SHEET N563



XCELITE, INC., 32 Bank St., Orchard Park, N.Y., U.S.A.
Canada: Charles W. Pointon, Ltd., Toronto, Ont.

--- for more details circle 47 on post card



NEW PRODUCTS

ADHESIVE/SEALANT 400

A high temperature silicone rubber adhesive/sealant is said to withstand temperatures up to 40

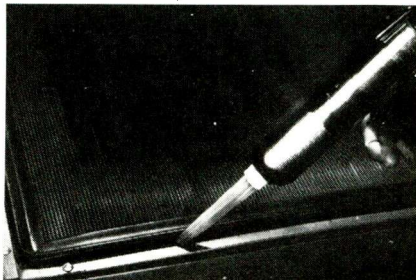

percent higher than conventional silicone adhesive sealants. A one-part material, packaged in tubes and cartridges, the material is specially formulated to withstand long-term use at temperatures up to 600°F. The material is identified as RTV-106 and is red in color. Available in 3 oz tubes, 6 oz cartridges and 12 oz tubes. Price \$1.27 to \$6.38 ea in quantities. General Electric.

REGULATOR CONTROLLER 401

A full range regulator controller is reportedly designed for use with motor-driven Powerstat variable

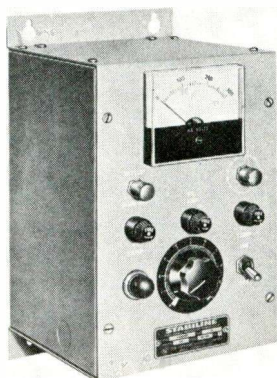

transformers to maintain constant output voltage, adjustable to any value within the full range of the transformer used. The device can regulate output voltage from any motor-driven variable transformer rated for 120 or 240-v, 50/60 cps single phase duty. The announcement said that output voltage will remain within a 2-v band when used with 120-v variable transformer and within a 4-v band when used with 240-v types. Superior Electric.

INDUSTRIAL TUBE TESTER 402

A tube tester is said to feature a complete range of test potentials that permits setting test conditions

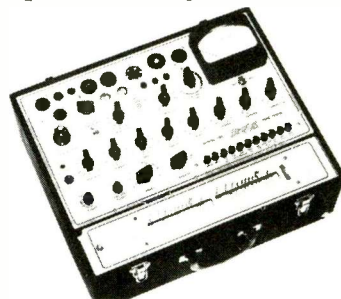

directly from a tube handbook without reference to the roll chart. The Model 580 is solid state and has a transistorized gas test circuit which permits measurement of gas effects down to 0.05 μ amp the maker said. Completely portable. Hickok.

SPEED CONTROL 403

A series of rugged controls which allow continuous variation of the speed of any ac/dc motor is an-

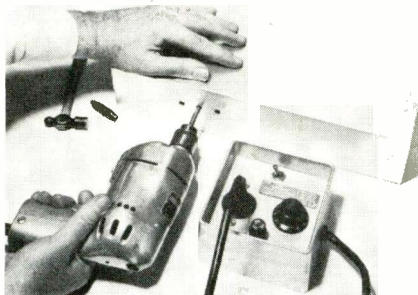

nounced. It is said that a unique feedback circuit is used to avoid loss of power under load. Price, 5 amp to 15 amp models, from \$25.95 to \$69. IRC.

PORTABLE CLOCK 404

A light-weight, automatic field clock is said to be accurate to within one-thousandth of a second in 24 hours, and has a built-in continuous print-out mechanism that

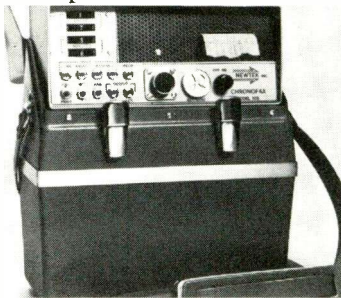

visibly records the time on "command" as frequently as every 25 msec (40 times per second). Newtek.

ULTRASONIC Leak Detector

■ An electronic detection unit helps medical equipment repair technicians at Letterman General Hospital locate leaks in centralized gas and vacuum systems in minutes.

The portable unit, used by the hospital's medical equipment maintenance branch, locates leaks as small as 0.001 in. by detecting the ultrasonic energy created by the escaping gas molecules. Whereas technicians previously had to paint tubing with soap solution and watch for bubbles, a single, 9-lb transistorized, battery-powered instrument is the only equipment needed to pinpoint leaks in oxygen, nitrous oxide and central suction systems serving the sprawling, 750-bed facility. The detector consists of a hand-held directional, probe microphone, which responds only to ultrasonic energy in the 35-kc to 45-kc range, and a 10-in.-tall case containing the electronic circuitry which converts these high-frequency sounds to audible ranges.

The following procedure is used in surveying gas systems ultrasonically: Starting at the manifold, the operator determines if the cylinder connections are secure and whether the fault lies in a leaky regulating valve.

As he moves along, the technician merely points the probe along the tubing valves and couplings comprising the pressure system. A leak is indicated when the detector's speaker emits a hissing sound identical to the familiar sound of a punctured innertube.

The device reportedly detects and locates leaks in the pressure systems as small in diameter as a human hair from 2 to 10 ft away, depending on the pressure in the line.

Because almost any technician can recognize the sound of leaking gas on the detector, no special operator is required.

In other applications, the device is gaining wide use in testing and maintaining industrial and communications pressure, vacuum and hydraulic systems. For example, the transistorized device reportedly can detect leaks in pressurized, aerial, telephone cables from the ground—pinpointing leaks as small as 0.03 in. in a low-pressure (3-psi) line from 50 ft away. ■

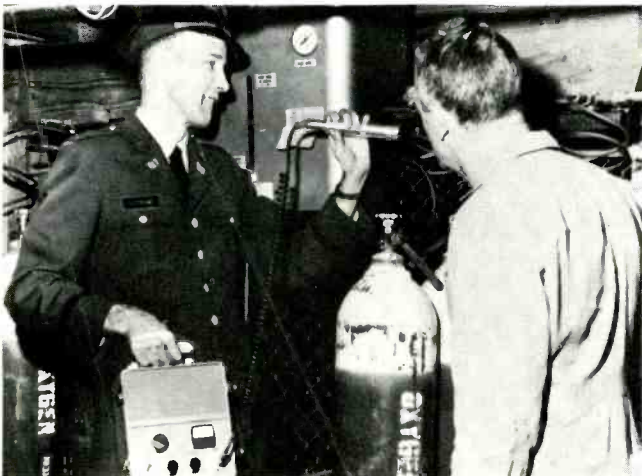

Checking a 10-tank central oxygen system, medical equipment repair technicians locate leaks by detecting ultrasonic energy created by escaping gas molecules. U. S. Army photograph.

AUGUST 1964

TRIPLET

FINEST OF ITS KIND

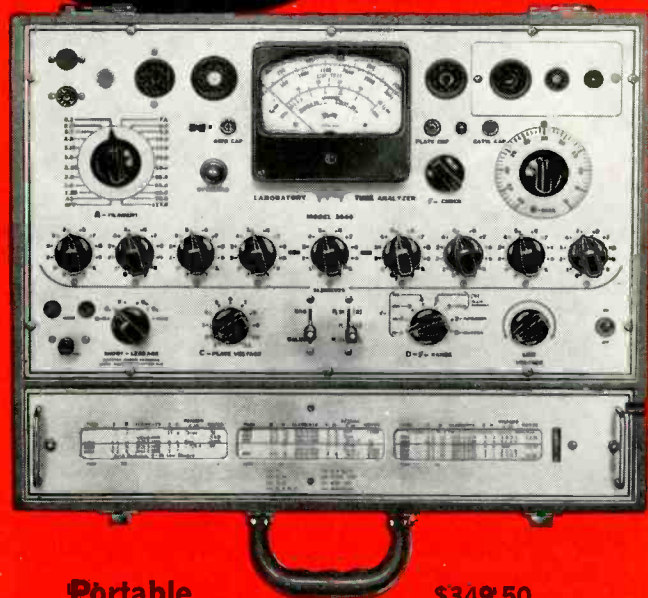

Portable

\$349.50

True Dynamic Mutual Conductance

MODEL 3444 TUBE ANALYZER

FACTS MAKE FEATURES:

- 1** The only tube tester under \$1,000 that is simple and fast to operate, and will measure tube characteristics at known readable potentials.
- 2** The only tube tester under \$1,000 that is simple and fast to operate, and provides readings to:
 - (a) Plot tube characteristic curves.
 - (b) Measure grid current at known potentials.
 - (c) Compare cutoff characteristics of dual tubes.
- 3** The only tube tester under \$1,000 that is simple and fast to operate, and reads directly in micromhos with a self checking Gm circuit.

This superb unit speedily and accurately solves the most perplexing tube analysis problems. Measures true Gm without any compensating factors; using proper value DC electrode potentials. Checks PLATE current cutoff. Checks GAS under actual operating conditions. Checks RECTIFIERS under load. Checks THYRATRON firing voltage and grid currents. Checks DUAL section tubes with only one lever movement. Provides SHORTS and leakage measurements from 0-10 megohms using a filtered DC supply of 85 volts. Case: Wood, gray leatherette covered, 15 $\frac{3}{16}$ " x 18 $\frac{3}{16}$ " x 7 $\frac{3}{4}$ ".

TRIPLET ELECTRICAL INSTRUMENT COMPANY, BLUFFTON, OHIO

--- for more details circle 39 on post card

THE WORLD'S MOST COMPLETE LINE OF V-O-M'S.
AVAILABLE FROM YOUR TRIPLET DISTRIBUTOR'S STOCK.

NEW PRODUCTS

FOR MORE INFORMATION CIRCLE PRODUCT NUMBERS ON POSTCARD FOLLOWING PAGE 100.

FM AMPLIFIER 200

A compact FM amplifier, called the FM Supercharger is announced. It is said that the unit can cut down



background noise, and bring in perfect FM reception on stereo or monaural units in suburban, fringe and even deep fringe areas. Specifications: transistor: 2N2495, gain: min. +17 db, bandpass: 88-108 Mc, response: flat, $\pm 1/2$ db, VSWR: input, 1.2:1; output, 1.25:1, signal input: .25 to 45,000 μ v, max. signal output: 360,000 μ v, input impedance: 300 Ω , output impedance: 300 Ω , ac cord, 117 v 60 cps 2.1 w. Price: \$17.95. Winegard Co.

UHF ANTENNA 201

The patented log-periodic Zig-a-Log antenna is a frequency, horizontally polarized, back-fire surface wave antenna, according to a recent announcement. It is designed especially to have maximum usable gain for weak signal areas, and to have minimal side-lobes for best ghost rejection, the report said. Input impedance to the antenna was designed to match a 300 Ω transmission line by adjusting the

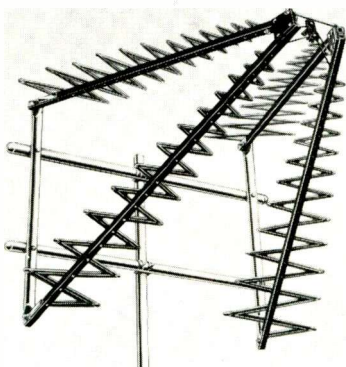

spacing between the two lightning shaped elements, and the VSWR remains less than 1.8:1 across all the UHF channels, the maker announced. JFD.

TITLING DECALS 202

It is announced that new titles have been added to this label line for quick, easy labeling of electronic equipment. The decals have been added in 36 individual sets, 18 each

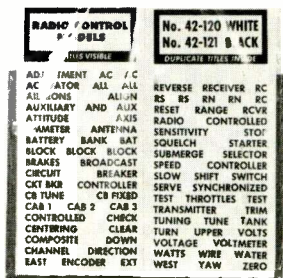

black and 18 each white, for use in all engineering and experimental electronic applications. The labels are said to provide a professional appearance to finished panels, control centers and apparatus; used by engineers, designers, manufacturers, technicians, Hi-Fi enthusiasts, amateurs, custom builders and particularly the "do-it-yourself" group. WalSCO Electronics.

SOLDERING IRON 203

A pistol-grip soldering iron for light to medium work in electronics, communications, and allied industries is announced. The iron features a choice of three 60-w integral tip and heater assemblies, or 40 or 60-w heater which will accommodate 20 different interchangeable ironclad or copper screw-in tips, according to the report. An electrical

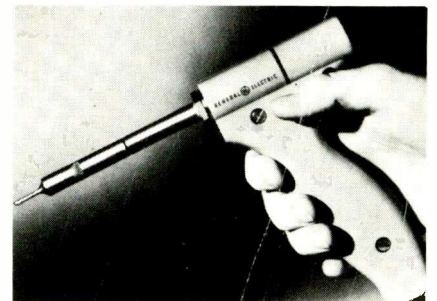

"sliding contact" in the shank allows the working face of any tip to be turned to the desired position, eliminating the hazards of cord or wire twisting inside the handle. In addition, the unit is equipped with a 3-conductor cordset and standard ground plug for added safety. G-E.

CAPACITOR ANALYZER 204

The Model TO-6, designed and priced primarily for the modern service shop, is announced. The unit incorporates accuracy features which make it equally suitable for laboratory use, the announcement said. The analyzer also measures insulation resistance up to 50,000 M Ω , power factor up to 50 percent

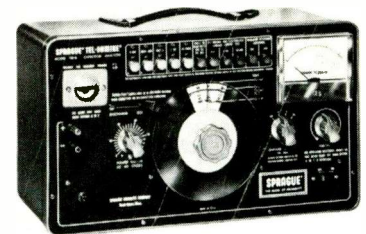

and leakage current in four ranges from 0 to 60 ma. Sprague.

CCTV CAMERA 205

A miniaturized television camera designated model 2000-100, with integral camera control circuitry and zoom lens all contained within a sealed 3-in. diameter cylindrical housing, is announced. The control unit attaches directly behind the camera head. The video signal meets standard 525 line EIA speci-

NEW... FROM THE JFD CHAMPAIGN, ILLINOIS LABORATORIES

JFD LPV-VU LOG PERIODIC

—the world's first all-channel VHF/UHF/FM antenna with single down-lead!

TAME
Television Antennas, Made in U.S.A. Institute
KEEP TV FREE

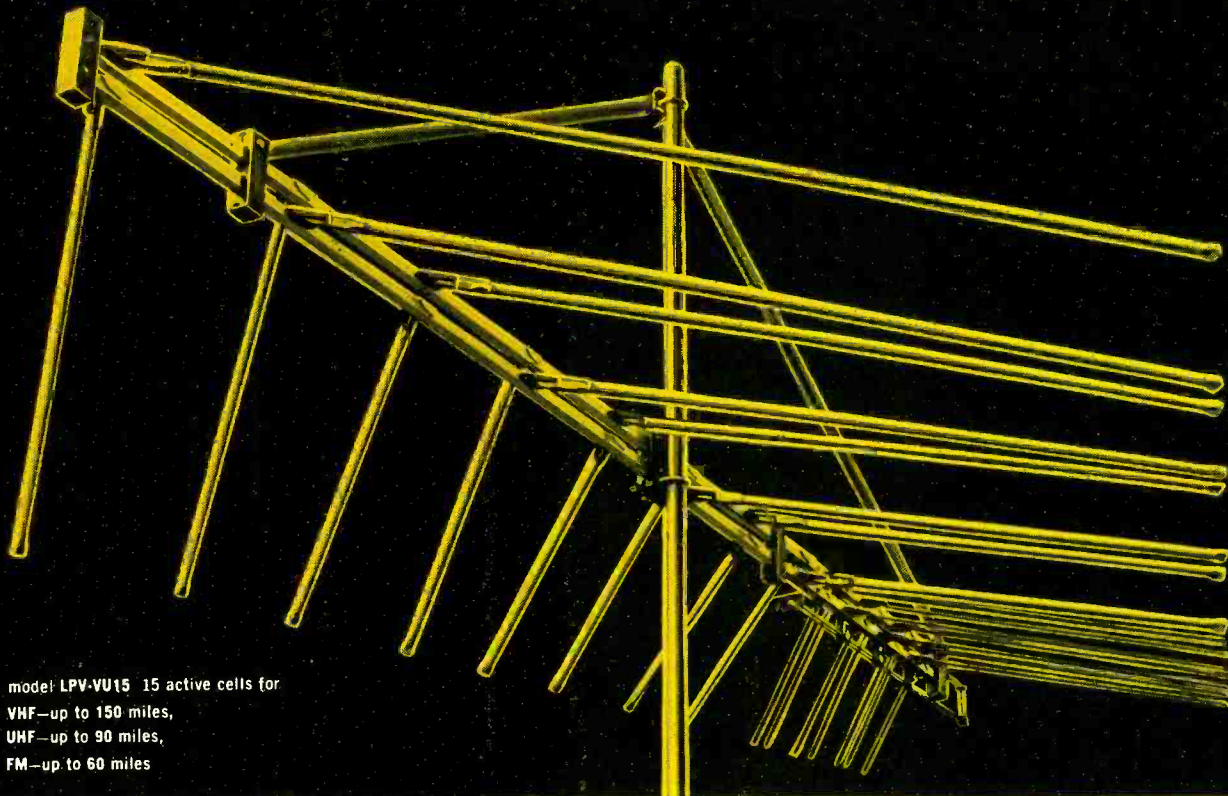

model LPV-VU15 15 active cells for
VHF—up to 150 miles,
UHF—up to 90 miles,
FM—up to 60 miles

space-age engineered for finest COLOR and B/W TV . . . FM/STEREO reception!

Two years ago, JFD made history with the revolutionary new Log Periodic LPV antenna for VHF/TV and FM.

Now, the totally new JFD LPV-VU Log Periodic—the world's first VHF/UHF/FM antenna—will make new history for JFD dealers and distributors!





Engineered by the JFD R & D Laboratories, the LPV-VU is today's most advanced application of the patented log periodic concept of the Antenna Research Laboratories of the University of Illinois because:

1. The JFD LPV-VU is the first and only truly all-channel antenna to receive all FCC authorized VHF and UHF TV channels 2 to 83, plus all FM/Stereo frequencies.
2. Frequency independent log periodic design provides an unprecedented combination of remarkable gain... flat, full bandwidth response... sharp directivity... high front-to-back ratios... matched impedance and low VSWR on all TV and FM bands.
3. Only one downlead is required (a JFD AC80 splitter is included so lead-ins can be run to VHF, UHF and FM set terminals).
4. Unique low-impedance twin crossarms (in place of usual crossed feeder harness) help effect maximum distribution of all VHF/UHF TV and FM signals without variance.

The JFD LPV-VU offers a host of new mechanical advances, too, such as the twin square aluminum crossarms, stainless steel terminals, oversized unbreakable Celanese "Fortiflex A" insulators, solid aluminum bus bar transformers—plus handsome, electrically-conductive gold alodizing.

Get the JFD LPV-VU from your local distributor today.

Why sell today's VHF/UHF/FM markets with yesterday's antennas? Rely on the JFD LPV-VU Log Periodic to make the sales others can't—in color, black and white, and FM stereo!

Model	Description	List
 LPV-VU18	18 Active Cells VHF—up to 175 miles UHF—up to 90 miles FM—up to 75 miles	69.95
 LPV-VU15	15 Active Cells VHF—up to 150 miles UHF—up to 90 miles FM—up to 60 miles	59.95
 LPV-VU12	12 Active Cells VHF—up to 125 miles UHF—up to 65 miles FM—up to 50 miles	49.95
 LPV-VU9	9 Active Cells VHF—up to 100 miles UHF—up to 40 miles FM—up to 40 miles	39.95

Write for brochure 701 for details regarding FREE N. Y. World's Fair trips for JFD Log Periodic dealers.

Whether the location calls for VHF...or UHF...or FM...or VHF/UHF/FM—there is a JFD Log Periodic antenna to suit your installation needs—perfectly.

JFD

JFD ELECTRONICS CORPORATION

15th Avenue at 62nd Street, Brooklyn, N. Y. 11219

JFD Electronics-Southern Inc., Oxford, North Carolina

JFD International, 64-14 Woodside Ave., Woodside 77, N. Y.

JFD Canada, Ltd., 51 McCormack Street, Toronto, Ontario, Can.

Copyright JFD Electronics Corp. 1964

— for more details circle 27 on post card

LICENSED UNDER ONE OR MORE OF U.S. PATENTS 2,958,081; 2,985,879; 3,011,168; 3,108,280 AND ADDITIONAL PATENTS PENDING IN U.S.A. AND CANADA. PRODUCED BY JFD ELECTRONICS CORPORATION UNDER EXCLUSIVE LICENSE FROM THE UNIVERSITY OF ILLINOIS FOUNDATION.

NEW TV and FM distribution designed specially



MODEL A-430
4-tube, 30 DB GAIN
distribution amplifier
\$84.95 list

Operates 1-50
TV-FM outlets,
100 with preamp.

3 New Winegard Distribution Amplifiers to Run 2 Sets, 200 or MORE



MODEL A-215
2-tube, 15 DB GAIN / general purpose TV-FM Amplifier
\$44.95 list

■ Provides 15 DB gain for home systems, small motels or apartment buildings. Drives up to 20 TV-FM outlets or line tap-offs . . . up to 40 with preamp. 30 volts AC is available by preamp switch at input jack to operate Colortron or Stereotron antenna directly from A-215 without extra power supply.

SPECIFICATIONS—Tubes: two 6HA5. **Gain:** +15db. **Bandpass:** 50-110MC, 170-220MC. **Response:** flat, ±.25db per 6 MC channel. **Noise Figure:** 3.7db lo-band, 5db hi-band. **Max. Signal Input:** 350,000 microvolts. **Max. Signal Output:** 2V. **Input Impedance:** 75 or 300 ohm. **Output Impedance:** 75 or 300 ohm. VSWR input and output better than 1.5 to 1. Two C-59 75 ohm connectors supplied. Blue Baked enamel perforated steel cabinet, 2 1/4 x 9 1/4 x 3 3/4". AC cord. **Switches:** On-Off; power to pre-amplifier. AC fuse. 117V 60 CPS 14 watts.

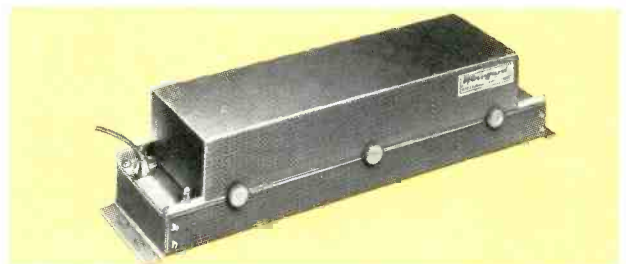

MODEL A-845
8-Tube, 45 DB GAIN/Distribution Amplifier \$159.95 list

■ For large hotels, motels, hospitals, schools and apartments. Operates 1-150 TV outlets, 300 sets with preamp. 30 volts available by switch at input jack for operating Colortron or Stereotron preamplifier directly from A-845 without extra power supply.

SPECIFICATIONS—Tubes: Six 6HA5; two 6DJ8. **Gain:** +45db. **Bandpass:** 50-110MC, 170-220MC. **Response:** flat, ±.25db per 6 MC channel. **Noise Figure:** 3.7db lo-band, 5 db hi-band. **Max. Signal Input:** gain control at max., .008V per band; gain control at min., .025V. per band. **Max. Signal Output:** 3.2V. **Separate Hi and Lo Band Gain Controls:** 0-10db; Separate hi and lo band tilt controls 3-6db. **Input Impedance:** 75 ohm. **Output Impedance:** 75 ohm. VSWR input and output better than 1.5 to 1. Blue baked enamel perforated steel cabinet. 2 1/4 x 14 1/2 x 3 3/4". AC cord. **Off-On switch.** AC fuse. 117V. 60 CPS 48 watts.

A COMPLETE LINE OF WINEGARD MATCHED DISTRIBUTION SYSTEMS

ANTENNAS

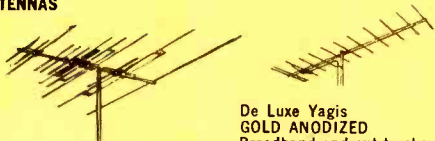

Colortron All-Channel Antennas
GOLD ANODIZED 4 models
\$24.95 to \$64.95.
Finest TV antennas made.

De Luxe Yagis
GOLD ANODIZED
Broadband and cut-to-channel.
Amplified or non-amplified.
High gain, rugged
construction, channels 2 to 13,
low band and hi band.

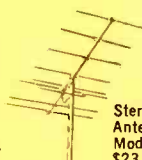

Stereotron FM
Antenna
Model SF-8
\$23.65
most powerful
FM antenna,
gold anodized.

ANTENNA PREAMPLIFIERS



Colortrons—twin nuvistors
300 ohm Model AP-220N,
\$39.95. 75 ohm
Model AP-275, \$44.95
Drive 1-6 sets



Red Head RD-300 transistor
preamplifier Drive
1-6 sets \$29.95



Stereotron Preamplifier for
FM. Twin Nuvistors Model
AP-320, 300 ohm \$39.95
Model AP-375, 75 ohm
\$44.95

system equipment by **WINEGARD** for the TV Service Technician

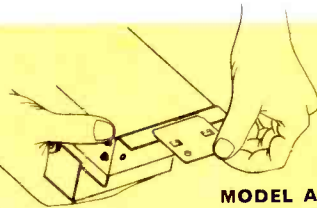
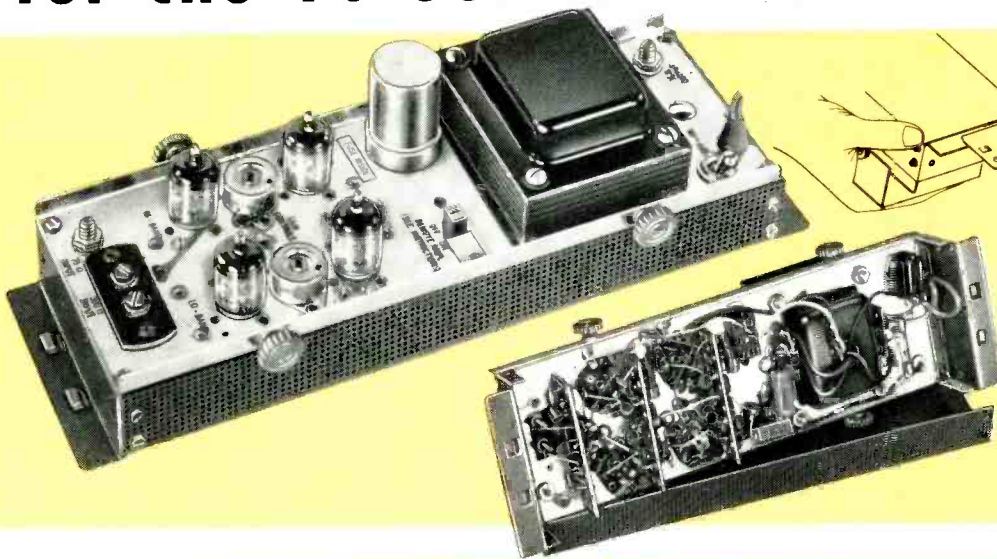

Exclusive wall hanger bracket for instant removal of amplifier.

MODEL A-430

SPECIFICATIONS—Tubes: four 6HA5. Gain: +30db. Bandpass: 50-110MC, 170-220MC. Response: ±25db per 6 MC channel. Noise Figure: 3.7db lo-band, 5db hi-band. Max. Signal Input: gain control at max., .02V. per band; gain control at min., .1V per band. Max. Signal Output: 2V. Separate Hi and Lo Band Gain Controls: 0-10db. Input Impedance: 75 or 300 ohm. Output Impedance: 75 ohm. VSWR input and output better than 1.5 to 1. Two C-59 75 ohm connectors supplied. Blue baked enamel fully ventilated perforated steel cabinet, 2 1/4" x 11" x 3 3/4". AC cord. Switches: OFF-ON; power to preamplifier. AC fuse. 117V. 60CPS 25 watts.

BEST DISTRIBUTION AMPLIFIERS MADE—HERE'S WHY

DESIGNED FOR COLOR AND FM STEREO

Flat frequency response, no phase distortion, full gain to top of FM band.

EASIEST TO SERVICE —

All jacks, controls, switches and connections accessible from top of chassis. Knurled thumb nuts for fast removal of dust cover.

LOWEST NOISE —

Only amplifiers made that use all high transconductance, low noise triodes—no pentodes.

FULLY VENTILATED TOP AND SIDES.

Perforated dust cover and chassis cover. Dissipate heat for extra long life.

EXTENDED BAND PASS —

Allows cascading without clipping in end channels.

With Winegard Equipment, any Good TV Technician Can Get Perfect Results with the First Installation

Winegard equipment has been engineered for the busy technician who doesn't have the time to do a lot of pre-planning and experimental work on the job. If you have been installing distribution systems, you will appreciate the way the engineering has been done in the factory to eliminate time on the job. If you haven't installed distribution systems, now you can get into this interesting, exceptionally profitable work in your area.

Every component of a Winegard distribution system is designed to match perfectly, from the antenna to the set... for installations in homes, apartment buildings, schools, hospitals, motels, hotels, trailer courts.

Practically every new public building today has a TV/FM distribution system, and systems are becoming standard equipment in new homes. You should be getting your full share of this profitable, interesting work. Winegard offers you the best equipment and free layout service. If requested, our engineers will be glad to check over your system or lay out a system for you. Same day attention will be given to your problems.

Example Winegard's Simplified System

For instance, an apartment house with 20 outlets; fringe area—stations 50 and 80 miles away—channels 3, 6 and 8 in 3 different directions.

Note the Winegard system uses only 4 major components to simplify the installation yet gives better performance as against other systems' use of 7 components.

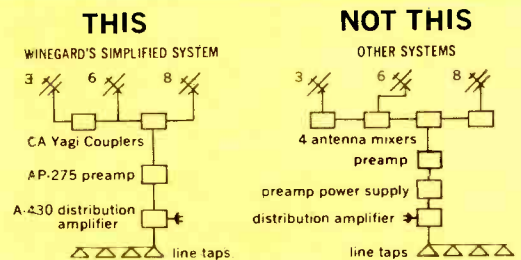

Write today for FREE Winegard layout guide and new book "How to Select and Use Master Antenna System Equipment".

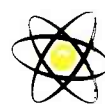

Winegard Co.

ANTENNA SYSTEMS

3019-1 Kirkwood, Burlington, Iowa

World's most complete line of TV & FM reception equipment.

ANTENNAS AND ACCESSORIES FOR EVERY INSTALLATION NEED

ANTENNA COUPLERS

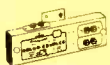

EC-230 Amplified 2 set Coupler Transistorized amplifies signal. \$17.95, 10 set, 6 set, 4 set and 2 set couplers for 2 to 10 TV or FM sets.



Yagi Couplers— Couple any combination of Winegard cut-to-channel or broadband yagis.



TV-FM Coupler— couples TV and FM antennas, also can be used to split TV-FM signals.

LINE TAP-OFFS, TV/FM OUTLETS, LINE DROP TAPS, SPLITTERS



Flush or surface mount line tap-offs. 75 and 300 ohm models.



TV-FM outlets for both flush and surface mount. Complete with outlet plugs— 10 models



Line Drop Taps— Drop branch lines from trunk lines. Split line 2 or 4 ways.

- Matching Transformers, . . .
- Pressure Taps,
- Attenuation Pads,
- TV-FM channel Traps.
- A complete line available for all purposes.

--- for more details circle 45 on post card

NEW PRODUCTS

fications. The 2000 series has all solid-state circuitry and is of modular construction, the announcement said. Optional accessories include a video line-driver amplifier or RF modulator, and a selection of fixed focal-length and zoom lenses. The camera may be operated from a 24 vdc source permitting mobile or "back-pack" operation. Kin Tel.



TUNER/AMPLIFIER 206

An 80-w FM stereo tuner/amplifier called the S-8000IV, features a powered center speaker channel. The integral channel permits direct connection of a center or third channel speaker system, or the addition of extension mono speakers in other rooms and no extraneous wiring or patching is needed and no external power source is required, the report said. A front-panel stereo headphone jack and a speaker disabling switch gives the listener complete control over his listening options. Specifications indicated a 1.8 μv (IHF) sensitiv-

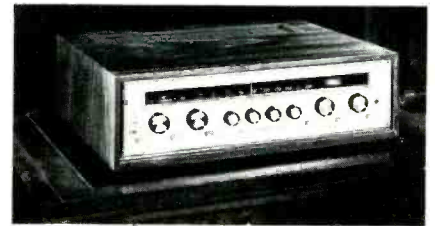

ity, 2.4 db capture effect and FM distortion of 1/3 percent at 100 percent modulation. Price \$329.50. Sherwood.

INDOOR ANTENNA 207

A self-contained product display package for the model PT-E promotional indoor TV antenna is an-



nounced. The cardboard display stand is 12½ x 14¼ x 3 in. Colors are yellow, bronze and red so that the display will stand out on any shelf, in the window or on a floor display, the announcement said. Snyder.

FM 'SEARCHER' 208

The "Stereo Searcher," LT87, designed for the large market of FM tuners using external stereo multiplex adapters, is easily connected between adapter and tuner, and provides an audible tone signal

More useful than ever!

ALL
New!
COMPLETELY
INTEGRATED

B&K

CRT 445

Checks and Corrects
B & W and COLOR
Picture Tube Troubles



THE INDUSTRY'S STANDARD

*Most Widely Used Today
by Professional Servicemen*

Includes all desired features. Does the job in a few minutes right in the home without removing tube from TV set.

**SAVES CUSTOMERS—ADDS SERVICE INCOME
MAKES NEW TUBE SALES EASIER**

Gives new life to weak or inoperative tubes. Checks for leakage, shorts, open circuits and emission. Removes inter-element shorts and leakage. Repairs open circuits and low emission. Restores emission and brightness. Life Test checks gas content and predicts remaining useful life of picture tube. Quickly pays for itself. Net, \$74.95

TESTS AND REJUVENATES

all picture tubes at correct filament voltage from 1 to 12 volts.

TESTS AND REJUVENATES

all Hi G-2 and Lo G-2 picture tubes, including tubes that require as low a G-2 voltage as 30 volts. Supplies all three necessary voltages: Hi G-2, Low-1 G-2, and Lo-2 G-2.

TESTS AND REJUVENATES

110° tubes and the new 19" and 23" tubes.

TESTS AND REJUVENATES

color picture tubes, including the new 90° 23" 23BG22. Checks and corrects each gun of color tube separately.

UP-DATE YOUR B&K CRT WITH THESE ACCESSORIES

Model C40 Adapter. For use with previous Models 400 and 350 CRT's— to test and rejuvenate TV color picture tubes and 6.3 volt 110° picture tubes. Net, \$9.95

Model CR48 Adapter. For use with previous Models 400 and 350 CRT's— to test and rejuvenate 110° picture tubes with 2.34, 2.68, and 8.4 volt filaments. Net, \$4.95

Subscribe to
New
Picture Tube
Information
Service

See Your B&K
Distributor,
or Write for
Catalog
AP21-T

B&K MANUFACTURING CO.
DIVISION OF DYNASCAN CORPORATION
1801 W. BELLE PLAINE AVE. • CHICAGO 13, ILL.
Canada: Atlas Radio Corp., 50 Wingold, Toronto 19, Ont.
Export: Empire Exporters, 253 Broadway, New York 7, U. S. A.

B&K

--- for more details circle 14 on post card

EVERYDAY EVERYDAY

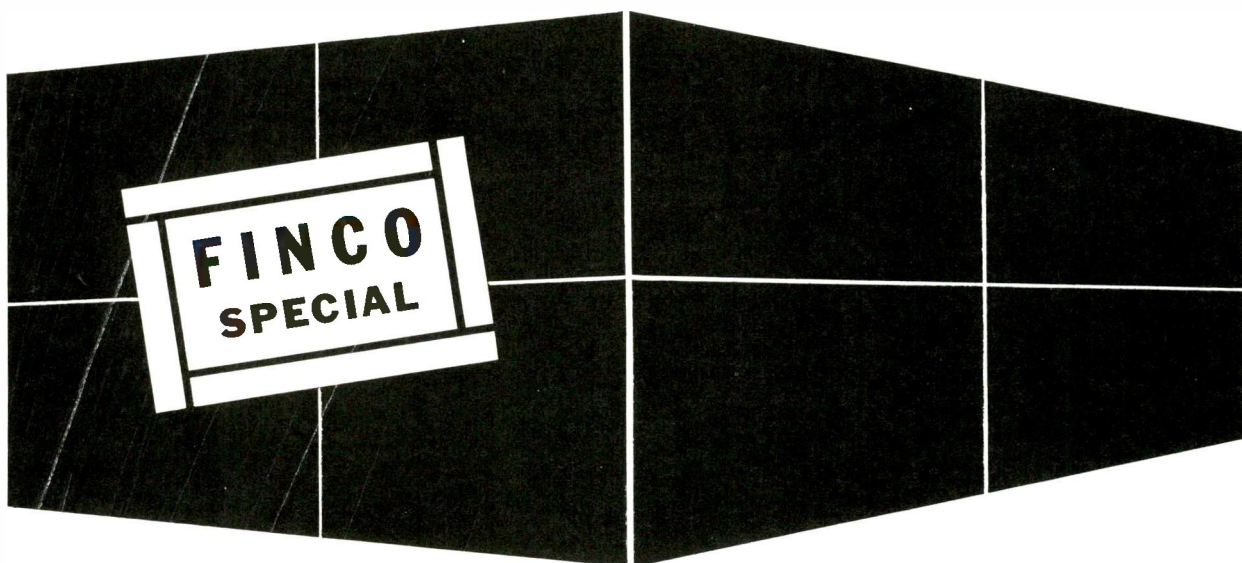

not just once a year,
FINCO designs and ships
a new "special area de-
sign" TV ANTENNA.
We've shipped 3,152
already. Each antenna
proved best in its own
area. Got a Finco Spe-
cial in your area? Want
one? See your Finco
distributor, or write us.

THE FINNEY COMPANY

Bedford, Ohio

COMPARE Degaussing COILS

**SAFE TO USE
NO EXPOSED
TAPE WINDINGS**



No. 2590

then buy WALSCO

- **MOLDED HI-IMPACT CASE LASTS A SERVICE LIFETIME**
- **SAFE TO USE • NO EXPOSED TAPE WINDINGS**
- **MOMENTARY SWITCH ELIMINATES DANGER of "LEFT ON" CURRENT**

Quality speaks for itself. See the only coil on the market with the hi-impact molded case, the case that eliminates any danger of electrical shorts or malfunction. Momentary switch couples convenience with safety. See it now. Ask your distributor about other WALSCO COLOR TV TOOLS and use the coupon to send for the catalog of the complete Walsco line.

WALSCO ELECTRONICS Co.
DIVISION OF GEC ELECTRON ELECTRONICS, INC.
LOS ANGELES 18, CALIF. ROCKFORD, ILL., U.S.A.

Send to Walsco, Dept. 37, 400 S. Wyman, Rockford, Ill.
 Send me the latest Walsco Catalog

NAME _____

ADDRESS _____

CITY, STATE _____

--- for more details circle 42 on post card

NEW PRODUCTS



through the speaker system for instant identification of a stereo FM station broadcast, the maker said. Single switch controls tone function. With connecting cable and instructions. Specifications. Tubes—6BE6, 1 diode. Size 2-11/16 x 3 x 9½ in. For 117 v, 50/60 cps ac. Price \$19.95. Lafayette.

CLEANER 209

A glass and plastics treatment compound, GTC-59, is announced. It cleans and degreases, leaves a



clear, lustrous, water-repellent and protective surface, cancels static fields which attract dust and dirt, keeps surface free from dirt build-up, and has excellent anti-fogging properties, the announcement said. It may also be used on enamel, chrome, stainless steel and most other smooth surfaces as well as glass and plastic. Available in 6 oz bottles, 16, 32 oz and one gallon cans. Also available in 55 gal drums. Beaver Labs.

UHF CONVERTER 210

A tunnel diode converter, the

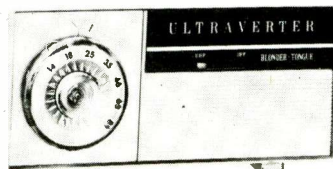

Ultraverter, model BTD-44, is announced. It is said to be the first converter to use a tunnel diode rather than transistors. With a single flashlight battery as its power supply, it operates as a cordless unit. Blonder-Tongue.

CCTV CAMERA 211

A low-cost CCTV camera, model AE-50, that operates through the ordinary home TV set as well as a



professional video monitor, is announced. The camera is a one-piece 9-lb transistorized unit. It has a built-in automatic light compensator and comes with a 25mm f/1.4 lens. Additional lenses are available for wide-angle viewing, telephoto or extreme close-ups. Price \$495. GBC America.

MINIATURE CLIP 212

A miniaturized insulated test clip for use with test leads has been announced. The model 1410M clip has been designed to reach hard-to-get-at areas in electronic chassis. Thoroughly insulated with nylon, the clip provides a practical solution for the protection of valuable

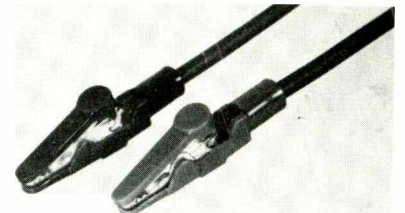

test equipment against accidental shorts or contacts with power leads, the report said. Made of cadmium-plated steel, these units meet or exceed all applicable military requirements and are available in either red or black, as pairs, or in single units, the announcement said. Industrial Devices.

SENSING/EXPANDER MODULE 213

A "sensing/expander" module for use with the Galaxy Series commercial-industrial amplifiers is an-



Quick cure for focus problems in color television sets

SYMPTOMS:

- The colors have become indistinct, smeared, or "washed out."
- You agree with the customer that it is impossible to focus the television receiver by normal controls.

CAUSE:

- Focus control has been lost because the selenium Focus Rectifier has "aged," upsetting circuit parameters.

CURE:

- The selenium Focus Rectifier must be replaced. To do the job, select a Sarkes Tarzian Type CTV650 silicon rectifier. Because these devices exhibit no aging characteristics, they will continue to deliver full performance for the life of the set.

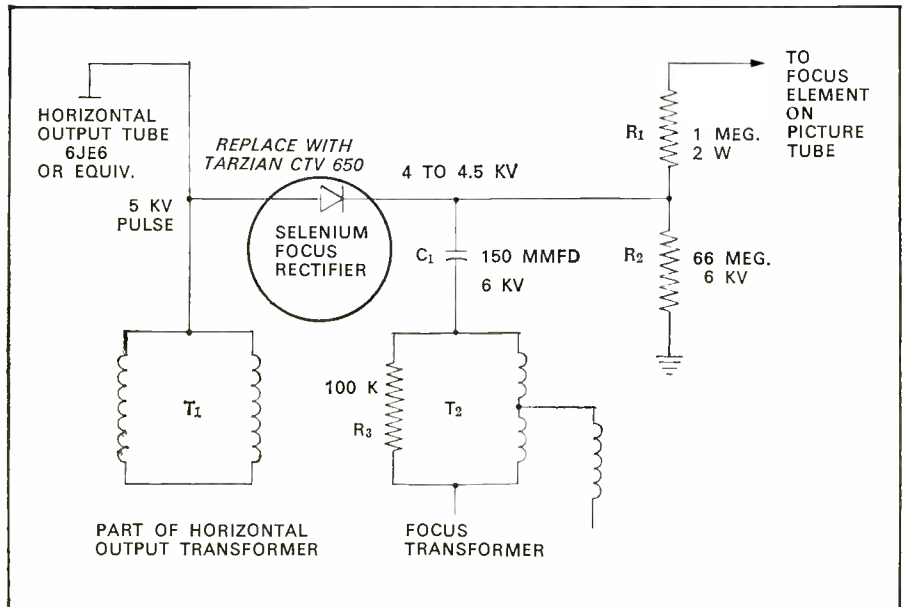

Insertion of Tarzian Silicon Rectifier CTV650 provides improved focus control for the life of the set.

Tarzian Silicon Rectifier Type CTV650 Is a Direct Replacement For:

Color TV Receiver	Part No.	Color TV Receiver	Part No.
Airline (Wells Gardner)	66X0035-001	Magnavox	530096-1
Dumont	1440977-1	Packard Bell	72110
Olympic	1440977-1	Philco	34-8053-2
RCA	1440977-1	Silvertone (Warwick)	86-44-3
Emerson	817123	Sylvania	16106-1
		Zenith	212-48

Tarzian CTV650 replacement rectifiers are available from your distributor.
List price for this life-of-the-set device is only \$8.35.

The complete Tarzian replacement line includes silicon rectifiers and conversion kits for a variety of electronic jobs, plus tube replacement silicon rectifiers and "condensed stack" selenium rectifiers. All are immediately available from distributors throughout the United States and Canada, in the quantities and ratings you want most. FREE CATALOG 63-SI-6 is crammed with 48 pages of interesting technical information and product specifications about Tarzian Silicon Rectifiers. Send for your copy today—be sure your files (and your shelves) are up to date on the rectifier line voted first choice among service technicians year after year.

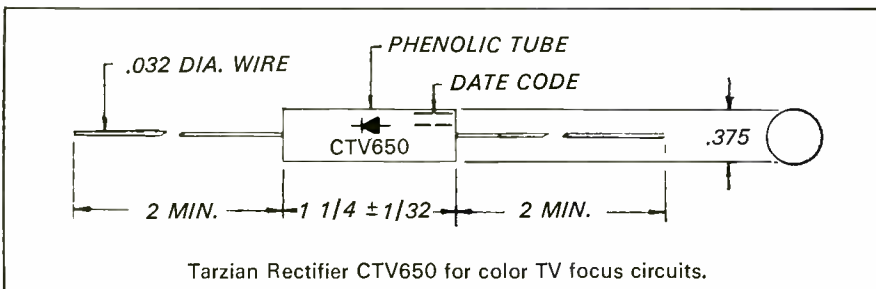

SARKES TARZIAN Inc.

World's Leading Manufacturers of TV and FM Tuners • Closed Circuit TV Systems • Broadcast Equipment • Air Trimmers • FM Radios • Magnetic Recording Tape • Semiconductor Devices

SEMICONDUCTOR DIVISION • BLOOMINGTON, INDIANA

Canadian Licensee: Marsland Engineering Limited • 350 Weber Street North, Waterloo, Ontario

... for more details circle 34 on post card

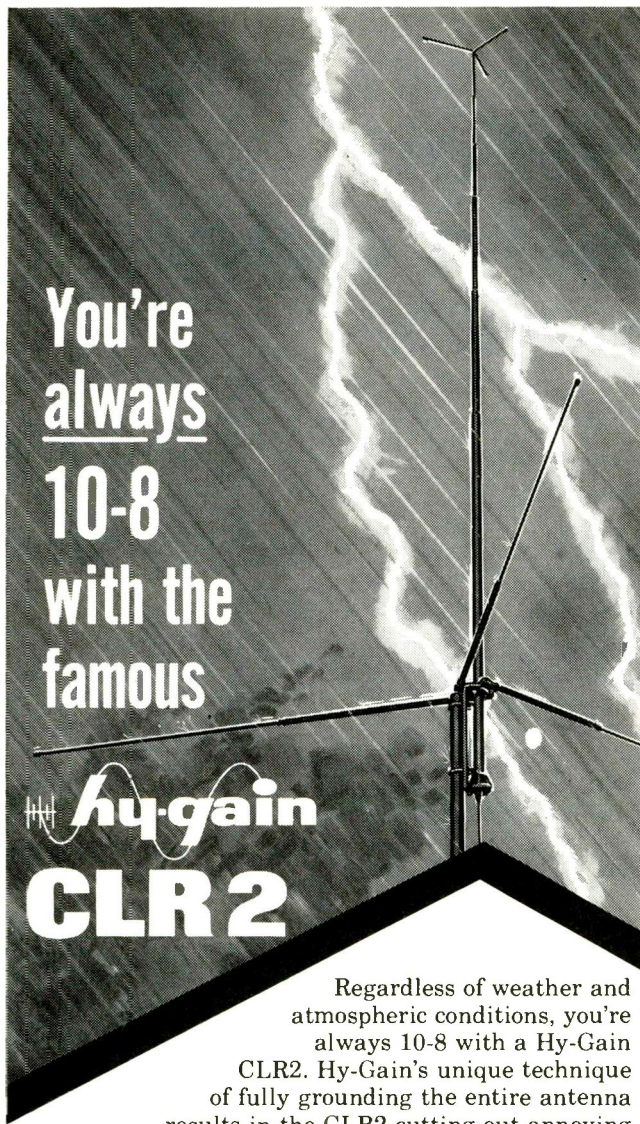

You're
always
10-8
with the
famous

Hy-Gain
CLR2

Regardless of weather and atmospheric conditions, you're always 10-8 with a Hy-Gain CLR2. Hy-Gain's unique technique of fully grounding the entire antenna results in the CLR2 cutting out annoying atmospheric noise and interference...even under the most severe weather conditions. Couple this noise and static-free performance with the stronger signal attainable from the CLR2's $\frac{5}{8}$ wavelength full signal-capture aperture radiator that concentrates the signal along the horizon and you're reading 'em loud and clear while others are forced off the air. The rugged construction of the CLR2 is also important during periods of violent weather...full circumference compression clamps provide an unshakable, vise-like joint between each length of taper-swaged seamless aluminum tubing used in the radiator and radials. The heavy gauge machine formed double-grip mast bracket gives unwavering support to the antenna. The solid state matcher and unique recessed feedpoint insure an uninterrupted flow of electrical energy. ■ If being on the air with a clear, strong signal in all weather is vitally important to you...or, if you just want the assurance you're using the finest omni-directional vertical antenna for Citizens Band...you'll want Hy-Gain's CLR2. **\$29.95 CB Net**



Get yours today from your favorite Hy-Gain Distributor. Ask for your free copy of Hy-Gain's 16-page catalog picturing and describing the finest and most complete line of antennas and accessories available for Citizens Band.

HY-GAIN ANTENNA PRODUCTS CORP.
8568 N. E. Highway 6 Lincoln, Nebraska

--- for more details circle 23 on post card

NEW PRODUCTS

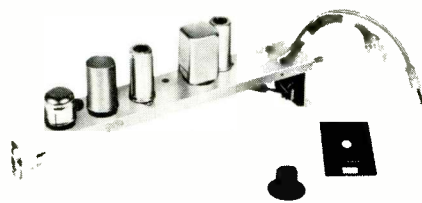

nounced. In addition to a normal program source pre-amplifier for low or high impedance microphone, the module incor-

porates a special expander section which when operating with a "sensing" microphone is designed to automatically adjust the sound output level of the entire sound system in proportion to a rise or fall in ambient noise. It is said the module will help solve the kind of problems that have long frustrated engineers and installers working with racetracks, airports, factories in heavy industry, arenas, etc. It serves to monitor the environment and imposes its intelligence upon the system, making the necessary adjustments as required. It makes possible a completely automated, unattended system in this respect. Harman-Kardon.

CCTV CAMERA

214

A self-contained CCTV camera and matching video monitor which has been designed for unattended operation is announced. The announcement said the model FLIC camera and FLS monitors are completely modular in construction and utilize the latest in circuit design. The camera is fully transistorized, is housed in a rugged extruded aluminum case and is fan cooled. The video monitors are available in sizes ranging from 8 to 27 in. The chain is capable of maintaining a horizontal resolution in excess of 800 lines, the report indicated. Finch.

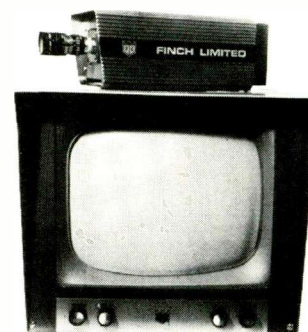

CB TRANSCEIVER

215

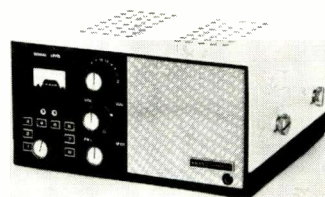

Two CB transceivers are announced. The D-333 is a fixed tuned unit with eight crystal controlled channels and the

D-333B offers eight crystal channels, external crystal socket, and a tunable receiver. A three stage noise limiter is said to provide optimum performance under the extreme noise conditions very frequently experienced on freeways, city streets and in industrial areas.

Color-TV servicing is profitable

GET THE MOST OUT OF IT WITH COLOR-TV TEST INSTRUMENTS FROM RCA—
PIONEER OF COLOR TV

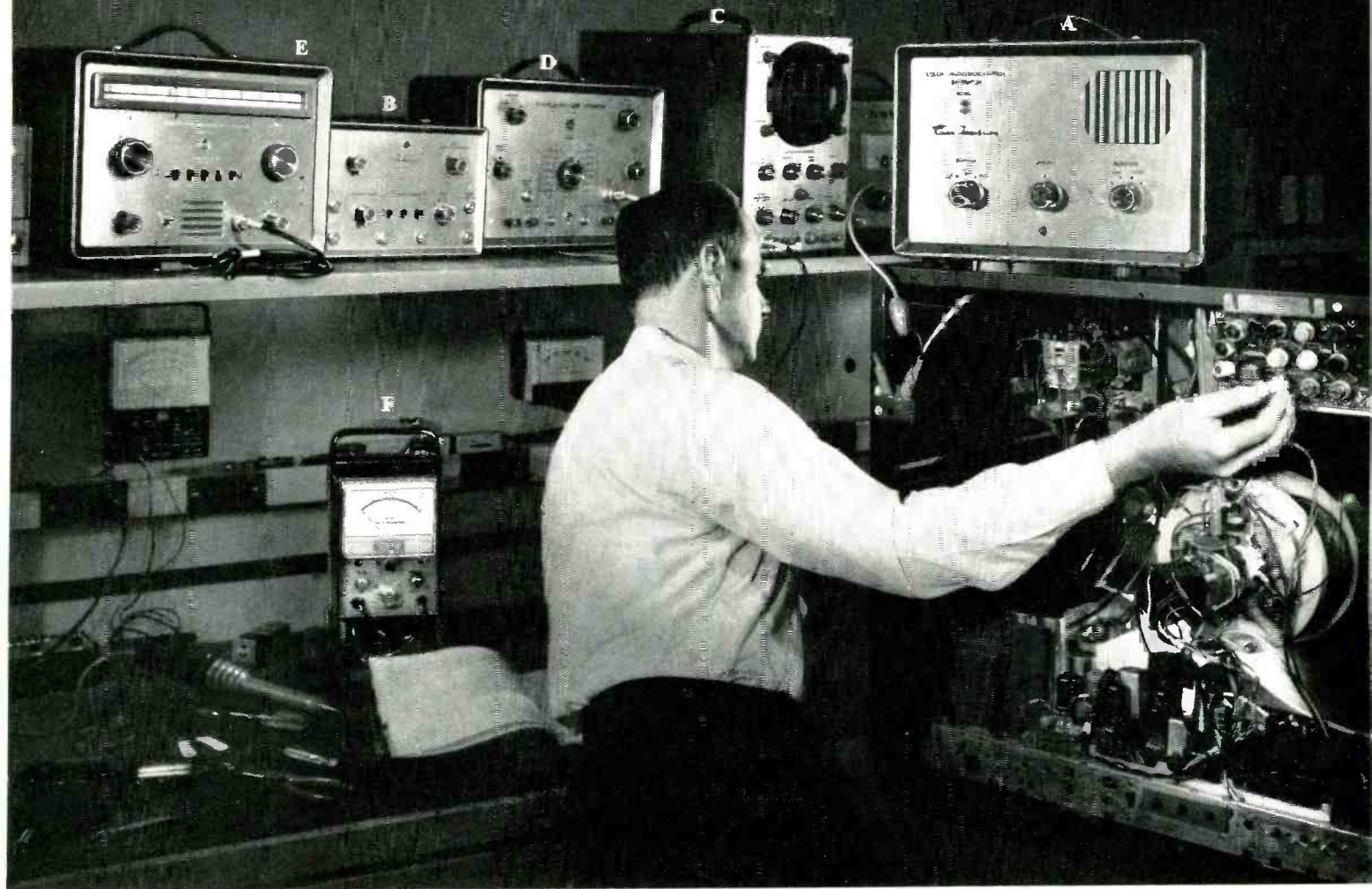

Making last-minute convergence adjustments on a color-TV receiver with an RCA WR-64A Color-Bar/Dot/Crosshatch Generator.

(A) RCA WR-64A COLOR-BAR/DOT/CROSSHATCH GENERATOR

Low-cost, lightweight, portable instrument that provides all essential Color-TV test patterns:

- *Color-bar pattern*: ten bars of color for checking phase and matrixing, and for automatic frequency and phase alignment.
- *Crosshatch pattern*: thin sharp lines for adjusting vertical and horizontal linearity, static and dynamic convergence, raster size, and overscan.
- *Dot pattern*: small dots to facilitate accurate color convergence.

\$189.50* with output cables

(B) RCA WR-70A RF/VF/IF MARKER ADDER

For use with a marker generator and a sweep generator. Used for RF, IF, and VF sweep alignment in color and B&W TV receivers.

- Choice of four different marker shapes
- Provides very high-Q markers of high amplitude and narrow bandwidth

\$74.50* complete with cables

(C) RCA WO-91A 5-INCH OSCILLOSCOPE

A wideband scope for checking colorburst signals and general troubleshooting.

- Dual bandwidth: 4.5 Mc at 0.053 volt rms/in. sensitivity; 1.5 Mc at 0.018 volt rms/in. sensitivity.
- Continuously adjustable sweep frequency range: 10 cps to 100 Kc

\$249.50* including direct/low capacitance probe and cable, ground cable, and insulated clip.

(D) RCA WR-69A TELEVISION FM SWEEP GENERATOR

For visual alignment and troubleshooting of color and B&W TV receivers, and FM receivers.

- IF/Video output frequency continuously tunable from 50 Kc to 50 Mc.
- Sweep-frequency bandwidth continuously adjustable from 50 Kc to 20 Mc on IF/Video and FM: 12 Mc on TV channels

\$295.00* including all necessary cables

(E) RCA WR-99A CRYSTAL-CALIBRATED MARKER GENERATOR

Supplies a fundamental frequency RF carrier of crystal accuracy for aligning and troubleshooting color and B&W TV receivers, FM receivers.

- Most-used IF and RF frequencies indicated on the dial scale
- Sound and picture carrier markers available simultaneously

\$256.50* complete with output cable and phone tip

(F) RCA WT-115A COLOR PICTURE TUBE TESTER

Designed specifically to test color-TV picture tubes, either in or out of the set. Tests each gun for emission quality, inter-electrode leakage and shorts.

- Large sensitive meter with separate 3-color scales
- Provision for accurate adjustment of cut-off point for each gun

\$89.50* with cable, carrying case and socket assembly



New RCA Color Pict-O-Guide is now available through Authorized RCA Electron Tube Distributors.

See them all at your Authorized RCA Test Equipment Distributor.

***Optional Distributor Resale Price**

All prices are subject to change without notice. Prices may be higher in Alaska, Hawaii and the West.



The Most Trusted Name in Electronics

ARE YOU IN THE TV SERVICE BUSINESS?

Here's a Calling Card that will guarantee customer satisfaction. While on your next service call, leave this MOSLEY calling card

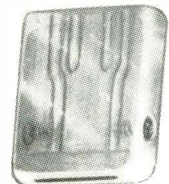

311



304

FAST * SIMPLE * SOLDERLESS

The MOSLEY 304 Input Adapter is an ideal connector for TV sets, boosters, etc. Just attach to the antenna terminal strip on chassis of TV and mate with the MOSLEY 311 Universal Transmission Line Socket.

THE FINISHING TOUCH FOR A LASTING IMPRESSION

The installation provides a handy plug-in antenna line for Customer Convenience!

A moment of your time, at a cost of pennys, will buy you a Public Relations job that Pays Off In

- * CUSTOMER SATISFACTION
- * REPEAT CALLS
- * REFERRALS

Send for your **FREE Mosley** Catalog. The one and only complete line of TV/FM accessories available on the market today!

Please send me your catalog containing the complete line of TV/FM installation accessories. ①

NAME
ADDRESS
CITY/STATE

Mosley ELECTRONICS, INC.

4610 NORTH LINDBERGH BOULEVARD
BRIDGETON, MISSOURI, 63044.

--- for more details circle 31 on post card

NEW PRODUCTS

Both models have a number of optional provisions, including tone squelch, remote control paging and transistor power supply. Price \$194.50 and \$229.50. Karr.

MOBILE ANTENNAS 216

Introduced is a line of 13 mobile radiotelephone antennas that can be lock-tuned by the user for peak



power. A patented feature of the new 'Band Spanner' W-600 line permits the selected antenna to be tuned simply and precisely to match the particular transmitter it serves, the announcement said. Ten models serve the low band business frequencies from 25 to 54 Mc including the 27 Mc citizens band and the 50-54 Mc 6 meter amateur band. Three models covering frequencies from 144 to 470 Mc serve the VHF region, the 2 meter amateur band, and the UHF business band. Webster.

AUTOMATIC TV CAMERA 217

Announced is a self-contained, transistorized and fully automatic TV camera which has a 12 Mc



bandwidth and transmits a picture with more than 650 lines of horizontal resolution, the announcement said. An on/off switch is the only external control, except a rear optical focusing knob (3 inches to infinity.) The power supply is self-contained for easy access and removal. Plug-in transistors and swing-out Fiberglas epoxy boards afford ease of maintenance. Price \$779.00. Packard Bell.

DISTRIBUTION AMPLIFIER 218

A high-low FM distribution amplifier, model LHD-404R, is announced. The unit is designed to feed low and high VHF and full FM signals into as many as four distribution lines with an output level of 50 dbmv at channel 13, it was reported. A matched single input terminal allows the unit to be fed from a directional coupler or

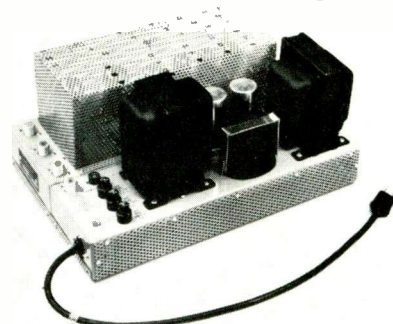

from the end of a distribution line—serving as either a bridging or a distribution line extender. Entron.

COLOR GENERATOR 219

A portable color generator for in-home as well as shop color TV set-up and servicing is announced.

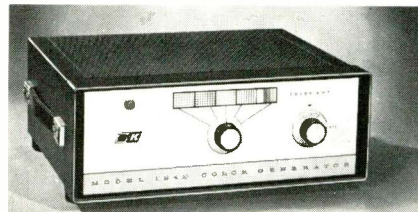

The model 1240 is designed for quicker, easier, more accurate convergence and color adjustment of TV sets, it was said. Specifications indicated that the instrument provides crystal-controlled keyed rainbow color display on TV screen, is designed for operation on channels 3, 4, or 5, and adjustable with out removing cabinet. No connection inside TV set is needed, the announcement said. B & K.

you get **PRODUCT PLUS** *from your Sylvania Distributor*

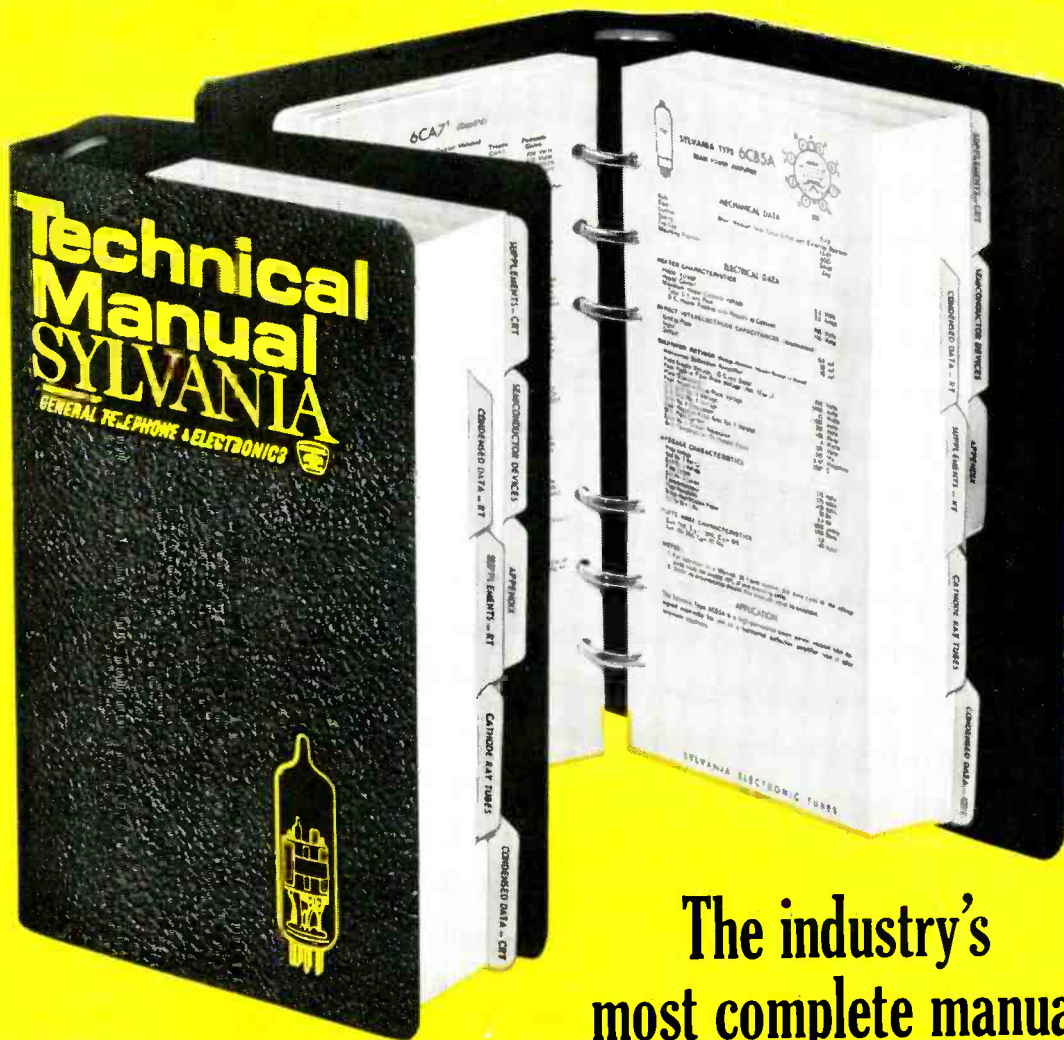

The industry's most complete manual

Even our non-customers say they can't do without it!

Sylvania's Technical Manual is still the most complete data source for up-to-date information on tubes... and has been since 1929. The current 12th Edition, for instance, will provide information on 2,225 tube types to more than 100,000 service men, technicians, dealers, distributors and other specifiers of tubes. (Incidentally, 2,225 is only the figure of the moment.) At periodic intervals, and at no extra charge, Sylvania mails supplementary data sheets to provide you with the latest information and insure that your Tech Manual is current.

Here are some of the other features you'll find in the manual's 700 pages:

- Data on Receiving Tubes, Cathode Ray Tubes, Semiconductor Diodes and Rectifiers, Special Purpose Tubes—all with complete characteristics.
- Picture Tube Interchangeability Guide
- European-American Receiving Tube Substitution Guide

- Semiconductor Diode Interchangeability Chart

- Master Index for quicker reference

All in a sturdy 9½" x 6½" 6-ring binder with tabbed dividers.

The cost for the industry's most comprehensive manual is only \$3.00. See your Sylvania Distributor. And don't forget to mail in the prepaid postcard for the free supplement service.

SYLVANIA
SUBSIDIARY OF
GENERAL TELEPHONE & ELECTRONICS **GTE**

NEW CAPABILITIES IN: ELECTRONIC TUBES • SEMICONDUCTORS • MICROWAVE DEVICES • SPECIAL COMPONENTS • DISPLAY DEVICES

NEW PRODUCTS

TV CAMERA

220

A transistorized broadcast system that gives a TV cameraman the mobility of a spectator when covering news events is announced. Called the "Newschief," the lightweight system includes a camera, audio and video transmitter, and a rechargeable battery pack. The transmitter and power units are



housed in a lightweight harness arrangement which is strapped to the cameraman's back—leaving the hands completely free. Sylvania.

A NEW CONCEPT IN COLOR TV ANALYZING PUTS YOU IN THE PROFITABLE COLOR TV SERVICE PICTURE AT A VERY LOW COST

Model 900 COLOR TV ANALYZER

- Checks color, video and picture tube circuits
- Checks the overall performance of color TV sets
- Provides for fast purity, convergence and gray scale tracking adjustments

Color TV set sales are booming all over the country! To help progressive servicemen get their share of the color service business Mercury has developed a highly efficient instrument based on an ingenious new engineering concept in color TV analyzing. The Model 900 Color TV Analyzer enables you to tackle color TV servicing in the home and in the shop with ease and confidence at a minimum cost.



FEATURES

- ✓ Makes all tests dynamically while color set is in operation
- ✓ Exclusive circuit eliminates need of range switches. Just set element selector and meter is automatically on right range
- ✓ Connects as easily as a picture tube brightener... no need to get under TV chassis
- ✓ Safety feature... circuit allows safe measurement up to 7000 volts on focus grid

See your electronics parts distributor or write for complete Mercury catalog

\$44.95 Slightly higher in the West

NEW

MAKE ANY ONE OF THESE TESTS IN MINUTES

- TEST each control grid voltage... indicates shorts or gas in each color gun
- TEST each color gun screen voltage and screen current... indicates trouble in power supply or boost circuits
- TEST focus voltage... indicates high voltage or horizontal deflection circuit trouble
- TEST each cathode voltage... indicates circuit trouble
- TEST each control grid emission current... indicates shorts or gas in each color gun
- TEST each color gun cathode emission... indicates dynamic quality of each color gun.

The Model 900 enables you to cut-out color guns in any combination and adjust for proper PURITY—CONVERGENCE—and GRAY SCALE TRACKING.

Mercury

ELECTRONICS CORPORATION

manufacturers of quality electronic products

111 Roosevelt Avenue, Mineola, New York

IN CANADA: R. C. Kohmert Sales Ltd., 359 Entorf Rd., Richmond Hill, Ontario

OUTLET BOX

221

A box with six outlets for simultaneous control of several appliances is announced. It incorporates a circuit breaker to protect the circuit fuse to which it is attached. A neon pilot light and a toggle switch both show whether current is on or off. The enameled steel cabinet is no larger than a cigar box and felt pads permit use on a finished surface without marring or injury, the re-



port said. Three models of the power outlet box are available. Prices are \$7.95 (Model 64), \$9.95 (Model 86) and \$17.95 (Model 87). E. M. Mfg. Co.

MICROPHONE

222

A noise-cancelling palm microphone, especially designed for CB and amateur radio use, is announced.



ed. Called the Model 202, the device is a ceramic type and features a noise-cancelling port in the top of its case that provides a sharp roll-off of the frequencies where background noise most seriously affects intelligibility, the report said. Shure Brothers.

BOOSTER AMPLIFIER

223

A booster amplifier, the 75BA, a 75-w amplifier, is announced. Specifications indicate a signal-to-noise figure of over 75 db and a full

UNIQUE "COMPONENT SYSTEMS"

THE VOICE  OF MUSIC
COMPATIBLE COMPONENTS



THE VOICE  OF MUSIC
COMPATIBLE COMPONENTS

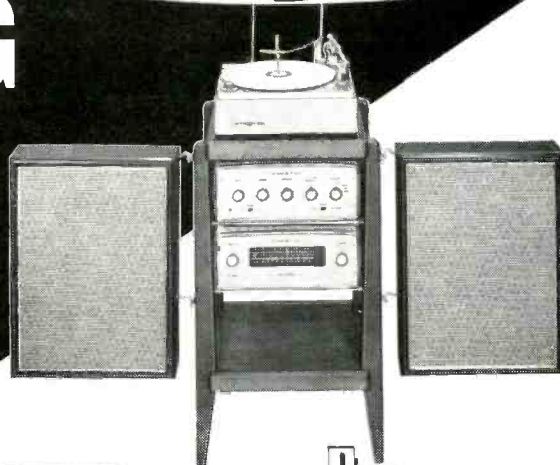

SELLING PLAN

THE VOICE  OF MUSIC
COMPATIBLE COMPONENTS

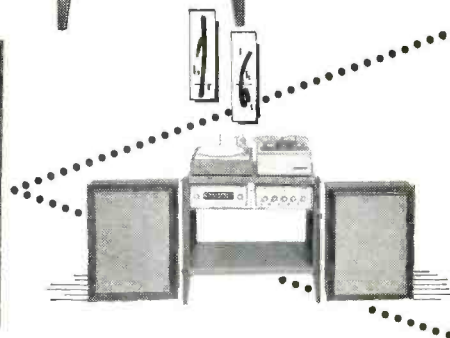

NEW, "2-way" Component Selling Centers in Fine Furniture Designs . . .

1. Sell V·M Compatible Component Systems **FIRST** . . .
2. Then go home with the buyer as choice furniture!



V·M has produced a new, easy to understand, full-color booklet telling how to select a component music system. Be sure to see this invaluable merchandising aid and learn how it can play an important part in building your component business.

Just look at all V·M has done to make your components selling easier and more effective! First, we designed three separate component selling and demonstration centers with one characteristic in common: each was created specifically to sell *complete V·M compatible component systems* . . . most acceptable to your customer, most profitable for you. Then, we designed them for effective step-up selling to help every salesman do a better job, more easily.

Finally, we planned these centers so V·M identification can be removed in a jiffy, and they are ready to go home with the customer to help you complete the sale. We had them

built to a fine-furniture standard of quality so they would be welcome anywhere . . . quality walnut is used throughout. What a closer! No need to ever discount when you have selling tools like these.

What's more you get the complete package of selling center and the components it contains for the price of the components alone! Fair enough?

Discover for yourself all the profit potential built into this unique "2-way" selling center plan . . . a telephone call is all it takes. And, we have two important new speaker systems to show you, too, designated Model 43 and Model 33. See them soon!

THE VOICE OF MUSIC®

NEW PRODUCTS

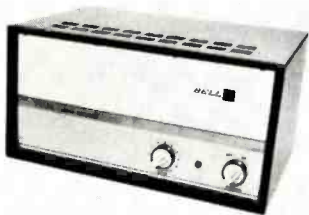

frequency response of 30 to 15,000 cps. A plug-in relay may be used

for remote control of ac power or standby operation. Hum and noise was listed as—80 db and sensitivity at 800 mv. Bell Sound.

GROMMET KIT 224

A vinyl grommet kit, 4209, has been announced. The kit features 260 vinyl grommets in six popular sizes, supplied in a plastic box with individual compartments for each size. A manufacturer's spokesman emphasized that the vinyl grommets offer many advantages over rubber grommets, including resistance to



oil, high dielectric properties and long life. The assortment includes grommets ranging from 1/8 to 1/2 in. hole diameter; 1/4 to 5/8 in. groove diameter. The kit price is \$3.25, through distributors. Waldom Electronics.



- Tests TV and Radio Tubes —both old and new
- Tests all Novars
- Tests Nuvistors, 10-pin Tubes, and 12-pin Compactrons
- Tests Voltage Regulators, Thyratrons, Auto Radio Hybrid Tubes, European Hi-Fi Tubes, and Many Industrial Types

B&K PROFESSIONAL QUALITY AT LOW COST

Model 600 Compact Portable Dyna-Quik Makes Tube Testing Quick, Accurate, Profitable!

It's amazing how quickly you can accurately check out tubes on every call—sell more replacements, and make more money—with this up-to-date, low-cost professional quality tube tester. Checks for all shorts, grid emission, leakage, and gas. Checks each section of multi-section tubes separately. Checks tube capability under simulated load conditions. Rejects bad tubes, not good tubes. Quickly reveals tube condition, saves customers, stops call backs, increases servicing profit.

Exclusive adjustable grid emission test. Sensitivity to over 100 megohms. Phosphor-bronze socket contacts.

Complete tube listing in handy reference index.

Handsome, sturdy leatherette-covered carry-case.

Size 8 1/2" x 11" x 4 1/2". Net, \$74⁹⁵



**QUICK, DIRECT, ERROR-FREE
READINGS WITHOUT MULTIPLYING**

Model 375
VTVM
Net, \$89.95



Model 360
VO Matic
Net, \$59.95

SHIRT POCKET RADIO 225

An 8 transistor miniaturized radio is announced. The model 6508 is 4 1/2 x 2 1/2 x 1 1/4 in. It is



said that new circuitry advances provide excellent pull-in power and exceptional tonal quality. It features 8 matched transistors plus 1 diode, a 2 1/4 in. PM speaker and a built-in ferrite antenna. Additional features include a vernier fine-tuning dial, sealed variable capacitor, cowhide carrying case with strap, and magnetic earphone with leather case for private listening. It operates on a standard 9-v battery. List price \$22.95. Channel Master.

MIKE MIXER AMPLIFIER 226

A four-channel all transistorized microphone mixer amplifier has been added to this public address equipment line. Designated the BE-M4, the mixer is designed to work with any existing PA Amplifier or booster amplifier to extend the input capability of the system.



See Your B&K
Distributor
or Write for
Catalog
AP21-T



B & K MANUFACTURING CO.

Division of DYNASCAN CORPORATION

1801 W. BELLE PLAINE • CHICAGO 13, ILL.

Canada: Atlas Radio Corp., 50 Wingold, Toronto 19, Ont.

Export: Empire Exporters, 253 Broadway, New York 7, U.S.A.

--- for more details circle 48 on post card

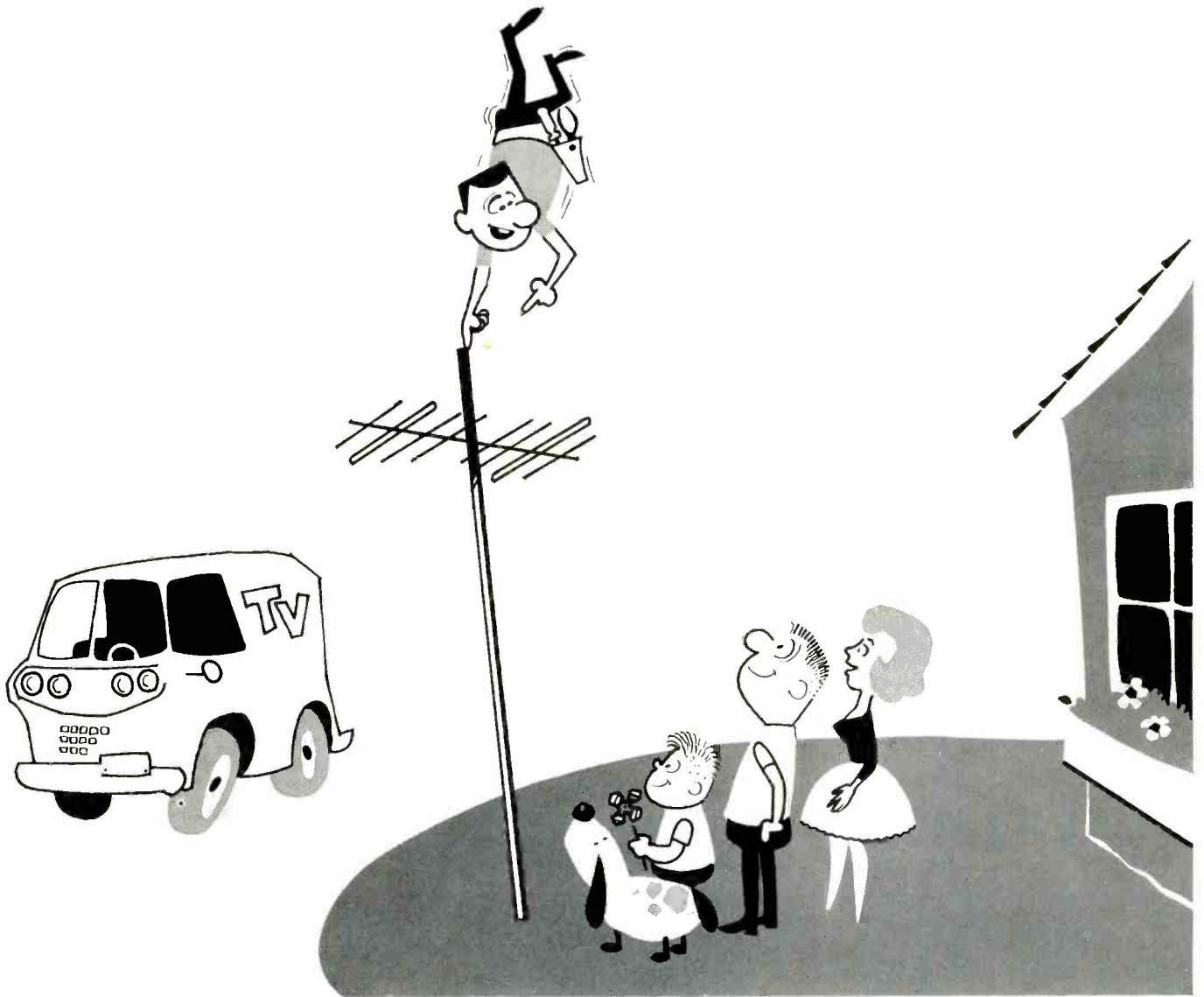

**You'll have a strong story to tell
when you sell TV masts of Armco ZINGGRIP Tubing**

Looking for TV masts and towers with features that will help you sell? Consider masts of Armco ZINGGRIP® Tubing. They're made of *strong steel* tubing. You can tell your customers how they stay aligned despite rough winter winds, snow loads. And show them the durable zinc coating that protects against rust, retains good looks.

Get names of manufacturers who make masts and towers of Armco ZINGGRIP Steel Tubing. Fill in and mail coupon.

Armco Division, Armco Steel Corporation
Dept. A-3074, P. O. Box 600
Middletown, Ohio 45042

Send me names of manufacturers who make TV masts and towers of Armco ZINGGRIP Steel Tubing.

NAME _____
 FIRM _____
 STREET _____
 CITY _____ STATE _____ ZIP _____



Armco Division

- - - for more details circle 12 on post card

NEW PRODUCTS

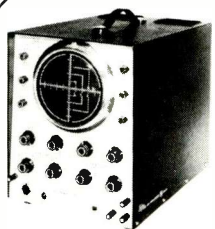

● CONVERGE ON YOUR TV PROBLEMS WITH TEST EQUIPMENT that has EXPERIENCE

Color bar-dot generator model 800

- EXCLUSIVE PUSH BUTTON PANEL - MAKES SEPERATE PATTERN OF COLOR SELECTION EASIER AND FASTER, CLEARLY MARKED FOR ERROR FREE SELECTION - STAND BY - ON-OFF - PATTERN - SOUND - CROSSHATCH - HORIZONTAL LINES - VERTICAL LINES - DOT PATTERN - EIGHT DIFFERENT COLORS
- CONVERGENCE IN 15 MINUTES - SIMPLE STEPS TO FOLLOW
- EASY TO SET UP - COLOR CODED CLIP-ON CONNECTIONS
- FRONT PANEL JACKS - ALLOWS EASY ACCESS OF VIDEO, SYNC OR COLOR DEMODULATOR SIGNALS
- VIDEO LEVEL CONTROL AND VIDEO OUTPUT JACK - PROVIDES EITHER POSITIVE OR NEGATIVE VIDEO INFORMATION
- COLOR GUN KILLER SWITCH - ALLOWS EASY SELECTION OF ANY COMBINATION OF 3 COLOR GUNS
- OPERATES ON TRANSFORMER - ISOLATED 117 VOLTS 50-60 CYCLE AC

DEALER NET \$239.95

5-inch wide-band high sensitivity oscilloscope model CRO-3

- WIDE BAND AMPLIFIER, FLAT WITHIN 1 DB FROM 20 CYCLES TO 4.5 MC
- TWO-RANGE VERTICAL DEFLECTION SENSITIVITY FROM 0.018 RMS VOLT PER INCH
- HIGHLY STABLE AMPLIFIER CIRCUITS - NO BALANCING REQUIRED
- POSITIVE OR NEGATIVE INTERNAL HORIZONTAL SYNC
- LINEAR SAWTOOTH SWEEP OSCILLATOR, 20 CYCLES THROUGH 50 KC
- INPUT CALIBRATING VOLTAGE, 10 VOLTS PEAK TO PEAK
- VERTICAL POLARITY REVERSAL
- HORIZONTAL SWEEP EXPANSION
- RETURN TRACE BLANKING
- Z-AXIS MODULATION - EXTERNAL OR INTERNAL 60-CYCLE
- DIRECT CONNECTIONS TO DEFLECTION PLATES WHEN REQUIRED

DEALER NET \$234.95

- ACCESSORY PROBES FOR THE JACKSON CRO-3
- LC2-1P LOW CAPACITY PROBE.....\$19.95
 - LC10P HIGH VOLTAGE LOW CAPACITY PROBE.....7.95
 - DEM-P DEMODULATION PROBE.....3.95



Jackson Electrical
Instrument Co.

124 McDonough St./Dayton, Ohio

--- for more details circle 26 on post card

It is said that the unit features a cueing facility on each microphone channel. Each microphone gain control can be pulled into the "cue" position and the VU meter may be switched to that microphone position, permitting the operator to adjust microphone levels and preview the sound, prior to switching it to the program line. It is fully-transistorized and is reported to have a response of 20 to 20,000 cps \pm 2db and requires only 5-w ac power for operation. Size is 3 x 10 x 15 in. Weight 9 pounds. Bell Sound.

BEAM PENTODE 227

A compactron beam pentode with a plate dissipation rating of 28 w and a separate beam plate connection has been registered for color television horizontal deflection service. The type 6JS6 is double-ended, with a plate top-cap. It measures only 1.56 in. in dia and



3.75 in. in seated height. It is said that the separate beam plate connection feature was designed principally to make it easy for TV receiver manufacturers to incorporate snivet-reducing circuitry. General Electric.

... COLOR DEMODULATOR

Continued from page 41
itself. This 3.58 Mc signal is our reference signal—or if you like—the signal that we applied to the second grid in Fig. 2 through 6.

It can be seen, therefore, that the color receiver must meet two requirements. First, since the color information comes in the form of two signals, we will need two de-

modulators. Secondly, since the color signals bear a fixed relationship to the 3.58 Mc subcarrier, and because this will be our reference signal, steps must be taken to maintain it in phase with the telecasting station subcarrier on which the color information is originally impressed. Otherwise, the outputs we obtain from the demodulators will be nothing like the original color intelligence telecast at the transmitter. In other words, a synchronous demodulator has to be synchronized. For this purpose, the burst signal transmitted along with the usual modulation consisting of about eight cycles of 3.58 Mc, is used.

As shown in Fig. 8, inputs to the second grids have been passed through phase shifting networks so each demodulator can work on its own axis. The upper frequency provides a voltage to drive the red kinescope grid and the lower one provides a voltage to drive the blue kinescope grid.

It should be kept in mind that although the inputs to the second grids have passed through a phase change, they will both retain a fixed relationship to the subcarrier because of the burst (or synchronizing) signal.

Inputs to the two first grids come from the bandpass amplifier. These signals are constantly varying in phase in accordance with the original modulation at the transmitter. The two tubes will now begin working in the same fashion as explained in Fig. 2 through 7. The voltage that drives the green kinescope grid is developed by mixing the correct proportions and polarities of the R-Y and B-Y outputs.

In practice, other phase angles may be used for demodulating and other tube types will be typical. But the basic principles remain the same and once the demodulator's action can be visualized, it becomes a lot easier to understand, adjust and troubleshoot. ■

... TINYVISION

Continued from page 41
reported already out with nine-inches. G-E's transistorized VHF/UHF portable was priced at \$159.95. It can be plugged into the cigarette lighter outlet on any automobile having 12 v batteries. It was urged, however, that such portables should be installed in the



“In our experience, advertising a service in the Yellow Pages brings in 5 times as many calls for that service,” says Del Short, owner, Del’s Appliance, Inc., Peoria, Illinois. **“The Yellow Pages ad for our new Television Service Department will be out soon, and we expect calls for TV repair to increase five times. New people in town go right to the Yellow Pages for appliance service—and those calls also lead to increased sales. We’ve grown so rapidly, we’ve had to move three times in six years. And Yellow Pages advertising has contributed to this growth—more than its share. I say advertising in the Yellow Pages is money well spent.”**



Display ad (shown reduced) runs under WASHING MACHINES, DRYERS & IRONERS. Call your Yellow Pages man to plan your program. Find him in the Yellow Pages under: ADVERTISING - DIRECTORY & GUIDE.

WASHING MACHINE SERVICE

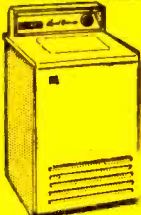

ALL MAKES
PHILCO — BENDIX
SALES — SERVICE — PARTS
PROMPT SERVICE
“AUTOMATICS A SPECIALTY”

PHONE
676-2106

DEL'S APPLIANCE, INC.
 1226 W. MAIN

--- for more details circle 10 on post card

EXCITING
NEW LINE!
EXCITING
NEW SOUND!



QUAM

FULL FIDELITY HI-FI SPEAKERS

Slim-line styling! Ceramic magnets! Superb reproduction over the full audio spectrum! Complete choice: coaxials, extended range, tweeters, woofers! The new Quam hi-fi line is as modern as tomorrow—and it's designed to offer the serviceman a top-quality product at a list price that's lower than others' "audiophile net." (Quam never advertises net prices—to protect your mark-up!)

Use Quam Hi-Fi Speakers in new systems, as extension speakers in existing hi-fi systems, and as replacement improvements in stereo consoles. They'll open your way to exciting new sales!

Write for your free copy of the new Quam Hi-Fi Catalog HF-64.

QUAM-NICHOLS COMPANY
234 East Marquette Road • Chicago, Ill. 60637

... for more details circle 32 on post card

auto's back-seat area and not up front if you would avoid trouble with city-and-state traffic officials. It is now obvious that the Japanese will no longer have tinyvision exclusively to themselves.

It was understood that Philco also had a 12-in. electron tube type portable in the works. Magnavox was reported on the market with a VHF/UHF 11-incher at around \$100. It was said that Admiral and G-E cut their VHF-only 11-inchers down below \$90 in the metropolitan New York market.

One thing is certain: TV-radio service-dealers and technicians will be servicing more toters — both color and B/W—in the months and years ahead.

For years ELECTRONIC TECHNICIAN has been beating the drums — urging technicians to up-date their knowledge of color and transistorized circuitry. We are still at it. The tempo is now more urgent. Tot-TVs and microelectronics are before us and an even higher level of knowledgeability is required. Get with it! ■

... ONE GUN CHROMATRON

Continued from page 45
affect the electron beam until *after* it has passed through the grids. Beam focus is affected only during the period while the beam is passing the distance separating the grids from the phosphor strips (0.5 to 1 in.). This arrangement creates a series of "electron lenses" around the grid wires—and the principle is sometimes called **post deflection focusing**.

No one can say definitely at this point what will happen with the Lawrence tube. But available information indicates that it will come into its own in the not too distant future and may make it possible to reduce the present cost of color TV sets approximately \$100. ■

... COLOR TROUBLE

Continued from page 53
Bob talked. Width, height and linearity seemed to be normal.

"Hey Bob, the focus control on this thing is on the bum. It acts like it's going to focus and then you reach the end of the pot."

"Which just goes to show that it pays to check the set out thoroughly. If you hadn't, chances

are good we'd have to bring the set back to the shop shortly after delivering it. Before you get all involved in circuitry, substitute those focus and high voltage tubes. Trouble's hard to catch on a tube tester and it may save you a lot of time."

Scot went to the end of the bench where the 'color only' tubes were kept. He took the necessary tubes and substituted them for the ones in the set. He switched the set on and waited for it to warm up. It came on as before. He turned the focus control but it still did not have sufficient range to focus properly.

"No luck," he announced. "It looks like the set is only half fixed after all. I hate to say it, Bob, but I'm stuck again. I don't know much about this circuit."

"You don't have to know anything about it to start with. What do you think I keep that manufacturers' literature file for? Get the manual out and look at what they say about the focus circuit. Or better yet, just look at the schematic and see what you can come up with. It will be good brain exercise."

Scot had pulled the manual out while Bob spoke and turned to the schematic. "Well, it has some voltages here. I'll start by measuring them and see if I can locate the trouble."

"Quite frankly, Scot, I wish you'd quit talking out loud and start talking to yourself. If you don't I'm afraid I'll never get this tape recorder finished."

"If that was a hint," Scot sneered, "it wasn't very subtle."

"It wasn't a hint, Scot, I'm telling you. If you took hints like you fix sets, I'd be hinting all day."

"OK, OK, I'll mind my own business."

Scot pulled the high voltage probe off the peg-board along the rear of the bench and attached it to the VTVM.

"Should read 25 kv," Scot predicted.

"Dammit, Scot, I mean it—all that mumbling's getting on my nerves."

"You're too touchy, Bob. Say, I only get 23 kv."

"That's about right for that set, Scot. Even though the schematic calls for 25 kv, you'll rarely ever see it. Besides, the regulator works quite well at anything over 22 kv."

1958...the RCA Radio-Phone Series

1959...the RCA Mark VII

1963...the RCA Mark VIII

and now 1964...

THE NEW RCA MARK NINE

the latest and greatest RCA CB radio of them all

Look at some of the new features...



NEW! Combination "S" Meter and Relative RF Output Meter

"S" Meter indicates the relative strength of incoming signal in "S" units. RF Output Meter (EO) indicates relative strength of the signal being transmitted.

NEW! Spotting Switch

Permits precise manual tuning of receiver without use of receiver crystals. Receiver can be tuned (or "spotted") quickly to any incoming channel. This means, when you buy crystals for extra channels, you can (if you wish) omit the RECEIVE crystals and buy only TRANSMIT crystals.

NEW! External Speaker Jack

Lets you connect an external speaker to the set, so incoming calls can be heard in remote locations.

RCA, a pioneer in the development of citizens' band radio, has been providing quality equipment since the inception of the Class D Citizens' Radio Service in 1958. Now, these years of experience culminate in the great new RCA Mark Nine.

Get all the Facts Before You Buy.
Mail Coupon Today. Paste on 4¢ Post-Card

- 9 fixed crystal-controlled TRANSMIT/RECEIVE channels, separately controlled
- All-channel continuously tunable receiver
- Illuminated meter and working channel indicator
- Push-to-talk ceramic mike with coiled cord

ONLY \$134⁷⁵*

AC UNIT

*Optional User Price



The Most Trusted Name in Electronics

RCA ELECTRONIC COMPONENTS AND DEVICES
Commercial Engineering Dept. H41-R
415 South Fifth Street, Harrison, N. J.

Please send more information on the RCA Mark Nine CB Radiophone

Name _____

Address _____

City _____ Zone _____ State _____

WE NOW OFFER THE BEST-FASTEST COLOR TV TUNER REPAIR SERVICE NATIONALLY ADVERTISED IN THE USA

24 HOUR SERVICE
VHF-UHF
All Makes



Personal Service

EACH TUNER COMPLETELY SERVICED BY AN EXPERIENCED TECHNICIAN

VHF TUNERS \$9.50
UHF TUNERS
UHF CONVERTERS NET

UHF-VHF COMBINATIONS \$17.95

Prices are for service and unutilized units. Missing, broken and damaged major parts, defective tubes charged extra at LOW net prices. We ship C.O.D.

FREE SURPRISE PACKAGE WITH EACH ORDER!

Useful in any TV shop or electronic lab—and are used in the manufacture of television, radio, hi-fi, stereo, phonographs

OUR GUARANTEED SERVICE INCLUDES:

All tuners mechanically and electronically inspected
 ● All necessary parts replaced ● Contact surfaces correctly cleaned and lubricated ● First test run for intermittents and drift indication ● Fine tuning range checked on all channels ● Local osc aligned to correct frequency all channels—XTAL controlled ● RF alignment—all channels—XTAL controlled ● AGC check, all channels—cut off of RF amp checked ● Overall response all channels, shield covers in position ● Quality control FINAL CHECK ALL UNITS. UHF-VHF

IMPORTANT: Ship complete. Include all broken parts. State model and complaint. Package well to avoid transit damage

JW ELECTRONICS PHONE 332-0665
P. O. BOX 51P BLOOMINGTON, IND.

--- for more details circle 28 on post card

"I notice a lot of that, Bob. Why do manufacturers always show such high voltages on their schematics?"

"They're not trying to trick you; with a new set in perfect condition, and with the specified line voltage, usually 120 v, you'll get pretty close to what they show in the specs. Of course, you have to allow 10 or 20 percent tolerance too, depending on the circuit. Most of the time our voltage here is about 115 so we have an automatic 4 percent handi-cap on our measurements.

Once again Scoot had penciled in the voltages he measured around the suspected tube. He scratched his head.

"I'm anxious to get back to good old black-and-white, Bob, how about a hand?"

"You're bound and determined to get that set out of the way before I finish the recorder aren't you? Where are you?"

"The thing seems to be working all right except the focus voltage is supposed to be 4.3 to 5.3 kv and I only get 4 at the highest end."

"Scoot, you're just plain lazy. It's only a bad voltage divider! Let's see, did you get the 870 v on the

bottom side of the divider from the boost voltage?"

"Just about. It was a little off, though."

"The next easy thing to do then is turn off the set and make a few resistance checks."

"I thought of that, but there aren't any on the schematic."

"You don't need any, Scoot. All we need to do is disconnect one end of these divider resistors and measure them."

Bob disconnected the wire between R144 and R146 (Fig. 2) and measured each of them with a VOM.

"There you are. Both of these units are way out of tolerance. They are supposed to be 18 MΩ jobs and they both measure about 12 MΩ."

"Boy, this sure has been a tough morning. I think I'll go out for coffee and a roll. I'd hate to get these resistors installed before you got that recorder finished anyway."

Bob grinned and shook his head as Scoot ducked out of the shop. One of these days, he thought, Scoot would make a good TV man. That is, when he started to think for himself.



service faster with Fast-Fax

Raytheon Fast-Fax puts tube data for 600 types right at your fingertips. Stays up-to-date with "pop-in" supplements (including new types in '65 sets). Operates as an interchangeability guide and inventory control. See it at your Raytheon Distributor. You'll wonder how you ever got along without it. Fast-Fax. Only \$3.95.



Keep Your Copies of ELECTRONIC TECHNICIAN

In This Attractive Binder For Quick Easy Reference

This durable, attractive hard cover binder makes a handsome addition to your book shelf and lets you refer past issues of ELECTRONIC TECHNICIAN, quickly and easily. Note these outstanding features:

- Long-wearing, leather-like cover and back
- Attractive gold leaf embosses
- Handles like a book, just open cover turn to any page, any issue
- Magazines held firm, kept neat and clean
- Holds a full two year's copies
- Binders come with a money back guarantee

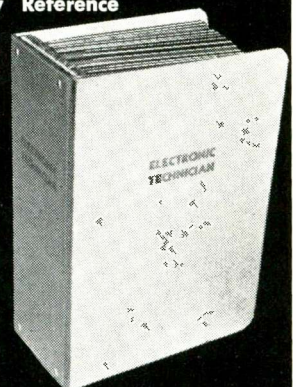

This handsome book binder is especially designed to help you keep your copies of ELECTRONIC TECHNICIAN handy for the fast reference. To order just fill out the coupon below and mail to:

ELECTRONIC TECHNICIAN, Reader Service Dept., Ojibway Building
Duluth, Minnesota 55802

Please send me book binders at \$4.95 each

I enclose \$.....

Name

Address

City Zone..... State.....

I understand that these are fully guaranteed and if I am not satisfied I can return the binder and have my money refunded.

ELECTRONIC TECHNICIAN



Marketing figures should be extrapolated in terms of flesh-and-blood statistics according to Charles E. Beck, president, Philco. "Next year," he says, "there will be 57.2 million U. S. households. By 1970, this will increase to 62.0 million and by 1980 to 73.6 million. We're tailoring our product and merchandising approaches to appeal to and sell this growing young market. We don't look upon these facts as dry statistics—they're living, breathing, happy customers—with money to spend!"



Space age tools have now become a reality. The first power tool designed and built specifically for an astronaut's use in space has been demonstrated. The

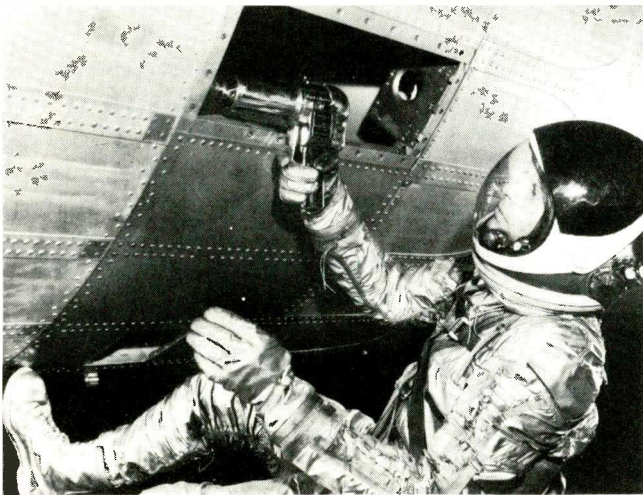

tool, which has near "zero reaction," may also have important earthbound commercial applications. It was developed for the Air Force Research and Technology Division's Aero Propulsion Laboratory by space engineers at Martin Company and power tool engineers of Black & Decker Manufacturing Co. It can be used as a drill, wrench, screwdriver, grinder or thread tap by a simple change of attachments. It has 96 percent less reactive torque than a comparable power wrench in use today, the report said.



Marine electronics repair begins early in March for many parts of the country and it's too late to get started now. But this is a good time to get down to the boat club docks and see what kind of equipment is in use and find out what problems boaters in your area are having. With this information under your hat, you'll be ready to start swinging early next spring.



Trade associations are explained in a booklet titled "Your Answers About American Trade and Professional Associations." The booklet is free for the asking. Requests should be directed to American Society of Association Executives, 2000 K St., N. W. Washington, D. C., 20006.

Communications, mobile radio...

A First Class FCC License

...or Your Money Back!

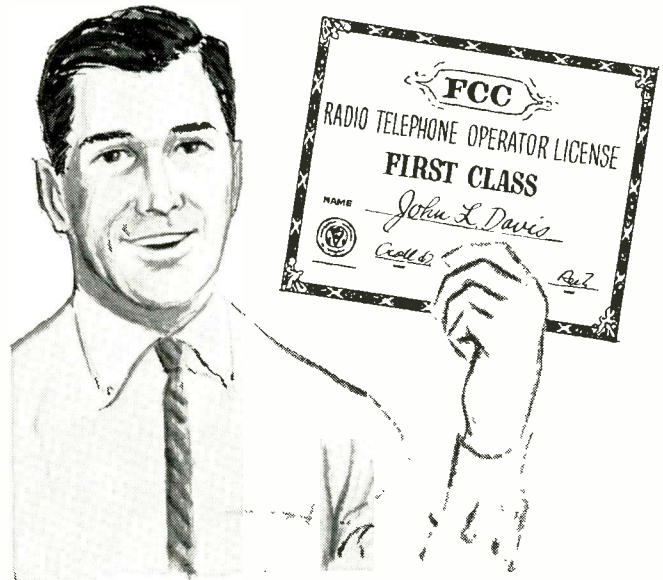

Your key to future success in electronics is a First-Class FCC License. It will permit you to operate and maintain transmitting equipment used in aviation, broadcasting, marine, microwave, mobile communications, or Citizens-Band. Cleveland Institute home study is the ideal way to get your FCC License. Here's why:

Our training programs will *quickly* prepare you for a First-Class Commercial Radio Telephone License with a Radar Endorsement. Should you fail to pass the FCC examination after completing your course, you will get a *full refund* of all tuition payments. You get an FCC License . . . or your money back!

You owe it to yourself, your family, your future to get the complete details on our "proven effective" Cleveland Institute home study. Just send the coupon below TODAY. There's no obligation.

Mail Coupon TODAY For FREE Catalog

Cleveland Institute of Electronics

1776 E. 17th St., Dept. ET-9
Cleveland, Ohio 44114

Please send FREE Career Information prepared to help me get ahead in Electronics, without further obligation.

How to Succeed in Electronics

CHECK AREA OF MOST INTEREST—

- | | |
|---|--|
| <input type="checkbox"/> Electronics Technology | <input type="checkbox"/> First Class FCC License |
| <input type="checkbox"/> Industrial Electronics | <input type="checkbox"/> Electronic Communications |
| <input type="checkbox"/> Broadcast Engineering | <input type="checkbox"/> Advanced Engineering |

Your present occupation _____

Name _____ (please print) Age _____

Address _____

City _____ State _____ Zip _____

Accredited Member National Home Study Council

NEW PRICES from **QUIETROLE**



the oldest, most widely proved and sold radio and TV lubricant

- | | |
|---------------------------------|-------------|
| 2 oz. bottle with dropper | LIST \$1.49 |
| 4 oz. bottle | LIST 2.54 |
| 4 oz. bottle (brush-n-cap) | LIST 2.64 |
| 8 oz. bottle | LIST 5.07 |
| 6 oz. spray can — with extender | LIST 2.79 |
| 3 oz. spray can — with extender | LIST 1.79 |



Quietrole is your guarantee of the most effective, quick silencer of noisy radio and TV controls — the quality product that is a top value. Get Quietrole at quality jobbers. Some territories still available for experienced representation.



--- for more details circle 33 on post card

WANTED

Harold William Lakeman is sought by the FBI as a fugitive on a charge of rape. He allegedly



Harold William Lakeman

raped a thirteen year old girl on the evening of July 9, 1958 in Lexington, Massachusetts.

Lakeman, who is pictured here, fled the Boston area and his car was located abandoned on July 23, 1958, at Rocky Hill, Connecticut. The fugitive has worked as a stock clerk and cleaner for a bus company and as a messman in the U.S. Merchant Marine from 1942 to

1945. Prior to Lakeman's flight from the state of Massachusetts, his occupation was that of a television repair man and he was formerly a partner in a television repair business.

Lakeman is a white American, born October 24, 1923, at Lynn, Massachusetts, is 5 ft 8 in., weighs 176 lbs, has blue eyes and brown hair. He has a small scar on the bridge of his nose.

Any person who can furnish information concerning Harold William Lakeman's whereabouts is urged to immediately notify the nearest office of the FBI. The number may be located on the first page of the telephone directory.

No action should be taken which would in any way endanger an employee or member of the public.

MOVING?

Be sure to let us know your new address. Please enclose a complete address label from one of your recent issues.

Me...? Rebuild Color Tubes???

Why Not!

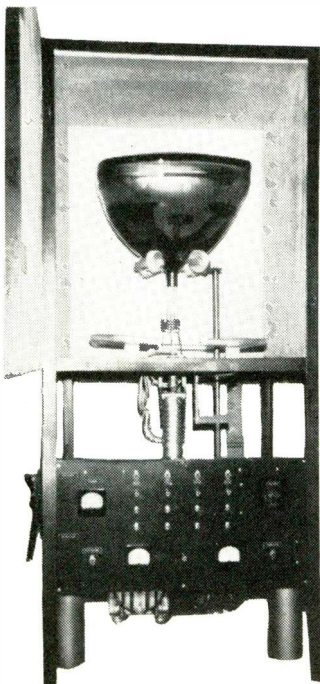

Windsor Equipment Handles Color & Bonded-Face As Well As Black-and-White Tubes.

So What?

Rebuilding with Windsor is a **QUALITY PROCESS . . . and PROFITABLE !!!**

Rebuild Color Tubes for a Cost of \$11.75 each ... You Sell them for???

Windsor Equipment pays for itself in a few months.

Financing Available
Free Training at our Plant

Write for our Booklet "The Open Door to TV Profits"

WINDSOR ELECTRONICS, INC.

Equipment Division
999 N. Main St., Glen Ellyn, Illinois

--- for more details circle 44 on post card

FOR MORE INFORMATION

CIRCLE THE NUMBER ON THE READER SERVICE POST CARD LOCATED AFTER PAGE 10

ANOTHER GREAT ADDITION TO THE
FAMOUS SERIES OF B&K ANALYSTS

SIMPLIFIES AND SPEEDS TV SERVICING

NEW!



Compact Model 1074 TELEVISION ANALYST FOR BLACK & WHITE and COLOR



Provides Thinnest
Horizontal Line and
Smallest Dot Patterns
(one scanning line high)
for Easiest Convergence



Dot Pattern



Crosshatch



Vertical Lines



Horizontal Lines

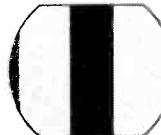

Color Pattern

Here is an exciting new addition to the famous B&K series of Television Analysts—*designed to give every service technician a faster, easier way to service more TV sets!*

The compact "1074" gives you a complete TV signal generating source of your own. Using the B&K *point-to-point signal injection technique*, you can isolate and pinpoint any performance problem for quick correction.

By injecting your own signals, with a visual check on the TV screen, *you can easily signal-trace and troubleshoot any stage* throughout the video, audio, r.f., i.f., sync and sweep sections of black & white and color television sets.

It becomes much easier to find and fix "tough dogs," and troublesome intermittents, as well as to solve other general TV set troubles—to the satisfaction of your customer, and to your own profit. Net, \$24995

Supplies complete r.f. and i.f. signals, with pattern video and tone audio. Video signals are switch selected for fast, visual troubleshooting. Provides FM modulated 4.5 mc sound channel, with built-in 900 cycle tone generator. Provides composite synchronizing signals. Provides separate vertical and horizontal plate and grid driving signals to check complete output circuit and interrelated components. Many other features.

Makes it Easy to Set-up and Service Color TV

Provides dot pattern, crosshatch, vertical lines, horizontal lines, burst signal and individual colors (Green, Blue, B-Y, R-Y, Red, I, and Q) one at a time on the TV set—all crystal controlled for maximum accuracy. Color phase angles are maintained in accordance with NTSC specifications. Thin lines and high stability assure fastest, easiest convergence and linearity adjustments. Color display makes demodulator alignment extremely simple.

Time-Saving, Money-Making Instruments Used and Preferred by Professional Servicemen Everywhere.



Model 375 Dynamic Automatic VTVM



Model 360 V O Matic Automatic VOM



Model 700 Dyna-Quik Tube Tester



Model 850 Color Generator



Model 445 CRT Tester Rejuvenator

See Your B&K Distributor
or Write for Catalog AP21-T



B&K MANUFACTURING CO.

DIVISION OF DYNASCAN CORPORATION

1801 W. BELLE PLAINE AVE. • CHICAGO 13, ILL.

Canada: Atlas Radio Corp., 50 Wingold, Toronto 19, Ont.

Export: Empire Exporters, 253 Broadway, New York 7, U.S.A.

• - - for more details circle 49 on post card



Actual Size
*Only 5/8 inches long...
 Extends just 29/32 inch
 behind front of panel*

BUSS Space Saver Panel Mounted Fuseholder

- Fuseholder takes 1/4 x 1 1/4 inch fuses. Converts to 9/32 x 1 1/4 inch fuses simply by changing screw type knob. Holder is rated at 30 ampere for any voltage up to 250.
- Also available in military type which meets all requirements of MIL-F-19207A.

BUSS

Write for BUSS
 Bulletin SFH-10

BUSSMANN MFG. DIV., McGraw-Edison Co., ST. LOUIS, MO. 63107

presentations in 25 sessions. Twenty of the sessions are scheduled for the morning hours August 25, 26, 27 and 28, and will be presented five-at-a-time at the Statler Hilton Hotel in Los Angeles. The remaining five are all special, invited sessions on key technical topics. They will be presented one each afternoon and one on Wednesday evening, the report said. Special sessions will cover "Microelectronics—The Needs, the Approaches, and the Potentials"; "Instrumenting the Sea Floor—Why and How"; "Extra High Voltage Direct Current Transmission"; "Information Sciences"; "Apollo Electronics—Design and Present Status."

Transistors Emphasized

Philco Corp. introduces its first completely all-channel (UHF/VHF) TV line and a phonograph line that emphasizes transistorization before about 5,000 persons in Radio City Music Hall. Dealers and distributors attending the "World's Fair" convention got a look at some products of the future, including a 9-in. transistorized TV set.

Polytronics Acquires Osborne

Polytronics Laboratories, Inc. reports the acquisition of Osborne Electronics Corp. of Hawthorne, Calif., John Doremus, president, stated in a letter to stockholders. Polytronics manufactures the Poly-Comm line of communications equipment. The entire facility has been moved to the Polytronics plant in West Caldwell, New Jersey.

BUSS: 1914-1964, Fifty years of Pioneering...

NEWS OF THE INDUSTRY

Color Sales Up

Orders received recently by Admiral Corp. for the new line of color TV receivers were the highest ever booked by the company, Ross D. Siragusa, Jr., vice president-marketing and sales, announced.

Castle Moves

Castle TV Tuner Service has moved its East Coast plant from Cliffside Park, New Jersey to 41-98 Vernon Boulevard, Long Island City, New York. Located at the foot of the Queensboro Bridge, Castle's new facilities are easily accessible to all New York City area technicians.

More Color Showing

Admiral introduces 20 new color TV receivers in the 1965 line, highlighted by six models with "sonar" wireless remote control, and by six solid state stereo theatre combinations with all-transistor AM/FM tuner, pre-amplifier and stereo amplifier.

Wescon Technical Program

Wescon recently revealed its 1964 technical program plans as outlined in a four-day schedule of 106

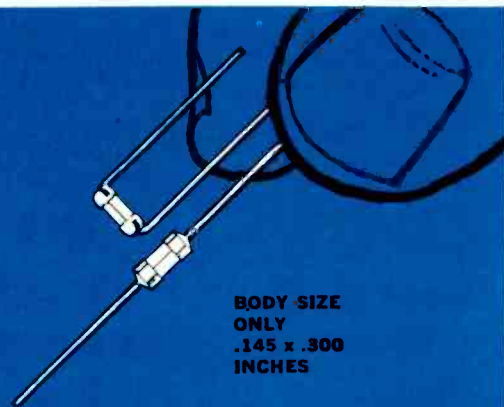

**BODY SIZE
 ONLY
 .145 x .300
 INCHES**

BUSS Sub-Miniature PIGTAIL TRON FUSES

Use Tron fuses where space saving is vital—on miniaturized devices—or on gigantic multi-circuit electronic devices.

Hermetically sealed for potting without danger of sealing material affecting operation. Extreme high resistance to shock or vibration. Operate without exterior venting.

BUSS

Write for BUSS
 Bulletin SFB

BUSSMANN MFG. DIV., McGraw-Edison Co., ST. LOUIS, MO. 63107

... for more details circle 16 on post card
 ELECTRONIC TECHNICIAN



**GMW FUSE
AND HWA
FUSEHOLDER
FUSE SIZE
ONLY .270 x .250
INCHES**

BUSS

**Sub-Miniature
FUSE-HOLDER COMBINATION**

Light-weight, protective device for spacetight applications. Fuse has window for inspection of element. Fuse may be mounted alone or used in holder.

Holder can be used with or without knob. Knob makes holder water-proof from front of panel.

Military type fuse FM01 meets all requirements of MIL-F-23419. Military type holder FHN42W meets all military requirements of MIL-F-19207A.

BUSS

Write for BUSS
Bulletin SFB

BUSSMANN MFG. DIV., McGraw-Edison Co., ST. LOUIS, MO. 63107

National Alliance of Television and Electronics Service Associations (NATESA). Philco was cited for its continuing cooperation with independent service-dealers and technicians.

Blonder Views CATV

"Community antenna operators will survive only if they apply for and operate the UHF stations in their areas, rather than compete with broadcasters assigned to their territories," said I. S. Blonder, chairman of Blonder-Tongue Labs, in a speech before the 13th annual convention of the National Community Television Association (NCTA). Mr. Blonder appeared on a panel with FCC Commissioner Robert E. Lee.

New Simpson Office

Simpson Electric Company announces the opening of a west coast sales office to service distributors and industrial accounts in Southern California and Arizona. The office will be located at 205 Pasadena Avenue, South Pasadena, California.

NAB for CATV Legislation

The Television Board of Directors of the National Association of Broadcasters (NAB) voted recently to seek congressional legislation which would give the Federal Communications Commission authority to regulate all forms of community antenna television systems. The legislation would be for the purpose of providing for the operation of CATV systems solely as auxiliary and supplementary broadcast services.

...New Developments in Electrical Protection

Broadcast Goes Portable

The newest and most sophisticated electronic TV equipment available today—compact and completely transistorized—will help ABC News provide flexible, thorough coverage of the national political conventions, Frank Marx, president of ABC engineers, reports. A lightweight, self-contained "television station," a portable, self-contained video tape unit and microwave transmitters and receivers are among the new equipment that will spearhead ABC's coverage at remote and studio locations, he said.

NATESA Convention

The National Alliance of Television & Electronic Service Associations' (NATESA) 1964 convention is scheduled to be held at Chicago's Edgewater Beach Hotel, August 14-16. Alert servicers from all parts of the nation were expected to take an active part in working out solutions to their problems.

Tinyvision Goes 'Teeny'

TV sets with 3-in. screens were on display at the recent Chicago Music Show. And so the two-decade TV circle has now been completed. Early sets were made with 3-in. screens. Some keen observers say this is something to watch. Teenyvision sets may become as numerous as present-day transistor portables.

Philco Repeats

For the second straight year Philco has been presented the "Friends of Service" award by the

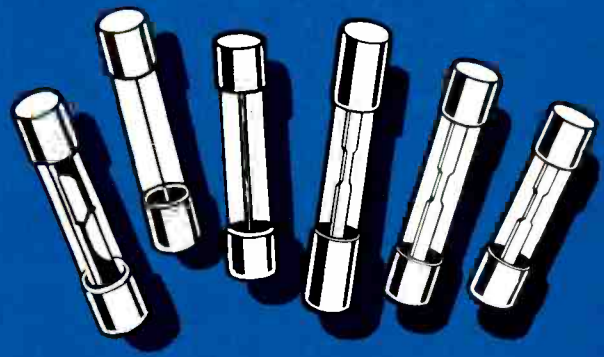

BUSS
quick-acting Fuses

"Fast Acting" fuses for protection of sensitive instruments or delicate apparatus;—or normal acting fuses for protection where circuit is not subject to starting currents or surges.

BUSS

Write for BUSS
Bulletin SFB

BUSSMANN MFG. DIVISION, McGraw-Edison Co., St. Louis, Mo. 63107

Winegard

Dealer of the month

No. 22 of a series

Glen Gustasen says: "I've used Winegard antennas consistently for the last 4 years and never had any breakage."



Winegard salutes Glen's TV, Atlantic, Iowa and their distributor, Omaha Electronics Co., Omaha, Nebraska.

Owner Glen Gustasen has kept his business specialized in Radio and TV work and it's been paying off for him in rapid growth and more efficient customer service. Over the years, Glen has tried them all and put his confidence in Winegard products. The rugged construction of Winegard Colortron and Color-Ceptor antennas has particularly impressed him... he's yet to have problems with breakage or faulty construction.

In the rural area around Atlantic, Glen often finds a need for extra power to bring in sharp, clean pictures. "We use a lot of Winegard AP-220N amplifiers to take out the snow we sometimes get out here. They insure the best possible pictures around these parts."

Recently Glen used a Winegard Antenna System on a local 17 unit motel installation. It was his first job of this size and he reported a smiling "A-OK" on the result.

Winegard has been happy to have grown with Glen Gustasen. He's one more important service man who knows Winegard's standards of excellence first hand.

Winegard Co.
ANTENNA SYSTEMS

D3019-H Kirkwood • Burlington, Iowa

--- for more details circle 46 on post card

NEW LITERATURE

CRT REBUILDING 300

A 16-page booklet, "The Open Door to TV Profits," tells how to rebuild CRTs. Windsor Electronics.

RELAYS 301

A 6-page brochure describes telephone type relays, Micropoise relays, time delay relays, pressure switches and ice detection devices and their applications. Cook Electric.

CUTTING TOOLS 302

Complete size and price data for instock miniature and sub-miniature precision cutting tools are contained in this 8-page illustrated catalog. Woodruff & Stokes.

SHOP EQUIPMENT 303

A 54-page catalog features a full line of steel shelving and shop equipment adaptable to maintenance and other operations. Hallowell/SPS

HARDWARE 304

More than 500 items of electronics hardware including turreted terminals, mounting hardware, handles, shaft locks, bushings and thumbscrews, plus items such as swaging tools, terminal boards, and universal-section boards are contained in a comprehensive 48 page catalog. Precision Metal Products.

COMING EVENTS

Aug. 21-23: National Convention, ARRL, Hilton Hotel, N.Y.

Aug. 25-28: Western Electronic Show and Convention (Wescon), Sports Arena and Hollywood Park, Los Angeles, Calif.

Sept. 14-16: 8th Nat'l Convention on Military Electronics, Shoreham Hotel, Washington, D.C.

Sept. 22-24: Antennas & Propagation Symposium, Int'l Airport, Idlewild, L.I., N.Y.

Sept. 23-25: Fall Conference, EIA, Boston, Mass.

Oct. 5-7, 10: Nat'l Communications Symposium, Utica, N.Y.

Oct. 12-15: 19th Annual Instrument Automation Conference & Exhibit, Park-Sheraton Hotel and Coliseum, N.Y.

ADVERTISERS INDEX

American Telephone & Telegraph	91
Amperex Electronic Corp.	3rd cover
Armco Steel Corporation	89
B & K Manufacturing Company	59
B & K Manufacturing Company	78
B & K Manufacturing Company	88
B & K Manufacturing Company	97
Blonder-Tongue Laboratories	32
Bussmann Mfg. Division	98-99
Cleveland Institute of Electronics	95
Delco Radio Division	61
EICO Electronic Instrument Co., Inc.	38
The Finney Company	79
General Electric Company	28-29
General Electric Company	62
Hallmark Instruments	26
Hy-Gain Antenna Products Corp.	82
International Rectifier	31
Jackson Electrical Instrument Co.	90
Jerrold Electronics	2nd cover
JFD Electronics Corporation	75
JW Electronics	94
P. R. Mallory & Co., Inc.	34
Mercury Electronics Corp.	86
Mosley Electronics	84
Quam-Nichols Company	92
Quietrole Company	96
Radio Corporation of America	
RCA Electronic Components & Devices	4th cover, 83, 93
RCA Parts & Accessories	33
RCA Sales Corporation	22-23
Raytheon Company	94
Sarkes Tarzian Semiconductor Div.	81
Sarkes Tarzian Tuner Service Div.	27
Seco Electronics, Inc.	19-20
Sencore, Inc.	37
Sprague Products Company	25
Sylvania Electric Products, Inc.	71, 85
Triplett Electrical Instrument Co.	73
V-M Corporation	87
Viking Electronics	30
Walsco Electronics Co.	80
Weller Electric Corp.	24
Windsor Electronics, Inc.	96
Winegard Company	76-77
Winegard Company	100
Xcelite, Inc.	72

MOVING?

Be sure to let us know your new address. Please enclose a complete address label from one of your recent issues.



How to replace top quality tubes with identical top quality tubes

Most of the quality TV sets you are presently servicing were designed around special Frame Grid tubes originated by Amperex. More and more tube types originated by Amperex are going into the sets you'll be handling in the future.

Amperex Frame Grid tubes provide 55% higher gain-bandwidth, simplify TV circuitry and speed up your servicing because their extraordinary uniformity virtually eliminates need for realignment when you replace tubes.

Amperex Frame Grid Tubes currently used by the major TV set makers include:

2ER5 2GK5 2HA5 3EH7 3GK5 3HA5 4EH7 4EF7 4ES8 4GK5 4HA5 4GJ7
6EH7 6EJ7 6ER5 6ES8 6FY5 6GJ7 6GK5 6HA5 6HJ5 6HG8 6GJ7

If your distributor does not yet have all the Amperex types you need, please be patient—in some areas the demand keeps gaining on the supply.
Amperex Electronic Corporation, Hicksville, Long Island, New York 11802.



... for more details circle 11 on post card

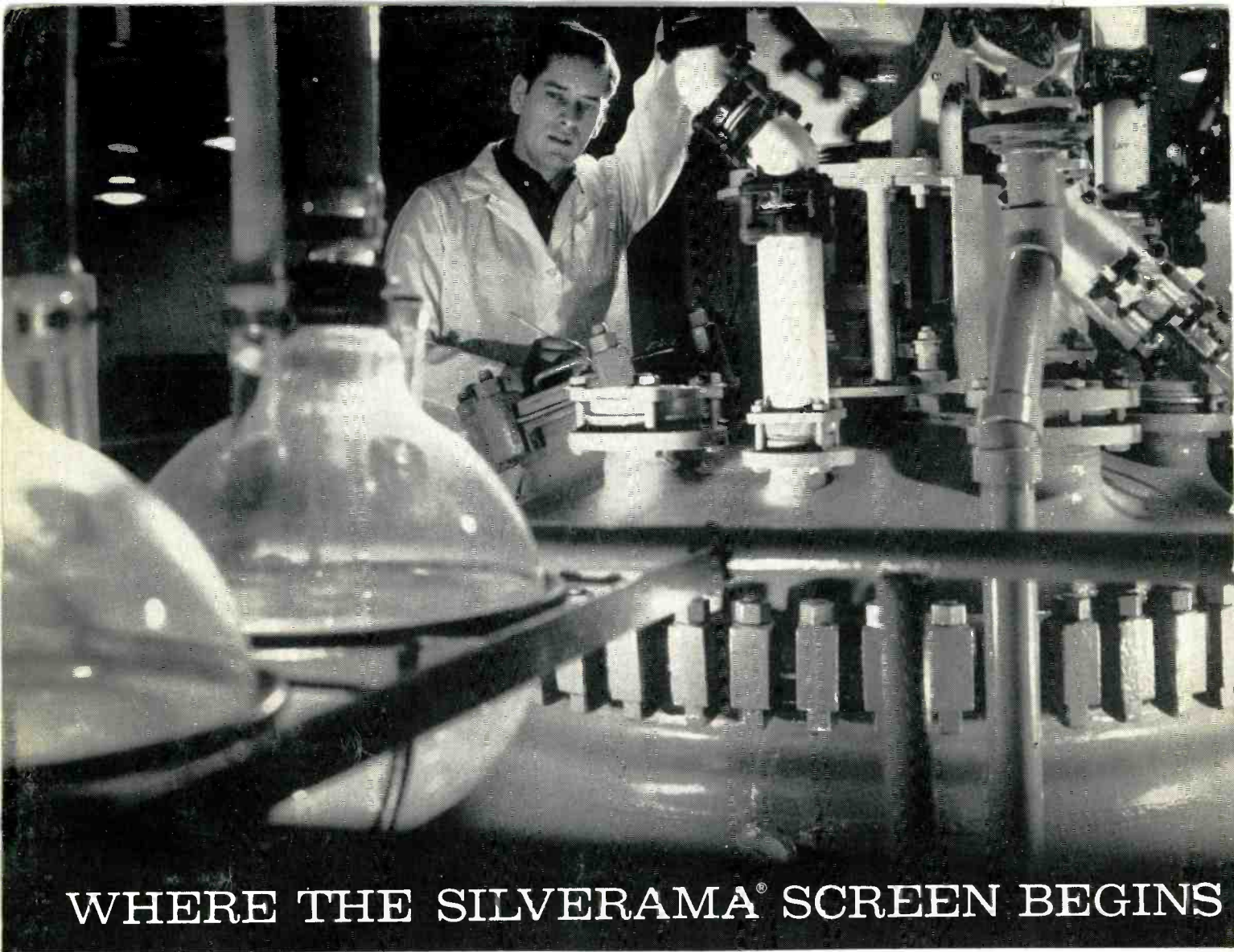

WHERE THE SILVERAMA® SCREEN BEGINS

TV picture quality depends on precise control of phosphors

Television picture quality depends on the quality of the phosphor screen inside the faceplate. That's why every RCA Silverama replacement picture tube is completely rescreened—in the same painstaking manner and with the same precision—as RCA picture tubes produced for use in original equipment. Before receiving their new Silverama screens, reused glass envelopes are scrubbed completely clean and given a series of chemical baths internally to restore them to the peak of their optical capabilities.

RCA produces and develops its own screen phosphors. These are

formed by reacting solutions of zinc sulfate and zinc and cadmium sulfates with hydrogen-sulfide gas in this complex precipitator, (above). The resulting zinc sulfide and zinc-cadmium sulfide are then activated, fluxed, fired, washed, dried, and screened to form phosphors which emit blue and yellow light, respectively. These are carefully blended to produce phosphors that possess the pleasing "white", high light output, and uniform smoothness, which characterize RCA Silverama picture tube screens.

Make RCA Silverama your first choice in picture tubes.



Drying ovens remove moisture from phosphor

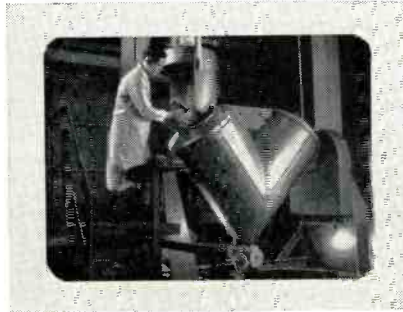

Phosphors are blended for best screen quality

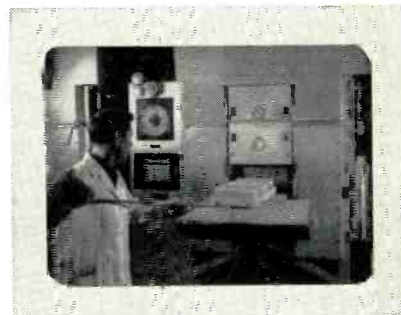

Base materials are fired to form the phosphors

RCA ELECTRONIC COMPONENTS AND DEVICES, HARRISON, N. J.



The Most Trusted Name in Electronics