

ELECTRONIC TECHNICIAN

Including 16 pages of
Circuit Digests

INSTRUMENT TEST PROBES

50¢

December • 1956

Caldwell-Clements Company



FUSE RESISTOR

IRC 629
FR 5.6

Stock No.
FR5.6

5.6 ohms



FUSE RESISTOR

Stock No.
FR5.6

5.6 ohms

IRC "Skin-Packed" Fuse Resistors

CONVENIENT TO BUY—Your IRC Distributor has IRC fuse resistors now on perforated display cards. You can buy one, a dozen or more—each on an individual "skin-packed" card section.

- Improved plug-in type for fast, easy replacement in the newer TV receivers. Terminal pin holes facilitate attaching leads where necessary.
- Featuring sturdy terminal pins—both attached inside a rugged ceramic case.
- "Skin-packed" cards protect each fuse resistor from dirt and handling.
- Available in 2 types—FR5.6 at 5.6 ohms and FR7.5 at 7.5 ohms to meet popular TV requirements.
- Type and range clearly identified on both fuse resistor and "skin-packed" card.

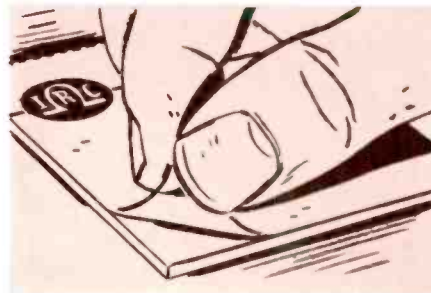

EASY TO STOCK—Heavy card helps prevent breakage or damage... "skin-packing" keeps every fuse resistor factory-fresh. Just peel off plastic skin, and you're all set.

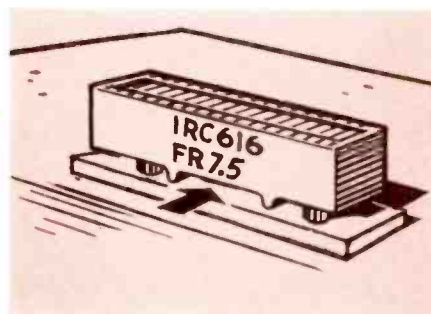

HANDY TO USE—Sturdy terminal pins. Simply plug fuse resistor into receptacle. Projections on bottom of case leave air space so receptacle won't overheat.

ORDER NOW FROM YOUR IRC DISTRIBUTOR

Wherever the Circuit Says



INTERNATIONAL RESISTANCE CO.

Dep't 577, 401 N. Broad St., Phila. 8, Pa.

In Canada: International Resistance Co. Ltd., Toronto, Licensee

ELECTRONIC TECHNICIAN

Including
Circuit Digests

TELEVISION • ELECTRONIC • RADIO • AUDIO • INDUSTRIAL

DECEMBER, 1956

ALBERT J. FORMAN *Editor*
M. CLEMENTS *Publisher*
O. H. CALDWELL *Editorial Consultant*
ROBERT CORNELL *Technical Editor*
A. O'ROURKE *Assistant Editor*
CHARLES F. DREYER *Art Director*

BUSINESS DEPARTMENT

480 Lexington Ave., New York 17, N. Y.
Telephone PLaza 9-7880

H. A. REED *General Sales Manager*
BERNARD BLOCK *District Manager*
N. McALLISTER *Production Manager*
JOHN J. BORGHI *Controller*
A. H. POND *Asst. Controller*
W. W. SWIGERT *Credit Manager*
M. RUBIN *Circulation Manager*
S. La MACCHIA *Asst. Circulation Mgr.*

P. H. DEMPERS *District Manager*
5010 Howard St., Skokie, Ill.
Chicago Telephone RAndolph 6-9225

CHRIS DUNKLE & ASSOCIATES
California Representative

3257 W. 6th Street, Los Angeles 5, Calif.
Telephone DUnkirk 7-6149



ELECTRONIC TECHNICIAN & Circuit Digests, Dec. 1956. Vol. 64, No. 6. \$5.00 a copy. Published monthly by Caldwell-Clements Co. Publication office, Emmett St., Bristol, Conn. Editorial, advertising and executive offices, 480 Lexington Avenue, New York 17. Telephone PLaza 9-7880.

Entered as second class matter at the Post Office at Bristol, Conn., June 10, 1954. Subscription rates: United States and Canada, \$4.00 for one year; \$6.00 for two years; \$8.00 for three years. Pan-American and foreign countries; \$7.00 for one-year; \$10.00 for two years; \$14.00 for three years. Copyright 1956 by Caldwell-Clements Co., New York. Title registered in U. S. Patent Office. Reproduction or reprinting prohibited except by written authorization of publisher. Printed in U.S.A. by Hildreth Press, Bristol, Conn.

FRONT COVER

Instrument test probes, and some of the many waveforms they are called upon to pick out of circuits, are portrayed. These vital adjuncts to oscilloscopes and meters are represented by a symbolic cross-section of a high-voltage type probe. For technical details, see article starting on page 24.

FEATURES and ARTICLES

| | |
|---|---|
| Your Future (Editorial) | 21 |
| "Tuning in the Picture" | 22 |
| Applications of Voltmeter & Oscilloscope Probes .. R. G. Middleton | 24 |
| Simplified Transistor Testing | B. Crisses 26 |
| "Tough Dog" Corner | H. M. Layden, C. G. Adair 27 |
| Response Errors in Hi-Fi Audio Amplifiers | N. H. Crowhurst 28 |
| Antenna Signal Variation With Height Above Ground | J. A. McRoberts 30 |
| You and the Law | F. Wilkins, Jr. 31 |
| Regeneration & Oscillation in TV I-F Systems | A. R. Clawson 32 |
| How to Handle "Tough Dog" Customers | J. Bermon 34 |
| Shop Hints | J. Elkish, C. Goldstein, W. Burgess, E. Kesgen, F. Felli 35 |
| Let's Look at Circuits (Inventer & Cath. Follower) | S. C. Silver 36 |
| Latest Test Instruments | 37 |
| New Audio Products | 38 |
| Scientific Progress: The Wonders of 1976 | Brig. Gen. D. Sarnoff 39 |
| New Electronic Products | 40 |
| Quick Solutions of Coil Problems | L. X. Shaw 46 |

DEPARTMENTS

| | | | |
|------------------------------------|----|--|----|
| Editor's Memo | 4 | Representatives | 15 |
| Letters to the Editor | 5 | New Books | 15 |
| Audio Newsletter | 12 | Catalogs & Bulletins | 18 |
| Association News | 13 | Calendar of Coming Events | 23 |
| News of the Industry | 14 | New Products | 37 |

CIRCUIT DIGESTS

57

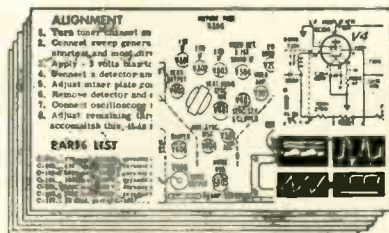

IN THIS ISSUE

(16 pp. latest schematics—see last page)
CROSLEY: TV Chassis 489, 490
GE: TV Chassis "ST" line
MAGNAVOX: TV Chassis 73 series
MOTOROLA: Audio radio Model 79MS
RCA-VICTOR: Transistorized portable
Chassis RC-1156A
WESTINGHOUSE: TV Chassis V-2311 etc.



AR-22



TR-2



TR-4

5-star feature...



the best color TV picture

the growth of color TV means an even greater demand for CDR Rotors for pin-point accuracy of antenna direction.



a better picture on more stations

CDR Rotors add to the pleasure of TV viewing because they line up the antenna perfectly with the transmitted TV signal giving a BETTER picture . . . and making it possible to bring in MORE stations.

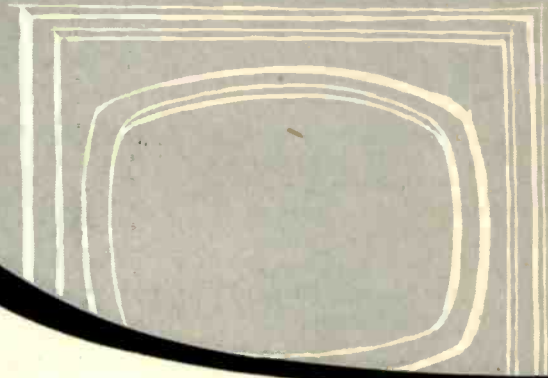

CDR ROTORS



TR 11 and 12



AR 1 and 2



tested and proven dependable

thousands and thousands of CDR Rotors have proven their dependability over years of unflinching performance in installations everywhere in the nation. Quality and engineering you know you can count on.



pre-sold to your customers

the greatest coverage and concentration of full minute spot announcements on leading TV stations is working for YOU . . . pre-selling your customers.



the complete line

a model for every need . . . for every application. CDR Rotors make it possible for you to give your customer exactly what is needed . . . the right CDR Rotor for the right job.



CORNELL-DUBILIER
SOUTH PLAINFIELD, N. J.



THE RADIART CORP.
CLEVELAND 13, OHIO

Rohn

only complete line of

TV and COMMUNICATION TOWERS

proven in Profits and Customer Satisfaction

• • • • HIGHLIGHTS OF THE ROHN LINE • • • •

look at these
ROHN exclusives

• HOT DIPPED GALVANIZED

The finest, most durable finish is available for ROHN Towers and accessories... all done entirely on the ROHN premises under careful ROHN supervision.

• UNEQUALLED DESIGN AND ENGINEERING

ROHN is the only design that has stood up over the years. ROHN has been first and foremost... and always the leader in new products to meet the changing demands.

• MASS PRODUCTION FOR LOW COSTS

ROHN was the first to utilize mass production techniques to build a superior tower at the most competitive prices. This means no sacrifice in quality yet far greater profits for you.

• UNIVERSAL CUSTOMER ACCEPTANCE

Thousands and thousands of installations prove the ROHN line first in customer satisfaction.

• PIONEER MANUFACTURERS

Pioneers in tower manufacturing—and today one of the world's largest manufacturers of this type equipment. The ROHN Company was built on satisfaction on the part of distributor, dealer and customer alike.

• COMPLETE LINE

Only ROHN offers a full line—one dependable one-stop source for all TV installation equipment. Save headaches, save shipping costs, save time... use ROHN unequalled service exclusively.

ALSO a full line of ROHN ACCESSORIES

Rotor posts, house brackets, eave brackets, peak and flat roof mounts, instant drive-in bases, hinged base sections, telescoping mast bases, guying brackets, UHF antenna mounts, erection fixtures, variety of mounts and supports for masts or tubing,

tower installation accessories, TV service tables, mast and TV horizontal galvanized tubing, guy rings, "twister-anchors", rubber tower grommets, insulator sections, hinged rotor platform, accessory shelf and platform and dozens of other items. Get the complete catalog TODAY!

ROHN Manufacturing Company

116 LIMESTONE, BELLEVUE
PEORIA, ILLINOIS

no. 6 tower

"All-Purpose" tower.

Fulfills 75% of your general tower needs—is structurally as sturdy—yet costs less than the well-known Rohn No. 10 Tower. Ideal for home and industrial installations, communication requirements... eliminates stocking many different tower models. Self-supporting to 50 ft. or guyed to 120 ft.! Easy to climb for fast, efficient servicing. Utilizes "Magic Triangle" which insures far greater strength and stability. Permanent hot-dipped galvanized coating. Dependability—a feature customers demand—is assured with the Rohn No. 6 Tower... designed to "stand up" for years to the rigors of weather and climatic conditions.

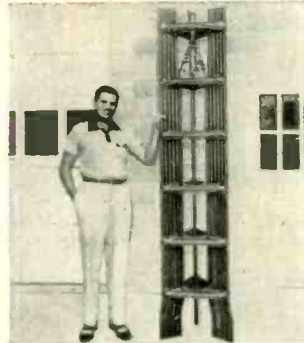

Package Tower*

"Space Saver"—cuts storage space 300% or more!

Popular PT-48 has almost 50' of sturdy tower within a compact 8' x 20" package! "Magic Triangle" design is adapted to a pyramid shape using a wide 19" base with progressively decreasing size upward. Decreases your overhead... easy to transport and assemble—cuts shipping costs. Galvanized throughout. Available in heights of 24, 32, 40, 48, 56 and 64 feet!

COMMUNICATIONS TOWER

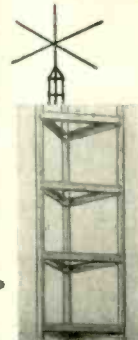

For extreme heights and communication purposes of all kinds, the Rohn No. 40 gives you strength and durability on which you can depend. The time tested and proven

equilateral triangle design using extra heavy duty tubing and corrugated steel cross-bracing is utilized. The No. 40 is structurally sound so you can install it for heights up to 300'; or at lesser heights when considerably greater strength is required because of excessive wind or antenna loading. Use for radio telephone, broadcasting, microwave relay and all other such communication purposes. If a particular job calls for this type tower, save real money by using ROHN towers.

Note: For lesser heights, use the Rohn No. 20 or No. 30 Tower.

Both Towers Feature THE ROHN MAGIC TRIANGLE*

For structural superiority, famed wrap-around "magic triangle" design is featured in these all-steel towers. Towers have full 2 1/2" wide corrugated cross-bracing welded to tubular steel legs. The exclusive design assures dependable strength and permanence.

Telescoping Masts

Heavy-duty hot-dipped galvanized steel tubing and rigid joints give extraordinary strength. Quick installation... mast attached to base—antenna fixed, then mast hoisted quickly to desired height. Utilizes special clamp and guy ring arrangement. Flanged interior section; crimped exterior section gives mast stability that can't be beat. Complete with guy rings and necessary erection parts. In 20, 30, 40 and 50 ft. sizes. Bases and ground mounts available.

ROHN FOLD-OVER TOWERS

These unique fold-over towers are perfect for experimentation, TV service departments, amateur use, and special purposes. Uses regular ROHN tower sections with kit. Now available in standard No. 10 tower to 50', and in ROHN No. 30 & No. 40 towers for heavy-duty use.

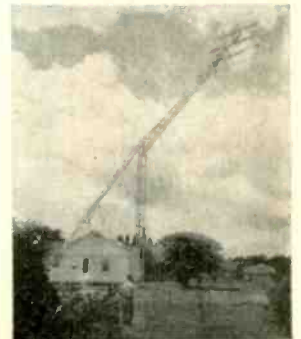

MAIL THIS COUPON FOR FREE LITERATURE!

Rohn Manufacturing Company
116 Limestone, Bellevue
Peoria, Illinois

Gentlemen: Please rush me complete details on the full line of Rohn Towers and Accessories.

Firm _____

Name _____ Title _____

Address _____

City _____ State _____

... another
MALLORY
service-engineered
product



among tubular
capacitors

MALLORY

"GEMS"

really *Shine*

Try Mallory "Gems" for your next replacement job... and we're sure you'll make them your favorite among plastic tubulars.

Made to rigid standards comparable to military specs, they give you high quality at modest cost.

"True center" construction, using separately molded case, eliminates chance of damage or deformation of the capacitor cartridge... prevents premature failure.

Securely fastened leads can't loosen or open when pulled, even under soldering iron heat.

Moisture-proof case won't burn, char, soften or dent.

Get your Mallory "Gems" today, in all popular ratings, from your nearby Mallory distributor.

P. R. MALLORY & CO. Inc.
MALLORY

P. R. MALLORY & CO. Inc., INDIANAPOLIS 6, INDIANA

- Capacitors
- Controls
- Vibrators
- Switches
- Resistors
- Rectifiers
- Power Supplies
- Filters
- Mercury Batteries

Editor's Memo

This month I've brewed a concoction of television, love and ingenuity in the form of a letter from Myra to that ever dependable lovelorn advisor, Dorothy Dix. This is exactly how Myra's letter was printed in the Philadelphia *Evening Bulletin*:

"Dear Dorothy Dix:

"I am a married woman of 19, separated from my husband for the past year and now awaiting a divorce. I've gone with several boys since the separation, but not until I met Dave did I get serious over any of them. He's a TV repair man, and the only time I can see him is when my set needs fixing. Needless to say, I manage to have it out of commission quite a lot.

"Dave never pays attention to me personally. How can I get his attention?"

I regret that the advice Miss Dix offered ("to try again for success in your marriage") completely overlooked the fabulous potential in heartbreak situations of this nature.

Consider the large number of lonely young women in the country, and the many attractive and masculine technicians. Should these girls—and there may be millions of them—get wise to the fact that charming companionship may be thrown into the bargain for a service call, I wouldn't doubt for a moment that TV repair would increase at least 25%.

This would necessitate some changes in shop promotion techniques. For one thing, it would no longer be sufficient to claim that your technicians are experienced and reliable. Better put in a plug for their good looks and charm.

There is one drawback to this scheme of things; namely, the inability of girls less skilled than Myra to put their sets out of commission. But where there is a demand, rest assured that American ingenuity and enterprise will come to the rescue.

To help out the non-technical lovelorn, some manufacturer will have to come out with a simple device for putting the set on the blink. After all, how many girls know how to put B-plus on the filaments? I'd suggest the device be called "The TV Troublemaker," that it be easily connected to the receiver, and that it come in two models. One model would be the get-acquainted type; it would merely blow a fuse or cause some equally simple repair. The second model would be the time-on-your-hands variety. It would insert a double intermittent in the set. Naturally, the girl must insist that the repair be made in her home.

Moral of this odd tale: If you get frequent calls from a damsel whose set keeps breaking down, either stay away... or else make sure you look neat and appealing.

Al Forman

LETTERS

To the Editor

Techmen Arise!

Editor, ELECTRONIC TECHNICIAN:

I look forward to receiving *Electronic Technician* as a high spot in the month. Your article "The Art of Techmanship" in the October issue was much more in keeping with the mental pace a technician maintains than some things written to appeal to baser instincts. I liked its abstract plane. Your article permits the technician to embrace his fundamental dignity. Thank you for that.

PETER CAMPIONE

Art TV
Philadelphia, Pa.

... Enjoyed "Art of Techmanship." Please send further information along with application forms for membership.

JOEL ATKINS

Portsmouth, Va.

... We are interested in forming a Techmanship branch at Zenith. Please send 15 application forms.

CHARLES H. NORRIS

Maywood, Ill.

... The Techmanship Society idea is very intriguing.

ALBERT BOSCH

Salina, Kansas

... Forward Techmanship application forms.

JOE BERNAL

Los Angeles, Calif.

... I like it very much, and am interested in more information on Techmanship.

ANGELO PERNA, JR.

Philadelphia, Pa.

... Please send application forms re your Society.

JOSEPH P. FRANK

Dewitt, Iowa

• *Whoa up, men! Whether our leg is being pulled or not, on behalf of the august Techmanship Society we welcome you to charter membership. Application blanks have been dispensed with . . . the Techmanship spirit is enough. Remember the rallying cry of Techmen everywhere: "One Up Forever! Knowledge Is As Knowledge Impresses!"—Ed.*

We Goofed

Editor, ELECTRONIC TECHNICIAN:

On page 26 of your October issue you printed my name in error. At the NATESA Convention in Chicago I was elected Western Vice-President.

W. D. HAINES

Burlingame, Calif.

(Continued on page 6)

... another
MALLORY
service-engineered
product

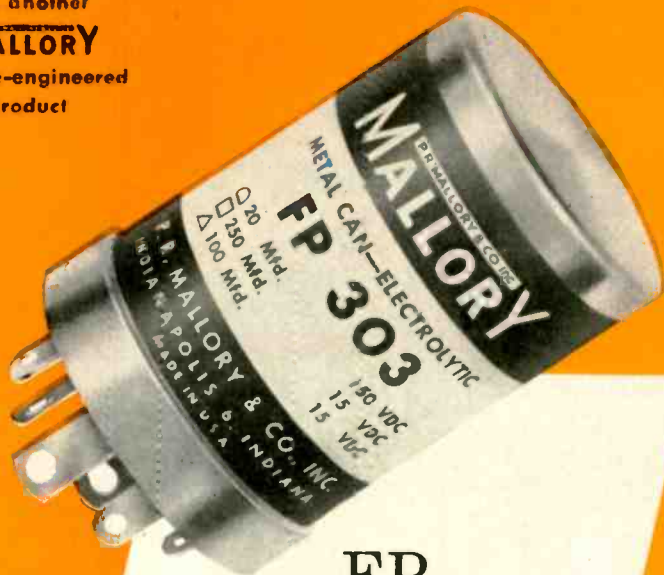

FP CAPACITORS take high ripple currents

(all FP's are Mallory)

No need to worry about ripple currents, when you choose Mallory FP (fabricated plate) capacitors for replacement. They're built to handle the toughest ripple . . . even the values you find in the latest color TV sets.

FP's, in fact, will stand 50 to 100% higher ripple current than usual industry expectation for a given rating. And this superior performance . . . proved by tests at 85° C ambient . . . can be expected of *all* FP capacitors, for they are manufactured to highest standards of uniformity. Mallory's unique FP construction makes this possible. It puts more electrolyte and more anode area into a smaller case . . . to give better heat dissipating qualities.

Be sure to specify Mallory FP's by name, not only for high ripple applications, but for all your electrolytic capacitor replacements. See your local Mallory distributor today!

P. R. MALLORY & CO. Inc.
MALLORY

P. R. MALLORY & CO. Inc., INDIANAPOLIS 6, INDIANA

- Capacitors
- Controls
- Vibrators
- Switches
- Resistors
- Rectifiers
- Power Supplies
- Filters
- Mercury Batteries

Weller soldering guns make safe repairs to Heat-Sensitive Components

A WELLER Soldering Gun gives you precise control of heat. This feature is especially important when replacing heat-sensitive components. Here are some typical applications:



1 REPAIRING PLASTIC-MOUNTED TRANSFORMERS. Your Weller Gun gives you precise heat control for this delicate operation. Prevents melting of plastic sockets; enables you to repair loose contacts and hair-thin coil-winding wire without damage.

2 SOLDERING VOICE COIL CONNECTIONS. Heat-control characteristic of Weller Guns enables you to repair loose or broken voice coil connections on the reflecting surface of paper resonating cone. The slightest mishandling of a soldering iron would burn cone.



3 REPLACING CRYSTAL OSCILLATOR. Controlled heat is imperative for replacing crystal oscillator in color demodulator circuits. With a Weller Soldering Gun you get perfect heat control, thus avoid damage to delicate crystal element.

4 REPAIRING REMOTE-CONTROL TUNING UNITS. Your Weller Soldering Gun fits neatly into the small spaces between the terminal tabs on telephone-type relay stacks. Also, heat shut-off feature of gun prevents damage to insulation.



There are professional model Weller guns
for every type of service work



Your choice of models . . . ranging from 100 to 250 watts single heat and 100 to 275 dual heat types. Suitable for every kind of service operation. All models heat in 5 seconds; provide instant, triggermatic control of temperature.

ORDER FROM YOUR ELECTRONIC PARTS DISTRIBUTOR

Weller ELECTRIC CORP.
601 Stone's Crossing Road, Easton, Pa.

(Continued from page 5)

From Far and Wide

Editor, ELECTRONIC TECHNICIAN:

Imagine my surprise when I started getting letters, telegrams, phone calls and four personal visits from as far as Canada, Utah and Missouri concerning the TV technician position open here. When I opened my July issue of Technician and saw that you had published my letter, I understood. The response was indicative of the interest in your magazine and the degree to which it is digested by TV folks. However, I didn't find the top flight man I am still looking for; guess he already has his own business and is doing well. I am paying \$125 a week now and for this size town that is considerable.

JAMES B. ROCK

Telerex
604 Orange Ave.
Fort Pierce, Fla.

Beware of Carbon Tet!

Editor, ELECTRONIC TECHNICIAN:

As the wife of a TV technician, I would like to call your attention to an article in October *McCall's* magazine which describes the dangers of using carbon tetrachloride. Since this cleaning fluid is widely used in TV-radio repairs, the article is certainly important to technicians. I wonder how many are aware of the danger. Believe me, the bottle of this deadly fluid in our shop is now on a high shelf, and in the future will be used with extreme caution. May I take this opportunity to tell you how much my husband enjoys ELECTRONIC TECHNICIAN? It is a great moment when your magazine arrives each month.

MRS. RICHARD E. HARRIS

Harris Television Shop
Franklin, Va.

• A sincere vote of thanks to Mrs. Harris for bringing this to our attention. Here are some highlights from the article: "Carbon tetrachloride is four times as dangerous as carbon monoxide and twice as toxic as chloroform. The vapor from one cupful in a poorly ventilated room has been sufficient to cause death. The damage may be done either through one heavy exposure or brief repeated exposures. It can be absorbed into the system through the skin. Contact of carbon tetrachloride with any flame or heated body often produces phosgene gas, one of the deadliest of killers. It particularly affects heavy drinkers, overweight and undernourished people, and sufferers of liver, lung, heart and kidney ailments. Medical diagnosis may be difficult. Symptoms may include dizziness, confusion, headache, abdominal pains, vomiting, stupor, sleeplessness, jaundice and urine discoloration. Safety rules include use in well ventilated rooms, very short exposure to vapors, washing from skin with soap and ointment, immediate disposal in outdoors of rags wet with it." —Ed.

NATESA Award

Editor, ELECTRONIC TECHNICIAN:

It gives us great pleasure to inform you that this organization of the independent service industry voted a Friends of Service Management Award to ELECTRONIC TECHNICIAN magazine. This is the highest award in our power to give to those companies who have rendered exceptional service to the independent service industry.

FRANK J. MOCH
Executive Director

NATESA
Chicago, Ill.

"Night Crawler" Letter— Thumbs Down

Editor, ELECTRONIC TECHNICIAN:

Charles Harbaugh's letter in your October issue criticizing the term "night crawler" is of considerable interest. It is a nasty word. Some of these part-time men are sincere and want to become legitimate service technicians. However, the argument of the established TV technician is equally valid. What would become of the medical or legal profession if they had to contend with so-called night crawlers? We need more trained men, but the place to get them is from established schools. It is not right for these men to train themselves using the customer's property. This all adds up to the belief that licensing is going to be the ultimate answer to the ills of our profession.

L. W. VAN SLYCK

Van's Radio & Television
Tampa, Fla.

... I admire Mr. Harbaugh's apparent honesty, but deplore the unfair competition inherent in part-time servicing. In lines where skill is required, it is traditional to serve an apprenticeship to protect the public. Why should TV servicing be different? If "night crawler" is offensive to Mr. Harbaugh, I suggest he forsake those ranks.

H. M. LAYDEN

Judd-Bennett Co.
New York, N.Y.

"Night Crawler" Letter— Thumbs Up

Editor, ELECTRONIC TECHNICIAN:

My wholehearted endorsement of Mr. Harbaugh's letter. As a correspondence school student and part-time technician, I want to point out that the Army and Navy encourage members of the Armed Forces to take technical correspondence courses. I do not know it all, but frequently have fixed sets that elaborate shops have muffed. Our critics are just jealous.

C. CLAYTON

Meridian, Miss.

... Mr. Harbaugh's letter reflects an excellent philosophy. As spare time servicemen we deserve better credit. My 100% approval.

HENRY P. AGUIGAM

Detroit, Mich.

Simpson...the most Complete Line of VOM's

Select the one that fits your needs!

MODEL

260

world's most
popular!

Over half a million Model 260's have been sold to date! 20,000 Ohms per volt. You'll find it wherever quick, accurate, electrical checks are needed. It's so handy, so dependable, so sensibly priced! Ask your jobber. Price, including Adjust-A-Vue Handle, only ... **\$38.95**

Carrying Cases from **\$6.75**



MODEL 262

Deluxe!



the new VOM with a 7" meter

20,000 Ohms per volt DC and 5,000 Ohms per volt AC sensitivity ... 33 ranges ... compact 7" case with Adjust-A-Vue Handle ... **\$59.50**

Carrying Case ... **\$ 9.95**

NEW!



MIDGETESTER Model 355—New shirt-pocket size Volt-Ohmmeter **\$29.95**

MODEL 240—Small VOM; 14 ranges; up to 3000 volts AC or DC **\$26.35**

MODEL 230—Small VOM; 12 ranges; up to 1000 volts AC or DC **\$24.95**

ROTO RANGER Model 221—25 Separate meters of turn of a switch **\$75.00**

LABORATORY STANDARD—For instrument colibration. Price on application.

MODEL 269

100,000
Ohms
per volt!



Most sensitive VOM

available! A Volt-Ohm-Microammeter with a big 7" meter in a compact 7" case ... 33 ranges ... Adjust-A-Vue Handle ... **\$88.00**

Carrying Case ... **\$ 9.95**

Simpson ELECTRIC COMPANY

World's Largest Manufacturer of Electronic Test Equipment

5200 W. Kinzie St., Chicago 44, Ill.

• ESTebrook 9-1121

In Canada: Bach-Simpson, Ltd., London, Ontario

Now FROM G.E. HELP YOU MODERNIZE

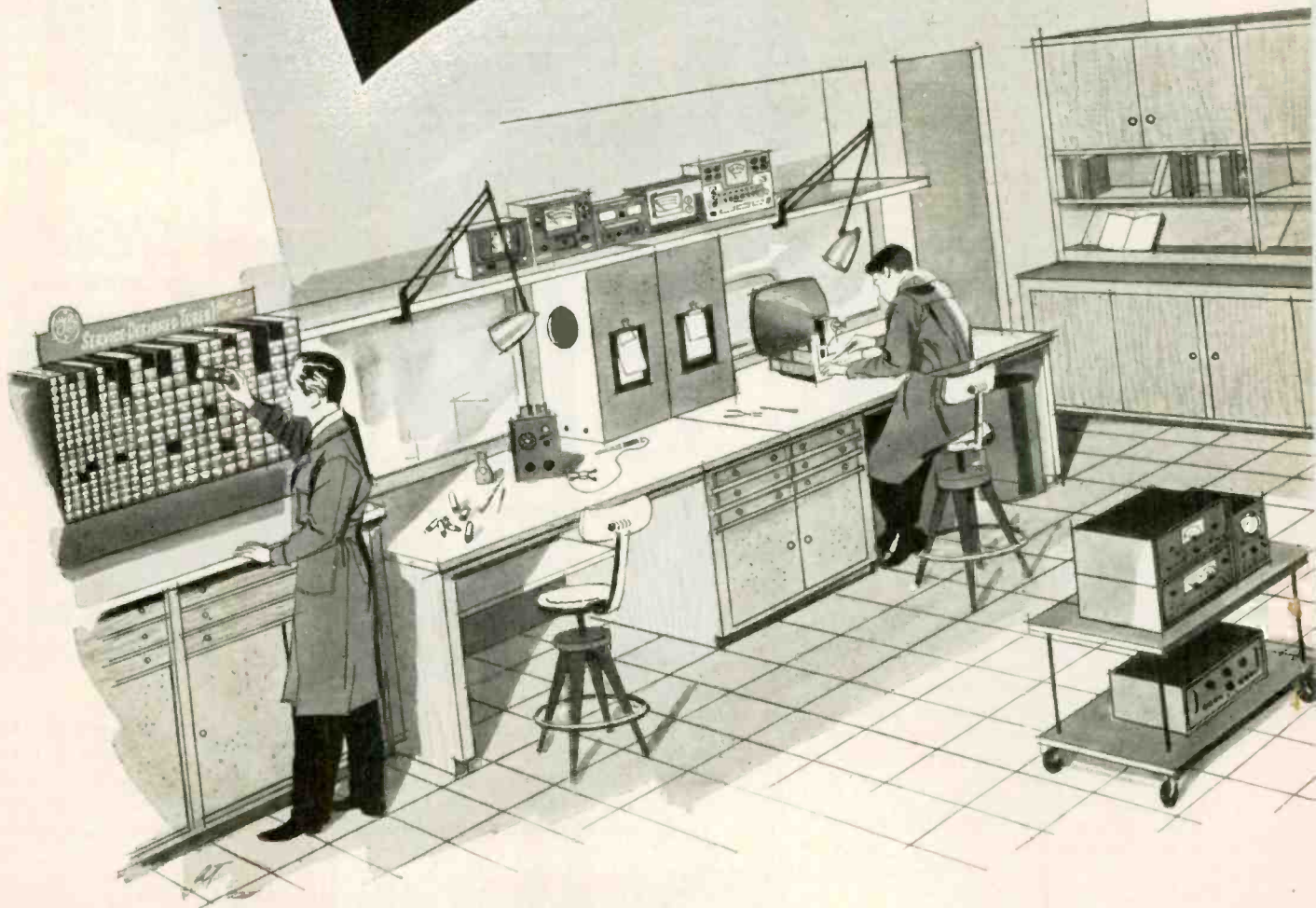

NEW SHOP PLANS THAT FOR BUSINESS GROWTH!

TODAY the servicing of TV receivers, plus tubes and parts needed, adds up to more dollars than TV-set sales. In order for you to obtain your share of this fast-growing volume, General Electric has prepared new shop plans that help you handle more service business...more efficiently, more economically.

Giles van der Bogert, American Institute of Architects, drew on the experience of TV-service experts for General Electric's shop layout. It is planned for an average-size service dealer, yet can

easily be expanded or reduced to meet varying requirements. The plan can be used as a whole, or individual parts adapted to your needs.

Efficient work-flow...well-planned bench and counter areas...adequate space for set storage...these and other advantages will improve your servicing facilities, add to your profit opportunities. Study the features below! Then phone your G-E distributor for the complete plans! *Electronic Components Division, General Electric Co., Schenectady 5, N.Y.*

* Layout provides complete facilities for two bench technicians, but can be expanded to accommodate up to ten.

* Modular, or unit-by-unit design, permits wide flexibility in adapting plan to your individual needs. Also, you can start with any part of the layout, and complete the plan by easy stages.

* Complete dimension drawings and material lists are supplied. Any carpenter or builder can start the job for you immediately upon your request.

* Service-bench area includes many new time-and-work-saving features. A TV-test and storage rack with ample dimensions has compartments for portables up to large-size color receivers. There are custom-designed cabinets for technical manuals and service records.

* Plan calls for standard-dimension lumber and other easily obtained construction materials, so that cost to you will be as low as possible.

* Layout includes separate display and sales area for over-the-counter transactions. Floor and window displays can be accommodated effectively.

* There is an enclosed manager's office, which also can be used for TV, radio, and hi-fi demonstration. Coat closet and lavatory room are provided.

* The complete shop-layout book you receive has realistic three-dimension illustrations to show how your new shop and store will look. Ask your G-E tube distributor for your copy!



Progress Is Our Most Important Product

GENERAL  ELECTRIC

**STOPS
TRAFFIC!**

\$

**SELLS
TRAFFIC!**

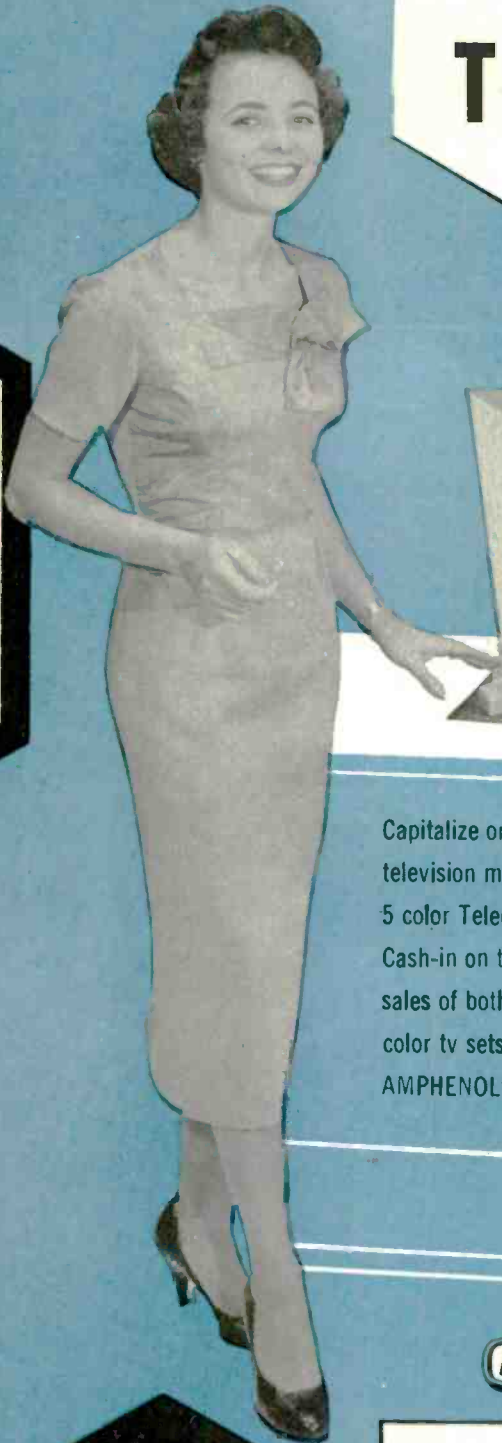

Capitalize on the growing two-set television market with this beautiful 5 color Telecoupler display. Cash-in on the increased Christmas sales of both black & white and color tv sets by displaying and selling AMPHENOL'S popular two-set coupler

AMPHENOL

TELE-COUPLER

see your
AMPHENOL
distributor



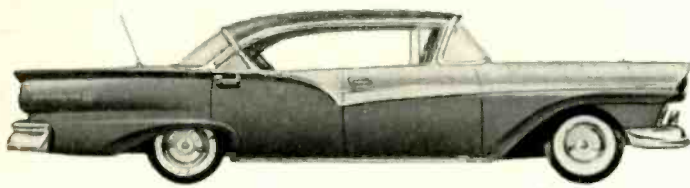

FORD

FOR '57...

CBS TUBES

FOR '57...

CBS TRANSISTORS

FOR '57



A new, sleek, long, low '57 Ford with the touch of tomorrow. Under the dash, a fine new Ford radio receiver, transistor-powered for the ultramodern touch. And in it, new low-voltage mobile radio tubes by CBS . . . new power output transistor by CBS.

That's only natural. CBS pioneered the first auto radio tube kit. CBS has been a major supplier of tubes to Ford and other leading auto radio set manufacturers for years. And now CBS offers tubes and transistors for the new "hybrid" auto radio receivers.

Whatever you need for auto radio replacements — tubes or transistors — old, modern, or ultramodern — follow the leading set manufacturers . . . replace with CBS.

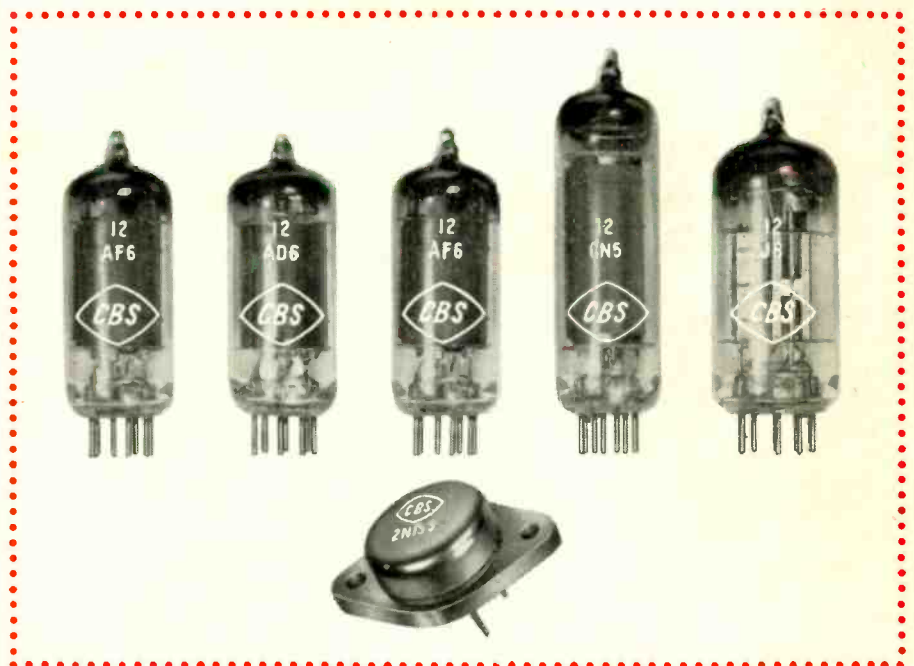

tubes • semiconductors

*Reliable products
through Advanced-Engineering*

CBS-HYTRON

Danvers, Massachusetts

A Division of Columbia Broadcasting System, Inc.

1546 PAGES...

the world's largest
electronic
parts
catalog!



**JUST
OUT!
1957**

Radio-Electronic
MASTER

(21st Edition)

- What product best fills your needs?
- What does it look like?
- How does it compare? • Who makes it?
- What does it cost?

Up-to-the-minute answers to all these questions are in The MASTER, Official Buying Guide of the Industry. The MASTER contains 4 to 5 times more product coverage than any other buying guide. It is 350 factory-prepared catalogs in one complete bound volume . . . the most authoritative and up-to-date buying and reference source ever produced.

AT YOUR BENCH . . . Compare specs and prices first—then buy your exact requirements.

OVER-THE-COUNTER and in the customer's home . . . Sell and bill direct from The MASTER'S pages. It shows list prices!

Keep up-to-date on all the latest developments in this fast-moving industry. Learn from The MASTER!

No matter what electronic component you look for . . . **YOU FIND IT FASTER
IN THE MASTER**

Get the 1957 edition from local parts distributors — or write for list.

THE Radio-Electronic MASTER
110 Lafayette St., New York 13, N. Y.

ONLY **\$2.95**
from parts distributors

Of course, The MASTER catalogs every item you use in radio-tv servicing—but it also offers thousands of other products which can lead to extra sales and servicing income. For example:

COLOR TV—The newest in color scopes, dot and color-bar generators . . . technical books . . . how to convert your present signal generator for color work.

TRANSISTORS, miniature components and testers for servicing the new pocket-size radios, hearing aids and many other electronic devices.

INDUSTRIAL servicing requires special meters, tubes, power supplies, transformers, controls, etc.

HI-FI and sound installation and service calls for changers, turntables, motors, speakers, intercoms, PA systems, etc.

- Over 125,000 items
- Descriptions
- Specifications—Prices
- 11,250 illustrations
- Fully indexed
- 8 1/2 x 11", 6 lbs.

Audio humor going the rounds describes the PA system that broke down when a lecturer had just begun his talk. The technician on the job quickly apologized to the crowd, explaining that there was a screw loose in the speaker.

The Institute of High Fidelity Manufacturers is growing. With the entrance of Duotone, Recoton, ORRadio and Elektra, membership has risen to 74.

Grist from the rumor mill: Ferrodynamics Corp., recent entry into the magnetic tape manufacturing field, is working up aggressive marketing plans.

Magnecord tape recorders have put in some 25,000 hours of continuous operation since they were installed at the Illinois Bell Telephone Center in Chicago 6 1/2 years ago. Recording heads are replaced every 2000 hours.

New Hi-Fi amplifier manufacturer is Madison Fielding Corp., 863 Madison St., Brooklyn 21, N. Y.

The 1957 West Coast Convention of the Audio Engineering Society will meet Feb. 7-8 in Los Angeles' Ambassador Hotel. Meeting accompanies Los Angeles High Fidelity Show.

Awards of over \$16,000 in recording machines, tape and discs are being offered to schools which come up with the best plans for the use of \$2000 worth of recording equipment for educational purposes. Contest entries must be received by Feb. 1, 1957, by Audio Devices, 444 Madison Ave., New York City.

Noteworthy new audio products: Transistorized portable PA system made by Antrex Corp. weighs only 18 lbs., operates for 50 hours on two flashlight batteries. The Kontak Mike made by Amperite for string instruments.

Association News

California Licensing Drive

Radio Television Technicians Association (RTTA Pasadena, Calif.) has authorized distribution of the proposed state licensing law to invite comment. The bill will be presented to the California State Legislature under the auspices of the California State Electronics Association (CSEA).

Reports from San Francisco note service association support, in conjunction with the International Brotherhood of Electrical Workers union (IBEW) for a city licensing bill "with teeth."

NATESA Hits Captive Service

"Set producers have, contrary to sane economics and in direct opposition to basic trends in all other industries, priced themselves out of their business. In a mad rush to be 'king of the hill,' they have thrown discretion to the winds and now are stuck with a pricing structure which leaves no room for decent profits at any level. . . . They have, therefore, decided to take over the field of service at retail, contrary to all established principles and in direct violation of legal concepts."—From Oct. 1956 NATESA Scope.

L.I. Guild Appointment

Richard T. Guidera has been appointed Executive Secretary for the Radio & Television Guild of Long Island (N.Y.). Duties include publicizing the Dec. 6-8 Electronics Fair and working on the coming program to increase patronage of member shops.



"Come on over sometime—I'm putting in a prescription department."

Save servicing time with

Authoritative Technical Publications

on RCA VICTOR

RADIO, PHONO and TV sets

Directories, Guides, and Service Data Books published by RCA—these are the basic RCA reference works for a technical library you'll depend upon now and in years to come. In these publications you'll find exact replacement parts lists for all RCA Victor home instruments, servicing and alignment instructions, and circuit diagrams—all detailed, *factory-originated data*—much of which cannot be obtained elsewhere.

BOUND VOLUMES OF RCA VICTOR SERVICE DATA

You'll save time and dollars by maintaining a complete file of these handsome, sturdily bound volumes. Here's authoritative data for rapid, profitable servicing of RCA Victor home instruments. Included are schematic diagrams, wiring diagrams, alignment procedures, waveforms, troubleshooting suggestions, production changes, complete parts lists, top and bottom chassis views, voltage charts, and shop tips. Vol. I (1923-1937) \$3.50; Vol. IV (1947-1948) \$6.00; Vol. V (1949) \$5.00; Vol. VI (1950) \$5.50; Vol. VII (1951) \$5.00; Vol. VIII (1952) \$5.00.



SERVICE PARTS DIRECTORIES FOR RCA VICTOR TV RECEIVERS



These publications contain schematic diagrams, top and bottom chassis views (except as noted), replacement parts lists, a cross reference index between model name and model number, and an index to previous publications.

SP-1007—1946 through June 1950 TV receivers (56 models). Does not include chassis views. 75 cents a copy.

SP-1014—1950 through 1951 TV receivers (71 models). \$1.50 a copy.

SP-1021—1952 TV receivers (27 models). 50 cents a copy.

SP-1028—1953 TV receivers (108 models). Includes Radio-TV combinations. \$1.35 a copy.

SP-1035—1954 TV receivers (106 models). Includes information on the CT-100 and 21-CT55 color TV receivers and the RP-197 and RP-198 3-speed record-changers. \$1.25 per copy.

RCA VICTOR TV SERVICE PARTS & TUNER PARTS GUIDE

SP-2001B—Available in December, lists stock numbers of major replacement parts for RCA Victor TV sets by receiver-model number and corresponding receiver-chassis number. Also listed are stock numbers of tuner-replacement parts for individual tuner-chassis. Covers the years 1946 through 1956. 25 cents per copy.

RCA PHONOGRAPH CARTRIDGE GUIDE

SP-2003B—Lists stock numbers of RCA cartridges and styli. Also lists stock numbers of RCA cartridges and RCA Victor model numbers of record-changers in which they are used. Single copy free on request.



RCA TECHNICAL PUBLICATIONS ON RCA SERVICE PARTS ARE AVAILABLE THROUGH YOUR RCA TUBE DISTRIBUTOR—OR FROM RCA, COMMERCIAL ENGINEERING, 415 S. 5TH ST., HARRISON, N. J.



SERVICE PARTS

RADIO CORPORATION OF AMERICA, HARRISON, N. J.

Page from the



RECOGNITION MANUAL

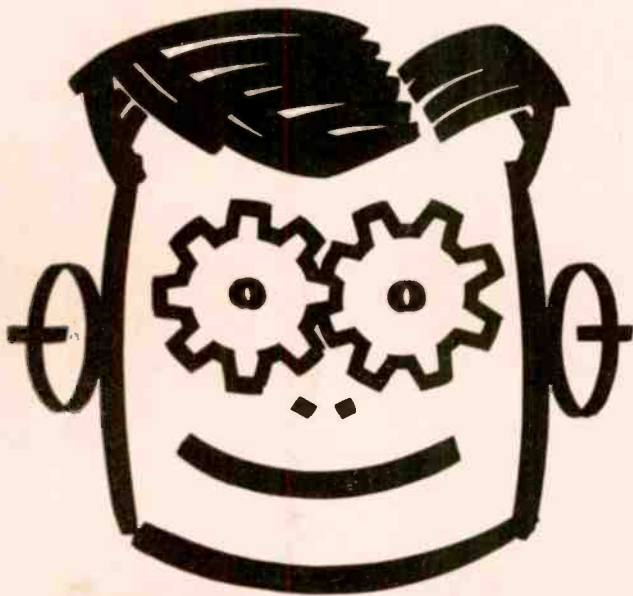

ROBOT ROBERT

This dependable space salesman may be recognized by his well rehearsed presentation and consistent use of stock phrases. His sales pitch to media buyers is mechanically punctuated by prepared human interest tidbits—"push pull, click click."

He has one great asset—the ability to boil down vastly complex problems to their most essential elements. Example: Manufacturer's problem is how to anticipate production requirements in face of shifting brand preferences and changing distribution concentrations. Robot Robert deduced essentials: Will the manufacturer sign the ad contract or not.

ELECTRONIC TECHNICIAN space salesmen have been called Robot Robert's only once . . . by the editor. He claimed the salesmen were being "digital" by thanking him 876 times for publishing such fine editorial material . . . and more of it than any other magazine in the field!

To be slightly digital about it, ELECTRONIC TECHNICIAN published 115.86 more editorial pages than competing Pub. A, 213.1 more than Pub. B, 226.73 more than Pub. C, and 310.78 more than Pub. D, Jan. '55-July '56. In case you don't know who A, B, C and D are, write us . . . we'll be glad to tell you tell you tell you.

ELECTRONIC TECHNICIAN

CALDWELL-CLEMENTS CO., 480 Lexington Ave., New York 17, N. Y. PLaza 9-7880

News of the Industry

MOTOROLA announces the appointment of **ROBERT L. BORCHARDT** as manager of the Technical Information Center, **FREDERICK W. ALEXANDER** to advertising manager, and **ROBERT E. NEWLIN** as product promotion supervisor.

UNIVERSITY LOUDSPEAKERS named **LAWRENCE J. EPSTEIN** Director of Sales and Merchandising and **CHARLES RAY** as Jobber Sales Manager.

VOKAR has appointed **JOSEPH J. WRIGHT, JR.** to its sales staff.

RAYTHEON has named **F. D. EDES** as assistant to Vice President and General Manager of the receiving and cathode ray tube operations.

CBS-HYTRON appoints **DAVID C. ADKINS** as Public Relations Manager.

SONIC INDUSTRIES has appointed **JACK GILBERT ASSOCIATES** to handle its advertising, with **RICHARD FELIX** as account executive.

PHILCO appoints **LEONEL M. SEARLE** as Vice President and General Manager of Automotive Div.

TUNG-SOL elects **MILTON R. SCHULTE** to new post of Executive Vice President.

INLAND ELECTRONICS CORP. announced the appointment of **BURTON BROWNE ADVTG.** to handle its advertising and public relations.

ELECTRONIC INDUSTRY SHOW CORP. issued \$7,062 in rebate checks to member exhibitors in the 1956 **ELECTRONIC PARTS DISTRIBUTORS SHOW**. This sum represents 7½ per cent rebate of the membership assessment for participation in the May 1956 show.

WORKMAN TV INC. announces that as a convenience to Canadian and other non-domestic jobbers, all its products are now warehoused in Canada by **LEN FINKLER**, Port Credit, Ontario, and **E. S. GOULD SALES CO.**, Montreal, Quebec. Similarly, **CRUSOL INC.** warehouses Workman products in Bayamon, Puerto Rico.

CORNELL-DUBILIER announces the acquisition of the substantial majority stock control in the **TOBE DEUTSCHMANN CORP.** of Norwood, Mass.

CLAROSTAT announces installation of a new Western Union private lease-wire circuit with automatic teletype equipment, which connects general offices and main plant in Dover, N. H., with branch plant and offices in North Aurora, Ill., and again with the New York sales office.

SYLVANIA ELECTRIC opened an 87,000 square-foot Distribution Center in Los Angeles and another of 79,000 square feet in the San Francisco area, thus doubling the warehousing and sales office facilities established in Calif. five years ago.

CBS-HYTRON, continuing its picture tube clean-up plan, has **GARRY MOORE** demonstrating to American

housewives on CBS TV Network why the TV picture tube faceplate and protective glass need cleaning.

HICKOK ELECTRICAL INSTRUMENT CO. announces a current 50 per cent increase in sales of electrical-electronic test equipment and indicating meters. To accommodate this increase, an exclusive 100 per cent production contract has been negotiated with **SUPREME ELECTRONICS CORP.**

WESTON ELECTRICAL INSTRUMENT announces the opening of following district sales offices: Los Angeles, 2001 S. Grand Ave.; Cincinnati, 7613 Reading Rd.; Philadelphia, 101 N. 33rd St.; Union, N. J., Caldwell Ave. and route 22.

FEDERATED PURCHASER, New York City, staged an all-day lecture-demonstration by **HICKOK** instruments engineers on how to service color-TV receivers.

Representatives

MEL SCHWARTZ CO. and **ORLANDO MARETT**, manufacturers' reps, have joined forces and formed the firm **Production Sales**, 39-16 Tierney Place, Fair Lawn, N. J. and 7808 15th Ave., Brooklyn, N. Y.

HERBERT L. DIENES CO., Philadelphia, has been appointed rep for the **Antenna & Electronics Div. of SNYDER MFG. CO.**

ROGERS ELECTRONIC CORP. announce as manufacturers' reps **HAL F. CORY CO.**, **RODGERS ASSOC.**, **PERLMUTH ELECTRONIC ASSOC.**, and **TERWILLIGER SALES CO.**

STANDARD COIL has named **KIRSCH SALES CO.** to represent them in Ind., Ky., and W. Ohio and **FRANK FAUER** to represent them in W. Penna and W. Va.

WESTERN ELECTRIC appoints **WARREN LAMACK** and **RICHARD L. "RICK" MARTIN** as reps for the sound division.

UNITED TRANSFORMER announces the appointment of **R. C. WHITMORE & ASSOC.** as industrial reps in Chicago and N. Ill.

New Books

RADIO-ELECTRONICS MADE SIMPLE. By *Martin Schwartz*. Published by *American Electronics Co.*, 1203 Bryant Ave., New York 59, N.Y. 191 pages. Paper cover. \$1.95.

This is a very basic textbook for the electronic novice. It covers fundamentals from magnetism, ac, dc and vacuum tubes, to receivers and transmitters. Primary circuits are briefly and accurately explained.

(Continued on page 16)

Here's why



tubular capacitors give you better performance and longer life!

All Aerovox P88N molded tubular capacitors are manufactured by a unique low-pressure, low-temperature molding process that insures perfectly centered sections with uniform wall thickness on every single unit. Only Aerovox gives you round, uniform, undistorted, coaxially-centered sections solidly imbedded in the *right* plastic for superb mechanical, electrical and climatic characteristics.

NOT
THIS



Off-centered
section

NOR
THIS



Distorted
section

AND
NEVER
THIS



Compressed
section

BUT
Always
THIS



Perfectly centered, undistorted, unimpaired section protected by uniform and adequate plastic wall thickness.

That's the inside story why Aerovox Duranite capacitors are recognized for their **top performance** and **utmost reliability** and **extra-generous** service life. Your local Aerovox Distributor carries a complete stock of Aerovox capacitors to meet **ALL** your service needs. Drop in soon and ask for a copy of the latest Aerovox catalog or write



AEROVOX CORPORATION

**DISTRIBUTOR SALES DIVISION
NEW BEDFORD, MASS.**

In Canada: **AEROVOX CANADA, LTD.**, Hamilton, Ont.
Export: Ad. Auriema, 89 Broad St., New York, N. Y. • Cable: Auriema, N. Y.

(Continued from page 15)

ELECTRONICS IN INDUSTRY. By George M. Chute. Published by McGraw-Hill Book Co., 330 W. 42 St., New York 36, N. Y. 431 pages. Hard cover. \$7.50.

This second edition covering a field of growing importance to electronic technicians is notably comprehensive. Focus is on electronics in the plant; communications is essentially absent from the text. Practical circuitry, waveforms and equipment are shown. Among the many topics covered, with a bare minimum of mathematics, are time-delay relays, welding controls, gas tubes, light controls, motor controls, heat controls, temperature recorders, servo-

mechanisms and test instruments. This volume is highly informative, and is well recommended.

RADIO-TELEVISION AND BASIC ELECTRONICS. By R. L. Oldfield. Published by American Technical Society, 848 E. 58 St., Chicago 37, Ill. 342 pages. Hard cover. \$4.95.

Clearly explained and nicely illustrated, this fundamental text provides a world of information for the technician just starting out, a basic reference for the old pro. In addition to covering basic circuits and components, the author discusses acoustics, broadcasting, color TV transmission and hi-fi systems. An excellent glossary defines many electronic terms.

ELEMENTS OF RADIO. By Charles I. Hellman. Published by D. Van Nostrand Co., Inc., 120 Alexander St., Princeton, N.J. 354 pages. Hard cover. \$4.95.

A fundamental but comprehensive text on various aspects of radio, this well illustrated book serves as a basic reference for the beginner, or excellent refresher for the old pro. In addition to basic electrical and communications theory, this third edition adds a chapter on transistors. TV, radar and photo-electricity are briefly covered.

PROFITABLE RADIO TROUBLESHOOTING. By William Marcus and Alex Levy. Published by McGraw-Hill Book Co., 330 W. 42 St., New York 36, N. Y. 344 pages. Hard cover. \$5.95.

Subtitled "A Professional Guide to the Technical and Business Methods of Operating a Radio-TV Service Business," this excellent volume tells the reader how to get at the root of radio set failures quickly, and how to run his business operation profitably. Chapters devoted to alignment, hum, squeals, intermittents, distortion and interference, among others, provide the technical data. Promotion, charges and record keeping cover the business end. TV may be the giant, but radio servicing can be quite profitable too.

DAVE RICE'S OFFICIAL PRICING DIGEST. Prepared and published by Electronic Publishing Co., 180 N. Wacker Drive, Chicago 6, Ill. 248 pages. Paper cover. \$2.50.

This handy replacement parts guide, fall 1956 edition, includes some 66,000 listings of radio-TV parts, along with their list or suggested resale price. In addition to providing a single up-to-date information source, this quarterly publication provides a means for proving to customers, when necessary, that proper parts charges have been made. A 6SN7GT? The book says \$2.15 m'am. A General Industries Type DV phonomotor? The book says \$21.75 for the unit, sir. It's a useful reference to have around.

PICTURE BOOK OF TV TROUBLES, Vol. 7. Edited and published by John F. Rider Publisher, Inc., 116 W. 14 St., New York 11, N.Y. 64 pages. Paper cover. \$1.50.

Sound circuits and low voltage power supplies are discussed in this seventh volume of the helpful troubleshooting series. As in the past, the picture or waveform is shown, along with related component failure, symptom and analysis. Subjects covered here include FM discriminators, i-f amplifiers, detectors and other low voltage stages. It's concise and practical.

MOST OFTEN NEEDED 1957 TELEVISION SERVICING INFORMATION. Compiled by M. N. Beitman. Published by Supreme Publications, 1760 Balsam Rd., Highland Park, Ill. 192 pages. Paper cover. \$3.00.

Based on set manufacturers' servicing data, this volume presents the circuits and repair data of 20 of the major brands. Included are alignment data, layouts and troubleshooting notes.

Hate to Install Antennas?

Here's one you can let your customers put up themselves

(and make a profit when they do!)

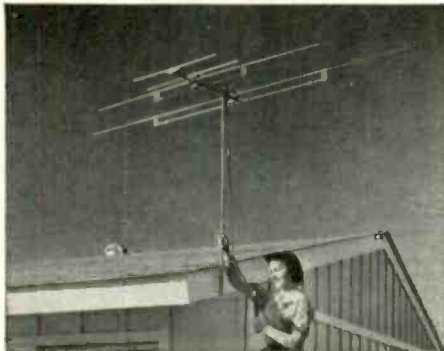

Winegard

These are all complete packaged antenna installations—not "kits". They are factory assembled. There's nothing to put together. Nothing else to buy. Even the lead-in wire is attached, ready to uncoil and snap on to the receiver terminals.



COLOR BEAM—Fully assembled. Just open it like an umbrella. All elements automatically snap into place and lock in position. Goes up in a jiffy. All you need is a hammer. (The nails are included!) All-aluminum, anodized in a beautiful gold finish. Guaranteed to improve reception in 50 mile range. **\$1795**
Retail Price

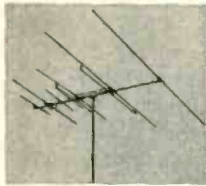

DELUXE COLOR BEAM—Similar to the regular Color-Beam, but bigger, with more elements. Guaranteed to give satisfactory reception within 100 mile radius. Snaps open. Can be installed in 5 minutes. Includes "Jigger Mount"—a new mounting base that attaches to any pitch roof, any kind of building. Anodized in gold. Retail Price **\$3395**



MINUTE-MOUNT—A revolutionary new conception for rugged fringe areas. Complete unit includes 10 ft. factory-assembled tower and high gain antenna with famous patented "Electro Lens". All-aluminum tower opens like a music stand. Adjusts for any kind of roof. Withstands strongest winds. Everything included—tower, antenna, lead-in, 7 insulators, lightning arrestor, ground-wire and ground-rod. Retail Price **\$4495**

OTHER WINEGARD ANTENNAS FOR PROFESSIONAL INSTALLATION TO MEET ANY CONDITION

Order from your Jobber, or write



Winegard Co.

3000 Scotten Blvd., Burlington, Iowa

*Pat. No. 2700105

new Sylvania TV SHOW

launches a dramatic new advertising program for TV Service Dealers



Biggest TV news this fall for you as a service dealer is Sylvania's new adventure thriller "The Buccaneers." Packed with exciting pirate lore, Sylvania's new TV show offers entertainment for the entire family.

And it offers you a brand-new opportunity to build your service business through a dramatic new consumer advertising campaign, "TV SMOG."

Millions of TV set owners will be reminded that TV Smog comes from old worn out picture tubes and receiving tubes. And they'll be reminded to see the service dealer who displays the Sylvania Radio & TV service sign for a TV Smog check-up.

To supplement this powerful TV advertising, a complete campaign in *TV Guide* magazine will also steer the TV set owner to you for a TV Smog check-up.

Get behind this TV Smog promotion: identify yourself as the dealer in your neighborhood who features "Silver Screen 85" picture tubes and Sylvania's quality brand receiving tubes.

And keep in touch with your Sylvania distributor for new Buccaneer promotion pieces and premiums.

SYLVANIA ELECTRIC PRODUCTS INC.
1740 Broadway, New York 19, N. Y.
In Canada: Sylvania Electric (Canada) Ltd.
Shell Tower Building, Montreal

LIGHTING • RADIO • ELECTRONICS
TELEVISION • ATOMIC ENERGY



SYLVANIA

"Buccaneers" seen Saturday,
CBS Network carries
"TV SMOG" commercials, sells service



... get a "TV SMOG" rating on your set



... the serviceman who displays this sign

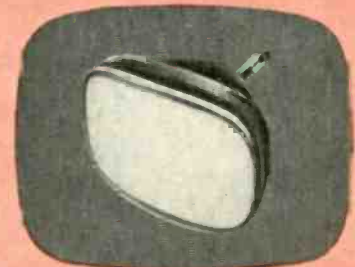

... will install a genuine "Silver Screen 85"



... and replace worn-out receiving tubes with Sylvania's quality brand

Catalogs & Bulletins

DC POWER SUPPLY: An illustrated catalog sheet explaining the construction and operating principles of a specially filtered DC power supply. Model "NFA" power supply has less than a 3/4 per cent ripple at top load and is used for design testing and servicing radios and electronic equipment. Available from R. C. Crossley, Electro Products Labs., 4500 N. Ravenswood Ave., Chicago 40, Ill. (ELECTRONIC TECHNICIAN B12-2)

HI FI EQUIPMENT: 55-page catalog containing seventy kits and including a complete line of hi-fi equipment, amateur radio gear, and service test instruments in kit form. Free copies of "Health kits for 1957" available from Heath Co., 305 Territorial Rd., Benton Harbor, Mich. (ELECTRONIC TECHNICIAN B12-1)

HI FI TUBES: Catalog No. HF656, an 8-page brochure, describes 6 tubes specifically designed for use in high quality audio equipment by Philips of the Netherlands, an affiliate of Amperex. Amperex Electronic Corp., 230 Duffy Ave., Hicksville, L. I., N. Y. (ELECTRONIC TECHNICIAN No. B12-20)

TV TRANSFORMER REPLACEMENT: A manual and subscription service to speed jobber sales and technician repairs. Included is a catalog of a complete line of TV coils, yokes and flybacks hermetically sealed in plastic containers. Free from local distributors or for 75¢ directly from Rogers Electronic Corp., 40 Bleecker St., New York 12, N. Y. (ELECTRONIC TECHNICIAN B12-3)

TWO-WAY RADIO: Bulletin ECR-380-A covers GE's new Progress Line 450 mc two-way radio. Gives details on printed circuitry, interchangeable components, cabinets and mounting. General Electric Co., Communication Equip. Section, Syracuse, N. Y. (ELECTRONIC TECHNICIAN B12-4)

LOUDSPEAKERS: "Speaking About Loudspeakers" is a 32-page booklet which answers basic popular queries with clarity and humor. Written at the lay level, both the general public and hi-fi enthusiasts will find this a valuable guide. Available to general public for 10¢ from University Loudspeakers, Inc., 80 S. Kensico Ave., White Plains, New York. (ELECTRONIC TECHNICIAN B12-5)

CAPACITORS: 1957 Replacement Capacitor Catalog 200D-3 for distributors covers electrolytic, paper tubular, industrial, mica, ceramic, filter and motor start capacitors. The 44-page 3-color catalog is sectionalized and thumb indexed for quick reference. Available from local distributors or from Cornell-Dubilier Electric Corp., South Plainfield, N. J. (ELECTRONIC TECHNICIAN B12-6)

CARTRIDGES: Pickup Cartridge Catalog Sheet 33-1 and Cross Reference Index CRC-56 is a single sheet containing a complete, up-to-date listing of all Astatic phonograph pickup cartridges, new and old stock numbers, illustrations of each cartridge, prices and pertinent specifications on all cartridges. Astatic Corp., Conneaut, Ohio (ELECTRONIC TECHNICIAN B12-7)

COILS: Catalog No. 57-A has 32 pages which list nearly 1,000 different replacement coils for TV set, radios, etc. Also catalogs new series of transistor antenna rods, oscillator coils, and I. F. transformers. All cataloged items are either stocked or available through leading Radio Parts Distributors. I. W. Miller Co., 5917 S. Main St., Los Angeles 3, Calif. (ELECTRONIC TECHNICIAN B12-8)

MICROPHONES: Shure Brothers, Inc., manufacturers of microphones and electronic components announce, in conjunction with the opening of their new scientific manufacturing center, a descriptive brochure stating many scientific reasons why they will be able to serve their manufacturers and distributors even better than before. Shure Brothers, Inc., 222 Hartrey Ave., Evanston, Ill. (ELECTRONIC TECHNICIAN B12-9)

BROADCAST
Quality For ...
P. A.!

The Brilliant
New ASTATIC
FUTURA

DYNAMIC

Metro 788

**PRECISION ENGINEERED,
RUGGEDLY CONSTRUCTED,
BEAUTIFULLY STYLED,
SENSIBLY PRICED!**

Feature for feature the finest buy in its field, the Metro 788 is a dramatically styled, extremely versatile dynamic. Never before has such elegance been combined with such rugged versatility at this moderate price! Capable of operating in difficult installations where other microphones fail because of feedback, the Metro 788 is perfect for all indoor or outdoor high fidelity public address, conference or recording applications. Frequency response 60-13,000 cps; output — 55 db; instant internal hi-low impedance selection; supplied with 360° swivel adaptor, belt clip, lavalier and 20 ft. two wire shielded cable.

Model A-8 Desk Stand Illustrated
... List Price \$8.25

\$79⁵⁰
List Price

For complete information on all Futura series microphones, write for Catalog No. S-438.



For Stand



For Lavalier



For Hand

THE **Astatic** CORPORATION, CONNEAUT, OHIO
KNOWN THE WORLD OVER

IN CANADA: CANADIAN ASTATIC LIMITED, TORONTO, ONTARIO

Export Sales Representative: 401 Broadway, N. Y. 13, N. Y. • Cable—ASTATIC, N. Y.

No antennas ever made can match the performance and sales appeal of these outstanding Channel Master models.

"Showman" indoor antenna
models for VHF or VHF-UHF reception



Smart styling eliminates ugly "rabbit ears." Metro Dyne electronic tuning brings in pictures sharp and clear.

T-W outdoor antenna

The most powerful antenna ever developed: • Highest Gain • Top Front-to-Back Ratios • Greatest Mechanical Strength.

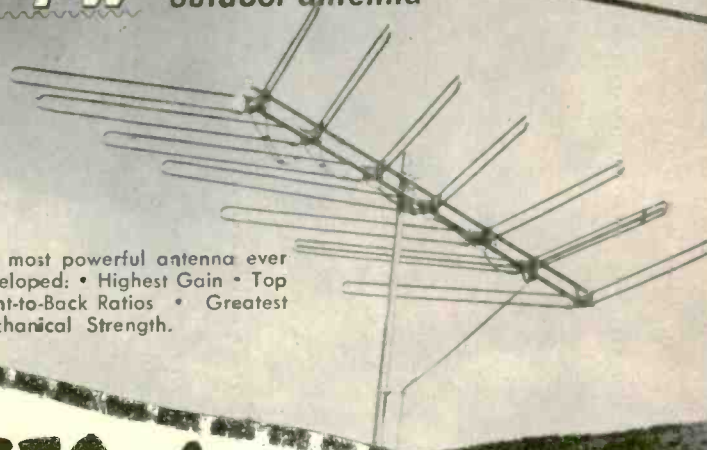

MORE PROFITS for CHANNEL MASTER dealers

In every TV reception area Channel Master dealers are racking up new sales records with the most popular TV antennas on the market today. Superior products plus consistent consumer advertising is a double-barrelled profit combination you can't beat. When you feature the Channel Master line you always have that extra selling edge . . . that extra PLUS that means faster turnover . . . easier sales . . . bigger profits.

Isn't it time you called your Channel Master distributor?

Channel Master's massive national and local advertising program . . . establishes you as the local TV authority . . . is creating loads of new prospects right in your own selling area . . . and is opening millions of homes to antenna replacement.



another Raytheon

FIRST



**100% INTERCHANGEABLE TV TUBES
THAT ELIMINATE SNIVETS***



6DQ6 12DQ6 17DQ6

Thanks to an exclusive new Raytheon fin design, the Raytheon 6DQ6 is the first TV tube which eliminates SNIVETS that is 100% interchangeable — will work without special selection. It eliminates borderline performance, too, because its new design gives it additional and improved sweep characteristics not available in ordinary types.

Raytheon 6DQ6 tubes provide SNIVET free performance because they are individually tested for deflection operation and are given special tests under sweep amplifier conditions. Raytheon 12DQ6 and 17DQ6 Tubes incorporate this same fin construction and will provide the same superior, trouble-free performance.

An added bonus from the Raytheon 6DQ6 is that its interchangeability simplifies stocking. (It's an improved replacement for 6CU6 and 6BQ6GA series.)

Finally, the Raytheon 6DQ6 is another outstanding example of how Raytheon's superior engineering skill and production know-how have brought you still another tube that is first and finest in the field.

* SNIVET — a vertical disturbance on the right hand area of the screen.



RAYTHEON MANUFACTURING COMPANY

Receiving and Cathode Ray Tube Operations

Newton, Mass. • Chicago, Ill. • Atlanta, Ga. • Los Angeles, Calif.

Raytheon makes all these { Receiving and Picture Tubes, Reliable Subminiature and Miniature Tubes, Semiconductor Diodes and Transistors, Nucleonic Tubes, Microwave Tubes.



Excellence in Electronics

ELECTRONIC TECHNICIAN

Including
Circuit Digests

Your Future

During the past ten years, the dollar volume of electronic-TV servicing has climbed rapidly past the annual \$2.1 billion mark.

Independent electronic technicians, purchasing parts from independent parts jobbers, have done the overwhelming majority of the repair work. Whether or not this will continue is in grave doubt.

Service Technicians: Credit and Blame

The one outstanding contribution of service technicians, which deserves the appreciation of everyone, is the excellent job done in maintaining the many millions of TV sets, radios, and audio equipment used every day. That they have done this to the public's satisfaction has been proven by independent polls showing 90% of the customers pleased by the technician's work.

However, electronic technicians are not blameless. Most have neglected to join service associations. Secondly, too many have overlooked good management procedures. These actions, or inaction, encourage manufacturer activities in service.

Enter the Manufacturers

It is to be expected that a set manufacturer will want to assure consumers that competent service is available for his products. But why the recent inclination to set up factory service outlets? For a decade independents did the job without serious complaint by manufacturers. Could the thinning of set maker's ranks, with consequent increase in the individual company's share of the market, have induced surviving firms to think that factory service will be profitable? We hope not.

Should factory-owned national service be fully established, inestimable damage would result. Although technicians would always be needed to do the work, the repair shop as a small business would be destroyed. The role of the jobber would be eliminated. The parts manufacturer would be reduced to the role of subcontractor.

However, with the exception of a few key areas, we believe set manufacturers will find factory-

owned captive service unprofitable, and will consequently restrict these efforts. Service is a local business. Skilled labor is its main ingredient; unlike mass production of goods, large factories offer little advantage in service. The loss of dealer support, already making itself evident, could be a serious blow to set makers. Furthermore there are overtones of monopoly in factory-owned service.

Crystal Ball Gazing

We do not think that independent electronic technicians and jobbers will disappear. We do believe, however, that there is an ominous cloud over their heads, and some changes are unavoidable. We envision the probability of a closer manufacturer-technician relationship, whereby manufacturers will designate many independent shops on a non-exclusive basis as "official service." To some extent this has been done over the years. It would be expected that most good shops would receive a few such authorizations, and remain free to repair any brand. Parts would be purchased from jobbers whose activities would also be more closely integrated with set producers. Other technicians would remain unaffiliated.

Recognize that this is not our proposal for an ideal solution. It is our realistic appraisal of the compromise most likely to result.

Yes, independents will survive, but unless they move quickly they will find themselves considerably less independent than before. Four vital steps you must take:

1. Put your full weight behind association activities. This means participation as well as moral support.
2. Get ready to service color, or else lose this growing volume of work by default to the set manufacturers.
3. Improve your management procedures and upgrade your technical skills.
4. Expand your opportunities by getting into allied electronic and industrial fields, as well as your present TV-radio-audio work.

Don't surrender to captive service!

Tuning In the

UNIONS & LICENSING. Look for redoubled efforts by electrical unions to have licensing instituted in areas where they gain strength among TV technicians. Example is recent move by International Brotherhood of Electrical Workers in San Francisco joined by the Service Guild, to set up a powerful Board of Examiners.

SET PARTS DECREASE. Use of multi-purpose tubes, printed circuits and potted stages have reduced the number of separate components in current TV sets. A count of the GE Model E chassis with 21 tubes reveals 585 parts, plus 19 major cabinet parts. The 100 tuner parts include: 38 capacitors, 23 resistors, 13 coils, 24 mechanical parts, and two tubes. The 485 main chassis parts are: 141 capacitors, 185 resistors & controls, 75 coils & transformers, 45 misc. electrical, 20 misc. mechanical, and 19 tubes. Nuts and bolts are not counted. Portables have about two-thirds as many parts.

A HIGHLY-PAID ENGINEER who has been with one of the networks ever since he ceased being a struggling, pre-war technician owner of a one-man shop, was surprised no end the other day when a customer send his \$6.70 as a "conscience" payment for a job done in 1939!

AUDIO AMPLIFIERS. How large should a four-stage audio amplifier be? 5x8x6 in.? 6x10x8 in.? For hi-power hi-fi, perhaps so. But Centralab has come up with a four-stage transistor amplifier TA-11, including five capacitors and 12 resistors. Gain is 75 db, frequency response is 250 to 20,000 cps, and output is 1 mw. The size? Just 1.175 in. long, 0.665 in. wide, and 0.25 in. thick!

RADAR CLEANUP—BEFORE & AFTER

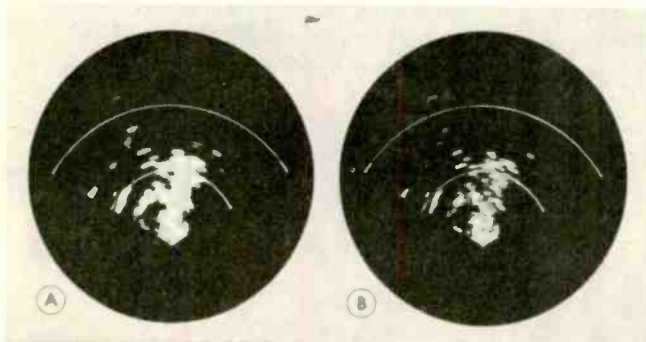

An automatic device which clearly separates radar targets and saves time for radar technicians is called the COAC—Clutter-Operated Anti-Clutter. This DuMont development uses impulses returned from small cluttered targets (left) to keep the small images from blending with the fringe of large images. The result is separately defined navigation landmarks (right). The gain control is thus eliminated, requiring adjustment of only antenna tilt and brightness controls.



MONOPOLISTS BEWARE. Congress can be expected to keep its eye on big companies which may crowd out small businesses. House Judiciary Committee Chairman Emanuel Celler reports: "Bigness must be watched closely not because we think it inherently bad but because its magnitude presents strong temptations to misuse its great power. . . . Do not expect the Congress to relax on the antitrust laws. . . . We regard it as the will of the people that monopoly, wherever found, whether big or small, must be stamped out."

INSTRUMENT WARRANTY. A new one-year service-instruction warranty covering most of Hickok's test instruments provides, in addition to the 90-day RETMA materials-workmanship guarantee, for a service engineer to call on the purchaser. The instrument is checked for calibration, and tester functions explained.

VANISHING TRIBE. Indicative of the fiercely competitive nature of TV manufacturing is the recent announcement that Crosley-Bendix is quitting TV production. Other set makers leaving the field this year include CBS-Columbia, Raytheon, Sentinel and Stromberg-Carlson. Also cutbacks or mergers at Hallcrafters, Capehart-Farnsworth and Sparton. Only new entry is GE's Hotpoint.

COLOR TV VOLUME UP. By the end of 1956 there will be an estimated 200,000 to 250,000 color TV sets in use, the majority of them sold this year. This is a small pebble on the huge TV beach in terms of percent of total sets. However, some RCA distributors who have put their shoulders behind the color campaign report that their dollar volume for color is almost equal to black-and-white. TV shops are receiving an increasing number of color service inquiries, but unfortunately too few are presently geared to make repairs.

Picture

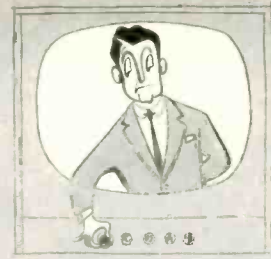

BUSINESS EXPECTATIONS. A Dun & Bradstreet survey of what business men expect for the first quarter of 1957 compared with 1956 results in a very promising picture. Though retailers were more conservative in their estimates than manufacturers or wholesalers, many expected sales and profit increases, few anticipated declines. Detail tabulation is as follows:

WHAT BUSINESS MEN EXPECT FOR THE FIRST QUARTER OF 1957 COMPARED WITH THE FIRST QUARTER OF 1956

| | | All Concerns | Mfrs. | Wholesalers | Retailers |
|-------------------|--|--------------|---------|-------------|-----------|
| Net Sales | Number Reporting | 1593 | 742 | 581 | 270 |
| | (Increase) | 60 | 63 | 63 | 49 |
| | Per cent (No Change Expecting (Decrease) | 34 6 | 32 5 | 32 5 | 44 7 |
| Net Profits | Number Reporting | 1478 | 691 | 540 | 247 |
| | (Increase) | 43 | 46 | 44 | 34 |
| | Per cent (No Change Expecting (Decrease) | 51 6 | 48 6 | 51 5 | 60 6 |
| Selling Prices | Number Reporting | 1564 | 726 | 571 | 267 |
| | (Increase) | 42 | 40 | 46 | 39 |
| | Per cent (No Change Expecting (Decrease) | 56 2 | 58 2 | 51 3 | 60 1 |
| No. of Employees* | Number Reporting | 1597 | 744 | 581 | 272 |
| | (Increase) | 15 | 20 | 11 | 8 |
| | Per cent (No Change Expecting (Decrease) | 82 3 | 76 4 | 86 3 | 86 6 |

* End of Quarter

CALENDAR OF COMING EVENTS

- Dec. 6-8: Electronics Fair (RTGLI), New York State U., Farmingdale, N. Y.
- Dec. 10-12: Eastern Joint Computer Conference, Hotel New Yorker, New York, N. Y.
- Jan. 14-16: Third National Symposium on Reliability and Quality Control in Electronics, Hotel Statler, Washington, D. C.
- Feb. 6-9: Los Angeles High Fidelity Show. Location still to be determined.
- Mar. 3-6: 1957 Annual Convention of National Education Assoc., Dept. of Audio-Visual Instruction, Sheraton Park Hotel, Washington, D. C.
- Mar. 18-21: IRE National Convention, New York Coliseum and Waldorf-Astoria Hotel, New York, N. Y.
- Apr. 14-27: U. S. World Trade Fair, New York Coliseum, N. Y.

PHRASES THE TECHNICIAN HEARS MOST OFTEN: "I think it's a tube," "How soon will your man be here?"; "My husband thinks the trouble is (you fill it in)—"; "Can't you please fix the set without taking it away?"; "I'll pay you next week."

BRINE BLIND. TV set owners along ocean shores are finding reception blacked out thanks to salt deposits on antennas. Solution: Turn on the garden hose to wash salt away . . . until it builds up again.

"NO CHARGE IF ESTIMATE IS REFUSED" is a new gimmick being used by some of the high-pressure service outfits in the big cities. Other offers stress a year's guarantee, 24-hour service, service within 2 hours; picture tubes up to as high as 50% off list.

RANDOM NOISE

OVER 75% OF TV OWNERS BELIEVE A FAIR PRICE FOR A HOUSE CALL OR AN HOUR OF LABOR IS \$3 OR UNDER; OVER 25% SAY \$2 OR LESS. ON THE OTHER HAND, A N.Y. CONSUMER COUNSEL SURVEY REPORTS, OVER 90% OF TV TECHNICIANS SAY THE CHARGE SHOULD BE \$3 TO \$5

INDUSTRIAL AND COMMERCIAL ORGANIZATIONS BOUGHT \$1 BILLION OF ELECTRONIC EQUIPMENT THIS YEAR—PRODUCING MANY NEW SERVICING OPPORTUNITIES

TOM HIGGINS JR.

COAL MINERS WORKING 190 FEET BELOW THE SURFACE LISTENED TO THE WORLD SERIES ON A TRANSISTOR RADIO, REPORTS WESTINGHOUSE

ELECTRONIC COOKING MAY CHANGE THE TYPE OF POTS IN OUR KITCHENS—SEEMS THAT METAL COOKWARE TENDS TO REFLECT THE HEAT-PRODUCING MICROWAVES

Applications of Voltmeter and

A Realistic View of the Uses and Limitations of

ROBERT G. MIDDLETON
SIMPSON ELECTRIC CO.

• Test probes were first used in the television service industry during the middle forties, and since that time their popularity has grown by leaps and bounds. Probes are now found in almost every service shop in the country, and are supplied by many manufacturers in both fabricated and in kit form. Probes have also been constructed by the thousands from miscellaneous parts found about service shops. It is noteworthy that test probes now occupy a prominent place in receiver manufacturers' service data; various circuit tests are specified for high-voltage probes, low-capacitance probes, detector probes, and other types.

High Voltage Probe

Because the applications and limitations of the various probe types are not always understood as well as could be desired from the standpoint of efficient troubleshooting work, a realistic recapitulation of these considerations is timely. The chief difficulty encountered in the use of the high-voltage d-c probe arises when the operator attempts to measure 2nd anode voltages with a voltmeter for which the probe was not designed. As shown in Fig. 1, the con-

isolates the circuit under test from the oscilloscope and minimizes the tendency to start parasitic oscillations due to the feedback loop established between the scope amplifier, power line, and receiver. Also serves as a low-pass filter probe, sharpening broad-marker pips which would otherwise mask important portions of response traces.

Used in all general purpose oscilloscope tests, where the circuit under test is low impedance and/or low frequency (because cable adds approximately 55 μfd capacity) and where direct scope connections are required, in order to utilize the maximum sensitivity of the scope. A fully-shielded direct probe avoids stray field pickup.

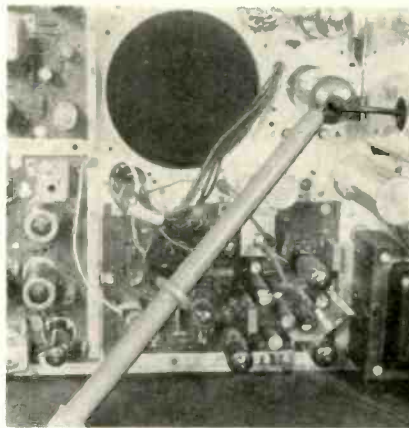

Fig. 2—High-voltage probe used to measure B+ at plate of horizontal-output tube.

figuration of a high-voltage d-c probe is quite simple, comprising only a multiplier resistor of suitable construction and a shielded cable for connection to the voltmeter. The value of the multiplier resistor must match the input resistance of the voltmeter with which it is used. If the probe is designed to operate with a 20,000 ohms-per-volt meter, it must be used with an instrument of this sensitivity—such a probe will not indicate correct voltage values on a 1,000 ohms-per-volt meter, or on a VTVM. The probe must also be used on the particular range of the voltmeter for which it is intended—thus, a probe designed for use on the

1,000-volt range of the meter will indicate correct voltages on this range only, and will indicate incorrect values on the 250-volt range, for example. Most high-voltage d-c probes can be disassembled, and a multiplier resistor of another value inserted. Thus, the probe can be adapted for use with more than one voltmeter by substitution of a suitable value of multiplier resistor.

It is sometimes supposed that a high-voltage d-c probe is useful only to check picture-tube voltages, but there is at least one other application of value in service work. Fig. 2 shows a high-voltage probe in use to measure the plate voltage of the horizontal-output tube on a VTVM.

Fig. 3—High-voltage cheater is hollow, to accommodate probe in color TV receivers.

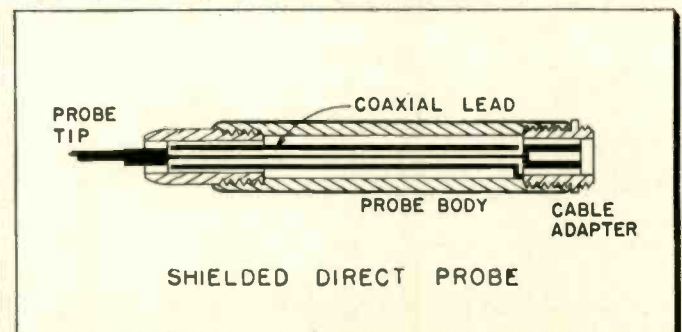
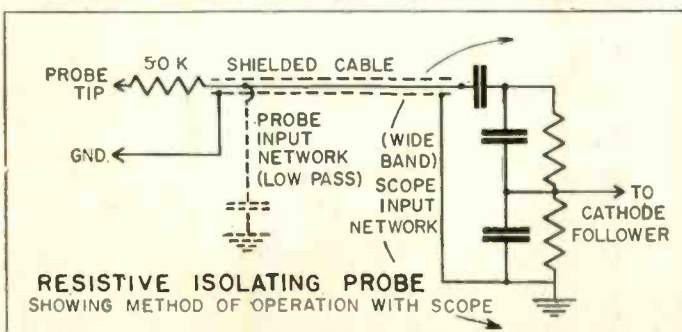

Oscilloscope Probes

Test Probes and Associated Equipment

Without the probe, the plate voltage could not be measured (most service notes specify "Do not measure"), because the 6000-volt a-c pulse which is present at the plate of the tube would over-ride the B+ voltage to be measured, and would damage the voltmeter. The B+ voltage at the plate of the horizontal-output tube can be successfully measured, however, when the probe is used, because the probe operates as a filter, to suppress the flow of a-c voltage to the meter, while passing the d-c B+ voltage. Inspection of Fig. 1 shows why this is so—the series resistance feeds into the shunt capacitance of the shielded cable, to provide an effective integrating circuit, or low-pass filter. D-C can pass, but a-c pulses cannot pass, into the meter circuit. When used with a VTVM, a high-voltage probe customarily multiplies the range by a factor of 100, so that the voltmeter can be set to the 5-volt range, for example, and a full-scale indication of 500 volts is obtained.

Note carefully, that this type of test cannot be made with a VOM, because the probe will not indicate properly or satisfactorily on any range except the one for which it was intended. The input resistance of a VOM is not constant on all ranges, but drops to low values on the lower ranges, and this type of test is not satisfactory or practical

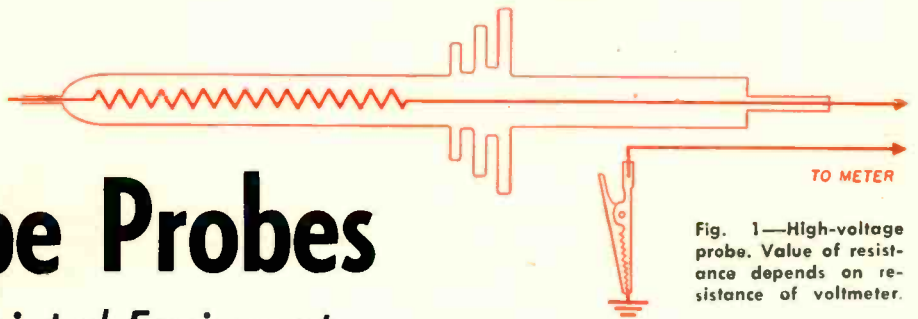

Fig. 1—High-voltage probe. Value of resistance depends on resistance of voltmeter.

measurement conveniently, without any disconnections or taps.

Signal-Tracing Probes

A VOM or VTVM can be used to check the signal level in oscillator, sync, video, and sound circuits when used with a suitable signal-tracing probe. To test the oscillator level in a radio receiver, the probe is applied to the signal grid of the converter tube, while the tuning dial is rotated through its range to check oscillator operation. Signal level at the input of the video amplifier, on a TV receiver, can also be determined. The relative waveform level at the horizontal-output tube and at the high-voltage rectifier tube can also be checked with a signal-tracing probe, by holding the tip of the probe against the glass wall of the tube. The indication in this case is made by means of capacitive pick-up. (Caution to avoid damage to the probe and meter avoid drawing an arc from the exposed tube caps and wire attached thereto.) No voltage indication shows that a fault is present before the output circuit, and the service man will next check the waveform voltage at the grid of the horizontal-output tube, to determine whether normal drive is present. Weak or no drive voltage points to trouble in the horizontal-oscillator circuit. Tests can be made in any



Fig. 4—Polarity-reversing probe speeds test.

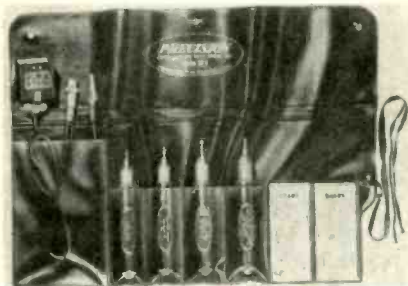
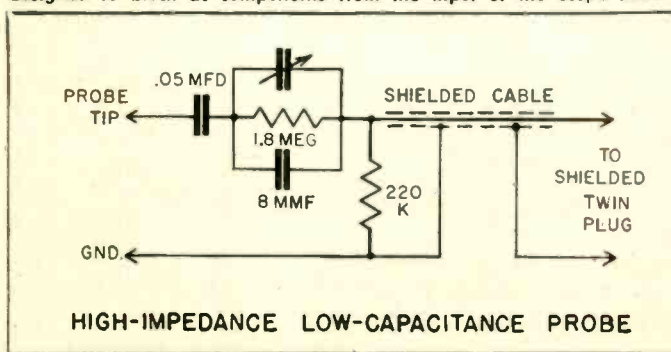

Fig. 5—Probe kit contains direct, isolating, demodulating, and low-capacity probes.

with a VOM. This is one of the advantages of a VTVM in service work, among other advantages.

Another important point in the use of the high-voltage probe concerns color-TV service work. Color-TV receivers use accelerating voltages up to 25,000 volts, and the most practical method of application is to use a high-voltage cheater with the probe; a suitable cheater is shown in Fig. 3. The cheater is hollow, and the high-voltage probe can be inserted into the cheater to make the

Presents low capacity and high impedance to the circuit being tested, thereby effectively converting the input of the scope for use in high impedance circuits. It is frequency-compensated to permit faithful scope reproductions of high-harmonic-content pulses. The probe is also designed to block dc components from the input of the scope itself.



The composite TV video signal consists of an RF carrier modulated by picture information plus blanking and associated sync pulses. The RF is removed by the probe before application to the oscilloscope so that the relatively low frequency modulation pattern (video and pulse information) may be seen. Used for alignment and signal tracing.

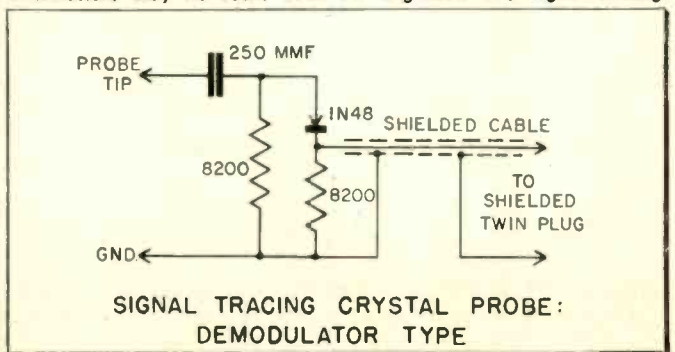

circuit in which the waveform has a reasonably high level, including the audio signal in the sound section. Thus it is apparent that when a signal-tracing probe is suitably utilized, a voltmeter can be made to do part of the job of a scope.

Polarity Reversal Probe

Transistors are coming into widespread use, and several ohmmeter checks are required. Front to back resistance ratios. For such jobs, the use of a polarity-reversing probe with an ohmmeter, as shown in Fig. 4, speeds up the checks and eliminates the annoyance of reversals of the test leads. Of course, a polarity-reversing probe is also a great convenience in checking conventional d-c voltages in receiver chassis, where both positive and negative voltages are encountered. If the pointer deflects to the left instead of to the right, the service man merely flips the switch in the probe housing.

Oscilloscope Probes

Oscilloscope probes have characteristics which are suited for waveform display. Three typical scope probes are illustrated in Fig. 5. The demodulator probe is a detector-type probe which has a much shorter time constant than a signal-tracing

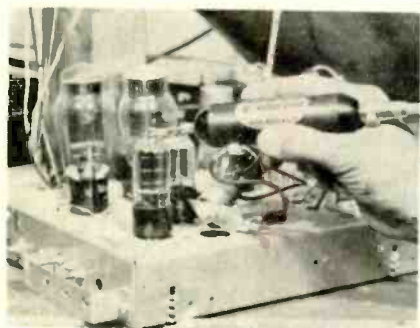

Fig. 6—100 to 1 voltage-divider probe at plate of horizontal output tube to check waveform and peak-to-peak voltage.



Fig. 7—VTVM peak-to-peak probe.

probe for use with a voltmeter. This point is not always fully understood. A voltmeter detector probe does not work with a scope because the voltmeter probe is a complete rectifier and filter. On the other hand, a demodulator probe rectifies and filters only the carrier frequency, but

passes the modulating frequency to the scope for display on the screen. A demodulator probe is utilized for tracing through the signal circuits of radio and TV receivers, and for sweep-frequency checks of video amplifiers. Demodulator probes are also required for frequency-response checks of the chrominance circuits in color-TV receivers. It is not always recognized that a demodulator probe does not have the bandwidth provided by many present-day scopes, with the result that a video signal becomes distorted to some extent in passage through the probe. The vertical sync pulses will appear prominently on the scope screen, but the horizontal sync pulses are considerably attenuated in the display. Thus, when wide-band signals are applied to a demodulator probe, the pattern requires a certain amount of interpretation by the operator.

Low-Capacitance Probe

Low-capacitance probes are used with a scope when high-impedance circuits are under test. It is essential to utilize this probe because a direct probe will load the circuit and cause waveform distortion. Sync circuits and video circuits often require the use of a low-capacitance probe. Most low-capacitance probes attenuate the signal by a factor of 10.

Voltage-Divider Probe

High-voltage a-c probes extend the field of application of a scope into flyback, damper, and yoke circuits, in which the a-c voltages are high enough to overload or damage the scope if the probe were not used. These probes usually attenuate the waveform voltage by a factor of 100. Thus, if a scope is used to check the 6000-volt pulse at the plate of the horizontal-output tube, the probe attenuates the pulse to a value of 60 volts, which can be properly handled by the oscilloscope. Typical application of the probe is illustrated in Fig. 6.

Low-capacitance and high-voltage a-c probes provide decimal attenuation factors of 10 and 100, so that the waveform voltages can be measured conveniently. When using a 10-to-1 probe, the service man adds one zero to his calibrating factor, and, when using a 100-to-1 probe, he adds two zeros. It is evident that suitable probes multiply the usefulness of test instruments many times over, and no service shop can afford to be without a complement of probes today. •

ILLUSTRATION CREDITS

- Fig. 2 Simpson Electric Co.
- Fig. 3 Walsco Electronics Corp.
- Fig. 4 Futuramic Co.
- Fig. 5 & Schematics Precision Apparatus Co.
- Fig. 6 Scala Radio Co.
- Fig. 7 Electronic Instrument Co.

Simplified Transistor Testing

BEN CRISSIS

Many servicemen have indicated a desire for an inexpensive instrument, and a simplified test procedure. There are 3 reliable, yet simple tests for a transistor. In very general terms a PNP, or NPN type of transistor can be treated as a dual diode rectifier connected back-to-back. As in the diode, the front-to-back resistance and current ratios provide us with two characteristics to look for.

The forward and reverse resistance readings can be made with any ohmmeter, whose internal voltage does not exceed the maximum potentials that can be safely applied to the transistor. A ratio of approximately 100 to 1 or better is desirable. (Technician page 48, April 1956). The test for reverse or leakage current is also just as simple as shown in Figure 1 and 2. The value of the biasing voltage, and reverse current is indicated

(Continued on page 49)

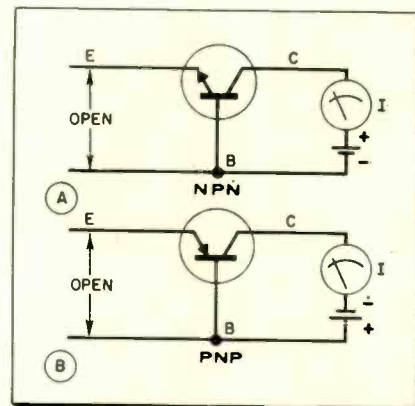
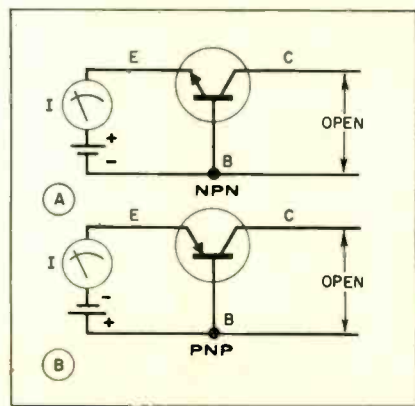
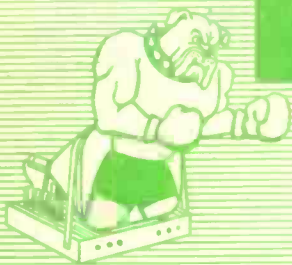

Fig. 1—Measuring collector leakage.

Fig. 2—Measuring rev. emitter leakage.





"Tough Dog" TV



Corner

Difficult Service Jobs Described by Readers

Erratic Vertical Hold

Have you ever run into a set that defied all your experience and gave you such a mental beating you resolved to be done with this crazy business? If you haven't, you're new at this game. Stick to it long enough, and you will meet some dillies. Like the Emerson, 206D, that came in because of erratic vertical hold. In turning the hold control it was noticed the range was off. The picture could be made to roll down, but not up. This would be a lead pipe cinch, the resistor in series with the control had increased, we reasoned; all that had to be done would be to slap in a new one, and the job would be duck soup. How wrong we were. The new 820K resistor did absolutely nothing for that set, the range was still off, and the picture slipped vertically downward at odd intervals. We got out the diagram, and found the circuit to be as pictured in Fig. 1. Notice the method of applying the sync pulse; to the plate, instead of the first grid.

Note how the output tube is part of the multivibrator. We scoped the integrator and traced the sync pulse right up to the plate of the first section. Everything seemed in order, the sync having a positive phase (the reason, evidently, why it was applied to the plate, multivibrators demanding a negative pulse when applied to the grid) and of proper amplitude. We looked at the waveform on the grid of the second section, the 6K6, and it was while monitoring the pulse here, that we observed the reason for the slipping. At odd intervals, but in step with the slipping, the pulse was being compressed. We went over the circuit components with a fine comb; we substituted a new coupling capacitor, the .1 μf item, we checked the resistors, but nothing we did seemed to help. We were stumped.

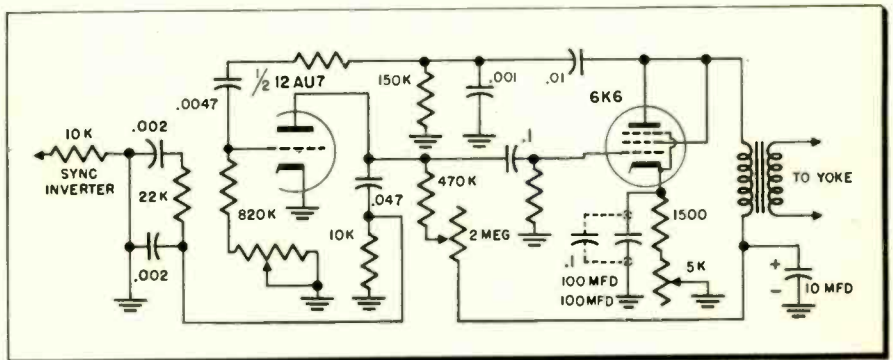

Fig. 1—Emerson 206D, vertical oscillator and output.

Later we returned to the set. Almost immediately, the answer seemed clear and simple. Look at that diagram again; notice the cathode of the 6K6, and the bypassing agent, a 100 μf electrolytic. What happens when an electrolytic in such a spot decides to become anti-bypassing? Degeneration? Sure. This could be causing the compression of the grid wave form. Electrolytics are notorious as bad bypassers of frequencies above 10,000 cycles; and since the saw-tooth is made up of many harmonics of the fundamental, this waveform was being distorted and compressed. The simple expedient of shunting the electrolytic with a paper, .1 μf , 600 v capacitor cleared the trouble completely, even to the correct range of the vertical hold control.—H. M. Layden, New York, N. Y.

Vibration Service

The TV set was a Packard-Bell model 2710, however, the same difficulty could occur in almost any make receiver. The complaint was that jarring or hitting the cabinet would make the picture vary from a good one to one loaded with sound bars to a complete loss of picture with streaking across the raster. All the tubes tested good, and an in-

spection of components and connections showed nothing wrong. When the picture was torn up with sound bars it could be cleared up fairly well by retuning the turret tuner oscillator slugs, but another tap would throw it off again. The turret was removed, and nothing was found amiss in the tuner. The entire tuner was removed and connected to the chassis with long leads. Tapping on the tuner had no effect on the picture. Tapping on the chassis produced the same trouble as before. The tuner was reinstalled in the chassis and tapping tried again at a lower intensity, and at various points on the chassis. This procedure indicated that the source of trouble might be near the center of the chassis where the video IF transformers were mounted. By reducing the intensity of the tapping to almost nothing, the last IF seemed to be the most sensitive component. No trouble was visible. The core was removed and found to be in three pieces. Jarring the set had rearranged the pieces in various patterns and thus altered the alignment of the last IF. Replacing the core with a new one and realigning the receiver restored the picture to normal. C. G. Adair, San Antonio, Texas.

Frequency Response Errors

The Causes of Undesirable Deviations from Flat Frequency

• Before we can do anything about either an excess or deficiency of either high or low frequencies, we must be sure that we know how to tell when such nonlinearity exists. This can be done by listening, as will be discussed shortly, or with instruments as described in an earlier article (*Hi-Fi Tests with a Scope*, July 1956 TECHNICIAN).

Many books state that high frequency loss (treble cutting) is the same as bass boosting, and similarly that high frequency or treble boosting is the same as bass cutting. While the two effects are certainly similar, to the high fidelity enthusiast there is considerable difference. In servicing it is important to know which effects you have in order to make a satisfactory approach to tracing the fault. Probably the best way to become familiar with the difference is to use one of the hi-fi preamplifiers that come provided with bass and treble controls, and to listen carefully for the difference.

First of all, to get clear the difference between treble boost and bass loss, play some program material with both tone controls in the middle position to get familiar with



NORMAN H. CROWHURST

flat response. Now, if you accentuate the treble, by turning the control up to maximum boost, you will notice there is an increased *edginess* to the response, occasioned by reproduction of the very high frequencies at greater intensity.

Returning this control to normal and turning the bass to minimum, an edginess is not produced, but rather the low frequencies become deficient and make the reproduction sound *thin*—as though the bass instruments had fallen out of the music. Comparison of these responses is shown in Fig. 1.

Listen Carefully

If you now turn the bass control to the other extreme, you will find that the difference is only noticeable on program material containing bass. If you happen to be playing a section of program material in which there is no particular emphasis on the low frequencies, you will be unable to hear any difference. But, if you have a piece of program material where the string bass has a part, or a bass drum is being played, you will quickly notice the difference—an increase in the relative loudness of these instruments, compared with the rest of the program. This increase is *not accompanied by any loss of sharpness in the higher end of the frequency response.*

If now you return the bass control to normal and turn the treble control to minimum, you will find that the upper frequencies become missing and the reproduction sounds somewhat *woolly*. This comparison is illustrated at Fig. 2.

After a little listening exercise of this kind you should be able to distinguish between the relative response of the low frequencies, the

middle frequencies and the high frequencies quite readily. This ability is important to successful handling of high fidelity systems.

While listening is a useful guide to what is wrong somewhere in the system, the oscilloscope method described in the previous article is useful in tracing the particular point at which highs or lows get lost or become excessive. The next step is to consider tracing the cause of this kind of fault in an individual amplifier.

Who Changed What?

You can often save yourself a certain amount of trouble by getting the customer's cooperation in tracing the history of his amplifier. With the abundance of articles in audio magazines, describing how to improve the performance of an amplifier by changing the output transformer, using different output tubes and various other modifications, it is not surprising that many high fidelity enthusiasts attempt their own alterations. What often happens then runs something like this:

The purpose of the suggested change is either to increase the available output or to bring distortion to a new low level. So, when the owner makes the change, he is listening particularly to the amount of output he can get from the system or to the minute degrees of distortion present. He does not pay particular attention to any possible change in frequency response. As a result it may be quite a little while before, or some particular favorite recording, he suddenly realizes there is something wrong: too much or too little treble or bass in the response. He will then conclude that some fault has developed in the system not connected in any way with the changes he made. At this point he realizes that the matter is beyond his powers, so he brings it to you.

He may conclude that the changes he made *should* have had no effect on frequency response: after all, changing the output stage of an amplifier from push-pull pentode or

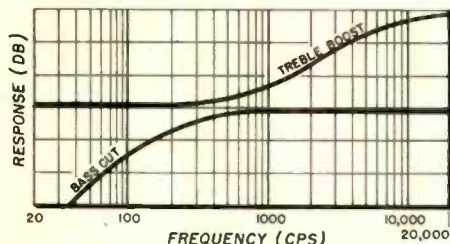
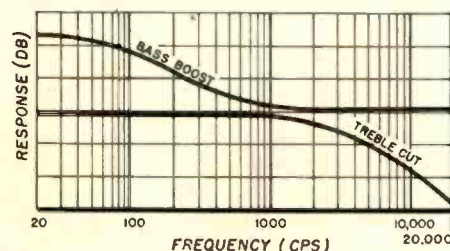

Fig. 1—Treble boost (upper curve) and bass cut (lower curve) are not identical effects.

Fig. 2—Bass boost and treble cut, while similar effects, are not identically the same.



in Hi-Fi Audio Amplifiers

Response May Vary Greatly Depending on Amplifier Design

triode operation to ultra-linear would hardly be expected to have much effect on response. But in feedback amplifiers it is never possible to be entirely sure of such an apparently obvious thing. So, if you can learn a little of the amplifier history, it will help you to determine whether the fault must have developed in the system by itself (and is therefore most likely due to a faulty component) or whether changes the owner has made will require attention.

An amplifier that has enjoyed considerable continuing popularity employs the Williamson circuit shown in Fig. 3. A true Williamson circuit uses push-pull KT66 (English) type output tubes (or maybe, with slight modifications, similar types such as 6L6 or 5881) connected as triodes, with 100 ohm resistors between plate and screen. The resistor R12 provides a considerable amount of overall feedback from the output transformer secondary back to the cathode resistor of the first stage.

The stability of the feedback is dependent upon fairly close control of all the components in the circuit, including the voice coil impedance connected at the output. The connection of a different loudspeaker to the output of a Williamson amplifier has been known to cause it to oscillate. Even if this does not happen,

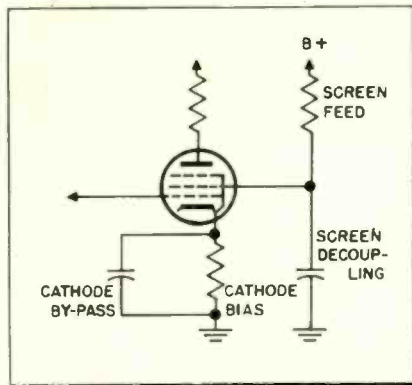

Fig. 4—Arrangement of screen and cathode decoupling in typical a-f pentode input stage.

the change of the loudspeaker can well result in either considerably increased or considerably reduced high frequency response. The impedance characteristic of the voice coil of whatever loudspeaker is connected to a Williamson amplifier can quite definitely affect amplifier response: one voice coil impedance will cause a rise in high frequency characteristic while another may cause it to fall.

Two loudspeakers may be compared on another non-feedback amplifier; then when the same two are connected to the Williamson amplifier, quite a different comparative response results. To get best results the feedback resistor R12 should be adjusted to suit whatever

loudspeaker is connected.

Any feedback amplifier behaves quite differently in certain respects from non-feedback amplifiers: indeed factors that normally (in a non-feedback amplifier) would produce one effect can sometimes produce the opposite effect when feedback is used.

Low Frequency Loss

In a non-feedback amplifier, loss of low frequencies can be due to defective coupling capacitors: an open circuit coupling capacitor will still pass the higher frequencies, due to some slight residual capacitance; however the lower frequencies are completely lost, because the full capacitor value has disappeared.

Excess of low frequencies can occur in a non-feedback amplifier due to partial failure of a by-pass or decoupling capacitor. A decoupling capacitor, such as C1 or C2 in Fig. 3, serves to make the junction between the decoupling resistor and the plate coupling resistor, R2 and R3, or R6 and R7, at ground potential to ac, or signal. However, at the extreme low frequency end of the response, the reactance of the capacitor allows some fluctuation with signal, and the coupling provided for the tube is a little more than just the coupling resistor R3 or R7. This causes a rise at the extreme low

Fig. 3—Circuit typifies Williamson amplifiers of the original design, shows components that can cause defects noted in the text.

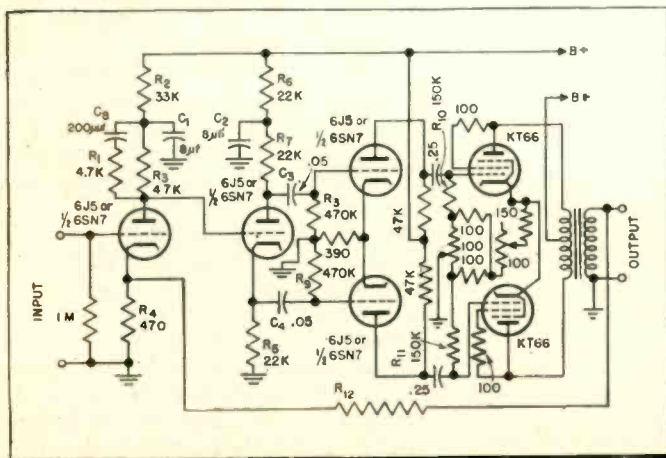
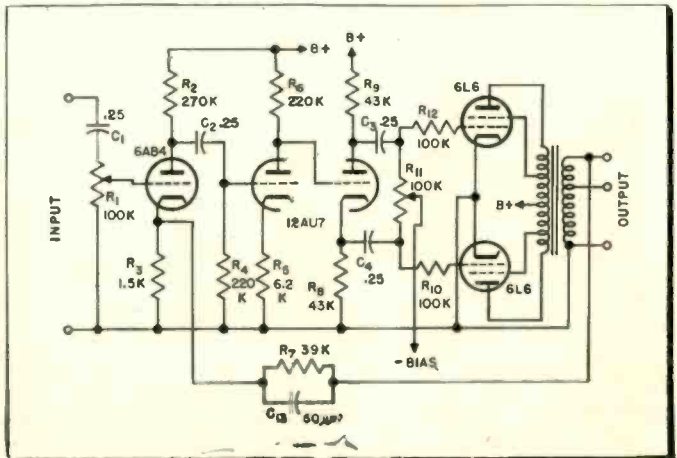

Fig. 5—This Fairchild 255 typifies many amplifiers using ultra-linear circuit developed, in general sense, from Williamson design.



end. When the capacitor has its normal value, this rise is below the audio band and offsets the loss due to the coupling capacitors. But electrolytic capacitors, such as are normally used for decoupling, tend to lose capacitance with age. This causes the rise in low frequency to occur higher up, where it comes within the audio band.

By-pass Capacitors

If cathode or screen by-pass capacitors are used, as shown in Fig. 4 for a pentode input stage, loss of capacitance here will result in loss of the low frequencies, because the effect of these by-pass capacitors is to increase the gain of the tube. So loss of the by-pass effect at the low frequency end will result in loss of gain in a non-feedback amplifier.

Loss or excess of high frequencies will usually be a little more difficult to trace, because there are no particular components responsible for maintaining high frequency response—or losing it. Usually defects in this case will be due to faulty tube sockets or a faulty output transformer. A faulty tube socket may sometimes show excessive capacitance between grid and cathode pins, or some other pair of pins. This may be due to a defect arising in the socket itself, but may also be due to solder having dropped between the pins. This may not cause a definite short but can increase capacitance due to reducing effective spacing.

The output transformer may develop shorted turns. Usually the most noticeable effect of shorted turns is a modification of the high frequency response. Sometimes it can accentuate it, but more often it causes high frequency loss. Shorted turns in the output transformer will also reduce the available output—but this effect may not be noticed so much as the effect on frequency response.

So much for the amplifier without feedback. But *most high fidelity amplifiers nowadays employ feedback*, and this means that the simple relationships just described can have either the same or reverse effects! In the Williamson circuit, deterioration of capacitance in the decoupling capacitors C1 and C2 (Fig. 3) may still cause excessive low frequency response—but may also result in low frequency roll-off at an unduly high frequency. An open-circuit coupling capacitor will usually result in loss of low frequencies, the same as without feedback—but it may also result in instability at a middle frequency due to introducing a most unusual phase shift in the middle of the frequency range.

For high frequency response in feedback amplifiers, the situation is even more complicated. In the Williamson amplifier of Fig 3, the series combination of R1 and C8 is connected across the plate resistor of the first tube to take care of a tendency toward instability at the high frequency end. Without feed-

back, this combination results in a high frequency slope-off which begins to take effect above 20 Kc, so it will not make any *audible* difference. However, with feedback connected it is necessary to prevent the amplifier going into supersonic oscillation.

Under certain circumstances even then, the amplifier may be subjected to this kind of oscillation—particularly if operated with the loudspeaker disconnected at any time. This may result in deterioration of R1 due to overheating so that, when the loudspeaker is reconnected the value of R1 has changed from 4.7k to something considerably lower. Under this condition the amplifier may continue to be unstable even with the loudspeaker reconnected, or it may have an excessive high frequency response.

Williamson Transformer

The Williamson amplifier, with a good loudspeaker, that does not have too much variation in voice coil impedance, and with the original transformer designed for the Williamson amplifier (or one with identical characteristics) gives quite good performance. However, a large number of transformers have appeared on the market, advertised as being Williamson output types. Many of these do not have identical characteristics with the original transformer. As a result the amplifier will produce results quite different from the performance of the
(Continued on page 50)

Antenna Signal Variation With Height Above Ground

JAMES A. McROBERTS

• The general rule "the higher the better" has its exceptions too. Frequently an added two or three feet of height may result in a decrease of signal strength instead of the anticipated increase.

The reason for the failure of this law is, the pickup follows a pattern of cyclic change in output as the height changes. The graph shows such a variation. The effect is important where every spare microvolt of signal must be grabbed in those fringe area installations.

The variation is also a function of frequency of the signal or its wavelength. Adjustment should be made on the weakest signal if several channels are being received.

Stronger stations will tend to take care of themselves.

Since the variation is a function of frequency, better performance is obtainable in some instances if the high frequency dipole is placed above the low frequency dipole or below it. Try both positions.

Variation of signal intensity with height.

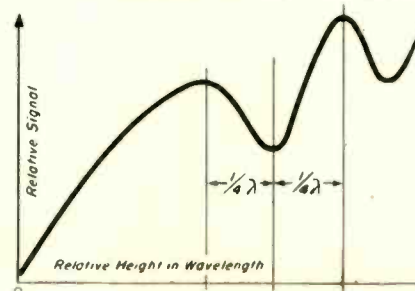

All such adjustments of height and position should be performed with the aid of a sensitive field strength meter. As a substitute, the a.g.c. voltage of the operating set can be monitored. Make the tests with height increments of about six inches. The height difference between a peak in the graph and a lull will be about a quarter wavelength. Minimum antenna height is of course determined by local conditions. The effect is most noticeable with the simpler antennas by contrast with the multi-element array types. Some variation with height is noted on all arrays.

The recurrent peaks in the graph are due to a sine factor in the aerial formula for intensity as the height varies in electrical degrees. •

YOU and the LAW

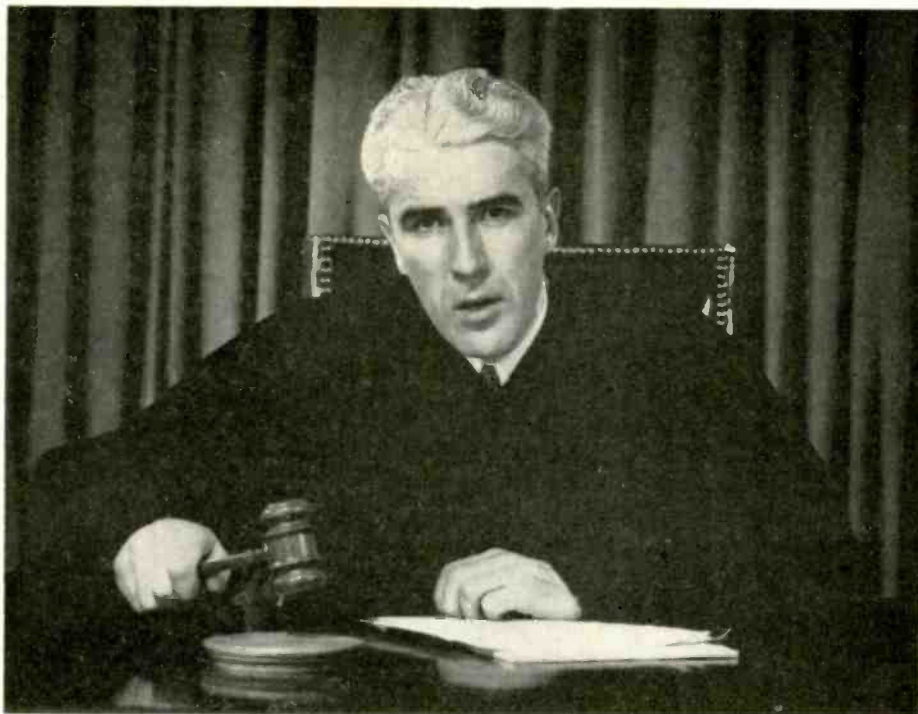

Shopkeeper's Duties to His Customers

FLOYD WILKINS, JR.
MEMBER, NEW YORK BAR

• Just as the technician has certain rights when on the property in control of another, the customer is entitled to certain protection while in the technician's shop. Our problems, therefore, are: Who is a customer? What are the shopkeeper's duties to that customer? And what can the shopkeeper do to limit his possible liability to the customer?

Throughout the country the general rule is clear that a customer is a person invited or permitted to go into and about the shop for any purpose related to the business of the shopkeeper. This definition covers persons who intend to request service or make a purchase, as well as those who are "just shopping." However, not all states include as a customer the child who accompanies a parent, the friend who enters with the customer or meets him there, or the relative or friend who brings lunch to an employee in the shop. But many courts do include such persons as customers on the theory that the shopkeeper has invited, or at least encouraged them, to enter in the hope of eventually doing business with them.

By stressing the fact of invitation courts have included as customers not only those persons just mentioned, but also one going into a store to use the telephone and one

passing through to another building or another street.

It is important to note three things in connection with the theory that the shopkeeper's "invitation" determines whether a person is a customer. First, the theory is becoming more popular with the courts. Second, this approach includes more persons than does the business purpose test. Third, the "invitation" to customers may be either expressed, as in the case of a sign or advertisement, or implied from the physical arrangement within the store and of approaches to it.

Limit Invitation

This implied invitation causes much trouble and is hard to express other than to say that one is a customer in any part of the store if he reasonably believes he was invited to use that part. For example, a side door to the store may reasonably appear to be an entrance, but when used it leads the customer into a dark storeroom where he falls and is injured. Or once inside the store, the customer may think that he is on the sales floor, whereas actually he has gotten behind a counter or a pile of merchandise in a storage area where he falls through a trapdoor leading to the basement. Where there are freight elevators or open shafts in an area near the area for customers, unless the openings are well

guarded and clearly placed out of bounds to customers, the visitor may unwittingly wander into this area, retaining his status as a customer, and will be able to recover for injuries incurred due to these foreseeably dangerous conditions. But if the shopkeeper has taken all reasonable precautions to exclude customers from a dangerous area, the person who enters that area generally does so without an invitation and cannot recover for injuries resulting from obvious dangers.

Other examples of persons who are customers or who receive the same treatment as customers are one returning for a mislaid pocketbook or package or for change that he forgot, one seeking employment, persons making deliveries or repairs, and those using a rear or side door which has a sign naming the shop in a manner that indicates an entrance. Whether one who uses the toilet is a customer or is merely present in the area by permission and not by invitation seems to depend on whether the toilet is generally available for customers; if so, one retains his status as a customer.

The rule regarding the shopkeeper's duties toward customers is easy to state. It is that the shopkeeper must use reasonable care to warn the customer of unreasonably dangerous conditions or activities, or to

(Continued on page 51)

Regeneration & Oscillation

In-Phase Feedback over One or More Stages Is the Cause;

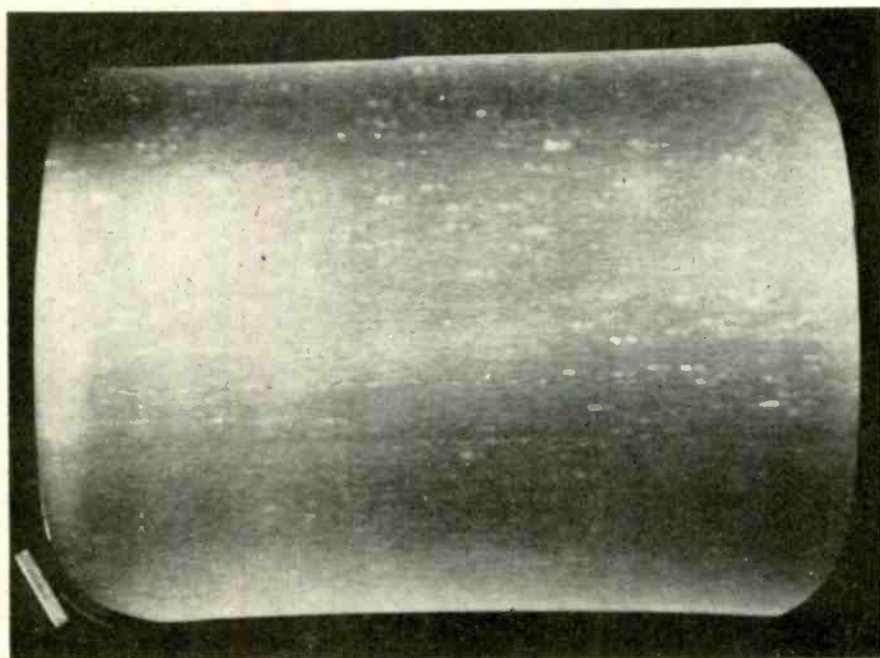

Fig. 1—Noise in raster displays regeneration in amount varying from borderline to excessive.

A. R. CLAWSON

• Regeneration in the intermediate frequency strip is generally undesirable if of any appreciable magnitude. Regeneration may result in distortion of the response curve from the desired response, possible overloading of the amplifier tubes in the i-f strip and/or overloading of the picture detector. Unwanted regeneration and/or oscillation (if the regeneration becomes excessive) will result in an accentuation of some frequencies at the expense of others with distortion of those frequencies and also of frequencies nearby.

The plain illuminated raster without a video signal is a very fortunate means for the observation of incipient oscillation due to excessive regeneration. Excessive streaking of the inherent noise will indicate excessive regeneration. Noise pulses should be sharp, just like any picture element of corresponding size. Noise pulses which trail or have a tail to them indicate that the amplifier is regenerating excessively at some frequency. Fig. 1 shows such a raster with noise pulses and with just about excessive regeneration—a

borderline case. The raster brilliance is increased by the brightness control, contrast is full on, and no station signal is employed in these tests.

A response curve that changes its shape with amplitude variation of the output of the sweep generator is indicative of excessive regeneration. Fig. 2 illustrates what is meant by such a change of shape: increasing the amplitude of the signal fed the i-f by the signal generator should increase the vertical amplitude of the observed response on the scope screen but not distort it. Fig. 3A shows an excessive response or "spike" at a point in the i-f pass band, due to excess regeneration. Beware of such spikes. They often become oscillatory "birdies," as in Fig. 3B. Not much provocation is necessary either.

Considerable care should be exercised in attachment of the sweep generator and the oscilloscope to the set; the shields are slightly 'hot' at the alignment frequencies. Do not cross generator and scope cables; also keep the scope on the opposite side of the chassis from the generator. Preferably use very short lengths of exposed inner conductor on the scope and the generator in-

ner conductors, and solder to the points applied—tacking is enough—so as to do without the customary clip.

A meter connected across the detector load will indicate some dc voltage due to contact potential and rectified thermal noise, a couple of volts being average. An increase in reading beyond this value is a sign of regeneration or oscillation. No signal is applied in such a test, of course.

Suspect Excessive Blacks

Remember particularly that the spike on the response curve can occur at any frequency and is an increase of amplitude at that frequency. Such increase means that picture elements corresponding to that frequency will be blacker than normal by the amount of the excess amplitude due to the spike or hump. Suspect therefore any excessive blackness of particular picture tube elements as displayed.

Regeneration is caused by feedback *in phase* at some frequency. There are numerous ways in which such feedback can occur. It may take place over a single stage or, as is more common, the output of one stage will feed back over several stages, particularly between those tuned to nearly the same frequency. The reader should remember that the mixer in the front end as well as the video detector are radio-frequency devices also at the intermediate frequency, and the feedback may and very frequently does involve these units or stages. Furthermore, an appreciable i-f signal is present in the video amplifier,

Fig. 2—Change in response curve shape with slight change in output from sweep generator.

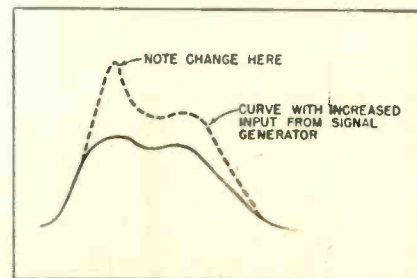

in Television I-F Systems

Shielding, Correct Lead Dress and Bypassing are Cures.

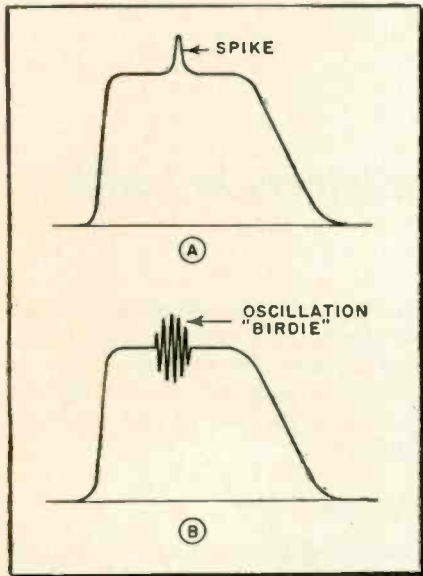

Fig. 3A—Spike due to excessive regeneration at one frequency. B—Oscillatory "birdy."

from which it may jump to the front end without much effort.

What to do depends in a large measure on the means by which the feedback occurs, and what stages are involved. The determination of just which stages are involved in the feedback chain is the first step. The easiest method to do this is to hook a voltmeter (dc) across the detector load and to kill the signal in each stage in turn starting from the mixer. A stage involved in the feedback will show a substantial reduction of the meter reading due to reduction of the regeneration. The 'killing' may be accomplished by the re-

moval of a tube or by grounding the grid or (through a capacitor) the plate. AC grounding through a capacitor is preferable since no mistakes resulting in the burning up of components is likely to occur.

Note particularly that the reduction of regeneration during such testing means that that stage is involved, and is the start of the chain; subsequent stages may or may not be part of the feedback chain. Fig. 4 is a block diagram showing several possibilities. The localization procedure cuts down the sections of the set that must be inspected and tested, so it is performed as a first step.

The solution to the problem from localization on is an experimental cut-and-try procedure, which may be greatly aided, however, by intelligent cutting and trying. The causes and cures of feedback may now be treated individually.

Inductive feedback may occur over a single stage or several stages. A piece of metal mounted on a stick and moved about in different locations while observing the meter (across the video detector's load resistor) or the raster will show a reduction in the regenerated signal when it cuts down the feedback. The metal may be grounded by touching to the chassis at convenient points. Metal foil is also suitable for this purpose. A permanent shield can be installed where the effectiveness is most pronounced. Moving the hand about will also result in a similar change, but using the metal is preferable. Some care must be exercised

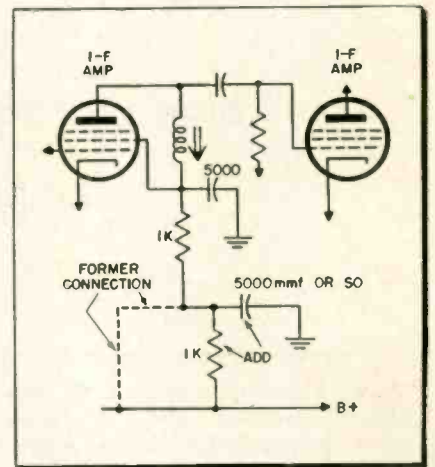

Fig. 5—Adding an extra decoupling network.

that the shielding is actually shielding and not just detuning which, upon realignment or alignment touch-up will restore the original condition. Therefore do not move the metal 'wand' closer than a couple of inches to a tuned coil, or if this must be done, consider the possible detuning.

Capacitive Feedback

Capacitive feedback may likewise occur over a single stage or several stages. The shielding wand just mentioned and subsequent permanent shielding are one form of a test for and a cure for capacitive feedback. A frequent source of capacitive feedback is poor lead dress of some wire(s) as a result of some prior service operation. Maybe even the factory misplaced wiring in getting the bugs out of the set originally. Feedback capacitively over a single stage is very frequent due to grid-plate interelectrode capacity plus any external capacity between leads to the control grid and the plate.

While the technician cannot do much about the C_{gp} of the tube (except to change tubes!) he can do enough in most cases with a small shield over the top of the tube socket and proper dress of the leads to the control grid and the plate. Sometimes a convenient bypass capacitor can be bent over the tube socket

(Continued on page 53)

Fig. 4—Block diagram of typical video strip, showing several possible feedback paths

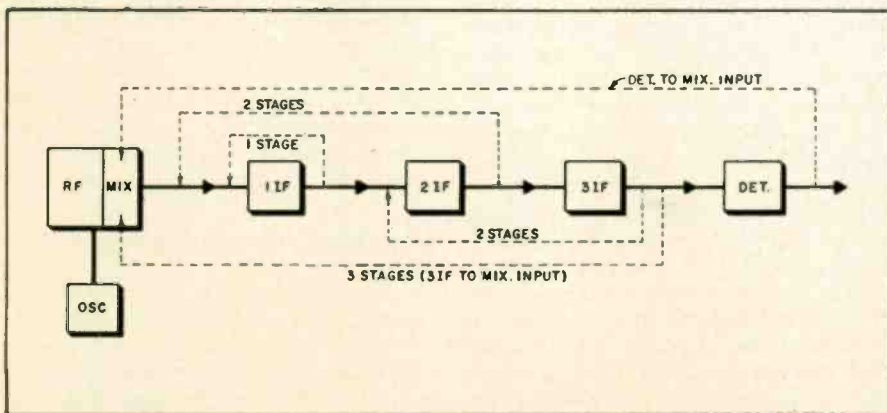

How to Handle "Tough Dog" Customers

Don't blow your top!

The right approach converts complainers to boosters.

JACK BERMAN

Jack Berman, president of the California rep firm bearing his name, and an old pro in both salesmanship and electronics, advocates the "set-side" manner for customer relations. It's patterned after the calm, clean-cut, confidence-building bedside manner employed by doctors . . . and it works!

• Neat dress, clean tools, a soft-spoken voice and a self-assured, sympathetic manner go a long way toward maintaining customer goodwill. Like the doctor, a clear diagnosis by the technician builds confidence in your ability to make repairs efficiently.

There are times when you run across customers who are problem "characters" with a capital C. For such people, heavy emphasis on the "set-side" manner pays dividends. Here are some of the toughest "tough dogs" reported by service technicians, together with specific suggestions for handling them.

The Suspicious Housewife.

You face the typical mother-in-law, with fat folded arms. She gives you that "all-TV-service-men-are-gyps" glare. This is a reader of expose magazines, and she lets you know how she feels about you.

Your approach: "Madam, are all doctors quacks? If they were, wouldn't this be a pretty horrible world? Let's face it, most physicians are sincere men who save lives as an every day job.

"Likewise, most TV service men have had years of training in electronics, and are professionally interested in putting your TV set

back in its best working order as perfectly as possible. Sure there are a few quacks who give medicine a bad name, and it's true there are a few unethical servicemen who give my profession a bad name.

"However, Madam, they hurt me worse than they hurt you, because they make good people like you suspicious of honest service men like me. My own business is built on my reputation, and my satisfied customers are my best advertisements. If you feel that I'm a gyp, I'd prefer not to touch your TV set."

Most people react favorably to this type of logical discussion, and are sorry they ever questioned your integrity.

The Outraged Customer.

Here you are facing the customer who believes you've done a bad job. Although you repaired her set last week, the picture has gone out again. Perhaps you replaced a flyback and a couple of tubes. Now you examine the set and discover that a selenium rectifier has burned out.

Here you can use a medical case comparison to advantage, convincingly, something like this: "Last week, Dr. Jones was called to treat the little Smith boy for measles. Monday, the boy recovered, and Wednesday he climbed a tree, fell out and broke his arm. The Smiths called Dr. Jones again, of course. They weren't angry about having to call him in again, because they understood that the broken arm had nothing to do with the measles.

"It's the same with your set. Last week I put it back in order by replacing a bad flyback transformer and two weak tubes. Today, I find that the selenium rectifier has

burned out. This is like the measles and the broken arm, there's no connection between the two types of trouble in your set. It's merely coincidence, just as it was with the Smith boy.

The Wise Guy.

Here's the typical brother-in-law. After reading 3-1/2 articles about electronics, which he doesn't understand, he likes to show off.

He's a cinch to handle. Just make him happy with a little flattery, the way a doctor does. Ever see Doc go to work on this kind of a patient? Doc explains the illness in medical Latin, giving the impression all the time that the confused "wise guy" understands every word. You work the same way:

"Mr. Smith, it's a pleasure to talk to someone like you, who understands electronics. Most people haven't the vaguest idea how a TV set works. But you can see, right here, that what's wrong is that the r-f section's components in your set's tuner housing are burned out. Then, even though the r-f stage was inoperative, sufficient signal was being capacitively coupled through the amplifier to the mixer that usable pictures were being reproduced through the local stations."

With this, you can proceed un hindered with your work. You've flattered a person who has a basic emotional need to feel important. This puts him on your side.

The Fellow Who Has a Friend.

The friend who is let's say an engineer, has explained in detail to your customer exactly what's wrong with the TV set. However, you find

(Continued on page 47)

SHOP HINTS



Tips for Home and Bench Service by Readers

Intermittent Filament Recorder

Four neon test lamps, mounted in a small box, plus five test leads is all that is needed for finding an intermittent filament in an AC/DC radio. Place the leads across the tube filaments as shown in the diagram. Turn

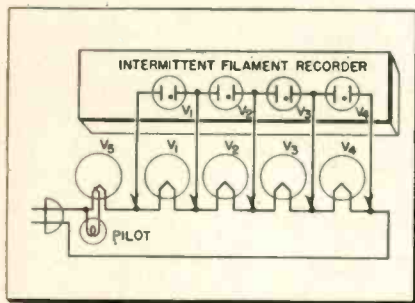

Intermittent filament recorder

on the radio and allow it to play. When the filament circuit is interrupted, the neon light connected across the break will glow. In the event none of the lights go on, when a break occurs, then it can be assumed that the rectifier tube is the culprit. The beauty part of this procedure is that the technician is free to work on other equipment while the radio under test is in working order.—*Jules Elkish, Philadelphia, Pa.*

Auxiliary Power Supply

An external power supply can be used to track down leaks and short circuits in TV and radio B⁺ supply lines. Especially when fuses are popping, and seleniums start smelling like rotten eggs. The set is not plugged into the ac house line. Disconnect the B⁺ lead from the cathode of the rectifier, and connect the auxiliary power supply observing proper polarity. Just before connecting the external supply, with the load disconnected, it is possible to plug in the set to check the transformer and input circuits. Having ascertained that the trouble exists elsewhere, then proceed. The voltage should be monitored. A voltmeter mounted on the supply source is convenient. The safest way to con-

duct this test, without causing undue damage is to connect one lead at a time until an unusual voltage drop occurs. Tracing out the line that is causing this drop, will lead to the defective component. Since there is no filament voltage supplied, the tubes are not conducting. There are times when excessive voltage drop occurs across a power amplifier, or other tube due to an upset in grid bias, or a shorted tube. This substitute power supply will not help in such a situation. However, it is still worthwhile having. The circuit is conventional, and the parts can usually be found in the "junk-box." It is a good idea to fuse the primary circuit. Other transformer windings such as a 6.3-v. ac, can be brought out to convenient terminals, and used when needed.—*Clifford H. Goldstein, Jackson Heights, N.Y.*

Antenna Cheater Cord

Many TV sets have a short 300 ohm lead connected between the tuner and the protective cover on the rear of the set. The length of this lead is just not long enough to permit the back cover to remain connected without causing a great deal of stress and strain. Broken strands and complete severance often occurs. The only remedy is to dig out the soldering gun, and then solder. After having to repair a number of these broken leads, I made up an extension consisting of 24 inches of 300 ohm wire, pins to fit into the socket on the back cover, and a double jack to accommodate the lead coming from the tuner. Some servicemen may be inclined to use insulated alligator clips instead of the plugs and jacks. It takes up little room in the tool box, and I haven't had a broken lead since.—*Wm. R. Burgess, Cedar Falls, Iowa.*

CRT Rejuvenator

This CRT rejuvenator may be used with any regular tube checker. The same voltage used to energize the filament also appears between the grid and cathode of the CRT. Grid current will flow during the positive

alternation. The duty cycle is sufficiently short to prevent damage to these elements. The only parts required are a CRT socket, and about 6 feet of 2 conductor wire. Wiring is self explanatory. Operation is simple.

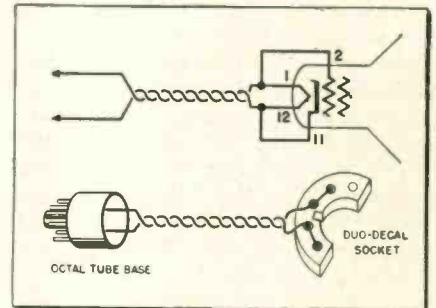

CRT rejuvenator

Tubes may be rejuvenated in the set or on the bench. Connect the 2 wires to the filament terminals on the tube tester, and the socket to the CRT. Apply the following voltages, for the approximate time as indicated: 12.5-v. for 20 seconds, and 10.0-v for 20 minutes, or less. The leads going to the tube checker may be connected to an old tube base, and plugged into the checker.—*Edward Kesgen, New Jersey.*

• Another servicer has submitted the following item dealing with this same subject.—*Ed.*

Instead of using the tube checker, which may not be available when in the customer's home, merely hookup a pair of clip leads between the CRT and the filament supply. One lead from pins 1 and 2 to one side of the 6.3-v. filament supply, and the other lead from pins 11 and 12 to the other side.—*Fred Felli, Chicago, Ill.*

SHOP HINTS WANTED

ELECTRONIC TECHNICIAN will pay \$5 for acceptable shop hints. Unacceptable items will be returned. Use drawings to illustrate your explanations wherever necessary. A rough sketch will do as long as it can be followed. Send your hints to "Shop Hints" Editor, ELECTRONIC TECHNICIAN, Caldwell-Clements Co., 480 Lexington Ave., N. Y. 17, N. Y.

Let's Look at CIRCUITS

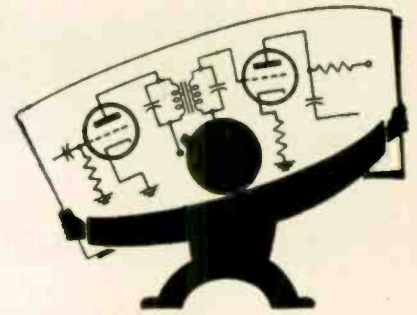

No. 10: The Split-Load Phase Inverter and the Cathode Follower

SIDNEY C. SILVER

Just to prove that the signal present at the cathode of an amplifier stage (actually, the signal across the cathode resistor) can be an asset rather than a nuisance, we are introducing a slight modification to the circuit shown in the first illustration accompanying last July's installment. We are connecting a lead from the top of the cathode resistor—between resistor and cathode, as in Fig. 1—and feeding it out through a coupling capacitor. This provides us with another output in addition to the one taken off across the tube from its plate, with which we are already familiar.

Reviewing phase relations of the signal at various points in the circuit once more: The signal across the cathode resistor is in phase with the input signal, but the signal across the tube is out of phase with the input. Therefore the signals at these two outputs, though they have the same shape, will be exactly opposite in phase to each other. There are many electronic circuits in which two signals, exactly the same in shape and amplitude, except that they are opposite in phase, are desired. So far, we have the desired similarity in shape and opposition in phase. We have seen, however, that

Fig. 1—Output may be taken from the cathode of an amplifier, as well as from its plate.

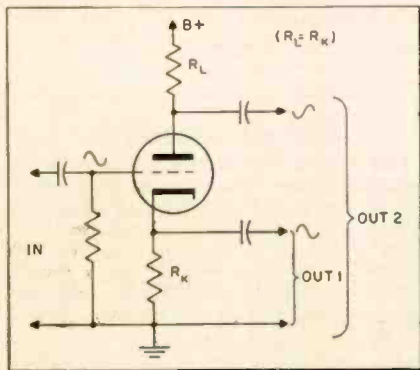

plate signal is generally much greater in size than that across the cathode resistor.

To adjust this difference, we can keep on increasing the size of cathode resistor R_K and reducing the size of plate load resistor R_L . In this way, we reach a point where the two outputs are equal in amplitude. Generally, this point is reached when plate and cathode resistors are equal in value.

There is one misunderstanding to be avoided here. When we have finished our adjustment, we do not end up with an equality of amplitude between the signal across the tube and that across the cathode resistor. Signal across the tube is still about twice the size of that across R_K . However, we must remember one thing: output from the plate to ground (output 2, in Fig. 1) is a combination of the signal across the tube with that across the cathode resistor. With the latter degenerating or bucking the former, the total of output 1 is cut down to the desired size.

The type of circuit we have just shown in its simplest form is variously called the split-load phase inverter (because of the way the load is divided between plate and cathode resistors), the paraphase amplifier, the phase splitter, among other names. It is not the only type of inverter stage we will ever encounter, but it is the best for many types of circuits. It finds very frequent application as the last stage in the sync amplifier section of many television receivers.

TV receivers so using it will be of the type that also employ a dual-diode phase detector as an automatic frequency control stage preceding the horizontal oscillator. Such phase detectors require that the horizontal sync pulse be fed to each diode in the same amplitude, but in opposite polarity or phase. In this case, the outputs from the phase splitter will of course consist of the rectangular horizontal pulses, rather

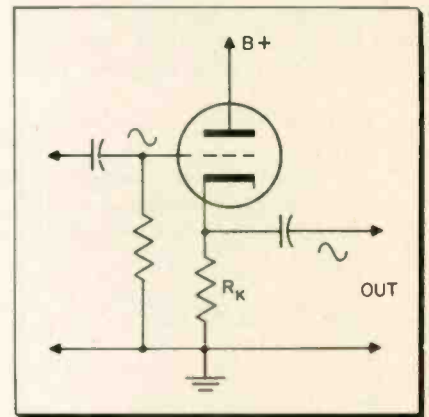

Fig. 2—Output may be taken only from the amplifier cathode, instead of from the plate.

than of the sine waves shown in the general case of Fig. 1. In sync-circuit use, there is a third take-off point, which may be either from the cathode or plate. This is to supply the single input for the vertical oscillator.

Output from the paraphase amplifier may be said to be in push-pull. It is clearly well-suited for application in high-fidelity and other push-pull audio amplifiers. Because of the good balance it can provide in the two out-of-phase outputs, and because of the wide-range response and low distortion available with it, it has become one of the identifying marks of the renowned Williamson-type and other quality audio amplifiers. In some circuits, the inverter drives each of the two push-pull output tubes directly from each of its two outputs. In the Williamson, each output from the inverter drives another separate triode stage of amplification, with each of these triode stages being identical to the other. After this additional amplification, each triode drives one of the two output tubes.

Having made some use of the cathode signal in addition to that at the plate, we can go to an extreme. We can use cathode output only.

(Continued on page 54)

Latest Test Instruments

Simpson MILLIVOLTMETER →

The new pocket-size millivoltmeter, for checking the voltage output of safety thermocouples on gas-fired equipment, is simple to use. The lead clips are merely placed across the thermocouple terminals to test for correct voltage. Ranges are 10, 30, 100, 300, and 1000 millivolts $\pm 3\%$. The tester has a low current draw of $750\mu\text{a}$, which permits accurate computing of instrument loading when necessary. It will speed service on heaters, refrigerators, furnaces, etc. Model 387 is \$29.95. Simpson Electric Co., 5208 W. Kinzie St., Chicago, Ill. (ELECTRONIC TECHNICIAN 12-18)

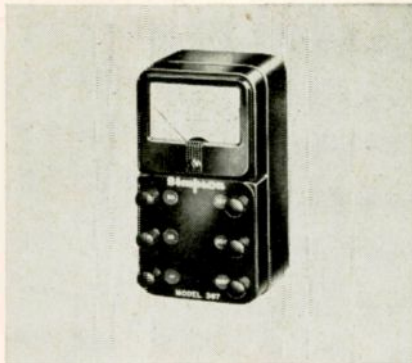

Eico SWEEP GENERATOR →

Ease and accuracy in alignment of FM, TV monochrome and color sets is now available in the new sweep generator; featuring an electronic sweep circuit with accurately biased inductor; AGC; internal crystal calibrated variable marker; variable marker size control; edge-lit hairlines; 50 ohms output impedance; and a phasing control. Sweep range is 3-216 mc in 5 fundamental bands, plus a calibrated harmonic band from 60-225 mc. Model 368 kit \$69.95, wired \$119.95. Eico, 84 Withers St., Brooklyn 11, N. Y. (ELECTRONIC TECHNICIAN 12-19)

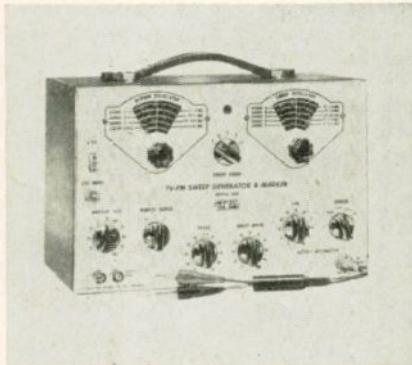

Heath OSCILLOSCOPE →

The model OM-2 is a new and improved scope and retains all the features of the preceding model, but provides wider vertical frequency response, extended sweep-generator coverage, and increased stability. A new tube complement and improvements in the circuit make these new features possible. Modern etched circuits are employed in critical parts of the design, also has one volt peak-to-peak reference voltage, 3-position step-attenuated input, adjustable spot-shape control, etc. Heath Co., Benton Harbor 18, Mich. (ELECTRONIC TECHNICIAN 12-25)

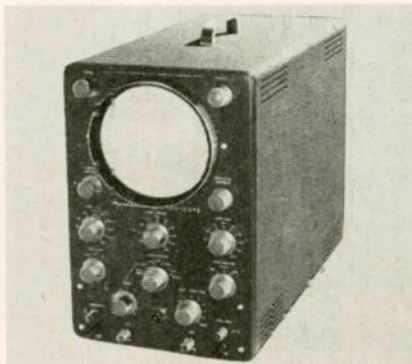

Century REJUVA-CHECK →

Tests for cathode emission; indicates shorts and leakage between elements; estimates the remaining useful life of the CRT; clears inter-element shorts and leakage; removes cathode surface contamination; restores emission and adds life to weak tubes. This newest aid to CRT servicing is designed so that it can be carried about in the tube caddy. Housed in a high impact case, it is ruggedly built with high quality components. Model RJC-1 \$7.95. Century Electronics Co., Inc., Mineola, N. Y. (ELECTRONIC TECHNICIAN 12-17)



Precise POWER-LAB

The new Power-Lab does the work of at least 11 pieces of equipment as follows: battery eliminator; battery charger; high current line voltage variac; ac line voltage meter, ammeter, wattmeter; line isolation transformer; low and high ac supply; dc line voltage variable supply; dc high current ammeter; and bias box. Model 711 kit (100 watts of isolation) at \$49.95 and \$64.95, factory wired. The model 713 kit (300 watts of isolation) \$62.95 and \$79.95 factory wired. Precise Development Corp., Oceanside, L. I., N. Y. (ELECTRONIC TECHNICIAN 12-15)

RAM X-CHECKER

The new X-Checker is a substitution box with a continuously variable resistor and capacitor which may be inserted alone, or in series combination, in an electronic circuit. The resistance range is 0 to 2500 ohms $\pm 10\%$ and the capacitance range is 20 to 450 mmf. Its applications include: elimination of sound bars due to insufficient filtering action of 4.5 mc trap; correction of lack of picture detail, improper horizontal linearity, brightness, width, AGC magnitude, or AFC pulse; elimination of yoke ringing, etc. Ram Electronics, Irvington-on-Hudson, N. Y. (ELECTRONIC TECHNICIAN 12-14)

Barjay CAPACITEST

Checks all types of capacitors and selenium rectifiers. The new compact series 11 capacitest, 4" x 4" x 2" with two test leads and instructions sells for \$49.95. Barjay Co., 145 W. 40 St., New York, N. Y. (ELECTRONIC TECHNICIAN 12-60)

EMC ELIMINATOR & TESTER

A combination vibrator checker, charger and battery eliminator, supplies continuous variable voltage from 0 to 8 v. or from 0 to 16 v. Able to check both 6 and 12-v. vibrators, the unit checks both interrupter and self-rectifier types for proper starting point as well as quality of operation. Housed in a single sloping rugged metal case, the battery eliminator and vibrator checker is priced at \$64.00 wired and \$42.90 in kit form. The battery eliminator-charger can be bought alone at \$37.50 wired and \$28.90 in kit form. Electronic Measurements Corp., 625 Broadway, New York 12, N. Y. (ELECTRONIC TECHNICIAN 12-16)

Binders for your CIRCUIT DIGESTS . . . see page 50.

Binders for your copies of ELECTRONIC TECHNICIAN . . . see page 52.

New Audio Products

Astatic CARTRIDGE →

A new phonograph pickup cartridge replacement for the Sears-Sonotone "mouse" has been released recently. The new cartridge is designed as a direct replacement for the Sonotone models W7500, 7530, and 7540 cartridges. A considerable audio replacement market exists for this cartridge, since it was employed in many Sears-Roebuck "Silvertone" record players. List price of the model 430 is \$7.50 and is available at the distributors. Astatic Corp., Box 120, Conneaut, Ohio. (ELECTRONIC TECHNICIAN 12-22)

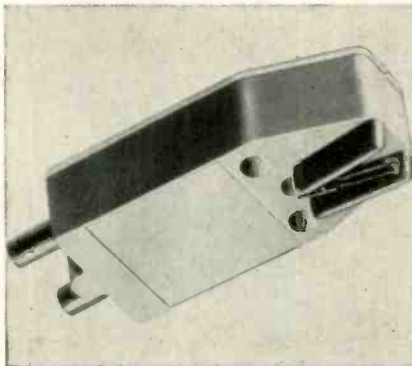

Shure PHONO CARTRIDGE →

The WC20 is the new phonograph replacement for the PC20A pickup ceramic cartridge, for the Chrysler Highway High Fidelity System. The cartridge fulfills the extremely rigid requirements necessitated by operating the record player in an automobile. It will track at 2½ grams, and has a frequency response to 12,000 cps. A 3 mil sapphire stylus is included. The PC20A has been used in all the Columbia Hi-Fi mobile players produced for Chrysler during the past year. Shure Brothers Inc., Evanston, Ill. (ELECTRONIC TECHNICIAN 12-23)

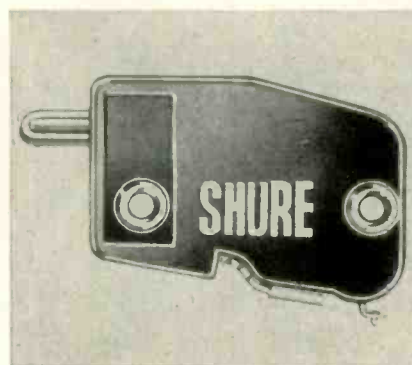

Ronette RONOMIKE →

The new microphone is cased in a slim, sturdy, die cast housing that is fully chrome plated. Its modern convenient shape adds strength and attractiveness and its performing features make it ideal for use with tape recorders, PA systems and in ham shacks. A high impedance instrument, it has a sensitivity of -55.4 db. The flat response from 30-10,000 cycles is peak-free when matched. IM distortion is so low it cannot be detected by existing equipment. Ronette Acoustical Corp., 135 Front St., New York City. (ELECTRONIC TECHNICIAN 12-20)



Magnemite TAPE RECORDER

Two models of the new 4-speed Magnemite portable, battery-operated, spring-motor recorder are now being put into production. This recorder measures 7" x 10" x 11" and weighs only 15 lbs. complete with flashlight-type batteries which have an operating life of 100 hours. Features include: fly-ball governor controlled motor assuring constant speed, precision-made tape transport mechanism and removable dynamically balanced flywheel. Amplifier Corp. of America, 398 Broadway, New York 13, N. Y. (ELECTRONIC TECHNICIAN 12-2)

Jensen HI FI PROJECTOR

The HF-100 is designed for use where weatherproof features or convenient unitary form must be combined with high fidelity performance. The unit is a two-way divided system, coaxially arranged heavy duty 8" loudspeaker and a horn-loaded compression driver tweeter unit opening to the front of the projector. Equipped with a sturdy "U" mounting bracket for post or wall mounting. Can be used indoors or outdoors. Jensen Mfg. Co., 6601 S. Laramie Ave., Chicago 38, Ill. (ELECTRONIC TECHNICIAN 12-3)

Teletronic INTERCOM

An attractive new portable "Intercom Set" designed to serve the homemaker as a baby sitter, personal messenger, second radio, and performs numerous other chores around the home or office. Plugs into any standard 110-v. ac wall outlet. Consists of two basic units, a remote station, and a master station, including 50' of insulated wire. Cabinets are made of Barrett urea, a rugged plastics material that has a smooth, hard surface and is nonelectrostatic, which attracts neither dust nor dirt. Teletronic Labs., 1835 W. Rosecrans Ave., Gardena, Calif. (ELECTRONIC TECHNICIAN 12-4)

Rayline SPIRALINE

Featuring premium 60/40 solder, by Alpha, in a package designed to eliminate waste and solder entanglements. Pull out only what you need. The plastic container eliminates shock hazard when working on a hot chassis. Available in rosin core, acid core, and solid wire. Rayline Inc., 307 Willis Ave., Mineola, N. Y. (ELECTRONIC TECHNICIAN 12-37)

FOR MORE TECHNICAL INFORMATION ON NEW PRODUCTS OR BULLETINS

use this convenient coupon. Enter below the reference numbers for all items desired.

New Products Editor
ELECTRONIC TECHNICIAN
 480 Lexington Ave.
 New York 17, N. Y.

Please send me more information on the following items:

.....
 My company letterhead or business card is enclosed.

Name
 Address
 Firm My position
 City State
 Business address (if different from above)

SHOP HINTS



Tips for Home and Bench Service by Readers

Intermittent Filament Recorder

Four neon test lamps, mounted in a small box, plus five test leads is all that is needed for finding an intermittent filament in an AC/DC radio. Place the leads across the tube filaments as shown in the diagram. Turn

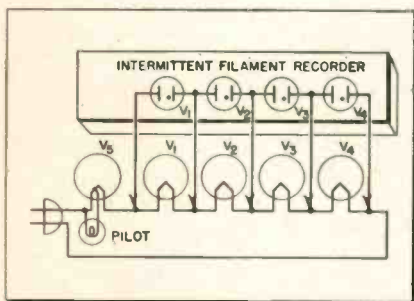

Intermittent filament recorder

on the radio and allow it to play. When the filament circuit is interrupted, the neon light connected across the break will glow. In the event none of the lights go on, when a break occurs, then it can be assumed that the rectifier tube is the culprit. The beauty part of this procedure is that the technician is free to work on other equipment while the radio under test is in working order.—*Jules Elkish, Philadelphia, Pa.*

Auxiliary Power Supply

An external power supply can be used to track down leaks and short circuits in TV and radio B+ supply lines. Especially when fuses are popping, and seleniums start smelling like rotten eggs. The set is not plugged into the ac house line. Disconnect the B+ lead from the cathode of the rectifier, and connect the auxiliary power supply observing proper polarity. Just before connecting the external supply, with the load disconnected, it is possible to plug in the set to check the transformer and input circuits. Having ascertained that the trouble exists elsewhere, then proceed. The voltage should be monitored. A voltmeter mounted on the supply source is convenient. The safest way to con-

duct this test, without causing undue damage is to connect one lead at a time until an unusual voltage drop occurs. Tracing out the line that is causing this drop, will lead to the defective component. Since there is no filament voltage supplied, the tubes are not conducting. There are times when excessive voltage drop occurs across a power amplifier, or other tube due to an upset in grid bias, or a shorted tube. This substitute power supply will not help in such a situation. However, it is still worthwhile having. The circuit is conventional, and the parts can usually be found in the "junk-box." It is a good idea to fuse the primary circuit. Other transformer windings such as a 6.3-v. ac, can be brought out to convenient terminals, and used when needed.—*Clifford H. Goldstein, Jackson Heights, N.Y.*

Antenna Cheater Cord

Many TV sets have a short 300 ohm lead connected between the tuner and the protective cover on the rear of the set. The length of this lead is just not long enough to permit the back cover to remain connected without causing a great deal of stress and strain. Broken strands and complete severance often occurs. The only remedy is to dig out the soldering gun, and then solder. After having to repair a number of these broken leads, I made up an extension consisting of 24 inches of 300 ohm wire, pins to fit into the socket on the back cover, and a double jack to accommodate the lead coming from the tuner. Some servicemen may be inclined to use insulated alligator clips instead of the plugs and jacks. It takes up little room in the tool box, and I haven't had a broken lead since.—*Wm. R. Burgess, Cedar Falls, Iowa.*

CRT Rejuvenator

This CRT rejuvenator may be used with any regular tube checker. The same voltage used to energize the filament also appears between the grid and cathode of the CRT. Grid current will flow during the positive

alternation. The duty cycle is sufficiently short to prevent damage to these elements. The only parts required are a CRT socket, and about 6 feet of 2 conductor wire. Wiring is self explanatory. Operation is simple.

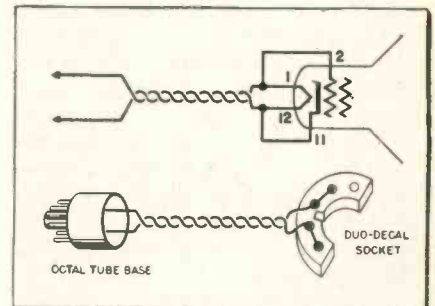

CRT rejuvenator

Tubes may be rejuvenated in the set or on the bench. Connect the 2 wires to the filament terminals on the tube tester, and the socket to the CRT. Apply the following voltages, for the approximate time as indicated: 12.5-v. for 20 seconds, and 10.0-v for 20 minutes, or less. The leads going to the tube checker may be connected to an old tube base, and plugged into the checker.—*Edward Kesgen, New Jersey.*

• Another servicer has submitted the following item dealing with this same subject.—*Ed.*

Instead of using the tube checker, which may not be available when in the customer's home, merely hookup a pair of clip leads between the CRT and the filament supply. One lead from pins 1 and 2 to one side of the 6.3-v. filament supply, and the other lead from pins 11 and 12 to the other side.—*Fred Felli, Chicago, Ill.*

SHOP HINTS WANTED

ELECTRONIC TECHNICIAN will pay \$5 for acceptable shop hints. Unacceptable items will be returned. Use drawings to illustrate your explanations wherever necessary. A rough sketch will do as long as it can be followed. Send your hints to "Shop Hints" Editor, ELECTRONIC TECHNICIAN, Caldwell-Clements Co., 480 Lexington Ave., N. Y. 17, N. Y.

Let's Look at CIRCUITS

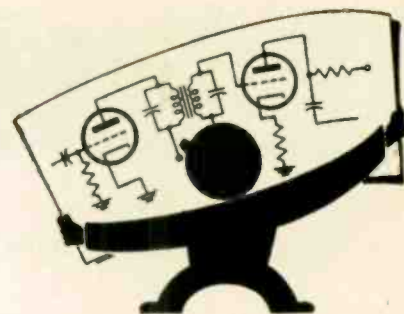

No. 10: The Split-Load Phase Inverter and the Cathode Follower

SIDNEY C. SILVER

Just to prove that the signal present at the cathode of an amplifier stage (actually, the signal across the cathode resistor) can be an asset rather than a nuisance, we are introducing a slight modification to the circuit shown in the first illustration accompanying last July's installment. We are connecting a lead from the top of the cathode resistor—between resistor and cathode, as in Fig. 1—and feeding it out through a coupling capacitor. This provides us with another output in addition to the one taken off across the tube from its plate, with which we are already familiar.

Reviewing phase relations of the signal at various points in the circuit once more: The signal across the cathode resistor is in phase with the input signal, but the signal across the tube is out of phase with the input. Therefore the signals at these two outputs, though they have the same shape, will be exactly opposite in phase to each other. There are many electronic circuits in which two signals, exactly the same in shape and amplitude, except that they are opposite in phase, are desired. So far, we have the desired similarity in shape and opposition in phase. We have seen, however, that

Fig. 1—Output may be taken from the cathode of an amplifier, as well as from its plate.

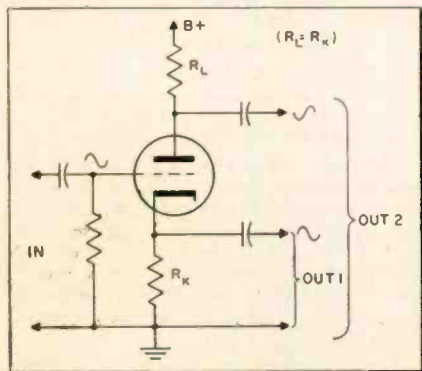

plate signal is generally much greater in size than that across the cathode resistor.

To adjust this difference, we can keep on increasing the size of cathode resistor R_K and reducing the size of plate load resistor R_L . In this way, we reach a point where the two outputs are equal in amplitude. Generally, this point is reached when plate and cathode resistors are equal in value.

There is one misunderstanding to be avoided here. When we have finished our adjustment, we do not end up with an equality of amplitude between the signal across the tube and that across the cathode resistor. Signal across the tube is still about twice the size of that across R_K . However, we must remember one thing: output from the plate to ground (output 2, in Fig. 1) is a combination of the signal across the tube with that across the cathode resistor. With the latter degenerating or bucking the former, the total of output 1 is cut down to the desired size.

The type of circuit we have just shown in its simplest form is variously called the split-load phase inverter (because of the way the load is divided between plate and cathode circuits), the paraphase amplifier, the phase splitter, among other names. It is not the only type of inverter stage we will ever encounter, but it is the best for many types of circuits. It finds very frequent application as the last stage in the sync amplifier section of many television receivers.

TV receivers so using it will be of the type that also employ a dual-diode phase detector as an automatic frequency control stage preceding the horizontal oscillator. Such phase detectors require that the horizontal sync pulse be fed to each diode in the same amplitude, but in opposite polarity or phase. In this case, the outputs from the phase splitter will of course consist of the rectangular horizontal pulses, rather

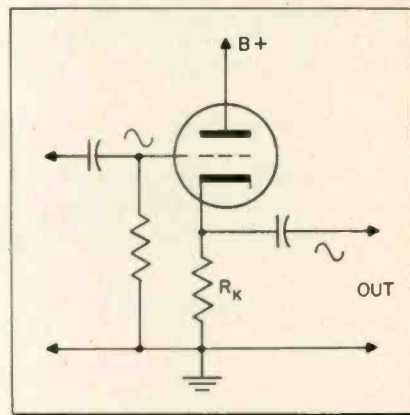

Fig. 2—Output may be taken only from the amplifier cathode, instead of from the plate.

than of the sine waves shown in the general case of Fig. 1. In sync-circuit use, there is a third take-off point, which may be either from the cathode or plate. This is to supply the single input for the vertical oscillator.

Output from the paraphase amplifier may be said to be in push-pull. It is clearly well-suited for application in high-fidelity and other push-pull audio amplifiers. Because of the good balance it can provide in the two out-of-phase outputs, and because of the wide-range response and low distortion available with it, it has become one of the identifying marks of the renowned Williamson-type and other quality audio amplifiers. In some circuits, the inverter drives each of the two push-pull output tubes directly from each of its two outputs. In the Williamson, each output from the inverter drives another separate triode stage of amplification, with each of these triode stages being identical to the other. After this additional amplification, each triode drives one of the two output tubes.

Having made some use of the cathode signal in addition to that at the plate, we can go to an extreme. We can use cathode output only.

(Continued on page 54)

Latest Test Instruments

Simpson MILLIVOLTMETER →

The new pocket-size millivoltmeter, for checking the voltage output of safety thermocouples on gas-fired equipment, is simple to use. The lead clips are merely placed across the thermocouple terminals to test for correct voltage. Ranges are 10, 30, 100, 300, and 1000 millivolts $\pm 3\%$. The tester has a low current draw of $750\mu\text{a}$, which permits accurate computing of instrument loading when necessary. It will speed service on heaters, refrigerators, furnaces, etc. Model 387 is \$29.95. Simpson Electric Co., 5208 W. Kinzie St., Chicago, Ill. (ELECTRONIC TECHNICIAN 12-18)



Eico SWEEP GENERATOR →

Ease and accuracy in alignment of FM, TV monochrome and color sets is now available in the new sweep generator; featuring an electronic sweep circuit with accurately biased inductor; AGC; internal crystal calibrated variable marker; variable marker size control; edge-lit hairlines; 50 ohms output impedance; and a phasing control. Sweep range is 3-216 mc in 5 fundamental bands, plus a calibrated harmonic band from 60-225 mc. Model 368 kit \$69.95, wired \$119.95. Eico, 84 Withers St., Brooklyn 11, N. Y. (ELECTRONIC TECHNICIAN 12-19)

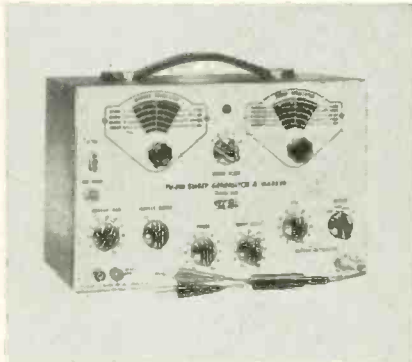

Heath OSCILLOSCOPE →

The model OM-2 is a new and improved scope and retains all the features of the preceding model, but provides wider vertical frequency response, extended sweep-generator coverage, and increased stability. A new tube complement and improvements in the circuit make these new features possible. Modern etched circuits are employed in critical parts of the design, also has one volt peak-to-peak reference voltage, 3-position step-attenuated input, adjustable spot-shape control, etc. Heath Co., Benton Harbor 18, Mich. (ELECTRONIC TECHNICIAN 12-25)

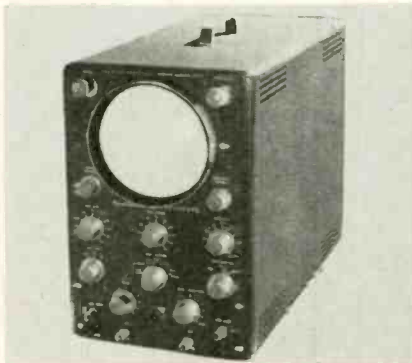

Century REJUVA-CHECK →

Tests for cathode emission; indicates shorts and leakage between elements; estimates the remaining useful life of the CRT; clears inter-element shorts and leakage; removes cathode surface contamination; restores emission and adds life to weak tubes. This newest aid to CRT servicing is designed so that it can be carried about in the tube caddy. Housed in a high impact case, it is ruggedly built with high quality components. Model RJC-1 \$7.95. Century Electronics Co., Inc., Mineola, N. Y. (ELECTRONIC TECHNICIAN 12-17)

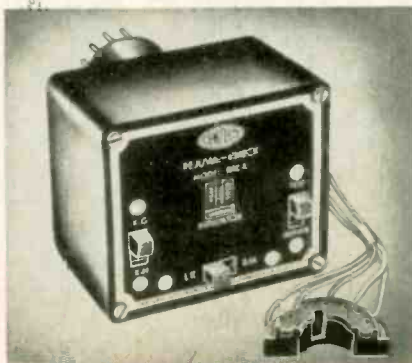

Precise POWER-LAB

The new Power-Lab does the work of at least 11 pieces of equipment as follows: battery eliminator; battery charger; high current line voltage variac; ac line voltage meter, ammeter, wattmeter; line isolation transformer; low and high ac supply; dc line voltage variable supply; dc high current ammeter; and bias box. Model 711 kit (100 watts of isolation) at \$49.95 and \$64.95, factory wired. The model 713 kit (300 watts of isolation) \$62.95 and \$79.95 factory wired. Precise Development Corp., Oceanside, L. I., N. Y. (ELECTRONIC TECHNICIAN 12-15)

RAM X-CHECKER

The new X-Checker is a substitution box with a continuously variable resistor and capacitor which may be inserted alone, or in series combination, in an electronic circuit. The resistance range is 0 to 2500 ohms $\pm 10\%$ and the capacitance range is 20 to 450 mmf. Its applications include: elimination of sound bars due to insufficient filtering action of 4.5 mc trap; correction of lack of picture detail, improper horizontal linearity, brightness, width, AGC magnitude, or AFC pulse; elimination of yoke ringing, etc. Ram Electronics, Irvington-on-Hudson, N. Y. (ELECTRONIC TECHNICIAN 12-14)

Barjay CAPACITEST

Checks all types of capacitors and selenium rectifiers. The new compact series 11 capacitest, 4" x 4" x 2" with two test leads and instructions sells for \$49.95. Barjay Co., 145 W. 40 St., New York, N. Y. (ELECTRONIC TECHNICIAN 12-60)

EMC ELIMINATOR & TESTER

A combination vibrator checker, charger and battery eliminator, supplies continuous variable voltage from 0 to 8 v. or from 0 to 16 v. Able to check both 6 and 12-v. vibrators, the unit checks both interrupter and self-rectifier types for proper starting point as well as quality of operation. Housed in a single sloping rugged metal case, the battery eliminator and vibrator checker is priced at \$64.00 wired and \$42.90 in kit form. The battery eliminator-charger can be bought alone at \$37.50 wired and \$28.90 in kit form. Electronic Measurements Corp., 625 Broadway, New York 12, N. Y. (ELECTRONIC TECHNICIAN 12-16)

Binders for your CIRCUIT DIGESTS . . . see page 50.

Binders for your copies of ELECTRONIC TECHNICIAN . . . see page 52.

New Audio Products

Astatic CARTRIDGE →

A new phonograph pickup cartridge replacement for the Sears-Sonotone "mouse" has been released recently. The new cartridge is designed as a direct replacement for the Sonotone models W7500, 7530, and 7540 cartridges. A considerable audio replacement market exists for this cartridge, since it was employed in many Sears-Roebuck "Silvertone" record players. List price of the model 430 is \$7.50 and is available at the distributors. Astatic Corp., Box 120, Conneaut, Ohio. (ELECTRONIC TECHNICIAN 12-22)

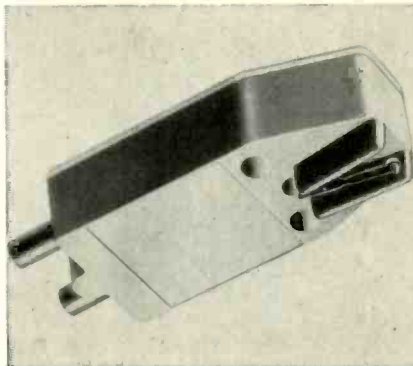

Shure PHONO CARTRIDGE →

The WC20 is the new phonograph replacement for the PC20A pickup ceramic cartridge, for the Chrysler Highway High Fidelity System. The cartridge fulfills the extremely rigid requirements necessitated by operating the record player in an automobile. It will track at 2½ grams, and has a frequency response to 12,000 cps. A 3 mil sapphire stylus is included. The PC20A has been used in all the Columbia Hi-Fi mobile players produced for Chrysler during the past year. Shure Brothers Inc., Evanston, Ill. (ELECTRONIC TECHNICIAN 12-23)

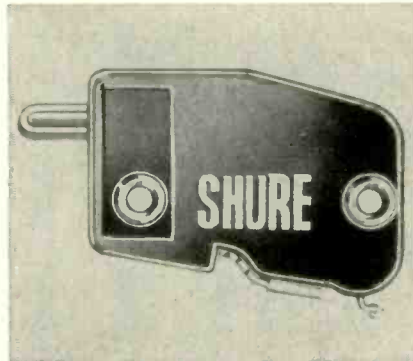

Ronette RONOMIKE →

The new microphone is cased in a slim, sturdy, die cast housing that is fully chrome plated. Its modern convenient shape adds strength and attractiveness and its performing features make it ideal for use with tape recorders, PA systems and in ham shacks. A high impedance instrument, it has a sensitivity of -55.4 db. The flat response from 30-10,000 cycles is peak-free when matched. IM distortion is so low it cannot be detected by existing equipment. Ronette Acoustical Corp., 135 Front St., New York City. (ELECTRONIC TECHNICIAN 12-20)



Magnemite TAPE RECORDER

Two models of the new 4-speed Magnemite portable, battery-operated, spring-motor recorder are now being put into production. This recorder measures 7" x 10" x 11" and weighs only 15 lbs. complete with flashlight-type batteries which have an operating life of 100 hours. Features include: fly-ball governor controlled motor assuring constant speed, precision-made tape transport mechanism and removable dynamically balanced flywheel. Amplifier Corp. of America, 398 Broadway, New York 13, N. Y. (ELECTRONIC TECHNICIAN 12-2)

Jensen HI FI PROJECTOR

The HF-100 is designed for use where weatherproof features or convenient unitary form must be combined with high fidelity performance. The unit is a two-way divided system, coaxially arranged heavy duty 8" loudspeaker and a horn-loaded compression driver tweeter unit opening to the front of the projector. Equipped with a sturdy "U" mounting bracket for post or wall mounting. Can be used indoors or outdoors. Jensen Mfg. Co., 6601 S. Laramie Ave., Chicago 38, Ill. (ELECTRONIC TECHNICIAN 12-3)

Teletronic INTERCOM

An attractive new portable "Intercom Set" designed to serve the homemaker as a baby sitter, personal messenger, second radio, and performs numerous other chores around the home or office. Plugs into any standard 110-v. ac wall outlet. Consists of two basic units, a remote station, and a master station, including 50' of insulated wire. Cabinets are made of Barrett urea, a rugged plastics material that has a smooth, hard surface and is nonelectrostatic, which attracts neither dust nor dirt. Teletronic Labs., 1835 W. Rosecrans Ave., Gardena, Calif. (ELECTRONIC TECHNICIAN 12-4)

Rayline SPIRALINE

Featuring premium 60/40 solder, by Alpha, in a package designed to eliminate waste and solder entanglements. Pull out only what you need. The plastic container eliminates shock hazard when working on a hot chassis. Available in rosin core, acid core, and solid wire. Rayline Inc., 307 Willis Ave., Mineola, N. Y. (ELECTRONIC TECHNICIAN 12-37)

FOR MORE TECHNICAL INFORMATION ON NEW PRODUCTS OR BULLETINS

use this convenient coupon. Enter below the reference numbers for all items desired.

New Products Editor
ELECTRONIC TECHNICIAN
 480 Lexington Ave.
 New York 17, N. Y.

Please send me more information on the following items:

.....
 My company letterhead or business card is enclosed.

Name

Address

Firm

My position

City

State

Business address (if different from above)

Scientific Progress: The Wonders of 1976

BRIG. GEN. DAVID SARNOFF

(From a talk presented by the Chairman of the Board of RCA on the celebration of his 50th year in radio.)

However impressive the events that have filled the last century, I am convinced that they will be eclipsed by the events of the next 20 years. Let us consider major developments likely to affect all of us within that time.

NUCLEAR ENERGY: Nuclear energy will be brought to a practical state of peace-time usefulness, not only for industry, but for planes, ships, trains and automobiles. Direct conversion of atomic energy into electricity, a principle already demonstrated experimentally, will be a fact.

SOLAR ENERGY: The energy of sun rays will be effectively harnessed and in worldwide use. It will prove of special value to tropical nations which cannot afford fully to utilize present-day fuels and power sources.

COMMUNICATIONS: Television, in full colors, will be completely global. Individuals will be able to hold private two-way conversations, and see each other as they talk. Moreover, the beginnings will have been made in the automatic and instantaneous translation of languages.

TRANSPORTATION: Jet-propulsion and rocket-type vehicles, using nuclear fuels, will travel at speeds as high as 5,000 mph with greater safety and comfort than today's aircraft. Inexpensive personal planes, flivvers of the skies, will fill the air. Automatically piloted aircraft for passenger service will be far advanced; guided missiles will transport freight over vast distances.

AUTOMATION: Automation, with cheap and abundant power, will increase production and decrease costs. The transition will create problems of adjustment, but ultimately it will free millions of people from arduous and hazardous work. It will increase employment, reduce hours of labor and increase leisure.

MATERIALS: Chemistry will make spectacular strides in providing ever new materials to meet almost any specifications. A tremendous array of new substances that as yet have no name will become available for personal and industrial uses.

(Continued on page 41)



Model TA-11
Measures only
1/2" x 1" x 1/4"

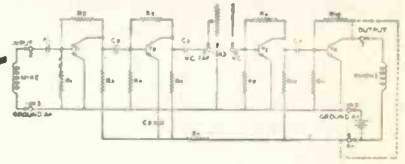
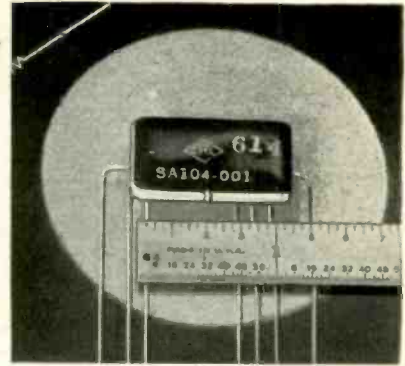

TALK ABOUT FUN!

It starts here, with this

New Centralab Four-Stage Transistor Amplifier

- ◊ You can use it in building all sorts of pocket-size radios and recorders, test equipment, computers, other projects where an ultraminiature, low-power, high-gain, dependable audio amplifier is desired.
- ◊ The most advanced form of Packaged Electronic Circuit. Includes four special transistors, in addition to five capacitors, 12 resistors, and wiring.
- ◊ Gain, 75 db. Supply voltage, 1.3v. Signal to noise ratio, 38 db. nominal.
- ◊ Ask your Centralab distributor for Model TA-11. Send coupon for Bulletin EP-75 containing complete information, schematics, and curves.

Centralab

A DIVISION OF GLOBE-UNION INC.
9021 East Keefe Avenue, Milwaukee 1, Wisconsin Y-5624

Send me free Bulletin EP-75.

Name _____
 Company _____
 Address _____
 City _____ Zone _____ State _____



©Trademark

New Electronic Products

Vokar IF-KIT →

The new IF-kit 5000, contains key components for a 6 transistor portable radio which can be built by amateurs, technicians, and experimenters. Each kit has 3 subminiature 455kc IF transformers, and 1 oscillator coil, which are impedance-matched to such well-known transistors as those made by GE, Raytheon, RCA, and General Transistor. A parts list, and schematic is included. Components can be used on either a printed or wired circuit. Lists for \$8.95. Vokar Corp., Dexter, Mich. (ELECTRONIC TECHNICIAN 12-35)

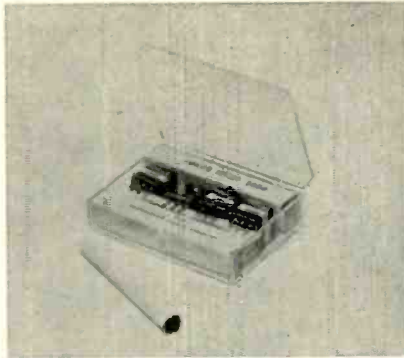

Snyder PICASSO →

A new "directronic" indoor TV antenna has been named the Picasso because of the crossed circular phasing bars, which help to clear up ghosts, shimmy, and snow. The phasing bars and the adjustable side elements are made of shiny brass to match the decor of modern furniture. A felt bottom on the base prevents marring. The directronic beam selector permits safe electronic selection of the clearest picture. The model 8-D sells for \$12.95. Snyder Mfg. Co., 22nd & Ontario Sts., Philadelphia, Pa. (ELECTRONIC TECHNICIAN 12-36)

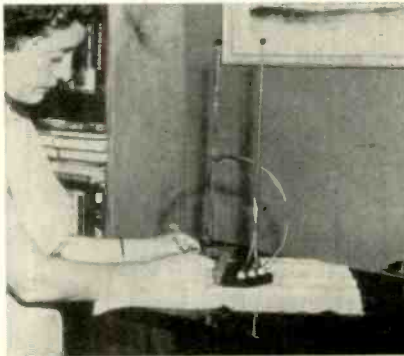

Fretco TRANSISTOR TESTER →

This economically low-priced tester for both the PNP and NPN transistors can also be used to check germanium, silicon, and other diodes. The unit is battery powered and portable. Rugged construction provides for long life and dependable service. Flexibility of test procedure insures against obsolescence and enables the servicer to make a rapid check, for gain and current leakage. Furnished with test leads, and handle. Fretco Inc., 406 North Craig St., Pittsburgh 13, Pa. (ELECTRONIC TECHNICIAN 12-44)

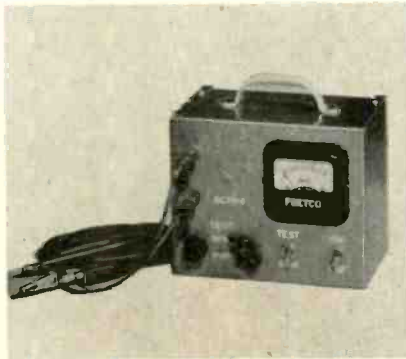

CBS POWER TRANSISTORS →

Low priced power transistors, intended for use by experimenters and radio amateurs. The 2N255 and 2N256 are PNP alloy-junction germanium type. They have high power-handling capability coupled with high current amplification. Electrically, they are similar, except that the 2N255 is intended for use with a 6-volt power supply, and the 2N256 operates on 12 volts. Hermetically sealed for increased protection and long life. CBS-Hytron, Danvers, Mass. (ELECTRONIC TECHNICIAN No. 12-57)



IR RECEIVER

Designed for monitoring police and fire department, utility, government and industrial radio frequencies. The small set 4" x 6" x 8", uses the latest type miniature tubes, transistors in auto sets, and an improved dual conversion superheterodyne circuit which employs a crystal for no-drift tuning stability. A squelch circuit silences "Volunteer" between calls. \$99.00 less crystal. Industrial Radio Corp., 428 N. Parkside Ave., Chicago, Ill. (ELECTRONIC TECHNICIAN 12-27)

RCA TEST INSTRUMENTS

Two new test instruments have been developed to simplify servicing of radio, TV, and audio equipment. One of these is an RF/IF/VF marker adder (WR-70A) intended for use in sweep-frequency alignment, and has 4 different marker shapes. The markers are added to the sweep-response curve by a system which eliminates distortion. The audio signal generator (WA-44B) features a wide frequency-range from 11cps to 100kc in 4 stages; AGC assures uniform output; separate high and low outputs; low hum-level of 0.1% or less of rated output; total harmonic distortion of 2.0% or less, from 30cps to 15kc; a stable oscillator; and a voltage-regulated power supply. RCA, 30 Rockefeller Plaza, New York, N. Y. (ELECTRONIC TECHNICIAN 12-40)

Walsco ALIGNMENT TOOLS

New self-service display enables the serviceman to select the desired radio-TV-alignment tool from a variety of 55. The unit eliminates buying errors by showing off the entire tool. Included in this complete alignment and specialty tool section are those for the 1956-57 radio and color TV sets, as well as 3 "Tel-A-Turn" tools with a built-in turn indicator. Walsco Electronics Corp., 3602 Crenshaw, Los Angeles, Calif. (ELECTRONIC TECHNICIAN 12-26)

RMS FOCUS

The Focus, is a powerful all-channel VHF-UHF indoor antenna. Diamond phasing loops, criss-cross phasing element, and a 12 position all-channel phasing switch produce high gain. A felt base pad guards against scratching furniture. Model F-38K lists for \$14.95. RMS, 2016 Bronxdale Ave., New York, N. Y. (ELECTRONIC TECHNICIAN 12-38)

Binders for your CIRCUIT DIGESTS . . . see page 50.

Binders for your copies of ELECTRONIC TECHNICIAN . . . see page 52.

(Continued from page 39)

ELECTRONIC LIGHT: Electroluminescence or "cold light" will change the appearance of our factories, streets, stores, highways and homes. Providing light without heat and almost without shadow, its flow will be subject to easy control for volume and color. Being light without glare it will eliminate many of the perils of night driving. It will ultimately replace the TV tube altogether with a thin, flat-surface screen that will be hung like a picture on the wall.

COMPUTERS: Recording and accounting will be taken over by robots, freeing for other work the great majority of the nine million Americans now engaged in clerical tasks. New products will, for the most part, have their performance predicted by computers, removing the need for building actual working models.

FOOD: Striking developments in irrigation and flood control, more efficient use of solar energy, the electronic acceleration of germination and growth, as well as new chemical and biological discoveries will greatly expand mankind's food resources. At the same time, the oceans will be efficiently "farmed" for nutritive products.

HEALTH: "The close ties now developing between biology, chemistry and physics, applying the new tools of electronics and atomics, will bring improvements in medicine. Biochemistry will furnish disease-controlling and health-sustaining drugs at an accelerated rate, especially in meeting the physical problems of old age. Man's life span will be further extended, probably within hailing distance of the century mark.

THE HOME: The day's chores in the home will be pre-scheduled, with each of the tasks performed electronically. The air in each part of the home will be automatically controlled and purged of bacteria and other contaminating matter. Electronic appliances will do the cooking, refrigerating and dishwashing, and will dispose of waste.

CLIMATE: Not only will the prediction of weather for months and even years ahead be perfected, but major steps will have been taken to make and control weather as desired. Ports now icebound will be unfrozen and icebergs rapidly melted. Progress will have been made in dissipating storms.

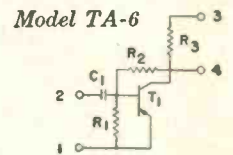

A PRIZE TROPHY

for miniaturized audio amplification

No closed season... no limit... to its applications

New Centralab Single-Stage Transistor Amplifier

- High-gain, low-power transistor amplifier can be used by itself in microphones and other miniature circuit designs. Or, you can combine several units, to get a multiple-stage unit for other audio applications.
- This is a complete amplifier housing capacitance, resistance, transistor, and wiring. Gain, 24 db. Noise level, less than $\frac{1}{2}$ millivolts. Supply voltage, 1.35 v.
- As small as an eraser on an ordinary lead pencil.
- Ask your Centralab distributor for Model TA-6—or TA-7. Send coupon for Bulletin EP-75 containing complete information, schematics, and curves.

Centralab

A DIVISION OF GLOBE-UNION INC.

9021 East Keefe Avenue, Milwaukee 1, Wisconsin

Y-5625

Send me free Bulletin EP-75.

Name _____

Company _____

Address _____

City _____ Zone _____ State _____



New Components

Clarostat RESISTORS →

Handy Greenohm power resistor assortments mounted on wall cards for display and convenience, now include six different selections, GK-1 through GK-6, of 2, 5 and 10 watt sizes ranging from 5 ohms to 50,000 ohms. The popular resistances selected for each card provide the serviceman with values best fitting his usual requirements. The resistance value of each resistor is marked on the card for ease in reordering or taking inventory. Clarostat Mfg. Co. Inc., Dover, New Hampshire. (ELECTRONIC TECHNICIAN 12-31)



Rogers SEALED CONTAINERS →

A complete replacement line of TV transformers, flybacks, yokes and coils in hermetically sealed plastic containers is now available. This moisture-free, dirt-proof packaging extends shelf-life indefinitely and minimizes failures and call-backs. Storage time depends in great measure on the transformer's exposure to humidity and dust. This fact is recognized by designers of military electronic equipment. Reliability is also most important in the replacement field. Rogers Electronic Corp., New York 12, N. Y. (ELECTRONIC TECHNICIAN 12-32)

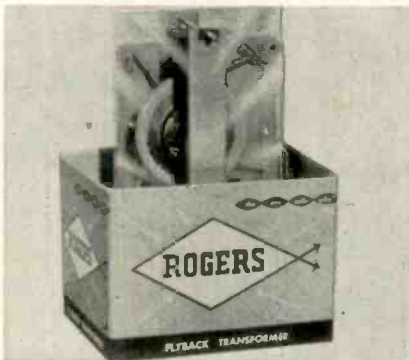

Sprague CAPACITOR KIT →

Just 4 of the new "universal" ceramic capacitors take the place of 42 conventional ceramics valued from 400 μf to .015 μf . The kit handles a large percentage of ceramic, paper tubular, and mica capacitor replacements. Also available in individual packages. Tables packed with the capacitors tell which to use for the desired capacitance, which of the 4 leads to use as terminals and which leads to solder together or clip off. No arithmetic is involved. Sprague Prods. Co., N. Adams, Mass. (ELECTRONIC TECHNICIAN 12-33)

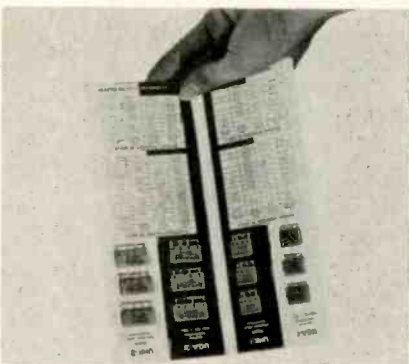

Merit YOKES, FLYBACKS & IFs →

Two new 70° cosine deflection yokes, with exact lead color coding and exact network, are exact replacement in over 200 models of Motorola, Hoffman and Hallicrafters. The new flybacks HVO-59 and HVO-61 with the new anti-corona ring plus exact lead color coding, are exact replacements for G. E. The HVO-62 is a replacement for over 100 Magnavox models. Four new permeability tuned, 455kc, miniature, and subminiature IF transformers for printed circuit applications are also available. Merit Coil Transformer, Chicago 40, Ill. (ELECTRONIC TECHNICIAN 12-34)

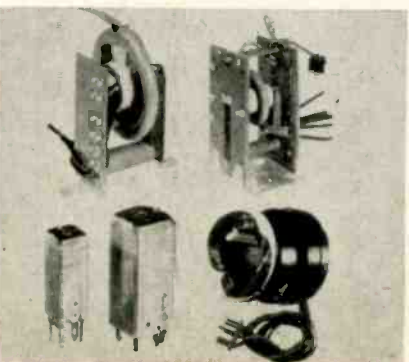

Colman UNIVERSAL KNOBS

This new type of knob allows the distributor or service-dealer to stock a minimum inventory and still have available a large number of knobs in 10 different colors and with a great variety of stem lengths and types. Basically, the principle used is that of a number of knob heads which can be assembled with any one of a large variety of stems, thus giving any desired size, color and shape of knob with any kind and length of stem. Colman Tool & Machine Co., Amarillo, Texas. (ELECTRONIC TECHNICIAN No. 12-59)

James VIBRATOR

A heavy duty vibrator that runs 8-10° C cooler, the model J-28 is specifically designed for the 2-way radio communications field where ambient heat problems require cool running components. This 6-12 volt, 7 prong, split-reed vibrator performs better and lasts longer because of its intrinsic cool operating characteristics. James Vibrapowr Co., 4050 N. Rockwell Ave., Chicago, Ill. (ELECTRONIC TECHNICIAN 12-88)

Astron NOISE FILTER

The new hermetically sealed, miniature, shock-resistant, RF noise suppression filter is an 8-section filter containing 11 capacitor sections, 11 toroids and 2 resistors. Astron Corp., 255 Grant Ave., East Newark, N. J. (ELECTRONIC TECHNICIAN 12-29)

Aerovox ELECTROLYTIC

A miniaturized version of the hermetically-sealed aluminum-can electrolytic is ideal for applications where size and weight must be kept at a minimum. Such tiny electrolytics are particularly suited for transistorized radios, hearing aids and other miniaturized assemblies. Type XPP units range in size from $\frac{3}{16}$ " to $\frac{3}{8}$ " dia., and from $\frac{1}{2}$ " to $\frac{3}{4}$ " long. Working voltages of from 3 to 25 D.C., and capacitance values of from 1 to 50 μf . Aerovox Corp., New Bedford, Mass. (ELECTRONIC TECHNICIAN 12-30)

GE SILICON RECTIFIERS

Hermetically sealed in metal cases, having glass to metal seals for maximum reliability. 3 new rectifiers, 1N536, 1N539, and 1N540 are rated respectively at maximum peak inverse voltages of 50, 300, and 400 volts. They supplement 2 previously announced types in this series, 1N537 and 1N538. Maximum rated output current, for the series, is 750 ma at an ambient temperature of 50°C. At an ambient temperature of 150°C. all the units have a maximum rated output current of 250 ma. General Electric Co., Syracuse, N.Y. (ELECTRONIC TECHNICIAN No. 12-58)

New Tubes

Raytheon TUBES

Three receiving tubes and one picture tube have been added to the company's line. The 8AU8 has a sharp-cutoff pentode and medium-mu triode in one envelope; except for a 450-ma heater, it is identical to the 6AU8; list price is \$2.90. The 17C5 miniature beam pentode with 450-ma heater is used in ac/dc receiver af output; list \$1.95. The 8CG7 miniature twin triode for H & V deflection oscillators has 450-ma heater; list \$2.20. The 24YP4 pix tube employs electrostatic focus, magnetic deflection, and external ion trap; list \$68.50. Raytheon Mfg. Co., Receiving & CR Tube Operations, 55 Chapel St., Newton 58, Mass. (ELECTRONIC TECHNICIAN 12-41)

RCA RECEIVING TUBES

Four new TV receiving tubes have been added. The 6CZ5 beam power tube provides vertical deflection for 110° pix tubes with ultor voltages up to 18 kv.; series string heater is 6.3 v, 450 ma; maximum plate dissipation is 10 watts. The 6Z01 is a premium version of the 12AT7, with high shock and vibration resistance. The 19AU4 glass-octal half-wave rectifier is intended for damper diode use; series heater is 18.9 v, 600 ma. The 6DG6-GT beam power tube is of the glass-octal type designed primarily as an audio amplifier output tube; it is similar to the 25L6-GT, except for 6.3 v, 1200 ma heater. RCA Tube Div., Harrison, N. J. (ELECTRONIC TECHNICIAN 12-42)

Amperex RECTIFIER

The GZ34 octal base, full-wave rectifier has a 5-v, 1.9 amp heater. Output is 250 ma. Features include low output impedance, small size and exceptional internal insulation. Directly replaces 5U4G, 5V4G, 5T4 and similar tubes. Particularly suited for hi-fi equipment. Special Purpose Tube Div., Amperex Electronic Corp., 230 Duffy Ave., Hicksville, N. Y. (ELECTRONIC TECHNICIAN 12-43)

Binders for your CIRCUIT DIGESTS . . . see page 50.

Binders for your copies of ELECTRONIC TECHNICIAN . . . see page 52.

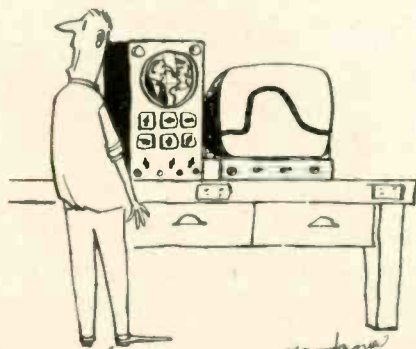

"Hey, Al!"

Time for Replacement?

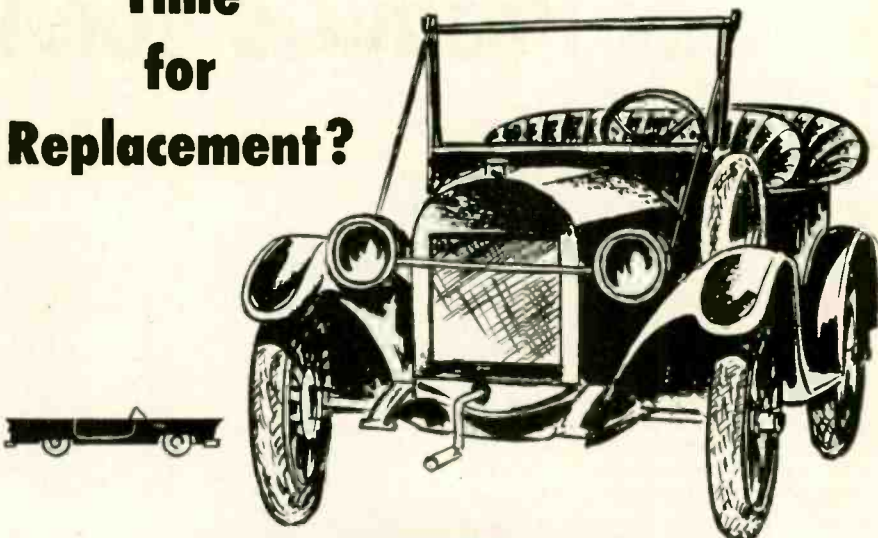

We GUARANTEE you speakers that are built to be the finest exact replacement speakers. We stand behind each and every speaker with a 100% guarantee against any mechanical or electrical defects for one full year.

OXFORD Replacement Speakers undergo a rigid inspection to make certain that they are as good or better than the original speaker. That's why more servicemen are switching to OXFORD . . . when it's time for replacement.

Illustrated literature is available without obligation. . . . at better jobbers!

OXFORD Components, Inc.

Subsidiary of OXFORD ELECTRIC CORP.

556 West Monroe Street, Chicago 6, Ill.

In Canada: Atlas Radio Corp., Ltd., Toronto

Export: Roburn Agencies, New York City

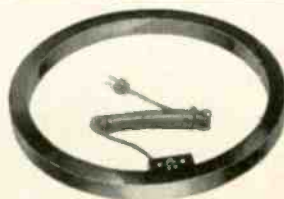

ADELCO Degaussing Coil

\$14.95 NET

The Adelco Degaussing Coil is for use in the degaussing of metal envelope color TV picture tubes. This unit is enclosed in a high impact plastic case with built-in slide switch.

ADVANCE ELECTRONICS CO.

8510 North End Avenue

Oak Park, Michigan

New Products for Technicians

Int. Rect. SELENIUM PLUG-IN →

Type 60-7788 is a small, compact plug-in selenium rectifier that has been especially designed to replace the 6AL5 tube in many TV sync discriminator circuits. These subminiature rectifiers are much smaller in size and do not require any heater power. Each diode is designed to deliver 20 volts d.c. at 1.5 ma for an RMS voltage input of 26 volts maximum and may be operated through an ambient temperature range of minus 50°C to 100°C. International Rectifier Corp., El Segundo, Calif. (ELECTRONIC TECHNICIAN 12-7)

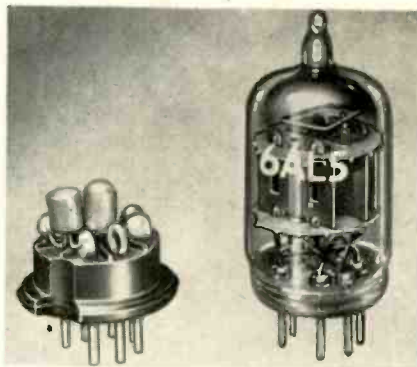

Belden CABLES →

New double shielded and double jacketed TV antenna system cables are designed for lowest losses, longer service life and maximum dependability. There is no variation from shipment to shipment. Essentially flat response with no peaks in attenuation to reduce the signal on either high or low TV channels. All cables are sweep tested, which assures maximum performance and minimum maintenance. Trade No. 8232 and 8233. Belden Mfg. Co., 4647 W. Van Buren St., Chicago, Ill. (ELECTRONIC TECHNICIAN 12-10)

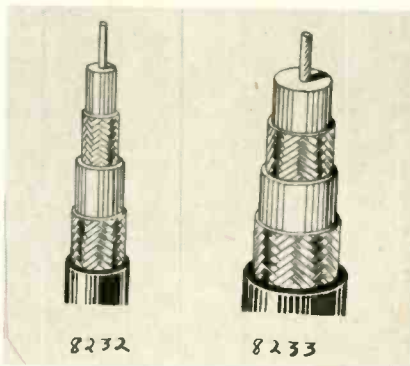

Utica BAUER COIL SPRING →

The spring is named after Albert Bauer, a tool maker for more than 50 years. It was initially installed at his suggestion in certain Utica pliers more than 6 months ago. It is now being made available in all models. Easily removable it allows quick and rapid plier action and is conveniently located. Fully guaranteed against breakage. Will not pinch the operator's fingers. Location of the spring permits the use of slip-on handles. Utica Drop Forge & Tool Corp., Utica 4, N. Y. (ELECTRONIC TECHNICIAN 12-13)

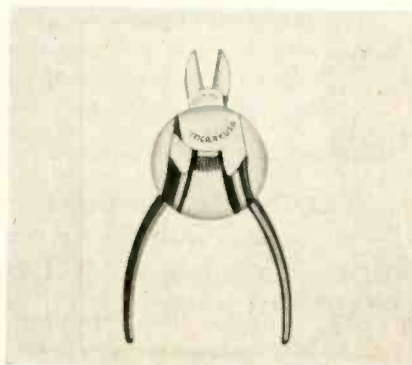

G-C CHEATER →

A newly developed safety device for color TV set servicing has just been announced. The "G-C Color Interlock Cheater," is said to render a serviceman completely safe when he removes the back of the set for repairs. The new tool is plugged into the set where it permits entry of a high voltage probe through its shell. LP \$0.99 dealer net 59¢. It is available through leading parts distributors. Additional information may be obtained by writing General Cement Mfg., 400 S. Wyman St., Rockford, Ill. (ELECTRONIC TECHNICIAN 12-11)



Pamcor REPAIR KIT

A new portable repair kit made of light-weight metal and partitioned, holds A-MP terminals, connectors and the Champ tool. This tool cuts wire, shears bolts, strips insulation and crimps terminals. Ease of inventory and identification is assured because of an illustrated diagram on the cover. American Pamcor, Inc., Havertown, Pa. (ELECTRONIC TECHNICIAN 12-5)

Triton SOLDERING PLIERS

Electric soldering tool with plier-action tips heats or cools instantly. The work is held firmly in place when applying heat and solder, and continues to hold while the solder solidifies. It is ideal for safe, precision and delicate soldering jobs. The hand tool is furnished with a 2 heat transformer. Triton Mfg. Co., E. Haddam, Conn. (ELECTRONIC TECHNICIAN 12-8)

C-D POWERCONS

Converts car battery power supply to 110v 60 cycle, 20 to 200 w. power similar to that found in the home. Motorists, servicemen and businessmen can now plug in their tape recorders, TV sets, record players, shavers, test instruments and dictating equipment. Can be installed in convenient spaces under the dashboard, or in trunk compartment. Cornell-Dubilier Electric Corp., S. Plainfield, N. J. (ELECTRONIC TECHNICIAN 12-9)

Vulcan SOLDERING IRON

New pencil type soldering iron, designed specifically for rapid production soldering. Small and lightweight, yet durable, it is especially applicable in mass production lines where fast, continuous soldering operations are required on small assemblies and on printed circuit panels. Standard models will be supplied in 30 watts at regular voltages with 1/4" tips. Vulcan Electric Co., 85 Holten St., Danvers, Mass. (ELECTRONIC TECHNICIAN 12-12)

Binders for your **CIRCUIT DIGESTS**

... see page 50. Binders for your copies of **ELECTRONIC TECHNICIAN**

... see page 52.

SENSATIONAL

A Completely New
Concept in Electronic
Knobs.

UNIVERSAL KNOB SYSTEM



- A small stock of knob heads and stems gives you any desired knob . . . in any needed color . . . in a matter of seconds.
- Costs no more than plain knobs.
- 15 Knobs . . . 10 stems . . . 1500 combinations.
- Any Knob . . . fits any stem . . . fits any shaft

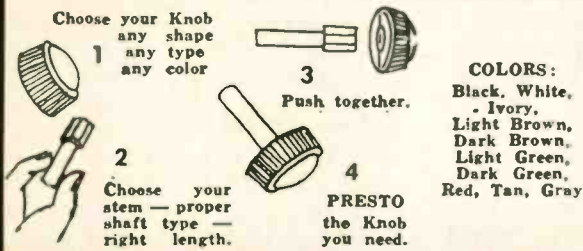

COLORS:
Black, White,
Ivory,
Light Brown,
Dark Brown,
Light Green,
Dark Green,
Red, Tan, Gray

Write Today for Full Particulars to
COLMAN TOOL & MACHINE CO.
P. O. Box 7026 Amarillo, Texas

**Mr. Dual-Match sez -
I am MOSLEY built for
that Big**

**2-Set
TV Market**

MOSLEY 902
List Price **\$2.95**

**Motels
Apartments
Duplex Homes
Any Multi-set
Installation**

MOSLEY "Dual-Match" TV Couplers answer the problem of *Low Cost* coupling of two TV sets to one antenna—without one set interfering with the other!

Quick, easy, solderless installation is your assurance of bigger profits and satisfied customers...insist on and use MOSLEY "Dual-Match" TV Couplers!

At Radio and Television Parts Distributors, Coast-to-Coast!

MOSLEY *Electronics, Inc.*

2622 St. Charles Rock Road

St. Louis 14, Mo.

YOU CAN REST EASY . . .

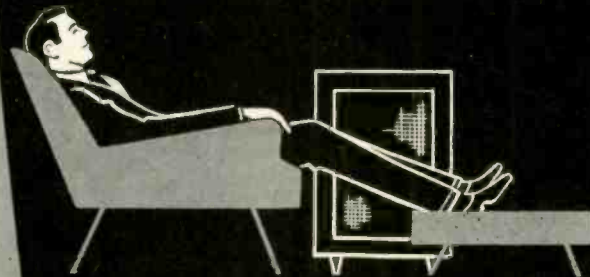

WHEN YOU INSTALL UTAH REPLACEMENT SPEAKERS

Yes, you can rest easy whenever you install a Utah pre-tested replacement speaker, because you know your customer will be satisfied.

Every service man knows he must be sure that the replacement speaker he uses will perform superbly and reflect favorably on his reputation as a highly skilled technician.

The name Utah on a speaker signifies the finest quality in design, engineering, production and performance that money can buy.

You can rest easy when you install a Utah. Because of customer satisfaction—repeat sales are assured with Utah.

All leading jobbers handle Utah—because Utah has the widest line of speakers available to the trade—Utah is your one complete speaker source.

UTAH YOUR ONE COMPLETE SPEAKER SOURCE

**AUTO • REAR DECK KITS
STANDARD REPLACEMENT
TELEVISION • PUBLIC
ADDRESS • HIGH FIDELITY
OUTDOOR • INTER-COMM
WOOD AND METAL BAFFLES**

Get your **FREE** copy of the latest Utah Catalog S-156 listing over 100 replacement speakers.

Available at your distributors or from

utah

RADIO PRODUCTS CORP.

HUNTINGTON, INDIANA

TV FM AM

HANDBOOK OF BASIC CIRCUITS

By
Matthew Mandl

At last—a quick, convenient reference to all types of communications circuits

including

- SWEEP SYSTEMS • SYNC SYSTEMS
- AUDIO & RF AMPLIFIERS • POWER SUPPLY DETECTORS
- OSCILLATORS • DISCRIMINATORS
- TRANSISTORS

136 important circuits

each illustrated by schematic drawing and explained as to characteristics and purpose. Math and formulas at a minimum.

An absolute necessity for

Graduate Engineers Students
Technicians Amateurs

Price \$7.50

MANDL'S TELEVISION SERVICING Rev. Ed.

By Matthew Mandl—\$6.50

NOW YOU CAN USE THE METHODS OF THE EXPERTS

Simple, clear explanations of the fundamentals of monochrome and color TV. Complete servicing instructions for UHF and VHF. Servicing details for the latest types of equipment: transistor, gated beam detector, color, TV circuits and 100 more.

You'll learn the time-saving methods used by the experts without unnecessary theory or involved math. Illustrated every step of the way.

**guarantee your future
SEND NOW!**

**STUDY ONE OR BOTH FREE
FOR 10 DAYS WITHOUT
OBLIGATION**

CLIP AND MAIL TODAY

The Macmillan Company, Dept. T1
60 Fifth Avenue, New York 11, N. Y.

Please send me:

- HANDBOOK OF BASIC CIRCUITS \$7.50
- MANDL'S TELEVISION SERVICING \$6.50

I will either remit the full price or return the book(s) in 10 days.

Check or money order enclosed saving me delivery charge.

Name.....

Address.....

City..... Zone..... State.....

Distributors in Canada: Brett-Macmillan Ltd.
25 Millbrook Road, Toronto 16.

Quick Solutions of Coil Problems

Some Emergency Measures When a Coil

Just Doesn't Make a Desired Value

LAWRENCE X. SHAW

• Whenever possible, the proper replacement component should be used, and the causes for the malfunction should be eliminated. When an important program makes the set owner want his set back days before a duplicate part can be secured, or if the set may be a refugee from a junk pile, then perhaps you may be justified in using these "butchering" techniques.

Adding A Coil

Instances arise where an inductance just doesn't make a desired value, either with the slug all the way in or all the way out. Fig. 1

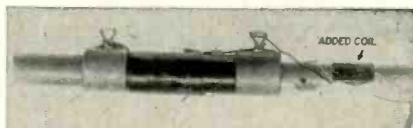

Fig. 1—Inductance may be changed by adding a small coil along the axis of the large coil

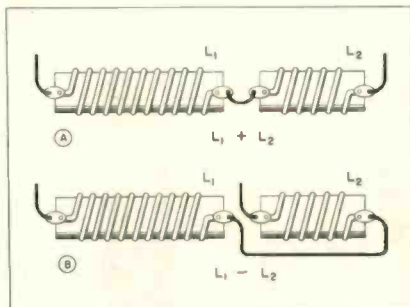

Fig. 2—Series aiding and opposing coils

shows how an extra inductance may be added to a linearity coil. As desired, the core in the added coil may be left in, or taken out. The inductance will increase when the direction of the windings is the same in both coils, as in Fig. 2A. The total inductance can be reduced by reversing the connections to the added coil, as shown in Fig. 2B.

Adding Turns

To increase or decrease inductance, even after the slug has been turned all the way, and when another coil is not readily available,

a few turns of wire can be added. A series aiding winding will increase, and a series opposing winding will decrease the total inductance. If necessary, a layer of insulating paper may be applied between the windings.

Adding a Core

An additional core from another coil may be used as is shown in Fig. 3. Push the new core into the winding coil form. The original core can still be adjusted. The increase in core area creates a longer high permeability path, which will increase the inductance. In the case of a coil wound on a solid form, or where it isn't possible to gain access to the center of the coil form, a core can be tied adjacent to the coil and as close to the axis as possible. Inductance is increased when an iron core is used. To decrease the inductance a core made of copper or brass (non-magnetic material) can be used.

Adding a Shield

Still another way remains to decrease the inductance a little. Fig. 4, shows a piece of ordinary foil from a cigarette package wrapped around a coil. A piece of wrapping material is left underneath the foil and serves as insulation. The foil acts as a shield, and therefore lowers the inductance.

All adjustments and modifications should be securely fastened. Since the "Q" of the coil is affected by these quick and dirty solutions, undesirable side effects may dictate finding the trouble, and replacing with proper components. •



Fig. 3—Extra core increases inductance

Fig. 4—Foil acts as shield, cuts inductance

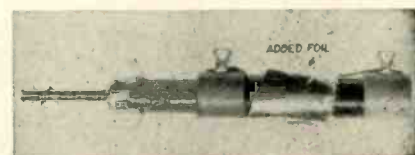

Tough Dog Customers

(Continued from page 34)

that the friend is way off base.

This one calls for tact, as you explain why the brilliant friend doesn't have the right answers. Try it this way: "Mr. Customer, electronics is a very complicated science. Every new model TV set has important circuit changes. Like medicine, electronics has become a field of specialties.

Most top electronic engineers would not even consider trying to service their own TV sets. Although they understand the theory perfectly, they don't have the best equipment or the training in the latest service techniques that they would need for the job. Again, it's like the field of medicine. The brain surgeon sends his children to the pediatrician. When the psychiatrist gets sick, he goes to another practitioner. Each of these medical men is thoroughly competent in his own field, but like the engineer, he can't tackle a repair job in every field."

The Bargain Hunter.

This is the prospect who has fallen prey to cut-price servicemen, and now has hatchet in hand, ready to chop away. Your prices are ridiculously high!

Look this tough one straight in the eye, and say: "Cheap is cheap, Madam. I've talked to many people who were unfortunate enough to have their TV sets repaired too cheaply. It's like looking for the cheapest doctor to perform an operation at the lowest price—or the cheapest lawyer to defend you in a law suit.

"You see, good TV replacement parts cost all servicemen the same amount of money, and all good servicemen receive approximately the same rate of pay. You can only get a lower price by cheap labor or cheap parts, and in almost all cases it costs less to do it right the first time, than to pay less and have it done over."

The Woman on Whose Set You Goofed.

Naturally, there are times when poor workmanship or a bad component crop up on one of your jobs. This customer is burning.

The only answer is to admit readily that the fault is yours. Explain
(Continued on page 48)

for service and lab. work

Heathkit PRINTED CIRCUIT OSCILLOSCOPE KIT FOR COLOR TVI

① Check the outstanding engineering design of this modern printed circuit Scope. Designed for color TV work, ideal for critical Laboratory applications. Frequency response essentially flat from 5 cycles to 5 Mc down only 1½ db at 3.58 Mc (TV color burst sync frequency). Down only 5 db at 5 Mc. New sweep generator 20-500,000 cycles, 5 times the range usually offered. Will sync wave form display up to 5 Mc and better. Printed circuit boards stabilize performance specifications and cut assembly time in half. Formerly available only in costly Lab type Scope. Features horizontal trace expansion for observation of pulse detail — retrace blanking amplifier — voltage regulated power supply — 3 step frequency compensated vertical input — low capacity nylon bushings on panel terminals — plus a host of other fine features. Combines peak performance and fine engineering features with low kit cost!

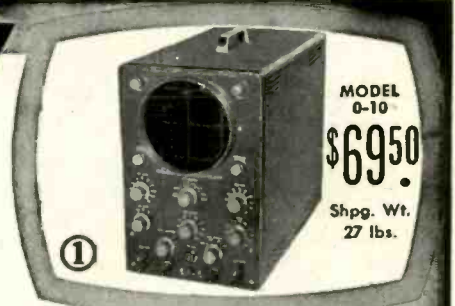

MODEL
0-10
\$6950
Shpg. Wt.
27 lbs.



MODEL
TS-4
\$4950
Shpg. Wt.
16 lbs.

Heathkit TV

SWEEP GENERATOR KIT ELECTRONIC SWEEP SYSTEM

② A new Heathkit sweep generator covering all frequencies encountered in TV service work (color or monochrome). FM frequencies too! 4 Mc — 220 Mc on fundamentals, harmonics up to 880 Mc. Smoothly controllable all-electronic sweep system. Nothing mechanical to vibrate or wear out. Crystal controlled 4.5 Mc fixed marker and separate variable marker 19-60 Mc on fundamentals and 57-180 Mc on calibrated harmonics. Plug-in crystal included. Blanking and phasing controls — automatic constant amplitude output circuit — efficient attenuation — maximum RF output well over .1 volt — vastly improved linearity. Easily your best buy in sweep generators.



KESTER



Absolutely non-corrosive and non-conductive, KESTER "RESIN-FIVE" CORE SOLDER contains an activated type of resin that gives you that fast, positive action on all your jobs . . . including the most difficult.



KESTER SOLDER COMPANY
4264 Wrightwood Avenue • Chicago 39, Illinois
Newark 5, New Jersey • Brantford, Canada

SOLDER

THE GREATEST VALUE IN TEST EQUIPMENT



MODEL
980 VOM

Only \$46⁷⁵/_{LIST}

A real value leader . . . accurate, compact, rugged, and low in cost. Has a combination of 28 functional ranges, simplified by a single dial. Ideal for radio and TV servicing, and for all 'round electronic and electrical measurement needs. At leading distributors, or write for literature. WESTON Electrical Instrument Corporation, Newark 5, N. J. A subsidiary of Daystrom, Inc.

WESTON test equipment
The Quality Line

(Continued from page 47)

in a matter-of-fact way, exactly what happened, and tell her sincerely how badly you feel about it. Then make good on it, of course. Human nature being what it is, it's often true that if you feel worse about it than the customer, she tries to console you. She might even wind up being a strong booster for you. •

TV Trap Eliminates Adjacent Channels

A TV filter called Trap-Ease which traps out adjacent channel interference has been developed by Jerrold Electronics. It is connected in series with the antenna lead-in, and mounted on the rear or top of the receiver.

Upper photo shows herringbone pattern resulting from adjacent sound channel in receiver i-f. Lower photo and drawing illustrates how tunable trap attenuates interfering signal, removing beat pattern.

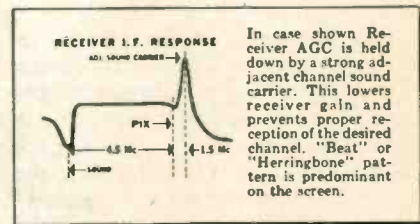
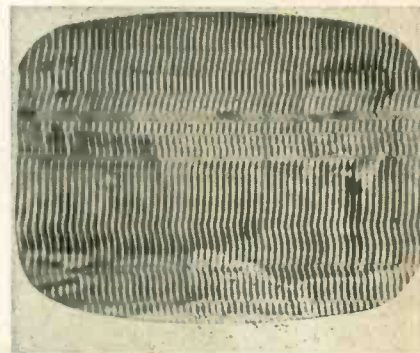

In case shown Receiver AGC is held down by a strong adjacent channel sound carrier. This lowers receiver gain and prevents proper reception of the desired channel. "Beat" or "Herringbone" pattern is predominant on the screen.

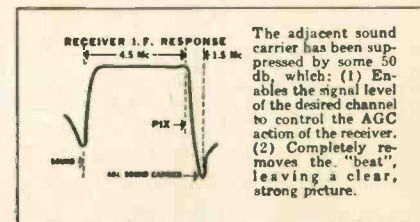

The adjacent sound carrier has been suppressed by some 50 db, which: (1) Enables the signal level of the desired channel to control the AGC action of the receiver. (2) Completely removes the "beat", leaving a clear, strong picture.

ask the
"Man-on-the-Roof"
why he prefers

South River

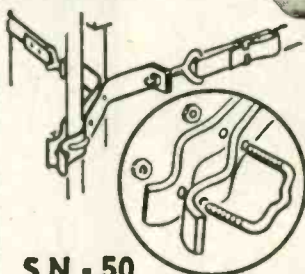

SN - 50 CHIMNEY MOUNT SNAP-IN TYPE

with unique U-Bolt INSTEAD OF SCREWS for easy one hand "Spintite" fastening. Hot Dip Galvanized — 12 Ft. Straps, two to a set. Same Unique U-Bolts used on Snap-In Wall Brackets. Also Available with Stainless Steel Banding.

Write for new 1956 catalog

SOUTH RIVER
METAL PRODUCTS CO., INC.
South River, New Jersey

pioneer & outstanding producer of finest line of antenna mounts

NEW

Build-Your-Own knight-kit TRANSISTOR & DIODE CHECKER KIT



only \$8.50

Save on this valuable new instrument! Checks leakage-to-gain ratio and noise level of all junction, point contact and barrier transistors. Can also check germanium and silicone diodes, and forward and reverse conduction of selenium rectifiers. Useful for continuity and short tests, as well as for noise level tests. Features: spring-return leakage gain switch, calibration control, full-vision meter, separate sockets for PNP and NPN type transistors. Complete kit with bakelite case, all parts, 22 1/2 v. battery and instructions. Shpg. wt., 2 1/2 lbs. Model 83 Y 149. Net only \$8.50

Net F.O.B. Chicago

FREE

356-PAGE ALLIED CATALOG
Lists dozens of other low-cost quality Knight-Kit test instruments, plus the world's largest selection of parts and equipment for service work. Write for FREE copy.

ALLIED RADIO

ALLIED RADIO, Dept. 25-L-6
100 N. Western Ave., Chicago 80, Ill.

- Send Kit described above. \$ _____ enclosed
- Send FREE 356-Page ALLIED Catalog

Name _____

Address _____

MERIT

first in exact replacement



MDF-82 for exact replacement in over 30 DUMONT models and chassis; equipped with octal plug and ground clamp. Another in the complete line of exact transformers, yokes and coils. Merit is the only manufacturer of transformers, yokes and coils who has complete production facilities for all parts sold under their brand name.

MERIT

MERIT COIL AND TRANSFORMER CORP.
4427 N. CLARK ST., CHICAGO 40, ILLINOIS

Transistor Testing

(Continued from page 26)

on the manufacturer's data sheet. If specifications are not available, compare readings with a transistor, of the same type, that is known to be good. As the voltage is increased, so will the reverse current, even on a good transistor. If damage is to be avoided, keep the applied voltages within limits. In general the lower, the reverse current reading, the better is the transistor. This check is made on both the emitter and collector with respect to the base.

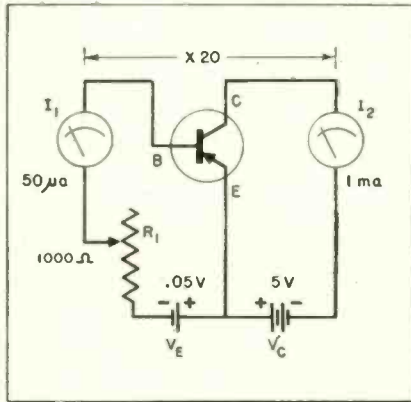

Fig. 3—Measuring PNP current gain.

At this point we have to depart from our diode analogy, and consider the current gain characteristics of the transistor. (A large change in collector current, caused by a small change in base current.) This check is still not a dynamic test, nor will it give an indication of frequency response, because the applied signal voltage is DC. It can be compared to a mutual conductance test of a vacuum tube using a fixed set of parameters. (Usually an ideal condition.) As a result a slightly higher current gain figure can be anticipated. The circuit is shown in figure 3. The value of the collector voltage V_c is about 5 volts for germanium, and 6 to 8 volts for silicon.

For the purpose of our discussion we shall consider a germanium transistor, and some "very round" values. The resistor R_1 should be approximately 10 times the common emitter input impedance. (Assuming $Z_e=100$ ohms, then $R_1=1,000$ ohms.) The value of the emitter voltage V_e can then be determined as follows: If the collector current is 1 ma, the current gain is 20, then the base current must be $50 \mu a$. $V=RI=1,000 \times 50 \mu a=.05$ volts. In a good transistor I_2 will read 1 ma. The ratio I_2 to I_1 , should be not less than specified by the manufacturer.

The Most Popular Line In America!

TRID
Sharpshooter
TV ANTENNAS

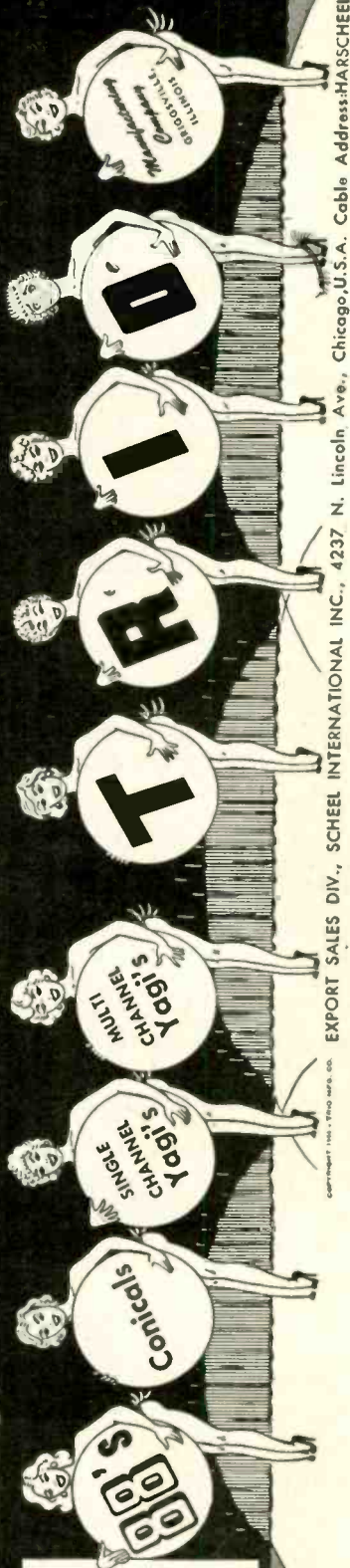

COPYRIGHT 1955, TRID MFG. CO.

EXPORT SALES DIV., SCHEEL INTERNATIONAL INC., 4237 N. Lincoln Ave., Chicago, U.S.A. Cable Address: HARSHEEL

BINDERS

for your

CIRCUIT DIGESTS . . .

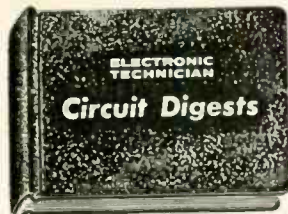

10¾"
X
14¼"

. . . are now available to

ELECTRONIC TECHNICIAN
subscribers!

These sturdy spring-type (no holes to punch) binders are bound in dark red, hard bookcover material

. . . they hold 24 monthly issues of **CIRCUIT DIGESTS** plus other reference literature.

. . . and are embossed in gold on the front and the back binding.

Another **ELECTRONIC TECHNICIAN** service—to help you preserve and get more convenient use out of your valuable **CIRCUIT DIGESTS**!

\$2.95 each—Postpaid

ELECTRONIC TECHNICIAN

480 Lexington Ave.
New York 17, N. Y.

Please ship "CIRCUIT
DIGEST Binders." I enclose \$

(please print)

Name

Street & No.

City Zone . . . State

126

Response Errors

(Continued from page 30)

original design. Usually this will be a difference in the high frequency end. Most often it will involve undue accentuation of the high frequencies resulting in extreme edginess or sharpness of reproduction, but sometimes the result may be the reverse, resulting in loss of the high frequencies.

A development from the Williamson amplifier is the *Ultra-linear* circuit, of which a typical example, capable of 25 watts output, is shown in Fig. 5 in the modern feedback amplifier. There is a common trend to put the phase correction capacitance, for taking care of stability at the high frequency end, across the feedback resistor, as shown in this case, with C13 across R7.

The best rule to follow in checking out either excess or deficiency of high or low frequencies is to look at all the capacitors in the circuit on the following basis: all the larger capacitors, say above 0.01-mfd, will be likely to influence the low frequency response of the amplifier. Thus, if bass response is unbalanced, either by excess or loss, check these components for accuracy of value or deterioration.

Also check the resistors in the circuit associated with them for example, the plate resistor R2 and joint resistor R4 associated with the coupling capacitor C2, because excessive deviation of associated circuit resistance can sometimes result in deterioration of frequency response.

If the high frequency response is defective, look for the small capacitors in the circuit, measured in mmfd, instead of mfd. In Fig. 5, there is only one such—the 50-mmfd unit connected across the 39k feedback resistor. In other circuits there may be several of these small capacitors connected at various points. If you have an amplifier of this latter type, it will be unwise to attempt to improve its performance without the assistance of an audio oscillator. But in the case of a simple amplifier, with only a single correction capacitor, such as that in Fig. 5, check the value of the feedback resistor R7, the cathode resistor R3, and the phase correcting capacitor C13. If any of these deviate by more than about 20% from their nominal value, replace with the correct value.

If these are on value, or replacement does not produce the desired

TRIAD ISOLATION TRANSFORMERS

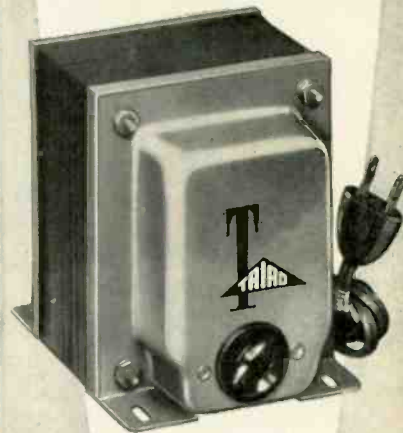

**AVAILABLE FROM STOCK
AT YOUR TRIAD JOBBER**

Triad Isolation Transformers are especially designed for isolation of laboratory test equipment
reduction of line disturbances
elimination of undesired grounds.

They are ideal for use in screen rooms. Such construction features as "Climate" treatment, liberal use of high quality materials and static shielding insure optimum performance and long life.

| Type No. | List Price | V. A. Output | Input Volts | Output Volts |
|----------|------------|--------------|-------------|--------------|
| N-51X | \$ 7.10 | 35 | 115 | 115 |
| N-68X | 8.95 | 40 | 230/115 | 115 |
| N-53M | 14.00 | 85 | 115 | 115 |
| N-54M | 17.10 | 150 | 115 | 115 |
| N-67A | 16.30 | 150 | 230/115 | 115 |
| N-55M | 30.20 | 250 | 115 | 115 |
| N-66A | 25.40 | 250 | 230/115 | 115 |
| N-57M | 50.70 | 500 | 115 | 115 |
| N-59M | 86.50 | 1000 | 115 | 115 |
| N-52M | 38.70 | 350 | 95 to 130 | 115 |

With switch and meter for primary voltage control. Detachable cord.

Write for
Catalog TR-56

TRIAD
TRANSFORMER CORP.
4055 Redwood Ave., Venice, Calif.

Little Devil COMPOSITION RESISTORS

Meet all MIL-R-11A requirements. Rated at 70C rather than 40C. Available in 1/2, 1, and 2-watt sizes in all standard RETMA values.

BROWN DEVIL® RESISTORS

Vitreous - enameled. In 5, 10, and 20-watt sizes.

TYPE AB POTENTIOMETERS

Resistance material is solid - molded, noise-free. Rated at 2 watts.

FR-7.5 FUSE RESISTOR

For easy replacement in all television receivers. 1 1/2" Tinned wire leads.

WRITE FOR STOCK CATALOG

Be Right with

OHMITE®

DEPENDABLE RESISTANCE UNITS

Eliminate call-backs due to faulty replacements. Use Ohmite components.

AXIAL-LEAD RESISTORS

Vitreous-enameled, power-type units designed to withstand high temperatures.

3 WATT SIZE
9/16" x 1/4"

5 WATT SIZE
1" x 11/32"

10 WATT SIZE
1-3/4" x 13/32"

OHMITE®

OHMITE MANUFACTURING CO.
3687 Howard Street, Skokie, Illinois

result, it may be that the constants of the output transformer (or the loudspeaker) do not suit the circuit, so try different values for C13. First of all try 43 mmfd and then 56 mmfd. If these do not correct the matter, but one of them shows slight improvement, try a further step in the same direction. If 43 mmfd shows improvement, try 33 mmfd. If 56 mmfd shows improvement, try 68. In this way it will usually be possible, by experiment, to correct matters so as to achieve the desired overall response.

In cases where a greater number of phase correction capacitors are used, or where the owner has made extensive circuit changes, it will generally be necessary to use an audio oscillator to align the amplifier. ●

You and the Law

(Continued from page 31)

make the area included in the invitation safe. However, the danger must be one known to the shopkeeper or one that he could reasonably have discovered, but he does not have to guard against dangers reasonably obvious to the customer, such as stairs, crowds or swinging doors.

The best way to learn about the shopkeeper's duties to his customers is to see where others in similar situations were held responsible for injuries to customers.

There are many cases involving injuries due to falls on stairs. The customer recovers not because there are stairs but because some dangerous defect exists. The top or bottom step may not be clearly marked or well illuminated. The lighting may cause deceptive shadows. Carpeting or rubber pads may be loose or the nails or metal trim intended to secure the covering may be worn, broken or loose. The best way to avoid liability in such clear cases is to inspect regularly. Naturally, the more stairs are used, the more frequent should be the inspections. If a defect is found, fix it at the time; later may be too late. Water or debris left on the stairs is another source of danger and, therefore, of liability.

Trapdoors and other openings in floors are another common source of injury resulting in the liability of the shopkeeper. This is particularly so when the opening is unguarded, is

(Continued on page 52)

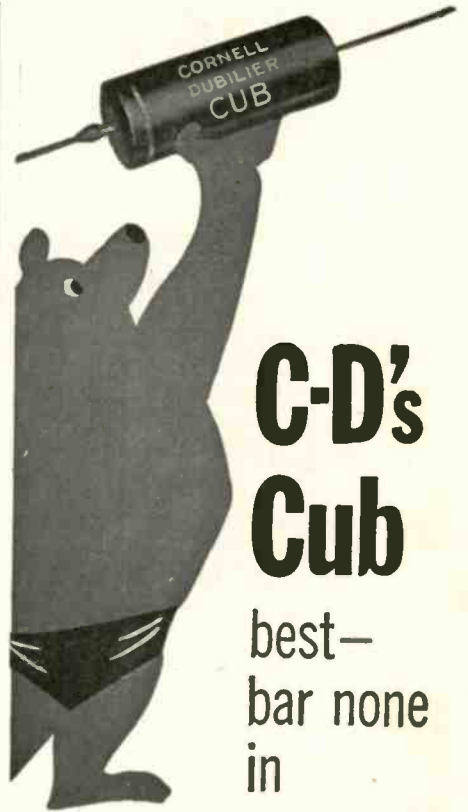

C-D's Cub

best—
bar none
in

molded tubular capacitors

The C-D "Cub" capacitor has proven itself the best on the market today—by out-lasting, out-performing, out-selling any other replacement capacitor for radio or TV. For consistent high quality—always rely on C-D, the only tubulars with the built-in extras required in servicing sets today. That's why distributors *who know*, carry the complete C-D line.

Special! "Cub-Kit" with bonus plastic service dispenser. IT'S FREE!

Ask your C-D Distributor. He's listed in your local Classified Telephone Directory.

CONSISTENTLY
CORNELL-DUBILIER
DEPENDABLE
DUBILIER



THERE ARE MORE C-D CAPACITORS IN USE TODAY THAN ANY OTHER MAKE.

PLANTS IN SD. PLAINFIELD, N. J.; NEW BEDFORD, WORCESTER AND CAMBRIDGE, MASS.; PROVIDENCE AND HOPE VALLEY, R. I.; INDIANAPOLIS, IND.; SANFORD AND PUGUAT SPRINGS, N. C.; SUBSIDIARY, RADIART CORP., CLEVELAND, OHIO.

IT PAYS TO

Save Your Copies

of

ELECTRONIC TECHNICIAN!



And in response to many requests . . . a supply of modern, sturdy, blade-type BINDERS, size 8½ x 11¼, is now being made up for

ELECTRONIC TECHNICIAN

subscribers.

These BINDERS hold securely and conveniently 24 issues of ELECTRONIC TECHNICIAN . . . and are made of dark red heavy-duty bookcover material—with steel spine and 24 steel blades.

They will preserve for you the valuable technical information and "know-how" in every issue of ELECTRONIC TECHNICIAN . . .

. . . and keep your copies conveniently at hand.

Gold-embossed on front cover and back binding.

\$3.25 each—Postpaid

ELECTRONIC TECHNICIAN

480 Lexington Ave.
New York 17, N. Y.

Please ship . . . "ELECTRONIC TECHNICIAN Magazine Binders." I enclose \$

(please print)

Name

Street & No.

City Zone . . . State

(Continued from page 51)

not clearly marked, or is near merchandise or any other area where a customer is likely to go. But where the opening is behind a counter where customers were not supposed to go, the proprietor was not liable. To protect himself against liability for such falls the shopkeeper has only to be sure that the opening is not in the customer's area, is well marked, and is kept securely closed whenever possible.

There are many sources of liability on the sales floor. Customers have recovered for injuries sustained in the following situations: customer fell backward over box in aisle alongside the counter; customer tripped over low platform painted the same color as the floor; a dip in the floor near the door filled with oil caused customer to slip; ladder or table leg poorly lighted and shelves projecting into aisle were bumped by customers; and customers fell on slippery spots caused by wet mop or oil. There is no sure way to avoid these dangers and thereby avoid liability. One can only inspect frequently depending on circumstances. For example, winter weather will mean wet floors due to customers' tracking in ice, snow or rain. To remedy this danger the shopkeeper can only mop as often as reasonably necessary.

Another source of harm to customers has been falling merchandise or other objects in the store. Generally some article that stood or leaned on end or edge has fallen and injured the customer. The theory is that the article would not have fallen if placed carefully by the shopkeeper. The same approach applies in cases where goods are in stacks, for example, boxes piled on top of each other.

Other dangers exist, but each store will have its own peculiar dangers. One can avoid resulting liability only by placing himself on an imaginary jury trying to decide what accidents could be foreseen, and by correcting all sources of accidents thus imagined. •

• Binders for your **CIRCUIT DIGESTS** . . . see page 50.

• For last complex index of all **Circuit Digests** published to date, see November 1956 issue. You may obtain the complete group of **Circuit Digests** published in any one issue for only 50¢ postpaid.

HQ For the 5 TOP-QUALITY brands of

STANDARD BRAND TUBES

AT SENSIBLE PRICES!

- 90-day RETMA guarantee
 - First quality only
 - Grand new • Individually boxed
 - No rebrands, rejects, or rewashed "bargains"
- WRITE FOR LATEST RECEIVING AND TV TUBE PRICE LIST, FREE!

BARRY SPECIALS!

BARGAINS IN HIGH QUALITY TEST AND SERVICE EQUIPMENT

5" DUMONT SCOPE MODEL 274A AT LESS THAN HALF PRICE!

Genuine Dumont model 274A, 5" oscilloscopes, regularly sold for \$150 now available for **LESS THAN HALF PRICE!** Look at these features: Frequency response within 50% from 20 to 200,000 cps with recurrent sweeps from 8 to 30,000 cps similar X and Y amplifiers and provision for intensity modulation. Portable, light weight. Shpg. wt. only 35 lb. Used, clean, checked out and guaranteed. F.O.B. N.Y.C. **\$65.00 SPECIAL!**

TEST EQUIPMENT BARGAINS!

- UHF SIGNAL GENERATOR
- GEN'L RADIO TYPE 804C52 (Worth Over \$800.00)
- 7.5 to 300 mcs. Made by U.M. & Federal Engineering. Used, clean, checked out and guaranteed. Special! **\$100.00**
- F.O.B. N.Y.C.
- ABSORPTION WAVEMETER. GEN'L. Radio type 758A
- 55-400 MCS. (Worth \$40.00) NEW . . . \$ 12.50
- 5" OSCILLOSCOPE. Dumont 274A. Vy. good. 75.00
- 5" OSCILLOSCOPE. Dumont 208B. Vy. good. \$110.00
- 5" OSCILLOSCOPE. RCA W0-88A. Vy. good. 95.00
- TV XTAL 13 CHANNEL MARKER. Kay "Megamarker" incl. all 13 stais. Vy. good. . . . \$49.50
- SIGNAL GENERATOR. Measurements Corp. model 80. 0-400 Mcs. Vy. good. . . . \$350.00
- SIGNAL GENERATOR. Measurements Corp. model 78FM. 86-11D Mcs. 30 Kc. deviation. Excellent condition . . . \$175.00

TRANSFORMER SPECIAL!

3100-0-3100 volts @ ½ amp! PRIMARY: tapped for 98-104-110-116-123 volts, 60 cycles AC. SECONDARY: 3100 volts each side of center @ 500 ma. 15 KV impregnated mica insulation. Conservatively rated. Meas. 9" L x 8" H x 7 ½" W. New guaranteed. Shpg. wt. 60 lbs. . . . **\$34.50**

TUBE STACKERS

Miniature or GT

Holds 10 of Either Size

SPECIAL! Per 100 **\$125**

\$10.00 Per Case of 1000 FOB NYC.

2 COLOR TUBE CARTONS

Keeps your tube stock neat. New safety partition prevents tube breakage. Distinctively lithographed in glossy red and black. The most distinctive tube carton available today. Minimum quantity: 100 for any one size. Write for case lot prices.

| SIZE | FOR TUBE | PER 100 |
|-----------------|--------------------|---------|
| Miniature . . . | 6AU6, etc. | \$1.00 |
| GT | 6SN7, etc. | 1.25 |
| Large GT . . . | 1B3, etc. | 1.50 |
| Large G . . . | 5U4G, etc. | 2.00 |

WHITE GLOSSY BOXES
Completely blank. No printing or color. Otherwise same as above. Same high quality, same low prices. Specify "WHITE" when ordering. When color is not stated, 2 color cartons will be shipped.

TUBE STACKERS
White glossy only. Ministacker holds 10 Mini. tube cartons; "GT" stacker holds 10 "GT" cartons.

| SIZE | PER EACH |
|-----------------------|----------|
| Ministacker | 1½¢ |
| GT | .02 |



TV Sweep Generators

RCA Model WR-59A

SPECIAL!

Excel. **\$75** Cond.

WRITE FOR "BARRY'S GREEN SHEET" FREE!

TERMS: 25% deposit with order, balance C.O.D. All merchandise guaranteed. F.O.B. N.Y.C.

BARRY ELECTRONICS CORP.

512 Broadway, Dept. ET, N.Y. 12, N.Y.
Phone: Walker 5-7000

**You're Ready
for any Service Job**

with

JACKSON

*"Service Engineered"
Test Equipment*



**TVG-2
Sweep
Marker
Generator**

Dealer Net \$259.95

A complete TV generator plus crystal calibrator. Sweep 30KC through 216MC. Width adjustable from 0 through 18MC. Accurate Marker 4MC through 216MC. Crystal oscillator for frequencies to 20MC. Provision for Video Modulation.

**CRO-2
Wide Band
High Sensitivity
5-inch Scope**

Dealer Net \$225.00

Flat within 1 db from 20 cycles through 4.5MC. Sensitivity from .018RMS volts per inch. Positive or Negative Internal Horizontal sync. Saw tooth sweep 20 cycles through 50KC. Many accessories including low capacity probes.



**Model 655
Wide Range
Audio Oscillator**

Dealer Net \$135.00

Highly stable RC sine wave generator. Range 20 cycles to 200 kc in 4 steps. Up to 500 milliwatt output at Impedances of 10, 250, 500, 5000 ohms or HIZ. Frequency characteristic 1db., 30 to 15k cycles. Accuracy 3% or 1 cycle.



**Model 648A
Dynamic®
Tube Tester**

Dealer
Net \$129.95

Fastest tester on the market—and featuring famous Jackson Dynamic Circuit. Meter calibrated in Good-Bad, as well as percent Transconductance. Correct test voltage for all tubes including latest 600-mil types. Line Voltage Indicator.

JACKSON
ELECTRICAL INSTRUMENT CO.

World's largest exclusive makers of
factory-built service test equipment.

16-18 S. Patterson Boulevard • Dayton 2, Ohio
In Canada: The Canadian Marconi Co.

Regeneration

(Continued from page 33)

so as to act as a shield. The outer conductor is connected to the chassis and will do very nicely as a small shield which may be just as effective as a larger one if properly placed. Maybe such a capacitor shield is present and has been misplaced in service operations!

In conjunction with capacitive feedback over a single stage we have the safe gain of the tube and stage to consider. The danger of oscillation (regeneration for even less gain) exists with a gain over that given by: $\sqrt{gm/3.14fC_{gp}}$ where gm is the mutual conductance of the tube, f is frequency in cps., and C_{gp} is the grid-to-plate capacity including the added external capacities. Bias variations may be the cause of such regeneration due to a faulty bypass capacitor across the cathode. AGC trouble may be indicated, perhaps also due to leaky capacitor(s), particularly for that stage.

Gain can always be lowered by lowering grid bias, or lowering the plate and screen voltages. This is a handy test method for tubes suspected of being in the feedback chain, although drastic reduction of gain means reduction in gain of the signal, too, as a permanent remedy. However, the test is excellent since, with reduction of gain, the feedback will be lessened and you have located one stage or more causing the trouble.

Feedback may and frequently does occur using the common supply lines as the feedback path. The B+ is common to many stages and is a very frequent offender, particularly at the elevated frequencies now common in i-f practice. A decoupling resistor may be rated at, say, 1000 ohm, but its effective resistance may be less. Note that even the garden type of resistor has a certain amount of capacity between its terminals. A second decoupling resistor, in series with a bypass to ground at the junction of the two resistors, is often sufficient to cool down a hot B line. The added decoupling resistor is about 1k and the added capacitor is around 0.005 to 0.05 mfd. Fig. 5 illustrates this additional decoupler added to an i-f stage. In passing, do not lose sight of the fact that some of the bypasses already present may have lost capacity. Did you check them first by bridging another capacitor across each for a test?

(Continued on page 54)

YOUR BEST BUY

in a UHF Converter



UL Approved

**B-T
LABS** Model '99'

**OFFERS TOP
PERFORMANCE
AT LOW COST**

only **\$19.95** LIST

- Tuned Input—
tracks with oscillator
- Precise Impedance Match
- One-Knob Tuning
- Drift-Free Performance

Check with your supplier
today. Also ask about
the Deluxe Ultraverter
... or write Dept. XM-16

BLONDER-TONGUE LABORATORIES, INC.
Westfield, New Jersey

don't be vague...

SPRAGUE
36C

**insist
on
SPRAGUE**

SPRAGUE
29C

*Cera-mite**

19C

disc ceramics

*Trademark

SPRAGUE

NORTH ADAMS, MASS.

for all your
**Exact Replacement
TV TRANSFORMERS**

**Specify
Stancor**

FREE

STANCOR TV Transformer Replacement Guide listing over 8000 models and chassis of 117 manufacturers... also STANCOR Auto Radio Replacement Guide with replacement data on over 540 auto radios of 40 manufacturers. Available from your distributor or by writing Chicago Standard.



**CHICAGO STANDARD
TRANSFORMER CORPORATION**

3513 Addison Street • Chicago 18, Illinois

(Continued from page 53)

The agc line likewise offends for the same type of trouble, and has the same type of cure—more and better decoupling. A slight help may be obtained by dressing the leads close to the chassis so as to form a sort of continuous capacity to the chassis. A small heater choke in series with a decoupling resistance is a trick which will work quite well in many situations. The choke may be substituted for the additional decoupling resistor here or in the B-plus line.

Heater lines may cause feedback. Additional bypass capacitors are a remedy to try. So too for additional choke coils—r-f chokes as used in the B-plus and agc lines. A heater that is hot may be found by unsoldering the hot heater lead from the socket terminal, then letting it touch the terminal while the set warms up. When the set has warmed up and while watching the response curve on the scope, or the voltmeter, or the raster, the heater wire is momentarily removed from the socket terminal. If the symptoms of regeneration stop or are greatly reduced, then that heater is "hot" to r-f as well as power-supply voltage. The thermal lag will still keep the electrons moving for a moment or so after disconnection, but the r-f cannot jump the gap now made. Finding even one point in a chain of feedback is quite an accomplishment. You eliminate the feed back piece-meal. •

Let's Look at Circuits

(Continued from page 36)

eliminating that at the plate. As shown in Fig. 2, when this is done the plate load resistor is eliminated altogether, since it is not needed. The input signal is introduced conventionally in the grid-cathode circuit, between grid and ground. Output is taken off across the cathode resistor, between cathode and ground. This output consists of most but not quite all of the original input signal. In other words, the stage not only ceases to provide us with amplification, but it actually reduces signal amplitude by a small amount. However, for practical purposes we may say, as we have said in the last installment concerning cathode signal, that it has essentially the same amplitude as the input signal. A stage of this sort is known as a cathode follower.

DON'T Just
say capacitors

Ask For Sprague By Catalog Number

Know what you're getting... get exactly what you want. Don't be vague... insist on Sprague.

Use complete radio-TV service catalog C-610. Write

Sprague Products Company,

65 Marshall Street,

North Adams,
Massachusetts.

SPRAGUE®

WORLD'S LARGEST CAPACITOR MANUFACTURER

IMPORTANT NOTICE TO SUBSCRIBERS

Changes of address require four weeks' notice. Notify your Postmaster and ELECTRONIC TECHNICIAN Circulation Department at the earliest possible moment.

When ordering change, please **INCLUDE IMPRINTED STRIP** showing exactly how magazine is now addressed. This will enable us to put the change into effect with a minimum of delay.

ADVERTISERS INDEX

DECEMBER 1956

| | |
|--|----------------|
| Advance Electronics Co. | 43 |
| Aerovox Corp. | 15 |
| Allied Radio Corp. | 48 |
| Amphenol Electronics Corp. | 10 |
| Astatic Corp. | 18 |
| Barrv Electronics Corp. | 52 |
| Belden Manufacturing Co. | Cover III |
| Blonder-Tongue Laboratories, Inc. | 53, 55 |
| CBS-Hytron | 11 |
| Centralab, Div. of Globe-Union, Inc. | 39, 41 |
| Channel Master Corp. | 19 |
| Chicago Standard Transformer Corp. | 54 |
| Colman Tool & Machine Co. | 45 |
| Cornell-Dubilier Electric Corp. | 2, 51 |
| Electronic Technician | 14, 50, 52, 54 |
| General Electric Co. | 8, 9 |
| Heath Co. | 47 |
| International Resistance Co. | Cover II |
| Jackson Electrical Instrument Co. | 53 |
| Jensen Industries, Inc. | 55 |
| Jensen Manufacturing Co. | 56 |
| Kester Solder Co. | 47 |
| Macmillan Co. | 46 |
| Mallory & Co., Inc., P. R. | 4, 5 |
| Merit Coil & Transformer Corp. | 49 |
| Mosley Electronics, Inc. | 45 |
| Ohmite Manufacturing Co. | 51 |
| Oxford Components, Inc. | 43 |
| Quietrol Co., Inc. | 55 |
| Radiart Corp. | 2, 51 |
| Radio Corporation of America | 13, Cover IV |
| Raytheon Manufacturing Co. | 20 |
| Rohn Manufacturing Co. | 3 |
| Simpson Electric Co. | 7 |
| South River Metal Products Co. | 48 |
| Sprague Products Co. | 54 |
| Sylvania Electric Products, Inc. | 17 |
| Triad Transformer Corp. | 50 |
| Trio Manufacturing Co. | 49 |
| United Catalog Publishers, Inc. | 12 |
| Utah Radio Products Corp. | 45 |
| Waller Electric Corp. | 6 |
| Weston Electrical Instrument Corp. | 48 |
| Winegard Co. | 16 |

While every precaution is taken to insure accuracy, we cannot guarantee against the possibility of an occasional change or omission in the preparation of this index.

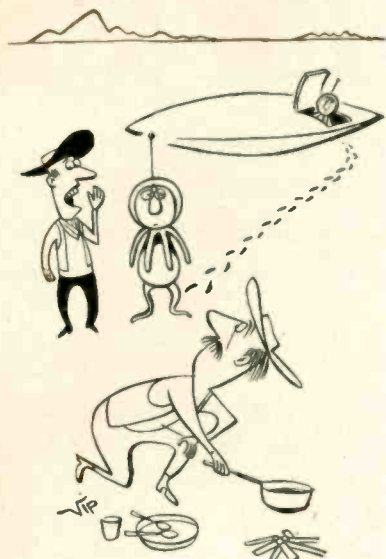

"Hey, Sam. This guy wants to know where's the nearest place he can find JENSEN NEEDLES."

Problem:

2 TV Sets
1 Antenna

Answer:



2-SET COUPLER

Model TV-42
Approved for Color TV
UHF, VHF and FM



Cost: ONLY \$2⁹⁵ LIST

Features:

- Matched resistive circuit
- Flat response — 0 to 900 megacycles
- 12db inter-set isolation
- Easy to install
- Couples 2 TV sets without ghost or smear

Application:

In class A signal areas the B-T 2-Set Coupler provides the ideal low cost solution to the problem of operating two receivers from one antenna. There are other applications. For example, the TV-42 can couple a TV set and FM receiver to one antenna—or it can be used, in reverse, to couple or mix 2-antennas to one receiver.

Write for FREE BOOKLET — "TV for 2 or 3... or More"
Covers all types of Multiple TV Systems

Sold by Radio-TV Parts Distributors and Jobbers

BLONDER-TONGUE LABORATORIES, INC.

Dept. XM-18 Westfield, New Jersey



Manufacturers of TV Cameras,
TV Amplifiers, Boosters,
UHF Converters, TV Accessories
and Originators of the Masterline
and 'Add-A-Unit' Master TV Systems.

big reasons why

3 QUIETROLE
Reg. U. S. Pat. Off.

is "The Choice of Better Service Dealers Everywhere"

1 MERIT

2 QUALITY

3 RELIABILITY

The original product for quieting noisy controls and switches... the universal lubri-cleaner for TV and radio...

Say "QUIETROLE" to your distributor... be sure you get it.

NO GUM!

NO GOO!

NO GRIME!

manufactured by

Carried by recognized jobbers everywhere!

QUIETROLE
COMPANY INC.
Spartanburg, South Carolina

IN CANADA: Active Radio & TV Distributors
58 Spadina Ave., Toronto 28, Ont.

PLUS performance ... PLUS value ... for a LIFETIME!

Jensen Hypex Horns and Lifetime Driver Units are way ahead in power rating . . . in efficiency . . . in dependability. They pack a terrific "punch" to penetrate high noise levels . . . to project sound over great distances. They are loaded with features that mean sturdiness, convenience and reliability. And you pay no more for all these PLUS values!

Jensen Hypex Horns and Lifetime Driver Units are standout members of the new Jensen Professional Series of loudspeakers especially designed for industrial commercial and institutional sound systems. Also included are Hypex Paging Projectors; Speech

Master speakers; High Fidelity Projector; 2-way coaxial and 3-way Triaxial* High Fidelity speakers; Extended Range speakers; Weather Master outdoor speakers; transformers, level controls and accessories.

*TM Reg.

We'd like to send you a copy of Catalog 1070. Send for copy today.

LIFETIME GUARANTEE

D-30; D-40 and DD-100 Lifetime Driver Units.

Every Lifetime Driver Unit is unconditionally guaranteed for life against failure when operated according to the instructions accompanying the unit.

Should any Lifetime Driver Unit become inoperative at anytime under these conditions, it will be repaired or replaced at our option entirely free from any service charge.

The instruction sheet supplements and is a part of the warranty under which the Lifetime Guarantee is extended.

JENSEN MANUFACTURING COMPANY

Jensen MANUFACTURING COMPANY

Division of THE MUTER COMPANY

6601 S. LARAMIE, CHICAGO 38, ILLINOIS

In Canada: Copper Wire Products Co., Ltd.

New and already famous!
Jensen RT-20
Functional rectangular
horn of molded glass
reinforced polyester.

BURTON BROWNE ADVERTISING

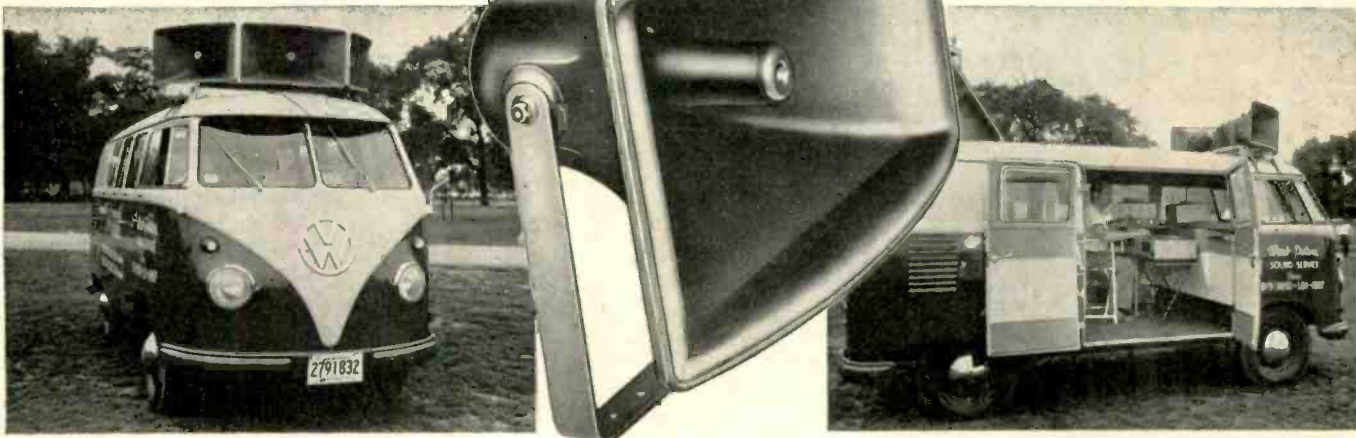

Jensen LIFETIME DRIVERS ARE GUARANTEED FOR A LIFETIME



D-30 New high rating for performance and dependability

30 WATTS



D-40 Higher efficiency and higher power rating

40 WATTS



DD-100 First Super Power Driver available

100 WATTS



Belden 8411

If it's worth Engineers' time . . .



Belden 8422

. . . It's worth Engineered Cable



Belden 8412



**Belden
microphone
cables**

Whatever the installation,
whatever the requirements,
there is an accurately
rated Belden Microphone
Cable built for the job.



Belden

WIREMAKER FOR INDUSTRY
SINCE 1902
CHICAGO

4-8

1001 WIRES FOR EVERY ELECTRONIC NEED

LOW BACKGROUND NOISE

MARSHALL F TACKETT
EUBANK
KENTUCKY
TN358R BI 5C119C

ELECTRICAL UNIFORMITY

LONG LIFE

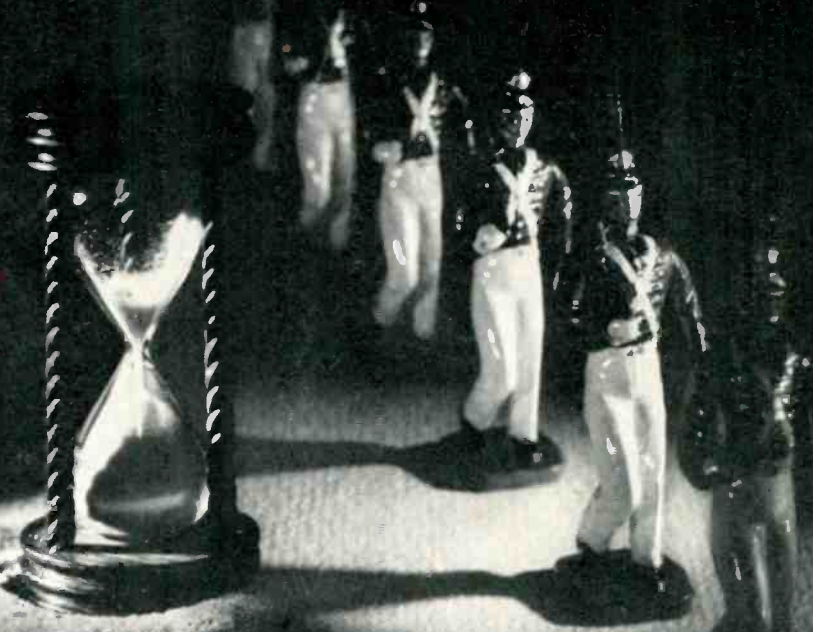

*Important features of RCA RECEIVING TUBES
for dependable replacement in radio, phono, and TV sets!*

“Low Background Noise...Long Life...Electrical Uniformity” are technical terms your service customers may not appreciate when talking to you about set troubles. But they do know when you have restored their sets to “like new” performance.

When the trouble is tube failure, you certainly want to minimize “tube juggling” and circuit realigning... to complete the service job quickly, confidently, profitably—with full customer satisfaction.

RCA enables you to give full customer satisfaction by controlling the quality of your replacement tubes. RCA’s “don’t spare the quality” selection of raw materials, stringent control of all manufacturing processes and techniques, second-to-none final inspection and testing methods are your assurance of tubes with low background noise, long life, electrical uniformity—your assurance that RCA RECEIVING TUBES are your most dependable replacement tubes!



RECEIVING TUBES

RADIO CORPORATION OF AMERICA
TUBE DIVISION • HARRISON, N. J.

ALWAYS USE DEPENDABLE-QUALITY TUBES...RCA TUBES