

TECHNICIAN

& Circuit Digests

BUYERS DIRECTORY Issue



ANTENNAS 1

AUDIO ACCESS. 2

AUDIO EQUIP. 3

BOOKS 4

CABINETS 5

CAPACITORS, FIXED, VARY 6

CIRCUIT ACCESS. 7

COILS, XFRMRS 8

COMMUNICATIONS &

INDUSTRIAL 9

HARDWARE 10

KITS 11

POWER SUPPLIES 12

RECEIVERS, TV-RADIO 13

RESISTORS 14

SEMICONDUCTORS 15

TEST EQUIPMENT 16

TOOLS 17

TUBES 18

WIRE & CABLE 19

50¢

May • 1956

Caldwell-Clements

Preview of ELECTRONIC PARTS SHOW

HERE'S WHY IRC EXACT DUPLICATES ARE DOUBLE-MONEY-BACK GUARANTEED

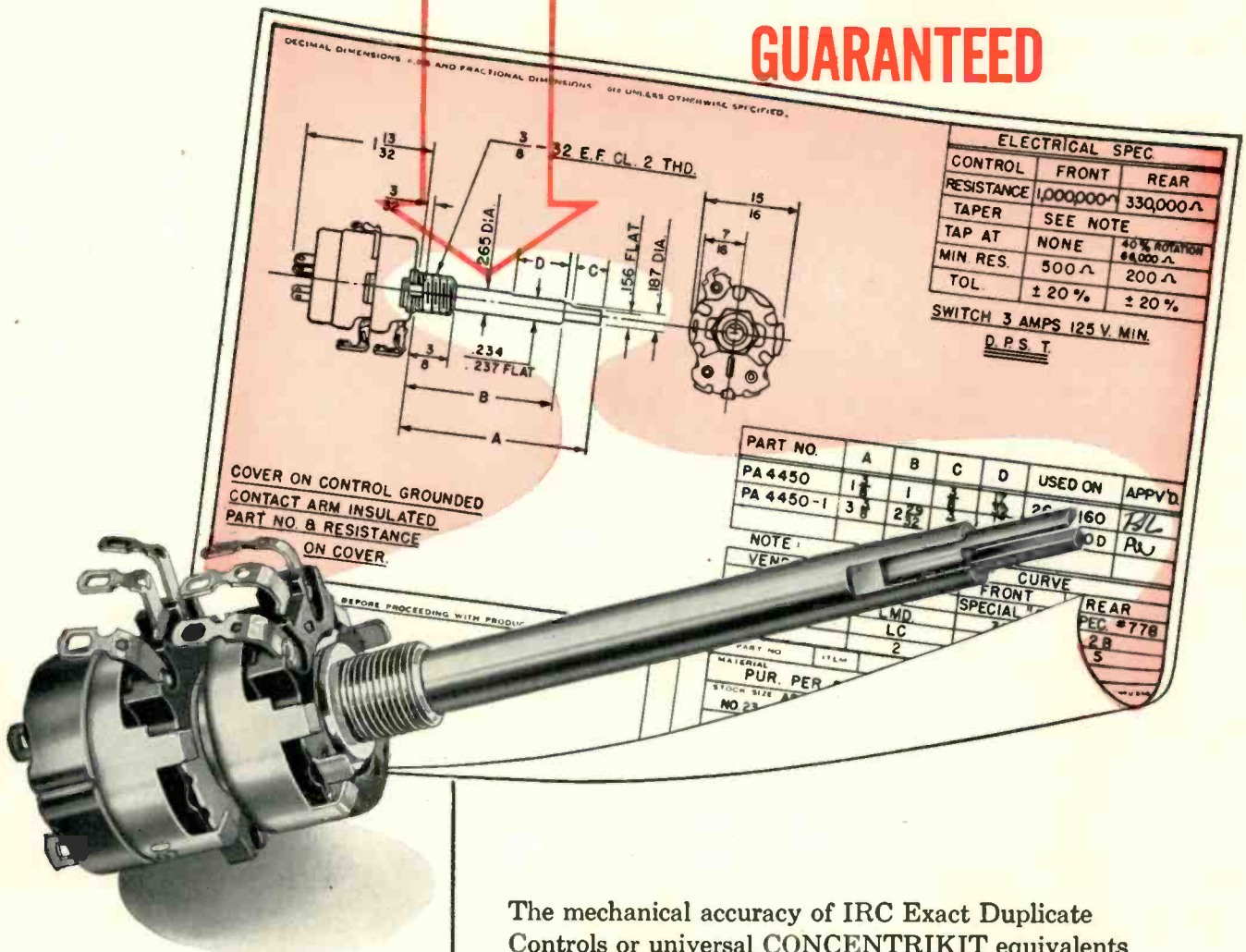

**ONLY IRC GUARANTEES
SATISFACTORY MECHANICAL FIT
AND ELECTRICAL OPERATION
OR DOUBLE-YOUR-MONEY-BACK**

The typical manufacturer's specifications shown here are exactly duplicated by IRC QJ-180 control. CONCENTRIKIT assembly includes P1-229 and R1-312 shafts with B11-137 and B18-132X Base Elements, and 76-2 Switch.



Wherever the Circuit Says ~~~

The mechanical accuracy of IRC Exact Duplicate Controls or universal CONCENTRIKIT equivalents is based on set manufacturers' procurement prints. Specifications on those prints are closely followed.

Shaft lengths are *never less* than the set manufacturer's nominal length—*never more* than $\frac{3}{32}$ " longer.

Shaft ends are precisely tooled for solid fit.

Inner shaft protrusion is accurately duplicated for perfect knob fit.

Alterations are never needed.

For Exact Duplicate Controls, specify IRC. Most Service Technicians do.

INTERNATIONAL RESISTANCE CO.

Dept. 572, 401 N. Broad Street, Philadelphia 8, Pa.

In Canada: International Resistance Co., Ltd., Toronto, Licensee

TECHNICIAN & Circuit Digests

TELEVISION • ELECTRONIC • RADIO • AUDIO • SERVICE

ALBERT J. FORMAN *Editor*
 M. CLEMENTS *Publisher*
 O. H. CALDWELL *Editorial Consultant*
 SIDNEY C. SILVER *Managing Editor*
 S. TANHAUSER *Assistant Editor*
 J. L. STOUTENBURGH *Contributing Editor*
 ELMER KETTERER *Circuit-Digest Production*
 GEORGE PUGLICI *Circuit Diagrams*

BUSINESS DEPARTMENT

H. A. REED *V.P. & General Sales Manager*
 BERNARD BLOCK *District Manager*
 MARSHALL FAILLACE *District Manager*
 M. H. NEWTON *Business Manager*
 N. McALLISTER *Asst. Business Manager*
 W. TAYLOR *Production Manager*
 A. H. POND *Controller*
 W. W. SWIGERT *Credit Manager*
 M. SOKOL *Circulation Records*
 480 Lexington Ave., New York 17, N. Y.
 Telephone Plaza 9-7880
 P. H. DEMPERS *District Manager*
 201 N. Wells St., Chicago 6, Ill.
 Telephone RAndolph 6-9225
 CHRIS DUNKLE & ASSOCIATES
California Representative
 3527 W. 6th Street, Los Angeles 5, Calif.
 Telephone DUnkirk 7-6149
 3077 Turk St., San Francisco 18, Calif.
 Telephone EXbrook 2-0377



TECHNICIAN & CIRCUIT DIGESTS, May 1956, Vol. 63, No. 5. \$50 a copy. Published monthly by Caldwell-Clements, Inc. Publishers also of MART including Price-Fax. Publication office, Emmett St., Bristol, Conn. Editorial, advertising and executive offices, 480 Lexington Avenue, New York 17. Telephone Plaza 9-7880. M. Clements, President; John J. Borghi, Vice President and Treasurer; M. B. Clements, Secretary.

Entered as second class matter at the Post Office at Bristol, Conn., June 10, 1954. Subscription rates: United States and Canada, \$4.00 for one year; \$6.00 for two years; \$8.00 for three years. Pan-American and foreign countries; \$7.00 for one year; \$10.00 for two years; \$14.00 for three years. Copyright 1956 by Caldwell-Clements, Inc., New York. Title registered in U. S. Patent Office. Reproduction or reprinting prohibited except by written authorization of publisher. Printed in U.S.A. by Hildreth Press, Inc., Bristol, Conn.

MAY, 1956

FRONT COVER Vast arrays of electronic parts and equipment, dependent on one another in a manner symbolized by an atomic structure, are classified in 19 major product categories of this 1956 Technician Buyers Directory Issue. Other features in this year-round reference include manufacturer addresses, service associations, reps, distributors and trade names. Starts on page 65.

FEATURES and ARTICLES

Some Manufacturers Are Missing the Boat (Editorial)	27
"Tuning in the Picture"	28
'56 Parts Show Preview	30
Diagnosing Defects in TV Picture Tubes Charles Garrett	32
Plan Your Shop Work Dan Valentine	31
Installing Mobile 2-Way Equipment John W. Hardy	34
How to File Circuit Digests	36
Prices Technicians Charge	37
Adapt Your Scope for Wideband Use K. F. Fehling	38
"Tough Dog" Corner R. Scarpelli, N. Brown, A. Olseh	41
Phono Repair Check List	42
Shop Hints J. Amorose, C. Goldstein, S. Clark, L. Williams	43
Latest Test Instruments	45
New Tools and Shop Aids	46
New Electronic Components	48
New Tubes	49
Antenna "Co-Phaser" Cancels Interference	50
Railroad TV	60

1956 TECHNICIAN BUYERS DIRECTORY 65

DEPARTMENTS

Letters to the Editor	6	Calendar of Coming Events	29
Editor's Memo	16	New Products	44
News of the Industry	20	Reps & Distributors	51
New Books	22	Association News	55
		Catalogs & Bulletins	56

CIRCUIT DIGESTS 117

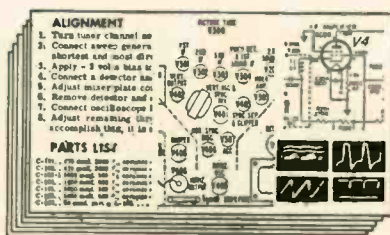

IN THIS ISSUE

ADMIRAL: Hi-Fi Phonograph Chassis 5N3
 BENDIX: TV Chassis T19
 DU MONT: TV Chassis RA-356, 357
 MOTOROLA: Transistor Portable Radio,
 Chassis HS-483
 SENTINEL: TV Models 1U-1202, etc.
 ZENITH: TV Chassis 17Y20, 17Y22

Align in HALF

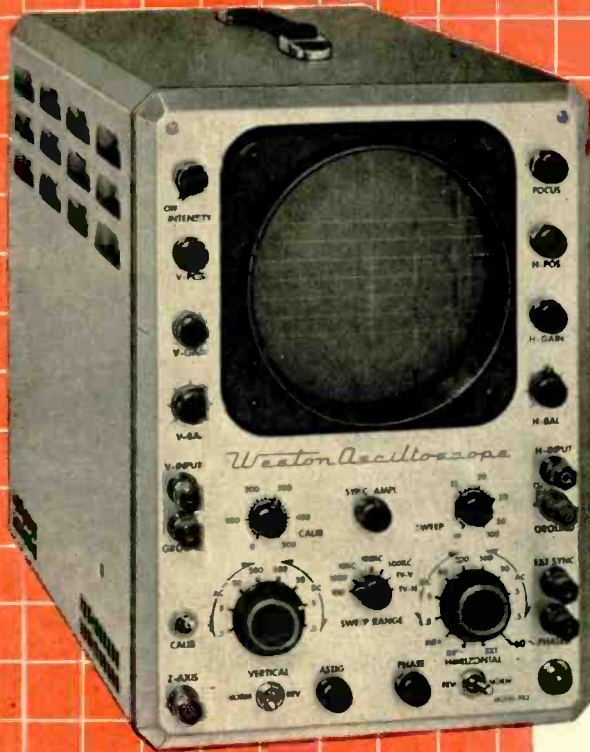

Model 983 WESTON Oscilloscope **\$329.50** net

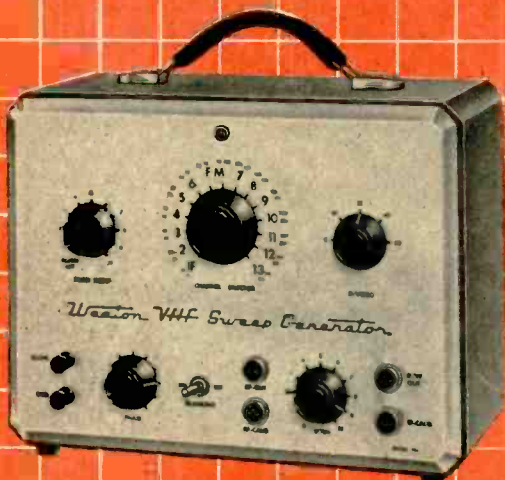

Model 984 WESTON Sweep Gener. for **\$199.50** net



Model 985 WESTON Calibrator **\$199.50** net

WESTON Simplified Method of Visual Alignment

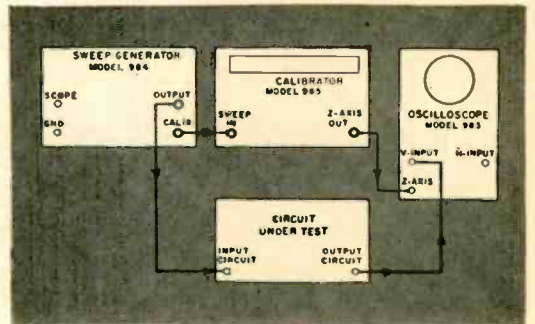

Conventional Method of Alignment

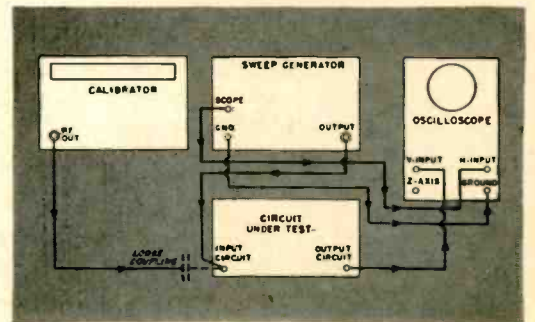

the usual time!

Simplified WESTON method makes aligning quick-easy-profitable for every serviceman!

There's real money in alignment . . . now that it's no longer necessary to use complicated, time-consuming methods. The Weston method is so *quick*, so *simple*, any serviceman can complete any alignment job in one hour maximum.

Note the simplicity of the hook-up illustrated at the left, in which the calibrator is *not* connected to the circuit under test. With only two simple connections to the receiver, oscillations encountered in conventional methods are entirely eliminated. Further, there is no disappearance of markers at trap frequencies. Z-axis modulation of the scope provides accurate intensity markers on the response curve under conditions where beat note markers would not be visible. Response curves are not disturbed. Annoying

trimmer touch-up on trap circuits is minimized. (See marker presentations shown below.)

All you need to align simply, quickly, and get the big profits from this constantly increasing class of work are the WESTON Calibrator and Sweep Generator, and the Weston Oscilloscope or any scope with provisions for Z-axis intensity modulation.



SEND for CATALOG NOW! A new catalog describing this simplified method and the instruments used, is available for the asking. Also included are descriptions of other Weston Test equipment including — Model 980 Volt-Ohm-Milliammeter \$42.50 net — Model 982 VTVM of \$69.50 net — Model 981 Tubechecker at \$199.50 net. Send for your copy now.

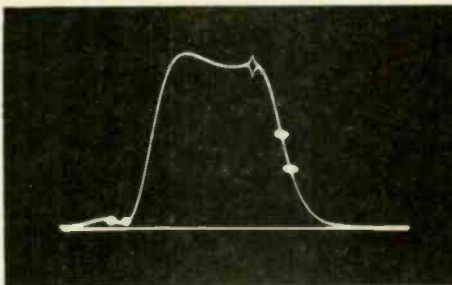

Simultaneous marker presentation of video and sound carrier frequencies (positive intensity markers).

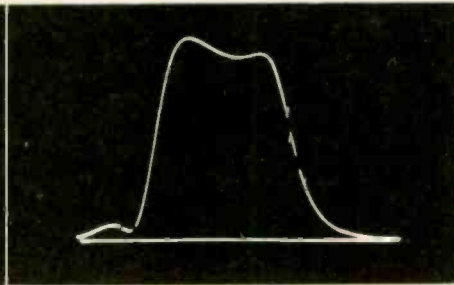

Simultaneous marker display of video and sound carriers (negative intensity markers).

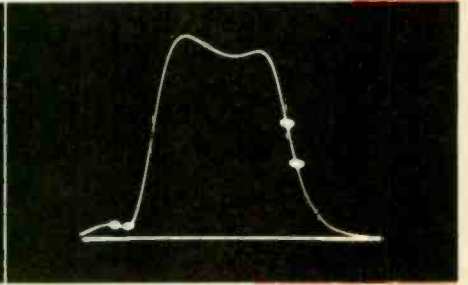

Note that with intensity markers there is no possible misinterpretation with spurious responses.

WESTON *Electronic Testing Equipment*

WESTON Electrical Instrument Corporation, 614 Frelinghuysen Avenue, Newark 5, N. J.
A subsidiary of Doystrom, Incorporated

"5,000 8,784 HOURS WITHOUT FAILURE"



Westinghouse Locked-TV Test* at Lew Bonn Company operates for over six (6) years viewing time!

ARE CALL-BACKS EATING UP YOUR PROFITS? Listen to this report from W. J. Heisel (at left in photo), General Manager, Lew Bonn Company, Minneapolis:

"We wanted to *prove* to our service dealers the outstanding dependability of Westinghouse RELIATRON Picture and Receiving Tubes. So we conducted a Westinghouse Locked-TV Test in our showroom. The set shown in the photo, completely equipped with *stock* Westinghouse RELIATRON Tubes, was turned on at two P.M. on April 25, 1955. As these words are written, this Westinghouse-equipped set has been operating continuously for 8,784 hours without a single tube failure—and it's still going strong!"

8,784 HOURS! Over *six* years of average family viewing! This is *real* dependability. Dependability that cuts costly call-backs practically to the vanishing point. And notice . . . the tubes used in the Lew Bonn Company test *were taken right from stock*. They're the identical kinds of tubes that *you* can handle—to protect your profits, win customer confidence—simply by calling your Westinghouse Distributor. Do it today. "You can be *sure* . . . if it's Westinghouse."

*This dramatic tube-endurance test was rechecked April 25, 1956 when this ad went to press. On that date, the test had been operating 365 days or 8,784 hours.

Westinghouse  Tubes

6ET-4109

WATCH WESTINGHOUSE WHERE BIG THINGS ARE HAPPENING FOR YOU!

WESTINGHOUSE ELECTRIC CORPORATION, ELECTRONIC TUBE DIVISION, ELMIRA, N. Y.

damaged, weather-worn, obsolete!

6 out of 10 need replacement now!

replace them with
CHANNEL MASTER
TV ANTENNAS

**FIVE ALL-CHANNEL FAVORITES —
TOPS FOR REPLACEMENT!**

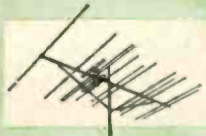

SUPER RAINBOW
model no. 331

Still the most sensitive all-channel antenna made! Other popular Rainbow models also available.

"K.O." model no. 1023
(broad band)

Knocks out "venetian blinds" with the highest front-to-back ratios ever recorded!



TRAILBLAZER model no. 335
Extra elements provide extra performance at no extra cost!

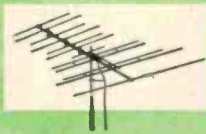

New SKYLARK model no. 327
Popular fringe-area installation — new rugged powerful design. Also available: Super Skylark, and economy "Challenger" model.



SUPER FAN model no. 313A
The finest of Fan-antennas — superior both electrically and mechanically!

Here's the greatest profit opportunity in TV today!

The "Golden Age" of antenna replacement is here! Time has finally caught up with millions of older TV antennas that no longer provide good reception.

A national survey shows that 65% of all TV set-owners in established areas are not getting the picture quality they should be getting. **THEY NEED NEW ANTENNAS!** And you can profit in a big way by replacing now with a powerful, new CHANNEL MASTER installation!

YOUR BEST REPLACEMENT BUY is Channel Master, America's most widely advertised and merchandised antenna line. Channel Master provides you with the most advanced electrical designs, the soundest construction, the easiest, fastest installation.

See your Channel Master distributor



CHANNEL MASTER CORP.

ELLENVILLE, N. C.

WORLD'S LARGEST MANUFACTURER OF TV ANTENNAS AND ACCESSORIES



with **UTICA®**
"Cushion Throat" Pliers

Here's a simple and effective way to control cut ends of wire—keep them from flying or falling into a chassis.

The UTICA® "Cushion Throat" is a tough, rubbery red plastisol coating bonded right beside the cutting edge of UTICA® pliers. As the pliers close, the cushion grips the short end of wire and holds it tightly.

The "Cushion Throat" is specially valuable in electronics work—makes it possible to cut inside chassis without danger of wire snips causing a short. Grips spring or hard wire, too—gives extra safety on every cutting job!

Order from your distributor, today!

Only \$1 list additional—applied to most UTICA diagonal or side-cutting pliers.

Exclusive UTICA Patent.



U T I C A

THE HALLMARK OF QUALITY
 UTICA DROP FORGE & TOOL CORP.
 UTICA 4, N. Y.

UTICA (when referring to hand tools) is a trade mark registered in the U. S. Patent Office.

LETTERS

To the Editor

Permission for Reprints

Editor, **TECHNICIAN**:

We would like to obtain permission to reprint the "You Can't Win" cartoon from your March issue in our association bulletin. This will be used as part of our membership drive.

BERNARD W. BOGNOVITZ
 Director

TV Service Assoc. of Metropolitan Wash. Washington, D.C.

• We are pleased to extend such permission, without charge, provided proper credit is given. Associations or individual techs similarly interested should write to us to obtain specific written permission.—Ed.

Eliminating Retrace Lines

Editor, **TECHNICIAN**:

While reading March **TECHNICIAN** "Letters to the Editor" column, I noted that one reader requested a copy of the article "Eliminating Vertical Retrace Lines" from your Sept. 1953 issue. You stated that a limited number of those copies were available. I would appreciate it if you would send me one.

BOB MESCHER

Bob's Radio & TV Service
 New Vienna, Iowa

... Would appreciate receiving a copy of "Eliminating Vertical Retrace Lines."

JOHN KUTA

John's Television Service
 Wellsville, Ohio

... I am encountering this retrace line problem. I hope you still have this article at hand.

GUY BOUCHER

G.M.B. Radio & TV
 Quebec, Canada

... I did not receive that issue. May I please have the article?

B. W. BERNHEIM

Bernheim Appliance-Television
 Memphis, Tenn.

... I would very much like to obtain a copy of "Eliminating Vertical Retrace Lines."

FRANK KOWNACKI

Philadelphia, Pa.

• We've been deluged with so many requests from on-their-toes readers that our free supply is exhausted. In response to the great interest in "Eliminating Vertical Retrace Lines" shown by techs, we are revising the article, and will publish it again within the next few months. For impatient readers who want copies now, the charge for five photostat pages, covering the entire original article, is \$2.50. Other past articles are listed in the index published in Nov. 1955 **TECHNICIAN**, p. 68.

Filling Circuit Digests

Editor, **TECHNICIAN**:

Circuit Digests are fine, but how do you file them so they can be found when wanted?

J. P. SCHAMING

Schaming Service
 Pittsburgh, Pa.

• See article on page 36.—Ed.

More on Part Timers

Editor, **TECHNICIAN**:

I have been reading **TECHNICIAN** for quite awhile now, and it's tops with me. It made me feel good to read Paul Smith's letter in the March issue (supporting part timers). I have had work in my shop supposedly done by a most respected service man. Components had been replaced with incorrect values. No honest person in this business will ever be hurt by the part time tech.

HOWARD WHEELER

Plant City, Fla.

The Phantom

Editor, **TECHNICIAN**:

Regarding the article, "Use a Phantom Antenna" in your March issue, can a satisfactory signal be picked up at 2600 feet? And does the antenna at the receiver have to be exactly parallel with the phantom antenna?

ARTHUR G. MOSER

Moser TV, Radio Sales & Service
 Pt. Marion, Pa.

• Quality of reception depends on local conditions such as field strength and terrain. For best results, both antennas should be facing one another, although broad radiation pattern of folded dipole phantom does not make it critical. The more off-parallel, the greater the reflected signal loss. However, phantom should face transmitter.—Ed.

Editor, **TECHNICIAN**:

May I suggest that the dipole terminals (of the phantom) be short-circuited instead of terminated in the characteristic impedance with a resistor? You see, terminating the antenna as suggested will burn up about 50% of the received power. Direct short-circuiting will make almost all of the received power available for re-radiation.

For servicemen who are also hams, this scheme also works "backwards"—for transmitting, that is, especially at VHF. Gets over obstacles nicely.

C. F. ROCKEY

Highland Park, Ill.

• Author McRoberts feels there is some question as to which loss will be greater: that across the matching resistor or the loss introduced by the mismatch of the short circuit. He suggests trying both methods for the best results in individual cases. Another alternative: use an additional dipole, terminating the first and stacked with it. This would eliminate the loss of the resistor, provide a match, and give substantially increased gain.—Ed.

(Continued on page 12)

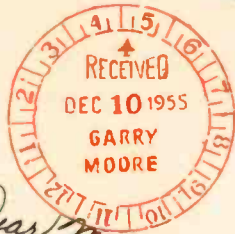

5447 N. Oakland Ave.
Melrose 11, Miss.
Dec. 9, 1955

Dear Mr. Moore:

On your morning show you say that CBS tubes are the best and I'll buy that! I've always had tube troubles and no matter how expensive an instrument we owned its performance was mediocre. Maybe we were too critical but a television picture is either good or it is not. When our picture tube gave up the struggle our serviceman at the Ace Electric Co. installed a CBS picture tube. We are delighted with the ultra bright and shadow clear picture we are receiving. I wanted you to know that we are glad we took your advice and believe me when the time comes to buy a new set it will be a CBS if they make them. (Do they?)

Sincerely
Mrs. Pauck Svensson

HERE'S PROOF

**your
customers
want
CBS tubes**

Since Garry Moore has been selling CBS tubes over the CBS Television Network, most service technicians have had women customers ask them for CBS tubes. And not just once in awhile.

Every day more and more women are requesting CBS tubes. We hear stories like Mrs. Svensson's often.

It all adds up to these important facts. You build good will . . . cut call-backs . . . and profit more when you install CBS tubes . . . the tubes with the Good Housekeeping Guaranty Seal.

Is your caddy well stocked with CBS tubes?



Show her the CBS carton with the Good Housekeeping Guaranty Seal. See Garry Moore sell your expert service over the CBS Television Network.

CBS-HYTRON

Danvers, Massachusetts

A DIVISION OF COLUMBIA BROADCASTING SYSTEM, INC.

Something **NEW** has

Centralab

Wirewound and carbon units
snap together — **in just seconds!**

Snap wirewound unit...

(with outer shaft cut to length)



To carbon unit...

(with blue shaft cut to length)



Snap on switch...

(from Fastatch KB series)



Add the knobs...

— and there's your wire-carbon combination



been added to

Centralab's Fastatch® Custom-Control system!

has wirewounds!

RATED 5 WATTS

Size of a 2-watt...
price of a 2-watt...

*The first really new development
in wirewound controls in 15 years*

*Now your Centralab distributor can give you the right
replacement for practically any dual-control custom—carbon,
wire-carbon, auto radio*

Why risk irritating a customer, because you have to wait for an exact replacement before you fix his TV, radio, or auto set? It's not necessary at all.

Chances are, you can find just what you're looking for, in Centralab's complete line of Fastatch duals. You can get more than 5,000 different combinations of resistance and taper, to duplicate exact electrical characteristics.

You don't have to do the manufacturer's job — there are no loose parts . . . no lugs to bend . . . no tricky assembling. Fastatch units — both wirewound and carbon — are assembled, tested, and guaranteed by Centralab.

Have your Centralab distributor show you Fastatch wirewound and carbon duals. Then, try them on your next jobs.

Send coupon for bulletin 42-218R.

Tear out coupon and mail today!

Centralab

A DIVISION OF GLOBE-UNION INC.

902-E E. Keefe Avenue • Milwaukee 1, Wisconsin

Send me free bulletin 42-218R.

Name.....
Company.....
Address.....
City..... Zone..... State.....

B-3058

limitless

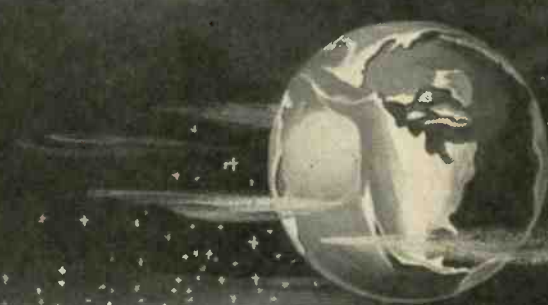

as the future of UNIVAC®

When planning your future, it is necessary to choose that company which presents the most complete program for you. The opportunity at Remington Rand Univac can only be limited by the individual. Excellent salaries, benefits and educational programs are yours to guarantee this limitless future.

At UNIVAC you will be working with men who developed much of the basic knowledge of computers—who designed and produced components being used by the manufacturers in the field—who set the standards that the others follow.

Now is the time to come to Univac where ambition and professional skill find their reward in limitless opportunities in an expanding organization.

Immediate openings for:

FIELD LOCATION TECHNICIANS for maintenance of our large Univac Computers. Qualified men receive 4 to 6 months training at full salary before assignment to a permanent computer location.

LABORATORY TECHNICIANS to assist engineers on research and development projects.

If you have an electronic school background and some experience in electronic maintenance, send a complete resumé to . . .

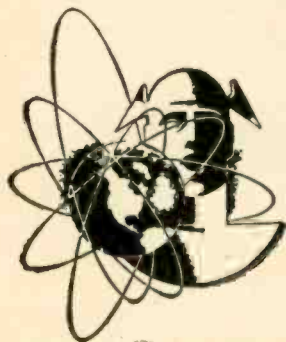

© Registered in U. S. Patent Office

Remington Rand Univac

DIVISION OF SPERRY RAND CORPORATION

— AT ANY OF THESE THREE PLANT LOCATIONS —

MR. D. A. BOWDOIN
Dept. MP-25
2300 W. Allegheny Ave.
Philadelphia, Pa.

MR. KURT PINKE
Dept. MS-25
1902 W. Minnehaha Ave.
St. Paul W4, Minn.

MR. FRANK KING
Dept. MN-25
Wilson Avenue
South Norwalk, Conn.

YOU PUT THIS TUBE IN AND...
 YAP... YAP... YAP... BLAH... BLAH... BLAH
 ...AND I MISSED MY FAVORITE PROGRAM



... IT'S **YOUR** REPUTATION!

Serviceman, at this point you are on your own! Your customer holds only you responsible if the picture tube goes bad because it was your selection. If your selection for replacement was a high quality brand, chances are your reputation for quality work wouldn't be under the gun like this.

When you use Du Mont picture tubes your reputation is backed by the pioneer commercial cathode-ray tube manufacturer of the country. The Twin-Screen Hi-Lite* alumi-

nized picture tube is a product of the finest engineering, design, and production features assembled in 25 years of commercial manufacturing. Your confidence is definitely assured because you know that the guarantee on Du Mont picture tubes is good—as it has always been.

Your reputation for high quality work is established when you use high quality products. You have a reliable partner when you use Du Mont picture tubes.

*The ultimate in aluminized picture tubes

*IT'S
 DEALERS
 CHOICE*

make it...



Cathode-Ray Tube Division

ALLEN B. DU MONT LABORATORIES, Inc., 750 Bloomfield Avenue, Clifton, N. J.



Complete SERVICE KNOWLEDGE

AT UNBELIEVABLY LOW COST!

RIDER MANUALS—THE ONLY FULLY FIELD-TESTED, FACTORY-APPROVED SERVICE DATA—IS AVAILABLE TO YOU AT AN INCREDIBLE PER CHASSIS COST OF 8¢! AT A PER-MODEL COST OF ONLY 2¢ . . .

ANNOUNCING TV 18

— For June 10th

ONLY \$19.80

HAVE YOU
GOTTEN YOUR
TV 17 YET?



HANDBOOK OF 630-TYPE TV RECEIVERS

by Miller & Bierman
Deals with all versions of the famous 630-type receivers made up to 1955. Explains modifications and circuit improvements made by various manufacturers, and includes 26 pages of troubleshooting charts. A book every technician can use to major advantage! Soft Cover, 200 pp., 5½ x 8½", illus.
#174 Only \$3.50

RECEIVING TUBE SUBSTITUTION GUIDE

by H. A. Middleton
Lists 2,500 radio-TV tube substitutions. Also lists ratings and wiring instructions, original and substitute tube socket illustrations. Soft Cover, 224 pp., 8½ x 11", illus.
#135 Only \$3.00

FIRST SUPPLEMENT: Lists 750 new and different tube substitutions, not listed in the original edition. Soft Cover, 48 pp., 8½ x 11", illus.
#139 Only \$.99

SECOND SUPPLEMENT: Features 134 TV picture tube substitutions as well as over 190 AM-FM-TV receiver tube substitutions. This set of Three books is the most complete coverage available on the subject. Soft Cover, 48 pp., 8½ x 11", illus.
#139-2 Only \$.99

PICTURE BOOK OF TV TROUBLES

by Rider Lab. staff
A series of books, each covering a different part of the TV receiver, and showing typical troubles, their symptoms and causes. All material is from actual case histories. These books do your troubleshooting for you! Soft Covers, 5½ x 8½", illus.

- VOL. 1: HORIZONTAL AFC-OSCILLATOR CIRCUITS
#168, 80 pp. Only \$1.35
- VOL. 2: VERTICAL SWEEP-DEFLECTION CIRCUITS
#168-2, 96 pp. Only \$1.80
- VOL. 3: VIDEO IF & VIDEO AMPLIFIER CIRCUITS
#168-3, 96 pp. Only \$1.80

If your jobber does not sell Rider Manuals order them from us.

VOL. 4: AUTOMATIC GAIN CONTROL CIRCUITS
#168-4, 96 pp. Only \$1.80

TV FIELD SERVICE MANUALS WITH TUBE LOCATIONS

edited by Harold Alsberg
A practical series of tube location handbooks, plus discussion of trouble symptoms, adjustments, etc. Each volume has 7 years coverage, starting with 1947. Soft Cover, spiral binding, 5½ x 8½", illus.

- VOL. 1: Covers sets by Admiral, Affiliated Retailers (Artone), Alncee (AMC), Air King, Air Marshall, Allied Purchasing, Andrea, Arvin, Automatle.
#155 Only \$2.10
- VOL. 2: Covers Benlix, Capehart, CBS-Columbia, Crosley, Dumont.
#155-2 Only \$2.40
- VOL. 3: Covers Emerson, Fada.
#155-3 Only \$2.10
- VOL. 4: Covers GE, Hallierafters, Hoffman.
#155-4 Only \$2.40
- VOL. 5: Covers Motorola, Philco.
#155-5 Only \$2.40

RIDER MANUALS

AND THE FAMOUS
LINE OF ECONOMICAL
RIDER BOOKS

ARE AVAILABLE AT
YOUR PARTS JOBBER.

LOOK FOR THE
RIDER BOOKSELLER.

FREE CATALOG ON REQUEST



JOHN F. RIDER PUBLISHER, INC.

480 Canal Street, New York 13, N. Y.

In Canada:
Charles W. Pointon, Ltd.
6 Alcina Ave., Toronto, Ontario
Prices approx. 5% higher.

LETTERS

To the Editor

(Continued from page 6)

Phoney Wholesale

Editor, TECHNICIAN:

Enclosed ad ("TV tubes 50-70% off, TV antennas 95¢," etc.) from the N.Y. Sunday Mirror was placed in the TV program section of this newspaper. With outfits such as Surplus Electronic Stores in the market, how can a TV man compete?

JULIO BELLBER

New York, N.Y.

Here's some more on phoney wholesale distributors. These ads ("17BP4 \$12.95, installed free," etc.) are from the N.Y. Sunday News.

NATHAN MEISTER

Meister Television Radio Repair
Farmingdale, N.Y.

Fast Buck Surplus Outlets

Editor, TECHNICIAN:

We've been griping about fast buck discount and surplus outlets long enough. We ought to do something about it, but none of us are "legal-beagles" and are afraid of being sued if we notify other service organizations of the activities of these manufacturers and distributors. Can we or can't we name names?

JOHN E. TYLER, JR.

Town Television
Branford, Conn.

• There's nothing to stop you from telling other techs, distrib and manufacturers why you refuse to buy a particular product or patronize some outlet. So far as naming names in print, you might consider doing as the Radio-TV Guild of L.I., Box 87, Bethpage, N.Y., does in its "Guild News." They publish a monthly distrib shopping report, listing jobber names and brands sold over-the-counter to people not identified as techs.—Ed.

Manufacturers' Literature

Editor, TECHNICIAN:

I wish to commend your magazine on its recent article (March issue) concerning a literature file for the TV servicemen. I have been receiving data sheets and catalogs from manufacturers for several years, and have benefited immeasurably. Filing this material is important, since it would be worthless to let it pile up. A practical means of filing would be to scrutinize the material, and place it back in the manufacturer's envelope. This segregates the manufacturer by name, makes it easier to file the great variety of sizes, and allows future data from the same company to be placed in the same envelope.

R. J. CISZAK

Bob's TV-Radio Service
Buffalo, N.Y.

New Motorola® **Transistor** POWERED Car Radio

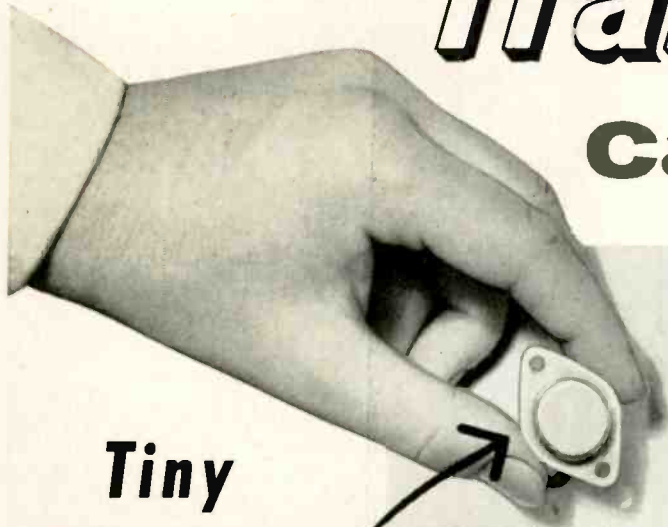

Tiny transistor replaces 15 vital car radio parts

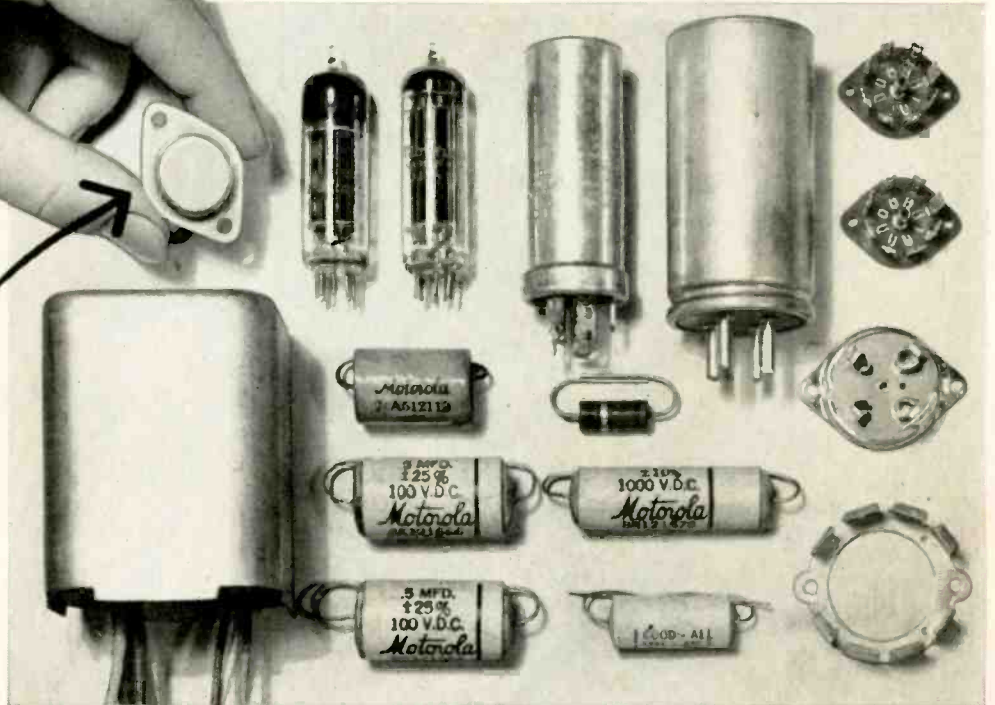

WITH A "GOLDEN HEART" THAT WON'T WEAR OUT"

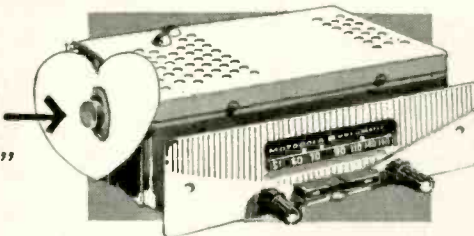

Motorola Transistor-Powered Car Radio. (Model 6TAS-8, 12 volt) \$99.95. Other new models from \$39.95

PLUS—NEW TWIN BAR STATION FINDER

Most automatic tuning of all! Electronically picks and pinpoints any station. Twin Search Bars move station selector either right or left from any point on the dial.

Most trouble-free car radio ever built—The amazing transistor heart won't ever wear out. And it replaces 15 parts that do wear out in conventional sets. (Including the vibrator and vacuum tubes.)

Cuts battery drain 50%—Transistors use hardly any power. Even with the engine off, this radio can play for hours without running down the battery.

Fits most cars—Custom fits instrument panels of most cars. Takes just a few minutes to put in. (Or, Motorola's Installation Depot can do it for you, in most cities.)

Here's how you fit in—Every fourth car lacks a radio. Car radio sales are up 30% . . . and still growing. And now, Motorola has produced the hottest car radio ever. Advertised in *Reader's Digest* (to reach every third American). Now's the time to get into the plus-profit car radio business. Send this coupon today. No obligation.

Motorola, Inc., Dept. T-5
4545 W. Augusta Blvd.
Chicago 51, Illinois

Attn.: Car Radio Department
Please give me all facts about the Motorola Car Radio business. Thank you.

Name _____
Firm _____
Street _____ City _____ State _____



MOTOROLA

World's Largest Exclusive Electronics Manufacturer



65 ma—#205G1



75 ma—#206G1



100 ma—#206G1



150 ma—#207G1



200 ma—#208G1



250 ma—#209G1



300 ma—#202E1



350 ma—#209G1



400 ma (compact)—#210G1



400 ma—#203G1



500 ma (compact)—#211G1



500 ma—#204G1

For dependable replacement

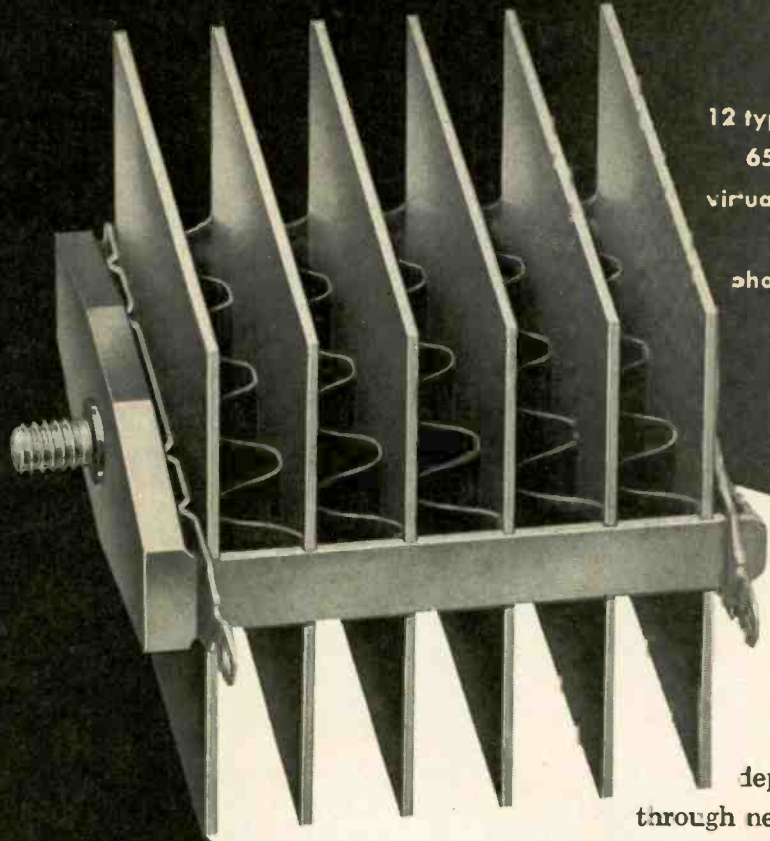

12 types—ratings from 65 ma to 500 ma—meet virtually all your replacement requirements in radio, phonograph, hi-fi, and TV sets.

RCA SELENIUM RECTIFIERS are manufactured to give long and dependable performance. This dependability is made possible through new, advanced design, careful selection of production material, and thorough quality control in manufacture. The new, open design permits greater heat dissipation . . . no possibility of center "hot spots."

RCA SELENIUM RECTIFIERS are a dependable replacement line because they are . . . cool in operation . . . sturdy in mechanical construction . . . efficient in electrical operation . . . easy-to-install.

Now available through your RCA distributor!

RCA SELENIUM RECTIFIERS



RCA RADIO CORPORATION of AMERICA
ELECTRONIC COMPONENTS
HARRISON, N. J.

Directronic[®] TV ANTENNA SYSTEMS

the Ultimate in Antenn-engineering

by **Snyder**
PHILADELPHIA

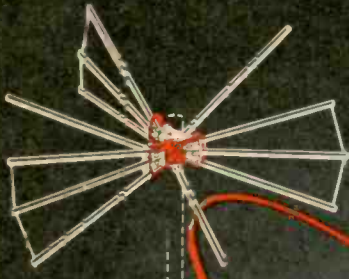

AX-520 METROPOLITAN
SINGLE BAY
SUPER DIRECTRONIC
22.⁵⁰ LIST

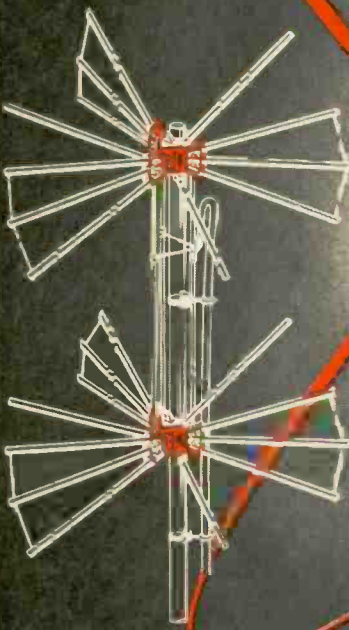

AX-524 FRINGE AREA
TWO BAY
SUPER DIRECTRONIC
47.⁵⁰ LIST

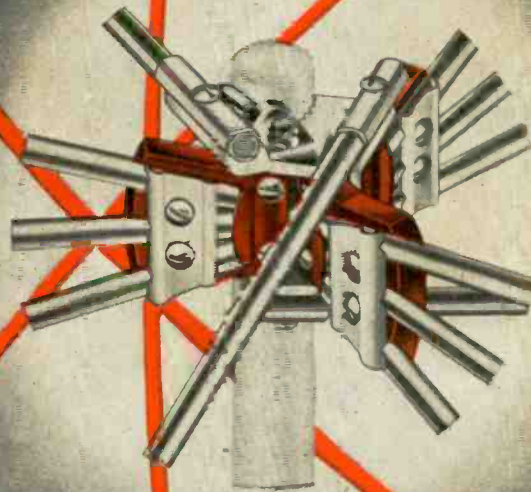

DIRECTRONIC
6-POSITION BEAM SELECTOR
CLEARS PIX INSTANTLY ON ALL CHANNELS



K-80 DIRECTRONIC
"DO-IT-YOURSELF"
TV TENNA KIT
COMPLETE! Nothing Else to Buy
24.⁷⁵ LIST



SNYDER

SNYDER MFG. CO., PHILADELPHIA 40, U.S.A.
BELLE JE TUBE MILL, INC., PHILADELPHIA
SNYDER ANTENNA-ENGINEERS LTD. TORONTO 14, CANADA
WORLD EXPR.: ROBURN AGENCIES, INC., N. Y.
VAN DER HOE ASSOC., LTD., NEW TORONTO, CANADA
SNYDER ANTENNA-ENGINEERS, INC., LOS ANGELES 58

keep your servicing
on-the-go
profitably with
RCA SERVICE PARTS

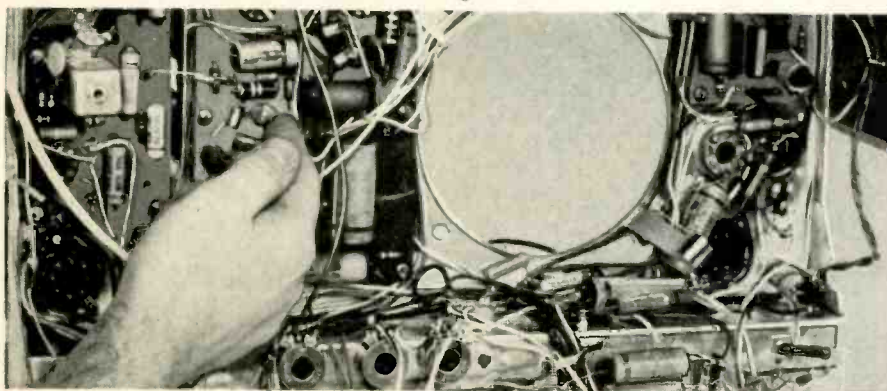

This is a peaking coil. It is an exact electrical replacement for the high-Q original used in RCA Victor TV receivers. Replacement peaking coils with improper inductance values can cause "trailing reversals" and "smearing." But, with this RCA peaking coil—as with all RCA Service Parts—you get maximum assurance that original performance will be restored—in quick bench-time. This is why successful servicemen everywhere depend on RCA Service Parts to keep their servicing on-the-go, profitably. RCA Service Parts for RCA Victor radios, TV receivers, record-changers, and "Victrola" phonographs are factory-tailored to fit right, install fast, and do their job precisely. So, when it's an RCA Victor home instrument you're repairing, insist upon an RCA Service Part—available from your local RCA distributor.

RCA SERVICE PARTS
RADIO CORPORATION OF AMERICA, HARRISON, N. J.

RCA VICTOR PRODUCTS • RCA SERVICE PARTS—made for each other!

Editor's Memo

Are pretty girls attracting or distracting?

This poser crops up frequently regarding publicity photos which manufacturers send to editors to focus attention on a new product or special event. To catch the reader's eye, the product is held (or pointed to, or sat on, or danced with) by a shapely model. Whether or not the reader will be inclined to turn his attention to the sexless equipment depends, of course on the individual.

The inclusion of come-hither female pictures in **TECHNICIAN** editorial material has been quite restricted for two reasons. From a practical viewpoint, our primary job is to present technical information, and any space devoted to the distaff side eliminates so much servicing data.

From our emotional viewpoint, we try to do the best job possible in every undertaking. One glance at a newsstand quickly reveals that there are other magazines better geared to present the fair sex.

However, just this once for the record, we present here some of the young ladies (minus the products) who grace manufacturer publicity. Never let it be said we don't give broad coverage of the industry!

Credits, from top down: Thompson Prod., Halli-crafters, Jensen Mfg., Motorola, Jersey Spec.



Al Foman

Always insist on

WARD
FIBERGLAS
AUTO AERIALS

Dura-ramic

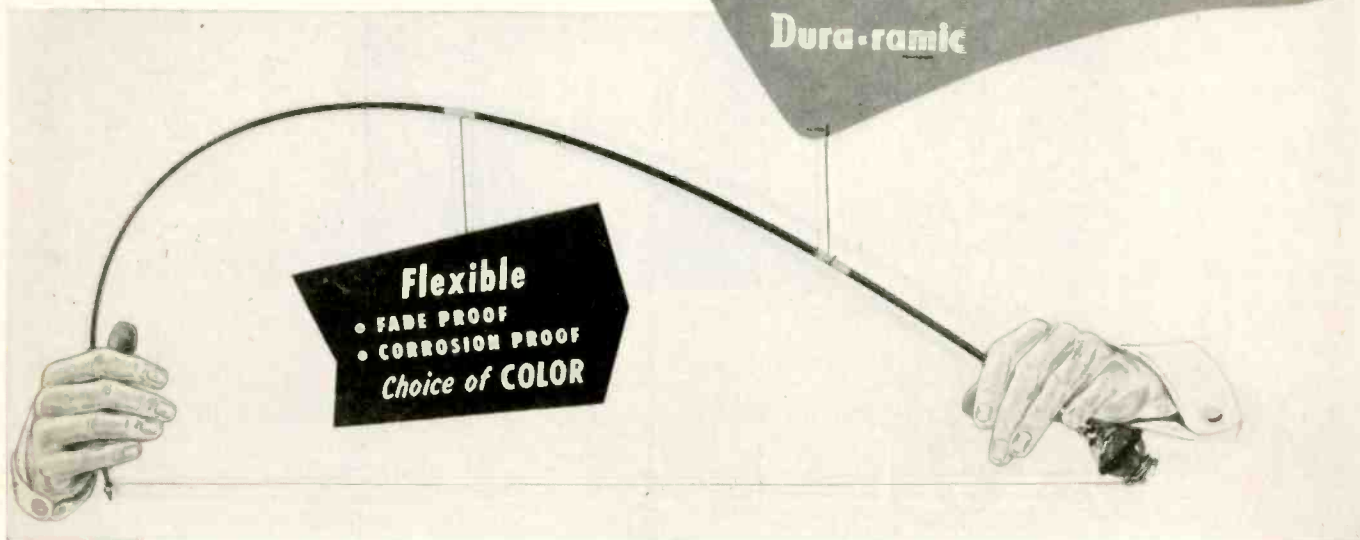

WARD

**AUTO
AERIALS...**

for:

- ★ **Top quality**
- ★ **Customer acceptance for over 20 years**
- ★ **Reliable performance**
- ★ **Easiest installation**

For every radio installation you make, a WARD AERIAL tops it off with the most dependable, acceptable and popular antenna you can buy... yet it costs no more than an ordinary aerial.

Here's the *complete* top-quality line for every requirement:

- EIGHT BALL—ever-popular favorite
- MAJORETTE—the economy model
- PHANTOM—disappearing antenna
- TWIN REAR MOUNT—midget 8-ball twins
- MIDGET PHANTOM—twin rear mounts
- SKY QUEEN—smartly styled side mount
- LONG RANGER—longer, for extra signal
- CONTINENTAL—flex-angle side mount for all foreign cars
- DURA-RAMIC®—the original Fiberglas aerial in full colors to complement the car. Can't fade, rust, warp, break or corrode.

Order your WARD AERIALS now. Keep a few on hand all the time. Keep your customers satisfied with the... *World's Finest!*

WARD

PRODUCTS CORPORATION
DIVISION OF THE GABRIEL CO.

1143 EUCLID AVE. • CLEVELAND 15, OHIO

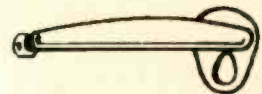

RADIART features
the complete line of **NEW**
COMMUNICATION VIBRATORS
in 6 Volt and 12 Volt Series
that outlast all others

These Ten Types Offer Complete Replacement for ORIGINAL Communication Equipment . . . the PROPER voltage for each application.

Old No.	New No.	
	6 volt	12 volt
5515	5715	6715
5518	5718	6718
★	5721	6721
★	5722	6722
★	5725	6725
5605	5805	6805
5620	5820	6820
5621	5821	6821
5622	5822	6822
★	5824	6824

For Specific Applications See Latest Radiart Vibrator Guide

Again because of SUPERIOR ENGINEERING and CONSISTENTLY INCREASED QUALITY, Radiart offers you communication vibrators that are DEPENDABLE! The RIGHT vibrator . . . for EACH application! See for yourself . . . You're RIGHT WITH RADIART.

SUBSIDIARY OF



THE **RADIART** CORPORATION
CLEVELAND 13, OHIO

TV ANTENNAS • AUTO AERIALS • VIBRATORS • ROTORS • POWER SUPPLIES

A report on Sylvania's **6-Million-Hour Field Test** in receiving tubes

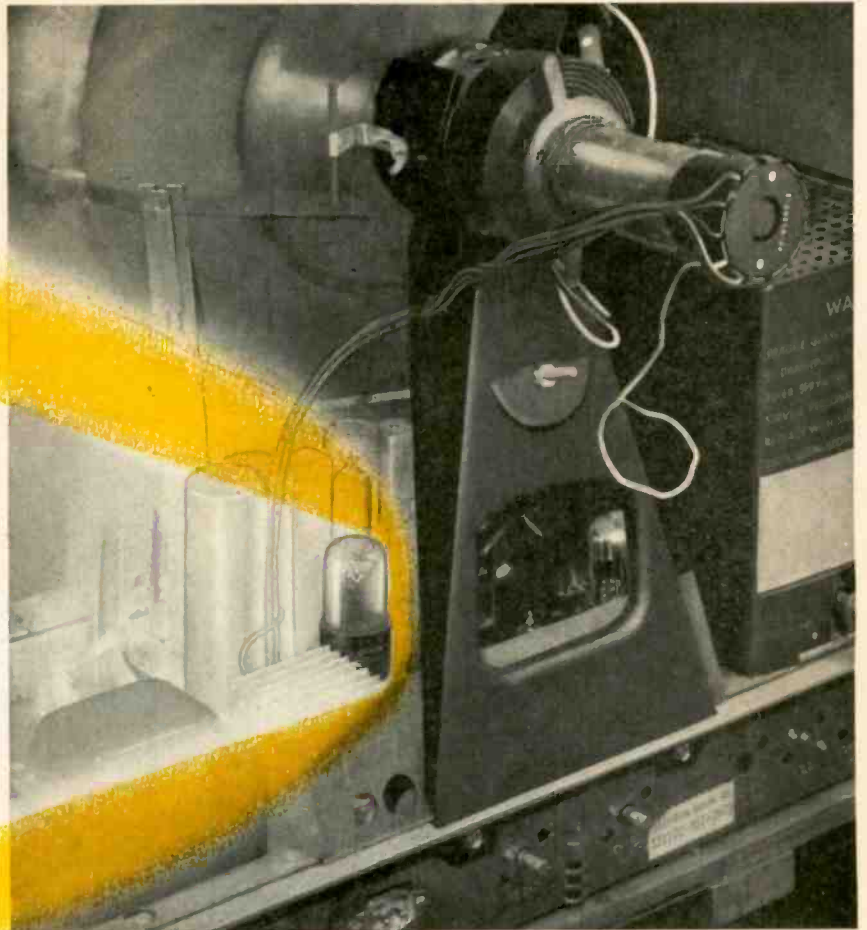

"Circuit tested" in 139 stock TV sets for universal protection against callbacks

FOR UNIVERSAL PROTECTION against callbacks, use the tube that's tested for top performance under actual operating conditions in the sets you service. Sylvania tubes in the familiar yellow and black carton are backed by more than 6 million hours of field testing in TV sets of leading manufacturers.

The 139 stock models selected for the *6-million-hour field test* represent a cross section of the industry and their tube complements include every important replacement tube type. The 6-million-hour field test stacks up as the most extensive program ever under-

taken on the servicemen's behalf to insure universally dependable tubes.

Every set-testing cycle is based on one year of set use, assuring you maximum dependability during the period of your responsibility. That's why we say Sylvania tubes are "time-tested" for trouble-free service and the maximum profits which go along with it.

Look for the yellow and black carton—it represents a new kind of dependability backed by the 6-million-hour field test.



 **SYLVANIA**[®]

SYLVANIA ELECTRIC PRODUCTS INC.
1740 Broadway, New York 19, N. Y.
In Canada: Sylvania Electric (Canada) Ltd.,
University Tower Bldg., Montreal

LIGHTING • RADIO • ELECTRONICS • TELEVISION • ATOMIC ENERGY

... another
MALLORY
service-engineered
product

Don't Settle For Less than MALLORY FP Capacitors

Only Mallory makes genuine FP Electrolytic Capacitors. Don't accept substitutes or imitations—for only FP Capacitors give you *all* these exclusive features, pioneered by Mallory and available without premium cost:

- Designed for 85° C—no de-rating
- Genuine fabricated plate anode
- High ripple current rating
- Unequaled shelf and service life
- Fast, easy twist-prong mounting

Always ask for Mallory FP's *by name*—and you'll be sure of getting the best replacement capacitors on the market.



P. R. MALLORY & CO. Inc.
MALLORY

P. R. MALLORY & CO. Inc., INDIANAPOLIS 6, INDIANA

- Capacitors
- Vibrators
- Resistors
- Power Supplies
- Controls
- Switches
- Rectifiers
- Filters
- Mercury Batteries

News of the Industry

UNITED TRANSFORMER CO. announces the appointment of H. C. HORNICKLE as general manager of its Pacific Div.

CLEAR BEAM has adopted a new package for its do-it-yourself antenna kit.

SYLVANIA has adopted a tube-for-tube replacement warranty procedure on all receiving tubes sold by authorized distributors. E. M. LONGMIRE has been named Southeastern district sales manager for Sylvania's Radio and Television Div.

JENSEN MFG. CO. has supplied loudspeaker equipment for the first atomic submarine, the Nautilus, and the carrier Forrestal. Jensen's "Do-It-Yourself" book on hi-fi speaker systems has gone into its second printing.

In a recent shift of training representatives by the **CLEVELAND INSTITUTE OF RADIO ELECTRONICS**, R. E. PAGE has taken over the San Francisco-Bay area and F. M. REDMOND the Long Beach, Cal. office.

PRESTO RECORDING CORP. has appointed SHAPPE-WILKES as ad agency for all products.

STANDARD COIL PRODUCTS CO., INC., has announced the promotion of R. W. RENIERS to assistant sales manager in charge of defense sales.

HARRY, JOE and LOU RESNICK, owners of **CHANNEL MASTER CORP.**, were honored at a testimonial dinner for their services to Ellenville, N.Y., the site of their plant.

SNYDER MFG. CO., manufacturer of rear-deck antennas for automobiles, predicts that by 1958 all auto manufacturers will employ the rear-deck installation for increased safety and driver-visibility.

JERROLD ELECTRONICS CORP. has installed the first hotel closed circuit TV system in Palm Beach, Fla. Jerrold has purchased three community antenna systems serving 5,000 subscribers.

RAYTHEON MFG. CO. has announced the promotion of NORMAN R. TEIFELD to material control and traffic manager, and STANLEY E. RENDELL to factory engineering manager. Raytheon's week-long school in color TV is conducted each month in Chicago.

MAGNAVOX has announced the appointment of PAUL B. LOVEGREN as sales manager of speakers and capacitors, and DAN R. CAVALIER as sales promotion manager.

CBS-HYTRON announces the appointments of **DONALD E. SMITH**, central district manager, **LEONARD M. MURCHISON**, west coast equipment sales manager, **WALTER J. FITZPATRICK**, west coast regional manager, **JOHN F. GILBERT**, midwestern district sales manager.

GENERAL ELECTRIC has initiated a tune-up program to provide new customer contacts for the service dealers. National advertising is being used to remind the consumer to tune up his equipment.

THOMPSON PRODUCTS, INC. has announced the appointment of **K. L. BISHOP** as president and general manager of **BELL SOUND SYSTEMS, INC.**, a subsidiary company.

RCA president **FRANK M. FOLSOM** has predicted that the electronics industry will reach a volume of \$18 billion in the next eight years.

ROHN MFG. CO. has announced the appointment of **RICHARD H. KLEINE** as sales manager.

ELECTRO-VOICE has expanded its sales force by the appointments of **JAY CARVER**, **FRANK STROEMPL**, and **JIM JOHNSON**.

INTERNATIONAL RESISTANCE CO. has signed a new union agreement providing for increased wages and employee benefits.

BURTON BROWNE, head of **BURTON BROWNE ADVERTISING** and president of the Gaslight Club has been named to an All-Chicago Citizens' Committee, formed to promote the city as "the greatest city in the world."

ACME ELECTRIC CORP. has appointed **FLOYD VAN ALSTYNE** as sales engineer for southern New York State.

WESTINGHOUSE ELECTRIC CORP., television-radio div., has announced the appointments of **KENNETH H. BROWN**, service manager, and **ROBERT M. FICHTER**, manager, product development dept. **RAYMOND LOEWY**, industrial designer, will design future Westinghouse TV lines.

BENDIX has appointed **J. P. BROCKI** TV service manager of the TV and broadcast receiver div.

GENERAL CEMENT MFG. CO. has appointed **RUSSELL D. GAWNE** general sales manager.

UNITED CATALOG has promoted **ARTHUR I. RABB** to general manager.

FAIRCHILD RECORDING EQUIPMENT CO. has announced the appointment of **R. E. CARLSON** as vice-president and general manager.

... another
MALLORY
service-engineered
product



To power transistorized miniature portables...

- make it mercury—
- make it MALLORY!

You're selling the best in performance and value, when you offer your customers Mallory Mercury Batteries for their transistorized miniature portables.

First, because these batteries give the extra long life and constant discharge service that you get only in the unique mercury battery. They actually cost much less per hour of operation than ordinary batteries.

And second, because Mallory Mercury Batteries have all the exclusive features of stability, dependability and quality that come from Mallory's fifteen years of experience in pioneering the mercury battery field.

Get set to snare your share of this growing market. Order a stock, in ratings for popular sets, from your Mallory distributor today.



- Capacitors
- Controls
- Vibrators
- Switches
- Resistors
- Rectifiers
- Power Supplies
- Filters
- Mercury Batteries

New Books

CLOSED-CIRCUIT AND INDUSTRIAL TELEVISION. By Edward M. Noll. Published by the Macmillan Company, 60 Fifth Ave., New York 11, N. Y. 230 pages. Paper cover. \$4.95.

For those with a background in entertainment TV interested in technical information about this fast-growing related field, there is the basis for comparing the two types of systems as to similarities and differences and a good serving of information on the pickup or

transmission end to fill in the gaps for techs whose background has been confined to TV reception. There is also considerable detail on cameras and other present-day equipments and systems. The book also covers applications of closed-circuit systems, current and potential.

PUBLIC ADDRESS. By N. H. Crowhurst. Published by Norman Price Publishers Ltd., 283, City Rd., London, E. C. 1, England. British Radio Electronics, 1833 Jefferson Pl. N.W., Washington 6, D.C. 64 pages. Paper cover \$1.25.

This is No. 4 in the Audio Handbook series, and should prove a handy reference for techs interested in public ad-

dress installation. The author covers the various problems encountered, equipment employed, and the proper techniques to be used in buildings. Of considerable interest is the section on electronic techniques, which includes helpful design nomographs and circuits.

RADIOMANS GUIDE. By Edwin P. Anderson. Published by Theo. Audel & Co., 49 W. 23 St., New York 10, N.Y. 1040 pages. Hard cover. \$4.

On an intermediate technical level, this information packed handbook covers the broad range of the electronic science. Among the many topics included are radio and sound fundamentals, components, transistor circuits, controls, public address systems, short wave, oscillographs, TV circuits, phototubes, radar fundamentals and Underwriter's standards.

TRANSISTORS I. Prepared and published by "The RCA Review," David Sarnoff Research Center, Princeton, N. J. 676 pages. \$4.50.

Written on an advanced technical level, this valuable book contains 41 technical papers written by RCA engineers, plus abstracts of 46 others published previously. Among the many subjects covered are "Basic Transistor Device Concepts," "The Drift Transistor," and "Transistorized Vertical Deflection for Television Receivers." An excellent source of information.

THE RADIO AMATEUR'S HANDBOOK (33rd Edition). By the Headquarters Staff of the American Radio Relay League. Published by the American Radio Relay League, West Hartford, Conn. 760 pages. Paper cover. \$3.00.

This leading reference work for amateurs, experimenters, students and engineers, as compared to last year's version, reflects interestingly the trends in communication that have been evident over so short a period. An entire chapter has been added, for example, on semiconductor devices, with special emphasis on transistors. On the other hand, there is less emphasis on microwave and UHF communication. In receiver construction, there is a swing toward simpler design. The transmitter section features units for the novice as well as advanced equipment.

WIRELESS & ELECTRICAL TRADER YEAR BOOK 1956. Prepared and published by Trader Publishing Co., Ltd., Dorset House, Stamford St., London, S. E. 1, England. 344 pages. Hard cover. 12 shillings and sixpence.

Here is a "bible" of the British radio, TV and electrical appliance field. Among the many items included are directors of organizations, legal data, wage rates, tube base connections, receiver specs, brand names and frequencies. If you want to learn who's who and what's what in the British electronic industry, this book will tell you.

PAYS ITS WAY every day

TESTS and REPAIRS TV PICTURE TUBES

Makes Customers Happy — Creates New Profits

Servicemen now earn new servicing dollars in minutes and build satisfied customers—with B&K Deluxe Portable CRT 400.

Spots and corrects picture tube troubles in a few minutes, right in the home, without removing tube from set! Restores emission, stops leakage, repairs inter-element shorts and open circuits. Grid cut-off reading indicates picture quality customer can expect. Life-test checks gas content and predicts remaining useful tube life. Cuts operating costs, eliminates tube transportation. Also saves money on TV set trade-in reconditioning. Profits start the very first day.

Send for Bulletin 104-1



DELUXE CRT 400 with 4½" Plastic Meter

Weighs only 5 lbs. mounted in rugged, luggage style, carrying case covered with handsome, durable leatherette. Size: 11 x 7½ x 5". Net \$54.95



CATHODE REJUVENATOR TESTERS

ECONOMY CRT 200

Every serviceman can cash in on picture tube repairs with this low priced quick profit maker. Performs most of the functions of the CRT 400. Has 3" meter. In leatherette carrying case. Size: 11 x 7½ x 5". Weighs 5 lbs. Net \$39.95

PROVEN IN THE FIELD EVERY DAY BY OVER 20,000 SERVICEMEN



Made by the Makers of the DYNA-QUIK Tube Tester

B & K MANUFACTURING CO.
3726 N. Southport Ave. • Chicago 13, Illinois



SERVICEMEN: NOW YOU CAN REDUCE
YOUR RECTIFIER NEEDS TO **4** TYPES WITH

Federal's

HI-DENSITY

SELENIUM RECTIFIERS

Engineered to handle
90% of your radio-tv
replacements!

Nearly

50%

SMALLER...!

More compact packages increase
rectifier capacity of your kit
... save time on service calls!

SEE YOUR
FEDERAL DISTRIBUTOR!



ACTUAL SIZE

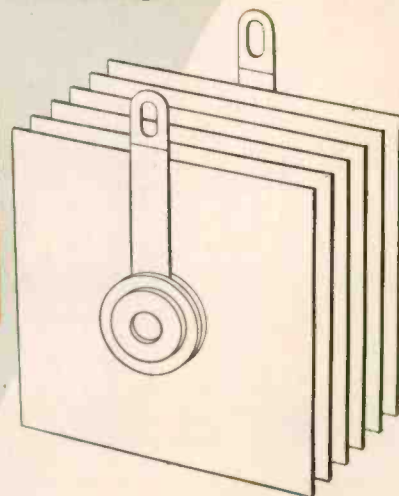

COMPARE—

Compare, Mr. Serviceman, Federal's new 250-300 Ma. HI-DENSITY stack with its larger predecessor of the same rating!

Just 4 types—ranging up to 600 Ma.—are needed to meet 90% of your requirements for radio-tv replacements.

Now you can really simplify rectifier replacement... with these smaller, lighter, higher-temperature, longer-lasting, more versatile HI-DENSITY stacks. Get the facts!

A Research and Development Triumph of Federal

Federal Selenium Rectifiers are listed in
Howard W. Sam's Counter-Facts and Photo Facts

Federal Telephone and Radio Company

A Division of INTERNATIONAL TELEPHONE AND TELEGRAPH CORPORATION
COMPONENTS DIVISION • 100 KINGSLAND ROAD • CLIFTON, N. J.

In Canada: Standard Telephones and Cables Mfg. Co. (Canada) Ltd., Montreal, P. Q.
Export Distributors: International Standard Electric Corp., 67 Broad St., New York

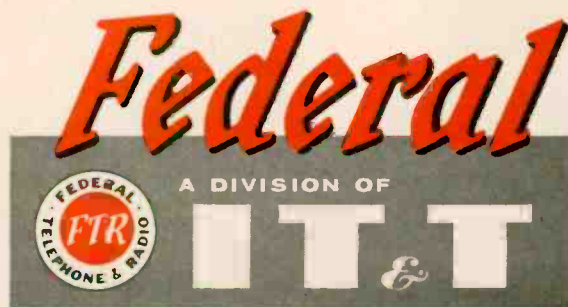

NEW!

CATCHES ALL LEAKY CAPACITORS

IN-CIRCUIT

... CHECKS
ALL COUPLING
CAPACITORS
FOR
LEAKAGE

OUT-OF-CIRCUIT

... CHECKS
ALL CAPACITORS
FOR LEAKAGE
AND
CAPACITANCE

Simpson

MODEL 383A

CAPACOHMETER

IN-CIRCUIT

CAPACITOR LEAKAGE TESTER

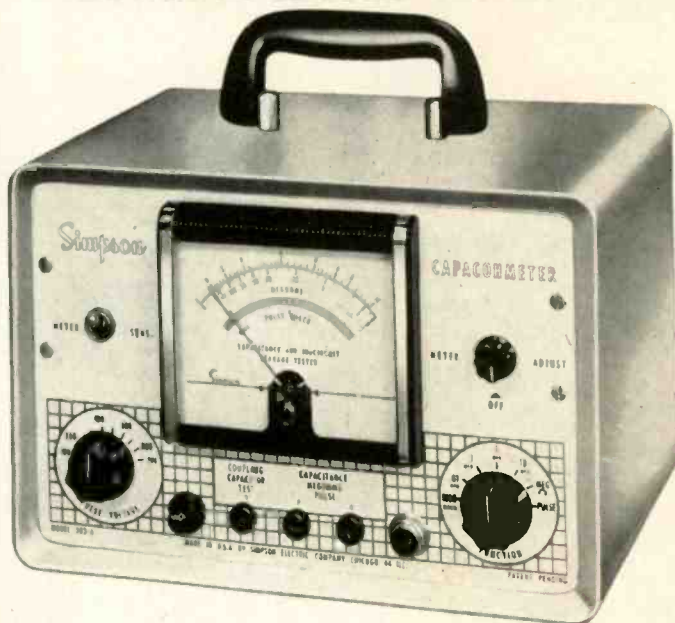

Here is the first *complete* "testing package" for all paper, mica, and ceramic capacitors. With this *one* instrument—the Simpson Capacohmeter—you can: (1) detect most borderline capacitors *in-circuit* by means of the exclusive Simpson *Pulse Test*; (2) measure leakage of defective capacitors, including coupling capacitors, in ohms; (3) determine the capacitance directly, of good capacitors, from 10.0 uuf to 10.0 uf.

With *this* instrument, most tests can be made *in-circuit*. *All* tests are made under load conditions. There is no fussing with bridge circuits and balancing controls. Readings are indicated on a large 4½" meter with better than 10% accuracy. But that's not all. You can use the Simpson Capacohmeter to test for leaky wiring, sockets, and transformers . . . to measure distributed capacitance of wiring to ground . . . to "high-pot" good components . . . and many other tests which you will discover.

Model 383A with leads and Operator's Manual . . . **\$89⁹⁵**

See your Jobber, or Write

SIMPSON ELECTRIC COMPANY

5200 W. Kinzie St., Chicago 44, Illinois
Phone: EStebrook 9-1121

In Canada: Bach-Simpson Ltd., London, Ontario

WORLD'S LARGEST MANUFACTURER OF ELECTRONIC TEST EQUIPMENT



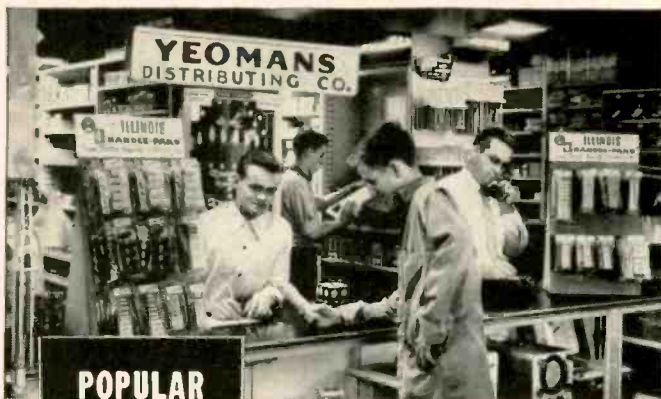

**POPULAR
WITH
SERVICEMEN**

**ILLINOIS "HANDEE-PAK"
CAPACITOR KITS**

Servicemen go for the new ILLINOIS "HANDEE-PAK" Capacitor Kit assortments because they take up little room in the service kit—are easily identified and since they are hermetically sealed in polyethylene bags, the capacitors are always factory fresh and clean! Each PAPER CAPACITOR KIT is made up of 10 assorted new Type ITC Ceramic Cased Paper Capacitors of the capacity and voltage ratings most used by servicemen. The ELECTROLYTIC KITS consist of 5 popular types.

LOOK FOR THEM ON THE NEW JOBBER COUNTER RACKS



New ILLINOIS "HANDEE-PAKS" are available at most better jobbers—carry a few "HANDEE-PAKS" in your service kit. They are the ultimate in packaging, convenience and reliability.

ILLINOIS CONDENSER CO.
1616 N. THROOP STREET CHICAGO 22, ILLINOIS

A Valuable Service for Television Technicians—

**SINGLE SCHEMATICS,
25¢ Each**

The publisher of **TECHNICIAN** is receiving so many requests for reprints or additional copies of its Circuit Digests that it is making single schematics available at 25¢ each, postpaid and the complete group, as published in any issue, for 50¢ postpaid. Schematics for all receivers indexed are in stock. Be sure to order by Circuit Digest number and give brand name and chassis number to prevent error.

Address Reader Service Dept., **TECHNICIAN**,
480 Lexington Ave., New York 17

Currency or postage must accompany order.

**Here's The
ANTENNA
YOU CAN
MAKE
MONEY
Installing**

*designed
for 1 man...
7 minute
installation*

**NEEDS ONLY A
HAMMER TO INSTALL**

GENUINE *Color Beam*
\$14.95 COMPLETE LIST

**YOU MAKE \$600
ON ANTENNA
SALE ALONE**

 *Exclusive with*
WINEGARD

**ANY ANTENNA THREE YEARS
OLD SPOILS THE TV PICTURE**

*"designed
for* **BLACK and
WHITE** and
COLOR

*Available at Leading Parts
Distributors Everywhere or Write*

Winegard Company
Burlington, Iowa

*For Pamphlet "How to Make Money
on One Man Antenna Installation."*



Antenna boxed—completely assembled—attached lead-in

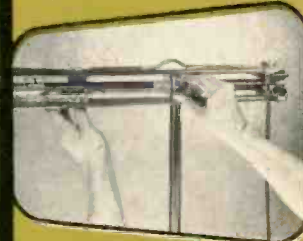

Raise main crossarm.

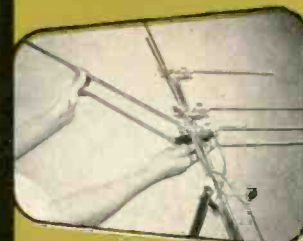

Snap secondary crossarms in place.



Nail up mounting bracket.

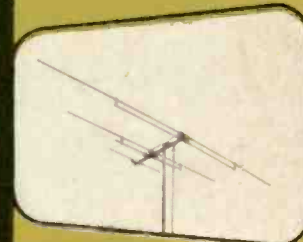

Drop lead-in wire.

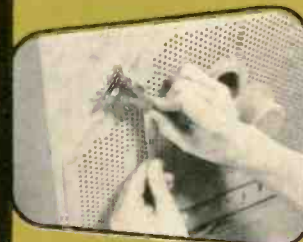

Attach lead-in to TV set—special clip snaps on.

ANOTHER **FIRST** FOR 

BONDED ELECTRONIC TECHNICIANS

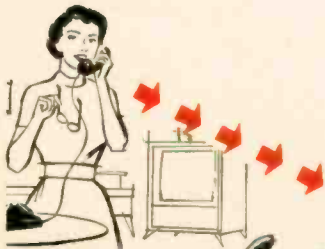

CUSTOMER



RAYTHEON BONDED SERVICE DEALER

WESTERN UNION
"Operator 25"
 will recommend them to more customers

Something new — and very important — has been added to the sales force of Raytheon Bonded Electronic Technicians. It's "Operator 25". Customers seeking Radio-TV Service simply call Western Union by number and ask for "Operator 25". In answer to their request for a reliable source of bonded service, "Operator 25" gives them the name and phone number of the nearest Raytheon Bonded Dealer. That means more business — exclusive business — for Raytheon Bonded Electronic Technicians.

This customer producing new sales advantage, plus the cash-protection of the Raytheon Bond,

the Raytheon Bonded Certificate, ID Cards, Decals, Raytheon Creed Displays, the Raytheon Code of Ethics, Classified Telephone Directory listings, all backed by sound, hard-hitting national advertising in LIFE, TIME, NEWSWEEK and TV GUIDE — make the Raytheon Bonded Electronic Technician Program the most powerful sales force a service dealer can have.

Call your sponsoring Raytheon Tube Distributor and ask him if you can qualify as a Raytheon Bonded Dealer.

If you can, you're well on your way to more volume and profit.



RAYTHEON MANUFACTURING COMPANY

Receiving and Cathode Ray Tube Operations

Newton, Mass. • Chicago, Ill. • Atlanta, Ga. • Los Angeles, Calif.

Raytheon makes all these { Receiving and Picture Tubes, Reliable Subminiature and Miniature Tubes, Semiconductor Diodes and Transistors, Nucleonic Tubes, Microwave Tubes



Excellence in Electronics

TECHNICIAN

& Circuit Digests

CALDWELL-CLEMENTS, INC., 480 LEXINGTON AVENUE, NEW YORK 17, N. Y.

Some Manufacturers Are Missing the Boat

In a field that is in a constant state of change, electronic manufacturers have kept their footing. In a field that demands technical ingenuity, they have worked near-wonders. In a field that is extraordinarily competitive, they have achieved notable profits. This may come as a surprise to some manufacturers presently in financial difficulties, but a recent analysis by Dun & Bradstreet of 70 different lines of business (drugs, foundries, hardware, lumber, paper, etc.) over the five-year period 1950-54 showed that producers of radio parts and supplies had the highest average net profits on tangible worth—a whopping 17.57%—of all 70 fields studied. Most industries averaged only 6 to 12%.

The reason for quoting these business statistics is to indicate that most electronic manufacturers possess a high degree of business know-how. Despite this ability, many of them miss the boat in matters directly affecting service technicians, the men who represent the entire electronic industry in the public's eye.

DIRECTION OF SALES EFFORT: The first step is for manufacturers of components, tubes, instruments, antennas and other parts to recognize who their *real* customers are. It's not the jobber. He's the vital middleman who funnels products to dealers and technicians. It's not the housewife. She doesn't know an ABC Company resistor from an XYZ Company ion trap, and she is not supposed to. She relies upon the choice of the service technician, who is the only electronic expert who ever enters her home. It's the technician who is the manufacturer's real customer. He *selects the product he wants and installs it as part of his service*. This is the same procedure followed by carpenters, plumbers, electricians and other skilled trades.

While much of this may seem self-evident, we

still find otherwise alert manufacturers who apparently don't know the identity of their real customers. They spend huge sums of money promoting their products to the general public, which knows practically nothing of technical details, and perhaps cares less. They promote their products to technicians in a manner that overlooks the fact that he is an electronic specialist. (One manufacturer showed a tech in an advertisement doing something no professional would do. Readers caught it.)

HELPING THE CUSTOMER: Once the manufacturer in the servicing and replacement market realizes the technician is his real customer, he should help him. This is smart business, and standard procedure in a great many industries. Aids can take the form of sales promotion devices for technicians to use, educational clinics, credit, making technical data readily available, etc. Such efforts should, of course, be scaled to the size of the manufacturer.

RELATIONS WITH CUSTOMER: It is a well known fact that customers carry a particular mental image of individual brands, an image that is not always arrived at logically. Many small and often unrecognized things cause customers to picture a company as friendly, crooked, dependable or foolish. The best general guide is to treat each customer as an individual. For one thing, make sure inquiry letters are answered promptly.

There are many manufacturers who do cater to the technician, provide him with aid and give him personal attention. That is why we have the greatest respect for most of these companies. It is to the others that we address this message: Recognize the technician as your real customer and treat him fairly!

Tuning In the

YOUR YEAR-ROUND REFERENCE, the annual Technician Buyers Directory published in this issue, tells you the entire who-what-where story of products and organizations. Want to find out who makes antenna rotators? Looking for the address of a cartridge manufacturer? The service associations in Oklahoma? The distributors in Delaware? All this, and much more, can be found in this only directory of the TV-electronic servicing industry. Keep it at hand throughout the year!

HOW MANY ELECTRONIC TECHS ARE THERE? According to a recent report released by the U.S. Dept. of Labor, there are 107,000. Included are 80,000 in radio-TV repair, 12,000 in broadcasting, 5,000 in aircraft manufacturing, 5,000 in electronic manufacturing, 3,000 in radio-TV manufacturing, and 2,000 in research.

LICENSING BILL calling for the creation of a state board to regulate TV servicing in Michigan has been killed by the state Senate. Proposed legislation was sent back to committee after opponents argued that law would protect gyps more than the public.

ELECTRONIC LIGHT AMPLIFIER, the Lumicon, consisting of image orthicon detector, amplifiers and TV pix tube, amplifies light 40,000 to 50,000 times. Linked with X-ray, it projects a bright image on a 1000-line-plus TV screen for the examination of mechanical castings, engine operation and the like. Other applications include medical radiography, astronomy and photography.

New video tape recorder (VTR) developed by Ampex records full hour TV program on 14-in. reel of 2-in. wide tape at a speed of only 15 in./sec. It is commercially available, and CBS has ordered three units at \$75,000 each. It records a 4 mc band by using a unique four-head assembly on a drum rotating at 14,000 rpm, one head always in contact with the tape. Magnetic signals for video are recorded transversely across the tape, rather than longitudinal as in conventional recorders. Units will first be used for network delayed programs. Compared to film-kinescope recording, VTR is less costly, has better quality, allows immediate playback, requires no processing, and may be reused.

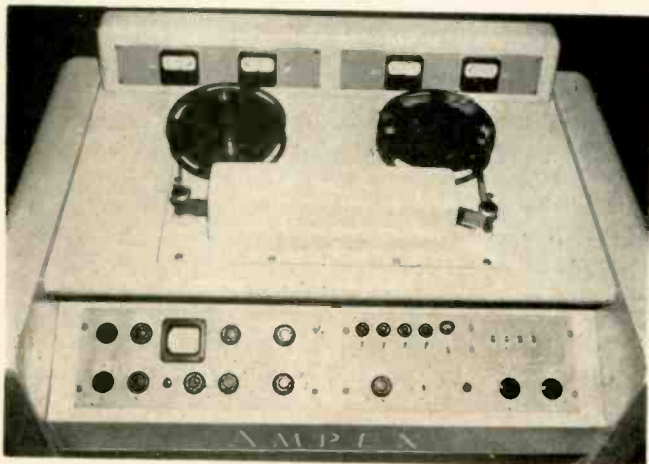

"I called every serviceman in town . . . had to be sure one would be here before the fight."

MAY 1956 NETWORK COLOR TV SCHEDULE

MONDAYS through FRIDAYS

May 1-4, 7-11, 14-18, 21-25, 28-31

3:00—4:00 PM (EST) NBC "Matinee Theatre" (Live)

5:30—6:00 PM (EST) NBC "Howdy Doody" (Live)

THURSDAY, May 3

10:00—11:00 PM (EST) NBC "Lux Video Theatre" (Live)

SATURDAYS, May 5, 12, 19, 26

7:00—7:30 PM (EST) CBS "Gene Autry Show" (Live)

SATURDAY, May 5

9:30—11:00 PM (EST) CBS "This Happy Breed" (Ford Star Jubilee) (Live)

SUNDAY, May 6

3:30—4:00 PM (EST) NBC "Zoo Parade" (Film)

4:00—5:30 PM (EST) NBC "Maurice Evans Presents" (Live)

THURSDAY, May 10

8:30—9:30 PM (EST) CBS "Shower of Stars" (Live)

SATURDAY, May 12

9:00—10:30 PM (EST) NBC "Max Liebman Presents" (Live)

TUESDAY, May 15

8:00—9:00 PM (EST) NBC "Milton Berle" (Live)

SUNDAY, May 20

3:30—4:00 PM (EST) NBC "Zoo Parade" (Film)

7:30—9:00 PM (EST) NBC "Sunday Spectacular" (Live)

MONDAYS, May 21, 28

7:30—7:45 PM (EST) NBC "Gordon MacRae" (Live)

TUESDAYS, THURSDAYS,

May 22, 24, 29, 31

7:30—7:45 PM (EST) NBC "Dinah Shore" (Live)

THURSDAY, May 24

8:30—9:30 PM (EST) CBS "Climax" (Live)

MONDAY, May 28

8:00—9:30 PM (EST) NBC "Bloomer Girl" (Live)

(Producer's Showcase) (Live)

WEDNESDAY, May 30

10:00—10:30 PM (EST) NBC "This Is Your Life" (Live)

The above schedule applies at press time.

Picture



COLOR TV RECEPTION requires closer attention to the condition of the antenna. According to Snyder Mfg. Pres. Ben Snyder, present indoor and outdoor high quality antennas are perfectly capable of receiving color, except when there is corrosion or breakage of wires or elements. For highest quality pictures, replacement every two years is recommended.

PIX TUBE REPLACEMENT market should offer a fairly steady demand at a volume of around 10,000,000 a year, predicts DuMont manager Edwin Hinck.

TUBE FORGERY RACKET has been exposed in Boston, where police arrested a California man who they said has made \$250,000 in the past 10 years by forging code numbers on old receiving tubes to show the tubes had burned out within the warranty period. The tubes were turned in to jobbers in exchange for new ones, and the new tubes sold to dealers.

WHAT ARE YOUR BUSINESS PROSPECTS? Statistics reported by H. Leslie Hoffman, president of RETMA and Hoffman Electronics, show the following:

REPAIRS AND SERVICE

Home Entertainment Devices (radio-TV-audio)

	Parts	Distribution Revenue	Service & Installation	Total
1955	\$ 680,000,000	\$ 450,000,000	\$ 930,000,000	\$2,060,000,000
1960	\$1,330,000,000	\$ 870,000,000	\$1,232,000,000	\$3,439,000,000
1965	\$2,330,000,000	\$1,538,000,000	\$1,685,000,000	\$5,553,000,000

CALENDAR OF COMING EVENTS

- May 21-24: 1956 Electronic Parts Distributors Show, Conrad Hilton Hotel, Chicago, Ill.
- May 22-23: RETMA Symposium on Reliable Applications of Electron Tubes, Irvine Auditorium, University of Pennsylvania, Philadelphia, Pa.
- June 27-30: Jobber-Rep-Mfrs. Conference, Breezy Point Lodge, Brainerd, Minn.
- July 16-20: 1956 Summer Market, Western Merchandise Mart, San Francisco, Calif.
- July 22-25: 1956 National Audio-Visual Convention and Trade Show, Hotel Sherman, Chicago, Ill.
- Aug. 30- Sept. 2: 3rd Conference, Rocky Mountain Chapter of "The Representatives," Colorado Hotel, Glenwood Springs, Colorado.
- Aug. 22- Sept. 1: 23rd Annual British National Radio Show, Earls Court, London, England.
- Sept. 9-12: 1956 Distributor Conference, Heart of America Chapter of "The Representatives," Lake Taneycomo, Mo.
- Sept. 14-16: NATESA Annual Convention, Sheraton Hotel, Chicago, Ill.
- Oct. 1-3: Canadian I.R.E. Convention and Exposition, Automotive Building, Canadian National Exhibition Park, Toronto, Canada.
- Nov. 2-5: High Fidelity Show, Palmer House, Chicago, Ill.

TRANSISTORS remain prominently in the news. Newly released price list by Texas Instruments show germanium transistors for general purpose, radio and audio are available in small quantities for as low as \$1.20. Many others are in the \$3 range. Emerson's Model 856 portable radio, with two transistors and three sub-miniature tubes sells for only \$28. Raytheon notes that its T-2500 transistor portable can be bought and operated for 3.2¢ per hour, while radio types cost 10 to 17¢ per hour for operation alone.

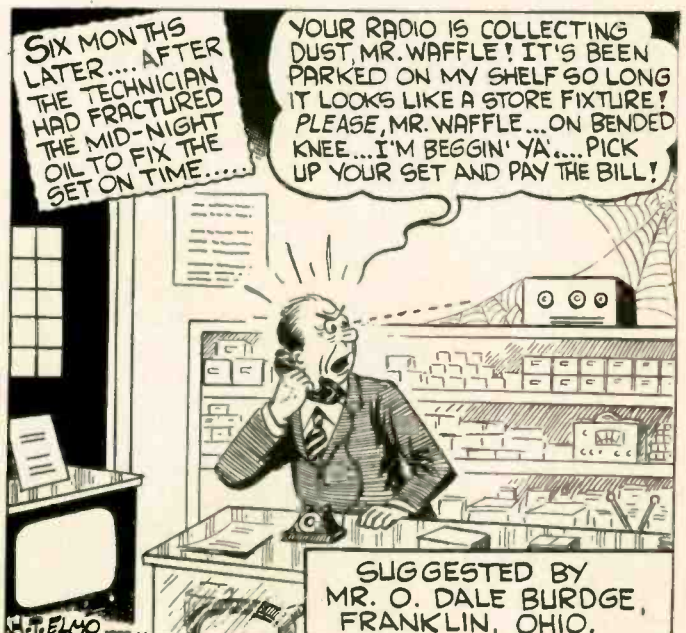

'56 Parts Show Preview

Distributor meet to be held in Chicago, May 21-24

The 1956 Electronic Parts Distributors Show will be held in Chicago's Conrad Hilton Hotel from May 21 through 24. Some 300 exhibit booths and display rooms will present the latest in electronic components and equipment to about 10,000 people.

Attendance at the Show is restricted to exhibitors, sales reps, parts distributors, government personnel, accredited advertising agencies and exporters up to 4 PM, May 21-23. On May 24, and after 4 PM on other days, non-exhibiting manufacturers will be admitted.

Five associations join hands to sponsor this show. These include the National Electronic Distributors Association, the Sales Managers Club Eastern Group, the Association of Electronic Parts & Equipment Manufacturers, the Radio-Electronic-Television Manufacturers Association, and the West Coast Electronic Manufacturers Association.

Serving as officers for this year's event are W. D. Jenkins, president; Ted Rossman, vice president; W. Walter Jablon, secretary; Herbert W. Clough, treasurer. Kenneth C. Prince is general manager, and S. I. Neiman is publicity counsel.

Under a new ruling, all persons qualified and planning to attend must register in advance by mail. No registrations will be processed at show time, and those who fail to preregister will not be admitted.

The following is a list of companies exhibiting at the show, together with the numbers of booths and rooms for each.

Company	Booth	Room
Aerovox Corp.	410	
All Channel Antenna Corp.	9	
Alliance Mfg. Co.	322	521
Alpha Wire Corp.	308	
Alprodeo, Inc.		619A-620A
Altec Lansing Corp.		504A
American Phenolic Corp.	207	560A-561A
American Television & Radio Co.	414	
Ames Manufacturing Corp.	14	
Amperite Company, Inc.	214	
Ampro Corp.		618A
Anchor Products Co.	12	

Company	Booth	Room	Company	Booth	Room
Antenna Specialists Co.		633	Eby Sales Co.	873	
Arco Electronics, Inc.	886		Elco Corporation	781	
Argos Products Co., Inc.		626A	Eidico of New York, Inc.		604A
Astatic Corp.	779	601	Electronic Devices Inc.	879	651
Astron Corp.	775		Electronic Instrument Co. Inc.	202	
Atlantic Wire & Cable Corp.	108		Electronic Measurements Corp.	112	
Atlas Sound Corp.	130		Electronic Publishing Co., Inc.		620
Audio Devices, Inc.	321		Electro Products Laboratories	417	
Audiogersh Corp.		634	Electro-Voice, Inc.	582	529 & 516
			Electrovox Company, Inc.	307	
Baker Manufacturing Co.	127		Elgin National Watch Co.	575	619
Barker & Williamson, Inc.	421		Equip-to-Div. Aurora Equip. Co.	688	
Baumker Mfg. Co.	116		Erie Resistor Corp.		613
Belden Mfg. Co.	404				
Berlant Concertone		500-501			
Birnbach Radio Co., Inc.		617	Fanon Electric Co., Inc.	789	603
B & K Mfg. Co.		604	Federal Electronics Sales	10	
Blonder-Tongue Labs., Inc.	131		Federal Telephone and Radio Co.	573	
David Bogen Co., Inc.		505A-507A	Fenton Company	674	655A
Brach Manufacturing Corp.	684	602A	The Flinney Co.	776	637
British Industries Corp.	407	614A-615A	Fisher Radio Corp.		621A-622A
Bryan-Davis Publishing Co.		611	Freed Transformer Co., Inc.	574	
Bud Radio Inc.		523	Fretco Incorporated	578	
Burgess Battery Company	310				
Bussmann Mfg. Co.	218				
Caldwell-Clements, Inc.		504	Gee-Lar Mfg. Co.	204	
Callfone Corp.	877	652A	General Cement Mfg. Co.	590	612
Cannon Electric Company	677		General Electric Company	209	
Carter Motor Company	211		General Industries Co.	413	
CBS-Hytron Sales Corp.	315		G & H Wood Products Co.	883	
Centralab	790		Gramer-Halldorson Transformer Corp.	419	
Central Electronics, Inc.		660A	Grayhill		631A
Channel Master Corp.		612A	Great Eastern Mfg. Co.		650A
Chicago Standard Transformer Corp.	405		Guardian Electric Mfg. Co.	303	
Cinch-Jones Sales	872				
Clarostat Mfg. Co. Inc.	589		Hallcrafters Co.	680	605-607
Clear Beam TV Antenna Corp.	675		Hardwick, Hindle, Inc.	101	
Cletron, Inc.	129	553	Harman-Kardon, Inc.		656A
Collins Radio Company		623	Hickok Electrical Instrument Co.	304	
Columbia Wire & Supply Co.	679		Hi-Lo TV Antenna Corp.	122	
Comfort Lines, Inc.	7		Hycon Mfg. Company	27	651A
Condenser Products Company	219				
Conrac, Inc.		613A	IE Manufacturing Co.	24	638A
Consolidated Wire & Assoc. Co's.	114		Illinois Condenser Company	206	
Continental Carbon, Inc.	316		Insuline Corp. of America	305	
Cornish Wire Co. Inc.	585		International Rectifier Corp.	1	
Cowan Publishing Corp.		519A-520A	International Resistance Co.	22	
Crest Transformer Corp.		661A			
J. W. Davis & Company	8		Jackson Electrical Instrument Co.	591	
Davis Electronics Co.	870		James Vibrapowr Co.	208	
DeJur-Amsco Corporation		621-622	J-B-T Instruments, Inc.	576	
Delco Radio Division	783		Jensen Industries, Inc.	418	528A
D & M Products	13		Jensen Manufacturing Co.		605A-607A
Drake Electric Works Inc.	592		Jerrold Electronics Corp.	671	
DuKane Corporation		512A-513A	Jersey Specialty Co. Inc.	102	
Allen B. DuMont Laboratories, Inc.	580		JFD Manufacturing Co., Inc.	212	520
Duotone Company, Inc.		610A-611A	Johns-Manville Dutch Brand Div.	125	
Dyna Company		641A	E. F. Johnson Company	412	549
Dynamic Electronics-New York Inc.	26	653	Jontz Mfg. Co. Inc.		657

Company	Booth	Room	Company	Booth	Room	Company	Booth	Room
Kester-Solder Company	119		Raytheon Manufacturing Co.	422		Ward Leonard Electric Co.	306	
Kuehne Mfg. Co.	787		Recaton Corporation	313		Ward Products Corp.	314	
Lance Antenna Mfg. Co.	777		Reeves Soundcraft Corp.	126		Webster-Chicago Corp.		537A
James B. Lansing Sound, Inc.		650	Regency Division—			Webster Electric Company		659
LaPointe Electronics Inc.	115		I. D. E. A., Inc.		539	Welco	672	616A
Littelfuse, Incorporated	584		Rego Insulated Wire Co.	687	657A	Weller Electric Corp.	309	
Lowell Manufacturing Co.	110	646A-647A	Rek-O-Kut Co.		522	Wendell Plastic Fabrics Corp.	4	633A
P. R. Mallory & Co. Inc.	416		Rhein Sound Systems, Inc.		628A	Wen Products Inc.	105	
Master Mobile Mounts, Inc.	681		John F. Rider Publisher, Inc.	302		Westinghouse Electric Corp.	113	644-645
Mechanical Steel Tubing Corp.		649A	Rockbar Corporation		609	Weston Electrical		
Merit Coil & Transformer Corp.	689		Rohn Manufacturing Co.	201	632A	Instrument Corp.	220	546A-648A
James Millen Mfg. Co. Inc.	217		Rogers Electronic Corp.	780		Winegard Company	5	656
J. W. Miller Company	118		Ronette Sales Corp.		609A	Winston Electronics, Inc.		637A
M. A. Miller Mfg. Co.	588		S & A Electronics	791		Workman TV Inc.	884	
Milwaukee Resistor Co.	25		Howard W. Sams & Co.	408		Worner Electronic Devices	881	
Model Engineering & Mfg. Co.	111		Sangamo Electric Co.	774	547	G. F. Wright Steel & Wire Co.	109	
Modern-Aire Mfg. Corp.		653A	Saxton Products, Inc.	3		Xcelite Incorporated	225	
Mosley Electronics, Inc.	123		Seco Manufacturing Co.	875	662A			
National Carbon Company	686	624A	Service Instruments Co.	778				
National Company, Inc.	572	532A-533A	Shepard Engineering Co.	887				
National Electric Products Corp.	133		Sherwood Electronic Labs.		660			
Newcastle Fabrics Corp.	117		Shure Brothers, Inc.	678	556A			
Newcomb Audio Products Co.		534	Sigma Instruments, Inc.		625A			
Ohmite Manufacturing	401		Simpson Electric Co.	124	539A			
Orradio Industries, Inc.	11		Mark Simpson Mfg. Co.		556			
Oxford Electric Corp.		533 & 536	Herman H. Smith, Inc.	221				
			Snyder Mfg. Co.	210				
			Sola Electric Co.	215				
			Sonotone Corporation		635			
			South River Metal Products Co.	871				
			Sprling Products Co.		512-513			
			Sprague Products Company	311				
			Standard Coil Products Co.	682				
			Standard Electrical Products Co.	120				
			Stevens Walden, Inc.	6				
			Stromberg-Carlson Co.		515A-517A			
			Superex Electronics Corp.		630A			
			Superior Electric Co.		614-616			
			Switchcraft, Inc.	406				
			Sylvania Electric Products Inc.	676	535A-536A			
			Talk-A-Phone Co.	409				
			Sarkes Tarzian, Inc.		521A			
			Tech-Master Corp.		623A			
			Technical Appliance Co.	21	553A			
			Technician—Caldwell Clements, Inc.					
			Telectronic Corporation		504			
			Telematic Industries, Inc.	571	626			
			TeleTest Instrument Corp.					
			Telex, Inc.	205				
			Telrex, Inc.	135				
			Tenna Manufacturing Co.	23				
			Terado Company	885				
			Tevco Insulated Wire	793				
			Thomas Electronics, Inc.	103				
			Thompson Products, Inc.	673	524A-526A			
			Thordarson-Meissner	402				
			Todd-Tran Corp.	784	629			
			Triad Transformer Corp.	579				
			Tricraft Products Corp.	216				
			Trio Manufacturing Co.	882	639-640			
			Trimm, Inc.	685				
			The Triplett Electrical Instrument Co.	320				
			Tung-Sol Electric, Inc.	104				
			Turner Company	223				
			T-V Products Co. Inc.	876				
			Ungar Electric Tools, Inc.	128				
			United Catalog Publishers, Inc.		683			655
			United Transformer Co.	301				610
			University Loudspeakers, Inc.	874	502 & 509			
			Utah Radio Products Co., Inc.	318				
			Vaco Products Co.	317				
			Vidatre Electronics Mfg. Corp.		664A			
			V-M Corp.	319				
			Vokar Corp.	888				
			Waldom Electronics, Inc.		658A-659A			
			P. Wall Mfg. Co.		602			
			Walsco Electronics Corp.	415				

Visit
TECHNICIAN & Circuit Digests
at the Parts Show
Room 504

Parker Metal Goods Co.	785	629A
Peerless Products Industries	107	
Penn Television Products Co.	203	636
Pentron Corp.	577	505-507
Permacel Tape Corp.	880	628
Perma-Power Company	586	
Permosflux Corporation		550A-551A
Permo, Incorporated	411	
Phaotron Instrument & Electronic Co.	782	618
Philmore Manufacturing Co. Inc.	587	557A
Pickering & Co., Inc.		534A
Pilot Radio Corporation		639A-640A
Potter & Brumfield	222	
Precise Development Corp.	121	
Precision Apparatus Company, Inc.	403	
Premier Metal Products Co.	878	
Presto Recording Corp.		600
Pyramid Electric Company	213	
Q-Line Manufacturing Corp.	106	
Quam-Nichols Company	312	
Racon Electric Co., Inc.		557
The Radlart Corporation	420	
Radio City Products Co. Inc.	581	
Radio Corporation of America	691	560-561
Radio & Electronic Jobber News		509A
Radio-Electronics		632
Radio Kits, Inc.	890	
Radio Merchandise Sales Inc.	583	
Radian Corporation		635A-636A
Radio Receptor Co.		530A
Radio & Television News		634A
Radio & Television Weekly		658
The Radix Wire Company	2	
Ram Electronics Inc.		537
Rauland-Borg Corp.		542A-544A

CLOSED-TV FOR BANK



At the Texas National Bank's motor bank, two blocks away from the main building in downtown Houston, four teller's booths like this are equipped with built-in closed-circuit television receivers made by Dage Television Div., Thompson Products, Inc., Michigan City, Ind. The receivers are part of a closed-circuit TV system which speeds signature checking between the drive-in branch and the bank's main bookkeeping department.

"Rollabout" Cart TV



A 2-wheeled cart affixed to the bottom of Raytheon's model M-1760-E, 17-in. table model, permits the set to be wheeled about from one room to another, upstairs or downstairs, in a house, motel or hotel. The two front legs, without wheels, provide solidity when the set is rolled into position. The cart is available with the set at no increase in price. The receiver is a metal-cabinet vertical-chassis design with top tuning.

Diagnosing Defects in

Before You Replace This Expensive Component,

CHARLES GARRETT

• Of all the tubes in a TV set, the crt or picture tube is the most difficult in which to isolate a defect accurately. The methods used to trace a picture defect to the crt are necessarily more complex than those used for regular receiving tubes, where direct substitution of a suspected tube is the usual simple way of proving them good or bad. The direct substitution method unfortunately is impractical with picture tubes due to the high cost of stocking even a small variety of tube types. Therefore other methods must be applied in order to prove a crt defective or not.

To begin with, the technician should acquaint himself, if he already hasn't, with defects that appear in the picture and on the screen which could be caused by a defective "big tube." Most of these are listed here, along with some possible internal defects in the tube which could cause them. They are: no brightness (low emission, open cathode, dead filament), low brightness (low emission, high-resistance cathode connection), no picture or faint picture (open grid), washed out or negative picture (low emission cathode, gassiness, defective grid), intermittently flashing picture and/or brightness (intermittent tube connection), and intermittent slowly fading picture and brightness (defective filament or filament base pin connections). Most of these conditions could also be caused by shorts or leakage between elements—and, of course, by other tubes and components in the set.

An important point to consider in checking pix tubes is the proper use of a crt tester. It might seem that many of the above picture conditions, if caused by the "big tube," would show up on such a tester, or a receiving tube tester with an adapter cable and socket. This, unfortunately, is not always the case. The emission test of a picture tube does not tell everything about its actual picture-reproducing qualities.

Often satisfactory performance can be obtained from tubes that in-

dicate low and even very low emission; while tubes that indicate high emission can give poor performance. Words to this effect are usually contained somewhere in the tester's operating instructions. This does not mean that these units are worthless; just that the emission test is not an absolute indication of actual tube performance. The real value of the tester is the checking for shorts, leakage, and gas, which would otherwise be difficult to locate.

Some Pix-Tube Defects

Picture tubes are subject to a variety of intermittent conditions; as much, if not more than regular receiving tubes. Among these are: intermittent filaments, cathodes, grids, and intermittent shorts. The following are some ideas on tracing an intermittent picture or brightness condition to the crt.

First, let us consider the filament,

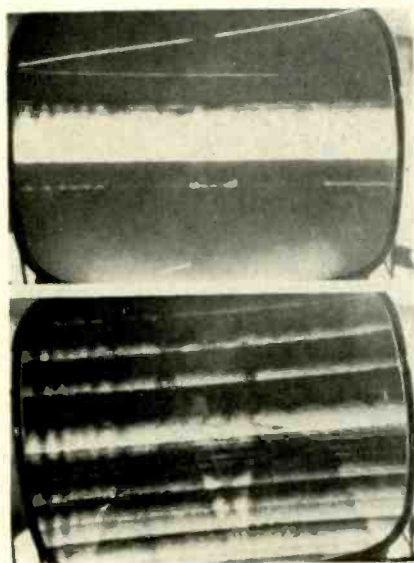

Fig. 1—These effects are produced when the neck of a crt with an open cathode is tapped.

since many of today's big-screen tubes develop filament trouble. Many cases of no brightness and fading brightness can be traced to a poor filament lead connection inside of the filament pins (pins 1 and 12) on the crt base, due to improper soldering during manufacture. When checking a set for an intermittent

brightness condition, always make a check on these pins.

With the set on, gentle twisting of the tube socket may cause the filament to go off and on; nevertheless, a visual inspection of the filament pins should be made. Look for a loose filament wire inside of the pin itself. If nothing is obvious, heat the pins with a soldering iron to remove the excess at the very tip. A thin shell of solder often falls away, revealing an unsoldered filament lead.

By crimping the defective pin or pins near the bakelite base with a pair of long-nose pliers, a good physical connection can be made which should clear up the trouble. If not, resolder. However, to solder it successfully, the pin may have to be split open at the seam by forcing a pointed tool into the end of the defective pin. This allows the wire and the inside of the pin to be cleaned of corrosion. Once cleaned and reshaped, solder will flow into it for a perfect bond.

No Pix or Raster

Another pix-tube condition, sometimes intermittent, shows up as an all-white screen with either no picture or a faint one; or a screen with no raster present at all. When this condition is intermittent, it may occur when the set is first turned on, then clear itself up after a few minutes; sometimes the reverse will happen.

Generally with a defective tube displaying a white-screen condition (only a raster present), the brightness (and sometimes the contrast) control is inoperative, and has a negligible effect on the raster. Nevertheless, if one of these conditions exists and no other cause can be found, try tapping the neck of the picture tube lightly with the plastic handle of a tool while watching the screen. Notice (if a black screen exists), whether the picture flashes on or whether white bars of picture content go across the screen; and (on a white screen) if flashes of picture go across. The entire picture may flash on and off also.

If these conditions show up when the tube neck is tapped, it indicates

Television Picture Tubes

Make Sure You Have Eliminated Other Possibilities

that the tube has either an open grid or cathode, or perhaps has a short between these two. Tapping of the neck may make a momentary correction of one of these conditions. Try tapping the chassis and surrounding tubes and components to be certain that something other than the crt isn't defective in this manner. When this condition is brought on by a particle of some kind shorting between elements in the tube, tapping can permanently dislodge the particle and completely clear up the trouble.

No Contrast, Negative Pix

A defective big tube can be the cause of the loss of contrast or a negative picture developing when the contrast or brightness control is advanced beyond a certain point. There are several methods of tracing these conditions to the picture tube. One is to rotate the brightness control through its range while noticing changes in picture contrast and definition. A defective crt can be suspected if both deteriorate beyond a certain setting.

A negative picture often forms at a high brightness setting although all may appear normal at a lower point. The tube can be suspected, since the brightness control effects only the crt circuit and not the video stages, where the same conditions could arise. Another check is to advance both brightness and contrast controls to full and then rotate the ion trap one way and then the other to reduce screen brightness slightly. In a defective tube, a position for the ion trap usually can be found that will greatly improve the contrast and picture definition.

One further check is to install a tube "brightener" or "filament booster" for a few minutes, recheck the ion trap setting, and notice if any worthwhile improvement develops. If so, there can be little remaining doubt that the tube is worn out. A brightener is also useful when checking a low brightness condition. This device uses a filament step-up transformer to raise the crt filament voltage from 6.3 to 8 or 9 volts to encourage a higher cathode

emission. Since a brightener sometimes "pops" a filament when left on, be careful not to give any guarantee when selling one.

If, after making the preceding tests and quick checks, the technician still is doubtful, one more test can be performed to isolate a defect.

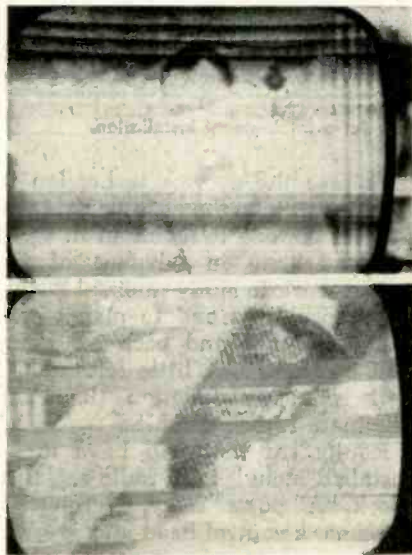

Fig. 2—These effects are produced when the neck of a crt with an open grid is tapped.

Direct substitution of the same crt type, of course, would be best, but the same results can be obtained by using an old 10 or 12 inch tube that is in known good condition. Simply install the small tube in the yoke; support it with any convenient support; connect the high voltage lead and tube socket, (also ion trap if needed), and then compare performance to that of the original tube. Width and focus may not be perfect when used on a big screen set; however, this is unimportant for testing purposes.

"Test Tube" Types

Convenient types to use as a "test tube" are the 10FP4 or the 12KP4, since they require no ion trap. If the tube used requires one, use the single-magnet type, since it is easier and quicker to set. The tube can be taken from an old junk set, or a low-cost "rebuilt" tube can be obtained for this purpose. Currently available

"universal" substitution types, like the 5AXP4, are also convenient, being made for just such applications.

The most important part of servicing picture tubes is being able to recognize those picture and raster conditions associated with defects. Being able simply and accurately to diagnose a big tube, good or bad, is a necessity to prevent the needless purchase of a new tube which, especially if an unusual size or type, might become stagnant stock and be very slow to sell. •

Plan Your Shop Work

DAN VALENTINE

A radio-TV repair shop could borrow something from a newspaper city room.

In the news room of nearly any big-city daily newspaper, you will always find an assignment sheet hanging on the wall. It may be a blackboard, or it may just be a large sheet of paper—but it is always plainly visible, showing the assignments of the day for the paper's editorial staff.

When a reporter checks in for work, he automatically looks at the assignment sheet or board to find his day's work mapped out for him in black and white. There is no wasted time, no wasted motion. He is ready to go to work the moment he steps into the office.

The city editor of the paper keeps the assignment sheet up to date. He knows where each man is at any moment and he knows what he is doing.

A radio-TV repair shop can run on the city-desk system. Why don't you become the city editor in your shop? Plan work the evening before, and place assignments on a large blackboard in the rear of the store or stockroom. This plan, which makes for added efficiency, can save much confusion.

If the board is kept up to date, workers in the shop do not lose track of time to report, days off, and quitting time. They will know as soon as they check the board just what has to be done that day, and in what order.

Installing

Procedures and



Typical mounting of the control head and the speaker for a trunk-mount installation.

JOHN W. HARDY
ROLLA COMMUNICATIONS SERVICE
(A MOTOROLA STATION)

• Methods of installing two-way radio units will vary with the type of vehicle—car, truck, boat, etc.—and with the individual service technician; yet a good installation will always be made with the following principles in mind:

First, install the equipment to satisfy the user's present needs and future convenience. Second, provide an installation that will enable the radio to give optimum performance, not just "satisfactory performance." Third, consider the problems that

may face the service technician in the future; take the attitude that you will be the one to maintain it.

Spend time in advance of the actual work to study unusual installation problems and to plan where the radio unit and each accessory will be located. A little forethought will reduce installation time and eliminate future troubles.

Equipment that will have to be installed includes the radio set, fuse block, "A" power relay, microphone, antenna, a control head and speaker in the case of a rear mount radio and, of course, the interconnecting power and control cables. Only general considerations for installing

two-way radio are given here; for specific details on a particular radio, see the manufacturer's literature.

One of the most difficult installations to make is that in a service truck used by gas and electric utilities. The first problem will be that of finding space inside the cab for the radio set. If that is impossible, a quick solution is to put the radio unit in a weatherproof housing and install on a sturdy part of the truck body.

Generally the left side of the truck is to be preferred for the housing as it is less exposed to branches, etc. than the right side. Because the chassis should be accessible for maintenance, it should be placed so that it can be pulled out without unloading articles normally carried in the truck. For the same reason, the cables should be long enough to permit removal of the chassis.

Accessories

Spacers, washers and overhung braces will be required for the type of installation. The last can be made from galvanized pole cross-arm braces such as are usually available from electric utilities. They are sufficiently strong and can be bent fairly easily.

The control head and microphone should be located so that they are easily reached by the operator, yet will not interfere in any way with the operation of the vehicle. It is well to consider left-handed operators when positioning the control head and microphone. Also, leave enough slack in the control cables so that the control head can be turned around for inspection.

Loudspeakers should be mounted near the operator. When inherent noise level is high, a good location is on the face of the dashboard. If there will be occasions when management will wish to contact the vehicle operator while he is away from the truck, it may be desirable to mount a small weatherproof loudspeaker on the outside and install a DPDT switch on the control head for speaker selection. These external directional speakers, even though driven by an ordinary output stage,

Detail for a trunk-mounted installation of a two-way mobile radio in an automobile.

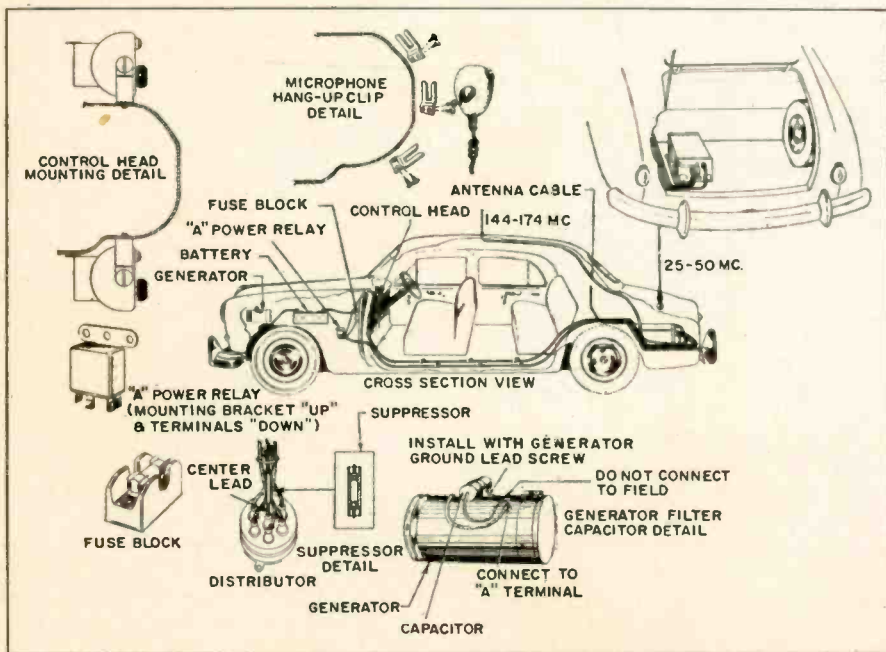

Mobile 2-Way Equipment

Practices for a Professional Job in All Types of Installations

can be heard a considerable distance from the vehicle.

The fuse block and relay are usually mounted with sheet metal screws on the engine side of the firewall in an accessible location. Be careful to place them so that acid overflowing from the battery cannot reach them. As additional protection, and to prevent foreign matter from entering the block, clamp a large flap of rubber cut from a discarded inner tube under one side of the block, lap it over and secure it with screws. A Buss "Clip-Clamp" can be used to keep the fuse from coming loose.

Quite often the "A" battery power lead is connected from the block to the starter relay, so that there will be no possibility of battery acid corroding the connection. The voltage drop in the battery cable is very small and does not add materially to the overall voltage drop of the "A" cable. However, if there is any evidence that ignition noise is being picked up by the "A" cable, it is better to connect a cable directly to the battery terminal. The battery acts as a large capacitor and bypasses the noise to ground. Proper care of the battery will prevent corrosion at the terminals.

Cable Routing

When the radio and its housing are mounted in the truck bed, cables must be thoroughly protected along their entire length. After the cable routing has been planned, route a length of Greenfield flexible conduit, "Sealtite," or other sturdy flexible conduit, from the fuse block and relay location on the firewall, alongside the frame on the inside of the "C" to the housing. Then mark and cut it. Metallic conduit is preferred over hose or plastic pipe because it is abrasion-proof and will not become crushed and difficult to work in subsequent installations. Conduit ends, if not terminated in "Tite-Bite" or similar connectors, should be wrapped with a piece of rubber (a reject lineman's rubber glove is perfect) leaving two inches excess over the ends. Then, when the cables have been fished through, the excess

sleeving can be poked back inside the conduit, thus protecting the cables from the abrasive effect of the ends of the conduit. The end of the conduit on the firewall should be placed under the rubber fuse block flap to keep dirt out.

Openings in the firewall for the passage of cable from "A" relay to control head should be made high enough to prevent the entry of water or mud into the operator's compartment. A rotary hole saw is the best tool for cutting a hole large enough for the cable and rubber or friction tape wrap used for protection against abrasion. Conduit hangers of the proper size can be used to secure the conduit along much of its route;

however, wire is sufficient to secure it to the truck frame and prevent rattles. If the cable passes through the bed floor, be sure it is protected from shovels, pikes, etc., using a piece of old car frame or angle iron fastened securely.

After the conduit has been properly routed and fastened down, fish the cables through it using, as a combination fish wire and ground, a #4 copper wire for a 30-watt radio set or two #4 wires for a 60-watt set. Leave the wire in the conduit and connect one end to the battery ground, the other end to the housing and radio ground cable. Be sure to leave enough excess cable at the

(Continued on page 53)

Cabling detail and connections to be made in installing a trunk-mounted mobile radio.

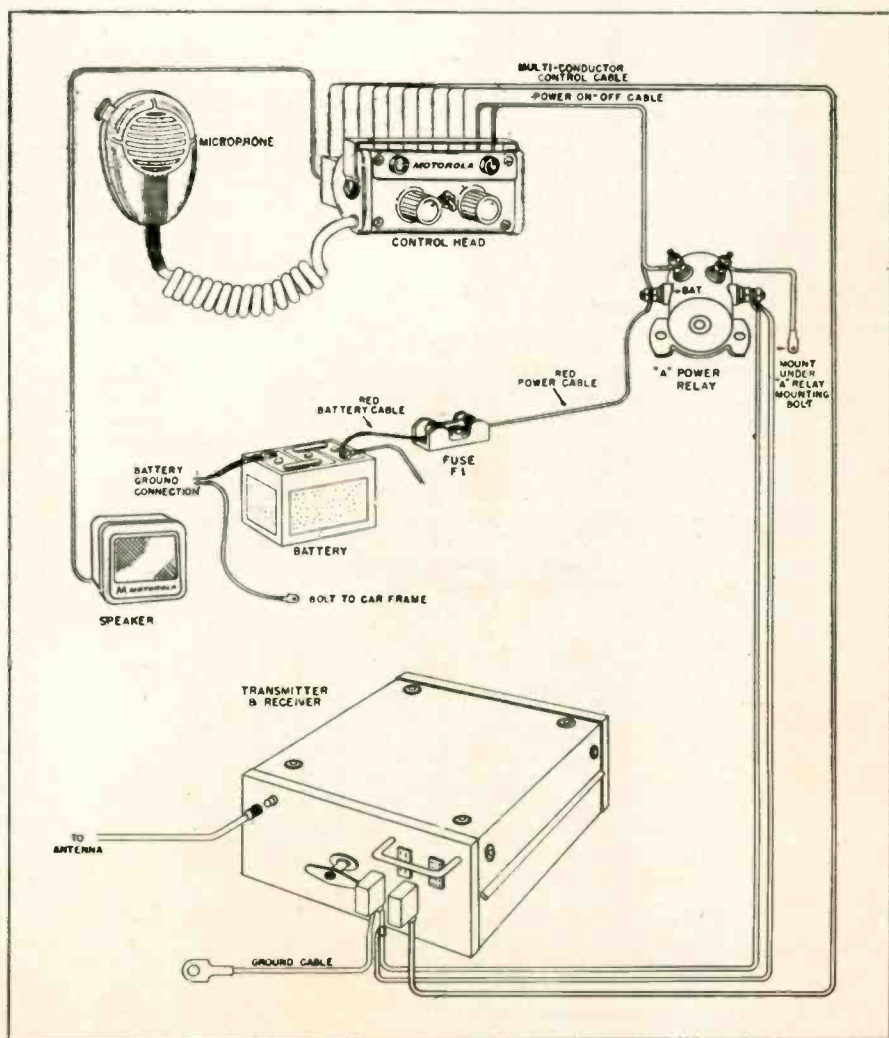

How to File Circuit Digests

Three Methods of Arranging Schematics for Instant Reference

The monthly 16-page Circuit Digests section of **TECHNICIAN** has been widely acclaimed by service techs across the U.S. and Canada. Perhaps the main reason for this praise is the fact that Circuit Digests provides more schematics soon after the introduction of new models, at no extra cost, than any other comparable service.

There are dozens of TV-radio manufacturers, and every year each

one introduces many new models. Were Circuit Digests to include only a couple of sets in each issue, the yearly coverage would be only a small percentage of new sets, making the service rather sketchy. Instead, Circuit Digests packs in as many new and important sets as possible, providing comprehensive coverage of new receivers. In 1955 there were 74 separate digests covering an even greater number of chassis and applicable to hundreds of individual models.

In order to include all these schematics, it is often necessary to print some of them back-to-back with other circuits. As many techs have discovered, this introduces no trouble in filing Circuit Digests if one of the two following filing systems are used.

1956 issue). This index gives the Circuit Digest number, which you can then pull out of the numerical file.

In this numerical filing, the Circuit Digests can either be kept folded in 16-page groups as they come in each issue of **TECHNICIAN**, with issue number showing (see Fig. 1), or they can be opened up to double-page size with Circuit Digests number showing (see Fig. 2). In either version, the Cumulative Index will tell you exactly where the make and model you want is located.



Fig. 1—Numerical filing by Circuit Digest groups as they appear in each issue. Cumulative Index lists makes and models covered, and gives Circuit Digests numbers included in each issue group.

Numerical Filing

Perhaps the simplest method is to file all schematics in numerical Circuit Digests order. To find any particular make and model, look up the model under the manufacturer's name in the Cumulative Index of all Circuit Digests to date, which is published every few months (latest index is in the April

Alphabetical Filing

Many techs prefer to file the circuit Digests in the alphabetical order of the manufacturer's name. One reason for this preference is an especially handy application of Circuit Digests made possible by the compact size and format. When a call for service comes in, the set owner is sure to know the brand name of his set, but seldom likely to know the chassis or model number. Many techs have found that it is then a simple matter to reach into the alphabetical file, remove the entire group of schematics under

Fig. 2 (l)—Numerical filing by individual Circuit Digests numbers. Cumulative Index lists makes and models covered.
Fig. 3 (r)—Alphabetical filing by manufacturer's name. Cross-

reference sheet is inserted to locate circuit printed on reverse side of another Circuit Digest filed under different company's name.

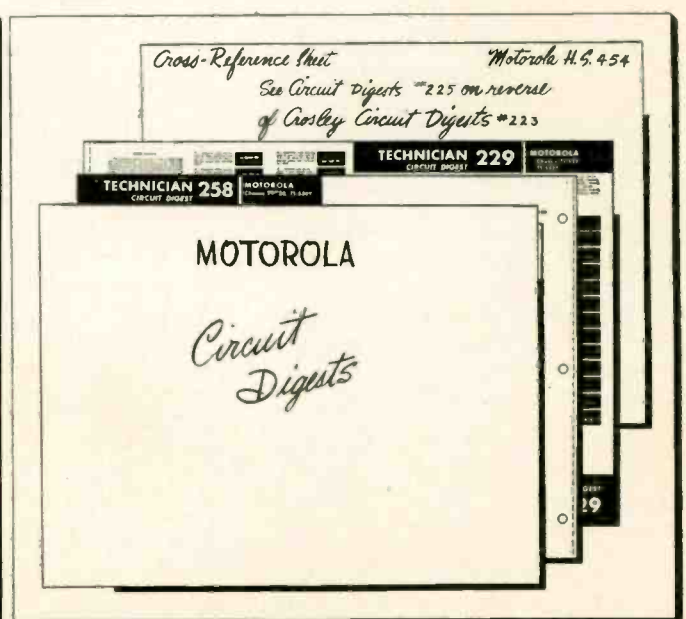

one manufacturer's name, and pack it into the tube and tool caddy without taking up a great deal of space. When the tech reaches the customer's home, he is thus equipped to expand the possibility of economical one-trip service in the owner's home by pulling out the appropriate Digest.

It's a simple matter to separate the circuits from each issue and file by company. In those cases where one company's schematic is on the back of another manufacturer's circuit, a cross-reference sheet eliminates filing problems. For example, take the particular case where Motorola HS-454 (Circuit Digest #225) is back-to-back with Crosley R100 (Digest #223). The sheet may be filed in place with Crosley schematics. The cross-reference sheet (see Fig. 3), which might read:

"Motorola HS-454. See Circuit Digest #225 on reverse side of Crosley Circuit Digest #223," is filed in place in the Motorola group. When the technician is using his group of Motorola data, he quickly flips through the group to check for cross-reference sheets. He can then complete the Motorola file, from these sheets, on the spot.

Physically, the Circuit Digests may be kept in a file drawer, separate cabinet, notebook, accordion-type folder or similar device. When alphabetical filing is employed, a large, labeled separation card between companies is helpful. In any case, the Cumulative Index will specifically tell you the many hundreds of chassis and thousands of models Circuit Digests covers.

In the latter connection, it is worth noting that many manufac-

turers add new models to their lines, using chassis already in existence, long after the appearance of the original group of models. Since Circuit Digests bring you the data you need as soon after the appearance of the chassis as possible, it is not always feasible to include later models in the listings. Therefore, if you should come across a model that does not appear to be covered by Circuit Digests, always double-check under the chassis number, which is listed first. Receiver coverage is actually even more extensive, in this sense, than the Cumulative Index shows.

If your file is not complete, you may obtain back copies listed in the Cumulative Index for only 25¢ per circuit, or 50¢ for the complete 16-page Circuit Digests section as it appeared in any issue.

Prices Technicians Charge

Survey Shows Averages for Various TV Servicing Jobs.

• In response to numerous inquiries, **TECHNICIAN** editors instituted a research project to determine how much technicians charge for making various TV repairs. The results are included in the accompanying chart, and provide all readers with a kind of yardstick against which their own charges may be measured. The survey was conducted among **TECHNICIAN** subscribers, practically all of whom are either shop owners or full-time techs.

If your charges are much higher than those shown, perhaps you've been losing customers because they think you overcharge. If your prices are much lower, you may be selling yourself short, and cutting your income unnecessarily.

In the chart, prices for installing an antenna or replacing a coil include both the cost for labor and part. To indicate the price variations in different localities, the charges made in a half-dozen different states across the country are presented, in addition to the national average. To see how techs evaluate their own charges, the following question was asked: "Do you consider your charges higher or lower than average for your area?" The bottom section of the chart shows that most

consider their charges average.

One point of interest not covered in the chart is the charge for replacing a 21-inch picture tube. There is considerable variation here, depending on whether a new or rebuilt

crt is used, a wide range of labor charges (from as low as \$3.00 to as high as \$20.00), etc. However, the national average is \$8.60 labor charge plus list price of the picture tube. •

	NATIONAL	CONN.	IND.	MINN.	N.J.	ORE.	TEXAS
Basic charge for house call	\$ 3.93	\$ 3.67	\$ 3.30	\$ 3.52	\$ 3.43	\$ 4.60	\$ 4.71
Avg. total charge for house call	\$ 7.82	\$ 5.20	\$ 7.19	\$ 7.25	\$ 7.58	\$ 9.35	\$ 8.04
Flat rate for installing single bay antenna	\$32.60	\$29.00	\$25.75	\$34.00	\$27.90	\$33.46	\$32.00
Total charge for replacing tuner	\$34.68	\$34.50	\$33.80	\$32.32	\$30.93	\$38.50	\$36.15
Total charge for replacing power transformer	\$29.45	\$28.92	\$26.25	\$29.14	\$29.85	\$29.73	\$30.87
Total charge for replacing deflection yoke	\$17.48	\$16.42	\$16.20	\$17.14	\$17.64	\$17.55	\$19.50
Total charge for replacing flyback transformer	\$18.79	\$19.00	\$16.90	\$18.18	\$19.28	\$19.80	\$19.44
Total charge for replacing horiz. osc. transformer	\$11.71	\$11.25	\$ 9.40	\$10.82	\$13.49	\$11.65	\$13.00
% of techs consider own charges:							
Above avg.	13.0%	17%	0%	0%	28%	20%	25%
Average	59.3%	33%	40%	77%	43%	60%	75%
Below avg.	27.7%	50%	60%	23%	29%	20%	0%

Adapt Your

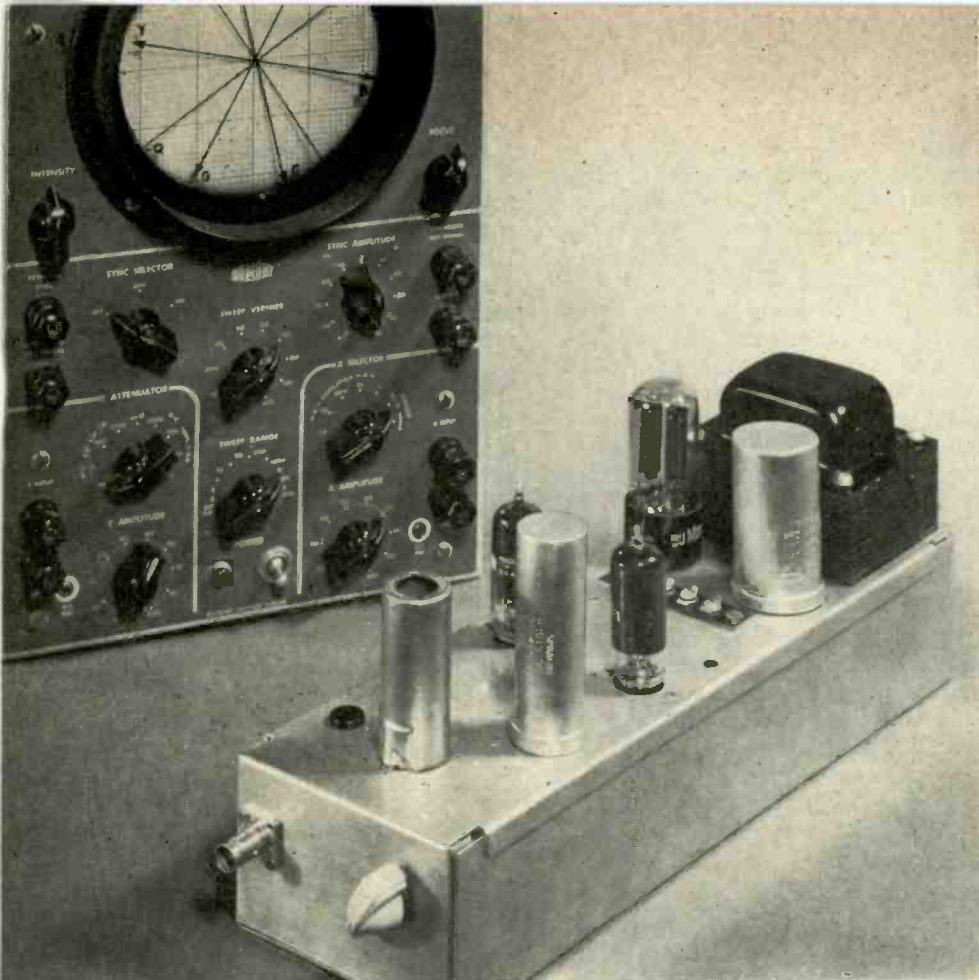

K. F. FEHLING, FORMERLY OF
ALLEN B. DUMONT LABS.

• An increasing need in the service shop, for black-and-white service as well as for use in color TV, is a wideband oscilloscope that is essentially flat to 4 mc. Many service shops have well-designed scopes of earlier vintage that meet all the requirements for modern servicing but one: limited bandwidth prohibits their use in many color and monochrome circuits.

Until such time as the shop is ready to invest in a new wideband oscilloscope, satisfactory work can be done with the old instrument, provided it is supplied with a wideband amplifier, to be connected to its vertical deflection plates, as a substitute for its own integral vertical amplifier. The wideband amplifier described here and shown schematically in Fig. 1, containing three tubes plus a rectifier, can be built at low cost to serve this purpose.

Design is simplified by the relatively low gain required. The average 5-in. crt must have about 20 volts applied directly to its plates to produce 1 in. of deflection. The lowest amplitude of any signal of interest in, say, a color receiver is the output of the video detector. Since this signal usually exceeds 2 volts, a gain of only 10 times would ap-

pear to be sufficient. However, since it is often essential to use a low capacitance probe for counteracting circuit loading, gain must be somewhat greater to overcome the probe loss.

The amplifier uses a 6AN8 triode-pentode to drive two 12BY7's in push-pull. The 6AN8 can be replaced with a 6U8 with little change in performance. The input triode,

connected as a cathode follower, features high input impedance, large signal-handling capability with low distortion, and low output impedance. The high impedance presents negligible loading to circuits under test. Low output impedance minimizes high frequency losses due to stray and wiring capacities. For the latter reason, placing the gain control in this low-impedance circuit reduces the usual distortion that occurs when the control is rotated from one position to another in a high-impedance circuit.

The pentode section of the 6AN8 is a good video amplifier, with very low output capacitance and high Gm, or transconductance. To realize maximum gain from this stage, combination shunt-series peaking is used. As a guide to those who may wish to build their own wideband amplifiers that depart from the design shown here or that use different tubes, computations used in determining values for this stage follow. See Fig. 2.

$$\begin{aligned} 6AN8 \text{ output cap.} &= 2.3 \text{ mmfd} \\ 12BY7 \text{ input cap.} &= 11.1 \\ \text{Stray cap. (est.)} &= 10 \\ \hline \text{Total cap.} &= 23.4 \text{ mmfd} \end{aligned}$$

Fig. 1—Complete schematic of the auxiliary scope wideband amplifier; also LCP schematic.

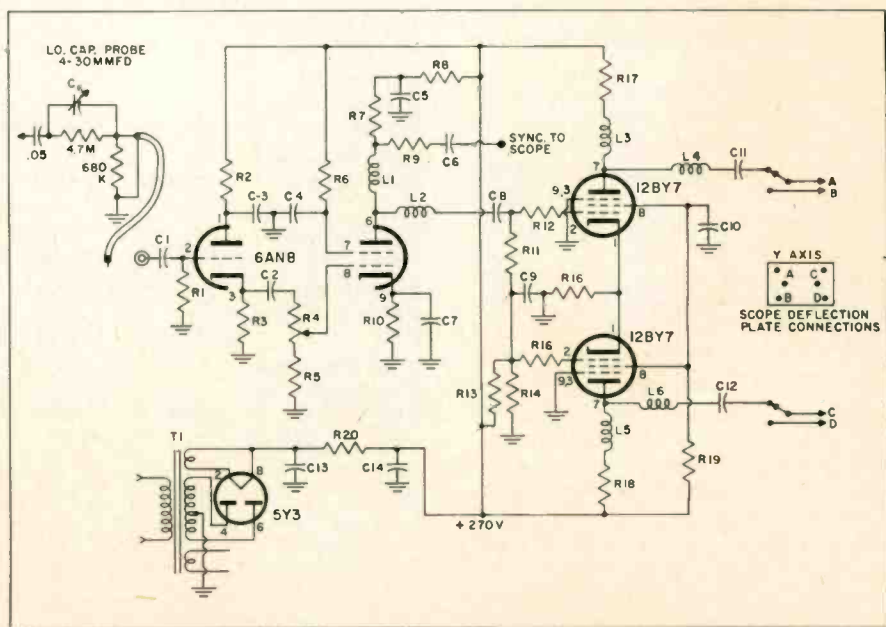

Scope for Wideband Use

Many Narrowband Scopes Now in Service Shops Can Be Used for Color, Other Wideband Work, with This Auxiliary Amplifier.

To simplify calculations, the value of C_t has been rounded out to 24 mmfd, which is accurate enough. Formulas used in determining the values of the load resistor (RL), the shunt peaking coil (L_1) and the series peaking coil (L_2) are given in Fig. 2, along with definitions of the values appearing in the formulas. To insure flat response at least to 3.58 mc, the value assigned to f is 4 mc. Substituting actual values in the formulas, we work out the following values for the load resistor and the two peaking coils:

$$RL = \frac{1.8}{6.28 \times 4 \times 10^6 \times 24 \times 10^{-12}} = 3000 \text{ ohms}$$

$$L_1 = .12 C_t RL^2 = .12 \times 24 \times 10^{-12} \times 9 \times 10^6 = 26 \text{ uh}$$

$$L_2 = .5 C_t RL^2 = .5 \times 24 \times 10^{-12} \times 9 \times 10^6 = 108 \text{ uh}$$

The only difficulty in working out the arithmetic is in getting the deci-

sistor, f is the lowest frequency to which flat response is desired, and C_c is the value of the capacitor in the compensating network. Inasmuch as a 30-mfd capacitor was already available in the 3-section

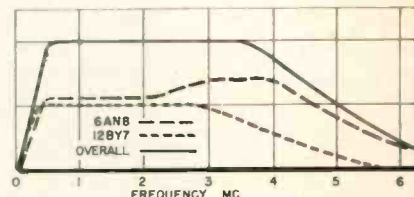

Fig. 4—Response curves for wideband stages.

develops an identical signal across R_c , the common cathode resistor of the two push-pull tubes. With the grid of V2 grounded, this latter stage (V2) uses its cathode as the signal-input electrode—as is common with grounded-grid amplifiers. Also as in other grounded-grid amplifiers, the signal present at the V2 cathode is amplified *without phase reversal* at the plate. Since V1 is meanwhile functioning as a normal amplifier with the grid used for signal input, it amplifies with the usual phase shift of 180 degrees.

Referring again to the complete circuit as shown in Fig. 1: because the 12BY7's operate with little or no bias, a positive bucking voltage is applied to the control grids through voltage divider R13 and R14.

12BY7 Compensation

Plate load resistors, as well as shunt and series peaking inductors, were selected for the 12BY7's according to the formulas already presented in Fig. 2 and worked out for the first stage of amplification. It should not be necessary to execute the mathematics again. Values used for the computations on the pentode section of the 6AN8 are used again here except, of course, that the capacitances are different. These are as follows:

$$\begin{aligned} 12BY7 \text{ output cap.} &= 3 \text{ mmfd} \\ \text{CRT input cap.} &= 20 \\ \text{Stray cap.} &= 10 \end{aligned}$$

$$\text{Total cap.} = 33 \text{ mmfd}$$

The input capacitance of the crt may vary from one scope to another depending on the input capacitance to the deflection plates of the particular crt used and the manner in which wiring for external connection

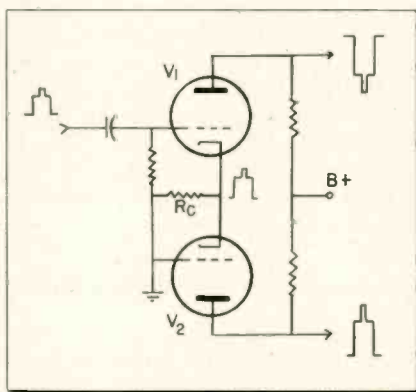

Fig. 3—Cathode-coupled paraphase circuit.

electrolytic chosen earlier for use in this amplifier, and the value of 1 cycle-per-second was assigned to f , the formula was used to solve for resistor R_c . This value was found to be 5300 ohms.

Use of a push-pull amplifier minimizes defocusing of the crt spot during use. For this circuit, 12BY7's were chosen for their high figure of merit and current-handling capability. To develop a sizeable output voltage, output current must be high, since a low value of plate resistance is made necessary for wide frequency response. For this reason, transmitting type tubes are often used in wideband high-gain amplifiers of this type. These latter tubes, however, require large driving voltages. For our application, the 12BY7 does a fine job.

Paraphase Circuit

To obtain push-pull signal for the output tubes, a cathode-coupled paraphase circuit is used. Commonly used in oscilloscope design for years, this network eliminates the need for a separate phase-splitter tube. Briefly, with reference to the simplified circuit in Fig. 3, it functions as follows: The signal input to V1

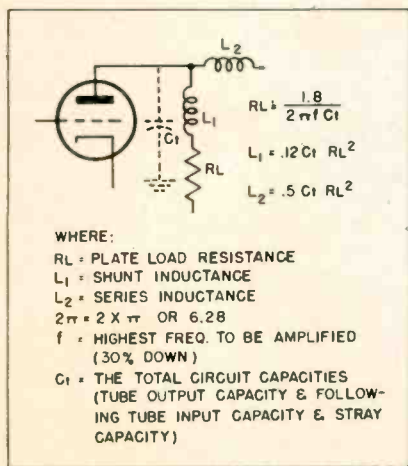

Fig. 2—Formulas for deriving values of load resistors and chokes for wideband stages.

mal point in the right place. Use of the powers of ten, as shown, helps considerably. Contrary to general belief, use of wire-wound resistors in the circuit will have little effect, if any, on overall response in this frequency range. The inductance of a typical wire-wound resistor for use in such an application is generally well under 5 uh.

The low-frequency compensation network (C_5 and R_8 in Fig. 1) is worked out from the following formula: $R_c = 1/2 f C_c$, where R_c is the value of the compensating re-

to these crt plates is made. Information as to the exact value of input capacitance may be sought in the specifications for the instrument, the tube manual, or from the instrument manufacturer. To allow for adaptability to different types of scopes, variable inductances could be used in the compensating networks. The value used in this case was for the Du Mont Type 304H scope, with which the amplifier was to be used. Ordinarily, differences in this value will not be great.

If the reader takes the trouble to verify some of the values shown with his own computations, he will find some small discrepancies in those actually used. This has been done for practical reasons. Where a slight sacrifice of bandwidth for gain has been made in one stage, it has been made up in another, by "staggering" the compensation over two stages. This has some similarity to stagger tuning used in TV i-f amplifier design. The effect can be seen

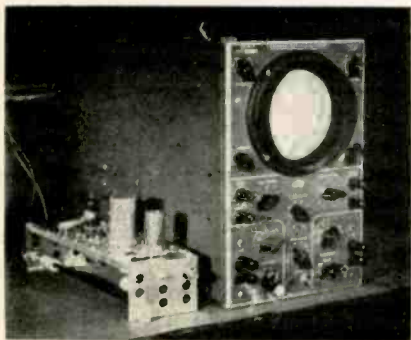

Fig. 5—Breadboard version of the amplifier.

by examining the separate response curves for the 6AN8 stage and the 12BY7 stage in Fig. 4. Combined, they produce the desired overall response curve, slightly down at 4 mc (about 3 db).

To facilitate development, a

breadboard type of chassis was used (see Fig. 5), consisting of a rigid frame and an assortment of punched phenolic plates. The plates accommodate all types of tube sockets and provide numerous insulated tie points. This saved the trouble of punching out a chassis only to find that changes later required in layout could not be made easily. On completion of the unit, if desired, it may be permanently built on a conventional chassis, like the one shown in the illustration at the beginning of the article. The bottom view of the completed box-type amplifier chassis (12 in. by 3 in. by 2½ in. deep) appears in Fig. 6.

Parts layout should follow good high-frequency wiring practice. Peaking coils, coupling capacitors, plate resistors, grid resistors, and all associated wiring should be well spaced from the chassis and each other. The arbitrary figure of 10 mmfd stray capacity allowed for in the calculations can be greatly exceeded if good practice is not observed.

Some Added Refinements

Peaking coils close to the computed values were selected from stock. Even flatter response can be obtained by the use of variable inductances. A switch has been included in the completed version to restore the oscilloscope to normal low-frequency use, when desired, without removing the input connection from the separate amplifier and transferring it to the scope input. Details of the switch and corresponding connections to the external deflection-plate tie points for the 304H scope are shown to the right in Fig. 1.

A low-capacitance probe can be purchased or built, since one will

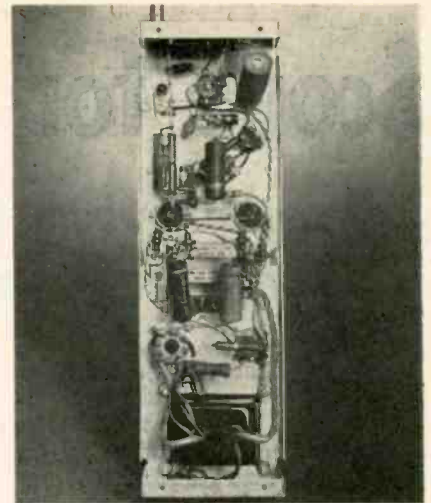

Fig. 6—Underside of the complete amplifier.

have to be used in conjunction with most high-frequency receiver circuits. The details of such a probe are shown at the upper left in Fig. 1. The components involved can be readily mounted in a length of phenolic tube having a ½-in. inside diameter. The compensating capacitor (Cc) should be adjusted for a flat-top square-wave response. Probe attenuation will be about 10 to 1.

When using the probe, any color signals may be observed without the need for a step attenuator in the amplifier input. The input stage of the amplifier will accept a 20-volt (peak-to-peak) signal without overload. Allowing for probe attenuation, this would correspond to a 220-volt (p-p) signal.

Measured sensitivity of the amplifier is 0.2 volt per in. Transient response is good.

Synchronizing voltage must be taken from the separate amplifier and applied to the external sync input of the companion oscilloscope. This take-off point is indicated as "Sync to Scope" in Fig. 1. Resistor R9, in this sync output point, is used to prevent the loading down of the 6AN8 pentode plate circuit when the sync connection is made. •

450-ma Series-String Tubes

The GE Tube Department announces a new line of TV receiving tubes intended to reduce series-string heater power 25%, easing design problems in the trend to smaller, portable sets. These tubes will draw 450 ma of heater current, instead of 600 ma.

Some advantages of this new line: elimination or reduction of heater dropping resistor, reduced cabinet size, reduction of ventilation problems and overheating, improved stability, and lower component cost.

PARTS LIST

C1 0.2, 600 v	C14 40, 450 v (B)	R13 100k, 1 w, 10%
C2 100, 25 v	R1 1 meg	R14 2.7k, 10%
C3 10, 250 v (A)	R2 10k, 2 w	R15 47
C4 10, 250 v (A)	R3 1k, 1 w	R16 100, 1 w
C5 30, 250 v (A)	R4 1k, pot.	R17 2.5k, 7 w
C6 0.01, 500 v	R5 150	R18 2.5k, 7 w
C7 0.0005, 200 v	R6 56k, 2 w	R19 6.8k, 2 w
C8 0.5, 400 v	R7 2.4k, 2 w	R20 500, 10 w
C9 50, 25 v	R8 5k, 2 w	L1 16-24, or 22 fixed
C10 10, 250 v (B)	R9 100k	L2 105
C11 0.1, 600 v	R10 100, 1 w	L3 22
C12 0.1, 600 v	R11 470k	L4 93
C13 30, 450 v (B)	R12 47	L5 22
		L6 93

Power xformer (min. specs.): 6.3 v, 2 amp; 5 v, 2 amp; 650 v, ct, 80 ma. (Merit #P2951, or similar)

Switch, DPDT, wafer type

Unless otherwise stated, capacitor values are in microfarads, resistors in ohms at ½ watt and 20% tolerance, and inductances are in microhenries.

Capacitors marked (A) are sections of a triple-electrolytic can.

Capacitors marked (B) are sections of a triple-electrolytic can.

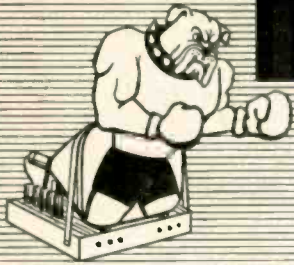

"Tough Dog"



Corner

Difficult Service Jobs Described by Readers

Vertical Size Problem

We couldn't get enough vertical size on this CBS-Columbia TV receiver. All components in the vertical circuit checked normal. A few replacements were tried for the vertical output tube, to no avail. The symptoms indicated leakage at the plate of the vertical output tube but,

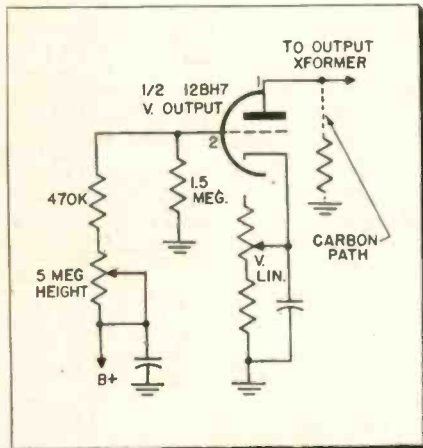

Hidden socket leakage path reduced output.

except for the fact that the voltage was low at this point (pin 1, 12BH7, in the diagram), all checks of components showed normal conditions.

After spending some time to carefully eliminate other possibilities, it was decided that the pin on the tube socket must be at fault. However, after the pin was replaced, the trouble was still there. In a sense, this was our undoing, because it served to mask the actual trouble still further.

After some time spent in rechecking, it was once more concluded that the trouble had to be somewhere in that tube socket. From what could be seen of the socket while it was in the chassis, there were no abnormal indications. However, after it was removed, it was easy to see what had been causing the trouble. A carbon path had been burned between pin 1 and the center of the socket, which was grounded, creating a resistive leakage path from the plate of the

vertical output tube to ground. The guess is it was probably not the 420 volts of boosted B-plus at the plate of this tube that had set up this path, but rather the higher peak-to-peak value of the vertical output waveform at this plate that had been arcing. In any case, next time I come across a suspicious-looking pin on a tube socket, I'm going to save time by replacing the whole socket instead of one pin.—*Russell Scarpelli, Gulfport, Mississippi.*

Low-High VHF Converter

In your March issue, reader L. D. Howard of Tunnelton, West Virginia makes inquiry about a converter to change a high VHF channel into one on a low band. Several years ago, I successfully built such a device to convert Channel 13 to Channel 6. The device is illustrated here. Since reader Howard may wish to use channels other than the ones I used, the winding details given for the coils may vary from the figures given. However, with these details as a guide and a little experimenting with the coils and/or variable condensers to insure proper coupling on the channels he wishes to use, I believe it would work well for him too.—*N. L. Brown, St. Johnsville, N. Y.*

Schematic and coil detail for converter with input on Channel 13, output on Channel 6.

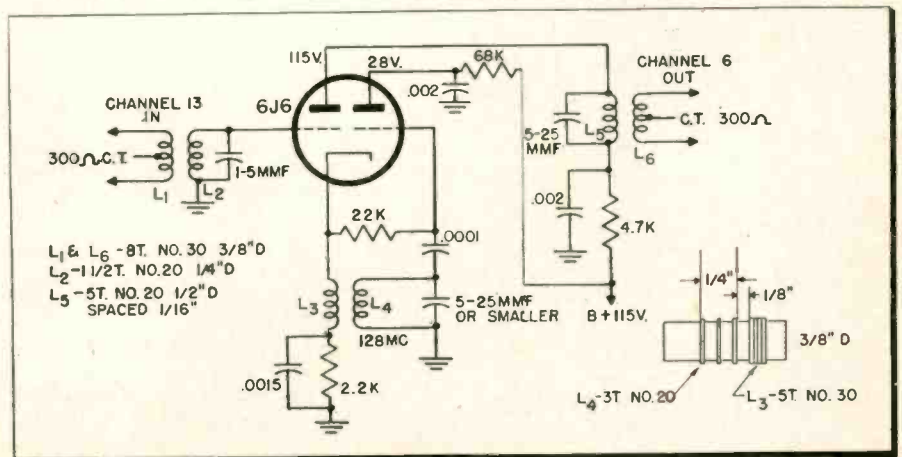

\$10 For Your "Tough Dog Story"

Have you tangled with a difficult or obscure service problem recently? Write it up, telling us how you licked it. Use drawings to illustrate your explanations wherever necessary. A rough sketch will do as long as it can be followed. Send it to "Tough Dog" Editor, TECHNICIAN, Caldwell-Clements, Inc., 480 Lexington Ave., N. Y. 17, N. Y.

Sound in Pix

This set, a Philco, first came into the shop with low sound output. It was a simple matter to repair, and the set was returned to the owner. Not an hour later, the customer was back with another complaint.

At full volume, when the set was really blasting away, sound bars were so evident that they tore the picture apart. I checked for audio on B-plus line and found it there, as expected. The logical step was to bridge the bypass filters in the audio output stage; however, this didn't help.

The next check was on the agc line, where the sound modulation was also in evidence. To see how much of the sound was in the video circuits, I checked there. The video trace on the scope was just jumping with sound signal. Next the agc line was disconnected and straight dc bias from a battery was substituted. This got rid of the visible symptom.

(Continued on page 52)

Phono Repair Check List

Guide to Symptoms and Location of Trouble Sources

For quick reference, presented below are commonly encountered phono system troubles, together with servicing tips and the location of probable sources. For detailed explanations of servicing techniques for phonos and associated audio equipment, see accompanying list of selected articles.

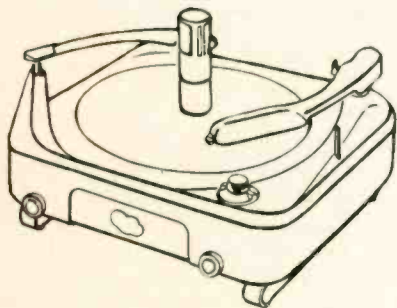

✓ Jamming

Symptom: Changer sticks momentarily or stops completely during record changing cycle.

Source: Dirt, burrs or broken part in trip actuating, drive or indexing mechanisms. Excessive friction or no lubrication between moving parts. Wiring enmeshed in gears. Bind in spindle bearing or motor shaft, motor stalling. Very low line voltage. **Tip:** With power off, rotate turntable by hand, observing action of parts under base.

✓ Wow

Symptom: Pitch changes caused by variations in turntable speed.

Source: Drive wheel wobble, worn or eccentric idler. Turntable bent or rubbing against obstruction. Loose

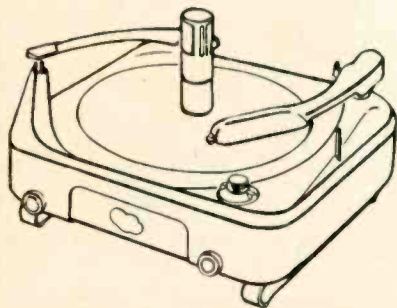

bearing, washer missing on central bearing. Slippage caused by oil on drive wheel or belt. Loose idler spring. **Tip:** Extremely small dent on wheel can cause wow, so don't rely on visual inspection alone.

✓ Rumble

Symptom: Low frequency mechanical vibrations transmitted to pickup. **Source:** Changer not floating properly on spring isolators or cushions. Excessive cabinet vibrations. **Tip:** Make sure shipping screws fastening changer tightly against base have been loosened or removed. Sponge rubber turntable mat may help.

✓ Hum

Symptom: Continuous undesired pickup of 60-cycle ac.

Source: Improper placement or shielding of wires from pickup. Ground lead absent or broken. Stray field from turntable motor reaching pickup. Faulty cartridge. Unbalanced output tubes. **Tip:** Sometimes

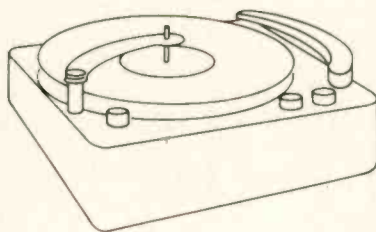

changing orientation of amplifier, with its husky power transformer, cuts inductive coupling.

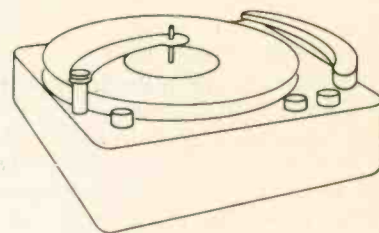

✓ Output

Symptom: Output low, intermittent or absent.

Source: Worn or broken needle, faulty cartridge. Failure in amplifier. Poor connection between elements of system. **Tip:** After disconnecting cartridge, touch finger to amplifier phono input. If hum is heard, trouble may be attributed to pickup.

✓ Tracking

Symptom: Needle skips or repeats record grooves.

Source: Worn needle, inadequate arm pressure, turntable not level. Cartridge not properly positioned in arm. Binding in arm mount. High turntable vibration (see "rumble"). Warped and worn record discs. **Tip:** When groove skipping occurs only at beginning of record, check arm indexing mechanism.

AUDIO SERVICING

Selected articles from **TECHNICIAN** recommended for improving your troubleshooting and installation efficiency.

"Tape Recorder Case Book"—March 1956.

"Tell-Tale Marks Reveal Tape Recorder Flaws"—Feb. 1956.

"Connecting High Fidelity Phono Pickup Cartridges"—Jan. 1956.

"Servicing Hi-Fi Record Preamplifier Equalizers"—Nov. 1955.

"Tooling Up for Hi-Fi"—June 1955.

"You Can Service Hi-Fi"—June 1955.

"PA Installation Problems"—May 1955.

"Adding Extra Speakers"—March 1955.

"Sound System Application Guide"—Jan. 1955.

"Tape Recorder Repairs"—Dec. 1954.

"Electrostatic Hum Pickup"—Nov. 1954.

"Hum-Bugging Audio Amplifiers"—Oct. 1954.

"Setting Up a Successful PA Sound System"—Aug. 1954.

"Servicing Automatic Record Changer Trip Mechanisms"—April 1954.

"Servicing Phono Motors and Drive Assemblies"—Nov. 1953.

SHOP HINTS



Tips for Home and Bench Service by Readers

Vise Net Catches Parts

When parts are worked in a vise on the bench, there is often trouble because small parts fall from the

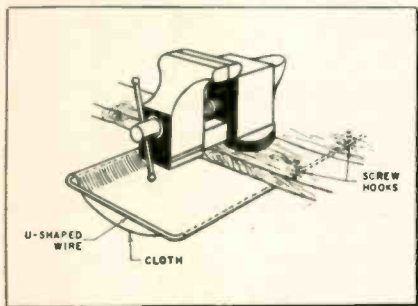

Net under bench vise catches falling parts.

vise to the floor of the shop. This can be avoided by the use of a simple cloth net, supported on a wire frame, placed right underneath the vise below the bench top. The frame is made of stiff wire bent into an approximate U shape, as shown in the illustration. The frame slides in and out of screw eyes or hooks, so that the net can be removed when needed. The edges of the cloth may be hemmed to fit over the wire, or held in place with safety pins.—Stanley Clark, E. Bradenton, Fla.

Low-Cap Probe Clips

When testing with crystal probes in high-frequency circuits—about the only place these probes are used—tests should be made with the probe in relatively permanent contact with the circuit element. This is advisable to keep the hand, arm, body, etc. away from the tested circuit. Enough stray variation occurs from the very presence of the probe case and leads without adding any additional variation due to hand capacity.

To accomplish this type of connection for relatively low-frequency circuits, such as in the video amplifier of a TV set for setting 4.5-mc traps and the like, the hot probe tip may have an alligator clip slipped on it as is shown in photo A. If the probe tip does not fit tightly into the end of the clip, crimp the round end of the clip to make a tight fit. For higher frequencies, such as in the i-f system, where even the additional capacity of an alligator clip may present a problem, a small paper clip may be used to make the connection. It is bent into the shape shown in photo B and slipped on the probe tip. The probe can be attached to circuit elements easily with this device.—L. A. Williams, Brooklyn, N. Y.

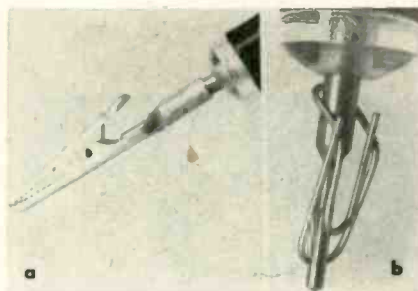

Probe clips for use in high-frequency tests.

Extra Duty for H-V Aids

Accessories use in service work on high-voltage circuits can be employed for other unheralded jobs, in many cases. Anti-corona "dope," for example, makes an excellent replacement for the cement used in making speaker cone repairs. In fact, it does a much neater and more thorough job than regular speaker cone cement. Even when used with tissue paper patches, the black corona dope, heavy and undiluted though it is, sets evenly and smoothly.

High-voltage tape also has applications for which it was not originally intended. When wound around the base of a picture tube, it prevents the base from pulling out. It can also be wound around the neck

of the picture tube at the point where the flare of the pix-tube bell begins. This protects the yoke windings whenever pix tube removal is necessary. The latter function is very important because, in many sets, the clearance between the neck of the tube and the yoke is very, very small.—Clifford H. Goldstein, E. Elmhurst, N. Y.

Loopstick Adjustment

Widely used as original AM receiver antennas as well as for replacement, the adjustable loopstick-type aerials are often annoying and tedious to adjust. As the coils come from the manufacturer, they are provided with a tiny screwdriver slot at the end of the core's screw, often making them difficult to tune. Much time can be wasted in attempting this procedure with the small screwdriver.

By soldering an ordinary lug on the screw as shown in the accompanying illustration, you can easily speed up the process of tuning and adjusting. If space around the loopstick coil is at a premium, the lug may be conveniently bent at right angles. Also, if it is desirable to do so, the lug can be snipped off shorter than is shown. It will still provide a convenient way of making the desired adjustments.—Joseph Amorse, Richmond, Virginia.

Lug on loopstick coil facilitates adjustment.

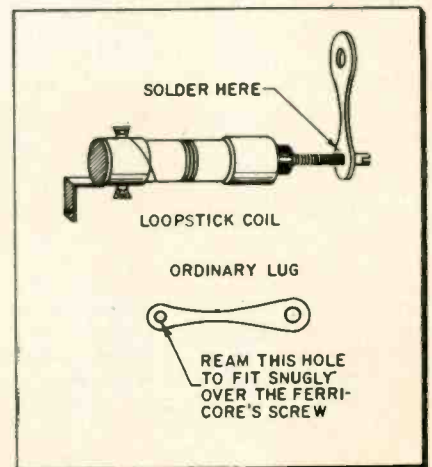

SHOP HINTS WANTED

TECHNICIAN will pay \$5 for acceptable shop hints. Unacceptable items will be returned. Use drawings to illustrate your explanations wherever necessary. A rough sketch will do as long as it can be followed. Send your hints to "Shop Hints," Editor, TECHNICIAN, Caldwell-Clements, Inc., 480 Lexington Ave., N. Y. 17, N. Y.

New Products for Technicians

Allweather CONICAL

New type conical antenna has solid aluminum elements mounted on a giant tuning fork, thus eliminating common insulator. Manufacturer reports method gives increased signal strength, and prevents insulator failure due to sea-shore salt air or city soot. Close-up shows air gap separating opposing antenna elements. Design is built around the metal "tuned insulators" which are intended to tune out coating of foreign matter. Allweather Antennas Mfg. Corp., 350 S. Egg Harbor Rd., Hamonton, N.J. (TECHNICIAN No. 5-15)

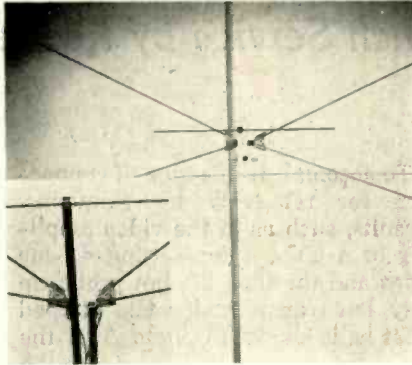

James POWER SUPPLY

Model C-1450 fixed/mobile communications power supply enables user to power equipment from 6 or 12 v. ignition systems or 117 v. 60 cycle. DC output is up to 250 v. at 100 ma for receiving, and dual output 500 v. at 175 ma and 250 v. at 75 ma for transmitting. When operating from 117 v. ac, it also supplies up to 10 amps for 6 or 12 v. filaments. Complete with control circuits. For commercial and amateur service. James Vibrapower Co., 4050 N. Rockwell St., Chicago 18, Ill. (TECHNICIAN No. 5-14)

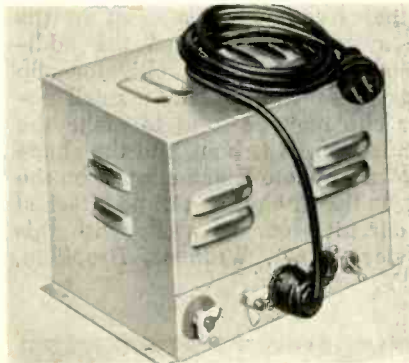

Telex TV "LISTENER"

Where individual TV listening is desired, the "Listener," part No. 9900 may be attached to set. The control unit has two jacks into which two earsets may be plugged. It also has a volume control and switch for turning set's speaker on or off. Unit measures 3½" diameter, 1" thick. Comes with 15-ft. cord from set to control, and earset with 4-ft. cord to control. Perfectly safe. Protected from damage by cushioning polyethylene ring with hanger. Telex, Inc., Electro-Acoustic Div., Telex Park., St. Paul 1, Minn. (TECHNICIAN No. 5-13)



Delco AUTO AERIAL

Dual automobile radio aerial designed for rear deck installation is packed in a handy display carton. Each contains two chrome plated aeriels, mounts, extension leads, clips and all necessary fasteners. Base assembly has been designed for top mounting, which overcomes restricted space problems often found in rear fender applications. Masts extend to 30", and are of 3-section design with built-in anti-rattlers. Delco Div., United Motors Service, General Motors Bldg., Detroit 2, Mich. (TECHNICIAN No. 5-12)



Bell PA SYSTEMS

"Pacemaker" line of public address amplifier systems contains eight models including 10, 20 and 33 watt systems; and two 6-volt and 12-volt mobile amplifiers. Accessories include three-speed phono top and case to carry two 12" speakers and 25 ft. of cables. Design utilizes ceramic pick-ups, and internal phono jacks provide for tape machine or second phono use from front panel. Bell Sound Systems, Inc., 555 Marion Rd., Columbus 7, Ohio. (TECHNICIAN No. 5-16)

Alpha WIRE SPOOLS

"ServiceSpool" packaged wire line contains the 114 most widely used wire items on three sizes of metal spools. Designed for the technician, it includes tubing, HV wire, filament wire, mike cable, multi-conductor cable, shielded cable, test lead, hook-up wire, tinned copper and many others. Alpha Wire Corp., 430 Broadway, New York 13, N.Y. (TECHNICIAN No. 5-17)

Elgin CARTRIDGES

New turnaround "throwaway" ceramic phono cartridge, light as a 4.5-gram peanut shell, are available with osmium and sapphire needles for 33-1/3, 45 and 78 rpm. A positive snap-in action automatically locates the single needle replacement in proper alignment without the use of tools. Elgin National Watch Co., Electronics Div., Elgin, Ill. (TECHNICIAN No. 5-18)

Vidaire FERRITE ANTENNA

A service replacement ferrite coil antenna for radio sets, called the Ferri-Loop Model FL-6, may be used in place of older round loops. It is designed to track over the broadcast band with most of the standard variable capacitors in use today. It is sensitive and very compact. Vidaire Electronics Mfg. Corp., 576 W. Merrick Rd., Lynbrook, N.Y. (TECHNICIAN No. 5-19)

Parker "STRATO"

"Strato" straightens guy wire as it comes off the spool and eliminates kinking, coiling, tangling and stretching. It does away with bulky boxes of coils and reduces waste. This tool consists of a special pulley and bracket arrangement on which the spool of wire mounts. Excellent for TV antenna installation. Parker Metal Goods Co., Summer St., Worcester, Mass. (TECHNICIAN No. 5-60)

For more technical information on new products, use inquiry coupon on page 46

Latest Test Instruments

Triplet OSCILOSCOPE →

Cathode ray oscilloscope, 5" Model 3441-A, at \$249.50, permits changing polarity to vertical input amplifiers and thus keep wave form on tube showing in a conventional manner. Calibrated meter is included for comparison voltage measurements. Multi-vibrator type of internal sweep generator provides linear sweep voltages up to 60 kc, and wide frequency range provides for TV and FM servicing, including color. Size 15-11¹/₂" x 11-1¹/₂" x 16". Wt. 38 lbs. Triplet Electrical Instrument Co., Bluffton, Ohio. (TECHNICIAN No. 5-3)

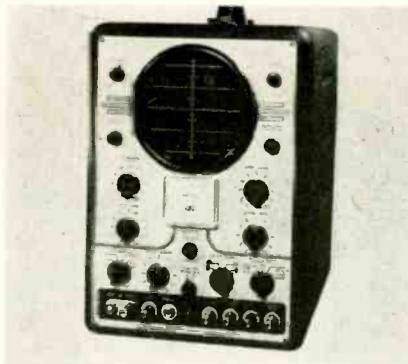

RI VIDEO PROBE METER →

R-F probe and absorption meter is designed to differentiate high and low frequencies. By placing pickup loop at right place on top or under TV or radio chassis, almost all circuits can be checked. Tests include video tracing, oscillator check, picks up sweep signal from outside tube, shows sync, drive, agc, detects arcing, etc. Used to adjust phasing circuits. Compact and easy to use. \$31.50. Also useful for color TV servicing. Research Inventions & Mfg. Co., 617 F St. N.W., Washington 1, D.C. (TECHNICIAN No. 5-2)

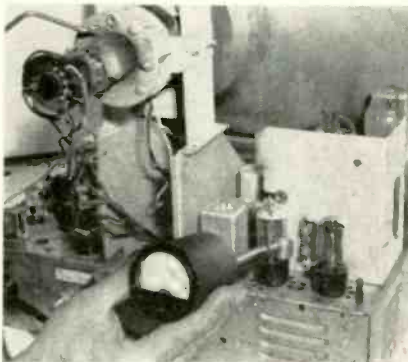

Hycon DIGITAL VTVM →

Designed for mounting in a standard 19" rack, Model 615R Digital VTVM brings speed and accuracy to voltage and resistance measurements. A direct-reading, 3-digit counter eliminates interpolation and parallax errors, makes accurate readings easy, and avoids multiple-scale confusion. One-millivolt sensitivity is provided on the low scale, and accuracy is 1% on DC and resistance, 2% on AC. Illuminated polarity signs. Hycon Electronics, Inc., 321 So. Arroyo Parkway, Pasadena, Calif. (TECHNICIAN No. 5-1)



Hickok METERS →

Newly developed 4⁵/₈" rectangular meters permitting maximum length of scale to an accuracy of 1¹/₂% are now available in ac and dc models. Identified as Models 68 and 69, these meters are made for semi-flush panel mount applications and are supplied with or without illumination feature. New illumination technique permits bulb replacement from front of meter case without removal from the panel. Hickok Electrical Instrument Co., 10523 Dupont Ave., Cleveland 8, Ohio. (TECHNICIAN No. 5-4)



Phaostron METER

Line of 3¹/₂" rectangular panel meters feature a die cast bezel that can be finished in either polished chrome and black or in a solid black. Metal cases give antimagnetic shielding. Accuracy is 2% full-scale calibration. Phaostron Instrument and Electronic Co., 151 Pasadena Ave., South Pasadena, Calif. (TECHNICIAN No. 5-6)

Win-Tronix HV PROBE

High voltage probe with built-in voltage indicators, designated the Thermometer Model 900, is a self-contained high voltage tester requiring no meter or external indicator. Six calibrated neon counters show at a glance the amount of high voltage on the picture tube or other voltage source. The neon indicators are located in the handle of the probe. Calibration is from 2¹/₂ to 25 kv. Dealer net \$8.95. Winston Electronics, Inc., 4312 Main St., Philadelphia 27, Pa. (TECHNICIAN No. 5-5)

HP FREQUENCY METER

High-accuracy frequency meter with expanded scale, Model 500B, covers frequencies 1 cps to 100 kc and providing direct readings accurate within ±2% full scale. A feature of the new instrument is an expanded scale permitting any 10% or 30% segment to be viewed full meter range for high accuracy. Input requirements are 0.2 volt on sine waves and 1 volt minimum to 250 volt peak maximum on pulsed signals. Hewlett-Packard Co., 275 Page Mill Road, Palo Alto, Calif. (TECHNICIAN No. 5-7)

Shasta VTVM

Model 204 ac vacuum tube voltmeter is designed specifically for accurate measurements of ac voltages from .03 to 300 volts full scale in the low frequency range of 2 cps to 300 kc. Features of this instrument are: its regulated power supply, a large easy to read 6" meter, and an illuminated range selector switch which displays only the range that the operator is using. Accuracy is 2 to 5%. Shasta Div., Beckman Instruments, Inc., P.O. Box 296, Station A, Richmond, Calif. (TECHNICIAN No. 5-8)

More New Products
on pages 46, 48, 49, 58, 61

For more technical information on new products, use inquiry coupon on page 46

New Tools & Shop Aids

Cauhorn WELDER



The "Handy Giant" welder may be plugged into any 115 volt, 60 cycle outlet to weld, braze or cut metals. With the "Magic Wand" attachment, the technician can solder, etch or preheat any part. Also, wand may be employed for soldering and welding without the transformer by connecting to battery. Guaranteed for one year. Lifetime exchange policy of power unit for \$16 and wand for \$4. Also useful for soldering. Cauhorn Distributing Co., 20722 W. Seven Mile Rd., Detroit 19, Mich. (TECHNICIAN No. 5-29)

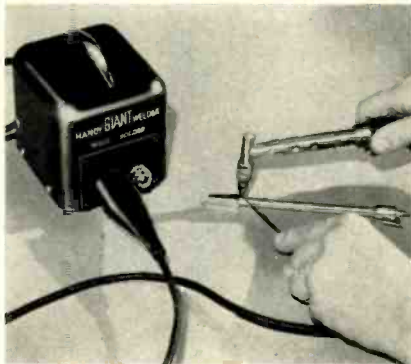

Walsco SCREWDRIVER



Precision screwdriver holds extremely tiny screws securely while starting or removing. Screws as small as #1 and #4 used in transistor radios and similar instruments may be held. Tool available in 4" and 7" lengths has 1/8" diameter shank. The 4" screwdriver (Catalog #2568) is sold at user's net of \$1.98. The 7" screwdriver (Catalog #2569) is \$2.24. Both tools for servicing miniature equipment are made of durable material. Walsco Electronics Corp., 3602 Crenshaw Blvd., Los Angeles 16, Calif. (TECHNICIAN No. 5-28)

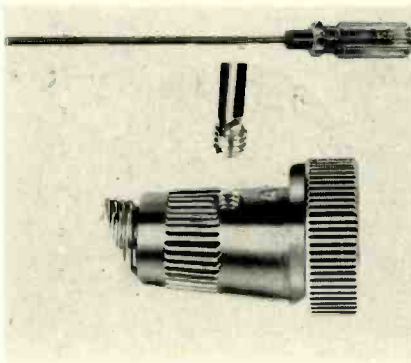

Techniques SCREEN KIT



Perfect duplication of printed circuits, nameplates, dials and even greeting cards may be accomplished with this silk screen process kit. Kit contains resist ink, squeegee, DuPont film and chemicals, and instruction brochures. Reproduce almost anything that can be photographed, from one to more than 10,000 units. Kit shown, #5006P, is \$27. Smaller etched wire printed circuit kits also available at \$3.75, \$4.75 and \$9.75. Techniques, Inc., 178-84 Central Ave., Hackensack, N. J. (TECHNICIAN No. 5-30)



3M ELECTRICAL TAPE

High voltage splicing tape, "Scotch" brand No. 23 electrical tape, is self bonding, and uses butyl rubber base. High dielectric strength, 650 volts/mil, provides excellent ozone resistance. Shortly after application, tape fuses into homogeneous mass, yielding maximum moisture resistance. Minnesota Mining & Mfg. Co., Dept. D6-12, St. Paul, Minn. (TECHNICIAN No. 5-31)

Hunter THREAD TAP

"Tri-Tap" is a single tool which cleans or cuts any of the three most common thread sizes found in electronic and other craft work. Three taps are on one rod, graduated from smallest at tip to largest nearest handle. Sizes are 1/32, 3/32 and 1/16. Hunter tool, Box 564, Whittier, Calif. (TECHNICIAN No. 5-32)

LS "WALKING" HAND TRUCK

Lightweight magnesium hand truck enables one man to handle TV sets or air conditioner. The "Hyker" walks up stairs on rubber-covered legs when its handles are pumped. It lifts appliances over obstructing furniture or radiators on its screw-operated lifter shelf. L-S Heating & Engineering Co., 900 W. Lycoming St., Philadelphia 40, Pa. (TECHNICIAN No. 5-33)

E&L LAMINATED LADDERS

Single and double section laminated wood ladders available in lengths from 8 to 30 ft. can support loads up to 1300 lbs. Features include long service life and ability to carry maximum loads for a long period of time. Engineering & Laminating Corp., 506 S. Central Ave., Baltimore 3, Md. (TECHNICIAN No. 5-34)

PE STAIR CLIMBING TRUCK

"E-Z Climber" hand truck has two rocker arms which act like an extra pair of wheels to carry loads up to 600 lbs. up and down stairs. Built of welded 1" OD tubular steel frame, with overall size 46" x 17 1/4", it weighs 39 lbs. \$39.90 fob Illinois. Precision Equipment Co., 3716 Milwaukee Ave., Chicago 41, Ill. (TECHNICIAN No. 5-35)

FOR MORE TECHNICAL INFORMATION ON NEW PRODUCTS OR BULLETINS

use this convenient coupon. Enter below the reference numbers for all items desired.

New Products Editor
TECHNICIAN & Circuit Digests
480 Lexington Ave.
New York 17, N. Y.

Please send me more information on the following items:

.....
My company letterhead or business card is enclosed.

Name

Address

Firm My position

City State

Business address (if different from above)

More New Products
on pages 48, 49, 58, 61, 62



SEE US IN BOOTH NO. 213 AT MAY PARTS SHOW



Burton Brown / New York

HE PROVED IT FOR HIMSELF!

The new Pyramid Imp is smaller, yet better than any other molded paper tubular capacitor; Operates at full rating of 100°C (212°F—boiling point); Exceeds moisture resistance requirements of U. S. Government specifications MIL-C-91A; Copperweld leads are securely imbedded to withstand 4 360° bends without breaking.

These features, plus an almost indestructible thermo-setting plastic encasement make Pyramid Imps your best molded paper tubular capacitor.

For full information on Pyramid capacitors and rectifiers, see your local distributor or write to



DISTRIBUTOR DIVISION

PYRAMID ELECTRIC COMPANY

1445 Hudson Blvd., North Bergen, N. J.

New Electronic Components

Astron FILTER

Miniaturized r-f noise suppression filter AF1108 contains fourteen toroids and eight capacitor sections for noise suppression in the range of 0.15 to 1000 mc. It is designed to withstand great amounts of shock and vibration, as well as elevated operating temperatures. It is hermetically sealed, small and light in weight, useful for portable equipment. Designed to meet and surpass the requirements of military specification MIL-1-11748. Astron Corp., 255 Grant Ave., Newark, N.J. (TECHNICIAN No. 5-23)

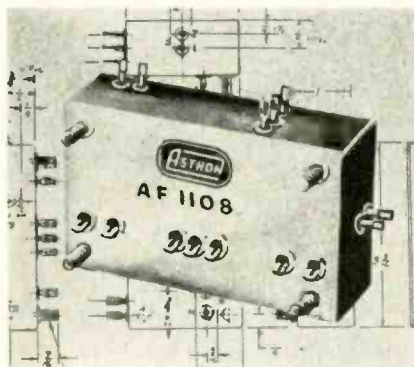

Amphenol CONNECTORS

Two r-f cable connectors eliminate the operation of soldering cable braid to the connector shell. These are the 83-851 and 83-850, the latter also eliminating soldering the center conductor of the cable to the contact. No special tools needed. They are made of brass, cadmium finished, with silver plated contacts. Both are re-usable. Dielectric material is mica-filled bakelite. Electrically similar to 83-1SP plug. The 83-851 is in the UHF series. American Phenolic Corp., 1830 S. 54 Ave., Chicago 50, Ill. (TECHNICIAN No. 5-21)

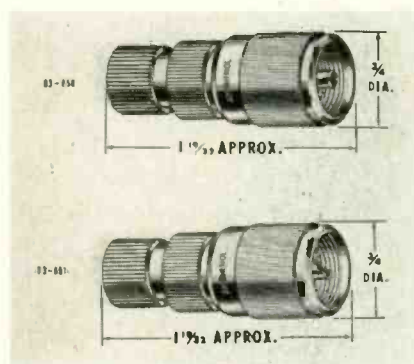

Sprague ELECTROLYTIC

Hermetically sealed solid electrolyte tantalum electrolytic capacitor Type 150D for transistorized and other miniature equipment is only 1/8" in diameter, 1/4" long. Yet it has a capacity of 12 µf. Its capacitance varies only 5% from room temperature over the range of -132° to 185°F. Stability is comparable with the best oil-paper types rather than 10 times larger paste electrolytics. Engineering bulletin 3520 provides technical data. Sprague Electric Co., 97 Marshall St., North Adams, Mass. (TECHNICIAN No. 5-20)

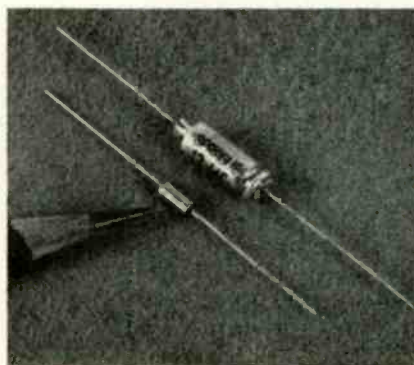

Merit TRANSFORMER

HVO-53 horizontal and high voltage output transformer is an exact replacement for the following parts numbers in Zenith equipment: S-15015; S-15709; S-15911; S-15912; S-16191; S-16204; S-16566; S-17130; S-17140; S-17233; S-17244; S-17245; S-17265; S-71435; S-17646; S-17669; S-17767; S-17812; S-17925; S-17939; S-18125; S-17487; S-18537; S-18930; and S-20908. Additional data is available. Merit Coil & Transformer Corp., 4427 N. Clark St., Chicago 40, Ill. (TECHNICIAN No. 5-22)

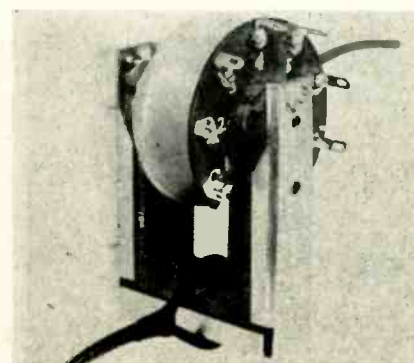

Clevite TRANSISTORS

Six germanium power transistors for handling up to 20 watts input are of the PNP type. They are available for nominal 12 and 28 volt operation. They are particularly suitable for class A operation in the audio output stage of automobile radios. Clevite Transistor Products, 241 Crescent St., Waltham 54, Mass. (TECHNICIAN No. 5-26)

Quam FOCALIZER

New focalizer unit QF-4 which fits all TV picture tubes regardless of size or anode voltage replaces part numbers QF-1, QF-2 and QF-3. It is easy to install and comes attractively packaged. Designed with ceramic magnets. Diameter 3 1/16"; depth 1 1/16" at min. flux, 1 3/4" at max. flux. Bracket is 3 1/4 x 5 1/2". Shipping weight 1 lb. List \$4.25. Quam-Nichols Co., Marquette Rd. & Prairie Ave., Chicago 37, Ill. (TECHNICIAN No. 5-24)

Philco TRANSISTOR

Subminiature transistor, so small that 20 can be placed on a dime, operates in the audio range. Designated as the M-1, it has a 70 db gain, or a power gain of 10 million, and will operate on as little as 0.0001 watt. This germanium junction transistor is of the PNP type. Among many potential applications are hearing aids, portable radios, computers and guided missiles. Philco Electronic Tube & Transistor Div., Tioga & C Sts., Philadelphia 34, Pa. (TECHNICIAN No. 5-25)

Triad FLYBACKS

Eight new correct replacement flybacks (horizontal output transformers) are designed for use in Admiral, Emerson, Motorola, Philco, Wells-Gardner, Westinghouse, Airline, Firestone, Raytheon and Bendix TV receivers. They are electrically and mechanically interchangeable with manufacturer's original equipment. Listed in Catalog TV-56. Triad Transformer Corp., 4055 Redwood Ave., Venice, Calif. (TECHNICIAN No. 5-27)

More New Products
on pages 44, 58, 61, 62, 64

For more technical information on new products, use inquiry coupon on page 46

New Tubes

Westinghouse CASCODE TUBES

Two sharp cut-off cascode r-f amplifier tubes for TV receivers employing low B+ supplies are the 6BX8 and 4BX8 double triodes. The 6BX8 employs the conventional 6.3-v., 400-ma heater, while the 4BX8 with 4.5-v., 600-ma heater is designed for series strings. Both tubes operate with only 60 v. plate-to-cathode voltage, to give more gain than cascode tubes not especially intended for low plate voltage operation. Basing is same as the 6BZ7-6BS8 family. Westinghouse Electronic Tube Div., Dept. T-075, Route 17, Elmira, N.Y. (TECHNICIAN No. 5-9)

RCA TUBES

Six new tubes are designed for use in TV sets. The 5CG8 and 6CG8 are miniature triode-pentode converters for use as combined oscillator and mixer in sets with 40 mc i-f. Heater ratings are 6.3 v., 450 ma for the 6CG8, 4.7 v., 600 ma for 5CG8. The 2NB4 and 6NB4 are medium-mu miniature triodes for use as r-f amplifiers in VHF tuners. Transconductance is 6800 micromhos 6BN4 heater is 6.3 v., 200 ma; 2NB4 is 2.1 v., 600 ma. Two other tubes are the beam power 7-pin miniatures, 6CU5 and 12CU5, for use in TV audio output stages. Maximum output is 2.3 watts. 6CU5 heater is 6.3 v., 1200 ma; 12CU5 is 12.6 v., 600 ma. Tube Div., Radio Corp. of America, Harrison, N.J. (TECHNICIAN N. 5-10)

GE THYRATRONS

Three thyatron tubes with 6.4-amp negative control characteristics, the GL-6807, GL-6808 and GL-6809, carry high commutation factor ratings. They are particularly suitable for motor control and other inductive load circuits without cushioning. Their ability to operate over the wide temperature range of -55° to 70°C make them particularly useful in industrial applications. General Electric Tube Dept., Schenectady 5, N.Y. (TECHNICIAN No. 5-11)

Raytheon RECEIVING TUBES

Five new types in the line of TV receiving tubes include: 3B2 half-wave vacuum rectifier of HV pulses in TV scanning systems; 6CB5 high-perveance beam power amplifier designed for horizontal deflection in color sets; 6DC6 semi-remote cutoff pentode for color pix i-f stages and tuner r-f amplifier; 6BR8 triode pentode miniature for use as local oscillator-mixer in TV and FM; and 6BK4 low-current sharp-cutoff beam triode for HV low-current regulation in color TV power supplies. Raytheon Mfg. Co., Receiving & CR Tube Operations, 55 Chapel St., Newton 58, Mass. (TECHNICIAN No. 5-36)

REPLACE WITH

General RADIO BATTERIES



General batteries are factory-fresh . . . shipped from 11 conveniently located warehouses. They test "Good" on your meter, and always give your customers *dependable service*. Your customers will rely on *you* to supply these top-quality replacement radio batteries. Ask your jobber about General Batteries.

FREE— We would like to give you, for your day-to-day use, General's handy new pocket-size replacement batteries cross reference. It shows specifications and list prices of batteries, and covers all of the most popular types of batteries. Send in the coupon below — today!



General

DRY BATTERIES, INC.

13000 ATHENS AVE., CLEVELAND 7, OHIO
BDelevator 2-0030

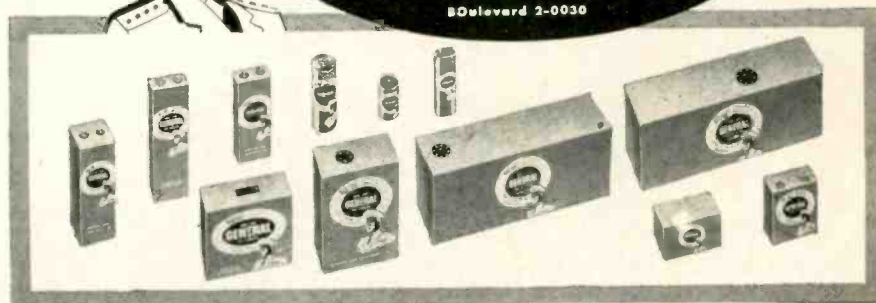

EXPORT OFFICE: 431 5th Ave., New York 16, New York
IN CANADA: General Dry Batteries Ltd., Toronto 4, Canada

J. J. Langlois, General Sales Manager

GENERAL DRY BATTERIES, INC.

13000 Athens Ave., Cleveland 7, Ohio

Please send me General's new radio replacement batteries pocket-size cross reference.

Name _____

Firm Name _____

Address _____ (street) _____ (city) _____ (state)

Every Serviceman's Profit-Maker Team...



**Service Aids and
Your G-C Distributor!**

G-C—MAKERS OF
SPRA-KLEEN

STOPS TELEVISION
AND RADIO CONTROL NOISES

ELIMINATES NOISE due to dirt, dust and corrosion
on electrical contacts.

JUST SPRAY ON... convenient power spray can
does the job in a wink. No need to dismantle
chassis.

CLEANS AND LUBRICATES contacts, controls, re-
lays, switches and other sliding electrical contact
devices in one operation.

SAVES TIME AND MONEY—gets the job done fast—
long lasting—full 6 ounces. No. 8666



POOF!
THERE GOES
NOISE



GENERAL CEMENT MFG. CO.

919 Taylor Avenue • Rockford, Illinois

FREE COPY... G-C Catalog. Send postcard today!



G-C
Chemicals



G-C
Alignment
Tools



G-C
Hardware



G-C
Service
Aids



TV-radio service work is faster, easier, more profitable... when you use
G-C Service Aids. You'll find thousands of them at your G-C parts distributor.

SEE US... BOOTH 590—ROOM 612—PARTS SHOW

KESTER



Absolutely non-corrosive and non-conductive, KESTER "RESIN-FIVE" CORE SOLDER contains an activated type of resin that gives you that fast, positive action on all your jobs... including the most difficult.



EASIER
TO USE

LONGER
LASTING

KESTER SOLDER COMPANY
4264 Wrightwood Avenue • Chicago 39, Illinois
Newark 5, New Jersey • Brantford, Canada

SOLDER

Antenna "Co-Phaser" Cancels Interference

Where interference is picked up by the antenna, it can be fed to a control box and used to cancel itself out! So says S. D. Wooten, an inventor of Memphis, Tennessee. Wooten has filed patents on a device he calls the "Co-Phaser," which he says will do just that.

The inventor became interested in the problem when a man in Clarksdale, Miss., complained of interference. The complainant was having trouble picking up WREC-TV, in Memphis, because another station in Jackson, Miss., which was using the same channel, managed to give co-channel interference although his antenna was beamed on the Memphis station. The Clarksdale man had already picked up one of the special antennas designed for co-channel interference problems but, in this instance, it didn't help.

Wooten installed a secondary antenna, putting it below the existing antenna, and beaming it in the opposite direction to pick up the unwanted channel. His Co-Phaser control box is connected directly to the receiver input. By adjustment of its amplitude control, the pickup from the second antenna is made to cancel out the interfering wave from the main antenna, so that only the desired signal is fed into the receiver.

An experiment is being planned at some receiving point midway between the Jackson and Memphis transmitters. It is believed possible that reception from either of the two stations on the same channel, originating from these two points, can be chosen by adjustment of the control device, giving the user his choice. The opinion has been voiced that, if interference can be controlled in this way, VHF channel assignments could be rearranged for more widespread use. In addition, a major antenna manufacturer is reported to be interested in the device.

Wooten believes his control box could be manufactured to sell for less than \$30.

Articles Wanted!

Think you really know something about TV, radio, audio, test equipment, antennas, components, or UHF? Why not put it into an article. Emphasis, of course, should be on service technique or other practical bread-and-butter aspects. For further information, get in touch with Manuscript Editor, TECHNICIAN & Circuit Digests, 480 Lexington Avenue, New York 17, N. Y.

Reps & Distributors

ALMO RADIO, Eastern parts distributor, has awarded Harry Caldabaugh's **BOULEVARD TV** of Salisbury, Md., \$200 first prize in Almo's "New Look" contest for the best looking, well equipped service shop. Contest did not require any purchase. Runners up were **OVERBROOK RADIO**, Phila.; **HOLT-BY'S**, Lansdowne, Pa.; **APPLEBY'S**, Millville, N.J.; and **ASTRAL**, Phila. Almo Pres. **MORRIS GREEN** has been appointed chairman of **NEDA Inter-Industry Relations Committee**.

NICK J. FAYMOVILLE, Jr., Minneapolis, has been appointed **LITTELFUSE** rep in Minn., N. D., S. D., and northwest Wisc.

MEL SCHWARTZ of 39-16 Tierney Pl., Fair Lawn, N. J., has established himself as a manufacturer's rep serving electronic field in N. Y.-N. J.-Conn. area. Mr. Schwartz has been an electronic sales engineer and manager for 13 years.

New tube promotion program announced by **WESTINGHOUSE** ad manager **J. C. LANE, JR.**, covers areas of identification, standards, operating material and a "dividend." Three-way push promotes names of manufacturer, jobber and service tech.

SYLVANIA has appointed four new distributors to handle the company's full line of tubes: **DEMAMBRO RADIO SUPPLY**, Keene, N. H.; **LEADER ELECTRONIC DISTRIBUTORS**, Tampa, Fla.; **RADIO SUPPLY**, Reno, Nev.; and **WORLD RADIO LABS**, Council Bluffs, Iowa.

H. W. KNAGGS, Belleville, Ill., and **ENGINEERING SERVICES CO.**, St. Louis and Kansas City, Mo., have been named reps for **RADIO RECEPTOR**.

MILO RADIO, New York City, becomes distributor for **AMPEREX ELECTRONICS**.

CRESCENT INDUSTRIES has appointed **H. L. DALIS**, N.Y., distributor.

Officers of the Rocky Mountain Chapter of **THE REPS** for 1956 are Pres. **DICK HYDE**, VP **BILL PEYSER**, Sec. **BILL GOLLIER**, and Treas. **KEN RAYMOND**.

TODD-TRAN has named **GARY MARTIN** of Palisades, N.J., industrial rep for its TV replacements. In the South, **MANUFACTURERS SALES AGENCY**, Wilmington, N.C., has been appointed jobber rep.

ROGERS ELECTRONIC CORP. has named two reps, **ARTHUR K. ELLIOT CO.**, Kansas City, Mo., and **AL ENGELMAN CO.**, Memphis.



SAD?

because you
weren't able
to get your

1956 *Radio Electronic* MASTER

Sorry you were disappointed. In many areas, there just weren't enough **MASTERS** to meet the demand.

But — cheer up. If you act fast, we can help you get your industry-wide buying guide. We've located several distributors with extras on hand.

And what's more . . . you'll only pay the \$2.95 distributor price instead of the regular \$7.50.

- 100,000 Items
- Complete descriptions
- Specifications—Prices
- 11,000 illustrations
- 8 x 11", 6 lbs.
- 350 mfrs.

*So send your coupon now . . .
first-come — first-served.*

1450-Page Buying Guide . . . helps you shop before you buy. The supermarket pages of **The MASTER** enable you to compare specs and prices first — then buy and save.

Right in Your Customer's Home . . . you can sell direct from **The MASTER's** pages. Watch it pay off in extra sales!

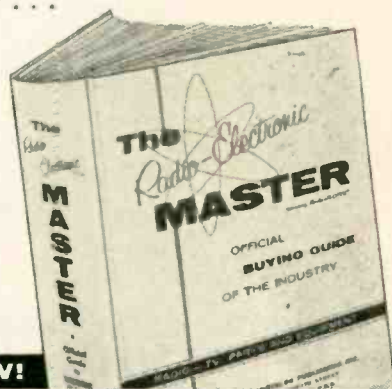

MAIL COUPON NOW!

UNITED CATALOG PUBLISHERS, INC., 110 LAFAYETTE ST., NEW YORK 13, N. Y.
Here's my \$2.95. Please rush me the 1956 MASTER, Official Buying Guide of the Electronic Parts and Equipment Industry.

Name.....

Address.....

City..... Zone..... State.....

T-5

CORNING LOW-POWER RESISTORS

available now through

ERIE
distributors

for Service Replacements

Corning Low-Power Resistors Types LP-4 and LP-5 have been especially designed for radio, TV, and similar applications. They have the highest resistance range of any low-power resistors on the market, and are used by leading manufacturers. They are stable and non-inductive, and impervious to moisture and dirt. Resistance spiralling is automatic and is electronically controlled.

For complete service information and prices . . . see your Erie Distributor.

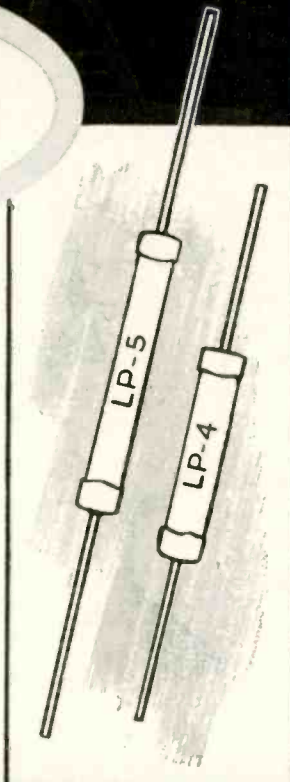

ERIE ELECTRONICS DISTRIBUTOR DIVISION

ERIE RESISTOR CORPORATION

Main Offices: ERIE, PA.

Factories: ERIE, PA. • LONDON, ENGLAND • TRENTON, ONTARIO



Star Performers on Your Service Team...



Television Hardware and
your TELCO Distributor

BRINGING YOU THE ALL NEW

RATCHET CHIMNEY MOUNT

FAST INSTALLATION... simply thread strap thru ratchet bolt and tighten.
REALLY HOLDS... ratchet bolt design never lets go. **FITS MAST UP TO 1 1/2" DIAMETER.**
LONG LASTING zinc plated and dicromate dipped for double weather proofing.
No. 9218 Ratchet mount with 24' galvanized straps.
No. 9219 Ratchet mount with 24' stainless steel straps.



FOR
FAST, SURE,
PERMANENT
INSTALLATIONS!

PAT. PEND.

TELEVISION HARDWARE MFG. CO.

Division of General Cement Mfg. Co

919 Taylor Avenue, Rockford, Illinois

FREE COPY... TELCO Catalog. Write for yours now!

**TELCO
HARDWARE**



Everything for fast profitable TV installations—stand-offs, mounts, towers, arrestors, all accessories. The complete line is at your nearby TELCO distributor.

SEE US . . . BOOTH 590—ROOM 612—PARTS SHOW

Tough Dogs

(Continued from page 41)

Tracing back through the agc system with the scope, a point was reached where a 0.047-mfd condenser runs under the cathode resistor of the audio output tube. This condenser was cut loose from ground to see whether it would pick up any audio from being near the resistor physically. It didn't.

This condenser in the agc circuit is grounded to the same lug as is the cathode resistor from the audio output stage. The scope was then placed on this ground connection—and there was the audio. This poor ground was corrected by disconnecting all components from this lug, re-wrapping and resoldering them. The audio signal was then gone. Without a good ground, audio signal at this point was coupled into the agc line through this common point.

This connection had not been suspected because sound output was of good quality and very loud, but a scope never fails on a faulty ground connection, just as it can be depended upon for so many other things. It cannot be overused.—Andrew J. Olsen, Cut Off, La.

Easy-Install Antenna



One of the quick-installation no-tools-required features of the Winegard Color Beam antenna kit is the ingenious clip that fastens the lead-in wire to the receiver's antenna input. This clip is being explained by John Winegard (left), president of the Winegard Co., Burlington, Iowa, to his local jobber, Ron Korf, mgr. of Union Supply Wholesale Co. Hugh B. Cummings (right), Winegard gen. mgr., looks on approvingly. The only tool required to install the Color Beam in 7 minutes is a hammer.

Mobile 2-Way Installation

(Continued from page 35)

radio end so that it is not necessary to disconnect the plugs in order to service the set.

The next step is to install the antenna and connect the co-ax leads. The 152-174 mc. quarter-wave whip antenna is generally placed on the center of the roof top. The 30-50 mc. spring-base antenna should be placed on the left side of truck in order to prevent damage by branches, etc.

Installation of the roof-top antenna requires drilling a hole through the metal roof top without damaging the lining. This can be accomplished with a hole saw and a 3/4" conduit coupling. File one end of the coupling flat and then put teeth on that end with the file. When tightened around the hole saw blade, the coupling will act as a stop when the



Mobile units used by utility companies are housed in heavy steel all-weather boxes and placed to take up minimum usable truck space. Here complete unit is in housing atop truck cab, with battery and control cables fed through flexible metal conduit to truck cab.

blade has just cut through the metal and will simultaneously remove a ring of paint to provide a good ground.

A good fish wire for the installation of the co-ax lead can be made from a piece of very stiff steel wire. Point the end and form a series of grooves around the wire near the point with a pair of heavy-duty side cutters. Expand a piece of flexible shield braid and insert both fish wire and co-ax leads through it. Then wrap some soft wire around the braid over the grooves in the fish wire. The co-ax leads can be pulled up through the hole by means of the

fish wire. If desired, the antenna co-ax lead can be protected by flexible conduit in the same manner as the power and control cables.

Automobile Installations

Installing two-way radio in a car is simpler than installing it in a truck. No conduit or weatherproof housings are used, and it is generally much easier to find a place for the radio set.

When mounting a radio set in the trunk, the major problem will be that of routing the cable. Usually the cables are run under the floor mats

without twisting, alongside the hump in the floor. Here, they will be least noticed and less likely to be stepped on. Abrasive action of the rear seat can be overcome by making a slight hump in the front spring support bar with a large pair of pliers so that there is room for the cable to pass through. For further protection, place a piece of discarded inner tube over the cable.

A good way to dress the cables in the front of the car is to extend them behind the cardboard heater duct and thence to the terminals. The power cable can be passed through

(Continued on page 54)

MOBILE COMMUNICATIONS

MICRO-WAVE

Find out how YOU CAN INCREASE YOUR INCOME by installing and maintaining mobile communications and microwave equipment!

Over 700,000 transmitters! Yes, without considering any government, military or amateur equipment, there are almost 3/4 of a million transmitters in daily use—and only an FCC licensed technician can install and maintain those transmitters.

The field of mobile communications and microwave has literally sky-rocketed in recent years. It will grow even faster in the coming years. "Private" radio-phone systems are in great demand. More people are requesting regular "car telephones" from the telephone companies. Microwave links are replacing land wire. Radio stations are going "remote."

These developments are not be-

ing restricted to big cities. The growth is just as extensive in smaller town and rural areas. But, in all areas, the supply of qualified technicians is not sufficient. Equipment users are not getting adequate service in many areas. In many cases, they must get technicians hundreds of miles away.

You are undoubtedly a good radio-television serviceman. Why not add a commercial FCC license to your qualifications and become an expert electronics technician. Your FCC license will open the door to hundreds of types of jobs which you don't handle now. Regardless of the job, if it involves electronics, Cleveland Institute will help you prepare for it.

Are You Qualified

TO GET YOUR SHARE OF THE PROFITS FROM THIS MULTI-MILLION DOLLAR FIELD?

Do You Have

YOUR COMMERCIAL FCC LICENSE?

For full details (without cost or obligation) on our program for guaranteeing you your success with the FCC exams—without interfering with present work—send for the free booklet shown here.



Cleveland Institute of Radio Electronics

DEPT. T-2, 4900 EUCLID BLDG., CLEVELAND 3, OHIO

Member



for service and lab. work

Heathkit PRINTED CIRCUIT OSCILLOSCOPE KIT FOR COLOR TV!

① Check the outstanding engineering design of this modern *printed circuit* Scope. Designed for color TV work, ideal for critical Laboratory applications. Frequency response essentially flat from 5 cycles to 5 Mc down only 1½ db at 3.58 Mc (TV color burst sync frequency). Down only 5 db at 5 Mc. New sweep generator 20-500,000 cycles, 5 times the range usually offered. Will sync wave form display up to 5 Mc and better. Printed circuit boards stabilize performance specifications and cut assembly time in half. Formerly available only in costly Lab type Scope. Features horizontal trace expansion for observation of pulse detail — retrace blanking amplifier — voltage regulated power supply — 3 step frequency compensated vertical input — low capacity nylon bushings on panel terminals — plus a host of other fine features. Combines peak performance and fine engineering features with low kit cost!

Heathkit TV SWEEP GENERATOR KIT ELECTRONIC SWEEP SYSTEM

② A new Heathkit sweep generator covering all frequencies encountered in TV service work (color or monochrome). FM frequencies too! 4 Mc — 220 Mc on fundamentals, harmonics up to 880 Mc. Smoothly controllable all-electronic sweep system. Nothing mechanical to vibrate or wear out. Crystal controlled 4.5 Mc fixed marker and separate variable marker 19-60 Mc on fundamentals and 57-180 Mc on calibrated harmonics. Plug-in crystal included. Blanking and phasing controls — automatic constant amplitude output circuit — efficient attenuation — maximum RF output well over .1 volt — vastly improved linearity. Easily your best buy in sweep generators.

MODEL 0-10
\$69.50
Shpg. Wt. 27 lbs.

MODEL TS-4
\$49.50
Shpg. Wt. 16 lbs.

Heath COMPANY
A SUBSIDIARY OF DAYSTROM, INC.
BENTON HARBOR 18, MICH.
WRITE FOR FREE CATALOG
...COMPLETE INFORMATION



"It's the serviceman — he forgot to bring a JENSEN NEEDLE!"

F. C. C. LICENSE QUICKLY!

Correspondence or Residence Preparation for FCC Examinations. Results Guaranteed.

Our specialty is preparing you to pass FCC license examinations. Beginners get 2nd class license in 8 weeks, 1st class in 4 additional weeks. Students with background often finish more rapidly.

Here's proof! A few of our recent graduates, the class of license they got, and how long it took them:

	Class of License	Weeks
Joe Pofsgrove, R 2, Herrodsburg, Ky.	1st	9
Harry Neal, Box 145, Coraleen, N.C.	1st	10
G. R. Hamann, RR 2, Carroll, Iowa	1st	11
R. Purcell, 1347 Rittenhouse NW, Washington	1st	11
W. C. Goodall, 500 Forest Bl., Indianapolis	1st	10
Jock Sanders, 118 Nagle, Harrisburg, Pa.	1st	11
J. Yearly 500 Lynn Pl., Falls Church, Va.	1st	13
Robert LaVoy, 247 Rochelle Rd., Toledo, O.	1st	11
Irvin Gemora, 5008 Pembroke, Baltimore, Md.	1st	8

Learn by Mail or in Residence

Correspondence training from Washington, D. C. DAY and EVENING resident classes held in Hollywood, Calif., and Washington, D. C. Enter any course you choose.

OUR GUARANTEE
If you should fail the FCC exam after finishing our course, we guarantee to give you additional training at NO ADDITIONAL COST. Read details in our free booklet.

FCC-TYPE EXAMS
FCC-type tests are used throughout the Grantham course. Constant practice with these FCC-type tests helps you prepare for the actual FCC examination.

Write for our free booklet, telling how you can get your commercial FCC license quickly. There is no obligation and no salesman will call.

Grantham School, Desk 7-A,
821 19th Street, N.W. OR 5910 Sunset Blvd.
Washington, D. C. Hollywood 28, Calif.

Mobile 2-Way Installation

(Continued from page 53)

the firewall slightly above this duct.

The same general principles apply when installing front-mount sets. Attach the bottom bracket to the floor or as close to a horizontal portion of the floor as possible. Obtaining solid mounting of the top bracket to the dashboard may be difficult. If the dashboard is not reinforced, either mount the nuts with large washers to distribute the load, or else add a reinforcing member.

Most of the screws used for mounting will be sheet metal or self-tapping screws. The best way to start them is to provide a pilot hole



Front-mount unit, with integral speaker and controls. This type must be mounted solidly.

with a hammer and a sharp pointed punch having a gradual taper. In this way the metal that would otherwise be lost if the holes were drilled is merely pushed out of the way and provides more holding surface for the screw.

To a great extent, the user will base his opinion of your service on the type of installation you make. In every installation, the quality of workmanship should be of the highest calibre to be consistent with the engineering knowledge and manufacturing skill that has gone into the radio itself. •



"Al, you know that transformer with the open filament section from Mrs. Gallan's TV: Well, would you look up the model number again?"

Association News

New Wholesale-Retail Angle

In an appeal to distributors, Television Service Dealers Assn., 5016 York Rd., Philadelphia 41, Penna., raises a practical point in the matter of retail sales by distributors. Service techs, claims TSDA, are avoiding distributors who give them slow service because countermen are tied up for half an hour or more finding some 50-cent item for a "student" or "hobbyist" as the dealer waits for service.

While the dealer usually takes advantage of the distributor's delivery service, when he does come in himself it is because he has a tech and a set tied up waiting for needed material. Under these circumstances, the distributor is wasting his own time as well as that of the dealer by handling unprofitable business. Increase your own efficiency, TSDA tells jobbers, by putting this small business on the retail level where it belongs, and stop driving away your real customers.

Stabilizing Charges

Associated Radio-TV Service Dealers, 2552 N. High St., Columbus 2, Ohio, is holding discussions on price stabilization so that action may be taken by a stabilization committee to formulate some guide in determining service charges. Aim of the measure is to combat unfair charges. This association is also continuing its work toward a clearing house for credit information, to cut down on credit losses by members.

New ARTSNY Officers

Officers of Assoc. Radio-TV Servicemen of N. Y. for 1956 include Peter La Presti, pres.; Bob Olson, exec. secy.; and Jack Spegal, treas. Chairman of the board of directors is Max Liebowitz.

Recent issue of ARTSNY Newsletter tells story of the role played by the organization in cooperating with law enforcement officials to bring TV gyps to justice, despite threats and attempts at bribes.

TSDA Publication Bows

The Television Service Dealers Association of San Mateo County, California, has launched its own official publication. First edition of *TV Service* appeared in March. This association has a grievance committee set up to handle customer complaints against service by its members. The committee is settling an average of 3 or 4 complaints a month.

Jack Webb Gets Ass'n Award

An achievement award for "exposing the practices of some TV service men who victimize the public" on his TV show, "Dragnet," will go to Jack Webb from the Federation of TV-Radio Service Ass'ns of Penna. Presentation of the award will be made in California by the California State Electronics Ass'n, 123 S. 3rd St., San Jose 13, Calif.

RTASCV By-Laws

As a service to its readers and members, the Radio and TV Association of Santa Clara Valley, Calif., is publishing

its by-laws serially in its official organ, *RTA*. It leads off in the March issue with the first of 3 articles.

New Ass'n Publications

Joining the ranks of service organizations with their own official publications is the North Bay Radio and TV Association, Box 52, Vallejo, Calif. Vol. 1, No. 1 discusses zoning laws as they apply to TV repair techs operating out of their own homes, a membership drive, fair play with respect to wholesale-retail selling, and the role of the publication in acting as a sounding board for the membership.

There are many
reasons why you
should use

QUAM

Adjust-a-Cone[®]

SPEAKERS

but it all comes down to this...

*ask for QUAM, the quality line,
for all your speaker needs*

QUAM-NICHOLS CO.

226 East Marquette Road

Chicago 37, Illinois

- Adjust-a-Cone[®] Suspension
- U-Shaped Pot
- Heavier Magnetic Structures
- Factory packaged
- Universal Mounting Brackets
- Baked Aluminum Finish
- Listed in Counterfacts and Photofacts

Your customer
can hear
the Quality
that is built
into every
Quam Speaker

MECHANICAL & ELECTRICAL

ENGINEERS

All Levels

More Than A Career,

LEAR, Inc.

offers you

A Way of Life

—a way to work

Since it was founded 25 years ago, LEAR, Inc. has maintained an uncompromising standard of quality in high-precision electronic and mechanical accessories, devices and instruments for the aviation industry. Among these are: Servo Systems, Magnetic Modulators, Stable Gyro Platforms, Magnetic Sensing and Guiding Devices, Precision Actuators and Electronic Switches. Today these standards have helped create a large and ever-growing demand for LEAR products. This is the LEAR "way to work"—its problems and achievements—which we offer to share with qualified engineers.

—a way to live

You create an entirely new way of life when you make your home in Grand Rapids, Michigan. In addition to the many cultural and educational facilities, you will find a thriving yet uncongested community . . . neighborly people . . . and the unlimited recreation and relaxation that the beautiful surrounding countryside offers.

We Now Have Openings

for men with varying degrees of experience in research, design and development.

To Arrange Interview

send resume to:

Employment Manager



LEAR, Inc.

110 Ionia Ave., N.W.
Grand Rapids 2, Mich.

Catalogs & Bulletins

TUBE CROSS REFERENCE: Up-to-date (8th edition) guide for miniature tubes lists 416 types regardless of make (88 of them new) and includes 168 basing diagrams. Large-bulb prototypes are also listed in this 16-page brochure. Bulletin #PA-1, available free. CBS-Hytron, Danvers, Mass. (TECHNICIAN No. B5-1)

CORRESPONDENCE COURSES: Home-study courses to prepare for FCC license examinations, with individual instruction, coaching, pre-exam tests and other features, including a guarantee tied to passing of examination, are described in 16-page brochure on FCC License Information. Cleveland Institute of Radio Electronics, 4900 Euclid Ave., Cleveland, Ohio. (TECHNICIAN No. B5-2)

SALUTE-TO-SERVICE POSTER: Window-sized blow-ups of its recent ad, "Sprague Salutes the Independent Service Dealer," printed in 2 colors, are available free from the manufacturer on letterhead request. Poster RP-15. Sprague Products Co., North Adams, Mass. (TECHNICIAN No. B5-3)

REPLACEMENT COILS, XFORMERS: Cross-reference guide to replacement yokes and flyback transformers lists Todd numbers, set mfr's numbers, models & chassis for 50 different makers. 16 pp. Available on request. Supplementary replacement guide. Todd-Tran Corp., Mount Vernon, N. Y. (TECHNICIAN No. B5-4)

BATTERY GUIDE: Dual-purpose radio battery replacement guide and comparative slide chart shows interchangeable types of various manufacturers and also lists types for most popular portable radios by 34 leading manufacturers. Available free. Ray-O-Vac Co., 212 E. Washington Ave., Madison, Wisc. (TECHNICIAN No. B5-5)

GERMANIUM DIODES: Technical data sheets give specs and ratings on complete line of glass subminiature germanium diodes, general-purpose and special types. Clevite Transistor Products, 241 Crescent St., Waltham 54, Mass. (TECHNICIAN No. B5-6)

TROL-MASTER DATA: Bulletin detailing operation of the Trol-Master cleaner and lubricator for radio-TV controls, together with information on adapters to accommodate special controls and control shafts, also describes Kleentrol solvent. *Bulletin No. 22. R-Columbia Products Co., Inc., Highwood, Ill. (TECHNICIAN No. B5-7)

HI-FI: "This is High Fidelity" 100 page booklet explains functions of units. Lists components and systems in a wide range of prices. Allied Radio Corp., 100 N. Western Ave., Chicago 80, Ill. (Ask for B5-9)

COMMERCIAL SOUND: Multi-color catalog covers complete line of Pacemaker commercial amplifiers, including portable and low-voltage mobile units, as well as accessories such as universal speaker housings, carrying cases, connectors. H. H. Seay, v-p sales, Bell Sound Systems, Inc., 555 Marion Road, Columbus 7, Ohio. (TECHNICIAN No. B5-8)

TAPE TIMING: User can determine at a glance the time and length factors used in tape recording for regular, long play, and extra long play tapes, determining in advance how much tape will be needed for recording job, or how much time can be put on a given length of tape. For all tape speeds, single and dual track. Soundcraft Timing Chart; \$1.20. Reeves Soundcraft Corp., 10 E. 52nd St., New York 22, N. Y. (TECHNICIAN No. B5-19)

SERIES-STRING TUBES: Quick-selection chart lists 600-ma controlled-heater-warmup tubes, classifies 48 types according to elements, lists typical service and heater voltages, other characteristics. Chart ETD-1163-A. GE Tube Dept., Schenectady, N. Y. (TECHNICIAN No. B5-10)

ELECTRICAL TAPES: Various types and sizes of friction, rubber insulating, vinyl and color tapes are covered together with the applications for which each is best suited, and practical suggestions for use, in "Big 4 Electrical Tapes." Johns-Manville, Dutch Brand Div., 7800 S. Woodlawn Ave., Chicago 19, Ill. (TECHNICIAN No. B5-11)

CERAMIC CAPACITORS: Comprehensive 20-page catalog covers all popular disc, tubular, slug-type and special-type ceramic capacitors, including Tiny Mike line. Pat. No. 616. Sales Promotion Dept., Cornell-Dubilier Electric Corp., S. Plainfield, N. J. (TECHNICIAN No. B5-12)

CRT, TUBE SALES PROMOTION: 16-page brochure describes consumer give-away literature, prizes, book matches, decals, banners, other aids promoting Silver Screen 85 pix tubes and other electron tubes. Sylvania Electric Products, Inc., Advertising Dept., 1100 Main St., Buffalo 9, N. Y. (TECHNICIAN No. B5-13)

PHONO STYLII: Form 5602 covers new phono needle kits for set-up of stylus sales departments, displays, sales material, combination offers including storage cabinets and microscope. Recoton Corp., 52-35 Barnett Ave., Long Island City 4, N. Y. (TECHNICIAN No. B5-14)

H-F TRANSISTORS: Tentative spec bulletin describes high frequency transistors, series GT-760. General Transistor Corp., 95-18 Sutphin Blvd., Jamaica 35, N. Y. (TECHNICIAN No. B5-15)

HI-FI: Amplifiers and tuners illustrated with specifications and descriptive high-lights. Available from dealers. Harman Kardon, 520 Main St., Westbury, N. Y. (Ask for B5-16)

AUDIO, HI-FI: Up-to-date 130-page 1956 catalog gives comprehensive rundown of leading lines of all types of audio and Hi-Fi equipment. Terminal Radio Corp., 85 Cortlandt St., New York 7, N. Y. (TECHNICIAN No. B5-17)

AUTO-RADIO XFORMERS: Replacements for nearly 500 models of auto radios, including 12-volt models, in 8-page Auto Radio Replacement Guide, Cat. No. AR-56. Vibrator power and audio output xformers cross-referenced for all makes. Triad Transformer Corp., 4055 Redwood Ave., Venice, Calif. (TECHNICIAN No. B5-18)

TUBES & CRT'S: 16-page booklet on picture tubes, their characteristics and replacement information (Form No. KB-106) includes color crt's, is designed to enable quick choice of a direct replacement. Revision of "RCA Receiving Tubes for AM, FM, and TV Broadcast," describes more than 600 types including pix tubes, includes classification chart, in 28 pages. Either booklet, 20 cents per copy. Commercial Engineering, RCA Tube Div., Harrison, N. J. (TECHNICIAN No. B5-20)

AUTO-RADIO ANTENNAS: Illustrated folder with specs on complete line of auto radio antennas of all types. Antenna Specialists Co., 12435 Euclid Ave., Cleveland 6, Ohio. (TECHNICIAN No. B5-21)

MERCURY CELLS: Complete line of industrial mercury cells and batteries, ranging from dime-size units up to unlimited arrangements for desired voltage and current, described in 4-page brochure. General Dry Batteries, Inc., 13000 Athens Ave., Cleveland 7, Ohio. (TECHNICIAN No. B5-22)

HI-FI AMPLIFIERS: Bulletin 222 describes complete line of separate amplifiers, preamp-control units and combination control amplifiers, all output ratings and prices, with special features. Electro-Voice, Inc., Buchanan, Mich. (TECHNICIAN No. B5-23)

ANTENNA PROMOTION: Brochures list newspaper mats and other sales aids for promoting sales of antennas and antenna kits, for dealers and jobbers. Clear Beam Antenna Corp., P. O. Box 471, Canoga Park, Calif. (TECHNICIAN No. B5-24)

CLOSED-CIRCUIT TV: Low-cost TV camera and system for marketing and installation through local service outlets described in 4-page brochure. Mfr. offers assistance in planning systems for local hotels, schools, stores, banks, etc. Blonder-Tongue Laboratories, Inc., 526-536 North Ave., Westfield, N. J. (TECHNICIAN No. B5-25)

WIRE-WOUND RESISTORS: Power w-w resistors, tubular and flat, described with technical and physical data in detailed charts and graphs. Bulletin C-1a, 12 pages. International Resistance Co., 401 N. Broad St., Philadelphia 8, Penna. (TECHNICIAN No. B5-26)

Your Partner for Profitable Installations . . .

TELCO VHF-UHF ANTENNAS and your TELCO Distributor!

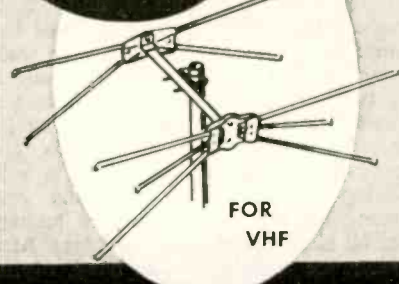
FOR VHF

**BRING YOU THE MASTERLINE
CONICAL ANTENNA**
ALL ALUMINUM!

ALUMINUM CROSS ARM—high Tensile Alloy.
UNBREAKABLE INSULATOR—made of Styron.
DOWELED ELEMENTS—doweled with 6" dowels, 3/8" dia neter, closed end aluminum elements.
DOUBLE LIFE AGAINST RUST . . . zinc plated and diromate dipped insures long-lasting protection.
CROSS BAR ASSEMBLED . . . insures fast installation.
ALL CHANNEL COVERAGE engineered for peak reception.

No. A-8700-8S	8-Element 1-Bay
No. A-8700	10-Element 1-Bay
No. A-8702-8S	8-Element 2-Bay
No. A-8702	10-Element 2-Bay

TELCO ELECTRONICS MFG. CO.

Division of General Cement Mfg. Co.
919 Taylor Avenue, Rockford, Illinois

FREE COPY . . . Telco "Supermarket" Catalog. Send postcard today!



Telco Roto-Indoor Antenna
No. A-9263



Telco Deluxe Corner Reflector
No. A-8984



Telco UHF 10-Element Golden Yagi No. A-320



With such a wide variety of TELCO Antennas to choose from, you can be sure of profitable installations regardless of distance or location. Your nearby TELCO distributor will be glad to show you the complete TELCO line.

SEE US . . . BOOTH 590—ROOM 612—PARTS SHOW

the Talk of the Industry

an amazing new service tool . . .

at a Fantastically Low Price!

BOSIPT*

SOLD ONLY THROUGH DISTRIBUTORS





No more need for expensive, elaborate equipment to repair picture tubes. The convenient BOSIPT* does the job in two minutes without removing the chassis. Easy to set up — easier to use, it repairs filament-to-cathode and grid-to-cathode shorts in a jiffy. Restores brightness control operation. There's no bulky testing case, no extra leads required.

See your favorite Local Parts Jobber



WORKMAN

INC.

TV

Manufacturers of
Electronic SPECIALTIES

TEANECK, N. J.

* *Repairs open shorts in picture tubes*

PAYS FOR ITSELF — with the first use.

REPAIRS PICTURE TUBES — in the set.

GIVES LONGER PICTURE TUBE LIFE — to regular customers.

TWO MINUTE OPERATION — saves \$40 tube.

SIMPLE AND EASY TO USE — and fits into your kit.

\$5.95 list

only \$3.57

DEALER NET

More current instantly available
from standby to transmission

New Low Cost DC POWER SUPPLY

by **Electro**
ELECTRONIC EQUIPMENT



Service
LPI and 10 watt
6/12 volt mobile
communications
equipment
from AC lines

End unreliable battery servicing with Electro's new Model "H" performance-tested power supply. For servicing all low power input and mobile communications receivers used by taxis, police cars, fire trucks, ambulances, Red Cross and civil defense vehicles . . . also portable equipment used by forest rangers, construction crews, etc.

- ✓ Delivers 6 volts to 20 amperes or 12 volts to 10 amperes continuously.
- ✓ Adequate regulation.
- ✓ Current up to 30 amperes instantly available for short test transmission periods.
- ✓ 5% ripple at maximum output.
- ✓ The only power supply offering so much performance and so much value at this price . . . backed by Certified Performance Chart.

See your Radio Parts Distributor or
send directly for technical data

Electro
ELECTRONIC EQUIPMENT

ELECTRO PRODUCTS LABORATORIES
4501-T N. Ravenswood Ave.
Chicago 40, Illinois

609

New Products

Rek-O-Kut TURNTABLE ARM

Model 120 is for records up to 12 in. in diameter and Model 160 for records up to 16 in. Prices \$26.95, and \$29.95, respectively. The arm proper is of tubular construction, with cartridge shell attached by bayonet-lock arrangement. A twist secures shell to arm while a twist in the other direction permits quick removal. Cartridge shells are available separately at \$4.95. No soldering required. Silver plating and spring-loading assure positive contact for all standard pickup cartridges. Arm resonance is below audio band. Stylus pressure is adjusted by a counterweight threaded to far end of the arm tube. Rek-O-Kut Co., 38-01 Queens Blvd., Long Island City 1, N. Y. (TECHNICIAN No. 5-37)

Ram FLYBACKS

The X126 flyback is a composite which replaces 12E-23939 and 12E-24612 for Airline, Coronado, Firestone, Raytheon and Truetime, including 28 chassis and 81 models. The X126 is an autotransformer-type flyback which is used in 66-70° systems. It delivers 13 to 15 kv. The X127 transformer covers Westinghouse numbers V-11548, -1, -2, V-12073, V-14346, V-14627, V-15324-1, -2, and V-15650. The X127 may operate both in the 66-70° and 90° systems, delivering from 15 to 19 kv. Ram Electronics Sales, S. Buckhout St., Irvington-on-Hudson, N. Y.—TECHNICIAN (Ask for No. 5-38)

Berkshire STROBE LAMP

Model 18-A, is a small, inexpensive stroboscope unit, giving 60 brief flashes of light per second when connected to 60-cycle power. It is useful for determining speeds of rotation of motors, machines, phonograph turntables, etc. Model 18-A uses a standard neon bulb for replacement. The instrument is housed in a chromium plated case, the same size as a standard two-cell flashlight. Price, \$9.95. Berkshire Laboratories, 518 Bank Village, Greenville, N. H. (TECHNICIAN No. 5-39)

Heyco STRAIN RELIEFS

Expressly designed for 300-ohm twin-lead, these strain reliefs are used where the wire enters UHF converters, indoor antennas or the TV set itself. Installation is in two simple steps. Heyco's "unitized" construction, which joins the two parts with nylon, cuts assembly time. Reliefs grip the wire, insulate and anchor it to chassis or antenna at the point of entry, absorb push, pull or torque. Available also for other wire sizes and applications. Heyman Mfg. Co., 100 Michigan Ave., Kenilworth, N. J. (TECHNICIAN No. 5-40)

Kedman SCREWDRIVER

"Midget" series of Quick Wedge drivers will hold, start, and drive #0 to #4 wood screws and bolts; #2 to #4 sheet metal screws. Quick Wedge ends dropping and fumbling with screws, lets you "reach" a screw into a tight spot. Precision-built, unconditionally guaranteed with shockproof, unbreakable handles, spring steel hollow-ground blades. The Midget #1253 has a spring pocket clip. Kedman Co., 233 S. 5th West, Salt Lake City 1, Utah. (TECHNICIAN No. 5-41)

Capcon MIN. CAPACITORS

Uncased "mylar" capacitors are available in sizes smaller than other miniatures for high-temperature uses up to 200°C. Type designations are: UR, for uncased round mylar capacitors, and UF, for uncased flat. Both types are available in standard tolerances of 0.5, 1.0, 2.0 and 5.0 percent. Capacity ranges are from 1 mmfd to 10 mfd. Working voltages are: 50, 100, 150, 200, 250, 300, 400 and 600 volts. Capcon, Inc., 25 Willett Street, New York 2, New York (TECHNICIAN No. 5-42)

Dodge AUTO-TRUCK

A vehicle for installing and servicing home appliances has the load capacity of a panel truck, comforts of a passenger car and greater versatility than a station wagon. The Dodge Town Wagon truck has passenger car styling but greater road clearance for use on rutted and muddy roads where cars cannot travel. Offered in 8 and 6-passenger models. Center and rear seats are easily removed. Maximum payload capacity is 1650 lbs. permits 90 cu. ft. of load space even with 6 passengers. Dodge News Bureau, 2751 E. Jefferson, Detroit 7, Mich. (TECHNICIAN No. 5-43)

Phaostron VOM

The 666 VOM is fused to prevent most common burn-outs and instrument damage through misapplications. An overload signal light warns the operator of overloads, or incorrect polarity. An illuminated dial is used. The 666 measures: dc volts from 1.5 to 1500 at 20,000 ohms per volt; ac volts from 1.5 to 1500 at 2,000 ohms per volt; dc current from 50 ua to 15 amps; db from -10 to +50; resistance from .25 ohms to 10 meg. Phaostron Instrument and Electronic Co., 151 Pasadena Ave., S. Pasadena, Calif. (TECHNICIAN No. 5-44)

PLAN AHEAD

Merit

FIRST IN EXACT REPLACEMENT.

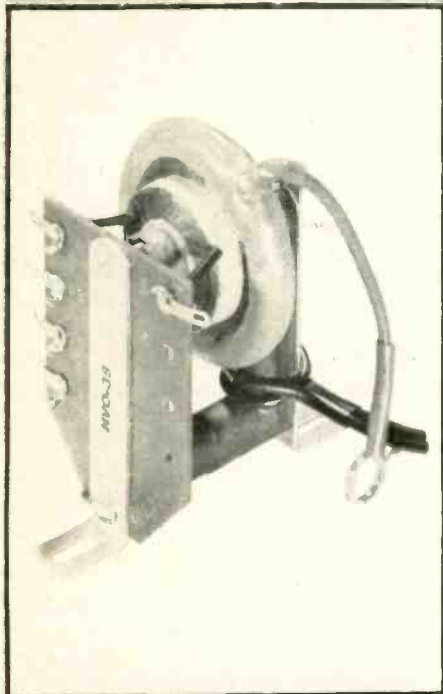

HVO-38 and HVO-54 FOR EXACT REPLACEMENT in ADMIRAL . . . another in the complete Merit line of exact and universal transformers, yokes and coils. Merit is the only manufacturer of transformers, yokes and coils who has complete production facilities for all parts sold under their brand name.

Merit

MERIT COIL & TRANSFORMER CORP.
4427 N. CLARK ST., CHICAGO 40, ILL.

Transistor Replacements

Although interchangeability of different transistor makes and types has not yet reached the high degree of excellence available with tubes, a number of these units may be used as replacements for other type numbers when servicing transistorized radios. In some cases the characteristics of two different types may not be identical, but they may be close enough to permit the set to operate when they are interchanged.

Listed below are three portables, the transistors they contain, and the interchangeable types usable for replacements, as reported by General Electric. Note that a PNP type is never directly substituted for a NPN type.

RAYTHEON MODEL 8TP1

USE	RAYTHEON TYPE	GENERAL ELECTRIC REPLACEMENT
Oscillator	CK-760 PNP	2N136 PNP
Converter	CK-759 PNP	2N135 PNP
IF	CK-760 PNP	2N136 PNP
1st Audio	CK-721 PNP	2N45 PNP
2nd Audio	CK-721 PNP	2N45 PNP
Audio Output	CK-721 PNP	2N44 PNP
Audio Output	CK-721 PNP	2N44 PNP

EMERSON MODEL 838

USE	EMERSON TYPE	GENERAL ELECTRIC REPLACEMENT
Audio Output	815003 PNP	2N44 PNP
Audio Output	815003 PNP	2N44 PNP

EMERSON MODEL 842

USE	TEXAS INSTRUMENT TYPE	GENERAL ELECTRIC REPLACEMENT
Converter-Oscillator	830 NPN	2N78 NPN
1st IF	2N146 NPN	2N78 NPN
2nd IF	2N146 NPN	2N78 NPN
Driver	310 PNP	2N44 PNP
Push-Pull Output	353 PNP	2N44 PNP
Push-Pull Output	353 PNP	2N44 PNP



"Okay! Okay! So you're a man from Mars!"

ALL-CLEAR TV PICTURES

with the new

B-T LABS ANTENNA BOOSTER

(BROADBAND VHF)



MODEL AB

4 TUBES

25DB

GAIN

\$95.00

LIST

WITH

MULTI

VOLTAGE

POWER

SUPPLY

- Low-noise, all-triode circuit
- Easy mast-mounting
- Automatic 'on/off' from set
- 24 and 110v AC available plus step-ups for long-line drop
- Single lead line carries power 'up' and signal 'down'

*For Servicing and Maintenance . . . chassis swings down - trap door fashion - for easy handling and tube replacements.

For complete details, use this coupon



BLONDER-TONGUE LABORATORIES, INC.
Dept. GE-18 Westfield, New Jersey

Please send complete specs of your new Antenna Booster. I am also interested in:

- TV Amplifiers UHF Converters
 Master TV Systems

Name _____

Address _____

City _____ Zone _____ State _____

THE HANDIEST TESTER YOU CAN HAVE IN YOUR KIT

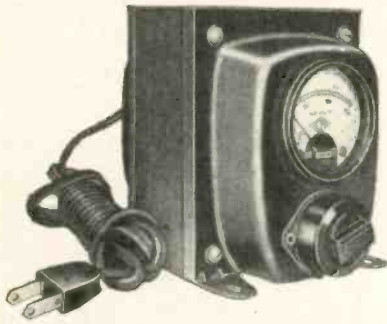

THE ACME ELECTRIC T-8394 VOLTAGE ADJUSTOR

Smart service men, who like to save time and make more money by doing so, are using the Acme Electric T-8394M Voltage Adjustor on every service call. With this unit, varying voltage conditions ranging from 95 to 125 volts input can be simulated. Under these varying voltage conditions defective components that function properly at normal voltage, but cause trouble at low voltage or over voltage can be located and replaced.

And, in thousands of instances, service customers have insisted on buying this handy unit from the service man so that they may maintain a normal voltage at the set and enjoy top TV reception.

Furnished complete: primary cord and plug; secondary receptacle; accurate meter indicates output voltage; control switch regulates secondary voltage. Compact, inexpensive.

See this at your dealers.

ACME ELECTRIC CORPORATION
885 WATER STREET CUBA, NEW YORK

Acme Electric
TRANSFORMERS

Railroad TV

A successful TV installation in a passenger car of the Chicago, Indianapolis & Louisville Ry. paves the way to adding this attraction in club, parlor and pullman cars. The techniques are also adaptable to installation in off-shore and inland watercraft.

The installation, made in the executive office car of the rail line's president, uses a Taco Trapper antenna and a Crown CAR6B antenna rotator. The Trapper, a high-gain single-lobe antenna with all elements in the same plane, meets railroad regulation requirements that limit antenna height to 20 in. above the top of the car. Also, its spring-loaded tension boosters meet the stress placed on antenna elements as the car moves along at high speed. Shielded 300-ohm twin-lead wire was used to solve the problem of interference and stray-field pickup.



Taco Trapper antenna atop railroad car.

the strong wind resistances encountered during travel. On a round trip between Chicago and Rome, Ga., good reception was reported all along the way. Neither antenna nor rotator was affected by the rigors of the trip.



TV receiver (upper left) and rotator control box (lower left) inside executive RR car.

The Crown rotator, incorporating a strong and dependable drive mechanism, was capable of accurately aligning the antenna against

Why Fused Resistors?

The reason for using fused resistors has been concisely summed up by Workman TV of Teaneck, N. J. Their explanation states: "The need for using a current-limiting resistor in series with a selenium power rectifier is well known. In addition, it is quite obvious that, for protection against overloads, a fuse should also be used in these circuits. To the TV set manufacturer, however, the addition of these components, as well as the extra hardware needed, was too costly and so a way was sought to 'cut corners.' Instead of installing a separate fuse, holder, and power resistor; which would be ideal from the standpoint of servicing; they conceived the idea of the fused resistor."

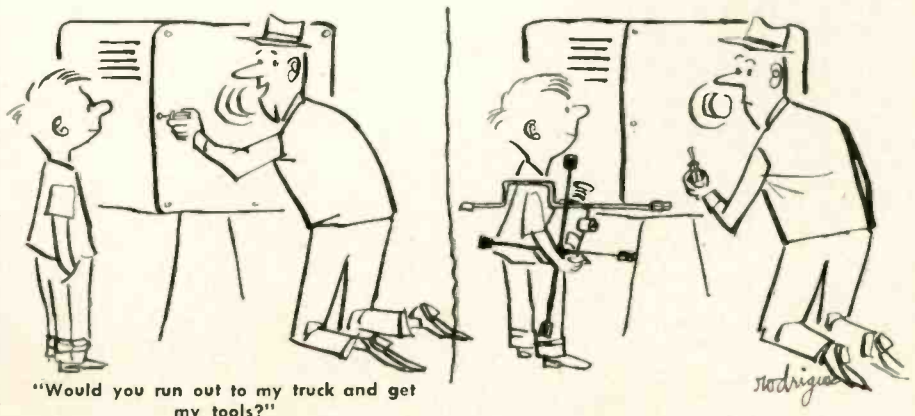

"Would you run out to my truck and get my tools?"

International

presents

"AIRKORE"

a new selenium replacement
rectifier so outstanding it

Outperforms them all!

- 12° to 15° lower core temperature.
- Overload capacity 7 times normal rating.
- 20% less aging.
- Maximum air flow in any vertical mounting position (regardless of degree of rotation).
- Increased efficiency throughout life.

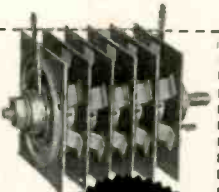

SO GOOD IT'S
guaranteed
for 1 year!

AirKore provides these outstanding advantages without sacrificing the basic design of proven superiority—"center-support" construction!

Compare any other rectifier with the new AirKore. Guaranteed for a full year, this new design assures increased efficiency...will help cut costly "call-backs." For products of the highest quality, manufactured under the most rigid standards in the industry, look for the name International.



This exclusive device provides greater contact area—uniform temperature rise across the plates—increased efficiency.

AirKore design permits maximum circulation of air around the plates, through the core and spring itself.

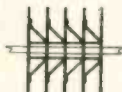

A WORLD OF DIFFERENCE
...THROUGH RESEARCH

International Rectifier

C O R P O R A T I O N

El Segundo, California • Phone ORegon 8-6281

In Canada: Atlas Radio Corp., Ltd.,

50 Wingold Ave. W., Toronto, Ontario • RU 1-6174

THE WORLD'S LARGEST SUPPLIER OF
INDUSTRIAL METALLIC RECTIFIERS

New Audio Products

Magnavox HI-FI UNITS

The Concerto, model TP264B, is a phonograph-amplifier for table or floor-stand use. Push-pull output with 3 tubes plus rectifier. Three speakers include 2 6x9 oval reproducers and one 5-in. unit. Collaro 3-speed intermix changer features automatic shut-off, muting switches and dual sapphire stylii. Available with floor stand in mahogany, oak or cherry at \$119.50 retail.

The Concert Master, model 268B, is a radio-phono console with an 8-tube AM-FM tuner, two 12-in. speakers, one 5-in. speaker, and a 20-watt 5-tube push-pull amplifier plus 2 rectifiers. Collaro 3-speed intermix changer features sapphire stylii. Available in mahogany, oak or fruitwood, priced as low as \$288.50. The Magnavox Co., Fort Wayne 4, Ind. (TECHNICIAN No. 5-48)

Fisher AMPLIFIER

Low-priced standard amplifier, model 20-A, features response from 15 to 30,000 cps within 1 db, less than 0.7 percent distortion at 15 watts, hum and noise level of 90 db below rated output, excellent stability and superior transient response. This basic power amplifier is designed to be used with any separate preamplifier-equalizer-control unit. An octal socket provides ac and dc voltages for a companion unit that lacks its own power supply, plus connections for remote on-off switching. Price is \$59.50. Fisher Radio Corp., 21-21 44th Drive, Long Island City 1, N. Y. (TECHNICIAN No. 5-49)

Garrard PHONO CHANGERS

Three new instruments include the RC88 Triumph, a deluxe auto-manual 3-speed changer replacing the RC80. Features include 1-piece bent spindle, interchangeable large spindle, design features to eliminate hum, rumble and flutter, non-resonant tone arm. Price is \$54.50 less cartridge and 45-rpm spindle. Model RC98 Crown, replacing the RC90, includes the features of the RC88 plus variable speed control at all 3 speeds to facilitate perfect pitch adjustment. Large extra spindle is included in the consumer price, \$67.50. The Renown, model RC121, is a compact straight-spindle changer with quality features that is small enough to be used as a replacement changer. Price, less cartridges and extra spindle, is \$42.50. Garrard Sale Corp., Dept. G-36, Port Washington, N. Y. (TECHNICIAN No. 5-50)

More New Products
on pages 44, 46, 48, 49, 58

be a
man
in the
know



at no cost!

"THE CAPACITOR" comes prepaid direct to your home every month—12 times a year. 16 to 24 pages, including a complete full length technical or constructional article—AND the "TRADING POST" section for your ad. Yes, as a subscriber to the CORNELL-DUBILIER monthly magazine "THE CAPACITOR", you can use its famous "TRADING POST" section to run an advertisement (no cost to you), to SELL—SWAP—or BUY all sorts of equipment and services helpful in your business.

A service of
CORNELL-DUBILIER
world's largest manufacturers of capacitors

GET ON THE LIST
FOR CORNELL-DUBILIER'S
"CAPACITOR"—YOURS

FREE

Editor—"The Capacitor"
CORNELL-DUBILIER ELECTRIC CORP.
Dept. RT-105 South Plainfield, N. J.

—Yes Sir! Put me down for a FREE
Subscription to Cornell-Dubilier's
"THE CAPACITOR"

name _____
please print

address (home) _____

city _____ zone _____ state _____

my occupation or
job title is _____

to
be
SURE!

buy
VOKAR

the original-
equipment
VIBRATOR

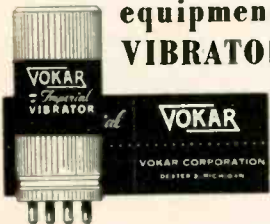

Leading manufacturers of original-equipment auto-radios specify Vokar vibrators as components for installation on the production-line. Why? They're sure Vokar quality never varies — will always contribute to top performance demanded of today's radios.

You too can depend on Vokar vibrators—for sure starts, longer life, silent operation. For all replacement jobs, buy Vokar Imperial or Quality Brand vibrators to be sure of satisfied customers.

Now is the time to stock up on 12-volt vibrators—ONLY TWO VOKAR IMPERIALS ARE NEEDED TO FILL ALL REPLACEMENTS!



VOKAR—preferred by leading manufacturers of auto-radios.

VOKAR

VOKAR CORPORATION
DEXTER 4, MICHIGAN

New Products

Harman-Kardon HI-FI TUNERS

The Overture, Model T-10, is a mating AM-FM tuner to the Prelude amplifier, featuring tuner r-f stage on FM and AFC. Retail price is \$79.50. The Rondo, Model T-120 is a mating AM-FM tuner for the Melody amplifier. Features include FM rumble filter, 10kc AM whistle filter, cathode-follower output, and 3-microvolt FM sensitivity for 20 db quieting. Price is \$95.00. The Solo, Model TA-10, is a single-chassis tuner-amplifier. It combines features of the Overture tuner with those of the Prelude amplifier, including 10-watt output, equalization controls for tape and disc, rumble filter and loudness contour. Price is \$129.50. Harman-Kardon, Inc., Westbury, L. I., N. Y. (TECHNICIAN No. 5-46)

Fanon AUTOMATIC PHONO

The "Varsity" portable record player, model F-80, is a low-priced, 3-speed changer-player with intermix and slumber-switch features, dual sapphire styli, volume and tone controls, in a two-tone carrying case. List price is \$59.50. Fanon Electric Co., Inc., 150-09 South Road, Jamaica, N. Y. (TECHNICIAN No. 5-47)

Telco WALL MOUNT

TV antenna wall mast mount, the V-7, provides 7" of wall clearance. It is constructed of zinc plated heavy gauge steel, and is designed to support any mast up to 1.5" diameter. Catalog No. 9236, list price \$1.50. Television Hardware Mfg. Co., Div. of General Cement, 919 Taylor Ave., Rockford, Ill. (TECHNICIAN No. 5-51)

Colman PIX CONVERSION

Conversion kit allows changeover from 21" metal pix tube to all glass or aluminized crt's in Emerson TV receivers. Designated as No. C-3, with a



list price of \$5.95, the kit will work on both front and side tuning models. Colman Tool & Machine Co., Box 7026, Amarillo, Texas. (TECHNICIAN No. 5-52)

Only TOP-QUALITY brands of

STANDARD BRAND TUBES

NEW . . . FIRST QUALITY. Each tube carries a ONE YEAR GUARANTEE. Latest datings, no rejects, no rebrands or reworked bargains.

Name Brand

4 B Q 7 98¢
2 A F 4 A 89¢

WHILE THEY LAST

6AC7 69¢	6V6G 29¢
6SL7 59¢	6SN7 65¢
6AK5 49¢	12AT7 72¢
5U4GB 63¢	6AF4A 98¢
3585 63¢	

AUDIO OUTPUT TRANSFORMERS

MATCH 6V6—HEAVY DUTY 59¢
MATCH 6K6—FINE QUALITY 39¢
MATCH 50L6—35L6-25L6 39¢
MATCH 3V4—3Q4-354 39¢

T.V. "CHEATER" CORDS 22¢ ea.

BY PASS CONDENSERS

75¢ Doz.

.001 . . . 600V	.0082 . . . 400V	.02 . . . 600V
.002 . . . 400V	.01 . . . 400V	.035 . . . 600V
.0027 . . . 600V	.0125 . . . 1000V	.1 . . . 250V
.0022 . . . 400V	.015 . . . 400V	.47 . . . 200V

GOV'T SURPLUS 6C4 28¢

NAME BRAND SELENIUM RECTIFIERS

300 MA 79¢ | 400 MA \$1.19
350 MA 99¢ | 500 MA \$1.39

No order Too Small. Merchandise shipped within 24 hours of receipt of order. 25% deposit required with order. F.O.B. Brooklyn.

FEDERATED TELEVISION

MART, INCORPORATED

513 Rogers Ave., Dept. T, Brooklyn 25, N. Y.

Fidelitone
Fidelitone
Fidelitone
Fidelitone
Fidelitone
Fidelitone
Fidelitone



PERMO, INC. Chicago 26, Illinois

NOW millions of 21" TV sets can be converted to aluminized picture tubes in only ONE HOUR!

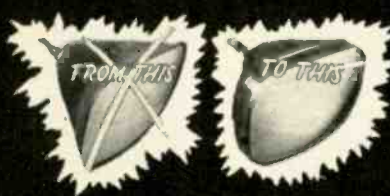

METAL PICTURE TUBE - GLASS PICTURE TUBE

EACH KIT CONTAINS ALL YOU NEED EXCEPT THE NEW PICTURE TUBE

Kit No.	21" Sets	List Price
C-1	Early RCA's	\$5.95
C-2	Late RCA's	\$6.95
C-3	Emerson	\$5.95
C-4	Stewart-Warner	\$5.25
	Silvertone	
	Truetone	
	Hallcrafters	
	Coronado	
C-5	Silvertone	\$6.25
	Firestone	
	CBS-Columbia	

Write for Complete List of Model Numbers

Free adjustable power grip wrench offered with each kit. Write name and address on back of box flap and mail to factory. Wrench will be sent free. Offer expires Sept. 30, 1956.

Arrow Manufacturing Division
COLMAN TOOL & MACHINE CO.
P. O. BOX 7026 AMARILLO, TEXAS

NOW! INSTANT **SOLDER GUN** and COMPLETE "DO-IT-YOURSELF" KIT

FOR HUNDREDS OF RADIO, TV AND HOMECRAFT JOBS

SOLDER GUN ONLY - MODEL G14 \$7.95

BEST KIT VALUE! MODEL G14K \$8.95

Includes:

- ✓ 150-Watt Instant Solder Gun Model G14
- ✓ Cutting Tip for plastic tile, old putty, toys, etc.
- ✓ Smoothing Tip for furniture scratches, sealing, etc.
- ✓ Famous Kester TV-Radio Resin Core Solder
- ✓ Sandpaper for cleaning parts

"You'll like the way it HANDLES!"

COMBINES ALL THE ADVANTAGES OF THE SOLDER GUN AND THE CONVENTIONAL SOLDERING IRON. No waiting - press trigger and solder at once. Ideal tool for shop or home use. Takes only half the space of transformer guns in tool boxes.

120 Volts AC-DC 1/4" Tip (also available 1/8" Tip)

COMPARE THESE FEATURES WITH ORDINARY SOLDER GUNS!

POWER PACKED-150 Watts

NO HEAVY TRANSFORMER - weighs only 8 oz.

STURDY LIFETIME TIP - no soft fragile wire

HEAT RIGHT IN TIP - new unique element design

LONGER, THINNER REACH - EFFECTIVE SPOTLITE

HEXACON ELECTRIC COMPANY
180 WEST CLAY AVENUE, ROSELLE PARK, NEW JERSEY
Serving Craftsmen for a Quarter of a Century

First Modular Scope

Du Mont Labs has unveiled what is believed to be the first oscilloscope, Type 350, to use modular or "tinker-toy" design. This design uses components printed on ceramic wafers. Each module represents a complete circuit element and is wired into its proper position. The circuits are connected by printed wiring.

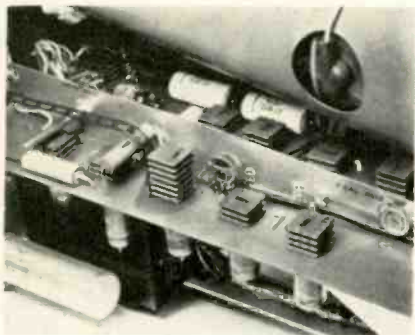

Tinker-toy design uses modules under tubes.

The outstanding advantage of modular construction is the simplicity of maintenance and repair. Instruments are repaired simply by discarding a faulty module and replacing it with a new one.

GE Tune-Up Campaign

A nation-wide TV-radio tune-up program to provide new customer contacts for service techs who sell GE tubes has been announced by John T. Thompson, mgr. of distributor sales for the company's Tube Dept. Thompson is urging service dealers to get in on the promotion by pushing their own local tune-up programs in conjunction with the national plan.

The tune-up plan, part of GE's 5-year "Circus of Values" sales program, is now before the public in a series of ads being run in Life, Look, Collier's, TV Guide, and This Week. The promotion will continue through June. Sales and promotion aids that tie in with this campaign are available from GE tube distributors.

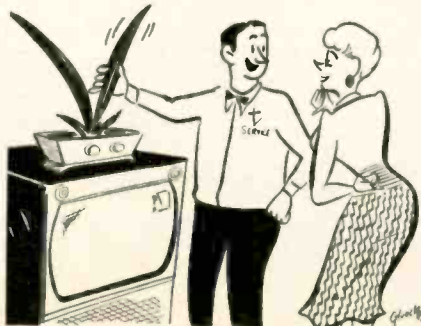

"You just adjust these leaves, see—it's your antenna . . ."

Only the 5 TOP-QUALITY brands of
STANDARD BRAND TUBES

AT SENSIBLE PRICES!

- Individually boxed ● 1st quality only ● 90-day RETMA guarantee ● No rebrands or rewashed bargains ● Brand new ● No private brands ● No rejects

FREE! Newest handy air-mail order form for your ordering convenience. Write for your free copy.

- Lists ALL popular TV & radio types
- Makes mail-ordering a real pleasure
- Orders over \$25.00 (with remittance) post-paid.

TYPE	EACH	TYPE	EACH	TYPE	EACH
024	.50	6AT6	.55	7C7	1.15
1AX2	1.00	6AT8	1.10	7H7	.85
1B3GT	.90	6AU6GT	1.05	7I7	1.35
1H5GT	.80	6AU6GT	1.25	7K7	1.20
1L4	.85	6AU6	.70	7L7	1.15
1L6	1.10	6AU7	.90	7M7	.95
1LA4	1.00	6AV5GT	1.25	7O7	1.00
1LA6	1.00	6AV6	.55	7R7	1.30
1L84	1.00	6AX6GT	.85	7T7	1.30
1LCS	1.00	6AX5GT	.75	7W7	1.30
1LCS	1.00	6B4G	1.25	7X7	1.00
1L05	1.00	6B4G	.65	7Y4	.70
1LE3	1.00	6B4T	.90	7Z4	.70
1L05	1.00	6B4C	1.60	12A4	.85
1LH4	1.00	6BC5	.70	12AL5	.70
1LN5	1.00	6BC7	1.25	12AQ5	.75
1N5GT	.95	6BD5	1.40	12AT6	.55
1Q5GT	1.15	6BD6	.75	12AT7	.95
1R4	1.00	6BE6	.70	12B7A	.65
1R5	.85	6BF5	.85	12AU7	.80
1S4	.90	6BF6	.70	12AV6	.55
1S5	.70	6BGG6	1.80	12AV7	1.00
1T4	.80	6BH6	.85	12AW6	1.00
1T5GT	1.05	6B16	.85	12X4GT	.90
1U4	.75	6BK5	1.00	12X7	.80
1U5	.70	6BK7A	1.10	12AY7	1.75
1V	.95	6BL7GT	1.15	12AZ7	.90
1V2	.70	6BN6	1.15	12BA4	.85
1X2B	.95	6BQ6GT	1.40	12BL7GT	1.00
2AF4A	1.40	6BQ7A	1.20	12BA7	.95
2D21	1.00	6BR7GT	1.25	12BD6	.75
2X2	.50	6BY5G	1.30	12BE6	.70
3A3	1.10	6BZ7	1.25	12BF6	.65
3A5	.75	6C4	.50	12C7A	1.00
3A5	.75	6C5	.85	12BK5	1.00
3AL5	.65	6CB5	4.50	12BQ6GT8	1.40
3AD6	.70	6CB6	.70	12B7A	.95
3AV6	.60	6CD6G	1.80	12B7T	1.00
3B2B	.80	6CF6	.90	12C6	1.40
3B8G	1.05	6CG6	.85	12CA7GT	.85
3B16	.75	6CL6	1.15	12SC7	.95
3C86	.85	6CM6	.85	12S7	.75
3CF6	.85	6C36	.75	12SK7GT	.70
3L14	1.20	6C6	1.40	12SL7GT	1.00
3Q4	.85	6D6	.85	12TA7GT	.80
3Q5GT	1.00	6F5	.85	12SQ7GT	.70
3S4	.80	6F6G	.80	12V6GT	.75
3V4	.85	6H6	.75	12W6GT	.90
4B7A	1.30	6J4	3.95	14A4	1.00
4B7	1.25	6J5	1.20	14T7	1.30
5AN8	1.05	6J6	.70	14A7	.85
5AN8	1.10	6J7	.95	14AF7	1.00
5AR5	.75	6K6GT	.70	14B6	.85
5AT8	1.10	6K7	.90	14C7	1.00
5A7B	1.10	6K8	1.25	14T6	1.30
5A7B	1.15	6L6G	1.35	14E7	1.30
5AW4	1.15	6L6GA	1.30	14F7	1.00
5A74	.60	6L6M	1.75	14F8	1.30
5I4	.90	6N7	1.20	14H7	1.00
5T8	1.75	6Q7	1.00	14J7	1.00
5U4G	.60	6S4	.65	14O7	.95
5U16B	.70	6S8GT	1.10	14R7	1.30
5U8	1.10	6SC7	.90	14S7	1.25
5V16	.95	6SF5	.95	14W7	1.35
5V6GT	.70	6SF7	.75	15AG6G	2.00
5W4GT	.70	6SG7	.95	19T8	1.20
5X4G	.80	6SH7	.95	25AV5GT	1.30
5X8	1.05	6S17M	.75	25AX4GT	1.10
5Y6GT	.55	6S17GT	1.05	25B45	1.00
5Y4G	.65	6S17GT/B	1.05	25B6GT	1.40
5Z3	.90	6S7GT/A/B	.80	25C6GCA	1.80
5Z4	1.25	6S7GT	.70	25C6	1.35
6A8	1.15	6SR7	.75	25L6GT	.70
6A85	1.15	6SS7	1.00	25W4GT	.75
6A8GT	1.10	6T8	1.05	25Z5	.80
6A84	.65	6U8	1.05	25Z6GT	.65
6AC5GT	1.15	6V3B	1.30	35A5	.70
6AC7	1.10	6V6GT	.65	35B5	.70
6A27G	.55	6V6M	1.30	35C5	.70
6AF4	1.30	6W4GT	.75	35L6GT	.65
6AF6G	1.20	6W6GT	.90	35W4	.45
6A25	.75	6X4	.50	35Y4	.45
6AG7	1.35	6X5GT	.55	35Z5	.45
6AM4GT	.85	6XB	1.00	41	.85
6A5	.85	6Y6G	.95	42	.85
6A5	1.75	7A5	.95	43	.85
6AK5	.75	7A6	.80	50A5	.70
6AK6	.80	7A7	.85	50B5	.70
6AL5	.60	7A8	.80	50C5	.70
6AL7GT	1.65	7AG7	1.00	50L6GT	.65
6AM4	1.55	7AH7	1.00	50X6GT	.90
6AMB	1.15	7B4	.80	50Y6GT	.80
6AN4	1.50	7B5	.70	50Y7GT	.80
6AN5	1.50	7B6	.80	70L7GT	1.55
6AN8	1.00	7B7	.80	117A6GT	1.15
6AD5	.70	7B8	.90	117L7GT	2.00
6AQ6	.60	7C5	.80	117M7GT	2.50
6AR7GT	1.20	7C6	.80	117P7GT	2.00
6AR5	.75	7C7	.85	117Z3	.70
6A55	.75	7E7	1.20	117Z4GT	1.15
6A56	2.25	7F7	.90	117Z6GT	1.15
6A58	1.20	7F8	1.20	5642	1.00

We stock over 1000 types including Diodes, Transistors, Transmitting and Special Purpose types.

CASH PAID FOR EXCESS TUBE INVENTORIES! MUST BE NEW, BOXED & CLEAN. WHITE!

TERMS: 25% with order, balance C.O.D. All merchandise guaranteed. F.O.B., N.Y.C.

BARRY ELECTRONICS CORP.
Dept. T
512 Broadway, N. Y. 12, N. Y.
Call us day or night
24 hour telephone service
WALKER 5-7000

EICO 84 Withers St., Brooklyn 11, N. Y. T-51

SAVE ME 50% on precision instruments—
send **FREE CATALOG** on EICO's 46 models
in factory-wired and kit form.

My Name.....
Address.....
City..... Zone..... State.....



NEW! COLOR
and Black-&White
DC to 5 MC LAB & TV
5" OSCILLOSCOPE

#460
Factory-wired
and tested **\$129⁵⁰**
Also available as kit **\$79⁹⁵**

• Features DC Amplifiers!

Flat from DC-4.5 mc, usable to 10 mc. VERT. AMPL.: sens. 25 rms mv/in; Z 3 megs; direct-coupled & push-pull thruout; K-follower coupling bet. stages; 4-step freq-compensated attenuator up to 1000:1. SWEEP: perfectly linear 10 cps-100 kc (ext. cap. for range to 1 cps); pre-set TV V & H positions (30 & 7875 cps); auto. sync. ampl. & lim. PLUS: direct or cap. coupling; bal. or unbal. inputs; edge-lit engraved lucite graph screen; dimmer; filter; bezel fits std photo equip. High intensity trace CRT. 0.06 usec rise time. Push-pull hor. ampl., flat to 400 kc, sens. 0.6 rms mv/in. Built-in volt. calib. Z-axis mod. Sawtooth & 60 cps outputs. Astig. control. Retrace blanking. Phasing control.

BEFORE you buy ANY instruments—get the FACTS on the money-saving, high-precision EICO line. Fill in coupon for FREE catalog & name of your nearby distributor.

EICO 84 Withers St., Brooklyn 11, N. Y.
Prices 5% higher on West Coast

*** HUSH**

T.V. Tuner Cleaner

*** EVER-QUIET**

Potentiometer Cleaner

*** EVER-KLEER**

Picture Tube and Glass Cleaner

HUSH • • • EVER-QUIET • • • EVER-KLEER
are "Three Musts" to every good servicing
technician.

Visit us at our room at the Palmer House
during May Parts Show in Chicago.

Representatives Wanted

*Reg. U.S. Pat. Off.

**CHEMICAL ELECTRONIC
ENGINEERING, INC.**

Matawan, New Jersey

New Products

Major WRENCH

Self-locking and self-adjusting "instant-grip" wrench works by simply placing the moveable jaw against the surface of the nut, and swinging the handle. No worm-type adjustment required. Drop forged steel in three sizes with openings up to 5/8", 1 1/8" and 1 1/16". Major Products Co., 17342 Evergreen Rd., Detroit 19, Mich. (TECHNICIAN No. 5-53)

Boonton RF VOLTMETER

Model 91-A r-f voltmeter provides measurements down to 0.001 v. from 0.2 to 400 mc. Two probes, a high-impedance unit and a 50-ohm type with low vswr are provided. As a power meter with the 50-ohm probe, the instrument can measure down to 0.02 uw. Boonton Electronics Corp., 738 Speedwell Ave., Morris Plains, N. J. (TECHNICIAN No. 5-54)

CBC CRT BRIGHTENER

Picboost "Duz-All" TV picture tube brightener, Model DUB, is designed to cover every brightener-isolation requirement. In addition it features a full sweep variable voltage control which enables the user to increase voltage in small increments. Slide switch enables the user to select either series or parallel. List price is \$4.90. CBC Electronics Co., Inc., 2601 N. Howard St., Philadelphia 33, Pa. (TECHNICIAN No. 5-45)

TV "Dish" Hoisting

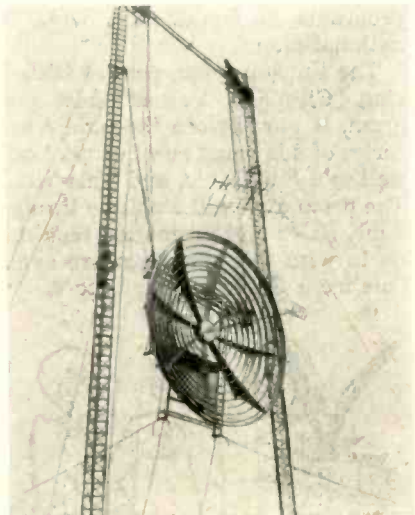

Giant TV "dish" antenna is on its way up to resting post atop two 100 foot towers. The 3,500 lb. paraboloidal structure was built by Jerrald Electronics Corp. to experiment in pickup of New York channels to be carried over the Ventnor, N. J., community antenna system. Worker standing on left tower appears pint-size next to the huge antenna.

Take Home The Winner

in weak signal and coastal areas

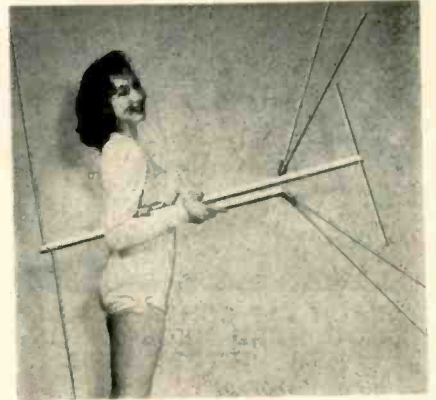

Miss All-Weather Antennas of 1956

says . . . The model 400 (which she is holding) is the only major improvement in TV antennas . . . the only 100% all-metal high gain all-channel TV antenna on the market which does away with common insulators due to a new principle known as "Tuned Insulators"

- HIGHER SIGNAL STRENGTH
- LONGER LIFE—REGARDLESS OF WEATHER CONDITIONS
- GREATER LIGHTNING PROTECTION
- LESS WIND RESISTANCE
- NO ANTENNA SAGGING OR DROOPING
- GREATER PHYSICAL STRENGTH

DEALERS AND SERVICE TECHNICIANS:

Write for brochure and specs
DISTRIBUTORS: We'll be at the PARTS SHOW
at the Hotel Sherman



Hammonton 1,
New Jersey

1073 N. Vine St.
Hollywood, Calif.

**THE JEWEL OF
TV AND RADIO
SERVICING**

a professional instrument
designed for testing a T.V.
ABOVE and BELOW
chassis!

**THE VIDEO
PROBE METER!**

Saves **TWO HOURS PER
DAY** when used in shop for
under chassis work.



With the attachable pick-up loop, (where sufficient signal is available) the Probe Meter can detect and indicate radiation of signal thru I.F. and video amp tubes. (Simply slide loop over tube being tested.) Where internally shielded tubes are encountered, remove tube and insert probe tip into grid pin of socket. Indicates gain per stage.



**Dealers
Net Price**

\$31.50

Can accurately trace signals in the following T.V. circuits—(from tuner to plx tube) R.F., I.F., Det., Video, Sync, local osc., Hz. osc., Hz. Drive, audio output, sound I.F. (Signal tracing radios.)

**EXCELLENT FOR TRACING AND COMPARING
COLOR T.V. CIRCUITS.**

ADDITIONAL FEATURES

Voltmeter, 0-500V. D.C., 20,000 ohms/volt.

Fully Guaranteed

If your dealer cannot supply you, order direct (full purchase price refunded if not satisfied).

DEALERS & REPS. INQUIRIES WILL RECEIVE IMMEDIATE ATTENTION.

Research Inventions & Manufacturing Co.

617 F St., N. W., Washington 1, D. C.

1956 TECHNICIAN BUYERS DIRECTORY

★ Product Finding Index	66
★ Product Listings	68
★ Brand & Trade Name Index	86
★ Service Technicians Associations	91
★ Electronic Parts Distributors	93
★ Electronic Representatives	106
★ Manufacturers, alphabetically listed with Special Localizer Index	111

PRODUCT SECTIONS

ANTENNAS	1
AUDIO ACCESS.	2
AUDIO EQUIP.	3
BOOKS	4
CABINETS	5
CAPACITORS, FIXED, VARY	6
CIRCUIT ACCESS.	7
COILS, XFRMRS	8
COMMUNICATIONS &	
INDUSTRIAL	9
HARDWARE	10
KITS	11
POWER SUPPLIES	12
RECEIVERS, TV-RADIO	13
RESISTORS	14
SEMICONDUCTORS	15
TEST EQUIPMENT	16
TOOLS	17
TUBES	18
WIRE & CABLE	19

50¢

1956 TECHNICIAN BUYERS DIRECTORY

CLASSIFIED PRODUCTS LISTINGS, PAGE 68

ALPHABETICAL LISTING OF MFRS., PAGE 111

Product Finding Index

A fast reference guide that enables you to find the product you want in the *Product Directory*—quickly. Here's how to use the *Product Finding Index*: (1) Look for the product you want (under the name you ordinarily use to identify it). (2) Turn to the

section number given in the *Product Finding Index*. (3) From the manufacturers listed in this section, select only those with the code numbers (listed in the *Product Finding Index*) after their names. These are the manufacturers of the products you want.

Product	Section & Code Numbers	Product	Section & Code Numbers	Product	Section & Code Numbers	Product	Section & Code Numbers
Accessories, antenna, Misc.	1-1	Cable, telephone	19-8	Converters, UHF-TV	13-5	Handsets, phone	3-12
Adapters	7-1	Caddles, tube	5-7	Copper braid	19-1	HARDWARE & MISCL	10
Adhesives	10-1	Calibrators, frequency	16-6	Cords, extension	19-9	PARTS	10
Alignment tools	17-1	Calibrators, voltage	16-7	Cards, lacing	19-10	Headphones	3-13
Ammeters, milli, micro	16-1	CAPACITORS	6	Cards, line & cheater	1-12	Heads, recording, disc	3-14
Amplifiers	3-1	Capacitors, buffer	6-1	Couplers, TV antenna	1-12	Heads, recording, magnetic	3-15
Analyzers, audio	16-2	Capacitors, ceramic	6-2	Cradles, chassis	17-6	Hearing aids & accessories	3-16
Analyzers, interference	16-3	Capacitors, electrolytic	6-3	Crimping tools	17-7	Horns, speaker	3-17
Analyzers, r-f	16-4	Capacitors, feed-thru	6-4	Cross-over Networks	2-5	Inductors, taroid	8-15
ANTENNAS & ANTENNA ACCESSORIES	1	Capacitors, glass	6-5	CRT Reactivators	16-41	Inductors, variable	8-16
Antenna masts	1-16	Capacitors, mica	6-6	Cutters	17-8	Industrial TV systems	9-4
Antenna mounts	1-17	Capacitors, molded	6-7	Decades, capacitance	16-14	Insulation, spaghetti	10-18
Antenna outlets, TV	1-18	Capacitors, molded, paper composition	6-7	Decades, inductance	16-15	sleeving	10-18
Antenna strips, lead-in	1-22	Capacitors, molded, paper & wax	6-8	Decades, resistance	16-16	Insulators, antenna	1-14
Antenna systems, master	1-2	Capacitors, motor	6-9	Decals	10-9	Insulators & Insulating materials	10-19
Antenna whips, mobile	1-26	Capacitors, oil-filled	6-10	Deflection yokes	8-10	Intercom systems	3-18
Antennas, AM outdoor	1-3	Capacitors, paper	6-11	Detectors, crystal	15-1	Interlocks	7-8
Antennas, auto radio	1-4	Capacitors, paper metalized	6-12	Detectors, diode	18-1	Inverters, DC to AC	12-9
Antennas, communications	1-5	Capacitors, photoflash	6-13	Diagrams, Service	4-1	Ion traps	7-9
Antennas, FM	1-6	Capacitors, piston	6-14	Dials and dial accessories	10-10	Jacks	7-10
Antennas, loop core AM	1-7	Capacitors, silicone-filled	6-15	Diodes, crystal	15-3	KITS	11
Antennas, TV, indoor	1-8	Capacitors, tantalum	6-16	Diodes, germanium	15-4	Kits, AM, FM Tuner	11-1
Antennas, TV, outdoor	1-9	Capacitors, tuning	6-17	Diodes, selenium	15-13	Kits, audio	11-2
Antennas, TV, window	1-10	Capacitors, variable	6-18	Diodes, silicon	15-5	Kits, battery charger eliminator	11-3
Attenuators	14-1	Caps, tube (grid & plate)	10-6	Discs, recording blanks	2-6	Kits, crystal set	11-4
AUDIO ACCESSORIES	2	Car-top speaker platforms	2-2	Dividers, voltage	12-6	Kits, educational radio-TV	11-5
AUDIO EQUIPMENT	3	Cartridges, ceramic	3-5	Drills, electric	17-9	Kits, electric-eye equipment	11-6
Automatic tuning mechanism, radio	13-1	Cartridges, crystal	3-6	Drills, hand	17-10	Kits, pix tube conversion	11-7
Baffles & enclosures, speaker	3-3	Cartridges, magnetic	3-7	Drivers, nut, screw	17-11	Kits, power supply	11-8
Ballasts	14-2	Carts & Hand Trucks	17-5	Drivers, speaker	3-10	Kits, radio control	11-9
Batteries, dry cell radio	12-1	Cases, carrying	5-8	Drives, phono	2-7	Kits, short-wave set	11-10
Batteries, hearing aid	12-2	Cases, meter	5-9	Dynamators	12-7	Kits, speaker enclosure	11-11
Batteries, mercury	12-14	Chassis, blank	10-7	Electronic hardware, misc.	10-11	Kits, test equipment	11-12
Batteries, solar	12-13	Checkers, condenser	16-8	Equalizers, phono pre-amp	3-11	Kits, TV booster	11-13
Batteries, storage	12-3	Checkers, CRT	16-9	Escutcheons	10-12	Kits, TV chassis	11-14
Battery chargers	12-4	Checkers, fly-back	16-10	Filters, audio	8-11	Knobs	10-20
Battery eliminators	12-5	Checkers, transformer	16-11	Filters, bandpass	8-12	Ladders	17-34
Bearings	10-2	Checkers, vibrator	16-12	Filters, interference	8-13	Lamps & bulbs	10-21
Benches, work	17-2	Chokes, AF	8-1	Filters, noise	8-14	Leads, test	17-12
Binaural equipment	3-4	Chokes, filter	8-2	Flocking material	10-13	Lightning arresters	1-15
Bits, drill	17-3	Chokes, RF	8-3	Flux	10-14	Limiters, noise	8-17
Blow torches	17-4	CIRCUIT ACCESSORIES	7	Frequency standards	16-17	Line cords, resistors	14-4
BOOKS & SERVICE DATA	4	Circuit breakers	7-3	Fuse Clips & Holders	7-6	Lubricants	10-22
Boosters, TV	13-2	Cleaners, chemicals	10-8	Fuses	7-7	Lug Tools	17-13
Boosters, UHF	13-3	Clippers, sine-wave	16-13	Garage door openers, electronic	9-2	Magnets, CRT	7-11
Brackets, mounting	10-3	Clips	7-4	Gauges, needle pressure	2-8	Manuals, test equip	4-8
Bridges	16-5	Cloth, speaker grille	2-3	Gauges, wire	19-12	Manuals, tube	4-9
Brighteners, CRT	7-2	COILS, FILTERS & TRANSFORMERS	8	Geiger counters	9-3	Masks, adhesive	10-23
Brushes, record	2-1	Coils, field	8-4	Generators, audio	16-18	Masks, CRT	10-24
Bushings	10-4	Coils, focus	8-5	Generators, bar	16-19	Megaphones, power	3-19
Business forms, file systems	4-11	Coils, IF, oscillator & RF	8-6	Generators, color signal	16-20	Meters, audio	16-26
CABINETS, CASES & TABLES	5	Coils, peaking	8-7	Generators, dot	16-21	Meters, field-strength	16-27
Cabinets, chassis	5-1	Coils, speaker voice	8-8	Generators, marker	16-22	Meters, frequency	16-28
Cabinets, custom	5-2	COMMUNICATIONS & INDUSTRIAL ELECTRONIC EQUIP	9	Generators, pattern	16-23	Meters, grid-dip	16-29
Cabinets, equipment	5-3	Compensators, record	3-8	Generators, power	12-8	Meters, modulation	16-30
Cabinets, metal	5-4	Cones, loudspeaker	2-4	Generators, signal RF, IF	16-24	Meters, snap-around	16-31
Cabinets, plastic	5-5	Connectors	7-5	Generators, sweep	16-25	Meters, sound level	16-32
Cabinets, wood	5-6	Connectors, antenna	1-11	Grille, metal & screen	10-15	Meters, time	16-33
Cable, auto radio	19-2	Controls, Industrial electronic	9-1	Grommets	10-16	Meters, watt	16-34
Cable clamps	10-5	Controls, linearity & width	8-9	Grounding equipment	10-17	Microphones & accessories	3-20
Cable, coaxial	19-3	Controls, loudness, volume, tone, etc.	14-3	Guides, capacitor color code	4-2	Mirrors, inspection	17-14
Cable, intercom	19-4	Conversion strips, UHF-TV	13-4	Guides, component replacement	4-3	Mixers, audio	3-21
Cable, microphone	19-5	Converters, color TV	13-19	Guides, pricing	4-4	Mobile 2-way radio systems	9-5
Cable, phonograph	19-6			Guides, rectifier replacement, selenium	4-5	Motors	2-9
Cable, shielded	19-7			Guides, resistor color code	4-6	Mounts	10-25
				Guides, tube replacement	4-7	Multimeters	16-35
				Guying equipment	1-13	Needles	2-10

For the purpose of checking violation of the publisher's copyright or other misuse of this directory, the products or listings have been coded. While these lists may be used for mailing purposes by individual manufacturers only, use of the lists by publishers or commercial mailing services, or any reproduction of the lists in part or whole is strictly prohibited.

Product	Section & Code Numbers	Product	Section & Code Numbers
Ohmmeters	16-36	Spray guns	17-26
Oilers	17-15	Spray, plastic protective	10-38
Oscillators, phono	3-22	Standoffs	1-21
Oscillators, VFO	16-37	Standoffs, terminal	10-39
Oscilloscopes, cathode-ray	16-38	Staplers	17-27
Pads, H, T, etc.	14-5	Storage Bins & Cabinets for parts	5-10
Pads, turntable	2-23	Strippers, wire	17-28
Paint, lacquer & varnish	10-26	Strips, lead-in	1-22
Panels	10-27	Stroboscopes	16-42
Parts, phono, misc.	2-11	Suppressors	6-19
Phonographs	3-23	Switches	7-17
Photo-electric controls	9-6	Suppressors, auto ignition	8-18
Pickup arms	3-2	Suppressors, audio noise	3-30
Pick-ups, telephone	2-12	Switches, antenna	1-23
Pliers	17-16	Switches, electronic	16-43
Plugs, hole	10-28	Tables, TV	5-11
Plugs, power & socket	7-12	Tape, friction & insulating	10-40
Polishes	10-29	Tape demagnetizers	2-19
Potentiometers	14-6	Tape, magnetic recording	2-20
POWER SUPPLIES, BATTERIES & ACCESS.	12	Tape players	3-31
Power Plants & Supplies	12-10	Tape, pre-recorded	2-21
Preamplifiers	3-24	Tape, recorder test	2-22
Preamplifiers, antenna matching	1-19	Tape splicing	3-33
Printed circuit repair kits	17-17	Television sets, color	13-12
Printed circuits	7-13	Television sets, monochrome	13-13
Probes, meter & scope	16-39	Terminals	7-18
Prods	17-18	TEST EQUIPMENT	16
Public address systems	3-25	Testers, battery	16-44
Pulleys, idler	10-30	Testers, continuity	16-45
Punches, taps, dies	17-19	Testers, filament	16-46
Q-meters	16-40	Testers, insulation	16-54
Radioactivity detectors	9-7	Testers, metal rectifier	16-47
Radio sets, AM	13-6	Testers, transistor	16-53
Radio sets, AM-FM	13-7	Testers, tube	16-48
Radio sets, FM	13-8	Thermistors	14-20
Radio sets, transistor	13-9	Thermocouples	7-19
Reactifiers, CRT	16-41	Timers	9-9
Reamers	17-20	TOOLS FOR SERVICING	17
RECEIVERS, TV-RADIO CONVERTERS & TUNERS	13	Tools, alignment	17-1
Receivers, & meters, coin operated	13-10	Tools, electric	17-29
Receivers, communications	9-8	Tools, hand	17-30
Record changers, automatic	3-26	Towers, TV antenna	1-24
Record cleaning cloths & chemicals	2-18	Tracers, signal	16-49
Recorders, disc	3-9	Tranceivers, portable hand	9-10
Recorders, tape	3-32	Transformers, antenna	1-25
Recorders, wire	3-36	Transformers, antenna matching	8-19
Records	2-13	Transformers, audio	8-20
Records, test	2-14	Transformers, constant voltage	8-21
Rectifiers, copper	15-6	Transformers, filament	8-22
Rectifiers, crystal	15-7	Transformers, flyback	8-23
Rectifiers, diode	15-8	Transformers, IF, oscillator & RF	8-24
Rectifiers, germanium power	15-9	Transformers, isolation	8-25
Rectifiers, selenium	15-10	Transformers, power	8-26
Rectifiers, silicon	15-11	Transformers, step-down	8-27
Rectifiers, tube	18-2	Transformers, variable	8-28
Reels, tape	2-15	Transformers, vibrator	8-29
Reference & text books	4-10	Transmission line, TV	19-13
Regulators, voltage	12-11	Transmitters, communication	9-11
Relays	7-14	Transistors	15-12
Remote control units, TV	13-11	Trimmers & Padders	6-20
RESISTORS & RESISTIVE CONTROLS	14	Tube pin straighteners	17-31
Resistors, adjustable, tap	14-7	Tube pullers	17-32
Resistors, carbon	14-8	TUBES	18
Resistors, fixed composition	14-9	Tubes, cathode-ray (oscilloscope)	18-3
Resistors, fixed wire wound	14-10	Tubes, cathode-ray (television)	18-4
Resistors, fuse	14-11	Tubes, control	18-5
Resistors, glass	14-12	Tubes, electron-ray (indicator-eye)	18-6
Resistors, molded	14-13	Tubes, photoelectric	18-7
Resistors, power	14-14	Tubes, receiving	18-8
Resistors, precision	14-15	Tubes, subminiature	18-9
Resistors, variable carbon	14-16	Tubes, transmitting	18-10
Resistors, variable wirewound	14-17	Tubing	10-41
Resistors, vitreous	14-18	Tuners, AM	13-14
Rheostats	14-19	Tuners, AM-FM	13-15
Rotators, antenna	1-20	Tuners, FM	13-16
Saws	17-21	Tuners, front-end TV	13-17
Screws, Nuts, Bolts, Washers	10-31	Tuners, TRF broadcast	13-18
Selectors, crystal	15-2	Turntables	3-34
SEMICONDUCTORS	15	Tweeters	3-35
Shafts, control	10-32	Vibrators, auto radio	12-12
Shielding	10-33	Voltage adjusters	8-30
Shields, tube & coils	10-34	Voltmeters	16-50
Shims, speaker	10-35	Voltmeters, vacuum-tube	16-51
Snaps & studs	10-36	Volt-ohm milliammeters	16-52
Sockets	7-15	Wave traps	8-31
Solder	10-37	Windows, dial	10-42
Soldering guns	17-22	WIRE & CABLE	19
Soldering irons	17-23	Wire, antenna	19-14
Soldering stands, access.	17-24	Wire, bus	19-15
Solenoids	7-16	Wire, grid	19-16
Sound systems, home	3-27	Wire, grounding	19-17
Sound systems, industrial	3-28	Wire, guy	19-18
Speakers	3-29	Wire, high-voltage	19-19
Speaker parts & accessories	2-16	Wire, hook-up	19-20
Splicers, line	17-25	Wire, litz	19-21
Splicers, tape	2-17	Wire, magnet	19-22
		Wire, magnetic recording	2-24
		Wire, phono	19-23
		Wire, test-lead	19-24
		Woofers	3-37
		Wrenches	17-33

TECHNICIAN magazine

still going UP! UP! UP!

1ST IN ADVERTISING GAIN

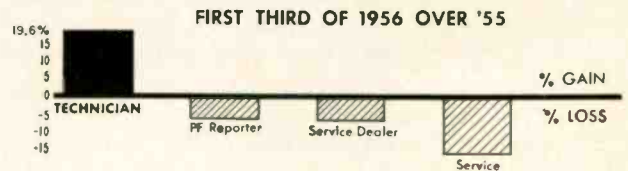

1ST IN ABC PAID CIRCULATION

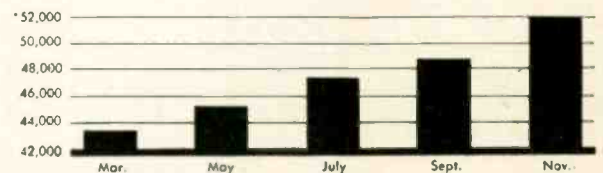

* November issue, ABC Publishers Statement, December 31, 1955.

1ST IN ADVERTISING VALUE

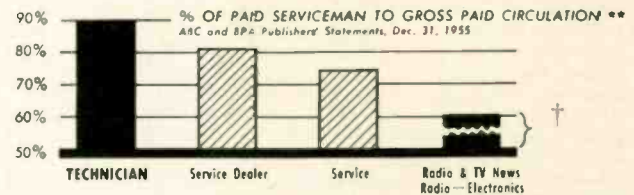

† These are not business publications classified as general magazines by ABC—and cannot furnish audited occupational breakdown.

Publication	Paid Serviceman Circulation	12 ti pg. rate	Cost per 1,000 paid service circ.
TECHNICIAN (ABC 12/31/55)	48,542	\$535	\$11.02
Service Dealer (BPA 12/31/55)	37,158	\$600	\$16.16
Service (ABC 12/31/55)	35,875	\$540	\$15.61
Service Mgt. (BPA 12/31/55)	26,145 controlled	\$395	\$15.11

** PF Reporter: Not an audited publication. No occupational breakdown or post office receipts showing verification of print order, are available.

The facts show TECHNICIAN is FIRST over all TV-electronic service publications

MAKE IT NO. 1 ON YOUR AD SCHEDULE

TECHNICIAN
& Circuit Digests



CALDWELL-CLEMENTS COMPANY
480 Lexington Avenue, New York 17, N. Y.
Plaza 9-7880

1956 TECHNICIAN BUYERS DIRECTORY

Product Listings

This is a complete listing of all service and replacement products, component parts, equipment, instruments, and materials in the radio-TV-electronic service industry—with the names and addresses of the

companies that make them. Product categories are arranged according to major group headings. Manufacturers are listed alphabetically under these groups.

1—ANTENNAS & ANTENNA ACCESSORIES

Accessories, antenna, misc.	1
Antenna systems, master	2
Antennas, AM outdoor	3
Antennas, auto radio	4
Antennas, communications	5
Antennas, FM	6
Antennas, loop-core, AM	7
Antennas, TV, indoor	8
Antennas, TV, outdoor	9
Antennas, TV, window	10
Connectors, antenna	11
Couplers, TV antenna	12
Grounding Equip. (see Sec. 10)	
Guying equipment	13
Insulators, antenna	14
Lightning Arresters	15
Masts, antenna	16
Mounts, antenna	17
Outlets, TV antenna	18
Preamplifiers, antenna matching ..	19
Rotators, antenna	20
Standoffs	21
Strips, lead-in	22
Switches, antenna	23
Towers, TV antenna	24
Transformers, antenna	25
Whips, antenna, mobile	26
Wire, grounding TV (see Sec. 19)	
Wire, guy (see Sec. 19)	

Accurate Electronics Corp., 169 S. Abbe Rd., Elyria, Ohio-11-14-22
 Admiral Corp., 3800 W. Cortland St., Chicago 47, Ill.-1-8-9-10-15-16-17
 Advance Electronics Co., 8510 North End Ave., Oak Park 37, Mich.-6-9
 Aerolite Electronics Corp., 507 26 St., Union City, N. J.-15-21-22
 Aermotor Co., 2300 W. Roosevelt Rd., Chicago, Ill.-24
 Air-E-O Electronics, 374 N. 27 St., Milwaukee 8, Wis.-9
 Airflyte Electronics Co., 21 Cottage St., Bayonne, N. J.-1
 All Channel Antenna Corp., 47-39 49 St., Woodside 77, N. Y.-8-9
 Alliance Mfg. Co., Lake Park Blvd., Alliance, Ohio-20
 Allweather Antenna Mfg. Corp., 350 S. Egg Harbor Rd., Hammononton, N. J.-9
 Alpradco, Inc., Kempton, Ind.-20-24
 American Electronics Co., 1203 Bryant Ave., New York 59, N. Y.-1-6-8-12
 American Elite, Inc., 7 Park Ave., New York 16, N. Y.-4-5-6-11-14
 American Phenolic Corp., 1830 S. 54 Ave., Chicago 50, Ill.-1-5-6-9-12-15-16-22
 American Radio Hdw. Co., 152 MacQueen St., Pkwy S., Mt. Vernon, N.Y.-1-11-16-17-23
 American Tower Co., Shelby, Ohio-24
 Amplitel, Inc., 342 W. 40 St., New York 18, N. Y.-2-18
 Amy, Aceves & King, 11 W. 42 St., New York 36, N. Y.-2
 Anchor Products Co., 2712 Montrose Ave., Chicago 18, Ill.-12-23
 Antenna Products, 3628 N. Lincoln Ave., Chicago 13, Ill.-1-6-9-16-17
 Antenna Specialists, 12435 Euclid Ave., Cleveland 6, Ohio-3-4-5-26
 Antennex Co., 4060 Ocean Park Ave., Venice, Calif.-9
 A P Electro Lab., Box 862 Chestnut Station, Union, N. J.-14
 Armac Co., P. O. Box 1083, Macon, Ga.-16

Arvin Industries, Inc., Columbus, Ind.-7
 Audio Products, 2265 Westwood, Los Angeles 64, Calif.-9-15
 Automatic Metal Products, 315 Berry St., Brooklyn 11, N. Y.-11
 Baker Mfg. Co., 133 Enterprise, Evansville, Wisc.-1-13-16-17-24
 Band-It Co., 2550 Walnut St., Denver 5, Colo.-1
 Barb City Industries, 1150 S. 4 St., DeKalb, Ill.-1-2-9-13-17
 Baumker Mfg. Co., 3826 Summit St., Toledo 11, Ohio-11-13-17
 Beacon Corp., 2846 Milwaukee Ave., Chicago 18, Ill.-9
 Belnord & Co., 481 Sterling Pl., Brooklyn, N. Y.-4
 Bestcraft Products Co., 626 Broadway, New York 12, N. Y.-9
 Best Electronics Corp., 617 19 St., Manhattan Beach, Calif.-11-25
 Birnbach Radio Co., 145 Hudson St., New York 13, N. Y.-1-11-14-15-21-22
 Blaco Mfg. Co., 6541 Euclid Ave., Cleveland 3, Ohio-1
 Blonder-Tongue Labs., 526 North Ave., Westfield, N. J.-1-2-11-12-18-19
 Brach Mfg. Corp., Div. Genl. Bronze Corp., 200 Central Ave., Newark, N. J.-2-3-4-6-8-9-12-18-20-25
 Browning Labs., Inc., 750 Main St., Winchester, Mass.-6
 Buchan Co., R. J., P. O. Box 9, Bricelyn, Minn.-5
 Bud Radio, Inc., 2118 E. 55 St., Cleveland 3, Ohio-16-17-24
 Bullet Electronics, 2637 S. Lowell, Springfield, Ill.-1-16
 Caddell-Burns, 40 E. 2 St., Mineola, N. Y.-7
 Cal-Lee Mfg. Co., 5653 W. Adams Blvd., Los Angeles 16, Calif.-11
 Camburn, Inc., 32-40 57 St., Woodside 77, N. Y.-1-4-6-9-10-11-12-16-21-23
 Carling Electric, Inc., 505 New Park Ave., W. Hartford 10, Conn.-23
 Cass Machine Co., 691 Antoine St., Detroit 1, Mich.-1-6-9-13-14-15-16-17
 Cava TV Eng'g., 1904 Michigan Hwy 139, Benton Harbor, Mich.-1
 CBC Electronics Co., 2601 N. Howard St., Philadelphia 33, Pa.-1-6
 Centralab Div. Globe Union Inc., 902Y E. Keefe Ave., Milwaukee 1 Wisc.-14-21-23
 CGS Labs., Inc., 391 Ludlow St., Stamford, Conn.-1
 Chance Co., A. B., 210 N. Allen St., Centra, Mo.-13
 Channel Master Corp., Ellenville, N. Y.-8-9-16-17
 Cinch-Jones Div., Cinch Mfg Corp., 1026 S. Homan Ave., Chicago 24, Ill.-11
 Circuitron, Inc., 155 W. Main St., Rockville, Conn.-6-9-12-20-24
 Circon Component Co., Santa Barbara Municipal Airport, Goleta (Santa Barbara) Calif.-11
 Clear Beam Antenna Co., 21341 Roscoe Blvd., Canoga Park, Calif.-1-6-8-9-17
 Clegg Labs., Inc., Box 641, Morristown, N. J.-9
 Cletron, Inc., 1974 E. 61 St., Cleveland 3, Ohio-9
 Columbia Products Co., Shakespeare Rd., Columbia, S. Car.-5
 Coaxial Connector Co., 37 N. 2 Ave., Mt. Vernon, N. Y.-11-12-17-26
 Callins Radio Co., Cedar Rapids, Iowa-5-6
 Commercial Products, 417 Main St., Toledo 5, Ohio-13-17-21
 Control Electronics Co., 1925 New York Ave., Huntington Sta., N. Y.-8-9
 Cornell-Dubilier Electric Corp., 333 Hamilton Blvd., S. Plainfield N. J.-1-3-4-6-8-9-17-20
 Coronet Electronics, 1313 N. State St., Chicago, Ill.-8
 Crowley Co., Henry L., 1 Central Ave., W. Orange, N. J.-7
 Crown Controls Co., 40 S. Washington St., New Bremen, Ohio-12-13-20
 Dage Electric Co., 67 N. 2 St., Beech Grove, Ind.-11
 Danforth Mfg. Co., 1003 S. 8 St., Monmouth, Ill.-9-13-16-17

Davis Electronics Co., 4002 W. Burbank Blvd., Burbank, Calif.-1-4-5-9-26
 Deal Products, Hellertown Rd. (MR 37), Easton, Pa.-24
 Delco Radio, 1446 S. Home Ave., Kokoma, Ind.-4
 Delson Mfg. Co., 126 11 Ave., New York, N. Y.-8-12-16
 Diamond Expansion Bolt Co., Garwood, N. J.-1
 Di-Co TV & Plastic Co., 322 Boston Post Rd., Milford, Conn.-1-6-9
 Duala Co., P. O. Box 70, Coal Fork, W. Va.-12-14-15
 DuMont Labs., Inc., Allen B., 750 Bloomfield Ave., Clifton, N. J.-5-26
 Dwyer Eng'g., P. O. Box 483, Nashua, N. H.-15
 Dynamic Electronics, 73-39 Woodhaven Blvd., Glendale, L.I., N. Y.-8
 Easy-Up, Inc., 908 State St., Racine, Wisc.-1-16-17-24
 Ebor Electronics Co., 87 Merrick Rd., Baldwin, N. Y.-5
 Eby Co., Hugh H., 4700 Stenton Ave., Philadelphia 44, Pa.-21
 Eby Sales Co., 130 Lafayette St., New York 13, N. Y.-1-11-12
 Eddy Stoker Corp., P. O. Box 458, Wheeling, Ill.-24
 Electrend Products Corp., State & Water Sts., St. Joseph, Mich.-1-4
 Electronic Hardware Corp., 2420 W. Cermak Rd., Chicago 8, Ill.-1-8-9-13-14-16-17-21-22-24
 Electronic Specialties Mfg., 76 Irving St., Worcester 10, Mass.-1-2-3-5-6-12-23-25
 Elreco Corp., 2900 Cormany Ave., Cincinnati 25, Ohio-9
 Epco Electronics, 140 Liberty St., New York 6, N. Y.-1-12-23
 E-Z Way Towers, 5901 E. Broadway, Tampa, Fla.-5-24
 Falmer Mfg. Co., 312 N. Walnut St., Youngstown 2, Ohio-9
 Federal Electronics Sales, Federal Electronics Bldg., Rockville Centre, N. Y.-1-8-12
 Federal Telephone & Radio Co., Div 1 T & T, 100 Kingsland Rd., Clifton, N.J.-5-6
 Finney Co., 4612 St. Clair Ave., Cleveland 3, Ohio-9
 F K B Opticon Co., 1738 Calvert St., South Bend, Ind.-9
 Forest Electric Co., 7216 Circle Ave., Forest Park, Ill.-25
 Frazier Eng'g Co., 1965 Peck St., Muskegon, Mich.-17
 Fretco, Inc., 406 N. Craig St., Pittsburgh 13, Pa.-3-5-6-8-9-10-11-14
 Fretz, Gross Co., 22 St. & Sedgley Ave., Philadelphia 32, Pa.-17
 Garde Mfg. Co., 588 Eddy St., Providence 3, R. I.-11-21
 Gee-Lar Mfg. Co., 418 S. Wyman St., Rockford, Ill.-1-12-15-16-17-18-21
 General Aluminum Products, 287 5 Ave., New York, N. Y.-16
 General Cement Mfg. Co., 919 Taylor Ave., Rockford, Ill.-11-12-15-18-22-23
 General Electric Co., Apparatus Sales Div., Schenectady, N. Y.-15
 General Instrument Corp., 829 Newark Ave., Elizabeth 3, N. J.-7
 Gerrard & Co., A. J., 1950 Hawthorne Ave., Melrose Park, Ill.-1
 Gonset Co., 801 S. Main St., Burbank, Calif.-1-5-9-16-17
 Great Eastern Mfg. Co., 165 Remsen Ave., Brooklyn 12, N. Y.-12
 Hillburn Electronic Products, 55 Nassau Ave., Brooklyn 22, N. Y.-7-25
 H. M. H. TV Industries, 746 N. Pickering St., Whittier, Calif.-1-11
 Holloway Electronics Corp., Fort Lauderdale, Fla.-9
 Haskey Co., 29 E. Madison St., Chicago 2, Ill.-9
 Hi-Lo TV Antenna Co., 3540 N. Ravenswood Ave., Chicago 13, Ill.-8-9-10-14-15
 Hi-Par Products Co., 347 Lunenburg St., Fitchburg, Mass.-6-9-17-21
 Hotel Radio Corp., 601 W. Fort St., Detroit 26, Mich.-2
 Hy-Gain Television Products, 1828 N. St. Lincoln, Nebr.-1-9

Hy-Lite Antennae, 242 E. 137 St., New York 51, N. Y.-5-6-9

iE. Mfg., 325 N. Hoyle Ave., Chicago 12, Ill.-1-3-8-9-10-14-16-17-18-21-22-24

Imperial Radar & Wire, 820 E. 233 St., Bronx, N. Y.-14-15-17

Industrial Hardware Mfg. Co., 109 Prince St., New York 12, N. Y.-11-21

Industrial TV, Inc., 359 Lexington Ave., Clifton, N. J.-12

Insuline Corp. of America, 186 Granite St., Manchester, N. H.-1-3-4-5-8-9-10-11-12-14-15-16-17-18-21-22-23-26

Isolantite Mfg. Corp., Warren Ave., Stirling, N. J.-1-14-21

JaMac Products Co., 8845 NE Sandy Blvd., Portland 20, Ore.-5-8-9-16-17-26

Jan Hdw. Mfg. Co., 75 N. 11 St., Brooklyn 11, N. Y.-21

Javex, P. O. Box 646, Redlands, Calif.-1-12

Jerrold Electronics Corp., 2222 Chestnut St., Philadelphia 3, Pa.-1-2-12-18-19

Jetron Mfg. Co., 1665 Milwaukee Ave., Chicago 47, Ill.-9

Jewell Inc., A. W. Elyria, Ohio-9

JFD Mfg. Co., 6101 16 Ave., Brooklyn 4, N. Y.-1-4-8-9-10-11-12-15-16-17-18-20-21-22-23

Jones, Div., H. B., Cinch Mfg., 1026 S. Homan Ave., Chicago 24, Ill.-11

Jones & Laughlin Steel Corp., 3 Gateway, Pittsburgh 30, Pa.-16

Jontz Mfg. Co., 1101 E. McKinley Ave., Mishawaka, Ind.-16-17-24

Jordan Mfg. Co., Morrice, Mich.-16

Koto Engineering Co., 1415 1 Ave. N., Mankato, Minn.-20

Kay-Townes Antenna Co., 1511 Dean Ave., Rome, Ga.-6-9-17

Kenwood Eng'g. Co., 265 Colfax Ave., Colfax, N. J.-1-16-17

K & G Electronics, 2738 N. Sheffield Ave., Chicago 14, Ill.-1-8-22-23

Kuehne Mfg. Co., 19 & Olive Sts., Mattoon, Ill.-24

Langevin Mfg. Corp., 47-37 Austell Pl., Long Island City 1, N. Y.-25

LoPolite Electronics, 155 W. Main St., Rockville, Conn.-6-9-12-20

Larson Co., C. O., P. O. Box 358, Sterling, Ill.-1

Leader Electronics Corp., 2925 E. 55 St., Cleveland, Ohio-20-23

Lear, Inc., 11916 W. Pico Blvd., Los Angeles 64, Calif.-14

Lerco Electronics, Inc., 501 S. Varney St., Burbank, Calif.-21

Lynmar Engineers, Inc., 1432 N. Carlisle St., Philadelphia 21, Pa.-1-2-9-12-19-25

McGregor Electronic Industries, McGregor, Iowa-25

Mario Technical Products Co., 1150 E. Henry St., Linden, N. J.-8

Mar-Ko TV Supplies, 441 Summit St., Toledo 4, Ohio-9-16-17

Master Electronics & TV, Rt. 1 Box 36, Libertyville, Ill.-2

Master Mobile Mounts, 1306 Bond St., Los Angeles 15, Calif.-17-26

Mathis Tower & Equip. Co., P. O. Box 126, E. Peoria, Ill.-24

Mechanical Steel Tubing Corp., 500 Barry St., Bronx 59, N. Y.-16

Medal Mfg. Co., 124 E. Silver St., Sharon, Pa.-6-8-9-10-13-14-15-17-25

Meritena Mfg. Co., 120 W. Thomas St., Seattle 99, Wash.-1

Midwest Naturlite Co., 228 W. Kinzie Ave., Chicago 10, Ill.-8-9

Miller Co., J. W., 5917 S. Main St., Los Angeles 3, Calif.-7

Miller Electronics, 2840 Naomi St., Burbank, Calif.-1-4-6-8-9

Mi-TEE Midget Antennas, High Point, N. C.-8

Modern-Aire Mfg. Corp., 4436 W. Roosevelt Rd., Chicago 40, Ill.-1-16-17

Modern Wire Co., 39-30 Review Ave., Long Island City 1, N. Y.-1-16-17-22

Monarch Condenser, 550 Westchester Ave., New York 55, N. Y.-1-12-15-23

Moore Tower & Equip., 1st National Bank Bldg., Peoria, Ill.-16

Mosley Electronics, 8622 St. Charles Rock Rd., St. Louis 14, Mo.-1-11-12-14-18-23

Mueller Electric Co., 1501 E. 31 St., Cleveland, Ohio-21

Munston Mfg. & Service, Beech St., Islip, N. Y.-5

National Aircraft Corp., Electronics Div., 3411 Tulare Ave., Burbank, Calif.-25

National Co., 61 Sherman St., Malden 48, Mass.-14

National Electric Products, 140 Stanwix St., Pittsburgh 22, Pa.-1-9-12-16-17

Notional Tel-Tronics Corp., 52 St. Casimir Ave., Yonkers, N. Y.-22

Neal Electronic Co., 1307 Hunt Ave., Huntsville, Ala.-9

New York Coil Co., 40 2 Ave., Phoenixville, Pa.-25

Nicholas Equia. Co., Bellevue, Ohio-9

Nikah Tube Co., 5000 S. Whipple St., Chicago 32, Ill.-9

Palmer, Inc., M. V., 4002 Fruit Valley Rd., Vancouver, Wash.-5

Parker Metal Goods Co., 161 Summer St., Worcester, Mass.-1-8-14-16-17-21-24

Peerless Products Industries, 812 N. Pulaski Rd., Chicago 51, Ill.-6-8-21

Penn Boiler & Burner Mfg., Fruitville Rd., Lancaster, Pa.-1-9-24

Penn TV Products Co., Allegheny & Trenton Aves., Philadelphia, Pa.-9-12-23-24

Philco Corp., Accessory Div., A & Allegheny Ave., Philadelphia 34, Pa.-1-4-6-8-9-16-17-20

Philmore Mfg. Co., 113 University Pl., New York 3, N. Y.-7-11-15-22

Philson Mfg. Co., 60 Sackett St., Brooklyn, N. Y.-1-3-4-6-9-10-17

Phoenix Electronics, 50 Island St., Lawrence, Mass.-1-3-9-11-12-14-16-21

Pioneer Mfg. Co., Huntley, Ill.-9-24

Pipestone Sales Co. Div., Pipestone Aviation Services, Pipestone, Minn.-16-24

Plymouth Electronics Corp., 50 Kingsbury St., Worcester 3, Mass.-1-2-9-12-13-17-19-23

Porcelain Products, P. O. Box 300, Findlay, Ohio-14

Premax Products, Div. Chisholm-Ryder Co., College & Highland Aves., Niagara Falls, N. Y.-5-17-26

Press Wireless Labs., 25 Prospect Pl., West Newton 65, Mass.-5-19

Q-Line Mfg. Corp., 1562 61 St., Brooklyn 19, N. Y.-1-4-6-8-9-10-11-12-15-17-18-25

Radiart Corp., 3455 Vega Ave., Cleveland 13, Ohio-4-6-8-10-20

Radio Merchandise Sales, 2016 Bronxdale Ave., New York 62, N. Y.-8-9-10-15-16-17-18-20-21-23

Radion Corp., 1130 W. Wisconsin Ave., Chicago 14, Ill.-1-6-8-15

Radio Supply & Eng'g. Co., 85 Selden St., Detroit 1, Mich.-1-9

Ramsey Radio & TV Co., 925 St. Louis Ave., Vandalia, Ill.-24

Rohn Mfg. Co., 116 Limestone Bellevue, Peoria 5, Ill.-1-16-17-24

Ryan Industries, 10910 S. Vermont Ave., Los Angeles, Calif.-1

S & A Electronics, 1025 Nevada St., Toledo 5, Ohio-5-6-8-9

Saxton Products, Inc., 2101 Grand Concourse, Bronx 53, N. Y.-15

Scala Radio Co., 2814 19 St., San Francisco, Calif.-1-8-24

S/C Laboratories, Inc., 37 George St., Newark 5, N. J.-8-9

Scranton Aluminum Mfg. Co., 419 S. Wyoming Ave., Scranton, Pa.-17

Service Welding Co., Cedar Grove, Wisc.-15-16-17

Sherrick Products, 86-11 Soncho St., Hollis 23, L. I., N. Y.-26

Skyline Mfg. Co., 1652 Rockwell, Cleveland, Ohio-3-6-9

Sky Ray Mfg. Co., McLeansboro, Ill.-9

Skysweeper, Inc., P. O. Box 92, McHenry, Ill.-3-6-9-16-17

Smith, Inc., Herman H., 2326 Nostrand Ave., Brooklyn 10, N. Y.-11-21-23

Smolin Labs., 721 Walton Ave., New York 51, N. Y.-2-5-8-9

Snyder Mfg. Co., 22 & Ontario Sts., Philadelphia, Pa.-4-8-9

Southern Industries, 1401 Reisterstown Rd., Baltimore, Md.-16

South River Metal Prods. Co., 377 Turnpike, South River, N. J.-1-16-17

Spaulding Products Co., 550 W. Barner St., Frankfort, Ind.-24

Special Instruments Lab., 312 W. Vine St., Knoxville, Tenn.-9

Specialty Assembling & Pocking, 79 Clinton Pl., Brooklyn 38, N. Y.-17

Spencer-Kennedy Laboratories, 1320 Soldiers Field Rd., Boston 35, Mass.-2-19

Spiriting Products Co., P. O. Box 411, Hicksville, N. Y.-3-9

Stone Machine & Tool Co., Bedford, Ind.-17

Summit Eng'g. Co., 3324 Main St., Hartford, Conn.-9

Suporex Electronics Corp., 4-6 Radford Pl., Yonkers, N. Y.-1-3-7-12

Taylor Mfg. Co., 302 S. Union St., Lima, Ohio-13-17

Technical Appliance Corp., 1 Taco Ave., Sherburne, N. Y.-1-5-6-9-12-13-16-17-18

Tel-A-Ray Enterprises, 335 Clay St., Henderson, Ky.-6-9-10-16

Telco Electronics Mfg. Co., 919 Taylor Ave., Rockford, Ill.-1-8-9-10-16

Tele-Beam Industries, 6 & Soscol Ave., Napa, Calif.-1-6-9-12-16-18-25

Tele-Clear Corp., 185 N. Wabash Ave., Chicago 60, Ill.-9

Tele-Ex-Pand Products Sales Corp., Berwick, Pa.-24

Telematic Industries, Inc., 16 Howard Ave., Brooklyn 21, N. Y.-1-12

Telesine Antenna Corp., 3421 Terry Rd., Jackson 3, Miss.-9

Teletenna Co., 1033 Indiana Ave., La Porte, Ind.-9

Tele-Vue Towers, 701 49 St. S., St. Petersburg 7, Fla.-24

Telkor, Inc., P. O. Box 186, Elyria, Ohio-1-9-10-12-15

Teirex Labs., Hwy. 35, Asbury Park, N. J.-1-2-5-6-9-16-20

Television Labs., Wauconda, Ill.-7-9

Tennalab, 417 S. 10 St., Quincy, Ill.-5-9

Tenna-Lite Corp., 1809 N. Milwaukee Ave., Chicago 47, Ill.-4

Tenna Mfg. Co., 7580 Garfield Blvd., Cleveland 25, Ohio-4-6-8-9-15-26

Tentenna, Inc., 122 E. 42 St., New York 17, N. Y.-8-9

Terwilliger TV Mast Co., Pontiac, Ill.-16

Tescan, Inc., Springfield Gardens, N. Y.-9

Thomas Mold & Die Co., Box 126, Wooster, Ohio-24

Thompson Products, Inc., Electronics Div., 2196 Clarkwood Rd., Cleveland 3, Ohio-20

Thorarson-Meissner Mfg. Div., Maguire Industries, Mt. Carmel, Ill.-25

Tresca, Inc., 3824 Terrace St., Philadelphia 28, Pa.-25

Tricraft Products Corp., 1535 N. Ashland Ave., Chicago 22, Ill.-1-6-8-9-15-16-17

Trio Mfg. Co., Griggsville, Ill.-9-20

TV Equipment Mfg. Co., 17 & Sherman Sts., Wausau, Wisc.-24

TV Hdw. Mfg. Co., 919 Taylor Ave., Rockford, Ill.-1-11-12-14-15-16-17-18-21-22

TV Products Co., 145-68 228 St., Springfield Gardens 18, N. Y.-1-8-9-16-17

U.H.F. Resonator Co., 1405 16 St., Racine, Wisc.-5

Ultra-Hi TV Mfg. Co., 69 Hammond St., Worcester, Mass.-1-9

Unique Ventilation Co., 615 Tiffany St., Bronx 59, N. Y.-17

United Technical Labs., Morristown, N. J.-7-12

Universal Products, 4100 Taylor Ave., Racine, Wisc.-17-24

Utilities Service Co., 1 Pine St., Allentown, Pa.-1-13

Vector Electronic Co., 3352 San Fernando Rd., Los Angeles 65, Calif.-21

Victor Insulators, Inc., Maple Ave., Victor, N. Y.-14

Vidaire Electronics Mfg. Corp., 576 W. Merrick Rd., Lynbrook, N. Y.-1-12-23

Video Accessory Mfg. Co., Box 223, Tulsa 1, Okla.-1-16-17

Video Electronic Lab., 304 Rodgers Rd., Des Moines 15, Iowa-5-9

Vokar Corp., Dexter, Mich.-7

Vulcan TV Mast & Tower, 1224 National St., Birmingham 7, Ala.-1-13-16-24

Waldom Electronics, 4625 W. 53 St., Chicago, Ill.-1-2-11-12

Walnut Machine Co., 732 Western Ave., South Bend, Ind.-24

Walco Electronics Corp., 3602 Crenshaw Blvd., Los Angeles 16, Calif.-9-10-17

Ward Products Div., Gabriel Co., 1148 Euclid Ave., Cleveland, Ohio-1-3-4-5-6-9-11-13-16-17-24-26

Waterproof Electric Co., 801 S. Main St., Burbank, Calif.-1-2-3-5-11-12-13-14-16-17

Wayco, Inc., P. O. Box 115, Waynesboro, Tenn.-9-24

Welco Mfg. Co., 225 S. 3 St., Burlington, Iowa-8-9

Western Coil & Electrical Co., 215 State St., Racine, Wisc.-13-16-17-21-24

Wincharger Corp., E. 7 & Division Sts., Sioux City 2, Iowa-17-24

Wind Turbine Co., E. Market St. & Penno R.R., W. Chester, Pa.-3-6-13-14-16-17-20-21-23-24

Winegard Co., 3000 Scotten Blvd., Burlington, Iowa-9

Winpower Mfg. Co., Newton, Iowa-24

Wizard Electronics, 705 Herman Ave., St. Louis 5, Mo.-8

Woodland Mfg. Co., 416 Woodland Ave., Toledo 2, Ohio-9

2—AUDIO ACCESSORIES

Brushes, record	1
Car-top speaker platforms	2
Cloth, speaker grille	3
Conas, loudspeaker	4
Cross-over Networks	5
Discs, recording blanks	6
Drives, phonograph	7
Gauges, needle pressure	8
Motors	9
Needles	10
Parts, phono, misc.	11
Pickups, telephone	12
Record cleaning cloths & chemicals	18
Records	13
Records, test	14
Reels, tape	15
Speaker parts & accessories	16
Splitters, tape	17
Tape demagnetizers	19
Tape, magnetic recording	20
Tape, pre-recorded	21
Tape, recorder test	22
Turntable Pads	23
Wire, magnetic recording	24

Affton Industries, 8300 Flex-O-Lite Dr., St. Louis 23, Mo.-20

Alliance Mfg. Co., Lake Park Blvd., Alliance, Ohio-9

American Electronics, Inc., 655 W. Washington Blvd., Los Angeles 15, Calif.-9
 American Molded Products, 2727 W. Chicago Ave., Chicago 22, Ill.-15
 American Phenolic Corp., 1830 S. 54 Ave., Chicago 50, Ill.-5
 Ampex Corp., 934 Charter St., Redwood City, Calif.-22
 Amplifier Corp. of America, 398 Broadway, New York 13, N. Y.-19-20
 Argos Products Co., Genoa, Ill.-11-16
 Atlas Sound Corp., 1449 39 St., Brooklyn 18, N. Y.-5
 Audok Co., 500 5 Ave., New York, N. Y.-24
 Audio Devices, Inc., 444 Madison Ave., New York, N. Y.-6-20
 Audio-Moster Corp., 17 E. 45 St., New York 17, N. Y.-20-21
 Beam Instruments Corp., 350 5 Ave., New York, N. Y.-5
 Bennett & Co., Poul, 230 E. Ohio St., Chicago 11, Ill.-10
 Berkshire Recording Corp., 150 W. 90 St., New York 24, N. Y.-21
 Bestcraft Products Co., 626 Broadway, New York 12, N. Y.-3-11
 Bomac Labs., Salem Rd., Beverly, Mass.-3
 Bozak Co., R. T., P. O. Box 966, Darien, Conn.-5
 British Industries, 80 Shore Rd., Port Washington, N. Y.-5
 Brush Electronics Co., 3405 Perkins Ave., Cleveland 14, Ohio-15-20
 Capehart-Farnsworth Corp., 3700 Pontiac St., Fort Wayne, Ind.-3-4-5-11
 Capitol Records, Inc., 1730 Broadway, New York 19, N. Y.-13
 Capps & Co., Frank L., 20 Addison Pl., Valley Stream, N. Y.-10
 CBC Electronics Co., 2601 N. Howard St., Philadelphia 33, Pa.-16
 CBS-Columbia, Inc., 3400 47 Ave., Long Island City 1, N. Y.-13
 Cletron, Inc., 1974 E. 61 St., Cleveland 3, Ohio-5-16
 Colosseum Records, Oakwood Rd. R.R. #3, Norwalk, Conn.-13
 Concertopes, Inc., 400 Jackson Ave., Glen-coe, Ill.-21
 Concert Hall Society, 43 W. 61 St., New York, N. Y.-13
 Consolidated Radio Products, 350 W. Erie St., Chicago 10, Ill.-16
 Cook Laboratories, 114 Manhattan St., Stamford, Conn.-13-14
 Cousino, Inc., 2326 Madison Ave., Toledo, Ohio-17
 Decca Records, Inc., 50 W. 57 St., New York, N. Y.-13
 D & M Products, 13144 W. McNichols Rd., Detroit 35, Mich.-3-11-16
 Duala Co., P. O. Box 70, Coal Fork, W. Va.-5
 Dubbling Sales Corp., 41-10 45 St., Long Island City, N. Y.-14-22
 DuMont Labs., Inc., Allen B., 750 Bloomfield Ave., Clifton, N. J.-2
 Duotone Co., Locust St., Keyport, N. J.-1-6-10-15-18-20-23
 DX Radio Products Co., 2300 W. Armitage Ave., Chicago 47, Ill.-16
 Eby Sales Co., 130 Lafayette St., New York 13, N. Y.-5
 Ecor, Inc., 1501 W. Congress St., Chicago 7, Ill.-11
 Electric Motors & Specialties, King & Hamsher Sts., Garrett, Ind.-9
 Electric & Musical Industries (U.S.) Ltd., 38 W. 48 St., New York 36, N. Y.-13-21
 Electro-Eng'g. Prods. Co., 609 W. Lake St., Chicago 6, Ill.-9
 Electro-Sonic Labs., 35-54 36 St., Long Island City, N. Y.-20
 Electrosonic Specialties, 7230 Clinton Rd., Upper Darby 19, Pa.-21
 Electro-Voice, Inc., Buchanan, Mich.-7-16
 Electrovox Co., 60 Franklin St., E. Orange, N. J.-1-8-10-18
 Elektra Records, 361 Bleeker St., New York 14, N. Y.-13-19-21
 Elek-Trik Seal Labs., 2419 Lanterman Terrace, Los Angeles 39, Calif.-18
 Eltron Corp., 109 W. Station St., St. Anne, Ill.-16
 E.M.C. Recordings, 806 E. 7 St., St. Paul, Minn.-21
 Esoteric Records, 238 E. 26 St., New York 10, N. Y.-13
 Federal Electronics Sales, Federal Electronics Bldg., Rockville Centre, N. Y.-5-18
 Fidelitone, Inc., 6415 Ravenswood Ave., Chicago 26, Ill.-20-24
 Fortune Records, 11629 Linwood Ave., Detroit 6, Mich.-13
 Gard Industries, Inc., Green Bay Rd., Wilmette, Ill.-18
 Garod Radio, 70 Washington St., Brooklyn 1, N. Y.-20
 Garrard Sales Corp., Sub. British Industries, 80 Shore Rd., Port Washington, N. Y.-8

Gee-Lar Mfg. Co., 418 S. Wyman St., Rockford, Ill.-3
 General Apparatus, 344 E. 32 St., New York 16, N. Y.-5
 General Cement Mfg. Co., 919 Taylor Ave., Rockford, Ill.-3-7-11-15-18-23
 General Industries Co., Olive & Taylor Sts., Elyria, Ohio-7-9
 Graybar Electric Co., 420 Lexington Ave., New York, N. Y.-20
 Great Eastern Mfg. Co., 165 Remsen Ave., Brooklyn 12, N. Y.-18
 Honsen Mfg. Co., 1111 S. Hart St., Princeton, Ind.-9
 Hartley Products Co., 521 E. 162 St., New York 51, N. Y.-4-15-16
 Haydn Society, Inc., 30 Huntington Ave., Boston, Mass.-13
 Heath Co., 305 Territorial Rd., Benton Harbor, Mich.-5
 Hunt Co., Philip A., Palisades Park, N. J.-18
 I. G. Textile Co., 30 E. 21st St., New York, N. Y.-3
 Ingalls Electronics, 30 W. Putnam Ave., Greenwich, Conn.-23
 Insuline Corp. of America, 186 Granite St., Manchester, N. H.-14
 Interelectronics Corp., 2432 Grand Concourse, New York 58, N. Y.-1-18
 International Pacific Recording Corp., 858 N. Vine St., Hollywood 38, Calif.-19-21-22
 Jensen Industries, Inc., 7333 W. Harrison St., Forest Park, Ill.-10-18
 Jensen Mfg. Co., Div. Muter Co., 6601 S. Laramie Ave., Chicago 38, Ill.-5-16
 Jones Apparatus Co., Walter M., P. O. Box 277, Sheffield, Mass.-5
 Klipsch & Associates, P. O. Box 64, Hope, Ark.-5
 Kral Products, 1704 Walnut St., Philadelphia 3, Pa.-1
 Livingston Electronic Corp., Livingston, N. J.-21
 London Chemical Co., 1535 N. 31 St., Melrose Park, Ill.-18

Pfanstiehl Chemical Corp., 104 Lake View Ave., Waukegan, Ill.-10
 Phonotapes, Inc., 248 W. 49 St., New York 19, N. Y.-21
 Pickering & Co., 309 Woods Ave., Oceanside, L. I., N. Y.-8
 Plymouth Electronics Corp., 50 Kingsbury St., Worcester 3, Mass.-5
 Precision Electronics, 9101 King Ave., Franklin Park, Ill.-9
 Presto Recording Corp., P. O. Box 500, Paramus, N. J.-6-23
 Prosound Corp., 175 5 Ave., New York 10, N. Y.-1
 Racon Electric Co., 1261 Broadway, New York 1, N. Y.-16
 Radio Corp. of America, Camden, N. J.-15-20
 Radio Corp. of America, Custom Record Sales Div., 630 5 Ave., New York, N. Y.-10-13-14
 Rason Mfg. Co., 3050 W. 21 St., Brooklyn 24, N. Y.-17
 Recorded Tape of the Month, Inc., 449 W. 51 St., New York 19, N. Y.-21
 Recordisc Corp., 395 Broadway, New York 13, N. Y.-6
 Recotone Corp., 52-35 Barnett Ave., Long Island City 4, N. Y.-10-11-20
 Reeves Soundcraft Corp., 10 E. 52 St., New York 22, N. Y.-6-20
 Remington Records, 551 5 Ave., New York, N. Y.-13
 Replica Records, 7210 Westview Dr., Des Plaines, Ill.-13
 Robins Industries Corp., 214-26 41 Ave., Boy-side 61, N. Y.-11-17-23
 Rola Co., 2330 Superior Ave., Cleveland 14, Ohio-4
 Romar Plastics, Inc., 1311 E. Main St., St. Charles, Ill.-11
 Ronette Acoustical, 135 Front St., New York, N. Y.-10
 Rowe Industries, 1702 Wayne St., Toledo 9, Ohio-5
 Royal Diamond Tool Co., 172 Green St., Boston 3, Mass.-10
 Seeco Records, 39 W. 60 St., New York, N. Y.-13
 Sherwood Electronic Labs., 2802 W. Cullom Ave., Chicago 18, Ill.-5
 Shura-Tone Products, Inc., 440 Adelphi St., Brooklyn, N. Y.-10
 Smith, Inc., Hermon H., 2326 Nostrand Ave., Brooklyn 10, N. Y.-11
 Sonic Recording Products, 58 Mill Rd., Freeport, N. Y.-6
 SOS Cinema Supply, 602 W. 52 St., New York 19, N. Y.-17
 Speak-O-Phone Recording & Equip., 23 W. 60 St., New York 23, N. Y.-6-10-20
 Spectrune Sound Associates, 66 E. Gloucester Pike, Barrington, N. J.-13
 Stancil-Hoffman, 921 N. Highland Ave., Hollywood 38, Calif.-20
 Star Record Co., 243 W. 72 St., New York, N. Y.-13
 Stevens Products, 86 Main St., E. Orange, N. J.-4-16
 Sutton Electronic Co., 424 W. Short St., Lexington, Ky.-12
 Tannoy (America) Ltd., 38 Pearl St., New York 4, N. Y.-5-10
 Tayloreel Corp., 3 Rutter St., Rochester 6, N. Y.-15
 Technical Tape Corp., 177 St. & Harlem River, Bronx, N. Y.-20
 Teochrome, Inc., 88 Merrick Rd., Amityville, L. I., N. Y.-5
 Telectro Industries Corp., 35-16 37 St., Long Island City, N. Y.-15-20-22-24
 Televex Co., 46 Lakeview Ave., Yonkers, N. Y.-10
 Tempo Record Co. of America, 8540 Sunset Blvd., Hollywood 46, Calif.-13-21
 Tetrad Corp., 62 St. Mary's Ave., Yonkers 2, N. Y.-10
 Thorens Co., New Hyde Park, N. Y.-9-11
 Toman & Co. E., 8700 W. 47 St., Lyons, Ill.-11
 Transcriber Co., 98 County St., Attleboro, Mass.-10
 Trend Textiles, Inc., 180 W. Randolph St., Chicago 1, Ill.-3
 University Loudspeakers, Inc., 80 S. Kensico Ave., White Plains, N. Y.-4-5-16
 U.S. Recording Co., 1121 Vermont Ave., N.W., Washington 5, D. C.-20
 Uranic Records, Inc., 40 E. 19 St., New York, N. Y.-13
 Utah Radio Products Co., 1123 E. Franklin St., Huntington, Ind.-5
 Vanguard Recording Soc. Inc., 256 W. 55 St., New York 19, N. Y.-13
 Vidair Electronics Mfg. Corp., 576 W. Merrick Rd., Lynbrook, N. Y.-5
 V-M Corp., 280 Park St., Benton Harbor, Mich.-19
 Vox Productions, 236 W. 55 St., New York 19, N. Y.-13
 Waldom Electronics, 4625 W. 53 St., Chicago, Ill.-4-16
 Walsco Electronics Corp., 3602 Crenshaw Blvd., Los Angeles 16, Calif.-3
 Weathers Industries, 66 E. Gloucester Pike, Barrington, N. J.-8-14
 Webster-Chicago Corp., 5610 W. Bloomingdale Ave., Chicago 39, Ill.-20-21
 Wendell Plastic Fabrics Corp., 17 W. 17 St., New York 11, N. Y.-3
 Westminster Recording Co., 275 7 Ave., New York, N. Y.-13

TECHNICIAN BUYERS DIRECTORY

London Records, Inc., 539 W. 25 St., New York 1, N. Y.-13
 Louis Labs., 175 W. 97 St., New York 25, N. Y.-18
 Lyrichord Discs, Inc., 619 W. 54 St., New York 19, N. Y.-13
 McGregor Electronic Industries, McGregor, Iowa-16
 Magnasync Mfg. Co., 5546 Satsuma Ave., N. Hollywood, Calif.-15-17
 Magnavox Co., 2131 Bueter Rd., Ft. Wayne 4, Ind.-4
 Major Electronics, 42 Meserole St., Brooklyn 6, N. Y.-11
 Marine View Electronics, 28 Main St., White Plains, N. Y.-5
 Mercury Record Corp., 35 E. Wacker Dr., Chicago, Ill.-13
 MGM Records, 701 7 Ave., New York 36, N. Y.-13
 Microtron Co., Div. Crest Labs., 84-11 Rockaway Beach Blvd., Rockaway Beach 93, N. Y.-5-12-19
 Miller Electronics, 2840 Naomi St., Burbank, Calif.-15-21
 Miller Mfg. Co., M. A., 4 & Church St., Libertyville, Ill.-10-18
 Minn. Mining & Mfg. Co., 900 Fauquier Ave., St. Paul 6, Minn.-20
 Montilla LP Record Co., 447 W. 50 St., New York, N. Y.-13
 Musical Masterpieces, 43 W. 61 St., New York, N. Y.-13
 Musitapes, Inc., 8540 Sunset Blvd., Hollywood 46, Calif.-13-21
 National Tel-Tronics Corp., 52 St. Casimir Ave., Yonkers, N. Y.-16
 Newcastle Fabrics Corp., 153 W. 23 St., New York 11, N. Y.-3
 Norco Mfg. Co., 392 Bleeker St., New York 14, N. Y.-18
 Olin Mathieson Chemical Corp., Electrical Div., 275 Winchester Ave., New Haven, Conn.-18
 Orradio Industries, 120 Marvyn Rd., Opelika, Ala.-15-20
 Pacific Transducer Corp., 11836 W. Pico Blvd., Los Angeles 64, Calif.-8-10-11-14
 Palmer, Inc., M. V., 4002 Fruit Valley Rd., Vancouver, Wash.-12
 Pentron Corp., 777 S. Tripp Ave., Chicago 24, Ill.-21
 Perfection Electric Co., 2635 S. Wabash Ave., Chicago 16, Ill.-16
 Permoflux Corp., 2835 N. Kedzie Ave., Chicago 18, Ill.-5-12-16
 Permo, Inc., 6415 N. Ravenswood Ave., Chicago 26, Ill.-1-10-20-24

OMISSIONS

Listings have been omitted in all cases where, after three requests, a company has failed to return our directory questionnaire or otherwise verify its activity.

White Inc., Stan, 725 S. La Salle St., Chicago 5, Ill.-16
 Wilcox-Gay Corp., Charlotte, Mich.-6-20
 Wright Zimmerman, Inc., New Brighton, St. Paul 12, Minn.-16

3—AUDIO EQUIPMENT

Amplifiers	1
Arms, pickup	2
Attenuators (see Sec. 14)	
Baffles & Enclosures, speaker	3
Binaural Equipment	4
Cabinets (see Sec. 5)	
Cartridges, ceramic	5
Cartridges, crystal	6
Cartridges, magnetic	7
Compensators, record	8
Disc Recorders	9
Drivers, speaker	10
Equalizers, phono preamp	11
Handsets, phone	12
Headphones	13
Heads, recording disc	14
Heads, recording magnetic	15
Hearing aids & accessories	16
Horns, speaker	17
Intercommunication Systems	18
Megaphones, power	19
Microphones & Accessories	20
Mixers, audio	21
Oscillators, phono	22
Phonographs	23
Preamplifiers	24
Public Address Systems	25
Record Changers, automatic	26
Sound Systems, home	27
Sound Systems, industrial	28
Speakers	29
Suppressors, audio noise	30
Tape Players	31
Tape Recorders	32
Tape Splicing	33
Tuners (see Sec. 13)	
Turntables	34
Tweeters	35
Wire Recorders	36
Woofers	37

Acoustic Research, Inc., 23 Mt. Auburn St., Cambridge 38, Mass.-29
 Admiral Corp., 3800 W. Cortland St., Chicago 47, Ill.-26
 Aero-Tone Mfg. Co., 4836 Joy Rd., Detroit 4, Mich.-29
 Alamo Electronics Corp., 1415 N. Brazos St., San Antonio 1, Texas-1
 Alco Electronics Mfg., 3 Walcott Ave., Lawrence 1, Mass.-16
 Allied Radio Corp., 100 N. Western Ave., Chicago 80, Ill.-1-24-25-27-28-32
 Alonge Products, Inc., 163 W. 23 St., New York 11, N. Y.-33
 Altec Lansing Corp., 9356 Santa Monica Blvd., Beverly Hills, Calif.-1-10-20-23-24-25-27-28-29
 American Elite, Inc., 7 Park Ave., New York 16, N. Y.-15-20-23-25-26-28-29-32-35-37
 American Microphone Co., Div. Elgin National Watch Co., 370 S. Fair Oaks Ave., Pasadena, Calif.-5-6-20
 American Scientific Development, 336 S. Main St., Ft. Atkinson, Wisc.-27-31-32
 Ampex Corp., 934 Charter St., Redwood City, Calif.-1-4-21-23-25-27-28-29-31-32
 Amplitel, Inc., 342 W. 40 St., New York 18, N. Y.-1
 Ampro Corp., 2835 N. Western Ave., Chicago 18, Ill.-32
 Ansley Mfg. Co., Arthur, Doylestown, Pa.-1-23
 Anton Electronic Labs., 1226 Flushing Ave., Brooklyn 37, N. Y.-24
 Applegate & Co., C. J., 1816 Grove St., Boulder, Colo.-1
 A.R.F. Products, 7627 Lake St., River Forest, Ill.-29
 Argos Products Co., Genoa, Ill.-3
 Art Specialty Co., 3245 W. Lake St., Chicago 24, Ill.-20
 Astatic Corp., P.O. Box 120, Conneaut, Ohio-5-6-20
 Atlas Sound Corp., 1449 39 St., Brooklyn 18, N. Y.-10-17-20-29-35
 Audak Co., 500 5 Ave., New York, N. Y.-2-7-9
 Audio Equipment Co., 15749 Wyoming Ave., Detroit 38, Mich.-1-3-16
 Audlogersh Corp., 23 Park Pl., New York 7, N. Y.-26-34
 Audio-Master Corp., 17 E. 45 St., New York 17, N. Y.-25-26-27-28-31-32

Audio Products, 2265 Westwood, Los Angeles 64, Calif.-1
 Allegro Electronics, 226 New York Ave., Huntington, L. I., N. Y.-23
 AMI, Inc., 1500 Union Ave., S.E., Grand Rapids 2, Mich.-23
 Ampro Corp., 2835 N. Western Ave., Chicago 18, Ill.-32
 Authorized Mfrs. Service, 919 Wyckoff Ave., Brooklyn 27, N. Y.-1-11-18-21-24-25
 Autocrat Electronics Co., 5024 Elm St., Skokie 8, Ill.-1-23-26
 Beam Industries, Inc., 624 S. Michigan Ave., Chicago 5, Ill.-23
 Beam Instruments Corp., 350 5 Ave., New York, N. Y.-1-3-10-24-29-35-37
 Becker Electronics Mfg. Corp., 1091 Rockaway Ave., Valley Stream, L. I., N. Y.-29
 Bell & Howell, 7100 McCormick Rd., Chicago 45, Ill.-32
 Bell Sound Systems, 555 Marion Rd., Columbus 7, Ohio-1-3-4-9-18-24-25-27-28-29-32
 Bennett & Co. Paul, 230 E. Ohio St., Chicago 11, Ill.-23
 Bennett Laboratories, Inc., 2700 Bay Rd., Redwood City, Calif.-18
 Bergen Labs., 11 Godwin Ave., Fair Lawn, N. J.-1-32
 Berger Communications, 109-01 72 Rd., Forest Hills, N. Y.-1-5-24
 Berlant Instruments, Audio & Recordata Div., 4917 W. Jefferson Blvd., Los Angeles 16, Calif.-4-15-32
 Bestcraft Products Co., 626 Broadway, New York 12, N. Y.-3
 Birnbach Radio Co., 145 Hudson St., New York 13, N. Y.-20-30
 Blonder-Tongue Labs, 526 North Ave., Westfield, N. J.-1
 Boetsch Bros., 115 Cedar St., New Rochelle, N. Y.-23
 Bogen Co. David, 29 9 Ave., New York 14, N. Y.-3-17-18-20-23-24-25-27-28-29-34
 Bohn Sound Eng'g. Co., Lincoln Highway E., Fort Wayne, Ind.-1
 Bozak Co., R. T., P. O. Box 966, Darlen, Conn.-3-29-35-37
 Brainard Electronics, 8586 Santa Monica Blvd., Los Angeles 46, Calif.-4-11-24-27-28
 British Industries Corp., 80 Shore Rd., Port Washington, N. Y.-1-2-13-24-37-39
 B & R Electronics, 1701 Boone Ave., New York 60, N. Y.-23
 Brociner Electronics Corp., 344 E. 32 St., New York 16, N. Y.-1-29
 Brush Electronics Co., 3405 Perkins Ave., Cleveland 14, Ohio-1-4-7-13-15-20-24
 Bud Radio, Inc., 2118 E. 55 St., Cleveland 3, Ohio-22
 Butler Mfg. Co., B. B., 3150 Randolph St., Bellwood, Ill.-3
 Callfone Corp., 1041 N. Sycamore Ave., Hollywood 38, Calif.-23-25-27-28-29-34
 Calbest Electronics Co., 4801 Exposition Blvd., Los Angeles 16, Calif.-1-18-27-28
 Cal-Lee Mfg. Co., 5653 W. Adams Blvd., Los Angeles 16, Calif.-3
 Cannon Co., C. F., Springwater, N. Y.-13
 Capcon, Inc., 25 Willett St., New York 2, N. Y.-30
 Capehart-Farnsworth Corp., 3700 Pontiac St., Fort Wayne, Ind.-1-3-5-7-8-20-23-24-26-28-29-32-35-37
 Capitol Records, Inc., 1730 Broadway, New York 19, N. Y.-23
 Capps & Co., Frank L., 20 Addison Pl., Valley Stream, N. Y.-20
 Carbonneau Industries, 100 Lexington Ave. S. W., Grand Rapids 4, Mich.-29
 CBS-Columbia, Inc., 3400 47 Ave., Long Island City 1, N. Y.-23-29
 Centralab Div., Globe Union Inc., 902Y E. Keefe Ave., Milwaukee 1, Wisc.-1-24
 Chase & Sons, Randolph, Mass.-33
 Clegg Labs., Inc., Box 641, Morristown, N. J.-1-24
 Cletron, Inc., 1974 E. 61 St., Cleveland 3, Ohio-18-25-27-28-29
 Cline Electric Mfg., 3405 W. 47 St., Chicago 32, Ill.-1
 Codetypewriter Laboratories, 550 5 Ave., New York 19, N. Y.-18
 Colortone Electronics, 100 Frank Rd., Hicksville, N. Y.-18
 Columbia Records, 799 7 Ave., New York 19, N. Y.-23-32
 Components Corp., 106 Main St., Denville, N. J.-9-34-35
 Connecticut Telephone & Electric Corp., Meriden, Conn.-13
 Consolidated Radio Products, 350 W. Erie St., Chicago 10, Ill.-12-13-29-37
 Cook Laboratories, 114 Manhattan St., Stamford, Conn.-2-24
 Cooper Electronics, Inc., 5637 Tulip St., Philadelphia 24, Pa.-1-3-18-24-28
 Cornell-Dubilier Electric Corp., 333 Hamilton Blvd., S. Plainfield, N. J.-30
 Crescent Industries, Inc., 5900 W. Touhy Ave., Chicago 30, Ill.-23-26-29-32
 Crosley Radio & TV, 1329 Arlington St., Cincinnati 25, Ohio-23
 Davis & Co., J. W., 9212 Denton Drive, Dallas 9, Tex.-3
 Daystrom Electric Corp., 887 Main St., Poughkeepsie, N. Y.-32
 Dean Sales Co., 425 Devoe Ave., Bronx 60, N. Y.-1-18-23

Decca Records, Inc., 50 W. 57 St., New York, N. Y.-23
 DeJur-Amsco Corp., 45-01 Northern Blvd., Long Island City 1, N. Y.-32
 Delco Radio, 1446 S. Home Ave., Kokomo, Ind.-29
 Delson Mfg. Co., 126 11 Ave., New York, N. Y.-1
 DeWald Radio Mfg. Corp., 35-15 37 Ave., Long Island City 1, N. Y.-23
 Dictograph Products, Inc., Hi-Fidelity Music Div., 95-25 149 St., Jamaica 35, L. I., N. Y.-27-28
 D & M Products, 13144 W. McNichols Rd., Detroit 35, Mich.-29
 Donner Scientific Co., 2820 7 St., Berkeley, Calif.-1
 Dormitzer Electric & Mfg. Co., 5 Hadley St., Cambridge, Mass.-1-18-24
 D & R Ltd., 402 E. Gutierrez St., Santa Barbara, Calif.-34
 DuKane Corp., St. Charles, Ill.-1-3-18-23-24-25-28-32
 DuMont Labs., Inc., Allen B., 750 Bloomfield Ave., Clifton, N. J.-1-25
 Dunkle Coil Co., 3257 W. 6 St., Los Angeles 6, Calif.-32
 Dunwell Mfg. Co., Dept. T56, Carlstadt, N. J.-29-35
 Dufone Co., Locust St., Keyport, N. J.-1-3-29
 Dwyer Eng'g., P. O. Box 483, Nashua, N. H.-1
 DX Radio Products Co., 2300 W. Armitage Ave., Chicago 47, Ill.-29
 Dynamic Electronics, 73-39 Woodhaven Blvd., Glendale, L. I., N. Y.-29
 Dynamu Magnetics Corp., Div. Maico Co., 21 N. 3 St., Minneapolis 1, Minn.-15
 Dynavox Corp., 40-05 21 St., Long Island City 1, N. Y.-22-23
 Eagle Speaker Co., 15 S. Fairview, Park Ridge, Ill.-29
 Eby Sales Co., 130 Lafayette St., New York 13, N. Y.-1
 Eder Eng'g. Co., 1568 S. 1st St., Milwaukee, Wisc.-4-24
 Edu-Craft Sales Corp., 150-45 12 Ave., White-stone, N. Y.-23
 Eicar, Inc., 1501 W. Congress St., Chicago 7, Ill.-32
 Elcraft Electronics, 32-28 49 St., Long Island City, N. Y.-23
 Electrod Products Corp., State & Water St., St. Joseph, Mich.-1-21-25-27-28-31
 Electron Enterprises, 6917 Stanley Ave., Berwyn, Ill.-3-23-26
 Electronic Crafts Co., 74 Cortland St., New York 7, N. Y.-23
 Electronic Hardware Corp., 2420 W. Cermak Rd., Chicago, Ill.-3
 Electronic Instrument Co., 84 Withers St., Brooklyn 11, N. Y.-1
 Electronic Tube Corp., 1200 E. Mermald Lane, Philadelphia 18, Pa.-1-24
 Electronic Utilities Corp., 153 W. Huron St., Chicago 10, Ill.-23
 Electro-Sonic Labs., 35-54 36 St., Long Island City, N. Y.-3-7-11-24-27-28-32
 Electrosonic Specialties, 7230 Clinton Rd., Upper Darby 19, Pa.-31-32
 Electro Sound Corp., 115 Halleck St., Boston 20, Mass.-1-3-18-24-27-28
 Electro-Voice, Inc., Buchanan, Mich.-1-2-3-5-6-10-11-17-20-24-25-27-28-29-35-37
 Elektra Records, 361 Bleecker St., New York 14, N. Y.-29
 Eltrac Corp., 109 W. Station St., St. Anne, Ill.-29-35-37
 Emerson Radio & Phonograph Co., 14 & Coles Sts. Jersey City, N. J.-23-32
 Epc Electronics, 140 Liberty St., New York 6, N. Y.-1
 Executone, Inc., 415 Lexington Ave., New York 17, N. Y.-18
 Fairchild Recording Equip., 154 St. & 7 Ave., Whitestone, N. Y.-1-2-7-9-24-32
 Fanon Electric Co., 150-09 South Rd., Jamaica 33, N. Y.-1-18-23-27-28
 Federal Electronics Sales, Federal Electronics Bldg., Rockville Centre, N. Y.-13-16-30
 Federal Mfg. & Eng'g., 1055 Stewart Ave., Garden City, L. I., N. Y.-32
 Federal Telephone & Radio Co., Div. I T & T, 100 Kingsland Rd., Clifton, N. J.-1-12-18
 Feiler Eng'g. & Mfg. Co., 8026 N. Monticello Ave., Skokie, Ill.-18
 Fenton Co., 15 Moore St., New York 4, N. Y.-2-6-7-16-20-24-26
 Ferranti Electric Co., 30 Rockefeller Plaza, New York 20, N. Y.-2-7
 First American Products, 1717 Wyandotte St., Kansas City, Mo.-29
 Fisher Radio Corp., 21-21 44 Dr., Long Island City 1, N. Y.-1-3-7-10-23-24
 Flexo Int'l. Co., 3245 W. Lake St., Chicago 24, Ill.-20
 Fonotalk Corp., 11 S. LaSalle St., Chicago, Ill.-18
 Freed Electronics & Controls Corp., 200 Hudson St., New York 13, N. Y.-1
 Furst Electronics, Inc., 3322 W. Lawrence Ave., Chicago 25, Ill.-1-24
 Garod Radio, 70 Washington St., Brooklyn 1, N. Y.-1
 Garrard Sales Corp., Sub. British Industries, 80 Shore Rd., Port Washington, N. Y.-26-34
 General Cement Mfg. Co., 919 Taylor Ave., Rockford, Ill.-3-31-36
 General Industries Co., Olive & Taylor Sts., Elyria, Ohio-9-26-32-34

General Phones Corp., 5711 Howe St., Pittsburgh 32, Pa.-13-29
 G & H Wood Products Co., 75 N. 11 St., Brooklyn 11, N. Y.-3-17
 G & M Equipment Co., 7315 Varna Ave., N. Hollywood, Calif.-1-13
 Gonset Co., 801 S. Main St., Burbank, Calif.-1
 Gotham TV Corp., 123 W. 64 St., New York 23, N. Y.-1-11-23-24
 Granco Products, Inc., 36-07 20 Ave., Long Island City, N. Y.-23
 Graybar Electric Co., 420 Lexington Ave., New York, N. Y.-1-20-24-25-29-35-37
 Grayline Eng'g. Co., 12243 Ave. O, Chicago 33, Ill.-1-23
 Gray Research & Development, 658 Hilliard St., Manchester, Conn.-1-2-11-23-27
 Greene Co., L. Charlton, 314 Washington St., Newton 58, Mass.-18-22-23
 Guild Radio & Television Co., 460 N. Eucalyptus Ave., Inglewood 3, Calif.-23
 Hallcrafters Co., 4401 W. 5 Ave., Chicago 24, Ill.-1-23
 Hamilton Electronics, 2726 Pratt Ave., Chicago 45, Ill.-1-3-16-18-20-21-23-24-25-27-28
 Harman-Kardon, 520 Main St., Westbury, L. I., N. Y.-1
 Hartley Products Co., 521 E. 162 St., New York 51, N. Y.-1-3-10-24-27-29-31-32
 Heath Co., 305 Territorial Rd., Benton Harbor, Mich.-1-3-24
 Hedco Mfg., 161 W. Huron St., Chicago 10, Ill.-23
 Heppner Mfg. Co., Box 608, Round Lake, Ill.-29
 Hoffman Electronics Corp., 3761 S. Hill St., Los Angeles 43, Calif.-23-26
 Hotel Radio Corp., 601 W. Fort St., Detroit 29, Mich.-28
 Industrial Test Equip. Co., 55 E. 11 St., New York 3, N. Y.-1-24
 Insuline Corp. of America, 186 Granite St., Manchester, N. H.-3
 Interelectronics Corp., 2432 Grand Concourse, New York 58, N. Y.-1-24-25-27-28
 International Electronics Corp., 159 Howell St., Dallas 7, Texas-29
 International Radio & Electronics Corp., Box 123 Route 4, Elkhart, Ind.-32
 International Research Associates, 2221 Warwick Ave., Santa Monica, Calif.-1-20
 International Scientific Industries, 3101 42 St., Minneapolis 6, Minn. 32
 Interstate Photo Supply, 17 W. 17 St., New York 11, N. Y.-36
 Irvington Varnish & Insulator, Div. Mlnn. Mlnng & Mfg. Co., 6 Argyle Terrace, Irvington 11, N. J.-33
 James Instrument Labs., 9110 S. 52 Ct., Oak Lawn, Ill.-1-29-32
 Jov Cee Corp., 475 Cosgrove St., Philadelphia Pa.-20
 Jayell Mfg. Co., 1379 Washington Ave., New York 56, N. Y.-3
 Jensen Mfg. Co. Div. Muter Co., 6601 S. Laramie Ave., Chicago 38, Ill.-3-10-17-29-35
 Jerrold Electronics Corp., 2222 Chestnut St., Philadelphia 3, Pa.-1
 Johns-Manville, Dutch Brand Div., 7800 Woodlawn Ave., Chicago 19, Ill.-33
 Karlson Associates, Inc., 1483 Coney Island Ave., Brooklyn 30, N. Y.-3
 Kay Lab., 5725 Kearny Villa Rd., San Diego 12, Calif.-24
 Kendall Co., Polyken Sales Div., 222 W. Adams St., Chicago 6, Ill.-33
 Kingdom Products, 23 Park Pl., New York, N. Y.-29-35
 Klipsch & Associates, P. O. Box 64, Hope, Ark.-17
 Kraft Bros., 148-12 94 Ave., Jamaica 52, N. Y.-23
 Krohn-Hite Instrument Co., 580 Massachusetts Ave., Cambridge 39, Mass.-1
 Lab. of Electronic Eng'g., 413 "L" St. N.W., Washington 1, D. C.-29
 Lanaevin Mfg. Corp., 47-37 Austell Pl., Long Island City 1, N. Y.-1-24
 Lansing Sound, James B., 2439 Fletcher Dr., Los Angeles, Calif.-27-28-29
 Lear, Inc., 11916 W. Pico Blvd., Los Angeles 64, Calif.-1-13-29
 LEL, Inc., 380 Oak St., Coplaque, N. Y.-24
 Lipos, Edwin A., 5485 W. Washington Blvd., Los Angeles 16, Calif.-14-15
 Livingston Electronic Corp., Livingston, N. J.-2-4
 Logo Sound Engineers, J. M., 2171 W. Washington Blvd., Los Angeles 18, Calif.-1-18-25
 London Records, Inc., 539 W. 25 St., New York 1, N. Y.-23
 Lowell Mfg. Co., 3030 Laclede Station Rd., St. Louis 17, Mo.-3-18
 Lynmor Engineers, Inc., 1432 N. Carlisle St., Philadelphia 21, Pa.-24
 McGohan, Inc., Don, 3700 W. Roosevelt Rd., Chicago 24, Ill.-1-3-20-23-24-25-29
 McGregor Electronic Industries, McGregor, Iowa-1-29
 McIntosh Eng'g. Labs., 320 W. Water St., Binghamton, N. Y.-1-24
 Maanadyne Co., 84 S. Water St., Port Chester, N. Y.-2-7-11-23-27-34
 Maanosync Mfg. Co., 5546 Satsuma Ave., N. Hollywood, Calif.-14-15-28-32-33
 Maanovox Co., 2131 Bueter Rd., Ft. Wayne 4, Ind.-1-3-6-23-29
 Maanecord, Inc., 1101 S. Kilbourn, Chicago 24, Ill.-31-32

Major Electronics, 42 Meserole St., Brooklyn 6, N. Y.-1-2-23-26
 Malin Enterprises, 3733 E. Olympic Blvd., Los Angeles 23, Calif.-29
 Manfredi Wood Products Co., 226 New York Ave., Huntington, N. Y.-3
 Marantz Co., 44-15 Vernon Blvd., Long Island City 1, N. Y.-24
 Marine View Electronics, 28 Main St., White Plains, N. Y.-1-4-11-18-21-24-25
 Markel Electric Products, 147 Seneca St., Buffalo, N. Y.-26
 Martin & Co. H. S., 1916 Greenleaf Ave., Evanston, Ill.-1
 Mattison TV & Radio Corp., 10 W. 181 St., New York 53, N. Y.-3
 Metzner Eng'g. Corp., 1041 N. Sycamore Ave., Hollywood 38, Calif.-34
 MGM Records, 701 7 Ave., New York 36, N. Y.-23
 Michigan Electronics, 854 N. Rockwell St., Chicago 22, Ill.-19-25-31-32-36
 Midwest Radio & TV Corp., 909 Broadway, Cincinnati, Ohio-26
 Miller Co., J. W., 5917 S. Main St., Los Angeles 3, Calif.-22
 Miller Electronics, 2840 Naomi St., Burbank, Calif.-18
 Miller Instrument, Inc. Wm., 325 N. Halstead Ave., Pasadena 8, Calif.-1
 Milwaukee Record Changer Corp., 39 Warren St., New York, N. Y.-26
 Minn Mining & Mfg. Co., 900 Fauquier Ave., St. Paul 6, Minn.-33
 Mitchell Mfg. Co., 2525 Clybourn Ave., Chicago 14, Ill.-23-32
 Motorola, Inc., 4545 Augusta Blvd., Chicago 51, Ill.-23-26
 MP Eng'g. Co., Fairfield 3, Conn.-23
 Munston Mfg. & Service, Beech St., Islip, N. Y.-1
 National Aircraft Corp. Electronics Div., 3411 Tulare Ave., Burbank, Calif.-24
 National Co., 61 Sherman St., Malden 48, Mass.-1-27-28
 Newcomb Audio Products, 6824 Lexington Ave., Hollywood 38, Calif.-1-21-23-24-25-27-28
 New London Instrument Co., 82 Union St., New London, Conn.-1
 North American Philips Co., 10 E. 42 St., New York, N. Y.-23
 Northern Products Co., 2210 N. Clark St., Chicago 14, Ill.-29

Precision Electronics, 9101 King Ave., Franklin Park, Ill.-1-4-24-25-27-28-37
 Precision Radiolab Instruments, Inc., 4223 W. Jefferson Blvd., Los Angeles 16, Calif.-1-11-24-27
 Press Wireless Labs., 25 Prospect Pl., West Newton 65, Mass.-1-32
 Presto Recording Corp., P. O. Box 500, Paramus, N. J.-9-32-34
 Prosound Corp., 175 5 Ave., New York 10, N. Y.-26
 Quam-Nichols Co., 234 E. Marquette Rd., Chicago 37, Ill.-29
 Quincy Speaker Mfg. Corp., 221 Oak St., Quincy, Ill.-29-35-37
 Racon Electric Co., 1261 Broadway, New York 1, N. Y.-10-17-20-29-35
 Rada-Phone Corp., 609 W. Fulton St., Chicago 10, Ill.-25
 Radio Corp. of America, Camden, N. J.-1-3-6-7-10-18-20-23-24-25-32-34
 Radio Corp. of America, RCA Tube Div., Harrison, N. J.-29
 Radio Craftsmen, Inc., 4400 N. Ravenswood Ave., Chicago 40, Ill.-1-11-24-27
 Radio Merchandise Sales, 2016 Bronxdale Ave., New York 62, N. Y.-18
 Radio Music Corp., 84 S. Water St., Port Chester, N. Y.-1-2-7-11-23-27-34
 Radio Supply & Eng'g. Co., 85 Selden St., Detroit 1, Mich.-2-23-26
 Rangertone, Inc., 73 Winthrop St., Newark 4, N. J.-32
 Rauland-Borg Corp., 3515 W. Addison St., Chicago 18, Ill.-1
 Raytheon Mfg. Co., TV-Radio Div., 5921 W. Dickens Ave., Chicago 39, Ill.-29-32
 R & B Electronics, Box 6998, Washington 20, D. C.-24
 Recoton Corp., 52-35 Barnett Ave., Long Island City 4, N. Y.-2-7
 Reeves Soundcraft Corp., 10 E. 52 St., New York 22, N. Y.-33
 Regency Division, Idea, Inc., 7900 Pendleton Pike Indianapolis 26, Ind.-1-24
 Relter Co. F., 3340 Bonnie Hill Dr., Hollywood 28, Calif.-33
 Rek-O-Kut Co., 38-01 Queens Blvd., Long Island City 1, N. Y.-9-23-25-34
 Retron Corp., 697 N. Lake Ave., Pasadena 6, Calif.-1
 Revere Camera Co., 320 E. 21 St., Chicago, Ill.-32
 Ristaucrat, Inc., 1216 E. Wisc Ave., Appleton, Wisc.-23
 River Edge Sales Corp., Sub. British Industries, 80 Shore Rd., Port Washington, N. Y.-3
 RJ Audio Products, Sub. British Industries, 80 Shore Rd., Port Washington, N. Y.-3
 Roanwell Corp., 662 Pacific St., Brooklyn, N. Y.-12-13-20
 Robins Industries Corp., 214-26 41 Ave., Bay-side 61, N. Y.-33
 Rockbar Corp., 215 E. 37 St., New York 16, N. Y.-23-26-34
 Rola Co., 2330 Superior Ave., Cleveland 14, Ohio-29
 Ronette Acoustical, 135 Front St., New York, N. Y.-2-6-7-20-32-35
 Rowe Industries, 1702 Wayne St., Toledo 9, Ohio-1-10-17-29
 Russell Speaker Co., 6158 S. Kedzie Ave., Chicago, Ill.-29
 Sargent-Raymont Co., 1401 Middle Harbor Rd., Oakland 20, Calif.-1
 Saxony Ceramics, Saxonyburg, Pa.-5
 Scott, Inc., H. H., 385 Putnam Ave., Cambridge 39, Mass.-1-11-24-34
 Scott Radio Labs., Liberty St., Plymouth, Ind.-23
 Seeburg Corp., J. P., 1510 N. Dayton, Chicago, Ill.-23
 Sentinel Radio Corp., 2100 Dempster St., Evanston, Ill.-23
 Sherwood Electronic Labs., 2802 W. Cullom Ave., Chicago 18, Ill.-1-29
 Shrader Sound, Inc., 2803 "M" St., N.W., Washington 7, D. C.-28
 Shura-Tone Products, Inc., 440 Adelphi St., Brooklyn, N. Y.-23
 Shure Bros., 222 Hartrey Ave., Evanston, Ill.-2-5-6-7-12-14-15-16-20
 Sightmaster Corp., 111 Cedar St., New Rochelle, N. Y.-1-26-27-29
 Simpson Mfg. Co., Mark, 32-29 49 St., Long Island City 3, N. Y.-1-9-18-21-24-25-27-28-32
 Smith, Inc., Herman H., 2326 Nostrand Ave., Brooklyn 10, N. Y.-30
 Sonex, Inc., 245 Sonsom St., Upper Darby, Pa.-1-4-11-24-27-28
 Sonic Industries, 30-30 Northern Blvd., Long Island City, N. Y.-23
 Sonotone Corp., 570 5 Ave., New York, N. Y.-5
 SOS Cinema Supply, 602 W. 52 St., New York 19, N. Y.-1-3-9-10-13-14-18-20-24-25-27-28-29-32
 Speak-O-Phone Recording & Equip., 23 W. 60 St., New York 23, N. Y.-9-32
 Special Products Co., P. O. Box 188, Rockville 9, Md.-1-21-24-30
 Specialty Assembling & Packing, 79 Clinton Pl., Brooklyn 38, N. Y.-1-13
 Spencer-Kennedy Laboratories, 1320 Soldiers Field Rd., Boston 35, Mass.-1-24
 Standard Wood Products Corp., 47 W. 63 St., New York 23, N. Y.-3
 Steelman Photo & Radio, 230 Anderson Ave., Mt. Vernon, N. Y.-23



O'Brien Electric Corp., 6514 Santa Monica Blvd., Hollywood 38, Calif.-25-28
 Olympic Radio & TV, Inc., 34-01 38 Ave., Long Island City 1, N. Y.-23
 Optron Mfg. Co., 3223 N. Sheffield Ave., Chicago 13, Ill.-23
 Oxford Electric Corp., Distr. Sales Div., 556 W. Monroe St., Chicago 6, Ill.-29
 Pacific Transducer Corp., 11836 W. Pico Blvd., Los Angeles 64, Calif.-2-6-7-11
 Packard-Bell Co., 12333 W. Olympic Blvd., Los Angeles 64, Calif.-23
 Palmer, Inc., M. V., 4002 Fruit Valley Rd., Vancouver, Wash.-12-18-25
 Paraplex Mfg. Co., 10068 Franklin Ave., Franklin Park, Ill.-1
 Pathfinder Electronics, 6836 Lexington Ave., Los Angeles 38, Calif.-1-25
 Pedersen Electronics, P. O. Box 572, Lafayette, Calif.-1-24
 Peirce Dictation System, 5900 N. Northwest Hwy., Chicago 31, Ill.-32-36
 Pentron Corp., 777 S. Tripp Ave., Chicago 24, Ill.-21-31-32
 Perfection Electric Co., 2635 S. Wabash Ave., Chicago 16, Ill.-29
 Permacel Tape Corp., Highway U S #1, New Brunswick, N. J.-33
 Permoflux Corp., 2835 N. Kedzie Ave., Chicago 18, Ill.-3-4-13-35-37
 Philco Corp., Accessory Div., A & Allegheny Ave., Philadelphia 34, Pa.-26-29
 Philco Corp., Tioga & C Sts., Philadelphia 34, Pa.-23
 Philharmonic Radio, 235 Jersey Ave., New Brunswick, N. J.-23
 Philmore Mfg. Co., 113 University Pl., New York 3, N. Y.-1-12-15-29
 Physical Research Assoc., 1 Azurelee Dr., Malibu, Calif.-1-3-29-35-37
 Pickering & Co., 309 Woods Ave., Oceanside, L. I., N. Y.-2-6-7-8-11-24
 Pilot Radio Corp., 37-06 36 St., Long Island City 1, N. Y.-1-23-24
 Port-O-Matic Co., 438 E. 91 St., New York 28, N. Y.-23
 Power Supplies, 1005 Olive St., Highland, Ill.-1
 Precise Development Corp., 2 Neil Court, Oceanside, L. I., N. Y.-1-24

Stephens Mfg. Corp., 8538 Warner Dr., Culver City, Calif.-1-20-27-28-29-35-37
 Stromberg-Carlson Co., 100 Carlson Rd., Rochester, N. Y.-1-3-10-12-13-17-18-20-23-24-25-26-27-28-29-35-37
 Super Ear Products Co., 675 Merrick Rd., Lynbrook, N. Y.-13-16
 Superex Electronics Corp., 4-6 Radford Pl., Yonkers, N. Y.-13
 Switchcraft, Inc., 1328 N. Halsted St., Chicago 22, Ill.-21
 Sylvania Electric Products, Inc., 1740 Broadway, New York 19, N. Y.-23
 Symphonic Radio, 160 Washington St. N., Boston 8, Mass.-23
 Talk-A-Phone Co., 1512 S. Pulaski Rd., Chicago 23, Ill.-18
 Talkmaster, Inc., 543 Laurel St., San Carlos, Calif.-18
 Tannoy (America) Ltd., 38 Pearl St., New York 4, N. Y.-1-7-17-20-24-25-28-29-35-37
 Tape Recorders, Inc., 1501 W. Congress St., Chicago 7, Ill.-32
 Toylorel Corp., 3 Rutter St., Rochester 6, N. Y.-13-16
 Technical Apparatus Builders, 109 Liberty St., New York 9, N. Y.-23
 Telechrome, Inc., 88 Merrick Rd., Amityville, L. I., N. Y.-1
 Telecom, Inc., 1019 Admiral Blvd., Kansas City 8, Mo.-18-27-28
 Telectra Industries Corp., 35-16 37 St., Long Island City, N. Y.-1-4-15-18-25-28-31-32-36
 Telex, Inc., 1633 Eustis St., St. Paul, Minn.-4-13-16-20-29
 Thordarson-Meissner Mfg. Div., Maguire Industries, Mt. Carmel, Ill.-1-24-27
 Thorens Co., New Hyde Park, N. Y.-2-6-7-23-26-34
 Tibbetts Industries, Colcord Ave., Camden, Me.-16-20
 Toman & Co. E., 8700 W. 47 St., Lyons, Ill.-2-23
 Transformer Metal Prods. Corp., 343 W. 26 St., New York 1, N. Y.-2
 Transvision, Inc., New Rochelle, N. Y.-27
 Troy-Ler Radio, 571 W. Jackson Blvd., Chicago 6, Ill.-23
 Tri-Dex Electronics, P. O. Box 1207, Lindsay, Calif.-1-24
 Trimm, Inc., 400 W. Lake St., Libertyville, Ill.-4-12-13
 Trutone Electronics, Inc., 812 N. Highland Ave., Hollywood 36, Calif.-1-27-28
 Truvox Mfg. Co., 575 3 Ave., New York 16, N. Y.-3
 Turner Co., 909 17 St. N.E., Cedar Rapids, Iowa-20
 Ultra Hi-Fi Co., 709 5th St., Union City, N. J.-3-27-28-29
 United Audio Products, Div. United Optical Mfg., 202 E. 19th St., New York 3, N. Y.-26-29-35-37
 Universal Microphone, 424 Warren Lane, Inglewood, Calif.-20
 University Loudspeakers Inc., 80 S. Kensico Ave., White Plains, N. Y.-3-10-17-19-25-29-35-37
 Univox Corp., 102 Warren St., New York 7, N. Y.-1-32
 Utah Radio Products Co., 1123 E. Franklin St., Huntington, Ind.-3-29-35-37
 Vanity Fair Electronics, 50 S. 4 St., Brooklyn 11, N. Y.-1-23-34
 Vidair Electronics Mfg. Corp., 576 W. Merrick Rd., Lynbrook, N. Y.-1
 Video Corp. of America, 229 W. 28th St., New York 1, N. Y.-23
 Videon Electronic Corp., 902 E. Michigan St., Indianapolis 2, Ind.-1
 Viking of Minn., Inc., 3520 E. 43 St., Minneapolis 6, Minn.-32
 V-M Corp., 280 Park St., Benton Harbor, Mich.-23-26-32
 Vocaline Co. of America, Coulter St., Old Saybrook, Conn.-18
 Warren Corp., 21 Hanse Ave., Freeport, N. Y.-32
 Waterproof Electric Co., 801 S. Main St., Burbank, Calif.-1
 Waters Conley Co., Rochester 1, Minn.-23
 Weathers Industries, 66 E. Gloucester Pike, Barrington, N. J.-2-6-7-8-11-22-23
 Webster-Chicago Corp., 5610 W. Bloomingdale Ave., Chicago 39, Ill.-23-26-32
 Webster Electric Co., 1900 Clark St., Racine Wisc.-2-5-6-15-18-21-24-25-27-28-29-31-32
 Western Sound & Electric Labs., 805 S. 5 St., Milwaukee 4, Wisc.-1-18
 Westinghouse Electric Corp., Metuchen, N. J.-23-26
 Weston Electrical Instrument Corp., Subsidiary Doystrom, Inc., 614 Frelinghuysen Ave., Newark 5, N. J.-1
 Wheeler Insulated Wire Co., Div. Sperry Rand Corp., 150 E. Aurora St., Waterbury 20, Conn.-1-12-18
 White Sound, Inc., 5844 N. Broadway, Chicago 40, Ill.-1

White, Inc., Stan, 725 S. LaSalle St., Chicago 5, Ill.-27-28-29
 Wilcox-Gay Corp., Charlotte, Mich.-1-9-23-32
 Worner Electronic Devices, Rankin 1, Ill.-18
 Wright, Inc., 2235 University Ave., St. Paul, Minn.-29
 Wright Zimmerman, Inc., New Brighton, St. Paul 12, Minn.-29-35-37
 Zenith Radio Corp., 6001 Dickens Ave., Chicago 39, Ill.-23
 Z & W Machine Products, Electronics Div., 30240 Lakeland Blvd., Wickliffe, Ohio-1

4—BOOKS & SERVICE DATA

Business forms, file systems	11
Diagrams, service	1
Guides, capacitor color code	2
Guides, component replacement	3
Guides, pricing	4
Guides, rectifier replacement, selenium	5
Guides, resistor color code	6
Guides, tube replacement	7
Manuals, test equipment	8
Manuals, tube	9
Reference & text books	10

Aerovox Corp., Distr. Div., 740 Belleville Ave., New Bedford, Mass.-3
 Allied Engraving & Stamping Co., 17 Elm St., Buffalo 3, N. Y.-1
 American Electronics Co., 1203 Bryant Ave., New York 59, N. Y.-10
 Arvin Industries, Inc., Columbus, Ind.-1
 Audel & Co., Theo., 49 W. 23 St., New York 10, N. Y.-10
 Bell Sound Systems, 555 Marion Rd., Columbus 7, Ohio-1
 British Industries Corp., 80 Shore Rd., Port Washington, N. Y.-10
 Caldwell-Clements Manuals Corp., 480 Lexington Ave., New York 17, N. Y.-8
 Capehart-Farnsworth Corp., 3700 Pontiac St., Fort Wayne, Ind.-1-3-7
 CBS Hytron Div., Columbia Broadcasting System, 100 Endicott St., Danvers, Mass.-9
 Centralab Div., Globe Union, Inc., 902Y E. Keefe Ave., Milwaukee 1, Wisc.-2-3-6
 Cislun, Harry G., Amagansett, N. Y.-7-10
 Dover Publications, 920 Broadway, New York 10, N. Y.-10
 DuMont Labs, Inc., Allen B., 750 Bloomfield Ave., Clifton, N. J.-4
 Eitel-McClough, Inc., 798 San Mateo Ave., San Bruno, Calif.-7
 Emerson Radio & Phonograph Co., 14 & Coles Sts., Jersey City, N. J.-1
 Federal Telephone & Radio Co., Div. IT&T, 100 Kingsland Rd., Clifton, N. J.-5
 Ferris Business Equip., Inc., 45 Seymour St., Stratford, Conn.-1
 Gernsbach Library Inc., 154 W. 14 St., New York 11, N. Y.-1
 Harper & Bros., 49 E. 33 St., New York N. Y.-10
 Lee Radio & TV, 1001 E. Elm St., Macomb, Ill.-11
 Lytle Eng'g. & Mfg. Co., 105 W. Monroe St., Chicago 3, Ill.-10
 McGraw Hill Publ. Co., 330 W. 42 St., New York 36, N. Y.-10
 MacMillan Co., 60 5 Ave., New York 11, N. Y.-10
 Markem Service Systems, 145 Hudson St., New York 13, N. Y.-11
 Nichols Products Co., 325 W. Main St., Moorestown, N. J.-3
 Oelrich Publications, 4308 Milwaukee Ave., Chicago 41, Ill.-4-11
 Ohmite Mfg. Co., 3601 Howard St., Skokie, Ill.-6
 Pitman Publishing, 2 W. 45 St., New York, N. Y.-10
 Prentice-Hall Publ. Co., 70 5 Ave., New York, N. Y.-10
 Rider Publisher, Inc., John F., 480 Canal St., New York 13, N. Y.-1-8-9-10
 Rinehart & Co., 232 Madison Ave., New York 16, N. Y.-10
 Sams & Co., Howard W., 2201 E. 46 St., Indianapolis 5, Ind.-1
 Scientific Book Publ., Vincennes, Ind.-10
 Supreme Publications, 1760 Balsam Rd., Highland Park, Ill.-1-10
 Sylvania Electric Products, Inc., 1740 Broadway, New York 19, N. Y.-3-7-9
 Technician & Circuit Digests, 480 Lexington Ave., New York 17, N. Y.-1
 Thordarson-Meissner Mfg. Div. Maguire Industries, Mt. Carmel, Ill.-3
 Triplett Electrical Instrument Co., Harmon Rd., Bluffton, Ohio-8
 United Catalog Publishers, 106 Lafayette St., New York 13, N. Y.-3-10
 Van Nostrand Co., D., 120 Alexander St., Princeton, N. J.-10
 Wallace Telaides, Inc., 136 Day St., Jamaica Plain 30, Mass.-1
 Wiley & Sons, John, 440 4 Ave., New York 16, N. Y.-10
 Workman TV, Inc., 309 Queen Anne Rd., Teaneck, N. J.-3

5—CABINETS, CASES & TABLES

Cabinets, chassis	1
Cabinets, custom	2
Cabinets, equipment	3
Cabinets, metal	4
Cabinets, plastic	5
Cabinets, wood	6
Caddies, tube	7
Cases, carrying	8
Cases, meter	9
Storage Bins & Cabinets for parts	10
Tables, TV	11

Admiral Corp., 3800 W. Cortland St., Chicago 47, Ill.-4-6-11
 Akro-Mils, Inc., P. O. Box 989, Akron 9, Ohio-2-3-4-5-8-10
 Alden Products Co., 117 N. Main St., Brockton 64, Mass.-1-2-4
 Aluminum Mfg. Co., 1629 Portland Ave., Louisville 3, Ky.-7
 Aids for Goodhousekeeping, 21 Plandome, Manhasset, N. Y.-11
 Arbor Mfg. Co., Depew, N. Y.-10
 Arbuck, Inc., 116 Troutman St., Brooklyn 6, N. Y.-11
 Argos Products Co., Genoa, Ill.-6-8
 Audio Equipment Co., 15749 Wyoming Ave., Detroit 38, Mich.-2-3-4
 Baumker Mfg. Co., 3826 Summit St., Toledo 11, Ohio-1-2-3-4
 Bell Sound Systems, 555 Marion Rd., Columbus 7, Ohio-8
 Bergsma Bros., 1000 36th St. S. E., Grand Rapids 8, Mich.-11
 Bestcraft Products Co., 626 Broadway, New York 12, N. Y.-11
 Bolain Bending Co., 1702 N. Milwaukee Ave., Chicago 47, Ill.-11
 British Industries Corp., 80 Shore Rd., Port Washington, N. Y.-4
 Brookcraft Mfg., 123 Lafayette St., New York 13, N. Y.-11
 Bud Radio, Inc., 2118 E. 55 St., Cleveland 3, Ohio-1-2-3-4-8-9
 Butler Mfg. Co., B. B., 3150 Randolph St., Bellwood, Ill.-6
 California Cabinet Co., 522 S. San Pedro St., Los Angeles 13, Calif.-6
 Capehart-Farnsworth Corp., 3700 Pontiac St., Fort Wayne, Ind.-1-2-3-6
 Casard Furniture, 507 E. Russell St., High Point, N. C.-11
 Case Mfg. Co., P. O. Box 889, High Point, N. C.-11
 CBS Hytron Div., Columbia Broadcasting System, 100 Endicott St., Danvers, Mass.-7
 Churchill Lighting Corp., 344 Franklin St., Melrose 76, Mass.-1-2-4-8
 Cincinnati Ventilating Co., 302 Madison Ave., Covington, Ky.-2-4-7-10
 Cline Electric Mfg., 3405 W. 47 St., Chicago 32, Ill.-10
 Columbus Eng'g. Co., Electronics-Nucleonics Div., P. O. Box 464, Columbus, Nebr.-1-2-3-4-8
 Comfort Lines, 1735 Diversey Pkwy., Chicago 14, Ill.-11
 Di-Co TV & Plastic Co., 322 Boston Post Rd., Milford, Conn.-7
 Duro Specialty Co., 8 Bennett St., Lynn, Mass.-11
 Electronic Hardware Corp., 2420 W. Cermak Rd., Chicago 8, Ill.-1-2-4-10-11
 Electro Sound Corp., 115 Halleck St., Boston 20, Mass.-3-4
 Emerson Radio & Phonograph Co., 14 & Coles St., Jersey City, N. J.-4-5-6-8
 Equipto, Aurora, Ill.-10
 Fisher Co., Oscar, 1000 N. Division St., Peekskill, N. Y.-4
 Garrard Sales Corp., 80 Shore Rd., Port Washington, N. Y.-8
 Gee-Lar Mfg. Co., 418 S. Wyman St., Rockford, Ill.-7
 General Cement Mfg. Co., 919 Taylor Ave., Rockford, Ill.-11
 General Industries Co., Olive & Taylor Sts., Elyria, Ohio-5
 General Products Corp., Webb St., Union Springs, N. Y.-5
 G & H Wood Products Co., 75 N. 11 St., Brooklyn 11, N. Y.-11
 Gits Moulding Corp., 4600 W. Huron St., Chicago 44, Ill.-5
 Gosnet Co., 801 S. Main St., Burbank, Calif.-1-4
 Gravely Novelty Furniture, Ridgeway, Va.-11
 Gusdorf & Son, 6900 Monchester Ave., St. Louis 17, Mo.-11
 Hamilton Electronics, 2726 Pratt Ave., Chicago 45, Ill.-2-4
 Hartley Products Co., 521 E. 162 St., New York 51, N. Y.-2-3
 Hi-Lo TV Antenna Co., 3540 N. Ravenswood Ave., Chicago 13, Ill.-11
 Hobbs, Inc., Guy, Dallastown, Pa.-11
 Hoffman Electronics Corp., 3761 S. Hill St., Los Angeles 43, Calif.-11
 Hubbell Mfg. Co., H. L., Rte. 21, Zeeland, Mich.-4-11

For the purpose of checking violations of the publisher's copyright or other misuses of this directory, the products or listings have been coded. While these lists may be used for mailing purposes by individual manufacturers, any use of the lists, in part or whole, by other sources is prohibited.

IE Mfg., 325 N. Hoyne Ave., Chicago 12, Ill.-1-2-4
 Industrial TV, Inc., 359 Lexington Ave., Clifton, N. J.-4
 Insuline Corp. of America, 186 Granite St., Manchester, N. H.-1-4-8-9
 Jacobson Mfg. Co., S. I., 1414 S. Wabash Ave., Chicago 5, Ill.-7-8
 Jamestown Table Co., Jamestown, N. Y.-11
 Janso Woodworking Corp., 315 Meserole St., Brooklyn, N. Y.-8
 Karyoll Body, Inc., 8221 Clinton Rd., Cleveland 9, Ohio-10
 Kellogg Switchboard & Supply Co., 79 W. Monroe St., Chicago 3, Ill.-1-2-6
 K & G Electronics, 2738 N. Sheffield Ave., Chicago 14, Ill.-11
 King & Sons, J. E., Peru, Ind.-11
 Kleer-Vue Mfg. Co., P. O. Box 10304, Pittsburgh 34, Pa.-4
 Koch Sons, Geo., 10 S. 11 Ave., Evansville 4, Ind.-11
 Kraft Bros., 148-12 94 Ave., Jamaica 52, N. Y.-8
 Lowell Mfg. Co., 3030 Laclède Station Rd., St. Louis 17, Mo.-1-2-4
 Ludgate Assoc., John P., 351 5 Ave., Pittsburgh 22, Pa.-11
 Macahan, Inc., Don, 3700 W. Roosevelt Rd., Chicago 24, Ill.-8
 Magnavox Co., 2131 Bueter Rd., Ft. Wayne 4, Ind.-6
 Manco Mfg., Washington & Locust, Bradley, Ill.-11
 Mancor Co., 5831 S. Green St., Chicago, Ill.-11
 Manfredi Wood Products Co., 226 New York Ave., Huntington, N. Y.-11
 Markell Associates, Jeff, 764 6 Ave., New York 10, N. Y.-2-6
 Masco Mfg., 1319 N. Market St., St. Louis, Mo.-11
 Mastra Co., 2104 Superior Ave., Cleveland 14, Ohio-3-6-7-8-9
 Mathis Tower & Equip. Co., P. O. Box 126, E. Peoria, Ill.-11
 Mottison TV & Radio Corp., 10 W. 181 St., New York 53, N. Y.-2-6
 Michigan Electronics, 854 N. Rockwell St., Chicago 22, Ill.-11
 Middletown Mfg., Stack St., Middletown, Conn.-4
 Midwest Cabinet, 2047 Churchill St., Chicago 47, Ill.-6-11
 Milford Tool Co., 108 Gulf St., Milford, Conn.-11
 Muckle Mfg. Co., Owatonna, Minn.-4-8-10
 National Teletable, P. O. Box 1289, High Point, N. C.-11
 Newcomb Audio Products, 6824 Lexington Ave., Hollywood 38, Calif.-8
 O'Brien Electric Corp., 6514 Santa Monica Blvd., Hollywood 38, Calif.-2-3-4
 Par-Metal Products, 32-62 49 St., Long Island City, N. Y.-4
 Peerless Products Industries, 812 N. Pulaski Rd., Chicago 51, Ill.-11
 Period Tables, Henderson, Ky.-11
 Phaostron Instrument & Electronic Co., 151 Pasadena Ave., S. Pasadena, Calif.-9
 Planet Wood Products, 3902 8 Ave., Brooklyn, N. Y.-11
 Plymouth Electronics Corp., 50 Kingsbury St., Worcester 3, Mass.-4
 Porter Mfg., 1524 Frederick St., Racine, Wisc.-11
 Q-Line Mfg. Corp., 1562 61 St., Brooklyn 19, N. Y.-1-4
 Radio Merchandise Sales, 2016 Bronxdale Ave., New York 62, N. Y.-8
 River Edge Sales Corp., Sub. British Industries, 80 Shore Rd., Port Washington, N. Y.-2-3-6
 Rogal Tube Bending Co., 3543 S. Normal Blvd., Chicago 9, Ill.-11
 Romar Plastics, Inc., 1311 E. Main St., St. Charles, Ill.-2-5-9
 Service Parts Systems, 13380 E. 9 Mile Rd., E. Detroit, Mich.-4-10
 Standard Wood Products Corp., 47 W. 63 St., New York 23, N. Y.-6
 Stone Machine & Tool Co., Bedford, Ind.-4
 Streamline Wood Prods., 4849 N. Cicero Ave., Chicago 30, Ill.-6
 Tables, Inc., 5105 W. Lawrence Ave., Chicago, Ill.-11
 Tannoy (America) Ltd., 38 Pearl St., New York 4, N. Y.-6
 Telematic Industries, Inc., 16 Howard Ave., Brooklyn 21, N. Y.-8
 Tele-Vue Towers, 701 49 St. S., St. Petersburg 7, Fla.-11
 Tell City Furn. Co., Tell City, Ind.-11
 Tel-Rad Mfg. Co., 7 Madison St., Fennimore, Wisc.-6
 Thomas Associates, 4607 Alger St., Los Angeles 39, Calif.-8-9
 Transformer Metal Prods. Corp., 343 W. 26 St., New York 1, N. Y.-1-2-3-4-8-9
 Truvox Mfg. Co., 575 3 Ave., New York 16, N. Y.-2-3-6
 TV Engineers, Inc., 3325 W. Bryn Mawr Ave., Chicago 45, Ill.-7-8
 TV Hdw. Mfg. Co., 919 Taylor Ave., Rockford, Ill.-11
 U M & F Mfg. Corp., 10929 Vanowen St., North Hollywood, Calif.-1-2-4
 United Mfg. Co. Div., W. L. Maxson Corp., 41 Halg St., Hamden 14, Conn.-4
 Unversal Co., High Point, N. C.-11
 Universal Woodcrafters, LaPorte, Ind.-11

University Loudspeakers, Inc., 80 S. Kensico Ave., White Plains, N. Y.-6
 Utah Radio Products Co., 1123 E. Franklin St., Huntington, Ind.-6
 Vineta Mfg. Co., Div. K-G Electronics, 2738 N. Sheffield Dr., Chicago 14, Ill.-11
 Waldom Electronics, 4625 W. 53 St., Chicago, Ill.-9
 Walsco Electronics Corp., 3602 Crenshaw Blvd., Los Angeles 16, Calif.-10
 Waterproof Electric Co., 801 S. Moin St., Burbank, Calif.-4

Industrial Condenser Corp., 3243 N. California Ave., Chicago 18, Ill.-3-9-10-11-12
 Insuline Corp. of America, 186 Granite St., Manchester, N. H.-19
 Jennings Radio Mfg. Co., P. O. Box 1278, San Jose 8, Calif.-7
 JFD Mfg. Co., 6101 16 Ave., Brooklyn 4, N. Y.-18
 Kellogg Switchboard & Supply Co., 79 W. Monroe St., Chicago 3, Ill.-10-12
 Magnavox Co., 2131 Bueter Rd., Ft. Wayne 4, Ind.-3
 Mollory & Co., Inc., P. R., 3029 E. Washington St., Indianapolis 6, Ind.-1-3-9-13-16
 Micamold Electronics Mfg. Corp., 1087 Flushing Ave., Brooklyn 37, N. Y.-3-5-6-7-8-9-10-11-12
 Miller Co., J. W., 5917 S. Main St., Los Angeles 3, Calif.-18-19
 Millen Mfg. Co., James, 150 Exchange St., Malden 48, Mass.-18
 Monarch Condenser, 550 Westchester Ave., New York 55, N. Y.-8
 Mucon Corp., 9 St. Francis St., Newark 5, N. J.-2
 National Capacitor Co., 60 Washington St., Quincy, Mass.-5-8-12
 National Co., 61 Sherman St., Malden 48, Mass.-2-20
 New York Coil Co., 40 2 Ave., Phoenixville, Pa.-11
 Ohmite Mfg. Co., 3601 Howard St., Skokie, Ill.-16
 Ortho Filter Corp., 196 Albion Ave., Paterson 2, N. J.-19
 Philco Corp., Accessory Div., A & Allegheny Ave., Philadelphia 34, Pa.-2-3-8
 Philmore Mfg. Co., 113 University Pl., New York 3, N. Y.-18-19-20
 Planet Mfg. Corp., 225 Belleville Ave., Bloomfield, N. J.-3
 Plastic Capacitors, 2511 W. Moffat St., Chicago 47, Ill.-10-15
 Pyramid Electric Co., 1445 Hudson Blvd., North Bergen, N. J.-1-3-4-8-9-10-11-12-15
 Radio Condenser Co., Davis & Copewood Sts., Camden, N. J.-18
 Radio Supply & Eng'g Co., 85 Selden St., Detroit 1, Mich.-1-2-3-6-8
 Romar Plastics, Inc., 1311 E. Main St., St. Charles, Ill.-6
 Sangamo Electric Co., Marion, Ill.-1-3-4-6-7-8-9-10-11
 Shallcross Mfg. Co., 520 Pusey Ave., Collingdale, Pa.-20
 Skottie Electronics, Inc., 204 Bridge St., Peckville, Pa.-2-4
 Smith, Inc., Herman H., 2326 Nostrand Ave., Brooklyn 10, N. Y.-19
 Sprague Products Co., North Adams, Mass.-1-2-3-4-6-8-9-10-11-12-13-16
 Stone City Machine & Tool Co., Bedford, Ind.-20
 Telectro Industries Corp., 35-16 37 St., Long Island City, N. Y.-18
 United Condenser Corp., 3400 Park Ave., New York 56, N. Y.-8
 United Electronic Mfg. Corp., 542 39 St., Union City, N. J.-3
 Welch Mfg. Co., W. M., 1515 Sedgwick St., Chicago 10, Ill.-10
 Wilmar Mfg. Co., 1110 Truman Rd., Kansas City 6, Mo.-18

6—CAPACITORS

Capacitors, buffer	1
Capacitors, ceramic	2
Capacitors, electrolytic	3
Capacitors, feed-thru	4
Capacitors, glass	5
Capacitors, mica	6
Capacitors, molded composition	7
Capacitors, molded, paper & wax	8
Capacitors, motor	9
Capacitors, oil-filled	10
Capacitors, paper	11
Capacitors, paper metalized	12
Capacitors, photoflash	13
Capacitors, piston trimmer	14
Capacitors, silicone-filled	15
Capacitors, tantalum	16
Capacitors, tuning	17
Capacitors, variable	18
Suppressors	19
Trimmers & Padders	20

Aerovox Corp., Distri. Div., 740 Belleville Ave., New Bedford, Mass.-1-2-3-4-5-6-7-8-9-10-11-12-13-15
 Ajax Condenser Co., 932 W. Wrightwood Ave., Chicago 14, Ill.-1-3-4-7-8-10-11
 American Condenser Co., 4410 Ravenswood Ave., Chicago 40, Ill.-3-8-10
 American Radionic Co., 51 Austin St., Danbury, Conn.-1-2-8-9-10-11
 Anchor Radio Corp., 2125 S. St. Louis Ave., Chicago 23, Ill.-4-8-10
 Arco Electronics, 103 Lafayette St., New York 13, N. Y.-1-2-4-6-8-17-18-20
 Astron Corp., 255 Grant Ave., E. Newark, N. J.-1-3-7-8-10-11-12
 Bel Fuse, Inc., 311 Mountain Rd., Union City, N. J.-14-20
 Birnboch Radio Co., 145 Hudson St., New York 13, N. Y.-19
 Capcon, Inc., 25 Willett St., New York 2, N. Y.-1-2-3-4-6-7-8-10-11-12-15
 Cardwell Electronics Productions Corp., Allen D., 97 Whiting St., Plainville, Conn.-17-18
 Centralab Div. Globe Union, Inc., 902Y E. Keefe Ave., Milwaukee 1, Wisc.-1-2-4-14-18-20
 Chicago Condenser Corp., 3255 W. Armitage Ave., Chicago 47, Ill.-1-4-7-8-10-15
 Condenser Products Co., 7517 N. Clark St., Chicago 26, Ill.-8
 Continental Carbon, Inc., 13900 Lorain Ave., Cleveland 11, Ohio-19
 Cornell-Dubilier Electric Corp., 333 Hamilton Blvd., S. Plainfield, N. J.-2-3-4-6-7-8-9-10-11-12-13-16
 Corning Glass Works, Corning, N. Y.-5-18
 Corson Electric Mfg. Corp., 540 39 St., Union City, N. J.-10-11-15
 Delco Radio, 1446 S. Home Ave., Kokomo, Ind.-3
 Deutschmann Corp., Tobe, Providence Hgwy., Norwood, Mass.-4-8-9-10-11-12-15
 Dunkle Coil Co., 3257 W. 6 St., Los Angeles 6, Calif.-3-6-8-18
 Dwyer Eng'g., P. O. Box 483, Nashua, N. H.-2
 Eitel-McCullough, Inc., 798 San Mateo Ave., San Bruno, Calif.-18
 Electronic Fabricators, 682 Broadway, New York 12, N. Y.-10-15
 Erie Resistor Corp., 644 W. 12 St., Erie 6, Pa.-2-5-18
 Federal Electronics Sales, Federal Electronics Bldg., Rockville Centre, N. Y.-2
 Federal Telephone & Radio Co., Div. IT&T, 100 Kingsland Rd., Clifton, N. J.-17-18
 General Electric Co., Apparatus Sales Div., Schenectady, N. Y.-9-10-16
 General Instrument Corp., 829 Newark Ave., Elizabeth 3, N. J.-10-17-18-20
 General Products Corp., Webb St., Union Springs, N. Y.-11-12
 Girard-Hopkins, 1000 40 Ave., Oakland 1, Calif.-10-12
 Good-All Elec. Mfg. Co., Ogallala, Nebr.-10-15
 Gudeman Co., 340 W. Huron St., Chicago 10, Ill.-1-2-3-4-5-9-10-11-12-13-15
 Hammarlund Mfg. Co., 460 W. 34 St., New York 1, N. Y.-18-20
 Illinois Condenser Co., 1616 N. Throop St., Chicago 22, Ill.-2-3-8-9-10-11-12-13

7—CIRCUIT ACCESSORIES

Adapters	1
Brighteners, CRT	2
Circuit Breakers	3
Clips	4
Connectors	5
Fuse Clips & Holders	6
Fuses	7
Hardware (see Sec. 10)	
Interlocks	8
Ion Traps	9
Jacks	10
Magnets, CRT	11
Plugs, power & socket	12
Printed Circuits	13
Relays	14
Sockets	15
Solenoids	16
Switches	17
Terminals	18
Thermocouples	19

Accurate Electronics Corp., 169 S. Abbe Rd., Elyria, Ohio-5-6-8-15-18
 Advance Relay Co. Div., Elgin National Watch Co., 2435 N. Naomi St., Burbank, Calif.-14
 Aero Instrument Co., 11423 Vanowen St., N. Hollywood, Calif.-17
 Aerolite Electronics Corp., 507 26 St., Union City, N. J.-5-6-8-10

- Alden Products Co., 117 N. Main St., Brockton 64, Mass.-1-5-6-18
- Allied Control Co., 2 East End Ave., New York 21, N. Y.-14
- American Electronics Co., 1203 Bryant Ave., New York 59, N. Y.-10
- American Pamcor, Inc., 181 Hillcrest Ave., Havertown, Pa.-18
- American Phenolic Corp., 1830 S. 54 Ave., Chicago 50, Ill.-5-10-12-15
- American Radio Hdw. Co., 152 MacQuesten Pkwy. S., Mt. Vernon, N. Y.-1-5-6-10-12-15-17
- Anchor Products Co., 2712 Mantrouse Ave., Chicago 18, Ill.-2
- Anton Electronic Labs, 1226 Flushing Ave., Brooklyn 37, N. Y.-5
- A P Electro Lab, P. O. Box 862 Chestnut Station, Union, N. J.-18
- Arrow-Hart & Hegeman, 103 Hawthorne St., Hartford 6, Conn.-17
- Atlas E-E Corp., Bedford Airport, Bedford, Mass.-4-6-13-15
- Audio Development Co., 2833-13 Ave. S., Minneapolis 7, Minn.-10
- Audio Products, 2265 Westwood, Los Angeles 64, Calif.-13
- Automatic Metal Products, 315 Berry St., Brooklyn 11, N. Y.-1-5-12-14-17
- Automatic Processing Corp., 121 S. Cowen St., Garrett, Ind.-13
- Becks, Inc., 298 E. 5 St., St. Paul 1, Minn.-13
- Bergen Labs., 11 Godwin Ave., Fair Lawn, N. J.-14
- Birnbach Radio Co., 145 Hudson St., New York 13, N. Y.-4-5-6-8-17-18
- Blonder-Tongue Labs, 526 North Ave., Westfield, N. J.-5-14
- B & M Electric Corp., 838 3 Ave., Brooklyn 32, N. Y.-5
- Bomac Labs, Salem Rd., Beverly, Mass.-17
- Browning Labs, Inc., 750 Main St., Winchester, Mass.-13
- Bud Radio, Inc., 2118 E. 55 St., Cleveland 3, Ohio-1-3-5-10
- Busman Mfg. Co., University at Jefferson, St. Louis 7, Mo.-6-7
- Cal-Lee Mfg. Co., 5653 W. Adams Blvd., Los Angeles 16, Calif.-6
- Cannon Electric Co., 3208 Humboldt St., Los Angeles 31, Calif.-5-12-16
- Carling Electric, Inc., 505 New Park Ave., W. Hartford 10, Conn.-17
- Carter Parts Co., 213 W. Institute Pl., Chicago 10, Ill.-10-17
- Cass Machine Co., 691 Antoinet St., Detroit 1, Mich.-1
- CBC Electronics Co., 2601 N. Howard St., Philadelphia 33, Pa.-1-2-5
- Centralab Div. Globe Union, Inc., 902Y E. Keefe Ave., Milwaukee 1, Wisc.-13-17
- Centrad Transformer Corp., 1877 Eastern Parkway, Brooklyn 33, N. Y.-16
- CG Electronics Corp., 305 Dallas St. NE, Albuquerque, N. Mex.-14
- Chance Co., A. B., 210 N. Allen St., Centralia, Mo.-5
- Chatham Electronics, Div. Gera Corp., 630 W. Mt. Pleasant Ave., Livingston, N. J.-7-17
- Chicago Standard Transformer Corp., 3501 W. Addison St., Chicago 31, Ill.-2
- Chicago Telephone Supply, 1142 W. Beardsley Ave., Elkhart, Ind.-17
- Cinch-Jones Div., Cinch Mfg. Corp., 1026 S. Homan Ave., Chicago 24, Ill.-5-12-15
- Circon Component Co., Santa Barbara Municipal Airport, Goleta (Santa Barbara), Calif.-5-13
- Clarostat Mfg. Co., 1 Washington St., Dover, N. H.-9-17
- Cline Electric Mfg., 3405 W. 47 St., Chicago 32, Ill.-14
- Clum Mfg. Co., Electronic Div., 611 W. National Ave., Milwaukee 4, Wisc.-17
- Coaxial Connector Co., 37 N. 2 Ave., Mt. Vernon, N. Y.-1-5-10
- Coil Co. of America, 207 Washington St., Northvale, N. J.-16
- Colman Tool & Machine Co., P. O. Box 7026, Amarillo, Texas-12
- Continental Carbon, Inc., 13900 Lorain Ave., Cleveland 11, Ohio-17
- Cornell-Dubilier Electric Corp., 333 Hamilton Blvd., S. Plainfield, N. J.-13
- Crest Transformer Corp., 1834 W. North Ave., Chicago 22, Ill.-2
- Curtiss-Wright Corp., Electronic Div., 631 Central Ave., Carlstadt, N. J.-14
- Cutler-Hammer, Inc., 315 N. 12 St., Milwaukee 1, Wisc.-3-14-17
- Dage Electric Co., 67 N. 2 St., Beech Grove, Ind.-1-5
- Daven Co., Route 10, Livingston, N. J.-17
- DeJur-Amsco Corp., 45-01 Northern Blvd., Long Island City 1, N. Y.-5
- Deltron, Inc., 2905 N. Leithgow St., Philadelphia 33, Pa.-14
- Digital Products, Inc., 7643 Fay Ave., LaJolla, Calif.-13
- D & M Products, 13144 W. McNichols Rd., Detroit 35, Mich.-4-17
- Doormasters, Inc., 2310 Michigan Ave., Santa Monica, Calif.-1
- Dorn Equipment Corp., 88 Broad St., Boston 10, Mass.-1-5-10-12
- Drake Mfg. Co., 1713 W. Hubbard St., Chicago 22, Ill.-15
- Dunkle Coil Co., 3257 W. 6 St., Los Angeles 6, Calif.-9-13
- Durakool, Inc., 1010 N. Main St., Elkhart, Ind.-1
- Dwyer Eng'g., P. O. Box 483, Nashua, N. H.-13
- Ebert Electronics Corp., 212-26 Jamaica Ave., Queens Village 28, N. Y.-14-17
- Eby Co., Hugn H., 4700 Stenton Ave., Philadelphia 44, Pa.-1-4-5-10-13-15-17-18
- Eby Sales Co., 130 Lafayette St., New York 13, N. Y.-1-5-8-10-13-14-15-17
- Edison, Inc., Thomas A., Lakeside Ave., W. Orange, N. J.-14
- Eitel-McCullough, Inc., 798 San Mateo Ave., San Bruno, Calif.-5-15
- Elco Corp., M St. Below Erie Ave., Philadelphia 24, Pa.-5-15
- Electrend Products Corp., State & Water Sts., St. Joseph, Mich.-1
- Electronic Hardware Corp., 2420 W. Cermak Rd., Chicago 8, Ill.-4
- Electronic Instrument Co., 84 Withers St., Brooklyn 11, N. Y.-1
- Electro-Tech Equipment, 308 Canal St., New York 13, N. Y.-14-16-17-19
- Erie Resistor Corp., 644 W. 12 St., Erie 6, Pa.-17
- Farrington Mfg., 76 Atherton St., Boston, Mass.-13
- Federal Anti Capacity Switch Co., 72 Kingsley St., Buffalo 8, N. Y.-17
- Federal Electronics Sales, Federal Electronics Bldg., Rockville Centre, N. Y.-13
- Federal Screw Products, 3917 N. Kedzie Ave., Chicago 18, Ill.-18
- Federal Telephone & Radio Co., Div. IT&T, 100 Kingsland Rd., Clifton, N. J.-14-17
- Fisher-Pierce Co., 170 Pearl St., S. Braintree, Mass.-14
- Forest Electric Co., 7216 Circle Ave., Forest Park, Ill.-13
- Fretco, Inc., 406 N. Craig St., Pittsburgh 13, Pa.-13
- G-C Electronics Mfg. Co., 919 Taylor Ave., Rockford, Ill.-17
- Ge-Lar Mfg. Co., 418 S. Wyman St., Rockford, Ill.-6-15-17
- General Cement Mfg. Co., 919 Taylor Ave., Rockford, Ill.-1-4-5-6-8-10-12-15-17
- General Electric Co., Apparatus Sales Div., Schenectady, N. Y.-3-6-14-16-17-19
- General Instrument Corp., 829 Newark Ave., Elizabeth 3, N. J.-13
- General Products Corp., Webb St., Union Springs, N. Y.-18
- Grayhill Co., 561 Hillgrove Ave., LaGrange, Ill.-4-17
- Great Eastern Mfg. Co., 165 Remsen Ave., Brooklyn 12, N. Y.-2
- Guardian Electric Mfg. Co., 1621 W. Walnut, Chicago 12, Ill.-14-16-17
- Haydon Switch, Inc., 536 S. Leonard St., Waterbury, Conn.-17
- Heppner Mfg. Co., P. O. Box 608, Round Lake, Ill.-9-11
- Hi-Lo TV Antenna Co., 3540 N. Ravenswood Ave., Chicago 13, Ill.-4-6-7
- Hobson Bros., 4940 W. Lawrence Ave., Chicago 30, Ill.-4
- Hoffman Electronics Corp., 3761 S. Hill St., Los Angeles 43, Calif.-15-18
- Holub Industries, 413 DeKalb Ave., Sycamore, Ill.-4
- Hubbell, Inc., Harvey, State St. & Bostwick Ave., Bridgeport, Conn.-5-7-10
- Ideal Industries, 3316 Park Ave., Sycamore, Ill.-5-6
- iE Mfg., 325 N. Hoyle Ave., Chicago 12, Ill.-1-2-4-6-18
- Imperial Radar & Wire, 820 E. 233 St., Bronx, N. Y.-5
- Industrial Devices, 22 Slate Rd., Edgewater, N. J.-12
- Industrial Hardware Mfg. Co., 109 Prince St., New York 12, N. Y.-5-8-12-15-18
- Industrial Instruments, Inc., 89 Commerce Rd., Cedar Grove, N. J.-17
- Insuline Corp. of America, 186 Granite St., Manchester, N. H.-1-4-5-6-10-15-17-18
- Interelectronics Corp., 2432 Grand Concourse, New York 58, N. Y.-13
- International Register, 2620 W. Washington St., Chicago 12, Ill.-17
- Jan Hdw. Mfg. Co., 75 N. 11 St., Brooklyn 11, N. Y.-10
- Javex, P. O. Box 646 Redlands, Calif.-5-13-15
- J-B-T Instruments, 441 Chapel St., New Haven 8, Conn.-9-17
- Jerrold Electronics Corp., 2222 Chestnut St., Philadelphia 3, Pa.-1-5
- JFD Mfg. Co., 6101 16 Ave., Brooklyn 4, N. Y.-17
- Jones, H. B., Div. Cinch Mfg., 1026 S. Homan Ave., Chicago 24, Ill.-10-12
- Kellogg Switchboard & Supply Co., 79 W. Monroe St., Chicago 3, Ill.-4-14-17-18
- Keystone Electronics Corp., 423 Broome St., New York 13, N. Y.-4-5-6-10-18
- Kings Electronics Co., 40 Marbledale Rd., Tuckahoe, N. Y.-1-5-10
- Kurman Electric Co., 35-18 37 St., Long Island City 1, N. Y.-14
- Leach Relay Co., 5915 Avalon Blvd., Los Angeles 3, Calif.-14
- Leader Electronics Corp., 2925 E. 55 St., Cleveland, Ohio-17
- Leland, Inc., G. H., 123 Webster St., Dayton 2, Ohio-14-16
- Lerc Electronics, Inc., 501 S. Varney St., Burbank, Calif.-4-18
- Littelfuse, Inc., 1865 Miner St., Des Plaines, Ill.-6-7
- Livingston Electronic Corp., Livingston, N. J.-14-15
- Lumenite Electronic Co., 407 S. Dearborn St., Chicago 5, Ill.-14
- McGregor Electronic Industries, McGregor, Iowa-14
- Maccon Co., 3260 Motor Ave., Los Angeles 34, Calif.-5-12-18
- Magnadyne Co., 84 S. Water St., Port Chester, N. Y.-14
- Malco Tool & Mfg. Co., 4025 W. Lake St., Chicago 24, Ill.-18
- Mallory & Co., P. R., 3029 E. Washington St., Indianapolis 6, Ind.-10-17
- Mandex Mfg. Co., 2608 W. 16 St., Chicago 8, Ill.-1-5-10-15-18
- Micro Switch, Div. Minneapolis-Honeywell Regulator Co., Chicago & Spring Sts., Freeport, Ill.-17
- Miller Co., J. W., 5917 S. Main St., Los Angeles 3, Calif.-9-18
- Moran Electronic Components, 7660 Woodbury Dr., Silver Spring, Md.-16
- Mueller Electric Co., 1501 E. 31 St., Cleveland Ohio-4
- Nameplates, Inc., 425 E. 101 St., Brooklyn 36, N. Y.-13
- National Aircraft Corp. Electronics Div., 3411 Tulare Ave., Burbank, Calif.-16
- National Co., 61 Sherman St., Malden 48, Mass.-12-18
- National Tel-Tronics Corp., 52 St. Casimir Ave., Yonkers, N. Y.-5-8-10-12-15-18
- Network Mfg. Corp., 213 W. 5 St., Bayonne, N. J.-17
- Nichols Products Co., 325 W. Main St., Moorestown, N. J.-1-5
- North American Model Prod., 9802 Warwick Rd., Warwick, Va.-13
- Ohmrite Mfg. Co., 3601 Howard St., Skokie, Ill.-14-17
- Pacific Electricord Co., 3217 Exposition Pl., Los Angeles 8, Calif.-1-5-10-12
- Palmer, Inc., M. V., 4002 Fruit Valley Rd., Vancouver, Wash.-14-17
- Perfection Electric Co., 2635 S. Wabash Ave., Chicago 16, Ill.-11
- Perma-Power Co., 4727 N. Damen Ave., Chicago 25, Ill.-2
- Phaotron Instrument & Electronic Co., 151 Pasadena Ave., S. Pasadena, Calif.-3-10-14-16
- Philmore Mfg. Co., 113 University Pl., New York 3, N. Y.-5-10-11-17
- Photocircuits Corp., New St., Glen Cove, N. Y.-13
- Phen-O-Tron, Inc., 455 Main St., New Rochelle, N. Y.-13
- Pomona Electronics Co., 1126 W. 5 Ave., Pomona, Calif.-1
- Potter & Brumfield, Princeton, Ind.-14
- Precise Development Corp., 2 Neil Court, Oceanside, L. I., N. Y.-2-13
- Proto Tools, 2209 S. Santa Fe, Los Angeles 54, Calif.-15
- Q-Line Mfg. Corp., 1562 61 St., Brooklyn 19, N. Y.-1
- Quam-Nichols Co., 234 E. Marquette Rd., Chicago 37, Ill.-9-11
- Radio Music Corp., 84 S. Water St., Port Chester, N. Y.-14
- Radio Supply & Eng'g. Co., 85 Selden St., Detroit 1, Mich.-5-7-11-24
- Raytheon Mfg. Co., Equip. Marketing Dept., Waltham, Mass.-6-10-18
- Recora Co., 56 W. 103 St., Chicago 28, Ill.-17
- Revere Corp. of America, Wallingford, Conn.-17-19
- Roanwell Corp., 662 Pacific St., Brooklyn, N. Y.-17
- Ripley Co., Middletown, Conn.-14
- Royal Electric Co., 95 Grand Ave., Pawtucket, R. I.-7
- Sequoia Process Corp., 871 Willow St., Redwood City, Calif.-13
- Shallcross Mfg. Co., 520 Pusey Ave., Collingdale, Pa.-17
- Sightmaster Corp., 111 Cedar St., New Rochelle, N. Y.-7
- Smith, Inc., Herman H., 2326 Nostrand Ave., Brooklyn 10, N. Y.-1-4-5-6-8-10-15-17
- Star Expansion Products, 142 Liberty St., New York 6, N. Y.-12
- Star Fuse Co., 235 Canal St., New York 13, N. Y.-6-7
- States Co., 19 New Park Ave., Hartford, Conn.-18
- Stone City Machine & Tool Co., Bedford, Ind.-6-18
- Struthers-Dunn, Lamb's Rd., Pitman, N. J.-14
- Super Ear Products Co., 675 Merrick Rd., Lynbrook, N. Y.-15
- Superex Electronics Corp., 4-6 Radford Pl., Yonkers, N. Y.-1
- Switchcraft, Inc., 1328 N. Halsted St., Chicago 22, Ill.-5-10-17
- Sylvania Electric Products, Inc., 1740 Broadway, New York 19, N. Y.-15
- Techniques, Inc., 178 Central Ave., Hackensack, N. J.-5-13-15
- Telectro Industries Corp., 35-16 37 St., Long Island City, N. Y.-14-16
- Telematic Industries, Inc., 16 Howard Ave., Brooklyn 21, N. Y.-2
- Telex, Inc., 1633 Eustis St., St. Paul, Minn.-10
- Tenna Mfg. Co., 7580 Garfield Blvd., Cleveland 25, Ohio-5

Terado Co., 1067 Raymond Ave., Dept. 2, St. Paul 14, Minn.-14
 Thomas Associates, 4607 Alger St., Los Angeles 39, Calif.-4
 Thompson-Bremer & Co., 520 N. Dearborn St., Chicago 10, Ill.-18
 Thordarson-Meissner Mfg. Div., Maguire Industries, Mt. Carmel, Ill.-2
 Tinnerman Products, P. O. Box 6688 Dept. 16, Cleveland 1, Ohio-4
 Tork Clock Co., 1 Grove St., Mt. Vernon, N. Y.-17
 Trico Fuse Mfg. Co., 2948 N. 5 St., Milwaukee 12, Wisc.-6-7
 Tri-Dex Electronics, P. O. Box 1207, Lindsay, Calif.-13
 Trlmm, Inc., 400 W. Lake St., Libertyville, Ill.-10
 Tung-Sol Electric, Inc., 95 8 Ave., Newark 4, N. J.-14
 TV Hdw. Mfg. Co., 919 Taylor Ave., Rockford, Ill.-4-6-8-9-18
 U M & F Mfg. Corp., 10929 Vanowen St., North Hollywood, Calif.-18
 United Electric Controls, 85 School St., Watertown 72, Mass.-17
 United Technical Labs., Morristown, N. J.-5
 Universal Circuit Controls Corp., 3610 Oakton St., Skokie, Ill.-17
 U S Relay Co., 1744 Albion St., Los Angeles 31, Calif.-14-16
 Vaco Products Co., 317 E. Ontario St., Chicago 11, Ill.-18
 Vector Electronic Co., 3352 San Fernando Rd., Los Angeles 65, Calif.-1-5-12-15-18
 Vemaline Products, P. O. Box 222, Hawthorne, N. J.-17
 Vidair Electronics Mfg. Corp., 576 W. Merrick Rd., Lynbrook, N. Y.-1-2
 Vokar Corp., 7300 Huron River Dr., Dexter, Mich.-13-16
 Waldom Electronics, 4625 W. 53 St., Chicago, Ill.-5-8-15-18
 Ward Leonard Electric Co., Mt. Vernon, N. Y.-14
 Welch Mfg. Co., W. M., 1515 Sedgwick St., Chicago 10, Ill.-9
 Weston Electrical Instrument Corp., Subsidiary Daystrom, Inc., 614 Frelinghuysen Ave., Newark 5, N. J.-14-19
 Whitney Blake Co., 1565 Dixwell Ave., New Haven 14, Conn.-5
 Wirt Co., 5221 Green St., Philadelphia 44, Pa.-17
 Witelrad Electrical Mfg. Co., 75 Pulaski St., Stamford, Conn.-12
 Workman TV, Inc., 309 Queen Anne Rd., Teoneck, N. J.-2-4
 Zierick Mfg. Corp., Beechwood & Rockdale Aves., New Rochelle, N. Y.-4-18

8—COILS, FILTERS & TRANSFORMERS

Chokes, AF 1
Chokes, filter 2
Chokes, RF 3
Coils, field 4
Coils, focus 5
Coils, IF, oscillator & RF 6
Coils, peaking 7
Coils, speaker voice 8
Controls, linearity & width 9
Deflection yokes 10
Filters, audio 11
Filters, bandpass 12
Filters, interference 13
Filters, noise 14
Inductors, toroid 15
Inductors, variable 16
Limiters, noise 17
Suppressors, auto ignition 18
Transformers, antenna matching 19
Transformers, audio 20
Transformers, constant voltage 21
Transformers, filament 22
Transformers, flyback 23
Transformers, IF, oscillator & RF 24
Transformers, isolation 25
Transformers, power 26
Transformers, step-down 27
Transformers, variable 28
Transformers, vibrator 29
Voltage adjusters 30
Wave traps 31

Acro Transformer & Mfg. Corp., 26-02 4 St., Long Island City 2, N. Y.-1-2-11-12-15-20-22-25-26-27-29
 Advance Electronics Co., 8510 North End Ave., Oak Park 37, Mich.-31
 Aerovox Corp., Distr. Div., 740 Belleville Ave., New Bedford, Mass.-3-13-14
 Airdesign, Inc., 241 Fairfield Ave., Upper Darby, Pa.-2-3-20-22-25-26
 Ajax Condenser Co., 932 W. Wrightwood Ave., Chicago 14, Ill.-13-14
 Altec Lansing Corp., 9356 Santa Monica Blvd., Beverly Hills, Calif.-1-2-20-26
 American Electronics Co., 1203 Bryant Ave., New York 59, N. Y.-13
 American Elite, Inc., 7 Park Ave., New York 16, N. Y.-18
 Anchor Products Co., 2712 Montrose Ave., Chicago 18, Ill.-30
 Arvin Industries, Inc., Columbus, Ind.-2-3-6-20-24
 Astron Corp., 255 Grant Ave., E. Newark, N. J.-13-14
 Atlantic Industrial Co., 101-38 91 St., Ozone Park 17, N. Y.-20
 Audio Development Co., 2833-13 Ave. S., Minneapolis 7, Minn.-11-12-19-20-21-22-25-26-27-29
 Barry Electronics Corp., 512 Broadway, New York 12, N. Y.-30
 Bergen Labs, 11 Godwin Ave., Fair Lawn, N. J.-6-7
 Bestcraft Products Co., 626 Broadway, New York 12, N. Y.-31
 Best Electronics Corp., 617 19th St., Manhattan Beach, Calif.-19



Birnbach Radio Co., 145 Hudson St., New York 13, N. Y.-11-18
 Blackburn Electronic Corp., 55 W. 7 St., Wyoming, Pa.-4-5-6-7-8-10
 Blonder-Tongue Labs, 526 North Ave., Westfield, N. J.-14-19
 Brach Mfg. Corp., Div. Genl. Bronze Corp., 200 Central Ave., Newark, N. J.-19
 Bradley Labs, 168 Columbus Ave., New Haven, Conn.-17
 Bud Radio, Inc., 2118 E. 55 St., Cleveland 3, Ohio-3-13
 Caddell-Burns, 40 E. 2 St., Mineola, N. Y.-2-3-6
 Camburn, Inc., 32-40 57 St., Woodside 77, N. Y.-12
 Campbell X-Ray Corp., 110 Cummington St., Boston 15, Mass.-22-26
 Capcon, Inc., 25 Willett St., New York 2, N. Y.-11-12-13-14-18
 Centralab Div. Globe Union, Inc., 920Y E. Keefe Ave., Milwaukee 1, Wisc.-9-11
 Centroid Transformer Corp., 1877 Eastern Parkway, Brooklyn 33, N. Y.-20-22-25-26-27-29
 CGS Labs, Inc., 391 Ludlow St., Stamford, Conn.-16-19
 Chicago Electronic Eng'g., 3223 W. Armitage Ave., Chicago 47, Ill.-20-22-26
 Chicago Standard Transformer Corp., 3501 W. Addison St., Chicago 31, Ill.-1-2-11-12-15-20-22-23-25-26-27-28-29-30
 Clarostat Mfg. Co., 1 Washington St., Dover, N. H.-9
 Clippard Instrument Lab, 7350 Colerain Rd., Cincinnati 24, Ohio-3-6-7-13-19-24
 Coil Co. of America, 207 Washington St., Northvale, N. J.-2-4-16-20-22-25-26-27-28-29
 Coil Winders, Inc., 100 New York Ave., Westbury, N. Y.-1-2-3-4-5-6-22-24-28
 Colman Tool & Machine Co., P. O. Box 7026, Amarillo, Texas-6
 Communication Accessories, Hickman Mills, Mo.-1-2-3-11-12
 Consolidated Radio Products, 350 W. Erie St., Chicago 10, Ill.-1-2-4-5-10-20-21-22-23
 Continental Carbon, Inc., 13900 Lorain Ave., Cleveland 11, Ohio-6-18
 Cornell-Dubilier Electric Corp., 333 Hamilton Blvd., S. Plainfield, N. J.-11-12-13-14
 Corning Glass Works, Corning, N. Y.-6
 Crest Transformer Corp., 1834 W. North Ave., Chicago 22, Ill.-1-2-11-20-22-25-26-27-29
 Crown Controls Co., 40 S. Washington St., New Bremen, Ohio-27
 Dane Electronics Labs, P. O. Box 209, Solem, Mass.-19
 Delco Radio, 1446 S. Home Ave., Kokomo, Ind.-6-26
 Delson Mfg. Co., 126 11 Ave., New York, N. Y.-31
 Deutschmann Corp., Tobe, Providence Hwy., Norwood, Mass.-11-12-13-14
 Dormitzer Electric & Mfg. Co., 5 Hadley St., Cambridge, Mass.-2-22-26

Drake Co. R. L., 18 E. Central Ave., Miamisburg, Ohio-13
 D & R Ltd., 402 E. Gutierrez St., Santa Barbara, Calif.-11-12-13-15
 DuMont Labs, Inc., Allen B., 750 Bloomfield Ave., Clifton, N. J.-31
 Dunkle Coil Co., 3257 W. 6 St., Los Angeles 6, Calif.-5-6-20-23-29
 DX Radio Products Co., 2300 W. Armitage Ave., Chicago 47, Ill.-1-2-3-4-5-6-7-8-10-11-12-13-14-15-20-22-23-24-25-26-27-29-31
 Dyna Co., 5142 Master St., Philadelphia 31, Pa.-20
 Eagle Electronics Corp., P. O. Box 775, Meriden, Conn.-11-12-13-14
 Electronic Communications Equip. Co., 1249 W. Loyola Ave., Chicago 26, Ill.-20
 Electronic Components, 2655 W. 19 St., Chicago 8, Ill.-26
 Electronic Specialties Mfg., 76 Irving St., Worcester 10, Mass.-19
 Electro-Physics Co., 287U Broadway, New York 7, N. Y.-30
 Electro-Tech Equipment 308 Canal St., New York 13, N. Y.-21-25-26-27-28
 Electro-Voice, Inc., Buchanan, Mich.-11
 Epco Electronics, 140 Liberty St., New York 6, N. Y.-13
 Espey Mfg. Co., 200 W. 57 St., New York 19, N. Y.-1-2-3-6-20-24-26
 Federal Electronics Sales, Federal Electronics Bldg., Rockville Centre, N. Y.-11-13-14-18-31
 Federal Telephone & Radio Co., Div. IT&T, 100 Kingsland Rd., Clifton, N. J.-2-4-12-15-16-20-25-26-29
 Fenton Co., 15 Moore St., New York 4, N. Y.-27
 Ferranti Electric Co., 30 Rockefeller Plaza, New York 20, N. Y.-20-22-25-26
 Filtron Co., 131-15 Fowler Ave., Flushing 55, L. I., N. Y.-13-14
 Fisher Eng'g. Co., Huntington, Ind.-1-2-20-22-26-27
 Fisher Radio Corp., 21-21 44 Dr., Long Island City 1, N. Y.-11-14
 Forbes & Wagner, 345 Central Ave., Silver Creek, N. Y.-1-2-3-6-7-9-10-16-23-24
 Forest Electric Co., 7216 Circle Ave., Forest Park, Ill.-1-2-4-11-14-19-20-21-22-25-26-27-28-29
 Freed Transformer Co., 1718 Weirfield St., Brooklyn 27, N. Y.-1-2-11-12-15-20-21-22-25-26-27-29
 General Crystal Co., Burlington, Wisc.-12
 General Electric Co., Apparatus Sales Div., Schenectady, N. Y.-20-23-26
 General Instrument Corp., 829 Newark Ave., Elizabeth 3, N. J.-1-2-3-4-5-6-7-9-10-15-16-19-23-24
 Gromer-Holldorson Transformer Corp., 2734 N. Pulaski Rd., Chicago 39, Ill.-1-2-3-4-5-9-10-12-15-16-19-20-22-23-25-26-27-28-29
 Great Eastern Mfg. Co., 165 Remsen Ave., Brooklyn 12, N. Y.-2
 Gudeman Co., 340 W. Huron St., Chicago 10, Ill.-11-12-13-14-28
 Harnett Electric Corp., 138 Haven Ave., Port Washington, N. Y.-3-6-15-16-23-24
 Heath Co., 305 Territorial Rd., Benton Harbor, Mich.-25
 Heppner Mfg. Co., Box 608, Round Lake, Ill.-23
 Hevi Duty Electric Co., 4212 W. Highland Blvd., Milwaukee 1, Wisc.-26-27
 Hillburn Electronic Products, 55 Nassau Ave., Brooklyn 22, N. Y.-3-6-7-9-23-24
 Hindle Transformer Co., Woods Church Rd., Flemington, N. J.-22-25-26-27
 Illinois Transformer Co., 412 S. Green St., Chicago 7, Ill.-2-4-20-22-25-26-27-29
 Insuline Corp. of America, 186 Granite St., Manchester, N. H.-3-13-14-18
 Interelectronics Corp., 2432 Grand Concourse, New York 58, N. Y.-11-12
 International Resistance Co., 401 N. Broad St., Philadelphia 8, Pa.-3
 James Vibrapow Co., 4050 N. Rockwell Ave., Chicago 18, Ill.-20-22-29
 Jan Hdw. Mfg. Co., 75 N. 11 St., Brooklyn 11, N. Y.-9
 Jay Cee Corp., 475 Cosgrove Ct., Philadelphia, Pa.-23
 Jefferson Electric Co., 900 25 Ave., Bellwood, Ill.-26
 Jerrald Electronics Corp., 2222 Chestnut St., Philadelphia 3, Pa.-13-19
 JFD Mfg. Co., 6101 16 Ave., Brooklyn 4, N. Y.-18-27-31
 Kay Lab., 5725 Kearny Villa Rd., San Diego 12, Calif.-12
 Kellogg Switchboard & Supply Co., 79 W. Monroe St., Chicago 3, Ill.-10
 Kenyon Transformer Co., 840 Barry St., New York 59, N. Y.-2-20-22-25-26-28
 Kepco Labs, 131-38 Sanford Ave., Flushing 55, N. Y.-30
 Krohn-Hite Instrument Co., 580 Massachusetts Ave., Cambridge 39, Mass.-12
 Langevin Mfg. Corp., 47-37 Austell Pl., Long Island City 1, N. Y.-19-20-21-22-25-26-27-28-29
 Lear, Inc., 11916 W. Pico Blvd., Los Angeles 64, Calif.-6-12-13
 LEL, Inc., 380 Oak St., Copiague, N. Y.-19
 Linell Eng'g. Corp., 447 South Blvd., Oak Park, Ill.-19-24
 Lynmar Engineers, Inc., 1432 N. Carlisle St., Philadelphia 21, Pa.-14-19

McGregor Electronic Industries, McGregor, Iowa-1-2-3-6-8-10-19-20-21-23-24-27-29
 McIntosh Eng'g Labs, 320 W. Water St., Binghamton, N. Y.-20
 Magnadyne Co., 84 S. Water St., Port Chester, N. Y.-2-11-12-20-22-25-26-27
 Marine View Electronics, 28 Main St., White Plains, N. Y.-1-2-3
 Merit Coil & Transformer Corp., 4427 N. Clark St., Chicago 40, Ill.-2-3-5-6-7-9-10-13-19-20-22-23-24-25-26-27-28-29
 Micamold Electronics Mfg. Corp., 1087 Flushing Ave., Brooklyn 37, N. Y.-13
 Mico Instrument Co., 80 Trowbridge St., Cambridge 38, Mass.-15
 Microtron Co., Div. Crest Labs, 84-11 Rockaway Beach Blvd., Rockaway Beach 93, N. Y.-1-2-11-20-21-22-25-26-27-28-29
 Millen Mfg. Co., James, 150 Exchange St., Malden 48, Mass.-3
 Miller Co., J. W., 5917 S. Main St., Los Angeles 9, Calif.-2-3-6-7-12-13-14-16-19-24-31
 Miller Co., Sanford, 691 Bedford Ave., Brooklyn 6, N. Y.-2-27
 Milwaukee Transformer Co., 5231 N. Hopkins St., Milwaukee, Wisc.-2-3-20-22-23-26
 Monarch Condenser, 550 Westchester Ave., New York 55, N. Y.-13-18
 Moran Electronic Components, 7660 Woodbury Dr., Silver Spring, Md.-6-7-20-22-24-26
 National Aircraft Corp., Electronics Div., 3411 Tulare Ave., Burbank, Calif.-1-2-3-6-15-19-20-21-22-23-24-25-26-30
 Newcomb Audio Products, 6824 Lexington Ave., Hollywood 38, Calif.-20
 New London Instrument Co., 82 Union St., New London, Conn.-1-2-20-22-26-27-29
 New York Coil Co., 40 2 Ave., Phoenixville, Pa.-3-6-14-19-20-22-24-26-27
 Non-Linear Systems, Del Mar Airport, Del Mar, Calif.-12-13-14
 North Hills Electric Co., 203-18 35 Ave., Bay-side 61, N. Y.-7
 Nyl Electronics, Inc., 2979 N. Ontario St., Burbank, Calif.-1-2-4-7-11-12-13-14-15-19-20-21-22-25-26-27-29
 Ohmite Mfg. Co., 3601 Howard St., Skokie, Ill.-3
 Ortho Filter Corp., 196 Albion Ave., Paterson 2, N. J.-11-12-13-14-18-20-22-25-26-27-31
 Oxford Electric Corp., Distr. Sales Div., 556 W. Monroe St., Chicago 6, Ill.-20
 Palmer, Inc. M. V., 4002 Fruit Valley Rd., Vancouver, Wash.-11-12-15
 Penn Transformer Corp., Bellefonte, Pa.-10-23
 Peschel Electronics, 13 Garden St., New Rochelle, N. Y.-25-27
 Philmore Mfg. Co., 113 University Pl., New York 3, N. Y.-3
 Pioneer Scientific, 161 Great Neck Rd., Great Neck, L. I., N. Y.-13
 Power Supplies, 1005 Olive St., Highland, Ill.-11-13-14
 Precise Development Corp., 2 Neil Court, Oceanside, L. I., N. Y.-25
 Precision Electronics, 9101 King Ave., Franklin Park, Ill.-13-31
 Q-Line Mfg. Corp., 1562 61 St., Brooklyn 19, N. Y.-19
 Radio Corp. of America, RCA Tube Div., Harrison, N. J.-4-5-6-7-10
 Radio Merchandise Sales, 2016 Bronxdale Ave., New York 62, N. Y.-12
 Radio Music Corp., 84 S. Water St., Port Chester, N. Y.-2-11-12-20-22-25-26-27
 Ram Electronics, S. Buckhout St., Irvington-on-Hudson, N. Y.-3-6-7-9-10-23-25
 Rav-Par, Inc., 7810 W. Addison St., Chicago 13, Ill.-6-15-16-22-23-24
 Raytheon Mfg. Co., Equip. Marketing Dept., Waltham, Mass.-1-2-3-6
 Regency Division, Idea, Inc., 7900 Pendleton Pike, Indianapolis 26, Ind.-13
 Retron Corp., 697 N. Lake Ave., Pasadena 6, Calif.-8-10-15-16-23
 R K Mfg. Co., P. O. Box 112, Marion, Ill.-1-2-20-22-25-26-27-29
 Rogers Electronic Corp., 43 Bleecker St., New York 12, N. Y.-9-10-23-24
 Ross Mfg. Co., 5031 Broadway, Chicago 40, Ill.-2-3-6-9-10-20-22-23-24-26
 Sanaamo Electric Co., Marion, Ill.-13-14-20-21-22-24-26
 Scientific Coil Co., 5619 Broadway, Chicago 40, Ill.-5-6-7-10-15-16
 Service Instruments Co., 171 Official Rd., Addison, Ill.-30
 Shasta Div., Beckman Instruments, Inc., P. O. Box 296 Station A, Richmond, Calif.-16
 Shure Bros., 222 Hartrey Ave., Evanston, Ill.-19
 Smith, Inc., Herman H., 2326 Nostrand Ave., Brooklyn 10, N. Y.-18
 SNC Mfg. Co., P. O. Box 277, Oshkosh, Wisc.-4-20-21-22-25-26-27-28-29
 Sola Electric Co., 4633 W. 16 St., Chicago 50, Ill.-21
 Southwestern Industrial Electronics Co., 2831 Post Oak Rd., Houston 19, Texas-1-2-20
 Spencer-Kennedy Laboratories, 1320 Soldiers Field Rd., Boston 35, Mass.-12
 Sprague Products Co., North Adams, Mass.-13-14
 Standard Electrical Products, 2240 E. 3 St., Dayton 3, Ohio-1-2-15-16-20-21-22-25-26-27-28-29
 Standard Winding Co., 44 Johns St., Newburgh, N. Y.-2-3-6-9-13-16
 Stanwyck Winding Co., 137 Walsh Ave., Newburgh, N. Y.-2-6-7-10

Stromberg-Carlson Co., 100 Carlson Rd., Rochester, N. Y.-1
 Superec Electronics Corp., 4-6 Radford Pl., Yonkers, N. Y.-3-6-7-13-14-31
 Technical Apparatus Builders, 109 Liberty St., New York 9, N. Y.-2-3-28
 Telechrome, Inc., 88 Merrick Rd., Amityville, L. I., N. Y.-2-3
 Telectro Industries Corp., 35-16 37 St., Long Island City, N. Y.-1-11-14
 Telematic Industries, Inc., 16 Howard Ave., Brooklyn 21, N. Y.-12-13-31
 Televiso Corp., 1415 Golf Rd., Des Plaines, Ill.-11-12-13-14
 Telex, Inc., 1633 Eustis St., St. Paul, Minn.-20
 Television Labs., Wauconda, Ill.-2-5-10-12-15-20-26-29
 Texas Instruments, Inc., 6000 Lemmon Ave., Dallas 9, Tex.-2-3-6-11-12-13-14-15-16-20-22-24-25-26
 Thermador Electrical Mfg. Co., Electronics Div., 2000 Comfield Ave., Los Angeles 22, Calif.-2-20-22-25-26
 Thordorson-Meissner Mfg. Div., Maguire Industries, Mt. Carmel, Ill.-1-2-3-4-5-6-7-9-10-11-12-13-14-19-20-21-22-23-24-25-26-27-28-29-30-31
 Todd-Tron Corp., 156 Gramatan Ave., Mt. Vernon, N. Y.-10-23-26
 Tresco, Inc., 3824 Terrace St., Philadelphia 28, Pa.-1-2-19-20-22-25-26-27-29
 Triad Transformer Corp., 4055 Redwood Ave., Venice, Calif.-1-2-5-15-20-22-23-25-26-27-29
 Triwec Transformer Co., 3261 N. Milwaukee Ave., Chicago 18, Ill.-22-24-25-26
 United Technical Labs., Morristown, N. J.-12-13-14
 United Transformer Co., 150 Varick St., New York 13, N. Y.-1-2-11-12-13-14-15-16-20-21-22-25-26-27-28-29-30
 University Loudspeakers, Inc., 80 S. Kensico Ave., White Plains, N. Y.-8-11-20-21
 Utah Radio Products Co., 1123 E. Franklin St., Huntington, Ind., 1-2-20-22-25-26-27-28-29
 Valor Electronic Components Co., 5808 Marilyn Ave., Culver City, Calif.-15-27
 Vidair Electronics Mfg. Corp., 576 W. Merrick Rd., Lynbrook, N. Y.-12-13-14-19-30-31
 Vokor Corp., 7300 Huron River Dr., Dexter, Mich.-2-3-5-6-13-24
 Waldom Electronics, 4625 W. 53 St., Chicago, Ill.-4
 Waterproof Electric Co., 801 S. Main St., Burbank, Calif.-17
 Webster Electric Co., 1900 Clark St., Racine, Wisc.-20
 Wheeler Insulated Wire Co., Div. Sperry Rand Corp., 150 E. Aurora St., Waterbury 20, Conn.-1-2-20-22-26
 Wilco Corp., 546 Drovers St., Indianapolis 21, Ind.-1-2-3-7
 Wilmar Mfg. Co., 1110 Truman Rd., Kansas City 6, Mo.-6-24
 Wirt Co., 5221 Green St., Philadelphia 44, Pa.-3-15-16
 Workman Tv, Inc., 309 Queen Anne Rd., Teaneck, N. J.-25-30

Anton Electronic Labs., 1226 Flushing Ave., Brooklyn 37, N. Y.-7
 Atlas Overhead Door Co., 375 Mill St., Quaker-town, Pa.-2
 Barber-Colman Co., P. O. Drower 99, Rockford, Ill.-2
 Becks, Inc., 298 E. 5 St., St. Paul 1, Minn.-1
 Blonder-Tongue Labs., 526 North Ave., Westfield, N. J.-1-4
 Brainard Electronics, 8586 Santa Monica Blvd., Los Angeles 46, Calif.-4-11
 Calbest Electronics Co., 4801 Exposition Blvd., Los Angeles 16, Calif.-2-8-11
 Calder Mfg. Co., Lancaster, Pa.-2
 CGS Labs., Inc., 391 Ludlow St., Stamford, Conn.-8-11
 Columbus Eng'g. Co., Electronics-Nucleonics Div., P. O. Box 464, Columbus, Nebr.-1-2-3-6-7
 Crawford Door Co., 20263 Hoover Rd., Detroit 5, Mich.-2
 Curtiss-Wright Corp., Electronic Div., 631 Central Ave., Carlstadt, N. J.-9
 Cutler-Hammer, Inc., 315 N. 12 St., Milwaukee 1, Wisc.-1
 Delfron, Inc., 2905 N. Leithgow St., Philadelphia 33, Pa.-1
 Doormasters, Inc., 2310 Michigan Ave., Santa Monica, Calif.-1-2-11
 DuMont Labs., Inc., Allen B., 750 Bloomfield Ave., Clifton, N. J.-1-4-5-8-11
 Eicor, Inc., 1501 W. Congress St., Chicago 7, Ill.-9
 Electric Power Door Co., Minneapolis 7, Minn.-2
 Electrical Service Co., 1271 Mission St., San Francisco 3, Calif.-6
 Electronic Instrument Co., 84 Withers St., Brooklyn 11, N. Y.-3
 Electron-Radar Products, 4806 W. Chicago Ave., Chicago 51, Ill.-1-2-6
 Electro-Physics Co., 287U Broadway, New York 7, N. Y.-1-6
 Electro-Tech Equipment, 308 Canal St., New York 13, N. Y.-1-2-9
 Engineered Instruments, Inc., DV Controls Div., 937 Soto St., Hayward, Calif.-2
 Espey Mfg. Co., 200 W. 57 St., New York 19, N. Y.-8
 Federal Telephone & Radio Co., Div. IT&T, 100 Kingsland Rd., Clifton, N. J.-5-6
 Fisher Co., Oscar, 1000 N. Division St., Peekskill, N. Y.-6
 Fisher-Pierce Co., 170 Pearl St., So. Braintree 85, Mass.-1-6-9
 General Electric Co., Apparatus Sales Div., Schenectady, N. Y.-1-6-7-9
 General Motors Corp., Guide Lamp Div., Anderson, Ind.-6
 Gosnet Co., 801 S. Main St., Burbank, Calif.-5-8-10
 Hamilton Electronics, 2726 Pratt Ave., Chicago 45, Ill.-9
 Hammarlund Mfg. Co., 460 W. 34 St., New York 1, N. Y.-1-8
 Heath Co., 305 Territorial Rd., Benton Harbor, Mich.-3-9
 Hoffman Electronics Corp., 3761 S. Hill St., Los Angeles 43, Calif.-3-8
 Howell Mfg. Co., 7199 Hasbrook Ave., Philadelphia 11, Pa.-2
 International Register, 2620 W. Washington St., Chicago 12, Ill.-9
 Jan Hdw. Mfg., 75 N. 11 St., Brooklyn 11, N. Y.-1
 Kay Lab., 5725 Kearny Villa Rd., San Diego 12, Calif.-4
 Kurman Electric Co., 35-18 37 St., Long Island City 1, N. Y.-9
 Livingston Electronic Corp., Livingston, N. J.-9
 McKee Door Co., 85 Hanks Ave., Aurora, Ill.-2
 Magnasync Mfg. Co., 5546 Satsuma Ave., N. Hollywood, Calif.-1
 Mallory & Co., P. R., 3029 E. Washington St., Indianapolis 6, Ind.-9
 Mitchell Industries, P. O. Box 17, Mineral Wells, Texas-8-11
 Michigan Electronics, 854 N. Rockwell St., Chicago 22, Ill.-1-6-9-10
 Mobil Electronics Mfg., 1111 State Rd. 67 E., Anderson, Ind.-8
 Morrow Radio Mfg. Co., 2794 Market St., Salem, Ore.-5-8-11
 Motorola, Inc., 4545 W. Augusta Blvd., Chicago 51, Ill.-5-8-11
 Multi-Tron Lab., 4624 Washington Blvd., Chicago 44, Ill.-2-6
 Nucleonic Co. of America, 196 Degraw St., Brooklyn 31, N. Y.-3-7
 Olymco Radio & TV, Inc., 34-01 38 Ave., Long Island City 1, N. Y.-8
 Overhead Door Corp., Hartford City, Ind.-2
 Parapleics Mfg. Co., 10068 Franklin Ave., Franklin Park, Ill.-1-6
 Penwood Numechron Co., 7249 Frankstown Ave., Pittsburgh 8, Pa.-9
 Perma-Power Co., 4727 N. Damen Ave., Chicago 25, Ill.-2
 Peschel Electronics, 13 Garden St., New Rochelle, N. Y.-1
 Photostron Instrument & Electronic Co., 151 Pasadena Ave., S. Pasadena, Calif.-9
 Photo Crystals, Inc., 15 S. 1 St., Geneva, Ill.-1-6
 Precise Development Corp., 2 Nell Court, Oceanside, L. I., N. Y.-2-3
 Precision Radiation Instruments, Inc., 4223 W. Jefferson Blvd., Los Angeles 16, Calif.-7
 Press Wireless Labs., W. Newton Mass.-1-8-11

9—COMMUNICATIONS & INDUSTRIAL ELECTRONIC EQUIPMENT

Antennas, commercial communications (see Sec. 1)	
Controls, industrial electronic	1
Garage door openers, electronic	2
Geiger counters	3
Industrial TV systems	4
Mobile 2-way radio systems	5
Photo-electric controls	6
Radioactivity detectors	7
Receivers, communications	8
Sound systems, industrial (see Sec. 3)	
Test equipment (see Sec. 16)	
Timers	9
Transceivers, portable hand	10
Transmitters, communications	11
Admiral Corp., 3800 W. Cortland St., Chicago 47, Ill.-3	
Aero Instrument Co., 11423 Vanowen St., N. Hollywood, Calif.-9	
Alco Electronics Mfg., 3 Wolcott Ave., Lawrence 1, Mass.-3	
Alden Electronic & Impulse Recording Equip. Co., Westboro, Mass.-1-9	
Alliance Mfg. Co., Lake Park Blvd., Alliance, Ohio-2	
American Electronics, Inc., 655 W. Washington Blvd., Los Angeles 15, Calif.-1-3-7	
American Elite, Inc., 7 Park Ave., New York 16, N. Y.-5	
Amplitel, Inc., 342 W. 40 St., New York 18, N. Y.-4	

Radio City Products Co., Centre & Glendale Sts., Easton, Pa.-3
 Radio Craftsmen, Inc., 4400 N. Ravenswood Ave., Chicago 40, Ill.-7
 Raytheon Mfg. Co., Marketing Dept., 190 Willow St., Waltham, Mass.-1
 Remington Rand Univac, Div. Sperry Rand Corp., 1902 W. Minnehaha Ave., St. Paul 4, Minn.-1
 Richard-Wilcox Mfg. Co., Aurora, Ill.-2
 Sessions Clock Co., 61 E. Main St., Forestville, Conn.-9
 Small Labs., 721 Walton Ave., New York 51, N. Y.-1-4-6
 Special Products Co., P. O. Box 188, Rockville 9, Md.-6
 Spencer-Kennedy Laboratories, 1320 Soldiers Field Rd., Boston 35, Mass.-4
 Stanley Works, Hardware Div., 195 Lake St., New Britain, Conn.-2
 Technical Apparatus Builders, 109 Liberty St., New York 9, N. Y.-6
 Telechrome, Inc., 88 Merrick Rd., Amityville, L. I., N. Y.-4
 Telecom, Inc., 1019 Admiral Blvd., Kansas City 8, Mo.-1
 Telectro Industries Corp., 35-16 37 St., Long Island City, N. Y.-7
 Tensitron, Inc., 28 Depot Rd., Harvard, Mass.-1
 Tork Clock Co., 1 Grove St., Mount Vernon, N. Y.-9
 Transi-Mite Radio Lab., Manteo, N. C.-3-10
 U. M. & F. Mfg. Corp., 10929 Vanowen St., North Hollywood, Calif.-3
 United Electric Controls, 85 School St., Watertown 72, Mass.-1
 U. S. Motors Corp., 412 Nebraska St., Oshkosh, Wisc.-2
 Vemaline Products Co., P. O. Box 222, Hawthorne, N. J.-6-9
 Wilmor Mfg. Co., 1110 Truman Rd., Kansas City 6, Mo.-11
 Worner Electronic Devices, Ronkin 1, Ill.-1-6

Allied Engraving & Stamping Co., 17 Elm St., Buffalo 3, N. Y.-10-12-20-27
 Allweather Antenna Mfg. Corp., 350 S. Egg Harbor Rd., Hammonton, N. J.-38
 Alpha Metals, Inc., 56 Water St., Jersey City 4, N. J.-14-37
 Alpha Wire Corp., 200 Varick St., New York 14, N. Y.-18-33
 Alprodoc, Inc., Kempton, Ind.-41
 Aluminum Mfg. Co., 1629 Portland Ave., Louisville 3, Ky.-31
 American Elite, Inc., 7 Park Ave., New York 16, N. Y.-21
 American Phenolic Corp., 1830 S. 54 Ave., Chicago 50, Ill.-5-12
 American Radio Hdw. Co., 152 MacQuesten Pkwy. S., Mt. Vernon, N. Y.-4-10-11-16-20-28-31-32
 American Screw Co., W. Main St., Willimantic, Conn.-31
 American Solder & Flux Co., 19 & Willard Sts., Philadelphia 40, Pa.-14
 Anchor Metal Co., 244 Boerum St., Brooklyn 6, N. Y.-14-31-37
 Anchor Products Co., 2712 Montrose Ave., Chicago 18, Ill.-6-15
 A. P. Electro Lab., Box 862 Chestnut Station, Union, N. J.-1-13-22-26-29-41
 Art Specialty Co., 3245 W. Lake St., Chicago 24, Ill.-21
 Atlas E-E Corp., Bedford Airport, Bedford, Mass.-5-33-34
 Audio Equipment Co., 15749 Wyoming Ave., Detroit 38, Mich.-15
 Baker Mfg. Co., 133 Enterprise, Evansville, Wisc.-25
 Barco Chemical Products, 701 S. LaSalle St., Chicago 5, Ill.-8
 Boumker Mfg. Co., 3826 Summit St., Toledo 11, Ohio-7-17-27
 Beck's, Inc., 298 E. 5 St., St. Paul 1, Minn.-27
 Behr-Manning Corp., 2054 Saifert St., Troy, N. Y.-40
 Bentley-Harris Mfg. Co., Lime & Hector Sts. Conshohocken, Pa.-18
 Besterford Products Co., 626 Broadway, New York 12, N. Y.-10-15-18
 Biggs Co., Carl H. 2255 Barry Ave., Los Angeles, Calif.-1-8-19
 Birnbach Radio Co., 145 Hudson St., New York 13, N. Y.-5-10-11-18-19-20-31-33-41
 Bloco Mfg. Co., 6541 Euclid Ave., Cleveland 3, Ohio-17-22
 Brach Mfg. Corp., Div. Gen'l Bronze Corp., 200 Central Ave., Newark, N. J.-37

DeJur-Amsco Corp., 45-01 Northern Blvd., Long Island City 1, N. Y.-39
 D & M Products, 13144 W. McNichols Rd., Detroit 35, Mich.-15-20
 Dorn Equipment Corp., 88 Broad St., Boston 10, Mass.-10-28
 Drake Mfg. Co., 1713 W. Hubbard St., Chicago 22, Ill.-21
 Easy-Up, Inc., 908 State St., Racine, Wisc.-17
 Eborc Electronics Co., 87 Merrick Rd., Baldwin, N. Y.-38
 Eby Co., Hugh H., 4700 Stanton Ave., Philadelphia 44, Pa.-11-20-34-39
 Eby Sales Co., 130 Lafayette St., New York 13, N. Y.-8-20-22
 Elastic Stop Nut Corp., 2330 Vauxhall Rd., Union, N. J.-31
 Elco Corp., M St. Below Erie Ave., Philadelphia 24, Pa.-34
 Electronic Chemical Corp., 813 Communipaw Ave., Jersey City 4, N. J.-8-26
 Electronic Hardware Corp., 2420 W. Cermak Rd., Chicago 8, Ill.-7-25-31-39
 Electrovox Co., 60 Franklin St., E. Orange, N. J.-8
 Elfron Corp., 109 W. Station St., St. Anne, Ill.-15
 Federal Screw Products, 3917 N. Kedzie Ave., Chicago 18, Ill.-11-31
 Federated Metals, 120 Broadway, New York 5, N. Y.-37
 Fidelity Chemical Products Corp., 470 Frelinghuysen Ave., Newark 5, N. J.-8-26
 Gorde Mfg. Co., 588 Eddy St., Providence 3, R. I.-19-39
 Gee-Lar Mfg. Co., 418 S. Wymon St., Rockford, Ill.-20-25
 General Aluminum Products, 287 5 Ave., New York, N. Y.-41
 General Cement Mfg. Co., 919 Taylor Ave., Rockford, Ill.-1-5-6-8-10-11-13-14-15-16-18-19-20-22-26-28-29-30-31-35-37-38-40-41
 Great Eastern Mfg. Co., 165 Remsen Ave., Brooklyn 12, N. Y.-8
 Hobson Bros., 4940 W. Lawrence Ave., Chicago 30, Ill.-6-11
 Hoffman Electronics Corp., 3761 S. Hill St., Los Angeles 43, Calif.-11
 Holub Industries, 413 DeKalb Ave., Sycamore, Ill.-31
 Hudson Lamp Co., Arlington, N. J.-21
 Ideal Industries, 3316 Park Ave., Sycamore, Ill.-8
 IE Mfg., 325 N. Hoyne Ave., Chicago 12, Ill.-3-5-6-7-16-31-39
 Imperial Radar & Wire, 820 E. 233 St. Bronx, N. Y.-3-19-41
 Industrial Devices, 22 State Rd., Edgewater, N. J.-20-21
 Industrial Hardware Mfg. Co., 109 Prince St., New York 12, N. Y.-39
 Injection Molders Supply, 3514 Lee Rd., Cleveland, Ohio-38
 Insl-X Sales Co., 26 Rittenhouse Pl., Ardmore, Pa.-19
 Insuline Corp. of America, 186 Granite St., Manchester, N. H.-3-4-5-7-10-11-15-16-18-19-20-25-27-30-31-34
 Irvington Varnish & Insulator, Div. Minn. Mining & Mfg. Co., 6 Argyle Terrace, Irvington 11, N. J.-18-19-40-41
 Isolantite Mfg. Corp., Warren Ave., Stirling, N. J.-4-39-41
 Jan Hdw. Mfg. Co., 75 N. 11 St., Brooklyn 11, N. Y.-11-32-33-34
 JFD Mfg. Co., 6101 16 Ave., Brooklyn 4, N. Y.-3-5-33
 Johns-Manville, Dutch Brand Div., 7800 Woodtown Ave., Chicago 19, Ill.-40
 Jones, H. B. Div., Cinch Mfg., 1026 S. Homan Ave., Chicago 24, Ill.-27-28
 Jontz Mfg. Co., 1101 E. McKinley Ave., Mishawaka, Ind.-25
 Kellaga Switchboard & Supply Co., 79 W. Monroe St., Chicago 3, Ill.-10-37
 Kendall Co., Polyken Sales Div., 222 W. Adams St., Chicago 6, Ill.-1-40
 Kenwood Eng'g. Co., 265 Colfox Ave., Colfox, N. J.-3-25
 Kerden Chemical Co., 6400 Hermon Ave., Cleveland 2, Ohio-8
 Kester Solder Co., 4201 Wrightwood Ave., Chicago, Ill.-37
 Keystone Electronics Corp., 423 Broome St., New York 13, N. Y.-2-3-4-11-19-27-39
 K & G Electronics, 2738 N. Sheffield Ave., Chicago 14, Ill.-3
 Krylon, Inc., Ford & Washington Sts., Norristown, Pa.-38
 Lenk Mfg. Co., 30-38 Cummington St., Boston 15, Mass.-14-37
 Lerco Electronics, Inc., 501 S. Varney St., Burbank, Calif.-39
 Lingren & Assoc., Erik A., 4515 N. Ravenswood, Chicago 40, Ill.-33
 London Chemical Co., 1535 N. 31 St., Melrose Park, Ill.-14-37
 Lowell Mfg. Co., 3030 Laclede Station Rd., St. Louis 17, Mo.-3-15
 Lytle Eng'g. & Mfg. Co., 105 W. Monroe St., Chicago 3, Ill.-4-7
 Macson Co., 3260 Motor Ave., Los Angeles 34, Calif.-25
 Master Mobile Mounts, 1306 Bond St., Los Angeles 15, Calif.-34
 Matchless Electric Co., 1700 Washington Blvd., Chicago 12, Ill.-21
 Mathis Tower & Equip Co., P. O. Box 126, E. Peoria, Ill.-3-25

10—HARDWARE & MISCELLANEOUS PARTS

Adhesives	1
Bearings	2
Brackets, mounting	3
Bushings	4
Cable clamps	5
Caps, tube (grid & plate)	6
Chassis, blanks	7
Cleaners, chemicals	8
Decals	9
Dials & dial accessories	10
Electronic Hardware, misc.	11
Escutcheons	12
Flocking Material	13
Flux	14
Grilles, metal & screen	15
Grommets	16
Grounding Equipment	17
Insulation, spaghetti sleeving ..	18
Insulators & Insulating Materials	19
Knobs	20
Lamps & Bulbs	21
Lubricants	22
Markers, adhesive	23
Masks, CRT	24
Mounts	25
Paints, Lacquer & Varnish	26
Panels	27
Plugs, hole	28
Polishes	29
Pulleys, idler	30
Screws, Nuts, Bolts, Washers	31
Shafts, control	32
Shielding	33
Shields, tube & coil	34
Shims, speaker	35
Snaps & Studs	36
Solder	37
Spray, plastic protective	38
Standoffs, terminal	39
Tape, friction & Insulating	40
Tubing	41
Windows, dial	42



Brady Co., W. H., 727 W. Glendale Ave., Milwaukee 12, Wisc.-9-19-23
 Brand & Co., Wm., North & Volley Sts., Willimantic, Conn.-41
 Bridgeport Brass Co., Aerosol Div., 774 E. Main, Bridgeport, Conn.-38
 British Industries Corp., 80 Shore Rd., Port Washington, N. Y.-15
 Bud Radio, Inc., 2118 E. 55 St., Cleveland 3, Ohio-2-3-4-6-7-10
 Cordwell Electronics Products Corp., Allen D., 97 Whiting St., Plainville, Conn.-3-4
 Coss Machine Co., 691 Antoinet St., Detroit 1, Mich.-3-4-7-11-19-20-25-30-31-36
 CBC Electronics Co., 2601 N. Howard St., Philadelphia 33, Pa.-13
 Centralab Div. Globe Union, Inc., 902Y E. Keefe Ave., Milwaukee 1, Wisc.-3-19
 Chompin Bronze Powder & Paint Co., 2526 W. Vanburen St., Chicago 12, Ill.-38
 Channel Master Corp., Ellenville, N. Y.-19
 Chose & Sons, Randolph, Mass.-19-40
 Chemical Electronic Eng'g., Matawan, N. J.-8
 Churchill Lighting Corp., 344 Franklin St., Melrose 76, Mass.-3-7-11-27
 Cinch-Jones Div., Cinch Mfg. Corp., 1026 S. Homan Ave., Chicago 24, Ill.-28
 Circon Component Co., Santa Barbara Municipal Airport, Coleta (Santa Barbara) Calif.-11-21-31-39
 Coaxial Connector Co., 37 N. 2 Ave., Mt. Vernon, N. Y.-19
 Colman Tool & Machine Co., P. O. Box 7026, Amarillo, Texas-20
 Columbus Eng'g. Co., Electronics-Nucleonics Div., P. O. Box 464, Columbus, Nebr.-3-5-7-27
 Constad Laboratories, 15 Bridge St., New York 4, N. Y.-26
 Cook Laboratories, 114 Manhattan St., Stamford, Conn.-37
 Co-Operative Industries, 100 Oakdale Rd., Chester, N. J.-33
 Creative Plastics Corp., Rt. 25 A, Stony Brook, N. Y.-4-16-19
 Dale Products, Inc., P. O. Box 136, Columbus, Nebr.-20
 Deal Products, Hellertown Rd., Easton, Pa.-3-25

Accurate Electronics Corp., 169 S. Abbe Rd., Elvira, Ohio-4-5-11-19-20-27
 Acromark Co., 9 Morrell St., Elizabeth 4, N. J.-10-27
 Aerolite Electronics Corp., 507 26 St., Union City, N. J.-5-27-32-39
 Alden Products Co., 117 N. Main St., Brockton 64, Mass.-6-7-21

Mattison TV & Radio Corp., 10 W. 181 St., New York 53, N. Y.-3
 Mechanical Steel Tubing Corp., 500 Barry St., Bronx 59, N. Y.-41
 Medal Mfg. Co., 194 E. Silver St., Sharon, Pa.-3-17
 MeRix Chemical Co., 1021 E. 55 St., Chicago 15, Ill.-8-38
 Mico Instrument Co., 80 Trowbridge St., Cambridge 38, Mass.-14-37
 Micro-Circuits Co., New Buffalo, Mich.-1-26-33
 Millen Mfg. Co., James, 150 Exchange St., Malden 48, Mass.-2-6-10-20-33-34-35
 Miller Co., J. W., 5917 S. Main St., Los Angeles 3, Calif.-34
 Minn. Mining & Mfg. Co., 900 Fauquier Ave., St. Paul 6, Minn.-23
 Miracle Adhesives Corp., 214 E. 53 St., New York 22, N. Y.-1
 Mitchell Rand Insulation, 51 Murray St., New York 7, N. Y.-19
 Mobil Electronics Mfg. Co., 1111 State Rd. 67 E., Anderson, Ind.-7
 Modern-Aire Mfg. Corp., 4436 W. Roosevelt Rd., Chicago 40, Ill.-17-31
 Modern Wire Co., 39-30 Review Ave., Long Island City 1, N. Y.-37
 Male-Richardson, 937 N. Sycamore Ave., Hollywood 38, Calif.-21
 Mueller Electric Co., 1501 E. 31 St., Cleveland, Ohio-17-19
 Multicore Sales Corp., Sub. British Industries, 80 Shore Rd., Port Washington, N. Y.-14-37
 Nagel-Chase Mfg. Co., 2811 N. Ashland Ave., Chicago 13, Ill.-3
 Nameplates, Inc., 425 E. 101 St., Brooklyn 36, N. Y.-10-12
 National Co., 61 Sherman St., Malden 48, Mass.-10-20-28-31
 National Electric Products 140 Stanwix St., Pittsburgh 22, Pa.-3-25
 National Tel-Tronics Corp., 52 St. Casimir Ave., Yonkers, N. Y.-11-19
 Newcomb Audio Products, 6824 Lexington Ave., Hollywood 38, Calif.-27
 Nichols Products Co., 325 W. Main St., Moorestown, N. J.-4-10-19-20
 Norco Mfg. Co., 329 Bleecker St., New York 14, N. Y.-21
 Nylok Corp., E. 14 St. & Grand Central Ave., Elmira Heights, N. Y.-31
 Oxford Electric Corp., Distr. Sales Div., 556 W. Monroe St., Chicago 6, Ill.-21
 Pacific Electric Co., 3217 Exposition Pl., Los Angeles 8, Calif.-28-39
 Pacific Transducer Corp., 11836 W. Pico Blvd., Los Angeles 64, Calif.-20
 Parker Metal Goods Co., 161 Summer St., Worcester, Mass.-19-31
 Perfection Mica Co., 20 N. Wacker Dr., Chicago, Ill.-33
 Permacel Tape Corp., Highway U. S. #1, New Brunswick, N. J.-19-40
 Phaostron Instrument & Electronic Co., 151 Pasadena Ave., S. Pasadena, Calif.-10
 Phelps Dodge Copper Products Corp., 300 Park Ave., New York 22, N. Y.-41
 Phillips Mfg. Co., 2816 Aldrich Ave. S., Minneapolis, Minn.-14
 Philmore Mfg. Co., 113 University Pl., New York 3, N. Y.-3-11-31
 Philson Mfg. Co., 60 Sackett St., Brooklyn, N. Y.-3
 Phoenix Electronics, 50 Island St., Lawrence, Mass.-25
 Plasti-Kote, Inc., 425 Lakeside, N.W., Cleveland 13, Ohio-26-38
 Plymouth Electronics Corp., 50 Kingsbury St., Worcester 3, Mass.-3-7-25-27
 Polymer Corp., Reading, Pa.-2-4-18-19-31-40-41
 Pomona Electronics Co., 1126 W. 5 Ave., Pomona, Calif.-27
 Porcelain Products, P. O. Box 300, Findlay, Ohio-19
 Precise Measurements Co., 942 Kings Highway, Brooklyn 23, N. Y.-10
 Premax Products Div., Chisholm-Ryder Co., Niagara Falls, N. Y.-17
 Q-Line Mfg. Corp., 1562 61 St., Brooklyn 19, N. Y.-3-7
 Quetrale Co., 395 St. John St., Spartanburg, S. C.-8-22
 Radio Merchandise Sales, 2016 Bronxdale Ave., New York 62, N. Y.-17
 Radio Supply & Eng'g Co., 85 Selden St., Detroit 1, Mich.-16-20
 Rare Earths, Inc., Box 488, Pompton Plains, N. J.-29
 Raytheon Mfg. Co., Equip Marketing Dept., Waltham, Mass.-20
 R-Columbia Products Co., 305 Waukegan Ave., Highwood, Ill.-8
 Reed & Prince Mfg. Co., 10 Duncan Ave., Worcester 1, Mass.-31
 Rhodes & Sons, M. M., 12 Porter St., Taunton, Mass.-5
 Rite-Lite Mfg. Co., 3243 W. Lawrence Ave., Chicago 25, Ill.-21
 Rochester Iron & Metal, 335 St. Paul St., Rochester, N. Y.-41
 Roal Tube Bendina Co., 3543 S. Normal Blvd., Chicago 9, Ill.-41
 Rogan Bros., 8031 N. Monticello Ave., Skokie, Ill.-20
 Rohn Mfg. Co., 116 Limestone Bellevue, Peoria 5, Ill.-3-16
 Romar Plastics, Inc., 1311 E. Main St., St. Charles, Ill.-10-12-20

Saxonburg Ceramics, Saxonburg, Pa.-19
 Scranton Aluminum Mfg. Co., 419 S. Wyoming Ave., Scranton, Pa.-25
 Signalite, Inc., 37-41 Neptune Hwy., Neptune, N. J.-21
 Silicone Spray Products, 3514 Lee Rd., Cleveland 22, Ohio-38
 Smith, Inc., Herman H., 2326 Nostrand Ave., Brooklyn 10, N. Y.-4-5-11-16-20-28-31-32-34-39
 South River Metal Prods. Co., 377 Turnpike, South River, N. J.-17-25
 Specialty Assembling & Packing, 79 Clinton Pl., Brooklyn 38, N. Y.-10
 Spencer-Kennedy Laboratories, 1320 Soldiers Field Rd., Boston 35, Mass.-3
 Stone City Machine & Tool Co., Bedford, Ind.-3-4-7-11-15-25-34
 Superex Electronics Corp., 4-6 Radford Pl., Yonkers, N. Y.-8
 Sylvania Electric Products, Inc., 1740 Broadway, New York 19, N. Y.-21-34
 Technical Appliance Corp., 1 Taco Ave., Sherburne, N. Y.-3-17
 Technical Tape Corp., 177 St. & Harlem River, Bronx, N. Y.-40
 Technicraft Co., 1156 Commonwealth Ave., Boston 34, Mass.-1-8-10-21-31
 Techniques, Inc., 178 Central Ave., Hackensack, N. J.-23
 Tele Plastics Co., 202 Broadway, Brooklyn, N. Y.-10-12-24-27-42
 Thomas Associates, 4607 Alger St., Los Angeles 39, Calif.-3-5
 Thompson-Bremer & Co., 520 N. Dearborn St., Chicago 10, Ill.-31
 Tinnerman Products, P. O. Box 6688 Dept. 16, Cleveland 1, Ohio-5-31
 Transformer Metal Prods. Corp., 343 W. 26 St., New York 1, N. Y.-11-15
 Trico Fuse Mfg. Co., 2948 N. 5 St., Milwaukee 12, Wis.-5
 Tricraft Products Corp., 1535 N. Ashland Ave., Chicago 22, Ill.-21
 Trimm, Inc., 400 W. Lake St., Libertyville, Ill.-27-28
 Tru-Pine Co., 7638 S. Vincennes Ave., Chicago 20, Ill.-8-26-38
 Tung-Sol Electric, Inc., 95 8 Ave., Newark 4, N. J.-21
 TV Development Corp., 2024 McDonald Ave., Brooklyn 23, N. Y.-20
 TV Hdw. Mfg. Co., 919 Taylor Ave., Rockford, Ill.-5-6-9-17-25-31-38-39
 U. M. & F. Mfg. Corp., 10929 Vanowen St., North Hollywood, Calif.-7-27
 United Screw & Bolt Corp., 2513 W. Cullerton St., Chicago 8, Ill.-31
 United Technical Labs., Morristown, N. J.-38
 Univox Corp., 102 Warren St., New York 7, N. Y.-25
 Utah Radio Products Co., 1123 E. Franklin St., Huntington, Ind.-3
 Utilities Service Co., 1 Pine St., Allentown, Pa.-5-17-31
 Varflex Corp., 512 W. Court St., Rome, N. Y.-18-19-41
 Vector Electronic Co., 3352 San Fernando Rd., Los Angeles 65, Calif.-11-39
 Victor Insulators, Inc., Maple Ave., Victor, N. Y.-19
 Vidair Electronics Mfg. Corp., 576 W. Merrick Rd., Lynbrook, N. Y.-10
 Video Accessory Mfg. Co., Box 223, Tulsa 1, Okla.-25
 Vulcan TV Mast & Tower Co., 1224 National St., Birmingham 7, Ala.-17
 Waldom Electronics, 4625 W. 53 St., Chicago, Ill.-11-12-16-20-24-27-31-35
 Walnut Machine Co., 732 Western Ave., South Bend, Ind.-25
 Walsco Electronics Corp., 3602 Crenshaw Blvd., Los Angeles 16, Calif.-1-4-5-8-9-11-14-15-16-18-22-26-29-31
 Waterproof Electric Co., 801 S. Main St., Burbank, Calif.-3-7
 Wheatland Tube Co., Bankers Securities Bldg., Philadelphia, Pa.-41
 Workman TV, Inc., 309 Queen Anne Rd., Teaneck, N. J.-1-8

Allied Radio Corp., 100 N. Western Ave Chicago 80, Ill.-1-2-3-4-8-10-12
 American Electronics Co., 1203 Bryant Ave., New York 59, N. Y.-5
 Anton Electronic Labs., 1226 Flushing Ave., Brooklyn 37, N. Y.-5-8
 Arrow Mfg. Div., Box 423, Amarillo, Tex.-7
 Arvin Industries, Inc., Columbus, Ind.-7
 Berger Communications, 109-01 72 Rd., Forest Hills, N. Y.-3-7-8-9
 Butler Mfg. Co., B. B., 3150 Randolph St., Bellwood, Ill.-11
 Central Electronics, 1247 W. Belmont Ave., Chicago 13, Ill.-12
 Certified Radio Labs., 5507 13 Ave., Brooklyn 19, N. Y.-5-14
 CG Electronics Corp., 305 Dallas St., N.E., Albuquerque, N. Mex.-9
 Chicago Standard Transformer Corp., 3501 W. Addison St., Chicago 31, Ill.-2
 Collins Audio Products, P. O. Box 368, Westfield, N. J.-1
 Colman Tool & Machine Co., P. O. Box 7026, Amarillo, Tex.-7
 Cofortone Electronics, 100 Frank Rd., Hicksville, N. Y.-8-12
 D & M Products, 13144 W. McNichols Rd., Detroit 35, Mich.-2-11
 DX Radio Products Co., 2300 W. Armitage Ave., Chicago 47, Ill.-4-13
 Dyna Co., 5142 Master St., Philadelphia 31, Pa.-2
 Eby Sales Co., 130 Lafayette St., New York 13, N. Y.-2-8
 Electronic Instrument Co., 84 Withers St., Brooklyn 11, N. Y.-2-3-12
 Electronic Measurements Corp., 280 Lafayette St., New York 12, N. Y.-3-12
 Electron-Radar Products, 4806 W. Chicago Ave., Chicago 51, Ill.-6
 Electro-Voice, Inc., Buchanan, Mich.-11
 Federal Electronics Sales, Federal Electronics Bldg., Rockville Centre, N. Y.-4-5
 Feiler Eng'g & Mfg. Co., 8026 N. Monticello Ave., Skokie, Ill.-12
 Franklin Electronics, King St., Franklin Park, Ill.-12
 General Apparatus, 344 E. 32 St., New York 16, N. Y.-2-11
 Gotham TV Corp., 123 W. 64 St., New York 23, N. Y.-1-14
 Greene Co., L. Charlton, 314 Washington St., Newton 58, Mass.-2
 Heath Co., 305 Territorial Rd., Benton Harbor, Mich.-1-2-3-4-8-10-11-12
 Hubbell, Inc. Harvey, State St. & Bostwick Ave., Bridgeport, Conn.-12
 Insuline Corp. of America, 186 Granite St., Manchester, N. H.-13
 Jensen Mfg. Co., 6601 S. Laramie Ave., Chicago 38, Ill.-11
 McGregor Electronic Industries, McGregor, Iowa-2
 Michigan Electronics, 854 N. Rockwell St., Chicago 22, Ill.-2-5-9
 Miller Co., J. W., 5917 S. Main St., Los Angeles 3, Calif.-4
 North American Model Prod., 9802 Warwick Rd., Warwick, Va.-9
 Ortho Filter Corp., 196 Albion Ave., Paterson 2, N. J.-10
 Permoflux Corp., 2835 N. Kedzie Ave., Chicago 18, Ill.-11
 Peschel Electronics, 13 Garden St., New Rochelle, N. Y.-3-8-12
 Philmore Mfg. Co., 113 University Pl., New York 3, N. Y.-2-4-5-9-10-14
 Precise Development Corp., 2 Neil Court, Oceanside, L. I., N. Y.-1-2-3-8-12
 Precision Electronics, 9101 King Ave., Franklin Park, Ill.-2-12
 Progressive "Edu-Kits," Inc., 497 Union Ave., Brooklyn 11, N. Y.-5
 Radio City Products Co., Centre & Glendale Sts., Easton, Pa.-12
 Service Instruments Co., 171 Official Rd., Addison, Ill.-12
 Shober Organ Corp., 35 Dall St., New Hyde Park, N. Y.-2
 Sonar Radio, 3050 W. 21 St., Brooklyn 24, N. Y.-10
 Superex Electronics Corp., 4-6 Radford Pl., Yonkers, N. Y.-1-4
 Tech-Master Corp., 75 Front St., Brooklyn 1, N. Y.-1-2-5-14
 Technical Apparatus Builders, 109 Liberty St., New York 9, N. Y.-2-3
 Techniques, Inc., 178 Central Ave., Hackensack, N. J.-2-5-6-8-9-10
 Tele-Diagnosis Co., 155 W. 72 St., New York 32, N. Y.-12
 Telematic Industries, Inc., 16 Howard Ave., Brooklyn 21, N. Y.-13
 Thordarson-Meissner Mfg. Div., Maguire Industries, Mt. Carmel, Ill.-2
 Trans-Mite Radio Lab., Monteo, N. C.-4-5-10
 Triad Transformer Corp., 4055 Redwood Ave., Venice, Calif.-2
 United Mfg. Co., Div. W. L. Maxson Corp., 41 Halg St., Hamden 14, Conn.-12
 United Transformer Co., 150 Varick St., New York 13, N. Y.-2
 University Loudspeakers, Inc., 80 S. Kensico Ave., White Plains, N. Y.-11
 Vector Electronic Co., 3352 San Fernando Rd., Los Angeles 65, Calif.-12
 Videon Electronic Corp., 902 E. Michigan St., Indianapolis 2, Ind.-4-5-8-13
 Worner Electronic Devices, Rankin 1, Ill.-6

11—KITS

Kits, AM, FM Tuner	1
Kits, audio	2
Kits, battery charger, eliminator	3
Kits, crystal set	4
Kits, educational radio-TV	5
Kits, electric eye equipment	6
Kits, plix tube conversion	7
Kits, power supply	8
Kits, radio control	9
Kits, short-wave set	10
Kits, speaker enclosure	11
Kits, test equipment	12
Kits, TV booster	13
Kits, TV chassis	14

Alco Electronics Mfg., 3 Wolcott Ave., Lawrence 1, Mass.-3-4-5-8-12

12—POWER SUPPLIES, BATTERIES & ACCESSORIES

Batteries, dry cell radio	1
Batteries, hearing aid	2
Batteries, mercury	14
Batteries, solar	13
Batteries, storage	3
Battery chargers	4
Battery eliminators	5
Dividers, voltage	6
Dynamotors	7
Generators, power	8
Inverters, DC to AC	9
Power Plants & Supplies	10
Regulators, voltage	11
Selenium Rectifiers (see Sec. 15)	
Vibrators, auto radio	12

Acme Battery Corp., 59 Pearl St., Brooklyn, N. Y.-1-2
 Alco Electronics Mfg., 3 Wolcott Ave., Lawrence 1, Mass.-10-11
 American Electronics, Inc., 655 W. Washington Blvd., Los Angeles 15, Calif.-7-8-9-10
 American Elite, Inc., 7 Park Ave., New York 16, N. Y.-12
 American TV & Radio, 300 E. 4 St., St. Paul 1, Minn.-4-5-9-12
 Anton Electronic Labs., 1226 Flushing Ave., Brooklyn 37, N. Y.-11
 Applegate & Co., C. J., 1816 Grove St., Boulder, Colo.-11
 Associated Specialties, 1751 Main St., Orfield, Pa.-10
 Authorized Mfrs. Service, 919 Wyckoff Ave., Brooklyn 27, N. Y.-11
 Barker & Williamson, 235 Fairfield Ave., Upper Darby, Pa.-10
 Barry Electronics Corp., 512 Broadway, New York 12, N. Y.-10
 Berger Communications, 109-01 72 Rd., Forest Hills, N. Y.-4-5
 Bond Electric Corp., Div. Olin Industries, 505 Park Ave., New York, N. Y.-1
 Bright Star Industries, 600 Getty Ave., Clifton, N. J.-1
 Burgess Battery Co., Freeport, Ill.-1-2
 Burlington Instrument Co., 203 N. 3 St., Burlington, Iowa-11
 Carter Motor Co., 2644 N. Maplewood Ave., Chicago 47, Ill.-7
 CBC Electronics Co., 2601 N. Howard St., Philadelphia 33, Pa.-11
 Chatham Electronics, Div. Gera Corp., 630 W. Mt. Pleasant Ave., Livingston, N. J.-4-11
 Chicago Standard Transformer Corp., 3501 W. Addison St., Chicago 31, Ill.-11
 Clarostat Mfg. Co., 1 Washington St., Dover, N. H.-6
 Colortone Electronics, 100 Frank Rd., Hicksville, N. Y.-11
 Cornell-Dubilier Electric Corp., 333 Hamilton Blvd., S. Plainfield, N. J.-9-12
 Crest Transformer Corp., 1834 W. North Ave., Chicago 22, Ill.-11
 Delco Radio, 1446 S. Home Ave., Kokomo, Ind.-12
 Delco-Remy Div., General Motors Corp., Anderson, Ind.-12
 DuMont Labs. Inc., Allen B., 750 Bloomfield Ave., Clifton, N. J.-9
 Ecor, Inc., 1501 W. Congress St., Chicago 7, Ill.-9-10
 Electro-Eng'g. Prods. Co., 609 W. Lake St., Chicago 6, Ill.-7
 Electronic Instrument Co., 84 Withers St., Brooklyn 11, N. Y.-4-5
 Electro-Physics Co., 287U Broadway, New York 7, N. Y.-11
 Electro Products Labs., 4501 N. Ravenswood Ave., Chicago 40, Ill.-5-10
 Electro-Tech Equipment, 308 Canal St., New York 13, N. Y.-11
 Elgin Electronic Corp., P. O. Box 13, Bluffton, Ind.-4
 Federal Telephone & Radio Co., Div. IT&T, 100 Kingsland Rd., Clifton, N. J.-4-5-11
 Forest Electric Co., 7216 Circle Ave., Forest Park, Ill.-11
 Furst Electronics, Inc., 3322 W. Lawrence Ave., Chicago 25, Ill.-10-11
 General Dry Batteries, Inc., 13000 Athens Ave., Cleveland 7, Ohio-1-2-14
 Genefac Electric Co., Apparatus Sales Div., Schenectady, N. Y.-4-7-9-11
 G & M Equipment Co., 7315 Varna Ave., N. Hollywood, Calif.-9
 Heath Co., 305 Territorial Rd., Benton Harbor, Mich.-5
 H & H Products, P. O. Box 2333, Term. Annex, Los Angeles, Calif.-4
 Hoffman Electronics Corp., 3761 S. Hill St., Los Angeles 43, Calif.-13
 Inet Div., Leach Corp., 4441 S. Santa Fe Ave., Los Angeles 58, Calif.-10
 Interelectronics Corp., 2432 Grand Concourse, New York 58, N. Y.-1-2-3-4-7-9

Int'l Rectifier Corp., 1521 E. Grand Ave., El Segundo, Calif.-13
 Int'l Research Assoc., 2221 Warwick Ave., Santa Monica, Calif.-10
 James Vibrapow Co., 4050 N. Rockwell Ave., Chicago 18, Ill.-9-12
 JFD Mfg. Co., 6101 16 Ave., Brooklyn 4, N. Y.-11
 Kato Engineering Co., 1415 1 Ave., N., Man-kato, Minn.-4-8-9-10
 Kay Lab, 5725 Kearney Villa Rd., San Diego 12, Calif.-10
 Kellogg Switchboard & Supply Co., 79 W. Monroe St., Chicago 3, Ill.-1-3-4-5
 Keppo Labs., 131-38 Sanford Ave., Flushing 55, N. Y.-5-10
 Krohn-Hite Instrument Co., 580 Massachusetts Ave., Cambridge 39, Mass.-10
 Kurman Electric Co., 35-18 37 St., Long Island City 1, N. Y.-12
 Lab. of Electronic Eng'g., 413 "L" St. N.W., Washington 1, D. C.-10
 McColpin-Christie Corp., 3410 W. 67 St., Los Angeles 43, Calif.-4-9
 Magnavox Co., 2131 Bueter Rd., Ft. Wayne 4, Ind.-1-2
 Mallory & Co., P. R., 3029 E. Washington St., Indianapolis 6, Ind.-2-4-12-14
 Marathon Battery Co., 840 Henrietta St., Wausau, Wisc.-1-2
 Marine View Electronics, 28 Main St., White Plains, N. Y.-4-6-8
 Microtran Co., Div. Crest Labs., 84-11 Rockaway Beach Blvd., Rockaway Beach 93, N. Y.-11
 Miller Instrument, Inc. Wm., 325 N. Halstead Ave., Pasadena 8, Calif.-9-11
 Miller Co., Sanford, 691 Bedford Ave., Brooklyn 6, N. Y.-4-5-10
 Morgan-Rhein, Inc., 2319 McRae Ave., Orlando, Fla.-10
 Moulic Specialties Co., 1005 W. Washington St., Bloomington, Ill.-10
 Multi-Tron Lab., 4624 Washington Blvd., Chicago 44, Ill.-11
 National Carbon Co., 30 E. 42 St., New York 17, N. Y.-1-2
 Nylt Electronics, Inc., 2979 N. Ontario St., Burbank, Calif.-10



Ohmite Mfg. Co., 3601 Howard St., Skokie, Ill.-6
 Olin Industries, 655 Madison Ave., New York, N. Y.-1-2
 Onan & Sons, D. W., 2515 University Ave., S.E., Minneapolis 14, Minn.-10
 Perma-Power Co., 4727 N. Damen Ave., Chicago 25, Ill.-5-11
 Peschel Electronics, 13 Garden St., New Rochelle, N. Y.-4-5-11
 Philco Corp., Accessory Div., A & Allegheny Ave., Philadelphia 34, Pa.-1
 Pioneer Gen-E-Motor Corp., 5941 W. Dickens Ave., Chicago 39, Ill.-4-8
 Plastic Capacitors, 2511 W. Moffat St., Chicago 47, Ill.-11
 Precise Development Corp., 2 Neil Court, Oceanside, L. I., N. Y.-4-5-11
 Precise Measurements Co., 942 Kings Highway, Brooklyn 23, N. Y.-9-11
 Power Supplies, 1005 Olive St., Highland, Ill.-4-5-9-10-11
 Press Wireless Labs., 25 Prospect Pl., West Newton 65, Mass.-6
 Radiart Corp., 3455 Vega Ave., Cleveland 13, Ohio-10-12
 Radio Corp. of America, Camden, N. J.-12
 Ray-O-Vac Co., 212 E. Washington St., Madison 10, Wisc.-1-2
 Raytheon Mfg. Co., Equip Marketing Dept., Waltham, Mass.-4-11
 Sangamo Electric Co., Marion, Ill.-7-8
 Schauer Mfg. Co., 45 Alpine St., Cincinnati 36, Ohio-4-5
 Service Instruments Co., 171 Official Rd., Addison, Ill.-5
 Shallcross Mfg. Co., 520 Pusey Ave., Collingdale, Pa.-6-11
 Signalite, Inc., 37-41 Neptune Hwy., Neptune, N. J.-11
 Simpson Electric Co., 5208 W. Kinzie St., Chicago 44, Ill.-7
 Sola Electric Co., 4633 W. 16 St., Chicago 50, Ill.-10-11
 Sonar Radio, 3050 W. 21 St., Brooklyn 24, N. Y.-3-4
 Sterling Mfg. Co., 7201 Wentworth Ave., Cleveland, Ohio-4
 Stromberg-Carlson Co., 100 Carlson Rd., Rochester, N. Y.-5
 Summit Electronics, Inc., 7 Industrial Pl., Summit, N. J.-4
 Technical Apparatus Builders, 109 Liberty St., New York 9, N. Y.-4-5-10

Telkor, Inc., P. O. Box 186, Elyria, Ohio-5-9
 Terado Co., 1067 Raymond Ave., Dept. 2, St. Paul 14, Minn.-9-10
 U. S. Electric Mfg. Co., 222 W. 14 St., New York 11, N. Y.-1-3
 United Transformer Co., 150 Varick St., New York 13, N. Y.-11
 Vidale Electronics Mfg. Corp., 576 W. Merrick Rd., Lynbrook, N. Y.-11
 Vokar Corp., 7300 Huron River Dr., Dexter, Mich.-5-11-12
 Welch Mfg. Co., W. M., 1515 Sedgwick St., Chicago 10, Ill.-4
 Willard Storage Battery Co., 246 E. 131 St., Cleveland 1, Ohio-1-3-4
 Wincharger Corp., E. 7 & Division Sts., Sioux City 2, Iowa-7-8-9-10
 Winpower Mfg. Co., Newton, Iowa-8-10
 Workman TV, Inc., 309 Queen Anne Rd., Teaneck, N. J.-11
 Yardney Electric Corp., 40 Leonard St., New York 13, N. Y.-3

13—RECEIVERS, TV-RADIO CONVERTERS & TUNERS

Automatic Tuning Mechanism, radio	1
Boosters, auto radio	2
Boosters, TV & UHF	3
Conversion Strips, UHF-TV	4
Converters, color TV	19
Converters, UHF-TV	5
Radio sets, AM	6
Radio sets, AM-FM	7
Radio sets, FM	8
Radio sets, transistor	9
Receivers, communications (see Sec. 9)	
Receivers & Meters, coin-operated	10
Remote Control units, TV	11
Television sets, color	12
Television sets, monochrome	13
Tuners, AM	14
Tuners, AM-FM	15
Tuners, FM	16
Tuners, front-end TV	17
Tuners, TRF broadcast	18

ABT Mfg. Co., 715 N. Kedzie Ave., Chicago 12, Ill.-10
 Admiral Corp., 3800 W. Cortland St., Chicago 47, Ill.-6-9-11-12-13
 Aeromotive Equipment, 1632 Central St., Kansas City 8, Mo.-15
 Allied Radio Corp., 100 N. Western Ave., Chicago 80, Ill.-15
 Altec Lansing Corp., 9356 Santa Monica Blvd., Beverly Hills, Calif.-6-7
 American Elite, Inc., 7 Park Ave., New York 16, N. Y.-6-7-8-9-16
 American TV & Radio, 300 E. 4 St., St. Paul 1, Minn.-12-13
 Ampro Corp., 2835 N. Western Ave., Chicago 18, Ill.-14
 Anchor Radio Corp., 2215 S. St. Louis Ave., Chicago 23, Ill.-5
 Andrea Radio, 27-01 Bridge Plaza N., Long Island City 1, N. Y.-6-7-8-12-13
 Ansley Mfg. Co., Arthur, Doylestown, Pa.-7-15
 Arvin Industries, Inc., Columbus, Ind.-6-7
 Astatic Corp., P. O. Box 120, Conneaut, Ohio-3
 Authorized Mfrs. Service, 919 Wyckoff Ave., Brooklyn 27, N. Y.-14-15-16
 Automatic Radio Mfg. Co., 122 Brookline Ave., Boston 15, Mass.-6-7-8-9
 Bell Sound Systems, 555 Marion Rd., Columbus 7, Ohio-15-16
 Bendix TV & Broadcast Receiver Div., Bendix Aviation Corp., E. Joppa Rd., Towson 4, Md.-13
 Benrus Watch Co., 50 W. 44 St., New York, N. Y.-6-7-8
 Bergen Labs., 11 Godwin Ave., Fair Lawn, N. J.-1-11
 Berger Communications, 109-01 72 Rd., Forest Hills, N. Y.-15-17
 Blonder-Tongue Labs., 526 North Ave., Westfield, N. J.-3-4-5-11
 Boen Co., David, 29 9 Ave., New York 14, N. Y.-3-14-15-16
 Brainord Electronics, 8586 Santa Monica Blvd., Los Angeles 46, Calif.-6-7-8-14-15-16
 B & R Electronics, 1701 Boone Ave., New York 60, N. Y.-6-7-8
 Browning Labs., Inc., 750 Main St., Winchester, Mass.-15-16
 Bulova Watch Co., Bulova Park, Flushing 70, N. Y.-6-7-8-9
 Calbest Electronics Co., 4801 Exposition Blvd., Los Angeles 16, Calif.-6-7-8-13
 Cal-Lee Mfg. Co., 5653 W. Adams Blvd., Los Angeles 16, Calif.-14-15-16
 Capehart-Farnsworth Corp., 3700 Pontiac St., Fort Wayne, Ind.-4-7-13-15
 CBS-Columbia, Inc., 3400 47 Ave., Long Island City 1, N. Y.-5-6-7-9-12-13

CGS Labs., Inc., 391 Ludlow St., Stamford, Conn.-1
 Collins Audio Products, P. O. Box 368, Westfield, N. J.-16
 Color Converter, Inc., P. O. Box 250, Columbia City, Ind.-19
 Conrac, Inc., 19217 E. Foothill Blvd., Glendora, Calif.-13
 Crosley Radio & TV, 1329 Arlington St., Cincinnati 25, Ohio-6-7-8-13
 Delco Radio, 1446 S. Home Ave., Kokomo, Ind.-6
 DeWald Radio Mfg. Corp., 35-15 37 Ave., Long Island City 1, N. Y.-6-7-9-13
 DuMont Labs. Inc., Allen B., 750 Bloomfield Ave., Clifton, N. J.-3-8-11-12-13
 DX Radio Products Co., 2300 W. Armitage Ave., Chicago 47, Ill.-3-5-17
 Dynavox Corp., 40-05 21 St., Long Island City 1, N. Y.-6
 Edu-Craft Sales Corp., 150-45 12 Ave., White-stone, N. Y.-16
 Electrend Products Corp., State & Water Sts., St. Joseph, Mich.-2
 Electron Enterprises, 6917 Stanley Ave., Berwyn, Ill.-6-10
 Electro-Voice, Inc., Buchanan, Mich.-15-16
 Emerson Radio & Phonograph Co., 14 & Coles Sts., Jersey City, N. J.-6-7-8-9-12-13
 Espey Mfg. Co., 200 W. 57 St., New York 19, N. Y.-7-15
 Fada Radio & Electric Co., 525 Main St., Belleville 9, N. J.-12-13
 Federal Electronics Sales, Federal Electronics Bldg., Rockville Centre, N. Y.-11
 Fisher Radio Corp., 21-21 44 Dr., Long Island City 1, N. Y.-6-7-8-15
 Fleetwood Corp., 1037 Custer Dr., Toledo 12, Ohio-13
 Fleming, Inc., Edward, Broad St., Westport, Conn.-11
 Garod Radio, 70 Washington St., Brooklyn 1, N. Y.-14-15
 General Instrument Corp., 829 Newark Ave., Elizabeth 3, N. J.-1-3-4-5-17
 Gosset Co., 801 S. Main St., Burbank, Calif.-6-8-11-14-16
 Gotham TV Corp., 123 W. 64 St., New York 23, N. Y.-6-13
 Granco Products, Inc., 36-07 20 Ave., Long Island City, N. Y.-5-7-8-16
 Graybar Electric Co., 420 Lexington Ave., New York, N. Y.-15
 Guild Radio & Television Co., 460 N. Eucalyptus Ave., Inglewood 3, Calif.-6-13
 Hallcrafters Co., 4401 W. 5 Ave., Chicago 24, Ill.-6-7-8-13-15
 Harman-Kardon, 520 Main St., Westbury, L. I., N. Y.-7-8
 Hastings Products, 161 Newbury St., Boston 16, Mass.-8
 Haydon Mfg. Co., 245 E. Elm St., Torrington, Conn.-14-15
 Heath Co., 305 Territorial Rd., Benton Harbor, Mich.-6-14-16
 Hinners-Golanek Radio Corp., 25-14 Broadway, Long Island City 6, N. Y.-6-7
 Hoffman Electronics Corp., 3761 S. Hill St., Los Angeles 43, Calif.-6-11-12-13
 Hotel Radio Corp., 601 W. Fort St., Detroit 26, Mich.-10
 Industrial TV, Inc., 359 Lexington Ave., Clifton, N. J.-3-5
 Insuline Corp. of America, 186 Granite St., Manchester, N. H.-3
 International Research Associates, 2221 Warwick Ave., Santa Monica, Calif.-6-9-13-14
 Jarno Mfg. Corp., TV Hush Div., 16 Howard Ave., Brooklyn 21, N. Y.-11
 Jerrold Electronics Corp., 2222 Chestnut St., Philadelphia 3, Pa.-3-5
 Kay Lab., 5725 Kearney Villa Rd., San Diego 12, Calif.-11
 Kraff Bros., 148-12 94 Ave., Jamaica 52, N. Y.-10
 LEL, Inc., 380 Oak St., Copiaque, N. Y.-6-9
 Lytle Eng'g. & Mfg. Co., 105 W. Monroe St., Chicago 3, Ill.-15-16-17
 Magnavox Co., 2131 Bueter Rd., Ft. Wayne 4, Ind.-6-7-12-13-17
 Major Electronics, 42 Meserole St., Brooklyn 6, N. Y.-6
 Malin Enterprises, Inc., 3733 E. Olympic Blvd., Los Angeles 23, Calif.-11
 Martin & Co. H. S., 1916 Greenleaf Ave., Evanston, Ill.-15
 Mattison TV & Radio Corp., 10 W. 181 St., New York 53, N. Y.-3-6-7-12-13
 Meck Industries, John, Plymouth, Ind.-13
 Mercury Marine Electric Co., 2905 Jones St., San Francisco, Calif.-1
 Miller Electronics, 2840 Naomi St., Burbank, Calif.-6
 Miller Co., J. W., 5917 S. Main St., Los Angeles 3, Calif.-14-18
 Mitchell Mfg. Co., 2525 Clybourn Ave., Chicago 14, Ill.-6-7-8

Monarch Condenser, 550 Westchester Ave., New York 55, N. Y.-3
 Motorola, Inc., 4545 Augusta Blvd., Chicago 51, Ill.-6-9-12-13
 Muntz TV, Inc., 1000 Grey Ave., Evanston, Ill.-12-13
 National Aircraft Corp. Electronics Div., 3411 Tulare Ave., Burbank, Calif.-9
 National Co., 61 Sherman St., Malden 48, Mass.-6-7-8-15
 Newcomb Audio Products, 6824 Lexington Ave., Hollywood 38, Calif.-6-15
 Oak Electronics Co., 150 Oak St., Buffalo, N. Y.-3
 Olympic Radio & TV, Inc., 34-01 38 Ave., Long Island City 1, N. Y.-6-7-9-13
 Pacific Mercury, 8345 Havenhurst, Sepulveda, Calif.-12-13
 Packard-Bell Co., 12333 W. Olympic Blvd., Los Angeles 64, Calif.-6-7-12-13
 Palmer Inc., M. V., 4002 Fruit Valley Rd., Vancouver, Wash.-8
 Pedersen Electronics, P. O. Box 572, Lafayette, Calif.-15
 Philco Corp., Tioga & C Sts., Philadelphia 34, Pa.-6-7-8-9-12-13
 Pilot Radio Corp., 37-06 36 St., Long Island City 1, N. Y.-5-15-16
 Pioneer Gen-E-Motor Corp., 5941 W. Dickens Ave., Chicago 39, Ill.-5
 Precision Electronics, 9101 King Ave., Franklin Park, Ill.-15
 Precision Radiation Instruments, Inc., 4223 W. Jefferson Blvd., Los Angeles 16, Calif.-15-16
 Radio Corp. of America, Camden, N. J.-6-7-8-9-12-13
 Radio Corp. of America, RCA Tube Div., Harrison, N. J.-17
 Radio Craftsmen, Inc., 4400 N. Ravenswood Ave., Chicago 40, Ill.-15-16
 Radio Eng'g. Labs., 36-40 37 St., Long Island City 1, N. Y.-16
 Raytheon Mfg. Co., TV-Radio Div., 5921 W. Dickens Ave., Chicago 39, Ill.-6-9-12-13
 Regency Division, Idea, Inc., 7900 Pendleton Pike, Indianapolis 26, Ind.-2
 Roland Radio, 716 S. Columbus Ave., Mt. Vernon, N. Y.-6-7
 Ryan Industries, 10910 S. Vermont Ave., Los Angeles, Calif.-18
 Sargent-Raymont Co., 1401 Middle Harbor Rd., Oakland 20, Calif.-15
 Scott, Inc., H. H., 385 Putnam Ave., Cambridge 39, Mass.-15-16
 Scott Radio Labs., Liberty St., Plymouth, Ind.-6-7-8-12-13
 Sentinel Radio Corp., 2100 Dempster St., Evanston, Ill.-6-7-9-12-13
 Service Instruments Co., 171 Official Rd., Addison, Ill.-3
 Setchell-Carlson Inc., 330 5 Ave., N. New Brighton, St. Paul 12, Minn.-6-13-17
 Sherwood Electronic Labs., 2802 W. Cullom Ave., Chicago 18, Ill.-15
 Simpson Mfg. Co., Mark, 32-29 49 St., Long Island City 3, N. Y.-3
 Sonora Radio & TV, 2023 W. Carroll Ave., Chicago 12, Ill.-6-7-8-13
 Specialty Assembling & Packing, 79 Clinton Pl., Brooklyn 38, N. Y.-14
 Spencer-Kennedy Laboratories, 1320 Soldiers Field Rd., Boston 35, Mass.-5
 Standard Coil Products, 2085 N. Hawthorne Ave., Melrose Park, Ill.-4-17
 Stratford TV, 2555 W. 21 St., Chicago 8, Ill.-13
 Stromberg-Carlson Co., 100 Carlson Rd., Rochester, N. Y.-6-7-8-13-14-15-16-17
 Superex Electronics Corp., 4-6 Radford Pl., Yonkers, N. Y.-3-6
 Sutton Electronic Co., 424 W. Short St., Lexington, Ky.-5
 Sylvania Electric Products, Inc., 1740 Broadway, New York 19, N. Y.-6-12-13
 Tech-Master Corp., 75 Front St., Brooklyn 1, N. Y.-6-12-13-16-17
 Techniques, Inc., 178 Central Ave., Hackensack, N. J.-9
 Telechrome, Inc., 88 Merrick Rd., Amityville, L. I., N. Y.-12
 Telectro Industries Corp., 35-16 37 St., Long Island City, N. Y.-3
 Telematic Industries, Inc., 16 Howard Ave., Brooklyn 21, N. Y.-3-5-11
 Tenna-Lite Corp., 1809 N. Milwaukee Ave., Chicago 47, Ill.-3
 Thordarson-Meissner Mfg. Div., Maguire Industries, Mt. Carmel, Ill.-6-7-8-14-15-16
 Trad TV Corp., 1001 1 Ave., Asbury Park, N. J.-13
 Trav-Ler Radio, 571 W. Jackson Blvd., Chicago 6, Ill.-6-7-8-13
 Trukaradio Nat'l. Sales, 228 E. Park Ave., Wheaton, Ill.-6
 Trutone Electronics, Inc., 812 N. Highland Ave., Hollywood 36, Calif.-6-7-8-14-15-16
 TV Remote Control Co., 820 N. Fairfax Ave., Los Angeles, Calif.-11
 TV Tuner Co., 40-09 82 St., Jackson Heights, N. Y.-17
 Voricor Corp., 65 Hope St., Brooklyn 11, N. Y.-5
 Videon Electronic Corp., 902 E. Michigan St., Indianapolis 2, Ind.-3-5
 Waldom Electronics, 4625 W. 53 St., Chicago, Ill.-1
 Waterproof Electric Co., 801 S. Main St., Burbank, Calif.-14-16-17
 Wells-Gardner & Co., 2701 N. Kildare Ave., Chicago 39, Ill.-13

Westinghouse Electric Corp., Metuchen, N. J.-6-7-12-13
 Zenith Radio Corp., 6001 Dickens Ave., Chicago 39, Ill.-6-7-8-9-13

14—RESISTORS & RESISTIVE CONTROLS

Attenuators	1
Ballasts	2
Controls, loudness, volume, tone, etc.	3
Line Cords, resistor	4
Pads, H, T, etc.	5
Potentiometers	6
Resistors, adjustable tap	7
Resistors, carbon	8
Resistors, fixed composition	9
Resistors, fixed wire wound	10
Resistors, fuse	11
Resistors, glass	12
Resistors, molded	13
Resistors, power	14
Resistors, precision	15
Resistors, variable carbon	16
Resistors, variable wirewound	17
Resistors, vitreous	18
Rheostats	19
Suppressors, auto ignition (see Sec. 8)	
Thermistors	20

Aerovox Corp., Distr. Div., 740 Belleville Ave., New Bedford, Mass.-8-9-10-13-15-16
 A-K Mfg. Co., 115 S. Northwest Hwy., Barrington, Ill.-4
 Allen-Bradley Co., 1326 S. 2 St., Milwaukee, Wisc.-3-6-9-16-17-19
 American Elite, Inc., 7 Park Ave., New York 16, N. Y.-6-15-17-19
 Anchor Electronics, Inc., 717 Sip St., Union City, N. J.-10-15
 Anchor Products Co., 2712 Montrose Ave., Chicago 18, Ill.-3
 Applegate & Co., C. J., 1816 Grove St., Boulder, Colo.-9
 Art Specialty Co., 3245 W. Lake St., Chicago 24, Ill.-2
 American Volume Control, 554 W. 168 St., New York, N. Y.-3
 Atlas Resistor Co., Main & Cotton Sts., Philadelphia 27, Pa.-7-10-14-17-18
 Birnbach Radio Co., 145 Hudson St., New York 13, N. Y.-4
 Blackburn Electronic Corp., 55 W. 7 St., Wyoming, Pa.-7-10-13-15-17-18
 Blonder-Tongue Labs., 526 North Ave., Westfield, N. J.-1
 Campbell Industry, Inc., 3806 St. Elmo Ave., Chattanooga 9, Tenn.-9-15
 Carborundum Co., Global Div., Niagara Falls, N. Y.-20
 Carter Parts Co., 213 W. Institute Pl., Chicago 10, Ill.-3-5-6-17
 Centralab Div. Globe Union, Inc., 902Y E. Keefe Ave., Milwaukee 1, Wisc.-1-3-5-6-9-16-17-19
 Chatham Electronics, Div. Gera Corp., 630 W. Mt. Pleasant Ave., Livingston, N. J.-2
 Chicago Telephone Supply, 1142 W. Beardsley Ave., Elkhart, Ind.-3-6-17
 Cima Corp., 119 Braintree St., Allston 34, Mass.-7-10-15-18
 Clarostat Mfg. Co., 1 Washington St., Dover, N. H.-1-2-3-5-6-7-9-10
 11-12-14-15-16-17-19
 Coil Co. of America, 207 Washington St., Northvale, N. J.-2
 Colman Tool & Machine Co., P. O. Box 7026, Amarillo, Texas-10-18
 Corning Glass Works, Corning, N. Y.-12
 Continental Carbon, Inc., 13900 Lorain Ave., Cleveland 11, Ohio-8-10-13-14-15-17-18-19
 Cufker-Hammer, Inc., 315 N. 12 St., Milwaukee 1, Wisc.-19
 Dale Products, Inc., P. O. Box 136, Columbus, Nebr.-10-14-15
 Daven Co., Route 10, Livingston, N. J.-1-10-15
 DeJur-Amsco Corp., 45-01 Northern Blvd., Long Island City 1, N. Y.-6-17-19
 Delco Radio, 1446 S. Home Ave., Kokomo, Ind.-3
 D & M Products, 13144 W. McNichols Rd., Detroit 35, Mich.-3-17
 Dunwell Mfg. Co., Dept. T56, Carlstadt, N. J.-3
 Dwyer Eng'g., P. O. Box 483, Nashua, N. H.-3
 Electron-Radar Products, 4806 W. Chicago Ave., Chicago 51, Ill.-1-12
 Electro-Tech Equipment, 308 Canal St., New York 13, N. Y.-6-10-17-18-19
 Electro-Voice, Inc., Buchanan, Mich.-3
 Erie Resistor Corp., 644 W. 12 St., Erie 6, Pa.-12-15
 Federal Electronics Sales, Federal Electronics Bldg., Rockville Centre, N. Y.-3

OMISSIONS

Listings have been omitted in all cases where, after three requests, a company has failed to return our directory questionnaire or otherwise verify its activity.

Federal Telephone & Radio Co., Div. IT&T, 100 Kingsland Rd., Clifton, N. J.-1-15-17-20
 G-C Electronics Mfg. Co., 919 Taylor Ave., Rockford, Ill.-3-8-9
 General Cement Mfg. Co., 919 Taylor Ave., Rockford, Ill.-11-20
 General Electric Co., Apparatus Sales Div., Schenectady, N. Y.-2-6-7-10-14-19
 Instrument Resistors Co., 1036 Commerce Ave., Union, N. J.-10-14-15
 Insuline Corp. of America, 186 Granite St., Manchester, N. H.-4
 International Resistance Co., 401 N. Broad St., Philadelphia 8, Pa.-3-6-7-8-9-10-11-13-14-15-16-17-19
 I T E Circuit Breaker Co., 19 & Hamilton Sts., Philadelphia, Pa.-9-10-15-16-17
 Jan Hdw. Mfg. Co., 75 N. 11 St., Brooklyn 11, N. Y.-3
 Jarvis Electronics Corp., 6058 Fullerton Ave., Chicago 39, Ill.-6-7-10-15-17-19
 Jerold Electronics Corp., 2222 Chestnut St., Philadelphia 3, Pa.-1-5
 JFD Mfg. Co., 6101 16 Ave., Brooklyn 4, N. Y.-2-4
 Lectrohm, Inc., 5560 Northwest Hwy., Chicago 30, Ill.-7-10-11-14-18
 McGregor Electronic Industries, McGregor, Iowa-2
 Mallory & Co., P. R., 3029 E. Washington St., Indianapolis 6, Ind.-6-7-8-10-14-16-17-18-19
 Matchless Electric Co., 1700 Washington Blvd., Chicago 12, Ill.-2
 Micamold Electronics Mfg. Corp., 1087 Flushing Ave., Brooklyn 37, N. Y.-10
 Miller Electro-Research Labs., 5529 S. 5 St., Milwaukee 7, Wisc.-15-20
 Milwaukee Resistor, 700 W. Virginia St., Milwaukee 4, Wisc.-7-10-14-17-18
 Model Eng'g. & Mfg. Co., 50 Frederick St., Huntington, Ind.-10-17
 Ohmite Mfg. Co., 3601 Howard St., Skokie, Ill.-1-3-5-6-7-8-9-10-11-13-14-15-16-17-18-19
 Penn TV Products Co., Allegheny & Trenton Aves., Philadelphia, Pa.-1
 Phoatron Instrument & Electronic Co., 151 Pasadena Ave., S. Pasadena, Calif.-8-15
 Philco Corp., Accessory Div., A & Allegheny Aves., Philadelphia 34, Pa.-9
 Photo Crystals, Inc., 15 S. 1st St., Geneva, Ill.-1
 Polarad Corp., 43-20 34 St., Long Island City, N. Y.-1
 Press Wireless Labs., 25 Prospect Pl., West Newton 65, Mass.-1



Radio Corp. of America, RCA Tube Div., Harrison, N. J.-13
 Radio Supply & Eng'g. Co., 85 Selden St., Detroit 1, Mich.-9-16-17
 Reon Resistor Corp., 117 Stanley Ave., Yonkers, N. Y.-10-13-14-15-18
 Resistance Products Co., 914 S. 13 St., Harrisburg, Pa.-8-10-15
 Resistors, Inc., 5226 W. 26 St., Chicago 50, Ill.-7-10-18
 Retron Corp., 697 N. Lake Ave., Pasadena 6, Calif.-10-15-17
 Shallcross Mfg. Co., 520 Pusey Ave., Collingdale, Pa.-6-7-10-13-14-15-17-18
 Shallice, Inc., 10 Mill St., Paterson 1, N. J.-10
 Simpson Electric Co., 5208 W. Kinzie St., Chicago 44, Ill.-6
 Smallin Labs., 721 Walton Ave., New York 51, N. Y.-3-16-17-19
 Sprague Products Co., North Adams, Mass.-10-14-15-18
 S & R Electronics, 297 Central Ave., Bethpage, N. Y.-2
 Stackpole Carbon Co., Electronic Components Div., St. Marys, Pa.-3-16
 States Co., 19 New Park Ave., Hartford 6, Conn.-10
 Stone City Machine & Tool Co., Bedford, Ind.-20
 Tech-Ohm Resistor, 36-11 33 St., Long Island City, N. Y.-1-2-7-10-15-18
 Tru-Ohm Products Div., Model Eng. & Mfg. Co., 2800 N. Milwaukee Ave., Chicago 18, Ill.-7-10-11-14-17-18-19
 University Loudspeakers, Inc., 80 S. Kensico Ave., White Plains, N. Y.-5
 Vidair Electronics Mfg. Corp., 576 W. Merrick Rd., Lynbrook, N. Y.-1
 Ward Leonard Electric Co., Mt. Vernon, N. Y.-7-10-14-17-18-19
 Weston Electrical Instrument Corp., Subsidiary Daystrom, Inc., 614 Frelinghuysen Ave., Newark 5, N. J.-6
 Wirt Co., 5221 Green St., Philadelphia 44, Pa.-3-6-10-16-17
 Workman TV, Inc., 309 Queen Anne Rd., Teaneck, N. J.-8-10-11-18-20
 Yonkers Industries, 28 School St., Yonkers, N. Y.-10

15—SEMICONDUCTORS

Crystal, detectors	1
Crystal selectors	2
Diodes, crystal	3
Diodes, germanium	4
Diodes, selenium	13
Diodes, silicon	5
Rectifiers, copper	6
Rectifiers, crystal	7
Rectifiers, diode	8
Rectifiers, germanium power	9
Rectifiers, selenium	10
Rectifiers, silicon	11
Transistors	12

American Elite, Inc., 7 Park Ave., New York 16, N. Y.-10
 Amperex Electronic Corp., 230 Duffy Ave., Hicksville, L. I., N. Y.-4-12
 Anchor Metal Co., 244 Boerum St., Brooklyn 6, N. Y.-5
 Barry Electronics Corp., 512 Broadway, New York 12, N. Y.-10-12
 Bliley Electric, Union Station Bldg., Erie, Pa.-1-3-7
 Bogue Electric Mfg. Co., 52 Iowa Ave., Paterson 3, N. J.-12
 Bradley Laboratories, 168 Columbus Ave., New Haven, Conn.-6-8-10-11
 CBS Hytron Div., Columbia Broadcasting System, 100 Endicott St., Danvers, Mass.-3-4-5-12
 Clark Electronic Labs., Box 165, Palm Springs, Calif.-9-10-11
 Conant Labs., 6500 "O" St., Lincoln 5, Nebr.-6-10
 Cryco, Inc., 1138 Mission St., S. Pasadena, Calif.-3
 Eagle Electronics Corp., P. O. Box 775, Meriden, Conn.-10
 Eidson Electronic Co., 1902 N. 3 St., Temple, Texas-3
 Electronic Devices, Inc., 429 12 St., Brooklyn 15, N. Y.-10
 Electro-Tech Equipment, 308 Canal St., New York 13, N. Y.-9-10
 Federal Telephone & Radio Co., Div. IT&T, 100 Kingsland Rd., Clifton, N. J.-4-5-9-10
 Fretco, Inc., 406 N. Craig St., Pittsburgh 13, Pa.-4-5-12
 Gohagan, Inc., 11 W. 4 St., Bethlehem, Pa.-1-3-4-7-8
 General Crystal Co., Burlington, Wisc.-1-2
 General Electric Co., Apparatus Sales Div., Schenectady, N. Y.-6-9-10-12
 General Transistor Corp., 95-18 Sutphin Blvd., Jamaica 35, L. I., N. Y.-12
 Germanium Products Corp., 26 Cornillon Ave., Jersey City 4, N. J.-12
 Hoffman Electronics Corp., 3761 S. Hill St., Los Angeles 43, Calif.-5-11
 Hughes Aircraft Co., Products Div., Int'l Airport Station, Los Angeles 45, Calif.-4-5-8-11-12
 Hydro-Aire, Inc., 3000 Winona Ave., Burbank, Calif.-3-4-5-7-8-9-11-12
 Insuline Corp. of America, 186 Granite St., Manchester, N. H.-1
 International Rectifier Corp., 1521 E. Grand Ave., El Segundo, Calif.-3-4-5-8-9-10-11-13
 International Resistance Co., 401 N. Broad St., Philadelphia 8, Pa.-4-8-10
 Kemtron Electron Products, 14 Prince Pl., Newburyport, Mass.-4-5
 Knights Co., James, Sandwich, Ill.-5
 McCoy Electronics Co., Mt. Holly Springs, Pa.-1
 Metal Treating Equip. Exchange, 9825 Greeley Ave., Detroit 11, Mich.-10
 Midland Mfg. Co., 3151 Fiberglas Rd., Kansas City 15, Kan.-3
 Mallory & Co., P. R., 3029 E. Washington St., Indianapolis 6, Ind.-6-10-12
 Miller Co., Sanford, 691 Bedford Ave., Brooklyn 6, N. Y.-9-10
 Minn. Honeywell Reg. Co., Transistor Div., 2753 4 Ave. S., Minneapolis 8, Minn.-12
 Multi-Tron Lab., 4624 Washington Blvd., Chicago 44, Ill.-8
 National Aircraft Corp. Electronics Div., 3411 Tulare Ave., Burbank, Calif.-4-5-9-11-12
 National Union Electric Corp., Orange, N. J.-4-12
 Philco Corp., 4700 Wissahickon Ave., Philadelphia 29, Pa.-2
 Photo-Crystals, 15 S. 2 St., Geneva, Ill.-12
 Premier Research Labs., 79 7 Ave., New York 11, N. Y.-2
 Pyramid Electric Co., 1445 Hudson Blvd., North Bergen, N. J.-10
 Radio Corp. of America, RCA Tube Div., Harrison, N. J.-10-12
 Radio Development & Research Corp., 26 Cornillon Ave., Jersey City 4, N. J.-11-12
 Radio Receptor Co., 251 W. 19 St., New York 11, N. Y.-3-4-7-8-10
 Rapid Electric Co., 2881 Middletown Rd., Bronx 61, N. Y.-9-10
 Raytheon Mfg. Co., Newton, Mass.-9-10-12
 Richardson-Allen Corp., 116-15 15 Ave., College Point, N. Y.-6-9-10-11

Schouer Mfg. Co., 45 Alpine St., Cincinnati 36, Ohio-7
 Smallin Labs., 721 Walton Ave., New York 51, N. Y.-9-11-12
 Sprague Electric Co., 233 Marshal St., N. Adams, Mass.-12
 Superior Rectifier, 3000 Kenwood St., Hammond, Ind.-10
 Sylvania Electric Products, Inc., 1740 Broadway, New York 19, N. Y.-1-3-4-5-7-8-9-10-11-12
 Tarzian, Inc., Sarkes, 415 N. College Ave., Bloomington, Ind.-10-11
 Technical Apparatus Builders, 109 Liberty St., New York 9, N. Y.-6-7-8-9-10-11
 Texas Instruments, Inc., 6000 Lemmon Ave., Dallas 9, Tex.-3-12
 Transistor Products, 241 Crescent St., Waltham 54, Mass.-4-9-12
 Transiron Electric Corp., 403 Main, Melrose, Mass.-9-12
 Tung-Sol Electric, Inc., 95 8 Ave., Newark 4, N. J.-3-4-8-12
 Valpey Crystal Corp., 1244 Highland St., Holliston, Mass.-3
 Vector Electronic Co., 3352 San Fernando Rd., Los Angeles 65, Calif.-10
 Westinghouse Electric Corp., Electronic Tube Div., Elmira, N. Y.-12

16—TEST EQUIPMENT

Ammeters, mill, micro	1
Analyzers, audio	2
Analyzers, interference	3
Analyzers, r-f	4
Bridges	5
Calibrators, frequency	6
Calibrators, voltage	7
Checkers, condenser	8
Checkers, CRT	9
Checkers, fly-back	10
Checkers, transformer	11
Checkers, vibrator	12
Clippers, sine-wave	13
Decades, capacitance	14
Decades, inductance	15
Decades, resistance	16
Frequency standards	17
Generators, audio	18
Generators, bar	19
Generators, color signal	20
Generators, dot	21
Generators, marker	22
Generators, pattern	23
Generators, signal RF, IF	24
Generators, sweep	25
Meters, audio	26
Meters, field-strength	27
Meters, frequency	28
Meters, grid-dip	29
Meters, modulation	30
Meters, snap around	31
Meters, sound level	32
Meters, time	33
Meters, watt	34
Multimeters	35
Ohmeters	36
Oscillators, VFO	37
Oscilloscopes, cathode-ray	38
Probes, meter & scope	39
Q-Meters	40
Reactivators, CRT	41
Stroboscopes	42
Switches, electronic	43
Testers, battery	44
Testers, continuity	45
Testers, filament	46
Testers, insulation	54
Testers, metal rectifier	47
Testers, transistor	53
Testers, tube	48
Tracers, signal	49
Valtmeters	50
Voltmeters, vacuum tube	51
Volt-ohm-milliammeters	52

Aero Instrument Co., 11423 Vanowen St., N. Hollywood, Calif.-28-33
 Aerovox Corp., Distr. Div., 740 Belleville Ave., New Bedford, Mass.-8
 Alco Electronics Mfg., 3 Wolcott Ave., Lawrence 1, Mass.-14-16-27
 American Elite, Inc., 7 Park Ave., New York 16, N. Y.-43

- American Radio Mfg. Co., 152 MacQuesten Pkwy. S., Mt. Vernon, N. Y.-39-43
 American Scientific Development, 336 S. Main St., Ft. Atkinson, Wisc.-48
 Amplifier Corp. of America, 398 Broadway, New York 13, N. Y.-26
 Anchor Products Co., 2712 Montrose Ave., Chicago 18, Ill.-9-46
 Anko Mfg. Co., 5042 W. State St., Milwaukee 8, Wisc.-48
 Authorized Mfrs. Service, 919 Wyckoff Ave., Brooklyn 27, N. Y.-24-25-35-41-44-49-51
 Barker & Williamson, 235 Fairfield Ave., Upper Darby, Pa.-5
 Barjov Co., 145 W. 40 St., New York 18, N. Y.-8
 Barrett Electronics, 22319 Kathryn Ave., Torrance, Calif.-8-35-45-50
 Barry Electronics Corp., 512 Broadway, New York 12, N. Y.-7
 Becks, Inc., 298 E. 5 St., St. Paul 1, Minn.-43
 Beede Electrical Instrument Co., West St., Penacook, N. H.-1-30-32-50-52
 Bergen Labs., 11 Godwin Ave., Fair Lawn, N. J.-26-36-50-51
 Berkshire Laboratories, 692 Bank Village, Greenville, N. H.-7-22-42
 B & K Mfg. Co., 3726 N. Southport, Chicago 13, Ill.-9-41-48
 Blonder-Tongue Labs., 526 North Ave., Westfield, N. J.-27
 Bomac Labs., Salem Rd., Beverly, Mass.-17
 Brodney, A. I., 351 Atlantic Ave., Brooklyn 17, N. Y.-39
 Brownlmg Labs., Inc., 750 Main St., Winchester, Mass.-28-38
 Brush Electronics Co., 3405 Perkins Ave., Cleveland 14, Ohio-5
 Budelman Radio Corp., 375 Fairfield Ave., Stamford, Conn.-34
 Burlington Instrument Co., 203 N. 3 St., Burlington, Iowa-1-26-30-33-50
 Burton-Rogers Co., 42 Carleton St., Cambridge 42, Mass.-1-44-50
 Central Electronics, 1247 W. Belmont Ave., Chicago 13, Ill.-9-41
 Century Electronics Co., 111 Roosevelt Ave., Mineola, N. Y.-9-41
 CG Electronics Corp., 305 Dallas St., N.E., Albuquerque, N. Mex.-48-53
 Chatham Electronics, Div. Gera Corp., 630 W. Mt. Pleasant Ave., Livingston, N. J.-43-48
 Chicago Industrial Instrument Co., 865 N. Sangamon St., Chicago 22, Ill.-44-48-52
 Clarostat Mfg. Co., 1 Washington St., Dover, N. H.-16
 Clippard Instrument Lab., 7350 Colerain Rd., Cincinnati 24, Ohio-14-16-51
 Clough-Bregle Co., 6014 Broadway, Chicago 40, Ill.-5-18-24-25-40-51
 Colortone Electronics, 100 Frank Rd., Hicksville, N. Y.-6-7-17-20-28-38-39-51
 Color TV, Inc., 973 E. San Carlos Ave., San Carlos, Calif.-45
 Continental Carbon, Inc., 13900 Lorain Ave., Cleveland 11, Ohio-43
 Cornell-Dubilier Electric Corp., 333 Hamilton Blvd., S. Plainfield, N. J.-5-8-10-14-16-36-39-51
 Daven Co., Route 10, Livingston, N. J.-28
 DeJur-Amsco Corp., 45-01 Northern Blvd., Long Island City 1, N. Y.-1-32-50
 Deltron, Inc., 2905 N. Leithgow St., Philadelphia 33, Pa.-8
 Donner Scientific Co., 2820 7 St., Berkeley, Calif.-2-5-18-26
 D & R Ltd., 402 E. Gutierrez St., Santa Barbara, Calif.-17-26
 Dubrow Development Co., 235 Penn St., Burlington, N. J.-6-7-8-16-28-43-51
 DuMont Labs., Inc., Allen B., 750 Bloomfield Ave., Clifton, N. J.-18-38
 Dynamic Electronics, 73-39 Woodhaven Blvd., Glendale, L. I., N. Y.-29
 Ebert Electronics Corp., 212-26 Jamaica Ave., Queens Village 28, N. Y.-43
 Eby Sales Co., 130 Lafayette St., New York 13, N. Y.-8-9-19-35-36-45-46-47-49
 Eitel-McCullough, Inc., 798 San Mateo Ave., San Bruno, Calif.-43
 Electro Mechanical Instrument, 812 Chestnut St., Perkasie, Pa.-1-50
 Electronic Instrument Co., 84 Withers St., Brooklyn 11, N. Y.-5-6-7-8-9-10-14-16-18-19-24-25-35-36-38-39-43-44-48-49-50-51-52
 Electronic Measurements Corp., 280 Lafayette St., New York 12, N. Y.-14-16-18-19-21-22-23-24-38-48-51-52
 Electronic Specialties Mfg., 76 Irving St., Worcester 10, Mass.-45-46
 Electronic Test Instrument, 13224 Livernols Ave., Detroit 38, Mich.-9-45-46-48
 Electronic Tube Corp., 1200 E. Mermaid Lane, Philadelphia 18, Pa.-38
 Electro-Tech Equipment 308 Canal St., New York 13, N. Y.-1-5-14-15-16-28-31-33-34-35-36-38-42-44-45-48-50-51-52
 Epco Electronics, 140 Liberty St., New York 6, N. Y.-19-35-36-50
 Esco Mfg. Co., Box 344, Summit, Ill.-42
 Espey Mfg. Co., 200 W. 57 St., New York 19, N. Y.-24-27
 Federal Telephone & Radio Co., Div. IT&T, 100 Kingsland Rd., Clifton, N. J.-4-5-14-16-27-28-38-50
 Feller Eng'g. & Mfg. Co., 8026 N. Monticello Ave., Skokie, Ill.-38-39-43-49-51
 Ferris Instrument Co., 110 Cornelia St., Boonton, N. J.-6-24-27
 Franklin Electronics, King St., Franklin Park, Ill.-51
 Freed Transformer Co., 1718 Weirfield St., Brooklyn 27, N. Y.-5-14-17
 Frequency Standards, Box 504, Asbury Park, N. J.-17-28
 Furst Electronics, Inc., 3322 W. Lawrence Ave., Chicago 25, Ill.-26
 Garod Radio, 70 Washington St., Brooklyn 1, N. Y.-2
 G-C Electronics Mfg. Co., 919 Taylor Ave., Rockford, Ill.-43
 General Cement Mfg. Co., 919 Taylor Ave., Rockford, Ill.-39-43
 General Electric Co., Apparatus Sales Div., Schenectady, N. Y.-1-28-33-34-36-50
 General Electronic Equip. Co., Mantua Ave. & Glendale St., Easton, Pa.-38
 General Test Equipment, 38 Argyle Ave., Buffalo, N. Y.-24
 General Transistor Corp., 95-18 Sutphin Blvd., Jamaica 35, L. I., N. Y.-53
 G & M Equipment Co., 7315 Varna Ave., N. Hollywood, Calif.-17-24-25
 Grayhill Co., 561 Hillgrove Ave., LaGrange, Ill.-43
 Harvey-Wells Electronics, Southbridge, Mass.-27
 Haydon Mfg. Co., 245 E. Elm St., Torrington, Conn.-33
 Heath Co., 305 Territorial Rd., Benton Harbor, Mich.-2-5-7-8-9-12-14-16-18-19-21-23-24-25-26-28-29-34-35-36-37-38-39-40-49-50-51-52
 Hevi Duty Electric Co., 4212 W. Highland Blvd., Milwaukee 1, Wisc.-15
 Hewlett-Packard Co., 481 Page Mill Rd., Palo Alto, Calif.-2-18-22-24
 Hickok Electrical Instrument Co., 10514 Dupont Ave., Cleveland 8, Ohio-7-9-19-20-21-22-23-24-26-27-28-31-32-34-35-36-38-39-42-44-48-50-51-52
 Hoffman Electronics Corp., 3761 S. Hill St., Los Angeles 43, Calif.-21
 Hycon Electronics, Inc., 321 S. Arroyo Pkwy., Pasadena, Calif.-19-20-21-38-39-51
 Ideal Industries, 3316 Park Ave., Sycamore, Ill.-45
 Industrial Development Labs., 17 Pollock Ave., Jersey City, N. J.-5-8-36
 Industrial Devices, 22 State Rd., Edgewater, N. J.-50
 Industrial Instruments, Inc., 89 Commerce Rd., Cedar Grove, N. J.-5-14-16-36
 Industrial Test Equip. Co., 55 E. 11 St., New York 3, N. Y.-5-18-34-51
 Industrial TV, Inc., 359 Lexington Ave., Clifton, N. J.-27
 Instrument Laboratories, 315 W. Walton Pl., Chicago 10, Ill.-7-36-45-50-52
 Insuline Corp. of America, 186 Granite St., Manchester, N. H.-39
 International Research Associates, 2221 Warwick Ave., Santa Monica, Calif.-6-9-41-53
 Jackson Electrical Instrument Co., 18 S. Patterson Blvd., Dayton 2, Ohio-2-6-8-9-18-20-22-24-25-38-47-48-51
 Javex, P. O. Box 646, Redlands, Calif.-39
 Jerold Electronics Corp., 2222 Chestnut St., Philadelphia 3, Pa.-25-27
 J-B-T Instruments, 441 Chapel St., New Haven 8, Conn.-28-33
 Jones Electronics Co., M. C., Bristol, Conn.-34
 Kay Electric Co., Pinebrook, N. J.-14-16-18-20-22-24-25
 Kay Lab., 5725 Kearny Villa Rd., San Diego 12, Calif.-24-50
 Kellogg Switchboard & Supply Co., 79 W. Monroe St., Chicago 3, Ill.-28-45
 Keystone Electronics Corp., 423 Broome St., New York 13, N. Y.-39-45
 Kings Electronics Co., 40 Marbledale Rd., Tuckahoe, N. Y.-24-28
 Knights Co., James, Sandwich, Ill.-17
 Krohn-Hite Instrument Co., 580 Massachusetts Ave., Cambridge 39, Mass.-18
 Lampkin Labs., Bradenton, Fla.-28-30
 LaSalle Tube Mfg. Co., 155 E. Grand Ave., Chicago, Ill.-9
 Lear, Inc., 11916 W. Pico Blvd., Los Angeles 64, Calif.-27
 Leitch Eng'g. Corp., 326 Lincoln St., Manchester, N. H.-36-50-51
 Link Aviation, Inc., Binghamton, N. Y.-45
 Lumenite Electronic Co., 407 S. Dearborn St., Chicago 5, Ill.-22-43
 Lynmar Engineers, Inc., 1432 N. Carlisle St., Philadelphia 21, Pa.-27
 McCoolpin-Christie Corp., 3410 W. 67 St., Los Angeles 43, Calif.-44
 Mallory & Co., P. R., 3029 E. Washington St., Indianapolis 6, Ind.-43
 Marion Electrical Instrument Co., Manchester, N. H.-1-32-33-50
 Marma Electronic Co., Div. Fidelity Amplifier Co., 703 W. Willow St., Chicago 14, Ill.-16
 Martindale Electric Co., Box 617 Edgewater Br., Cleveland 7, Ohio-1-36-50
 Master Appliances, Inc., 1600 Factory Ave., Marion, Ind.-54
 Measurements Corp., Boonton, N. J.-5-24-26-27-29
 Meters, Inc., 5353 N. Keystone Ave., Indianapolis 20, Ind.-1-35-36-50-52
 Micro Switch, Div., Minneapolis-Honeywell Regulator Co., Chicago & Spring Sts., Freeport, Ill.-43
 Microtran Co., Div. Crest Labs., 84-11 Rockaway Beach Blvd., Rockaway Beach 93, N. Y.-41
 Millen Mfg. Co., James, 150 Exchange St., Malden 48, Mass.-29-38
 Mitchell Rand Insulation, 51 Murray St., New York 7, N. Y.-12
 Mobil Electronics Mfg. Co., 1111 State Rd. 67E., Anderson, Ind.-18
 Morrow Radio Mfg. Co., 2794 Market St., Salem, Ore.-27
 Munston Mfg. & Service, Beech St., Islip, N. Y.-24
 New London Instrument Co., 82 Union St., New London, Conn.-17-24-29-30-48-51
 Non-Linear Systems, Del Mar Airport, Del Mar, Calif.-36-50
 Ohmrite Mfg. Co., 3601 Howard St., Skokie, Ill.-16
 Pacific Transducer Corp., 11836 W. Pico Blvd., Los Angeles 64, Calif.-18-25-42
 Peschel Electronics, 13 Garden St., New Rochelle, N. Y.-45-47
 Phaostron Instrument & Electronic Co., 151 Pasadena Ave., S. Pasadena, Calif.-1-26-32-33-35-36-44-45-50-51-52
 Philco Corp., Accessory Div., A & Allegheny Ave., Philadelphia 34, Pa.-9-20-23-24-25-27-38-48-51-52
 Philmore Mfg. Co., 113 University Pl., New York 3, N. Y.-7-8-14-17-28-50
 Pioneer Electronics Corp., 2235 S. Carmelina, Los Angeles 64, Calif.-43
 Polaroid Corp., 43-20 34 St., Long Island City, N. Y.-23-24-25
 Pomona Electronics Co., 1126 W. 5 Ave., Pomona, Calif.-9
 Power Supplies, 1005 Olive St., Highland, Ill.-5-12
 Precise Development Corp., 2 Nell Court, Oceanside, L. I., N. Y.-5-7-8-9-14-16-18-19-20-21-22-23-24-25-26-29-35-36-38-39-44-45-48-50-51-52
 Precision Apparatus Co., 70-31 84 St., Glendale 27, L. I., N. Y.-1-9-18-22-24-25-35-36-37-38-39-48-50-51
 Precision Electronics, 9101 Kina Ave., Franklin Park, Ill.-8-35-36-39-49-50-51
 Pres. Probe Co., 4034 N. 6 St., Milwaukee 2, Wisc.-8
 Press Wireless Labs., 25 Prospect Pl., West Newton 65, Mass.-6-29
 Probescope Co., 44-05 30 Ave., Long Island City, N. Y.-38
 Pyramld Instrument Corp., 630 Merrick Rd., Lynbrook, N. Y.-8
 Quaker Industries, 2140 W. 60 St., Kenosha, Wisc.-41
 Radio City Products Co., Centre & Glendale Sts., Easton, Pa.-8-9-10-18-20-21-22-23-24-25-35-36-38-39-45-48-51-52
 Radio Corp. of America, RCA Tube Div., Harrison, N. J.-39-51
 Radion Corp., 1130 W. Wisconsin Ave., Chicago 14, Ill.-27
 Radio Supply & Eng'g. Co., 85 Seiden St., Detroit 1, Mich.-38
 Raytron Labs., Inc., 9701 Reading Rd., Cincinnati 15, Ohio-41
 Rectifier Eng'g., 1803 E. 7 St., Los Angeles 21, Calif.-44
 ReFable Electronics Corp., 30 Irvin Ave., Calingswood, N. J.-48
 Research Inventions & Mfg., 671 F St., N.W., Washington 1, D. C.-39
 Ripley Co., Middletown, Conn.-43
 Rowe Industries, 1702 Wayne St., Toledo 9, Ohio-44
 Scala Radio Co., 2814 19 St., San Francisco, Calif.-6-39-49
 Schauer Mfg. Co., 45 Alpine St., Cincinnati 36, Ohio-12
 Scott Inc., H. H., 385 Putnam Ave., Cambridge 39, Mass.-32
 Seo Mfg. Co., 5015 Penn Ave. S., Minneapolis 19, Minn.-10-11-48-49
 Sel-Son Electronic Tube Corp., Darby, Pa.-9
 Service Instruments Co., 171 Official Rd., Addison, Ill.-8-45-46-48
 Shallcross Mfg. Co., 520 Pusey Ave., Collingdale, Pa.-5-14-15-16-43-50-52
 Shasta Div., Beckman Instruments, Inc., P. O. Box 296 Station A, Richmond, Calif.-5-7-15-18-28-37-50-51
 Shurite Meters, 61 Hamilton St., New Haven, Conn.-1-44
 Simpson Electric Co., 5208 W. Kinzie St., Chicago 44, Ill.-1-27-28-35-36-38-44-48-50-51-52
 Sittler Corp., 18 N. Ada St., Chicago 7, Ill.-45
 Smithguld, Inc., 360 W. 8 St., Erie, Penn.-45-48
 Smith, Inc., Herman H., 2326 Nostrand Ave., Brooklyn 10, N. Y.-43
 Smolin Labs., 721 Walton Ave., New York 51, N. Y.-20-23-24-48

For the purpose of checking violations of the publisher's copyright or other misuse of this directory, the products or listings have been coded. While these lists may be used for mailing purposes by individual manufacturers, any use of the lists, in part or whole, by other sources is prohibited.

Sonex, Inc., 245 Sansom St., Upper Darby, Pa.-13
 Southwestern Industrial Electronics Co., 2831 Post Oak Rd., Houston 19, Texas-36-37-51
 Special Instruments Lab., 312 W. Vine St., Knoxville, Tenn.-5-23
 Special Products Co., P. O. Box 188, Rockville 9, Md.-45
 Specialty Assembling & Packing, 79 Clinton Pl., Brooklyn 38, Calif.-35-36-50-51
 Spencer-Kennedy Laboratories, 1320 Soldiers Field Rd., Boston 35, Mass.-25
 Sprague Products Co., North Adams, Mass.-8
 Sterling Mfg. Co., 7201 Wentworth Ave., Cleveland, Ohio-1-50
 Summit Eng'g. Co., 3324 Main St., Hartford, Conn.-5-27-45
 Superex Electronics Corp., 4-6 Radford Pl., Yonkers, N. Y.-9-41
 Superior Instrument Co., 2435 White Plains Rd., New York 67, N. Y.-10-23-48
 Supreme Instrument Corp., P. O. Box 552, Greenwood, Miss.-1-18-23-35-50
 Talley Electronic Development Co., 800 Schmidt Bldg., Cincinnati 2, Ohio-39
 Tompa Video Service, 6105 Interbay Blvd., Tampa 9, Fla.-18-41
 Tektronix, Inc., P. O. Box 831, Portland 7, Ore.-38
 Telechrome, Inc., 88 Merrick Rd., Amityville, L. I., N. Y.-4-19-20-21-23-25-43
 Teleco Industries Corp., 35-16 37 St., Long Island City, N. Y.-5-6-14-16-18-24-27-28
 Tele-Diagnosis Co., 155 W. 72 St., New York 32, N. Y.-9
 Telomatic Industries, Inc., 16 Howard Ave., Brooklyn 21, N. Y.-3
 Tele-Test Instrument Co., 92-24 Queens Blvd., Rego Park, L. I., N. Y.-8-9-10-41
 Telex, Inc., 1633 Eustis St., St. Paul, Minn.-16
 Tel-Instrument Electronics, 728 Garden St., Carlstadt, N. J.-19-20-21-22-23-24-25
 Telonic Industries, 73 N. 2 Ave., Beech Grove, Ind.-19-20-21-22-23-24-25
 Tescon Inc., Springfield Gardens, N. Y.-41
 Texas Instruments, Inc., 6000 Lemmon Ave., Dallas 9, Tex.-29
 Transvision, Inc., New Rochelle, N. Y.-8-10-45-47
 Tricraft Products Corp., 1535 N. Ashland Ave., Chicago 22, Ill.-46-48
 Triplett Electrical Instrument Co., Harmon Rd., Bluffton, Ohio-1-19-20-21-24-25-32-35-36-44-48-50-51-52
 Triumph Mfg. Co., 1829 S. 55 St., Chicago 50, Ill.-38
 Trojan Electronics, 3706 N. Halsted St., Chicago 13, Ill.-9
 TV Engineers, Inc., 3325 W. Bryn Mawr Ave., Chicago 45, Ill.-9-48
 TV Hdw. Mfg. Co., 919 Taylor Ave., Rockford, Ill.-46
 TV Products Co., 145-68 228 St., Springfield Gardens 18, N. Y.-9-41
 United Audio Products, Div. United Optical Mfg., 202 E. 19 St., New York 3, N. Y.-36
 United Technical Labs., Morristown, N. J.-23
 United Transformer Co., 150 Varick St., New York 13, N. Y.-15
 Universal Circuit Controls Corp., 3610 Oakton St., Skokie, Ill.-43
 Vector Electronic Co., 3352 San Fernando Rd., Los Angeles 65, Calif.-39
 Vidair Electronics Mfg. Corp., 576 W. Merrick Rd., Lynbrook, N. Y.-3-41
 Visulite Co., 423 Broome St., New York, N. Y.-39-45
 Waveforms, Inc., 333 6 Ave., New York 31, N. Y.-1-18-26-51
 Welch Mfg. Co., W. M., 1515 Sedgwick St., Chicago 10, Ill.-34-35-50
 Weston Electrical Instrument Corp., Subsidiary Daystrom, Inc., 614 Frelinghuysen Ave., Newark 5, N. J.-1-26-28-34-35-36-48-50-51-52
 Winston Electronics, Inc., 4312 Main St., Philadelphia 27, Pa.-4-10-19-20-21-27-47
 Workman TV, Inc., 309 Queen Anne Rd., Teaneck, N. J.-41

Wuerth Enterprises, 7819 Farnsworth St., Philadelphia 15, Pa.-41
 Yonkers Industries, 28 School St., Yonkers, N. Y.-36-51

17—TOOLS FOR SERVICING

Alignment tools	1
Benches, work	2
Bits, drill	3
Blow torches	4
Carts & Hand Trucks	5
Cradles, chassis	6
Crimping tools	7
Cutters	8
Drills, electric	9
Drills, hand	10
Drivers, nut, screw	11
Ladders	34
Leads, test	12
Lug tools	13
Mirrors, inspection	14
Oilers	15
Pliers	16
Printed Circuit repair kits	17
Prods	18
Punches, Taps, Dies	19
Reamers	20
Saws	21
Soldering guns	22
Soldering irons	23
Soldering stands, access.	24
Splicers, line	25
Spray guns	26
Staplers	27
Strippers, wire	28
Tools, electric	29
Tools, hand	30
Tube Pin straighteners	31
Tube pullers	32
Wrenches	33

Acra Tools & Die Works, 4554 N. Broadway Ave., Chicago 40, Ill.-6
 Admiral Corp., 3800 W. Cortland St., Chicago 47, Ill.-1
 Aerolite Electronics Corp., 507 26 St., Union City, N. J.-1-12-18
 A-K Mfg. Co., 115 S. Northwest Hwy., Barrington, Ill.-12
 Alden Products Co., 117 N. Main St., Brockton 64, Mass.-12
 Allied Mfg. & Sales Co., 201 N. Wells St., Chicago 6, Ill.-5
 Alpert Co., Ned, 2878 N. Holton St., Milwaukee 12, Wisc.-8
 Amalite, Inc., 1884 Pitkin Ave., Brooklyn 12, N. Y.-11
 American Electric Cable Co., 181 Appleton St., Holyoke, Mass.-12
 American Electrical Heater Co., 6110 Cass Ave., Detroit 2, Mich.-23-24
 American Mercantile Co., 33 W. 42 St., New York 36, N. Y.-23
 American Phenolic Corp., 1830 S. 54 Ave., Chicago 50, Ill.-1
 American Radio Hdw. Co., 152 MacQuesten Pkwy. S., Mt. Vernon, N. Y.-1-18-33
 Anchor Products Co., 2712 Montrose Ave., Chicago 18, Ill.-23
 A P Electro Lab., Box 862 Chestnut Sta., Union, N. J.-15
 Argos Products Co., Genoa, Ill.-2
 Arrow Fastener Co., 1 Junius St., Brooklyn 12, N. Y.-27
 Audak Co., 500 5 Ave., New York, N. Y.-8
 Bacche Semon & Co., 636 Greenwich St., New York 14, N. Y.-14
 Barb City Industries, 1150 S. 4 St., DeKalb, Ill.-30
 Baumker Mfg. Co., 3826 Summit St., Toledo 11, Ohio-2-5
 Berger Communications, 109-01 72 Rd., Forest Hills, N. Y.-17-22
 Birnbach Radio Co., 145 Hudson St., New York 13, N. Y.-12-27
 Black & Decker, Towson 4, Md.-9-11-21-29
 Blaco Mfg. Co., 6541 Euclid Ave., Cleveland 3, Ohio-3-33
 Blonder-Tongue Labs., 526 North Ave., Westfield, N. J.-8-28
 Bruno Tools, Inc., 9330 Santa Monica Blvd., Beverly Hills, Calif.-30
 Caliri Mfg. Co., 15 Union St., Lawrence, Mass.-23
 Cal-Lee Mfg. Co., 5653 W. Adams Blvd., Los Angeles 16, Calif.-30
 Cass Machine Co., 691 Antoinet St., Detroit 1, Mich.-11
 Cahorn Mfg. Co., 9999 Broadstreet St., Detroit 4, Mich.-29
 C. H. Electronics, 839 E. Manchester, Los Angeles 1, Calif.-17
 CBS Hytron Div., Columbia Broadcasting System, 100 Endicott St., Danvers, Mass.-30-31-32

Champion DeArment Tool Co., S. Main St., Meadville, Pa.-8-16-30
 Chase Mfg. Co., 5008 W. Jefferson Blvd., Los Angeles 16, Calif.-11
 Colman Tool & Machine Co., P. O. Box 7026, Amarillo, Texas-17
 Columbus Eng'g. Co., Electronics-Nucleonics Div., P. O. Box 464, Columbus, Nebr.-19
 Components Corp., 106 Main St., Denville, N. J.-8
 Cummins-Chicago, 4740 N. Ravenswood, Chicago, Ill.-9-10-21
 Dee Electric Co., 1101 N. Paulina St., Chicago 22, Ill.-24
 Drake Electric Works, 3656 N. Lincoln Ave., Chicago 13, Ill.-22-23-24
 Dreier Bros., 5642 Lake Park Ave., Chicago 37, Ill.-21
 Dunwell Mfg. Co., Dept. T56, Corlstadt, N. J.-12
 Duofone Co., Lucast St., Keyport, N. J.-8
 Duro Specialty Co., 8 Bennett St., Lynn, Mass.-31-32
 Ebarc Electronics Co., 87 Merrick Rd., Baldwin, N. Y.-1-16-30-33
 Eitel-McCullough, Inc., 798 San Motea Ave., San Bruno, Calif.-32
 Electric Soldering Iron Co., W. Elm St., Deep River, Conn.-22-23
 Electronic Hardware Corp., 2420 W. Cermak Rd., Chicago 8, Ill.-1-2-3-33
 Electro-Physics Co., 287U Broadway, New York 7, N. Y.-19
 Epto, Aurora, Ill.-2-5
 Enco Mfg. Co., 4520-26 W. Fullerton, Chicago 39, Ill.-30
 Engineering & Laminating Corp., 506 S. Central Ave., Baltimore 3, Md.-34
 Erwood, Inc., 1770 W. Berteau Ave., Chicago 13, Ill.-8-30
 Esca Mfg. Co., Box 344, Summit, Ill.-5
 Fairbanks Co., 393 Lafayette St., New York, N. Y.-5
 Federal Electronics Sales, Federal Electronics Bldg., Rockville Centre, N. Y.-16-30
 Floot-Lock Corp., AMF Co., 261 Madison Ave., New York 16, N. Y.-30
 Forsberg Mfg. Co., Bridgeport, Conn.-3-10-11-21-29-30
 Gee-Lar Mfg. Co., 412 S. Wyman St., Rockford, Ill.-5-14-31-32
 General Aluminum Products, 287 5 Ave., New York, N. Y.-34
 General Cement Mfg. Co., 919 Taylor Ave., Rockford, Ill.-1-5-6-7-12-14-16-17-18-28-31-32
 General Electric Co., Apparatus Sales Div., Schenectady, N. Y.-23
 Gramer-Hallardson Transformer Corp., 2734 N. Pulaski Rd., Chicago 39, Ill.-22
 Greenlee Tool Co., 1887 Columbia Ave., Rockford, Ill.-19
 Grobet File Co. of America, 421 Canal St., New York 13, N. Y.-30
 Heller Co., 2135 Superior Ave., Cleveland 14, Ohio-27
 Hexacon Electric Co., 161 W. Clay Ave., Roselle Park, N. J.-22-23-24
 Holub Industries, 413 DeKalb Ave., Sycamore, Ill.-3-28
 Hunter Sales R N Div., Hunter Tools, 6608 S. Gretna Ave., Whittier, Calif.-1-11-30
 Ideal Industries, 3316 Park Ave., Sycamore, Ill.-23-28-29-30
 iE Mfg., 325 N. Hayne Ave., Chicago 12, Ill.-1-3-31-32
 Imperial Radar & Wire, 820 E. 233 St., Bronx, N. Y.-28
 Insuline Corp. of America, 186 Granite St., Manchester, N. H.-1-7-8-12-18-23-32
 International Resistance Co., 401 N. Broad St., Philadelphia 8, Pa.-30
 Jacobson Mfg. Co., S. I., 1414 S. Wabash Ave., Chicago 5, Ill.-5
 Jerrold Electronics Corp., 2222 Chestnut St., Philadelphia 3, Pa.-7
 JFD Mfg. Co., 6101 16 Ave., Brooklyn 4, N. Y.-1-6-12
 Kedman Co., 233 S. 5 St., West, Salt Lake City 1, Utah-11
 Kellogg Switchboard & Supply Co., 79 W. Monroe St., Chicago 3, Ill.-3-4-7-8-10-11-16-21-23-24-27-28
 Kemode Mfg. Co., 161 W. 18 St., New York 11, N. Y.-23
 Keystone Electronics Corp., 423 Broome St., New York 13, N. Y.-1-7-12-13-18
 K & G Electronics, 2738 N. Sheffield Ave., Chicago 14, Ill.-5
 Kirby Co., 13000 Athens Ave., Cleveland, Ohio-28
 Klein & Sons, Mathias, 7200 McCormick Rd., Chicago 45, Ill.-16-19-30
 Kraeuter & Co., 563 18 Ave., Newark 3, N. J.-16-33
 Kwikheat Mfg. Co., 3732 San Fernando Rd., Glendale 4, Calif.-23-24
 Lenk Mfg. Co., 30-38 Cummington St., Boston 15, Mass.-4-22-23-24
 L-S Heating & Eng'g Co., 900 W. Lycoming St., Philadelphia 40, Pa.-5
 Martindale Electric Co., Box 617 Edgewater Br., Cleveland 7, Ohio-28
 Mathis Tower & Equip Co., P. O. Box 126, E. Peoria, Ill.-2-5
 Memo Aerial Ladder Co., 1007 N. W. 36 St., Oklahoma City 18, Okla.-34
 Mico Instrument Co., 80 Trowbridge St., Cambridge 38, Mass.-8
 Micro-Circuits Co., New Buffalo, Mich.-17



PAID
CIRCULATION
 of
TECHNICIAN
MAGAZINE
OVER 50,000

Miller Radio & TV, 627 E. Maumee St., Adrian, Mich.-6
 Millers Falls Co., 57 Wells St., Greenfield, Mass.-9-10-11-21-29-30
 Milwaukee Truck & Caster, 6511 W. State St., Milwaukee, Wisc.-5
 Mitchell Industries, P. O. Box 17, Mineral Wells, Texas-22-23
 Mitchell Mfg. Co., 2525 Clybourn Ave., Chicago 14, Ill.-33
 Moody Machine Products, 42 Dudley St., Providence 5, R. I.-30
 Mosley Electronics, 8622 St. Charles Rock Rd., St. Louis 14, Mo.-25
 Mueller Mfg. Co., 23 Tuscan Rd., Maplewood, N. J.-14
 National Tel-Tronics Corp., 52 St. Casimir Ave., Yonkers, N. Y.-18
 Olympic Instrument Labs., Cove Wash.-8
 Oryx Sales Co., 9015 Wilshire Blvd., Beverly Hills, Calif.-23
 Pacific Electric Cord Co., 3217 Exposition Pl., Los Angeles 8, Calif.-12
 Phillips Mfg. Co., 2816 Aldrich Ave., S. Minneapolis, Minn.-22-23-24
 Philmore Mfg. Co., 113 University Pl., New York 3, N. Y.-12-16-18
 Portable Elec. Tools, 320 W. 83 St., Chicago 20, Ill.-9-11-21-29
 Precise Measurements Co., 942 Kings Highway, Brooklyn 23, N. Y.-8-18
 Precision Equipment Co., 3714 N. Milwaukee Ave., Chicago 41, Ill.-5
 Production Tool & Fixture Co., 37 W. Main St., Oyster Bay, N. Y.-31
 Proto Tools, 2209 S. Santa Fe, Los Angeles 54, Calif.-11-16-28-30-33
 Radia City Products Co., Centre & Glendale Sts., Easton, Pa.-12
 Reed & Prince Mfg. Co., 10 Duncarr Ave., Worcester 1, Mass.-11
 Robertson & Roth, Box 534, Elmhurst, Ill.-8
 Roche Co., Paul C., 11 Park Place, New York 7, N. Y.-22
 Rohn Mfg. Co., 116 Limestone, Bellevue, Peoria 5, Ill.-2
 Safety Nail Drive Corp., Clifton, N. J.-30
 Scala Radio Co., 2814 19 St., San Francisco, Calif.-18
 Schupack Supply Co., 7331 Cottage Grove Ave., Chicago 19, Ill.-29
 Scranton Aluminum Mfg. Co., 419 S. Wyoming Ave., Scranton, Pa.-34
 Self-Lifting Piano Truck Co., Findlay, Ohio-5
 Simpson Electric Co., 5208 W. Kinzie St., Chicago 44, Ill.-1
 Sinko Mfg. & Tool Co., 3135 W. Grand Ave., Chicago 22, Ill.-30
 Sittler Corp., 18 N. Ada St., Chicago 7, Ill.-12-28
 Skil Corp., 5033 Elston Ave., Chicago 30, Ill.-8-9
 Smith Heat Treating Co., 5869 Wilmington St., Los Angeles, Calif.-33
 Smith, Inc., Herman H., 2326 Nostrand Ave., Brooklyn 10, N. Y.-1-12-18-25-31-32-33
 South River Metal Prods. Co., 377 Turnpike, South River, N. J.-34
 Special Products Co., P. O. Box 188, Rockville 9, Md.-16
 Speedway Mfg. Co., 1834 S. Laramie Ave., Cicero 50, Ill.-9-27
 Star Expansion Products Co., 142 Liberty St., New York 6, N. Y.-31
 Stark Mfg., P. O. Box 489, Tuscaloosa, Ala.-23
 Stevens Walden, Inc., 467 Shrewsbury St., Worcester, Mass.-1-11-19-20-30-33
 Tatu, Inc., Albert J., 85 Columbia Dr., Williamsville 21, N. Y.-30
 Technicraft Co., 1156 Commonwealth Ave., Boston 34, Mass.-8-23-30
 Techniques, Inc., 178 Central Ave., Hackensack, N. J.-17-19
 Telematic Industries, Inc., 16 Howard Ave., Brooklyn 21, N. Y.-12
 Time Mfg. Co., Westminster, Mass.-11
 Tipco Co., 5865 Wilmington Ave., Los Angeles 1, Calif.-28
 Trico Fuse Mfg. Co., 2948 N. 5 St., Milwaukee 12, Wisc.-15
 Turner Brass Works, 821 Park St., Sycamore, Ill.-4
 TV Accessories Co., Box 368, Scottsdale, Ariz.-23
 TV Hdw. Mfg. Co., 919 Taylor Ave., Rockford, Ill.-5-7-13-30
 U M & F Mfg. Corp., 10929 Vanowen St., North Hollywood, Calif.-5
 Ungar Electric Tool Co., P. O. Box 312, Venice, Calif.-23-24
 U. S. Products, Inc., 1549 Hutchins St., Columbus, Ind.-2-5
 Utica Drop Forge & Tool Corp., 2415 Whitesboro St., Utica 4, N. Y.-16-30-33
 Vaco Products Co., 317 E. Ontario St., Chicago 11, Ill.-7-13-16-28-30
 Vemaline Products Co., P. O. Box 222, Hawthorne, N. J.-22-23
 Viking Tool & Machine, 2 Mair St., Belleville, N. J.-30
 Visulite Co., 423 Broome St., New York, N. Y.-18
 Vulcan Electric Co., 88 Holten St., Danvers, Mass.-23-24
 Waldom Electronics, 4625 W 53 St., Chicago, Ill.-7

Wall Mfg. Co., P., Grave City, Pa.-4-18
 Walsco Electronics Corp., 3602 Crenshaw Blvd., Los Angeles 16, Calif.-1-14-19-28-31
 Wassco Elec. Products Corp., 126 W. Case St., Joliet, Ill.-23
 Weller Electric Corp., 808 Packer St., Easton, Pa.-22
 Wen Products, Inc., 5806 Northwest Hwy., Chicago 31, Ill.-21-22
 Weston Electrical Instrument Corp., Subsidiary Daystrom, Inc., 614 Frelinghuysen Ave., Newark 5, N. J.-12
 Workman TV, Inc., 309 Queen Anne Rd., Teaneck, N. J.-12
 Xcelite, Inc., Bank St., Orchard Park, N. Y.-11-16-30
 Yeats Appliance Dolly Sales, 2103 N. 12 St., Milwaukee 5, Wisc.-5

18—TUBES

Detectors, diode	1
Rectifiers, tube	2
Tubes, cathode-ray (oscillograph) ..	3
Tubes, cathode-ray (television) ..	4
Tubes, control	5
Tubes, electron-ray (indicator-eye) ..	6
Tubes, photoelectric	7
Tubes, receiving	8
Tubes, subminiature	9
Tubes, transmitting	10

Admiral Corp., 3800 W. Cortland St., Chicago 47, Ill.-4
 American Elite Inc., 7 Park Ave., New York 16, N. Y.-2-3-6-8-9-10
 American Standard TV Tube Corp., 94-50 158 St., Jamaica 33, N. Y.-4
 American Vacuum Prods., 2242 S. Colby Ave., Los Angeles 64, Calif.-4
 Amperex Electronic Corp., 230 Duffy Ave., Hicksville, L. I., N. Y.-5-9-10
 Anton Electronic Labs., 1226 Flushing Ave., Brooklyn 37, N. Y.-7-9
 Barry Electronics Corp., 512 Broadway, New York 12, N. Y.-3-4-5-6-7-8-9-10
 Beam Instruments Corp., 350 S. Ave., New York, N. Y.-3
 Bendix TV & Broadcast Receiver Div., Bendix Aviation Corp., E. Joppa Rd., Towson 4, Md.-4-8
 Bomac Labs., Salem Rd., Beverly, Mass.-8
 Bradley Labs., 168 Columbus Ave., New Haven, Conn.-7
 British Industries Corp., 80 Shore Rd., Port Washington, N. Y.-8-10
 Calverdo Tube Corp., 5232 W. 104 St., Los Angeles 45, Calif.-4
 CBS Hytron Div., Columbia Broadcasting System, 100 Endicott St., Danvers, Mass.-1-2-4-8
 Certified Tube Co., 16 & Luzerne Sts., Philadelphia 40, Pa.-8
 Chatham Electronics, Div. Gera Corp., 630 W. Mt. Pleasant Ave., Livingston, N. J.-8-9
 Chromatic TV Labs., 1501 Broadway, New York 36, N. Y.-4
 Claremont Tube Corp., 36-02 35 Ave., Long Island City 6, N. Y.-4
 Clark Electronic Labs., Box 165, Palm Springs, Calif.-2
 Continental Electric Co., 715 Hamilton St., Geneva, Ill.-2-4-7
 Continental Electronics Corp., 5320 Lancaster Ave., Philadelphia, Pa.-4
 Dale Electronics, 31 Samersett Pl., Clifton, N. J.-5
 Delco Radio, 1446 S. Home Ave., Kokomo, Ind.-8
 DuMont Labs., Inc., Allen B., 750 Bloomfield Ave., Clifton, N. J.-3-4
 Eitel-McCullough, Inc., 798 San Mateo Ave., San Bruno, Calif.-2-10
 Electronic Tube Corp., 1200 E. Mermaid Lane, Philadelphia 18, Pa.-3-4
 Electron-Radar Products, 4806 W. Chicago Ave., Chicago 51, Ill.-7
 Electrons, Inc., 127 Sussex Ave., Newark 3, N. J.-2
 Ferranti Electric Co., 30 Rockefeller Plaza, New York 20, N. Y.-2-3-4
 Furst Electronics, Inc., 3322 W. Lawrence Ave., Chicago 25, Ill.-2
 General Electric Co., Apparatus Sales Div., Schenectady, N. Y.-2-7
 General Electronic Equip. Co., Mantua Ave., & Glendale St., Easton, Pa.-48
 Graybar Electric Co., 420 Lexington Ave., New York, N. Y.-2-8
 Haydu Bros. of N. J., Box 1226, Plainfield, N. J.-3-4-8-10
 Hughes Aircraft Co., Products Div., Int'l Airport Station, Los Angeles 45, Calif.-3
 Int'l Rectifier Corp., 1521 E. Grand Ave., El Segundo, Calif.-7
 Kriss Electronics, Inc., 191 Oraton St., Newark 2, N. J.-3-4
 Laine Electronics & Mfg. Co., 91 Industrial Ave., Little Ferry, N. J.-5-10
 Le-Hi Electric Co., 115 Coit St., Irvington, N. J.-8

Livingston Electronic Corp., Livingston, N. J.-5
 Magnavision Electronics Corp., Garwood, N. J.-4
 Martin & Co., H. S., 1916 Greenleaf Ave., Evanston, Ill.-4
 Midland Mfg. Co., 3151 Fiberglas Rd., Kansas City 15, Kans.-4
 Multi-Tron Lab., 4624 Washington Blvd., Chicago 44, Ill.-2-3-4-5-6
 National Union Electric Corp., Orange, N. J.-3-4-8-9
 Philca Corp., Accessory Div., A & Allegheny Ave., Philadelphia 34, Pa.-4-8
 Photo Crystals, Inc., 15 S. I St., Geneva, Ill.-7
 Pioneer Electronics Corp., 2235 S. Carmelina, Los Angeles 64, Calif.-4
 Practical Electronics Mfg. Co., 2214 S. Michigan, Chicago, Ill.-4
 Progressive Electronics, 41 Hudson St., Yonkers, N. Y.-3-4
 Radio Corp. of America, RCA Tube Div., Harrison, N. J.-3-4-5-6-7-8-9-10
 Radio Supply & Eng'g. Co., 85 Selden St., Detroit 1, Mich.-4
 Rauland Corp., 4245 N. Knox Ave., Chicago, Ill.-4
 Raytheon Mfg. Co., Newton, Mass.-3-4-5-6-7-8-9-10
 Richardson-Allen Corp., 116-15 15 Ave., College Point, N. Y.-2
 SOS Cinema Supply, 602 W. 52 St., New York 19, N. Y.-2-8
 S & R Electronics, 297 Central Ave., Bethpage, N. Y.-1-2-3-4-6-8-9
 Standard TV Tube Corp., 706 Dryades St., New Orleans 12, La.-4
 Stromberg-Carlson Co., 100 Carlson Rd., Rochester, N. Y.-2
 Sylvania Electric Products, Inc., 1740 Broadway, New York 19, N. Y.-1-2-3-4-5-6-7-8-9-10
 Super Ear Products Co., 675 Merrick Rd., Lynbrook, N. Y.-9
 Taylor Tubes, Inc., 2313 Wabansia Ave., Chicago 47, Ill.-2
 Technical Apparatus Builders, 109 Liberty St., New York 9, N. Y.-2
 Tele-Ray Tube Co., 984 Sawmill River Rd., Yonkers, N. Y.-3-4
 Tel-O-Tube Corp. of America, 180 Van Riper Ave., E. Paterson, N. J.-4
 Texas Instruments, Inc., 6000 Lemmon Ave., Dallas 9, Texas-2
 Thomas Electronics, 118 9 St., Passaic, N. J.-4
 Tube Service Corp., 2 Gaston Ave., Garfield, N. J.-4
 Tung-Sol Electric, Inc., 95 8 Ave., Newark 4, N. J.-1-2-4-5-6-7-8-9-10
 Westinghouse Electric Corp., P. O. Box 284, Elmira, N. Y.-3-4-5-8-10
 Windsor Electronic Tube Co., 2612 Nostand Ave., Brooklyn, N. Y.-4

19—WIRE & CABLE

Braid, copper	1
Cable, auto radio	2
Cable, coaxial	3
Cable, intercom	4
Cable, microphone	5
Cable, phonograph	6
Cable, shielded	7
Cable, telephone	8
Cords, extension	9
Cords, lacing	10
Cords, line and cheater	11
Gauges, wire	12
Transmission line, TV	13
Wire, antenna	14
Wire, bus	15
Wire, grid	16
Wire, grounding	17
Wire, guy	18
Wire, high-voltage	19
Wire, hook-up	20
Wire, litz	21
Wire, magnet	22
Wire, phonograph	23
Wire, test-lead	24

Accurate Insulated Wire Corp., 25 Fox St., New Haven 1, Conn.-9-11-19-20-24
 Admiral Corp., 3800 W. Cortland St., Chicago 47, Ill.-13
 A-K Mfg. Co., 115 S. Northwest Hwy., Barrington, Ill.-1-2-3-4-5-6-7-8-9-11-14-15-17-19-20-23-24
 Alden Products Co., 117 N. Main St., Brockton 64, Mass.-2-4-5-6-7-8-9-10-11
 Alpha Wire Corp., 200 Varick St., New York 14, N. Y.-1-2-3-4-5-6-7-8-10-11-14-15-16-17-19-20-23-24
 Aluminum Mfg. Co., 1629 Portland Ave., Louisville 3, Ky.-14-17
 American Electric Cable Co., 181 Appleton St., Holyoke, Mass.-1-2-3-4-5-6-7-8-9-11-14-17-19-20-23-24

American Elite, Inc., 7 Park Ave., New York 16, N. Y.-5
 American Mercantile Co., 33 W. 42 St., New York 36, N. Y.-21-22
 Ames Mfg. Corp., 4320 Park Ave., New York 57, N. Y.-4-13-14-17-18-20
 Amphelonic Electronic Corp., 1830 S. 54 Ave., Chicago 50, Ill.-3-5-13-14
 Anchor Metal Co., 244 Boerum St., Brooklyn 6, N. Y.-24
 Anchor Products Co., 2712 Montrose Ave., Chicago 18, Ill.-6-19
 Anchor Wire Corp., 183-16 Jamaica Ave., Jamaica 3, N. Y.-18
 Ansonia Wire & Cable Co., 111 Martin St., Ashton, R. I.-4-7-8
 Atlantic Wire & Cable Co., 119-14 14 Rd. College Point, N. Y.-3-4-5-7-8-9-13-24
 Beam Instruments Corp., 350 5 Ave., New York, N. Y.-3-4-5-7-8
 Belden Mfg. Co., 4647 W. Van Buren St., Chicago 44, Ill.-3-4-5-7-9-14-15-20-21-22-24
 Birnbach Radio Co., 145 Hudson St., New York 13, N. Y.-1-3-5-7-8-9-10-11-14-15-16-17-18-19-20-21-22-24
 Black & Decker, Towson 4, Md.-9
 B & M Electric Corp., 838 4 Ave., Brooklyn 32, N. Y.-9-11
 Bogen Co., David, 29 9 Ave., New York 14, N. Y.-4-5-7
 Brand & Co., Wm., North & Valley Sts. Williamst., Conn.-3-4-5-6-7-13-14-19-20
 Buchan Co., R. J., P. O. Box 9, Briceyn, Minn.-13-14
 Calcon Mfg. Co., 100 Oakland Ave., Washington 1, Pa.-14-15-19-20-23-24
 Camburn, Inc., 32-40 57 St., Woodside 77, N. Y.-14-18
 Campbell X-Ray Corp., 110 Cummington St., Boston 15, Mass.-19
 Capps & Co., Frank L. 20 Addison Pl., Valley Stream, N. Y.-5
 Cass Machine Co., 691 Antoinet St., Detroit 1, Mich.-13-14-18
 CBC Electronics Co., 2601 N. Howard St., Philadelphia 33, Pa.-5-9
 Channel Master Corp., Ellenville, N. Y.-13
 Chester Cable Corp., Chester, N. Y.-2-3-4-5-6-7-8-14-15-17-18-19-20-21-23-24
 Clifton Conduit, Piereway Div., 75 Montgomery St., Jersey City 2, N. J.-20
 Coleman Cable & Wire Co., 4515 W. Addison St., Chicago 41, Ill.-14-15-17-19-20-21-22-23-24
 Colortone Electronics, 100 Frank Rd., Hicksville, N. Y.-4
 Columbia Technical, 5 E. 57 St., New York 22, N. Y.-3
 Columbia Wire & Supply, 2850 Irving Park Rd., Chicago 18, Ill.-1-2-3-4-5-6-7-8-9-10-11-12-13-14-15-16-17-18-19-20-21-22-23-24
 Commercial Products, 417 Main St., Toledo 5, Ohio-18
 Consolidated Wire, 1635 S. Clinton St., Chicago 16, Ill.-1-2-3-4-5-6-7-8-9-10-11-12-13-14-15-16-17-18-19-20-21-22-23-24
 Co-Operative Industries, 100 Oakdale Rd., Chester, N. J.-1-7
 Copperweld Steel Co., 322 Frick Bldg., Pittsburgh 19, Pa.-14-17-18
 Cornish Wire Co., 50 Church St., New York 7, N. Y.-4-5-7-9-11-14-20-24
 Eagle Electronics Corp., P. O. Box 775, Meriden, Conn.-3-4-5-6-7-8-20
 Easy-Up, Inc., 908 State St., Racine, Wisc.-17
 Eby Sales Co., 130 Lafayette St., New York 13, N. Y.-9

Eitel-McCullough, Inc., 798 San Mateo Ave., San Bruno, Calif.-16
 Electronic Hardware Corp., 2420 W. Cermak Rd., Chicago 8, Ill.-14-17-18
 Essex Wire Corp., 1601 Wall St., Ft. Wayne 6, Ind.-2-4-5-6-9-11-20-22-24
 Federal Telephone & Radio Co., Div. I T & T, 100 Kingsland Rd., Clifton, N. J.-3-4-5-7-8-13-14-19-20
 Fenton Co., 15 Moore St., New York 4, N. J.-3-5-13-18
 Flexo Wire Div., Copperweld Steel Co., Oswego, N. Y.-1-14-20
 Forest Electric Co., 7216 Circle Ave., Forest Park, Ill.-13
 Fretco, Inc., 406 N. Craig St., Pittsburgh 13, Pa.-13-14-17
 Gee-Lar Mfg. Co., 418 S. Wyman St., Rockford, Ill.-11
 General Cement Mfg. Co., 919 Taylor Ave., Rockford, Ill.-10
 General Insulated Wire Works, 69 Gordon Ave., Providence, R. I.-3-5-8
 Gosnet Co., 801 S. Main St., Burbank, Calif.-13
 Goodline Corp., 309 Date Ave., Alhambra, Calif.-2-3-4-5-6-7-14-16-17-20-23-24
 Graybar Electric Co., 420 Lexington Ave., New York, N. Y.-3-5-13
 Hi-Lo TV Antenna Co., 3540 N. Ravenswood Ave., Chicago 13, Ill.-13-14
 Hitemp Wires, Inc., 26 Windsor Ave., Mineola, L. I., N. Y.-19-20-21-22
 Hudson Wire Co., Winsted Div., Winsted, Conn.-21-22
 iE Mfg., 325 N. Hoyle Ave., Chicago 12, Ill.-2-14-17-18
 Imperial Radar & Wire, 820 E. 233 St., Bronx, N. Y.-3-4-5-6-7-8-9-10-11-12-13-14-15-16-17-18-19-20-21-22-23-24
 Insuline Corp. of America, 186 Granite St., Manchester, N. H.-2-3-7-11-14-18-24
 Jan Hdw. Mfg. Co., 75 N. 11 St., Brooklyn 11, N. Y.-12
 Jersey Specialty Co., Burgess Pl., Mountainview, N. J.-13-20
 JFD Mfg. Co., 6101 16 Ave., Brooklyn 4, N. Y.-2-3-9-11-14-18-20-24
 Kellogg Switchboard & Supply Co., 79 W. Monroe St., Chicago 3, Ill.-1-4-8-10-20
 Lenz Electric Mfg. Co., 1751 N. Western Ave., Chicago 47, Ill.-21
 Medal Mfg. Co., 194 E. Silver St., Sharon, Pa.-14-17-18
 Miller Electric Co., 120 Main St., Pawtucket, R. I.-9
 Mohawk Wire & Cable Corp., 320 River St., Fitchburg, Mass.-2-3-4-5-6-7-8-14-19-20-24
 Modern-Aire Mfg. Corp., 4436 W. Roosevelt Rd., Chicago 40, Ill.-17-18
 Modern Wire Co., 39-30 Review Ave., Long Island City 1, N. Y.-14-17-18
 New England Electrical Works, 365 Main St., Lisbon, N. H.-1-21-22
 Nichols Wire & Aluminum, 1725 Rockingham Rd., Davenport, Iowa-14-17
 Porker Metal Goods Co., 161 Summer St., Worcester, Mass.-13-14-20
 Pentron Corp., 777 S. Tripp Ave., Chicago 24, Ill.-9
 Peschel Electronics, 13 Garden St., New Rochelle, N. Y.-19
 Phalo Plastics Corp., 25 Foster St., Worcester 8, Mass.-3-4-5-6-7-8-11-14-19-20-23-24
 Phelps Dodge Copper Products Corp., 300 Park Ave., New York 22, N. Y.-3-5-7-8-9-13-17-19-20-22
 Plastoid Corp., 42-61 24 St., Long Island City, N. Y.-3-4-5-6-7-8-13-20-23

Plymouth Electronics Corp., 50 Kingsbury St., Worcester 3, Mass.-18
 Radio Merchandise Sales, 2016 Bronxdale Ave., New York 62, N. Y.-17
 Radio Supply & Eng'g Co., 85 Selden St., Detroit 1, Mich.-18-19-20-23-24
 Radix Wire Co., 26260 Lakeland Blvd., Cleveland 32, Ohio-13-20
 Rego Insulated Wire Co., 830 Monroe St., Hoboken, N. J.-13
 Revere Corp. of America, Wallingford, Conn.-7-20
 Rogers Electronic Corp., 49 Bleecker St., New York 12, N. Y.-13
 Royal Electric Co., 95 Grand Ave., Pawtucket, R. I.-9-11-20
 Runzel Cord & Wire, 4727 Montrose Ave., Chicago 41, Ill.-7-20
 Saxton Products, Inc., 2101 Grand Concourse, Bronx 53, N. Y.-13-14-17
 Sequola Process Corp., 871 Willow St., Redwood City, Calif.-3-4-5-7-8-19-20
 Service Instruments Co., 171 Official Rd., Addison, Ill.-11
 Sittler Corp., 18 N. Ada St., Chicago 7, Ill.-17-20-24
 Smith, Inc., Herman H., 2326 Nostrand Ave., Brooklyn 10, N. Y.-9-10-19-24
 South River Metal Prods. Co., 377 Turnpike, South River, N. J.-17-18
 Special Products Co., P. O. Box 188, Rockville 9, Md.-10
 Sprague Products Co., North Adams, Mass.-22
 Superior Insulated Wire, W. Haverstraw, N. Y.-13-20
 Technical Appliance Corp., 1 Taco Ave., Sherburne, N. Y.-14-18
 Telectro Industries Corp., 35-16 37 St., Long Island City, N. Y.-22
 Tensolite Insulated Wire Co., Tarrytown, N. Y.-1-3-4-5-6-7-11-20-21-22-23-24
 Trimm, Inc., 400 W. Lake St., Libertyville, Ill.-3-9
 TV Hdw. Mfg. Co., 919 Taylor Ave., Rockford, Ill.-18
 TV Wire Products Co., 119 Prospect Ave., Burbank, Calif.-14-17
 Union Plastics Corp., Wire & Cable Div., 1627 Paterson Plank Rd., Secaucus, N. J.-2-3-4-5-6-7-8-14-20-24
 U. S. Wire & Cable Co., Progress Ave. & Monroe, Union, N. J.-3-5-7-9-19-24
 Utah Radio Products Co., 1123 E. Franklin St., Huntington, Ind.-13
 Utilities Service Co., 1 Pine St., Allentown, Pa.-18
 Varflex Corp., 512 W. Court St., Rome, N. Y.-10
 Victor Electric Wire & Cable Corp., 64 Ackerman Ave., Clifton, N. J.-2-3-4-5-6-7-11-13-14-19-20
 Vulcan TV Mast & Tower, 1224 National St., Birmingham 7, Ala.-17-18
 Waldom Electronics, 4625 W. 53 St., Chicago, Ill.-9-11
 Walco Electronics Corp., 3602 Crenshaw Blvd., Los Angeles 16, Calif.-14-18
 Wheeler Insulated Wire Co., Div. Sperry Rand Corp., 150 E. Aurora St., Waterbury 20, Conn.-21-22
 Whitney Blake Co., 1565 Dixwell Ave., New Haven 14, Conn.-4-5-6-7-8
 Wind Turbine Co., E. Market St. & Penna RR, W. Chester, Pa.-18
 Witelrod Electrical Mfg. Co., 75 Pulaski St., Stamford, Conn.-9-11
 Wright Steel & Wire Co., G. F., 243 Stafford St., Worcester 3, Mass.-18

1956 TECHNICIAN BUYERS DIRECTORY

Brand & Trade Name Index

The brand names of service and replacement products, component parts, equipment, instruments, and materials in the radio-TV-electronic service industry are listed alphabetically, with

the name of the manufacturer. The address of the manufacturer whose brand or trade name is listed may be obtained by referring to the Alphabetical listing of Manufacturers, page 109.

ACA Magnasync Mfg.	ACROETCH Acromark Co.	Fenton Co.	Quam-Nichols Co.	Roanwell Corp.	Channel Master
ACCOUSTIFLEX CBC Electronics	ACRO INK Acromark Co.	ADAPHONE PILLOW Fenton Co.	ADJUST-A-VOLT Standard Electrical Products Co.	AIRBOY Mitchell Industries Inc.	ALUZOOM JFD Mfg. Co.
ACCWIRE Accurate Insulated Wire	ACROPLAC Acromark Co.	ADAP-TEST Vidale Electronics	ADVANCE Acme Battery	AIR-CORE American Phenolic	AMBERYL Vaco Products Co.
ACME Trimm, Inc.	ACROPRENE Acromark Co.	ADA-SET Electronic Specialties	AECO American Elect Cable	AKRA-OHM Shallcross Mfg.	AMCO American Solder & Flux
ACOUSTALLOY Electro-Voice, Inc.	ACROPRINTER Acromark Co.	ADASHAFT Centralab Div., Globe Union, Inc.	AEROCO Aerovox Corp.	ALLIED Scranton Aluminum	AMCON American Condenser Co.
ACOUSTONE Newcastle Fabrics	ACRO-STAMP Acromark Co.	AD-A-SWITCH Clarostat Mfg. Co.	AERODYNAMIC Radio Corp. of America	ALPHATAPE Int'l Pacific Record'g	AMERCO American Mercantile
ACROBOSS Acromark Co.	ACROSOUND Acro Products Co.	ADCOLA British Electronic Sales	AEROFILM Aerovox Corp.	ALPHLEX Alpha Wire Corp.	AMERICAN BEAUTY American Electrical Heater Company
ACRODIE Acromark Co.	ACTO-tenna Acme Tool & Specialties	ADELCO Advance Electronics Co.	AEROLENE Aerovox Corp.	ALUMACOTE Mechanical Steel Tubing	AMERITE TV TOWERS American Tower Co.
	ADAPHONE	ADJUST-A-CONE	AEROSENSOR	ALUMAST	

A-MP American Marine Prods.
 AMPEC Centralab Div., Globe Union, Inc.
 AMPHENOL American Phenolic
 AMRECON Ohmite Mfg. Co.
 AMVAC American Vacuum Prods
 ANGEL Electric & Musical Inds
 ANKOSEAL Ansonia Wire & Cable
 ANTENAPLEX Radio Corp. of America
 ANTENSIFIER Blonder-Tongue Labs.
 API American Pamcor
 ARCOLECTRIC British Electronic Sales
 ARHCO American Radio Hdw.
 ARISTOCRAT Electro-Voice Inc
 ARISTOCRAT Trio Mfg.
 ARROW Colman Tool & Machine
 ATLANTIC Livingston Electronic
 ATLANTICABLE Atlantic Wire & Cable
 ATLEE Atlas E-E Corp.
 ATOM Sprague Electric Co.
 ATTIC-TENNA Control Electronics
 ATR American TV & Radio
 AUDAX Audak Co.
 AUDET Centralab Div., Globe Union, Inc.
 AUDIO-AID Ansley Mfg., Arthur
 AUDIO AID Greene Co., L. Charlton
 AUDIODISCS Audio Devices, Inc.
 AUDIOFILM Audio Devices, Inc.
 AUDIO POINTS Audio Devices, Inc.
 AUDIOSCOPE Audio-Master Corp.
 AUDIOSPHERE Livingston Electronic
 AUDITORIUM Jensen Mfg. Co.
 AUTOBOOSTER Industrial Television
 AUTO BRIDGE Industrial Instruments
 AUTO COUPLER Industrial Television
 AUTOGRIP Magnasync Mfg.
 AUTOPOSITIONER Collins Radio Co.
 AUTOTUNE Collins Radio Co.
 AVCOLECTRIC British Electronic Sales
 AVIGATOR Mitchell Industries Inc.

BACH GUILD Vanguard Recording Soc.
 BABEE SITTER Greene Co., L. Charlton
 BALANCE Self-Lifting Piano Truck
 BALINE JFD Mfg. Co.
 BANSHEE JFD Mfg. Co.
 BANTAM Aerovox Corp.
 BARONET Electro-Voice, Inc.
 BARRYPACK Barry Electronics
 BASEBALL Antenna Specialists
 BASS ULTRAFLEX Jensen Mfg. Co.
 BATTERY-SCOPE McColpin-Christie
 BAT WING Telrex Inc.
 BBB Butler Mfg., B. B.
 BEAMADJUSTER Perfection Electric
 BEAMED POWER ROTARIES Telrex Inc.

BEE LINE Radio Merchandise Sales, Inc.
 BELFONE Bell Sound Systems, Inc.
 BERLANT-CONCERTONE Berlant Instruments
 BESTENNA Bestcraft Products Co.
 BH Bentley-Harris
 BI-FI Federal Electronics
 BIG BERTHA Telrex Labs.
 BIG DAN Danforth Mfg. Co.
 BIG JACK Kay-Townes Antenna
 BIG SHOT Radio Merchandise Sales
 BIRACO Birnbach Radio Co.
 BIRCH Boetsch Bros.
 BIRFLENE Birnbach Radio Co.
 BIRLON Birnbach Radio Co.
 BIRMINGHAM SOUND British Electronic Sales
 BJ British Electronic Sales
 BLACK BEAUTY Sprague Electric Co.
 BLACK & WHITE Tru-Pine Co.
 BLUE JACKET Sprague Electric Co.
 BLUEPOINT Astron Corp.
 BLUE RIBBON American Standard TV Tube
 BLUE SHAFT Centralab Div., Globe Union, Inc.
 BLU-FLEX Millers Falls Co.
 BLU-MOL Millers Falls Co.
 B & O Fenton Co.
 BOOST-A-VOLT Workman TV, Inc.
 BORON X Technicraft Co.
 BOSIPT Workman TV, Inc.
 BOSTON Livingston Electronic
 BOW-FLECTOR JFD Mfg. Co.
 BOW-TIE JFD Mfg. Co.
 BOY-MAR Electrical-Service Co.
 BRADLEYOMETER Allen-Bradley Co.
 BRADLEYUNITS Allen-Bradley Co.
 BRANDES Cannon Co., C. F.
 BRELSCO British Electronic Sales
 BRENELL Fenton Co.
 BRENKERT Radio Corp. of America
 BRILOK American Screw Co.
 BROADCASTER Int'l Radio & Electr
 BROWN DEVIL Ohmite Mfg. Co.
 BRUNSWICK Decca Records
 BT Illinois Condenser Co.
 BULPLATE Sprague Electric Co.
 BUSS Bussmann Mfg. Co.
 BUTTON Erie Resistor Corp.

CABINART G & H Wood Products
 CADET Raytheon Mfg. Co.
 CAMCO Camburn, Inc.
 CANNON-BALL Cannon Co., C. F.
 CAPTAIN Medal Mfg. Co.
 CARBOFILM McColpin-Christie
 CARBOWING Aerovox Corp.
 CARBOMITE Continental Carbon Inc.
 CARBON-TET Korden Chemical Co.
 CARDAX Electro-Voice Inc.
 CARDINAL Midland Mfg. Co.

CARDYNE Electro-Voice Inc.
 CARLTON Hudson Lamp Co.
 CARRILON DYNAMIC Miller Mfg. Co., M. A.
 CARTWHEEL Aerovox Corp.
 CASCADE Industrial Television
 CASCODE JFD Mfg. Co.
 CASTOHM Shallcross Mfg. Co.
 CAVALIER RADIO Hlnners-Galanek Radio
 CDP Electro-Voice Inc.
 CDR Radiart Corp.
 CEEC Calbest Eng'g & Electronics Co.
 CELAB Clark Electronic Labs.
 CENTILATOR Kay Electric Co.
 CENTRATHENE Centralab Div., Globe Union, Inc.
 CEN-TRI-CORE Alpha Metals, Inc.
 CENTURION IV Electro-Voice, Inc.
 CENTURY American Standard TV Tube
 CENTURY Electro-Voice, Inc.
 CERAMELEX Erie Resistor Corp.
 CERAMICON Erie Resistor Corp.
 CERA-MITE Sprague Electric Co.
 CEROC Sprague Electric Co.
 CETRA-SORIA Capitol Records
 CETRON Continental Electric Co.
 CHALLENGER BY BOGEN Bogen Co., David
 CHALLENGER (hack saw frame) Dreier Bros.
 CHALLENGER RECORDER Rek-O-Kul Co.
 CHAMPION Channel Master
 CHANALYST Radio Corp. of America
 CHANGE-A-CYCLE Carter Motor Co.
 CHANGE-A-VOLT Carter Motor Co.
 CHANNEL AUTOBOOSTER Industrial Television
 CHANNEL CHIEF Barb City Industries
 CHANNELITE Vidalre Electronics
 CHANNEL KING Armac Co.
 CHANNEL KING Marjio Tech Products
 CHANNEL LOCK Champion DeArment Tool
 CHARGALYZER McColpin-Christie
 CHARGOMATIC 88 Electric Card Co.
 CHASBESTOS Chase & Sons
 CHASSIS CARRIER Barb City Industries
 CHASSIS SUPPORT Barb City Industries
 CHEM-ETCH-CIRCUITS Automatic Processing
 CHEMIFLEX Technicraft Co.
 CHEMIGLAS Technicraft Co.
 CHITRAN Chicago Standard Transformer Corp.
 CHROMABAR Kay Electric Co.
 CHROMALYZER Telechrome, Inc.
 CHROMATIC Radio Merchandise Sales Inc.
 CHROMATRON Chromatic Television
 CIMALOHM Cima Corp.
 CINELITE Mole-Richardson Co.
 CINEVISION Calbest Eng'g & Electronics Co.
 CIRCLE "B" Vocaline Co. of America
 CIRCLE-VANE Ward Products Corp., Div. The Gabriel Co.

CIRCULETRON Electro-Voice, Inc.
 CIRCON Universal Circuit Control
 CIR-O-LINE Atlantic Wire & Cable
 C LINE Clarostat Mfg. Co.
 CLARI PIX Vidair Electronics
 CLARKSTAN Pacific Transducer
 CLARO Clarostat Mfg. Co.
 CLEF Permaflux Corp.
 CLEVITE Transistor Products Inc.
 CLIX British Electronic Sales
 CLOCK-TENNA Radio Merchandise Sales
 CLOCK TIMER International Register
 CLOVER-V-BEAM Telrex, Inc.
 COAXIAL Jensen Mfg. Co.
 COILCO Call Co. of America
 COILTENNA Electrad Products
 CO-LATEVAL Finney Co.
 COLLEGIATE Hamilton Electronics
 COLORBEAM Tennialab
 COLOR BEAM Winegard Corp.
 COLORSCOPE Simpson Electric Co.
 COLOR-TENNA JFD Mfg. Co.
 COLORTOP Trico Fuse Mfg.
 COMBO Winegard Co.
 COMET Antenna Products
 COMET Astron Corp.
 COMMANDO (hack saw frame) Dreier Bros.
 COMMERCIAL Trimm, Inc.
 COMMUNO-PHONE Bogen Co., David
 COMPENTROL Centralab Div., Globe Union, Inc.
 CONCERT Jensen Mfg. Co.
 CONCERTASTER Electrosonic Specialties
 CONCERTO Jensen Mfg. Co.
 CONFIDENCER Roomwell Corp.
 CONICAL-V-BEAM Telrex, Inc.
 CONNOISSEUR Livingston Electronic
 CONQUEROR Neal Electronic Co.
 CONSTELLATION JFD Mfg. Co.
 CONTACTENE Welco Electronics
 CONTENNA Conn. Telephone & Electric Corp.
 CONTINENTAL DeJur-Amsco Corp.
 CONTROL GUARDS D & M Products
 CON-YAGI Tennalab
 COPROX Bradley Laboratories
 CORONET Camburn, Inc.
 CORONET Permaflux Corp.
 CORRIE Ohmite Mfg. Co.
 CORVEK JaMac Products Co.
 CORVETTE JFD Mfg. Co.
 COSMOPOLITAN Radion Corp.
 COTRAP Skyline Mfg. Co.
 COUNTRY-BELLE Guild Radio & TV
 COUPLATE Centralab Div., Globe Union, Inc.
 CRAFTSMEN Radio Craftsmen Corp.
 CRESTBRITE Crest Transformer
 CRESTRAN Crest Transformer
 CRESTROL Crest Transformer

CRESTWOOD Daystrom Electric Corp.
 CRL Centralab Div., Globe Union, Inc.
 CROFLEX Waldom Electronics
 CROLITE Crowley & Co., Henry L.
 CROLOY Crowley & Co., Henry L.
 CRONAME Waldom Electronics
 CROWN Int'l Radio
 C T S Chicago Telephone Supply
 CUE TAPE Rangertone Inc.
 CUNNINGHAM Radio Corp. of America
 CUSTOMLINE Antenna Products
 CUSTOMLINER Fretco Inc.
 CUTTER CARTRIDGE Shure Bros.
 CX75 Self-Lifting Piano Truck

DALMOTRON Talkmaster, Inc.
 DALOHM Dale Products, Inc.
 DANDEE Aerovox Corp.
 DAVIS SUPER-VISION Davis Electronics
 DAVOHM Daven Co.
 DAVONOIL Daven Co.
 DeARMOND Rowe Industries
 DECI Dwyer Engineering
 DECOR-TENNA Midwest Naturlite Co.
 DeFOREST Radio Corp. of America
 DELPEC Centralab Div., Globe Union, Inc.
 DELTA BEAM K-G Electronics Corp.
 DENSICHRON Densitometers
 DENSITOMETERS Welch Mfg. Co., W. M.
 DEPENDABLE Trimm, Inc.
 DERMOHM Ohmite Mfg. Co.
 DIABOW Tibbests Industries
 DIALAMATIC JFD Mfg. Co.
 DIAL SAW Erwood Inc.
 DIAMOND PHONO STYLI Royal Diamond Tool Co.
 DIAMOND WEAVE General Instruments
 DIBAND Antenna Products
 DIFFERENTIAL Electro-Voice Inc.
 DIMENSION Fretco, Inc.
 DIMINUETTE Permaflux Corp.
 DIOMITE Transistor Products Inc.
 DIP-A-ROD JFD Mfg. Co.
 DIRECT-DRIVE Shure Bros.
 DIRECTRON Miller Co., Sanford
 DIRECTRONIC Snyder Mfg. Co.
 DIRON Peerless Prods Industries
 DISCOVERS Electrovox Co.
 DISPATCHER Shure Bros.
 DIVIDOHM Ohmite Mfg. Co.
 DMC0 Dunwell Mfg.
 DO-ALL Radio City Products
 DODO JFD Mfg. Co.
 DOUBLE HEADER Antenna Specialists
 DOUBLETALK Radio Merchandise Sales
 DREADNAUGHT Wall Mfg. Co., P.

DROP-LOCK South River Metal Prod.
 DUAL United Audio Products
 DUALCOTE Mechanical Steel Tubing
 DUARC Mole-Richardson Co.
 DUETTE Jensen Mfg. Co.
 DUNCO Struthers-Dunn
 DUO Permaflux Corp.
 DUOBEAM Antenna Products
 DUOFONIC Paraplegics Mfg.
 DUO-KAP Centralab, Globe Union, Inc.
 DUO-MOUNT South River Metal
 DUO SEAL Welch Mfg. Co., W. M.
 DUOSONIC Sonic Industries
 DUOTAPE Duotone Co.
 DUO-TENNA Waldom Electronics
 DUO-VOLT Carter Motor Co.
 DURAFLEX Co-Operative Industries, Inc.
 DURAMEG Sprague Electric Co.
 DURAMIC Aerovox Corp.
 DURANITE Aerovox Corp.
 DURA-RAMIC Ward Products
 DURIAM London Int'l Records
 DURPOINT Duotone Co.
 DUZ-ALL CBC Electronics Co.
 DYMON-VANE Ward Products Corp. Div., The Gabriel Co.
 DYNACO Dyna Co.
 DYNACORD Pentron Corp.
 DYNAKIT Dyna Co.
 DYNAMIC Jackson Electrical Instrument Co.
 DYNAQUIK 500 B & K Mfg. Co.
 DYNASCOPY Century Electronics Co.
 DYNASET Telex Inc.
 DYNATRACER Century Electronics Co.
 DYNATROL North America Model Products, Inc.
 DYNO-MITE Millers Falls Co.

EAG-L-LINE General Aluminum Products
 EARSET Telex, Inc.
 EASYCAP Waldom Electronics
 EASYCOUPLE Waldom Electronics
 EASYSPICE Waldom Electronics Sales
 EASY-VISION Hoffman Electronics
 ECHOPHONE Hallcrafters Co.
 ECONO-SWITCH Centralab Div., Globe Union, Inc.
 EDISWAN British Electronic Sales
 EFCON Electronic Fabricators
 EICO Electronic Instrument
 8-BALL Ward Products Corp., Div. The Gabriel Co.
 EIMAC Eitel-McCullough, Inc.
 EKOTAPE Webster Electric Co.
 EL Electrons, Inc.
 ELCOR Eagle Electronics
 ELECTENN Electrend Products
 ELECTRACER Special Products
 ELECTRALOY Circon Component Co.

ELECTRICORD
Pacific Electricord Co.

ELECTRO-GRAPHIC
Precise Measurements

ELECTROLOX
Schauer Mfg. Corp.

ELECTRONAMIC
Precision Apparatus Co.

ELECTRONIC BUTLER
Miller Electronics

ELECTRONIC "STETHOSCOPE"
Faller Eng'g. & Mfg.

ELECTRO-PROBE
Erwood, Inc.

ELECTROSCOPE
Faller Eng'g. & Mfg.

ELECTRO-WIPE
Duotone Co.

ELECTROX
Schauer Mfg. Corp.

ELEKTRAN
Ward Products Corp. Div., The Gabriel Co.

ELIM-A-TRACE
Vidair Electronics Mfg. Co.

ELITE
American Elite, Inc.

ELITE
Camburn Inc.

ELPHCO
Electro-Physics

ELSCO
Electronic Specialties

EMC
Electronic Measurements Corp.

EMICO
Electro Mechanical Instrument

EMPIRE
Electro-Voice, Inc.

EMPIRICAL
Livingston Electronic

ENCORE
Technical Tape Corp.

ENTISER
Master Electronics & TV

ENVOY
Ansley Mfg., Arthur

ESICO
Electric Soldering Iron

ESICOLUGER
Electric Soldering Iron

ESL
Electro-Sonic Labs.

ESOTERIC
Livingston Electronic

EVEN-DIP
Vulcan Electric Co.

EVERARD
Electro-Physics Co.

EVERLOCK
Thompson-Bremer

EVER-QUIET
Chemical Electronic Eng'g. Inc.

EVEREADY
National Carbon Co.

EVER-KLEER
Chemical Electronic Eng'g. Inc.

EXACTOHHM
Workman TV, Inc.

EXPANDIT
Tele-Ex-Pand Corp.

EXPRESS CONTROLS
Centralab Div., Globe Union, Inc.

EXTENSION JAX
Switchcraft, Inc.

EYE WITNESS
Radio Corp. of America

E-Z
Ideal Industries, Inc.

E-Z-BEE
Sprling Products Co.

EZC
Kleer-Vue Mfg. Co.

E-Z FIND
Akro-Mils

E-Z WIRE STRIPPERS
Ideol Industries, Inc.

FAN FARE
Fannon Electric Co.

FASTATCH
Centralab Div., Globe Union, Inc.

FATHOMETERS
Raytheon Mfg. Co.

FB-7
National Co.

FEATHERIDE
Webster Electric Co.

FEATHERWEIGHT
Trim, Inc.

FEDTRO
Federal Electronics

FELCO
Forest Electric Co.

FEN-TONE
Fenton Co.

FENTUBE-AIRSPACED
Fenton Co.

FENWIRE
Fenton Co.

FERRI-CHOKE
Superex Electronics

FERRI-LOOPSTICK
Superex Electronics

FEROTRON
Polymer Corp.

FG-EZ
Fretz Gross Co.

FIDELIS
V-M Corp.

FIDELITONE
Permo, Inc.

FIDELITY PHASING
Finney Co.

FIDELITY X-UAR
STRIPPER

FIDELITY CHEMICAL
FIDELIVOX

FIDELITY SPECIALTIES
FILMITE

FILM X
Good-All Elec. Mfg. Co.

FILPEP
Centralab Div., Globe Union, Inc.

FILPLATE
Centralab Div., Globe Union, Inc.

FILTA-COUPLER
Superex Electronics

FILTERMITES
Deutschmann Corp., Tobe

FILTEROL
Sprague Electric Co.

FILTERPOINT
Duotone Co.

FIL-TEST
Vidair Electronics

FIL-TRAN
Vidair Electronics

FINCO
Finney Co.

FINNFLEX
Finn & Co., T. R.

FISHBONE
Telrex Labs.

FIXTOHM
Campbell Industries

FIXTOHM
Clarostat Mfg. Co.

FLATOHM
Centralab Div., Globe Union, Inc.

FLEETWAY
Conn. Telephone & Electric Corp.

FLEETWOOD
Conrac Inc.

FLEXARM
Art Specialty Co.

FLEXITUBE
Walco Electronics Co.

FLEXO
Art Specialty Co.

FLEXOHHM
Clarostat Mfg. Co.

FLUTTER METER
Amplifier Corp. of America

FLUXCOTE
London Chemical

FLYWEIGHT MAGNEMITE
Amplifier Corp. of America

F M E
Federal Mfg. & Eng'g.

FOAMFLEX
Phelps Dodge Copper Products Corp.

FONOFLUID
Ronette Acoustical Corp.

FORMEX
Fidelity Chemical Products

FORTISSIMO
Permoflux Corp.

FOTO-ELECTRIC
Worner Electronic Devices

FRAWLEY
Hotel Radio Mfrs.

FRAZIER-MAY
LOUDSPEAKERS

FRESHMAN
Hamilton Electronics

FRETARAY
Fretco Inc.

FRETLINE
Fretco Inc.

FRINGE BEAM
Neal Electronic Co.

FRINGE LEADER
Radio Merchandise

FSK
National Co.

FSL
National Co.

FSR
National Co.

STV4
Workman TV, Inc.

FUSE-LITE
Alden Products Co.

FUSETRON
Bussmann Mfg. Co.

FUSE-O-LET
Hilo TV Antenna Corp.

FUTURAMIC
Channel Master

FUZ-LOX
D & M Products

FUZOHM
Clarostat Mfg. Co.

GALVO-O-MAST
Mechanical Steel Tubing

GB JET
Workman TV Inc.

G-C
General Cement Mfg.

GEARMOTOR
Atlas Overhead Door

GEMCO
Great Eastern Mfg. Co.

GENALEX
British Industries Corp.

GENEMOTOR
Carter Motor Co.

GENERAL
Medal Mfg. Co.

GENERAL HI-FI PHONES
General Phones Corp.

GENESCOPE
Simpson Electric Co.

GEOMATIC
Finney Co.

GEORGIAN
Electro-Voice, Inc.

GI
General Industries Co.

GIBSON GIRL
Robins Industries

G-I
Gee-Lar Mfg.

GLAMORAMIC
Radio Merchandise Sales

GLASLINE
Knights Co., James

GLASOHHM
Clarostat Mfg. Co.

GLASTERRA
Chase & Sons

GLASWITCH
Revere Corp. of America

GLOBE
American Standard TV Tube

GLOBE TROTTER
Radio Corp. of America

GLO-MELT
Wasco Electric Products

GOLD CUP
Carboneau Industries

GOLDEN THROAT
Radio Corp. of America

GOLDEN VOICE
Motorola, Inc.

GOLDEN WAND
Peerless Prods Industries

GOODMAN
Rockbar Corp.

GP
Erie Resistor Corp.

GRACOIL
Gramer-Halldorson Transformer

GREEN BAND
Todd-Tran Corp.

SHURE BULLET
Shure Bros.

GREENOHHM
Clarostat Mfg. Co.

GRIP-SPINTITE
Stevens Walden Inc.

GROMMES
Precision Electronics

GUIDE-A-TUBE
S/C Laboratories

GYRO-TENNA
Delson Mfg. Corp.

HACK SWAIN
Livingston Electronic

HALLDORSON
Gramer-Halldorson

HALLOWELL
Standard Pressed Steel

HALOLIGHT
Sylvania Electric

HAMS SWITCHES
Mallory & Co., Inc., P. R.

HANDIE-TALKIE
Motorola, Inc.

HAN-D-OHM
Cima Corp.

HANDY
Akro-Mils

HANDY-KIT
Insuline Corp. of America

HANDYPAK
Technicraft Co.

HARMIC
Wall Mfg. Co., P.

HARMONIC
Dean Sales

HAZ-BIN
Akro-Mils

HEARD EVERYWHERE
Lowell Mfg. Co.

HEATHKIT
Heath Co.

HELICON
Tibbetts Industries

HELIX
Biggs Co., Carl H.

HERCULES
Shure Bros.

H-E WAGON
Hamilton Electronics

HFS
National Co.

HI-BALL
Radiart Corp.

HI-FYRE
Master Electronics & TV

HI-KAPS
Centralab Div., Globe Union, Inc.

HIK
Erie Resistor Corp.

HI-K CERAMICON
Erie Resistor Corp.

HI-Q
Aerovox Corp.

HIRSCHMANN
American Elite, Inc.

HIS MASTER'S VOICE
Radio Corp. of America

HI-STAB
Erie Resistor Corp.

HI-TEMP
Consolidated Wire & Associated Companies

HI-TENSION
JFD Mfg. Co.

HI-TOP
Tele-Ex-Pand Corp.

HI-VO-DISCS
Centralab Div., Globe Union, Inc.

HI-VO-KAPS
Centralab Div., Globe Union, Inc.

HI-VOLT VOLTMETER
Industrial Devices Inc.

HOBBY-TIME
Western Coil & Electrical Co.

HOLGUN
Black & Decker

HONEYWELL
Micro Switch Div., Minn.-Honeywell

HORIZON
National Co.

HORTON SPEAKERS
Becker Electronics Mfg. Corp.

HOUSE OF RESISTORS
Clarostat Mfg. Co.

HOWDY DOODY
Shura-Tone Products

HOYT METERS
Burton-Rogers Co.

HQ
Hammarlund Mfg. Co.

HRO
National Co.

HUBBELL LOCK
Hubbell Inc., Harvey

HUDSON
Oxford Electric Corp.

HUMDINGER
Clarostat Mfg. Co.

HUSH
Chemical Electronic Components Corp.

HY/LOW
Stevens Products Inc.

HYPASS
Sprague Electric Co.

HYPEX
Jensen Mfg. Co.

ICA
Insuline Corp. of America

IHC
Illinois Condenser Co.

IHT
Illinois Condenser Co.

ILLINI-HYCAP
Illinois Condenser

ILLINI-300
Illinois Condenser

IMP
Carter Parts Co.

IMP
Winegard Co.

IMPERIAL
Jensen Mfg. Co.

IMPERIAL
Skylone Mfg. Co.

IMPERIAL
Int'l Radio & Electronics

IMPERIAL
Vakar Corp.

IMPERIAL KITS
D & M Products

IMS RECORD SPRAY
Silicone Spray Products

IN-A-GRIP
Stevens Walden Inc.

INCREDUCTOR
CGS Labs. Inc.

INDCO OIL
Industrial Condenser

INDOOR TENNA
Sprling Products

INDUCT-O-PHONE
Fenton Co.

INDUCTUBE
Drake Co., R. L.

INDUCTUNERS
Mallory & Co., P. R.

INLINE
American Phenolic

IN-LINE
JFD Mfg. Co.

IN-STA-COM
Marine View Electronics

INTELIN
Federal Telephone and Radio Co., Div. of IT&T

INTERCEPTOR
Winegard Co.

INTERLOCK
Hubbell Co., Harvey

INTER-MATIC
International Register

INT'L LEAGUER
Antonna Specialists

INVADER
Ward Products Corp.

IRA
Int'l Research Assoc.

IRC
Int'l. Resistance Co.

IRISH
ORRadio Industries Inc.

IRON GRIP
Equipo Div. Aurora

ISI
Int'l Scientific Industries

ISOHHM
CBC Electronics Co.

ISO-KAP
Centralab, Globe Union, Inc.

ISOPHON
Dunwell Mfg. Co.

JACKNIFE
Radio Merchandise Sales

JACKSON
Vulcan Electric Co.

JAVABOND
Javex

JAZZTATE
Int'l Pacific Record'g

JEF
Jarvis Electronics

JECO
Jarvis Electronics Div., Speer Carbon Co.

JET
Carboneau Industries

JETENNA
JFD Mfg. Co.

JET-HELIX
JFD Mfg. Co.

JETOMIC
JFD Mfg. Co.

JET PROBE
Workman TV, Inc.

JIFFY
Akro-Mils

JIFFY-TENNA
Delson Mfg. Corp.

JIL
James Instrument Labs.

JK PRODUCTS
James Knights Co.

JOLTA
Jan Hdw. Mfg.

JUNIOR
Hamilton Electronics

KANTARKS
Trico Fyse Mfg. Co.

KATOLIGHT
Kato Engineering

KENCO
Kenwood Eng'g Co.

K-51
Polymer Corp.

KILO
Kay Electric Co.

KINE-LITE
Vidair Electronics

KIN-EX
Vidair Electronics

KLEE NEEDLE
Robins Industries

KLEEN-SWEEP
Duotone Co.

KLIP
South River Metal

KLIPLOK
Trico Fuse Mfg. Co.

KLIPSCHORN
Klipsch & Associates

KLIPZON
United Technical Labs.

K-LOK
Erie Resistor Corp.

KNIGHT
Allied Radio Corp.

KOOLOHM
Sprague Electric Co.

KRAFTONE
Kraft Bros.

KRANK-UP MASTS
Jontz Mfg. Co.

KURMELEC
Kurman Electric Co.

KWIK
South River Metal

KWIK KLIP
South River Metal

KWICK-N-EASY
Jontz Mfg. Co.

KWICK-UP
Jontz Mfg. Co.

LABCAL
Berkshire Labs.

LABMARKER
Berkshire Laboratories

LABOHHM
Berkshire Laboratories

LABSTROBE
Berkshire Laboratories

LAMP-TENNA
S/C Labs. Inc.

LARGO
Permoflux Corp.

LAZY-X
Radiart Corp.

LEAK
British Industries

LEDEX
Leland Inc., G. H.

LEMCO
Lytle Eng'g. & Mfg.

LEVER-TYPE
Shure Bros.

LEV-R SWITCHES
Switchcraft, Inc.

LEWIS VERTICAL
Universal Products

LIFETONE
Duotone Co.

LIFT-A-DOR
Alliance Mfg. Co.

LIGHTNING LIFT
Atlas Overhead Door

LINE-O-LIFE
Carter Motor Co.

LITEMASTER
Art Specialty Co.

LITTEL JAX
Switchcraft, Inc.

LITTEL PLUGS
Switchcraft, Inc.

LITTLE BERTHA
Telrex Labs.

LITTLE CHAMP
Malin Enterprises

LITTLE DEVIL
Ohmite Mfg. Co.

LITTLE GIANT
JFD Mfg. Co.

LITTLE JEWEL
Danforth Mfg. Co.

LITTLE NIPPER
Radio Corp. of America

LL300
Buchen Co., R. J.

LL450
Buchen Co., R. J.

LOAD-D-X
Radiart Corp.

LOGATEN
Kay Lab.

LONG RANGER
Ward Products Corp.

LONG SHOT
Antenna Products

LOOPSTICK
Superex Electronics

LORENZ
Kingdom Products

LO-VOLT TESTER



LUSTERIZED American Electric Cable

LYNN Vaco Products Co.

LYRICHORD Livingston Electronic

LYTICAP Planet Mfg. Co.

LYT-L TUNER Lytle Engineering

McMITE McCoy Electronics Co.

MAESTRO Permaflux Corp.

MAG-ELECTRIC National Aircraft

MAGIC EYE Radio Corp. of America

MAGIC MONITOR Radio Corp. of America

MAGIC-TEE Plymouth Electronics

MAGIC-TIP Hunter Tools

MAGMOTOR Carter Motor Co.

MAGNAPHONIC Magnasync Mfg. Co.

MAGNA-TORC Hansen Mfg. Co.

MAGNECORDER Magnecord Inc.

MAGNELOOP Amplifier Corp. of America

MAGNEMITE Amplifier Corp. of America

MAGNEPAIN Micro-Circuits Co.

MAJORETTE Major Electronics Co.

MAJOR LEAGUER Antenna Specialists

MANAGER Fanon Electric

MANHATTAN Radion Corp.

MARBELITE Good-All Elec. Mfg.

MARINERS PATHFINDER Raytheon Mfg. Co.

MARKA Kay Electric Co.

MARK TWAIN Raytheon Mfg. Co.

MARVELCO National Aircraft

MARVELITE CBC Electronics Co.

MARVELCO National Aircraft

MASCO Simpson Mfg. Co., Mark

MASTERLINE Blender-Tongue Labs.

MASTERTAPE Audio-Master Corp.

MASTER-TENNA Radio Corp. of America

MAVERICK Channel Master

MAX-MIXER Special Products

MEGA-PIX Kay Electric Co.

MEGA SWEEP Kay Electric Co.

MEG-O-MAX Sprague Electric Co.

MEISSNER Thordarson-Meissner

MELLOTONE Electronic Enterprises

MELODIER Waters-Conley Co.

MEMOTRON Hughes Aircraft Co.

MERCURY Electro-Voice, Inc.

MERCURY Vulcan Electric Co.

MERTONE Autocrat Electronics Co.

METALITE Astron Corp.

METER-MATIC International Register

METER-MATIC Lelich Eng'g

METRO Radion Corp.

METRO Telematic Industries

METROPOLITAN Radion Corp.

MICAP Micramold Radio Corp.

MICRO Kay Electric Co.

MICRO Trans-Mite Radio Lab.

MICRO CIRCLE Precise Measurements

MICRO-GAP Shure Bros.

MICROLATOR Kay Electric Co.

MICRO-MIXER Kay Lab.

MICROPAINT Micro-Circuits Co.

MICROTHERM Raytheon Mfg. Co.

MICROTRAN Crest Laboratories Inc.

MIDGET Sprague Electric Co.

MIDGETESTER Simpson Electric Co.

MIDGETROL Mallory & Co., P. R.

MIKESTER Art Specialty Co.

MILLIMAG Transistor Products, Inc.

MINI-BEAM Telrex Labs.

MINIBOX Bud Radio Inc.

MINI-CON Switchcraft, Inc.

MINI-COUPERS Javex

MINIFON Interstate Photo

MINI-KIT Insuline Corp.

MINI-MIX Switchcraft, Inc.

MINI-PLATES Javex

MINISEL Electronic Devices

MINI-SOCKETS Javex

MINI-VOLT VOLTMETER Industrial Devices, Inc.

MIN-KAPS Centralab Div., Globe Union, Inc.

MIRO-POINT Duatone Co.

MIRROR-TONE Scott Radio Labs.

MI-TEE-RAY Fretco Inc.

MITEY-MITE Jantz Mfg. Co.

M-JAX Switchcraft, Inc.

MOBILFONE Mobile Electronics Mfg.

MOBILTONE Mobil Electronics

MOLARC Mole-Richardson Co.

MOLD-KAP Centralab Div., Globe Union, Inc.

MOLDTYPE United Condenser Corp.

MOLD-X American Radion Co.

MONARCH British Electronic

MONITOR Radio Merchandise Sales

MONOPLEX Shure Bros.

MONOSET Telex, Inc.

MORRICE Jordan Mfg. Co.

MOTEK Fenton Co.

MOTEX TAPE DECK Fenton Co.

MOTORLYC Micamold Radio Corp.

MOUNTIE Danforth Mfg. Co.

MOVIE-CLEAR Sylvania Electric Products

MUGWUMP Radio Merchandise Sales

MULTIBOOSTER Industrial Television

MULTI-MODE Tele-Beam Industries

MULTI-RAY Barb City Industries

MULTIPLE UNIT Hevl Duty Electric Co.

MULTIPIX Chicago Ind. Instrument

MULTITESTER Barrett Electronics

MUL-TEL Brach Mfg. Corp.

MULTICOUPLER Amy, Aceves & King

MULTI-DRAWERS Cincinnati Ventilating

MULTI-SWITCHES Switchcraft, Inc.

MUSICAL MASTER

Greene Co., L. Charlton

MUSIC LOVER Shure Bros.

MUSITAPES Tempo Record Co.

MUTED SYLLUS Shure Bros.

MYERS Allweather Antennas

MYKAPLAST United Condenser Corp.

NA-ALD Alden Products Co.

NABROC Hitemp Wires, Inc.

NATCO National Co.

NATFAB Hoffman Electronics

NEPCO National Electric Products Corp.

NEPCOLINE National Electric Products Corp.

NEVATIP Radio Merchandise Sales

NEVER-STAIN Nichols Wire & Aluminum Co.

NIPPER Radio Corp. of America

NITELIGHTER Fisher-Pierce Co.

NOBLELOY Continental Carbon Inc.

NOBLETTE Continental Carbon Inc.

NO NOISE Electronic Chemical

NO-OX Walsco Electronics Corp.

NORMA United Audio Prods.

NTT National Tel-Tronics

NUMECHRON Pennwood Numechron

NYCO New York Coil Co.

NYLAFLOW Polymer Corp.

NYLASINT Polymer Corp.

NYLATRON Polymer Corp.

OBSERVER Blender-Tongue Labs.

OCEANIC Livingston Electronic

O-GYRO Dynamic Electronics

OHM Shallcross Mfg. Co.

OHM-SPUNE States Co.

OILMITE Deutschmann Corp., T.

OMEGATAPE Int'l Pacific Recording

OMNI-GLOW PILOTLIGHT Industrial Devices

OPTO-MATIC Trico Fuse Mfg. Co.

ORPHEUS Int'l Research Assoc.

ORYX American Mercantile

ORYX TV Accessories Co.

OSCIL-O-PEN General Test Equipment Co.

OV-O-LINE Atlantic Wire & Cable Corp.

PACE Precision Apparatus

PACEMAKER Bell Sound Sys.

PACE-SETTER JFD Mfg. Co.

PAINTON British Electronic

PAL JFD Mfg. Co.

PAMCO Paraplegic Mfg. Co.

PANCOUSTIC U. S. Recording Co.

PANDUX Pacific Transducer

PAN-I-LITE Alden Products Co.

PANORAMIC Radio Merchandise

PARABORAY Neal Electronic Co.

PARACON Ward Products Corp.

PARA-FLUX Radio Music Corp.

PARANITE Essex Wire Corp.

PATRICIAN Electro-Voice, Inc.

PARTRIDGE British Electronic Sales

P & B Potter & Brumfield

P.E.C. Centralab Div., Globe Union, Inc.

PECO Panama Electronics Co.

PEERAGE Electro-Voice, Inc.

PEERLESS Altec Lansing Corp.

PEE-WEE Mueller Electric Co.

PENDET Centralab Div., Globe Union, Inc.

PENN-TRAN Penn Transformer Corp.

PEN-OSCIL-LITE General Test Equipment

PERCO Linell Eng'g Corp., CS

PE REX Fenton Co.

PERM-A-CAPS Chicago Condenser

PERMALINE Columbia Wire & Supply

PERMASEAL Sprague Electric Co.

PERMA-TUBE Jones & Laughlin Steel

PERMO-SWITCH Centralab Div., Globe Union, Inc.

PET LINES Portable Electric Tools

PFAN-TONE Pfanstiehl Chemical Co.

PHANTOM PLASTICS Tele-Beam Industries

PHAZOR Industrial Test Equip.

PHOENIX SPEED-TENNAS Phoenix Electronics, Inc.

PHONO-DOODLE Shure-Tone Products

PHONOLA Waters Conley Corp.

PHONOSTROBE Berkshire Laboratories

PHOTOTRON Thomas Electronics, Inc.

PICBOOST CBC Electronics Co.

PICK-A-SHAFT Clarostat Mfg. Co.

PIC-SYNC TAPE Fairchild Recording Equip. Co.

PIC-TRON Tube Service Corp.

PILOTONE Pilot Radio Corp.

PILOTUNER Pilot Radio Corp.

PINHEAD Sprague Electric Co.

PIONEER Walsco Electronics

PIP-JET JFD Mfg. Co.

PISTOGRIP Wall Mfg. Co., P.

PIXIE Winegard Co.

PLASTICON Condenser Products Co.

PASTICORD Chester Cable Corp.

PLASTICOTE Chester Cable Corp.

PLASTI-PAK Centralab Div., Globe Union, Inc.

PLASTISEL Electronic Devices

PLEXICON Eric Resistor Corp.

PLYMOUTH Calortone Electronics

PLYTUBULAR Tennalab

POLEX Union Plastics Corp.

POLYCOUPLER CGS Labs., Inc.

POLYKEN Kendall Co.

POLYPENCO Polymer Corp.

POLYPHANE Technical Tape Corp.

PORTA-KALL Loge Sound Engrs., J. M.

PORT-A-PHONE Feller Eng'g & Mfg. Co.

PORTAPLEX Chiago Ind. Instrument Co.

PORTOFONIC Dynavox Corp.

PORTO SNEARS Black & Decker

PORTROLA Bell Sound Systems

POWER FIREBALL JFD Mfg. Co.

POWER HELIX JFD Mfg. Co.

POWER-PAGE University Loudspeakers

POWERSEL Electronic Devices

POWR BLOX Authorized Mfg. Co.

POWR-KORD Royal Electric Co.

POWRMIKE University Loudspeakers

POWR PAKT Alliance Mfg. Co.

POWR-RIB Ohmite Mfg. Co.

PRECEDENT Radio Engineering Labs.

PREH American Elite, Inc.

PRINCE Int'l Radio & Electr

PROFESSIONAL Trimm, Inc.

PROKAR Sprague Electric Co.

PYGYM Vulcan Electric Co.

QI Superex Electronics Corp.

QUAD Beam Instruments Corp.

QUADNAURAL Dynamic Electronics

QUADRILINE Radio Engineering Labs

Q-2005 Polymer Corp.

QUARTET Callfane Corp.

QUICK-WEDGE Kedman Co.

QUICK-RIG JFD Mfg. Co.

QUIK-SHOT Kemade Mfg.

QUINTENNA Tennalab

R & A British Electronic

RADA Kay Electric Co.

RADALIGNER Kay Electric Co.

RADAMETER Raytheon Mfg. Co.

RADOR Atlas Overhead Door

RADARANGE Raytheon Mfg. Co.

RADAX Electro-Voice, Inc.

RADIOCRATER Technicraft Co.

RADIODYNE Western Coil & Electrical Co.

RADIOHM Centralab Div., Globe Union, Inc.

RADIOLA Radio Corp. of America

RADIO'S MASTER United Catalog Pub.

RADIOTRON Radio Corp. of America

RAINBOW JFD Mfg. Co.

RALTEX Technical Tape Corp.

RANGER Shure Bros.

RAREOX Rare Earths, Inc.

RAY-SCOPE Di-Co TV & Plastic Co.

RAYOFLEK Walsco Electronics

RCA VICTOR Radio Corp. of America

RCP Radio City Products Co.

REACTION United Condenser Corp.

RECITALIST Rek-O-Kut Co.

RECORDIO Wilcox-Gay Corp.

RE-CORD-O-FONE Bell Sound Systems, Inc.

RECTICHARGER Raytheon Mfg. Co.

RECTIFILTER Raytheon Mfg. Co.

RECTISEL Electronic Devices, Inc.

RECTODYNE JFD Mfg. Co.

RECIPOLYN Christy Corp.

RECTO POWER Mallory & Co., P. R.

REDI-RIG Radio Merchandise Sales

RED SEAL Radiart Corp.

RED SEAL Radio Corp. of America

RED-WOOD JFD Mfg. Co.

REGENCY Electro-Voice, Inc.

REGENCY IDEA, Inc.

REG-O-MATIC CBC Electronics Co.

REGOVAC Technical Apparatus

REK-O-KLEEN Kral Products

REL Radio Engineering Labs.

RELIATRON Westinghouse Electric

REMBRANDT All Channel Antenna

RESLO Fenton Co.

RETEP Hitemp Wires, Inc.

REVCOTHENE Revere Corp. of America

REX American Elite

REX Fenton Co.

REX Shure Bros.

RIVERSIDE Livingston Electronic

RHYTHMASTER Rek-O-Kut Co.

RICHMOND Lowell Mfg. Co.

RICHOMATIC Television Remote Control Co.

RITEOHM Ohmite Mfg. Co.

RMS Radio Merchandise Sales

ROCKETENNA TV Products Co.

ROLLOCON Circon Component Co.

ROLLPIN (R) Elastic Stop Nut Corp.

RONDINE Rek-O-Kut Co.

ROTALYZER Kay Electric Co.

ROTO-KING JFD Mfg. Co.

ROTO-RANGER Simpson Electric Co.

ROTO-TENNA Motorola, Inc.

ROTOR QUEEN Radio Merchandise Sales

ROYAL Permaflux Corp.

ROYAL-NOARK Royal Electric

R & P RECESS Reed & Prince

RPC Resistance Products Co.

RSE Radio Supply & Eng'g Co.

RTV-PROGRAM Clarostat Mfg. Co.

RYTEL Cal-Lee Mfg.

SABRE Welco Mfg. Co.

SAFE-T-KLIP Industrial Devices Inc.

SAFETVISION Bennett Laboratories

SAFETY MARGIN Astron Corp.

SAFETY-MATIC Columbus Eng'g

SAUCERLINE Fretco Inc.

SAXL Tensitron, Inc.

SCINTILLATOR Precision Radiation Instr

SCOTCH
Minnesota Mining & Mfg. Co.

SCRUGUN
Black & Decker

SECRET RECORDER
Amplifier Corp. of America

SECTOR
Jensen Mfg. Co.

SEEZAK PRODUCTS
U. M. & F. Mfg. Corp.

SELECT-A-CALL
Telecom, Inc.

SELECTOHM
Chicago Industrial Instrument Co.

SELET-O-VISION
Mullin Enterprises

SELETRON
Radio Receptor Co.

SELFOCUS
DuMont Labs., Allen B.

SELPO
Self-Lifting Piano Truck

SENCO
Service Instruments

SENIOR
Hamilton Electronics

SENSI-BEAM
Antenna Products

SERAMELITE
Good-All Elec. Mfg. Co.

SERRASOID
Radio Engineering Labs.

SERV-A-UNIT
Alden Products Co.

SERVICE ENGINEERED
Jackson Electrical Instrument Co.

SERVICE SPOOL
Alpha Wire Corp.

SERVOTRON
Raytheon Mfg. Co.

7 STAR
Tele-Ex-Pand Corp.

SHELF-PAK
Centralab Div., Globe Union, Inc.

SHOPMATE
Portable Electric Tools

SHORTHORN
Klipsch Associates

SHUT-OUT
JFD Mfg. Co.

SIE
S W Industrial Electr

SIGHTMASTER
Art Specialty Co.

SIGNA-GLOW
Industrial Devel Labs

SIGNALETTE
Lytle Eng'g. & Mfg.

SIGNA-MATCHER
Centralab Div., Globe Union, Inc.

SIGNATURE
Lansing Sound Inc., James B.

SILENT-SOUND
General Phones

SILERTEX
Erle Resistor Corp.

SILIKONE
Ebarc Electronics

SIL-LUBE
Ebarc Electronics

SILVER ARROW
Fretco, Inc.

SILVERCEL
Yardney Electric

SILVERLINE
General Instrument

SILVER WAND
Peerless Products

SIMPLEX
Chicago Industrial Instr. Co.

SK
Skottle Electronics Inc.

SKYCHIEF
Camburn Inc.

SKY-HI
Thomas Mold & Die Co.

SKYLARK
Electro-Voice, Inc.

SKY-LOK
JFD Mfg. Co.

SKY-MASTER
Jewell Inc., A. W.

SLENOYNE
Shure Bros.

SLIMAIR
Electro-Voice, Inc.

SLIM-X
Shure Bros.

SLIP-DRIVE
Clarostat Mfg. Co.

SLUMBERTONE
Electro Sound Corp.

SMA
Lytle Eng'g. & Mfg. Co.

SMALL BROADCAST
Shure Bros.

SMALL UNIDYNE
Shure Bros.

SMART SET
Calbest Eng'g & Electronics Co.

SMATCO
Stone City Machine

SMITH-BALDWIN
SPEAKERS
Consolidated Radio Products

SMITTY
Hunter Tools

SNAPOUT RIGID-RIG
Medal Mfg. Co.

SNAPPER
Curtiss-Wright

SNAP-TITE
Centralab Div., Globe Union, Inc.

SNS
Special Products

SNAPPER CLIP
Mueller Electric Co.

SNYDERMATIC
Snyder Mfg. Co.

SOLARSPTS
Male-Richardson Co.

SOLAVOLT
Sola Electric

SOLDERALL
Brach Mfg.

SOLDER MASTER
Hexacon Electric Co.

SOLDER-QUIK
Stark Mfg.

SOLDERWHIZ
Wassco Electric Products Corp.

SONA
Kay Electric Co.

SONALINE
Kay Electric Co.

SONARMETER
Raytheon Mfg. Co.

SONODYNE
Shure Bros.

SOPHOMORE
Hamilton Electronics

SOUNDCRAFT
California Cabinet

SOUNDCRAFT
Reeves Soundcraft Corp.

SOUND IN THE ROUND
Concertapes Inc.

SPAR
Video Accessory Mfg. Co.

SPEAR
British Electronic Sales

SPECO
Special Products

SPEECH MASTER
Jensen Mfg. Co.

SPEED-CESSORIES
Phoenix Electronics, Inc.

SPEE-DEE
Radiart Corp.

SPEDEX
General Cement Mfg.

SPEE-D-LOK
Radio Merchandise Sales, Inc.

SPEED-MOUNTS
Phoenix Electronics

SPEEDTENNAS
Phoenix Electronics

SPHEREX
Electro-Voice, Inc.

SPICE-CHEST
Guild Radio & TV Co.

SPICO SUPER PHANTOM
Spirling Products Co.

SPINLAB
Special Instruments Lab., Inc.

SPINTITE
Stevens Walden Inc.

SPIRAFIL
Phelps Dodge Copper Prods

SPIRAL-TENNA
Hilo TV Antenna Corp.

SPONGEE
Imperial Radar & Wire Corp.

SPRAINT
Waldom Electronics

SPRAYWAY
Tru-Pine Co.

STABLEX CAPACITORS
Industrial Condenser Corp.

STACO
Standard Electrical Products Co.

STANCOR
Chicago Standard Transformer Corp.

STANDEE
Clarostat Mfg. Co.

STA-PUT
Consolidated Wire & Associated Cos.

STANDO
Parker Metal Goods

STAR-HELIX
JFD Mfg. Co.

STARLIGHT
Metzner Eng'g Corp.

STARLINE
Duatone Co.

STATI-CLEAN
Electrovox Co.

STATI-MUTE
Eby Sales Co.

STAVOLT
McColpin-Christie Corp.

STEACAP
Micamold Radio Corp.

STEELEBINDER
Gerrard & Co., A. J.

STENO
Crescent Industries

STENTORIAN
Beam Instruments Corp.

STEP-SERVO
Bergen Labs.

STEREO-MAGNEMITE
Amplifier Corp. of America

STEREOSCOPIC
Radio Merchandise Sales, Inc.

STERLING CABLE
Beam Instruments Corp.

STRATO
Spirling Products Co.

STRATOBELM
Antenna Products

STRATOLINER
Shure Bros.

STRATO TOWERS
Pipestone Sales Co.

STRATO-TOWERS
Spaulding Products Co.

STRIP-EASE
Radix Wire Co.

STRIPMASTER
Ideal Industries, Inc.

STYROFLEX
Phelps Dodge Copper

SUPER-BEAM
JFD Mfg. Co.

SUBURBAN
Radion Corp.

SUPERBULLSEYE
Radion Corp.

SUPER CAP
United Electronic Mfg.

SUPER ROYAL
Permaflux Corp.

SUPER-SCANNER
TV Products Co.

SUPER-SONAX
Electro-Voice, Inc.

SUPER SPECTRUM
Fretco Inc.

SUPER STAR HELIX
JFD Mfg. Co.

SUPERTENNA
Tennalab

SUPER THUNDER BIRD
Telrex Labs.

SUPER-X
Camburn, Inc.

SWING-BIN
Akra-Mills

SWITCHMASTER
Tork Clock Co.

SWITCHMAT
Recora Co.

SWIVELBEAM
Radio Merchandise

SWIVLTOP
Moody Machine Products Co.

SYMPHONETTE
Electronic Utilities

SYMPHONETTE
Hedco Mfg. Corp.

SYNCHRON
Hansen Mfg. Co.

SYNCROLL DRIVE
Fairchild Recording Equip. Co.

SYNKINETIC
Magnasync Mfg.

SYNKOTE
Plastold Corp.

SYNTHINOL
Consolidated Wire & Associated Cos.

SYNTHOLVAR
Varflex Corp.

TABLITE
Technical Apparatus

TABPAK
Technical Apparatus

TABTRAN
Technical Apparatus

TACO
Technical Appliance

TALKING COMICS
Kraft Bros.

TAPE-O-MATIC
V-M Corp.

TAPGUN
Black & Decker

TARGET
S & A Electronics

TEECO
Trutone Electronics

TEFEX
Union Plastics Corp.

TEFIFON
Audio-Master Corp.

TEFLON
Polymer Corp.

TELAIDES
Wallace's Telades

TEL-AIR
Tele-Beam Industries

TELA-SET
Telex, Inc.

TEL-ATTEN
Vidair Electronics

TELECABLE
Whitney Blake Co.

TELECAP
Sprague Electric Co.

TELE-CHECK
Telematic Industries, Inc.

TELECON
Teletenna Co.

TELE-COUPLER
Vidair Electronics

TELEFUNKEN
American Elite, Inc.

TELEFUNKEN
London Int'l Records

TELE-MATCH
Vidair Electronics

TELE-MIX
Hamilton Electronics

TELE-MOBILE
Tele-Ex-Pand Corp.

TELE-PLEX
JFD Mfg. Co.

TELERING
Telkor Inc.

TELETALK
Webster Electric Co.

TELETRON
Dumont Labs., Allen B.

TELE-TWIN
JFD Mfg. Co.

TELE-VANES
Ward Products Corp.

TELEVER SWITCHES
Switchcraft, Inc.

TELEVOLTER
Jackson Electrical Instrument Co.

TEL-OHMIKE
Sprague Electric Co.

TELVAC
Television Accessories

TEMPCLAD
Hittemp Wires

TEMPRENE
Hittemp Wires

TEMPREX
Hittemp Wires

TEMPRITE
Hittemp Wires

TEMPTUBE
Hittemp Wires

TENNA-CLAMP
Mueller Electric Co.

TENNA-CLIP
Industrial Television

TENNA-LINER
Crown Controls Co.

TENNA-MASTER
Spirling Products Co.

TENNA-MATCH
Vidair Electronics

TENNA-PAK
JFD Mfg. Co.

TENNA ROTOR
Alliance Mfg. Co.

TENNA-SHINGLE
Javex

TENNA-SWITCH
Leader Electronics

TENNA-SWITCH
Vidair Electronics

TENNATUBE
National Electric Products Corp.

TENNA-TUBE
Javex

TENNA TUNER
Kato Engineering

TENSOLEX
Tensolite Insulated Wire

TENSOLON
Tensolite Insulated Wire

TEN SPOT
Fenton Co.

TEN-TENNA
Waldom Electronics

TESCON
TV Products Co.

TEST MASTER
Precision Apparatus Co.

TEST-O-LITE
Brach Mfg. Corp.

TESTOMETER
United Mfg. Co. Div., W. L. Maxson Corp.

THERMALON
Hittemp Wires

THERMOCUBE
Radio Engineering Labs.

THERMO-GRIP
Ideal Industries

THERM-O-METER
Simpson Electric Co.

THERMOROD
Technicraft Co.

THERMYSTAL
Knights Co., James 3-PI

THE SAURUS
Radio Corp. of America

THRUPASS
Sprague Electric Co.

THUNDER BIRD
Telrex Labs.

TICO
Livingston Electronic

TI-MATCH
Camburn, Inc.

TIME-ALL
International Register

TIMES RECORDS
Cook Laboratories, Inc.

TINI-JAX
Switchcraft, Inc.

TINI-PLUGS
Switchcraft, Inc.

TINY GLOW
Industrial Devices, Inc.

TINYFORMER
Gramer-Halldorson

TINY TEMP
Knights Co., James

TIPWRENCH
Smith Heat Treating Co.

TITONE
Sonatone Corp.

T-JAX
Switchcraft, Inc.

TNT TOTE BOXES
Mastra Co.

TOBE
Deutschmann Corp., ToBe

TOBEMITE
Deutschmann Corp., ToBe

TOMAHAWK
Stevens Walden Inc.

TOMBONE
Ward Products Corp.

TOM THUMB
Automatic Radio Mfg.

TOM THUMB
Spirling Products Co.

TOPPER
Camburn, Inc.

TORKMASTER
Tork Clock Co.

TOWERETTE
Easy-Up, Inc.

TOWN & COUNTRY
Kraft Bros.

TRAILER-TENNA
Clear Beam Antenna

TRAK
CGS Labs., Inc.

TRANSALYZER
Kay Electric Co.

TRANSCENDENT
Brodnier Electronics

TRANSCO
Coll Co. of America

TRAPPER
Technical Appliance

TRIAIAL
Jensen Mfg. Co.

TRICO
Trico Fuse Mfg. Co.

TRI-FLY
Tape Recorders, Inc.

TRIG-R-HEAT
Wall Mfg. Co., P.

TRIG-R-TROL
Turner Brass Works

TRI-O-MATIC
V-M Corp.

TRI-PAK
Reed & Prince

TRI-PLEX
Jensen Mfg. Co.

TRI-TRAN
Triwec Transformer Co.

TROMBONE
Ward Products Corp., Div. The Gabriel Co.

TROPICANA
Technicraft Co.

TROPICAP
Micamold Radla Corp.

TRU-OHM
Model Eng'g. & Mfg. Co.

TRU-SONIC
Stephens Mfg. Corp.

TRYLON
Wind Turbine Co.

TSC
Technicraft Co.

TUBE-MASTER
Precision Apparatus Co.

TUCK
Technical Tape Corp.

TUF-FLEX
Millers Falls Co.

TUF-GUY
Fenton Co.

TUNER-TONIC
Electronic Chemical Corp.

TUNE TAPE
Miller Electronics

TURBO
Brand & Co., Wm.

TURBOLENE
Brand & Co., Wm.

TURBOLEX
Brand & Co., Wm.

TURBOTHERM
Brand & Co., Wm.

TURBOTRANS
Brand & Co., Wm.

TURBOTUF
Brand & Co., Wm.

TV-DUETTE
Jensen Mfg. Co.

23-CLIPPER
Centralab Div., Globe Union, Inc.

TWILT
Electro-Voice Inc.

TWIN
Fanon Electric Co.

TWIN-LEVER
Shure Bros.

TWINSET
Telex Inc.



BRAND & TRADE NAME INDEX

TELE-PLEX
JFD Mfg. Co.

TELERING
Telkor Inc.

TELETALK
Webster Electric Co.

TELETRON
Dumont Labs., Allen B.

TELE-TWIN
JFD Mfg. Co.

TELE-VANES
Ward Products Corp.

TELEVER SWITCHES
Switchcraft, Inc.

TELEVOLTER
Jackson Electrical Instrument Co.

TEL-OHMIKE
Sprague Electric Co.

TELVAC
Television Accessories

TEMPCLAD
Hittemp Wires

TEMPRENE
Hittemp Wires

TEMPREX
Hittemp Wires

TEMPRITE
Hittemp Wires

TEMPTUBE
Hittemp Wires

TENNA-CLAMP
Mueller Electric Co.

TENNA-CLIP
Industrial Television

TENNA-LINER
Crown Controls Co.

TENNA-MASTER
Spirling Products Co.

TENNA-MATCH
Vidair Electronics

TENNA-PAK
JFD Mfg. Co.

TENNA ROTOR
Alliance Mfg. Co.

TENNA-SHINGLE
Javex

TENNA-SWITCH
Leader Electronics

TENNA-SWITCH
Vidair Electronics

TENNATUBE
National Electric Products Corp.

TENNA-TUBE
Javex

TENNA TUNER
Kato Engineering

TENSOLEX
Tensolite Insulated Wire

TENSOLON
Tensolite Insulated Wire

TEN SPOT
Fenton Co.

TEN-TENNA
Waldom Electronics

TESCON
TV Products Co.

TEST MASTER
Precision Apparatus Co.

TEST-O-LITE
Brach Mfg. Corp.

TESTOMETER
United Mfg. Co. Div., W. L. Maxson Corp.

THERMALON
Hittemp Wires

THERMOCUBE
Radio Engineering Labs.

THERMO-GRIP
Ideal Industries

THERM-O-METER
Simpson Electric Co.

THERMOROD
Technicraft Co.

THERMYSTAL
Knights Co., James 3-PI

THE SAURUS
Radio Corp. of America

THRUPASS
Sprague Electric Co.

THUNDER BIRD
Telrex Labs.

TICO
Livingston Electronic

TI-MATCH
Camburn, Inc.

TIME-ALL
International Register

TIMES RECORDS
Cook Laboratories, Inc.

TINI-JAX
Switchcraft, Inc.

TINI-PLUGS
Switchcraft, Inc.

TINY GLOW
Industrial Devices, Inc.

TINYFORMER
Gramer-Halldorson

TINY TEMP
Knights Co., James

TIPWRENCH
Smith Heat Treating Co.

TITONE
Sonatone Corp.

T-JAX
Switchcraft, Inc.

TNT TOTE BOXES
Mastra Co.

TOBE
Deutschmann Corp., ToBe

TOBEMITE
Deutschmann Corp., ToBe

TOMAHAWK
Stevens Walden Inc.

TOMBONE
Ward Products Corp.

TOM THUMB
Automatic Radio Mfg.

TOM THUMB
Spirling Products Co.

TOPPER
Camburn, Inc.

TORKMASTER
Tork Clock Co.

TOWERETTE
Easy-Up, Inc.

TOWN & COUNTRY
Kraft Bros.

TRAILER-TENNA
Clear Beam Antenna

TRAK
CGS Labs., Inc.

TRANSALYZER
Kay Electric Co.

TRANSCENDENT
Brodnier Electronics

TRANSCO
Coll Co. of America

TRAPPER
Technical Appliance

TRIAIAL
Jensen Mfg. Co.

TRICO
Trico Fuse Mfg. Co.

TRI-FLY
Tape Recorders, Inc.

TRIG-R-HEAT
Wall Mfg. Co., P.

TRIG-R-TROL
Turner Brass Works

TRI-O-MATIC
V-M Corp.

TRI-PAK
Reed & Prince

TRI-PLEX
Jensen Mfg. Co.

TRI-TRAN
Triwec Transformer Co.

TROMBONE
Ward Products Corp., Div. The Gabriel Co.

TROPICANA
Technicraft Co.

TROPICAP
Micamold Radla Corp.

TRU-OHM
Model Eng'g. & Mfg. Co.

TRU-SONIC
Stephens Mfg. Corp.

TRYLON
Wind Turbine Co.

TSC
Technicraft Co.

TUBE-MASTER
Precision Apparatus Co.

TUCK
Technical Tape Corp.

TUF-FLEX
Millers Falls Co.

TUF-GUY
Fenton Co.

TUNER-TONIC
Electronic Chemical Corp.

TUNE TAPE
Miller Electronics

TURBO
Brand & Co., Wm.

TURBOLENE
Brand & Co., Wm.

TURBOLEX
Brand & Co., Wm.

TURBOTHERM
Brand & Co., Wm.

TURBOTRANS
Brand & Co., Wm.

TURBOTUF
Brand & Co., Wm.

TV-DUETTE
Jensen Mfg. Co.

23-CLIPPER
Centralab Div., Globe Union, Inc.

TWILT
Electro-Voice Inc.

TWIN
Fanon Electric Co.

TWIN-LEVER
Shure Bros.

TWINSET
Telex Inc.

TWIN-TILT Electro-Voice Inc.	UNI-RACK Alden Products Co.	VARI-LOOPSTICK Superelex Electronics	VIDI-TONE Electron-Rodar	VOLT-OHMATIC Bergen Labs.	WIN-TRONIX Winston Electronics Inc.
TWIN-TRAX RECORDER Amplifier Corp. of America	UNIT-IZED Setchell-Carlson	VARIPOLE Califone Corp.	VIDI-TROL Electron-Rodar	VORTEXION TAPE Fenton Co.	WIRELESS INTERCOM Feiler Eng'g. & Mfg.
TWIN TUBE North American Model Prod.	UNITONE Duotone Co.	VARPAK Deuschmann Corp., T.	VIKING Forsberg Mfg. Co.	VO-TRON Vokar Corp.	WIRENUT Ideal Industries
TWISTLOCK Hubbell Inc., Harvey	UNIVERSAL Mueller Electric Co.	VARIOSCOPI Radio Merchandise Sales	VIKING SPEAKERS Jensen Mfg. Co.	VU MAGNEMITE Amplifier Corp. of America	WIREWATT Ohmrite Mfg. Co.
TWIST-LOK Sprague Electric Co.	URBANETTE Videon Electronic Corp.	VARRO Davis Electronics	VIL-MAGNEMITE Amplifier Corp. of America	WONDERO Workman TV, Inc.	WONDERO Columbia Products Co.
TWISTUBE Fenton Co.	UTC United Transformer Co.	VARSITY Hamilton Electronics	VINEX Union Plastics		
TWO-TIMER Vocaline Co. of America Inc.	UTONE Utah Radio Products Co.	VASCO Mitchell Industries Inc.	VISCOFILM Industrial Condenser	WALCO Electrovox Co.	XCEL Xcelite, Inc.
TYNISWITCH Sessions Clock Co.		VEE-BEAM JFD Mfg. Co.	VISITRON Rauland Corp.	WALDEN Stevens Walden Inc.	XELA Klein & Sons, M.
		VEE-D-X Lapoint Electronics	VIS-U-ALL Television Engineers Inc.	WALLY Wall Mfg. Co., P.	XTALATOR Kay Electric Co.
		VELA Video Electronic Lab.	VITAMETER Electronic Test Instrument	WEATHER MASTER Jensen Mfg. Co.	X-VAR Fidelity Chemical Products
		VERSA-TOOL Phillips Mfg. Co.	VITAMIN Q Sprague Electric Co.	WEEBEE Webster-Chicago Corp.	
ULTRA Kay Electric Co.	VACDAC Technical Apparatus	VERSI-MOUNT Radio Merchandise Sales	VITROHM Ward Leonard Electric	WEE-PEE-WEE CLIP Mueller Electric Co.	YAGI HELIX JFD Mfg. Co.
ULTRA-BEAM Camburn Inc.	VAGABOND Int'l Research Assoc.	VERTICAL DRIVE Shure Bros.	V-LINE Millers Falls Co.	WELDPPOWER Raytheon Mfg. Co.	YOK-EX Vidaire Electronics
ULTRA-TELECON Teletenna Co.	VAGABOND Shure Bros.	VIBRAPACK Mallory & Co., P. R.	V & M National Tel-Tronics	WHALE Forsberg Mfg. Co.	
ULTRATONE Audio Industries Inc.	VAM Video Accessory Mfg. Co.	VIBRALYZER Kay Electric Co.	V-M, THE VOICE OF MUSIC V-M Corp.	WHARFEDALE British Industries Corp.	
ULTRAVERTER Blonder-Tongue Labs.	VARFLO Varflex Corp.	VICTOR Radio Corp. of America	VOCATRON Vocaline Co. of America	WHETHA-TUBE Wheatland Tube Co.	ZEC-BEAM Welco Mfg. Co.
U-MIX-IT Technicraft Co.	VARGLAS SILICONE Varflex Corp.	VICTORIA Fretco Inc.	VOLTA-CHEK Electronic Test	WHIRL-TENNA K & G Electronics	ZIG-ZAG Trio Mfg. Co.
UNECAP United Electronic Mfg. Corp.	VARIABLE D Electro-Voice, Inc.	VICTROLA Radio Corp. of America	VOLTER Electro-Physics	WHIZ-SAWS Forsberg Mfg. Co.	ZINKTRON Constad Laboratories
UNICON United Condenser Corp.	VARI-CHOKE Superelex Electronics	VIDEO Tech Master Corp.	VOLTOHMST Radio Corp. of America, RCA Tube Dept.	WIDNEY-DORLEC British Industries Corp.	ZIP JFD Mfg. Co.
UNIDIAL Chicago Ind. Instrument	VARICON Elco Corp.	VIDEOLA Tech Master Corp.		WIGO United Audio Prods	ZIPPERS Centralab Div., Globe Union, Inc., ZOOM-UP Camburn, Inc.
UNIMATIC Calbest Eng'g & Electronics Co.	VARIDOT Simpson Electric Co.	VIDEO-BEAM Camburn, Inc.		WILKOR Aerovox Corp.	
	VARI-FEED Trico Fuse Mfg.	VIDEOTRON National Union Radio		WINCHESTER Olin Industries	
	VARIJUST Anton Electronic Labs				

Service Associations 1956 Roster

Standard Bearers of Professional Technicians Now Number 184

ALABAMA

GADSDEN—Radio & TV Technician's Guild 404 N 16 St Guy Brooks Secy

ARIZONA

PHOENIX—Better Electronic Service Technicians (BEST) Box 1284 Hal Heath Secy
TUCSON—Electronic Assoc of Tucson Ariz 2616 E Broadway Arthur Wheeler Pres

ARKANSAS

FORT SMITH—Fort Smith Radio & TV Technicians Assoc P O Box 133 Geo Goodin Secy
HOT SPRINGS—Hot Springs Radio Servicemen's Assoc 608 W Grand Ave W Malsoll Secy
NORTH LITTLE ROCK—TV Service Assoc of Arkansas P O Box 542 W T Head Secy

CALIFORNIA

ANAHEIM—RTA of Orange County P O Box 105 James L Liedtke Secy
BAKERSFIELD—TV Service Assoc PO Box 553 V C Stiles
COLTON—Citrus Belt Radio Technician Assoc Box 344 Roy Clark Recording Secy
GLENDALE—Radio Technicians Assoc 1745 W Glenoaks Dell Davis
LONG BEACH—Radio TV Technicians Assoc P O Box 4085 John Whitaker Secy
LOS ANGELES—Electric League of Los Angeles Inc 2508 W Olympic Blvd Glen L Logan Assn Mgr
LOS ANGELES—Radio & TV Assoc 3257 W 6 St C Dunkle Pres
LOS ANGELES—Society of TV Engineers c/o General Electric Co 11840 W Olympic Blvd B S Angwin Secy
MAR VISTA—Cinema Technicians Society 520 Edinca Plaza A F Bruns Secy
OAKLAND—TV & Radio Assoc of Alameda County Inc 4223 E 14 St Fred W Rock Secy
POMONA—Radio & Technicians Assoc 891 W 2 St Dave Laycox Secy
RICHMOND—TV & Radio Servicemen's Assoc of Contra Costa County P O Box 1334 Phil Rios Secy
SAN CARLOS—TV Service Dealers Assoc P O Box 801 Ed Mitchell Secy
SAN FRANCISCO—Radio & TV Dealers Assoc 6299 Mission St T R Hogman Pres
SANTA MONICA—Radio TV Technicians Assoc P O Box 275 Ocean Park Station Herb Sulkin Secy
SANTA PAULA—Radio Electronic Specialist Assoc 622 Main St Robt Simmons Pres

VAN NUYS—Society of Radio & TV Technicians P O Box 126 Arnold J Meyer Pres

COLORADO

ARVADA—Rocky Mt Radio-TV Guild 8201 W Grandview Mlo G Scram Pres
COLORADO SPRINGS—Radio TV Technicians Assoc 2530 W Colorado Richard Sturm Secy
GREELEY—Rocky Mountain Radio & TV Guild Greeley Chapter 814 16 St G M Norris Secy
PUEBLO—Pueblo Radio Servicemen's Assoc P O Box 3063 George E Nix Secy-Treas

CONNECTICUT

BRIDGEPORT—Radio & TV Dealers Assoc 1243 Main St Thomas P Calora Pres
NEW BRITAIN—TV Service Assoc 20 Orange St Deane Gould Secy
WATERBURY—Waterbury Chapter of TELSIA Inc 9 Woodtick Rd Anthony Rolli Secy

DISTRICT OF COLUMBIA

WASHINGTON—National Community TC Assoc 710 14 St NW M F Malarkey Jr Pres

FLORIDA

JACKSONVILLE—Jacksonville Electronics Technician Society 1526 Gary Thomas Thompson Pres
PENSACOLA—Pensacola Radio Service Dealers Assoc 106 E Wright St W J Corner Jr Secy
TAMPA—Radio & TV Service Assoc 6105 Interbay Blvd Ross Askey Secy

IDAHO

BOISE—Radio & TV Technicians Assoc 1724 Fairview R A Burrell Secy

ILLINOIS

BERWYN—Professional TV Service Assoc 2137 S Euclid Ave Wm Voss Secy
CHICAGO—Associated Radio & TV Servicemen 433 S Wabash Ave James Pintl Secy
CHICAGO—National Alliance of TV & Electronic Service Assoc 5908 S Troy St Robt Hester Secy
CHICAGO—TV Installation Service Assoc 5908 S Troy St Jos Isaak Secy

DECATUR—Radio Assoc of Macon County 753 N Water St F R Hollingsworth Pres
JOLIET—Will County Radio & TV Assoc 35 W Van Buren St Art McAllister Secy
ROCKFORD—Greater Rockford Appliance Dealers Assoc 100 W Jefferson St H L Berry Secy

INDIANA

ANDERSON—Radio & TV Service Engineers Assoc 1624 W 5 St Joe Graves Pres
COLUMBUS—Radio-TV Service Dealer Assoc 1824 Home Ave Henry L Perry Corres Secy
EVANSVILLE—Ethics In TV Committee 117 Main St Lee White Secy
EVANSVILLE—Radio Service Men's Assoc 105 N Spring St Bay Temple
SEYMOUR—TV Servicemen's Assoc R R #3 Cliff Lockman Secy

IOWA

DES MOINES—TV Servicemen's Assoc 1606 Locust Ed Villmick Secy
FT DODGE—Assoc of Radio Technicians 1726 Central Ave Homer L Davidson Pres
OTTUMWA—Ottumwa TV Service Dealer Assoc 515 Church St Gerry Brown Secy

KANSAS

ELLINWOOD—TV Electronic Service Assoc State Organization Box 154 E A Redmon Secy
LYONS—TV Electronic Service Assoc Midwest Chapter Ralph Renfro Secy
SALINA—TV Electronic Service Assoc Salina Chapter 682 S 9 St Melton Shelton Secy
WICHITA—TV Electronic Service Assoc Wichita Chapter 333 N Waco St Wm Nichols
WICHITA—Wichita Appliance Dealers Assoc 822 Central Bldg C D Hughes Secy

MASSACHUSETTS

ARLINGTON—Radio-TV Technicians Guild of NE 210 Mass Ave Edmund Chobator Secy
CAMBRIDGE—Assoc of TV Service Engineers 18 Jackson St I Werlin Pres
FALL RIVER—Radio-TV Technicians Guild of Greater Fall River PO Box 1307 Maurice Provost Pres
NEW BEDFORD—Radio Technicians Guild 110 Topham St James L Shapley Secy
WORCESTER—Worcester County Assoc of TV Technicians General Delivery M R Hildebrand Secy

MICHIGAN

DETROIT—Electronic Service Assoc 1763 E Seven Mile Rd T T Czarnicki Secy
DETROIT—TV Service Assoc of Mich 1415 Dime Building Harold Chase Chairman of Board
E DETROIT—McComb TV Service Assoc 22391 Gratiot Ave
KALAMAZOO—Radio TV Assoc of Kalamazoo PO Box 773 Wm G West Pres

MINNESOTA

MINNEAPOLIS—Assoc of Radio and TV Service 1100 1st National Bank Building Miles Chadwick Pres
MINNEAPOLIS—Minn TV Service Engrs PO Box 42 Warren Schel Secy
MINNEAPOLIS—Radio Servicemen of America 1010 Second Ave S J R Trovall
MINNEAPOLIS—Radio & TV Assoc 2451 Hennepin Harold Simmonson Pres
ST PAUL—TV Electronic Service Assoc 2068 Ford Pkwy Joe Driscoll Secy

MISSOURI

JOPLIN—TV Technicians & Electronics Assoc 1418 Main St Wm Thomas Secy
KANSAS CITY—Electric Assoc of Kansas City 2201 Grand St C M Anderson Secy
KANSAS CITY—TV Service Engineers Inc 7149 Prospect Omar Melvin Secy
ST LOUIS—TV Electronic Service Assoc 1724 S 39th St Paul Lubin Secy

NEBRASKA

LINCOLN—Nebraska Electronics Service Assoc 1617 S 17 St T M Duffield Secy
OMAHA—TV & Electronics Service Assoc & Nebraska Electrical Council 1104 Woodman of World Bldg Day Hacke Secy

NEW HAMPSHIRE

MANCHESTER—Radio TV Assoc of New Hampshire 334 Mitchell St E R Gellinas Secy

NEW JERSEY

BRIGANTINE—Electronic Technicians Assoc of S J 234 34 St P J Palmer
IRVINGTON—W J Radio Appliance Dealer's Assoc 1156 Springfield Ave W A Bohr Pres
MARGATE—Electronic Technicians Assoc of S J 220 N Argyle Ave Wm J McGill Secy
PATERSON—Radio & TV Servicemen of N J 211 Market St J P Murphy Secy
PERTH AMBOY—TV Technician of Perth Amboy 414 Amboy Ave Bud Anderson Pres
PITMAN—Allied TV Technicians Assoc H Donald Brown
TRENTON—Delaware Valley Radio Assoc 315 Beechwood Ave Lester H Allen Pres
TRENTON—Radio Servicemen's Assoc 72 S Olden Ave M E Toth Secy

NEW YORK

ALBANY—Albany TV Service Assoc 364A Central Ave Mr O'Dea
ARDSLEY—Westchester TV Guild 21 Taft Lane Cliff Kantor Pres
BEACON—Hudson Valley Electronic Technician Assoc 55 Prospect St Thomas P Thorne Assoc Mgr
BETHPAGE—Radio & TV Guild of L I PO Box 87 C Stratigos Secy
BINGHAMPTON—Southern Tier Chapter R. S. A P O Box 201 M Harris Secy
BRONX—Empire State Federation of Electronic Technicians Assoc 1215 Thierlot Ave O Capitelli Pres
BROOKLYN—Nat'l Electronic Technician Service Dirs Assoc 1431 Flatbush Ave Max Leibowitz Pres
BROOKLYN—Radio & Electronic Dealers & Servicemen's Assn 1044 Rutland Rd Irving Horowitz
BROOKLYN—TV Radio & Appliance Dealers Assoc 925 Kings Highway E Y Perlman
BUFFALO—Buffalo Radio Institute Alumni 45 W Mohawk St Robert Dorio Recording Secy
BUFFALO—Radio Technicians Assoc 657 Broadway Theodore J Telnak Pres
BUFFALO—TESA TV & Electronic Service Assoc Station E BOX 28 Homer Johnson Secy
BUFFALO—Western Electronics Guild 2011 Hertel Ave L Marshall Secy
DELHI—Catskill Mt Radio Servicemen's Assoc Radio Service Labs A Hayes Pres
ELMIRA—Southern Tier Electronics Assoc 1000 Sullivan St R M Hapeman Secy
FOREST HILLS—Forest Radio & TV Assoc 109-01 72 Rd G Berger Pres
HEMPSTEAD—Standard Parts 277 N Franklin St Earl Horton
JAMESTOWN—Electronic Technicians Assoc 21 Lake St Kermit Johnson Secy
KINGSTON—Kingston Radio Servicemen's Assoc 107 Henry St Hilton B Matthews

KINGSTON—Ulster Electronic Technicians Assoc 94 Furnace St Charles A Kohl Secy
MINEOLA—National Electronics Service Dealers Assoc 138 Jerome Ave John A Wheaton Secy
MT VERNON—Independent Radio & TV Technicians of Westchester County 60 S 3 Ave H Wiegand
NEW YORK—Alumni Assoc of RCA Institute 350 W 4 St John Mustillo Secy
NEW YORK—Radio & TV Electronics Technicians Assoc 52 E 19 St Chas Vassallo Pres
OCEANSIDE—Long Island Electronic Technicians Assoc 3156 4 St Aram Chankallan Secy
PORT EWEN—Kingston TV Service Assoc Floyd Light
POUGHKEEPSIE—Poughkeepsie TV Service Assoc Violet Ave Fred Booth
ROCHESTER—Radio TV Technicians Guild PO Box 802 N H DeMay Secy
SYRACUSE—Syracuse TV Technicians Assoc 139 Fabius St E F Richardson Secy
YONKERS—TV Contractors Assoc of NY 855 Midland Ave A E Rhine Pres

NORTH CAROLINA

CHARLOTTE—Radio & TV Service Assoc 1300 E 4 St A C Kimbiri Pres
GASTONIA—Universal TV & Appliance Co Jim Pruett
GREENSBORO—Greensboro Radio & TV Service Assoc 321 S Elm St Joe Woods Secy

OHIO

AKRON—Akron Radio Technicians Assoc 1185 Manchester Rd
CANTON—Canton TV Assoc 1410 7 St NW W H Blecker Pres
COLUMBUS—Associated Radio-TV Service Dealers 2552 N High St Jack Voltz Secy
DAYTON—TV Service Guild 333 W Monument Ave Marshall Rankin Secy
HILLSBORO—Southern Ohio Radio TV Technicians Assoc 345 W Main St W E Jamison Secy
SPRINGFIELD—Radio & TV Assoc 3136 W Main St Wade Campbell Secy
TOLEDO—Electronic Technicians Assoc of Toledo 626 Pleasant Pl O G Shanteau Secy



OKLAHOMA

OKLAHOMA CITY—Oklahoma Radio & TV Service Assoc 5707 North Western Russ Snyder Secy
OKLAHOMA CITY—TV Service Assoc of Okla P O Box 9664 W L Jones Secy

PENNSYLVANIA

ALTOONA—Altoona Radio & TV Service Engineers 800 Chestnut Ave William Moffett
ALTOONA—Blair County Assoc of Radio-TV Service Engineers 1812 4 Ave Chas Howard Secy
BETHLEHEM—Lehigh Valley Radio Servicemen's Assoc 221 Summit St George Lange
BETHLEHEM—Lehigh Valley Servicemen's Assoc 1335 N Long St Claude Kramer
CARBONDALE—Federation of Radio Servicemen's Assoc P O Box 61 Leon J Helk Secy
CHESTER—Federation of TV-Radio Service Assoc 619 Highland Ave William Morrow Vice Chairman
EPHRATA—Northern Lancaster County Electronics Servicemen's Assoc P O Box 264 Ray McCoy Secy
HARRISBURG—Embassy Television & Sound Service 1845 Whitehall St Frank R Fetrow Jr Mgr
HARRISBURG—Mid-State Radio Servicemen's Assoc of Penna 1519 N 4 St G E Hardy Secy
HERSHEY—Federation of TV-Radio Service Assocs Box 162 L B Smith Treas
HOLLIDAYSBURG—Blair County Assoc of Radio Service Engineers 103 Broad St D I Dodson Pres
INDUSTRY—Federation of TV-Radio Service Assocs RD #1 Ray Blackwood Recording Secy
JOHNSTOWN—Greater Johnstown TV Assoc 109 Haynes St Paul L Weir Pres
KINGSTON—Radio Servicemen's Assoc of Luzerne County 94 W Bennett St Milan J Cooper
LANCASTER—Conestoga TV Assoc 915 New Holland Ave R G Wiegand Secy
OLYPHANT—Lackawanna Radio Technicians Assoc 104 Hull Ave Howard Green Secy
PHILADELPHIA—Council of Radio & TV Service Assoc 1300 N 3 St Albert Haas Pres
PHILADELPHIA—Northeast TV Dealers Service Assoc 6321 Frankford Ave Harvey Morris Secy
PHILADELPHIA—Phila Radio Servicemen's Assoc 1643 S Wilton St Fred Cohen Secy
PHILADELPHIA—TV Contractors Assoc 123 S 46 St William Well Secy
PHILADELPHIA—TV Service Dealers Assoc 6017 Ogontz Ave L J Smith Secy
PITTSBURGH—Federation of TV-Radio Service Assocs 1741 East St B A Bengener Chairman
PITTSBURGH—Radio & TV Servicemen's Assoc of Pittsburg P O Box 6844 Tom Ging Recording Secy

READING—Berks County Electron Service Dealers Assoc 524 Windsor St Joseph A Kasper Secy-Treas
READING—Reading Radio Service Technicians 704 Walnut St John C Rader Secy
STEELTON—Mid-State Radio Servicemen's Assoc 22 S Front St Fred J Schmidt Secy
WASHINGTON—Radio TV Service Assoc 471 W Chestnut St Carl J Wagner Secy-Treas
WILKES-BARRE—Radio & TV Servicemen's Assoc of Luzerne County P O Box 309 Milan J Krupa Secy
WILLIAMSPORT—Associated Radio Servicemen of Central Pa 1643 Memorial Ave Phil Marchionni Secy
YORK—Southern Pa Radio & TV Assoc 736 E Market St Carl E Sheffer Secy

RHODE ISLAND

PROVIDENCE—Rhode Island Radlomen's Business Assoc 959 Hope St E J Oliver Secy

SOUTH CAROLINA

CHARLESTON—Charleston TV & Appliance Dealers Assoc 285 Meeting St J A Hood Jr

TENNESSEE

CHATTANOOGA—Radio & TV Service Assoc 3507 Rossville Blvd David Oshison Secy
KINGSPORT—Bays Mountain Radio Club c/o Tennessee Eastman Recreation Club
MEMPHIS—TV Electronic Service Assoc 966 E McLemore Ave Mrs Juanita Grover Secy

TEXAS

CORPUS CHRISTI—Corpus Christi Radio & TV Assoc 1109 Santa Fe Eddie Fox Pres
DALLAS—Dallas Radio TV Sales & Service Assoc 2605 Inwood Rd D F Comer Secy
FORT WORTH—Fort Worth Radio & TV Assoc 1610 8 Ave Truett Kimzey Pres
HOUSTON—Texas Electronic Technicians Assoc P O Box 15011 Al Gasky Assoc Mgr
SAN ANTONIO—American Electronic Council 801 St Mary's St F L Baker Chairman
SAN ANTONIO—San Antonio Radio & Television Assoc 730 S St Mary's St Alton Roberts Secy

UTAH

SALT LAKE CITY—Utah Assoc of Radio & TV Servicemen 418 Frick Bldg 23 E 1 St John F Burns Pres

VIRGINIA

NEWPORT NEWS—Tidewater Radio Servicemen's Assoc 4313 Hunt Ave David Heorn Pres
NORFOLK—Tidewater Radio Servicemen's Assoc 343 S Olney Rd E C Sholar Secy

WASHINGTON

SEATTLE—North West Appliance & TV Assoc 512 1 Ave W D M Lombardo Secy
SNOHOMISH—Everett Radio Servicemen's Club 1120 1 St Joe Mulholland Pres

WEST VIRGINIA

HUNTINGTON—Electronic Technicians Assoc P O Box 262 Scott Adams Pres

WISCONSIN

EAU CLAIRE—Indianahead Radio-TV Servicemen's Assoc 602 Water St B F O'Connell
MADISON—Radio Technician Assoc 1314 Williamson St
MILWAUKEE—Milwaukee Assoc of Radio & TV 1312 W Atkinson St Carl Lenz Pres

WYOMING

CHEYENNE—Cheyenne TV Technicians Assoc 1020 E Pershing Homer E Moyer Pres

CANADA

HAMILTON ONTARIO—Radio Electronic Technicians Assoc of Ontario 29 Wavelle Ave G F Leeks Secy
KELOWNA B C—Assoc Radio Technicians of B C 519 Osprey Ave Ralph Mattie
MILNER B C—Assoc Radio Technicians of B C R R 1 Fraser Valley Roy Tom
ORGANVILLE ONTARIO—Radio Electronic Technicians Assoc Box 414 V E Sharp
VANCOUVER B C—Assoc Radio Technicians of B C 918 Rogers Bldg W Munton
VICTORIA B C—Victoria & Island Chapter Radio Elec Technicians Assoc 783 Fort St D Banfield Pres
WINNIPEG MANITOBA—Radio Electronic Technicians Assoc Box 391 C Harder Secy

Copyright 1956

TECHNICIAN BUYERS DIRECTORY

Distributors

These are the names and addresses of organizations handling the distribution of radio-TV-electronic parts and equipment in the United States. Listings are alphabetical under states and cities. Asterisk (*) indicates membership in National Electronic Distributors Association (NEDA).

ALABAMA
ANNISTON
Dickert Supply Co 105 W 10 St AD 5-3933
Radio Dist & Supply 125 W 10 St AD 6-0671
BESSEMER
Bessemer Radio Supply 114 N 20 St 5-9573
BIRMINGHAM
Ack Radio Supply 3101 4th Ave SE 4-0588
Air Engineers 1529 2 Ave 54-3431
Auto Service 1916 S 4 Ave 3-4102
*Clary Co J W 1713 2 Ave S 4-2488
Forbes Distr 2600 3 Ave S 3-4105
Graybar Elec 709 1 Ave N B1 4-1861
Lewis Supply Co 1025 N 19 St 7-1148
McDavid & Co R P 1430 2 Ave S 7-7165
*Reid Distributing 1724 5 Ave N 4-7357
Steel City Supply 600 N 7 St 4-0433

DECATUR
Radio & Television Supply 415 Bank 2231
DOTHAN
Carmichael Wholesale 140 S Foster St 2-1255
Hand Supply Co 705 S Oates 4-3300
Signal Supply 1505 Montgomery Hwy 4-0360

GADSDEN
Radio Dist & Supply Co Hqrs Anniston
Southeastern Radio Parts Hqrs Atlanta
HUNTSVILLE
Radio & TV Supply Hqrs Decatur

JASPER
Ramco Radio Supply 20 St & 2 Ave 2-5321
MOBILE
Emrich Radio Supply 656 Dauphin St HE 8-2596
Forbes Electronic 57 N Washington HE 2-7661
General Elec 54 Eslava St 8-4571
Graybar Elec Supply 701 N Joachim St HE 2-3511
Harris Supply 10 Water 2-0541
McDavid Co R P Hqrs Birmingham
McGowin-Lyons Water & St Louis Sts HE 2-8721
*Nelson Radio 451 St Louis 2-0411
Radio Labs 111 N Royal 2-1715

MONTGOMERY
Nolin-McInnis 211 Commerce St 7323
Southeastern Radio Parts 224 N Court St 3-6488
Teague Hardware PO Box 24-0541
Walther Bros 2245 W Fairview Ave
SELMA
Reid Distributing Hqrs Birmingham
SHEFFIELD
Radio & TV Supply Hqrs Decatur
SYLACAUGA
Campbell Distributing Co 300 W 1 St 2-4122
TUSCALOOSA
*Allen & Jemison Co 8-2781
Radio Parts 402 20 Ave 8-5585

ARIZONA
PHOENIX
Electrical Comm 202 E Fillmore Al 2-8248
Electrical Equip 1 Ave at Madison 3-3186
General Electric Sup 1102 N 22 Ave AL 8-6721
Graybar Electric 434 W Madison AL 2-2375
Mathias & Co Albert Hqrs El Paso Tex
Midland Specialty 1930 N 22 Hqrs El Paso Tex
*Radio Parts of Ariz 214 S 11 Ave Al 8-6476
Radio Spec & Appl 305 E Roosevelt AL 4-7184
Southwest Wholesale 2 at Madison AL 2-1743
Westinghouse Elec 1110 N 21 AL 4-9276

TUCSON
Art Electronic Supply 145 S Park 4-4413
*Elliott Electronics 418 N 4 Ave 4-2473
General Electric Supply 2 E 6 St 3-4773
Graybar Electric 212 S Park Ave 2-6439
*Standard Radio Parts 218 N 1 Ave 3-2545

ARKANSAS
BLYTHEVILLE
Teague Radio-TV PO 3-4056
FORT SMITH
Carter Electronic 805 N 11 St 3-4129
*Wise Radio Supply 1001 Towson Ave SU 3-8926
HOT SPRINGS
White Radio Supply David Hqrs Little Rock
JONESBORO
Martin Wholesale Radio Sup Hqrs Paragould
LITTLE ROCK
*Cariton Wholesale 606 E Capitol FR 2-0248
General Electric Supply 601 E Markham 5-5328
Graybar Electric 417 Byrd St FR 5-1246
Frank Lyon 214 E Markham St FR 5-5311
Southern Radio 1419 Main St FR 2-4198
Thurman Supply 115 W 11 St 7308
*White Radio Supply 1222 Main FR 6-1391

NORTH LITTLE ROCK
Rye Wholesale 117 W Washington FR 5-2426

PARAGOULD
Martin Wholesale 1207 W Kings Hwy CE 6-4049
PINE BLUFF
White Radio Supply David Hqrs Little Rock
TEXARKANA
*Lavender Radio Supply 520 E 4 St 2-4195
McCulloch Whse TV 305 E Front St 22-8411

CALIFORNIA
ALHAMBRA
*Coast Electronic Supply 2708 W Main CU 3-4049
BAKERSFIELD
Arbuckle J C 500 E 19 St Hqrs Fresno
Dunlap Radio & TV 1134 33 St Hqrs Stockton
Radio Specialties Hqrs Los Angeles
Valley Radio Supply 716 Baker St FA 7-8831
BERKELEY
Pacific Radio Supply 1940 Ashby Ave TH 3-8900
BURBANK
Dean's Electronics Hqrs Long Beach
Pacific Radio Exch Hqrs Hollywood
Valley Electronic Supply 1302 N Magnolia Blvd
CATHEDRAL CITY
*Wholesale Electronic Specialists PA 8-3302
CHICO
Dunlap Radio & TV Hqrs Stockton
Kemp Co E M 815 Main St FI 2-8703
Radio Television Products Hqrs Sacramento
CONCORD
Pacific Radio Supply Hqrs Berkeley
EL CENTRO
Aliza Electronic 540 Broadway EL 2-2528
EL MONTE
Kimball-Stark 713 S Tyler FO 0-2594
EUREKA
Redwood Electronics 711 Summer St HI 2-1301
FRESNO
Arbuckle J C 2349 Kern 4-6555
Billings Wholesale Radio 817 Broadway
DeJarnatt Whse B J 223 Fulton 2-2153
Dooley Harry 725 L St 2-4108
Dunlap Radio & TV 2617 Tulare St Hqrs Stockton
General Elec Supply 1234 O St 4-4746
Graybar Electric 101 Van Ness Ave FR 2-4175
Inland Electronic Sup 843 Divisadero St 6-9666
Kinney & Faust 1740 Van Ness 6-8321
Ports Mfg Co 3265 Belmont 3-6728
Westinghouse Elec 2608 Calif 4-5091

FULLERTON
United Radio & Elect Hqrs Los Angeles
GARDENA
Video Suppliers 14526 Crenshaw DA 9-4053
GLENDALE
Hagerty Radio 6826 San Fernando Rd TH 8-2453
*Weatherford Co R V 6921 San Fernando RO 9-2281
HOLLYWOOD
Hollywood Radio 5606 Hollywood HO 4-8321
Pacific Radio Exch 1407 Cahuena HW 2-1393
Western States Elec 1509 N Western HO 5-7185
Yale Radio Elec 6616 Sunset Blvd GL 4169
INGLEWOOD
Cook Electronics 210 E Hardy St OR 8-7644
Ingleswood Electronics 836 S LaBrea OR 4-2366
Newark Electric Hqrs Chicago
LONG BEACH
Cal-Tenna Electronic 363 South St NE 6-1239
Dean's Electronics 2310 American Ave GA 7-0955
Electronic Supply 3363 Lime St Hqrs Pasadena
General Electric Supply 840 W 12 St 3-5311
Gough Industries 838 W 12 Hqrs Los Angeles
Graybar Electric 800 W 16 St HE 2-2911
Kierulff & Co 1760 Pacific Ave Hqrs Maywood
Lynde Electronics 1526 E 4 St 7-4807
*Scott Radio Supply 266 Alamitos 7-8629

LOS ANGELES
American Electronic 567 S Fairfax Ave WE 6-5181
Bell Radio Supply 1311 W Florence Ave PL 2-7191
Calif Sound Prods 7264 Melrose WE 1-1557
Ceazan J N Co 3535 S Broadway AD 1-9133
Dunkle Radio Parts 2506 W 8 St
*Federated Purchasers 11275 W Olympia BR 2-0831
Figart's Radio 6320 Comm Sloat Dr YO 6218
General Elec Supply 700 Turner St MA 5-7141
G.L. Electronics 1632 Venice Blvd RI 9-8188
Gough Industries 560 S Mission Rd MA 6-2474
Graybar Electric 210 Anderson SA 3-7282
Henderson Co 628 N Alvarado DU 2-8301
Henry Radio 11240 W Olympic Blvd GR 7-6701
Hollywood Electronics 7460 Melrose Ave WE 3-8208
Kerwin Co J J 1525 S Flower St PR 5323
Kierulff Electronics 820 W Olympic RI 7-0271
K & L Radio Parts 1406 Venice Blvd RI 9-0553
Los Angeles Radio 10217 Venice TE 0-5862
Pacific Television 4032 S Figueroa AD 3-8058
*Papal Bros 2605 E 4 St AN 2-5151
Quality Dist 1715 W 8 St

MAYWOOD
Kierulff & Co 6058 Walker Ave LO 8-1192
MENLO PARK
Peninsula TV & Radio Supply Hqrs San Jose
MERCED
Dunlap Radio & TV Hqrs Stockton
MODESTO
Dunlap Whse Radio Hqrs Stockton
Inland Electronic Suppliers Hqrs Fresno
Pacific Teletronic & Radio Sup 417 7 St 3-7751
MONTEREY
Peninsula TV & Radio Supply Hqrs San Jose
Wholesale Electronics 229 Alvarado ST 2-7642
NORTH HOLLYWOOD
N Hollywood Radio 4212 Lankershim ST 7-3063
OAKLAND
Brill Co W D 198 10 St TE 2-6100
Cass Altschuler Co 6038 Telegraph UL 3-7557
*Elmar Electronics 140 11 St HI 4-7011
General Electric Sup 5400 Hollis St OL 3-4433
Graybar Elec 1911 Union St GL 1-5451
*Millers Radio & TV 336 E 8 St TW 3-3848
Wenger Co E C 1450 Harrison GL 1-1020
Westinghouse Elec 711 E 8 TE 4-9900

OXNARD
Kierulff & Co Hqrs Maywood
PALO ALTO
Associated Radio Distr Hqrs San Francisco
Zack Radio Supply Hqrs San Francisco
PARAMOUNT
Ley Co EW 16514 S Garfield ME 3-5108
PASADENA
Dow Radio 1759 E Colorado SY 3-1196
Electronic Supply 2685 E Foothill SY 5-5901
Empire Electronic Dis 37 E Union RY 1-7671
PITTSBURG
Dunlap Radio & TV Hqrs Stockton
POMONA
Anderson-Maggs 1095 E Third LY 9-9669
REDWOOD CITY
Electronic Supply 1740 Broadway EM 8-4093
TV-Radio Supply 415 Lathrop Hqrs San Francisco
RICHMOND
Millers Radio & TV Supply Hqrs Oakland
RIVERSIDE
Electronic Supply Hqrs Pasadena
SACRAMENTO
Broil-Parks 2225 19 St GI 2-2983
Capitol Electronics 1714 10 St GI 3-5931
*Dunlap Whse Hqrs Stockton
General Elec Supply 1131 "S" St GI 3-9001
Graybar Electric 1900 14 St GI 2-8976
*Kemp Co E M 1115 R St GI 3-4668
Mayberg Co Leo J Hqrs San Francisco
Radio Television Prod 2012 19 St GI 2-7691
*Sacramento Electronics 1219 "S" St HU 1-4821
Westinghouse Elec 1730 14 St GI 3-6525

SALINAS
Peninsula TV & Radio Hqrs San Jose
SAN BERNARDINO
Featherstone Radio & TV 1010 E St 81-1306
General Elec Supply 485 S "I" St 5135
Gough Industries PO Box 222 Hqrs Los Angeles
Graybar Electric 655 S "H" St ST 9-1051
*Inland Electronic Supply 843 Colton Ave 6-5571
Kierulff & Co Hqrs Maywood
SAN DIEGO
Electric Supplies Dist 435 2 Ave
Electronic Equip Dist 1228 2 Ave BE 2-3155
General Elec Supply 450 2 Ave BE 9-0271
Gough Industries 3255 5 Ave Hqrs Los Angeles
Graybar Electric 720 State St BE 3-1361
Radio Parts Co 2060 India BE 9-9361
Radio Specialties Hqrs Los Angeles
Shanks & Wright 2045 Kettner BE 9-0176
Western Radio & TV 1415 India St BE 9-0361
SAN FRANCISCO
*Assoc Radio Distr 1929 Market St HE 1-0212
Basford Co H R 235 15 St MA 1-8545
*Brown Co C 61 9 St MA 1-7000
Edwards Co Frank 382 6 St MA 1-9700
Ets-Hokim & Galvan 551 Mission St EX 2-0432
General Electric Supply 1201 Bryant St UN 3-4000
Graybar Electric 1750 Alameda St MA 1-5131
Hauer Radio Parts Karl 281 9 St MA 1-0552
Kaemper & Barrett 1850 Miss UN 3-3080
*Meyberg Co L J 33 Gough St MA 1-3400
Offenbach & Remus 1564 Market St KL 2-2100
*Pacific Whse 1850 Mission St UN 1-4843
*San Francisco Radio 1284 Market UN 3-6000
*Smith & Crawford 789 Stevenson St UN 3-2045
*Television Radio Supply 326 Market St EX 2-2898
Westinghouse Elec 201 Potrero UN 1-5051
*Wholesale Radio 140 9 St HE 1-3680
*Zack Radio Supply 1424 Market MA 1-1424

SAN JOSE
Peninsula TV & Radio 881 S 1 St CY 4-8781
*Quement Frank 161 W San Fernando St CY 4-0464
San Jose TV Supply 999 S 1 St CY 4-7900
Schad Electronic 256 W San Fernando CY 7-5858
SAN LEANORO
Millers Radio & TV Supply Hqrs Oakland
Styles & Engleman 2255 Bancroft Ave LO 9-9433
SAN MATEO
Associated Radio Distrs Hqrs San Francisco
SAN RAFAEL

Radio Doc 721 S Main St VA 3104
*Radio Equip Dist 1340 S Olive St PR 9151
Radio Parts Sales 5220 S Vermont PL 9-9178
Radio Prod Sales 1501 S Hill RI 9-7471
Radio Spec 1956 S Figueroa St RI 9-7271
Radio TV Sup 341 W 18 St RI 8-7131
Shelley Radio 2008 Westwood GR 6-7641
United Radio & Elec 1924 S Grand RI 9-5241
*Univ Radio Sup 1729 S Los Angeles PR 5241
Warsco Sales Co 4301 S Figueroa St AD 3-8171
Westinghouse Elec Sup 905 E 2 MA 9-4161
MARYSVILLE
Dunlap Whse Radio Hqrs Stockton
MAYWOOD
Kierulff & Co 6058 Walker Ave LO 8-1192
MENLO PARK
Peninsula TV & Radio Supply Hqrs San Jose
MERCED
Dunlap Radio & TV Hqrs Stockton
MODESTO
Dunlap Whse Radio Hqrs Stockton
Inland Electronic Suppliers Hqrs Fresno
Pacific Teletronic & Radio Sup 417 7 St 3-7751
MONTEREY
Peninsula TV & Radio Supply Hqrs San Jose
Wholesale Electronics 229 Alvarado ST 2-7642
NORTH HOLLYWOOD
N Hollywood Radio 4212 Lankershim ST 7-3063
OAKLAND
Brill Co W D 198 10 St TE 2-6100
Cass Altschuler Co 6038 Telegraph UL 3-7557
*Elmar Electronics 140 11 St HI 4-7011
General Electric Sup 5400 Hollis St OL 3-4433
Graybar Elec 1911 Union St GL 1-5451
*Millers Radio & TV 336 E 8 St TW 3-3848
Wenger Co E C 1450 Harrison GL 1-1020
Westinghouse Elec 711 E 8 TE 4-9900

OXNARD
Kierulff & Co Hqrs Maywood
PALO ALTO
Associated Radio Distr Hqrs San Francisco
Zack Radio Supply Hqrs San Francisco
PARAMOUNT
Ley Co EW 16514 S Garfield ME 3-5108
PASADENA
Dow Radio 1759 E Colorado SY 3-1196
Electronic Supply 2685 E Foothill SY 5-5901
Empire Electronic Dis 37 E Union RY 1-7671
PITTSBURG
Dunlap Radio & TV Hqrs Stockton
POMONA
Anderson-Maggs 1095 E Third LY 9-9669
REDWOOD CITY
Electronic Supply 1740 Broadway EM 8-4093
TV-Radio Supply 415 Lathrop Hqrs San Francisco
RICHMOND
Millers Radio & TV Supply Hqrs Oakland
RIVERSIDE
Electronic Supply Hqrs Pasadena
SACRAMENTO
Broil-Parks 2225 19 St GI 2-2983
Capitol Electronics 1714 10 St GI 3-5931
*Dunlap Whse Hqrs Stockton
General Elec Supply 1131 "S" St GI 3-9001
Graybar Electric 1900 14 St GI 2-8976
*Kemp Co E M 1115 R St GI 3-4668
Mayberg Co Leo J Hqrs San Francisco
Radio Television Prod 2012 19 St GI 2-7691
*Sacramento Electronics 1219 "S" St HU 1-4821
Westinghouse Elec 1730 14 St GI 3-6525

SALINAS
Peninsula TV & Radio Hqrs San Jose
SAN BERNARDINO
Featherstone Radio & TV 1010 E St 81-1306
General Elec Supply 485 S "I" St 5135
Gough Industries PO Box 222 Hqrs Los Angeles
Graybar Electric 655 S "H" St ST 9-1051
*Inland Electronic Supply 843 Colton Ave 6-5571
Kierulff & Co Hqrs Maywood
SAN DIEGO
Electric Supplies Dist 435 2 Ave
Electronic Equip Dist 1228 2 Ave BE 2-3155
General Elec Supply 450 2 Ave BE 9-0271
Gough Industries 3255 5 Ave Hqrs Los Angeles
Graybar Electric 720 State St BE 3-1361
Radio Parts Co 2060 India BE 9-9361
Radio Specialties Hqrs Los Angeles
Shanks & Wright 2045 Kettner BE 9-0176
Western Radio & TV 1415 India St BE 9-0361
SAN FRANCISCO
*Assoc Radio Distr 1929 Market St HE 1-0212
Basford Co H R 235 15 St MA 1-8545
*Brown Co C 61 9 St MA 1-7000
Edwards Co Frank 382 6 St MA 1-9700
Ets-Hokim & Galvan 551 Mission St EX 2-0432
General Electric Supply 1201 Bryant St UN 3-4000
Graybar Electric 1750 Alameda St MA 1-5131
Hauer Radio Parts Karl 281 9 St MA 1-0552
Kaemper & Barrett 1850 Miss UN 3-3080
*Meyberg Co L J 33 Gough St MA 1-3400
Offenbach & Remus 1564 Market St KL 2-2100
*Pacific Whse 1850 Mission St UN 1-4843
*San Francisco Radio 1284 Market UN 3-6000
*Smith & Crawford 789 Stevenson St UN 3-2045
*Television Radio Supply 326 Market St EX 2-2898
Westinghouse Elec 201 Potrero UN 1-5051
*Wholesale Radio 140 9 St HE 1-3680
*Zack Radio Supply 1424 Market MA 1-1424

SAN JOSE
Peninsula TV & Radio 881 S 1 St CY 4-8781
*Quement Frank 161 W San Fernando St CY 4-0464
San Jose TV Supply 999 S 1 St CY 4-7900
Schad Electronic 256 W San Fernando CY 7-5858
SAN LEANORO
Millers Radio & TV Supply Hqrs Oakland
Styles & Engleman 2255 Bancroft Ave LO 9-9433
SAN MATEO
Associated Radio Distrs Hqrs San Francisco
SAN RAFAEL

SAN JOSE
Peninsula TV & Radio 881 S 1 St CY 4-8781
*Quement Frank 161 W San Fernando St CY 4-0464
San Jose TV Supply 999 S 1 St CY 4-7900
Schad Electronic 256 W San Fernando CY 7-5858
SAN LEANORO
Millers Radio & TV Supply Hqrs Oakland
Styles & Engleman 2255 Bancroft Ave LO 9-9433
SAN MATEO
Associated Radio Distrs Hqrs San Francisco
SAN RAFAEL

SAN JOSE
Peninsula TV & Radio 881 S 1 St CY 4-8781
*Quement Frank 161 W San Fernando St CY 4-0464
San Jose TV Supply 999 S 1 St CY 4-7900
Schad Electronic 256 W San Fernando CY 7-5858
SAN LEANORO
Millers Radio & TV Supply Hqrs Oakland
Styles & Engleman 2255 Bancroft Ave LO 9-9433
SAN MATEO
Associated Radio Distrs Hqrs San Francisco
SAN RAFAEL

SAN JOSE
Peninsula TV & Radio 881 S 1 St CY 4-8781
*Quement Frank 161 W San Fernando St CY 4-0464
San Jose TV Supply 999 S 1 St CY 4-7900
Schad Electronic 256 W San Fernando CY 7-5858
SAN LEANORO
Millers Radio & TV Supply Hqrs Oakland
Styles & Engleman 2255 Bancroft Ave LO 9-9433
SAN MATEO
Associated Radio Distrs Hqrs San Francisco
SAN RAFAEL

SAN JOSE
Peninsula TV & Radio 881 S 1 St CY 4-8781
*Quement Frank 161 W San Fernando St CY 4-0464
San Jose TV Supply 999 S 1 St CY 4-7900
Schad Electronic 256 W San Fernando CY 7-5858
SAN LEANORO
Millers Radio & TV Supply Hqrs Oakland
Styles & Engleman 2255 Bancroft Ave LO 9-9433
SAN MATEO
Associated Radio Distrs Hqrs San Francisco
SAN RAFAEL

SAN JOSE
Peninsula TV & Radio 881 S 1 St CY 4-8781
*Quement Frank 161 W San Fernando St CY 4-0464
San Jose TV Supply 999 S 1 St CY 4-7900
Schad Electronic 256 W San Fernando CY 7-5858
SAN LEANORO
Millers Radio & TV Supply Hqrs Oakland
Styles & Engleman 2255 Bancroft Ave LO 9-9433
SAN MATEO
Associated Radio Distrs Hqrs San Francisco
SAN RAFAEL

SAN JOSE
Peninsula TV & Radio 881 S 1 St CY 4-8781
*Quement Frank 161 W San Fernando St CY 4-0464
San Jose TV Supply 999 S 1 St CY 4-7900
Schad Electronic 256 W San Fernando CY 7-5858
SAN LEANORO
Millers Radio & TV Supply Hqrs Oakland
Styles & Engleman 2255 Bancroft Ave LO 9-9433
SAN MATEO
Associated Radio Distrs Hqrs San Francisco
SAN RAFAEL

SAN JOSE
Peninsula TV & Radio 881 S 1 St CY 4-8781
*Quement Frank 161 W San Fernando St CY 4-0464
San Jose TV Supply 999 S 1 St CY 4-7900
Schad Electronic 256 W San Fernando CY 7-5858
SAN LEANORO
Millers Radio & TV Supply Hqrs Oakland
Styles & Engleman 2255 Bancroft Ave LO 9-9433
SAN MATEO
Associated Radio Distrs Hqrs San Francisco
SAN RAFAEL

Abbott Co E B 345 Francisco GL 3-1130
SANTA ANA
 Electronic Supply Hqrs Pasadena
 Graybar Electric 301 French St KI 3-8309
 Hurley Electronics 1434 S Main KI 3-9237
 Radio & TV 207 Oak KI 2-6741
SANTA BARBARA
 Channel Radio Supply 523 Anacapa W0 2-3429
 Dealers Wholesale 209 W Canon Perdido Hqrs Ventura
SANTA MARIA
 Dealers Wholesale Supply Hqrs Ventura
SANTA MONICA
 Santa Monica Radio 117 Santa Monica EX 3-8231
SANTA ROSA
 Santa Rosa Electro 1066 Santa Rosa Ave 7708
SOUTH GATE
 Mac's Radio Supply 8320 Long Beach LU 8-4111
STOCKTON
 DeJarnatt Whse B J 515 N Hunter Hqrs Fresno
 *Duntap Radio & TV 27 N Grant HO 6-7907
 General Electric Supply 24 N Aurora ST HO 5-7231
 Kemp Co E M 50 N Wilson Way Hqrs Sacramento
 Radio TV Products Hqrs Sacramento
 Sacramento Elec Supply Hqrs Sacramento
 *Stockton Electronics 710 E Main ST HO 5-2691
TEMPLE CITY
 Radio Specialties Hqrs Los Angeles
VALLEJO
 Associated Radio Distr Hqrs San Francisco
 Walker Co R Lyman 1219 Monterey St VA 3-5675
VAN NUYS
 Kierulff & Co Hqrs Maywood
 Tags Radio & TV Supply 14530 Calvert St ST 5-3123
VENTURA
 Dealer's Whse Supply 265 S Laurel MI 3-6147
WALNUT CREEK
 Millers Radio Hqrs Oakland
WEST LOS ANGELES
 California Electronics 11801 W Pico BR 2-2126

COLORADO

BOULDER
 Boulder Distri Co 1633 18 St 2-8750
COLORADO SPRINGS
 D & M Electr Supply 717 N Weber St ME 3-0902
 Murray Radio Co 9 E Vermijo ME 3-8248
 Walker Radio Co L B Hqrs Pueblo
DENVER
 Electric Accessories 1959 Stout St
 Electronic Parts Co 1322 Lincoln St TA 5-2661
 Fiestels Radio 1085 Lincoln St MA 3-3197
 General Electric Supply 1429 18 St KE 4-6301
 Graybar Elec 104 Wazee Market TA 5-7116
 Hassco Inc 1745 Wazee Keystone 4-8151
 Inter-State Radio 1200 Stout St TA 5-5347
 Niles Phono & Radio 1254 Arapahoe AM 6-1671
 Radio Products Sales 1237 16 St CH 4-6591
 Ward Terry 70 Rio Grande Blvd CA 2-1871
 Walker Radio L B 620 Broadway Hqrs Pueblo
GRAND JUNCTION
 Radio & Elec Supply 511 Ute Ave 486
 Walker Radio Co L B Hqrs Pueblo
PUEBLO
 Pueblo Radio TV Supply 211 Polk 8515
 *Walker Radio L B 100 N Victoria Ave LI 2-1924

CONNECTICUT

BRIDGEPORT
 Coastal Radio 1106 Barnum Ave 5-7441
 D'Elia Distri 1330 Fairfield Ave ED 3-0195
 General Elec Supply 1899 Seaview Ave FO 8-1621
 *Hatry of Bridgeport Hqrs Waterbury
 Kaufman Electronics 1710 Main St ED 3-1842
 Sprague Electrical Supplies 347 RR Ave ED 6-2535
 Waldhaus L N 1132 Norman St FA 5-7985
 Westconn Electronics 195 Colorado Ave FO 7-7747
DANBURY
 Pilgrim Electronics 11 Spring St 3-4617
EAST HAVEN
 J V Electronics 690 Main St HO 7-3034
HARTFORD
 Dei Padre Assoc LL 374 Main St
 Emerson Radio 20 Chestnut St JA 5-1476
 Freed Electronics Inc 1301 Main St CH 9-7579
 General Elec Supply 2964 Main St JA 2-4111
 Graybar Electric 453 New Park Ave AD 3-2631
 *Hatry of Hartford Hqrs Waterbury
 *Moses Radio & Elec 54 Flower St 7-7247
 Seeli & Co R G 78 Maple Ave JA 2-1144
 Signal Center 21 New Britain Ave JA 2-8116
 Sprague Electrical Hqrs Bridgeport
 Wood-Alexander Co 100 Locust St
 Yale Radio Electronics 1215 Main JA 2-9300
KENSINGTON
 *Modern Radio 1224 Farmington Ave VA 8-3544
NEW BRITAIN
 United Electronic Supply 49 E Main BA 3-3641
 Universal Radio Co 61 E Main St
NEW HAVEN
 Amerling 203 Henry St SP 7-7383
 American Distr 76 Franklin UN 5-0861
 American TV 84 Commerce St LO 2-6122
 Ammirad Co 843 Grand Ave UN 5-4508
 *Brown Co T H 15 Whiting St SP 7-7695
 Congress Radio 207 Congress UN 5-6365
 Connecticut Appl Distri 140 Ferry St LO 2-9941
 Dale Electr Div Dale-Conn 150 James SP 7-5555
 General Elec Supply 74 Forbes St HO 7-6331
 Graybar Electric 25 Union St UN 5-4163
 *Hatry of New Haven Hqrs Waterbury
 Plymouth Electric Co 393 Chapel St ST 7-0291
 Radio Shack Corp 230 Crown St Hqrs Boston
 Tower Distr H M 48 County St SP 7-5320
NORWICH
 Aikins Electronic Supplies 98 Water St TU 9-8427
STAMFORD
 Stamford Radio Supply 562 Atlantic St

Westchester Elec Sup 181 Stillwater Ave FI 8-5397
WATERBURY
 *Bond Radio Supply 439 W Main St 3-2149
 General Elec Supply 23 Nichols Dr PL 4-2143
 *Hatry of Waterbury 89 Cherry 5-1181
 Mac's Radio & Electronic 200 Bank St

DELAWARE

WILMINGTON
 Almo Radio 1122 French St Hqrs Philadelphia
 Delta Electronics Supply 220 W 4 St DL 4-7932
 D & M Radio & Electronics 215 W 4 St DL 6-2222
 General Electric Supply 310 S Market St 5-5561
 Graybar Electric 1005 W 4 St ST 6-7761
 Radio Electric 3 & Tainall Sts 6-8664
 Westinghouse Electric 400 S Market 5-9611
 Wholesale Electronic 3rd & Monroe Sts 6-1144
 Wilmington Elec Supply 405 Delaware Ave 5-4321

DISTRICT OF COLUMBIA

WASHINGTON
 *Capitol Radio 2120 14 St N W HO 2-0800
 *Electronic Wholes 2345 Sherman N W HU 5200
 General Electric Sup 705 Edgewood N E HU 3-6800
 Graybar Elect 60 Fla Ave N E AD 4-4800
 Kenyon Radio Supply 2020 14th St N W DE 2-5800
 *Rucker Electronic 1312 14 St NW AD 2-8554
 *Silberne Radio 3400 Georgia Ave NW TV 2-7800
 *Southern Electronics 3405 Georgia NW TV 2-5000
 Southern Wholes 707 Edgewood NE HU 3-3422
 Sun Parts Distr 514 10 St NW ME 8-2697
 Westinghouse Elec 1216 K St NW NA 8-9700

FLORIDA

DAYTONA BEACH
 Hammond Electronics Hqrs Orlando
FORT LAUDERDALE
 Certified Radio TV 2606 S Federal Hwy JA 3-6451
 Graybar Electric 845 N W 6th Ave JA 3-9672
FORT PIERCE
 McNeas Radio Supply 900 S Dixie Hwy 2728
GAINESVILLE
 Baird Hardware Co 1 SE 1st 2-8531
MIAMI
 Herman Radio Supply Hqrs Miami
JACKSONVILLE
 Acme Electronics Distr 811 Main St 6-0485
 General Elec Supply 530 E Forsyth St EL 3-9011
 Graybar Electric 12 & Main Sts EL 6-7611
 Kinkade Radio 1402 Laura Hqrs Tampa
 Peard Electronic Sup 535 Washington EL 5-3473
 Puffuff Co G F 2231 W Beaver EL 6-1591
 Southeast Audio Co 930 W Adams ST 4-6372
 Southern Hardware 11 S Newman St
 *Thurrow Distributors 15 E Church St 5-3727
 Westinghouse Elec 545 E 4 St 3-7431
LAKELAND
 Hammond Electronics Hqrs Orlando
 Radio Accessories Hqrs Orlando
LAKE WORTH
 McNeas Radio Supply Hqrs Ft Pierce
MIAMI
 Certified Radio TV 675 NW 11 St 82-1637
 East Coast Radio 1932 NW Miami Ct 82-4636
 Electronic Supply 61 NE 9 St 9-4512
 Emerson Radio of Fla 131 NE 10th St
 Flagler Radio Co 1068 W Flagler St
 Graybar Electric 2111 NW 22 Ave MI 65-1411
 *Herman Radio Supply 1365 NW 23 NE 4-6591
 Radio-TV Parts 2611 NW 21 Terrace NE 5-0626
 Sanders Electronics Co 3408 NW 7 Ave 65-1389
 Sea Coast App Dist 1481 NW 22 St ST 9-1761
 *Thurrow Distributors 2207 NE 2 Ave 9-6571
 *Walder Radio & Appl 1809 NE 2 Ave 9-4794
 Westinghouse Electric 11 NE 6 St 82-3691
ORLANDO
 General Electric Supply 523 N Garland 3-6407
 Goddard-Orlando 631 W Central Ave 5-5331
 Graybar Electric 400 Pittman St OR 5-4551
 Hammond Electronics 533 W Central Ave 5-2688
 Radio Accessories Co 2305 McRae St 5-2677
 *Thurrow Distributors 625 W Central Ave
PANAMA CITY
 Electronic Supply 316 Laverne Ave SU 5-4821
PENSACOLA
 Grice Radio & Elec 300 E Wright St HE 3-4616
 Gulf Elec & Hdwe 115 E Gregory St 6146
PENSACOLA
 Hundley Distributing 1110 N 13 Ave HE 2-5457
SARASOTA
 Radio Accessories Hqrs Orlando
ST PETERSBURG
 Cooper Radio Co 648 2 Ave S 7-7120
 Graybar Electric 1900 1 Ave S ST 7-4161
 Southern Electronic Labs 938 9 St S 75-2911
 TeeVee Parts 702 3 St S 7-0533
 *Thurrow Distr 342 3 Ave S Hqrs Tampa
 Welch Radio Supply 408 9 St S 7-8655
TALLAHASSEE
 General Elec Supply 705 S Woodward St 3-0520
 Radio-Television Supplies 1320 S Adams St 3-2337
 *Thurrow Distributors 739 Monroe Hqrs Tampa
TAMPA
 Elec Supply Co 106 S Franklin St 2-3745
 Emerson Radio of Fla 209 S Franklin St
 General Electric Supply 514 S Morgan 2-1805
 Goddard Distr 1502 Grand Central Ave 8-3117
 Graybar Electric 416 Eflamae Ave TA 2-4621
 Kinkade Radio Supply 1707 Grand Central 8-6043
 Radio Accessories Co 417 E Platt Hqrs Orlando
 *Thurrow Distributors 134 S Tampa St 2-1885
 Westinghouse Electric 417 Eflamae Ave 2-5595
WEST PALM BEACH
 Goddard Distributors 1309 N Dixie 3-5701
 *Thurrow Distr 327 Okochee Rd

GEORGIA

ALBANY
 General Electric Supply 410 Hodges Ave NE 5-5631
 Specialty Distributing Hqrs Atlanta
 Stewart's Radio 212 N Washington 2-1072
 Westinghouse Elec 610 N Washington 667
ATLANTA
 Atlanta Phonograph 27 Pryor SW WA 3380
 Garvin Electric 69 Forsyth St WA 2290
 General Electric Supply 172 Haynes St SW MA 3811
 Graybar Electric 333 North Ave NW CY 1751
 Jackson Electronic Sup 840 Marletta St NW EL 5808
 Southeastern Radio Parts 400 W Peachtree 6-9761
 Specialty Distributing 425 Peachtree EL 5815
 Thomas Electronics H 331 Luckie St NW LA 8477
 Westinghouse Elec 1299 Northside Dr NW AT 2721
 Yancey Co 1500 Northside Dr NW EL 8843
AUGUSTA
 General Elec Supply 1547 15 St 6-8422
 *Prestwood Electronics 1445 Greene St 4-5444
 Specialty Distributing Hqrs Atlanta
COLUMBUS
 Radio Sales 2000 12 Ave 7-3296
 Westad 1047 13th St
MACON
 *Electronic Distr 995 Riverside Dr
 Telephone 3-9379
 Guy M White President
 H W Chapman Store Manager
 Mrs Janice Richards Office Manager
 Area served State of Georgia
 Hatcher Co A S 586 3 St 3-5464
 Specialty Distg PO Box 102 Hqrs Atlanta
ROME
 Electronic Supply 217 E 1st St 7842
SAVANNAH
 General Electric Supply 301 E Bay St 4-2231
 Graybar Electric 2601 Whitaker St SA 2-1121
 Southeastern Radio Parts 38 Montgomery St 7565
 Specialty Distg 411 PO Box 102 Hqrs Atlanta
 Tuten & Long 1508 E 50 St
 Westinghouse Elec 580 Indian 3-9682
 Yancey Co 666 Indian St 4-1611 Hqrs Atlanta

IDAHO

BOISE
 *Graddock Radio Sup PO Box 297 2-6471
 General Electric Supply 618 S 8 St 4343
 Graybar Electric 1325 Idaho St BO 2-4501
 *Kopke Electronics 3113 Rosehill 2-2371
 Robbins Radio 4001 Hill Rd 2-8892
 Strevell-Paterson Hqrs Salt Lake City
 Westinghouse Electric 318 S Capital Blvd 2-3531
IDAHO FALLS
 Schwendinnam Distributing Co 380 E St 4393
POCATELLO
 Ballard-Carter Hqrs Ogden
 Billmeyer's Wholesalers 625 S 1st 698
TWIN FALLS
 United Automotive 328 3 St E 2355

ILLINOIS

ALTON
 Radonics Alton Inc Hqrs St Louis
AURORA
 Pioneer Radio Supply 103 S La Salle St
BELLEVIEWE
 *Lurtz Electric 219 N Illinois St AD 3-0942
BENTON
 *Lampley Radio 802 N McLeansboro 5111
BLOOMINGTON
 Alverson Sales Co 217 E Front St 2-8380
 Aroo Electric Supply 908 S Lee St 2-5145
 Suter TV Supply Hqrs Springfield
CALUMET CITY
 Chaunceys Inc 136 Pulaski Ave Hqrs Chicago
CENTRALIA
 Centralia Elec Supply 108 S Chestnut 7111
CHAMPAIGN
 Electronic Parts Co 905 S Nell St 6-1896
CHICAGO
 *Allied Radio 100 N Western Ave HA 1-6800
 American Electric 621 W Randolph DE 2-5226
 Arpio Sales 4305 Lincoln St WE 5-7781
 Ashbach Leonard 743 N LaSalle St WH 4-0077
 Atronic Sales 6566 Sheridan Rd 1-2424
 *Bowman & Co J G 515 E 75 St TR 4-8070
 Broadwin TV & Radio 5004 Broadway UP 8-6060
 *Chaunceys Inc 4740 W Chicago Ave ES 8-0830
 Chicago Radio Apparatus 415 S Dearborn HA 7-2276
 Clayton Radio 3202 N Pulaski AV 3-2570
 *Electronic Expeditors 2909 W. Devon Ave RO 4-8640
 General Elec Supply 845 S Clinton WA 2-5656
 Graybar Electric 850 W Jackson Blvd CA 6-4100
 Green MHI Radio Supply 145 W 111 St PU 5-9840
 Grove Electronic Sup 4103 W Belmont KI 5-6806
 Howard Electr 4140 Archer Ave CI 4-1777
 Lukko Sales Corp 5024 Irving Park Rd AV 3-4800
 Merquist Co 5904 W Roosevelt Blvd AU 7-6274
 Mid-States Electronic 5028 N Bldy LO 1-2894
 *Midwest Electr 6907 N Western Ave RO 1-1160
 Newark Electric 223 W Madison ST 2-2950
 Olson Radio 623 W Randolph DE 2-5226
 Pilgrim Distributing 1230 E 53 St FA 4-6043
 Pioneer Radio Supply 5243 W Diversey Ave BE 7-5754
 Premier TV Radio 3239 W North St AR 6-5550
 *Radio Parts Co 612 W Randolph DE 2-5556
 Radio-TV Supply 4345 W Armitage Ave HU 9-3311
 RCA Victor Distr 5000 S Kedzie PR 8-3000
 RPD Arther Nagel Inc 918 E 55 St BU 8-5050
 Star Electronic 7736 S Halsted HU 3-8440
 Stolz-Wicks 8110 S Western RE 7-3363
 Triangle Industries 600 W Adams AN 3-5060
 U S Radio & TV 6346 S Ashland WA 5-4111
 *Walker-Jimison 311 S Western Ave CA 6-2525
 Westinghouse Elec 113 N May St TA 9-5000
DANVILLE
 Bad Electronic 118 E Van Buren St E 925
 Westinghouse Electric 603 N Gilbert 1901

DECATUR
Crum Dist 704 N Monroe 3-7776
Toughnane & Co 802 N Water St 2-4187
York Radio & TV 518 E Prairie St 3-3484

DIXON
Illinois Appliance 407 W 1 St 4-0091

EAST ST LOUIS
Electronic Part Supply 3619 State St UP 4-1212

ELGIN
Elgin Electronic 157 Brook St SH 2-7635

ELMHURST
Malone Electronics 123 Addison St IE 4-5110

EVANSTON
Chauneys Inc 1908 Central St Hqrs Chicago

HARRISBURG
Standard Distrs 432 W Poplar St 640

JACKSONVILLE
Baptist Radio & TV 419 S Mauvasterre CH 5-4109

JOLIET
Joliet Radio Supply 460 N Chicago 3-9328

KANKAKEE
Radio Doctors 892 W Station St 2-4726
York Radio & TV Hqrs Decatur

LA SALLE
Warren Radio Co Hqrs Peoria

MACOMB
Baptist Radio & TV Hqrs Jacksonville

MATTOON
Mattoon Radio & TV 212 N 20 St. 5457

MOLINE
Lofgren Dist Co 1202 4 Ave MO 4-7436

MT CARMEL
Wabash Electronics 700 Plum St 728

OAK PARK
Melvin Electronics 541 Madison VI 8-3960

PEORIA
Graybar Electric 704 S Adams PE 6-0765
Griffin Distributing Co 400 Franklin St
Hardware Prod Co 3408 N Adams Hqrs Sterling
Herberger Radio Supply 136 I St
Klaus Radio & Electric 707 Main St
Ross Radio 1915 Main St 3-3721
Selectronic Supplies 803 S Adams Hqrs Toledo
Warren Radio 308 Oak St 4-5998
Westinghouse Electric 2800 N Adams St 2-5456
Williams Inc 828 S Adams St 3-4446
Yeomans Distributing 3302 N Adams 5-7631

QUINCY
Cooper Supply 419 S 10 St 237

ROCK FALLS
Hardware Prod Co Hqrs Sterling

ROCKFORD
General Electric Supply 810 20 St 5-0551
H & H Electronic Sup 510 Kishwaukee St 5-4625
Johnson Sales Art A 1117 Charles St
J & M Radio & Telev 1133 Railroad Ave
Mid-West Associated 506 Walnut St 4-5843
State-Wide Wholesale 922 North Ave
Superior-Rockford Hqrs Racine Wis
Westinghouse Elec Supply 323 S Main St 5-0577

ROCK ISLAND
Cameron Co 1714 5 Ave 8-7457
Tri-City Radio Supply 1919 4 Ave 8-5681

ST JACOB
Michael's Electrical Supply 4th & Douglas 3200

SPRINGFIELD
Bruce Harold 1120 E Capitol Ave 8-7523
General Electric Supply 1007 E Jefferson 3-4509
Graybar Elec Co 405 N MacArthur Blvd SP 8-0484
Sasco United Tel 217 E Washington 2-6837
Sater TV Supply 1500 E Sangamon Ave 8-7369
Wilson Supply 106 W Jefferson 7845

YORK
York Radio & TV Hqrs Decatur

STERLINGS
Hardware Promets 201 Locust St 70

TUSCOLA
Moulden Distributing 106 W N Central Ave 163

WAVERLY
Waverly Wholesale 7471

INDIANA

ANDERSON
Seyberts Radio Supply 1331 Main St 3-5431

ANGOLA
Lakeland Radio Supply 525 S West St 70
Shaw Electronic Supply 200 S Darling St 291

BEDFORD
Electronic Supply Co 1718 K St 2350

BLOOMINGTON
Stansifer Radio 1805 S Walnut St

COLUMBUS
Williams Co H A 1003 Washington St 7646

CROWN POINT
Hub Distributors 106 N Main St 1110

ELKHART
Electronics Parts Inc 725 S Main St 2-1208

EVANSVILLE
Castrup's Supplies 1014 W Franklin HA 2-7618
General Electric Supply 2000 N New York Ave 5-2655
Graybar Electric 1709 E Columbia St EV 6-1357
Hatch & Son 919 Vine St HA 4-6731
Ohio Valley Sound 20 E Sycamore 5-6173
Wesco Radio Parts 428 Penn St HA 2-2141
Westinghouse Electric 201 N W 1 St 5-7276

FORT WAYNE
Bohn Sound Eng'g Lincoln Hwy East EA 1202
Fort Wayne Electronics 3606 Maumee EA 3431
General Electric Supply 1609 S Calhoun HA 3243
Midwest Electronics 2016 S Webster St K-5330
Pemberton Labs 236 E Columbia E-1812
Protective Electronics 130 W Columbia A-9331
Radio Equip 1815 E Wayne Hqrs South Bend
Van Sletke Radio 1320 S Calhoun E-4136
Wall Distributing 241 Pearl St E-2027
Warren Radio 1716 S Harrison Hqrs Toledo
Wayne Hardware 254 W Main St A-7153
Westinghouse Elec Supply 610 S Harrison AN 3421

FRANKFORT
Dosssett Co M H 355 N Columbia 5394

GARY
Cosmopolitan Radio 524 Washington TU 5-0551
R-B Distr 3763 Broadway GA 4-8824
Walker-Jimleson 615 W 11 Ave Hqrs Chicago

HAMMOND
Broadwin Radio-TV 6547 Kennedy Ave TI 4-7200
General Elec Supply 506 Fayette St SH 5155
Graybar Electric 6445 Indianapolis Blvd TI 4-7800
Nationwide Radio 7015 Calumet Ave DE 2-6843
Westinghouse Electric 6341 Ind Blvd RU 9400

HUNTINGTON
Colfax Co 67 E State St 3610

INDIANAPOLIS
Associated Distrs 210 S Meridian St LI 2593
General Electric Supply 1250 Stadium Dr ME 4-8445
Graham Electronics 102 S Penna St ME 4-8487
Graybar Electric 1300 W 16 St AT 2351
Hoosier Radio Supply 132 W 13 St ME 4-5579
Meunier Radio Supply 524 N Illinois St LI 8884
Moore Electronic Parts 320 Virginia ME 4-4346
Peerless Electric 122 S Meridian PI 2361
Radio Distributing 103 N Capital Ave ME 5-8311
Radio Equipment Co 1010 Central Ave PL 6453
Rodefeld Co 614 N Capital Hqrs Richmond
Warren Radio 908 N III St Hqrs Toledo
Westinghouse Elec Supply 139 S Penna St MA 3301

JEFFERSONVILLE
Moakler Electronic 500 E Chestnut 2-4311

KOKOMO
George's Electronic 125 N Buckeye 6771
Radio TV Distr 507 N Washington 2-5651
RPD-Arthur Nagel Inc Hqrs Chicago

LAFAYETTE
Holmes Radio State Rd 25 Box 559 2-6845
Lafayette Radio Supply 408 E North St 2-5217

LOGANSPOUT
Conrad Co AE RFD 4 5-6456
Television-Radio Dist Hqrs Peru

MARION
Mobile Radio Supply 507 N Washington NO 2-2981
Myers Radio Supply 115 W 22 St 1357

MICHIGAN CITY
Tri-State Electrical 216 E Michigan St

MUNCIE
General Electric Supply 904 Burlington Dr. MU 6614
Muncie Electronics 305 N Madison 8837
Standard Radio Parts 1104 S Walnut 5525

PERU
Television-Radio Distr 812 W Main 2005

RICHMOND
Fox Electronics 711 S 9 St 2-4676
Radio & TV Dist Hqrs South Bend
Rinehart Inc 511 Main 2-2581
Rodefeld Co 96 W Main St 2-4088

SOUND BEND
Colfax Co 802 S Main AT 9-5548
General Elec Supply 422 E Monroe St 6-3411
Radio Distributing 1212 High St AT 8-4666
Radio Equipment Co 1202 S Lafayette AT 9-2471
Radio & TV Distr 116 N Hill St 3-9394
Wayne Hdw 1630 Lincolnway W Hqrs Ft Wayne

TERRE HAUTE
Eyringer Co G T 1216 Wabash Ave CR 7757
General Elec Supply 801 Poplar St GR 9695
Terre Haute Radio PO Box 804 LI 2-6025

VALPARAISO
Bowman & Associates Jess Hqrs Chicago

IOWA

BURLINGTON
Union Supply Co 409 Washington 7270 PL 2-5444

CEDAR RAPIDS
Gifford-Brown 726 5 St Hqrs Des Moines
Iowa Radio Supply 508 3 Ave SE 4-5346
Ken-Elis Radio Sup 67 16 Ave SW Hqrs Ft Dodge
Midwest Specialty 614 I St SW

COUNCIL BLUFFS
World Radio Labs 3415 W Broadway 2-0277

CRESTON
Mid State Distr Hqrs Des Moines

DAVENPORT
Crescent Elec Supply 511 Pershing St 3-9973
Graybar Electric 206 E 5 St DA 3-2768
Midwest-Timmerman 114 Western Ave 7-5288
RCA Victor Distr 1235 W 5 St 4-9847
TCR Distrs 1205 E River Dr 3-8051
Union Supply Co 320 E 4 St 2-3531
Westinghouse Electric 402 E 4 St 3-9966

DES MOINES
General Electric Supply 108 E 4 St 8-7401
Gifford-Brown Inc 14 S Walnut St 3-1257
Graybar Electric 24 11 St DE 3-8614
Iowa Radio Corp 1212 Grand 2-8197
Mid-State Distr 1201 Grand 8-7231
Midwest-Timmerman Hqrs Davenport
Onthank Co G W 10 & Mulberry 3-8166
Radio Trade Supply 1224 Grand AT 8-7237
Schneiderhahn Co A A 319 SW 5th St
Westinghouse Elec Supply 1400 Walnut 2-0244

DUBUQUE
Boe Distributing 1605 Rockdale Rd 3-5795
Crescent Electric Supply Hqrs Davenport

FORT DODGE
Ken-Elis Radio Supply 501 1st Ave WA 3880

MASON CITY
Ray-Mac Supply Co 307 9 St 5900

OTTUMWA
Friday-Lynch Radio 429 W 2 St MU 2-5407
Mid State Dist Hqrs Des Moines

SIOUX CITY
Barghardt Radio 611 E 5th St 5-8023
Crescent Electric Sup 308 Iowa St Hqrs Davenport
Duke's Radio 209 6 St 5-5056
Graybar Elec Co 510 Pearl St SI 8-7507
Power City Radio 410 Jones Hqrs Sioux Falls SD
Warren Radio Supply Hqrs Sioux Falls SD
Westinghouse Electric 1005 Dace St 5-7634

WATERLOO
Farnsworth Radio & TV 201 E Mullan Ave AD 4-6682
McDermott Electric D A 200 Bailou St AD 3-5296
Westinghouse Electric 300 W 3 St 4679

KANSAS

ATCHISON
Bliss Wize & Stillman 223 S 5th St

COFFEYVILLE
Four State Radio Hqrs Joplin Mo

GREAT BEND
Radio Supply Co of Great Bend 1109 Main 9491

HUTCHINSON
Acme Radio & Television Hqrs Topeka
Interstate Electronic Supply 325 W 4 St 2-7941

KANSAS CITY
Henshaw Radio Hqrs Kansas City Mo
RCA Victor Fairfax & Funston Rd AT 3075

MANHATTAN
Acme Radio Supply Hqrs Topeka

PITTSBURG
Pittsburg Radio Supply 212 S Broadway 356

SALINA
Radio Supply Co 533 N Santa Fe 7-3841
Western Dist 227 Santa Fe N 7-0561

TOPEKA
Acme Radio Supply 412 E 10 St 5-1363
General Elec Supply 115 Jackson 5-4474
Overton Electric 522 Jackson St 3-2611

WICHITA
Amateur Radio 1203 E Douglas HO 4-3579
Excel Distributors 118 W 2 4-4783

KENTUCKY

ASHLAND
Ashland Radio Supply 2125 Winchester 3125

BOWLING GREEN
Crescent Radio Supply 212 W 10 St VI 2-2444

COVINGTON
United Radio Inc Hqrs Cincinnati

HARLAN
General Electric Supply Hoskins St 815

HOPKINSVILLE
Randolph & Hale Hqrs Nashville

LEXINGTON
Electronic Distr 134 W 3 St 2-7414
General Electric Supply 309 N Ashland Ave 2-1887
Ky Radio Supply 376 E Main St 2-3373
Lex-Tronics 810 E 3rd St 4-3470
Miller's Barney 232 E Main 2-9622
Radio Equip Co 480 Skain Ave 3-1577

LOUISVILLE
Arby Electronics Hancock & Gray WA 8851
Burks Co P I 911 W Broadway JU 4-0254
Ewald Distributing 309 S 9 St JA 8227
Falls City Supply 315 Roland WA 7447
Fulmer Inc Arthur 118 W Chestnut Hqrs Memphis
General Electric Supply 2311 S Brook St CA 3651
Graybar Electric 614 Myrtle ME 7-5411
Peerless Elec Equip 2210 S 7 St CA 7678
R-K Distr 801 W St Catherine JA 5-5349
Universal Radio Supply 533 S 7 St JU 4-4166

MADISONVILLE
Hutch & Son Hqrs Evansville

NEWPORT
Apex Distributing 506 York St AX 1949
Holub & Wogg Co Hqrs Cincinnati

OWENSBORO
Centronics Inc 600 W 3 St 3-6727
Peerless Elec Equip Hqrs Louisville

PADUCAH
Warren Radio 455 S 31st St 2-4367

LOUISIANA

ALEXANDRIA
Brown-Roberts Hdw Supply 1810 3rd St
Central Radio Supply 601 N 3 St 3-4517

BATON ROUGE
Electronic Supply 1753 N 21 St 2-0517
Gautreaux's 1370 Government St Hqrs New Orleans
General Electric Supply 5575 Adams Ave 7-7586
Graybar Electric 2442 T Danham Ave BA 3-3427
La Radio TV Distr 1645 Plank Rd 8-1456
Ole Miss Supply 1801 N Boulevard 3-4035
Ralph's Radio Electronic Supply 812 Main St

BOGALUSA
Gautreaux's Hqrs New Orleans

HOUMA
Crescent Radio & Sup Hqrs New Orleans

LAFAYETTE
Ralph Radio & Electronic 1419 Cameron St
Wholesale Radio Hqrs Lake Charles

LAKE CHARLES
Graybar Electric 206 W 11 St HE 3-4229
Wholesale Radio Equip 324 Ryan St HE 9-9017

MONROE
C & O Electronics 500 N 3 St 3-5732
Hale & McNeil 421 Walnut St 2-5136
Poulans Electrical Co 501 Morris Ave 3-7701

NEW ORLEANS
Allen Supply Co W B 1601 Orleans Ave RA 8222
Audiotronics Supply 1834 N Claiborne VI 5579
Bell Radio Supply 2625 Tulane Ave TU 0644
Columbia Radio & Supply 3940 3 St TW 5-4893
Crescent Radio & Supply 1600 Baronne St CA 3112
Electrical Supply Co 201 Magazine St
Electronic Distrs 1526 Magazine MA 6700
Gautreaux's Elec Supply 2746 Orleans Ave AU 1619
General Elec Supply 4221 Blenville CA 5771
Graybar Electric 1116 Magnolia St CA 6263
Industries Sales 2927 Jackson Ave
Interstate Electric 1001 S Peters CA 8541
Pee-Jay Radio 2306 Tulane Ave AU 0807
Pelican Radio Supply 824 N Broad St
Radio Parts Inc 807 Howard Ave CA 0217
Radio Specialty 3119 S Carrollton Ave

Shuler Supply 2508 Tulane Ave RA 2166
 *Southern Radio Supply 1909 Tulane TU 2345
 Stratton-Baldwin PO Box 253
 Telev & Appl Dists 500 N Carrollton AU 8701
 Walther Bros 1722 Poydras St CA 7731
 Westinghouse Elec 2538 Poydras TU 5411

OPALOUSAS

Wholesale Radio Equip Hdqrs Lake Charles
SHREVEPORT

Baggett Radio & TV 872 Texas Ave 2-5137
 Duncelman Distributing Co 119 Beech St 2-8452
 General Electric Supply 1430 Dalzell St 5-8631
 Graybar Electric 90 Fannin St SH 5-3271
 Interstate Electric Co 1410 Culpepper St 3-6131
 *Koelemay Sales Co 2530 Linwood Ave 3-4256
 *Lavender Radio & TV 936 Millam St 3-7161
 Ports Electronics Parts 309 Airport Dr 2-2193
 Westinghouse Electric 120 Caddo St 3-0583

MAINE

AUBURN

*Radio Supply Co 26 Cross St 4-5486

AUGUSTA

Westinghouse Electric 98 Water St 2040

BANGOR

Commercial Dists 135 Exchange St
 General Elec Supply 840 Hammond St 7331
 *Maine Electronic Hdqrs Portland
 Radio Serv Lab 16 Salem Ct Hdqrs Manchester NH
 Radio Supply Co Hdqrs Auburn
 Westinghouse Elec Supply 175 Broad St 6487

HALLOWELL

*Powell Radio 115 Water St 3-3839

PORTLAND

Brown Co F M 12 Free St 3-4791
 Commercial Distributors 35 Commercial St
 General Electric Supply 170 Anderson St 2-3721
 Graybar Electric Center & Commercial SP 3-1766
 *Maine Electronic Supply 148 Anderson 4-0301
 Radio Serv Lab 1004 Congress Hdqrs Manchester

MARYLAND

BALTIMORE

American Distr Co 1200 N Fulton LO 6-8930
 Berman H O Co 12 E Lombard LE 9-7002
 D & H Distr Co 2025 Worcester St SA 7-5100
 General Elect Supply 1500 Barclay LE 9-3565
 Graybar Electric 100 South St SA 7-5050
 *Kann-Ellert Electronics 9 S Howard SA 4242
 Lytron Distr Co 1338 W North Ave LA 3-8880
 *Radio Elec Serv 5 N Howard LE 9-3835
 Spartana Co A R 239 Gay St SA 7-0484
 Valley Electronics Inc 1735 E Joppa Rd VA 5-7820
 Video Electronics 5617 Belair Rd HA 6-7913
 Westinghouse Electric 2415 W Franklin LO 6-4400
 *Wholesale Radio Parts 308 W Redwood St MU 5-2134

CUMBERLAND

Altoona TV Supply Hdqrs Altoona Pa
 *Zimmerman Wholesalers 162 Bedford 920

FREDERICK

Hankey's Radio & TV 404 Elm St MO 2-1381

HAGERSTOWN

General Elec Supply 1095 Jefferson Blvd 6216
 Stoddard Supply Co 354 S Cannon 6342
 York Radio 67 W Franklin Hdqrs York Pa
 *Zimmerman Wholesalers 114 E Washington St 408

SALISBURY

Almo Radio Co Hdqrs Philadelphia Pa
 Standard Electronics 301 Snow Hill Rd 7593

SILVER SPRING

Rucker Electronics 8049 13 St Hdqrs Washington
 Silver Spring Electronic 948 Silgo JU 8-3567

MASSACHUSETTS

ARLINGTON

Herman Co Louis M Hdqrs Boston

BOSTON

Arvedon Distributors 73 Portland CA 7-4034
 Commercial Radio 36 Brattle Rd RI 12 1241
 *Cramer Electronics 811 Boylston CO 7-4700
 *DeMambro Radio 1111 Commonwealth St 2-7870
 Electro Sales Co 50 Eastern Ave CA 7-3456
 General Electric Supply 145 N Beacon AL 4-5300
 *Gerber Radio Supply 1900 Columbus GA 7-1144
 Globe Electronics Co 200 Washington St LA 3-3117
 Graybar Electric 287 Columbus KE 6-4567
 Herman Co L M 885 Boylston St CO 7-5620
 *Mayer Co A W 895 Boylston CO 7-5530
 *Radio Shack 167 Washington LA 3-3700
 Radio Wire TV 110 Federal St Hdqrs NYC
 Sager Elec Supply 201 Congress St LI 2-2281
 Tee-Vee Supply 3211 Washington JA 2-9380
 Westinghouse Elec 95 Brookline Ave CO 7-3100
 Yankee Electronics 257 Huntington Ave CO 6-0212

BROCKTON

*Ware Radio Supply 913 Centre St 8-0810

CAMBRIDGE

Eastern Co 620 Memorial TR 6-4720
 *Electrical Supply 1739 Mass Ave UN 4-6300
 HI-FI Lab 89 Mt Auburn St TR 6-2666
 Northeastern Dists 304 Vassar St
 Selden Distr Co 800 Mass Ave KI 7-0920

FALL RIVER

Ross & Co E A 341 Columbia St 3-0921

FITCHBURG

*Young & Young 372 Water St 3-3078

HOLYOKE

Springfield Radio 93 High Hdqrs Springfield

LAWRENCE

*Young & Young 262 Lowell St 7171

LOWELL

McCartin Co F P 181 Market St GL 9-9750

LYNN

Des Roberts Elec 24 Mt Vernon St LY 5-0015

WHOLESALE RADIO PARTS CO. INC.

311 W. BALTIMORE ST. BALTO. 1, MD.
 PHONE Mulberry 5-2134

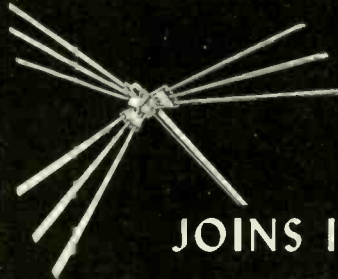

JOINS IN
 HONORING



TEE VEE SUPPLY

3211 WASHINGTON ST.
 BOSTON—PEABODY

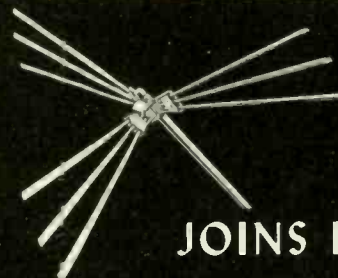

JOINS IN
 HONORING



MEDFORD
Durrell Distr 222 Mystic Ave MY 6-8780

MELROSE
*Melrose Sales Co 60 Essex St ME 4-3821

NATICK
Willett Radio Supply 11 Court 1313

NEW BEDFORD
*Beckman Co C E 11 Commercial WY 6-8201
Ross & Co E A 1663 Purchase St Hqrs Fall River

NEWTON
Delta Distr 314 Washington Bl 4-1560

NORTHAMPTON
C & I Distributors 228 Pleasant St JU 4-4164

NORWOOD
Herman Co Louis M Hqrs Boston

PEABODY
TeeVee Supply 39 Main St Hqrs Boston

PITTSFIELD
Del Padre Supply 111 West St
*Pittsfield Radio 41 West St
Young & Young Hqrs Springfield

QUINCY
Gerber Radio Supply 1153 Hancock St MA 9-4300

SPRINGFIELD
*Cushing T F 349 Worthington St ST 8-7341
*Del Padre Assoc L L 236 Chestnut 9-5658
General Electric Supply 484 Worthington RE 4-8255
Graybar Electric 32 Patton ST 8-7331
Radio & TV Supply 906 State St RE 6-5641
Regent Sales 236 Chestnut St
*Soundco Electronic 147 Dwight RE 9-3847
Spinney Co B H 153 Plainfield St RE 4-8284
*Springfield Radio 405 Dwight St RE 2-3411
Western Mass Distr 1 Belmont Ave RE 6-6374
Westinghouse Elec 46 Hampden 4-3101
*Young & Young 169 Spring St RE 4-1138

TAUNTON
*Dean & Co D B 85 Cohannet St TA 4-4117

WORCESTER
*DeMambo Radio Supply Hqrs Boston
General Elec Supply 163 Mechanic W0 6-4351
Graybar Electric 108 Grove PL 6-4311
Johnson Electronic 12 E Worcester PL 6-7136
*Radio Electronic Sales 52 Chandler PL 7-5671
*Radio Maint Supply 80 Thomas St PL 6-8311
Westinghouse Elec 107 Thomas St 7-5641

MICHIGAN

ADRIAN
Wedemeyer Electronic Supply Hqrs Ann Arbor

ALBION
Matteson Electronics Hqrs Jackson

ANN ARBOR
Purchase Radio 605 Church 8-8696
*Wedemeyer Electronic 214 N 4 Ave 2-4457

BATTLE CREEK
*Electronic Supply 94 Hamblin 2-9515

BAY CITY
Klinde Distr Co 504 Washington St 7461

BENTON HARBOR
Benton Electronic 643 W Main 5-1373
Radio & TV Distr Co 1331 N-139 WA 5-3301

CHEBOYGAN
*Straits Distributors 412 N Main St 960

DEARBORN
*Westside Radio 7521 Wyoming WE 3-6972

DETROIT
Audio Equip Co 15749 Wyoming UN 4-1884
Detroit Electronic 8000 Grand River TY 6-9500
Duffy & Co M N 2040 Grand River W0 3-2270
*Ferguson Radio 2306 Puritan Ave UN 1-6700
General Elec Supply 680 Antoinette St TR 5-9400
*Glendale Supply 12866 Woodward Ave TU 3-1500
Graybar Electric 15045 Hamilton Ave TO 8-5550
Hi-Park Distrs 155 La Belle Ave TO 8-9409
*Kia Labs 7422 Woodward TR 4-1100
Nor-West TV & Radio 21223 Grand Ave KE 5-0300
RCA Victor Distr 7400 Intervale TE 4-3500
Radio Distr 15401 Woodrow Wilson TO 9-7900
Radio Electronic 1112 W Warren TE 2-5611
*Radio Specialties 456 Charlotte TE 2-0800
*Radio Supply 85 Seiden TE 1-3171
Reno Radio Co 1314 Broadway W0 2-6851
*Rissi Electronic 14405 Wyoming Ave TE 4-8420
Rizzo Radio Dist 8801 Fenell Ave WE 3-9829
Westinghouse Electric 2211 Kirby W TY 8-9000

ESCANABA
Electronic Expeditors Hqrs Milwaukee
Felton Radio 1617 Ladington 2855

FERNDALE
Erickson's Electronic 1201 Woodward Hts LI 5-6710

FLINT
C & S Electronic Sup 758 E Witherbee St CE 8-1739
General Electric Supply 4705 N Dort Hwy SU 9-9101
Graybar Electric 2424 Kansas CE 2-4101
*Lifsey Distr Co 1409 N Saginaw CE-6657
Radio Tube Merch Co 508 Clifford CE 4-3654
*Shand Radio Spec 2608 Leith St CE 2-9714
Westinghouse Electric 2330 N Dort H'way 4-8623

GRAND RAPIDS
Bursma Radio Supply 870 Grandville CH 5-0501
General Electric Supply 305 Fulton St W 9-3243
Graybar Electric 432 Monroe Ave N W GL 1-2561
*Radio Electronic 505 Jefferson S E 9-4611
Radio Equip Co 13 Ionia Ave S W Hqrs S Bend
Radio Parts Inc 542 S Division 9-0247
Warren Radio 24 Logan St S W GL 6-5385
Westinghouse Elec 511 Monroe Ave N W 9-4664

JACKSON
*Fulton Radio 1208 Greenwood St 4-6106
Matteson Electronic 1617 E Michigan ST 2-8286

KALAMAZOO
*Electronic Supply Hqrs Battle Creek
General Electric Supply 112 Parkway 3-2645
Ralston Co R M 201 N Park St 5-0188
*Warren Radio Hqrs Toledo

LANSING

*Elec Product Sales 427 E Mich Ave IV 2-4123
Fulton Radio Supply Hqrs Jackson
General Elec Supply 428 N Grand IV 7-5401
Graybar Elec Supply 421 E Elm St IV 7-5075
*Offenhauer Co 227 W Washentaw 2-9896
*Wedemeyer Electronic Hqrs Ann Arbor

LAURUM
*Northwest Radio 435 Tamarack 797

LINCOLN PARK
Glendale Electronic Sup Hqrs Detroit

MANISTEE
Gardner Radio 258 River St 1653

MARQUETTE
Northwest Radio Hqrs Laurum

MUSKEGON
Bell-Lourin 1839 Peck St 2-6019
Bursma Radio Hqrs Grand Rapids
*Fitzpatrick Elec 444 Irwin 2-6621

MUSKEGON HEIGHTS
Western Electronic 1781 5 St 2-7628

PONTIAC
*Electronic Supply 248 E Pike St 2-8341

PORT HURON
Main TV Supply Hqrs Akron Ohio

SAGINAW
Carson Distrs 708 N Washington Ave 5-5301
General Elec Supply 125 Davenport St 3-6474
Orem Distributing 401 S Franklin St 3-6571
*Radio Paris Co 803 S Washington 5-5338
Saginaw Distributors 1751 E Genesee Ave 3-5444

SAULT STE MARIE
Straits Distributors Hqrs Cheboygan

YPSILANTI
Wedemeyer Electronic Supply Hqrs Ann Arbor

MINNESOTA

AUSTIN
Radio Elec Sup Hqrs Minneapolis

DULUTH
Bonn Co Lew 228 E Superior Hqrs Minneapolis
General Electric Supply 246 Lake Ave S 2-0826
Graybar Electric 320 W 1 St RA 2-6646
*Northwest Radio 123 E 1 St RA 7-1565
*Stark Radio 17 N 2 Ave E Hqrs Minneapolis
Westinghouse Elec 230 Lake Ave S ME 2-2625

MANKATO
Southern Minn Supply 2 & Main Sts 4501

MINNEAPOLIS
*Bauman Co 3033 S Lyndale Ave GI 1745
*Bonn Co Lew 1211 La Salle St FE 9-6351
Ecklen Radio 114 N Lyndale Ave FE 3-0516
*Electronic Center 107 3 Ave N LI 8678
Forster Distr 1122 Harmon PI FE 3-5471
General Electric Supply 63 S 13 St BR 3266
Graybar Electric 824 S 4 St FE 6-1621
Hayer Co F C 250 3 Ave N AT 1401
Larson Elec J H 114 Glenwood Ave FE 9-2761
National Electronics 1215 Nicollet FE 8-8821
Northwest Radio 52 S 12 St Hqrs St Paul
Radio Elec Supply 2451 Nicollet FE 7733
Radio Maintenance 3016 1/2 27th Ave S DR 7546
Reinhard Bros 11 S 9 St K GE 2681
Royeratt Co 1625 Hennepin Ave GE 8881
Spencer George 444 Stinson Blvd ST 9-7241
*Stark Radio Supply 71 S 12 St FE 3-1325
Sterling Electric 33 S 5 Ave PA 4-1460
Westinghouse Electric 515 S 7 St LI 7001

ROCHESTER
Elliott & Hanson 119 1 Ave NW 2-2778
S Minn Supply Hqrs Mankato

ST CLOUD
Stark Radio Supply Hqrs Minneapolis

ST PAUL
Bonn Co Lew 141 W 7 St CA 4-2821
*Electronic Distr 856 Raymond PR 3911
General Electric Supply 540 N Fairview Ave PR 2761
Gerner Supply 173 W 454 CA 2-5549
Gopher Electronics 370 Minnesota St CA 4-9666
Graybar Electric 717 N Prior Ave NE 2631
*Hall Electric Co 566 N Robert St CA 4-5696
Northwest Radio & Electronic 194 W 4 St GA 3801
*Stark Radio 250 W Kellogg Hqrs Minneapolis
Westinghouse Electric 253 E 4 St GA 7441

WADENA
Central Co-op Wholesale Hqrs Superior Wise

WORTHINGTON
Radio Elec Sup Hqrs Minneapolis

MISSISSIPPI

BILOXI
Geautreux's Electronics Hqrs New Orleans
Nelson Radio Supply 613 Calliavet St 2-8651

COLUMBUS
Bluff City Distg Hqrs Memphis
Swan Distg Hqrs Jackson

GREENVILLE
Bluff City Distg Hqrs Memphis
Goyer Supply Co 815 Alexander St 8151

GULFPORT
Crescent Radio Hqrs New Orleans

HATTIESBURG
Swan Distg Hqrs Jackson

JACKSON
*Cabell Elec Co 422 S Farish 2-2624
Elliington Radio 816 S Gallatin St 3-1327
General Electric Supply 614 Gesco PI 2-5041
Graybar Elec 154 E Porter St JA 3-6316
May & Jackson Dist Co 628 S State St 5-6880
Southern Distributors 1400 Terry Rd 2-3456
Swan Distr Co 342 N Gallatin 2-5516
Television & Radio 323 N West 5-6406
Westinghouse Elec 325 S Farish 4-8354

LAUREL
Radio & TV Essentials Box 1131 6100

MERIDIAN
Griffin Radio Supply 2511 8 St 2-6174

MISSOURI

BUTLER
Henry Radio Co 211 N Main St 395

CAPE GIRARDEAU
General Electric Supply 402 S Sprigg 805
*Suedekum Electronic 2215 Broadway 5-8202

JEFFERSON CITY
*Central Mo Distr Co 324 E Capital Ave 6-3149

JOPLIN
*Brotherson Co M 515 N Byers Ave 3-1596
Continental Elec Hqrs Kansas City
*Four States Radio 201 Main St MA 4-0369
General Electric Supply 922 Penna Ave MA 4-5622

KANSAS CITY
*Burstain-Applebee 1012 McGee St BA 1-1155
Continental Electric 1321 W 13 GR 1180
General Elec Supply 2101 Broadway HA 7447
Graybar Elec Co 1644 Baltimore Ave BA 1644
*Henshaw Radio 3617 Troost Ave WE 1-5550
*Manhattan Radio & Equip 1732 Grand BA 1-9797
*McGee Radio & Electric 1422 Grand Ave VI 9045
RCA Victor Distr Corp 2113 Broadway HA 0300
Radiolab 1612 Grand Ave HA 0171

MOBERLY
Central Missouri Dist Co Clark & Coates St 260

POPLAR BLUFF
*Tri-State Radio 536 E Pine Blvd 2821

ST JOSEPH
*Acme Radio Supply 892 S 10 St 4-4558
*St Joseph Radio 720 S 9 St 2-8000

ST LOUIS
*Ashe Radio Co Walter 1125 Pine CH 1125
Brightman Distr 4421 Ridgewood SW 7575
Brown Radio Co Tom 3924 Washington St JE 1-2259
*Ebinger Radio 2501 S Jefferson MO 4-7700
General Elec Supply 2653 Locust St JE 1-3000
Graybar Electric 600 S Taylor Ave JE 1-4700
*Interstate Supply 24 S 10 St CH 2325
Napper Electronic 6253 Natural Bridge EV 1-8358
Phone Craft Co 427 N Euclid FO 1-3147
*Radionics 5040 Easton Ave FO 1-7311
Toler Radio Ralph 4855 Easton Ave FO 1-9169
*Van Sickle Radio 1113 Pine St CH 1-1814
Westinghouse Elec 1011 Spruce St CE 4838

SPRINGFIELD
General Elec Supply 1301 W Webster 2-1722
Graybar Electric Co 524 St Louis St SP 2-0587
Norman Electronic 700 E Brower 5-1435
*Reed Radio Supply Harry 805 Boonville St 4-0752
Stout Radio Supply 702 Boonville 2-9444

MONTANA

BILLINGS
American Appliances 2505 Montana St
Central Distr Co P O Box 1551 8-8447
Electronic Supply 250 11 St W 2-2197
General Elec Supply 2710 Montana Ave 9-4550
Heard Supply 3008 1st St N 5-5141
Midland Implement 2301 Montana Ave
Northwestern Auto 420 N Broadway 3-3146
Smith Supply 2521 Montana Ave Hqrs Butte

BUTTE
General Electric Supply 900 E Front St 2-2314
Graybar Electric 604 E Aluminum St BU 3233
Smith Supply 201 E Park St 2-8278
Westinghouse Electric 949 S Montana St 2374

GREAT FALLS
Bakers Radio & TV Supply 20 2 St S 2-7825
Lindgren Co Geo 16 4 St NW 8-8721
Radio Electronic Box 1376 2-6610
Smith Supply Co 808 Central Ave Hqrs Butte
Valley Motor Sup 512 1 Ave S Hqrs Havre

HELENA
Latus & Co D N 1531 Nat'l Ave HI 2-3940

MISSOULA
*Northwest Distr 509 S Higgins 4-4311

NEBRASKA

BEATRICE
Central Radio Sup Hqrs Hastings

GERING
Messersmith-Corr Radio-TV 1345 S St W 625

GRAND ISLAND
Central Radio Sup Hqrs Hastings
Radio & Equip Co Hqrs Omaha

HASTINGS
Central Radio Supply 518 W 1 St 2-2139

KEARNEY
Western Radio 1400 W 22 St
Telephone 2-3521
P S Beshore Pres-Purchasing
W P Beshore Gen Mgr
All principal lines
National coverage with 250,000 catalogs per year

LINCOLN
General Radio & TV 322 S 12 St 2-600Q
*Hicks Radio Co 1422 "O" St 2-7561
*Leuck Radio Supply 243 S 11 St 2-2797
Scott Electronic Supply 2201 O St 2-6558

NEBRASKA CITY
Arbor Radio TV Supply 921 Central 757

NORFOLK
Radio Equip Co Hqrs Omaha

OMAHA
Alco Radio 4011 Cumling St WA 8461
General Appliance 1101 Harney WE 4620
General Elec Supply 914 N 18 St JA 0456
Graybar Electric 3626 Martha St WE 7676
*JB Distr Co 1616 Cass St AT 5525
Omaha Appl 18 & St Mary's AT 3440
*Radio Equip Co 2852 Douglas AT 7700
*Siddis Co 7302 Pacific St RE 5225
Westinghouse Elec 117 N 13 HA 8700

SCOTT'S BLUFF
Joachim Radio 1913 Broadway 109
Skinner Supply Co 1305 1 Ave 700

NEVADA

LAS VEGAS
Radio & Sound Sap 25 E California Ave DU 2-5585
Savlers Elec Prod 110 E Charleston Hqrs Reno

RENO
Osborne & Dermody 300 Valley Rd 2-6957
Radio Supply 690 Tahoe St 3-4680
Savlers Elec Prod 640 Sierra St 2-9134

NEW HAMPSHIRE

CONCORD
*Evans Radio PO Box 312 CA 5-3538

DOVER
*American Radio Corp 6 St 404

MANCHESTER
*DeMambro Radio Supply Hqrs Boston
General Elec Supply 57 Bedford 5-5418
Graybar Electric 103 Hampshire Lane MA 4-4341
*Radio Serv Lab 670 Chestnut 5-5444
Westinghouse Electric 147 Hanover 5-5456

RYE BEACH
Delta Distributors Hqrs Newton Mass

NEW JERSEY

ATLANTIC CITY
Almo Radio 4401 Ventnor Ave Hqrs Phila
BR Elec Supply 926 Atlantic Ave AT 5-3448
*Kearns Inc Harrisburg & Atlantic AT 5-3233
*Radio Elec 452 N Albany Ave Hqrs Camden

BLOOMFIELD
Berger Electronic 241 Bloomfield BL 2-7900

BRADLEY BEACH
Lippman & Co Aaron Hqrs Newark

BRIDGETON
*Joe's Radio Shop 67 S Pearl 9-0251

CAMDEN
Almo Radio 1133 Haddon Ave Hqrs Phila
General Radio 600 Penn St W0 4-8393
Radio Elec Service 513 Cooper St W0 4-2830

CLIFFSIDE PARK
Nidisco-Cliffside 658 Anderson Ave CL 6-0510

CLIFTON
Eastern Radio 312 Clifton Ave GR 1-2800
Graybar Electric 1454 Main Ave GR 1-4800

EAST ORANGE
Gross Service 444 William St OR 6-7500
*International Distr 185 Central OR 5-1927

ELIZABETH
Jersey Radio-TV Sup 1068 Elizabeth Ave EL 2-7324
New Jersey TV Supply 906 E Westfil EL 3-6166
Tubes of N Y 1148 E Grand St Hqrs Newark

HACKENSACK
American Distr 756 Main St Hqrs North Bergen
Nidisco-Hackensack 55 State St HU 9-2000
Radio & Elect Supply Co 756 Main St HU 7-1267
Trade Radio Sales 14 Essex St HU 7-5512

HILLSIDE

Sherwood Distr 1255 Liberty Ave EL 2-1126

JERSEY CITY
*Hallmark Electric 592 Communipaw DE 2-9696
Nidisco-Jersey City 713 Newark Ave OL 3-2360

MORRISTOWN
M & M Television 7 Maple Ave MO 4-5274

MORRIS PLAINS
Continental Sales 642 Speedwell Hqrs Newark
Park Electronics 187 Speedwell MO 4-6922

MOUNTAINSIDE
Federated Purchaser 1021 US Route 22 WE 2-8200

NEWARK
All-State Distr 457 Chancellor WA 3-4900
Apello Distr Co 15 Shipman MI 2-7266
*Continental Sales 521 Bloomfield HU 2-8223
Electronic Marketeers 25 Hoyt St MA 3-2516
Electronic Supply Corp 357 Avon Ave BI 2-1470
Emerson-New Jersey 985 Broad MA 2-2217
*Federated Purchaser 114 Hudson Hqrs Mountainside
General Elec Supply 254 Elizabeth Ave BI 2-1600
Graybar Electric 2 Liberty St MA 2-5100
Hudson Radio & TV 35 Market St Hqrs NYC
Igoe Bros 35 Halsey St MA 4-2000
*Krich-New Jersey 428 Elizabeth BI 8-7408
Leader Electronic Supply Corp 88 Lock St MA 4-8842
*Lippman & Co Aaron 99 Newark St MA 3-9477
Pyramid Supply 343 W Market MA 3-7800
Radio Wire Television 24 Central Ave Hqrs NYC
Tubes of New York 944 18 Ave ES 2-2631
Variety Electric 468 Broad MA 2-6760
Westinghouse Elec Supply 528 Ferry MI 2-3450

NEW BRUNSWICK
Graybar Electric 2762 Livingston Ave CH 9-4300
William Radio Supply 265 Woodbridge CH 7-4908

NORTH BERGEN
American Distr 6335 Hudson Blvd UN 5-5306

PASSAIC
Nidisco-Passaic 294 Passaic St PR 9-4962

PATERSON
General Elec Supply 561 E 31 St LA 5-5100
*Jersey Electronic Distr 524 21st Ave LA 5-3134
Trade Radio Sales 780 E 18 St Hqrs Hackensack

PERTH AMBOY
Bennett's Radio 224 Market St HE 2-1736

PHILLIPSBURG
*Williams Co C B 154 S Main St 5-1245

PLAINFIELD
Radio Wire TV Inc Hqrs NYC
Union TV Parts 403 Watchung Ave PL 4-6930

RED BANK
Monmouth Radio 404 Shrewsbury RB 6-3300

RIDGEFIELD
Nidisco-Ridgefield Inc 480 Bergen Blvd CL 6-0510

RIDGEFIELD PARK
NRM Wholesale Radio 284 Teaneck Rd HU 7-0715

SOMERVILLE
Masters TV Supply 96 N Gaston Ave RA 5-3583

TEANECK
Ross Homer M 367 Queen Anne Rd TE 6-5331

TRENTON
Allen & Hurley 23 S Warren St EX 3-0386
Allied Electric 333 S Warren Hqrs Phila
Cooper Sales 508 Hamilton Ave EX 2-8008
Dragon Co 959 Liberty St 4-1479
Fireburg's 547 S Broad TR 4-5125
General Elec Supply Brunswick Circle Ext TR 5-3453
Nidisco-Trenton 985 Princeton Ave EX 3-4536
Westinghouse Electric 745 E State St 5-5421

W POINT PLEASANT
Ocean Electronics Co 2108 Lakewood Rd

NEW MEXICO

ALBUQUERQUE
General Electric Supply 820 I St NW 2-5246
Midland Specialty Hqrs El Paso
Radio Equip Co 523 Central Ave NE 2-5681
Tele-Radio Supply 915 Central NE 2-1141
Walker Radio L B Hqrs Pueblo

LOS ALAMOS
Valley Eng'g Co 601 Cedar St 2-3310

ROSWELL
R & R Supply 605 E 2 St Hqrs Lubbock Tex
Supreme Radio 129 W 2 St MA 2-6320

SANTA FE
A-1 Communications 441 Cerrillos Rd 3-8041

NEW YORK

ALBANY
Air Waves Electronic Radio 43 Hudson Ave 4-8119
*Ft Orange Radio 904 Broadway 5-1594
Graybar Electric 40 Van Woert AL 5-1564
R T A Distrs 36 Broadway PR 5-7346
*Taylor Co E E 465 Central 8-8713
Westinghouse Electric 19 R R Ave 8-7801

AMSTERDAM
*Adirondack Radio Supply 185 W Main St VI 2-8350

AUBURN
*Dare Radio 22 Genesee 2-0441
Roberts & O'Brien Hqrs Syracuse

BINGHAMTON

Broome Distr 221 Washington St 2-4273
*Federal Radio 188 State BI 2-2394
Graybar Electric 518 Security Mutual Bldg 2-5296
Morris Distr 195 Water Hqrs Syracuse
Stack Electronics Inc 25 State St 3-7337

BUFFALO
Bergman Co W Oak & Eagle MO 6300
Bison Electrical 1137 Main St LI 8447
Buffalo Radio 219 E Genesee WA 9004
*Dymac Inc 2329 Main PA 2300
Faysan Distrs 506 7th St SU 1300
General Electric Supply 960 Bustl EL 5100
*Genesee Radio & Parts 205 E Genesee CL 1970
Graybar Electric 180 Perry WA 3700
*Huron Electronics Supply 324 N Oak St MO 6865
RCA Victor Distr 1209 Broadway FI 1209
Radio Elec Prods 186 E Genesee CL 6454
Radio Equipment 147 E Genesee MA 9676
Scheller Radio 929 Kensington Ave AT 2100
Standard Elect 1501 Main GA 5000
Summit Distrs 916 Main GR 3100

CORTLAND
Winchell Radio 149 Main St SK 3-0868

ELMIRA
*Harrison Co F C 108 W Church 3-5676
LeValley-McLeod 312 State St 6167

FLUSHING See Long Island

FREDONIA
Barker-Higbee 27 Water 2-8666

FULTON
Roberts & O'Brien Hqrs Syracuse

GLENS FALLS
*Ray Supply Upper Glen St 2-5848

GLOVERSVILLE
Fulton County Distr 16 Bleecker 5-2515

HENMPSTEAD—See Long Island

HICKSVILLE—See Long Island

HORNELL
Hornell Electr Motor & Equip 286 Main St 2451

ITHACA
*Stallman of Ithaca 714 W Clinton St 4-9918

JACKSON HEIGHTS See Long Island

JAMAICA See Long Island

JAMESTOWN
Johnson Radio & Electr Equip 119 Hunt Rd 8-916
Warren Radio 31 Forest Hqrs Erie Pa

JOHNSON CITY
Westinghouse Elec 419 Grand Ave 9-1561

KINGSTON
*Arace Electronics 25 Henry 6622
Certified Electronics Hqrs Middletown

LOCKPORT
Standard Electronics 8 Elm St 4-3684

MALONE
Pond Electric 123 E Main St 135
Ray Supply 55 W Main St Hqrs Glen Falls

MASSENA
Beacon Electronics Hqrs Utica

MIDDLETOWN
Artec Distr 17 Cottage 3173
*Certified Elect Montgomery Rd 2-1055
Roskin Bros 27 W Main
S & L Electronics 17 Cottage 3175
MINEOLA See Long Island

MONTICELLO
Fleisher Distrs 248 Broadway 1820

MOUNT VERNON
Davis Radio 70 E 3 RD 4-0747
Radelco Inc 246 W 1 MO 8-6173

NEWBURGH
Chief Electronics Hqrs Poughkeepsie
Newburgh Distr 354 Liberty St 4830
Shapiro Distrs 315 Broadway
Westinghouse Electric 26 Liberty 5420

NEW YORK CITY, BRONX & STATEN ISLAND
Arrow Electronics 65 Cortland St DI 9-4714
Avnet Electronic 34 N Moore St BE 3-5780
Barry Electronics 512 Broadway WA 5-7000
*Bay Electronics 1736 Jerome Ave LU 3-2384
*B & D Distr 639 Tompkins Ave Rose Bank
Staten Island 617 7-2660
*Bruno-New York 460 W 34 LO 4-2252
Calvert Electronics 536 Broadway CA 6-7400
Center Electronics Co 72 Cortland St CO 7-6475
Concord Radio 55 Vessey DI 9-1133
Consolidated Radio 768 Amsterdam AU 2-2678
Dale Distr Co 40 E 32 MU 9-5252
Dalis Inc H L 175 Varlek AL 5-3000
Doroshin Distr 10 W 13 OR 5-6765
Douglas Radio Sup 128 Greenwich St W0 4-0470
Edlie Electronics 154 Greenwich DI 9-3143
Electronics Wholesalers 5047 Broadway LO 9-4906
Electronics Center 118 Duane St BA 7-2241
Emeltone Electronics 71 Broadway RE 2-1696
Emerson-NY Inc 524 W 23 St WA 9-2264
*Federated Purchaser Hqrs Mountainside N J
*Fordham Radio 265 E 149 St LU 5-0330
General Electric Supply 585 Hudson AL 5-3300
Goldman Louis 251 W 42nd St BR 9-8872
Graybar Electric 420 Lexington LE 2-4000
Greylock Electronics 554 W 168 St TO 7-9050
Haas Electronics 862 Southern DA 9-1466
Harrison Radio 225 Greenwich BA 7-7777
Harvey Radio 103 W 43 JU 2-1500
*Hudson Radio & TV 37 W 65 St TR 3-2900
HuGo Radio & TV 1275 Webster LU 8-0991
Lafayette Radio 100 6 Ave RE 2-8600
*Leonard Radio 69 Cortlandt CO 7-0315
Midway Radio 60 W 45 MU 7-5053
*Milo Radio & Electronics 200 Greenwich BE 3-2980
Moss Electronic Distr 3849 10 Ave WI 2-0292
*National Radio 1165 Southern Blvd DA 8-8800
North Radio 62 Cortlandt St CO 7-1430
O & W Radio 141 Cedar CO 7-2635
*Powell Radio 142 W 169 CY 3-2623
Radio Wire TV Inc 100 6 Ave RE 2-8600
Rand Radio Corp 84 Cortlandt St CO 7-7368
Roburn Agencies 431 Greenwich W0 6-2130



NIDISCO

television, radio and electronic
parts distributors—
conveniently located at:

JERSEY CITY

713 Newark Avenue
Oldfield 3-2360

TRENTON

985 Princeton Avenue
EXport 3-4536

PASSIAC

294 Passaic Street
PRescott 9-4962

RIDGEFIELD

480 Bergen Blvd.,
Cliffside 6-0510

HACKENSACK

55 State Street
HUBbard 9-2000

Consistently
high quality

ELECTRON TUBES

at sensible prices!

...SEE OUR AD
ON PAGE 63
IN THIS ISSUE OF
TECHNICIAN

BARRY ELECTRONICS
CORP.

512 Broadway, N. Y. 12, N. Y.

CALL DAY OR NIGHT
24 HOUR TELEPHONE SERVICE
WALKER 5-7000

*Sanford Elect 157 Chambers DI 9-0550
*State & Co 2755 Webster LU 4-0614
*Steve-El Electronics 61 Reade ST CO 7-0086
*Sun Radio & Electronics 650 6 Ave OR 5-8600
*Swedgal Electronics M 258 Broadway WO 2-5485
*Sylvan-Wellington 269 Canal CA 6-5811
*TAB Co 111 Liberty St RE 2-6245
*Terminal Radio 85 Cortlandt WO 4-3311
*Time Electronic Sales 368 Broadway BA 7-3922
*Tri-Par Distr 1403 Bronx River Ave TY 3-7060
*United Electr Sup 181 West End Ave EN 2-9695
*Westinghouse Electric 40 Wall St WH 3-4321
*Wholesale Electronics 673 Elton Ave LU 5-6705
*Wilco Radio 383 E 138 MO 9-1654

LONG ISLAND

BROOKLYN

*Acme Electronics 74 Willoughby TR 5-3833
*Benray Electronics 485 Coney Island BU 7-9650
*Buchman Radio 492 Atlantic UL 5-5143
*Dorosin Dist 1749 MacDonal Hdrs NYC
*Federated Television Mart 513 Rogers BU 2-7597
*Green Tele-Radio 472 Sutter HY 5-0200
*Laco Electronics 4924 4th Ave HY 2-5920
*National Radio Parts Distr'g 572 Albany PR 8-0800
*Stan Burn Radio 558 Coney Island UL 3-8049
*Witmal Electronic 126 Manhattan EV 8-0945

FLUSHING

*Melville Radio 134 Dahlia Ave Hdrs White Plains
*Stuart Electronic 149-09 Union Ave OL 8-3553

FOREST HILLS

*Berger Distr 109-01 72 Rd

HEMPSTEAD

*Arrow Electronics 215 Front St
*Davis Electronics 204 Main St IV 3-9200
*Island Radio 412 Fulton HE 2-1097
*Standard Parts 277 N Franklin IV 1-9010

HICKSVILLE

*Gem Electronics Distr 236 Broadway HI 3-3400
*General Electric Supply 4 & Bway HI 3-1890

JACKSON HEIGHTS

*National Radio Distr 73-20 Northern Blvd Hdrs
NYC

JAMAICA

*Chanrose Radio 170-16 Jamaica OL 8-2900
*Electronic Maintenance 172-24 Jamaica Ave
JA 3-2870

*Harrison Radio 144-24 Hillside Ave Hdrs NYC
*Norman Radio 94-29 Merrick Rd RE 9-4651
*Peerless Radio Distr 92-32 Merrick Rd RE 9-6080

LONG ISLAND CITY

*Dalis Inc HL 35-35 24 St
*Electronic Supply 41-08 Greenpoint Ave ST 6-2730
*Mannfred Electronics 21-26 36 Ave EX 2-6000
*Philco Distr 47-51 33 St ST 6-8400
*Schweber Electronics 122 Herricks Pl 6-6520
*Sperfa Electronic Supply 37-10 33 St ST 6-2199
*Westinghouse Elec 29-50 Northern Blvd HU 6-7700

H. L. Dalis, Inc.

35-35 Twenty-Fourth Street
Long Island City 6, N. Y.

extends its greetings to Snyder Manufacturing Company
on their 25th anniversary.

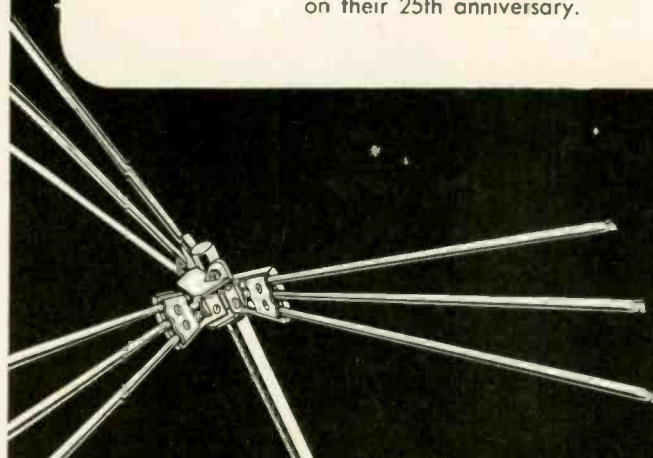

JOINS
IN
HONORING



MINEOLA
Schweber Electronics 122 Herricks Pl 6-6520

PATCOGUE
South Bay Radio 159 W Main St PA 3-4488

RICHMOND HILL
Anchor Electronics 116-01 101 Ave VI 6-2420

ROCKVILLE CENTER
Green Tele-Radio Dist Hqrs Brooklyn

WOODSIDE
Boro Electronics 69-18 Roosevelt Ave HA 6-9718
(end of Long Island)

NEW YORK

NIAGARA FALLS
General Electric Supply 11 & Whitney 6921
Niagara Radio & Parts 1518 Main
Radio Equipment Corp 1363 Pierce Ave NI 5531

OLEAN
Radio Equip Corp 449 N Union St OL 8560
Standard Electronics Olean Corp 2-0109
Wanamaker & Redstone 415 N Union St

ONEONTA
Crouch Distr 202 Main 2596

PATCOGUE See Long Island

PEEKSKILL
B & B Electronics 1607 Main 7-3150

PLATTSBURG
Ray Distr Hqrs Glens Falls

PORT CHESTER
Ratee Inc 136 Irving Ave WE 9-3940

POUGHKEEPSIE
Chief Electronics Inc 14 N Bridge St 7300
Mid-Hudson Elec 408 Main St
Victory Specialties 6 Raymond 7247

ROCHESTER
American Electronic Sup 482 St Paul St LO 3010
Beaucaire Inc 319 W Main St HA 2830
Case Electronic Supply 82 St Paul St BA 4580
General Electric Supply 67 Mortimer HA 7500
Graybar Electric 185 N Water BA 7700
*HI-C Radio Electronics 109 State St BA 8119
Kemp Equipment 57 Mt Hope HA 8050
Masline Radio 192 Clinton N HA 0790
RCA Victor Distr 120 Portland Ave LO 4180
Radio Parts & Equip 108 Sylvan Rd MO 5272
*Rochester Radio 600 E Main St LO 9900
Silver Corp N E 120 Portland Ave BA 7300
Westinghouse Electric 1 McKee Rd GE 8880

ROCKVILLE CENTER see Long Island

ROME
Rome Electronic Supply 102 Erie Blvd E 5550

SCHENECTADY
*Electric City Radio 1566 State
Schenectady Electronic Dist 1667 Broadway 4-8520
Schwartz & Son Maurlee 710 Broadway DI 6-4717

SYRACUSE
Baldwin-Hall Co 475 Oswego 3-5103
*Berndt Co W E 655 S Warren 2-3385
Broome Distributing 100 Tully 75-3176
City Electric 514 W Genesee 3-5171
Gordon Dist Co L 935 W Genesee St 74-3338
Graybar Electric 327 N West SY 74-6851
Karl-William Co 404 S Crouse 75-2755
Morris Distr 1153 W Fayette 75-9955
Paul-Jeffrey Co 519 Erie E 75-4126
Penfield Mfg 516 Erie 75-4154
Reliance Distr 343 W Jefferson 75-2157
*Roberts & O'Brien 839 Hiawatha Blvd 2-0421
*Smith Inc S W 325 E Water 2-7768
Stage Roy C 265 Erie Blvd W 2-8686

TROY
Empire State Wholesale 218 Congress St AS 2-6160
Q & O Electronic Supply 801 Jacob St AS 4-7323
*Trojan Elec Sup 15 Middleburg St AS 4-4481

UTICA
Associated Eleet Supply 1427 Sunset Ave 3-1695
*Beacon Electronics 411 Columbia St 5-4411
*Electronic Lab 1415 Oriskany W 4-5168
Miller Electric 11 Hopper St
Vaeth Electric 35 Genesee 2-5177
Westinghouse Elec 112 N Genesee St 4-8116

WOODSIDE see Long Island

WATERTOWN
*Beacon Electronics 680 Mill St Hqrs Utica
Watertown Electronics 411 W Main 863
Westinghouse Electric 245 State 6527

WHITE PLAINS
Emerson Radio 285 Mamaroneck WH 6-3816
Hub Electronics 249 Tarrytown Rd WH 6-3121
*Melville Radio 259 Mamaroneck WH 8-6131
*Westchester Elec 602 Mamaroneck WH 9-5765

YONKERS
General Electric Supply 16 Harrison Ave 8-3700
Yonkers Elec 541 Nepperhan YO 9-6044

NORTH CAROLINA

ASHEVILLE
*Freck Radio Supply 38 Biltmore Ave 3-3633
General Electric 47 Ranklin Ave 2-4481
Graybar Electric 221 Patton Ave AS 3-4761
*Longs Distr 12 Biltmore Ave 3-4371

BURLINGTON
Womack Electric Supply 623 Worth St

CHARLOTTE
Allied Electronics Hqrs Raleigh
Allison Erwin 209 E 5th St
Dixie Radio Sup 1431 Bryant St Hqrs Columbia S C
General Electric Supply 700 Tuckasegee FR 5-7321
Glasgow Supply Co 224 S Cedar St FR 6-2457
Graybar Electric 120 W Morehead FR 6-4886
*Radiotronic Distr 208 N College 2-1258
Shaw Distr 205 W First St FR 6-3533
Southern Radio 1625 W Morehead 6-4461
Westinghouse Electric 324 N College 5-3715

CONCORD
Dixie Radio Supply Hqrs Columbia S C

NORTH DAKOTA

BISMARCK
Bristol Dist Co Hqrs Fargo

FARGO
Bonk Co Low Hqrs Minneapolis
*Bristol Distr 419 Northern Pacific Ave 2-7493
General Electric Supply 69 1/2 Broadway 2-8131
Hayer Co FC 714 1st Ave N 2-7479
Radio Equipment 624 2nd Ave N 5462
Westinghouse Elec 109 Roberts 2-4446
Wolter Electronics 65 S N 4886

WORLD EXPORT

ROBURN AGENCIES INC.

431-435 GREENWICH ST.
NEW YORK 13, N. Y.

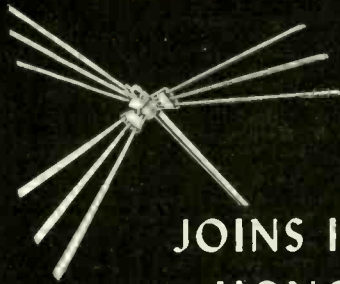

**JOINS IN
HONORING**



DURHAM
Graybar Electric 303 S Duke DU 2-1135

FAYETTEVILLE
Eastern Radio 532 Hay 2-7161
General Electric Supply 461 Robeson St 2-5143

GASTONIA
Bryant Supply 605 E Franklin Ave UN 5-3466
Dixie Radio Supply Hqrs Columbia S C

GOLDSBORO
Signal Radio Kinston Hwy 3234

GREENSBORO
General Electric Supply 1111 Willowbrook 3-8207
*Johannesen Elec 312 N Eugene 3-6906
*Southeastern Radio Hqrs Raleigh
Westinghouse Elec 1410 Westover Ter 3-8661

GREENVILLE
Carolina Sales Corp 1410 Evans St 3143
General Electric 200 Hooker Rd 5104
Radio Equip Co Hqrs Norfolk Va

HICKORY
Bryant Supply Co Hqrs Gastonia
Victor Radio & TV 1058 3 Ave Dr NW 2-6927

MOREHEAD CITY
Machine & Supply Co Box 335 2-5971

RALEIGH
Allied Electronics 413 Hillsboro 3-4627
Electrical Wholesalers PO Box 247 3-5588
General Electric Supply 800 W Poole 3-4691
Nash-Steele-Warren 615 W Hargett St
*Southeastern Radio 414 Hillsboro 3-1936
Walker-Martin PO Box 391 LD 950
Westinghouse Electric 319 W Martin 3-4841

ROCKY MOUNT
Graybar Electric 761 Planters St RO 2-5171
*Womack Electronics 105 Marigold St 2-6153

SALISBURY
Leonard Electronics 316 N Depot St 5280

WASHINGTON
Jowdy Distributing 110 N Respass St 40

WILMINGTON
French Radio 1220 Dock 9878

WINSTON SALEM
*Dalton-Hege 924 W 4 2-5141
Graybar Electric 955 Brookstown WI 4-2461

GRAND FORKS
Bristol Dist 1017 S Washington St Hqrs Fargo

MINOT
Bristol Dist Co 25 Main Hqrs Fargo
McFall Radio 5 N Main St

OHIO

AKRON
Akron Electr Supply 107 S Arlington St PO 2-8818
Electronic Engineering 362 W Bowery FR 6-3191
General Electric Supply 225 E Mill FR 6-8195
Graybar Electric 185 Carroll JE 5-4143
Main TV Supply 1013 N Main St WA 8-2117
Olson Radio 73 E Mill St JE 9191
Sacks Electrical 605 S Main St JE 8196
*Sun Radio 110 E Market St HE 2171
*Warren Radio 71 S Broadway Hqrs Toledo

ASHTABULA
*Morrison's Radio 331 Center St 3-9336

CANTON
Armstrong Electr 1261 Cleveland NW GL 2-6533
*Burrughs Radio 711 2 St NW 5-0273
Fall Radio Supply 410 Arlington Ave NW 5-8451
General Electric Supply 123 6 St S W 4-5187
Sommer Electric 818 3 St NE 5-9454

CINCINNATI
*Chambers Electronic 1669 Central Pkwy MA 1-7616
General Electric Supply 215 W 3 St GA 1750
Graybar Electric 115 W McMicken MA 1-0600
Herrlinger Distr 15 & Vine Sts CH 1-7273
Holub & Hogg 1400 Sycamore St CH 1-7974
*Hughes-Peters 1128 Sycamore Hqrs Columbus
Lockie & Glenn 2110 Gilbert WO 3396
Myronic 121 W Central Pkwy GA 2245
Ohio Appt 804 Sycamore St DU 1-5430
Radio/TV & Refr 1129 Walnut MA 1-2940
*Schuster Electric 321 E 8 St CH 1-7610
*Steinbergs 633 Walnut St CH 1-1880
Teletronics Supply 3935 Montgomery Rd
Tri-State Distr 8th & Broadway DU 7400
United Radio 1314 Vine St CH 1-6530
Westinghouse Elec 3011 Stanton CA 1300

CLEVELAND
Broadway Electric 6209 Broadway DI 1-8500
Carnegie Radio Distr 2536 Prospect Ave CH 1-2433
Euclid Radio 16379 Euclid GL 1-1375
Freshman Chas 6610 Euclid Ave EX 1-8723
General Electric Supply 4958 Woodland Ave HE 1-7280
General Radio Supply 1588 Hayden Ave UL 1-0700
Goldhamer 2239 E 14 St CH 1-1690
Graybar Electric 1100 E 55 St HE 2-2500
Kane 1666 E 40 St EX 1-4800
Main Line Cleveland 1260 E 38 St EX 1-1800
Northern Ohio Appt 5403 Prospect Ave HE 2-0500
*Northern Ohio Labs 2073 W 85 WO 1-2756

Chas. Freshman & Co.

6610 Euclid Ave.

Cleveland 3, Ohio

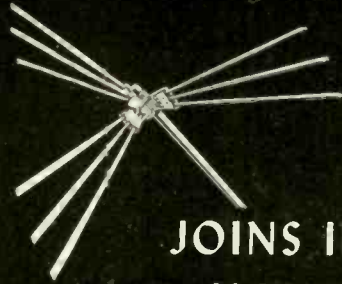

JOINS IN
HONORING



Olson Radio 2020 Euclid MA 1-6187
*Pioneer Electronic 2115 Prospect Ave SU 1-9410
Progress Radio 413 Huron Rd CH 1-5630
*Radio & Electronics 3235 Prospect UT 1-6060
Taylor G W 2157 Fairhill Rd SW 1-5442
Tecca Distr 4501 Prospect HE 2-1040
Westinghouse Elect 1809 E 22 TO 1-5660
*Winteradio 1468 W 25 St MA 9383

COLUMBUS

Bennett Distrs 1051 W Goodale Blvd CA 4-6216
Buckeye Electronics 242 E Long St CA 8-2697
*Electronic Supply 134 E Long St
General Electric Supply 146 N 3 St CA 8-4371
Graybar Electric 3 & Chestnut St CA 8-3811
*Hughes-Peters 111 E Long CA 1-6575
Kane 168 N 3 St Hdrs Cleveland
Thompson Radio 182 E Long CA 1-7434
Tracy-Walls 175 N Front St
Westinghouse Electric 266 N 4 St MA 5571
*Whitehead Radio 124 E Long St AD 6131

DAYTON

*Allied Supply 359 W Monument MI 9833
General Electric Supply 601 E 3 St MI 0781
Graybar Electric 332 W Monument Ave MI 5665
*Hughes-Peters 300 W 5 St Hdrs Columbus
Moore Equip Inc 18 Bruen St HE 2841
*Srepeo 314 Leo St MI 3874
Stotts-Friedman 135 E 2nd St MI 8373
Westinghouse Electric Supply 226 W 5 St MI 0331

DEFIANCE

Hutch & Son Hdrs Lima

E LIVERPOOL

D & R Radio 631 Dresden Ave Hdrs Steubenville

ELYRIA

EI-A-Co 235 Ludl St 2169

FINDLAY

Lima Radio Parts Hdrs Lima

LANCASTER

Bletzacker Electronics 135 W Chestnut St 2137
Snyder Electric 319 Forest Rose 2986

LIMA

Allied Supply 460 S Main St Hdrs Dayton
*Hutch & Son 125 S Elizabeth St 9-8411
*Lima Radio Parts 600 N Main 6-6756
Northwestern Radio 131 S Elizabeth St 4-2878
*Warren Radio Co 222 S Elizabeth St 7-2011

LORAIN

Pioneer Electronic Supply Hdrs Cleveland

MANSFIELD

*Burroughs Radio 218 E 2nd St 1691-6
Wholesaling Inc 775 Springmill 7287-6

MARIETTA

Marietta Radio & Elect 221 2 St FR 3-4987

MARION

Bell Radio 527 N Main St 2-5513
Dillman Radio Supply 389 W Center St 2-8063
Servex Distributing 213 N Main St 2-0031

MASSILLION

Martin M H 1118 Lincoln Way TE 2-7467

PAINESVILLE

Morrison's Radio Hdrs Ashtabula

PORTSMOUTH

General Electric Supply 1723 10 St 3-2341
Graybar Elec Co 923 Washington St PO 3-1766
Blng & Irwin 1007 Lawson St
Sound Elec Supply Co 7 & Finley St

SANDUSKY

Barco Electronic Parts 119 E Water 2471
Servex Electronic Dist Hdrs Marion

SPRINGFIELD

Eberle's Radio Supply 522 W Main St FA 3-8552
Standard Radio 1300 St Paris Rd FA 5-6431

STUBENVILLE

D & R Radio Supply 221 S 3 St AT 3-3643
*Hausfeld Radio Supply 116 N 3 St 2-4391

TIFFIN

Hutch & Son Hdrs Lima

TOLEDO

Benarr Distrs 1034 Grand Ave CH 4-6753
General Electric Supply 28 N St Clair's GA 8661
Graybar Elec 1700 Canton Ave CH 1-9166
Harry's Auto-Radio 713 Adams St FA 3447
*Howard's Electronic 135 17 CH 3-2277
Kane Co 1926 Canton St Hdrs Cleveland
Lifetime Electronics 1501 Adams St CH 1-5643
Main Line Distributors 380 S Erie St CH 4-4996
Selectronic Supplies 1320 Madison Ave CH 8-3361
*To-Jo Radio Spec 1215 Jackson St AD 5828
*Warren Radio 1002 Adams St Hdrs Lima
Westinghouse Electric 1225 Indiana AD 6184

WARREN

D & J Electronic 236 Vine Ave SE 3721-6
*Radio Specialties 136 Pine St SE 5-8770
Sommer Electric 2609 Youngstown Rd 7-5055

WASHINGTON COURT HOUSE

Hutch & Son 209 E Market Hdrs Lima

YOUNGSTOWN

General Electric Supply 265 W Rayen Ave RI 6-6511
Graybar Elec 602 W Rayen Ave RI 4-0124
Hood Electric Co 128 W Rayen Ave 4-0255
Kane Co W Rayen Ave Hdrs Cleveland
Ross Radio 325 W Federal St RI 6-8881
TV Parts Co 1408 Market St Hdrs New Brighton PA

ZANESVILLE

Thompson Radio 135 S 60 St GL 2-8473

OKLAHOMA

ADA

Johnson Wholesale Electronics Hdrs Okla City

ARDMORE

Johnson Wholesale Electronics Hdrs Okla City

BARTLESVILLE

Four States Supply Hdrs Joplin Mo

ENICH

Johnson Wholesale Electronics Hdrs Okla City

LAWTON

*Radio Supply Hdrs Okla City
*Reynolds Radio 909 1/2 C Ave 1292

MCLESTER

McAlester Radio & TV 407 N Main St GA 3-2282

MUSKOGEE

*Muskogee Electronic 211 Callahan St MU 2-9651

OKLAHOMA CITY

Capitol Distr 1017 W Reno St
Dulaney's 100 N W 44 St JA 5-1511
Electronic Supply 212 N W 10 CE 2-5215
General Electric Supply 127 E Calif Ave FO 5-5475
Graybar Electric 12 E California FO 5-9351
Johnson Wholesale 927 N W 1 St FO 5-6388
*Miller-Jackson 121 E Calif St FO 5-8426
Modern Parts Distr 15 E Grand RE 9-1523
*Radio Supply 724 N Hudson St CE 2-6128
Southwest Radio & Equip 3 N E 8 St RE 6-8535
Westinghouse Electric 850 N W 2 St 2-7101

TULSA

General Electric Supply 18 N Guthrie St 3-6121
Graybar Electric 2406 E 12 St TU 6-2121
Industrial Electronic Supply 1124 E 4 St
Midwest Electronic 219 E 1 St CH 2-8086
OH Capitol Electronics 923 E 4 LU 4-2437
Patterson Radio 211 E 13 5-3179
*Radio Inc 1000 S Main 4-9127
*S & S Radio 537 S Kenosha St CH 2-7174
Westinghouse Electric 307 E Brady St 3-7155
Wholesale Radio Supply 538 S Lewis St

VENITA

Pittsburg Radio Sup Hdrs Pittsburg Kansas

OREGON

EUGENE

*Carlson Hatton & Hay 971 Oak St DI 4-4255
Graybar Electric 2180 6 Ave W EU 4-2224
*United Radio Supply Hdrs Portland

KLAMATH FALLS

R F Supply 2367 S 6 St 6572

MEDFORD

General Electric Supply 121 W 4 St 3-2423
United Radio Supply Hdrs Portland
*Walker Co V G 205 W Jackson 2-4558

PORTLAND

Appliance Whole 600 NW 14 AT 6584
*Central Distrs 1131 NW Couch CA 8-0146
Connely Co F B 905 NW 12th Ave CA 1755
Eoff Electric Hdrs Salem
General Electric Supply 300 NW 14 Ave BR 0651
Graybar Electric Park & Flanders BR 6641
Home Makers Supply 824 SW 18 St CA 9385
H & R Radio Sup 5210 NE Sacramento AT 7-0057
Johnson Co Lou 1506 NW Irving CA 2-9551
North Pacific Supply 2950 NW 29 Ave CA 8-9576
Northwest Radio Supply 110 SE 8 Ave BE 4-9787

*Portland Radio 1234 W Stark St AT 8647
Saelens Radio 1605 NW Everett CA 8-6395
*Stubbs Electric 33 NW Park Ave BR 5404
Television & Radio 720 SE Alder BE 2-1104
*Tracey & Co 937 NW Gilsan St CA 3-6263
*United Radio Supply 22 NW 9 Ave CA 3-6323

SALEM

Eoff Electric PO Box 709 3-9251
Johnson Co Lou 935 S Commercial Hdrs Portland
United Radio Sup 697 S 12 Hdrs Portland

PENNSYLVANIA

ALLENTOWN

Bell Co Chas L 14 & Gordon HE 3-5101
*Federated Purchaser Hdrs Mountainside N J
General Electric Supply 16 & Summer St HE 3-5206
Graybar Electric 1941 Hamilton HE 4-9341
Luckenbach & Johnson 1828 Tilghman St HE 4-6235

PETERS A

Peters A A 231 N 7 St HE 4-9361
Steedle Norman D 1005 N 19 HE 5-6753
Westinghouse Elect 745 Union Blvd HE 4-5105

ALTOONA

Altoona TV Supply 1713 Union Ave 4-0827
General Electronics 508 Crescent Hdrs Wheeling
*Hollenbach's Radio Supplies 2221 8th Ave 6171

AMBRIDGE

Barrett Bros 127 Merchant St AM 6-6750

BETHLEHEM

*Buss Radio Electric 431 W Broad St UN 7-3151

BRADDOCK

Marks Parts Co 317 Braddock Ave EL 1-1314

BRADFORD

Johnson Radio Hdrs Jamestown N Y

BRISTOL

Cooper Sales Co 449 Mill St BR 8-6577

BUTLER

Barron's Radio 333 E Jeff 7-5930

TV Parts Co Hdrs New Brighton

CHESTER

A C Radio Supply Hdrs Phila

Bell Electronics Supply 1835 W 9 St 4-7161

CLEARFIELD

Altoona TV Supply Hdrs Altoona

EASTON

*Federated Purchaser Hdrs Mountainside N J

Radio Electric Service Hdrs Philadelphia

ELKINS PARK

A G Radio Parts 939 Township Line TU 6-5100

ERIE

B & D Whole Distr 502 E 10 St

*Duncombe Co J V 1011 W 8 St 4-5278

Erie Electronic Supply 801 W 21 St

General Electric Supply 824 E 9 2-1477

*Jordan Electronic Co 1130 German St 2-2462

*Warren Radio 1315 Peach St 4-5286

Westinghouse Elec 1820 State 4-8191

Young Brothers 1909 Peach St 4-5297

M. V. MANSFIELD CO.

and

South Hills Electronics
McKeesport Electronics

John Marshall Co.
Mon Valley Electronics

Pittsburgh, Pa.

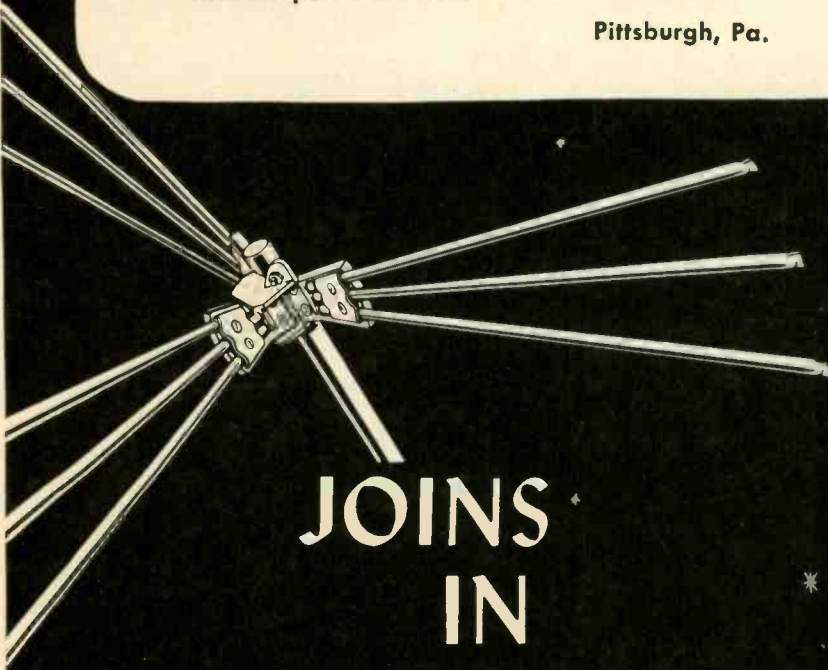

JOINS
IN
HONORING



GETTYSBURG

Hartley & Co M A Hqrs Staunton Va

GREENSBURG

General Electronics Hqrs Wheeling W Va

HANDOVER

York Radio & Refrigeration Parts Hqrs York

HARRISBURG

Blessing Co John A 48 N Cameron St CE 6-9311

D & H Distr 2535 N 7 St CE 8-7327

Excelsior Radio 17 & Derry St CE 8-8261

Graybar Electric 1039 S 13 HA 8-7303

Harrisburg Radio 1124 Market St CE 6-2755

Knerr C G 317 S Cameron St

*Radio Distr 915 S 13 4-0139

HAZELTON

Cerullo Electric 39 S Vine 1296

Moyer Electric 758 N Locust

JOHNSTOWN

*Baker Radio Electric 111 John St

*Cambria Equip 17 Johns 6-1291

Dick's Automotive 633 Napoleon St

TV & Radio Parts 226 Main St 7-5345

Westinghouse Electric 75 Hickory St 8-1293

LANCASTER

Barbey Co G D 622 Columbia Hqrs Reading

Eshelman Supply 110 N Water 4-5625

York Radio 519 W King St Hqrs York

LEBANON

Barbey Co Geo D Hqrs Reading

LEWISTOWN

Alvo Electronics Hqrs State College

McKEESPORT

*Barno Radio 321 6 Ave

McKeesport Electronics 1661 5th 8-5111

MEADVILLE

Mansfield Co M V Hqrs Pittsburgh

Warren Radio Inc Hqrs Erie

MONESSEN

Mon Valley Electric 456 Schoonmaker Ave 1233

NANTICOKE

Modern Electronic Hqrs Wilkes-Barre

NEW BRIGHTON

Mansfield Co M V Hqrs Pittsburgh

Television Parts Co 509 5 Ave NB 3000

NEW CASTLE

Midwestern Elec 235 W Grant OL 4-9961

NEW KENSINGTON

Boarer Electric 1017 5 Ave ED 5-5801

NORRISTOWN

Almo Radio Co 550 Market St Hqrs Phila

General Radio Supply 624 W Airy St NO 8-8115

Kratz Bros Kohn & Oak BR 5-4379

PHILADELPHIA

*A C Radio Sup 1539 W Passyunk HO 2-9379

*A G Radio Parts 3552 N 17 St Hqrs Elkins Park

*Allied Electric 1320 W Erie Ave BA 9-8800

*Almo Radio 412 N 6 St WA 2-5153

*Barnett Bros 622 Arch St LO 3-9780

*Consolidated Radio 612 Arch St LO 3-7871

*Emerson Radio 223 N Broad LO 4-3350

Everybody's Supply 810 Arch St WA 2-7800

General Electric Sup 401 E Hunting Park GA 6-8800

Graybar Electric 910 Cherry WA 2-5405

*Herbach & Rademan 1204 Arch LO 7-4309

Leontic Research Lab 715 Arch MA 7-6771

*M & H Sporting Goods 722 Market LO 7-2587

Nadisco 3960 M 16 BA 6-2020

*Nat-Lazar Radio 4231 Lancaster Ave BA 2-5604

Neuber H K 1539 Race St LO 7-2125

*Penn Electronic 5303 Frankford JE 5-1533

*Radio Electric 3412 Germantown BA 9-5900

*Radio Elec Serv 7 & Arch LO 3-5840

*Rosen & Co Raymond 2121 Market St Tr 8-2200

*Steinberg & Co 2520 N Broad BA 3-9400

Westinghouse Electric 141 N 11 St WA 2-8950

*Wile Eugene G 218 S 11 St WA 3-1343

PITTSBURGH

Atlantic Dist 1630 Saw Mill Run TU 2-0504

*Cameradio Radio 1121 Penn Ave

Electronic Parts 5744 Baum Blvd MD 1-6413

Fischman Co Max 1141 Penn Ave EX 1-3232

General Electric Supply 200 W River Ave FA 2-1530

Graybar Electric 711 Galveston Ave FA 2-0300

Hamburg Bros 213 Galveston Ave AL 1-2400

Mansfield Co M V 937 Liberty Ave GR 1-4175

Marks Parts 508 E Ohio Hqrs Braddock

*Marshall Co John 201 Anderson FA 1-5400

*Radio Parts 6339 Penn Ave EM 1-6053

Rogers Co C R 5210 Liberty Ave MA 1-4700

South Hills Electronic 1420 W Liberty Ave FI 1-6200

*Superior Dist 5124 Liberty Ave MU 1-4311

Variety Electronics 605 Bigelow Blvd EX 1-1524

Westinghouse Elect 209 W Gen'l Robinson AL 1-5500

POTTSTOWN

Barbey Co Geo D Hqrs Reading

POTTSVILLE

Schuykill Electric 611 Mauch Chunk St 4404

READING

A G Radio Parts Hqrs Elkins Park

Barbey Geo D 155 Penn St 6-7451

*Barnett Bros 201 S 4 Hqrs Phila

General Electric Supply 447 N Front RE 4-2169

Graybar Electric 22 S 3 St RE 6-1581

Westinghouse Electric 4 & Elm Sts 6-7236

ROCHESTER

Reliable Radio & TV 402 Adams St

SAIN T MARYS

*B & R Electric 26 Railroad St 4-4918

SCRANTON

Consolidated Distr 844 Cypose DI 7-6380

General Electric Supply 204 Monroe Ave DI 4-8563

General Radio & Refr 1129 Wyoming Ave DI 7-5033

Morris Distr 228 Franklin Hqrs Syracuse

Pursell Fred P 1221 N Washington Ave DI 7-5616

Scott Charles B 119 Franklin Ave 2-8221

*Scranton Radio/TV Supply 419 Poplar St DI 3-1259

Shelborne Corp 239 Franklin Ave DI 7-2005

SHARON

Sharon Electronics 1336 E State DI 6-3014

STATE COLLEGE

Alvo Electronics 103 S Pugh St AD 8-6277

SUNBURY

Electronic Sales 734 Market St AT 6-4212

Moyer Electronic Hqrs Hazelton

UNIONTOWN

*Zimmerman Wholesalers Hqrs Hagerstown Md

WILKES-BARRE

General Electric Supply 85 E Union St VA 2-5106

General Radio 396 S Main Hqrs Scranton

Modern Electronic Supply 245 S Main St VA 3-6872

Radio Service 346 S Main VA 3-7713

Sonoret Tele-Radio Co 36 Woodbury St VA 2-2431

Wall R B 16 E Union St VA 4-2411

WILLIAMSPORT

Alvo Electrs Distrs Hqrs State College

General Radio & Refrig Hqrs Scranton

Westinghouse Electric 465 Hepburn St 2-6184

*Williamsport Radio 518 W 3 St 7696

YORK

Eshelman Supply 10 Broad St Hqrs Lancaster

*J R S Distr 646 W Market 2-8624

Westinghouse Elec Ogantz St & 6 Ave WO 5556

*York Radio & Refrig 263 W Market St 8-1586

RHODE ISLAND**PROVIDENCE**

Dandrea & Co Wm 129 Regent Ave UN 1-2800

*DeMambo Radio 90 Broadway

Eddy & Co 43 Hospital St GA 1-2045

Edwards & Co W H 94 Broadway GA 1-6158

General Electric Supply 241 Harris Ave GA 1-6523

Graybar Electric 194 Richmond DE 1-8100

Rimaco Sales Co 488 Friendship St DE 1-9199

Television Access House 41 Broadway JA 1-7515

Westinghouse Elec 233 Harris GA 1-6484

SOUTH CAROLINA**ANDERSON**

A & S Electronics 205 W River St CA 5-8266

Dixie Radio Supply Hqrs Columbia

CHARLESTON

General Electric Supply 287 E Bay St 2-0220

Radio Labs 215 King St 3-5328

Wholesale Radio 78½ Calhoun St

COLUMBIA

Associated Distr 822 Gervais St

Caroline Sales Hqrs Greenville N C

*Dixie Radio Supply 1700 Laurel St 4-0383

General Electric Supply 107 Berea Rd

Graybar Electric 710 Lady St CO 2-2125

Horlacher & Barrett 1909 Main

Perry-Mann Electric 901 Taylor St 2-4375

Southeastern Radio Parts Hqrs Atlanta

Westinghouse Electric 915 Lady 8145

CONWAY

Southern Electronics 208 Elm 9-3621

FLORENCE

Dixie Radio Supply Hqrs Columbia

*Florence Radio Supply 355 N Irby St 2-1446

GREENVILLE

Carolina Radio 221 W Wash 2-6740

Dixie Radio Supply Hqrs Columbia

General Electric Supply 111 Welborn St 2-2881

Gillam Radio 802 Buncombe St 5-0438

Graybar Electric 302 W Washington St 9-1338

Perry-Mann Electric 400 Rhett St 5-1677

Westinghouse Electric 205 Airport Rd 3-6201

SPARTANBURG

Hemcor-McElhenney Co 481 Union St 6308

SUMTER

Southern Electronics 8 E Hampton Ave SP 3-8060

SOUTH DAKOTA**ABERDEEN**

Burghardt Radio Supply Hqrs Watertown

RAPID CITY

Burghardt Radio Supply Hqrs Watertown

Power City Radio Hqrs Sioux Falls

SIoux FALLS

Graff Motor Supply 122 W 7 St 4-6911

Graybar Electric 300 N Phillips St SI 4-5621

Lippert L C 506 Selff Ave 4-7577

*Power City Radio 209 S 1 Ave 4-4077

*Warren Radio Supply 105 S Indiana Ave 8-6051

WATERTOWN

*Burghardt Radio Supply Box 746 5749

TENNESSEE**BRISTOL**

Clark Radio Supply 620 Broad St SO 3301

Graybar Electric 536 Anderson St SO 4415

*Roden Electrical Supply Hqrs Knoxville

CHATTANOOGA

Curle Radio Supply 439 Broad St 6-4720

General Electric Supply 112 W 13 St 5-4571

Graybar Electric 210 N Highland Park Ave CH 4-3351

Radio & Appliance Distr 323 W Main St 7-6541

Radio Sales 401 Broad St 7-4581

Specialty Distributing Hqrs Atlanta Ga

Standard Appliances 618 Broad St

JACKSON

Carlton Wholesale Radio 312 S Shannon 7-0816

*Rush L K 425 N Royal St 2-4731

JOHNSON CITY

General Elec Supply 114 Ashe St 3117

KINGSFORT

Radio Electric Supply 245 E Market St CI 5-1471

KNOXVILLE

Chemistry Radio & Elec 12 Emory Pk 4-3641

General Electric Supply 701 W Jackson Ave 5-2104

Graybar Elect Henley & Union KN 3-6171

Almo Radio Co.—Wholesale DistributorsExecutive Offices
412-16 N. Sixth St.
Phila. 23 Pa.
Walnut 2-5153STORES
509 Arch Street
Phila. 6, Pa.6205 Market St.
Phila. 39, Pa.
Northeast Branch
7540
Frankford Ave.
Phila. 36, Pa.Norristown, Pa.
550 Markley Street
201 Calhoun St.
Trenton, N.J.
Wilmington, Del.
1122 French Street
Atlantic City N.J.
4401 Ventnor Ave.Camden, N.J.
1133-37
Haddon Ave.
Salisbury, Md.
317
Park Heights Ave.JOINS IN
HONORING

McClung Appliances 310 Georgia St 4-1811
 *Roden Electrical 808 N Central 3-0491

MEMPHIS
 *Bluff City Distr 234 East St BR 6-4501
 Electronic Supply 1100 Union Ave 7-0366
 Fulmer Co Arthur 296 Monroe Ave JA 3-5711
 General Electric Supply 500 S Front St 37-5531
 Graybar Electric 1474 Lamar Ave ME 7-7150
 *Lavender Radio Supply 180 S Gasper BR 6-2757
 McGregor's 1071 Union Ave 36-3301
 Mills-Morris 171 S Dudley 36-3351
 Shobe Inc 1195 Union Ave BR 2-3411
 Ufer Co Frank G 1318 Madison Ave BR 6-4555
 Westinghouse Elect 845 N Main 37-9431
 Woodson & Bozeman 733 S Somerville 32-2445
 W & W Distr 644 Madison JA 7-4628

MORRISTOWN
 Clark Radio Supply Hqrs Bristol

NASHVILLE
 Braid Elec 1100 Demonbreun St CH 2-6511
 Currey's 1600 McGavock St AL 5-7331
 Electra Distr 1914 West End Ave 5-8444
 General Elect Supply 90 Peabody St 4-7661
 Graybar Electric 125 16 Ave N NA 4-6501
 Keith Simmons 14 Cummins Sta 4-1761
 Radio & Appliance 4 Commins Station
 Randolph & Cole 1213 McGavock St CH 2-5426

TEXAS

ABILENE
 General Electric Supply 190 Locust 2-2827
 Graybar Elec Co 1601 S Treadway AB 2-2861

AMARILLO
 Alltronic Supply Inc 1401 W 7 Ave DR 4-0031
 General Electric Supply 701 E 5 Ave DR 6-7254
 Graybar Electric 601 E 2 St AM 2-6778
 *R & R Electronics 707 Adams DR 2-3255
 Westinghouse Electric 99 Taylor 2-6536
 *West Texas Radio Supply 1026 W 6 2-3179

AUSTIN
 Electronic Hqrs 310 Willow St GR 6-6818
 Graybar Electric 214 E 3 St AU 8-5674
 *Hargis Co 410 Baylor St GR 8-6618
 Standard Radio 309 Lavaca St 7-9241

BEAUMONT
 General Electric Supply 1295 Pearl St 4-6435
 Graybar Electric 1070 Fannin St BE 2-8484
 Hall Inc RC & LF Hqrs Houston
 *Montague Radio 760 Laurel 4-5697
 Reed Co 200 Fannin St 4-7431
 *Sterling Radio Hqrs Houston
 Westinghouse Electric 265 Cypress 4-8635

BROWNSVILLE
 Electronic Equip Hqrs Corpus Christi

CORPUS CHRISTI
 *Electronic Equip 805 S Staples 3-9271
 General Electric Supply 1134 E Port Ave TU 2-9237
 Graybar Electric 1311 Agnes TU 4-6374
 Hayes Radio Sup 1116 S Staples St 4-1991
 Westinghouse Elect 110 N Staples St 2-3351
 *Wicks Radio Equip 513 S Staples St TU 4-8285

DALLAS
 Adleta Co 1914 Cedar Springs PR 7576
 *All State Distr 2411 Ross Ave RI 1295
 Budrow Radio Supply 3400 Oakland Ave HA 8-9015
 *Crabtree Whole Radio 2608 Ross ST 5361
 Dallas Electric 1800 Magnolia RI 5396
 Engineering Supply 6000 Denton Dr FL 7-2861
 General Electric Supply 1811 N Lamar St RA 2201
 Graybar Elect 717 Latimer RA 6452
 *Industrial Electronic 134 Leslie 3-8122
 *Southern Radio 3137 Ross Ave VI 6396
 *South West Radio 1820 N Harwood RI 6272
 Wanslow & Co 912 N Peak St TA 9836
 Westinghouse Electric 601 Latimer St RA 2401
 Wholesale Electronic 2800 Ross Ave ST 5736
 *Wilkinson Bros 2406 Ross Ave PR 1571

DENISON
 *Denison Radio Supply 310 W Woodard 45

EL PASO
 Elec & Mech Supply 2000 Texas St 2-4614
 General Electric Supply 300 Dallas St 3-3407
 Graybar Electric 3513 Rosa St EL 3-7561
 *McNicol C C 811 N Estrella 5-3992
 Midland Specialty 425 W San Antonio 3-2401
 Momen-Dunnegan-Ryan 800 E Overland 3-1621
 Reeves Radio Supply 720 N Stanton 3-5752
 Sunland Supply 1200 E Missouri 3-7409
 Walz Co W G 500 San Francisco St 3-1677

FORT WORTH
 *Electronic Equip 917 Florence St ED 5407
 General Electric Supply 409 Jones St FA 5385
 Graybar Electric 1107 Foeht St ED 4525
 *H & L Radio Supply 1608 Commerce St ED 2-7311
 *"Scooter's" Radio 509 Commerce St FO 7448
 *Sutton's Electronics 104 S Main St ED 5-9515
 *Swileo Co 1518 E Lancaster ED 2-7157
 *United Electronics 403 Jones ED 9295
 Westinghouse Elec 205 NE 7 FO 5611

GALVESTON
 Hall R C & L F Hqrs Houston

GRAND PRAIRIE
 All-State Dist Co Hqrs Dallas

HOUSTON
 Automatic Distr 100 Jackson CA 0261
 Beyer & Co A R 1318 Polk Ave CA 8-7491
 Busacker Electric 1721 Waugh Dr JU 5546
 City Radio & TV Parts Co 2321 Milam JA 2-1556
 Covington Distr 34 N Hamilton CA 2-0326
 Crumpacker Distr 1200 National CH 9366
 Electrotex Electronics 2401 Taft St JA 9-3211
 Electro-Mechanical Prods 4811 Gulf Freeway WA 6-6411
 Electronic Distrs 419 Caroline CA 2-9961
 Franklin Co R E 1905 Chartres St CA 0194
 General Electric Supply 1312 Live Oak FA 3121
 Geophysical Supply 1311 Dallas Ave BL 0561
 Graybar Elect 1701 Cullen AT 4571

Gulf Coast Electronic 1110 Winbern St JA 8-1551
 *Hall Inc R C & L F 1301 Polk CA 2-9731
 Harrison Equip 1422 San Jacinto AT 6315
 Houston Radio Supply Clay at La Branch CA 6261
 Lenert Co 2213 Congress Ave CA 4-2663
 Moore Bros 3401 Milam St JU 4175
 *Radio Parts 902 Crawford CA 5-0137
 Sound Sales & Engineering 2005 La Branch
 *Sterling Radio P O Box 1746 CA 5-1321
 Straus-Frank 4000 Leeland CA 1201
 Tele-Radio 1721 Waugh Dr JA 3-8151
 Walk & Co JA 4301 Gulf Freeway CA 3-4281
 Westinghouse Elect 1903 Ruiz CA 7272

LAREDO
 Guarantee Radio 1314 Iturbide St 3-6913
 Pan American Electronic 1015 Iturbide St 3-6242

LONGVIEW
 Wholesale Electronic Hqrs Dallas

LUBBOCK
 *B & L Radio & TV Supply 2424 Texas Ave PO 5-6352
 General Electric Supply P O Box 1361 PO 3-8271
 Graybar Electric 905 Ave F PO 3-9656
 *R & R Supply 1607 Ave G PO 5-5737
 Westinghouse Electric 605 Main St 3-0425
 West Texas Radio Supply 1009 Ave Hqrs Amarillo

LUFKIN
 Sterling Radio Products Hqrs Houston

MCALLEN
 Guarantee Radio Parts & Equip Hqrs Laredo
 *Rio Radio Supply 608 S Broadway MU 6-5781

ODESSA
 Midland Specialty 2101 Andrews Hwy Hqrs El Paso

PORT ARTHUR
 Diehl Radio & TV Supply 1927 7 St 2-6311
 Radio Parts Co Hqrs Houston

SAN ANGELO
 Gunter Wholesale Co 606 S Irving St 9182

SAN ANTONIO
 Amateur Headquarters & Supply 828 Brooklyn GA 7388
 Electronics Inc 512 Broadway CA 4-8381
 General Electric Supply 1801 Broadway CA 7-1261
 Graybar Elec 1401 N Hackberry FA 6274
 Lamp's Electronics 828 Brooklyn Ave CA 7-7388
 *Mission Radio 1229 S St Marys St CA 7-8323
 Modern Radio Supply 635 Soledad St CA 6-0175
 Olsen Radio Supply 412 Pereda St
 Radio & Television Parts Co 118 7 St CA 6-5329
 Sherman Electronics 722 San Pedro CA 6-0247
 South Texas Appl 641 S Flores St
 Straus-Frank Box 600 CA 6-0101
 Westinghouse Electric 1211 E Houston GA 9271

TEMPLE
 Central Radio & Supply 410 E Ave A

TEXARKANA
 McCulloch Whsle TV Supply 811 W 13 St 32-8411

TYLER
 Bryan Radio Service Sup 110 University 4-4441
 General Electric Supply 416 N Broadway 2-1673
 *Lavender Radio Supply 503 E Oakwood St PH 4-6315

VICTORIA
 L & G Electronic 1412 N Main HI 3-2272

WACO
 Best Electronics 122 N 18 St 4-3100
 General Elec Supply 217 S 4 St 2-1611
 *Hargis Co 1205 Washington Ave 4-5667
 L & M Sales 1307 Austin Ave 2-3391
 Wholesale Electronic Supply Hqrs Dallas

WICHITA FALLS
 *Clark & Gose Radio 1203 Indiana St
 *Mooney Radio 1300 12 St 2-0731
 Wholesale Electronic Supply Hqrs Dallas

UTAH

OGDEN
 Ballard & Carter 3109 Washington Blvd 3-8604
 Iverson Radio 265 25 St ST 6286
 Tri-State Electronic 2217 Kiesel Ave 4-3438

SALT LAKE CITY
 Ballard & Carter 1486 Major St Hqrs Ogden
 Central Supply Co 47 E 5th St S 3-2631
 Flint Distr Co Box 1470
 General Electric Supply 312 W 2 S St 3-3911
 Glenn Earl 245 S 1st West 3-7601
 Graybar Electric 336 N 3 St WA 9-8771
 Kimball Distr Co 350 Pierpont Ave EM 3-5813
 Lloyd Co W B 51 S 2nd W 3-3825
 Moore Radio Supply 157 Motor Ave
 O'Loughlin's Radio Supply 113 E 3 S St EM 4-4051
 Ross S R 1212 S State St 6-8607
 Standard Supply 225 E 6 St EL 5-2971
 Stravell-Paterson 126 S W Temple DA 2-5795
 Westinghouse Elec 210 Rio Grande 22-2441

VERMONT

BURLINGTON
 General Electric Supply 316 Pine St 3-3424
 Oakman Elec Sup Hqrs Rutland
 Radio Service Lab Hqrs Manchester N H
 Vermont Hdw 180 Flynn Ave 4-6835
 Westinghouse Electric 208 Flynn Ave 4-9885

RUTLAND
 Oakman Electric Supply 12 Wales St PR 5-5558

VIRGINIA

ALEXANDRIA
 Certified Radio 1330 Powhatan St KI 8-5115
 Suburban Distr 222 S Henry St KI 9-6804

ARLINGTON
 Rucker Electronic Hqrs Wash D C

BRISTOL
 Bristol Radio 31 Moore St N-3544

CHARLOTTESVILLE
 Virginia Radio 715 Henry Ave 2-4124

DANVILLE
 *Womack Radio 502 Craghead 4622

HAMPTON
 General Elec Supply 1247 39 St Hgwy 3-6526

LYNCHBURG
 Eastern Electric Co 920 Commerce St 2-3497
 Lynchburg Battery 406 5 St 2-1236

NEWPORT NEWS
 General Supply 4215 Huntington 2-4007

NORFOLK
 Crump Co B T Granby & Plume Hqrs Richmond
 General Electric Supply 709 E 26 St 2-7183
 Graybar Electric 1081 W 35 St NO 5-7441
 *Radio Equip 821 W 21 St MA 7-4534
 *Radio Parts Distr 128 W Olney MA 2-5711
 *Radio Supply 711 Granby St MA 7-9211
 Schultz Inc G J 639 W 24 St PH 2-7985
 Trant Inc R F 924 W 21 St MA 2-2683
 Westinghouse Elec 2600 Hampton 5-0525
 Wyatt-Cornick 919 W 21 St Hqrs Richmond

PETERSBURG
 Virginia Battery 21 E Bank St RE 2-5051

RICHMOND
 Cottrell Jr W C 408 E Main St 3-2402
 Crump Co Benl T 1332 E Franklin 7-1941
 Duval Distr Co 1221 Admiral St
 General Elect Supply 1505 Sherwood 6-4941
 Graybar Electric 10 S 6 St RI 7-3491
 Johnson Co D R 1315 E Cary St 7-3617
 *Johnston-Gasser Co 3023 W Marshall 6-9405
 Mattson's Electronics 2224 Chamberlayne 6-6719
 Meridian Electronic 1001 W Broad 5-2834
 *Radio Supply 3302 W Broad St 6-5565
 Richmond Electronic Supply 800 W Cary St 7-1082
 Tiller Inc A R 957 Myers St
 Trant Dist R F 1221 Admiral St 2-2805
 Westinghouse Electric 511 E Boyd St 3-0111
 Wyatt-Cornick 1705 Brook Rd Hqrs Norfolk

ROANOKE
 *Baker Sales H C 19 Franklin Rd 4-9209
 General Elec Supply 515 Norfolk Ave SW 3-1564
 Graybar Elec 601 Salem Ave RO 3-3615
 *Leonard Electronic 131 Center Ave NW 3-9339
 Peoples Radio & TV 1015 Moorman Rd NW 5-8900
 *Radio Supply Hqrs Richmond
 Roanoke Electronic 1322 Williamson 4-6612
 Westinghouse Electric 732 1 St SE 7771

STAUNTON
 Hartley & Co 327 N Central 5-2333
 Radio Electric Products 114 N Central 5-3061
 Southern Electric 818 Greenville Ave 5-2313

WHITE STONE
 Channel Electric Products HE 5-5255

WASHINGTON

ABERDEEN
 C & G Radio Supply Co Hqrs Tacoma

BELLINGHAM
 Waitkus Supply 110 Grand Ave 274

BREMERTON
 C & G Radio Supply Co Hqrs Tacoma

CENTRALIA
 C & G Radio Supply Co Hqrs Tacoma

ELLENSBURG
 Gedge Radio W A 1101 Columbia 2-7701

EVERETT
 *Pringle Radio Whole 2514 Colby Ave

KENNEWICK
 Wibbe Radio Supply Hqrs Tacoma

OLYMPIA
 C & G Radio Supply Co Hqrs Tacoma

PASCO
 Lay & Nord Hqrs Yakima

SEATTLE
 Central Electronics 2023 7th Ave
 Coast Radio 110 University St MA 9133
 Connelly Co C F 1015 Republican St SE 4155
 Electronic Supply 5601 Calif Ave AV 4500
 Fidelity Electric 960 Republican St SE 5100
 Garretson Radio Supply 2416 2 Ave MU 4380
 General Elect Supply 1212 1 Ave SE 6400
 *General Radio 100 Wall St EL 4784
 Graybar Elec King & Occidental MU 0123
 Pacific Electronic Sales 1201 1 Ave MU 5390
 *Radio Products Sales 1213 1st Ave MA 1035
 Radio TV & Appl 500 Westlake Ave N MA 0787
 *Seattle Radio Supply 2117 2 Ave SE 2345
 *Western Electronic 717 Dexter Ave SE 3200
 Westinghouse Elec 1051 1 Ave S EL 7001
 Westlake Electronic 511 Westlake N MA 6601
 *Zobrist Co H E 2121 Westlake MU 2121

SPOKANE
 Columbia Electric E 3420 Ferry Ave KE 0611
 Frank's Radio Supply 161 S Adams St MA 8108
 General Electric Supply E 1805 Trant Ave KE 0431
 Graybar Electric 1033 W Gardner Ave EM 6611
 Johnson Co E M W 615 1 Ave RI 5432
 *Northwest Elec N 102 Monroe MA 9289
 Prudential Distr 318 W Trent Ave MA 6002
 Spokane Radio Supply 301 W 2 Ave RI 8441
 Standard Sales 1219 W 1 Ave RI 7196
 Taylor Distributing E 206 Augusta EM 3301
 Westinghouse Elec N 1023 Monroe EM 3371

TACOMA
 C & G Radio Supply 2502 Jefferson Ave BR 3181
 General Electric Supply 2316 A St BR 8454
 Graybar Electric 2112 A St MA 0164
 Stewart Co A T 711 Broadway BR 3174
 Westinghouse Elec 1930 Pacific BR 8417
 *Wibbe Radio Supply 2360 S Fawcett St BR 8395

VANCOUVER
 Saelens Radio Hqrs Portland

WALLA WALLA
 Kar Radio & Electric 12 & Pine Sts 4572

WENATCHEE
 Mid-State Radio 611 1/2 N Wenatchee Ave 510

YAKIMA
 Lay & Nord 112 S 2 St 3-5591

Westinghouse Elec 210 W B YA 3-4701
Yakima Wholesale Radio 506 S 1st 4670

WEST VIRGINIA

BECKLEY
*Chemelty Radio & Elec 1708 S Kanawha St 2-5353

BLUEFIELD
Bluefield Supply 6121
Dixie Appliance 232 Bluefield Ave
*Meyers Electronics 813 Bluefield Ave

CHARLESTON
Charleston Elec 914 Kanawha 6-0321
*Chemelty Radio & Elec 103 Clendenin St 2-8151
Graybar Electric Kenawha & Capitol St 6-0411
Hicks Radio Supply 10 Virginia St 3-5583
Mountain Electronics 708 Bigley 3-9582
Virginian Electric P O Box 2833 6-0631

CLARKSBURG
Mountain Electronics 433 Clark St 4-5559
Trenton Radio Co Hqrs Morgantown
Westinghouse Electric 315 N 4 4-6311
White Electric 903 W Pike St 4-5591

HUNTINGTON
*Electronic Supply 422 11 St 8779
*King & Irwin 314 11 St 3-8414
Mountain Electronics 1127 3 Ave 2-0339
*TV Supply 1226 3 Ave 6639
Van Zandt Supply 1123 4 Ave JA 5-5193

MARTINSBURG
Plummers Radio 526 W King St 3821

MORGANTOWN
Trenton Radio 507 Beechurst Ave 5637

PARKERSBURG
Cox Radio Supplies 554 7 St
General Electronics Hqrs Wheeling
Randle & Hornbrook 536 7 St 8-3391

WHEELING
General Electric Supply 1818 Eoff St WH 2555
General Electronics 735 Main St 5738
Hamburg Bros 360 National Rd 727
*Radio Parts Co 1312 Main St
Westinghouse Electric 1803 Eoff St 3980
Wheeling Radio Supply 924 Market St WH 1077

WISCONSIN

APPLETON
Appleton Radio Supply 1217 N Richmond St 3-3345
Electronic Expeditors Hqrs Milwaukee
General Electric Supply 1307 S Spencer St AP 4-7155
Valley Radio Distr 518 N Appleton St 3-6012

CHIPPEWA FALLS
Bushland Radio Specialties PA 3-6052

EAU CLAIRE
Bushland Radio Specialties Hqrs Chippewa Falls
Larson Electrical J H Hqrs Minneapolis

FOND DU LAC
*Harris Radio 289 N Main St 8204

GREEN BAY
Electronic Expeditors Hqrs Milwaukee
Graybar Elec Co 1140 N Irwin Ave HE 7-3284
Neslo Electronic 308 N Chestnut HE 5-4881
*Northern Radio & TV 708 S Broadway HE 5-3789
Westinghouse Electric 619 Main HE 5-3751

HUDSON
Larson Elec Co J H Hqrs Minneapolis

JANESVILLE
Goodenough Radio 111 N Jackson St PL 4-7033

KENOSHA
Chester Electronic 2012 52nd St OL 2-8607
Midwest Electronics Hqrs Chicago

LA CROSSE
General Electric Supply 222 Pearl St 2-7802
Lew Bonn Co 115 Pearl St 4-7378
Southern Minn Supply Hqrs Mankato Minn
*Stark Radio Supply Hqrs Minneapolis

MADISON
Graybar Elec Co 103 N Park St MA 5-0005
*Radio Dist 701 E Johnson St AL 6-6801
*Satterfield Electronics 326 W Gorham AL 6-0267
Superior Radio Parts Hqrs Racine
Westinghouse Elec 1022 E Washington 5-4868

MANITOWOC
*Harris Radio Corp Hqrs Fond du Lac

MARINETTE
Popkey Co G M Main & 9 Sts

MILWAUKEE
*Ackermann Radio N 3861 N 35 HI 5-1860
*Acme Radio 1009 N Water St BR 1-0641
*Central Radio 1723 W Fond du Lac Ave WE 3-2982
Dykro Distrs 340 N Milwaukee St BR 6-4400
Electronic Expeditors 2205 W Vilet WE 3-5804
Electro-Plance Distr 2458 W Lisbon Ave DI 2-9240
General Electric Supply 540 S I BR 6-7730
Graybar Elec 180 N Jefferson BR 6-8400
Juneau Radio Sup 3110 W Lisbon Ave DI 4-2266
*Marsh Radio Supply 838 N 4 St BR 6-1320
Mid-City Electronic 2327 W Wells WE 3-8304
Pritzaff John Hdw 333 N Plankinton Ave BR 1-1965
*Radio Parts Co 940 N 27 St WE 31-5131
Roth Appl 647 W Virginia BR 1-1111
Seemuth Distr 2406 W Lisbon St DI 2-9240
State Distr Co 3500 W Pierce St EV 3-6200
Stolz-Wicks 4120 W Fond du Lac Hqrs Chicago
Taylor Elec 4080 N Pt Wash Rd WD 4-4321
Television Parts 714 W State BR 2-6111
Westinghouse Elec 546 N Bway DA 8-1800

OSHKOSH
Electronic Expeditors Hqrs Milwaukee
Neslo Electronic Dist Hqrs Green Bay

RACINE
Allen's Merchandising 1206 N Wisconsin St 3-8589
Badger Electronic 856 Washington 3-4024
*Standard Radio Parts 1244 State St 4-3634
Superior Racine 908 State St ME 2-5142

SHEBOYGAN
Koopzell Co J J 1010 S 9 St GL 7-3646
Nitze's 1129 N 8 St GL 7-9531

STEVENS POINT
AMCO Electronics N 2nd & Franklin 3351

WAUSAU
*Radio Service & Supply 615 3 St 3272

WYOMING

CASPER
Fleming Supply 328 1/2 East A St 3-6056
General Electric Supply 428 S Elm St 2-7333

CHEYENNE
*Houge Radio & Supply 4012 Central 2-6474

SHERIDAN
Barton Battery & Electric Co. 102 Grinnell St 59

TECHNICIAN BUYERS DIRECTORY

Your year round
reference!

ALASKA

ANCHORAGE
Yukon Radio Supply Box 406 2-7964

CANADA

ONTARIO, NEW TORONTO
Vanderhout Assoc Victor 70 14 St

HAWAII

HONOLULU
Radio-TV Corp 777 Ala Moana Rd 50-2901
Radio Wholesale & Supply 817 Alakea St 6-3996

Features of forthcoming issues
of

TECHNICIAN & Circuit Digests

June—Foreign Radios

August—Test Equipment

September—Antennas

October—Audio

Plus . . . regular monthly Circuit Digests—
articles—data—vital technical, business, and
equipment information for TV-electronic
servicemen.

Over 50,000



paid circulation

Caldwell-Clements, Inc.
480 Lexington Avenue,
New York 17, N. Y.
Plaza 9-7880

VICTOR VANDERHOUT ASSOCIATES

70 14TH STREET
NEW TORONTO, ONTARIO, CANADA

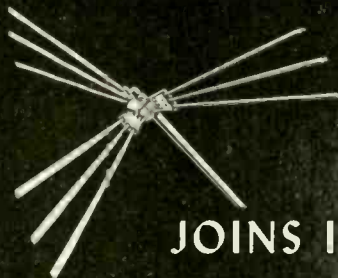

JOINS IN
HONORING



TECHNICIAN BUYERS DIRECTORY

Representatives ("Reps")

This section of the 1956 Technician Buyers Directory lists those representatives operating as independent "reps" who handle two or more lines. They do not include factory staff salesmen. "Reps" are listed alphabetically under states and cities. Asterisks (*) indicate membership in "The Representatives" of Electronic Product Manufacturers, Inc. Telephone numbers are given to speed contacts.

ALABAMA

BIRMINGHAM

Hayden Associates Paul Hdgrs E Point Ga
Smith Co Maitland K Hdgrs Atlanta Ga

ARIZONA

PHOENIX

Moore Sales Co Harry A Box 7245 AM 5-4662
Neely Enterprises Hdgrs N Hollywood
Sheller Co H George Box 1587 AL 8-7893

TUCSON

Marshall Co G S Hdgrs Pasadena

CALIFORNIA

LOS ANGELES AREA

Alderson Co Wes 10422 National Blvd TE 0-1030
*Appleton Co Harry 136 San Fernando CA 5-5513
*Barron-Jur Co 817 S Hoover St DU 3-5248
*Barstow & Doran 1406 S Grand Ave RI 6191
Baughman E J 1914 N Cogswell (El Monte) FO 0-7586
*Becker Co Herb 1140 Crenshaw Blvd WE 1-1257
Berman Co J 1141 La Cienega St OL 5-8921
*Brazan P L 3257 W Pico Blvd RE 1-2186
*Cochrane-Barron Co 408 S Alvarado St DU 5-1715
Cohn S H 1769 S Holt Ave TE 0-4398
*Costello J D 1917 S Bronson Ave RE 3-6322
Craig Ralph P 715 N Harper Ave WE 0468
Davidson & Assoc J 2803 LosFlores (Lynwood) NE 6-2245
*Davis Sales Co George 5259 E Beverly Blvd UN 3-3594
Detsch & Co Hdgrs San Francisco
Dudek & Co R C 407 N Maple Dr (Beverly Hills) BR 2-8097
Dunkle B 3257 W 6 St
*Ealy Co M D 633 S La Brea WE 5-0771
*Edwards & Co Jackson 6047 Hollywood Blvd HO 5-1141
Electrair Co 3903 Warner Blvd (Burbank) VI 9-2874
*Emmett F A 2837 W Pico Blvd RE 1-8211
Engineering Sales 406 S Main St MA 6-9159
Erlanger Sales 4217 W Jefferson Blvd RE 1-2238
*Feldman Co Henry 1244 S Grand RI 9-8803
Fox Associates 5401 Santa Monica Blvd HO 3-7194
Gelst Co W K 3177 Glendale Blvd MO 5-8910
Graham Sales 1200 Sycamore Ave (Hollywood) HO 2-3552
Hansen C A 1406 S Grand Ave RI 8-6191
Hardie Co R M 901 S Manhattan PL RE 4-2752
*Harmon Co W S 121 N Robertson Blvd (Beverly Hills) BR 2-3321
*Harris A W PO Box 1116 (Gardena) DR 8-4817
Hast Nate 301 S Reeves Dr (Beverly Hills) CR 5-2652
*Hastings Sales Co 4942 Vineland Ave (N Hollywood)
Heeger Inc 1011 Venice Blvd DU 9-6775
*Hill Sales Co J T 420 S Pine St (San Gabriel) AT 7-9633
King-Moon Co 15044 Ventura (Sherman Oaks) ST 4-5404
*Kittleson Co 416 N La Brea WE 3-7371
*Knight Co W Bert 10373 W Pico Blvd BR 2-5647
*Koessler Sales 6907 Melrose Ave WE 6-6271
La Moree G D 1325 San Julian RI 8-7341
Larshan Inc 1409 Wilshire (Santa Monica) TE 0-8489
*Lasure Co Harry A 9041 W Pico Blvd BR 2-7805
*Loukota Co Douglas 1052 W 6 St MA 6-4505
Lynch & Son C R 3307 Glendale Blvd MO 3-8236
Lynn & Brooks 3055 Wilshire Blvd DU 2-2255
Mann Associates Martin 14751 Keswick St (Van Nuys)
*Marsh Co J W 4216 W Jefferson RE 2-0145
*Marshall Co G S 40 S Los Robles (Pasadena) SY 5-2022
*Marshank Sales 7422 Melrose Ave WE 8-2591
Maynard Sales Co 6214 W Manchester OR 8-3150
*Miller G B 1550 N Highland (Hollywood) HO 2-1195
Mitchell C H 256 S LaPeer (Beverly Hills) BR 2-0183
*Neely Enterprises 3939 Lankershim Blvd (N Hollywood) ST 7-0721
*Olander & Co Roland 7225 Beverly Blvd WE 5-1211
Osborne R E 1044 S Park View DU 8-1039
*Owens Co Lee H 2331 W Washington RE 5-0230
Perlmuth Electronic Assoc 2419 S Grand Ave RI 7-4321
Posner Co 1223 Venice Blvd DU 8-0508

*Power Ralph L 767 Castelar St MU 5277
Renz Roy E 1406 S Grand Ave RI 7-3893
*Rissal A J 2724 S Peck Rd (Monrovia) DO 6-2135
*Roberts & Assoc E V 5068 W Washington WE 8-2541
*Rupp Co V T 2230 W 11 St DU 3-4197
*Saul & Assoc H M 5015 San Vincente Blvd WE 8-3591
*Schoendave H W 7407 Melrose Ave WE 3-7276
*Selgel Co Samuel 1133 S LaCienega Blvd OL 5-8870
Slevers Edward S 1662 Hillhurst Ave NO 2-1105
Skahill Ed A 933 N Kenmore Ave NO 3-4453
Smedley A B Box 67-C (Pasadena) SY 8-1174
Snitzer T Louis 5777 W Pico Blvd WE 8-2074
Snyder L G 1418 N Highland (Hollywood) HO 9-6278
Starr Edwin E 4101 Rhodes Ave (N Hollywood) ST 7-5879
Stern & Co I R 4109 Burbank Blvd (Burbank) VI 9-1195
*Stolaroff Co M A 4622 W Slauson Ave AX 3-6219
*Stone Assoc Carl A 1102 S Western Ave BR 2-8103
*Stone Sales Co R L 9548 W Pico Blvd BR 2-4916
*Strasser Co Conrad R 1865 N Western Ave HO 7-7086
Tivy George S 1148 S Grand Ave RI 7-7553
*Tubergen Assoc 2234 W 11 St DU 9-3173
Uecke E H 4938 Neola Pl CL 7-9611
Van Groos Co 14515 Dickens St (Sherman Oaks) ST 7-9615
*Wallace & Wallace 1206 Maple Ave RI 7-0401
*Weber Co Wedge 1217 Venice Blvd DU 7-2111
*Weightman H G 4104 Burbank Blvd (Burbank) VI 9-2435
*Western Electronic Enterprises 3348 W Compton Blvd (Gardena) DR 8-4817
*Willey Paul F 1632 Silverlake Blvd NO 3-8028
*Wood Co A M Box 150 (Elmonte) CU 3-1201

SACRAMENTO

Neely Enterprises Hdgrs N Hollywood

SAN DIEGO

Neely Enterprises Hdgrs N Hollywood

SAN FRANCISCO AREA

*Ault C E 625 Laurel Ave (Menlo Park) DA 5-4983
*Barstow & Doran 248 9 St UN 3-2079
*Belchamber P A 1401 Middle Harbor Rd (Oakland) GL 1-4460
*Berman Co E L 780 Natoma St UN 3-0317
Brainard W V 1010 Grosvenor Pl (Oakland)
*Brandt E W 1355 Market St UN 1-2367
Cochrane-Barron (Palo Alto) Hdgrs Los Angeles
Detsch & Co 341 10 St MA 1-2788
Elchorn & Melchior 749 Bryant St
Electronic Eng'g Assoc 1040 Brittan Ave (San Carlos)
*French S P 721 Garland Dr (Palo Alto) DA 3-0597
Harriss Sales Co L H 383 Brannan St YU 6-1084
Held Herman E 147 10 St UN 3-4250
*Hodges Elmer C 921 Bryant St UN 1-2367
Jewett S O 13537 Addison St (Sherman Oaks) ST 9-6027
Kittleson Co 2166 Market St HE 1-5304
*Lebell Frank 195 2 Ave SK 1-7298
*Lewis Assoc Dean 219 9 St UN 3-1414
*Logan Assoc Les S 154 8 St HE 1-0692
*Logan Sales Co 150 8 St HE 1-0692
Marshall Co G S (Redwood City) Hdgrs Pasadena
Marshall Harry E 104 Olive St OR 3-2173
*Melchior Wm 749 Bryant St DO 2-1038
*Meyer & Ross 113 10 St HE 1-0652
*Moulthrop Co F W 1234 Folsom St UN 3-0445
*Moulthrop & Hunter 165 11 St HE 1-2624
Moxon Sales G E 422 Lajolla Ave (San Mateo) FI 5-2866
*Neely Enterprises 2830 Geary Blvd Hdgrs N Hollywood
*Newman H L 420 Market St YU 6-3897
*Nickerson & Rudak 381 Brannan St YU 2-2982
*Nott & Co L A 1061 Howard St HE 1-4738
*Purdy Co W J 312 7 St UN 3-4321
*Ross Co D H 534 El Camino Real (San Carlos) LY 3-8224
*Sinal Arnold A 65 9 St UN 1-6259
*Tompkins & Co W W 941 Newell Rd (Palo Alto) DA 3-3270
*Vermilya R H 1258 Fitzgerald Ave VA 4-6714

STOCKTON

Detsch & Co Hdgrs San Francisco

COLORADO

BOULDER

*Gollner W B 1003 Grandview Ave HI 2-7895

COLORADO SPRINGS

*Peysor & Co 1501 N Weber St ME 4-3401

DENVER

*Bowen Co Ronald G 446 Broadway SH 4-2501
Bower Co C R 2759 W 33 Ave GR 7292
Cluphf & Assoc Stan 7825 W Colfax Ave BE 3-6025
*Connors Co W H 375 Birch St DE 3-7628
Halliday Gail 2576 S Millwaukee St PE 2650
*Hyde Sales Co 3250 S Oaxter SK 6-7151
Koeher-Cox Co 120 W 13 Ave MA 3-3544
*McLoud & Raymond 5528 E Colfax FR 3067
*Mal-Pearson & Co 1011 S Josephine St SP 7-7878
Mueller Mark G 1644 Blake St AC 2-3515
*Nelson Co A J Box 5502 KE 6751
O'Brien Sales A J Box 1681 BE 3-4845
*Williams Co Allen I 124 W 12 Ave MA 3-0343

FT COLLINS

*Leeper & Assoc Wilson 123 Fishback St 3-0444J

GREELEY

*Moss Gordon G Box 428 Phone 770

CONNECTICUT

ANDOVER

*Seyd Ernest K Long Hill Rd Pilgrim 2-6604

BRIDGEPORT AREA

Hannigan Co W T 1115 Main St ED 3-2772
Perron & Co Ray (Trumbull) Hdgrs Boston
Reynolds Co Harrison 211 State St BR 5-9634

CANAAN

Holliday-Hathaway Co Hdgrs Cambridge

DARIEN

Jacobson Leo 3 Bellevue Rd ST 3-0828

HARTFORD AREA

Akeroyd Co A E (Kensington) Hdgrs Boston
Gates A W 46 1/2 Summer St (Manchester) MI 9-7761
Gibson Engineering Co 141 Washington St CH 7-6919
Hutton A T 1000 Farmington (W Hartford) AD 3-3613
Pettibrew R S 62 La Salle Rd (W Hartford) HA 3-8533
White Sales Co (Berlin) Hdgrs Needham Mass

NEW HAVEN AREA

Abbott & Huslis Hdgrs Boston
Feldman & Co George 525 Norton Pkwy SP 6-9823
Gerber Sales Co Hdgrs Brookline
Hisco Sales 880 Elm St UN 5-2806
*Lavin Assoc Henry Box 196 (Meriden) BE 7-4555
Steele Assoc J R 22 Green Garden (E Haven) HO 7-5864
Sturgeon Ine Paul R (Milford) Hdgrs Boston

STAMFORD

Electronic Associates 200 5 St DA 4-7300

WESTPORT

Nief Assoc P W 15 Oak St CA 7-3834

DISTRICT OF COLUMBIA

WASHINGTON

Burlingame Assoc Hdgrs NYC
Cerf & Co Art Hdgrs Philadelphia Pa
Henry & Co 3741 Jocelyn St NW KE 7-1448
Jodon Inc F R 8510 Beechtree Rd OL 2-4406
MacDonald Inc Samuel K Hdgrs Philadelphia Pa
Massey Associates Hdgrs Nabeth Pa
*Shilt N C 3308 14 St NW Co 5-3938

FLORIDA

BRADENTON

Hayden Assoc Paul Hdgrs E Point Ga

FORT LAUDERDALE

Rogers & Assoc C B Hdgrs Atlanta

FORT MYERS

Lynch Arthur H & Assoc Box 466 ED 4-4431

JACKSONVILLE

*Cole Harry A 534 10 Ave 5-2971

LUTZ

*Wallace Assoc Stanley K PO Box 767 TA 99-3241

MIAMI BEACH

Gaertner Co Jack 823 86 St UN 6-6664

ORLANDO

McCorvey Co V Avis Hdgrs Decatur Ga

ORMOND BEACH

*Smith Co Maitland K Hdgrs Atlanta

SARASOTA

Hasemeier & Assoc W L 236 S Washington Dr RI 8-4321

TAMPA

Cartwright & Bean Hdgrs Memphis

Minthorn Co L L Hdgrs Portland Ore

*Wallace Assoc Stanley K Hdgrs Lutz

WINTER HAVEN

Taylor Co Morris F Hdgrs Silver Spring Md

*Van Dusen R H 940 Lake Elbert Dr 4-6671

GEORGIA

ATLANTA

*Adair Clark 1426 High Point Pl NE VE 3053
*Burwell Co Henry W 1025 Ponce de Leon Ave AT 2127
*Cartwright & Bean Hdgrs Memphis
*Duckett Sales Co Grady 26 E Andrews Dr NE CH 5308
*Fausett & Son F 777 Pinehurst Ter SW RA 3104
Hart Engrs & Sales Co 132 Walker St SW AL 9854
*Hollingsworth & Still 508 Whitehead Bldg MA 5878
*Hutto V 1036 Peachtree St NE AT 6858
*Joyner J E PO Box 341 Station A PL 8-4910
*Millar Assoc James 1036 Peachtree NE EL 0919
*Murphy & Gota 1409 Peachtree NE EL 3020
*Nickerson Co Frank C 1150 Zonolite Rd NE EM 9808
*Pepper & Assoc John B PO Box 7036 Sta C AT 8266
Rogers & Assoc C B 1000 Peachtree NE EL 1733
*Smith Co Maitland K 317 Forrest Ave NE WA 6094
Taylor Co Morris F Hdgrs Silver Spring Md
Thornwell Inc E A Howell Mill & Berkeley WA 3548
Wallace Assoc Stanley K Hdgrs Lutz Fla

DECATUR

- *McCorvey Co V Avis 215 Church St CR 6167

EAST POINT

- *Hayden Assoc Paul Box 331 PO 7-9646

ILLINOIS**CHICAGO AREA**

- American Mfrs Agency 2215 W Wilson Ave RA 8-5153
- *Angel & Co J C 2743 W Peterson Ave UP 8-0653
- *Arnold Co A W 1321 Rosedale Ave ED 4-6457
- *Bauman Robt 6025 N Keystone KE 9-3108
- *Beler Co Leroy W 6518 W North Ave BE 7-2420
- *Bierhaus J J 4804 W Madison AU 7-2089
- *Bluzat Co Rene 2842 N Cicero Ave PE 6-2238
- *Booth Claude R 400 W North Ave CA 7-2810
- *Brouillette & Assoc 5049 Quinsy St MA 6-0499
- *Bruning Co A H 2215 W Wilson Ave ED 4-0989
- *Burgoyne Wm E 7001 N Clark St HO 5-2112
- *Caine Sales Co 3020 N Cicero Ave SP 7-4022
- *Cappels & Assoc J L 1214 W Madison TA 9-1818
- *Chambers Co Larry A 5906 North Ave TU 9-4884
- *Champion Earl T 6459 N Sheridan Rd AM 2-3565
- *Cole Co G McL 6514 W Higgins Rd SP 4-3535
- *Cozzens W B 845 Chicago Ave (Evanston) DA 8-4800
- *Crossley & Assoc 4501 N Ravenswood UP 8-1141
- *Cumming & Assoc B 6029 W Belmont Ave ME 7-3770
- Cushing Co L G 605 N Michigan Ave DE 7-6456
- *Dietrich Co Russ 2030 W Montrose St LO 1-6831
- *Dolfin Sales D 3353 Peterson
- *Doyle Co W J 7002 N Western Ave RO 1-3130
- *Elliinger Sales Co 6540 Northwest Hwy RO 3-1570
- *Elliinger Sales Co W H 6571 N Olmsted St RO 3-4154
- Ellis Co Arthur J 1607 Howard St AM 2-2708
- *Engle Co Karl D 4724 N Sheridan Rd UP 8-6363
- Everett Associates 6744 N California AM 2-3702
- *Felleisen & Assoc 5839 W Montrose Ave WH 4-4822
- *Fitzsimmons J J 6124 Milwaukee Ave NE 1-7660
- *Gassner & Clark Co 6644 N Western Ave RO 4-6121
- *Gebhard Co Harry W 5129 W Devon Ave RO 3-3636
- *Glanaras Sales Co 2345 W Devon Ave AM 2-2100
- *Golten Co Jerry 2750 W North EV 4-5959
- *Green & Assoc L F 5218 W Diversey Ave PA 5-6824
- *Halnes E Ralph 949 Lake St (Oak Park) EU 6-4476
- *Hallinton Co Harry 5500 W Devon Ave RO 3-2132
- Haskell Assoc 1033 Ontario St (Oak Park) EU 6-5741
- *Higgins Co Royal J 10105 S Western Ave CE 3-7388
- *Hill-Gray 41 1/2 Harrison St (Oak Park) ES 8-7050
- *Hitechock Material Sales R C 2949 W Diversey SP 2-3410
- Hoflacher Sales W A 1605 W Devon Ave RO 4-9487
- Howe & Pretat 4 N Cicero Ave CO 1-3146
- *Hunter Assoc T B 4441 W Irving Park SP 7-2500
- *Hutmacher Assoc R R 6647 N Oliphant NE 1-3248
- *Jones Mel M 2800 N Milwaukee Ave EV 4-2646
- *Kadell Sales Assoc 2406 W Bryn Mawr LD 1-3042
- *Karet-Margolin Inc 13 W Hubbard St WH 4-6345
- Kelburn Eng'g Co 3136 Clarence Ave (Berwyn) ST 8-6485
- *Kleker Co J H 177 Sunset (Glen Ellyn) GL 2297
- *Langhaus-Levy Assoc 2215 S St Louis RO 2-6321
- Levin & Assoc Sol 2823 W Chase Ave RO 4-7082
- Lewis & Trimble 5420 W Fullerton Ave NA 2-0706
- *Linz Co W M 7115 N Mobile Ave RO 3-3326
- Lombard Co V Box 355 (Grayslake) KI 6-1760
- Lund-Hansen Co 1900 Montrose Ave LO 1-2551
- *McBride Sales J J 328 E Burlington (Riverside) 7-8131
- *McCarthy Co L C 5933 Addison St KI 5-7976
- *Magnuson Associates 3347 W Irving Park Rd KE 9-7555
- Memac Sales Co 4740 N Austin Ave KI 5-1033
- *Monson Corp 6957 N Keating (Lincolnwood) OR 3-9361
- *Mulay Sales 400 W North Ave BE 5-7411
- *Necker E J 6514 W Higgins Rd SP 4-3535
- *Newman-Krause Co 5306 W Lawrence Ave PE 6-6776
- *Petitt Co G349 Ashland (River Forest) CO 1-0342
- *Pivan Eng'g Co 2871 N Lincoln Ave OI 8-6885
- Quackenbush Al 2629 N 77 Ct GL 3-3446
- *Ridley Assoc 1551 N Austin Blvd TU 9-2940
- *Ritter Sales Co 5839 W Montrose Ave MU 5-7440
- *Rose & Co J K 2323 W Devon Ave AM 2-5584
- *Rothschild P A 221 W Huron SU 7-7919
- Ryan Co Gerald G 549 Washington Blvd ST 2-7665
- *Saffro-Gottelman Co 227 W Chicago Ave DE 7-5092
- *Sarkis & Co Henry 5608 N Western Ave AR 1-3774
- *Sparf W H 3592 Milwaukee Ave PE 6-0555
- *Stamm R Edward 5681 W Lake St ES 9-2700
- *Strauss-Whitmore 639 Diversey Pkwy WE 5-6460
- *Sullivan Ralph T 1551 N Austin Blvd NA 2-4074
- *Swinko & Co W F 541 Diversey Pkwy BI 8-4343
- *Tatro & Assoc F B 6022 N Rogers Ave JU 8-0333
- *Taylor Co R F 308 W Washington St AN 3-1808
- *Twintronie Sales Co 2114 W Carroll CH 3-5242
- *Twist Co J G 2800 N Milwaukee Ave HU 9-2550
- *Victoria Sales Co 1413 Howard St BR 4-5400
- *Vollassociates Ltd 2154 N Halsted St LA 5-7755
- *Warner Co D L 15423 Honore Ave (Harvey) ED 1-6247
- *West Jack 6747 N Octavia Ave RO 3-3500
- Whitmore & Assoc R C (Homewood) WA 8-2225
- Wiley Co S J 2629 W Fitch Ave SH 3-6548
- *Wilson Sales Agency 2750 W North Ave CA 7-7600
- *Withers & Ropke 5439 W Division St AU 7-7292

INDIANA**ANGOLA**

- *Clancy & Co Joe PO Box 267 793

FORT WAYNE

- *Bieberlich Walter W 2817 Plaza Dr KE 2928
- *Central Sales Co 255 Central Bldg EA 4635
- *Fisch & Assoc Bld 419 W Sherwood Terr HA 1089

- *Hoenig Sales Co Butler Ct AN 2083
- *Homsher B F 2018 Jessie Ave EA 4920
- *Southern Sales Co 1605 Lincoln Tower AN 5278
- *Valentine Forrest C 511 Ft Wayne Bk Bldg AN 9122

INDIANAPOLIS

- *Blind & Co Harrison J 1508 Winton Ave BE 0191
- Clancy & Co Joe Hdqrs Angola
- Grandall & Assoc R M 6220 E 56 St LI 6-8373
- *Cunningham Assoc Quinn 6101 College Ave GL 3222
- *DeVoe Co Leslie M 4010 Washington Blvd HU 1395
- *Macnabb V C 909 Westfield Blvd BR 6770
- *MacPherson-Thomas 5226 N Keystone Ave GL 6915
- Murphy Joe 202 Pam Rd R 4-7202
- Ridgeway Eng'g Co 1606 N Illinois St WA 5-6464
- *Schulz Co Edwin A 721 Sherwood Dr BR 1993
- *Whitesell & Assoc R O 6620 E Washington ME 2-8517
- *Wright Eng'g Co 4241 Melbourne Rd WA 3-8888

MARION

- Musser Victor W 608 W 2 St NO 2-7874

SOUTH BEND

- Karet-Margolin Inc Hdqrs Chicago

IOWA**CEDAR RAPIDS**

- *Vrbik Jerry 621 Guaranty Bldg 4-0835

DES MOINES

- Kay Sales Co Hdqrs Kansas City

KANSAS**IOLA**

- Russell Sales Co H E 315 N Jefferson 64

KANSAS CITY AREA

- *Koenig Sales 6359 Antioch Ave (Merriam) HE 2-3166
- *Zimmer Sales 5620 Woodward Ave (Merriam) HE 2-1121
- *Terwilliger Sales 7143 W 80 St (Overland Park) NI 2-2421

WICHITA

- Harris Co 3241 E Douglas MU 3-9226

**KENTUCKY****LOUISVILLE**

- Cobb Sales Co 1629 Portland Ave CL 9486
- Schnee Assoc Earl W Hdqrs London, Ohio

LOUISIANA**NEW ORLEANS**

- Bornemann W E 4719 Cartier Ave FA 2504
- Cartwright & Bean Hdqrs Memphis
- Moore Co Earl K 5864 Louisville St AU 2407
- Redmann S M 2322 Valmont St UP 3767

MARYLAND**BALTIMORE**

- Cerf & Co Art c/o David Bros Hdqrs Newark
- Closs Co Thomas H 21 W Pennsylvania Ave VA 5-4445
- Goodman Co S W 32 W Biddle St VE 7-2240
- MacDonald Inc Samuel K Hdqrs Philadelphia Pa
- *Randall Co Ken Hdqrs Philadelphia

SILVER SPRING

- Gawler-Knoop Co Hdqrs Roseland NJ
- *Lienau & Co C W 9427 Georgia Ave JU 7-5888
- *Taylor Co Morris 9431 Georgia Ave JU 9-4002

TOWSON

- *Barnhill & Assoc R B 412 Woodbine Ave VA 5-3431
- Maguire & Co Hdqrs Camden
- *Wilkinson R L 707 Stevenson Lane VA 3-7800

MASSACHUSETTS**BOSTON AREA**

- *Abbott & Hustis 1105 Commonwealth Ave AL 4-8100
- *Akeroyd A E 2311 John Hancock Bldg HA 6-2433
- *Anderson Sales Co 177 State St CA 7-2980
- *Boeing J E PO Box 186 (Arlington) MI 8-2900
- *Brown K L 54 Atherton Rd (Brookline) BE 2-3969
- Burlington Assoc (Waltham) Hdqrs New York NY
- *Chamberlin H A CIV AIR TERM (Bedford) CR 4-0044
- *Cookley Tim 148 Needham (Newton Highlands) DE 2-4800
- *Drew D D PO Box 208 (Arlington) AR 5-9496
- Electronics Assoc (N Quincy) Hdqrs Stamford Conn
- *Gerber Sales 48 Pearl St (Brookline) BE 2-2425
- Gibson Eng'g Co 1018 Commonwealth Ave AS 7-5074
- *Goldman W W 256 Aspinwall (Brookline) AS 7-2669
- *Goss Co Jack 99 Highland Ave (Somerville) PR 6-2262
- *Gray R W 572 Washington St (Wellesley) WE 5-5296
- *Greene Dan PO Box 124 (Cambridge) UN 4-2220
- *Hannigan W T 272 Centre St (Newton) DE 2-3252
- *Harris Co S A 317 Chestnut St (Needham) ME 3-4780

- Hart Co F H 115 Pond St (Nahant) JU 1-0381
- *Hathaway Electronics G M 238 Main (Cambridge) EL 4-1751

HENDRICKSON

- W A Lawson Park (Seltuate) 652
- *Hooker S C 397 Highland Ave (Winchester) WI 6-2745

HOW INC

- D 445 Statler Office Bldg HU 2-4638
- Kelly & Co W T 77 Lovett (Beverly) 65
- *Lavin Assoc Henry (Needham) Hdqrs Meriden Conn
- Limnani Co M A 115 Garden St (Lawrence) 2-8638
- MacArthur R S (Belmont) BE 5-4613
- *Macdonald-Wadman Co 457 Stuart St CO 6-2337
- *Moster & Payer 945 Gr Plain Ave (Needham) NE 3-5060

NICKERSON

- C S 200 Somerset Ave (Winthrop) OC 3-3276

PARLER

- Blair H 610 Atlantic Ave LI 2-9214
- *Perron & Co Ray 1870 Centre St FA 3-1008
- *Pruy Sales W B 44 Washington St (Wellesley Hills) WE 5-3199

PURLINTON

- R M 43 Leon St GA 7-6006
- *Reynolds Co Harrison 313 Washington St (Newton) DE 2-4620

SEBASTIAN

- Assoc 4 Waltham St (Lexington) VO 2-3578
- *Scott Co Michael 90 Edmunds Rd (Wellesley Hills) WE 5-0102

SEGEL

- Co Charles 143 Newbury St KE 6-9755
- *Segel Co Henry P 143 Newbury St KE 6-3012
- *Sturgeon P R 25 Huntington Ave CO 6-7705
- *Wadman Eugene 457 Stuart St CO 6-2337
- Waters & Drew 64 Gray St (Arlington) 5-9496
- *Waters Inc R A 4 Gordon St (Waltham) WA 5-6900
- *White Sales Co 945 Great Plain (Needham) NE 3-3676

WILLSON

- J E 33 Maple St (Malden) MA 4-7460
- *Yewell P G 751 Main (Waltham) WA 5-7420

LINCOLN

- *Stevens & Co K C Box N CL 9-8408

SHARON

- Clough A P 10 Winslow Rd SH 506

SPRINGFIELD

- *Rogers Assoc G J 198 Old Farm Rd RE 3-8428

MICHIGAN**DETROIT AREA**

- ABM Sales 10116 Puritan Ave UN 2-1300
- *Beltel Co Wayne 139 W Maple (Birmingham) MI 6-0311
- *Burzwil & Co K C 22128 Grand River Ave KE 3-7700
- Clancy & Co Joe (Royal Oak) Hdqrs Angola Ind
- *Fitzner Co B J 8803 Michigan Ave LU 4-0180
- *Haggerty-Ludwig 23525 Woodward (Ferndale) LI 7-4771

HILL CO

- B R 19481 James Cozens Hwy VE 8-3460
- *Koehler-Pasmora Co 11833 Hamilton TD 8-3322
- *Lee W S 22128 Grand River Ave KE 3-7700
- *Liddle Edwin F 18925 Grand River VE 7-5310
- McCaffrey Co J A 6432 Cass Ave TR 1-4600
- *Merchant R C 4829 Woodward Ave TE 1-1677
- *Milk Co R 19763 James Cozens Hwy BR 3-2930
- Moore Sales Co 401 Margaret West TU 3-0218
- *Norstrom & Co R L 580 N Woodward (Birmingham) JD 4-6129

ODELL

- Co M P Hdqrs Cleveland Ohio
- Satullo Co 4512 N Woodward Ave (Royal Oak) LI 9-3910

SHAFER

- Co Grant 14241 Fankell Ave BR 3-5390
- Sterling Co S 15310 W McNichols Rd BR 3-2900
- *Thorpe Jack M 640 Hidden Lane TU 4-4360
- *Tri-Dnie Sales 13331 Livernols TE 4-9039
- Vogt Martin 1328 Maxwell Ave (Royal Oak) LI 1-1192

WALTON

- Co H E 76 Kereheval TU 1-5858
- *Zaffini Co L F 7351 Gratiot Ave WA 1-2885

GRAND RAPIDS

- Beltel Co Wayne Hdqrs Birmingham
- JACKSON
- Jordan E H 2024 Glen Dr 2-0694

MINNESOTA**MINNEAPOLIS**

- Aaron & Assoc Irvin I Hdqrs Milwaukee Wise
- Allen Inc T B 3918 Beard Ave S WH 3861
- Barlleson Co Bill 330 Oak Grove FE 3-6709
- Brady & Assoc Paul 3624 Blaisdel Ave S RE 5213
- Eller Equipment Co 1107 S 2 St FE 2-8881
- Foster Mel 1036 Lumber Exchange Bldg FE 5622
- Franklin Co Merrill 538 E Franklin Ave FE 6-2315
- Gibb Co C R 1409 Hennepin Ave FE 8-2550
- Helmann Co 1711 Hawthorne FE 2-5457
- Hill Co Fred B 6110 Excelsior Blvd MU 9-6727
- Kirkeby Marvin H 437 Oliver Ave S FE 6-4945
- Lamb Co N J 4710 Quail Ave OR 7-7000
- Ozman E W 12 E 25 St FE 9-3298
- Pinkney & Hine 1925 Nicollet Ave LI 0523
- Richardson & Co H M 9 E 22 St FE 6-4078
- Rosser Sales Co 413 S 4 St FE 9-2383
- Schultz Co D A 801 SE 8 St FE 9-7701
- Walkowski Al 2760 W River Rd PA 4-3384
- Warner Co A J 5022 29 Ave S PA 4-1895

ST PAUL

- Crossley Assoc Alfred Hdqrs Chicago
- Engelbreton Co W M 906 Ottawa Ave CA 2-2338
- Ragon Inc R G 1406 W Idaho Ave MI 6-6937

MISSOURI**JEFFERSON CITY**

- *Paden Co Ward Box 569 5-1023

KANSAS CITY

- Automatic Gen'l Sales 66500 Troost Ave JA 7375
- *Bettis Co Maury E 406 W 34 St LO 1-0772
- *Clemmson Co R E 1206 E 9 St HA 1-4428
- *Elliott A K PO Box 8493 MI 0654



BLAIR-

STEINBERG CO.

REPRESENTING

CORNELL DUBILIER ELECTRIC CORP.
DAVID BOGEN CO., INC.

12 Men Covering

Metropolitan N. Y., New Jersey, Eastern Pennsylvania, Delaware, Maryland, District of Columbia and Virginia.

UNIVERSITY LOUDSPEAKERS, INC.
PHAOSTRON COMPANY
MIDDLESEX WOOD PRODUCTS

BE-ESCO ASSOCIATES

REPRESENTING

THORDARSON-MEISSNER CORP.
THE RADIART CORP.
JACKSON ELECTRICAL INST. CO.
ELECTRONIC SPECIALTIES CO.
HOFFMAN LABS.

Phones:

Yonkers 3-0150

45 SOUTH BROADWAY
Yonkers, N. Y.

Everett Assoc 1629 E 31 St WA 3-9539
 *Farris Co R W 406 W 34 St LO 1-7495
 Forristal Young Sales Hdqrs St Louis
 *Fry & Co W E 406 W 34 St JE 1-5236
 *Kay Sales Co 2600 Grand BA 1-3800
 Kelly Co W C 9106 Central EM 3-1207
 *Larrabee Co Fred H 4608 Nicholas Pkwy LO 1-2520
 Lee Mark Assoc PO Box 8467 DE 1-5480
 Lowell Theodore B Hdqrs St Louis
 *Maynard Co (Clayton) PA 5-3723
 *McGrade Co E W 213 W 75 St DE 9242
 *Morse Jr L H 1103 E 47 St VA 1-4442
 *Roes & Co H A 2601 Cherry St BA 1-0866
 *Scholz Co P G 210 W 8 St HA 1-7111
 *Schultz Co J O 917 VFW Bldg LO 9824
 *Schryer Sales Co Clyde H 4550 Main St LO 1-4826
 *Somers & Co F C Grand Ave Bank Bldg GR 1-1355
 *Thibau Co A R 402 Mfrs Exchange Bldg VI 7057

ST LOUIS AREA
 *Benche Co Jules 575 Arcade Bldg CE 1-1677
 Borghoff Co Wm 1210 Edgewater Dr UN 7-5313
 *Forristal Young Sales 8147 Delmar Blvd PA 5-7701
 Kay Sales Hdqrs Kansas City
 *Knaags Co H W 7503 Melba Lane (Belleville) EX 7-2398
 *Lowell Theodore B Box 21 Normandy BR EV 5-7803
 McGary Co William T 6635 Delmar Blvd PA 5-6430
 McGrade Co E W 1110 S Brentwood PA 5-6550
 Roes & Co H A Hdqrs Kansas City
 *Sebright & Co Russ D 7283 Natural Bridge Rd
 *Waelterman L F 3938 Lindell Blvd DL 2-6455
 *Wellman Co W N (Fenton) 6-0313
 Wells-White Co 6625 Delmar Blvd PA 7-7622
 Winlow Design & Sales 106 W Madison (Kirkwood) YQ 5-5880

NEW JERSEY

NORTHERN NJ (See New York NY Area)
SOUTHERN NJ (See Philadelphia Pa Area)

NEW MEXICO

ALBUQUERQUE
C G Electronics Corp 305 Dallas NE 6-6121
Gates Co Hdqrs Salt Lake City Utah
Neely Enterprises Hdqrs N Hollywood Calif
Williams Co Allen I Hdqrs Denver Colo

NEW YORK STATE

ALBANY
Carga Electric Corp 100 State St 3-3628
BINGHAMTON
*Holiday-Hathaway Co Hdqrs New York NY
Johnson Agencies H C Hdqrs Rochester

BUFFALO
 *Ball Assoc 54 E Quaker St (Orchard Park) ID 4416
 Cerf & Co Art c/o L J McTaggart (Kenmore) Hdqrs Newark NJ
 Eyre Phillip B 89 Pearce Dr CI 0534
 *Farber Assoc Maury 1210 Hertel Ave RI 2423
 Fillmore & Fillmore 647 Elmwood Ave SU 3355
 Holiday-Hathaway Co Hdqrs New York NY
 *Jackson Co Robert W 833 Elliott Sq Bldg MA 3306
 Johnson Agencies Hdqrs Rochester
 Keller Industrial Hdqrs Rochester
 Mitscher Co R W 487 Elliott Sq Bldg WA 2517
 Wink Willis 235 Hendricks Blvd AN 6426

DE WITT
 Taylor Co Frank W Box 222B SY 72-5198

FAYETTEVILLE
 Andrews Martin P 10 Mott Road 65-8405
 Johnson Agencies H C Hdqrs Rochester

LIVERPOOL
 *Wadsworth Mfg Assoc 509 Balsam St 69-7043

LOUDEVILLE
 Holiday-Hathaway Co Hdqrs New York NY

PHELPS
 *LeRoy & McGuire Inc RD 1 228 KI 8-4891

ROCHESTER
 Brown Assoc Jack Hdqrs New York NY
 Electro Tech Assoc Hdqrs New York NY
 Johnson Agencies Inc H C 111 Mt Hope Ave HA 1090
 Keller Industrial Products 217 East Ave HA 3255
 *Richter Wm 650 Linden Ave H1 0580
 Schmitz A W 82 St Paul St HA 3090
 *Wolfe-Marsey Sales Co 74 Park Ave GR 9088

SCHENECTADY
 Johnson Agencies H C Hdqrs Rochester

SYRACUSE
 *Allen Leonard D 2401 S State St 4-4195
 Ball Assoc Hdqrs Buffalo
 Burlingame Assoc Hdqrs New York NY
 Cerf & Co Art Hdqrs Newark NJ
 Holiday-Hathaway Hdqrs New York NY
 Keller Industrial Prods Hdqrs Rochester
 Osman & Assoc E A 308 Merritt Ave 9-3825
 Paston-Hunter Co 609 Demong Dr 72-0656
 Richter Corp Wm Hdqrs Rochester
 Ryerson Assoc J D 412 E Genesee St 76-8344
 *Stone John L 1445 Teal Ave 73-4280
 *Swank Wally B 2310 Bellevue 4-2141
 *Wolf O C 15 Centennial Dr MO 6228
 Wolfetange Jr F 808 State Tower Bldg 3-8013
 Zimmerman Inc Wilson H 112 Dewitt St 74-4889

NEW YORK CITY METROPOLITAN AREA (INCLUDING NORTHERN NJ)
 *Aaron P D Professional Bldg (Port Wash NY) 7-5670
 Adelman Co Leon L 25 Chittenden Ave TO 7-1145
 *Banfield Assoc Carroll S 104 Mountain Way (Rutherford NJ) WE 9-6784

more man hours per line!

Eleven outside men give active, frequent service on selected outstanding lines. Point of purchase service and jobber promotions stimulate continued sales by jobber salesmen and counter-men through programs tested by twenty-five years' experience.

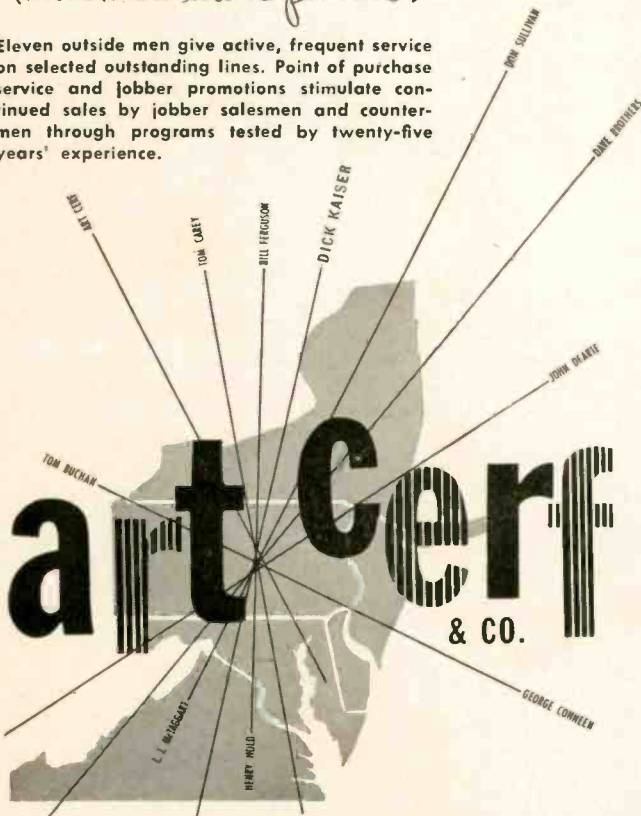

ART CERF & CO. 744 BROAD ST., NEWARK 2, N. J. PHONE MITCHELL 2-6734
Branches: Philadelphia, Pa. Easton, Pa. Buffalo, N.Y. Syracuse, N.Y. Washington, D.C.
Representing Manufacturers of Television, Radio and Phonograph Products

TECHNICIAN Magazine makes BIG NEWS!

In response to TECHNICIAN's first literature card which appeared in the March, 1956 issue,

OVER 12,000 READERS ASKED FOR OVER 550,000 ITEMS, AND PAID OVER \$8,275 IN CASH.

Yes, TECHNICIAN is FIRST IN READER INQUIRIES—FIRST IN ACTIVE BUYING READERSHIP—FIRST IN ABC PAID SERVICEMAN CIRCULATION.

52,036*



circulation

TECHNICIAN
& Circuit Digests

*November, '55 issue ABC Publisher's Statement, December, 1955

Caldwell-Clements Company
480 Lexington Avenue,
New York 17, N. Y.

*Baum S H 70-15 Fleet St (Forest Hills NY) BO 3-8101
 Baume Electronic 44 Cranberry Lane (Bethpage NY) WE 1-7769
 *Be-Eso Associates 395 Broadway Wd 4-7321
 Berger G E 109-01 72 Rd (Forest Hills NY)
 Blakel Assoc Samuel 205 E 42 St MU 4-1655
 *Bittan Co D R 53 Park Pl BA 7-2789
 Bittan-Shafer Sales 120 E 32 St MU 4-2229
 *Blair-Stenberg Co 45 S Broadway (Yonkers NY) 3-0150
 *Bloom Assoc 7 Huntswood Pl (Mt Vernon NY) MO 7-5063
 *Boeck G A 81 Lake Dr (Mountain Lakes NJ) DE 4-2921
 *Border Barrett 10 Highwood (Tenafly NJ) EN 3-2354
 *Brennan Co F X 180 Glenridge (Montclair NJ) 3-2461
 *Bressler Jules J 4808 Bergenline Ave (Union City NJ) UN 4-9577
 *Breuer Co R E 250 W 57 St CO 5-0440
 *Brown Ivy 1500 Carroll St (Brooklyn NY) HY 3-1379
 *Brown Assoc Jack 207 Rosedale (Yonkers NY) SP 9-7330
 Burlingame Assoc 103 Lafayette St DI 9-1240
 *Camber Marty 1700 York Ave EN 9-4222
 *Candner Sales 80 Shore Rd (Port Wash NY) PO 7-7712
 *Cerf & Co Art 744 Broad St (Newark NJ) MI 2-6734
 Christie & Co R S 175 S Ave GR 7-4226
 *Cooper DIBlasi 90 Main St (Port Wash NY) PO 7-0470
 *Dietrich E S 110 E End Ave LE 5-6590
 Director Assoc Murray 115-62 237 St (Elmont NY) CU 5-6823
 *Drexler Chester 509 Lombardy Blvd (Brightwater NJ) 7-3949R
 *Egert & Fields Co 97 Reade St WO 4-0996
 *Electro Tech Assoc 107-61 Hollis Ave (Hollis NY) AX 7-3525
 *ERA Inc 340 Great Neck Rd (Great Neck NY) HU 2-9320
 *Erde S S 271 Hempstead (Malverne NY) LY 9-6900
 *Finlay Robert Lincoln Bldg (Ridgewood NJ) OL 2-0088
 *Forrest Bernard J 102 Warren St CO 7-1712
 *Forsyth John M 27 Park Pl BA 7-4977
 Frazer & Hansen 120 Broadway WO 4-3454
 *Freed & Co Leo 420 Lexington Ave LE 2-4771
 *Friedman Co A 519 S 5 Ave (Mt Vernon NY) 4-4866
 *Galasso D P 921 Bergen Ave (Jersey City NJ) JO 4-7277
 *Gary-Martin 232 Bread Ave (Palsades Park NJ) WI 7-0300
 Gawler-Knoop Co 178 Eagle Rock Ave (Roseland NJ) CA 6-4545
 Goldman & Co Louis R 251 W 42 St BR 9-8872
 Gray Assoc Harold 21-10 33 Rd (Long Island City NY) YE 2-3825
 *Greenberg Jerry 29 Woodmere Blvd (Woodmere NY) FR 4-3748
 *Gross Assoc Adolph 23 Park Pl WO 4-8585
 *Harris Arthur M 210-02 43 Ave (Bayside NY) 9-7447
 *Hess Assoc Art 62-07 68 Ave (Glendale NY) HY 7-7498
 *Hicks W M 4 Spruce Dr (Roslyn NY) PI 7-0110
 Holliday-Hathaway Co 270 Park Ave MU 8-5858
 *Hughes Co Kenneth E 4808 Bergenline (Union City NJ) UN 7-3204
 *Hy-Art Co 53 N Park Ave (Rockville Centre NY) RD 6-6500
 Instrument Center 55 Rende St WO 4-1290
 *Jacobs & Assoc Jack 1800 E 12 St (Brooklyn NY) DE 9-4374
 *Joseph Ben 521 S Ave MU 2-0815
 *Kaelber & Mack 1 Park Ave (Manhasset NY) MA 7-1459
 *Kahgan Jack J 1261 Broadway MU 4-7772
 Kahant Assoc 11 Park Pl CO 7-5326
 *Koppke Assoc J J 9 W Prospect Ave (Mt Vernon NY) 4-5577
 Kubrick Dave 200 W 34 St BR 9-6517
 *Land-C-Alr Sales 42 Oak Ave (Tuckahoe NY) WO 1-4700
 *Landis Sales Cliff 81-11 Roosevelt Ave (Jackson Hts NY) IL 8-7900
 Lerman Leonard S 1093 Salem Rd (Union NJ) MU 8-9406
 L & M Assoc 253 Boulevard (Hasbrouck Helghts NJ) 8-2665
 *Levison Melvin S 5 Waverly Pl DR 4-4464
 *Lichter Wm 26 Teakwood Lane (Roslyn NY) 3-2636
 *Luca & Co R P 7 Beechwood Rd (Summit NJ) CO 7-3550
 Maslin Co O F 1 Wolff's Lane (Pelham) PE 8-4510
 Merlican J C 1 Christopher St AL 5-6387
 *Miller Ben 401 Broadway WA 5-3964
 *Miller Co Harry 27 Mechanic St (Red Bank NJ) 6-9300
 *Mingins Sales 107-37 71 Ave (Forest Hills NY) BO 3-1643
 Minthorne L L Hqrs Portland Ore
 *Morse Sales Irv 150 Broadway Co 7-2913
 Meyer H A PO Box 14 (Haddonfield NJ) 9-6347
 *Newhope Corp 6 E 39 St LE 2-7372
 *Nichols Paul 42 Oak Ave (Tuckahoe NY) TU 3-5500
 Nief Assoc Paul W 7 Greenridge Ave WH 8-1454
 *Pickett James M 205 E 66 St TR 9-9520
 RMC Assoc 170 E 80 St TR 9-2023
 Rockbar Corp 215 E 37 St VA 6-3463
 *Ross Milton 550 S Ave IN 6-0653
 *RSA Co 15 Park Ave (Rutherford NJ) GE 8-4200
 *Ryan Assoc J L 263 Edgemont Pl (Teaneck NJ) TE 6-1075

*Sattler Perry 157 W 57 St CI 7-3855
 Sanford L C 202 Woodland (Rutherford NJ) WE 9-0979
 Scheffler Co Charles 1124 Douglas Pl (Seaford NY) SU 1-4656
 *Schmitt Co F Edwin 136 Liberty St WO 2-6550
 *Schwartz Adolph 15 Exchange Pl (Jersey City NJ) DE 3-2424
 Schwartz Mei 39-16 Tierney Pl (Fair Lawn NJ) FA 4-3435
 *Shaw Co S A 444 Kneeland Ave (Yonkers NY) YO 3-5700
 *Shulan & Co Wally 880 Bergen Ave (Jersey City NJ) SW 5-2220
 Silver Assoc Lou 1665 Warwick Rd (Hewlett NJ) FR 4-2093
 *Simberkoff Sales Co 68 Hudson St (Hoboken NJ) HO 2-5211
 *Smith Howard F 259 W 14 St CH 2-2398
 *Sonkin David 10 Fiske Pl (Mt Vernon NY) MO 8-9809
 *Spellman Co Fred 200 Plandome Rd (Manhasset NY) MA 7-3399
 *Sprung Joseph 254 W 31 St LO 5-1820
 *Stang Sales 1 Crestwood Lane (New Rochelle NY) NE 6-6622
 *Sussman & Co Jules 130 Lafayette St WO 2-7766
 *Taylor Co BB 241 Sunrise Highway (Rockville Ctr NY) RO 6-1014
 Technical Representatives 69-10 140 St (Flushing NY) LI 4-5058
 *Tobias & Co D F 30 Church St CO 7-4350
 Tursney & Beale 214-27 Northern Blvd (Bayside NY) 4-4000
 Varrelman-Gorman Co Box 503 (Hicksville NY) WE 1-7452
 Verter Sales Co 1195 Sherman Ave CY 3-0211
 Weber Assoc Jack Lake & Main Sts (Tuckahoe NY) WO 1-4044
 *Welland G H 77-43 166 St (Flushing NY) OL 8-4061
 *Welnberg Co H L 1 Lois Pl (Merrick NY) VA 5-3677
 *Welsh & Assoc W W 1780 Broadway CI 6-5777
 *Willgold Electronic Sales 350 S Ave LO 4-2525
 *Wineblatt Edward 10 Fiske Pl (Mt Vernon NY) 4-3216
 *Wolfe Michael 136-52 71 Rd (Flushing NY) BO 3-1400
 *Woolf Assoc Irving W 135 Liberty St RE 2-9673
 Zlowe Leonard 764 6 Ave CH 3-3142

Odell Co M P 2536 Euclid Ave PR 1-6171
 *Olson Co John O 16201 Shaker Blvd WY 1-2624
 Rosenwasser Sales F A 1581 Coventry Rd FA 1-0463
 Roth Sales Co Mike 13947 Cedar Rd YE 2-4262
 *Rauer Frank W 4144 Marvin Ave ME 1-8350
 Satullo Co Hqrs Royal Oak Mich
 Schenck Assoc Earl W Hqrs London
 *Scott & Steffen 1836 Euclid Ave MA 1-2626
 Silverman Lou 2300 Payne Ave CH 1-7559
 Sterling Co S Hqrs Detroit
 Weller-Rabe Co Hqrs Worthington
COLUMBUS
 *Derr Co Norbert F 937 S Ashburton Rd BE 1-2603
 Henger-Fairfield Co Hqrs Cleveland
 *Lehmer Co J W 367 Brynhild Rd AM 8-5260
 *McFadden William E 150 E Broad St CA 1-3363
 *Pugh Co C L 2144 Riverside Dr HU 8-4855
 *Walter-Rabe Co Box 212 (Worthington) FR 2-7819
DAYTON
 *Bear Corp Neal Hqrs W Richfield
 Beedle Equipment Hqrs Cincinnati
 Boehme Associates B-4 Talbot Bldg FU 8188
 Bruno L D Far Hills Branch PO Box 61 WA 8703
 Burtner R K Far Hills Branch PO Box 529 OX 3980
 Crossley & Assoc Alfred Hqrs Chicago Ill
 Eggs & Feotini 1434 Vancouver Dr TA 9345
 Grimm A N 1731 Ruskin Rd OR 1496
 Henger-Fairfield Co Hqrs Cleveland
 Jay Eng'g Co 1721 E 3 St KE 2151
 Klein Wm 1472 Earlham Dr RA 0943
 Magee Edward E 5845 Paddington Rd OX 2333
 Nace Co Allen Hqrs Brecksville
 Odell Co M P Hqrs Cleveland
 Ohmer George H 235 Southern Rd WA 3761
 Satullo Co Hqrs Royal Oak Mich
LIMA
 Hecht Co Fred J 1832 Wendell Ave 9-4378
LONDON
 Schenck Assoc Earl W PO Box 223 LO 1555
MAUMEE
 Henger Fairfield Co 1130 Key St 3-3211
WEST RICHFIELD
 *Bear Corp Neal 3435 Streetsboro Rd OL 9-3331
WORTHINGTON
 *Weller-Rabe Co PO Box 212 TU 5-7819

OREGON

PORTLAND
 Bowers Robert S Hqrs Seattle Wash
 *Burcham Co Don H 510 NW 19 Ave CA 7-3830
 Carlson Co Fred W Hqrs Seattle Wash
 Eckersley James W3150 SW Hamilton St CA 8-0308
 Hawthorne Electronics 700 SE Hawthorne Blvd FI 9375
 Lee Co D M Hqrs Seattle Wash
 *Legg Co Richard 3834 SE Milwaukie Ave BE 6-8918
 *Minthorne Co L L 7521 NE Gilsan St KE 3-0010
 Stroum Co S N Hqrs Seattle Wash
 *Weber Co Dale 234 Sherlock Bldg AT 5403

PENNSYLVANIA

PHILADELPHIA AREA
 *Andress P M 3823 Oak Rd VI 4-9100
 *Benge J R 25 S Easton Rd (GlenSide) TU 7-1325
 *Biggs & Co J Alan Box 450 (Doylstown) 9457
 Blumenstein Assoc 14 Trent Rd MI 9-9523
 *Boenecke Assoc 238 Penn St (Camden NJ) WO 4-8650
 Braddock Edward (Haddonfield NJ) HA 9-0087
 *Brookfield R F 55 Cricket Ave (Ardmore) MI 2-6911
 Burlingame Assoc (Upper Darby) Hqrs New York City
 Cerf & Co Art Hqrs Newark NJ
 *Cooper Richard 3507 Wellington MA 4-5486
 *Cordray W Henry 18 W Chelton Ave VI 8-0447
 *Danco Corp (Fairview Village) BR 5-2600
 Densham Harry W 250 S 7 St KI 5-1947
 Dienes Co H L 1505 Papermill Rd (Erdenheim) CH 7-3454
 Doull Co Harry A 2342 Cheltenham Ave WA 4-7625
 Duncan & Assoc William I 5452 Charles St CU 9-7525
 Egan M J 237 Kenilworth Ave LI 8-8491
 Edmunds E J 102 N Lexington (Havertown)
 *Estershorn Harry 395 E Cliveden St VI 8-2836
 *Fairbanks H J 1615 Darby Rd (Havertown) GR 2-2467
 *Foley Andrew A 640 Federal St (Camden NJ) WO 6-2550
 *Friedman Martin 1006 Western Sav Fund Bldg PE 5-4778
 *Fryburg Charles H 111 S 22 St RL 6-5699
 Gatty Sidney 11 N Clermont Ave (Margate NJ) 2-1361
 Gawler-Knoop (Wyncote) Hqrs Roseland NJ
 Girard Co W E 715 Fairhead Rd (GlenSide) TU 7-4411
 Hile Co Charles R Hillview Rd Box 144 (Paoli) EL 6-2266
 Hillard Assoc 1125 Old York Rd (Abington) TU 4-6100
 *Humes Jr David 7416 Shisler Ave FI 2-5348
 *Jeffries S A 105 Forrest Ave (Narberth) MO 4-8500
 *Keefe Electronic Sales 228 E Kings Hwy (Haddonfield NJ) 9-4650
 Krieger Sales 300 S Broadway (Camden NJ) WO 3-5951
 *Leban & Graham 1412 Manoa Rd MI 9-9822
 Lewis Herman 1622 68 Ave LI 8-1281
 *Lowery Inc L D 50 E Wynnewood Rd (Wynnewood) MI 2-9100
 *Macdonald Inc S K 1531 Spruce St KI 5-1205
 *Maguire & Co J A 116 N 7 St (Camden NJ) WO 6-3118
 Massey Assoc 529 Brookhurst Ave (Narberth) MO 4-4200



NORTH CAROLINA

CHARLOTTE
 Cartwright & Bean Hqrs Memphis
 Furman & Assoc C M Jr PO Box 2624 ED 4-7855
 Highsmith & Co James L Box 1011 FR 5-6436
 *Howard Co Fay M 2908 Avondale Ave FR 5-6646
 Ranson Wallace & Co 116 1/2 E 4 St ED 4-4244
 Wallace Assoc Stanley K Hqrs Lutz Pla
GREENSBORO
 *Atcheson & Adams 601 N Elm St Bldg 2-6838
WILMINGTON
 *Butters J T 4923 Oleander Dr 5749
WINSTON-SALEM
 Holliday-Hathaway Co Hqrs New York NY

OHIO

AKRON
 Clancy & Co Joe Hqrs Angola Ind
CANTON
 Conrad & Assoc E T 516 38 NW 2-5450
 Henger-Fairfield Co Hqrs Cleveland
CINCINNATI
 *Baehr Albert M 3916 St Johns Terr TW 3827
 Beedle Equip Co Roselawn Center Bldg PR 1-2241
 Clark Sales Co Hqrs Cleveland
 Henger Fairfield Co Hqrs Cleveland
 Laing Co W C 3253 Lambert Pl EA 1-1435
 Wahl Co A C 416 W Benson St VA 1-3270
 Whitesell & Assoc R O Hqrs Indianapolis Ind
CLEVELAND AREA
 Ambos Jones Co 3951 Lee Rd SK 2-3030
 Baehr Albert M 14700 Detroit Ave
 *Baier & Co Arthur H 12429 Cedar Rd FA 1-5644
 Brandes C O 4900 Euclid Ave HE 1-0414
 *Braucher & Assoc W J 15631 Lakewood Hts LA 1-7268
 Clark Sales Box 708 Warrensville Br PR 1-2241
 Dannemiller Assoc J R 4606 MacKale Rd
 *Daugherty Co F A 1120 Croyden Rd HI 2-3311
 *Dolfuss Jr Chas H 2108 Payne Ave PR 1-1270
 *Edwards-Lohse & Co 2123 E 9 St TO 1-5753
 Elliot Co Howard C 2637 E 130 St CE 1-0225
 *Goory J 19555 Henry Rd CL 1-1500
 Hanger-Fairfield Co 1812 Columbus Rd CH 1-1018
 Jay Eng'g Co Hqrs Dayton
 Jubell Assoc PO Box 762 WA 1-1490
 *Landfeare Co J M 12429 Cedar Rd FA 1-4533
 *Levin & Assoc Sid 4217 Okalona Rd EV 2-2734
 *Midwest Sales Co 3219 W 117 St VI 1-2700
 *Morrow Co Les A 3123 W 117 St CL 1-5700
 *Nace A S 7601 Parkview Rd (Breckville) JA 6-4323

*Moyer H A PO Box 14 (Haddonfield NJ) 9-6347
 *Muckenfuss T F 8 Tanner St (Haddonfield NJ) 9-8533
 *Muggelworth J C 324 Hadden Ave (Collingswood NJ) 5-7200
 *Maudain L Parker Suburban Sta Bldg RI 6-3185
 *Newson Jr C H 150 Terminal Ave CH 8-0282
 *Nolan J J 314 W Sparks St WA 4-1595
 *Oral Co John F Box 346 (Bryn Mawr) LA 5-6212
 *Paragon Sales Co 111 S 22 St RI 6-5699
 *Pearl Eng'g & Tool Co 8056 Rodney St LI 8-4103
 *Perna Co Frank J 2015 Chestnut St LO 4-3954
 *Quinlan D G 4700 Frankford Ave JE 3-0650
 *Randall Co Ken 121 N Broad St LO 4-2151
 *Rellinger Co A R 3617 N 8 St SA 2-0500
 *Robinson I E 7404 W Chester Pike (Upper Darby) FL 2-7017
 *Shelps George A 1625 Spruce St KI 6-1066
 *Slubin & Co Lewis 2305 Fairmount Ave ST 7-2072
 *Stinson J T 219 Sagamore Rd (Havertown) HI 7-0922
 *Stobbs A J 56-14 Revere Rd (Drexel Hill) CL 9-3881
 *Stratton Co C H 7852 Montgomery Ave MA 5-2231
 *Taylor Co Morris F Hqrs Silver Springs Md
 *Tech Representation 25 S Easton (Glenide) TU 7-1325

*Trinkle Wilmer S PO Box 40A (Hatfield) SO 3-9425
 *Weber Linz Assoc 238 Sholmire St CH 31611
 *White H J 1839 W Albanus St MI 4-1880
 *Williams V W 5 Circle Dr (Margate NJ) AT 2-7859
PITTSBURGH
 *Clark Co Russell F 1404 Clark Bldg AT 1-8089
 *Levine Albert 11 Jonquil Pl LO 1-7027
 *Lips E C 1565 McFarland Rd FI 1-5100
 *Lowry-Dietrick Co 1404 Swantok St WA 1-2959
 *MacDonald Inc Samuel K Hqrs Philadelphia
 *Odell Co M P Hqrs Cleveland
 *Olson Co John O 104 E Lathan Dr CA 2729R
 *Podolyn James H 4716 Coleridge St HI 1-0800
 *Squires Co M B 1 Cedar Blvd FI 1-6673
 *Stover & Co S H 5495 Penn Ave EM 1-7533
 *Tanner & Covert 300 Mt Lebanon Blvd LO 1-5067
 *Taylor Co Morris F Hqrs Silver Springs Md
READING
 *Bell Thomas H 3623 Jacksonwald Ave Esterly 5-6837
 *Loose & Co W L 646 Gordon St RE 2-7094

TENNESSEE
CHATTANOOGA
 *Johnson Jesse P 413 Dome Bldg 5-3463
KNOXVILLE
 *Hough Co A R 3601 Chapman Hwy 7-6660

MEMPHIS
 *Cartwright & Bean 1336 Madison Ave BR 5-1914
 *Engelmann Co A S 3205 Crump Ave 48-6263
 *Moody Co Joe 1215 Central Ave BR 5-1067

TEXAS

DALLAS
 *Anderson Co Geo E 1901 Griffin St RI 5931
 *Antle G M 2154 W Amherst DI 7982
 *Aymond Co Edward F 4312 Maple Ave LO 5233
 *Berthold Sales Co 4411 Maple Ave LO 8329
 *Branum Co PO Box 10204 RI 4743
 *Camplon Sales Co 9002 Chancellor Row FL 7-4095
 *Communication Service 3209 Canton St PR 1852
 *Corry Co Hal E 6315 Hillcrest Ave JU 9172
 *Crockett-Land & Co 2204 Griffin St RA 5764
 *Delzell-Maynard Sales 3409 Oaklawn Ave JU 2411
 *Guenther J B 4533 N Central Expressway JU 6286
 *Heidenreich Co 6115 Denton Dr DI 3389
 *McKinney Sales J F 1330 N Industrial Blvd ST 1997
 *Schoonmaker Co J Y 2011 Cedar Springs ST 3335
 *Smith Co J Earl 505 N Ervay St RA 2966
 *Smith Wm Jr 7614 Kaywood Dr D1 4519
 *Texport Co 726 Meadows Bldg FO 8-4422
 *Wilks Co Ernest I 1212 Camp St PR 2637
 *Yount Jack 1431 Pleasant Dr EX 1-0988

FT WORTH
 *Harris Co 716 Dan Waggoner Bldg 0738
HOUSTON
 *Anderson Co Geo E Hqrs Dallas
 *Delzell-Maynard Sales Hqrs Dallas
 *Kitepera Co M F Box 3113 JA 8459
 *McKinney Sales Jack E Hqrs Dallas
 *Packard J & D 770 M & M Bldg CA 7349
 *Smith Co J Earl Hqrs Dallas
 *Whitson Co G G 1821 W Alabama JU 1634
WACO
 *Brockenbrough & Sanders 500 Professional Bldg 4-0441

UTAH

SALT LAKE CITY
 *Cluph & Assoc Stan Hqrs Denver
 *Gates Co 200 S Main St 9-1101

VIRGINIA

ALEXANDRIA
 *American Eng'g Equip PO Box 186 TE 6-1718
 *Brown & Assoc W A 3610 Mt Vernon Ave OV 3-6100
 *Martin Ed 102 E Beal St (Highland Springs) FA 2503
RICHMOND
 *Ranson Wallace & Co Hqrs Charlotte
 *Simpson & Son P M 717 Byrd Park Ct 4-0287

WASHINGTON

SEATTLE
 *Backer Co Jas J 221 W Galer AL 6470
 *Burcham Co Don H Hqrs Portland
 *Carlson Co Fred W 120 Dexter Ave EL 6630
 *Dooley J R 3606 Magnolia Blvd AL 3208
 *Drake Rush 1806 Bush Pl EA 1737
 *Haight Co Fred H 3212 Eastlake EA 1818
 *Jensen Co Vernor O 2616 2 Ave MU 2929
 *Johnston Co Ray 11009 Evanston Ave EM 0956
 *Lee Co Dave M 2517 2 Ave MA 5512
 *Legg Co Richard Hqrs Portland
 *Levinson Co Harry 1117 2 Ave MA 5317
 *Marsh Agencies 2601 1 Ave MA 8761
 *Merritt Co Ron 120 W Thomas GA 6644
 *Norris Co George D 3010 1 Ave EL 1344
 *Northwestern Agencies 4130 1 Ave S EL 8882
 *Parsons & Co C B 3028 1 Ave MU 3933
 *Porter Co Burt C 4310 Roosevelt Way ME 6828
 *Stroum Co S N 1612 Broadway FR 7515
 *Wedel Co Frank 3215 Western Ave GA 0222
 *Widdekind Co M K 216 1 Ave N EL 6981
SPOKANE
 *Quinn J P PO Box 7051 EM 6621

WISCONSIN

MILWAUKEE
 *Aaron & Assoc I I 829 N Marshall St BR 6-8515
 *Dickinson & Assoc E A 744 N 4 St BR 2-0517
 *Laub Co Nick J Hqrs Minneapolis
 *Loeb Sales E R 5052 N Shoreland Ave WO 4-2155
RACINE
 *Darnold D H 914 Kentucky St ME 2-9644

CANADA

MONTREAL
 *Pound H 5093 Randall Ave WA 3402
TORONTO
 *Armstrong Allen Jr 700 Weston Rd RO 2-7535
 *Painont C G 6 Ateina Ave OL 7984
VANCOUVER
 *McLennan Ltd D Eldon 2191 W 1 Ave BA 2898

HAWAII

HONOLULU
 *Branna & Browne Inc PO Box 2098 26-5275
 *Plety Gene 2030 Home Rule St 8-3105

OVER 25 YEARS OF SERVICE TO MANUFACTURERS INDUSTRIALS • GOVERNMENT • DISTRIBUTORS

IN THIS TERRITORY:

• • • • •
 PENNSYLVANIA • NEW JERSEY
 DELAWARE • MARYLAND
 VIRGINIA • WEST VIRGINIA
 DISTRICT OF COLUMBIA



SAMUEL K. MACDONALD, INC.

MANUFACTURERS REPRESENTATIVES

1531 Spruce St., Phila. 2, Pa.

Other offices:

Pittsburgh, Baltimore
 Washington, D.C.



(MAC)
 SAMUEL K. MACDONALD



(Noble)
 Noble C. Shilt



(JACK)
 John J. Mahoney



(JACK)

James J. D'Angelo



(JOHN)

John E. Larkin, Jr.



(JIM)
 James P. Faries



"Beanie"

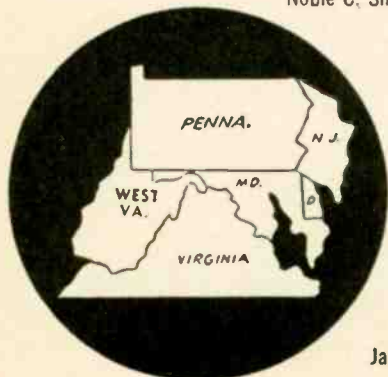

1956 TECHNICIAN BUYERS DIRECTORY

Alphabetical Listing of Manufacturers

WITH THE NEW, EXCLUSIVE LOCALIZER INDEX

A complete listing of the names and addresses of manufacturers of service and replacement products, component parts, equipment, instruments and materials as well as technical publishers. In the LOCALIZER INDEX listings a number of manufacturers have listed such data as home office telephone numbers, executive personnel, brand names, products, branch and regional offices as well as local reps. The LOCALIZER IN-

DEX provides the shortest means of contacting any manufacturer. Symbols show type of sales:

BO branch office
D distributor
DS distributor sales
GV government sales
IDS indus & distr sales
IS industrial sales
R representative
SE sales engineer

Indented listings are advertisements.

ABT Mfg Co 715 N Kedzie Ave Chicago 12 III
Accurate Electronics Corp 169 S Abbe Rd Elyria Ohio
Accurate Insulated Wire 25 Fox St New Haven 1 Conn
Acme Battery Corp 59 Pearl St Brooklyn NY
Acme Electric Corp 8812 Water St Cuba NY
Acoustic Research 23 Mt Auburn St Cambridge 38 Mass
Acromark Co 9 Morrell St Elizabeth 4 NJ
Aero Products Co 369 Shurs Lane Philadelphia 28 Pa
Aero Tool & Die 4554 N Broadway Ave Chicago 40 III
Aero Transformer 26-02 4 St Long Island City 2 NY
Admiral Corp 3800 W Cortland St Chicago 47 III
Advance Electronics 8510 North End Ave Oak Park Mich
Advance Relay Div Elgin Natl Watch Burbank Calif
Aero Instrument 11423 Vanowen N Hollywood Calif
Aerolite Electronics Corp 507 26 St Union City NJ
Aeromotive Equipment 1632 Central St Kansas City 8 Mo
Aermotor Co 2300 W Roosevelt Rd Chicago III
Aero-Tone Mfg Co 4836 Joy Rd Detroit 4 Mich
Aerovox Corp Distr Div 740 Belleville New Bedford Mass
Afton Industries 8300 Flex-O-Lite Dr St Louis 23 Mo
Aids for Goodhousekeeping 21 Plandome Manhasset NY
Airdesign Inc 241 Fairfield Ave Upper Darby Pa
Air-E-D Electronics 374 N 27 St Milwaukee 8 Wis
Airlyte Electronics Co 21 Cottage St Bayonne NJ
Ajax Condenser Co 932 W Wrightwood Ave Chicago 14 III
A-K Mfg Co 115 S Northwest Hwy Barrington III
Ako-Mills Inc P O Box 989 Akron 9 Ohio
Alamo Electronics 1415 N Brazos San Antonio Tex
Alco Electronics Mfg 3 Wolcott Ave Lawrence 1 Mass
Alden Electronic & Impulse Recording Westboro Mass
Alden Products Co 117 N Main St Brockton 64 Mass
All Channel Antenna Corp 47-39 49 St Woodside 77 NY
Allegro Electronics 226 New York Ave Huntington LI NY
Allen-Bradley Co 1326 S 2 St Milwaukee 8 Wis
Alliance Mfg Co Lake Park Blvd Alliance Ohio
Allied Control Co 2 East End Ave New York 21 NY
Allied Engraving & Stamping Co 17 Elm St Buffalo 3 NY
Allied Mfg & Sales Co 201 N Wells St Chicago 6 III
Allied Radio Corp 100 N Western Ave Chicago 80 III
Allweather Antennas Mfg Corp Hammonnton 1 N J
Logan 1-1990 [California] 1073 N Vine St Hollywood 38) HO 2-2453

President—James E Myers Jr
VP—Eastern Manager—James E Myers Sr
VP—Western Manager—Sonny Greenberg
Factory Foreman—Bill Harvey
Products: Salt-free Antennas & Accessories
Brand Names: TUNED INSULATORS TENNA-COAT
SHUR-LOK ANTENNA MOUNTS
Western Sales Rep: Ted Heil 979 N Hancock L A 46 Calif
Eastern Sales Rep: Lee Doneker 281 Glenwood Ave Burlington NJ

Alonge Products Inc 163 W 23 St New York 11 NY
Alpert Co Ned 2878 N Holton St Milwaukee 12 Wis
Alpha Metals Inc 56 Water St Jersey City 4 NJ
Alpha Wire Corp 200 Varick St New York 14 NY
Alprodeco Inc Kempton Ind
Altec Lansing 9356 Santa Monica Beverly Hills Calif
Aluminum Mfg Co 1629 Portland Ave Louisville 3 Ky
Amalfite Inc 1884 Pitkin Ave Brooklyn 12 NY
American Condenser 4410 Ravenswood Chicago 40 III
American Electric Cable 181 Appleton Holyoke Mass
American Electrical Heater 6110 Cass Ave Detroit 2 Mich
American Electronics 1203 Bryant Ave New York NY
American Elite Inc 7 Park Ave New York 16 NY
American Mercantile Co 33 W 42 St New York 36 NY
American Microphone Div Elgin Natl Watch 370 S Fair-oaks Pasadena Calif
American Molded Products 2727 W Chicago Chicago III
American Pamcor Inc 181 Hillcrest Ave Havertown Pa
American Phenolic Corp 1830 S 54 Ave Chicago 50 III
American Radio Hdw 152 Macquesten Pkwy Mt Vernon NY
American Radlonic Co 51 Austin St Danbury Conn
American Scientific 336 S Main St Ft Atkinson Wis
American Screw Co W Main St Willimantic Conn
American Solder & Flux 39 & Willard Philadelphia Pa
American Standard TV Tube 94-50 158 St Jamaica NY

American Tower Co Shelby Ohio
American TV & Radio 300 E 4 St St Paul 1 Minn
American Vacuum 2242 S Colby Los Angeles Calif
American Volume Control 554 W 168 St New York NY
Ames Mfg Corp 4320 Park Ave New York 57 NY
AMI Inc 1500 Union Ave S E Grand Rapids 2 Mich
Amperex Electronic Corp 230 Duffy Ave Hicksville LI NY
Ampro Corp 934 Charter St Redwood City Calif
Amplifier Corp of America 398 Bdw New York NY
Amplitel Inc 342 W 40 St New York 18 NY
Ampro Corp 2835 N Western Ave Chicago 18 III
Amy Aceves & King 11 W 42 St New York 36 NY
Anchor Electronics Inc 717 51 St Union City NJ
Anchor Metal Co 244 Boerum St Brooklyn 6 NY
Anchor Products Co 2712 Montrose Ave Chicago 18 III
Anchor Radio Corp 2215 S St Louis Ave Chicago 23 III
Anchor Wire Corp 183-16 Jamaica Ave Jamaica 3 NY
Andrea Radio 27-01 Bridge Pl N Long Island City NY
Anko Mfg Co 5042 W State St Milwaukee 8 Wis
Ansiey Mfg Co Arthur Doylestown Pa
Ansonia Wire & Cable Co 111 Martin St Ashton RI
Antenna Products 3628 N Lincoln Ave Chicago 13 III
Antenna Specialists 12435 Euclid Ave Cleveland 6 Ohio
Antennex Co 4060 Ocean Park Venice Calif
Anton Electronic 1226 Flushing Ave Brooklyn NY
A P Electro Lab Box 862 Chestnut Station Union NJ
Applegate & Co C J 1816 Grove St Boulder Colo
Arbor Mfg Co Depew NY
Arbuck Inc 116 Troutman St Brooklyn 6 NY
Arco Electronics 103 Lafayette St New York 13 NY
Arco Transformer 1602 S Hanna St Ft Wayne Ind
A R F Products 7627 Lake St River Forest III
Argos Products Co Genoa III
Armae Co PO Box 1083 Macon Ga
Arrow Fastener Co 1 Junius St Brooklyn 12 NY
Arrow-Hart & Hegeman 103 Hawthorn Hartford Conn
Arrow Mfg Div Box 423 Amarillo Texas
Art Specialty Co 3245 W Lake St Chicago 24 III
Arvin Industries Inc Columbus Ind
Associated Specialties 1751 Main St Orefield Pa
Astatic Corp PO Box 120 Conneaut Ohio
Astron Corp 255 Grant Ave E Newark NJ
Atlantic Industrial Co 101-38 91 St Ozone Park 17 NY
Atlantic Wire & Cable 119-14 14 Rd College Point NY
Atlas E-E Corp Bedford Airport Bedford Mass
Atlas Overhead Door Co 375 Mill St Quakertown Pa
Atlas Resistor Main & Cotton Sts Philadelphia 27 Pa
Atlas Sound Corp 1449 39 St Brooklyn 18 NY
Audak Co 500 5th Ave New York NY
Audel & Co Theo 49 W 23 St New York 10 NY
Audio Devel Co 2833-13 Ave S Minneapolis 7 Minn
Audio Devices Inc 444 Madison Ave New York NY
Audio Equipment 15749 Wyoming Ave Detroit Mich
Audiogersh Corp 23 Park Pl New York 7 NY
Audio-Master Corp 17 E 45 St New York 17 NY
Audio Products 2265 Westwood Los Angeles 64 Calif
Authorized Mfrs Service 919 Wyckoff Brooklyn NY
Autoerac Electronics Co 5024 Elm St Skokie 8 III
Automatic Metal Products 315 Berry St Brooklyn 11 NY
Automatic Processing Corp 121 S Cowen St Garrett Ind
Automatic Radio Mfg Co 122 Brookline Boston Mass

Bache Semon & Co 636 Greenwich St New York 14 NY
Baker Mfg Co 133 Enterprise Evansville Wis
Band-It Co 2550 Walnut St Denver 5 Colo
Barb City Industries 1150 S 4 St DeKalb III
Barber-Colman Co PO Drawer 99 Rockford III
Barco Chemical Products 701 S LaSalle St Chicago 5 III
BarJay Co 145 W 40 St New York 18 NY
Barker & Williamson 235 Fairfield Ave Upper Darby Pa
Barratt Electronics 22319 Kathryn Ave Torrance Calif
Barry Electronics 512 Broadway New York 12 NY
Baumker Mfg Co 3826 Summit St Toledo 11 Ohio
Beacon Corp 2846 Milwaukee Ave Chicago 18 III
Beam Industries Inc 624 S Michigan Ave Chicago 5 III
Beam Instruments Corp 350 5 Ave New York NY
Becker Electronics 1091 Rockaway Valley Stream NY

Becks Inc 298 E 5 St St Paul 1 Minn
Beede Electrical Instrument Co West St Penacook NH
Behr-Manning Corp 2054 Selfert St Troy NY
Belden Mfg Co 4647 W Van Buren St Chicago 44 III
Bel Fuse Inc 311 Mountain Rd Union City NJ
Bell & Howell 7100 McCormick Rd Chicago 45 III
Bell Sound Systems 555 Marlon Rd Columbus 7 Ohio
Belnor & Co 481 Sterling Pl Brooklyn NY
Bendix TV & Broadcast Receiver Div Bendix Aviation Corp E Joppe Rd Towson 4 Md
Bennett Labs Inc 2700 Bay Rd Redwood City Calif
Bennett & Co Paul 230 E Ohio St Chicago 11 III
Benrus Watch Co 50 W 44 St New York NY
Bentley Harris Lime & Hector Sts Conshohocken Pa
Bergen Labs 11 Godwin Ave Fair Lawn NJ
Berger Communications 109-01 72 Rd Forest Hills NY
Bergsma Bros 1000 36th St SE Grand Rapids 8 Mich
Berkshire Laboratories 692 Bank Village Greenville NH
Berkshire Recording 150 W 90 St New York 24 NY
Berlant Instruments Audio & Recordata Div 4917 W Jefferson Blvd Los Angeles 16 Calif
Bestera't Products Co 626 Broadway New York 12 NY
Best Electronics 617 19th St Manhattan Beach Calif
Biggs Co Carl H 2255 Barry Ave Los Angeles Calif
Birnback Radio Co 145 Hudson St New York 13 NY
B & K Mfg Co 3726 N Southport Chicago 13 III
Blackburn Electronic Corp 55 W 7 St Wyoming Pa
Black & Decker Towson 4 Md
Blaco Mfg Co 6541 Euclid Ave Cleveland 3 Ohio
Bliley Electric Union Station Bldg Erie Pa
Blonder-Tongue Labs 526 North Ave Westfield NJ
B & M Electronic Corp 838 4 Ave Brooklyn 32 NY
Boetsch Bros 115 Cedar St New Rochelle NY
Bogen Co David 29 9 Ave New York 14 NY
Bogue Electric Mfg Co 52 Iowa Ave Paterson 3 NJ
Bohn Sound Eng'g Lincoln Rwy E Fort Wayne Ind
Bolain Bending Co 1702 N Milwaukee Ave Chicago 47 III
Bomac Labs Salem Rd Beverly Mass
Bond Electric Div Olim Ind 505 Park Ave New York NY
Bozak Co R T PO Box 966 Darien Conn
Brach Mfg Div Genl Bronze 200 Central Ave Newark NJ
Bradley Laboratories 168 Columbus Ave New Haven Conn
Brady Co W H 727 W Glendale Ave Milwaukee 12 Wis
Brajnar Electronics 8586 Santa Monica Los Angeles
Brand & Co Wm North & Valley Sts Willimantic Conn
B & R Electronics 1701 Boone Ave New York 60 NY
Bridgeport Brass Aerosol Div Bridgeport Conn
Bright Star Industries 600 Getty Ave Clifton NJ
British Industries 80 Shore Rd Port Washington NY
Brociner Electronics Corp 344 E 32 St New York 16 NY
Brodney A I 351 Atlantic Ave Brooklyn 17 NY
Brookcraft Mfg 123 Lafayette St New York 13 NY
Browning Labs Inc 750 Main St Winchester Mass
Bruno Tools 9330 Santa Monica Blvd Beverly Hills Calif
Brush Electronics 3405 Perkins Ave Cleveland Ohio
Buchan Co R J PO Box 9 Bricleyn Minn
Budelmam Radio Corp 375 Fairfield Ave Stamford Conn
Bud Radio Inc 2118 E 55 St Cleveland 3 Ohio
Bullet Electronics 2637 S Lowell Springfield III
Bulova Watch Co Bulova Park Fushing 70 NY
Burgess Battery Co Freeport III
Burlington Instrument Co 203 N 3 St Burlington Iowa
Burton-Rogers Co 42 Carleton St Cambridge 42 Mass
Bussman Mfn Co University at Jefferson St Louis 7 Mo
Butler Mfg Co B B 3150 Randolph St Bellwood III

Caddell-Burns 40 E 2 St Mineola NY
Calbest Electronics 4801 Exposition Blvd Los Angeles
Calcon Mfg Co 100 Oakland Ave Washington 1 Pa
Caldor Mfg Co Lancaster Pa
Caldwell-Clements Manuals 480 Lexington New York NY
Callione Corp 1041 N Sycamore Ave Hollywood 38 Calif
Calif Cabinet 522 S San Pedro St Los Angeles 13 Calif
Calliri Mfg Co 15 Union St Lawrence Mass
Cal-Lee Mfg 5653 W Adams Blvd Los Angeles Calif
Calvendo Tube Corp 5232 W 104 St Los Angeles 45 Calif
Camburn Inc 32-40 57 St Woodside 77 NY

Campbell Industry 3806 St Elmo Chattanooga Tenn
 Campbell X-Ray 110 Cummington St Boston 15 Mass
 Cannon Co C F Springwater NY
 Cannon Electric 3208 Humboldt St Los Angeles 31 Calif
 Capcon Inc 25 Willett St New York 2 NY
 Capehart-Farnsworth 3700 Pontiac St Ft Wayne Ind
 Capitol Records Inc 1730 Broadway New York 19 NY
 Capps & Co Frank L 20 Addison Pl Valley Stream NY
 Carbonneau Ind 100 Lexington SW Grand Rapids Mich
 Carborundum Co Global Div Niagara Falls NY
 Cardwell Electronics Productions A D Plainville Conn
 Carling Electric 505 New Park W Hartford Conn
 Carter Motor Co 2644 N Maplewood Ave Chicago 47 Ill
 Carter Parts Co 213 W Institute Pl Chicago 10 Ill
 Casard Furniture 507 E Russell St High Point NC
 Case Mfg Co PO Box 889 High Point NC
 Cass Machine Co 691 Antoinette St Detroit 1 Mich
 Cauhorn Mfg Co 9999 Broadstreet St Detroit 4 Mich
 Cayo TV Eng'g 1904 Michigan Hwy Benton Harbor Mich
 CBC Electronics Co 2601 N Howard St Phila Pa
 CBS-Columbia Inc 3400 47 Ave Long Island City 1 NY
 CBS-Hytron 100 Endicott Danvers Mass
 Centralab 902Y E Keefe Milwaukee 1 Wis
 Central Electronics 1247 W Belmont Ave Chicago 13 Ill
 Centroid Transformer 1877 Eastern Pkwy Brooklyn 33 NY
 Century Electronics Co 111 Roosevelt Ave Mineola NY
 Certified Radio Labs 5507 13 Ave Brooklyn 19 NY
 Certified Tube Co 16 & Luzerne Sts Philadelphia 40 Pa
 CG Electronics 305 Dallas NE Albuquerque N Mex
 CGS Labs Inc 391 Ludlow St Stamford Conn
 Champion Bronze Powder 2526 W Vanuren St Chicago
 Champion DeArment Tool Co S Main St Meadville Pa
 Chance Co A B 210 N Allen St Centra 1a Mo
 Channel Master Corp Ellenville NY
 Chase Mfg 5008 W Jefferson Blvd Los Angeles Calif
 Chase & Sons Randolph Mass
 Chatham Electronics Div Gera Corp Livingston NJ
 C H Electronics 839 E Manchester Los Angeles 1 Calif
 Chemical Electronic Eng'g Matawan NJ
 Chester Cable Corp Chester NY
 Chicago Condenser 3255 W Armitage Ave Chicago 47 Ill
 Chicago Electronic 3223 W Armitage Chicago Ill
 Chicago Industrial Instr 865 N Sangaman Chicago Ill
 Chicago Std Transformer 3501 W Addison Chicago Ill
 Chicago Telephone Sup 1142 W Beardsley Elkhart Ind
 Chromatic TV Labs 1501 Broadway New York 36 NY
 Church III Lighting 344 Franklin St Melrose 76 Mass
 Clma Corp 119 Braintree St Allston 34 Mass
 Clinch-Jones Div Clinch Mfg 1926 S Homan Ave Chi Ill
 Cincinnati Ventilating Co 302 Madison Ave Covington Ky
 Circon Component Co Santa Barbara Calif
 Circultron Inc 155 W Main St Rockville Conn
 Cisin Harry G Amagansett NY
 Claremont Tube 36-02 35 Ave Long Island City NY
 Clark Electronic Labs Box 165 Palm Springs Calif
 Clarostat Mfg Co 1 Washington St Dover NH
 Clear Beam Antenna 21341 Roscoe Canoga Park Calif
 Clegg Labs Inc Box 641 Morrilton NJ
 Cletron Inc 1974 E 61 St Cleveland 3 Ohio
 Cleveland Institute of Radio Electronics 4900 Euclid Bldg Cleveland 3 Ohio
 Clifton Conduit Pierceway 75 Montgomery Jersey City NJ
 Cline Electric Mfg 3405 W 47 St Chicago 32 Ill
 Clippard Instrument 7350 Colerain Cincinnati Ohio
 Clough-Brengle Co 6014 Broadway Chicago 40 Ill
 Clism Mfg 611 W National Milwaukee 4 Wis
 Coaxial Connector Co 37 N 2 Ave Mt Vernon NY
 Codeltyper Laboratories 550 5th Ave New York 19 NY
 Coil Co of America 207 Washington St Northvale NJ
 Coil Winders Inc 100 New York Ave Westbury NY
 Coleman Cable & Wire 4515 W Addison St Chicago 41 Ill
 Collins Audio Products PO Box 368 Westfield NJ
 Collins Radio Co Cedar Rapids Iowa
 Colman Tool & Machine PO Box 7026 Amarillo Tex
 Color Converter Inc PO Box 250 Columbia City Ind
 Colorstone Electronics 100 Frank Rd Hicksville NY
 Color TV Inc 973 E San Carlos Ave San Carlos Calif
 Colosseum Records Oakwood Rd RR 3 Norwalk Conn
 Columbia Products Co Shakespeare Rd Columbia SC
 Columbia Records 799 7 Ave New York 19 NY
 Columbia Technical 5 E 57 St New York 22 NY
 Columbia Wire & Sup 2850 Irving Park Chicago Ill
 Columbus Eng'g Co PO Box 464 Columbus Nebr
 Comfort Lines 1735 Diversy Pkwy Chicago 14 Ill
 Commercial Products 417 Main St Toledo 5 Ohio
 Communication Accessories Hickman Mills Mo
 Components Corp 106 Main St Denville NJ
 Conant Labs 6500 O St Lincoln 5 Nebr
 Concertapes Inc 400 Jackson Ave Glencoe Ill
 Concert Hall Society 43 W 61 St New York NY
 Condenser Products Co 7517 N Clark St Chicago 26 Ill
 Connecticut Telephone & Electric Corp Meriden Conn
 Conrac Inc 19217 E Foothill Blvd Glendora Calif
 Consolidated Radio Prods 350 W Erie Chicago Ill
 Consolidated Wire 1635 S Clinton St Chicago 16 Ill
 Constat Laboratories 15 Bridge St New York 4 NY
 Continental Carbon 13900 Lorain Ave Cleveland 11 Ohio
 Continental Electric Co 715 Hamilton St Geneva Ill
 Continental Electronics 5320 Lancaster Phila Pa
 Control Electronics 1925 NY Ave Huntington Sta NY
 Cook Laboratories 114 Manhattan St Stamford Conn
 Co-operative Industries 100 Oakdale Rd Chester NJ
 Cooper Electronics Inc 5637 Tulip St Philadelphia 24 Pa
 Copperwell Steel Co 322 Frick Bldg Pittsburgh 19 Pa
 Cornell-Dubilier Electric Corp S Plainfield NJ
 Corning Glass Works Corning NY
 Cornish Wire Co 50 Church St New York 7 NY
 Coronet Electronics 1313 N State St Chicago Ill
 Corson Electric Mfg Corp 540 39 St Union City NJ
 Cousino Inc 2326 Madison Ave Toledo Ohio
 Crawford Door Co 20263 Hoover Rd Detroit 5 Mich
 Creative Plastics Corp Rt 25A Stony Brook NY
 Crescent Industries 5900 W Touhy Chicago 30 Ill
 Crest Transformer 1834 W North Chicago 22 Ill
 Crosley Radio & TV 1329 Arlington Cincinnati Ohio
 Crowley Co Henry L 1 Central Ave W Orange NJ

Crown Controls 40 S Washington New Bremen Ohio
 Cryo Inc 1138 Mission St S Pasadena Calif
 Cummins-Chicago 4740 N Ravenswood Chicago Ill
 Curtiss-Wright Corp Electronic Div Carlstadt NJ
 Cutler-Hammer Inc 315 N 12 St Milwaukee 1 Wis
 Dage Electric Co 67 N 2 St Beech Grove Ind
 Dale Electronics 31 Somerset Pl Clifton NJ
 Dale Products Inc PO Box 136 Columbus Nebr
 Dane Electronics Labs PO Box 209 Salem Mass
 Danforth Mfg Co 1003 S 8 St Monmouth Ill
 Daven Co Route 10 Livingston NJ
 Davis & Co J W 9212 Denton Drive Dallas 9 Texas
 Davis Electronics 4002 W Burbank Burbank Calif
 Daystrom Inc 200 Elmora Ave Elizabeth NJ
 Daystrom Electric Corp 887 Main St Poughkeepsie NY
 Deal Products Hellertown Rd (MR 37) Easton Pa
 Dean Sales Co 425 Devoe Ave Bronx 60 NY
 Decca Records Inc 50 W 57 St New York NY
 Dee Electric Co 1101 N Paulina St Chicago 22 Ill
 DeJure-Amsco 45-01 Northern Blvd Long Island City 1 NY
 Deleg Radio 1446 S Home Ave Kokomo Ind
 Delco-Remy Div General Motors Corp Anderson Ind
 Nelson Mfg Co 126 11 Ave New York NY
 Deltron Inc 2905 N Lehigh St Philadelphia 33 Pa
 Deutschmann Corp Tube Providence Hwy Norwood Mass
 DeWald Radio 35-15 37 Ave Long Island City 1 NY
 Diamond Expansion Bolt Co Garwood NJ
 Diagraph Products 95-25 149 St Jamaica 35 LI NY
 Di-Co TV & Plastic 322 Boston Post Rd Millford Conn
 Digital Products Inc 7643 Fay Ave LaJolla Calif
 D & M Prods 13144 W Nichols Rd Detroit Mich
 Donner Scientific Co 2820 7 St Berkeley Calif
 Doormasters Inc 2310 Michigan Ave Santa Monica Calif
 Dormitzer Electric 5 Hadley St Cambridge Mass
 Dorn Equipment Corp 88 Broad St Boston 10 Mass
 Dover Publications 920 Broadway New York 10 NY
 Drake Electric 3656 N Lincoln Ave Chicago 13 Ill
 Drake Mfg Co 1713 W Hubbard St Chicago 22 Ill
 Drake Co R L 18 E Central Ave Miamisburg Ohio
 Dreler Bros 5642 Lake Park Ave Chicago 37 Ill
 D & R Ltd 402 E Gatterlee St Santa Barbara Calif
 Duala Co PO Box 70 Coal Fork W Va
 Dubbing Sales Corp 41-10 45 St Long Island City NY
 Dubrow Development Co 235 Penn St Burlington NJ
 DuKane Corp St Charles Ill
 DuMont Labs A B 750 Bloomfield Ave Clifton NJ
 Dunkle Coll Co 3257 W 6 St Los Angeles 6 Calif
 Danwell Mfg Co Dept T56 Carlstadt NJ
 Duotone Co Locust St Keyport NJ
 Durakool Inc 1010 N Main St Elkhart Ind
 Duro Specialty Co 8 Bennett St Lynn Mass
 Dury Eng'g PO Box 483 Nashua NH
 DX Radio Products 2300 W Armitage Chicago 47 Ill
 Dyna Co 5142 Master St Philadelphia 31 Pa
 Dynamic Electronics 73-39 Woodhaven Glendale LI NY
 Dynamu Magnetics Div Maleo 21 N 3 St Minneapolis
 Dynavox Corp 40-05 21 St Long Island City 1 NY
 Eagle Electronics Corp PO Box 775 Meriden Conn
 Eagle Speaker Co 15 S Fairview Park Ridge Ill
 Easy-Up Inc 908 State St Racine Wis
 Ebor Electronics Co 87 Merrick Rd Baldwin NY
 Ebert Electronics 212-26 Jamaica Queens Village NY
 Eby Co Hugh H 4700 Stenton Ave Philadelphia 44 Pa
 Eby Sales 130 Lafayette New York 13 NY
 Eddy Stoker Corp PO Box 458 Wheeling Ill
 Edor Eng'g Co 1568 S 1st St Milwaukee Wis
 Edison Inc Thomas A Lakeside Ave W Orange NJ
 Edu-Craft Sales Corp 150-45 12 Ave Whitestone NY
 Ecor Inc 1501 W Congress St Chicago 7 Ill
 Eldson Electronic Co 1902 N 3 St Temple Texas
 Eitel-McCullough 798 San Mateo San Bruno Calif
 Elastic Stop Nut Corp 2330 Vauxhall Rd Union NJ
 Eteo Corp M St Below Erie Ave Philadelphia 24 Pa
 Eleraft Electronics 32-28 49 St Long Island City NY
 Electrend Products State & Water Sts Joseph Mich
 Electric Motors & Specialties Garrett Ind
 Electric & Musical Industries 38 W 48 St New York NY
 Electric Power Door Co Minneapolis 7 Minn
 Electric Soldering Iron Co W Elm St Deep River Conn
 Electrical Service 1271 Mission San Francisco 3 Calif
 Electric-Eng'g Prods Co 609 W Lake St Chicago 6 Ill
 Electro Mechanical Instrument 812 Chestnut Perkasie Pa
 Electron Enterprises 6917 Stanley Ave Berwyn Ill
 Electronic Chemical 813 Conningpaw Ave Jersey City NJ
 Electronic Communications 1249 W Loyola Chicago Ill
 Electronic Components 2655 W 19 St Chicago 8 Ill
 Electronic Crafts Co 74 Cortland St New York 7 NY
 Electronic Devices Inc 429 12 St Brooklyn 15 NY
 Electronic Fabricators 682 Broadway New York 12 NY
 Electronic Hardware 2420 W Cermak Rd Chicago 8 Ill
 Electronic Instrument 84 Withers St Brooklyn 11 NY
 Electronic Measurements 280 Lafayette New York 12 NY
 Electronic Specialties 76 Irving St Worcester 10 Mass
 Electronic Test Instr 13224 Livernois Ave Detroit Mich
 Electronic Tube Corp 1200 E Merald Lane Phila Pa
 Electronic Utilities Corp 153 W Huron St Chicago 10 Ill
 Electron-Radar Products 4806 W Chicago Chicago 51 Ill
 Electrons Inc 127 Sussex Ave Newark 3 NJ
 Electro-Physics Co 287U Broadway New York 7 NY
 Electro Products 4501 N Ravenswood Ave Chicago Ill
 Electro-Sonic Labs 35-54 36 St Long Island City NY
 Electronic Specialties 7230 Clinton Upper Darby Pa
 Electro Sound Corp 115 Halleck St Boston 20 Mass
 Electro-Tech Equipment 308 Canal St New York 13 NY
 Electro-Voice Inc Buchanan Mich
 Electrovox Co 60 Franklin St E Orange NJ
 Elektra Records 361 Bleeker St New York 14 NY
 Elek-Trik Seal 2419 Lanterman Terr Los Angeles Calif
 Elgin Electronic Corp PO Box 13 Bluffton Ind
 Elreco Corp 2900 Cornway Ave Cincinnati 25 Ohio
 Eltran Corp 109 W Station St St Anne Ill
 E M C Recordings 806 E 7 St St Paul Minn
 Emerson Radio & Phono 14 & Coles Jersey City NJ
 Enco Mfg Co 4520-26 W Fullerton Chicago 39 Ill
 Engineered Instruments DV Controls Div Hayward Calif

Eng'g Laminating 506 S Central Baltimore 3 Md
 Epcu Electronics 140 Liberty St New York 6 NY
 Equipto Aurora Ill
 Erle Resistor Corp 644 W 12 St Erie 6 Pa
 Erwood Inc 1770 W Berteau Ave Chicago 13 Ill
 Esco Mfg Co Box 344 Summit Ill
 Esoteric Records 238 E 26 St New York 10 NY
 Espey Mfg Co 200 W 57 St New York 19 NY
 Essex Wire Corp 1601 Wall St Ft Wayne 6 Ind
 Executione Inc 415 Lexington Ave New York 17 NY
 E-Z Way Towers 5901 E Broadway Tampa Fla
 Fada Radio & Electric Co 525 Main St Belleville 9 NJ
 Fairbanks Co 393 Lafayette St New York NY
 Fairchild Recording Equip Whitestone NY
 Falmer Mfg Co 312 N Walnut St Youngstown 2 Ohio
 Fanon Electric Co 150-09 South Rd Jamaica 33 NY
 Farrington Mfg 76 Atherton St Boston Mass
 Federal Anti Capacity Switch 72 Kingsley Buffalo 8 NY
 Federal Electronics Rockville Centre NY
 Federal Mfg & Eng'g 1055 Stewart Ave Garden City NY
 Federal Screw Prods 3917 N Kedzie Chicago 18 Ill
 Federal Telephone & Radio 100 Kingsland Rd Clifton NJ
 Federal Telephone and Radio Company A Division of International Telephone and Telegraph Corporation 100 Kingsland Road Clifton New Jersey
 President—R S Perry
 Vice President, Components Division—S J Powers
 Selenium Product Line Manager—J E Van Wageningen
 Dielectric Product Line Manager—A A Segal
 Vacuum Tube Product Line Manager—W C Schmitt
 Rectifier Equipment Product Line Manager—J A Curtis
 Transformer Product Line Manager—R A Felmy
 General Sales Manager—Components Div J G Solari
 Distributor Sales Manager—E L Shaw
 Germanium Diodes Only
 Columbus-IDS—Jack W. Lehner 367 Bryhill Road Covers Ohio-West Virginia-Pennsylvania (that portion of the State lying West of but not including the Counties of Tioga, Lycoming, Northumberland, Dauphin, and York)
 Atlanta-IDS-DS—Cartwright & Bean 3223 Coins Hill Rd NW Exchange 2273 Covers Alabama-Florida-Georgia-Mississippi-North Carolina-South Carolina-Tennessee
 Atlantic City-IDS—Victor W. Williams 5 Circle Drive Margate Atlantic City 2-7859 Covers Maryland-District of Columbia-Delaware (Counties of Kent and Sussex)-Virginia
 Albuquerque-IDS—Hyde Sales Company 2220 Utah Street Covers Nebraska-Ipanhandle territory of the western section of the state including Scottsbluff Nebraska) New Mexico-Utah-Wyoming
 Boston-DS—Abbott & Hustis 1105 Commonwealth Avenue Algonquin 4-8100 Covers Maine-New Hampshire-Vermont-Massachusetts-Rhode Island-Connecticut
 Boston-IDS—Robert W. Gray Inc 572 Washington Street Wellesley 81 Wellesley 5-5296, 5-0191 Covers Connecticut (except Counties of Fairfield, New Haven and Middlesex) Maine-Massachusetts-New Hampshire-Rhode Island-Vermont
 Buffalo-IDS—R W. Mitscher 487 Ellicott Square Building Washington 2517 Covers New York (except Counties of Bronx, Kings, Nassau, New York, Queens, Richmond, Rockland, Westchester, Suffolk)
 Charlotte-North Carolina-IDS—Cartwright & Bean 625 Horwyn Drive Franklin 6-8648 Covers Alabama-Florida-Georgia-Mississippi-North Carolina-South Carolina-Tennessee
 Chicago-IDS—Ringland M. Krueger 5306 W Lawrence Avenue Pensacola 6-3107 Covers Illinois-Wisconsin (South of an East-West Line through La Crosse but not including the City of La Crosse and East of a North-South Line through Ironwood, Michigan)
 Chicago-DS—William J. Doyle Company 7002 N Western Avenue Rogers Park 1-3130 Covers Illinois-Wisconsin (South of an east-west line through LaCrosse, but not including the city of LaCrosse and East of a north-south line through Ironwood Michigan)
 Dallas-IDS-DS—Branum Sales Inc PO Box 10204 Riverside 4995 Covers Arkansas-Louisiana-Oklahoma-Texas
 *Dayton-IDS—Neal Bear Corp 136 W 2nd Street Fulton 2555 Covers Ohio-West Virginia-Pennsylvania (that portion of the State lying West of but not including the Counties of Tioga, Lycoming, Northumberland, Dauphin and York)
 Denver-IDS—Hyde Sales Company 3250 South Dexter Street Skyline 6-7151 Covers Colorado-Idaho (Southern half of state including counties of Washington-Gem-Boise-Custer-Clark- and Fremont—Montana—eastern half of state to the boundaries of Hill-Chouteau-Judith-Bosin Wheatland-Sweetgrass and Park)
 Detroit-IDS—K C Burrow and Company 22128 Grand River Avenue Kenwood 3-7700 Covers Michigan
 Indianapolis-IDS—Quinn Cunningham & Associates 6101 College Avenue Glendale 3222, 0225 Covers Indiana-Kentucky
 Kansas City-IDS—F C Somers 18th and Grand Avenue Office Grand 11355 Covers Iowa-Nebraska-Missouri-Kansas
 Los Angeles-IDS—J W Mosh Company 4216 W Jaf

(Listings continued next page)

(Federal Continued)

Ierson Blvd REpublic 2-0145 Covers California-Nevada-Arizona

Memphis-IDS—Cartwright and Bean 1336 Madison Avenue MEmpHis 2-1914 Covers Alabama-Florida - Georgia - Mississippi - North Carolina - South Carolina-Tennessee

Minneapolis-IDS—H M Richardson* 9 East 22nd Street GeneVa 4078 Covers Minnesota-North Dakota-South Dakota-Wisconsin (the Section North of an East-West Line through LaCrosse including the City of LaCrosse and West to a North-South Line to Ironwood Michigan)

New York-DS—Mingins Sales Company 107-37 71 Avenue Forest Hills Island 8Oulevard 3-1643 Covers New Jersey - except the city of Trenton and all area south of the city of Trenton—New York counties of Bronx-Kings-Nassau-Queens-Richmond-Rockland-Westchester-Suffolk

Oaklyn-New Jersey IDS-DS—Victor W Williams-1100 White House Pike COllingswood 5-6332 Covers Virginia

Philadelphia-IDS—J R Benge Technical Representation 25 S Eoston Road Suite 200 Glenside Pa TUrner 1325 and 1326 Covers Delaware-District of Columbia-Maryland (New Castle County)-New Jersey (Radio Corp of America at Princeton the City of Phillipsburg the City of Trenton, and all area south of the City of Trenton); Pennsylvania (all the area West to and including the Counties of Tioga, Lycoming, Northumberland, Dauphin, and York)

Phoenix-IDS—J W Marsh Company 1011 West Whittan AMherst 6-9124 Barney Schlecht Covers California-Nevada-Arizona

Ridgefield-Conn-DS—Abbott & Huslis 52 Main St Covers Connecticut - Maine - Massachusetts - New Hampshire-Rhode Island-Vermont

San Francisco-IDS—J W Marsh Company 1258 Fitzgerald Avenue Valencia 4-6714 Covers California-Nevada-Arizona-Hawaii

Santa Fe-NM-DS—Hyde Sales Co 206 Lugar De Monte Vista Santa Fe 3-7884 Covers New Mexico-Texas (El Paso County)-Utah-Wyoming

Seattle-IDS—Fred H Haight Company 3212 East Lake Avenue EAst 1818 Covers Oregon-Washington-Idaho (Northern half of the State including Counties of Adams, Walle, Lemhi)-Montana (Western half of the State including Counties of Hill, Chateau, Judith Basin, Wheatland, Sweetgrass, and Park)

Tampa-IDS—Cartwright & Bean 4525 S Lois Street Covers Alabama-Florida-Georgia-Mississippi-North Carolina-South Carolina-Tennessee

West Hartford-Conn-IS—Robert W Gray Inc 121 Loomis Drive ADams 3-5629 Covers Connecticut (except Counties of Fairfield, New Haven and Middlesex)-Maine-Massachusetts-New Hampshire-Rhode Island-Vermont

West Richfield Ohio-IDS-DS—Neal Bear Corporation* 3435 Streetsboro Rd West Richfield Oliver 9-3331 Covers Ohio, West Virginia, Pennsylvania (that portion of the State lying West of but not including the Counties of Tioga, Lycoming, Northumberland, Dauphin, and York)

Federated Metals 120 Broadway New York 5 NY
 Federated TV Mart 313 Rogers Ave Brooklyn 25 NY
 Feller Eng'g & Mfg 8026 N Monticello Skokie Ill
 Fenton Co 15 Moore St New York 4 NY
 Ferranti Electric 30 Rockefeller Pl New York NY
 Ferris Business Equip Inc 45 Seymour St Stratford Conn
 Ferris Instrument Co 110 Cornelia St Boonton NJ
 Fidelityone Inc 6415 Ravenswood Ave Chicago 26 Ill
 Fidelity Chemical 470 Frellinghuysen Ave Newark NJ
 Filtron Co 131-15 Fowler Ave Flushing 55 LI NY
 Finney Co 4612 St Clair Ave Cleveland 3 Ohio
 First American Prods 1717 Wyandotte Kansas City Mo
 Fisher Co Oscar 1000 N Division St Peekskill NY
 Fisher Eng'g Co Huntington Ind
 Fisher-Pierce Co 170 Pearl St So Braintree 85 Mass
 Fisher Radio Corp 21-21 44 Dr Long Island City 1 NY
 F K B Opticon Co 1738 Calvert St South Bend Ind
 Fleetwood Corp 1037 Custer Dr Toledo 12 Ohio
 Fleming Inc Edward Broad St Westport Conn
 Flexo Int'l Co 3245 W Lake St Chicago 24 Ill
 Flexo Wire Div Copperweld Steel Co Oswego NY
 Float-Lock Corp 261 Madison Ave New York NY
 Fonotalk Corp 11 S LaSalle St Chicago Ill
 Forbes & Wagner 345 Central Ave Silver Creek NY
 Forest Electric Co 7216 Circle Ave Forest Park Ill
 Forsberg Mfg Co Bridgeport Conn
 Fortuna Records 11629 Linwood Ave Detroit 6 Mich
 Frazier Eng'g Co 1965 Peck St Muskegon Mich
 Franklin Electronics King St Franklin Park Ill
 Freed Electronics & Controls 200 Hudson New York 13 NY
 Freed Transformer Co 1718 Welldel St Brooklyn 27 NY
 Frequency Standards Box 504 Asbury Park NJ
 Fretco Inc 406 N Craig St Pittsburgh 13 Pa

President—Joseph V Fisher
 Vice President—Frank H Robinson
 Sales Manager—C D Hall
 Products: TV antennas & accessories; Open wire lead-in; Semi-conductor products
 Brand Names: Super Spectrum; Victoria; Freteray; Spectrum; Customliner; 3-D Dimension; Mi-tee-Ray; Silver Arrow; Fretline; Souceterline; Bo-Ti; Strato-Ray
 Representatives:
 CALIF—David Ellis David Ellis Co 919-D East California St Pasadena Ryan 19108 Territory: Southern Calif-Ariz & Las Vegas Nevada

CALIF—F J Marchuk F J Marchuk Co 261 E Colorado St Pasadena Sycamore 30240 Territory: Northern California
 D C—L H Leiber International Buyer Service 217 Bond Bldg Washington D C Sterling 30623 Territory: Cuba
 ILL—George E Lewis G E Lewis Inc 5420 W Fullerton Ave Chicago National 20708 Territory: Illinois-Wis-Minn
 IND—Paul B Fishman 4440 N Campbell Ave Indianapolis Liberty 65477 Territory: Indiana & Kentucky
 KAN—C L Omer Inland Associates 6047 Howe Dr Mission Territory: Iowa-Neb-Missouri-Kansas
 MASS—Ray Bridge The Ray Bridge Co 100 Memorial Dr Cambridge University 43696 Territory: Maine-Vt-Mass-Rhode Island-New Hampshire-Conn (Represents for Transistors only)
 N Y—Henry Vitarelli H V Associates 1047 Mc Donald Ave Wantagh L I Territory: New York-N Jersey down to Trenton
 N C—Paul E Moore Paul Moore Co P O Box 6003 —Five Points Station Raleigh 37533 Territory: North & South Carolina
 TEXAS—Hal F Corry Hal F Corry Co 6313 Hillcrest Ave Dallas Territory: Ark-La-Texas-Okl-Miss
 CANADA—Mike Rosen Active Radio & TV Distrs 58 Spadina Ave Toronto Empire 42755 Territory: Canada
 Fretz Gross Co 22 St & Sedgley Ave Philadelphia 32 Pa
 Furst Electronics 3322 W Lawrence Chicago 25 Ill

Gahagan Inc 11 W 4 St Bethlehem Pa
 Gard Industries Inc Green Bay Rd Wilmette Ill
 Garde Mfg Co 588 Eddy St Providence 3 RI
 Gard Radio 70 Washington St Brooklyn 1 NY
 Garrard Sales Corp 80 Shore Rd Port Washington NY
 G-C Electronics Mfg Co 919 Taylor Ave Rockford Ill
 Gee-Lar Mfg Co 418 S Wyman St Rockford Ill
 General Aluminum Products 287 5 Ave New York NY
 General Apparatus 344 E 32 St New York 16 NY
 General Cement Mfg Co 919 Taylor Ave Rockford Ill
 General Crystal Co Burlington Wisc
 General Dry Batteries 13000 Athens Cleveland 7 Ohio
 General Electric Apparatus Sales Div Schenectady 5 NY
 General Electric Co Syracuse NY
 General Electronic Equip Mantua & Glendale Easton Pa
 General Industries Co Olive & Taylor Sts Elyria Ohio
 General Instrument Corp 829 Newark Ave Elizabeth 3 NJ
 General Insulated Wire 69 Gordon Ave Providence RI
 General Motors Corp Guide Lamp Div Anderson Ind
 General Phones Corp 5711 Howe St Pittsburgh 32 Pa
 General Products Corp Webb St Union Springs NY
 General Test Equipment 38 Argyle Ave Buffalo NY
 General Transistor 95-18 Sutphin Blvd Jamaica LI NY
 Germanium Products 26 Cornelison Ave Jersey City 4 NJ
 Gensback Library 154 W 14 St New York 11 NY
 Gerrard & Co A J 1950 Hawthorne Ave Melrose Park Ill
 G & H Wood Products Co 75 N 11 St Brooklyn 11 NY



Girard-Hopkins 1000 40 Ave Oakland 1 Calif
 Gifts Moulding Corp 4600 W Huron St Chicago 44 Ill
 G & M Equip Co 7315 Varma Ave N Hollywood Calif
 Gosnet Co 801 S Main St Burbank Calif
 Good-AH Elec Mfg Co Ogallala Neb
 Goodline Corp 309 Date Ave Alhambra Calif
 Gotham TV Corp 123 W 64 St New York 23 NY
 Gramer-Halldorson 2734 N Pulaski Chicago Ill
 Grantham Products Inc 36-07 20 Ave Long Island City NY
 Grantham School 821 19 St NW Washington DC
 Gravely Novelty Furniture Ridgeway Va
 Graybar Electric Co 420 Lexington Ave New York NY
 Grayhill Co 561 Hillgrove Ave LaGrange Ill
 Grayline Eng'g Co 12243 Ave O Chicago 33 Ill
 Gray Research & Devel 658 Hilliard Manchester Conn
 Great Eastern Mfg Co 165 Remsen Ave Brooklyn 12 NY
 Greene L Charlton 314 Washington Newton 58 Mass
 Greenlee Tool Co 1837 Columbia Ave Rockford Ill
 Grobet File Co of America 421 Canal St New York 13 NY
 Guardian Electric 1621 W Walnut Chicago 12 Ill
 Gudeman Co 340 W Huron St Chicago 10 Ill
 Gullid Radio TV 460 N Eucalyptus Inglewood 3 Calif
 Gusdorf & Son 6900 Manchester Ave St Louis 17 Mo

Hallcrafters Co 4401 W 5 Ave Chicago 24 Ill
 Hamilton Electronics 2726 Pratt Ave Chicago 45 Ill
 Hammarlund Mfg Co 460 W 34 St New York 1 NY
 Hansen Mfg Co 1111 S Hart St Princeton Ind
 Harman-Kardon 520 Main St Westbury LI NY
 Harnett Electric 138 Haven Port Washington NY
 Harper & Bros 49 E 33 St New York NY
 Hartley Products Co 521 E 162 St New York 51 NY
 Harvey-Wells Electronics Southbridge Mass
 Haskey Co 29 E Madison St Chicago 2 Ill
 Hasltnas Products 161 Newbury St Boston 16 Mass
 Hayden Society Inc 30 Huntington Ave Boston Mass
 Hayden Mfg Co 245 E Elm St Torrington Conn
 Hayden Switch Inc 536 S Leonard St Waterbury Conn
 Haydu Bros of N J Box 1226 Plainfield NJ
 Heath Co 305 Territorial Rd Benton Harbor Mich

Hedco Mfg 161 W Huron St Chicago 10 Ill
 Heiler Co 2135 Superior Ave Cleveland 14 Ohio
 Heppner Mfg Co Box 608 Round Lake Ill
 Hevi Buty Electric 4212 W Highland Milwaukee 1 Wisc
 Hexacon Electric Co 161 W Clay Ave Roselle Park NJ
 Hewlett-Packard Co 481 Page Mill Rd Palo Alto Calif
 H & H Prods PO Box 2333 Term Annex Los Angeles Calif
 Hickok Electrical Instr 10514 Dupont Cleveland Ohio
 Hillburn Electronic Products 55 Nassau Ave Brooklyn NY
 Hi-Lo TV Antenna 3540 N Ravenswood Chicago Ill
 Hindle Transformer Co Woods Church Rd Flemington NJ
 Hinners-Galanek Radio 25-14 Bdwg Long Island City NY
 Hi-Par Products Co 347 Lunenburg St Fitchburg Mass
 Hitemp Wires Inc 26 Windsor Ave Mineola LI NY
 HNH TV Industries 746 N Pickering Whittier Calif
 Hobbs Inc Guy Dallastown Pa
 Hobson Bros 4940 W Lawrence Ave Chicago 30 Ill
 Hoffman Electronics 3761 S Hill St Los Angeles Calif
 Holloway Electronics Corp Fort Lauderdale Fla
 Holub Industries 413 DeKalb Ave Sycamore Ill
 Hotel Radio Corp 601 W Fort St Detroit 26 Mich
 Howell Mfg Co 7199 Hasbrook Ave Philadelphia 11 Pa
 Hubbell Inc Harvey State & Bostwick Bridgeport Conn
 Hubbell Mfg Co H L Rte 21 Zealand Mich
 Hudson Lamp Co Arlington NJ
 Hudson Wire Co Winsted Div Winsted Conn
 Hughes Aircraft Int'l Airport Los Angeles Calif
 Hunt Co Phillip A Fallades Park NJ
 Hunter Sales 6608 S Gretna Whittier Calif
 Hycon Electronics 321 S Arroyo Pkwy Pasadena Calif
 Hydro-Aire Inc 3000 Winona Ave Burbank Calif
 Hy-Gain Television Products 1828 N St Lincoln Nebr
 Hy-Lite Antennae 242 E 137 St New York 51 NY

Ideal Industries 3316 Park Ave Sycamore Ill
 IE Mfg 325 N Hoyne Ave Chicago 12 Ill
 I G Textile Co 30 E 21 St New York NY
 Illinois Condenser Co 1616 M Throp St Chicago 22 Ill
 Illinois Transformer Co 412 S Green St Chicago 7 Ill
 Imperial Radar & Wire 820 E 233 St Bronx NY
 Industrial Condenser 3243 N California Chicago 18 Ill
 Industrial Development 17 Pollock Ave Jersey City NJ
 Industrial Devices 22 State Rd Edgewater NJ
 Industrial Hdw Mfg Co 109 Prince St New York 12 NY
 Industrial Instruments 89 Commerce Rd Cedar Grove NJ
 Industrial Test Equip Co 55 E 11 St New York 3 NY
 Industrial TV Inc 359 Lexington Ave Clifton NJ
 Inet Div Leach 4441 Santa Fe Ave Los Angeles Calif
 Ingalls Electronics 30 W Putnam Ave Greenwich Conn
 Injection Molders Supply 3514 Lee Rd Cleveland Ohio
 Inst-X Sales Co 26 Rittenhouse Pl Ardmore Pa
 Instrument Labs 315 W Walton Pl Chicago 10 Ill
 Instrument Resistors Co 1036 Commerce Ave Union NJ
 Insuline Corp of America 186 Granite St Manchester NH
 Interlectronics Corp 2432 Grand Concourse New York
 Int'l Electronics Corp 159 Howell St Dallas 7 Texas
 Int'l Pacific Rec'dg 858 N Vine St Hollywood 38 Calif
 Int'l Radio & Electronics Box 123 Route 4 Elkhart Ind
 Int'l Rectifier Corp 1521 E Grand Ave El Segundo Calif
 Int'l Register 2620 W Washington St Chicago 12 Ill
 Int'l Research Assoc 2221 Warwick Santa Monica Calif
 Int'l Resistance 401 N Broad St Philadelphia 8 Pa
 Int'l Scientific Industries 3101 42 St Minneapolis Minn
 Interstate Photo Supply 17 W 17 St New York 11 NY
 Irvington Varnish & Insulator Div Minn Mining & Mfg Co 6 Argyle Terrace Irvington 11 NJ
 Isolantite Mfg Corp Warren Ave Stirling NJ
 ITE Circuit Breaker 19 & Hamilton Philadelphia Pa

Jackson Electr Instrument 18 S Patterson Dayton Ohio
 Jacobson Mfg Co S I 1414 S Wabash Ave Chicago 5 Ill
 JaMac Products Co 8845 NE Sandy Blvd Portland Ore
 James Instrument Labs 9110 S 52 Ct Oak Lawn Ill
 Jamestown Table Co Jamestown NY
 James Vibration Co 4050 N Rockwell Ave Chicago 18 Ill
 Jan Hdw Mfg Co 75 N 11 St Brooklyn 11 NY
 Jansa Woodworking Corp 315 Meserole St Brooklyn NY
 Jarno Mfg TV Hush Div 16 Howard Ave Brooklyn NY
 Jarvis Electronics Corp 6058 Fullerton Chicago 39 Ill
 Javex PO Box 646 Redlands Calif
 Jay Cee Corp 475 Cosgrove St Philadelphia Pa
 Jayell Mfg Co 1379 Washington Ave New York 56 NY
 J-B-T Instruments 441 Chapel St New Haven 8 Conn
 Jefferson Electric Co 900 25 Ave Bellwood Ill
 Jennings Radio Mfg Co PO Box 1278 San Jose 8 Calif
 Jensen Industries Inc 7333 W Harrison Forest Park Ill
 Jensen Mfg Div Mater 6601 S Laramie Chicago Ill
 Jerrold Electronics Corp 2222 Chestnut Philadelphia Pa
 Jersey Specialty Co Burgess Pl Mountaintop NJ
 Jetron Mfg Co 1665 Milwaukee Ave Chicago 47 Ill
 Jewell Inc A W Elyria Ohio
 JFD Mfg Co 6101 16 Ave Brooklyn 4 NY
 Johns-Manville Dutch Brand Div 7800 Woodlawn Chicago
 Johns Apparatus Co Walter M PO Box 277 Sheffield Mass
 Jones Electronics Co M C Bristol Conn
 Jones Div Cinch Mfg 1026 S Homan Ave Chicago Ill
 Jones & Laughlin Steel Corp 3 Gateway Pittsburgh 30 Pa
 Jontz Mfg Co 1101 E McKinley Ave Mishawaka Ind
 Jordan Mfg Co Morrice Mich

Karlson Assoc 1483 Coney Island Ave Brooklyn 30 NY
 Karyall Body Inc 8221 Clinton Rd Cleveland 9 Ohio
 Kato Engineering Co 1415 1 Ave N Mankato Minn
 Kay Electric Co Pinebrook NJ
 Kay Lab 5725 Kearney Villa Rd San Diego 12 Calif
 Kay-Townes Antenna Co 1511 Dean Ave Rome Ga
 Kedman Co 233 S 5th St West Salt Lake City 1 Utah
 Kellogg Switchboard 79 W Monroe St Chicago Ill
 Kemode Mfg Co 161 W 18 St New York 11 NY
 Kemtron Electron Prods 14 Prince Pl Newburyport Mass
 Kendall Co Polyken Sales 222 W Adams St Chicago 6 Ill
 Kenwood Eng'g Co 265 Colfax Ave Colfax NJ
 Kenyon Transformer Co 840 Barry St New York 59 NY
 Kepco Labs 131-38 Sanford Ave Flushing 55 NY

Kerden Chemical Co 6400 Herman Ave Cleveland 2 Ohio
 Kester Solder Co 4201 Wrightwood Ave Chicago III
 Keystone Electronics 423 Broome St New York NY
 K & G Electronics 2738 N Sheffield Ave Chicago 14 III
 Kingdom Products 23 Park Pl New York NY
 King & Sons J E Peru Ind
 Kings Electronics Co 40 Marbledale Rd Tackahoe NY
 Kirby Co 13000 Athens Ave Cleveland Ohio
 Kleer-Vee Mfg Co PO Box 10304 Pittsburgh 34 Pa
 Klein & Sons Mathias 7200 McCormick Chicago 45 III
 Klipsch & Associates PO Box 64 Hope Ark
 Knights Co James Sandwich III
 Koch Sons Geo 10 S 11 Ave Evansville 4 Ind
 Kraemer & Co 563 18 Ave Newark 3 NJ
 Kraft Bros 148-12 94 Ave Jamaica 52 NY
 Kraft Products 1704 Walnut St Philadelphia 3 Pa
 Kris Electronics Inc 191 Oraton St Newark 2 NJ
 Kohn-Hite Instrument 580 Mass Ave Cambridge Mass
 Kroyon Inc Ford & Washington Sts Norristown Pa
 Kuehne Mfg Co 19 & Olive Sts Mattison III
 Kerman Electric Co 35-18 37 St Long Island City 1 NY
 Kwikheat Mfg 3732 San Fernando Rd Glendale Calif

Lab of Electronic Eng's 413 L St NW Washington 1 DC
 Laine Electronics & Mfg 91 Industrial Little Ferry NJ
 Lampkin Labs Bradenton Fla
 Langervin Mfg 47-37 Austell Pl Long Island City 1 NY
 Lansing Sound J B 2439 Fletcher Dr Los Angeles Calif
 LaPointe Electronics 155 W Main St Rockville Conn
 Larson Co C D PO Box 358 Sterling III
 LaSalle Tube Mfg Co 155 E Grand Ave Chicago III
 Leach Relay Co 5915 Avalon Blvd Los Angeles 3 Calif
 Leader Electronics Corp 2925 E 55 St Cleveland Ohio
 Lear Inc 11916 W Pico Blvd Los Angeles 64 Calif
 Lectrohm Inc 5560 Northwest Hwy Chicago 30 III
 Lee Radio-TV 1001 E Elm Macomb III
 Le-Hi Electric Co 115 Colt St Irvington NJ
 Letch Eng's Corp 326 Lincoln St Manchester NH
 LEL Inc 380 Oak St Copiague NY
 Leland Inc G H 123 Webster St Dayton 2 Ohio
 Lenk Mfg Co 30-38 Cummington St Boston 15 Mass
 Lenx Electric Mfg Co 1751 N Western Ave Chicago 47 III
 Lerco Electronics Inc 501 S Varney St Burbank Calif
 Lindgren & Assoc E A 4515 N Ravenswood Chicago III
 Linell Eng's Corp 447 South Blvd Oak Park III
 Link Aviation Inc Binghamton NY
 Lipps E A 5485 W Washington Los Angeles 16 Calif
 Littelfuse Inc 1865 Miner St Des Plaines III
 Livingston Electronic Corp Livingston NJ
 Lose Sound J M 2171 W Washington Los Angeles Calif
 London Chemical Co 1535 N 31 St Melrose Park III
 London Records Inc 539 W 25 St New York 1 NY
 Louis Labs 175 W 97 St New York 25 NY
 Lowell Mfg Co 3030 Laealde Station Rd St Louis 17 Mo
 L-S Heating & Eng's 900 W Lycoming St Phila 40 Pa
 Ludgate Assoc John P 351 S Ave Pittsburgh 22 Pa
 Luminate Electronic Co 407 S Dearborn St Chicago 5 III
 Lyman Engrs 1432 N Carlisle St Philadelphia 21 Pa
 Lyrichord Discs Inc 619 W 54 St New York 19 NY
 Lytle Eng's & Mfg Co 105 W Monroe St Chicago 3 III

McColeman-Christie 3410 W 67 St Los Angeles 43 Calif
 McCoy Electronics Co Mt Holly Springs Pa
 McGohan Inc Don 3700 W Roosevelt Rd Chicago 24 III
 McGraw-Hill Book Co 330 W 42 St New York 36 NY
 McGregor Electronic Industries McGregor Iowa
 McIntosh Eng's Labs 320 W Water St Binghamton NY
 McKee Door Co 85 Hankes Ave Aurora III
 MacMillan Co 60 S Ave New York 11 NY
 Mason Co 3260 Motor Ave Los Angeles 34 Calif
 Magnavox Co 2131 Bueter Rd Ft Wayne 4 Ind
 Magnadyne Co 84 S Water St Port Chester NY
 Magnasynce Mfg 5546 Satsuma Ave N Hollywood Calif
 Magnavision Electronics Garwood NJ
 Magrecord Inc 1101 S Kilbourn Ave Chicago 24 III
 Major Electronics 42 Meserole St Brooklyn 6 NY
 Maleo Tool & Mfg Co 4025 W Lake St Chicago 24 III
 Mallin Enterprises 3733 E Olympic Los Angeles Calif
 Mallory & Co P R 3029 E Wash Indianapolis Ind
 Manco Mfg Washington & Locust Bradley III
 Mancor Co 5831 S Green St Chicago III
 Mandex Mfg Co 2608 W 16 St Chicago 8 III
 Manfred Wood Products 226 NY Ave Huntington NY
 Marantz Co 44-15 Vernon Blvd Long Island City 1 NY
 Marathon Battery Co 840 Henrietta St Wausau Wis
 Marline View Electronics 28 Main St White Plains NY
 Marlon Electrical Instrument Co Manchester NH
 Marjo Technical Prods 1150 E Henry St Linden NJ
 Markel Electric Products 147 Seneca St Buffalo NY
 Markell Associates Jeff 764 6 Ave New York 10 NY
 Markem Service Systems 145 Hudson St New York 13 NY
 Mar-Ko TV Supplies 441 Summit St Toledo 4 Ohio
 Marma Electronic Div Fidelity Amplifier 703 W Willow Chicago III
 Martin & Co H S 1916 Greenleaf Ave Evanston III
 Martindale Electric Box 617 Edgewater Br Cleveland Ohio
 Masco Mfg 1319 N Market St St Louis Mo
 Master Appliances Inc 1600 Factory Ave Marlon Ind
 Master Electronics & TV Rt 1 Box 36 Libertyville III
 Master Mobile Mounts 1306 Bond Los Angeles Calif
 Mastra Co 2104 Superior Ave Cleveland 14 Ohio
 Matchless Electric 1700 Washington Chicago 12 III
 Mathis Tower & Equip Co PO Box 126 E Peoria III
 Mattison TV & Radio 10 W 181 New York 53 NY
 Measurements Corp Boonton NJ
 Mechanical Steel Tubing 500 Barry St Bronx 59 NY
 Meck Industries John Plymouth Ind
 Medal Mfg Co 194 E Silver St Sharon Pa
 Memco Aerial Ladder 1007 NW 36 Oklahoma City Okla
 Mercury Marine Electric 2905 Jones San Francisco Calif
 Mercury Record Corp 35 E Wacker Dr Chicago III
 Merit Coil & Transformer 4427 N Clark Chicago III
 Meritanna Mfg Co 120 W Thomas St Seattle 99 Wash

Merix Chemical Co 1021 E 55 St Chicago 15 III
 Metal Treating Equip 9825 Greeley Ave Detroit 11 Mich
 Meters Inc 5353 N Keystone Ave Indianapolis 20 Ind
 Metzner Eng'g 1041 N Sycamore Ave Hollywood 38 Calif
 MGM Records 701 7 Ave New York 36 NY
 Micamold Electronics 1087 Flushing Ave Brooklyn NY
 Michigan Electronics 854 N Rockwell St Chicago 22 III
 Mico Instrument 80 Trowbridge Cambridge 38 Mass
 Micro-Circuits Co New Buffalo Mich
 Micro Switch Div Minn-Honeywell Regulator Freeport III
 Microtran Co Div Crest Labs 84-11 Rockaway Beach Blvd Rockaway Beach 93 NY
 Middletown Mfg Stack Co St Middletown Conn
 Midland Mfg Co 3151 Fiberglass Rd Kansas City 15 Kan
 Midwest Cabinet 2047 Church III St Chicago 47 III
 Midwest Naturlite Co 228 W Kinzie Ave Chicago 10 III
 Midwest Radio & TV Corp 909 Broadway Cincinnati Ohio
 Milford Tool Co 108 Gulf St Milford Conn
 Millen Mfg Co James 150 Exchange St Malden 48 Mass
 Miller Co J W 5917 S Main St Los Angeles 3 Calif
 Miller Co Sanford 691 Bedford Ave Brooklyn 6 NY
 Miller Electric Co 120 Main St Pawtucket RI
 Miller Electronics 2840 Naomi St Burbank Calif
 Miller Electro-Research 5529 S 5 St Milwaukee Wis
 Miller Instrument Wm 325 N Halstead Pasadena Calif
 Miller Mfg Co M A 4 & Church St Libertyville III
 Miller Radio & TV 627 E Maume St Adrian Mich
 Millers Falls Co 57 Wells St Greenfield Mass
 Milwaukee Record Changer 39 Warren New York NY
 Milwaukee Resistor 700 W Virginia Milwaukee 4 Wis
 Milwaukee Transformer 5231 N Hopkins St Milwaukee
 Milwaukee Truck 6511 W State St Milwaukee Wis
 Minn-Honeywell Reg Co Transistor Div 2753 4 Ave S Minneapolis 8 Minn
 Minn Mining & Mfg 900 Faugler Ave St Paul Minn
 Miracle Adhesives Corp 214 E 53 St New York 22 NY
 Mitchell Industries PO Box 17 Mineral Wells Texas
 Mitchell Mfg Co 2525 Cloyburn Ave Chicago 14 III
 Mitchell Rand Insulation 51 Murray St New York 7 NY
 Mi-Tee Midget Antennas High Point NC
 Mobil Electronics 1111 State Rd 67 E Anderson Ind
 Model Eng's & Mfg Co 50 Frederick St Huntington Ind
 Modern-Aire Mfg 4436 W Roosevelt Rd Chicago III
 Modern Wire 39-30 Review Ave Long Island City NY
 Mohawk Wire & Cable Corp 320 River St Fitchburg Mass
 Molo-Richardson 937 N Sycamore Ave Hollywood 38 Calif
 Monarch Condenser 550 Westchester Ave New York 55 NY
 Montilla LP Record Co 447 W 50 St New York NY
 Moody Machine Products 42 Dudley St Providence 5 RI
 Moore Tower & Equip 1st National Bank Bldg Peoria III
 Moran Electronic 7660 Woodbury Silver Spring Md
 Morgan-Rheln Inc 2319 MeRaue Ave Orlando Fla
 Morrow Radio Mfg Co 2794 Market St Salem Ore
 Mosley Electronics 8622 St Charles Rock St Louis Mo
 Motorola Inc 4545 Augusta Blvd Chicago 51 III
 Moulic Specialties Bloomington III
 MP Eng's Co Fairfield 3 Conn
 Muecke Mfg Co Owatonna Minn
 Muecon Corp 9 St Francis St Newark 5 NJ
 Mueller Electric Co 1501 E 31 St Cleveland Ohio
 Mueller Mfg Co 23 Tusean Rd Maplewood NJ
 Multicore Sales 80 Shore Rd Port Washington NY
 Multi-Tron Lab 4624 Washington Blvd Chicago 44 III
 Munston Mfg & Service Beech St Islip NY
 Muntz TV Inc 1000 Grey Ave Evanston III
 Musical Masterpieces 43 W 61 St New York NY
 Musitapes Inc 8540 Sunset Blvd Hollywood 46 Calif

Nagel-Chase Mfg Co 2811 N Ashland Ave Chicago 13 III
 Nameplates Inc 425 E 101 St Brooklyn 36 NY
 Nat'l Aircraft Corp Electronics Div Burbank Calif
 Nat'l Capacitor Co 60 Washington St Quincy Mass
 Nat'l Carbon Co 30 E 42 St New York 17 NY
 Nat'l Co 61 Sherman St Malden 48 Mass
 Nat'l Electric Products 140 Stanwix St Pittsburgh 22 Pa
 Nat'l Teletable PO Box 1289 High Point NC
 Nat'l Tel-Tronics Corp 52 St Casimir Ave Yonkers NY
 Nat'l Union Electric Corp Orange NJ
 Neal Electronic Co 1307 Hunt Ave Huntsville Ala
 Network Mfg Corp 213 W 5 St Bayonne NJ
 Newcastle Fabrics Corp 153 W 23 St New York 11 NY
 Newcomb Audio Prods 6824 Lexington Hollywood Calif
 New England Electrical Works 365 Main St Lisbon NH

New London Instrument 82 Union New London Conn
 New York Coll Co 40 2 Ave Phoenixville Pa
 Nicholas Equip Co Bellevue Ohio
 Nichols Products Co 325 W Main St Moorestown NJ
 Nichols Wire 1725 Rockingham Rd Davenport Iowa
 Nikoh Tube Co 5000 S Whipple St Chicago 32 III
 Non-Linear Systems Del Mar Airport Del Mar Calif
 Norco Mfg Co 392 Bleeker St New York 14 NY
 North American Model Prod Warwick Va
 North American Phillips Co 100 E 42 St New York NY
 North Hills Electric Co 203-18 35 Ave Bayside 61 NY
 Northern Products Co 2210 N Clark St Chicago 14 III
 Nucleonic Co of America 196 Degraw St Brooklyn 31 NY
 Nylok Corp 14 & Grand Central Elmira Hts NY
 Nyl Electronics Inc 2979 N Ontario St Burbank Calif

Oak Electronics Co 150 Oak St Buffalo NY
 O'Brien Electric 6514 Santa Monica Hollywood Calif
 Oemitec Publications 4308 Milwaukee Ave Chicago 41 III
 Oemitec Mfg Co 3601 Howard St Skokie III
 Ohl Industries 655 Madison Ave New York NY
 Ohl Matheson Chemical Electrical Div New Haven Conn
 Olympe Instrument Labs Cove Wash
 Olympe Radio-TV 34-01 38 Ave Long Island City NY
 Onan & Sons D W 2525 University SE Minneapolis
 Oprton Mfg Co 3223 N Sheffield Ave Chicago 13 III
 Oradio Industries 120 Maryn Rd Opelika Ala
 Ortho Filter Corp 196 Albion Blvd Beverly Hills Calif
 Oryx Sales Co 9015 Wilshire Blvd Beverly Hills Calif
 Overhead Door Corp Hartford City Ind
 Oxford Electric Corp 556 W Monroe St Chicago 6 III

Pacific Electricord 3217 Exposition Pl Los Angeles Calif
 Pacific Mercury 8345 Havenhurst Sargolveda Calif
 Pacific Transducer 11836 W Pico Los Angeles Calif
 Packard-Bell 12333 W Olympic Blvd Los Angeles Calif
 Palmer Inc M V 4002 Fruit Valley Rd Vancouver Wash
 Parapolegols Mfg 10068 Franklin Ave Franklin Park III
 Parker Metal Goods Co 161 Sumner St Worcester Mass
 Par-Metal Products 32-62 49 St Long Island City NY
 Pathfinder Electronics 6836 Lexington Los Angeles Calif
 Pedersen Electronics PO Box 572 Lafayette Calif
 Peerless Prods Industries 812 N Putaski Chicago 51 III
 Peerce Dictation 5900 N Northwest Hwy Chicago 31 III
 Penn Boller & Burner Mfg Fortville Rd Lancaster Pa
 Penn Transformer Corp Bellefonte Pa
 Penn TV Prods Allengy & Trenton Ave Philadelphia Pa
 Pennwood Namechorn 7249 Frankstown Ave Pittsburgh Pa
 Pantron Corp 777 S Tripp Ave Chicago 24 III
 Perfection Electric 2635 S Washburn Ave Chicago 16 III
 Perfection Mica Co 20 N Wacker Dr Chicago III
 Period Tables Henderson Ky
 Permael Tape Corp Highway US #1 New Brunswick NJ
 Perma-Power Co 4727 N Damen Ave Chicago 25 III
 Permoflux Corp 2835 N Kedzie Ave Chicago 18 III
 Permo Inc 6415 N Ravenswood Ave Chicago 26 III
 Peschel Electronics 13 Garden St New Rochelle NY
 Pfanstiel Chemical Corp 104 Lake View Waukegan III
 Phalo Plastics Corp 25 Foster St Worcester 8 Mass
 Phasotron Instrument & Electronic Co S Pasadena Calif
 Phelps Dodge Copper Prods 300 Park Ave New York NY
 Phen-O-Tron Inc 455 Main St New Rochelle NY
 Philco Corp Access Div A & Allegheny Philadelphia 34 Pa
 Philco Corp Tingo & C Sts Philadelphia 34 Pa
 Philharmonic Radio 235 Jersey Ave New Brunswick NJ
 Phillips Mfg Co 2816 Aldrich St S Minneapolis Minn
 Philmore Corp 113 University Pl New York 3 NY
 Philson Mfg Co 60 Sackett St Brooklyn NY
 Phoenix Electronics 50 Island St Lawrence Mass
 Phototypes Inc 248 W 49 St New York 19 NY
 Photocredits Corp New St Glen Cove NY
 Physical Crystals Inc 15 S 1 St Geneva III
 Physical Research Assoc 1 Azurelee Dr Malibu Calif
 Pickering & Co 309 Woods Ave Oceanide LI NY
 Pilot Radio Corp 37-06 36 St Long Island City 1 NY
 Pioneer Electronics 2235 S Carmelina Los Angeles Calif
 Pioneer Gen-E-Motor 5941 W Dickens Ave Chicago 39 III
 Pioneer Mfg Co Hantley III
 Pioneer Scientific 161 Great Neck Rd Great Neck LI NY
 Pipestone Sales Div Pipestone Aviation Pipestone Minn
 Pitman Publishing 2 W 45 St New York NY
 Planet Mfg Corp 225 Belleville Ave Bloomfield NJ
 Planet Prod Products 3902 8 Ave Brooklyn NY
 Plastic Capacitors 2511 W Moffat St Chicago 47 III
 Plastic-Kote Inc 425 Lakeside NW Cleveland 13 Ohio
 Plastold Corp 42-61 24 St Long Island City 3 NY
 Plymouth Electronics 50 Kingsbury St Worcester 3 Mass
 Palamad Corp 43-20 34 St Long Island City NY
 Polymer Corp Reading Pa
 Pomona Electronics Co 1126 W 5 Ave Pomona Calif
 Porcelain Products PO Box 300 Findlay Ohio
 Portable Elec Tools 120 W 83 St Chicago 20 III
 Porter Mfg 1524 Frederick St Racine Wis
 Port-O-Matic Co 438 E 91 St New York 28 NY
 Potter & Brumfield Princeton Ind
 Power Supplies 1005 Olive St Highland III
 Practical Electronics Mfg 2214 S Michigan Chicago III
 Precise Developments 2 Nell Court Oceanide LI NY
 Precise Measurements 942 Kings Hwy Brooklyn 23 NY
 Precision Apparatus Co 70-31 84 St Glendale 27 LI NY
 Precision Electronics 9101 King Ave Franklin Park III
 Precision Equip 3714 N Milwaukee Ave Chicago 41 III
 Precision Radiation Instr 4223 W Jefferson Los Angeles
 Premax Products Niagara Falls NY
 Premier Research Labs 79 7 Ave New York 11 NY
 Prentice-Hall Publ Co 70 5 Ave New York NY
 Press Probe Co 4034 N 6 St Milwaukee 2 Wis
 Presto Recording Corp PO Box 500 Paramus NJ
 Probescope Co 44-05 30 Ave Long Island City NY
 Production Tool & Fixture 37 W Main St Oyster Bay NY
 Progressive "Edu-Kits" 497 Union Ave Brooklyn 11 NY
 Progressive Electronics 41 Hudson St Yonkers NY
 Prosound Corp 175 5 Ave New York 10 NY

LOCALIZER SYMBOLS

The following symbols after the name of each city indicate the type of representative in a particular area.

- DS Distributor Sales
- IS Industrial Sales
- IDS Indus & Distr Sales
- D Distributor
- BO Branch Office
- GV Government Sales
- R Representative
- SE Sales Engineer

Proto Tools 2209 S Santa Fe Los Angeles 54 Calif
Pyramid Electric Co 1445 Hudson Blvd North Bergen NJ
Telephone UNion 5-1776
VP-Gen Sls Mgr—Arnold R Andrews
Sls Mgr—Jobber Div—Jack K Poff
Brand Names—Cartrij-Dry; Glossel; IMP; Metl can;
Twist-Mount; Tyne-Dry; Kool-Sel
Representatives

Calif—Jack Berman Co 1141 So LaCienega Blvd
Los Angeles 35 Calif Phone—Bradshaw 2-9138
Territory: Ariz-S Calif-Clark Co-Nev (Ind &
Jobber)

Calif—E L Berman Co 758 Natoma St San Fran-
cisco 3 Calif Phone—Underhill 3-0317 Territory:
N Calif-Nev except Clark County (Ind &
Jobber)

Colo—McLoud & Raymond Ca 5528 E Colfax Ave
Denver Colo Phone—Freemant 7-3067 Territory:
Colo-N M-Utah-Wyo-El Paso Texas (Ind & Job-
ber) W Montana & S Idaho (Jobber Only)

Ga—Frank C Nickerson & Co 1150 Zanolia Rd
Nw Atlanta Ga Phone—Emerson 8908 Territory:
Fl-Ga-S Carolina (Ind & Jobber) North Caro-
lina (Jobber only)

Ill—Earl Chompon 6459 N Sheridan Road Chicago
26 Illinois Phone—Amherst 2-3565 Territory: E
Wisc-N Ill (Jobbers only)

Ill—John G Twist & Co 2800 No Milwaukee Ave
Chicago 18 Ill Phone—Humboldt 9-2550 Terri-
tory: E Wisc & N Ill (Ind only)

Ind—Kenneth G Reinhardt R 10 Box 319L In-
dianapolis Ind Phone—Blackstone 6341 Terri-
tory: Ind & Ky (Jobber only)

Ind—William Meily 4017 So Garrison Ft Wayne
Ind Phone—Kenmore 2-4611 Territory: Ind &
Ky & Berrien City-Mich (Ind only)

Mo—William G Kelly 9106 Central Kansas City 14
Mo Territory: Iowa & Neb (Ind & Jobber)

Mass—Masher & Peyer Co Inc 1116 Great Plain
Ave Needham Mass Phone—Needham 3-3773
Territory: New England (Ind & Jobber)

Mich—Tri-Onic Sales Co Inc 13331 Livernois De-
troit 38 Mich Territory: Michigan Except Ber-
rien City for Ind (Ind & Jobber)

Minn—Don V Hamilton & Co 6516 Normandale
Road Minneapolis 10 Minn Phone—West 9-
8286 Territory: Minn-N D-S D-W Wisc (Ind &
Jobber)

Mo—Theodore B Lowell P O Box 21 Normandy
Branch St Louis 21 Mo Phone—Mulberry 7803
Territory: S Ill-Kan-Mo (Ind & Jobber)

N J—Art Cerf & Co 744 Broad St Newark 2 New
Jersey Phone—Mitchell 2-6734 Territory: D C-
Del-Md-N J-N Y-E Pa-Va (Jobber only)

N J—Electronic Sales Assoc Inc 107 Broadway E
Paterson N J Territory: N New Jersey (Ind
only)

N Y—William A Franklin 3 Holly Road North Syra-
cuse New York Phone—Syr 5-4383 Territory:
New York State (except Met Area-Ind only)

N Y—Fred Spellman 200 Plandome Rd Manhasset
LI NY (Industrial only) covering Metropolitan
NY

Ohio—Mike Roth Sales Co 13947 Cedar Road Cleve-
land 18 Ohio Phone—Yellowstone 2-4262 Terri-
tory: Ohio-W Pa-W Va (Ind & Jobber)

Po—Howard Fairbanks 1615 Darby Road Havertown
Pa Phone—Granite 2-2467 Territory: E Pa-S
N J (Ind only)

Md—R B Barnhill & Assoc 412 Woodbine Ave Tow-
son 4 Md Phone—Valley 5-3431 Territory: Md-
Del-D C-Va-N Carolina (Ind only)

Tenn—Al Engelman Co 3205 Crump Ave Memphis
Tenn Phone—48-6263 Territory: Ala-Miss-Tenn
(Ind & Jobber)

Texas—J Earl Smith 505 Na Ervay St Dallas 1 Texas
Phone—Randolph 2966 Territory: Ark-La-Okla-
Texas except El Paso (Ind & Jobber)

Wash—Fred H Haight Co 3212 Eastlake Ave Seattle
2 Washington Phone—East 1818 Territory:
Oregon-Idaho-Montana-Br Col-Washington (Ind
only)

Wash—Frank Wedel Co 3215 Western Ave Seattle
1 Washington Territory: Br Cal-Washington-
Oregon-N Idaho-E Montana-Alaska (Jobber
only)

Pyramid Instrument Corp 630 Merrick Rd Lynbrook NY

Q-Line Mfg Corp 1562 61 St Brooklyn 19 NY
Quaker Industries 2140 W 60 St Kenosha Wisc
Quam-Nichols Co 234 E Marquette Rd Chicago 37 Ill
Quintrole Co 395 St John St Spartanburg SC
Quincy Speaker Mfg Corp 221 Oak St Quincy Ill

Racon Electric Co 1261 Broadway New York 1 NY
Rada-Phone Corp 609 W Fulton St Chicago 10 Ill
Radiart Corp 3455 Vega Ave Cleveland 13 Ohio
Radio City Products Co Centre & Glendale Sts Easton Pa
Radio Condenser Co Davis & Copewood Sts Camden NJ
Radio Corp of America Camden NJ
Radio Corp of America RCA Tube Div Harrison NJ

D Y Smith—Vice President and General Manager
L F Holleran—General Marketing Manager
L F Holleran—Sales Manager (Acting)
D M Branigan—Manager Distributor Sales
Distributor Sales Regional Sales Offices:
Northeastern District—RCA Room 2301 200 Berkeley
St Boston Mass HUbbard 2-1700
Eastern District—RCA 36 W 49th St New York NY
JUdson 6-3800
Southeastern District—RCA 522-33 Forsyth Bldg
Forsyth and Luckie Sts NW Atlanta Ga LAmor
7703
East Central District—RCA 1600 Keith Bldg 1621
Euclid Ave Cleveland Ohio CHerry 1-3450
Central District—RCA Merchandise Mart Room 1186
Chicago Illinois DElaware 7-0700

West Central District—RCA 340 Dierks Bldg 1006
Grand Ave Kansas City Mo HARRison 6480
Southwestern District—RCA 1907-11 McKinney Ave
Dallas Texas RIVERSide 1371
Western District—RCA 1560 N Vine St Hollywood
Calif HOLLYwood 9-2154

Radio Corp of America Record Div 630 5 Ave New York
Radio Craftsmen 4400 N Ravenswood Ave Chicago 40 Ill
Radio Devel & Research 26 Cornell Jersey City 4 NJ
Radio Eng's Labs 36-40 37 St Long Island City 1 NY
Radio Merchandise Sales 2016 Bronxdale New York NY
Radio Music Corp 84 S Water St Port Chester NY
Radio Corp 1130 W Wisconsin Ave Chicago 14 Ill
Radio Reception Co 251 W 19 St New York 11 NY
Radio Supply & Eng's Co 85 Selden St Detroit 1 Mich
Radix Wire Co 26260 Lakeland Blvd Cleveland 32 Ohio
Ram Electronics S Buckhout St Irvington-on-Hudson NY
Ramsey Radio & TV Co 925 St Louis Ave Vandalia Ill
Rangertone Inc 73 Winthrop St Newark 4 NJ
Rapid Electric Co 2881 Middletown Rd Bronx 61 NY
Rare Earths Inc Box 488 Tompkins Plains NJ
Rason Mfg Co 3050 W 21 St Brooklyn 24 NY
Rauland-Borg Corp 3515 W Addison St Chicago 18 Ill
Rauland Corp 4245 N Knox Ave Chicago Ill
Ray-O-Vac Co 212 E Washington St Madison 10 Wisc
Ray-Par Inc 7810 W Addison St Chicago 13 Ill
Raytheon Mfg TV-Radio 5921 W Dikens Chicago Ill
Raytheon Mfg Co Equip Sales Waltham Mass
Raytheon Mfg Co 55 Chapel St Newton 58 Mass (Re-
ceiving and Cathode Ray Tube Operations)

Albuquerque-R—Ronald G Bowen Co C T Carlberg
210 Cagua Drive NE PO Box 3177 Station D
Phone 5-4603

Atlanta-R—F C Nickerson Co 1150 Zanolia Rd
Emerson 8908 Covers N & S Car-Go-E Fla
Birmingham-R—G O Jesse 919 Palmetto Street
TRemont 1-5316 Covers Tenn-Ala-Miss-NW Fla
Boston-R—Arthur E Akeroyd John Hancock Bldg
Rm 2311 HANcock 6-2433 Covers Me-NH-Vt-
Conn-Mass-Rl

Buffalo-R—Art Cerf & Co L J McTaggart 116 Eise-
man Ave Kenmore 17 NY-Buffalo Riverside 1009
Covers Western NY State

Chicago-R—E Ralph Haines 949 Lake St Oak Park
Ill EUclid 6-4476 Covers E Wisc-Ill
Cleveland-R—Neal Bear Corp 3435 Streetsboro
Road West Richfield Ohio OLiver 9-3331 Covers
Ohio W Pa-W Va

Dallas-R—Campian Sales Co 9002 Chancellor Row
Fleetwood 7-4095 Covers Texas-Louisiana
Dayton-R—Neal Bear Corp R E Whelan 136 W
Second Street

Denver-R—Ronald G Bowen Co 446 Broadway
SHERman 4-2501 Covers E Mont-Wyo-Utah-Cola-
N Mex

Des Moines-R—Kay Sales Co Ralph Sharp 3807
Adams St DEs Moines 5-4584

Detroit-R—K C Purcaw Suite 207 22128 Grand
River Ave KENwood 3-7700 Covers Michigan

Kans City-R—Kay Sales Co 2600 Grand Ave BAlti-
more 3800 Covers Neb-Iowa-Mo-Kan-Ark-Okla
Los Angeles-R—J J Perlmuth 2419 S Grand Ave
Richmond 7-4321 Covers S Cal-Ariz-Hawaii

Louisville-R—Cabb Sales Co 1629 Portland Ave
CLay 9406 Covers Ind-Ky

Miami-R—F C Nickerson Co W B Brown 723 NE
112th St Biscayne Park Plaza 7-4452

Minneapolis-R—Fred B Hill Co 6110 Excelsior Blvd
West 9-6727 Covers N & S Dak-Minn-W Wisc
Philadelphia-R—L D Lowery Inc 50 E Wynnewood
Rd Wynnewood Pa Midway 2-9100 9101 9102
Covers E Pa-NJ-Md-Dist Cal-Del-Va

Portland-R—Don H Burcham Co 510 NW 19th
Ave Capitol 7-3830 Covers Wash-Ore-Idaho-
W Mont-Alaska-Br Columbia

St Louis-R—Kay Sales Co E H Murly 3505 Ridgedale
Ave

San Francisco-R—Harold L Newman 420 Market St
YUkon 6-3897 Covers N Cal-Nev

Seattle-R—Don H Burcham Co R M Loughrey 1327
Norcross Way

Syracuse-R—Art Cerf & Co William Ferguson 117
Fayette St Manlius NY MAnlius 62-3301 Covers
Eastern NY State

Toronto-R—John S Plewes Co 52 Humbcrest Blvd
ROper 2051 Covers Quebec Ontario

Raytronc Labs Inc 9701 Reading Rd Cincinnati 15 Ohio
R & B Electronics Box 6998 Washington 20 DC
R-Columbia Products Co 305 Waukegan Avs Highwood Ill
Recora Co 56 W 103 St Chicago 28 Ill
Recorded Tape of the Month 449 W 51 New York 19 NY
Recordise Corp 395 Broadway New York 13 NY
Reconitor Corp 52-35 Barnett Ave Long Island City 4 NY
Rectifier Eng'g 1803 E 7 St Los Angeles 21 Calif
Reed & Prince Mfg Co 10 Duncan Ave Worcester 1 Mass
Reeves Soundcraft Corp 10 E 52 St New York 22 NY
Regency Div Idea 7900 Pendleton Pike Indianapolis Ind
Rego Insulated Wire Co 830 Monroe St Hoboken NJ
Reiter Co F 3340 Bonnie Hill Dr Hollywood 28 Calif
Rek-O-Kut Co 38-01 Queens Blvd Long Island City 1 NY
Reliable Electronics Corp 30 Irvin Ave Collingswood NJ
Remington Rand 1902 W Minnehaha St Paul Minn
Remington Records 551 5 Ave New York NY
Reon Resistor Corp 117 Stanley Ave Yonkers NY
Replica Records 7220 Westview Dr Des Plains Ill

Research Inventions 617 F St NW Washington 1 DC
Resistance Products Co 914 S 13 St Harrisburg Pa
Resistors Inc 5226 W 26 St Chicago 50 Ill
Retron Corp 697 N Lake Ave Pasadena 6 Calif
Revere Camera Co 320 E 21 St Chicago Ill
Revere Corp of America Wallingford Conn
Rhodes & Sons M 12 Porter St Taunton Mass
Richardson-Allen Corp 116-15 15 Ave College Point NY
Richard-Wileox Mfg Co Aurora Ill
Rider Publisher John F 480 Canal New York 13 NY
Rinehart & Co 232 Madison Ave New York 16 NY
Ripley Co Middletown Conn
Ristaurat Inc 1216 E Wisc Ave Appleton Wisc
Rite-Lite Mfg Co 3243 W Lawrence Ave Chicago 25 Ill
River Edge Sale 80 Shore Rd Port Washington NY
R J Audio Products 80 Shore Rd Port Washington NY
R K Mfg Co PO Box 112 Marlon Ill
Roanwell Corp 662 Pacific St Brooklyn NY
Robertson & Roth Box 534 Elmhurst Ill
Robins Industries Corp 214-26 41 Ave Bayside 61 NY
Roche Co Paul C 11 Park Place New York 7 NY
Rochester Iron & Metal 335 St Paul St Rochester NY
Rockbar Corp 215 E 37 St New York 16 NY
Rogal Tube Bending 3543 S Normal Blvd Chicago Ill
Rogan Bros 8031 N Monticello Ave Skokie Ill
Rogers Electronic Corp 49 Bleecker St New York 12 NY
Rohn Mfg Co 116 Limestone Bellevue Peoria 5 Ill
Rola Co 2330 Superior Ave Cleveland 14 Ohio
Roland Radio 716 S Columbus Ave Mt Vernon NY
Romar Plastics Inc 1311 E Main St New York NY
Ronetta Acoustical 135 Front St New York NY
Ross Mfg Co 5031 Broadway Chicago 40 Ill
Row Industries 1702 Wayne St Toledo 9 Ohio
Royal Diamond Tool Co 172 Green St Boston 3 Mass
Royal Electric Co 95 Grand Ave Pawtucket RI
Runzel Card & Wire 4727 Montrose Ave Chicago 41 Ill
Russell Speaker Co 6158 S Kedzie Ave Chicago Ill
Ryan Industries 10910 S Vermont Ave Los Angeles Calif

S & A Electronics 1025 Nevada St Toledo 5 Ohio
Safety Nail Drive Corp Clifton NJ
Sams & Co Howard W 2201 E 46 St Indianapolis 5 Ind
Sangamo Electric Co Marlon Ill
Sargent-Raymont 1401 Middle Harbor Rd Oakland Calif
Saxtonburg Ceramics Saxtonburg Pa
Saxton Products Inc 2101 Grand Concourse Bronx 53 NY
Scala Radio Co 2814 19 St San Francisco Calif
Schauer Mfg Co 45 Alpine St Cincinnati 36 Ohio
Schupack Supply 7331 Cottage Grove Ave Chicago 19 Ill
Scientific Book Publ Vincennes Ind
Scientific Coll Co 5619 Broadway Chicago 40 Ill
S/C Laboratories Inc 37 George St Newark 5 NJ
Scott Inc H H 385 Putnam Ave Cambridge 39 Mass
Scott Radio Labs Liberty St Plymouth Ind
Seranton Aluminum 419 S Wyoming Seranton Pa
Seco Bfg Co 5015 Penn Ave S Minneapolis 19 Minn
Seeburg Corp J P 1510 N Dayton Chicago Ill
Seco Records 39 W 60 St New York NY
Self-Lifting Plano Truck Co Findlay Ohio
Sel-Soa Electronic Tube Corp Darby Pa
Sentinal Radio Corp 2100 Dempster St Evanston Ill
Sequoia Process Corp 871 Willow St Redwood City Calif
Service Instruments Co 171 Official Rd Addison Ill
Service Parts Sys 13380 E 9 Mile Rd E Detroit Mich
Service Welding Co Cedar Grove Wisc
Sessions Clock Co 61 E Main St Forestville Conn
Setchell-Carlson 330 5 Ave N New Brighton Minn
Shalleoss Mfg Co 520 Pusey Ave Collingdale Pa
Shallite Inc 10 Mill St Paterson 1 NJ
Shasta Div Beckman Instruments Inc Richmond Calif
Sherick Products 86-11 Sancho St Hollis 23 LI NY
Sherwood Electronic Labs 2802 W Cullom Chicago 18 Ill
Shober Organ Corp 35 Dial St New Hyde Park NY
Shrader Sound Inc 2803 M 44th NW Washington 7 DC
Shura-Tone Products Inc 40 Adolph St Brooklyn NY
Shure Bros 222 Hartney Ave Evanston Ill
Shurite Meters 61 Hamilton St New Haven Conn
Sightmaster Corp 111 Cedar St New Rochelle NY
Signalite Inc 37-41 Neptune Hwy Neptune NJ
Silicone Spray Products 3534 Lee Rd Cleveland 22 Ohio
Simpson Electric Co 5208 W Kinzie St Chicago 44 Ill
Simpson Mfg Mark 32-29 49 St Long Island City 3 NY
Sinko Mfg & Tool Co 3135 W Grand Ave Chicago 22 Ill
Sittler Corp 18 N Ada St Chicago 7 Ill
Skill Corp 5033 Elston Ave Chicago 30 Ill
Skottite Electronics Inc 204 Bridge St Peckville Pa
Skyline Mfg Co 1652 Rockwell Cleveland Ohio
Sky Ray Mfg Co 109 Heard St McLeansboro Ill
Skysweeper Inc PO Box 92 McHenry Ill
Smithgull Inc 360 W 8 St Erie Pa
Smith Heat Treating 5869 Wilmington Los Angeles
Smith Inc H H 2326 Monstrand Ave Brooklyn 10 NY
Smolin Labs 721 Walton Ave New York 51 NY
SNC Mfg Co PO Box 277 Oshkosh Wisc
Snyder Mfg Co 22 & Ontario Sts Philadelphia Pa
Sola Electric Co 4633 W 16 St Chicago 50 Ill
Sonar Radio 3050 W 21 St Brooklyn 24 NY
Sonex Inc 245 Sansom St Upper Darby Pa
Sonic Ind 30-30 Northern Blvd Long Island City NY
Sonic Recording Products 58 Mill Rd Freeport NY
Sonora Radio & TV 2023 W Carroll Ave Chicago 12 Ill
Sonotone Corp 570 5 Ave New York NY
SOS Cinema Supply 602 W 52 St New York 19 NY
Southern Industries 1401 Reisterstown Rd Baltimore Md
South River Metal Products 377 Turnpike South River NJ
Southwestern Industrial Electr 2831 Post Oak Houston Tex
Spaulding Products Co 550 W Barner St Frankfurt Ind
Speak-O-Phone Recording 23 W 60 St New York 23 NY
Special Instruments Lab 312 W Vine St Knoxville Tenn
Special Products Co PO Box 188 Rockville 9 Md
Specialty Assembling 79 Clinton Pl Brooklyn 38 NY
Spectratone Sound 66 E Gloucester Pike Barrington NJ
Speedway Mfg Co 1834 S Laramie Ave Cleero 50 Ill
Spencer-Kennedy 1320 Soldiers Field Rd Boston 35 Mass
Spirling Products Co PO Box 411 Hicksville NY
Sprague Products Co North Adams Mass
S & R Electronics 297 Central Ave Bethpage NY
Stackpole Carbon Electronic Components Div St Marys Pa



Stanch-Hoffman 921 N Highland Ave Hollywood 38 Calif
Standard Coil Prods 2085 N Hawthorne Melrose Park III
Standard Electrical Products 2240 E 3 St Dayton 3 Ohio
Standard TV Tube 706 Dryades St New Orleans 12 La
Standard Winding Co 44 Johnes St Newburgh NY
Standard Wood Products 47 W 63 St New York 23 NY
Stanley Works Hdq Div 195 Lake St New Britain Conn
Stanwick Winding Co 137 Walsh Ave Newburgh NY
Star Expansion Products 142 Liberty St New York 6 NY
Star Fuse Co 235 Canal St New York 13 NY
Stark Mfg PO Box 489 Tuscaloosa Ala
Star Record Co 243 W 72 St New York NY
States Co 19 New Park Ave Hartford 6 Conn
Steelman Pleno & Radio 230 Anderson Mt Vernon NY
Stephens Mfg Corp 8538 Warner Dr Culver City Calif
Sterling Mfg Co 7201 Wentworth Ave Cleveland Ohio
Stevens Products 86 Main St E Orange NJ
Stevens Walden Inc 467 Shrewsbury St Worcester Mass
Stone Machine & Tool Co Bedford Ind
Stratford TV 2555 W 21 St Chicago 8 Ill
Streamline Wood Prods 4849 N Cleora Chicago III
Stromberg-Carlson Co 100 Carlson Rd Rochester NY
Struthers-Dunn Lamb's Rd Pitman NJ
Summit Electronics Inc 7 Industrial Pl Summit NJ
Summit Eng'g Co 3324 Main St Hartford Conn
Super Ear Products Co 675 Merrick Rd Lynbrook NY
Superelex Electronics Corp 4-6 Radford Pl Yonkers NY
Superior Instrument 2435 White Plains Rd New York NY
Superior Insulated Wire W Haverstraw NY
Superior Rectifier 3000 Kenwood St Hammond Ind
Supreme Instrument Corp PO Box 552 Greenwood Miss
Supreme Publications 1760 Balsam Rd Highland Park III
Sutton Electronic Co 424 W Short St Lexington Ky
Switchcraft Inc 1328 N Halsted St Chicago 22 Ill
Sylvania Electric Products 1740 Bdw New York 19 NY

Telephone Judson 6-2424
Sales Manager—H H Rainier
Special Sales Rep—W J Hopkins
Eastern Region—Sylvania 1740 Broadway New York
19 New York JU 6-2424 G C Isham Regional
Manager

Metropolitan District—Sylvania 1000 Huyler St Te-
terboro NJ Hasbrouck Heights 8-9484 J J Mc-
Carthy District Manager

Mid-Atlantic District—Sylvania 4700 Parkside Ave-
nue Philadelphia Pa Greenwood 7-5000 R C
Hoffman District Manager

Mid-Eastern District—Sylvania 300 Mt Lebanon
Blvd Pittsburgh 34 Pa LEhigh 1-4975 J B
Pomeroy District Manager

Northeastern District—Sylvania 100 Sylvan Road
Woburn Mass Woburn 2-3500 S J McDonald
District Manager

Southeastern District—Sylvania 660 Murphy Ave S
W Atlanta Georgia Amherst 1673 W T Busch-
mann District Manager

Midwest Region—Sylvania 2001 N Cornell Ave Mel-
rose Park Ill Estebrook 9-2525 E B McEvoy
Regional Manager

East Central District—Sylvania 4848 West 130th St
Cleveland Ohio Clearwater 2-0500 J P Vail
District Manager

Central District—Sylvania 2001 N Cornell Ave Mel-
rose Park Ill Estebrook 9-3535 R L McNelis
District Manager

Southwestern District—Sylvania 100 Fordyce Street
Dallas Texas Riverside 4836 J A Still District
Manager

Western District—Sylvania 450 Funston Road Kansas
City Kansas Drexel 3773 E J Haese District
Manager

Pacific Coast Region—Sylvania 215 Market St Rm
1200 S Francisco Cal Garfield 1-1846 W G
Patterson Regional Manager

Northwestern District—Sylvania 3466 East Marginal
Way Seattle Wash Main 6888 R P Guion Dist-
rict Manager

Northern California District—Sylvania 6450 Hollis
St Emeryville Calif Olympic 3-0457 W L Wroy
District Manager

Southern California District—Sylvania 2936 East
46th St Los Angeles Calif Logan 5-8121 E A
Larson District Manager

Symphonic Radio 160 Washington St N Boston 8 Mass

Tables Inc 5105 W Lawrence Ave Chicago III
Talley Electronic Davel 800 Schmidt Bldg Cincinnati O
Talk-A-Phone Co 1512 S Putaski Rd Chicago 23 Ill
Tampa Video Service 6105 Interbay Blvd Tampa 9 Fla
Tannoy (America) Ltd 38 Pearl St New York 4 NY
Tape Recorders Inc 1501 W Congress St Chicago 7 Ill
Tazlan Inc Sarkes 415 N College Ave Bloomington Ind
Tate Inc Albert J 85 Columbia Dr Williamsport 21 NY
Talkmaster Inc 534 Laurel St San Carlos Calif
Taylorel Corp 3 Ratter St Rochester 6 NY
Taylor Mfg Co 302 S Union St Lima Ohio
Taylor Tubes Inc 2313 Wabansia Ave Chicago 47 Ill
Tech-Master Corp 75 Front St Brooklyn 1 NY
Techneraft Co 1156 Commonwealth Ave Boston 34 Mass
Tech-Ohm Resistor 36-11 33 St Long Island City NY
Technical Apparatus Builders 109 Liberty New York NY
Technical Appliance Corp 1 Taco Ave Sherburne NY

Phone—Sherburne 7-2211
President—H H Brown

Vice Pres Sales—Tore Lundahl
Vice Pres Commercial Div—Kendrick Lippitt
Sales Pro Mgr—Fred R Voorhaar

Chief Engineer—Robert T. Leitner
Credit Mgr—William H Resch
Purchasing Agent—Harold Senkel
Buffalo—Leonard D Allen Inc 109 Easton Ave Hum-
boldt 6511

Casselberry (Fla)—John C Wagner Atcheson &
Adams Box 105 Fern Park Post Office Winter
Park 27-2562

Chicago—A H Bruning Co 2215 Wilson Ave EDge-
water 4-0989, 4-0990, 4-0991

Cincinnati—John O Olsen Co 6225 Joyce Lane JEF-
erson 1-3998

Cleveland—John O Olsen Co 16201 Shaker Blvd
WYoming 1-2624

Dallas—John B Guenther 4533 No Central Express-
way Justin 6286

Detroit—R C Merchant & Co Inc 4829 Woodward
Ave Temple 1-1677

Denver—Koehler-Cox Co 120 W 13th Ave MA 3-3544
Greensboro—Atcheson & Adams Suite 315 601 North
Elm St Bldg Phone 2-6838

Kansas City—W E Fry & Co 406 North 34th St
Jefferson 1-5236

Los Angeles—Lee H Owens Co 2331 W Washington
Blvd Republic 5-0203

Minneapolis—The Heimann Co 1711 Hawthorne Ave
Federal 2-5457

Nashville—E E Scott Atcheson & Adams PO Box 157
DOnelson 6-2429

Needham (Mass)—Stanley A Harris Co 317 Chestnut
St Phone 3-4780

New York—Cliff Landis Sales Co 81-11 Roosevelt
Ave ILincoln 8-7900

Philadelphia—Somuel K Macdonald Inc 1531 Spruce
St Kingsley 5-1205

Pittsburgh—John O Olsen Co 3552 Wallace Drive
TUxedo 4-0472

San Carlos (Cal)—David H Ross Co 534 El Camino
Real Lyell 3-8224

Seattle—James J Backer Co 221 West Goler St
ALder 6470

St Louis—W E Fry & Co 4378 Lindell Blvd Jefferson
5-1434

Syracuse—Leonard D Allen Inc 2401 South State
St Phone 4-4195

Toronto—Hockbusch Electronics Ltd 23 Primrose Ave
Melrose 2453

Washington—Samuel K Macdonald Inc 217 Riggs
Bank Bldg 3308-14th St NW Columbia 5-3938

Technical Tape Corp 177 St & Harlem River Bronx NY
Technics Inc 178 Central Ave Hackensack NJ
Tektronix Inc PO Box 831 Portland 7 Ore

Tel-A-Ray Enterprises 335 Clay St Henderson Ky
Telex Electronics Mfg Co 919 Taylor Ave Rockford III
Tele-Beam Industries 6 & Soscol Ave Napa Calif

Telebeam Inc 88 Merrick Rd Amityville LI NY
Tele-Clear Corp 185 N Wabash Ave Chicago 60 Ill
Telecom Inc 1019 Admiral Blvd Kansas City 8 Mo

Teletro Industries 35-16 37 St Long Island City NY
Tele-Diagnosis Co 155 W 72 St New York 32 NY
Tele-Ex Prod Products Sales Corp Berwick Pa

Telematic Industries Inc 16 Howard Ave Brooklyn 21 NY
Tele Plastics Co 202 Broadway Brooklyn NY
Tele-Ray Tube Co 984 Sawmill River Rd Yonkers NY

Telesine Antenna Corp 3421 Terry Rd Jackson 3 Miss
Teletenna Co 1033 Indiana Ave La Porte Ind
Tele-Test Instrument 92-24 Queens Blvd Rego Park NY

Telexco Co 46 Lakeview Ave Yonkers NY
Televisto Corp 1415 Golf Rd Des Plaines Ill
Tele-Vue Towers 701 49 St S St Petersburg 7 Fla

Telex Inc 1633 Euclid St St Paul Minn
Tel-Instrument Electronics 728 Garden St Carlstadt NJ
Telkor Inc PO Box 186 Elyria Ohio

Tell City Furn Co Tell City Ind
Telonic Industries 73 N 2 Ave Beech Grove Ind
Tel-O-Tube Corp 180 Van Riper E Paterson NJ

Tel-Rad Mfg Co 7 Madison St Fennimore Wis
Telrex Labs Hwy 35 Asbury Park NJ
Television Labs Wauconda Ill

Tempe Record 8540 Sennet Blvd Hollywood Calif
Tennalab 417 S 10 St Quincy Ill
Tenna-Lite Corp 1809 N Milwaukee Ave Chicago 47 Ill

Tenna Mfg Co 7580 Garfield Bldg Cleveland 25 Ohio
Tensitron Inc 28 Depot Rd Harvard Mass
Tensolite Insulated Wire Co Tarrytown NY

Tenna Inc 122 E 42 St New York 17 NY
Terado Co 1067 Raymond Ave Depot 2 St Paul 14 Minn
Terwillinger TV Mast Co 531 Lincoln Ave Pontiac Ill

Tescon Inc Springfield Gardens NY
Tetrad Corp 62 St Marys Ave Yonkers 2 NY
Texas Instruments Inc 6000 Lemmon Ave Dallas 9 Texas

Thermador Electrical Mfg Co Electronics Div 2000 Cam-
field Ave Los Angeles 22 Calif
Thomas Associates 4607 Alger St Los Angeles 39 Calif

Thomas Electronics 118 9 St Passaic NJ
Thomas Mold & Die Co Box 126 Wooster Ohio
Thompson-Bremer 520 N Dearborn St Chicago 10 Ill

Thompson Prods Electr Div 2196 Clarkwood Cleveland O
Thordarson Melsner Mt Carmel Ill
Thorens Co New Hyde Park NY

Tibbetts Industries Colcord Ave Camden Me
Time Mfg Co Westminster Mass
Tinnerman Prods PO Box 6688 Dept 16 Cleveland 1 Ohio

Tlpc Co 5865 Wilmington Ave Los Angeles 1 Calif
Todd-Tran Corp 156 Gramatan Ave Mt Vernon NY
Toman & Co E 8700 W 47 St Lyons Ill

Tork Clock Co 1 Grove St Mt Vernon NY
Trad TV Corp 1003 1 Ave Asbury Park NJ
Transcriber Co 98 County St Atleboro Mass

Transformer Metal Prods 343 W 26 St New York 1 NY
Transi-Mite Radio Lab Waukegan Ill
Transistor Products 241 Crescent St Waltham 54 Mass

Transitron Electric Corp 4053 Main Melrose Mass
Transvision Inc New Rochelle NY
Trav-Ler Radio 571 W Jackson Blvd Chicago 6 Ill

Trend Textiles Inc 180 W Randolph St Chicago 1 Ill
Tresco Inc 3824 Terrace St Philadelphia 28 Pa
Triad Transformer Corp 4055 Redwood Ave Venice Calif

Trico Fuse Mfg Co 2948 N 5 St Milwaukee 12 Wis
Triferact Products 1535 N Ashland Ave Chicago 22 Ill
Tri-Dex Electronics PO Box 1207 Lindsay Calif

Trimm Inc 400 W Lake St Libertyville Ill
Trlo Mfg Co Griggsville Ill
Triplett Electrical Instrument Bluffton Ohio

Triumph Mfg Co 1829 S 55 St Chicago 50 Ill
Triwee Transformer 3261 N Milwaukee Ave Chicago III
Trojan Electronics 3706 N Halsted St Chicago 13 Ill

Tru-Pine Co 7638 S Vinennes Ave Chicago 20 Ill
Trutone Electronics 812 N Highland Ave Hollywood Calif
Truxox Mfg Co 575 S Ave New York 16 NY
Tube Service Corp 2 Gaston Ave Garfield NJ
Tung-Sol Electric Inc 95 B Ave Newark 4 NJ
L E Catsen Mgr Renewal Sales

Sales Offices: Tung-Sol Sales Corp
Eastern Div—95 8th Ave Newark 4 NJ W-R Ohlsen
Mgr

Atlanta—1859 Cheshire Bridge Rd NE J B Secrist
Melrose Park III—1975 North Hawthorne Avenue
D L Lindborg Mgr

Columbus—755 W Goodale Blvd J N Hoover Mgr
Culver City—8575 Washington Blvd Charles Silvey
Mgr

Dallas—The Branum Co 1518 Slocum St Mose
Branum

Denver—The James H Blinn Co 1140 Speer Blvd
James H Blinn

Seattle—Ron Merrill Co 120 W Thomas St Ron Mer-
rill

Turner Brass Works 821 Park St Sycamore Ill
Turner Co 909 17 St NE Cedar Rapids Iowa

TV Accessories Co Box 368 Scottsdale Ariz
TV Development 2024 McDonald Ave Brooklyn 23 NY
TV Engineers 3325 Bryn Mawr Ave Chicago 45 Ill

TV Equipment Mfg Co 17 & Sherman Sts Wausau Wis
TV Hdq Mfg Co 919 Taylor Ave Rockford III
TV Products 145-68 228 St Springfield Gardens 18 NY

TV Remote Control 820 N Fairfax Ave Los Angeles Calif
TV Toner Co 40-09 82 St Jackson Heights NY
TV Wire Products Co 119 Prospect Ave Burbank Calif

U H F Resonator Co 1405 16 St Racine Wis
Ultra HI-FI Co 709 Slip St Union City NJ
Ultra-HI TV Mfg Co 69 Hammond St Worcester Mass

U M & F Mfg 10929 Vanowen St N Hollywood Calif
Ungar Electric Tool Co PO Box 332 Venice Calif
Union Plastics Corp Wire & Cable Div Secaucus NJ

Unique Ventilation Co 615 Tiffany St Bronx 59 NY
United Audio Prods 202 E 19 New York NY
United Catalog Publ 106 Lafayette New York 13 NY

United Condenser Corp 3400 Park Ave New York 55 NY
United Electric Controls 85 School Waterturn Mass
United Electronic Mfg Corp 542 39 St Union City NJ

United Mfg Div W L Maxson 41 Halg St Hamden Conn
United Screw & Bolt 2513 W Cullerton St Chicago 8 Ill
United Technical Labs Morristown NJ

United Transformer Co 150 Varick St New York 13 NY
Universal Circuit Controls 3610 Oakton St Skokie Ill
Universal Co High Point NC

Universal Microphone 424 Warren Lane Inglewood Calif
Universal Products 4100 Taylor Ave Racine Wis
Universal Woodcrafters LaPorte Ind

University Loudspeakers 80 S Kenosca White Plains NY
President—Sidney Levy

General Sales Mgr—Lawrence J Epstein
Engineering Mgr—Abraham B Cohen
Purchasing Agent—Seymour Blumenfeld

Adv & Prom Mgr—Irving Greene
Univox Corp 102 Warren St New York 7 NY
Uranla Records Inc 40 E 19 St New York NY

U S Electric Mfg Co 222 W 14 St New York 11 NY
U S Motors Corp 412 Nebraska St Oshkosh Wis
U S Products Inc 1549 Hutchins St Columbus Ind

U S Recording 1121 Vermont NW Washington 5 DC
U S Relay Co 1744 Albion St Los Angeles 31 Calif
U S Wire & Cable Co Progress Ave & Monroe Union NJ

Utah Radio Products 1123 E Franklin Huntington Ind
Utica Drop Forge & Tool 2415 Whitesboro Utica 4 NY
Utilities Service Co 1 Pine St Allentown Pa

Vaco Products Co 317 E Ontario St Chicago 11 Ill
Valor Electronic 5808 Marilyn Culver City Calif
Valpey Crystal Corp 1244 Highland St Holliston Mass

Vanguard Recording 256 W 55 St New York 19 NY
Vanity Fair Electronics 50 S 4 St Brooklyn 11 NY
Van Nostrand Co D 120 Alexander St Princeton NJ

Vareflex Corp 512 W Court St Rome NY
Varicon Corp 65 Hope St Brooklyn 11 NY
Vector Electronic 3352 San Fernando Los Angeles Calif

Vemaline Products Co PO Box 222 Hawthorne NJ
Victor Electric Wire & Cable 64 Ackerman Clifton NJ
Victor Insulators Inc Maple Ave Victor NY

Vidair Electronics Mfg 576 W Merrick Rd Lynbrook NY
Video Accessory Mfg Co Box 223 Tulsa 1 Okla
Video Corp of America 229 W 28 St New York 1 NY

Video Electronic Lab 304 Rodgers Des Moines Iowa
Video Electronic 902 E Mich St Indianapolis 2 Ind
Viking of Minn Inc 3520 E 43 St Minneapolis 6 Minn

Viking Tool & Machine 2 Main St Belleville NJ
Vlneta Mfg 2738 N Sheffield Chicago III
Vsalife Co 423 Broome St New York NY

V-M Corp 280 Park St Benton Harbor Mich
Vocalline Co of America Coulter St Old Saybrook Conn
Vokar Corp 7300 Huron River Dr Dexter Mich

Vox Productions 236 W 55 St New York 19 NY
Vulcan Electric Co 88 Holten St Danvers Mass
Vulcan TV Mast & Tower 1224 National Birmingham Ala

Waldom Electronics 4625 W 53 St Chicago III
Wallaces Telalides 136 Day St Jamaica Plain Mass
Wall Mfg Co P Grove City Pa

Walnut Machine Co 732 Western Ave South Bend Ind
Walco Electronics 3602 Greshaw Los Angeles Calif
Ward Leonard Electric Co Mt Vernon NY

Ward Prods Div Gabriel 1148 Euclid Cleveland Ohio
Manufacturers of antennas for
Auto-TV-FM and Communications

Atlanta—Maitland K Smith Co 317 Forrest Ave WAI-
nut 6094 Covers Alabama; Florida; Georgia;
North Carolina; South Carolina

Boston—Anderson Sales Co 177 State St Capital
7-2980 Covers Connecticut; Maine; Massachu-
setts; New Hampshire; Rhode Island; Vermont

Charlotte-NC—Jim Clymer 2422 Marlow Ave Covers
Ala-Fla-Ga-N C S C
Chicago—William M Linz Co 7115 North Mobile
RO 3-3326 Covers Illinois; East Wisconsin