

TECHNICIAN & Circuit Digests



Santa Salutes

Progress in PARTS & COMPONENTS

December • 1954

HERE'S **WHY** IRC EXACT DUPLICATES ARE DOUBLE-MONEY-BACK **GUARANTEED**

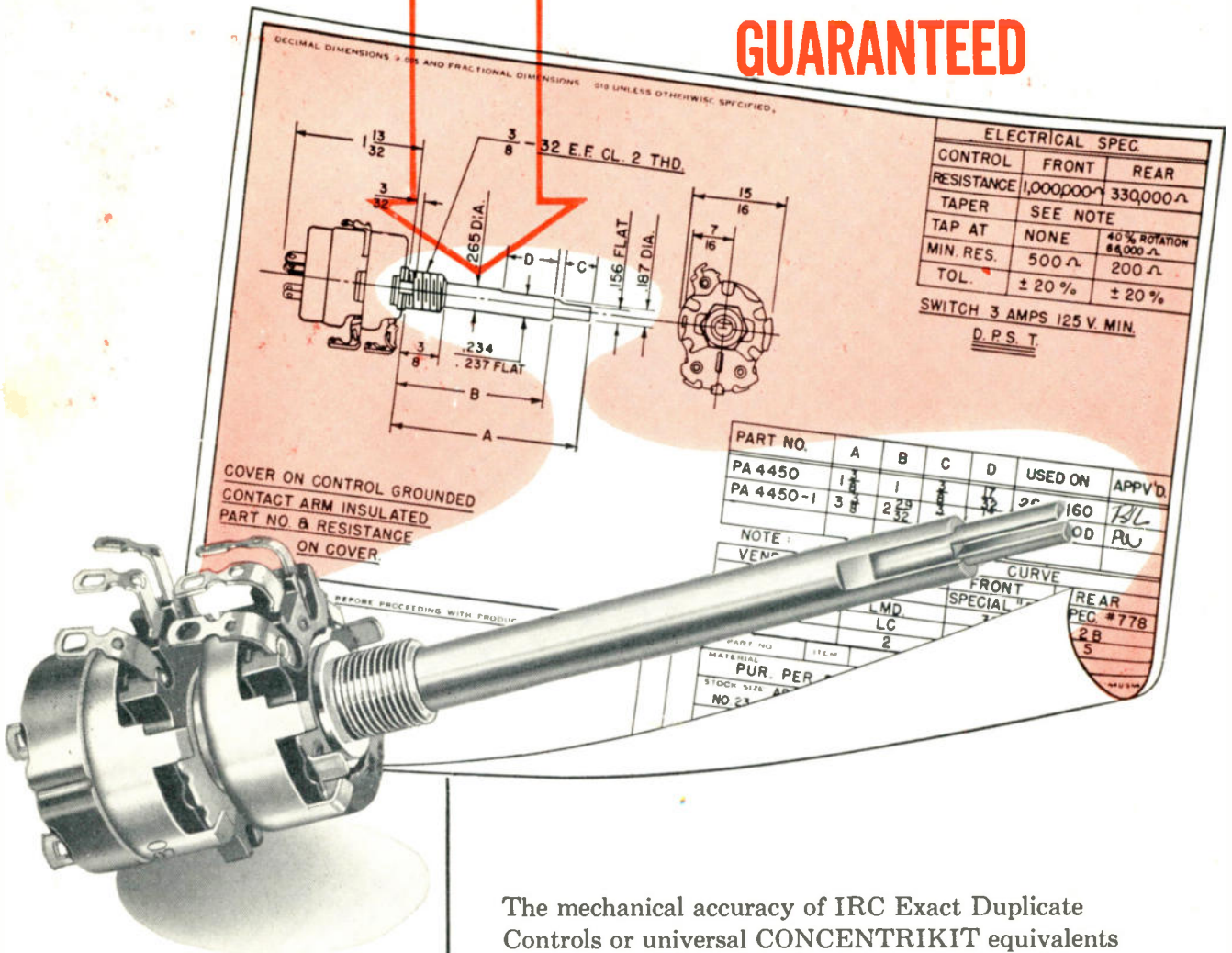

**ONLY IRC GUARANTEES
SATISFACTORY MECHANICAL FIT
AND ELECTRICAL OPERATION
OR DOUBLE-YOUR-MONEY-BACK**

The typical manufacturer's specifications shown here are exactly duplicated by IRC QJ-180 control. CONCENTRIKIT assembly includes P1-229 and R1-312 shafts with B11-137 and B18-132X Base Elements, and 76-2 Switch.



Whenever the Circuit Says ~~~

The mechanical accuracy of IRC Exact Duplicate Controls or universal CONCENTRIKIT equivalents is based on set manufacturers' procurement prints. Specifications on those prints are closely followed.

Shaft lengths are *never less* than the set manufacturer's nominal length—*never more* than $\frac{3}{32}$ " longer.

Shaft ends are precisely tooled for solid fit.

Inner shaft protrusion is accurately duplicated for perfect knob fit.

Alterations are never needed.

For Exact Duplicate Controls, specify IRC. Most Service Technicians do.

INTERNATIONAL RESISTANCE CO.

425 N. Broad Street, Philadelphia 8, Pa.

In Canada: International Resistance Co., Ltd., Toronto, Licensee

TECHNICIAN & Circuit Digests

TELEVISION • ELECTRONIC • RADIO • AUDIO • SERVICE

M. CLEMENTS O. H. CALDWELL
Publisher *Editorial Consultant*
 SIDNEY C. SILVER, *Managing Editor*
 CREIGHTON M. MARCOTT, *Assistant Editor*
 ANN O'ROURKE, *Assistant Editor*
 ALBERT J. FORMAN, *Consulting Editor*
 J. L. STOUTENBURGH, *Consulting Editor*
 DR. A. F. MURRAY, *Contributing Editor*
 CHARLES F. DREYER, *Art Director*
 ELMER KETTERER, *Circuit-Digest Production*
 GEORGE PUGLICI, *Circuit Diagrams*

BUSINESS DEPARTMENT

M. H. NEWTON, *Business Manager*
 H. A. REED, *General Sales Manager*
 LEE GRAVES, *Eastern Sales Manager*
 CHARLES S. ROEVER, *District Manager*
 P. J. CARNESE, *Sales Promotion Manager*
 N. McALLISTER, *Asst. Business Manager*
 ELMER DALTON, *Circulation Manager*
 CAROL YOUNG, *Production Manager*
 KATHLEEN CAFARO, *Reader Service*
 JOHN J. BORGHI, *Controller*
 W. W. SWIGERT, *Credit Manager*
 480 Lexington Ave., New York 17, N. Y.
 Telephone PLaza 9-7880

S. M. GASKINS, *Western Manager*
 JOHN D. LUPTON, *District Manager*
 R. E. SCHULTZ, *District Manager*
 201 N. Wells St., Chicago 6, Ill.
 Telephone RAndolph 6-9225

CHRIS DUNKLE & ASSOCIATES
California Representative
 3257 W. 6th Street, Los Angeles 5, Calif.
 Telephone DUmkirk 7-6149
 1651 Market Street, San Francisco 3
 Telephone UNderhill 3-5282



TECHNICIAN & CIRCUIT DIGESTS® December 1954, Vol. 60, No. 6, \$.50 a copy. Published monthly by Caldwell-Clements Inc., Publication Office, Emmett St., Bristol, Conn. Editorial, Advertising and Executive Offices, 480 Lexington Ave., New York 17, N. Y. Entered as second class matter at the Post Office at Bristol, Conn. June 10, 1954. M. Clements, President; M. H. Newton, Assistant to President; John J. Borghi, Vice President and Secretary; M. B. Clements, Treasurer. Subscription rates: United States and Canada, \$4.00 for one year; \$6.00 for two years; \$8.00 for three years. Pan-American and foreign countries: \$7.00 for one year; \$10.00 for two years; \$14.00 for three years. Printed in U.S.A.

Copyright by
 Caldwell-Clements, Inc., 1954

DECEMBER, 1954

FRONT COVER: We wanted to dramatize this month's emphasis on parts and components on the cover—but we couldn't let December go by without extending our Season's Greetings. We ended up with a way of doing both! Artist Charles F. Dreyer gets the credit for a big assist in his striking execution of cover motif.

| | |
|--|----|
| <i>The Whole—and the Parts; Keeping Ahead</i> | 13 |
| <i>"Tuning in the Picture"</i> | 14 |
| <i>Burst Separator Circuits & Service Problems</i> | 16 |
| Peter Orne | |
| <i>Parts Progress Parade</i> | 18 |
| <i>Tape Recorder Repairs</i> | 19 |
| Charles G. Wescott | |
| <i>Shop Hints</i> | 20 |
| <i>Dynamic Condenser Checking</i> | 21 |
| Arno Tuteur | |
| <i>Test Equipment "Spec" Chart</i> | 23 |
| <i>Antennas & Related Items</i> | 24 |
| <i>Vertical Raster Lines</i> | 25 |
| Cyrus Glickstein | |
| <i>New Parts & Components</i> | 26 |
| <i>New Sound Equipment</i> | 28 |
| <i>New Tubes</i> | 31 |
| <i>"Tough Dog" Corner</i> | 32 |
| <i>Radio-TV Electronic Technician: A Profile</i> | 40 |
| <i>Circuit Digests Cumulative Index</i> | 44 |
| <i>Circuit Digests</i> | 49 |

CBS-Columbia: (Color)
 Models 205C1, 205C2
 Crosley: Chassis 431-2

Emerson: Chassis 120233-D,
 120235-D, 120234-D,
 120236-D, 120238-F
 Stewart-Warner: Models
 17T-9620A, etc.

Stromberg-Carlson: Chassis
 21T-22T Series
 Zenith: Chassis 5R60T

DEPARTMENTS

| | | | |
|------------------------------|----|-------------------------------------|----|
| Letters to the Editors | 6 | Distributors | 38 |
| New Products | 22 | Manufacturers' Catalogs & Bulletins | 42 |
| News of the Industry | 34 | New Books | 43 |
| News of the Reps | 38 | Service Association Reports | 45 |

CALDWELL-CLEMENTS, INC.

Publication Office, Bristol, Conn.

Editorial/Business Offices 480 Lexington Ave., New York 17, N. Y., Tel. Plaza 9-7880

Publishers also of MART and TELE-TECH & ELECTRONIC INDUSTRIES

*Reg. U. S. Patent Office

I'm following the lead of Successful Electronic

SO NATURALLY

I'm building my Electronics Business

On **DELCO** and

UNITED MOTORS SERVICE

DIVISIONS OF GENERAL MOTORS

It's just plain good business to build on solid names like Delco and United Motors Service. They are both names you know for product dependability and business

integrity—names that have won the respect of your customers. And they alone can offer you these advantages that help you to build a more profitable electronic business.

ONE SOURCE

- Delco offers special application parts as well as complete coverage of the most important universal parts groups.

ONE POLICY

- A single sales policy for all electronics parts eliminates the confusion of dealing with many manufacturers.

ONE BILLING OPERATION

- Means fewer records to keep, fewer purchase orders; cuts bookkeeping time and costs to a minimum.

READY-MADE MARKET

- In addition to supplying universal replacement parts, Delco is the sole source for original equipment replacement parts on all Delco radios.

TECHNICAL ASSISTANCE

- Current bulletins and field schools play an important part in keeping the industry well posted on new developments.

DISTRIBUTION

- United Motors Service maintains 21 strategically located warehouses to assure ample supply of all parts.

QUALITY

- You are assured of uniformity of parts, built to high standards of production and to exacting specifications.

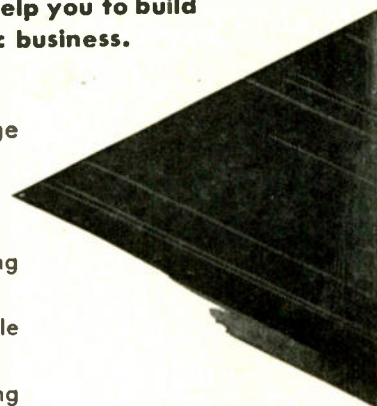

A GENERAL MOTORS PRODUCT



A UNITED MOTORS LINE

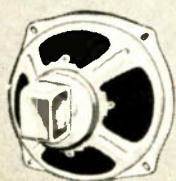

SPEAKERS

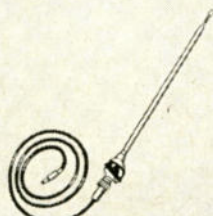

AUTO RADIO AERIALS



VIBRATORS

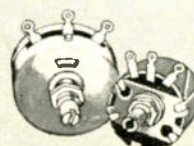

CONTROLS

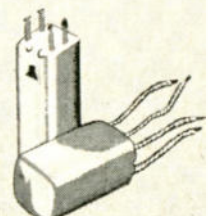

COILS

Parts Distributors-

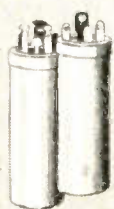
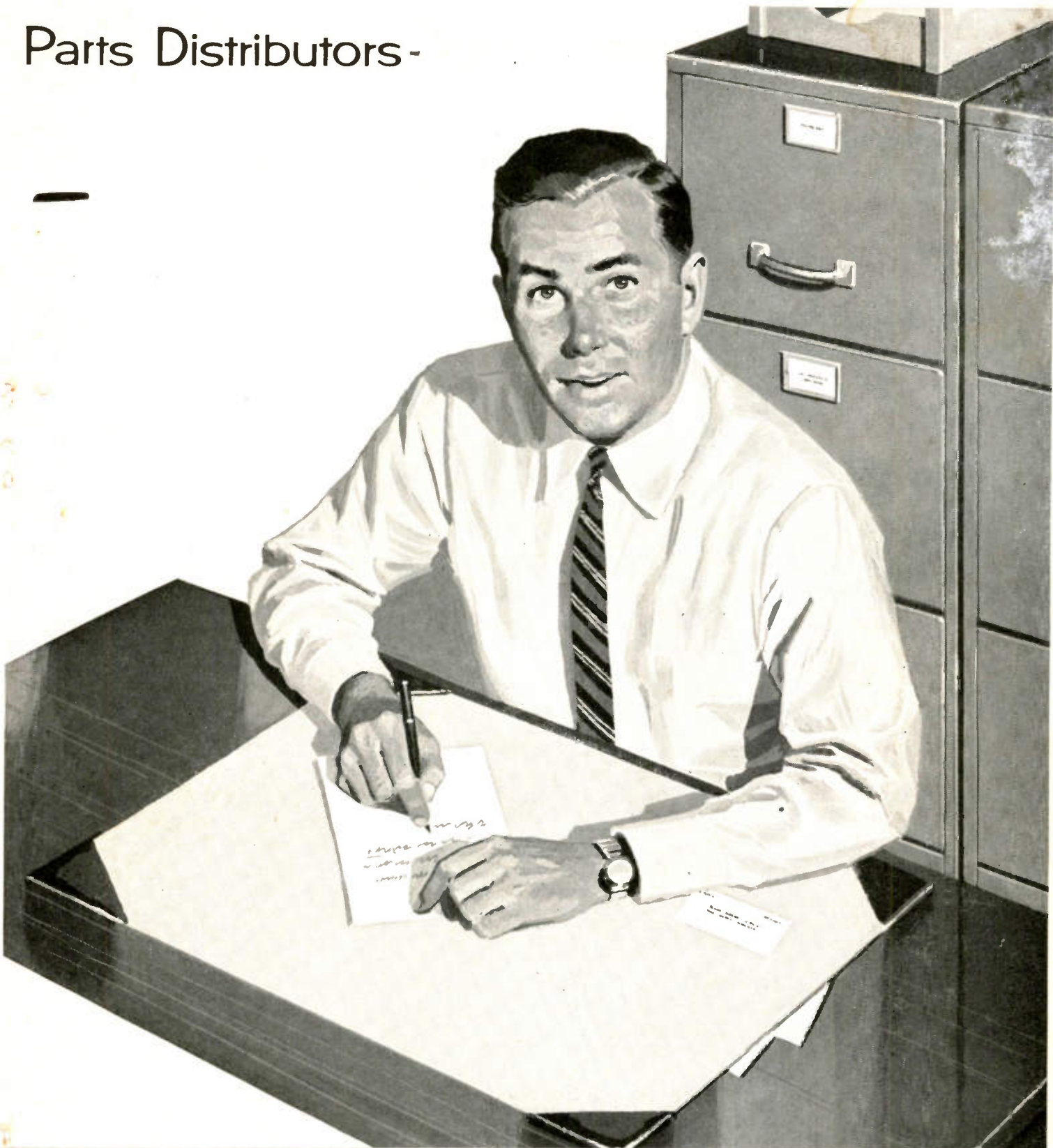

CAPACITORS



RECEIVING TUBES



PICTURE TUBES



SUPPRESSION PARTS

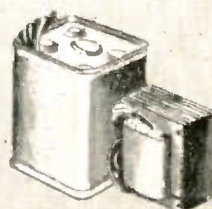

TRANSFORMERS

distance smashers!

Telrex

**SUPER-
PERFORMANCE
4-BAY**

"CONICAL-V-BEAMS"®

- THE FINEST FRINGE AREA ANTENNA EVER PRODUCED
- UNEQUALLED FOR DISTANCES UP TO 200 MILES
- "HURRICANE-BUILT"
—WEIGHT APP. 16 LBS.

The famous Telrex Model 8X-TV, undisputed distance champion for over 6 years. The accepted standard in fringe area installations... if the Model 8X-TV does not provide a usable signal, reception is either impossible or impractical. Built of weather-proven components throughout to withstand severest weather conditions.

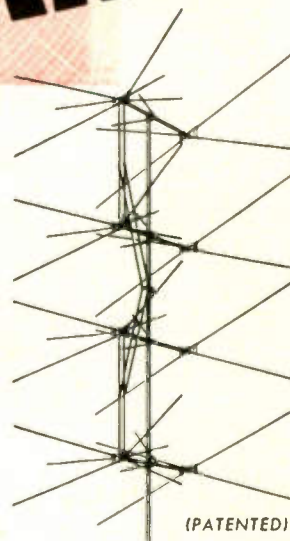

MODEL 8X-TV

Telrex guaranteed to outperform any antenna or combination of cut-to-frequency antenna. Also available in 2-BAY stacked array, Model 4X-TV.

NEW VHF "KING PIN" BEST FOR B & W OR COLOR TV!

The new Telrex "KING PIN" — utilizing the Patented "Conical-V-Beam" theory to perfection — provides excellent performance on both VHF and UHF. "Conical-V-Beam" dipoles afford best and most uniform match to 300 or 200 ohm line across entire band. Write for catalogs and prices today!

- Maximum Gain
- Maximum F/B Ratio
- Minimum Spurious Lobes
- No Phase Shift
- Pre-assembled
- Installs Quickly

**TELEREX HAS THE ANSWER TO ANTENNA PROBLEMS
OVER 100 MODELS FOR EVERY TYPE INSTALLATION**

• "CONICAL-V-BEAMS" are produced under U. S. Patent No. 23,346, Canadian Patent No. 500,436 and British Patent No. 691,485. Other patents pending.

Telrex INC.
"CONICAL-V-BEAMS"®

AMERICA'S
OUTSTANDING
TELEVISION
BEAM

**ASBURY PARK 2
NEW JERSEY**

FOR COLOR SERVICING

Add These Two New
RCA Test Instruments
to Your Present
Black and White
Equipment

The RCA WR-61A Color-Bar Generator and RCA WR-36A Dot-Bar Generator plus proper test facilities for servicing b & w receivers give you complete test equipment for servicing color receivers.



\$247.50
(Suggested User Price)



\$147.50
(Suggested User Price)

RCA WR-61A COLOR-BAR GENERATOR

Generates signals for producing 10 bars of different colors simultaneously (without manual switching), including bars corresponding to the R-Y, B-Y, G-Y, I, and Q signals, for checking and adjusting phasing and matrixing in all makes of color sets. Crystal-controlled oscillators (color sub-carrier, picture carrier, sound carrier, bar frequency, and horizontal sync) ensure accuracy and stability. Luminance signals at bar edges for checking color "fit" or registration. Adjustable sub-carrier amplitude for checking color sync action. Lightweight and compact.

RCA WR-36A DOT-BAR GENERATOR. Provides pattern of optimum-size dots for adjusting convergence in color receivers. H- and V-Bar patterns for adjusting linearity in both color and b & w sets. RF output on channels 2-6. High-impedance video output (plus and minus polarities). Choice of internal 60-cps vertical sync, or external sync. Number of dots and bars is adjustable, 8 to 15 horizontal bars, 10 to 13 vertical bars. Lightweight, compact for home and shop use.



RCA WO-88A (5") and WO-55A (7") Oscilloscopes

—essentially flat response to 500 Kc—excellent for mcs' color servicing. For certain applications, such as measurement of 3.58-Mc signals, the new WO-78A wideband scope is recommended.



RCA WR-88A Crystal Calibrator

provides the accuracy essential for color work. Continuous frequency coverage from 19 to 260 Mc with built-in 2.5-Mc crystal calibrator and 4.5-Mc crystal oscillator.



WR-59C Sweep Generator

Includes the essential video sweep range, down to 5 Kc for checking and adjusting vice and chrominance circuitry and bar d-pass filters. The new accessory WG-295A Video Marker provides 5 simultaneous markers, with finger-touch identification.



RCA VoltOhmysts*

with high-impedance inputs and isolating probes are tops for color. Accessory high-voltage probes extend range to 50,000 volts. Accessory demodulator probe extends frequency range to 250 Mc.

Now off the press—RCA's new enlarged, 2nd edition of "Practical Color Television for the Service Industry." Price: \$2.00—from your RCA Distributor.



RADIO CORPORATION of AMERICA
TEST EQUIPMENT

HARRISON, N. J.

VTM:R. Rev.

LETTERS

To the Editors

Seeks Third Hand

EDITORS, TECHNICIAN:

Instructions for soldering generally tell you to hold pliers between the component and its terminal, the idea being to carry away excessive heat. Now all this is fine, but I have never yet found instructions as to where to secure the *third hand* to hold the pliers while you use the two regular hands you were born with to handle the solder and solder gun.

It is too bad some enterprising tool maker doesn't market pliers made of hard aluminum alloy that would really carry off heat. They should have spring loaded handles that would normally hold the long slim jaws closed and would open when the handles were pressed. They should find a greedy market.

I like your magazine fine. I have been at this game since 1934, taking magazines all the time, and know a good thing when I see it.

C. L. VAN LIEW

Raymond, Washington

Tough Dog Fan

EDITORS, TECHNICIAN:

I enjoy your Tough Dog Corner. One of the articles cured a tough one for me a while ago.

KEITH S. JENSEN

Snohomish, Washington

If You Don't See It, Ask

EDITORS, TECHNICIAN:

Just a few suggestions for TECHNICIAN which I think would be good reading material, and help a good many service men: articles on theory, function and servicing of TV detectors, vertical oscillators and amplifiers, horizontal oscillators and amplifiers, afc and agc; also test patterns and symptoms, with diagrams of each circuit and faults, with servicing notations enclosed in circles, on the diagram.

Keep up the good work. I cancelled my subscription to and, just as soon as expires, I will not renew. My subscription to TECHNICIAN is paid up to December 1960. It will not be long until there will be only one magazine, TECHNICIAN.

HENRY E. SCHMIDTZ

Toledo, Ohio

Use For Circuit Digests

EDITORS, TECHNICIAN:

TECHNICIAN is certainly a boon to servicemen. Your schematics are just the right size to carry in a service kit—and I use them thus very frequently.

L. C. BENTZ

New York, N. Y.

- Put it on your counter
- Send it with your bills
- Leave it on service calls
- Send it to your mailing list



Beware the Service Bargain..

You'll never see your doctor advertise a special sale on appendicemias ...
You'll never see your lawyer announce cut-rates for divorce cases ...
You'll never see your dentist hold a "2-for-1" sale on extractions ...
AND You'll never see the day when you can take your TV set in for a service "bargain" and be sure you're getting a square deal!

"Bargains" in home electronic service are as scarce as the proverbial hen's teeth! Here's why—

The expert service technician, just like other professional people, must undergo years of study and apprenticeship to learn the fundamentals of his skill. And a minimum investment of from \$3000 to \$6000 per shop technician is required for the necessary equipment to test today's highly complex sets. Finally, through manufacturer's training courses and his own technical journals, he must keep up with changes that are developing as fast as they ever did in medicine, law, or dentistry. Those best equipped to apply modern scientific methods are almost certain to be

most economical for you and definitely more satisfactory in the long run.

Unfortunately, as in any business, there will always be a few fly-by-night operators. But patients, clients, and TV set owners who recognize that you get only what you pay for, will never get gypped. "There just are no service bargains"—but there is GOOD SERVICE awaiting you at FAIR PRICES!

Henry Kahan
SPRAGUE PRODUCTS COMPANY
North Adams, Mass.

SPRAGUE

WORLD'S LARGEST MANUFACTURER OF ELECTRIC CONDENSERS

BUILD THE REPUTATION YOU DESERVE...

Simply and clearly, "Beware The Service Bargain" tells the story you want to get across to your customers.

Why you . . . on the basis of receiver complexity, years of training, and capital equipment required . . . are just as entitled to a fair price for your service as doctors, lawyers, and dentists. And, why there can't be any such thing as a service "bargain."

This may be your last chance to get reprints of "Beware The Service Bargain" in an ideal size for mailing, and with adequate space for your imprint *at cost*: \$3.00 for 1000; \$25.00 for 10,000. Order Form RP10 through your distributor or directly from the Sprague Products Co.,* 393 Marshall Street, North Adams, Massachusetts.

Mats for newspaper advertising are also available.

*Distributors' Division of Sprague Electric Co.

don't be vague . . . insist on

SPRAGUE WORLD'S LARGEST CAPACITOR MANUFACTURER



These **RAYTHEON** **SERIES STRING TUBES** HAVE **300% GREATER RELIABILITY**

High voltage surges due to inequalities of heater warmup time previously have limited the most effective use of "series connections" of tube heaters in TV receivers. The new Raytheon "Series String" Tubes — now used by many leading set manufacturers — virtually eliminate heater burnouts, permitting the use of this type of circuitry which results in lighter, more compact receivers.

Raytheon helped set manufacturers solve this warmup problem, by designing a new line of "Series String" Tubes which feature tightened controls on heater warmup, identical current value and a heater stability so improved that heater burnouts from warmup surges are rare. By narrowing the tolerances on heater wire to one-third of the former specifications and improving heater coating techniques this has been achieved. This important advance plus Raytheon's thorough knowledge of every aspect of tube construction guarantees the superior quality of Raytheon "Series String" Tubes.

| | | | | |
|---|--|---|--|--|
| <p>RAYTHEON 3AL5 is a heater-cathode type double diode of miniature construction. Its principal application is as a diode detector, automatic volume control rectifier, or as a low current power rectifier.</p> | <p>RAYTHEON 3AU6 is a heater-cathode type, sharp cutoff pentode of miniature construction designed for service as a high-frequency amplifier in radio and television receivers.</p> | <p>RAYTHEON 3BC5 is a heater-cathode type, sharp cutoff pentode of miniature construction. Used as an RF amplifier and as a high-frequency, intermediate amplifier.</p> | <p>RAYTHEON 3BN6 is a 7-pin miniature, heater-cathode type, sharp cutoff pentode. Designed to perform the combined functions of limiting and frequency discrimination in FM and TV receivers.</p> | <p>RAYTHEON 3CB6 is a heater-cathode type sharp cutoff pentode of miniature construction designed for use as an intermediate frequency amplifier, operating at frequencies in the order of 40 megacycles, or as an RF amplifier in VHF Television Tuners.</p> |
| <p>RAYTHEON 5AM8 is a diode pentode of miniature construction designed for use as a video detector and IF amplifier in television receivers.</p> | <p>RAYTHEON 5AN8 is a medium-μ triode and a sharp cutoff pentode of miniature construction designed to perform combined functions of a video detector or IF amplifier and sync separator.</p> | <p>RAYTHEON 5J6 is a heater-cathode type, double triode of miniature construction designed for mixer applications.</p> | <p>RAYTHEON 5U8 is a heater-cathode type triode-pentode of miniature construction designed for use as an oscillator mixer.</p> | <p>RAYTHEON 6S4A is a heater-cathode type medium-μ, high-perveance triode of miniature construction for use as a vertical deflection amplifier in TV receivers.</p> |
| <p>RAYTHEON 6SN7GTB is a dual triode designed for use as a combined vertical oscillator and vertical deflection amplifier in television receivers.</p> | <p>RAYTHEON 7AU7 is a heater-cathode type double triode of miniature construction designed for use as a resistance coupled voltage amplifier, phase inverter, horizontal deflection oscillator or vertical deflection oscillator-amplifier in television receivers.</p> | <p>RAYTHEON 12AX4GT is a heater-cathode type diode designed for use in horizontal frequency damper service in television receivers.</p> | <p>RAYTHEON 12BH7A is a heater-cathode type medium-μ double triode of miniature construction designed for use as a vertical deflection amplifier in television receivers employing "Series String" heater designs.</p> | <p>RAYTHEON 12BK5 is a miniature beam power pentode designed for use as a power output tube in radio and TV receivers.</p> |
| <p>RAYTHEON 12BY7A is a heater-cathode type pentode of miniature construction designed for use as a video amplifier.</p> | <p>RAYTHEON 12L6GT is a heater-cathode type beam pentode power amplifier. Generally used as an output tube in ac-dc receivers.</p> | <p>RAYTHEON 12W6GT is a heater-cathode type beam pentode designed for service as a vertical deflection amplifier in TV receivers having a relatively low B supply voltage.</p> | <p>Ask your Raytheon Tube Distributor about these and other new Raytheon "Series String" Tubes.</p> | |



RAYTHEON MANUFACTURING COMPANY

Receiving and Cathode Ray Tube Operations
Newton, Mass., Chicago, Ill., Atlanta, Ga., Los Angeles, Calif.

RAYTHEON MAKES ALL THESE:

RECEIVING AND PICTURE TUBES • RELIABLE SUBMINIATURE AND MINIATURE TUBES • SEMICONDUCTOR DIODES AND TRANSISTORS • NUCLEONIC TUBES • MICROWAVE TUBES

Excellence in Electronics

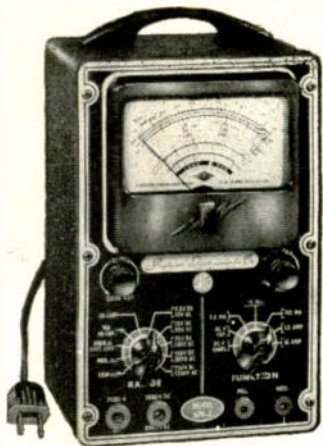

Superior's new
Model 670-A

SUPER METER

A COMBINATION VOLT-OHM MILLIAMMETER PLUS
CAPACITY REACTANCE INDUCTANCE AND DECIBEL MEASUREMENTS

SPECIFICATIONS:

D.C. VOLTS: 0 to 7.5/15/75/150/750/1,500/7,500 Volts
 A.C. VOLTS: 0 to 15/30/150/300/1,500/3,000 Volts
 OUTPUT VOLTS: 0 to 15/30/150/300/1,500/3,000 Volts
 D.C. CURRENT: 0 to 1.5/15/150 Ma. 0 to 1.5/15 Amperes
 RESISTANCE: 0 to 1,000/100,000 Ohms 0 to 10 Megohms
 CAPACITY: .001 to 1 Mfd. 1 to 50 Mfd. (Good-Bad scale for checking quality of electrolytic condensers.)
 REACTANCE: 50 to 2,500 Ohms 2,500 Ohms to 2.5 Megohms
 INDUCTANCE: .15 to 7 Henrys 7 to 7,000 Henrys
 DECIBELS: -6 to +18 +14 to +38 +34 to +58

ADDED FEATURE:

Built-in ISOLATION TRANSFORMER
reduces possibility of burning out meter through misuse.

The Model 670-A comes housed, in a rugged crackle-finished steel cabinet complete with test leads and operating instructions.

\$2840
NET



Superior's new
Model TV-11 **TUBE TESTER**

- ★ Tests all tubes, including 4, 5, 6, 7, Octal, Lock-in, Peanut, Bantam, Hearing Aid, Thyatron Miniatures, Sub-miniatures, Navals, Thyatrons, Proximity fuse types, etc.
- ★ Uses the new self-cleaning Lever Action Switches for individual element testing. Because all elements are numbered according to pin-number in the RMA base numbering system, the user can instantly identify which element is under test. Tubes having tapped filaments and tubes with filaments terminating in more than one pin are truly tested with the Model TV-11 as any of the pins may be placed in the neutral position when necessary.
- ★ The Model TV-11 does not use any combination type sockets. Instead individual sockets are used for each type of tube. Thus it is impossible to damage a tube by inserting it in the wrong socket.

- ★ Free-moving built-in roll chart provides complete data for all tubes.
- ★ Newly designed Line Voltage Control compensates for variation of any Line Voltage between 105 Volts and 130 Volts.
- ★ NOISE TEST: Phono-jack on front panel for plugging in either phones or external amplifier will detect microphonic tubes or noise due to faulty elements and loose internal connections.

The model TV-11 operates on 105-130 Volt 60 Cycles A.C. Comes housed in a beautiful hand-rubbed oak cabinet complete with portable cover

\$4750
NET

EXTRA SERVICE—The Model TV-11 may be used as an extremely sensitive Condenser Leakage Checker. A relaxation type oscillator incorporated in this model will detect leakages even when the frequency is one per minute.

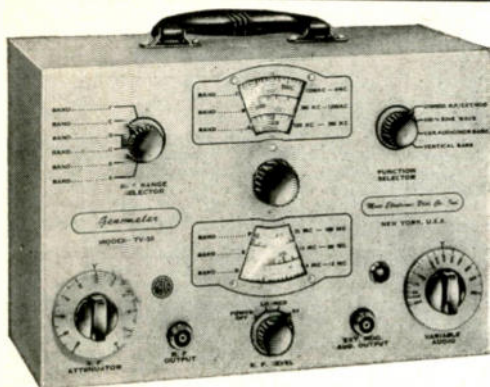

THE NEW
MODEL
TV-50 **GENOMETER**

A versatile all-inclusive GENERATOR which provides ALL the outputs for servicing:
A.M. Radio • F.M. Radio • Amplifiers • Black and White TV • Color TV

7 Signal Generators in One!

- ✓ R. F. Signal Generator for A.M.
- ✓ R. F. Signal Generator for F.M.
- ✓ Audio Frequency Generator
- ✓ Bar Generator
- ✓ Cross Hatch Generator
- ✓ Color Dot Pattern Generator
- ✓ Marker Generator

R. F. SIGNAL GENERATOR: The Model TV-50 Genometer provides complete coverage for A.M. and F.M. alignment. Generates Radio Frequencies from 100 Kilocycles to 60 Megacycles on fundamentals and from 60 Megacycles to 180 Megacycles on powerful harmonics.

VARIABLE AUDIO FREQUENCY GENERATOR: In addition to a fixed 400 cycle sine-wave audio, the Model TV-50 Genometer provides a variable 300 cycle to 20,000 cycle peaked wave audio signal.

BAR GENERATOR: The Model TV-50 projects an actual Bar Pattern on any TV Receiver Screen. Pattern will consist of 4 to 16 horizontal bars or 7 to 20 vertical bars.

CROSS HATCH GENERATOR: The Model TV-50 Genometer will project a cross-hatch pattern on any TV picture tube. The pattern will consist of non-shifting, horizontal and vertical lines interlaced to provide a stable cross-hatch effect.

DOT PATTERN GENERATOR (FOR COLOR TV) Although you will be able to use most of your regular standard equipment for servicing Color TV, the one addition which is a "must" is a Dot Pattern Generator. The Dot Pattern projected on any color TV Receiver tube by the Model TV-50 will enable you to adjust for proper color convergence.

MARKER GENERATOR: The Model TV-50 includes all the most frequently needed marker points. The following markers are provided: 189 Kc., 262.5 Kc., 456 Kc., 600 Kc., 1000 Kc., 1400 Kc., 1800 Kc., 2000 Kc., 2500 Kc., 3579 Kc., 4.5 Mc., 5 Mc., 10.7 Mc., (3579 Kc. is the color burst frequency.)

THE MODEL TV-50 comes absolutely complete with shielded leads and operating instructions. Only ...

\$4750
NET

SHIPPED ON APPROVAL NO MONEY WITH ORDER — NO C.O.D.

Try any of the above instruments for 10 days before you buy. If completely satisfied then send down payment and pay balance as indicated on coupon. No Interest or Finance Charges Added! If not completely satisfied return unit to us, no explanation necessary.

MOSS ELECTRONIC DISTRIBUTING CO., INC.

Dept. D-86, 3849 Tenth Ave., New York 34, N.Y.

Please send me the units checked. I agree to pay down payment within 10 days and to pay the monthly balance as shown. It is understood there will be no finance, interest or any other charges, provided I send my monthly payments when due. It is further understood that should I fail to make payment when due, the full unpaid balance shall become immediately due and payable.

Model 670-A Total Price \$28.40 \$7.40 within 10 days. Balance \$3.50 monthly for 6 months. Model TV-11 Total Price \$47.50 \$11.50 within 10 days. Balance \$6.00 monthly for 6 months. Model TV-50 Total Price \$47.50 \$11.50 within 10 days. Balance \$6.00 monthly for 6 months.

Name
Address
City Zone State

A new standard in
electrical and mechanical
perfection in all **32**
new YAGI antennas



Featuring the new
WALSCO "Octopus"
Model #4110.
A combination
Yagi-conical for
superlative all-channel
reception.

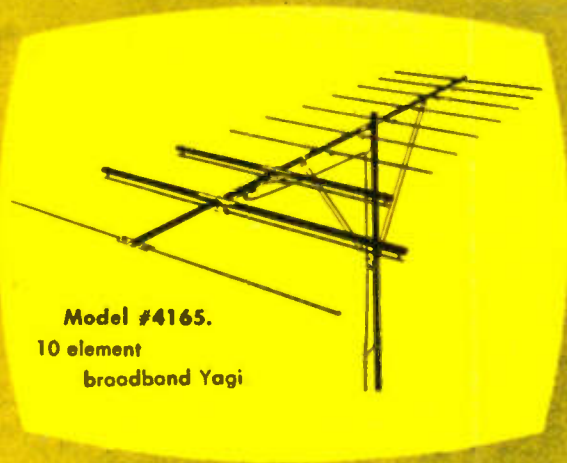

Model #4165.
10 element
broodbond Yagi

Walsco's exclusive
"umbrella" snap-out
design provides perfect
element alignment
instantly.

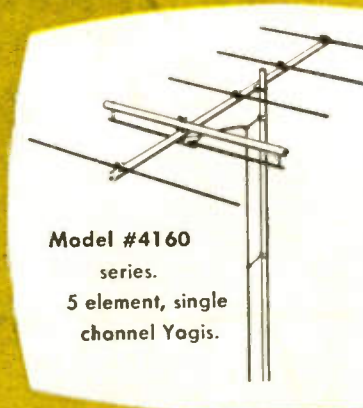
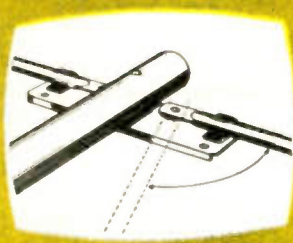

Model #4160
series.
5 element, single
channel Yagis.

WALSCO "futurized" YAGIS reach everywhere

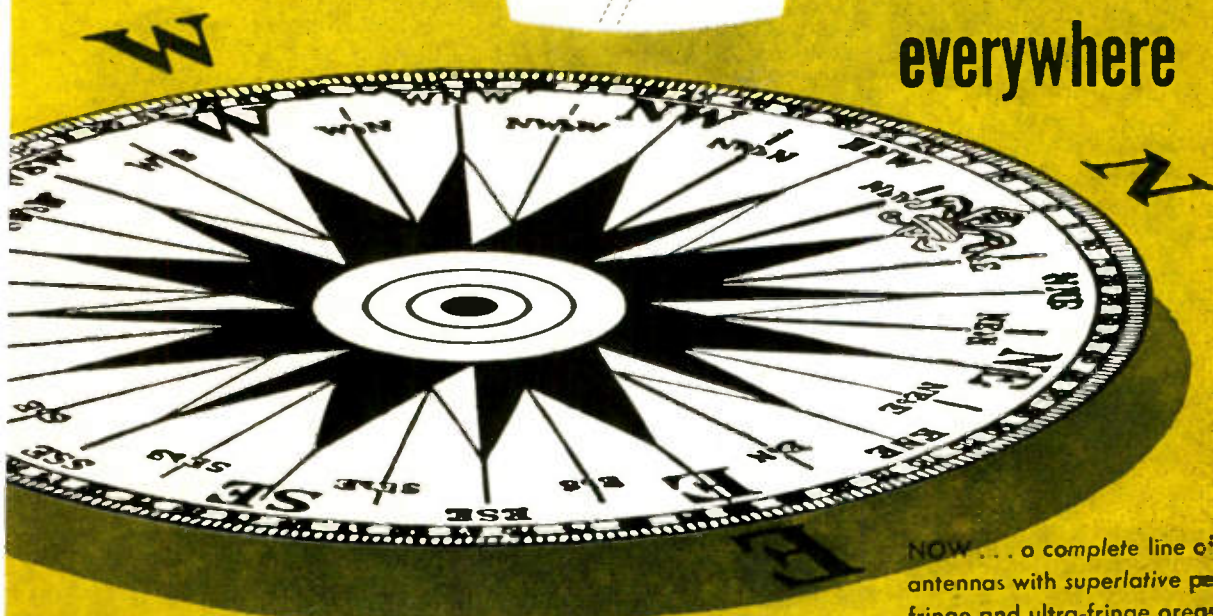

NOW . . . a complete line of 32 "futurized" Yagi antennas with superlative performance . . . for fringe and ultra-fringe areas; for black and white and color on all present and future channels. No loose hardware . . . completely pre-assembled using Walsco's exclusive "umbrella" snap-out design. Nothing compares at any price!

Write for complete information
on all 32 "futurized" Yagi models



ELECTRONICS CORPORATION

3602 Crenshaw Blvd. • Los Angeles 16, California

Overseas Distributor:

Ad Auriemo, Inc. • 89 Broad St., New York 4, N.Y.

As a  is 2 a



or a  is 2 a



or a  is 2 a

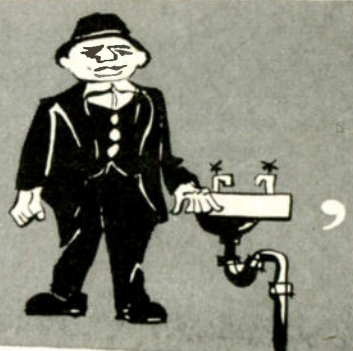

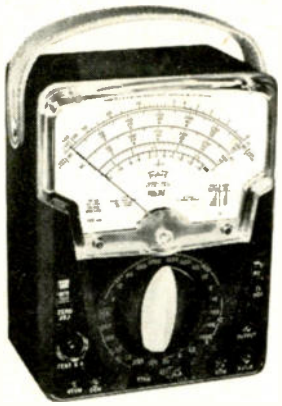
the  is 2 U!

MODEL 631 VOM-VTVM \$59.50 NET

Because—it's TWO-in-One for the price of one! It's a VTVM—It's a VOM with just the flip of a switch!

This one combination instrument will be the serviceman's most frequently used piece of test equipment. No need to invest in two separate testers when one will do his work at half the price—\$59.50 net.

Flip the switch, it's a VTVM (completely portable; battery operated—VTVM accuracy not subject to line voltage fluctuations — Input Impedance of 11 megohms).

Flip the switch and it's a VOM (with the sensitivity to match readings in all the service manuals—20,000 ohms per volt DC, 5,000 ohms per volt AC).

Ranges entirely adequate for servicing needs. All 34 ranges selected by one knob control—minimizes incorrect settings and burnouts. Unbreakable clear plastic meter case front floods light on long, readable scales.

Triplett Model 631 is sold by leading distributors everywhere.

All Triplett test instruments meet the requirements of tomorrow's color TV!

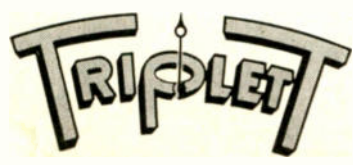

TRIPLETT ELECTRICAL INSTRUMENT CO., Bluffton, Ohio



JET-HELIX®

"The RAINBOW Antenna"

a radical new flat plane helical concept
for VHF-LHF black and white
or COLOR reception

Compare

its revolutionary microwave helix design that delivers highest signal magnitude on all channels with the least amplified noise—the same helical configuration used in amateur and commercial reception where the ultimate in high gain and sharp directivity is vital.

Compare

its preassembled jet-action construction with sensational new "Hi-tension" aluminum elements brackets that slash assembly time to seconds. You don't ever need a screw driver because there is no hardware to tighten. It's automatic!

Compare

its tremendous consumer advertising support that presells you customers! newspaper ads, motels, direct mail displays, streamers, radio and television, movie commercials, national publicity.

Compare

its up-notch front-to-back (up to 23 db) and front-to-side (up to 20 db) ratios that reject co-channel and adjacent channel interference!

Compare

its matchless Alcoa aluminum construction!



Compare

the Jet Helix by any standards known and you will agree with thousands of dealers—the JET HELIX is the "hottest" antenna in the industry, both in performance and sales!

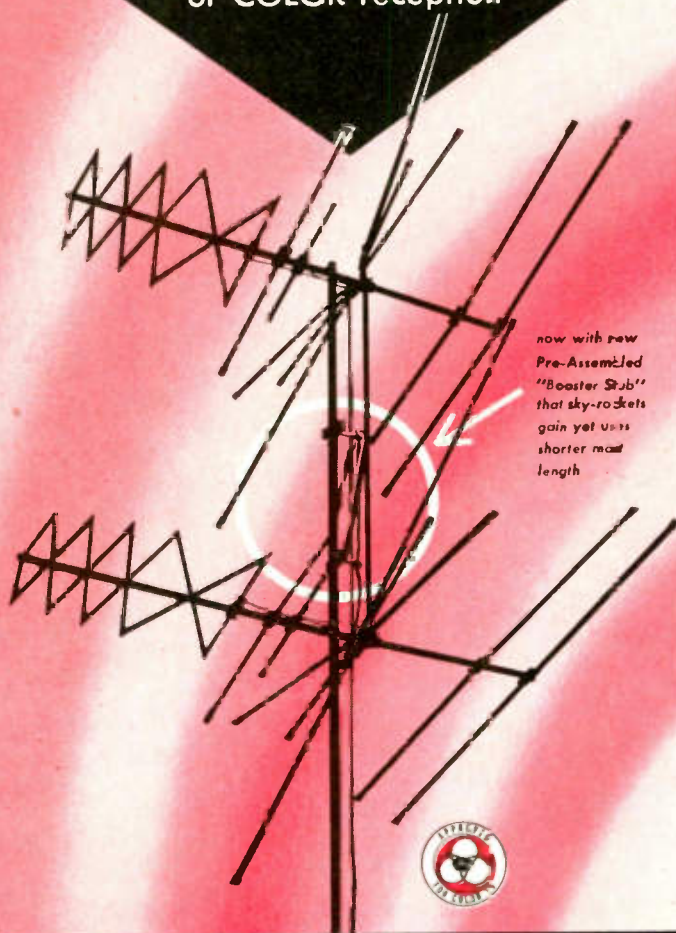

now with new Pre-Assembled "Booster Stub" that sky-rockets gain yet uses shorter mast length



INCREDIBLE MICROWAVE HELICAL DESIGN!

SKY-ROCKETS GAIN!

COMPARE THE DIFFERENCE

For your "pot of gold" follow the JFD RAINBOW Antenna

Compare its S/N Figure of Merit!
JFD JET-HELIX—57.85%*

| Model | Boys | List |
|------------|-------------------|-------|
| JET 913 | SINGLE | 25.50 |
| JET 913S | STACKED | 52.50 |
| JET 913S-5 | HALF WAVE STACKED | 55.00 |

The Signal to Noise Figure of Merit is the sum of the individual characteristics of an antenna in one concise value for quick and accurate comparison. Note the S/N Figure of Merit analysis in detail.

gain represents that over 1/2 wave reference folded dipoles

Horizontal Pattern

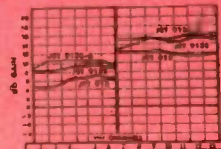
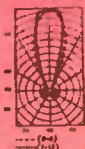

| ANTENNA | CHANNELS | | | | | | | | | | | | |
|--------------------------------------|----------|------|------|------|-----|------|------|------|------|------|------|------|--|
| | 2 | 3 | 4 | 5 | 6 | 7 | 8 | 9 | 10 | 11 | 12 | 13 | |
| "JET-HELIX" JET913S | 8.3 | 8.6 | 9. | 9.5 | 9.4 | 15.2 | 15.8 | 15.5 | 15. | 14.8 | 15.1 | 15.3 | |
| "JET-HELIX" JET913S-5 | 9.2 | 10.5 | 11.1 | 10.5 | 9.8 | 13.5 | 14.4 | 14.8 | 15.2 | 15.5 | 15.5 | 15. | |
| "SUPERJET" JET213S | 6.8 | 8.3 | 9.5 | 8.8 | 8.6 | 10.5 | 11.2 | 12. | 13.5 | 13.8 | 13.6 | 12.9 | |
| "SUPER POWERJET" JET213S-5 | 7.5 | 9.5 | 11.2 | 10.5 | 9.3 | 11.8 | 12.2 | 12.8 | 13.2 | 13.3 | 14.2 | 14. | |
| "DODO" Screen Type REFLECTOR | 4.75 | 4.5 | 7.2 | 7.1 | 7. | 11. | 11.2 | 11.8 | 11.5 | 11.1 | 12.1 | 12. | |
| "SUPER DODO" Screen Type REFLECTOR | 6.3 | 6.8 | 8.8 | 7.8 | 7.5 | 9.5 | 11.2 | 11.8 | 12. | 11.1 | 12.1 | 12. | |
| Broad Band Yagi with Phasing Stubs | 4.3 | 5.7 | 4.5 | 7.1 | 9. | 13. | 14. | 13.5 | 14. | 13. | 14. | 15. | |
| Inline Yagi with Phasing Stubs | 5.2 | 5.5 | 6 | 8. | 8. | 11.5 | 9.5 | 10 | 9. | 11. | 11.5 | 11.8 | |
| Inline Yagi with Triple Dipole | 6.25 | 6.5 | 8.7 | 8.6 | 9. | 11.5 | 11.7 | 11.8 | 11.5 | 11.1 | 13.1 | 13.5 | |
| Super-Inline Yagi with Triple Dipole | 6.75 | 7. | 10.2 | 10.3 | 11. | 11.5 | 12.2 | 12.8 | 13.5 | 12.1 | 14.6 | 15.5 | |

Jerrold TV Multi-Outlet SYSTEM



DISTRIBUTION AMPLIFIER

Type ABD-1—Amplifies antenna signal 25 channels 2-13. Sensitive 5-tube cascade circuit. Exceptionally low noise—only 6db (approaching theoretical minimum). Mount indoors. 115 volt operated. 72 or 300 ohm antenna input. 72 ohm output to "Splitter." Flat response for color.

...for fast, low-cost installation
in motels, apartments, clubs

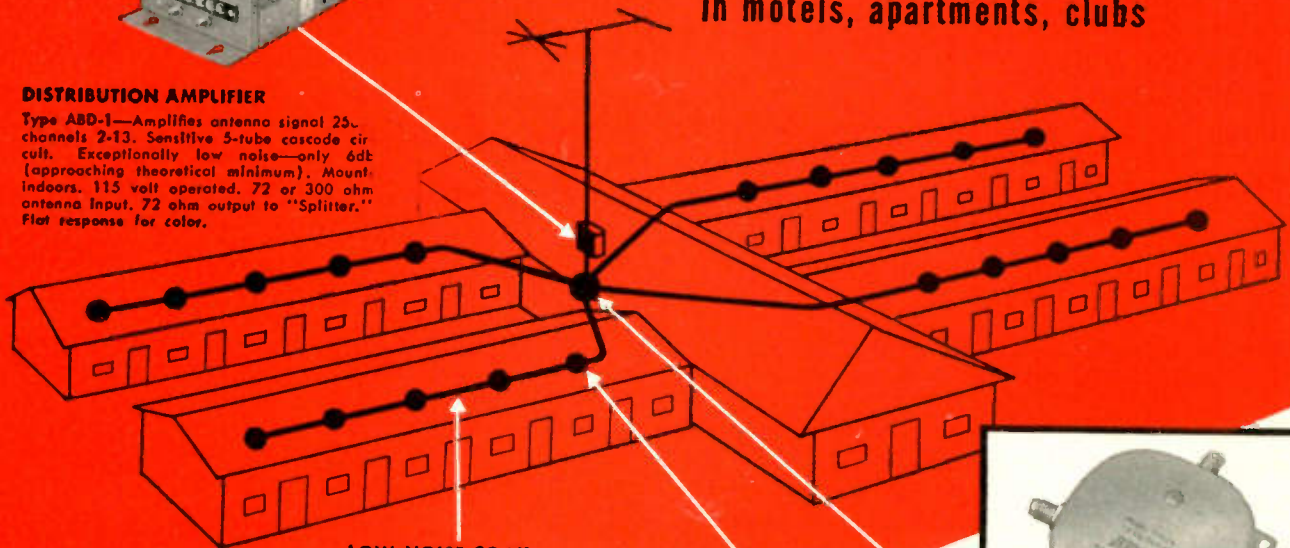

LOW-NOISE COAX

Use any length to interconnect receivers, Amplifier and Line Tap compensate for line losses.



LINE SPLITTER (if needed)

Type T1604—Equally divides amplifier output up to 4 ways. No tubes. Cannot overload.

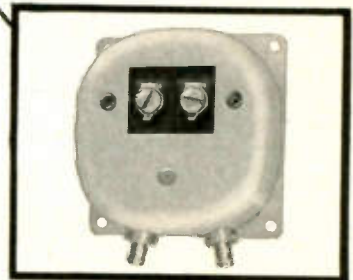

LINE TAP IMPEDANCE MATCHER

One for each receiver. Compensates for line response tilt. Completely isolates receivers from each other. Matches 72 ohm feed line to 300 ohm set. No tubes.

Here's a TV *Multi-Outlet* distribution system that gives clean, snow-free reception to every receiver . . . with an increase in signal strength and with signal-to-noise ratio maintained in the bargain. A single *Multi-Outlet* Jerrold System can feed 20 receivers, and Jerrold Distribution Amplifiers can be grouped for larger installations. Reception at each receiver, on all channels, will be the best the antenna can provide in the area.

The complete Jerrold Distribution System designed for 24 hour operation is built to the same standards as larger Jerrold Community TV systems which serve as many as 5000 sets from a single antenna. Yet a Jerrold *Multi-Outlet* System costs less than half the price of ordinary installations using unsightly separate antennas for each receiver.

Investigate this profitable field now! Send for free catalog sheets describing all components.

INSTALLATION MADE EASY

Profusely-illustrated booklet tells all about distribution systems—theory, cost estimates, installation, etc. Free with each ABD-1 Amplifier, 25c separately. Write for your copy today.

JERROLD

JERROLD ELECTRONICS CORPORATION

26TH & DICKINSON STS.
PHILADELPHIA 46, PA.

TECHNICIAN & Circuit Digests

CALDWELL-CLEMENTS, INC., 480 LEXINGTON AVENUE, NEW YORK 17, N. Y.

The Whole—and the Parts

As has been the case for some years, dollar volume in the replacement business this year will show an increase over 1953. For makers of parts and components, this dramatizes a shift in their market outlook as a whole. Years ago, they would concentrate attention on manufacturers of completed units of equipment, as buyers of *original* components. However, the *replacement* market, which is expected to account for over \$1 billion in business this year, is virtually in its infancy. This means that you, as a major customer, can start insisting on the consideration to which you have long been entitled.

Brand-name buying gives you the chance to help those who help you. Use this power wisely. There are several points you should be thinking about when you buy. None are new; all are worth renewed emphasis in the light of the current trend:

- At one time or another you have bought a non-standard replacement, perhaps a flyback transformer, that couldn't be fit into the set, physically or electrically, without extensive alterations. It was listed as an "exact replacement" in its manufacturer's catalog, either through carelessness or outright dishonesty. After fighting with it for half a day, you brought it back. Did you get an exchange or credit?

- Does the maker guarantee his product for a reason-

able period? If he does, he is probably giving you protection in more than one direction. When he stands behind his merchandise, it is more likely to be of such quality as to spare you the embarrassment of repairs that backfire.

- Can you offer your customers an easy-payment "deal" on expensive replacement items, like picture tubes? With the growth of service volume, large service outfits and big department stores are out to give you a fight for the business. One of their big weapons is the ability to arrange for time payments. You can compete only if the component manufacturer, anxious for your business, is willing to support you in a parallel program.

- Is the manufacturer supporting you with his own advertising? Is he willing to support you in a cooperative advertising plan? Or is he competing with you in appeals to the ultimate consumer that take the initiative away from you, the technician?

- Is the manufacturer making it easy for you to buy what you need? You don't have the research facilities to determine how much of each of hundreds of different components you should have on hand. Alert manufacturers are giving attention to stock guidance. Many offer assortment purchases, or other combination packaging plans, to fit in with the needs of the small independent.

Keeping Ahead

What are you doing to improve your professional standing? Are you keeping up with new developments? What do you know about color, aside from having a vague notion as to the difference between chrominance and luminance signals, or dimly recalling that NTSC has something to do with it? Have you been finding out how tape recorders or other Hi-Fi units work, and how they are serviced? Do you know anything about transistors or printed circuits? Or is the daily job of working over TV and radio chassis as far as you care to go?

To keep his standing, the doctor must constantly be reading books and periodicals or undertaking new studies in his field, despite the fact that the human mechanism he keeps in repair hasn't undergone any important changes in many centuries. The professional electronic doctor has a great deal more change to reckon with.

Even in dealing with standard chassis that have been around for years, have you let your theoretical background, so many years behind you, slip away? Have you become just another journeyman with a pair of pliers and a soldering iron? When did you last read a book or attend a lecture related to your field?

You can shrug off new developments if you want to. You can tell yourself you'll worry about them when they get here. We know some radio service people who took that attitude when TV was on its way. They were busy enough fixing radios. TV sets were too much to bother with. Just turn them over to the manufacturer's service unit—or to that other dealer a few blocks away who was crazy enough to waste his time on these impossible monsters. Some of these radio-only people are still making money—in other lines of business.

Tuning In the

HOW'S BUSINESS DEPARTMENT: TV set sales continue strong; radios are picking up briskly, and phonos look good for Xmas selling . . . Service revenue is holding up well in most areas, but is off in some sections, due, say shop operators to uneasiness over unemployment . . . Incidentally, the employment picture is greatly improved at this writing and this situation should be reflected in a record-breaking volume of repair business this month . . . **TECHNICIAN** editors forecast that December's service volume should run to about 16 percent of the year's total, and that it will be up at least 10 percent over December, 1953 . . . Parts and tubes inventories at the retail level appear to be in excellent shape—lower than last year . . . Dealer credit, generally, is in good condition.

ODD-BUT-TRUE DEPARTMENT: In numbers of areas, dealers are selling and servicing Geiger counters to "professional" and amateur prospectors . . . After several calls, a technician finally found the trouble in a customer's tape recorder which was alleged to be "skipping" The user had been cutting the tape (for splicing) with magnetized scissors! . . . Long Island, N. Y., shop owner's wife became so infuriated over the fact that several days had gone by without hubby's finding the time to fix the family TV set that she called in a competitor. To kid her better half, she found out what was wrong with the receiver, and told hubby she'd fixed it herself! He believed it until the bill came in.



EUROPEAN TV: Italy and Germany are taking the lead in Western Europe, according to Ernest A. Marx, Director of Du Mont's International Division . . . **ITALY:** A chain of TV stations which covers more than half the nation is expected to extend across the rest of it soon. Large-screen sets are popular . . . **GERMANY:** Rapidly growing TV network may soon include 28 stations . . . **FRANCE:** Fairly well covered with TV stations, but the high cost of sets is keeping sales down . . . **SWITZERLAND AND BELGIUM:** Industry progress is slow . . . **ENGLAND:** Furthest advanced, technically, with 3½ million sets in use . . . Eurovision, the all-nation continental network, appears to have a bright future.

COMMENTING ON THE NECESSITY FOR maintaining proper customer relationships, the "Lieta News" says: "In all cases (complaints) that we have on file, the fault has been an inadequate approach by the service technician to explain his services and charges fully; and when this has been pointed out to him, he and his customer have both agreed that maybe they were both a little wrong." ("Lieta" stands for Long Island (N.Y.) Electronic Technicians Assn.)

SMART SHOP OWNERS are spreading the Christmas cheer at this time of the year in order to build and hold customer good-will. Some of the Yuletide activities include the sending of Xmas cards to folk on the mailing list; the setting up of special Xmas windows and in-store displays, and many shops are planning to pipe holiday music out into the sidewalk in front of their stores via PA systems.

CLOSED-CIRCUIT TV: 50 large-screen projection units are going into independent and chain hotels around the country. Theatre Network Television (TNT) has appointed RCA Service Co. to supervise the installation. TNT is planning to use the circuits for business meetings and conventions in major markets throughout the nation. Coast-to-coast closed-circuit conferences will be possible.

QUOTABLE QUOTES: "A recent survey shows that \$450,000,000 will be paid this year for the electric current used to operate television and radio sets in America homes—" Brig. Gen. David Sarnoff, chairman of the board, RCA. . . . "The day is not far off when most homes and restaurants will consider the intercom to be as necessary a piece of equipment as a television set or a radio, and when every factory will find its own closed broadcasting system as important as a time clock."—Miryam Simpson, VP, Mark Simpson Mfg. Co. . . . "Recorded tape ultimately will replace discs in the quarter-billion dollar home entertainment market, but not until both recorded tape and tape playing instruments have been made simpler, cheaper and easier to operate."—Everett W. Olson, communications director, Webster-Chicago Corp. . . . "The cost of black-and-white television receivers has been reduced 92 percent per square inch of viewing area since commercial telecasts began in 1947."—W. C. Johnson, Admiral VP. . . . "There will be as much black-and-white television receiver business as there will be color, at least for the next five years."—Louis Hausman, VP, CBS-Columbia.

GOOD RESOLUTIONS DEPARTMENT for 1955: **For manufacturers:** Please do a better job on quality control. Think of the technician in designing chassis lay-outs—don't put parts and tubes in hard-to-get at places . . . **For distributors:** Speed up adjustments on defective components returned to you; fight back-door selling of tubes and parts . . . **For chiseling shop operators:** Cut it out fellows. It's just as easy to be honest, and, besides, you're giving all of us a black eye.

Picture

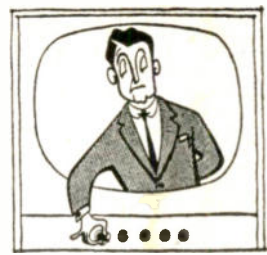

WITH COLOR TV PROMISING MUCH more than another false start in '55, and perhaps poised to play a bigger part in the market picture than even the most far-seeing prophets are presently predicting, the warning to technicians is—GET READY! New know-how and new equipment will be needed. One of the best ways to get ready is to clean house during inventory-taking time next month. A physical inventory of parts on hand will help the department to size up its situation stock-wise; help eliminate worthless junk which always accumulates, and will aid in ferreting out shortages of frequently used tubes and other components.

COMMERCIAL ELECTRONICS will expand from its present 8 percent share of the business to 25 percent in the next 10 years, predicts GE exec., Wm. J. Morlock. Breaking down industrial electronics into 3 broad categories—automation and instrumentation, communications, and business office electronics—Morlock foresees a growth in the last-named area that will even outstrip the trend toward automation. Electronic clerks will replace office workers in accounting, inventory control, material control, payrolls, purchasing and order service.

COOKING WITH GAS? No, with electrons. A large turkey was roasted in half an hour; a cake was baked in six minutes, at a 2-day seminar on microwave cooking sponsored by Raytheon in Waltham, Mass. Cooking is accomplished without heating the walls of the oven or the utensil in which the food is cooked.

HERE AND THERE WE HEAR BEEFS about trouble with color TV sets—the demonstration models—in stores. Seems some of the complaints have to do with charges imposed by distributors in cases where they have to send field men out to work on the receivers. However, to look at this situation on the optimistic side, let's say that color TV is now in the throes of growing pains, and that after this coming year reaches its end, most difficulties will have been ironed out.

IN SPITE OF THE FACT THAT COLOR-TV, at long last, is actually out of the false-step stage, there's hardly been any adverse effect on B & W sales. During other "starts" on Color TV, the publicity put the brake on monochrome sales in most areas.

ANOTHER BANNER YEAR FOR PHONO RECORDS is ahead in '55—and business was very good this year, too—about 230,000,000 discs will have been sold in '54, TECHNICIAN editors estimate. All of which leads us to talking about the opportunities existing in every shop for the sale of quality needles and for increasing service revenue by going after phono service work. Never before has there been a greater interest in fine music for the home, and smart shop operators are cashing in on this current trend. Some signs in the show-window. "We Service Phonographs and Hi-Fi Instruments," for example, should help to bring in some plus business.

TECHNICIAN EDITORS ESTIMATE that the nation's TV-radio service departments will obtain new revenue to the tune of \$50,000,000 next year from two sources—color TV service and installation, and from work on music reproducing equipment for the home.

TV MEMORY MIRROR: What ever happened to tuner afc? Some of the earlier split-sound circuits used to feed back a control voltage (via a reactance tube) from the FM detector to the local oscillator. This promising set-up wiped out sound distortion due to drift and enabled elimination of the fine tuning control. Increased popularity of intercarrier design and improved stability of front end components reduced the need for afc . . . Remember the phoney "color filters," being sold for \$1 or thereabouts, that were supposed to "convert" any set to color reproduction? They were transparent masks, tinted with blue, red and green dyes in horizontal strips, that were to be mounted over the picture tube.

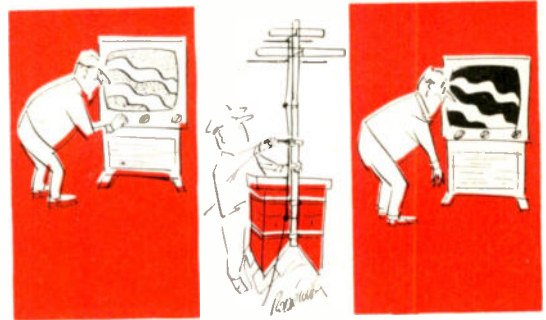

FIX-IT-YOURSELF BOOKS, while they may not have cut into the technician's income in the long run, are affecting him in other ways, some good, some bad. Some "self-educated" customers, determined not to let the servicer "get away" with anything, try to dictate the repairs they couldn't accomplish themselves. With others, the smattering of information they acquire is just enough to help the technician explain the what and the why of the repair—and the bill. Diplomacy is often the key to such situations.

TECHNICIAN RHYME: "Yes, Ma'm," said Doakes, "your radio is all fixed up and set to go. It's here somewhere right on the floor—or maybe it's behind the door." He pawed through a pile of repaired sets, all boasting dirty cabinets. He fished out one, and handed it to Mrs. Smith, who had a fit, when she saw fingermarks and dust—she eyed Joe Doakes with deep mistrust. "You're sure it's fixed?" she asked the guy, and now Joe Doakes still wonders why Mrs. Smith came in no more but switched to a competitor.

Now it's a fact, that sure as hell, a dirty shop's bound to repel. Though Doakes' work was well up to par, his crummy store just served to mar what might have been wide reputation, as a top-flight man in his location.

Burst Separator Circuits

Locating Defective Stages and Sections; Identifying

BY PETER ORNE

• Consideration of service problems associated with the separator circuit will be helped if it is remembered that the burst output, as noted in earlier articles in this series, is used to prevent the color killer from performing its function. Therefore, if there is no output from the burst amplifier—or if that output is weak—the killer continues to disable the color sections of the receiver. As a result, color programs can be reproduced only in black and white and even colored snow will not be seen.

To make sure that the absence of color is due to a defect in the burst amplifier, the color killer must be disabled—the easiest way is simply to remove the killer tube—to see whether the other color circuits are functioning. If the defect is indeed in the burst separator-amplifier, color will now be present, but it will be out of sync. That is to say, a normal-appearing picture will be reproduced in black and white but, over it will be moving color bars.

Causes of a defective burst separator include: a bad tube, absence of B-plus at either plate or screen grid, absence of the keying pulse at the cathode, absence of input at the grid. These symptoms are similar to troubles found in more conventional amplifiers or keyed stages; the technician should have little trouble tracing them.

Sometimes the stage is working, but providing improper separation. Instead of the desired burst alone, for example, some video or chroma information is getting through the amplifier in addition. The condition is illustrated in Fig. 1D. This is somewhat comparable to improper sync separation in a monochrome receiver. The symptoms will depend on just how much undesired "junk" is mixed in with the burst signal when the latter is applied to the discriminator of the color sync section.

If only a slight amount of undesired information is present, the hue of the colors will change with a change in picture content. As the amount of unwanted signal increases—that is as we get poorer burst

separation—the change in hue gets more pronounced. At worst, the colors tear out occasionally with a change in picture content. This kind of trouble can be seen on a good scope as information present in the spaces between the bursts. The trouble can be caused by a bad tube, or improper bias, which may be caused by changed part values.

Finally there is the possibility that the burst is improperly separated due to improper keying. The keying pulse may be too small or it may be incorrectly shaped (that is, too wide or too narrow) or it can be incorrectly timed. Refer to Fig. 1 C, E.

Insufficient keying pulse amplitude will cause insufficient burst output. This may be caused by a defective flyback winding, or, if the horizontal sweep and the high voltage are also affected, by any of the familiar troubles in the horizontal section.

A narrow pulse will cause part of the burst to be missing. This will

result in severe changes in hue when the horizontal hold control is varied. A wide pulse will show similar effect when the hold control is varied. In addition, it will allow unwanted video to appear in the burst output, causing changes of hue with scene changes. This type of trouble is not frequent and is usually due to incorrect replacement of flyback or yoke. The old trick of getting a wider picture by adding a condenser across the width coil or the yoke will also cause a wide pulse, for example, and should therefore not be attempted in a color set. An incorrectly timed pulse will also produce similar symptoms. It can be caused by incorrect adjustment of the horizontal section; primarily the lock-in range, phase, and frequency adjustments will affect the timing of the horizontal retrace with respect to the incoming sync pulse.

The horizontal section of the color receiver is adjusted the same way as in modern conventional sets but, since adjustment now affects more than one section, it should be done with added care.

Circuit Variations

As progress in color continues, it is only to be expected that improvements and variations in circuit design will appear. Of interest in connection with burst separator circuits is the arrangement used in the 28-tube experimental RCA set for use with the 21-in. crt (see issue of October 1954, Section 2). The burst in this receiver is amplified along with the chroma information in the chroma amplifier, a 2-stage amplifier that corresponds to the bandpass amplifier of earlier designs. There is an advantage in passing both signals through the same circuits: tank circuits, which tend to detune with age, can cause phase shift. With both burst and chroma information affected equally as they pass through the same stages, hue of the picture would remain unchanged. This would also prevent changes of hue as the receiver drifts during its warm-up period. The block diagram of this arrangement is in Fig. 2.

Fig. 1A—Normal keying pulse applied to burst separator. B—Normally separated burst signal (For clarity, full sequence is not shown). C—Excessive pulse width. D—Faulty separation which results. E, F—Improperly timed pulse produces insufficient burst separation.

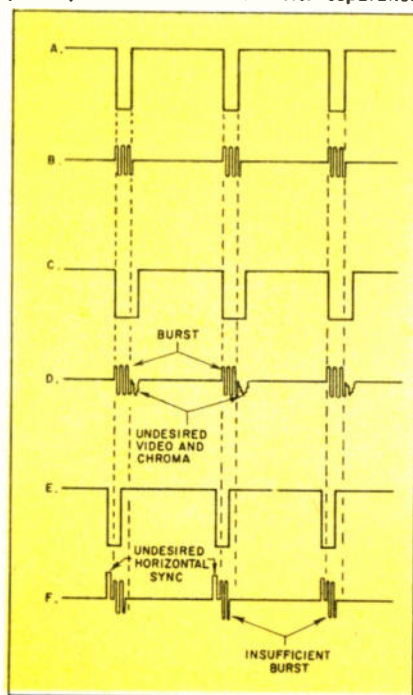

and Service Problems

Types of Defects; Comparison of Separator Circuits

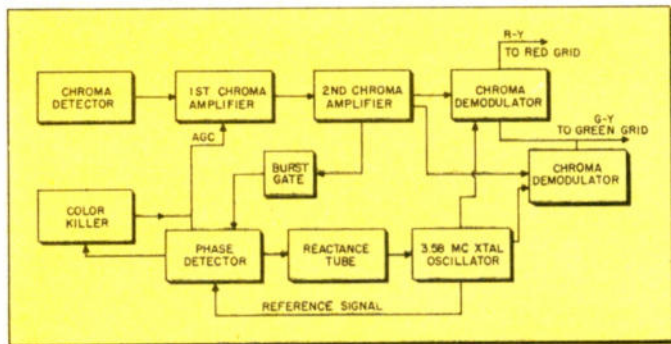
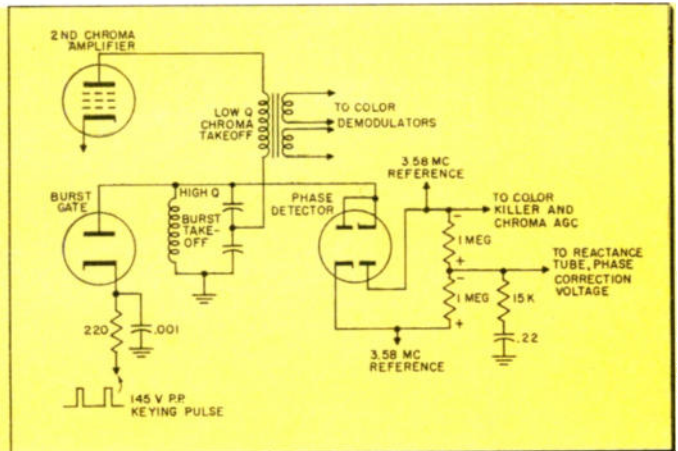

Fig. 2 (above)—Block diagram of the burst-chroma circuit arrangement as used in the 28-tube experimental color receiver. Fig. 3 (right)—This partial schematic helps explain how the burst sequence is separated in the 28-tube experimental design.



For the actual burst separation a gating diode is used. The circuit is shown in simplified form in Fig. 3. The output of the second chroma amplifier consists of two circuits in series. The top circuit is low in Q and couples the chroma information to the demodulators. The second is a high Q circuit tuned to the burst frequency and shunted by the gating diode. When no pulse is applied to the cathode of the diode, the tube will conduct heavily and act as a virtual short to ground so that all the chroma information will appear across the chroma output transformer and thus be passed to the demodulators. When the keying pulse, a positive pulse of about 145 volt peak to peak amplitude, is applied, the diode is cut off. The high Q tank circuit is now the main effective load, and the burst which occurs at this time will develop most of its voltage across it.

This serves a dual function. The burst appearing across the high Q circuit is applied to the phase detector, where it is compared with the output of the local 3.58 mc oscillator. The output of the phase detector will thus depend on the phase difference between burst and the local 3.58 mc oscillator. The correction voltage thus derived is applied to a reactance tube to correct the phase of the oscillator.

In addition, the amount of burst fed to the demodulators is very small due to the relative Q of the two circuits in the output of the chroma amplifier. This reduction in burst

amplitude is necessary to prevent the burst from reaching the grids of the crt, where it would become visible during the retrace.

Chroma AGC

In this new circuit, there is also a separate agc for the chroma system. The presence of the burst signal results in a negative voltage across one section of the phase detector. This negative voltage is used to control the gain of the chroma amplifier. Such a separate system becomes desirable for this reason: there are often variations in strength of the burst signal that are independent of variations in the video carrier, therefore beyond control by the ordinary r-f and i-f agc voltage that is ultimately determined by carrier strength. In older sets, this variation or fading would cause sudden changes in color saturation. Use of a chroma agc system prevents this.

The output of the phase detector is also applied to a color killer. If no burst is received, the grid of the color killer is near zero, the tube conducts heavily and the negative voltage developed at the killer's plate is used to cut off the first chroma amplifier. When burst is received, the grid of the color killer becomes more negative and the plate less negative, permitting conduction of the chroma amplifier.

This represents only one problem. As stated above, the color killer will cut off the chroma amplifier when no burst is received. However, the

reader will remember that the burst must go through the chroma amplifier in order to get to the phase detector. How then can we ever get burst through to begin with? To avoid this dilemma, a keying pulse of negative polarity is applied to the grid of the color killer. This pulse turns on the chroma amplifier by cutting off the color killer. Thus the chroma amplifier always conducts during the horizontal retrace period, which is also the time when burst occurs. The chroma amplifier is then cut off, if no burst comes in, for the duration of the next line. As soon as a burst does come in, the chroma amplifier keeps on conducting; and the amount of conduction will depend on the amount of burst, giving us the agc action.

As far as servicing this circuit is concerned, the same procedure should be followed as described for the previous circuit. The only additional problem is the new agc circuit. As with any agc system, the easiest way to locate the trouble is to apply an override bias. That is to say, a battery is applied to the bottom end of the chroma take-off coil and bias is adjusted for normal operation. If normal operation cannot be obtained, the fault lies in the chroma amplifier, color oscillator, or demodulators if no color picture appears at all; if colors appear but are torn out, the fault is either in the burst gate or the color sync section. If a normal color picture is obtained with override bias the fault is either in the killer or the chroma agc. •

Parts Progress Parade

Many old-line products took on a "New Look" in 1954.

In many respects, the year 1954 was a milestone for the postwar electronic parts industry. Major manufacturers, despite their preoccupation with plans for color, hi-fi and transistorization, found time to concentrate on improvements in their bread-and-butter items, the established products that are the backbone of the replacement market. The changes hit every corner of the field: capacitors, inductances, resistors, selenium rectifiers.

For the technician, it was an encouraging picture. The new designs meant more dependable parts, fewer call-backs. And, in most of the changes, the technician gained what he needed most—flexibility. Now he had parts which could fill a number of purposes, be adjusted to a range of values, or fit various mounting restrictions.

Selenium Rectifiers

A determined bid, sales-wise, was made by the selenium rectifier industry. Until now, the big obstacle to replacement sales has been the difficulty in physically installing the rectifiers; the need for removing the TV chassis, and, sometimes, for taking the set to the shop. This time-consuming labor is eliminated now by plug-in sockets. Using these sockets, the selenium rectifiers are replaced with the same ease with which we now change tubes. This innovation is long overdue.

Another notable improvement is the edge-mounting feature recently introduced by one manufacturer. This type of construction is stronger and permits full air circulation between the plates, smaller overall size per rating, and simpler mounting.

Selenium rectifier kits, consisting of plates and stacking hardware, also

hit the market. With these packages the serviceman can assemble his own rectifiers to suit his needs.

Coils and Transformers

One of the major improvements was in the field of inductances. As the year draws to a close the technician finds a variety of variable inductances on the market. They cover the full range of values and find many applications. One of the typical dual-winding, permeability-tuned coils combines the width, age and horizontal phase detector functions in one unit. Other similar coils also serve dual purposes.

Printed Circuits

Up to this point, printed circuits have seen only limited service in TV receivers. They have achieved some popularity as vertical integrator networks, and have been variously applied to front ends, but their importance has been, on the whole, rather negligible. This phase seems to be coming to an end. For 1955, one of the very top manufacturers has designed almost his entire line of TV receivers around printed circuits. He has spent the last few years checking out similar circuits in his line of radios and has decided now that the time is ripe for the change. For us, the technicians, it means that the door is being opened to a brand new field of servicing.

Capacitors

In the condenser field, the spotlight was on metal-cased and glass tubular types, with an overall emphasis on miniaturization. Plastic dielectrics were being employed by more and more manufacturers. Mod-

ifications in the design of high-voltage capacitors lead to easier mounting and more universal application.

Resistors

Chief progress in the resistor field was in the specialized types such as boron-carbon and high frequency resistors. For the technician, the biggest news was the increasing popularity of the make-your-own kits of resistive controls. A number of versions were available. Some featured a choice of shafts; others, a variety of resistance values and forms from which the technician could make his own dual controls.

Receiving Tubes

Perhaps the most striking progress was made in tube design. In the course of the year virtually all of the established tubes had extensive design changes or were completely superseded by new types. Topping the list was the venerable 5U4, workhorse of the industry for so many years. With a brand new slim-design envelope, wafer stem construction and improved plates, the new 5U4-GB was capable of operating at 275 ma, at 450 v., with peak plate currents up to 1.0 a., a 48% higher output than the old 5U4G. This striking improvement was matched in varying degrees in other tube types, such as the 12SN7, 1B3, 6BQ6, 6AX4 and 6BX7.

More and more emphasis was being placed on transistors, though little opportunity existed to service transistorized equipment. The switch to silicon had opened the door to power transistors and transistor radios. At the year's end, one major manufacturer was marketing an all-transistor radio at \$49.50.



Tape Recorder Repairs

Mechanical Tips for the Tech Who Knows the Electronic Angles

By CHARLES G. WESTCOTT

• This year, of about a million and a half tape recorders now in American homes, a good percentage will require repair or adjustment. Many will be turned away from repair shops with a stock answer: "I'm sorry; we don't handle recorders. Why don't you send it back to the factory?"

The tape recorder owner is a customer worth cultivating. Statistics say he is in a good income group, owning at least one television set, a car radio and two table radios.

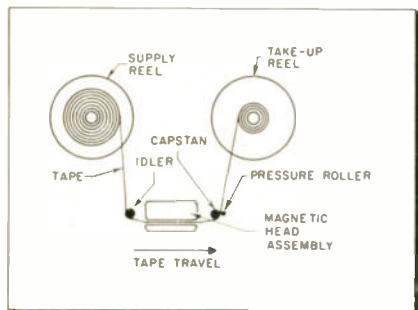

Fig. 1—Basic external tape transport system.

Someone is going to get his business. It can be you if you are set up to accommodate him.

Since the tape recorder combines mechanical and electronic parts, some mechanical know-how is necessary. Actually most recorders are less complicated and less critical than record changers. There are, for example, no delicate cycling and tripping adjustments.

One feature that may be unfamiliar is the clutch. Essentially this is a device for coupling one rotating member to another in such a way that some leeway is permitted in the transfer of motion. Why such devices are used can be seen from a study of Fig. 1, which shows the common method for carrying tape past the record-reproduce heads at constant speed. This constant speed is set by the capstan, which is coupled directly to a flywheel. (See Fig. 2. Except for the capstan and roller, the elements shown in Fig. 2 are not generally exposed to view on the average recorder.) A tight grip between the metal capstan and the rubber roller keeps the tape moving at the desired rate.

The take-up reel must also be driven, but not at a constant speed. At the beginning, as shown in Fig. 1, this reel must be spinning fairly rapidly to reel up the tape being fed out of the capstan-roller combination. As the tape accumulates, however, its diameter on the take-up reel is greater and it would therefore be taking up at a faster rate if its speed of rotation remained constant. This would change the recording speed, if the capstan permitted some slippage, or break the tape, if no slippage were permitted.

To overcome this problem, some slippage is built into the take-up reel so that it may slow down, when necessary, although its drive mechanism keeps going. This slippage is provided by using a clutch instead of a shaft directly connected to the reel. It may take the form of a brake or shoe, lined with felt, that provides friction enough to hold and rotate the reel, but allows it to slip free when there is a counter-force. Clutch action may be observed and the location of the clutch mechanism may be determined by holding the take-up reel manually while it is being driven, and observing what portions of its mounting stand still with it and which ones continue to rotate. There are adjustments for regulating the tension of the clutch. If tape tends to pull and tear, tension must be reduced; if tape spills

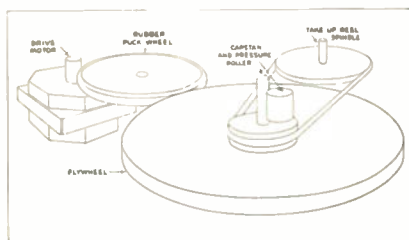

Fig. 2—Typical drive system (Revere 1700).

or hangs loose between the capstan and the reel, increase tension.

The recorder is subject to repair through failure of moving parts like shafts and bearings, which depend on proper lubrication for long life. Many dependable bearings are made of powdered bronze, wherein the oil is actually impregnated permanently into the bearing material. These do not require oiling.

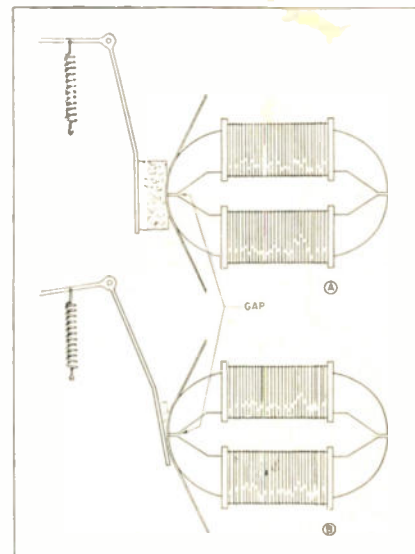

Fig. 3A—Normal position for pressure pad. B—Position of excessively worn pressure pad.

In many cases, oil is more to be feared than desired. Excessive oil may spread to rubber drive wheels, drive belts or the pressure roller, causing slippage in tape motion which is heard as wow or flutter in the reproduced sound.

A big menace is dirt, dust and grit. Particles may get between shafts and bearings, scouring and causing wear. Oxide from the tape may deposit on the pressure roller, causing speed changes. These rubber parts need only be cleaned with carbon tetrachloride, acetone, alcohol or any cleaner recommended by the manufacturer. The manufacturer may recommend against the use of a particular cleaner that may be harmful to the rubber compound he is using.

Pressure pads are also subject to constant abrasive wear, and require occasional replacement. They are little pads, generally of felt, that press the tape against the head while the tape is in motion. A tension spring holds them in place. Fig. 3 shows normal and worn pads.

Also subject to wear are the magnetic heads themselves, which are constantly being abraded by the passing tape. Wear on these results in widening of the gap. A wider gap results in reduced high-frequency response. These may also be replaced. •

Shop Hints to Speed Servicing

Tips for Home and Bench Service Contributed by Readers

Heat for Intermittents

When heat is applied to a chassis, as with a lamp, to make an intermittent component break down, there is always the danger of damaging other parts. However, there is a way to concentrate heat on individual suspected components.

We took a burned out tip from a soldering gun and spot welded to it a half shell made from a length of $\frac{3}{4}$ -in. copper tubing. The length of tubing used was $1\frac{1}{2}$ in. The accom-

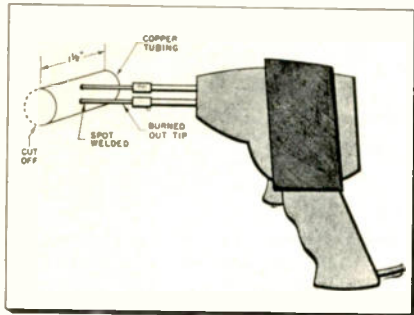

panying figure shows the completed job, with the tip replaced in the soldering gun. Different sizes and lengths of tubing can be made up on different tips, as required.

When using this device to concentrate heat on a suspected component, note that even a good part will break down if heat is applied too long. Only a few seconds are necessary if the component is intermittent to start out with.—*Joseph F. Valenti, Bronx, N.Y.*

Screw Replacement Trick

Replacing screws in hard-to-reach places on the chassis usually takes a great deal of time and patience. One way to save on both is simply to scrape a little wax from a paper condenser in the set itself. The wax is pushed into the slot of the screw, and the screwdriver is then inserted in the slot. This fastens the driver and the screw to each other very well, and makes it simple to guide the screw into its proper place without losing it.

A similar trick works just as well on a hex-head screw as it does on slotted-head screws. Put a little wax along the outer edge of the head before slipping it into a spin wrench. The screw, which is now prevented from dropping out of the wrench, is easily maneuvered into its hole.—*Richard Nowak, Maumee, Ohio.*

Wiring Replacement Yokes

When a defective deflection yoke is replaced with another that is entirely acceptable, but that is of another brand, it often turns out that the picture is upside down or reversed from left to right or both, because of differences in the color coding of wires. With a picture on the air, it is not difficult to get the raster right side up, but there is often no way to identify the hook-up of the horizontal section unless one wants to spend time waiting for some writing or lettering to show up in the picture.

Delay can be avoided, I have found, by using the vertical retrace lines as an indicating device. The retrace lines always slant down to the left and, when a picture is on, have a break in their structure on the left side of the screen. See part A of the illustration. By reducing contrast and increasing brightness, these lines can be made visible on most sets.

When no picture is on the air or no antenna is handy, the vertical

the reverse effect is shown by the vertical controls.—*Charles Garrett, New London, Connecticut.*

(As far as left-to-right deflection is concerned, you're still not cooked if you have no picture or if an effective blanking circuit kills off all retrace lines. You can temporarily misadjust the horizontal drive control to produce bright vertical lines. If the yoke is properly wired, these lines will appear at the left of the raster. When using this method, be sure to note the original position of the control, to which it should be restored after misadjustment has served its purpose.—*Ed.*)

Stop Tube Tester Wear

One of the annoying jobs we run into is the continual changing of wornout tube sockets in our tube checkers, a tough and time-consuming task. I have found that, by plugging a tube-testing adapter into each of the more frequently used sockets of my tester (see photo), I save this

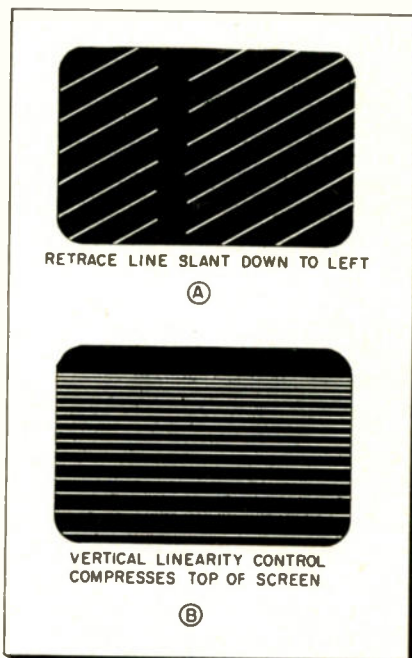

time. A small amount of service cement is used to hold the adapter firm. When the socket in the adapter itself is worn out, simply pull it out and insert a new one. The time saved more than compensates for the cost of the adapter.—*James C. Houston, San Antonio, Texas.*

SHOP HINTS WANTED

TECHNICIAN will pay \$5 for acceptable shop hints. We are particularly interested in hints on the following subjects: Hi-Fi servicing, TV and radio interference, industrial electronics, TV antennas, test equipment and UHF. Unacceptable items will be returned. Send your hints to "Shop Hints" Editor, TECHNICIAN, Caldwell-Clements, Inc., 480 Lexington Ave., N. Y. 17, N. Y.

Dynamic Condenser Checking

Test Capacitors without Disconnecting Them from the Circuit

by ARNO TUTEUR

• It is not too difficult to test a condenser for a short while it is still wired into its circuit, even when it has a resistor in parallel with it. All one needs is the ohmmeter. If the meter reads the value of the parallel resistor, the capacitor is not shorted. Where a short or appreciable leakage exists, the meter will register zero ohms or a lower value than that of the shunt resistor. With the same set-up, an intermittent short is revealed when the condenser under test is tapped.

If no short can be detected, the possibility still exists that the capacitor is giving trouble because it is open. For this test, unhappily, the suspected component usually has to be removed from the circuit, or at least one of its leads has to be unsoldered. Otherwise, other elements in the same circuit, in shunt with the condenser, will make a test for an open condition impossible.

The nuisance of having to get out the soldering iron for this simple check can be easily avoided. If the service technician has an r-f signal generator with a-f modulation, an oscilloscope and a demodulator probe, it will be worth his while to assemble the simple and inexpensive adapter described here. The insignificant investment in time and money will be more than repaid after the device has been in use a short time.

Simple Assembly

Very little additional construction information is needed to supplement the drawing of the adapter elsewhere on this page. The one made by the author was built on a small aluminum chassis. The input cable was terminated so as to provide easy connection to the signal generator. The output cable, designed for connection across suspected capacitors, was terminated in alligator clips. A jack was provided, in this case, for the demodulator probe, as well as a ground lug for the scope.

The coil used in the adapter is simple to wind: use 10 turns around a form that has a 1/4-in. diameter; space the windings to cover 1/2 in.

The condensers used were ceramics. The length of RG59U cable was 4 ft.

To check for an open capacitor, the adapter is connected across the suspected part as shown. Also as shown, connection is made to the signal generator's output. The detector probe is tapped in at the indicated point, and its output is fed to the oscilloscope. Scope ground is connected to the ground of the adapter chassis. The generator is set for modulated output at about 20 mc. The scope is adjusted to show the frequency of the a-f modulation. If the suspected condenser is indeed open, there will be no indication on the oscilloscope. If the capacitor is good, adjustment of the oscilloscope should result in a sine wave at the frequency of the modulating signal.

How It Works

Here is how the indications are produced. With no test condenser connected across its terminals, the circuit of the adapter is tuned roughly to about 20 mc. Since this tuned circuit is effectively in shunt with the combination of demodulator probe and scope, it will act as a short to signal from the generator at this frequency. The scope-probe combination, thus bypassed, will have no signal applied to it. No indication will therefore appear on the scope. When the test condenser is connected, it will have no effect on the tuned circuit if it is open. There will still be no signal applied to the circuit. The continued absence of any scope indication is therefore evidence that the capacitor is open. If the capacitor is *not* open, it will de-



tune the circuit of the adapter, which will no longer act as a bypass at 20 mc. Some signal will now go to the probe. When this happens, detected modulation is fed to the scope, where its presence indicates that the condenser is not open.

The figure of 20 mc as the resonant frequency, as stated, is only approximate. There will be some variation depending upon exact values represented by the adapter's condensers, the coil and the length of cable. The generator setting that happened to work with the model built by the author was 16.5 mc. Once the correct test frequency is determined—by producing a null on the scope with no test condenser connected—this point can be permanently marked on the generator for future use.

The adapter will work successfully on condensers as low in value as 50 mmfd. The test will still be successful when resistance in shunt with the capacitor being checked is as low as 50 ohms. •

With the illustrated adapter, condensers can be checked without removal from the circuit.

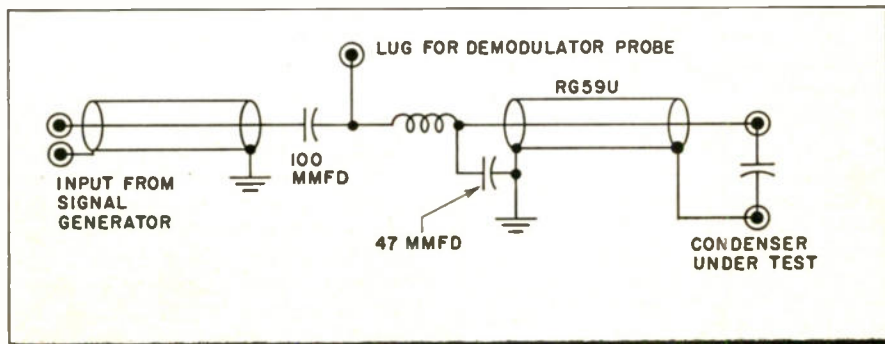

TV-Electronic Technician

Sweep and Signal Generators; Flyback Checker; Hand Tools

Precision SIGNAL GENERATOR

Model E-300 sine-square wave generator covers the audio-video ranges. The sine wave function covers from 20 cps to 200 kc in four bands; the square wave function from 20 cps to 200 kc in



three bands. Four fixed high-frequency square waves are provided for analysis of video and other wideband amplifiers up to 20 mc bandwidth. The application of square wave testing of frequency response, phase shift and amplitude distortion is outlined in an operating manual included with the instrument. Also available separately at 25¢ per copy. Precision Apparatus Co. Inc., 92-97 Horace Harding Blvd., Elmhurst, L. I., N. Y.—TECHNICIAN (Ask for No. 12-48)

RCP SWEEP GENERATOR

All electronic "Do-All" Model 780 sweep generator features an electronically regulated power supply and highly linear sweep. Range is 3.4 mc to 900

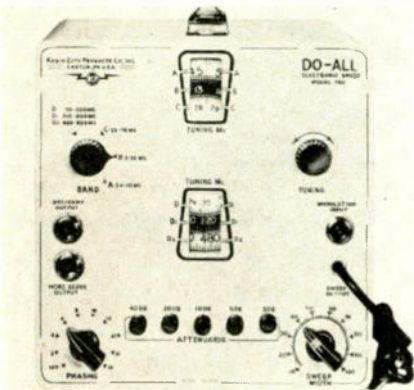

mc.; sweep width control 0 to 40 mc. AGC. Automatic internal blanking with straight line base generation eliminates return trace. Precision, triple shielded attenuator. Applicable to b&w and color TV, also FM and AM radio. \$189.50. Radio City Products Co., Easton, Pa.—TECHNICIAN (Ask for No. 12-54)

C-B SIGNAL GENERATOR

New Model 552 standard r-f signal generator covers the frequency range from 32 kc to 70 mc in seven ranges. R-f carrier may be modulated from the internal oscillator or from an external source. Features include minimum leakage and stray fields, high reading accuracy of the frequency dial and low cable standing wave errors. Clough-Brengle Co., Dept. TR, 6014 Broadway, Chicago 40.—TECHNICIAN (Ask for No. 12-3)

Winston PATTERN GENERATOR

White dot and bar patterns for use with either color or monochrome TV receivers are provided by the Model 160 generator. The large and small white dots facilitate the convergence adjustments on the 3-color kinescopes. Internally generated vertical sync pulses, locked to the line frequency, insure stable operation. Additional features are r-f carrier outputs and external modulation provisions. Winston Electronics Inc., 4312 Main St., Phila. 27—TECHNICIAN (Ask for No. 12-50)

PRINTED CKT. SERVICE KIT

Chemicals and tools to speed the servicing of Admiral's 1955 line of printed circuit TV receivers are now available in kit form. The kit contains a resinous lacquer, to protect the circuit from moisture and dust accumulation, a solvent for the lacquer, a special solder particularly suitable for repairing printed circuitry, 2 special hand tools and a service manual. \$5.75. Admiral Corp., 3800 Cortlandt St., Chicago 47, Ill.—TECHNICIAN (Ask for No. 12-56)

Wall SOLDERING GUNS

Constant heat regulation through thermostat control, and B.T.U. outputs up to 200% more than older type guns are the outstanding features of the "Trig-R-Heat" line. Models 212LT and 214TN have interchangeable tips and element assemblies which allow a power range from 150 watts to 650 watts. All guns have steel clad tips and a 10-watt spotlight with separate switch. Distributed by Garden City Industries Inc., 900-910 W. Jackson Blvd., Chicago 7—TECHNICIAN (Ask for No. 12-47)

MORE TECHNICAL INFORMATION

describing the new products presented here may be obtained by writing on company letterhead to New Products Editor, *TECHNICIAN*, 480 Lexington Ave., New York 17, N.Y., listing numbers given at end of each item of interest. Please mention title of position held.

B&B BIAS SUPPLY

An adjustable source of fixed bias between 0 and 17 vdc is produced from any radio or TV receiver's 6.3 v. heater supply by the Model 703 bias box. In operation the box is mounted on the chassis proper using alligator clips, which also act as electrical ground. Calibrated control adjusts bias voltage to specifications. Chief application is to the alignment of receivers. Available in either kit form or factory wired. Boland & Boyce Inc., 236 Washington Ave., Belleville 9, N. J.—TECHNICIAN (Ask for No. 12-52)

Seco FLYBACK CHECKER

Horizontal output transformers and yokes are checked by measuring the flyback interval time. Instrument uses variable frequency oscillator to find the flyback resonant frequency, which is



standard on all sets within reasonable tolerances. Transformers, yokes and other inductances are checked by the comparison method. Seco Mfg. Co., 5015 Penn Ave., Minneapolis 19—TECHNICIAN (Ask for No. 12-51)

Approved UHF SIGNAL GENERATOR

Coverage of 450 to 900 mc, on fundamentals, is provided by the Model A-900 generator. Tuning is accomplished by a cavity system, and output is indicated by a 3-in. calibrated output meter. Output is rated at minimum of 1 v. across the band. 50 ohm terminated cable. 400 cycle internal modulation, with separate modulation control. R-f attenuator 0-120 db total. Approved Electronic Instrument Corp., Dept. TN, 928 Broadway, N. Y. 10, N. Y.—TECHNICIAN (Ask for No. 12-55)

MORE NEW PRODUCTS
ON PAGE 24

Test Equipment "Spec" Chart

Data on New Specialized Test Instruments for the TV Technician

CATHODE RAY TUBE TESTERS and REACTIVATORS

| MANUFACTURER | MODEL NO. | INDICATOR | REMARKS | PRICE |
|---|-----------|------------------------|--|-----------------------|
| AUTHORIZED MFG. CO., 919 WYCKOFF AVE., BROOKLYN 27, N.Y. | 101 | 3-IN. METER | | \$ 49.95 |
| BOLAND & ZOYCE, INC., 236 WASHINGTON AVE., BELLEVILLE, N.J. | 701 | 4½-IN. METER | INCLUDES A 600 DCV RANGE FOR CHECKING RECEIVER SUPPLY VOLTAGES. | \$ 29.95* \$ 39.95 |
| ELECTRONIC INSTR. CO., INC., 84 WITHERS ST., BROOKLYN, N. Y. | 630 | NEON LAMP | | \$ 17.95* \$ 24.95 |
| JACKSON ELECTRICAL INSTR. CO., 18 S. PATTERSON ST., DAYTON, O. | 707 | METER AND NEON LAMP | INCLUDES ROLL CHART AND AIRPLANE LUGGAGE-STYLE CARRYING CASE. | \$149.95 |
| MILLER TV CO., 2940 NAOMI ST., BURBANK, CALIF. | D-60 | METER AND NEON LAMP | ALSO A CRT REACTIVATOR. COMES IN A METAL CARRYING CASE. | \$ 89.95 |
| PRECISION APPARATUS CO., INC., 92-27 HORACE HARDING BLVD., ELMHURST 13, N. Y. | CR-30 | METER AND NEON LAMP | HARDWOOD PORTABLE CARRYING CASE. | \$104.75 |
| RAYTRONIC LABS., INC., 9701 READING RD., CINCINNATI, O. | CB-54A | METER AND NEON LAMP | ALSO A CRT REACTIVATOR. RESTORES CATHODE CONTACT BY WELDING CATHODE TAB. METAL CARRYING CASE. | \$279.00 |
| SUPERIOR INSTRUMENT CO., 2435 WHITE PLAINS RD., N. Y. 67 | TV-40 | METER | "EMISSION" TESTER. | \$ 15.85 |
| TRANSVISION, INC., 460 NORTH ST., NEW ROCHELLE, N. Y. | 100 | METER | "COMPONENT TESTER"; CHECKS AND REACTIVATES PICTURE TUBES. ALSO CHECKS FLYBACK TRANSFORMERS, YOKES, SELENIUM RECTIFIERS, CAPACITY AND CONTINUITY. | \$ 49.95 |

* Denotes kit.

FLYBACK TRANSFORMER TESTERS

| MANUFACTURER | MODEL NO. | INDICATOR | METER SENSITIVITY | WEIGHT | REMARKS | PRICE |
|--|-----------|-----------------|-------------------|---------------|---|--------------------|
| CORNELL-DUBILIER ELECTRIC CO., 333 HAMILTON ST., S. PLAINFIELD, N. J. | BF-80 | 4½-IN. METER | 50 μ A | 8 LBS., 6 OZ. | 3 SCALES. PORTABLE METAL CARRYING CASE. | \$46.45* |
| ELECTRONIC INSTRUMENT CO., INC., 84 WITHERS ST., BROOKLYN, N. Y. | 944 | 4½-IN. METER | 50 μ A | | 3 SCALES. SEPARATE CALIBRATION FOR AIR- AND IRON-CORE TRANSFORMERS. | \$23.95 \$34.95 |
| KIRBY PRODUCTS CORP., 20 E. HERMAN ST., PHILADELPHIA 44, PA. | 98 | METER | 50 μ A | 5 LBS., 4 OZ. | 2 SCALES—FOR SHORT AND CONTINUITY TESTING. | \$34.95 |
| RADIO CITY PRODUCTS CO., CENTRE & GLENDALE STS., EASTON, PA. | 123 | METER | | 6 LBS., 6 OZ. | 3 SCALES. 1 SCALE FOR YOKES. | \$39.95 |
| SECO MANUFACTURING CO., 5015 PENN AVE., MINNEAPOLIS, MINN. | FB-4 | TUNING EYE | | | USES VFO TO MEASURE FLYBACK RESONANT FREQUENCY. | \$38.95 |
| TELETEST INSTRUMENT CO., 31-01 LINDEN PL., FLUSHING, N. Y. | | METER | | | NEEDS NO REFERENCE FLYBACK. | \$44.95 |
| TRANSVISION INC., 460 NORTH ST., NEW ROCHELLE, N. Y. | 100 | METER | 50 μ A | | "COMPONENT TESTER"; CHECKS FLYBACK TRANSFORMERS AMONG OTHERS. | \$49.95 |
| | | TUNING EYE | | | ALSO YOKE, CONDENSER AND CONTINUITY TESTER. | \$24.95 |

* Denotes kit.

New Antennas & Related Items

Late Designs in UHF-VHF Outdoor Antennas; Installation Accessories

Fretco VHF-UHF ANTENNA

New fringe area antenna, the "Fretaray Super Spectrum," features a front-to-back ratio of 50-1 and effective shielding against all angles of polarization due to the screened back. Range

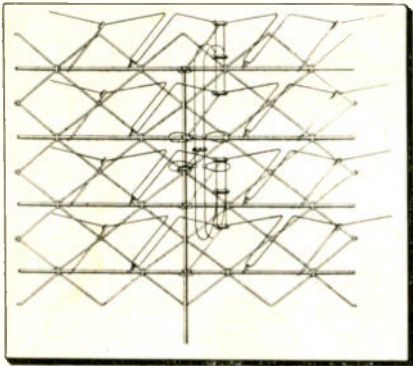

of the antenna is said to be 300 miles. Operates on channels 2 to 83. On most channels antenna is perfectly matched; on no channel is the mis-match greater than 2-1. Durability proven in 100 mph wind tests. Fretco Inc., 406 N. Craig St., Pittsburgh 13, Pa.—TECHNICIAN (Ask for No. 12-29)

Kenco EAVE MOUNTS

New mount eliminates need for extended side mounting brackets to clear eaves. 2-piece unit is mounted at apex of roof using 4 lag screws. Lower member is slotted to allow vertical align-

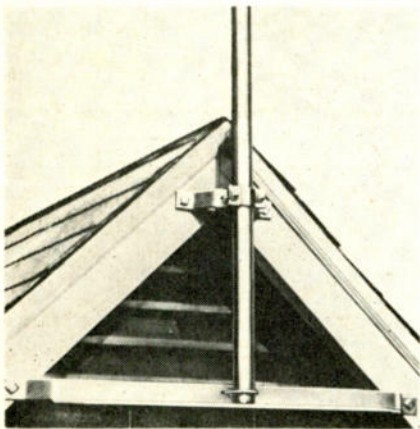

ment of the mast, and also provides footing for bottom end of antenna. Constructed of heavy gauge galvanized steel. Available in 3 sizes: 22-in. lower member, \$3.95; 28-in. lower member, \$4.95; 48-in. lower member, \$5.95. Kenwood Engineering Co., Inc., 265 Colfax Ave., Kenilworth, N.J.—TECHNICIAN (Ask for No. 12-32)

**MORE NEW PRODUCTS
ON PAGE 26**

CBS COLOR ANTENNA

With each color TV receiver CBS-Columbia is including this specially designed broad-band antenna. The unit is of Delta-V-Reflector design and maintains a flat response within 2 db.

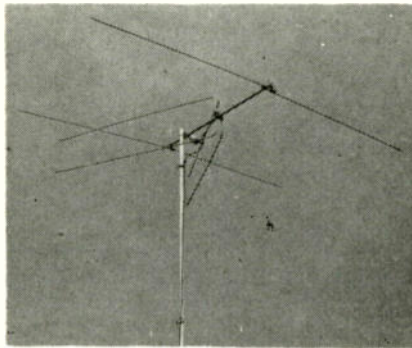

across the entire UHF and VHF spectrums. Average gain is approximately 7 db, relative to resonant dipoles at UHF and approximately 3 db. at VHF. Elements are colored bright yellow. CBS-Columbia, 3400 47th Ave., L. I. C., N. Y.—TECHNICIAN (Ask for No. 12-19)

K-T ANTENNA

Exceptionally high front-to-back ratios and high directivity are claimed for the "Rear-Guard" antenna. Tests

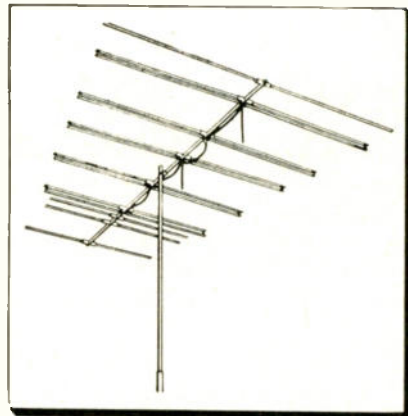

on all bands have shown up to 100-to-1 ratios, according to the manufacturer. Kay-Townes Antenna Co., Box 586, Rome, Ga.—TECHNICIAN (Ask for No. 12-31)

MORE TECHNICAL INFORMATION

describing the new products presented here may be obtained by writing on company letterhead to New Products Editor, **TECHNICIAN**, 480 Lexington Ave., New York 17, N.Y., listing numbers given at end of each item of interest. Please mention title of position held.

Taco VHF ANTENNA

Developed with an eye to the requirements for color reception, the "Shark" has high directivity and provides a gain on the order of 7 db on the low band and 8 db on chan-

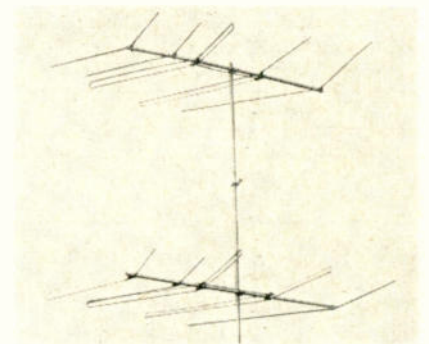

nels 7 through 13. Comprises five working elements, 2 directors, 2 driven elements, and a reflector, with all elements angled forward to provide a single lobe pattern on both high and low band reception. Twin folded dipoles provide a terminal impedance to match 300 ohm line. Technical Appliance Corp., Sherburne, N. Y.—TECHNICIAN

T-M COUPLERS

Latest in the Metro series of antenna couplers, the Model AM-84 is housed in a compact case with bronze finish and is designed to permit the operation of

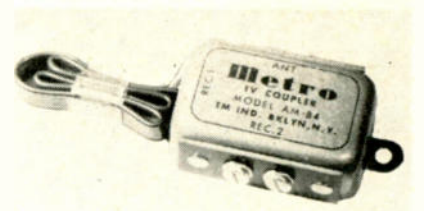

2 receivers from a single antenna. Units are now being marketed in unique counter model automatic dispenser which holds 24 couplers. Tele-Matic Industries Inc., 16 Howard Ave., Brooklyn, N. Y.—TECHNICIAN (Ask for No. 12-13)

Crown 2-SET COUPLER

Designed for either indoor or outdoor use, the new Model M-2 coupler features moisture proof construction and high efficiency inductive coupling. Matches 300 ohm line. Internal signal loss is claimed to be negligible. Dimensions are 3½ x 1¼ x ¾ in. Complete with mounting screws. Crown Controls Co., Inc., New Bremen, O.—TECHNICIAN (Ask for No. 12-16)

Vertical Raster Lines

Causes and Remedies for Hard-to-Localize Troubles

- Classification of the various types of vertical lines and background material on their origination in the horizontal circuit were presented in the first part of this article (see November 1954 *TECHNICIAN*, p. 18). Also covered were a list of specific cures for black and white vertical lines, and for white lines on the left side of the raster. Additional symptoms and cures are listed and localization techniques are discussed in this concluding section:

White lines and/or non-linearity at the right side of the picture or raster:

- Defective horizontal output tube.
- A leaky coupling condenser from the horizontal oscillator to the

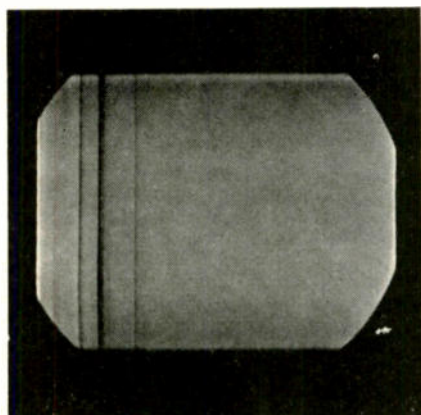

Fig. 1—Lines due to Barkhausen oscillation in horiz. output tube. (Courtesy G.E. Technitalk)

horizontal output stage will usually cause non-linearity or foldover at the right. In this condition the top of the modified sawtooth signal that is applied to the horizontal output stage is flattened.

- Change in value of the grid resistor of the horizontal output stage has the same effect as a leaky coupling condenser.

- Defective low-value parasitic-suppressor resistor in the grid circuit of the horizontal output stage can cause one or more white lines.

Wrinkles (with vertical white lines) at the left side of the picture, decreasing in intensity to the right:

- Defective damper tube.
- Yoke ringing; defective yoke-

Part 2

BY CYRUS GLICKSTEIN

balancing condenser.

- Horizontal linearity control defective.

- Open damper filter condenser.

Thin vertical black line(s) near left side of screen:

- Barkhausen oscillation in the horizontal output stage. Some characteristics of this type of oscillation are: It is more noticeable on high channels, especially with weaker signals coming in, and on blank channels with contrast at maximum; the line or lines shift position on the screen at different channel settings. See Figs. 1 and 2.

- Spurious oscillations in horizontal oscillator stage (usually caused by a defective tube).

Where there is some doubt, especially in the case of a thin black line, whether the signal responsible for the line is reaching the screen by way of the video circuit, or is coming directly from the horizontal section, remove the video detector or video amplifier tube. If the line is still visible, it is the result of a defective sawtooth in the horizontal deflection coil. If the line disappears, it is coming in through the video signal circuit.

Waveform examination is a simple supplementary bench-servicing method for locating the source of vertical line trouble. The usual system of checking key points of the

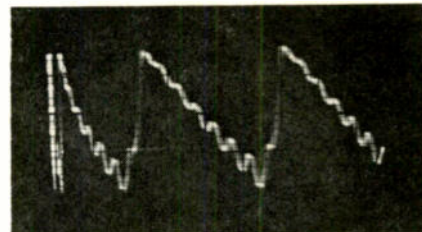

Fig. 2—Current oscillations in yoke responsible for the ringing illustrated in Fig. 1. (Photo courtesy G.E. Technitalk)

horizontal circuit with an oscilloscope is used, starting with the horizontal oscillator. The observed waveform is compared to the one shown in the manufacturer's service manual for both shape and peak-to-peak amplitude. At the point where a defective waveform is noted, a series of routine voltage and resistance checks for trouble is made.

Localization tests in the horizontal section are not always simple. There are some cases where a defect in a following circuit may be responsible for a defective waveform in a preceding stage. This is true especially in the damper circuit, which provides boosted B+ to the oscillator and output stages. A damper circuit defect or a ripple in the boosted B+ supply may cause the latter supply voltage to drop below normal, which in turn may cause the oscillator waveform to be distorted. In difficult servicing problems, it is helpful to have an independent source of boosted B+ voltage—a separate B+ boost power supply, in other words—to connect to the oscillator stage,

(Continued on page 39)

Fig. 3—Anti-ringing network in the secondary circuit of the horizontal output transformer.

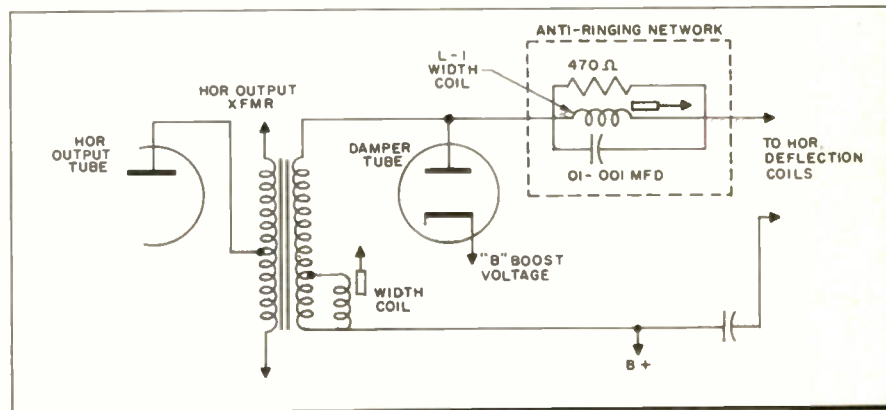

New Parts & Components

Corona-Proof Tube Mount; Capacitors, Resistors, Selenium Rectifiers

Trutone HI-VOLTAGE SHIELD

Precision molded, polystyrene high-voltage tube socket assembly eliminates the need for corona rings. Effectively shields high voltage at most critical point. Voltage breakdown characteris-

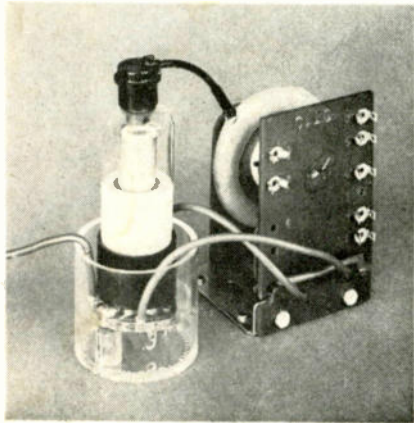

tics of the material used is 600v/0.01 in. The minimum thickness anywhere on the assembly is 0.1 in. \$1.00. Trutone Electronics Inc., 812 N. Highland Ave., Los Angeles—TECHNICIAN (Ask for No. 12-42)

Daven RESISTOR

Sub-miniature, encapsulated resistor, Type 1273, is 1/4-in. in diameter by 5/16-in. long and can be supplied in resistances up to 400K. Mounting is by radial leads and power rating is 1/10-watt. Available in accuracies up to .05% and with any type resistance wire, depending upon the temperature coefficient required. Daven Co., 191 Central Ave., Newark 4, N.J.—TECHNICIAN (Ask for No. 12-35)

C-D CAPACITORS

New high temperature steatite-cased "Miniroc" capacitors require no voltage derating even at +130°C, and provide maximum moisture resistance. Dielec-

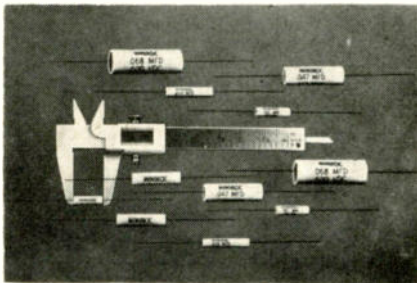

tric is Mylar polyester. Non-inductively wound extended foils are firmly soldered to the wire leads to insure low r-f impedance. Cornell-Dubilier Electric Corp., 333 Hamilton St., S. Plainfield, N.J.—TECHNICIAN (Ask for No. 12-44)

Pyramid SELENIUMS

New rectifier construction features edge mounted plates providing full air circulation between plates, light constant contact pressure to eliminate hot spots, rigid construction, smaller over-

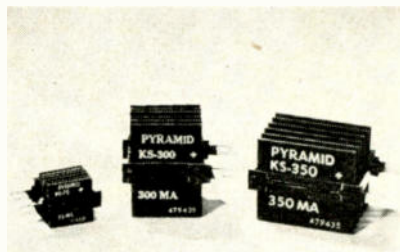

all size per rating and simpler mounting. Design is claimed to assure longer life and more efficient operation at high ambient temperatures. Units can be used as replacements for all existing standard rectifiers. Pyramid Electric Co., 1445 Hudson Blvd., North Bergen, N.J.—TECHNICIAN (Ask for No. 12-38)

JFD PISTON CAPACITOR

Expansion piston in the VC-13G variable trimmer capacitor has a traverse motion free from mechanical backlash, giving smooth capacitance tracking over

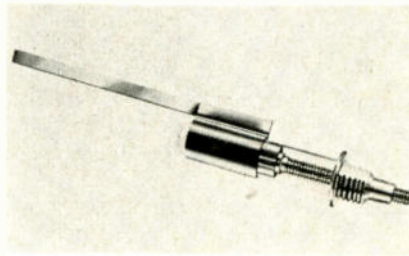

the complete range. Rigid grip at all times between the piston and inner wall of the dielectric tube makes the capacitor free from effects of vibration and shock. Flat ductile copper lead offers low loss at high frequencies and ease of attachment. Unit withstands up to 10,000 vdc without flashover. Electronics Div., JFD Mfg. Co., 6101-16th Ave., Brooklyn 4, N.Y.—TECHNICIAN (Ask for No. 12-33)

MORE TECHNICAL INFORMATION

describing the new products presented here may be obtained by writing on company letterhead to New Products Editor, *TECHNICIAN*, 480 Lexington Ave., New York 17, N.Y., listing numbers given at end of each item of interest. Please mention title of position held.

Astron CAPACITOR KIT

Plastic and metal "Swing Bin" contains 166 capacitors of 36 different values, with a maximum of 5 of each type. Each of the nine bins swings out 180° for easy access to stock and movable



dividers. Capacitors are molded plastic tubulars which feature new thermo-setting impregnant for high stability over the entire temperature range (-40°C to +85°C). Bonded seal and shell are impervious to vibration, heat and moisture. Astron Corp., 255 Grant Ave., East Newark, N.J.—TECHNICIAN (Ask for No. 12-45)

Sprague RESISTORS

New subminiature 3-watt wire-wound resistor is the same size as conventional 1/2-watt molded carbon types. Designed for application in point-to-point and terminal board wiring as well as on printed wiring boards. Measures 13/64-in. in diameter and 17/32-in. in length. Maximum resistance value of 10,000 ohms. Coating is blue vitreous enamel. Sprague Electric Co., 65 Marshall St., North Adams, Mass.—TECHNICIAN (Ask for No. 12-43)

Amperex TRANSISTORS

Types OC70 and OC71 P-N-P junction transistors are designed for low level audio applications. The OC70 has a grounded emitter current gain from 20 to 40, the OC71 a gain of 30 to 75. Both transistors have average noise figures of only 10 db and are particularly suited to hearing aids and other portable circuits. Types O80C and O81C are metal-cased transistors having standard JETEC base and dimensions. The metal casing allows a higher collector voltage and a dissipation of 50 milliwatts at 45°C. Engineering Dept., Amperex Electronic Corp., 230 Duffy Ave., Hicksville, N.Y.—TECHNICIAN (Ask for No. 12-34)

MORE NEW PRODUCTS
ON PAGE 28

All the Newest and Best in this

FREE CATALOG

Get a copy from your **Admiral**
DISTRIBUTOR

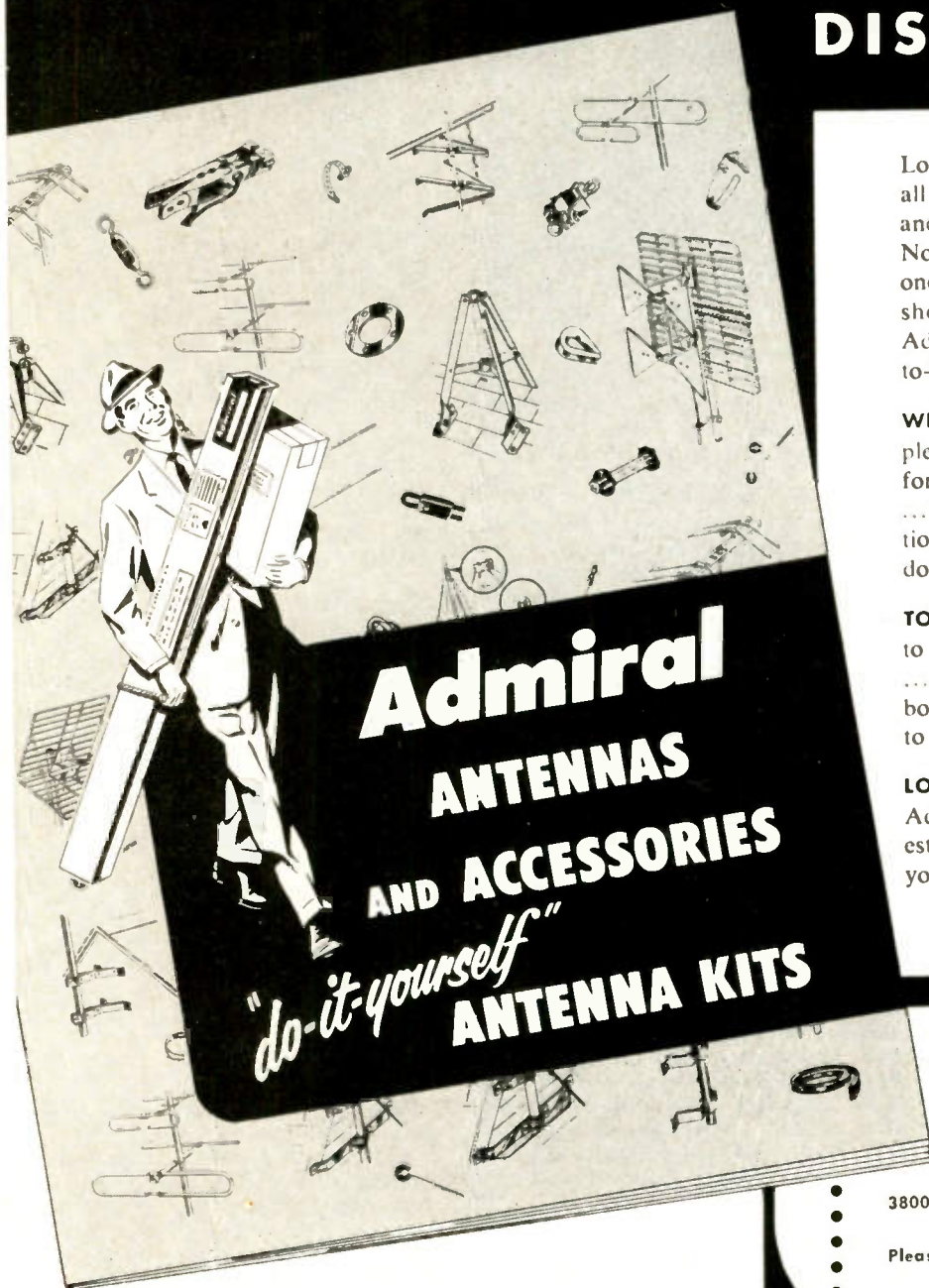

Look to your Admiral distributor for all your requirements in TV antennas and antenna mounting accessories. Now you can get everything from one source...no need to waste time shopping around. Count on your Admiral distributor for quick, close-to-home service.

WIDEST SELECTION—Here is a complete range of antenna equipment... for VHF, UHF or VHF-UHF areas ...for metropolitan or fringe locations...for indoor, roof-top or window mounting.

TOP QUALITY—Every item conforms to Admiral's high quality standards ...fully tested in Admiral laboratories both for performance and for ability to stand up under severe conditions.

LOW COST—Huge production enables Admiral to quote the industry's lowest prices. Compare costs! Send for your Admiral catalog *today*.

.....
Admiral Corporation,
Accessories Division

3800 Cortland St., Chicago 47, Illinois

Please send free catalog.

Name _____

Address _____

City _____ State _____ T-12

Phone your **Admiral** distributor or
MAIL COUPON TODAY

New Sound Equipment

Amplifiers, Speakers and Tape Recorders; Hi-Fi Conversion Kit

Mohawk TAPE RECORDER

Battery-operated pocket tape recorder has only three controls. It records for one hour on dual track tape and simultaneously erases old material as new recordings are made. Hearing



aid type batteries used with the unit have an extended life of over 45 hrs. A battery life indicator gives a warning when the battery has two hrs. of recording time remaining. Dimensions are $3\frac{7}{8} \times 1\frac{7}{8} \times 8\frac{1}{2}$ in. Weight $3\frac{1}{4}$ lbs. Price of \$229.50 includes a recording cartridge in which the tape is wound, batteries, crystal microphone and earphone. Mohawk Business Machines Corp., 944 Halsey St., Brooklyn 33, N. Y.—TECHNICIAN (Ask for No. 12-14)

G.E. SPEAKER

For use in low-cost hi-fi systems, the new 8-in. extended range speaker, Model "850," provides a frequency response up to 12,000 cps. It is equipped with an aluminum voice coil and uses a 6.8 oz. Alnico 5 magnet. Power output is rated at 15 watts. Recommended resale price—\$9.95. Special Products Div., Radio-TV Dept., General Electric, Electronics Park, Syracuse.—TECHNICIAN (Ask for No. 12-25)

Snyder MIKE STAND

New floor stand for microphones, Model MS-2, consists of chrome-plated telescoping staffs which extend to $61\frac{1}{2}$ in., collapse to $32\frac{1}{2}$ in. Folding base is cast iron with gray crackle finish. Open, ready for use, the base measures 16 in. in diameter, collapses to 6 in. for storage. Snyder Mfg. Co., 22nd & Ontario Sts., Phila., Pa.—TECHNICIAN (Ask for No. 12-2)

Stephens COAXIAL SPEAKER

Tru-Sonic Model 152AX 15-in. coaxial loudspeaker employs a double exponential horn to assure wide-angle coverage and proper loading of high frequency driver. Fully-enclosed magnet structure uses $2\frac{1}{2}$ lb. Alnico V magnet; provides low frequency response to 30 cps; high frequencies to 18,000 cps. Free space cone resonance is 48 cps. Nominal impedance 12 ohms. Power capacity 20 watts. \$118.00. Stephens Mfg. Corp., 8538 Warner St., Culver City, Calif.—TECHNICIAN (Write for No. 12-26)

MAGNETIC CARTRIDGE KIT

Radio-phono consoles of good quality can be adapted to handle the new hi-fi wide range recordings by replacing the ordinary cartridge with a magnetic cartridge and adding a pre-amplifier.



These two units, together with connecting cables, are provided now in kit form. No soldering necessary. Pfans-tiehl Chemical Co., Waukegan, Ill.—TECHNICIAN (Ask for No. 12-27)

Masco SOUND SYSTEM

Six-watt, self-contained sound system consists of amplifier, 8-in. speaker, crystal microphone with 15-ft. cable and connector, and 3-speed manual turn-



table. Complete system is housed in plywood carrying case finished in 2-tone dark grey pigskin and light grey tweed leatherette. Frequency response is 50-12,000 cps. Designated Model CS-6P-3. \$110.00. Mark Simpson Mfg. Co., Inc., 32-28 49th St., L. I. C., N. Y.—TECHNICIAN (Ask for No. 12-22)

MORE TECHNICAL INFORMATION

describing the new products presented here may be obtained by writing on company letterhead to New Products Editor, TECHNICIAN, 480 Lexington Ave., New York 17, N.Y., listing numbers given at end of each item of interest. Please mention title of position held.

Langevin AMPLIFIER-PRE-AMP

New 20-watt amplifier, Model LH-20, features a frequency response of 20 to 50,000 cps, ± 1 db at 20 watts output. Harmonic distortion is under .33% at rated output; intermodulation distortion

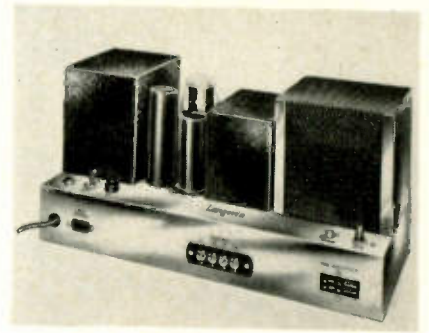

less than .5%. The equalizer-pre-amplifier, Model LH-21, provides remote control for the LH-20 amplifier. Inputs include: record, tape, microphone, TV, tuner. Equalizing is achieved by three methods—switch selection of 7 bass or 7 treble positions, or continuously variable bass and treble control. Langevin Mfg. Corp., 37 W. 65th St., N. Y. 23.—TECHNICIAN (Ask for No. 12-21)

Magnecord TAPE RECORDERS

Designed for the semi-professional and home audio markets, the Model M30-D "Aristocrat" and Model M-34 "Educator" tape recorders are the latest in the line designed around the basic M-30 mechanism. The M-30D has two inputs for a high impedance microphone and phono or tuner. Tape speeds of $3\frac{3}{4}$, or $7\frac{1}{2}$ ips. Dimensions are $13\frac{1}{4} \times 12 \times 20\frac{1}{2}$ in. In mahogany veneer or maple. Weight—40 lbs. Model M-34 has, in addition, a self-contained 10 watt amplifier with two 6-in. wide range speakers, and separate treble and bass controls. Price: for the M-30D—\$339.00; M-34—\$429.00. Magnecord Inc., 225 W. Ohio St., Chicago 10.—TECHNICIAN (Ask for No. 12-5)

Granco FM RECEIVER

Model 610 table model FM-only receiver features $5 \mu\text{v}$ sensitivity for 20 db of quieting, and stability in terms of frequency drift at ± 5 kc across the entire band. Audio output is $1\frac{1}{2}$ watts. 6-in. oval Alnico V PM speaker. Hum level of 80 db below full output. In walnut, blond or ebony plastic. \$29.95 in ebony, slightly higher in blond or walnut. Granco Products Inc., 36-17 20th Ave., L. I. C. 5, N. Y.—TECHNICIAN (Ask for No. 12-4)

**MORE NEW PRODUCTS
ON PAGE 30**

The One Big Reason Big-Screen Color TV Sets are on the Market Now

It took more than engineering promises before leading set manufacturers invested in production of color TV sets. It took a practical big-screen color picture tube . . . the CBS-Colortron "205."

It took *creative* engineering to conceive this advanced design in color picture tubes. And it took *advanced-engineering* knowledge to produce it.

Today, these set manufacturers are demonstrating their recognition of the leadership of CBS-Hytron. For they are shipping color TV sets *and these sets are equipped with the CBS-Colortron "205."*

There can be no better evidence of the *advanced-engineering* knowledge of CBS-Hytron . . . *Advanced-engineering* knowledge you can depend upon to produce the finest in television tubes . . . for color *or* for black and white.



WRITE FOR FREE BULLETIN E-227 TODAY.
Four pages of engineering application data
on the "205."

CBS-COLORTRON PATENT NO. 2,690,518. OTHER PATENTS PENDING



CBS-HYTRON Main Office: Danvers, Massachusetts
A Division of Columbia Broadcasting System, Inc.

A member of the CBS family: CBS Radio • CBS Television • Columbia Records
CBS Laboratories • CBS-Columbia • CBS International • and CBS-Hytron

**IT'S NEW!
IT'S COMPLETE!
IT'S AVAILABLE!**



**TRIAD'S *CORRECT
REPLACEMENT
TV GUIDE TV-55**

Triad's new TV Guide is available now. It is a complete up-to-date catalog of Triad's *Correct Replacement TV Transformers, exhaustively checked for accuracy. Your jobber has copies of TV-55 in stock... or write us direct.

*Correct Replacement (*CR) transformers are mechanically correct and electrically correct ruggedized versions of original manufacturers' items built to give a longer more satisfactory life.

Triad *CR Transformers are listed in Sam's Photofact folders & Counter Facts and Riders Replacement Parts List.



4055 Redwood Ave., Venice, Calif.



New Product Briefs

SHURE CARTRIDGES: New RK-54 Cartridge Replacement Kit contains 3 crystal cartridges which replace 192 of the most popular types. The cartridges are: Model W22AB 3-speed, 2-needle; Model W26B, all-purpose, single-needle; and Model W78, a 78 rpm, dual-volt, dual weight cartridge. Kit comes with technical data and replacement chart folder. Shure Bros. Inc., 225 West Huron St., Chicago 10, Ill.—TECHNICIAN (Ask for No. 12-59)

R-B HI-FI AMPLIFIER: Model 1811 amplifier features 12 watts output, with frequency response of 20 to 20,000 cps., ± 0.5 db. Four inputs, and separate bass and treble tone controls. Rauland-Borg Corp., 3515 W. Addison St., Chicago 18, Ill.—TECHNICIAN (Ask for No. 12-60)

FIELD-PHONE: Portable, 2-way radio telephone provides dependable FM quality voice communication. It is powered by self-contained, long-life batteries, and is comfortably carried with a shoulder strap. Industrial Radio Corp., 428 N. Parkside Ave., Chicago 44—TECHNICIAN (Ask for No. 12-57)

UTICA PLIERS: Diagonal and side cutting pliers in the Utica line are now available with the "Cushion Throat" safety feature which eliminates the "flying chips" hazard in cutting springs or hard wire. The "cushion" is red Plastisol, bonded beside the pliers cutting edges, which grips the short end of the wire as the cut is made. Utica Drop Forge & Tool Corp., 2415 Whitesboro St., Utica, N. Y.—TECHNICIAN (Ask for No. 12-63)

DUMONT MOBILE RADIO: Two new complete mobile radio base stations, for the 25-54 mc and 450-470 mc bands, respectively, fill the requirements for 2-way FM communications at any pre-selected frequency in the band. Multi-frequency operation up to four channels is available for the transmitter within band of 1% of carrier frequency. Termination panel permits remote operation through 2-wire or 4-wire lines for both receiving and transmitting. Units are designated as the MCA-151-A and MCA 450-A. Mobile Communications Department, A. B. Du Mont Labs Inc., 750 Bloomfield Ave., Clifton, N. J.—TECHNICIAN (Ask for No. 12-64)

SWITCHCRAFT ADAPTERS: To simplify the connection of equipment having different type connectors in sales and service departments, laboratories, etc., a package of 10 adapters, in a transparent plastic case, provides combinations for hook-ups between microphone connectors, phone jacks, phone plugs, binding posts, banana plugs or tip jacks. Switchcraft, Inc. 1328 N. Halsted St., Chicago 22, Ill.—TECHNICIAN (Ask for No. 12-50)

HEXACON SOLDERING TIPS: Heavy durable coating of iron alloy over a copper base on the new Hexclad Soldering iron tips is claimed to provide up to ten times the life of plain copper tips. Will not erode or pit. Furnished tinned ready to use. Available in sizes to fit any one of the 40 types of Hexacon irons. Hexacon Electric Co., 180 W. Clay Ave., Roselle Park, N. J.—TECHNICIAN (Ask for No. 12-54)

TRUTONE SPEAKER SYSTEM: "Symphonette" unit consists of 3 speakers, with a crossover network, mounted in an enclosure 11 x 24 x 10 in. deep. Power input—20 watts. Response—20 to 14,000 cps. In leatherette, blonde or mahogany finish. Trutone Electronics Inc., 812-14 North Highland Ave., Los Angeles 38, Calif.—TECHNICIAN (Ask for No. 12-58)

REK-O-KUT TURNTABLES: New Rondine Jr. 12-in. turntable is designed for 2-speed operation only—33 $\frac{1}{3}$ and 45 rpm. Features the "floating idler" which eliminates acoustical coupling between motor and turntable, a built-in retractable hub for 45 rpm records and permanently affixed strobe disc. 4-pole induction motor. \$49.95. Rek-O-Kut Co., 38-01 Queens Blvd., L. I. C., 1, N. Y.—TECHNICIAN (Ask for No. 12-49)

CLAROSTAT POTENTIOMETERS: Series 42-900 precision pots are designed for prototypes and laboratory testing. Features include gold-plated bushings, terminals and screws; front and rear plates of anodized aluminum; each potentiometer center-tapped. Available in ranges from 50 ohms to 100,000 ohms. Power rating 3 watts. Clarostat Mfg. Co., Inc. Washington St., Dover, N. H.—TECHNICIAN (Ask for No. 12-51)

GERRARD TOOLS: Both flat strapping and round wire can be cut with the new No. 503 cutter which has a double duty set of cutting blades for strapping, and a second set of cutting surfaces near the rear of the cutter head for round wire. Handles strap as heavy as .035 in., or 12 gauge wire. A. J. Gerrard & Co., 1950 N. Hawthorne Ave., Melrose Park, Ill.—TECHNICIAN (Ask for No. 12-52)

SHALLCROSS SWITCHES: Precision, oval instrument-type "1200 Series" rotary switches are of heavy-duty construction, and are available in shorting types with either 20° or 30° indexing or in non-shorting types with 40° or 60° indexing. Up to 3 poles per deck and up to 10 decks per switch. Nominal rating is 1 a, 110 v, 60 cps. Shallcross Mfg. Co., Collingdale, Pa.—TECHNICIAN (Ask for No. 12-46)

MORE TECHNICAL INFORMATION describing the new products presented here may be obtained by writing on company letterhead to New Products Editor, TECHNICIAN, 480 Lexington Ave., New York 17, N.Y., listing numbers given at end of each item of interest. Please mention title of position held.

CLETRON SPEAKER SYSTEMS: Line of 12-in. and 15-in. console enclosures, an 8-in. table model and 5, 6, 8, 10 and 12 in. custom wall baffles. Available in modern blond or mahogany finish. 4-page brochure available on request. Cletron Inc., 6611 Euclid Ave., Cleveland 3, Ohio—TECHNICIAN (Ask for No. 12-47)

MOTOROLA LOUDSPEAKER: Inverted cone speaker now available for 2-way mobile radio units is claimed to greatly improve the intelligibility of messages through its ability to reproduce the entire voice frequency range. Provides up to 43% greater cone area than conventional mobile radio speakers. Magnet assembly is inside the cone in order to reduce space requirements. Housing measures $8\frac{1}{2} \times 6\frac{3}{4} \times 2\frac{3}{4}$ in., including mounting bracket. Motorola Communications & Electronics Inc., Technical Information Center, 4501 W. Augusta Blvd., Chicago 51, Ill.—TECHNICIAN (Ask for No. 12-48)

IGNITION PLIERS: New "Diamalloy" 4-in. groove joint ignition pliers have adjustable jaws which lock into parallel positions up to $\frac{1}{2}$ in. Fully chrome plated. Diamond Calk Horseshoe Co., Duluth, Minn.—TECHNICIAN (Ask for No. 12-53)

AMPEREX GERMANIUM DIODES: Types OA71, OA73, and IN87G all glass envelope germanium diodes feature high resistance to humidity and other environmental conditions. IN87G and OA73 find application as video detectors; the OA71 is a high back resistance type for computer and general purpose applications. Amperex Electronic Corp., 230 Duffy Ave., Hicksville, L. I., N. Y.—TECHNICIAN (Ask for No. 12-55)

SHELF TRUCK: Hard vulcanized fibre body, reinforced with all steel channel body bands gives this 4-wheel shelf truck high structural strength with a low weight factor. Suitable for stock handling or chassis transport. Wm. Bal Corp., 10 Johnson St., Newark 5, N. J.—TECHNICIAN (Ask for No. 12-56)

GRAMERCY SPEAKER SYSTEM: Employs an 8-in. Goodmans Axiette 101 speaker. Specifications: response—40-15,000 cps; flux density—13,500 Gauss; total flux—51,200 Maxwells. Cabinet is of $\frac{3}{4}$ -in. wood; in mahogany or blonde. Dimensions: $24 \times 10\frac{1}{2} \times 17$ in. Price \$64.50. Gramercy Sound Assoc., 176 Fifth Ave., N. Y. 10—TECHNICIAN (Ask for No. 12-61)

TELEX HEADSETS: Lightweight, 1.6 oz., over-the-head style headset consists of plug-in mechanism, thin stainless steel band, and two clear plexiglas air cushions, which slide on the steel band to adjust to the correct length. Impedance is 128 and 2,000 ohms. Telex Inc., Telex Park, St. Paul 1, Minn.—TECHNICIAN (Ask for No. 12-62)

See "Radio TV
Electronic Technician:
A Profile" pages 40, 41

TECHNICIAN • December, 1954

New Tubes

Regulator Tube

The 6BD4A, announced by CBS-Hytron, is a high-voltage regulator triode designed for anode and convergence supplies of color TV receivers. Supercedes and is a direct replacement for the 6BD4. Added advantages are: Increased maximum dc plate voltage, increased maximum unregulated dc supply voltage rating and increased maximum plate dissipation voltage rating. Has electron-gun type construction, and an amplification of 1650.

TV Receiving Tubes

Latest in the G. E. line of "service-designed" tubes are the 12SN7-GTA, 6AX4-GT and the 6BX7-GT, replacement types. Features of the 12SN7-GTA are: button stem base, shorter leads and better lead insulation, reduced tube leakage and 28% less bulb height. Tube has 450 v. maximum plate voltage per plate compared with 300 for 12SN7-GT, and maximum heat dissipation per plate of 5 watts, compared to $3\frac{1}{2}$ watts for the 12SN7. On the 6AX4-GT, a new "pigtail" winding places a separate, insulated barrier between the heater wire and the cathode to prevent heater-cathode shorts. The 6BX7-GT features "flipper" apertures in the mica spacers for four-corner grip to grid legs, to reduce microphonics and help cut down vertical video "jitter."; gold-plating of grid wires to cut emission and special slots in mica spacers and notched plate design to reduce arc-overs and leakage.

Horizontal Output Tube

Sylvania's 6BQ6GTA features wafer stem construction, high temperature top cap solder and 1-piece beam confining plate. Folded edges on the plate prevent bulb bombardment by eliminating openings where plate halves are joined.

Miniature Twin-Triode

RCA's new 6CG7 general-purpose medium-mu twin triode is a 9-pin miniature equivalent of the 6SN7-GT. It measures less than 1-in. in diameter and is $2\frac{5}{8}$ -in. in length. Design features include: a 600 ma heater with controlled warm-up time; an internal shield which prevents electrical coupling between the triode units, and an internal structure which holds grid operation to a cool level and minimizes grid emission.

New Tung-Sol 6550

Designed specifically for audio applications, the new 6550 beam power amplifier has double the power handling capability of the 5881. A pair of 6550's, in push-pull, can produce up to 100 watts output. Main application is public address systems. Features include: Glass button stem construction, mic-anol wafer and metal shell base, triple gettering, and maximum control of grid emission through gold plating and carbonizing.

INTERNATIONAL

Selenium Rectifiers

for
TV
RADIO
Replacement

the
Replacement
Rectifier
that's Right!

all types
available
from your
parts distributor

INTERNATIONAL RECTIFIER

CORPORATION

El Segundo, Calif.

NEW YORK

ORegon 8-6281

CHICAGO

World's Largest Supplier of
Quality Industrial Rectifiers

"Tough Dog" Corner

Difficult Service Jobs Described by Readers

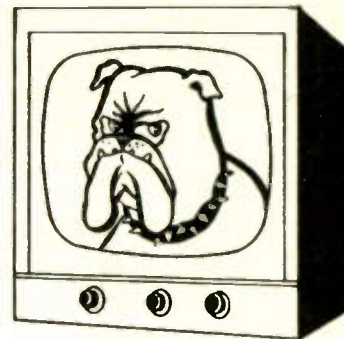

\$ For Your "Tough Dog Story"

Have you tangled with a difficult or obscure service problem recently? Write it up, telling us how you licked it, and send it to "Tough Dog" Editor, TECHNICALIAN, Caldwell-Clements, Inc., 480 Lexington Ave., New York 17, N.Y. \$10 will be paid for usable material. Unacceptable items will be returned to the contributor.

Horizontal—or Vertical?

After restoring high voltage on a Zenith 24H20 chassis, a trapezoidal raster was encountered with the picture being drawn in at the bottom about one inch on each side. In addition, there was a slight pulling effect across the top.

A thorough check of the yoke proved it to be in perfect condition. Voltage and resistance checks of the horizontal output and feedback circuits disclosed nothing out of the way. However, the waveform on the grids of the horizontal output tubes showed a slight oscillation at the beginning of the sawtooth trace. A scope check of the horizontal oscillator and discharge stages showed normal waveforms, so the trouble must be somewhere in the horizontal output or feedback circuits—but where?

During examination, an attempt was made to readjust raster shape with the controls. Vertical size and linearity were found to be rather critical to adjust. A more extensive search, in a slightly different direction, showed that the 20-mfd filter capacitor, connected to the high side of the vertical output transformer, was open. Replacement of this part cleared up all the troublesome symptoms. Plate voltage for the vertical output tube is obtained from the best boost voltage developed at the damper tube cathode, in the horizontal output circuit. Hence this open condenser in the vertical output circuit deteriorated performance in the horizontal system as well.—John Jacobson, Norfolk, Va.

No Pix, Fuzzy Raster

I recently worked on a Freed-Eisman model CHT 1900 that had me going for a while. When the set was on, there was no picture but the screen seemed to be lit up with something less than full brightness. Focus appeared to be so bad that it was impossible to see raster or retrace lines.

I checked high voltage, B-plus, B-minus, the focus control, the focus coil, focus-coil current and the filter condensers. Everything seemed to be in order. Before tearing my hair out, I decided to move the picture down a little with the vertical centering control to get a look at the top edge of the raster. When I touched the control, the picture jumped into view.

A check of the centering control showed that, sure enough, that's where the trouble was all along. At one point, the control shorted out altogether. The raster apparently was moved right off the screen when this happened, with the illumination on the tube resulting from secondary emission. Since the total value of the control was only 20 ohms, it had no appreciable effect on the readings I had taken even when it was shorted out.—Bernard Singer, New York, N. Y.

It's All in the Touch

Symptoms were: streaks across the picture, poor contrast, ringing of fine detail and gurgling sound. The fault looked like i-f oscillation but a check of tubes and voltages revealed only a high agc voltage on the grids of the 1st and 2nd i-f stages and a high negative voltage on the grid of the 1st video amplifier, 12AT7.

We pinpoint an oscillating stage

by applying the sweep generator and looking at the i-f response curve. In this case, the scope trace showed a very high peak at 24 mc, the resonant frequency of the 3rd i-f transformer. With sweep still on, touching the 3rd i-f plate or the input to the detector brought the curve to normal. But a careful check of all components in this circuit, together with the replacement of a suspicious cathode decoupling condenser, still left the oscillation.

At this point a second opinion was called for. The second chap suggested shunting the video detector peaking coils "just in case." I did—no good. Being a suspicious type, he tried it himself—away went the oscillation. I tried—back it came. He tried—it went away! The thing was becoming a farce, and there seemed no explanation, until we discovered that we performed the operation in slightly different ways. I shunted directly across the 500 microhenry peaking coil ends (see part B of the illustration). He shunted from the grid of the 12AT7 to one end of the 4700-ohm resistor. The same thing? Not quite, because he bridged the joint between the coil and the resistor, and the joint was cold! A touch of the solder gun and everything was normal.

Oscillation occurred because the plate load of the 3rd i-f is shunted by (and normally damped by) the detector diode in series with the detector load. With a high resistance joint, shunt effect and damping were reduced, and the stage took off. The high negative voltage developed at the 12AT7 grid produced high agc, hence poor contrast.—R. Eldridge, Vancouver, Canada.

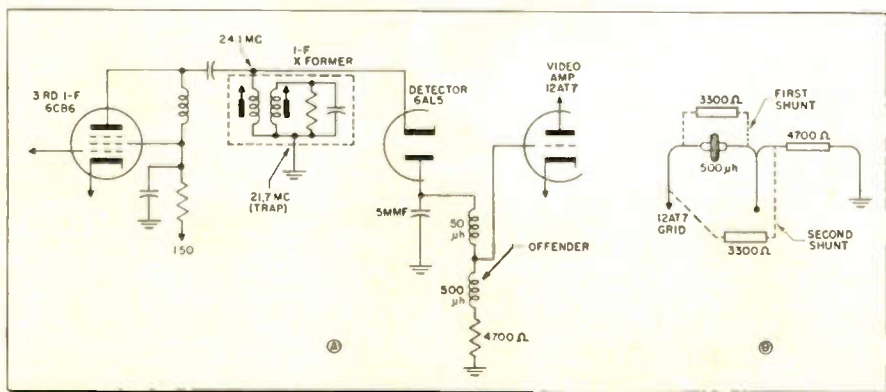

More Ranges - More Visibility - More V.O.M.

the **PRECISION** MODEL **120**



Gives You What You Want in a

HIGH SENSITIVITY MULTI-RANGE TEST SET

**20,000 OHMS PER VOLT D.C.
5,000 OHMS PER VOLT A.C.**

- ▶ **MORE RANGES** — The '120' gives you 44 . . . which start lower and go higher . . . to outrange any professional V.O.M. of similar size or type.
- ▶ **AN EXTRA-LOW RESISTANCE RANGE** — The '120' gives you a 2-ohm center scale range, powered by long-lived, internal 1.5 volt battery source.
- ▶ **AN EXTRA-LOW VOLTAGE RANGE** — The '120' gives you 1.2 volts full scale, A.C. and D.C.
- ▶ **AN EXTENDED LOW CURRENT RANGE** — The '120' gives you a 60 microampere first D.C. current range.
- ▶ **A LARGER AND EASIER READING SCALE FACE** — The '120' gives you a new, extra-large 5¼" meter with full 4¾" extra-wide window.
- ▶ **SIMPLE, POSITIVE RANGE SELECTION** — The '120' gives you an 18-position, positive-detenting, master range selector with low resistance, dependable, silver-plated contacts.
- ▶ **RUGGED, POSITIVE CONTACT JACKS and PLUGS** — The '120' gives you specially designed, low resistance, solid brass, banana type plugs and jacks.

Compare These Wide-Spread Ranges and Special Features:

- ★ **8 DC VOLTAGE RANGES:** 20,000 ohms per volt. 0-1.2-3-12-60-300-600-1200-6000 volts.
- ★ **8 AC VOLTAGE RANGES:** 5,000 ohms per volt. 0-1.2-3-12-60-300-600-1200-6000 volts.
- ★ **8 AC OUTPUT RANGES:** same as AC volt ranges. With built-in 600 volts blocking capacitor.
- ★ **7 DC CURRENT RANGES:** 0-60-300 Microamperes. 0-1.2-12-120-600 Ma. 0-12 Amperes.
- ★ **5 RESISTANCE RANGES:** self-contained batteries. 0-200-2000-200,000 ohms. 0-2-20-megohms.
- ★ **8 DECIBEL RANGES:** from -20 to +77 DB. 0 DB = 1 Milliwatt, 600 ohms.

- ★ **EXTRA LARGE 5¼" RUGGED 'PACE' METER:** 40 microamperes sensitivity, 2% accuracy.
- ★ **1% MULTIPLIERS and SHUNTS:** wire-wound and high stability deposited-film types employed throughout.
- ★ **ONLY 2 PLUG-JACKS SERVE ALL STANDARD RANGES:** separately identified and isolated jacks provide for extra-high ranges.
- ★ **"TRANSIT" SAFETY POSITION:** on master range selector protects meter during transportation and storage.
- ★ **CUSTOM-MOLDED PHENOLIC CASE and PANEL:** set a new standard for compact, efficient, laboratory instrument styling. Deeply engraved panel characters afford maximum legibility throughout the life of the instrument.

MODEL 120: complete with internal ohmmeter batteries, banana-plug test leads and operating manual. Over-all case dimensions: 5 3/8 x 7 x 3 1/8 " Net Price: \$39.95

WILL COLOR TELEVISION MAKE PRESENT TEST EQUIPMENT OBSOLETE?

THE ANSWER IS NO! It will create even more uses for your PRECISION instruments! Color servicing will merely add one or two special-purpose units . . . which PRECISION will produce when field requirements are clearly defined.

As for V.O.M.'s — a volt is a volt, an ohm is an ohm and a mil is a mil . . . in color TV, monochrome or plain ordinary radio!



PRECISION Apparatus Company, Inc.

70-31 84th Street, Glendale 27, L. I., N. Y.

EXPORT: 458 BROADWAY, N. Y. 13, N. Y. U. S. A. Cables: Morhane
CANADA: Atlas Radio Corp. Ltd., 560 King St. West, Toronto. 2B

Outstanding

FROM EVERY ANGLE

CROWN
Tenn-a-Liner

in consumer's
acceptance

in dependable
performance

in dealer
profits

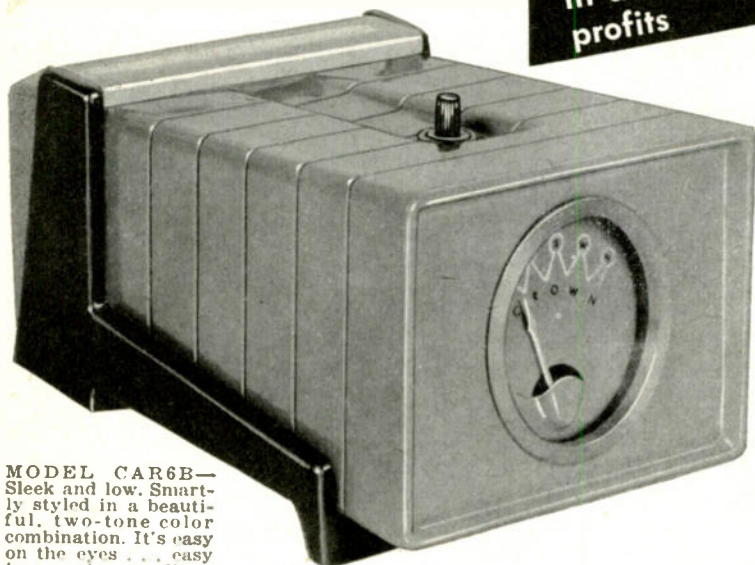

MODEL CAR6B—Sleek and low. Smartly styled in a beautiful, two-tone color combination. It's easy on the eyes . . . easy to operate . . . literally sells itself.

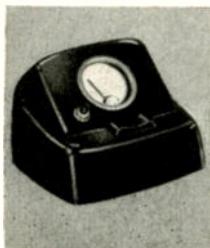

MODEL CAR6A—Has all the famous proved and exclusive features synonymous of Crown engineering. Attractively styled in rich mahogany bakelite.

See both outstanding models of the new Crown Tenn-a-Liner . . . Get the complete story about Crown's outstanding consumer acceptance . . . dependable performance . . . and outstanding profit plan. Then look at the Crown Tenn-a-Liner from every angle. You will be amazed at the bigger profits you will make by selling the exclusive, sales appealing features of the new Crown Tenn-a-Liner. You, too, will agree it's the best buy in antenna rotators on the market. Contact your Crown distributor or write us direct. Get the complete story on Crown, today!

SELL *with confidence*
sell **CROWN**

CROWN CONTROLS Co., Inc. NEW BREMEN OHIO

Canadian Subsidiary Crown Controls Mfg. Ltd. Export Division, 15 Moore St., New York, N. Y., Cable—"Minthorne"

News of the Industry

Victor E. Carbonara, president of Kollsman Instrument Corp., Elmhurst, N. Y., has been appointed a director of Standard Coil Products Co. Inc. following the retirement of Robert E. Petersen.



Victor E. Carbonara Edwin A. Freed

Edwin A. Freed, formerly operational head and sales manager of the Elizabeth headquarters division of General Instrument Corp., has been named general sales manager for all products made by firm and its manufacturing subsidiaries.

Robert J. Mueller is the new vice-pres. in charge of sales at Walsco Electronics Corp., Los Angeles.

Milton Schindler has been appointed administrative assistant to Ben Snyder of Snyder Mfg. Co., Phila.

James F. White, former CBS-Columbia contracts division manager, has been named general sales manager at Crescent Industries, Inc., Chicago.

Stanley Kramer has been promoted to assistant sales manager of the Semiconductor Div., Radio Receptor Co., Inc., N.Y.

H. G. Cheney is the new midwestern sales manager for the Electronic Tube Div., Westinghouse.

Bill Marcus, N. Y. area sales rep for John F. Rider Publisher, celebrated his 20th anniversary with the firm.

D. R. Yoder, formerly with the Tube Div., RCA, has joined Raytheon as district manager of their new western district sales office, Los Angeles.

Will James has been named Director of operations, responsible for all purchasing and manufacturing, at CBS-Columbia.

Sprague Electric Co. of North Adams, Mass. has announced plans to construct a new plant in Los Angeles. Chief products will be electronic items for the aircraft industry. The building will also house the distributor division, Sprague Products Co., and the West
(Continued on page 36)



Weston Model 981
Proportional Mutual Conductance Tubechecker

FILTERED D-C POTENTIALS

for accurate
 G_m
measurements

OUTSTANDING FEATURES:

G_m MEASUREMENTS— G_m measurements are made more accurately by using filtered d-c plate, screen grid and control grid potentials. A precision voltage divider network and selector switch allows a proportionate value of signal voltage to be chosen for testing tubes having transconductances up to 30,000 micromhos. Signal voltages of 5.2, 2.6, 1.3, and 0.65 volts peak-to-peak having a frequency of 5000 cycles are provided.

GRID BIAS, SCREEN GRID AND PLATE VOLTAGE: Filtered d-c potentials of 90, 130, and 220 volts are available for plate and screen potentials. A variable filtered d-c voltage in two ranges of 0-5 and 0-20 volts are used to obtain better resolution of Grid Bias settings. *Far greater accuracy is obtainable with filtered d-c potentials than previously possible in portable tubecheckers.*

METER MEASUREMENT OF HIGH LEAKAGE RESISTANCE—Since tube leakage as high as several megohms can cause poor performance in TV Receivers, this tubechecker is designed to provide an accurate meter measurement of leakage resistance as high as 5 megohms between tube elements, thus being particularly useful for TV servicing and TV line production assembly.

TWIN SECTION TUBES—Three toggle switches make it possible to rapidly check and compare the respective sections of twin section tubes at only one setting of the selector switches.

WESTON 980 LINE
TEST EQUIPMENT

THE 980 LINE PROPORTIONAL MUTUAL CONDUCTANCE TUBECHECKER

SEND COUPON TODAY FOR
COMPLETE DESCRIPTION AND PRICES

Weston Electrical Instrument Corporation
614 Frelinghuysen Avenue
Newark 5, New Jersey

Please send literature on the new 981 Tubechecker.

NAME _____

ADDRESS _____

TN

You can REPAIR PICTURE TUBES right in your own shop



with the sensational new RAYTRONIC CATHODE BEAMER

Only Instrument of its Kind—The Cathode Beamer not only thoroughly tests every TV kinescope, but really repairs many faults. It reactivates tubes by exclusive Cathode Sweeping, restoring emission, and greatly increasing picture brilliance and contrast. It burns off shorts, even those tough ones between Cathode and Grid. It welds broken Cathode Tabs. It expands the grid of old tubes allowing them to produce a satisfactory picture once again. And, all these repair procedures are done with skill quickly acquired right in your own shop.

Service Dealers Report Good Profits—Here is one instrument that actually pays for itself, and in only a few weeks. Dealers save their customers big tube replacement costs, yet make a good profit on almost every service job. And, customers are mighty pleased with the results. The Cathode Beamer has been thoroughly tested in actual service work and is endorsed by set manufacturers.

See the Cathode Beamer at your distributor's today. Or write

RAYTRONIC LABORATORIES, INC.

9701 READING ROAD

CINCINNATI 15, OHIO

(Continued from page 34)

Coast sales office . . . Van Dyke Instruments Inc. of St. Petersburg, Fla. producers of precision potentiometers for guided missiles and automation equipment, has been purchased by International Resistance Co., Phila. . . Melvin Electronics Inc. have completed the move to their new home at 541 Madison St., Oak Park, Ill.

Olson Radio Warehouse Inc., Akron, O. has opened a new store at 5918 Penn Ave., Pittsburgh. Manager is Leonard D. Berringer . . . A new radio and TV factory distributing branch has been opened at 1093-1099 Columbus Ave., Boston by CBS-Columbia . . . Simpson Electric Co. has purchased the complete plant facilities of O. D. Jennings & Co., located at 4307 W. Lake St., Chicago. The 4-story building, with over 100,000 sq. ft. of space, will be used for manufacturing Simpson's new line of color TV test equipment . . . On or about Jan. 1st, G. E. will open a Communication Equipment Center in Redwood City, Calif. to handle sales and service on the company's line of 2-way radio equipment.

Rohn Mfg. Co., Peoria, Ill. mfr. of TV towers, masts and accessories, acquires an additional 20,000 sq. ft. of factory and office space with the purchase of their third plant at 116 Farmington Rd., Peoria . . . Trav-Ler Radio Corp. has opened a factory distributing branch at 1251 Folsom St., San Francisco . . . E-Z Way Towers, Inc., TV tower mfr., moved to new and larger quarters at 5901 E. Broadway, Tampa, Fla.

Channel Master COUPLERS

Using the "SelecTenna" series of single-channel bandpass filters, an unlimited number of antennas individually directed can be coupled to a single transmission line. These low-loss circuits are enclosed in weatherproof polystyrene boxes which are installed on the mast. One coupler is usually used for each channel to be received. Recommended for areas in which multi-directional reception is presently obtained through the use of rotators, multiple lead-ins or omni-directional antenna types, and particularly for multi-outlet installations using these devices. Channel Master Corp. Ellenville, N.Y.—TECHNICIAN (Ask for No. 12-70)

RETMA Color TV Book

A 44-page book, *Fundamentals of Color TV for Service Technicians*, is now available from member companies of the Radio-Electronic-Television Manufacturers Association. This includes most of the TV set manufacturers. The publication is designed to form a basis for an industry-sponsored lecture program on color TV, and will be distributed in connection with company training programs. The book, and related film strips and slides, were prepared by the RETMA Service Committee. (Ask for No. 12-4)

Field Tested and Proven

by Hundreds of Thousands of Satisfied Users

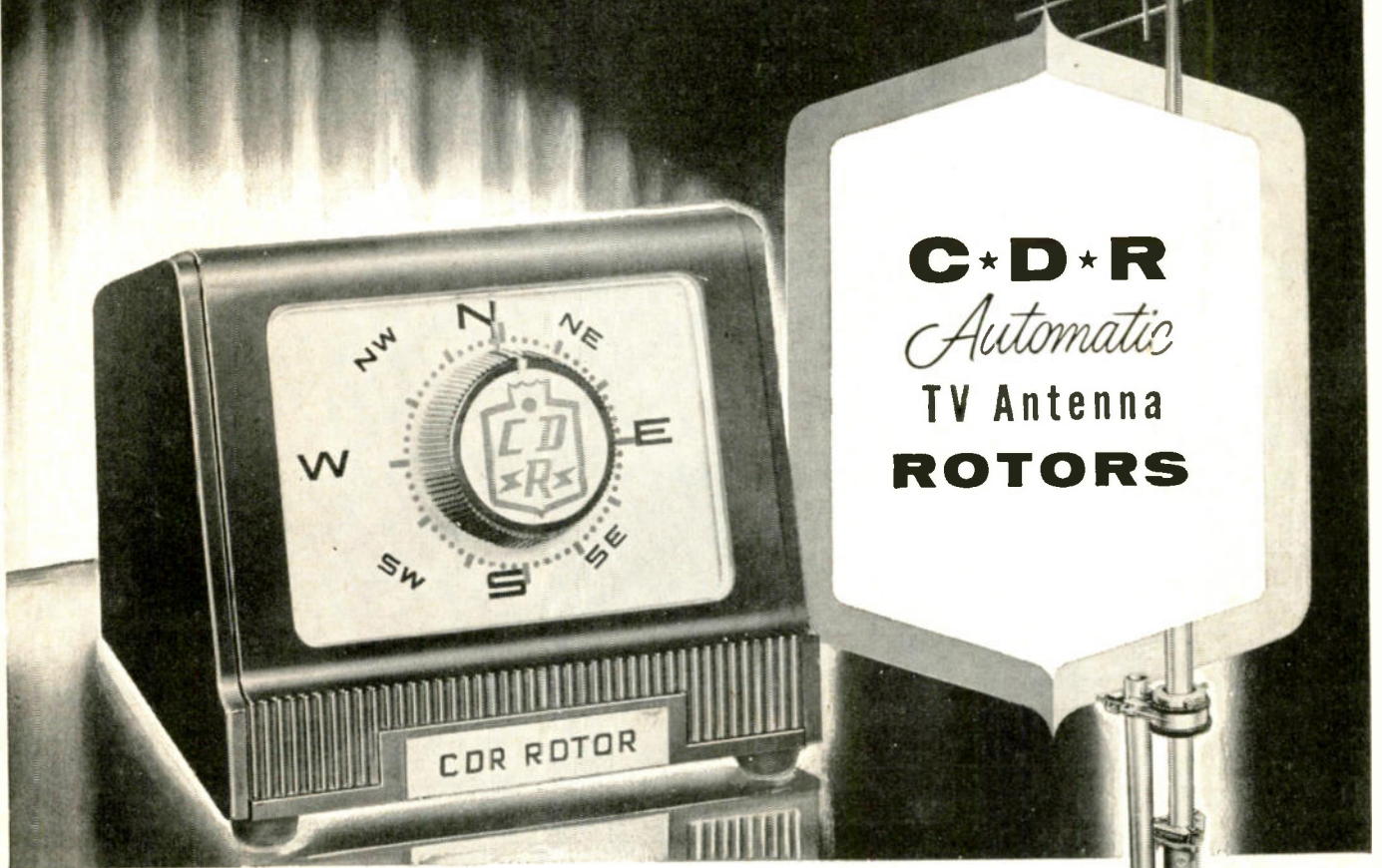

model AR-2... complete AUTOMATIC rotor with thrust bearing... and handsome modern design cabinet, uses 4 wire cable

model AR-1... same as AR-2 without thrust bearing

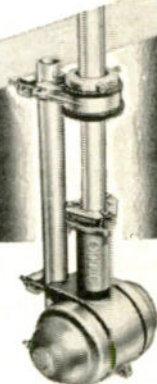

model TR-12

A special combination value consisting of complete rotor including thrust bearing. Handsome modern cabinet with meter control dial, uses 4 wire cable.

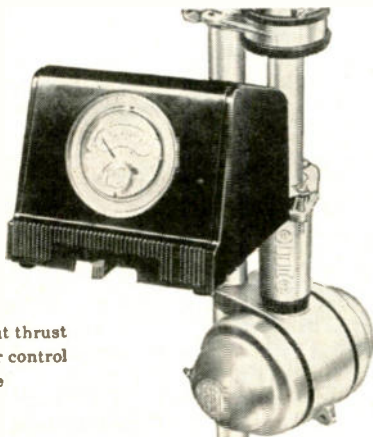

model TR-11

The same as the TR-12 without thrust bearing, complete with meter control dial cabinet, uses 4 wire cable

model TR-2

The heavy-duty rotor with plastic cabinet featuring "Compass Control", illuminated "perfect pattern" dial, uses 8 wire cable

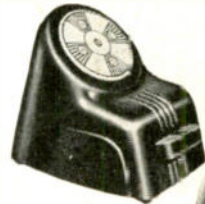

model TR-4

The heavy-duty rotor complete with handsome, modern design cabinet with meter control dial, uses 4 wire cable.

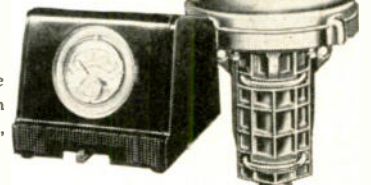

CORNELL-DUBILIER
SOUTH PLAINFIELD, N. J.



THE RADIART CORP.
CLEVELAND 13, OHIO

News of the Reps

The Los Angeles chapter of "The Representatives" has announced the resignation of R. L. Power and the appointment of Mal Mobley Jr. as executive secretary-treasurer . . . The national organization of "The Reps" reports the addition of two new senior members and five associate members to bring the total membership to 656, an all time high. New members are: in Chicago, Jay C. Angel, as senior member, his sons, J. R. and Les Angel, John J. Lightner, Lawrence B. Cole and

Wallace B. Phillips, as associates. In L. A.: LeRoy J. Smith, as senior member. Frank B. Koessler was recently promoted from associate to senior membership in the L. A. chapter.

Joseph Sprung, with offices at 254 W. 35th St., N.Y.C., has been appointed to represent Crescent Industries Inc. Chicago, tape recorders and speakers, on industrial accounts in the greater N.Y. area. . . . The importing and sales of the Ronette line of audio equipment will be handled by Ronette Acoustical Corp., 135 Front St., N.Y.; jobber and dealer sales through the Ronette Sales Corp., 48-08 Bergenline Ave., Union City, N.J. . . . Krylon products are being repre-

sented in Western Penna. and W. Va. by the John D. Olsen Co., Cleveland. . . . Workman TV Inc. of Teaneck, N.J., TV accessory mfr., has named Frank J. Perna, 2506 Stoneybrook La., Drexel Hill, Pa. to handle their line in Eastern Penna., Del., Md., and Fairfax Ct., Va. and John Zenkus, 801 Crotona Pk. North, Bronx, N. Y. for Va., except Fairfax Ct.

The Mike Roth Sales Co., 13947 Cedar Rd., Cleveland, has been named rep for Ohio, W. Va., and Western Penna., by Astatic Corp., mfr. of phono cartridges, pickups, microphones and stands, and TV UHF converters. . . . Oxford Electric Corp. announced the appointment of Jack L. Weber, 4348 N. Park Ave., Indianapolis to handle sales of their speakers and transformers to industrial accounts in Indiana. . . . Dunvar Inc., Chicago is representing Condenser Products Co. in Ill., Wisc., Ind. and Iowa. . . . The Wm. G. Kelly Co., 303 Belleair St., Burlington, Iowa will handle sales of Pyramid Electric Co. products to jobbers in Ia. and jobbers and industrials in Neb.

John B. Guenther, 7322 Marquette Ave., Dallas, has been named to represent the Technical Appl. Co. (Taco) line of antennas and accessories in Tex., La., Okla., and Ark.

Distributors

Dean A. Hill has joined Chauncey's Inc., Chicago parts distributor, as executive vice-pres. He was formerly general sales mgr. at Remco Inc. . . . Lavender Radio Supply Co., Inc., Webcor wholesale distributor at Texarkana, Tex. and Shreveport, La., has been appointed distributor for this line in Memphis, Tenn.

Sylvania Electric Products Inc. has signed up five new distributors for their line of radios and TV receivers: Erskine-Healy, Inc., 420 St. Paul St., Rochester, N.Y.; Mid-Cal Distributors, 1239 F St., Fresno, Calif.; Randolph & Williams, Inc., 204 Carter St., Columbia, Tenn.; The Bay Co., 2043-45 Liberty St., Jacksonville, Fla.; and Hallmark Electronic Corp., 401 Anderson Ave., Fairview, N.J.

The Geo. D. Barbey Co., Reading, Pa., was recently appointed exclusive distributor for the Reading and Harrisburg markets for the Regency Div., I.D.E.A., Inc. Sales emphasis is on the packaged hi-fi system, including Regency AM-FM tuner and amplifier, with Webcor changer and Jensen cabinet-speaker.

Added to the list of Magnecord background music distributors are the following: Lake Television Laboratory, Waukegan, Ill.; Peerless Electronic Equipment Co. Inc., Louisville, Ky.; Lee C. Hartman Sound Equipment, Roanoke, Va.; J. O. Story & Co., Rockford, Ill.; and H. W. Dolph Distributing Co., Tulsa, Okla.

HOTTEST IN THE FRINGES.. NATION-WIDE! CLEAR BEAM'S BIG

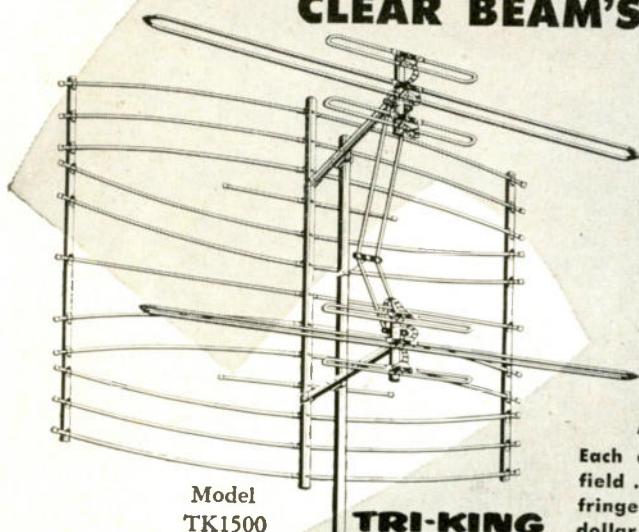

Model
TK1500



ALL-BAND FRINGE ANTENNAS

Each a peak performer in its field . . . a triple threat to any fringe problem . . . with more dollar-for-dollar construction value!

TRI-KING

The Tri-King TK1500 offers super fringe performance through better design features. Half wave electrical spacing between dipoles for higher gain on every channel. Positive "back up action" through the use of a full radar screen . . . acclaimed industry-wide as the finest reflector ever designed for ghost rejection and elimination of co-channel

interference! Fully wind tunnel tested. Available in single bay (Model TK1000) and Super, wide spaced array (Model TK1800).

Clear Beam BIG CHIEF

2 Bay Model BC 12-2

An advanced conical-Yagi with element diameters varied for precision tuning, matched sensitivity and peak performance on high and low band!

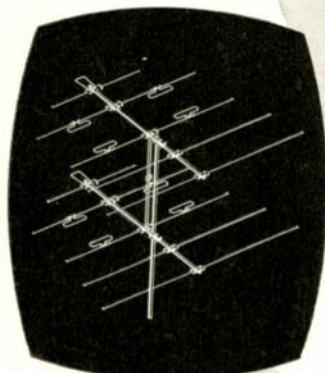

Clear Beam HUNTER

2 Bay Model MYH 50-2

New wave trap principle gives extremely high gain, sharp directivity, in-phase tuning on all channels. New, flat design for low wind resistance!

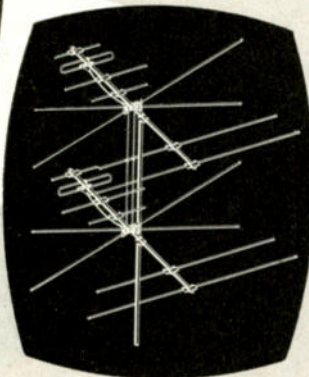

CLEAR ANTENNA CORP. BEAM

Canoga Park, Calif. • Chicago, Ill.
affiliated with TEMPO TV products

Warehouses in Seattle, Portland, San Francisco, Honolulu, Dallas, Kansas City, Chicago, Detroit, Baltimore

Vertical Raster Lines

(Continued from page 25)

to determine if this stage is functioning correctly, or whether the trouble lies at some point after this stage.

To summarize: In trouble-shooting the horizontal sweep circuit for vertical line troubles, a careful examination of the picture or raster is made, to note the symptoms present and the probable site of the trouble. In the case of vertical lines which can be caused by bad tubes or improper setting of controls, these should be the first components checked. If adjustments of the drive, linearity, and width controls do not remedy the condition, all tubes in the horizontal circuit should be changed, as the next step. This includes the horizontal oscillator, output, damper, and high-voltage rectifier tubes.

Localize by Tube Removal

If pickup in the video circuits is suspected (Barkhausen or other spurious oscillation), this can be checked for by removing the video detector or video amplifier stage. In other cases, further localization can be performed by signal tracing with an oscilloscope, if necessary. When the defective stage is found, resistance and voltage checks can be used to locate the defective part.

The following are some additional suggestions for curing some of the more difficult vertical line problems:

The usual cures for Barkhausen oscillation include: changing horizontal output tube; shorter leads to the horizontal output transformer; a single-magnet ion trap around the horizontal output tube, rotated for minimum indication on the screen; readjustment of the horizontal drive control.

In the case of yoke ringing, the correct value of replacement yoke-balancing condenser must be used. On occasion, this may require some experimentation before the correct value is found. A condenser with a voltage breakdown rating of 2000 v should be used. If yoke ringing results from the replacement, then another condenser of the same value should be tried, since the tolerance variation of the capacitor may be enough to introduce a small amount of ringing.

Another remedy for ringing is a 10 k resistor inserted in series with the yoke-balancing condenser. This reduces width somewhat, but also

reduces ringing. It has been helpful in some cases to install a parallel-tuned circuit in series with the secondary of the horizontal output transformer, to reduce residual ringing. The circuit consists of a condenser (0.01 to 0.001 mfd, depending on the inductance of the coil), a 470-ohm, 1-watt resistor, and an additional width coil. As shown in Fig. 3, the parts are connected in parallel with each other, then the combination is put in series between the secondary of the output transformer and the yoke. L-1, the coil, is tuned for minimum ringing.

With some high-impedance yokes,

it has been helpful to place a 0.047 mfd 400 v capacitor across the vertical section of the yoke. This procedure will help when ringing is being caused by internal coupling between the vertical and horizontal yokes (cross-talk).

There have been some cases where the ringing has been traced to the horizontal linearity coil. The symptoms in these instances manifest themselves as faint dark and light vertical lines at the left of the picture or raster. In such cases, placement of a 5.6k resistor across this coil has been found effective in damping out the ringing. •









The ONE Source for EVERY Phonomotor Need!

*First choice of America's
Leading Manufacturers*

Any speed, any type — no matter what your phonomotor requirements may be, you'll always be right if you follow the lead of America's foremost manufacturers and choose from the GI "Smooth Power" line.

Specified as original equipment for many years on the finest recording and play-back devices, GI motors have built up an unmatched record of trouble-free performance and dependability.

When you need phonomotors . . . any speed, any type . . . remember that the greatest names in the industry rest their reputations on "Smooth Power" quality . . . remember to "Specify GI"

Write today for quantity-price quotations and specifications.

GI Phonomotors for: *Portable Phonos • Tape Recorders • Record Changers • Hi-Fi Units*

- Combinations • Replacement



THE GENERAL INDUSTRIES CO.

DEPARTMENT MD • ELYRIA, OHIO

I NEVER LOSE A WINK OF SLEEP
WORRYING ABOUT TUNG-SOL TUBES



Tung-Sol Tube quality is the best insurance a dealer can have against service call-backs. You safeguard your service work and protect your profit when you use dependable Tung-Sol Tubes for replacement.

TUNG-SOL®
dependable
PICTURE TUBES



TUNG-SOL ELECTRIC INC., Newark 4, N. J.
Sales Offices: Atlanta, Chicago, Columbus,
Culver City (Los Angeles), Dallas, Denver,
Detroit, Newark, Seattle.

Radio-TV Electronic

Part 1

A study recently completed by the U. S. Dept. of Labor has turned up some interesting statistics on the average education, skill, personality, age and interests of the electronic technician. Although the study was aimed broadly at electronics techs as a group, sub-divisions were made to compare the fields of radio-TV repair, broadcasting, aircraft electronics, research, radio-TV manufacturing

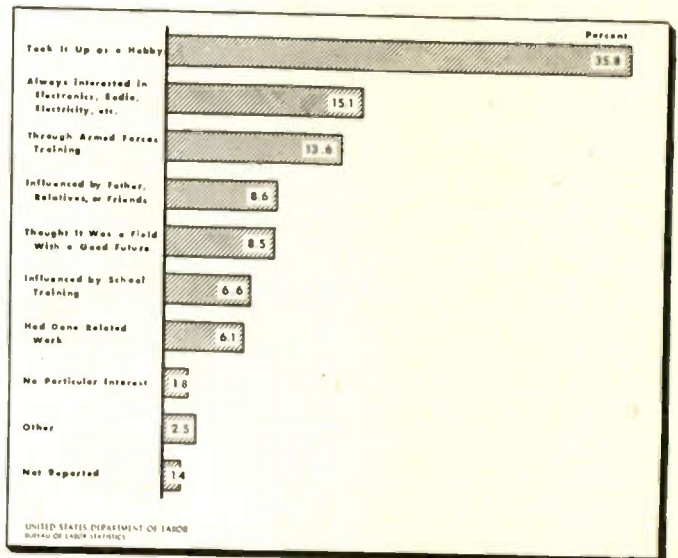

Fig. 1—How technicians first became interested in electronics

and manufacturing of other electronic equipment. In later issues of **TECHNICIAN** we will give you a picture of how the TV technician compares, education, skill and salary-wise, with the rest of the industry. But for now, let us take a look at what the study turned up in regard to the TV technician's personal life.

Hobbies and Interests

As we would immediately suspect, certain early indications are usually shown by men cut out for our field. Tables 1 and 2 point out that from 60 to 70% of the technicians interviewed had a strong liking for mathematics or physics in high school and had pursued electronics as

Fig. 2—Mathematics and physics were favorite high school subjects

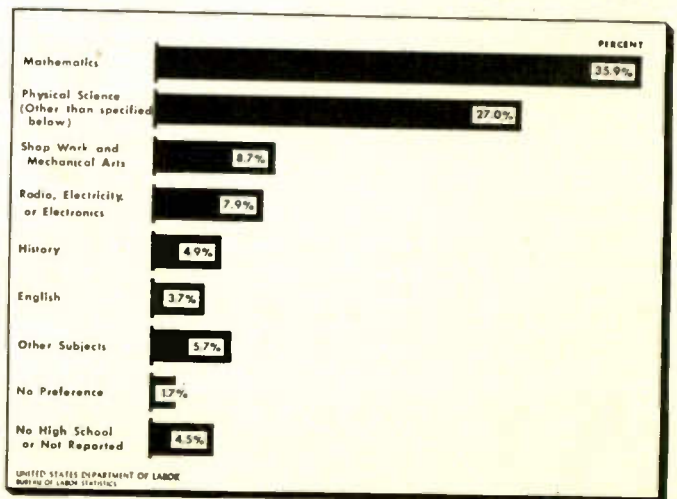

Technician: A Profile

a hobby. Many others had been in contact with the field during the early formative years. A rather surprisingly small group, 14%, attributed their interests in electronics to armed forces training. Only a meagre 2% of the techs interviewed said that their entering the field was accidental.

Young Man's Business

Electronic technicians, as a group, are considerably younger than the average skilled workers. From Table 3 we see that over half of them are between the ages of 25 and 34, and less than 3% are over 54 years of age. In contrast, only 25%, or half as many, percentage-wise, of the total male labor force, are in the age group 25-34, and 18% are over 54.

The average age for radio-TV repair technicians was found to be 33 years, or three years more than the median age for electronics technicians as a whole.

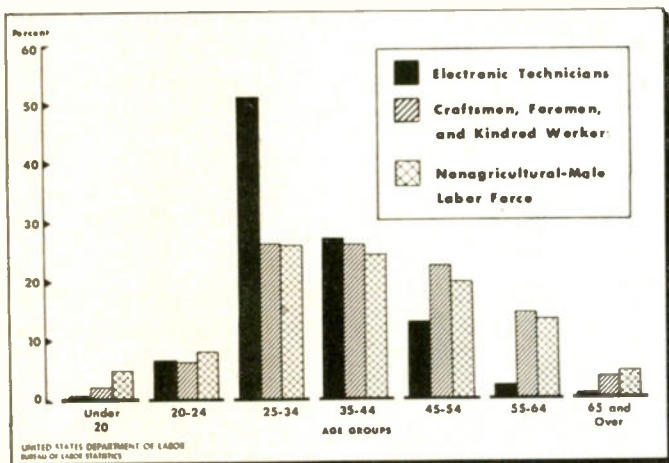

Fig. 3—Electronic techs are a young group of skilled workers

More than 80% of the technicians interviewed were married, and about 75% of the married men were fathers. About 83% had one or more dependents in addition to themselves.

Living Standards

Despite their rather mediocre earnings record, electronics technicians show a marked tendency toward home-ownership. The survey showed that in 1952 approximately 42% (more than 50% of the married techs) owned their own homes. Of those in the radio-TV repair field 39% were home-owners. As of this writing, the figures are no doubt even higher. This high percentage can probably be attributed to the general familiarity with tools which makes home-ownership less of a burden.

Military Status

About 62% of all the electronic technicians were veterans of World War II. Over half of the veterans had served in the Army, 14% in the Air Force, 27% in the Navy, 3% in the Marines and 1% in the Coast Guard. Eight percent belonged to a military reserve unit.

The study referred to in this article was conducted by the Bureau of Labor Statistics of the U. S. Dept. of Labor during the months of April and May, 1952. The information was obtained through a personal interview survey of 1,926 electronic technicians employed in Atlanta, Baltimore, Boston, Chicago, Detroit, Los Angeles, New York and Philadelphia. 1,017 of those interviewed were radio-TV repair technicians.

IT'S FUN TO STAY UP WHEN YOU HAVE SUCH GOOD, CLEAR RECEPTION



The Tung-Sol Tubes you get from your wholesaler are the same high quality tubes used by leading radio and TV set manufacturers. You'll be giving customers like me the best possible service when you replace with Tung-Sol Tubes.

TUNG-SOL[®]
dependable
TUBES—DIAL LAMPS

TUNG-SOL makes All-Glass Sealed Beam Lamps, Miniature Lamps, Signal Flashers, Picture Tubes, Radio, TV and Special Purpose Electron Tubes and Semiconductor Products.



KESTER



Since the most important single step in Radio-Television Servicing is soldering . . . it's just plain good sense to use the best — KESTER SOLDER . . . Key Name in Solder for More Than 50 Years.



KESTER SOLDER COMPANY
4264 Wrightwood Avenue • Chicago 39, Illinois
Newark 5, New Jersey • Brantford, Canada

SOLDER

AUDELS TV-RADIO SERVICE LIBRARY

HERE IS LATE INFORMATION IN A HANDY FORM FOR RADIO AND TELEVISION REPAIRMEN, SERVICEMEN AND STUDENTS



2 VOLS. \$6 COMPLETE \$1 A MONTH PAY ONLY 1 MO.
AUDELS T.V.-RADIO SERVICE LIBRARY—Highly Endorsed—1001 Facts—Over 1552 Pages—625 Illustrations, Diagrams of Parts. Presents Important Subjects of Modern Radio, Television, Industrial Electronics, F.M., Public Address Systems, Auto, Marine & Aircraft Radio, Phonograph Pick-Ups, etc.

IT PAYS TO KNOW!
The Basic Principles—Construction—Installation—Operation—Repairs—Trouble Shooting. Shows How to get Sharp, Clear T.V. Pictures, Install Aerials—How to Test, Explains Color Systems, Methods of Conversion, Terms, etc. Includes Ultra High Frequency (U.H.F.)—Valuable for Quick Ready Reference & Home Study. Tells How to Solve T.V. & Radio Troubles—Answers Your Questions.

Get this Information for Yourself.
7 DAY TEST—ASK TO SEE IT!

MAIL ORDER

AUDELS Publishers, 49 W. 23 St., N.Y. 10, N.Y.
Mail AUDELS T.V. RADIO SERVICE LIBRARY 2 Vols. \$6 on 7 days free trial. If O. K. I will remit \$1 in 7 days and \$1 monthly until \$6 is paid. Otherwise I will return them.

Name _____
Address _____
Occupation _____
Employed by _____ TC

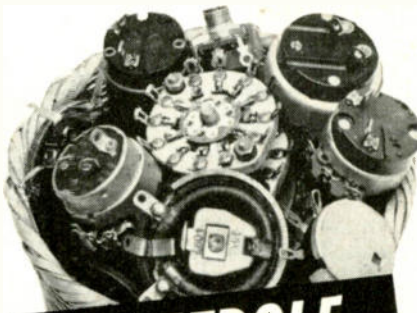

QUIETROLE
Reg. U. S. Pat. Off.
The ORIGINAL
NON-INFLAMMABLE
NON-CONDUCTIVE
LUBRICANT CLEANER



CONTROLS & SWITCHES like new by the BASKETFUL for only a few PENNIES . . . that's what QUIETROLE can do for you, and only QUIETROLE will give that long lasting smooth, quiet operation . . . even new controls last longer and operate quieter when treated with QUIETROLE . . . the original and most reliable product of its kind.

THE CHOICE OF BETTER SERVICEMEN "EVERYWHERE"
Supplied in 2; 4; and 8 oz. sizes. Ask for it at your distributor.



manufactured by
QUIETROLE COMPANY
Spartanburg, South Carolina

MFRS' Catalogs & Bulletins

TEST EQUIPMENT: Multi-colored brochure now available describes and illustrates a complete line of servicing instruments for both color and b&w TV, together with tube testers and instruments for industrial applications. Radio City Products Co., Inc., Easton, Pa. (Ask for No. B12-1)

COILS; TRANSFORMERS: "TV Technician's Coil Replacement Guide", 20 pages, cross references the part numbers of the major TV manufacturers and the Miller replacement part numbers. Handy reference for all modern TV receivers. Covers all transformers and coils, and gives data on line of universal video and sound i-f transformers. Free. J. W. Miller Co., 5917 S. Main St., Los Angeles 3 (Ask for No. B12-2)

PARTS AND EQUIPMENT: 196-page catalog, with four-color varnished stock cover, lists thousands of electronics products, components and equipment. Features a 100-page rotogravure section, 64 pages of hi-fi gear, and an augmented industrial equipment and apparatus section. Newark Electric Co., 223 W. Madison St., Chicago 6, Ill. (Ask for No. B12-3)

JFD ANTENNA DATA: A 6-page, 2-color brochure complete with charts, diagrams, and photographs provides technical specifications on the new "Jet-Helix" antenna. Includes explanation of the "Signal-to-Noise" method of measuring antenna performance. Free on request to JFD Mfg. Co., 6101-16th Ave., Brooklyn 4, N. Y. (Ask for No. B12-10)

ANTENNA EQUIPMENT: Catalog 54-55 describes and illustrates a complete line of TV antenna accessories. Featured are antenna switches, multi-set couplers, flush-mounted sockets, solderless transmission line connectors and transmission line splicers. Mosley Electronics Inc., 8622 St. Charles Rock Rd., St. Louis 14, Mo. (Ask for No. B12-5)

RCA PARTS DIRECTORY: For dealers and technicians, a new 36-page directory, SP-1021, contains basic service and parts-replacement data for all 1952-model RCA home TV receivers. Covers 27 different receivers and includes schematics, wiring diagrams, parts lists and top and bottom chassis views. Available at 50¢ a copy from RCA parts distributors, or from Commercial Engineering, RCA Tube Division, Harrison, N. J. (Ask for No. B12-11)

OBTAIN THESE BULLETINS

described here by writing on company letterhead to Bulletins Editor, **TECHNICIAN**, 480 Lexington Ave., New York 17, N.Y., listing numbers given at end of each item of interest. Please mention title of position held.

New Books

THE ABC OF COLOR TV. By H. G. Cisin. Published by Harry G. Cisin, Amagansett, N.Y. 25 pp. Paper cover. \$1.00

While for most TV technicians, the actual servicing of color sets is rather remote, the trend toward color is here and the alert serviceman, if he is to cope with this new medium when it arrives, must first get a basic fundamental knowledge of his subject. The author has tailored this book to fit this need perfectly. He has avoided the usual mathematical approach to the subject and concentrated instead on a down-to-earth explanation. He begins with an analysis of the basic color principles, then proceeds to an explanation of how the signal is made up at the transmitter, and the process through which it is demodulated at the receiver. Finally, he reviews the various color tubes now on the market. (Ask for No. B12-6)

TV DOCTOR. By Harry G. Cisin. Published by Harry G. Cisin, Publisher, Amagansett, N.Y. 37 pp. Paper cover. \$1.00

As the author points out in the first sentence of his foreword, this book is written for the beginner—the novice in TV servicing. It is essentially a “seat of the pants” approach; instead of an explanation of *why* the trouble occurs, the author concerns himself with *how* do we go about fixing the trouble. There is much to be said for his method. The topics covered include a particularly lengthy section on locating TV troubles, an over-all review of modern TV receivers, antenna principles and test equipment. (Ask for No. B12-8)

TELEVISION SERVICING COURSE. Compiled by M. N. Beitman. Published by Supreme Publications, 1760 Balsan Rd., Highland Park, Ill. 192 pp. Paper cover. \$3.00.

There is now, as always, an urgent need for *practical* instruction in servicing receivers; for material which the technician can lift from the page and immediately apply in his work. It is in this sense, that this book can be highly recommended. The author has limited the theoretical discussion. He has preferred, instead, to deal directly with the typical TV receivers and the troubles which are usually encountered. Included are chapters on test pattern analysis, antenna principles, cathode-ray tubes, circuit explanations, test equipment and alignment and UHF converters and tuners. The text is illustrated with schematic drawings and pictures of actual commercial receivers. (Ask for No. B12-9)

OBTAIN THESE BULLETINS

described here by writing on company letterhead to Bulletins Editor, TECHNICIAN, 480 Lexington Ave., New York 17, N.Y., listing numbers given at end of each item of interest. Please mention title of position held.

The CHRISTMAS GIFT

that has everything for servicemen, hams or experimenters

EXCELLENT FOR HI-FI ASSEMBLY JOBS

Perfect gift to give or receive . . . useful all year 'round. Each kit includes:

- Weller 8250A Soldering Gun—250 watts
- Famous Kester Solder—general purpose spool
- Soldering Tip—for all kinds of soldering
- Smoothing Tip—for mending and sealing
- Cutting Tip—for plastic tile, etc.
- Wrench—for tip interchange
- Instruction Booklets—handy soldering and homecraft hints
- Metal Case—for storage and carrying

Nothing else to buy for soldering, sealing, cutting, mending, joining and smoothing.

only \$14.95 LIST
MODEL 8250AK



SEE NEW WELLER GUNS & KITS AT ELECTRONIC PARTS DISTRIBUTORS

Junior SOLDERING GUN

- New, Compact Design
 - Heats in 5 Seconds
- Over 100 Watts
 - Trigger Switch Control
 - Dual Spotlights

An ideal soldering tool for shop or home. No other soldering gun or iron offers the professional quality, practical features and low price of the Weller JUNIOR.



Weller

ELECTRIC CORPORATION
805 Packer St., Easton, Pa.

SOLDERING GUNS • SOLDERING KITS • POWER SANDERS

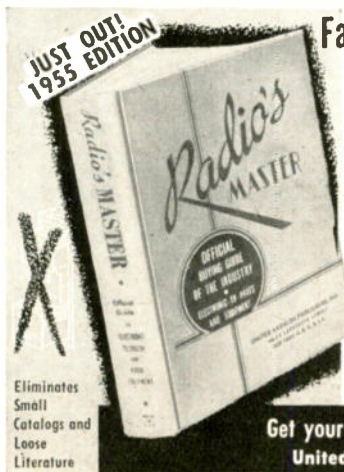

Eliminates Small Catalogs and Loose Literature

Faster, Easier, more PROFITABLE Operation

Get into the MASTER habit!

Brings you the product data of the industry in one handy book—all products vital to your daily sales and service operations. In the customer's home, across the counter or on the bench, you'll value the MASTER'S thoroughly complete descriptions, specs, illustrations and prices . . . all systematically organized in 18 big sections. Over 1300 pages of unabridged catalog data direct from the manufacturers. Keeps you abreast of all latest electronic products. Increase your sales and speed-up your buying—the MASTER way.

As Low As **\$1.95** at your parts distributor. Publisher's price **\$6.50.**

OFFICIAL BUYING GUIDE OF ELECTRONICS-TV-RADIO INDUSTRY

- 1370 pages
- 8" x 11"—5 lbs.
- Over 8,000 illus.

Just a few of the more than 85,000 items included:

Tubes—Transmitters
Test Equip.—Receivers
Transformers
Capacitors—Antennas
Resistors—Wire & Cable
Coils & Relays
Recording & PA
Hardware & Tools

Get your MASTER now from leading parts distributors or write to:
United Catalog Publishers, Inc., 110 Lafayette St., N. Y. 13

ALL "CIRCUIT DIGESTS" TO DATE

Including Current Issue. CIRCUIT DIGEST NOS. 162 to 167 will be found in this issue of TECHNICIAN

| All Units Are TV Receivers Unless Otherwise Noted | |
|---|--------------------|
| Model | Circuit Digest No. |
| ADMIRAL | |
| Chassis 2242: Models 520M15, 520M16, 520M17. | |
| Chassis 22A2A: Models 520M11, 520M12. | |
| Chassis 22M1: Models 121M10, 121M11A, 121M12A, 121M11, 121M12, 121K15A, 121K16A, 121K17A, 121K15, 121K16, 121K17, 221K45A, 221K46A, 221K47A, 221K45, 221K46, 221K47. | |
| Chassis 22Y1: Models 321M25A, 321M26A, 321M27A, 321M25, 321M26, 321M27, 421M15A, 421M16A, 421M15, 421M16, 421M35, 421M36, 421M37, 521M15A, 521M16A, 521M17A, 521M15, 521M16, 521M17 | 1 |
| Chassis 19B1: Model 17DX10, 17DX11. | |
| Chassis 19C1: Model 121DX12, 121DX16, 221DX15, 221DX16, 221DX17, 221DX26, 221DX38. | |
| Chassis 19F1A: Model 121DX11. | |
| Chassis 19H1: Model 222DX15 | 15 |
| Chassis 22A3, 22A3Z: Models 122DX12, 222DX-15B, 222DX16H, 222DX17B, 222UDX15, 222UDX16, 222UDX17, 222DX27B, 322DX16A, 322UDX16 | 101 |
| Chassis 20A2, 20A2Z, 20D2 | 111 |
| Chassis 20L2: Models TA2216A, TA-2217A, CA2236A, FA2226 | 134 |
| Chassis 21A3Z: Models T2311Z (Coral Gables), T2312Z (Bell-Aire), T2316Z (Beverly Hills), T2317Z (Bermuda), T2318Z (Bar Harbor), C2316Z (Catalina), C2317Z (Casablanca), C2326Z (Del-Monte), C2327Z (California), F2326Z (El Dorado), F2327Z (Riviera), F2328Z (Deauville) | 142 |
| Chassis 20AX5, 20AX5A, 20AX5C, 20AX5D, 20AX5EZ, 20AX5F: Models TA1831, TA1832, TA1842, CA2256, TA2212B, CA2306Z, CA2307Z, TA1812B | 161 |
| ANDREA | |
| Chassis VM21: Models T-VM21, C-VM21, 2C-VM21, CO-VM21 | 44 |
| ARVIN | |
| Chassis TE331: Models 6175TM, 6179TM | 13 |
| Chassis 337-341: Models 7210, 7212, 7214, 7216, 7218, 7219 | 45 |
| TV Dual Tuner, used in Chassis TE 330, 332, 340, 341 | 75 |
| Chassis TE 359: 9200 series | 100 |
| Chassis TE 373-UHF: Model 9245 | 128 |
| Chassis "D" 379-UHF, "D" 382-VHF: Models 21-550, 551, 552, 553 | 150 |
| BENDIX | |
| Chassis T14: Models 21K3, 21KD, 21T3, 21X3, OAK3 | 20 |
| Chassis T17: Models KS21C, TS21C. Chassis T17-1: Model TS17C | 50 |
| Chassis T14-3: Models FM27C, HB27C. Chassis T14-10: Models TM24DS, TB24DS. Chassis T14-11: Models TM24DU, TB24DU | 116 |
| Chassis T14-15, T14-16 | 144 |
| CAPEHART | |
| Chassis CX-36, RF-IF chassis coded R-3, Deflection chassis coded D-4: Models 1T172M, 2C172M, 3C212M, 32212B, 4H212M, B, 5F212M, 6F212M, B, 7F212M, 8F212B, 9F212M, 12F272M, 10W212M, 11W212M | 17 |
| Chassis CX-37: Models 1T172MA, 1T172BA, 3C212MA, 3C212MG, 3C212BA, 4H212MA, 4H212BA, 5F212MA, 6F212BA, 7F212MA, 8F212BA, 9F212MA, 11W212MA, 1C213M, 2F213F, 3C213M, 4T213M, 4T213B, 5H213M, 8F213B | 37 |
| Chassis CX-37 and CX-37-1, 1955 series | 151 |
| CBS-COLUMBIA | |
| Chassis 817: Model 17T18, 17M18, 17C18. | |
| Chassis 820: Models 20T18, 20M18, 20M28 | 14 |
| Chassis 1027: Models 27C11, 27C21 | 77 |
| Chassis 750-3: Models 17M06, 22C06, 22C38 | 95 |
| Chassis 921-11: Models U22C05, U22C07, U22C07B, U22T09, U22T09B, U22T09EB, Chassis 921-13: Models U22T19, U22T19B. Chassis 921-14: Models 22C09, 22C09B, 22T19B | 145 |
| Models 205C1, 205C2 (Color Receiver) | 167 |
| COLUMBIA RECORDS | |
| 360 Phono Amplifier | 43 |
| CROSLLEY | |
| Chassis 380: Models EU-17COM, EU-17TOB, EU-17TOM. Chassis 381: Models EU-21CDB, EU-21CDM, EU-21CDN, EU-21COBa, EU-21COMa | 2 |

| Model | Circuit Digest No. |
|--|--------------------|
| VHF Chassis 392: Models EU-COMUa, 21COBUa, 21CDMU, 21CDBU, 21CDNU (Chassis 392 is very similar to the 380—refer to Circuit Digest No. 2) | |
| Chassis 388: Models EU-30COMU, 30COBU | 33 |
| Chassis 393: Models EU-21TOLU, EU-21-TOLBU. Chassis 394: Models EU-21COLU, EU-21COLBU | 46 |
| Chassis 402: Models F-17TOLH, F-17TOLBH; Chassis 403: Models F-21TOLH, F-21TOLBH; Chassis 404: Models F-21COLH, F-21COLBH, F-21CDLH, F-21CDLBH; Chassis 402-1: Models F-17TOLU, F-17TOLBU; Chassis 403-1: Models F-21TOLU, F-21TOLBU; Chassis 404-1: Models F-21COLU, F-21COLBU, F-21CDLU, F-21CDLBU | 82 |
| Chassis 411: Models F-24COLH, F-24COLBH; Chassis 411-1: Models F-24COLU, F-24COLBU | 96 |
| Chassis 412: Models F-24CDMH, F24CDBH, Chassis 412-1: Models F-24CDMU, F-24CDBU; Chassis 416: Models F-27COMH, F-27COBH; Chassis 416-1: Models F-27COMU, F-27COBU | 106 |
| Chassis 426: Models G-17TOMH, G-17TOBH, G-17TOWH | 126 |
| Chassis 431-2: Models H-21COMH, H-21COBH, H-21COWH, H-21COSH, H-21COSBH, H-21-HCBH, H-21HCWH, H-21COMU, H-21COBU, H-21COWU, H-21HCBU, H-21HCMU | 163 |
| DELCO | |
| Buick Selectronic Model 981551 (see main section of magazine) | 149 |
| DE WALD | |
| Models ET-140R, DT-163R, DT-163A, ET-170, ET-171, ET-172, ET-191, DT-190D | 69 |
| DU MONT | |
| Chassis RA-164: Model Clinton. Chassis RA-165: Models Beverly, Ridgewood, Shelbourne, Milford, Wakefield | 3 |
| Chassis RA-166/167, 170/171: Models 17T350, 21T327, 21T328, 21T329, 21T359, 21T366, 21T376, 21T377, 21T378 | 51 |

HOW TO FIND MONTH in which any CIRCUIT DIGEST APPEARED

| Circuit Digest Numbers | Month | Year |
|------------------------|-------|------|
| 1- 8 | Sept. | 1952 |
| 9- 16 | Oct. | 1952 |
| 17- 24 | Nov. | 1952 |
| 25- 30 | Dec. | 1952 |
| 31- 36 | Jan. | 1953 |
| 37- 43 | Feb. | 1953 |
| 44- 49 | Mar. | 1953 |
| 50- 58 | Apr. | 1953 |
| 59- 64 | May | 1953 |
| 65- 70 | June | 1953 |
| 71- 76 | July | 1953 |
| 77- 81 | Aug. | 1953 |
| 82- 88 | Sept. | 1953 |
| 89- 94 | Oct. | 1953 |
| 95-100 | Nov. | 1953 |
| 101-105 | Dec. | 1953 |
| 106-110 | Jan. | 1954 |
| 111-115 | Feb. | 1954 |
| 116-120 | Mar. | 1954 |
| 121-125 | Apr. | 1954 |
| 126-130 | May | 1954 |
| 131-133 | June | 1954 |
| 134-138 | July | 1954 |
| 139-143 | Aug. | 1954 |
| 144-149 | Sept. | 1954 |
| 150-155 | Oct. | 1954 |
| 156-161 | Nov. | 1954 |
| 162-167 | Dec. | 1954 |

Note: Months prior to September, 1953, refer to issues of Television Retailing (predecessor of TECHNICIAN)

| Model | Circuit Digest No. |
|--|--------------------|
| Chassis RA-306, 307: Models Summit RA-306A1 & RA-307A1, Warren RA-306A2 & RA-307A2, Hampton RA-306A3 & RA307A3, Bristol RA-306A4 & RA307A4, Newport RA-306A5 & RA-307A5, Rutland RA-306A6 & RA-307A6, Hartford RA-306A7 & RA307A7, Sheffield RA-306A8 & RA-307A8, Westbrook RA-306A9 & RA-307A9, Windsor RA-306A10 & RA-307A10, Bradford RA-306A11 & RA-307A11, Warwick RA-306A12 & RA307A12 | 107 |
| Chassis RA-301, 302: Models RA-301-A1, RA-301-A2, RA-301-A3, RA-302-A1, RA-302-A2, RA-302-A3 | 120 |
| Chassis TA-312, 313: Models Barton, RA-312-A1, or RA-313-A1; Baylor, RA312-A2 or RA-313-A2; Winsted, RA312-A3 or RA313-A3; Clifford, RA-312-A4 or RA-313-A4; Hamilton, RA-312-A5 or RA-313-A5; Dellwood, RA-312-A6 or RA-313-A6; Richfield, RA-312-A7 or RA-313-A7; Belvidere, RA-312-A8 or RA-313-A8; Bradley, RA-312-A9 or RA-313-A9 | 139 |
| EMERSON | |
| Chassis 120166-D: Models 721D, 728D | 10 |
| Chassis 120168-D: Models 716F, 717F, 719F, 727D. Chassis 120169-B: Models 711F, 712F, 720D, 732B, 734B | 31 |
| Chassis 120174-B: Models 752A, 755A, 784A; Chassis 120198-D: Models 753F, 785C, 785E | 91 |
| Chassis 120182-D: Models 741F, 757D, 758F. Chassis 120196-B: Model 781A. Chassis 120206-D: Models 792D, 781E. Chassis 120197-B: Models 784E, 784K. Chassis 120197-D: Model 784G. Chassis 120195-D: Models 785K, 759C. Chassis 120211-D: Model 784M | 121 |
| Chassis 120220-D: Models 1030D, 1032D. Chassis 120239-D: Models 1058D, 1060D, 1062D, 1064D | 152 |
| Chassis 120233-D: Models 1066D, 1070D, 1072D. Chassis 120235-D: Models 1000H, 1002H, 1004H, 1006H, 1008H, 1010H, 1018H, 1022H, 1028H, 1040H, 1042H, 1074D, 1084D, 1044D, 1046D, 1048D, 1054D, 1086D, 1088D, 1090D, 1092D. Chassis 120234-D: Models 1067D, 1071D. Chassis 120236-D: Models 1009J, 1011J, 1075D, 1047D, 1049D. Chassis 120238-F: Models 1041F, 1045F, 1047F | 162 |
| ESPEY | |
| 513-C AM-FM Tuner | 70 |
| FADA | |
| The "Imperial" Series: Models 17T6, 17T9, 17C2, 17C4 | 25 |
| Models U2100C, U2150C, U2100T, UDL2100T, UH21T | 83 |
| GENERAL ELECTRIC | |
| "Stratopower" chassis: Models 17C125, 20C107, 21T1, 21C208, 21C204, 21C201, 21C202, 21C214, 21C206 | 4 |
| UHF-TUNER Model UHF-103 | 52 |
| "F" Chassis: Models 17C127, 21T14, 21C115, 21C116, 21C117, 21C119, 21C120, 21C121, 17T15, 21T10, 21T12, 21T4 | 84 |
| UHF Tuner, Model S-UHF-80 | 104 |
| Chassis "EE": Models 21T7, 21T8, 21T20, 21T21, 21C225, 21C226, 21C227, 21C228, 21C229, 21C230, 21C231, 21C232, 21C233 | 113 |
| Chassis "G" line: Models 17T20, 21T22, 21T23, 21T24, 21T25, 21C103 and 21C104 | 135 |
| Chassis "H" line: Models 21T26-T27, 21C240-C241 | 146 |
| GRANCO | |
| UHF Converter Model CTU | 74 |
| HALLICRAFTERS | |
| Chassis A1200D, K1200D or W1200D: Models 1010P, 1012P. Chassis D1200D, L1200D or X1200D: Models 1021P, 1026P. Chassis F1200D: Model 1013C. Chassis G1200D: Models 1022C, 1027C. Chassis U1200D: Model 1056C. Chassis T1200D: Models 1051P, 1055C, 1056C, 1050C, 1061C. Chassis P1200D: Model 1052P. Chassis R1200D: Models 1053P, 1054P. Chassis Z1200D: Models 1057C, 1062C, 1063C. Chassis Z1200D: Model 1057U | 21 |
| Chassis A1300D: Model 1075 | 38 |
| Model TW-1000 World-Wide 8-Band Portable Radio | 49 |
| Chassis A1400D: Models 21K201B, 21K211M, 21K221B, 21K231M | 102 |
| Chassis B1600D: Models 21T320W, 21T-320M, 21T320B, 21K330B, 21K330M | 153 |

(Continued on page 46)

TV Voltage Trouble?

WRITE FOR
THIS HELPFUL
TeleVolt BULLETIN



The Sola TeleVolt Bulletin can save you many hours and make you many dollars. It shows how you can automatically correct bad line voltage . . . high, low, and fluctuating voltage. The TeleVolt automatically maintains proper voltage levels for proper performance and protects costly TV components against damaging high voltage surges.

The Sola TeleVolt, Constant Voltage Transformer, is not a voltage booster . . . it is a patented voltage regulator that automatically stabilizes voltage to within $\pm 3\%$ of nominal value, regardless of line voltage variations as great as $\pm 15\%$.

Write today for Bulletin 81-CV-175
or see your electronic distributor



SOLA
Tele Volt

Automatic Constant Voltage
TRANSFORMERS

SOLA ELECTRIC CO.
4633 W. 16th St. Chicago 50, Ill.

Service Ass'n. Reports

Association at Local Fair (LIETA, N. Y.)

Building up good will for local technicians was an exhibit by Long Island Technicians Assn. at the local Mineola Fair and Industrial Exposition. The notion of representation at county and local fairs by associations



holds interesting possibilities. Other LIETA activities: Non-members were welcomed to the recent annual open-house meeting. The organization's program and benefits of membership were discussed.

Sad Story (TRA, Calif.)

The Television Radio Association of Alameda County, 145 Sunnyside Drive, San Leandro, Calif., reports a single-line answer, given by a diplomatic technician to a customer's query, that tells a whole story. It is repeated here without superfluous comment or explanation: "Yes, ma'am, you were perfectly right; it was only a loose wire—in the 27MP4!"

TRA liked our September editorial (. . . and AWAY WE GO) well enough to reprint the section on Public Relations in their periodical, *TV Flashes*. Editorially, the publication has come out for licensing from within the industry: "A good many of the members are in favor of some sort of licensing program, but would like to see it written by a group of TV shop operators rather than by a politician in Sacramento."

Color Lecture (ARTS, Illinois)

Continuing its series on color TV, the Associated Radio & Television Servicemen, 433 South Wabash Avenue, Chicago, Illinois, sponsors a lecture on December 7 covering the CBS planar mask tube and its operation. A staff engineer from CBS-Hytron will deliver the talk.

COMING JAN. 15!

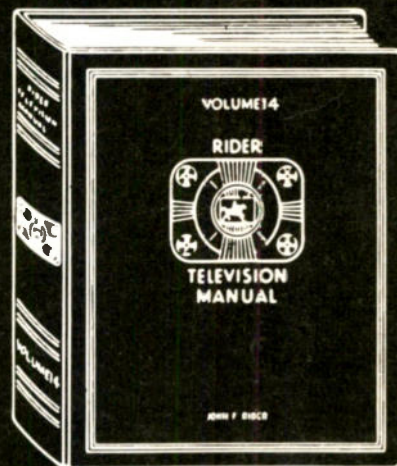

RIDER'S TV 14

LIMITED PRINTING-

tell your jobber to
reserve your copy now!

only \$24.

Circuit Digest Index

(Continued from page 44)

HOFFMAN
Circuit Digest No.
Chassis 213: Models 21M903, 21B904, 21P905 32
Chassis 403-24: Models 24M725, 24B726, 24P727 92
Chassis 406-21: Models 21M160, 21B161, 21M333, 21B334 130
Chassis 407-21: Models 21M178, 21B179, 21P180, 21M345, 21B346 156
JACKSON
Chassis 317A, 320A, 321A, 324A: Models 277, 217, 221-T, 321-C, 217-T, 317-C, 221-C, 621 64
MAGNAVOX
Model J, K-105 Series: CT331, 332, 333, 334, 335, 336, 337, 338, 339, 340, 341, 342, 343, 344, 345, 346, 347, 348, 349 23
UHF Converter Tuner Model 700359 53
107 Series: Chassis CT 358 65
UHF Converter Tuner 595461 (700359 Revised) 80
Chassis 108A series: Models CT, CU & CMU 401A: CT, CU & CMU 402A: CT, CU & CMU 403A: CT, CU & CMU 404A 112
Series 106C: Models CT 381C, CU 381C & CMU 381C 129
Chassis 300 series: Models CTA, CUA & CMUA, 401B: CTA, CUA & CMUA 402B: CTA, CUA & CMUA 403B: CTA, CUA & CMUA 404B 136
Chassis 250 series: Models CTA-435AA, CMUA-435AA, CTA436AA, CMUA436AA 157
MAJESTIC
Chassis Series 110-111: Models 21T20, 21T21, 21C80, 21C31, 21D50, 21D51, 21P60, 21P61, 21P62, 21P63, 21P70, 21P71 26
Chassis 112: Models 17T38, 17T40, 17T41, 17C42, 17C43; Chassis 113: Models 21T40, 21T41, 21C42, 21C43 76
Chassis 115, 116 Series: Models 21T22, 21T23, 21C36, 21C37, 21P46, 21P47, 21D54, 21D56, 21D57, 21D58, 21D59, 21P64, 21P65, 21P72, 21P73, 21PR80, 21PR81 143
MALLORY
TV-101 UHF Converter 58
MOTOROLA
Chassis TS-292: Models 21C1, 21C1B, 21F2, 21F2B, 21F3, 21F3B, 21K4, 21K4A, 21K4B, 21K4W, 21K5, 21K5B, 21K6, 21K7, Chassis TS-324: Models 21T4A, 21T4EA, 21T5A, 21T5BA 9
Models TC-101, TC-101B UHF Converters 59
Auto Radio Mopar Models 610T 72
Chassis WTS-518 Series: Models 21T15, Y21T15, Chassis TS-418 Series: Models 17T20, Y17T20, 17T20R, Y17T20R, 17T20F, Y17T20F, 17T20M, Y17T20M, Chassis TS-518 Series: Models 21T16, Y21T16, 21T16B, Y21T16B, 21T16E, Y21T16E, 21T17, Y21T17, 21T17B, Y21T17B, 21K19, Y21K19, 21K19B, Y21K19B 147
MUNTZ
Chassis 17B1 or 17B2: Models 2053A, 2054-A, 2055-A, 2056-A, Chassis 17B2: Model 2055-B, Chassis 17B3 or 17B4: Models 2457-A, 2461-A, Chassis 17B5 or 17B6: Models 2158-A, 2159-A, 2162-A 39
OLYMPIC
Chassis TK: Models 17T40, 17T48, 17C44, 17K41, 17K42, 17K50, Chassis TL: Models 20T46, 20T47, 20C45, 20C52, 20C53, 20D49, 20K43, 20K51 30
Chassis TMTN: Models 17T56, 17C57, 17K55, 21T58, 21T59, 21T70, 21T74, 21C65, 21C68, 21C72, 21C73, 21D60, 21D64, 21K61, 21K62, 21K63 68
PACIFIC MERCURY
Chassis 201 Series 124
PACKARD-BELL
Chassis 2720: Models 2721, 2722, Chassis 2710: Models 2728, 2724 60
Chassis 2740: Models 2742, 2743, 2744, 2842, 2843, 2844 117
PHILCO
RF Chassis 91, Deflection chassis J-1 used in 1953 Code 126: Models 2269, 2270, 2271, 2273, 1853, 1853L, 2127, 2266, 2268, 2286, 2286, 2287 5
RF Chassis 81, Deflection Chassis H-1: Models 1824, 1825, 1826, 1852, 1852L, 2125, 2125L, 2152, 2152L, 2226, 2227, 2262, 2272, 2272L 22
R-R chassis 97, Deflection chassis J-7: Model 2750 47

Circuit Digest No.
All-Speed Record Changer: Model M-24 29
R-F Chassis R-201, Deflection Chassis D-201: Models 4308, 4110, 4108, 3104, 4008 89
R-F Chassis R-191, Deflection Chassis D-191, Code 140: Models 3002, 4002, 4004, 4102, 4106, 4109, 4150, 4302, 4304, 4306, 4307, 4005, 4007, 4107, 4112 118
Chassis 350: Models 22C4016, 22C4016L, 22C-4124, 22C4124L, 22C4126, 22C4312, 22C4412 158
RADIO CRAFTSMEN
AM-FM Tuner C-800 28
RAYTHEON
Chassis 17T1: Model M1733A, C1735A, C1736A, Chassis 17T2: Model M-1734A, Chassis 21T1: Model M-2107A, C-2108A, C-2110A, C-2111A, Chassis 21T2: Model C-2109A 16
UHF Tuner 54
Chassis 21T8: Models UM-2133, UM-2134, UM-2135, UM-2136, UM-2139, UM-2141, UM-2142, UM-2144, UM-2145 94
Chassis 21T11: Models M-2131A, C-2137A and C-2138A 114
Chassis 24T13: Models C-2401A, C-2402A 125
Chassis 17T18 (Challenger series): Models M-1750A, M-1750C, M-1750G, M-1750K, M-1751D, M-1751F, M-1752E, M-1752L, Chassis 21T19 (Challenger series): Models M-2160A, M-2160C, M-2160G, M-2160K, M-2161D, M-2161F, M-2162E, M-2162L 141
RCA VICTOR
Chassis KCS72: Models 17T200, 17T201, 17T202, 17T211, 17T220 6
UHF Selector Chassis KCS70: Model U70 42
Chassis KCS78 or KCS78B: Models 17-T-301, 17-T-301U, 17-T-302, 17-T-302U, 17-T-310, 17-T-310U 48
UHF Selector Model U2: Chassis KCS79 55
Chassis KCS81: Models 21-D-305, 21-D-317, 21-D-326, 21-D-327, 21-D-328, 21-D-329, 21-D-330; Chassis KCS81B: Models 21-D-305U, 21-D-317U, 21-D-326U, 21-D-327U, 21-D-328U, 21-D-329U, 21-D-330U 67
Chassis KCS83C: Models 21-S-354, 21-S-362; Chassis KCS83D: Models 21-S-354U, 21-S-362U 90
Chassis KCS77D, KCS77H: Models 27-D-382U, 27-D-383U, 27-D-384U 103
Chassis KCS84C: Models 24-T-420, 24-T-435; Chassis KCS84E: Models 24-T-420U, 24-T-435U 119
Chassis CTC2: Model CT-100 (color) 131
Chassis KCS88J: Models 21-S-503U (Arlen), 21-S-504U (Kent), 21-S-505U (Ellis), 21-S-506U (Rupert), 21-S-517U (Consolette), 21-S-519U (Radnor), 21-S-521U (Felton), 21-S-522U (Benson), 21-S-525U (Wister), 21-S-5251U (Wister), 21-S-501U (Medalist), 21-S-502U (Lambert), 21-S-518U (Trafton), Chassis KCS88L: Model 21-S-537U (Bromley), Chassis KCS88M: Model 21-S-526U (Carroll), Chassis KCS88VA: Model 21-S-523U (Pickford) 140
Chassis KCS87: Models 17-S-450 (Trent), 17-S-451 (Newton), 17-S-453 (Ashburn), Chassis KCS87A: Models 17-S-450U (Trent), 17-S-451U (Newton), 17-S-453U (Ashburn) 154
REGENCY
UHF Converter Model RC-600 73
SENTINEL
Chassis 118: Models 454, 1U-454, 455, 1U-455, 456, 1U-456, 457, 1U-457 18
1U-532, 1U-552, 1U-554 85
Models: 1U-581, 1U-582, 1U-584, 1U-585 108
Models: 1U-901, 1U-911, 1U-914, 1U-921, 1U-924, 1U-991 159
SHERATON
Chassis 250XL: Models T1750, T2150, T1755, T2120, T2155, C2125 81
SPARTON
Chassis 25D213: Models 5342, 5343, 5382, 5383, 5384, 5386, 5390, 5391 24
Chassis 27D218: Models 5342A, 5343A, 5384A, 5386A, 5382A, 5383A, 10352, 10353 40
Chassis 29U213: Models 22312, 22313, 23322, 23323 71
Kingston UHF Converter 105
Chassis type 23U214: Models 14A204 (Cornell), 12A204 and 12A210 (Princeton), 11T210 (Stanford) 138
STANDARD COIL
Tuner Models TV-1532, TV-2232 86
STEWART-WARNER
Chassis 9210: Models 9210-C, 21T-9210A, 21C-9210C 34
Models: 24C-9370A, 24C-9370AB 109
Models 17T-9620A, 17T-9620B, 21C-9630C, 21C-9630CB, 21C-9630D, 21T-9630A, 219-9630AB 164

Circuit Digest No.
STROMBERG-CARLSON
Chassis 421 series: Models 421 TX, 421 CM, 421 CDM 19
521 Series: Models 521T, 521TO, 521CM, 521CDM, 521C5M, 521C50, 521C5Dec 66
Chassis 621A series 110
Chassis 21T-22T Series: Models 21TQ, 21TM, 21TB, 21TW, 21TF 165
SYLVANIA
Chassis 1-508-1, 1-508-2: Models 172K, KU, M & MU; 175B, BU, L, LU, M & MU; 176B, BU, L, LU, M & MU; 177B, BU, M & MU; 178B, BU, M & MU 12
Chassis 1-504-1, 1-504-2: Models 105B, 105BU, 105M, 105MU, Chassis 1-510-1, 1-510-2: Models 120B, 120BU, 120M, 120MU, 126B, 126BU, 126L, 126LU, 126M, 126MU 35
Chassis 1-509-1, 1-509-2: Models 187B, BU, M, MU 41
UHF Converter Models C31M, C32M, C33M 87
Chassis 1-518-1, -2, -3: Models 175-18, 372, 373, 375, 376, 377 97
Chassis 1-514-1, -3, -4: Models All 105-14, 300 series
Chassis 1-520-1, -3, -4, -7, -8: Models All 120-20, series
TRAVLER
Chassis 36A2: Models 217-32, 217-33, 220-35, 221-36 27
Chassis 46A3, 46A4, 46B3: Models 317-44, 317-44A, 317-47, 321-R45, 321-46, 321-48, 321-54, 321-55, 321-480, 3210-60, 3210-61 137
Chassis 510A4, 511A4 160
TRUETONE
Model 2D1344A 61
Chassis 21T2A: Model 2D1326A 98
MONTGOMERY WARD
Manual 4107A: Model 25WG-3056A 36
Auto Radio, Model 35BR-6796A 93
WEBSTER-CHICAGO
Webcor Model 210 Tape Recorder 62
WELLS-GARDNER
Models: 321MS31-35A6-386-1, 2321MS31-35A6-388-1 123
WESTINGHOUSE
Chassis V-2207-1: Model H-706T16, Chassis V-2220-1: Model H-708T20 11
Model H-803 all channel UHF Tuner 56
Chassis V-2208-1: Model H-716T17 63
Chassis Assembly V-2233-4: Models H-746K21, H-747K21 78
Chassis V-2243-1: Models H-770T21, H-771T21, H-772K21, H-773K21, H-774K21, H-775K21, H-776T21 99
Chassis Assembly V-2250-1: Models H-816T24 and H-817K24 115
Chassis Assembly V-2263: Models H-830K21, H-831K21 127
Chassis V-2313: Models H-838K21B, H-841T21, H-842T21, H-843K21, H-844K21, H-847K21, H-848K21, H-861T21, H-862T21, H-867T21, H-868T21, H-871T21, H-872T21, Chassis V-2323: Models H-841TU21, H-842TU21, H-843KU21, H-844KU21, H-847KU21, H-848KU21, H-861-TU21, H-862TU21, H-867TU21, H-867TU21A, H-868TU21, H-868TU21A, H-871TU21, H-872-TU21 148
ZENITH
Chassis 19K22: Models K1812E, K1812R, Chassis 19K20: Models K1815E, K1815R, K1820E, K1820R, K1846E, K1846R, K1850E, K1850R, K1880R, Chassis 19K23: Models K2259R, K2259E, K2268R, K2268E, Chassis 21K20: Models K2230E, K2230R, K2240E, K2240R, K2260R, K2260E, K2266, K2266R, K2267E, K2267R, K2270H, K2270R, K2287R, K2290R, K2291E 7
VHF-UHF Turret Tuner 57
Portable Radio Chassis 5L42: Model L507 79
Chassis 22L20: Models L2571R, L2572R, L2573E, L2574R, L2575E, L2592R, L2593H, L2876E, L2876R, L2878R, L2879E, L2894HU 88
Chassis 19L26: Models L1820E or R; L1812E or R, Chassis 19L28: Models L1846E or R; L2229E or R; L2235E or R; L2236E or R; L2237E or R; L2250E or R; L2258E or R; L2262C; L2262R; L2281 or E; L2281R; L2285 R, Chassis 19L30: Models L2237EU or RU, Chassis 19L33: Models L2228R, Chassis 19L34: Models L1800R 122
Chassis 20M20, 20M20U: Models M2237R, M-2260R, M2261E, M2267Y 133
Chassis 19R20: Models R1800E & R, R1812E & R, Chassis 19R21: Models R2229E & R, R2230E & R, R2249E & R, R2250E & R, R2253M, R2258E & R 155
Chassis 5R60T: Models R532TR, TF, TV & TW 166
BASIC ALIGNMENT DATA 8
Copyright 1954 by Caldwell-Clements, Inc.

CLEAR TV PICTURE PERMANENT INSTALLATION—



WITH A

WINPOWER TV TOWER

Permanent, one-man tower erection—fewer guy wires—no special tools. Offer better reception at lowest cost—eliminate mounting troubles and service calls.

Adapter locks mast or serves as rotor bracket.

"All-Angle" feet fit any roof.

5' or 10' height.

WRITE FOR FREE FOLDER TODAY!

WINPOWER
NEWTON, IOWA

WAIT!

DON'T BUY ANY
SOLDERING IRON
UNTIL YOU SEE

THE New ESICO LUGER SOLDERING IRON

Makes all other irons
obsolete!

*The shape of
soldering irons to come!*

UNVEILING EARLY IN 1955

ESICO

Electric Soldering Iron Co., Inc.
DEPT. H DEEP RIVER, CONN.

ADVERTISERS INDEX DECEMBER, 1954

| | |
|---|------------|
| Admiral Corp. | 27 |
| Audel & Co., Theo. | 42 |
| CBS-Hytron Div., Columbia Broadcasting System | 29 |
| Clear Beam Antenna Corp. | 38 |
| Cornell-Dubilier Electric Corp. | 37 |
| Crown Controls Co., Inc. | 34 |
| Electric Soldering Iron Co., Inc. | 47 |
| General Industries Co. | 39 |
| International Rectifier Corp. | 31 |
| International Resistance Co. | Cover 2 |
| Jerrold Electronics Corp. | 12 |
| JFD Manufacturing Co. | 11 |
| Kester Solder Co. | 42 |
| Moss Electronic Distributing Co., Inc. | 8 |
| Precision Apparatus Co., Inc. | 33 |
| Quietrole Co. | 42 |
| Radiart Corp. | 37, 48 |
| Radio Corporation of America | 5, Cover 4 |
| Raytheon Manufacturing Co. | 7 |
| Raytronic Laboratories, Inc. | 36 |
| Rider Publisher, Inc., John F. | 45, 47 |
| Sola Electric Co. | 45 |
| Sprague Electric Co. | 6, Cover 3 |
| Telrex, Inc. | 4 |
| Triad Transformer Corp. | 30 |
| Triplett Electrical Instrument Co. | 10 |
| Tung-Sol Electric Inc. | 40, 41 |
| United Catalog Publishers, Inc. | 43 |
| United Motors Service Div., General Motors Corp. | 2, 3 |
| Walsco Electronics Corp. | 9 |
| Weller Electric Corp. | 43 |
| Weston Electrical Instrument Corp. | 35 |
| Winpower Manufacturing Co. | 47 |

While every precaution is taken to insure accuracy, we cannot guarantee against the possibility of an occasional change or omission in the preparation of this index.

FIX EVERY TV RECEIVER!

TV FIELD SERVICE MANUALS Edited by Harold Alsberg

JUST PUBLISHED: VOLUME 3

A complete TV tube location handbook . . . PLUS all these other valuable features: for each model, a table of more than 30 trouble symptoms, showing tubes to check, parts to check, adjustments to make . . . field (and shop) adjustments on horizontal oscillators, tuner oscillators, AGC controls, picture tubes . . . explanation of 40 most-commonly-found troubles, with picture tube patterns to illustrate each one—drawings of front & rear preset controls and tuner dial stringing, tube complement, key voltages, series filament wiring 7 years (1947-1953) of TV receiver production in each volume! Spiral bound—open the book and it stays open! Why wait? Order all 3 volumes today!

VOL. 3 (JUST PUBLISHED) (Cat. #155-3) covers:
Emerson, Fada only \$2.10

VOL. 2 (Cat. #155-2) covers: Bendix, Capchart
CBS-Columbia, Crosley, DuMont . . . only \$2.40

VOL. 1 (Cat. #155) covers: Admiral, Affiliated
Retailers (Artone), Amcece (AMC), Air King,
Air Marshall, Allied Purchasing, Andra, Arvin,
Automatic only \$2.10

SIZE OF ALL 3 BOOKS: 5½x8½
OTHER VOLUMES COMING SOON!

These books tell you how!

TV MANUFACTURERS' RECEIVER TROUBLE CURES

JUST PUBLISHED: VOLUME 6

QUESTION: Who's the one man who can tell you—better than anybody else—how to cure a specific fault in a specific receiver?

ANSWER: THE MANUFACTURER!

Nobody knows his own set like the manufacturer! And here—in one compact, inexpensive series—64 different TV receiver manufacturers give you the facts on specific "bugs" that have come up in their models! In our new Volume 6, for instance (all new—coverage up through 1954—no duplication—new manufacturers), 12 makers list 249 precise, "how-to" answers about specific troubles and improvements in their sets! Volumes 1 to 5 give you similar coverage! Every volume gives you important information on such typical problems as picture bending . . . intercarrier buzz . . . fringe area operation . . . sync instability . . . interference . . . jitter . . . retrace blanking . . . poor picture quality . . . and much, much more! Not theory or "perhaps" information—actually tells you how to cure existing faults! Lists step-by-step procedures to follow, parts needed, etc.—also shows you how to improve performance of the set! One service call pays for all 6 volumes! Order your set today!

VOL. 6 (JUST PUBLISHED) (cat. #143-6) covers:
Admiral, Amcece (AMC), Arvin, Bendix, Cadillac
TV, Capchart, CBS-Columbia, Conrac, Crosley,
DuMont, Emerson, Firestone.

VOL. 1-5 cover 61 manufacturers from A to Z!
EACH VOLUME 128 (5½ x 8½") PAGES
ONLY \$1.80 EACH

Rider books are sold by parts jobbers and book stores throughout the country. If YOUR dealer doesn't have these books, mail this coupon to us!

JOHN F. RIDER PUBLISHER, INC.
Dept. T-12, 480 Canal Street, N.Y.C.

Please RUSH me:

TV FIELD SERVICE MANUALS
 Vol. 1 \$2.10 Vol. 2 \$2.40 Vol. 3 \$2.10

TV RECEIVER TROUBLE CURES
 Vol. 1 \$1.80 all 6 volumes @ \$1.80 each

Name
Address
City & State

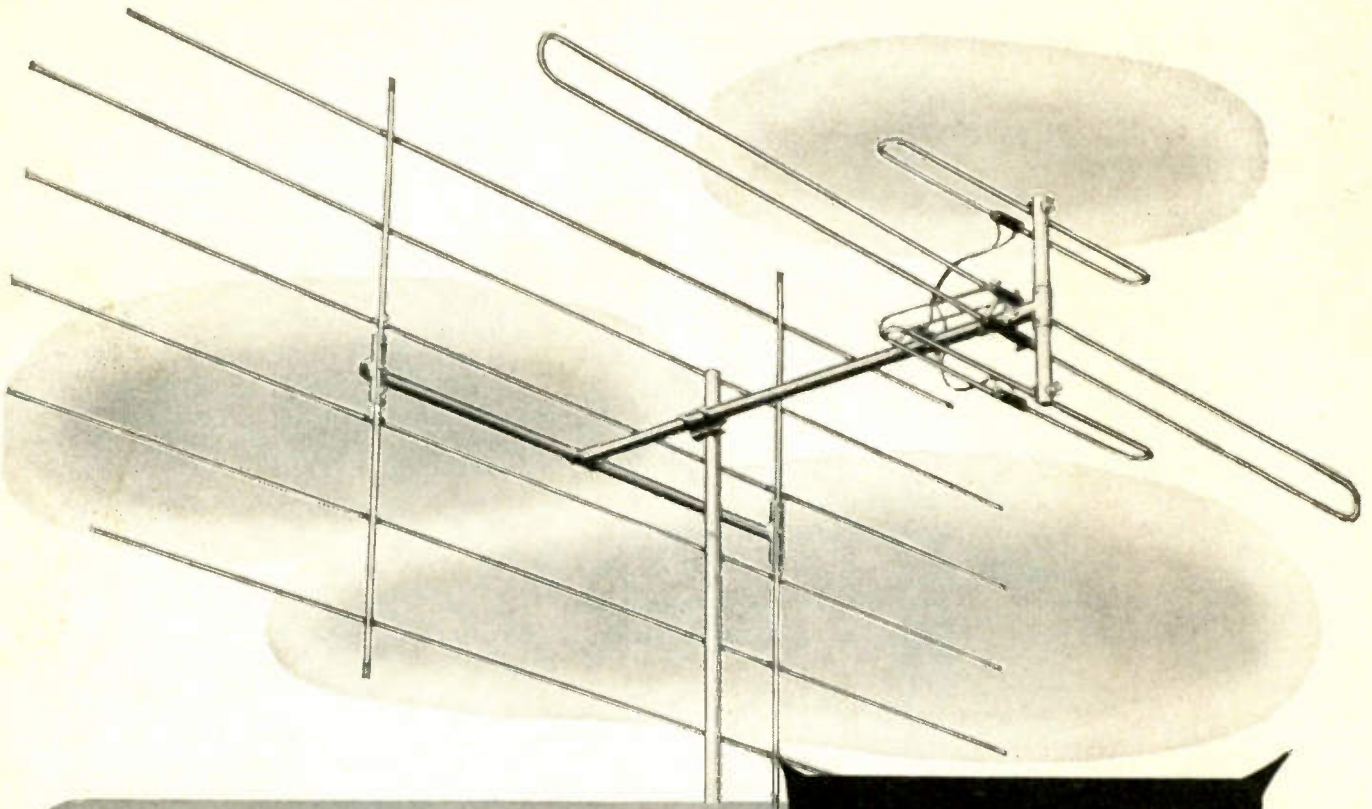

RADIART ULTAMATIC All-Channel TV Antenna

for the
FIRST time
...the **FIRST**
Antenna with
which You Can
*See the
Difference*

perfectly synchronized for
monochromatic and color TV

THESE QUALITIES HAVE BEEN COMBINED INTO THIS SINGLE ANTENNA — THE ULTAMATIC . . .

- ★ **LOW VOLTAGE STANDING WAVE RATIO** . . . the mis-match between antenna and transmission line is lower than four competitive types tested, an attribute to its broad band quality.
- ★ **FRONT-TO-BACK RATIO** . . . higher than multi-element, yagi-type antennas, minimizing co-channel interference.
- ★ **GAIN** . . . expressed in decibels, is a ratio of signal voltage developed by an antenna over that of reference folded dipoles. It is not a quality sold by the pound or achieved by the addition of meaningless elements. The curves shown accurately describe the gain of the Ultamatic. Loss of sound or picture due to erratic antenna response is eliminated.

MECHANICAL FEATURES

- ★ Aluminum screen reflector of exclusive fold-out design, assembled in seconds with adequate stability for years of trouble-free service. Longer elements insure maximum front-to-back ratio on channels 2-6 and are more closely spaced for increased performance on channels 7-13.
- ★ Dipole and boom assembly are of heavy gauge, seamless tubing. Dipoles fold out and are rigidly supported and reinforced to minimize sag and sway.
- ★ Specifically designed mechanically by stress analysis of each unit and sub-assembly to provide a low vibrational period of all elements — your assurance of trouble-free installations.

MODEL UM-213 . . . double stacked UM-213-2



THE RADIART CORPORATION
CLEVELAND 13, OHIO

TV ANTENNAS ★ AUTO AERIALS ★ VIBRATORS ★ ROTORS ★ POWER SUPPLIES

Most Uniform Gain Response The gain response **DOES NOT VARY MORE THAN 3 D. B. ON ANY CHANNEL** across the band. This quality is exceedingly important in color reception to insure adequate color synchronization without resetting.

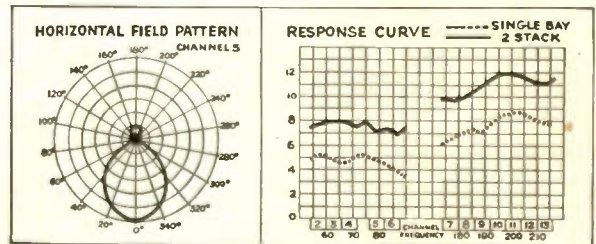

capacitor replacements

FOR SETS OF THE MONTH

CBS—COLUMBIA COLOR TV MODEL 205

| Symbol No. | Rating μF @ WVDC | CBS-Columbia Part No. | Sprague Replacement |
|----------------|------------------------------------|-----------------------|----------------------------|
| C11-5 | 1 @ 50 | 21000671 | TVA-1300 |
| C13-1C | 40 + 20 @ 450 / 20 @ 250 / 50 @ 25 | 21000881 | TVL-4732 |
| C13-2C | 40 + 20 @ 450 / 20 @ 250 / 50 @ 25 | 21000881 | TVL-4732 |
| C14-2B | 20 @ 450 / 500 + 500 @ 25 | 21000871 | R-1643 |
| C14-10B | 20 @ 450 / 500 + 500 @ 25 | 21000871 | R-1643 |
| C15B-3 | 2 @ 450 | 21000672 | TVA-1701 |
| C17-2 | 2 @ 450 | 21000672 | TVA-1701 |
| C23-2A | 40 + 20 @ 450 / 20 @ 250 / 50 @ 25 | 21000881 | TVL-4732 |
| C23-3A | 40 + 20 @ 450 / 20 @ 250 / 50 @ 25 | 21000881 | TVL-4732 |
| C24B-2 | 2 @ 450 | 21000672 | TVA-1701 |
| C25A-1, C26A-1 | 4 @ 450 | 21000673 | TVA-1702 |
| C27A-1 | 4 @ 450 | 21000673 | TVA-1702 |
| C27B-2B | 20 @ 450 / 500 + 500 @ 25 | 21000871 | R-1643 |
| C32-5H | 20 + 20 + 20 @ 450 / 100 @ 50 | 21000931 | TVL-4740 |
| C32-6H | 20 + 20 + 20 @ 450 / 100 @ 50 | 21000931 | TVL-4740 |
| C32-11 | 1000 @ 15 NP | 21000961 | R-1644 |
| C34-4H | 20 + 20 + 20 @ 450 / 100 @ 50 | 21000931 | TVL-4740 |
| C36-7G, C36-8G | 30 + 30 + 30 @ 50 | 21000921 | TVL-3320 |
| C36-9G | 30 + 30 + 30 @ 50 | 21000921 | TVL-3320 |
| C40-19, C40-20 | 200 @ 250 | 21000901 | TVL-1542 |
| C41B-2 | 5 @ 25 | 21000941 | TVA-1203 |
| C41B-4 | 100 @ 25 NP | 21000971 | * } TVA-1208 } TVA-1208 |
| C42A-5H | 20 + 20 + 20 @ 450 / 100 @ 50 | 21000931 | TVL-4740 |
| C42B-2 | 5 @ 25 | 21000941 | TVA-1203 |
| C42B-6 | 100 @ 25 NP | 21000971 | * } TVA-1208 } TVA-1208 |
| C43A-2 | 5 @ 25 | 21000941 | TVA-1203 |
| C43A-4 | 100 @ 25 NP | 21000971 | * } TVA-1208 } TVA-1208 |
| C43A-5 | 25 @ 50 | 21000677 | TVA-1306 |
| C43A-6 | 150 @ 50 | 21000951 | TVA-1311 |
| C44-1D | 80 @ 450 / 40 + 40 @ 250 | 21000911 | R-1641 |
| C45-1F | 60 + 10 + 10 @ 450 / 40 @ 250 | 21000891 | R-1642 |
| C45-2F | 60 + 10 + 10 @ 450 / 40 @ 250 | 21000891 | R-1642 |
| C45-3F | 60 + 10 + 10 @ 450 / 40 @ 250 | 21000891 | R-1642 |
| C45-4F | 60 + 10 + 10 @ 450 / 40 @ 250 | 21000891 | R-1642 |
| C45-5 | 25 @ 50 | 21000677 | TVA-1306 |
| C46-2D | 80 @ 450 / 40 + 40 @ 250 | 21000911 | R-1641 |
| C46-4D | 80 @ 450 / 40 + 40 @ 250 | 21000911 | R-1641 |
| C37-1 | 1200 μF @ 15 KVDC | 23000151 | 703C1A2 |
| C37-2 | 1200 μF @ 15 KVDC | 23000151 | 703C1A2 |
| C38-1 | 1200 μF @ 15 KVDC | 23000181 | 703C1A3 |
| C39-1 | 2000 μF @ 30 KVDC | 23000161 | 703C7 |

*Connect in series tying negative leads together.

Sprague makes more capacitors . . . in more types . . . in more ratings . . . than any other capacitor manufacturer. Send 10¢ for the 65-page giant seventh edition TV Replacement Manual to Sprague Products Co., 65 Marshall St., North Adams, Mass., or get it FREE from your Sprague distributor.

EMERSON CHASSIS 120233-D, 120234-D, 120235-D, 120236-D, 120238-F

| Symbol No. | Rating μF @ WVDC | Emerson Part No. | Sprague Replacement |
|------------|-------------------------------|------------------|---------------------|
| C53 | (Also Contains C21, C65) | 925280 | R-1639 |
| C54 | (Also Contains C55, C56, C66) | 925242 | R-1522 |
| C67 | 50 μF @ 2000 | 928097 | * |

*Use Sprague CK-1 yoke capacitor replacement kit to select proper value.

CROSLEY CHASSIS 431-2

| Symbol No. | Rating μF @ WVDC | Crosley Part No. | Sprague Replacement |
|------------|--------------------------------|------------------|---------------------|
| C132 | 200 + 5 @ 150 | 157836-1 | R-1645 |
| C138 | 20 @ 450 | 157903-1 | TVA-1709 |
| C139 | 200 @ 200 | 158557-1 | R-1646 |
| C140 | 140 + 5 @ 300 / 200 + 30 @ 150 | 157838-3 | R-1553 |
| C129 | Sync. Take-Off Network | 157813-1 | 102C17 |

STEWART-WARNER MODEL 17T-9620A, B; 21C-9630C, CB, D; 21T9630A, AB

| Symbol No. | Rating μF @ WVDC | Stewart-Warner Part No. | Sprague Replacement |
|------------|-----------------------------|-------------------------|--------------------------------|
| 64 | 40 + 40 @ 450 | 521578 | TVL-2764 |
| 69 | 4 @ 450 | 504719 | TVA-1702 |
| 71 | 40 @ 300 | 160095 | TVA-1611 |
| 72 | 80 @ 250 / 100 @ 50 | 509002 | ¹ TVL-3722 |
| 136 | 10 @ 150 | 505174 | TVA-1406 |
| 145 | Integrator Plate | 508062 | ² } V-1 } 5HK-51 |

¹Omit 20 μF section.

Connect 5HK-51 in series with the input lead of V-1.

STROMBERG-CARLSON 21T-22T Series

| Symbol No. | Rating μF @ WVDC | Stromberg-Carlson Part No. | Sprague Replacement |
|------------|-------------------------------|----------------------------|---------------------|
| C231 | 20 @ 300 | 111089 | TVA-1608 |
| C232 | 20 @ 300 | 111089 | TVA-1608 |
| C261 | 5 @ 50 | 111093 | TVA-1003 |
| C290 | 40 + 40 + 10 @ 450 / 100 @ 50 | 111115 | TVL-4747 |
| C291 | 40 + 40 + 20 + 20 @ 250 | 111113 | R-1640 |

ZENITH CHASSIS 5R60T

| Symbol No. | Rating μF @ WVDC | Zenith Part No. | Sprague Replacement |
|------------|-----------------------------|-----------------|---------------------|
| C16 | 80 + 40 @ 150 / 20 @ 25 | 22-2603 | R-1498 |

DON'T BE VAGUE...INSIST ON

SPRAGUE

(Distributors' Div. of the Sprague Electric Co.)

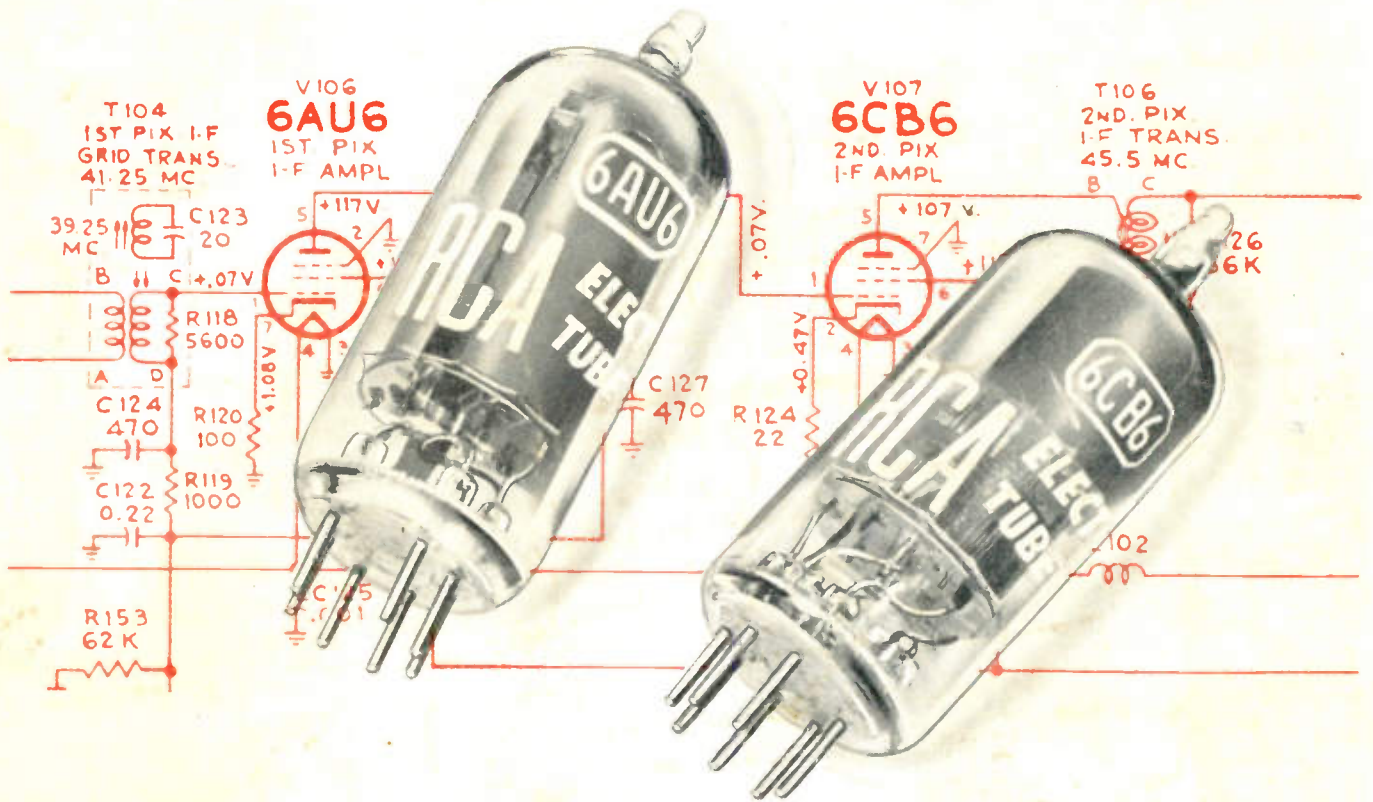

SAVE TIME IN REPAIRING TV IF CIRCUITS!

Use RCA Tubes with built-in quality!

HERE'S WHY . . . Strict quality control in manufacturing RCA Tubes assures consistent uniformity of characteristics. For example, careful control of transconductance, plate-current cutoff, and tube capacitances in RCA Tubes for TV IF Circuits is your assurance of quick servicing without quality difficulties.

In circuits so vital to the production of sharp pictures and strong signals—be sure, use RCA Tubes!



RADIO CORPORATION of AMERICA
ELECTRON TUBES
HARRISON, N. J.

Your First Choice for TV circuits . . . dependable RCA Tubes.