

CALDWELL-CLEMENTS'

TELEVISION RETAILING

Radio • Appliances • Records • Servicing



POLITICS

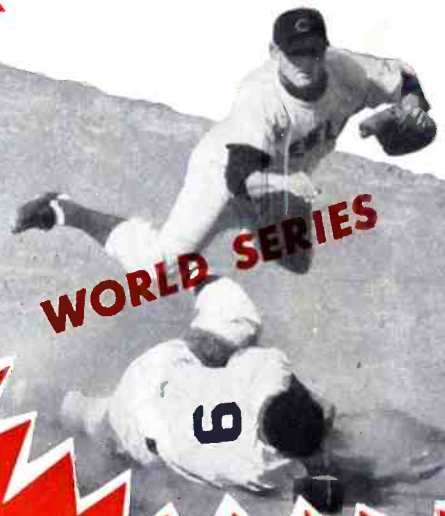

WORLD SERIES

*Coming Programs
Are Tops...
Match Them with
AGGRESSIVE SELLING!*



Mrs. Joan Gil
437 Nevitt St.,
Lancaster, Pa.



Return to
IN-HOME LIVING

U.S. POSTAGE
8c Paid
Permit No. 225
Bristol, Conn.

September • 1952

CBS *Columbia*

**ANNOUNCES THE MOST
POWERFUL SELLING PLAN
IN THE TELEVISION INDUSTRY...**

Featuring

**1 A Brand-New Line
of the Most Exciting
Television Receivers
in America!**

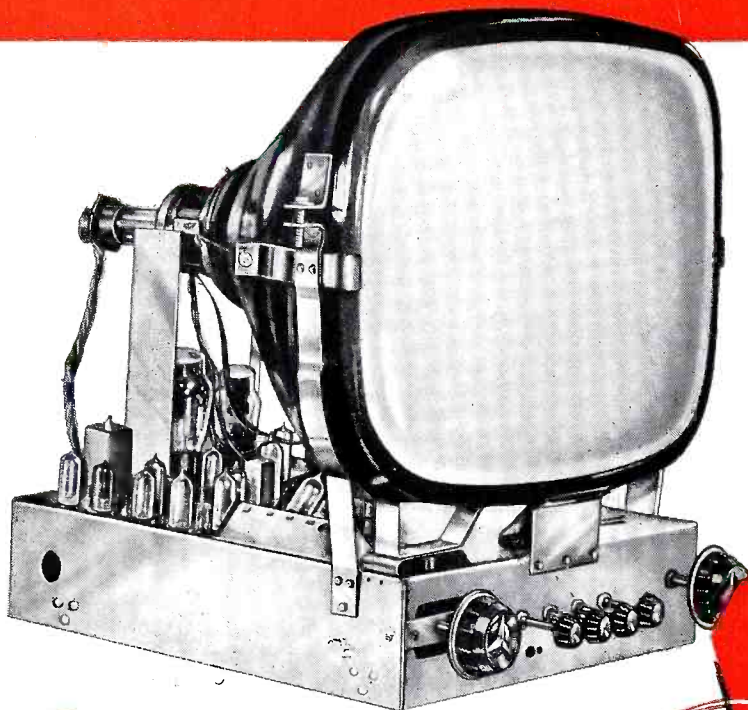

**2 The Exclusive CBS
Power-Tron Chassis!**

The finest performing
power plant in all TV



The **AMBASSADOR**
21" Mahogany



The **FUTURA**
21" Blonde



The **CORONATION**
21" TV-EM-AM-Phono

ENGINEERED BY

CBS *Columbia*

The Greatest Name in TV... Radio... Broadcast Research



**3 A Profit-Making Program
to Move Merchandise—Now!**

The *Power-Tron* Chassis is proof positive of PERFORMANCE! In addition, CBS-Columbia gives you PRICE with leader merchandise... PROFITS with step-up models... PRESTIGE with the greatest name in the industry... PROMOTION in every medium. Add them all up and they spell out a Powerful SELLING Plan designed to move merchandise—now! Call or write your CBS-Columbia Distributor today for further details.

CBS-COLUMBIA Inc.

A Subsidiary of the Columbia Broadcasting System

CONTACT YOUR CBS-COLUMBIA DISTRIBUTOR TODAY!

TELEVISION RETAILING

Including "RADIO & TELEVISION"
"RADIO & TELEVISION TODAY"
"TV TECHNICIAN" and
"ELECTRICAL RETAILING"

IN THIS ISSUE

SEPTEMBER, 1952

ORESTES H. CALDWELL
Editorial Director

M. CLEMENTS
Publisher

JOHN L. STOUTENBURGH
Executive Editor

EDWARD A. CAMPBELL
Managing Editor

SOLOMON HELLER
Technical Editor

RICHARD ELLANEY
Assistant Editor

CHARLES F. DREYER
Art Director

BUSINESS DEPARTMENT
M. H. NEWTON
Business Manager

HOWARD A. REED
General Sales Manager

DIXON SCOTT
District Manager

HAROLD C. WELTNER
District Manager

G. A. DILLEN
Sales Promotion Manager

N. McALLISTER
Asst. Business Manager

A. O'ROURKE
Production Supervisor

JOAN ROTH
Director, Reader Service

BRANCH OFFICE
CHICAGO 6

M. GASKINS, Western Manager
JOHN D. LUPTON, District Manager
201 N. Wells St., Randolph 6-9225
LOS ANGELES 5

CHRIS DUNKLE & ASSOCIATES
Southern California Representative
2506 W. 8th Street, Dunkirk 7-6149

V. SPINETTA, Directory Manager
WARREN S. BROWN, Circulation Mgr.

W. W. SWIGERT, Credit Manager

TELEVISION RETAILING*

September 1952, Vol. 56, No. 3, 35 cents
copy. Published monthly by Caldwell-
Clements, Inc. Publication Office, Emmett St.,
Bristol, Conn. Editorial, Advertising and Exe-
cutive Offices, 480 Lexington Ave., New
York 17, N. Y. Entered as second class
matter at the post office at Bristol, Conn.,
July 17, 1952, under the Act of March 3,
1879. M. Clements, President; Orestes H.
Caldwell, Treasurer. Subscription rates United
States and U. S. Possessions \$2.00 for one
year, \$3.00 for two years, \$4.00 for three
years, Canada \$3.00 for one year, \$4.00 for
two years, \$5.00 for three years. Pan American
countries \$4.00 for one year, \$7.50 for two
years, \$10.00 for three years. All other coun-
tries \$5.00 for one year, \$7.50 for two years,
\$10.00 for three years. Printed in U.S.A.
* Trade-Mark Reg. U. S. Pat. Off.

Copyright 1952 by

CALDWELL-CLEMENTS, Inc.
Publishers also of TELE-TECH

* A.M., F.M. Television

Cover—Real Opportunity to Increase Sales	
Are List Prices Doomed?	39
What's Ahead—in Radio, Appliances, Records and Television	40, 41
Business Is on the Upswing—Cash in Now	44, 45
Price-Cutting Is a Speedway to Disaster	46, 47
Outstanding Service Pulls in Sales	48, 49
National Electronic Distributors Association Convention	50, 51
Spark Your Sales With Sales Contests	52, 53
Latest TV, Radio, Phono Players on the Market	58, 63
Specifications of the New Television Models	70, 74, 75, 76
Sell Hi-Fi the Best Way	78
"Balanced Store" Builds Sales	82
Selling Tough Customers	84

* Records, Phonographs, Accessories

Phono Record Market News and Trends	40, 41
Make Your Record "Clerks" into Salesmen	54, 55
Latest Records and Industry Activities	begins on page 56

* Electrical Appliances

Appliance Industry Market Trends	40, 41
News in the Appliance Field	64
Latest Electrical Appliances	65
Appliance Service Trends	66
Sell the Complete Home Laundry	68

* TV-Electronic Technician

Keep Your Promises, Keep Your Customers	95
Servicing Horizontal Circuits	96, 97
Practical Troubleshooting on TV Sets	98, 99
Improve Efficiency Through Short Cuts	100
Latest Products for Servicers	104, 107

Latest Product Specifications, Directories, etc. that have appeared in TELEVISION RETAILING:

Specifications:		Directories (Continued):	
Television Receivers	This Issue, p. 70	Custom Components Mfrs.	Apr. '51, p. 34
Radios, Home Receivers	Apr. '51, p. 59	Distributors	Jan. '52, p. 117
Radios, Portable and Auto	Apr. '51, p. 56	Electric Housewares	Feb. '52, p. 46
Clothes Dryers	Jan. '52, p. 80	Phono Record Mfrs.	July '51, p. 42
Dishwashers	Oct. '51, p. 62	Roster of Representatives	Oct. '51, p. 101
Electric Ranges	Mar. '52, p. 58	Test Instruments	May '51, p. 100
Hand Irons	Dec. '51, p. 42	TV & FM Antenna Mfrs.	Mar. '51, p. 36
Ironers	Nov. '51, p. 50	Reference Charts:	
Refrigerators	Sept. '51, p. 65	Battery Replacement Chart	Apr. '51, p. 73
Room Air Conditioners	Apr. '52, p. 48	FM Coverage Areas	July '50, part II
Vacuum Cleaners	July '51, p. 67	Four-Field Statistics	Jan. '52, p. 58
Washing Machines	May '51, p. 84	TV Sets in Use	Jan. '52, p. 59
Directories:		UHF Coverage Areas	Aug. '51, p. 44
Mfrs. of Radio, TV, FM, Phonos, Phono Records,		Recorders, Servicing and Sound,	May '52, p. 101



CALDWELL-CLEMENTS, INC., Publication Office, Bristol, Conn.
Editorial and Executive Offices, 480 Lexington Ave., New York 17, N. Y. Plaza 9-7880

Better See

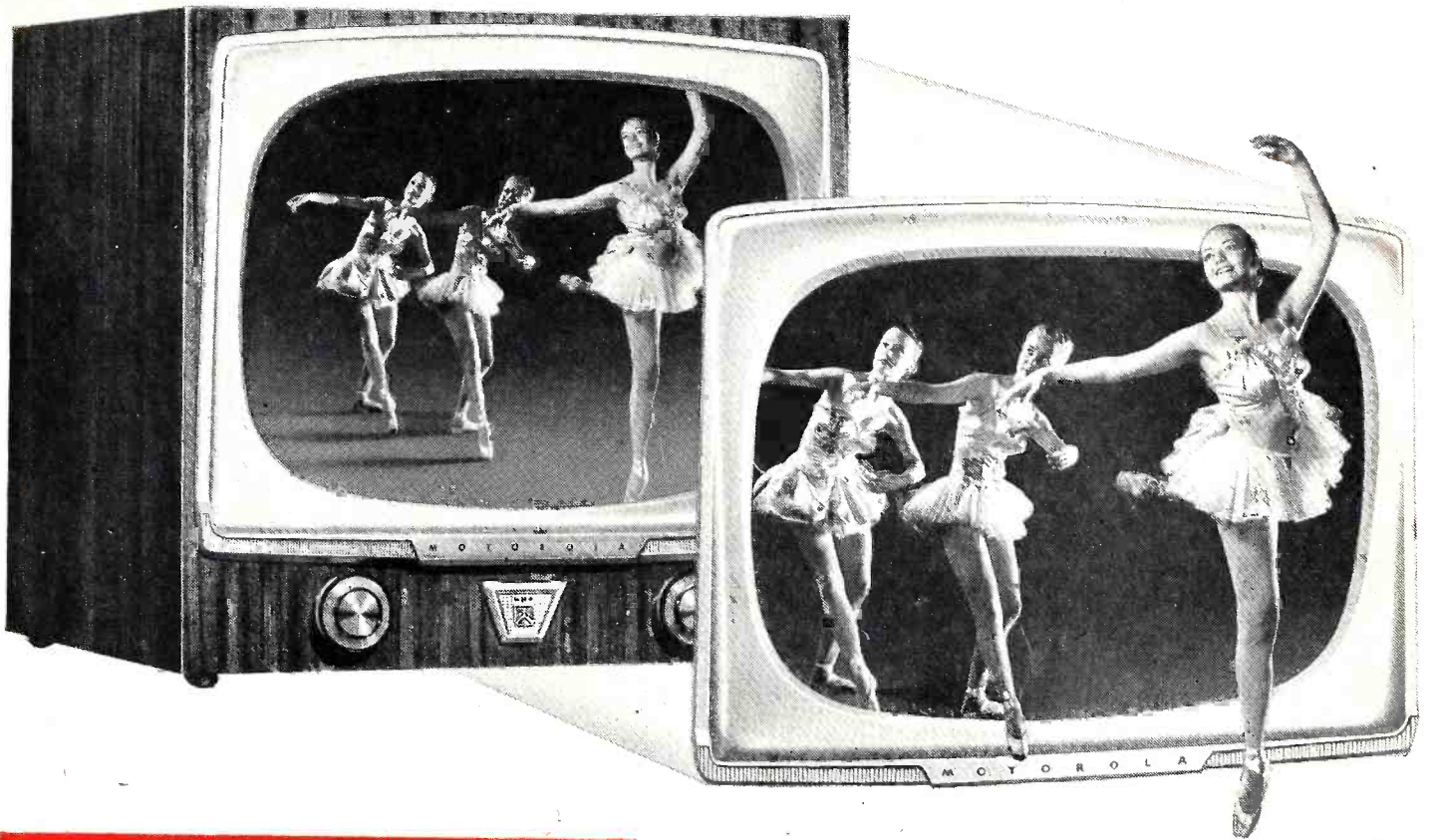

The Standout Franchise

In All Television—

For Bigger Profits...

Bigger Sales

Every month more and more dealers coast-to-coast acclaim the Motorola franchise as one of their most valuable assets.

It is their guarantee of the very latest in engineering—year after year, they have seen Motorola lead in new, revolutionary electronic developments; have seen others imitate and follow. It is their guarantee of a fast-moving, years-ahead line that combines quality, attractive pricing, dependability, and national recognition. Write for details.

Motorola, Inc.
Chicago 51, Ill.

A new kind of picture . . . new life for TV sales! It's all there in the new 1953 Motorola Line, the line with the revolutionary, exclusive *Standout Picture!*

A host of brand new or improved features are aimed right at your "hold out" customers, pointed squarely at replacement and second set sales. New, patented, simplified circuits, more powerful, more dependable, save on electric power consumption. UHF covered from every angle. New stylized, contour molded bezel sparks up design and appearance. Amazing new "SABRE JET" Tuner improves picture clarity. These and scores more . . . truly the standout line for a sell-out season!

31 beautiful models

Motorola TV

with the sensational "NEW DIMENSION"

Standout Picture

That brings the action into the room—

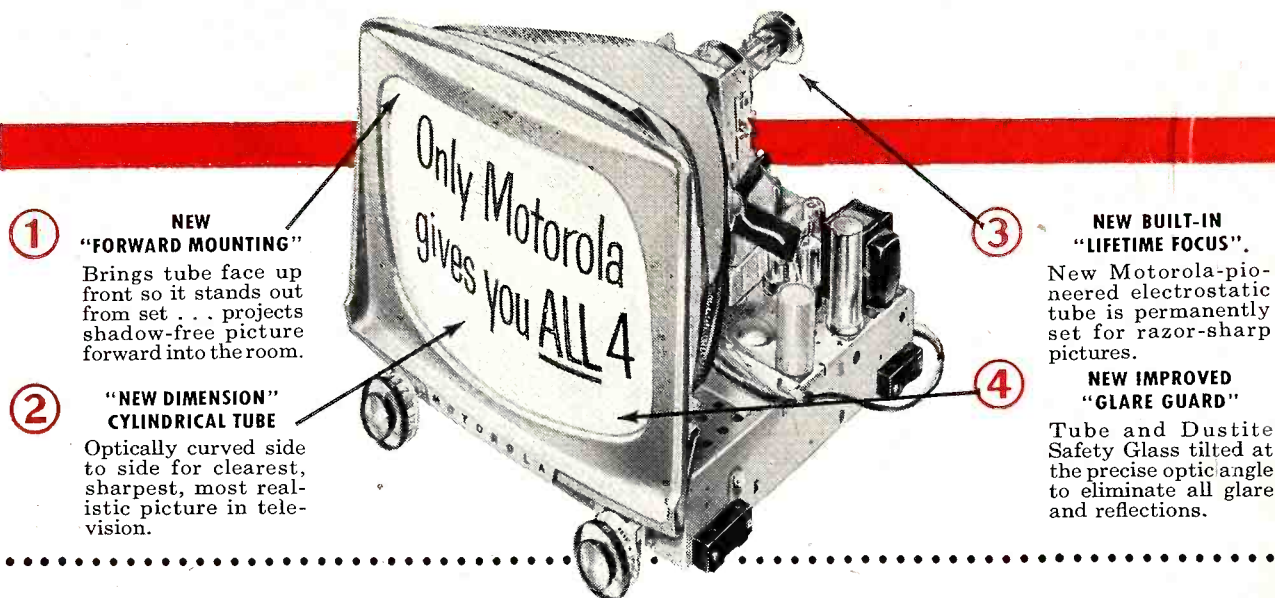

① **NEW "FORWARD MOUNTING"**
Brings tube face up front so it stands out from set . . . projects shadow-free picture forward into the room.

② **"NEW DIMENSION" CYLINDRICAL TUBE**
Optically curved side to side for clearest, sharpest, most realistic picture in television.

③ **NEW BUILT-IN "LIFETIME FOCUS"**
New Motorola-pioneered electrostatic tube is permanently set for razor-sharp pictures.

④ **NEW IMPROVED "GLARE GUARD"**
Tube and Dustite Safety Glass tilted at the precise optic angle to eliminate all glare and reflections.

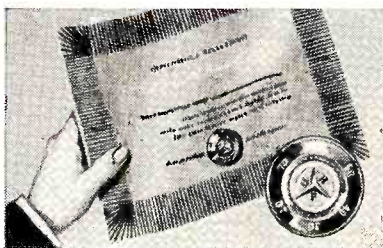

Bonded All Channel UHF

Built-in provisions for 70 Channel UHF. Installed locally or at factory. Exclusive Gold Bond for future installation.

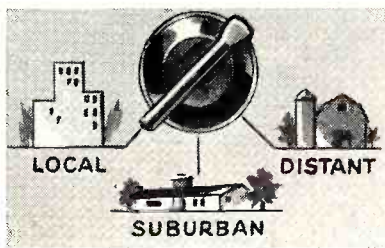

Area Selector Switch

Adjusts pull-in power for perfect picture regardless of miles . . . provides increased sensitivity for fringe area customers.

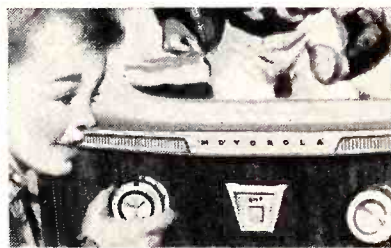

One-Knob Tuning with New "Channel-light"

Two simple controls. Channel numbers lighted for quick selection even in the dark.

And many other new features that will Make Sales

—all priced competitively!

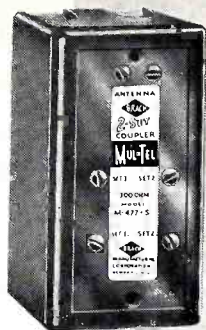

2 set coupler
Model 477-S*
List \$5.45



4 set coupler
Model 478
List \$6.95

2 set coupler Old List
Model 300-300 \$14.95

Now \$10.95



4 set coupler
Model 72-72

Old List
\$19.75

Now \$11.95



4 set coupler Old List
Model 300-72 \$19.75

Now \$11.95



Mul-Tel

Brach

Brings You The New,

Aluminated, Easy-to-Install Inductive Mul-Tel

Brach Manufacturing Corporation, the founders of the Mul-Tel coupler, proudly present the new advanced-designed Inductive Mul-Tel with the exclusive aluminated* feature . . .

- *the only coupler shielded from the inside
- internal electrostatic sprayed shield keeps interference away from distribution coils
- attractively boxed in shielded plastic housing
- complete filter action insured by Brach's factory-adjusted coils
- three hundred ohm lead rests on plastic case without danger of shorting effects

Compare these features with any comparative unit now on the market and you will agree with Brach's constant laboratory and consumer testing . . . there is no finer buy than Brach's new Inductive Mul-Tel. Remember . . . they're aluminated!

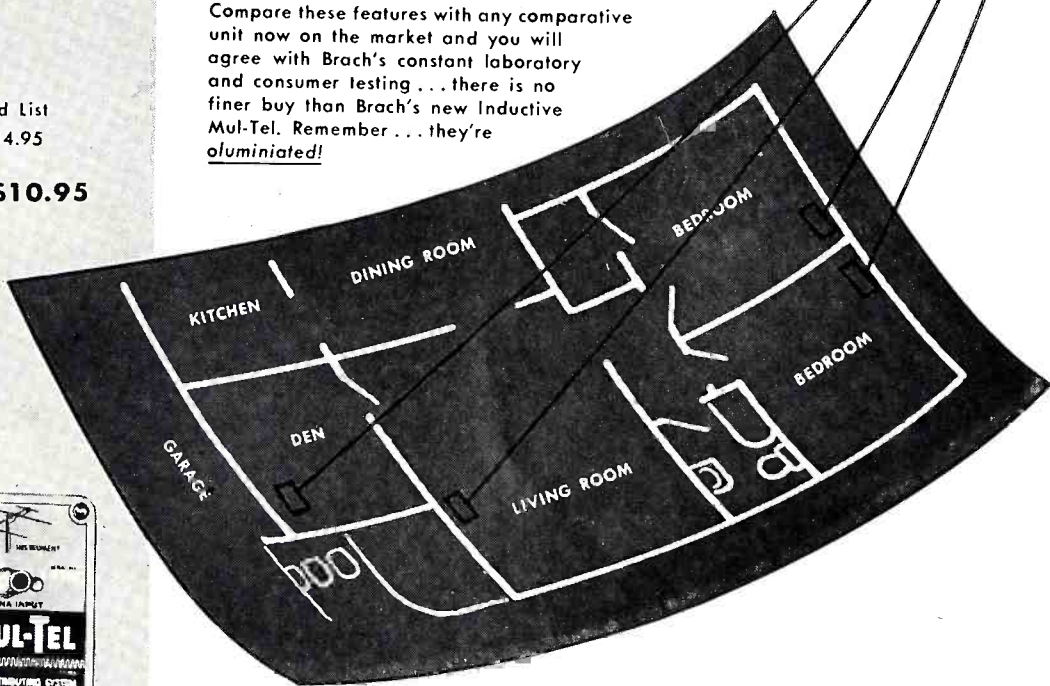

Brach again leads the way with a price reduction—due to increased production on our standard Mul-Tel. These models, long accepted as a criterion throughout the television industry, retain all their original quality features, including:

- lifetime guarantee
- heavy cast-aluminum box
- lowest standing-wave ratio components
- high-pass filter action
- no loading effects between connected television sets
- the only 2-set coupler that works for 72 and 300 ohm antenna lines simultaneously

FREE Write for booklet "Preparing for UHF Television" by Ira Kamen, noted TV authority.

MANUFACTURING CORPORATION

Division of General Branze Corporation

200 CENTRAL AVENUE, NEWARK 4, NEW JERSEY

Remember: Brach leads the way for better reception! Write, wire, or phone your order today.

QUALITY FIRST... A PHILCO POLICY

NEW FROM PHILCO

THE ONLY BUILT-IN AERIAL
FOR TELEVISION
FOR **BOTH UHF**
AND **VHF**

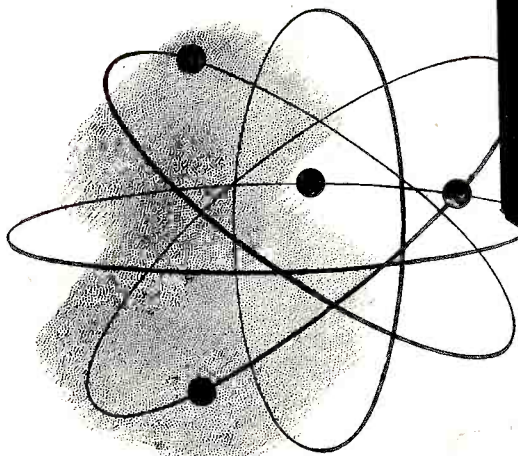

ELECTRONIC AND DIRECTIONAL!

PHILCO 4-STEP CONTROL MAKES IT
POSSIBLE TO BEAM THE AERIAL **ELECTRONICALLY**
TOWARDS THE STRONGEST, CLEAREST
SIGNAL FROM ANY STATION. ACTUALLY IT'S
LIKE FOUR AERIALS IN ONE!

**JUST PLUG IN
AND PLAY!**

NO OUTSIDE AERIAL
NEEDED FOR **UHF**
OR **VHF** IN UP
TO 8 OUT OF 10
LOCATIONS

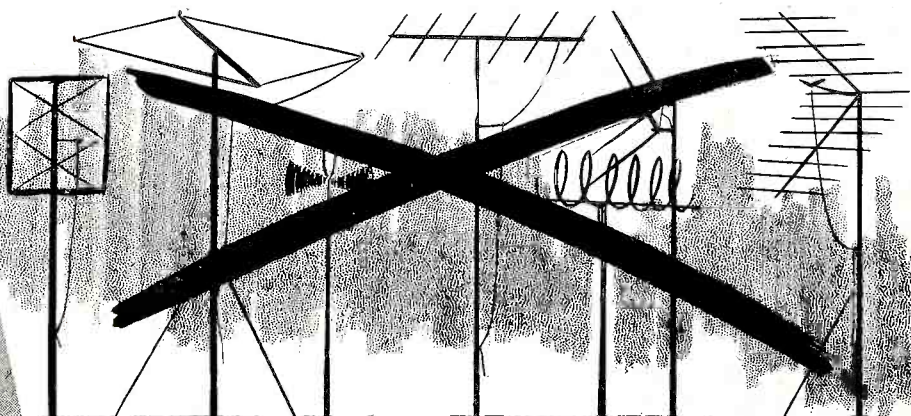

PHILCO FAMOUS FOR QUALITY THE WORLD OVER

G.E. TELLS YOUR CUSTOMERS!

National advertising sponsored by General Electric gives public the facts about the important service rendered by a skilled, highly-trained industry.

This ad, now running in LIFE and COLLIER'S, will help 35,000,000 readers to understand and respect the television serviceman and his work.

As a manufacturer of high-quality tubes and parts, General Electric has an important stake in your business, and is anxious to see a greater appreciation of your experience and abilities.

For extra copies of this LIFE-COLLIER'S ad write General Electric Company, Tube Department, Schenectady 5, New York.

AMERICA'S NEWEST "PROFESSION" KEEPS 18 MILLION TV SETS HEALTHY!

EIGHTEEN MILLION new "patients" is a tremendous responsibility for the television service industry—an industry that had only 2,000 sets to take care of just five short years ago. The phenomenal growth of TV has challenged every resource of service shop and individual technician. Television itself embodies new electronic principles which had to be learned by over 51,000 servicemen, most of whom were radio specialists. Manufacturers did everything they could to make it easy for these men to become the highly-qualified TV experts they are today. Schools and courses were established . . . new test equipment was developed . . . replacement tubes and parts were distributed to every TV area. But the real responsibility for acquiring

TV know-how rests with the serviceman. As a group, these technicians have done an unprecedented job of meeting the service needs of the "TV epidemic". They have built for themselves an important new industry based on one ideal: to safeguard a billion-dollar owner investment in TV. Your TV serviceman deserves your full respect and confidence. He has invested over \$3,000 in special test and other equipment in servicing sets. He is technically trained . . . experienced . . . familiar, by constant study, with latest television improvements. Call your favorite TV serviceman whenever you want your set put in top working order. He will always do his best to serve you promptly and at a fair, reasonable cost!

This advertisement is published as a tribute to the television servicemen of America by the Tube Department of the General Electric Company, Schenectady, N. Y.

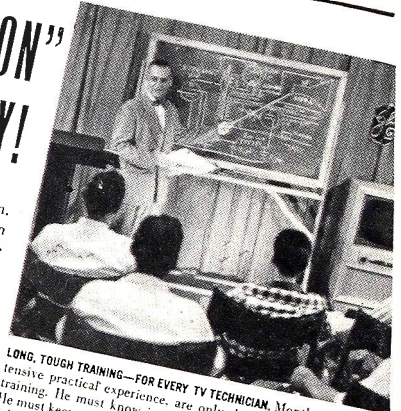

LONG, TOUGH TRAINING—FOR EVERY TV TECHNICIAN. Months of study, and intensive practical experience, are only the start of your serviceman's training. He must know intimately the circuit of every make of TV. He must keep posted on all design changes. No professional man in a field is obliged to read and study more continuously.

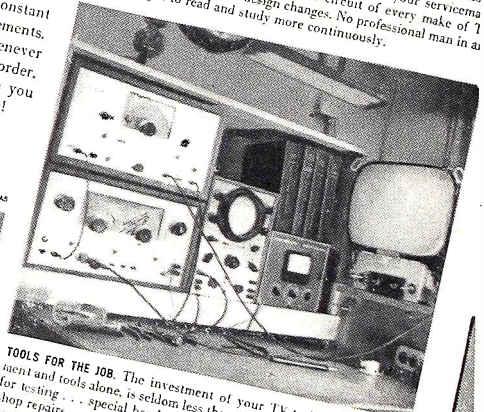

TOOLS FOR THE JOB. The investment of your TV technician in equipment and tools alone, is seldom less than \$3,000. Precision instruments for testing . . . special hand-tools . . . bench equipment for major TV shop repairs . . . these are pluses he must add to the customary business man's investment in shop and trucking facilities.



OPERATION TELEVISION—RIGHT IN THE HOME. When your TV serviceman removes your TV chassis from its cabinet, ask him to show you the myriad tubes, coils, and other parts, inter-connected by an "orderly maze" of wiring! Only highly-skilled hands can safely probe for faults, make repairs—usually on the spot—that restore the picture and sound to normal. His tools and equipment are as complete for their purpose as the contents of a doctor's kit. Aided by his specialized training, your serviceman diagnoses TV troubles, and restores your set to "health", in the least time and at the least cost to you.

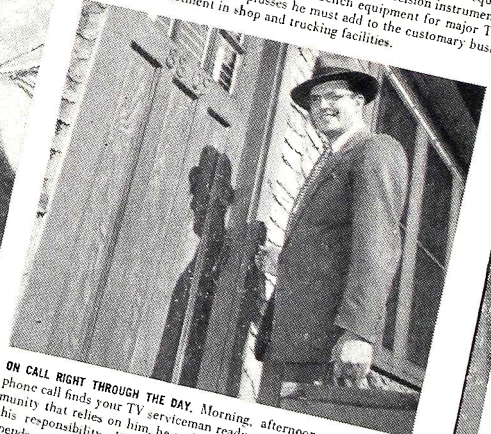

ON CALL RIGHT THROUGH THE DAY. Morning, afternoon, or evening, a phone call finds your TV serviceman ready to respond. Serving a community that relies on him, he makes every possible effort to live up to this responsibility. His charges—which reflect the actual time he spends serving you plus any necessary tubes and replacement parts—are your best investment in television satisfaction.

★ THIS ADVERTISEMENT IS PUBLISHED AS A TRIBUTE TO THE TELEVISION SERVICEMEN OF AMERICA BY THE TUBE DEPARTMENT OF THE GENERAL ELECTRIC COMPANY

The whole world knows

Hallicrafters quality

...easier to sell because it's easier to prove!

- Born of **Hallicrafters** world leadership in communications equipment
- Sensibly priced to give your customers better value

Claims of quality can be made by many.

Proof of quality can be assured by few.

Among all manufacturers in the United States today, Hallicrafters has the largest experience in building precision instruments of communication using television frequencies!

The Hallicrafters name and Hallicrafters performance are famous in 89 different countries, and Hallicraft-

ers equipment is used by 33 governments 'round the globe!

Why follow the false prophets of profitless *low* prices or out-of-reach *high* prices? Major in the quality that's *easier* to sell—Hallicrafters quality—easier to prove—guaranteed to your customers in writing—sensibly priced to give *you* an edge on competition. Phone, wire or write for complete details today . . . Hallicrafters Company, Chicago 24, Illinois.

Our Guarantee

**TO YOUR CUSTOMERS
—IN WRITING!**

"Every Hallicrafters Television Receiver is built with such remarkable precision that we give you a written warranty on *all parts* for *one full year* from date of purchase, at *no extra cost!* You take no chances on costly replacements. Each Hallicrafters set is precision-built for *guaranteed* quality and your protection is in writing!"

Two examples of the complete Hallicrafters Quality Line at sensible prices

Model 1051—and stunning new Hallicrafters *Telecart*—gleaming, modern ebony-plastic cabinet with 17-inch, 152 square inch, screen. Non-glare tilted glass front. *Telecart* is TV's hit of the year! Roll your Hallicrafters across the room, onto the porch or patio—Hallicrafters picture stays clear and steady!

Model 1052—in gleaming mahogany plastic—the finest TV picture in the world, in modern mahogany plastic cabinet. 17-inch screen with non-glare tilted glass front, and big true-tone speaker. Simple tuning controls. Full provision for UHF. Console type base at slight extra cost, has easy-rolling casters, rich metallic cloth grille.



hallicrafters

World's Leading Manufacturers of
PRECISION TV AND RADIO

First again in Quality,
Performance and Dollar Value

Westinghouse television

WITH THE

Electronic Clarifier

"Plug-In" UHF...Single Dial Tuning

Westinghouse provides these three famous and EXCLUSIVE improvements as standard equipment on all models, regardless of price or picture size.



The Dover
17-inch Picture
Model 681T17



The Huntley
17-inch Picture
Model 704T17



The Drake*
17-inch Picture
Model 700T17



The Marlow
17-inch Picture
Model 667T17



The Dryden
20-inch Picture
Model 708T20



The Prescott
20-inch Picture
Model 724T20



The Clayton
20-inch Picture
Model 725T20

YOU CAN BE SURE...IF IT'S

Westinghouse

WESTINGHOUSE ELECTRIC CORP. • TELEVISION-RADIO DIVISION • SUNBURY, PA.

**SEE YOUR
WESTINGHOUSE DISTRIBUTOR**

for handsomely styled
Consoles and Table Models
with 17" to 24" pictures

Brilliant New Combinations
with 21" Television,
3-Way Record Player,
AM and FM radio.



**The Winslow
17-inch Picture
Model 678K17**



**The Whitney*
17-inch Picture
Model 702K17**



**The Barrington
20-inch Picture
Model 718K20**



**The Westfield
21-inch Picture
Model 710T21**



**The Markley
21-inch Picture
Model 695K21**



**The Welburn*
21-inch Picture
Model 714K21**

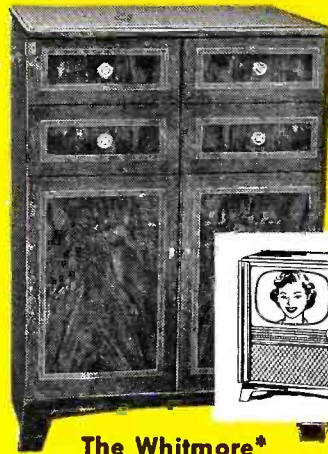

**The Whitmore*
21-inch Picture
Model 720K21**



**The Salem
21-inch Picture
Model 722K21**



**The Madison
24-inch Picture
Model 688K24**

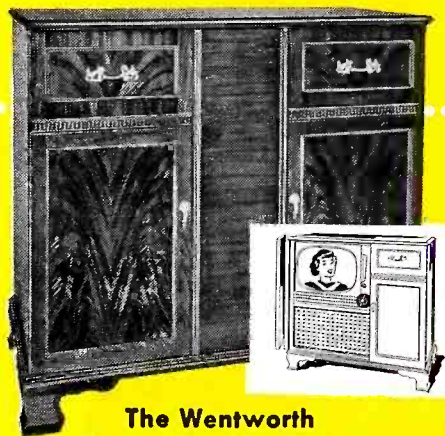

**The Wentworth
5-way Combination
21-inch Picture
Model 730C21**



**The Warfield*
5-way Combination
21-inch Picture
Model 732C21**

**Tune in on history! Only Westinghouse brings you
complete coverage of political campaign over
CBS television and radio.**

*Also available in frosted oak.

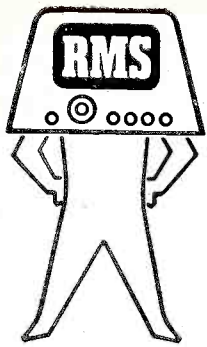

A properly selected **RMS** antenna helps you do...

THE BEST JOB IN YOUR AREA

HOW TO SELECT THE PROPER RMS ANTENNA FOR YOUR PARTICULAR INSTALLATION

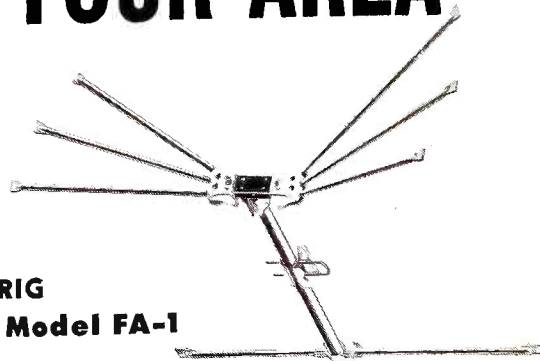
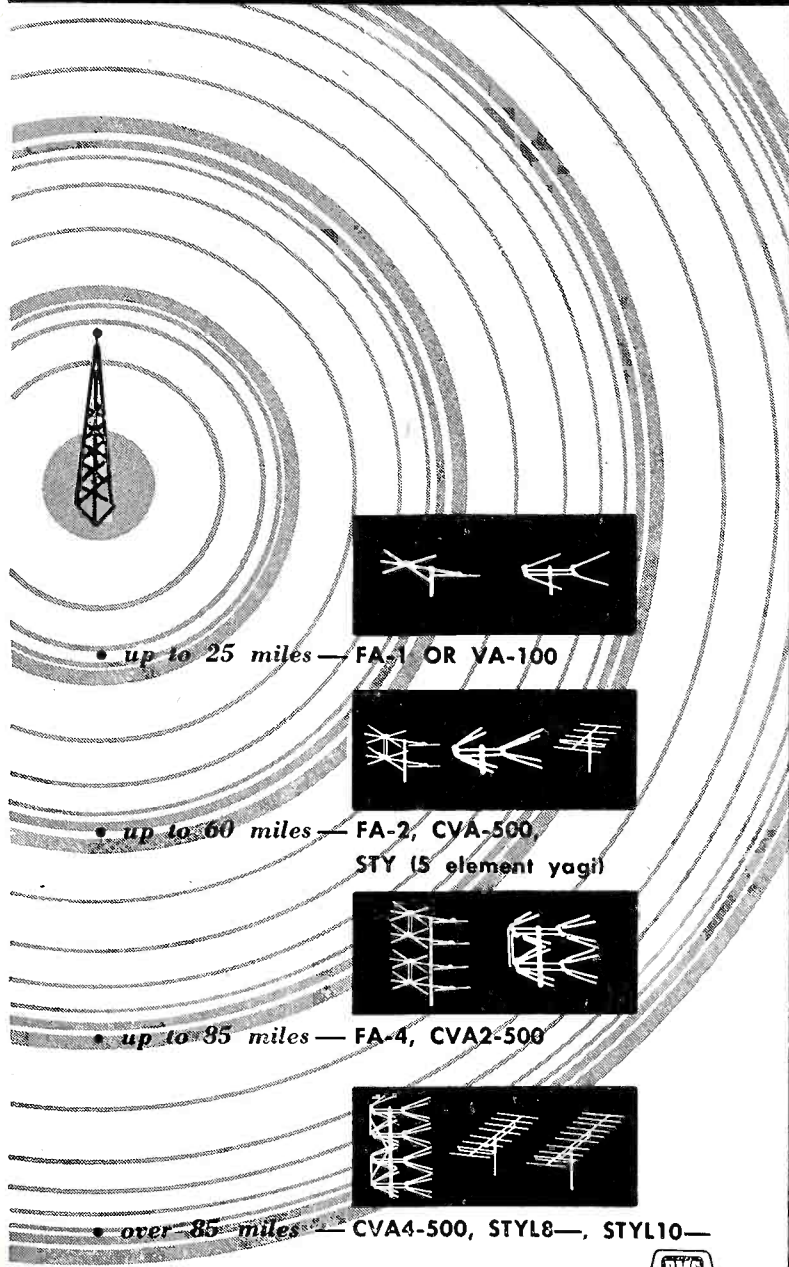

REDI-RIG RMS Model FA-1

- Completely preassembled — no loose parts or hardware.
- Exceptionally flat response across entire tv band.
- 3/8" dowel-reinforced aluminum elements.
- Plus six other distinctive mechanical and structural advantages!

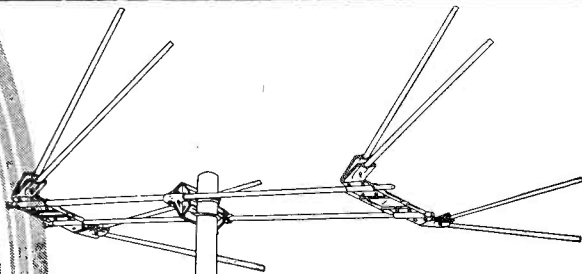

FRINGELEADER END-FIRED ARRAY RMS Model CVA-500

- Completely preassembled.
- High gain on all channels.
- 3/8" dowel-reinforced aluminum elements with unique double U-bolt attachment to the mast.

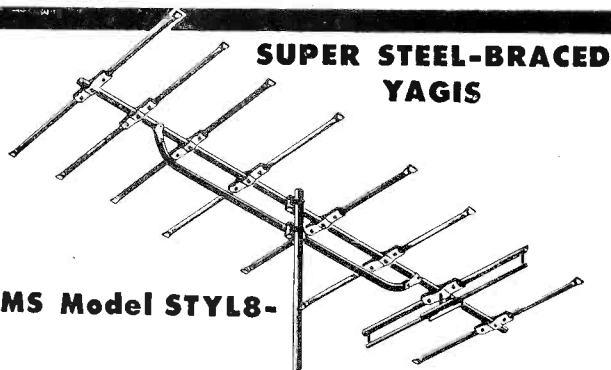

RMS Model STYL8-

- Cut for specific channel — one of the highest gain antennas in use today.
- Steel brace assures permanent orientation.
- Deluxe construction and engineering features — the fastest installing long boom yagi on the market!

SEE YOUR
RMS JOBBER

RMS



2016 BRONXDALE AVENUE • NEW YORK 60, N. Y.



LOOK WHAT'S COMING YOUR WAY!

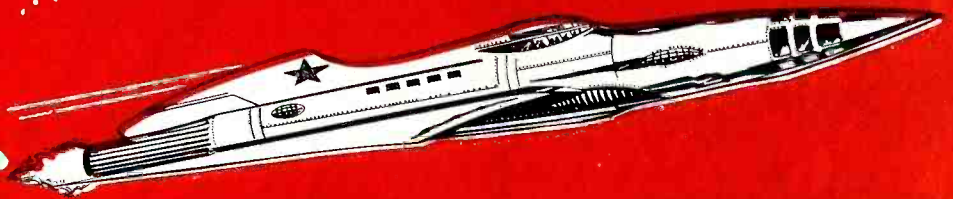

BIGGEST HOTTEST
 "Bring-em-into-the-store"
 TV Promotion Ever Staged!

BUCK ROGERS
 and 30,000,000 KID-SALESMEN
 will bring
 MILLIONS OF PROSPECTS
 to **SYLVANIA TV DEALERS**

WATCH FOR IT... COMING SOON!

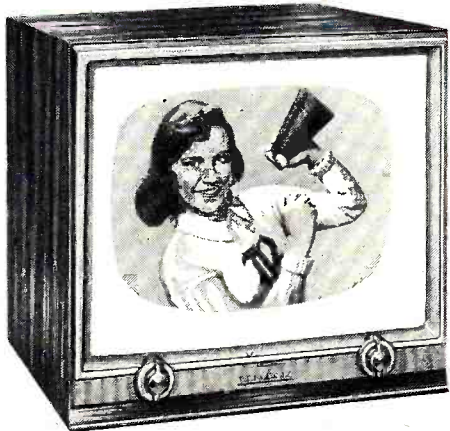

The **ARLINGTON (175M)** 21" Table Model with **HALOLIGHT**. Mahogany veneer cabinet. Stratopower "508" Chassis. Available with built-in UHF reception. Also in Blonde (175B).

GET READY to climb aboard Sylvania's big "Space Ship" promotion — and rocket your TV sales to new highs for '53!

This most spectacular promotion in TV history is going to *double, triple and quadruple* store traffic for Sylvania dealers everywhere. Watch for it! Contact your Sylvania Distributor right away—and get set for the biggest sales drive ever put on in your territory!

America's Fastest Growing Television. The new 1953 Sylvania TV with **HALOLIGHT** is the most powerful, most beautiful line of television ever offered to public and trade. Backed by record-breaking advertising and promotion, Sylvania and its dealers will zoom to new heights this year!

Tie in with Sylvania's "Out-of-this-world" promotion! Your Sylvania Distributor has all the details — contact him *now!*



SYLVANIA TV

with better-than-ever **HALOLIGHT***

The Original Frame of Light That's Kinder To Your Eyes

*Sylvania Trademark

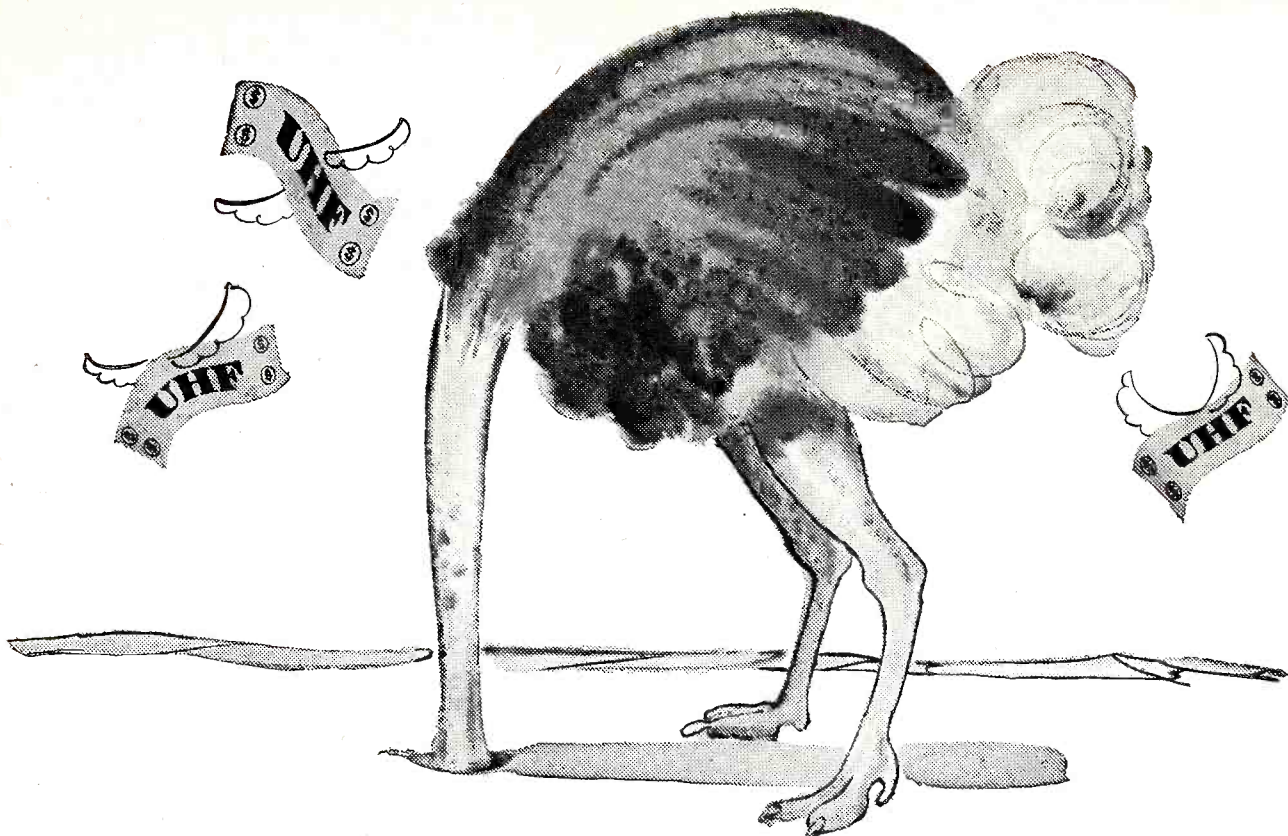

Why not face the facts about uhf?

You know it . . . we know it . . . it won't be long before there'll probably be not only VHF in your area but UHF, too. New stations . . . new markets . . . new big business . . . double your opportunity. If you face it NOW, that is!

And you can! Yes, you can face UHF now and make profits on it! Because Raytheon TV is the line that's ready for UHF . . . with its sensational and exclusive "VU-matic" all-channel reception that gives your customers the matchless picture perfection of TWO TV SETS IN ONE! No strips! No converters! No bulky gadgets!

Your American public wants the latest and most complete—and this is it! There's nothing like it anywhere—all 70 new UHF-TV channels and all 12 present VHF-TV channels! You could dial them in *today* with Raytheon's amazing "Channelite" tuning!

So why not face the facts about UHF—and *sell* it today and make *money* on it today with Raytheon TV! For full details about this line and the Raytheon Assured Profit Plan, phone or wire your Raytheon distributor. Or for his name, get in touch with us.

Catch UHF profits now with the complete all-channel coverage of

Raytheon



Raytheon Television & Radio Corp.,
5921 W. Dickens Ave.,
Chicago 39, Ill.



There's a Raytheon TV in both "Continental" and "Suburban" Models . . . to fit your customer's every home style and interior . . . to retail from \$199.95 to \$750.00, Federal Excise Tax and One-year Warranty Included.



DISTRIBUTOR RECOMMENDS COMMERCIAL CREDIT PLAN—Mr. R. W. Evans, left, Vice President and General Manager of Pittsburgh Products Co., Pittsburgh, Pa., discusses sales features of a new home freezer with Mr. L. A. Anderson, Sales Manager of the Crosley Division. Mr. Evans in heartily endorsing the COMMERCIAL CREDIT PLAN for use by dealers said, "It gives the dealer an opportunity to stock merchandise without investing too much of his own capital," he says. "Also, COMMERCIAL CREDIT often takes care of dealer needs that local financing concerns are unable to handle."



**More appliance dealers use
Commercial Credit financing
than any other national plan**

INSURANCE PROTECTION HELPS SELL CUSTOMERS—Every appliance sold under the COMMERCIAL CREDIT PLAN is automatically insured, thus protecting customers against loss of, or damage, to the merchandise, as defined in the policy. Also, Life Insurance cancels the unpaid balance in event of purchaser's death. These are real selling points to tell your customers.

DESIGNED ESPECIALLY FOR YOUR NEEDS—The complete COMMERCIAL CREDIT package gives you everything you need in the way of financing . . . from a wholesale plan that enables you to keep floor stock up without tying up needed working capital . . . down to the last detail of retail financing that helps sell customers more appliances.



CALL, WRITE OR WIRE your nearest COMMERCIAL CREDIT office for a copy of our interesting book that analyzes the appliance market, shows how you can build sales and profits with COMMERCIAL CREDIT PLAN. Or ask your distributor for a copy.

COMMERCIAL CREDIT CORPORATION

A subsidiary of Commercial Credit Company, Baltimore . . . Capital and Surplus over \$125,000,000 . . . offices in principal cities of the United States and Canada.



PANASCOPE—421 TQ—Value leader in today's 21" TV market. Compact table cabinet finished in Plextone.



INVADER—421 CM2—Compact 21" console. Full cabinet-wide safety glass front, durable Perma-veneer in mahogany finish.



PANATOMIC—421 TX—21" table model in durable mahogany finish Perma-veneer, stain-proof and mar-proof.

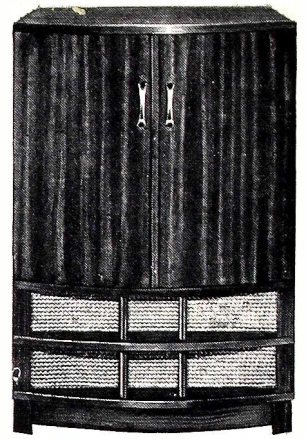

PAN-AMERICAN—421 CDM—21" console in contemporary cabinet of African mahogany veneers, curved doors.

Now Great Models

—PRICED FROM \$295**

*More Picture Visibility—
Wider Viewing Angle
—than any other 21" TV*

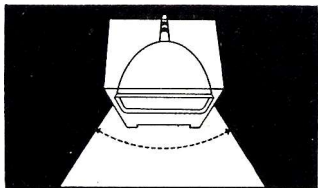

Conventional position of tube, recessed in cabinet behind safety glass—"boxes in" edge of picture—limits viewing angle.

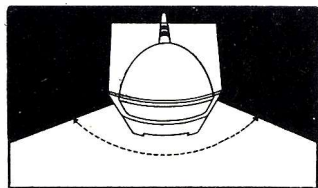

PANORAMIC VISION places tube out front, snug against curved safety glass. No dead spots from any viewing angle.

Here is a line with an exciting, exclusive new development you can demonstrate—talk—sell! Here is a line that gives you an appeal to every taste and every budget. Stromberg-Carlson is your most promising franchise for a big, profitable Fall season!

NEW SUPER 21 CHASSIS in all models

- 21-inch cylindrical picture tube
- New high gain tuner, quickly adaptable to UHF, with replaceable tuning strips
- Automatic focusing
- New custom tuning
- Proved fringe area superiority
- Phono jack
- Built-in antenna
- Permanent magnet speaker for finest tone
- Opti-curved glare-proof safety glass, easily removable for cleaning

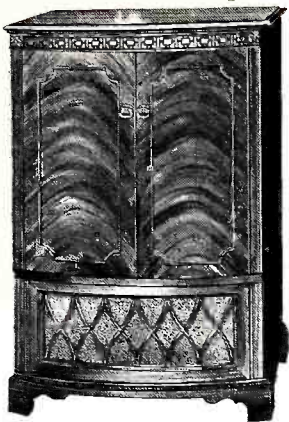

YORKSHIRE—421 CDM2—
21" console in Chippendale
cabinet of Honduras mahogany
veneers, curved doors.

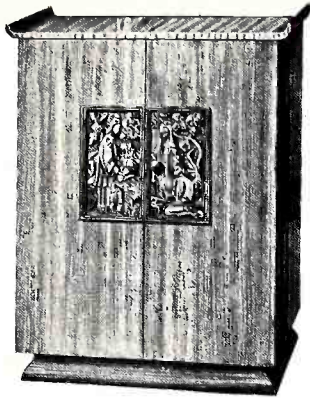

CLASSIC 21—421 C50—
21" console in comb-grain white
oak, most appropriate in
contemporary setting. Full
length doors with Chinese
story carving in panels.



CLASSIC 21—421 C5M—21"
console in distinctive Chinese
Classic style, African ribbon-
striped mahogany veneers.
Chinese story carving on doors.



CLASSIC 21—421 C5D—21" console
in famous Chinese Classic design.
Doors hand decorated with symbolic
Chinese story design on background
of ivory, red or ebony lacquer.
Ultimate in fine TV cabinetry.

with

Exclusive 21"
PANORAMIC VISION*
by
STROMBERG-CARLSON

"There is nothing finer than a

STROMBERG-CARLSON®

Stromberg-Carlson Company, Rochester 3, N. Y. In Canada, Stromberg-Carlson Co., Ltd., Toronto

Feature These Popular Gift Radios!



MusiClock—wakes you up, lulls you
to sleep, times appliances. Ebony cabi-
net with red and silver gray trim . . .
Model C1 . . . \$38.95**



Dynatomic—table radio in smart plastic
cabinet. Model 1500 HB in brown \$34.95**
Model 1500 HR in maroon . . . \$37.50**
Model 1500 HI in ivory . . . \$37.50**

More POWER to you...

with the Radiart TV Booster

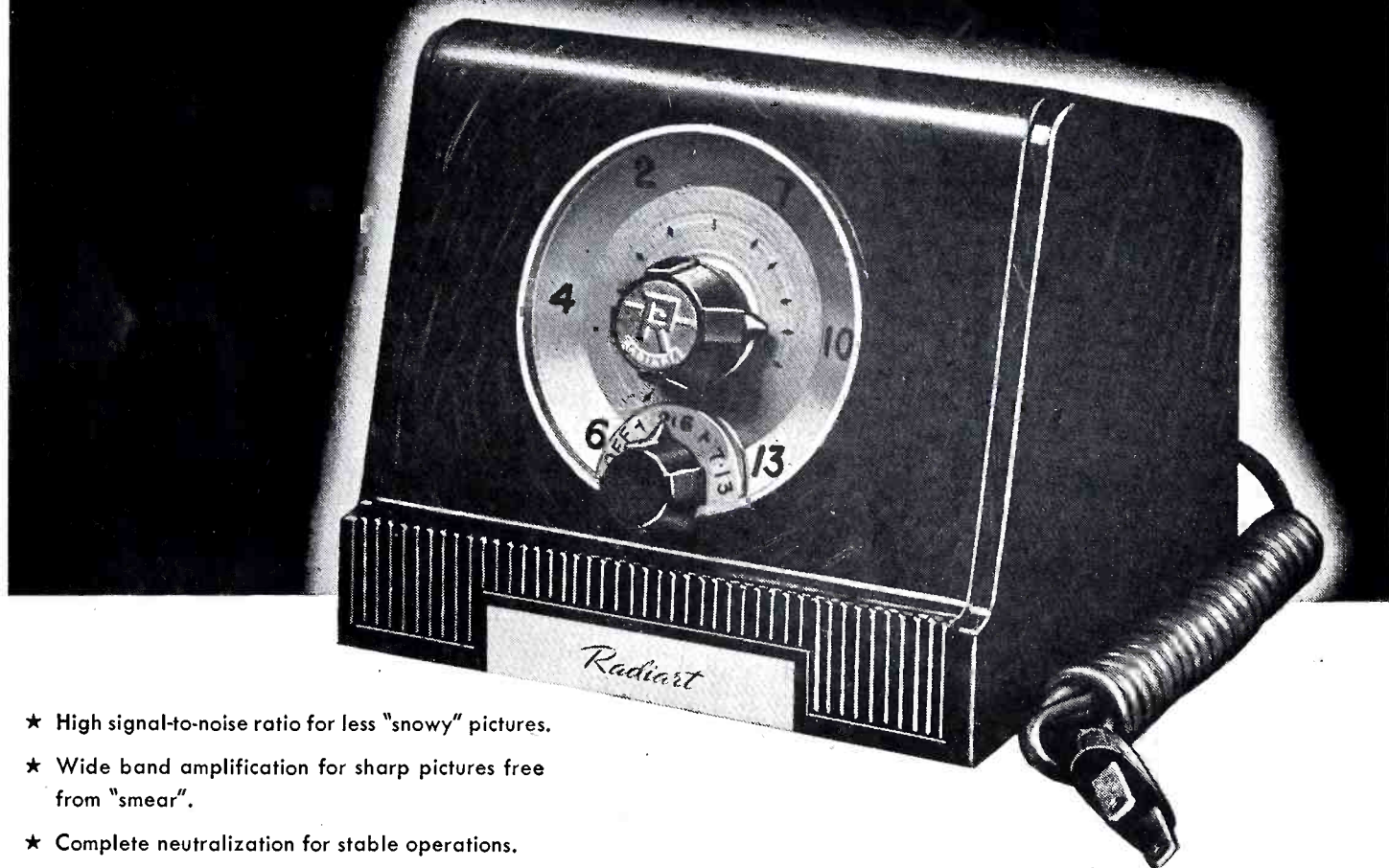

- ★ High signal-to-noise ratio for less "snowy" pictures.
- ★ Wide band amplification for sharp pictures free from "smear".
- ★ Complete neutralization for stable operations.
- ★ Large, handsome dial face for easy reading.
- ★ Operates on 115 V. A. C., 60 cycle current.
- ★ **Attractively styled cabinet with mahogany grained polished finish . . . matching the rotor control cabinet . . . together making the TV TWINS . . . the ideal combination for the MOST in TV reception.**

Here's the power boost needed to get the MOST from any TV set! It improves the picture because it increases contrast . . . minimizes ghosts, snow and interference and actually STRENGTHENS the signal! Easily installed — simple in operation — a welcome addition to any home.

The Perfect Partner to the CDR Rotor...they go together



THE RADIART CORPORATION CLEVELAND 13, OHIO

VIBRATORS • AUTO AERIALS • TV ANTENNAS • ROTATORS • POWER SUPPLIES

GET

the *Capewhart* **STORY**

FROM

your *Capewhart* **DISTRIBUTOR**

and **JUMP ON**

THE *Capewhart* **BANDWAGON**

for **PRESTIGE** and **PROFITS**

with this Superb Television Line

R.S.V.P.*



The CAPEHART "Monticello"
(Blond)



The CAPEHART "Charlestown"
(Blond)



The CAPEHART "Atlantan"
(Blond)

HERE IS THE COMPLETE
NEW LINE OF *Caphart* TELEVISION

INSTRUMENTS WITH THE



The CAPEHART "Monticello"

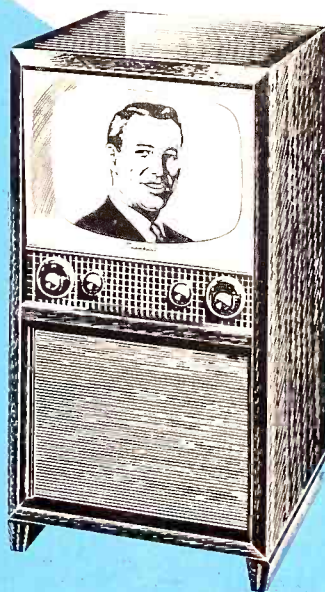

The CAPEHART "Monmouth"



The CAPEHART "Charlestown"



The CAPEHART "Chicagoan"
(Blond)

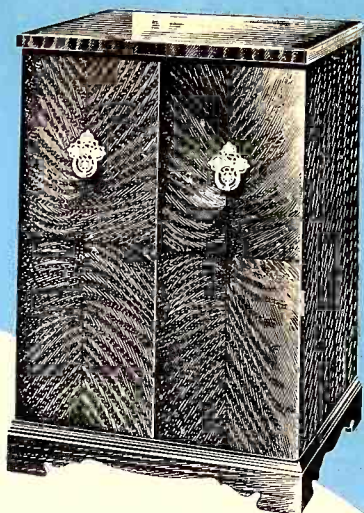

The CAPEHART "Redwood"

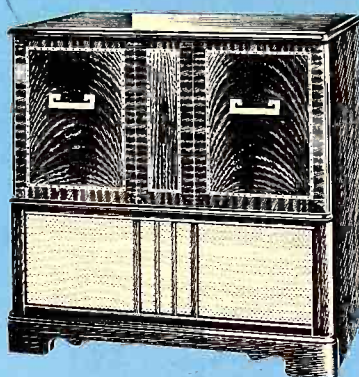

The CAPEHART "Ticonderoga"



CHASSIS



The CAPEHART "Saratoga"

...AND READY FOR UHF

NOW!

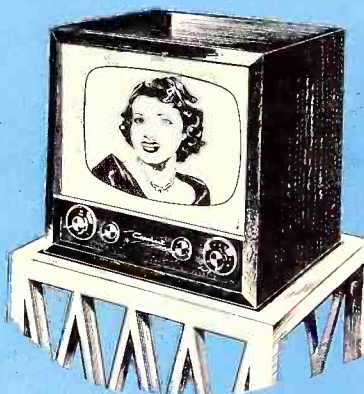

The CAPEHART "Trenton"

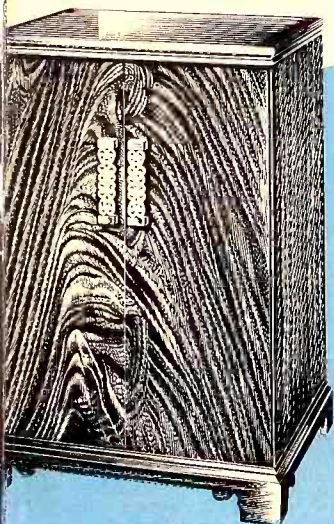

The CAPEHART "Bostonian"



The CAPEHART "William Penn"

*Reserve Supply Video Power

THE REVOLUTIONARY

Capehart

CX-36

CHASSIS *with*

R.S.V.P.*

will be a
Top Seller
for YOU!

CHECK THESE SALES-MAKING POINTS...

- ***Reserve Supply Video Power** to capture images from near and far with unbelievable clarity and detail.
- **26 Tubes** for more power, more quality, more clarity.
- **Exclusive Area Control** cancels noise, assures maximum performance in fringe or local areas.
- **Cascade Type Tuner** reaches out for signals . . . automatically controls signal variance.
- **All owner operated controls on front panel.**
- **New intermediate frequency amplifier** gives top results for present and future UHF channels.
- **New Video detector and amplifier** . . . up power to higher limits.
- **Symphonic-Tone System** eliminates static buzz . . . automatically compensates for timbre tone.
- **Ready for UHF any time, anywhere**—individual channel coils a cinch to insert.
- **"Right Slant" tube mounting** in conjunction with cylindrical face electrostatic picture tube eliminates reflection.
- **Maximum rated power supply** of chassis on the market.
- **Automatic focusing system** gives constant clarity over complete picture area.
- **Phono-Jack** for all record players.

Here is the culmination of 25 years' pioneering in television . . . the new CX-36 Chassis by Capehart-Farnsworth. Here is POWER . . . **Reserve Supply Video Power* that reaches out to pull in images of superb clarity and fineness of detail from stations far and near. This *new standard* in picture quality . . . *plus* world-famous Symphonic-Tone System . . . *plus* cabinetry renowned for distinctive design . . . *adds up* to bigger profit possibilities. There may be a valuable Capehart franchise available in your territory. Check the Capehart distributor in your territory or write: Capehart-Farnsworth Corporation, Fort Wayne 1, Indiana.

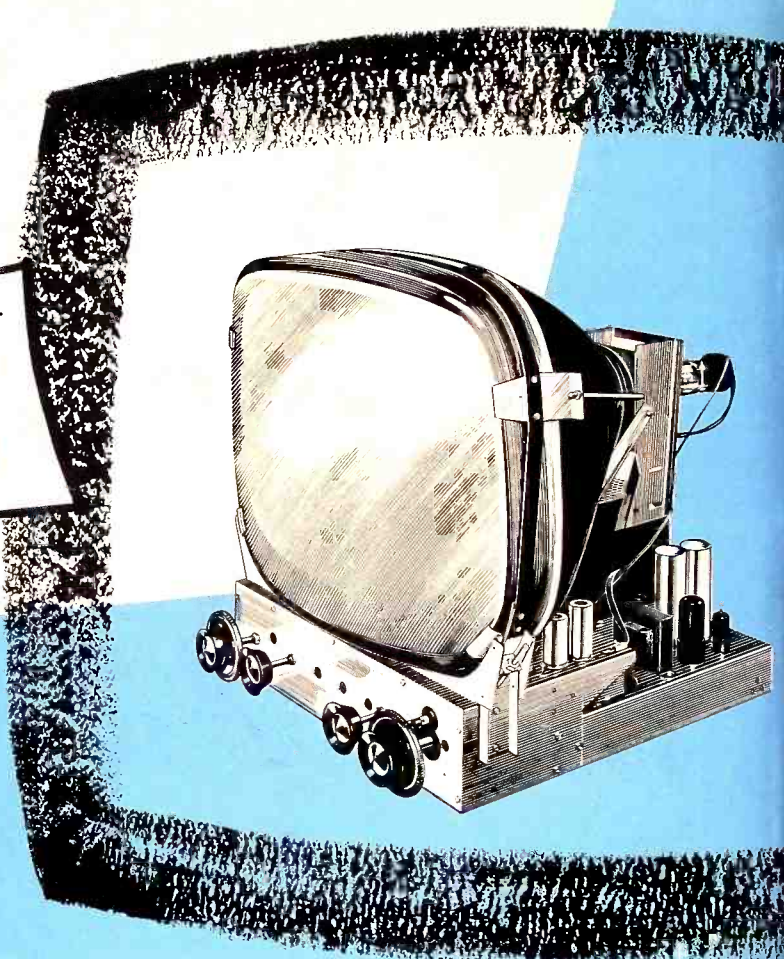

**\$4⁰⁰ opens up
A NEW BUSINESS
FOR YOU...**

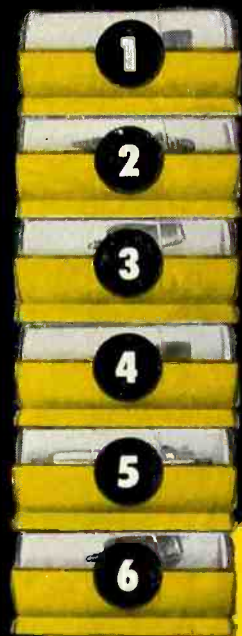

**GOLDEN OPPORTUNITY FOR ALERT SERVICEMEN
TO TURN \$4.00 INTO HUNDREDS**

The market is wide-open... a ready market... an actual \$70,000,000 Phono-Cartridge Replacement market. Facts and figures prove it! What an opportunity for you and every serviceman to get new business, profitable business you're not getting now!

ELECTRO-VOICE SHOWS YOU HOW... AND PAVES THE WAY

E-V helps you with everything you need to build a money-making Professional Phono Service business—New Sales Aid Kit, Manufacturer's Set Model Replacement Guide, Dramatic Direct Mail Campaign including Post Cards and Stuffers, Handbook on Cartridge Sales and Service, Professional Phono Service Sign, Window and Wall Streamers, Service Tags, etc. With these sales tools you can easily turn that \$4.00 into HUNDREDS.

The E-V Basic 6 Preferred Type Cartridges enable you to make over 92% of all cartridge replacements and give immediate replacement service. Not only that... every E-V Cartridge now comes like a jewel in a new golden yellow, self-stacking plastic box.

It's the most powerful, most effective merchandising plan ever conceived in the phono service field!



Look for the Golden Yellow Cartridge Box

FREE

Send Now for Bulletin CP-1. Gives You the E-V Plan—Tells you How to Make \$4.00 Open New Business for You.

ELECTRO-VOICE, INC.
422 CARROLL STREET
BUCHANAN, MICHIGAN

Please Rush FREE Bulletin CP-1

Electro-Voice

422 CARROLL STREET • BUCHANAN, MICHIGAN

Export: 13 East 40th St., New York 16, U.S.A. Cables: Arlab
PHONO CARTRIDGES • MICROPHONES • HI-FI SPEAKERS • TV PRODUCTS

NAME _____

ADDRESS _____

CITY _____ ZONE _____ STATE _____

MY DISTRIBUTOR'S NAME _____

NOW!

Give Your "Personal" Radio Customers

**LONGER LISTENING
AT LOWER COST**

with the new

**"EVEREADY"
BRAND**

**RADIO BATTERY
COMPLEMENT**

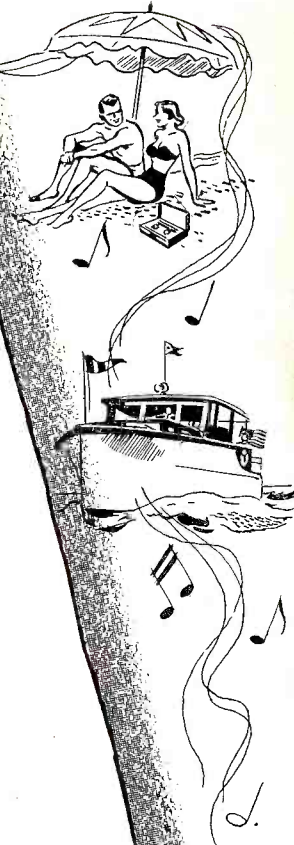
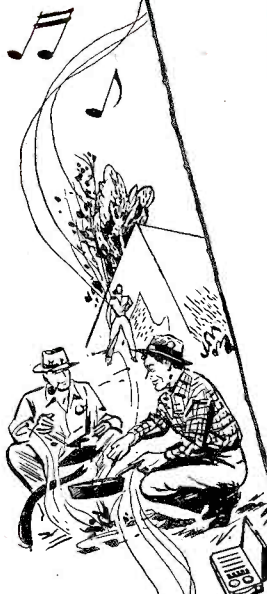

**No. 964
"A" BATTERY**

Lowest priced "A" battery of its size on the market, "Eveready" No. 964 provides many more listening hours than "A" batteries previously available for personal-size sets.

LIST PRICE ONLY 25¢ EACH!



No. 477—"B" BATTERY

Lowest priced "B" battery of its size on the market, new "Eveready" No. 477 "Mini-Max" battery... gives high *sustained* voltage for peak-volume listening throughout its long life.

LIST PRICE ONLY \$2.35 EACH!

THE COMPLEMENT

Two No. 964 "A" Batteries
One No. 477 "B" Battery

**ONLY
\$2.85
COMPLETE!**

**LOWEST INITIAL COST AND LOWEST COST-PER-HOUR OF ANY
RADIO BATTERY COMPLEMENT ITS SIZE ON THE MARKET!**

**BATTERY ENGINEERED BY
BATTERY MANUFACTURERS FOR
BEST BATTERY PERFORMANCE**

The terms "Eveready", "Mini-Max", "Nine Lives" and Cat Symbol are registered trade-marks of Union Carbide and Carbon Corporation

NATIONAL CARBON COMPANY

A Division of Union Carbide and Carbon Corporation

30 East 42nd Street, New York 17, N. Y.

District Sales Offices: Atlanta, Chicago, Dallas, Kansas City, New York, Pittsburgh, San Francisco

IN CANADA: National Carbon Limited, Montreal, Toronto, Winnipeg

You've Never Had A Portable  With Such

demonstrable features

It's the Handsome, New, Extra-Powerful



ZENITH
REG. U.S. PAT. OFF.
UNIVERSAL

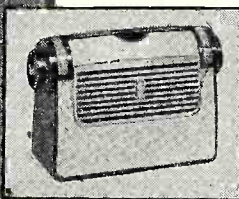

AC, DC AND
EXTRA-LONG LIFE
BATTERY PORTABLE

Model J-504

Talk 'em Up



and You'll Sell 'em!

NEW End Tuning

Quick and easy to tune from any side. Oversize tuning knobs fit naturally to grip. Big, clear revolving dial.

NEW Rich "Big Set" Tone

Powerful Superheterodyne Circuit, Zenith built speaker and Wavemagnet antenna give amazingly true tone.

NEW Carrying Handle

Fits the hand comfortably. "Snuggles down" against cabinet when not in use. Smart-looking, easy-to-carry.

NEW Durability

Rugged plastic frame and knobs with sturdy Black "Stag" covered body; or Brown, with Tan "Madagaska" cover.

NEW Long-Life Battery

New self-contained Z909 long-life battery with patented battery-saver switch for remarkably long service.

NEW Beauty of Design

Trim, streamlined case is compact, lightweight. Combines function with fashion for unusual smartness.

Here it is—Zenith's brand new portable that opens the way to a summerful of sales for you! Just check all its sales-making new features—its trim, trend-setting beauty—its golden-mellow tone. When one portable has all this to offer, it's bound to make profit history. And remember, these aren't "hidden values"—they're ones you can easily point out and demonstrate—values that have real meaning for your customers.

Now, when summer picnics, vacations, and outings put a portable radio in bigger-than-ever demand—the profit-getting potential of the new Zenith Universal is virtually unlimited. Talk it up—and chalk up plus business!

R2188



ZENITH RADIO CORPORATION, Chicago 39, Illinois



dealers! Here's why the V-M

V-M *only* tri-o-matic[®] phonographs have all the features your customers want

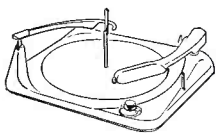

V-M tri-o-matic Model 951. \$46.50*

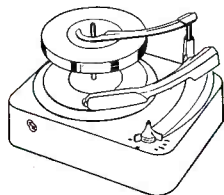

V-M tri-o-matic Model 920. \$39.95*

V-M tri-o-matic Model 985. \$77.95*

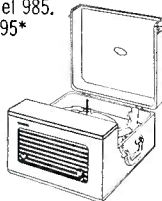

V-M 150 tri-o-speed Portable. \$46.50*



V-M 45 Spindle. \$2.95

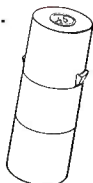

V-M 110 tri-o-speed Portable. \$29.50*

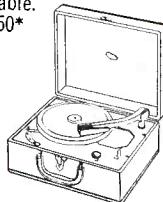

*SLIGHTLY HIGHER IN THE WEST.

Get These Tested, Profit-Building Sales Helps!

- 1 V-M display stands, background, banner, turntable action display.
- 2 Tie-in newspaper advertising kit.
- 3 Colorful customer promotion mailings.
- 4 Simple, effective demonstration tips.

V-M Corporation — WORLD'S LARGEST MANUFACTURER OF RECORD CHANGERS



line is easy to sell!

V-M tri-o-matic[®] phonographs

have all the features you want!



The compact tri-o-matic 972 gives you care-free record playing pleasure anywhere in your home. It has style, life-time construction, and every feature shown below. all for . . . only \$57.50!

to give you—
Convenience, Record Protection,
A Better Buy ALL Ways

<p>Siesta Switch Sit back, relax or go to sleep to music. V-M's exclusive Siesta Switch turns off everything after last record plays. Even a lamp, plugged into V-M Models 920 and 972, turns off at the same time.</p>	<p>NEW V-M "45" SPINDLE Slips quickly over standard V-M tri-o-matic spindle to let you play up to twelve 45 rpm records; eliminates cost and bother of inserting adapters in each record.</p>
<p>PLAY "10's" AND "12's" MIXED POSITIVE INTERMIX of any ten, 10" and 12" records of same speed. V-M tri-o-matic phonographs play ten 12", twelve 10" or twelve 7" records.</p>	<p>JAMPROOF MECHANISM All moving parts, including tone arm, may be held at any time during playing cycle without damaging the mechanism.</p>
<p>POSITIVE RECORD PROTECTION Records are gently lowered to spindle shell, floated on an air-cushion to turntable. V-M's patented spindle eliminates slapping and center-hole wear.</p>	<p>FEATHERWEIGHT, TWO-NEEDLE TONE ARM Gentle needle contact reduces record wear; two-needle cartridge assures finest reproduction from either "slow-speed" or standard 78 rpm records.</p>
<p>COMPLETELY AUTOMATIC OPERATION V-M tri-o-matic phonographs play records of any speed, 33 1/3, 45 and 78 rpm, automatically! Play all sizes, 7", 10" and 12", automatically!</p>	<p>AUTOMATIC TONE ARM SETDOWN Needle is placed at starting point of any size record, automatically. No manual adjustment is ever needed.</p>
<p>HANDY "CONTROL CENTER" All controls for multiple- or single-record playing in one, easy-to-reach spot. Turntable speed dial and ON-OFF-REJECT knob are together.</p>	<p>AUTOMATIC SHUT-OFF Tone Arm returns to rest and Turntable stops after last record plays. Works with records of any size or speed.</p>

<p>Siesta Switch Sit back, relax or go to sleep to music. V-M's exclusive Siesta Switch turns off everything after last record plays. Even a lamp, plugged into V-M Models 920 and 972, turns off at the same time.</p>	<p>NEW V-M "45" SPINDLE Slips quickly over standard V-M tri-o-matic spindle to let you play up to twelve 45 rpm records; eliminates cost and bother of inserting adapters in each record.</p>
<p>PLAY "10's" AND "12's" MIXED POSITIVE INTERMIX of any ten, 10" and 12" records of same speed. V-M tri-o-matic phonographs play ten 12", twelve 10" or twelve 7" records.</p>	<p>JAMPROOF MECHANISM All moving parts, including tone arm, may be held at any time during playing cycle without damaging the mechanism.</p>
<p>POSITIVE RECORD PROTECTION Records are gently lowered to spindle shell, floated on an air-cushion to turntable. V-M's patented spindle eliminates slapping and center-hole wear.</p>	<p>FEATHERWEIGHT, TWO-NEEDLE TONE ARM Gentle needle contact reduces record wear; two-needle cartridge assures finest reproduction from either "slow-speed" or standard 78 rpm records.</p>
<p>COMPLETELY AUTOMATIC OPERATION V-M tri-o-matic phonographs play records of any speed, 33 1/3, 45 and 78 rpm, automatically! Play all sizes, 7", 10" and 12", automatically!</p>	<p>AUTOMATIC TONE ARM SETDOWN Needle is placed at starting point of any size record, automatically. No manual adjustment is ever needed.</p>
<p>HANDY "CONTROL CENTER" All controls for multiple- or single-record playing in one, easy-to-reach spot. Turntable speed dial and ON-OFF-REJECT knob are together.</p>	<p>AUTOMATIC SHUT-OFF Tone Arm returns to rest and Turntable stops after last record plays. Works with records of any size or speed.</p>

58,608,392! That's the impressive number of hard-hitting customer impressions this V-M advertising will make to pre-sell the big feature-full V-M Line of Phonographs! Most important . . . hundreds of *your customers* will see the advertisement — many will want to know where to go to see V-M tri-o-matic Phonographs in action!

This glowing full-color 1/2-page advertisement runs in COLLIER'S, October 25, on the stands October 17. Your customers will see it also as a black and white 2/5-page in the October 19 AMERICAN WEEKLY and a 1/4-page in BETTER HOMES and GARDENS on sale September 25.

Make the most of this prime selling season! Tie-in with V-M's year around program of aggressive advertising!
Call your distributor today or write direct.

<p>V-M tri-o-matic Model 951 \$45.50*</p>	<p>V-M tri-o-matic Model 920 \$39.95*</p>	<p>V-M tri-o-matic Model 985 \$79.95*</p>
<p>V-M tri-o-matic Model 950 \$45.50*</p>	<p>V-M tri-o-matic Model 970 \$49.50*</p>	<p>V-M tri-o-matic Model 980 \$64.50*</p>

ALL MODELS UNDERWRITERS' APPROVED *SLIGHTLY HIGHER IN THE WEST.
MFG. BY V-M CORPORATION, BENTON HARBOR, MICH.

V-M Corporation — FOURTH AND PARK STREETS, BENTON HARBOR, MICHIGAN



NEW COMPLETE LINE TO OUTGROSS, OUTNET THEM ALL!

MODEL 551—G.E.'s Clock-Radio with phono-jack and Audio-Magic Switch and all automatic services. Mahogany (551), Pearl gray plastic (552). **\$49.95***
*Slightly higher West and South. Subject to change without notice.

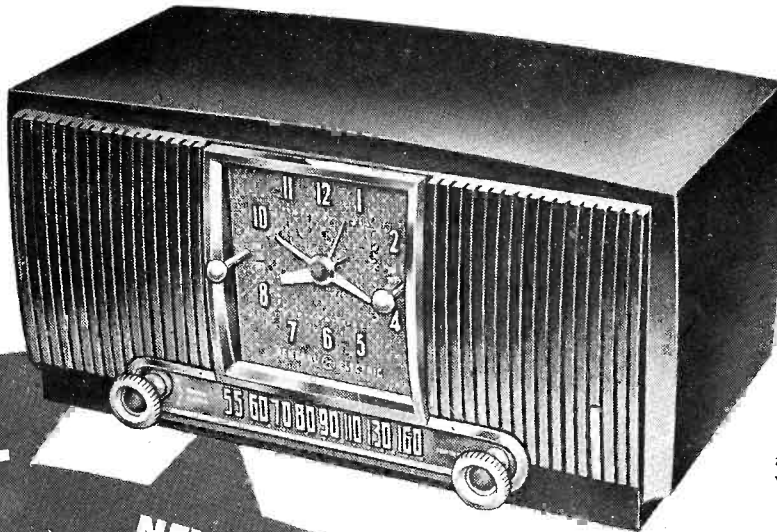

• Any record player can now be operated through the new G-E phono-jack at back of 551 or 552.

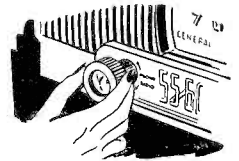

• New G-E Audio-Magic Switch enables you to control record or radio volume by a twist of the knob.

**NEW
PHONO-
JACK**

**NEW
FEATURES**

**NEW
MODELS**

**NEW
COLORS**

**NEW
PRICE
RANGES**

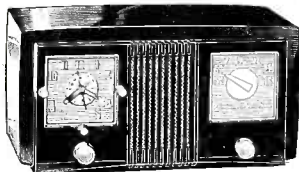

MODEL 535—Super-powered. Rich cordovan (535), alabaster ivory plastic cabinet (535W). **\$44.95***

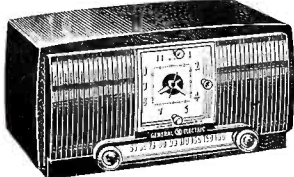

MODEL 546—Mahogany plastic. Alabaster ivory (547), Persian red (548), kitchen white (549). **\$39.95***

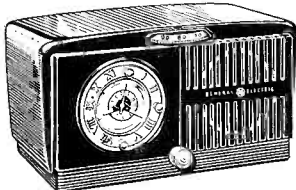

MODEL 542—Wake up to music. Mahogany (542) and alabaster ivory plastic (543). **\$34.95***

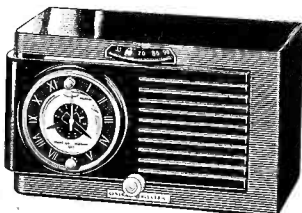

MODEL 514—New price leader in modern-styled mahogany plastic. Fine toned radio. **\$29.95***



CLOCK-RADIO

MORE THAN EVER THE WORLD'S MOST USEFUL RADIO

★ With prices ranging from \$29.95* to \$49.95*, General Electric gives you a complete new line to outgross and outnet them all! Now you can offer America's #1 Favorite to fit every purse—and with no extra charge for choice of colors.

Startling new Model 551 with phono-jack and Audio-Magic Switch opens up an entirely new market. For the first time, records can be played through a clock-radio and the volume of radio and records

controlled with a single flip switch located on the front. Also for the first time, the record-player is connected with the Electronic Servant—G.E.'s automatic appliance outlet. Now you can go to sleep or wake up to recorded music of your own choice!

Added to undisputed sales leadership, a complete line and unmatched features, is the most aggressive advertising and sales promotion campaign in the entire industry. See your G-E Radio distributor today!

General Electric Company, Receiver Department, Syracuse, N. Y.

You can put your confidence in—

GENERAL  **ELECTRIC**

Sentinel

builds a sound platform for

Dealers' Profits



POWER-FACTOR CHASSIS!

Put a new *Sentinel* into any home in your area—steel frame apartment or fringe area farm—and *Power-Factor* performance sells it...fast!

Sentinel Stays Sold and Snubs Service Calls

—two reasons why profits come faster and remain in your bank account. And *Sentinel* is pre-sold for you by powerful ads in *Saturday Evening Post*, *Time*, *Better Homes & Gardens* and *Farm Journal*. Buy *Sentinel* TODAY.

Sentinel TV

SENTINEL RADIO CORPORATION • EVANSTON, ILLINOIS



Ellinger Sales Co. Moves

The Ellinger Sales Co., manufacturers representatives, recently moved to new and larger quarters at 6540 Northwest Highway, Chicago, Ill.

New Fitzner Warehouse

The B. J. Fitzner Company, Detroit rep firm, announces a new service to accounts in Michigan, Ohio and Indiana, and the manufacturers it represents, with the opening of its new offices and warehouse in Detroit. The company covers the jobbing and industrial trade in the three states and provides overnight shipping service everywhere in the territory from warehouse stock.

New Capitol Co. Officers

At a recent meeting of the board of directors of the Capitol Distributing Co., Ray E. Friedman was elected president of the company, distributors for Emerson TV and radio for the state of Rhode Island and southeastern Massachusetts since 1945. Louis J. Roehr has been appointed office manager and assistant to the president. Friedman succeeds Leroy L. Rosenfeld, who resigned to form his own distributing company, Emerson Radio of Texas, Inc.

Three New Clients for Hill

J. T. Hill Sales Co., Los Angeles, has announced three new clients which it will represent in the southern California and Arizona areas. They are Oxford

Electric Corp., Chicago, Ill.; Aero-Tone Manufacturing Co., Detroit, Mich.; and Electro-Mechanical Research, Inc., Ridgefield, Conn.

Five Named to NEDA Nominating Committee

George Wedemeyer, president of the National Electronic Distributors Association, has named five members to serve on the NEDA nominating committee in selecting a slate of officers for the 1952-1953 term. Elections will be held during the Third Annual NEDA Convention in Atlantic City, N. J., September 22-25. Chairman of the nominating committee is Anthony Dybowski, Dymac, Inc., Buffalo, assisted by Albert Steinberg, Albert Steinberg & Co., Philadelphia; James Prestwood, Jr., Prestwood Electronics Co., Augusta; Bill Kerlin, Shuler Supply Co., New Orleans, and H. Tory Horn, Western Electronic Supply Co., Seattle. Acceptances have been received by the national office in Chicago from all committee appointees.

Farnham in Westinghouse Post

F. M. Sloan, manager of the television-radio division, Westinghouse Electric Corporation, announced the appointment of Richard E. Farnham as public relations supervisor. Farnham, in his new post, will be responsible for the proper dissemination of all publicity releases emanating from the TV-radio division. He will also maintain the divisional public relations programs in both Sunbury, Pa. (his headquarters) and Metuchen, N. J.

Ward Appoints New Rep

Bill Bartleson, 4605 Blaisdell Ave., Minneapolis 9, Minn., has been appointed representative for the Ward Products Corp. in the Minnesota, North and South Dakota area, announces J. L. Fine, commercial products sales manager for the firm. Bartleson is now contacting distributors on the Ward lines of auto, TV and communications antennas.

Cohan Sales Rep For Westinghouse Tube Div.

William E. Cohan has been appointed New England sales representative of the electronic tube division, Westinghouse Electric Corp., it was announced by H. G. Cheney, sales manager. Cohan's offices will be located in the Westinghouse district headquarters office at 10 High St., Boston, Mass.

Name Change for Belmont

Directors of Raytheon Manufacturing Co., Waltham, Mass., recently voted to change the name of its television manufacturing subsidiary, Belmont Radio Corporation, to Raytheon Television and Radio Corporation. The move was made to identify the company name more closely with the Raytheon trademark, under which it nationally advertises and distributes its line of television and radio receivers.

TELEVISION FURNITURE
That is
Selling!

Patented

Television Tables for every TV Table Model

Illustrated is one of our most popular-selling television table designs . . . your choice of three sizes: 21" x 21", 21" x 24" and 22" x 26". The functional beauty, fine quality appearance, hand-finished wood and excellent sales appeal of this table is indicative of our complete line. SELL television tables at a profit and sell more TV table models than ever before. ORDER TODAY!

Patent applied for

The NEW Engineered
ADJUSTA-BASE

Priced low enough that you can SELL more table models at a PROFIT!

Here is the UNIVERSAL BASE that you demanded . . . the one easily adjustable base to handle your complete line (extends to 26 3/4" wide) . . . the one base that transforms ANY table model into a beautiful console . . . the one base that is made of heavy grained, five-ply veneer in mahogany, limed oak and blonde. Packed KD in well-engineered shipping carton. WRITE for illustrated literature TODAY!

Sold through recognized distributors only.

Universal WOODCRAFTERS inc.
of LA PORTE, Indiana

The Nation's Leading Furniture Specialists to the Radio and Television Industry

Get a head start on competition with

Arvin *America's foremost radio line!*

... spearheaded by brand new, fast-selling models!



Arvin Cosmopolitan—Exquisitely styled with lighted pointer and gold-plated plastic numerals; AC/DC superhet with 5 tubes including rectifier, automatic volume control, loop antenna, heavy duty speaker and Velvet Voice tone with Magna-Bass amplifier. California Tan, Willow Green, Ebony and Ivory. **\$29.95**

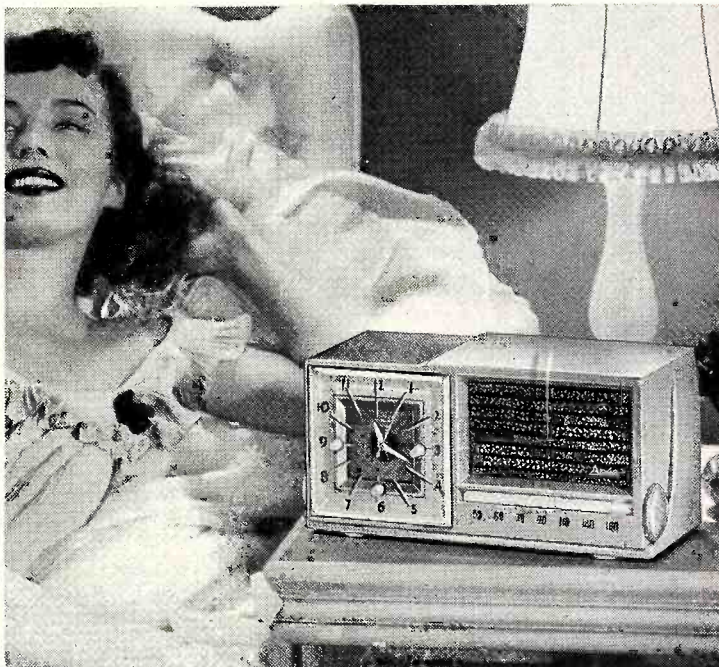

Arvin Sleepytimer—Most beautiful of all clock-radios. Telechron clock and automatic timer; follow-up buzzer alarm; handy 1100-watt appliance outlet; luminous clock hands. Arvin Velvet Voice Radio with 5 tubes including rectifier; rod-type Magnetenna; 5-inch speaker. California Tan, Willow Green, Ebony, Ivory. **\$39.95**



Arvin International—Newest short wave receiver for foreign broadcasts, or standard AM programs. Improved AC/DC superhet circuit, with 5 tubes including rectifier, gives amazing range and razor-sharp selectivity. Satin-gold pointer, edge-lighted dial. Beautifully styled plastic cabinet in Sea Mist Gray. **\$39.95**

Millions of new radios will be sold this fall. Millions of dollars in profit will be made by energetic dealers. Arvin—America's highest-quality, biggest-value, widest-appeal radio line—is planned to help you get a big share of that profitable business. To meet every purse and preference, Arvin offers 11 different table models in 35 color variations at 12 different prices, ranging from \$16.95 to \$59.95. They include AC/DC, straight AC, clock-radio, short wave, 3-way portable—and four phono-radio console combinations in addition. All designed and priced to meet a proved demand.

But the merchandise is only part of the story. Arvin's complete radio selling program for you includes (1) national advertising to millions of magazine readers, (2) newspaper mats and radio spot announcements to help you localize the effect of national advertising, and (3) lavish point-of-sale displays and selling helps to help clinch the sale for you! Contact your Arvin Distributor!

Radio & Television Division

ARVIN INDUSTRIES, INC., Columbus, Indiana

(Formerly Noblitt-Sparks Industries, Inc.)

REVOLUTIONARY!...

Emerson 1953

BACKED BY A TREMENDOUS NATIONAL ADVERTISING PROGRAM
 ...PROMOTING YOUR STORE IN YOUR COMMUNITY

NATIONAL NEWSPAPER ADS WITH YOUR OWN NAME FEATURED!

IT COULDN'T BE DONE...
 so Emerson did it!

Now in Emerson... it's better in color... Emerson's "Amazing Achievement" is yours! You name the store, we'll feature your name in our ads!



Over 1400 full-page and 1000 line ads appearing in 110 newspapers in 84 cities—powerful ads that will feature your store name in your neighborhood.

NATIONAL MAGAZINE ADS IN THE LEADING MAGAZINES!

An insertion almost every week! Full-page, full-color ads in LIFE, LOOK, SATURDAY EVENING POST, BETTER HOMES & GARDENS dramatically tell the new 1953 Emerson story.

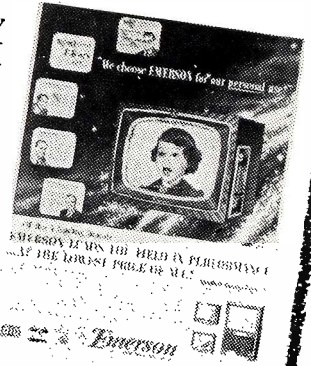

FURTHERMORE, MR. DEALER—

Emerson's new discount policy provides the greatest profit margins in our history with complete price protection to Jan. 1, 1953, giving you the safest buying advantages and greatest selling opportunity in the market today!

POWERFUL BILLBOARDS WITH YOUR OWN IMPRINT IN YOUR OWN NEIGHBORHOOD!

High-impact 24-sheet poster billboards will be spotted in strategic points all over the country—a great opportunity for you to feature your store in your territory.



COOPERATIVE DEALER MATS AND TIMELY RADIO SPOTS!



You have a wide selection of hard-hitting full-page (and tabloid) ads to run under your own name; also a variety of radio commercials to give added impetus to your sales program.

...PLUS A WIDE ASSORTMENT OF BRILLIANT, ATTENTION-GETTING SALES PROMOTION MATERIAL FOR YOUR STORE!

OVER 13,000,000 SATISFIED OWNERS—Emerson ... America's best buy!



NEW!...EXCLUSIVE!

"SIDE-CONTROL" MODELS



LARGEST
PICTURE
IN MOST COMPACT
CABINET!

MODEL 721 — New 17" Table Model with side controls. Largest picture in most compact cabinet. Selected pin-stripe Mahogany veneers.

SIDE CONTROL, the most revolutionary development in television design in the last 5 years. At last, the biggest picture in the most compact cabinet ever produced. Only Emerson — famous for pioneering-engineering could conceive this model first!

And here, Mr. Dealer, is the Emerson Model 731, a 17-inch television, clock-radio and three-speed phonograph all rolled into a compact cabinet only 37" high. Be the first in your community to feature this amazing television innovation.

See Emerson's Great New Complete Line for 1953 — 17" and 21" Table Models, Consoles and Combinations! From 179⁹⁵ up including excise tax and warranty.



NEW
EMERSON
"SIDE-CONTROL"
PANEL



Proof again! THAT **Emerson**

IS THE LINE WITH THE DEALER IN MIND

Emerson Radio and Phonograph Corporation, New York 11, N. Y.

*Reg. U. S. Pat. Off.

KEEP

Profits

IN HAND

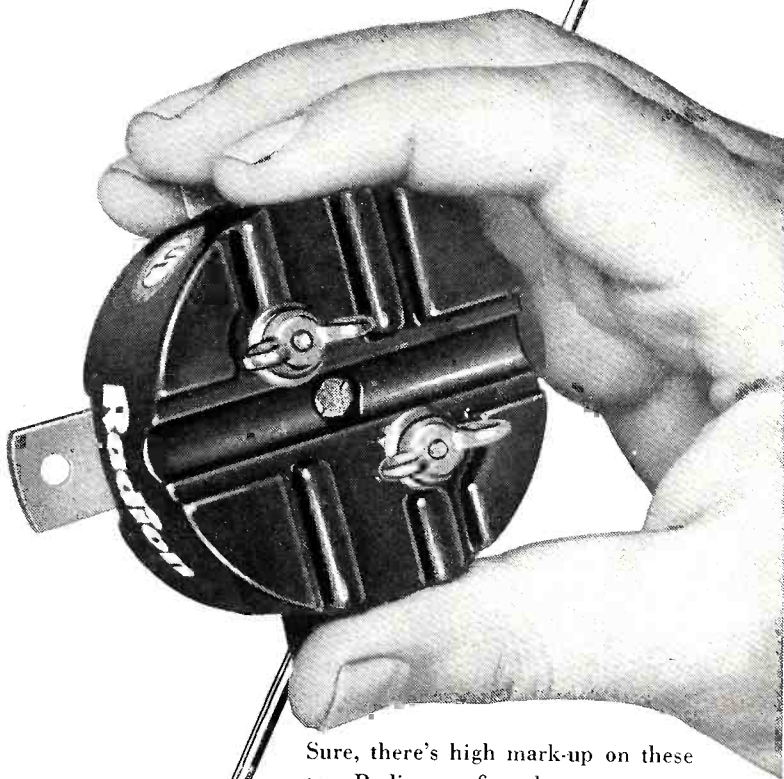

Sure, there's high mark-up on these two Radion profit-makers . . . *what's more*, they're designed to save your profit on TV set sales and service. Sell TV with the metropolitan—the indoor antenna and you save time and manpower, move sets in volume with “free installation,” move “second” sets and trade-ins at attractive low prices.

Plus over the counter sales at \$6.95 list!

So does Radion's NEW lightning arrester at \$1 list for low-loss phenolic and deluxe model in hi-dielectric porcelain at \$1.50 list! It's the *all-purpose* arrester that fits all twin leads, mounts anywhere! Be sure—for profit-making, profit-keeping . . . specify only Radion!

Send today for Radion Profit Plans!

Radion

The Radion Corporation
1130 W. Wisconsin Ave., Chicago 14, Ill.

NAMM Elects New Officers; H. E. Callaway, President

The National Association of Music Merchants board of directors recently elected the following new officers to spearhead the NAMM during the coming year: president, Henry E. Callaway, president, Thearle Music Co., San Diego, Cal.; vice-president, Russell B. Wells, president, The Chas. E. Wells Music Co., Denver, Colo.; secretary, Ben F. Duvall, secretary, W. W. Kimball Co., Chicago, Ill.; treasurer, Parker M. Harris, president, Philip Werlein, Ltd., New Orleans, La. Frank O. Wilking, president, Wilking Music Co., Indianapolis, Ind., has been elected NAMM trustee to the American Music Conference. At the Annual Meeting of Members, the following were elected to the board of directors each for a term of three years: Charles B. Adams, president, Adams Music Co., Peoria, Ill.; J. A. Brown, president, Brown Music Co., Jackson, Miss.; E. E. Forbes, Sr., president, E. E. Forbes & Sons Piano Co., Birmingham, Ala.; E. R. McDuff, president Grinnell Bros., Detroit, Mich.; Chas. O. Morgan, president, Morgan Piano Co., Miami, Fla.; Emory Penny, president, Penny-Owsley Music Co., Los Angeles, Calif.; Wm. H. Schmoller, II, president, Schmoller & Mueller Piano Co., Omaha, Neb.; and Wm. R. Steinway, vice-president & secretary, Steinway & Sons, New York, N. Y.

Martin Joins RIAA

John W. Griffin, executive secretary of the Record Industry Association of America, Inc., has announced the appointment of Joseph C. Martin as director of industry promotion. This is part of the RIAA plan to put into effect an industry-wide promotion campaign. The national publicity campaign will be instituted this month through the cooperative efforts of the forty-one record manufacturers who are members of the RIAA. The campaign will be concerned with all types of records, regardless of brand name.

Commercial Credit “History Book”

“Helping America Buy What It Wants” is the title of a new booklet recently put out which gives the history of the Commercial Credit Company from 1912 to 1952. Dedicated to 40 years of constructive service to America's financial and industrial progress by that company, the magazine tells the story of just how Commercial Credit does help people purchase. This very attractive booklet has many very interesting illustrations which depict the aim of the book—to tell the story of the growth and expansion of the company.

Larger Quarters for Sonkin

David Sonkin, manufacturers rep, recently moved from 1775 Broadway, New York, to new offices at 10 Fiske Place, Mt. Vernon, New York.

SPARTON DEALERS!

How's this for a national TV campaign that sells?

Buying TV? These facts about Sparton Cosmic Eye will help you get your money's worth!

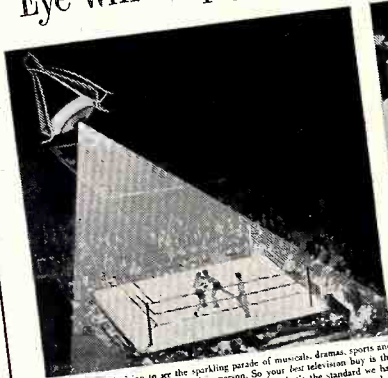

1 YOU BUY television to see the sparkling parade of musicals, dramas, sports and public events you'd like to attend in person. So your best television buy is the instrument that is the best substitute for your eye. And that's the standard we had in mind in perfecting Cosmic Eye Television—to bring you reception so steady, clear and true it's like having an eye in the sky! Here is realistic television.



3 WHETHER YOU live in a fringe area or near the station, the Sparton Ultra-Range Tuner, built behind Sparton's built-in tuning, pulls in more pictures, feeds more line-up into the powerful channels. Simple addition of tuning strip adapts the U-R Tuner to UHF reception. No attachment!



4 YOU'LL WANT trouble-free performance, too, to avoid high service costs and the annoyance of missing shows a few feet out of order. Sparton attention to detail assures one of the most sets money can buy. Talk to TV servicemen. See why Spartons so seldom need servicing!



5 COSMIC EYE Television inherited the famous Sparton tone. "Radio's Richest Voice Since 1920." Sparton speakers are electronic jewels. When shopping Sparton, close your eyes and concentrate on the tone. It's rich, resonant, true to the picture. Here's perfect reception for your ear as well as eye.



6 TELEVISION should be fine furniture, too. Sparton makes its own cabinets, is one of the few manufacturers who do. Once a famous piano factory, the Sparton plant at Sargent, Illinois, is staffed with furniture craftsmen who have spent a lifetime working with finely wood, fine grains and finishes.

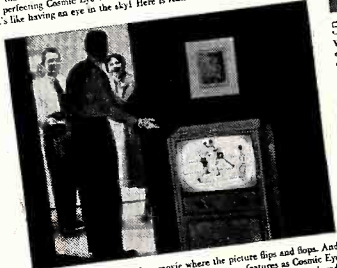

2 YOU WOULDN'T sit in a movie where the picture slips and hops. And TV is like a movie in your home. Such Sparton features as Cosmic Eye Picture-Lock, which grips the picture tight, and big screens give relaxed, strainless viewing. When you see a super-bargain price in a local TV sale, chances are you'll pay in fewer features, poorer performance.



7 WHETHER YOU choose a console or table model, there is a Sparton to blend beautifully with your present furniture grouping. No small feat in the smart-lined Sleek, smooth, mahogany veneer models are finished in mahogany veneer, blond oak or blonde feature substance modern or traditional cabinets.



8 SPARTON PRICES are another "feature." Sparton sells direct to dealers, saves distribution costs. The savings go into the engineering extras that give the superb, long-lived Sparton performance. One specialty chosen dealer in a community or shopping area handles this reputable line. For your TV money's worth, see your Sparton dealer now!



THE SUPERB **Sparton** cosmic eye television
SHOWPIECE OF YOUR HOME

Sparton Radio-Television, Jackson, Michigan, Makers of fine electronic equipment since 1900. Also Sparton of Canada, Ltd., Sparton Advertising Division, Steiger Furniture Co., divisions of The Sparks-Winkelman Company, Jackson, Mich.

Appearing in
the POST

COLLIER'S

HOLIDAY

and TIME

ON EVERY side Sparton dealers are finding a new, aggressive approach in the Sparton way of doing business.

There are new models, new merchandising, new promotions, a new zip in Sparton selling.

Now Sparton tops its plans with a great new fall and winter national advertising campaign that talks the greatest language in retail selling . . . "your money's worth!"

No "me, too" advertising claims. No vague generalities. Nothing but facts about Sparton manufacture that start selling for Sparton dealers right on the magazine page. And those magazines include *The Saturday Evening Post*, *Collier's*, *Time* and *Holiday* . . . the cream of the national magazines . . . every month.

Here's real steam behind the sensational Cosmic Eye theme Sparton launched for you last year.

IF YOU ARE NOT A SPARTON DEALER
Inquire today if the Sparton franchise is available in your community or shopping area. It may be the most important letter you ever wrote. Address: B. G. Hickman, Sales Manager, Sparton Radio-Television, Jackson, Michigan.

THE SUPERB

Sparton

THE SET THAT STAYS SOLD

SPARTON RADIO-TELEVISION • JACKSON, MICHIGAN

Radically new as a Jet engine

G.E.'s

NEW

ULTRA-VISION

New G-E
STRATOPOWER Chassis

... the heart of G-E's revolutionary Ultra-Vision. 267% more sensitive than any chassis found in previous sets. Virtually immune to interference. More range and power for clear steady picture in the tough reception areas.

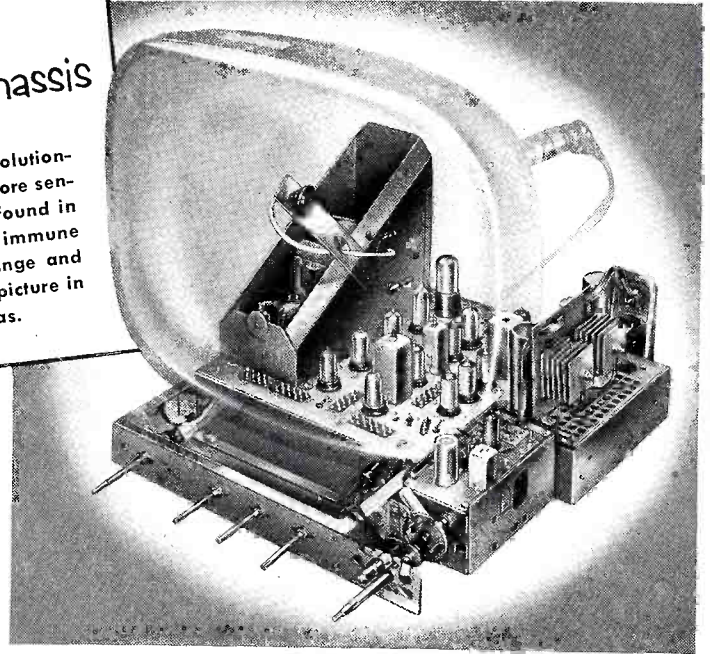

LUCILLE BALL, Star of
CBS Television's "I Love Lucy!"

267% more sensitive!

ANYWHERE GREATER POWER
ANYPLACE CLEARER PICTURE
ANYTIME LESS GLARE
THAN ANY TV TESTED NATIONWIDE!

Model 21C214. All new 21-inch console with new G-E Stratopower chassis. Beautiful doors framed in solid mahogany. Concealed swivel casters. \$449.95*

*Includes Federal Excise Tax, one-year Factory warranty on picture tube and 90 days on parts. Slightly higher West and South. All prices subject to change without notice.

You can put your confidence in—

GENERAL



ELECTRIC

... Revolutionary as a Rocket!



Ordinary picture tube. Has no mirror to direct light. Wayward light is lost. Image is weaker. Picture quality is degraded. Whites are dark, blacks too gray! Result: poor contrast, less realism.

G-E Ultra-Vision—World's only TV with 21" G-E cylindrical-faced Aluminized Tube, plus tilted dark tone safety glass. Banishes glare. Widest range of contrast ever achieved. Blacker blacks. Whiter whites. 3 dimensional definition. See the dramatic difference.



Acclaimed at the shows...TV's finest picture!

THE whole trade is buzzing about G.E.'s new Ultra-Vision! Ask anyone who saw it at the Music Show in New York! Ask anyone who saw it at the G-E distributors' special previews! They'll tell you it's the finest, clearest, sharpest picture ever seen! Proved by comparison! They'll tell you it sets a new high standard for television reception!

Radically new as a jet engine—G-E Ultra-Vision is 267% more sensitive than any previous sets. Here is the only 21-inch TV in the world using the cylindrical-faced G-E Aluminized Picture Tube... *plus* the G-E optically tilted and tinted safety glass... *plus* the great new G-E Stratopower chassis. These radical advancements—greatest in the industry's history—add up to *Greater Power* anywhere... *Clearer Picture* anyplace... *Less Glare* anytime—than any TV tested nationwide.

The new G-E story breaks in full-page national magazine ads, network TV promotions, dramatic TV film commercials, and intensive 20-times-a-week spot-radio campaign. Visit your G-E distributor today.

The new fast-turn G-E line includes the hottest 17, 20 and 21-inch values in the industry! Fifteen brand new models—all easily adaptable to UHF. G-E retail prices include federal tax and warranty—no "extras." Sell the quality line of the industry—G-E Black-Daylite TV.

General Electric Company, Receiver Department, Syracuse, N. Y.

FAST-TURN 15 MODEL LINE 17's 20's 21's prices from \$199.95

(Includes Federal Excise Tax, one-year Factory warranty on picture tube and 90 days on parts.)

GE BLACK-DAYLITE TV



MODEL 21C201. Magnificent open-face 21" console with genuine mahogany veneers top and sides, and solid mahogany mouldings and front frame. 2" concealed swivel roller casters.
\$419.95*



MODEL 21C202. Genuine comb grain American oak is used in this lovely new 21" console of modern design. Non-marking swivel casters are concealed in base.
\$439.95*

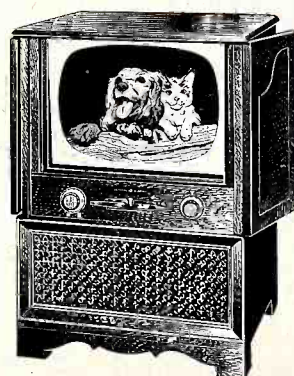

MODEL 21C206. Finest example of American Provincial design in genuine black cherry veneers. Beautiful half doors. 21" Tube. Easy-moving swivel casters concealed in base.
\$449.95*

Your dollar buys
more "instrument"
... in our Model

630



Volt-Ohm-Mil-Ammeter
by R. L. Triplett
PRESIDENT

Because we build every major part of our instruments the quality is carefully controlled. For example, we know we have more torque driving our pointers because we designed and built the complete instrument. We know we have sustained dependence in the shafts and switch contacts of our test equipment for the same reason. Cycle tests for switches exceed several times the rigid requirements of the armed forces.

There is another important value to you. Because we make our own components we eliminate the profit another manufacturer would make in selling them to us. And this "profit" is passed on to you.

Consider these features of Model 630 V.O.M., for example—

One Hand Operation—One switch with large recessed knob has a single position setting for each reading. Leaves one hand free. Eliminates switching errors, trouble, saves time.

Ranges—AC-DC Volts: 3-12-60-300-1200-6000 (AC, 5000 Ohms/Volt; DC, 20,000 Ohms/Volt). 60 Micro-Amps. 1.2, 12, & 120 Mil Amps. DB scales at 1.73V on 500 Ohm line, 0-66 DB output.

Highest Ohm Reading—To 100 Meg. in steps of 1000-10,000-100,000 Ohms—100 Megohms.

Yes, with us it's a matter of personal pride to make "Triplett" stand for better construction and more service for your test equipment dollar.

R. L. Triplett

PRESIDENT
TRIPLETT ELECTRICAL INSTRUMENT CO.
Bluffton, Ohio



630 V.O.M.

only \$3950



Triplett

For service, accuracy, highest dependability, buy

TELEVISION RETAILING • September, 1952



"ON THE BEAM" with CROSLLEY TV

You can see it **BETTER** on a CROSLLEY



CROSLLEY'S 1953 TV CAUSES STIR IN TRADE

Factory production drastically increased to meet demand

When the new Crosley TV lines were unveiled to the trade in Cincinnati, distributors enthusiastically felt these sets would catch the public fancy and sell fast.

Why? Because they were electronically engineered to give the clearest picture in all television; were housed in rich wood cabinets, not plastic or metal. And these sets were competitively priced to appeal to the most



TV Star Dagmar—She helped introduce the exciting new Crosley TV lines

Questions and Answers about CROSLLEY

Q. What's Crosley's answer to UHF?

A. Crosley has the Industry's most complete answer to UHF. There are three approaches: 1. All Crosley sets can be bought with a combination tuner built-in. 2. Crosley sets can be converted in the field by a UHF tuner installed within the set. 3. An external adaptor can be easily and quickly attached. With all three approaches you have full coverage of all VHF and UHF stations.

Q. Do Crosley sets which are equipped with a VU (VHF-UHF) tuner have a separate built-in UHF antenna?

A. Yes. All Crosley sets with combination tuners have a separate UHF antenna which is automatically connected when the tuner is dialed to a UHF station.

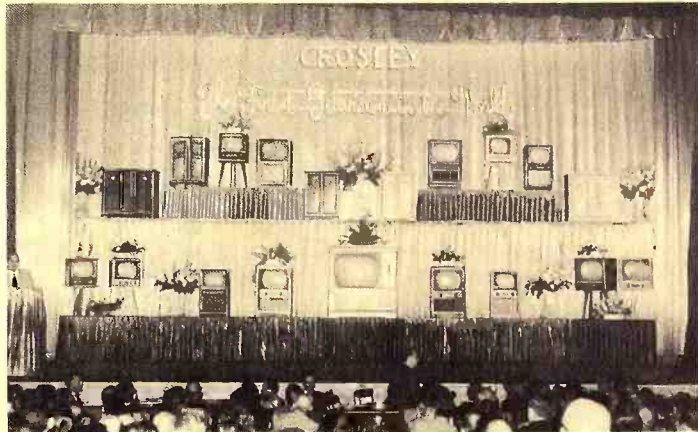

money-conscious buyers.

In addition, Crosley offers the customer a Custom line with or without built-in UHF and a Deluxe line with or without built-in UHF. In the Deluxe line, blond-finish or mahogany-finish sets are at no extra cost.

Today, actual cold-cash sales testify to the quick public acceptance of the new Crosleys. Figures already received show a sales increase of 300% over last year for a like period.

EVEN THE MAYOR OF SIOUX FALLS WAS THERE!



Mayor Henry Saure (right) admires the unique Crosley "cut-away" TV receiver in the Crosley "Display Center" featured by Power City Radio to celebrate the opening of the Sioux Falls, So. Dakota, new TV station.

This unusual receiver has glass sides, top, and bottom—letting people see just what goes on inside a Crosley while the set is operating.

Thousands of TV buyers were attracted to this "Display Center," and Crosley TV sales zoomed to a new high.

Crosley's sales picture is brighter than bright. And every day reports from distributors and dealers all over the country show that the new sales position is not only being held, but improving. Last month a new production line was begun at the Crosley plant. This new line



alone is geared to turn out as many as 5000 sets a month. Further increases are predicted for the near future.

CROSLLEY "INBOARD PRICING" BOON TO TV BUYERS

What is "Inboard Pricing"? "Inboard Pricing" is Crosley's honest policy of including in every TV list price all the fixed charges determined in advance.

For example, the Crosley TV price tag includes Federal Excise Tax and full-year warranty charges on all chassis parts and the big picture tube.

What does it do for the customer? "Inboard Pricing" is designed to eliminate all hidden charges for the customer . . . The price he sees on the set is the price he pays! (Except for state and local taxes.) The consumer gets a break with a price tag that reflects the amount he actually pays for an item.

W.A. Blees says



"... The electronics business is considerably healthier today than it has been at any time since the 'rigid buyers' market' days following the outbreak of the Korean War. Inventories are more normal than they have been for some time. The past few weeks have shown a marked increase in television business at all levels. This is due in large part to what I like to refer to as 'television's election year.'



"... Of more lasting and long-range effect is the lifting of the three and one-half year old freeze of TV station construction. Early in 1953, new television stations will begin operation on an average rate of approximately three new transmitters per week. In my opinion, the new television market ushered in by UHF will stay with us for a long time as the present limited television broadcast service is expanded into a nationwide medium of education, communication and entertainment.



"... As you know, any receiver Crosley ever built can be easily adapted to UHF reception by the addition of a Crosley tuner. The prices, too, of our new TV sets offer unparalleled values in the brief history of television's development. Some of our 1953 sets have the complete tuners for all VHF and UHF bands built in them. All can be easily adapted in the field when UHF stations come on the air.



"... Put these wonderful new 1953 sets on your floor now and get off to a running start. Take advantage of the good television volume we will have this fall and in 1953. Remember, 'The early bird gets the worm.'"

"ON THE BEAM".....with CROSLEY TV

WORCESTER DEALER TAPS BIG KEY MARKET—APARTMENT DWELLERS

UNIQUE STORE LAYOUT RESEMBLES APARTMENTS; ATTRACTS MANY CUSTOMERS

Edward Blaum, owner of an exclusive full-line Crosley dealership in Worcester, Mass., proved that it really pays off to cater to apart-



ment house tenants. Success in developing this large profit-making market is due, in part, to his company's unique store layout—which lets customers see how appliances and television will look and work in their own apartments!

The store is located on the first floor of an old three-floor apartment house. Show-

rooms have been left strategically undisguised and appear as typical apartments, creating a strong "home atmosphere" for customers. The store front is located on what used to be the front porch of the apartment house.

"We try to make it seem as much like home here as possible. And, take a customer out of the usual environment of a store and place him, or better still, her, in the familiar surroundings of a home or apartment and you provide an easier sales atmosphere," is Blaum's advice.

TV SETS ON DISPLAY BLEND WITH FURNITURE

What used to be the main dining room of an apartment is now a television showroom where new Crosley TV is featured exclusively. Left untouched were an antique mahogany-paneled fireplace and wall mirrors which fall into Blaum's "home atmosphere" plan. In this showroom only mahogany-finished Crosley TV sets are shown. In an adjoining living room, with blond-wood furniture, blond-finished TV sets are on display.

"We offer other advantages to customers," says the owner. "We're open until 9, Monday through Friday, and a service crew is always on hand to talk with prospective customers about the problems of TV installation in homes or apartments."

WIN \$500

With Your Best Sales Story

"When customers come in to trade in old appliances, I gladly look them over. During early stages of the Korean War most people would take first price I offered. Now, they are cautious buyers. Whenever I make an offer of \$65 for a 10-inch TV set that a customer paid over \$300 for when new, the customer thinks he should get a lot more for it.

"The best way to make them realize that isn't worth too much now, I believe, is to show them that you'll buy it for \$65 and sell it back to them for \$50."

John Evans, Evans Food Lockers, Westerville, Ohio.

Why Dealers Grow Gray

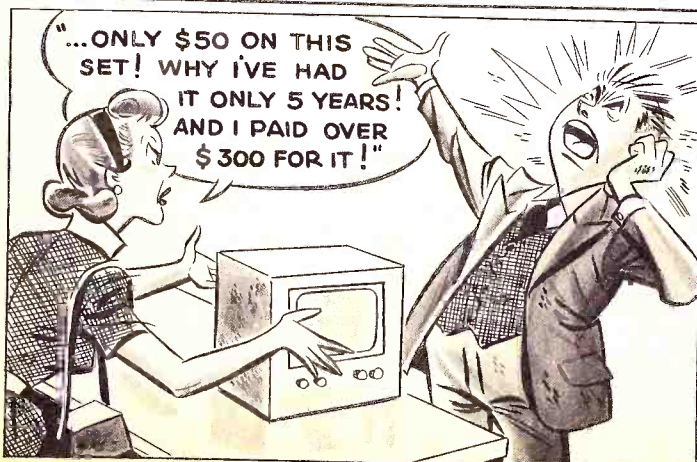

DID YOU SEE THIS PICTURE IN "TIME"?

Here's Ike Eisenhower's campaign manager, Arthur Summerfield, leading his Michigan delegation on the floor of the Republican Convention at Chicago. See what he's been reading and holding in his hand? It's that big Crosley advertisement headed "Here's why this year you must SEE and know the man you vote for!"

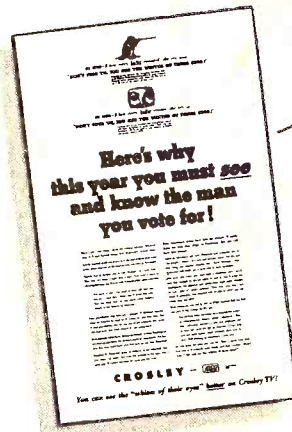

There's a typical sample of the timeliness of Crosley advertising—and the prestige Crosley institutional advertising messages command!

TV Service Training a Boost for Dealers

What's in it for you when you send your service people to the Crosley Service Classes in Cincinnati? (1) Better set installation right at the start. (2) More perfect set operation over longer periods of time. (3) Satisfied customers. (4) Fewer service calls to make.

Service school classes for advanced electronics training deal with the two new 1953 Crosley TV lines. Service personnel are made familiar with all changes and features in new models prior to introduction of sets on the market. Classes, which are free to dealer and distributor service personnel, meet the full first week of each month.



Service people from thirteen cities and eight states shown at a recent Crosley service class. First Row—Left to Right: A. W. Edwards, Fort Worth, Texas; R. Roussell, New Orleans, La.; A. Rostas, Grove City, Pa.; E. H. Sharkey, Ft. Wayne, Ind.; D. Uhrig, Chillicothe, O. Second Row—Left to Right: H. Carpenter, Chillicothe, O.; A. Holzapfel, Wellston, O.; D. Antor, Howard City, Mich.; S. W. Barnes, Charleston, W. Va. Third Row—Left to Right: W. K. Slack, Westerville, O.; L. Maulit, Columbus, O.; C. Newell, Wosso, Mich.; W. Ragen, Skidmore, Mo.; E. Freeland, Hastings, Mich. Standing: Robert Younger, Crosley Service Department.

CROSLEY REVEALS 30-INCH SUPERSCREEN



When Crosley distributors got a sneak preview of the amazing new Crosley Superscreen TV set, they started asking questions: Q—What's the tube size?

A—The set has a 30" picture tube, world's largest direct-view TV tube now in production!

Q—When will set production begin? A—Crosley executives replied that production will begin in September, with shipments to follow immediately.

TUNING IN THE DEALERS

"We are pleased with Crosley television in our area. Bakersfield is a definite fringe area, being about 112 miles from metropolitan Los Angeles. Additionally, there is a large mountain range over 5000 feet high that lies between Los Angeles and Bakersfield. ... After exhaustive tests we have found that Crosley outpulls, outplays and outperforms all others tested..."

Gerald Prosser (and Vance Ketchum), Co-owners, House of Television, Bakersfield, Calif.

TELEVISION RETAILING

ing "Radio & TELEVISION,"
ADIO & TELEVISION TODAY,"
"TV TECHNICIAN" and
"ELECTRICAL RETAILING"

O. H. CALDWELL, Editorial Director



M. CLEMENTS, Publisher

Are List Prices DOOMED?

A great many consumers are being educated to believe that all list prices on TV, radios, appliances and phono records are phonies. They are coming to look on lists as mere yardsticks—jumping-off places—from which they can start to chisel. And just as bad, they think *that prices on the before-mentioned products are inflated!* (When, lord knows they're not.)

The blame for this deplorable situation can be laid at the doorstep of those manufacturers, distributors and dealers *who are spending millions of dollars to publicize the fact that their products are not sold at list prices.* They are spending this money through co-op and non-co-op advertising, in price-cutting window displays, and by word-of-mouth through "salesmen" who sell nothing but price.

And here are the sorry results being accomplished through the all-out "campaigns" to "sell" the public off list prices: 1. Reduced profits. 2. Irreparable damage to time-honored brand-names. 3. Development of chiseling tendencies in consumers. 4. Belief by customers that our products are priced too high. 5. Dependence on deals to sell merchandise on the part of manufacturers and distributors—loss of dealer loyalty to brands.

Price-cutting has always plagued our industry, and it would be wishful thinking to believe that we can stamp it out completely at this time. But, it's high time the powers that be clamp down on the widespread abuses associated with co-op advertising. The public is being bombarded with a flood of cut-price advertising the like and volume of which has never been seen before.

It's high time we stopped spending money to ruin the market!

If the destructive conditions are not curbed, products in our field, which have always enjoyed comparatively firm list prices may well fall into the pattern of pricing of merchandise in some other fields where selling prices are fixed by retailers, based on costs.

If this is what we want, continued flaunting of list prices before the consumer's eyes will certainly accomplish it.

If we don't want such pricing method, let's commence advertising list prices, and selling list prices as representing top value.

It's possible to run power-packed ad copy on list prices, and to give power-packed sales talks on the value of the list price and still get better results than gimmicked sales presentations will ever achieve.

What's Ahead! — in Radio,

AS PREDICTED HERE, BUSINESS IS PICKING UP, even in the erstwhile heavily distressed areas. (It has been good all through '52 in some localities, notably in parts of the South.) Right now industry leaders are more optimistic than they have been all year, but there's a wide discrepancy when it comes to forecasting TV production for 1952, with estimates ranging from 4,500,000 to 6,500,000 sets.

SOME SUPER FOOD MARKET TYCOONS eyeing the appliance field anew, and with more than academic interest. With numbers of super markets now handling electric housewares, and a few stocking major appliances, established dealers are beginning to worry. To combat any such outside competition, merchants can count heavily on their service facilities, and should try to hang on to valuable franchises.

ODD WAY PHONO RECORDS ARE BEING sold in many of our larger cities today. Some big outlets are and have been selling all discs at list prices while others in the same volume brackets continue to offer platters to the public at discounts, with both apparently doing about the same amount of business. You figure it out!

IT USED TO BE THAT WHEN ONE SAW a man or woman in the TV-radio section of a department store busily examining price tags and making copious notes, he could identify such individual as a "shopper" from a competitor's establishment. Today, many of such folk are consumers out "shopping" for a price.

TELEVISION SETS IN USE reached 18,950,000 by September 1. After almost four years of the "freeze" on new TV stations, the FCC has started granting authorizations to applicants. Thus the ball has started rolling again to make TV truly national. Denverites acted with lightning rapidity after their city was granted authorizations, and have established the first new TV station since the lifting of the freeze, and the nation's 109th. With this speedy action as an inspiration, it is likely that a number of the other permittees in various parts of the country will also get on the air before the year is out.

PURCHASE OF AN APPLIANCE MANUFACTURING FIRM by a very large TV-appliance company likely to materialize any day now.

AMERICAN INDUSTRY WILL SOON have enough producing capacity to raise living standards "beyond our fondest dreams," says J. M. McKibbin, Westinghouse vice-president. Selling machinery must be geared, however, to expanding employment up. Since 1942, salesmen in this country have increased only 18 per cent. Volume of goods sold, however, has increased 80 per cent, the executive points out.

RETURN OF FAIR TRADE HAVING EFFECT on the big operators who had been playing hob with famous brands, slashing them right and left. Now, such outlets are promoting non-price-fixed merchandise.

Trans-Atlantic TV — a Look Into the Future Shows Number of Proposed Methods

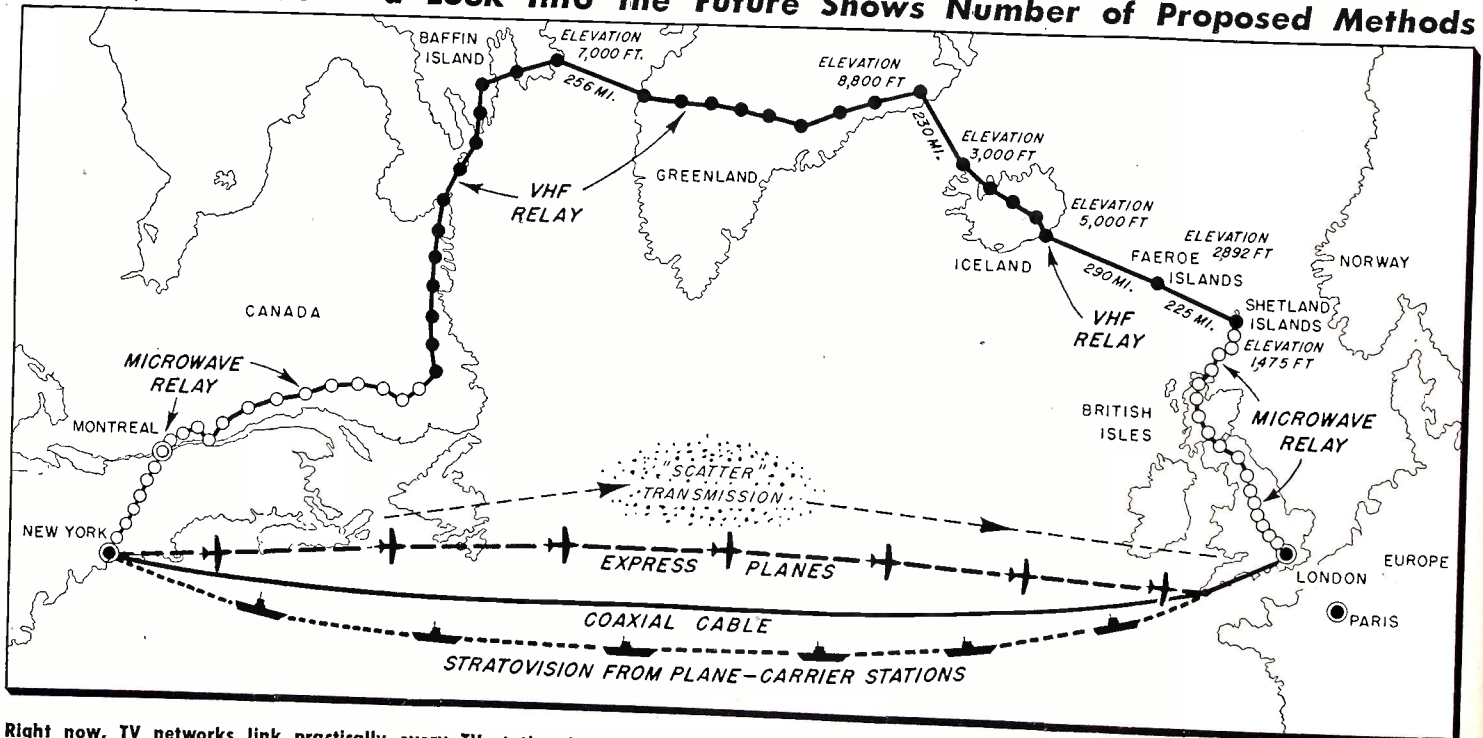

Right now, TV networks link practically every TV station in the U.S. Canadian and Mexican transmitters have just been added to the American continental system. Next step in TV networking obviously must be to Europe and South America. Following are some of the methods for trans-ocean TV which have been proposed: 1. Airplane-relay between a dozen or more express planes continuously flying a regular route across the ocean. 2. "Stratovision-relay" between "stationed" planes flying in circles over a series of flat-top carriers suitably spaced at ocean intervals. 3. A microwave and employing transistors to reduce current drain of the many repeaters required. 4. A submarine cable using new coaxial techniques and crease of transmitter power. 5. Long-distance "scatter" transmission, offering possibilities with in-moon reflections during limited (5-hour) periods at varying times.

Appliances, Records and Television

GRIST FROM THE RUMOR MILL: Two biggies in the TV field wondering how to stop factory "leaks" concerning prices and developments under wraps . . . Watch for a flock of manufacturers to fair-trade their merchandise after being pressured by dealers and distributors . . . And watch, too, for a "revolutionarily" new franchise plan to be offered by a set maker . . . Possibility that a certain maker will bring out a super-duper Hi-Fi instrument, a complete "entertainment center" with TV, and all, at a price this high up! . . . So many shifts a month or so ago in one big firm that many of the top execs haven't even had time to meet one another. In one instance, a big wheel was ordered by a lesser light to do some searching for certain filed records, and to "clean up" a certain desk. Brother, were there some fireworks! . . . With business as tough as it is, "complacency" was given as a very good reason why a couple of big-shots were let out of a big company.

"A LITTLE NONSENSE NOW AND THEN . . ." Investigating complaints of high electric consumption, alleged by the owner to be due to a newly-purchased refrigerator, a dealer's mechanic found that the maid was in the habit of leaving the refrigerator door open to "cool the kitchen" . . . Overheard at the New York Music Show: "There's very little competition and no price-cutting in harps." . . . One wit's definition of a combination bar-TV-radio receiver: "a potable set." . . . And then there was the moron who sat for hours behind the TV set waiting for some action on the part of the fly-back transformer; and that technician's dumb girl friend who thought a lightning arrestor was a motorcycle cop, that a tuner was some kind of fish, and who was just certain that a bow-tie antenna was some sort of fastidious singer.

BRISK MARKET IN ROOM AIR CONDITIONERS not due to the hot weather alone. Last year the temperatures were right up there too, yet heavy inventories were carried over. Big ad campaigns have educated numerous consumers to the virtues of the units, and many more good dealers took on the product this year. '53 will be bigger and better than ever if manufacturers, distributors and dealers keep pushing the merchandise.

BIG APPLIANCE MAKERS, EYEING THE FUTURE, and investing plenty of money promoting low saturation products such as dryers, dishwashers and disposers.

REMEMBER 'WAY BACK WHEN (in '46) manufacturers were working on hush-hush plans for a rectangular TV picture tube? . . . When consumers were loud-speaker conscious, buying units in great numbers from retailers? . . . When, during the Depression, an "automatic" refrigerator (no controls) appeared on the market? . . . And when there was some money being made by servicers in converting prewar TV sets to receive all channels . . . And the days of early auto-radio when so many protests were printed, asserting that car operators couldn't drive and listen at the same time? . . . When the newly introduced glass coffee-makers, and hand-operated juice-extractors were going like hotcakes? . . . When servicers and consumers "baked" receiving tubes to "rejuvenate" them? . . .

TV SERVICE DEPARTMENTS SEE PLENTY of switching by customers these days. Reasons are dissatisfaction with work, delay in answering calls, and unresolved disputes over charges. Even some of those who have contracts are getting sets repaired in other places on a per-call charge basis. Dealers who want to retain good-will should read, "Keep Your Word and You'll Keep Your Customers," appearing elsewhere in this issue.

PARKING PROBLEMS IN THE LIMELIGHT. A plan has been drafted in Tucson, Ariz., to provide 3,500 off-street parking spaces at a cost of \$5,000,000 . . . Denver has received a report from an engineering firm finding that its plans for financing \$4,000,000 worth of off-street parking facilities through revenue bonds would be economically feasible . . . Parking meters are again illegal in North Dakota as the result of the voters reject at the primary election of a referred act to legalize meters.

HAVING FAILED TO BLOCK the Congressional action revitalizing state fair trade laws, in effect in all states except Missouri, Texas and Vermont, opponents of such statutes may conduct campaigns for their repeal in many of next year's legislative sessions. Beside resisting such moves, fair trade proponents may revive unsuccessful past efforts to obtain enactment of fair trade laws in the three states now without them. Fair trade laws were raised as a legislative issue this year only in Louisiana, where a repealer was killed in committee.

OF INTEREST TO DEALERS IN FARM AREAS is a new electrically-operated trap to electrocute corn borer moths, cotton boll worm moths and other destructive insects. Made by the Steber Mfg. Co., Broadview, Illinois, the new device is appropriately called the "Killer Cage." It is a completely assembled and factory wired unit including sturdy steel pole mounting bracket. Moths are attracted to the Killer-Cage by four 300 Watt lamps mounted behind a wire grid which is energized by a 7500 volt 18 MA transformer. In attempting to reach the light source, the moths must pass through the charged grid and are instantly electrocuted.

Future Events of Interest to Readers

- Sept. 14-17: 4th Western Housewares Show, Hotel Biltmore, Los Angeles, Calif.
- Sept. 22-25: 3rd National Convention, Nat'l. Electronic Distributors Association, Ambassador Hotel, Atlantic City, N. J.
- Sept. 29-Oct. 1: National Electronics Conference, Sherman Hotel, Chicago.
- Oct. 1-4: International Assoc. of Electrical Leagues 17th Annual Conference, Minneapolis, Minn.
- Oct. 6-10: National Hardware Show, Grand Central Palace, N. Y.
- Oct. 20-21: National Farm Electrification Conference, Statler Hotel, Detroit, Mich.
- Oct. 20-25: Summer Furniture Market, Merchandise Mart, Chicago.
- Oct. 21-23: RTMA-IRE Fall Meeting, Syracuse, N. Y.
- Oct. 29: 2nd National Home Vacuum Cleaning Conference, Hotel Commodore, N. Y. C.
- Oct. 29-Nov. 1: The Audio Fair, Hotel New Yorker, N. Y. C.
- Jan. 5-16: The International Home Furnishings Market, Merchandise Mart, Chicago.

Here's America's FASTEST

RCA

★ **HERE'S WHY:**



RCA Victor Shelley (Model 17T200)

The sensational price leader in this new low-priced line! Full RCA Victor 17-inch *quality* television. Modern cabinet in lustrous ebony finish. Matching stand extra.

\$199⁹⁵

Including Federal Excise Tax and full-year warranty on picture tube.



RCA Victor Lambert (Model 21T208). Cabinet finished in walnut, mahogany or blond (slightly higher). **\$279.95.** With matching console base (Model 21T208EN). **\$299.95**

All prices shown are suggested list prices, subject to change without notice and to Government Price Ceiling Regulations. Prices slightly higher in far West and South.

1. Survey after survey has shown that more people *have* owned, *now* own and *want* to own RCA Victor than any other make of television.
2. The most powerful advertising campaign in the history of the industry (launched in July) saturated every market with the terrific sales story on the great new RCA Victor lines.
3. RCA Victor sets are *triple-tested*—not only *factory-tested* and *field-tested*—but *family-tested*, using information from RCA Service Company records, the most extensive performance records in the history of the electronic industry!

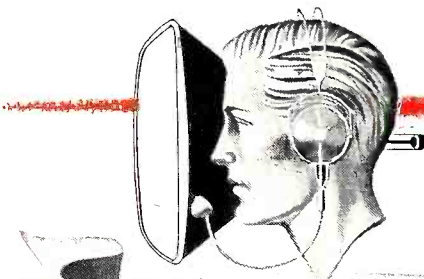

The "Magic Monitor"

...acts like an engineer inside your set

What it is: TV studio engineers constantly "monitor" each program to transmit the very best image over the air. In all new RCA Victor television instruments, the "Magic Monitor" does the same job *automatically* inside your set!

What it does:

- 1 Screens out static . . . **AUTOMATICALLY.** Double-shielded tuner and completely shielded chassis filter out interference caused by airplanes, cars, appliances.
- 2 Steps up power...**AUTOMATICALLY.** Amplifies weak signals...holds picture constant.
- 3 Adjusts set for clearest picture—the best sound is obtained . . . **AUTOMATICALLY.**

MOVING Television Line

VICTOR

4. Cabinet styles of proven popularity to fit any home, any décor, any budget! And on all wood cabinets there's no extra charge for the favorite finish—mahogany!

5. At your service—the vast facilities of the RCA Service Company—the most successful TV servicing plan in America!

So—check your RCA Victor distributor on delivery dates NOW . . . stock up with the sets your customers want—the sets they're pre-sold on—for faster, more profitable TV sales!



RCA Victor Brookfield (Model 21T217). New furniture—front cabinet. "Golden Throat" tone system. Mahogany, walnut finish, blond slightly extra. **\$339.50**

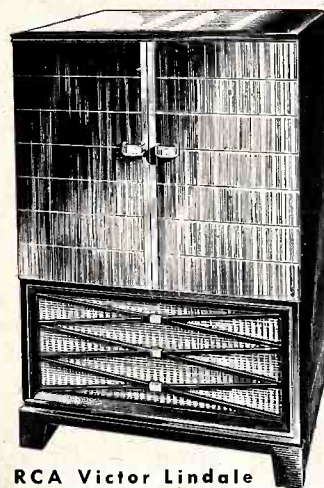

RCA Victor Lindale (Model 21T227). A new style-leader in 21-inch television. Mahogany or walnut finishes. Also blond, slightly extra . . . **\$389.50**

For the ultimate in television today

RCA VICTOR Television Deluxe

- Filling out the top end of the greatest RCA Victor television line-up in history, these sets are the ultimate in the electronic industry today.
- They are designed, assembled and finished with the finest material and craftsmanship available in America today.
- They have extra tubes and extra components for all-round extra performance.
- They are specially engineered for areas with high interference and tough "fringe" reception.
- The fine cabinetry is designed for the most discriminating tastes.

At your service—the vast facilities of the RCA Service Company.



RCA Victor Ainsworth (Model 17T261DE). For clearer pictures in those tough reception areas. Finished in mahogany and walnut. (Blond extra.) **\$339.50**



RCA Victor Rockingham (Model 21T178DE). Clearer, steadier pictures with television's first double-shielded tuner! Has 12-inch speaker. Cabinet finished in walnut or mahogany. **\$495.00**

Every year more people buy

RCA VICTOR

than any other television



Tmks. ©

Cash in on Interest in Politics

Everything's Coming Back—the Folk From Vacations, the Big Shows to the Air—And Business, Too, If We'll Work Like Beavers

• It looks now, at long last, as though business is coming back. Sales are perking up all over the country, and while the rate of increase isn't anything to write home about right at this time, business is much better than it was, and shows every promise of developing into what all expect to be a satisfactory market.

As shown on the cover of this issue, there are at least four factors which should make millions of people throughout the nation want to buy more TV sets, radios, phonographs, records, and other products, and to call heavily on the service departments for maintenance work.

A Great Opportunity

These four factors include, first, of course, the trek back to in-home living, just in time to see the big shows return to the air, and the settling down to life within the family circle. Next, the all-out interest in the political campaigns will continue the rest of this year, and into 1953 for inauguration ceremonies, etc. The World Series will compete heavily with the political goings-on for the public's interest, as will football.

Never before in the history of the country has the dealer been given such a great opportunity to promote sales—the consumer so many reasons to buy TV sets, radios and associated products. To make the prospects appear even rosier,

Christmas selling is near at hand.

However, in spite of all the very genuine reasons why folk should rush out to buy new receivers, they show no inclination to do so. They are still reluctant to part with money, even in these days and times when employment is high and people have plenty of cash. Today's consumer *must be sold*, and the smart dealer knows this, and is doing something about it. He knows how to stimulate interest, and how to justify purchasing through selling quality and value. He uses effective display and advertising to create the desire to own, and to attract the would-be buyers to his store. He uses his service facilities to attract customers, and to enhance his reputation.

Because there are so many good reasons at this time why customers should want to buy additional receivers, replace old, defective sets and trade in small-screen units, the merchant should do all in his power to keep such reasons before prospective purchasers.

Slant Store Displays

Show-window and in-store displays should emphasize the benefits the customer can obtain in buying now. For instance, displays should be angled heavily toward the fact that—(A) The big shows are back on the air. (B) The political campaigns are musts for seeing and

hearing. (C) The World Series is on the way. (And remember, that in addition to the dyed-in-the-wool fan who watches baseball *all season*, there are a great many who don't pay much attention to this sport except during the Series.) (D) Millions of folk are interested in football, and will want the best possible reception in their homes.

Train Servicemen to Sell

The before-mentioned features should be stressed in advertising copy as *plus* enjoyment for the customer. Salesmen should point out all of the great things now available in programming, and should familiarize themselves with what's being offered, and what's on the way in broadcasting. A great many salesmen over-emphasize the product itself, its performance, cabinetry, etc., overlooking the fact that the chief reason any person buys a TV set or a radio is to enjoy programs.

During the recent Conventions, dealers throughout the nation enjoyed the biggest volume of servicing business they've seen for many a year. Technicians were hard put to keep up with the flood of last-minute requests, and this greatly accelerated demand shows every sign of continuing.

In the light of such all-out service activity, smart merchants see a greater necessity for training their technicians to be salesmen. Since the servicer enjoys the confidence of the customer, he can get a lot of replacement sales, or at least pave the way for them, if he is properly coached.

Not only will the firm benefit greatly by such sales effort on the part of the serviceman, but the customer will share equally in being able to avail himself of expert opinion when it comes to recommendations made to replace receivers which are no longer worth fixing.

It is a fact that the dealer who permits his men to repair worthless sets is doing his customers a disservice. The technician sees more of the customer than does the dealer or the salesman, and, since, the servicer also is an expert in the eyes of

To Increase Sales - -

Tie in promotions to the all-out interest in programming.

Angle ads and displays to the political campaigns, the World Series, and football.

Train technicians to develop sales-consciousness — recommend trade-ins on old sets.

Use free home trials to stimulate business.

Work in the outside field, and follow up all prospective customers.

Put in longer hours, gear up activities in all departments.

Baseball, Football!

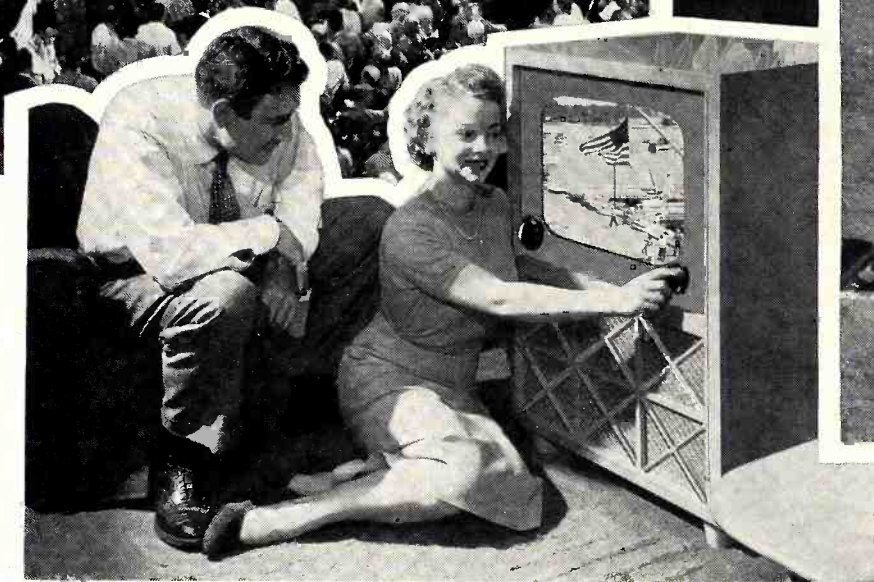
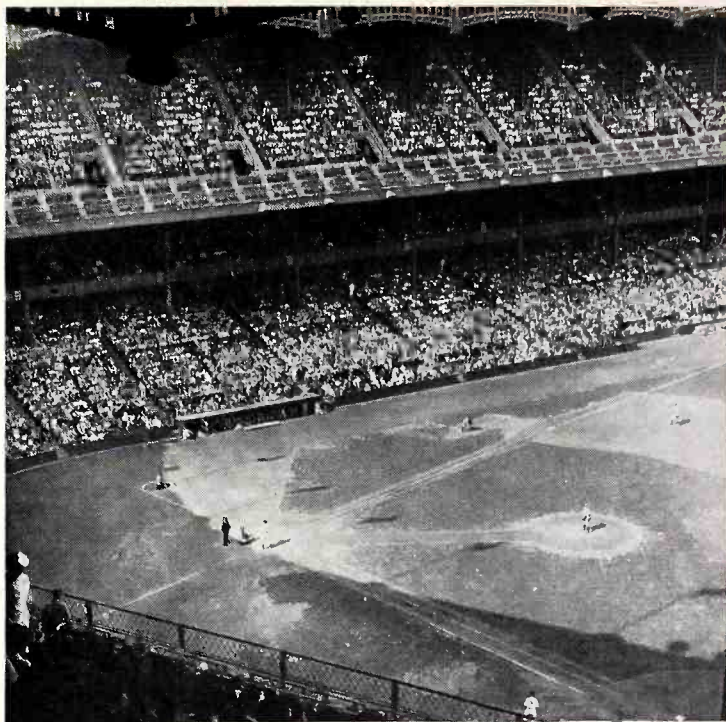

the set owner, he has a great big when it comes to influencing customers to trade in receivers which have outworn their usefulness.

Dealers who continue to overlook the necessity for instilling sales-mindedness into their technicians are bypassing a Number One bet, and, additionally, they may lose a lot of good-will in trying to patch up junk owned by their customers.

With servicemen making more and more calls to homes in his area, the dealer can increase his sales volume through getting his technicians to double in brass. Numbers of merchants pay commissions to servicers for leads resulting in sales, but too few actually train them to develop sales-consciousness. With all of the big things now on the air, and on the way, servicers who sug-

gest trade-ins or extra sets can get good results sales-wise.

Another effective technique to employ in connection with upping sales is the tying in of free home trials to the specific events highlighted over radio and TV.

Though certain retailers are opposed to free home trials on the premise that they are unprofitable, a great many others use this method most successfully.

For those dealers who live up to offers they make, avoiding the use of trickery and gimmicks, the sales batting average has been very high—around 90 per cent for most. High-pressure outfits who make wild offers they don't intend to fulfill are getting high response rates, but a low percentage of sales.

For the dealer who wants to try

the free home trial method, the advice is as follows: 1. Make straightforward offers, and fulfill them to the letter. 2. Send sets only to responsible persons. 3. Demonstrate sets thoroughly in the home. 4. Follow-up the customer promptly just before term of trial expires. 5. Be sure that the receiver you send is in perfect operating condition. (One firm we know of sent out a TV set for a week's trial, during which time, plus two additional days, the customer was unable to get *any* picture. The receiver was set up by two inexperienced delivery men who left it in an inoperable condition. Repeated calls by the would-be purchaser went by the board, no servicer showing up. And it was nine days before the firm picked up the unit and brought it back to the store! Result: An unprofitable transaction to the store, and a thoroughly dissatisfied prospective customer.)

In addition to all of the foregoing
(Continued on page 112)

For the Average Dealer

Price-Cutting Is

Net Profit Depends on Selling of Doing Business. Only



• Price-cutting is the kind of medicine which cures the disease and kills the patient.

Price-cutting is, for most dealerships, a quick route to financial suicide. A little elementary arithmetic will show you why.

Business experts teach us that "the cumulative markup percentage for a period is based on the original retail value of the goods handled during the period."

Now suppose you operate a TV-appliance store with an annual cumulative markup close to the classical average of thirty-one per cent.

This means that every time you cut your retail prices thirty per cent, you are selling your merchandise for less than its cost price.

Overhead Goes On

If you add the cost of doing business to the loss born of selling below cost, it is easy to see why price-cutting is a sure road to bankruptcy.

The rate of speed at which price-cutting can take your business to bankruptcy is easily predictable.

The operating expense of an average store doing \$500,000 annually varies from thirty per cent to thirty-four per cent of retail volume.

Even under the most favorable circumstances, average markup barely covers average operating expenses. It is not difficult to understand why less than six per cent of all the business firms in the United States are twenty-five years old—why ninety-two per cent of all businesses ever started no longer exist.

"But there are times when you

have to cut prices on merchandise!

Certainly. National figures of average operating expenses include an item of about eight per cent for necessary markdowns.

However, let us bring the issue closer to your own business. Whether your figures are near or far from the classical average, your business is still bound by the laws of arithmetic.

Net Profit Explained

Your *net* profit depends on selling your merchandise a certain percentage of retail *above* your cost of merchandise *plus* your cost of doing business.

Now, your cost of doing business already includes a percentage of your retail sales for necessary price-cuts.

Suppose you operate your business to obtain a *net* profit of four per cent of gross volume annually. All you have to do is add five per cent more price-cuts to your acceptable markdowns, and your business will automatically start operating in the red.

Price-cutting on a large scale endangers the health of your business by driving away a great many of your best customers!

Let us explain by reminding you of certain discoveries made by business researchers.

The vast majority of merchandise sold in the United States can be classified into three broad price areas.

These three price classifications of all merchandise sold are volume

(or middle range), promotional, and prestige.

The volume, or bread-and-butter, price range probably accounts for from fifty to seventy-five per cent of all your sales. When you cut prices in this price classification you are trifling with the very backbone of your business.

Bad Effect on Customers

Once you educate your customers to the idea that price-cuts in this classification are frequent enough to justify their waiting, watch out. Many of your customers will simply sit tight until you just *have* to cut prices again and again in order to pay your mounting bills. If your markup is small to begin with, even accelerated turnover cannot keep continuous price-cutting from putting you permanently in the red.

Price-cutting in the prestige price area automatically nullifies the value of the prestige classification itself.

What prestige can an item give your store if you cut its price?

The price-cut itself talks louder than any reputation. The price-cut says quite obviously that nobody has wanted to buy the "prestige" piece at its regular price. (Ergo, it is probably over-priced, even with the new price-cut, the customer will believe.)

Building Bargain Hunters

As for price-cutting in the promotional price area, that is like cutting the arm off a one-armed man.

The markup on promotional merchandise is usually so low that any additional price-cutting usually makes such profit fade away completely.

Many merchants believe that sales in the promotional class of merchandise should not exceed one-third of a store's volume.

The majority of markdowns in a well run store are usually due to left-overs from merchandise bought

a Speedway to Disaster

at a Certain Percentage of Retail Above Cost of Merchandise Plus Cost

"Special" Operations Can Slash Lists Continually and Still Keep in the Black

exclusively for promotion.

If your promotional-price merchandise does one-third of your volume and you double its share of your business, the implication is obvious. You have changed the whole face of your business. You may have lost many of your best customers, those who buy your profitable, prestige and middle-price range products. Your business will no longer be a healthy business. Two-thirds of your business will depend on bargain-hunters, the most expensive and hard-to-please customers in the world.

Few Can Keep It Up

Except in very special cases, the habitual price-cutter eventually cuts himself out of business.

The average customer's reaction to a price-cut is, "What's wrong with the item?"

Most people who have been fooled several times by phony price-cuts or by "savings" on defective items which were bought only because the prices were cut are telling their friends that "You only get what you pay for. No more bargains for me. Next time I will buy the best I can afford."

In recent years, price-cutting has become entirely too popular with business men as a quick solution for complicated problems.

From the position of a necessary evil in selling, price-cutting has graduated into a philosophy of doing business.

Poor Substitute

More and more business men are shifting the emphasis of their business from satisfactory salesmanship and service to habitual price-cutting.

In general, as stated at the beginning of this article, price-cutting is a cure which is worse than the disease which it seeks to alleviate.

Habitual price-cutting is dangerous because it costs you the control

of your business. For instance:

1. Every price-cut educates your customers to wait for more price-cuts before making purchases now.

2. Every price-cut spurs your competitors to cut deeper than you, which in turn forces you to cut again, etc.

Very Few Can Make It Pay

While it is true that certain "specialty" operators in our field can specialize in price-cutting and make profits in the process, the average merchant who gets no better than run-of-the-mill discounts, is headed for trouble once he launches his business on a career of knocking something off on every transaction. Some of the big fellows have

"angles" they work to keep their businesses in the black in spite of all-out price-cutting. Many get preferential treatment from suppliers, and most of them are heavily capitalized, and can survive on small profits on huge volume.

Service vs. Low Price

But for the average dealer, the advice is to stay away from participation in any price war. One of the largest price-cutters in the East recently told members of a dealer's organization that they can get their share of business in the locality by competing with him, not on a price basis, but by offering better service than he can ever hope to give.

5 Ways to Make More Profits

1. **Don't over-buy.** In many cases where a dealer has bought too heavily, he is forced to cut prices, sometimes on fast-moving merchandise, in order to raise cash.
2. **Buy Carefully.** Choose brands and models you believe your customers will accept. Stay away from suppliers who "live" exclusively "off deals."
3. **Work closely with your suppliers** in order to get advance notice of coming model changes, price reductions, etc.
4. **Train salesmen to sell quality and service.** Let them stress the reputation of the dealer and the manufacturer.
5. **Don't enter any of the price-wars being run by the bigshots.** Offer your customers "extras" to offset price competition—such extras being good service and after-sale interest.

Outstanding SERVICE

\$500,000 Sales Volume Due to High Re

Albany, N. Y., Dealer Spends \$50,0

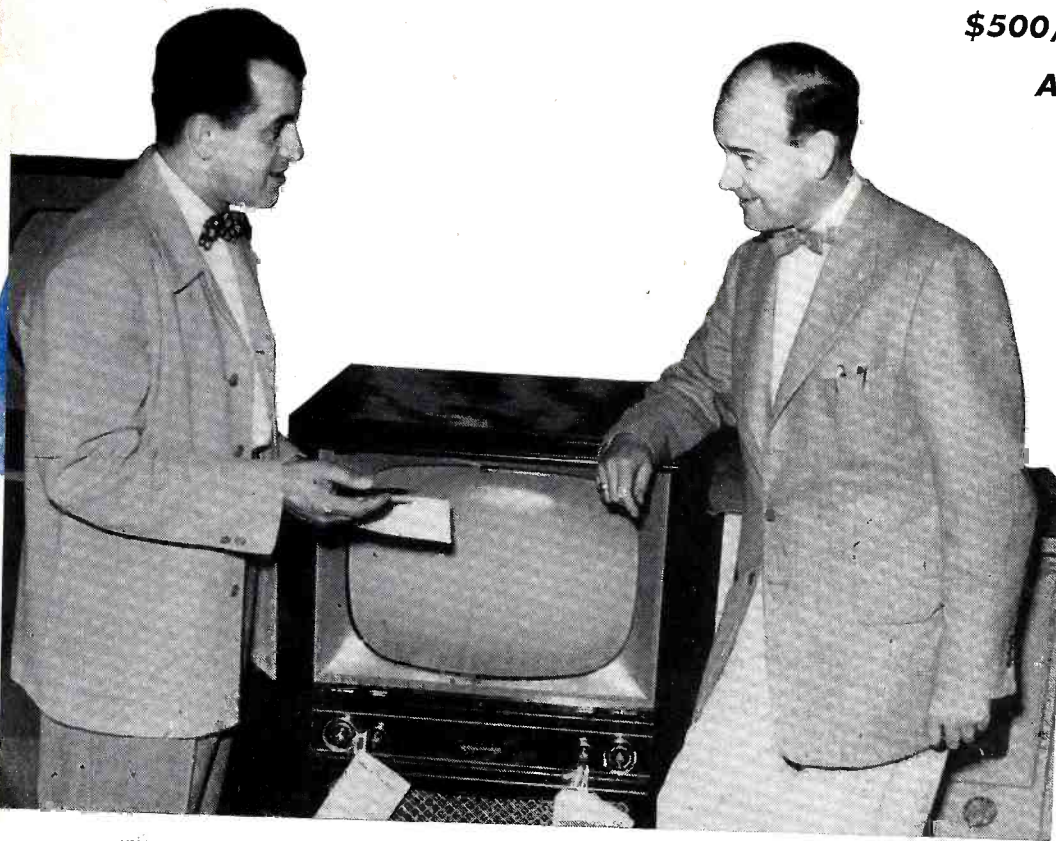

"We service everything we sell," says salesman on left. That's a strong sales point at Economy Appliance Co., progressive Albany firm.

Owner James Albertine, Sr., of Economy Appliance Company discusses service department operations with his son, James, Jr., who manages the nine-man department.

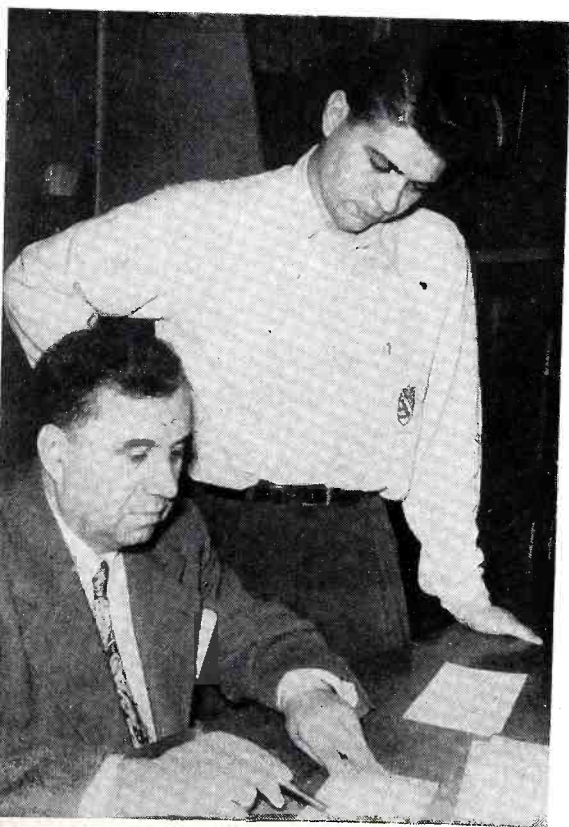

* The television-appliance dealer with a trained, carefully supervised, and well-equipped service department of his own has an enormous advantage over the dealer with haphazard service or a "farming-out" arrangement, in the opinion of James (Jim) Albertine, president of Economy Appliance Co., Inc., 394 Broadway, Albany, N.Y.

Albertine should know. He's spent 15 years in retailing in this field, and every minute of that time his slogans of operation have been "We Service What We Sell" and "The House that Service Built." Those are no meaningless mottos. They represent an alert, effective pro-

gram which has built a \$500,000 annual volume from a start as the small Economy Vacuum and Washer Company 15 years ago.

"Service can never be a direct profit-maker," Albertine asserts. "We feel lucky if we break even. But service is indispensable to the dealer for several other reasons. First, it helps take good care of the customer. Second, it makes it easier to sell the customer, when he knows we will service what he takes from us. Third, it brings in prospects for new products. Many people come to us to fix an old, used appliance. If service is the best solution, we repair the appliance. But there are always the others who see a new model and decide to trade in the old one. These sales can be traced directly to our service department."

Economy spends \$30,000 to \$35,000 per year in salaries alone for service department personnel. It has \$12,000 in parts, \$4,000 in tools and equipment, and partial use of the firm's five trucks. Toss in the advertising costs plus a proportionate share of the overhead cost of running the business, and you'll see that its service department is a major phase of the business.

Here's how the service department is set up for operation: Economy has 19 employees—nine of these are full-time members of the service department. There are four television technicians, one refrigerator mechanic, one antenna man, two men for washers and cleaners, and a foreman, James Albertine, Jr., son of the owner. Economy hires servicemen with some previous experi-

Facts About the Economy Appliance Co.

Firm tries to make service department break even

Economy spends \$30,000 to \$35,000 per year to pay service personnel

Service department stocks \$12,000 in parts; \$4,000 in tools and equipment; has 5 trucks

Survey made by firm finds 96% of its customers satisfied with products and service.

Builds Big Business

Customer Satisfaction.

War in Effective Ad Campaign

nce, and in addition has them "briefed" by a local electrical distributor.

Store hours are 8 A.M. to 9 P.M., and the service department functions this complete time. Television service is day-long, with the first man reporting at 8 and the last at about 11.

Economy occupies an entire four-story building at 394 Broadway. The front half of the main floor is the sales room. In the rear are offices, reconditioned appliances, and two separate service departments. One is a 22-foot long work bench for traffic appliances. The other is a 25 x 25 room for TV, radio, washer, and refrigerator repair.

Economy emphasizes same-day or next-day service on all calls. The girl who takes the calls notes on a job form the name and address of customer, phone number, age of the appliance, and nature of the complaint. She then checks her files and notes whether the appliance was purchased from Economy. (The firm accepts service calls on products it did not sell.) The form is then turned over to the service foreman.

The foreman makes up routes for the servicemen about to go out. Usually they include early-morning calls and calls which came in the previous afternoon and evening. The servicemen call in once a day—about halfway through their routes—and are informed of any additional stops to be made along their route.

The standard price for a television-service call in the city limits of Albany is \$4.50. Outside the city it's \$5.50. For up to 20 miles, it's \$7.50. About 75% of the time, the television service job is done in the home.

Economy offers an optional service contract on all TV receivers it sells, but there is no sales pressure exerted on the prospect to take this contract. About 25% of all TV buyers take a 90-day agreement. A one-year contract costs \$50 to \$60 for standard TV sets, and \$60 to \$70 for combinations.

Economy attempts to sell in a trade area of 100-mile radius, but most sales are within 20 or 30 miles or less. Occasionally a TV receiver or appliance is sold to a customer

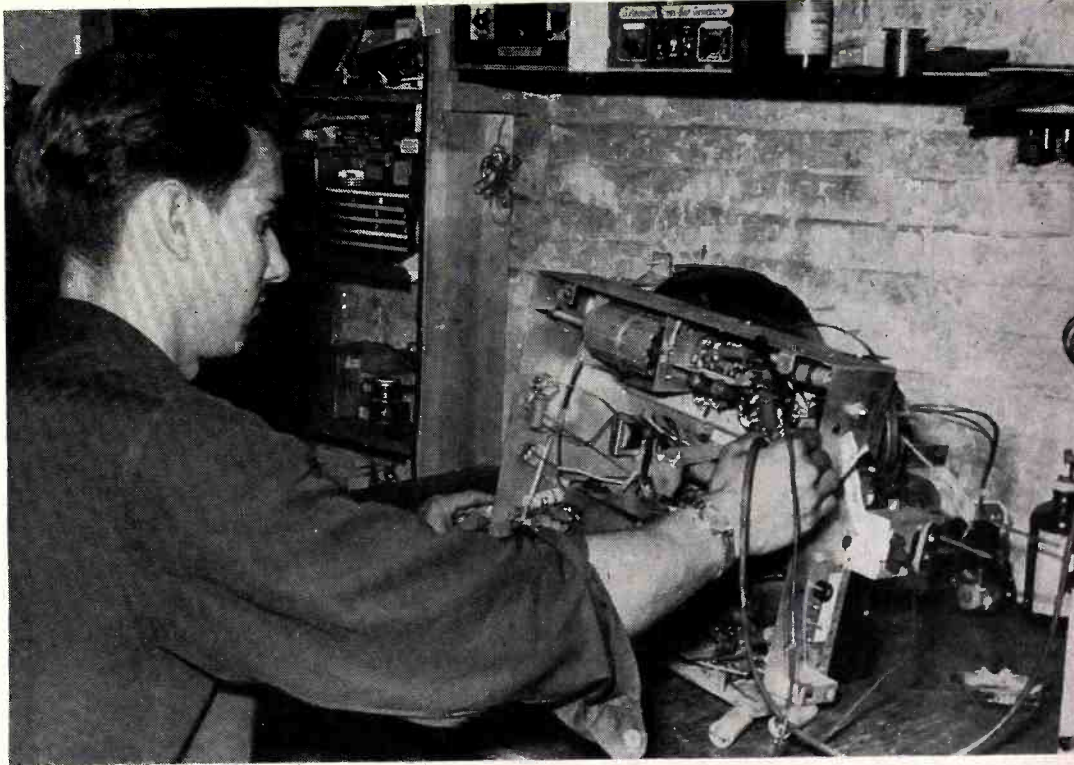

Excellent TV and radio service is provided by Economy. 75% of all repairs are in the home.

who lives 50 or 60 miles from Albany. Albertine has a flat policy of never turning down any service call, regardless of distance.

"You can't try to balance the cost of complete service with service income," Albertine concludes. "It doesn't work that way. Look. This morning a man came in looking for an agitator for his washing machine.

It was a very old machine and we didn't have the part; if we had it, we'd have been happy to give it to him. But he did notice an automatic washer which we demonstrated and sold to him. Without the service and parts department, we'd never had made that sale."

Word-of-mouth advertising helps
(Continued on page 108)

Two of the nine-man service staff are assigned to repairing washers and cleaners.

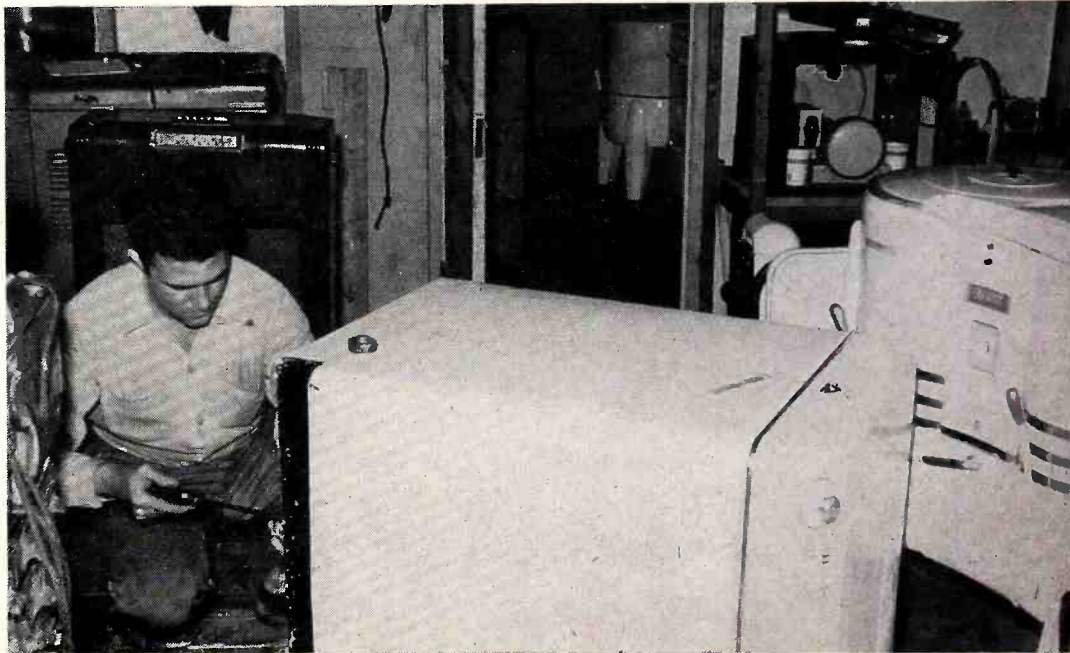

At the NEDA Convention

Distributors Will Cope

Discussions on UHF to Be Featured at Get-Together of Wholesalers,

• Mayor Joseph Altman, of Atlantic City, will officially welcome members and guests of the National Electronic Distributors Association at NEDA's third annual Convention and Manufacturers Conference at the Ambassador Hotel, September 22-25, by proclaiming the conven-

tion-conference dates as "Electronics Week in Atlantic City."

Conference quarters will be occupied by a "blue-ribbon" list of a number of the industry's leading manufacturers. The conference quarters, furnished as small sitting rooms in which manufacturers and

distributors may meet in private, will serve to maintain the atmosphere of a Conference rather than an exhibit-type Show, according to Aaron Lippman, chairman of the Convention Committee, and will be in keeping with NEDA's plan to afford distributors and their suppliers with every opportunity to discuss business under as nearly ideal conditions as can be provided.

The rooms, with eight-foot separating walls, will line the lounge floor of the Ambassador Hotel. There will be no elaborate displays or exhibits of merchandise. Conference quarters will be open each afternoon from 1 PM to 6 PM on September 23 and 24, and from 10 PM until 6 PM on September 25.

Conference Booth Holders

Included in the list of manufacturers whose contracts have been processed for conference quarters on the lounge floor of the Ambassador Hotel are:

Alliance Mfg. Co., Alliance, Ohio; American Phenolic Corp., Chicago; Astatic Corp., Conneaut, Ohio; Belden Mfg. Co., Chicago, Ill.; Bell Sound Systems, Inc., Columbus, Ohio; David Bogen Co., Inc., New York; Bud Radio, Inc., Cleveland; Burgess Battery Co., Freeport, Ill.; Bussman Manufacturing Company, St. Louis; Channel Master Corp., Ellenville, New York; Chicago Transformer Corp., Chicago; Collins Radio Co., Cedar Rapids, Iowa; Cornell-Dubilier Electric Corp., South Plainfield, N. J.; Allen B. DuMont Labs., Inc., Clifton, N. J.; Electro-Voice-Mfg., Buchanan, Mich.; Fretco, Inc., Pittsburgh; General Cement Mfg. Co., Rockford, Ill.; General Electric, New York; Greenlee Tool Co., Rockford, Ill.; Hickok Electrical Instrument Co., Cleveland, Ohio; Hytron Radio & Electronics, Salem, Mass.; Industrial Development Engineers Associates, Inc., Indianapolis, Ind.; Insuline Corp. of America, Long Island City, N.Y.; International Resistance Co., Philadelphia, Pa.; J.F.D. Mfg. Co., Brooklyn; Jensen

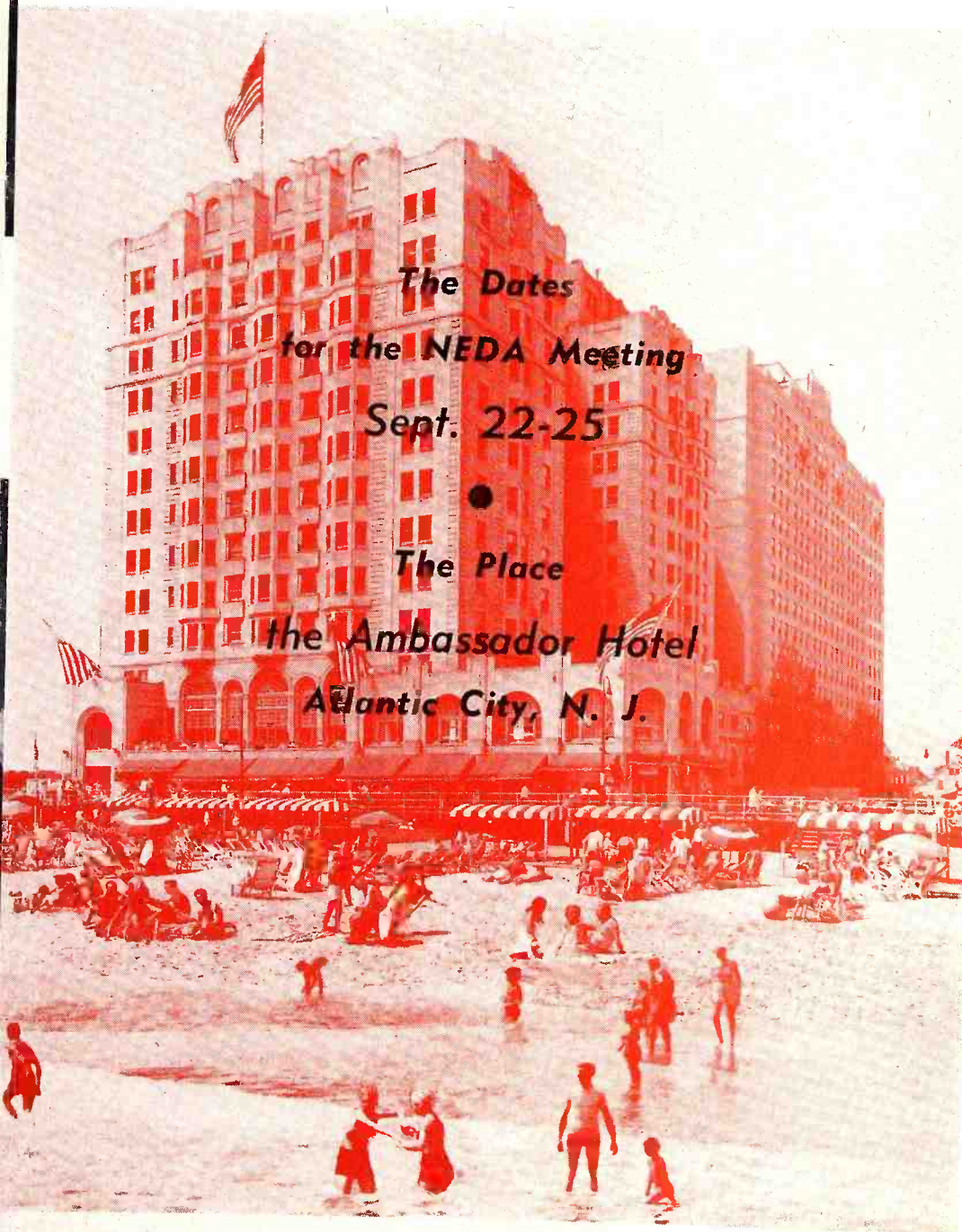

With Current Problems

Manufacturer-Sponsors, and Representatives. Educational Sessions Scheduled

Industries, Inc., Chicago; Jensen Mfg. Co., Chicago, Ill.; LaPointe-Plascomold Corp., Rockville, Conn.

Also, Littlefuse, Inc., DesPlaines, Ill.; Masco Electronic Sales Corp., Long Island City, N.Y.; Merit Coil and Transformer, Chicago; Minnesota Mining & Mfg. Co., St. Paul, Minn.; National Carbon Co., New York; National Electric Products Corp., Ambridge, Pa.; National Union Radio, Orange, N.J.; Ohmite Mfg. Co., Chicago; Oxford Electric, Chicago; Pentron Corp., Chicago, Ill.; Permoflux Corp., Chicago, Ill.; Pilot Radio Corp., New York, N.Y.; Pyramid Electric, North Bergen, N.J.; Quam-Nichols Co., Chicago; Radiart Corp., Cleveland; Radio Craftsmen, Inc., Chicago; Radio Corporation of America (RCA Victor Division) Harrison, N.J.; Radio Merchandise Sales, Inc., New York; Raytheon Mfg. Co., Newton, Mass.; John F. Rider Publisher, Inc., New York; Howard W. Sams & Co., Inc., Indianapolis, Ind.; Shure Brothers, Inc., Chicago; Snyder Mfg. Co., Philadelphia, Pa.; South River Metal Co., South River, N.J.; Standard Transformer Corp., Chicago, Ill.; Sylvania Electric Products, New York; Triplet Electrical Instr. Co., Bluffton, Ohio; Tung-Sol Electric, Inc., Newark, N.J.; United Catalog Publishers, Inc., New York; United Transformer Co., New York, N.Y.; V-M Corporation, Benton Harbor, Mich.; Ward Products Corp. (Gabriel Co.), Cleveland; Webster-Chicago Corp., Chicago, and Workman TV Inc., Teaneck, N.J.

Bersche to Speak

Current problems of distributors and their solutions is the theme for the educational session.

In keeping with the 1952 convention theme, UHF, the new, vital phase of the industry, is given precedence on the educational program. Hal F. Bersche, manager, renewal sales, RCA Tube Department, Radio Corporation of America, is scheduled as one of the principal speakers. His talk, "UHF In Your Fu-

ture," will be directed toward an evaluation of the opportunities in UHF for the distributor and his dealer.

Tuesday has been designated "Ultra-High Day." At 10 AM, "Success Hill," the RCA movie on UHF will be shown. A panel of manufacturers will lead the general discussions. The panel includes Harry A. Ehle, International Resistance Co., Philadelphia, moderator; R. D. Maddox, Belden Mfg. Co., Chicago; L. C. Ebel, Anaconda Wire & Cable Co., New York; Harold Harris, Channel Master Corp., Ellenville, N. Y.; Kenneth Weitzel, General Electric, Syracuse, N. Y.; Robert Furst, David Bogen Co., New York and Wilfred B. Whalley, Sylvania Electric Products, Inc., New York.

On Wednesday, there will be panel discussions on "How Distributors Can Do a Better Selling Job," with Harry A. Ehle as moderator; Albert

N. Haas, president, Television Contractors Assn.; James T. Daly, president, Philadelphia Radio Servicemen's Assn.; Mort Farr, president, National Appliance-Radio Dealers Assn.; John B. Davidson, purchasing agent, RCA and John T. Thompson, sales manager replacement tubes, General Electric. This will be followed by a panel discussion on "How I Can Be Sold," with Ehle as moderator; Milton Fischer Dist. Co., New York; Elliott Wilkinson, Wilkinson Bros., Dallas; Arthur W. Mayer, A. W. Mayer Co., Boston; V. N. Zachariah, Zack Radio Supply, San Francisco; W. D. Jenkins, Radio Supply Co., Richmond, Va.; H. Tory Horn, Western Electronic Supply Co., Seattle; Dahl W. Mack, Scranton Radio & Television Supply Co., Scranton Pa.; Manuel L. Kann, Kann-Ellert, Baltimore and Frank Baratta, A. C. Radio Supply Co., Philadelphia.

WHO'S WHO in NEDA

OFFICERS

President
GEORGE WEDEMAYER
Ann Arbor, Michigan

Exec. Vice President
L. B. CALAMARAS
Chicago, Ill.

1st Vice President
W. D. JENKINS
Richmond, Virginia

2nd Vice President
BYRON C. DEADMAN
Green Bay, Wisconsin

Treasurer
H. E. RUBLE
Dayton, Ohio

Secretary
HARRY STARK
Minneapolis, Minnesota

DIRECTORS

Chairman of the Board
AARON LIPPMAN
Newark, New Jersey

GEORGE W. BAUMAN
St. Paul, Minnesota

JOHN G. BOWMAN
Chicago, Illinois

ANTHONY DYBOWSKI
Buffalo, New York

ROGER FJELSTAD
Seattle, Washington

RAYMOND FULLIERO
Waterbury, Connecticut

J. ALEX GETTMAN
Knoxville, Tennessee

OWEN H. GRIFFITHS
St. Louis, Missouri

HENRI JAPPE
Boston, Massachusetts

RALPH JULIUS
Columbus, Georgia

BILL KERLIN
New Orleans, Louisiana

J. HOWARD KLEIN
Dallas, Texas

CRANDALL LASSAUX
Des Moines, Iowa

AARON LIPPMAN
Newark, New Jersey

L. E. MONTAGUE
Beaumont, Texas

HENRY MORRISON
Ashtabula, Ohio

C. E. PHILPOTT
Flint, Michigan

J. D. POTTENGER
Wichita, Kansas

CECIL C. ROARKE
San Francisco, California

LESLIE C. RUCKER
Washington, D. C.

A. W. SATTERFIELD
Madison, Wisconsin

L. B. WALKER
Pueblo, Colorado

R. V. WEATHERFORD
Glendale, California

R. C. WHITEHEAD
Columbus, Ohio

GLENN O. ZIMMERMAN
Hagerstown, Maryland

Sales Contests Build

Properly Planned, Well-Executed Projects Stimulate Salesmen

• Sometimes a salesman needs a shot in the arm or a kick in the pants. Dealers wonder which is best. Some suggested sales programs are lacking in all the elements necessary to build morale and to increase sales for the TV-appliance retailer.

Sales contests, however, provide the needed stimulant—competition, rewards, and activity. With a sales contest that is properly planned, conducted, and climaxed the sales-

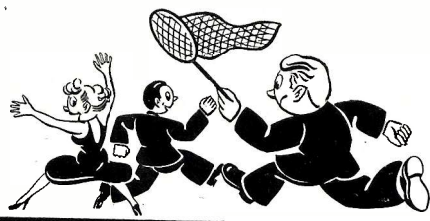

Worthwhile prizes will get the salesmen on their toes, and they'll go after sales like everybody's business! Prizes can be merchandise or money.

men get a shot in the arm and do not need the kick in the pants.

Salesmen, football players, and soldiers seem to grow in professional stature when they are in conflict. A top-notch football team could practice all season and fall down miserably when they got into a game. They need the early season games to help them develop skill that will pay off when the chips are down in the big game.

Clock a runner around the track. He will turn in a good performance. But, check his time when he is running against another man who has the same time for the distance. They will both do better and records will fall. We all need the kind of stimulant we get with competition.

TV-appliance salesmen respond the same way. When the chips are down in a sales contest they do a better job of selling. They work a little harder . . . sell a little more.

Here are some suggestions that dealers have found helpful in planning sales contests that have been successful:

1. SET A CONTEST OBJECTIVE

One reason some sales contests fall short of the mark is that they do not have an objective. To be most successful the contest should have a definite goal—something specific that is to be accomplished by the contest.

The objective for your sales contest might be to sell more complete installations—television, antenna, and service contract. Or, you may want to key the goal to one specific item such as to sell more combination sets. Another theme that might help would be to sell more higher-priced sets.

These suggestions for sales contest goals are in a general nature. The contest is more effective if these goals are reduced to something specific—sell ten combinations a week, sell a specific dollar volume of television sets, increase dollar sales 10% and keep the unit sales at the same level, or to hit a higher average sale for every order written up.

You will find that your sales contest objective will be most effective when there is a definite aim established and a specific time limit set for its accomplishment.

2. DEVELOP A SINGLE SCORING CHART

Salesmen want to know where they stand all the time they are participating in a sales contest. They want to know the score. Deal-

TIME FOR ACTION!

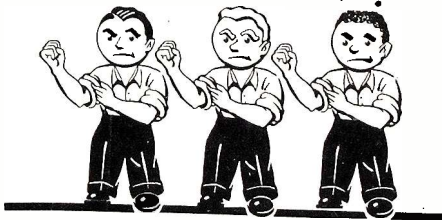

Salesmen, football players and soldiers grow in stature when they are in conflict. The sales contest stimulates the spirit of competition which is still the life of trade.

ers who have the best luck with their sales contests claim that part of the success is due to the scoring chart they have developed.

One retailer, for instance, wanted to sell more television sets. He outlined on a piece of cardboard the channel selector for ten sets and assigned a salesman's name to each selector. With every TV receiver sale he colored one of the channel indicators and when all channels were colored the salesman was ready to qualify for the prize.

Another dealer divided his salesmen into two teams. His objective was to sell a service contract with



The right kind of sales contest can start a merry-go-round of selling in the store with every salesman after the brass ring.

every television set. He set up a scoring chart for each team with twenty models stocked in the store. Every time a sale was completed by a team a service tag was placed over the picture of the set. However, when a sale was made without the service contract another television set was added to the team's scoring chart. Winner, of course, was the first team to have service tags over all of its TV sets.

Still another contest designed to reach the goal of selling higher-priced sets was very effective. The dealer determined the average unit sale—divided total number of sets into the total dollar sales—and used this as a base for his scoring chart.

Every time a better-than-average unit was sold the total dollar value over the average price was added to this salesman's score. On the other hand, when a television set was sold that was below the average unit price this amount was deducted from the salesman's total. A football field was used for a scoring chart and each ten yard line represented one hundred dollars in plus or minus sales. Play started from the forty-yard line and the players' symbols moved forward and back according to the value of the set sold.

In several of these sales contests, the scoring plans were established with a joint meeting of the dealer and all of the salesmen. With this



One angle is to offer prizes to salesmen who sell the most number of "complete" jobs—TV sets with installations, contracts, etc.

Business Volume

and Help Move Specific Models in the Dealer's Store

participation in contest planning the possibility of the rules being too tough and discouraging to the salesman is eliminated. Then, too, the rules will not be too easy to place the contest in the category of being a pushover for the salesman.

3. COMPLETE, CLEAR, CONCISE RULES

Salesmen participating in a sales contest want to know the "ground rules." This gives them a guide to use in measuring their activities and to weigh the results against the effort required.

One rule that should be established is the length of time the contest will continue. Some dealers favor a short contest—a week or ten days. Others like a long contest because they feel that they can award better prizes for the results of the long pull.

One successful sales contest was continued for six months, but this was an exception. As a general rule, you will find that a contest is best when the time is limited from two weeks to a month in duration. This gives the salesman time to meet the requirements and also will keep

will be more willing to put forth their best efforts. They will feel that the contest is fair and square—that they will be rewarded and penalized as the rules state in clear and simple language.

4. KEEP ENTHUSIASM AT A HIGH PITCH

Enthusiastic participation of the salesman is maintained by the advance planning to keep the stimulation up during the contest. Announcements of the contest will set the stage.

One retailer made his announcement of the sales contest in an unusual way. He sent unsigned announcements on postal cards to the wives of his salesman with copy like this: "Would you like a matched set of luggage?" These cards were mailed each day until all of the contest prizes had been covered.

Curiosity among the salesman and their families was aroused. They were talking about the prizes. Then, another announcement of the contest was sent to the wives giving all of the details. This was sent special delivery to the home and while it was being delivered the salesman

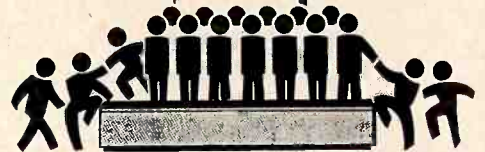

Use simple, easy-to-understand "scoreboards" to help salesman or teams know where they stand. Novel themes should be employed to dramatize the contest, and to keep interest alive.

for the same results would be utterly unprofitable.

5. HAVE A NOVEL THEME

Sales contest themes give the contest a flavor that may prove helpful for its success. The more unusual or novel the theme the better the chance the contest has for success. Here are four ways to develop unusual themes for dealer sales contests:

1. *Symbolic Theme:* One retailer wanted to realize \$50,000 in sales in thirty days. He played around with the number fifty for awhile and then decided on one less—49. His theme was the days of "49'er" and all of his scoring and buildup was based on this angle—gold-dust bags, gold pans, Western style announcements.

2. *Seasonal Theme:* Every season of the year can serve as a "thought-nudger" for an unusual theme for a sales contest. For instance, during the Fall the theme could be football, Winter basketball, Spring baseball, and Summer swimming. Sports themes that are seasonal in nature lend themselves to all kinds of gimmicks and gadgets that will add interest to the contest.

3. *Prize Theme:* Regardless of what the prizes are for the sales contest, it is possible to twist them around to a theme. For instance, a vacation trip could be located on a map and each dollar in sales volume could move the salesman closer to the vacation spot. Hotel stationary and

(Continued on page 116)

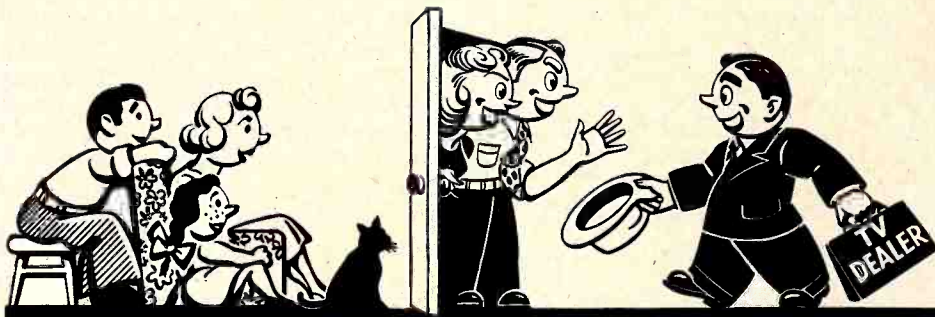

Notify the members of the family about the contest via a special delivery letter. They'll really work on pop to win some of those prizes the minute he gets home.

their enthusiasm at a high pitch.

Scoring rules should be presented in a clear and concise manner. Complicated scoring systems confuse salesman and they may then feel that the contest is not fair because they do not understand the rules used in scoring their sales.

Prizes should be listed specifically. For instance, if the prize is a vacation trip the salesman will want to know if it is a flat cash settlement or if it includes everything—transportation, lodging, meals, tips, entertainment, etc.

When the salesman know all the requirements of the contest they

received the same memo at the office. When they went home the dinner-table conversation centered around the sales contest and the plans for winning the prizes.

Selection of the prizes has a bearing on how enthusiastic the salesman will be about the contest. Most TV-appliance retailers have found that merchandise prizes are the best.

Prizes selected for the sales contest should be worth the effort required. A contest with a prize of \$5 to sell ten television sets would lack the necessary stimulant. On the other hand, a prize of \$500 dollars

How to Make

SALESPEOPLE of Your

Careful Selection and Training Will Result in Bigger Disc Sales

• Phonograph record department managers who select sales personnel carefully, and train them thoroughly will be rewarded by increased sales volume, and a number of other profitable benefits including better relationships between customers and employes, less employe turnover, and a lively spirit of cooperation between the folk in the disc and instrument sections of the store.

Some record department heads go along with the premise that because they can't afford to pay high salaries they must be satisfied with hiring and maintaining "clerks." Additionally, they feel that it would be futile to try to train such "clerks" to rise above any job higher than that of order-filler.

"Waiting on" vs Selling

In stores where management resigns itself to operation of the department by such "clerks," some or all of the following unprofitable and undesirable things usually take place:

1. A great many sales are lost because "clerks" don't suggest substitutes for numbers out of stock.
2. A great many sales are smaller than they should be because the employe fails to suggest other records, being content with saying, "Is that all?" or "Anything else?"
3. Lack of interest on the part of employes costs the store money in misplaced and damaged stock, and in failure to advise management of calls for records or albums out of stock.
4. Constant personnel turn-over often bewilders, sometimes annoys customers who see so many new faces, yet would much prefer to deal with the same person on each store visit.

For those department managers who aren't happy about the way things are going, and who are having difficulty in maintaining satisfactory volume, and in holding customers and employes, there's a way to build a bigger and better depart-

ment. The way to improve conditions is to start in on a more efficient method of selecting disc sales personnel, and in training them so that they will be proud of their positions, providing them some genuine incentive to make more and better sales.

Even if the disc department can't afford to pay big salaries, it can afford the time to *select* prospective salespeople carefully.

It is a fact that in most localities there are numbers of people—mostly young folk—who are looking for jobs selling records. In most cases, according to dealers, such people want to get into the record department because they are intensely interested in records, many of them being music students. It's much the same sort of thing as the small fry wistfully thinking about how swell it would be to get a job behind a soda fountain. Many of the would-be phono record salespeople,

Your disc department can double its sales volume if you hire the right kind of people and show them how to stimulate and promote business.

while they may know music, are just about as unsuited to selling discs as the little kid would be to jerking sodas. But numbers of such hopefuls who seek jobs in the disc department, are potentially good salespeople, if the management can take the time to train them.

What happens to a great many newcomers to the ranks of record salesmanship shouldn't happen in your store. By this, we mean that in many cases a likely person will be

hired after a very sketchy interview, then thrown abruptly on the salesfloor where he is coached by others as to stock, and given the barest information on policies. Such individual, if he doesn't quit in disgust, often ends up becoming an automaton, for whom the phono record no longer holds its past glamor, and for whom no incentive for extra effort exists.

Two Important Steps

It's just like the kid who grows up to become a soda fountain clerk. The first few days he'll guzzle sodas and sundaes to beat the band, but it won't be long before these delicacies, once considered out of this world, will become commonplace things to him.

From the foregoing it will be seen that in order to set up the ideal personnel arrangement, two steps must be taken. First, the candidates for jobs should be carefully selected, and next, they should be trained so that they will continue to be interested in discs from both cultural and financial viewpoints. It's useless to screen applicants carefully, then neglect to train them, and it's equally silly to try to train persons who are obviously unsuited to selling.

Screening the Applicants

Following are some of the things to look for in choosing individuals to sell phono records:

1. *Sales Ability.* Is the person a good mixer? Has the applicant had any sort of selling experience, and if so, did the individual like the work? After explaining that the store is in business to make money, ask the applicant point-blank some qualifying questions such as, "Do you believe that you can help us increase our sales?" In fact, ask numbers of questions so that you'll learn a lot about the individual's hobbies, ambitions, etc., so that you can size up his possibilities.

2. *Personality.* The applicant should present a good appearance, which is, of course part of his or her

Phono Record "Clerks"

Volume, and Higher Morale and Less Turn-Over in Personnel



personality, as expressed in actions, posture, etc. One of the greatest requirements of a good phono record salesperson is *patience*—patience enough to wait on the fussy customer who wants to hear just about every disc in the place, and patience enough to handle all kinds of "problem" customers, including the ebullient young folk.

3. *Interest in Records.* Though there is a difference of opinion among dealers on the subject of whether record salespeople should know music, there's no question that the applicant who knows something or even a lot about music, and has an interest in records, *plus* selling ability, usually is the most successful kind of salesperson. However, people who are "over-arty" in music, and who are also unwilling to become interested in the financial side of the business, are out, as are those who have such strong preferences in certain types of music that they are likely to take belligerent or cynical views of those customers who go for other types.

4. *Orderliness.* It is very important to you to hire nothing but orderly people, those who are capable of taking care of the stock. Salespeople who misplace records and albums, and who strew them all over the department lose money for the store, cause friction among employees and antagonize customers.

And, of course, make certain that the applicant is honest before you take him into your store. It is absolutely essential that you get references and check them.

When it comes to training inexperienced disc salespeople, the poorest method, and one employed by too many dealers, is to let the "other" employes "teach" the newcomer—when they have time. Under this plan, the new salesperson gets a lot of conflicting advice, spends too long a time learning the ropes, and wastes the time of others in asking questions. Before sending any new person out to sell on the floor, some time, perhaps at least a day, should be spent in explaining just how things tick. The training should be done by the department manager or the owner, following which the newcomer should be taken in tow out on the salesfloor to work under the direction of one person.

Things to Learn

Here are things the new salesperson should learn:

1. How to greet customers.
2. What to say when a customer asks for a record not in stock, and how to suggest substitute numbers.
3. How to sell additional records through making suggestions.
4. How to handle exchanges, returns, claims of damaged discs,

charge accounts, requests for deliveries, etc.

5. How to take care of stock, and to make reports on wanted numbers.

In addition, of course, the new salesperson should be briefed on salesmanship, and should be called a salesperson, not a clerk.

The most successful phono record departments are those in which sales meetings are held regularly, and in which salespeople operate on some sort of incentive basis, such as commissions or bonuses. Many smart dealers run sales contests for their personnel, and greatly stimulate sales via use of this method.

Upgrade Disc Personnel

A great deal of money will be made in phono record departments where salespeople are selected and trained to *sell*—not merely employed to wrap up purchases customers decide to make.

The time has come to upgrade disc personnel, and to make salesmen and saleswomen of them.

In TV-appliance-record stores, the disc department is the only one using the old-fashioned term "clerk." It's high time that such title be dropped in order to boost morale of record personnel, and give them the proper incentive to *originate sales*.

News of the Record Industry

RCA VICTOR says that "Kiddie records have come of age." RCA kiddie productions are lavish and entail almost as much work and detail as a Hollywood production. For example, their "Alice In Wonderland" album utilizes a full cast of 14 actors, three sound-effects men, a 20-piece orchestra, composer, producer, art director, and many supernumeraries in allied art and engineering fields. This album cost \$10,000



for talent alone, not including royalties. A recent survey by Victor uncovered four "musts" for any kiddie album: 1) familiar stories and well-loved characters must be selected. 2) the young listener, with a limited span of attention, must have a change of pace every 10 or 15 seconds. 3) writing and narration must provide three equally spaced high points per record side. 4) voice of narrator and characters must faithfully convey tone and mood of story.

MERCURY's Ralph Marterie and his orchestra have waxed *The Peanut Vendor* backed by *Dark Eyes*. "Vendor" has been done many times in many ways, but it always provides good listening and Marterie's new disc is no exception.

England's Old Vic Theatre, with a cast of outstanding players headed by Alec Guinness and Pamela Brown, has recently recorded a complete version of Shakespeare's *Macbeth* for RCA VICTOR. The album is the first to be recorded by the famous theatre company under a newly-signed contract.

The arranging team of Sauter and Finegan have turned their talents towards the playing of music, as well as arrangement. The former arrangers for such top bandmen as Goodman and Miller have put together a hand-picked organization in order, as they put it, "to add a broader range to the conventional combination of instruments, spiced with some new combinations of our own." Great listening comes from this merger as evidenced by their new discs on the RCA Victor label. *Rain* is backed by *Stop! Sit Down! Relax! Think!* on one platter, while the second offers *Doodletown Fifers* backed by *Azure-Te*.

COLUMBIA's Liberace, piano virtuoso, runs the musical gamut from Carmichael to Beethoven in an unusual album of popular songs and classical favorites. Entitled *Liberace At The Piano*, this recorded recital offers such melodies as *Stardust*, *Liebesträum*, *Warsaw Concerto*, *Carioca*, *Malaguena*, and *As Time Goes By*.

The Benny Goodman Trio (Goodman, Gene Krupa and Teddy Wilson) is reunited in a new Columbia album entitled *The Benny Goodman Trio Plays For the Fletcher Henderson Fund*. It includes such famous favorites as *Runnin' Wild*, *I Found A New Baby*, *China Boy* and *Body and Soul*. The Trio becomes a quartet as *On The Sunny Side Of The Street* introduces the bass of Eddie Safranski. John Smith, recent member of Goodman's Sextet, adds his guitar to make *After You're Gone* a slightly chaotic affair. Buck Clayton flashes his muted trumpet form in a lengthy rendition of Fats Waller's *Honeysuckle Rose*, and Lou McGarity soulfully recreates *Basin Street Blues*. *One O'Clock Jump* provides nearly seven minutes of improvisational blues by all the soloists for a fitting climax.

REMINGTON Records president Don Gabor has announced that Louis Livingston, formerly special consultant for public relations, has been appointed vice-president in charge of sales promotion and public relations. Livingston, in his new position, announced that the Record Review Service has been expanded and is now headed by Mrs. Francine Barth, Susan Carr, and a committee of musicologists working with the department in the preparation of program notes and items of interest pertaining to new Remington recordings.

WESTMINSTER's scheduled releases for this month include the complete version of Berlioz' 3-act opera, *The Trojans At Carthage*. Soloists Arda Mandikian, Jean Gradeau, Jeannine Collard and Xavier Depraz are among those featured. The Orchestre Societe Des Concerts De Conservatoire is conducted by Hermann Scherchen and the Ensemble Vocal de Paris is under the direction of Andre Jouve. Donizetti's comic opera *Don Pasquale* is on the Westminster roster for October. Argeo Quadri conducts the orchestra of the Vienna State Opera.

Columbia Appoints Schwartz

Irving Townsend, advertising manager of Columbia Records, Inc., has announced the appointment of Arthur Schwartz as sales promotion manager for that company. Schwartz will be responsible for the conception and preparation of all sales promotion material and will participate in all phases of advertising and promotion initiated by the advertising department.

DECCA records has been recording the Stadium Symphony Orchestra in representative excerpts from the repertoire of the series of summer symphonic concerts held at Lewisohn Stadium, located on the campus of the College of the City of New York. This is the first time in their 35-year history that the Stadium Concerts have been recorded. Good fare for the out-of-towner who could not attend as well as N. Y. residents who enjoyed the concerts first hand. The summer vacationer to New York might bring these home as a "souvenir."

MGM's Billy Eckstine is backed by Nelson Riddle and his orchestra in an adaptation of the lovely *La Cumparsita* entitled *Strange Sensation*. The sultry tango style and Eckstine interpretation are reminiscent of currently-popular *Kiss of Fire*. Flipside is *Have A Good Time*, a really lovely blues-ballad that should do quite well.

Acquaviva! This is a name to remember. Conductor Tony Acquaviva's MGM disc debut is entitled *Beyond The Next Hill*. It's one of the loveliest instrumentals to come out in quite a while. A haunting, suggestive melody, it gets excellent arrangement and presentation

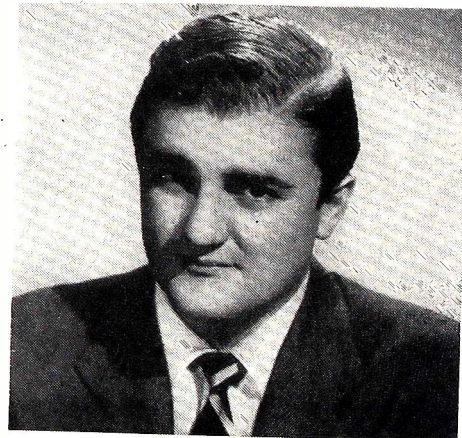

by the conductor (above). Coupling is *Tillie's Tango*—guaranteed to amuse.

The jazz collector should relish the new albums MGM has recently released of the famous Woody Herman Concert, held in 1947 in Carnegie Hall. Available in all three speeds, the two volumes feature Red Norvo, Chubby Jackson, Flip Phillips, Bill Harris, Pete Candoli and Sonny Berman. Woody Herman And The Herd play *Sweet and Lovely*, *Wild Root*, *Mean to Me*, and *The Man I Love*, to name a few. The six-year interim does not dull the brilliancy of this collection for those who love jazz.

**More News of Phono
Records, Phonographs,
on Page 120**

Record Group & RTMA Meet

Continuing its long-range program to increase interest in and use of phono records, The Record Industry Association of America, Inc. has announced that a meeting held between representatives of the RIAA and the Radio-Television Manufacturers Association resulted in plans for a cooperative effort to promote the inclusion of either record playing equipment or phono jacks on all TV sets. This plan calls for the early reactivation of the RTMA's Phonograph Industry Committee and for a survey to be made among TV manufacturers which would determine the number of video sets now being made with phono jacks. It was disclosed during the RIAA-RTMA meeting that only about 4 per cent of all new TV sets are now being manufactured with record players. During the first quarter of 1950, however, over 20 per cent of all sets were phono-equipped. The RTMA Phonograph Industry Committee has been inactive since the advent of the Korean conflict, but has never been disbanded by the set manufacturers. As a result, J. A. Berman, vice-president of Shure Brothers and chairman of the Phonograph Industry Committee, assured the RIAA that he would call a meeting of the group early in October in order to reactivate the committee. The session held at New York recently, at which plans for reviving the Phonograph Industry Committee were made, was attended by Berman, William Doyle of the Astatic Corporation, Harold Blumenthal of Shure Brothers, Vincent Liebler of Columbia Records and John W. Griffin, secretary of the RIAA.

Symphonic Announces '53 Line

A high-fidelity phonograph, model 790, and operetta console, model 791, head the list of Symphonic Radio & Electronic Corp.'s 1953 line of record players. A PA transcription record player, model 795, is also included. The back-to-college trend is evidenced in the ten new three-speed phonographs in the line. They are, Freshman Trio, model 712, Teen Ager Trio, model 713, Campus Trio, model 723, Co-Ed model 729, Studio Trio Plug-In model 743, Studio Trio model 749, Fraternity model 759, Varsity Trio model 739, Fraternity DeLuxe model 760, and Collegiate Trio model 733. Two new radio and phono combinations with three-speed record players are the Symphony Trio model 773 and Concerto Radio model 783. Rounding out the line are two single-speed phonographs—Pal Junior, model 717 and Mypal model 718. Some of the features included are Alnico #5 magnet, two-tube amplifier (including rectifier) and range, switch and volume controls.

New Crosley Post for Gold

Gene Gold, formerly sales promotion manager of the Crosley Distributing Corp., N. Y., has been promoted to the position of advertising and sales promotion manager.

Andrea Optimistic About TV

Enthusiasm for the future of TV sales were expressed by Frank A. D. Andrea, president of Andrea Radio Corp., Long Island City, N. Y., at a recent sales and marketing conference presided over by Lynn Eaton, Andrea's general sales manager. "The upturn in sales this Summer has been very encouraging and gives substance to the optimistic forecasts from industry leaders across the nation. Election year has been a stimulating influence on the business and the inventory situation at all levels is a healthy one. This condition as opposed to last Summer's hiatus can't help but have a stabilizing effect on sales," Andrea stated. Eaton outlined

the company's plan to introduce a new and revolutionary line of TV receivers at a late Summer showing for distributors and New York dealers, to be held at the Waldorf-Astoria Hotel. Without disclosing details, Andrea commented that his new line will incorporate every known advance in the art. Questioned about the company's reported heavy backlog of defense orders and its effect upon television production, Andrea stated, "The defense contracts held by my company make a healthy balance between military and civilian production. We will, of course, continue TV production on a scale to meet the increasing demand for our type of quality receiver that can brag of averaging less than one service call per set, per year."

**Reliable
Manufacturer
for over
35
years**



Your proven best
source for PHONOGRAPH
NEEDLES over the years—this newest
and most modern needle factory assures you
of continued dependable service for your
Miller Replacement Needles and
Carillon Dynamic Conventional
Needles.

New Address • 4th & Church Streets
• Libertyville,
• Illinois

M. A.
Miller **Manufacturing Co.**

"Manufacturers of the world's largest line of long-life playback and recording needles"

Latest Radio, TV Products

Webster-Chicago

In the new line of phonographs and recorders, the "Maestro" is a portable three-speed manual phonograph unit available in two color combinations—



forest green and French gray or plain burgundy. Price is \$49.50. Webster-Chicago Corp., 5610 W. Bloomingdale Ave., Chicago 39, Ill.—TELEVISION RETAILING.

Olympic

Electrically controlled clock-television is the feature of the 1953 Olympic TV line. Two "Tele Timer TV" models are included in the 14-set line retailing



from \$159.95 to \$399.95. Shown is model 17C44, Tele Timer 17-inch open faced console in mahogany listing at \$229.95. Olympic Radio & Television, Inc., 34-01 38th Ave., Long Island City, N. Y.—TELEVISION RETAILING.

Arvin TV

Prices have been adjusted to include federal tax and warranty on the 1953 Arvin TV line. Revised price list is shown in the complete "Selling Features of the Latest TV Sets," elsewhere in this issue.

Du Mont

The new line of fifteen Telesets range in price from \$199.95 ("Clinton," 17-inch table model with Plextone finish) to \$549.95 ("Flanders," 21-inch console). All prices include federal tax. Pictured

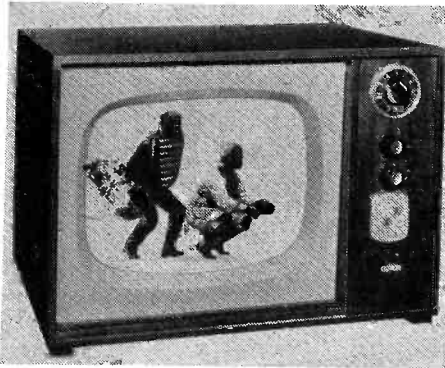

is the "Devon," 17-inch modern table model with wooden cabinet in mahogany or limed oak, retailing at \$279.95 in mahogany and \$289.95 in blonde. Allen B. Du Mont Labs, Inc., East Paterson, N. J.—TELEVISION RETAILING.

General Electric Clock-Radios

Nine new models have been added to the General Electric line of clock-radios. List prices range from \$29.95 to \$49.95. Models 551 and 552 have

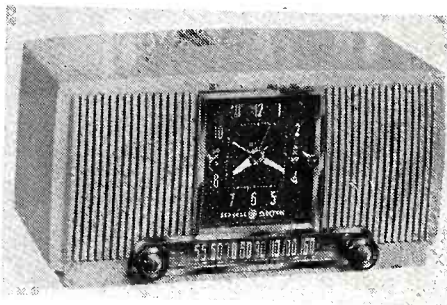

"Audio-Magic" switch and phono jack which allows the user to play his favorite recordings. The 551's mottled mahogany plastic cabinet and the 552's pearl gray plastic cabinet house six-tube chassis. The cabinets of models 546, 547, 548 and 549 are similar in design to those of models 551 and 552. All four utilize a 5-tube chassis, large dynapower speaker, built-in beamscope antenna and slide rule radio dial. The regular GE clock-radio features are also included. 5-tube models 542 and 543 represent new styling applied to the popular "wake-up-to-music" GE models. 543 has an alabaster ivory plastic cabinet, while 542 is available in mahogany mottled plastic. Model 514 has a cabinet of light-colored mahogany plastic. It has a 5-tube chassis and features a built-in beamscope antenna with the wake-up-to-music feature and buzzer. Electric Company, Electronics Park, Syracuse, N. Y.—TELEVISION RETAILING.

Sylvania

30 models are included in the new Sylvania TV line, said to feature exceptionally bright pictures, high sensitivity, greatly minimized interference pickup and "HaloLight," the border of



light framing the picture. Shown is the "Arlington," model 175M, 21-inch table model in mahogany. Available with built-in UHF reception. List price is \$389.95, and \$399.95 in blonde. Sylvania Electric Products, Inc., 254 Rano St., Buffalo 7, N. Y.—TELEVISION RETAILING.

Shura-Tone

Model 3-S is a 3-speed, 2-tube amplified portable phonograph covered in washable leatherette. Part of the new line of Shura-Tone and Howdy Doody



phonographs, the 3-S is said to be the lowest priced 3-speed portable phonograph on the market. Shura-Tone Products, Inc., 440 Adelphi St., Brooklyn, N. Y.—TELEVISION RETAILING.

T.V. Development

New 3-speed manual table model phonograph attachment is designed for use with TV or radio set. Equipped with universal needle, the unit is covered in pyroxylin coated alligator grain leatherette and carries suggested list of \$22.50. T. V. Development Corp., 2024 McDonald Ave., Brooklyn 23, N. Y.—TELEVISION RETAILING.

**the LEADER LINE
that spells...**

Quality

FADA'S *New*
PRESIDENT series
of television receivers

Only our 32 years of experience in electronics could enable us to make this epoch announcement. Only our vast experience in quality manufacture could make it possible for us to make two complete lines of saleable merchandise, both of which will meet your most exacting standards!

Fada's new PRESIDENT series currently comprises six brand-new models — in *genuine mahogany* or blonde mahogany, and priced to *compete!* Yet, quality-wise they will equal in performance *any TV receiver on the market.* Fada list prices start at \$199.95 for a full-size 17-inch table model and go to \$469.95. All prices include tax and warranty — nothing extra, no hidden charges! Every set is *quality* built for television's greatest values.

Fada's deluxe IMPERIAL series of fourteen cabinet makers' masterpieces, with famous

Power Plus CONTROL

is the Fringe Area's Greatest Performer! Every cabinet is hand-rubbed to a pinnacle of perfection by our master craftsmen... the "Power-Plus" chassis proves once again that "wherever television will perform, Fada will perform better!"



The CONCORD — Model 173T

Low priced, quality-built 17" table model. Handsome, modern, all mahogany cabinetry. Removable glass front for easy cleaning of picture tube. Model 173TBM, same in Blonde Mahogany.

FADA

RADIO & ELECTRIC CO., INC., BELLEVILLE, NEW JERSEY

See the COMPLETE LINE OF DELUXE TV receivers at your Fada distributor . . . all screen sizes and styles. All can be adapted for UHF reception in seconds by merely changing strips in the Turret Tuner. Fada UHF converters are available for all Fada TV receivers ever manufactured.

STEWART-WARNER for '53

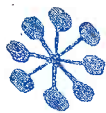

21 ways better!



Yes, 21 advanced features that put Stewart-Warner TV for '53 out in front in performance... styling... value.

Amazing new Power Booster... new Wide-Range Tone Control...
Built-in Provision for U.H.F. with Cascode Turret Tuner...
improved Syncro-Brain circuit... a total of 21 outstanding features
you can demonstrate and SELL... and only Stewart-Warner has all 21.

Before you buy any TV see Stewart-Warner for '53... "21 ways better" —
NOW on display at your Stewart-Warner distributor.

STEWART
SW
WARNER

STEWART-WARNER ELECTRIC • Division of Stewart-Warner Corp. • 1300 N. Kostner Ave. • Chicago 51, Illinois
Foremost manufacturer of radar, communications and other precision electronic equipment for the U.S. Government.



17" TABLE MODEL 21T-9211B—
 The finest... in compact mahogany table model... and in big picture 21" TV performance. In you SELL all 21 features that make STEWART-WARNER 21 ways better for 1953. Also in Blonde Oak (Model 21T-9211C).



17" TABLE MODEL 17T-9202G—
 Here's a price leader that has plenty of quality for you to SELL. Syncro-Brain circuit perfectly synchronizes TV signal for finest picture, plus many other advanced STEWART-WARNER features. Smart, modern design in mahogany finish.



21" CONSOLE MODEL 21C-9210C—
 Life-like big picture television in handsome modern mahogany cabinet styling. Exclusive new Power Booster, Wide Range Tone Control, and famous Syncro-Brain circuit for finest picture in television today.



21" CONSOLE MODEL 27C-9212A—
 Bigger than life-size picture in a luxurious mahogany cabinet. Power Booster, Tone Control, Syncro-Brain circuit, Built-in Provision for all 21 famous STEWART-WARNER selling features are

STEWART WARNER

TV For '53



21" CONSOLE MODEL 21C-9211F—
 Luxury console in modern mahogany with half-length doors. Full 21" screen, and all 21 features only STEWART-WARNER can offer. Power Booster, Tone Control, Syncro-Brain circuit, Built-in Provision for new U.H.F. stations, and all the rest. Also in Blonde Oak (Model 21C-9211G).



21" CONSOLE MODEL 21C-9211D—
 Big picture 21" TV that's "21 ways better" ... with Wide-Range Tone Control, NEW Power Booster for unequalled fringe reception. In graceful mahogany cabinet. Also in Blonde Oak (Model 21C-9211E).



NEW STEWART-WARNER AM, AM-FM, AND CLOCK RADIOS WITH FAMOUS CONCERT GRAND* TONE



MODELS 9160-A,F,G,
 Big set performance... atational price! 4 tubes plus 1 rectifier, Alnico V PM speaker. In Mahogany, Porcelain White, Arctic Gray, Green, Aquamarine or Red plastic.



AM MODELS 9161-C,D,E.
 New "Sweep-Station" dial. Full-size PM speaker, 4 tubes plus 1 rectifier. Improved iron core I.F. transformers. In Yellow and Ebony, Porcelain White and Royal Red, or Mahogany.



CLOCK RADIO MODEL 9162-C,D,E. Turns radio or appliances on and off automatically. Alarm buzzer. In Ivory, Cocoa Brown and Tan, Mist Green and Yellow. Also Model 9164-C in mahogany. Some but without appliance outlet and automatic shut-off.

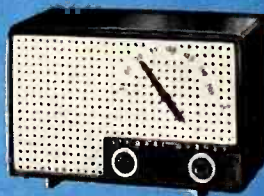

AM MODELS 9165-A,B. Powerful AM set—5 tubes plus 1 rectifier, 3-Gang Tuned RF stage, heavy duty PM speaker. Continuously variable tone control. In Ebony and Yellow or Santa Fe Red and Mexican Tan.



FM-AM MODEL 9166-A. Static-free FM and AM reception. Power-packed chassis—7 tubes plus 1 rectifier, big 6" Alnico PM speaker. Electronic FM drift suppressor, plug-in phono jack. Arctic Gray plastic.

*Trade Mark Registered

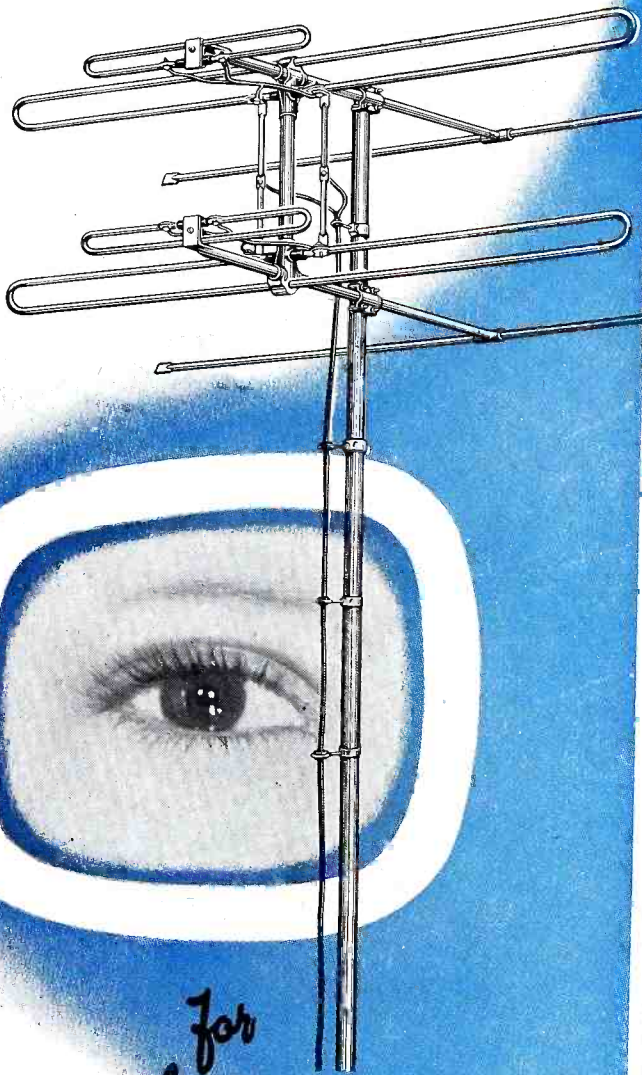

For
better
TV
Picture
Quality...

AMPHENOL **— IN LINE —**
ANTENNA

Trav-Electric



MIGHTY MIDGET CONVERTER

2 1/2" x 2 1/2" x 3 1/2" Converts 6 volt D.C. to 60 cycle A. C. 40 Watts, 110 volts. Just plug in cigar lighter. Fully Guaranteed. Trav-Electric operates small Radios, Electric Shavers, Phonographs, Small Electric Soldering Irons, Small Dictating Machines. Popular with Salesmen, Truckers, Sportsmen, Service men.

Model
6-1160
List
Price
\$15.95



Trav-Electric Sales prove its popularity Small inventory, good turnover, fine profit. Write for details today.

1000's in use
Attractive Discounts to
Jobbers and Dealers

TERADO COMPANY

1068 Raymond Ave., St. Paul 8, Minn.

The symbol of
QUALITY and **PERFORMANCE**

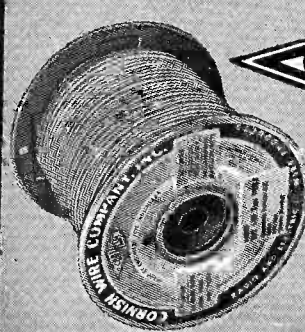

*Flexible
Cords*

in convenient lengths, on smart metal spools for fast and profitable "footage" business ... well known to your trade as the choice of leading manufacturers... also U-L approved Cord Sets that put an end to CORDelirium.

For exacting uses requiring special resistance to oil, heat and light, our SO and SJO cords are supplied with Neoprene jackets ... both 40% and 60%

CORNISH WIRE CO., INC.

50 Church St., New York 7, N. Y.

For the Autumn Market

General Electric

The new TV line includes 12 models ranging from \$199.95 to \$449.95, including federal excise tax, picture tube and parts warranty. In addition, three pre-



viously announced models, the 21T4, 21T5, and 21C200 have been retained. Shown is the 21C201, "Ultra Vision" 21-inch open-faced console in mahogany at \$419.95. General Electric Co., Electronics Park, Syracuse, N. Y.—TELEVISION RETAILING.

Tele King

Highlight of the current Tele King TV line is the "Randolph," model KD-27, 27-inch full-door console of American Chippendale design incorporating



12-inch extended range loudspeaker. Set is priced at \$595, including tax and warranty. Tele King Corp., 601 W. 26 St., New York, N. Y.—TELEVISION RETAILING.

**More New Products
Elsewhere in This Issue**

Magnavox

The new "International Modern" TV receiver utilizes a 27-inch picture tube in a 33-inch wide cabinet mounted on a new functional wrought iron base. Available in oak or mahogany, this model lists at \$595. Also available with



matching wood legs. Companion piece is the optional radio-phono unit shown placed on top and designed for operation in conjunction with the TV set. Both units combined as shown (TV plus radio-phono) are priced at \$750. Magnavox Co., Ft. Wayne 4, Ind.—TELEVISION RETAILING.

Dynavox

A feature of the new line is the model 960, portable automatic radio-phonograph combination. Unit features V-M changer, 5 tube amplifier and radio with built-in loop aerial and slide-rule dial. The 960 will play records with the lid



closed, and lists for \$89.50. Also in the new line is a phono-hassock for small-fry, portable manual phonographs in single and 3-speeds, all-speed automatics, radio-phono combinations, radios and a series of four transcription models. Dynavox Corp., 40-05 21st St., Long Island City, N. Y.—TELEVISION RETAILING.

Motorola 1953 TV Line

33 sets in new line of TV models are keynoted by a 17-inch plastic table set (17T13) priced at \$179.95 and a 21-inch plastic table set (21T3) at \$229.95. Line includes 11 table sets, 16 consoles and 6 TV-radio-phono combinations. Top of the line is a 27-inch console (27K1) listing at \$695., while the luxury combination is a 21-inch TV-radio-phono



unit priced at \$650 in mahogany (21F3) and \$675 in blond (21F3B). All prices include federal tax and one-year warranty on picture tube, receiving tubes and parts. Features of the new line include an improved Cascade tuner, automatic contrast compensation circuit, brighter pictures due to higher anode voltage and lighted channel selector. Sets are designed to accommodate a built-in UHF tuner when required. Motorola, Inc., 4545 W. Augusta Blvd., Chicago 51, Ill.—TELEVISION RETAILING.

Stromberg-Carlson

Featured in the new line is the 21-inch "Yorkshire," model 421CDM2, with three-quarter length curved doors in



Chippendale styling. Among the features of the set are retrace blanking, high gain Cascade tuner with provision for UHF strip and 12-inch speaker. Price is \$479.50 plus warranty. Stromberg-Carlson Co., Rochester 3, N. Y.—TELEVISION RETAILING.

Electrical Appliance

Westinghouse Names Dobson

R. M. Oliver, manager of appliance specialties, has announced the appointment of Robert E. Dobson as manager of the vacuum cleaner department for the Westinghouse Electric Appliance Division. Dobson will be responsible for the development, production and marketing of the complete line of vacuum cleaners including upright, tank and hand models and attachments as well as the new twin-brush floor polisher.

Maytag Appoints Hughes

The Maytag Company of Newton, Iowa, has announced the appointment of George M. Hughes of Springfield, Ohio as regional sales manager for the firm. Hughes will be in charge of nine counties in Ohio and will work under L. F. Webb, manager of the Cincinnati branch.

New Bendix Distributor

One of the South's largest distributor organizations, George H. Lehleitner & Co., 601 Galvez St., New Orleans, has been appointed as the wholesale outlet for Bendix Home Appliances, a division of Avco Manufacturing Corp. Parker H. Ericksen, director of sales for Bendix, announced the new franchise.

Coolerator Reorganizes Sales Department

Reorganization of the coolerator sales department resulted in promotions for five sales executives. Douglas W. Berguson is now district manager of sales in the New England states. Norman C. Sabee has been appointed manager of advertising and sales promotion. Roderick G. McKenzie is now manager of market research. Harry R. King is manager of the Coolerator sales order department, and Lloyd W. Wicklund has moved up to manager of Coolerator advertising production.

Thor Appoints Best

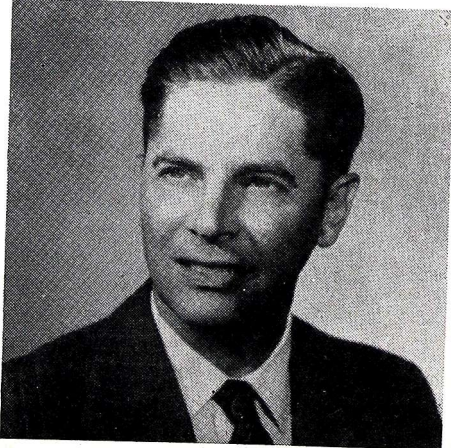

Emil G. Best (above) has been appointed dryer product manager for Thor Corp., it was announced by M. R. Wilson, general sales manager.

NEMA Okays Housewares Gift Campaign

Final details of the 1952 fall-Christmas phase of the electric housewares gift campaign were approved by the electric housewares section of the National Electric Manufacturers Association at a midyear meeting at Haddon Hall, Atlantic City, N. J. At the same time, G. W. Orr, general sales manager at Chicago Electric Mfg. Co., was appointed to succeed J. P. McIlhenny, vice-president of Waring Products Corp., as chairman of the section's sales promotion committee. Industry members received the report from the committee on the progress of the gift campaign during the first six months of 1952. The report stressed as significant the greatly increased local level participation on the part of dealers, distributors, area committees, electrical leagues, electric light and power companies and others concerned with the sale of electric housewares. Added impetus was given the campaign by intensive participation of over 825 newspapers throughout the country working with the industry-prepared sales plan book and mat kit. A recent survey indicates that the majority plan to actively tie in with the 1952 Fall-Christmas and future programs. The dealer kit for the coming Christmas will consist of a comprehensive sales planner which will contain suggestions for window displays, newspaper ads, traffic pullers, gift certificates and check list.

Proctor Shows Easier Ironing



"Take It Easy!" was the theme of Proctor Electric Company's exhibit at the recent American Home Economics Association convention in Atlantic City. Mary Proctor (Mrs. Paul Riedel), director of women's activities and the Information Center, Proctor Electric Co., Philadelphia (left) and Dr. Helen July Bond, head of the Department of Home Economics, Teachers College, Columbia University, show enthusiasm for the cause of easier ironing as they examine a chart which compares the Mary Proctor sit-down ironing method with the old methods of ironing.

Two Deepfreeze Zone Managers

Ben G. Sanderson, general sales manager of the Deepfreeze Appliance Division of Motor Products, Inc., N. Chicago, Ill., has announced the appointment of two zone managers for the Southern region. William M. Marsh is the new zone manager at Memphis, Tenn.; assisting district manager John P. Strange whose headquarters are in Birmingham, Ala. The other Southern appointment is Robert N. York, Jr., whose headquarters are Charlotte, N. C. under district manager W. D. Randolph of Atlanta.

Hotpoint Sales Upped 40 Per Cent Via Contest

Hotpoint realized a 40 per cent increase in sales of kitchen and laundry appliances over a comparable 1951 period from a nationwide 60-day "Summer Sweepstakes" sales campaign recently ended. John F. McDaniel, vice-president of marketing for the Chicago company said in announcing winners of the contest. The "Summer Sweepstakes" contest centered around a race-track theme in which General Electric Supply Co., Graybar Electric Co., and independent distributor houses participated. National and district "purses" worth up to \$1,000 were offered distributor salesmen, distributor sales managers, distributor branch managers, and sales promotion managers. Grand national prize for the top distributor salesman in the country was a Buick Riviera car and a \$1,000 vacation. Winners were selected on a basis of sales performance over contest quotas assigned by the factory. Appliances on which sales gains could be scored included ranges, water heaters, dish washers, automatic washers, refrigerators, freezers, garbage disposal units, rotary ironers, and electric clothes dryers. National grand prize of a Buick Riviera car and \$1,000 vacation was won by G. H. Efrid, General Electric Supply Co., Greensboro, N. C., McDaniel said. Efrid's final score with 661 per cent over quota, the highest figure for any distributor salesman in the nation. National prizes of \$1,000 each went to: General Electric Supply Co. salesman J. F. Newell, Asheville, N. C., 567 per cent; R. Gibson, sales promotion manager, Charlotte, N. C., 161.9 per cent; J. A. Walker, sales manager, Charlotte, N. C., 161.9 per cent; Graybar Electric Co. salesman, F. Nabors, Jackson, Miss., 466.5 per cent; L. L. Henry, sales promotion manager, Columbia, S. C., 165.6 per cent; G. L. Kirbo, sales manager, Columbia, S. C., 165.6 per cent; and Harry W. Cameron Inc., Chattanooga, Tenn. salesman, L. W. McCoy, 263 per cent, P. H. Kuhn, sales promotion manager, 142.3 per cent; A. B. Moore, sales manager, 142.3 per cent.

News and New Products

Picking Lewyt Vacuum Winner



Elizabeth Sweeney Herbert (above) food and appliance editor of McCall's Magazine and newly installed president of the American Home Economics Association, picks the winner of a Lewyt vacuum cleaner at the Association's convention in Atlantic City. The winner of the Lewyt was Miss Sue H. Taylor, Watauga County, N. C. Miss Taylor is a well-known home economist through the Southern states and was at one time an executive with the Farmer's Home Administration.

GE Campaigns for Heating Pads

General Electric has introduced a new heating pad sales campaign, called the "Big Top," which features extra pads and special displays at no extra charge to participating dealers.

Westinghouse Units Sing and Cycle for the Home Launderer



Any part of the washing cycle on the new Westinghouse Laundromat (left) can be started, stopped, repeated or eliminated to conform to the type of load, and any washing time from two to 20 minutes with full rinsing action is possible, through dial control. The new model (LB-6) also has a 16 per cent larger weigh-to-save door for easier loading and unloading. To the tune of "How Dry I Am," the new Westinghouse automatic clothes dryer signals the end of any drying cycle pre-selected on the three-way-dial. Available as a 230-volt model (D-5) or a 115-volt model (D-5A).

General Electric CLOCKS

The three new GE clocks are called the Contour, the Helper, and the Beckoner. The Contour is a kitchen clock featuring a streamlined molded plastic case. It has a large, shatterproof crystal, with numerals hot-stamped directly into the crystal. Available in white, green or red, the recommended price is \$6.95. The Helper, a low-price kitchen clock, had a snap-on shatterproof crystal and large, easy-to-read numerals. The dial is white, the numerals and hour hands black, and the second hand red. Words are enclosed in a fluted plastic case, available in red, yellow or white. Price—\$4.95. The Beckoner is an alarm clock, styled in ivory plastic. It features a green wrap-around dial and a shatterproof crystal. Recommended retail price is \$6.95. General Electric Co., 1285 Boston Ave., Bridgeport, Conn.—TELEVISION RETAILING.

Markel HEETAIRE SERIES

Markel announces two new additions to their Heetaire series. Designated as "Thriftee" Heetaires, the newly developed L147T and L148T (1320 watts and 1650 watts respectively) contain an automatic thermostatic control which automatically produces, distributes and maintains any desired temperature between 40° F. and 80° F. Extra economy and convenience are insured. Just "set it and forget it."

New Universal APPLIANCES

The Universal travel iron is light weight, portable and packs into a plastic case shaped to fit into luggage. 21 sq. in. soleplate is of polished steel with heating element mounted in recess close to bottom for fast heat. Indicator registers degrees of heat. Handle locks in ironing position and folds for carrying by pressing a release button. Current is 375 watts; 110-120 V., AC or DC. Retail price is \$9.95.

Universal Sandwich Grill and Waffle-maker (shown) is finished in heavily-plated chromium over nickel on steel base. Has two sets of easy-to-change grids and opens flat for handy table use. One-piece heating element of nichrome construction gives even heat distribution. Current 110-120 V. 750 watts. AC or DC. Retail price \$19.95.

Standard Universal heating pad is a 3-heat pad for dry pack use only. Has washable removable cover. Heating

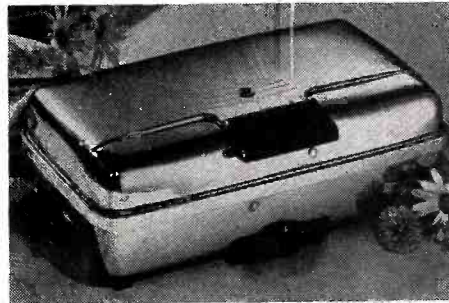

element has four separate thermostats, channelled asbestos covered wiring and extra heavy padding for comfort. Multi-heat control is adjustable to any of three degrees of heat desired. 60 watts; 110-120 V. AC or DC. Retail price is \$6.95. Universal DeLuxe heating pad had same features as standard model, but can be used for either wet or dry heat applications. Double-coated rubber cloth completely encloses heating element and is entirely waterproof. Element is 12 x 15 inches. 60 watts; 110-120 V. AC or DC. Retail Price is \$8.95. Universal leader heating pad is economy pad with 3-speed heat control, washable-removable cover. Heating element with two thermostats has channelled insulated wire and heavy padding. Heating speeds adjustable by 3-position switch; low, 20 watts; medium, 35 watts; high, 55 watts. Current 55 watts; 110-120 V. AC or DC. Retail Price \$5.95. Landers, Frary & Clark, New Britain, Conn.—TELEVISION RETAILING.

Am. Kitchens Dishwashers

Three models in the line—a dishwasher-sink combination, at \$439.95, a free-standing unit, at \$339.95, and an under-counter model, at \$319.95. American Kitchens Div., Avco Mfg. Co., Connersville, Ind.—TELEVISION RETAILING.

Appliance Service Trends

Closer Cooperation Between Manufacturer, Distributor and

Dealer Seen as Sales and Good-Will Builder



The following article was condensed from a speech made by H. E. Putnam, customer service manager, Landers, Frary & Clark, New Britain, Conn., before a conference of the International Association of Electrical Leagues at New Orleans.

• To state that a dealer either gives service or he doesn't is the same as stating that a dealer is either in business or he is on his way out. To sell—the dealer must give service—service and sales go hand in hand.

While all of our national advertising and sales promotion are aimed at the consumer, our direct contact with the consumer is through our dealer upon whom we are dependent to follow through in functioning for us not only sales-wise but service-wise. There has been too much emphasis placed on the production and sales of finished goods and too little emphasis placed on customer service at all levels. A poor service operation can tear down business as fast as good sales promotion and advertising can build it up.

A Buyer's Market

We, as manufacturers and the distributor, have a job to perform and so has the dealer. We need his coordination to complete our service picture.

With the turn of events during the last few months we have been faced with an over abundance of appliances rather than the predicted shortage. It has been a buyer's market with inventories in some in-

stances 100% above normal. The dealer has had to learn how to sell to survive. The alert dealer has combined an aggressive sales campaign with an efficient service operation.

The average factory service man is prone to be super critical of the dealer, because back at the factory he must constantly live with complaints from the consumer on dealer treatment—of course product grief is his business. For this reason, I personally try to read as many reports and articles as possible written from the sales angle or from sources outside the industry with the hope that my views will not become warped.

One Cause of the Slump

In all of these down to earth reports of general conditions at the retail level, it is pointed out in no uncertain terms that inadequate product service is at least one of the prominent causes for the slump in sales with many dealers.

To be sure, we are going through an abnormal period and a period of uncertainties. But too many dealers are willing to sit back and lay the blame for low sales volume on government regulations, high cost of living, too much competition, consumer resistance and a dozen and one other drawbacks. To be sure, they are factors but little or no thought has been given by too many dealers to the fact that inefficient service or the lack of product service has had a hand in keeping their volume at a low ebb—or that a concentrated service effort along with aggressive selling could give them the jump on their competitors. There may be consumer resistance to finished goods sales but there is never resistance to a good service operation.

An Era of "Automatics"

Let us go back a few years and review past history. The manufacturers should be somewhat humble about the lack of stress they placed on the importance of servicing. The industry as a whole was not en-

tirely alert to this angle of their business until World War II.

Shortly before World War II the industry arrived in an era of highly mechanized automatic appliances. Previous to this period we were producing only the manually operated Electric Housewares and semi-automatic major appliances on which service was comparatively easy.

Emphasis on Production

Upon entering this new era, we should have recognized the need for more service education at the dealer level in the appliance industry. But during the war and for two years after the emphasis was placed on the production of finished goods. We had a seller's market—the distributor—the dealer—the consumer—were all crying for merchandise with no thought given to product service. Service was just another operation within the industry that had to be tolerated. This was true of most lines of merchandise at that time.

Suddenly the supply met the demand and we all woke up to the fact that we could not sell without service.

An Important Function

Top managements in the industry recognizing this weakness took definite action. The service department or the product service division has stepped up into prominence as a very important function within the factory organization. And why not, when service is so vital to sales volume? This operation may not show a large paper profit but it can be responsible for that intangible profit so invaluable—the creation of good-will with the customer. The factory sales and service divisions are now working closely together coordinating their efforts. Ten years ago they were strangers.

The battle between production and service is over. Service requirements are at least on a par with finished goods requirements. It is not uncommon today to have a shut-down on the assembly line

(Continued on page 116)

The "Big Three" in TV

SCOTT · Meck · MIRROR-TONE

For more than a quarter of a century the name Scott Radio Laboratories, Inc., has represented the utmost in quality. Today, that great name is linked with Meck and Mirror-Tone as part of *the most complete line in the radio-television field.*

There's a model for every taste, a price for every purse —ranging from the economy-styled Mirror-Tone sets, through the "big screen" Meck series, to the magnificent Scott radio-television-phonograph combinations, unexcelled masterpieces of beauty, style, performance.

More than one and a half million families are satisfied owners of these sets . . . proof of the ever-growing popularity of this complete family line.

Remember, the "Big Three" in television and radio—Scott, Meck and Mirror-Tone.

Your customers have . . . *for more than a quarter of a century.*

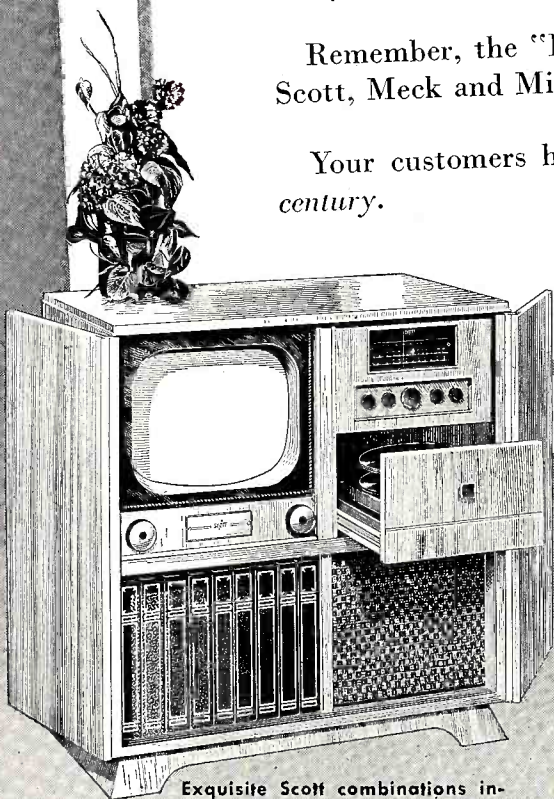

Exquisite Scott combinations incorporate the "Silver Anniversary" TV chassis . . . triple speed phonograph . . . AM/FM radio with high fidelity amplification unit.

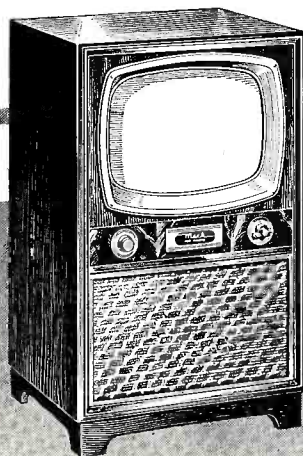

Smartly styled Meck series features crystal clear picture quality . . . full picture depth . . . clean, sharp contrasts for maximum viewing enjoyment. Adaptable to U.H.F., of course.

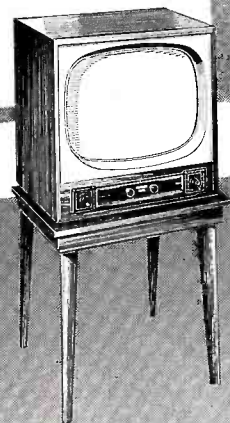

Mirror-Tone... world's lowest priced television set. Sells for as low as \$99.95— with no sacrifice of quality or performance.

MECK TV, INC.

1020 North Rush Street, Chicago, Illinois

Sell a

Great Opportunity Now to Get Results Stressing Economy
and Convenience Angles to an Aware Public

COMPLETE Home Laundry

• Never before in the history of the home laundry equipment field has there been a greater opportunity for the aggressive merchant to increase his volume in washers, ironers, dryers and electric irons.

Several most significant factors have entered into the picture, combining to make the selling of *complete* home laundries an outstandingly attractive and profitable proposition to the dealer.

Here are some of the reasons why housewives, in greater numbers than ever before, will be interested in buying:

1. Commercial laundry prices are at an all-time high, and there's always the inconvenience of waiting for the delivery man, and the possibility of damage and loss.

2. The "self-service" laundries, while they are competitors of the dealer, have "introduced," via vivid demonstration, the efficiency of modern equipment. A great many people, men and women alike, who became fed up with the inconvenience and waiting in dealing with

the self-service laundry, have come around to buying units for their home so that they can save time and money.

3. The extreme difficulty householders are having in getting domestic help, and the high salaries prevailing in the servant market are reasons, too, why many folk will be interested in buying complete laundries. Some housewives, unable to afford to have maids, will buy equipment for their own use, while others who are fortunate enough to find efficient help, and financially able to pay the high wages, can be sold on the fact that servants are more likely to stay put and be happy when working with modern washers, ironers and dryers.

Since it is certainly obvious that there are numbers of powerful sales arguments in favor of owning complete home laundries today, the dealer needs only to capitalize upon them through salesmanship, advertising and demonstration in order to increase his volume.

He should not be content to sell a washer here and there, an occasional ironer, and now and then a dryer. He should try, in each instance, to sell the customer a *complete laundry*. In so doing, he will, of course, get much larger sales per customer, and, additionally, will be performing a real service to the purchaser.

In contemplating action in this job of selling *complete laundries* to his customers, the merchant should review in *his mind* some of the things he knows are going on in the minds of non-owners and owners of *incomplete* home laundries, in order to capitalize on the known desires and buying habits of such folk. And also, of course, to get encouragement in realizing the great potential ready for exploitation.

How to Get Prospects

For instance, let's examine some typical bits of behaviorism on the part of "prospects" for laundry products, and how we can go about cashing in on them. Every dealer knows that:

1. In a great many homes where a hand-iron is the only piece of laundry equipment owned, discussions are going on concerning the advisability of buying a washing machine, or an ironer, or perhaps a complete laundry. The chances are that while the members of the family are convinced that our modern products will work efficiently, they are weighing the whole proposition chiefly from a financial viewpoint. The husband and wife want to find out whether it will cost them less to do their own work. They want to know whether they'll save time. They want to get a rough idea as to the life of the equipment. And, if they reach a decision to buy, they'll want to know where to buy.

The dealer has convincing answers to all of the questions, including the "where-to-buy" one. What he needs to do is to find the folk who are thinking about buying equipment. And when he does find them to start them off on the right foot—with a complete laundry. The ways to ferret out such prospects are, of course, through newspaper advertising, through ads in telephone directories (so that if the Joneses decide to buy equipment, and don't know a dealer, they'll be likely to look one up in such directory). Then, there's outside selling, wherein the salesman may drop in or telephone at the right psychological moment. Finally, there are
(Continued on page 112)



Mrs. Housewife's Modern Kitchen
Is a COMPLETE ONE . . .
And she wouldn't settle for anything less!

She Can Be Sold a
COMPLETE HOME LAUNDRY
as Well, and the Wide-Awake Merchant
IS GOING AFTER SUCH SALES TO INCREASE HIS
VOLUME AND TO BETTER SERVE HIS CUSTOMERS

Hotpoint

Has PACED the GREAT TRANSITION in the Appliance Industry!

OPPORTUNITY UNLIMITED...

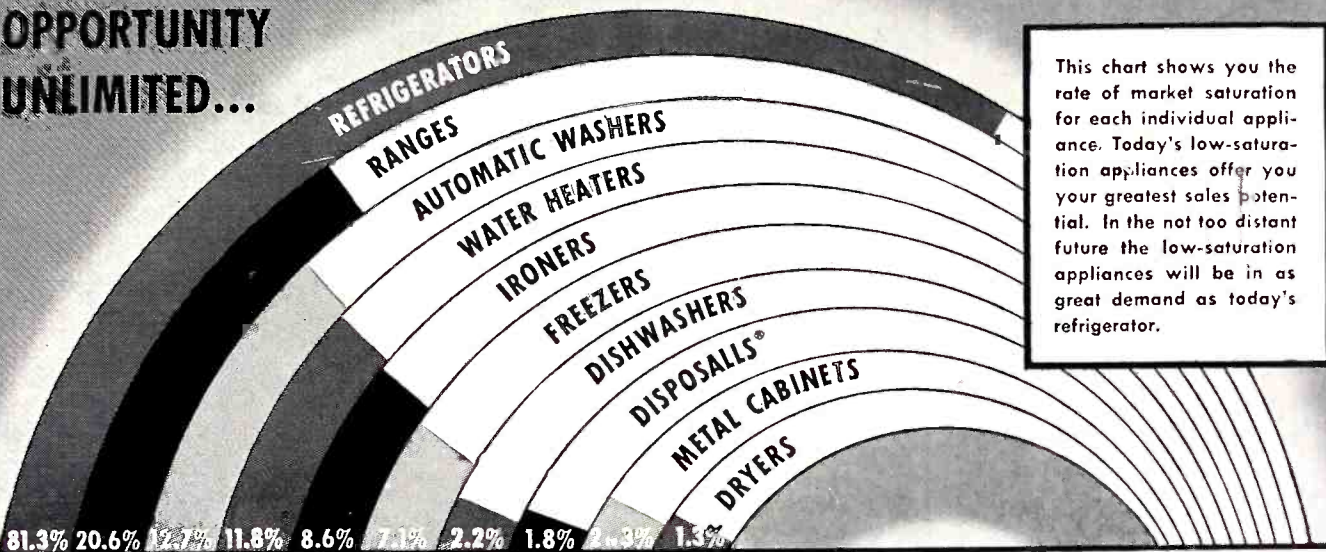

This chart shows you the rate of market saturation for each individual appliance. Today's low-saturation appliances offer you your greatest sales potential. In the not too distant future the low-saturation appliances will be in as great demand as today's refrigerator.

LEADERSHIP in the Promotion of Low-Saturation Appliances!

Today's modern homemakers are demanding all-electric living. No longer are they satisfied with the ownership of just one or two electric appliances. Their sights are set on complete all-electric kitchens and home laundries. Hotpoint's aggressive promotion of all the ingredients of the all-electric kitchen and laundry has paced this great transition and has established upsurging markets for the full and complete Hotpoint line. All-electric living has arrived!

Hotpoint has predicated its postwar expansion program on the newer appliances—appliances which hold a great future—a future with virtually unlimited marketing potentials. Electric ranges, automatic dishwashers, automatic clothes washers and dryers, electric water heaters, freezers, and food-waste disposals are all moving into the acceptance stage. The future of any successful appliance dealership lies in the active promotion of these low-saturation appliances.



The future belongs to those who prepare for it. Hotpoint has paved the way for every American home to enjoy the benefits of electrical living. Hotpoint dealers are in a position to cash in on this upsurging trend. Have a talk with your Hotpoint distributor and prepare for greater profits today and tomorrow with Hotpoint's Full-Line Franchise.

Hotpoint

...The Foremost Franchise in the Industry!

RANGES • REFRIGERATORS • DISHWASHERS • DISPOSALLS® • WATER HEATERS
 FOOD FREEZERS • AUTOMATIC WASHERS • CLOTHES DRYERS • ROTARY IRONERS • CABINETS
HOTPOINT CO. (A Division of General Electric Company) 5600 West Taylor Street, Chicago 44, Illinois

Selling Features of Latest TV Sets

MFR. and Model No.	LIST PRICE (Incl. Tax and Warranty)	TUBE SIZE (Inches)	TYPE	AM-FM PHONO JACK	UHF
Admiral, 3800 Cortland St., Chicago 7, Ill.					
17DX11	179.95	17	TP		AS
17DX10	189.95	17	TP		AS
121DX11	199.95	21	TP		AS
121DX12	219.95	21	TP		AS
121DX16	259.95	21	TW		AS
221DX15	279.95	21	CW		AS
221DX16	289.95	21	CW		AS
221DX17	299.95	21	CW		AS
221DX26	319.95	21	CDW		AS
222DX15	309.95	21	CW		AS
222DX16	339.95	21	CW		AS
222DX17	349.95	21	CW		AS
222DX26	379.95	21	CDW		AS
222DX27	399.95	21	CDW		AS
228DX16	675.00	27	CDW		AS
228DX17	695.00	27	CDW		AS
321DX26	359.95	21	CW	AM-PH	AS
321DX15	429.95	21	CW	AM-PH	AS
321DX16	449.95	21	CW	AM-PH	AS
321DX17	469.95	21	CW	AM-PH	AS
322DX16	499.95	21	CW	AM-PH	AS
221DX38	349.95	21	CDW		AS
222DX48	419.95	21	CDW		AS
222DX49	429.95	21	CDW		AS
Air Marshall Corp. 12 E. 44 St., New York 17, N. Y.					
	149.95	17	TW		AS
Andrea Radio Corp., Long Island City 1, N. Y.					
TVL17	249.50	17	TW	FM-PJ	AC
CVL17	299.95	17	CW	FM-PJ	AC
2CVL20	489.50	20	CDW	FM-PJ	AC
Ansey Radio & TV Inc., 85 Tremont St., Meriden, Conn.					
Empire	21	CDW	PJ		AS
Hampshire	21	CDW	PJ		AS
Arvin Industries, Columbus, Ind.					
7212CFP1UHF	549.95	21	C		
7212MEA-UHF	549.95	21	C		
7216CB-UHF	529.95	21	C		
7219CM-UHF	549.95	21	C		
7214CM-UHF	499.95	21	C		
7214CM	449.95	21	C		
7210CB-UHF	469.95	21	C		
7210CM-UHF	449.95	21	C		
7210CB	419.95	21	C		
7210CM	399.95	21	C		
7218CB-UHF	419.95	21	C		
7218CM-UHF	399.95	21	C		
7218CB	379.95	21	C		
7218CM	359.95	21	C		
6215CB	319.95	21	C		
6215CM	299.95	21	C		
6213TM	249.95	21	T		
6175TM	239.95	17	T		
6179TM	199.95	17	T		
Atlantic Video Corp., 18 Clinton St., Brooklyn 2, N. Y.					
520TM	299.95	20	TW	PJ	AS
620CM	329.95	20	CW	PJ	AS
621CM	354.95	21	CW	PJ	AS
720DCM	399.95	20	CDW	PJ	AS
721DCM	424.95	21	CDW	PJ	AS
X20SM	499.95	20	PJ		AS
X21SM	524.95	21	PJ		AS
824TM	399.95	24-0	TW	PJ	AS
924CM	449.95	24-0	CW	PJ	AS
X24CD	599.95	24-0	CDW	PJ	AS
1027TM	599.95	27	TW	PJ	AS
X27CD	759.95	27	CDW	PJ	AS
X30CD	999.95	30-0	CDW	PJ	AS
1130TM	795.00	30-0	TW	PJ	AS
Base TV Corp., S. Hackensack, N. J.					
Rem. Cont. 21"	449.95	21	TW		AS
Rem. Cont. 24"	599.95	24-0	TW		AS
P-80-82-83-					
84-85	639.95	21	CDW	PJ	AS
C-100	895.95	21	CDW	PJ	AS
M112	795.95	24-0	CDW	PJ	AS
M-113	815.95	24-0	CDW	PJ	AS
Bell TV, Inc., 552 W. 53rd St., N. Y. 19, N. Y.					
5220	*495.00	20	TW		AC
Belmont — see Rzytheon TV.					

MFR. and Model No.	LIST PRICE (Incl. Tax and Warranty)	TUBE SIZE (Inches)	TYPE	AM-FM PHONO JACK	UHF
Bendix TV & Radio, Baltimore 4, Md.					
OAK3	*379.95	21	CW		AS
21T3	*319.95	21	TW		AS
21KD	*399.95	21	CDW		AS
21K3	*369.95	21	CW		AS
20K2	*299.95	20	CW		AC
1702	*179.95	17	TW		AC
Berger Communications, 109-01 72nd Rd., Forest Hills, L. I., N. Y.					
PJY	229.95	17	TW		J
Capehart-Farnsworth, Ft. Wayne 1, Ind.					
1T172M	229.95	17	TW		
2C172M		17	CW		
3C212M	349.95	21	CW		
3C212B	369.95	21	CW		
4H212M	399.95	21	CDW		
4H212B	429.95	21	CDW		
5F212M	429.95	21	CDW		
6F212B	449.95	21	CDW		
7F212M	475.00	21	CDW		
8F212B	475.00	21	CDW		
9F212M	475.00	21	CDW		
10W212M	599.95	21	CW	AM-PH	
11W212M	795.00	21	CW	AM-PH	
12F272M		27	CDW		
CBS-Columbia, 170-53 St., Brooklyn 32, N. Y.					
17M18	219.95	17	TM	PJ	
17C18	239.95	17	TW	PJ	
17T18	279.95	17	CW	PJ	
20M18	269.95	20	TM	PJ	
20T18	289.95	20	TW	PJ	
21C18	349.95	21	CW	PJ	
21K28	499.95	21	CDW	AM-FM-PH	
21T11	339.95	21	TW	PJ	
21C11	399.95	21	CW	PJ	
21C21	429.95	21	CDW	PJ	
21C31	449.95	21	CDW	PJ	
21C41	449.95	21	CDW	PJ	
21K11	649.95	21	CDW	AM-FM-PH	
27C11	699.95	27	CDW	PJ	
20TX8	279.95	20	TW	PJ	
20MD8	279.95	20	TW	PJ	
17M1	*169.95	17	TM	PJ	
20M1	*199.95	20	TM	PJ	
20M3	*199.95	20	TM	PJ	
20T2	*219.95	20	TW	PJ	
20C4	*249.95	20	CW	PJ	
20C3	*299.95	20	CDW	PJ	
Conrac, Inc., Glendora, Calif.					
35M61	399.95	21	CDW	PJ	AS
36B61	414.95	21	CDW	PJ	AS
38M61	349.95	21	CW	PJ	AS
38B61	359.95	21	CW	PJ	AS
32M44	549.95	24	CDW	PJ	AS
34P44	564.95	24	CDW	PJ	AS
Crosley Div.—Avco, Cincinnati 25, Ohio					
EU-17TOL	199.95	17	TW		AC
EU-17TOLE	199.95	17	TW		AC
EU-17TOM	249.95	17	TW		AC
EU-17TOB	259.95	17	TW		AC
EU-17COL	239.95	17	TW		AC
EU-17COLB	239.95	17	CW		AC
EU-17COM	269.95	17	CW		AC
EU-21TOL	259.95	21	TW		AC
EU-21TOLE	259.95	21	TW		AC
EU-21COL	279.95	21	TW		AC
EU-21COLB	279.95	21	CW		AC
EU-21COM	359.95	21	CW		AC
EU-21COMU	409.95	21	CW		AC
EU-21COB	379.95	21	CW		AI
EU-21COBU	429.95	21	CW		AI
EU-21CDM	429.95	21	CWD		AI
EU-21CDMU	479.95	21	CWD		AI
EU-21CDB	449.95	21	CWD		AI
EU-21CDBU	499.95	21	CWD		AI
EU-21CDN	469.95	21	CWD		AI
EU-21CDNU	519.95	21	CWD		AI
EU-21PDMU	625.00	21	CWD	AM-FM-PH	AI
EU-21PDBU	645.00	21	CWD	AM-FM-PH	AI
EU-30COMU	1495.00	30	CW		AI
EU-30COBU	1545.00	30	CW		AI

MFR. and Model No.	LIST PRICE (Incl. Tax and Warranty)	TUBE SIZE (Inches)	TYPE	AM-FM PHONO JACK	UHF
DeWald, Long Island City 1, N. Y.					
ET140	201.95	14	TW		AS
ET170	208.15	17	TW		AS
ET172	276.85	17	CDW		AS
ET171	359.95	17	CW	AM-PH	AS
FT200	243.25	20	TW		AS
ET190	328.05	20	CDW		AS
FT201D	317.45	20	CDW		AC
DuMont Labs, Allen B., E. Paterson, N. J.					
Clinton	199.95	17	TP		AS
Milford	279.95	21	TW		AS
Beverly	349.95	21	CW		AS
Ridgewood	375.00	21	CDW		AS
Wakefield	389.95	21	CDW		AS
Shelburne	399.95	21	CDW		AS
Devon	279.95	17	TW	PJ	AS
Banbury	439.95	21	CDW	PJ	AS
Wickford	439.95	21	CW	PJ	AS
Somerset	449.95	21	CDW	PJ	AS
Newbury	459.95	21	CDW	PJ	AS
Wimbledon	479.95	21	CDW	PJ	AS
Whitehall-II	499.95	21	CDW	PJ	AS
Dynasty	499.95	21	CDW	PJ	AS
Flanders	549.95	21	CDW	PJ	AS
Emerson, 111 S Ave., N. Y. 11, N. Y.					
727	179.95	17	TW		AS
716	229.95	17	TW		AS
721	249.95	17	TW		AS
717	269.95	17	TW		AS
709	*289.95	20	TW		AS
711	319.95	21	TW		AS
712	329.95	21	TW		AS
714	279.95	17	CW		AS
722	299.95	17	CDW		AS
715	319.95	17	CDW		AS
719	319.95	17	CDW		AS
720	339.95	21	CW		AS
723	379.95	21	CDW		AS
732	379.95	21	CDW		AS
733	449.95	21	CDW	AM-PH	AS
Fada, Belleville 9, N. J.					
721	†*199.95	17	TW		AS
7T32	†*229.95	17	TW		AS
775T	†*239.95	17	TW		AS
7C42	†*279.95	17	CW		AS
7C52	†*309.95	17	CDW		AS
20T12	†*279.95	20	TW		AS
20C22	†*339.95	20	CW		AS
24T10	†*419.95	24-0	TW		AS
General Electric Co., Syracuse, N. Y.					
17T10	199.95	17	TW		AC
17T12	239.95	17	TW		AC
21T2	239.95	21	TW		AC
17C125	239.95	17	CW		AC
20C107	349.95	20	CW		AC
21T1	349.95	21	TW		AC
21C208	389.95	21	CW		AC
21C204	429.95	21	CDW		AC
21C201	419.95	21	CW		AC
21C202	439.95	21	CW		AC
21C214	449.95	21	CDW		AC
21C206	449.95	21	CDW		AC
21T4	319.95	21	TW		AC
21T5	339.95	21	TW		AC
21C200	369.95	21	CW		AC
Hallcrafters, 4401 W. 5 Ave., Chicago 24, Ill.					
1051	199.95	17	TP		AC
1052	209.95	17	TP		AC
1053	249.95	21	TW		AC
1054	259.95	21	TW		AC
1055	279.95	21	TW		AC
1056	289.95	21	TW		AC
1057-U	339.95	21	TW		AI
1060	329.95	21	CW		AC
1061	349.95	21	CW		AC
1062	349.95	21	CW		AC
1063	379.95	21	CDW		AC
1067	595.00	21	CW		AC
1068	625.00	27	CW		AC

O—Round
 T—Table
 C—Console
 D—With Doors
 P—Plastic
 M—Metal
 L—Leatherette
 W—Wood
 PH—Phonograph
 PJ—Phono Jack
 AI—As Is
 AS—Add Strip
 † Warranty Extra
 AC—Add Converter
 AT—Add New Tuner
 CH—Chassis
 * Tax Extra

(Continued on page 74)

All tubes rectangular unless shown as O—Round. In some instances, prices slightly higher in certain localities. Tax and Warranty included in prices unless indicated by * and/or †. Models and prices are reproduced from the latest information received from the manufacturers up to press time.

Bendix TV

Television's 
Crowning
Achievement



THE MARYLAND
Model 21KD
Mahogany console
with doors,
21" picture



THE VIRGINIA
Model 21K3
Open-face mahogany
console with
21" picture



THE FLORIDA
Model OAK3
Open-face blond oak
console with
21" picture



THE MICHIGAN
Model 21T3
Mahogany
table model
with 21" picture



THE ARIZONA
Model 21X3
Blond table model
with 21" picture
and 301B drawer base



THE MICHIGAN
Model 21T3
Mahogany table model
with 21" picture and
200M shelf base



THE DELAWARE
Model 20K2
Open-face mahogany
console with
20" picture



THE BELAIR
Model C172
Full-door, maple-finish
console with
17" picture



THE RUXTON
Model 1702
Mahogany
table model
with 17" picture

...for profit-minded TV retailers

Dealers who want a fast-moving TV line with minimum investment and maximum profit are going for Bendix* TV *in a big way.*

Because Bendix TV is aimed straight at the heart of the most profitable market, *it can bring you a steadier sales volume.*

Because Bendix TV offers generous discounts right across the board, *it can build you bigger, firmer profits.*

Because Bendix TV delivers superbly dependable performance . . . with the finest picture science has ever produced . . . *it can create long-time customer goodwill.*

The answer is unmistakably clear. From every angle, Bendix TV offers Television's Crowning Achievement in profit opportunity. That's a fact alert retailers are proving every day.

*REG. U. S. PAT. OFF.

GET FULL DETAILS ON BENDIX TV TODAY!

Bendix TV is going places . . . *fast!* If you're interested in moving along with it, write us at once for complete details. A few valuable territory franchises are still open.

One more way that  helps you sell more and profit more!

AVIATION CORPORATION—THE NAME MILLIONS TRUST

BENDIX RADIO TELEVISION AND BROADCAST RECEIVER DIVISION

BALTIMORE 4, MARYLAND

Quality Proven for Over a Quarter Century!



DEWALD
HIGH-DEFINITION
TELEVISION
and Superperformance
RADIOS

The integrity of DeWALD products is known throughout the world. Its the line that offers trouble-free satisfaction to every customer — makes friends and profits for every dealer. Full 1 year warranty on all TV tubes and TV set parts.

JOBBERS and REPRESENTATIVES

Some choice territories now available.
Write today for full information.

in RADIO and TELEVISION for SOMETHING BETTER, it's **DEWALD**

DEWALD RADIO MFG. Corp. 35-15 37th Ave., Long Island City 1, N. Y

Zenith Transfers Barnes



Mathew F. Barnes (above) has been appointed regional sales manager for Zenith Radio Corp. in the territory which includes San Francisco, as the headquarters city, Sacramento, Fresno, Salt Lake City, and Denver, it was announced by L. C. Truesdell, Zenith vice-president of radio and television. Barnes was formerly manager of Zenith's territory in the Southwest.

New Raytheon Distributor

William J. Helt, general sales manager, Belmont Radio Corp., manufacturer of Raytheon radio and television receivers, recently announced the appointment of Joske's of San Antonio, Texas, as the Raytheon distributor in that territory.

National Video Moves To New Plant

National Video Corp., Chicago producers of television picture tubes, have begun operation in their new 115,000 sq. ft. plant, it was announced by A. J. Cole, president. The new structure, located at 4300 W. 47th St., Chicago, was designed by the architectural firm of Epstein & Sons. Video's own staff of engineers created, designed and supervised the construction of all production line machinery. Railroad sidings run directly into the plant and large trucking docks span the outside of the shipping and receiving entrances. NVC expects to be able to double its output as a result of this new move.

Emerson Honors Abrams



Benjamin Abrams, president of Emerson Radio and Phonograph Corp., is presented with an album depicting 30 years of merchandising and manufacturing progress by David Hopkins (left) Emerson's former West Coast representative, at the testimonial dinner tendered to Mr. Abrams in celebration of his 30 years as Emerson's president.

ANOTHER PENTRON EXCLUSIVE



NOW! Over 4 HOURS RECORDING & PLAYBACK

NEW

MULTI-SPEED PENTRON TAPE RECORDER

10 1/2" REEL ADAPTER attaches in 1 Minute

X302
Reel Extension Kit
List \$30.00
Recorder \$179.50

Send for FREE Literature today!

Designed for standard N.A.B. reels. Converts Pentron recorder and players . . . doubles normal playing time for professional needs. Reel adapter can also be used for smaller size reels without detaching from recorder or player. Another Pentron accessory . . . the only complete line.

THE PENTRON CORPORATION

221-Rr E. Cullerton St., Chicago 16, Ill.
In Canada: Atlas Radio Corp., Ltd., Toronto

Good Advice to the Passerby

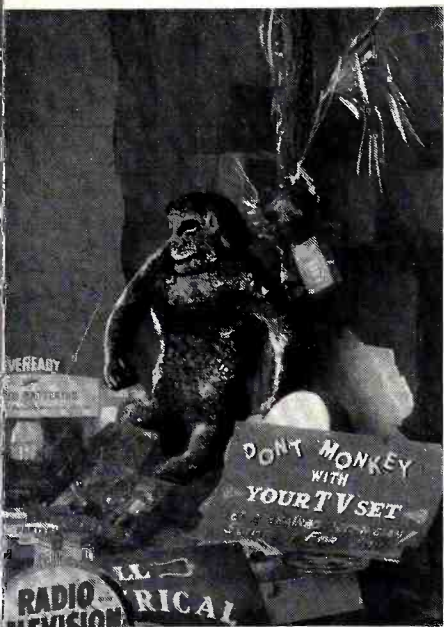

Here's how one dealer makes good use of a small show-window to stop traffic (including just about all the young ones in the neighborhood), and to urge people to get experts to service their sets. The exhibit is at the store of Jimmy Austin, proprietor of the A.A.A. Radio & Television Service, 1901 Mott Ave., Far Rockaway, N. Y. The "ape" was made by a local art student. Accompanying card reads: "Don't Monkey With Your TV Set. Let a Trained Technician Service It For You."

Olympic Clock-TV Sets

Electrically controlled clock-television, which automatically turns video programs on and off at any desired moment, is the newest innovation in television reception and is an outstanding feature of the 1953 line of receivers being manufactured by Olympic Radio & Television, Inc. Two "Tele Timer TV" models are highlights of the 14-set line. Retailing from \$159.95 to \$399.95, including picture tube and parts warranty, but exclusive of tax, the new Olympic models, with picture tubes ranging from 17 to 21 inches, are characterized by hand-finished mahogany cabinets with many new decorative features.

Stromberg Merchandising Plans

Recognizing the retailers' problems in selling television on a profitable basis in today's market, Stromberg-Carlson announced at a distributor meeting held at the Waldorf-Astoria Hotel in New York City that important changes have been made in its merchandising policies which are definitely keyed to the times. The first step in this realistic merchandising approach involves the recent announcement that the company will feature only one line throughout the entire year, as a means of protecting dealers against obsolescence and the confusion which now exists as a result of multi lines each year. Second, only eight models in popular table and console cabinet designs will be included in the Fall line—all featuring Stromberg-Carlson's exclusive Panoramic Vision with Super 21" television chassis. This chassis fulfills requirements both in fringe and primary broadcasting areas.

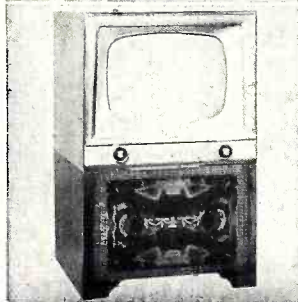
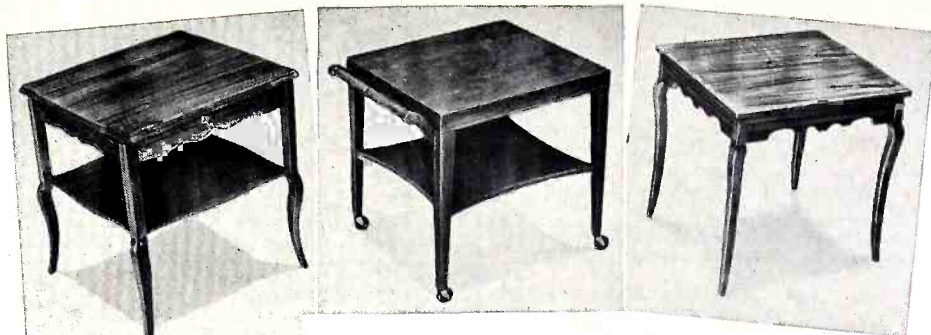

THERE IS A
Ridgeway
TV TABLE OR BASE

- For Every Television Set
- For Every Home Decor
- For Every Buyer's Purse

Every Ridgeway TV table and base, from designing board to the finished product, is built in the Ridgeway owned and operated furniture plant. This has made possible the consistent high quality and low prices that has made it America's No. 1 line.

Distributors! Chain Stores! Department Stores! Dealers!
Write for full information and illustrated brochure.

Over 50-Years
of Experience
Is Your Assurance
of Satisfaction



New York Sales Offices TV Division
LOUIS R. GOLDMAN & CO.
251 West 42nd St., New York 36, N. Y.

SERVICEMEN!

Have You Entered
THE BIG

Jensen
\$5,000.00

Cash Prize Contest?

SEE YOUR *Jensen* NEEDLE DISTRIBUTOR
TODAY FOR DETAILS AND ENTRY BLANKS.

Selling Features of

MFR. and Model No.	LIST PRICE (Incl. Tax and Warranty)	TUBE SIZE (Inches)	TYPE	AM-FM PHONO JACK	PHONO UHF
Hoffman, 6200 S. Aravan Blvd., Los Angeles 3, Calif.					
7M109	199.95	17	TW		AS
7M112	229.95	17	TW		AS
7B113	239.95	17	TW		AS
21M121	279.95	21	TW		AS
21B122	289.95	21	TW		AS
21M115	319.95	21	TW	PJ	AS
21B116	329.95	21	TW	PJ	AS
21M305	319.95	21	CW		AS
21B306	329.95	21	CW		AS
21P307	329.95	21	CW		AS
21M308	379.95	21	CW	PJ	AS
21B309	389.95	21	CW	PJ	AS
21P310	389.95	21	CW	PJ	AS
21M506	379.95	21	CW		AS
21B507	389.95	21	CW		AS
21P508	389.95	21	CW		AS
21M700	449.95	21	CW		AS
21B701	459.95	21	CW	PJ	AS
21P702	459.95	21	CW	PJ	AS
21M709	459.95	21	CW	PJ	AS
21B903	775.00	27	CW	PJ	AS
21P904	485.00	21	CW	AM-PH	AS
21P905	495.00	21	CW	AM-PH	AS
21M900	495.00	21	CW	AM-PH	AS
21B901	775.00	21	CW	AM-FM-PH	AS
21P901	795.00	21	CW	AM-FM-PH	AS
21P902	795.00	21	CW	AM-FM-PH	AS

MFR. and Model No.	LIST PRICE (Incl. Tax and Warranty)	TUBE SIZE (Inches)	TYPE	AM-FM PHONO JACK	PHONO UHF
Jackson Industries, Chicago 16, Ill.					
217T		17	T		
221T		21	T		
221C		21	C		
321C		21	C		AM
621		21	CD		AM
27CD		27	CD		
477T		21	TL		

MFR. and Model No.	LIST PRICE (Incl. Tax and Warranty)	TUBE SIZE (Inches)	TYPE	AM-FM PHONO JACK	PHONO UHF
Jewel Radio, Long Island City 1, N. Y.					
17TL-7	169.95	17	TL		AS
17TW-7	199.95	17	TW		AS
17CW-7	239.95	17	CW		AS
20TL-7	229.95	20	TL		AS
21-TW-7	249.95	21	TW		AS
21CW-7	279.95	21	CW		AS

MFR. and Model No.	LIST PRICE (Incl. Tax and Warranty)	TUBE SIZE (Inches)	TYPE	AM-FM PHONO JACK	PHONO UHF
Kaye-Halbert, Culver City, Calif.					
012M	*249.95	20	TW	PJ	AS
114W	*269.95	21	TW	PJ	AS
114M	*279.95	21	TW	PJ	AS
114PR	*299.95	21	TW	PJ	AS
122M	*299.95	21	CW	PJ	AS
124W	*329.95	21	CW	PJ	AS
124M	*339.95	21	CW	PJ	AS
124PR	*359.95	21	CW	PJ	AS
104M	*399.95	21	CW	PJ	AS
104PR	*419.95	21	CW	PJ	AS
154M	*399.95	21	CDW	PJ	AS
164M	*449.95	21	CDW	PJ	AS
144B	*459.95	21	CW	PJ	AS
144B/W	*469.95	21	CW	PJ	AS
145	*469.95	21	CW	PJ	AS
146	*469.95	21	CW	PJ	AS
425M	*499.95	24	CW	PJ	AS
425PR	*519.95	24	CW	PJ	AS
426M	*549.95	24	CDW	PJ	AS
426PR	*569.95	24	CDW	PJ	AS

MFR. and Model No.	LIST PRICE (Incl. Tax and Warranty)	TUBE SIZE (Inches)	TYPE	AM-FM PHONO JACK	PHONO UHF
Keeney & Co., J. H., 2600 W. 50 St., Chicago 32, Ill.					
	229.95	17	TW		AS
	264.95	20	TW		AS
	289.90	21	TW		AS
	274.95	17	C		
	299.95	20	C		
	329.25	21	C		

Lion Mfg., 2640 Belmont Ave., Chicago 18, Ill.
Information not available at press time.

MFR. and Model No.	LIST PRICE (Incl. Tax and Warranty)	TUBE SIZE (Inches)	TYPE	AM-FM PHONO JACK	PHONO UHF
Magnavox, Ft. Wayne 2, Ind.					
MV33J	279.50	17	CW		AT
MV91L	550.00	21	CDW	AM-PH	AT
MV68L	695.00	21	CDW	AM-FM-PH	AT

MFR. and Model No.	LIST PRICE (Incl. Tax and Warranty)	TUBE SIZE (Inches)	TYPE	AM-FM PHONO JACK	PHONO UHF
Magnavox (continued)					
MV104H	249.50	20	T		AT
MV42H	395.00	20	CDW		AT
MV88H	498.50	20	CDW	AM-PJ	AT
MV89H	545.00	20	CDW	AM-FM	AT
MV83H	550.00	20	CDW	AM-FM-PH	AT
MV100L	445.00	21	CDW		AT
MV45L	445.00	21	CDW		AT
MV90L	595.00	21	CDW	AM-FM-PH	AT
MV103H	269.50	20	CW		AT
MV102L	379.50	21	CW		AT
MV106L	289.50	21	CW		AT
MV107L	339.50	21	CW		AT
MV93L	695.00	21	CDW	AM-FM-PH	AT
MV110M	595.00	27			AT
MV110MP	750.00	27			AT

MFR. and Model No.	LIST PRICE (Incl. Tax and Warranty)	TUBE SIZE (Inches)	TYPE	AM-FM PHONO JACK	PHONO UHF
Majestic, Div. Wilcox-Gay, 385 4 Ave., N. Y. 16, N. Y.					
30	189.95	17	TW		AS
17T20	219.95	17	TW		AS
17T21	229.95	17	TW		AS
17C30	239.95	17	CW		AS
17C31	249.95	17	CW		AS
34	259.95	21	TW		AS
35	269.95	21	TW		AS
32	289.95	21	CW		AS
33	299.95	21	CW		AS
21F88	329.95	21	CDW		AS
21F89	349.95	21	CDW		AS
21F86	399.95	21	CDW		AS
21T20	269.95	21	TW		AS
21T21	279.95	21	TW		AS
21C30	299.95	21	CW		AS
21C31	309.95	21	CW		AS
21D50	349.95	21	CDW		AS
21D51	369.95	21	CDW		AS
21P60	479.95	21	CDW	AM-FM-PH	AS
21P61	509.95	21	CDW	AM-FM-PH	AS
21P62	549.95	21	CDW	AM-FM-PH	AS
21P63	579.95	21	CDW	AM-FM-PH	AS

MFR. and Model No.	LIST PRICE (Incl. Tax and Warranty)	TUBE SIZE (Inches)	TYPE	AM-FM PHONO JACK	PHONO UHF
Mattison TV & Radio, 893 Broadway, N. Y. 3, N. Y.					
27BB6	499.50	27	CW	PJ	AS
21BB6	399.95	21	CW	PJ	AS
21006	369.95	17	CW	PJ	AS
21HR6	495.00	21	CDW	PH-PJ	AS
21RE6	525.00	21	CDW	PH-PJ	AS
21RI6	650.00	21	CD	FM-PJ	AS
27RP6	795.00	27	CD	FM-PJ	AS
170U6	595.00	27	CD	FM-PJ	AS
210U6	495.00	17	CD	PJ	AS
17CA6	550.00	17	CD	PJ	AS
20CA6	495.00	17	CD	PJ	AS
210UA6	550.00	20	CDW	PJ	AS
17DI6	429.00	17	CDW	PJ	AS
20DI6	495.00	20	CDW	PJ	AS
17CO6	429.00	17	CDW	PJ	AS
20CO6	495.00	20	CDW	PJ	AS

Meek Ind., John, Div. Scott Radio Labs., Plymouth, Ind.
Information not available at press time.

MFR. and Model No.	LIST PRICE (Incl. Tax and Warranty)	TUBE SIZE (Inches)	TYPE	AM-FM PHONO JACK	PHONO UHF
Mitchell Mfg. Co., 2525 N. Clybourn, Chicago 14, Ill.					
T172M	269.50	17	CW	FM	AT
T212M	329.50	21	CW	FM	AS

MFR. and Model No.	LIST PRICE (Incl. Tax and Warranty)	TUBE SIZE (Inches)	TYPE	AM-FM PHONO JACK	PHONO UHF
Motorola, 4545 Augusta Blvd., Chicago, Ill.					
17T13	179.95	17	TP		AC-AT
17T11E	189.95	17	TP		AC-AT
17T11	199.95	17	TP		AC-AT
17T12W	219.95	17	TW		AC-AT
17T12	229.95	17	TW		AC-AT
17T12B	239.95	17	TW		AC-AT
17K14W	259.95	17	CW		AC-AT
17K14	269.95	17	CW		AC-AT
17K14B	279.95	17	CW		AC-AT
17K15	299.95	17	CW		AC-AT
17K15B	309.95	17	CW		AC-AT
17K16	319.95	17	CW		AC-AT
17F13	449.95	17	CW	AM-PH	AC-AT
17F13B	469.95	17	CW	AM-PH	AC-AT

MFR. and Model No.	LIST PRICE (Incl. Tax and Warranty)	TUBE SIZE (Inches)	TYPE	AM-FM PHONO JACK	PHONO UHF
Motorola (continued)					
21T3	229.95	21	TP		AC-AT
21T4E	249.95	21	TP		AC-AT
21T4	259.95	21	TP		AC-AT
21T5	279.95	21	TW		AC-AT
21T5B	289.95	21	TW		AC-AT
21C1	289.95	21	CW		AC-AT
21C1B	299.95	21	CW		AC-AT
21K4W	299.95	21	CW		AC-AT
21K4	319.95	21	CW		AC-AT
21K4B	329.95	21	CW		AC-AT
21K5	369.95	21	CW		AC-AT
21K5B	389.95	21	CW		AC-AT
21K6	399.95	21	CW		AC-AT
21K7	429.95	21	CDW		AC-AT
21P2	575.00	21	CW	AM-PH	AC-AT
21P2B	600.00	21	CW	AM-PH	AC-AT
21P3	650.00	21	CW	AM-PH	AC-AT
21P3B	675.00	21	CW	AM-PH	AC-AT
27K1	695.00	27	CW		AC-AT

MFR. and Model No.	LIST PRICE (Incl. Tax and Warranty)	TUBE SIZE (Inches)	TYPE	AM-FM PHONO JACK	PHONO UHF
National Co., 61 Sherman St., Malden, Mass.					
TV-1701	†269.95	17	TW		
TV-1725	†319.95	17	CW		
TV-1729	†339.95	17	CDW		
TV-2029	†419.95	20	CDW		

MFR. and Model No.	LIST PRICE (Incl. Tax and Warranty)	TUBE SIZE (Inches)	TYPE	AM-FM PHONO JACK	PHONO UHF
Olympic Radio & TV Inc., 34-01 38 Ave., Long Island City, N. Y.					
17T40W	*159.95	17	TW		AS
17T40M	*179.95	17	TW		AS
17C44	*229.95	17	CW		AS
17K41	*299.95	17	CDW	AM-PH	AS
17K42	*319.95	17	CDW	AM-PH	AS
20T46	*229.95	20	TW		AS
20C45	*269.95	20	CW		AS
20K43	*369.95	20	CDW	AM-PH	AS
17T33	*199.95	17	TW		AS
17T20M	*229.95	17	TW		AS
17T20B	*239.95	17	TW		AS

Latest Television Sets

MFR. and Model No.	LIST PRICE (Incl. Tax and Warranty)	TUBE SIZE (Inches)	TYPE	AM-FM PHONO JACK	UHF
Philco (continued)					
2273FRC	529.95	21	CDW	AT	
2273CRC	529.95	21	CDW	AT	
1883	369.95	17	CW	PH	AT
1884	399.95	17	CW	AM-PH	AT
1886	459.95	17	CDW	AM-PH	AT
1886L	489.95	17	CDW	AM-PH	AT
2183	479.95	20	CW	AM-PH	AT
2285	599.95	21	CDW	AM-PH	AT
2285L	629.95	21	CDW	AM-PH	AT
2285RC	669.95	21	CDW	AM-PH	AT
2285LRC	699.95	21	CDW	AM-PH	AT
2286	649.95	21	CDW	AM-PH	AT
2286RC	719.00	21	CDW	AM-PH	AT
2287	775.00	21	CW	AM-PH	AT
2287RC	845.00	21	CW	AM-PH	AT

Philharmonic Radio & TV, New Brunswick, N. J.					
920	219.95	20	TW	PJ	AS
9120	249.95	20	CW	PJ	AS
9820	299.95	20	CDW	PJ	AS
9121	279.95	21	CW	PJ	AS
9821	329.95	21	CDW	PJ	AS
924	379.95	24-0	CW	PJ	AS
9821-DM	369.95	21	CDW	PJ	AS

Pilot Radio Corp., 37-06 36 St., Long Island City, N. Y.					
TV271	†299.50	17	TW	PJ	AT
TV273	†359.50	17	CW	PJ	AT
TV291	†359.50	20	TW	PJ	AT
TV293	†425.00	20	CW	PJ	AT
TV274	†475.00	17	CDW	AM-FM-PJ	AT
TV294	†575.00	20	CDW	AM-FM-PJ	AT

RCA Victor Div., Camden, N. J.					
17T200	199.95	17	TM	PJ	AC
17T201	219.95	17	TM	PJ	AC
17T202	229.95	17	TM	PJ	AC
17T211	269.95	17	CW	PJ	AC
17T220	299.95	17	CDW	PJ	AC
21T208	279.95	21	T	PJ	AC
21T208EN	299.95	21	TW	PJ	AC
21T217	339.50	21	C	PJ	AC
21T218	369.50	21	CW	PJ	AC
21T227	389.50	21	CDW	PJ	AC
21T228	399.50	21	CDW	PJ	AC
21T229	399.50	21	CDW	PJ	AC
21T242	495.00	21	CDW	AM-PH	AC
21T244	595.00	21	CDW	AM-FM-PH	AC
17T250DE	279.95	17	TW	PJ	AC-AT
17T261DE	339.50	17	CW	PJ	AC-AT
21T159DE	359.50	21	TW	PJ	AC-AT
21T165DE	399.50	21	CW	PJ	AC-AT
21T174DE	439.50	21	CDW	PJ	AC-AT
21T176DE	450.00	21	CDW	PJ	AC-AT
21T177DE	475.00	21	CDW	PJ	AC-AT
21T178DE	495.00	21	CDW	PJ	AC-AT
21T179DE	525.00	21	CDW	PJ	AC-AT
21T197DE	795.00	21	CDW	AM-FM-PH	AC-AT

Radio Craftsmen Inc., Chicago 40, Ill.					
C202-CH	336.80	17, 20, 21, 24			AS

Radio & Television, Inc., Brunswick Div., 119 W. 57 St., N. Y. 19, N. Y.					
KP-221	399.50	21	CDW	PJ	AS
MA-221	399.50	21	CDW	PJ	AS
2400	435.00	24-0	CW	PJ	AS

Raytheon TV, 5921 W. Dickens Ave., Chicago 39, Ill.					
M1733	199.95	17	TL		AT
M1734	239.95	17	TL		AT
C1735	259.95	17	CW		AT
C1736	269.95	17	CW		AT
M2107	249.95	21	TL		AT
C2108	339.95	21	CW		AT
C2110	349.95	21	CW		AT
C2109	379.95	21	CW		AT
C2111	359.95	21	CW		AT
C2112	429.95	21	CW	AM-PJ	AI
C2113	449.95	21	CW	AM-PJ	AI
C2114	479.95	21	CDW	AM-PJ	AI
C2115	499.95	21	CDW	AM-PJ	AI
C2116	499.95	21	CDW	AM-PJ	AI
RC-2117	750.00	21	CDW	AM-PH	AI

MFR. and Model No.	LIST PRICE (Incl. Tax and Warranty)	TUBE SIZE (Inches)	TYPE	AM-FM PHONO JACK	UHF
Regal Electronics, 605 W. 130 St., New York 27, N. Y.					
17T20	†199.50	17	TW		AS
17C20	†217.50	17	CW		AS
20T20	†239.95	20	TW		AS
20C20	†259.95	20	CW		AS
21H20	†299.50	21	CDW		AS
24C20	†397.50	24	CW		AS

Scott Radio Labs., 1020 N. Rush St., Chicago 11, Ill.					
1000TC	1495.00	24	CDW	AM-FM-PH	AS
520TA	815.00	20	CDW	AM-FM-PH	AS
520T	785.00	20	CDW	AM-FM-PH	AS
AAV1000CA	1095.00		CDW	AM-FM-PH	AS
AAV520	545.00		CDW	AM-FM-PH	AS
AAV510AA	575.00		CDW	AM-FM-PH	AS
924W	645.00	24	CDW	AM-FM-PH	AS
820C	379.00	20	CW	AM-FM-PH	AS
820T	329.00	20	TW	AM-FM-PH	AS
817C	349.00	17	CW	AM-FM-PH	AS
817T	299.00	17	TW	AM-FM-PH	AS

Sentinel, 2100 Dempster St., Evanston, Ill.					
454-TW	199.95		TW		AS
454-TM	229.95		TW		AS
455-TM	269.95		TW		AS
456-CM	339.95		CW		AS
456-CB	349.95		CW		AS
457-CM	369.95		CDW		AS
457-CB	379.95		CDW		AS
458-TM	259.95		TW		AS
459-TM	299.95		TW		AS
459-TB	309.95		TW		AS
460-CM	379.95		CW		AS
460-CB	389.95		CW		AS
461-CM	419.95		CDW		AS
461-CB	429.95		CDW		AS
461-PP	439.95		CW		AS
462-CM	575.00		CW		AS
463-CM	625.00		CDW		AS
463-CB	645.00		CDW		AS

Setchell-Carlson, New Brighton, 12, Minn.					
531	349.00	21	CW		AS
5301	389.00	21	CW	FM-PH-PJ	AS
53	299.00	21	TW		AS
53	319.00	21	TW	FM-PJ	AS
P53	259.00	17	TL		AS

Shaw TV, 195 Front St., Brooklyn 1, N. Y.					
121	350.00	21	TW	PJ	AS
1521	439.95	21	CDW	PJ	AS
421	459.95	21	CDW	PJ	AS
2621	489.95	21	CDW	PJ	AS
2221	519.95	21	CDW	PJ	AS
2321	549.95	21	CDW	PJ	AS
3321	549.95	21	CDW	PJ	AS
921	589.95	21	CDW	PJ	AS
2021	589.95	21	CDW	PJ	AS
2521	609.95	21	CDW	PJ	AS
3421	639.95	21	CDW	PJ	AS
3521	659.95	21	CDW	PJ	AS
3021	719.95	21	CDW	PJ	AS
2727	749.95	27	CDW	PJ	AS
2827	829.95	27	CDW	PJ	AS

Sheraton Television Corp., Red Bank, N. J.					
17MC10	229.95	17	TL	PJ	AS
17MC20	239.95	17	TW	PJ	AS
21MT10	269.95	21	TW	PJ	AS
21BT10	279.95	21	TW	PJ	AS
21MC10	299.95	21	CW	PJ	AS
21BC10	319.95	21	CW	PJ	AS
21MD10	339.95	21	CDW	PJ	AS
21BD10	359.95	21	CDW	PJ	AS
27MD10	599.95	27	CDW	PJ	AS
530DX10	219.95	20	CH	PJ	AS

MFR. and Model No.	LIST PRICE (Incl. Tax and Warranty)	TUBE SIZE (Inches)	TYPE	AM-FM PHONO JACK	UHF
Shevers Inc., Harold, 123 W. 64 St., N. Y. 23, N. Y.					
217P	199.95	8 1/2-0	TL		AS
B217		21	TDW		AS
2271	†299.95	17	TW		AS
2273	†339.95	17	TL		AS
2275	†399.95	17	DL		AS
219	†299.95	17	CDW		AS

Sightmaster Corp., 111 Cedar St., New Rochelle, N. Y.					
17E52	†199.00	17	TW	PJ	AC
20K52	†595.00	20	CDW	PJ	AC
20E52	†299.00	20	CW	PJ	AC

Sound Laboratories, 323 E. 48 St., New York 17, N. Y.					
5230	695.00	21	CDW	AM-FM-PH	AS

Spartan Radio-Television, Jackson, Mich.					
5301	199.95	17	TP		AS
5325	259.95	17	TW		AS
5340	279.95	21	TW		AS
5342	329.95	21	TW		AS
5362	319.95	17	CW		AS
5380	339.95	21	CW		AS
5383	379.95	21	CW		AS
5384	439.95	21	CDW		AS
5386	459.95	21	CDW		AS
5390	589.95	21	CDW	AM-PH	AS

Sterling—see Atlantic Video					
------------------------------------	--	--	--	--	--

Stewart-Warner, 1826 Diversey Pkwy., Chicago 14, Ill.					
17T-9202G	199.95	17	TW		AS
21T-9132A	349.95	21	TW		AS
21T-9210A	279.95	21	TW		AS
21T-9211B	319.95	21	TW		AS
21T-9211C	329.95	21	TW		AS
17C-9202C	229.95	17	CW		AS
17C-9202E	249.95	17	CDW		AS
21C-9210AB	299.95	21	CW		AS
21C-9210C	329.95	21	CW		AS
21C-9211D	349.95	21	CW		AS
21C-9211E	359.95	21	CW		AS
21C-9211F	389.95	21	CDW		AS
21C-9211G	399.95	21	CDW		AS
27C-9212A	499.95	27	CW		AS
17C-9121E	499.95	17	CW	AM-FM-PH	AS
20C-9124A	449.95	20	CDW	AM-FM-PH	AS

Stromberg-Carlson, 100 Carlson Rd., Rochester 3, N. Y.					
421TQ	†295.00	21	TP	PJ	AS
421TX	†329.50	21	TP		

Selling Features of Latest TV Sets

(Continued from page 75)

MFR. and Model No.	LIST PRICE (Incl. Tax and Warranty)	TUBE SIZE (Inches)	TYPE	AM-FM PHONO JACK	UHF
Tele King Corp., 601 W. 26 St., New York, N. Y.					
K73LV	169.95	17	T		
K74	199.95	17	TW		
K72	249.95	17	TW		
K72B	269.95	17	TW		
K71	289.95	17	CW		
K72B	309.95	17	CW		
KD71	329.95	17	CDW		
KD72B	349.95	17	CDW		
KD71X	339.95	17	CDW	AM-PH	
KD71XB	359.95	17	CDW	AM-PH	
K22	229.95	20	TW		
K21	299.95	20	TW		
KC21	339.95	20	CW		
KC22B	359.95	20	CW		
K11	319.95	21	TW		
K11B	339.95	21	TW		
KD11	399.95	21	CDW		
KD11B	429.95	21	CDW		
KD12M	429.95	21	CDW		
KD12C	429.95	21	CDW		
KD13	399.95	21	CDW		
KD11X	439.95	21	CDW	AM-PH	
KD11XB	469.95	21	CDW	AM-PH	
KD27	595.00	27	CDW		
KD28	629.95	27	CDW		
KC11	359.95	21	CW		
KC11B	379.95	21	CW		
Trad TV Corp., Asbury Park, N. J.					
Information not available at press time.					
Trans-Vue—see Jackson					
Trav-Ler Radio Corp., Chicago, Ill.					
244-30	*99.95	14	TW	AC	
217-31	*134.95	17	TW	AS	
217-32	*149.95	17	TW	AS	
217-33	*169.95	17	CW	AS	
220-34	*149.95	20	TW	AS	
220-35	*169.95	20	TW	AS	
221-36	*199.95	21	CW	AS	
Universal Major Appliance, Lima, Ohio					
UTV240CM	569.95	24	CW	AC	
UTV21-2DCM	429.95	21	CDW	AC	
UTV210CM	369.95	21	CW	AC	
UTV21TM	299.95	21	TW	AC	
UTV20TM	229.95	20	TW	AC	
UTV-21-OCB	379.95	21	CW		
UTV-21-2DCB	445.95	21	CDW		
UTV-21-2DCKP	489.95	21	CDW		
UTV-21-2DCFP	499.95	21	CDW		
UTV-24-OCB	589.95	24-0	CW		
Vidaire Mfg. Co., 576 W. Merriek Rd., Lynbrook, N. Y.					
Standard	379.95	20	CW	PJ	AS
Modern	419.95	20	CDW	PJ	AS
Economy	249.95	17	TW	PJ	AS
Mod. Deluxe	489.95	20	CDW	PJ	AS
Regent	459.95	20	CDW	PJ	AS
Arlington	509.95	20	CDW	PJ	AS
Video Products—see Sheraton Television Corp.					
Westinghouse Electric Corp., TV-Radio Div., Sunbury, Pa.					
H-706T16	189.95		TP		AT
H-681T17	199.95		TP		AT
H-704T17	229.95		TP		AT
H-700T17	249.95		TW		AT
H-701T17	259.95		TW		AT
H-699K17	269.95		CW		AT
H-702K17	289.95		CW		AT
H-703K17	299.95		CW		AT
H-708T20	259.95		TP		AT
H-725T20	289.95		TW		AT
H-692T21	299.95		TW		AT
H-710T21	299.95		TW		AT
H-713K21	359.95		CW		AT
H-695K21	369.95		CW		AT
H-714K21	369.95		CW		AT
H-715K21	389.95		CW		AT
H-720K21	425.00		CDW		AT
H-721K21	425.00		CDW		AT
H-722K21	475.00		CW		AT
Westinghouse (continued)					
H-688K24	625.00		CDW		AT
H-730C21	595.00		CW	AM-FM-PH	AT
H-732C21	499.95		CW	AM-FM-PH	AT
H-733C21	525.00		CW	AM-FM-PH	AT
Zenith Radio, 6001 W. Dickens Ave., Chicago 39, Ill.					
K1812R	199.95	17	TL		AS
K1812E	209.95	17	TL		AS
K1815R	219.95	17	TL		AS
K1815E	229.95	17	TL		AS
K1820R	239.95	17	TW		AS
K1820E	249.95	17	TW		AS
K2229R	269.95	21	TL		AS
K2235R	279.95	21	TW		AS
K2230R	299.95	21	TL		AS
K2230E	309.95	21	TL		AS
K2240R	319.95	21	TW		AS
K2240E	329.95	21	TW		AS
K1846R	269.95	17	CW		AS
K1850R	289.95	17	CW		AS
K1850E	299.95	17	CW		AS
K2258R	349.95	21	CW		AS
K2260R	379.95	21	CW		AS
K2263E	399.95	21	CW		AS
K2266R	429.95	21	CDW		AS
K2267E	449.95	21	CDW		AS
K2268R	499.95	21	CDW		AS
K2873R	695.00	27	CDW		AS
K2873E	750.00	27	CDW		AS
K1880R	449.95	17	CDW	AM-FM-PH	AS
K2286R	499.95	21	CDW	AM-FM-PH	AS
K2287R	599.95	21	CDW	AM-FM-PH	AS
K2290R	695.00	21	CDW	AM-FM-PH	AS
K2291E	750.00	21	CDW	AM-FM-PH	AS

O—Round
T—Table
C—Console
D—With Doors
P—Plastic
M—Metal
L—Leatherette
W—Wood
PH—Phonograph
PJ—Phono Jack
AI—As Is
AS—Add Strip
AC—Add Converter
AT—Add New Tuner
CH—Chassis
* Tax Extra

† Warranty Extra

All tubes rectangular unless shown as O—Round. In some instances, prices slightly higher in certain localities. Tax and Warranty included in prices unless indicated by * and/or †. Models and prices are reproduced from the latest information received from the manufacturers up to press time.

NAMM to Meet in Colorado

Harry E. Callaway, president of the National Association of Music Merchants, has completed the appointment of his executive committee and has called a meeting of that group for September 19 and 20 at the Hotel Colorado, Glenwood Springs, Colorado.

Members of the executive committee include in addition to Mr. Callaway, NAMM board chairman, Ray S. Erlandson, San Antonio, Texas; vice-president, Russell B. Wells, Denver, Colorado; secretary, Ben F. Duvall, Chicago, Illinois; treasurer, Parker M. Harris, New Orleans, Louisiana.

At the executive committee meeting the principal subjects to be discussed include the location of the Midyear meeting of the NAMM board of directors which will be held in February 1953; membership promotion and main-

tenance; appointment of new committee chairmen and formulation of committees.

Of great interest to the executive committee members will be the preliminary results of the poll currently being taken among the exhibitors at the 1952 Music Industry Trade Show. The poll is being taken to ascertain the opinion as to whether or not the 1955 Music Industry Trade Show should be held again in New York City. A new finding is also being made to ascertain exhibitor preference as to holding the show in mid-June or mid-July. Results of this exhibitor poll will affect only the arrangements for the 1955 Trade Show since the 1953 and 1954 exhibits are already scheduled for the Palmer House in Chicago the weeks of July 13 and July 12 respectively.

Final action on the Association's exhibitor query will be taken by the full

board of directors at their Midyear meeting.

Florsheim Heads EP&EM

Francis F. Florsheim, of Columbia Wire & Supply Co., Chicago, was named chairman of the Association of Electronic Parts and Equipment Manufacturers, a trade association of 120 Midwest firms, at the group's annual meeting here at Chicago. Karl W. Jensen, of Jensen Industries, Inc., Chicago, was named vice-chairman.

Helen Staniland Quam, of Quam-Nichols Co., Chicago, was reelected to her fifteenth term as treasurer and Kenneth C. Prince was reappointed executive secretary of the association.

Florsheim, who had been vice chairman of EP&EM, succeeds John H. Cashman, of Radio Craftsmen, Inc., as chairman.

Another case history of the Profitable Magnavox Franchise

"Our Magnavox sales represent 84% of our Television-Radio-Phonograph volume — despite the fact that we sell three other big-name lines."



Al Mehagian
Mehagian's, Phoenix, Arizona

President

- AND Magnavox makes another all-important contribution to Mehagian's, a home furnishings store which caters to a distinctive clientele . . . Magnavox builds prestige for the entire store.

• In President Mehagian's words:

• "I consider Magnavox to be the most highly honored franchise in our store. It has brought both prestige and profit to our organization and the enthusiasm for your products increases each year. This enthusiasm for the Magnavox line is shared also by our entire store personnel.

• "In 1951, our purchases from Magnavox were considerably greater than from any other source

serving our store . . . our Magnavox sales represented 84% of our total television and radio-phonograph volume.

• "We have followed the pattern outlined by your fine company in regard to the merchandising of television and it has led to a *profitable* operation in this highly competitive business and changing market."

the magnificent

BETTER SIGHT . . . BETTER SOUND . . . BETTER BUY
Magnavox

television - radio - phonograph

COAST-TO-COAST THE STORY IS THE SAME . . . for a sound, profitable, long-term business, Magnavox is the BEST franchise.

The Hi-Fi Picture Today

All Segments of Industry Seen Ready to Cooperate in Cashing In on Increased Consumer Interest. Tips on Selling and Assembling

• Numbers of people are hearing about Hi-Fi today, and are becoming interested in buying custom-built units to provide them with better music.

Some dealers are making money selling instruments they assemble to discriminating customers, and also in building Hi-Fi components into instruments owned by consumers.

A long-range view of the possibilities for real profits and satisfactory volume in Hi-Fi at the dealer level reveals the fact that in order to attain such goal several steps must be taken by suppliers and retailers.

First, of course, the retailer must be able to purchase equipment at discounts which are attractive to him, and second, such equipment must be available through established distribution channels. Second, and of utmost importance is the fact

that the dealer must do a lot of spade-work in selling Hi-Fi to his customers.

Because a great many important component manufacturers are sold on the future of Hi-Fi it is quite likely that they will see to it that the dealer is properly implemented to do a good job. Such manufacturers realize that in order to get the ball rolling they will have to count on the nation's retailers with service departments to do the necessary missionary work in the field. They know that the only way to attain large sales volume is to work through the dealers. In light of these facts, retailers are justified in foreseeing a rosy future for them in this Hi-Fi field where consumer interest is growing daily.

There are things the dealer can do today to get started in the Hi-Fi

business. Those who have been eyeing the possibilities with a wistful eye, and nothing more than some vague plans for the future, should get started now with some definite action. Some of the steps to take are such preliminary ones as finding sources of supply, acquiring technical information on components, and accumulating other data such as prices.

Display Fine Cabinets

For those who have already done some Hi-Fi work for customers, and hence, have gained considerable experience, the advice is to try to increase volume through advertising, calling on users for leads, and in setting up demonstration centers in the store.

One Long Island, N. Y., dealer displays a number of attractive blank cabinets in his show-window and inside the store, along with signs stressing the fact that the firm builds sets in all sorts of combinations for its customers, providing them with high-fidelity reception.

The satisfied user is of course a prime source of leads since he is always proud of the fine equipment he owns and never loses an opportunity to demonstrate it to each and every visitor.

Use Effective Ad Copy

Advertising can be made to pay if copy is properly prepared so that the reader understands it quickly and thoroughly. Such phrases as "high fidelity reception," "fine music," and "superb tone" should be used instead of "Hi-Fi" in ad messages. The dealer should offer to "convert" customer's equipment, build fine instruments to order, or in cases where he has completely-assembled units, invite folks in to hear them.

One of the best ways to get volume in fine instruments is to have a demonstration center in the store. Here, the discriminating customer can see fine cabinetry, be offered a variety of finishes, and can listen to fine music through records, tape recordings or off the air.

(Continued on page 108)

CUSTOM BUILT HI-FI COMBINATION

John Jones
(Customer's Name)

	MAKE & MODEL	PRICE
TELEVISION	<i>Already has - We will connect</i>	\$ 50.00
PHONOGRAPH	<i>3 speeds - Model 21</i>	100.00
AM-FM RECEIVER or TUNER	<i>Johnson 828</i>	75.00
LOW FREQUENCY "WOOFER"	<i>12" Halscy</i>	45.00
HIGH FREQUENCY "TWEETER"	<i>5" Halscy</i>	50.00
ASSEMBLY, HOOKUP, incl. 90 day labor warranty		
CABINET	<i>We will install in customer's cabinet</i>	\$ 320.00
Total		

Plus installation in customer's home @ \$5.00 /hr.

It is understood that all parts used in this installation and purchased from Blank Radio are under the standard RTMA 90 day warranty.

PAID \$75.00 on account. Balance due on completion of installation.

W.A. Meyer

Achieved in the tradition of **Quality**

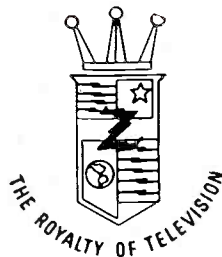

ZENITH

Proudly Announces

THE ROYALTY LINE

WITH THE NEW "K-53" CHASSIS AND SUPER-AUTOMATIC STATION SELECTOR

The Finest Television Receivers

Ever To Bear The Zenith Name

It's here—after two years of research and planning—the line destined to make profit history! We think it's the best-looking, best-performing TV line ever developed . . . and tests and comparisons bear us out.

There's the new "K-53" Chassis—so powerful, so superior to anything the TV industry's ever known—that its million-dollar cost to us was more than worth while. There's the amazing Super-Automatic Station Selector—the quickest, most satisfactory provision for adding UHF ever devised. And there are scores of other miracle new TV features.

See this great new line at your Zenith Distributor's. Note the wide range of decorator styles. Check the power and sensitivity of every set. Then look at those low price tags! Yes, this year your every customer can afford Zenith Quality TV— at prices starting at \$199.95, including tax and warranty.

Plan now to get behind 1953 Zenith TV—the line that has everything.
It's a direct line to profits.)

T2224



ZENITH RADIO CORPORATION, Chicago 39, Illinois

Building Direct-Mail Lists

How to Collect Names,
Keep Records Up to Date

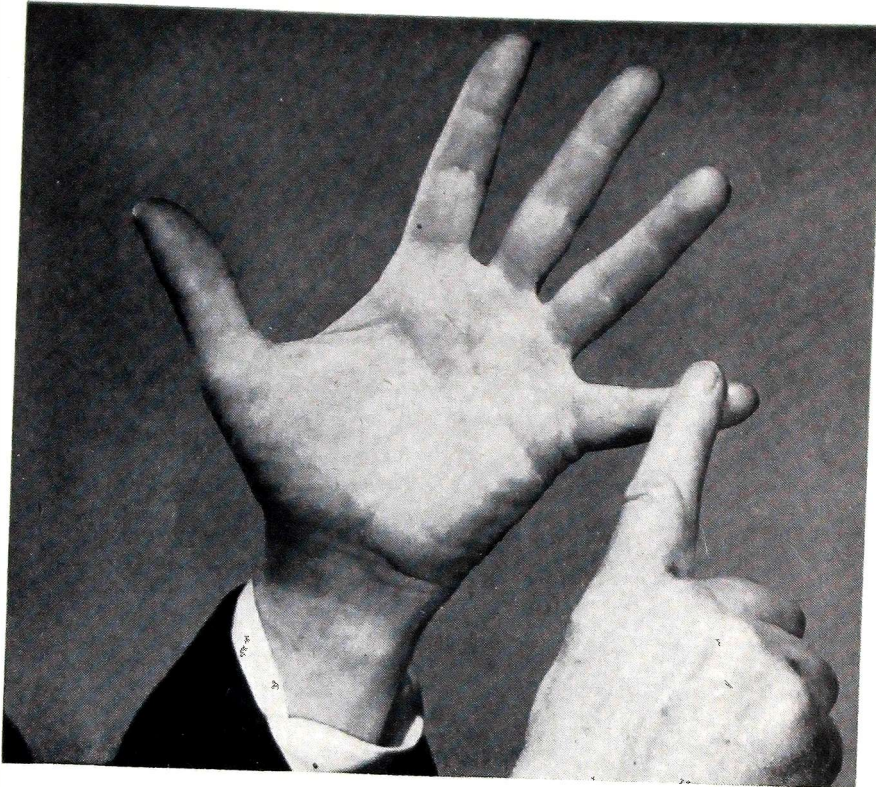

There Are
5

Main Steps
to Building
the Valu-
able Mail-
ing List

•
Read the
How-to
Rules in
this
Article

whom the pieces are directed. It is the advertiser's task to establish his own list, upon which depends the success of his own campaign.

Compiling the Mailing List

Building a good list is not a difficult job. It requires, however, rigid adherence to certain basic rules which are listed below:

1. *The Names Must Be Potential Customers.* The people on the list must be logical prospects for the items advertised. The recipient must be in a present or future position to adapt the ideas you are trying to impart.

2. *The List Must Be Up-to-date.* Most people are in a constant state of flux. They are always moving. They get married. They have children. They die. A good list changes with similar regularity.

3. *The List Must Be Accurate.* One of the surest ways to antagonize a customer is to misspell his name or call him "Mrs." instead of "Mr." When you are gathering your list, it is essential to get correct information as to spelling and other details. This, too, must be kept up-to-date to insure accuracy.

4. *The List Must Be Complete.* It should contain complete data which will enable the advertiser to know his prospects well. If possible, a list should contain financial status and any other pertinent information which can be obtained.

5. *The List Should Be Free of Duplication.* In gathering lists from separate sources, it is important that there is no duplication of names. If one person receives two identical mailing pieces, the effect of both may be lost entirely.

Gathering the Names

Mailing lists can either be bought or built. There are companies which specialize in compiling and selling lists. You can buy a list of names in practically any desired quantity and grouped in many varied categories. You can purchase names of people in your own town listed according to income bracket groups, neighborhoods, educational qualifications, etc. Remember, however, that

(Continued on page 112)

• For the TV-appliance-phonograph record dealer, direct-mail advertising can be an extremely important medium. Many successful businesses have been built by employing this mode of promotion almost exclusively. Others have utilized direct-mail to supplement newspaper and radio advertising. In almost every case, it has proved to be a substantial business getter. Its importance cannot be over-emphasized. Let us, therefore, probe into direct-mail advertising to see what makes it tick.

Many Advantages

Basically, direct-mail consists of any advertising matter which is sent through the mails directly to potential customers. The message may be carried in the form of postcards, letters, leaflets, booklets, folders, broadsides or catalogs. In contrast with other media such as newspapers, magazines or radio, direct-mail is not accompanied by any "interest" or editorial material. Its success depends upon its own merits and its biggest competitor is the wastepaper basket. The recipient must be attracted to the mailing piece, immediately, or

the costly advertising matter becomes scrap. Even with this important obstacle, direct-mail possesses some very intrinsic advantages, most important of which are as follows:

1. Direct-mail costs are more flexible than the costs of other media. You can spend as little or as much as you desire.

2. Direct-mail can be used with a minimum "waste" circulation. The advertiser selects the list of prospects to whom the piece will be sent.

3. Direct-mail advertising results can be checked accurately. Each recipient is known by the sender and can be subjected to various types of copy approaches. This means that after testing, advertising matter can be improved.

4. The advertiser controls his direct-mail circulation as to amount, distribution and quality. He establishes and maintains his own list. He can send a personalized message and can devote more space to the recipient's individual problems. In other words, he can sell his merchandise *in terms of his customers' specific desires and needs.*

Probably the most important element in successful direct-mail advertising is the list or the names to

THERE ARE NO FALL GUYS HERE!

REPRINTED FROM
ETAILING DAILY

ATTENTION ALL T.V. AND APPLIANCE RETAILERS "LO BROTHER FALL GUYS"

- ? How did you enjoy working last year for the television manufacturers, for free?
- ? What did you think of selling TV for less net profit than your operating cost and subsidizing the TV manufacturers with profits from white goods?
- ? How did you like the way your margins were cut by the ruse of quoting excise tax and warranty separately on your invoices and sales, then handling this money, from the customer to the distributor, at a bookkeeping loss, and paying this money, with your capital, before you received it?
- ? Was it a privilege to be forced to purchase a parts warranty you did not want, and then be forced to go through an elaborate system of bookkeeping for parts return & replacement, and pay freight & handling? Both ways?
- ? How did it agree with your company policy to set a price and then tell the customer what she had to pay to own it? Did you fully appreciate customer reaction to this practice? There are a number of other questions we would like to put in this box but we do not think it good policy to put them in print as they all pertain to the basic reasons behind this condition and the question of survival for the dealer.

"LISTEN BROTHER FALL GUYS"

- You can do something about this. If you don't you can kiss your business "good bye," for it is only a question of time.
- Get together with other dealers and dealer associations in your area and do what we are doing.
- We will not buy any TV set unless it carries a fair margin of profit.
- We refuse to pay separate charges on any invoice or handle money without profit.
- We will continue to spend advertising money, like this, to awaken other dealers to the fact that they are the customers and can give their money to charity if they desire, but they do not have to donate to the TV manufacturers the profit made in other lines.
- Now do your part—Start the ball rolling in your area—Take action on policy now and advertise in the trade papers. Don't be a fall guy any longer.

Appliance Dealers Association of Stamford, Conn., 32 Worth St., Stamford, Conn.

With *Tele King*
you make almost
twice the usual
profit... and it's
all yours!

Drake's radio and appliances
A LETTER FROM A TELE KING DEALER
171 MAIN STREET • MIDDLETOWN, CONN. TELEPHONE 6-78
TELEVISION • CONSOLES • PHONO-RADIO COMBINATIONS • PORTABLES • TABLE RADIOS • AIR CONDITIONING
February 7, 1952
WE'RE ALL MAKERS OF LOSS

Tele King Connecticut Corp.
63 Buckingham Street
Hartford, Connecticut

Attention: Nathan Altman, District Mgr.

Dear Nate:

My auditor has just finished the annual audit of my books and you will no doubt be pleased to learn that his report shows conclusively that the Tele King line has afforded me double the profit that I have enjoyed on any other merchandise.

Today Tele King is the top line in this store and both myself and my floor salesmen concentrate our efforts on selling and installing Tele King sets.

We find that from all angles, service wise and absence of electronic trouble, Tele King deserves every bit of attention we can give it and we will continue to merchandise Tele King to the utmost of our efforts.

Please accept my earnest thanks for your continued cooperation and good will.

Any time that any of your dealers wishes my frank and honest opinion he has my permission to call me or write me.

Very sincerely yours,
Stanley A. Drake

Tele King says you're entitled to a decent profit—and does something about it!

1. Biggest mark-up in the industry!
2. Quality that's tested and proved by over a half million sets in use!
3. Tele King requires a minimum of service calls—the Tele King tuner has fewer moving parts to get out of order!

Top working for peanuts—sell TELE KING, America's No. 1 profit line!



Tele King

THE BEST IN TELEVISION AT ANY PRICE!

TELE KING 601 WEST 26TH STREET, NEW YORK 1, N. Y.

Send for FREE book—it's loaded with selling ideas!

"Balanced" Store Builds Sales

Kansas Dealer Gives Equal Attention to Radio, Records, Appliances, Servicing and Makes Each Department Pay Its Own Way



Here's the radio and record section of The Appliance Mart. Manager Bob Smalley likes the idea of demonstrating records on a new combo, in order to get prospects acquainted with the instrument. Counter at right is self service.

• There is a sizable and gilt-edged stream of traffic among the various sections of the store called The Appliance Mart, 612 N. Main, Newton, Kansas, and it has made a real "diversification" fan out of the manager, Bob Smalley.

The handsome store has four main lines of approach to the customer—radios, appliances, records and service—and there's nearly always something doing.

On the "appliance side" of the big store in Newton, Kansas, refrigerators are shown against the newly painted dark-green wall; other appliances at the center. The Appliance Mart stocks room air conditioners, too, for summer-month emphasis and for extra profits during the warm weather.

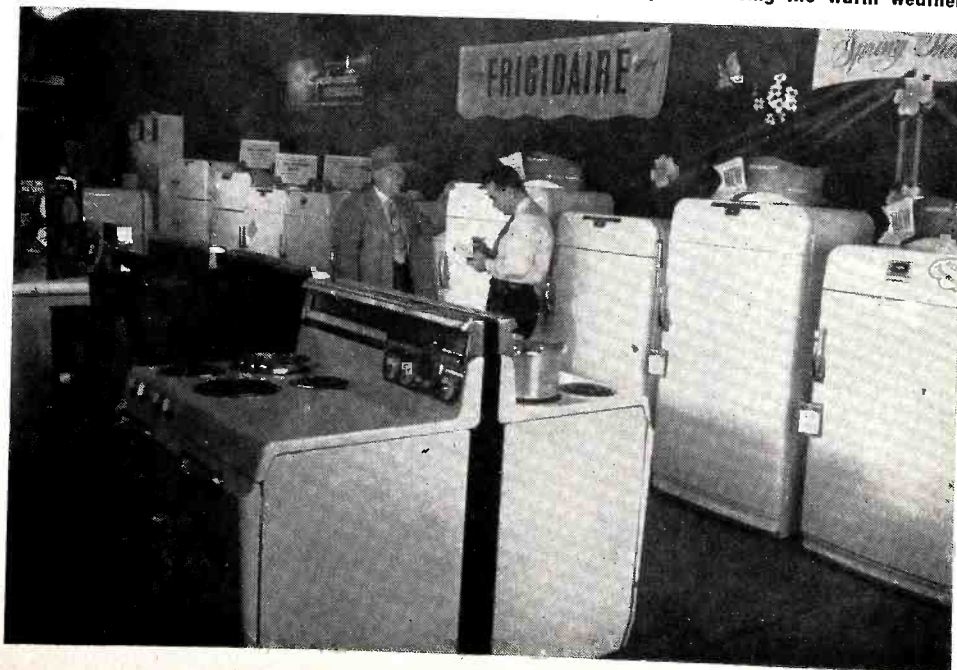

"I'll tell you this," says Smalley, "the record department gets us radio sales. We average a number of good console sales a month, to record customers. And another thing: in the summer, when a lot of our appliances are 'hot,' I'd say that one out of every 10 service calls results in a sale of a major appliance. In the winter, it drops to about one out of twenty, but it still shows that a dealer can profit by offering his own service on the merchandise he sells."

The store has two service departments—one for radio and TV, the other for appliances. In the hot-weather months, three servicemen are kept busy; otherwise there are always two men on the job. Besides the major and small appliances, and all types of radios, the store stocks some cameras, and sewing machines. It's a more-irons-in-the-fire style of doing business, and it has been successful at this spot for the last seven years.

In the record section, the Mart has done away with record booths, in an effort to get more people wise to the self-selling qualities of new radio-phonos. Disc customers play their records on a new console combination; if they don't know how to

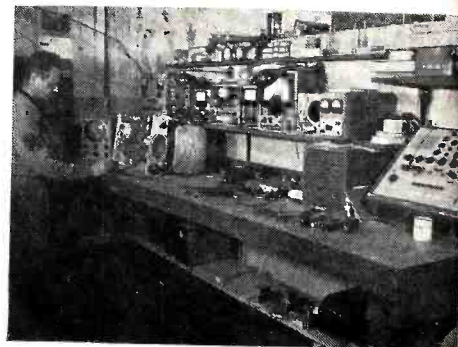

This Kansas store believes strongly in "our own" service. This section of the repair department is for radio, record players and TV. Appliance repairs are handled in an adjacent area.

work it, Smalley says that it's very simple and shows 'em. It sells consoles, and very little damage is done to records because of the non-scratch pickup on the combo. Very soon, regular customers are apt to "fall" for the charms of the instrument, and out it goes. They like the 3-speed feature; they like the tone.

As a matter of fact, Smalley says that even if there wasn't a dime's worth of profit in the record section, it would still create enough traffic to pay its way. Popular numbers are all on a self-service basis, with the combo standing by, ready.

Here's another way the Mart sells radios via an adjacent department: When a repair job is going to take some time, the customer gets a new radio to use while the job is being done. Even if they don't buy it the first time, they begin to see advantages in the newer set.

The Mart service itself is a selling point. Smalley thinks that when a merchant is selling an appliance or a radio, it helps a lot if he can say, in effect, that "we have an up-to-the-minute service department that has experience and know-how—we can stand behind everything we sell."

Several other sales-stimulating ideas help keep things humming at the Mart. A major to-do occurs when new models come in—at least two big "shows" a year, sometimes an anniversary celebration. The Mart is ready with its name-and-address cards.

Also, the Newton Chamber of Commerce has a welcome-to-new-

(Continued on page 120)

THE DUMONT DE LUXE AND NEW DUMONT TELESETS*
 answer consumer demand for
DUMONT-QUALITY...IN A FULL RANGE OF PRICES!

**PROOF
 YOU CAN SEE
 AND SELL...**

AT A BIGGER SHARE OF PROFIT!

DuMont receives more!

NEW DUMONT CASCADE TUNER. Clearest local or distant reception! **CONTRAST BOOSTER.** Greatly increases usable picture contrast! **FRINGE AREA RECEPTION.** High-power circuits for full range picture!

DuMont gives more!

FULL RANGE PICTURE. All tones from blackest black to whitest white! **DUMONT SELFOCUS* TUBE.** Clearest automatic focus in television. **4-WAY GLARE REJECTION.** Anti-glare tube face, cylindrical surface, tilted tube and safety glass. **AUTHENTIC CABINET DESIGN.** Lasting, exclusive style-appeal. **OVERSIZED PARTS.** For stable, longer life—Engineered dependability!

**POLICIES, PROMOTION, PRICES AND DISCOUNTS
 MADE WITH YOU IN MIND**

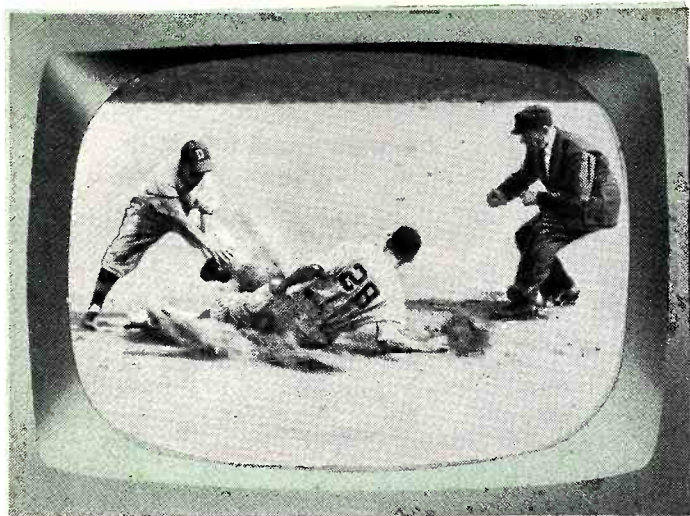

The **DYNASTY**,
 by DuMont
 21" rectangular
 Selfocus tube.
 Chinese Chippendale
 cabinet of mahogany
 veneers. Built-in
 drawer for record
 player.

\$49995**

The **RIDGEWOOD**,
 by DuMont
 21" rectangular Selfocus
 tube. Modern cabinet of
 fine mahogany or limed
 oak veneers. Built-in
 antenna.

\$37500**



**DUMONT
 QUALITY
 now starts at
 \$199⁹⁵****



The **CLINTON**, by DuMont
 17" rectangular Selfocus tube.
 Contemporary Plexitone-finish
 cabinet in sandal brown or
 blond. Built-in antenna.
\$19995**



\$45995**

The **NEWBURY**,
 by DuMont
 21" rectangular
 Selfocus tube.
 Built-in drawer for
 record player. Modern cabinet
 of mahogany or (at right) limed
 oak veneers.

\$47995**

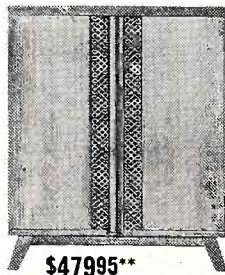

*Suggested retail price, includes Federal Excise Tax and Warranty.
 Prices slightly higher in Far West & South West.

*Trade Mark

Allen B. DuMont Laboratories, Inc., Television Receiver Division, East Paterson, New Jersey, and the DuMont Television Network, 515 Madison Avenue, New York 22, New York

There's Less Competition in Selling Tough Customers!

Some Dealers Write Off the Patience-Trying Folk as Price-Buyers and Chiselers, But There's a Way to Do Business With Them

• I am a salesman who has been successful in selling the Tough Customer. Who I am doesn't matter, but what does count is that I've always been willing to take on the people the other salesmen give up, finding such work challenging, stimulating, and profitable.

Furthermore, I learned that once I had sold the Tough Customer—

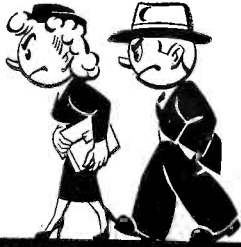

After fighting a delaying action for a long time, and having been given up by just about every salesman in the locality, the tough customers are ready to do business with the guy who'll spend a little time with them.

made that initial sale—the Tough Customer not only became a firm friend of mine but a steady customer who from then on bought additionally without any of the fussing and delay which characterized pre-sale negotiations.

Before going on any further, let's see what I mean by a Tough Customer. Such person may be male or female, old or young, rich or poor (though most likely to be well to



One can't get anywhere fighting the Tough Customer. You have to play ball with him in order to get to first base sales-wise.

do). Whatever he is, he requires special handling. To begin with, the Tough Customer cannot be rushed into signing an order, and even after numerous follow-up calls the salesman who pushes for a close will often see the Tough Customer close up like a clam.

The Tough Customer wants to be a hundred per cent satisfied that he's getting the best product at the best price. By and large, he is not a chiseler, but rather a stickler for details, even the most minute ones. He wears down the average salesman's patience by repeated visits to the store where he asks the same questions over and over, and even thinks up some new ones. Far from being an emotional buyer, he is always a skeptic in the pre-sale period, and since he is never sold until he makes up his own mind, most salesmen finally take the card bearing his name from the prospect file, write "hopeless" on it, and put it in the dead file.

After having been given the cold



Overselling and pressure will get you just nowhere with the Tough Customer. He wants the best he can get for his money and has scads of time to spend in arriving at a decision.

shoulder by a number of salesmen, Mr. Tough Customer, who actually wants to buy the product, a big-ticket item, but can't make up his mind as to the brand, is a prime prospect for me. One reason is that I've narrowed down the competition.

The Tough Customer has been dropped by a lot of salesmen who consider him to be not only a pest, but several degrees lower than a "suspect." He's too hard to sell. It takes too long to even qualify him. He'll pester the life out of the

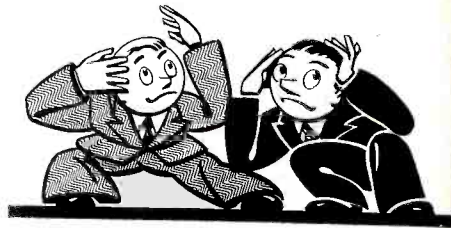

A great many salesmen duck when they see the Tough Customer coming in to haunt the store again. But the Tough Customer can be your meat if you know how to handle the situation.

dealer if he does finally buy, crying about everything, they say.

But the way I worked with the hard-to-sell folk was to build up a big following of these Tough Customers. I made frequent calls on them at their homes. I carted them around to the houses of satisfied users. I found that after I'd gained their confidence, they began to feel that what I'd said about the product was not just salesman's talk but sincere facts. Then, in nine cases out of ten, those tough customers who bought asked me for the order blank!

A great many of the Tough Customers whom I had worked consistently on didn't buy for a long time, but kept straggling into the store or called me on the phone, sometimes years after I'd finally quit calling on them. (Yes, I had to write some of them off myself.) These late-coming sales were set-ups since the Tough Customer had already made a buying decision when he contacted me. Such sales came like maturity dates

(Continued on page 86)

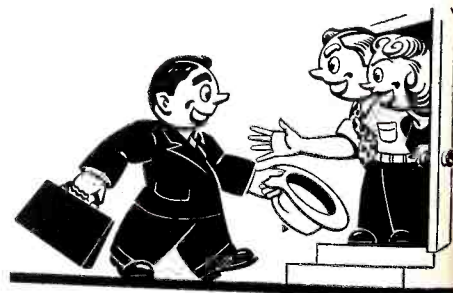

For the salesman who can take it, and work with the tough customers, there's a reward, for as a rule the Tough Customer usually buys additional products without fussing, and becomes a loyal customer.

ONLY OLYMPIC HAS IT!

**Most Advanced Sales
Feature in 5 Years!**

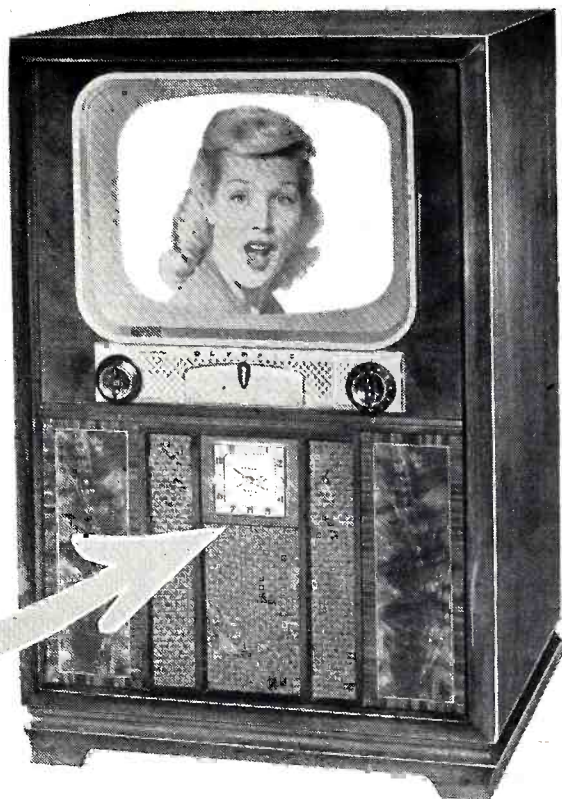
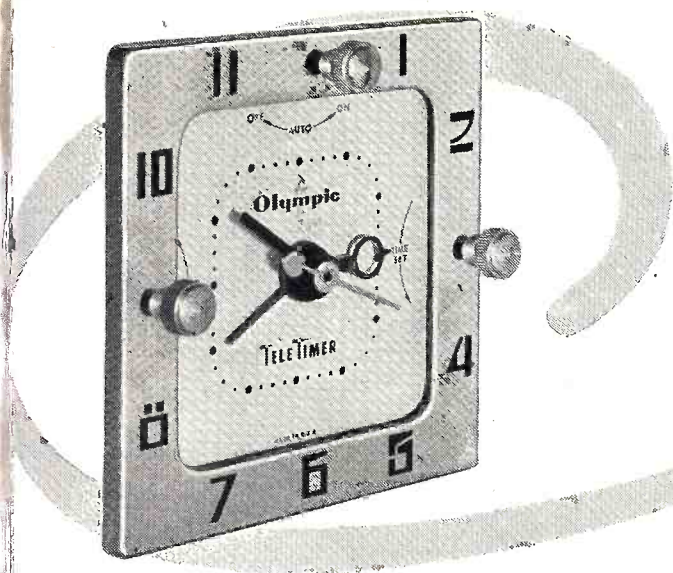

NEW OLYMPIC TELETIMER TV

**TURNS TV ON and OFF
... AUTOMATICALLY!**

Serves as a Beautiful Clock too!

**See it at your Olympic
Distributor Showing**

Only Olympic gives you the sales-magic of TELETIMER TV. Only Olympic gives you this exciting feature that salesmen can demonstrate, that customers can see and understand. TELETIMER TV is another extra that Olympic builds into its sets to give you features that attract, features that sell, features that close sales.

TELETIMER turns the Olympic ON and OFF automatically. Just set the attractive dial for the exact moment you want the Olympic to go on. Just set it and forget it! TELETIMER will remember for you. Precisely at the time selected, the set turns on... never lets you forget your favorite programs.

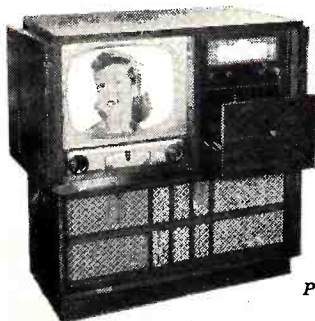

Olympic offers a complete line of television receivers priced to retail as low as \$159.95*. Sensationally priced Olympic 5 way TV, radio, phono combinations start at an amazing \$299.95*.

*Including warranty, tax extra.
Prices slightly higher in South & West

Olympic
America's Favorite
TELEVISION

Olympic Radio & Television, Inc., Long Island City 1, New York



Service dealers and technicians in Michigan now have their annual Television Service Clinics. The clinic idea originated with the B. J. Fitzner Co., Detroit, mfrs. rep. firm. Current TV chassis and new circuits and service methods were explained by field engineers and factory service managers. About 2000 attended both clinics, in Detroit and Grand Rapids. In top picture, is the committee for the first annual clinic in Detroit. l to r, D. G. Knodle, serv. mgr., RCA Victor Dist. Corp.; Harold Chase, pres.-Television Service Assn. of Michigan; Chas. Nutting, Jr., C. A. Nutting Co.; Harry Gensler, serv. mgr., GE Supply Corp.; Chas. Wykoff, serv. mgr., Motorola Det. Co.; Jack Rathsburg, general chairman, B. J. Fitzner Co.; mfrs. reps. At bottom is the Grand Rapids clinic. Seated l to r, Charles Dressel, TRTA; Sieger Hays, TRTA pres.; June Beaver, Radio Parts; Harold Cook, Radio Elect. Supply. Standing, l to r, Jack Rathsburg, general chairman—B. J. Fitzner Co.; Milt Bursma, Bursma Radio; F. J. Buckley, V. P. TRTA; Wm. Rademacher, TRTA, Chet Peabody, serv. mgr.—Dyrgert Dist. Co.; Wm. Sweers, TRTA.

Tough Customer

(Continued from page 84)

on endowment policies.

The Tough Customer requires a lot of after-sale attention, as I've found out. You have to keep him sold. But the time spent is well worth while since one can sell such person many other products, and obtain numbers of live leads. Once I called on the neighbor of a particularly tough customer who'd bought, at long last, an \$800 oil burner installation from me. Said the neighbor, "Gee, if that guy bought your make it must be good. Either that or you're a magician!"

In the Tough Customer's favor is the fact that he is usually *quality-conscious*, and realizes the value of *service*. Once the salesman has sold himself, the product and the firm to the Tough Customer he can usually get around the price angle which often crops up.

Need Special Handling

When a person keeps coming back to ask more and more questions about a big-ticket item, say a high-priced television set, and persists in trying to beat down the price, the smart salesman realizes that such person is sold on (a) the firm, (b) the receiver, and (c) the fact that he'll get after-sale service. If *this were not the case the Tough Customer would go elsewhere and get a big discount faster than one can say "price-cutting."* Genuine patience, and courteous salesmanhip can finally sell such pre-sold customer.

My advice in selling the Tough Customer is to give him the special handling he requires. Don't classify him as a *price-buyer* if he continues to inquire about products *he can get elsewhere at a lower price*. Don't use eager-beaver tactics on the man or woman who wants scads of information on the big-ticket product. Give such information willingly. Bear down heavily on what the product will do for the customer; how he will benefit by purchasing it. How the product's value compares with competitive makes. And how your firm stands back of all of the merchandise it sells after the sale has been made.

The Tough Customer may be of the type who could try the patience of Job, but you'll get a lot of real satisfaction in selling the man or woman who was just too tough for the other fellow to land.

Universal Promotion Campaign

Timed to run simultaneously with the national election is the promotion campaign presently being staged by Landers, Frary & Clark. Six new top quality appliances, four exciting promotions and national advertising support in seventeen leading national magazines combine for the Fall and Christmas program. "Elect Universal Electric Housewares" is the theme, and the six new "winning candidates" heading the Universal ticket are a deep fryer, travel iron, automatic waffle baker and sandwich grill combination and three new heating pads. First of the four "planks" is a Coffeematic promotion aimed at the 87,000,000 potential coffee-maker customers who will read, hear and see Coffeematic's story in magazines, radio and TV. Plank #2 is featuring Elsa Maxwell using the Cook-a-matic waffle iron and sandwich grill. Plank #3 is called Slumber Party Jamboree and ties in with Universal's new electric blankets, while plank #4 is aimed at Christmas Gift Buying and will feature the entire line of Universal electric housewares. Under the theme "For A Merrier Christmas All Through The House," Universal will tie the program down to the local level with a spectacular multi-colored life size "Gift-House" display.

Proctor Announces Fair Trade Price Schedule

Joseph Tiers, general merchandising manager for Proctor Electric Company, has announced that Fair Trade prices, following the signing of the McGuire Bill by President Truman, are in all instances lower than the advertised retail ceiling prices that Proctor has featured in its national advertising to date. The 1469 toaster dropped from its former advertised list price of \$16.95 to the new Fair Trade list price of \$14.95; the 1483 toaster—from \$23.50 to \$21.95; and 989 Champion iron—from \$12.95 to \$10.95; the 991 Never-Lift iron—from \$14.95 to \$13.95; the 990 Never-Lift steam iron—from \$16.95 to \$14.95; the 75 attachment—from \$5.95 to \$5.00; the 50A Cordminder remains at \$3.95; and the 61 Hi-Lo table with wheels dropped from \$14.95 to \$13.95.

New items available to consumers this month have the following Fair Trade prices: Model 27 Mary Proctor Zedalon ironing table pad and cover, \$4.95; Model 26 Zedalon elastic edged pad and cover, \$3.95; Model 62 apartment size adjustable ironing table without wheels, \$11.95; Model 2026-50 ironing table, pad and cover and Cordminder, \$22.85. The above prices take effect at consumer level on September 15.

WE SALUTE THESE

Salesmen of Security

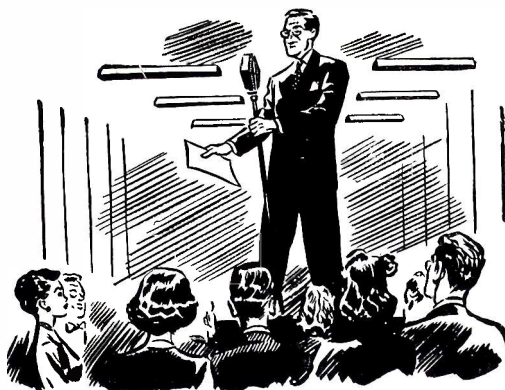

The executives of the more than 20,000 companies that have sponsored the Payroll Savings Plan



The 7,500,000 workers who are each investing on the average of \$20 per month in Savings Bonds



The employees who serve as volunteers selling U. S. Savings Bonds to their fellow employees

ere's a sales force that's helping to win economic peace
mind for the nation. It already has dealt heavy blows
inflation, fear, and doubt. *This sales force is comprised
people who really are doing something to build security
and protect the American way of life.*

They are building security for themselves by buying
onds. Every \$3 they invest will pay \$4 at maturity.

They are building security for their companies. As
each Bondholder's own sense of security increases with
his Bond purchases, he becomes a better worker. Plant
morale improves. Production increases. Absenteeism,
labor turnover, and the accident rate all decline. Concur-

rently relations between employer and employee improve.

They are building security for the nation. Savings Bond
dollars are deferred purchasing power—an assurance of
good business to come. The Treasury uses net Savings
Bond dollars to fight inflationary credit potential in the
banking system by retiring short-term bank-held Federal
securities.

If your company isn't an active part of this sales force,
better join now and get in on the benefits! Full informa-
tion is available from your State Director, Savings Bonds
Division, U. S. Treasury Department. Phone him or
write the Treasury Department, Washington 25, D. C.

The Treasury Department acknowledges with appreciation the publication of this message by

TELEVISION RETAILING



This is an official U. S. Treasury advertisement prepared under the auspices of the Treasury Department and The Advertising Council.

CHANNEL MASTER

proudly introduces

the world's first Broad Band Yagi

the

f·u·t·u·r·a·m·i·c

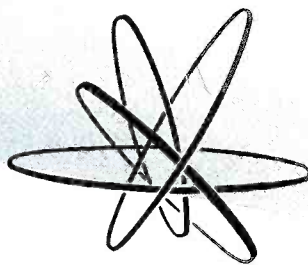

**A great new type of antenna
that combines:**

-  **Broad Band coverage** *with the*
-  **high gain and directivity of the Yagi**

Spectacular high gain! Razor-sharp directivity! In fact, all the brilliant performance that only a Yagi can deliver, is now yours with the FUTURAMIC — not on just one channel, but CLEAR ACROSS THE BAND!

For the first time in television history, here is an antenna that not only solves today's installation problems — but also provides for the new VHF channels of the future. This is the antenna you have been waiting for — the 10 Element FUTURAMIC is a true Broad Band Yagi!

the antenna designed for today and tomorrow!

The same **FUTURAMIC** that . . .

✧ Solves **today's** reception problems

✧ Will also receive **tomorrow's** new VHF channels

THE FUTURAMIC MEANS BIG BUSINESS FOR YOU IF YOU SERVE ANY OF THESE 3 BOOMING VHF MARKETS!

1. Areas in which the FCC has ordered VHF stations to change channels (on the same band).

When a channel-shift takes place, the thousands of *single-channel* Yagis in use will become obsolete overnight. The set owner will face a dilemma: If he changes his antenna before the channel-shift, he will be without reception until the shift occurs. If he waits until the station changes channels, he will be without reception until his new antenna is installed. You can install the Futuramic now — before the rush starts! It will provide *better* reception than conventional Yagis on the present channels—and when the shift occurs, this superior reception will continue on the new channel without interruption!

2. Areas in which a new VHF station is being added to the present one.

The hundreds of thousands of single-channel Yagis now in use will not bring in the new channel. This means that an additional Yagi will have to be installed and tied into the present installation with a separate lead, through an annoying switching system. However, one Futuramic will do the job of *both* antennas — at lower cost — with *better* results on *both* channels. Install the Futuramic now to improve your present picture. And at the same time be ready for future channels on the same band.

3. Areas served at present by two or more VHF stations (on the same band).

In such areas, the installation man must choose between conventional broad band antennas and separate Yagis for each channel. Each approach has important advantages. Only the Futuramic will give you the advantages of *BOTH*, combining highest gain, and sharpest directivity on each channel with simple, economical installation.

Model No.	Channels Covered	List Price
1173	7, 8, 9, 10, 11, 12, and 13	\$20 ⁸³
1124	2, 3, and 4	\$40 ⁹⁷
1125	2, 3, 4, and 5	
1136	3, 4, 5, and 6	
1146	4, 5, and 6	

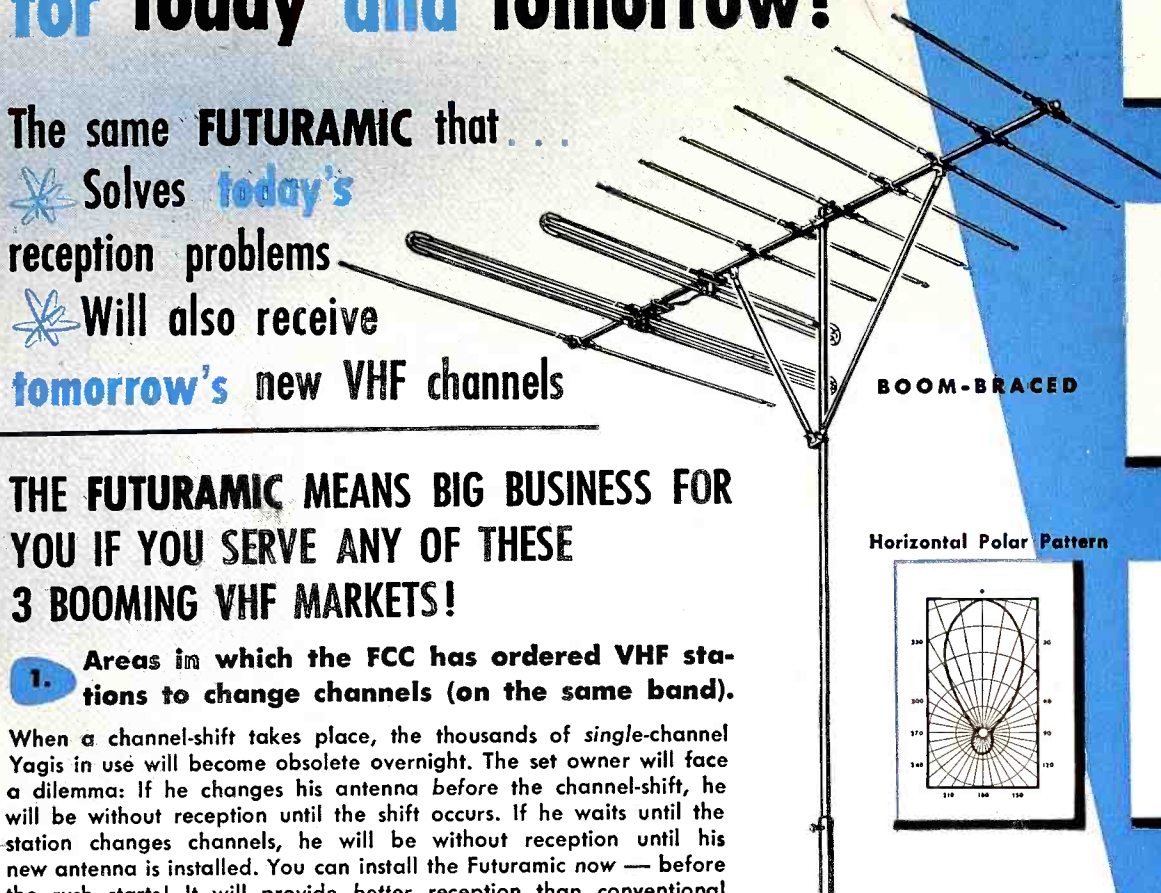

BOOM-BRACED

Horizontal Polar Pattern

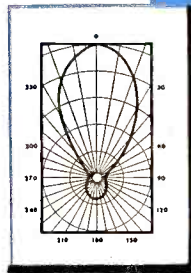

GAIN CURVES

Model 1124

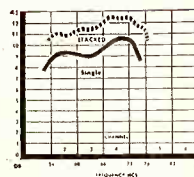

Covers Ch. 2, 3, 4

Model 1125

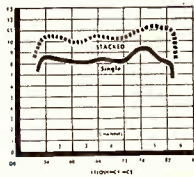

Covers Ch. 2, 3, 4, 5

Model 1146

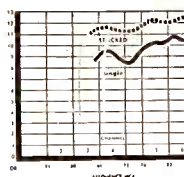

Covers Ch. 4, 5, 6

Model 1173

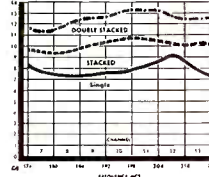

Covers Ch. 7, 8, 9, 10, 11, 12, 13

Model 1136

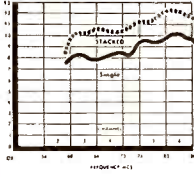

Covers Ch. 3, 4, 5, 6

ALL THIS AND Z-MATCH TOO!

The Futuramic uses Channel Master's famous Z-Match system which eliminates mismatch, gives maximum stacking gain, and provides stacking bars at no extra cost.

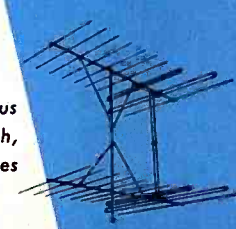

SHATTERS all performance records!

- Channel for channel, the Broad Band Futuramic will outperform any conventional SINGLE-CHANNEL Yagi!
- On each of its specified channels, one single Low Band Futuramic will outperform any 4-bay conical or fan array!
- A single High Band Futuramic will outperform any 2-bay conical or fan array on every channel from 7 to 13!
- A high-low Futuramic combination is the most sensitive array ever devised for all-channel VHF reception!

Write for complete technical literature.



CHANNEL MASTER CORP. ELLENVILLE, N. Y.

MEMBER



Selling the Better Sets

Modern Store Cashes in on the New Interest in Hi-Fi to Sell

and Service Fine Receivers; Boost Phono Record Volume



with the TV set in front (Wichita is still fringe) and a strong display of high-styled combos in the background, Bennett's gets table jobs, portables and records into one big radio window lay-out. Radio manager Clark is shown here in the "specialty" room at the Wichita, Kansas, store—a kind of sales laboratory for high fidelity. Custom jobs going out of here cost from \$700 to \$1,000.

• "If, as a merchant bidding for success nowadays, you have any connection at all with musical merchandise, good recordings, or high-fidelity reproduction, you should latch on to it, develop it, and put extra emphasis on it."

This is the comment of Edwin R. Clarke, radio manager at the Bennett Music House, Wichita, Kansas. Clarke says that, in a very concrete way, his radio and phono prospects are becoming more and more con-

scious of good tone, and that he intends to seize the chance to sell them better radios, quality-type cabinets, and the better recordings. In Wichita, television still has the fringe status.

In the Wichita area, Clarke says that there are at least three facts supporting the trend toward more quality, all of them very noticeable in Bennett's current business: (1) Long-playing records have been a prime cause of more people getting

genuinely interested in recorded music, (2) More people are asking for higher-priced combinations and custom-built jobs with extension speakers in adjoining rooms, and (3) The per cent of people who like classical and semi-classical music has been increasing sharply.

Bennett's, who have been a big factor in the musical merchandise picture in Kansas for the last 43 years and don't mind saying so in their advertising, have an enormous stock of records of all types on the first floor, and a handsome assortment of radios and combos on another floor of the 6-floor store. Table model radios and phonos, and portables, are shown in the "traffic area" on the first floor.

The store has a wide selection of pianos, musical instruments and accessories, plus a big stock of sheet music. Bennett salesmen naturally get next to more of the musically-minded customers. It means that if they are on their toes, they can sell the quality radio equipment instead of the lower-priced units, and really make each sale count. That's what pays off in the long run.

Here is one section of the Bennett service dept., with Don Floyd, left, and Jim Stites on the job. The store employs 4 servicemen; puts a marked emphasis on keeping customers' sets in tip-top shape.

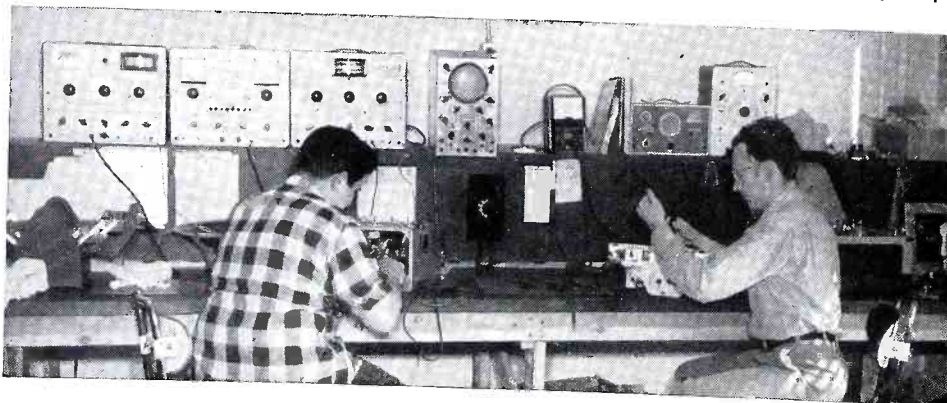

HIS CHOICE IS

Regency

LARGEST SELLING VHF BOOSTER . . . AT ANY PRICE!

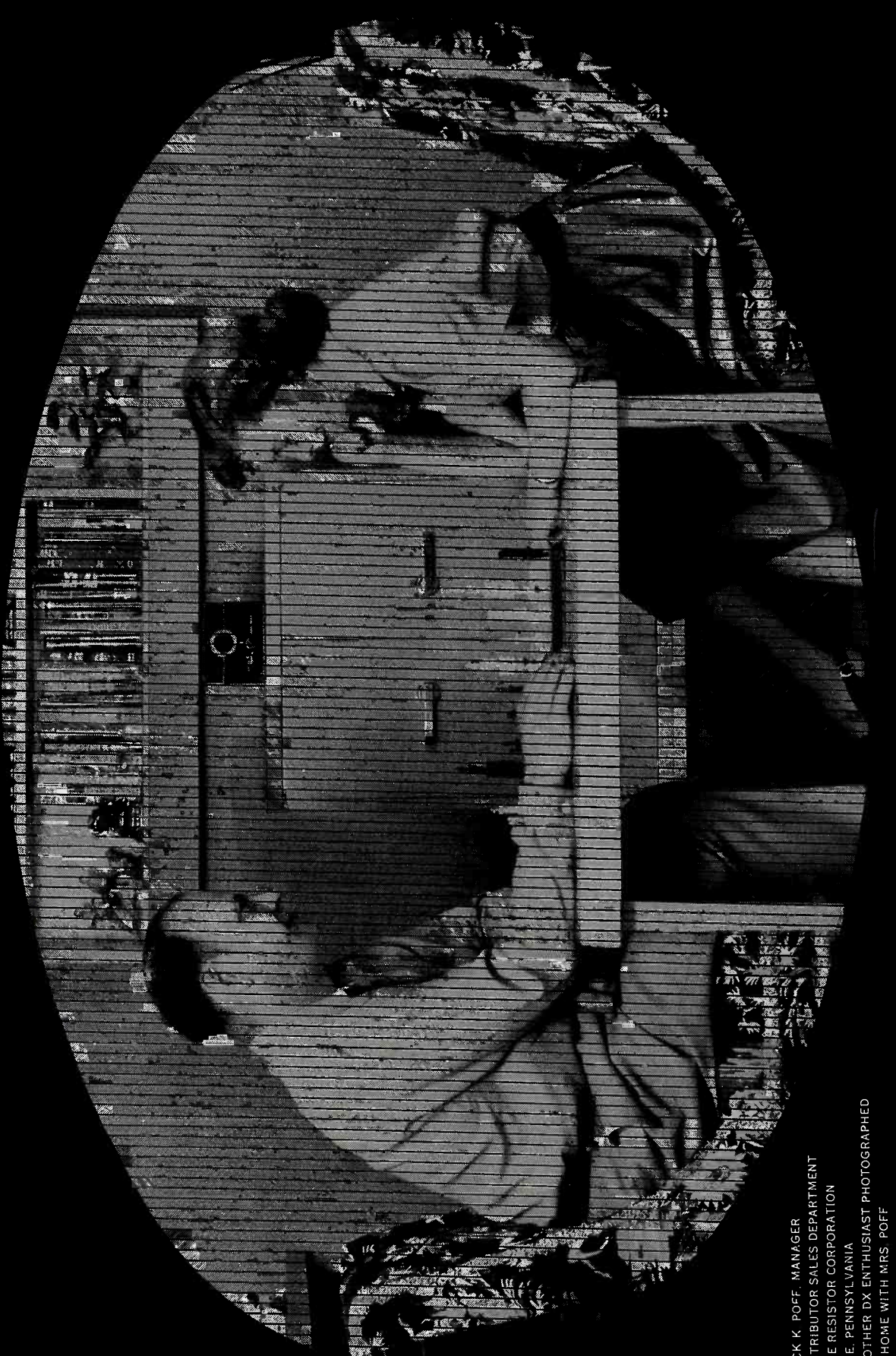

JACK K. POFF, MANAGER
DISTRIBUTOR SALES DEPARTMENT
ERIE RESISTOR CORPORATION
ERIE, PENNSYLVANIA
ANOTHER DX ENTHUSIAST PHOTOGRAPHED
AT HOME WITH MRS. POFF

ALSO MAKERS OF THE

Regency

UHF CONVERTER

BURTON BROWNE ADVERTISING

NEEDED — Better Salesmanship

WHAT MAKES A GOOD SALESMAN !

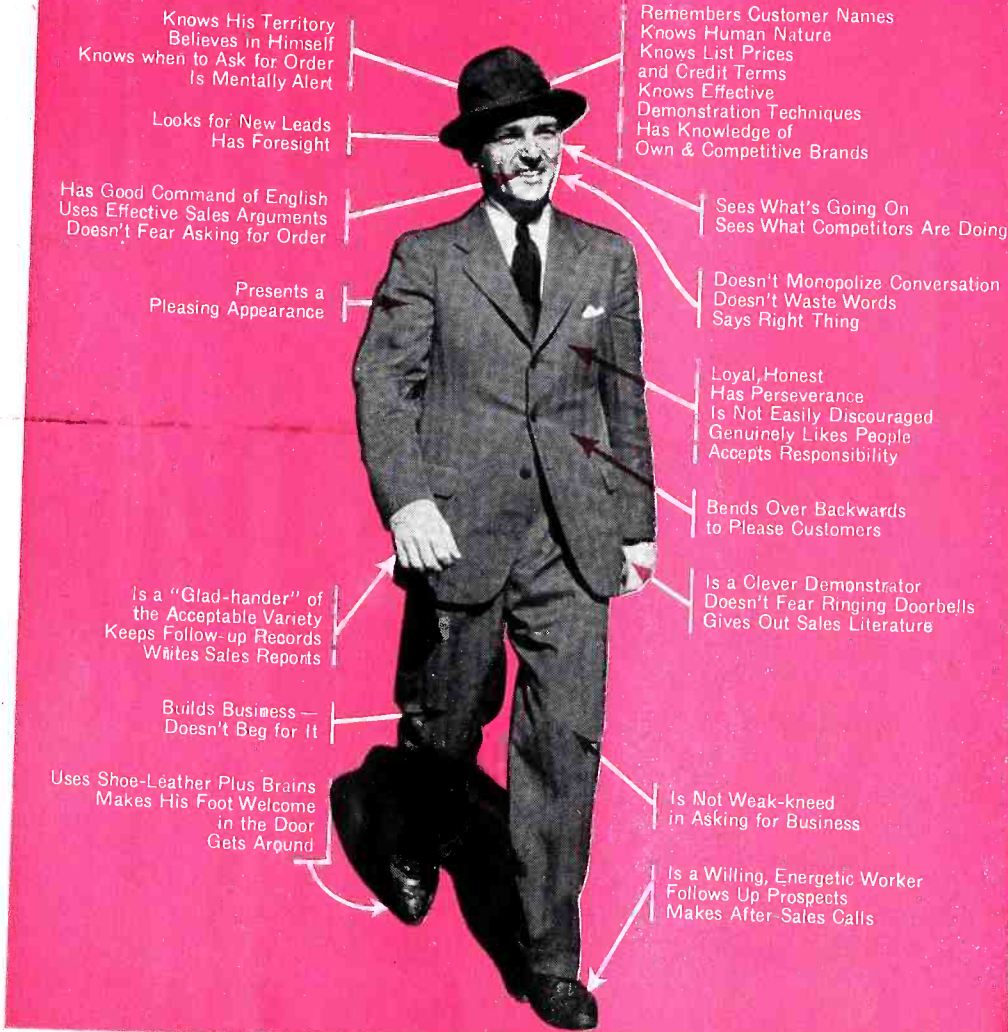

accept the buyer's money provided the latter doesn't expect too much in the way of salesmanship or exposition of the products.

Indifference is also demonstrated in the failure to obtain names of store visitors, or to follow-up those who have expressed an interest in certain TV sets, radios or appliances.

Selective Selling is the specialization in fast-moving items only—the unwillingness to devote proper effort to those presenting certain problems, usually because they are new, more or less unfamiliar products.

Unfamiliarity with products makes the salesperson vulnerable to competition. He is unable to *effectively* present his brands when the customer mentions competitive makes. Too often such salesperson merely resorts to knocking the other man's equipment, a technique which is bound to antagonize any intelligent person. Too, unfamiliarity with products always results in weak, clumsy demonstrations.

Right now there are two outstanding reasons for sales slow-ups. One is consumer resistance, and the other is poor salesmanship.

The *good* salesman can do a good job in spite of high prices.

People want and need new TV receivers, radios and appliances, but it takes good salesmanship to get them to sign on the dotted line. In cases where they do not feel like putting cash on the line, time contracts should be *sold*. Good salesmen are selling installment contracts today.

In striving to be a good salesman let us sell ourselves completely on the fact that there's always the fly in the ointment.

Look at it like this:

When financial conditions are "bad," people haven't the money to buy products *at low prices*.

In all cases where a *seller's market* exists, merchandise is so scarce that volume is low—headaches are common, and customer good-will is threatened.

When John Q. Public has plenty of cash in his jeans, prices are high.

In merchandising, life is one damned thing after another.

So, there's no point waiting for conditions to change.

The time to be a better salesman is today!

• From here on, good *salesmanship* is going to make the difference between business success and failure.

From here on, the salesman who shrugs off lost sales with a laugh is going to find that the last laugh's on him—and it won't be funny!

All over the country the customer "walk-out" rate is high . . . the follow-up rate abysmal.

Competition is increasing in intensity. Slowly, but surely, business is drifting into the stores where salespeople are showing an active interest in making sales.

The salesman can make or break a customer. He is to the dealer what the dealer is to the manufacturer . . . the man at the point-of-sale. All things depend upon the salesman. Without good salesmanship all money spent on advertising, display and store modernization is wasted.

The dealer who wants to stay in business is demanding *genuine* salesmanship today. Such merchant realizes that the fruits of *synthetic* salesmanship can be bitter as gall, resulting in unwanted *loss* and *accumulation*—loss of customers, and an accumulation of products not being pushed because they require extra sales effort.

Some of the most outstanding sales volume-reducing practices being employed today by careless salesmen, or by those who never were or will be salesmen, include *indifference*, "*selective*" selling of products, *unfamiliarity with merchandise*, and *clumsy demonstrating methods*.

Indifference is seen in the standing-around attitudes of all too many salesmen. Such individuals convey the idea to customers that as a special sort of favor they will

Coming in January!

1953

DISTRIBUTOR DIRECTORY

to be published as a
bound-in section of

**TELEVISION
RETAILING**

TELEVISION
RADIO
PARTS
SOUND
APPLIANCES
RECORDS & ACCESSORIES

30,000 CIRCULATION

to dealers, distributors and service dealers.

3,000 REPRINTS

to factory sales managers or wholesale executives.

UNUSUAL
ADVERTISING
OPPORTUNITY

Manufacturers and distributors may use any standard unit of display space, from inserts to fractional advertisements.

Manufacturers may also use logotypes spotted through the geographical listings to identify their distributors or to back them up.

Reps may use any standard unit of display space to get new lines or make known their facilities, territory or specialization.

CHOICE POSITIONS

On a first-come, first-served basis, advertisements may be positioned alongside, facing or adjacent to editorial listings but cannot be guaranteed in all cases.

- The most complete nationwide directory of radio-television-appliance distributors; parts, sound and electronic distributors.
- Distributors are listed alphabetically under states and cities.
- Names of owners or buyers, with phone numbers, are given.
- Listings show product categories handled by each distributor.
- New distributor names, new features, new usefulness.
- All data compiled from original sources, and copyrighted.

The 1953 Distributors Directory, like the previous edition, will be indispensable to manufacturers who are planning, extending, rearranging or upgrading their distribution. Valuable also as a medium for distributors seeking new lines or additional customers. Equally important as a Where-to-Buy for dealers and servicemen. Outstanding in its immediate value and day-to-day usefulness throughout the year.

Write today for advertising rates,
dimensions, closing dates, etc.

CALDWELL-CLEMENTS, INC.

480 Lexington Ave., New York 17

CHICAGO—201 N. Wells St., Chicago 6

CALIFORNIA—Chris Dunkle & Assoc., 2506 W. 8th St., Los Angeles 5,

PLaza 9-7880

RAndolph 6-9225

DUnkirk 7-6149

Publishers also of
TELE-TECH

Get ready now FOR YOUR ADVERTISEMENT IN THIS UNRIVALED MARKETING GUIDE

Brand New for '53...and only from



Model 121DX11

New "DX-53" Chassis

5 YEARS IN THE MAKING!

No mere "warmed over" version of previous models, this superb new chassis is the achievement of five years' development... with new tools and dies... new "super duty" components... new and better circuits. The result: a chassis that outmodes all previous ideas of "fringe area" reception... that makes thrilling performance possible in "pockets" where countryside or buildings "blank out" ordinary sets... that delivers strikingly superior pictures *anywhere!*

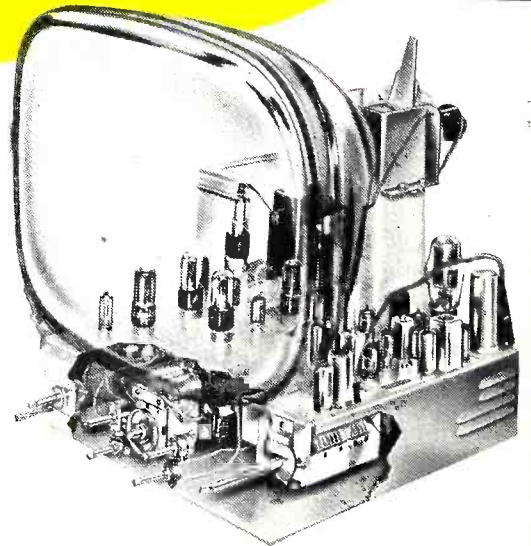

17DX10. Value-priced 17" TV with new "DX-53" Chassis—ebony or walnut color. Base extra.



121DX16. 21" Dyna-Ray picture tube... "DX-53" Chassis. Smart mahogany cabinet with legs.



221DX15. 21" Dyna-Ray picture tube... "DX-53" Chassis... walnut, mahogany or blonde finish.

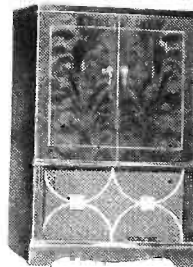

221DX26. 21" Dyna-Ray picture tube... "DX-53" Chassis... mahogany cabinet with half doors.

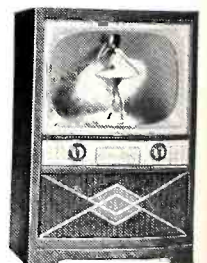

222DX15. 21" Panoramic tube... Super "DX-53" Chassis... walnut, mahogany or blonde finish.

Admiral!

WORLD'S
LARGEST
TELEVISION
MANUFACTURER

21" TV

at price of other 17's

43% bigger picture for the same money!

\$199⁹⁵

Fed. Tax and warranties included.

Model 121DX11 Ebony

Bigger—yes—but that's not all! It's an amazingly *better* picture, too. Because it's powered by Admiral's extraordinary new "DX-53" Chassis, plus a host of "extra" 1953 features. Features such as Admiral's new "DX" Range Finder that "customizes" reception in any signal area . . . salesmaking superiorities such as *guaranteed* UHF reception with Admiral's famed Cascade Turret Tuner. See this amazing value and its companion models at your Admiral Distributor's now. It's the most exciting new line in television!

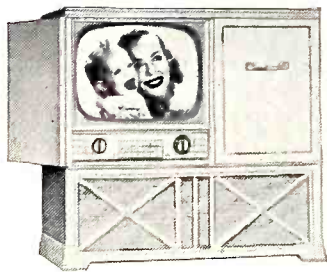
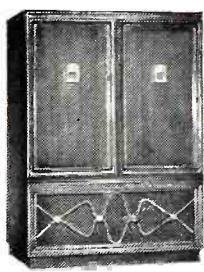
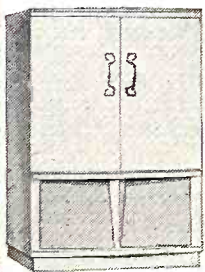

222DX26. 21" Panoramic tube . . . Super "DX-53" Chassis . . . mahogany or blonde, half doors.

228DX16. Big 27" picture tube . . . Super "DX-53" Chassis . . . hand rubbed mahogany or blonde.

321DX15. 21" Dyna-Ray tube, radio, phono . . . "DX-53" Chassis . . . walnut, mahogany or blonde.

321DX26. 21" TV-radio-phono only 22¼" wide! Has new "DX-53" Chassis . . . mahogany finish.

322DX16. 21" Panoramic tube, radio, phono . . . Super "DX-53" Chassis . . . hand-rubbed mahogany.

JFD 10-ELEMENT "Baline": YAGI

* **12 db** (gain of stacked JFD BALINE over a tuned folded dipole)

* **9½ db** (gain of single JFD BALINE over a tuned folded dipole)

*These figures have been verified by the Hazeltine Corporation, world famous research laboratory. All JFD gain figures are based on a reference tuned folded dipole. Beware of exorbitant gain figures which are not based on any reference level.

ACTUAL FIELD TESTS PROVE IT

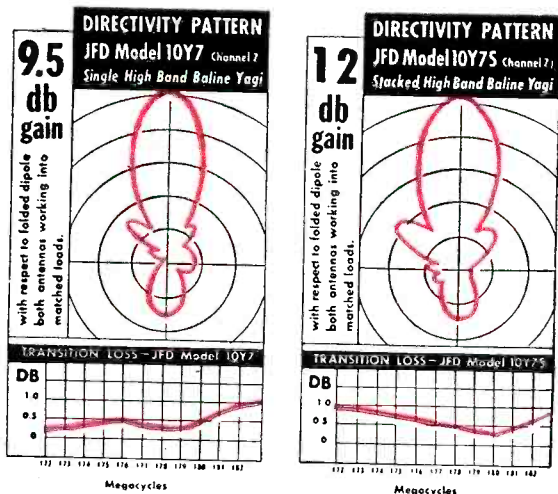

Single JFD High Band BALINE Yagis

Channels	Models	List Price
7-13	10Y7-10Y13	\$13.85

Stacked JFD BALINE Yagis

Channels	Models	List Price
2	10Y2S	\$63.70
3	10Y3S	63.70
4	10Y4S	56.90
4-5	10Y45S	67.80
5	10Y5S	56.90
6	10Y6S	51.40
7-13	10Y7S-10Y13S	27.70

Include JFD Baline matching transformers at no extra charge

Single JFD Low Band BALINE Yagis

Channels	Models	List Price
2	10Y2	\$31.85
3	10Y3	31.85
4	10Y4	28.45
4-5	10Y45	33.90
5	10Y5	28.45
6	10Y6	25.70

illustrated: JFD No. 10Y2S-10Y6S
Low Band Stacked Baline Yagi



The antenna sensations of the Nation!

JETENNA... the conical with jet-action assembly
...no other fan conical assemblies so fast, performs so well!

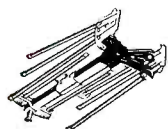

1. Pre-assembled JFD JeTenna as packaged. Note its compactness of construction and craftsmanship of design.

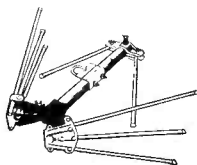

2. As the JeTenna swings open, dipole elements fan instantly into exact position by riding along unique fulcrum indices.

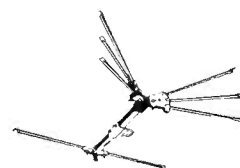

3. JeTenna elements lock into position effecting 35° forward inception angle and 40° dipole angulation for greater signal pickup. Reflectors snap into place for quick tightening by wing nuts.

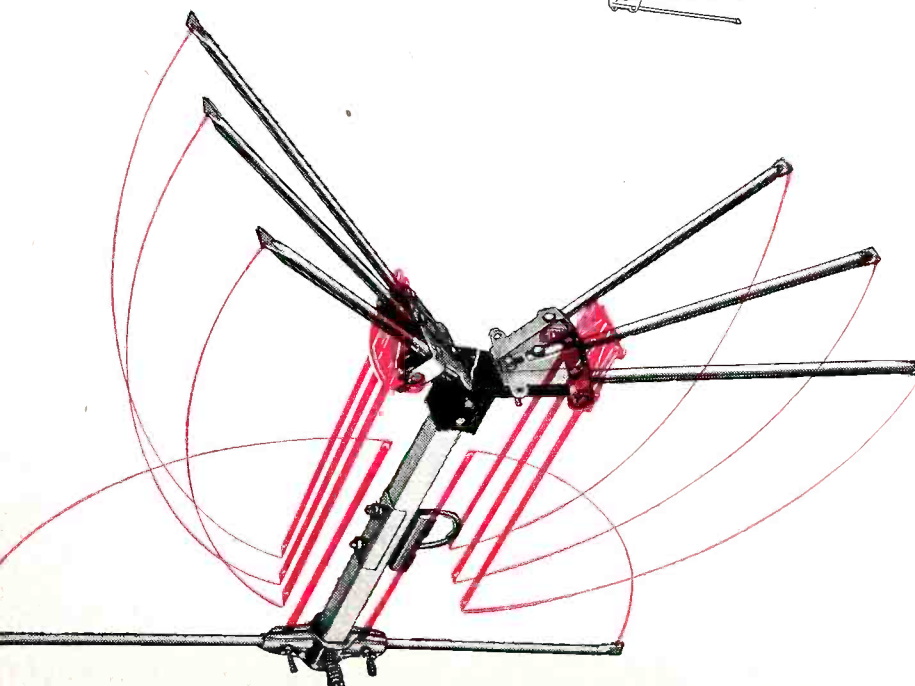

Series with 1" seamless aluminum square crossarm and seamless aluminum elements reinforced with Fibreglas dowels.

No. JET160	Single Bay	Up to 8.8 db*	\$12.50 list
No. JET161	2 Bay	Up to 12.5 db*	\$26.40 list
No. JET164	4 Bay	Up to 15.5 db*	\$56.80 list

Series with 1" seamless square aluminum crossarm and wood-doweled butt-seam aluminum elements.

No. JET660	Single Bay	Up to 8.8 db*	\$ 9.75 list
No. JET661	2 Bay	Up to 12.5 db*	\$20.70 list
No. JET664	4 Bay	Up to 15.5 db*	\$45.40 list

*Performance tested and figures verified by the Hazeltine Corporation, Little Neck, N.Y. World Famous Research Laboratory.

JFD MFG. CO.
BROOKLYN 4, N. Y.
BENSONHURST 6-9200



World's Largest Manufacturer of TV Antennas and Accessories

TECHNICIAN

Section of **TELEVISION RETAILING**
Including Radio Service and Sound

®Trademark

Keep Your Word and You'll Keep Your Customers

• There comes a time in the life of every service manager when he wonders why business is falling off. If he's smart—and managers generally don't hang on to a top-rung position if they aren't—he'll consider the possibility that customers are switching to other stores. A good deal of such switching is going on these days, and poor service policies are to blame.

Customers don't change service dealers because good service, fair treatment and reasonable prices have made them mad. Something else has gotten their goat, and the service manager should find out what it is. Foremost among the reasons why service departments lose customers are:

1. Poor work, necessitating numerous call-backs.
2. Unsettled or unsatisfactorily-settled disputes over service charges.
3. Failure to keep promises re completion of work, service calls, pickups and deliveries.

Most service managers will readily admit the validity of the first two

reasons. The third one, however, is not as widely recognized or accepted as a potent force in alienating customers. Let's look into it a bit.

First, is promise-breaking really bad?

In certain nooks and crannies of the business world, breaking a promise is about as important as loosening one's collar on a hot day. If keeping a promise is inconvenient, it is blithely broken. There is no feeling of business honor among people who carry on in this way, and they inevitably suffer for it.

Some service managers' feeling is, so what if the customer has to wait one, two or four days longer than he expected, to get his set delivered? He can't help himself. The store has the set, and the customer must leave it there to get it fixed. No sense in breaking one's neck to fulfill a minor promise, something that really wasn't a promise at all. Besides, service departments can't be run like post-offices, and in any case, the customer doesn't really mind waiting.

What these managers don't realize is

that the good-will of the customer is a precious intangible that should not be gambled with. When a customer has been told his TV set will be ready on, say, Thursday evening, he counts on having the set back at that time. He may look forward to viewing a favorite program that evening. He confidently expects the set to be ready as specified, since the service department didn't qualify their delivery date with ifs, ands, and buts.

Comes Saturday evening, and no set. 7 o'clock chases 6 away. Still no delivery. Half the evening is wasted. The customer rings up the store.

"Isn't my set being delivered?" he asks.

"I'm sorry, it's not ready yet," replies the service manager suavely, in that apologetic tone he has perfected for such situations.

The customer hangs up, after getting another "promise" of delivery. He hasn't said much, hasn't described how disappointed he is. He feels an ill-will, how-

(Continued on page 108)

CAN YOU IDENTIFY THESE CUSTOMERS!

Customer at the left has just heard that her repaired TV set is being delivered on schedule. Customer at the right is learning that delivery of his set has had to be postponed a second time. \$64 question: Which customer needs the aspirin? Which one is going to switch to another dealer?



Remedying Troubles

Hints on Yoke Faults, Insufficient Width, 'Spook'

Boosting Horizontal Sweep

Horizontal sweep insufficient? Can't boost it enough by putting a .1 across the linearity coil? Perhaps a different-type horizontal output tube will do the trick.

In run 23 of chassis 21K1, 21L1, 21M1 and 21N1, Admiral has changed the horizontal amplifier tube—V406—from a 6BQ6GT to a 6CD6G, to increase the deflection power generated in the output circuit. (This production change is listed in Admiral Service Manual Supplement No. S362-A). The following circuit changes become necessary (see fig. 1): Condenser C433 (across the width coil) is omitted. Resistor R437, the grid-return resistor of V406, is changed from 470K to 1 megohm; and screen dropping resistor R442, 6,800 ohms, 2W, is replaced by two 3,300-ohm 2-watt resistors in series (represented by symbols R442 and R451).

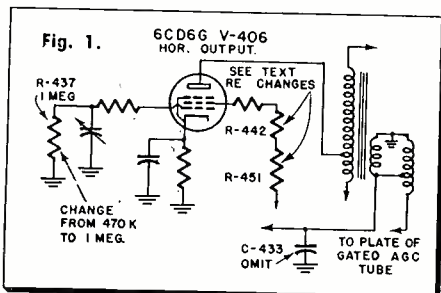

C433 is probably omitted to prevent the unnecessary reduction of the high voltage (with the 6BQ6, the condenser, by reducing the high voltage, increased the sweep). R437 is no doubt increased to raise the drive of the tube. The 6CD6 can handle a larger drive. The change re the screen resistors is suggested because the screen current will now be higher, necessitating the use of resistors with wattage ratings capable of handling it.

A comparison of the two tubes shows the following: The 6BQ6 provides a maximum DC plate current of 100 MA, and has a maximum plate dissipation of 10W; the 6CD6-G, on the other hand, offers a maximum DC plate current of 170 MA, and 15W maximum plate dissipation.

If the serviceman intends to make the tube swap in some receiver other than the Admiral models covered by the production change, he should make sure the power transformer present can handle the extra power it will be required to supply. The filament current of the 6CD6G is 2.5A, compared to 1.2A in the 6BQ6GT. The transformer's 6.3V filament winding must be capable of handling the additional current.

Philco, in Service Bulletin 52-T1, covering 1952 Philco receivers, cites a production change in D-1 and D-1A deflection chassis to increase width. R816,

horizontal-output screen dropping resistor, is changed from 6500 ohms, 5W, to 5100 ohms, 5W. A similar change will, of course, increase width in receivers other than Philco. The amount that the screen dropping resistor can be reduced depends on the ability of the horizontal amplifier tube present to handle the increased power without overheating, or producing a non-linear sweep.

At normal line voltages, some model 421 Stromberg-Carlson receivers produce second anode voltages in excess of 18 KV, often resulting in insufficient picture width. This second anode voltage can be reduced, and sufficient width obtained, by connecting a 60 MMF, 3 KV mica capacitor (part no. 110814) in series with a 560 ohm resistor (part no. 28155) between terminals no. 3 and no. 7 of the horizontal output transformer. The resistor must connect to terminal no. 3, and the capacitor to no. 7, to avoid corona. R-203, screen dropping resistor for the 6AV5 horizontal output tube, is also decreased in value from 15,000 to 12,000 ohms (from *Stromberg-Carlson Current Flashes*).

Mistakes Re Yokes

Capehart in its *Service Bulletin*, calls attention to the fact that a large percentage of CX-33 and CX-33DX horizontal deflection yoke replacements are unnecessary. Servicemen assume that an inadequate resistance reading across the yoke indicates that it has shorted windings. Actually, the 56 MMF 1500 V capacitor across one-half of the yoke winding is defective. Check this capacitor when you suspect the yoke, advises Capehart. Servicemen can extend this bit of advice to other receivers as well.

Excessive 25BQ6 Failure

A trouble that kayos horizontal output tubes in Motorola receivers using series-parallel filament strings is described in Motorola's *Service and Installation Bulletin*. The defect causes excessive 25BQ6 failure in some TS-325 and TS-326 series TV chassis. Heater-to-cathode flashovers in some 12AX4 damper tubes puts an excessive voltage on the 25BQ6 filament, causing it to open-circuit. Arcing between the heater and cathode of the 12AX4, caused by the high-voltage pulse on the 12AX4 cathode breaking down the insulation between cathode and heater, is the source of the trouble. The condition may be remedied by installing a disc-type 5000 MMF ceramic capacitor, Motorola part no. 21R115312 from pin 7 (heater connection) of the 12AX4 to ground. Use the chassis ground kick-out immediately adjacent to pin 7 for the condenser ground point. The condenser serves to bypass the pulse, pre-

venting the breakdown of the 25BQ6. This capacitor has been added in production of later sets.

Linearity Adjustment

A simple, fast and accurate method for adjusting horizontal linearity which does not require a station test pattern is described in a Sentinel Radio Corp. Service Bulletin. The test device, shown in fig. 2, consists of a 6-8 V, 150 MA pilot light, no. 44, with two clip leads. Here's the way it should be worked:

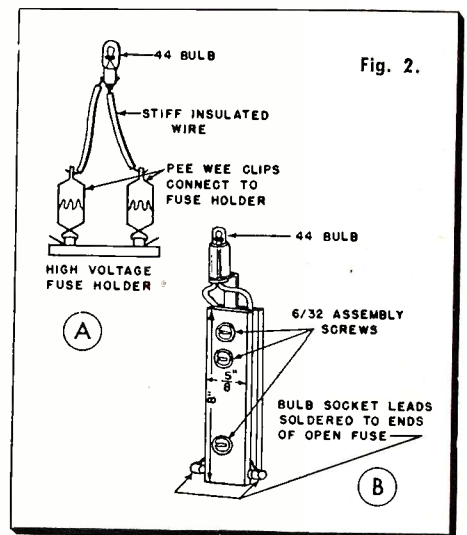

1—Remove the high-voltage fuse from its holder in the high-voltage cage.
2—Clip a lead from the pilot light to each terminal of the fuse holder. 3—Adjust the horizontal linearity control for minimum pilot light brightness.

The above system is just as accurate as the 150 MA meter method recommended in the latest Sentinel Service Manuals. Many servicemen feel that the pilot light brightness method is easier to use.

An easy way to make a tool that will snap into the fuse-holder is to use two strips of bakelite about 8" by 5/8", fastening an open fuse in one end, and a pilot light holder in the other, as illustrated in fig. 2B. This unit raises the light above the edge of the high-voltage cage for easier viewing. A 200-MA bulb can be used—it gives less light and reduced glare. At minimum current, the light almost goes out.

Horizontal Jitter

When horizontal pulling or tearing is present, the serviceman will generally check the horizontal AFC and sync circuits for trouble. In some cases he may poke his nose into the horizontal amplifier or oscillator circuits, or even the HV section (any nose-poking in this circuit should be purely figurative). Who would think, however, of looking for the source of jitter in the yoke?

Interference, Tube Defects and Linearity Adjustment

Du Mont (*Du Mont Service News*) cites such a trouble for the RA-160 and 62 receiver models. The symptom is horizontal jitter at the top of the picture and/or random white streaks in the picture, with moderately weak signals coming in. The probable fault is internal corona in C501 (see fig. 3), the anti-ringing capacitor that is connected

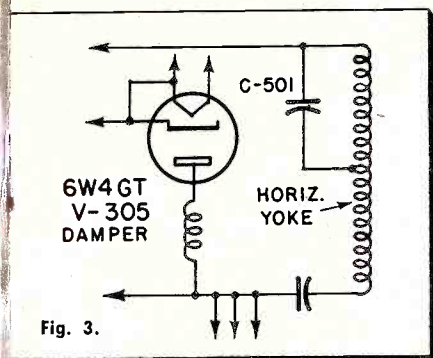

across part of the horizontal yoke. The remedy is to replace C501 with a 68 MMF, 2KV capacitor, part number B3 112 700. This capacitor is used in current production of Du Mont models. If the trouble is found in receivers other than Du Mont, replace the condenser cited with one having a much higher voltage-break-down rating, and note results.

Non-Oscillating 6SN7 GTA Tubes

Trouble in models 300 and 400 series Stromberg-Carlson receivers has been traced to non-oscillating 6SN7 GTA tubes. It has been found that these tubes do not oscillate as readily as 6SN7 GT tubes in the horizontal oscillator position, particularly when rapidly switching from "radio" or "phono" position to "TV" position, or rapidly turning the set "on" after turning it "off." When the oscillator does not immediately oscillate, there is no drive applied to the horizontal amplifier, causing the high-voltage fuse to blow repeatedly. (from *Stromberg-Carlson Current Flashes*)

Yoke Ringing

Motorola, in its *Service and Installation Bulletin*, calls attention to the fact that the horizontal yoke shunt capacitor value can be critical. In a note on its TS-325, TS-326 and TS-351 series TV chassis, the company says ringing can result if C-285, the anti-ringing capacitor, varies too much from its optimum value. The 27 MMF capacitor that gave satisfactory service in earlier yokes, has been found to be too low for the distributed-capacity yokes used in current receivers. Although 47 MMF is about right for the present yokes, 50 MMF and 56 MMF capacitors have been used. If ringing is encountered, replace the capacitor with one of the correct

value, as found by experiment. The capacitor must have a 2000 V rating.

Ringing, we need hardly remind the serviceman, is a condition that tends to produce one or more vertical lines at the left-hand side of the raster. If such lines are present, the anti-ringing capacitor (in any make receiver) should be checked for correct capacitance.

Line Voltage Trouble

Olympic's *Service Bulletin 114-B* points out that low line voltage is one of the most frequent causes of consumer dissatisfaction. The company recommends that on complaint of insufficient width (or height) line voltage should be checked before service on the receiver is attempted. Olympic receivers, it says, are designed with an extra margin of safety to allow for all but the most extreme cases of line voltage reduction.

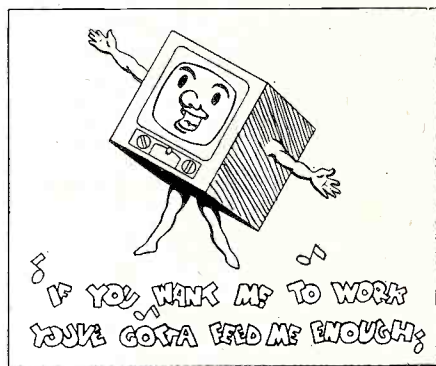

'Spook' Interference

Visible interference in the picture or instability of the synchronizing circuits may be caused by a type of high-frequency radiation from the damper tube and its leads which is picked up in the receiver rf and if circuits. The interference appears in the picture as a narrow vertical line very near the left margin of the raster and looks similar to Barkhausen oscillation. When this interference was first observed as an effect distinct from Barkhausen oscillation, its nature seemed quite mysterious and, as a result, it became known as the 'spook' in the industry. If the signal is weak, the line is black and has ragged edges; if the signal is stronger, the line has visible crawling 'beats' within its margins. The line usually is not seen because it is in the blanked portion of the raster or off the kinescope screen.

Appearance of this 'spook' interference is coincident with the start of conduction in the damper tube. Shortly after the completion of retrace, the damper-tube current rises from zero to its peak value of approximately 400

milliamperes within a period of the order of 0.1 microsecond. A Fourier analysis of the waveform of this current change would show the high-frequency harmonics to be of appreciable amplitude. These high-frequency harmonics are easily radiated and picked up by the sensitive rf and if circuits of the television receiver. As a result, the 'spook' interference at low radio frequencies is more pronounced; it diminishes steadily at higher frequencies.

In order to minimize 'spook' interference, the antenna and the rf and if circuits should be placed as far as possible from the deflection circuits. It is also desirable to minimize the radiation as much as possible. In the autotransformer type of deflection circuits, most of the radiation usually comes from the B+ wiring connected to the damper-tube plate. An rf choke of the order of 2 microhenries placed in series with the damper-tube plate at the tube socket is quite effective in keeping the rf off the B+ leads; in addition, the use of a mica bypass capacitor of approximately 100 micromicrofarads between B+ and the chassis may be helpful. Small rf chokes in other leads to the damper-tube at the socket usually decrease the radiation further. When these steps are taken, virtually the only sources of radiation are the elements of the damper-tube itself. It is important, therefore, that the high-voltage enclosure in which the damper tube is located provide adequate shielding from the rest of the receiver, and that coupling between the damper tube and leads which come out of the enclosure be minimized. (from *RCA Application Note AN-51*)

Correcting for Ragged Picture

A defective 6AU5GT horizontal output tube can cause the ragged picture effect illustrated in the figure below. Circles on the picture appear as cog-

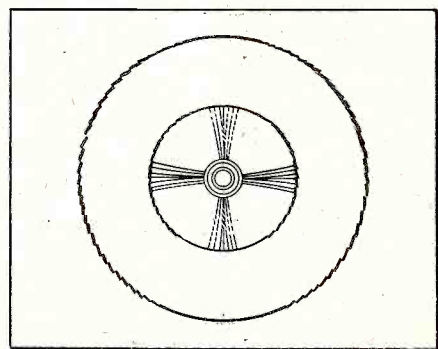

wheels, and vertical or diagonal lines are jagged. The effect is sometimes more pronounced than the one shown in the figure. The remedy is, of course, to replace the 6AU5GT. (from *Westinghouse Service Hints*)

Troubleshooting Hints

Tracking Down a Twin Intermittent.

"Double Trouble" Intermittent

When one intermittent TV trouble is present, the difficulties encountered are often great enough to build a man's vocabulary and strengthen his character. When two intermittents are simultaneously present, the quantity of irritation generated will fuel two servicemen indefinitely. When two obscure intermittent troubles are simultaneously present that produce the same symptoms, however, that friends, is enough to drive a good TV man to the psychoanalyst's couch.

Such a combination of unfortunate circumstances occurred in an instance

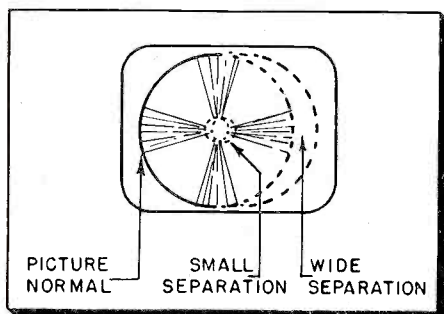

Fig. 1—Effect on test pattern of set trouble.

recounted by one of our readers. A serviceman known to the editor as an exceptionally fast, competent technician, worked on the receiver for at least 12 hours and finally cornered its defects.

The symptom evident—from time to time—was instability of the picture in the horizontal direction. The details of this instability may be described as follows:

Imagine the two fields of the picture to be two pieces of paper (with alternate horizontal strips missing), one laid over the other, normally meshing to form what looks like a single piece of paper. Imagine, further, that the two pieces of paper are stapled together at their left-hand side.

After a short time, one piece of paper begins to shrink in the horizontal direction. It does so noticeably at the right-hand side, where it is not attached. It cannot do so readily at the left-hand side, where it is stapled to the other sheet.

As you watch, the two sheets—or the two pictures—keep pulling further and further apart. A maximum displacement of one inch is finally attained at the right-hand side. The pulling-apart action continues up to a point about one-half inch away from the left-hand edge of the picture (see fig. 1).

On first inspection, it was thought that a picture field displacement was

taking place. Such a pulling-apart of the fields could be due to vertical sweep or sync signals, or a 30-cycle interfering signal of some sort, getting into the AFC system. The signals might contribute in-phase voltage additions to the horizontal lines of one field, and out-of-phase voltages to the horizontal lines of the second field. The result would be that the lines of one field would have different amplitudes or lengths than the lines of the other field, and would not fall exactly over each other, as they normally do.

To see if such a condition was responsible for the symptom present, the horizontal circuits were checked with a scope for the presence of low-frequency signals. The scope was set at 30 cycles, and its vertical input leads attached across the horizontal yoke.

The waveform obtained was a straight-sided blur. This indicated that no low-frequency signals were present. The blur was due to the examination of the fast-traveling horizontal signals at a low-frequency scope setting. If low-frequency interfering signals had been present, they would have affected the envelope of the waveform, and would have caused the waveform's horizontal sides to vary in amplitude instead of being straight and parallel.

A check was next made with the scope frequency controls turned up to 5000 cycles. Several horizontal signals were now seen. Interestingly enough, alternate horizontal-signal waveforms

were observed to have different amplitudes. This accounted for the different lengths and starting points of alternate lines, and explained why the two fields didn't interlace properly.

Trouble in the AFC circuit was now suspected. The AFC tube was pulled out, and the picture examined. A single picture could be locked into an almost stationary position, with the tube out. This indicated that there was no trouble in the horizontal oscillator. With the AFC tube in, such a single picture could not be obtained.

Scope checks in the AFC circuit seemed to be called for. A ratio detector type AFC system (see fig. 2) using a 6AL5 was found to be present. The output plate and cathode of the 6AL5 was checked.

The waveshape at the plate should normally be the complement of the waveshape at the cathode. That is, the upper half of a sawtooth should be observed at one element, and the bottom half of the sawtooth at the other. The waveform at the cathode was ok, but it was improperly shaped at the plate (fig. 3).

The positive sync pulse waveform that should appear at one diode element was normal; so was the negative sync pulse at the other diode element.

A leaky condenser feeding the diode element where the sawtooth was incorrect, was suspected. C-1 the condenser in question, connected between the split-phase sync amplifier tube and

Fig. 2—Partial schematic of circuit section that produced a split test-pattern. Points designated as A, B, C and D were waveform-tested. For waveforms obtained at these points, see fig. 3.

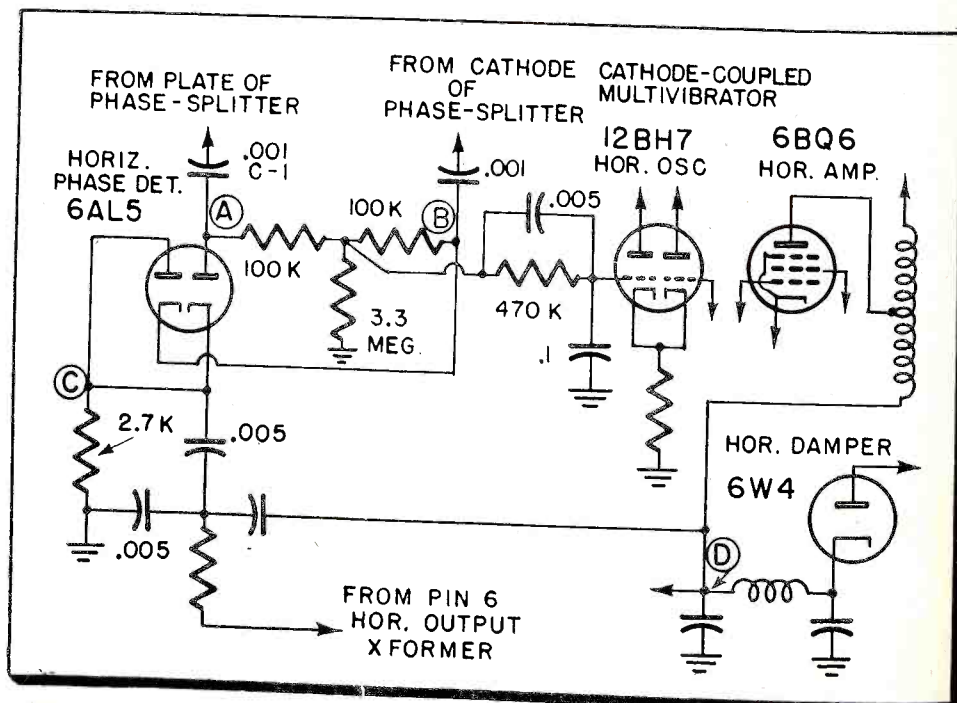

Diagnosing Cause of Insufficient Picture and Raster Height

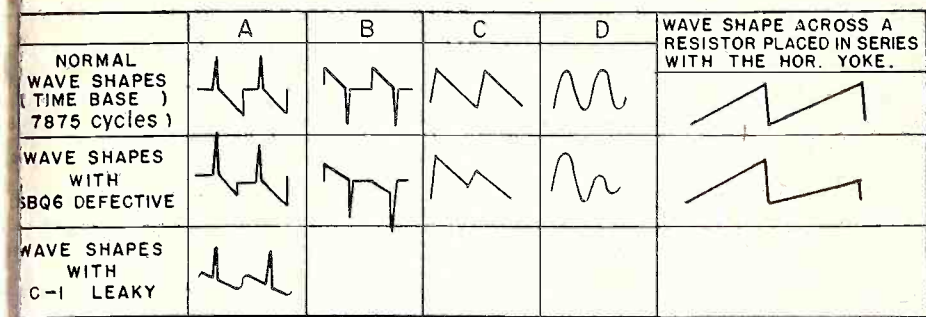

Fig. 3—Normal vs abnormal scope wave shapes obtained at different test points in the receiver.

the 6AL5 diode plate. If this condenser is leaky, the conduction of the 6AL5 diode section made up of the right-hand diode plate and cathode would be incorrect, due to the excessive positive voltage imposed between plate and cathode. A voltage check confirmed this suspicion. The condenser was replaced, and the trouble disappeared. Disappeared for one hour, that is. Then it showed up again.

Originally, the trouble had appeared after 10 minutes of operation. Now, it turned up after one hour. The symptom, while the same in each case, was apparently caused by two different defects.

The AFC waveforms now checked (fig. 3), so trouble in the horizontal deflection circuits was suspected. The waveform at the damper cathode, an important check-point, was examined. It normally resembles a sine-wave. In this case, the sine-wave type waveform had two unequal peaks, resembling somewhat the unequal peak-to-peak voltage of alternate hum signals at the output of a half-wave rectifier, when the diode does not conduct equally during each half of its cycle.

Trouble in the horizontal amplifier damper was likely. All the tubes in the horizontal section had been replaced when troubleshooting had first been instituted, then re-inserted, when no improvement was noticed. It didn't seem likely, therefore, that a tube was the source of the trouble. A suspicion that the 6BQ6 was oscillating couldn't be proven, however.

Normally, only old-type 6BG6-G tubes are suspected of oscillation. Why couldn't a 6BQ6, however, develop the same disease? To test for the condition, the permanent-magnet core of a discarded PM speaker was placed near the 6BQ6. If the latter was oscillating, the magnet should affect the picture; just as in the case of an oscillating 6BG6-G, if the oscillation is producing a Barkhausen line, putting a magnet near the tube will remove the line (and the oscillation).

Sure enough, when the magnet was brought near the 6BQ6, the split image sections of the picture started to pull together. The 6BQ6 was then replaced, and the trouble disappeared. Furthermore, it has not re-appeared after 3 weeks of set operation, indicating that it is (cross our fingers) permanently gone.

Possibly the first-discovered trouble caused the second to develop, but this is one of the mysteries that, like some cases in the files of Scotland Yard, may remain forever unsolved.

Olympic 752U

There was very little height on picture and raster in this TV receiver. Voltage checks revealed only one suspicious element voltage—the one present on the plate of the vertical amplifier. This voltage went from a near-normal to a considerably below normal value, while it was being tested.

A resistance check between plate and

ground revealed no short—rather, the slow swing of the needle showed that a condenser-charge effect was present, indicating an open circuit.

An ohms check between pin 10 of the cathode-ray tube to the 5U4 cathode (see fig. 4) gave a correct reading, eliminating the circuit between point A and the 5U4G as a possible source of the trouble. A similar check between the plate of the vertical amplifier and the 5U4 cathode showed an excessively high resistance, localizing the trouble to the plate circuit components of the vertical amplifier. Units in the plate circuit were then successively resistance-tested, resulting in the discovery of a very much off-value, practically open decoupling resistor (R-55, fig. 4).

A scope check showed a waveform of 330 V peak-to-peak amplitude, but incorrect in shape, at the vertical amplifier plate. The intermittent nature of the decoupling resistor defect under load, was apparently responsible for this waveform.

When the decoupling resistor was replaced, it was discovered with a shock (mental, not electrical) that insufficient vertical height was still present. The presence of a horizontal bar at the top of the very small raster, indicating vertical non-linearity, led to a manipulation of the vertical linearity control. Adequate height and proper linearity were quickly attained by this adjustment. It was then recalled that the vertical linearity control setting had been changed, in an attempt to get sufficient height, when the set had first been checked.

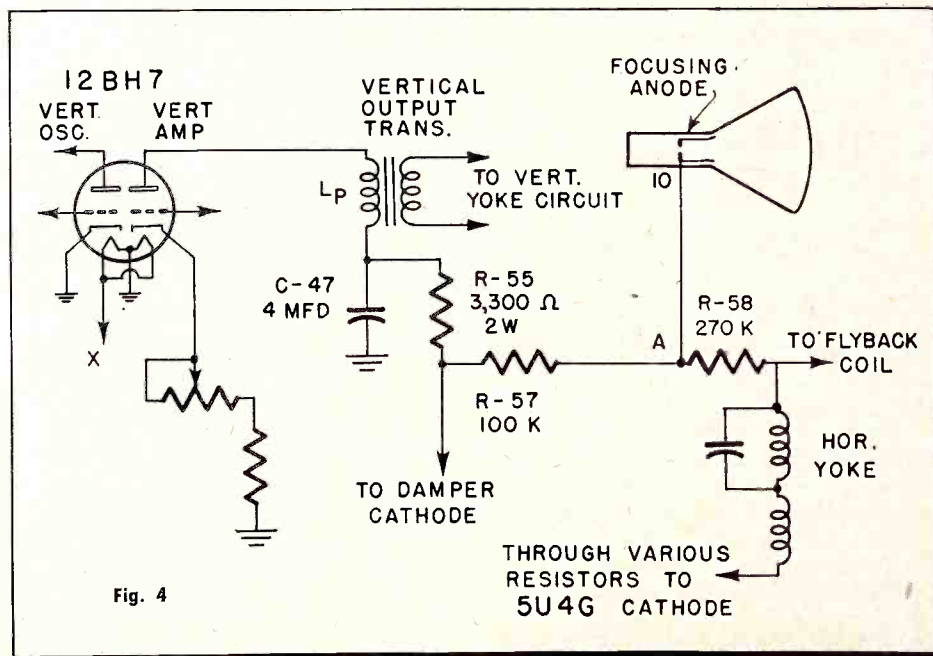

Fig. 4

Shop Shortcuts Speed Servicing

Tips for Home and Bench Service Contributed by Readers

Easier Schematic Reading

Schematics, especially those used for TV, are often hard to work with, because of the many closely-spaced circuit wires that run parallel and at right angles to each other, for relatively long distances. Many times the serviceman will start out tracing a line across the page, only to find himself on an entirely different circuit from the one he started

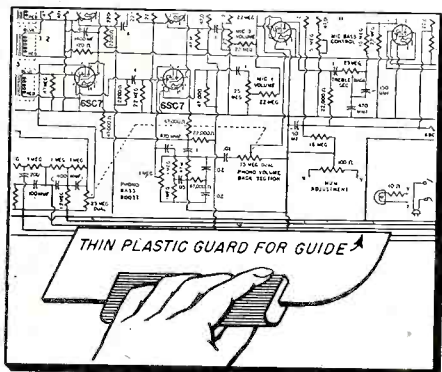

with, having "jumped" a line. This is especially apt to happen when the serviceman suffers from some degree of astigmatism, as many people do.

I have found that the use of an ordinary "Trim Guard," obtainable at any paint store (see sketch) will enable the serviceman to follow drawn lines on the schematic, no matter how closely-spaced they are. The handle is made of aluminum and the "Guard" of plastic (not transparent). The unit sells for about a quarter, and is a real headache-saver. —M. G. Goldberg, Beacon Radio Service, 130 E. 4th Street, St. Paul 1, Minn.

Atmospheric Corona Discharge

Corona discharges can occur external to the receiver from atmospheric electricity, namely at the antenna. In certain sections of the country, during the Spring months, electrical discharges to or from the antenna have produced crackles and pops in the sound signal received by the TV receiver. This symptom usually occurs around sunset, when the ionization of the atmosphere changes markedly. The crackling and popping sounds may reach a point where they override the sound, and make listening to the audio part of the telecast impossible. Noise flashes in the picture are seen co-incidentally with the disturbance in the sound. The picture is not, however, markedly impaired. Such discharges also occur during the approach of lightning storms. Symptoms decrease very noticeably (in both the latter and former cases) when a lightning discharge has "cleared the air," so to speak.

SHOP HINTS WANTED

Payment of \$5.00 will be made for any service hint or shop kink accepted by the editors as usable on this page. Unacceptable items will be returned to the contributor. Send your ideas to "Technical Editor, TELEVISION RETAILING, 480 Lexington Ave., New York 17, New York."

Siren Noise, Broken Raster

The trouble on this TV set was one which could as readily have occurred on many other makes of receivers. When the set was turned on, it would start with a low-frequency whine, which rose in pitch, like a siren. No picture was present. The raster started breaking up almost immediately (see sketch). As the sound increased in pitch, the number of blanking bars that appeared between raster sections increased. The symptoms lasted for three minutes. At the end of that time, sound and picture suddenly became normal.

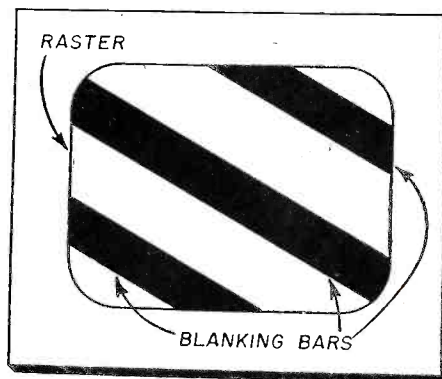

Trouble in the sweep circuits was at first suspected. I thought the vertical sweep signal might be getting into the audio and video amplifiers, through an open decoupling condenser. If this signal got into the video amplifier, it would also get into the sound, since this was an intercarrier-type set.

A scope check of the sweep circuits, however, showed that they weren't the source of the trouble. This check involved watching to see if the frequency of the vertical or horizontal signals changed as the frequency of the disturbance increased. No such change was noted, so the sweeps were absolved of blame.

The front-end oscillator was next suspected. Sure enough, when it was changed, the trouble cleared up. The fault had, apparently, been parasitic oscillation in the front-end oscillator. As

the oscillator tube heated up, it drifted through a frequency range that was capable of supporting parasitic oscillation. When it reached a stable operating frequency, however, its tuning fell beyond or before the frequency of the parasitic oscillation, and the latter was therefore eliminated at this time. —Peter W. Orne, 58-40 150th Street, Flushing, N. Y.

Preventing Condenser Shorts

To check for an open condenser, or a condenser that has lost capacitance, or to substitute for a condenser whose value is unknown, some servicemen connect a pair of alligator clip-ended leads to a test condenser; the other end of each lead has a test prod on it, and is connected across the points to which

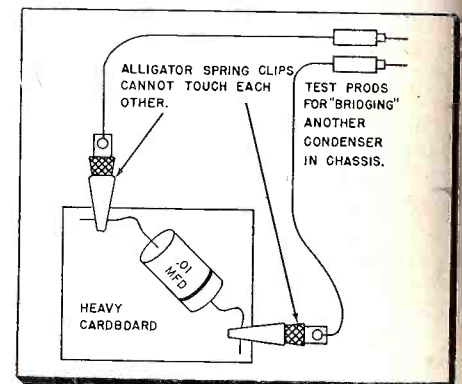

the original condenser goes. The set-up is similar to the one shown in the sketch, but without the cardboard. During the motion of the test prods, the two spring clips are apt to touch each other. This can cause damage to set components. By clipping to a piece of cardboard as illustrated, the possibility of such shorts is made much more remote, even when the test prods are moved vigorously. Joseph Amorose, Route 4, Richmond, Va.

Scope Grid Substitute

When a scope grid (the ruled plastic unit that fits over the scope's cathode-ray tube front surface) is lost, an effective substitute is a small plastic transparent flexible ruler or small T square, or protractor etc.—the kind many five and ten cent stores carry. The unit is most serviceable when its length is less than the maximum height or diameter of the cathode-ray tube (which is usually five inches). If it is longer than the CRT, it will have to be bent slightly, in order to lay it flat against a section of the CRT surface. The plastic unit pinch-hits for the scope grid in making AC voltage measurements.

Does the job better!

Tops them all...

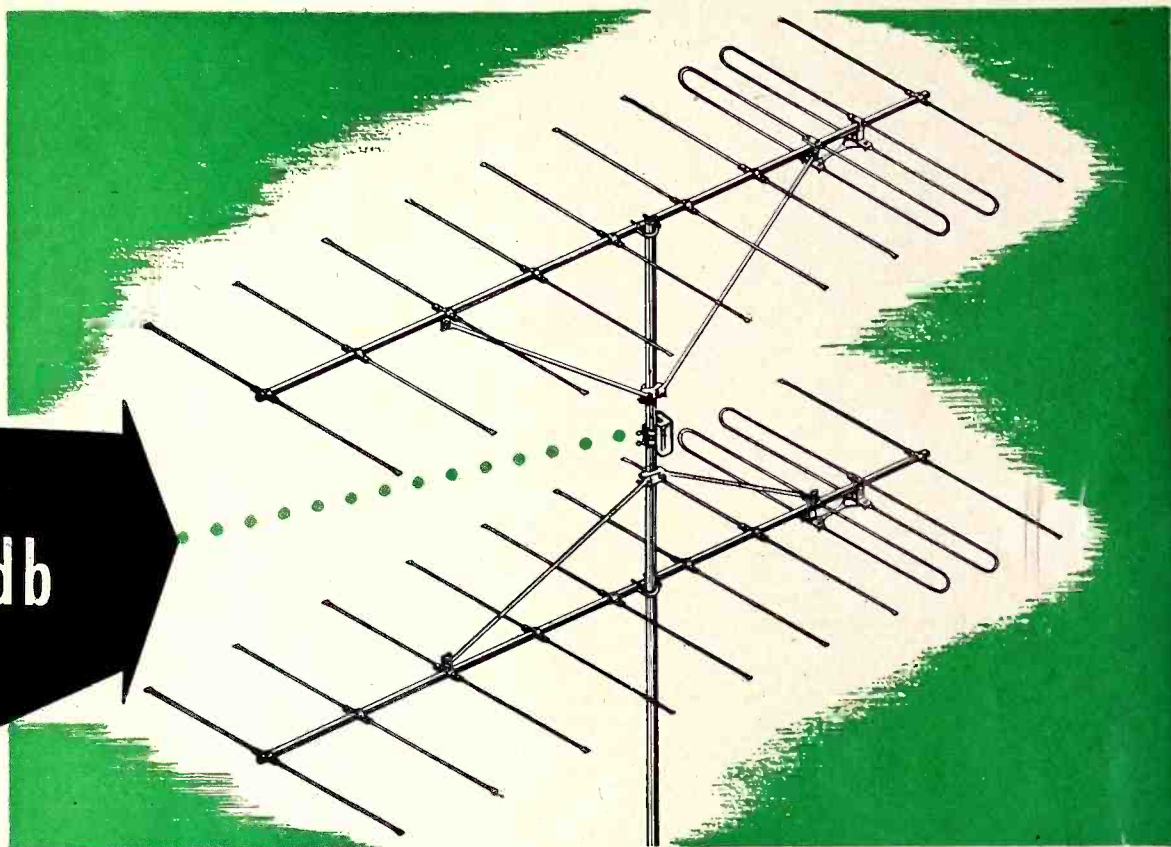

30 db
GAIN

Silver Streak **YAGI**

plus

Supercharger

The most powerful TV antenna system. 30 db gain over a tuned dipole plus highest signal-to-noise ratio. Unequaled for low-signal areas.

Look the "Silver Streak" over carefully—compare the materials, workmanship, construction, and above all—the performance.

GUARANTEE THE SUCCESS OF YOUR INSTALLATIONS WITH TACO ANTENNAS

FREE—Your copy of Catalog No. 38 "The TV Installers Handbook" at your jobber's—get it today.

TECHNICAL APPLIANCE CORPORATION,
Sherburne, N. Y.

IN CANADA: STROMBERG-CARLSON CO., LTD., TORONTO 4, ONT.

TRIO ANNOUNCES SENSATIONAL NEW **ZIG-ZAG** ANTENNA

Patent Pending

★ **Higher Gain than any Yagi!**
Plus

★ **All-Channel VHF Performance!**

Here's the greatest advance in TV antennas since TRIO'S introduction of the dual channel yagi! The sensational new TRIO ZIG-ZAG antenna is basically a multiple element yagi type antenna on each channel, yet one 2-bay antenna — and in some models a single bay antenna — covers all VHF channels!

This sensational antenna has sharper directivity and higher front-to-back ratio. It provides snow-free pictures, and fade-free sound even in the most remote fringe areas.

Tremendous forward gain is accomplished without long, bulky, arrays that operate on only one channel. With the new fringe area model ZIG-ZAG antenna, one bay provides tremendous gain on all low channels, 2 thru 6, and the other bay provides similar high gain on channels 7 thru 13.

HOW THIS AMAZING ANTENNA WORKS

Trio ZIG-ZAG antennas utilize a new principle whereby an array is composed of a series of elements, one or more of which is resonant on any one channel while the remaining elements, which are non-resonant on that channel, provide parasitic voltages having the proper phase relative to the direct voltage. These act as very efficient directors and reflectors. All elements are directly connected to the feed-line.

The various models, listed below, are designed to provide a simple installation for all areas, from metropolitan to extreme fringe. Two bay models, like the single bay models, are operated with a single 300 ohm lead-in to the set, with less than a 3:1 standing wave ratio.

8 MODELS FROM WHICH TO CHOOSE:

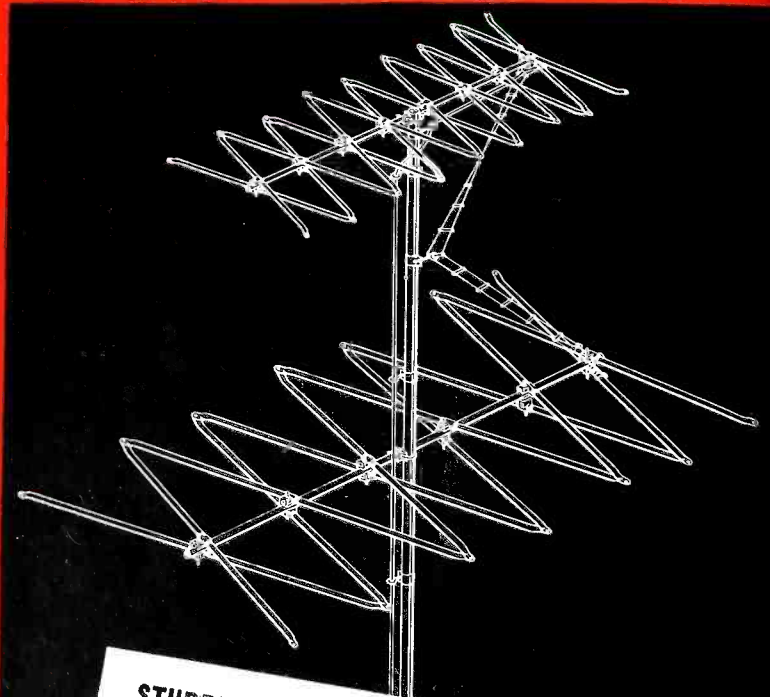

STURDY, VIBRATION-PROOF CONSTRUCTION
Rugged strength is designed into all models. Antenna is shipped with all hardware mounted on the boom with the exception of the mast clamp. Complete assembly consists only of matching color-coded elements to the color-coded boom and tightening nuts which furnish clamping action. Complete assembly is accomplished in minutes.

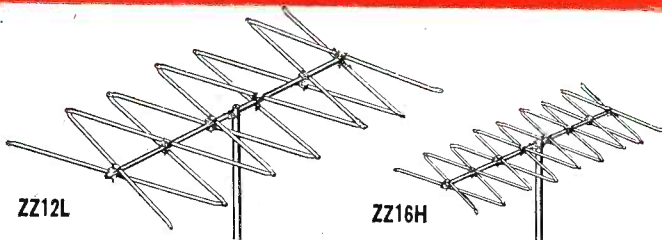

ZZ12L

ZZ16H

FOR EXTREME FRINGE RECEPTION — ZZ16H provides over 14 DB voltage gain as compared with a resonant reference dipole on Channels 7 thru 13, and ZZ12L provides gain of 12 to 14 DB on Channels 2 thru 6. Gain of the ZZ12L is 12 DB on Channels 2 and 3 and is 14 on Channels 4, 5 and 6. These models have narrowest forward lobe and highest front-to-back ratio and should be used in areas where co-channel interference is a problem.

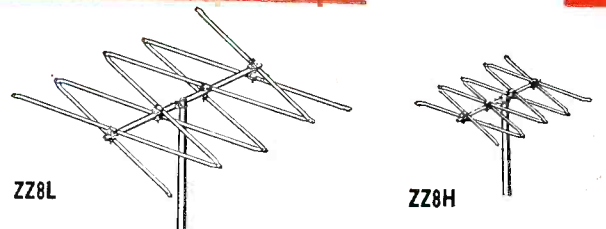

ZZ8L

ZZ8H

FOR NORMAL FRINGE RECEPTION — Where maximum gain is not necessary, these models are ideal. The ZZ8H for Channels 7 thru 13 and the ZZ8L for Channels 2 thru 6. Voltage gain is 9 DB on Channels 2 and 3 and 11 DB on Channels 4 thru 13. These models have patterns comparable to a well designed multi-element single channel yagi.

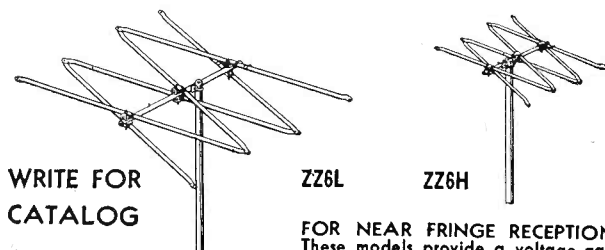

WRITE FOR CATALOG

ZZ6L

ZZ6H

FOR NEAR FRINGE RECEPTION — These models provide a voltage gain of 8 to 9 DB on Channels 2 thru 13. These models have pattern and gain comparable to a cut-to-channel yagi. ZZ6L covers Channels 2 thru 6. ZZ6H covers Channels 7 thru 13.

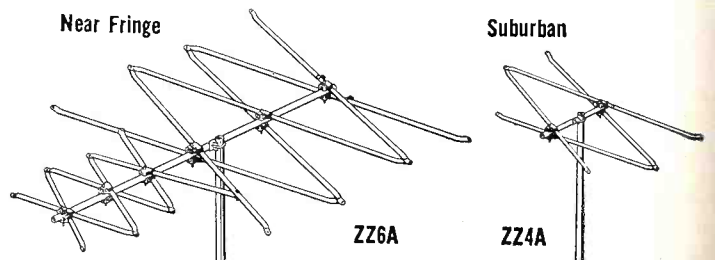

Near Fringe

Suburban

ZZ6A

ZZ4A

SINGLE BAY ALL-CHANNEL RECEPTION — Model ZZ4A is a single bay antenna providing adequate gain and directivity on all channels, 2 thru 13, in suburban areas. Model ZZ6A is also an all-channel single bay antenna providing greater gain for near fringe use.



TRIO MANUFACTURING COMPANY • GRIGGSVILLE, ILLINOIS

The TRIO ROTATOR

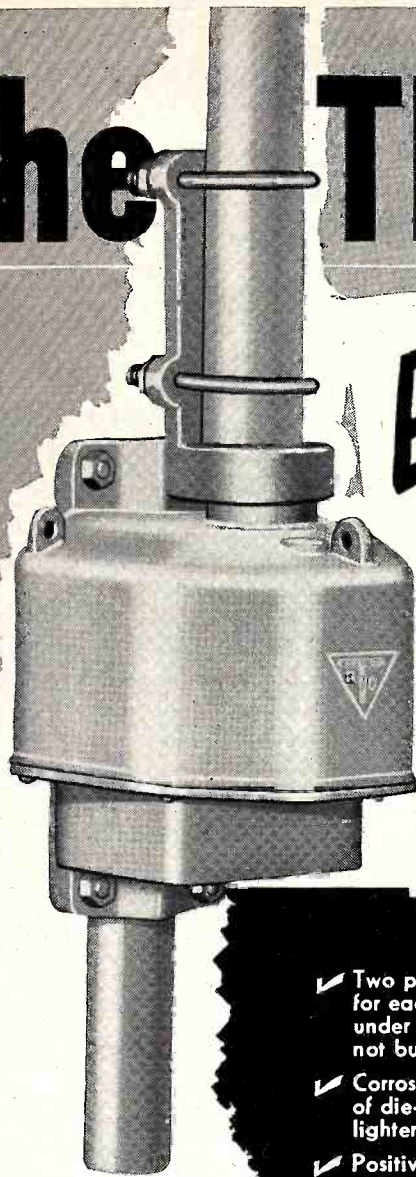

Easy to Sell!

It's easy to sell a product with as many plus features to talk about as the TRIO ROTATOR. In design, in construction, appearance; it is by far the outstanding TV antenna rotator in the market today!

Stays Sold!

In addition to providing a powerful sales story, the features listed below are your assurance of complete customer satisfaction: Assurance that the TRIO ROTATOR will give dependable performance year in and year out — in all kinds of weather!

- ✓ Two powerful 24 volt motors used — one for each direction of rotation. Each motor under load only fraction of time — will not burn out!
- ✓ Corrosion resisting, weatherproof housing of die-cast aluminum for greater strength, lighter weight, perfect alignment of parts!
- ✓ Positive electrical stops at ends of 360° rotation prevent damaging or twisting of leads!
- ✓ Will support heavy TV arrays — even in 80 MPH winds!
- ✓ Permanently lubricated with special grease that functions perfectly in high and low temperature extremes!
- ✓ Ball-bearing end thrusts on all shafts, including motor! Main shaft vertical load carried on large oversized "Oilite" self-lubricating bearing!
- ✓ All motors, shafts and gears mounted on a rugged, one-piece casting for true alignment and longer life!
- ✓ 1 1/16" diameter tool steel main shaft and mast holder will withstand 4500 inch pounds bending moment!
- ✓ Rotator and mast holder fits any pipe size up to 2" OD!
- ✓ Precision built to extremely close tolerances!



Smartly Styled

DIRECTION INDICATOR

The TRIO Direction Indicator is housed in a sturdy plastic cabinet of graceful lines. It is a beautiful instrument that will blend harmoniously with any furniture style.

Utmost ease in selecting the desired antenna direction is provided by a new "finger tip" control that operates at a light touch and the easy-to-read dial face that clearly and instantly indicates the exact antenna position.



**FULLY TESTED
BEFORE
SHIPMENT**

Each TRIO ROTATOR is thoroughly factory tested to the equivalent of 3 months of constant operation. This, plus an additional torque test guarantees each unit to be perfect in every detail of assembly.

The TRIO ROTATOR's sound design and construction has been proven by three years of extensive field testing under every extreme of weather.



TRIO *Manufacturing Company*
GRIGGSVILLE, ILLINOIS

TV Antennas and Accessories

Alliance TV BOOSTER

This new booster, the Cascamatic, mounts on the back of a TV set, is easy



to install, turns on and off with the set, is pre-tuned to all channels, and contains three tubes. Alliance Manufacturing Co., Alliance, Ohio.—TELEVISION RETAILING.

RMS TV ANTENNA SWITCH

Model LDS is a local-distance switch that is intended to eliminate overloading of the TV receiver on strong signals. The switch is inserted into the antenna circuit. It is set at the "local" position for strong stations, and at "distant" setting for weaker ones. In the "local" po-

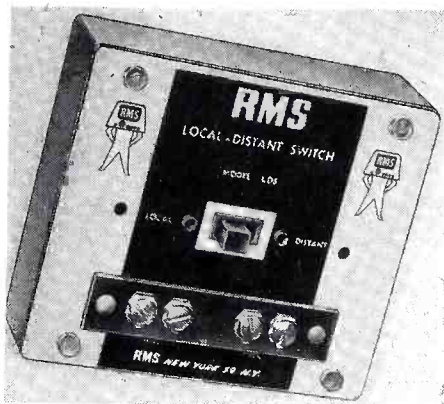

sition, the switch reduces the signal input to the receiver, thus preventing overloading. Unit mounts conveniently to walls and baseboards. Radio Merchandise Sales, Inc., 1165 Southern Boulevard, New York 59, N.Y.—TELEVISION RETAILING.

JFD ANTENNA MASTS

The "Sky-Scraper Specials," four brand new "Zoom-Up" mast combinations, are packaged in 14, 24, 34 and 44 ft. lengths. With the uppermost section in each being 14 ft., the "Sky-Scraper Specials" were designed to provide ample single unit mast length where ordinary 10 ft. mast sections fall short for four bay arrays. With every purchase of the ZU-0345-44 "Sky-Scraper," the universal combination base and roof mount, ZUB2 $\frac{1}{4}$ ", is included at no extra charge. JFD Mfg. Co., Inc., 6101 16th Ave., Brooklyn 4, N. Y.—TELEVISION RETAILING.

Heppner ION TRAP

A new low-priced slip-on ion trap features a new simplified steel construction which is said to lower manufacturing costs by fully utilizing for the first time the maximum efficiency of the Alnico permanent magnet. This

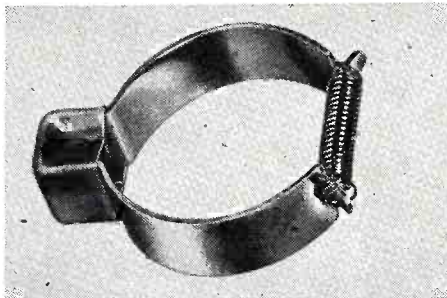

makes Model T-312 the lowest priced ion trap available, according to the manufacturer. Installation time is 2 or 3 seconds. Model T-312 is also light in weight, $\frac{3}{8}$ ounce, so the tube's neck cannot be harmed. Heppner Mfg. Co., P. O. Box 612, Round Lake, Ill.—TELEVISION RETAILING.

Bogen TV BOOSTER

The Bogen BB1-A retains the electronic circuit features of the BB-1 booster. Separate 6J6 triodes operate in independent push-pull circuits to provide maximum gain and bandwidth with measurably superior signal-to-noise characteristics. One knob tunes

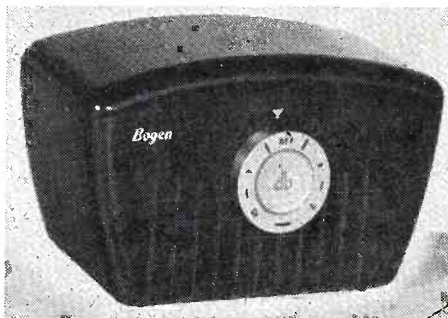

continuously from Channel 2 to 13. The "off" position disconnects the booster and connects the television set directly to the antenna for use on channels which do not require the aid of the booster. A newly designed and tooled thermal switch assures automatic control of power to the booster. List price BB1-A, \$32.50, mahogany; BB1-B, \$33.50, blonde. David Bogen Co., Inc., 29 Ninth Ave., New York 14, N. Y.—TELEVISION RETAILING.

Telematic TVI LINE FILTERS

Two low pass line filters have been designed to eliminate diathermy interferences above 70 cycles that enter a TV receiver through the AC line. WT-29, a tunable hi-freq line filter with a variable frequency range of high attenuation in the diathermy spectrum prevents diathermy frequencies from entering a TV set via the AC line. Hi-freq line filter, WT-30, with a cut-off frequency of 70 cycles, prevents any frequency above 70 cycles from entering the receiver through the AC line. Telematic Industries, Inc., 1 Joralemon St., Brooklyn, N. Y.—TELEVISION RETAILING.

Ward CONICAL ANTENNA

Cross-folded dipoles are used on the "Lucky-4" to provide a better impedance match and higher gain, and the company claims that tests have shown the "Lucky-4" to average 2 DB greater gain on all channels as compared to

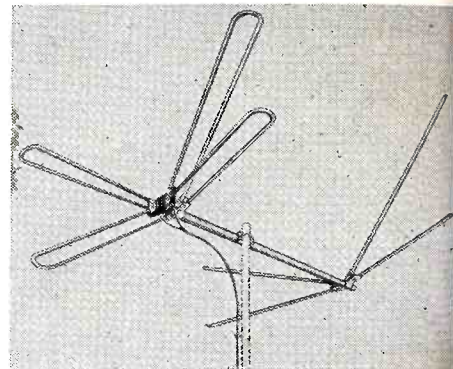

standard 8-element conical antennas. Mechanically, the cross-folded dipoles reduce strain on the Bakelite insulator. Two point element support and closed ends restrict vibration and "singing." All-aluminum, pre-assembled construction are other features of "Lucky-4." Ward Products Corp., Div. of The Gabriel Co., 1523 E. 45 St., Cleveland 3, Ohio.—TELEVISION RETAILING.

Trio TV ANTENNA ROTATOR

The new Trio 2-motor TV antenna rotator is said to possess the ability to function under the most severe weather conditions. Manufacturer claims it has

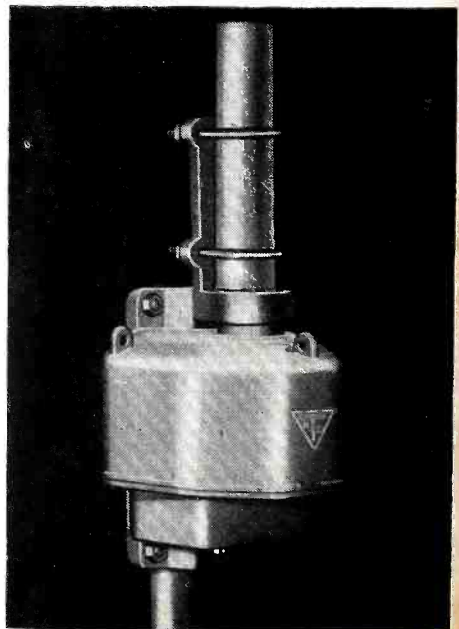

a structural strength not found in TV rotators of comparable size or price. Trio Mfg Co., Griggsville, Ill.—TELEVISION RETAILING.

Plastoid COAX CABLE

A new radiation-proof coaxial cable, especially engineered for community installations, is said to provide better picture reception and also greater tensile strength needed for long lines. Plastoid Corporation, 42-61 24th St., Long Island City, N. Y.—TELEVISION RETAILING.

NEVER BEFORE SUCH ANTENNA NEWS!

VHF-UHF AND FRINGE ANTENNAS for EVERY PURPOSE

WARD, the oldest, largest and leading manufacturer of antennas, has done it again. The new 1952-53 exciting WARD SIGNALINE will put you years ahead. Not 1 . . . not 2 . . . but 5 ingeniously designed, radically different and sensationally better TV antennas. Now, your WARD LINE is the only line that completely covers every application.

WARD THE ONLY COMPLETE LINE

Plus a brilliant promotion program to help you sell the complete WARD LINE of TV-Auto-Communication and FM Antennas.

HAVE YOUR WARD
DISTRIBUTOR
SHOW YOU
THIS BOOK—

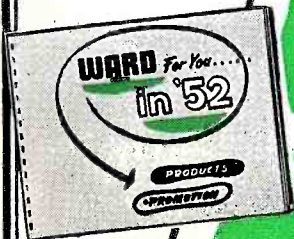

WARD Signaline

Trombone

U-Vee

Lucky 4

5 Star

MUSKETEER

ZIP-HI

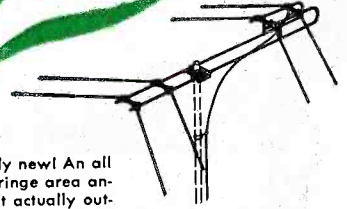

Completely new! An all channel fringe area antenna that actually outperforms Yagis on many channels! The 3-in-1 antenna for use on VHF, — VHF and UHF, — UHF. Opens up new markets with new ideas of good pictures! Light and rugged! Completely preassembled!

3-in-1 antenna — for UHF, VHF — UHF and VHF. Protects your customers on new UHF stations, while giving them the best in VHF today! High gain, all-channel, completely pre-assembled.

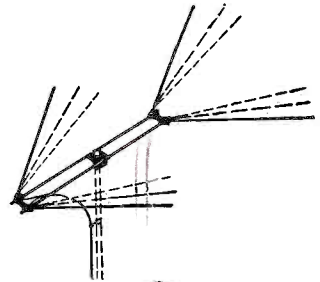

The first major advance in conicals! Higher gain! Better impedance match! Completely pre-assembled! With six extra features!

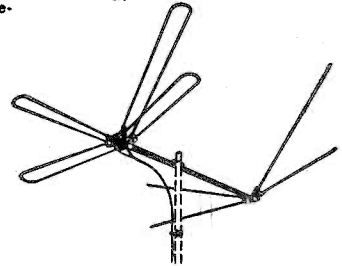

The Yagi with the radar-proved T match and exclusive offset elements! Extra gain, extra efficiency, plus rugged preassembled construction.

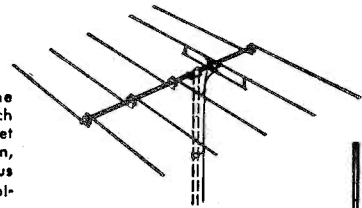

The first true broad-band Yagi — covers channels 3, 4, 5 and 6 with uniformly high gain! The first triple-driven Yagi. Completely preassembled!

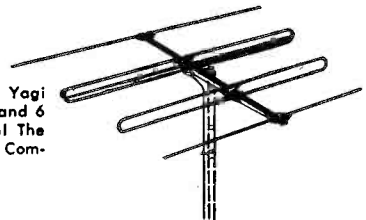

The new WARD telescopic mast made from corrosion-proof PERMATUBE! Four different heights, all with exclusive anti-collapse feature. Can be erected by one man. Comes in 2, 3, 4, and 5 section models.

IN CANADA: Atlas Radio Corp., Toronto, Ontario

THE WARD PRODUCTS CORPORATION

DIVISION OF THE GABRIEL COMPANY

1523 EAST 45 STREET • CLEVELAND 3, OHIO

UHF-VHF

you're prepared for everything with **Trombone**

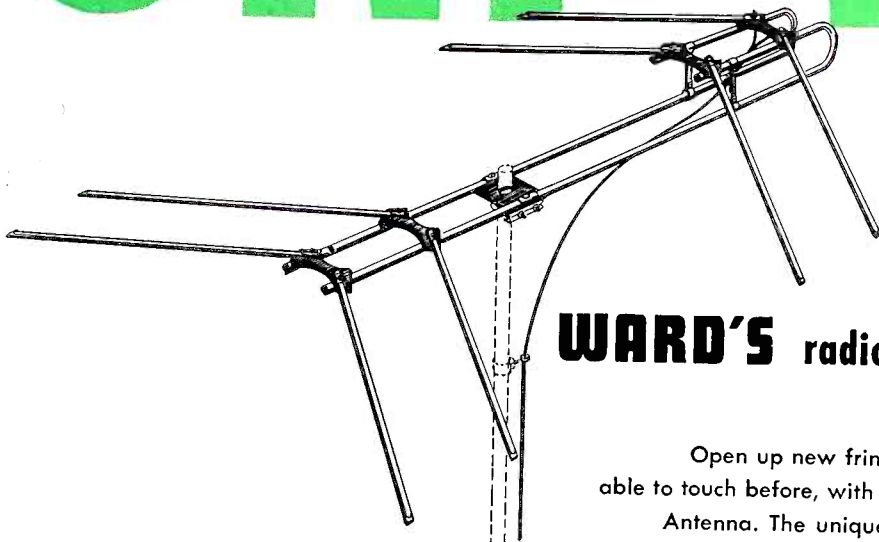

WARD'S radically new all-channel antenna!

Open up new fringe areas! — Bring in markets you've never been able to touch before, with WARD'S radically new, all-channel "TROMBONE" Antenna. The unique three-bay "TROMBONE" delivers high gain on all channels . . . up to 16 db . . . on 2 to 83. Best of all, "TROMBONE" protects your customers against channel changes and new stations. It's the "plus feature" antenna you can sell with confidence . . . the antenna that gets the best in VHF today and the best in UHF tomorrow.

All-aluminum construction . . . completely pre-assembled . . . streamlined vibration-proof design . . . are added features of this outstanding antenna.

Cash in on WARD'S big promotion plan. Sell the complete WARD line for sales, profits and customer protection. See the TROMBONE and other Signaline Antennas at your distributor today.

The "TROMBONE" is but one of the excitingly new WARD*Signaline Antennas; here are four more of them:



THE WARD PRODUCTS CORP.

DIVISION OF THE GABRIEL COMPANY

1523 EAST 45 STREET • CLEVELAND 3, OHIO

IN CANADA: ATLAS RADIO CORP., TORONTO, CANADA

New Hi-Fi Equipment

Pfanstiehl TONEARM

The Pfan-wood tonearm has a novel design intended to provide optimum high-fidelity reproduction. Natural resonances of the arm fall outside the audible frequency range. Adjustable spring is present on top of arm to help control the stylus force. (Different



mounts of stylus force are needed for micro-groove and standard-groove records.) According to the manufacturer, beauty has been sacrificed for functional perfection in the design of this unit. Pfanstiehl Chemical Co., 104 Lake View Ave., Waukegan, Ill.—TELEVISION RETAILING.

Brociner 3-WAY CORNER HORN

The "Transcendent" represents a further development of the corner horn principle. The bass range below 250 CPS is reproduced by a special, heavy-duty 5-inch speaker driving a large folded exponential horn. The walls and floor comprising the room corner form an extension of this horn. The middle register and high frequencies are reproduced by a twin-cone driver unit, which reproduces the range from 250

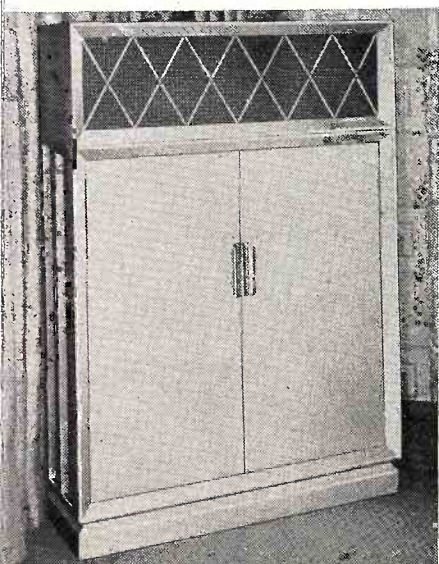

cycles to 20,000 cycles with smoothness and freedom from peaks. The twin cone unit drives a horn which includes a reflector-diffuser element that evenly distributes the higher frequencies throughout the listening space. Model 250 lists at \$736; Model 250-R (Modern) at \$868; and Model 250-T (Traditional) at \$976. Brociner Electronics Laboratory, 1546 Second Ave., New York 28, N. Y.—TELEVISION RETAILING.

Newcomb 25 WATT AMPLIFIER

The new Classic 25 amplifier is designed for custom home music installations and features a remote control unit finished in brushed brass. Frequency response from below 10 to over 100,000 CPS with very low distortion. "Audio-balance" permits adjustment for perfect balance of output tubes. "Adjust-a-panel" extends control

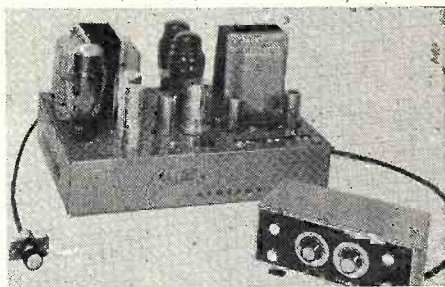

shafts instantly for easy cabinet mounting through panel if desired. Six inputs are provided, for radio, TV, tape recorder, crystal and magnetic (2) pickups. "Fletcher-Munson" compensated volume control maintains aural balance. A crossover selector simplifies attainment of correct playback response, includes foreign and domestic recordings and the A.E.S. standard. Newcomb Audio Products Co., 6824 Lexington Ave., Hollywood 38, Calif.—TELEVISION RETAILING.

Jensen SPEAKER

The Coaxial H-222 is a 12" speaker that was designed to bring improved speaker performance to those applications where speaker size is limited by enclosure restrictions. Low frequencies below 2000 cycles are reproduced by a special direct-radiator unit. The range above 2000 cycles is handled by means of an electrically and mechanically independent compression-driver unit loaded with a six-cell Hypex formula horn. Low and high frequency units constitute a true 2-way system. Frequency range rating, +7LIM; input impedance, 16 ohms; power rating, 25 watts maximum speech and music signal input. Jensen Mfg. Co., 6601 South Laramie Ave., Chicago 38, Ill.—TELEVISION RETAILING.

GE PHONO ACCESSORIES

GE has added a new variable reluctance cartridge and a wide-range stylus to its line of phono accessories. The Model RPX-052 cartridge is designed to perform with uniform velocity response up to 15,000 CPS. Changing from standard to microgroove stylus is achieved by twisting the positioning knob. The "Baton" styli are constructed to reproduce sound frequencies from 30 to 15,000 cycles. Damping blocks increase fidelity and eliminate mechanical noise. The Model RPX-052 cartridge is equipped with a dual wide-range sapphire and diamond "Baton" stylus, and lists for \$38.95. Dual stylus combination in sapphire lists for \$5.95, and in diamond for \$49.95. Diamond and sapphire combinations list for \$31.00. General Electric Co., Receiver Dep't., Electronics Park, Syracuse, N.Y.—TELEVISION RETAILING.

University SPEAKER

The Diffusicone-8 is an 8", wide-range, wide-dispersion speaker, intended to fill the need for a compact, popularly-priced high-quality reproducer for both commercial and high-fidelity applications. 25-watt power ra-



ting. Designed for distortion-free reproduction of transient peaks. The superior dispersion characteristics of the unit, it is said, eliminates the need for special baffling. University Loudspeakers Inc., 80 South Kensico Ave., White Plains, N. Y.—TELEVISION RETAILING.

Bell AMPLIFIER

Designed as a medium-priced addition to Bell's line of high fidelity amplifiers for custom home music systems, the new model 2200 has a power output of approximately 20 watts at less than .3% harmonic and intermodulation distortion, the maker states. Six controls are provided, including a 5-position

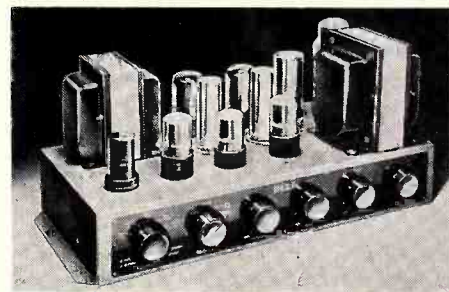

equalizer switch for different phono record characteristics. Inputs are provided for tuner, crystal mike, 2 magnetic pickups, TV sound and tape recorder. Desired input is selected by a 5-position switch. Response is said to be 20-20,000 CPS, plus or minus 1/2 DB. Bell Sound Systems, Inc., 555 Marion Rd., Columbus 7, Ohio.—TELEVISION RETAILING.

G-C LONG NOSE PLIERS

No. 8387 insulated long nose plastic pliers for TV servicemen measure six and one-quarter inches in length, and are claimed to be absolutely shock-proof. List price is \$1.65. General Cement Manufacturing Co., 919 Taylor Ave., Rockford, Ill.—TELEVISION RETAILING.

Hi-Fi Picture

(Continued from page 78)

With the new interest in records, there is a great opportunity for the merchant to make money in Hi-Fi, serving a market where there are always folk who for a number of reasons don't want to buy even the best mass-produced instruments. Perhaps they own an instrument in a highly-prized cabinet which they would like to retain yet still enjoy improved radio reception, and a modern changer. Or perhaps they'll go for a custom-built job because of what they have been reading about Hi-Fi in some of the consumer magazines.

In many cases, the smart salesman can originate desire to own a fine instrument on the part of those who know nothing about Hi-Fi. In the latter instance, the store demonstration set-up can be put to good use.

Technically, there are four important parts to the high-quality instrument. They are tuner, record player or recorder, amplifier and loudspeaker. The inventory problem is not great, but components and units such as tuners, amplifiers, preamplifiers, cartridges, pickups, needles, speakers, cabinets, record changers and recorders must be of top quality, and the assembled unit must emerge as an excellent job from both operational and appearance viewpoints.

Unless he is fortunate enough to have technicians who are skilled woodworkers, the average dealer will make a mistake in attempting to do any work on cabinets, but will be much better off if he gets a tie-in with a local cabinet maker so that customers will get the best in cabinetry. In custom work, appearance counts heavily, since the person who paid say \$700 for a built-to-order unit will not be satisfied with superb reception if the appearance of the job isn't up to par.

Great care must be used in estimating on conversion and made-to-order Hi-Fi instruments. Many of such jobs call for unusual work thought up by the customer, and in some instances these "specials" can turn out to be real headaches, particularly where time is concerned.

With the current wave of price-cutting slashing into every dealer's profit structure, custom-building offers at least one avenue of escape from madhouse competition. Those who start now in Hi-Fi may be getting in on the ground-floor of a very big business, and will establish

their stores as headquarters.

Right now there are profits for those dealers who use salesmanship, have technical know-how, and who are skillful and accurate in estimating these very special Hi-Fi jobs more and more consumers are becoming interested in.

Keep Your Word

(Continued from page 95)

ever, that bodes the store no good. The next time his set needs service, he's quite apt to take his chances with another store. Why should he go back to the first one, anyhow?

The efficient service manager always keeps in mind that, no matter how busy he is, or his men are, the customer comes first. The motto is the cornerstone of every successful business. The manager therefore schedules his repairs, possibly on a special sheet. He makes sure that any promises made by subordinates are listed on that sheet. He also checks at periodic intervals to see whether servicemen are adhering to the schedule. If he is wise, he will allow several hours, possibly half a day, on each repair job for delays, and make his promises to the customer conform accordingly.

If, in some case, the lack of a component is going to introduce a delay, the service manager immediately telephones the customer, and acquaints him with that fact. The manager also sees to it that irresponsible subordinates don't make rash promises, to get rid of pesty customers.

The manager, in short, treats the customer as an integral part of the business, and not merely an unpleasant accessory to it, short-circuiting his "switching" problems, to mix a metaphor.

Big Business

(Continued from page 49)

publicize Economy's service, but Albertine doesn't depend on that alone to strengthen his reputation. Virtually all his advertising—and he spends \$50,000 a year gross, mostly on a co-op basis—includes the slogan "We Service What We Sell," along with an explanation of customer benefits in buying from an organization with its own service department. A typical recent insert in a full-page ad reads:

"THE HOUSE THAT SERVICE BUILT . . . A recent survey of hundreds of customers served by Economy Appliance Co. shows that 96% of them are satisfied with the products and service rendered by Economy. Economy Appliance has

always serviced what it sells . . . refrigerators, ranges, radio, and television, and during these years, we have strived to give customer satisfaction. Our actions have been characterized by fair dealings—and a great proportion of our customers have come back to buy at Economy. We pledge ourselves to serve you in the best way possible . . . to give you the best products made at the best prices obtainable. We maintain, as always, our own service department, so that anything bought at Economy will be serviced by experienced men employed by Economy. Our slogan always will be: 'We Service What We Sell.'"

Effective Advertising

Economy's voluminous newspaper advertising ranges from small squibs in the classified section to large four-page pre-Christmas inserts in the local newspaper. In radio advertising, Albertine likes to "shop around" and vary his ad budget among news, shows, and spots. He also has a 13-week Sunday evening science show sponsorship on television. One Schenectady station is the only video outlet currently available to the Capital area (Albany, Troy, Schenectady). All advertising plugs special items and Economy's service department.

Economy sells in televisions RCA Victor, Philco, Admiral, and Motorola TV; Philco, Norge, Admiral, International Harvester refrigerators, as well as a line of air conditioners, ranges, heaters, fans, ironers, vacuum cleaners, and some smaller electric housewares.

The senior Albertine is proud of having come up the "hard way," after a career including selling newspapers, coal-mining, telegraph work, and sales for the Eureka Vacuum Cleaner Corp. He established his first store at 21 Plaza Street in Albany 15 years ago. In the present location he has a 45 x 70 salesroom plus offices and service on the main floor, and three floors of warehouse space. He still declares emphatically "It's the house that service built."

New Reps for Standard Wood

George Entin, jobber sales manager of Standard Wood Products Corp., Long Island City, N. Y., has announced the appointment of two sales representatives: Earl K. Moore Co., 562 Sizeler St., New Orleans, La. for the Louisiana, Arkansas, Mississippi, W. Tennessee, Mobile, Ala. and Pensacola, Fla. territory; and Don H. Burcham Co., 917 S. W. Oak St., Portland, Ore. for the Oregon, Washington, Idaho and Montana territory.

Sturdy

...to support any antenna array

Power

...more than you'll ever need

MAXIMUM STRENGTH

in the
PARALLELOGRAM OF FORCES

featuring built-in thrust-bearing to take up down thrust

all yours in the **MODEL TR-12**

the **CDR** Rotor

All you could ask for in an antenna-turning device ... the TR-12 CDR ROTOR is the last word in streamlined efficiency! It will support and turn with ease any antenna array—even 4-stack designs ... you just can't beat it! Some of the features include: speedy installation, no loose parts to assemble—quick-mounting antenna mast collet—dependable, trouble-free, fool-proof operation!

MODEL TR-12 ... Complete rotor with handsome modern design plastic cabinet and meter control dial—fingertip lever—using 4-wire cable
\$47.95

MODEL TA6 ... thrust-bearing accessory, separately **\$4.95**

MODEL TR-11 ... same as TR-12 without thrust-bearing **\$44.95**

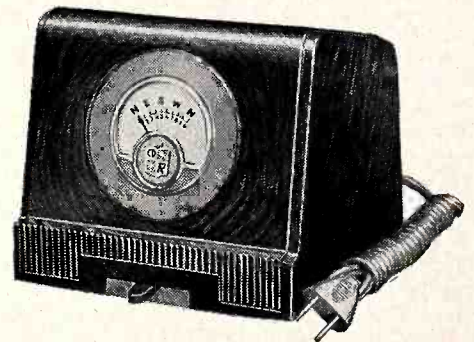

SUBSIDIARY OF



THE RADIART CORPORATION CLEVELAND 13, OHIO

VIBRATORS • AUTO AERIALS • TV ANTENNAS • ROTATORS • POWER SUPPLIES

Broad-Band Yagi Antenna

The High Gain of a Yagi Is Obtained Over Five to Seven Channels

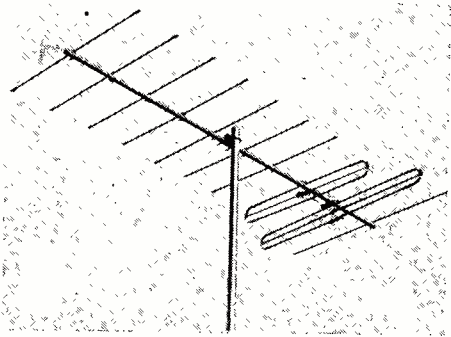

Fig. 1—Channel Master's new broad-band Yagi antenna. Unit shown is for the high band.

• A Yagi antenna with a broad-band characteristic has reached the market which may provide a solution to some troublesome installation problems. The new Channel Master Yagi is designed to cover up to four channels on the low band. A unit designed for the higher frequencies is said to cover the entire high band. Let's see what the new Yagi consists of, and how it works.

The "Futuramic Yagi" is made up of two dipoles, one reflector and seven directors. The heart of the new Yagi is its two-dipole system. To understand its action, let's first consider the response of a single folded dipole. The gain curve of a single folded dipole and reflector is shown in fig. 2. Note that maximum signal pickup occurs at channel 2 (the channel to which it was cut), falls off sharply at the low end of

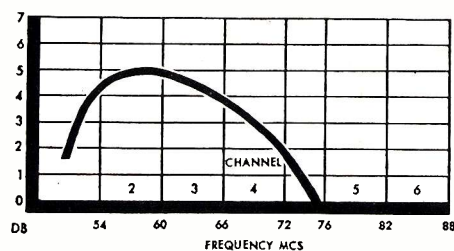

Fig. 2—Gain curve of folded dipole and reflector cut for channel 2.

the low band, and drops off more gradually at the high end. Combining two dipole systems cut for different channels would give the over-all response shown in fig. 3. In such a case, a folded dipole with reflector for channel 2 would be used which covered frequencies up to channel 4 with moderate gain; the second one would be cut to channel 5, and would also cover channel 4 with moderate gain.

The new broad-band Yagi's 2-dipole system builds and improves on this basic idea. Dipole A is tuned to the lower end of the band covered; dipole B

is tuned to the higher end of this band. The action of the system may be analyzed by reference to fig. 4. The transmission line is 15-degrees forward of the low-frequency or longer dipole (courtesy of a length of twin-lead). The higher frequency dipole is fed to the x-mission line through a length of twin-lead 45 degrees long. This line section is transposed, however, so that its effective electrical length is 45 plus 180, or 225 degrees.

A vector analysis is necessary here, to indicate the conditions present. Let's call the signal voltage at the feed point

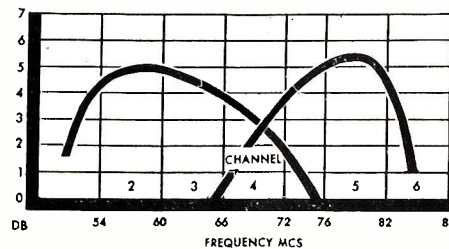

Fig. 3—Gain curve of folded dipole and director cut for channel 5, super-imposed over gain curve of folded dipole and reflector cut for channel 2.

of the antenna E_t . E_a , the signal voltage arriving at the low frequency dipole, lags E_t by 15° , since the signal coming from the LF dipole is 15° behind the signal present at the feed point. If the line to the right of the feed point were not transposed, the signal voltage coming from the higher-frequency dipole would be in a 45-degree lagging relationship with respect to E_t , due to the 45° piece of line present between the feed point and the HF dipole. However, it is not lagging E_t by merely 45° , but by $45^\circ + 180^\circ$ (due to the transposed line), or 225° .

Signal reaching the LF dipole is at the frequency to which the unit has been cut. The LF dipole is thus resonant to the incoming frequency, and current and voltage are in phase in this dipole.

At this same lower frequency to which the LF dipole is cut, the HF dipole acts as a capacitive reactance, since the frequency of the HF dipole's effective tuned circuit is higher than that of an incoming low-frequency signal. In a circuit that is capacitively reactive, current can lead voltage up to 90° . In the case under consideration, the design of the system is such that the current in dipole 2 leads the voltage in dipole 2 by 75° . The currents in the two dipoles are therefore 135° apart.

Now the dipoles are also 45 degrees apart in free space (physically). Therefore we have a 45 degree physical spacing and a 135 degree electrical spacing.

The result of this arrangement is that signals coming from the front will have a 90 degree phase difference ($135-45$) whereas signals coming from the rear will have a 180 degree phase difference ($135+45$). Thus the arrangement gives a high front-to-back ratio as well as increased sensitivity from the front (1.4 times more signal pickup than if a single dipole were used.).

When the higher-frequency signals are coming in, the voltage vectors are similar; the current vectors change, however. Current in the smaller dipole is now in phase with the voltage in this dipole since the smaller dipole is resonant to these HF signals. The larger dipole, which has been cut to a lower frequency, presents a certain amount of inductive reactance to the incoming signals, causing its current to lag its voltage by 75° . Note that the currents in the two dipoles are still 135° degrees apart, so the system still functions as it did in the previous case, producing gain and directivity.

The seven directors provide strong gain at the higher frequencies. The addition of more than one reflector will not significantly increase signal pick-

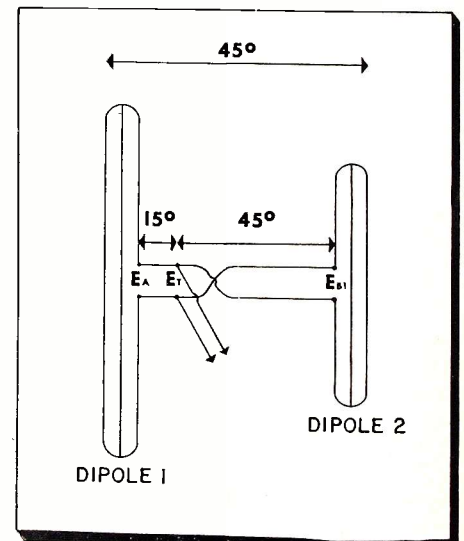

Fig. 4—Phasing harness of the broad-band Yagi's twin-dipole system.

up, so only one such parasitic element is employed.

To improve gain by stacking, the Z-match system is used—i.e., the impedance of each of two bays is dropped, then stepped up to approximately 600 ohms. The parallel 600-ohm impedances result in a net impedance of 300 ohms for the stacked array, providing a match for a 300-ohm line.

Single and stacked broad-band Yagis are available. There are models that cover either the high band, the low band, or both.

NOW...

Quality Matched

TV REPLACEMENTS BY

DU MONT

**COMPLETE INFORMATION
ON
REQUEST**

REPLACEMENT SALES
Cathode-ray Tube Division
Allen B. Du Mont
Laboratories, Inc.
Clifton, New Jersey

DEFLECTION YOKE . . .

Type Y2A1 with distributed winding provides edge-to-edge focus. Built to withstand conditions of high temperature and humidity. Short overall length.



FLYBACK TRANSFORMER

Type H1A1 - with universal mounting bracket. Mount it on its side or bottom. "Matched" for use with the Type Y2A1 Deflection Yoke. Ferrite core insures high efficiency.

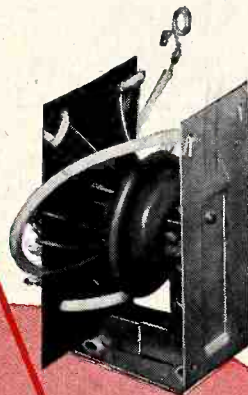

WIDTH AND LINEARITY COILS . . .

For use with H1A1 and Y2A1 and complete the "universal" deflection system. Designed to withstand heavy pulses required to sweep wide angle picture tubes. Utilize adjustable iron cores.



ORIGINAL TELEVISION PARTS . . .

A complete line of replacement television parts incorporated in Du Mont Telesets. Ask your local distributor for cross-reference literature, or write. Look for the package with "original television part," your only guarantee of fitness.

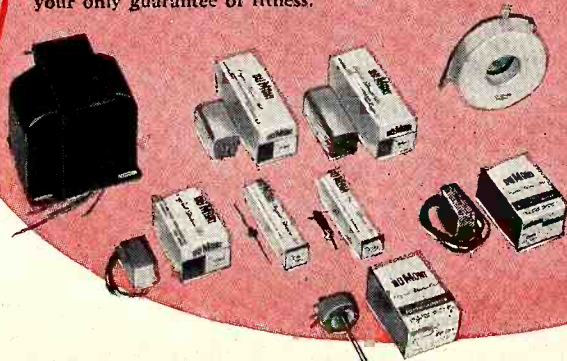

TELETRONS . . .

Quality standard of the industry. Electromagnetic, low-voltage electrostatic focus, and exclusive Selfocus. Complete line of popular sizes.



Direct-Mail

(Continued from page 80)

"canned" lists can be obtained by anyone who is willing to pay the price . . . and that includes your competitor. "Home-made" mailing lists, though more difficult to obtain, are usually more effective, for they represent a more carefully selected group of people whose names make up a list available to no one else.

For dealers in this field, great opportunities exist to build an excellent mailing list in their own business. Following are a list of convenient sources:

1. Present and past customers. Salesmen should take the time to write down all necessary information. Dates of actual purchases should be kept for regular reminder service when the new model arrives.

2. Answers to advertisements soliciting mail inquiries. The use of a coupon at the bottom of your newspaper advertisement will facilitate inquiries and give you the information you desire.

3. Names of friends submitted by established customers. Inexpensive gift items offered for a certain number of names submitted will stimulate action.

4. Names from newspaper announcements of moving families, engagements, weddings, graduations, new homes being built or bought, etc.

5. Municipal records of licenses and permits usually available at the City Hall of your town.

6. Payroll lists of local companies, sometimes available.

7. Convention rosters, membership lists, of commercial, professional and social clubs.

8. The main and classified sections of local telephone directories.

9. The exchange of lists with non-competitive firms.

The compiling of an effective direct-mail list, though not too difficult a job, requires care, patience and resourcefulness.

Classification of Lists

After the names have been gathered in sufficient quantity, it is wise to give thought to the information which has been compiled. Correct classifications will keep your list alive and accurate. Most important is to divide your list into "active" and "inactive" groups. After subjecting your "active" file or customers to a predetermined number of

mailing pieces, unresponsive names should be transferred to the "inactive" file. This will keep your list alive with customers who react favorably to your selling appeals. Other possible groupings include marital status, age, financial ability, etc.

Maintaining the List

Both the careful gathering and the accurate classification of your lists are almost useless unless these names are continuously maintained. Data changes will occur from time to time. These changes should be noted. Address changes are probably most frequent. Changes in marital status rank second. Intelligent "direct" advertisers diligently inspect their lists, making frequent changes. Care and patience in the tending of a "live" list will pay off in large dividends.

Home Laundries

(Continued from page 68)

show-window and in-store display and live demonstration centers. These were made to order for the customer thinking about laundry equipment, who perhaps, just dropped in to buy nothing more than a light bulb.

And every dealer knows that:

2. Just about every housewife who owns a washing machine is thinking about an ironer—isn't happy with ironing by hand or farming the work out. And nowadays, many of those who are thinking about ironers are thinking about dryers, too. *The big job here is to find such folk in order to capitalize upon their desire to buy. Such prospects can be discovered via the methods before-mentioned. Additionally, however, dealers already know of many likely prospects among those who have purchased washing machines from them in the past. Merchants should contact these satisfied users in order to interest them in complete laundries.*

Dealers know, also that:

3. Almost all owners of "ancient" washers and ironers are thinking about trading them in one day because (A) They know such equipment isn't efficient. (B) Maintenance costs are high, and (C) They dislike the appearance of the "junk." *Here again, dealers need to find these people through the same methods before-mentioned. And to sell them along the same lines previously outlined.*

The job facing all who want to up sales of washers, ironers, dryers

and modern hand-irons is to find the prospects, solicit their business, and sell the advantages of the *complete laundry* as the best answer to the householder's problem since such set-up saves time and money, and provides the customer with ideal sanitary conditions.

Today's modern kitchen is always a *complete one*, and customers wouldn't have it any other way but *comparatively few of the modern homes* at this time have *complete laundries*, and it's up to the alert dealers of the nation to see to it that their customers are sold the advantages in owning products to do a complete laundry job for them.

Sales Upswing

(Continued from page 45)

suggestions for cashing in on the tremendous sales appeal of our products at this time, outside selling looms as a very large potential means of obtaining a great many sales. As pointed out in numerous articles in this magazine, the outside field is ripe and ready for exploitation as it never was before. For those dealers who firmly believe that they cannot engage in such activities at this time, the least they can do is to make certain that all store visitors and recent purchasers are followed up by their salesmen.

All in all, there's big business ahead for the management which is on the alert. If we can't do a bang-up volume in TV sets and radios with such "naturals" in programming as are now in the works, there's something very wrong—and for most dealers it will probably turn out to be nothing that genuine effort, energetic selling and longer hours can't correct.

Let's get on the bandwagon now, and start the wheels rolling. Let's forge a tie-in between the great things on the air and our products which bring such outstanding entertainment into the home.

Four New NEDA Members

Four new members have joined the National Electronic Distributors Association reports the national office in Chicago, Ill. Joseph F. d'Aquin, Crescent Radio & Supply, Inc., New Orleans, La., has joined the Louisiana-Mississippi Chapter and Howard Bristol, Bristol Distributing Co., Fargo, N. Dak., is now a member of the Minnesota Chapter. Two parts distributors recently joined the St. Louis Chapter. They are Harold Bruce, Harold Bruce Co., Springfield, Ill. and V. R. Lampley, Lampley Radio Co., Benton, Ill.

102 BILLION

FREE SALES BOOSTS A YEAR FOR YOU!

NEW
CBS-HYTRON
BRAND
gives you:



1,973,326,000 times a week! 102,612,952,000 times a year! The magic letters "CBS" are seen and heard on radio and TV station breaks. Impact is terrific. An average of 13 sales impressions weekly for every man, woman and child in the country. Every one of your customers knows CBS. Knows he can depend upon CBS. Consumer acceptance of your CBS-Hytron brand grows hourly.

Acceptance



Engineering



As a division of the Columbia Broadcasting System, Inc., CBS-Hytron commands tremendous engineering resources for you. Because CBS embraces the field of electronic entertainment: Radio broadcasting. TV broadcasting. Radio, television, and phonograph sets. Records. Electronic research laboratories. And CBS-Hytron tubes.

Leadership



For example, CBS-Hytron originated: the GT tube . . . the subminiature tube . . . the rectangular picture tube . . . specialized, low-cost TV receiving tubes. CBS-Hytron's new picture-tube and miniature-tube plants are the most modern in the world. Such aggressive leadership guarantees you the newest and best in tubes.

YOU CAN'T BUY BETTER

Demand the CBS-Hytron brand. You get the finest electron tubes that progressive engineering skill and craftsmanship can make. You get the brand known and respected by every one of your customers. You get the brand they see and hear the most . . . CBS-Hytron.



MAIN OFFICE: SALEM, MASSACHUSETTS

Television & Appliance Retailing*

*Trademark Reg. U.S. Pat. Off.

Sentinel 1953 Line

18 new models in the Sentinel 1953 TV line range in price from \$199.95 to \$645, and include three 17-inch, twelve 21-inch and three 27-inch receivers. Six of the 18 sets are table models, while the rest are consoles. Lead-off model is 17-inch walnut table model 454-TW, listing at \$199.95. 21-inch mahogany table model 455-TM is priced at



\$269.95. Model 643CM, shown, is clock-controlled, as are the other two 27-inch models. This full-door mahogany console is priced at \$625.00. All models are easily adaptable to UHF by inserting a strip in the Cascade-type tuner, and all prices include one year warranty and federal tax. Sentinel Radio Corp., Evanston, Ill.—TELEVISION RETAILING.

Unique Telechron Clock Design

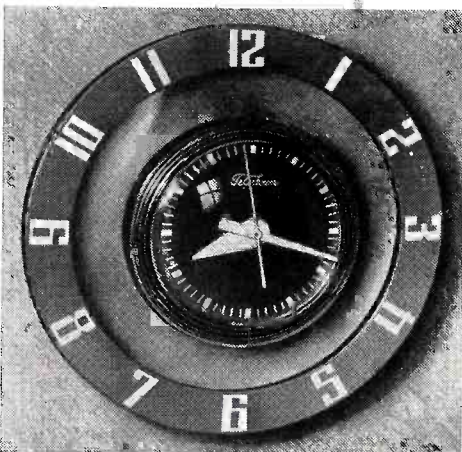

This Telechron electric clock strikes a new note in kitchen clock styling. Clear plastic disc between numeral band and case gives a fascinating illusion. Telechron is offering its design to people who want a better kitchen clock than is usually offered. Red or aqua case and dial with white numerals and hands; white or yellow case with brown numerals and hands; polished silver color bezel. Recess for excess cord. Suggested retail price is \$8.95 plus tax.

Perfection Electric Ranges

Models L403 and L301 electric ranges are the latest additions to Perfection Stove Company's line. The L403 is a divided-top model, 40-inches wide, with four Chromalox surface units. Seven heat speeds, from deep-fat frying to simmering are featured. The oven is lined with white porcelain and has a "Tele-Vue" window in the oven door. Automatic timed heat control permits cooking by the clock. Also included are the Perfection Adjusta-Lamp, one



standard and one timed electric outlet; and an interval timer mounted on the front panel of the range. The 36-inch L301 also has a divided top. There are three Chromalox surface units, a 1250-watt, 2100-watt and a six inch, 1600-watt "high-power" unit. The deep-well cooker, of 6 qt. capacity, has a stationary heating unit. Automatic heat control and a surface lamp-indicator as well as ample storage space for utensils, etc., are furnished. Perfection Stove Co., 7609 Platt Ave., Cleveland 4, Ohio.—TELEVISION RETAILING.

Hoover STEAM-DRY IRON

A new electric steam or dry iron will be in dealer stores throughout the country this Fall. Hoover's new product features the use of the "flash-steam" principle, which eliminates all danger of steam pressure. Another feature is the automatic shutting off of steam when the iron is placed on its heel to rest. The big safety-set dial, a popular feature of Hoover's dry iron, has been retained. The face of the dial, however, is of satin aluminum for easier reading of the indicators. The degree of heat can be changed by simply turning the dial with the fingertip or thumb without removing the hand from the handle. The Hoover Co., No. Canton, Ohio—TELEVISION RETAILING.

**More New Products
Elsewhere in This Issue**

Hoffman 1953 Line

With the introduction of the 1953 TV, this firm inaugurates a policy of introducing new models only once each year. The new line of 26 models includes three 17-inch table models, four 21-inch table sets, twelve 21-inch consoles, six 21-inch combinations and one 27-inch console. The line starts at \$199.95 with a molded wood 17-inch table model

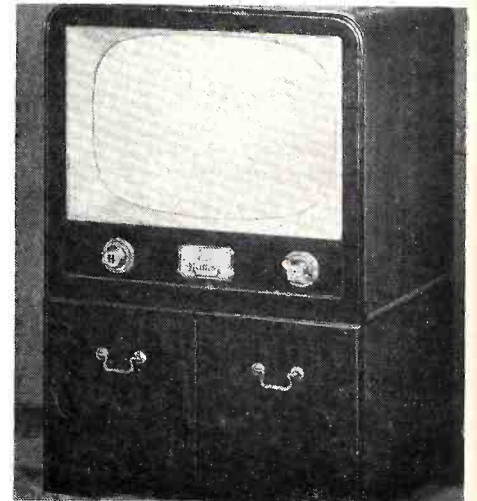

(7M109), ranging up to the 27-inch console (27M709) priced at \$775. Shown is model 21M121, 21-inch mahogany table model priced at \$279.95. Prices include federal tax and warranty. Hoffman Radio Corp., 6200 S. Avalon Blvd., Los Angeles 3, Calif.—TELEVISION RETAILING.

Mitchell AIRCRAFT RADIO

The 1952 Mitchell Airboy Sr. is a self powered receiver and transmitter. Weighing only 5½ pounds, it includes loudspeaker and battery pack. It requires a 25½ inch whip antenna or the VHF antenna already on the plane, two flashlight batteries, and two B batteries. One crystal is tuned at 121.5 MG, the other two are optional according to local tower needs. The set can send shortwave voice signals for 75 miles. List price, \$99.50. Mitchell Industries, Inc., P.O. Box 17, Mineral Wells, Texas.—TELEVISION RETAILING.

Mars

The Riviera in a modern cabinet with rolling doors and built-in bar includes a 20-inch screen, FM radio, 3-speed phono. A 31-tube set, it is built with #630 chassis and comes in bleach, cordovan and cherry. Retail at \$795.00. Mars Television, Inc., 112-33 Colonial Ave., Corona, N. Y.—TELEVISION RETAILING.

How to use the Mallory **UHF** Converter

as a sales-builder for **VHF** sets now

NOT FOR ME! That's what lots of prospective set buyers are saying right now because they think the present VHF sets will have to be "junked" when UHF comes along.



YOU CAN BEAT that kind of sales-killing thinking **RIGHT NOW** with the help of the Mallory UHF Converter.



JUST BUY ONE Mallory UHF Converter *now* . . . show it to your customers . . . and explain that it is the answer to *any* future UHF transmission in your area. There's no reason why they should put off buying a VHF set now because when UHF transmission starts, they can buy the MALLORY UHF Converter . . . enjoy completely satisfactory VHF-UHF reception with the set they buy *now*.



START TODAY to boost VHF set sales by using the Mallory UHF Converter as a sales-tool. Display it in your store . . . talk about it . . . use it in your advertising and sales promotion.



Extra Sales for You when UHF Comes to Town . . .

You can count on the Mallory UHF Converter for extra sales and profits when UHF transmission starts in your area. It's bound to please your customers . . . make more sales for you.

The Mallory UHF Converter works with *any* set and offers reception of all UHF channels . . . no sacrifice of VHF channels . . . built-in UHF antenna . . . high quality picture definition . . . fast, easy installation.

SEE YOUR MALLORY DISTRIBUTOR TODAY

for complete information about the Mallory UHF Converter. It's a two-way sales-builder for you.

*Make Sure . . .
Make it Mallory*

P. R. MALLORY & CO. Inc.
MALLORY

CAPACITORS . . . CONTROLS . . . VIBRATORS . . .
SWITCHES . . . RESISTORS . . . RECTIFIERS . . .
VIBRAPACK* POWER SUPPLIES . . . FILTERS
*Reg. U.S. Pat. Off.

APPROVED PRECISION PRODUCTS

P. R. MALLORY & CO., Inc., INDIANAPOLIS 6, INDIANA

Sales Contests

(Continued from page 53)

luggage stickers can be obtained to keep the theme before the salesmen at all times.

4. *Merchandise Theme*: If some special brand is being promoted—or a special line of sets such as combinations—the sales contest can be developed with this in mind. An illustration has been given of the retailer who used the channel selector for his scoring chart. This theme can be altered to fit the locality. Salesmen who are behind would be required to watch certain channels until they sold enough sets to cover the best local station.

Sales contests to be most effective require time for planning all of the necessary details. It takes extra effort on the part of the retailer to keep enthusiasm high. And, there is some expense involved in the prizes to be awarded.

However, these problems are offset by the increased sales volume that will result—salesmen get a shot in the arm and do not need a kick in the pants.

Appliance Service

(Continued from page 66)

so that the needs for service may be met.

Service engineering sections have been developed to prepare complete manuals, parts price lists, parts identification sheets and technical bulletins—so important to the dealer. And, in the case of my company as with many others, there has never been a charge made for such material. These service manuals are being written so that the man on the street can understand them.

Factory trained field service representatives are now covering the country, policing service policies, working with distributor and dealer service departments and the authorized service stations for the improvement of service in the field. Field service meetings are being conducted for dealers under distributor and utility sponsorship. These men are keeping their fingers on the pulse of service in their respective territories, constantly reporting back to the factory.

General correspondence sections have been enlarged to handle service inquiries from the trade or consumer. Complaints and referrals are being handled promptly. Policy and

product information is being forwarded with dispatch. These sections act as clearing houses for all service problems.

The manufacturer has come a long way towards placing his house in order service-wise. Not only has he installed new methods and new policies but new thinking. This new thinking must be impressed on the distributor and the dealer.

It is my prediction and all signs point that way—that just as we are now featuring the quality, beauty, and convenience of our appliances in national advertising, we will soon be featuring the service which backs up our products. The consumer will be buying with service in mind. It will be good business on their part and we should prepare ourselves for it.

A prompt and efficient service call offers the best possibility for making a sale on major appliances. Just the other day in Portland, Maine, the proprietor of a service agency remarked to me that although he was exclusively service, he was continually called by customers who were so satisfied with his service that they were almost insistent on buying new appliances through his shop.

One of the surest ways for a dealer to break down his prestige with the consumer is not to answer a request for service promptly. If he does not handle his own service—it is imperative that he follow through to see that the appointed agency makes the call as soon as possible.

Yes, the new thinking on customer service for the appliance industry is in full swing and the manufacturer's product service division stands ready to do its share.

The dealer who recognizes the importance of product service at all times and sets up an efficient operation to cope with the consumer's service problem will reap benefits in future sales—not only in periods of emergency when there are shortages of finished goods, but year in and year out—good times or bad.

With the determination of the manufacturers to develop the electric appliance volume by aggressive selling plus service—with the many, many service-conscious distributors, dealers and utilities now in operation—and with the very excellent cooperation and constructive criticism offered by your leagues—we are bound to win.

**For Latest TV Sets
See Pages 70, 74, 75, 76**

Jensen Names New Rep

The Burt C. Porter Company of Seattle, Washington, has recently been appointed to represent Jensen Manufacturing Company, Chicago loudspeaker manufacturers, in the territory comprising Washington, Oregon, Alaska, western Idaho and western Montana, according to an announcement by C. A. Hansen, Jensen sales manager.

Graybar to Distribute Raytheon

Graybar Electric Company has been appointed distributor of the Raytheon line of radio and television receivers in the Boston area, according to announcement by Ralph C. Goodwin, manager of Graybar's television and radio sales. Graybar will distribute Raytheon receivers throughout Massachusetts, New Hampshire and Vermont.

Hughes-Peters Wholesaling Arvin Television & Radio

Raymond P. Spellman, radio and TV sales manager of Arvin Industries, Inc., has announced the appointment of Hughes-Peters, Inc., Columbus, Ohio as exclusive distributors of Arvin radios and television receivers in Columbus, Dayton, Cincinnati and adjoining towns and cities.

No "Wildcat" Food Plans for Amana

Anticipating an even greater rush of "food plans" of the type that have begun to engulf the nation, the Chicago distributor of Amana Home Freezers states that all such plans involving the sale of an Amana freezer will be carefully inspected to insure complete honesty in every claim advertised to promote acceptance of the plan.

Provided with the best possible background in setting up "quantity purchase savings" for its purchasers, Amana initiated a practical "food plan" long before the current trend became such a popular means of introducing the public to the advantages of freezer preservation and storage. On the sale of an Amana freezer, dealers directed the new owners to a conveniently located food supplier in that area where quantity purchases could be made at substantial savings from an inspected and approved source. No complicated procedures were involved in the Amana plan, and no extra charges for cutting, packaging, labeling etc., were made. Basically, this same original plan is available to every purchaser of an Amana Home Freezer. An initial "stocking up" purchase of foods, scientifically planned for a well-balanced selection of meats, fruits and vegetables is offered. However, the customer is free to select substitutes if certain foods are not agreeable. A minimum delivery fee is charged by the food supplier for this original "stocking up" quantity of foods, and additional orders or deliveries are made only on the request of the customer.

USE TUNG-SOL TUBES FOR TROUBLE-FREE SERVICE!

TUNG-SOL "QUALITY CONTROL" recognizes but one standard. All Tung-Sol Tubes meet the highest original equipment requirements of leading radio and tv set manufacturers.

TUNG-SOL ELECTRIC INC., Newark 4, N. J.
Sales Offices: Atlanta · Chicago · Culver City · Dallas
Denver · Detroit · Newark



No Call-Backs for me, pal

Here's a real lively "stopper" to attract attention to your place of business and emphasize the quality of your service. Colorful—bright red and two shades of blue. 15 inches high. Your jobber salesman will tell you how to get one.

TUNG-SOL MAKES ALL-GLASS SEALED BEAM LAMPS, MINIATURE LAMPS, SIGNAL FLASHERS, PICTURE TUBES, RADIO, TV AND SPECIAL PURPOSE ELECTRON TUBES

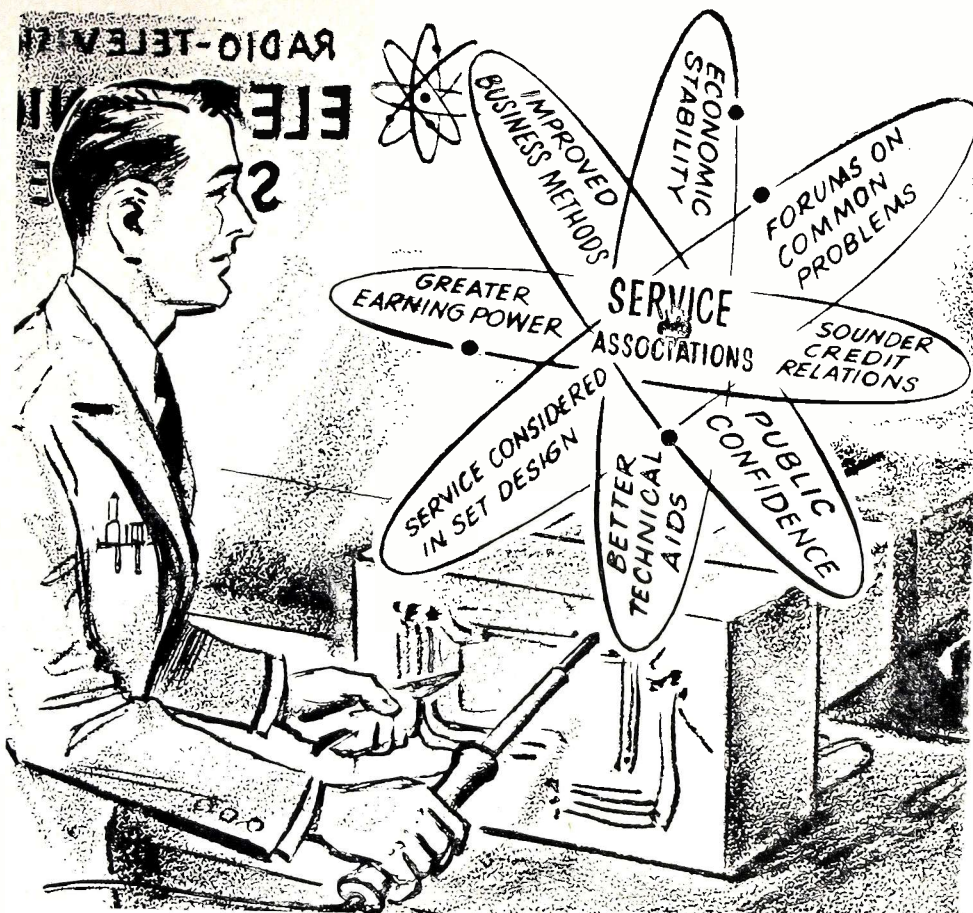

THE MODERN ELECTRONIC TECHNICIAN HAS A NEW VIEWPOINT!

A changing attitude on the part of the radio and television service technician is the thing that is pulling the electronic service profession out of the doldrums. He is learning that he cannot call himself a success, as an individual, until he can look around and see other technicians who have assets he can admire or compare with his own. As long as there are too many in his profession operating without scruples, and trying to get along under a "hand to mouth" economic operation without adequate testing instruments and other technical aids, there is not much to measure one's success by.

His interest and attendance at the local service association meeting shows that the modern Electronic Technician is beginning to look beyond the "tip of his soldering iron." Through these associations, he is rapidly gaining recognition, not only in his own community, but also in the vast electronic industry, as being an essential link between the manufacturer and consumer.

In addition to getting valuable technical "know-how" from non-commercial sponsored lectures and demonstrations, he is finding out how to make his business bring a fair return on his rather large investment in training, experience,

and testing instruments. He is also learning how to be fair to both his customers and himself by keeping his "know-how" and test equipment up-to-date and not resorting to price cutting for his service in diagnosing trouble.

As technicians gain that feeling of mutual respect and esteem among themselves by regarding each other as business associates instead of raw competition, their most valuable asset—technical "know-how"—will no longer be obscured. The technician's interest in matters which affect his economic welfare will lead him and the entire service industry to greater economic stability.

The time and money you devote to your service organization is not an expense—it is an investment in your future that will be paid back many, many times.

Our 25th Year

SUPREME

Testing Instruments

"SUPREME BY COMPARISON"

TUBE TESTERS • SIGNAL GENERATORS

PANEL METERS • MULTI-METERS

OSCILLOSCOPES

Supreme, Inc. Greenwood 5, Mississippi

TV ANTENNAS

Vee-D-X VHF-UHF ANTENNA

The Ultra Q-Tee, a VHF-UHF combination antenna, was designed so that it may be installed now, yet be ready for UHF as stations come on the air. For use in all TV areas from primary to fringe, this antenna may be installed singly, two-stacked or four-stacked. The VHF portion of the Ultra Q-Tee is similar to the Vee-D-X Q-Tee. For the addition of UHF, a six-circuit filter is employed between the common VHF and UHF transmission line feed points. The Ultra Q-Tee replaces the need for separate VHF and UHF antennas as well as two transmission lines, a switch at the receiver, and other equipment necessary for such an installation. List price is \$14.25. La Pointe Plascomold Corp., Rockville, Conn.—TELEVISION RETAILING.

RMS YAGIS

These new multi-element yagi antennas feature an unusual bracing device included with low band models which runs horizontally below the crossarm. The crossarm and brace are provided with their own U-Bolt attachments, and when assembled to the mast provide structural rigidity nec-

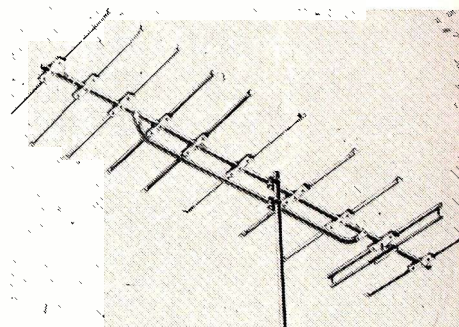

essary to keep the antenna free of rocking and swaying off the azimuth. The elements are $\frac{3}{8}$ " aluminum with pinched ends, and the antenna utilizes a step-up type receiving element constructed of 1" and $\frac{3}{8}$ " aluminum tubing. 8-element model is STYL8, the 10-element model is STYL10. The braces can be ordered separately. Radio Merchandise Sales, Inc., 2016 Bronxdale Ave., New York 60, N. Y.—TELEVISION RETAILING.

Easy-Up ROTOR-ADAPTER

The "Rota-Dapter" is designed for use with Easy-Up model 300 or 600 tower. Provides a means for holding any of the standard rotators now on the market. Ball-bearing thrust bearing above the rotator is adjustable to any size pole up to 2" OD. Constructed of steel tubing and steel bar, to provide a very strong, light-weight and low wind-resistance unit. Easy-Up Tower Co., 427 Romaine Ave., Racine, Wisconsin.—TELEVISION RETAILING.

Grayburne HAM TVI FILTER

The Grayburne model CPH "Clear-Pix" filter is designed to have high rejection efficiency for the 21 MC ham band. Easily installed in any TV set in less than one minute, it lists at only \$1.98 each. Grayburne Corp., 103 Lafayette St., New York 13, N. Y.—TELEVISION RETAILING.



TUBE AND TOOL CARRYING CASE
Holds 137 tubes — plus all regular tools.

FLASHING SERVICE DISPLAY
A 6-color display featuring your ability to "Clear Up The Picture."



PLEXIGLO ILLUMINATED SIGN
A bright and colorful service selling sign.

To help you increase your profits...
To help you work more efficiently...



has made these useful
NEW SALES AND SHOP AIDS
AVAILABLE TO YOU!



POLITICAL WINDOW STREAMER
You can use this effectively from now 'til November.



ILLUMINATED TEST PATTERN CLOCK
A Telechron motored beauty.



SHOP JACKETS and COATS
Expertly designed, sturdy, long wearing, comfortable garments. Full length of jacket style.

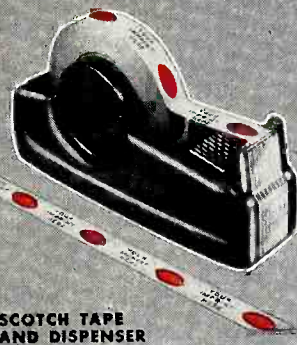

SCOTCH TAPE AND DISPENSER
3/4" Scotch Acefate Tape bearing your name. Handy Dispenser.

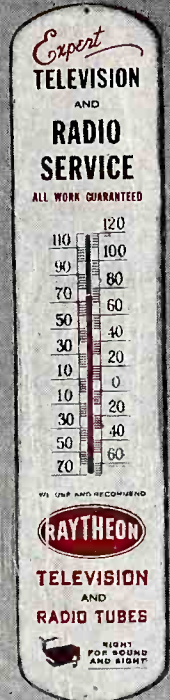

OUTDOOR THERMOMETER
A heavy gauge, jumbo size (8" x 39") outdoor unit.



Write for FREE BOOKLET!

It's chock full of these and many other useful shop aids and sales promotion items that are musts for every service dealer — imprinted stationery, job tags and record cards, ad mats, post cards, shipping labels, decals, etc. Some are free, others available at less than cost. Ask your Raytheon Tube Distributor for them or write for booklet to Department C.

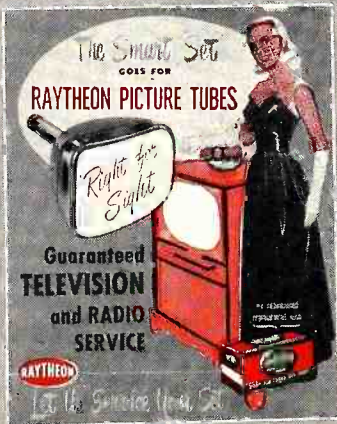

DISPLAYS
Colorful displays that sell your service.



RAYTHEON MANUFACTURING COMPANY

Receiving Tube Division
Newton, Mass., Chicago, Ill., Atlanta, Ga., Los Angeles, Calif.

RAYTHEON MAKES ALL THESE:

RECEIVING AND PICTURE TUBES • RELIABLE SUBMINIATURE AND MINIATURE TUBES • GERMANIUM DIODES AND TRANSISTORS • NUCLEAR TUBES • HIGHWAY TUBES

Excellence in Electronics

New Store Features Hi-Fi Display

The Arrow Audio Center, devoted exclusively to the sale and display of high-fidelity radio, audio, sound reproduction equipment and television, opened recently at 65 Cortlandt Street, New York. The Audio Center, a new division of Arrow Electronics Inc., radio and electronics distributors, will provide actual living-room conditions for listening to all major makes of amplifiers, tuners, speakers, record players, etc., and will schedule lectures throughout the year by authorities on music appreciation, new audio developments and new equipment demonstrations, as a public service.

Needle Sales Aid

The M. A. Miller Manufacturing Co., Chicago, Ill., manufacturers of long-life play-back and recording needles, has announced the repackaging of their popular #550 and #560 needles. The #550 (50 cent bent-shank needle) card is made up of two joined cards of 12 needles each, which may be separated or used easel fashion. The #560 (\$1.00 bent-shank needle) card holds 12 needles. A new item is the #35 straight shaft needle tipped with high grade osmium alloy. The tip size is designed to play all speeds in cartridges using conventional thumbscrew mountings. The new #35 card carries 12 needles.

Late Record Releases

MGM has big Fall plans for their monthly series of kiddie singles featuring the cat-and-mouse team, Tom and Jerry. A package deal by which dealers will be able to obtain free Tom and Jerry display racks for both 45 and 78 RPM with purchases of a minimum of platters in the series is currently in the works. Also planned is a radio push, with a script service for sponsors of kiddie radio shows and radio stations using MGM kiddie records. Theater tie-ins will play a big part too—theatres featuring Tom and Jerry cartoons, especially in Saturday kiddie shows, will have Tom and Jerry records played at kiddie matinees, displayed in lobbies, and offered as prizes in special contests run for kids by theatre managers.

RCA VICTOR has introduced a new and longer playing 45 RPM record, known as the 45 "extended play" or "EP" record. The new discs play up to 8 minutes per side or a total of 16 minutes per record. They are the same size and operate on the same turntable at the same speed as standard 45 records. They are designed to permit the recording of entire selections of certain types of classical music on a single side, as well as to reduce by half the number of records presently required in an album of popular music.

URANIA Records has signed the La Scala Opera chorus and orchestra to an exclusive recording contract, according to announcement by Norman Chase, Urania's managing director. The first schedule of recordings includes complete versions of *La Forza del Destino*, *Don Pasquale*, *Don Carlos*, *La Gioconda*, *Mefistofele* and the *Sicilian Vespers*. The first of these new discs will be released in October to tie-in with the opening of the opera season at the Met. Others will be released subsequently. Specially prepared point-of-sale material will be supplied to all record dealers through their distributors.

"Balanced" Store

(Continued from page 82)

comers deal, and the Mart hastened to be the only appliance store in the picture. The CC representative gives out free-gift cards, and the new-comers come trooping in. The Mart courteously starts getting acquainted.

On the TV side, the Mart is getting a new mobile TV antenna demonstrator unit. It will determine the antenna requirements at each home—an adjustable break-down job mounted on a trailer. The policy will be to leave the trailer at a prospect's house for three days.



"CONICAL-V-BEAMS"

REGISTERED TRADE MARK

3 BIG REASONS WHY

Telrex

is your logical ANTENNA CHOICE!



①

TELREX "FISHBONE" WITH TEN WORKING ELEMENTS GUARANTEED TO OUTPERFORM ANY YAGI ANTENNA! Recommended for superior reception in suburban and outlying areas, the "Fishbone" is constructed for lasting, trouble-free installations.

"BAT WING" the finest top-of-set antenna made REQUIRES NO TUNING, PRUNING OR ADJUSTMENTS! Outperforms any other indoor type and features modern, rich styling to harmonize with finest furnishings.



②



③

UNIVERSAL SERIES "CONICAL-V-BEAMS" WITH HI-V-REFLECTOR AVAILABLE NOW CUSTOMIZED FOR YOUR OWN RECEPTION AREA! These famous-for-superior-performance antennas are supplied to your distributor custom-cut for best reception in your particular location.

NOW! THE DUAL-DRIVEN FISHBONE JR.

FOR ALL VHF CHANNELS — New six element TV series. Extremely high forward gain and front to back ratio exceeds most 8 element beams — compares favorably with many 10 element antennas. Supplied to distributors custom cut.

"CONICAL-V-BEAMS" are covered by Patent No. 23,346
CANADIAN and FOREIGN PATENTS PENDING



telrex INC.
CONICAL-V-BEAMS

AMERICA'S
OUTSTANDING
TELEVISION
BEAM

Originators and
Manufacturers of
"CONICAL-V-BEAMS"
—INSIST on
the original!

ASBURY PARK 2, N. J.

SEE US AT THE NEDA SHOW—BOOTH 117

Rauland Tubes give you a prettier profit picture



Rauland picture tubes are first choice of an ever growing number of service dealers and men. First, because of the completeness of the Rauland replacement line.

Second, because you get the benefit of acknowledged leadership in picture tube engineering. Rauland research has developed more picture tube improvements since

the war than any other company.

You get quality you can count on, too. Rauland production employs machines unique in the industry—many of them designed by Rauland engineers and built in Rauland's own plant.

And finally, you get assurance of customer satisfaction beyond

what any other line can give you. Installation and adjustment of Rauland tubes is faster and better. The Indicator Ion Trap gives you the surest known protection against ion burn and shortened tube life.

Specify Rauland—deliver Rauland—and assure yourself of pleased picture tube customers.

THE RAULAND CORPORATION



Perfection Through Research

4245 N. KNOX AVENUE • CHICAGO 41, ILLINOIS



NEW!
G-C's
UNIVERSAL TV
LIGHTNING ARRESTER

- ✓ For Both 300-Ohm & 450-Ohm Open Line
- ✓ Indoor or Outdoor Use
- ✓ Safe... ✓ Sure... ✓ Speedy!

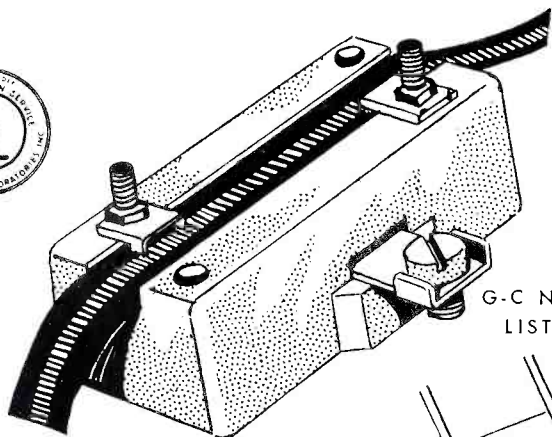

G-C NO. 8640
 LIST \$1.25

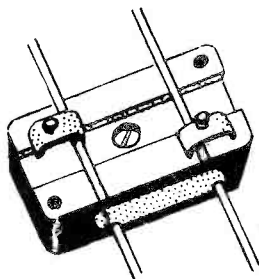

G-C's new all-weather, Underwriters' approved Lightning Arrester is specially designed to make television antenna installation easy and trouble-free. Designed for both lead-in styles, it's easy to connect and install—with no wires to strip. Bakelite housing is not affected by heat.

G-C ALIGNMENT TOOLS

All G-C Alignment Tools are precision engineered and service proved to make TV work easier, quicker. With the widest range and selection to choose from, you can be sure of getting just what you need for every application. See the remarkable new G-C TV Tool Display at your distributor.

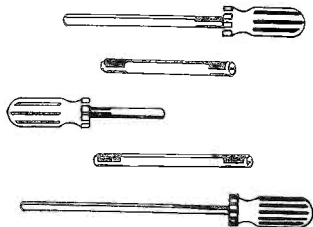

FREE! G-C's big 80-page Catalog plus new 16-page supplement. Write for your copy today!



GENERAL CEMENT MANUFACTURING CO.
 302 TAYLOR AVENUE
 ROCKFORD, ILLINOIS

Capehart Big Ad Campaign

A Fall advertising program which includes Capehart messages in eleven leading mass circulation magazines is announced by S. A. Morrow, director of advertising of the Capehart-Farnsworth Corporation, an I. T. & T. associate. The Saturday Evening Post, Collier's, Look, The New Yorker, Sunset, Better Homes & Gardens, House Beautiful, House & Garden, Newsweek, Time, and U. S. News and World Report—with a total circulation of more than 15,000,000—will carry the Capehart story to more than 63,000,000 people, Mr. Morrow estimates. Built around the new Capehart CX-36 chassis, the ads will stress the power and performance of the new Capehart instruments. The Capehart national schedule will be launched with a full-color double spread in the September 27 issue of The Saturday Evening Post, Mr. Morrow said.

New Revere Tape Recorders

Two new Revere tape recorders, automatic key control models with built-in-radios have been announced for home, school and office use, by E. J. McGookin, general manager of the Revere Camera Company. The new radio-recorder models are the Revere TR-800, which features a two-hour play on a seven-inch reel at a speed of 3.75 inches per second, and the Revere TR-20 studio model, which has a speed of 7.50 inches per second for a one-hour play. The TR-800 is now available, and the studio model with radio will be out in late October.

Universal Sales Clinics Will Reach 8,000 Dealers

Cognizant of the need for intensive training in retail selling of home cleaning equipment in the approaching buyer's market, Landers, Frary & Clark is reaching into the grass roots level with what is reputed to be the biggest retail sales training effort ever staged in the vacuum cleaner industry, Lee Moss, sales manager of the home cleaning equipment division has announced.

In a series of 300 Jet 99 retail sales clinics to be held in cities and small towns across the country, a total of 8,000 Universal retailers will undergo intensive sales training aimed to equip sales personnel with proven, time-tested sales techniques to build sales volume in their areas. The clinics are scheduled to commence on September 2nd and continue throughout October 14.

The Universal meetings are being conducted as clinical workshops. Each clinic will include product training, tested sales techniques, merchandising methods, store and home demonstrations, advertising, promotion, and publicity tie-ins for local area promotion. The sales staffs of the retail stores represented will learn how to handle trade-ins, service and house to house selling.

FOR THE FIRST TIME... **ANYWHERE!**

A BROAD-BAND, 3-TUBE, 3-STAGE,
FULLY AUTOMATIC BOOSTER WITH
ALL-CHANNEL GAIN IN EXCESS OF 16 db.

and only
\$39⁵⁰
LIST

THE NEW **B-T**
BOOSTER

MODEL HA-3 Fully Automatic

Designed and Manufactured by
Blonder-Tongue Laboratories for
Better Television

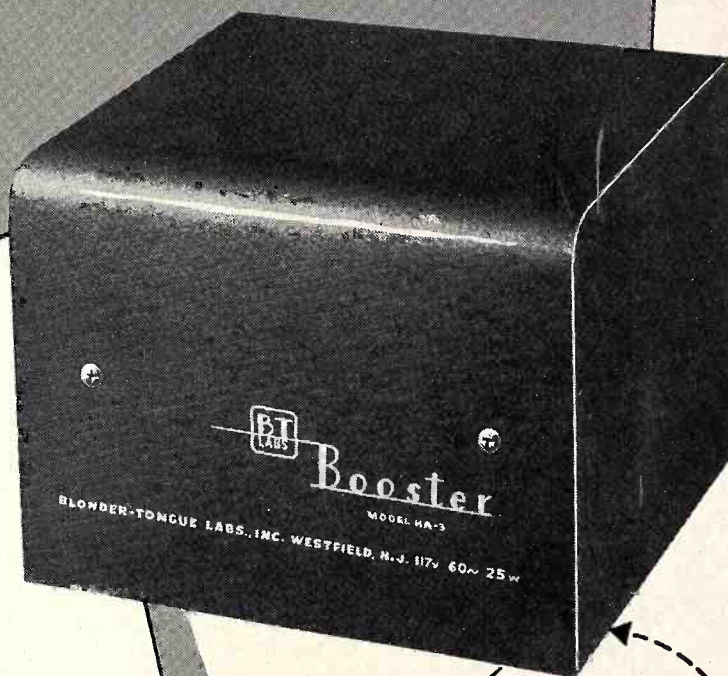

NO Knobs to Set
NO Tuning
NO Band-Switching

COMPARE THESE SUPERIOR FEATURES:

- ★ Fully Automatic Broad Band Performance . . . NO Tuning.
- ★ Fully Automatic 'On and Shut-off' Power Control.
- ★ Full UHF Adaptability.
- ★ Gain on all channels in Excess of 16 db. Plus Attenuator Switch.
- ★ 3-Tube, 3-Stage Cascade push-pull Circuit.
- ★ Lower Noise Factor.

Standard RTMA Warranties Apply

Specify **B-T** Amplifiers and Accessories
for Easy-to-Install Master TV Systems

Write for complete Data.



BLONDER-TONGUE LABORATORIES, INC.

WESTFIELD, NEW JERSEY

Now the one definitely better television booster

THE **SCANAFAR** NEW MODEL CT-1

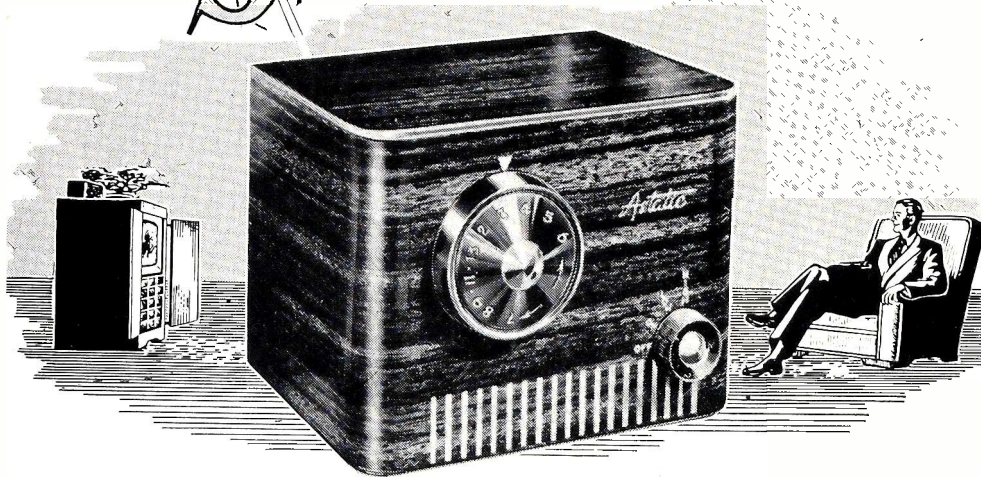

by **Astatic**

Great, major improvements in new television receivers have left ordinary boosters wanting. Where such boosters had been able to effect some slight improvement in the reception obtained with older model sets, the new sets have actually been found to suffer, in picture clarity and definition, when oldstyle boosters are cut into the circuit. That's why Astatic's new Scanafar TV Booster, model CT-1, is causing such a stir in trade circles. Here is a booster of brand-new design that more than meets the tougher requirements of today . . . works to the advantage of the best new receiver front-ends . . . makes fine reception finer and poor reception fine . . . imposes no loss of picture definition nor suppression of sound. The Scanafar is truly the **one** definitely better TV Booster. Your first trial hook-up will show the real difference.

LIST PRICE \$32.50

FEATURES

The Scanafar employs a balanced, cascaded circuit, with a neutralized 6J6 tube driving a 6BQ7 (the highly touted "quiet tube"). Both tubes are used over the entire TV frequency range. Band width is over seven megacycles on all channels. Provision is made for either 72 ohm or 300 ohm impedance input and output. For other descriptive and technical information, write for illustrated literature.

THE
Astatic
ASTATIC CORPORATION
 CONNEAUT, OHIO
IN CANADA: CANADIAN ASTATIC LTD., TORONTO, ONTARIO

EXPORT DEPARTMENT

401 Broadway, New York 13, N. Y. Cable Address: ASTATIC, New York

CBS-Columbia TV Receivers On Allocation Basis

Orders from dealers and distributors for the new 1953 line of CBS-Columbia television receivers have out-distanced production by such a margin that an allocation system on all shipments from the factory has been established, it has been announced by David H. Cogan, president of the firm. Allocation of all shipments, according to Mr. Cogan, will be based on market potential, past performance, and other such factors. Priority will be given to orders currently on file. "We are doing everything possible to assure a fair distribution of CBS-Columbia television receivers," Mr. Cogan declared. "As far as we can tell at this moment," he explained, "our 'Studio' and 'Masterline' Series will be on allocation throughout the Fall."

Westinghouse Names Hoag

The appointment of Jerome E. Hoag, Jr., as district sales manager, St. Louis area for the Television-Radio Division, Westinghouse Electric Corporation has been announced by Joseph F. Walsh, sales manager. The St. Louis district comprises Missouri, Kansas, Arkansas, Oklahoma and Western Tennessee.

Zenith Distributors

The Harry Knodel Distributing Company of Cincinnati has been appointed distributor for Zenith radio and television products in a total of twenty-three counties in Ohio, Kentucky, and Indiana, it has been announced by L. C. Truesdell, Zenith Radio Corporation vice-president of radio and television.

New Sparton Receivers

New Sparton models include two 17" table receivers, four 21" table models, one 17" open-face console, four 21" open-face consoles, two 21" radio-TV-phono combinations with doors. Line is described in "Selling Features of Latest TV Sets" elsewhere in this issue.

New Capehart Radio Line

The Capehart-Farnsworth Corp. is showing the following new line of radios: Model RP-152, AM radio and phono combination, clock-radio model TC 20 in grey-blue, ivory, burgundy and ebony; clock-radio, TC-100, brown and ivory; clock-radio TC101, in grey-blue; table model, T-30, brown and ivory; portable model 10, desert sand and burgundy, and a five-way radio, model 15 in desert sand and burgundy. Capehart's new TV line is listed in "Selling Features of Latest TV Sets" elsewhere in this issue.

Admiral 21-Incher at \$199.95

Highlighting the 1953 Admiral line is a 21-inch (121DX11) listing at \$199.95, including tax and warranty. Incorporated in this compact model are the new Cascade long-range AC chassis with power transformer, a range-finder, built-in antenna, removable safety screen, etc. The complete Admiral line appears in "Selling Features of Latest TV Sets" elsewhere in this issue.

RCA Victor Names Alexander



William I. Alexander, above, has been appointed advertising and sales promotion manager of the RCA Victor record department, it was announced by Paul A. Barkmeier, vice-president in charge of the department.

New Combo in Radio-Phonograph Industry

Fred Buhlman and Jack Grand have joined in a venture wherein Buhlman will manufacture a complete line of record players under the well-known name of Clinton Radio & Phonograph Corporation and Grand will do the national merchandising through Clinton Sales Corporation. Henry Vitarelli is sales manager for the latter organization. Headquarters are in New York City.

Palmer Appoints Canady

Oscar Palmer, president of the Palmer Manufacturing Corp., has announced the appointment of Jack Canady to the position of sales promotion manager for the Phoenix, Arizona, evaporative cooler and heater concern. Canady has had vast experience in the appliance field.

Vocatron INTERCOM

A new "wire-less" and completely portable intercom, the Vocatron, provides instant two-way communication between rooms or offices in a building, or in separate buildings served by the same transformer. The units can be



carried from room to room, need no extra wiring or installation of any kind. They plug in any standard 105-120 volt AC or DC electrical outlet. Standard model CC-2 sells for \$79.50 a pair of talk-listen units. Special model CC-25 (S), which provides longer range and greater sensitivity, retails for \$97.50 a pair. Vocaline Company of America, Inc., 409 Bristol Building, Old Saybrook, Conn.—TELEVISION RETAILING.

Alprodco

ALUMINUM TOWERS

TV • FM • AM

BROADCASTING
AND
RECEIVING

The Height of
Perfection



ALPRODCO AIRCRAFT ALUMINUM TOWERS

Lower Cost per Installation

Easy to Install

Light Weight

Strong

Long Lasting

Attractive

the most complete line of tower accessories on the market

Alprodco Towers are sold through local parts distributors.

Write for literature and full details.

ADDRESS DEPT. A

Alprodco, Inc.

KEMPTON, INDIANA
MINERAL WELLS, TEXAS
DUBLIN, GEORGIA

Clarostat Executive Discusses Prompt Delivery Advantages

Fred J. Chamberlain, head of distributor sales for Clarostat Mfg. Co., Inc., Dover, N. H., recently stated that prompt availability accounts for the growing acceptance of exact-duplicate TV controls. He says that immediate availability is a very important factor in profitable radio-TV servicing and that Clarostat, to offset past doubts about adequate jobber's stocks because of the considerable investment required, has maintained outstanding deliveries, made possible by a large factory stock at all times as well as speedy handling of all orders. According to Chamberlain, "It is a fact that Clarostat can

deliver better than 95% of all exact-duplicates called for." He also says "It is this prompt availability that is swinging the tide in favor of exact-duplicate controls, particularly in concentric duals.

New AmpereX Plant

S. E. Morris, president of AmpereX Electronic Corporation, has announced that its newly constructed Long Island plant is already in full operation. Located at 230 Duffy Ave., Hicksville, N. Y., the modern structure not only houses executive and clerical departments, but contains elaborate research, engineering, and production facilities for the design and manufacture of electronic tubes exclusively.

Du Mont Discusses New Outlet



Dr. Allen B. Du Mont (second from right) discusses television receiver distribution with principals of Equipment Distributors, Inc., Boston, at Allen B. Du Mont Laboratories, Inc., national distributor convention in New York City. L to r are Albert Bersin, treasurer, Equipment Distributors; Alvin Zises, president, Dr. Du Mont, and Jerry Zises, vice-president of the Boston firm.

S. Abrams Resigns From Emerson

Stanley M. Abrams, director of sales for Emerson Radio & Phonograph Corporation, has resigned his post to become a distributor of Emerson products in Nassau and Suffolk Counties, Long Island, N. Y., according to an announcement by Benjamin Abrams, president of the Emerson Corporation. The new distributing company, Emerson-Long Island, Inc., of which Stanley M. Abrams is president, is located at 465-469 Jericho Turnpike, Mineola.

3 Reps for Ram

Richard W. Mayersohn, national sales manager of Ram Electronics Sales Co., has announced the appointment of the following sales representatives: Lee B. Naylor Co., 1250 1st Ave. S., Seattle, Washington, for the Pacific Northwest territory; Albert Leban Co., 218 Lloyd Land, Phila., Pa., for the eastern Pa., Washington, Maryland, Delaware, southern New Jersey and Virginia territory; and Hy Mates, 5510 Market St., Pittsburgh, Pa., for the western Pa., and West Virginia territory.

Jensen Phono Needle Promotion



Jensen Industries, Inc., Chicago, has launched a big phonograph needle campaign called "Win a Grand" contest. Contestants are the nation's radio and TV servicemen who sell the most Jensen phonograph needles during a four-month promotion which closes on December 31st. \$5000 in cash prizes is awaiting the lucky winners. See your Jensen distributor for details. Shown in the picture are Karl W. Jensen (left) vice-president, Jensen Industries, and Paul J. Steffen, Paul J. Steffen Advertising Agency, Chicago. They are looking at one of the many posters which will promote the contest.

NO! the most expensive sets don't
always work better in the fringe areas,
BUT...

ANY television receiver equipped with a

TARZIAN TUNER

will do the best job of pulling in distant stations

It's no wonder that manufacturers of many of the better known TV sets on the market today depend upon the trouble-free TARZIAN TUNER for the excellent performance of their sets.

No other commercial tuning unit possesses so many of the desirable features found only in the TARZIAN TUNER. For unexcelled selectivity . . . stability . . . and reception—especially in fringe areas—there is no better tuner than the

TARZIAN TUNER

The sensible Tarzian approach to UHF—a full band, all station tuner—is a typical engineering example of keeping up with—or rather—one step ahead of—developments in the ever changing industry.

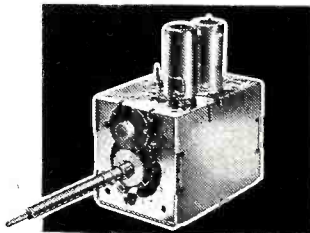

SARKES TARZIAN, Inc., Tuner Division, Bloomington, Indiana

TARZIAN MADE PRODUCTS



Tuners



Air Trimmers



Selenium Rectifiers



Cathode-Ray and Receiving Tubes

STATIONS WTTS (5000 WATTS) AND WTV (CHANNEL 10)
OWNED AND OPERATED BY SARKES TARZIAN IN BLOOMINGTON

The GE Stratopower Chassis



Douglass Cooper of General Electric's Chicago distributor R. Cooper, Jr., A. A. Brandt, sales manager, and P. H. Leslie, television sales manager of the GE receiver department talk over the Strato-power chassis featured in nine of GE's new line of Black Daylite television. GE says engineering innovations in this new chassis are credited with producing 267% more sensitivity, clearer, sharper pictures and noise-free audio even in super-fringe areas.

Finn in New RCA Post

David J. Finn, formerly advertising manager of the RCA Victor record department, has assumed responsibility for sales of the company's custom records division, announced Paul A. Barkmeier, vice-president in charge of the record department. Finn will report to J. P. Davis, manager of the division. He will be responsible for the company's custom recording and record pressing services, which include broadcast transcriptions, brand-line records, and discs for slide films.

Bruning Represents Cornish Wire

The A. H. Bruning Company has been appointed to represent the Cornish Wire Co., Inc., 50 Church St., New York N. Y. in the Chicago territory, which includes Indiana, northern Illinois and southeastern Wisconsin. The new agency will represent Cornish in its division of radio and electronic products.

Two New Reps for Newcomb

Newcomb Audio Products Co., Hollywood 38, California, announces the appointment of Tim Coakley of 11 Beacon St., Boston 8, Mass., as New England representative, and the Morris Taylor Co., 8416 Georgia Ave., Silver Spring, Md., as Southern representative.

Zenith Appoints Smith



Robert G. Smith has been appointed regional sales manager for Zenith Radio Corp. in the Southwest, it was announced by L. C. Truesdell, Zenith vice-president of radio and television. His territory includes the headquarters city of Dallas and Houston, Amarillo, Lubbock, San Antonio and Shreveport.

22Db GAIN OVER A TUNED DIPOLE

Most Powerful TV Antenna Ever Developed for Home Use

- ★ 10 Times More Powerful than Stacked 10 Element Yagis
- ★ Extends Fringe Area Reception An Additional 40 Miles

... Plus ...

- ★ Motorless ALL DIRECTION RECEPTION
- ★ Broadband ALL CHANNEL RECEPTION
- ★ Quick Rig Flip Out Assembly
- ★ HALF COST OF STACKED YAGIS
- ★ U. S. Patent No. 2,585,670 For Your Protection

MONEY BACK GUARANTEE

To outperform any present day antenna array using a rotomotor including 10 element stacked yagis, 4 bay conicals, fans, double V's, etc.

List Price **\$27.60** Model AD 2-8

Order Now — Don't Delay

You Have Everything to Gain

Nothing to Lose

ALL CHANNEL

ANTENNA CORPORATION

70-07 Queens Blvd. • Woodside 77, N. Y.

Two New Reps for Insuline

Bernard L. Cahn, general sales manager for the Insuline Corporation of America, Long Island City, N. Y., has announced the appointment of two new regional sales representatives for that company. Nick Laub of Minneapolis, Minn., will cover Minnesota, North and South Dakota, and western Wisconsin. James H. Podolny of Pittsburgh, Pa., will cover West Virginia, Ohio and the western part of Pennsylvania. The Gerber Sales Company of Boston, Mass., which has been representing Insuline for some time, has added Paul Spector to its staff to cover the state of Connecticut.

New Graybar Post for Berry

According to announcement by C. S. Powell, St. Louis district manager, W. J. Berry has been appointed manager of the Memphis branch of the Graybar Electric Company. He succeeds J. W. Horne, who has been made manager at Norfolk.

McCarthy To Distribute Sound

The Visual Products Section of the Radio Corporation of America announces the appointment of McCarthy Distributors, Inc., 236 West 55 St., New York 19, N. Y., to handle RCA 16 mm sound projectors and associated accessories.

RCA Victor Announces Prizes



R. W. Saxon, general sales manager of RCA Victor's home instrument department (seated) and J. M. Williams, manager of the department's advertising and sales promotion, spread good cheer among RCA Victor dealers. Mr. Saxon is notifying the winners of the \$20,000 contest held in connection with the RCA Victor Television Sales Clinics. To be eligible for awards, winning dealers and dealer salesmen in the contest had to attend all the sales clinics and answer correctly a question based on the material used in the program.

G-C Facilities Brochure

A 16-page illustrated brochure, called "The Story of G-C," has recently been published by General Cement Manufacturing Company. It shows the part played by this firm in supplying electronic components to the radio-television industry and other fields. Free copies are available by writing to the company at 919 Taylor Street, Rockford, Ill.

Promote Two At United Electronics

Charles A. Rice has been elected president of United Electronics Company of Newark, N. J., manufacturers of special-purpose electron tubes. Rice was formerly executive vice-president of the corporation for more than 10 years, and is a veteran of the radio industry. John R. Beers has been appointed vice-president in charge of operations. He was formerly vice-president in charge of engineering, and has been engaged in electron tube engineering fields since 1922.

IH Television Service Truck



An International L-120 truck with Aristocrat Service-Utility body is used for one-trip television installation service by Air Vision, Inc., television dealers at Waukegan and Wilmette, Ill. The versatile Aristocrat body enables easy hauling of receivers, assembled antennas, ladders, parts and tools. Readily accessible are tool and parts bins in the horizontal and vertical compartments of the Aristocrat body. Several large television sets are easily carried in the open pickup section. The open body can be covered with a form-fitting canvas canopy.

SPEED UP
YOUR
SERVICING
WITH
"STANCOR
TRIOS"

(Groups-of-three most frequently used Stancor TV Replacement Components listed below)

Don't Waste valuable time waiting for a replacement—carry it in stock!

STANCOR CHOKES	C-2325 C-2326 C-2327	COVER 70% of your TV REPLACEMENTS*
STANCOR DEFLECTION YOKES	DY-1 DY-8 DY-9	COVER 70% of your TV REPLACEMENTS*
HORIZONTAL DEFLECTION OUTPUTS	A-8127 A-8128 A-8130	COVER 45% of your TV REPLACEMENTS*
VERTICAL DEFLECTION OUTPUTS	A-8112 A-8115 A-8123	COVER 70% of your TV REPLACEMENTS*
VERTICAL BLOCKING OSCILLATORS	A-8111 A-8121 A-8122	COVER 65% of your TV REPLACEMENTS*

* Based on a statistical analysis of all replacement recommendations in the Stancor TV Replacement Guide.

Stancor Transformers are listed in HOWARD W. SAMS' Photofact Folders and JOHN RIDER'S Tek-Files.

FREE!

Stancor's new 24-page catalog listing over 475 transformers and related components for all types of electronic applications. Includes over 100 TV units. Get your free copy from your Stancor distributor or write Stancor direct!



STANDARD TRANSFORMER CORPORATION

3594 ELSTON AVENUE, CHICAGO 18, ILLINOIS

Raytheon Honors Distributor



Lynn Dickerson (left) Houston, Texas, was named the outstanding Raytheon television distributor in the U. S. and presented with an engraved watch in Chicago. William J. Helt, general sales manager for Belmont Radio Corp., manufacturer of Raytheon radio and television receivers, made the presentation and announced that Dickerson's company has done the outstanding sales job in Raytheon television history and made 1,074 per cent of quota.

Mars Offers Home Decorating Service

With the release of its new modern television set, the Riviera, executives of Mars Television, Queens, N. Y., are offering a free decorator's service to purchasers of Mars sets. At the notification of the television dealer, a Mars consultant will call to make an appointment at the home of any customer to advise on integrating the TV set with the style of the other furniture. At the same time, he will answer questions on any phase of decoration in the home. This service is available to anyone through his television dealer.

Hoffman Names New Jobber

Southwest Wholesale Distributors, Inc., San Antonio, Texas, is the new Hoffman distributor in the southwestern portion of the Lone Star state, according to M. D. (Bud) Schuster, sales director for Hoffman Radio Corp., Los Angeles. Administrative quarters and sales display rooms are at 533 Delaware St. in San Antonio. Charles Ely and E. J. Dorr are president and vice-president respectively.

Emerson Appoints Hopkins



David J. Hopkins (above) has been appointed director of sales and advertising for the Emerson Radio and Phonograph Corp., it was announced by Benjamin Abrams, president of the firm. Hopkins has resigned as president of the distributing company, Emerson West Coast Corp. to accept his new position.

Bendix Opens Regional Offices

Bendix Television and Radio has announced the opening of regional offices in New York, Chicago and San Francisco as the first step in a nationwide expansion program. The new offices are planned to give quick and expert guidance to dealers and distributors within the region on sales, advertising, and service problems.

Correction on Emerson Price

The price of the Emerson 3-way portable radio model 646 was shown incorrectly in the August issue of Television Retailing. The correct price is \$29.95 less batteries.

New Admiral Distributor

Golden State Appliance Distributing Company is the name of the new factory branch organized by Admiral Corporation to handle sales and service of the company's television and radio receivers, refrigerators and ranges in the Los Angeles area. Located at 242 S. Anderson St., Los Angeles, the new organization replaces Herbert H. Horn, Inc. Arthur J. McGettrick is vice-president and general manager of the new branch; George A. Prendergast, operations manager; J. R. Hill, service manager; George Gramlich, advertising manager; and Charles Mack, credit manager.

GREATEST CONICAL YET!



Model No. C-4 Conical

- ALL ALUMINUM
- CORROSION RESISTANT
- BIGGEST VALUE FOR YOUR DOLLAR!

Featuring! THE NEW

"FLIP-OPEN" ASSEMBLY

- NO NUTS!
- NO BOLTS!
- NO TIGHTENING!

Simply "FLIP-OPEN" — and Install!

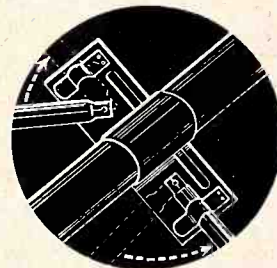



Clear Beam

TV ANTENNAS AND ACCESSORIES

The largest and most complete antenna line manufactured under one roof

100 PROSPECT AVENUE • • • BURBANK, CALIFORNIA
ROCKWELL 9-2141 CHARLESTON 0-4886

Vee-D-X "Ruggedized" Construction

Fred A. Hess, sales manager of the LaPointe-Plascomold Corp., announces that the Vee-D-X Q-Tee, all-channel antenna with electronic channel separators, is now supplied with "Ruggedized construction" at no extra cost. In order to insure high safety under the most severe conditions and to eliminate any possible draw from tight stacking harnesses, structural changes have been made on all element supporting portions of the antenna. They consist principally of special strengthening brackets. The new feature has been extensively laboratory and field tested with satisfactory results.

Goldberg Rep for Transvision

Saul Goldberg has been engaged as sales representative in the Queens and Long Island areas for Transvision, Inc. He will represent the firm with a full line of TV service instruments and parts for the assigned territory.

Kassler & Co. Appoints Hast

Nate Hast has been appointed vice president and director of sales for Kassler & Company Inc., Los Angeles, the firm recently named as southern California distributors for Arvin TV, radio and appliances. Hast was formerly Midwest sales manager for Olympic Radio & Television.

Jester With Standard Coil



Oden F. Jester (above) has been appointed sales manager of the distributor division of Standard Coil Products Co., Inc. He is a former vice-president of the Meissner-Thordarson-Radiart Division of Maguire Industries.

New Hallicrafters Distributor

The Southern Radio Supply Company, 1900 Tulane Ave., New Orleans has been appointed a distributor for the Hallicrafters Company, manufacturers of precision radio and television, announces Rollie Sherwood, general sales manager. The company will distribute Hallicrafters' home radio and TV line in New Orleans and surrounding areas.

South River Reps

South River Metal Products Co., Inc., has announced the addition of four sales representatives to give greater sales coverage to television reception areas throughout the U. S. and Canada. Earl T. Champion, 6459 N. Sheridan Rd., Chicago, Ill. will cover Illinois and Wisconsin; H. E. Walton Co., 128 Kercheval Ave., Detroit, Mich., will cover the state of Michigan; A. T. R. Armstrong Co., 50 St. Clair Ave. W. Toronto, Canada, for all of Canada but British Columbia; and Frank Wedel Co., 3215 Western Ave., Seattle, Wash. to cover British Columbia, Washington and Oregon.

RCA Service Task Force



TV task force fleet of a dozen RCA Service Co. trucks, rushed into Denver, Colo., to help put this largest non-TV city on the television map, is shown lined up on a lot adjoining the Denver headquarters of the Hendrie & Bolthoff Co., RCA Victor television distributor in the area. In center foreground, Harry Inglee (center in group of three), manager of the radio division of Hendrie & Bolthoff, and J. P. Boksenbom, vice-president of the RCA Service Co. exchange congratulations as Kenneth Hall, radio-TV sales manager of the distributor firm, looks on. RCA Victor sets, test equipment, factory trained installation and service technicians, were flown to the Colorado capital following the granting of a construction permit to KFEL-TV by the FCC.

This is the Mast they
are all talking about . . .

KENMAST

TRADE MARK

• Servicemen, Dealers, Distributors and Jobbers are all talking about Kenmast. Talking about Kenmast because of its neat appearance—its light weight—its telescoping feature—and its low cost.

The square tubing on the lower section of Kenmast is a new development in T-V masts; additional strength is gained and it gives Kenmast clean, trim, lines that will appeal to home owners. Kenmast comes in a light gray paint-plated finish.

Kenmast is easily and quickly installed by one man. The ease of handling and installation cuts installation costs. All work is done on the ground—no dangerous work on roofs or ladders.

The telescoping feature of Kenmast with its hand-crank appeals to all. After the mast with the antenna are raised into position alongside the house, Kenmast is cranked to its full height of 50 feet. The owner can easily crank it down in high winds or for servicing the antenna.

Get your order in now for your stock of Kenmasts.

\$64.50

(List Price)

THE TENNA-TRAILER COMPANY
321 North Plum Street • Pontiac, Illinois

Do you have a
TENNA-TRAILER?
Over 3000 in daily use.

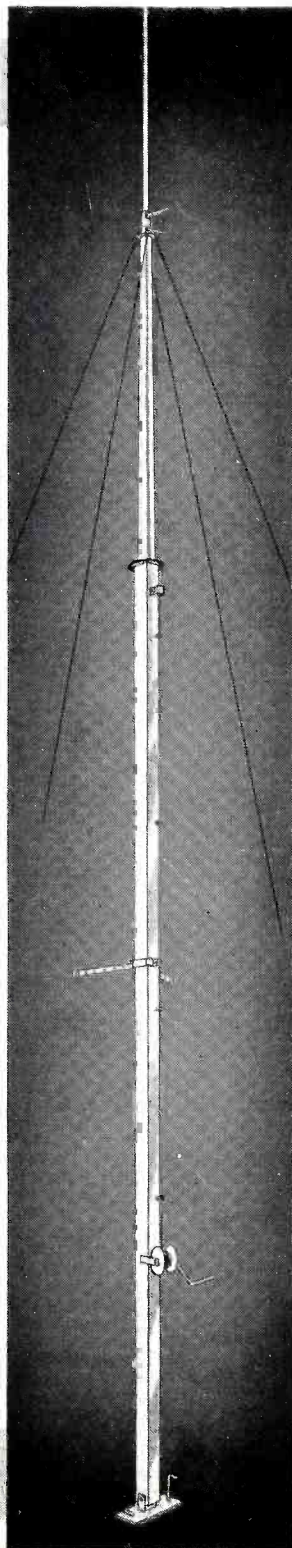

Testing Units

Hickok MODEL 670 OSCILLOGRAPH

This scope, model 670, is built to provide a sensitivity of 10 mv RMS/inch. This extra sensitivity will permit the proper viewing of TV response curve—even on receivers that are far out of alignment. The vertical amplifier has a DC range to 500 KC and usable to beyond 2 MC. This scope is designed for visual testing and alignment of FM and TV sets, and to measure voltages of AC signals, or hum, gain and distortion in audio amplifiers. Provision is made for direct connection to both horizontal and vertical plates of the CRT. Hickok Electrical Instrument Co., 10606 Dupont Ave., Cleveland 8, Ohio—TELEVISION RETAILING.

EICO PICTURE TUBE-TEST ADAPTOR

With the new CRA picture tube test adaptor and an EICO tube tester, the serviceman is now able to check picture tubes as fast and easily as any ordinary tube. With the CRA, a quantitative

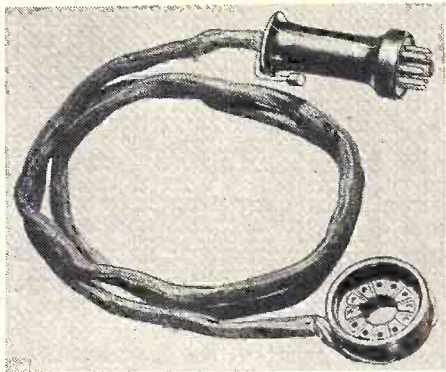

measurement of cathode emission, and tests for filament continuity and inter-element shorts can be made on a tube tester. It comes with a 4-ft. cable that enables the picture tube to remain in the set while testing. Model CRA is priced at \$4.50. Electronic Instrument Co., 84 Withers St., Brooklyn 11, N. Y.—TELEVISION RETAILING.

T.C.I. PICTURE TUBE SAVER

The Stay-Brite picture tube saver is said to improve contrast and restore the brilliance of old tubes. The unit works automatically. Five positions permit increasing filament voltage to prolong the useful life of all tubes for a year or more, the maker states. No technical knowledge is required for the installation of the instrument, which requires no wiring or outside connections. Retail at \$9.95. Television Communications Industries, 222 N. Wells, Chicago, Ill.—TELEVISION RETAILING.

Keith LOOP REPLACEMENT

The L-47 is a miniature coil, ferrite-core replacement for AM standard loop antennas; the L-47S is the screw version of this miniature coil, with a palnut mounting. Manufacturer claims that both units have a 10% higher Q, and a 20% higher inductance, than other makes tested. Due to their high Q, they provide better selectivity and sensitivity, and pick up less noise, it is said. Keith Radio, Laurel, Mississippi—TELEVISION RETAILING.

Townsend at Vee-D-X

Charles D. Townsend has been appointed director of manufacturing of the La Pointe-Plascomold Corp., Rockville, Conn., announced Jerome E. Respress, president. His main duty will be to coordinate the manufacturing methods and processes in La Pointe's various plants from a top-level management position.

Ward FM Antenna Pamphlet

"Your Road to Better FM" is the title of a new pamphlet describing Ward FM antennas. It was designed both as a catalog and as an envelope stuffer, and is being used by many distributors and dealers in their sound rooms.

Changes at Stewart-Warner



Three regional sales managers were recently appointed to represent Stewart-Warner Electric, the radio and television division of Stewart-Warner Corp., Philip J. Wood, merchandise and field sales manager has announced. J. T. Sharkey, who will headquarter in Radnor, Pa., R. A. Conroy, whose office is in Minneapolis, and Michael Caffrey, Jr., at Detroit, (l to r) are shown with Mr. Wood.

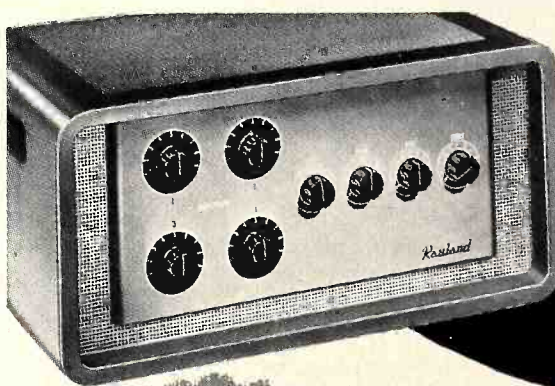

**Toughest
P. A.
Power House!**



"Green Gem" Bi-Power 60 WATT P. A. AMPLIFIER

You can really "give the gun" to the tough RAULAND 1960 Bi-Power (biased power) 60 watt Amplifier without a sign of "crack-up" even at peak output. And you can *sell* these "plus" features: 4 mike inputs (each convertible for use with low-impedance mikes by use of a plug-in transformer); 2 phono inputs with dual fader; true electronic mixing and fading on all 6 inputs; separate bass and treble tone controls; provision for remote mixing of 3 mikes. It's a beauty, too, in its new dark green hammerloid cabinet, with metallic bronze control panel set in a perforated aluminum finish front section.

SELL THE COMPLETE RAULAND LINE!



32 WATT AMPLIFIER
Featuring 3 mike inputs, 2 phono inputs, bass and treble tone controls, electronic mixing on all inputs.



16 WATT AMPLIFIER
Featuring 2 mike inputs, 1 phono input, electronic mixing on all inputs—tops for medium-power use.

Also 20 Watt and 30 Watt Mobiles

SPECIFICATIONS

Power Output: 60 watts at 5% or less total harmonic distortion, measured at 100, 400 and 5000 cycles. 85 watts peak output.

Gain: Mike—130 db (2 meg); 120 db (100,000 ohms); 120 db (150 ohms). Phono—83 db (1/2 meg). Voltage required for rated output: High inp. input—.005; low-imp.—.0004; Phono—.5 volts.

Frequency Response: ± 1 db, 40 to 15,000 cps.

Output Impedances: 4, 8, 80 (70 volts), 250, 500 ohms.

Hum and Noise Level: 70 db below rated output (unweighted).

Tubes (15): 5-6SQ7, 2-6SC7; 2-6SN7GTA; 2-6L6; 2-5U4G; 2-5Y3GT.

The RAULAND 1960 P.A. Amplifier gives you high-power to sell, along with complete P.A. facilities, maximum flexibility, superb tone and distinctive styling—the plus selling edges you want. Get the full details today!

See your RAULAND-BORG Distributor for full information on the complete years-ahead RAULAND "Green Gem" Public Address Line. Build a solid, profitable sound business around RAULAND'S dependability and quality.

SOUND
EQUIPMENT

Rauland

INTER-
COMMUNICATION

RAULAND-BORG CORPORATION • 3523-L Addison St., Chicago 18, ILL.

A NEW, RAPIDLY GROWING INDUSTRY PROMISES YOU NEW PROFITS!

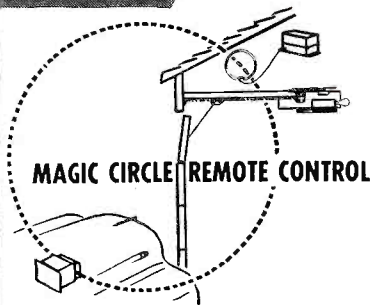

THOUSANDS IN USE!

Sell and Install Nationally Advertisised Electronically Controlled Garage Door Operators!

Here's a new line that offers profits which appliance dealers have never had before! The selling and installation of remote control garage door operators is still a new field with a great potential.

The electronic sets are in the low frequency band and meet the low power requirements of the FCC. Simple in design, these units are easily installed and serviced. These operators are made to open and close over head type garage doors. When a button is pushed in the car . . . the door goes up and the lights come on. Push the button again—the operation is reversed.

Nationally advertised in leading home and architectural magazines. Leads and selling plans are furnished. Dealer selling aids are also available.

Television and radio dealers are best equipped to get these new profits! Many dealers have already discovered these unexpected profits . . . there are many dealerships still available! Write about yours today!

H. W. CRANE COMPANY
1443 W. Lake St. Chicago 7, Illinois

Crosley Promotes Feilen



Frank Feilen has been appointed field service manager of the Crosley Div., Avco Mfg. Corp., it was announced by R. H. Schneberger, general service manager.

Grayline Introduces New Phonograph Device

A new and unique development in the phonograph field is Grayline Engineering's "Phono Gard," designed to prevent damage to either record or mechanism. The operation is fairly simple. A record is set on the turntable. A button located on the cabinet initiates a cycle which sets the mechanism in motion. A glass canopy moves forward and closes the aperture at the front of the cabinet, and at the same time, the isolated tone arm moves forward in proper position over the disc. When the canopy completes its forward motion, the arm drops vertically into playing position. After the record is completed, the cycle is repeated in reverse. The tone arm is at all times protected from handling by the operator. Facilities for "sampling" or playing parts of a record are provided through a band selector which raises and rotates the arm in order to play or replay any portion of the record. Two models of "Phono Gard" are available—a table model and a console. The latter is intended for strictly Hi-Fi installation; however, both units may be provided with either conventional or Hi-Fi components. Descriptive literature may be obtained by writing the company at Ave. "O" at 122 St., Chicago 33, Ill.

Rackmil Universal President

Milton R. Rackmil, president of Decca Records, Inc., has been elected president of Universal Pictures Company, Inc., to succeed N. J. Blumberg, who at the same time, was elected chairman of the board. Within the past year Decca Records, through purchases negotiated by Rackmil, obtained 42% of Universal's common stock which gave Decca the controlling interest in Universal Pictures. These purchases were highlighted when Decca acquired from General Cinema Finance Corp., Ltd., one of the J. Arthur Rank interests, its entire holdings consisting of 134,375 shares of the common stock of Universal. Rackmil will continue as president of Decca.

Finest TV Reception

**the Hi-Lo
TV Spiral Indoor
ANTENNA**

*U. S. Patent No. 2,495,579
Canadian patents 1951

\$9.95
LIST PRICE

Model 101*

Available at leading jobbers!

Hi-Lo TV ANTENNA CORP.
3540 N. Ravenswood Chicago 13.

Nat'l Carbon Promotes Bryan



Arthur C. Bryan, (above) has been appointed vice-president in charge of sales for National Carbon Co., a division of Union Carbide and Carbon Corp., it was announced by A. S. Johnson, National Carbon's president.

Largest Webcor Order



The largest order for Webcor products in the history of Webster-Chicago Corp. and their New York distributors, Sanford Electronics Corp., was signed at the N.A.M.M. show in N. Y. The order totals 35 carloads of the new Webcor line of merchandise previewed at the Show. Charles Ollstein, president of Sanford Electronics (seated) and Max Horowitz, general sales manager of Sanford (left) are seen delivering the order to Norman Owen, general sales manager of Webcor.

Kathi Norris Tries Vocatron



Vocatron, the two-way communication device which is simply plugged into an ordinary wall-socket, is used with pleasure by Kathi Norris as she listened to encouragement from producer Wilbur Stark, her husband, when she prepared to go on the air at the Du Mont Studios, N. Y.



NEW LIGHT... "SALES"!

leads to more "SALES"!

The ORIGINAL
"TENNA-BOAT!"

Indoor Antenna —
now has indirect lighting
from cockpit—interior of
boat is completely illu-
minated.

Pat.
App.
for

Suggested
list price

\$12.95

Model TB 400

Model TB 400-L
with light

\$14.95

- Beautiful ceramic of finest quality
- Best performance
- Eye-appeal to create sales
- Ease of operation—move boom of boat to orient for peak reception.
- Tuning condenser assures perfect impedance match

SOLD through JOBBERS ONLY!
Write for new Literature!

*T*ricraft Products Co.

1535 North Ashland Ave., Chicago 22, Ill.

Manufacturers of complete line of Television, FM and AM antennas and accessories

a "TESCO" exclusive

the ROCKETENNA



by T-V PRODUCTS CO.



- ✓ Amazingly Powerful Reception
- ✓ Rugged All-Aluminum Construction
- ✓ Lifetime Factory Warranty

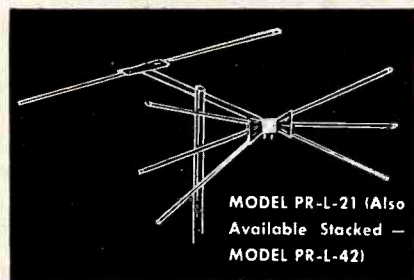
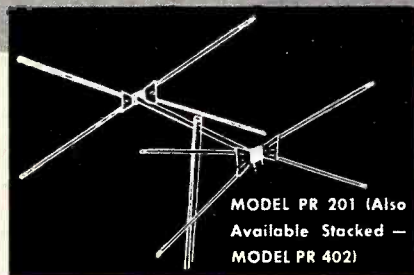

Complete factory Preassembly features sensational "Quick-as-a-Wink" construction. No Nuts or Bolts to Tighten... rugged rivet assembly prevents damage by wind and storm vibration.

ANOTHER "TESCO" PRODUCT

T-V

PRODUCTS CO.

152 SANDFORD ST. • B'KLYN, N. Y.



In Cornell-Dubilier Post



Raymond T. Leary has been appointed sales manager of the jobber division of Cornell-Dubilier Electric Corp., it was announced by Octave Blake, president of the firm.

Pioneer Offers Tube Guarantee

Pioneer Electronics Corp., Santa Monica, Calif., manufacturer of cathode ray tubes and special high frequency vacuum tubes, is now offering a full year factory guarantee on all its TV picture tubes. "Quality and long life of a picture tube," explains Laurence M. Perrish, president, "are determined by the amount of gas remaining after final evacuation. By reducing the gas content of our tubes 12 times less than the allowed RTMA maximum, we are able to guarantee longer picture tube life.

Mosley Organizes New Dept.

Organization of a new department of advertising and sales promotion to be headed by George E. Mobus has been announced by Carl E. Mosley, general manager of Mosley Electronics, Overland, Mo. In making the announcement, Mosley states that the primary objective of future Mosley advertising will be to better acquaint television dealers, installers and servicemen with the added profit and customer good-will possible through providing better TV installations.

RMS Antenna Demonstrated



Amity Radio & Appliance held a very interesting display of RMS TV antennas and accessories at the recent Sport & Industry Show, Amityville, Long Island, N. Y. Featured was convincing TV reception from N.Y.C. transmitter 35 miles away, using an RMS CVA-500 fringe leader antenna hooked up to a CBS-1000 receiver. Amity Radio says the antenna was mounted only 10 ft. above ground and was not used with a booster. The lovely girl is Ritchie Weisl, wife of the N. Y. CBS-Columbia distributor, displaying the new RMS video booster used at fringe locations on Long Island.

Off to a Flying Start



Ready to "take off" on the celebration of the 1 1/2 millionth Walsco antenna to be produced. Harriet Barnes, attractive TWA hostess, deposits free vacation certificates in lucky 1,500,000 antenna carton. Walter L. Schott (left) and Jack Carter, Walsco sales manager, offer assistance in ceremony that will launch a nation-wide search for this antenna, and 4 all-expense vacations to the service man and jobber who finds it.

New Distributor for Sylvania

John K. McDonough, general sales manager, radio and television division, Sylvania Electric Products Inc. has announced the appointment of a newly formed organization, Western Empire Distributors of San Francisco as the distributor of Sylvania television and radio receivers in the northern California area. Donald Courtleigh, whose offices are at 715 Bryant St., San Francisco, is the head of the company. Other executives are George Holden and Barrett Wells.

Do you carry
PHILCO or **RCA**
TV SETS ?

Carry them in the rugged, quilted canvas protection of Wrapabouts—secure from damaging jolts, jars, and scratches. Webb Wrapabouts are weather-resistant, thickly padded, lined with soft, scratchless white flannel and easily adjusted to different cabinets.

FOUR WRAPABOUT MODELS FIT ALL SIZES OF EVERY MAKE

Easy to slip on, they eliminate need for laborious crating and messy unpacking on customer's premises. Wrapabouts pay for themselves over and over again through repeated use in protecting mirror-finishes.

Write Webb today
 for Wrapabout sizes and low prices



WEBB MANUFACTURING CO.
 2920 N. 4th Street • Phila. 33, Pa.

Sensational! **BEACON** *New!*
SPIRAL TV ANTENNA
 AND FM

Licensed under Pat. # 2,495,579

MODEL NO. 400
 No Rods to Pull or Bend.
 No Orienting in MOST Locations.
 All channel for both TV and FM.
 Hide it and forget it.

Available in silver or gleaming gold finish.
 Attractive Jobbers Discount
 Your inquiries are invited.
 List price **\$9.95**

BEACON CORPORATION 2846 MILWAUKEE AVE.
 CHICAGO 18, ILLINOIS

MORE
RECOTON Phoneedles
 are sold by retailers
 than any other brand in the world!

There's a reason—Recoton's Reputation for Quality is world famous. Music lovers ask for Recoton needles. Give them what they want!

RECOTON
World Famous for Quality

147 West 22nd St., • New York 11, N.Y.

GE Promotes Goodhart



David T. Goodhart (above) has been appointed assistant to sales manager, television receivers, it was announced by Arthur A. Brandt, general sales manager of GE's receiver department. He was formerly district manager of the receiver department at Minneapolis, Minn.

Zenith Appoints 555

555, Inc., of 711 W. 8th St., Little Rock, has been appointed wholesale distributor for Zenith radio and television products in forty-four counties in the state of Arkansas. Included in the territory are principal cities.

Ward Antenna Promotion Piece

A new Ward promotional piece, to supplement other auto aerial material now being used by dealers and distributors to promote auto antenna sales is entitled "All Dressed Up." It is in the form of a trick folder dramatizing how a new Ward aerial "dresses up your car." It includes specifications on all popular Ward auto aerials, and a handy installation chart. All promotion pieces are now available through Ward distributors.

Arvin "Through-the-Year" Policy is Announced

Harlan B. Foulke, vice-president of Arvin Industries, Inc., Columbus, Ind., has announced that Arvin is inaugurating a "through-the-year" policy on its television offerings whereby a complete line will be introduced each Summer and maintained for the ensuing 12 months. Foulke pointed out the obvious advantages to the retailing end of the industry in having "perennial" radio and television lines. The Arvin executives stated, "We agree with Mort Farr, president of the National Appliance and Radio Dealers Association, and other competent observers, that the distributor and the dealer will be less confused, and more certain of their promotion and merchandising efforts, if they have a basic line to start with and can be sure that it will not become partly or wholly out-moded within a few months."

New Raytheon Chicago Manager

James J. Tynan, manager of equipment sales divisions of Raytheon Manufacturing Company has announced the appointment of George J. Zipf as district manager in charge of sales and service for the Chicago district. This district, with offices at 5016 W. Madison St., Chicago, serves the area of Indiana, western Kentucky, Wisconsin, Illinois, Minnesota, Iowa, Missouri, N. Dakota, S. Dakota, Nebraska and Kansas.

Unique Mitchell Installation



Two Mitchell 3/4 HP air conditioners in the Paul Angle jewelry store, Winter Haven, Florida, allow store walls and windows to be kept clear for displays by being mounted in two small windows above the store front. Mounted 9 1/2' above the floor level, the units are controlled by special remote switches at a convenient height. Made by the Mitchell Manufacturing Co. of Chicago, and installed by the Ellsworth Electric Co. at Winter Haven, the versatile units handled the problem of leaving window display area free.

In Every Line There Is An Outstanding Leader!

IN PHONOGRAPHS AND RADIO-COMBINATIONS IT'S

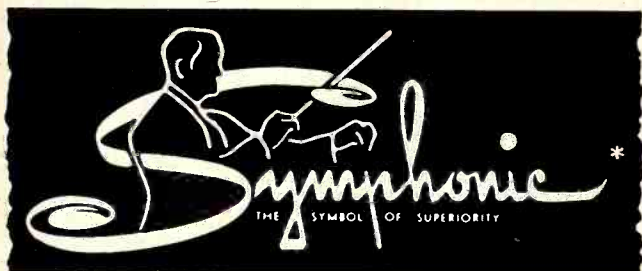

- ★ The Leader In Styling!
- ★ The Leader In Features!
- ★ The Leader In Performance!
- ★ The Leader In Value!

CO-ED MODEL 729: A Symphonic "Best Seller!" New luggage type ladies' train carrying case. 3-Speeds, Full Range Tone Control, Switch and Volume Controls. Gaborine Blue Pin-Seal Grain Pyroxilyn Coated Covering. 2-Brass Plated Locks and Carrying Handle.



Write for New Symphonic Illustrated Dealer Broadside with Complete Line Information.

SYMPHONIC RADIO & ELECTRONIC CORP.

160 North Washington St., Boston 14, Mass.
N.Y. Office: 1926 Broadway, New York 23, N.Y.

New- RADIO & TV DEALERS' FLOATER POLICY

A new answer to a new industry's need

Covers:

- Your radios, TV sets and household appliances while out on demonstration, trial, loan or rental.
- Your customers' radios, TV sets and household appliances while in your custody for adjustment or repair.
- Both your own and your customers' radios, TV sets and household appliances while in transit on your delivery vehicles.

Mail the coupon below. Our agent in your city will call and tell you all about this new policy. No obligation, of course.

THE AUTOMOBILE INSURANCE COMPANY
THE STANDARD FIRE INSURANCE COMPANY
HARTFORD 15, CONNECTICUT

Please have your agent tell us about your new Radio-TV Dealers' Floater Policy.

Name.....

Address.....

Audio Products

Racon LOUDSPEAKERS

The new Racon horns and loudspeakers are for use in sound systems which require high intelligibility combined with mechanical and electrical ruggedness and wide horizontal angle of coverage. The COB-15 and COB-16 will handle 25 watts of program material

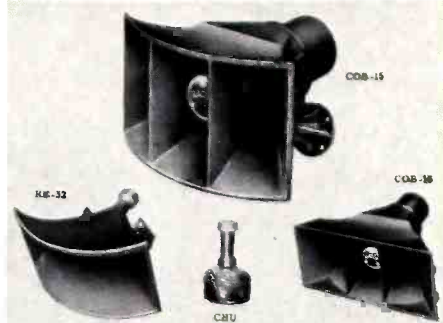

continuously. Their response range is 350-11,000 CPS; horizontal dispersion is 60-degrees, vertical dispersion 30-degrees. Model RE-32 is a "straight" horn design, with a nominal cutoff at 500 cycles, to provide crisp, highly articulate quality. Model CHU is a 15,000-cycle driver unit for use with the RE-32 horn when the latter is employed as a tweeter in 2- and 3-way high-fidelity systems. Racon Electric Co., 52 E. 19th St., New York 3, N. Y.—TELEVISION RETAILING.

Telex HEADSET

Specially designed to permit wearing all day without fatigue is the new "Dynaset" headset with under-the-chin styling and light weight (1.25 oz.). Features higher fidelity range, permitting more exact reproduction of high and lows of both music and speech, and is suitable for office transcribing machines, telecasting, radio monitoring, etc. Electro-Acoustic Div. Telex, Inc., Telex Park, St. Paul 1, Minn.—TELEVISION RETAILING.

Argos Products BAFFLE

This new bass-reflex speaker baffle for corner mounting is available in mahogany or blonde leatherette at the same price. Heavy 3/8" wood sides and back, plus 1/2" cellufoam acoustic lining

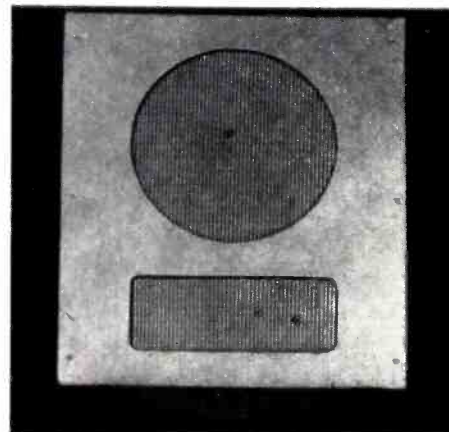

assure resonant tone, according to the manufacturer. The CB-8 (for 8" speaker) is offered to dealers for a net price of \$5.10; the CB-12 (for 12" speaker) is \$8.55 net to dealers. Argos Products Co., 4753 N. Broadway, Chicago 40, Ill.—TELEVISION RETAILING.

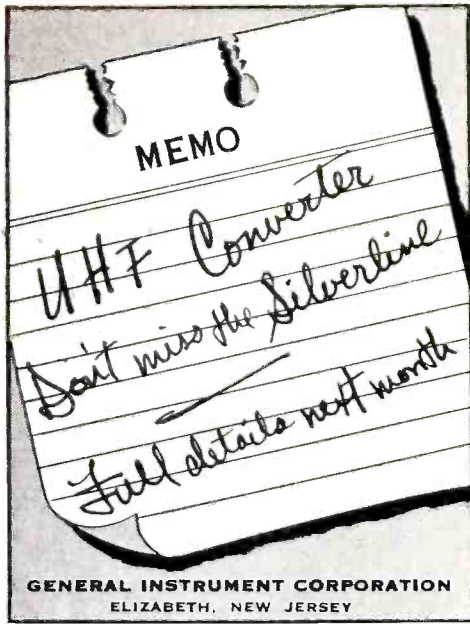

GENERAL INSTRUMENT CORPORATION
ELIZABETH, NEW JERSEY



NEW!

Transformer Catalog and TV Replacement Guide

Halldorson's new one-source catalog has the components you need, well classified for easy use.

This highly active line has been super-charged with 114 new items. Special attention is given to TV replacements. A self-contained guide section tells you where they are used.

Here's extra value, too. Halldorson prices actually have been reduced, but Halldorson quality is even better than ever.

Ask for a copy at your distributor, or write direct.

The HALLDORSON COMPANY
4500 N. Ravenswood Ave., Dept. RR-9
Chicago, 40, ILL.

Halldorson
QUALITY Transformers SINCE 1913

Ask the Man who Knows



JOHN MILLER

- Q. Who produced the first commercially manufactured West Coast Antenna?
A. John Miller—five years ago. Quality built . . . realistically priced, an antenna bearing the name Miller enjoys an unmarred reputation with jobbers, mfg. reps. and retailers.
- Q. Why should I buy a Miller Antenna?
A. Because a customized Miller TV Antenna is guaranteed for top performance. Each antenna sold is backed up unconditionally.

Solve your antenna problems by asking John Miller . . . the West's pioneer producer of over 1/2 million quality antennas in California alone. A Miller customized antenna is designed to provide good TV reception in all areas, under all conditions. Prepaid to all points in the U. S. Jobbers and mfg. reps. write for new Miller Catalog R-9 for answers to your technical questions . . . also for choice territories now opening.

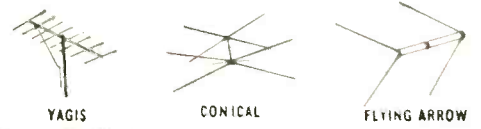

YAGI
ANTENNA MANUFACTURERS ASSOCIATION

CONICAL

FLYING ARROW



CLOSING

DATES

FOR

RADIO & TELEVISION RETAILING

5th of preceding month for all ads requiring proofs, composition, foundry work, key changes, etc.

10th of preceding month for complete plates only—no setting.

1st of month—Publication Date.

Cancellations not accepted after 5th of preceding month.

Caldwell - Clements, Inc.

480 LEXINGTON AVENUE

NEW YORK 17

INDEX TO ADVERTISERS — SEPTEMBER 1952

Admiral Corp.	92, 93	National Carbon Co.	22
Aetna Life Affiliated Co.	135	Olympic Radio & Television, Inc.	85
All Channel Antenna Co.	127	Pentron Corp.	72
Allied Radio Corp.	138	Philco Corp.	5
Alproco, Inc.	125	Radiart Corp.	16, 109, 138
American Television & Radio Co.	137	Radio Corporation of America	42, 43, Cover 4
American Phenolic Corp.	62	Radio Merchandise Sales, Inc.	10
Arvin Industries, Inc.	29	Radion Corp.	32
Astatic Corp.	124	Rauland Corp.	121
Beacon Corp.	134	Rauland-Borg Corp.	131
Bendix Radio Television and Broadcast Receiver Corp.	71	Raytheon Mfg. Co.	119
Blonder-Tongue Labs	123	Raytheon Television & Radio Corp.	12
Brach Mfg. Corp.	4	Recoton Corp.	134
Capehart-Farnsworth Corp.	17-20	Regency Div., Idea, Inc.	89
Channel Master Corp.	87, 88	Ridgeway Div. Gravely Novelty Furniture Co., Inc.	73
Clear Beam TV Antennas & Accessories	129	Sarkes Tarzian, Inc.	126
CBS-Columbia Inc.	Cover 2	Sentinel Radio Corp.	27
Commercial Credit Corp.	13	South River Metal Products Co., Inc.	138
Cornish Wire Co., Inc.	62	Sparton Radio-Television	33
Crane Co., H. W.	132	Standard Transformer Corp.	128
Crosley Div., Avco Mfg. Corp.	37, 38	Stewart-Warner Electric, Div. of Stewart-Warner Corp.	60, 61
DeWald Radio Mfg. Corp.	72	Stromberg-Carlson Co.	14, 15
Du Mont Labs Inc., Allen B.	83, 111	Supreme, Inc.	118
Electro Voice, Inc.	21	Sylvania Electric Products Inc.	11
Emerson Radio and Phonograph Corp.	30, 31	Symphonic Radio & Electronic Corp.	135
Fada Radio & Electric Co., Inc.	59	Technical Appliance Corp.	101
General Cement Mfg. Co.	122	Tele King Corp.	81
General Electric Co.	6, 26, 34, 35	Telrex, Inc.	120
General Instrument Corp.	136, 138	Tenna-Trailer Co.	130
Halldorson Co.	136	Terado Co.	62
Hallicrafters Co.	7	Tricraft Products Co.	133
Hi-Lo TV Antenna Corp.	132	Trio Mfg. Co.	102, 103
Hotpoint Co.	69	Triplett Electrical Instrument Co.	36
Hytron Radio & Electronics Co.	113	Tung-Sol Electric, Inc.	117
JFD Mfg. Co.	94	T-V Products, Co.	133
Jensen Industries, Inc.	73	Universal Woodcrafters Inc.	28
LaPointe-Plascomold Corp.	Cover 3	V-M Corp.	24, 25
Magnavox Co.	77	Ward Products Corp.	105, 106
Mallory & Co., P. R.	115	Webb Mfg. Co.	134
Meck TV, Inc.	67	Westinghouse Electric Corp.	8, 9
Miller, M. A. Mfg. Co.	57	Zenith Radio Corporation	23, 79
Miller Television Co.	136		
Motorola, Inc.	2, 3		

ATR

AUTO RADIO VIBRATORS

have Ceramic Stack Spacers



Free **UTP**

ATR VIBRATOR ANNUAL
A Complete Vibrator Line
MINNEAPOLIS, MINN.

A COMPLETE LINE OF VIBRATORS . . .

Designed for Use in Standard Vibrator-Operated Auto Radio Receivers. Built with Precision Construction, featuring Ceramic Stack Spacers for Longer Lasting Life. Backed by more than 20 years of experience in Vibrator Design, Development, and Manufacturing.



NEW MODELS

NEW DESIGNS

NEW LITERATURE

"A" Battery Eliminators, DC-AC Inverters, Auto Radio Vibrators

See your jobber or write factory

AMERICAN TELEVISION & RADIO Co.

Quality Products Since 1931

SAINT PAUL 1, MINNESOTA-U.S.A.

MEMO

UHF Converter
Don't miss the Silverline
Full details next month

GENERAL INSTRUMENT CORPORATION
 ELIZABETH, NEW JERSEY

Emerson Appoints Two

The appointment of Edward Kantowitz as advertizing manager and Albert Leon as sales promotion manager was recently announced by David J. Hopkins, director of sales and advertizing of Emerson Radio & Phonograph Corp.

New Regency Converter Cabinet

The new Regency converter for adding ultra-high frequency station reception to a TV set features a sleek cabinet designed by the firm of Painter, Teague and Petertil, Chicago. The cabinet, a style companion to the Regency TV signal booster, complements either period or contemporary television cabinets. Color and finish blend well with either blonde or dark furniture.

New Rep for EICO

The George Pettit Company has been appointed sales representative in the territory of Illinois, Wisconsin and Minnesota for the Electronic Instrument Co., Inc., designers and manufacturers of the EICO line of test instruments and kits. Pettit Co. headquarters are at 549 W. Washington Blvd., Chicago 6, Illinois.

Insuline Honors Romm

Irving W. Romm, manager of the special order division of the Insuline Corporation of America, Long Island City, N. Y., was recently honored with a surprise party celebrating his completion of 25 years of continuous service with the firm. He was presented with a gold watch by Samuel J. Spector, president of Insuline, as well as other gifts from fellow workers.

Sylvania Appoints Warncke Co.

John K. McDonough, general sales manager, Radio & Television Div., Sylvania Electric Products, Inc., has announced the appointment of the R. Warncke Company of Houston and San Antonio, Texas as the distributors of Sylvania radio and television in the Houston area.

Mitchell

The "Madrigal" is a new 6-tube AC-DC radio said to provide big-set performance in a small cabinet. Unit has built in "Air-Magnet" antenna, slide-

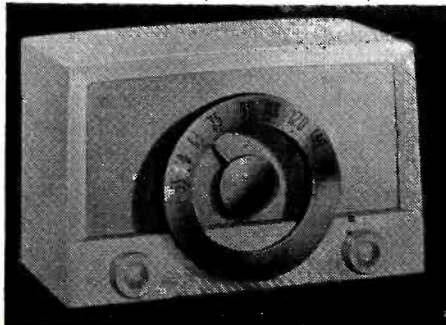

rule dial and is priced at \$32.95 in white plastic or \$29.95 in mahogany plastic. Mitchell Mfg. Co., 2525 N. Clybourn Ave., Chicago 14, Ill.—TELEVISION RETAILING.

**FASTER
 STURDIER**
 Lower Installed Cost

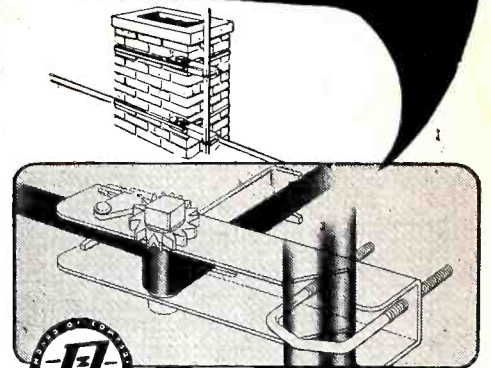

**RADIART SPEE-DEE
 CHIMNEY MOUNT**

Model AK 85 The fastest-installed chimney mount ever devised for TV antennas! Rugged in design—simple to install. Simply thread strapping through ratchet, around chimney and back through ratchet—wind up ratchet tight—and the job's done! Heavy gauge, zinc-plated steel with large "U" bolt for up to 1 3/4" O.D. mast and full length galvanized steel strapping.

THE RADIART CORPORATION
 CLEVELAND 13, OHIO

1953 ALLIED CATALOG

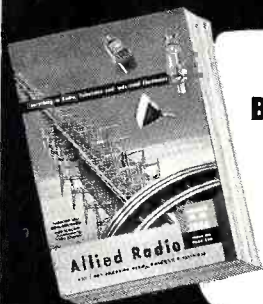

**236-PAGE
 BUYING GUIDE**

**Complete
 Up-to-Date
 FREE!**

**EVERYTHING IN RADIO, TV
 AND INDUSTRIAL ELECTRONICS**

Service Technicians, Engineers: You'll want the latest ALLIED Catalog. It's complete, authoritative—packed with the world's largest stocks of test instruments, amplifiers, P.A. systems, tubes, parts, tools and accessories. Save time and money at ALLIED. Send today for your FREE 236-page Catalog.

FREE—SEND FOR IT!

ALLIED RADIO

ALLIED RADIO CORP., Dept. 25-J-2
 833 W. Jackson Blvd., Chicago 7, Illinois

Send FREE 1953 ALLIED Catalog

Name _____

Address _____

City _____ Zone _____ State _____

South River
 ★ NEWS ★

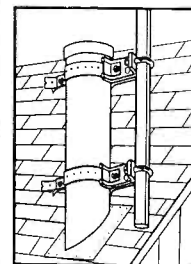

**DUO-PIPE
 MOUNT
 Model
 P-1**

Permits mounting of antenna masts to cylindrical shapes such as vent pipes, etc. Simple, inexpensive, constructed of aluminum extrusion and galvanized strapping. Serrated surface grips the vent pipe in a firm hold. WILL NOT SLIP OR TURN. Special "U" bolt fits all size masts up to 1 1/2" O.D. Complete with hardware. (CAN ALSO BE FURNISHED WITH STAINLESS STEEL STRAPPING.)

South River Antenna Mounting Accessories are carried by every leading TV Parts Jobber from coast to coast.

New catalog mailed to all Dealers and Service Men.

Write, if you haven't received yours!

**SOUTH RIVER METAL
 PRODUCTS CO., INC.**
 SOUTH RIVER, N. J.

PIONEER AND OUTSTANDING PRODUCER
 OF FINEST LINE OF ANTENNA MOUNTS



Why TV dealers everywhere
are standardizing on the

VEE-D-X Q-TEE

with RUGGEDIZED CONSTRUCTION

REVOLUTIONARY ALL-CHANNEL ANTENNA

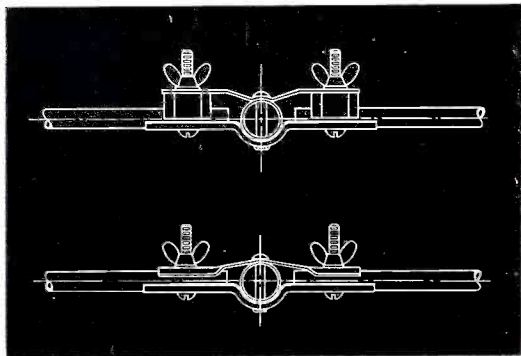

NEW RUGGEDIZED CONSTRUCTION — For positive element support under the most severe conditions, the Q-Tee is now supplied at no extra cost with special reinforcing brackets, making the Q-Tee the strongest antenna for its weight ever made. (See below) →



PRINTED CIRCUIT FILTERS — These bright red band reject filters* use newly developed printed circuits for the first time in any TV antenna, making possible the Q-Tee's simple, pleasing design as well as brilliant all-channel performance.

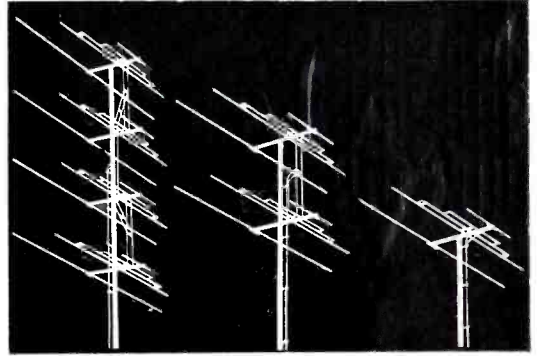

EASY STACKING — Makes the Q-Tee a pleasure to install—thanks to its pre-assembled construction and light weight. Three series: Q-Tee Single Bay for primary areas; Q-Tee Double (2-bay) for near fringe areas; Q-Tee Quad (4-bay) for fringe areas.

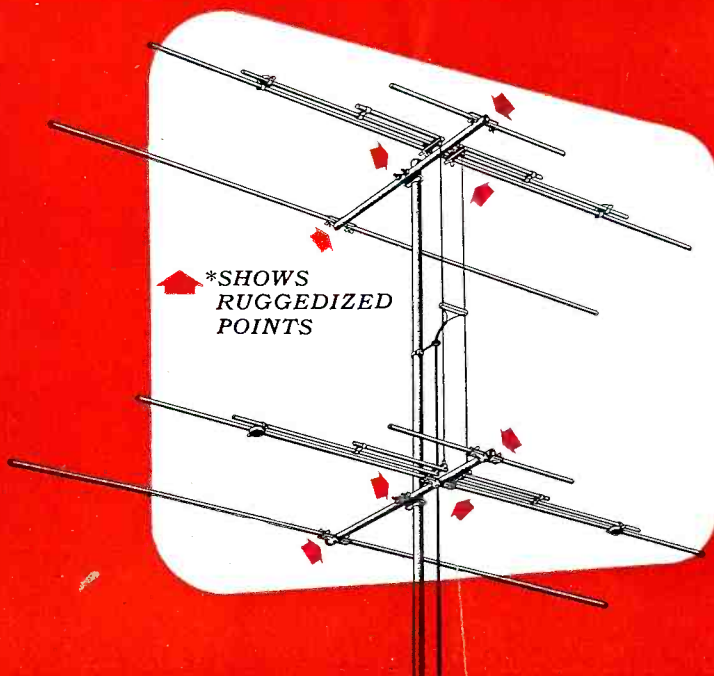

- Brilliant all-channel performance
- Ideal for all multi-channel areas — primary, near fringe and fringe
- Higher average gain than other broad band antennas
- Higher uniform gain over all channels
- Better front-to-back ratio
- Perfect 300 ohm match
- Lowest standing wave ratio
- Easily installed and serviced
- Better rooftop appearance
- Smaller, lighter, yet SO STRONG with RUGGEDIZED CONSTRUCTION

Write for complete Q-Tee literature!

Single Bay only **\$775** list

Q-Tee Double Shown ...16.55

THE L. POINTE-PLASCOMOLD CORPORATION — ROCKVILLE, CONNECTICUT

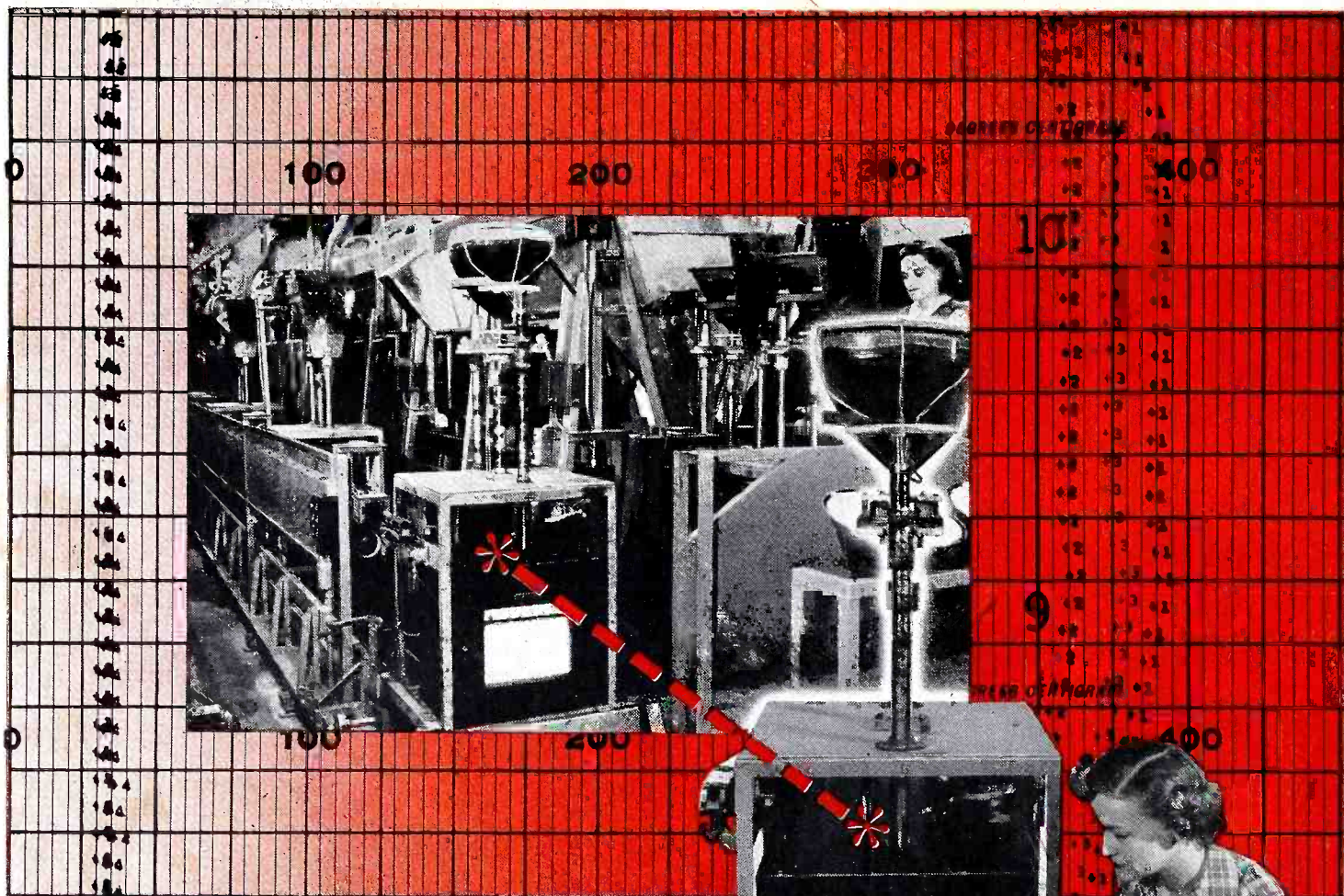

The guinea pig that "runs a fever"

to bring you better picture tubes

IN THE straight-line exhaust systems used at RCA picture-tube plants, each picture tube rides through a long oven on its own "exhaust cart." As the tube passes through this oven, the envelope is freed of gas by baking it at high temperatures.

These high temperatures must be carefully controlled for each picture tube type, and held to rigidly prescribed limits, in order to avoid setting up harmful strains in the glass, especially at the faceplate and wall of the tube.

Here is where the "electric guinea pig" comes in. The "guinea pig" actually consists of a sample tube, with five thermocouples attached to its outside surfaces. These thermocouples are connected to an instrument known as a recording pyrometer. At intervals during the day, this "guinea pig" travels through the oven, and emerges with a complete and accurate "fever chart" for the particular tube type in production. In this manner, temperature deviations are quickly spotted . . . and promptly corrected.

This is another example of the care exercised in the manufacture of RCA picture tubes. Through constant vigilance, RCA closely guards its own reputation for quality . . . and yours as well.

With RCA Receiving Tubes, as well as RCA Kinescopes, TOP-QUALITY CONTROL makes the difference.

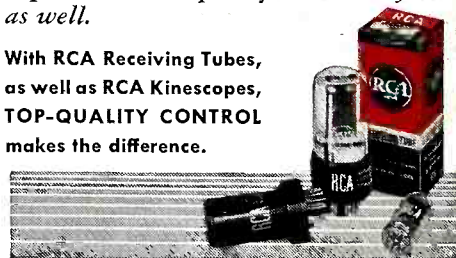

RADIO CORPORATION of AMERICA
ELECTRON TUBES

HARRISON, N. J.

TMKS. ®