

Sept 49

RADIO & TELEVISION RETAILING

IN TWO PARTS • PART ONE

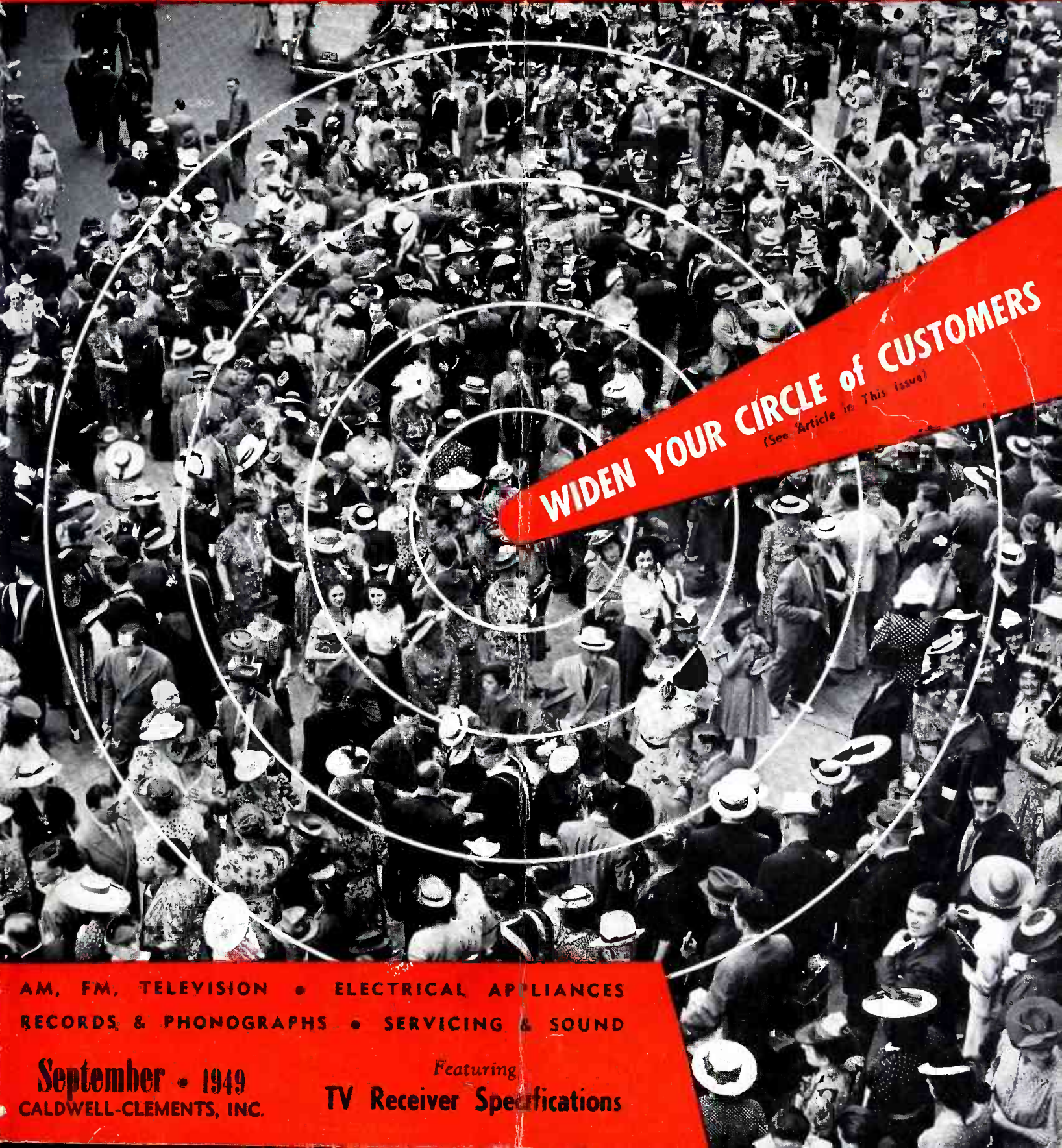

WIDEN YOUR CIRCLE of CUSTOMERS
(See Article in This Issue)

AM, FM, TELEVISION • ELECTRICAL APPLIANCES
RECORDS & PHONOGRAPHS • SERVICING & SOUND

September • 1949
CALDWELL-CLEMENTS, INC.

Featuring
TV Receiver Specifications

It's not explosive... but

VERSATILITY

LONG RANGE RECEPTION

IT'S DYNAMITE!

PERFORMANCE

DEPENDABILITY

WARREN Magnifier Lens, Strapped—Clear or Blue 10"—12". (ML).

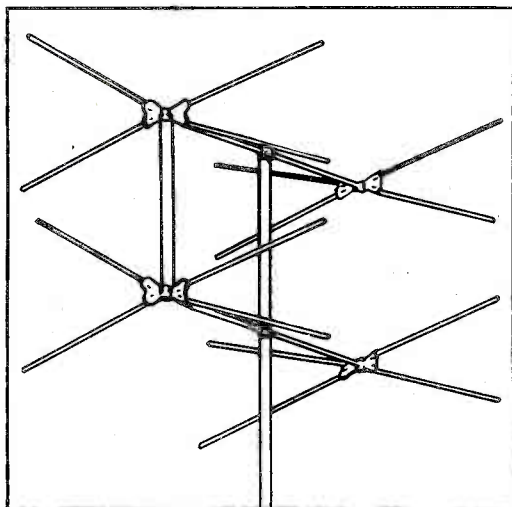
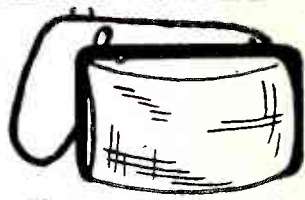

The "CORONET" (4-CN)

This great CONICAL ANTENNA overcomes maximum distances. Tests proved this model out-performs all other stacked types in any area—even 100 miles from the station. High frequency lobes provided upon request.

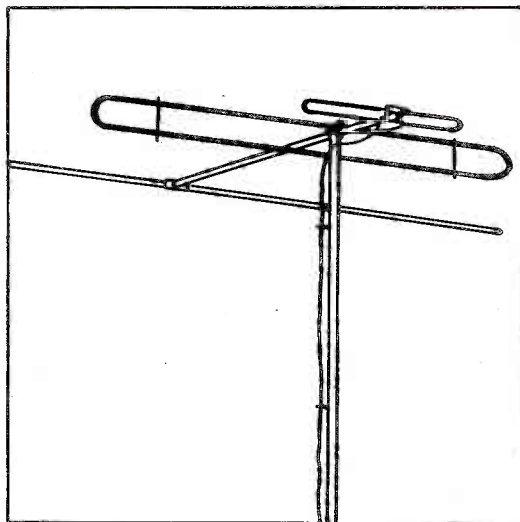

Folded Dipole with Folded Director and Straight Reflector (FDFDR). A Broad-Band Antenna covering channels 2 to 13. Easy to assemble, employing only one wing-nut. Maximum response using 300-ohm. 3 WING NUTS COMPLETES INSTALLATION

Wall Brackets, 3½" (right). Heavy steel, cadmium plated. Each adjustable for 1" to 2" mast. (WB3½)

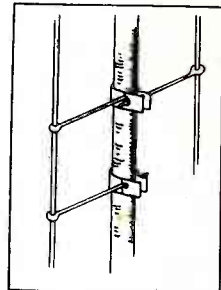

SWAY-PROOF MAST CLAMPS with 3" Screw Eyes (above). Keep your lead-in steady against mast, minimize vibration from wind. Can mount one or two screw eyes, as shown. (MC3)

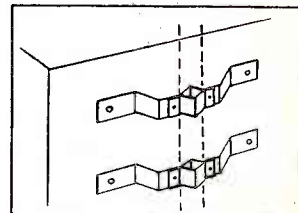

**WARREN MANUFACTURING CO.,
INCORPORATED OUTLETS**

Main Office
250 EAST ST., NEW HAVEN, CONNECTICUT

Brookline, Mass.
84-86 Boylston St.
Mr. I. W. Dingwell
Beacon 2-4349

Springfield, Mass.
14 Wight Place
Lou Del Padie
9-5658

Providence, R. I.
67 Atwells Ave.
Anthony Di Paolo
Jackson 1-4448

Syracuse, N. Y.
219 West Willow St
Don J. Rizzo
2-6536

\$\$\$ SAVINGS!!

WARREN'S policy of MANUFACTURER DIRECT to DEALER has paid off in NEW PRICE SLASHES!

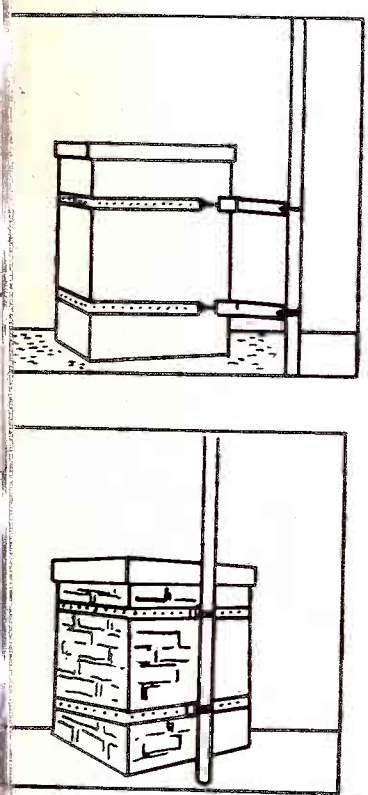

Corner Chimney Mount (CCM). Sturdy, hard steel, cadmium plated, with 13½ feet of strapping to fit even largest chimneys. Extends 7" from corner of chimney to mast clamp.

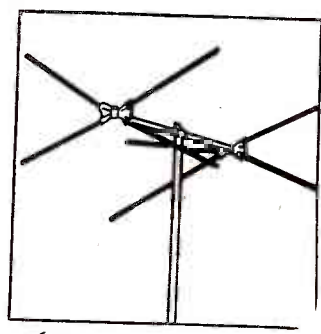

The "BROADBAND" (2-CN) A CONICAL ANTENNA that combines exceptional performance with moderate price. Precision-built with scientific care, the "Broadband" is outstanding from any viewpoint.

Offset Chimney Mount (OCM). For secure antenna installations. Clamps adjustable for 1" to 2" masts.

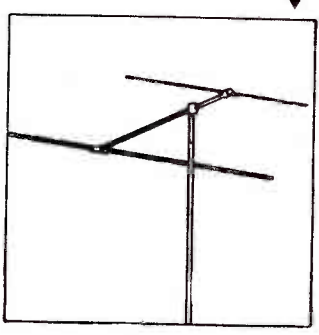

Straight Low . . . Can be combined with Folded or Straight High. Cut to your own channel specifications. Made of hard dural aluminum. 2 WING NUTS ASSEMBLES ANTENNA.

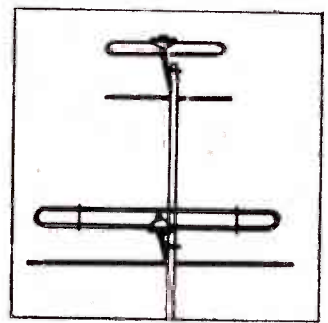

Folded High - Low Antenna (FHL). All-band antenna covering channels 2-13. Additional bays can be added by ordering proper stacking rods, available at slight extra cost. 4 Wing Nuts Completes Assembly

Choice territories still open for exclusive franchise outlets.

CONTACT YOUR NEAREST WARREN OUTLET OR THE MAIN OFFICE FOR BIG \$\$\$ SAVINGS

New Haven, Conn.
130 Bradley St.
W. Schneider
8-0595

New Castle, Pa.
339 S. Croton Ave.
M. L. Chirozzi
3695

Bronx, N. Y.
2101 Boston Road
J. Friedman
Ludlow 4-8910--8911

Charlotte, N. C.
823 W. Morehead St.
J. B. Edminston
4-7579

Ardmore, Pa.
12 Rittenhouse Place
W. Fordyce
7820

Washington, D. C.
Warren Sales Co.
2208 Nickols Ave. S.E.
Lincoln 6-3435

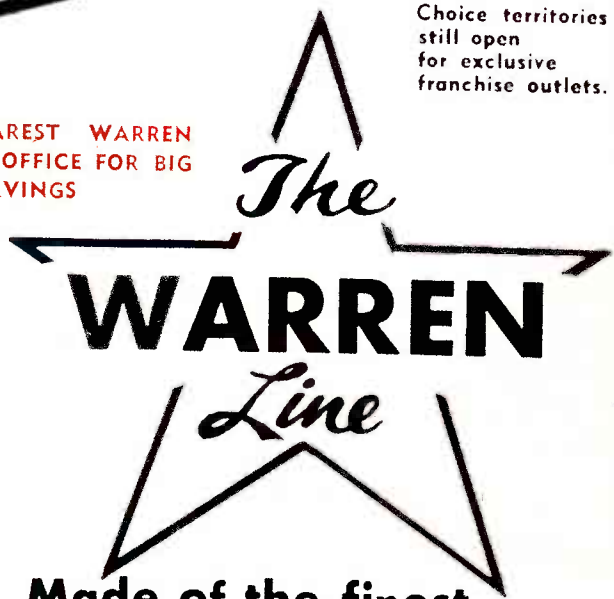

Made of the finest hard-grade aluminum

**OUR
NEW
BABY!**

**Regal Proudly Presents
"THE DOUGLAS"
Unmatched In Features,
Performance and Value!**



GIANT 16-IN. TUBE

COMPLETE AM RADIO

COMPLETE FM RADIO

36-TUBE AC CHASSIS

Priced Below Competition

399⁵⁰

Don't confuse the new Regal "Douglas" with other low priced TV sets which have been stripped of important performance components. The Regal "Douglas" is built with the finest components obtainable and engineered to deliver unmatched performance in fringe as well as metropolitan areas. RCA licensed.

REGAL HAS THE LOW PRICED LEADERS IN EVERY TUBE SIZE

10-IN. MODEL 1007

Big 61-sq. in. screen, oval speaker, FM sound, super-powered circuit, mahogany veneer cabinet. **199.50**

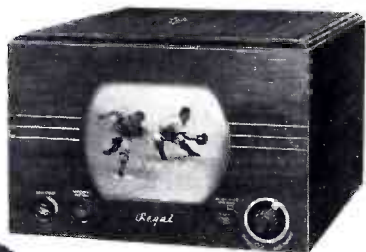

16-inch

MODEL 1607

299⁵⁰

Giant 140-sq. in. screen, oval speaker, super-powered AC circuit, FM sound, automatic "Regalok", mahogany veneer cabinet.

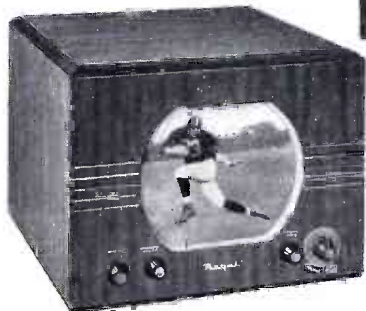

12½-IN. MODEL 1207

91-sq. in. screen, oval speaker, FM sound, super-powered circuit, mahogany veneer cabinet. **229.50**

Regal Offers A Liberal Discount to All Dealers. Write for Full Information.

**REGAL ELECTRONICS CORPORATION
603 WEST 130th ST., NEW YORK 27, N. Y.**

NEW!

VUE-SCOPE

SUPER Vision

LENS

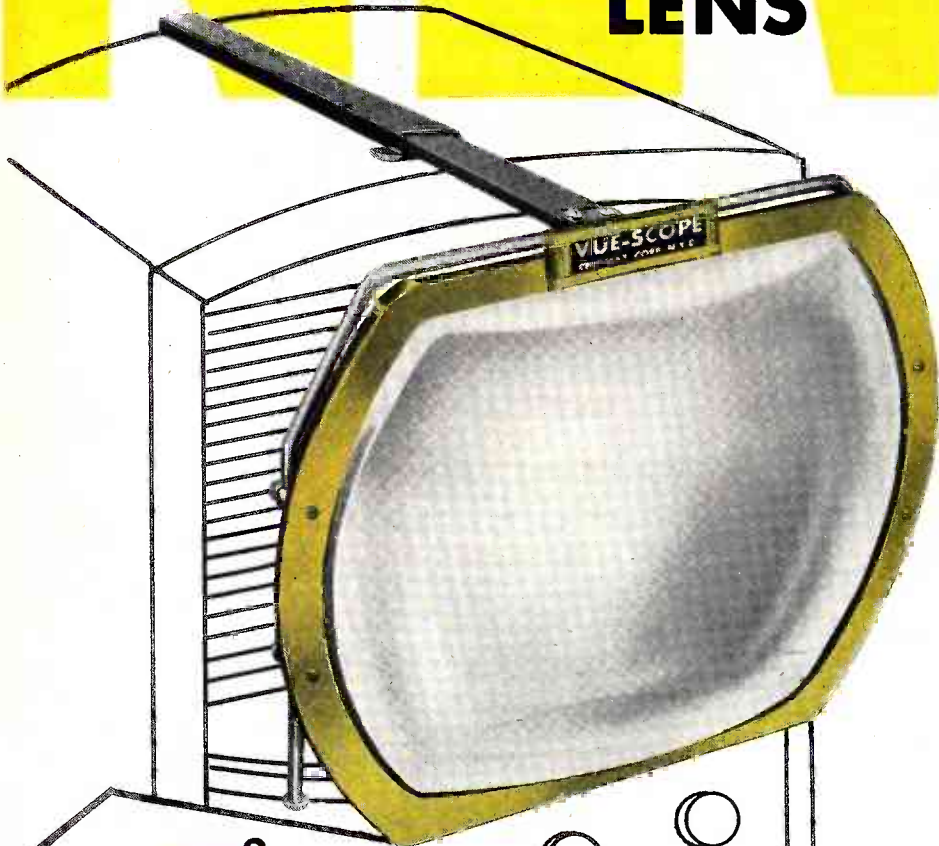

25% Greater Side Angle View!



15% Greater Magnification!



Less Weight without Sacrificing Performance



New Look Lens styled to conform with the new TV Lens Contour.

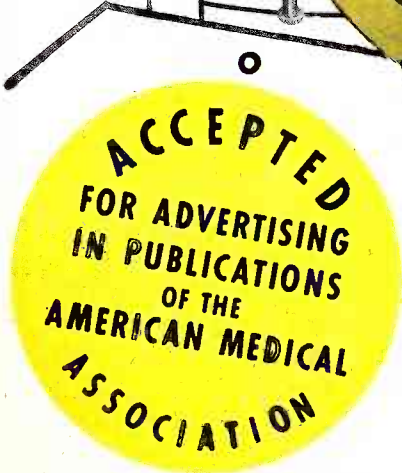

Here's BIG Improvements for GREATER Profits!

Less eye-strain! Less fatigue! No distortion! Bigger, brighter, clearer pictures! Greater side angle view! Greater magnification! That's why the A.M.A. accepts the Vue Scope Super Vision Lens for advertising. Each and every Vue Scope Super Vision Lens carries the A.M.A. seal.

Here's your best bet for profits in this or any other year—the sensational new, improved, Vue Scope Super Vision Lens! Already accepted for advertising by the American Medical Association—this scientifically designed lens offers your customers more for their money. You sell more because your customer sees more!

W·R·I·T·E—W·I·R·E—P·H·O·N·E
For details today. Dept. R

CELOMAT CORPORATION 521 WEST 23rd STREET
NEW YORK 11, N. Y.

HERE'S HOW YOU CAN PROFIT

FROM THE NEW Capehart-IT&T ASSOCIATION

YOU CAN PROFIT by the backing of a strong manufacturer. The pioneer names of Capehart and Farnsworth are now sponsored by International Telephone and Telegraph Corporation — with its world-wide research, operating and manufacturing facilities.

YOU CAN PROFIT by selling a product with a name that for more than 20 years has stood for highest quality.

YOU CAN PROFIT from a line that can be the keystone of a permanent business. Capehart quality and Capehart performance guarantee customer satisfaction.

YOU CAN PROFIT by advertising and merchandising support that's in tune with today's and tomorrow's market conditions.

YOU CAN PROFIT by selling television by CAPEHART.

GET IN TOUCH with your nearest Capehart distributor. Or, if you are a distributor, call on us direct. There are still a few choice franchises available.

AN **IT&T**
ASSOCIATE

Capehart-Farnsworth

CORPORATION

Fort Wayne, Indiana

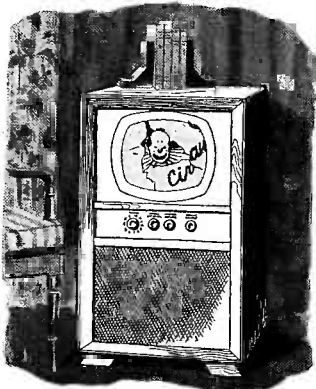

THE CAPEHART Prelude — For the small home this compact television set provides both economy of space and investment — with a clear, brilliant image and Capehart's true tonal fidelity. Rich mahogany finish. \$299.50

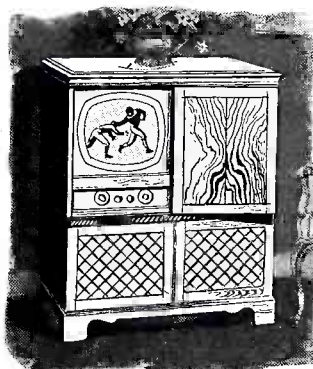

THE CAPEHART Symphony — For spacious homes Capehart provides the Symphony. Television with 16 inch picture, AM-FM radio and the Capehart record changer which plays all types of records automatically. Ample record space. \$795.00

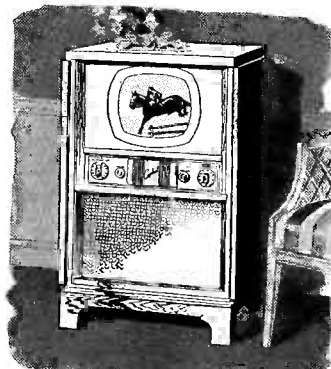

THE CAPEHART Overture — Capehart's Regency styling for those who prefer modest size with luxurious cabinetry. Rock-steady pictures — brilliant and clear — plus unmatched fidelity of tone. Television and AM-FM service. \$489.50

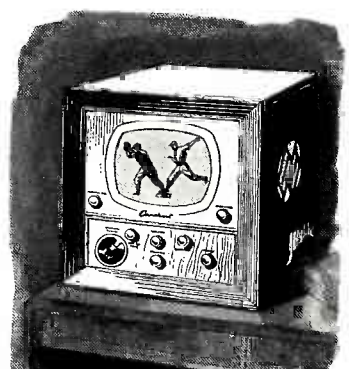

CAPEHART-Modern. Here's smart functional design... eye-appealing simplicity. Rich mahogany finish and well balanced proportions add to its attractiveness. Sharp, clear pictures. Capehart's unmatched fidelity of tone. \$269.50

IN RADIO AND TELEVISION TUBE SALES

1949 IS A G-E YEAR

Now . . . help toward streamlining your service calls! The brand-new **POCKET OFFICE** (a General Electric "first" for more sales and profits) organizes your cards, prices, order blanks, job records in a handy 5" by 8" wallet.

YOU have only so many working hours. And an hour lasts but sixty minutes. How can you make your time more productive?

One answer is the new G-E Pocket Office. All the papers you need on the job, are tucked away neatly in this flat binder that slips conveniently into your coat pocket. When you want a business card, a tube price, a job ticket, it's *there* . . . no searching for a form left back at your headquarters, no calling on your memory to record data best jotted down in pencil.

Handsome in rich brown simulated leather with gold lettering . . . strongly made, durable . . . the G-E Pocket Office is an accessory you'll be proud to own. It holds:

- Your business cards.
- New, cleverly designed "out" cards.
- Tube price list, beneath a clear acetate protective cover.
- Resistor-condenser color code card.
- Job tickets, repair stickers, tube-test stickers.
- Large memo pad.

Ask your General Electric tube distributor to show you the Pocket Office, and give you the details on how to secure this up-to-date aid to efficiency. Then use it to convert every minute of your working time into profits! *Electronics Department, General Electric Company, Schenectady 5, New York.*

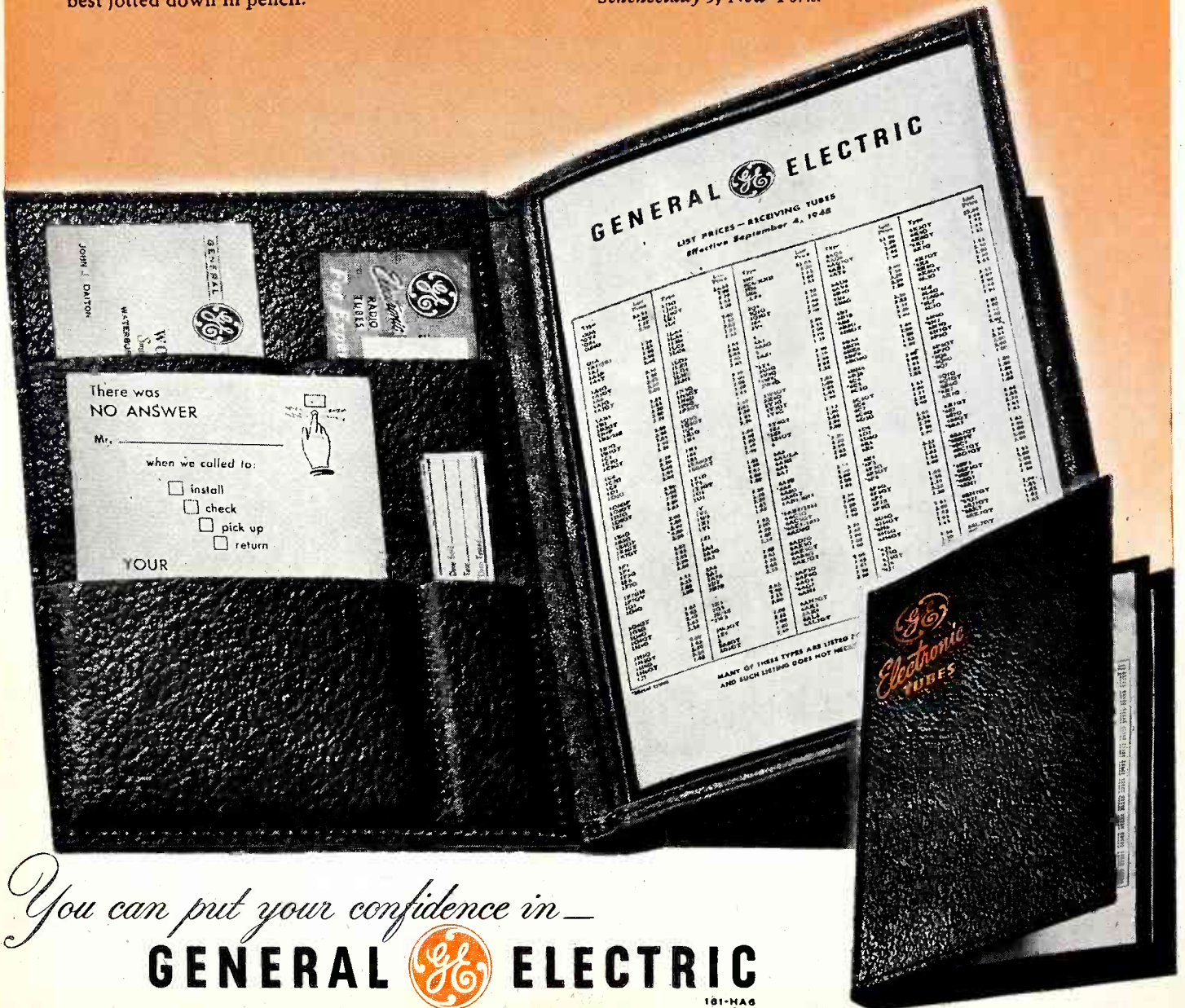

You can put your confidence in—
GENERAL  ELECTRIC

Here

NOW-

STEWART

FUTURE

SEE YOUR STEWART-WARNER
DISTRIBUTOR FOR
TELEVISION'S GREATEST
ADVANCE NOW!

TELE

Most in Television

WARNER

DRAMA

VISION!

- ☆ UNI-PANEL CONTROL
- ☆ CHANNEL-EYE TUNING
- ☆ AM-FM RADIO
- ☆ MIRACLE TURRET TUNER
- ☆ DYNA-POWERED CHASSIS

for Years to Come!

STEWART-WARNER ELECTRIC • DIVISION OF STEWART-WARNER CORPORATION, 1826 DIVERSEY PARKWAY, CHICAGO 14, ILL.

"Fastest turnover



TABLE MODELS: Not midget but full-size radios with big-set features! Priced for full size sales!
\$19.95* to \$49.95*



PORTABLES: Dependable portables for everyone—from the low-priced mass market to the deluxe buyers.
\$29.95* to \$44.95*



CONSOLES: The finest record reproduction ever heard. G-E Electronic Reproducer for long-playing and standard records.
\$109.95* to \$189.50*



DAYLIGHT TELEVISION: The greatest selling feature in television today. Full line of table models, consoles and combinations.
\$259.95* to \$499.95*

"We sold 590 G-E Clock-Radios between February 16 and May 30. That's almost one every hour which is certainly the fastest turnover I ever saw! This item knows no season and even television can't touch it."

Jack Blackman

TURNOVER... that's the sure way to greater profits! And for spectacular turnover, the General Electric Clock-Radio sets an all-time high! Today it's radio's hottest item, standing alone in features that make it a big year-round seller and traffic builder. Get the amazing story of General Electric's five great lines from your G-E radio and television distributor. Or write to *General Electric Company, Receiver Division, Electronics Park, Syracuse, New York.*

I ever saw!"

says

JACK BLACKBURN

Merchandise Manager,
Hart Furniture Company, Dallas, Texas



G-E CLOCK-RADIO with the amazing Slumber Switch

Model 65, above, is the newest addition to the history-making G-E Clock-Radio line. It introduces for the first time an amazing new way to go to sleep. With one setting, it lulls people to sleep to music . . . then shuts itself off. Next morning it wakes them to music—all automati-

cally. If they doze off, it then buzzes until they do get up. Serves as a dependable electric clock, as a stunning "superhet" table radio and an electronic reminder. Luminous-tipped hands and dial markings tell time in the dark. G-E Clock-Radios from \$29.95* to \$36.95*

*Prices slightly higher West and South.
Subject to change without notice.

You, ^{too} can put your confidence in—

GENERAL ELECTRIC

HERE TODAY! Television that

SYLVANIA TELE

SEE the difference in SYLVANIA **MOVIE CLEAR** TELEVISION!



1. Sharper contrast! Finer detail! Sylvania's super-powered "Electron Gun" gives needle-point sharpness to picture-making beam. This finer, sharper beam makes blacks blacker, whites whiter, *brings out more detail more clearly!* Here, for the first time, is *movie-clear* television reproduction!

2. Steadier pictures! New Sylvania "Triple Lock" makes pictures stay put, stay rock-steady *even under adverse conditions!* Locked horizontally by new "Discriminator" circuit; locked vertically by "Blocking Oscillator"; locked in brightness by "Automatic Gain Compensator." Pictures never "tumble," never "drift," never fall out of synchronization, *never need adjusting!*

3. Minimum picture interference! Sylvania's shielded "Coaxial" lead-in eliminates "picture static" ordinarily picked up by conventional lead-ins.

HEAR the difference in SYLVANIA **MOVIE CLEAR** TELEVISION!

1. FM high-fidelity circuits with wide-range speaker and exclusive "Audio-Balanced" tone control!

2. "Intercarrier Sound" eliminates "howls," "microphonic noise," and "acoustic feedbacks"!

3. Sound locked in with picture! Sound automatically maintains its volume and quality no matter how often you switch channels!

Make the "Blindfold Test" —

Close your eyes and compare Sylvania FM sound with sound of any other fine television set!

Check these **EXTRA SELLING FEATURES TOO!**

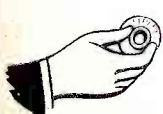

✓ Easy, one-hand operation!



✓ Better reception in apartment houses!



✓ Better reception in "fringe" areas!



✓ Sensational new "Pay-back" Service Contract. Exclusive with Sylvania!

wasn't expected until 1952!

VISION

MOVIE CLEAR*



10" Mahogany Table Model (shown left)

also available

10" Blonde Table Model

12 1/2" Mahogany Table Model



10" Mahogany Console (shown right)

also available

12 1/2" Mahogany Console

16" Mahogany Console



10" Mahogany Console Combination (shown above)

12 1/2" Mahogany Console Combination also available

Big Picture, Direct View Television with Super-Powered "Long Distance" Chassis and FM Sound!

STYLED RIGHT for you and your customers! There's a model to please every customer, and every model's a fast-mover! Keeps your inventories low!

PRICED RIGHT for you and your customers! Low prices for big sales — high markup for big profits!

PLUS NEW "PAY-BACK" SERVICE CONTRACT — saves money for your customers! Sylvania Service Contract guarantees expert service by Sylvania-skilled technicians. And new "Pay-back" feature means *customers pay only for service they need!*

SYLVANIA **MOVIE CLEAR** TELEVISION

will be sold by huge, hard-hitting advertising campaigns aimed at your local customers! Get ready, get set for the biggest television sales and profits ever! Call your Sylvania Television distributor today!

*TRADE MARK

SYLVANIA TELEVISION

MOVIE CLEAR

TELEVISION — YEARS AHEAD OF ITS TIME!

Sylvania Television, 1280 Main St., Buffalo 7, N. Y.

Another Zenith TV "first"!

MIRACULOUS NEW *Easy-on-the-Eye* GLARE-BAN "BLACK" TUBE TELEVISION

Relieves eyestrain
by reducing glare, yet
increasing picture clarity
60% in lighted rooms!
Medical authorities
recommend this way
to view television!

Old Way — Conventional "White" Tube

All conventional television tube faces are practically white. Television "paints" its pictures on them with millions of tiny pin points of light. When viewed in a lighted room—the way medical authorities say television should be viewed—the resulting pictures look faded, washed-out. They lack sharp contrast—like drawing on a white board with white chalk. Your eyes squint and strain to make up for this lack of clarity. This is a major cause of television eyestrain.

New Way — Zenith Glare-Ban "Black" Tube

Television's greatest picture improvement! Gives you pictures with depth and quality never seen before on any television set. Its special built-in Oxide lens intensifies the dark parts of the picture, reduces glare, and actually increases picture clarity 60% in lighted rooms. The result is a far clearer, sharper picture—with amazingly lifelike quality and depth. The difference in viewing pleasure and freedom from eyestrain is *unbelievable* until you experience it.

A "natural" for store demonstration! The lighter your showroom, the more startling the difference between this greatest of all picture improvements and conventional television receivers!

PLUS

Zenith Giant Circle Screen with New Picture Control Switch!



Conventional
Shape — much
smaller picture.

Zenith Television Receivers give you either of these two picture shapes at the flick of a switch.

Zenith's Giant Circle "C" Screen gives you up to 165 sq. in. picture. And New Picture Control Switch gives you choice of the circular or rectangular type picture—lets you prove to yourself how much bigger, better, the Giant Circle picture really is!

Another sales-closing exclusive Zenith demonstration! Show your customers how Zenith gives either the Giant Circle picture or the Rectangular type—at the flick of a finger!

SEE YOUR ZENITH DISTRIBUTOR
ZENITH RADIO CORPORATION, CHICAGO 39, ILL. ®

Zenith One-Knob Simplified Automatic Tuning

One twist, there's your station, picture, sound!
Does automatically what on many other sets
takes up to 5 or 6 manual tuning operations!
Ends repeated re-tuning nuisance!

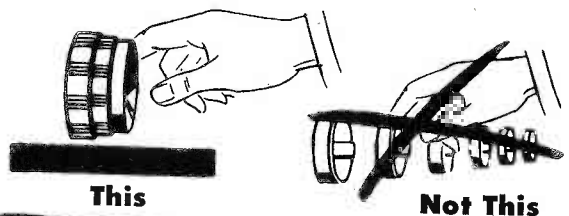

Sheldon CUSTOM-MADE "TELEGENIC" * TELEVISION PICTURE TUBE

SHELDON DIRECT VIEW TUBES

10BP4—10" Flat Face, Magnetic Focus and Deflection.

12LP4—12½" Flat Face, Magnetic Focus & Deflection.

16HP4—16" Flat Face Glass Tube, Magnetic Focus and Deflection. (60° Deflection Angle.)

Sheldon presents a most outstanding development in Picture Tubes, which makes Television more pleasing, more restful, more realistic. Sheldon "Natural-Image" SOFT GLOW Picture Tubes produce more life-like quality. They provide greater contrast range & detail with visual-comfort brightness.



*TELEGENIC—Televiews well

Sheldon
NATURAL IMAGE

SOFT GLOW
Picture Tube

BLACK IS BLACK - WHITE IS WHITE -

and between

ALL THE NATURAL INTERMEDIATE SHADING!

NOTE THE DIFFERENCE IN PICTURES



TUBE A—Yellows and Grays



TUBE B—Blues with Extreme Brilliance



SHELDON—Black and White with intermediate shading

BETTER TONAL QUALITY! As in a fine photograph, Sheldon "Natural-Image" SOFT GLOW Tubes bring out the subtle blending of blacks and whites that give realism to the picture. They make it possible to get maximum contrast without sacrificing clarity. Sheldon Tubes give clear, clean, polished pictures of people, animals and objects.

Sheldon SOFT GLOW Tubes can be viewed for hours at a time, under normal daylight or artificial lighted night conditions, WITH NO VISUAL DISCOMFORT. Extreme contrast is no longer necessary for better video images thereby minimizing glare. Sheldon Television Tubes give MAXIMUM BRIGHTNESS and DEFINITION.

Sheldon Tubes provide better viewing at greater distances. Eye glass wearers find them particularly restful.

Sheldon Television Picture Tubes are guaranteed against defects in design and workmanship for a period of 13 months from date of shipment from Sheldon's factory or

MOVIES and NEWS REELS come in clear and distinct. Glare accessories are unnecessary.

The 12½" flat face and the 16" flat-face tubes are the finest direct-view tubes ever produced. The flat face and the new deflection angle means the finest video image with maximum, usable area and with a minimum of distortion.

THE 16" SHELDON TUBE IS TRULY SENSATIONAL! Sheldon was the first to manufacture the 16" flat-face glass tube.

Air Conditioned rooms to mix chemicals and to settle phosphorus produces a consistently uniform screen in every tube.

Sheldon "Telegenic" Picture Tubes are custom-made. They have a life of more than 4,000 hours.

In stock at leading radio and electrical jobbers. Write for descriptive literature.

GUARANTEE

branch warehouses. The guarantee, with a definite expiration date, is printed on a sticker attached to each tube.

Sheldon production processes are designed for Quality.

SHELDON ELECTRIC CO.

DIVISION OF ALLIED ELECTRIC PRODUCTS, INC.

Branch Offices & Warehouses:

CHICAGO 6, ILL.—626 W. Jackson Blvd.
LOS ANGELES 6, CAL.—2559 West Pico Blvd.



The Chambers Company store, 164 N. York St., Elmhurst, Ill.

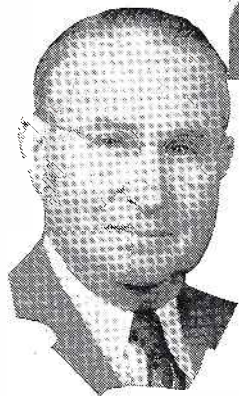

Clyne Chambers
A journeyman printer in 1929
Then came the crash

He does \$250,000 a year in appliances in a town of 16,000

Clyne Chambers has sold more than a million dollars' worth of appliances. The most important appliance in his life, however, is one he didn't sell. It's the one he bought for his own home in 1929.

How he parlayed it into an annual volume of more than \$250,000 in a town of 16,000 and built the largest independent outlet for electrical merchandise in Elmhurst, Illinois, is a depression born success story every appliance retailer can read with profit.

His general manager, Frank Viola, likes to tell the story. "Up to 1931," Frank will tell you, "Chambers was a journeyman printer. As a result of the depression, his weekly paycheck, when he did get work, was amounting to just about a good day's pay.

From Printer to Salesman

"As he worried about the situation," Viola said, "he thought about his electric refrigerator. He had had it some time and he and his wife were sold on it plenty.

"One day he said to her: 'You know, it ought to be a cinch to sell these new refrigerators. I'm going over to the Elmhurst Furniture Company and see if I can't make a deal selling on commission.'

"On his first day out, he sold a refrigerator. The next day he sold two. In a few months, he was the best refrigerator salesman in town.

"By 1934, he was selling more than 300 Kelvinators a year for Elmhurst Furniture. In that year, the store sold out. The next year he got the Kelvinator franchise and opened up his first store. His wife took care of the store while Chambers

went out punching doorbells.

Then Came the War

"In 1938, he took over a bigger store. But he didn't foresee the war. When his inventories were gone, he moved into a smaller place and opened a record shop. From there he kept in contact with his customers until he opened this new place in October, 1945. He asked me to come with him as general manager, which I did in December, 1946.

"We now have eight men on the job and even the bookkeeper sells. Sure, it's harder to sell today than right after the war. But this business was built by going after customers," Frank will tell you. "In one week, we can't ring all the doorbells in our territory, yet that same week a lot of people are going to become ripe prospects. So we use advertising to keep our name and merchandise before everybody we have a chance to sell."

What kind of advertising does the Chambers Company do? During recent months, the manufacturers and distributors of seven different items sold by the Chambers Company ran campaigns in the Chicago Sunday Tribune using that newspaper's selective area advertising plan.

They Believe in Advertising

Under this plan, the Chambers Company gets virtually the full benefit of big-space advertising, usually a full-page, featuring the store name and address in large type, in connection with strong, retail-store-type of copy promoting one of the lines Chambers sells.

"We have participated in every campaign of this kind offered to us," Viola said. "These participations have cost us \$727 to date. That's not much when you figure what we get. I don't know of anybody in Elmhurst who doesn't read the Sunday Tribune. So when we can get a full page ad in the Sunday Tribune for under \$40, we think we have made a good buy.

"These pages keep our name before everybody in our trading area we would think of calling on. With so many manufacturers and distributors using this kind of advertising, we get an almost continuous string of big-space ads keeping our store out in front as a leader. This gives us not only strong, business-building promotion. It gives us a regular program keeping our name before the public—a program we couldn't otherwise afford to buy."

★ ★ ★

MANUFACTURERS: Clyne Chambers is one of more than 1,100 appliance retailers in Chicago and suburbs who have participated in the Chicago Tribune's selective area advertising plan.

So well does this plan of factory-controlled, agency-placed promotion fit the needs of dealer, manufacturer and distributor that more than \$550,000.00 has been spent under the plan to sell products ranging from shoes and records to washing machines and electronic products.

Ask a Tribune representative to place before you specific suggestions for using this tested plan to develop your full potential in the Chicago market. Call him today.

Chicago Tribune

THE WORLD'S GREATEST NEWSPAPER

June average net paid total circulation: Daily, Over 940,000
Sunday, Over, 1,500,000

Chicago Tribune representatives: A. W. Dreier, 810 Tribune Tower, Chicago 11; E. P. Struhsacker, 220 E. 42nd St., New York City 17; W. E. Bates, Penobscot Bldg., Detroit 26; Fitzpatrick & Chamberlin, 155 Montgomery St., San Francisco 4; also, 448 S. Hill St., Los Angeles 13. MEMBER: AMERICAN NEWSPAPER ADVERTISING NETWORK, INC., FIRST 3 MARKETS GROUP, AND METROPOLITAN SUNDAY NEWSPAPERS, INC.

FOR SALE... FLORIDA CHAIN of TELEVISION and APPLIANCE STORES...at INVENTORY VALUE!

*Make Big Money AND Live In Florida **

For 20 YEARS Associated Stores have been the largest and most progressive Radio, Music, Appliance, Camera and now Television stores in the South. From an humble beginning to a tremendous present, establishes Associated at "TOPS" in its outstanding record of accomplishment. Read Mr. Guernsey's article below WHY this very profitable great organization can be purchased store by store or the entire chain at inventory value.

*UNITED STATES CHAMBER OF COMMERCE SAYS THAT FLORIDA IS THE FASTEST GROWING AND MOST PROMISING OF ALL STATES.



Welburn Guernsey, owner and president of Associated Stores, Inc. and numerous other successful business enterprises, has decided to sell all his interests and concentrate on developing a new project to be known as GUERNSEY CITY, a multi-million dollar development. Hundreds of acres of land have been purchased by Mr. Guernsey and his agents in the last five years, directly between Tampa and St. Petersburg, Florida, which towns now practically join each other. There he will build a complete city, to bear his own name. With this huge program already in progress, he desires to be mentally free from all other business affiliations and to utilize all available cash in his newest and largest business venture.

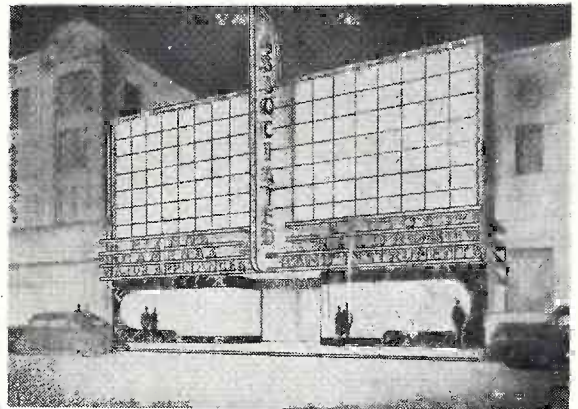

Want To Live In Florida ?

GO INTO BUSINESS FOR YOURSELF...

LEARN ABOUT ASSOCIATED

BUY ONE OR ALL STORES

- Annual Sales—approximately \$2,500,000.
- Six big stores in six key cities.
- "Big Time" Store Managers in all locations with an organization completely self-operating and highly efficient.
- Over \$2,000,000 spent in newspapers to establish Company name.
- All stores centrally located . . . 95% or better.
- Only "tip-top" brands of merchandise sold.
- Practically NO obsolete or slow stock on hand.
- Over 7,700 Accounts Receivable amounting to \$678,299 with 96.8% current.
- Purchase of Accounts Receivable optional.
- Television just starting throughout Florida.
- Very valuable, long-term leases on all stores available at today's prevailing rentals.
- This is the largest business of its kind in the South.
- Stores can be purchased separately or as a chain for actual inventory value of merchandise and operating equipment, with NO charge for Goodwill or Franchises.

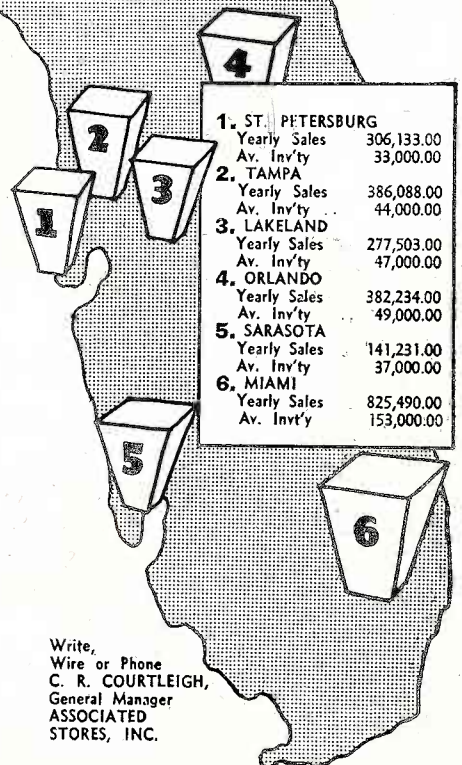

THE SOUTH'S LARGEST RADIO AND APPLIANCE DEALERS



WE INVITE YOUR MOST RIGID INVESTIGATION

ASSOCIATED STORES

912 FRANKLIN ST. • TAMPA • Phone M 8461

TAMPA LAKE LAND
ORLANDO ST PETE
SARASOTA MIAMI

"WORLD SERIES" time means . . .

your chance for *Extra* sales with

CROSLY TRUE-PICTURE[†] television!



- September—that's the month when millions of fans all over the country are getting excited over baseball and the coming World Series. What a chance to interest 'em in TV!

- September is also the month when TV sales begin their big Fall upsurge. Get in the picture right now by featuring Crosley TRUE-PICTURE[†] TV. Tell your customers about Crosley's many technical advantages—automatic picture synchronization . . . continuous tuning . . . simplified controls . . . and all the other big features that go into Crosley's exclusive TRUE-PICTURE[†] TV.



- Here's your chance for a real double play—bigger sales with the increasing Fall demand for TV—better sales with Crosley, a strong, fast-growing organization that's got plenty on the ball.

MAKE A BIG SALES HIT WITH THE FULL CROSLY LINE!

Here are just a few of the fine Crosley products that can help you to happier and more profitable retailing:



9-409 M
"Family Theatre"

THE "FAMILY THEATRE," TRUE-PICTURE TV in a magnificent Carrollton cabinet

- Brilliant pictures on a big 12½" picture tube
- 3-speed automatic record player—for 33⅓, 45, and 78 rpm
- Complete AM radio and full-range FM radio



9-403 MA
"Good Time"

THE "GOOD TIME," a magnificent TRUE-PICTURE table model that provides brilliant television on a 10" picture tube . . .

- With an *extra* sales feature—full-range FM radio
- In a handsome cabinet of rich mahogany veneer

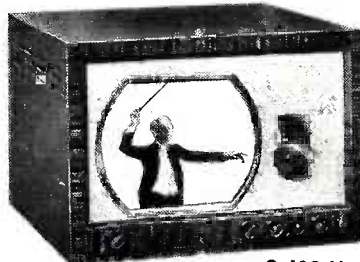

9-419 M
"Popularity"

THE "POPULARITY," TRUE-PICTURE TV on a big 12½" picture tube . . .

- Automatic picture synchronization and simplified tuning
- With an *extra* sales feature—full-range FM radio

MAKE A BIG SALES HIT WITH THE FULL CROSLY LINE!



**THE "MASTER SHOWMAN,"
TRUE-PICTURE TV on a huge
16" picture tube . . .**

- Clear, brilliant pictures on a new expanded French Oval Screen
- With an extra sales feature—full-range FM radio



**THE "PORTA-VISION"
popular new TRUE-PICTURE
lightweight portable TV receiver . . .**

- Brilliant pictures on a 7" picture tube
- Handsomely cased in brown leatherette with handy leather carrying handle



**"THE GOOD NEIGHBOR,"
TRUE-PICTURE TV in a
beautiful console of matched
mahogany veneer . . .**

- Clear, brilliant pictures on a big 10" picture tube
- Static-free FM sound for all TV channels—plus a full-range FM radio

**Customers STAY satisfied
with a Crosley**

Reports from Crosley TV users, dealers and service men indicate that *freedom from trouble and repairs* is an extra—and powerful—Crosley selling point. Service and maintenance, they say, is far less of a problem with Crosley TV. Of many sound reasons for this, three stand out: (1) Crosley's continuous tuner with simplified controls is the most trouble-free method of TV tuning . . . (2) Crosley circuit and parts are built for heaviest possible duty . . . a plus in construction that makes for long freedom from servicing . . . (3) The Crosley system of double inspections, with human eye and electric eye, ensures that TV receivers are in precise working order when they leave the factory.

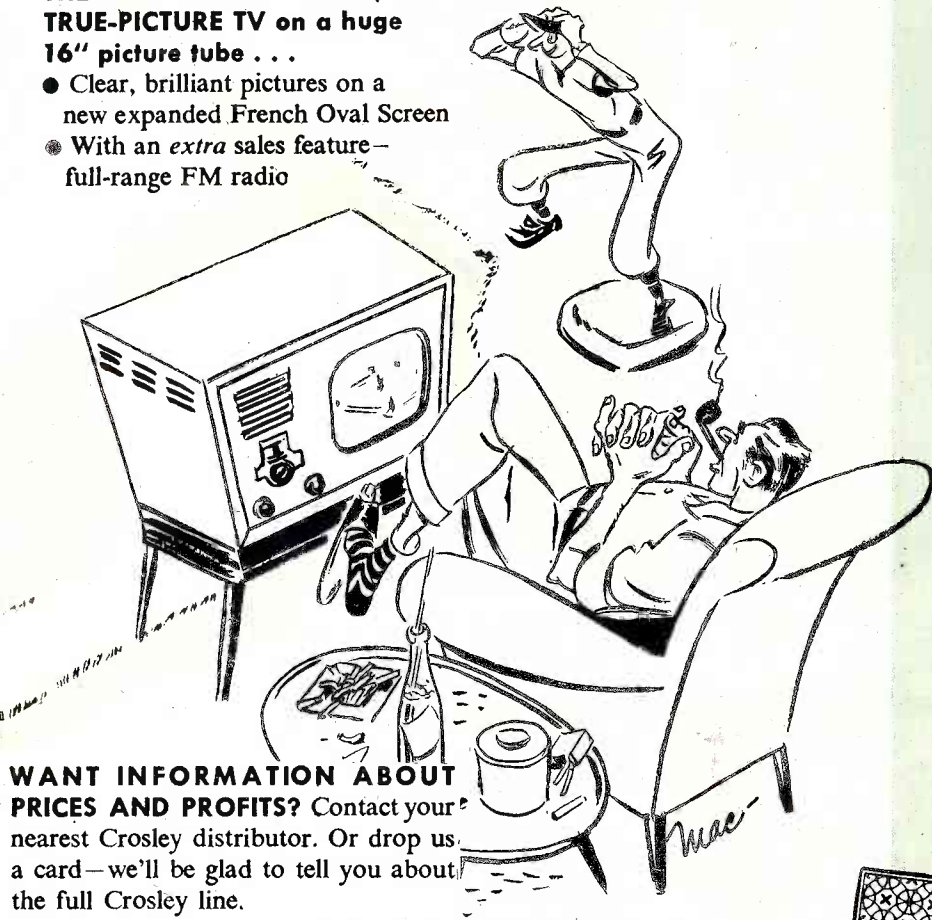

**WANT INFORMATION ABOUT
PRICES AND PROFITS?** Contact your nearest Crosley distributor. Or drop us a card—we'll be glad to tell you about the full Crosley line.

Crosley Division
Avco Manufacturing Corporation
1329 Arlington Street
Cincinnati 25, Ohio

CROSLEY

Better Products for Happier Living

Shelvador* Refrigerators . . . Kitchen Freezers . . .
Ranges . . . Radios . . . Radio Phonographs . . . Television

DIVISION



The famous Crosley TRUE-PICTURE results from exclusive engineering features and precision design.

NOTE: With the continuous tuner in Crosley TV receivers, future provision can be made, if desired, to secure reception on proposed UHF (Ultra High Frequency) channels based on present standards.

MAKE A BIG SALES HIT WITH THE FULL CROSLEY LINE!

Your Best Buy!

DU MONT Type 16FP4

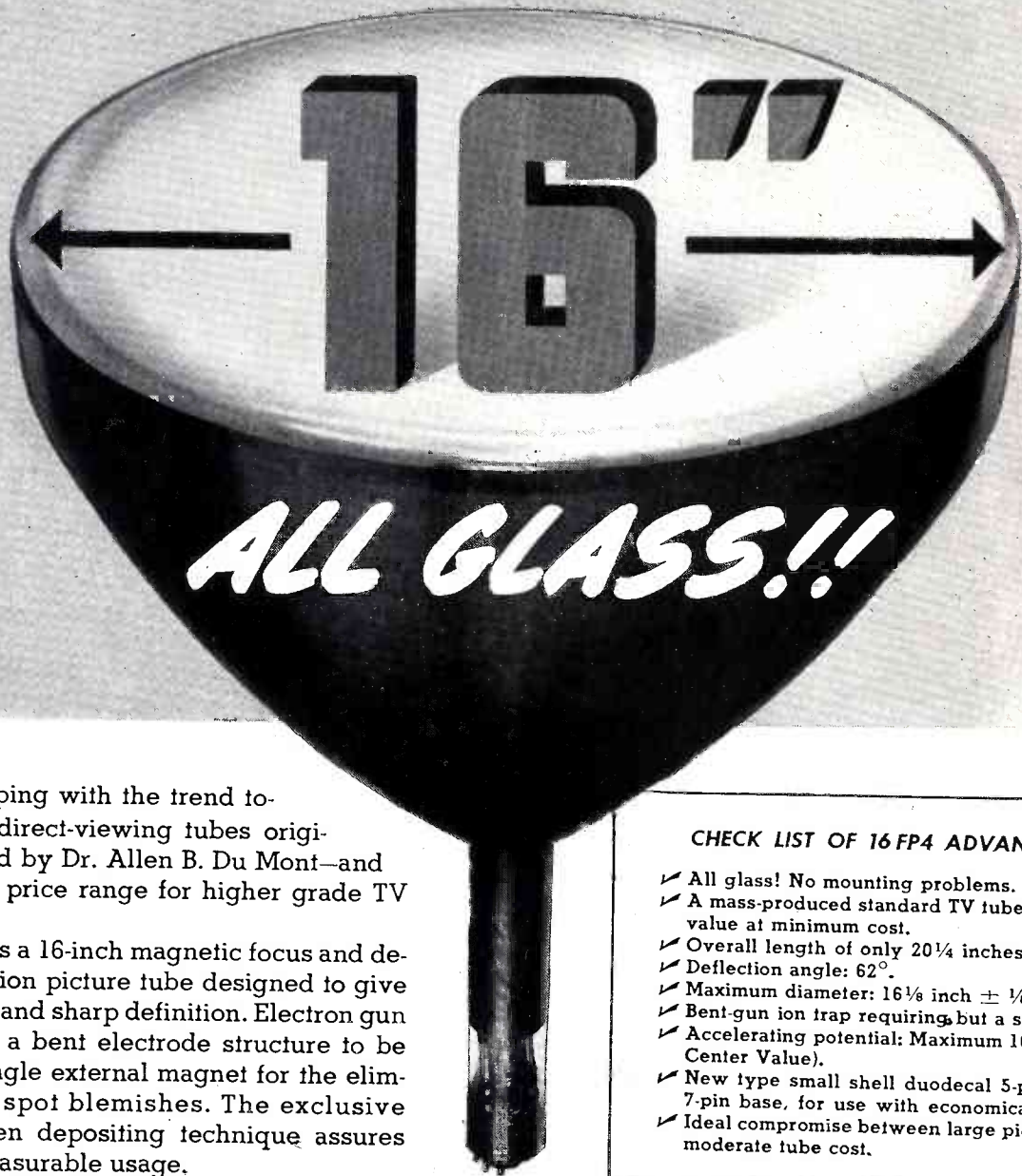

Fully in keeping with the trend towards larger, direct-viewing tubes originally pioneered by Dr. Allen B. Du Mont—and also the lower price range for higher grade TV offerings.

Type 16FP4 is a 16-inch magnetic focus and deflection television picture tube designed to give high brilliance and sharp definition. Electron gun design utilizes a bent electrode structure to be used with a single external magnet for the elimination of ion spot blemishes. The exclusive Du Mont screen depositing technique assures the longest pleasurable usage.

CHECK LIST OF 16FP4 ADVANTAGES...

- ✓ All glass! No mounting problems.
- ✓ A mass-produced standard TV tube for maximum value at minimum cost.
- ✓ Overall length of only 20¼ inches.
- ✓ Deflection angle: 62°.
- ✓ Maximum diameter: 16½ inch ± ½ inch.
- ✓ Bent-gun ion trap requiring but a single magnet.
- ✓ Accelerating potential: Maximum 16 KV; (Design Center Value).
- ✓ New type small shell duodecal 5-pin instead of 7-pin base, for use with economical half-socket.
- ✓ Ideal compromise between large picture size and moderate tube cost.

Detailed Specifications on request. Let us quote on quantity requirements.

© ALLEN B. DU MONT LABORATORIES, INC.

FIRST WITH THE FINEST
IN TELEVISION TUBES

DU MONT

Teletrons

ALLEN B. DU MONT LABORATORIES, INC., TUBE DIVISION, PASSAIC, N. J.

STOCK and SELL this new Sales Stimulator!

WEBSTER ELECTRIC'S

NEW

dri-pack

moistureproof
packaging for all

Featheride

Trademark Reg. U. S. Pat. Off.

CRYSTAL CARTRIDGES



SMART

PRACTICAL

MOISTURE-
PROOF

UN-
BREAKABLE

Here's the sales help dealers have been waiting for—a *natural* stimulator for replacement cartridge sales.

"*dri-pack*" glorifies one of the finest crystal cartridges on the market—the *Featheride*—and protects its quality.

By sealing out moisture, "*dri-pack*" assures the dealer and his customers that this fine *Featheride* cartridge is in perfect condition when installed. Thus it assures more marked improvement in tone quality, longer life for the cartridge, and good will for the dealer.

Display Featheride Cartridges in the new "*dri-pack*"—in the store . . . in the serviceman's kit!

Display them on the counter. Have servicemen carry them in their kits and show them to customers. And you'll build replacement cartridge sales! "*dri-pack*" is a natural for carrying in the kit, because it's unbreakable; it guards against damage to the cartridge; it helps sell customers on the quality of the dealer's products and service.

WEBSTER  ELECTRIC

Webster Electric Company, Racine, Wisconsin . . . Established 1909

Export Dept. 13 E. 40th St., New York 16, N. Y. • Cable Address: "ARLAB", New York City

"WHERE QUALITY IS A RESPONSIBILITY AND FAIR DEALING AN OBLIGATION"



THE MANHATTAN—TV with "Opera Glass" tuning. A touch of a button gives double-size close-up. Normal 61 sq. in. screen. Cabinet in African ribbon-striped mahogany veneers. #TC-10-HM. \$249.95*



THE CENTURY—TV table model. 89 sq. in. picture, automatically locked steady. True-to-life tone with 8" speaker. Exceptional "fringe" area performance. Phono jack. Mahogany veneers. #TC-125-HM. \$295.00*



THE DORSET—TV, FM and AM. 92 sq. in. picture. Same super-powered chassis as Chinese Classic. 8" "Full-Floating" speaker. One knob for all normal picture adjustments. Phono-graph jack. Mahogany veneer cabinet. #TS-125-HM. \$369.95*



THE BRENTWOOD—TV console. 89 sq. in. picture, locked steady. Superb sound with 12" speaker. Exceptional "fringe" area performance. Compartment for 45 rpm phono. Mahogany veneers: #TC-125-LM. \$359.95* Blond: #TC-125-LA. \$369.95*

VAL

STROMBERG TELEV

HERE is the television franchise made to order for today's market. It's built on VALUE—VALUE to you in profitable turnover—VALUE to your customer in the soundest dollar's worth in the industry. Broad selection of models—in a range from \$249.95 to \$895—all available under the new Stromberg-Carlson price-protection plan.

Intensive advertising in principal TV markets! In your community, step out front in television sales this fall with Stromberg-Carlson.

*Plus installation and excise tax. Slightly higher in zones 2, 3 and 4.

THERE IS NOTHING
STROMBERG

©Stromberg-Carlson Company, Rochester 3, N. Y.

WE!

-CARLSON VISION

- MOST in Sight and Sound
- MOST in Appearance
- MOST in Suitability
- MOST in Trouble-Free Performance

and at prices
millions of prospects
can afford!

FINER THAN A
-CARLSON

—In Canada, Stromberg-Carlson Co., Ltd., Toronto

THE WEYMOUTH—TV, FM and AM. 92 sq. in. picture. Same chassis as Chinese Classic—the most powerful of them all! Phono jack. Mahogany veneers. #TS-125-LM. \$429.50*. With compartment for 45 rpm changer. #TS-125-LX. \$449.50*



THE SOMERSET—TV, FM and AM—automatically plays 33 $\frac{1}{3}$, 45, and 78 rpm records. Huge 139 sq. in. picture. Most powerful chassis. Period cabinet, full-opening doors. Stromberg-Carlson's finest for complete entertainment. #TS-16-PM. \$895*

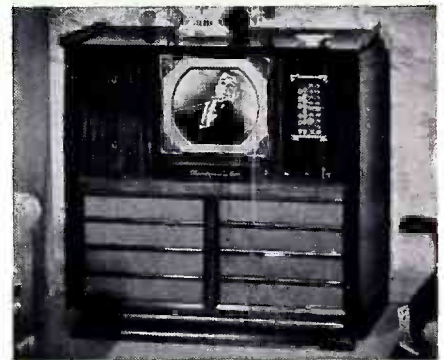

THE CHINESE CLASSIC—TV, AM-FM radio-phonograph. 92 sq. in. picture, 42 tube chassis, 12" speaker. Automatically plays 33 $\frac{1}{3}$ rpm, 45 rpm, and 78 rpm records. Ribbon-stripped mahogany veneers. #TS-125-MSM. \$795* Also available in hand-decorated cabinets. \$895*



THE EMPEROR—TV console with largest direct-view screen—203 sq. in.—19" tube. "Top-Tuning"—concealed controls. 12" speaker. Compartment for 45 rpm changer. Mahogany veneers. #TC-19-LM. October delivery.

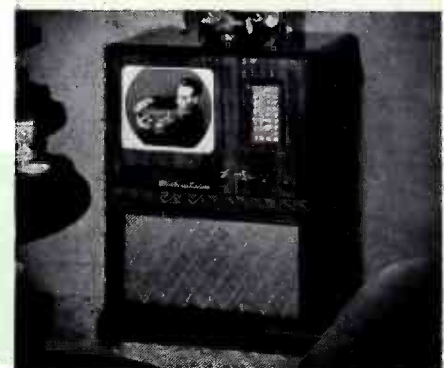

Sensational



16 in. T.V.

Super Quality!

Priced for Volume Sales

SELL QUALITY... SELL QUANTITY... SELL SENTINEL... BE SAFE, FOR FAST PERMANENT PROFITS... THAT'S WHAT SENTINEL OFFERS YOU!



YOU TRAVEL THE PROFIT ROAD WITH

Sentinel Radio and Television

EVANSTON, ILLINOIS

Here's exciting new merchandise that FITS. It fits the majority of people's fondest wishes, it fits their ability to buy. It fits YOUR need for fast turnover. It's quality merchandise through and through.

T-V is settling into a staple-selling operation. And Sentinel gives you the opportunity to turn over a volume of sets with styling and pricing that brings people in. Performance that sells them and keeps them selling FOR you! Get in touch now with your Sentinel Distributor and get going down the Profit Road With Sentinel!

Top of the line! This Beautiful 16-inch Sentinel Television... priced right. A standout in a hand rubbed Period Style Mahogany Console. With big, 140 square inch screen... amazingly lifelike undistorted pictures. Leading the field with these other Sentinel favorites!



411 CVM

The finest in television... gives clear-as-a-bell pictures of 82 square inches.



409 TVM

Full 140 square inch picture... perfectly matched with rich FM sound. Sure-fire sales-maker!



406 TVM

Sells on sight! Crystal clear, undistorted picture—fully 12% larger than the ordinary 12" picture size.



401 TVM

More for your TV dollar! A full 60 square inches of picture. In a beautiful hand rubbed mahogany cabinet.



400 TV

Eye-catching portable! In luggage style leather grain case. 12 channel operation.

And Sentinel's new, profitable, full line radios!



314-I

Sound money-maker! Simplified slide-rule dial, automatic volume control makes tuning-in quick and easy.



316

3-way personal portable. Exciting in tan, red, white or green. Lightweight.



332-I

Super sensitive for low-range reception... Full range tone control. Beautiful walnut finish plastic cabinet.



331-W

Priced for volume sales! Radio's grandest achievement in design and engineering.



333-W

FM-AM at a price that sells! Built-in antenna. Loaded with sales appeal!

All table models available in Walnut or White cabinets.



From this tiny $2\frac{1}{2}$ -inch tube

Norelco PROTELGRAM now offers



Life-Size
MORE
Life-Like
Television

... in a choice of picture sizes!

Many of America's important manufacturers of TV receivers will presently announce to your customers a wider variety of screen sizes in PROTELGRAM-equipped receivers.

These manufacturers have already introduced to the trade their sets featuring the popular 192-square-inch picture (16" x 12", 20" diagonal, square corners).

Look to them for early news about these two companion sizes—130 square inches with 16" diagonal and rounded corners, and 234 square inches with 20" diagonal and rounded corners.

And the latest version of PROTELGRAM for the projection of a giant 3' x 4' picture on a home-movie type screen is now available from several well-known makers, with others soon to be announced.

PROTELGRAM is the result of nearly fifteen years of development by the world's greatest electronic laboratories. It is an entirely new conception of quality television picture reproduction—a big *life-size*, more *life-like* image free from glare and easier on the eyes—at the lowest cost per square inch of viewing area.

PROTELGRAM has been adopted by leading TV manufacturers because it is the perfect answer to your customers' demand for bigger, better, more true-to-life television. It is your best bet for bigger television profits in 1949. Get the facts today on the profit-making opportunities in PROTELGRAM-equipped receivers. North American Philips Company, Inc., Dept. PE-9, 100 East 42nd Street, New York 17, N. Y.



PROTELGRAM

An exclusive development of
NORTH AMERICAN PHILIPS

New!

FADA CONSOLE Television

that will Capture
customer attention

Immediately!

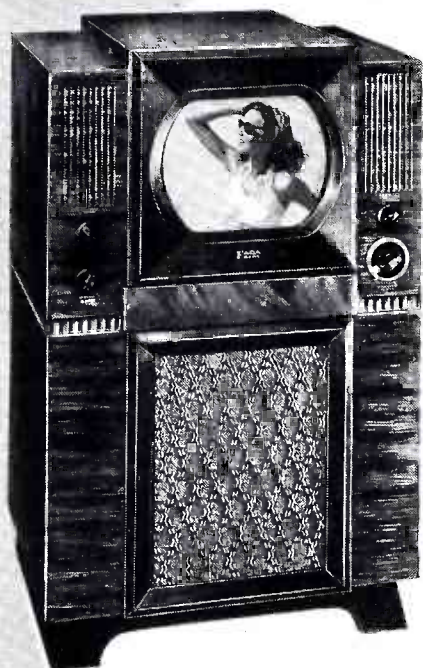

**MODEL 940
BIG EXTENDED 12½ INCH TUBE**

- Excellent performance in fringe areas.
- Clear, Steady, Non-distortion pictures . . . extended 91 sq. in. screen.
- Miracle 10 inch "Sensive-Tone" speaker gives concert quality.
- Classic cabinetry, custom built for distinction — in hand-rubbed Mahogany veneer.

List **NOW \$349.95**

Originally intended to list at \$100. more



**MODEL 965
BIG EXTENDED 16 INCH DIRECT VIEW TUBE**

- Unsurpassed for Performance and Value.
- Large 10 inch "ALNICO V" Permanent Magnet Speaker.
- Steady, flickerless, brilliant pictures even in daylight . . . extended 145 sq. in. screen.
- Superb custom built cabinetry in hand rubbed piano finish Mahogany veneer.

List **NOW \$449.95**

Originally intended to list at \$100. more

**SEE FADA • HEAR FADA
YOU'LL BUY FADA**

**MODEL 895
THE LAST WORD IN
DISTINCTIVE STYLING**

Console Combination with Big 91 sq. in. screen TV, FM-AM radio with new De Luxe Two-Speed Automatic Phonograph with provision for 45 R.P.M. player. Genuine Mahogany Veneer with Crotch Mahogany veneer door panels.

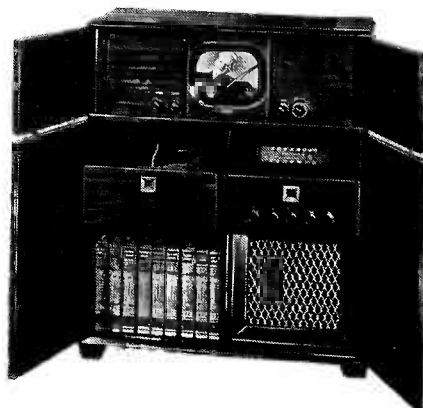

**FADA RADIO & ELECTRIC CO. Inc.
BELLEVILLE, NEW JERSEY**

"Pioneers in Radio & Electronics Since 1920"

YOU JUST CAN'T SERVICE F.M. and T.V. BY **EAR!**

Or any Quality A.M. radio
— for that matter

2 Minutes . . . Reading Time
Benefits . . . for a Life Time

TODAY, modern time and labor-saving Test Equipment is a **MUST** to do the servicing job that brings satisfied customers *back* to you . . . and eliminates costly "callbacks" . . . in short, to be profitable, jobs must be done *right* the first time.

The days of "Servicing-by-Ear" are gone . . . only the alert, aggressive and properly-equipped technician can thrive and make money. Any Radio Serviceman, anywhere in the U.S.A., can now own new, up-to-date Test Equipment . . . *plus* many luxury items for his home, office, or hobby . . . *At No Cost* . . . through the famous N.U. DEALER EQUIPMENT PLAN . . . the only Plan that gives you this opportunity!

Since 1933, successful servicemen from every state in the Union have built their businesses around the 84,000 pieces of Equipment awarded them through the N.U. Dealer Equipment Plan . . . they earned them without any special effort . . . simply through their usual day-by-day purchases of N.U. Radio Tubes.

**ONLY YOUR N.U. DISTRIBUTOR
CAN OFFER YOU THE N.U. PLAN**

TEST EQUIPMENT: Ask him *today* to tell you how you can equip your shop, store or office.



LUXURY GIFTS: Mail the coupon below for the **FREE** 16-page fully-illustrated catalog.

Select the Test Equipment of your own choice from your N.U. Distributor's large, diversified stock . . . tell him you want to go on the N.U. Dealer Equipment Plan . . . get on-the-spot delivery of the Equipment . . . now you're on your way to a sounder, more profitable career in FM-TV and AM servicing.

Remember too National Union's help to the Service Engineer does not stop with Equipment. Each N.U. Tube, like the thoroughbred it is, best displays its 20 years of fine laboratory breeding, under the most severe operating conditions. No wonder N.U. Tubes are known throughout the industry as the Premium Quality Tube.

Free! Fully Illustrated
Luxury Gifts Catalog

NATIONAL UNION RADIO CORP.
352 Scotland Road, Orange, N. J.
Send me the **FREE** Luxury Gift Catalog and tell
me more about the N.U. Dealer Equipment Plan.

Name _____
Street Address _____
City _____ Zone _____ State _____
My Parts Distributor is: _____

For Prompt Action . . . Mail Today!



NATIONAL UNION RADIO CORPORATION

ORANGE, NEW JERSEY

RECEIVING TUBES • TRANSMITTING TUBES • CATHODE RAY TUBES • TELEVISION TUBES • SPECIAL PURPOSE TUBES
PHOTOTUBES • BALLASTS • BATTERIES • CAPACITORS • PANEL LAMPS • VIBRATORS • VOLUME CONTROLS

you'll need more than BIG

the new 1950

Motorola

line gives you more

of everything you need for fast sales...

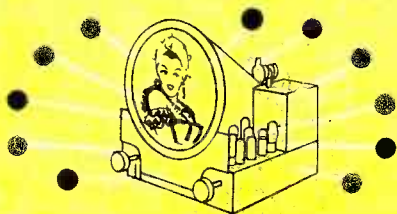

11 New Inventions and Improvements!

With Motorola television you're not just selling last year's television done over. The new Motorola MASTERPIECE television incorporates 11 new inventions and improvements that revolutionize the industry. Sales-producing, patented features like the Picture Stabilizer, Sensitizer, Noise Rejector, Hush Tuner, Reflexi-Focus Circuit and Magic Focus — all entirely new improvements that add up to the brightest, steadiest, sharpest pictures your customers have ever seen.



Lower Prices All Along the Line!

Motorola's gigantic production facilities offer you a quality television line at prices among the lowest on the market. All along the production line, wherever a corner could be cut without sacrificing top quality, Motorola has done so—passing the dollar savings on to your customers.

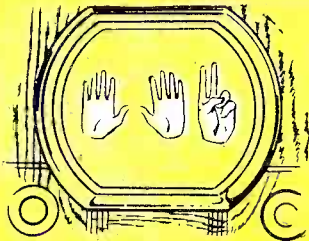

Saleable Features by the Dozen!

Here are features you can sell to the limit—and back up to the hilt! Features most wanted by television customers, like bigger BROADVIEW screens that give 25% more picture area . . . Simplified Controls a child can operate . . . Target Tuning that automatically locks picture and sound together . . . beautiful Furniture Styled cabinets . . . and the sensational new BILT-IN-TENNA that eliminates the need for an outside antenna in good signal areas.

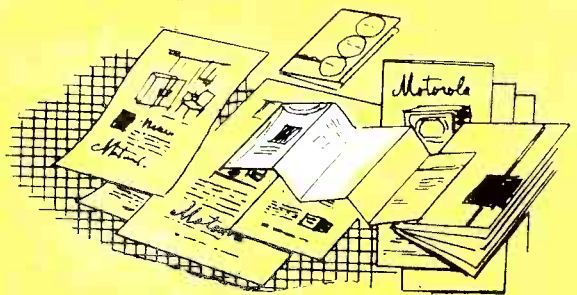

More to Help You Sell!

Motorola pitches in your battle for radio and television profits with an army of sales helps. Handbooks, window displays, streamers, consumer passouts, spot commercials, transcriptions, catalogs, manuals, suggested sales outlines, sales training movies—the whole works to help you sell the profitable Motorola line this season.

BRAGS to sell this year!



A Complete Line—13 TV Sets Alone!

Motorola's new line covers the complete market with radios and television receivers to fit every individual need and every budget! Included in the Motorola 1950 television line are smaller table models with 7 inch and 8½ inch picture tubes—to 10 inch, 12½ inch and giant 16 inch direct view screens in stunning consoles and combinations. In radios, Motorola represents new profits with FM-AM, Shortwave and AM table radios—and FM-AM radio-phonograph combinations. In the portable field, Motorola appeals to four different price markets.



A Powerful National Ad Campaign!

The Motorola New Horizon national campaign is a hard-hitting, two-fisted campaign that rolls up its sleeves to roll up profits for you! Get the benefit of these powerful, colorful ads at no cost to you: Saturday Evening Post, Life, American Weekly, House Beautiful, Time, Esquire, Parade, Better Homes & Gardens, Fortune, This Week, and so on down the list. It's a whopping big campaign that reaches every market from the big city to the smallest country hamlet. Feature — Display — Sell Motorola — for profit's sake now!

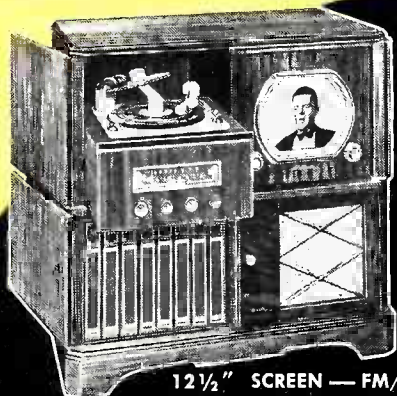

12½" SCREEN — FM/AM-PHONO COMBINATION . . . Big screen TV. Multi-Play changer plays all types of records. Beautiful mahogany or limed oak. 12VF4



12½" SCREEN CONSOLE . . . GORGEOUS . . . BROADVIEW SCREEN. Simplified controls. Beautiful hand rubbed mahogany or limed oak. 12VK11



MOTOROLA QUALITY, BUDGET-PRICED . . . 7" BROADVIEW screen at a startling new low price! 7VT2

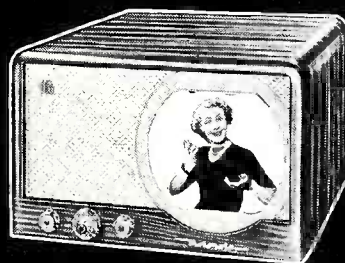

NEW 8½" SCREEN SCOOP . . . Television's biggest value — more picture for less money. Mahogany cabinet. 9VT1

CALL, WIRE, OR WRITE YOUR MOTOROLA DISTRIBUTOR TODAY

MOTOROLA INC., 4545 AUGUSTA BLVD., CHICAGO 51, ILLINOIS

**IT'S
SYLVANIA
AGAIN!**

**ION TRAP IN SYLVANIA
TELEVISION TUBES
ASSURES HUNDREDS
OF HOURS FREE FROM
SCREEN BURNS**

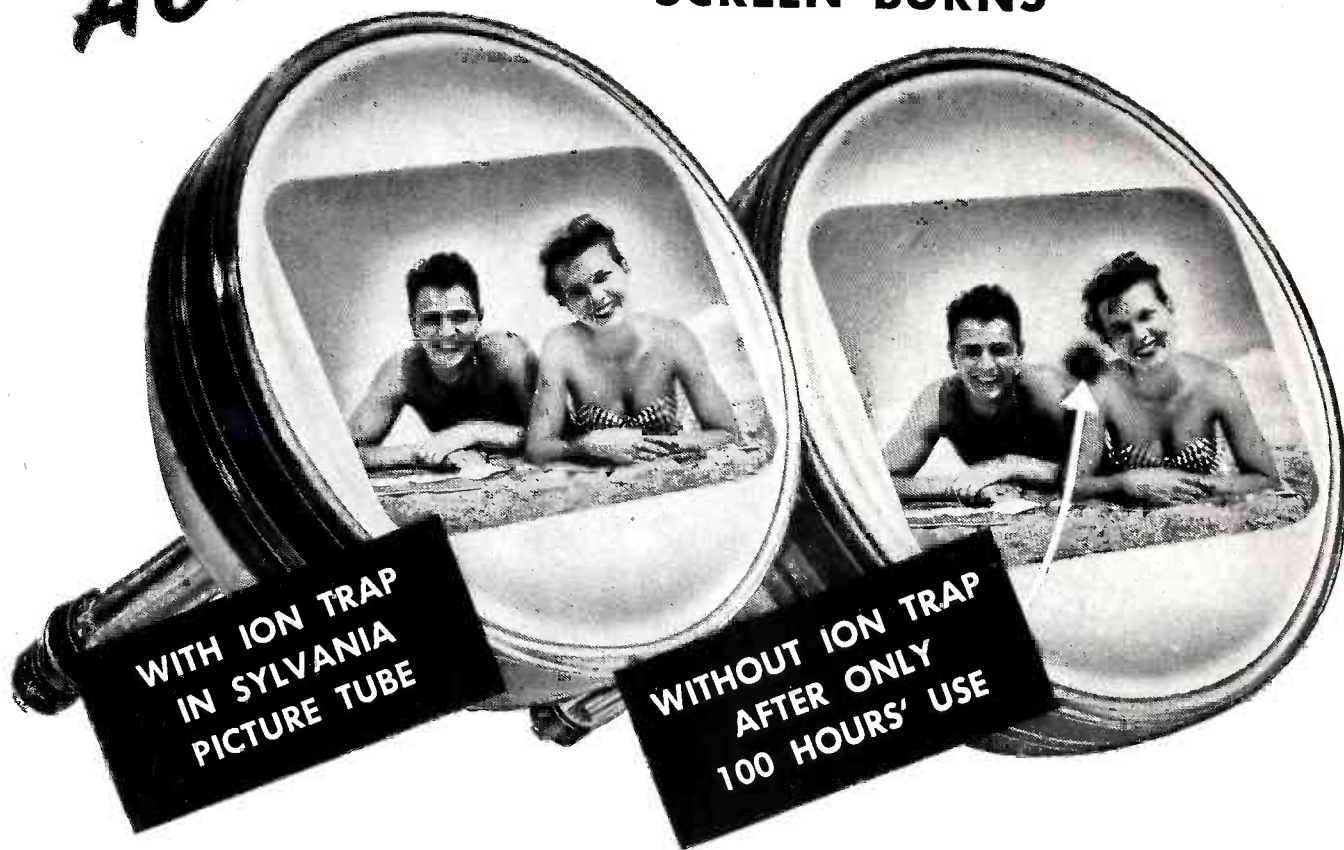

HERE'S HOW IT WORKS...

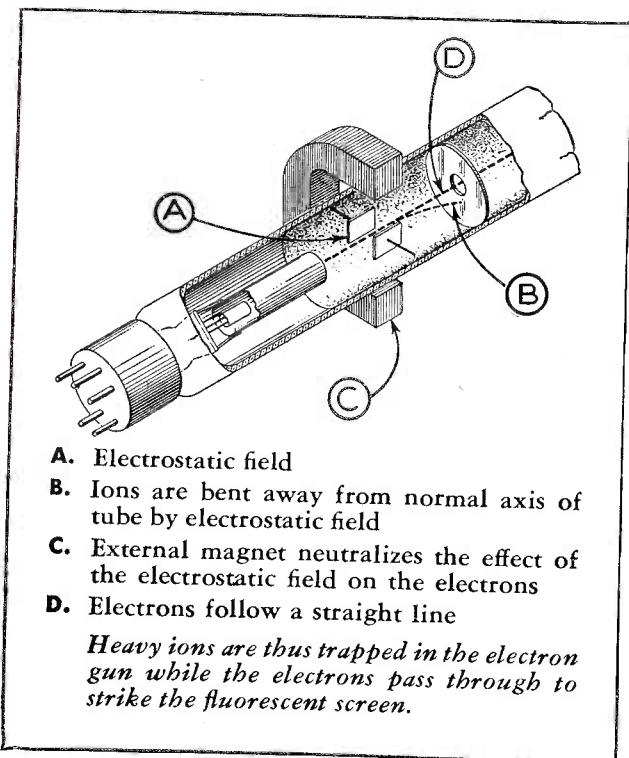

Owners of television sets equipped with Sylvania Television Picture Tubes report their screens still bright and unblemished after more than 1000 hours' use. Much credit for this top quality performance belongs to Sylvania scientists who hold the basic patents on the magic "ion trap." With this device these scientists prevented destruction of the fluorescent screen by heavy ion bombardment. So successful is this ion trap that now many other major TV tube makers are using it under agreements with Sylvania.

These same Sylvania Television Tube scientists are now developing shorter large-screen picture tubes and special tubes for uhf television. Their continued research makes the Sylvania label your guarantee of the newest and finest in television picture tubes. Sylvania has a complete line of all-glass and glass-metal types for television and general purpose cathode ray applications. They are available now from your Sylvania Distributor.

Write for free characteristics and TV set complement chart. Advertising Department, Box R-2109 Emporium, Pa.

**SYLVANIA
ELECTRIC**

RADIO TUBES; CATHODE RAY TUBES; ELECTRONIC DEVICES; FLUORESCENT LAMPS, FIXTURES, WIRING DEVICES, SIGN TUBING; LIGHT BULBS; PHOTOLAMPS

Compare these
typical
ARVIN
VALUES!



\$19⁹⁵

ARVIN MODELS 358-359T—Smart modern Willow Green or rich, harmonious Sandalwood, both with gold fittings. Absolutely peak performance in the 5-tube class for long range, extreme sensitivity, and beautiful tone. Alnico speaker; built-in antenna. Underwriters' listed. Priced for your profit!



\$12⁹⁵

ARVIN MODEL 341T—Sets the value standard for shatterproof, kidproof durability and exceptional performance. Sandalwood with Burgundy trim. Compact, convenient, for hotel, hospital, or dormitory use, perfect for children. AC/DC superhet. Underwriters' listed. An outstanding price leader.

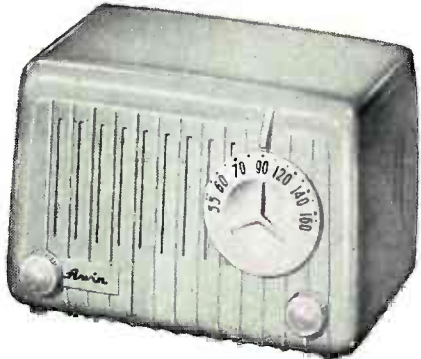

\$16⁹⁵

ARVIN MODELS 356-357T—High-styled in Willow Green or Sandalwood, with gold trim. AC/DC superhet; 5 tubes including rectifier. Modern fingertip tuning; built-in antenna. Alnico V speaker. Tops anything else on the market for sheer value in this price class. Gives you an edge on competition.



Leader
in Value, Performance
and Profit!



If your distributor hasn't yet given you the story on these profit-earning radios, mail the coupon for complete details.

NATIONALLY ADVERTISED!
RECOGNIZED TRADE NAME!
COMPETITIVE LIST PRICES!
OUTSTANDING PERFORMANCE!
PLUS *the soundest profit structure in the industry!*

RADIO & TELEVISION DIVISION (RR-9)
NOBLITT-SPARKS INDUSTRIES, INC., COLUMBUS, INDIANA
Please see that I get full information on Arvin Radio Models 341T, 356-7T and 358-9T.

Name.....
Company.....
Street..... City..... State.....

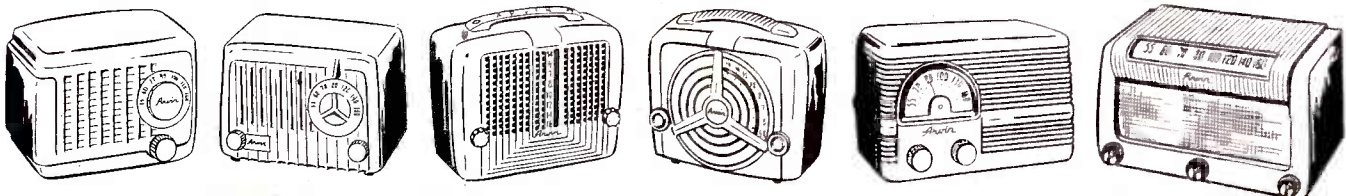

Sell the Complete Table Model Line—Sell Arvin!

the 3 **D**'s for Profitable Sales

Display



Display the attractive Webster-Chicago Wire Recorders in some conspicuous spot in your store. It will attract attention, it will draw many inquiries—especially if you back it up with some of the attention compelling Webster-Chicago display material.

Demonstrate

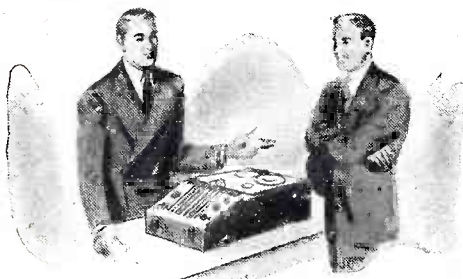

Demonstrate the efficient Webster-Chicago *Electronic Memory Wire Recorders*. *With no other product* does a prospect so quickly begin to associate himself with the actual merchandise as he does with the Webster-Chicago *Electronic Memory Wire Recorder*. Once your prospect has heard his own voice played back—you are on your way to a profitable and mutually satisfying sale.

Deliver

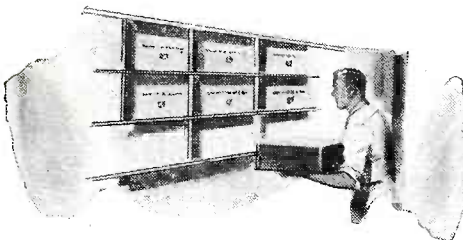

Back up your display and demonstration practices with an adequate stock so that you can give immediate delivery. "I can get it for you in a few days" isn't half so effective as "will you take it with you or shall we deliver it?"

THE FAMOUS WEBSTER-CHICAGO *Electronic Memory* WIRE RECORDERS



Model 180

The completely portable *Electronic Memory Wire Recorder*. Handsome, sturdy all wood carrying case covered in attractive burgundy leatherette. \$149.50*

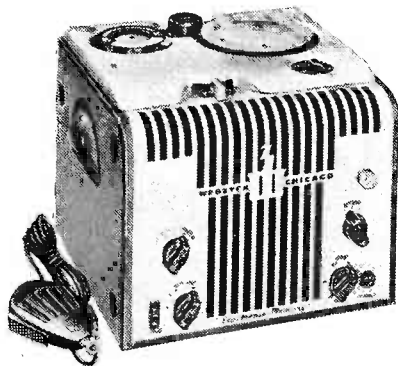

Model 181

The heavy duty, all purpose Wire Recorder for permanent or semi-permanent installation. \$114.50*

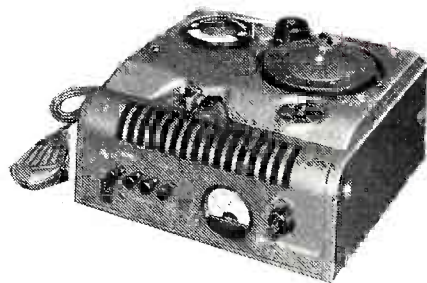

Model 178

The ideal model for installation in the record compartment of a radio console. Takes programs direct from radio independent of radio volume. \$107.50*

*Slightly higher west of the Rockies.

For "Sound" Profit... **DISPLAY, DEMONSTRATE AND DELIVER**



WEBSTER-CHICAGO

5612 WEST BLOOMINGDALE AVENUE

CHICAGO 39, ILLINOIS



announcing :
The Greatest Advent in Speaker Development!

The New
PERMOFLUX
High-Fidelity
SPEAKERS

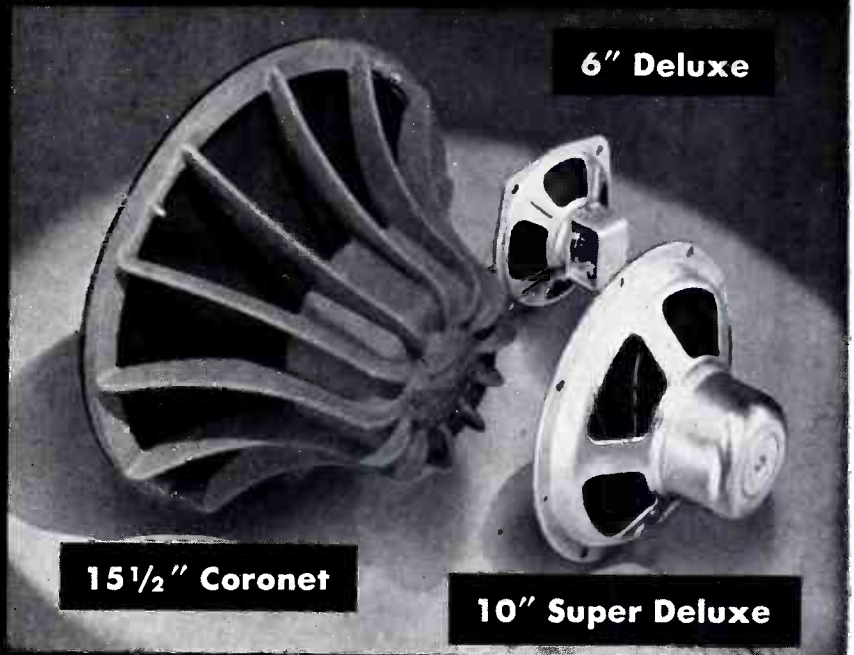

15 1/2" Coronet

6" Deluxe

10" Super Deluxe

A Special Treatment in Design that Eliminates Distortion!

These outstanding, new, deluxe high-fidelity speakers make PERMOFLUX, the most complete speaker line in the world!

SERVICEMEN — DEALERS

- Insist on the best!
- Buy PERMOFLUX Speakers!
- See your jobber today!

PERMOFLUX speakers will outperform, model for model, any speaker on the market.

PERMOFLUX HIGH-FIDELITY SPEAKERS

Deluxe High Fidelity Models—Heavy Magnets—No Pot Covers					
SIZE	MODEL NO. OR CODE	MAGNET DATA FLUX GAUSS	VOICE COIL DIA-METER	DATA IMPEDANCE	WATTS
6"	6L-1	10000	3/4"	3.2	5
8"	8T-8-1	10000	1"	8.0	8
10"	10T-8-1	10000	1"	8.0	9
12"	12T-8-1	10000	1"	8.0	10
Super Deluxe High Fidelity Models—Extra Heavy Magnets—With Pot Covers					
8"	8WP-8-1	10000	1 1/4"	8.0	10
10"	10WP-8-1	10000	1 1/4"	8.0	11
12"	12WP-8-1	10000	1 1/4"	8.0	12
15"	15WP-8-1	10000	1 1/4"	8.0	15
"Coronet" Supreme High Fidelity					
12 1/2"	125Z-16	15000	2"	16 ohms	20
15 1/2"	155Z-16	15000	2"	16 ohms	35

NEW catalog available upon request. Write for your FREE copy!

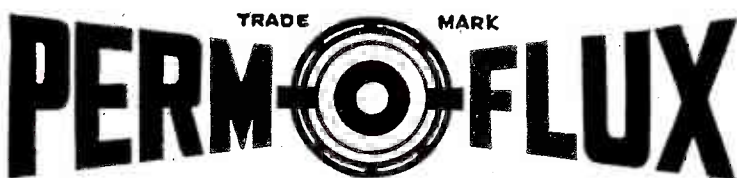

PERMOFLUX CORPORATION

Two Factories to Serve You

Chicago 39, Illinois 4900 West Grand Avenue

Glendale 5, California 236 South Verdugo Road



WATCH

For the first time in Crosley history . . . we have decided to introduce our complete new line of white goods early in October, in addition to the great new line of electric ranges, just announced. This decision is the result of careful planning on what we could do to be most helpful to dealers in the season when traffic is slowest and sales are lowest. We feel that an October announcement of the complete new line of white goods—*backed up by a sound and powerful retail selling activity*—will build both traffic and sales during the fall and winter. It also will enable Crosley dealers to get off to a fast start toward higher sales volumes during spring and summer months.

Watch next month for the most spectacular advertising and promotion campaign the industry has ever seen! Keep your eye on Crosley!



for
**SENSATIONAL
NEWS ABOUT
~~CROSLEY~~**

in next month's issue of this magazine

~~CROSLEY~~
DIVISION

Better Products for Happier Living

AVCO
MANUFACTURING CORPORATION

SHELVADOR* REFRIGERATORS... KITCHEN FREEZERS
RANGES... RADIOS... RADIO PHONOGRAPHS TELEVISION

*T.M. Reg. U.S. Pat. Off.



TUNG-SOL DEPENDABLE SOURCE OF SUPPLY FOR HIGH QUALITY ELECTRON TUBES

Tung-Sol's reputation has been built because, year after year, Tung-Sol's quality has consistently been of the highest standard. There is a TUNG-SOL Tube to satisfy every receiving tube requirement. That is why Tung-Sol's customers are among the foremost manufacturers in the electronics industry.

IN THE ORIGINAL EQUIPMENT MARKET Tung-Sol is small enough to give individual attention to every customer and large enough to produce high quality products in large quantities. Tung-Sol has always realized that the quality of a customer's product is de-

pendent upon the quality of the tubes used. IN THE REPLACEMENT MARKET most reputable wholesalers prefer to handle Tung-Sol tubes. They like their uniform high quality and appreciate TUNG-SOL's friendly way of doing business. TUNG-SOL LAMP WORKS INC., NEWARK 4, N. J.



Send for the "TUNG-SOL Technical Data Book". It is a valuable aid to troubleshooting. You will find its 400 pages to be an up-to-date source of information on types of tubes, both new and old, and their characteristics. In addition to written descriptions there are diagrams, graphs, and curves for at-a-glance reference. Price \$4.75 delivered.

TUNG-SOL TELEVISION AND RADIO TUBES

SALES OFFICES: ATLANTA • CHICAGO • DALLAS • DENVER • DETROIT • LOS ANGELES • NEWARK
ALSO MANUFACTURERS OF MINIATURE INCANDESCENT LAMPS, ALL-GLASS SEALED BEAM HEADLIGHT LAMPS AND CURRENT INTERMITTORS

Tele King

featuring **TEE-VEE-TENNA**
WITH TELE-INDICATOR*
 the amazing indoor antenna

• THE TV SENSATION ACROSS THE NATION •



145 SQUARE INCHES...
16" DIRECT VIEW SCREEN

Magnificent table model • Master designed wood mahogany cabinet • Finest components
 Amazing TELERAMIC picture
 Razor-sharp image
 Automatic gain control
 Simplified operation

\$319⁹⁵
 PLUS EXCISE TAX

16" TABLE MODEL T616

\$179⁹⁵
 PLUS EXCISE TAX



10" TABLE MODEL T510

HERE'S THE TELE KING TEE-VEE-TENNA WITH TELE-INDICATOR*...
 IS ALL NEW! SPECIFICALLY DESIGNED INDOOR ANTENNA...

TELE KING TABLE MODELS ONLY. INSTALLED IN 15 SECONDS... LIFT
 IN 2 SECONDS. NO TOOLS REQUIRED... SO EASY A CHILD CAN
 ADJUST IT. IDEAL FOR MOST AREAS. ASSURES BRILLIANTLY CLEAR PICTURE.
 TELE-INDICATOR—A DISC THAT FITS IN BASE OF TEE-VEE-TENNA. CALI-
 BRATED SO ANTENNA ARMS POSITIONS CAN BE PERMANENTLY MARKED
 FOR INSTANTANEOUS CHANNEL TUNING. SEE THE TELE KING
 TEE-VEE-TENNA WITH TELE-INDICA-
 TOR... TWO TREMENDOUS TELE
 KING ENGINEERING TRIUMPHS!

SELLS FASTER... EVERYWHERE!
PRICED SO RIGHT FOR QUICK, VOLUME SALES

Gorgeous wood mahogany cabinet • Ex-
 panded 61 square inch DIRECT VIEW Teleramic
 picture • Tele Lock • All channel reception
 Precision performance • Another TELE KING
 sales leader.

\$219⁹⁵
 PLUS EXCISE TAX

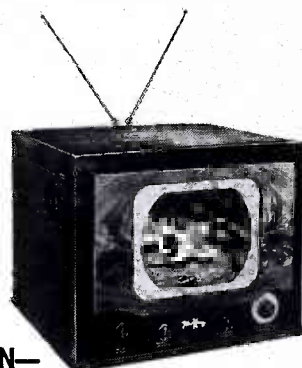

12 1/2" TABLE MODEL T712



\$349⁹⁵
 PLUS EXCISE TAX

16" CONSOLE MODEL C816

91 SQUARE INCH DIRECT VIEW SCREEN—

A REAL BEAUTY FOR GIANT SALES!

Designed wood mahogany cabinet • Brilliant Teleramic picture
 Superior components • Automatic frequency control circuit

TOPS IN CONSOLES...
FOR PERFORMANCE... BEAUTY... VALUE
145 SQUARE INCHES... 16" DIRECT VIEW PICTURE

Supremely attractive wood mahogany cabinet • Designed for any decor • Eye-
 appeal with buy-appeal • Teleramic picture with Tele Lock for brilliantly clear,
 steady viewing • Automatic frequency and gain control • Simplified operation
 A masterpiece of art and engineering • TV at its very best.

NO BETTER TELEVISION AT ANY PRICE

Tele King

CORP.

601 WEST 26th STREET • NEW YORK, N. Y.

new

SALES
POLICY

new

PRODUCT
LINE

new

PRICE
POLICY

new

SELLING
FEATURES

new

ADVERTISING
CAMPAIGN

new

RETAIL
PROMOTIONS

Westinghouse

MEANS BUSINESS

in Television

ADD THESE GREAT NEW BUSINESS
ADVANTAGES TO THE ALREADY FAMOUS
WESTINGHOUSE REPUTATION
FOR TELEVISION QUALITY
AND YOU'LL AGREE

**WESTINGHOUSE MEANS BUSINESS
FOR YOU IN TELEVISION**

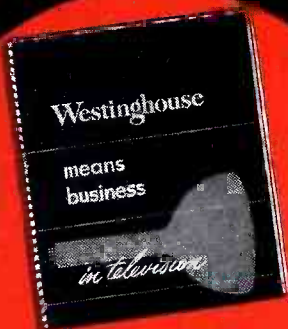

Be sure to see this new
presentation. Ask your
Westinghouse Distributor.

RADIO & TELEVISION RETAILING

Including "Radio & Television"
and "Radio & Television Today"

Established in 1922
as ELECTRICAL RETAILING

O. H. CALDWELL, Editorial Director



M. CLEMENTS, Publisher

WIDESPREAD "SWITCHING" BY THE RETAILER THESE DAYS due to some or all of the following reasons: 1. Makes, and/or models, being price-slashed by competitors. 2. Products require too much free service time on part of dealer, before or after sale. 3. Merchandise priced too high from competitive aspect. 4. Resentment due to "deals" considered by merchant to be unfair or unprofitable. 5. Lack of cooperation from suppliers.

BIG INCREASE IN ADS OFFERING trade-ins noted within the past several months. Also, more "easy terms" being stressed in copy during the past few weeks.

NATIONAL RADIO WEEK will be celebrated October 30 to November 5 this year according to a joint announcement received from RMA's President R. C. Cosgrove and Justin Miller, president of the National Association of Broadcasters.

"WE ARE FAST APPROACHING THE POINT where television production and selling costs will level out . . . We are nearing that point in price-cutting as well. The 'suicide' dealers who have been sacrificing their normal profits, and forcing others to do so; by their senseless price cutting, will soon face the choice of either selling for profit or getting out of the television business."—John W. Craig, vice-president of AVCO and general manager of the Crosley Division.

MANUFACTURER (NOT NOW IN THIS FIELD) planning to bring out a line of high-priced deluxe TV sets having 3-way changers, AM and FM; featuring fine cabinets.

ON THE PREMISE THAT IT'S PSYCHOLOGICALLY bad business, one large wholesale firm no longer asks its salesmen to attempt to collect delinquent accounts owed by retail firms.

Status of TV

The following TV stations are expected to go on the air this month: WTVN—Columbus, Ohio; WOR-TV—New York City; WOW-TV—Omaha, Neb.; KMTV—Omaha, Neb.; WKTV—Utica, N. Y.; WMBR-TV—Jacksonville, Fla. Sets in use in the U. S. as of September 1 have reached 2,400,000; with 79 stations on the air.

MANUFACTURERS AND WHOLESALERS tightening up on administration of cooperative ad plans, scanning all angles of contracts to avoid being "taken over." At least one firm found itself on the short end of a deal to the tune of a handsome sum.

MORE THAN \$1,000,000 WORTH OF orders were written by Du Mont salesmen at the Music Show in New York, according to Ernest A. Marx, general manager of the receiver sales division of Allen B. Du Mont Laboratories, Inc.

THE SECOND ANNUAL NATIONAL TELEVISION and Electrical Living Show opens October 1 and runs through October 9, at the Chicago Coliseum. Friday evening, September 30, will be dealer's night, with attendance restricted to retailers.

TIME SWITCH HAS MANY USES, Westinghouse Electric Supply Company stresses in literature on the Inter-Matic, model TS-41. The wide range of applications, according to WESCO, now extends into the home "where light after dark simulates occupancy and serves as an economical form of burglary insurance."

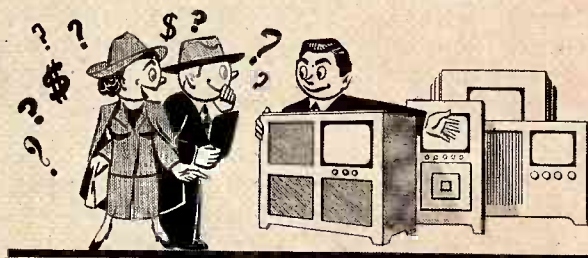

EVEN IN SECTIONS WHERE TV sets are being cut right and left, consumers, by and large, haven't the slightest idea how much video receivers are worth or how much they're priced at. Many do know, though, the names and addresses of dealers who'll give them something off. Like the old days when people valued radios according to the number of tubes, today's consumer uses the picture size as his yardstick of value.

FEUDIN' AN' FIGHTIN' going on between department heads in a big—very big store. Results: The radio manager won't recommend the combo-buying customer to the firm's phono record department. The record manager sends no prospects for instruments to the store's radio department.

What's Ahead!—in Radio,

PREDICTION ON DISCOUNTS: Look for widespread lengthening of discounts to retailers in 1950. So far as TV is concerned, though, long discounts are still a long way off over the whole picture.

WATCH FOR A FLOOD OF BUILT-IN antenna TV jobs equipped with consumer-operated aerial trimmers. However, so long as present transmission standards are used numbers of installations will continue to require outdoor and indoor antennas.

WOULD TAX THE CO-OPS. H.R. 5064, introduced in Congress by Rep. Noah Mason, Illinois, and referred to the Ways and Means Committee, provides that every corporation, including presently exempt or partially exempt cooperatives and other tax-exempts shall be subject to Federal income tax on their business income.

"SATURATION" NEEDS INTERPRETATION to take the sting out of the term. When we see a figure pointing out, for instance, that X number of wired homes have electric refrigerators, let's guess optimistically that the "X number" needing to be replaced is quite large. This is the theme of a successful retail sales manager who went to the mat with a number of outside salesmen who'd turned in reports of "have refrigerator" on their call cards.

"FM IS THE ADDED PLUS THAT EXCITES buyer interest, and apparently FM can't miss so long as this trend keeps up . . . With 750 FM stations on the air in 450 cities FM represents a national market of 100 million people."—William E. Ware, president of the Frequency Modulation Association.

THE PICTURE OF TODAY'S OVERALL business situation depends on what each individual wants to see, Harry G. Moock, recently retired vice-president of the Plymouth division of Chrysler, told members of the American Washer and Ironer Manufacturers Association at a recent meeting. "To some," he said, "the situation today is 'curtains', to some, it's normal. To some, it's tops. Even the economists are confused, in disagreement. You hear of inflation, depression, recession, disinflation, readjustment, the buyer's market."

TO OFFSET "A TELEVISION-CONSCIOUS UNDERWORLD", the General Electric Supply Corporation has installed Babaco alarm systems on its trucks carrying TV sets to dealers and distributors. System protects windows and doors, and in addition, prevents a hijacker from driving off with the vehicle.

PHONO RECORD SALESMAN in a very large New York City department store told a shopper that the firm hadn't stocked any ——— discs or players for same because the manufacturer "will shortly bring out an entirely different record set-up," playing at a "different speed."

TREND TOWARD PRICE PROTECTION plans available to dealers said to be stimulating sales. For some months a great many merchants have been buying from hand to mouth, with inventories hitting new lows.

RADIO & TELEVISION RETAILING's big Annual Directory issue coming next month! Complete information covering radio, FM, TV, combinations, electrical appliances, phono records and players, and servicing and sound is brought to the reader, compiled by this publication's experts in all fields.

"TOO MANY STORES HERE NOW" was the advice received at every hand by a former retailer who plans to open a place of business in a big town (about 20,000) near a large city. In spite of the competition situation, the new store will be opened, advises the merchant. "After 'shopping' all of the stores and talking with numbers of consumers I've decided that almost all of the existing establishments are *vulnerable*." He explains that poor salesmanship, slipshod customer relations and poor display and advertising techniques are responsible for existing stores' vulnerability.

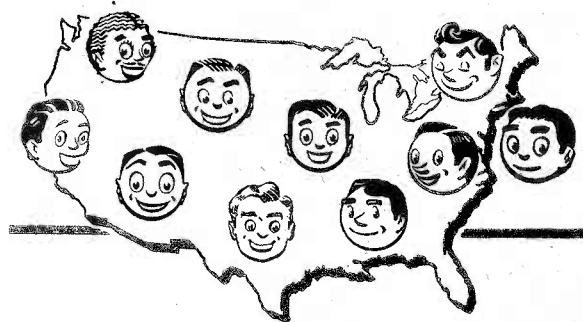

FIRST EIGHT MONTHS OF 1949 period has seen more top personnel changes than any year since the war ended. In the four fields covered by this magazine there are many old faces in new places, many new faces in old places.

OUTSTANDING RADIOMEN GET VALUABLE publicity in local newspapers when they do unusual things. In Rock Valley, Iowa, for instance, a columnist on the *Rock Valley Bee* had the following to say about the proprietor of a sales and service store: "Johnny Gort is to be congratulated on the progress he has made in being the first to bring television to Rock Valley. He has worked hard to bring the new visual miracle of the air waves to his home. . . ."

4,500,000 ELECTRIC FANS OF all types were produced in 1948. Look for the '49 sales figure to be larger than that of last year when the industry sold \$67,500,000 worth of air-moving equipment.

Appliances, Records and Television

TRENDS IN THIS TIGHTENED MARKET: More tanks than uprights being produced right now by the vacuum cleaner makers . . . Numbers of small screen TV sets being taken as trade-ins finding ready sale at healthy prices . . . "Show 'em in the store, sell 'em in the home" technique being successfully employed by many TV merchants today . . . Our free enterprise system really works: Newcomers, some starting with small capital, have gone places in TV, in the manufacture of small appliances; in the vacuum cleaner business, and in the radio parts and accessory business, to mention just a few lines.

BIOLOGICAL INSERTS FOR THE storage of sera, blood, blood plasma, toxins, anti-toxins and other medical and pharmaceutical supplies needing refrigeration have been developed for all models of Westinghouse refrigerators. Inserts can be sold by dealers to physicians, veterinarians, drug stores and hospitals. Prices range from \$37.50 to \$112.50, depending upon the size of the customer's refrigerator.

FM COVERAGE—In last month's chart "FM vs AM", we feel sure it was clear to readers that the FM areas (red) also covered a large part of the AM areas (gray-black) as indicated by the shiny red ink (FM) overlying the dark-gray AM areas. "Sets in use" represented the total of FM and FM-AM sets plus all television receivers which provide 100-mc FM-band listening. All receiver figures, including 1949, were of course estimated.

AS PREDICTED BY this publication, all eyes were on TV at New York's Music Show. In spite of a number of reception problems, sets in the New Yorker Hotel and in the Manhattan Center performed well. Land-office business reported by some of the exhibitors.

TWO FORMS OF PROMOTION MATERIAL, including mats for local dealer newspaper ads, will be distributed early this autumn by the RMA Advertising Committee in anticipation of National Radio Week.

FROM HERE ON THE SPACE-HEATER business should pick up. Reason: Inventory of distressed merchandise very low; manufacturing of current models at production rate geared to realistic absorption level.

BASIC SELLING TECHNIQUES AND STRATEGY, plus a generous amount of electric vs LP gas information have been packed into the Sell All-Electric Sales Training Film package, now being offered at \$15 by NEMA Farm Electrification Bureau, 155 E. 44 St., New York 17. Package contains a 35mm. silent sales training film; two copies of a narration to be read with film, and 100 copies of the rate comparison folder.



TWO SCORCHING SUMMERS in a row covering most of the country should insure a record-breaking sales volume of room air conditioners in 1950, and also an expanded refrigeration market. Dealers report that they've been run ragged with service on old refrigerators this summer, and expect that many a user will replace with new equipment in order to save money and eliminate grief before next summer rolls around.

AND SPEAKING OF THE HEAT in connection with selling new refrigerators, compressor-type room air conditioners and electric fans, most dealers find that sales peaks come with the first heat wave, and that thereafter a great many customers say they'll buy "next year" because "we've gone through most of it now." In many of such cases customer's just too hot to be bothered, and salesman's too hot to bother. Those hardy individuals, however, who are able to make home demonstrations of fans and room coolers bat high sales averages during periods when the mercury's high as a kite.

FUTURE EVENTS OF INTEREST TO READERS

SEPT. 11-17: National Home Week.

SEPT. 11-OCT. 10: Chicagoland Home and Home Furnishings Festival.

SEPT. 26-28: 1949 National Electronics Conference, Edgewater Beach Hotel, Chicago.

SEPT. 30-OCT. 9: National Television & Electrical Living Show, Chicago Coliseum, Chicago.

OCT. 1-OCT. 9: National Electrical Living Week, Chicago.

OCT. 8, 9: NEDA Board of Directors, Cleveland Hotel, Cleveland, O.

OCT. 12-15: 14th Annual Conference, International Association of Electrical Leagues, Cleveland Hotel, Cleveland, O.

OCT. 27-29: Audio Fair, Audio Engineering Society, Hotel New Yorker, New York City.

OCT. 30-NOV. 5: National Radio & Television Week.

NOV. 14-18: National Electrical Manufacturers Association, Chalfonte-Haddon Hall, Atlantic City, N. J.

NOV. 14-18: 6th All-Industry Air Conditioning & Refrigeration Exposition, Atlantic City, N. J.

DEC. 4-7: The American Society of Refrigerating Engineers, 45th Annual Meet, Edgewater Beach Hotel, Chicago.

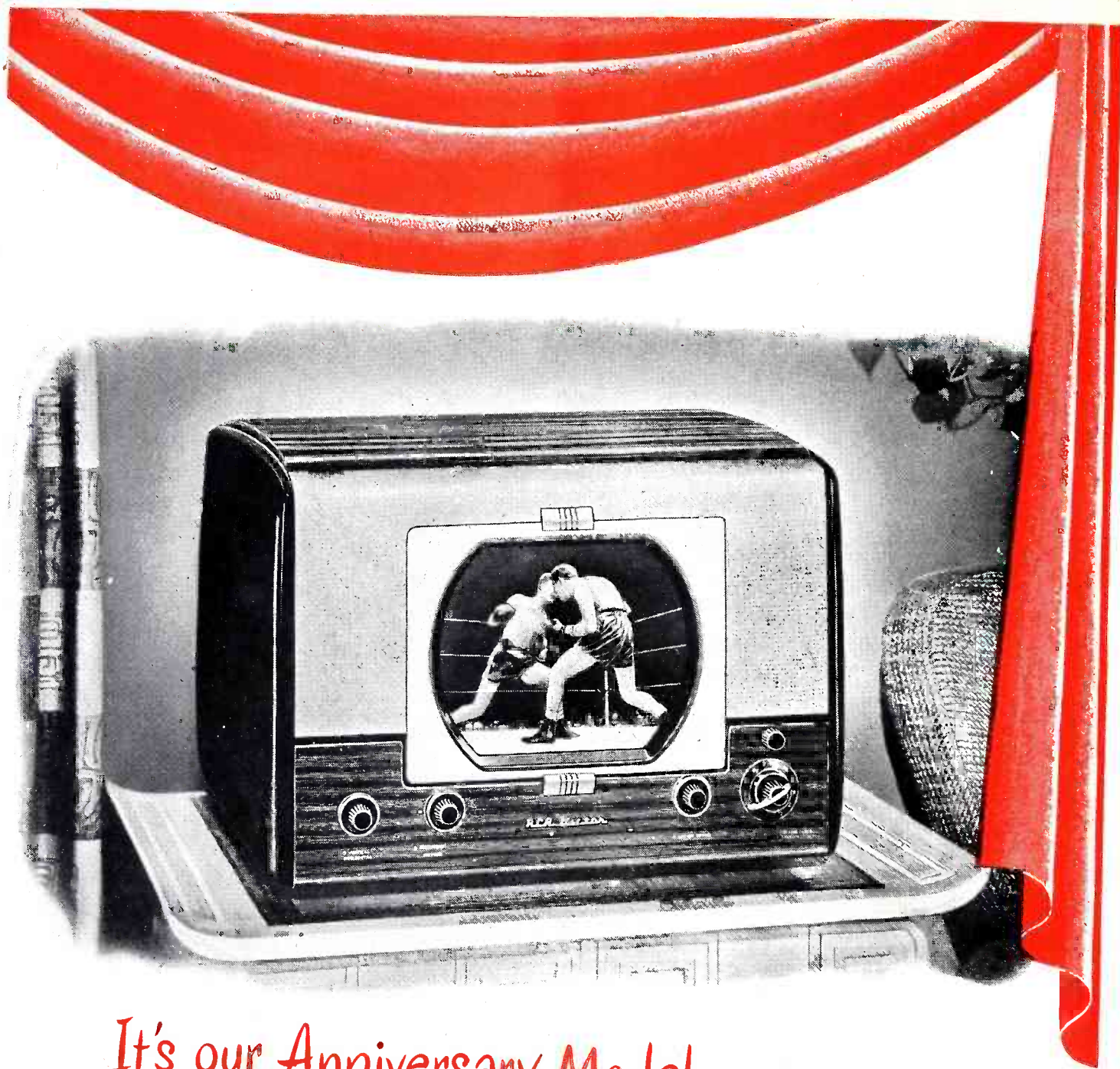

It's our Anniversary Model...

...your Profit Maker... it's the 9T246!

Now you can offer your customers brilliant, *locked in tune* Eye Witness television in a handsome cabinet... at a "never before" price!

Yet—the 9T246 offers your customers the same high quality that has made RCA Victor Eye Witness television America's favorite. It is such an outstanding value that it

will be your store-wide sales leader—and your star "sell-up" set to the more expensive receivers!

Like *all* RCA Victor instruments, the 9T246 has faster turnover because it offers your customers highest possible quality at a fair price. It's our anniversary present to you... and to your customers!



ONLY RCA VICTOR
HAS THE
"GOLDEN THROAT"



The beautiful, matching Consolette Base for Model 9T246 helps sell the set... and boosts your profits, too!

ONLY RCA VICTOR
MAKES THE VICTROLA

RCA VICTOR



"Victrola"—T. M. Reg. U. S. Pat. Off.

DIVISION OF RADIO CORPORATION OF AMERICA

RADIO & TELEVISION RETAILING • September, 1949

Here's why your profits are greater with this RCA VICTOR

*Higher quality and outstanding selling points of
ALL RCA VICTOR instruments keep turnover high!*

Look at the features of this Special Anniversary Model!

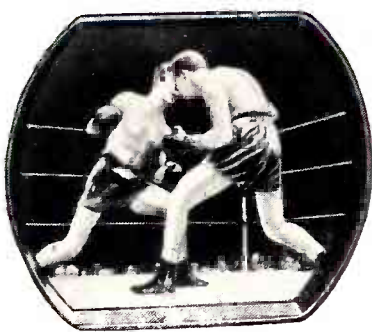

Big 61-square-inch Screen— offers your customers a newer, wider view of famous RCA Victor Eye Witness pictures. "Power On" circuit makes face of picture tube glow white when the television transmitter has gone off the air and the set has been left on!



Graceful Cabinet—smartly finished with a wood graining and deep maroon that's baked on for greatest beauty and permanency. Specially woven grille cloth . . . flecked with shining, copper-colored metallic thread . . . enhances its truly outstanding beauty.

Lowest
Price
Ever!
\$199⁹⁵

—for America's favorite RCA Victor Eye Witness television! It's a special low price for a special occasion! It's a price that makes our anniversary your customers' celebration!



PLUS . . . another example of RCA Victor quality!

Now, thanks to extensive RCA Victor research, all new RCA Victor television chassis incorporate changes which make it possible to satisfactorily pick up low signals in "fringe" areas. Because "television-educated"

prospects are now looking for a set which gives them top performance in these "fringe" areas . . . you stand a better chance of closing more television sales when you sell the outstanding RCA Victor line.

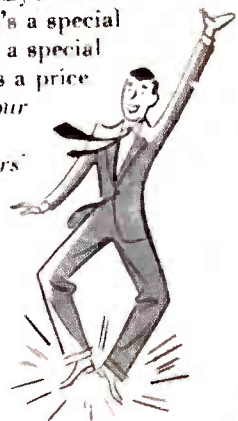

RCA VICTOR—World Leader in Radio . . . First in Recorded Music . . . First in Television

In Today's Tightened Market You Must Get **MORE** Customers

Profitable Method Bypasses Necessity for Price-Cutting and for Slashing Inventories to Dangerously Low Levels

● In spite of the fact that the consumer presently has the largest disposable income (income remaining after taxes) in the history of the nation, there is no denying that he's spending carefully and slowly.

Dealers all over the country are feeling the effects of this buying slowdown. Some are sitting in their stores crying the blues because of the diminished flow of store traffic . . . and doing nothing about it. Still others resort to price-cutting, and some are overdoing the "hand-to-mouth" advice on reducing inventories to the point where they refuse to stock even fast-moving products. The go-getters, realizing that the potential market is still large, are working the field for all it's worth.

In viewing this current situation it is

quite likely that many a merchant will overlook a very important reason back of the drop in sales volume. Such slump may well be due to the fact that the retailer *hasn't added enough new customers* to take up for the slack in buying by his old, established patrons.

It is a fact that the dealer cannot hope to do today the same volume with the same number of customers that he did a couple of years ago or even last year. It just isn't in the wood. If he believes that almost all consumers have tightened up their purse-strings, then he must believe that the only answer is to scurry out and get *more customers* . . . keeping his old ones, the while, of course.

Since conditions vary in the different sections of the country, it is not likely

that an accurate set of figures could be obtained for the purpose of telling the merchant just how many new customers he needs, for instance, to do the same volume he racked up in 1947. He may need to double the number, or he may need to bring up his list to four times what it used to be during the wrap-up sales days. All in all, though, it is a fact that most retailers in this field today need to add *materially* to their customer lists.

A leveling off in business conditions such as we are experiencing today always requires extra effort on the part of those who would prosper in the market. Because of the general attitude of the consumer, the dealer having a "static" list of customers, can do just so much business with them, and no more.



**Get Leads on New Customers
From ----**

- Local civic groups
- Local utility companies
- Real estate agents
- Building contractors
- Building report agencies
- Established customers
- Special invitations

JONES RADIO & APPLIANCE COMPANY
Invites You to A Special
TELEVISION SHOW
at its store, in the newly remodeled
Demonstration Room
Saturday, November 12th.

to Make **MORE** Money!

The merchant who is satisfied that he cannot greatly improve upon his present sales methods, selection of products, display, advertising and all other business-attracting features, is certainly justified in making a drive for new customers. If, for instance, he's about breaking even with a thousand active customers today, five hundred more may well represent a neat profit.

"Unexplored" Sales Area

There are a few dealerships in the country where merchants have about all of the customers available to them, but such set-ups are few and far between. Most merchants still have plenty of "unexplored" sales areas awaiting cultivation. In almost all localities there are consumers who travel considerable distances to stores in other towns and cities, shopping in such places for various reasons. Such folk can often be attracted to the "home" store if they can be convinced that it is to their advantage to do business with the local retailer.

Prospective new customers are at every hand. In the community there are always homes where no salesman has called recently to offer replacements for worn-out radios and appliances considered "good" or "satisfactory" by the resident who has not been given the opportunity to compare such junk with modern products.

Prospective new customers are always among the ranks of the newcomers, and the alert retailer makes every endeavor to obtain names of those recently settled in the community, as well as those *planning to do so*. There are several sources where such information is obtainable, and these include real estate agents, builders, local public utilities, organizations, etc.

The "new home" business in electrical appliances is a very big proposition all over the country, and too many dealers are ready to throw in the sponge when it comes to trying to get a share of sales in this market. In many instances the local dealer is bypassed, particularly in the large developments where building contractors can obtain much merchandise "direct." But even in such situations the local merchant can obtain new customers. He can, for instance, offer repair services. He can often sell products not included in the "package" home.

In some territories dealers get a good share of the new home business by

Business Increase Is on the Way— Get YOUR SHARE

**The peak selling season's
almost here. More new customers;
more sales to the old = more profits to you!**

"jumping the gun" to the extent of obtaining *advance* information from services such as those offered by the F. W. Dodge Corporation (Dodge Reports) wherein names and addresses of those planning to build homes are listed. Armed with such information the dealer is often able to sell the person having a home built his particular makes as opposed to a "stock" selection recommended by the contractor.

New customers are often secured through participation in various civic activities by the dealer. He may serve local groups as a chairman or member of a committee. He may give talks before clubs, and he may build up his customer list through publicity in the local newspapers obtained through writing articles on timely subjects.

In addition to personal solicitation, and advertising, the show windows of the store can be made to bring in new customers, particularly in heavy traffic areas. The stressing of repair work, *listing the products serviced*, is always a good method to use in bringing new people into the store.

Customer-Attractors

In many cases dealers attract passersby with displays of regular and "special" electric light bulbs and with "accommodation" items, such as vacuum cleaner belts, small electrical parts and supplies. Diversification of products is quite important today, since such method not only keeps the regular customers coming in, but brings in new ones as well.

"Invitations," whether included in

newspaper advertising, in direct-mail pieces, over the air or on the phone are very often an effective means for getting prospective customers into the store. Such "invitations" can include bids to attend a "television show," the demonstration of a new range; a "concert" via a three-speed record player, and numbers of other events that come to mind. It is important to set up a certain day and a certain hour in all invitation messages to the public.

Many new customers can result from systematic follow-up calls on established customers, a technique that has always been successful when handled courteously.

Some dealers find that offers of commission payments or a gift of some sort act as a stimulant to many patrons in furnishing the dealer with leads, and often with leads so thoroughly "pre-conditioned" that the sales closing is more or less a matter of routine. Great care and judgment must be used in asking established customers for leads, or suggesting rewards for their efforts in this direction. Some customers furnish leads to the salesman with the understanding that their names will not be

(Continued on page 97)

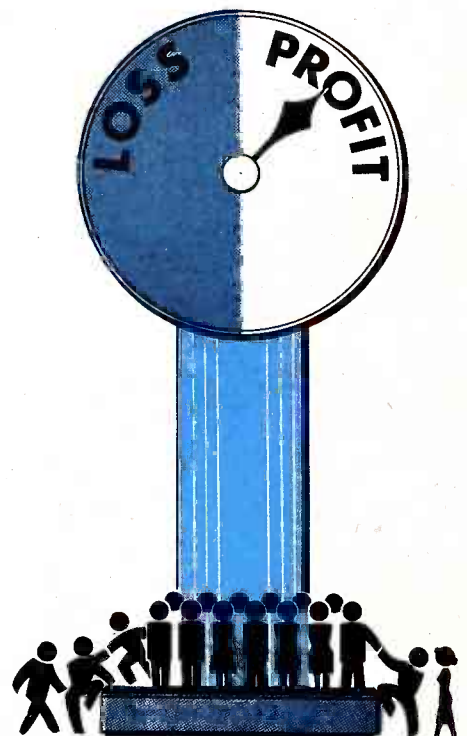

Add more customers to tip your business scale pointer to the profit side of your ledger.

Service Brings New Firm

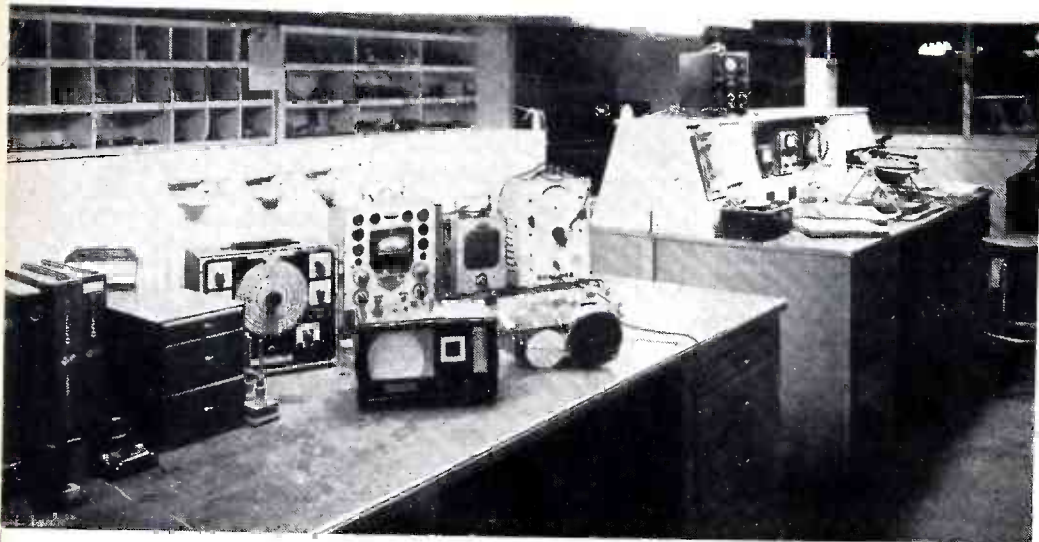

Fast, efficient radio servicing is performed in a department having modern equipment, and laid out in an orderly manner. Customers are taken on tours through radio and appliance repair sections.

● The importance of carrying a full line of parts and backing this up with reliable service is well illustrated at Moore-Tally, Inc., new Four-Way dealership in Reno, Nevada—for due to its ability to service any type of radio and appliance operating in the community, the firm did a half-million dollars' worth of retail sales in its first fiscal year.

Milo Tally, young head of the firm, bought the retail end of the Saviers Electrical Products Corporation of Reno

in Spring of 1948, when Saviers turned to 100% wholesaling and distributing of all varieties of electrical products. The purchase included a handsome new building, with a neon-lighted glass block tower on which names of leading lines such as Philco and Westinghouse are visible for many blocks either way. This was Savier's old location, which makes it possible for Moore-Tally to capitalize on the goodwill built up by the older firm over many years of sales and service. "Savier's still re-

Radio and record department features modern lighting, ample aisle space and well arranged displays.



Reno Dealership's

Big Parts Stock

and Repair Know-How

Proves Profitable

ceives calls for appliances which are transferred to us," Tally indicated, "which illustrates some of the value of a good, soundly established name to us."

Instead of building up sales first, Tally went into the service end of his organization from the outset, and built up this department before the first products went into the showroom. With 22,000 square feet of space in the building, the firm devotes almost half of it to service operations, with five major divisions, nine expert mechanics, such features as exhaust-fan equipped spray rooms, conveyor belts and castered platforms included in the basement rooms. The service departments are so handsomely arranged with glass partitions between sections, modern power tools, good lighting, and so forth, that Tally feels no qualms about escorting potential buyers through the shops, pointing out that such facilities are bound to result in better servicing. "I play the service end hard for the simple reason that Reno is distant from any other large community, and residents must depend on local firms for service," said Tally.

"Included among our valuable customers are wealthy mine owners, ranchers, stockmen and tourist center operators in the remote mountain areas of northern California and Nevada. Each now knows that we'll move mountains to maintain our guarantees, and such knowledge is the biggest boon to merchandising in this area."

Big Parts Inventory

Dovetailing closely with this line of thinking was Tally's next step—the acquisition of a parts stock second to none in the Desert states. The parts stock is kept at a level approximating \$15,000 and is bought on a highly practical basis—by surveying the brands of radio and appliances owned by residents, and allocating the purchase orders to cover them.

Moore-Tally has parts for any make of refrigerator, for example, which was

Half-Million \$ Volume



Above, this showroom is said to be the largest between Denver and the California coast. Symmetrical array of products is pleasing to the eye, and speeds selection by customers. New firm with servicing background purchased the handsome building shown below.

found in visiting homes and business places.

The firm has a service department devoted entirely to reconditioning and repainting of used products.

Reno has expanded as have many other Western communities, and the generally solvent public here has bought a lot of new appliances in the past two years. As is typical of the "Biggest Little City in the World" Moore-Tally displays products "in the grand manner" with a 100 x 50 foot showroom at the front, lined with alternate refrigerators, washing machines and ranges down the sides, with separate rooms for radio and record selling, and in the basement, a big housewares salon to attract the housewife. Rich satin hangings line the walls on both sides, with plenty of comfortable seats for customers. There are private, air-conditioned offices for discussing buying terms, etc. All of such factors help to dramatize products, Tally believes, but he wisely recognizes that it is the big parts inventory and the service which counts most heavily. Therefore almost every prospect willing to spend the time goes on a tour of the service departments.

During April, Moore-Tally (Partner C. Moore is an ex-Air Force pilot, and young as are all employes of the firm) pulled a dramatic stunt, when the firm

staged a "Birthday Promotion," giving away a thousand dollar's worth of gifts to throngs of people who poured into the store. A full page newspaper ad, daily display ads and radio advertising invited Reno residents to visit Moore-Tally and receive a gift, "demonstrating our gratitude for a fine first year in business." Each ad was headed "Our Birthday Present to You." Moore-Tally backed up the offer with really worthwhile gifts, including small appliances, plastic refrigerator covers, carving sets, kitchen gadgets, salad bowls and other practical items.



Close Those TV Sales!

Answer Current Customer Objections the Right Way to Increase Volume

●Television retailers are probably well aware of the fact that hardly a day goes by during which the newspapers and magazines do not carry some news, rumors, surveys or prognostications about TV . . . and the prospective customer seems to read every item. Consequently, in order that he may answer questions that come up (some important, most trivial), and that he may cope with all the objections the customer may raise, the dealer must try to keep abreast of all the latest developments, and keep informed so that he may evaluate them. The editors of RADIO & TELEVISION RETAILING have collected many of the "stumbling blocks" to TV sales, presenting them at this time with suggestions as to how they may be overcome.

UHF: there is no doubt about the fact that we will have TV channels allocated in the 500 megacycle band, but it is certainly not an immediate reason for anyone postponing purchase of a set.

Present channels will be retained (2-13), present receivers will continue to receive these channels, and it is likely that new UHF channels will not be allocated in cities which already have several VHF stations in operation. Cities like New York, Los Angeles, Chicago,

Philadelphia, etc., probably will not be allotted any more channels. It is more likely that the new frequencies will be used to provide channels in cities and towns which have no coverage under the present allocation.

Furthermore, UHF is not an actuality yet. Engineers state that it is not yet possible to generate power sufficient for coverage of the nature of present VHF channels with existing equipment, particularly tubes. A similar difficulty exists in making receivers work at these frequencies, although the same order of power is not required. However, we are assured that when UHF comes, if it should happen that VHF and UHF channels exist side-by-side, converters for present TV sets will be made available at a reasonable cost.

Color Not Ready

COLOR: This is in an even more ephemeral state than UHF. Color has been demonstrated experimentally but not practically. Equipment shown so far has been found wanting either in quality, in cost, or in requirements of transmission. The recent pronouncement of the FCC which was described in the consumer press as giving color the go-ahead signal was really of little signi-

fiance. The FCC invited proposals for commercial color broadcasting IF it can be shown that the system can work in a 6 megacycle channel (the same bandwidth we are now using for black and white) and if it can be received on an ordinary receiver with relatively minor modifications. None of the systems shown experimentally so far fits these conditions, nor do they lend themselves to modification to fit these conditions. Therefore, the FCC announcement was little more than an "invitation," and the editors of RADIO & TELEVISION RETAILING still feel that color on a com-

What Do YOU Say When the Customer Asks About - - -

New Channels?

Color Television?

Obsolescence?

Current Prices?

Antenna Problems?

Programs Available?

"Damage" to Eyes?

Have the answers ready to change "waiting" into "buying," and they'll sign up now.

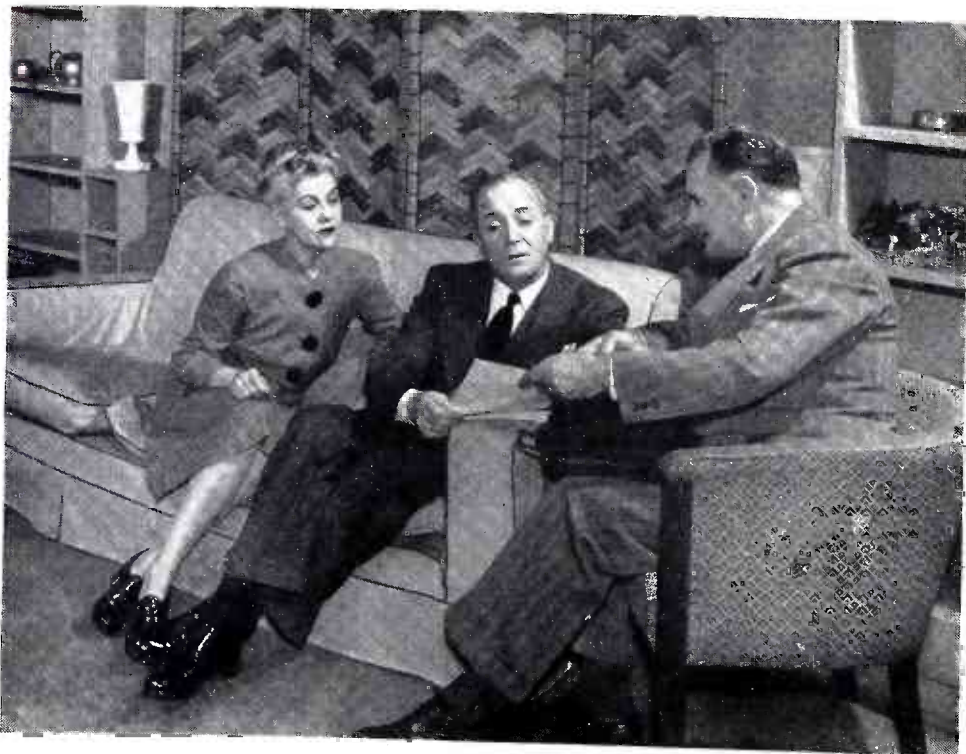

mercial scale is at least five years away. "SETS NOT PERFECTED YET": Nothing we have ever produced in this country was "perfected" in the sense that it reached a point where no further improvements could be made on it. Of course there will be continual improvements in TV, but this does not mean that present sets will be obsolete before the owners have had their "money's worth" out of them . . . any more than sets purchased two years ago are obsolete. As a matter of fact, TV sets produced 10 years ago are still in use. These sets were modified when frequencies were changed in 1945 and are still giving good performance. Post-war sets give more brightness than those old sets, and probably better definition (sharpness and clarity), but owners of the old sets enjoy Milton Berle as well as anyone else. An an-

(Continued on page 52)

GUESS WHO OPERATES THE WORLD'S LARGEST TELEVISION ASSEMBLY PLANT

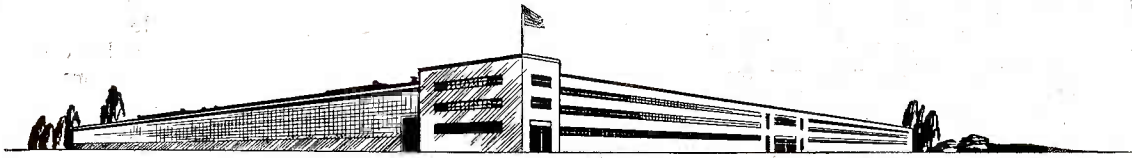

Unless someone has told you, you'd probably guess wrong.

Actually the world's largest television assembly plant operates under a name which has become widely familiar only in the last couple of years. It belongs to a company which started business about twenty years ago, with a capital of \$500, and has literally lifted itself by its own bootstraps—the company that made electronic television commercially practical by developing the cathode ray television picture tube from a laboratory curiosity—the one company that is in all of television and only in television. That company is DuMont.

DuMont marketed the first commercial television receiver ten years ago in 1939. Many of them are still operating.

After World War II, DuMont was first to be back on the market with a line of receivers that were years ahead of the rest of the industry. And the public—which is a lot smarter than some people think—was quick to recognize DuMont's superior quality, and to buy every DuMont set that could be made.

Even when there were a dozen orders for every DuMont that came off the assembly line, DuMont never yielded to the temptation to cut corners. Every DuMont receiver had to pass the most rigid examination.

People could see that DuMont receivers, in addition to having larger screens, gave a clearer, brighter, steadier picture. They were dependable

in operation. They brought in good pictures in outlying areas. They had fine tone quality. Their cabinets were well designed and well made. And because television was new and interesting, people talked about these things.

So DuMont's reputation grew very fast, and since most Americans want the best rather than the cheapest, people were eager to get DuMont.

That's how it happens that the little, independent company is today operating the world's largest television assembly plant—with four other DuMont factories making picture tubes and other electronic parts.

The public built that plant.

Built it by recognizing real quality. By being generous enough to pass the word along. By having good judgment to pay the few dollars more for the soundly designed and well built article.

Now new DuMont models are starting to pour off the new assembly lines.

You can see them at your DuMont dealer's today.

They are the finest DuMonts ever made; improved in every way; larger screens, clearer pictures, greater power and sensitivity. And every one made and inspected with the same expert, meticulous care as when a day's output was numbered in dozens.

And when you look at their price tags, you will find that these new and better DuMonts pass on the great economies of quantity production—pass it on to the public whose recognition and acceptance made this great assembly plant possible.

DUMONT *first with the finest in television*

COPYRIGHT 1949, ALLEN B. DU MONT LABORATORIES, INC.

Allen B. DuMont Laboratories, Inc. • Home Offices: 2 Main Ave., Passaic, N.J. • Receiver Manufacturing Factory: East Paterson, N.J.

Close TV Sales

(Continued from page 50)

alogy to this can be found in autos: many cars on the market today operate without clutch and gearshift, and in a sense, conventional types are "obsolete." They are not, however, unusable.

If the customer, in raising the "perfection" angle, brings up the fact that TV sets require more service than radios, several facts can be mentioned: 1) A great percentage of service calls are complaints about reception, which requires antenna work, and which is often of no avail due to the location; 2) A great percentage of the service calls come when the set is new and the customer is not well versed in its operation and its characteristics. A relatively small percentage of the total service calls involve actual servicing of the set, and if these run into larger numbers than was customary with radio, it may be pointed out that the average TV set has about five times as many tubes and parts as a radio. This means five times as many chances of trouble. In addition, the operation of TV components is more critical than radio, since the eye is more critical than the ear.

It is interesting to note in connection with the so-called "perfection" of sets that in a recent national survey of receiver owners by Sylvania, more people gave "good reception" as a reason for satisfaction with their sets than any other reason. Good reception, of course, depends on the location of the home and the installation of the antenna rather than the design of the receiver.

PRICE: Probably the biggest single cause of sales resistance today is price, and one of the objections raised by customers is that sets are getting cheaper all the time, and that such-and-such manufacturer is rumored to have a cheaper model on the way shortly.

Need Realistic Approach

Despite the appearance of lower-priced models, the average price paid for TV sets is about 7 times the average price paid for radios. It is not conceivable that this gap will be closed up for many, many years. Secondly, the cost of materials going into TV sets has gone down very little in the past two years, and labor not at all. Therefore, the lower-priced sets of today represent to a great extent economies achieved by lowering the number of tubes and parts, and in some cases the quality. We have not, in the short space of two years, arrived at a point where we can make the same product for much less than before.

Obviously this tendency to find shortcuts will reach a limit someplace, until such time as new techniques are developed which will enable manufacturers to produce the same results with

the use of fewer components. Many feel that this limit has been reached already, and that prices will tend to stabilize at present levels for a while.

Customers should be warned not to interpret clearance sales of certain video receivers by some retailers as an indication that prices are tumbling and that a \$14.95 TV set is in the offing. Rather, watch the established brands and their current list prices for more accurate guidance.

It is also a good idea to establish in the customer's mind a realistic approach to price in relation to size of picture. The fact that there is a set with a 3-inch picture tube selling for under \$100.

of programming, and the growth of networks and "kinescope recordings" is making these programs available all over the country. This problem, of course, must be handled locally by the dealer, and the best thing he can do is to know *all* the types of programs which are available, and to keep in touch with what is scheduled to occur in the near future.

EYE-STRAIN: Every once in a while someone pops up with the idea that TV will injure the eyes. There isn't any foundation in fact for this, of course, although it is possible to develop eye fatigue from watching too long and/or

SALESMEN—Have the RIGHT ANSWER READY

Sell those "waiting" customers
Invite them to enjoy TV NOW
Overcome objections courteously
Justify present prices
Prove that TV is truly HERE!

does not provide any indication that there will shortly be a 16-inch set in the same price range.

ANTENNAS: Another objection sometimes raised by customers is that they are not permitted an outdoor antenna and therefore they cannot have a set now. While it is true that in general an outdoor antenna gives better results than an indoor antenna, no dealer who has had much experience with TV accepts this excuse without a murmur. Countless locations have provided satisfactory (although not necessarily perfect) reception on an indoor antenna, as the tremendous sale of these devices will testify. Some of the largest and most experienced installation and service organizations are testing all metropolitan installations with an indoor antenna first, regardless of whether an outdoor antenna is permitted, since the results prove in numbers of cases that an indoor aerial is satisfactory. This, of course, is not so true beyond 15 or 20 miles from the station, but roof antenna permission problems are not so acute at those distances, either.

PROGRAMS: There are still some people who believe that TV programs consist of "nothing but sports," or "nothing but vaudeville," and if they don't happen to care for such types of entertainment, they're not interested. This is hardly true anywhere any more. There is a greater multiplicity of types

too close to the screen, or with the picture very bright and the room very dark—just as it is possible to get eye fatigue from reading too long (or reading in a poor light), watching two full-length features in a row at the movies, etc. As a matter of fact, in the old days there were all sorts of dire predictions about what moving pictures would do to us, all of which seem too silly to mention now. For the customer who insists that there is too much brightness and "glare" from a TV screen, the dealer might suggest the use of a filter.

"Blue Sky" Rumors

NEW DEVELOPMENTS: Finally, there is always a rumor that some new development is afoot which will revolutionize the art as we know it today. One of the more recurrent of these is that cathode ray tubes will be done away with, and TV sets will be as small, cheap and simple as radios. Since it is hardly possible that the merchant can keep up with the latest rumors (nor is it advisable), we can only assure him that any significant development will be promptly reported in the pages of **RADIO & TELEVISION RETAILING.**

If the American public had waited for autos with plastic bodies which are indestructible, or a substitute for gasoline which would be much cheaper and more powerful, there would have been but few automobiles sold in the last few years.



Sales Stimulators Like These Are Pulling in Profits for RAYTHEON *Bonded* ELECTRONIC TECHNICIANS



Wherever Service Dealers are riding the Raytheon "Bond" Wagon, volume and profit are riding high, too. The bigger and better RAYTHEON *Bonded* ELECTRONIC TECHNICIAN Program has a complete line of brand new displays, decals, mats, mailing pieces, shop and sales aids specially designed to create customer confidence and stimulate sales. Most of these hard-hitting sales tools are yours for the asking — if you can qualify as a RAYTHEON *Bonded* Technician. The Bond costs you nothing — but it pays big dividends.

Better ask your RAYTHEON TUBE DISTRIBUTOR whether you can ride the "BOND" Wagon to bigger business.

ASK YOUR RAYTHEON TUBE DISTRIBUTOR for this presentation. It gives you the complete "Bonded" story and shows you why you can't afford to pass up this free Raytheon "dividend".



The Raytheon Bantall Tube simplifies your tube stock without loss of sales. Eight fast-moving Bantalls replace sixteen equivalent GT and metal types. A new and better tube at no extra cost! Ask your Raytheon Distributor for Raytheon Bantall Tubes.

RAYTHEON

MANUFACTURING COMPANY

Radio Receiving Tube Division

NEWTON, MASS. • CHICAGO, ILL. • ATLANTA, GA. • LOS ANGELES, CAL.

RADIO RECEIVING TUBES • CATHODE RAY TUBES • SPECIAL PURPOSE TUBES • SUBMINIATURE TUBES • MICROWAVE TUBES



UP Sales of Batteries

Make Your Store a "Battery Center"

to Get the Most From This Profitable Product

● Virtually every American home uses batteries of some type. These batteries require periodic replacement, a profitable business which recommends itself to the radio-appliance dealer because of its simplicity to him combined with necessity to the consumer. Dry batteries, in fact, can be displayed as easy as boxes of moth balls, and installed by the consumer himself much as he puts in a new light bulb.

Since batteries decline in usefulness in a relatively short time regardless of whether or not they are used, it is essential that they be continually replaced, a fact of which the dealer may remind his customers the year 'round to their mutual advantage. In some instances, such as flashlights and battery-powered lanterns, the device is seldom used but is depended upon to work in an emergency. The customer should be continuously reminded to keep "fresh" batteries in such devices.

Some devices are out of use and on the shelf for want of batteries—this is as true of radios as it is of flashlights and lanterns. Seeing batteries on display or receiving a direct verbal or mailed suggestion to buy batteries will often remind the customer to get these items back in service—if for no other reason than to protect the investment made in them originally.

Dry and wet batteries are used in countless appliances, such as battery-portable radios, 3-way portable radios, farm radios, electric fences, personal radios, hearing aids, flashlights, lanterns, photoflash attachments for cameras, door-bells and chimes, telephones, ignition systems, and radio transmitters (not only "hams," but also police, fire, etc.). Stocking batteries for these de-

vices is like stocking shoes: if you don't have full assortment of sizes and types, you probably won't sell any, since the customer always wants the one you don't have.

This fact is probably the chief reason why more dealers don't try to do more with batteries . . . because they're afraid of "getting stuck" with a lot of batteries which go "stale" on the shelf.

There are two ways to avoid this: first, understand your battery stock, and second, promote it vigorously and continuously to establish yourself as a "battery center."

The first step to "understanding" batteries is to keep a cross reference list showing the different models of different manufacturers which are equivalent types, and listing the equipment in which they are found. Just as flashlight batteries are also used in some personal radios, hearing aids, photoflash attachments, etc., many other battery types find varied uses. In addition, a battery specifically for one use, such as a portable radio, may be found in several different models.

Such a reference list should show the voltages furnished, the dimensions of the battery, and the type of terminals. These facts can be indicated by code letters. Such a list would show that in many instances, batteries are identical except for a slight variation in size, or in the type of terminal. If one portable radio battery, to cite an example, furnishes the same voltages as another, and is similar in size (but no larger in any dimension), but uses a different type of plug, the plug could be changed if one or the other battery were not stocked. Many obsolete pre-war types of equipment can be "con-

verted" in this manner, since they usually used larger rather than smaller batteries than types in use today. In other words, the new batteries will easily fit into the space provided.

By such methods as these, the total number of types carried could be limited to those known to be in greatest demand in your locality, so long as you or your serviceman knows what to do when someone requests a type you do not carry. Of course, this should not be construed to encourage replacement with anything at hand regardless of its fitness—but only similar or virtually identical types. For instance, a flashlight cell should not be used to replace a 1½-volt "A" battery in a radio unless that is what was there before, since the usual "A" battery is designed to supply more current for a much longer time.

Promote the fact that you specialize in carrying fresh batteries for every use in every way you can in order to achieve the reputation of a "battery center." In-store and window displays are simplified because of the ease of stacking batteries, and because a few types displayed suggest all types of batteries. Reminders about batteries can be brought in as tag lines in newspaper ads. "Envelope stuffers" plugging batteries can be sent out with bills in addition to regular direct-mail efforts.

Finally, there should be at least one person in the store who fully understands batteries, knows the different types and their uses, their prices, and what is in stock and what isn't. Batteries aren't a complicated subject to learn, but the customer is favorably impressed by the salesperson who knows instantly what is required, where to find it and how much it is. The customer is also pleased if the salesperson can make helpful suggestions about the proper installation and use of batteries and battery-operated appliances.

The end result will not only be a profitable battery business, but increased store traffic as a result of it, as well as increased service business, for most of the devices utilizing batteries are items which also require service.

Merchandising storage batteries is perhaps not as simple as dry batteries, since it requires facilities for testing and charging batteries. Such facilities, however, far from being troublesome, are an important extra source of revenue in themselves. Beyond this fact, this type of battery follows the same general merchandising pattern of other types, as outlined in this article.

8740

8743

8734

8735

8738

8739

8747

8433

8799

8752

INTERCOMMUNICATION AND SOUND SYSTEM CABLES

Every Type for Every Service

Sold Exclusively Through Recognized Wholesale Distributors

Belden *Radio* WIRE

New Television Receivers

Emerson TV RECEIVER

The new model 637 is a 10-inch TV table set in a wooden cabinet to retail for \$199.50, the first Emerson 10-inch set to retail under \$200. Also among additions to the 1950 line is a 7-inch wood-cabinet

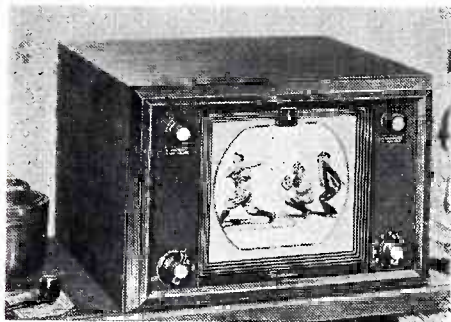

model at \$129.95 (model 639) and a 12½-inch table model in mahogany (model 644) priced at \$249.50. Emerson Radio and Phonograph Corp., 111 Eighth Ave., New York 11, N. Y.—RADIO & TELEVISION RETAILING.

Air-King 10-INCH TV

Model A-2010 is a 10-inch table set in wood cabinet, with 20-tube chassis featuring the low price of \$199.95. Long range reception is claimed for this model. Air King Products Co., Inc., 170 53rd St., Brooklyn 32, N. Y.—RADIO & TELEVISION RETAILING.

RCA 1950 TV LINE

Nine new models were introduced, featuring a 10-inch set in a metal cabinet for \$199.95 (model 9T246). 12-inch sets were included for the first time, highlighted by a console set at \$299.50 (9TC245), while 16-inch sets were led off by a table model (9T270) at \$395. A 10-inch console set for \$269.50 was also featured. The only TV-radio-phono combination shown was a 16-inch model, 9TW390, at \$795. The projection



set, model 9PCS41, is being continued. Circuit features of the sets were substantially the same as in the '49 line, with 24 tubes in the 10- and 12-inch sets and 27 in the 16-inch sets (except the combination). RCA Victor Division of RCA, Camden, New Jersey.—RADIO & TELEVISION RETAILING.

Dumont TV SETS

Featured are the Rumson, a 12½-inch table set with FM radio priced \$329.50, and the Bradford, a TV-FM-phono console with the new Dumont 19-inch metal tube and 203-square-inch picture. The new tube



is considerably shorter than the glass 20-inch tube. A new 15-inch console, the Sussex, and a 12½-inch console, the Sheffield, are also included in the line. Allen B. Dumont Labs, 515 Madison Ave., New York 22, N. Y.—RADIO & TELEVISION RETAILING.

Motorola TV SETS

The 1950 line features "Bilt-In-Tenna," a TV antenna built into the cabinet, as well as simplified tuning, with only station selector and volume control knobs on the front of the sets. Model 9TVI features the new 8½-inch picture tube. Said to provide a 50% larger picture than 7-inch sets, this model will retail for \$149.95. The Gainsborough and the Van Dyck are new 16-inch consoles, the former equipped with AM-FM radio and 3-speed phono, to retail at \$795, the latter a straight-TV set priced at \$450. The 1950 portable TV set is priced at \$139.95. Eight other TV models have been announced, including 3 with 12½-inch tubes. Motorola, Inc., 4545 Augusta Blvd., Chicago, Ill.—RADIO & TELEVISION RETAILING.

Pilot 12-INCH TV SET

Model TV-121 is a 12-inch table TV set with FM radio and a phono jack retailing for \$269.50. The set has 26 tubes including rectifiers, continuous tuning, and three con-



trols: on-off and volume, tuning, and contrast. Cabinet is mahogany veneer with a glass front. Pilot Radio Corp., 37-06 Thirty-sixth St., Long Island City 1, N. Y.—RADIO & TELEVISION RETAILING.

G.E. 16-INCH TV SET

Model 815 is a 16-inch direct-view console (receiver and matching table) with an eastern list price of \$495. The cabinet

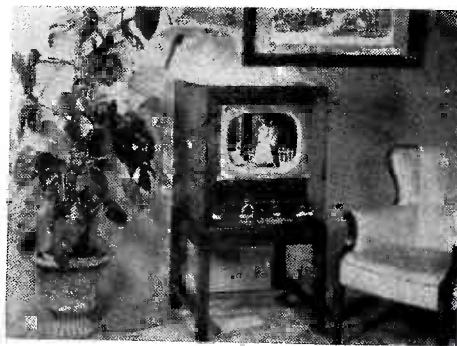

is mahogany veneer, and two loudspeakers are provided. General Electric Co., Syracuse, N. Y.—RADIO & TELEVISION RETAILING.

Magnavox 16-INCH TV SETS

Leader of the line is a 16-inch table set (the Constellation) with 27 tubes and 148-square-inch expanded screen priced at \$399.50. Three other sets with 16-inch tubes, the Contemporary, Normandy, and Brit-



tany, are priced at \$495, \$495 and \$595, respectively. All three sets have 12-inch loudspeakers. Magnavox Co., Fort Wayne 4, Indiana.—RADIO & TELEVISION RETAILING.

Admiral

The two features of the latest Admiral line of TV sets are a 10-inch console in wood at \$249.95 and a 12½-inch combination including AM, FM and 3-speed phono at \$399.95. At the same time, the firm announced a reduction in price on the 10-inch plastic console to \$219.95, and the 16-inch console to \$399.95. A small table radio-phono set (model 5W12) is also being featured at \$49.95. The phono is for 7-inch records only, both 33⅓ and 45 RPM. Admiral Corp., 3800 Cortland St., Chicago 47, Ill.—RADIO & TELEVISION RETAILING.

#1
tops
in everything but price!



NEW! SUPER-STYLED!

**Big 90 Sq. In.
 Table-Top Receiver
 THE SUPER-CHIEF
 \$249.95**

- All new 1950 engineering advancements
- Attractive, new type "wide angle" screen
- Contemporary cabinet of genuine Honduras mahogany
- Hand rubbed, fine furniture finish

Olympic
 TELEVISION

EXCLUSIVE!

**Local—Long Distance
 Switch**

A flip of the switch gives extra power for "fringe area" or "indoor antenna" reception.

- ★ **QUALITY** . . . meets the highest standards of the industry
- ★ **PERFORMANCE** . . . crystal-clear, even in "fringe areas"
- ★ **BUDGET-PRICED** . . . for "mass-market" selling
- ★ **A BETTER MARK-UP...**

HERE'S WHAT YOU'VE BEEN WAITING FOR!!!

Now delivering 1950 Olympic TV line. 10-12½-16 in. table and console sets. Each a winner at prices from \$199.95 to \$449.50. Wire or write for full details.

OLYMPIC RADIO AND TELEVISION, INC., 34-01 38TH AVENUE, LONG ISLAND CITY 1, N. Y.

Sales Appeal in New Sets

Philco 1950 TV SETS

Featured in the new receivers are built-in antennas with a tuning knob on the front of the sets, "no-glare" viewing screen, achieved by tilting the safety glass so that room light reflects to the floor, and 3-speed record changers with a single tone arm



and a single spindle. Prices range from \$199.95 for the 7-inch table set (T702) to \$860 for a 12½-inch console combination. One 16-inch set is included, a console at \$499.95. Price leader of the line is model 1477, a 12½-inch console with AM, FM and phono at \$399.95. Philco Corp., Philadelphia, Penna.—RADIO & TELEVISION RETAILING:

Stromberg-Carlson TV SETS

Featured in the Stromberg line are the Manhattan, a 10-inch table set with "opera glass" control which "blows up" the picture to a full circle, the Somerset, a 16-inch console with AM, FM and 3-speed phono facilities priced at \$895, and the Chinese Classic with 12½-inch tube, AM, FM and 3-speed phono facilities at \$795. "Wide screen" pictures are provided in these and the other models in the line, as well as automatic gain control and automatic brightness control, which features are said to greatly simplify tuning. Stromberg-Carlson Co., Rochester 3, New York.—RADIO & TELEVISION RETAILING.

Meck 16-INCH TABLE TV

A 16-inch direct-view table TV set in a wooden cabinet has been announced, priced to retail at \$279. Improved manufacturing techniques are said to have made this price possible on the 16-inch set, as well as a 12-inch receiver retailing at \$219, and a 10-inch set at \$179. All three are table models. Also in the new line are a 16-inch console at \$299, and a 12-inch console at \$249, and a 7-inch table model at \$149.90. John Meck Industries, Inc., Plymouth, Indiana.—RADIO & TELEVISION RETAILING.

Tele King TV LINE

The new line includes a 16-inch console priced at \$349.95, a 16-inch table model for \$319.95, a 12½-inch table set for \$219.95,



and a 10-inch table model for \$179.95. All are wood cabinets, and feature automatic gain control. Tele King Corp., 601 West 26th St., New York, N. Y.—RADIO & TELEVISION RETAILING.

Andrea 12-INCH CONSOLE

The "Ridgeway" has an 85-square-inch screen plus AM-FM radio and a 3-speed record player. The set, in a mahogany

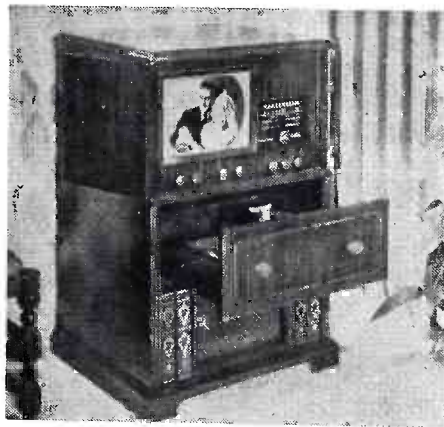

vener cabinet, lists for \$585. Andrea Radio Corp., 27-01 Bridge Plaza North, Long Island City 1, N.Y.—RADIO & TELEVISION RETAILING.

Mars 16-INCH TV SET

The "Hampshire" model is a 16-inch, 4-way combination with 40 tubes, 12-inch speaker, and 3-speed automatic record changer listing for \$695. The cabinet is hand-rubbed mahogany. Other models in the line are the La Salle, 16-inch console at \$575, the Baldwin, a 12-inch table model at \$395, and the Princeton, a 16-inch table model at \$495. Mars Television, Inc., 29-05 40th Road, Long Island City 1, N.Y.—RADIO & TELEVISION RETAILING.

Sparton 10-INCH TV

Model 4954 is a 10-inch table set in a mahogany veneer cabinet with a contrasting metal front panel and lucite knobs

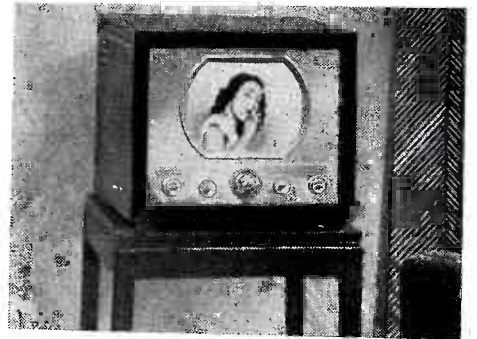

priced at \$199.95. A feature of the circuitry is automatic gain control. A matching table with swivel top is an optional extra. Sparks-Withington Co., Jackson, Michigan.—RADIO & TELEVISION RETAILING.

Arvin TELEVISION SETS

Five models have been announced, including 3 consoles and 2 table sets: a 10- and a 12½-inch table set, and 10-, 12½- and 16-inch consoles. All models have 22



tubes plus rectifiers, and have only two controls in addition to the channel selector: picture contrast and sound volume. Noblitt-Sparks Industries, Inc., Columbus, Indiana.—RADIO & TELEVISION RETAILING.

Crosley TV CONSOLE

Model 9-409M provides 12½-inch screen, AM-FM radio and 3-speed automatic record changer in a period cabinet. Called the "Family Theater," the model lists for \$579.95. Crosley Div., Avco Manufacturing Corp., Cincinnati, Ohio.—RADIO & TELEVISION RETAILING.

Hallicrafters TV RECEIVERS

Four home receivers are being featured at new low prices: the 514, a 7-inch portable at \$149.50, the 513, a 10-inch table set with plastic cabinet at \$199.50, the 512, a 12½-inch console with 85-square-inch screen at \$299.50, and the 515, a 15-inch console with 13-square-inch screen at \$399.50. The Hallicrafters Co., 4401 West Fifth Ave., Chicago 24, Ill.—RADIO & TELEVISION RETAILING.

easier, faster TV sales in D.C. areas with C-D Converters



Input Volts: 110 V.D.C.; Output Volts: 110 V.A.C.; Watts Cont.: 150 W.; Watts Int.: 250 W.; Variable Frequency Control

- easily installed on all types of TV sets
- simple design eliminates lubrication and other mechanical maintenance
- quiet, more efficient service at lowest cost
- a complete line to meet all needs

For further details write to
Cornell-Dubilier Electric Corporation,
South Plainfield, New Jersey, Dept. JD99
Other large plants in
New Bedford, Worcester, and Brookline, Mass.;
Providence, R. I., and Indianapolis, Ind.



The Phono Record Business Is

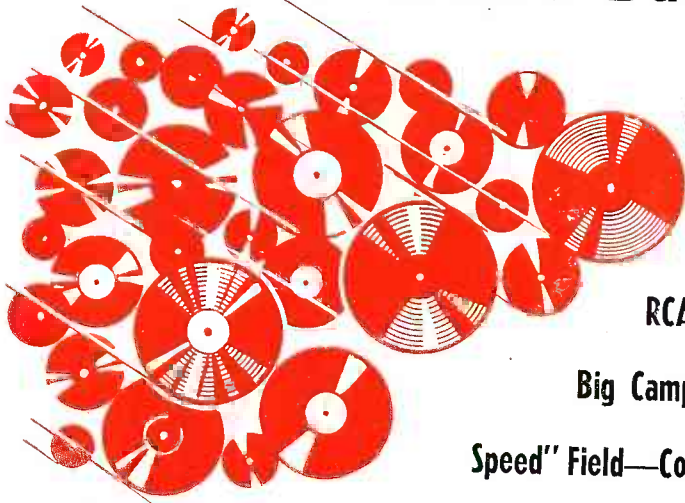

ON THE MOVE!

RCA Victor to Reduce Price on Player Attachment; Launches Big Campaign—Decca Pressing 33 1/3 RPM Discs Enters "Two-Speed" Field—Columbia Launches Big Promotional Campaign to Help Dealers

RCA VICTOR



DECCA



COLUMBIA



A gigantic 45-RPM promotion will hit the consumer commencing September 20, focusing on the 9JY record player attachment. This unit will be reduced in price as of that date to \$12.95. The more attractive price is aimed to make music on 45 RPM records available to a larger audience.

Details of the promotion campaign and the new price schedule will be outlined to RCA Victor dealers in a series of meetings to be held during the week September 6-15. An arrangement for price adjustment on dealers' present stocks of 9JY's will be presented at this time.

Announcement of the new price on the 45 RPM player will be placed in newspapers in 154 cities commencing September 20. This announcement will be followed by a series of 12 ads to run on a weekly basis in 88 markets. Cooperative advertising funds will be available in this connection. Radio spot announcements have been booked to provide national radio coverage for the promotion, and the "Kukla, Fran and Ollie" TV show will also be used for this purpose. Films will be available to dealers for use on TV. For store promotions, window displays and point-of-sale displays have been prepared.

Another feature of the campaign is a new "You Can't Lose" contest for dealers, details of which will be outlined at the dealer meetings before mentioned.

Milton R. Rackmil, president of Decca Records, Inc., has announced that as of September 5th, Decca will start to make available its great catalog of albums on 33 $\frac{1}{3}$ long-play microgroove, unbreakable records. Mr. Rackmil emphasizes that the release of these albums on 33 $\frac{1}{3}$ long play will in no way affect the production and promotion of Decca's catalog of albums on 78 RPM. However, in the future all newly released albums will be made available for both speeds. The Decca president pointed out that Decca will continue to release single records at 78 RPM only.

The first release of 33 $\frac{1}{3}$ long-play records will include such famous Decca show albums as "Oklahoma," "Annie Get Your Gun," "Carousel," in addition to the new "Jolson Sings Again" album and other best-selling albums by Bing Crosby, Dick Haymes, Carmen Cavallero, Fred Waring, Guy Lombardo and additional well-known artists. Subsequent releases will include the best-selling "Merry Christmas" album by Bing Crosby as well as albums by other Decca artists. Discs come in 10- and 12-inch sizes, and prices on first list issued were set at \$2.85, \$3.85, \$4.85 and \$5.85. Decca will market a Microverter and a player for 33 $\frac{1}{3}$ at \$9.95 each.

Since the introduction of the LP records in June of last year, this system has been steadily gaining in acceptance, both by the consumer and by other record pressers, as a most practical economical and convenient method for playing long classical selections on a phonograph. Musical comedy albums have also been successful, and the firm will continue to assist the dealer with promotion of such collections as new shows appear, with the obvious price advantage of the LP record over the 78 RPM album exploited.

September is "LP" (Lasting Pleasure) month, a Columbia theme to help dealers settle back into fall and winter activities. Display material stressing this theme has been prepared by the company for dealer use.

Promotion of the "Microverter" attachment for converting 78 RPM phonos to LP, and the low-priced LP player attachment, either for \$9.95, will also be continued at the dealer level to widen the market of LP purchasers.

Columbia expects to sell 6 million LP records, this year, and 30 million records of other types, according to a statement made by Edward Wallerstein, chairman of the board, Columbia Records, Inc., who pointed out that each LP record sold is the equivalent of five single records.

Late news from three major disc firms appearing on this page is chiefly concerned with the "new speeds." It seems certain that the tremendous promotional campaigns presently under way and planned for these speeds will be reflected in larger and larger sales increases as time goes on. Meanwhile, despite gloomy reports from some sectors, the "Business as Usual" sign is out for 78 RPM, with firm indications that sales will again top 200 million discs this year.

ANOTHER
EMERSON

MONEYMAKER!

Big
Brilliant
Pictures

AC-DC
TELEVISION

only \$129⁹⁵

NEW 1950
MODEL
639



Smart,
Genuine Mahogany
Veneer Cabinet.
Easy To Carry

Easiest to
STOCK!

Easiest to
DISPLAY!

Easiest of all
to **SELL!**

No
Outdoor Antenna
Necessary
In Most
Localities

Staticclear
FM
Sound

Super-Powered
Long Distance
Circuit

SEE ALL THE BIG MONEYMAKERS IN EMERSON'S COMPLETE, NEW '50 LINE...
EVERY SIZE AND MODEL IN 10", 12½", 16" AND PROJECTION TELEVISION.
EMERSON, AND ONLY EMERSON, MAKES THE VALUES THAT MAKE YOUR PROFITS!

Emerson
BETTER VISION, STYLE, TONE,



Television
PERFORMANCE, VALUE



BULLETIN ON THE "BATTLE OF THE INCHES"

An Important Message to Emerson Dealers

The tendency to describe the size of kinescope tubes in terms of square inches has resulted in misleading claims which in turn result in loss of consumer confidence, and sales. We strongly urge all Emerson dealers to

refer to picture tubes as 10", 12½" or 16"—the *diameter* size is the only *correct* representation in advertising and store demonstration. *No one can sell prospects by confusing them.*

EMERSON RADIO AND PHONOGRAPH CORP.
New York 11, N. Y.

How to Sell FRINGE TV

Equipment and Know-How Brings Video "DX" Beyond the Horizon

• The enthusiastic determination of the American public to view television is causing a complete re-evaluation of the capabilities of TV, and a paraphrase of a familiar slogan to: "Never underestimate the power of a television signal!"

Engineering books tell us that Very High Frequency (VHF) radio waves are quasi-optical in nature, and may be considered effective only to the horizon. For a broadcasting antenna 1,000 feet high, the horizon is about 35 miles away. The area within a circle with a radius of 35 miles would be known as the "primary service area" or "normal range" for such an antenna, and beyond that would be the "fringe area."

Dealers soon found that good reception is possible beyond that 25-35 mile limit, and that some sort of reception is possible even as much as 100 and 150 miles away when the installation is given special consideration. Such consideration includes the use of special high-gain antenna arrays, antenna towers, and TV "booster" amplifiers (see article on TV Signal Boosters in the June 1949 issue of RADIO & TELEVISION RETAILING).

Additional height for the receiving antenna is an obvious device for increasing signal pickup in fringe areas. In theory, an antenna 50 feet high will add 8 miles to the line-of-site distance, 100 feet high will add 12 miles, 200 feet, 16 miles, etc. In practice, such antenna heights have proven even more effective than the theory would indicate.

Boosters and Antennas

Another feature of antenna height is that it gets the antenna farther away from local interference, such as auto ignition. Although the lead-in wire may pick up such interference, certain techniques have proved very successful in reducing this pickup, namely the use of shielded lead-in, and of twisting ordinary twin-lead.

Since at great distances, two or three stations in the same city which are spaced as much as a mile apart will appear to be at practically the same point

of the compass, it is possible to utilize an antenna with a narrower angle of pickup. Such a directional antenna results in higher gain than an ordinary straight dipole antenna. In addition, "stacking" of antennas narrows down the vertical angle of pickup, which also increases the gain of the system.

The "booster," as explained in the previously mentioned article from our June issue, contributes in several ways to an improved TV signal. The writer has seen instances in a fringe area (75 miles from the station) where no signal at all could be obtained without the booster, and a usable (though snowy) picture was obtained when the booster was turned on and tuned in. These instances occurred in the daytime. At night, receivers in that particular area could receive pictures without a booster, but these pictures were greatly improved in contrast and brightness when the booster was used.

Experience-Swapping

Of course, dealers in distant areas have found that certain receivers work better than others, especially since a great many sets have appeared in recent months which were especially designed for metropolitan (high signal) areas. In addition to the number of stages of amplification in a set, importance is attached to the efficiency of the set in rejecting interference and unwanted signals. Boosters, too, vary in their performance. Some will be found effective up to a certain range and not beyond, others may prove to be most effective at great distances. Technicians would do well to compare notes with others who have been successful at similar distances in order to short-circuit some of the elimination processes. "Letters to the Editor" of RADIO & TELEVISION RETAILING concerning long-range TV have been received in increasing numbers as time goes on, and suggest a possible source of names for experience-swapping.

It will be found that there are dealers who swear by "stacked arrays," some who believe that antenna height

is the only answer, while others rely on boosters. Actually each of these factors contribute, and all may be necessary in extreme cases. In a really extreme case, a fixed-tuned booster located on the antenna mast provided a workable solution, since the signal was boosted before it made the long trip down the lead-in. In other extreme long-distance areas (over 100 miles), technicians have been re-aligning the sets for sharper resonance peaks. While this cuts down picture quality, it also increases the amplification within the set, often providing a picture where none was obtainable before.

Sell Conservatively

All this trouble, experimentation, and expense which has gone into fringe area reception only serves to demonstrate the before-mentioned enthusiastic determination to receive television. Many hundreds and thousands of viewers (and incidentally, customers) can now be counted in areas which theoretically are not covered by television. An example of this was the city of San Diego, in which approximately 1,000 TV set owners were watching programs from Los Angeles (approximately 110 miles distant) prior to the date that the San Diego station came on the air, May 16 of this year.

Fringe area viewers must, of course, put up with the vagaries of the TV signal, which is affected by the time of day, the weather, the season, etc., as well as more trouble with ignition and other forms of interference than is customary in "normal" range areas. Dealers in such areas are wise to use very low-pressure selling methods, making no promises, and leaving the decision up to the customer as to whether results are "satisfactory." To the interested customer, however, the dealer may confidently sell up the cost of installation, since additional height, higher-gain arrays, boosters and the other methods mentioned are almost certain to make an improvement in the results, even though they don't necessarily result in a "good" picture.

THE ULTIMATE IN COMMERCIAL TELEVISION RECEIVERS HAS ARRIVED

RAPIDLY BEING INSTALLED IN HUNDREDS OF
PRESTIGE LOCATIONS INCLUDING JACK DEMPSEY'S
RESTAURANT, NEW YORK CITY

..it's **tradioVision!**

1728 SQUARE INCHES
(4 ft. x 3 ft.) of perfect, brilliant, sharp,
static-free, audio-visual reception, day or night!

only TRADIOVISION

offers the alert dealer relief from the cut price competition of the home set market, and supplies a complete advertising and merchandising package to help you make more profits.

only TRADIOVISION

gives you a compact, complete single unit mobile receiver, especially designed for commercial locations, with a life-like and life-size 4 ft. by 3 ft. picture. It can be moved anywhere and faced in any direction. Cabinet measures 71¼" high; 54" wide; 29½" deep.

only TRADIOVISION

gives you a 2 year guarantee against any changes in frequencies, or color transmission. Conversions will be made ABSOLUTELY FREE OF CHARGE.

only TRADIOVISION

remote control unit provides for video control from any distance and contains an accessory speaker plus FM reception.

only TRADIOVISION

utilizes unique plug-in unit assembly that permits rapid servicing and guarantees against obsolescence.



Console width
4 feet x 3 feet picture
List price \$1695.

Console width
3 feet x 2¼ feet
picture
List price \$1495.



Remote Control Unit
with FM tuner
Dimensions
H. 12½"—W. 14"—D. 19"

AGGRESSIVE DEALERS—

If you're interested in the TRADIOVISION Franchise, which protects you on profits and offers unlimited business opportunities, contact us by letter, wire or phone, or fill out and mail the coupon below.

TRAD TELEVISION CORP. Send full details of the
 377 4th Ave., New York 16, N. Y. **TRADIOVISION franchise.**

Name

Street Address

City Zone State

TRAD

TELEVISION CORP.

1001 First Avenue, Asbury Park, N. J., ASbury 2-7447

New York Office and Showrooms

377 Fourth Avenue MUrray Hill 3-9757

Terrific Volume for you

IN THE NEW
Trans-Vue
CINÉ TELEVISION LINE!



Ciné 90XFM—Trans-Vue table console television set with 90 square inch direct view screen on 12½ inch tube...FM radio, long range reception. Complete with matching "Unilock" table.



Trans-Vue Ciné 145 Console—compact 30 tube unit features world's largest screen...145 square inches of direct view telepicture on 15" Dumont tube. FM and AM radio, phonograph adaptation.



Ciné 90X - incorporates all of the features of the Ciné 90XFM but designed for televiewing exclusively.

Now...Trans-Vue, makers of the first commercial television systems... take pride in introducing the new Ciné line... the finest in home television receivers. The Ciné line incorporates all of the superior television and engineering features that have made the Trans-Vue name synonymous with quality and value in the field of commercial television.

These Trans-Vue home sets mean bigger sales, bigger profits for YOU, because:

Trans-Vue gives your customers the best in television at a moderate cost. Trans-Vue offers the finest standard circuitry, the finest engineering, the finest designing... plus:

- THE LARGEST EXPANDED DIRECT VIEW SCREEN!
- FAST AND ACCURATE 4-KNOB TUNING!
- FAMED, ACCURATE, SIMPLE "INSTANTUNER"!
- CRYSTAL-CLEAR LOCAL AND FRINGE AREA RECEPTION!
- FLICKER-FREE TELEPICTURES!
- SUPERB CABINET DESIGN BY PIERRE RENAULT!
- BEAUTIFUL BLONDE AND RICH MAHOGANY FINISHES!

Don't pass up the terrific sales and profit possibilities in the new Trans-Vue Ciné Television line... Write Today!

Investigate The Trans-Vue Inventory Insurance Policy!

Some Territories Still Available For Distributorship

WRITE...WIRE...OR PHONE

Trans-Vue

CORP.
1139-41 S. WABASH AVE.
CHICAGO 5, ILLINOIS

An RCA Merchandising First...



You GIVE AWAY this toy truck with every RCA-VS022T Farm Pack

Each standard-size RCA Farm Pack is now shipped in a container that any child can easily assemble into a handsome and serviceable toy truck.

All the details children look for are there... head-lights, fenders, bumpers, license plates—wheels that fold out of the bottom! Solid lines indicate where to cut—dotted lines where to fold. It's as simple as that!

This toy truck makes the RCA-VS022T Farm Pack a doubly attractive package for the whole family. And, without additional cost!

Order a generous supply of RCA-VS022T's from your nearest RCA Battery Distributor today. The RCA Toy Truck presents a sales opportunity you can't afford to pass up!



And another RCA First in Counter Merchandising...

the Carry Kit Package of eight RCA-VS036 sealed-in-steel "A" batteries that stimulates larger unit-of-sale purchases. Increase *your* share of the big portable "A" business by ordering an ample supply today.

ALWAYS KEEP IN TOUCH WITH YOUR RCA DISTRIBUTOR



RADIO CORPORATION of AMERICA

HARRISON, N. J.

GUARANTEED PROFITS!

THE HENRY PARKS . . . 16" tube CONSOLE, STARRETT OPTICLEAR \$399.95



ONLY STARRETT GIVES YOU ALL THIS! THERE'S A STARRETT OPTICLEAR TELEVISION SET IN EVERY PRICE RANGE . . . AND EVERY ONE 'WAY OUT IN FRONT OF COMPETITION!

the great new popular-priced METROPOLITAN SERIES WITH SENSATIONAL BUILT-IN ANTENNA \$249.95 to \$495.00

the superb decorator-cabinet CUSTOM SERIES \$459 to \$1295

Federal excise tax extra



THE NATHAN HALE . . . 12 1/2" tube TABLE MODEL, STARRETT OPTICLEAR \$249.95

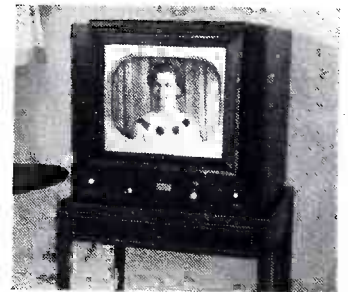

THE HENRY HUDSON . . . 16" tube TABLE MODEL, STARRETT OPTICLEAR \$349.95

with the only scientifically FILM FREED* PICTURE TUBE! making STARRETT America's TOP QUALITY LINE, bar none!

Starrett Opticlear TELEVISION



THE KING ARTHUR . . . 20" tube Club Model, AM-FM radio. \$795.00

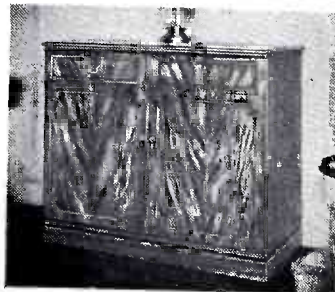

THE LINCOLN . . . 16" tube CONSOLE, AM-FM radio; 3-speed AUTOMATIC record changer. \$1095.00

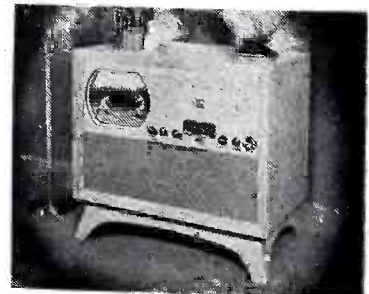

THE JACKSON . . . 16" tube CONSOLE, AM-FM radio. \$695.00

Patents Pending

STARRETT TELEVISION CORPORATION

PROFITS GUARANTEED!

ONLY *Starrett*  Opticlear

GIVES SO MUCH PROFIT PROTECTION!

All list and net prices guaranteed up to December 1st!
Full credit on all sets inventoried on your floor should we find it to your benefit to lower prices before December plus full guaranteed 30 days notice of any price change after December 1st.



THE JEFFERSON . . . 12 1/2" tube CON- \$39800
SOLE, STARRETT OPTICLEAR



THE ADAMS . . . 12 1/2" tube CONSOLE, \$49500
AM-FM radio; 3-speed AUTOMATIC record changer.



THE COSMOPOLITAN . . . 16" Break- \$129500
front, AM-FM radio; 3-speed AUTOMATIC record changer.

THE GOTHAM . . . same without breakfront . . . \$1095

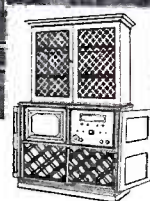

STARRETT OPTICLEAR TELEVISION: housed in the world's most distinguished designer-cabinets; crafted of the finest imported and domestic woods; finished and detailed for enduring beauty.

Discounts up to 40%

EXCLUSIVE STARRETT FRANCHISE DEALERS GET THE LARGEST PROFIT SET-UP IN THE UNITED STATES. YOUR STARRETT FRANCHISE MEANS PROTECTED PROFITS AND **NO COMPETITION** IN YOUR AREA

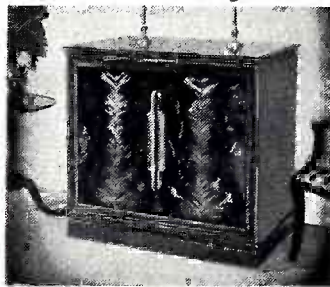

THE CLEVELAND . . . 16" CONSOLE, \$89500
AM-FM radio; 3-speed AUTOMATIC record changer.

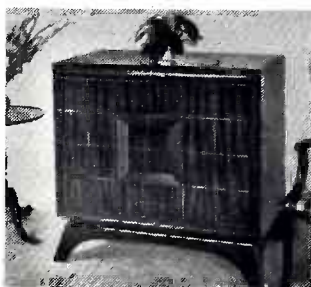

THE JOHN HANCOCK . . . 16" CON- \$79500
SOLE, AM-FM radio; 3-speed AUTOMATIC record changer.

601 W. 26th St. • New York 1, N. Y.

BE FIRST IN YOUR AREA! SEND THIS COUPON NOW!

STARRETT TELEVISION CORPORATION
601 West 26th Street, New York 1, N.Y.

PLEASE RUSH ME COMPLETE DETAILS OF YOUR FRANCHISE-DEALER SET UP. I am attaching our Company letterhead to this request.

NAME _____

ADDRESS _____

COMPANY NAME _____

if you know what's in this book

and pass the information
on to your customers...



we'll all benefit!

- ★ **YOU...Customer Satisfaction
More Sales**
- ★ **YOUR CUSTOMERS...
Better TV Pictures**
- ★ **WE...Your Good Will --
More Sales**



The prospective TV-set owner is interested primarily in the PICTURE HE WILL SEE. And you are interested primarily in being sure he gets the maximum enjoyment out of his set.

But to sell effectively, you must know the right answer to every question about TV sets *AND MORE BESIDES*. The Sales Manual, "Sell a TV PICTURE", is one of the most important guides available for selling TV. **YOU CAN'T AFFORD NOT TO READ AND STUDY IT.** Do you know, for example, that it has been proved time after time that "an inferior set with a good antenna will outperform a better set with a poor antenna"?

This 16-page book was especially planned for those TV dealers who want to become more familiar with the factors of importance in producing the best picture.

"Sell a TV PICTURE" gives power-packed selling information... exact, scientific data in easily understood terms... that will help you help your customers.

Written and prepared by radio-electronic experts, the manual is a new approach to TV picture selling and all information contained therein is backed by results from laboratory and field tests.

Write for your free copy.

★ **SELL A TV PICTURE FOR CUSTOMER SATISFACTION**
SELL

AMPHENOL - IN LINE - ANTENNAS

AMERICAN PHENOLIC CORPORATION
1830 SO. 54TH AVENUE • CHICAGO 50, ILLINOIS

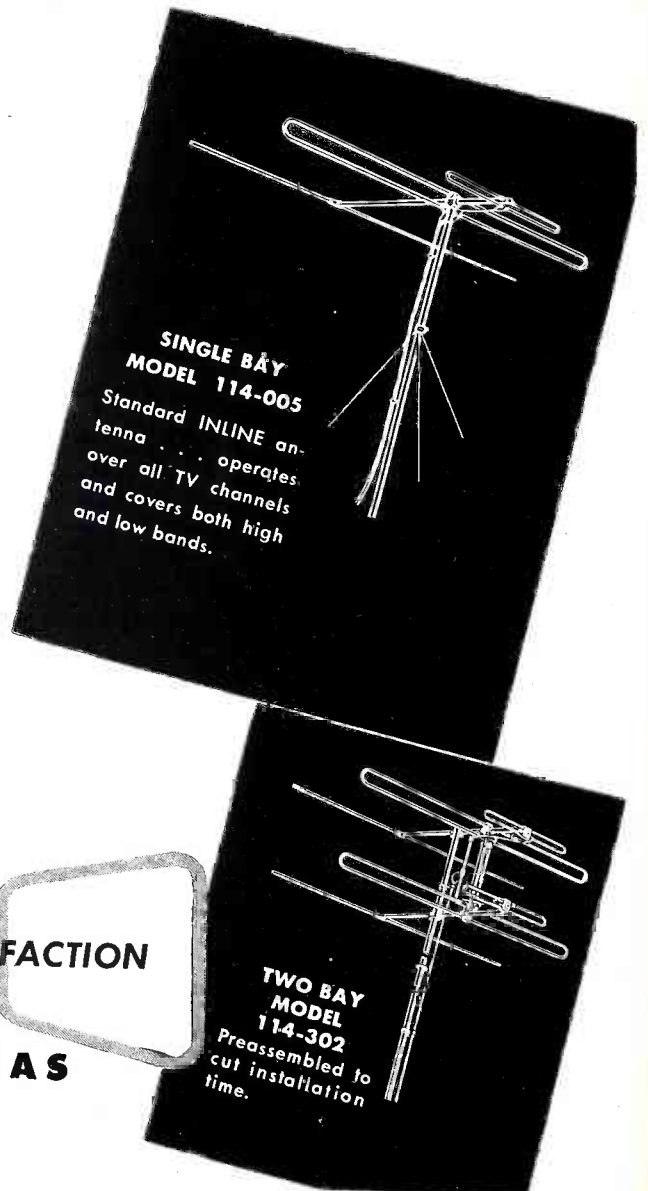

RAYTHEON ANNOUNCES

A NEW FRANCHISE POLICY!

Providing Complete Price Protection

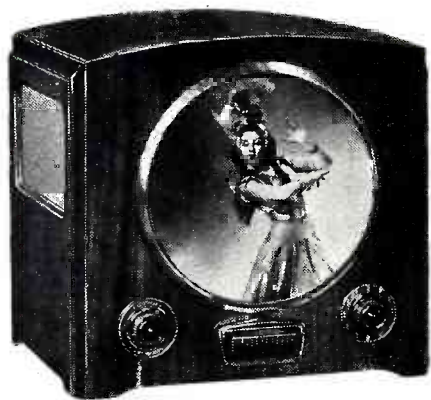

Model M-1101 12½" Mantel Set 115 volts, AC only

Effective with the announcement of the new 1950 Television Line, Raytheon inaugurates a new Price Protection Policy; to help stabilize the market, eliminate indiscriminate price cutting and protect Raytheon franchised distributors and dealers against changes in list prices. In PRICE . . . in PERFORMANCE . . . in STYLING . . . the complete new Raytheon line of 10-inch, 12-inch, and 16-inch Television Receivers will set the pace in 1950.

Write or wire today for complete details on the Raytheon Franchise and the new Price Protection Policy.

RAYTHEON

20/20 teleVISION

WITH THE *Super Circle Screen*

BELMONT RADIO CORPORATION *Subsidiary of Raytheon Manufacturing Corporation* 5921 W. Dickens Dept. 100 Chicago 39, Ill.

RADIO & TELEVISION RETAILING • September, 1949

more "Dynamite" from

2

NEW TELEVISION SENSATIONS FROM ADMIRAL
SUPERCHARGED WITH SELLING POWER

BIG 16"

TELEVISION CONSOLE

WITH NEW INSIDE ANTENNA INCLUDED!

REVOLUTIONARY NEW SUPERPOWERED CHASSIS

AUTOMATIC GAIN CONTROL... SIMPLIFIED TUNING

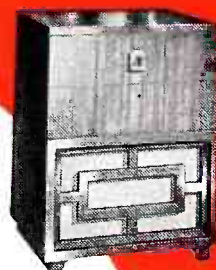

*Prices slightly higher in south and west. Subject to change without notice.

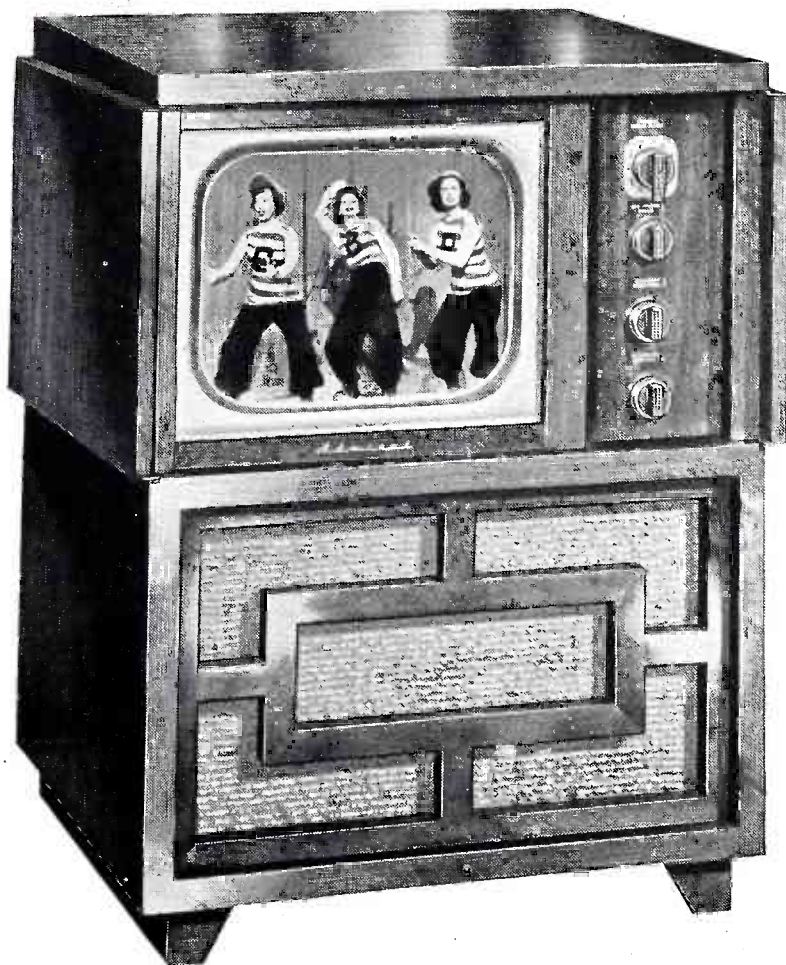

25A15—WALNUT—FED. TAX EXTRA

*
\$ **399**⁹⁵

Here's one more reason for you to tie to Admiral for profit-making television. This new Admiral super-value puts you right on top of the big-picture market with a stunningly beautiful, 16" tube television console that retails for less than many consoles with 12½" tube. Note these features. There's only space for a few: Pictures clear as the movies, free from flutter or "breathing." New, superpowered chassis. Split-second station selector with perfect pictures and FM sound every turn of the knob. Smart cabinet styling. Rugged construction. Costly, hand-rubbed veneer finishes. Yes, this new Admiral model is one more overwhelming value that makes Admiral your best television bet. Get it on your floor without delay. Admiral Corp., Chicago 47.

SEE! HEAR! ON TELEVISION! SPONSORED BY ADMIRAL!
"STOP THE MUSIC," ABC NETWORK, THURSDAYS, 8 PM, EDT

Admiral

BIG 12½"

TELEVISION COMBINATION

IT'S ADMIRAL'S FAMOUS THREE-FOOT HOME THEATER... THE COMBINATION THAT HAS BEEN THE TALK OF THE INDUSTRY... NOW WITH BIG 12½" FULL VISION SCREEN AT NO INCREASE IN PRICE



30F15—WALNUT—FED. TAX EXTRA

*
\$399⁹⁵

Admiral sells more than 50% of all television combinations. Now watch that percentage shoot even higher with this great, new value. It's Admiral's amazing, NEW Three-Foot Theater, with Magic Mirror Television, Dynamic FM-AM Radio and Triple-Play Phonograph. You know what a "seller" Admiral's Three-Foot Theater was with a 10" tube. Now it has a 12½" tube... new super-powered chassis... new inside antenna included... full vision screen... automatic gain control... split-second station selector. But no change in price. Still \$399.95. That's what Admiral's engineering and manufacturing skill have done for you and your customer. Stock this value-sensation at once. Get your share of television-combination sales.

REVOLUTIONARY, NEW CHASSIS
Outperforms Any Set, Anywhere, Any Time

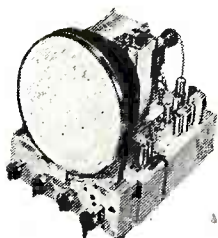

A great stride forward in television engineering. Pictures clear as the movies, free from flutter and "breathing," even in outlying areas where ordinary sets fail. Tunes easy as a radio. Unique "automatic gain control" reduces station selection to a single knob.

4 SURE WINNERS

*for the 1949
Children's Market*



Hear them—sell them to your best “children” customers—Watch the repeat sales roll in—

STAMPEDE

Gene Autry and supporting cast with orchestra conducted by Carl Cottner. Story by Henry Walsh and Peter Steele; Music by Ellstein.

Set MJV-55 2-10" RECORDS

SLUGGER AT THE BAT

(Story by Peter Lyon and Peter Steele)

(Music by Morris Surdin)

(Produced by Hecky Krasno)

Jackie Robinson and Pee Wee Reese with supporting cast. Carl Frank, Narrator.

Set MJV-57 2-10" RECORDS

CHUMMY (The Records That Play With You)

Peter Donald

Set MJV-58 2-10" RECORDS

RUDOLF, THE RED-NOSED REINDEER

Gene Autry and The Pinafores

IF IT DOESN'T SNOW ON CHRISTMAS

Gene Autry



Set MJV-56 1-10" RECORD

These All-Time Children's Favorites Now Available on (LP) for greater sales opportunity

- | | |
|---|--------------------------|
| Nursery Songs | JL 8001 (MJV-26, MJV-49) |
| Many Moons—The Eager Piano | JL 8002 (MJV-46, MJV-43) |
| Goldilocks and the Three Bears—The Gingerbread Boy | JL 8003 (MJV-36, MJV-37) |
| Rhumpy The Rhino—Kankie And The Concertina | JL 8004 (MJV-47, MJV-39) |
| Pancho Goes To A Fiesta—Come To The Circus | JL 8005 (MJV-48, MJV-44) |
| Little Black Sambo—Little Red Riding Hood | JL 8006 (MJV-28, MJV-35) |
| The Pied Piper Of Hamelin—The Shoemaker and the Elves | JL 8007 (MJV-34, MJV-29) |
| Peter Rabbit—Songs From When We Were Very Young | JL 8008 (MJV-30, MJV-42) |
| Hansel & Gretel | ML 2055 (MM-632) |
| Robin Hood | ML 2063 (MM-583) |
| Peter and the Wolf—Treasure Island | ML 4038 (MM-477, MM-553) |
| Sinbad, The Sailor—Oliver Twist | ML 4072 (MM-767, MM-700) |
| Dickens: Christmas Carol | ML 4081 (MM-521) |
| The Comedians | ML 4083 (MX-295) |
| I Can Hear It Now | ML 4095 (MM-800) |
| Alice In Wonderland | ML 4148 (MM-713) |
| You Are There | ML 4149 (MM-822, MM-823) |
| Nutcracker Suite | ML 4151 (MM-714) |
| The Three Musketeers | ML 4162 (MM-659) |
| Young Person's Guide To The Orchestra | ML 4197 (MM-703) |

FOR THE FINEST RECORDED MUSIC OF EVERY KIND

COLUMBIA RECORDS

"Columbia" and  Trade-Marks Reg. U. S. Pat. Off. Marcas Registradas  Trade-Mark

RECORDS

Section of **RADIO & TELEVISION RETAILING**

Disc Hits for Early Autumn

"DANCES NOT FOR DANCING," *The First Piano Quartet*. RCA Victor (available on 78 and 45 rpm)

Ample listening pleasure in the eight-handed arrangements of favorites such as Weber's "Invitation to the Dance"; "Dance of the Toy Pipes" from Tchaikovsky's "Nutcracker Suite"; Boccherini's "Minuet"; and other dances by Gliere, Smetana, Milhaud, Handel, Chopin, Gluck and Rossini.

"FOUR INTERMEZZI," Dimitri Mitropoulos conducting the Robin Hood Dell Orchestra of Philadelphia. Columbia MX-317; ML 2053 (With Menotti: Sebastian "Ballet Suite") Intermezzi from "The Jewels of the Madonna," "Manon Lescaut" and "Cavalleria Rusticana" make up a memorable and unusual album.

MOZART: "Quartet No. 15 in D Minor," *Hungarian String Quartet*. RCA Victor (available on 78 and 45 rpm)

Recording made in England, this chamber music gets a noteworthy release in this country.

"MUSIC OF CHOPIN," Andre Kostelanetz and his orchestra. Columbia MM-840; ML 2056

Eight of Chopin's more popular works as interpreted in the Kostelanetz manner.

"TRIANA"—"DANCE OF THE BUFFOONS," *Boston Pops Orchestra*, Arthur Fiedler, conductor. RCA Victor (Available on 78 and 45 rpm)

"Triana" from "Iberia", Book II, by Albeniz, and the "Dance of the Buffoons," from Rimsky-Korsakoff's "Sne-gurochka," a popular Red Seal.

GIGLI, BENIAMINO: "Di Quella Pira" from "Il Trovatore"—"Amor Ti Vieta," from "Fedora." RCA Victor (available on 78 and 45 rpm)

Tenor Beniamino Gigli's recordings are continually welcome by collectors . . . availability on unbreakable, better fidelity recording. A new feature.

PINZA, EZIO: "Introductory Chorus and Cavatina from 'Norma'" Columbia 72826-D; 3-229

Popular aria from "Norma" as performed by the increasingly popular

Mr. Pinza, bound to be a big draw. Available on both shellac and 7-inch LP disc.

"SONGS OF THE DEFENDERS OF ISRAEL," *Israel Music Foundation*

Unbreakable Vinylite album presents six songs in the spirit of the pioneer soldiers of Israel. Titles include "Haganah March," "The Oath," "Palmach," "Anachnu," "Tel Chay," "Moledet."

ALLEN, ROSALIE: "Square Dance Polka"—"Yodeling Bird" RCA Victor 48-0068; 21-0072

"Square Dance" complete with sound effects, crowd murmurs and dancing rhythms; reverse spots Rosalie doing some top yodeling bits, interspersed with bird whistles.

AMES BROTHERS: "Lingering Down the Lane"—"Still Waters and Green Pastures" Coral 60091; "Noah's Ark"—"Tears of Happiness" Coral 60092

These two new Ames Bros. platters give listeners four distinctive type tunes, and give the quartet a unique opportunity to demonstrate their versatility on everything from an "authentic" negro spiritual and a Western ballad to a pop favorite.

ANDREWS SISTERS: "I Can Dream, Can't I?"—"Wedding of Lili Marlene" Decca 24705

"I Can Dream" presentation, assisted by Gordon Jenkins and orchestra, is really going places. Patti Andrews does a solo turn that should have the fans asking for more.

CROSBY, BING: "Katrina"—"Headless Horsemen" Decca 24702; "Ichabod"—"It's More Fun than a Picnic" Decca 24703

First three tunes are from new Walt Disney film, "Ichabod and Mr. Toad," which Bing narrates. "Picnic" from musical "As the Girls Go". Four sides wonderful for children.

DAY, DORIS: "It's a Great Feeling"—"At the Cafe Rendezvous" Columbia 38517; 1-264

Both of these songs sung by Doris in her new film, "It's a Great Feeling." "Cafe Rendezvous," a cute tune, features a French accent.

DESMOND, JOHNNY: "The Wedding of Lili Marlene"—"Let Me Grow

Old with You" MGM 10499

"Lili Marlene" number currently riding high on English Hit Parade—American audiences should go for this tune as well; Desmond's rendition tops. Coupling is easy listening.

ECKSTINE, BILLY: "Solitude"—"I Do, Do You?" National 9086

For Eckstine fans two more tunes they can stash away in their collections—and call "great."

ELLINGTON, DUKE: "Take Love Easy"—"I Could Get a Man" Columbia 38519; 1-266

Both sides in easy dance tempo, with blues touch . . . features outstanding sax and trumpet solos.

FARRELL, BILL: "Through a Long and Sleepless Night"—"Circus" MGM 10488

The label is going all-out for Bill Farrell—its newest baritone discovery. "Sleepless Night" from film "Come to the Stable" an outstanding ballad that provides the young singer with an excellent opportunity to show what he can do—and he does it.

GILLESPIE, DIZZY: "That Old Black Magic"—"Jump Did-Le Ba" RCA Victor 47-2940; 20-3481

Bongo rhythms do something for "Black Magic" tune with Johnny Hartman doing the ballad straight; reverse is in the familiar Gillespie bop manner.

IVES, BURL: "The Return of the Way-faring Stranger" C-186; CL 6058

"On Springfield Mountain," "Little Mohee," "Lord Randall," "Bonnie Wee Lassie" and "The Devil and the Farmer" among nine of the wonderful songs included in this album.

KAYE, SAMMY: "Fiddle Dee Dee"—"It's a Great Feeling" RCA Victor 47-2942; 20-3483

Following up his "Four Winds" hit platter, Kaye offers these bouncy novelties from film "It's a Great Feeling" for another happy pairing.

LAWRENCE, BILL: "All Year 'Round"—"I'll Keep the Lovelight Burning" RCA Victor 47-2948; 20-2948

(Continued on page 74)

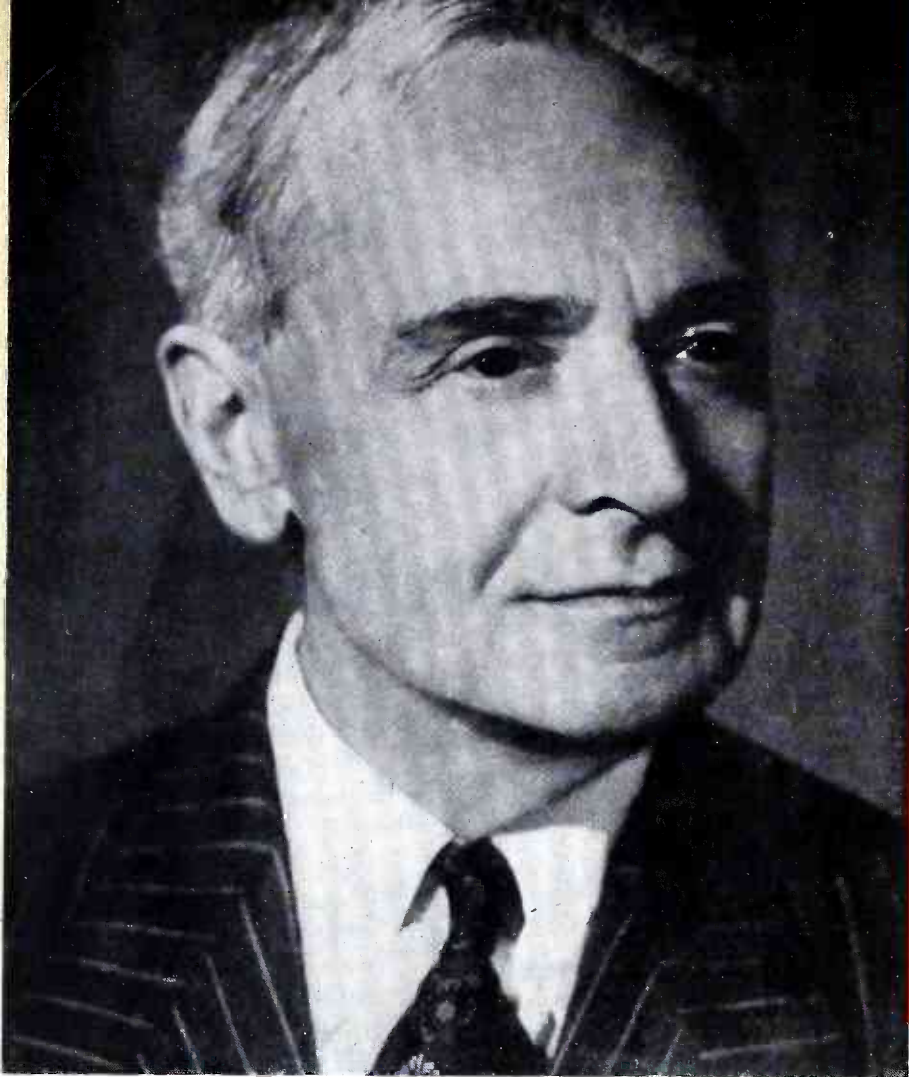

Serge Koussevitzky has recorded for RCA Victor additional favorites as performed by him and the Boston Symphony at the Berkshire Music Festival.

Disc Hits for Early Autumn

Customers Finding More Selections on New Speeds

Several Pop Tunes Shaping Up Into Big Sellers

(Continued from page 75)

The young crooner has been getting good build-up, via air shows and personal exploitation. His sensitive delivery appealing.

LEE, PEGGY: "Neon Signs"—"Through a Long and Sleepless Night" Capitol 57-703

Decca has great hopes for this collection from the new Jolson film.

A Collection of Songs featured in the Columbia Technicolor Production

DECCA RECORDS

"JOLSON SINGS AGAIN"

PRETTY BABY - I'M TALKING OVER A FOUR LEAF CLOVER
 BABY FACE - GIVE MY REGARDS TO BROADWAY - I'M JUST WILD ABOUT MARY
 I ONLY HAVE EYES FOR YOU - AS BY THE WAY WHAT THEY SAY ABOUT DIXIE
 with MORRIS STOLOFF and His Orchestra
 AFTER YOU'VE GONE
 with BETTY MALONE and His Orchestra
 EPHRAIM
 DECCA ALBUM No. A-716

Paul Weston is music director for Capitol Records, and a good "sales puller" for the label.



"Neon Signs" a Western-flavored square-dance type novelty; "Sleepless Night" from film, "Come to the Stable."

LOMBARDO, GUY: "Hop Scotch Polka"—"Dangerous Dan McGrew" Decca 24704

Kenny Gardiner does both vocals—with good results. "Polka" side "Scotch Hop" good listening.

MacRAE, GORDON: "A Kiss In the Dark"—"Body and Soul" Capitol 57-704

"Kiss" nostalgic number from film, "Look for the Silver Lining" in which singer is starred; "Body and Soul" a re-release for which there has been great demand.

"MADAME BOVARY," composed and conducted by Miklos Rosza, with the MGM Studio Orchestra. MGM 43

Background music from film starring Jennifer Jones, James Mason and Louis Jourdan presented as a suite of five contrasted sections . . . "Waltz, Part 1 and 2," "Prelude," "Romance," "Torment," "Passepied."

MARTIN, FREDDY: "Roseanna"—"A Sunday Out in the Country" RCA Victor 47-2943; 20-3484

Some pleasant song stylings featured on both sides. Merv Griffin and Martin Men take the vocals.

MARTIN, TONY: "Circus"—"No, No and No" RCA Victor 47-2947; 20-3488

"Circus" a dramatic ballad with deep overtones. Martin does a superlative job of song-selling in this unusual rendition. "No, No," a tango tempo serenade.

MONROE, VAUGHN: "Someday"—"And It Still Goes" RCA Victor 47-2987; 20-3510

"Someday" not a new tune—but the Monroe delivery gives it a new pace; Vaughn does the vocal on the flip, with full band backing.

MOONEY, ART: "Wouldn't It Be Fun"—"Hop-Scotch Polka" MGM 10500 "Fun" side heralded by label as a



Rise Stevens and Dennis Morgan relax during a lull in rehearsals for their forthcoming Columbia album, "The Merry Widow," available on shellac and LP.

runner-up to "Four Leaf Clover" . . . the number is an oldie given bouncing Mooney treatment. The flip has a bright polka beat and punch.

THORNHILL, CLAUDE: "On the 5:45"—"Who Do You Know in Heaven" RCA Victor 47-2978; 20-3506

Tinkling train tune, "5:45" spots Russ McIntyre and Nancy Clayton dueting on board the "commuters' special." "Heaven" flip, has some nice Thornhill ivory work; Russ McIntyre singing the romantic lyrics.

VENTURA, CHARLIE: "F. Y. I."—"A.M.—P.M. Song" National 9087

"FYI" (For Your Information) side features Bennie Green on the trombone with Jackie Cain and Roy Kral doing the bop vocal; reverse is a Ventura oldie—that is still way out in front in the bop field

WARREN, FRAN: "Now that I Need You"—"There's No Getting Away from You" RCA Victor 47-294; 20-3482

"Need You" from film, "Red Hot and Blue"; blues ballad right up Miss Warren's alley and she delivers it with a wallop. Coupling from musical "As the Girls Go" in which the thrush had a leading role.

Kenny Roberts' "I Never See Maggie Alone" a Coral hit.



Mercury's Kitty Kallen does "Milwaukee" on current release.



Look for Bill Farrell, new MGM artist, to ring up big sales.



3 GREAT NEW TITONES

meet changing pickup needs!

NOW a full line of Titone's amazing ceramic pick ups—made by famous Sonotone! All with these great basic features: Full frequency (response from 50 to 10,000 cycles.) Bell-like supertone makes new or old players thrilling. Climate-proof, moisture-proof, fungus-proof! Lightest pressure saves needle wear, revives worn records. NO needle talk! NO crystals, magnets, filaments to fail. NO pre-amplifiers. Performs perfectly for years!

3 NEWEST! TITONE MICROGROOVE PICKUP

For all 45 and 33 1/3 rpm players. Highest compliance and 5 to 6 grams needle pressure give minimum wear on record and needle! Aluminum case—1-mil permanent sapphire needle.

Order # W 7530 \$7.95 list

2 NEWER! TITONE 3-MIL PICKUP

New superlight aluminum pickup complements famous original Titone pickup below. 15 grams needle pressure gives unparalleled reproduction, lowest wear!

Order # W 7540 \$7.95 list

1 NEW! ORIGINAL CERAMIC TITONE

Within a few scant months in widest use from coast to coast! Plays at 20 grams needle pressure. Used instead of the newer aluminum Titone above for changers requiring over 15 grams pressure to "flip" records.

Order # 7500 \$7.50 list

NO TONE LIKE TITONE



Call your Jobber or write to SONOTONE, Box 5, Elmsford, N. Y.

ASTATIC CARTRIDGE UTILITY KITS

WIN APPLAUSE

for valuable help in Selling, Servicing, Maintaining Inventories

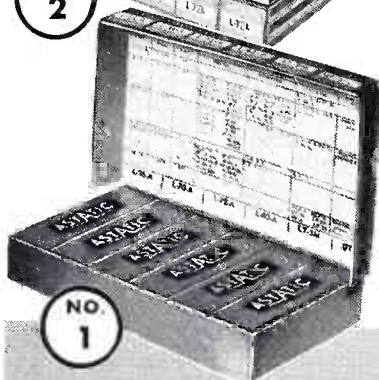
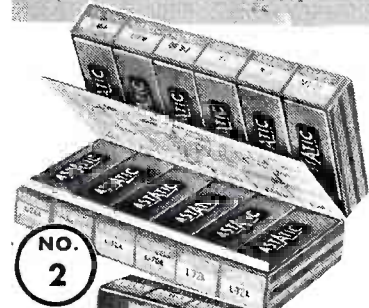
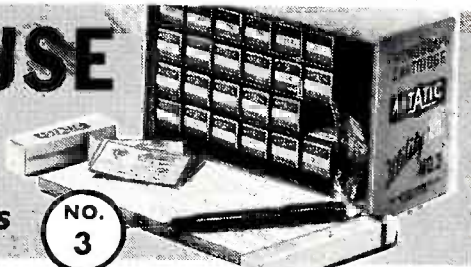

Astatic Crystal Devices manufactured under Brush Development Co. patents

JOBBERS, dealers, servicemen alike—all have been enthusiastic in their praise for the valuable aid and extras offered in Astatic's three new cartridge kits. It's the handy, economical way to buy the fastest selling types of Astatic Cartridges and needles . . . the kits and extras are yours at no additional cost. They provide compact, orderly containers for cartridges on or off your shelves. Accompanying cartridge replacement charts offer on-the-spot technical information, other details. Labeling of individual compartments as well as each cartridge box that fits into them makes maintenance of balanced inventory a simple procedure. Other extras thrown in with the handsome, wood No. 3 Kit, for example, include a pen-size needle pressure scale; an assortment of cartridge mounting screws, needle screws and terminal clips. These are only part of the advantages—it will pay you to investigate further. Why not write for complete descriptions and details on these important new contributions to the cartridge trade?



33 3 7 12 45 78 10

RIGHT FOR EVERY RECORD

The V-M "100" Record Player

The V-M Model "100" plays all records, all sizes, all speeds—with all the original beauty of the music faithfully reproduced.

The Model "100" plugs into any AC outlet. It has its own amplifying system, tone and volume controls, a Dual-Needle Reversible Cartridge. A special adapter is furnished for large-center-hole records.

Get full details today on the new V-M "100" from your local distributor.



BENTON HARBOR, MICHIGAN

Record News Notes

The Board of Directors of the NATIONAL ASSOCIATION OF MUSIC MERCHANTS re-elected Hugh W. Randall president, and Ray S. Erlandson, vice-president of the association. Newly elected were Harry E. Callaway, treasurer, and Emert S. Rice, secretary. The new Board members are: Earl Campbell; Thomas Dahl; Otto B. Heaton; Louis G. LaMair; Paul E. Murphy; William H. Schmoller; Clay Sherman; Claude P. Street; and Carl Wittich.

WALCO PRODUCTS, INC., East Orange, N. J., has announced a static eliminating product designed to end the problem of static electricity in Vinylite records. It is a liquid which, when applied to record surfaces, creates a condition in the record which causes it to discharge any inherent static electricity so that it will no longer attract dust particles. Retail price is \$1.00 for a one-ounce bottle.

Future recordings of the ISRAEL MUSIC FOUNDATION will be produced in the Long Playing 33 1/3 rpm type, as well as the standard speed variety, it was announced by Oliver Sabin, the Foundation's record adviser. Scheduled for early release by the Foundation are two new albums, "Songs of Hope" and "Israel Folk Dances." All are recorded in Israel and pressed in the United States on unbreakable Vinylite.

More OF THE WORLD'S GREATEST ARTISTS ARE ON 45 RPM

Here is RCA Victor's big October Red Seal release!
All on conventional 78 rpm records too!

Licia ALBANESE

Amarilli—Caccini; Se Florindo e Fedele—Scarlatti;
Oh! Quand Je Dors—Liszt; Clair de Lune, Op. 83,
No. 1—Szulc; Lullaby, Op. 16, No. 1—Tchaikovsky;
A Spirit Flower—Campbell-Tipton. MO-1316, \$4.00.
WMO-1316 (45 rpm) \$3.35.

Alexander BRAILOWSKY

Concerto No. 1, In E Minor, Op. 11—Chopin. RCA
Victor Symphony Orchestra, William Steinberg, Cond.
DM-1317, \$6.00. WDM-1317 (45 rpm) \$4.30.

Arthur FIEDLER

Boston Pops Orchestra: Sleigh Ride, Serenata—
Anderson. 10-1484, \$1.00. 49-0515 (45 rpm) 95¢.
Jalousie (Jealousy)—Gade; Ritual Fire Dance—Falla.
12-0977, \$1.25. 49-0526 (45 rpm) 95¢.

Serge KOUSSEVITZKY

Boston Symphony Orchestra: Symphony No. 4, In
F Minor, Op. 36; Final Side: Waltz from Serenade in
C, Op. 48—Tchaikovsky. DM-1318, \$7.25. WDM-1318
(45 rpm) \$5.25.

Nathan MILSTEIN

Concerto In A Minor, Op. 82; Final Side: Meditation,
Op. 32—Glazounoff. RCA Victor Symphony Orchestra,
William Steinberg, Cond. DM-1315, \$4.75. WDM-1315
(45 rpm) \$3.35.

Pierre MONTEUX

San Francisco Symphony Orchestra: Le Roi Malgré
Luis, Act II Fête Polonoise—Chabrier. 12-0978, \$1.25.
49-0517 (45 rpm) 95¢.

Robert SHAW

Conducting the RCA Victor Chorale: Onward
Christian Soldiers. Onward, Christian Soldiers; Holy,
Holy, Holy; O God, Our Help In Ages Past; All
Creatures Of Our God And King; All People That
On Earth Do Dwell; Now The Day Is Over. MO-1314,
\$4.00. WMO-1314 (45 rpm) \$3.35.

Blanche THEBOM

Melancolie—Chopin; Love In The Dictionary—
Dougherty. William Hughes at the Piano. 10-1485,
\$1.00. 49-0516 (45 rpm) 95¢.

Special Re-issue!

Gems From Jerome Kern's Musical Shows! (conventional records only)

VERY GOOD EDDIE

Isn't It Great To Be Married
Some Sort of Somebody
On The Shore Of Le Lei Wi
Babes In The Wood

MUSIC IN THE AIR

I've Told Every Little Star
One More Dance
The Song Is You
When Spring Is In The Air

SALLY

Wild Rose
Whippoorwill
Look For The Silver Lining

ROBERTA

The Touch of Your Hand
Yesterdays
Smoke Gets In Your Eyes

LEAVE IT TO JANE

Leave It To Jane
Siren's Song
What I'm Longing To Say
The Sun Shines Brighter
The Crickets are Calling

CAT AND THE FIDDLE

The Night Was Made For Love
She Didn't Say Yes
One Moment Alone
Try To Forget

OH BOY

A Pal Like You
Nesting Time In Flatbush
An Old Fashioned Wife
Till The Clouds Go By

THE GIRL FROM UTAH

Why Don't They Dance
The Polka Anymore
The Land of Let's Pretend
Same Sort of Girl
They Didn't Believe Me

MEDLEY OF HITS

Who (from "Sunny")
Left Alone Again Blues
(from "The Night Boat")
Ka-Lu-A
(from "Good Morning Dearie")
Sunny (from "Sunny")

SWEET ADELINE

'Twas Not So Long Ago
Here Am I
Why Was I Born
Don't Ever Leave Me

SHOW BOAT (Part 1)

Make Believe
You Are Love
Misery Motive
Can't Help Lovin' Dat Man

SHOW BOAT (Part 2)

Why Do I Love You
Bill
O' Man River

RCA Victor Light Opera Company
Leonard Joy, Conductor.
Album CO-31, \$8.50.

All prices are suggested list, subject
to change without notice, exclusive
of local taxes. Prices of single rec-
ords do not include Federal Excise
tax. DM albums also available in
manual sequence, \$1 extra.

The world's
greatest artists
are on

RCA VICTOR Records



It's Here, THE WEBSTER-CHICAGO MODEL 762



THIS **2** SPEED
PORTABLE PHONOGRAPH
plays both
33 $\frac{1}{3}$ AND 45 RPM
7-INCH RECORDS

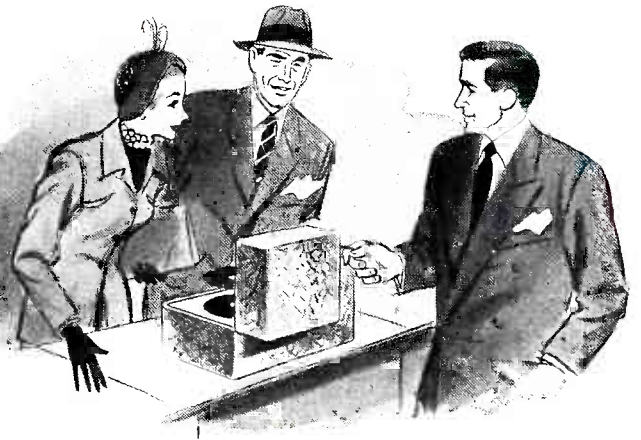

These Outstanding Features Make Model 762 Really Easy to Sell!

- Plays up to eight 33 $\frac{1}{3}$ or 45 rpm records automatically.
- 3-second change "cycle"—"from music to music" . . . fastest on the market.
- Velocity-Trip—no lateral pressure on delicate record grooves, assures quick, fool-proof record change—low record wear.
- Single Tone Arm—smooth controlled tone arm performance, properly balanced for either record.
- Needle matched to cartridge for superb tracking and better reproduction—5 to 7 gram needle pressure.
- Fool-proof spindle record release with ingenious rubber record retaining shoulder that will not damage the records.
- Positive, easily selected speed control.
- Reject mechanism features "Memory Delay"—positive acting, never fails.
- Attractive burgundy leatherette carrying case.
- Popularly priced—only \$48.95.
(West of the Rockies, \$49.95)

Cash In on the Back-to-School Market

Now . . . sales really come easy with this *new* Webster-Chicago Portable Two-Speed Phonograph. Plays 33 $\frac{1}{3}$ and 45 rpm records in the new 7-inch size.

It's especially popular with students—a market that offers plenty of sales potential. Besides, mothers and dads will find this new Portable Phonograph handy to own—as well as clubs, schools, churches, and everywhere there are records to be played.

It's appealing on FOUR big counts—performance, appearance, construction quality and price.

Your own enthusiasm for this new Webster-Chicago Model 762 Two-Speed Portable Phonograph will quickly lead you into extra sales, profits. Check with your distributor today . . . or write . . .



WEBSTER-CHICAGO



5610 WEST BLOOMINGDALE AVENUE • CHICAGO 39, ILLINOIS

ELECTRICAL APPLIANCES

Section of RADIO & TELEVISION RETAILING

Here's How to MAKE MORE REPLACEMENT SALES

Rich and Poor Alike, Too Many Householders Continue to Use Broken-Down Junk Because No Salesman Has Suggested Good Reasons for Buying Modern Appliances

• If dialogues, similar to the one which follows, take place in your store, it's time to determine to "qualify" the customer in order to up replacement sales volume:

Salesman: "Let me show you the latest refrigerator models, Mrs. Jones."

Customer: "Thanks, but it isn't necessary. I have a good refrigerator."

Salesman: "Oh, I see. Well, when you are in the market for a new one, we'll appreciate an opportunity to explain the features of our line."

The salesman in this instance certainly made no attempt to "qualify" the customer. He let the customer "qualify" herself.

Both salesman and customer went their respective ways in ignorance. The salesman had no idea whether the Jones family refrigerator was made in 1932 or 1949. If Mrs. Jones actually owned an out-of-date refrigerator, she was not given the opportunity to compare it with the new, gleaming models on the showroom floor. Did she know, for instance, that the new models would cost less to operate? That in buying a new refrigerator she would eliminate the possibility of costly repairs? Was she told that the 1949 jobs provided space for keeping frozen foods? That the current models provided more storage space, yet occupied less floor space? That they'd enhance the appearance of the kitchen, and are easier to operate—easier to keep clean, and noiseless?

No, she wasn't told any of these things, because when she said that she had a "good" refrigerator, the salesman took it for granted that she did, and let it go at that.

What the salesman must realize is that the customer's idea of "good" is

QUALIFY all customers to
FIND out who has those old
appliances
SELL customers reasons why
it's dollar-wise to replace
them

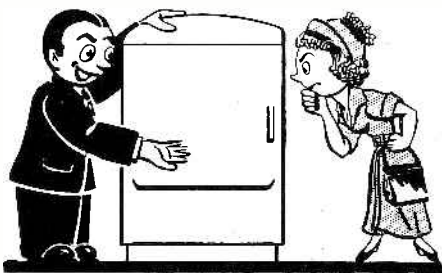

People will keep right on using old junk until some clever salesman shows them why such equipment should be replaced.

often on the fantastic side. To prove this, the salesman has but to visit the section of the store where the trade-ins are kept. Look at the 25-year-old hand-irons, the old-enough-to-vote radios, the straight-suction floor vacs of the John Held, Jr., era; the washers with the non-balloon type wringers; models that gladdened the heart of the housewife when Mr. Hoover was president!

Yes, look at the accumulation of trade-ins, and realize that *the bulk of such equipment is not in the stores of the dealers today, but is in the homes of American citizens.*

And we don't mean that most of such junk is in the homes of the low-income folk, either, because the wealthy resi-

dence is well represented when it comes to equipment badly in need of replacement.

It is obvious that the first step to take in meeting an objection to buy on the grounds that present equipment is operating satisfactorily is to get from the customer an approximate age of the appliances in use. Armed with such information, the salesman can create the desire to replace old products by comparing them with the new ones, stressing economy of operation, efficiency, and most important, justifying the expenditure in the customer's mind.

The salesman must know something about the age and condition of the appliance presently owned by the customer in order to do a good job of comparison selling. He must be able to convince the customer, and honestly so, that it is to the customer's advantage to get rid of inefficient appliances, replacing them with new ones.

Getting back to the homes of the more or less wealthy folk, those in which domestic servants are employed, salesmen often encounter refusals to buy modern equipment because the woman of the house cannot see reasons for giving servants new things to work with. No good salesman will overlook the opportunity to point out the *very definite advantages* of providing domestic servants with the very best tools to work with.

The home-owner, faced today with the very serious problem of keeping help, will certainly appreciate the fact that servants will be happier with modern appliances; that they will be able to turn out better work, and more of it with up-to-date equipment, and that the modernizing project will result in

(Continued on page 97)

Electrical Appliance

Universal CLEANERS

Two new motor driven brush cleaners announced. Shown is deluxe model 5708 cleaner—retails at \$59.95. Features: all steel frame motorhood; nozzle housing finished in two-toned combination of chrome, and baked blue enamel; blue twill bag



with gold lettering; Day-Glo headlight with gold reflector panel; 25 ft. cord; suction regulator; automatic rug-adjusting nozzle; disposable "ever-clean" paper bag.

VC5706 upright cleaner features: suction regulator; automatic rug adjusting nozzle; motor-driven brush; all metal construction; "Lite-All" headlight; pleated grey sanibag. Special set of deluxe cleaning attachments for use with either model available at \$19.95; standard set at \$13.95. Landers, Frary & Clark, New Britain, Conn.—RADIO & TELEVISION RETAILING.

Presteline APPLIANCES

New line of gas ranges, a new refrigerator and three new electric ranges added to line. Gas range line available immediately in a 20-inch apartment type range, a 36-inch standard model and a 36-inch deluxe model with lamp and timer. A 9 cu. ft. refrigerator features a full-length front door which serves as a cold seal and a dust seal for the beverage storage compartment, temperature control; three cold zones; meat keeper; standard shelving; 35 lb. capacity frozen food chest. Electric ranges of 29-inch apartment size and 36-inch non-automatic standard model also added to line. Presteline Home Appliance Division Leeson Steel Products, Inc., 447 American Furniture Mart, 666 Lake Shore Drive, Chicago.—RADIO & TELEVISION RETAILING.

Walton HUMIDIFIER

Model 30 humidifier, evaporates approximately three gallons of water per hour; all that is needed is connection to water supply and electric current. Units may be used in multiple to provide uniform, controlled humidity conditions in an enclosure. Walton Laboratories, Irvington 11, N. J.—RADIO & TELEVISION RETAILING.

Proctor TOASTER

Model 1482 "Custom Toaster" features: silent, cushioned pop-up control; sliding



crumb tray; full range of color settings; ability to reheat cold toast without burning. Packaged in distinctive blue and gold gift box with suede finish. List price is \$22.50. Proctor Electric Co., Philadelphia, Pa.—RADIO & TELEVISION RETAILING.

GE SUNTAN METER

"Suntan Meter" tells sun bathers how long they may expose themselves safely to the sun's rays. Meter consists essentially of proper correction filters, light sensitive recording device. Dial on the face of the cells and a sensitive recording device. Dial on the face of the meter gives a reading which may be translated readily in terms of minutes in which a "pinking" of the skin will be produced. General Electric Lamp Department, Cleveland, O.—RADIO & TELEVISION RETAILING.

Wyre-Safe ELECTRICAL PLUG

Electrical plug developed to eliminate danger wherever lamps or other electrical appliances are used. Plaster plug provides cylindrical storage area in which surplus cord is wound. Cord plays out or can be retracted according to location of appliance or unit. Available in choice of ivory or brown finish; priced at 98¢ each. Page Industries, P.O. Box 927, Hollywood 28, Calif.—RADIO & TELEVISION RETAILING.

Hopax PLUG

Attachment plug that doubles as circuit breaker, designed to guard against overloading, stalling or rotor locking on any machine employing a fractional horsepower motor. Plug reset by removing it from receptacle, then raising and lowering lever between prongs. Plug operates only when conditions become dangerous for particular appliance on which it is installed. Hopax Electric, Inc., New York City.—RADIO & TELEVISION RETAILING.

Whirlpool WASHER, DRYER

New line of competitively priced wringer-type washers introduced. Electric dryer shown is also included in line. Washer series consists of three models: Standard,

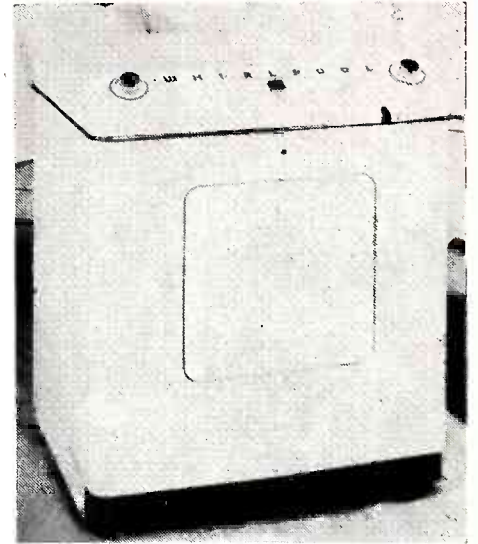

Deluxe, and Supreme. Washers have many deluxe features, including automatic timer. Nineteen Hundred Corp., St. Joseph, Mich.—RADIO & TELEVISION RETAILING.

Hubbell ELECTRICAL RECEPTACLE

This new safety receptacle, named SP-49, was designed to reduce the possibility of accidental shock and the hazards resulting from children inserting small metal toy parts, wires, pins, and other metal objects into electrical receptacles. The heart of the SP-49 is four insulated rollers, two of which have to be engaged simultaneously in order to energize the unit. The rollers are located within the unit in a manner to prevent activation with metal objects other than the standard cap. Harvey Hubbell, Inc., Bridgeport, Conn.—RADIO & TELEVISION RETAILING.

Kool-N-Heetaire COMBINATION

Two-speed, portable combination fan and heater available in 1320 and 1650 watt models. (#265 D2 and 266 D2, respectively.) Unit finished in baked spatter enamel with smooth high gloss surface; has 8-inch high speed 4-bladed aluminum fan; quiet; two-speed blower principle allows unit to circulate a moderate volume of air when used for heating, and greatly increase the volume when used as a fan alone; independent fan control switch for cooling; Size: 14 inches high, 11¾ inches wide by 5¼ inches deep. Retails for \$16.95. Markel Electric Products, Inc., and La Salle Lighting Products, Inc., Buffalo.—RADIO & TELEVISION RETAILING.

Profit-Makers for Dealers

Fresh'nd-Aire HEATERETTE

Small size circulating type heater-fan combines features of a fan for summer cooling plus efficient circulating heater for winter use in one case which measures 10 inches wide and less than 12 inches high. Three-blade metal propeller mounted

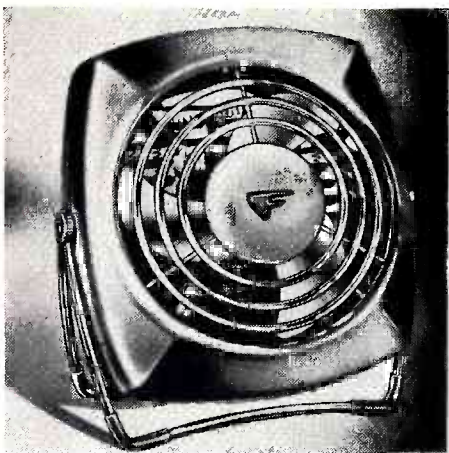

in front of six inch square heating coil; horizontal slot-type vents behind heating element provide for free flow of air. Carrying handle at top. Circular chrome front grill for safety. Weighs 5¾ lbs.; finished in light tan, baked enamel and trimmed with chrome grill. Marketed east of Denver for \$13.95; \$14.95 in the West. Fresh'nd-Aire Co., 221 No. La Salle St., Chicago.—RADIO & TELEVISION RETAILING.

Portman SEWING MACHINE

Lightweight portable all-purpose sewing machine features: open "lower arm" arrangement for darning and mending; built-in soft glow director work light; cleverly designed carrying case opens to form work

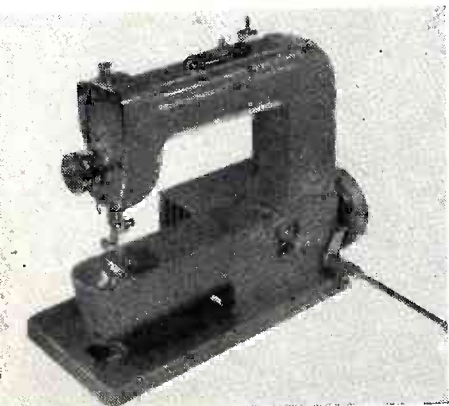

table; variable speed electric drive motor; adjustable control for regulating stitch length; horizontally located bobbin. Various attachments are included. Portman Sewing Machine Co., Inc., 70 Portman Road, New Rochelle, N.Y.—RADIO & TELEVISION RETAILING.

Cory COFFEE BREWERS

"Coralume," model EAB, shown, is priced to retail at \$19.95, plus tax. Automatic coffee brewer made of special aluminum

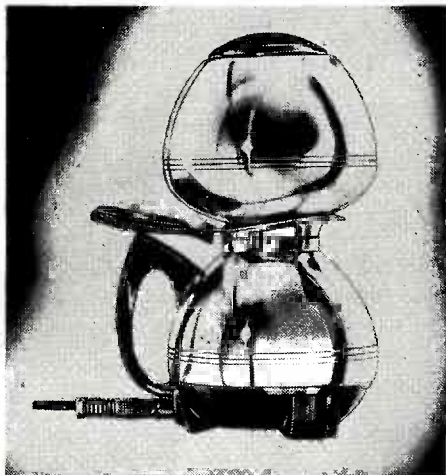

alloy treated with exclusive process finish. Unit is stain resistant, of feather weight construction, and has silver-like lustre finish. Full 2-8 cup capacity with cup markings. No external operating levers; brewing controlled by thermostat mechanism. Handle of black plastic.

"Custom" model ACB, to retail at \$28.50, plus tax, designed to compete for gift and carriage trade sales. Difference in the two models is in metals only, all working mechanisms identical. Both bowls are of copper with heavy chromium finish that looks like fine silverware. Cory Corp., 221 No. La Salle St., Chicago.—RADIO & TELEVISION RETAILING.

Fasco OSCILLATING FAN

Model 101 deluxe heavy-duty fan delivers air at 705 C.F.M.; standard model 103 has air delivery capacity of 510 C.F.M. Priced at \$19.95 and \$14.95 respectively. Streamlined styling; finished in grey; fans are powered by precision-built shaded pole induction motors; both models have wide aluminum blades for smooth air movement. Fasco Industries, Inc., Rochester 2, N. Y.—RADIO & TELEVISION RETAILING.

La Salle WALLAMPS

Wallamps and Pullup lamps feature new decorators' colors and materials, including brass galleries, parchment shades, pompons, etc. Indirect wallamps are made with patented "stay-straight hangers," to prevent tipping. Three of the new wallamps have special push switch built-in. La Salle Lighting Products, Inc., Buffalo, N. Y.—RADIO & TELEVISION RETAILING.

GE TOASTER

Automatic toaster with a streamlined one-piece chrome-plated shell to be fair traded at \$21.50. Features: thermostatic control which permits the toasting of bread slices to same shade of brownness; controls can be set so that toast pops up or remains inside toaster until served; Snap-in crumb tray; cord set permanently attached. General Electric Co., Bridgeport 2, Conn.—RADIO & TELEVISION RETAILING.

Superstar APPLIANCES

Mastergrills models 18, 16, 190 and 180 designed to be used as a sandwich toaster. Twin waffle iron, no. 60, with thermostat heat control on each waffle, and a deluxe waffle maker, with thermostatic heat control, model 24, in the line. Automatic "Toastrite" toaster, model 650, features removable crumb tray, adjustable control knob, luxurious finish. Stern-Brown, 42-24 Orchard St., Long Island City.—RADIO & TELEVISION RETAILING.

Cooper THERMOMETERS

Style No. 26 AD portable oven thermometer features: accuracy of indication up to 600 degrees F.; ease of reading; attractive nickel-plated case, aluminum dial; two-way positioning.

No. 27 AD refrigerator thermometer features: simplified one-piece frame; frosted aluminum finish dial; accurately calibrated; hangs from shelf rod or stands on shelf. The Cooper Oven Thermometer Co., Pequabuck, Conn.—RADIO & TELEVISION RETAILING.

Kent-Moore LIGHTING FIXTURE

"Val-Lite" fluorescent lighting fixture, designed for use in creating merchandise displays and "point-of-purchase" advertising, as well as for general illumination in retail stores. Available in standard models



having two or four 40-watt fluorescent lamps for single or multiple unit continuous strip lighting applications. Letters are six inches high. Units wired for 110 volt, 60 cycle, AC operation. Kent-Moore Organization, Inc., Lighting Div., General Motors Bldg., Detroit 2, Mich.—RADIO & TELEVISION RETAILING.

Additional New Products
Elsewhere in Issue

Universal Appointments

R. M. Oliver, general merchandise manager of the Portable Electric Appliance Division of Landers, Frary & Clark announces the appointments of R. C. Beatty and Ralph Moore as district managers for portable electric appliances in southeastern United States. Mr. Beatty's new territory with Landers, Frary & Clark will be in Tennessee, Georgia and South Carolina. Mr. Moore will serve as district manager in Virginia, North Carolina and West Virginia.



Frank Barmore, above, has been appointed assistant sales manager of the electric range division of Landers, Frary & Clark, makers of "Universal" products. Announcement was made by H. M. Parsons, vice-president in charge of major appliances.

GE Representative

A. H. Heitzler has been named General Electric clock representative in the company's Pacific district, according to B. M. Tassie, district manager of appliance sales. Mr. Heitzler's territory includes California, Nevada, Arizona and Hawaii.

Westinghouse Sales Aid



For use in places where 220-volt service is not available, this portable unit is designed to demonstrate "Medium High," the "Pan Fry" heat of the Corox unit of the Westinghouse electric ranges. The demonstrator, which is equipped with a compact carrying case, can be used for steaming eggs; frying bacon in six to seven minutes without watching or turning; frying eggs in two minutes on stored heat; and popping popcorn.

APPLIANCE NEWS

Blackstone Wholesalers

A number of distributors for home laundry products of Blackstone Corporation, Jamestown, New York, have been appointed, including the following: Superior Distributing Co., 917 No. Robinson St., Oklahoma City; Edwards-Harris Co., 258 Peachtree Street, Atlanta, Ga.; Elliott & Evans, Inc., 4800 Prospect Avenue, Cleveland, Ohio, and S. S. Fretz, Jr., Inc., 1902 Chestnut St., Phila., Pa.

Hotpoint Suggests Small Kitchen Appliance Set-Up

Small kitchens needn't cramp your style. A new package of matched appliances will fit in a five-foot space, providing ample cooking, dishwashing, refrigeration and storage facilities.

The basic unit has an electric apartment range with three or four surface units, and a full-size oven; a sink that will accommodate a garbage disposal; and a four-cubic foot refrigerator. A variety of plastic, linoleum or stainless steel counter tops with attached sink bowl fits over the sink front and refrigerator.

Above these appliances are two 30-inch steel wall cabinets with adequate storage for dishes and other items in small kitchens. If you have a slightly larger space, your kitchen can include an automatic dishwasher. The new counter tops provide continuous work surface, and give a "custom" appearance to the kitchen, according to Hotpoint, Inc., manufacturer of the appliances.

Florida Store Owner to Sell Business—Build a City



Welburn Guernsey, founder and owner of Associated Stores, Inc., large Florida chain store organization, shown addressing a gathering of top executives at his estate in Tampa, has announced that he will sell his six stores in principal cities in Florida. Mr. Guernsey plans to devote all of his time to the building of "Guernsey City" at a location adjacent to the east end of the Gandy Bridge, connecting Tampa and St. Petersburg. The chain stores being offered for sale are said to be doing nearly two and a half million dollars annually.

Amana Representative

J. Joseph Spelman has been appointed special representative, of the sales department Amana Society, refrigeration division, according to an announcement made by E. L. Hinchliff, director of sales. Spelman has been associated with the appliance industry since 1932, first in retail sales activities of utility companies in New York state, and later, from 1935 to 1942 in sales promotion work with Servel, Inc.

Promoted by Norge

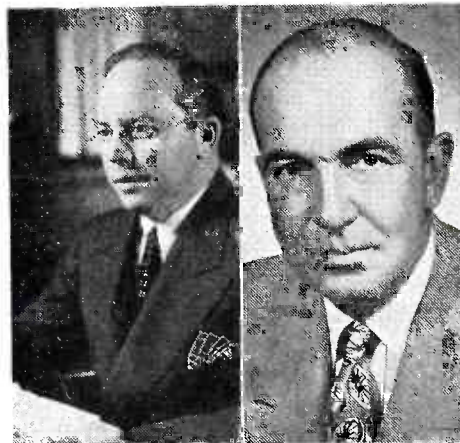

Howard E. Blood, president and general manager of Norge, has been elevated to the position of chairman of the board of Norge division. Mr. Blood, shown at left, continues as president of Detroit Gear division. George P. F. Smith, at right, a Borg-Warner vice-president succeeds Mr. Blood as president and general manager of Norge. John A. Underwood has been named vice-president in charge of sales. H. L. Clary remains with Norge as director of sales.

Duo-Therm Appointments

M. F. Cotes, executive vice-president, Motor Wheel Corporation has announced the appointment of Karl Egeler to the position of sales manager, Duo-Therm Division. Louis C. Vandertill has been appointed as advertising manager, Mr. Egeler's previous post.

"GET IN THERE AND SWING"



You'll sacrifice a lot of potential profit if you don't make a strong play for the time-payment business that becomes increasingly important with each passing month.

But don't go after it haphazardly. Inexperience or inefficiency in granting credits can work damage two ways. Too tight a policy results in turning down some good risks. Too easy a policy leads to collection problems and possible losses.

Your Commercial Credit representative can help you with financing plans and services that avoid the pitfalls, promote sales and protect the profits. Make a date with him. Find out what he has to offer you.

COMMERCIAL CREDIT CORPORATION

A Subsidiary of
Commercial Credit Company, Baltimore • Capital and Surplus \$100,000,000

MORE THAN 300 OFFICES IN PRINCIPAL CITIES OF THE UNITED STATES AND CANADA

Tube Testers for Today and Tomorrow...

SPECIFY

TRIPLETT

UP and DOWN

Lever Switching Connects Each Tube Pin to Proper Circuit

- 1. ALL ELEMENT CHECK** — Thorough conclusive test of tube elements, shields and taps. The only commercial tester to get at each tube pin and make an open and short check.
- 2. NO HUNTING FOR SOCKETS** — No plugging into wrong socket. Circuit flexibility requires only one socket for each type of tube base.
- 3. CIRCUIT CLARITY** — Lever switch numbering corresponds to RMA tube pin numbers, connected to bring out each active tube element. A simple up or down motion of the lever instantly makes the connection.
- 4. OPERATION SIMPLICITY** — Minimum of control settings plus straightforward arrangement of this outstanding emission circuit. Generally not more than five of the 10 lever switches need be set.
- 5. "PICTURE" YOUR CIRCUIT** — Assures confidence in tests and enables special tube checks for balanced circuits, special loads, etc. "Trick" switching circuits make it more difficult for the serviceman to "picture" his test circuit.
- 6. SET UP YOUR OWN TEST FOR NEW TUBES** — The "pictured" circuit and straightforward test procedures enable the user to set up data for new tubes. A feature rarely found in commercial type tube testers.
- 7. INDIVIDUAL CONTROL FOR EACH TUBE ELEMENT** — Takes care of roaming elements, dual cathode structures, multi-purpose tubes, etc., in addition to standard value tests.

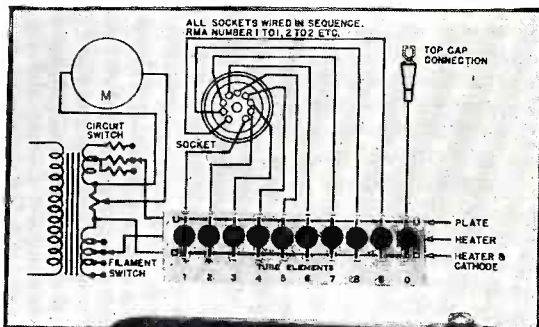

TUBE TESTER MODEL 3413

Triplett lever switching circuit arrangement has 7 distinct advantages contributing to maximum flexibility, simplicity of operation and anti-obssolescence.

**NET DEALER \$66.75
PRICE**



MODEL 3480 \$98.75 ... U.S.A. Dealer Net

... Combination Volt-Ohm-Mil-Ammeter Model 3480

This tester combines the Tube Tester Model 3413 with complete facilities for voltage current and resistance analyses ... a real economy for those shops requiring a combination tube tester and volt-ohm-mil-ammeter ... Attractive two tone metal case with detachable hinged cover ...

TECH DATA

D. C. Volts: 0-3-12-60-300-1200, at 10,000 Ohms/Volt.
 A. C. Volts: 0-3-12-60-300-1200, at 2,000 Ohms/Volt.
 D. C. Amps: 0-12, at 250 Millivolts.
 D. C. Milliamps: 0-1.2-12-120, at 250 Millivolts.
 Ohms: 0-1000-10,000 (10-100 at center scale).
 Megohms: 0-1-50 (10,000-500,000 Ohms center scale).
 Output: Output Jacks, Condenser in series with A. C. Volt ranges.
 Scale: 5.6" long on top scale arc. 0-1000 Ohms and 0-50 Megohms on top arc. 0-12-60-300 A. C. and D. C. Volt figures are on four separate arcs. Scale markings are black on white except A. C. are red on white; 0-1K Ohms scale is green on white.

Precision first... to Last



SEE AT YOUR RADIO PARTS DISTRIBUTOR OR FOR MORE INFORMATION ... WRITE
TRIPLETT ELECTRICAL INSTRUMENT COMPANY • BLUFFTON, OHIO, U.S.A.

In Canada: Triplett Instruments of Canada, Georgetown, Ontario

SERVICE & SOUND

Section of **RADIO & TELEVISION RETAILING**

New TV Receivers

Emerson Modified Intercarrier, Stromberg "Split" Front End, Philco Built-In Antenna, Olympic Sensitivity Switch, RCA Metal Cabinet

• The new EMERSON line, exemplified by model 621, features a basic chassis which provides for AM, FM and phono facilities. 28 Tubes (including rectifiers and kinescope) are used, of which two are deleted when AM-FM facilities are not included. The 2-tube, Standard Coil turret tuner is utilized, feeding a modified intercarrier system in which the sound is picked off at the pix detector instead of after the video amplifier. This change is said to eliminate the "buzz" due to 4.5 mc beat found in some intercarrier sets. The sound IF frequency is

the TS-16's a 16-inch metal tube. The basic TV chassis includes facilities for AM and FM radio reception, and is the same for all models. The front end features continuous tuning of the permeability type, with 4 separate ranges (selected by a range switch): high band TV, low band TV, FM and AM. Each one of these bands has a separate RF stage, and the first three each have separate permeability slugs, while the AM has a gang-condenser. The four variable tuning devices and the tuning-dial pointer are all connected together by dial cords so that only one tuning knob is necessary. A conventional two-channel (video and sound) system is used, except that the FM utilizes the TV sound system, and so has the same IF

frequency (21.9 mc). All the sets in this line feature AGC, and automatic brightness (which is called automatic black level, or A.B.L.), and have provisions for using either separate high and low band TV antennas, or one antenna for both. All the sets have a 6U5 tuning indicator, all except the 12-inch table model use two 6V6's for audio, all have two 1B3's in the high voltage supply, and all the 15 and 16 inch sets have two 6BG6's for horizontal deflection, connected in parallel. The total number of tubes ranges from 40 in the 12-inch table set to 43 in the 16-inch models (including rectifiers and kinescope).

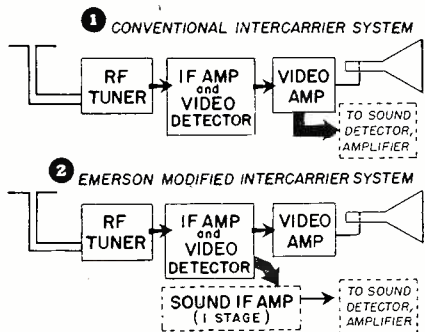

4.5 mc. The video sound is trapped out at the pix detector at that frequency, and the FM sound (at 23.5 mc) is beat with a 28 mc oscillator to produce a 4.5 mc IF so that it, too, may be amplified in the same sound channel. A phono jack, speaker plug, and phono motor AC plug are provided on the rear apron of the chassis so that the same set may be used in phono-radio consoles. A 5U4-transformer type low voltage supply is used in these receivers.

The new STROMBERG-CARLSON "TS" series receivers all use a basic chassis assembly with modifications of the kinescope tube mount and the deflection and high voltage systems to accommodate the different size picture tubes. The TS-125's use a 12-inch tube, the TS-15's a 15-inch glass tube, and

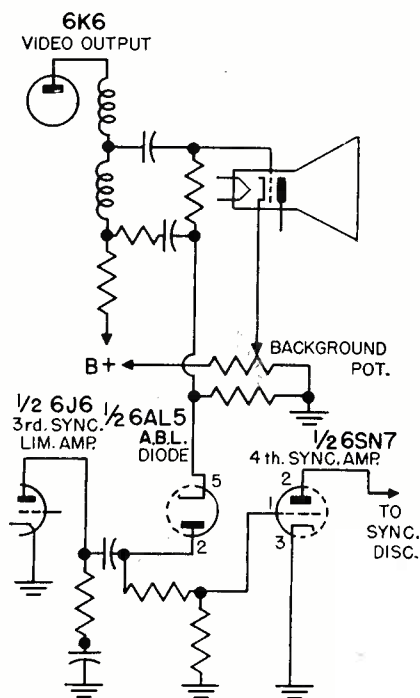

Stromberg's "A.B.L." biases kine according to amplitude of sync signal.

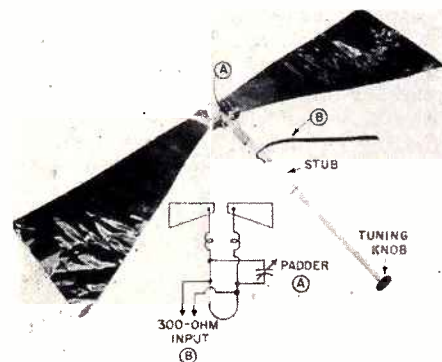

Philco's built-in antenna fits under the top of TV set cabinet.

A built-in antenna is a feature of the new PHILCO line of TV sets. The dipole consists of two triangular elements constructed of aluminum foil which approximate the electrical characteristics of a conical antenna cut for the FM band. A mica padder loads the center of the dipole, and can be tuned by the customer by means of a knob on the front of the set connected to the padder through a wooden shaft. A stubbed-line transformer matches the antenna to the receiver input terminals. The antenna is said to provide satisfactory reception in most locations within the

(Continued on page 97)

TV Service Hints

Coupling Sweep and Marker Generators to Receiver

When using a sweep generator, marker generator and oscilloscope to check the I-F response curves of a television receiver, it is sometimes difficult to obtain the correct balance between sweep output and marker output. This is particularly true when the ranges of the individual attenuators are limited. For best results, the amplitude of the

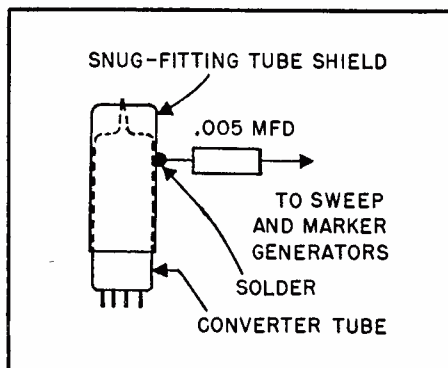

applied sweep voltage as well as that of the marker voltage must be adjusted to a fairly critical level.

The coupling method shown above provides additional control of the sweep and marker voltages. By sliding the tube shield up or down on the tube, the capacitance between the shield and the tube elements is varied, and the coupling can be adjusted as desired. Another advantage of this method is that it is not necessary to make a direct connection to the circuit under test; simply slide the tube shield over the converter tube. Any tube shield can be used provided that it fits the tube snugly and does not ground to the chassis. *Courtesy Westinghouse.*

Antenna Stubs

Occasionally we hear of or recommend the use of a quarter-wave stub of transmission line for trapping out unwanted signals or partially attenuating powerful interfering nearby TV stations. This is satisfactory as far as the reduction or elimination of the undesired signal is concerned, but it will also cause a change in the R-F response curve of the head-end unit on channels close to the tuned frequency of the stub. This may result in a serious impairment of the picture detail due to smearing.

It has been found that it is much more desirable to insert a small capacitor in series with each line of the stub at the point where the stub fastens to the head-end terminals. These capacitors should be 5 mmf. for stubs in the low frequency TV spectrum and the FM

band, and 2 mmf. for stubs used in the high frequency band. This gives a series parallel tuned trap which is much sharper in response and will not affect the response curve of the head-end unit unless the stub is tuned directly in the channel.

The capacitors in the tuning stubs result in a longer piece of line being used for a particular frequency. The best method of determining the proper length of line is to clip off small portions until maximum attenuation is obtained. —*Courtesy General Electric Co.*

Matching 72 Ohm Coax Cable to 300 Ohm Balanced Input

In some areas it may be desirable to use 72 ohm coaxial cable as a transmission line between the antenna and the receiver in order to reduce noise pickup. The problem of matching the coaxial cable to the receiver input in such installations can be solved as shown.

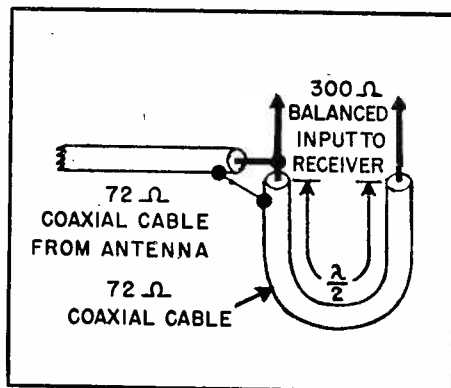

The matching section should be one half wavelength long at the most critical frequency. If reception is possible on one channel only, cut the matching section to the video carrier frequency of that channel. If operation on more than one channel is possible, cut the matching section to the video carrier frequency of the weakest signal. —*Courtesy Westinghouse.*

Ground Connection to Aquadag

Wear or vibration may sometimes develop a poor connection between the outside coating of the cathode ray tube and its grounding springs. The attendant arcing at that point can result in tearing of the picture and insufficient picture width.

To insure a permanent ground contact, a piece of aluminum foil may be inserted between the aquadag and the grounding springs. This foil, one side of which is coated with adhesive, is

first cut to size of 1" x 1 1/2". One edge is then folded 1/4" over the adhesive side of the foil. Finally, the foil is placed between the aquadag and the grounding spring in such a manner that adhesive holds the foil to the aquadag, the spring bears against the uncoated side of the foil, and the uncoated side of the 1/4" fold bears tightly against the aquadag. —*Courtesy Westinghouse.*

Shielded 300-Ohm Line

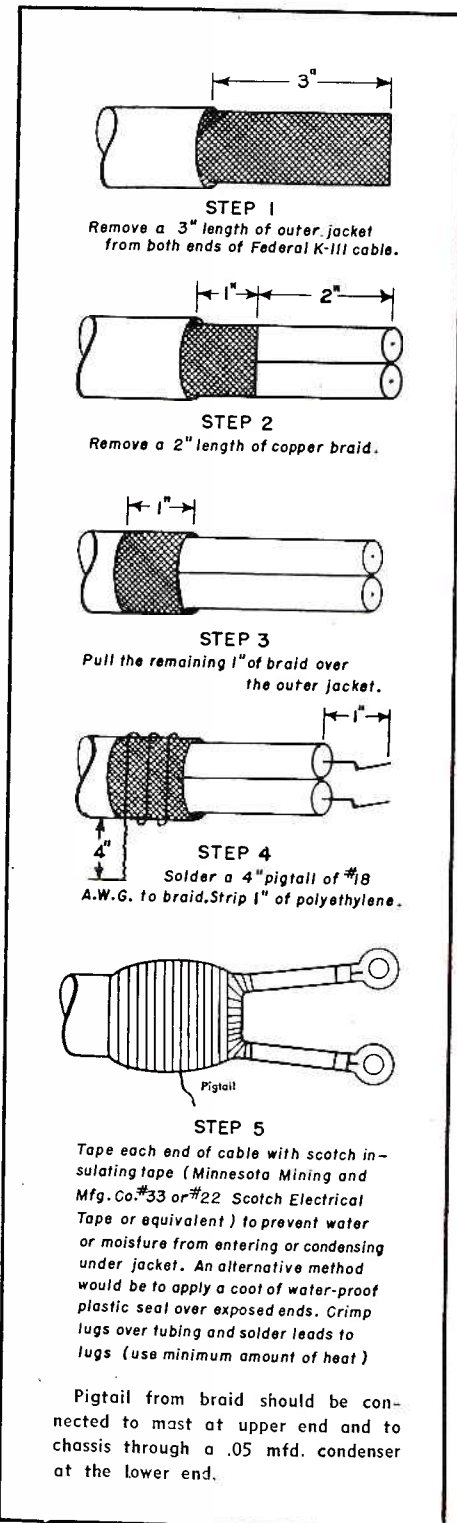

—*Courtesy Federal Telephone & Radio Co.*

This is it!
"LITTLE GIANT"



RADIART

TELE-ROTOR

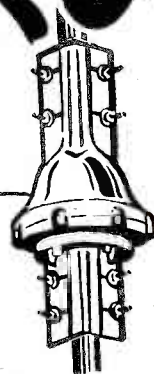
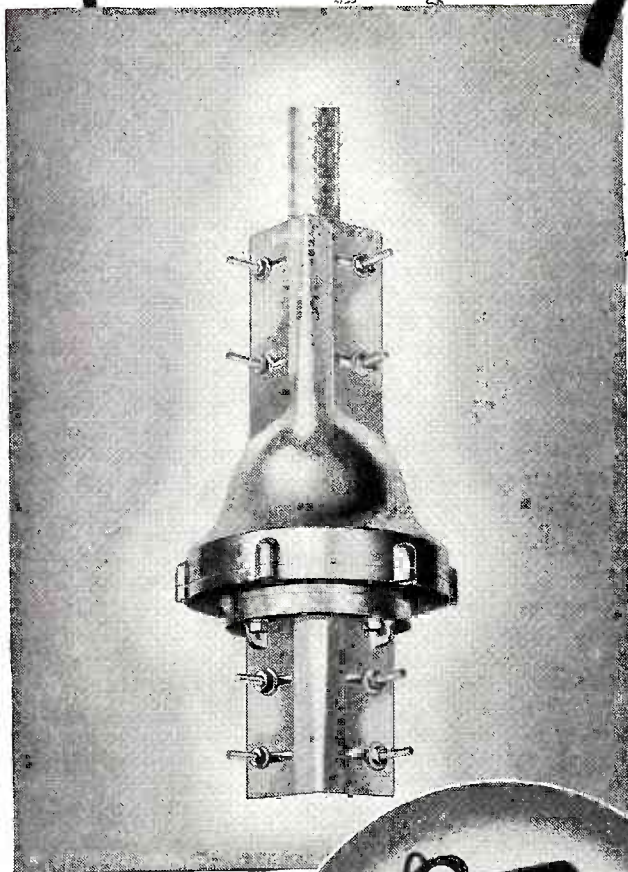
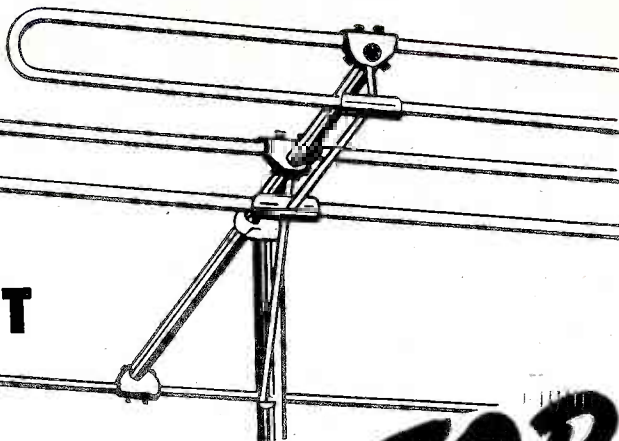

At last... the ultimate in rotators... a triumph in engineering skill. Months and months of patient research and development... now... we are proud to announce our latest triumph... the Radiart "Little Giant" TELE-ROTOR! Not a single factor has been overlooked to bring you the best... true to Radiart tradition that makes Radiart products... **THE STANDARD OF COMPARISON!** To you who have wanted a superior rotator that out-performs all others... **THIS IS IT!**

Better Because:

- Handles Heavier Loads... With Ease
- Remarkably Durable, Sturdy Design and Construction
- Absolutely Trouble-Free and Fool-Proof
- Available with "Compass Control" Directional Indicator

Check These Features:

- Heavily Reinforced Die-cast Housing
- Two 6½" Ball-Bearing Races
- Heavy-duty Precision Gears
- Positive Stop at End of Rotation
- Takes ¾" to 2" Upper and Lower Masts
- Motor Instantly Reversible
- Mast or Platform Mounting
- Three Heavy-duty Guy-Wire Lugs
- Completely Weather-Sealed
- Factory Lubricated for Life

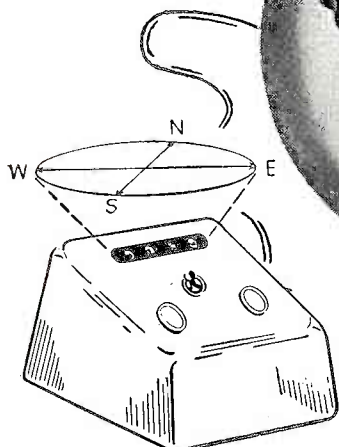

IT'S RIGHT WHEN IT'S RADIART!



THE RADIART CORPORATION
 CLEVELAND 2, OHIO



Manufacturers of the Famous Red Seal Vibrators

Cash in on Custom TV

Kits Solve Demand for Special Video Units



• Kits and chassis' present a flexible solution to many customer problems, and offer an important source of revenue to the alert merchant. A kit may be described as a complete complement of parts, requiring assembly, for some model set, while a chassis is completely assembled but without cabinet. TV sets are available in both kit and chassis form, in both direct view and projection types.

The customer may not like the furniture represented by current cabinet models; or may not have room for additional furniture and wish to build the set into an existing piece, or into a wall; or he may not wish to spend money on cabinet alone, feeling that he could afford better components if he didn't have to pay for hand-rubbed mahogany or limed oak.

In particular, TV chassis' and kits have additional advantages: first, a custom installation is more flexible than a manufactured model, permitting easier modification, modernization, or repair. Second, TV consoles containing radio, phono, record storage, etc., are rather bulky, and the customer might prefer to spread the components around a room.

It is often possible to build in a set in a space which is not of the right size or shape to hold a cabinet. One projection chassis available is only 13¾ inches deep, and 25 inches wide. This factor alone might make a large-screen set possible in a recess or a closet, where insufficient space was present for any cabinet model.

The construction of kits has been greatly simplified and standardized by most kit manufacturers such as Transvision, Philmore, Techmaster, Television Assembly Co., Telekit, etc., so as to provide: parts numbered and supplied in numbered envelopes; suggested plan for assembly by successive stages, with a separate diagram for each stage (such as filament and B plus leads); parts requiring special equipment for alignment come factory prealigned (such as front end and IF transformers); all necessary hardware is included, and detailed suggestions are provided for mounting in a cabinet, utilizing different size picture tubes, etc. Many sets, such as the Hallicrafters chassis for direct-view, provide two or more separate sub-chassis', making size and shape of the mounting space flexible.

The skilled technician may, of course, build a set from scratch, but at the

present this will probably not prove profitable either from a time or materials point of view.

Many components are peculiar to television, and must be designed to complement each other in a particular set: IF transformers, yokes, focus coils, vertical and horizontal output transformers, etc. In addition, the front end presents a mechanical as well as an electrical problem. Furthermore, the layout of parts and leads is very critical at high frequencies, and the builder can save time by following the plan worked out by some manufacturer's engineering department.

Modifications are possible, however, and may often be executed by the technician without too much trouble, resulting in a more satisfied customer and a higher bill. Such modifications include the addition of a high-powered, high fidelity amplifier and loudspeaker to the sound system, where it is not provided in the original chassis, or by adding AGC, or AFC for the RF oscillator.

In merchandising the custom installation, the dealer will often do well to establish contact with a cabinet maker or contractor so that he (the dealer) can handle the whole installation. In this way he can be certain the set will work in its final form, and also be of more service to the customer (and probably make a little more on the deal).

The question of guarantees and servicing arises when the dealer sells a set of his own making. Current practice indicates that the best method is either to 1) sell the set "as is" with no installation or guarantee, or 2) sell installation and guarantee "policy" for a long term, such as a year. Prices of such policies on manufactured sets can serve as a guide in establishing a rate.

The dealer who handles this phase of the operation should remember that if the installation is non-residential, the set will be operated by more people (and possibly require more service);

and also, that if it goes bad, priority service will be expected, especially in the case of bars and restaurants. For these reasons, non-residential installation and guarantee policies are usually higher-priced.

Selling price of custom sets must be a compromise between a cost-plus-markup figure and the selling price of competitive type manufactured models. It is suggested that the price be built up in "layers," so as to be more easily appreciated by the customer. That is: so much for the completed chassis, so much for the custom installation, so much for the antenna installation and guarantee. If the job starts from a kit, a rough addition of 50% onto the cost of kit plus custom installation usually is a good working figure. If the starting point is a chassis, the net and list are more or less fixed by the manufacturer's advertising.

A little outside soliciting for custom work will usually prove to be very profitable, since many people are not aware of this handy solution to their problems. A special price might be offered to the first few customers in exchange for permission to leave a small but prominent sign on the front of the set "custom built and installed by"

Leads are also involuntarily furnished by shoppers who complain that this or that set is not suitable because it does not fit into their scheme of things for one reason or other. . . . "This set is just what I'd like but it's too large," or "I don't like the cabinet," etc. Bars, clubs, restaurants, and the like, who bought small sets in the early days of TV (that is, 12 to 24 months ago) are likely prospects for large custom models, since they are already aware of the shortcomings of their present set.

The prospects of the custom TV installation not only point to many extra sales, but the possibility of building a sizable business and reputation on this score alone, and are well worth careful consideration and exploitation by the dealer.

**The Success of
TV Reception is Assured**

with Sensational New
JP-TV

VERTICAL ANTENNA

- High gain Vertical Array for television or FM.
- Complete all channel coverage 2-13.
- Exceptional high gain on the high band. The low band is same as a folded dipole with a reflector.
- Exceptional light weight — Shipped partially assembled.
- Easy to handle and install — not clumsy — neat appearing.
- One lead in — No adaptor required to bring in other channels.
- Bi directional.
- Sold on unconditional money back guarantee.
- Combines the principles used in several types of antennas.
- Operates efficiently indoors or outdoors.
- List Price — \$23.30. Exceptionally good profits for dealers.

This revolutionary new development — a Vertical Array Antenna — is the biggest forward step made to date toward improved TV reception. Designed and built by skilled engineers with years of Television experience, it is guaranteed to out-perform all other types of TV Antennas.

JP-TV Antennas operate equally well indoors or outdoors. No elaborate mounting required . . . no ugly stack necessary. Brings in all channels with equal clarity. You haven't known customer satisfaction until you've installed a JP-TV Antenna.

BE CONVINCED — Order a single JP-TV Antenna . . . Install it . . . then if it doesn't out-perform any TV Antenna you've installed before, just return it to us and your money will be cheerfully refunded. You'll find this newest antenna development a real profit maker for you . . . with complete and lasting customer satisfaction on every installation.

Be the first in your community to install this latest and greatest antenna — order one today — shipment made immediately, C.O.D. Parcel Post.

DEALER PRICE LIST

1	-	-	-	\$12.95 ea.
5	to	9	-	12.30 ea.
10	to	14	-	11.65 ea.
15	to	19	-	11.05 ea.
20	to	24	-	10.50 ea.

F.O.B. DeKalb, Ill.

DISTRIBUTORS WANTED

Send for distributor's
price list.

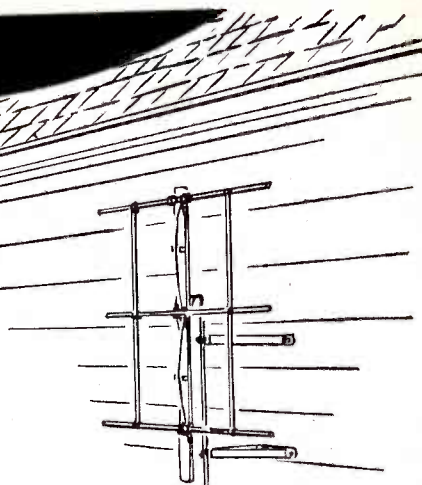

**Guaranteed to Operate
Perfectly facing
TV Transmitter**

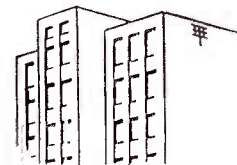

**STORES AND
OFFICES**



HOMES



APARTMENTS



IN THE ATTIC

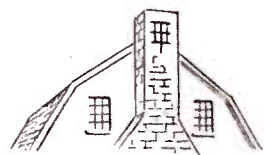

AGAINST CHIMNEY

Now being sold and installed with outstanding results by 7 dealers in LaPorte, Ind., 51 miles from Chicago. Also being used successfully in South Bend, Ind., 79 miles from Chicago.

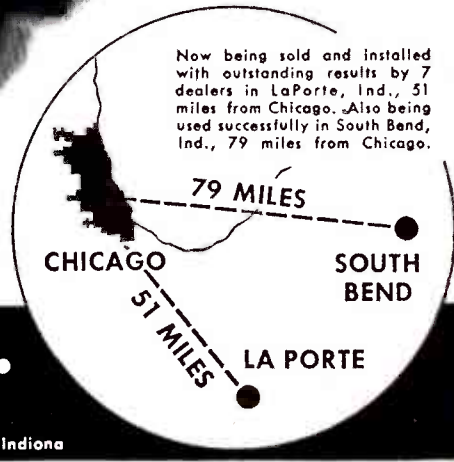

THE JOHN PRINTUP ANTENNA CO.

8543 GLENCOE CIRCLE

FACTORY — DeKalb, Illinois

MILWAUKEE 13, WISCONSIN

SALES AGENCY

SWY Advertisers Service Co., LaPorte, Indiana

TELEVISION TECHNICIAN

SECTION OF RADIO & TELEVISION RETAILING

Taco TV ANTENNA

Type 900 Taco television antenna features four driven elements, two in the vertical plane and two in the horizontal plane, in place of parasitic elements, permitting lobe-switching. With this antenna it is possible by means of a diplexer network to eliminate co-channel interference present in many locations where two stations are on the same channel or adjacent channels and located about 180° apart at the installation. It also makes possible the reception from either direction without the necessity of turning the antenna itself. Technical Appliance Corp., Sherburne, N. Y.—RADIO & TELEVISION RETAILING.

Baker TV TOWERS

Models included in the newly designed line of Monitor towers for television are guyed ground and roof mounting towers and a three-post, self-supporting tower, all of steel construction, galvanized for rust-free appearance and long life—engineered

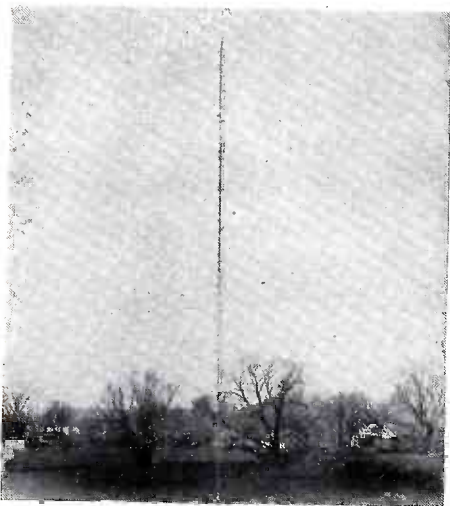

to withstand an 80-mile wind. Guyed ground mounting model TX (illustrated) has a tapered top section. Tapered bottom section ends in a universal joint, permitting base mounting at any angle. Models are also available with a standard flat top section. Baker Mfg. Co., Evansville, Wis.—RADIO & TELEVISION RETAILING.

Tune-Vue TV ANTENNA ROTATOR

The Tune-Vue rotator, designed for use with roof-top antennas for television and F. M. receivers, is powered by an induction-type motor that plugs into 110-volt 60-cycle power source. Up to 360 degrees of rotation is provided in either direction, with automatic mechanical reverse. A three-way switch, conveniently placed beside the receiver, controls rotation and provides instant stop. The rotator is said to greatly simplify tuning-in of clear images and sound. Aircraft Products Co., 113 St. Clair Ave., N.E., Cleveland 14, Ohio.—RADIO & TELEVISION RETAILING

Snyder TV ANTENNA

All Redi-Mount TX aerials now embody the Hi-Paq cantilever truss construction. The new truss construction features a material of extreme tensile strength said not to be affected either mechanically or electrically by weather or temperature. Like previous

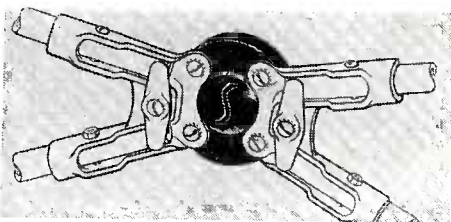

models, the new Snyder Redi-Mount TX aerials are preassembled and packed folded. Snyder Mfg. Co., 22nd and Ontario Sts., Philadelphia 40, Pa.—RADIO & TELEVISION RETAILING.

TV TWIN-LINE CONNECTORS

These are small, polystyrene blocks drilled to hold stripped ribbon leads, with a small set screw to maintain contacts.

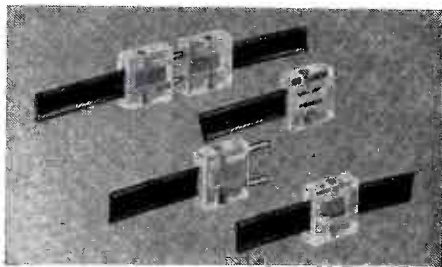

There are several different types for special uses. Products Engineering Co., 4753 N. Broadway, Chicago 40, Ill.—RADIO & TELEVISION RETAILING.

Regency TV BOOSTER

The model DB-213 TV signal booster is an extremely stable, high gain wide-band, pre-amplifier for use with television receivers in low signal areas, the maker states. The DB-213 uses two push-pull fully neutralized



6J6 triode circuits with iron core tuning on both inputs and outputs. A gain of 24 db is claimed on the low channels and 12 db on the high channels. The DB-213 carries a list price of \$29.95. Regency Div., IDEA, Inc., 55 N. New Jersey St., Indianapolis 4, Ind.—RADIO & TELEVISION RETAILING.

Electro TV DISTRIBUTION SYSTEM

The TVD-8 may be used on TV channels 2 to 13 inclusive and is built for continuous duty service. No resistance networks or switches are required for the operation of TV receivers from the TVD-8 and from one to eight sets may be used with each unit. The TVD-8 is useful in stores, small apart-

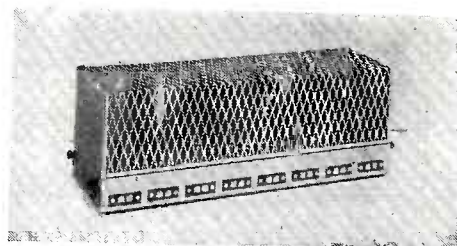

ment houses and multiple dwellings and wherever a good antenna can be installed in a location providing 5,000 to 10,000 micro-volts signal strength. The TVD-8 is priced at \$167, less the usual trade discount, complete with tubes (less antenna). Electro Engineering and Mfg. Co., 627 W. Alexandrine, Detroit 1, Mich.—RADIO & TELEVISION RETAILING.

Masco TV BOOSTER

A new TV Booster, model 1MB-13, is said to be especially valuable in fringe areas. It has all channel tuning with an extra fine tuning control for the high channels. The swivel based antenna plugs into a jack on top of the booster cabinet. The antenna



may be rotated completely to any desired position to obtain maximum signal. The Masco 1MB-13 all channel TV indoor antenna booster uses two 6AK5's and a selenium rectifier, and lists at \$42.50. Mark Simpson Manufacturing Co., Inc., 32-28 Forty-ninth St., Long Island City 3, N. Y.—RADIO & TELEVISION RETAILING.

T-V SALES FOR YOU!

Radion*

MAKES T-V SALES

QUICK AND EASY!

Model 50
The Newest Radion.
In Beautiful Brass
15 inches tall.

**NO
INSTALLATION
COST... FITS
ANYWHERE...
WORKS
INSTANTLY**

Model 49
The original Radion.
Stylized Base in Black
or Mahogany bakelite.

*PATENTED

Solves that installation problem in a jiffy.

Yes, you get quicker and easier T-V sales because Radion cuts installation costs. Cuts buyer resistance, too.

Makes on-the-spot sales for any set you sell.

A natural for closing home demonstrations.

Two proven leaders . . . two pleasing designs to choose from, for home or office. Either fits into any decorative scheme.

Accepted standard by manufacturers and dealers. Over 350,000 in use.

Dealers everywhere are using Radion as a most effective sales closer. Radion makes spot sales easier for T-V sets.

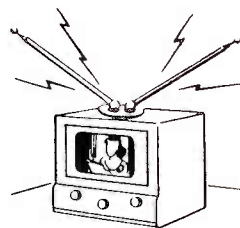

See your Set Distributor or Parts Jobber or
send inquiries directly to:

THE RADION CORPORATION

1137 Milwaukee Ave.

Chicago 22, Ill.

Name _____

Address _____

City _____

State _____

New Units for PA and Service

Permoflux HI-FI SPEAKERS

A new group of speakers has been added to the Permoflux line, featuring wide range (40-12,000 cps) and freedom from distortion, the maker states. Special treatment

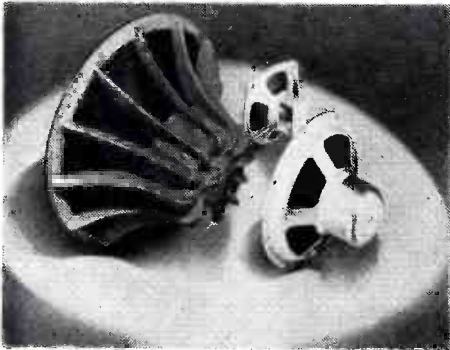

of edge damping is said to give good low frequency response although the physical strength of the material has been increased to prevent hangover effects. Permoflux Corp., 4900 West Grand Ave., Chicago, Ill.—RADIO & TELEVISION RETAILING.

Comet 3-SPEED CHANGER

The new Comet 3-speed, single arm record changer does not need any special record-center-pole adapter. A product of the Milwaukee Stamping Co., the changer



utilizes a separate spindle for 45 RPM records. A single needle pressure plays all types, and a double-tipped needle is provided. Comet Corp., 540 Lake Shore Drive, Chicago 11, Ill.—RADIO & TELEVISION RETAILING.

Sylvania SIGNAL GENERATOR

A new FM-AM signal generator providing an RF signal source ranging from 80 kc to 120 mc may be used for aligning both FM and AM receivers by either the standard AM alignment method or the FM method utilizing an oscilloscope. An rf output meter plus step-by-step and smooth attenuator controls are provided to assure constant reference level over the rf bands. AM output is available from 80 kc to 60 mc with AM modulation of 400 cycles. FM output is available up to 120 mc on fundamental frequencies with sweep of ± 350 kc with 60 cycles modulation and ± 75 kc with 400 cycles modulation. Sylvania Electric Products, Inc., 500-5th Ave., New York 18, N. Y.—RADIO & TELEVISION RETAILING.

Duoband TV ANTENNAS

Basic antenna is a "V" type folded dipole for outdoor use. Additional models are available with reflectors, with high band antenna, and in stacked arrays. Data, including lobe patterns, standing wave ratios, etc., available on request from Di-electric Products Co., Inc., 125 Virginia Ave., Jersey City 5, N. J.—RADIO & TELEVISION RETAILING.

Electro-Voice MIKES

The "Mercury" series of crystal and dynamic mikes feature compactness and low-cost for general purpose use. Tilttable head and on-off switch are provided on both types. Frequency response is 50-8000 cps, output level is -48 db for crystal and -53 db for dynamic. Model 611-8 dynamic lists at \$29.50, 911-8 crystal lists at \$22.50. Electro-Voice, Inc., Buchanan, Michigan.—RADIO & TELEVISION RETAILING.

TeleMatic TV ANTENNAS

The Telematic line of TV outdoor antennas includes straight and folded dipoles and conical antennas in various combinations. A special feature of the line are the "Adap-ta-wings" which can be added to any straight dipole antenna to convert it into a broad band conical type. Each "wing" consists of two "V-ed" elements attached to a clamp which attaches to one of the existing dipoles. Telematic Industries, Inc., 32 Wyckoff St., Brooklyn 2, N. Y.—RADIO & TELEVISION RETAILING.

Radiart TV ANTENNAS

Model 85X and T85X is an all-channel TV antenna for use with a rotator, or where all signals are received from one general direction. On high band reception the low band folded dipole acts as a reflector for the high band folded dipole. Also announced is the Radiart Tele-Rotor, a TV antenna rotator providing 375 degree rotation in either direction at 1 RPM, constructed in a frame said to be able to support a 150-pound load. List price of the Tele-Rotor is \$39.95, or \$49.95 with direction indicator. The Radiart Corp., 3571 W. 62nd St., Cleveland, Ohio.—RADIO & TELEVISION RETAILING.

Vertrod TV ANTENNA

The new Vertrod "4 'n' 1" antenna permits setting up for any of these four requirements, as needed: (1) straight dipole; (2) folded dipole; (3) 72 ohm line; (4) 300 ohm line. The "4 'n' 1" requires no tools for assembly. The mast is available with 5 or 10 foot sections. Vertrod Corp., 11 Park Place, New York, N. Y.—RADIO & TELEVISION RETAILING.

Vee-D-X YAGI ARRAY

This array features a stepped-up driven element which affords a match for 300 ohm transmission line. Also a high front to back ratio helps to reject unwanted signals. Several arrays may be mounted on the same mast and directed to different transmitters, providing maximum signal strength from each without rotating. LaPointe-Plascomold Corp., Unionville, Conn.—RADIO & TELEVISION RETAILING.

Hytron AUTO RADIO TOOL

Another Hytron contest winner, the auto radio tool is designed to facilitate tuning, adjusting and aligning an auto radio when

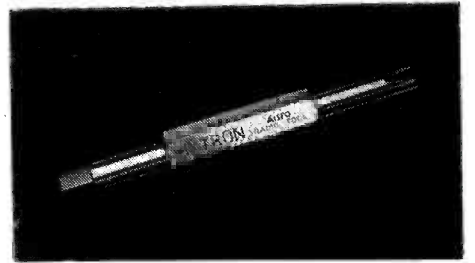

it has been removed from the car. This unique bargain tool for servicemen can be obtained from Hytron jobbers for 24c. Hytron Radio & Electronics Corp., Salem, Mass.—RADIO & TELEVISION RETAILING.

Oak Ridge TV MOUNT

The Universal Floor Mount is designed to hold any mast diameter from 1 inch to 1 1/4 inches in any position. It has a swivel top ratcheted and serrated to stay in position when tightened. The base can be screwed to a roof, wall, chimney or any base sloping or flat. Model number is UFN-5. Oak Ridge Antennas, 239 East 127th St., New York 35, N. Y.—RADIO & TELEVISION RETAILING.

South River BRACKETS

The new Duo Wall brackets are used to support TV and FM antennas, and are one-piece units providing 2-point connection to the wall and a U-bolt arrangement to hold the mast. WB-3, the 3" bracket, lists at \$2.00, and WBA-6, the 6" bracket, lists at \$2.50, both complete with all necessary hardware. South River Metal Products Co., Inc., South River, N. J.—RADIO & TELEVISION RETAILING.

University COAXIAL SPEAKER

Model 6201 is a wide-range coaxial speaker with built-in tweeter. Tweeter is driven unit type (not a small cone) and operates through the pole piece of the woofer

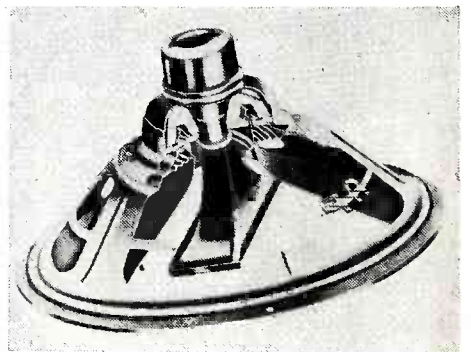

magnet. An LC dividing network is built in, and a high frequency attenuator with sufficient cable length for panel mounting is provided. University Loudspeakers, Inc., 80 S. Kensico Ave., White Plains, N. Y.—RADIO & TELEVISION RETAILING.

Get the **NEWEST . . . Get the BEST . . . NICHOLAS**

NICHOLAS

TV or FM ANTENNA-ROTATOR

MOTOR

A COMPLETE INSTALLERS PACKAGE

Compare! Nicholas antenna-rotator Motors are furnished as a complete package with nothing else to buy. Includes insulators . . . 60' four conductor control wire connected at the motor . . . control case with 7' approved line cord . . . superbracket . . . and all hardware. . . . Boxed individually, ready to install.

LIST PRICE

\$44.95

F O B FACTORY

FITS ANY
TV or FM
ANTENNA

OPERATES
IN ANY
WEATHER

EASILY, QUICKLY
INSTALLED

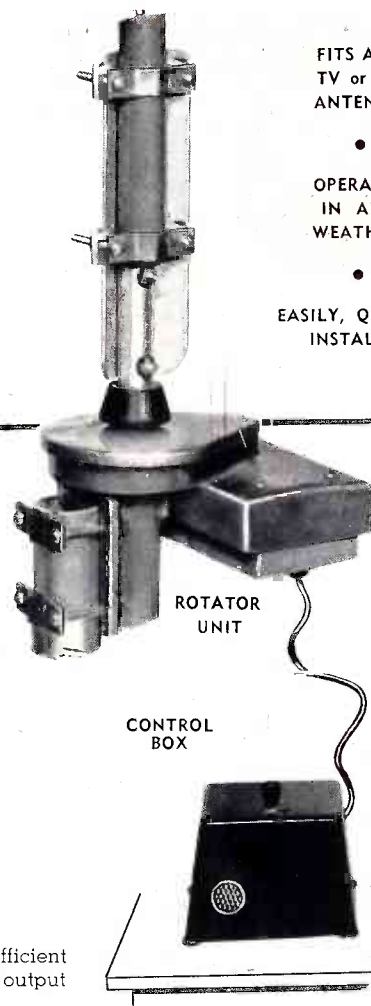

THE real answer to consistent performance over the entire television band is the Nicholas antenna-rotator Motor. It will permit orientation of any style or make TV or FM antenna from a control box adjacent to the receiver. By simply moving control switch to left or right it is possible to rotate the antenna 370 degrees. It is instantly reversible and will hold the antenna in a fixed position, without drifting, indefinitely . . . enabling operator to select exact position for "peaked" reception. Thus, any all-channel antenna can be oriented for maximum gain, minimum interference, and "ghosting."

Compare these PLUS FACTORS in Nicholas

● Mounts **any** weight TV-FM antenna or mast up to 2" diameter, plated mounting clamps and bolts furnished.

● **Guaranteed** motor and gear assembly completely enclosed in sturdy cast aluminum (salt resistant) weather-proof case . . . cannot warp or rust.

● **Nothing** else to buy. Comes complete with insulators, 60 ft. 4-conductor control wire connected at the motor . . . and all controls, super bracket and hardware. **Only 4** connections to make.

● Rustproof **Ball Bearings** on output shaft for smooth effortless operation . . . never requires lubrication.

● 370° rotation aids quick selection of "peaked" reception. **Instantly** reversible at any point.

● Release of finger-tip control automatically engages electric interlock and stops antenna **instantly** preventing coasting and drift.

● **Foolproof**—can be stalled indefinitely. A child can operate this device without harming it. Absolutely **NO** shock hazard.

● **Dependable**, efficient chain drive to output shaft.

● **Signal** light on control box indicates end of rotation in either direction. Antenna **MUST** be grounded. Failure of ground makes light inoperative. An additional safety feature.

● Beautiful one-piece walnut finish plastic control unit with **finger-tip** operating switch and signal light.

● Pilot circuit always on line . . . keeping motor dry and warm. Operates efficiently in **any** weather.

● Motor can be stalled indefinitely—**cannot** burn out.

● Will operate **any** TV-FM antenna. Tested to **300** pounds.

NICHOLAS ANTENNA ROTATOR MOTORS

Manufactured by NICHOLAS EQUIPMENT COMPANY, Bellevue, Ohio

New TV Circuits

(Continued from page 87)

metropolitan and suburban areas adjacent to transmitters, while an outdoor antenna is still recommended for fringe and near-fringe areas. The rotary switch tuner described in the June issue of *RADIO & TELEVISION RETAILING* is used in some of the models, and the Standard turret tuner is used in the others. The sound IF signal is taken from the cathode of the 3rd video IF stage, and further amplified by 2 sound IF stages preceding the FM detector. 12 and 16 inch sets are provided with two 1B3's for high voltage doubling. A feature of the line is that the safety glass over the pix tube is tilted from the vertical so that room light is reflected toward the floor and does not have the effect of lightening the picture.

The tilted safety glass is also a feature of the 16-inch sets in the new RCA line. The 24 tube chassis in the new metal cabinet 10-in. set is essentially the same as that in the 8T241 and 9T240, a feature of which is direct coupling between the video amplifier and the kine grid, which makes a DC restorer unnecessary. RCA is now shipping the 10-inch sets with the pix tube already installed.

The new OLYMPIC TV sets feature a sensitivity switch which may be operated by the customer to improve contrast in fringe areas. In effect, the switch disables the AGC to the front end, and reduces the developed AGC to the IF's. More gain is provided, and a better signal to noise ratio is said to result with the switch in the "long distance" position.

Raytheon Appointment

Raytheon Manufacturing Company announces the appointment of Art Cerf & Company, Newark, New Jersey, as sales representative for their voltage stabilizers in the upper New York State area. Art Cerf is well known in the jobbing trade throughout the state of New York, having served as a leading sales representative in this area since 1939.

Starrett Proposal

The Starrett Television Corp., New York, is advocating the establishment of a "Bureau of Television Optical Standards." Purposes of this new industry-wide set-up are explained by company officials as: a means to combat any and all adverse publicity surrounding the so-called optical hazards to viewing television; to establish for the television industry a seal of Commendation for sets meeting highest optical standards; to develop a continuing program of public relations to tell the public "the truth about television enjoyment"; and to function as a central agency to aid dealers in promoting the sale of television sets.

The Bureau, to be known as the B.T.O.S. would be a non-profit organization open to all television manufacturers, distributors and dealers.

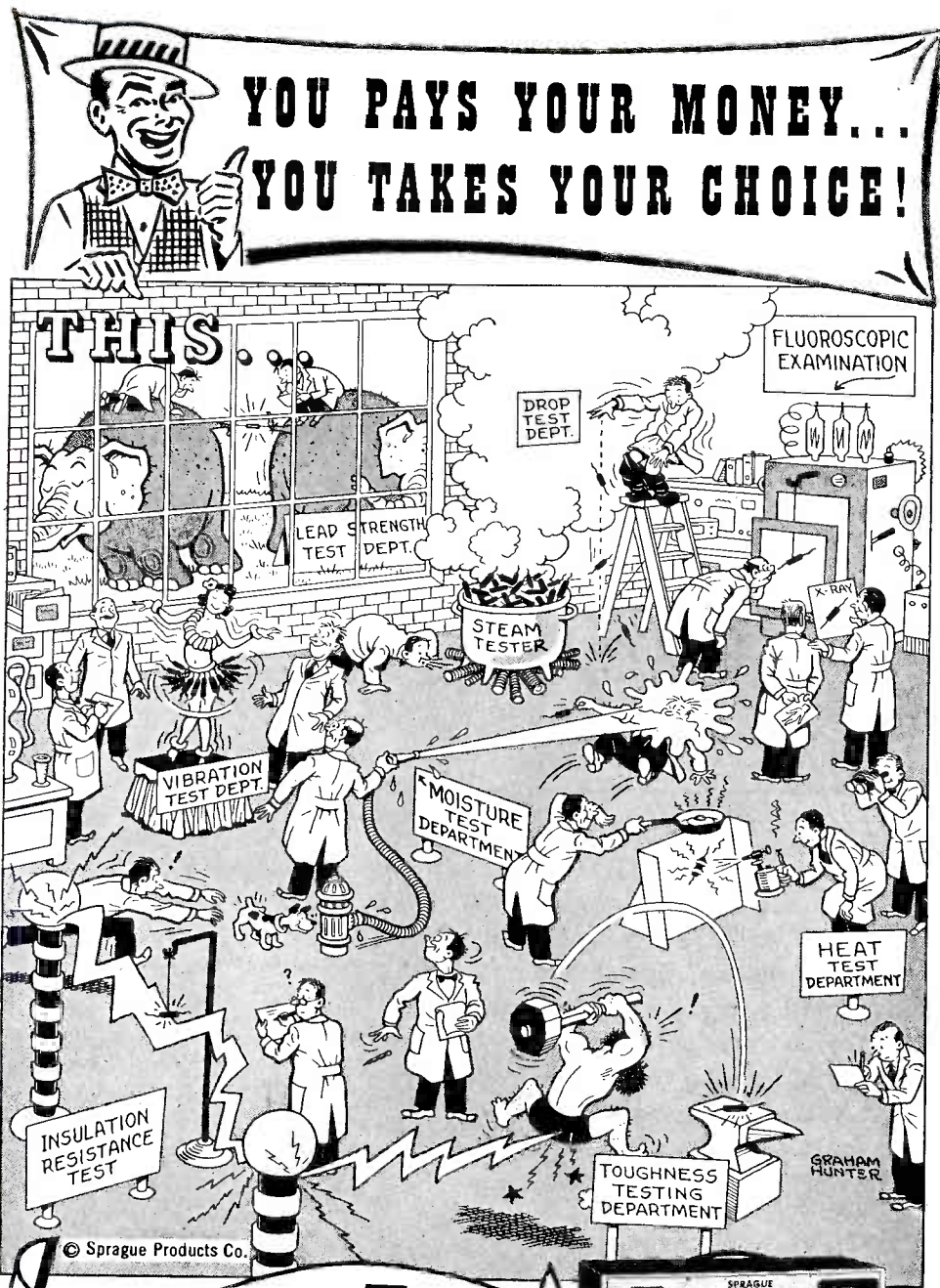

© Sprague Products Co.



Sprague Tel-Ohmike analyzer for fast, easy testing of all essential capacitor and resistor characteristics.



Sprague Capacitors for dependable service in any application.

SPRAGUE

FREE! LARGE REPRINTS OF THIS CARTOON

Handsomely lithographed with advertising removed, size 11" x 14", suitable for framing. Send 10c to cover mailing and handling cost.

SPRAGUE PRODUCTS CO., North Adams, Mass.
Distributors' Division of the Sprague Electric Company

Exaggerated? Not by a jugful! So many claims are being made for the average capacitor these days, you'd almost need a test department like this to prove whether or not the manufacturers are telling the truth.

For everyday testing of essential capacitor characteristics in your own service shop, we recommend the Sprague Tel-Ohmike Analyzer. Measures capacitances from .00001 to 2000 mfd., electrolytic power factor to 50%, and electrolytic leakage under rated voltage from built-in power supply. Checks insulation resistance of ceramic, paper and mica capacitors. Measures resistors from 2.5 ohms to 25 megohms. Also is a 0-15-150-750 volt and 0-1.5-15-75 ma. volt-milliammeter.

Write for catalog M-414 today.

Replacement Sales

(Continued from page 81)

actual money-saving to the purchaser.

In the final analysis, it's a fact that most people will be satisfied with old electrical appliances unless the desire to replace is instilled in their minds by the salesman who makes vivid comparisons, and presents dollar-wise reasons why the customer will benefit by replacing now.

The thing to do, then, is to find out who has products that have outlived their usefulness, and we can only do this by refusing to accept the customer's statement that the washer, refrigerator or vacuum cleaner is perfectly satisfactory unless we, in our own interests, and in the interests of the customer, can determine whether such statement is actually correct. Courteous questioning will "qualify" many a customer; bring about many a sale, and make more happy users in one's community.

More Customers

(Continued from page 47)

used. Such requests should be obeyed to the letter.

In setting out to make a drive for new customers, the dealer can establish a reasonable "quota" to shoot at, keep a record in a journal of the names of "new" clients he has secured for the store. Some of the larger stores may want to entertain the idea of running sales contests on the new customer angle.

Whatever method he uses, the retailer is certainly being smart in trying to build up his circle of patrons. The way things look at this time, he'll have to have more customers to make more money, since it is a fact that the buying rate has slowed down.

Turner Appoints Shaffer



Announcement of the appointment of Grant Shaffer, 1980 Lawrence Avenue, Detroit 6, as manufacturers' representative for Michigan has been announced by Wm. J. Nezerka, vice-president and sales manager of The Turner Company, Cedar Rapids, Iowa, manufacturer of microphones and electronic equipment.

BEFORE YOU ATTEMPT REMOTE INSTALLATIONS -

check with **telrex** because

TELREX CONICAL "V" BEAM ANTENNAS
are performance-proved
Up to 200 miles over land and up to 300 miles over all-water TV paths

For both remote or high signal areas, Telrex Conical Window Mounts, Stacked Bi-Directionals and Stacked Arrays are the antennas dealers and service men can depend upon for consistently good results. Each type is thoroughly engineered in the laboratory, service-tested in the field and built for long service life. Using Telrex Conical Antennas on every installation is one sure way to better, brighter pictures and a minimum of service call backs. Ask your distributor for catalog or write direct outlining your antenna problems.

TELREX ANTENNAS COVER CHANNELS 2 TO 13 AND FM—NO HIGH FREQUENCY HEAD NEEDED

TELREX MODEL 1X-BD

Bi-Directional Hi-Gain Conical "V" Beam
Broad Band Full Audio and Video Band Pass
Low Vertical Angle
Non-Varying Center Impedance 2 to 1 Front to Back Ratio
Uses 72, 150 or 300 Ohm Transmission Lines
Universal Mounting Clamp

TELREX, MODEL 2X-BD

Bi-Directional Stacked Conical "V" Beam
Low Vertical Angle
Extremely High Signal to Noise Ratio
Constant Center Impedance
Uses 72, 150 or 300 Ohm Transmission Lines
Universal Mounting Clamp

FOR THE ULTIMATE IN BI-DIRECTIONAL GAIN, USE TELREX MODEL 4X BD.

TELREX MODEL 4X-TV

2 Bay Uni-Directional Conical "V" Beam
Broad Band—Full Audio and Video Band Pass
Low Vertical Angle, Minimum Reflections
Maximum Signal to Noise Ratio
4 to 1 Front to Back Ratio All Frequencies
Non-Varying Center Impedance
Universal Mounting Clamp

TELREX SUPEREX

With antenna angle arm adjustable through 180° azimuth arc.
For high signal areas. Window, wall or attic mounting with flexible orientation possible. 2-piece arm is provided. Short arm is useful for parallel-to-wall orientation. Second arm permits other than parallel orientation.

ALL TELREX ELEMENTS ARE MADE OF LASTING DURAL

AMERICA'S OUTSTANDING TELEVISION BEAM

telrex INC

ASBURY PARK 2, NEW JERSEY

THE NEW SHURE TURNOVER PICKUP

PLAYS ALL THREE!

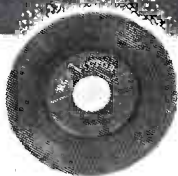

RCA 45 RPM

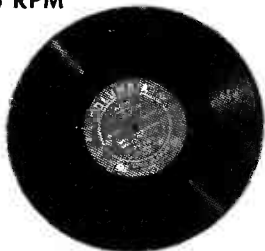

Columbia 33 1/3 RPM



Standard
78 RPM

45 RPM
33 1/3 RPM
78 RPM
with amazing
fidelity of tone.



Model: 901D
Code: RUZEL
List Price: \$16.25

Uses
NEW "Vertical Drive"
Turnover Cartridge with
"Quiet Play" Muted Stylus Needles.

With the All-Purpose Turnover Pickup you can provide your customers with "studio quality," custom-made reproduction at moderate cost.

The Model 901D Crystal Turnover Pickup . . .

1. Eliminates costly, awkward, two arm arrangements.
2. Is highly compliant, eliminating the need for weight changes.
3. Tracks with but 1/4 oz. (7 grams) on all records.
4. Has extended record-matched frequency response—needs no equalization.
5. Has output of 1.1 volts on standard 78 RPM records and 1 volt on 33 1/3, 45 RPM test records.
6. Provided with fully guarded 3-mil Osmium and 1-mil Sapphire "Muted Stylus" needles, individually replaceable.

Licensed under Brush Pats. Shure Pats. Pending

SHURE

SHURE BROTHERS, INC.

Microphones and Acoustic Devices

225 WEST HURON STREET, CHICAGO 10, ILL.

CABLE ADDRESS: SHUREMICRO

New Sentinel TV Set



Model 407CVM, shown above, is a mahogany console straight-TV set with 23 tubes including 16-inch picture tube, now being manufactured by the Sentinel Radio Corporation of Evanston, Illinois.

Sylvania Service Meetings

Ralph R. Shields and Clarence L. Simpson, engineers for the Radio Division of Sylvania Electric Products, Inc., at Emporium, Pa., are conducting a group of nation-wide meetings being sponsored by Sylvania Distributors for servicemen to discuss and instruct on the subject of television.

Meetings were scheduled between August 15 and December 15 in the following states: Arkansas, Oklahoma, Texas, Indiana, Kentucky, Michigan, Ohio, Illinois, Minnesota, North Dakota, Wisconsin, Colorado, Idaho, Iowa, Kansas, Missouri, Nebraska, New Mexico, Montana, Oregon, Washington, Alabama, Florida, Georgia, Louisiana, Mississippi, North Carolina, South Carolina, Tennessee, Maryland, West Virginia, Pennsylvania, Connecticut, Delaware, New Jersey, New York, and the District of Columbia.

Advertising Consultant



Milton Samuels, 2 So. Pinehurst Ave., New York 33, N. Y., well-known advertising executive, who has just resigned from Emerson Radio & Phonograph Corporation, announces that he will serve as consultant to radio and television manufacturers in preparing cooperative advertising copy, display pieces, streamers, folders, etc.

Represents Telectron Co.

Curtis Sales Corporation, 4019 Prospect Avenue, Cleveland, is handling a line of TV components, such as deflection yokes, focus coils, horizontal output transformers and other parts made by The Telectron Company of Cleveland. Territory covered by the Curtis organization extends from Buffalo to Chicago, including Ohio, West Virginia, Indiana, Michigan and Cook county, Illinois. Curtis R. Stoutenburg heads the Curtis Sales Corporation.

Eureka TV Names Stanier

Eureka Television and Tube Co., 69 Fifth Avenue, Hawthorne, N. J., has announced the appointment of Andrew F. Stanier as director of production. Mr. Stanier was formerly associated with the Allen B. Du Mont laboratories. Eureka is now in production on a quality line of 10, 12½, 16 and 20-inch video tubes, available to the dealer through jobbers, and to manufacturers direct from the plant.

Bendix Merchandisers

Edward C. Bonia, general sales manager Television and Broadcast Division, Bendix Aviation Corporation has announced the following appointments of district merchandisers: Ervin L. Teeter for the state of Kansas and several counties in western Missouri; Max Fischman for the Pittsburgh area.

New Admiral Wholesalers

Appointment of Farrar-Brown, 494 Forest Avenue, Portland, Maine, as exclusive distributors of Admiral electric ranges, refrigerators, radios, phonographs, and television sets for the Portland, Maine area has been announced by W. C. Johnson, vice-president in charge of Sales of the Admiral Corporation. Established in 1917 as a small store to handle automotive products in Portland's immediate vicinity, the firm added an appliance division in 1922 and continued to expand so that today it has branches in six cities throughout the state of Maine.

Trans-Vue on West Coast

The entire new fall line of Trans-Vue television equipment was recently introduced to dealers of the San Francisco peninsula area in an outdoor showing by Televisco, Inc., northern California distributor. Dealer representatives from the entire area attended. Don W. Clark, head of Televisco, played host to the dealers, their service engineers and their friends, and was assisted by his entire staff of sales engineers. The new Trans-Vue line was set up and in operation at Mr. Clark's residence, 60 miles from San Francisco. R. R. Greenbaum, president of Trans-Vue, flew out to attend the showing and expressed his satisfaction with the response of the dealers.

1. SAVE INSTALLATION TIME. Actually save enough for additional installations each week. Simplicity of Brach Antenna design, together with maximum pre-assembly at the factory, take whole hours of "time-on-the-roof" off your installation costs. And, for easier, quicker, on-the-job handling, Brach TV Antenna Kits are individually packaged, complete with all necessary hardware. Brach Universal Base Mount is a real time saver.

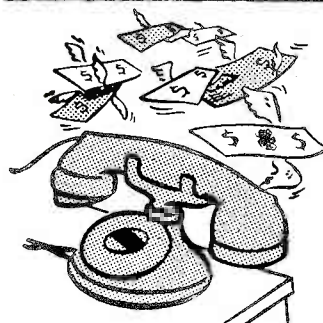
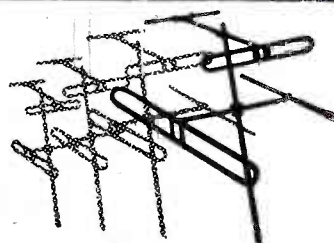

2. ELIMINATE EXPENSIVE CALL-BACKS. Brach quality engineering and bulldog ruggedness combine to help make your initial installation completely satisfactory. Developed by a name as old as radio itself, Brach TV Antennas are products of the manufacturer's own laboratory. From the rugged structural steel base mount to the tip of the sturdy mast, they're designed to stand up and shrug off the worst the weather has to offer—and deliver superior reception—longer. Factory pre-tuned and matched for 300-ohm transmission line, all Brach Antennas feature large-diameter aluminum elements for better signal pick-up.

3. MAKE PURCHASERS YOUR BEST SALES-MEN. The future success of your television line depends upon the success of your past installations. There's a Brach TV Antenna to meet every television problem better. Each Brach array you install puts you further ahead of your competition performance-wise.

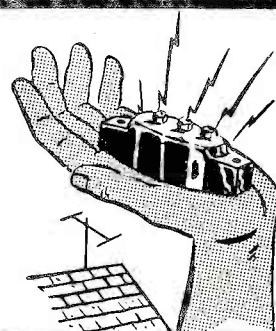
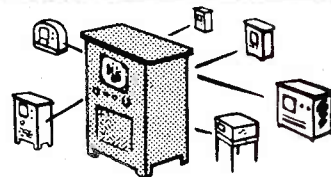

A NECESSARY EXTRA BRACH LIGHTNING & STATIC ARRESTER #4004

Helps keep the buck and jump out of the image when due to static discharge. Protects certain delicate receiver parts. Complete with all necessary hardware, the Brach Rare Gas Arrester is easily attached to any downlead. Constructed of porcelain and non-corrosive metal parts. Tested and listed by Underwriters' Laboratories.

SEND FOR BRACH CATALOG NO. RR1304

BRACH L. S. BRACH MFG. CORP.
200 CENTRAL AVENUE, NEWARK, N. J.
WORLD'S OLDEST AND LARGEST MANUFACTURERS OF RADIO ANTENNAS AND ACCESSORIES

Starrett Appoints Sales Reps Throughout Nation

Mitchell Fein, vice-president of Starrett Television Corp., New York, has announced appointment of the following representatives to represent Starrett in various territories:

For Massachusetts, New Hampshire, Rhode Island and Vermont, the H. F. Bell Sales Co., 709 Beacon Street, Boston, Mass., a partnership of Harry F. Bell and Frank B. Semple, both well-known for their achievements in the appliance and television fields. Logan Sales Co., 530 Gough Street, San Francisco, Calif. has been appointed exclusive representative for northern California. This firm, headed by Les Logan, is an outgrowth of the Les Logan Com-

pany, manufacturers representatives, which was founded in 1936. Symphonette Corporation, 112 E. Walton Place, Chicago, has been appointed exclusive representatives for northern Illinois, northern Indiana, and Wisconsin. This firm is headed by Gerry Rissman, president, well-known in radio and phonograph circles; J. F. Fisher, vice-president, former appliance merchandise manager of Alden's Mail Order Co., and Jerry Garland, vice-president in charge of sales.

For eastern Pennsylvania and southern New Jersey, Norman M. Sewell, Inc., Lansdale, Pa., will represent Starrett exclusively. This firm is headed by Norman M. Sewell, the former president and manager of Century Radio Co.

Readers Say . . .

Pocket Radio Praised

Editor,

RADIO & TELEVISION RETAILING

Just a line to say that the "pocket" 4-tube, hearing-aid type radio picks up about 8 broadcast stations with good volume. You put the hearing part in your ear and your hands are free. It's the only portable radio that I know of which is really portable. It is always with you, without hanging from your fist, or from a swinging shoulder strap. This set is manufactured by the Raytheon-Belmont Corporation of Chicago.

I have taken your magazine since around 1921 and look for everything new in radio and television in your magazine as it comes along.

Crocker J. Mann
17 Pinehurst Ave.
Natick, Mass.

Reports Unusual "DX" TV

Editor,

RADIO & TELEVISION RETAILING

In a recent issue of your magazine, C. A. Weaver states he has had DX television. It may be of interest to DX fans to know what stations I have received since June 9th, 1949, on one receiver, a Fada TTV30 in my store. I am located here on a main street in Youngstown, a poor location about 100 feet below the surrounding hills, near the steel mills, with very heavy auto and trolley-bus traffic on the street.

I have picked up 4 stations on the same channel by simply rotating my antenna. These are: WNBK, Cleveland, WKY, Oklahoma City, WTVJ, Miami, and WBZ, Boston. Enclosed are photos of KLEE-TV, Houston and WTVJ, Miami, taken June 9. Other stations I have received are: WDSU-TV, New Orleans, WJBK, Detroit, WWJ-TV, Detroit, WXYZ, Detroit, WEWS, Cleveland, WDTV, Pittsburgh, WLWC, Columbus, WSPD, Toledo, KRSC, Seattle, WFMB, Indianapolis, WLWT, Cincinnati, WTTG, Washington, WBEN-TV, Buffalo, WLWD, Dayton, WICU, Erie, WFIL-TV, Philadelphia, and WABD, New York.

With the exception of KRSC, all the above stations were received while a humid and cloudy atmosphere extended over the area between here and the received stations, and all distant stations (over 200 miles) were received during the day and early evening. My antenna is 73 feet high on a steel tower which stands on the ground, 100 feet back from the street, using two folded dipoles stacked, with reflectors spaced over $\frac{1}{2}$ -wave and cut to channel 4. Each dipole has a $\frac{1}{2}$ -wave phasing line which is made rigid by running the line to the rear of the dipoles, to the reflectors, then to the mast, where the lead-in is attached. I use an Alliance

A RELIABLE SOURCE OF 6-VOLT DC



STANCOR MODEL 752 Power Pack

Ideal for . . .

Servicing auto radios . . .
demonstrating auto accessories . . . replacing storage batteries . . . testing push-button solenoids . . . testing 6-volt battery-type radios . . . electroplating and many other uses.

The Stancor Model 752 Power Pack is an efficient selenium rectifier type of power supply—indispensable for many uses around the modern service shop where a dependable source of 6-volt DC is required.

Low internal resistance provides high current capability with good voltage regulation, while heavy duty components are designed to withstand high over-loads. For demonstrating or testing auto radios, several sets with motor tuning can be operated simultaneously.

The Stancor Model 752 Pack plugs into the standard 115-volt, 50-60 cycle AC supply to provide a continuous output of 6-volts at 12.5 amperes DC, or 25.0 amperes intermittently. A built-in voltmeter permits visual checking of output voltage, and a seven-position switch provides variation of output voltages over a convenient range for various loads.

ONLY
\$43⁹⁰

SEE THE STANCOR MODEL 752 POWER PACK AT YOUR DISTRIBUTOR TODAY



Write or ask your Stancor distributor for the new Stancor catalog, listing complete specifications and prices of more than 400 Stancor transformers, chokes and related components for radio and television servicing.

STANDARD TRANSFORMER CORPORATION
ELSTON, KEDZIE & ADDISON • CHICAGO 18, ILLINOIS

rotator to turn the antenna. I have received many other stations that I could not identify. I'm an old radio DX'er, back when U. S. stations would go off the air so we could try to get Europe in 1924 or '25, and I'll tell you all the thrills of those days are here again on TV.

Chester J. Baker
1309 Wilson Ave.
Youngstown 8, Ohio

TV in Arizona

Editor,

RADIO & TELEVISION RETAILING

We thought you might like to inform your readers of the progress being made in the television field here in Phoenix, Arizona. We have been experimenting with various types of receivers and antennae here in our store for the past six months, and have had truly remarkable results. We have in the past received programs from Memphis, Tenn., Ft. Worth, Tex., Houston, Tex., and Oklahoma City, Okla. For the past several weeks we have had almost daily reception from the following stations:

KLEE-TV	Houston
WMCT-TV	Memphis
KSD-TV	St. Louis
WBAP-TV	Ft. Worth
WNBQ-TV	Chicago
WKY-TV	Oklahoma City

We have received regularly programs of the Goldberg Family, Hopalong Cassidy, Bill Sterns Sportcast, Arthur Godfrey, boxing and wrestling matches, and many others. The reception of these various programs has been very clear visibly and audibly; in fact, the sound at times is just like a local 5 KW station.

We are using standard equipment for all our tests; regular stock receivers and antennas. We are using at present a Masco booster, a stacked dipole antenna with director and reflectors, and an antenna rotating motor. We have tried to date Admiral, Packard-Bell, RCA, Motorola, and Pilot receivers, and have had good results with all sets.

Our local station is due to be on the air in the near future; I believe they will start test patterns in September. Call letters will be KTLX, and the station will operate on channel five.

We might add that we tuned in on the Wolcott-Charles fight broadcast from KSD-TV in St. Louis, and approximately 13 rounds of the fight were received, both at our store location, and at the home of one of our customers.

We are enclosing a news article from one of our local papers which we thought you might find interesting.

I. W. Brayer
Whitey's Radio-Record, Appliance Co.
1902 East McDowell
Phoenix, Arizona

EDITOR'S NOTE: The clipping enclosed from the Phoenix Gazette included photographic proof of Whitey's TV set receiving WMCT-TV, Memphis TV station.

New Major TV Tubes

Following extensive laboratory and field tests over a period of six months, the Major Television Corporation, headed by Col. Stuart Frank, announces that it will specialize in the manufacture of hand blown tubes. Already a number of set manufacturers have contracted for the use of the hand blown tube in their TV sets, the firm advises.

Originally, Major planned the hand blown tube, processed in the Warren Kessler plant in Long Island, for their own exclusive use in their 12½ and 16 inch sets. Major postponed the program of set manufacturing to concentrate on the tube for the near future "because of the tremendously favorable labora-

tory report and eagerness of set makers for the unique tube," a company statement says. Advantages claimed for the tube include more optical perfection; uniformity of glass face thickness; high efficiency of light transmission; greatly reduced weight; greater tensile strength; electrical characteristics equal to or better than other tubes.

Tele-tone Distributors

Tele-tone Radio Corp. has appointed the Lew Bonn Co., Minneapolis, as distributors for the complete Tele-tone radio and television line, it has been announced by Morton M. Schwartz, general manager of Tele-tone.



WE'VE GOT IT!

**VISION...
to PERFECTION**

EUREKA'S JOBBER-DEALER POLICY

We are observing a fixed policy of marketing our TV tubes through distributors who supply the tube requirements of retail dealers, servicemen, hams, communications operators, home-constructors, etc.

Ample quantities are available for reputable distributors but we will not ship to job-lot wholesalers, cut-price outlets, etc.

Only by such restriction can we properly serve our distributors and cooperate with the manufacturers who adopt Eureka Television Tubes for their receivers and kits.

The price and quality to fulfill your cathode ray tube needs. . . .

We are ready to serve the television industry with a complete line of competitively priced glass cathode ray tubes in 10", 12½", 16" and 20" sizes.

PRICE + QUALITY = EUREKA

For information, write:

EUREKA TELEVISION AND TUBE CORPORATION

Offices & Plant—69 Fifth Avenue

HAWTHORNE, NEW JERSEY

Revolutionary NEW **Carbonneau Playsall** *

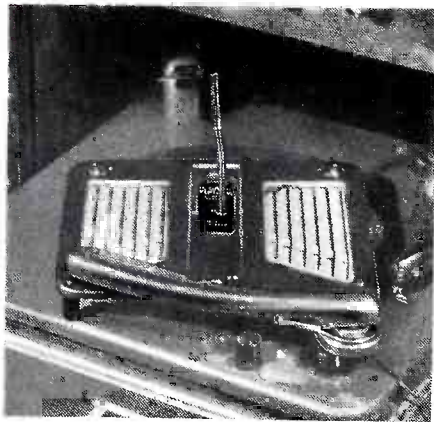

high profit for you
on each **\$14.95** sale
plus
tremendous new market
for "slow-speed" records!

Make quick profits with this sensational new record player and watch your sales of "slow-speed" records skyrocket! Just slip Playsall on the phonograph spindle . . . play 33 $\frac{1}{3}$ and 45 R.P.M. records. Slip it off — play standard records as usual! Playsall fits 99% of all phonographs without special installation . . . requires no outside wiring, no outside adapter. Display Playsall in your store — sell it on service calls. It's a sure-fire profit-maker!

*T.M.

BACKED BY COMPLETE MERCHANDISING PROGRAM

- National publicity
- Eye-catching displays
- Free mat service
- Attractive literature
- Tested radio spots
- Advertising allowance

Excellent Profit Margin! See your local distributor or write us for complete information — today!

CARBONNEAU INDUSTRIES, INC., Dept. 3, Grand Rapids 2, Mich.
Manufacturers of Jetline Speakers

WRITE FOR YOUR FREE COPY
NEW SOUTH RIVER CATALOG

Featuring Original Chimney Mount Antenna Base • Duo-Mount Antenna Base • Duo-Wall Brackets • Duo-18" Adjustable Wall Brackets • Duo-Pipe Mounts • Accessory Hardware • Adjustable Stand-Offs • Nail-ins with Wing Tips • Screw-type Insulators

SOUTH RIVER METAL PRODUCTS CO., INC.
Dept. RR, 17 Obert Street South River, N. J.

Sheldon TV Picture Tubes

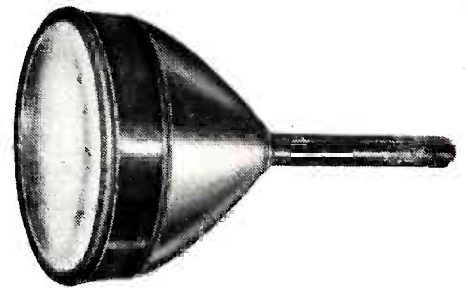

Sheldon's "Natural-Image" soft glow TV picture tube now being processed by the Sheldon Electric Company of Irvington, N. J., is said to produce pictures with higher definition, greater contrast range, and less eye strain due to extreme care in processing and in handling during manufacture. All-glass tubes with a flat face are made in 10, 12 $\frac{1}{2}$ and 16 inch sizes.

Named General Manager

W. C. Johnson, vice-president in charge of sales, of Admiral Corporation, has announced the appointment of Edwin M. Perkins as general manager of Admiral Corporation, Boston Distributing Division, Inc., 857 Commonwealth Avenue, Boston, Mass. Prior to his appointment, Perkins had been a regional manager for Admiral Corporation.

Form TV Lecture Bureau

Establishment of the Television Technicians Lecture Bureau to sponsor a nation-wide program of non-commercial lectures for radio and TV technicians has been announced by Paul H. Wendel. The lecture staff will be headed by Walter R. Jones of the Cornell University school of electrical engineering, and A. C. W. Saunders, director of Saunders Radio and Electronics School of Boston. The Bureau will make its headquarters at 55 E. Washington St., Chicago. An admittance fee will be charged at each lecture so that lectures can be maintained on an impartial basis, and to provide for visual aids and demonstration devices, as well as to employ lecturing talent.

For Speedy Installation



The Ward Products Corp., a division of the Gabriel Co., Cleveland 3, Ohio, is featuring its "Minute Man" TV antenna, model TV-46, a recent addition to the firm's line. Latest model cuts installation time and cost.

Westinghouse Protects Prices on TV Receivers

Factory list prices on all current Westinghouse television receivers have been guaranteed for all dealers and distributors in a comprehensive price protection policy announced by the Westinghouse Home Radio Division, Sunbury, Pa.

The plan, retroactive to July 1, will protect dealers and distributors from loss on any television inventory purchased within a 60 day period prior to price readjustment. It also will cover Westinghouse television models to be announced later this year.

New Catalogs, Books and Pamphlets

American Phenolic Corp.: A new condensed catalog for dealers illustrates Amphenol RF cable and RF connectors, polystyrene sheets, rods and tubes, microphone connectors, socket items, etc., as well as Amphenol TV and FM antennas and accessories, and Amphenol Twin-Lead. Catalog available on request to this firm at 1830 S. 54th Ave., Chicago 50, Ill., on your business letterhead.

Workshop TV Antennas—Catalog #49 illustrates the Workshop line of antennas and arrays with specifications and polar diagrams of response, along with mounting accessories and equipment. The Workshop Associates, Inc., 66 Needham St., Newton Highlands 61, Mass.

Hickok Tube Testers—A new 4-page folder describes and illustrates the latest complete line of dynamic mutual conductance tube testers. Hickok Electrical Instrument Co., 10523 Dupont Ave., Cleveland 8, Ohio.

Clarostat Resistors—Clarostat catalog #49 presents the complete line of resistors, controls and resistance devices, including the Pick-A-Shaft controls is available to anyone writing to Clarostat Mfg. Co., Inc., Dover, New Hampshire.

Illinois Condensers—The new Illinois Condenser catalog contains detailed information of a new and expanded line of condensers for all radio and TV uses. Copies may be obtained free from the Illinois Condenser Co., 1616 North Throop St., Chicago 22, Ill.

Permoflux Auto Speakers—Auto speaker chart #J-28 shows replacement speakers for practically all auto radio sets. Write for copy to Permoflux Corp., 4900 W. Grand Ave., Chicago, Illinois.

Swivelier Products—Bulletins #123 and #14A show illustrations, descriptions and prices of the Swivelier line of lighting fixtures and fixture-mounting accessories. Swivelier Co., Inc., 30 Irving Place, New York 3, N.Y.

Radiodyne Antenna Equipment—New catalog lists complete specifications and prices of Radiodyne heavy-duty stand-off insulators and antenna hardware fittings for TV, FM, and AM receivers and amateur transmission lines. Western Coil and Electrical Co., 215 State St., Racine, Wisconsin.

New Miami Headquarters

The executive offices, together with the Miami warehouse and display rooms, of the Florida Radio and Appliance Corp., are now located in their permanent building, at 2101-2111 N. Miami Ave., Miami, Florida.

Atwater in Larger Quarters

Atwater Television Co. has moved to new and larger quarters at 360 Furman St., Brooklyn 2, N. Y. This move will enable the firm to step up production and meet the demand of key stores around the country, Irving Ross, national sales manager of Atwater reported.

New Zenith Distributors

The Perry Shankle Company, newest San Antonio wholesaler, has been appointed distributor of Zenith's radio and television products in San Antonio and southern Texas, it has been announced by H. C. Bonfig, vice-president of Zenith Radio Corporation.

The new Zenith distributor, located in San Antonio at 1801 South Flores Street, opened its doors to the public with a two-day open house celebration.

Principals of the company are Perry Shankle, founder and president; A. W. Kilgore, vice-president; H. E. Woelke, secretary-treasurer; and Fred H. Strayer, manager of the radio and appliance division.

JERROLD

MUL-TV ANTENNA SYSTEM

for TV DISPLAY ROOMS OF DEALERS AND DISTRIBUTORS

PERMITS SIMULTANEOUS OPERATION OF A LARGE NUMBER OF TV OR FM RECEIVERS FROM ONE ANTENNA—NO SWITCHING IS NECESSARY

Install It Yourself

Other Features of the Jerrold Mul-TV System . . .

- Permits side-by-side demonstration at peak performance.
- Easy to remove or add sets or rearrange display.
- Receives all channels simultaneously—All sets always connected—No switching.
- Can be used in either Local or Fringe areas.
- All receivers easily tuned to any channel.
- Easy to install—Simple to operate.
- 72-ohm and 300-ohm receivers are matched properly and can be intermixed at will.
- Only one cable feeds all outlets.
- No fumbling of wires or switches in front of customer.
- System is neat, compact, built for continuous duty—may be expanded to cover new channels—including UHF.

PAYS FOR ITSELF . . . SELLS MORE SETS . . . INCREASES YOUR PROFITS

Mail this coupon immediately

JERROLD
ELECTRONICS
CORP.
121 N. Broad St.
Phila. 7, Pa.

Send catalog and instruction manual to:

Name

Street address

City..... Zone. . . State.....

This is it!

**A TELEVISION
BOOSTER THAT
REALLY DOES THE JOB**



THE ANCHOR TV-PRE-AMPLIFIER

*Here's What Others Say!**

"IT DOES HAVE MORE USEABLE GAIN THAN ANY OTHER 'BOOSTER' I HAVE SEEN, YIELDING SNOW-FREE PICTURES UNDER THE MOST DIFFICULT CONDITIONS."

JOHNSON & ELLIOTT
MONTICELLO, N. Y.

**An unsolicited statement from an independent service engineer.*

NOT MERELY ANOTHER BOOSTER — ANCHOR WILL POSITIVELY DO EVERYTHING AS CLAIMED OR YOUR MONEY BACK

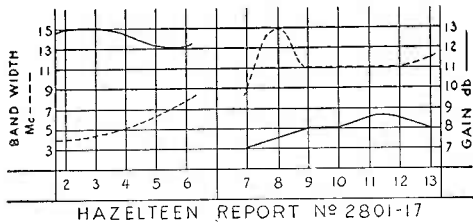

IT'S NEW — DIFFERENT HAS AMAZING PERFORMANCE

An ANCHOR TV-PRE-AMPLIFIER will out-perform any similar equipment in its class. Don't take anything less than the best—don't take anything less than ANCHOR.

Check These Features

- * 4 mc minimum Bandwidth on all channels
- * Impedance matching to receiver
- * Simultaneous iron core tuning of grid and plate
- * 2½ times average gain (Voltage Ratio)
- * Guaranteed coverage of low and high TV-Band

Carefully, thoroughly engineered, ANCHOR TV-PRE-AMPLIFIER is a product of long research—it is compact, beautifully styled and precision built to give outstanding, trouble-free performance. When you install an ANCHOR TV-PRE-AMPLIFIER you give your customers the best. Don't wait—don't miss this—see your jobber today. LIST PRICE \$37.50

Dealer aids available — Write for Further Information

ANCHOR
RADIO CORP.
2215 S. St. Louis Ave.
Chicago 23, Ill.

Something New In Hats



Chic black velvet turban glamorizes smallest TV picture tube, in the North American Philips Company's Protelgram. (10½ inches long; 2½-inch face—weight, 8 ounces.) Hat was displayed at New York during show and convention staged by National Association of Music Merchants.

New Walco Product

Walco Products, Inc., 60 Franklin St., East Orange, N. J., announces the introduction of an entirely new product designed to end the problems of static electricity in Vinylite records.

According to the company, this product, based upon a secret chemical formula, was developed over a two-year period in the creation of a static eliminating product for the photographic industry. It is a liquid which, when applied to record surfaces, creates a condition in the record which causes it to discharge any inherent static electricity so that it will no longer attract dust particles. Thus, a serious impediment to both the surface and the reproduction quality of Vinylite discs is easily and permanently removed by owners of unbreakable Vinylite records.

It is expected that the retail price will be \$1.00 for a one-ounce bottle, which, in treating two hundred records, will cost the consumer an average price of a half-cent per record.

"Fireball" TV Service Sign



Offered to radio dealers and servicemen, this new "Fireball" sign, recently introduced by the RCA Tube Department, is more brilliant than neon by actual light meter test, yet runs for 24 hours for one cent. Available in the RCA, RCA Victor and Cunningham brand names, the new sign measures more than 2 feet long and 2¾ inches deep, and has a six-inch-high face. The new sign is available from RCA tube and parts distributors.

MODEL 195B

HICKOK 5"
Television
OSCILLOSCOPES
Most practical sensitivity—.03 volts per inch.

World Famous

THE HICKOK ELECTRICAL INSTRUMENT CO.
10523 DUPONT AVE. • CLEVELAND 8, OHIO

SEE YOUR JOBBER OR WRITE FOR COMPLETE INFORMATION TODAY

Aerovox Appointment

To provide still more intensive sales and engineering services to Chicago manufacturers, Aerovox Corporation of New Bedford, Mass., manufacturer of capacitors for radio, electronic and electrical usages, announces the appointment of Leroy Eschner, 9 South Clinton St., Chicago 6, Ill. (Phone Central 6-1533.) Eschner will be manufacturer's representative for a part of the Chicago metropolitan territory. He will be assisted by Evert Keranen. Both men were formerly associated with a leading capacitor manufacturer and are known in the industry.

New Speaker Baffle

The Vibracloc Corporation, 425 Bush Street, San Francisco, California, announces production of a new speaker baffle in their popular price lines as an addition to their regular patented cabinets. This new corner-type baffle is made of masonite leatherboard, combined with hand finished plywood tops and bottoms. The baffle has an unusual rear construction and the manufacturers claim that this particular type of construction gives exceptionally better tone quality and wide frequency response. Prices range from \$7.50 to \$13.00.

Vibracloc baffles have been installed in many places throughout the country, and the manufacturers claim that this new Super Sector cabinet will be enthusiastically welcomed by the trade.

Phillips Is Promoted

Willis E. Phillips has been named vice-president and general manager of The Rauland Corporation, manufacturers of television picture tubes, according to E. N. Rauland, president. "Bill" Phillips was previously assistant to the president of The Rauland Corporation to which position he came from Motorola where he was division chief engineer.

According to Mr. Phillips, The Rauland Corporation plant has been completely converted for high speed mass production of metal and glass television picture tube types, and ample productive capacity is available to insure all customer orders being shipped according to schedule. Of particular interest to set manufacturers, are the new 12" metal tube, Type 12UP4, and the new short 16" metal tube, Type 16EP4, recently introduced by The Rauland Corporation.

Name Norman Siegel

Appointment of Norman Siegel as manager of major and small appliances at L. Bamberger & Co., Newark, N. J., has been announced by Alex Lewi, vice-president and merchandise administrator of home furnishings. Siegel replaces Herbert Wexler who was recently transferred to Macy's, New York as buyer of radio and television.

DEPEND ON IRC

FOR TELEVISION SERVICING

Television servicing requires replacements of *absolute* dependability. Otherwise, you risk expensive call-backs. Be positive of that dependability in resistors and controls... always buy "IRC"! Produced by the largest resistor manufacturer in the world, IRC parts are standard equipment in the finest television sets.

New, Advanced Type BT Resistors are IRC engineered to meet the rigorous requirements of television. They surpass Army-Navy Specification Jan-R-11. Small, fully insulated, and cool operating, Advanced BT's are supplied in 1/2, 1 and 2 watt sizes.

Every requirement of television servicing has been considered in the design of IRC's new, compact 16/16" volume controls. Revolutionary Interchangeable Fixed Shaft feature means faster and better servicing... resilient retaining ring cushions the turn; your customers can feel the difference.

New IRC PRECISTORS are ideal as low cost replacements for wire wound precisions and strings of insulated resistors. These deposited carbon units combine accuracy, stability and economy. Guaranteed accuracy 1%, in 2 sizes and a wide range of values.

For vertical or horizontal centering, IRC Type W Wire Wound Controls are furnished with a center tap. Tight, uniform windings insure accurate focusing.

International Resistance Co., 401 N. Broad St., Phila. 8, Pa. In Canada: International Resistance Co., Ltd., Toronto, Licensee.



ADVANCED TYPE BT'S
BT means Better Television!
Tiny 1/2, 1 and 2 watt resistors are JAN approved.

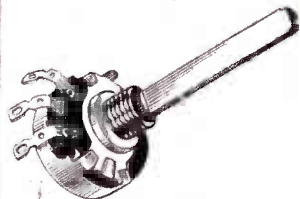

NEW INTERCHANGEABLE FIXED SHAFT CONTROLS
quiet operating, compact 16/16" design.

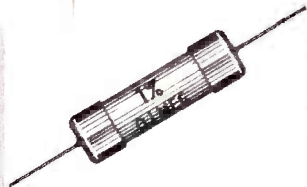

CLOSE TOLERANCE PRECISTORS
guaranteed accuracy 1%.

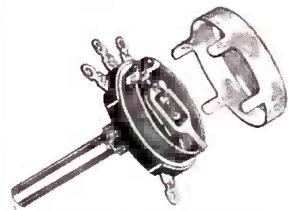

CENTERING CONTROLS
for accurate horizontal or vertical focusing IRC Type W Control

INTERNATIONAL RESISTANCE CO.

Wherever the Circuit Says 



CONICAL TV RECORD BREAKER

Matches any ohm wire. All channels 1 to 13. No booster required. Lightweight—approx. 7 lbs. Immediate delivery.

Users report up to 300 miles reception.

\$11.75 DOUBLE STACK
8V-TV LIST \$37.95

\$5.75 SINGLE STACK
4V-TV LIST \$18.95

NO JOBBERS. ORDER DIRECT.
20% DEPOSIT ON ALL C.O.D. ORDERS

RAYTRON—441 Summit—Toledo, Ohio



Magnetic Recorder Market Tops
\$50 Million Mark Annually

Chicago Dealer Sells 66 Units
From One 4 Column Ad

Get Your Share With This
**PROFIT-PROVEN
PENTRON LINE**

RADIO-PHONOGRAPH
PENTRON
Astra-Phonic
WIRE RECORDER
PUBLIC ADDRESS SYSTEM



All recorders
play or record con-
tinuously for 1 full hour.

List
\$199.50*

Complete
No. W 748

*Slightly higher
west of Rockies

4-IN-1 COMBINATION WIRE RECORDER • RADIO • PHONO

Fastest seller on the market . . . proof of profit definitely assured!
4 prospects instead of one. Precision-built for high-fidelity response,
dependable wide-range performance. Simple operation.

- Wire Recorder records, plays back own radio, phono, mike
- Superhet. Radio, highly selective, built-in antenna
- Record Player has tru-tracking arm and Astatic Cartridge
- P. A. System, medium gain
- Synchronized Timing Meter indexes all recordings
- 2-Way Automatic Shut-Off stops wire tangle, breakage

PENTRON
Astra-Phonic
WIRE RECORDER



List
\$149.50*
Complete
No. W 449



List
\$179.50*
Complete
No. T 549

WIRE RECORDER

Only recorder at this price with high-fidelity, dynamic range. Engineered for trouble-free operation.

- Wire Recorder records from mike or radio
- P. A. System, medium gain
- Synchronized Timing Meter
- 2-Way Automatic Shut-Off

2-Channel TAPE RECORDER

Unmatched full-range tonal fidelity. Exclusive features unobtainable in other recorders at this low price.

- Tape Recorder, high gain P. A. system
- Fast Speed, forward and reverse. No rethreading
- Synchronized Timing Meter

All Fully Covered by Product Liability Insurance

FREE! TESTED SALES AIDS BUILD MORE LOCAL TRAFFIC
See Your Distributor or Write to

THE PENTRON CORP., 611 W. Division St., CHICAGO 10, ILL.

YOUR JOBBER
HAS THE
SUPER-INSTANT
SOLDERING IRON

A NEW REVOLUTIONARY
INSTANT HEATING IRON

NO TINNING • NO FILING • NO WEAR
NO THERMOSTAT

BUT —

COMPLETE HEAT CONTROL
IN A NEWLY DISCOVERED
DESIGN IN HEATING ELEMENT

SUPER-INSTANT—the Giant of performance and efficiency but the Flyweight champ of the soldering irons—quick-heating, light, easy to handle, the SUPER-INSTANT is applicable to the smallest, most delicate of work, as well as rugged soldering to metal.

THE SUPER-INSTANT offers a new design in quick heating irons, by employing a quick-heating element, to bring the tip to soldering temperature, and a "bucking coil" to maintain this temperature and prevent over-heating and scalding. There is no 'hot and cold' action such as found in most thermostatic controlled equipment. The SUPER-INSTANT is maintained at a constant heat when the switch is held on.

THE SUPER-INSTANT is ideal for intermittent use by servicemen hobbyists, etc., as well as fast efficient production lines. TRY IT AND YOU'LL NEVER BE HAPPY WITH ANY OTHER.

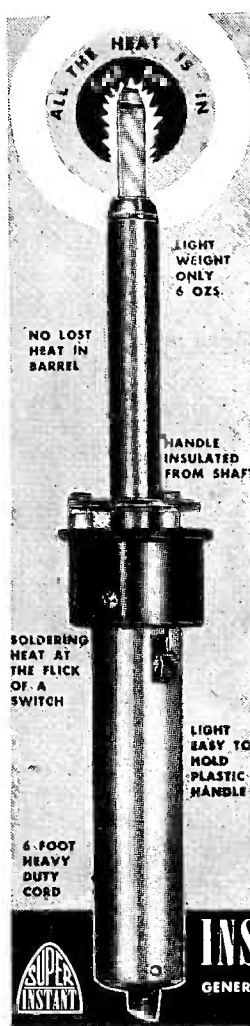

ONLY
\$795
LIST

STANDARD JOBBER DISCOUNTS
WRITE FOR CATALOG SHEET RT9

ORDER NOW
Our Monthly Ad
in
Radio & TV News
Is Bringing Big
Demands
Your Jobber Has
Super-Instant
Write Us For
Free Literature

INSTANT TOOL CORPORATION

GENERAL OFFICES: 231 WEST 29th STREET, NEW YORK 1
FACTORY: BINGHAMTON, NEW YORK

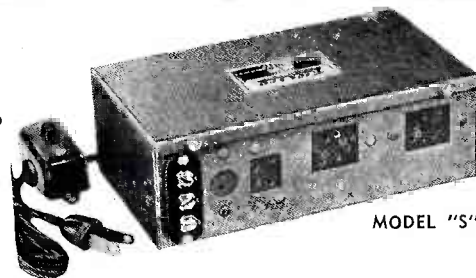

MODEL "S"

CONVERTS OUTDOOR RADIOS FOR INDOORS
NOW! Cash in on Big Timely Demand!

Sell Electro Battery Eliminator, converts dry battery radios into dependable AC receivers. The Model "S", with selenium rectifier, operates any 1.4 volt 4, 5 or 6-tube battery radio from 115 volt 60 cycle source. Filtered hum-free reception. Exclusive features give extra sales appeal:

- ★ Eliminates cost of batteries
- ★ Easily installed, fits most radios
- ★ Low operating cost, few cents per 100 hours
- ★ Operates in any position
- ★ On-off switch
- ★ Blue Hammerloid finish, handsome, durable

Model "P"—Compact. Same as Model "S" except has tube rectifier at low cost. Also available for 220 volt operation.

Model "F"—Compact. Operates 2 volt, 4, 5, 6 or 7-tube radio from 115 volt 60 cycle source. (0.5 amp. filament max.)

Model "FH"—Compact. Same as Model "F", but applies 0.65 amp. filament current.



Write today
for literature

Pioneer Manufacturers

of Battery Eliminators

ELECTRO PRODUCTS LABORATORIES, Inc.

549 WEST RANDOLPH STREET, CHICAGO 6, ILLINOIS

New Rembrandt Prices

New lower list prices on the Rembrandt line of television receivers, effective September 15, 1949, are as follows: Model no. 1606—\$389.00; 1606-15—\$479.00; 1950—\$329.00; 721—\$399.00; 130—\$479.00; 80—\$389.00.

Philco Training Programs

A new nationwide program is under way to assure owners of television receivers, radios and radio-phonographs of better service than ever before, it was announced by James M. Skinner, Jr., vice-president—Service and Parts Division, Philco Corporation, in opening a two-day convention at Philadelphia, which was attended by more than 250 service managers from the company's wholesale distributors throughout the country.

"We are providing the service managers of all our distributors with detailed technical information of the new Philco television, radio and phonograph models for 1950," Mr. Skinner said. "Then these service managers will set up a training program for television and radio dealers as well as independent servicemen in all parts of the United States."

To make this training the most effective possible, Philco is also providing a new series of simplified lessons on television servicing, as well as complete

manuals covering each new television, radio and phonograph model, Mr. Skinner explained. This material will be provided to members of Philco Service, an organization of about 40,000 carefully selected servicemen trained in the maintenance of television and radio receivers and electric appliances.

New "Dark Glass" for TV Picture Tubes

Pittsburgh Plate Glass has announced the development of "Teleglas," a gray tinted face-plate for TV picture tubes which is said to give improved contrast in pictures by reducing the incident of room lighting as well as halation from within the tube. Due to this dual function of the glass, tubes using the new face-plate are said to give better results than former types with filters attached on the outside. Zenith Radio Corporation is the first manufacturer to market Teleglas in receiving sets. The glass is featured in the new "Glare Ban" Zenith line.

Coolerator Distributors

Bowers Wholesale Corporation of Norfolk, Virginia, has been appointed distributor for Coolerator electric ranges, refrigerators, and family-size home freezers, it has been announced by William C. Conley, Jr., Coolerator sales manager.

Sparton Executive



Henry L. Pierce, general sales manager of Sparton Radio and Television has announced the appointment of Charles W. Snider, shown above, as advertising and sales promotion manager.

New Rep Firm

A new firm of manufacturers' representatives, the Egert & Fields Company, has been formed by two members of the New York Chapter of "The Representatives" of Radio Parts Manufacturers, Inc., Samuel S. Egert and Jack Fields. The new company represents several leading manufacturers in the radio and electronic industries, with headquarters at 11 Park Place, New York 7, New York.



NEW LOW PRICES AUDIO RECORDING WIRE

- STAINLESS STEEL
- HIGH FIDELITY
- PLAYS INDEFINITELY
- ERASABLE

Audio Recording Wire is the product of three years of research by specialists in our own wire mill devoted exclusively to the manufacture of recording wire.

Distributors—stock this item today—the new low prices will bring more profits—

Available in 1 hour, $\frac{3}{4}$ hour, $\frac{1}{2}$ hour and $\frac{1}{4}$ hour.

THE WIRE CORPORATION
WORCESTER 8, MASSACHUSETTS

Now! Lower Prices on the new, Improved

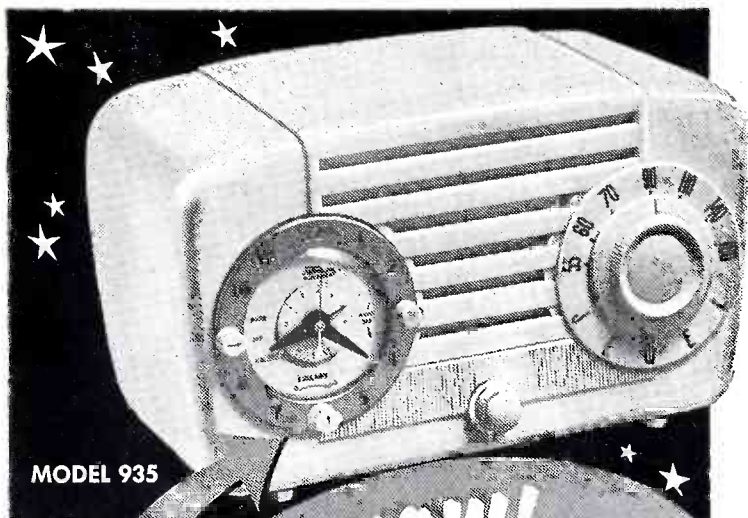

MODEL 935

NOW!
 Go to sleep with **MUSIC!**
 Wake up to **MUSIC!**
 Wonderful, New **LULLABY**
 SWITCH **DOUBLES** the **VALUE!**



JEWEL
Wakemaster

with **TELECHRON ALARM MOVEMENT**
 and **LULLABY SWITCH**

A wonderful JEWEL radio . . . now even GREATER! WAKE-MASTER now lulls the listener to sleep to his favorite music and TURNS ITSELF OFF AT A PRE-SET time, waking him to music or the early news and ringing an alarm 10 minutes later to make doubly sure. Accurate TELECHRON movement with sweep second hand operates with or independently of radio. In Walnut Prices are lower than ever!

\$29.95*
 in Ivory
 \$31.95*

DISTRIBUTORS! FACTORY REPS!
 Some good territories are open. Write for details.

Prices subject to change without notice. * Slightly higher west of the Rockies

JEWEL RADIO CORP.
 10-40 45th AVE., LONG ISLAND CITY 1, N. Y.

perfect **CORDination**

Electrical appliances work like a team with **CORNISH Cords and Plugs.** Sure contact, long wear—and an end to **CORDelirium** with

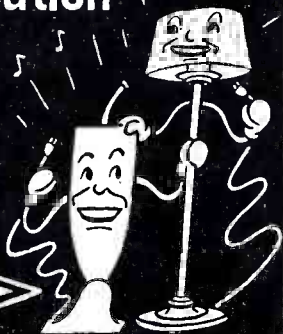

CORDS and CORD SETS

APPROVED BY UNDERWRITERS LABORATORIES

Selected by leading manufacturers . . . why not by **YOU**

A full line of Flexible Cords for the Repair and Service Industry, obtainable through Jobbers and Distributors

CORNISH WIRE COMPANY, INC.

15 Park Row New York 7, N. Y.

WHAT? NO LIGHTS?

Katolight Plants furnish the same kind of A.C. current as the Highlines. Sizes 500 Watts to 300 Kilowatts.

Also manufacturers of Rotary Converters, Frequency Changers, D.C. Motors 1/4, 1/3, and 1/2 H.P., A.C. Motors, single phase in 2, 3, and 5 H.P., high frequency Generators.

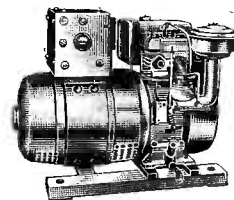

KATO 2500-Watt Light Plant

KATO ENGINEERING COMPANY
 1441 First Avenue Mankato, Minnesota

2nd Annual National **TELEVISION & ELECTRICAL LIVING SHOW**
CHICAGO COLISEUM
 1513 S. Wabash Avenue

October 1 thru October 9, 1949
 1 P.M. to 11 P.M. daily and Sundays
 SEE . . . Actual Television and Radio broadcasts
 SEE . . . Miles of interesting Exhibits
 SEE . . . Yourself on Television .

Sponsored by The Electric Association

Admission: \$1 incl Tax

SPECIAL! IN PERSON
 three shows daily

EDDIE CANTOR

• **Mad Russian**

• **Lou Breese**
 and his orchestra

• **Guffey**
 • **The Glens**
 • **Vicki Richards**
 • **David Powell**

RCA "PICT-O-GUIDE"

A new kind of handbook for TV troubleshooting and service, the "Pict-O-Guide" is a handy loose-leaf album of photos showing common operating troubles encountered, as they would appear on the TV screen. Simple captions under each photo describe the symptoms and explain the

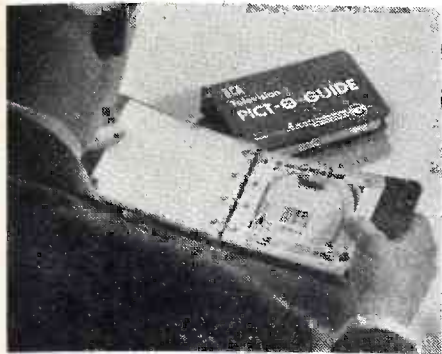

causes of the trouble. The photos were made from actual signals received on the RCA TV Dynamic Demonstrator. Both the Demonstrator and the Pict-O-Guide were conceived by John R. Meagher of the Tube Division of RCA. Pict-O-Guide is obtainable by users of RCA and Cunningham tubes, through their distributors. RCA Victor Div., RCA, Camden, N. J.—RADIO & TELEVISION RETAILING.

House of TV TELEMIRROR

Telemirror is an 8x10 plate glass mirror for use by servicemen to adjust a TV set from the rear. A floor stand 44 inches high



is provided to support the mirror. Telemirror lists for \$6.95 complete with stand. House of Television, Starrett-Lehigh Bldg., New York, N.Y.—RADIO & TELEVISION RETAILING.

Walco TV PRODUCTS

The Walco line now includes a portable TV antenna known as the Duo-Tenna which lists at \$5.95; an all-channel, tunable TV booster listing at \$37.50; and a TV tower of structural aluminum in 6-foot sections listing at \$15 per section. Also announced at this time is a static eliminator fluid for use on Vinylite phonograph records and plastic TV filters and lenses. This will list at \$1.00 per bottle. Walco Products, Inc., 60 Franklin St., East Orange, N. J.—RADIO & TELEVISION RETAILING.

FOR SHARPER,
BRIGHTER PICTURES
ON H.F. CHANNELS—

TACO TWIN-DRIVEN YAGI

BOOSTS SIGNAL!
LOWERS COSTS!
PINPOINT DIRECTION!

• WRITE FOR FREE BULLETIN ON TACO YAGIS.

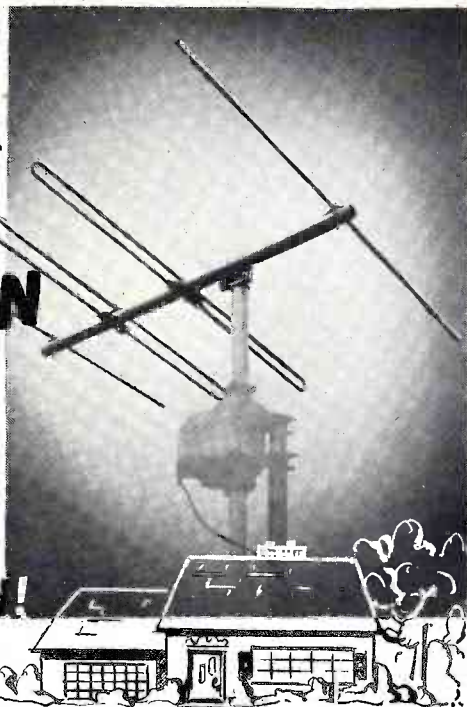

RADIO & ELECTRONIC
EQUIPMENT
TECHNICAL APPLIANCE CORP.
SHERBURNE, N. Y.

IN CANADA: STROMBERG-CARLSON CO., LTD., TORONTO 4, ONT.

New! The Grayhill

300 Ohm Twin Line Connector



NECESSARY FOR ALL TELEVISION AND FM RECEIVERS! CONNECTS RECEIVER LEAD TO ALLIED EQUIPMENT SUCH AS BOOSTERS, INSIDE AND OUTSIDE ANTENNA, MATCHING STUBS, ETC. SIMPLE AS PLUGGING INTO WALL SOCKET—MAKES SET EQUAL TO VARYING CONDITIONS.



Impedance within connector is matched to 300-ohm twin line wire. Packaged on merchandising board for counter display.

Write at once for full information —TODAY, while it's still new!

Grayhill

4534 West Madison Street
Chicago 24, Illinois

Four of a Kind!

Phoenix Stand-off Insulators

- FAST INSTALLATION
- TOP QUALITY—
- DEPENDABLE —
- LOW - PRICED!

New! TWIN Screw Type
7" stand-off—improves performance, cuts losses.
25c List

Nation's Favorite Antenna Mast Insulator
Attaches in 10 seconds to any size mast! Strong, permanent slipproof.*
19c List

New! DRIVE-IT
FAST — Just hammer it in — permanently secure. Cad. plated steel, Lo Loss Polyethylene insert.*
9c List.

NEW! TWIN STAND-OFF INSULATORS
Holds two twin lead conductors 7½" from mast. Fast, one man installation.*
35c list * Pat Pend

At Better Jobbers!
Order Today!
Send for Catalog R

PHOENIX ELECTRONICS, INC.

LAWRENCE, MASS.

Snyder "IN-LINE" ANTENNA

The new Redi-Mount TV-16A "in-line" TV antenna consists of high and low folded dipoles mounted in-line instead of one

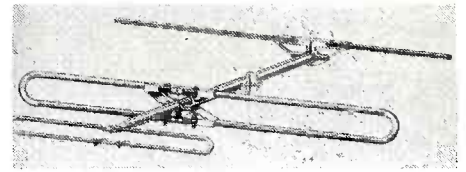

above the other, with a single reflector for both. Snyder Mfg. Co., 22nd & Ontario Sts., Philadelphia 40, Penna.—RADIO & TELEVISION RETAILING.

Knight AMPLIFIER

A new model of the Knight high fidelity 20-watt amplifier features wide range response, low distortion and low hum level, the maker states. Separate bass and treble controls and 5-speaker output impedance terminals are provided. Allied Radio Corp., 833 West Jackson Blvd., Chicago 7, Ill.—RADIO & TELEVISION RETAILING.

Taco JIFFY MAST CLAMP

Jiffy-Clamp consists of a stand-off with a clamp attached which will hold the stand-off to any mast from 1" to 1 5/16" in diameter, so that line may be run down the mast with standoffs. The clamp may be removed if desired, and the standoff used alone. Technical Appliance Co., Sherburne, N. Y.—RADIO & TELEVISION RETAILING.

For AM-FM and TELEVISION

The New Model TV-10

TUBE TESTER

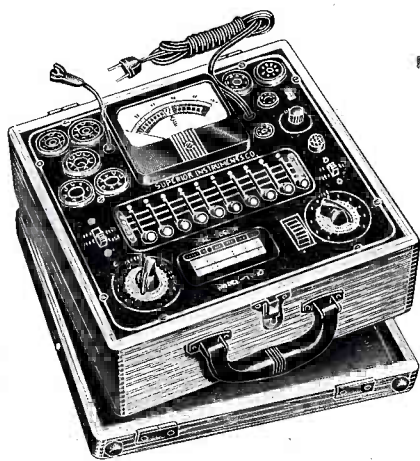

- ★ Tests all tubes including 4, 5, 6, 7, Octal, Lock-in, Peanut, Bantam, Hearing-aid, Thyatron, Miniatures, Sub-miniatures, Novals, etc. Will also test Pilot Lights.
- ★ Tests by the well-established emission method for tube quality, directly read on the scale of the meter.
- ★ Tests for "shorts" and "leakages" up to 5 Megohms.
- ★ Uses the new self-cleaning Lever Action Switches for individual element testing. Because all elements are numbered according to pin-number in the RMA base numbering system, the user can instantly

identify which element is under test. Tubes having tapped filaments and tubes with filaments terminating in more than one pin are truly tested with the Model TV-10 as any of the pins may be placed in the neutral position when necessary.

- ★ The Model TV-10 does not use any combination type sockets. Instead individual sockets are used for each type of tube. Thus it is impossible to damage a tube by inserting it in the wrong socket.
- ★ Free-moving built-in roll chart provides complete data for all tubes.
- ★ Newly designed Line Voltage Control compensates for variation of any line voltage between 105 Volts and 130 Volts.

The Model TV-10 operates on 105-130 Volt 60 Cycles A.C. Comes housed in a beautiful hand-rubbed oak cabinet complete with portable cover. Dealer's Net Price Only

\$39.50

NOW READY FOR IMMEDIATE DELIVERY AT YOUR REGULAR JOBBER

Manufactured by **SUPERIOR INSTRUMENTS CO.**

227 FULTON STREET

NEW YORK 7, N. Y.

Write for Catalog No. R50 for complete SUPERIOR line

G-C TV SERVICE MIRROR

This all-metal, unbreakable mirror measures 10x12 inches, and comes with a clamp that can be used on a chair or other convenient object so that the servicer may ad-

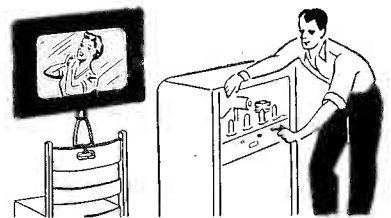

just the controls in the rear of the set while observing the picture on the front. Mirror lists for \$2.75, cloth carrying bag is \$1.00. General Cement Mfg. Co., 919 Taylor Ave., Rockford, Ill.—RADIO & TELEVISION RETAILING.

Tel-Tenna INDOOR ANTENNA

Tel-Tenna is a concealable indoor antenna for TV consisting of flat high and low band dipoles enclosed in what appears like a large rectangular card. It may be slipped under a rug, behind a curtain or drape, etc. The antenna is actually printed on the card utilizing "printed circuit" techniques. Tel-Tenna lists for \$4.95. Television Laboratories, Inc., 542 Parkside Ave., Chicago 44, Ill.—RADIO & TELEVISION RETAILING.

Admiral Has 120-Day Price Protection Plan

A 120-day price protection plan on television products has been announced by Admiral Corporation. The plan, effective August 1, states that refunds will be paid distributors if recommended list, suggested dealer and distributor prices are reduced, and to dealers if recommended list and dealer prices are reduced. These refunds will equal the prices actually paid and the reduced prices on current radio and TV models in inventory and shipped between July 1 and November 30th.

"This price protection plan," states W. C. Johnson, Admiral's vice-president in charge of sales, "is offered television distributors and dealers now as a solid contribution to stability within the industry."

Halligan in New Post

William J. Halligan, Jr., has been appointed to handle sales of communications equipment at the Hallicrafters Company, Chicago, it has been announced by Rollie J. Sherwood, general sales manager.

Jobber Firm Expands

For the second time in five years the Wilmington branch of Radio Electric Service Co. has found it necessary to move to larger quarters. This latest move finds the Wilmington unit occupying its new home on the corner of 3rd and Tatnall streets in the Delaware city.

Built of brick and concrete, the new building is approximately six times the size of the old store. Free parking facilities are provided for RESCO customers on the large parking lot in back of the building. Sal Furman is the manager.

Talking Business



Victor E. Olson, president of Olson and Co., Du Mont's Philadelphia distributor, listens to Dr. Allen B. Du Mont, president of Allen B. Du Mont Laboratories, Inc., make a point at the annual NAMM show in New York.

The KIDS GO CRAZY over Pian-o-Trola

Patented—Trademark Registered
THE SENSATIONAL

ANIMATED PHONOGRAPH
with KEYS THAT MOVE IN RHYTHM
as a record is being played

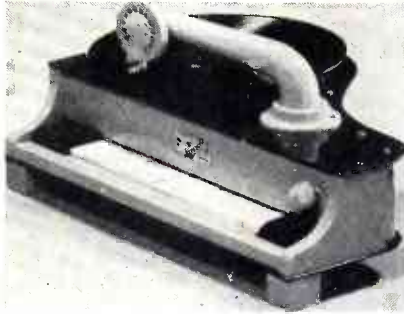

Model — P-AC-5
Acoustical Reproduction

1. Genuine Alliance Motor
2. Special Acoustic Arm to insure the best in reproduction of sound
3. Finished in washable, NON-TOXIC plastic-gloss lacquer
4. MOVING KEYS of white plastic
5. Packed in individual air-cushioned cartons
6. Plays all records up to 12"

LIST \$12.95

SIZES: Length — 17 $\frac{3}{4}$ ". Width — 11 $\frac{3}{4}$ ".
Height — 7"

COLORS: Red and Buff—Light Blue and Dark Blue

TERMS: 1/10 Net 30 Days,
F.O.B. Brooklyn, N. Y.



Model — P-AM-4
Amplifier Reproduction

1. Genuine Alliance Motor
2. Genuine Webster High-Gain Arm
3. 5-inch SPEAKER
4. Standard G.E. Tubes
5. Washable NON-TOXIC plastic-gloss paint
6. MOVING KEYS of white plastic
7. Packed in individual air-cushioned cartons
8. Plays all records up to 12"

LIST \$19.95

The Biggest Sensation in the History of Juvenile Phonographs
CATALOG ON REQUEST

Covrall Industries, Inc.

55 Ferris Street

Brooklyn 31, N. Y.

JUVENILE AND PORTABLE PHONOGRAPHS OF QUALITY



**AMERICA'S
FOREMOST
TV
ANTENNA**

Welin
CIRCLE 

- ALL CHANNEL RECEPTION
- PROVIDES CLEARER, SHARPER PICTURE
- EXTREMELY HIGH SIGNAL STRENGTH
- ELIMINATES GHOSTS
- QUICKLY ASSEMBLED AND INSTALLED

The Welin Circle "X" has extremely high signal strength, gives clearer, sharper pictures on all channels, (no "hain" a Quarter-Century)

Now, at New Low Prices

JOBBERS — REPRESENTATIVES
Some choice territories now available. Write for full information.

\$25.00

Dealer In-
vitation

Welin **EWALD**

CONTINENTAL COPPER

500 MARKET STREET

15 37th Ave., Long Island City 1, N. Y.

MEET
THE *New*
CHAMPION
OF ALL
ANTENNAS

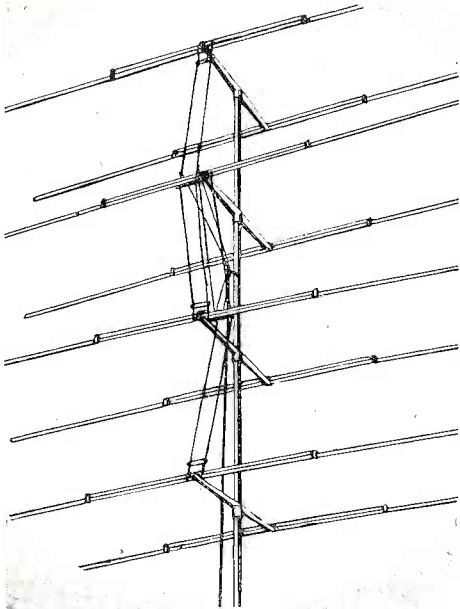

Model RD-13A Super

Vee-D-X engineers have scored again. Not content with the amazing record of their famous RD-13, holder of every record for long distance reception, they have improved it no less than six ways — achieving even greater gain and broader frequency response. Here are the big six improvements to what was considered the perfect antenna.

- Increased front to back ratio—29 DB
- 15 DB gain on Channel 4 and an increased DB gain on all other channels
- Highest gain over widest frequency spectrum of any antenna commercially available
- Center impedance 280 ohms with negligible variance throughout TV spectrum
- Very easily adaptable to rotators commercially available
- Narrow beam width is very helpful in eliminating ghosts and other undesirable interferences

OWNERS OF RD-13 SUPER—You can convert your present antenna to the RD-13A

Send for complete information on this new Champion and catalog of Vee-D-X products.

- as any of the pins may be placed in the
- ★ The Model TV-10 does not use any corner sockets are used for each type of tube, inserting it in the wrong socket.
 - ★ Free-moving built-in roll chart provides
 - ★ Newly designed Line Voltage Control control between 105 Volts and 130 Volts.
- The Model TV-10 operates on 105-130 Volt and is housed in a beautiful hand-rubbed oak cabinet with a portable cover. Dealer's Net Price Only . . .

NOW READY FOR IMMEDIATE DELIVERY

Manufactured by SUPER
227 FULTON STREET

Write for Catalog No. R50

Sams Reports Upped Sales

According to an announcement received from President Howard W. Sams, sales of Photofact Folders and other H. W. Sams publications and data used by radio, television and sound technicians, was twenty-four percent greater for the first six months of 1949 than for the same period in 1948. Rapid growth of the television industry has created an unprecedented demand for the company's comprehensive television course and manuals on the installation and servicing of antennas, while sales of the Sams' Auto Radio Manual, Automatic Record Changer Manuals, and the book, The Recording and Reproduction of Sound, are particularly outstanding, he said.

Fourteen Reps Named for Peerless Transformer Line

The complete jobber line of transformers made by Peerless Electrical Products Division of Altec Lansing Corporation will now be stocked and warehoused in the East as well as on the Coast, where the line is made, according to an announcement by A. A. Ward, Altec vice-president.

At the same time, Ward announced the appointment of fourteen representatives for the Peerless line. The reps are:

Haggerty Sales Co., Michigan and Toledo, O., jobbing area; Walter T. Hannigan, New England states; Jesse

P. Johnson Co., Alabama, Georgia, North Carolina, South Carolina, Mississippi and Tennessee; Frank M. Murphy, Illinois, Indiana and Wisconsin; George D. Norris Co., Washington, Oregon, Idaho and Montana; Joseph Pierson Associates, Wyoming, Utah, and Colorado; James H. Podolny, western Pennsylvania, West Virginia and eastern Ohio; David H. Ross, northern California and Nevada; George Shefler Co., Arizona and New Mexico; C. H. Shryver Sales Co., Kansas, Missouri, Nebraska and Iowa; David Sonkin, New York metropolitan area; Wilmer S. Trinkle, eastern Pennsylvania, southern New Jersey, Maryland, Delaware, Virginia and District of Columbia; Ernest L. Wilks Co., Arkansas, Louisiana, western Mississippi, Oklahoma and Texas; Wolfe-Marsey Sales Co., New York state.

Wexler in Macy Post

The appointment of Herbert Wexler as manager of the radio and television department of Macy's New York has been announced by David L. Yunich, vice-president. Mr. Wexler, who since June, 1947, has been department manager of electrical appliances and manager of the East Orange and Millburn stores of L. Bamberger and Co., a Macy affiliate, succeeds David Davis, whose retirement was announced recently.

Introducing . . .
the New Vibraloc

SUPER SECTOR!

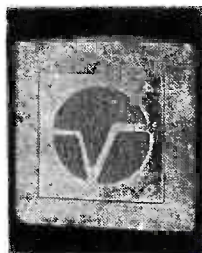

A Modern Streamlined Low Cost Speaker Baffle

- A combination of durable Masonite Leatherboard, formed by pressure and heat, with full strength at all bends . . .
- Plus heavy seasoned Western plywood top and bottom.
- Double bas-relief openings in rear between walls and baffle give greatly improved tone quality and wide frequency response.

List Prices

6"	\$7.50
8"	9.00
10"	11.00
12"	13.00

Choice of Brown,
Ivory or Grey.
Catalog on Request.

See your Jobber or order direct.

PATENTED ACOUSTIC PRODUCTS
Vibracloc corporation
425 BUSH ST., SAN FRANCISCO 8, CALIF.

Servicing on the Move

The completely equipped radio-TV-sound service truck has many potentialities which point to more widespread use in the future. Since proper TV installation and service require more elaborate equipment than can be carried in a tool box, the development of the special TV truck is already an actuality (see "Large Scale TV Service," Feb. 1949 RADIO AND TELEVISION RETAILING and "TV Shop on Wheels," Oct. 1948)

The extension of such a truck to include a portable sound system, and a portable radio and appliance repair shop has great possibilities, especially in suburban and country areas.

Few set owners enjoy having their radio (and especially TV set) dismantled and carted away without even an estimate of the probable repair cost. The combination radio service-sound-and TV truck will bring sufficient test equipment and tools to the job for a complete analysis and estimate of the work required, and often be able to do it on the spot.

The presence of a complete service shop, neatly installed in a truck and ready for any emergency, has a strong advertising value. Many a repair job will result from other customers seeing the truck in the vicinity. In addition, radio and TV repair service can be contacted while distributing sound to a local gathering.

Finally, the presence of complicated service equipment in the truck points up the fact that servicing requires more than a screwdriver and a soldering iron, and considerable know-how. This will tend to show that the dealer in question has the requisite equipment and know-how.

Universal Names Perkins

R. M. Oliver, general merchandising manager, Portable Electric Appliance Division of Landers, Frary & Clark announces the appointment of H. S. (Cy) Perkins as manager, Premium & Specialty Department of the Portable Electric Appliance Division for the entire country.

Readying Open House

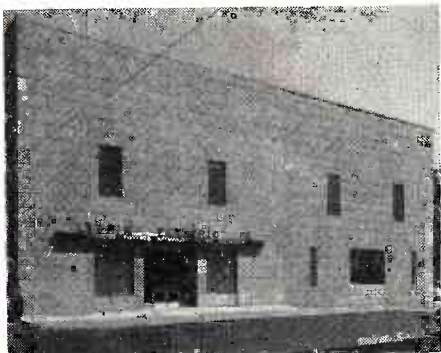

More than 2,000 dealers from Wisconsin and the upper peninsula of Michigan have been invited to attend open house to be held by Lappin Electric Company in its remodeled building at Milwaukee, September 18 and 19. Beautiful showrooms will feature lines carried by this wholesale firm presently staffed by 18 salesmen and 52 office and warehouse employees.

SPEED TELEVISION SALES and SERVICE!



TV—FM ANTENNA ROTATOR

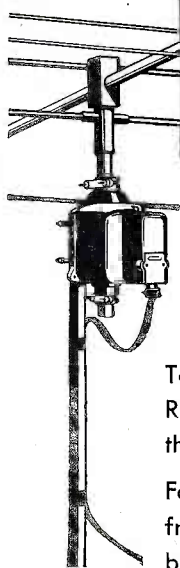

**Faster Installations! Fewer Call-Backs!
Bigger Profits! Happier Customers!**

Television dealers and service stores find Tenna-Rotor speeds installations—saves manhours on the job—brings an end to costly service call-backs.

Foolproof, weatherproof, instantly controlled from the set—this antenna beaming device brings up pictures sharp and clear, tunes out "ghosts" and reflections—in fringe or multi-station areas it **gets that station you couldn't get before!**

Join the trend to Tenna-Rotor! It pays off with more sales, faster service and happier customers!

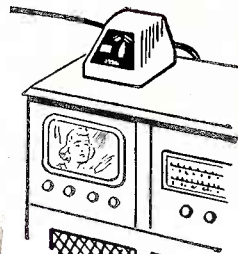

List price—**\$39.95.**
(slightly higher west of Rockies)

Be sure to ask for
ALLIANCE Tenna-Rotor
4-conductor cable

ALLIANCE MANUFACTURING COMPANY • ALLIANCE, OHIO

Export Department; 401 Broadway, New York, N. Y., U. S. A.



DEWALD
HIGH DEFINITION
TELEVISION
10" - 12½" - 16" MODELS

**featuring
Performance for Profit**

Here's truly outstanding television performance that assures satisfied customers—with that extra power for finest reception, even in fringe areas—backed by trouble-free dependability—styled to sell and priced right.

*Proven Quality for More
Than a Quarter-Century*

Now, at New Low Prices

JOBBERS — REPRESENTATIVES
Some choice territories now available. Write for full information.

**Presenting the New 16"
High-Definition Model DT-160**

A sensational table model with the big picture 16" tube. Ultra powerful circuit for finest reception, even in fringe areas. Available in Walnut or Mahogany finish.

in
RADIO
and
TELEVISION

for
SOMETHING
BETTER,
it's

DEWALD

DEWALD RADIO MFG. Corp. 35-15 37th Ave., Long Island City 1, N. Y.

TRYLON Announces

**... THE FIRST
PRACTICAL,
EASY-TO-INSTALL,
LOW COST
TV MAST**



- Easy to handle—easy to climb
- Mounts any type of TV antenna
- 40' Trylon mast and antenna installed by 2 men in 3 hours or less—at mast cost of about \$1 per foot!

Now you can get all the height you want for TV antennas—at little more than the cost of makeshift mast devices—and twice as easily installed! Trylon TV Antenna Masts are made in handy 10' sections. They weigh only about 2 lbs. per foot! Sections can easily be joined for mast heights of 20', 30', 40', 50' or 60' as desired. Triangular in shape, formed of double-welded "serpentine" steel rod construction, they can be mounted on either flat or peaked roofs and climbed like a ladder. Clamp-on working platforms are available for installation or adjustment of antennas. Safe, durable, fully tested in numerous installations.

WRITE TODAY!

Folder and price list giving full details of Trylon TV Masts and accessories now available. Write today. One out of every 4 TV users is an immediate prospect!

WIND TURBINE CO.

Tower and
Antenna Division

WEST CHESTER • PA.



New Television Receiver Models

Garod 16-INCH CONSOLE

The "Raleigh" is a 16-inch console with 140-square-inch screen featuring a continuous tuning unit and a slide rule dial. Known as model 1548, it lists at \$389.95.



The line also includes 10- and 12-inch receivers, starting at \$199.95 for a 61-square-inch model in a mahogany cabinet. "Tele-Zoom" models start at \$289.95. Garod Electronics Corp., 70 Washington St., Brooklyn 1, N.Y.—RADIO & TELEVISION RETAILING.

Regal 16-INCH TV SETS

Three new 16-inch table sets are all priced under \$400. Model 1607 with 20 tubes is \$299.50, 16T31 with 31 tubes is \$369.50, and 16T36 with 36 tubes is \$399.50.

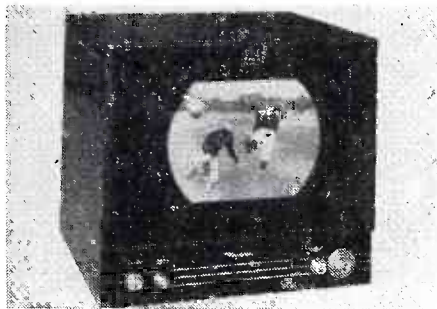

All three have 140-square inch screen, and the 16T36 includes AM-FM radio. Regal Electronics Corp., 603 West 130th St., New York 27, N.Y.—RADIO & TELEVISION RETAILING.

Craftsmen CUSTOM TV

The RC-100 custom TV receiver has been engineered especially for "fringe" reception, and tests are said to have proved its effectiveness at over 100 miles. Automatic gain control and 200-square-inch screen are features of the receiver. Radio Craftsmen, Inc., 1617 So. Michigan Ave., Chicago, Ill.—RADIO & TELEVISION RETAILING.



**QUICK, DEPENDABLE
COMMUNICATION for
TV & FM INSTALLERS
TELEPHONE, TELEGRAPH,
POWER LINEMEN and
EMERGENCY SERVICES**

**NO BATTERIES OR
POWER SUPPLY
REQUIRED**

Wheeler Sound-Powered Handsets give quick, dependable communication wherever temporary, convenient, portable and inexpensive 2-way telephone service is needed. They operate over two conductor full metallic or single wire, ground return circuits—are spark-free for safety. You can talk and hear clearly up to 25 miles. Rugged construction assures long, trouble-free service.

See your jobber today — or
write direct for full details.

**THE
WHEELER
INSULATED WIRE CO., INC.**
2409 EAST AURORA STREET

WATERBURY

CONNECTICUT



DIVISION OF THE SPERRY CORPORATION
MAGNET WIRE • COILS • BALLASTS

**MORE THAN 4000
JFD ITEMS TO HELP A
SERVICEMAN
MAKE MONEY**

JFD produces over 4000 items for TV and radio servicing. Here are a few of our most recent developments. Typical JFD quality at mass production prices... with a good margin of profit for you.

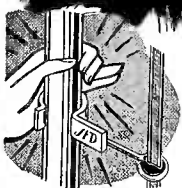

**JFD
"Snap-On"
Insulators
New!**

No other clamp like it. Snap... click... and it's on with a tight, spring steel grip. Polyethylene inserts for twin lead. Ask for No. SPT100 for 1" masts, and No. SPT125 for 1 1/4" masts. List

10c

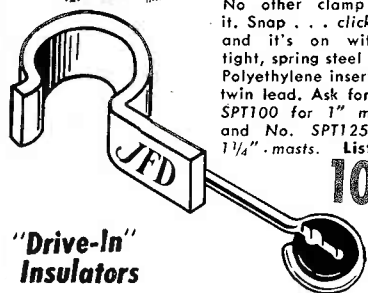

**"Drive-In"
Insulators**

Can be hammered in quickly and conveniently. No. NT100 for twin lead. No. NR100 for coaxial cable. List

6c

**R60 "Quik-Rig"
Ranger All-
Band Conical**

Top performance at rock-bottom price. Instant assembly.

List Only
\$1130



JFD R61

Same as R60 but 1/4 wavelength stacked for extra gain needed in fringe and remote areas.

List Only
\$2400

**JFD Twin Lead
Lightning Arrester**

Underwriters Laboratories approved for indoor-outdoor use. Safeguards sensitive TV parts against lightning and static charges. List

\$225

Write for Free JFD Catalog of TV Accessories No. TV100

More than a catalog, it contains installation and servicing data of interest to every Serviceman.

Also FREE for the asking JFD Catalog of Radio Accessories. No. 438.



MANUFACTURING CO., Inc.
6111 16th Avenue
Brooklyn 4, N. Y.

FIRST IN TELEVISION ANTENNAS AND ACCESSORIES

Copyright 1949 JFD Manufacturing Co., Inc.

**New Television
Receiver Models**

UST PROJECTION TV SETS

Two commercial models have been added to the UST line, both projection sets. One gives a picture 30 by 22 1/2 inches, and is priced at \$1795, the other has a 25 by 19 inch screen and lists for \$1595. Both units have 36 tubes and a 5-inch picture tube. U.S. Television Mfg. Corp., 3 West 61 St., New York 23, N.Y.—RADIO & TELEVISION RETAILING.

Tele-Tone PORTABLE TV

The new 7-inch portable is housed in a simulated cowhide cabinet with a door which closes over the face of the set when not in use. The set weighs less than 26

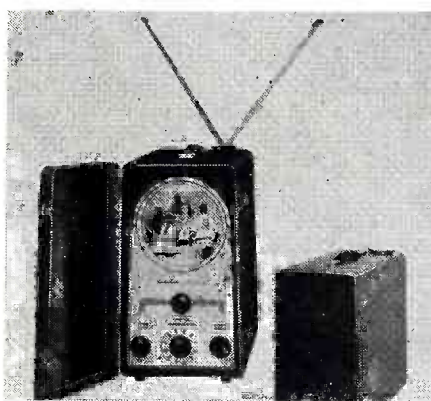

pounds and is provided with an attached indoor antenna. List price is \$169.95. Tele-Tone Radio Corp., 540 West 58th St., New York, N.Y.—RADIO & TELEVISION RETAILING.

**Freed-Eisemann 16-INCH
CONSOLE**

The Chippendale Console is a 16-inch receiver with AM, FM and two record changers incorporating a high-fidelity am-



plifier with 20 watts output. The Chippendale, with 43 tubes, retails for \$995. Freed Radio Corp., 200 Hudson St., New York 13, N.Y.—RADIO & TELEVISION RETAILING.



**"ANYTHING—ANYWHERE"
for a single charge!**

RAILWAY EXPRESS provides dependable, uniform shipping facilities through 23,000 offices from coast to coast. Here's fast, complete service, by rail or air, designed to meet your every shipping need—for a single, all-inclusive charge!

For really economical, "anything — anywhere" shipping, specify RAILWAY EXPRESS.



"Let's look ahead" is the watchword of the 60,000 Railway Express employees. They work and plan together to serve you and your community by meeting your exact shipping and distribution requirements.



NATION-WIDE RAIL-AIR SERVICE

Portable TRI-TUBE



Antenna MASTS

TELEVISION
FM • AMATEUR
COMMERCIAL

LOW COST
•
LIGHT
•
QUICK
•
EASY

Mast section is triangular in construction using 1" ID steel tubing with proper bracing, all electric welding. Lower unit is 20 ft. long hinged on frame with locking device. Levelling device compensates for position of vehicle on any test location. Upper unit is a smaller triangle and telescopes into lower unit on rollers, which allow smoother operation. Cable and drum provided with pin assembly for safety and locking into any height. Antenna mast can be set up by two men in a few moments... **NO GUYS - NO WRENCHES - NO BOLTS** All bolts have 'T' handles. Demountable by removing two bolts in four minutes. Aluminum painted ready to mount.

- #250 Basic Unit Complete 50 ft., 10 ft. pole
 - #251 Same as 250-Orientable at Any Height
 - #252 Same as 251, with Antenna Height 70 feet
- Dealer & Distributor Inquiries Invited

A. A. PETERS
TRI-TUBE MASTS
231 N. 7th Allentown Pa.

SHIPPED F. O. B.
ALLENTOWN, PA.

\$295
and up

FREE! Send for it NOW!

ALLIED'S NEW 1950 CATALOG!

196 PAGES—
Everything in
Radio and
Electronics



GET RADIO'S LEADING BUYING GUIDE

Service Technicians and Engineers: ALLIED'S 1950 Buying Guide brings you all the new releases and money-saving values—from the world's largest stocks of test instruments, amplifiers, P.A. systems and equipment, tubes, parts, tools, books and accessories—ready for instant expert shipment. Send today for your **FREE** new 196-page ALLIED Catalog.

ALLIED RADIO CORP., DEPT. 25-J-9
833 W. Jackson Blvd., Chicago 7, Ill.

Send **FREE** New ALLIED Catalog.

Name.....

Address.....

ALLIED RADIO

Record News Notes

RCA VICTOR'S record and phonograph plans are predicated solely on 45 rpm, the system it believes will eventually become an industry standard, and on 78 rpm, according to a statement by J. B. Elliott, vice-president in charge of RCA Victor Consumer Products. Mr. Elliott stressed the fact that "RCA Victor is going all the way with 45 rpm."

Publication of a new 45 rpm catalog by the company reveals that RCA VICTOR has more than doubled its basic library of available titles; in less than four months the categories of music has increased the number of individual titles to more than 900, approximately 300 of which are Red Seal releases.

RCA VICTOR has announced the availability of a number of outstanding imported recordings made in Europe by the Gramophone Co., Ltd., featuring pianist Moura Lympany, and conductors John Barbirolli, Wilhelm Furtwangler and Fritz Busch, pianist Artur Schnabel, tenor Beniamino Gigli and composer-pianist Nicholas Medtner.

COLUMBIA Records "Miss Liberty" album, featuring the original Broadway cast, has been released on six 10-inch conventional records (MM-860), and one 12-inch LP Microgroove record (ML 4220). Promotion aids for the album issued by the company include a bright colorful window display; a special die-cut display for counter use, or windows, or in listening booths; a poster for hanging on wall; plastic plates are available for postcard printing; and promotional mailers for use as envelope stuffers.

September is "LP" (Lasting Pleasure) month is a COLUMBIA theme to help dealers settle back into fall and winter activities. Display material stressing this theme has been prepared by the company for dealer use.

Jackie Robinson and Pee Wee Reese, Brooklyn Dodgers baseball stars, have recorded a children's album entitled "Slugger at the Bat" for COLUMBIA.

VOCO PRODUCTS, INC., New York City, has restyled its line of unbreakable kiddie records. Of transparent Vinylite, the records are available in a variety of colors, complete with attractive paper envelopes, with story notes on the back. The discs sell for 25 cents each.

PERMO, INC., 6415 Ravenswood Ave., Chicago, is pushing sales of the Fidelity 45 Needle Replacement Kit, designed to sell for \$2.00. The kit contains a needle specially designed for 45 rpm recordings, special replacement screws; combination tool for replacing the needles, and a mirror to simplify making the replacement.

More record news on pages 60, 75, 76 and 77, in this issue.

INSTALLATION IN SECONDS

WITH THE SENSATIONAL **RMS** **SPEE-D-LOK** TV antenna assembly

At last! A complete, varied antenneline featuring a new principle of instant assembly! No tools required.



Yes—more profit per installation—more installations per day—with RMS Spee-D-Lok Preassembled Antennas. No loose hardware, assembled completely by hand, no time wasted. Fast, efficient installations with the hottest antenna line in the Television picture. Spee-D-Lok antennas are stronger, too, with Dipoles locked against sway and vibration. There is a Spee-D-Lok antenna for every installation requirement.

Write today for complete catalog of antenna types.

RADIO MERCHANDISE SALES, INC.
550 WESTCHESTER AVENUE NEW YORK 55, N. Y.

Enjoy the ADDED Beauty of Your Lighted Tree in MOTION . . .

KASSON ELECTRIC CHRISTMAS TREE TURNER

Revolves 3 times a Minute
Adjustable to most Tree Sizes!



Ideal for holiday windows and for Christmas displays throughout the store. Sturdy, dependable A.C. motor. Will last for years

Modern Merchandise Displays Need LIGHTED MOTION!

New Model 712 revolves 3 RPM while permitting novel, self-contained lighting effects, or operation of electrical devices. 200 lbs. capacity. 18" dia. turntable. Will revolutionize your window trim!

KASSON Roto-sho ELECTRIC TURNABLES



Write for complete turntable catalog!
GENERAL DIE AND STAMPING CO.
Dept. TV, 262 Mott St., New York 12, N. Y.

ADVERTISERS

September 1949

Admiral Corp.	72, 73	Olympic Radio & Television, Inc.	57
Air King Products Co., Inc.	68	Pentron Corp.	118
Alliance Mfg. Co.	125	Permoflux Corp.	35
Allied Radio Corp.	128	Peters, A. A.	128
American Phenolic Corp.	70	Philco Corp.	Reverse Side Part II
Anchor Radio Corp.	116	Phoenix Electronics, Inc.	122
Associated Stores	19	Printup Antenna Co.	91
Astatic Corp.	78		
		Radiart Corp.	89
Belden Mfg. Co.	55	Radio Corp. of America	44, 45, 65, 79, Cover 4
Belmont Radio Corp., Subsidiary of Raytheon Mfg. Corp.	71	Radion Corp.	93
Bogen Co., Inc., David	129	Radio Merchandise Sales, Inc.	128
Brach Mfg. Corp., L. S.	99	Railway Express Agency	127
		Raytheon Mfg. Co.	53
Capehart-Farnsworth Corp.	6	Raytron	117
Corbonneau Industries, Inc.	102	Rauland Corp.	Cover 3
Celomat Corp.	5	Regal Electronics Corp.	4
Chicago Tribune	18	Rider Publisher, Inc., John F.	130
Colonial Radio Corp.	13, 14, 15		
Columbia Records, Inc.	74	Sentinel Radio & Television	26
Commercial Credit Corp.	85	Sheldon Electric Co., Inc.	17
Cornell-Dubilier Electric Corp.	59	Shure Brothers, Inc.	98
Cornish Wire Co., Inc.	120	Simpson Electric Co.	12
Covrall Industries, Inc.	123	Sola Electric Co.	69
Crosley Div., Avco Mfg. Corp.	20, 21, 36, 37	Sonotone Corp.	78
		South River Metal Products Co., Inc.	102
Daleo Enterprises	129	Sprague Products Co.	96
DeWald Radio Mfg. Corp.	125	Standard Transformer Corp.	100
Dumont Labs., Inc., Allen B.	22, 51	Starratt Television Corp.	66, 67
Electro Products Labs., Inc.	118	Stewart-Warner Corp.	8, 9
Emerson Radio & Phonograph Corp.	61	Stromberg-Carlson Co.	24, 25
Eureka Television & Tube Corp.	101	Superior Instruments Co.	122
		Sylvania Electric Products, Inc.	32
Fada Radio & Electric Co., Inc.	28	Sylvania Television	13, 14, 15
General Die & Stamping Co.	128	Technical Appliance Corp.	121
General Electric Co.	7, 10, 11	Tele King Corp.	39
Grayhill	121	Telrex, Inc.	97
		Trad Television Corp.	63
Hickok Electrical Instrument Co.	116	Trans-Vue Corp.	64
		Triplett Electrical Instrument Co.	86
Instant Tool Corp.	118	Tung-Sol Lamp Works, Inc.	38
International Resistance Co.	117		
		Vibracloc	124
Jerrold Electronics Corp.	115	V-M Corp.	78
Jewel Radio Corp.	120		
J.F.D. Mfg. Co., Inc.	127	Warren Mfg. Co., Inc.	2, 3
		Webster-Chicago Corp.	34, 80
Kato Engineering Co.	120	Webster Electric Co.	23
		Welin Div. Continental Copper & Steel Industries, Inc.	123
LaPointe-Plascomold Corp.	124	Westinghouse Electric Corp.	40
		Wheeler Insulated Wire Co., Inc.	126
Mollory & Co., Inc., P. R.	Cover 2	Wind Turbine Co.	126
Motorola, Inc.	30, 31	Wire Corp.	119
		Zenith Radio Corp.	16
National Television & Electrical Living Show	120		
National Union Radio Corp.	29		
Nicholas Equipment Co.	95		
Noblitt-Sparks Industries, Inc.	33		
North American Philips Co., Inc.	27		

Music as the Masters played it!
THE Bogen
RANGE MASTER



This new control permits your records to perform at their very best — an adjustable noise suppressor to correct for the particular condition of each record.

The Bogen PX15, fifteen watt high fidelity amplifier boasts eight other distinctive features, designed to multiply your listening pleasure. Write for complete new FREE High Fidelity Catalog.

David Bogen
 db **CO., INC.**
 663 BROADWAY, NEW YORK 12, N. Y.

TV BUYERS WANT TOP-NOTCH CABINETS!



DALEO
 MAKES FINER CABINETS FASTER,
 AT LOWEST COSTS!

CONSOLETTES CONSOLES — TABLE MODELS
 True furniture beauty and quality for eye-catching sales power! Made-to-order and stock for all types and finishes, all chassis and C.R. tubes. MANUFACTURERS! JOBBERS! DEALERS! ... write for quotation or catalog R to ...

DALEO ENTERPRISES
 752 E. 137 St. New York 54, N. Y.
 Manufacturer and sole distributor for Majestic Arts. Cabinet-crafters to the electronic, furniture and decorating industries for 35 years.

Sound Advice From One Serviceman To Another!

MAC'S Radio REPAIR

Choteau, Montana PHONE 7-1
BOX 638

John F. Rider Publisher, Inc.
480 Canal Street
New York 13, N. Y.

Rumors are running around financial circles to the effect that a good many ex G.I. radiomen who have gone into business for themselves are practically starving to death. I can well believe such rumors since I am an ex G.I., and after a year and a half I am just beginning to pull away from the deep part of that red ink pool. I think Dun & Bradstreet, Inc. still list me as a good cash-on-the-line customer. Since the above-mentioned rumors are probably true, I would like to take advantage of your advertising department to pass on some tips to ex G.I.'s who are now in or who contemplate entering the radio repair business.

A man entering radio repair must have some working capital, a good working knowledge of radio, adequate test equipment, and a GOOD REFERENCE LIBRARY. That good reference library cannot be stressed too much, because the big jobs, the mean jobs, and the tough jobs are dependent on that library.

Unfortunately there are quite a few radio wreckers operating, and the only complete key that I have found for setting those radios right is the use of Rider's manuals. If the manufacturer has made changes in the set, those changes are included in Rider's. In most cases all other changes should be discarded and the radio re-assembled according to schematic.

The SPEED with which repair work is completed has much to do with income. In the interest of speedy repair I recommend Rider's. A customer who is PLEASED with the work done on his radio doesn't mind paying a good price for it. Rider's manuals give you the information on nearly every radio made and if used will mean pleased customers. REPEAT BUSINESS and word-of-mouth advertising means extra money in your pocket. By doing conscientious work that proves satisfactory you will get both repeat business and good advertising.

There are many shops operating without Rider manuals, and that is especially true of newcomers to the business. I am sure that many of the newcomers will find that an investment in a complete set of Rider's manuals will mean the difference between success and failure in their business.

I have written this with the hope that it will help some of the boys who are busy pulling out what little hair is left in their heads, and also with the hope that it will serve to help a lot of men improve their work and thus give a better name to our business.

Yours truly,

A. E. McCorkle

A. E. McCORKLE

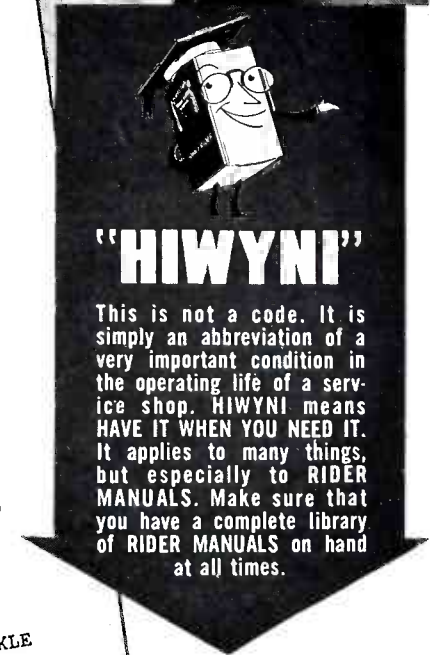

"HIWYNI"

This is not a code. It is simply an abbreviation of a very important condition in the operating life of a service shop. HIWYNI means HAVE IT WHEN YOU NEED IT. It applies to many things, but especially to RIDER MANUALS. Make sure that you have a complete library of RIDER MANUALS on hand at all times.

These RIDER books are the result of twenty years of specialized publishing for the Radio Servicing Industry

Television Manual, Volume 2 (Plus "How It Works" and Index) . . . \$18.00	Automatic Frequency Control Systems, 144 pages . . . \$1.75	Inside the Vacuum Tube, 424 pages, illustrated . . . \$4.50
Television Manual, Volume 1 (Plus "How It Works" and Index) . . . \$18.00	Servicing Superheterodynes, 288 pages, illustrated . . . \$2.00	Cathode-Ray Tube At Work, 338 pages, illustrated . . . \$4.00
PA Equipment Manual, Volume 1 . . . \$18.00	An-Hour-A-Day with Rider Series: "Alternating Currents in Radio Receivers", "D.C. Voltage Distribution", "Resonance and Alignment" . . . \$1.25	Servicing by Signal Tracing, 360 pages, illustrated . . . \$4.00
Volume XIX . . . \$19.80	"Automatic Volume Control", 96 pages each . . . \$1.25	Servicing by Signal Tracing, (Spanish Edition), 404 pages, illustrated . . . \$4.00
Volume XVIII . . . \$19.80	Servicing Receivers By Means of Resistance Measurements, 203 pages . . . \$2.00	Understanding Vectors and Phase, 160 pages, paper binding, 99c cloth . . . \$1.89
Volume XVII . . . \$16.50	Aligning Philco Receivers, Two Volumes. Vol. 1, 1929 to 1936, 176 pages. Vol. 2, 1937 to 1941, 200 pages. Each Volume . . . \$2.00	Vacuum Tube Voltmeters, 180 pages, illustrated . . . \$2.50
Volume XVI . . . \$ 8.40	Radar—What It Is, 72 pages . . . \$1.00	Understanding Microwaves, 385 pages, illustrated . . . \$6.00
Volume XV . . . \$19.80	FM Transmission and Reception, by John F. Rider and Seymour D. Uslan, 416 pages, illustrated . . . \$3.60	A. C. Calculation Charts, 160 pages, 9 1/2" x 12" . . . \$7.50
Volumes XIV to VII (each volume) . . . \$16.50	Broadcast Operator's Handbook, by Harold E. Ennes, 288 pages, illustrated . . . \$3.30	High Frequency Measuring Techniques Using Transmission Lines, 64 pages, illustrated . . . \$1.50
Volume VI . . . \$12.50	The Oscillator At Work, 256 pages, illustrated . . . \$2.50	The Meter at Work, 152 pages, illustrated . . . \$2.00
Abridged Manuals I to V (one volume) . . . \$19.80		The Radio Amateur's Beam Pointer Guide, 32 pages . . . \$1.00
Record Changers and Recorders . . . \$9.00		
Master Index, Covering Manuals, Vols. I to XV . . . \$1.50		
TV, How It Works, 203 pages . . . \$2.70		
TV Picture Projection and Enlargement . . . \$3.30		
Installation and Servicing of Low-Power PA Systems, 208 pages . . . \$1.89		

JOHN F. RIDER PUBLISHER, INC. • 480 Canal Street, New York 13, N. Y.
Export Agent: Rocke International Corp., 13 East 40th Street, New York City • Cables: ARLAB

NOTE: Are you receiving your copy of "Successful Servicing"? It's Rider's own publication of interest to every serviceman. In it you will find all of the circuit changes in sets . . . as soon as they are released. It's FREE!

NOTE: The Mallory Radio Service Encyclopedia, 6th edition, makes reference to only one source of radio receiver schematics—Rider Manuals. **ANOTHER NOTE:** The C-D Capacitor Manual for Radio Servicing, 1948 edition No. 4, makes reference to only one source of receiver schematics—Rider Manuals.

RIDER MANUALS mean Successful Servicing!

"I can't afford not to handle the Rauland Line"...

Says Peter Chanko, popular President of the New York Chapter of NEDA, and head of Chanrose Distributors, Jamaica, New York.

... "because Rauland is always ahead of the rest of the industry in new picture tube developments, because their aluminized tubes have better contrast and definition, because rejects and returns are at a minimum and because Rauland's policies protect us and allow a fair margin of profit."

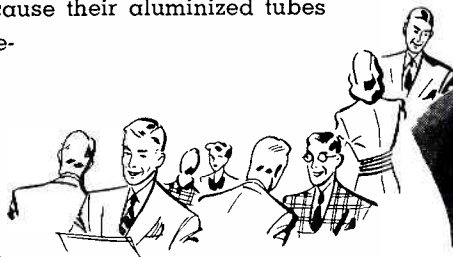

1 Sells on Sight!

Your customers see the difference instantly. They see the sharpest picture they've ever seen... better contrast... and up to 80% brighter when VISITRON replaces a standard tube. Brighter even in bright daylight without shades drawn! (Very important now with daylight saving and daytime sports.) VISITRON's remarkable *aluminizing* process makes the miracle difference!

2 Nets You More Profit!

With VISITRON, you can make more replacement sales. And VISITRON cuts your overhead as well—saves time and work—no adjusting of magnets, no rewiring. All you do is plug 'em in!

3 Boosts Filter Sales, Too!

You can recommend a filter without hesitation—without the usual risk of return—when you install a VISITRON picture tube. Only the *extra* brilliance of this aluminized tube can carry a bright, sharp picture clear through even a heavy filter—no dim, fuzzy image as with ordinary tubes.

FOR YOUR REPLACEMENT
SALES...NOW AT YOUR LOCAL JOBBER
...GET VISITRON TODAY

10 WAYS BETTER

1. More brilliance
2. Better contrast
3. Better definition
4. Greater fidelity
5. No ion spot
6. No cathode glow
7. No magnet
8. No circuit problem
9. Replaces any magnetic tube
10. Any filter can be used

THE RAULAND CORPORATION



Perfection Through Research

4245 KNOX AVENUE • CHICAGO 41, ILLINOIS



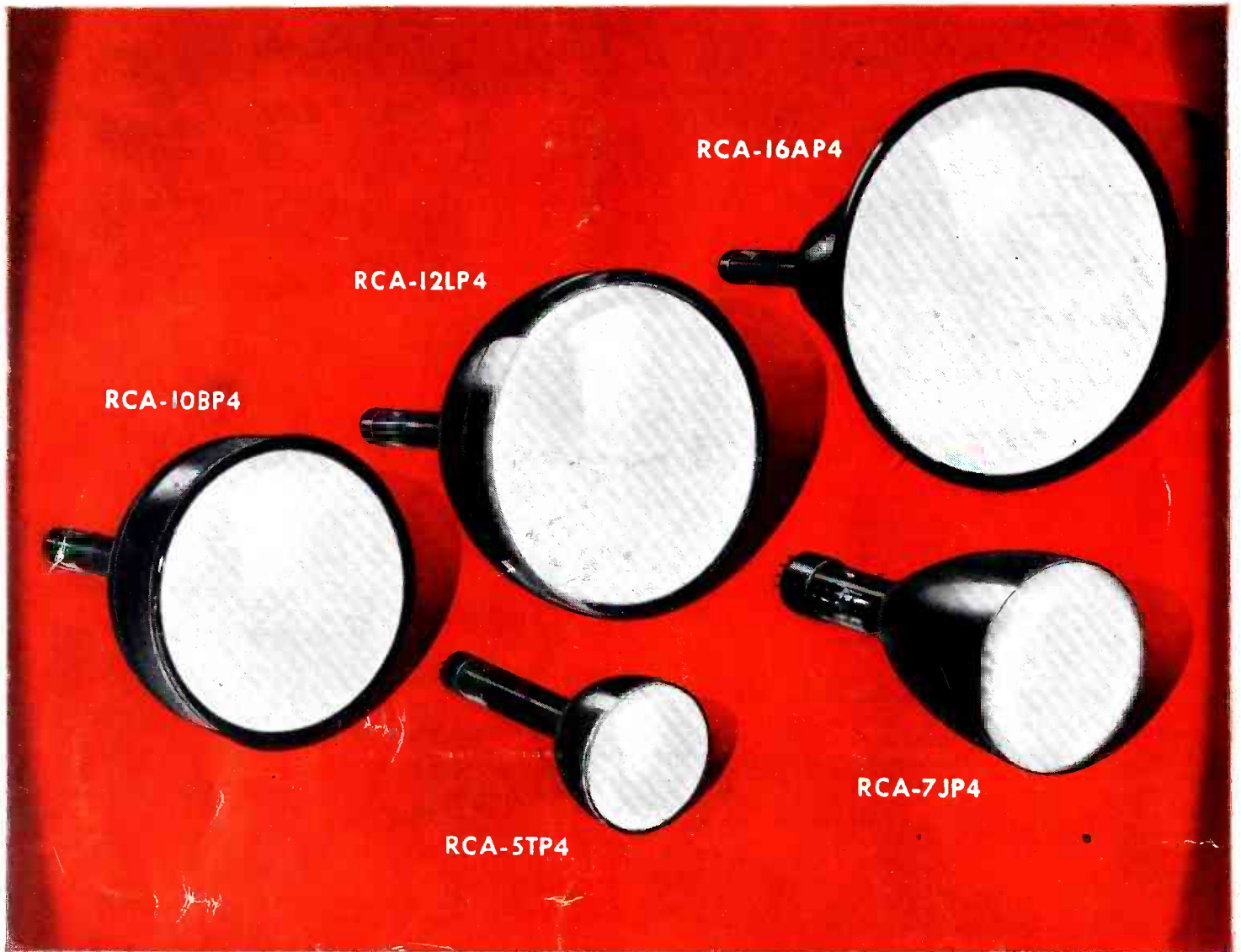

THE FOUNTAINHEAD OF MODERN TUBE DEVELOPMENT IS RCA

RCA knows how to make television picture tubes . . . the best your money can buy

RCA has all the popular type television picture tubes to meet your present and future renewal requirements. And you can get them from *one* dependable source . . . your RCA Tube Distributor.

Mass-produced under superior quality controls, RCA television kinescopes of all types are the best that money can buy. You can count on them to meet the critical requirements of television reception.

When you renew with an RCA kinescope, you're selling the brand that has top public preference. RCA kinescopes will help *your* business grow by leading customers to you as a dependable source for television and radio needs.

Get the full details on the leading line of television picture tubes and sales promotion material from your local RCA Tube Distributor today.



NOW . . . TV TROUBLE SHOOTING BY PICTURE ANALYSIS! Another RCA First in servicing aids . . . the Pict-O-Guide tells at a glance where to look for trouble in a TV receiver—and indicates how to cure it. To learn how you can get your copy, see your RCA Tube distributor without delay! The supply is limited.

ALWAYS KEEP IN TOUCH WITH YOUR RCA TUBE DISTRIBUTOR



RADIO CORPORATION of AMERICA

ELECTRON TUBES

HARRISON, N. J.

High Temperature is Tough
On Long Life . . .

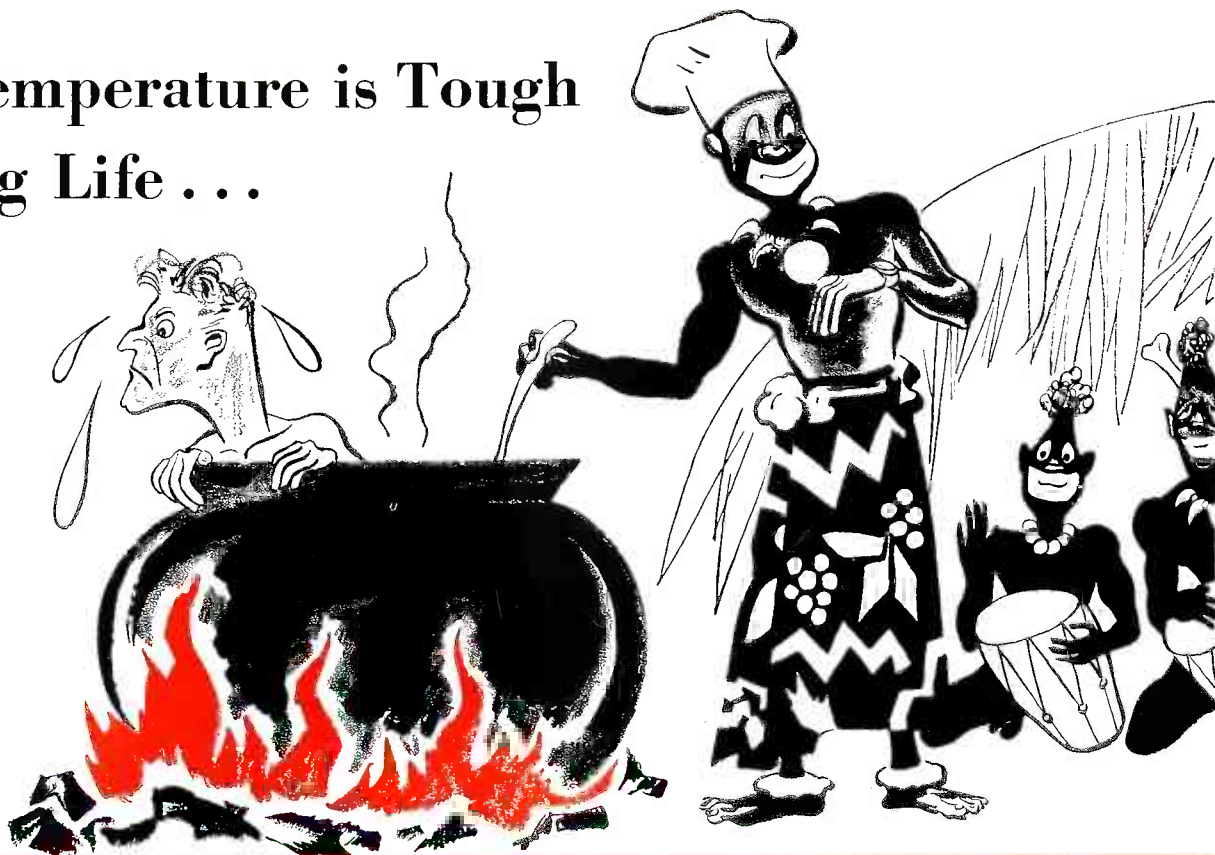

But

Mallory Capacitors Can Take It!

It's one thing for a capacitor to have long life. But it takes a MALLORY CAPACITOR to sustain its long life at high temperatures. Tests prove that the characteristics of Mallory FP Capacitors are practically unchanged after 2000 hours at a temperature of 185° F.

Rigid manufacturing controls guard MALLORY CAPACITORS against contamination—the enemy of long life. Mallory Capacitors are untouched by human hands; production workers wear rubber gloves. And Mallory specifications on chloride content of the gauze are even more rigid than on hospital gauze, for gauze is the base on which aluminum is sprayed to create the anode plate.

You can depend on Mallory Capacitors for longer shelf life—longer life in an inactive set—lower

RF impedance—ability to withstand higher ripple current.

Mallory Capacitors cost no more than ordinary capacitors. They're easy to install, and when they're installed they're *dependable* . . . and that means the kind of service that satisfies customers. Order from your Mallory distributor.

NEW IMPROVEMENTS IN MALLORY FP CAPACITORS . . . Feature stronger anode tabs—withstand higher discharge currents—improved high surge separators—still greater heat resistance—extra heavy rubber seal—heavy cathode tab—special etched cathode.

*Don't Miss the Mallory Television Service Encyclopedia.
Get Your Copy From Your Mallory Distributor . . . Only 35c!*

P. R. MALLORY & CO. Inc.
MALLORY

CAPACITORS . . . CONTROLS . . . VIBRATORS . . .
SWITCHES . . . RESISTORS . . . RECTIFIERS . . .
VIBRAPACK* POWER SUPPLIES . . . FILTERS

*Reg. U. S. Pat. Off.

APPROVED PRECISION PRODUCTS

P. R. MALLORY & CO., Inc., INDIANAPOLIS 6, INDIANA