

July 49

RADIO & TELEVISION RETAILING



July • 1949

CALDWELL-CLEMENTS, INC.

48th Annual
MUSIC SHOW
NEW YORK, N. Y.

JULY 25 — 28
HOTEL NEW YORKER
and MANHATTAN CENTER
← (IN CIRCLE)

AM, FM, TELEVISION • ELECTRICAL APPLIANCES
RECORDS & PHONOGRAPHS • SERVICING & SOUND

FAIRCHILD AERIAL
SURVEYS, INC.

Mallory Does It Again...

With the First Television Service Encyclopedia

35¢

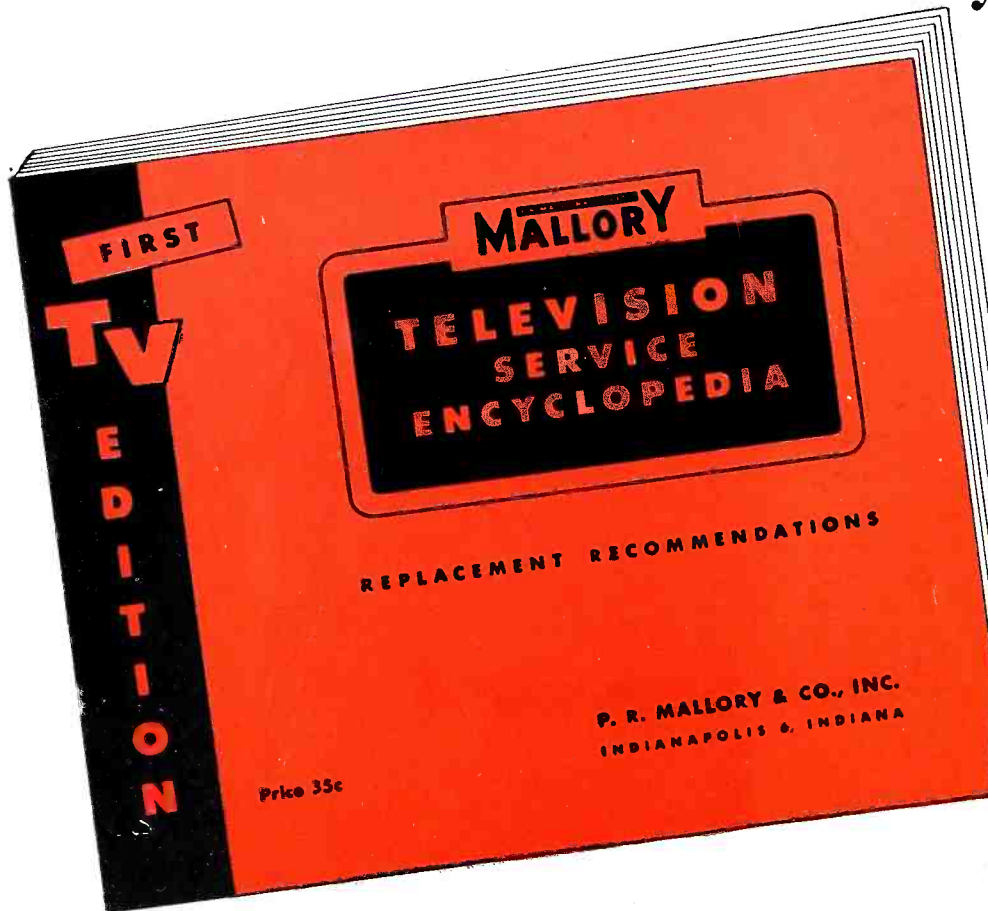

Here's What You Get

- Complete Tube Complements
- IF Alignment Data
- Circuit References
- Original Part Numbers
- Replacement Part Numbers
- Rider's References

HERE'S just what you've been waiting for—a complete encyclopedia of television replacement data, designed to help you service all popular television sets.

Authoritative, up to date, this book was written *for you*, only after a thorough study of original specifications and operating characteristics, by a trained staff of Mallory engineers. Like the Mallory Radio Service Encyclopedia, it is packed with information you can depend on.

Put this great new book alongside your Mallory Radio Service Encyclopedia and you have a compact reference library that will answer your servicing questions. It's a big, exciting value—only 35c. See your Mallory distributor right away!

P. R. MALLORY & CO., Inc.
MALLORY
CAPACITORS . . . CONTROLS . . . VIBRATORS . . .
SWITCHES . . . RESISTORS . . . RECTIFIERS . . .
VIBRAPACK* POWER SUPPLIES . . . FILTERS
*Reg. U. S. Pat. Off.
APPROVED PRECISION PRODUCTS
P. R. MALLORY & CO., Inc., INDIANAPOLIS 6, INDIANA

RADIO & TELEVISION RETAILING

IN THIS ISSUE

JULY, 1949

Including "Radio & Television"
and "Radio & Television Today"

Established in 1922
as ELECTRICAL RETAILING

•
ORESTES H. CALDWELL
Editorial Director

•
M. CLEMENTS
Publisher

•
JOHN L. STOUTENBURGH
Executive Editor

RUTH MORRIS
Records Editor

EDWARD A. CAMPBELL
Technical Editor

CHARLES F. DRYER
Art Director

•
BUSINESS DEPARTMENT

M. H. NEWTON
Sales Manager

EDWIN WEISL, JR.

M. E. SCHNEIDER
Production Supervisor

•
BRANCH OFFICES

CHICAGO 6

S. M. GASKINS, Manager

JOHN ROMANCHAK

201 N. Wells St. - Randolph 6-9225

LOS ANGELES 14

DUANE WANAMAKER

610 S. Broadway
Mutual 2161

•
CIRCULATION DEPARTMENT

B. V. SPINETTA
Circulation Director

•
W. W. SWIGERT
Credit Manager

•
Radio & Television Retailing*

July, 1949, Vol. 50, No. 1, 35 cents a copy. Published monthly by Caldwell-Clements, Inc. Publication Office, 1309 Noble St., Philadelphia 23, Pa. Editorial, Advertising and Executive Offices, 480 Lexington Ave., New York 17, N. Y. Subscription rates United States and U. S. Possessions \$2.00 for one year, \$3.00 for two years, \$4.00 for three years. Canada \$3.00 for one year, \$4.00 for two years, \$5.00 for three years. Pan American Countries \$4.00 for one year, \$5.00 for two years, \$6.00 for three years. All other countries \$5.00 for one year, \$7.50 for two years, \$10.00 for three years. Printed in U.S.A. Entered as second class matter February 21, 1949, at the Post Office at Philadelphia, Pa., under the act of March 3, 1879.

*Trade-Mark Reg. U. S. Pat. Off.

Copyright 1949 by

CALDWELL-CLEMENTS, Inc.

Publishers also of TELE-TECH

★ *AM, FM, Television*

COVER—48th Annual Music Show, Hotel New Yorker and Manhattan Center	
EDITORIAL—The Summer Slump	29
WHAT'S AHEAD—In Radios, Appliances, Records and Television	30
MAKING MONEY IN THE FACE OF TODAY'S CONDITIONS	32
SUPER SERVICE SPARKS SALES	34
SUMMER LINES OF NEW TV, RADIO, FM AND PHONO PLAYERS	36
USE MODERN IDEAS TO CLOSE MORE TV SET SALES	38
COLUMBIA EXECUTIVES ON THE PHONO RECORD SITUATION	42
MAKE MONEY WITH FM	44
HOW TO CHARGE FOR PROFITABLE SERVICING	46
VITAMIN A INSTEAD OF ASPIRIN	48
NEWEST TV AND RADIO SETS	51

★ *Records, Phonographs, Accessories*

DOUGH IN DO, RE, MI	56
WHAT'S AHEAD FOR RECORDS AND PHONOGRAPHS	58
TOP PERFORMERS BRING IN CUSTOMERS	62
NEW USES, NEW PLEASURES FROM NEW 45 RPM SYSTEM	74

★ *Electrical Appliances*

IN FAVOR OF THE SALES REPORT	40
NEW ELECTRICAL APPLIANCES FOR DEALERS	52
NEWS OF THE INDUSTRY	Begins on page 110

★ *Servicing and Sound*

COVER—Servicing the Clock Radio	113
VOLTAGE MULTIPLIER SYSTEMS IN TV RECEIVERS	114
TELEVISION TECHNICIAN	116
NEW AIDS FOR SERVICE AND PA	118
NEW SERVICE AIDS FOR AM, FM, TV	120
NEWS OF THE INDUSTRY	Begins on page 110

Photo Credits

Fairchild Aerial Surveys, Inc.	Cover
Ewing Galloway	32, 33, 48

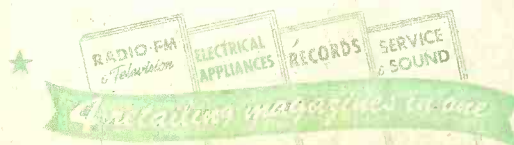

CALDWELL-CLEMENTS, INC.
480 Lexington Ave., New York, N. Y.

LET'S TALK ABOUT PROFITS

- Every good retailer knows there's no future in flash-in-the-pan profits with unreliable "cut-rate" products.

With Crosley products, you get present and *long-range* opportunities for steadier, more profitable business through Crosley's sound policy of...

- Thorough product research
- Precision engineering
- Skilled craftsmanship
- Good merchandising
- Consistent national and local advertising
- Fair play and cooperation

Why not assure yourself happier retailing by linking your business to Crosley's long-range planning? Start earning more profits and more satisfied customers *now* —by selecting Crosley, the name that's backed by the very finest precision engineering, the name that means *better products for happier living*. See the superb Crosley line at 1132 Merchandise Mart (Phone: MOhawk 4-4645), Chicago, Ill.



9-409 M
"FAMILY THEATRE"

THE "FAMILY THEATRE," a beautiful radio-phonograph-TV combination for the whole family...

- Automatic picture synchronizer and simplified controls
- Expanded screen gives clear, bright image on a 12½" direct-view picture tube
- 3-speed automatic phonograph that plays standard, 33⅓ rpm LP, and the new 45 rpm fine-groove records
- With complete AM radio and full-range FM radio

THE "MASTER SHOWMAN," brilliant new star of the family circle...

- Huge, 16" direct-view picture tube with expanded screen
- Sharp, lifelike pictures held steady and clear by the famous Crosley automatic picture synchronizer
- Beautifully styled cabinet of rich mahogany veneer, hand-rubbed to a luxurious satin finish



9-422 M
"MASTER SHOWMAN"

THE "POPULARITY," with a big 12½" picture tube...

- Expanded French Oval screen for clear, steady picture
- With special plug-in for all types of record players
- Automatic picture synchronization and simple controls
- With static-free FM sound, *plus* a full-range FM radio



9-419 M
"POPULARITY"

THE "GOOD TIME," a superb Crosley True-Picture TV table model in a convenient size...

- With a big 10" picture tube that provides crystal-clear images
- Handsome Carrollton mahogany-veneer cabinet
- Simple controls that even a child can operate
- With static-free FM sound *plus* a full-range FM radio



9-403 MA
"GOOD TIME"

THE "PLAYTIME," a lightweight portable with heavyweight performance...

- 3-way operation—AC, DC, or battery
- Plastic cabinet, in a choice of three colors selected by a consumer panel
- Automatic volume control



10-304 M
"PLAYTIME"

All Crosley TV sets have static-free FM sound, *plus* a full-range FM radio.

CROSLEY

DIVISION



Better Products for Happier Living

SHELVADOR* REFRIGERATORS . . . KITCHEN FREEZERS . . .
RANGES . . . RADIOS . . . RADIO PHONOGRAPHS . . . TELEVISION

INTERESTED IN PRICES AND PROFIT OPPORTUNITIES?

Just contact your nearest Crosley distributor, or drop us a line. If you are in Chicago, visit the Crosley display room at 1132 Merchandise Mart (Phone: MOhawk 4-4645), Chicago, Ill.

Crosley Division, Avco Manufacturing Corporation
1329 Arlington Street, Cincinnati 25, Ohio

**YOU
CAN'T
AFFORD
TO
MISS
TODAY'S
SMASH
NEWS
IN
TELEVISION!**

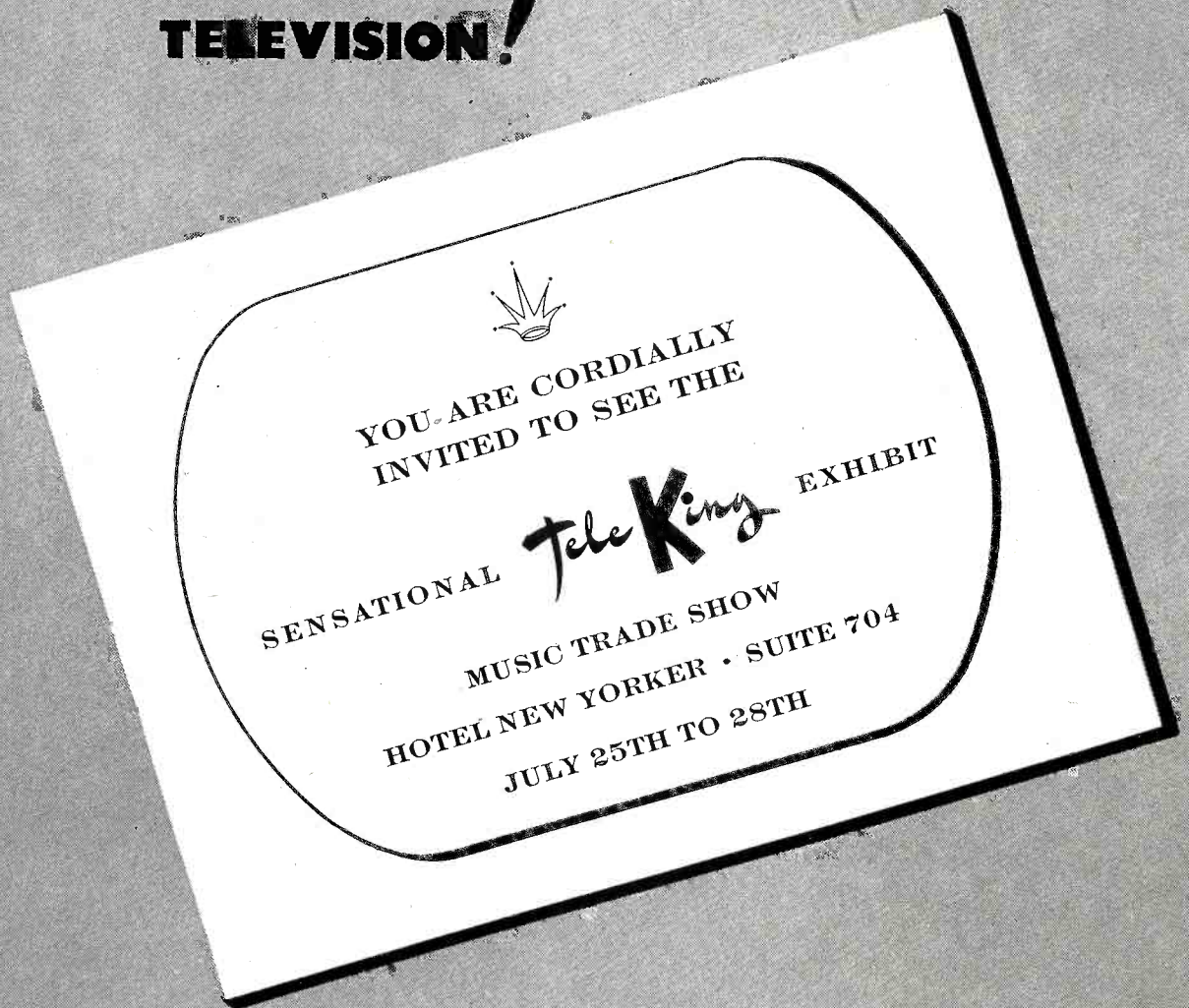

Tele King TELEVISION,
the outstanding mass-producer
of popular-priced quality sets.

THE TELEKING CORPORATION • 601 West 26th St., New York, N.Y.

**PECIALLY PRICED!
PECIALLY PACKAGED!
OR SUMMER SELLING!**

Famous

PHILCO

"Easy Out"
ICE TRAYS



Order Now!

An outstanding value
summer-priced at only . . .

\$5.95

RING UP EXTRA PROFITS . . . CASH IN FULLY ON THIS TIMELY BARGAIN OFFER

1 3 PHILCO EASY OUT ICE TRAYS
"Just lift the lever and out come the cubes".
Standard size fits most refrigerators . . .
brings truly modern ice service to old models.

plus

2 6 DECORATED BEVERAGE GLASSES
Gay and festive . . . assorted colors. Large
11 oz. size. Reinforced safety rim.

plus

3 6 PLASTIC SPOON STIRRERS
Useful for all kinds of iced summer drinks.

All in colorful counter display package! Separate
17" x 22" bulls-eye window poster, newspaper ad
mats and illustrated post cards also available.

Here's the hottest deal of the year to bring you
an extra share of this season's ice tray business. A
brand new sales stimulator . . . in an appealing
thirst-quenching package. You sell 3 trays instead
of one to a customer . . . and ring up a real profit!
Just what every owner
of an old refrigerator
needs! Display it! Ad-
vertise it! Ask 'em to
buy! Act at once and
make every selling day
count . . . Order from your
Philco distributor now.



See your Philco Distributor Today

① MORE FOR YOUR MONEY ①

NEW TV SWEEP GENERATOR-MARKER

TAILORED FOR
TRIPLET
TELEVISION

**Covers
All TV Picture
and Sound I.F.
and F.M. Ranges**

**MIRROR-SCALED
for ACCURACY!**

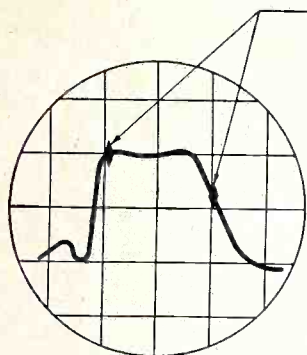

Two Built-in Markers Can Be Used Simultaneously Giving Facilities for Faster Identification of Bandpass of Curves Without Constant Tuning of Marker

**Model 3434
Only \$149⁵⁰**

Suggested USA Dealer Net (crystals not supplied)

TECH DATA

Frequency Coverage:

- | | |
|---|--|
| <ul style="list-style-type: none"> • SWEEP CENTER FREQUENCY
Range 1— 0-60 MC
Range 2— 60-120 MC
Range 3—120-240 MC • SWEEP WIDTH:
0-12 MC (Continuously Variable) • MARKER FREQUENCY
19.5 to 40 MC (fundamental), 39 MC to 240 MC (harmonic) | <ul style="list-style-type: none"> • CRYSTAL FREQUENCIES
To 20 MC on Fundamentals. Harmonics up to 216 MC. (Crystals Not Furnished) • MODULATION
400 Cycle on both Crystal and Marker Frequencies • AUDIO:
400 cycles |
|---|--|

Above also furnished in separate units . . . Sweep Generator . . . Variable Marker . . . Crystal Marker.

Precision first... to Last

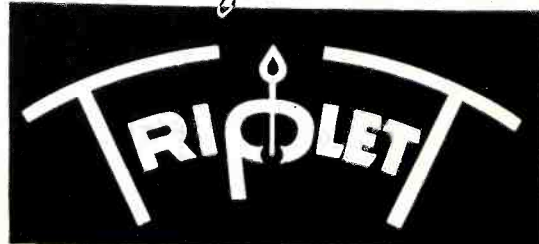

The new Triplet TV-FM Sweep Generator-Marker, with two built-in Markers and large mirrored dial, was "Tailored For Television" with YOU in mind! The two Markers can be used simultaneously . . . gives you the facilities for faster identification of bandpass of curves without constant tuning of Marker. Marker has both pip and absorption dip control.

The large Marker dial is mirrored for easy reading and greater reset accuracy. Straight line frequency tuning condensers used to provide linear scale markings.

No gaps in frequency . . . continuously variable Sweep width control.

Audio output for quick check on video and sound amplifiers.

Expertly-engineered shielding . . . all critical circuits enclosed.

Copper plated steel construction.

Contained in attractive black suede finish steel case, size 15-11/32" x 11-1/32" x 8 1/4" . . . leather handle . . . copper-plated feet for grounding when working on metal work bench top . . . panel is black, white and red etched on aluminum.

For Detailed Information

See your Radio Parts Distributor or write . . .

TRIPLET ELECTRICAL INSTRUMENT COMPANY • BLUFFTON, OHIO, U.S.A.

In Canada: Triplet Instruments of Canada, Georgetown, Ontario

Prices slightly higher west of Rockies

In Radio and Television Tube Sales

1949 IS A G-E YEAR



Clearly illustrated. You see the equipment! ★ Plenty of practical aid with your problem!

Make 1949 your year for profits!
Read TECHNI-TALK! General Electric publishes
this new, useful service magazine to help you
get more tube, parts, and repair business.



YOU'RE in a fast-moving profession, as radio-TV serviceman. Every day, new situations arise where you must know *what to do* to bring console-model radio, television receiver, or other sets up to par. Only by greater knowledge of methods, can you increase your repair volume . . . make your phone number the one owners dial when trouble occurs.

TECHNI-TALK is G.E.'s helpful answer to your need. Here's a bi-monthly service magazine edited by practical men for practical men—concise, down-to-earth, with just enough theory to give you the "why" of proved methods and time-saving short cuts. Read

every issue! Chances are, some problem awaiting you on your next round of service calls has been discussed, and solved for you, recently in TECHNI-TALK.

Your General Electric tube distributor will be glad to send you the latest TECHNI-TALK, and put you on his list for future issues. Phone or write him for your registration card! And don't forget: this expertly prepared magazine comes from a leading manufacturer of radio-TV equipment, in touch with service sources nationally. *You benefit from the sum total of G-E experience on any problem! Electronics Department, General Electric Company, Schenectady 5, New York.*

You can put your confidence in—

GENERAL  ELECTRIC

161-HAS



TO GUIDE THE INDUSTRY'S PURCHASING AND MARKETING

Caldwell-Clements' full-time staff of experts sifting product information for year-round use of buyers in wholesaling, retailing and servicing . . . To be published in

**RADIO & TELEVISION
RETAILING**

TWO GREAT ADVERTISING OPPORTUNITIES IN
TWO ISSUES THAT EVERYBODY WILL SAVE

1—TELEVISION SPECIFICATIONS

In September

Complete, authoritative, technical and merchandising specifications of every television make and model—Consoles and Table Models; Direct-view and Projection. New, accurate and exclusive.

For complete details, closing dates, etc., write

2—RADIO-TV BUYERS DIRECTORY

In October

Complete, up-to-the-minute listings of all manufacturers of Radio and Television, Parts and Accessories, Appliances, Records and Players, Recorders, Service, Test and Sound Equipment.

CALDWELL-CLEMENTS, INC.

480 Lexington Avenue
NEW YORK 17, N. Y.

How *Sparton* dealers are tuning in on a price-conscious TV market

only **\$199⁹⁵** **Striped Mahogany Veneers**
Model 4954TV

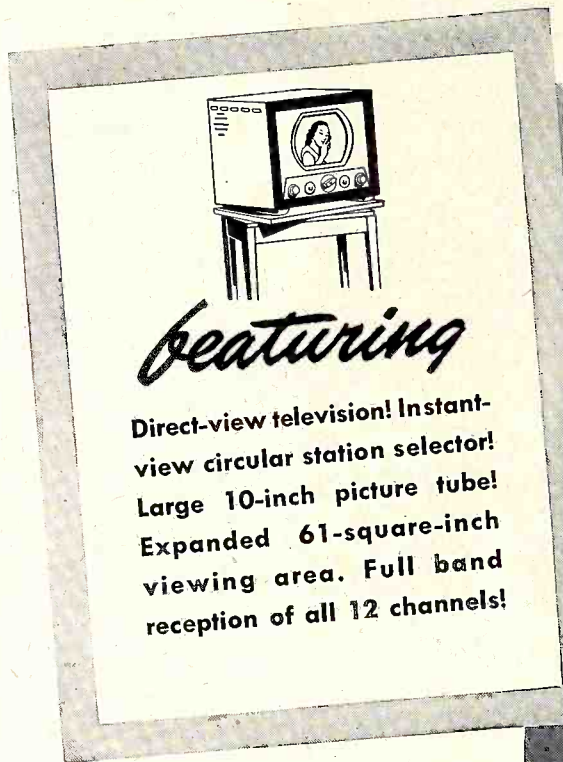

This is just one of the sensational new Sparton TV sets destined to start the trade buzzing at the Chicago Midsummer Show.

Large 10-inch picture tube with expanded 61-square-inch viewing area . . . automatic gain control . . . full-tone permanent-magnet Alnico No. 5 speaker . . . instant-view circular station selector . . . optional swivel-top table in matched design and finish . . . knobs of crystal-clear, polished Lucite . . . and a beautiful cabinet of striped mahogany veneers with ebonized wood trim, hand-rubbed to a piano finish.

Thanks to SCMP—the *original* Sparton Co-operative Merchandising Plan—Sparton dealers enjoy a definite price advantage in the trade. The middleman and his profit have been eliminated. Under the SCMP, Sparton sells direct to one dealer—and only one—in each community. SCMP has been successful in the radio field for more than a decade and is giving Sparton dealers an even greater advantage in television. And Sparton dealers have sets to suit every pocketbook.

Write today for more information on this unique and profitable plan. A Sparton franchise may be available to you.

Special! See the exciting new models at the permanent Sparton exhibit, Chicago Furniture Mart, Room 509B—Fifth Floor.

Here's how SCMP increases your profits

- Direct factory-to-dealer shipment
- One exclusive dealer in each community
- Low consumer prices
- National advertising
- Factory prepared and distributed promotional helps
- Seasonal promotions
- Uniform retail prices
- Products styled by outstanding designers

Sparton
Radio-Television's Richest Franchise

SPARTON RADIO-TELEVISION

Division of
THE SPARKS-WITHINGTON COMPANY
JACKSON, MICHIGAN

NO CHARGE!... with initial \$50 order of OLIN Radio Batteries



SUGGESTED \$50.³⁸ ORDER

- 12 #1710 "B" Batteries
- 6 #6210 "B" Batteries
- 6 #4918 "A" Batteries
- 2 #0614 "A-B" Packs
- 2 #0615 "A-B" Packs

IDEAL COMBINATION WINDOW AND FLOOR DISPLAY No. 640

- Will hold at least 200 lbs. of radio batteries
- Needs only 14x20 inches floor space...40" high
- Full-color, attractive design
- Lower shelf can display portable radio as "TODAY'S SPECIAL"

This combination full-color display available for immediate shipment: (Shown here in two colors only).

GET SET FOR SUMMER SELLING — order complete line Olin radio batteries and combination display from your Wholesaler's Salesman TODAY.

VISIT the General Electric Exhibit at the Music Merchants Show, July 25-28, Hotel New Yorker, Rooms 721-2-3, N. Y. C.

SEE—THE GREATEST SELLING FEATURE IN TELEVISION!

DAYLIGHT TELEVISION
 AT LEAST **80% BRIGHTER**
 than ordinary television under the same conditions... the new kind of television bright enough to provide top picture enjoyment under normal room lighting, as eye specialists recommend.
EASIER ON YOUR EYES

What a feature! You can demonstrate the difference in an instant! The vital, extra brightness that permits viewing in full room light, as recommended by the medical press and leading eye specialists! Yet this provably finer product is priced on the nose with ordinary television. What a setup for lush profits! Call your G-E television distributor today. Or write General Electric Company, Receiver Division, Electronics Park, Syracuse, N. Y.

MODEL 817—New Turn-about Console! Unique selling feature. Cabinet is adjustable to any angle for perfect viewing! Big 12½" tube. Daylight bright, daylight clear, daylight sharp pictures. Full-height cabinet, veneered in genuine mahogany. Model 817.

\$369.95*



MODEL 821—Sells itself on sight! Lowest-priced G-E Daylight Television model with big 12½" tube—biggest daylight picture yet! All active U. S. channels. Long range reception. Simplified tuning. Genuine mahogany veneered cabinet. Model 821.

\$329.95*



MODEL 818—Complete home entertainment center. Everything your customers want—in an exquisite, genuine mahogany veneered cabinet. G-E Daylight Television on a big 12½" tube—powerful FM-AM radio—two-speed automatic phonograph for 78 and 33½ rpm records. Model 818.

\$499.95*

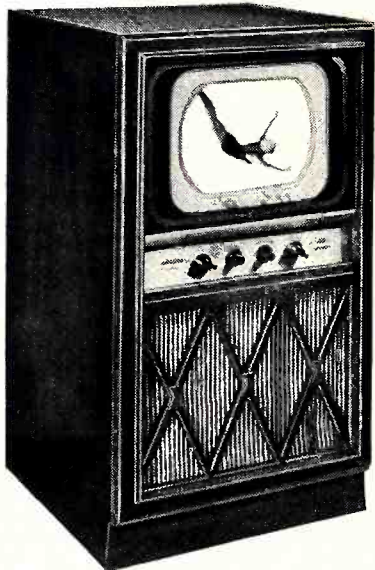

MODEL 805—Sensational seller! More picture per dollar! Big screen—nearly as wide as the cabinet itself! 10" conventional tube. Gets distant stations in fringe areas. Rich rosewood plastic cabinet. Priced for fast turnover! Model 805.

\$239.95*

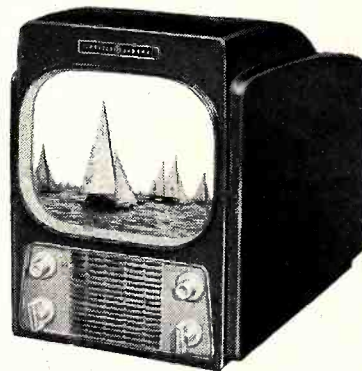

*Plus tax. Installation extra. Prices slightly higher West and South—subject to change without notice.

You can put your confidence in—
GENERAL ELECTRIC

Terrific!

10" at
\$199.95

TABLE NOT
INCLUDED

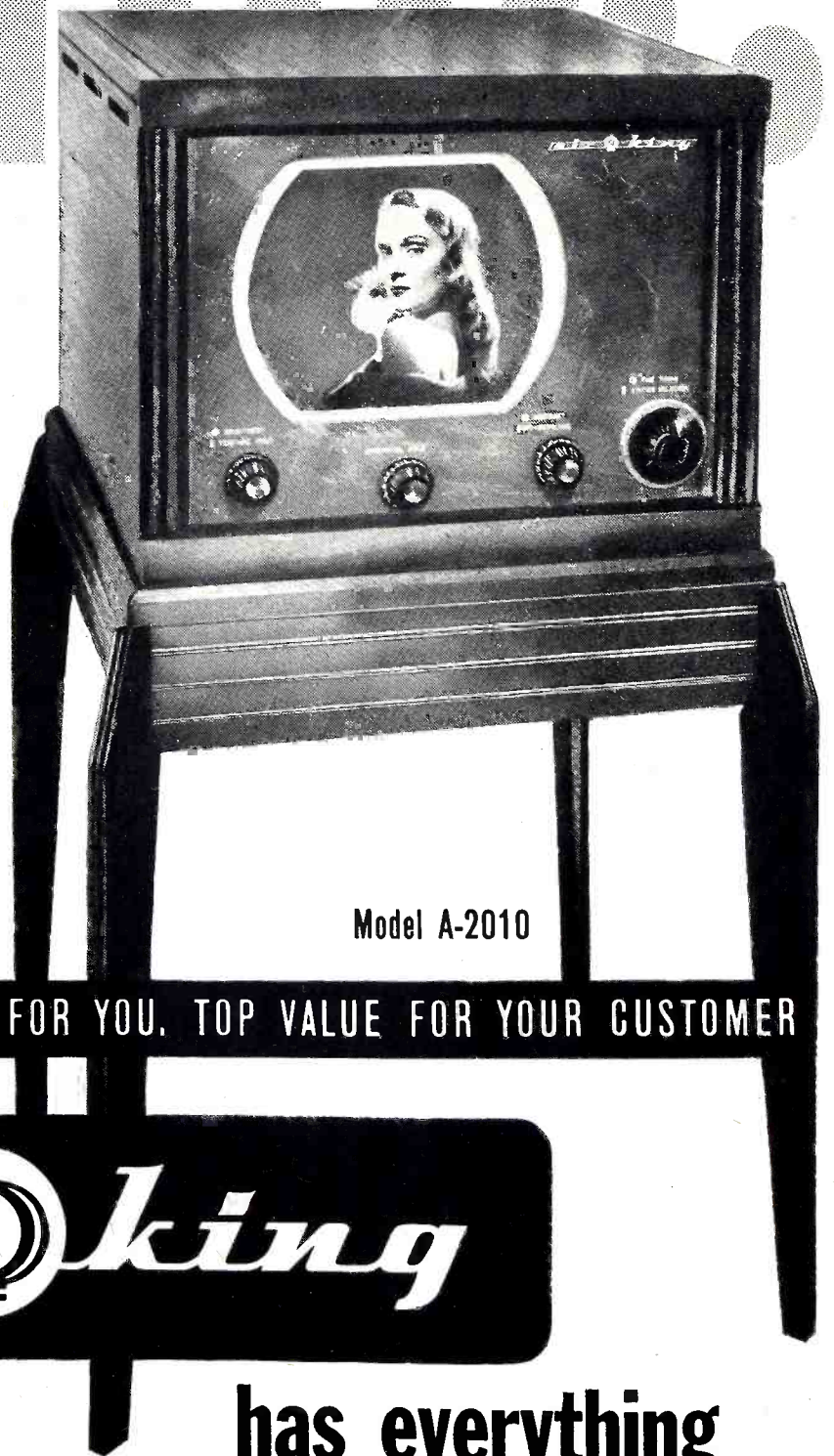

Model A-2010

BIG MARK-UP, FAST TURNOVER FOR YOU. TOP VALUE FOR YOUR CUSTOMER

air king

has everything

N. A. M. N. SHOW Visitors—See how TV Sets are made! Open House at the Air King factory during the Music Show.

AIR KING PRODUCTS CO., INC. • 170-53rd St., Brooklyn 32, N.Y.



She'll say **YES, YES**
to your **fan line**

YES!... if you feature the fans that people want — nationally advertised lines — THE LINES DISTRIBUTED BY **Graybar**

YES!... if you use good selling methods — modern merchandising and promotion tools — THE SALES HELPS AVAILABLE FROM YOUR LOCAL **Graybar** APPLIANCE SPECIALIST.

Yes, and you'll get prompt deliveries from a Graybar warehouse near you.

These are a few reasons why thousands of dealers throughout the nation make Graybar their No. 1 source of electrical appliances.

4968

Appliance Department
GRAYBAR ELECTRIC COMPANY, Inc.

Executive Offices:
Graybar Building, New York 17

THEY SAY YES WHEN YOU FEATURE APPLIANCES...

...recommended by
Graybar

IN OVER 100 PRINCIPAL CITIES

Bendix Radio

Topflight Television

A BIG **61** SQUARE INCH PICTURE

FOR ONLY

\$199⁹⁵

with your regular discount

IT'S THE NEW LOW-PRICED LEADER. Performance and quality are so fine, and features are so outstanding that nothing compares with this low-priced beauty within \$50 of its price. What's more, none of that low price comes out of *your* pocket. This

set carries the same generous discount rate as high-priced models! And its yours exclusively when you sign a Bendix Radio and Television franchise. No dealer in your community can offer it but you! See it—or write for complete story, today.

MORE HIGHLIGHTS OF THE FINEST PROFIT PLAN IN THE INDUSTRY—Exclusive dealership . . . direct factory-to-dealer franchise . . . rush shipments from nearby warehouses . . . exceptional discounts . . . freight prepaid to destination . . . national advertising.

**See the complete competitively-priced line
of Bendix Television and Radio**

American Furniture Mart
Space 545 D
Chicago, Ill.
July 5 thru 15

Music Merchants Show
Room 707
Hotel New Yorker
New York, N. Y.
July 25 thru 28

Western Furniture Mart
Space 552
San Francisco, California
August 1 thru 6

Or Send This Coupon for Details 

DON'T MAKE YOUR STORE A DISPLAY ROOM FOR COMPETITORS

ANSWERS THE DEMAND FOR at Everybody's Price

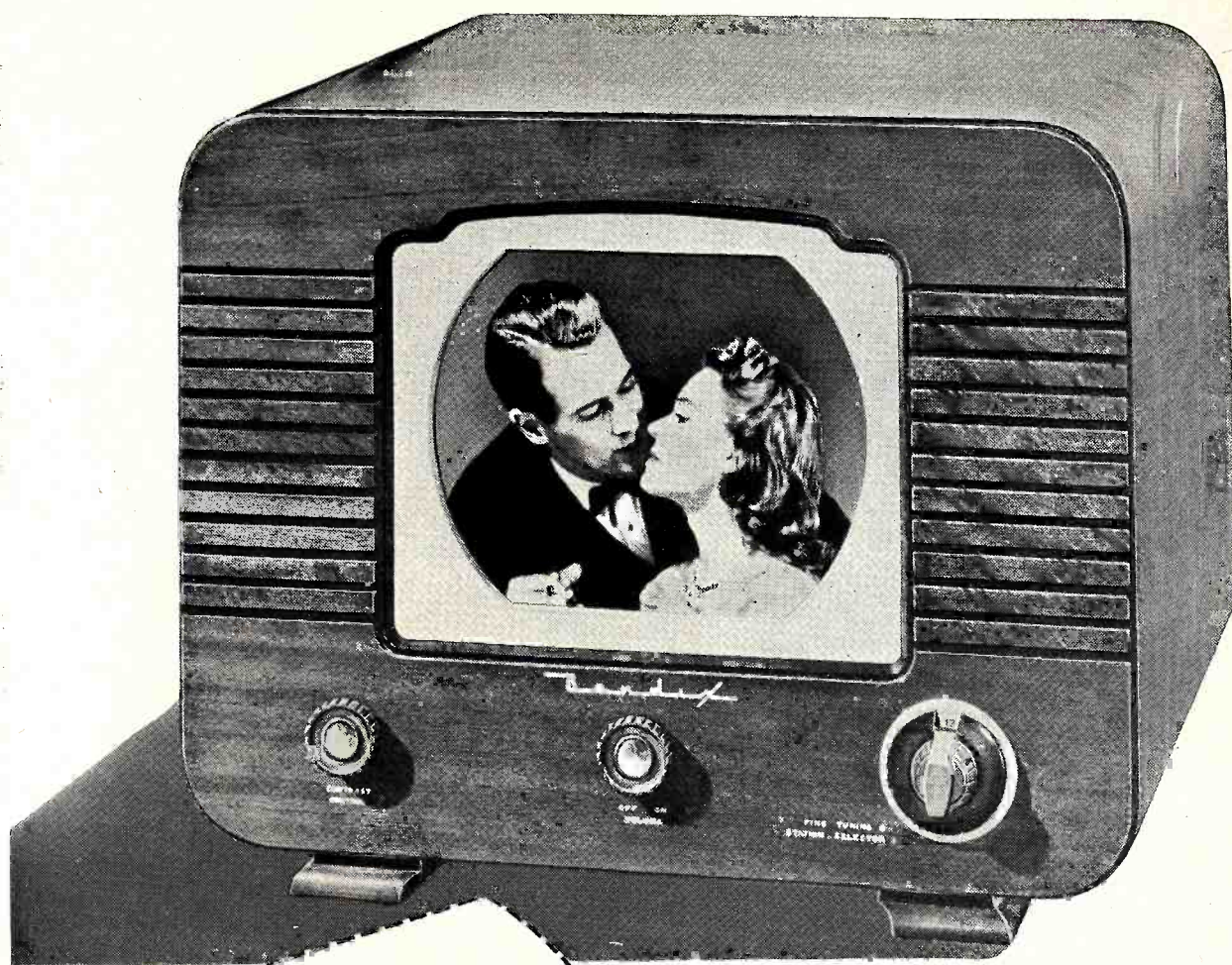

Edward C. Bonia, General Sales Manager
Bendix Radio Television and
Broadcast Receiver Division of
Baltimore 4, Maryland



Send me information on your franchise and your new
television line.

Name _____

Address _____

City _____

Zone _____

State _____

- ★ Mahogany wood cabinet
- ★ Built-in antenna
- ★ Straight AC receiver
- ★ Built by the brains behind radar
- ★ Sells for \$20 down and as little as 25 cents a day!

BENDIX RADIO

REG. U.S. PAT. OFF.

—SELL BENDIX, THE EXCLUSIVE FRANCHISE LINE



RCA Batteries are Radio-Engineered for Extra Listening Hours

Radio's Best Sellers...

and your best Profit Builders

Profit builders because RCA's *Selective Distribution* primarily to the Radio Trade virtually makes RCA Batteries *your exclusive brand!*

Profit builders because by selling virtually an exclusive brand you bring customers back to *you* for replacements!

Profit builders because the RCA Trade Mark and attractive package guarantee immediate customer acceptance—help you sell easier, faster!

Profit builders, too, because RCA has a *complete line*—serving 99% of all radio requirements. Included are

“hard-to-get” types—stocked in local warehouses for quick delivery through RCA Battery Distributors.

Build your business with the Battery line that packs a profit.

... and the best in selling aids

RCA provides you with the greatest array of selling aids in battery history . . . all geared to the radio trade. They'll help you build your battery business!



ALWAYS KEEP IN TOUCH WITH YOUR RCA BATTERY DISTRIBUTOR



RADIO CORPORATION of AMERICA

HARRISON, N. J.



TABLE MODELS • SMALL CONSOLES • LARGE CONSOLES

With 10" — 12½" — 16" Picture Tubes

"Perfection in Television"

"Town and Country" Model, with 10-inch and 12½-inch tubes. The original Nielsen over-size picture. Over 63 square inches, and over 90 square inches.

Nielsen TELEVISION — DIRECT-TO-DEALER



HAROLD V. NIELSEN
President

Has pioneered radio inventions at General Electric Company, Brunswick-Balke-Collender Co. and Bell Telephone Laboratories; then chief engineer at Sparton radio for over 12 years. During war, manufactured radio and radar for U. S. armed forces.



MATT J. JELEN
Vice President and
Chief Engineer

A veteran design engineer, formerly chief engineer of Stewart-Warner; responsible for outstanding designs at Zenith, Sparton and pioneer television manufacturers; also designed radio compasses and radar for Air Corps and Navy.



HERBERT E. YOUNG
Sales Manager

Nationally-known sales executive in radio, TV and appliance fields. "Herb" was vice president in charge of sales for the Grigsby-Grunow Co., the original Majestic, when they were leaders in the industry. Also sales manager, Gibson Electric Refrigerator Corp. Has directed sales of famous brands since earliest days of radio and television.

- ✓ REAL DEALER PROTECTION.
- ✓ ONLY ONE FRANCHISED DEALER TO AN AREA.
- ✓ GREATER DEALER DISCOUNTS.
- ✓ QUALITY AT AMAZING PRICES.
- ✓ BRILLIANT "FRINGE AREA" PERFORMANCE.
- ✓ ALL CHANNELS PRETUNED, USING BROADCASTS FROM STATIONS 40 TO 60 MILES AWAY.
- ✓ NIELSEN-ENGINEERED CHASSIS PRODUCED IN OUR OWN PLANT.
- ✓ BEAUTIFUL STYLING—SOLIDLY BUILT CABINETS.
- ✓ NIELSEN-ENGINEERED BUILT-IN ANTENNA. IT WORKS! (May be disconnected for distant reception).

EXHIBITING AT THE MUSIC INDUSTRY TRADE SHOW

Nielsen cordially invites you to Booths 43 and 44, Manhattan Center (adjoining Hotel New Yorker) during the 1949 show, July 25-28. See us at the show or write immediately for complete franchise details and prices.

It takes a NIELSEN to match a NIELSEN



Partial view of Nielsen's ivy-clad factory on a 6-acre tract in the hills of Norwalk, just off the Merritt Parkway—a perfect setting and atmosphere for scientists, engineers, technicians and other Nielsen workers.

NIELSEN TELEVISION CORPORATION • Norwalk, Connecticut

Factory & Executive Offices: Norwalk

Telephone Norwalk 8-0694

If You are Selling

**PLAYER COMBINATIONS,
RADIO, TELEVISION,
RECORD-PLAYERS,**

**This Study Will Help You
Play Your Own
Sales Tune
in Key**

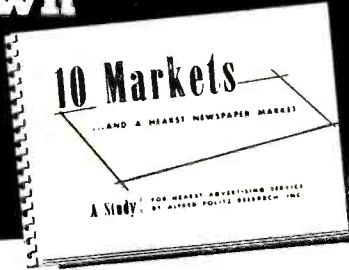

In this buyer's market and all the good, healthy competition that goes with it, there is no substitute for factual, practical, usable information as to:

- (1) The over-all potential that exists.
- (2) Brand preference based on actual ownership.
- (3) Brand preference, based on type and model.

This "10 Markets . . . and a Hearst Newspaper Market" Study was conducted through personal interviews by Alfred Politz Research Inc., in 10 of America's major markets where Hearst Newspapers are published. It reports in graph and table form the findings of the markets individually and the relationship of the Hearst housewife audience to those markets.

If you are selling radio, television, player combinations, you will want and find highly valuable the information that this authentic survey brings to light.

Contact the Hearst Advertising Service office most convenient to you and an H.A.S. man will be glad to come to your office and talk things over.

Hearst Advertising Service

Herbert W. Beyea, General Manager

959 Eighth Avenue, New York 19, N. Y.

Offices in principal cities
Representing

**New York Journal-American
Baltimore News-Post
Pittsburgh Sun-Telegraph
San Francisco Examiner
Detroit Times**

**Boston Record-American
Albany Times-Union
Los Angeles Examiner
Chicago Herald-American
Seattle Post-Intelligencer**

Sell the
"Back to School"
Crowd!



you saw it in
seventeen

- 4-color page in "Seventeen"
- Special display material
- Special newspaper mat
- "Keen-Teen" Tags

ARVIN Keen-Teen Radio

aimed at 8 million teen-age girls

Give your August radio sales a shot in the arm with this perfectly-timed Arvin promotion—aimed directly at the color-conscious, free-spending "Back-to-School" crowd!

It's the famous Arvin Model 242T . . . shatterproof, exceptional range and tone, compact, convenient, in six gay, youthful colors. The sales-building package includes (1) a full page in full color in the August "Back-to-School" issue of SEVENTEEN the "Style Bible" of the school and college crowd; (2) counter card carrying the actual ad with SEVENTEEN identification; (3) special newspaper mat, and (4) special Arvin Keen-Teen merchandise tags. Everything needed to snap up your summer sales! But be sure to act now—so you'll be ready when SEVENTEEN gets to readers on August 1st!

Arvin Radio and Television Division
NOBLITT-SPARKS INDUSTRIES, INC.
Columbus, Indiana

\$14.95* ● fox hunt red
● citron yellow
SIX GAY COLORS
● leaf green
● sand bronze
● ivory
● gunmetal

*Slightly higher in Zone 2

MAIL THIS COUPON TODAY

Radio & Television Division,
Noblitt-Sparks Industries, Inc., Columbus, Indiana
I want to be in on the Arvin Keen-Teen Promotion. Send me everything I need.

Name.....

Company.....

Address.....

City..... State.....

An

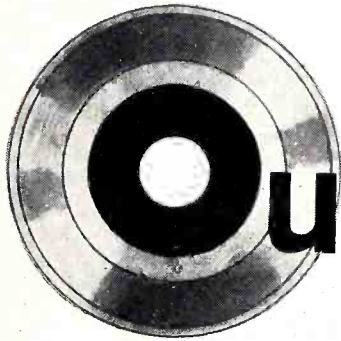

Outstanding Success!

Every day, more and more people are making their decision about the RCA Victor 45 rpm system: once they see it, once they hear it, they KNOW that it is the standard of the future for recorded music! They realize that the 45 rpm system offers them the *only* way of getting *all* they want in record enjoyment!

And the success of the 45 rpm system is creating a *bigger market* for you, in three important ways:

78 rpm owners are *adding* the finer, more economical 45 rpm system to their equipment . . .

The attractions of the new system are creating *brand-new* player owners, of 45 rpm only . . .

The lower cost and finer tone of RCA Victor 45 rpm records are leading to *more frequent record buying!*

So put your sales efforts solidly behind 45 rpm, and watch your volume grow!

Make full use of 45 rpm record-selling advantages . . . they'll help you sell:

- Records are designed for the "world's fastest changer."
- All records are the same size—you save space by storing 150 singles, or 18 average albums, on one foot of shelf. And because these records are non-breakable Vinylite, you cut inventory losses due to breakage.
- 7 colors identify the 7 types of music, make it easy for you to select records and put them away. Colors make your displays real eye-catchers, too!
- **NEW RELEASES** of RCA Victor 45 rpm records are coming out regularly . . . featuring all the famous RCA Victor stars!

There are still 16 million 78 rpm players. That's why RCA Victor will continue to provide you with 78 rpm records matching every 45 rpm release.

RCA VICTOR

DIVISION OF RADIO CORPORATION OF AMERICA

PIONEER AND WORLD LEADER IN RECORDED MUSIC



8224

8223

8222

8205

8209

8204

8216

8225

8235

TRANSMISSION LINE CABLES

Every Type for Every Service

Sold Exclusively Through Recognized Wholesale Distributors

8210

8226

8227

8229

8228

Belden

Radio **WIRE**

It's the Talk of the Trade!
Reach new Sales highs
with the line that tops them all!

FADA

Television

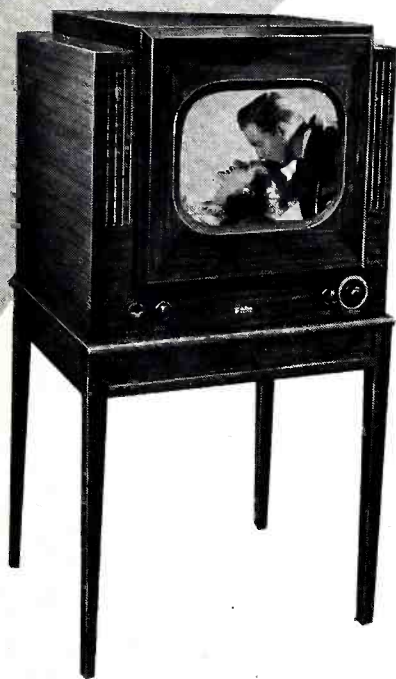

Fada engineering "Know-How" is built into every Television receiver. Fada Television is proven incomparable in fringe areas. Fada superb custom quality cabinetry is unsurpassed in the Television industry.

MODEL 925

16 Inch Direct View Picture

126 Sq. In. of viewing area. Dual Sensitive-Tone three dimensional sound system in acoustic chambers provides big concert tone quality. Genuine Mahogany, Walnut, Bleached Blonde Mahogany or Limed Oak veneer cabinets.

MODEL 930

12½ Inch Direct View Picture

72 Sq. In. Viewing Area
 Proved to be the ultimate in performance in Fringe areas, it brings clear, steady, flickerless, brilliant pictures even in bright daylight. Big concert quality is provided by Fada's miracle 'Dual Sensitive-Tone' Sound system. Classic cabinets of genuine Mahogany, Walnut, Bleached Blonde Mahogany or Limed Oak veneer.

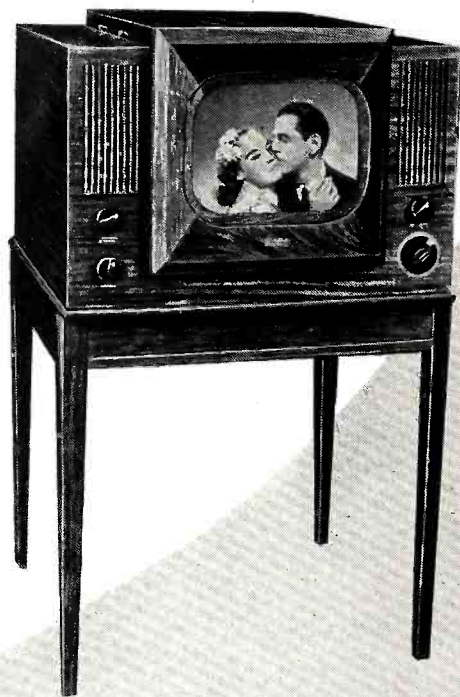

NEW! MODEL P-111

Tri-Powered Personal Portable Receiver

Extra battery powered AC-DC receiver. Gorgeous simulated jewelers yellow gold plastic grill. Light in weight. Ebony, Maroon or Ivory plastic cabinets.



"Pioneers in Radio & Electronics Since 1920"

FADA RADIO & ELECTRIC CO., INC., BELLEVILLE, NEW JERSEY

introducing...

WAFER

THIN

MARVEL-LENS

the **BIG** look in television

THE LENS YOUR CUSTOMERS READ ABOUT IN NATIONAL MAGAZINES!

People have been talking about this revolutionary invention and how it is changing the television picture ... making obsolete all magnifiers now on the market. Marvel-Lens enlarges the picture 2½ times when flush up against the set.

it's wafer thin

It weighs less than 3 pounds. Other lenses are bulky, top-heavy and oil filled. With Marvel-Lens, there are no bulky attachments to mar the beauty of your set. You look through Marvel-Lens, not around it.



Marvel-Lens



Old Lens

wider angle of vision

With Marvel-Lens, viewers on the far side of the room see the entire screen. You get a clear, undistorted picture. NO edge distortion! No glare. It's Marvel-Lens from every angle.

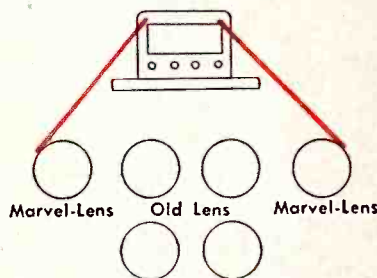

BRIGHTER! CLEARER! LIGHTER!

prevents **TV SQUINT**

RETAIL PRICES

7 and 10 inch screens	21.75
10 and 12 inch screens	24.75

AMPLE DISCOUNTS

SEE OUR BOOTH AT THE NAMM SHOW

MARVEL-LENS INDUSTRIES

MALVERN, PENNA.

This sign belongs on your door...



Customers "call again" for two reasons: they are either pleased with your service or displeased. Because the workings of an auto radio are quite intricate, no car owner can figure out for himself just who is at fault when a vibrator kicks up.

not on the Vibrators you use

Nevertheless, call backs on installations are costly affairs to you—both in time and reputation. The parts you choose must be as dependable as your own service. So stick with a name you know you can trust:

CORNELL-DUBILIER

Here's why C-D Vibrators are *reliable, quiet and last longer*



1. Exclusive C-D pole piece design and armature weight result in a perfectly-balanced unit with less vibration, minimum mechanical hum and maximum life.

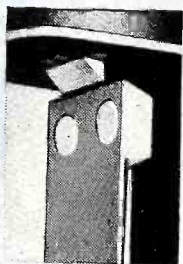

2. Exclusive C-D base mounting results in a full floating unit.



3. New stack design utilizing pure india ruby mica will take peak voltages of even 4,200 volts with no damage to vibrator.

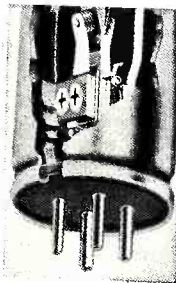

5. C-D designed electronic micro-metric equipment removes guesswork in contact point setting and assures consistent high quality.

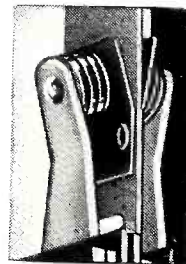

4. Unit completely enclosed in new, exclusive C-D super-soft, pure sponge rubber floating sock. Eliminates usual difficulties found in other vibrators.

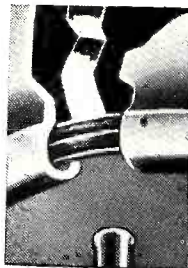

For the best in Vibrators insist on C-D's. Now at your local C-D distributor. Or write for full details to Cornell-Dubilier Electric Corporation, Dept. JD-79, South Plainfield, N. J. Other plants in New Bedford, Worcester and Brookline, Mass.; Providence, R. I., Indianapolis, Ind., and Cleveland, Ohio.

For your nearest C-D distributor, consult your local Classified Telephone Directory.



Reg. U. S. Pat. Off.

A GREAT NAME IN CAPACITORS - A GREAT NAME IN VIBRATORS

Tele-tone FIRST AGAIN

BIG **62** SQUARE INCH
TELEVISION

ONLY
\$179⁹⁵

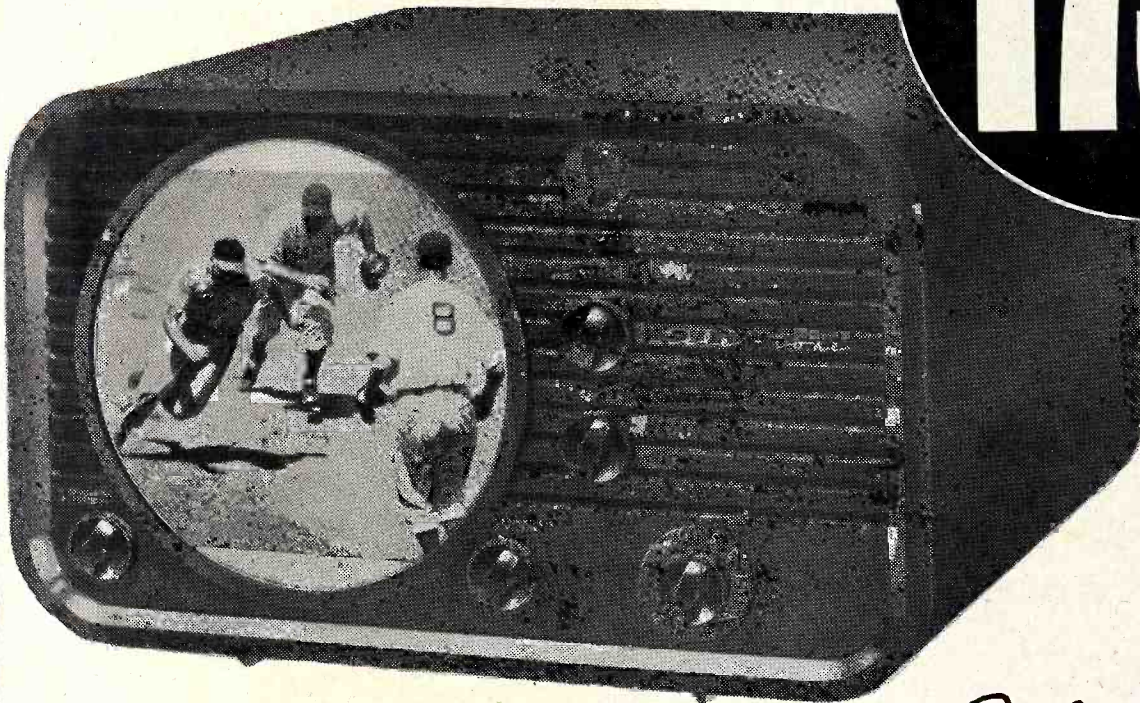

plus \$1.30 Federal tax
installation extra

- HANDSOME
- POWERFUL
- BRILLIANT
- SHARP FOCUS
- LONG RANGE
- LOW PRICE

YEARS AHEAD IN *Style* AND *Performance*

Tele-tone
Leads the Way with a
COMPLETE line of low
priced Radios and Tele-
vision Sets. It's the FIRST
line in FIRST stores!

Here it is . . . the set that meets your customer's demands for a quality-made television set at a price they can afford. It's the sensationally designed BIG PICTURE television set. It's light. It's luxury styled! It's low, low priced for increased traffic and extra profits. Stock and feature this Tele-tone Triumph and set your sights on new sales this season.

Tele-tone RADIO CORP.

540 WEST 58TH STREET • NEW YORK, N.Y.

IT & T

Welcomes

Capehart-Farnsworth

*and its
Nationwide Dealer
and
Distributor Organization*

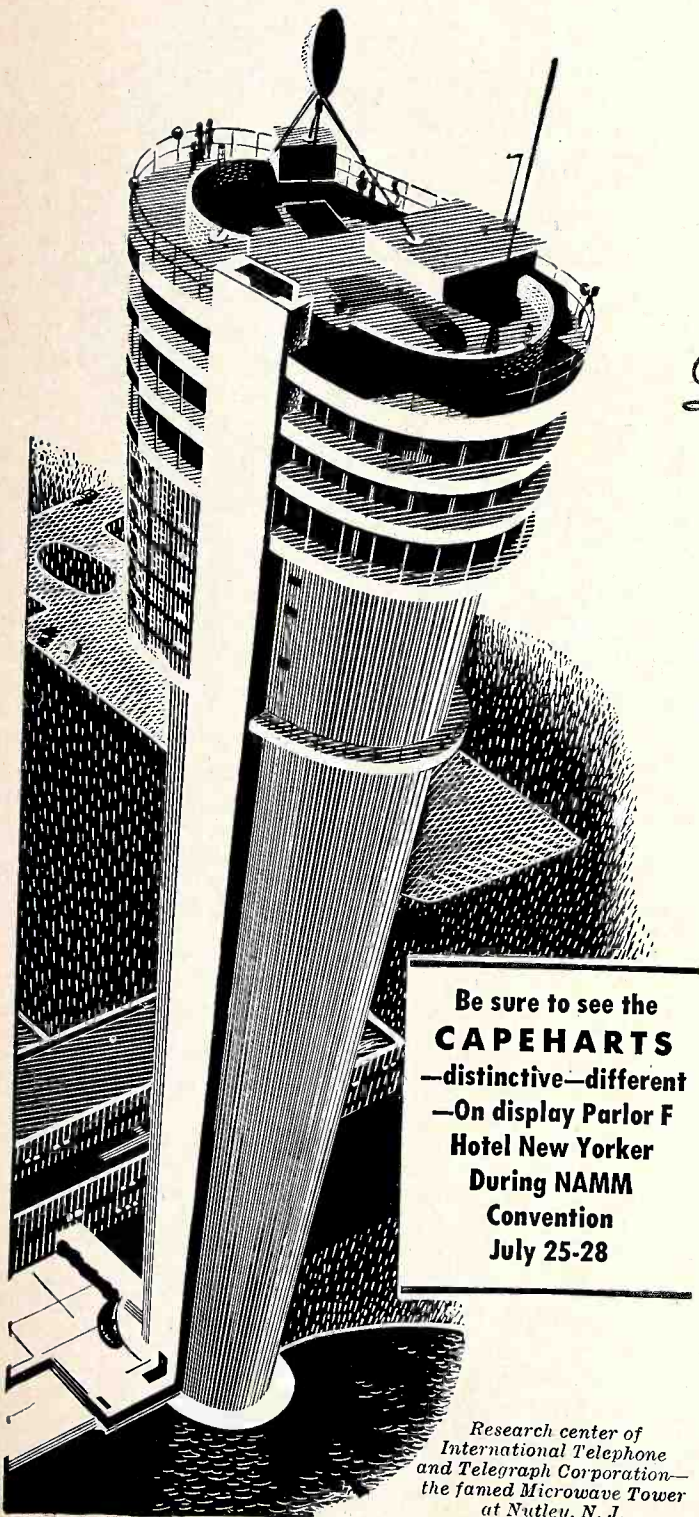

Be sure to see the
CAPEHARTS
—distinctive—different
—On display Parlor F
Hotel New Yorker
During NAMM
Convention
July 25-28

*Research center of
International Telephone
and Telegraph Corporation—
the famed Microwave Tower—
at Nutley, N. J.*

A NEW DAY dawns for Capehart-Farnsworth Corporation and its organization of dealers and distributors, under the sponsorship of the International Telephone and Telegraph Corporation. Together, we will share in the development and production of "better television for more people."

Capehart and Farnsworth are pioneer names . . . names of world-wide distinction. This new association means that these great names . . . and all they stand for . . . will be backed by I T & T resources and strengthened by I T & T leadership.

Already known for its complete line of radio broadcasting equipment and important contributions in the television field—I T & T now joins forces with Capehart-Farnsworth Corporation in manufacturing and marketing home television receivers. I T & T's world-known research laboratories are now linked to the manufacturing facilities and merchandising organization of the new Capehart-Farnsworth Corporation.

For full details on the Capehart line of television, AM-FM radio and record changer combinations—present and soon to be forthcoming—write to Capehart-Farnsworth Corporation, Fort Wayne, Indiana. Ask about a Capehart franchise. A few choice territories are available.

ITT &

INTERNATIONAL TELEPHONE AND TELEGRAPH CORPORATION
67 Broad Street, New York 4, N.Y.

SELL
BEFORE YOU ~~BUY~~ ANY TELEVISION SET

Check the Answers
to these Important
5 QUESTIONS

HERE'S ONE
OF THE FIRST
of a new series of
Capehart newspaper
advertisements—
being run by
Capehart dealers in
the important
television markets.

1. What about the PICTURE? Capehart gives you a large, clear, brilliant image—the finest picture yet produced by advanced television techniques. Sharp and steady in so-called “fringe” areas as well as favored city locations.

2. What about the TONE? Listen to the Capehart with your eyes closed. This test will convince you of the quality of Capehart tone—the same rich beauty and fidelity that won world fame for the Capehart phonograph radio. Now it's yours in television!

3. What about the CABINET? Your television set will occupy the place of honor in your living room. Capehart brings you that “heirloom” quality of cabinet-making, that authenticity of design which has always distinguished the Capehart.

4. What about the NAME? The name Capehart is a guarantee of integrity. It stands for excellence in musical reproduction... excellence in workmanship... excellence in electronic design. Every television set that bears the Capehart name must live up to the Capehart reputation.

5. And what about PRICE? Here's the best news of all. Capehart prices are astonishingly low. Find out for yourself how little it costs to own a Capehart and enjoy all that this great name means in quality and performance.



CAPEHART—Traditional. Authentic 18th Century English design... enduring beauty in lustrous mahogany finish... compact dimensions for any room arrangement. **\$299⁵⁰** Federal Tax Included

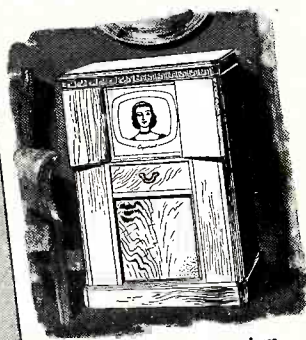

CAPEHART—Georgian
Fine period piece in richly finished mahogany—separate doors for screen and operating controls.

ONLY **Capehart**
ANSWERS ALL FIVE

A television set is a major investment! Choose yours with care. Check Capehart's answers to the five most important questions before you buy. Why not visit your Capehart dealer? When you have seen and heard the Capehart, you'll know why it's a distinction to own a Capehart!

AN **IT&T**
ASSOCIATE

Capehart—Farnsworth
CORPORATION
Fort Wayne, Indiana

NEW! STROMBERG-CARLSON "Manhattan" OPERA GLASS TUNING! SENSATIONAL PRICE!

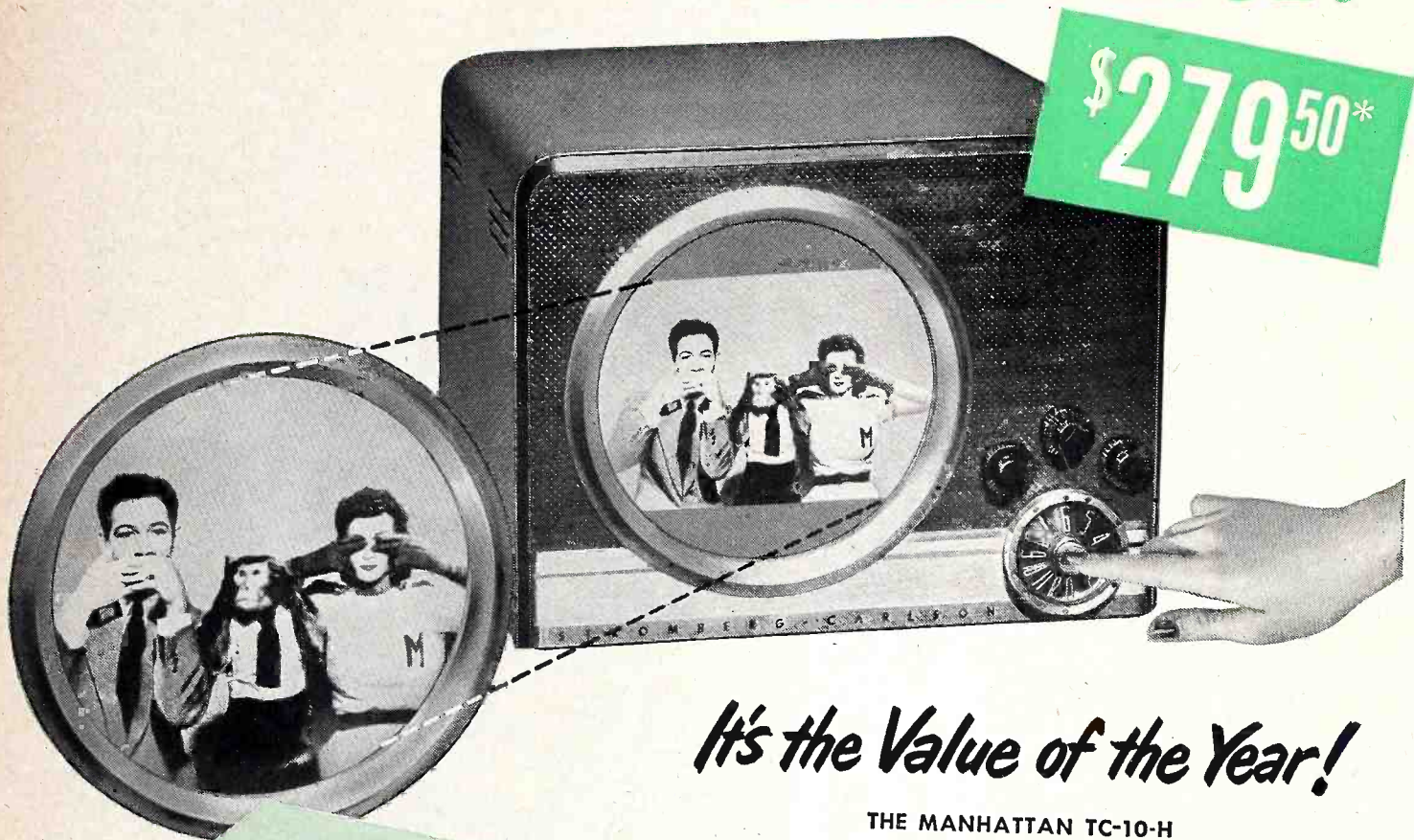

It's the Value of the Year!

THE MANHATTAN TC-10-H

Your customers get not only Opera Glass Tuning but also other Stromberg-Carlson quality features that will make the MANHATTAN a top best-seller.

- Unusually clear, steady direct-view picture.
- Simplified tuning—automatic gain and frequency controls. No drift.
- Clear, undistorted sound.
- Terminals and switch for either separate high and low band antennas or single all-channel antenna.
- Exceptional fringe area sensitivity.
- Real wood cabinet in selected mahogany veneers.

**Be sure to place your order now
to assure early delivery.**

**Slightly higher in South and West. Plus installation and \$1.42 excise tax.*

**INSTANTLY DOUBLES
CENTER OF INTEREST!**



At the touch of a button—
you boost the regular 10 inch
tube picture to a 70 square
inch picture!

You get a huge, intimate close-up of
the center of interest — enlarged to
more than twice its usual area.
Touch the button again, and instantly
you're back to normal wide view.

*See
it
Better*



*Hear
it
Better*

In television, as in radio, there is nothing finer than a
STROMBERG-CARLSON

©Stromberg-Carlson Company, Rochester 3, N. Y.—
In Canada, Stromberg-Carlson Co., Ltd., Toronto

RADIO & TELEVISION RETAILING

Including "Radio & Television"
and "Radio & Television Today"

Established in 1922
as ELECTRICAL RETAILING

O. H. CALDWELL, Editorial Director



M. CLEMENTS, Publisher

The Summer Slump

From Now On, the Sales Curve Goes Up — But Faster If You'll Push!

The perennial villain, Old Man Summer Slump, is "now in our midst." Veterans in the field recognize this bad actor. But many newcomers mistake this visitor for the devil himself come to camp forever on the industry's doorstep.

Such newcomer manufacturers, wholesalers, and dealers, suffering Old Man Summer Slump's visit for the first time, are so terrified at this character's sales-shriveling tactics that they're willing to throw in the sponge without putting up the semblance of a fight.

Such a defeatist attitude in dealing with any seasonal slump will get us just nowhere. And that's especially true of the slump we're presently in, because it has come at a time when the market as a whole has been in a most chaotic state. A *realistic* attitude, backed up with *sales action* and *optimism* will put Mr. Summer Slump to rout!

As will be seen in the chart below, sales have always been at the year's low during July and August. And just as the tides always return, our sales will commence climbing next month; September and October will register good business, and by the time November and December roll around, sales will have reached peak heights again. Based on all merchandising records, 50 per cent of 1949's business will probably be done during the last four months of this year!

Sound thinkers tell us there is no depression in sight; no untoward zoom in the direction of inflation. Wages and savings are at an all-high record, and a careful analysis of the "unemployment" situation reveals little cause for alarm.

If we view the current situation as merely a visit from Old Man Summer Slump, and key our promotional plans and aggressive selling to give him the bounce, our rewards will not be long in coming!

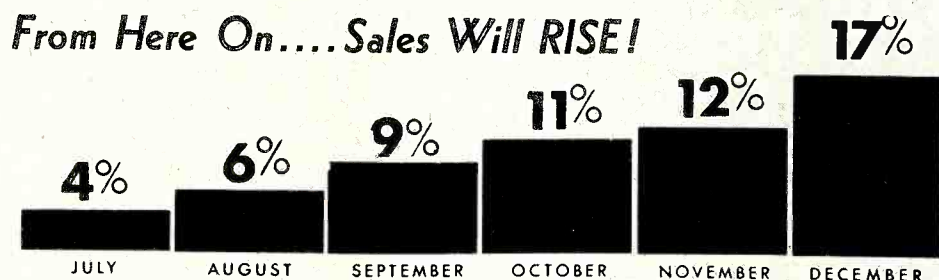

Figures represent percentage of total year's business done each month shown, based on retail records covering many years in the radio and appliance business. Recent experience shows television to be as seasonal as radio, with Christmas business running 14 to 17%.

What's Ahead!—in Radio,

CONSUMER OUTLOOK IMPROVED over this time last year, numbers of dealers agree. Last year, buyers were more or less in mental dithers over conditions. For instance, many felt that their jobs were insecure; that either inflation or recession was close upon them. Today's consumer seems to have adapted himself well to present conditions, buying slowly but with much less trepidation than he did twelve months ago.

THE FCC HAS RELEASED ITS TIME-TABLE for lifting the TV freeze and making the UHF allocation. Official announcement says it will be early Fall before final decision is reached. 6-MC TV operation is planned for lower half of the UHF band, and the Commission opens the door for 6 MC color on VHF and/or UHF channels if color can be received by minor modifications to ordinary receivers. (This provision is considered very surprising.) The upper half of the UHF band will be kept for TV research on stratorvision, poly-casting and high-definition television.

78 RPM DISCS BEING CUT and slashed everywhere as dealers strive to reduce inventories. Top executives doing the buying of platters these days, drastically paring order lists made up by clerks and salespeople.

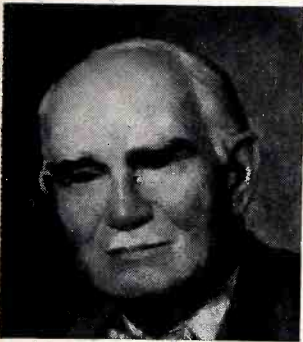

THIS PORTRAIT OF DR. LEE de FOREST, inventor of the audion 3-element tube which underlies all radio and TV, was painted by his daughter Harriet who was born the same year the tube was invented. To date the new industries founded on the deForest tube (radio, sound pictures, long-distance telephony, radar and television) have created over 50 billion dollars worth of products.

BIG EVENT COMING TO CHICAGO, September 30 to Oct. 9. The second annual National Television and Electrical Living Show will be held in the Chicago Coliseum. Harry Alter, prominent distributor, is chairman of the Electric Association committee. Among the committee members are C. Patrick Monaghan, of Hotpoint; E. K. Ploner, vice-president of Sunbeam Corporation, and Walter H. Stellner, vice-president, Motorola, Inc.

WATCH OUT! TROUBLE AHEAD? We agree with TV industry prophets that U.S. market will absorb two to 2½ million television receivers during '49. (This despite the present FCC "freeze", which is holding back retail sales, and even the early lifting of which, cannot be effective at the consumer level before next year!) But our editors have also been quietly compiling the individual production schedules planned by all principal TV makers for '49, and we find these add up to 3 to 3½ million sets for the year!—with the last half of '49 alone booked to exceed 2½ million sets! Such racing toward overproduction and disaster in the

next six months calls for some nifty stabilizing of production right now!—coupled with putting new pressure on aggressive selling, all along the line! There can be disaster for all, if the TV market is glutted by December. Careful!

"I AM EXTREMELY GRATIFIED to see the FCC initiate the first concrete action of removing the last deterrant to fullscale nationwide television on a truly competitive basis. The Commission's attitude with regard to color is the only possible intelligent approach. . . ."—Dr. Allen B. Du Mont on FCC announcement regarding proposed lifting of the TV freeze.

"FCC'S ANNOUNCEMENT THAT IT will soon open new television channels in the ultra high frequencies and lift the freeze on present television channels is the best thing that could have happened for the television industry and the public."—Commander E. F. McDonald, Jr., president of Zenith Radio Corporation.

RAYMOND C. COSGROVE has started his fourth term as head of the Radio Manufacturers Association, succeeding Max F. Balcom. Five new directors are J. B. Elliott, W. J. Halligan, R. A. O'Conner, R. L. Triplett and A. Liberman. Re-elected board members are Paul V. Galvin, L. F. Hardy, E. A. Nicholas, L. H. Coffin, Dr. A. B. Du Mont, W. Evans, G. R. Haase, R. E. Laux and S. H. Stackpole. Bond Geddes continues as executive vice-president and secretary; Leslie F. Muter as treasurer.

RECENT RENEWAL OF PUBLICITY on color TV will see dealers all over the video areas being obliged once again to sell customers on the wisdom of buying now.

ONE TV MANUFACTURER mulling over the possibilities of launching a unique sales idea which is revolutionary, to say the least.

GOOD DISPLAYS CAN be made to pull business. According to the New York State Department of Commerce, 75 per cent of shoppers buy at least one item on impulse; 24.6 per cent of all items are bought on impulse, and 66 per cent of impulse items purchased were on display.

Status of TV

Three new television stations are expected to go on the air this month: WBT-TV, Charlotte, N.C., July 15 and WAFM-TV, Birmingham, Alabama, both new "television cities"; and WTCN-TV, Minneapolis, Minn., a second station for that city. These three stations will bring the total to 73.

Appliances, Records and Television

SALES BATTLE OF THE BIG guys in the washing machine field on in dead earnest. Watch for more and more sales stimulators, drives, and innovations in mechanical operation to be announced from here on.

RURAL RETAILER MAKES hit with busy farmer customers by providing motor transportation to and from his store for members of farm families.

THE NEW BENDIX WASHER, the machine "that couldn't happen," has hit the market, retailing at \$179.95. The new washer loads through the top, is fully automatic and does not have to be bolted to the floor. Employing an agitator, the Economat also features a tub made by General Tire and Rubber Company that compresses to squeeze out the water under vacuum pressure.

NEW ACTIVITIES PLANNED BY Radio Manufacturers Association include standardization and uniform nomenclature for antenna makers and a study of new municipal ordinances and codes affecting TV installations by members of the antenna section with the object of drafting a model code proposal in cooperation with the service committee. RMA started its 26th year with a membership of 316.

A PROJECT AIMED AT ESTABLISHING standard service agreements and practices for TV sets has been started by the Television Manufacturers Association, it has been announced by Michael L. Kaplan, president of TMA and of Sightmaster Corp.

MORE AND MORE JOBBERS falling back on the sales contest as a prime means of encouraging salesmen to bring in more business.

INITIAL SHOWING OF THE first "display" facsimile receiver, for use in banks, stores, hotel lobbies and other public places, was recently made in Chicago by Stewart-Warner.

RUMORED THAT SOME OF THE new higher-priced cars will soon be coming through equipped with back-seat TV sets as an added feature.

THE WEST COAST ELECTRONIC Manufacturers Association has announced that the 5th annual Pacific Electric Exhibit will be held in San Francisco, August 30, 31 to Sept. 1.

IMPROVED TV PICTURE TUBE has been developed by Dr. Lee deForest's American Television, Inc., of Chicago. The new development is said to improve contrast ratio of black to white, and to reduce eye-strain by making it unnecessary to use excessive brilliance in order to attain an illusion of contrast. The process involves the admixture of opaque powders in the fluorescent coating on the inside of the face of the tube, said to eliminate halation due to internal reflection at the screen as well as diffuse reflection and scattering in the screen material surrounding the illuminated spot. The new process is said to allow the black portions of the image to remain black and not gray.

TV THE SUPER-MAGNET. Everybody and his brother wants to get in some angle of television. Persons in all walks of life seek association with the industry, at manufacturing, distributing, retailing or programming levels.

BIG SWING TO MOVIE FILMS as a most effective method of sales training noted in wholesaling circles. Jobbers report that retail and wholesale salesmen get lots of valuable information in a short time from the showings.

IMPORTANCE OF EFFICIENT demonstration of 3-way phono players needs to be realized by every sales-minded dealer. Unfamiliarity with the product makes operation of even the most simple machine appear to be extremely complicated in the eyes of the prospective purchaser.

FUTURE EVENTS OF INTEREST TO READERS

JULY 2-9: New York State Association of Electrical Contractors & Dealers, Inc., Golden Anniversary Convention, Saranac Inn, N. Y.

JULY 5-16: Summer Market, Merchandise & Furniture Marts, Chicago.

JULY 11-15: National Housewares & Home Appliance Manufacturers Exhibit, Auditorium, Atlantic City, N. J.

JULY 25-28: National Association of Music Merchants, Annual Show, Hotel New Yorker, New York City.

AUG. 1-6: Western Summer Market, Western Merchandise Mart, San Francisco.

AUG. 30-SEPT. 1: West Coast Electronics Manufacturers Association 1949 Electronic Exhibit, 1949 IRE Western Regional Convention Civic Center, San Francisco.

SEPT. 26-28: 1949 National Electronics Conference, Edgewater Beach Hotel, Chicago.

SEPT. 30-OCT. 9: National Television & Electrical Living Show, Chicago Coliseum, Chicago.

NOV. 14-18: National Electrical Manufacturers Association, Chalfonte-Haddon Hall, Atlantic City, N. J.

NOV. 14-18: 6th All-Industry Air Conditioning & Refrigeration Exposition, Atlantic City, N. J.

DEC. 4-7: The American Society of Refrigerating Engineers, 45th Annual Meet, Edgewater Beach Hotel, Chicago

Making Money IN THE FAC



How can I sell more AM, FM, TV sets in my 4-Way store*?

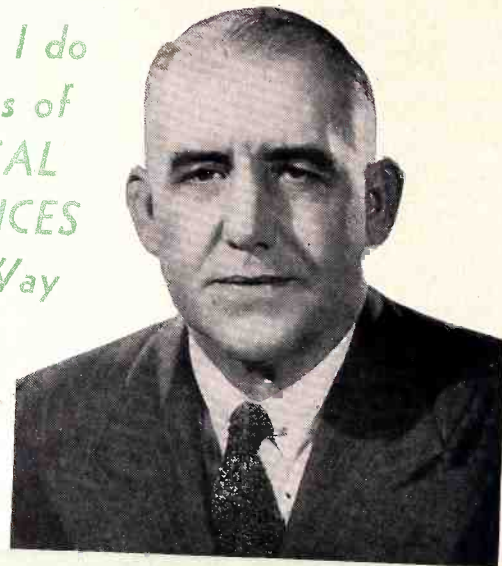

What can I do to up sales of ELECTRICAL APPLIANCES in my 4-Way store*?

Follow up all prospective purchasers, by telephone or by personal call. Business belongs to the man who goes after it.

Urge salesmen and servicers to offer to trade in all old sets that come in for repairs. The dealer who consistently follows such plan will find that his sales average will be high.

Make your store demonstration models SING—not merely play. Keep cabinets in perfect condition. Provide adequate and comfortable seating facilities for customers.

Know all the reasons needed to convince the "will-wait" customer why he should buy now. Know how to successfully cope with situations wherein the prospect says he'll wait "for prices to drop", or until "further improvements are made." "Enjoy it now" is a theme bound to appeal to almost everyone.

Set up window displays that SELL—not merely show. Use manufacturer's display material in order to stress features of the instrument. Plan ideas that really stop traffic through the use of light, motion, etc.

Use your service reputation to combat price-cutting competition. It's the best weapon you have at your disposal. In many instances it is possible to prove to a prospective purchaser that the cut-price set may cost more in the long run.

In the case of television, keep posted on the competitive picture, studying "rental" and "trial" plans being used by others. (See article on page 38, this issue, and another, "Is It Good Business to Let Them 'Try' TV Sets in the Home?" page 36, June, 1949, issue of RADIO & TELEVISION RETAILING.)

With more and more customers counting their pennies these days, an attractive financing plan can be made to clinch many a sale that would otherwise be lost. The alert merchant knows how to sell and explain the time-contract.

Get names of all store visitors. Follow them up as soon as possible. Use telephone to make appointments.

Use effective advertising. In newspaper and direct-mail copy make every word count. Distribute manufacturer-supplied literature. Such material stacked away on shelves will never sell a dime's worth of merchandise.

* 4-Way Dealer Sells Radio, Electrical Appliances, Records and Service

Before you repair any broken-down, worn-out appliance, try to get the customer to agree to trade it in for a new, modern product. Show customers that they can save money, time and patience by replacing the ancient piece of equipment.

"Live" demonstrators are a must. Have washers hooked up to show under actual home conditions. Set up a vacuum cleaner demonstration center where this appliance can be operated by customer. Offer an ice-cold drink from a refrigerator; show a package of frozen food in the home freezer.

Keep prospect files up to date, and be sure to keep adding to them. Obtain lists of newcomers from local utility companies or other sources, and call on such people shortly after they move in. Obtain names of persons intending to build homes in your community. Contact them by mail, by phone or by personal call. Work in the field gets results.

Use financing plans to sew up sales in cases where customers are reluctant to lay out cash. Sell the dignity and convenience of the time-payment plan.

Your service department's reputation can be made to nail down many a sale transaction wherein a similar product is offered by a competitor at a cut price. More and more people have found out that in instances where they need service on a new product, the guarantee is no better than the dealer's willingness and know-how in processing such agreement. The merchant who stands back of the appliances he sells has a priceless formula to use in justifying sales at list prices. He should advertise his service.

Go after replacement business. See article in this issue, in Electrical Appliances Section. Valuable suggestions and sales tips are given to up sales of refrigerators, washers and other products.

To increase sales, comb the outside territory, making canvass and appointment calls. Because the outside field is not being overworked as it was before the war, good results can be obtained by diligent workers. See article "How to Sell More Vacuum Cleaners", in March, 1949 issue of this magazine. See article, "How to Make Cold Turkey Canvassing Your Dish" in November, 1948 issue.

OF TODAY'S CONDITIONS

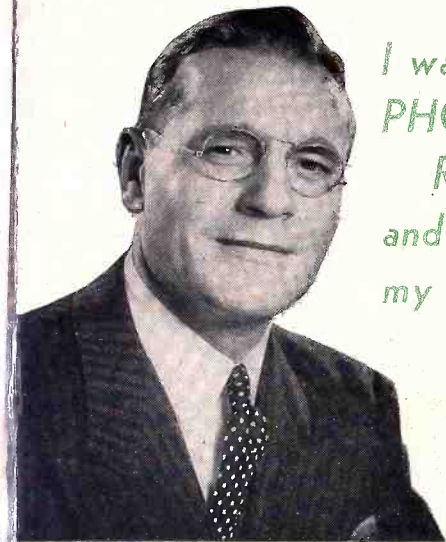

*I want to sell more
PHONO
RECORDS
and PLAYERS in
my 4-Way store **

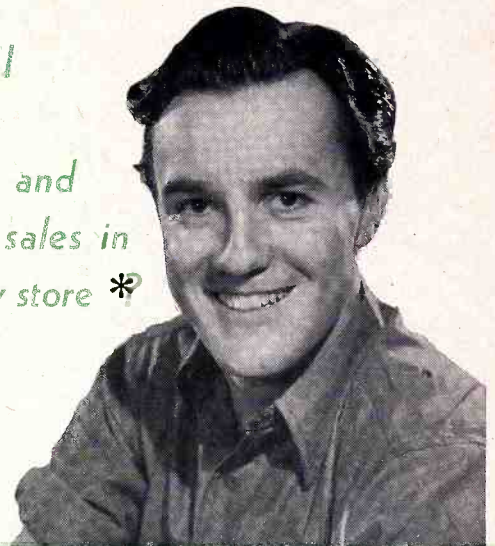

*How can I
build up
SERVICE and
SOUND sales in
my 4-Way store **

Keep right on the ball so far as the present multi-speed situation goes. How the merchant, the man at the point of sale, operates is of utmost importance. To help clarify the sales picture, read article on page 49, March, 1949, issue of RADIO & TELEVISION RETAILING.

Of prime importance is proper operation of new equipment and new discs. Salespeople must be able to give flawless demonstrations before customers.

It is important, too, that salespeople be able to give customers the real low-down on the "3-speed" picture. Because of the flood of adverse criticism in the press, numbers of consumers are incensed, and will continue to feel that they've been rooked unless the merchant is able to convince them otherwise. Explanation of the true facts—that 78 RPM discs are, and will continue to be available, and a statement concerning duplicate pressing of records, will help any dealer obtain more sales, and, at the same time create considerable good-will.

Capitalize on the approach of the return to "indoor living" on the part of the American public. From here on, disc sales should climb by themselves, but they'll climb much faster for the dealer who gets behind them with some real push.

Capitalize on the approach of the back-to-school trek. Slant advertising and window displays to suggest dance tunes, college songs and educational records.

Feature those juveniles, too. Remember that such discs represent 15 per cent of the total sales of all phonograph records.

Push sales of accessories. Nowadays a great many disc departments never suggest the purchase of a needle to the disc buyer. Many will buy accessories if invited to do so.

Take a new look at your salesforce (even if it's composed of but one person). Make certain that you're paying wages to salespeople, not clerks. With the new situation on discs, the dealer must look at the selling end as something that's radically changed. Record salespeople must now be able to sell instruments—attachments, single players, combinations.

Be sure to register store visitors in a "guest book," or similar device in order to get the names of such persons for mailing lists. Direct-mail pieces, featuring new platters can bring much additional business, but they must be sent to "live" people. Keep mailing list up to date.

Pave the way for repeat business and word of mouth advertising by performing service work in a thorough, careful, complete and effective manner so as to insure customer satisfaction, and keep up volume of repeat business.

Utilize skilled personnel and adequate test equipment so as to perform service work efficiently, keep costs down, profits up.

Keep a neat, orderly, professional appearing service department, visible to customers in the store, so as to attract attention to and instill confidence in it.

Take care of the customer's set as if it were your own, protecting it from scratches, lost knobs, back-covers, etc.

Utilize direct mail reminders to call attention to your service department, such as "have your portable put in shape for summer listening," "have your outdoor antenna system checked for lightning protection," "have those unused radios in attic or storeroom put in shape to provide a radio in every room," etc.

Utilize your technical knowledge and position in the community to build a business in the sale, installation, and rental of sound and public address equipment to diversify your operations and widen the base of profitable operation.

Underscore your know-how by giving the customer helpful information free: suggestions as to the proper operation of the set, placement of speakers in home so as to get the best tone, providing adequate ventilation for set, grounding AC sets and not grounding AC-DC sets, etc. (see December 1948 RADIO & TELEVISION RETAILING, page 57).

See that repair men who call at customer's home are courteous to the customer, careful of the customer's home and furnishings, and in general reflect credit on your organization.

Tie a tag or attach a label to sets you repair, giving your name and address so that the customer will know who to call the next time he wants to buy a radio or have one repaired.

Use some portion of your window and/or in-store display to advertise the availability and competency of your service department. Sell service just as you sell merchandise.

If you make a promise to complete, pick-up or return a repair job at a certain time, keep your promise.

Making Money IN THE FAC



How can I sell more AM, FM, TV sets in my 4-Way store*?

What can I do to up sales of ELECTRICAL APPLIANCES in my 4-Way store*?

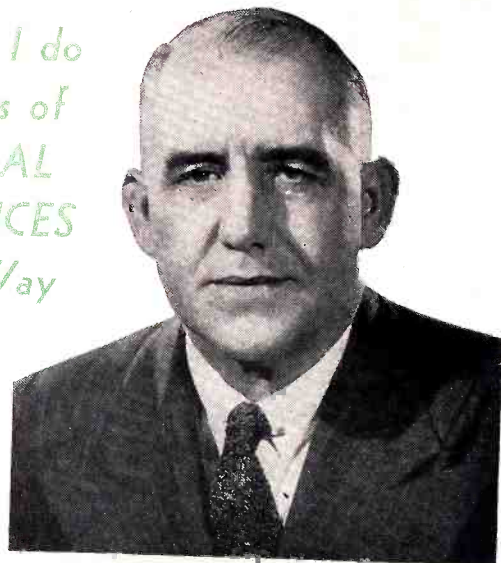

Follow up all prospective purchasers, by telephone or by personal call. Business belongs to the man who goes after it.

Urge salesmen and servicers to offer to trade in all old sets that come in for repairs. The dealer who consistently follows such plan will find that his sales average will be high.

Make your store demonstration models SING—not merely play. Keep cabinets in perfect condition. Provide adequate and comfortable seating facilities for customers.

Know all the reasons needed to convince the "will-wait" customer why he should buy now. Know how to successfully cope with situations wherein the prospect says he'll wait "for prices to drop", or until "further improvements are made." "Enjoy it now" is a theme bound to appeal to almost everyone.

Set up window displays that SELL—not merely show. Use manufacturer's display material in order to stress features of the instrument. Plan ideas that really stop traffic through the use of light, motion, etc.

Use your service reputation to combat price-cutting competition. It's the best weapon you have at your disposal. In many instances it is possible to prove to a prospective purchaser that the cut-price set may cost more in the long run.

In the case of television, keep posted on the competitive picture, studying "rental" and "trial" plans being used by others. (See article on page 38, this issue, and another, "Is It Good Business to Let Them 'Try' TV Sets in the Home?" page 36, June, 1949, issue of RADIO & TELEVISION RETAILING.)

With more and more customers counting their pennies these days, an attractive financing plan can be made to clinch many a sale that would otherwise be lost. The alert merchant knows how to sell and explain the time-contract.

Get names of all store visitors. Follow them up as soon as possible. Use telephone to make appointments.

Use effective advertising. In newspaper and direct-mail copy make every word count. Distribute manufacturer-supplied literature. Such material stacked away on shelves will never sell a dime's worth of merchandise.

*** 4-Way Dealer Sells Radio, Electrical Appliances, Records and Service**

Before you repair any broken-down, worn-out appliance, try to get the customer to agree to trade it in for a new, modern product. Show customers that they can save money, time and patience by replacing the ancient piece of equipment.

"Live" demonstrators are a must. Have washers hooked up to show under actual home conditions. Set up a vacuum cleaner demonstration center where this appliance can be operated by customer. Offer an ice-cold drink from a refrigerator; show a package of frozen food in the home freezer.

Keep prospect files up to date, and be sure to keep adding to them. Obtain lists of newcomers from local utility companies or other sources, and call on such people shortly after they move in. Obtain names of persons intending to build homes in your community. Contact them by mail, by phone or by personal call. Work in the field gets results.

Use financing plans to sew up sales in cases where customers are reluctant to lay out cash. Sell the dignity and convenience of the time-payment plan.

Your service department's reputation can be made to nail down many a sale transaction wherein a similar product is offered by a competitor at a cut price. More and more people have found out that in instances where they need service on a new product, the guarantee is no better than the dealer's willingness and know-how in processing such agreement. The merchant who stands back of the appliances he sells has a priceless formula to use in justifying sales at list prices. He should advertise his service.

Go after replacement business. See article in this issue, in Electrical Appliances Section. Valuable suggestions and sales tips are given to up sales of refrigerators, washers and other products.

To increase sales, comb the outside territory, making canvass and appointment calls. Because the outside field is not being overworked as it was before the war, good results can be obtained by diligent workers. See article "How to Sell More Vacuum Cleaners", in March, 1949 issue of this magazine. See article, "How to Make Cold Turkey Canvassing Your Dish" in November, 1948 issue.

OF TODAY'S CONDITIONS

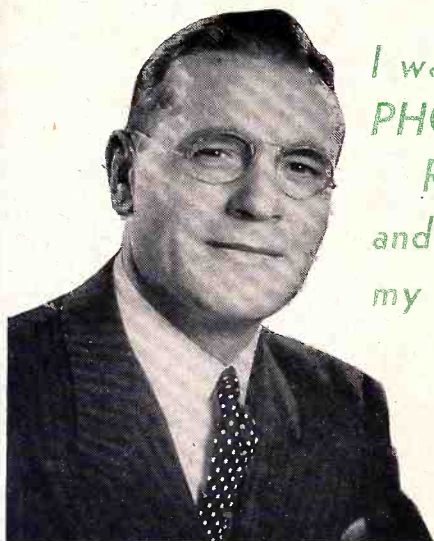

*I want to sell more
PHONO
RECORDS
and PLAYERS in
my 4-Way store **

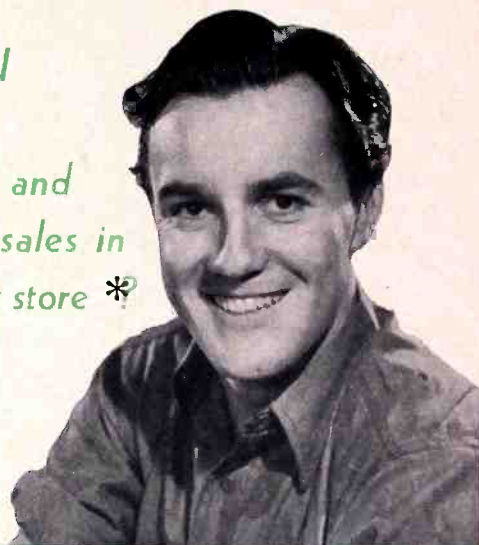

*How can I
build up
SERVICE and
SOUND sales in
my 4-Way store **

Keep right on the ball so far as the present multi-speed situation goes. How the merchant, the man at the point of sale, operates is of utmost importance. To help clarify the sales picture, read article on page 49, March, 1949, issue of RADIO & TELEVISION RETAILING.

Of prime importance is proper operation of new equipment and new discs. Salespeople must be able to give flawless demonstrations before customers.

It is important, too, that salespeople be able to give customers the real low-down on the "3-speed" picture. Because of the flood of adverse criticism in the press, numbers of consumers are incensed, and will continue to feel that they've been rooked unless the merchant is able to convince them otherwise. Explanation of the true facts—that 78 RPM discs are, and will continue to be available, and a statement concerning duplicate pressing of records, will help any dealer obtain more sales, and, at the same time create considerable good-will.

Capitalize on the approach of the return to "indoor living" on the part of the American public. From here on, disc sales should climb by themselves, but they'll climb much faster for the dealer who gets behind them with some real push.

Capitalize on the approach of the back-to-school trek. Slant advertising and window displays to suggest dance tunes, college songs and educational records.

Feature those juveniles, too. Remember that such discs represent 15 per cent of the total sales of all phonograph records.

Push sales of accessories. Nowadays a great many disc departments never suggest the purchase of a needle to the disc buyer. Many will buy accessories if invited to do so.

Take a new look at your salesforce (even if it's composed of but one person). Make certain that you're paying wages to salespeople, not clerks. With the new situation on discs, the dealer must look at the selling end as something that's radically changed. Record salespeople must now be able to sell instruments—attachments, single players, combinations.

Be sure to register store visitors in a "guest book," or similar device in order to get the names of such persons for mailing lists. Direct-mail pieces, featuring new platters can bring much additional business, but they must be sent to "live" people. Keep mailing list up to date.

Pave the way for repeat business and word of mouth advertising by performing service work in a thorough, careful, complete and effective manner so as to insure customer satisfaction, and keep up volume of repeat business.

Utilize skilled personnel and adequate test equipment so as to perform service work efficiently, keep costs down, profits up.

Keep a neat, orderly, professional appearing service department, visible to customers in the store, so as to attract attention to and instill confidence in it.

Take care of the customer's set as if it were your own, protecting it from scratches, lost knobs, back-covers, etc.

Utilize direct mail reminders to call attention to your service department, such as "have your portable put in shape for summer listening," "have your outdoor antenna system checked for lightning protection," "have those unused radios in attic or storeroom put in shape to provide a radio in every room," etc.

Utilize your technical knowledge and position in the community to build a business in the sale, installation, and rental of sound and public address equipment to diversify your operations and widen the base of profitable operation.

Underscore your know-how by giving the customer helpful information free: suggestions as to the proper operation of the set, placement of speakers in home so as to get the best tone, providing adequate ventilation for set, grounding AC sets and not grounding AC-DC sets, etc. (see December 1948 RADIO & TELEVISION RETAILING, page 57).

See that repair men who call at customer's home are courteous to the customer, careful of the customer's home and furnishings, and in general reflect credit on your organization.

Tie a tag or attach a label to sets you repair, giving your name and address so that the customer will know who to call the next time he wants to buy a radio or have one repaired.

Use some portion of your window and/or in-store display to advertise the availability and competency of your service department. Sell service just as you sell merchandise.

If you make a promise to complete, pick-up or return a repair job at a certain time, keep your promise.



Super Service Sparks Sales

▲ The record department of Perdue's, Montclair, N. J., is an attractive place in which to shop. L. to r. are: Bill Ward, Emily Rae and Nora Browne of the store's staff. Note natural wood counter, wall-to-wall storage features.



◀ Those record buyers who wish to do so, can use the enclosed listening booths located in rear of record section.

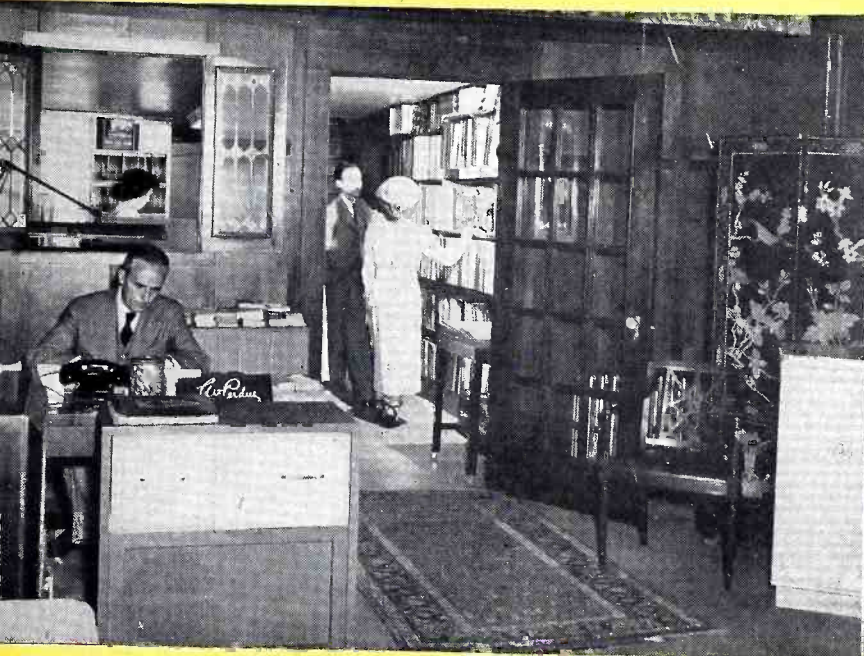

▲ Proprietor C. W. Perdue at his desk in front of record section.

▼ Separate service store maintained by Perdue's employs approximately seven men, two service trucks.

Shown is front section of separate service store. Peter Ibsen is at work at counter; Fred Stern at work-bench.

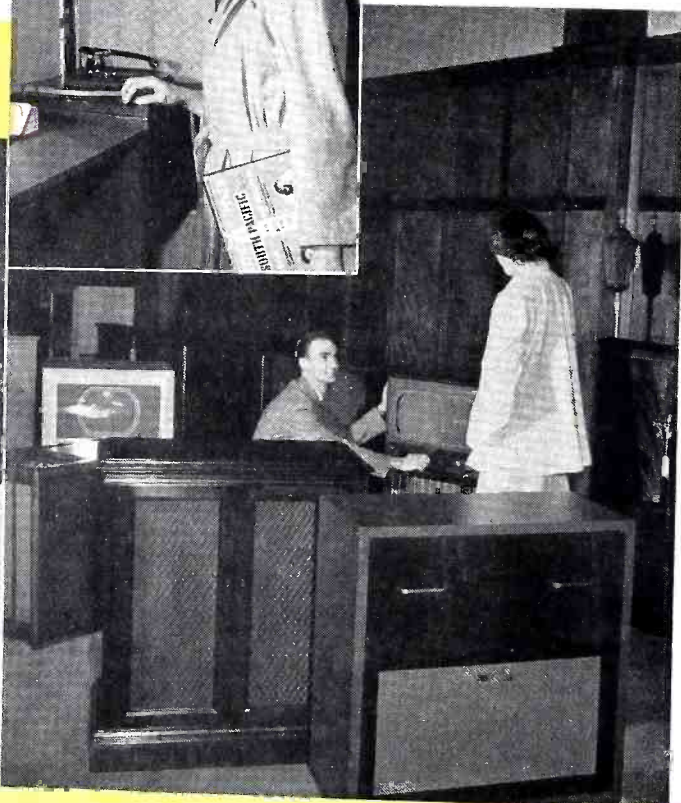

▲ Bob Perdue puts across a TV sales pointer.

In rear section of store is this new RCA TV test panel, used by Mr. Stern. The service department gets work from other dealers, and outside customers in addition to regular trade.

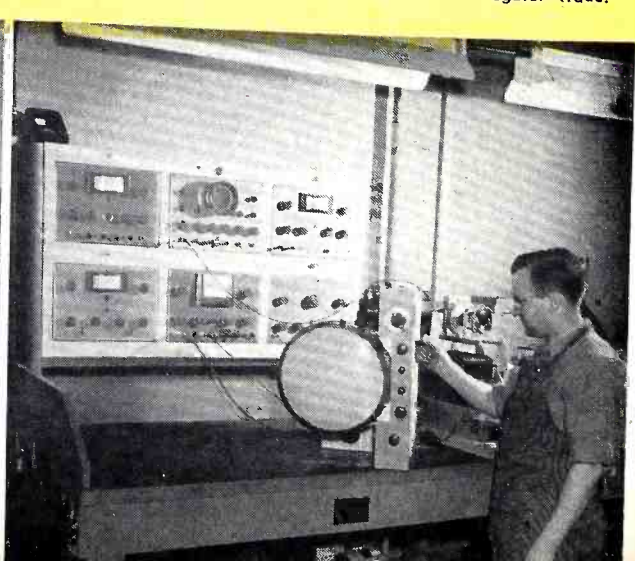

New baby in a proud family ...



5" ROUND PM LOUDSPEAKER

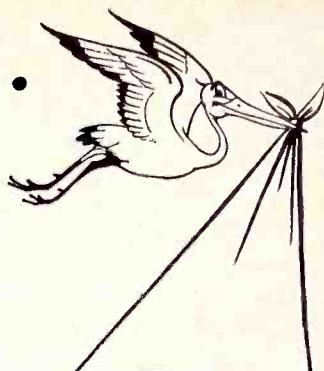

THERE'S always something new and better in the G-E Speaker Line—Now it's the G-E 5" Round—specifically designed for service replacement!

Naturally it has the quality you expect of a General Electric Speaker—sturdy all-weld construction, rock-steady G-E Alnico 5 magnet—plenty of power, sensitivity, fidelity! Give your customers the best—that G.E. gives you! See your G-E parts distributor and stock up today.

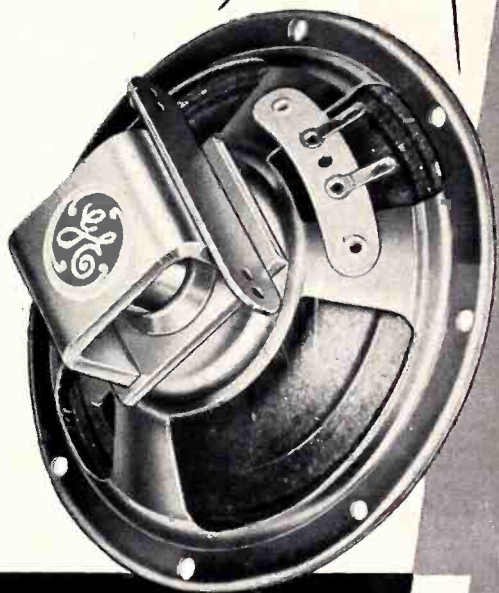

Of course it has the famous G-E Aluminum Foil Base Coil! Not subject to warping resulting from high humidity. Provides much higher power handling capacity. P. S. All G-E Speakers have this Metal Base Voice Coil—don't forget that!

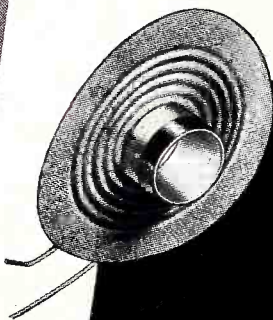

FREE—with all 4", 5" and 5¼" G-E Speakers!

Chassis Mounting Brackets

Save time, money and materials for the hard-working serviceman!

Well, now, here's the story. With the serviceman in mind, G. E. has cooked up these neat little mounting kits to save your temper and please your customers. They're adjustable—up, down or

sideways, for simplified mounting of speakers in small working areas. Less work for you—and a cleaner job for that important fellow—your customer. The brackets are FREE with every 4", 5" and 5¼" G-E speaker you get from your G-E distributor or jobber. *General Electric Company, Parts Section, Electronics Park, Syracuse, New York.*

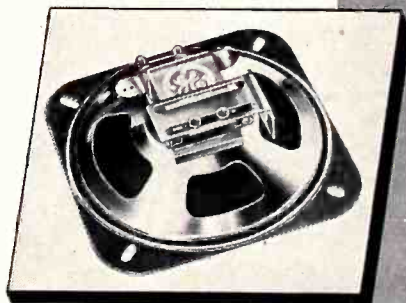
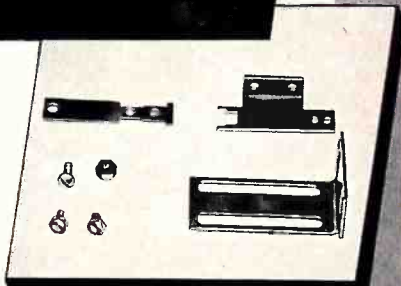

You can put your confidence in—

GENERAL  ELECTRIC

Summer Lines of New

Emerson PORTABLE TV SET

The new model 600 is a 7-inch AC/DC portable television receiver equipped with indoor aerial which may be installed in the top of the case or used away from the



receiver. Set is housed in simulated leather case, and a protective carrying case is also included. List price is \$179.95. Emerson Radio and Phonograph Corp., 111 Eighth Ave., New York 11, N. Y.—RADIO & TELEVISION RETAILING.

Magnavox TV RECEIVER

This new set provides a 16-inch metal picture tube, 24 tubes plus 3 rectifiers, and a 15-inch speaker, housed in a corner cabinet to achieve minimum space requirements. Acoustical correctness in placement of the loudspeaker is also achieved by the corner arrangement. Called the "Brittany," the set will list at \$595. Magnavox Co., Fort Wayne, Indiana.—RADIO & TELEVISION RETAILING.

Olympic TELEVISION SETS

Three new sets have been announced, the "Challenger" 10-inch model TV-106 will retail for \$199.95, the "Champion" 12½-inch model TV946 listing at \$299.95,

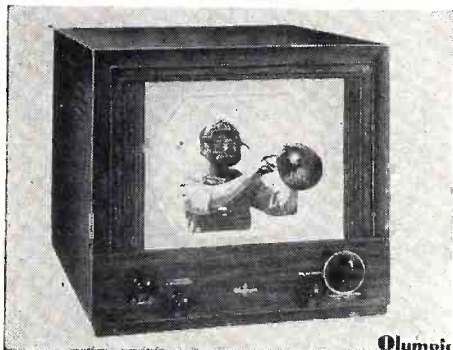

Olympic

and the "Baronet" 16-inch model TV947, priced at \$499.50. The latter is a console, the other two are table sets. Olympic Radio & Television, Inc., 34-01 38th Ave., Long Island City 1, N. Y.—RADIO & TELEVISION RETAILING.

Philco TELEVISION LINE

Five new 10-inch TV sets with 61-square inch screens feature substantially lower prices than previous models. All the sets use chassis of 20 tubes plus 2 rectifiers, and incorporate a new 12-channel tuner with fine tuning control. Models 1104E



(shown), 1104M, 1105M and 1105L are table sets, and 1106 is a consolette. The first two models are plastic, the others are mahogany. 1104E lists at \$249.95; 1104M, \$259.95; 1105M, \$269.95; 1105L, \$279.95, and 1106 is \$299.95. Philco Corp., Tioga and "C" Sts., Phila., Penna.—RADIO & TELEVISION RETAILING.

Tele-Tone 16-INCH TV SET

A new 16-inch TV set has been announced, a table model in mahogany cabinet with gold knobs and trim, featuring 130-square inch screen and supersensitive circuit designed to work in fringe areas. The set is priced to sell at \$449.95. Tele-Tone Radio Corp., New York, N. Y.—RADIO & TELEVISION RETAILING.

Starrett TV SETS

The new line comprises 16 sets, all home receivers with 16-inch tubes except the "King Arthur," a 20-inch set for bars and recreation rooms. The 16-inch sets are available in table and console models,

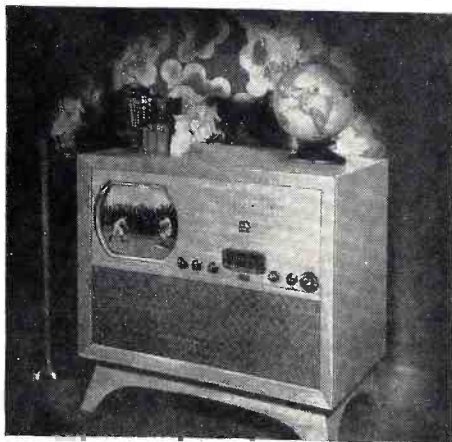

with and without AM-FM radio and three-speed record changing facilities. The Jackson, illustrated, is a modern console with AM-FM radio listing at \$729. Starrett Television Corp., 601 W. 26th St., New York 1, N. Y.—RADIO & TELEVISION RETAILING.

Crosley TV SETS

New model 9-419M is a 12½-inch table set providing 85-square inch screen plus FM radio is priced to retail at \$349.95. Set



is equipped with 5x7 inch speaker, and phono jack. Crosley Div., Avco Mfg. Corp., Cincinnati, Ohio.—RADIO & TELEVISION RETAILING.

Motorola TV SETS

Three new sets have been announced, 2 with 10-inch and 1 with 12-inch tubes. The 10-inch models provide 61-square inch screen. Model 10VT3 is a table model



priced at \$279.95 and 10VK9 is a consolette at \$299.95. The 12-inch model, 12TV16, provides 81-square inch screen in a table set and lists for \$369.95. Motorola, Inc., 4545 Augusta Blvd., Chicago 51, Ill.—RADIO & TELEVISION RETAILING.

Jackson TV SETS

Six new TV sets comprise the new line, a 10- and a 12-inch table set, a 12- and a 16-inch consolette, and 2 12-inch, 3-way consoles, one in mahogany and one in modern cabinet. Model 1000TV, shown, is

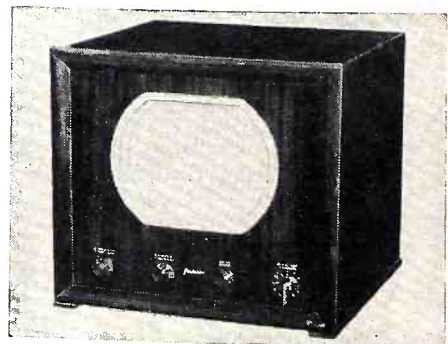

a 10-inch table set with 62-square inch picture listing at \$199.50. Jackson Industries, Inc., 58 E. Cullerton St., Chicago 16, Ill.—RADIO & TELEVISION RETAILING.

TV, Radio, FM, and Phono Players

RCA PORTABLE RADIO

The new portable model 9-BX-5 features operation on AC, DC or batteries, and is housed in a lightweight case of maroon



plastic. Set carries 4 tubes plus rectifier, built-in antenna, and suggested retail price of \$34.95 (less battery). Battery lists at \$4.90. RCA Victor Division, Camden, N. J.—RADIO & TELEVISION RETAILING.

Meck PORTABLE RADIO

This radio in leatherette carrying case operates on AC, DC or batteries and is equipped with 4 tubes plus selenium rec-

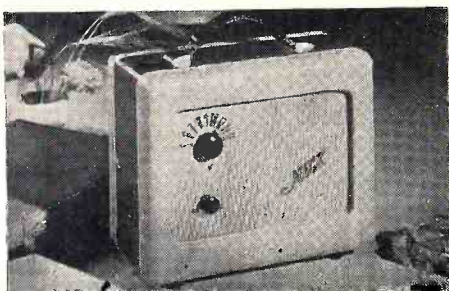

tifier. Exclusive of batteries, the set retails for \$24.95. Battery kit is \$3.45. John Meck Industries, Inc., Plymouth, Indiana.—RADIO & TELEVISION RETAILING.

Sentinel PORTABLE RADIO

Model 316-P is a 5½-pound portable for AC, DC and battery operation, available in tan, white, red and green. Designed as

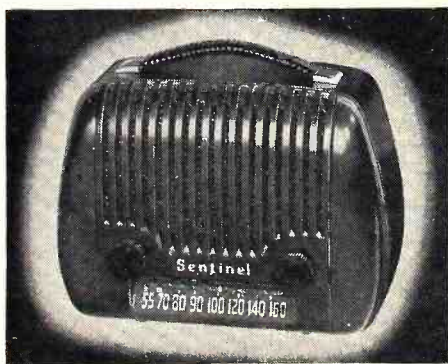

an "all-purpose" radio, the set is suggested for use anywhere in the home, as well as for portable operation outside the home. Sentinel Radio Corp., Evanston, Ill.—RADIO & TELEVISION RETAILING.

Westinghouse AM-FM RADIO

Model 198 is an AM-FM table set housed in a mahogany cabinet, and said to feature

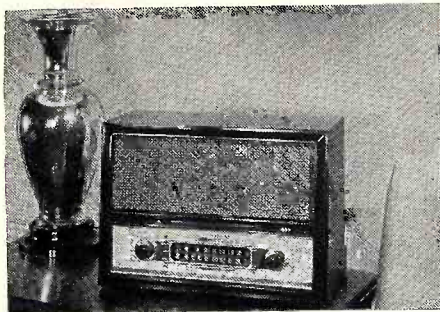

improved sensitivity and low noise levels. Suggested retail price in the East is \$89.95. Westinghouse Electric Corp., Sunbury, Pa.—RADIO & TELEVISION RETAILING.

Steger TELE-TABLE

Tele-table is a turn-table stand for table TV sets featuring a roller-bearing turn-table top which permits easy shifting of

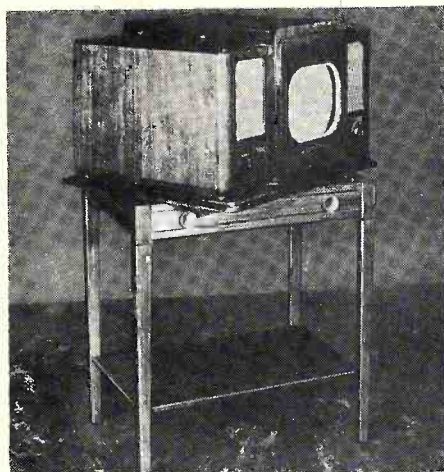

the set for better viewing. Priced at \$29.95, the table is 27 inches high, 25¾ wide and 20⅞ deep. Steger Products, Dept. 175, 317 Sherman St., Chicago 4, Ill.—RADIO & TELEVISION RETAILING.

GE CHILDREN'S RECORDER

"Playtalk" is an electronic toy for children using a grooveless paper disc coated with powdered iron to magnetically record music or voice. The device has a 3½-inch loudspeaker which also serves as a microphone. General Electric Co., Electronics Park, Syracuse, N. Y.—RADIO & TELEVISION RETAILING.

Ray-Dyne KIDDIE PHONO CONSOLE

This unit, model 60PR Kiddie Console includes a 5-tube radio plus phonograph and record storage space in a wood cabinet 24 inches high, 15¾ wide and 11½ deep. Suggested retail price is \$39.95. Ray-Dyne Mfg. Corp., 347 E. 22nd St., Paterson, N. J.—RADIO & TELEVISION RETAILING.

Trylon 2 AND 3 SPEED PHONOGRAPHS

These portable electric phonographs in leatherette carrying cases are equipped with 3-tube amplifier and 5-inch speaker. Model DM-180 plays 78 and 33½ RPM; DML-185 plays 45 and 33½ RPM; and TM-190 plays all three speeds. Units are all single-record players. Trylon Radio Labs, Philadelphia 23, Penna.—RADIO & TELEVISION RETAILING.

Duosonic 45 RPM PHONO

Model 45 is an automatic changer for the RCA 45 RPM records, provided with 3-tube amplifier and 5-inch loud speaker.



Leatherette cabinet available in brown, red and green. Set weighs less than 15 pounds complete. Sonic Industries, Inc., 221 W. 17th St., New York 11, N. Y.—RADIO & TELEVISION RETAILING.

Omara TELEVISION TABLE

This new table is designed to accommodate a table TV set on top and a radio or record changer in the cabinet underneath. Inside shelf in this model 404 is



adjustable to height, and wire-mesh doors may be closed for listening purposes. Suggested retail price, \$40. Omara Furniture Mfg. Co., 2141 W. Hubbard St., Chicago 12, Ill.—RADIO & TELEVISION RETAILING.

More New Merchandise
Elsewhere in Issue

Use Modern Ideas to Close More TV Set Sales

In this article, read
HOW TO—

Employ suggestive selling
Meet Customer objections
Capitalize on lost sales
Justify price differentials
Combat the discount house

• “Shopper” surveys by the editors of this magazine as well as some by many other independent organizations have revealed that there is plenty of room for improvement in selling TV—both in accentuating the positive and eliminating the negative—and this without high-pressure with meaningless or misleading information.

The first thing that the dealer or his salesman must have is a plan. He must be prepared to try to show the customer a certain item or items—prepared before the customer walks in. Too many salesmen start out with, “What kind do you want?” or “How much do you want to pay?”

Naturally, if it turns out that the customer has something particular in mind, the approach will have to be shifted. But at least the salesman has started out with a positive plan.

Orderly Presentation

An example of this is the luncheonette clerk who, instead of saying, “Can I help you?” says, “We have an especially tasty clam chowder for lunch today. Shall I get you some?”

One of the negative things to be avoided at this stage of the game is discussion of the brand or model which the dealer doesn't have in stock, or can't get a franchise for. Quite often the salesman will try to sell the customer away from a specifically-mentioned competitive make by knocking it. Generally such an approach is offensive to the customer. Much better is the friendly one: “Yes, that is a good set but we don't carry it. However, we have one here which we believe is equally as good and offers you even more features for your money.”

If the would-be customer is dead set on the brand you don't have and can't obtain, the best thing (surprisingly enough) is to thank the prospective

customer for visiting the store, and to express the hope that he will be satisfied with the competitive make, thus proving that you are not a sorehead.

This makes a very good impression on the customer, and will give you a better chance with him in the future, since the customer will not feel uneasy about revisiting your store.

Of course, with the customer in a good state of mind, we shouldn't let him just walk out of the store without suggesting something else (something in particular, not just “Is there anything else?”). You may not only sell the customer another product but you may even sell him your brand of TV set before he gets away—your “sporting” attitude having caused him to change his mind.

To get back to the prospect who has nothing particular in mind, it is essential that the seller know the features and prices, not only of the models he sells, but of the brands he doesn't carry. Among other things, this will help the customer settle on a particular model. It may seem obvious to the salesman that factors such as picture size, cabinet styling, and extra features such as radio and phonograph influence the pricing of the sets, but he must not assume that anything is obvious to the customer. There are some 12-inch table sets (straight television) which are the same price as 3-way console 10-inch sets. The customer has to be assisted in evaluating these factors, as well as informed of the differences.

Explain Price Ranges

It is important that the seller give an understandable explanation of some sort (but based on facts) for the difference in price between different models which have apparently the same features. Two straight television table sets with 10-inch tubes and made by the same manufacturer differ \$45. in price. One has 21 tubes, the other 30. The number of tubes isn't apparent to the customer, and when he is advised about the number of tubes, it may not have

any significance. But if he is told (if it is the case) that one is designed for metropolitan (or high signal strength) areas and the other for all-round reception (including fringe areas) it makes some sense. Or perhaps two sets are identical, but one has a plastic cabinet and the other mahogany. Here there is no difference in quality, only in appearance, which can be decided by the customer.

Sales Clinchers

If the customer likes a certain model but thinks the price is too high, sell him features (or in other words, value). If it appears that he thinks the value is good but he can't afford it, sell him time-buying. If he can afford it but thinks your price is high compared with someone else, sell him the service, reputation and integrity of your store. Most people patronizing discount houses overlook the service angle in TV. The writer has run across several instances where people could buy a certain brand of 16" TV set from a distributor (sic) at \$100. off, or about 20% off list. Incidentally, these people had the impression that they were buying “wholesale.” All they had to do was go and pick up the set, and get somebody to install and service it. In two instances checked, they were not able to get anybody reliable to handle the installation and service except on an “a la carte” basis—and the vendor would not even furnish a 90-day guarantee.

The local dealer, on the other hand, is, from the customer's point-of-view, someone he knows and has done business with; someone close by who is easy to reach, and who can be counted on to handle complaints, returns, service, etc.—someone who will deliver the set, handle financing, furnish instruction and advice in operating the set, and anything else he can do in order to maintain the good-will of the customer for future sales.

It is a well known fact that the American public are suckers for “getting
(Continued on page 126)

IT'S
CONSTRUCTIVE SELLING
to build a small sale into a big one
—especially when you're sure the
customer will be better satisfied.

Many of my customers say:

“IF I HAD ONLY

PAID A LITTLE MORE

FOR A BETTER SET!”



MAYBE you don't know me yet, but you will.

I'm the fellow who's going to sell you your first television receiver.

Television is a wonderful thing. It's worth every cent you spend for it — if you spend enough!

That's a hard fact you and I have to face together. Good television just can't be cheap.

I have never yet heard a customer say, "I wish I had bought a less expensive set."

But plenty of them say, "If I had only paid a little more for a set with a bigger screen and a better picture."

I sell Du Mont, and several other makes. I'd rather sell you a Du Mont

receiver because I know you'll be happy with it. Du Mont will give you a big, clear, bright picture; trouble-free service; long life.

So my suggestion would be that you drop in today and see the full line of Du Mont television receivers.

Perhaps the magnificence of the Du Mont Westminster — with the world's largest *direct-view* screen (213 square inches), AM, FM, world-wide short wave radio, and automatic record player — will not fit in with your schemes. There is a wide variety of lower priced Du Mont sets — the compact consoles and table-top receivers, in modern and traditional designs.

Television is too important to settle for anything less than the finest.

DU MONT *First with the Finest in Television*

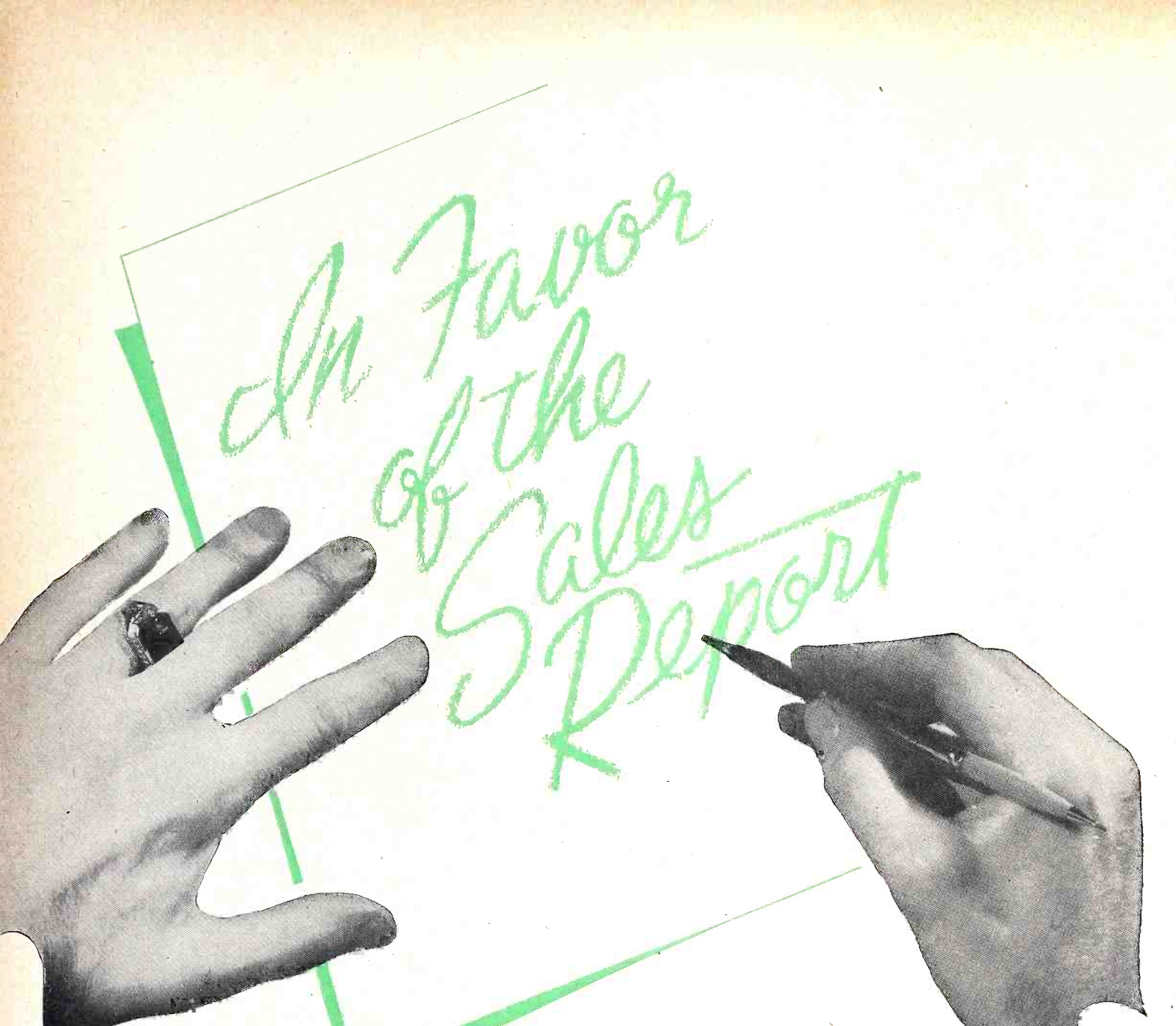

In Favor of the Sales Report

THE NEED for more intensified selling sees return of a former must method in merchandising—the sales report technique. There's no employe antagonism toward a properly operated system. The real low-down on how to operate it is in this article.

● In spite of popular belief to the contrary, *most salesmen* do not object to filling out daily or weekly sales reports.

Only in cases where absurd, complicated or unfair requirements are imposed will honest salesmen kick over the traces, or resort to "rigging" such reports in order to keep up with "competition" of other salesmen when out-of-line call quotas are established.

Everything is in favor of the use of the sales report. It benefits employer and employe alike. Its use puts orderliness into the selling chore. It eases consciences, helps to set up valuable information, protects the salesman's territory, aids in settling disputes over sales, and in driving out the sharpshooter.

Sales reports are just as necessary for the small organization as they are for the large one. As a matter of fact, sales reports are definitely a must for the one-salesman organization because

under such set-up the lone individual has no competitive pace to keep up with.

Establishments employing a number of salesmen who work both outside and on the floor are always open to territorial disputes, questions involving priorities in filing the names of prospects, etc. The firm having the records down in black and white can eliminate futile bickering, and maintain the right sort of morale among its personnel. Moreover, such records can be used as an accurate check against commission payments because salesmen will never forget to *list sales made*, though they may slip up on listing a no-result call

now and then.

The value of the sales report from a psychological viewpoint stands out like a sore thumb. An outstanding trait in all *good* salesmen is the burning desire to talk with someone about a deal just closed, a sale lost after a pitched battle, or the prospects for a future closing. Such salesmen are all keyed up as a result of their efforts. They want to talk about the transactions while they are fresh in their minds. They feel a deep urge to do so. If his boss, whether he is the owner or the sales manager, is too busy to talk with the salesman on a topic while it's hot—which is often the case—the poor guy will go about like a caged tiger.

Fortunately, however, there is at hand a means through which the salesman may express his pent-up feelings—the

sales report. It is made to order for this situation. The sales report capitalizes upon the fact that the good salesman just loves to talk shop. He'll talk shop at the drop of a hat—with his boss, with his fellow salesmen, and with any and all of those willing to listen to him at home.

In addition to wanting to get things off his chest, the good salesman wants to make oral or written reports of his activities because the more or less foot-loose aspects of salesmanship, particularly when out in the field, are a natural bed of roses for the faker. Sales calls are rather intangible operations under which the man's time is not controlled. The honest worker has a genuine desire to account for such time.

Reports Must be Processed

Under all the circumstances thus far outlined it will be seen that the properly and realistically arranged sales report plan is nothing for the employer to fear requiring nor the salesman to balk at accepting.

Now, let's see what the worthwhile sales report looks like; how to set it up and administer it.

First, unless the employer is willing to process his salesmen's reports regularly he may as well abandon the entire idea. Salesmen will soon become fed up with a system under which their reports are arbitrarily filed away; never discussed.

To be truly effective, the sales report should be processed as soon after it has been turned in as is possible. In going over such reports, much valuable information can be brought to light. Reasons for successful transactions can be passed on as patterns for future sales techniques. Faulty procedures can be viewed and analyzed for future correction. Lack of customer acceptance of certain makes or models can be discovered. Brand preferences can be disclosed.

Sales Meeting Ammunition

In large organizations, sales reports can be used to great advantage in open sales meetings as subjects of discussion and analysis. In the one-salesman firm, the dealer and the employe will find time spent in a huddle over the sales report to be of extreme mutual benefit.

It is one thing to ask a mechanic to keep an accurate record of his time spent in repairing, but it is unreasonable to expect the radio-appliance salesman to account for every hour and minute of his activities. A brief summary of calls and interviews, together with the results is sufficient. From such report prospects can be filed, credited to the salesman; call-backs can be arranged, and other information, pre-

viously mentioned in this article, may be obtained.

The required form should be simple. All complicated elements need to be eliminated. A minimum of "regimented" space should be used, but there should be ample space provided for "salesman's remarks" as much valuable information will turn up under this heading, as well as interesting character pictures of the salesman's personality.

One of the pitfalls the large establishment should avoid is the setting up of out-of-line call quotas. When men are asked to make an unreasonably large number of stops per day, they will actually lose sales because they feel they haven't the time to spend on any single visit. They become worried over the prospects of having their fellow salesmen turn in a greater number of stops.

While it's true that the good old "law of averages" is still in effect, one's enthusiasm for the belief that the more calls a man makes the more orders he'll get, should never be permitted to make him insist upon a certain number of outside visits per day. The salesman who goes out and gets an order on his first call may have used up time

equivalent to that required for ten calls in so doing. But, the order is what counts. After all, the man is supposed to be salesman, not a visitor, so great care must be exercised in setting up realistic and flexible call quotas.

Better Business a Result

Use of the sales report is equally valuable with all classes of salesmen, including those partly or entirely on the outside, and those who spend all of their time on the sales floor. The latter can term their "calls" "interviews."

Extremely popular during prewar days, the sales report technique got lost in the shuffle during the war and in the hectic period of the seller's market which followed. Now, with things tightening up, and faced with the fact that salaried salesmen are the order of the day—straight commission men a rarity—the dealer is eyeing the sales report with keen interest.

The case in favor of the sales report technique is a strong one indeed, and the merchant who sets up the right kind of system, and polices it diligently, will obtain more business and maintain a happier and more prosperous sales-force as a result.

Make Sales Report Requirements

Simple and Realistic.

Fair and Effective.

Honest Salesmen Like to Use Sales Reports

Because consciences are satisfied.

Because sales reports satisfy urge to "talk shop."

Because they "protect" the salesman's prospect list.

Dealers Find Sales Reports Profitable Because

They keep salesmen on toes.

They provide follow-up data.

They bring valuable sales information to light.

Sales Reports Must be Processed Regularly

When filed away and forgotten, salesmen soon lose interest. In this article, read how to keep the ball rolling.

Columbia Executives on the Phono Record Situation

Record merchants across the country have been asking many questions of late, not only about the future of the record business, but about where it's going—and what to do about it in the meantime.

In an exclusive interview, RADIO & TELEVISION RETAILING asked two of the foremost authorities in the business, Edward Wallerstein, chairman of the board, Columbia Records, Inc., and Paul Southard, vice-president in charge of merchandising, just what they think about the situation. These are their answers.

MR. SOUTHARD:

How can dealers best combat the spread of price-cutting on records, particularly on 78 RPM speeds?

"Distributors who have filed under Fair Trade laws have been able to control prices in some areas, but of course, in some states this has been impossible. However, we feel much more concerned with controlling prices on LP records, and have been able to maintain LP sales at list prices. We have guaranteed the price of LP records for both distributor and dealer purchases. In the event a reduction in these prices should be made, we will protect dealers and distributors on all purchases made during the sixty days preceding any such reduction by a rebate of the price differential. As far as shellac 78 RPM records are concerned we truthfully can



Paul Southard

see little possibility of controlling these prices for the time being—particularly in the light of current 'liquidation' sales."

Is there a possibility that dealer discount rates will be lengthened during 1949?

"As far as I can foresee, this is not likely."

Do you see any likelihood that record list prices will be cut materially before the end of 1949?

"Suggested list prices of \$4.85 for classical 12" LP records, \$3.85 for semi-classical 12" LP records, and of \$2.85 for pop 10" LP records have been guaranteed by us, and we are experiencing no difficulty in maintaining current price levels. In attempting to predict prices on shellac records, I'd just be putting myself out on a limb. However, it is possible that the competition caused by manufacturers who sell direct to dealers will have some effect on future prices."

Is it advantageous for a dealer to diversify his business operations—such as carrying a number of radio-TV, appliance products in addition to records? Or is specialization for some outlets still warranted in today's market?

"It is absolutely essential for most dealers to diversify. However, in practically every large city there is room for several record specialty shops. However, specialized selling techniques should be employed by '4-way' dealers. A store can build up a reputation for 'specializing' in records—and still do a good job on television, appliances, etc. As for the talk about record stores closing up and going out of business all over the country, we've seen very few signs of it. The stores that shut up, just couldn't keep going when the lush period was over."

Would you consider it feasible to sponsor a "packaged platter" plan, whereby dealers could stock a limited selection of sure-selling hits and standards?

"Truthfully, I've never seen a set-up like that actually work. We've found that consistent record buyers buy out of habit rather than on a hunch. They want a selection to choose from. And in order to please them, dealers have to carry a legitimate inventory. As far as classical records are concerned such a plan is completely out of the question. And when sure-fire hit tunes and show albums come along, it somehow doesn't seem quite fair to take these sales away from our legitimate dealers who carry

a fair inventory. As a matter of fact, we receive many letters from irate consumers complaining about difficulties they encounter in getting many selections we have advertised as available in the LP catalog—simply because some stores carry inadequate stocks."

MR. WALLERSTEIN:



Edward Wallerstein

In those areas where television is available, what has been the effect on record sales? What will the impact of national television ultimately be on record sales?

"In the biggest area where television is most available, record business is best. This fact would lead me to believe that except to the degree in which purchasers of TV sets find themselves in a position of having to allot portions of their time to various means of home entertainment, the effect has not been startling. Records will be with us for a long time to come—and they will continue to be called 'records.' Soothsayers had this business buried many times over—but it always recovered and came back. And until some other means of giving the public what it wants when it wants it is devised—recordings will stay with us."

We have forecast that 225 million discs will be sold during 1949. What is your estimate?

"I hesitate at this point to make an industry-wide estimate of record sales. However, it is important to note that each LP record sold is the equivalent of five single records. Columbia estimates that it will sell 6 million LP records this year, 30 million records of other types."

(Continued on page 123)

reasons why...

THE BUYERS' MARKET

IS THE MAHOGANY MARKET

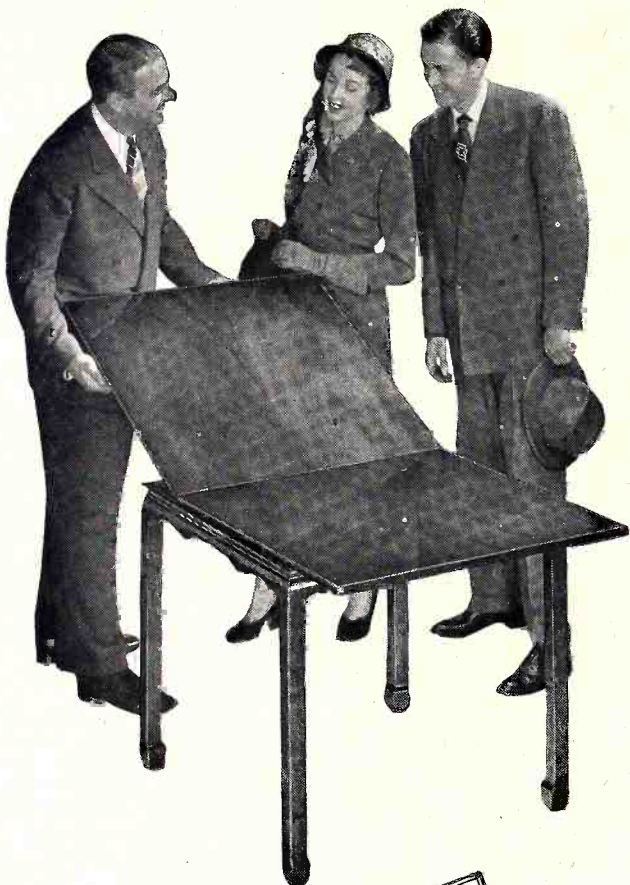

VALUE is the buy-word now. More for the money, or no sale—that's how it is in a buyers' market. And *nothing* offers so much as Mahogany! Of the things that make value in furniture, many belong to Mahogany alone . . .

BEAUTY . . . No other wood can match Mahogany for length, width, and freedom from defects. In warmth of color and variety of pattern, Mahogany has no equal.

STABILITY . . . Genuine Mahogany only mellows with the years. Its classic strength is timeless—the earliest piece known is still in top condition.

REPUTATION . . . Generations of craftsmen, generations of *customers* have honored Mahogany as the king of cabinet woods.

No question, buyers *want* Mahogany. And it's easier now to bring it to them—genuine Mahogany is again in good supply.

Easier, too, to *sell* Mahogany—you can't miss with the sales helps you'll find in "Facts to Help You Sell Mahogany" (see below).

facts to help you

sell **MAHOGANY**



Just as genuine Mahogany is the unquestioned mark of quality, so these labels are the mark of genuine Mahogany. They are issued by The Mahogany Association to protect you and your customers from substitution . . . *to help you sell Mahogany.*

Just issued! This free booklet has all the answers to the questions customers ask—answers that *sell*. Helps you sell period pieces and modern . . . all-Mahogany items . . . veneers . . . plywoods. Tells you what to look for, how to promote it. And besides, this folder is a handy guide to your 7th Edition Mahogany Book. If you don't have the Mahogany Book, write for it. And write today for "Facts to Help You Sell Mahogany."

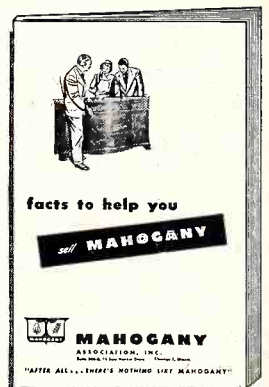

MAHOGANY

ASSOCIATION, INC.

Suite 803-C, 75 East Wacker Drive Chicago 1, Illinois

"AFTER ALL . . . THERE'S NOTHING LIKE MAHOGANY"

Make Money With FM

Sell This Extra Feature to Boost Radio Volume, Up Average Dollar Sale

• FM has been steadily gaining in circulation and acceptance. Properly promoted, it can hypo radio sales for many a retailer.

But FM needs to be vigorously and aggressively promoted . . . not as a novelty or an extra gimmick in a set, but as an *additional* feature which will provide more enjoyment for listeners.

First of all, the dealer must convince and sell himself on FM, for a half-hearted and uninformed salesman won't sell anyone except the rare character who is sold before he enters a store.

Despite the great growth of TV to date, there is still a gigantic, undiminished radio audience: partly because television hasn't blanketed the nation yet, partly because it does not provide dawn-to-bedtime programming seven days a week, and partly because not all types of programs are available on TV.

With approximately 94% of the families in the U. S. owning at least one radio, it is obvious that millions of them will be out buying radios each year. Additional numbers of people are using obsolete radios and could be sold new ones by direct-selling methods.

The average customer in these days of the well-guarded dollar will start out with the idea in mind of buying the cheapest thing he can lay his hands on, since "they're all about the same, anyway." This is where the radio retailer steps in. If he just lets the customer pick out a table model according to the color of the plastic cabinet, he might as well put in a turnstile and a sign "Self Service." But if he wants to *sell* radios, FM is a good firm hook on which to hang a sales approach . . . a good starting point to build that sales ticket up toward or past three figures.

One of the most important phases of the opening wedge on FM is to have a good, simple, brief explanation of what FM is—preferably one sentence. Preferably, describe FM not as different in type from radio, but merely an improved type of radio, or an improved technique, the two chief features of

which are: 1) static and interference free reception, and 2) improved tonal quality.

Some consumers have been indifferent to or actually soured on FM by early experiences. In the early postwar years there were few FM stations, and there was no duplication of AM programs. Furthermore, many sets of that period were inadequate, and an even greater number of installations were inadequate. As a result, some people felt disappointed in FM, while a great many others simply ignored that feature.

It is worth while to try to overcome these prior conceptions of FM. With the number of FM stations over 700 now, all areas formerly covered by AM are covered by FM, and many areas not previously covered, or previously poorly covered are now reached by this new type of transmission.

Demonstration Important

Over 85% of the FM stations duplicate AM programs, and all the popular programs may be heard . . . but heard much better! Many people who live in areas where static and interference are common on AM suspect that the FM set, with which they are unfamiliar, has broken down when, during a pause between programs or between words nothing comes out of the set—just utter silence! And the tone quality, even on small sets, is surprisingly better.

The most important clincher, of course, is the demonstration. This means that the dealer must have a good installation in his own store, capable of demonstrating more than one type of set. It means that he must be able to operate the sets with ease, and be able to select particular stations at will. If reception in the store is such that the comparison of AM and FM is *not too* astounding, the dealer can make it more so with a noise-creating gimmick. If the store has a service bench, a signal generator may do nicely . . . if not, various motor driven devices can be tried

out, starting with an electric shaver. The customer should be informed, "Now I am going to turn on such-and-such which you will notice creates unbearable noise in the AM, but none in the FM receiver." Such a demonstration is very compelling, and often will prove to be a closer.

Except in areas very close to the stations, FM sets require an outdoor antenna similar to a TV antenna, and proper installation is very important to reception. FM receivers are peculiar in that, with insufficient signal strength, reception will be noisy and distorted just as if there were something wrong with the audio amplifier. This might be likened to the water system in a house. With insufficient pressure, air gets into the pipes, and the water sputters from the spigot, but with adequate pressure, the water is free of air and flows smoothly and strongly.

In areas of inadequate signal strength, additional height and additional directivity of the antenna will prove rewarding. The installation of an antenna costing \$10 or more and involving three or four man-hours of work is a cost which must be sold to the customer.

Many dealers have been successful selling a set with the proviso that if it is not satisfactory in the home after a certain number of days, the customer may return it. Returns have been found to be as low as 1%, and ½ of 1%.

Keep Users Satisfied

Assuming that the customer keeps the set, it is wise to follow him up after a month or two to make sure that he is getting the most out of it. A satisfied customer can ease the way for many additional sales, but an indifferent owner may hinder sales.

In many cases, dissatisfied customers have been resold on FM after a "re-orientation" course in the home. That is, they didn't know how to tune the set, or weren't aware that some FM sets drift off tune within a few minutes after first being turned on. Sets that drift will be stable after an initial re-tuning. Continual drift points to either a need for service, or exceptionally weak response on some station.

To forestall complaints, the dealer would do well to be aware of the quality of reception of different stations in his area. If some particular station just cannot be received because of terrain or distance, the customer can be informed of this fact in advance.

If the foregoing suggestions and precautions seem to add up to a lot of trouble, the dealer should remind himself of the sales potentiality of FM, dollarwise. It certainly is worth a little trouble to make money.

SELL FM!

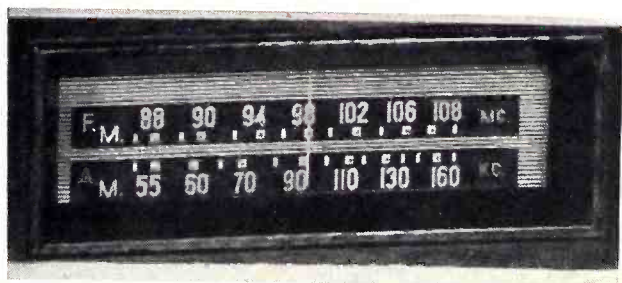

More PROFIT for YOU—More VALUE for Your CUSTOMER

Visible Value

Arvin television is here!

ARVIN Visible Value Television is here! It will be introduced in Chicago within the next few weeks and in other television markets as rapidly as expanded production permits.

The line includes every popular size of television receiver—10-inch screen table and console models, a 12-inch screen console and, later on, a giant 16-inch screen console.

Arvin Television is not just another television line. It is, in reality, a completely *new* line of *improved* design offering better performance and greater value. It represents years of research and development and is the logical culmination of Arvin's 15 years of successful experience in radio and electronics.

Arvin Television was developed around three major premises. We told our designing engineers that Arvin Television sets must: (1) give the customer the most for his money; (2) be dependable in operation—service calls must be

minimized—and (3) provide a sound profit structure for the dealer.

Arvin Television meets all these basic requirements—and more.

If you are now, or soon will be, in a television market, it will pay you to inquire immediately about an Arvin Television Franchise. For, in the months and years ahead, the Arvin franchise will become more and more valuable. Arvin's sound financial structure and 30-year background of producing for America's mass market is your assurance of more salable merchandise, protected profit and minimum servicing requirements.

We sincerely believe that Arvin television is . . . and will continue to be . . . the best value both in today's television market and in the foreseeable future . . . the most satisfactory set to own, the most satisfactory set to sell and service.

Glenn W. Thompson
President

NOBLITT-SPARKS INDUSTRIES, INC.
COLUMBUS, INDIANA

ARVIN VISIBLE VALUE TELEVISION . . . YOU CAN SEE THE DIFFERENCE!

How to Charge for Profitable Servicing

Smooth the Way With Adequate Advance Information

The third installment of a series by E. A. Campbell, Technical Editor. Part 1 (March) outlined a formula for pricing service work, and Part 2 (April) introduced the subjects of estimating and guarantees, which are continued in this issue.

Explaining the estimate to the customer is one of the most important parts of this particular operation. If the dealer allows himself any leeway on the estimated charge for the repair, the customer should be informed. If there is any question about a change in the estimate, it should be clearly explained. For instance, the estimator might say, "I don't think the power transformer is gone, but if it is I'll call you up and let you know how much it would be to replace." In this case, there is an unanswered question: Suppose the customer decided that rather than pay for a new power transformer (assuming that it has become necessary) he will junk the set and buy a new one. What about the time the servicer spent locating the trouble?

This raises again the question of minimum charges, and also the advisability of requesting a deposit in advance against the service charge.

There are three very definite instances where the dealer should have a minimum charge for his own protection.

The minimum charge should be prominently displayed and mentioned to the customer before a minute's work is done. The three occasions are: 1) Home calls. 2) "While-you-wait" repairs done at the shop, and 3) All work left for repairs. In the first instance, it would be to cover the expense of travelling to the home in the event that no work is contracted for, or the job is very simple. In the second case, it would cover tube checking (where the customer brings the tubes in) or a quick repair. In the last instance, it would be to cover jobs such as mentioned above where the customer decides not to have the necessary repair made.

Deposits Justified

Collecting an advance or deposit from strangers is, in most cases, justifiable and advisable, since, in the course of time, the dealer usually finds himself with several sets which have never been called for. The deposit serves as an incentive to get the customer to come back for the set, and also covers some of the work done in case he never does. Your local statute of limitations will determine how long you must retain the set before you can sell, destroy or cannibalize it (Displaying a sign "Not responsible for goods left over 30 days" is

not valid if the statute says otherwise).

In introducing the topic of the estimate, we perhaps did not dwell long enough on the "customer's description of the trouble." This can be very important in diagnosing the malady. The writer has experienced customer calls on inoperative appliances during a period in which the power lines were down and the customer without even electric lights. In another instance the customer connected a ground wire to an AC-DC chassis. Perhaps more well known is the anecdote of the customer who experienced interference during a certain period in the morning in which someone was operating an electric shaver. More obscure is the complaint that a set doesn't operate where it turns out that it fails to work only on one portion of the dial. Often it fails only to bring in only one low-powered independent station on the high end of the dial.

Phonograph troubles, in particular, require a careful explanation since they are often due to warped, off-size, or non-standard records. Sometimes, too, a person who purchases a new and expensive console has nothing but old Caruso records to play on the phono, and suspects trouble because they lack the quality of radio music. A complete description of the events leading up to the crime will often unearth an obscure cause of trouble. The average uninterrogated customer will provide little information, however, with his, "There's something wrong with my set, I think it's just a tube."

The rates below are printed on the back of bills issued by Graham and Colton, Radio and Appliance Sales and Service, Columbus, Ohio, and is an example of what may be done to acquaint customers with the pricing and warranty policies of a firm.

STANDARD SERVICE RATES	
<p>The standard charges listed below include only the work done in the shop and in the home. On outside service calls an additional charge is made for traveling time and transportation, depending upon the distance from our store. Out-of-town calls are based on \$2.50 per hour from the time the service man leaves the shop until he returns. Transportation is based on a mileage charge of 6c per mile.</p>	
REPLACEMENTS AND REPAIRS	
These standard charges cover service only and include all testing required to locate trouble. Prices for materials are extra.	
Audio Amplifier—resistor or capacitor replacement, wiring repairs	\$2.75
Audio Transformer—input or output replacement	3.75
Automatic Record Changer—cleaning, adjustment and lubrication	\$3.00 to 9.00
Automatic Volume Control System—resistor or capacitor replacement, wiring repairs	3.50
Ballast (Resistor cord type)—replacement	1.50
Ballast (Resistor cord type)—repair	50 to 1.50
Batteries—(Portable Radio)—replacement	1.00
Capacitor—(Component)—replacement	3.25
Capacitor—(Component)—replacement	4.00
Capacitor Assembly—(Tuning Gong) adjustment	2.50
Capacitor Assembly—(Tuning Gong) adjustment, wiring repairs	3.50
Detector Circuit—(First)—resistor or capacitor replacement, wiring repairs	3.50
Detector Circuit—(Second)—resistor or capacitor replacement, wiring repairs	3.50
Dial Drive—Belt or cable replacement	1.50 to 2.75
Dial Drive Mechanism—replacement or repair	2.25
Discriminator Circuit—resistor or capacitor replacement, wiring repairs	4.50
Discriminator Transformer—replacement or repair	5.50
Filter Choke Coil—replacement	3.75
Intermediate Frequency Amplifier—resistor or capacitor replacement, wiring repairs	2.75 to 4.50
Intermediate Frequency Transformer—Replacement or repair	4.00
Limiter Circuit—resistor or capacitor replacement, wiring repairs	3.75
Oscillator Circuit—resistor or capacitor replacement, wiring repairs	2.75 to 4.50
Oscillator Coil—replacement or repair	4.00
Oscillator Coil—Cleaning and lubrication	2.75
Phonograph Motor—Replacement	2.25 to 4.00
Phonograph Pick-up—replacement or repair	2.50
Power Supply Circuit—resistor or capacitor replacement, wiring repairs	2.75
Power Transformer—Replacement	4.50 to 6.50
Phonograph (Windup type) Main spring replacement	2.50 to 3.50
Phonograph (Windup type) Main spring repair and re-assembly	2.50 to 3.50
Phonograph (Windup type) Adjust turntable speed	50
Phonograph (Windup type) Install new reproducer	1.75
Phonograph (Windup type) Lubricate and clean	1.00
Phonograph cabinet—glue broken cabinet	50 to 2.00
Radio Frequency Amplifier—resistor or capacitor replacement, wiring repairs	3.10
Radio Frequency Transformer—replacement	4.00
Resistor (Voltage divider) replacement	2.75
Speaker (complete speaker replacement)	2.00 to 4.00
Speaker cone—re-casting	1.00 to 3.50
Speaker cone—remove, repair and re-assemble	2.00 to 4.00
Speaker Field Coil—replacement	3.00 to 4.50
Switch (Off-on) replacement	1.50 to 2.75
Switch (push button type)—repair contacts and clean and lubricate	2.50
Switch (radio-phonograph)—replacement	3.25
Switch (wave band)—Cleaning and lubrication	3.00
Tone control—replacement	3.25
Tone control—repair	1.00
Tubes—Quality and noise test on all tubes	1.00
Tube socket—replacement	1.00
Tube socket—repair contacts	2.00
Volume control—replacement	3.25
Volume control—repair	1.00 to 2.00
ALIGNMENT OF TUNED CIRCUITS	
Single Band Receivers (midrange and portable)	\$1.50
Single Band Receivers (Large Table Models and Consoles)	2.50
Multi Band Receivers	3.50
Frequency Modulation Sets	3.50 to 4.50
Automatic Tuning Adjustments—	
Push Button Type	1.50
Motor Operated Type	2.00
<p>The above prices are based on the correction of trouble that appears continuously and without interruption. For correcting trouble which occurs intermittently, requiring additional testing over a period of time, prices will be higher than those listed, depending upon the amount of additional time required.</p>	
<p>Our Service Department is one of the best equipped in the state. Each radio leaving our repair department is personally inspected by the service manager to see that its performance comes up to our standard.</p> <p>Our service charges are guaranteed from standard charges of the industry and from our 25 years experience, are being fair both to the customer and ourselves for high quality repair.</p>	
<p>GUARANTEE 90 DAYS</p> <p>On all parts and tubes which we install and on all labor operations performed.</p> <p>It does not cover parts and labor operations which we did not do.</p> <p>Parts replaced are listed on front of this statement and labor operations checked on back.</p> <p>WE APPRECIATE YOUR BUSINESS</p>	
<p>MINIMUM CHARGES \$1.00 ON ALL RADIOS BROUGHT TO SHOP \$1.50 PLUS TRANSPORTATION ON OUTSIDE CALLS</p>	

Records Important

The importance of keeping records of servicing experience, as outlined in the previous installment, cannot be over-emphasized. It will not only simplify the work and speed it up, but will also assist in keeping it profitable.

This is especially true of television servicing, where the time-consuming features of the work are not so well fixed in the mind of the dealer, and unknown to the customer. Here the questioning of the customer is even more important, since he is more in the dark about the subject. Most TV troubles will be described by the customer as "no picture," since an unsatisfactory picture is the same to him as no picture. If the TV service is being conducted on a "pay-as-you-go" basis, it becomes increasingly important to the dealer to correctly analyze the trouble so as to be able to give an accurate estimate of it.

(To be continued)

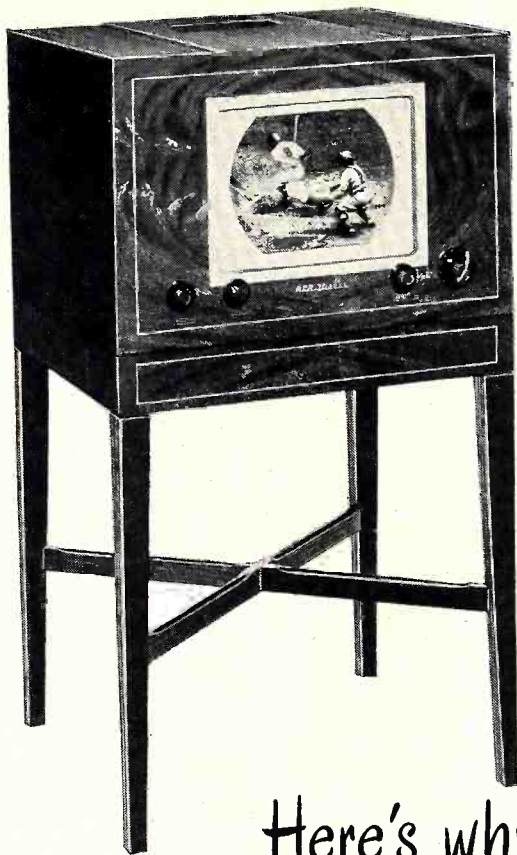

Visit the RCA Victor exhibit at
The SUMMER FURNITURE MART
 Space 340-A
The N.A.M.M. SHOW, Hotel New Yorker
 East Room and Booths 1, 2 and 3

High, Wide and
 Handsome Pictures...

at an amazingly low price . . . that's the selling appeal of the table model RCA Victor 9T240. It's a grand new value that offers improved Eye Witness Television on a big 61-square inch screen—at a lower price than 52-square inch reception. Like *all* RCA Victor instruments, the 9T240 has a faster turnover . . . because it offers your customers highest possible quality at a fair price.

Here's why your profits are greater
 with this **RCA VICTOR**

Higher quality and outstanding selling points of *All* RCA VICTOR instruments keep turnover high!

These big features sell the "High, Wide and Handsome" 9T240.

Big 61 Square Inch Screen!—Yes, RCA Victor "Eye Witness" television on a wide 61-square inch screen . . . and at a lower price than 52-square inch reception. Improved Picture Synchronizer *locks images in tune* with sending station . . . strengthens noise immunity.

New Low Price for same High Quality!
 —Your customers will go for the amazing quality of the new RCA Victor 9T240 . . . bearing the *lowest price tag* for any comparable set in RCA Victor's ten years of

commercial television activity. It's the result of manufacturing and engineering improvements which resulted in higher quality at lower cost.

Matching Consolette Base!—Carries out the delicate graining and the fine stripe seen on the front panel of the 9T240. Finished exquisitely to match the set . . . it places the receiver at the correct height for best viewing. It eliminates placement problem, adds beauty—is offered at a modest extra cost.

The 9T240 is Easy to Demonstrate . . . Easier to sell!—The big screen, amazingly low priced, and outstanding quality . . . coupled with the magnificent new Consolette Base . . . make it a best-seller.

ONLY RCA VICTOR
 HAS THE
 "GOLDEN THROAT"



ONLY RCA VICTOR
 MAKES THE VICTROLA

"Victrola"—T. M. Reg. U. S. Pat. Off.

RCA VICTOR



DIVISION OF RADIO CORPORATION OF AMERICA

RCA VICTOR—World Leader in Radio . . . First in Recorded Music . . . First in Television

Vitamin A Instead of Aspirin!

"The Day to Line Up, the Night to Sign Up Prospects", a Must in the Present Buyers' Market

There's a bang-up remedy at hand for the salesman who's been taking aspirin for the headaches due to the rough going in the present buyers' market. The remedy is a simple, fundamental prescription—*make more evening calls, and keep stores open nights.*

This "Vitamin A" formula will prevent "night-blindness" to the fact that the necessity for *using the day to line up, the night to sign up prospects* is again at hand.

In more than 90 per cent of all cases, *both husband and wife jointly decide* on purchases of major appliances and expensive radio and TV sets. Since very few male prospects are night watchmen, available at home during the day, the volume-minded salesman doesn't need to be told that the evening is the best time to get the man and wife together—in the home or in the store.

Today, some store owners who are crying the blues about business, are failing to insist that names and addresses of all store visitors be obtained so that follow-up calls can be made. Such merchants often refer to visitors who leave without buying as "walk-outs" or "lookers", when actually many of the latter are out-and-out *prospects*, ripe for evening calls.

For most dealers, a return to three fundamental sales practices is necessary at this time. First, there must be more "outside" selling; second, stores, most particularly those featuring TV sets, must be kept open evenings, and third, more night calls should be made.

One of the present drawbacks to evening selling, according to a number of merchants interviewed, is the unwillingness on the part of many salesmen to "work" at night. Some dealers are setting up shorter daytime hours for their salesmen in order to compensate for after-dark services. Still others have been able to convince salesmen that such "overtime" is highly profitable.

And highly profitable it is! To make a play on words, it is certainly true that "the night has a thousand 'eyes'" to the day's *one* when the salesman asks 'em to sign on the dotted line.

Trans-Vue

LEADING MANUFACTURERS
OF COMMERCIAL TELEVISION

NOW DOUBLES THE SCORE!

WITH NEW Ciné Television



TRANS-VUE—NATIONALLY KNOWN FOR QUALITY TELEVISION SYSTEMS AT CONSUMER ACCEPTED PRICES

Now you can satisfy your most discriminating customers . . . with Trans-Vue's Ciné home television receiver. Like the Trans-Vue multiple remote control television system, the Ciné is designed and engineered for sales appeal and customer value. This means *greater customer satisfaction . . . greater profits for you!* The enthusiasm which Trans-Vue distributors have shown for the Ciné is not unfounded. It has everything . . . newest engineering developments . . . performance beyond compare . . . and is priced to reach all income levels!

TRANS-VUE WILL PUT YOU IN THE PROFITABLE TELEVISION PICTURE!



Limited areas open for distributorships. For full details, write, wire or phone!

Trans-Vue's multiple unit remote control television . . . THE
WORLD'S FIRST AND FINEST COMMERCIAL TELEVISION SYSTEM!

Trans-Vue Ciné 145, 31 tube Console model, available in rich mahogany cabinet and blonde bisque finish. Washable woven plastic grille. World's largest direct view picture of 145 square inches on 15" Dumont tube. "Instantuner" dial for rapid, sensitive, accurate tuning, and positive "locked-in" picture control.

Sensational New Type Table Console also available, 25 tube equivalent. (not shown).

HERE'S WHAT TRANS-VUE CINÉ
MEANS TO YOUR CUSTOMERS:

- ★ 145 SQUARE INCHES OF ANIMATED ENTERTAINMENT!
- ★ WIDE ANGLE VISION FOR EYE COMFORT!
- ★ EXCLUSIVE "INSTANTUNER"...50% LESS MOVING PARTS!
- ★ FM STATIC FREE T-V SOUND!
- ★ AUTOMATIC VIDEO CONTROL FOR PICTURE BRILLIANCE!
- ★ SIMPLE, FAST OPERATION... ONLY 4 CONTROL KNOBS!
- ★ TELEVISION, AM, FM, PHONOGRAPH ADAPTOR IN 1 UNIT!
- ★ EXCLUSIVE CABINET DESIGN BY PIERRE RENAULT!



Trans-Vue

CORP.

1139-41 S. WABASH AVE.
CHICAGO 5, ILLINOIS



From this tiny 2½-inch tube

Norelco **PROTELGRAM** now offers

Life-Size
MORE
Life-Like
Television

... in a choice of picture sizes!

Many of America's important manufacturers of TV receivers will presently announce to your customers a wider variety of screen sizes in PROTELGRAM-equipped receivers.

These manufacturers have already introduced to the trade their sets featuring the popular 192-square-inch picture (16" x 12", 20" diagonal, square corners).

Look to them for early news about these two companion sizes—130 square inches with 16" diagonal and rounded corners, and 234 square inches with 20" diagonal and rounded corners.

And the latest version of PROTELGRAM for the projection of a giant 3' x 4' picture on a home-movie type screen is now available from several well-known makers, with others soon to be announced.

PROTELGRAM is the result of nearly fifteen years of development by the world's greatest electronic laboratories. It is an entirely new conception of quality television picture reproduction—a big *life-size*, more *life-like* image free from glare and easier on the eyes—at the lowest cost per square inch of viewing area.

PROTELGRAM has been adopted by leading TV manufacturers because it is the perfect answer to your customers' demand for bigger, better, more true-to-life television. It is your best bet for bigger television profits in 1949. Get the facts today on the profit-making opportunities in PROTELGRAM-equipped receivers. North American Philips Company, Inc., Dept. PE-7, 100 East 42nd Street, New York 17, N. Y.



PROTELGRAM

An exclusive development of
NORTH AMERICAN PHILIPS

See our exhibit at the NAMM Convention • Room 702, Hotel New Yorker • July 25-28, 1949

Newest TV and Radio Sets

Garod TABLE TV SET

Model 1244 "Madison" is a 12½-inch table TV set with 91-square inch screen featuring continuous tuning with a slide-rule dial, and priced at \$239.95 in mahog-



any. Other new models in the line include a 10-inch set at \$199.95, a 16-inch set at \$349.95, and several sets featuring "Tele-Zoom," and including AM-FM radio. Garod Electronics Corp., 70 Washington St., Brooklyn 1, N. Y.—RADIO & TELEVISION RETAILING.

Polaroid TV FILTERS

An improved, easy attaching method is a feature of the new Polaroid filters, utilizing an adhesive cellulose tape. The tape comes already fitted to the top edge of the filter, simplifying installation. An identifying red ribbon peels off when the filter is mounted. Pioneer Scientific Corp., 295 Lafayette St., New York 12, N. Y.—RADIO & TELEVISION RETAILING.

Mattison TV TABLE SET

The "Embassy" is a 15-inch set with 30 tubes including 3 rectifiers and picture tube, featuring 140-square inch screen in



a cabinet measuring 22 x 22 x 21 inches. Set carries suggested retail price of \$489.50. Mattison Television and Radio Corp., 220 Fifth Ave., New York 1, N. Y.—RADIO & TELEVISION RETAILING.

Teletone 10-INCH TV SET

Model TV-250 is a 10-inch direct view table model TV set with 62 square inch screen in a plastic cabinet featuring the low price of \$179.95. The heat-resistant plastic cabinet measures 19 inches deep

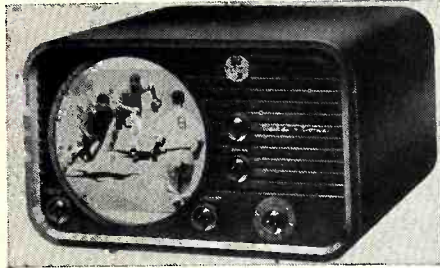

by 20 wide and 12¾ high, and has a mahogany finish. Chassis consists of 17 tubes plus 3 rectifiers. Tele-tone Radio Corp., 540 W. 58th St., New York 19, N. Y.—RADIO & TELEVISION RETAILING.

Nielsen TV SET

Model 1018-D, "town and country" model features: 10-inch tube; picture over 63

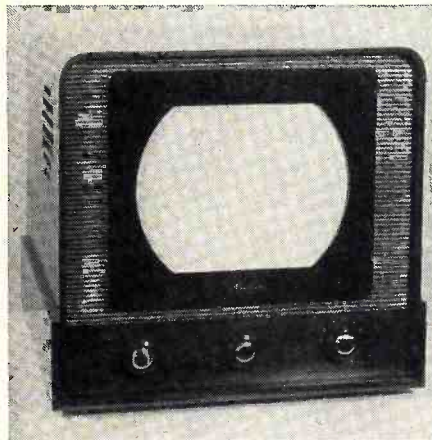

square inches; 30 tubes. Retail price is \$259.00. Nielson Television Corp., Norwalk, Conn.—RADIO & TELEVISION RETAILING.

Emerson TABLE RADIO

Model 561 is an AC-DC compact model utilizing 6 tubes (including rectifier), 5-inch speaker, built-in loop antenna and slide



rule dial. Cabinet is of figured walnut plastic. List price \$29.95. Emerson Radio and Phonograph Corp., 111 Eighth Ave., New York 11, N. Y.—RADIO & TELEVISION RETAILING.

I.T.I. HOME TV SET

The Century 326 "Teleceiver" is a TV console with 15-inch tube, 130 square inch direct-view picture, featuring a remote control unit which permits operation of the receiver from chairside. There are no knobs

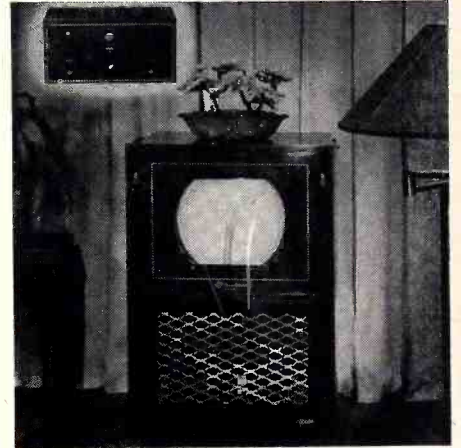

on the set. Remote control unit provides channel selector, contrast control, and volume control. Eastern list price of the walnut and mahogany, both Swedish modern and period style, is \$745. Industrial Television, Inc., 359 Lexington Ave., Clifton, N. J.—RADIO & TELEVISION RETAILING.

Kraft DOG RADIO

"Puppytune" is described as a talking and singing dog novelty for children. The 4-tube AC-DC radio is housed in a toy dog



measuring 10 inches long, and provided in pink, blue, brown or white. Kraft Mfg. Co., 1027 Findlay Ave., Bronx, N. Y.—RADIO & TELEVISION RETAILING.

Emerson 12½-INCH TV SET

Model 620 console TV set utilizes 12½-inch picture tube and 12-inch loud speaker, and is designed to provide "long-range" fringe reception. Cabinet is of mahogany veneers. List price, \$399.50. Emerson Radio and Phonograph Corp., 111 Eighth Ave., New York 11, N. Y.—RADIO & TELEVISION RETAILING.

More New Products Elsewhere
In This Issue

New Electrical

Universal REFRIGERATOR

Deluxe 8.5 cu. ft. model refrigerator, shown, features a freezer locker giving ample frozen food space in its 1.5 cu. ft. capacity; locker is horizontal in design, holds 50 lbs. of frozen meats, fruits and vegetables as well as four aluminum "quickout" ice cube trays. Adjustable sliding shelves, twin service crispers, which

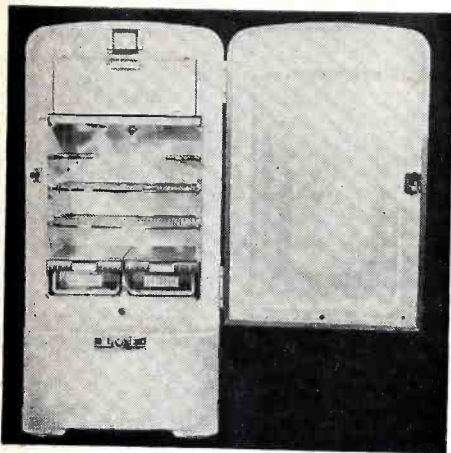

can be converted to auxiliary meat drawers, large storage cellar. The standard 9 cu. ft. refrigerator features a large 7 cu. ft. capacity large speed freezer equipped with two "easyout" ice cube trays and one dessert tray; holds up to 30 lbs. frozen foods. Other features found in both the deluxe and standard model refrigerators include: eye-level temperature control adjustable to 10 positions; aluminum ice cube trays; automatic interior recessed light; hermetically sealed economy freezing unit; seal-tight automatic door latch. Landers, Fray & Clark, New Britain, Conn.—RADIO & TELEVISION RETAILING.

Tracy COMBINATION SINK

Sink and laundry tray combination in deluxe porcelain; 48 inch sink top has one shallow bowl and one deep bowl. Sliding drainboard is part of the unit; is removable. Porcelain will not chip or wear off. Match-



ing undersink cabinet features cutlery drawer; ample storage space; insulated doors and drawers; concealed ventilation; stainless steel handles. Also has a streamlined faucet with spray attachment. Tracy Mfg. Co., Pittsburgh, Pa.—RADIO & TELEVISION RETAILING.

Westinghouse HOME FREEZER

Six cu. ft. upright home freezer with storage capacity of 210 pounds of food features reach-in convenience and easy loading, arranging and removal of foods. Designed as a companion model to the 1949 line of the company's refrigerators. Freezer has three compartments, each with a separate "handi-shelf" inner door; each com-

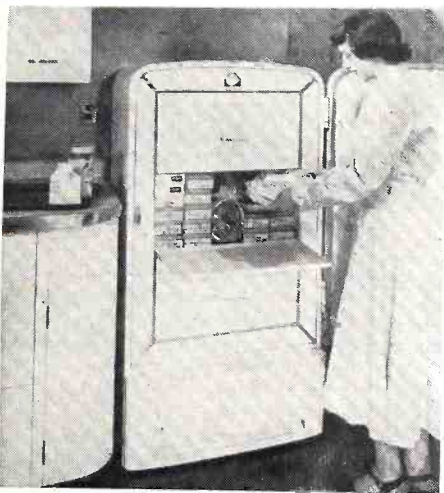

partment holds approximately 2 cu. ft. of food. Freezer has a primary and a secondary refrigerating system. With this type of system the freezer keeps the best temperatures for fast freezing in the freezing compartment, and keeps the storage areas in the model at zero or colder. Control dial has three settings—normal, off and coldest. Defrosting is seldom required. Cabinet is one-piece welded steel with a white deluxe finish. Westinghouse Electric Appliance Division, Mansfield, O.—RADIO & TELEVISION RETAILING.

Detroit Vapor ELECTRIC RANGE

Electric range model Ed-494, deluxe "Star" model features: four 7-heat, double-element surface units; full-length top lamp and an electric clock with automatic timer which controls the oven or electric appliance outlet. Range has a full-size oven with oven temperature control, warmer drawer and two service drawers. Also an automatic door stop for use when broiling. Also in the line are another 38-inch model and one 20-inch apartment size model. Detroit Vapor Stove Co., Detroit, Mich.—RADIO & TELEVISION RETAILING.

ILG FAN

Ventilating fan built for both daytime and nighttime service. Ilgualaire designed to draw in cool nighttime air during hot summer evenings and circulate air in living areas during the day. Fan is portable; friction pivot base allows fan to be turned to any angle. Furnished complete with safety chain for securing the fan when it is in the window. Ilg Electric Ventilating Co., Chicago.—RADIO & TELEVISION RETAILING.

Crosley SHELVDOR REFRIGERATOR

AA-7 refrigerator priced to retail at \$199.95. Model has full 7 cu. ft. capacity;

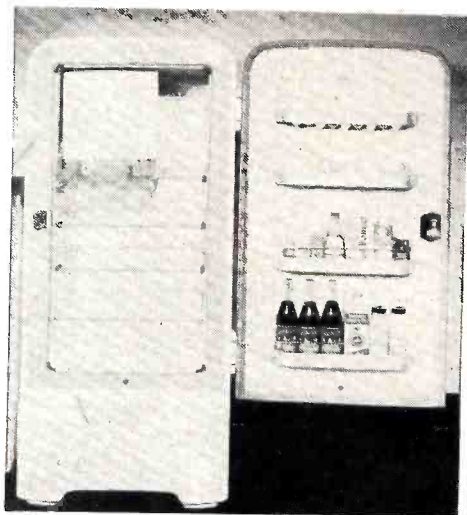

exterior cabinet requires no more floor space than standard four foot model. Crosley Division, Avco Mfg. Corp., Cincinnati, O.—RADIO & TELEVISION RETAILING.

Coolerator FREEZER

Ten cu. ft. deluxe family-size home freezer, model F-101 designed for the smaller family and for urban homes where limited space is a factor. Unit will freeze and store 350 to 400 lbs. of frozen foods. A convenient storage arrangement with



four wire baskets keeps foods up within easy reach and makes freezer contents accessible at all times. Outside dimensions are: 30¾ inches wide, 54½ inches long, 40 3/32 inches high. The Coolerator Co., Duluth, Minn.—RADIO & TELEVISION RETAILING.

Telechron ALARM CLOCK

"Serene" electric alarm clock with self-starting motor sells for \$3.98. Styled in an ivory plastic case; brown dial with white numbers; case is 3½ inches high by 4¾ inches wide. Telechron, Inc., Ashland, Mass.—RADIO & TELEVISION RETAILING.

Appliances for Dealers

American DISHWASHER

Fully automatic dishwasher requires no plumbing installation. Retail for \$169.50.



Single dial setting, washer will wash, rinse twice, dry and shut itself off. Dinnerware is cradled in a stationary rubber-cushioned rack; uses approximately 3½ gallons of normal tap-temperature hot water. Cabinet is standard height. Dimensions: 22 inches x 16 inches x 36 inches. Rolls on mar-proof casters. American Dishwasher Co., 299 Madison Ave., New York 17, N. Y.—RADIO & TELEVISION RETAILING.

King REFRIGERATOR

Deluxe model D 75 refrigerator, has a capacity of 7½ cu. ft. storage space. Offered to retail from \$159.95 to \$179.95. Features removable non-tip shelves with front guard rail; large vegetable storage crisper;

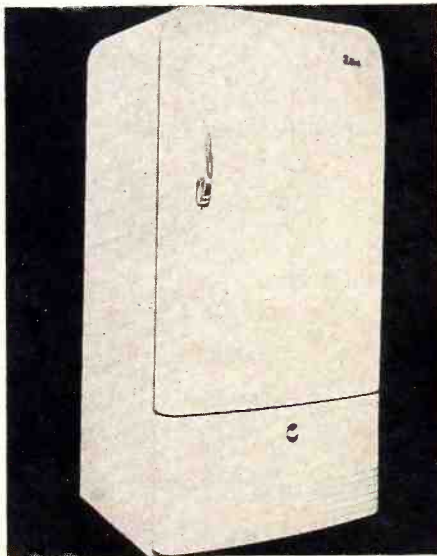

glass meat tray; 9-position temperature control with defrost setting. Dimensions are 58 inches high, 78 inches wide, 28 inches deep. Made of heavy 20 gauge steel, one piece sturdy wrap-around construction. Insulated with 3 inches of Fibreglas. Appliance Division, Symphonette Corp., 112 E. Walton, Chicago 11, Ill.—RADIO & TELEVISION RETAILING.

Florence ELECTRIC RANGES

Model 134, shown, features centralized controls, bake and broil indicator lights, 5-heat switches, full length storage compartment plus storage drawer. Shown with A-17 accessory which includes top-light, com-



ination electric clock and timer. Retail prices start below \$200. Deluxe 194 top model of the line features oven window and light; 5-heat switches and single lights, warming compartment, large storage drawers. Retail prices start at approximately \$250. Florence Stove Co., 205 School St., Gardner, Mass.—RADIO & TELEVISION RETAILING.

Lewyt CLEANER TOOL

Drapery and upholstery tool used in the vacuum cleaner improved by the addition of a Fuller brush which can be moved up

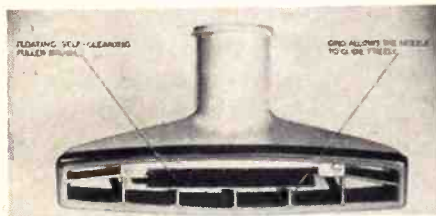

or down, forward or back. Four-way action picks up foreign material and automatically cleans the brush. New grids on the base of the nozzle prevent cloth materials from being sucked into the nozzle and allows the tool to glide freely across fabric. Made of plastic. Lewyt Corp., 60 Broadway, Brooklyn 11, N. Y.—RADIO & TELEVISION RETAILING.

Guth LUMINAIRE

"Seelux" is a modernly designed indirect luminaire for use with silver bowl lamps; finished with a fine emery-grain finish, permanently protected. Louvres are spun aluminum. Lamp used in luminaire contains the major reflector and the fixture can be restored to initial efficiency merely by a lamp change. Open louvres facilitate maintenance problems. Edwin F. Guth Co., St. Louis 3, Mo.—RADIO & TELEVISION RETAILING.

Sparton STEAM VAPORIZER

Steam vaporizer has a case made of Laminac resin, reinforced with Fibreglas mat and is equipped with an aluminum cover; gives product light weight. Gives steam within 90 seconds, has a capacity of one-half gallon, runs all night and shuts off automatically when the water is gone. Fiber-Tuff case is unbreakable, easy to use, designed with handle for carrying. Available at \$12.50. Sparton Co., Minneapolis, Minn.—RADIO & TELEVISION RETAILING.

Seaco REFRIGERATOR

Seven cu. ft. model, number 497 RS, has a freezing capacity of 8 lbs., plus 26.5 lbs. of frozen food storage. Retail for \$259.50. Features: meat keeper of heavy glass, enamel crisper drawer; acid resisting porcelain enamel interior; Fibreglas insulation; breaker-strip mouldings of pure Ethyl cellulose, will not wear off. Seaco, Inc., Sioux City, Iowa.—RADIO & TELEVISION RETAILING.

INDIRECT-LITE BULB

Fifteen-watt, white, indirect-lite lamp with an initial output of 2100 lumens; in combination with appropriate harps, bulb can be used to convert most medium screw socket portable lamps into new "higher

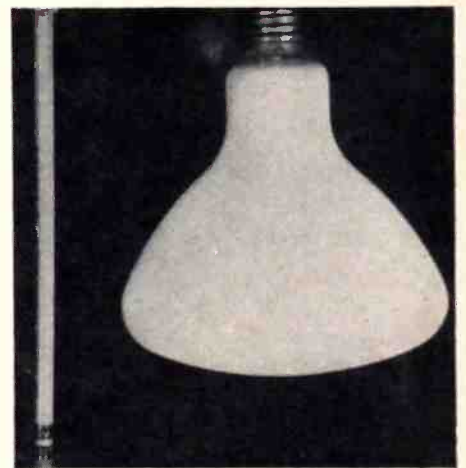

lighting level" variety. Maximum overall length is 6¼ inches. A special inside white coating diffuses the light from the side of the bulb, thereby minimizing direct or reflected glare. Westinghouse Lamp Division, Bloomfield, N. J.—RADIO & TELEVISION RETAILING.

More New Merchandise

Elsewhere in This

Issue.

"Got a NEW friend for YOU!"



The cream of the "cash" market has been lapped up. It's a cat-fight for what's left of it. Now it's the "time-payment" buyer that offers you the greatest possibilities for volume sales and profit.

There are more than thirty-three million wired homes in the country. At a conservative estimate, their owners and tenants figure to buy more than ten million appliances in 1949, with probably special interest in television, laundry equipment and refrigeration.

Your share of this market is waiting now to be sold... and your Commercial Credit representative can help you get it.

He is a sales-minded expert on time-payment financing. It will pay you to consult him.

COMMERCIAL CREDIT CORPORATION

A Subsidiary of

Commercial Credit Company, Baltimore • Capital and Surplus \$100,000,000

MORE THAN 300 OFFICES IN PRINCIPAL CITIES OF THE UNITED STATES AND CANADA

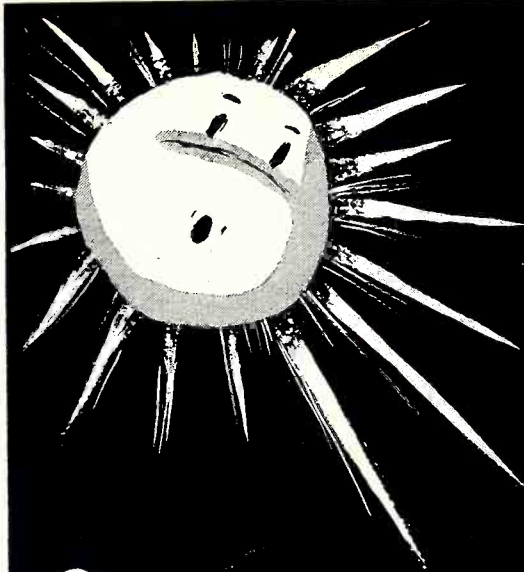

"SNOWBALLING"

in the summer, too!

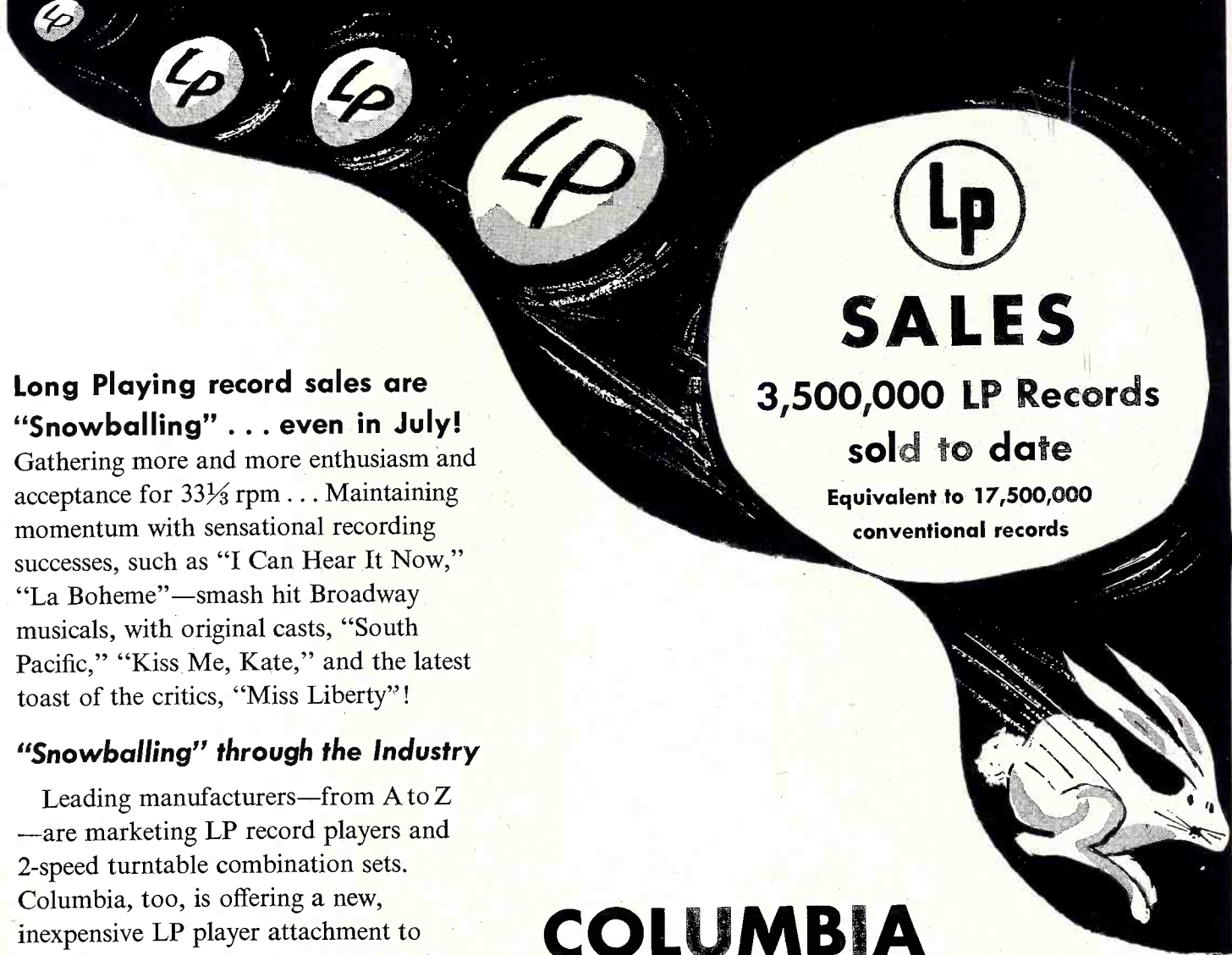

Long Playing record sales are "Snowballing" . . . even in July!

Gathering more and more enthusiasm and acceptance for 33 $\frac{1}{3}$ rpm . . . Maintaining momentum with sensational recording successes, such as "I Can Hear It Now," "La Boheme"—smash hit Broadway musicals, with original casts, "South Pacific," "Kiss Me, Kate," and the latest toast of the critics, "Miss Liberty"!

"Snowballing" through the Industry

Leading manufacturers—from A to Z—are marketing LP record players and 2-speed turntable combination sets. Columbia, too, is offering a new, inexpensive LP player attachment to keep consumer interest at a high peak!

The story of Columbia Long Playing Records is the success story of the year—with more exciting chapters to come! Roll with LP and roll in the profits!

Lp
SALES
3,500,000 LP Records
sold to date
Equivalent to 17,500,000
conventional records

COLUMBIA

Lp LONG PLAYING
RECORDS

Be sure to Visit Us at Booths
Nos. 19-20-21, NAMM Convention,
New York City—July 25 to July 28

"Columbia," "Masterworks" and  Trade-Marks Reg. U. S. Pat. Off. Marcas Registradas  Trade-Mark

DOUGH *In*

1949 Music Show in New York Will Keynote Business Optimism. TV Will Be a Feature. Expect Attendance Records to Be Broken

• The 48th annual Music Industry Trade Show and Convention, sponsored by the National Association of Music Merchants, will be held at the Hotel New Yorker and the Manhattan Center, New York, July 25 to 28. In addition to a large number of exhibits, in which TV will be an outstanding feature, those attending will

hear noted speakers discuss timely topics, and will attend forums designed to help the merchant make more money.

All attendance records are expected to be broken at this big event, which is NAMM's outstanding 1949 get-together. Last year's Show was attended by more than 8,000 registered guests.

In addition to the great interest in TV, the phonograph record situation will be discussed by prominent executives in the disc field, and many of the new multi-speed players will be exhibited. Experts will answer questions from the floor on marketing problems associated with the record industry.



L. G. LaMair
Lyon & Healy, Inc.
Chicago
Board Chairman, NAMM



Hugh W. Randall
J. B. Bradford Co.
Milwaukee
President, NAMM



Ray S. Erlandson
San Antonio Music Co.
San Antonio
Vice-President, NAMM



Russell B. Wells
Chas. E. Wells Music Co.
Denver
Secretary, NAMM



E. A. Turner, Jr.
Sherman, Clay & Co.
San Francisco
Treasurer, NAMM



William S. Gard
Executive Secretary
NAMM

NAMM Board of Directors

S. H. Almanrode
J & S Music Co., Shreveport, La.

George H. Beasley
Beasley Music Co., 309 E. Broad St., Texarkana,
Texas

Wm. Howard Beasley
Whittle Music Co., 1108 Elm St., Dallas 2, Texas

Fred A. Beasley
70 So. Main St., Salt Lake City 1, Utah

Ted W. Brown
Ted Brown Music Co., 1121 Broadway, Tacoma
2, Wash.

George L. Byerly
Byerly Bros. Music Co., 106 N. Adams St.,
Peoria, Ill.

Harry E. Callaway
Thearle Music Co., 640 Broadway, San Diego 1,
Calif.

C. G. Campbell
The Knight-Campbell Music Co., 1617 California
St., Denver, Colo.

W. Perry Chrisler
Aeolian Co. of Missouri, 1004 Olive St., St.
Louis 1, Mo.

Melville Clark
Clark Music Co., 416 S. Salina St., Syracuse,
N. Y.

Arthur E. Godfrey
Williams Piano Co., 218-220 S. Main Ave.,
Sioux Falls, S. Dakota

C. W. Gould
Gould Music Store, 1607 Nicolett Ave., Minne-
apolis, Minn.

Paul W. Jenkins
Jenkins Music Co., 1217 Walnut St., Kansas
City, Mo.

Stuart D. Julius
Julius Music House, 141-143 W. Market St.,
York, Pa.

Ted Korten
Korten's, 1400 Commerce Ave., Longview, Wash.

E. R. McDuff
Grinnell Bros., 1515 Woodward Ave., Detroit
26, Mich.

Geo. A. Mason
Mason & Risch, Ltd., 525 Adelaide St., Toronto,
Canada

Jerome F. Murphy
M. Steinert & Sons, 162 Boylston St., Boston,
Mass.

B. E. Neal
Neal-Clark-Neal Co., 682 Main St., Buffalo 2,
N. Y.

Wm. H. Richardson
Birkel Music Co., 1229 S. Hill St., Los Angeles,
Calif.

Robert A. Schmitt
Paul A. Schmitt Music Co., 88 South 10th St.,
Minneapolis 2, Minn.

J. M. Wylie
Wylie Piano Co., 115 Broadway, Fargo, No.
Dakota

DO, RE, MI! \$\$\$

LIST OF EXHIBITORS

Manufacturer	Booth	Room	Manufacturer	Booth	Room	Manufacturer	Booth	Room
Ace Accordion Co., 114 E. 18 St., N. Y.		549	The Woodwind Co., 461 Eighth Ave., New York 1, N. Y.	518, 519, 520		Wm. Kratt Co., 988 Johnson Place, Union, N. J.		602
Aeolian American Corp., East Rochester, N. Y.		847, 848, 849	Pietro Deiro Accordion Hdqrs., 46 Greenwich Ave., New York 11, N. Y.	503		Krauth & Benninghofen, 940 Symmes Ave., Hamilton, Ohio.		547
Aero Needle Co., 619 No. Michigan Ave., Chicago 11, Ill.	23		Dolnet (Paris), Box 148 Ansonia Station, New York 23, N. Y.	544		G. Leblanc Co., 2210 Sixtieth St., Kenosha, Wis.		618, 619, 531
Affiliated Musicians Service of America, Inc., Chicago	64		Allen B. DuMont Labs., Inc., 515 Madison Ave., New York 22, N. Y.	Parlor E, H		Leedy Drums, Elkhart, Ind.		811, 814, 815
A I M Industries, 41 Union Square, New York 3, N. Y.	36		Duotone Co., Inc., 799 Broadway, New York 3, N. Y.	84		Lester Piano Mfg. Co., Inc., 1533 Chestnut St., Phila. 2, Pa.		
Allen Organ Co., 8th & Pittston St., Allentown, Pa.		735	Eden Toys, Inc., 153 W. 23 St., New York 11, N. Y.	32		Lifton Mfg. Corp., 18 W. 18 St., New York 11, N. Y.		545
Aluminum Co. of America, 801 Gulf Bldg., Pittsburgh 19, Pa.		851	Electro-Music Accessories Co., 313-321 So. Fair Oak Ave., Pasadena 1, Calif.	738		Linton Mfg. Co., Inc., 919 No. Napanee St., Elkhart, Ind.		644
American Accordionist Assn., 113 W. 48 St., N. Y.	47		L. A. Elkington Co., 323 E. 34 St., New York 16, N. Y.	521		Manhattan Band Instr., Inc., 214-17 41 St., Bayside, L. I.	48	
American Society of Piano Technicians, 1022 W. Garfield Ave., Milwaukee 5, Wis.	958		Empire Accordion Co. (Acme Accordion Co.), 337 6th Ave., New York 15, N. Y.	608		Maurice Lipsky Music Co., 45 E. 17th St., New York 3, N. Y.		611
Amsco Music Publishing Co., 1600 Broadway, New York 29, N. Y.	645		Epiphone, Inc., 142 W. 14 St., New York, N. Y.	627, 628, 736, 737, 824, 840, 841		The London Gramophone Corp., 16-18 W. 22 Street, New York 10, N. Y.	107, 108	
Andrea Radio Corp., 27-01 Bridge Plaza No., Long Island City, N. Y.	68, 69		Estey Organ Co., Birge St., Brattleboro, Vt.			Ludwig & Ludwig Drums, Elkhart, Ind.		533
Ansley Radio & Television, Inc., 41 St. Joes Ave., Trenton 9, N. J.		726	Estey Piano Corp., Bluffton, Ind.			Maas Organ Co., 3015 Casitas Ave., Los Angeles 26, Calif.		729, 730
W. T. Armstrong Co., 200 E. Syracuse St., Elkhart, Ind.		612	Everett Piano Co., So. Haven, Mich.			MGM Records, A Div. of Loew's, Inc., 701 7th Ave., New York 19, N. Y.	106	
Atlantic Recording Corp., 301 W. 54 St., N. Y.	85		Excelsior Accordion, Inc., 333 Sixth Ave., New York 14, N. Y.	504, 505		Magnatone Distributors, Inc., 3707 W. Jefferson Blvd., Los Angeles 16, Calif.	34	
Audio Industries, 1001 Green St., Michigan City, Ind.	7		Farnsworth Television & Radio Corp., Ft. Wayne, Ind.	Parlor F		The Magnavox Co., Bueter Road, Ft. Wayne 4, Ind.		East Room
Vincent Bach Corp., 621 E. 216 St., New York 67, N. Y.		517	Federal Television Corp., 137 Duane St., N. Y.	45, 46		Magnolia Records Co., 14155 Magnolia Blvd., Van Nuys, Calif.	93	
The Baldwin Piano Co., 1801 Gilbert Ave., Cincinnati 2, Ohio		833, 834	Carl Fischer Musical Instrument Co., Inc., 62 Cooper Square, New York 3, N. Y.	620, 621		The Manual Arts Furniture Co., 1009-17 Hulbert Ave., Cincinnati 14, Ohio.		844
Herb C. Barger Mfg. Co., Inc., 2770-72 W. Colfax Ave., Denver 4, Col.		516	Fisher Radio Corp., 41 E. 47 St., New York 17, N. Y.	715		E. & O. Mari, Inc., 38-01 Twenty-third Ave., Long Island City 5, N. Y.		610
Barth-Feinberg, Inc., 17 Union Square W., New York 3, N. Y.		512	Clarke Fortner, Mfrs. Rep., 545 No. Cicero Ave., Chicago 44, Ill.	607		C. F. Martin & Co., Inc., 10 West North St., Nazareth, Pa.		608, 542
Beach Instrument Corp., 165 Oraton St., Newark 4, N. J.		727, 728	Marcin J. Frank, 246 Fifth Ave., N. Y.	13		Martin Band Instrument Co., Elkhart, Ind.		
Bendix Radio Television & Broadcast Receiver Division, Joppa Road, Baltimore 4, Md.		707	Freed Radio Corp., 200 Hudson St., New York 13, N. Y.	711, 712		Melodee Records, Inc., 314 W. 52 St., New York 19, N. Y.	18	
Bijou Toys, Inc., 16 W. 19 St., New York 11, N. Y.	28		Jesse French & Sons Piano Div., Elkhart, Ind.	842, 843		Melodiana Accordion Co., 6501 Bergenline Ave., West New York, N. J.	35	
Boetsch Brothers, 221 E. 144 St., New York 51, N. Y.		725	R. Galanti & Bro., Inc., 783 Broadway, New York 3, N. Y.	501		Mercury Record Corp., 839 So. Wabash Ave., Chicago 5, Ill.	100, 99	968, 969
Boosey & Hawkes, Inc. P. O. Box 148, Lynnbrook, L. I., N. Y.		604, 605	General Electric Co., Electronics Park, Syracuse, N. Y.	721, 722, 723		Merson Musical Products Corp., 111 E. 14 St., New York 3, N. Y.		632, 633
The Boston Music Co., 116 Boylston St., Boston, Mass.	14		Golden Records, 1230 6th Ave., New York, N. Y.	15		Mills Music, Inc., 1619 Broadway, New York 19, N. Y.	4	
Brodwin Piano Co., Inc., 246 W. 23 St., New York, N. Y.		948, 949	Gretsch & Brenner, Inc., 42 East 20 St., New York, N. Y.	603		Minshall-Estey Organ, Inc., 28 Birge St., Brattleboro, Vt.		734
Brunswick Radio Div., Radio & Television, Inc., 244 Madison Ave., New York 16, N.Y.		724	Fred Gretsch Mfg. Co., 60 Broadway, Brooklyn, N. Y.	634, 635		Musser Marimbas, Inc., 5115 Ravenswood Ave., Chicago 40, Ill.		552, 553
Buegeleiser & Jacobson, Inc., 5 Union Square, New York 3, N. Y.		511, 514, 515	French American Reeds Mfg. Co., 3040 Webster Ave., N. Y.	75		National Piano Corp., 54 Canal St., New York 2, N. Y.		850
Buescher Band Instrument Co., 225 E. Jackson, Elkhart, Ind.		642	Grossman Music Corp., 740 Bolivan Road, Cleveland 15, Ohio.	615		National Sales Co., 101 Hopkins Place, Baltimore 1, Md.		614
Capitol Records, Inc., 1507 No. Vine St., Hollywood 28, Cal.	26, 27		Gulbrandsen Co., 816 No. Kedzie Ave., Chicago 51, Ill.	960, 961, 962		N. Y. Band Instrument Co., Inc., 270 Fourth Ave., New York 10, N. Y.	43, 44	609
Caravan Records, Inc., 113 W. 57th St., New York 19, N. Y.	109, 110		Haddorff Piano Co., 630 So. Wabash Ave., Chicago 5, Ill.	852, 853		Nielson Telev. Co., Inc., 11 E. 21 St., N.Y.C.		702
Castiglione Accordion Co., 16055 Collingham Drive, Detroit, Mich.		508	Hammond Instrument Co., 4200 W. Diversey Ave., Chicago 39, Ill.	731, 732, 733		No. American Philips Co., Inc., 100 E. 42 St., New York 17, N. Y.		502
Central Commercial Co., 332 So. Michigan Ave., Chicago 4, Ill.		739, 740	Hardman, Peck & Co., 33 W. 57 St., New York 19, N. Y.	803, 804		P. Oagini & Bro., Inc., 289 Bleecker St., New York 14, N. Y.		532
E. Chiassarini, 1595 Broadway, New York, N. Y.		617	The Harmony Co., 3633 So. Racine Ave., Chicago 9, Ill.	631		Pan-American Instruments, Elkhart, Ind.		92
Chicago Musical Instrument Co., 30 E. Adams St., Chicago 3, Ill.		601, 653	Hershman Musical Instrument Co., Inc., 242-250 Fourth Ave., New York 3, N. Y.	625, 626		The Pentron Corp., 611 W. Division St., Chicago, Ill.		708
Cole Corp., 8235 Wabash Ave., Chicago 10.	81		Highland Mfg. Co., 1026 Kenner St., Cincinnati.	49		Penzel, Mueller & Co., Inc., 36-11 Thirty-third St., Long Island City, N. Y.		527, 528
Columbia Records, Inc., 1473 Barnum Ave., Bridgeport 8, Conn.	20, 21		Frank Holton & Co., Elkhorn, Wis.	622		Peripole Products, Inc., 2917 Avenue B, Brooklyn 29, N. Y.	112	
C. G. Conn, Ltd., Elkhart, Ind.		529, 530, 536, 537	Hudson Electronics Corp., 451 So. Fifth Ave., Mt. Vernon, N. Y.	9		Permo, Inc., 6415 N. Ravenswood Ave., Chicago 26, Ill.	94	55, 56, 57, 58, 59, 60, 61, 62
Connsonata, Div. of C. G. Conn, Ltd., Elkhart, Ind.		742, 743	Imperial Industrial Co., 699 E. 135 St., New York 54, N. Y.	40, 41		Philco Corp., C & Tioga Sts., Philadelphia 34, Pa.		
Continental Music Co., Elkhart, Ind.		534, 535	Industrial Television, Inc., Clifton, N. J.	30		Piano Cello Tone Co., 3148 Bellplane Ave., Chicago, Ill.		809, 810
Courall Industries, 55 Pennis St., Brooklyn, N. Y.	76		Israel Recording Co., 11 West 42 Street, New York 18, N. Y.	835, 836, 837		Pollina Accordion Mfg. Co., 6921-25 Gratiot Ave., Detroit, Mich.	39	
Crosley Div., AVCO Mfg. Corp., 1329 Arlington St., Cincinnati 25, Ohio.		714	Janssen Piano Co., Inc., 237 E. 23 St., New York 10, N. Y.	548, 963		Portofonic Mfg. Corp., 4116 First Ave., Brooklyn 32, N. Y.	16	
D'Andrea Manufacturing Co., 432 W. 29 St., New York 1, N. Y.		616	Jenco Musical Products, Box 168, Decatur, Ill.	718		Pratt, Read & Co., Inc., Main St., Ivoryton, Conn.		801, 802
The Danelectro Corp., 274 So. Bridge Ave., Red Bank, N. J.		652	Jewel Radio Corp., 583 Avenue of the Americas, New York 11, N. Y.	828, 827		Radio & Television Equip. Co., 207 Oak St., Santa Ana, Calif.		546
J. C. Deagon, Inc., 1770 Berneau Ave., Chicago 13, Ill.		649, 650, 651	Kay Musical Instrument Co., 1640 Walnut St., Chicago 12, Ill.	624				
Decca Records, Inc., 50 W. 57 St., New York 19, N. Y.	103, 104		W. W. Kimball Co., 306 So. Wabash Ave., Chicago 4, Ill.	830, 831				

(Continued on page 64)

What's Ahead for

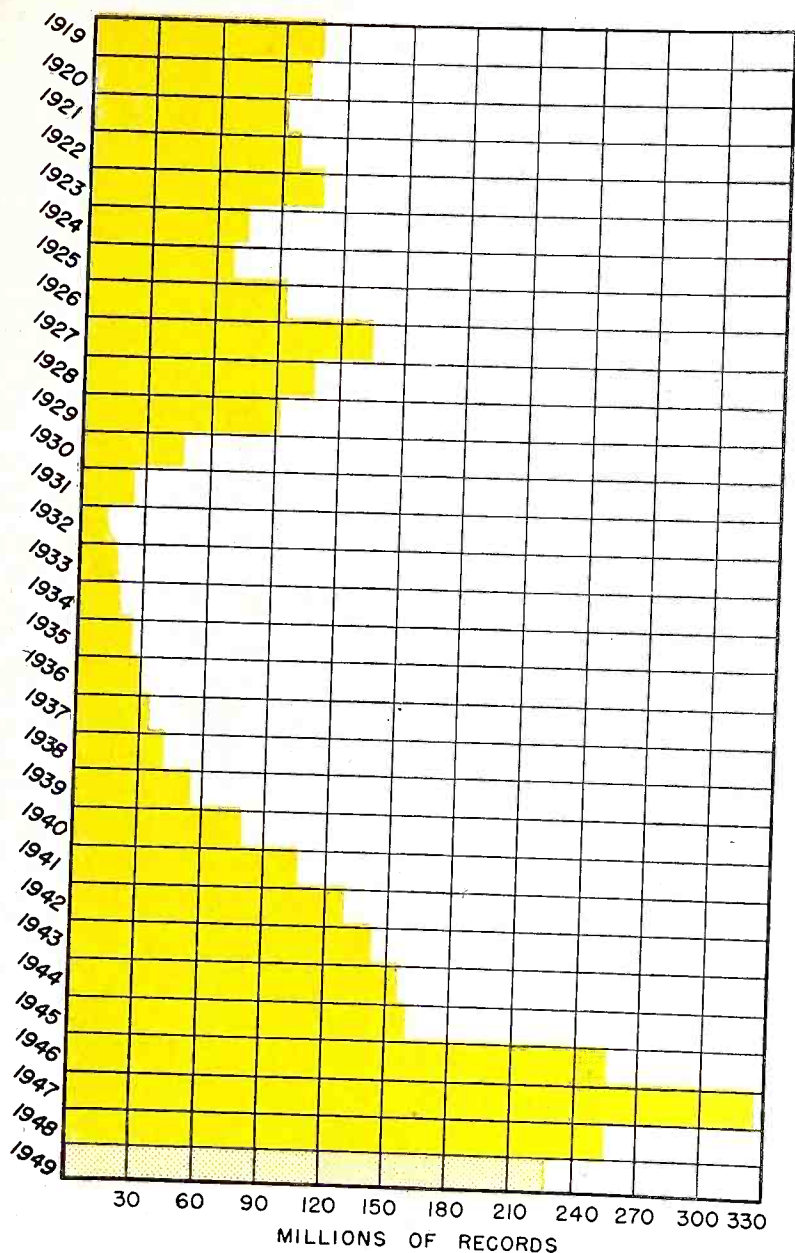

Phonograph record production figures from 1919 to present.

Despite Industry Ups and Downs, Future Looks Brighter—Large Sales Potential

• An America that is musically wide-awake is the key to the future of the recording industry. Despite the other additions to home entertainment facilities offered the public, such as radio and television, records will continue to be enjoyed by many millions of families.

The slogan, "Enjoy Life More With Music," is becoming more and more familiar to consumers throughout the United States as a result of the consistent publicity efforts of the American Music Conference in cooperation

with the National Association of Music Merchants. The efforts of these organizations in encouraging groups to play musical instruments, and to stimulate others in listening to and enjoying musical selections has been of inestimable value.

Other vital forces are at work for the dealer, constantly stimulating the public's desire for records, and encouraging musical interests. Schools, churches, civic groups, local clubs and national consumer magazines are all

doing an excellent job of fostering an interest in things musical. Traveling road shows of hit Broadway plays, personal appearances of concert artists, Metropolitan Opera Company troupes, entire symphonic orchestras visiting cities across the nation, appearance of ballet groups, the disc jockey and television are all helping to insure the future of the recording industry. Talk of planning homes with "entertainment centers" is frequently heard—and not only from decorators. A radio in every room is a familiar theme by now, and lately there has been more talk of extra phonographs for children, for the den, for the beach, etc. Retailers have found a growing awareness on the part of their customers to the advantages of making the home a place in which to live, to be entertained, and in which to relax.

In a recent issue of *RADIO & TELEVISION RETAILING*, record sales for the past thirty years were traced. The gradual rebirth of what had been a dormant disc-buying public—that culminated in the sale of 325 million recordings in 1947 clearly indicates a music-conscious buying public. Despite the leveling off to 225 million units, of all types, many popular records have already sold a million copies this year, and a few albums show promise of reaching that figure as well. Children's records account for almost 15% of total sales. Classical and serious music is more "popular" now, and more readily available to greater masses of people than at any time in history. Hill-billy discs, folk tunes with an international flavor and educational records are just a few of the many and varied types available.

Encourages Purchasers

The renewed flurry caused by the introduction of the new type recordings encouraged still more phonograph and record purchasers who were attracted to the new developments for reasons of greater fidelity, economy, unbreakability, and easy storage. Today, there are more players in use in homes than ever before. It is interesting to note that in the accompanying chart showing players in use in homes, the peak year for record sales in the '20's (1927), shows approximately 12 million phonographs in use. The 130,000,000 records sold represent about 10.8 records sold per player per year. Contrast this with the 250 million records sold in 1948 for

Records and Phonographs

21 million players in use, indicating that roughly 11.9 records were purchased for each player during that year. Note, too, that the actual purchase of records for home use greatly exceeds this 11.9 figure, since the 21 million players in use include juke boxes, broadcasting studios and other non-residential users.

The 1929 low in record sales was brought about by many things—the considerable growth of radio as well as the Depression, among them. Experts seem convinced that no such similar catastrophe will befall the record business again. Availability of the various types of record players in today's market, plus the consistent "plugging" of both popular and classical music on all sides, will continue to make communities and the people who live in them more record conscious.

Some dealers in television areas have reported that video had an immediate and quite serious effect on record sales, but report that after a while interest in platters picked up again.

More Players in Use

Record players in homes have more than doubled in number since the war. For the last three years we have been adding record players to homes at the rate of about 3 to 4 million a year. These have been bought by the public in console combinations, table combination, phono-amplifier units, radio-attachment units and portables. Dealers are consequently aware that there are many more potential buyers today than there were in 1941, and certainly many times the number there were in 1927, when a mere 130 million records were sold in what was supposedly a "good" year.

Surveys have definitely shown that consumers with new phonographs are the heaviest buyers of records. Dealers have been encouraged by public interest aroused by the introduction of the new speed players, as well as by the inclusion of a turntable in most television consoles.

It is interesting to note that some 40 million families in the United States have approximately 77 million radios, or almost 2 per family. Phonographs in homes, on the other hand, have by no means approached any such proportions. The 18 million players in use in homes still allows less than one player for every two radio families in the country.

The introduction of new record playing equipment is another effort by the

manufacturers to keep up with the times, and the heightened musical perception of some segments of the listening public. Tracing the course of the phonograph from the cylindrical record to the streamlined version of today we find the industry continually striving for better quality—at times far out front of public demand. Not only were tonal improvements sought after, but mechanical ones as well. The record changer, for example, represents an attempt to provide more music without the necessity for tending the machine, and also, an answer to the public's growing interest in the longer, more serious recording works.

Edison's tin-foil machine made its appearance in 1876, and it wasn't until 1896 that flat discs started to appear. Mechanical phonographs were in vogue from 1896 to 1928. Although electrical recording and reproduction was known about in 1925, sets for use by the public did not appear in any quantity until 1928. Acoustical (mechanical) phonographs with spring-wound motors are still manufactured and are very popular for beach, farm, camp, kiddie players and other uses, as well as for the export market.

A glance at the record sales chart shows that it wasn't until 1934-35 when

electric phonographs became available at a low price, that record sales started to climb again.

Today's market shows a somewhat parallel situation, with manufacturers striving to keep prices of new players as low as possible. Attachments to existing equipment for the new speeds have been offered at reasonable prices; and two-speed and three-speed units are available to consumers at the same price formerly asked for a single speed unit. Prices for the new records, too, show decided advantages for the record purchasers, and are priced at less than the shellac disc.

Publicize Music

With the good work being done by organizations like the AMC and NAMM, recorded music will continue as an integral part of the American scene for a long time to come. A glance at the accompanying charts clearly shows what happened in the past, and that despite its ups and downs, the industry is still going strong. The millions of dollars being poured into new developments by leaders, and the tremendous advertising budgets allotted to pushing records are renewed evidences of the faith held by those who foresee bigger and better days ahead.

Production of mechanical and electrical phonographs for past 23 years.

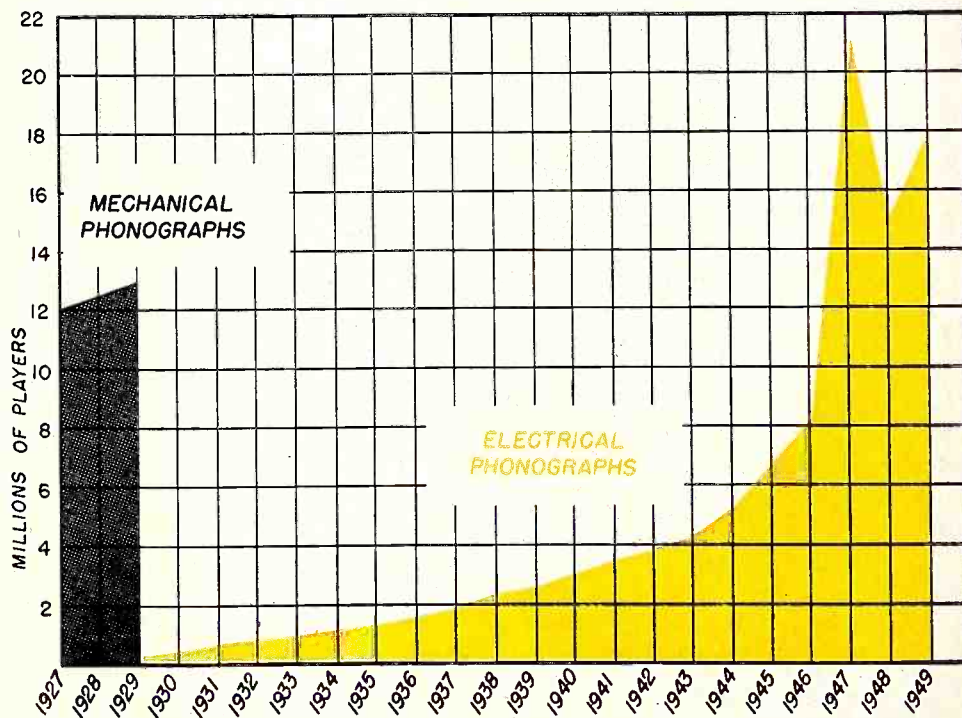



Irving Berlin watches Mary McCarty do a show-stopping song from his new musical, "Miss Liberty." Original cast has recorded stage version for what promises to be another Columbia "hit."



Pert Doris Day has been hitting the "top tunes" lists—particularly in duos with Buddy Clark.



Dinah Shore has proved to be one of the most versatile singers in Columbia's roster.



To his millions of fans, the name of Andre Kostelanetz synonymous with "melody."

Columbia

Top Performers Bring In

"Inimitable" is still the word for the all-time favorite—Bing Crosby.



Decca

Evelyn Knight has finally achieved the popularity she deserves with her current waxings.



Dick Haymes' renditions of love ballads have been steadily ringing the bell at the cash register; radio and movie work also help.



Continental →

Typical of the artists who perform for children, Scotty MacGregor's voice and style are well-liked by his listeners.

← MGM

His popularity still increasing, baritone Billy Eckstine's recordings have been best-sellers for MGM.





Jascha Heifetz's recordings, particularly of his concert favorites, are best-sellers.

Big publicity build-up given up-and-coming crooner Bill Lawrence, paying off in sales.

Fran Warren warbles "Wash that Man Right Outta My Hair." Note 45 RPM player on scene.

Conductor Serge Koussevitzky rehearsing for the Tanglewood Music Festival.

RCA Victor

Mercury

The "new" Vic Damone's song stylings have been meeting with increasing popularity.

Customers

• The array of artists pictured on these pages is by no means complete—for there are hundreds of other entertainment names that induce people to put down cold cash for their recordings.

Dealers know all too well that a good platter "sells itself," and that an artist is his own best salesman. But it is an obvious incentive to sales to have local window displays play up personal artist appearances in the vicinity. Whenever possible, distributors and publicity people will be glad to make arrangements for personal store appearances.

The availability of a particular artist on one of the new speeds is an important factor. Dealers are taking advantage of this situation to push the "Three Speeds Ahead" merchandising theme—urging customers to utilize both 45 RPM and 33 1/3 recordings, plus their 78 RPM equipment.



Mitchell Miller is a recording director for Mercury, and also a featured soloist.



Coral

Connie Haines has a way with a song that marks her for great things in the future.



The lively vocal antics of the Ames Bros. on the Coral label are tops.



Stan Kenton, left, and his "Artistry in Rhythm" orchestrations appeal to a select, but surprisingly large, audience. Margaret Whiting, right, a vocalist whose records appeal to a variety of buyers.

Capital

Peggy Lee started a string of hit songs with "Manana" - - all phenomenal.



New Phonographs and Equipment

As we went to press, some makers of combinations, phono players and phonograph equipment were not ready to announce new developments they are presently working on. Hence, they are not listed. Information on products of such manufacturers will appear in following issues.

RECORD PLAYERS AND CHANGERS	78 RPM	33 1/3 RPM	45 RPM	78 33 1/3 RPM	78 45 RPM	78 33 1/3 45 RPM
Admiral Corp., 3800 W. Cortlandt St., Chicago, Ill.						A*
Aero Metal Products Corp., 4704 W. Arthington St., Chicago 44, Ill.	A					
Aim Industries, 41 Union Sq., New York 3, N.Y.	M					A-M
Air Design, Inc., 241 Fairfield Ave., Upper Darby, Pa.	*	*	*	*	*	*
Air King Products Co., 170 53rd St., New York, N.Y.	A	A	A	A-M	A-M	A-M
Alamo Electronics Corp., 105 W. Romana, San Antonio 5, Texas.	A-M	A-M				
American Microphone Co., 370 So. Fair Oaks, Pasadena 1, Calif.		M	M			
Amplitone Corp., 1229 No. Broad St., Phila., Pa.	M			M		M
Andrea Radio Corp., 27-01 Bridge Plaza No., Long Island City 1, N.Y.						A-M*
Ansley Mfg. Co., Arthur, Doylestown, Pa.						M
Ansley Radio & Television, Trenton, N.J.						A*
Audar, Inc., Argos, Ind.	*	*	*	*	*	*
Audio Industries, Michigan City, Ind.	A		A	A		A
Audio-Master Co., 425 Fifth Ave., New York.				M	M	
Autocrat Radio Co., 3855 N. Hamilton Ave., Chicago 18, Ill.	A*		*			A*
Automatic Radio Mfg. Co., 122 Brookline Ave., Boston, Mass.	A-M*					
Beam Radionics Corp., 3700 Roosevelt Rd., Chicago 24, Ill.	A-M	M	A-M	A-M		A-M
Bell & Howell Co., 7100 McCormick Rd., Chicago 45, Ill.	M			M		
Bell Radio Co., 125 E. 46th St., New York 17, N.Y.						A*
Bell Sound Systems, Inc., 555 Marion Rd., Columbus 7, Ohio.	*	*	*			
Belmont Radio Corp., 5921 W. Dickens Ave., Chicago 39, Ill.			*			A-M*
Berger Recording, 109-01 72nd Rd., Forest Hills, Long Island, N.Y.	M					
Boetsch Bros., 221 E. 144 St., New York, N.Y.	A-M					A-M
Brunswick Radio & Television Div., Radio & Television, Inc., 244 Madison Ave., N.Y.C.	A*	A*	A*			
Calbest Sales Co., 828 N. Highland Ave., Hollywood 38, Calif.	A*	A*	A*			
Califone Corp., 1041 N. Sycamore, Hollywood 38, Calif.			A			M
Capitol Records, Inc., Sunset & Vine Sts., Hollywood 28, Calif.						
Carbonneau Industries, Grand Rapids, Mich.						A
Carron Mfg. Co., 741 West Harrison St., Chicago 7, Ill.	M	M	M	M	M	M
Colonial Radio Corp., 254 Rano St., Buffalo 7, N.Y.						*
Columbia Records, Inc., 1473 Barum Ave., Bridgeport, Conn.		M				
Crescent Industries, Inc., 4140 W. Belmont Ave., Chicago 41, Ill.	A*		A			
Crosley Div., Avco Mfg. Corp., 1329 Arlington, Cincinnati 25, Ohio.	A		A	A		A
DeWald Radio Mfg. Corp., 34-15 37th Ave., Long Island City, N.Y.	*			*		
DuMont Labs., Inc., Allen B., 1000 Main Ave., Clifton, N.J.			*	*		
Dynavox Corp., 40-05 21st St., Long Island City 1, N.Y.	A-M	M	M	M		A-M
Emerson Radio and Phonograph Corp., 111 Eighth Ave., New York 11, N.Y.			A			A-M
Espey Mfg. Co., 528 East 72nd St., New York 21.	*		*	*	*	*
Fada Radio & Electric Co., Belleville, N.J.	A	A	A	A	A	A
Fairchild Camera & Instrument Corp., 88-06 Van Wyck Blvd., Jamaica, N.Y.		M	M	M		M
Farnsworth Television & Radio Corp., Ft. Wayne, Ind.				A*		A*
Favorite Mfg. Co., 105 E. 12 St., New York, N.Y.	A-M		A			A
Federal Television Corp., 139 Duane St., New York 13, N.Y.	A*	A*	M*			A-M*
Fisher Radio Corp., 41 E. 47th St., New York 17, N.Y.	*					A*
Freed Radio Corp., 200 Hudson St., New York 13, N.Y.			A*	A-M*		
Garod Electronics Corp., 70 Washington St., Brooklyn 1, N.Y.				A*		A-M*

RECORD PLAYERS AND CHANGERS	78 RPM	33 1/3 RPM	45 RPM	78 33 1/3 RPM	78 45 RPM	78 33 1/3 45 RPM
Garrard Sales Corp., 315 Broadway, New York 7, N.Y.	A-M	A-M	A-M	A-M	A-M	A-M
Geib, Inc., 1751 N. Central Park Ave., Chicago 47, Ill.	M					
General Electric Co., Electronics Park, Syracuse, N.Y.	*			*		*
General Instrument Corp., 829 Newark Ave., Elizabeth 3, N.J.	A			A		A
Greene Mfg. Co., L. Charlton, Watertown 72, Mass.	A-M	A-M		A-M		A-M
Hamilton Electronics, 2726 Pratt Ave., Chicago 45, Ill.	*	*	*			
Hedco Mfg. Corp., 1282 Burke Ave., Bronx 67, N.Y.	M	M	A-M			M
Hoffman Radio Corp., 3761 So. Hill St., Los Angeles 7, Calif.	A*	A*	A*	A*		
Hollywood Electronics, 7460 Melrose Ave., Hollywood 46, Calif.	*			*		*
Hudson Electronics Corp., 110 East 3rd St., Mount Vernon, N.Y.	M	M	A-M	M	M	M
Industrial Television, Inc., 359 Lexington Ave., Clifton, N.J.			*	*		
Jewel Radio Corp., 10-40 45 Ave., Long Island City 1, N.Y.						A*
La Magna Mfg. Co., 51 Clinton Pl., E. Rutherford, N.J.	M					
Lavoie Laboratories, Morganville, N.J.			A			
Lincoln Engineering Co., 5701 Natural Bridge, St. Louis 20, Mo.						A
McGohan, Inc., Don., 3700 W. Roosevelt Rd., Chicago 24, Ill.	A	M	A	A-M*		A
Magnavox Co., Ft. Wayne 5, Ind.	A*	A*	A*	A*	A*	A*
Markel Electric Products, Inc., 145 Seneca St., Buffalo 3, N.Y.	A			A		A
Meck Industries, Inc., John, Plymouth, Ind.						M
Milwaukee Stamping Co., 800 So. 72nd St., West Allis 14, Wis.	A	A	A	A	A	A
Motorola, Inc., 4545 W. Augusta St., Chicago 51, Ill.			*			A*
MP Concert Installations, Fairfield 10, Conn.	*	*	*			
National Acoustic Products, 120 N. Green St., Chicago 7, Ill.	A		A	A	A	A
National Polytronics, Inc., 2430 Atlantic Ave., Brooklyn 33, N.Y.						M*
Newport Steel Corp., Radio Div. 1501 Beard Ave., Detroit 9, Mich.	A					
North Eastern Radio Co., 799 Broadway, New York 3, N.Y.	M					A-M*
Oak Mfg. Co., 1260 Clybourn Ave., Chicago 10, Ill.	A		A	A		
Orthon Corp., 196 Albion Ave., Paterson 2, N.J.	A-M*					
Peerless Television & Radio Co., 6508 Euclid Ave., Cleveland 3, Ohio.	M*	*	*	M		
Pentron Corp., 611 W. Division St., Chicago 10, Ill.	M*					A-M
Philco Corp., Tioga & C Sts., Philadelphia 34, Pa.	A*	M*		A*		
Plaza Mfg. Co., 869 Broadway, New York 3, N.Y.	A-M	A-M	A-M	M		A-M
Presto Recording Corp., P. O. Box 500, Hackensack, N.J.	M	M	M	M	M	M
Radio Corp. of America, RCA Victor Div., Front & Cooper Sts., Camden, N.J.	A*		A*	A*		
Radio-Music Corp., 84 So. Water St., Port Chester, N.Y.	M	M		M		
Raydyne Mfg. Corp., 347 E. 22nd St., Paterson, N.J.	*	*	*	*	*	*
Remler Co., 2101 Bryant St., San Francisco 10, Calif.	*		*			*
Robinson Recording Labs., 35 So. 9th St., Philadelphia 7, Pa.			*			*
Sandwich-Bowen Corp., 4712 Bethesda Ave., Bethesda, Md.		M	A	M		
Scott Radio Laboratories, 4541 Ravenswood, Chicago, Ill.	A*					M* A*
Sentinel Radio Corp., 2100 Dempster St., Evanston, Ill.			*			*
Setchell Carlson, Inc., 330 Fifth Ave., New Brighton, Minn.	A					
Shevers, Inc., Harold, 33 W. 46th St., New York City 19, N.Y.						*

Code: A—Automatic; M—Manual; "A" or "M" with asterisk—Unit made separate and in instruments; Asterisk alone—Only available in instruments.

RECORD PLAYERS AND CHANGERS	78 RPM	33 1/3 RPM	45 RPM	78 33 1/3 RPM	78 45 RPM	78 33 1/3 45 RPM
Simpson Mfg. Co., Inc., Mark, 32-28 49th St., Long Island City, N. Y.	A*	A*	A*	A*		A*
Sonic Industries, Inc., 221 W. 17th St., New York 11, N. Y.	A-M		A-M			A-M
Sound Engineering Laboratories, 2325 Madison Ave., Toledo, Ohio						A-M
Sparton Radio Television Div., Sparks-Withington Co., Jackson, Mich.	*		*			*
Speak-O-Phone Recording & Equip. Co., 23 West 60th St., New York 23, N. Y.	M			M		
Stark Sound Engineering Corp., 2131 Fairfield Ave., Ft. Wayne, Ind.	A-M*	A*	A-M*			A*
Starrett Television Corp., 601 W. 26th St., New York 1, N. Y.			A*	A*		A*
Steelman Radio Corp., 742 E. Tremont Ave., New York 57, N. Y.	A-M	A-M	A-M	A-M	A-M	A-M
Stewart-Warner Electric Div., Stewart-Warner Corp., 1826 Diversey Parkway, Chicago 14, Ill.	A-M*	A-M*	A*	A-M*		A-M*
Stromberg-Carlson Co., 100 Carlson Rd., Rochester 3, N. Y.	A*		A*	A*		
Symphonic Radio & Electronic Corp., 292 Main St., Cambridge 42, Mass.	A-M	A-M	A-M	A	A-M	A
Symphony Radio & Television Corp., 825 W. Pico Blvd., Los Angeles 15, Calif.						A*
Toman & Co., Inc., E., 2621 W. 21st Pl., Chicago 8, Ill.	*					
Tele-tone Radio Corp., 540 W. 58th St., New York 19, N. Y.	M					
Trav-Ler Radio Corp., 571 W. Jackson Blvd., Chicago 6, Ill.	A*					
Trylon Radio Laboratories, 1140 N. American, Philadelphia 23, Pa.	A-M*	A-M*	A-M*	A-M*	A-M*	A-M*
U. S. Television Mfg. Corp., 3 W. 61st St., New York 23, N. Y.				A*		
Video Corp. of America, 229 W. 28th St., New York 1, N. Y.						*
V-M Corp., Benton Harbor, Mich.						A-M
Waters Conley Co., 501 First Ave., N. W., Rochester, Minn.	A-M	A	A-M			A-M
Webster-Chicago Corp., 5610 Bloomingdale Ave., Chicago 39, Ill.	A	A		A	A	A
Wells Gardner & Co., 2701 No. Kildare Ave., Chicago 39, Ill.	*		*	*		*
Western Sound & Elect. Labs., 805 S. 5th St., Milwaukee 4, Wisc.	*	*		*		*
Westinghouse Electric Corp., Home Radio Div., Sunbury, Pa.	*			*		*
Wilcox-Gay Corp., Charlotte, Mich.	A-M*					A-M*
Zenith Radio Corp., 6001 W. Dickens Ave., Chicago 39, Ill.			A			*

MOTORS, Turntable

Alliance Mfg. Co., Alliance, Ohio	✓	✓	✓	✓		✓
Audio Industries, Michigan City, Ind.	✓			✓		✓
Beam Radionics Corp., 3700 Roosevelt Road, Chicago 24, Ill.	✓	✓	✓	✓		✓
Carron Mfg. Co., 741 W. Harrison St., Chicago 7, Ill.	✓					
Empire Radio, 125 E. 46th St., New York, N. Y.	✓	✓				
General Industries Co., Elyria, Ohio	✓	✓	✓	✓	✓	✓
General Phonograph Mfg. Co., Putnam, Conn.	✓	✓	✓	✓	✓	✓
LaMagna Mfg. Co., 51 Clinton Pl., E. Rutherford, N. J.	✓					
Radio-Music Corp., 84 S. Water St., Port Chester, N. Y.	✓	✓		✓		
Rek-O-Kut Co., 38-01 Queens Blvd., Long Island City 1, N. Y.				✓	✓	✓
Russell Electric Co., 4501 S. Western Blvd., Chicago 9, Ill.	✓	✓	✓	✓	✓	✓
Symphonic Radio & Electronic Corp., 292 Main St., Cambridge 42, Mass.	✓	✓	✓		✓	
Symphony Radio & Television Corp., 825 W. Pico Blvd., Los Angeles 15, Calif.						✓

PICKUPS

Airdesign, Inc., 241 Fairfield Ave., Upper Darby, Pa.	✓	✓	✓	✓	✓	✓
Astatic Corp., Conneaut, Ohio	✓	✓	✓	✓	✓	✓
Audak Co., 500 5th Ave., New York 18, N. Y.	✓	✓	✓	✓	✓	✓
Automatic Radio Mfg. Co., 122 Brookline Ave., Boston, Mass.	✓					
Barber & Howard, Westerly, R. I.	✓	✓				
Caltron Products Co., 1406 S. Hobart Blvd., Los Angeles 8, Calif.	✓			✓	✓	
Clarkstan Corp., 11927 West Pico Blvd., Los Angeles 34, Calif.	✓	✓	✓	✓	✓	✓
Electro-Voice, Inc., Buchanan, Mich.	✓	✓	✓	✓	✓	✓
Fairchild Camera & Instrument Corp., 88-06 Van Wyck Blvd., Jamaica 1, N. Y.	✓	✓	✓	✓	✓	✓
Garrard Sales Corp., 315 Broadway, New York 7, N. Y.	✓					✓
General Electric Co., Electronics Park, Syracuse, N. Y.	✓	✓	✓			
Magnavox Co., Ft. Wayne 5, Ind.						✓

PICKUPS

	78 RPM	33 1/3 RPM	45 RPM	78 33 1/3 RPM	78 45 RPM	78 33 1/3 45 RPM
Milwaukee Stamping Co., 800 So. 72nd St., West Allis 14, Wis.	✓	✓	✓	✓	✓	✓
MP Concert Installations, Fairfield 10, Conn.	✓	✓		✓		
Pentron Corp., 611 W. Division St., Chicago 10, Ill.						✓
Pickering & Co., Inc., 309 Woods Ave., Oceanside, N. Y.	✓	✓	✓			
Radio Corp. of America, RCA Victor Div., Front & Cooper Sts., Camden, N. J.	✓		✓			
Radio-Music Corp., 84 So. Water St., Port Chester, N. Y.	✓	✓		✓		
Recoton Corp., 251 Fourth Ave., New York 10, N. Y.	✓	✓	✓			✓
Robinson Recording Labs., 35 So. 9th St., Philadelphia 7, Pa.				✓		
Shure Bros., Inc., 225 W. Huron St., Chicago 10, Ill.	✓	✓	✓			✓
Sonotone Corp., Elmsford, N. Y.	✓	✓	✓	✓	✓	✓
Sound Projects Co., 2810 W. Harrison St., Chicago 12, Ill.	✓					
Symphony Radio & Television Corp., 825 W. Pico Blvd., Los Angeles 15, Calif.						✓
E. Toman & Co., 2621 W. 21st Place, Chicago 8, Ill.	✓					
U. S. Television Mfg. Corp., 3 W. 61st St., New York 23, N. Y.				✓		
Webster Electric Co., 1900 Clark St., Racine, Wisc.	✓	✓	✓	✓	✓	✓

NEEDLES

Acton Co., H. W., 370 Seventh Ave., New York 1, N. Y.	✓	✓	✓	✓	✓	✓
Aero Needle Co., 619 N. Michigan Ave., Chicago 11, Ill.	✓					
Aim Industries, 41 Union Sq., New York 3, N. Y.	✓					✓
Astatic Corp., Conneaut, Ohio	✓	✓	✓	✓	✓	✓
Audak Co., 500 5th Ave., New York 18, N. Y.	✓	✓				
Audio Devices, Inc., 444 Madison Ave., New York, N. Y.	✓	✓	✓			
Bonot Co., 114 Manhattan Street, Stamford, Conn.	✓	✓	✓			
Caltron Products Co., 1406 S. Hobart Blvd., Los Angeles 8, Calif.	✓			✓	✓	
Clarkstan Corp., 11927 West Pico Blvd., Los Angeles 34, Calif.	✓	✓	✓	✓	✓	✓
Columbia Records, Inc., 1473 Barnum Ave., Bridgeport, Conn.		✓				
Duotone Co., 799 Broadway, New York 3, N. Y.	✓	✓	✓	✓	✓	✓
Electro-Voice, Inc., Buchanan, Mich.	✓	✓	✓	✓	✓	✓
Electrovox, Inc., 60 Franklin St., East Orange, N. J.	✓	✓	✓			
Emerson Radio and Phonograph Co., 111 Eighth Ave., New York 11, N. Y.	✓					
General Industries Co., Elyria, Ohio	✓					
General Phonograph Mfg. Co., Putnam, Conn.	✓					
Industrial Sapphire Corp., Quakertown, Pa.	✓	✓	✓			
International Merit Products Corp., 4574 Broadway, New York 34, N. Y.	✓					
Jensen Industries, Inc., 329 S. Wood St., Chicago 12, Ill.	✓	✓	✓	✓	✓	✓
JFDMfg.Co., 6101 16th Ave., Brooklyn 4, N. Y.	✓					
Miles Reproducer Co., 812 Broadway, New York 3, N. Y.	✓	✓	✓	✓	✓	✓
Miller Mfg. Co., M. A., 1169 E. 43rd St., Chicago 15, Ill.	✓	✓	✓	✓	✓	✓
National Hollywood, 1475 E. Mirador Dr., Pasadena 2, Calif.	✓	✓	✓	✓	✓	✓
Permo, Inc., 6415 Ravenswood, Chicago 26, Ill.	✓	✓	✓			
Pfanstiehl Chemical Co., 104 Lake View Ave., Waukegan, Ill.	✓	✓	✓			
Phileo Corp., Tioga & C Sts., Philadelphia 34, Pa.	✓	✓				
Pickering & Co., Inc., 309 Woods Ave., Oceanside, N. Y.	✓	✓	✓			
Radio Corp. of America, RCA Victor Division, Front & Cooper Sts., Camden, N. J.	✓		✓			
Recordisc Corp., 395 Broadway, New York 13, N. Y.	✓					
Recoton Corp., 251 Fourth Ave., New York 10, N. Y.	✓	✓	✓			
Speak-O-Phone Recording & Equip. Co., 23 West 60th St., New York 23, N. Y.	✓	✓				
Stark Sound Engineering Corp., 2131 Fairfield Ave., Ft. Wayne, Ind.	✓					
Symphony Radio & Television Corp., 825 W. Pico Blvd., Los Angeles 15, Calif.						✓
Tetrad Corp., 60 N. Broadway, Yonkers, N. Y.	✓	✓	✓			
Walco, Inc., 60 Franklin St., E. Orange, N. J.	✓	✓	✓			
Webster-Chicago Corp., 5610 Bloomingdale Ave., Chicago 39, Ill.	✓	✓	✓			
Webster Electric Co., 1900 Clark St., Racine, Wisc.	✓	✓	✓	✓	✓	✓
Wilcox-Gay Corp., Charlotte, Mich.	✓	✓	✓			

Code: A—Automatic; M—Manual; "A" or "M" with asterisk—Unit made separate and in instruments; Asterisk alone—Only available in instruments.

Dough in Do, Re, Mi!

(Continued from page 57)

Manufacturer	Booth	Room
RCA Victor Div. of Radio Corp. of America, Front & Cooper Sts., Camden, N. J.	1	Mezz. Rooms 719, 720
Raydyne Mfg. Corp., 347 E. 22 St., Paterson, N. J.	83	
Record Guild of America, 882 Third Ave., Brooklyn, N. Y.	86	
Recoton Corp., 251 Fourth Ave., New York 10, N. Y.	22	
Regal Electronics Corp., 603 W. 130 St., New York 27, N. Y.	83	709, 710
Remle' Musical Products, Inc., Box 1750, Hollywood, Calif.		538
John H. Reuther, 311 Washington Ave., Brooklyn 5, N. Y.		510
Rippen Pianofabrik, Bilderdijkstraat 45, Den Haag, Holland		950, 951, 952
Rowe Industries, 1702 Wayne St., Toledo 9, Ohio		646
Rudolph Wurlitzer Co., DeKalb, Ill.		945, 946
Russi Musical Instruments, 214-17 41st Ave., Bayside, L. I.	79	507
St. Louis Music Supply Co., Inc., 440 Delmar Blvd., St. Louis 8, Mo.		524
Herman Savner & Son, 117 No. Wabash Ave., Chicago 2, Ill.		817
Savoy Regent Pop Records, 58 Market St., Newark, N. J.	89	
Schaff Piano String Corp., 2021 Clybourn Ave., Chicago 14, Ill.		953
Scherl & Roth, Inc., 2845 Prospect Ave., Cleveland 15, Ohio		540
Scott Radio Labs., Inc., 4541 No. Ravenswood Ave., Chicago 40, Ill.		701
Seaburg Mfg. Co., 250 Crescent St., Jamestown, N. Y.	33	
H. & A. Selmer, Inc., No. Main St., Elkhart, Ind.		623
Joseph Shale, 140 East Ave., Rochester 4, N. Y.		845
Mark Simpson Mfg. Co., 32-28 49 St., Long Island City 3, N. Y.	98	
Six Brothers Piano Co., 2309 So. Michigan Chicago, Ill.		964
Slingerland Drum Co., 1325 Beldon Ave., Chicago 14, Ill.		541
H. Foyer Smith Co., 10th & Walnut St., Philadelphia 7, Pa.		716
Sohmer & Co., Inc., 31 W. 57 St., New York 19, N. Y.		832
Sonic Industries, Inc., 221 W. 17 St., New York 11, N. Y.	113	
Sonola Accordion Co., 7 Cardinal Hayes Place, N. Y. C., N. Y.		948
Sorkin Music Co., Inc., 251 Fourth Ave., New York 10, N. Y.		639, 640, 641
The Starr Piano Co., Inc., So. 1st & A.B.C. & D. Sts., Richmond, Ind.		846
Starrett Telev. Corp., 601 W. 26 St., N.Y.C.	71, 74	
Steelman Radio Corp., 742 E. Tremont Ave., New York 57, N. Y.	25	717, 805, 806, 807
Story & Clark Piano Co., 64 E. Jackson Blvd., Chicago 4, Ill.		741, Parlor G
Stromberg-Carlson Co., 100 Carlson Road, Rochester 3, N. Y.		
Symphonic Radio & Electronic Corp., 329 Main St., Cambridge, Mass.	97	
Synthetic Plastics Sales Co., 461 8th Ave., New York, N. Y.	8	
Targ & Dinner, Inc., 425 So. Wabash Ave., Chicago 5, Ill.		636, 637
Tele King Corp., 601 W. 26 St., New York 1, N. Y.		704
Henry Teller & Son, Inc., 5490 Dorchester Ave., Chicago 15, Ill.		539
Tonk Mfg. Co., 1912 No. Magnolia Ave., Chicago 14, Ill.		808, 954
Trio Art Piano Co., 1940 Market St., Phila.		
"Uniforms By Ostwald," Inc., 73 Henry St., Staten Island 1, N. Y.	114	
U. S. Musical Merchandise Corp., 1658 Broadway, New York 19, N. Y.		522
The Vega Co., 155 Columbus Ave., Boston 16, Mass.		643
Vega-Vox, Ltd., 155 Columbus Ave., Boston 16, Mass.		744, 745
Waters Conley Co., Rochester, Minn.	91	
Weaver Piano Co., Inc., Broad & Walnut Sts., York, Pa.		812
Webster-Chicago Corp., 5610 W. Bloomingdale Ave., Chicago 39, Ill.		703
W. F. L. Drum Co., 1728 No. Damen Ave., Chicago 47, Ill.		543
David Trexler & Co., 1243 So. Wabash Ave., Chicago 5, Ill.		525, 526
Walco Products, Inc., 60 Franklin St., East Orange, N. J.	37	
The H. N. White Co., 5225 Superior Ave., Cleveland 3, Ohio		647
Winter & Co., 836 E. 141 St., New York 54, N. Y.		818, 819, 820, 821, 822, 823
Zenith Radio Corp., 6001 W. Dickens Ave., Chicago 39, Ill.		705, 706
Avedis Zildjian Co., 39 Fayette St., No. Quincy 71, Mass.		523

Music Industry Trade Show Program

July 25 - 28, 1949
Hotel New Yorker, New York City

TUESDAY, JULY 26

MANAGEMENT FORUM — 9:30 - 11:00

Chairman: Ray S. Erlandson, Vice-Pres. (NAMM); Vice-Pres. and Gen. Manager, San Antonio Music Co.

"Retailer's Role in the Nation's Capital"

Rowland Jones, Jr., President, American Retail Federation, Washington, D. C.
Mr. Jones reviews the Washington scene, emphasizing Legislative action.

"Good Employees, A Program, Incentive—Road to Profit!"

Clarence Pettit, Manager, Music Dept., R. H. Macy & Co., New York City
Veteran dealer Pettit discusses proper selection of personnel employee advancement program and incentives to attract new personnel.

MARKETING FORUM — 11:00 - 12:30

Chairman: Harry E. Callaway, Vice-Pres., Thearle Music Co., San Diego, Calif.

"Is Your Sales Force Producing?"

Ver Lynn Sprague, Merchandise Consultant to Motorola, Inc.
Mr. Sprague outlines importance of sales presentation, follow-through and presentation of merchandise by salesmen.

"Working at the Grass Roots"

Forrest McCallister, Director of Community Service, AMC. AMC slide film shown.

"Making Advertising Dollars Pay"

Donald W. Hobart, Research Director, Curtis Publishing Co., Philadelphia, Pa.
Importance of advertising in relation to the merchandising and promotion of musical merchandise. Special pointers on local tie-ins.

THURSDAY, JULY 28

MERCHANDISING FORUM — 9:30 - 11:00

Chairman: Stuart D. Julius, NAMM Director, Julius Music House, York, Pa.

"Selling Music to the Home"

Richard A. Hoefler, Publisher, House Beautiful Magazine
Review of August issue of House Beautiful, devoted entirely to music.

"AMC Working in Your Store" Sound-Slide Film

Premiere of film covering subject of how to expand community music school programs. Discussion of "mobile" selling methods.

RECORDS AND TELEVISION — 11:00 - 12:30

Chairman: Ted Korten, NAMM Director, Korten's, Longview, Washington

"The Dual Market in Television" Selling of table model and console TV sets.
John W. Craig

"Evolution in Records"

Edward Wallerstein, Chairman of Board, Columbia Records, Inc.
J. B. Elliott, Vice-Pres., charge of Consumer Products, RCA Victor Corp.
Objective discussion of 33 1/3 and 45 rpm recordings—with time provided for plenty of questions from the floor.

45



The industry is

on the march

45 rpm...The completely new system of
recorded music that's setting a new standard
both in performance and in selling power!

rpm



Model 9W103—FM and AM radio, a big 12-inch speaker, plus the exciting new 45 rpm system of recorded music. Distinctively modern . . . beautifully finished in limed oak, walnut, or mahogany. The cabinet stores 33 hours of recorded music—189 singles or 24 of the new albums.



Model 9W105—A console with AM and static-free FM radio with a powerful 12-inch speaker . . . 78 rpm record changer plus the new 45 rpm system of recorded music. Mahogany, walnut or blond-finished cabinet has ample storage for records . . . 7-, 10- and 12-inch.

The new Victrola 45

In value and performance, the most sensational phonograph

Model 9EY3—Smartly styled, compact RCA Victor Player in a rich maroon plastic cabinet with distinctive, gold-color trim. Here is a complete phonograph to offer your customers the advantages of 45 rpm system at an amazingly low price.

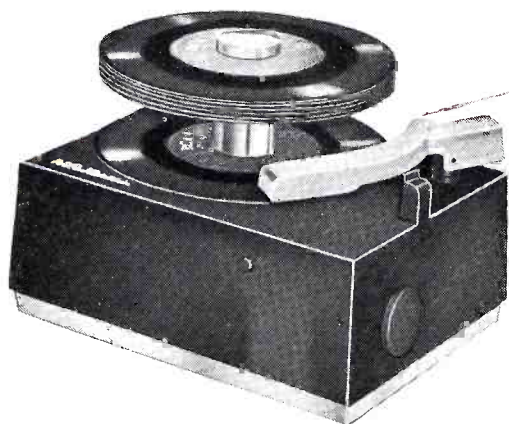
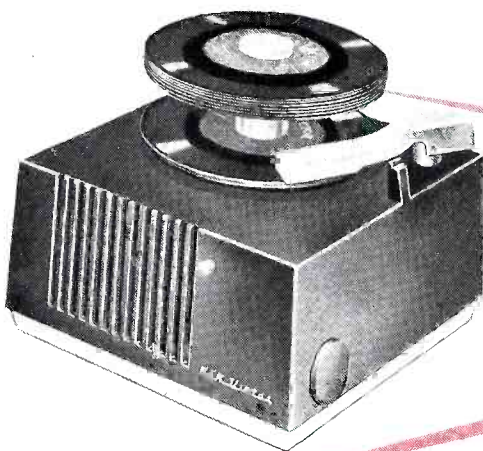

Model 9JY—Easily attached to any make of radio, phonograph or television combination, this fully automatic new RCA Victor player brings your customers the new distortion-free recordings—playing up to 10 sides without need of attention—at a new low price!



Model 9W101 — Superb FM-AM radio . . . and the new 45 rpm system of recorded music. Rich traditional cabinet of attractive walnut or lovely mahogany finish. Storage for 216 singles or 24 albums . . . more than 38 hours of this great new listening pleasure.

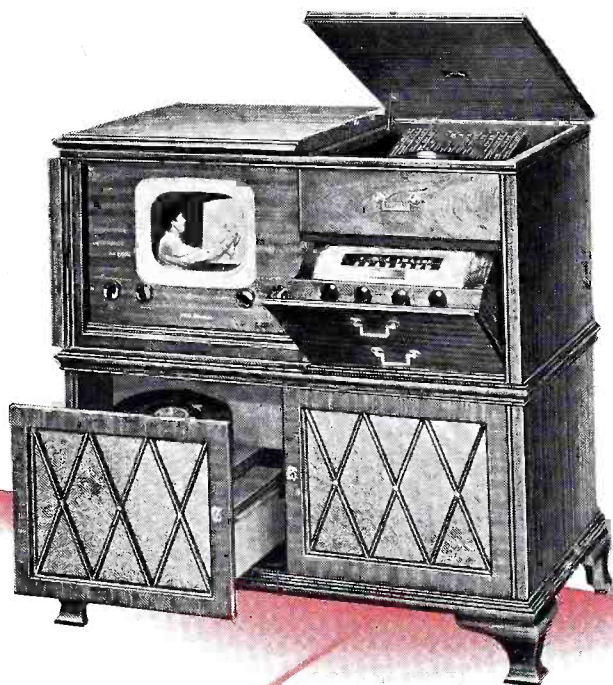

Model 9TW333 — RCA Victor Eye Witness Television, FM-AM radio, 78 rpm automatic changer for 10- and 12-inch records, plus the new 45 rpm system of recorded music. Walnut, mahogany or blond-finished cabinet with generous storage space for 7-inch records.

om Instruments

phs and combinations ever offered by RCA Victor

Model 9Y7 — The most amazing table combination ever offered. Imagine . . . an automatic record changer . . . powerful Standard Band radio plus storage space for as many as 60 playing sides —all in one compact table model. Finished in walnut, mahogany or blond.

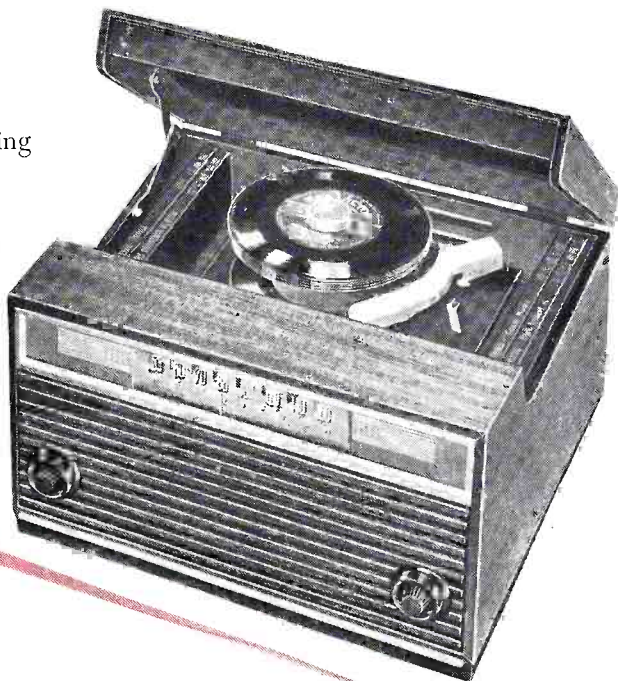

All with the exclusive
**"Golden Throat" tone system—finest
 in RCA Victor history!**

"Victrola"—T. M. Reg., U. S. Pat. Off.



**MORE PAGES
 ON 45 RPM**



Music in a finer groove...

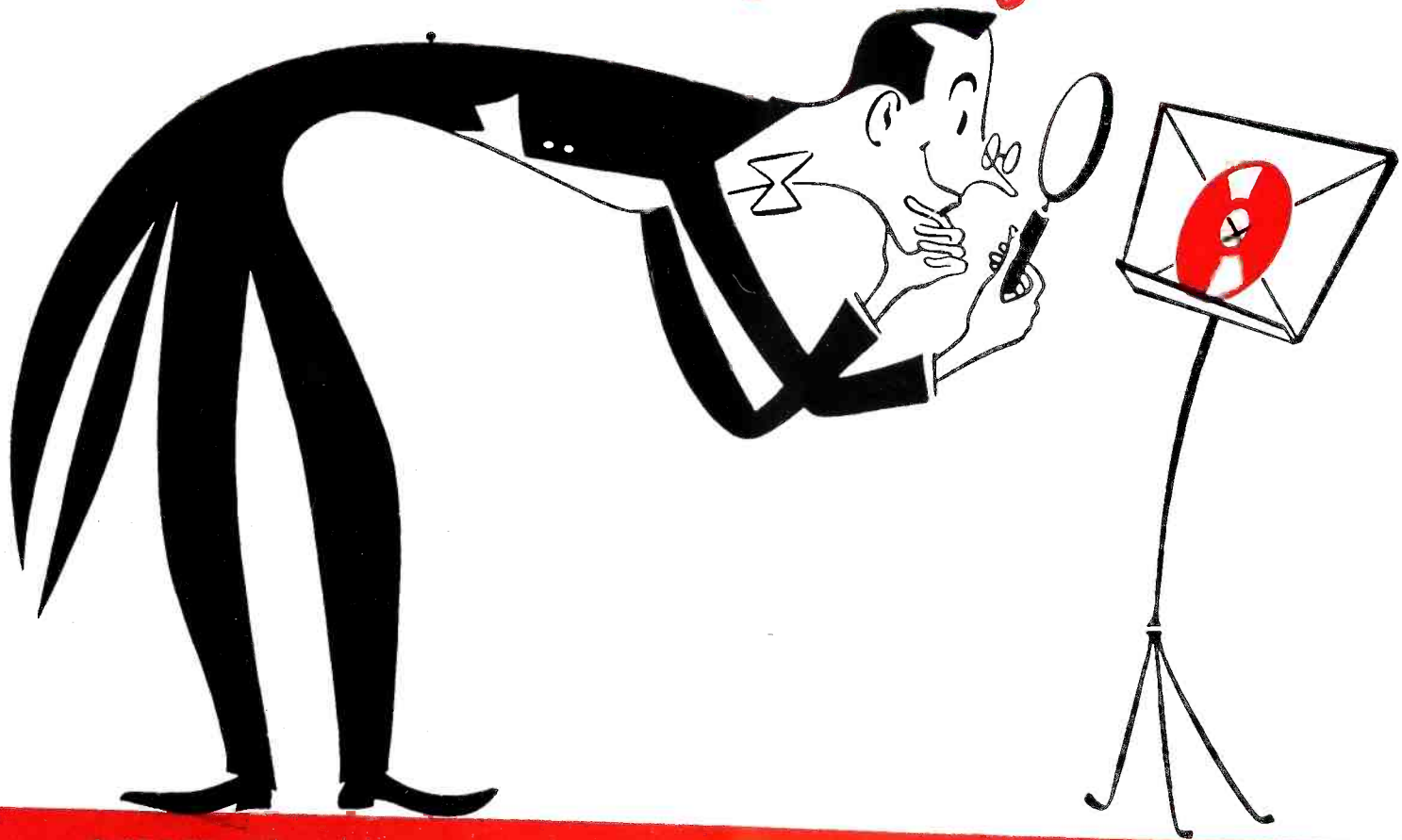

ONLY VINYLITE BRAND PLASTIC OFFERS THESE

Never miss the highs



High notes reproduced on conventional record surfaces are often accompanied by blurring needle scratch. The virtually silent surface provided by VINYLITE Plastic gives you music of supreme clarity even when your record player is set to reproduce every high.

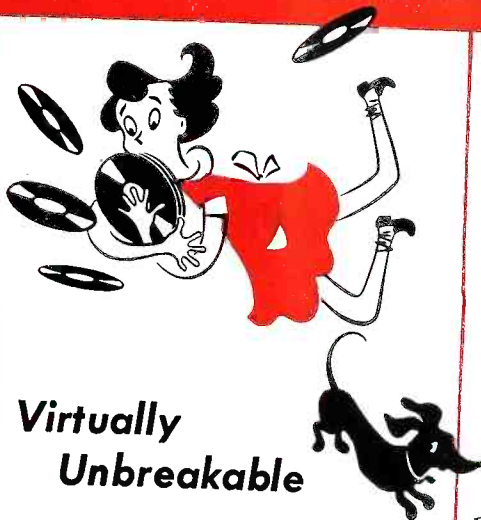

Virtually Unbreakable

Mishaps can be shattering experiences when they happen to precious recordings. That's why more and more enthusiasts are building their libraries with virtually accident-proof records of VINYLITE Plastic. This amazing material is almost non-breakable.

Less Surface Noise

The matchless surface provided by VINYLITE Plastic allows the pick-up to glide effortlessly in the groove... enables your record player to reproduce every note without distortion.



on records of **VINYLLITE Plastic!**

TRADE-MARK

The brilliant reproduction, reasonable cost and easy storage of the new RCA Victor 45 rpm records produced on VINYLLITE Brand Plastic are being hailed by music lovers everywhere.

Remember, this newest advance in recording technique could not have come about without VINYLLITE Plastic. Only this most nearly perfect of all recording materials provides the faithful master reproduction, easy moldability, long wear and unusually low noise level that makes possible the new techniques developed to compress the playing time of a standard 12-inch record into the "quality zone" of the wafer-thin 7-inch record. Of course, like all records of VINYLLITE Plastic they are virtually unbreakable . . . resist buckling and warping. In addition, because VINYLLITE Plastic comes in a range of rainbow hues, RCA has introduced a new system of color identification that helps in selecting the wanted type of music at a glance.

RCA Victor 45 rpm releases are coming thick and fast now. Your customers will want to hear them—and the other fine records produced on VINYLLITE Plastic. Pronounce the trade-mark "Vine-na-lite."

BAKELITE CORPORATION
Unit of Union Carbide and Carbon Corporation **UCC**
30 East 42nd Street, New York 17, N. Y.

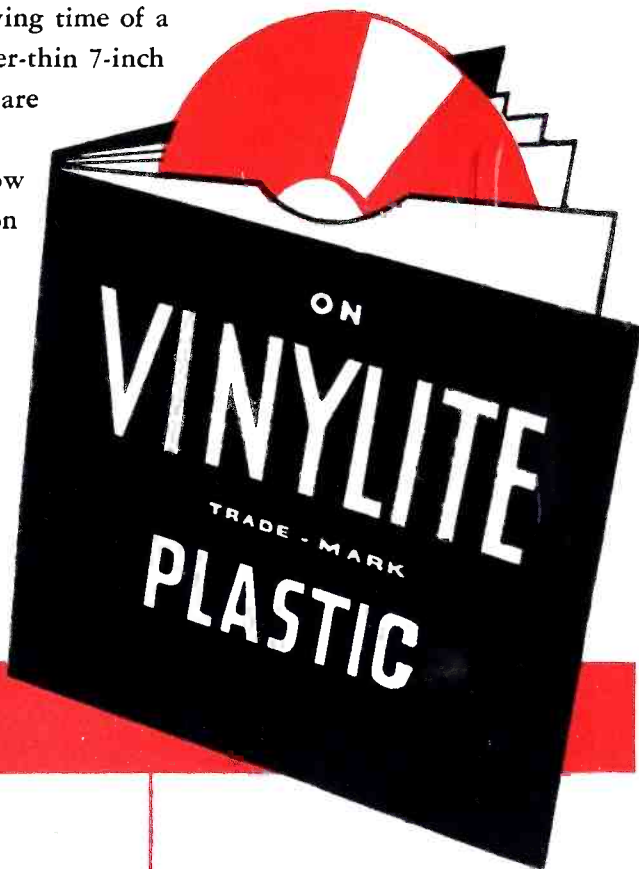

FINE QUALITY FEATURES

Non-warping

No longer must records be guarded like fragile china—kept like precious jewels. Records of VINYLLITE Plastic bend without breaking. That means fewer storage problems . . . records that can take the tussle of everyday living.



Matchless Fidelity

Records of VINYLLITE Plastic practically remove all barriers between the listener and the enjoyment of music. So superlative is their fidelity that VINYLLITE Plastic has been adopted almost exclusively for radio transcription—the severest test of all!

Longer Lasting

Records of VINYLLITE Plastic resist the passage of time . . . even after hundreds of playings their surface noise is less than that of many new records produced on conventional materials.





Century Presents...

SEE US AT
BOOTHS 40-41
NAMM SHOW

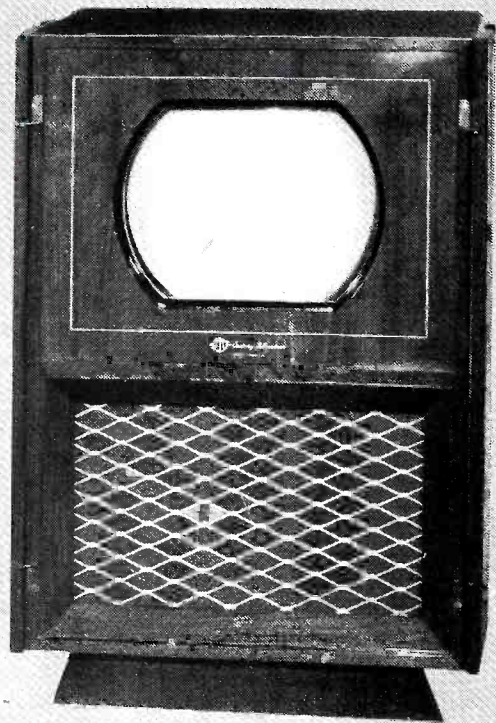
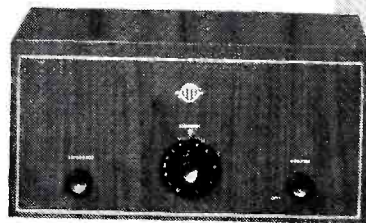

the Magic of Remote Control

16-INCH REMOTE CONTROL: THE SET THAT LETS YOU SIT

There's magic in the words Remote Control, and now you can use that magic to bring the *buying public* into your store. For good demonstrations are the key to your sales—and never before has there been a demonstrator like the Century Model 326.

The central knob selects your pre-tuned channels. The other two adjust contrast and volume. Controlled from any desired distance, from a comfortable viewing position . . . *it's like a magic wand!*

UNIT CONSTRUCTION—Here is the construction method of the future. The "326", shown above, has four separate chassis for separate functions: One for the remote control unit. One for video amplification and synchronizing circuits, as well as the accelerating voltage supply. One for the audio amplifying function. And one for the power supply chassis. This

method of construction means less servicing, and quicker, easier servicing should it be necessary. The small connecting cable meets all building codes.

OTHER FEATURES INCLUDE: Better picture quality, because you can adjust the picture from where you view it . . . A 16" screen, for graceful, room-sized groupings in comfortable chairs . . . Custom-built cabinets in either authentic Swedish Modern or traditional styles, in Korina, dark mahogany, or natural walnut . . . Wonderful tonal qualities from a 12" concert speaker that is mounted in an acoustically correct cabinet made with specially formed miters and high-frequency woodwelding techniques . . . Fine cabinetry at its hand-crafted best. Matched grains, hand-rubbed finishes and clean styling make the Century 326 "at home" with the best. Fine furniture to help you sell.



INDUSTRIAL TELEVISION INC.
359 Lexington Avenue
Clifton New Jersey

a Complete line

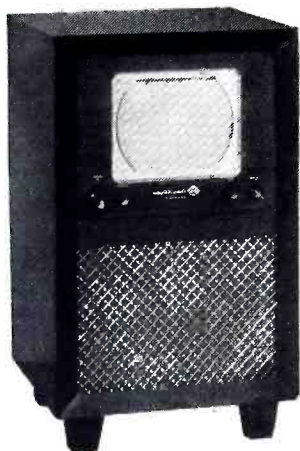

CENTURY'S "221" is the 12½" console. It is also available in modern or traditional styles.

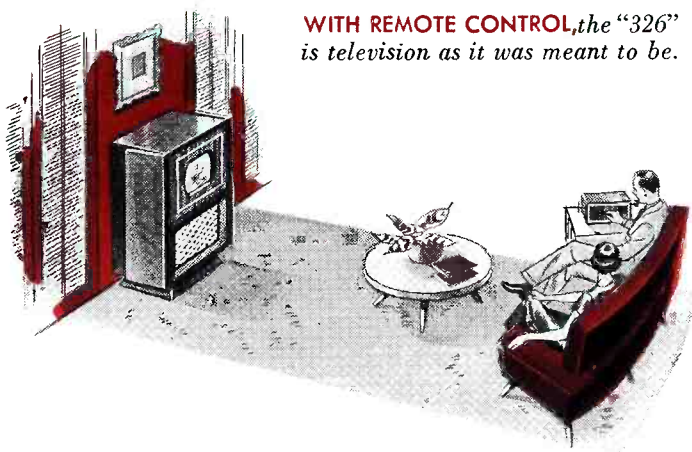

WITH REMOTE CONTROL, the "326" is television as it was meant to be.

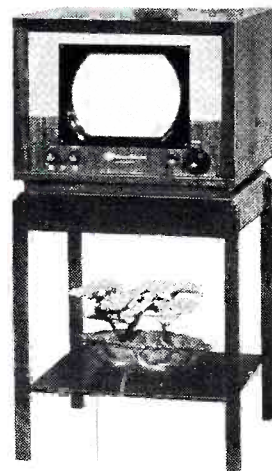

THE TABLE TOPPER or "521" has a 12½" screen and is one of the most popular Century models. It may be obtained with the table.

THE COMPLETE LINE

CENTURY TELECEIVERS for the home, in 12½" and 16" sizes and featuring the Century 326, a Remote Control Teleceiver.

INDUSTRIAL TELECEIVERS in 16" and 20" sizes for taverns, clubs and other commercial applications.

GUEST TELEVISION—a central control, multiple channel television system used in hotels and hospitals.

STATION MONITORS for TV studio and other monitoring uses.

MULTIVISION ANTENNA SYSTEMS for multiple dwellings and retail stores.

UHF TELEVISION EQUIPMENT for the new channels.

TV CHASSIS for custom cabinets or private label.

The acknowledged leader in commercial television, ITI has expanded its line to include all aspects of television receiving equipment. The same high standards of circuit design and component selection are incorporated in all ITI products.



INDUSTRIAL TELEVISION INC.
359 Lexington Avenue
Clifton New Jersey

A 45 R.P.M. RECORD PLAYER is an up-to-the-minute feature of the "435", an expanded version of the remote control unit on the opposite page. It also has AM and FM radio and storage space for record albums.

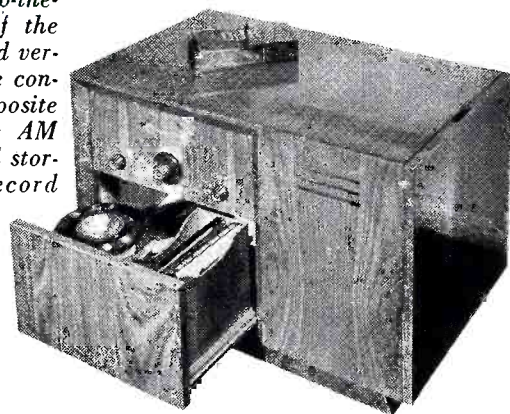

Above, the control unit for commercial viewers.

At right, a 20" viewing unit that has the largest direct view screen available—230 square inches.

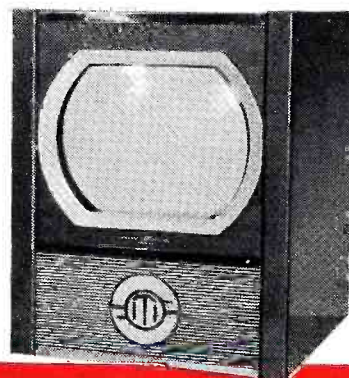

ITI, Century, Teleceiver and Guest Television are trade-marks of Industrial Television, Inc.

ITI • The Vision in Television





**Popular,
Classical, Folk
and Juveniles
Featured on
New Discs,
Played by
Fast Changer**

"It's like being in your living room," a passenger aboard this Eastern Air Lines plane en route from Newark, N. J., to Atlanta, reported. Hostess is shown operating RCA Victor's new 45 RPM phonograph.

New Uses, New Pleasures From

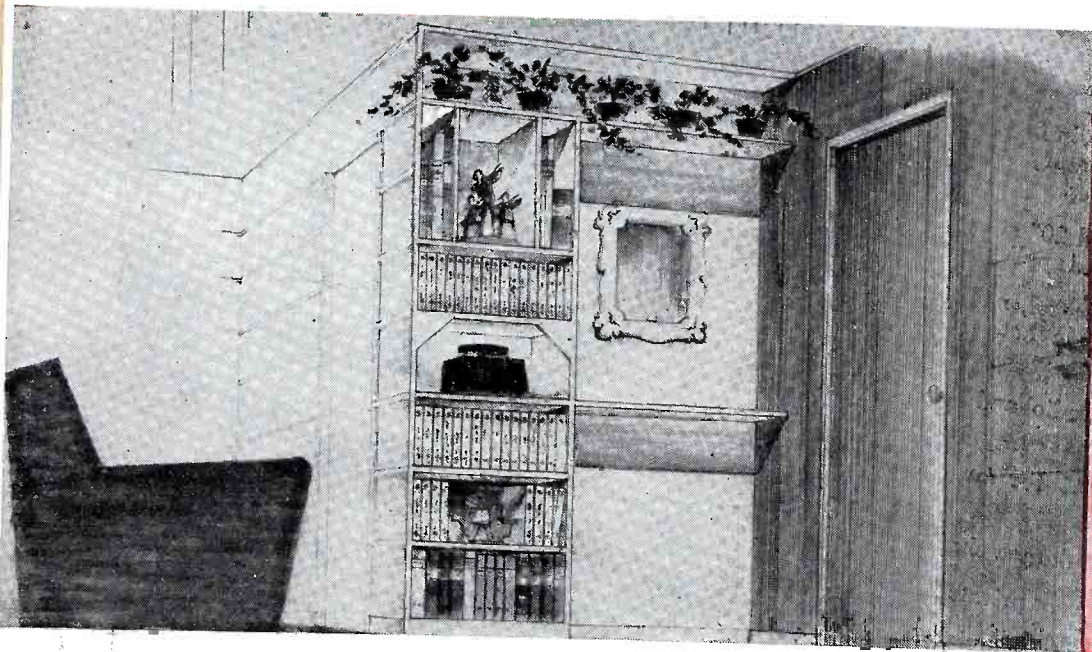

BIG THREE MUSTS in Selling the New Records

1. Tell your customer that the phono record industry is now stabilized!
2. Use live-wire demonstration and eye-catching displays to get results!
3. Sell effectively. Don't just take sales—make them!

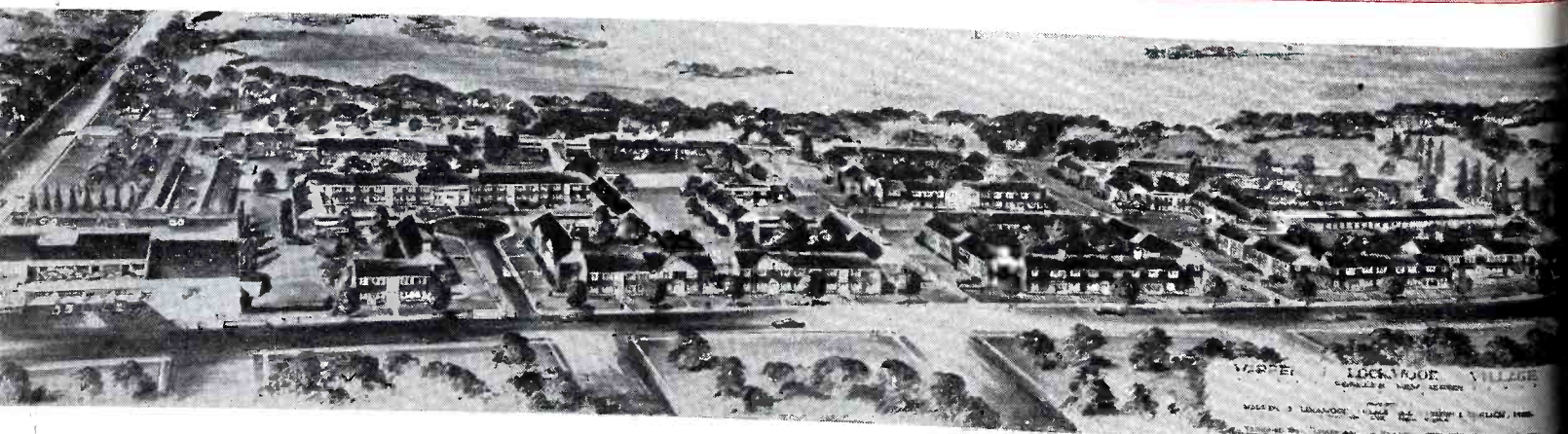

The "Musiccorner," upper left, unique living-room feature of the new Warren J. Lockwood housing development, Roselle, N. J., which will provide tenants of each of the 310 apartments with a built-in RCA Victor 45 RPM phonograph, shelves for record library, and a



At left, welcome addition to trailer home of Mr. and Mrs. Frank Moon are this compact, portable RCA Victor 45 RPM phonograph and library of the non-breakable records. Moon is a well-known jockey who has towed his trailer-home thousands of miles to ride winning horses on tracks all over the country. Here, they treat Linda Ann Taylor, 4-year-old neighbor to a "youth concert." Shown above, at right, is a close-up of the new RCA Victor 45 RPM system.

New 45 RPM System



Crew members of the USS submarine Sirago break out their new 45 RPM phonograph and records during a duty-break aboard the sub. The small size of RCA Victor's self-contained phonograph, and the lightweight, wafer-thin, non-breakable characteristics of the 45 RPM records make them especially adaptable in confined quarters.

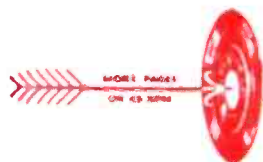

Emerson's great

THIS EMERSON SETS THE IN ALL ITS 26 YEARS

THE NEW EMERSON '50 Line of Television and Radio is packed with brilliant electronic improvements . . . styled with eye-winning beauty . . . engineered to top quality and priced to bring them flocking to your door.

It's backed by a multi-million dollar advertising program. More people in your community will hear about these great new models than ever before . . . and every proved point-of-sale device will be furnished you to clinch sales.

In every way, EMERSON is manufactured, priced and promoted to give you the big-volume lead in your store.

Your EMERSON Distributor has the story

—and it's a big one. Make sure you hear it. He's ready with facts and figures to prove that EMERSON's '50 Line is The Set Up To Get Your Net Up.

Get ready for your biggest year — with EMERSON!

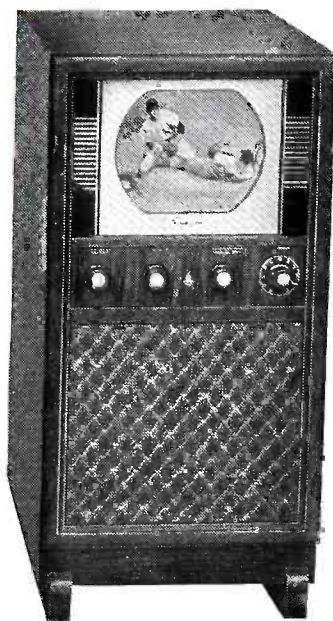

← EMERSON MODEL 638. 61 square inch picture screen. Super-Powered Long Distance Circuit. Magnificent hand rubbed console cabinet of selected pinstripe mahogany veneers. Sensational value **\$249.50** at list price.



→ EMERSON MODEL 626. 16" brilliant direct view tube. Super-Powered Long Distance Circuit. Luxurious pin-stripe mahogany veneer console cabinet. . . **\$449.50** list price.

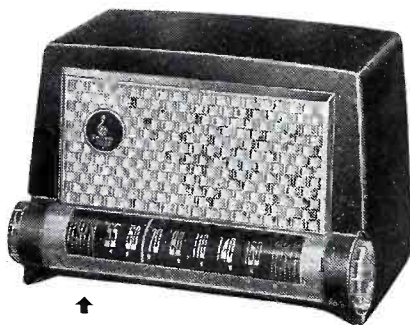

↑ EMERSON MODEL 610. Smart AC-DC compact. Enclosed Single-Loop Antenna. Automatic volume control. Cabinet in maroon plastic. **\$19.95** list price.

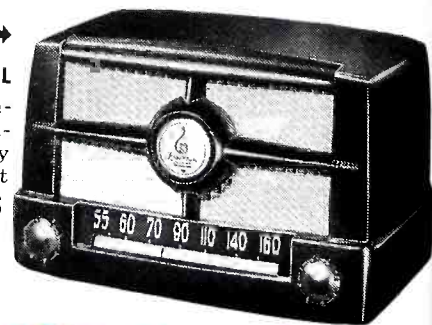

→ EMERSON MODEL 587. AC-DC compact. Cabinet molded of beautiful ebony plastic. The greatest value in **\$14.95** radio at . . . list price.

Emerson Radio and Television

EMERSON RADIO AND PHONOGRAPH CORPORATION • NEW YORK 11, N. Y.

New '50 Line

**YEAR,
FASTEST SELLING PACE
OF VALUE LEADERSHIP!**

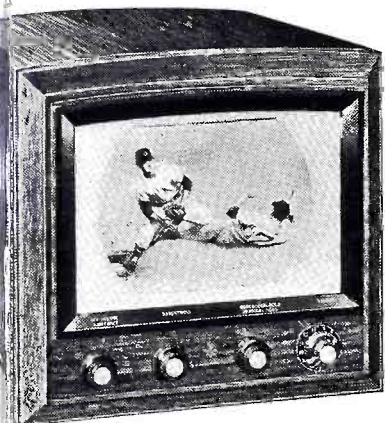

EMERSON MODEL 627. 12 1/2" direct view television. Long Distance reception. "Miracle" Picture-Lock. Automatic gain control circuit. Domed cabinet of selected pin-stripe mahogany veneers. **\$299.50** list price.

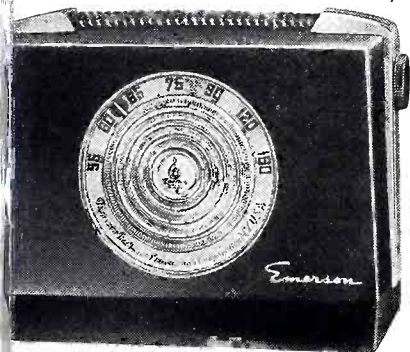

EMERSON MODEL 613. Self-powered 3-way Portable featuring the new Lift-Up "Fantenna" for increased sensitivity. Smart, lightweight cabinet of maroon plastic with gold end plates. **\$29.95** list price less batteries.

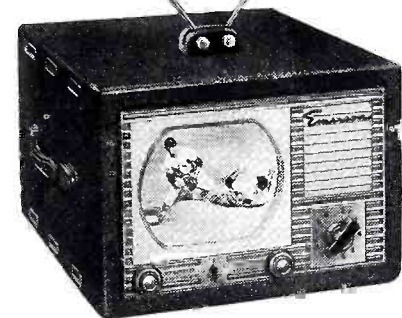

EMERSON MODEL 600. AC-DC Portable Television. 7" direct view tube. All channel coverage. Long Distance reception. Handsome lightweight luggage type cabinet with carrying handle. Complete with telescopic dipole antenna and base for only **\$169.95** list price.



EMERSON MODEL 575. Self-powered 3-way portable with extra RF stage. "Briefcase" design cabinet of highly polished plastic with contrasting colored basketweave grill in tan and sand. **\$34.95** list price less batteries.

EMERSON MODEL 635. Table model phonoradio with automatic record changer for 45 rpm records. Plays up to 10 records for more than 50 minutes. AC super-heterodyne radio. Walnut bakelite cabinet. **\$49.95** list price.



Get ready for your biggest year with Emerson!

THE SET UP TO GET YOUR NET UP!



Better Style, Tone, Performance, Value.



Starrett

TELEVISION

Starrett

TELEVISION

Starrett

TELEVISION



All Starrett Phono-Combinations
play 45 RPM records in addition
to 33 and 78 RPM

RIGHT NOW you KNOW
no finer QUALITY at any price
than the
"CUSTOM SERIES"

\$495 to \$1295

twelve 16" sets that give
STARRETT SELECTED DEALERS
their only opportunity to present
a COMPLETE LINE of

36 to 46 tube sets,
custom-designed

in the world's finest woods:
selected mahogany and walnut;
engineered for top-level performance!

Starrett

TELEVISION means

See What Starrett Means to You at
Music Industry Convention, BOOTHS 71-74,
MANHATTAN CENTER, July 25-28

means protected **QUALITY**

means protected **VALUE and QUALITY**

means protected **VOLUME, VALUE and QUALITY**

and

now...

news!

Starrett SELECTED DEALERS

get a great new
ADDITIONAL LINE!
the "METROPOLITAN SERIES"
LOW PRICED!

Up to 16" CONSOLE!
For VOLUME Sales!
For "dynamite" promotions!

To retail profitably
\$199 to \$449

Write NOW! Ask how YOU CAN BE A
STARRETT SELECTED FRANCHISED
DEALER and enjoy the profits
of promoting America's most complete
television line!

PROTECTED PROFITS for SELECTED DEALERS!

Starrett
TELEVISION

STARRETT TELEVISION CORP. 601 W. 26th ST. NEW YORK 1, N. Y.

MORE PAGES
ON 45 RPM



QUALITY PRODUCTS

1st Award



"EKOTAPE" wins

*highest honors from jury of
the most critical recorder users*

"First place for 'Ekotape!'" was the enthusiastic verdict of an independent jury of musicians—the severest critics of any recorder—after extensive "blindfold" tests of leading makes.

The "Ekotape" that won the first award from these judges also offers greater value for all other school uses. Clear, powerful tone is as important for speech as for music. So are simple operation, dependability, and the many features that offer wide versatility . . . features such as fast forward and rewind speeds, electronic recording volume indicator, separate bass and treble tone controls to overcome deficiencies in room acoustics.

"Ekotape" is first choice of educators for recording broadcasts and conferences; public address in classes and assemblies; speech correction; teaching public speaking, languages, music and music appreciation. Its outstanding quality makes it a wise investment.

See and hear "Ekotape"—compare it. You will be impressed by its superlative tone quality, power, convenience, and features. Get a demonstration from your dealer.

WEBSTER ELECTRIC

Ekotape
TRADE MARK

RECORDER-REPRODUCER

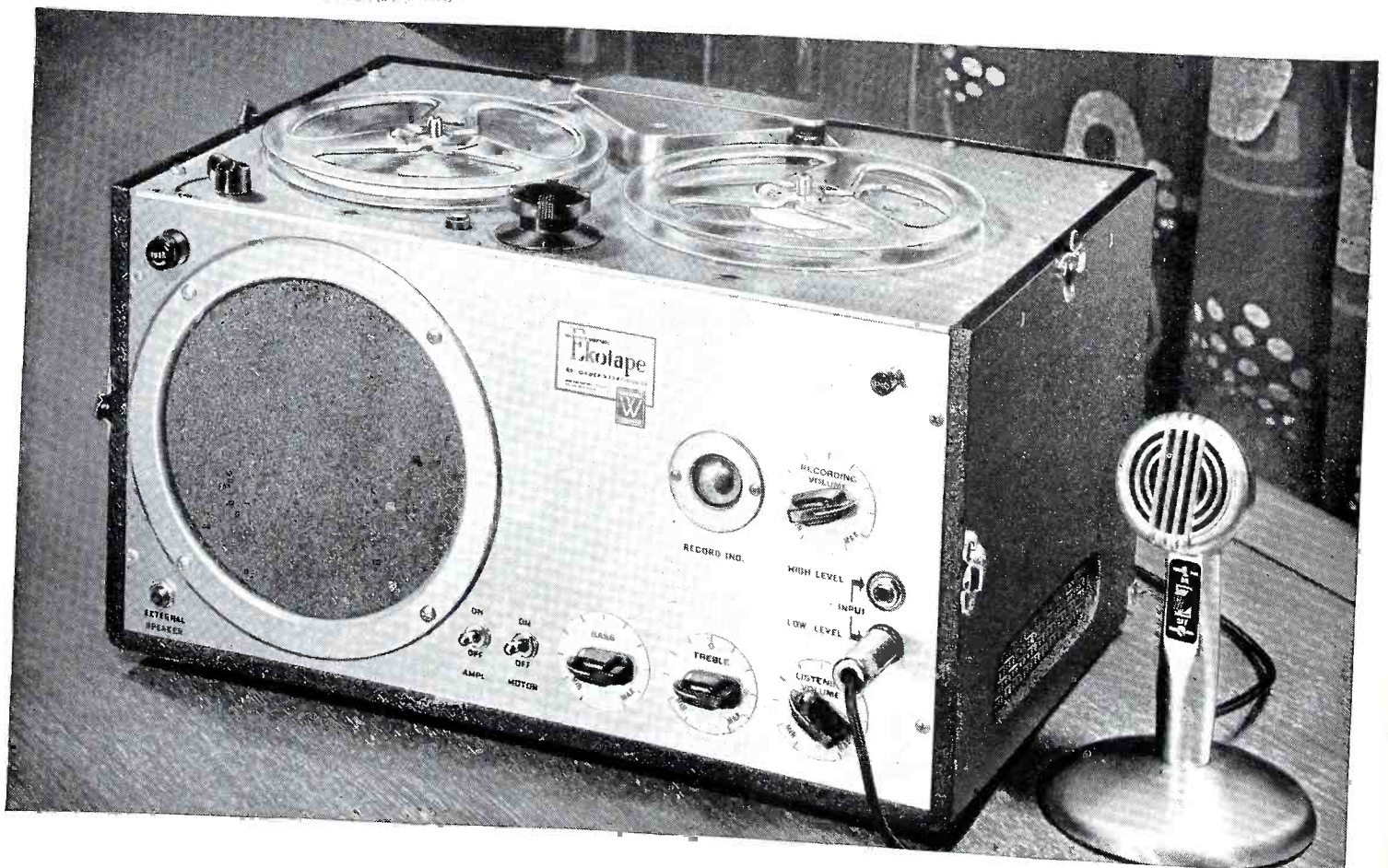

FOR THE MUSIC DEALER

WEBSTER ELECTRIC Featheride TONE ARMS

THAT MEET THE
REQUIREMENTS OF 33 $\frac{1}{3}$,
45 AND 78 RPM RECORDS

MODEL
BA-1

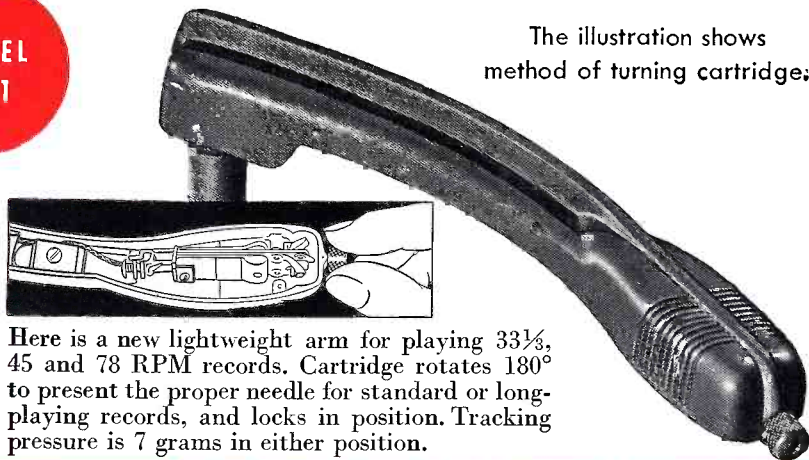

The illustration shows
method of turning cartridge:

Here is a new lightweight arm for playing 33 $\frac{1}{3}$, 45 and 78 RPM records. Cartridge rotates 180° to present the proper needle for standard or long-playing records, and locks in position. Tracking pressure is 7 grams in either position.

SPECIFICATIONS

APPLICATION: 33 $\frac{1}{3}$, 45 and 78 RPM Record players.
NEEDLES: Replaceable osmium-tipped. Single setscrew releases both needles.
TRACKING PRESSURE: 7 grams on both needles.
ARM CONSTRUCTION: Aluminum die-cast. Spring counterbalanced for 7 grams pressure.
CARTRIDGE CONSTRUCTION: Stamped aluminum half shells with front bracket extending through front of pick-up arm to permit rotating the cartridge.
TERMINALS: Pin type, grounded or ungrounded.
OUTPUT: 1 volt, 1000 cps.

MODEL
T1C7

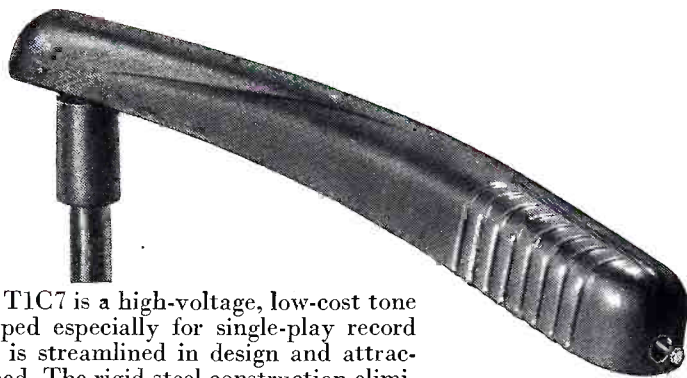

The Model T1C7 is a high-voltage, low-cost tone arm developed especially for single-play record players. It is streamlined in design and attractively finished. The rigid steel construction eliminates torque and resonance problems.

SPECIFICATIONS

APPLICATION: 78 RPM record players.
TRACKING PRESSURE: 1 $\frac{1}{4}$ oz. minimum.
OUTPUT: 3 volts, 1000 cps.
ARM CONSTRUCTION: Stamped steel housing. Tinnerman fastening.
COLOR: Antique copper tone.
NEEDLE: Any standard type.
LEAD WIRES: Plastic-covered—20 in.
Model V1F16.

MODEL
V1F16



This new tone arm of stamped aluminum, with an over-all length of 5 $\frac{1}{2}$ " is ideally suited for use on player units designed for playing the new 7" records, either 33 $\frac{1}{3}$ or 45 RPM. It incorporates the model A-1 miniature cartridge exerting a tracking pressure of only 7 grams without use of spring counterbalance.

SPECIFICATIONS

APPLICATIONS: 7" recordings (33 $\frac{1}{3}$ or 45 RPM).
ARM CONSTRUCTION: Stamped aluminum.
COLOR: Optional.
CARTRIDGE CONSTRUCTION: Bakelite half shells.
TERMINALS: Pin type.
NEEDLES: Replaceable, osmium- or sapphire-tipped.
LEADS: Optional.
TRACKING PRESSURE: 7 grams
OUTPUT: 1 volt, 1000 cps.

WEBSTER
RACINE



ELECTRIC
WISCONSIN

Established 1909

Export Dept. 13 E. 40th Street, New York (16), N. Y. Cable Address: "ARLAB" New York City

"Where Quality is a Responsibility and Fair Dealing an Obligation"



Simplest . . . Smoothest . . . Surest . . .

The New 3-Speed "MILWAUKEE"

Automatic Record Changer

AUTOMATICALLY Plays Any Size or Make of Record
using Original Center Hole — No Adaptors Required

- ★ **3-SPEED OPERATION** —78, 33 1/3, and 45 R.P.M. 6 to 8 grams needle pressure.
- ★ **SPLIT-SECOND ADJUSTMENT** —for playing all types of records.
- ★ **REQUIRES ONLY ONE PICK-UP ARM** —for playing all records regardless of size or speed. No adjustment of needle pressure needed.



Illustrating the "MILWAUKEE" Automatic Record Changer with 10- and 12-inch record spindle. Operates at 78 and 33-1/3 R.P.M. for all 10- and 12-inch records—any speed or type.

Other "Bonus" Features

Of The "MILWAUKEE" 3-Speed Automatic

- Newly developed velocity trip provides fool-proof tripping at minimum needle pressure, a requisite for slow speed records.
- All records, regardless of size, are shuffled on to the turntable by means of simple, time proven, accepted, edge push-off method. Minimizes record wear on all sizes of records, especially at center hole. No extensive or loose parts required on ejector mechanisms.
- Needle tracking that's virtually perfect.
- Exceptional freedom from lateral and vertical tone arm friction.
- Record slippage no problem.
- Single Stylus Crystal or Electronic Reproducer Pickup.
- Center hole adaptors can be used in records with 1 1/2" center holes if desired—eliminating 1 1/2" spindles.



Showing 7-inch record spindle for automatic playing of 7-inch records at 33-1/3 R.P.M.

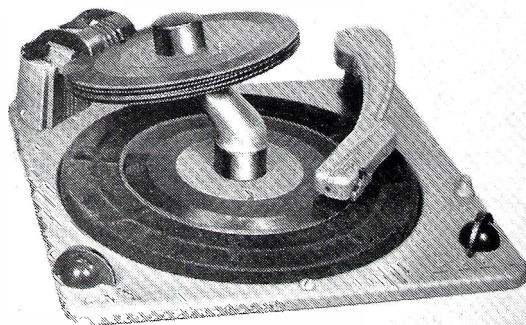

This 7-inch record spindle plays up to twelve 45 R.P.M. records with 1 1/2" center holes, fully automatically—without center hole adaptors.

MANUFACTURED BY

MILWAUKEE STAMPING COMPANY

Our 55th Year of Quality Production

MILWAUKEE 14

WISCONSIN, U.S.A.



A Complete Line You Can Sell!

ZENITH TELEVISION

WITH

GIANT CIRCLE SCREEN *and* BULLS EYE AUTOMATIC TUNING

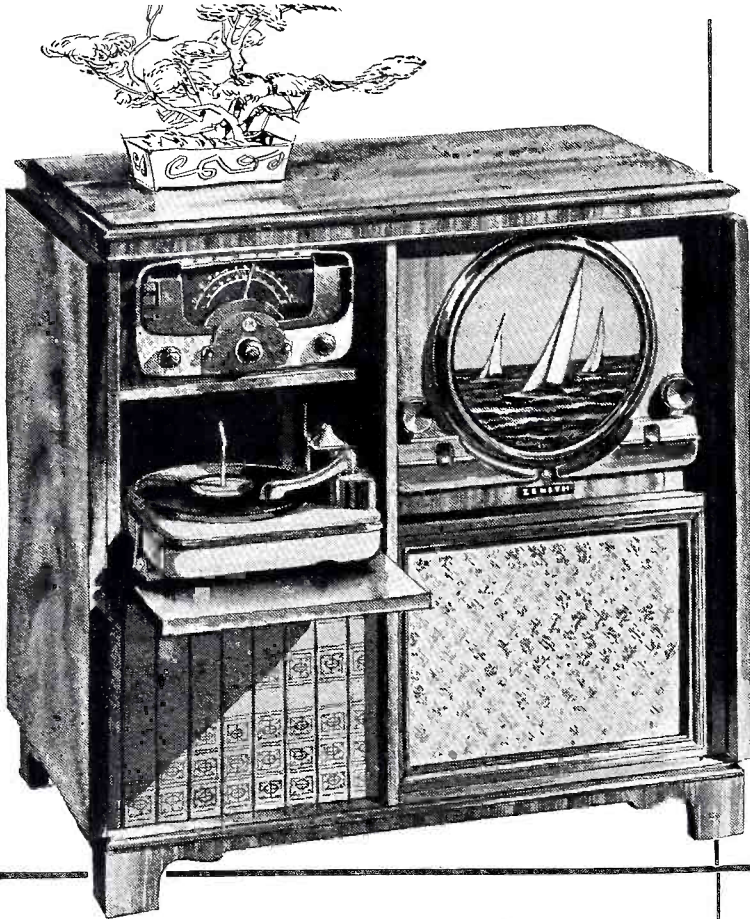

The Zenith Gotham—Zenith Television with "Big B" 105 sq. in. Screen; new Cobra Tone Arm automatic record player for all types of records—33-1/3, 45 and 78 RPM, 7, 10 and 12 inch sizes; Genuine Zenith-Armstrong FM and Zenith Long-Distance AM radio; all superbly combined in a console of breathtaking beauty in imported mahogany veneers. (Plus Federal Excise Tax and Installation) **\$695***

From the ultra-magnificent combinations to the beautifully streamlined table models, every Zenith Television set hits the "bulls eye" for sales appeal.

Every one has the sensational advancements found in *no* other television set . . . the Giant Circle Screen for a bigger, brighter, clearer picture . . . and Bulls Eye Automatic Tuning—one knob, one twist, there's your station, your giant picture, your sound . . . automatically pre-tuned to perfection!

The built-in tuner has provision for receiving the proposed new ultra-high-frequency channels on present standards—no "converter" necessary.

Yes, Zenith has what it takes to assure the ultimate in customer satisfaction and bring you the most beautiful profit picture in television!

SEE YOUR ZENITH DISTRIBUTOR

ZENITH RADIO CORPORATION

6001 Dickens Ave., Chicago 39, Ill.

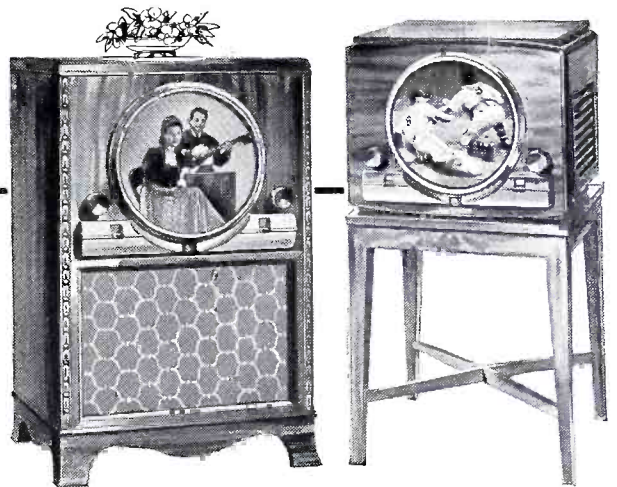

The Zenith Broadmoor—Skillful handling of period-type design in a cabinet of imported Afara veneers with mahogany finish. Has "Big B" 105 sq. in. Screen.

\$4500*

(Plus Installation)

The Zenith Claridge—Classic simplicity in a stunning cabinet of imported Gold Coast Afara veneers finished in mahogany. With "Big B" 105 sq. in. Screen.

\$39995*

(Plus Installation)



The Zenith Stratosphere† has the "Giant C" 165 sq. in. Screen. An exquisite console cabinet, in genuine mahogany veneers of glowing beauty. Full length doors close to conceal screen and grille, open flat against sides.

(Plus Federal Excise tax and Installation) **\$54500***

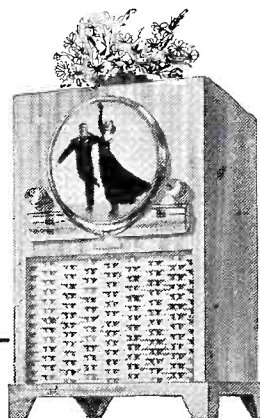

The Zenith Waldorf—Modern television console of imported Afara veneers in blonde finish. With "Big B" 105 sq. in. Screen.

(Plus Installation) **\$48995***



*Suggested retail price. West Coast prices slightly higher. Prices subject to change without notice.



New! Sensational!

Admiral

"triple-play" RADIO-PHONOGRAPH

- PLAYS 33 $\frac{1}{3}$ RPM COLUMBIA "LONG PLAY" RECORDS!
- PLAYS 45 RPM VICTOR RECORDS (WITH LARGE CENTER HOLE)!
- PLAYS 78 RPM STANDARD RECORDS!

All Automatically

First time ever in a table combination! Sensational new Admiral "triple-play" radio-phonograph plays all records . . . 33 $\frac{1}{3}$, 45 and 78 RPM . . . all sizes . . . 7, 10 and 12 inch . . . all automatically with a single high-fidelity Miracle Tone Arm. Comes equipped with standard center post to play all 10 and 12 inch records. Special center post for 7 inch, 33 $\frac{1}{3}$ RPM records, \$1.75; for 45 RPM records, \$5. Center posts quickly and easily interchanged. Admiral-perfected super-het radio tunes sharply . . . has glorious tone.



MODEL 6V12

\$69⁹⁵

Prices slightly higher in south and far west—subject to change without notice.

ASTATIC

NOTE THE ASTATIC "EXTRAS" in these Phonograph Pickups and Cartridges for 45, 33-1/3 and 78 RPM RECORDS

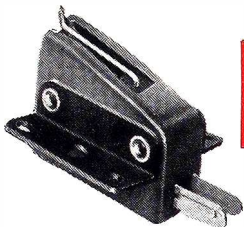

GC CERAMIC CARTRIDGE

First major engineering stride in phonograph pickup cartridges employing ceramic elements since Astatic pioneered in this type unit last year. The GC is the first cartridge of its kind with replaceable needle. Takes the special new Astatic "Type G" needle—with either one or three-mil tip radius, precious metal or sapphire—which slips from its rubber chuck with a quarter turn sideways. Resistance of the ceramic element to high temperatures and humidity is not the only additional advantage of this new development. Output has been increased over that of any ceramic cartridge available. Its light weight and low minimum needle pressure make it ideal for a great variety of modern applications.



CQ CRYSTAL CARTRIDGE

An entirely new Astatic design, featuring miniature size and five-gram weight. Model CQ-J fits standard 1/2" mounting and RCA 45 RPM record changers. Model CQ-1J fits RMA No. 2 Specifications for top mounting .453" mounting centers. Needle pressure five grams. Output 0.7 volts at 1,000 c. p. s. Employs one mil tip radius, Q-33 needle. Cast aluminum housing.

LQD DOUBLE- NEEDLE CRYSTAL CARTRIDGE



The LQD Cartridge—for 45, 33-1/3 and 78 RPM Records—quickly became the first choice of many of the nation's largest users, on the basis of comparative listening tests, and is, today, the PROVED TOP PERFORMER for turnover type pickups. Outstanding for excellence of frequency response, particularly at low frequencies. A gentle pry with pen-knife removes ONE needle for replacement . . . without disturbing the other needle, without removing cartridge from tone arm. Gentle pressure snaps new needle into place. Available with or without needle guards. Stamped aluminum housing.

6D TURNOVER PICKUP



TURNOVER TYPE pickup with double-needle crystal cartridge. Switches from 33-1/3 or 45 RPM records to standard 78 with turn of knob at front end of tone arm. Unique in ability to play both types of records at only eight-gram needle pressure, thus has no extra mechanism to change pressure when knob is turned, eliminating a potential source of trouble and varying reproduction quality. Employs LQD-1 Cartridge. Mounts seven inches from turntable center, die-cast curved arm finished in dark brown Hammerlin.

FL-SERIES PICKUP



DOES THE WORK of three pickups. Its U-J Crystal Cartridge for either 33-1/3 or 45 RPM records is easily, instantly replaceable with the U-78-J Cartridge for playing standard records. No adjusting of needle pressure, nothing else to be done. Cartridges slip in and out like barrel and cap of non-threaded fountain pens. Special Type "U" Taper-Lock replaceable needle has tongue and groove arrangement to hold in position, removes merely by gripping small tab at rear of needle and sliding towards rear of cartridge. Novel design at base of FL-33 eliminates tone arm resonances, assures perfect tracking. Die-cast arm, finished in high gloss black and polished aluminum.

Copyright Astatic 1949

WRITE FOR ADDITIONAL DETAILS

THE
Astatic
CORPORATION
CONNEAUT, OHIO
IN CANADA CANADIAN ASTATIC LTD. TORONTO ONTARIO

Astatic Crystal Devices manufactured
under Brush Development Co. patents



This will be the *Big Seller*

in the 7-INCH RECORD CHANGER MARKET

The *New* Webster-Chicago Phonograph

- Plays Both 45 and 33 rpm Automatically!
- No Spindles to Change!
- No Cartridge to Change!
- No Needle to Change!
- Beautiful Tone!
- Beautiful Plastic Cabinet in Burgundy or Ivory!
- Popular Price!

Sells for only
\$39⁷⁵

(Burgundy cabinet; west of Rockies, \$40.75*)



Ask your
Webster • Chicago
Distributor at Once!

Deliveries now being made. See the same WEBSTER-CHICAGO distributor who supplies the well-known WEBSTER-CHICAGO Wire Recorders and Phonographs.

*Ivory cabinet, Model 845, \$42.50 (west of Rockies, \$43.50)

Also available to distributors and manufacturers as record chassis only for replacement of existing equipment.

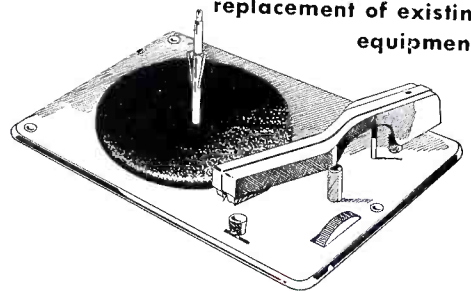

WEBSTER-CHICAGO

5610 WEST BLOOMINGDALE AVE. • CHICAGO 39, ILLINOIS



Choice of Music Lovers



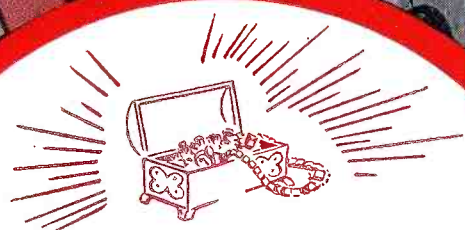
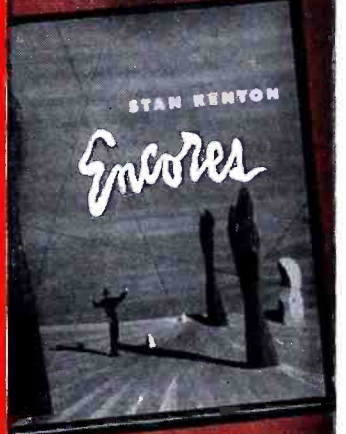
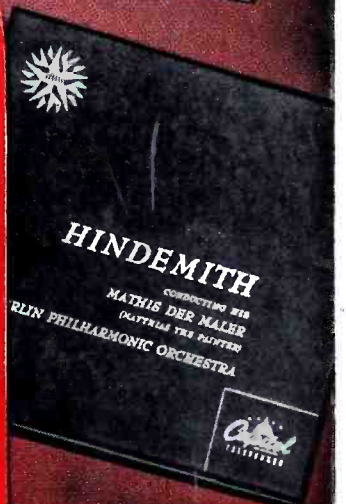
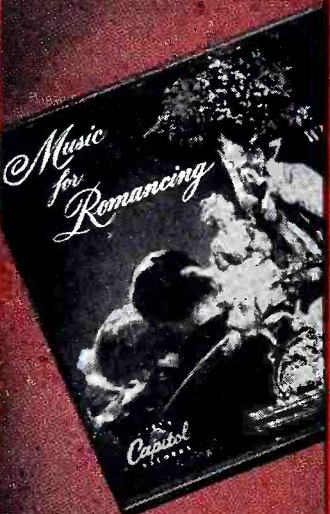
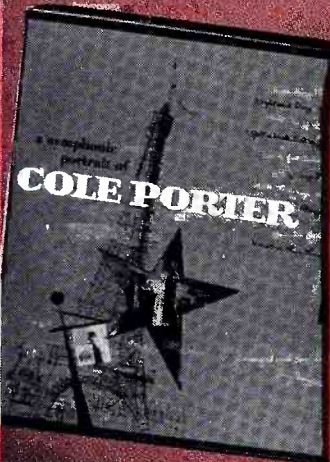
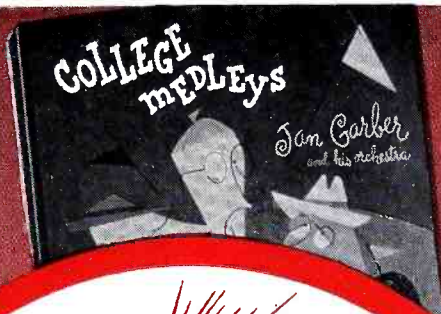
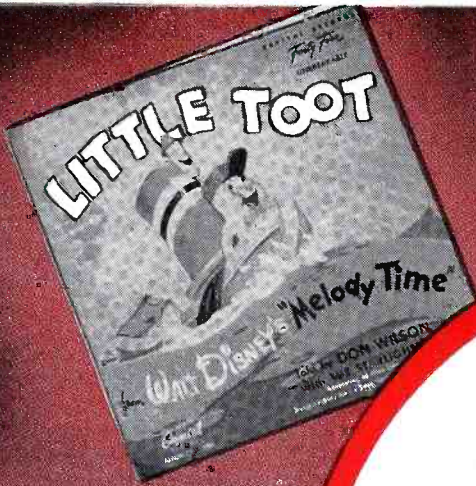

"JEWEL-BOX" APPEAL
 IN
Capitol
"45" PACKAGING!

Only the finest kind of packaging could be worthy of 45 tonal perfection—and Capitol has it! Classical "albums" of rich maroon leatherette, stamped in gold, with genuine gold foil edging. Colorful standard and pop albums; children's albums that are a new delight—especially the record-readers in book-size, handy for the tiniest fingers.

... and tone quality that hits a new peak of perfection. Here's why:

Capitol's new studios in Hollywood, adjacent to Paramount and RKO, have been equipped with the latest and finest recording and studio equipment. The initial recording is done on *magnetic tape*, which eliminates distortion to even the most critical ear.

All Capitol records and albums will continue to be issued on 78.

FIRST WITH THE HITS FROM HOLLYWOOD

★ ★ ★

Capitol
 REG. U.S. PAT. OFF.
RECORDS
HOLLYWOOD

Capitol's new sleeve for "45" singles, with dustproof telephone window and pull flap, is the most attractive and practical sleeve today!



Helping **YOU** to
Greater 45 RPM
Record Playing Profits

rescent

*Major Source of Supply
for the Entire Industry*

Yes, Crescent was first and remains the most important supplier of new 45 RPM record changers built to RCA Victor specifications. Large numbers of many types of foundation mechanisms, plug-in units and complete players are being produced now for other manufacturers. Information is ready on items on this page. Modifications can be made to meet your requirements.

CRESCENT INDUSTRIES, INC.

4140 West Belmont Avenue
Chicago 41, Illinois

Export: Scheel International, Inc., Chicago 18, Illinois, U. S. A.

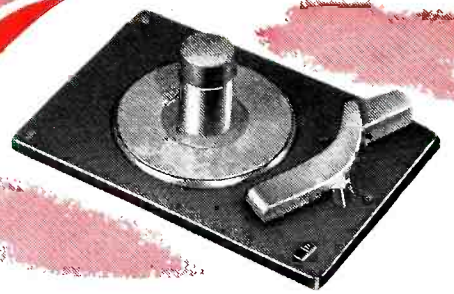

CRESCENT 45 RPM RECORD CHANGER

Model C-6A1—designed to take full advantage of RCA's new 45 RPM record playing system. Plays up to 10 records automatically with only 1½ second record change cycle. Crystal pickup cartridge, muting switch for silencing input circuit during change cycle. Heavy duty motor. Rugged steel mounting base. Instant starting and reject button. Attractive mahogany hammerloid finish, gold and brass trim.

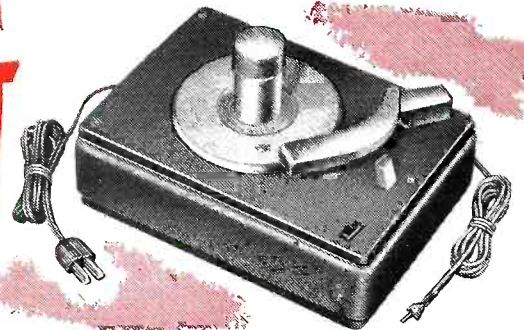

45 RPM AUTOMATIC RECORD PLAYER

Model H-10A1—complete plug-in unit for use with radios, radio-phonographs, television sets, or commercial amplifiers. A combination of the C-6A1 record changer and C-9X1 base cabinet. Equipped with 7 ft. A.C. power cord, 4½ ft. phono cable and plugs. Suitable for use on occasional table or book shelf near radio or television set. Small enough to be placed in many record storage compartments.

Model C-15X1—Crescent "Rollway" Mounting provides easy player installation in original equipment or for modernization.

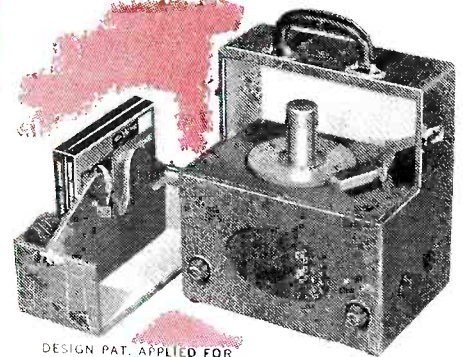

DESIGN PAT. APPLIED FOR

45 RPM PORTABLE RECORD PLAYER

Model H-16A1—45 RPM portable record player. Small size, light weight, yet gives big set performance. Compartment in lid provides space for up to 16 records and detachable power cord. Tubes used: 12SQ7, 50L6 and 35Z5. 5¼" speaker. For use on 117 volt 60 cycle A.C. Beautiful, brown alligator fabric-covered carrying case.

OTHER CRESCENT PRODUCTS

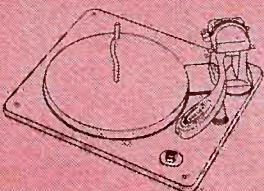

RECORD CHANGERS



WIRE RECORDERS

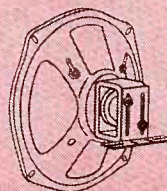

LOUD SPEAKERS

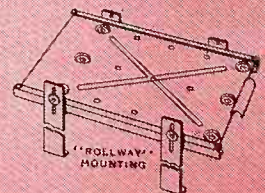

METAL STAMPINGS

Now!
RECOTON
brings you a
**REPLACEMENT
 NEEDLE CABINET**
for

**78/45/33 1/3 RPM
 CARTRIDGES**

No longer any need to hold up a repair job waiting for a needle. Here is an assortment kit which will take care of practically all of your requirements. Easy to reorder... just replace what you've sold.



**REPLACEMENT NEEDLE CABINET
 No. 250**

containing 1 needle each of Cat No. 301 through No. 314

LIST PRICE

Replacement Needle Cabinet

\$38.00

FREE

INTRODUCTORY DISCOUNT

50/10%

YOUR NET COST \$17.10

Recoton Replacement Needles are precision made of finest quality materials by Recoton skilled craftsmen.

REPLACEMENT NEEDLES

for

**ASTATIC • COLUMBIA • PHILCO
 RCA • SHURE • WEBSTER-CHICAGO**

CARTRIDGES

used by

**RCA VICTOR
 COLUMBIA • PHILCO • ADMIRAL
 MOTOROLA • MAGNAVOX
 WESTINGHOUSE and OTHERS**

SEND THIS COUPON TODAY!

RECOTON CORPORATION
 251 Fourth Avenue
 New York 10, N. Y.

Gentlemen:

We would like to take advantage of Recoton's offer for the Replacement Needle Cabinet No. 250

Please ship Cabinets No. 250 @ \$17.10 each

DEALER'S NAME.....

ADDRESS.....

CITY..... ZONE..... STATE.....

Signature

ORDER WILL BE SHIPPED THRU YOUR RECOTON DISTRIBUTOR



We Supply Leading Manufacturers with the
Finest Needles used in 45 R.P.M. Record Players
... as well as 78 and 33 R.P.M.!

Walco

MICROGROOVE TIP

PHONO NEEDLES

— and here's the money-maker of the year for the Dealers!

Walco "BIG 3" needle profit DEALS!

DEAL No. 1...
for larger outlets

DEALER COST
only... **\$36⁰⁰**

RETAIL VALUE
including FREE Bonus Needles **\$90⁰⁰**

DEALER PROFIT
\$54⁰⁰

48 RECORD SHOPPING BAGS—FREE

DEAL No. 2...
for smaller outlets

DEALER COST
only... **\$24⁰⁰**

RETAIL VALUE
including FREE Bonus Needles **\$60⁰⁰**

DEALER PROFIT
\$36⁰⁰

24 RECORD SHOPPING BAGS—FREE

DEAL No. 3...
for radio service men

DEALER COST
only... **\$18⁰⁰**

RETAIL VALUE
including FREE Bonus Needles **\$45⁰⁰**

DEALER PROFIT
\$27⁰⁰

POCKET SALES-WALLET—FREE

EACH DEAL ATTRACTIVELY PACKAGED! WRITE FOR DETAILS!

DISTRIBUTORS!

Important areas are open for distributors and factory representatives able to handle big-volume sales... the lines are the hottest in the industry.

VISIT OUR EXHIBIT AT NAMM SHOW—MANHATTAN CENTER, BOOTH 37

Walco

PRODUCTS, INC.

60 FRANKLIN ST., EAST ORANGE, N. J.

AMERICA'S FOREMOST TV ACCESSORY LINES

- TELE-VUE-LENS
- FILTERS
- TV TOWERS
- Other Fast-Selling Items

BEST SELLING... BEST PERFORMING...

new **BROADVIEW** television by Motorola

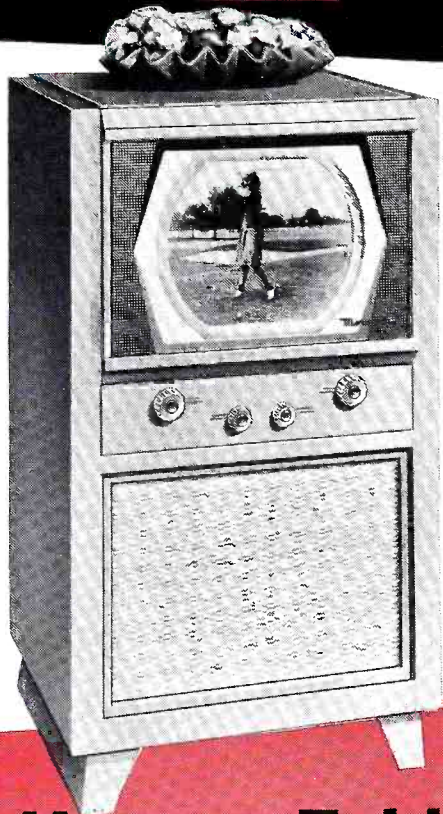

No Other Set Can Match This Performance —

Motorola's new BROADVIEW screen gives *more* picture area with new 12½" picture tube . . . does away with unnatural, eye-tiring distortion. Motorola's exclusive new circuit that gives clearer, *steadier* tv action — and at longer distances from the transmitter. New simplified controls. Stunning Furniture Styled cabinetry. **Model 12VK18.**

Hottest Table Model Set on the Market

Motorola's new BROADVIEW table model gives a console-sized 61 sq. in. distortion-free picture at unbelievably low price! Exclusive new circuit gives clearer, steadier pictures than ever before . . . at longer distances from transmitter! Simplified controls. Smart styling. **Model 10VT3.**



Nothing Can Touch This Portable Television Set

Motorola's VT73 operates anywhere there is AC current . . . in any television area. 7 inch picture tube gives amazingly bright, steady pictures. Good-looking simulated leather case. Weight only 33 lbs. Size: 9⅝" x 18¾" x 17¼". Complete with antenna. **Model VT73.**

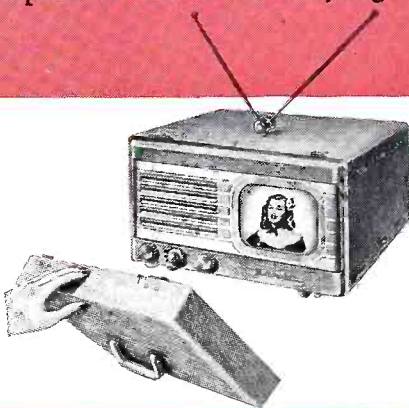

New — Exciting Portable 45 R. P. M. Record Player

Smart and practical, this luggage-type portable radio-phonograph plays up to 10 new 45 r.p.m. records . . . gives distortion-free automatic performance. Radiant AM reception. Size: 7" x 10½" x 13½". **Model 59F11.**



Motorola INC.

4545 AUGUSTA BLVD.

CHICAGO 51, ILLINOIS

Phone, write or wire your nearest Motorola Distributor today.



You've a record year ahead...



LIVING ROOM



RECREATION ROOM



PLAY ROOM

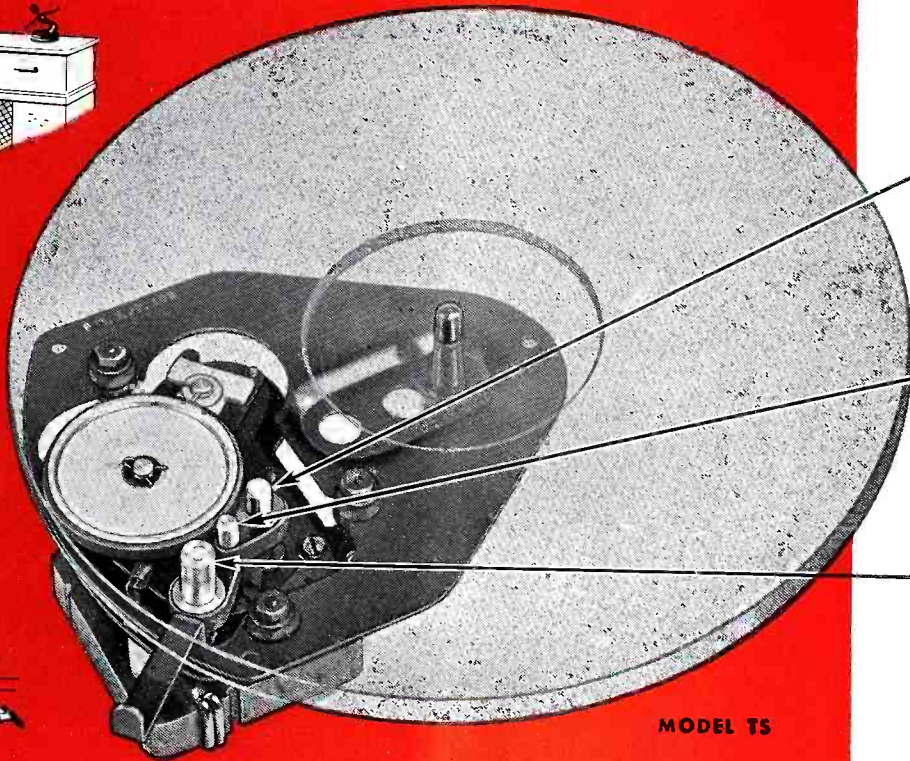

MODEL TS

33 1/3
RPM

78
RPM

45
RPM

...WITH THIS *3-Speed* PHONOMOTOR

Here's the motor that plays all three types of records without fuss or bother . . . the *one* motor designed, engineered and built to enable radio and phonograph manufacturers to offer their customers dependable, *complete* record entertainment. It's GENERAL INDUSTRIES' new Model TS three-speed phonomotor.

External speed change lever affords positive, accurate shifting to any of the three speeds without removing the turntable. Ingenious, yet simple, shift mechanism is both trouble-free and fool-proof. Compact size of motor makes it ideally suited for portables as well as console models. Cost is surprisingly low.

For complete information—blueprints, performance specifications and quotations—write, wire or phone *today*.

Other 45 R.P.M. Motors

General Industries offers prompt delivery of a *complete* line of single-speed 45 R.P.M. and dual-speed motors incorporating 45 R.P.M. operation. Quotations upon request.



The GENERAL INDUSTRIES Co.

DEPARTMENT I • ELYRIA, OHIO





PORTABLE RECORD PLAYERS

Designed for the new 45 rpm Vinylite RCA Records . . . the utmost in musical entertainment!

Styled for Volume Sales and Plus Profits!

Symphonic COLLEGIATE MODELS have these Outstanding Features

★ **WORLD'S FASTEST RECORD CHANGER**

★ **FEATHERWEIGHT PICK-UP ARM WITH PERMANENT "SAPPHIRE" NEEDLE**

★ **SCIENTIFICALLY DESIGNED HIGH FIDELITY AMPLIFIER**

- Quality components throughout for stability.
- Bass-compensated tone control permitting full range of expression from bass of organ to treble of piccolo.

★ **#5 ALNICO PERMALOY SPEAKER**

- Extra heavy permanent magnet.
- Distortionless reproduction of the full musical range.
- Unsurpassed console-tone quality.

★ **DELUXE PORTABLE CARRYING CASE**

- Solidly constructed attractively styled acoustically toned cabinet.
- Covered in durable, washable, simulated-alligator, pyroxlin-finish leatherette.
- Trimmed with high-polish brass hardware.
- Two front locks and keys for personal use and safety.
- This cosmetic-size case measures 8" high, 9¼" wide, 12½" long.
- Lightweight and compact. Weighs only 12 pounds.

Also available in U.L. type

MODEL 69
IN FIVE
FASHION COLORS

Sky Blue
Navy Blue
Lipstick Red
Seafoam Green
Alligator Brown



RCA Licensed Manufacturers

16 New Low Priced Models for 1950!

America's Choicest Line of Record Players

- \$ Portables of every type . . . with and without radio.
- \$ Singles . . . automatics . . . open and closed models.
- \$ 1-speed . . . 2-speed . . . 3-speed . . . 33⅓ — 45 — 78 rpm.
- \$ Join the ranks of other top distributors who praise this quality and profitable line.

Distributor inquiries invited.

Choice territories available for representatives.

See us at the New York
**MUSIC INDUSTRY
TRADE SHOW**

BOOTH 97
EXHIBITION HALL
MANHATTAN CENTER

**SYMPHONIC RADIO
& ELECTRONIC CORP.**

292 MAIN STREET · CAMBRIDGE 42, MASS.

CABLE ADDRESS: SYMPHONIC

Symphonic Record Players Perform a New High in Music Pleasure!



**G. I. comes to the rescue
of the Record Dealer!**

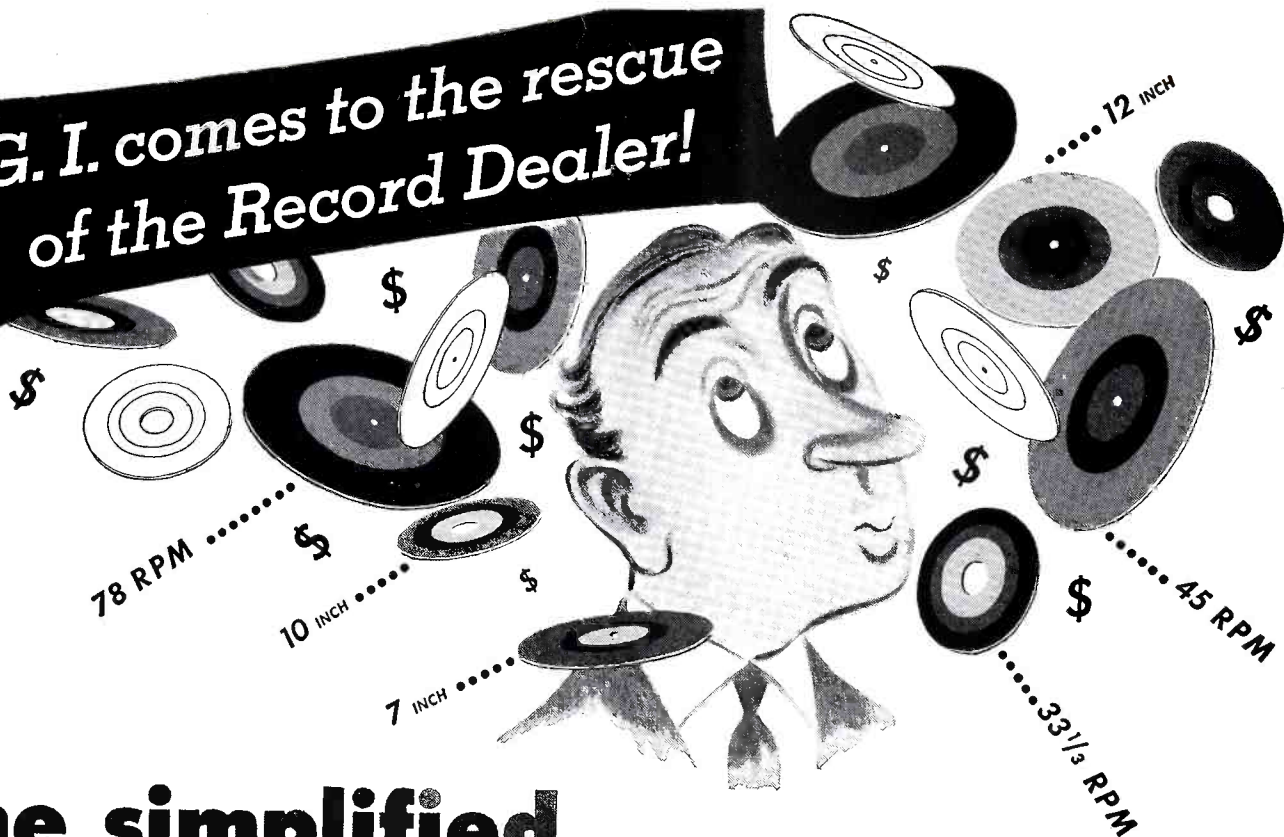

**one simplified
record changer
plays and changes
them all... AUTOMATICALLY!**



- 1 Just one tone arm and one record changer unit plays all record types.
- 2 No separate spindles or other loose parts to become lost or mislaid.
- 3 Operates as conventionally as older types of single speed changers.
- 4 No larger in size... and priced very low.

General **I**nstrument Corporation

829 NEWARK AVENUE • ELIZABETH 3, N. J.





Proudly Announces the **NEW**

SOUND-REEL

MAGNETIC TAPE RECORDERS FOR THE BEST IN TONE QUALITY AND TAPE SPEED

**ONE HOUR
and Half-Hour
Continuous Recording
in one Direction
on One Reel of Tape**



Parties

MODEL 375. One hour continuous recording time at tape speed of 3.75 in./sec. List Price **\$189.50**

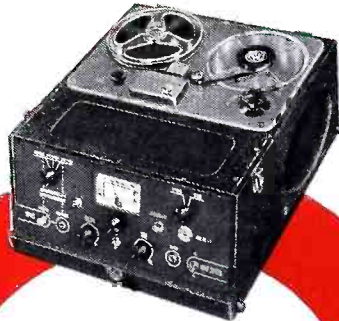

MODEL R-3. Same as 375 but has self-contained radio. List Price **\$218.50** including Fed. Excise Tax.



Weddings-
Choir

- Everyone can operate the MASCO Sound-Reel... No technical skill is required.
- Records from microphone, radio, records.
- Can be used as a Public Address System.
- Complete. Ready to use. Microphone and 1200 feet of tape included. Nothing else to buy.



MODEL D-7. Dual speed, 3.75 and 7.50 in./sec. for both one hour and half-hour continuous recording time. With dual channel pre-amplification. List Price **\$369.50**



Music

MODEL 750. Half-hour continuous recording time at tape speed of 7.50 in./sec. With dual channel pre-amplification. List Price **\$349.50**

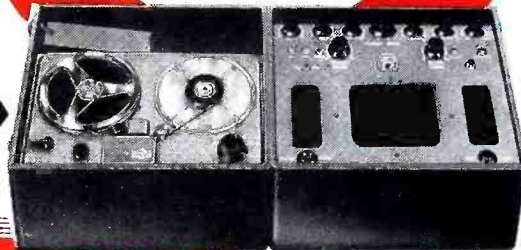

Conferences

Pre-Amplifiers with Bias Oscillator and Magnetic Tape Handling Mechanism Chassis

MASCO now makes it possible for you to use existing amplification equipment for magnetic tape recording and reproduction by using the Masco Pre-Amplifiers and Tape Handling Mechanisms. There are two models of Pre-Amplifiers, P-4

and P-5, designed for use with Masco Tape Handling Mechanisms. Masco Tape Handling Mechanisms for one hour, half-hour, and dual speed, are sold individually or with the Pre-Amplifiers with which they are designed to be used.

NEW!
MASCO J-Speed Portable Automatic Record Changers.
45, 33 1/3, 78 RPM
Too late to be photographed for this issue.
Write for details.

Communicate with your Masco representative or distributor or write to factory direct for information.



MARK SIMPSON MANUFACTURING CO., Inc.
32-28 49th Street, Long Island City 3, N. Y.

SOUND SYSTEMS and ACCESSORIES

RAvenswood 8-5810-1-2-3-4



The No. 1 Choice of **120** Department Stores

★
ALL
SOLID WOOD
CABINETS

RAY-DYNE KIDDIES

★
WITH
VOLUME
CONTROLS
★

PHONOGRAPHS & PHONO-RADIOS

FOR 78 and 45 RPM

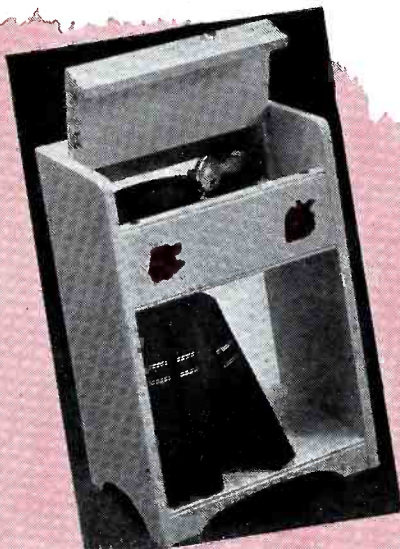

ACOUSTIC PHONOGRAPH
Patented Volume Control
Colors: Ivory, Pastel Pink and Blue
Size: 24" x 15 $\frac{5}{8}$ " x 11 $\frac{1}{2}$ "
MODEL 501E—\$21.95 Retail

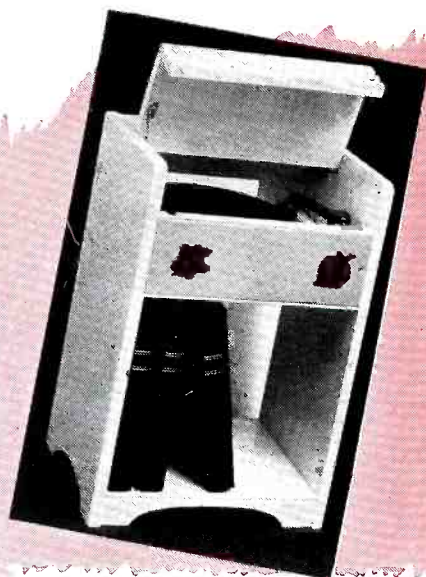
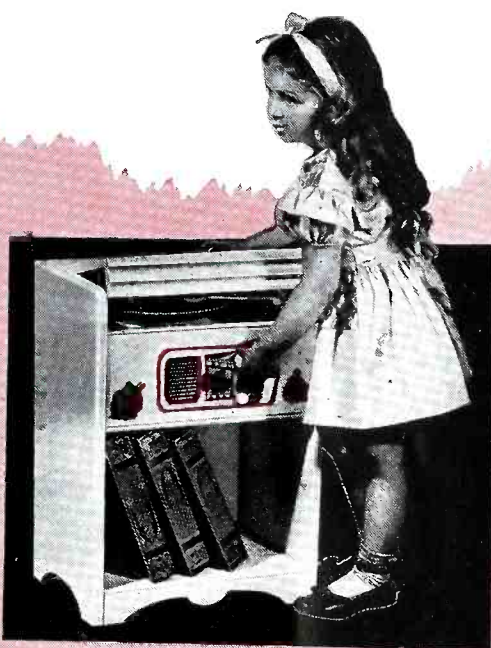

AMPLIFIED PHONOGRAPH
2 Tubes—Volume Control
Colors: Ivory, Pastel Pink and Blue
Size: 24" x 15 $\frac{5}{8}$ " x 11 $\frac{1}{2}$ "
MODEL 511A—\$29.95 Retail

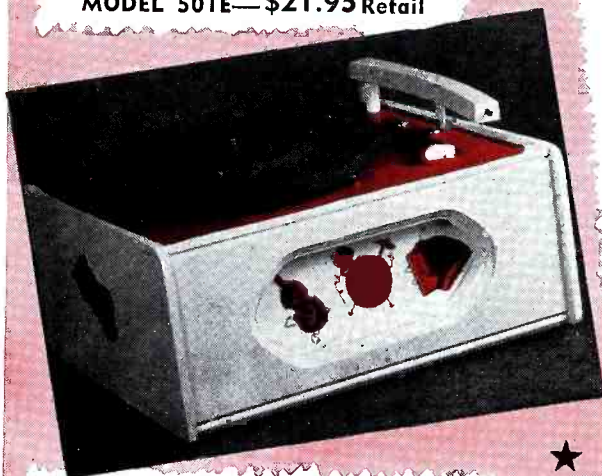

**PHONOGRAPH-RADIO
COMBINATION**
5 tube Radio and Fine
Phonograph
Colors: Ivory, Pastel Pink,
Blue and Maple
Size: 24" x 15 $\frac{5}{8}$ " x 11 $\frac{1}{2}$ "
**MODEL 60PR
\$39.95 Retail**



ACOUSTIC PHONOGRAPH
Patented Volume Control
Combination of Pastel Colors
Size: 12 $\frac{1}{2}$ " x 10 $\frac{1}{2}$ " x 6 $\frac{1}{2}$ "
MODEL 50—\$12.75 Retail

★
SAFE!
UNDERWRITERS
APPROVED
★

AMPLIFIED PHONOGRAPH
2 Tubes
Entirely new, different. Entire front
panel illuminated, and with
Volume Control
Size: 10 $\frac{3}{4}$ " x 12 $\frac{1}{2}$ " x 6 $\frac{1}{4}$ "
MODEL 11—\$19.95 Retail

**A QUARTER
CENTURY
OF PROGRESS**

RAY-DYNE MANUFACTURING CORP.

Licensed by Radio Corp. of America

347 E. 22nd St.
Paterson, N. J.

IT'S A REAL BEAUTY!



THE NEW

CROSLEY

"Merrymaker"

FOR EXTRA SALES . . . You can sell the record player separately!

When customers already have a standard radio phonograph but want to play the new 7" 45 rpm fine-groove records, here's your answer—the Crosley "Merrymaker" Record Player.

Once more Crosley precision engineering and manufacturing skill come forward with your answer to the new 7" 45 rpm fine-groove records. It's the superb new Crosley "Merrymaker"—a beautifully styled radio phonograph that's designed to catch the customer's eye. Just check these attractive sales features—

- The world's finest recorded music or brilliant AM radio—at the flick of a finger
- Encased in a brilliantly styled Carrollton cabinet of hand-rubbed mahogany veneer
- Tone control for fine reproduction of voice and music
- Plays up to 50 minutes of continuous recorded music
- Loads 10 records and makes changes twice as fast as conventional record players. Actually stores 35 records

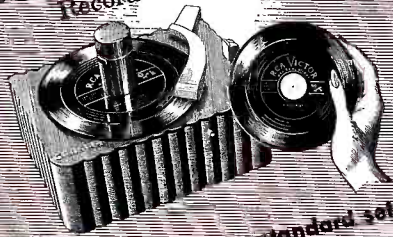

- Attaches easily to any standard set
- No tools needed for installation
- Smartly cased in mahogany plastic

CONTACT your nearest Crosley distributor for full details. Or write:

Crosley Division, Avco Manufacturing Corporation,
1329 Adlington Street, Cincinnati 25, Ohio.

CROSLEY

DIVISION 

Better Products for Happier Living

SHELVADOR* REFRIGERATORS . . . KITCHEN FREEZERS . . . RANGES
RADIOS . . . RADIO PHONOGRAPHS . . . TELEVISION * ©

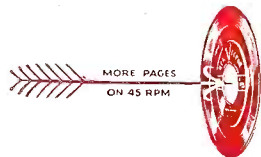

It's in Original Equipment ..and it's for Replacement in Thousands of 45 rpm Changers

New Series 34 Orthogonal

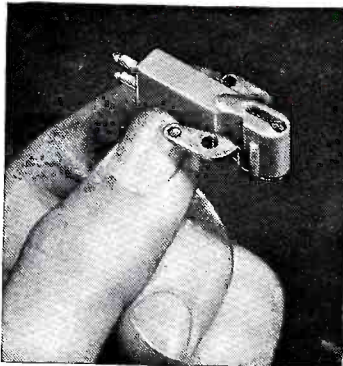

New Orthogonal (vertical-type) crystal cartridge—with $\frac{5}{8}$ " and $\frac{1}{2}$ " hole spacing—designed as replacement in RCA 45 rpm changers. Brings to the record player valuable benefits of E-V TORQUE DRIVE. Tracks at 5 grams pressure. Compliance (softness of needle touch to record) is well above unity. Frequency response is smooth, peak-free out beyond 10,000 c.p.s.—assures clean, true reproduction. Output is 1.1 volt on RCA 12-5-31V record at 1000 c.p.s. *Silicone moisture-proofed*. Simple to install. Needle is easy to replace.

Model 34. With Osmium needle. List \$6.50
Model 34-S. With Sapphire needle List \$7.50

Series 14 Crystal Cartridge

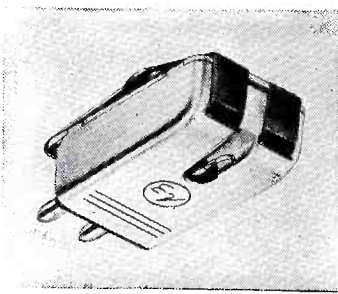

Used as original equipment in thousands of other 45 rpm changers. Series 14 tracks at 5 grams pressure on 45 and $33\frac{1}{3}$ rpm records, with very high needle compliance. Frequency response closely follows NAB standard curve. Output is 1 volt on RD90 test record at 1000 cps. *Silicone moisture-proofed*. Slips into the mounting plate. Needle is replaceable.

Model 14-A. With 1 mil Osmium needle, less mounting hardware List Price \$7.00
Model 14-AS. Same, with 1 mil Sapphire needle. List Price \$8.00
Model 14. With 1 mil Osmium needle, complete with mounting hardware List Price \$7.50
Model 14-S. Same, with 1 mil Sapphire needle. List Price \$8.50

(Available in Series 12 for 78 rpm. Also variable reluctance magnetic type.)

... the TWILT Plays all 3 Speeds

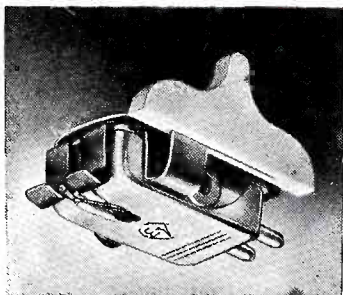

Plays 45, $33\frac{1}{3}$ and 78 rpm records with a single twin-tip replaceable needle, without weight change, with tracking pressure of only 6 grams . . . and does it with all the fidelity, the smoothness, the efficiency inherent only in E-V TORQUE DRIVE. With easy, positive-tilting, snap action, you merely tilt the TWILT to select the 1-mil or 3-mil needle tip, for fast or slow speed records . . . set-down is accurate. Frequency response closely follows NAB standard curve. Output is 1 volt on either tip. Mounts easily in most any standard pickup arm, with nothing more required than reducing needle pressure.

Model 16-TT. Complete with twin-tip 1 mil Sapphire and 3 mil Osmium needle List Price \$12.00
Model 16. Same, but without tilting mechanism. List Price \$9.00

(Also available in variable reluctance magnetic type.)

NO FINER CHOICE THAN

ELECTRO-VOICE, INC., BUCHANAN, MICH.

Export: 13 East 40th Street, New York 16, U.S.A.

Cables: Arlab



Puts Profitable

Cartridge Replacement

Business in Your Hands!

After exhaustive comparison tests, E-V Torque Drive phono pickup cartridges are now in thousands of 45 rpm changers, as well as in other single-speed and multi-speed record players. Exclusive features make the Torque Drive today's most efficient crystal cartridge for both 1 mil and 3 mil records. Its playing quality . . . its noiseless, distortion-free performance are unexcelled. Provides highest compliance per volt output. E-V silicone moisture-proofing increases crystal life some 20 times. E-V replacement needles bring you business, too.

For full details, contact your
E-V Distributor or send for
literature today.



E-V Cartridge Kits

Handy Sales and Service Kits help sell more cartridges, speed replacement service, save ordering-time and servicing-time. You make more profit. Inquire now!

E-V Pat. Pend. Licensed under Brush patents

Electro-Voice

45 RPM... 3 SPEED... STANDARDS

... All built in the
Phonola tradition of
quality and craftsmanship

PHONOLA MODEL K-245—45 RPM RECORD CHANGER!

The perfect portable changer for the new 45 RPM records. Engineered for quality at the best price. 3 tube distortion-free amplifier . . . 6" high fidelity permanent magnet speaker . . . 115 volt A.C. electric motor . . . conveniently placed Volume and "3 position" Tone Controls. Plays up to ten 45 RPM records with cover closed if desired. Tone arm is held down with unique attachment. Changer drops records noiselessly. Smartly designed in luggage-like leatherette in matched colors. Another Phonola "first". Sizes: Depth, 7"; Width, 12"; Length, 14 $\frac{1}{4}$ ". Shipping weight: 15 $\frac{1}{2}$ lbs.



Phonola PORTABLES

COMPETITIVELY PRICED FOR VOLUME SELLING

PHONOLA MODEL K-145—A SINGLE PLAY 45 RPM PORTABLE. Completely electronic. Roomy record compartment holds up to twenty 45 RPM records! 3 tube precision built amplifier . . . 6" speaker . . . handy Volume and "3 position" Tone Controls . . . 115 volt, A.C. electric motor. In simulated leather with matching colors and grains. Size: 7" x 12" x 14 $\frac{1}{4}$ ". Shpg. Wt. 11 $\frac{3}{4}$ lbs. (Shown at left.)

PHONOLA MODEL TK-134 — PLAYS AT ALL THREE SPEEDS. Rotating needle cartridge provides the right needle for the right record with just a twist of the fingers. 3 tube amplifier . . . 6" speaker . . . convenient Volume and "3 position" Tone Controls . . . 115 volt, A.C. motor . . . 9" turntable. Matching colors of simulated leather. Size: 7" x 14 $\frac{1}{4}$ " x 18". Shpg. Wt. 13 $\frac{1}{2}$ lbs. (Shown at right.)

TK-234—UNIVERSAL CHANGER. Plays and changes all size records at all 3 speeds. Simple adjustment for speed and needle change . . . silent changer. Same specifications as TK-134—with slightly larger case. Write for details. (Not shown.)

PHONOLA MODEL E-12 — THE MOST INEXPENSIVE VERSION OF THE HIGHER PRICED MODELS. Acoustically correct throwback tone arm with Phonola reproducer. 115 volt, A.C. electric motor . . . 8" flocked turntable. Metal case finished in two-tone hammerloid enamel. Size: 6" x 9 $\frac{3}{4}$ " x 13". Shpg. Wt. 7 $\frac{3}{4}$ lbs. (Shown at left.)

PHONOLA MODEL K-105—UNDERWRITER'S APPROVED STANDARD MODEL. 2 tube amplifier . . . 5" permanent magnet speaker . . . 115 volt A.C. electric motor. Streamlined case covered with two-tone simulated leather with matched hardware. Plays 10" and 12" records. Size: 5 $\frac{3}{4}$ " x 12" x 15 $\frac{1}{4}$ ". Shpg. Wt. 11 lbs. (Shown at right.)

Other acoustic and electronic standard models also available. Write for full details.



WATERS CONLEY COMPANY

ROCHESTER, MINNESOTA



45
rpm

PROFITS COME FASTER WITH NEW RCA VICTOR SALES HELPS!

Hard-hitting literature for
EVERY 45 rpm prospect!



45 RPM System
De Luxe Presentation Book!

- **De Luxe Presentation Book**—Form 2A5736 (illustrated); luxuriously designed, filled with potent "sell." Gives story of RCA Victor 45 rpm system. A "must" for all stores selling the RCA Victor system!
- **RCA Victor 45 rpm System Full Line Folder**—Form 2A5698; a complete folder to spearhead promotion. Presents instruments, includes introductory list of 45 rpm records. A powerful handout or mailing piece!
- **RCA Victor 9JY Envelope Stuffer**—Form 2A5707; compact—lightweight—two-color. Hard-hitting message on 45 rpm system with lots of selling punch for the 9JY attachment!
- **RCA Victor 9Y7 Envelope Stuffer**—Form 2A5715; brilliant two-color combination folder. Turns a bright sales spotlight on the big buyer appeal of this fast-moving 45 rpm table combination! Compact, persuasive!
- **RCA Victor 9W105 Envelope Stuffer**—Form 2A5717; features the FM-AM, 78 and 45 rpm console combination. A "best bet" for distribution among collectors of 78 rpm records. Two colors. Ready to do a big job for you!
- **"The Surest Selling Job You've Ever Had"**—Form 2A5711; pocket-size booklet with "how to do it" message for retail salespeople. Covers every sales angle of the RCA Victor 45 rpm system.
- **RCA Victor Miniature Catalog Sheet Service**—Form 2A5078; every instrument has its own descriptive catalog sheet. Sets the sales slant for the retailer. Special sheets for the 45 rpm system. Available through yearly service. Pocket size! The full-size sheets are ordered under Form 2A5178.
- **RCA Victor 45 rpm System Question and Answer Booklet**—Form 2K-1766; filled with easy-to-read information about the 45 rpm system. The ideal promotion piece for the prospect who wants to read all the details.
- **RCA Victor 45 rpm Record Delivery Bag**. Order by name; a two-color effect is created with tinted stock and contrasting ink. Draws attention after the purchase!
- **RCA Victor 45 rpm Record Catalog**—Form 2K-2050; this is the "basic" promotion catalog for all record dealers. A lasting reference file of all currently available RCA Victor 7-inch records. Every customer should have one!

POINT-OF-SALE PROFIT BUILDERS!



Versatile Revolving
Sales Aid!

- **RCA Victor 45 rpm System Demonstrator Unit**—Form 2A5706 (illustrated); versatile, compact traffic stopper. Displays an operating 9-EY-3. Makes shoppers *want* demonstrations!
- **RCA Victor 45 rpm Revolving Stocker**—Form 2K-1750 (illustrated); functional displayer with facilities for up to sixteen 7-inch record albums, plus many, many singles. Guarantees lots of impulse sales!
- **RCA Victor 45 rpm Record Wall Hangers**. These effective, multicolor wall hangers list the long-lived, top-selling records. There's a wall hanger for every kind of record. Each hanger has loads of "pull" in your record section. Count on them for real sales aid! Red Seal, Form 2K-1846; Pop Music, Form 2K-1847; Children's Music, Form 2K-1848; Blues, Rhythm, International, Pop Classics, Country and Western, Form 2K-1845; Record Price List Hanger, Form 2K-1945.

Contact your RCA Victor
Distributor to obtain the
promotion aids you want!



Effective Counter
Display Demonstrator!

RCA VICTOR

DIVISION OF RADIO CORPORATION OF AMERICA

Avoid **"TELE-TENSION"** Complaints!



Eye-Saver

CORRECTED SCREEN
PICTURE TUBE

**NOW AVAILABLE
FOR RECEIVER REPLACEMENT!**

There's a BIG Difference in EYE-SAVER Picture Tubes!

EYE-SAVER tubes have a CORRECTED SCREEN to overcome the obvious objections of standard television picture tubes and at the same time increase the detail and contrast definition.

The picture screens on ordinary video tubes consist of a uniform group of phosphorescent particles. The light from one particle disperses and lights up others nearby causing undesirable luminescent halation. What should be only a pin point of light becomes a larger, brighter area to cause eye-fatigue and loss of detail. (This effect is readily apparent when noticing the area immediately adjacent to the raster on a TV receiver. While it should be completely black, it becomes more and more gray as the raster brilliancy is increased. The only way it will ever look black then is to increase the whites enough to fatigue the eye into an optical illusion of contrast.)

EYE-SAVER picture tubes overcome this objectionable halation with an opaque agent between the phosphorescent particles. This reduces the "inter-action" of light and reduces the gray glare so that blacks and whites appear only where they are supposed to. Thus, a good contrast without halation or loss of detail is obtained.

In addition, the total amount of light needed for this greater definition is only a fraction of that necessary for an uncorrected screen. By lowering the brilliancy level formerly needed for apparent contrast and detail, EYE-SAVER tubes eliminate the cause of squinting and eye strain that has plagued so many Television viewers.

Your customers know what they want . . . and they know just as strongly they DON'T want television that will tire their eyes or give them that "Tele-Tension" feeling. They're more and more conscious of the irritation, eye strain, and headaches of most of today's spotlight bright TV receivers . . . and they want their television set to be enjoyable, relaxing and safe for their children's eyes even when viewed for hours at a time.

There's good reason for their concern, for the trend until now has been toward even more brilliant and eye tiring picture tubes. Other video tubes need extreme brilliance so their dull gray background will appear black in comparison. But in fatiguing the eye into this optical illusion of contrast, those same brilliant whites also lose detail and cause the eye strain that is the basis of most complaints against television today.

American Television's EYE-SAVER tubes are the answer to that problem of customer satisfaction. By starting out at a blacker level — instead of a gray-white — and by decreasing the cause of the brilliant halations, EYE-SAVER tubes can get a clearer, more detailed picture with good contrast definition at a much lower brilliance level . . . thus eliminating the tiresome gray glare and spotlight effect of older type picture tubes.

EYE-SAVER picture tubes are being proved by exhaustive tests in private and independent laboratories throughout the country, and more and more TV customers are insisting on EYE-SAVER picture tubes every day. They're available in all sizes for new sets as well as replacements . . . and they cost no more than ordinary picture tubes.



Write, wire or phone today
for complete information.

AMERICAN TELEVISION, INC.

Mr. U. A. SANABRIA, Pres.

Dr. LEE DeFOREST, Research Director

523 SO. PLYMOUTH CT.

• CHICAGO 6, ILLINOIS

NOW! A \$10 SALE

for every record-player in your area!

LIST PRICE \$7.50



SELL NEW TITONE PICKUP!

● FIRST BASIC PICKUP ADVANCE IN 10 YEARS—the original piezoelectric ceramic pickup!

● SELLS ITSELF IN A 2-TO-5-MINUTE CALL! Fits all tone arms. Whenever your service men make any call—let all your customers hear TITONE. They'll say "SOLD!" and you'll profit, because—

● TRANSCRIPTION TONE QUALITY! Full frequency to 10,000 cycles! Bell-like supertone makes even old players thrilling!

● SURE-FIRE IN HUMID CLIMATES! Utterly unaffected by climate, moisture, fungus! Booms sales, wins back customers.

● DOUBLES RECORD LIFE AND PLEASURE! Gives "ordinary" records sparkling quality—revives worn favorites. Will play down to 1/2 normal pressure, NO "needle talk!"

● RUGGED! PERMANENT! No crystals, magnets, filaments to fail! No pre-amplifiers. Ceramic TITONE performs perfectly for years!

NO TONE LIKE TITONE

CALL YOUR JOBBER or write to

SONOTONE
Box T-1, Elmsford, N. Y.

Gibson Officials Plan for 1950 Sales

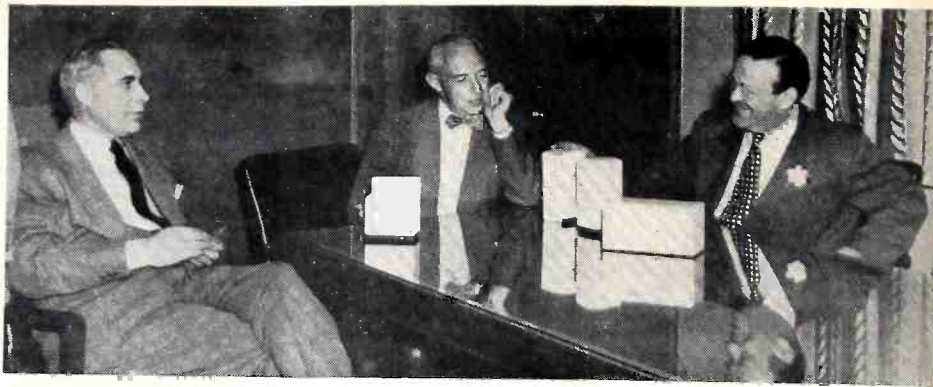

J. L. Johnson, general sales manager, left, and G. L. Rees, range sales manager, center, talk over next year's sales program for Gibson products with S. L. Abramson, vice-president and general manager of the State Distributing Co., Milwaukee, Gibson distributor for eastern Wisconsin.

News of Jobbers and Representatives

The Roycraft Co., pioneer major appliance distributors in the Midwest have recently taken over the exclusive distribution for A.B.C. washers and ironers. Roycraft serves approximately 1000 dealers out of their Minneapolis division which covers the entire state of Minnesota and 26 counties in western Wisconsin.

In line with the recently announced program of expansion and sales promotion efforts by the Anderson Stove Co., H. C. Erhard, general sales manager, announces the appointment of the following sales representatives: Thomas M. Schwartz, New York state; Philip Solomon, northern and eastern Ohio; Erwin C. Brandt, Wisconsin, Minnesota, Iowa and Nebraska, and T. W. Hukill, Kansas, Missouri, Colorado and Oklahoma.

The Deepfreeze Division, Motor Products Corporation, North Chicago, Ill., announces the appointment of Oakman Appliance Co., 14 Wales St., Rutland, Vermont, as distributor in the Rutland area. Other jobbers named by Deepfreeze include: Gross Distributors, 570 Lexington Ave., New York; City Electric Co., Inc., 514 W. Genesee St., Syra-

cuse, N. Y.; Lee Distributing Co., 422 Williams St., Buffalo, N. Y.; Philadelphia Distributors, 232 North 11th St., Philadelphia, Pa.; Nash-Steele-Warren, Inc., 615 W. Hargett St., Raleigh, N. C.; Air Engineers, Inc., 1529 Second Ave., Birmingham, Ala.; Bryant & Trimble, Inc., 406 Broad St., Chattanooga, Tenn.; Joseph B. Smith Co., 420 Madison Ave., Toledo, Ohio; Foster Distributing Co., 409 W. Main St., Louisville, Ky.; J. E. Redmond Supply Co., 402 W. Madison St., Phoenix, Ariz.

Sid Luckman, Chicago Bears' professional football star, has scored again! This time it's in television! Luckman heads the New World Distributors, Inc., 540 N. LaSalle St., Chicago, named as official distributor for Du Mont television receivers in the Chicago area. The announcement was made in New York by Ernest A. Marx, general manager of the Du Mont receiver sales division, Allen B. Du Mont Laboratories, Inc.

E. E. Martin, Graybar district manager, at Boston, which includes almost the entire New England territory, has announced the appointment of T. A. Huston as Boston district appliance sales manager.

Westinghouse Ventilator Display Unit and Mirror



A salesman demonstrates the permanent wall section plywood display unit in which the Westinghouse 10 PHV "Poweraire" home ventilator is mounted. Selling messages front and back of unit point out the Electric Corp., East Springfield, Mass.

Opto Vision Display



Television Filter Co., 225 W. 34 St., New York City, offers an attractive display for its Opto-Vision Filter. Display is 10 inches by 13½ inches, and is in three colors.

What's New

MISSOURI VALLEY CHAPTER of The "Reps" will hold an important conference in Kansas City, Mo., September 26, 27 and 28.

* * *

THE NEW 75-PASSENGER "CLIPPER AMERICA," latest addition to the fleet of Pan American World Airways, is equipped with a complete Kellogg intercom system to increase operational efficiency during projected landplane 8½-hour flights between San Francisco and Honolulu.

* * *

PEERLESS TELEVISION AND RADIO CO., successor to Planet Radio Mfg. Corp., 6508 Euclid Ave., Cleveland, is planning the production of 10-, 12- and 16-inch TV receivers in both table and console models, as well as the manufacture of an all-speed phono player.

* * *

"MORE BUSINESS WITH LESS PROFIT" tells the story of the average radio-television-appliance dealer's performance in 1948, according to the most recent National Appliance and Radio Dealers Association cost-of-doing-business survey. An analysis of returns from a nationwide sample of NARDA members participating in the Association's third annual survey indicates that total dollar sales in 1948 were 12 per cent above 1947. This compares with a gain of 43 per cent in 1947 over 1946.

* * *

LIFE-SIZE TELEVISION made its theater debut in the New Jersey shore area with the unveiling of Telecoin Corporation's reflection-projector system, Tele-Video, with a 48-square foot screen at the St. James Theater, Asbury Park.

* * *

TV SETS IN SUPERMARKETS. The leasing of a hundred TV receivers for use in twenty-five Grand Union stores throughout New York City to receive the "Market Melodies" program has been announced by Martin Sugar, president Bell Television, Inc., N. Y.

N. A. M. M.

You are cordially invited to visit the
Decca Booths 103 and 104 at the Hotel
New Yorker, July 25-28th.

WHAT'S IN THE GROOVE?

THE answer to that question determines how many records you sell. It's a fact that for 15 years Decca Records have had what it takes "in the groove". . . top artists, top tunes, and best arrangements—the recording "know-how" that has received the overwhelming approval of the record-buying public. Because what's "in the groove" has always determined volume (and profits) in the record business, we are confident that Decca Records will continue to be America's Fastest Selling Records!

DECCA

R E C O R D S

WANTED

DISTRIBUTORS
MANUFACTURERS REPRESENTATIVES
TO SELL — PLAYS-ALL

THE SENSATIONALLY NEW RECORD PLAYER

Converts any 78 RPM phonograph into a modern 3 speed instrument. To play either the new Columbia 33 1/3 speed, or RCA 45 RPM records. No installation problems. Just place it on the turntable like putting on a record and plug it in.

BEAUTIFULLY PACKAGED

FULL MARGIN OF PROFIT FOR DEALER
FULL MARGIN OF PROFIT FOR DISTRIBUTOR
GOOD COMMISSIONS FOR REPRESENTATIVE
ADVERTISING ALLOWANCE ON EVERY UNIT

Apply National Merchandise & Sales Co.
19437 Livernois Avenue
Detroit 21, Michigan

"Nothing like the factory-authorized data of RIDER MANUALS"

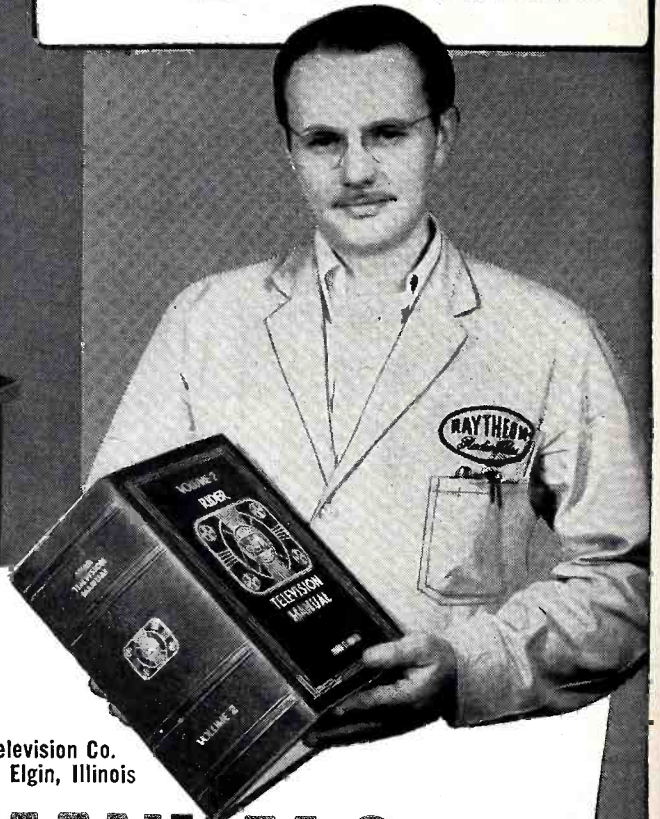

"Nothing like having servicing data direct from the factory when it comes to 'fixing' any kind of radio, TV or public address system. John F. Rider's Manuals have these facts, and I am glad to say that I'm making use of them constantly. Rider Manuals give me the greatest possible coverage, too. And with so many models and makes in existence today that coverage is an absolute necessity."

Charles R. Price
L.S.K. Radio and Television Co.
104 N. Spring St., Elgin, Illinois

For 20 Years, RIDER MANUALS have been "money-makers" for Servicemen!

Charles R. Price is only one of the thousands of servicemen who use Rider Manuals as a daily guide to better servicing...with resultant greater profits. For 20 years, RIDER MANUALS have been the most complete source of AUTHENTIC, OFFICIAL, RELIABLE Servicing Data, direct from the manufacturers themselves. As Servicing grows more complex, you'll find RIDER MANUALS all the more time-saving and profitable.

Now Available!
RIDER MANUAL
Volume XIX



The biggest and best yet! 2122 pages. More than 100 manufacturers, including AM-FM, Amateur Receivers, Auto Radio and Record Changers. Crammed full of schematics, "Clari-Skematrix", and voltage and resistance tables, and parts lists. Only RIDER gives you such a wealth of information at the lowest dollar-per-dollar cost in the industry.

Only **\$19.80**

Including Cumulative Index Volumes XVI, XVII, XVIII, XIX... PLUS the Famous Rider "HOW IT WORKS" Book.

NOTE:

Are you receiving your copy of "Successful Servicing"? It's Rider's own publication of interest to every Serviceman. In it you will find all of the circuit changes in sets... as soon as they are released. It's FREE!

And a PA "MUST"! RIDER PA MANUAL

Covers amplifier production of 147 manufacturers from 1938 to 1948. 2024 Pages PLUS "HOW IT WORKS" Book. Complete..... **\$18.00**

RIDER MANUALS

- | | |
|---|--|
| Television Manual, Vol. 2 \$18.00 (plus "How It Works" and Index) | Volume XIV to VII (each vol.).....\$16.50 |
| Television Manual, Vol. 1 18.00 (plus "How It Works" and Index) | Volume VI..... 12.50 |
| Volume XIX..... 19.80 | Abridged Manuals I to V (one volume)..... 19.80 |
| Volume XVIII..... 19.80 | Record Changers and Recorders..... 9.00 |
| Volume XVII..... 16.50 | Master Index, Covering Manuals, Vols. I to XV 1.50 |
| Volume XVI..... 8.40 | PA Equipment Manual, Vol. I..... 18.00 |
| Volume XV..... 19.80 | |

JOHN F. RIDER PUBLISHER, Inc.
480 Canal Street, New York 13, N. Y.
Export Agent: Rocke International Corp., 13 E. 40th St., N.Y.C.
Cable, ARLAB.

It's a TV "MUST"!
RIDER TELEVISION MANUAL
Volume 2



RIDER TELEVISION MANUALS present the information needed to properly service all television receivers and kits manufactured to date. 67 manufacturers are represented in Volume 2. Equivalent of 2300 pages, including Giant, Triple and Double Spread pages.

Only **\$18.00**

Including Cumulative Index Volumes I and 2... PLUS the Famous RIDER "HOW IT WORKS" Book.

NOTE:

The Mallory Radio Service Encyclopedia, 6th edition, makes reference to only one source of radio receiver schematics—Rider Manuals. ANOTHER NOTE: The C-D Capacitor Manual for Radio Servicing, 1948 edition No. 4, makes reference to only one source of receiver schematics—Rider Manuals.

RIDER MANUALS
Mean Successful Servicing

SERVICE & SOUND

Section of **RADIO & TELEVISION RETAILING**

Servicing the Clock Radio

G. E. Models 66 and 67 Incorporate Some Changes From Previous Versions

● Model 66 (rosewood plastic) and 67 (ivory plastic) are re-styled versions of earlier "wake-up-to-music" radios. These radios will turn on automatically at a time pre-set by the user. Another model (64 and 65) will also turn the radio off automatically. The difference between these two types is principally in the clock mechanism.

The schematic diagram and voltage readings for models 66 and 67 are shown. Later production receivers use a 35W4 type rectifier tube in place of the type 35Z5 tube in the first production chassis, and changes in wiring and voltage measurements are shown in the

diagrams. Early production receivers also use individual condensers C16, 17, 19 and 20; while later chassis incorporate these capacitors in a 4-section unit catalogued RCW-3013.

One side of the power line is connected to B—. Avoid any ground connections direct to B—. It is recommended that an isolation transformer be used when servicing the set out of the cabinet.

Alignment and servicing of this model is conventional for its type. Repairs and adjustments to the clock may be made as described below:

Alarm tone can be adjusted by either

bending the vibrator arm nearer or farther away from the field core. Bend arm near anchor point.

To clean, completely disassemble and



G. E. Model 67 radio utilizes clock-switch.

clean all moving parts in carbon tetrachloride or some similar cleaner. The inside of the sleeves and shaft surfaces may be cleaned of oxidized oil by rubbing with a fine grade of steel wool dampened in carbon tetrachloride.

Do not use too much oil, and apply by means of a small wire (drop oiler). Too much oil collects dust and later oxidizes.

1. Clock will not operate—defective field coil, defective rotor, binding of parts.

2. Clock loses time—binding of parts, too little friction on minute hand sleeve assembly, defective rotor. Clock time set shaft bent and rubs against hole in clock bracket.

3. Noisy clock—rotor defective, alarm armature improperly adjusted, loose parts, or binding of moving parts.

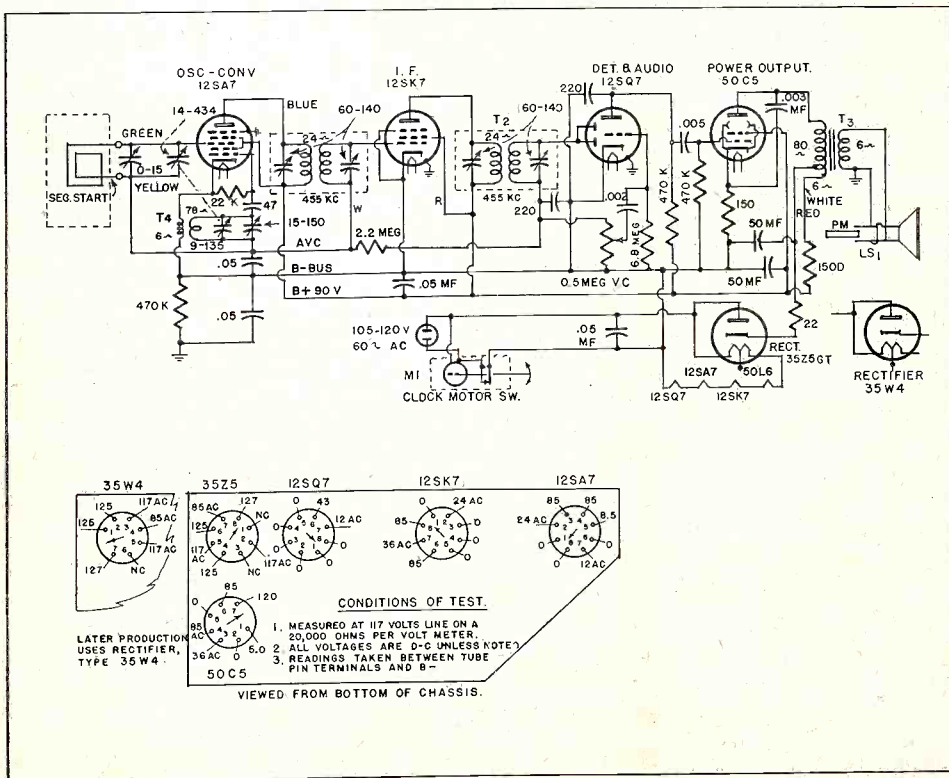

Voltage Multiplier Systems

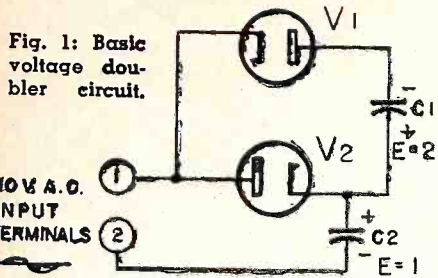

Fig. 1: Basic voltage doubler circuit.

POWER supplies incorporating voltage multipliers are to be found in increasing numbers in modern television receivers. Such systems are being used not only to double the voltage, but in many instances are utilized for voltage tripling and quadrupling purposes. The circuits employed are both practical and ingenious and serve to save space, eliminate the weighty power transformer, and make for lower cost. Their growing popularity makes it well worthwhile for the engineer, technician or serviceman working with sets incorporating such supplies to become familiar with the basic circuits involved.

Voltage doubling circuits are not new and extensive use of them is found in many electronic devices. A brief review of the foundation circuit, however, will serve as a basis for analysis of tripling and quadrupling circuits used by various television receiver manufacturers. A typical doubling circuit employing two diodes (or a duo-diode tube) is shown above. At one alternation of the AC current, input terminal No. 1 will be positive and terminal No. 2 negative. V2 will then conduct and charge C2 with voltage (E) of a polarity as shown.

During the time V2 conducts, V1 is in a non-conducting state, inasmuch as the plate is minus with respect to the plus cathode. When the next alternation of AC current arrives, it makes terminal No. 1 minus and terminal No. 2 plus. V2 now no longer conducts, but V1 does conduct by virtue of its plate being plus with respect to the minus cathode. Since C2 was previously charged to peak line voltage, its charge in combination with the line voltage is now impressed across C1, thus charging C1 to 2E.

Thus by successive doubling, designers obtain sufficiently higher voltages to operate a receiver. Notable examples of this procedure appear herewith.

* This article first appeared in the May issue of TELE-TECH, another Caldwell-Clements publication.

In this group the power supply section of certain Hallicrafter receivers are shown (Fig. 2 below left). At right Fig. 4 is shown how the negative single voltage source and the tripler stage are combined to quadruple. (Model T54). On the positive swing of the AC line voltage, C60A charges through CR1 and R73 to voltage "E." During this time (V15-B being non-conductive). On the negative swing of the line AC, this voltage adds to the line voltage to charge C58B to double voltage through V15B which now conducts. During this time the Selenium rectifier is not conducting, making it a virtual open circuit.

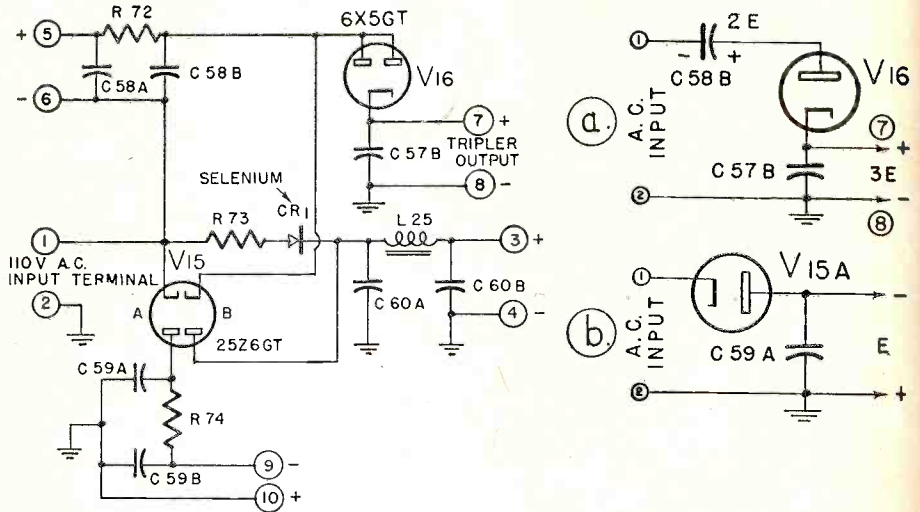

On its positive swing, the line voltage adds to 2E across C58B, to charge C57B through V16 to a voltage 3E. Fig. 4b is again a simple half-wave rectifier where the plus polarity is connected to ground. Its output is approximately equal to the voltage obtained from terminals 3 and 4, except for reversed polarity. Added to the voltage across terminals 7 and 8, it provides a quadruple voltage, 4E, used as plate supply to the vertical and horizontal sweep amplifiers.

Fig. 3: (right) indicates the single and double voltage sections in simplified form.

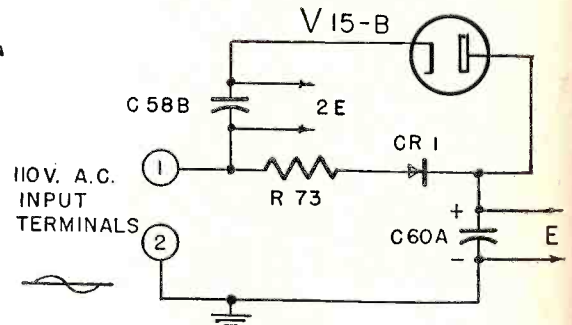
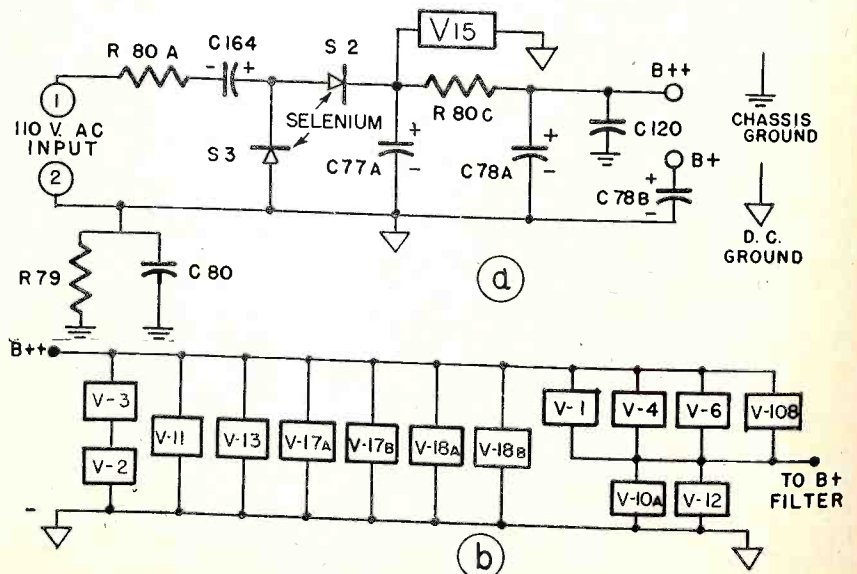

Fig. 5: A voltage doubling system of the Motorola TS-4F chassis is the VT-71 series. The unusual feature here is that the tubes themselves act as voltage dividers. The Two B voltages are delivered. The voltage multiplying takes place in a manner similar to that described above. R80A is used for current limiting.

In Fig. 5b, terminals as marked are connected to those in 5a. Plate voltage for V5 is taken directly from C-77A. For the other tubes the B++ output of the filter section is used. V3 and V2 are in series from B++ to DC ground, and that B+ is obtained by using the six tubes. V1, V4, V6, V10B, V10A, and V12 in a series-parallel combination.



in TV Receivers*

By M. MANDL and N. SHER,
Television Instructors, Temple University Technical Institute,
Philadelphia, Pa.

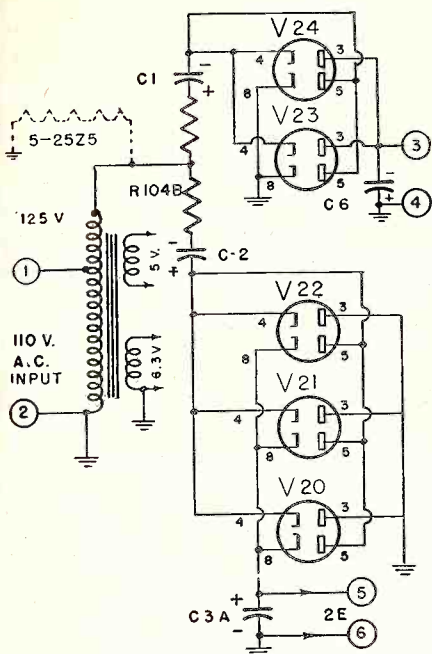

Fig. 6: In the Emerson, Model 571, five 25Z5 rectifier tubes are utilized. A parallel combination of two provides one doubler system and a parallel combination of three another doubler. The use of the rectifiers in parallel permits comparative larger amount of current to be used in TV receiver. The combined use of the two doublers, gives quadrupling action in the Emerson.

Fig. 6 shows the low voltage power supply section of this particular Emerson receiver. The 125 volts from the auto transformer secondary provides the heater voltage for the five 25Z5 rectifier heaters in series. Diode sections marked 3 and 4 of both V23 and V24 are paralleled as are sections 5 and 8 of these same tubes. Diode sections 3 and 4 of V20, V21 and V22 are in parallel as are sections 5 and 8. They are connected as a voltage doubler with positive output. A plate supply voltage proportional to 4E is used for the sweep circuits by combining the outputs of the two doublers. Output 4E in Fig. 6 is obtained from terminals 3 and 5.

In the Farnsworth FV-200 set, Fig. 8a below left shows the picture tube power source. Here V18, used in the "beam relaxor" circuit which generates the horizontal sweep current, cuts off during the horizontal retrace, and a positive pulse is produced at its plate. This pulse is stepped up by the auto transformer and is supplied to a voltage doubler circuit to produce the high voltage.

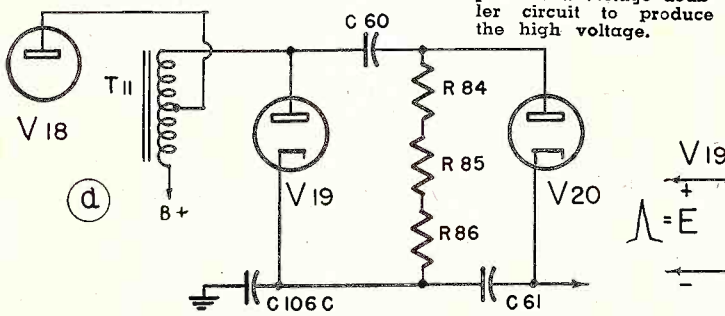
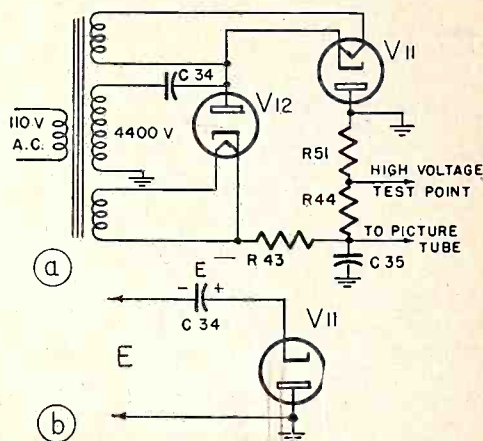
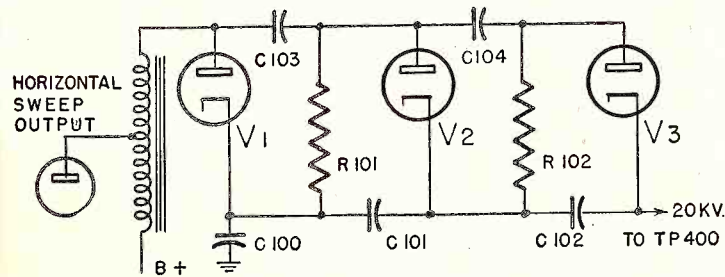

Fig. 7a shows the DuMont RA-101 voltage doubler source of high voltage for the picture tube. This differs from the usual inductive fly-back or high frequency oscillator type of second anode supplies so common that a power transformer is used, with a secondary delivering 4,400. On the negative swing of this high voltage secondary, C34 charges to voltage E through V12, as shown in Fig. 7b.



On the positive swing voltage E on C34 adds to the secondary voltage (input) to charge C35 through V12 and the limiter resistor R43. The charge thus placed on C35 is proportional to 2E. During this time V11 is not conducting. R44 and R51 are used as a bleeder and voltage divider to facilitate voltage measurement during servicing. The voltage across R51 is about 1% of the total.



The Philco high voltage supply Fig. 9 (in the Model 48-2500 receiver) furnish somewhat over 20,000 volts for the TP-400 projector tube. This is a triple circuit using three sections. The output is the sum of the voltage across C100, C101, and C102, each of which is charged to approximately 7,000 volts. C103 and C104 are likewise charged to the triple approximately 7,000 volts. The signal which is applied to the tripler is the positive pulse developed across the auto transformer of the horizontal output transformer from the horizontal fly-back during retrace.

Fig. 10: The 5TP4 projection tube power supply of the General Electric Model 901 uses a voltage quadrupler circuit to furnish 27,000 volts. The counterparts of C219 and R215 do not appear in the other high voltage sources, previously discussed. The values of these parts, (470 mmfd. and 47,000 ohms) are small enough so that C219 will be discharged through R215 between charging pulses. The DC voltage across C219 will be small compared to the voltages across the other capacitors and can be neglected insofar as its effect on the rest of the circuit is concerned. C219 and R215 will act to limit the charging currents flowing into the other capacitors. From the cathode of V209 to ground a voltage of 3E appears since each capacitor (excepting C219) is charged to voltage "E"—the pulse

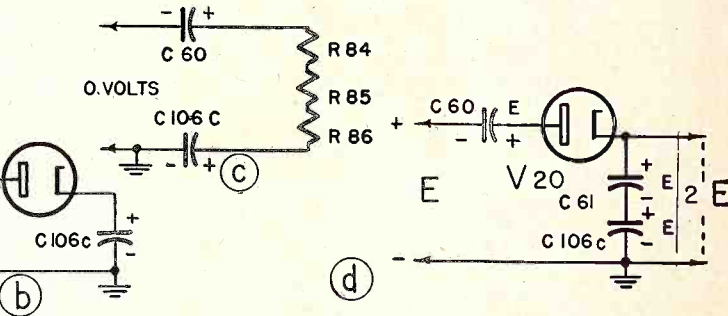

During the pulse, C106C charges to voltage E through V19. Between pulses, C106C will discharge through R84, R85 and R86, thus charging C60. After several cycles each capacitor builds up to voltage E (Fig. 8c). During pulses, voltage E on C60 adds to pulse voltage, to charge C61 and C106C through V20 to a total voltage 2E, with voltage "E" appearing across each. (Figure 8d) The output is the sum of the voltages across C61 and C106C.

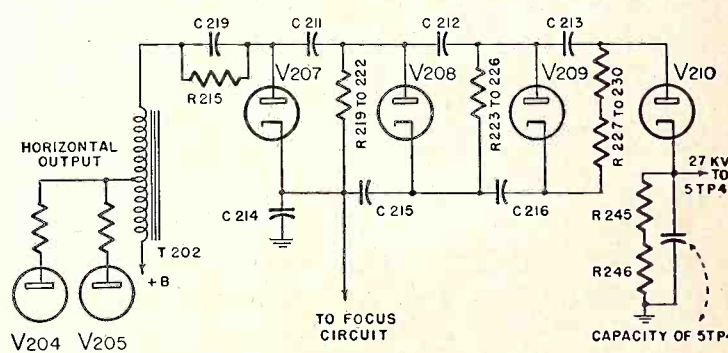

voltage. When a positive pulse appears at the top of the auto transformer, the voltages across C211, C212, and C213 (each of value "E") add to the pulse voltage to charge the capacity between inner and outer wall coatings of the 5TP4 to a potential of 27,000 volts, (through V210). The voltage across C214 is applied to a resistance voltage divider network from which focusing voltage for the 5TP4 is obtained. This use of the 5TP4 tube conductive coatings for a capacity is conventional. The high voltage is applied across inner and outer aquadag coatings, with the glass acting as the dielectric.

Television Technician

Section of RADIO & TELEVISION RETAILING

Bud TV BOOSTER

A new television antenna booster, T.A.B. 81, features the use of a separate amplifier for the high and low channels. The cabinet has a brown hammered finish with lettering in gold. List price is \$29.75. Bud Radio, Inc., 2118 East 55 Street, Cleveland, Ohio.—RADIO & TELEVISION RETAILING.

Wheeler HANDSETS

The system consists of two high impedance sound-powered telephone handsets; requires no batteries or other power supply. The cord set of each unit is equipped with two rubber-insulated test clips. The system is activated by simply attaching the clip leads of the handsets to two-conductor full metallic wire or single wire, ground return circuit. Operation is said to be efficient up to 25 miles of #16 twisted pair wire; up to 15 miles with #19 twisted pair. The Wheeler Insulated Wire Co., Inc., 150 East Aurora St., Waterbury 91, Conn.—RADIO & TELEVISION RETAILING.

Fedco TV PICTURE-VU

Picture-Vu is a device for TV installers, comprising a portable mirror on a heavy stand, and helps make TV adjustments on the rear apron of the set a one-man job. Dealer's net is \$6.00. Federal Engineering Co., 37 Murray St., New York 7, N. Y.—RADIO & TELEVISION RETAILING.

ABC 300 OHM TOOL

This new hand tool for 300 ohm twin lead will remove insulation between conductors, leaving rounded radius to prevent tearing.

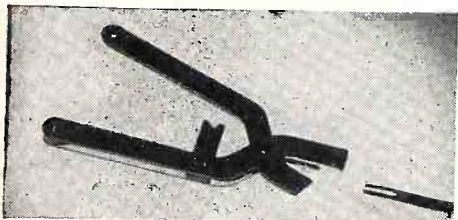

Insulation can be removed to 1/4 inch or more. ABC Tool Co., distributed by Chas. M. Arnt & Assoc., 3042 W. Irving Park Rd., Chicago 18, Ill.—RADIO & TELEVISION RETAILING

Alliance TENNA-ROTOR ACCESSORY

An accessory to the Alliance Tenna-Rotor, the Thrust Bearing Bracket is to be used in conjunction with the Tenna-Rotor for facilitating the support of heavier type TV and FM antenna. The Thrust Bearing Bracket (Model-TBB) retails for about \$8.00 and is designed to remove the entire weight of the heavy antennas from the Tenna-Rotor, and to transfer this weight to the ground, through the antenna mast. The Bracket is made for all weather operation. Alliance Mfg. Co., Alliance, Ohio.—RADIO & TELEVISION RETAILING.

Walsco WIRING NAILS FOR TV

These nails are designed for 300 ohm parallel twin leads. The maker states that laboratory tests indicated no appreciable effect on the impedance of the line since the heads are made of insulating material and the metal portion of the nails is held to an absolute minimum. The head is the same color as the standard brown lead, to blend with the cable. Walter L. Schott Co., 9306 Santa Monica Blvd., Beverly Hills, Calif.—RADIO & TELEVISION RETAILING.

Smith CLAMP STAND OFF

Clamp Stand Off for antenna masts for use in securing either twin lead or RG type line to antenna masts features the fact that it is not necessary to use any tool to tighten the Clamp Stand Off and by simply turning the screw eye, it is tightened in place. All the Smith Clamp Stand Offs are supplied with molded polyethylene inserts. Herman H. Smith, Inc., 405-44th Street, Brooklyn 20, N. Y.—RADIO & TELEVISION RETAILING.

JFD MAST LEAD-IN SUPPORTS

Mast-clamp screw-eye standoffs are designed for use in securing twin lead or co-ax downleads to any size mast or element from 1/2 inch to 2 inches in diameter. Several lengths are provided for various clearances between lead-in and mast: 3 1/2", 5 1/2", 7 1/2", and 12". A folder describing the mast-clamp standoff line is available on request from JFD Mfg. Co., Inc., 4117 Ft. Hamilton Parkway, Brooklyn 19, N. Y.—RADIO & TELEVISION RETAILING.

Mastercraft TV ANTENNA MOUNT

Designed for mounting TV antenna masts on chimneys, the Mastercraft mount provides for mounting the mast on one corner of a chimney and holding it in place with galvanized cable gripped by hammer-lock sleeves. Maker claims rapid installation by one man without special tools. Mastercraft Products, 60 South St., Boston 11, Mass.—RADIO & TELEVISION RETAILING.

Amphenol TUBULAR TWIN-LEAD

A new tubular Twin-Lead for television and FM antenna lead-ins has been introduced under the catalog number 14-271. This new transmission line brings to reception the weatherproof features of Amphenol's number 14-076 300 ohm tubular transmitting Twin-Lead introduced early in 1948 for use with amateur transmitting antennas. The tubular design holds moisture or dirt outside the concentrated field between the conductors and has lower wind resistance than the conventional flat Twin-Lead and greater strength. The outside diameter is approximately 5/16". Conventional coaxial cable type insulators may be used to support this new tubular Twin-Lead. American Phenolic Corp., Chicago 50, Ill.—RADIO & TELEVISION RETAILING.

Snyder PORTABLE TV ANTENNA

The new model MP Tele-Port TV antenna features ivory tone base and gold tone telescopic dipoles on a base suitable for

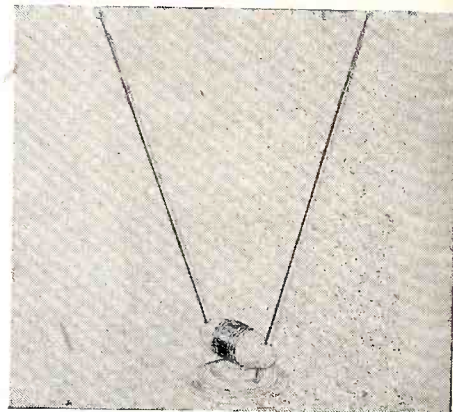

indoor installation. Designed for all-channel, all-way orientation, the MP comes complete with cable, ready for use. Snyder Mfg. Co., Philadelphia, Penna.—RADIO & TELEVISION RETAILING.

Ferris INDOOR TV ANTENNA

The new antenna features 12 channel coverage without requiring adjustment of any kind except orientation. List price is \$9.95 and will be fair traded. The antenna will be sold through jobbers only. Ferris Television Labs., 510 N. Dearborn St., Chicago 10, Ill.—RADIO & TELEVISION RETAILING.

Taco INDOOR ANTENNA

The first Taco indoor TV antenna, known as catalog number 975, features horizontal and vertical orientation, highly polished telescopic dipoles, attractive plastic base, all-channel coverage, and 300-ohm lead-in attached. The base is sufficiently heavy to carry the dipoles at different angles without tipping. Technical Appliance Corp., Sherburne, N. Y.—RADIO & TELEVISION RETAILING.

Camburn INDOOR ANTENNA

Identified as "Majorette" model TA59, is designed to receive all channels. The base is made of mottle finish catalin in mahogany grain with telescopic dipoles in three sections and swiveled to permit quick orientation for signal strength. The sections are chromium. The "Majorette" is supplied with transmission line. Camburn, Inc., Woodside, N. Y.—RADIO & TELEVISION RETAILING.

RCA INDOOR TV ANTENNA

The new antenna is designed to receive stations on television channels from 2 to 13 in areas where strong signals from these stations are normally received. The RCA antenna, which is an end-loaded dipole type, features two aluminum discs, one on each arm of the antenna. RCA Victor Division, Camden, N. J.—RADIO & TELEVISION RETAILING.

First with the Finest in TELEVISION TUBES!

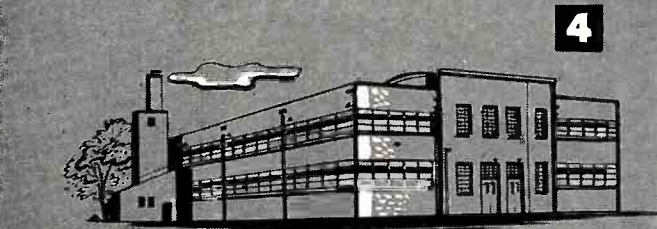
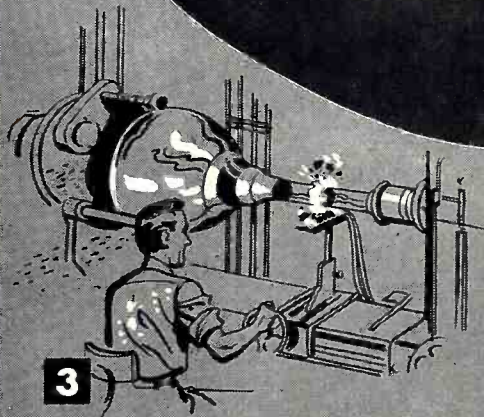
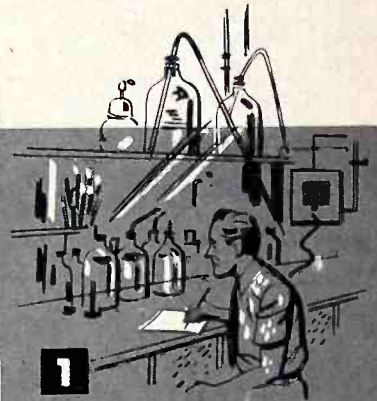

▶ Allen B. Du Mont gave us the commercialized cathode-ray tube. Starting with a scientific curiosity in 1931, he pioneered the practical television picture tube of today. And Du Mont pioneering has never ceased. Examples? **1** Du Mont chemical research has led to tube screens of various persistencies and intensities precisely matched to any television requirements. **2** Du Mont research and development engineers have always led in large television tubes—those 12½", 15" and 20" Teletrons*—because Dr. Du Mont has insisted on "comfortable" televiewing. **3** Du Mont craftsmen, provided with the finest glass-working equipment known, can translate advanced tube designs into greater tube values at lesser prices. **4** And to keep pace with the huge and still growing demands, Du Mont quantity-quality production has steadily stepped up, climaxed by the new Allwood plant. Yes, it's Du Mont Teletrons for the "First with the Finest in Television Tubes."

*Trade-mark

© ALLEN B. DU MONT LABORATORIES, INC.

FIRST WITH THE FINEST
IN TELEVISION TUBES

DU MONT Teletrons

ALLEN B. DU MONT LABORATORIES, INC., TUBE DIVISION, PASSAIC, N. J.

New Aids for Service and PA

Equipto STEEL DRAWER CABINETS

These new low priced steel drawer cabinets were designed especially for nuts, bolts, electrical parts, etc. They can be used singly, side-by-side, back-to-back, and stacked on top of each other. Equipto #11 has 18 drawers, each with 3 cross dividers, giving 72 adjustable compartments. The overall size is: width 34", height 13 3/4", depth 12". #11 sells for \$24.50 f.o.b. Aurora, Ill. Equipto #8 has 8 drawers, each with 2 cross dividers, giving 24 adjustable compartments. The overall size is: width 25 1/2", height 10", depth 12". #8 sells for \$11.50 f.o.b. Aurora, Ill. Equipto, Division of Aurora Equipto Co., Aurora, Ill.—RADIO & TELEVISION RETAILING.

RCP SIGNAL GENERATOR

Improved model 705A provides signals from 95 kc to 150 mc covering AM and FM requirements, with 400 cycle audio mod-

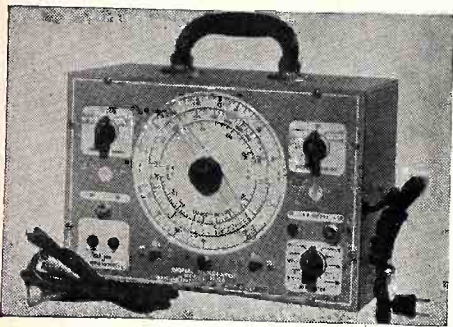

ulation available. Ladder attenuator controls output. Unit is priced at \$49.50. Radio City Products Co., Inc., 152 West 25th St., New York 1, N. Y.—RADIO & TELEVISION RETAILING.

Durst SOLDERING PLIERS

Electric soldering pliers employing the current-resistance principle feature instantaneous heat, require no tinning, heat elements or tips. Tool is always cool. The wires or parts to be soldered are held by the pliers, the foot switch is depressed for an instant, heating the wires or part sufficiently to melt the solder. Durst Manufacturing Co., 11110 Cumpston St., No. Hollywood, Calif.—RADIO & TELEVISION RETAILING.

Pioneer CHASSIS PUNCH

This is a self-aligning keyed socket punch which cuts a 1 1/64" diameter hole with a key especially designed for the radio and electronic fields. All locking advantages and non-rotating features of Amphenol "S" type socket and plugs or Millen Nos. 33004, 33005, 33006 and 33008 sockets are fully utilized by use of the Pioneer Keyed Socket Punch. The key prong in the punched hole locks the socket in a fixed position and prevents rotation. The new Pioneer Keyed Chassis Punch sells for \$3.50. Pioneer Broach Co., Dept. AR, 1424 South Main St., Los Angeles 15, Calif.—RADIO & TELEVISION RETAILING.

Turner MICROPHONE

New model 25 mike is available in either crystal (25X) or dynamic (25D) circuits. 25X frequency response is said to be flat from 50 to 9000 cycles, 25D 50 to 10,000 cycles



with output 52 and 54db below 1 volt/dyne respectively. Tilting head and 5/8-27 coupler are provided. The Turner Co., Cedar Rapids, Iowa.—RADIO & TELEVISION RETAILING.

Pentron RECORDING CHASSIS

PT-3-J is a basic tape recording mechanism for dual tracking at 7 inches per second, providing 1 hour from a standard reel of tape. Oscillator coil, suggested circuit diagram, parts list and parts layout are included in the net price of \$65.00.—RADIO & TELEVISION RETAILING.

Sylvania SUBMINIATURE TUBES

The new subminiature tube group includes a 1AD5 sharp cut-off r-f pentode; 1E8 pentagrid converter; 1T6 diode pentode; and 1AC5 output pentode. Filaments are rated at 1.25 volts and 40 milliamperes d-c. All four tubes are designed for plate voltages ranging from 30 to 67.5 volts and plate currents ranging from 0.30 to 2.0 ma. The tubes are supplied with 8-pin subminiature leads. Sylvania Electric Products, Inc., 500 Fifth Ave., New York 18, N. Y.—RADIO & TELEVISION RETAILING.

Ideal WIRE STRIPPER

The Ideal "Stripmaster" is designed for stripping building, fixture or telephone wire, automotive wiring, radio and instrument wire and cable, FM and TV down lead wire. Squeezing the handles grips the wire, cuts the insulation and strips the wire—all in one operation. Four models handle all wire gauges from Nos. 22 to 8. A fifth model is designed especially for FM and TV down lead wire. Blades are interchangeable on all models and can be taken off and replaced in less than one minute simply by removing two screws. Ideal Industries, Inc., 4039 Park Ave., Sycamore, Ill.—RADIO & TELEVISION RETAILING.

Slim Jim SOLDERING TOOL

The Slim Jim iron is approximately 9 inches long and weighs 3 ounces. It features the "thermo-cell" heating element, contained in the tiny replaceable tip, designed to retain the heat in the tip and prevent back-flow of heat into the handle. Transformer is separate from the iron, but supplied with it for the list price of \$14.50. Jet Thermal Device Co., 2173 86th St., Brooklyn 14, N. Y.—RADIO & TELEVISION RETAILING.

Shure MICROPHONE

The "Hercules," model 510 is a new controlled reactance mike for hand-held operation featuring high output and low price. The mike can be used either as a transmitter or a receiver, and is designed for use either outdoors or indoors. Provided with 7 ft. cable, with or without switch. Shure Brothers, Inc., 225 W. Huron St., Chicago 10, Ill.—RADIO & TELEVISION RETAILING.

Hytron TUBE LIFTER

This simple tool facilitates lifting tubes from their sockets, as well as vibrators, plugs, knobs and the like by lever action. Right-angle end of lifter for tight places in

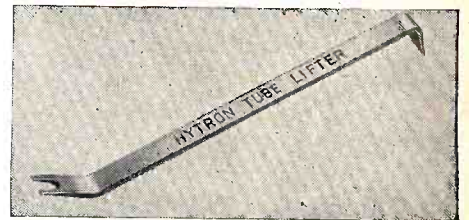

auto radios, 45-degree angle end reaches tubes from rear of cabinet. Slotted end fits around one pin of lock-in tubes. Available for 15c from Hytron jobbers. Hytron Radio and Electronics Corp., Salem, Mass.—RADIO & TELEVISION RETAILING.

C-D NOISE FILTERS

Four new television and radio noise filters have been developed for use on motors, generators and R.F. heating equipment. Three of these are intended for low voltage motors and generators. The other—NF-10084—is designed for equipment operation from power lines up to 250 V AC-DC. Current ratings range from 20 to 350 amperes. All have feed-through construction, and are compact and light weight. Cornell-Dubilier Electric Corp., South Plainfield, N. J.—RADIO & TELEVISION RETAILING.

Torchmaster HAND TORCH

The new Torchmaster is a general utility, self-contained hand torch only 2 1/4" by 13" burning liquid petroleum gas (Butane, Propane, etc.). It holds enough fuel for an average day's burning. It can be filled from standard containers for from three to five cents. I.E.P.C. lists the Torchmaster at \$19.50. Industrial Engineered Products Co., 7416 Melrose Ave., Los Angeles 46, Calif.—RADIO & TELEVISION RETAILING.

Famous Sylvania Polymeter now available with new plus features for complete television service!



- Shielded ac probe lead—reduces stray field effect.
- Microphone type panel connectors on probe leads insure firm, long life connections.
- RF probe features ground clip and detachable extension tip—extremely flexible in application.

CHECK THESE OTHER OUTSTANDING FEATURES:

The essentially flat frequency response of 20 cycles to 300 mc. and useful range to 500 mc. gives this complete vacuum tube voltmeter a range low enough to test high fidelity amplifiers, yet high enough to accommodate all television frequencies.

The instrument has seven current scales—six of them reading in milliamperes and one reading in amperes. The specially engineered Sylvania Subminiature Tube contained in the RF Probe permits the exceptionally high frequency range of this instrument at a high input impedance and an unusually low input capacitance.

The large 4½" meter affords maximum readability, while careful design minimizes error introduced by line voltage variation, tube variations and stray fields.

Be sure to send your coupon today to receive full particulars on the new Sylvania Polymeter Type 221!

SYLVANIA ELECTRIC

ELECTRONIC DEVICES; RADIO TUBES; CATHODE RAY TUBES; FLUORESCENT LAMPS,
FIXTURES, WIRING DEVICES, SIGN TUBING; LIGHT BULBS; PHOTO-LAMPS

RANGES

DC volts	0-3, 10, 30, 100, 300, 1000, 10,000*
AC volts	0-3, 10, 30, 100, 300, 1000
RF volts	0-3, 10, 30, 100, 300
Resistance Ohms	0-1000, 10,000, 100,000, 1 meg., 10 meg., 1000 meg.
Current Ma	0-3, 10, 30, 100, 300, 1000
Current Amps	0-10

DC, AC, RF and Ohm scales utilize authentic Vacuum Tube Voltmeter Circuits resulting in extremely low load when measuring delicate circuits.

FREQUENCY

AC volts	20 cps to 15,000 cps
RF volts	10,000 cps to 300 mc



*With this new DC Voltage Multiplier, Type 223, the 1,000 vdc range setting on the new Sylvania Polymeter will read 10,000 vdc full scale! The 300 vdc range setting will read 3,000 vdc full scale! Add this accessory and you have a Kilovoltmeter for testing TV circuits and other high dc voltage applications. Only \$9.95!

Sylvania Electric Products Inc.
Advertising Dept. R-2107
Emporium, Pa.

Gentlemen: Send full details on new Polymeter Type 221 and
accessory probe Type 223.

Name

Address

City

State Zone

New Service Aids for AM, FM, TV

Scott NOISE SUPPRESSOR

The new Type 211-A is an all-triode version of the Scott dynamic noise suppressor. Maker claims frequency range of 20 to 20,000 cycles, peak power output of 14 watts, low distortion and low hum level. An improved version of the 210-A is also available, with actual hum power level said to be reduced to .05 microwatt. Herman H. Scott, Inc., 385 Putnam Ave., Cambridge, Mass.—RADIO & TELEVISION RETAILING.

Alliance PHONOMOTORS

Model JP 45 is a 45 RPM phonomotor-turnstile assembly for use in original equipment and replacement, and features extreme quietness, freedom from mechan-

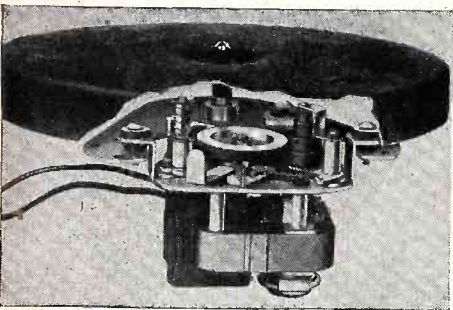

ical vibration, and decreased height. The same model J motor is utilized in the new 3-speed phonomotor assembly illustrated, which achieves speed change without belts or rubber bands, and is said to be "wow" free at all speeds. Alliance Mfg. Co., Alliance, Ohio.—RADIO & TELEVISION RETAILING.

RCA MINIATURE LAMPS

Designed to give the radio service dealer a wide assortment of fast-moving lamps for replacement needs, the line includes sixteen different types for radio panel and miscellaneous replacement use, and eight types for flashlight replacement. The lamps are packaged ten to a carton. Tube Dept., Radio Corporation of America, Harrison, N. J.—RADIO & TELEVISION RETAILING.

Vaco SCREWDRIVER KIT

Screw Driver Kit includes a handle and five different interchangeable shanks, thus enabling the user to service most screw driver needs, from light to medium heavy sizes including both Slot or Phillips Screws. Called the Vacombo screw driver kit No. ZB 50, this set consists of a 1" x 3 3/8" Ambery handle, with the following blades: 1/8", 3/16", 1/4", No 1 Phillips point, and No. 2 Phillips point. A 6" Extension may be purchased to fit in the extra pocket, thus giving the user 10 tools instead of 5, for 70 cents additional. The Vacombo screw driver kit comes in a seven-section leatherette holder, with tie laces, which when rolled makes a small compact unit easily carried in any pocket. Vaco Products Company, 317 E. Ontario Street, Chicago 11, Ill.—RADIO & TELEVISION RETAILING.

Electro-Voice MIKE STAND

A new type touch-to-talk desk stand is designed to fit any microphone with 5/8-27 coupler for "break-in" operation. Switch opens the moment pressure is released, but



may be locked in "on" position. Model 328 switch only lists as \$9.50, model 428 switch with stand lists as \$12.50. For further information, write for bulletin No. 150, Electro-Voice, Inc., Buchanan, Michigan.—RADIO & TELEVISION RETAILING.

Bond-Olin DRY CELLS

The two latest dry cell batteries of the new type of interlocked construction have just been announced for portable radios. One is a 90-volt "B" battery (No. 1713) and the other is a 4 1/2-volt "A" battery (No. 3816). The No. 1713 "B" battery is made up of three stacks, each of 20 plastic flat cells. Each of the 20 cells in each stack interlocked to make electrical connection. The only soldered connections are between the three stacks. The "A" battery (No. 3816) is made up of three cylindrical cells. Olin Industries, Inc., New Haven, Conn.—RADIO & TELEVISION RETAILING.

Goodell NOISE SUPPRESSOR

Model NSA-20 is a noise suppression filter amplifier providing attenuation above any selected frequency from 3500 to 16,000 cps. The circuit has no dynamic action. Both bass and treble controls have eleven position tapped switch with five positions of attenuation and five positions of boost. Radio and phone inputs are provided, and power supply for a pre-amplifier. Power output is 10 watts. Minnesota Electronics Corp., St. Paul, Minn.—RADIO & TELEVISION RETAILING.

Eagle RADIO KIT

The Pict-O-Graph Q-5 kit is an educational unit combining 4 basic circuits: amplifier, radio receiver, code practice oscillator, and miniature transmitter. The 5-tube kit is priced at about \$20. Additional information may be had by writing Eagle Electronics, Inc., 90 Walker St., New York 13, N. Y.—RADIO & TELEVISION RETAILING.

Lafayette AMPLIFIER

A new high fidelity amplifier specifying frequency response from 40 to 15,000 cycles is designed for use with microphone, wire recording head or low-level magnetic pickups. Both a low and high gain input are provided, and both channels can be intermixed. Record-playback and monitor volume controls are provided. The six-tube chassis includes 2-6V6's in push-pull, and built-in erase and bias oscillator for magnetic recording. Lafayette-Concord Radio, 100 Sixth Ave., New York 13, N. Y.—RADIO & TELEVISION RETAILING.

Triplet V-O-M

Model 666-R is a pocket-size volt-ohm-milliammeter with 3 resistance ranges to 3 megohms, 10 AC-DC voltage ranges to



5000, and 3 DC current ranges. Unit measures 3-1/16 x 5-7/8 x 2-9/16 inches. Triplet Electrical Instrument Co., Bluffton, Ohio.—RADIO & TELEVISION RETAILING.

Transvision TV REMOTE CONTROL

Remote control unit is said to be able to operate any TV receiver from a distance up to 50 feet. It turns set on and off, controls brightness and contrast, and provides continuous tuning on all TV channels. Sensitivity is said to be approximately 50 microvolts. Model TRCU is priced at \$69.00, or \$65.00 without cabinet. Transvision, Inc., New Rochelle, N. Y.—RADIO & TELEVISION RETAILING.

Mallory 6 VOLT POWER SUPPLY

The new unit, Mallory 6RS10, has been designed as a convenient source of DC current wherever 110-115 volt AC current is available. It is particularly suited for testing of automobile radio sets and has ample power to operate those with electrical tuning mechanisms. DC voltage is continuously variable from 0 to 8 volts. The unit may be safely operated continuously at 10 amperes and intermittently at 20 amperes. The power supply is fully equipped with a 0-20 ampere DC ammeter, a 0-10 Volt DC voltmeter, a self-resetting circuit breaker in the DC line, a switch and fuse in the AC line, and a six-foot AC cord. P. R. Mallory & Co., Inc., 3029 E. Washington St., Indianapolis 6, Ind. Refer to Catalog No. 6RS10—RADIO & TELEVISION RETAILING.



The Jobber Who Displays This Award... Is The Serviceman's ***BEST FRIEND***

Radiart is proud of its many loyal and faithful jobbers. In recognition of jobbers throughout the nation who have handled Radiart products for five years or more, we are presenting them these plaque awards with a gold star for each five years of service. *The jobber who features Radiart is the serviceman's best friend... because he is offering the serviceman the BEST electronic products of their kind.* We thank our jobbers for their continued loyalty... and to all our jobbers... to every serviceman who depends on RADIART... this is our pledge for continued highest standards of manufacture that have made Radiart...

THE STANDARD OF COMPARISON

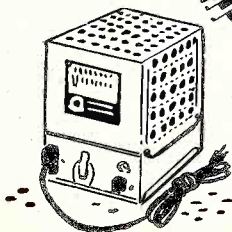
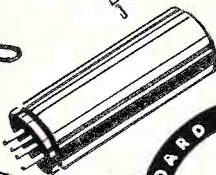
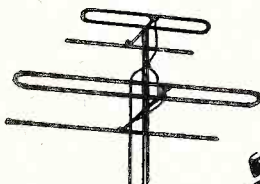

THE RADIART CORPORATION

CLEVELAND 2, OHIO

MANUFACTURERS OF THE FAMOUS RED SEAL VIBRATORS

Sylvania to Make TV Sets

Don G. Mitchell, president of Sylvania Electric Products, Inc., announces that his firm will place a full line of television receivers on the market this Fall, to be available about October 1. The line will feature 10 and 12½-inch table models, consolettes and console combinations, equipped with 3-speed record changers, AM and FM radio, as well as a 16-inch tube consolette.

Activities Among Jobbers and Reps

New distributors have been appointed by Pioneer Scientific Corp., creators of the Polaroid television filter, it is announced by Hunter L. Delatour, Jr., sales manager of the company of their New York offices, 295 Lafayette St., New York 12, N. Y. These distributors are: Klaus Radio & Electric Co., 707 Main St., Peoria, Ill.; Ewald Distributing Co., Inc., 309-315 S. 9th St., Louisville 3, Ky.; Hamburg Bros., 305 Penn Ave., Pittsburgh 22, Pa.; McGregor's, Inc., 1071 Union Ave., Memphis 3, Tenn.; Associated Distributors, Inc., 210 S. Meridian St., Indianapolis 4, Ind.; Ohio Appliances, Inc., 241 N. Fourth St., Columbus 15, Ohio.

Land-C-Air Sales Co., of 1819 Broadway, New York, N. Y., have been appointed sales representatives for the Duotone Line of phonograph needles, recording blanks and television lenses. The territory will include New Jersey, Delaware, Maryland, Washington, D. C., and eastern Pennsylvania.

Frank A. D. Andrea, president of the Andrea Radio Corp., has announced that he has received during the past few months, applications from more than 150 of the finest jobbers in the country who are anxious to distribute Andrea Television models in all territories in the United States. Mr. Andrea advises that he does not believe in spreading allocations of television sets thin, and is therefore, waiting until new production facilities can handle the increased demand for Andrea sets, before appointing any additional jobbers.

D. T. O'Connell, sales manager of the Radion Corporation of Chicago, announces the following appointments of sales representatives for the firm's portable TV Antennas: For the eastern states, Blair-Steinberg, 395 Broadway, New York 13. For New England: Michael Scott, 8 Todd Road, Cohasset, Mass. For Texas: J. H. Martin, 4304 Montrose, Houston, Texas.

I. M. Sandberg, general sales manager, Crosley Distributing Corp., New York, has announced the following appointments: Joseph A. McLaughlin, district supervisor in Brooklyn and Queens; Alfred Packer, district supervisor in Manhattan, Bronx and Westchester. Bick Caputo, field representative for midtown Manhattan; John F. Sand, Jr., field representative in upper Manhattan and Norman C. Macdonald, Jr., field representative in Queens.

Wilcox-Gay TV SETS

Signalling its entry into the television field, Wilcox-Gay has announced that current production includes the "Broadway" series of modern styled consoles and the "Manchester" with traditional styling. Ten and twelve inch tubes are used in these models, and instruments featuring the 16-inch tube will be added at an early date.

Universal Reduces Price of Washing Machines

A twenty dollar price reduction has been made on Universal's two-speed washer and a ten dollar reduction on other models of Universal washers has been made by Landers, Frary & Clark according to E. L. Farquharson, sales manager of the home laundry equipment division. Washer prices in the Universal line now stand at \$149.95 for the two-speed deluxe model with pump and \$89.95 for the WM1707 model without pump. Ironer prices have not been reduced.

New GE Appointees

James E. McCarthy and James F. Stark have been appointed sales managers of the General Electric Company's automatic blanket and sunlamp division and fan division respectively.

New Philco Broadside for Electromaster Ranges

As the kickoff in the trade promotion of its Electromaster range line, the Philco Corporation has mailed 40,000 copies of a large, colorful broadside to Philco and Electromaster dealers, it has been announced by R. J. White, manager, distribution of the Electromaster Division of Philco. The company will follow up this initial promotion with advertisements in dealer publications and with displays, booklets and other dealer helps, Mr. White pointed out.

Heavy Duty "B" Battery



New space-saving design and more rugged construction are features of the Willard Flat-Pack 67½ volt "B" battery for portable radios. Pictured above, the new battery is designated Type WBM-2, and is said to give 40 to 50 hours of service. Also being introduced is the Plasticlad "A" battery, designed to give longer life. These batteries are manufactured by the Willard Storage Battery Co. of Cleveland, Ohio.

Capehart-Farnsworth Officers Elected

The directors of Capehart-Farnsworth Corp., wholly-owned subsidiary of the International Telephone & Telegraph Corp., New York City, elected Ellery W. Stone as president and David R. Hull as executive vice-president. Other officers elected are: Philo T. Farnsworth, vice-president; Henry C. Roemer, vice-president; William Clausen, vice-presi-

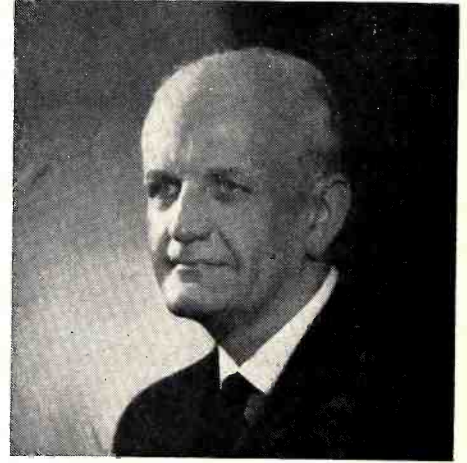

Ellery W. Stone, president

dent; P. H. Hartmann, treasurer; W. F. Hoepfner, comptroller; Chester H. Wiggins, secretary and assistant treasurer; Dudley M. Day, assistant secretary; C. Douglas Webb, assistant secretary; John J. Brosnan, assistant treasurer; Edmond H. Dufau, assistant treasurer; and Roy H. Workman, assistant comptroller.

Edwin A. Nicholas, former president of Fransworth Television and Radio Corp., will act as assistant to the president.

The board of directors of the newly-formed corporation is as follows: Sosthenes Behn, George Everson, Philo T. Farnsworth, William H. Harrison, Charles D. Hilles, Jr., David R. Hull, Edwin A. Nicholas, Henry C. Roemer and Ellery W. Stone.

Executive Changes Made at Westinghouse Corp.

Gwilym A. Price, president of the Westinghouse Electric Corporation, Pittsburgh, Pa., announces comprehensive executive changes designed to provide more adequately for the firm's greatly expanded postwar activities and new product lines.

Vice-president L. E. Osborne, primarily an operations official heretofore, is assigned staff supervision over all the company's manufacturing activities. James H. Jewell, recently-elected vice-president, takes over staff supervision of all sales and marketing on a company-wide basis.

John K. Hodnette, vice-president and head of the Transformer Division at Sharon, Pa., becomes general manager of industrial products with headquarters at Pittsburgh. John M. McKibbin, also a recently-elected vice-president and former head of advertising and sales promotion, now is appointed general manager of consumer products.

Columbia Interview

(Continued from page 42)

What has the introduction of 33 $\frac{1}{3}$ RPM Microgroove recordings done to the record business?

"The introduction of LP recordings has been a salvation to the business in a time of

1. Recession.
2. Increased competition for available consumer dollars by the reappearance of appliances in plentiful supply, and the new television sets.

The Long Playing record was exactly what the record business needed—a radical advance—a definite improvement that stimulated public interest and overcame inactivity."

Is it likely that within the next three years there will be but one speed for all phono records?

"No—that's not likely. But I will say there may be two speeds—33 $\frac{1}{3}$ RPM and 78 RPM. There are probably 12 million homes in the U. S. equipped with record playing instruments that satisfy the family of listeners. These people will continue to buy some 78 RPM records until their present playing equipment wears out. However, we are convinced that they can be induced to buy an attachment which will play LP records—with its obvious advantages of playing a complete symphony on a single record, unbreakability, price appeal, etc. I am particularly thinking of the new \$9.95 player, on which neither the dealer or distributor make any profit—but on which we find dealers average four and five LP record sales when they sell the attachment. People who are satisfied with current equipment may continue buying regular speed pop records. Of course, purchasers of new instruments capable of automatically playing our 7" discs, will prefer this type of popular record."

As to the future of recorded entertainment for the public—

a. Do you foresee any such trend as taperecording seriously in competition with discs during the next 4 years?

b. Isn't it likely that TV stars will be popular on records just as are those of audio radio and movies?

"To my mind, LP was such a radical advance that I don't foresee anything in the near future replacing it. We are continuously experimenting with new developments, and are up-to-date on the latest discoveries in the fields of tape, wire, film, etc. Our continuous aim and object is to provide the public with better products at lower cost—and bearing this in mind I can see no prospect of anything replacing LP.

"Naturally, the same people who are favorites in other entertainment medias will be listened to on records. Television simply provides another field for talent that will continue to flourish on records."

BRACH
TV ANTENNAS
build your
PROFITS
these **3** ways

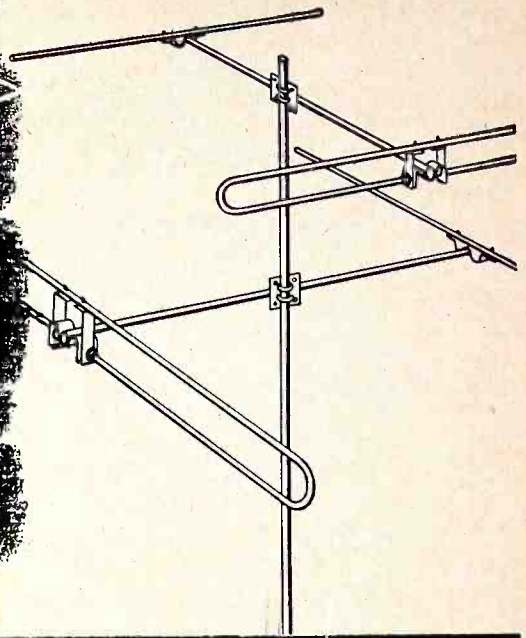

1. SAVE INSTALLATION TIME. Actually save enough for additional installations each week. Simplicity of Brach Antenna design, together with maximum pre-assembly at the factory, take whole hours of "time-on-the-roof" off your installation costs. And, for easier, quicker, on-the-job handling, Brach TV Antenna Kits are individually packaged, complete with all necessary hardware. Brach Universal Base Mount is a real time saver.

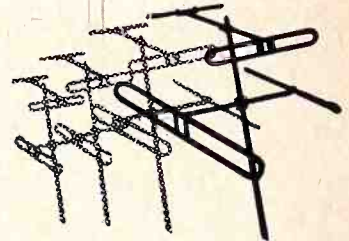

2. ELIMINATE EXPENSIVE CALL-BACKS. Brach quality engineering and bulldog ruggedness combine to help make your initial installation completely satisfactory. Developed by a name as old as radio itself, Brach TV Antennas are products of the manufacturer's own laboratory. From the rugged structural steel base mount to the tip of the sturdy mast, they're designed to stand up and shrug off the worst the weather has to offer—and deliver superior reception—longer. Factory pre-tuned and matched for 300-ohm transmission line, all Brach Antennas feature large-diameter aluminum elements for better signal pick-up.

3. MAKE PURCHASERS YOUR BEST SALES-MEN. The future success of your television line depends upon the success of your past installations. There's a Brach TV Antenna to meet every television problem better. Each Brach array you install puts you further ahead of your competition performance-wise.

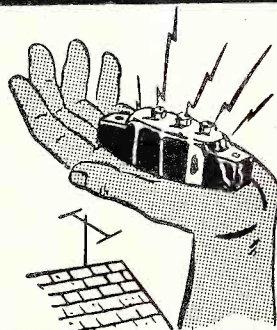
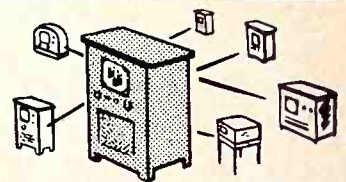

A NECESSARY EXTRA BRACH LIGHTNING & STATIC ARRESTER #4004

Helps keep the buck and jump out of the image when due to static discharge. Protects certain delicate receiver parts. Complete with all necessary hardware, the Brach Rare Gas Arrester is easily attached to any download. Constructed of porcelain and non-corrosive metal parts. Tested and listed by Underwriters' Laboratories.

SEND FOR BRACH CATALOG NO. RR1304



L. S. BRACH MFG. CORP.

200 CENTRAL AVENUE, NEWARK, N. J.

WORLD'S OLDEST AND LARGEST MANUFACTURERS OF RADIO ANTENNAS AND ACCESSORIES

How to Sell More Home Recorders

Large Market Favorably Disposed

to This Device Awaits Exploitation

● Although the home recording field has grown tremendously in comparison to what it was before the war, this important adjunct to the home entertainment field has by no means been exploited to the full. Its potentialities are virtually unlimited, and yet a substantial proportion of radio-appliance dealers carry no recorders in stock and an additional number merely carry a "sample" assortment "available" in case someone should ask about it.

Those dealers who have sought to expand and diversify sales through the addition of home recorders have had forcibly brought home to them a fact that almost everyone is vaguely aware of but very few have capitalized on. This is the fact that most people are fascinated with the sound of their own voice.

This fascination is at least as strong as the desire to see one's own likeness, a fact to which the prosperity of the snapshot business bears witness. Although a person may see his own likeness by just looking in a mirror, he very seldom has the opportunity to hear his own voice. Stores in busy shopping districts, and concessions in midways and fairs have long capitalized on this by running an on-the-spot recording business signalized by the simple invitation to "Record your voice."

Magnetic recorders offer the dealer an especially facile method of utilizing this public egotism, since one reel of wire or tape may be erased and recorded over and over. Thus free demonstration would be a matter of relatively small expense. A sign on a recorder in the store, "Hear your own voice Free" would attract many potential prospects who were "just looking" around the store—such a sign in the window would draw in many passersby (not only prospects for recorders, but for other merchandise)—and such a message in direct mail or advertising would inevitably draw many people who do not regularly walk past the store.

The dealer might readily say, "These are just curiosity seekers. Of course they want to hear their own voice, but will they buy?" That, naturally, depends on many things, but one thing is obvious: the first thing we must do to sell a product is to interest a number of people in it. If we unearth a large body of people who are agreeably dis-

posed toward or actually enthusiastic about the product, we have solved the first and one of the biggest problems. The rest of the problems depend upon the product, the salesman and the price.

For the product, we have several types: magnetic tape, magnetic wire, disc cutting and disc embossing. There is an infinitely greater variety of recorders available today than there were even two years ago, when they first started to break out of postwar shortages. Many improvements have been noted since that time, as well.

In the first place, makers of disc recorders, faced with a new competition in the form of magnetic recording which claimed to be simpler, cheaper, and better quality, have greatly improved their lines to meet this challenge. Home disc recorders have been simplified to the end that the user may make good quality, uniform recordings with a minimum of adjustments and attention. Disc recorders still have the advantage for short recordings in that no "cueing" is necessary to find the proper recording.

Improvements Made

Magnetic recording, on the other hand, has shaken out some "bugs" which caused criticism of early models. For instance, on most early models of tape recorders, it was necessary to thread the tape in a different manner for rewinding than was used in recording, which meant a rethreading operation every time the tape was reversed. Most current models can go forward or backward without rethreading, greatly simplifying their operation. In addition, where many early models had two or three motors to drive the various mechanisms, now most use only one motor, with belts to the different driven members, simplifying maintenance.

The appearance of long-playing records took some of the wind out of sales arguments in favor of magnetic recorders, since the 45 minutes for \$4.85 compared favorably with recording 30 minutes of music for \$3.50 on magnetic recorders. Two new developments in magnetic recorders have appeared to meet this challenge. The first is the "two-track" tape recorder, which records half the tape in one direction and half in the other, providing one

(Continued on page 125)

Philco Sets Up Separate Divisional Organizations

With the growth of Philco Corporation in television and other fields, William Balderston, president, has outlined a program of establishing a separate divisional organization for each major division of the business and announced the appointment of William H. Chaffee as vice-president, refrigeration operations, and Samuel N. Regenstrief as vice-president, refrigeration production. W. Paul Jones is vice-president of the refrigeration division, which includes not only household refrigerators, but freezers and single-room air conditioners. A similar organizational pattern has already been put into effect for the television and radio division, with Larry F. Hardy, vice-president of the division, and Joseph H. Gillies, vice-president in charge of operations.

Meck Ups TV Production

In a significant move to meet the greatly increased demands for television sets, John Meck Industries, Inc., Plymouth, Indiana, manufacturers of television and radio receivers, has announced a step-up in television output to 80 per cent by dollar volume of total production.

John Meck, president of the company, pointed out that although within recent months the production schedule has called for 20 per cent television as compared with 80 per cent radio, continually increasing orders for video have made it necessary to alter radically plans for the firm's future output.

In the announcement, Meck said that his organization would shortly go into production on 16-inch and 12½-inch television receivers, as well as the 10-inch and 7-inch sets currently being turned out. His future plans also include manufacture of a consolette, as well as a combination FM-AM-TV console model.

Anchor Representatives

Anchor Radio Corp., Chicago 23, Ill., has announced the appointment of the following representatives: Fred Ahrbecker, 1916 N. Merridian St., Indianapolis, Ind.; Art Cerf, 744 Broad St., Newark 3, N. J.; Jim Lacey, Kendallville, Ind.; John O. Olsen, 1456 Waterbury Rd., Cleveland, Ohio; Ward Paden, Jefferson City, Mo.; J. K. Rose, 6240 N. Francisco, Chicago 45, Ill.; Robert Szymanski, 22¾ S. Primrose, Alhambra, Calif.; Dale G. Weber, 234 Sherlock Bldg., Portland 4, Oregon; Gerald Wilson, 403 Second St., Jackson, Michigan, and H. A. Gilliam, 1311 Fannin, Houston 2, Texas.

Olympic Sales Offices

Olympic Radio & Television Inc. of Long Island City, New York, has announced the establishment of sales offices in Pittsburgh, to operate under the name Olympic of Pittsburgh, at 534 First Avenue. John Gusky has been appointed manager of this new office.

Home Recorders

(Continued from page 109)

hour of recording. The other is the use of 3¾ inches per second tape speed instead of the 7 inches which was customary in the beginning. Improved methods of utilizing the tape recording method are said to give satisfactory fidelity at this speed, which provides 1 hour from a standard reel.

Sound embossing is relatively new and limited in the home recording field, but offers many interesting features. A small plastic disc is embossed rather than cut, and the recording process requires no adjustment or attention by the user other than to turn it on or off. The disc is tiny and quite low priced (less than 25¢) as well as indestructible. An additional feature is that the disc may be played back, not only on the recorder, but also on phonograph designed for long-playing records.

A great range of prices is now available in home recorders, and the dealer would do well to consider what is contained in the instrument before judging its price and quality. For instance, a wire recorder with a 3-tube amplifier and 4-inch loudspeaker could not properly be compared with a tape recorder with a 7-tube amplifier and 8-inch loudspeaker. The price of home recording units is not only influenced by the type of mechanism used, but also the amplifier, loudspeaker, cabinet or case, and additional features included (microphone, radio, versatile switching panel, sound level indicator, cueing indicator, etc.).

Assuming that we have interested a customer by letting him hear the sound of his own voice, the additional uses to point out are unlimited. The recorder may be used as a novelty at parties, it may be used to record music from the radio (which is otherwise lost forever) and from records (which wear out); it may be used to record the voices of growing children, it may be used for speech training, to record small musical groups, it may be used for business "homework," or for actual office dictating, and so on, ad infinitum.

Many stores and businesses are using recorders as a sort of robot demonstrator or advertisement in the store. This technique naturally suggests itself in the radio-appliance store, where the dealer may record a sales message which not only sells his other products but sells itself, since it is demonstrating itself. Leave such a machine running in your store and you will find people gather around it to listen where they would ignore a "live" human being doing the same thing.

Hallcrafters Rep

The Earl S. Dietrich Co., Cleveland, has been selected by The Hallcrafters Co., Chicago, as its Ohio representatives, it is announced by William J. Halligan, Hallcrafters president.

For Dependable Trouble-Free TV Servicing

REPLACE
WITH

STANCOR EXACT DUPLICATE TELEVISION TRANSFORMERS

Eliminate callbacks and dissatisfied customers—get a bigger share of the profitable television service business with Stancor *Exact Duplicate* Replacement Transformers. These units are *exact* physical and electrical duplicates of original equipment used in popular receivers—they're precisely what is needed for "new set" performance!

Don't take a chance with replacements that are "almost exact"; use Stancor *Exact Duplicate* Replacement Transformers. Representative types listed below.



HORIZONTAL DEFLECTION OUTPUT AND HV TRANSFORMER

Stancor Part No. A-8117. *Exact duplicate* of RCA type 211T1. For use with direct viewing kinescopes such as RCA types 7DP4 and 10BP4.



FILTER CHOKE

Stancor Part No. C-2326. *Exact duplicate* of filter choke used in RCA models 630TS, 630TCS and 8TS30 receivers.



PLATE AND FILAMENT TRANSFORMER

Stancor Part No. P-8157. *Exact duplicate* of Motorola part No. 25C484095 used in models VK106, VT105 and VT107.



HORIZONTAL BLOCKING- OSCILLATOR TRANSFORMER

Stancor Part No. A-8120. *Exact duplicate* of RCA type 208T1. Generates 15,750 cps. pulse required to drive grids of horizontal discharge tubes.



VERTICAL DEFLECTION OUTPUT TRANSFORMER

Stancor Part No. A-8115. *Exact duplicate* of RCA type 204T2. Used with kinescopes such as types 10BP4, 7DP4 and 5TP4.

SEE YOUR STANCOR distributor or write for Catalog DD337, listing complete specifications and prices of Stancor Television Components.



JUST PUBLISHED! Write for the New Stancor Transformer Catalog listing over 400 replacement transformers, reactors and related components for radio and television.

STANDARD TRANSFORMER CORPORATION

ELSTON, KEDZIE & ADDISON • CHICAGO 18, ILLINOIS

GENUINE BLUE PLEXIGLAS TELEVISION FILTER SCREENS MADE TO FIT INDIVIDUAL SETS

No tape or other devices needed to attach to set in most cases.

12" Zenith molded to fit tube lens	\$8.50
10" Zenith molded to fit tube lens	\$7.00

Others at 4½¢ per square inch

UNIVERSAL TYPES

7"	\$2.25
10"	3.00
12"	4.50

40% discount given from list.

ABERDEEN AUTO PARTS

Box 283-A, Aberdeen, Maryland

Phone—Aberdeen 258

This is it!

**A TELEVISION
BOOSTER THAT
REALLY DOES THE JOB**

THE ANCHOR TV-PRE-AMPLIFIER

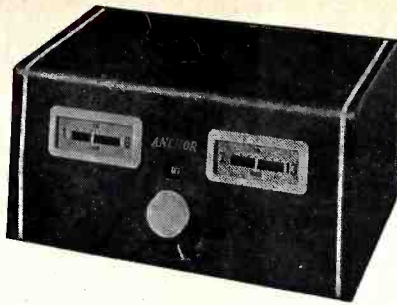

*Here's What Others Say!**

"IT DOES HAVE MORE USEABLE GAIN THAN ANY OTHER 'BOOSTER' I HAVE SEEN, YIELDING SNOW-FREE PICTURES UNDER THE MOST DIFFICULT CONDITIONS."

JOHNSON & ELLIOTT
MONTICELLO, N. Y.

**An unsolicited statement from an independent service engineer.*

**NOT MERELY ANOTHER BOOSTER — ANCHOR
WILL POSITIVELY DO EVERYTHING AS
CLAIMED OR YOUR MONEY BACK**

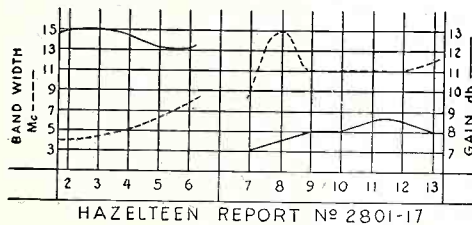

**IT'S NEW — DIFFERENT
HAS AMAZING PERFORMANCE**

An ANCHOR TV-PRE-AMPLIFIER will out-perform any similar equipment in its class. Don't take anything less than the best—don't take anything less than ANCHOR.

Check These Features

- * 4 mc minimum Bandwidth on all channels
- * Impedance matching to receiver
- * Simultaneous iron core tuning of grid and plate
- * 2½ times average gain (Voltage Ratio)
- * Guaranteed coverage of low and high TV-Band

Carefully, thoroughly engineered, ANCHOR TV-PRE-AMPLIFIER is a product of long research—it is compact, beautifully styled and precision built to give outstanding, trouble-free performance. When you install an ANCHOR TV-PRE-AMPLIFIER you give your customers the best. Don't wait—don't miss this—see your jobber today. LIST PRICE \$37.50

Dealer aids available — Write for Further Information

2215 S. ST. LOUIS AVE.
CHICAGO 23, ILLINOIS

ANCHOR

RADIO CORP.

2215 S. St. Louis Ave.
Chicago 23, Ill.

RECORD ALBUMS

Everything from 7 to 16 inch,
including the

Famous Protecto-Flap

See us at Booth 92

PEERLESS ALBUM COMPANY
BROOKLYN, N. Y. LOS ANGELES, CALIF.

TV Sales Ideas

(Continued from page 38)

something for nothing, and it is well to point out to them that we rarely do get anything for nothing. This is as true of the different prices on the same item quoted by different sellers as it is of the different prices on different items sold by the same dealer. It is up to the dealer to show the customer what he is paying for so that he will feel confident that he is spending his money wisely.

In the drive to change more and more TV "lookers" into buyers there are many other merchandising methods which cannot be covered in this brief article. But if the dealer determines to go after his share of the more than two million TV receivers to be sold this year, he'll need, among other things to sell with a plan, sell his service in combatting the price-cutter, and to know all the features of his merchandise as well as those stressed in competitive makes.

Starrett Launches Big Campaign on TV Sets

Starrett Television Corporation has announced the inauguration of its program of consumer and trade advertising. Keynote of the program will be "Perfection in Television at competitive prices".

Starrett, in its "protected dealer" program, is pledged to work closely with the dealer; to protect his interests and make possible the greatest margin of profit to the dealer, a company statement stressed.

Consumer advertising will be touched off in each city as dealers are appointed. Starrett's advertising will carry its dealers' names, directing consumers to the dealer in their community. A complete mat service consisting of over 100 combination ads is available to the dealer for cooperative advertising, ranging from 100 line to full page ads. A completely illustrated ad book, 14" x 17" in size, containing a variety of ads for each of Starrett's fifteen models is available to Starrett dealers. Twelve of the Starrett sets feature 16" and 20" tubes.

Starrett dealers will tie in with cooperative local advertising of their own. Under the "limited dealership" plan, dealers are able to harness the full power of their newspaper advertising. A 36 inch neon sign for dealers' windows, two fluorescent standing signs and a series of lucite display signs are now in preparation and will soon be made available to dealers.

Filters for Round Screens

Polaroid television filters for round screen television sets are now available in all sizes, it has been announced by Hunter L. Delatour, Jr., sales manager of Pioner Scientific Corporation, New York, creators of the Polaroid television filter.



Fred C. Kennedy, above, has been appointed vice-president and general manager of Waters Conley, Co., Rochester, Minn., manufacturers of Phonola portable phonographs. The company's new line features 45 RPM, 3-speed and standard portable players.

Freed Ups Production; Reduces TV Set Prices

Greatly increased factory production and reduced materials costs have enabled Freed Radio Corp., manufacturers of Freed-Eisemann 16-inch television consoles, to reduce prices on all its television models, it is announced by Arthur Freed, president.

New prices represent reductions of from \$80 to \$300. The Sheraton console, a 16-inch television receiver, has been reduced from \$625 to \$545, a saving to consumers of \$80. The Chinese Chippendale Console, which features high-fidelity FM and AM radio in addition to 16-inch television, has been reduced \$150 from \$795 to \$645. The Regency Chest console, 16-inch television plus AM-FM radio, which was formerly priced at \$845 has been reduced to \$675, a total of \$170. The Chippendale console which incorporates FM, AM, two record changers for playing all three types of records and a high-fidelity sound reproduction system with dual speakers in addition to 16-inch television, was reduced from \$1295 to \$995.

Pushes Coffeematic Sales



Jim Voels, salesman at Moran's, New Britain, Conn., pours a demi-tasse for a customer, thereby giving an actual demonstration of the new Landers, Frary & Clark Universal Coffeematic.

4 ALL-METAL KITS

meet every service need

Streamline your shop and sharpen your service with these attractive IRC *All-Metal* Kits and Cabinets.

New *All-Metal* Resist-O-Kit is the latest addition to IRC's family of popular METAL kits. Small, flat size makes it ideal for service calls. Choice of 2 assortments—45 half watt, or 30 one watt resistors in popular ranges.

IRC Resist-O-Cabinets are again available in heavy-gauge metal. Large and sturdy, these *All-Metal* cabinets are supplied in 3 assortments—83 one watt, 100 half watt, or a combination assortment of 92 half, one and two watt insulated resistors and new close tolerance PRECISTORS—all carefully selected ranges. Four "non-spill" drawers and 28 compartments.

All-Metal IRC Volume Control Cabinet is a long time favorite in modern service shops. Stock of 18 Interchangeable Fixed Shaft Controls plus switches and special shafts handles over 95% of all listings in the Industry Red Book. 20 compartments and 3 handy drawers.

For all of your daily resistor requirements (from 1/2 watts to heavy duty power wire wounds) IRC offers the *All-Metal* Basic Kit. Wide variety of selected values makes this your *basic* resistor stock. International Resistance Co., 401 N. Broad St., Phila. 8, Pa. In Canada: International Resistance Co., Ltd., Toronto, Licensee.



NEW RESIST-O-KIT
flat, all-metal 1 1/4" x 3 1/4" x 6 3/4" 1/2 and 1 watt assortments.



ALL-METAL RESIST-O-CABINET
choice of 2 resistor assortments, 4 drawers, 28 compartments.

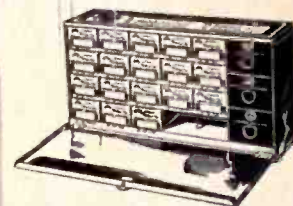

VOLUME CONTROL CABINET
all-metal handles 95% of all listings in Industry Red Book.



ALL-METAL BASIC KIT
basic resistor stock, ideal for new service shops.

INTERNATIONAL RESISTANCE CO.



IRC ALL-METAL KITS ARE FURNISHED AT NO EXTRA CHARGE—YOU PAY ONLY THE REGULAR PRICE OF THE MERCHANDISE.

Wherever the Circuit Says ~~~~~

NEW IMPROVED PR7 MODEL

★ **POLIC FM ALARM** ★

FOR POLICE CALLS TAXI CABS AND OTHERS

Tunes 152-162 Megacycles

F. M. Superheterodyne, 115 Volts, A.C.-D.C. Tubes—12AT7, (2) 6BJ6, 19T8, 35B5, 35W4. 2 stages high gain 10.7 Megacycle I.F.'s. Ratio detector. Plastic cabinet 10 1/2 x 6 3/4 x 6 deep. Schematic and instructions. Shipping weight 7 lbs.

Sensitivity 10 Microvolts or better. Selectivity 250 K.C.'s or better.

Reception expectancy with attached antenna from 50 Watt transmitter 3 miles, much farther from transmitter of more power or outside antenna.

Ready to plug in and use; 28 Watts power consumption.

\$39.95

Attached Antenna

SEE YOUR DEALER FIRST OR WRITE

Slightly higher West Coast Excl Tax Included F.O.B. Indianapolis \$10.00 with order, rest C.O.D.

DELUXE CA-2 COAXIAL ANTENNA

FOR BEST RECEPTION—LIST

\$5

RADIO APPARATUS CORP.

303 FOUNTAIN SQ. THEATER BLDG. INDIANAPOLIS 3, INDIANA

New Catalogs, Manuals, Sales Aids

Mallory Vibrator Guide: The new, enlarged "Vibrator Guide" is a 40-page book containing alphabetical listing of radios and vibrator power supplies, plus installation notes, buffer capacitor references, auto radio service notes, and many other helps. The book is available at 15¢ either through Mallory distributors or direct from P. R. Mallory & Co., Inc., 3029 E. Washington St., Indianapolis 6, Ind.

Delson Catalog: A new 10-page catalog containing illustrations, descriptions and price of the Jiffy-Tenna line, Delson inverters, Del-Co filters, Del-Co sound powered telephones, etc., is available on request from Delson Mfg. Co., 126 Eleventh Ave., New York 11, N. Y.

Merit Transformer Catalog: New catalog No. 4911 includes a complete series of transformers for outdoor sound as well as universal line units, and TV replacement transformers. Illustrations of models and mountings are included. Merit Coil and Transformer Corp., 4427 N. Clark St., Chicago 40, Illinois.

Aerovox Research Worker: This monthly publication featuring up to the minute know-how on radio-electronic technique is being published again on a regular basis after being suspended during the war and for 3 years thereafter. Covering subjects such as TV booster, transistors, video IF amplifier design, TV antennas, etc., the book may be had from one's jobber or, with the endorsement of the jobber, direct from Aerovox Corp., New Bedford, Mass.

Sams Record Changer Manual: Volume 2 has been issued to bring this useful manual up to date, including many dual speed models for the new type records, as well as tape and wire recorders. A feature is a cross-reference index showing model of changer in various combination sets. The 432-page book lists for \$6.75. Howard W. Sams & Co., Inc., Indianapolis, Ind.

Philco Radio Components Handbook: A new handbook of radio parts and components is a 200-page volume of data, tables, charts, curves and other material on all radio and TV components. The book is priced at \$2.50. Philco Corp., Tioga and "C" Sts., Philadelphia, Penna.

Hytron Radio and Electronics Corp.: The new "all-ways" tube carton is imprinted twice and back-to-back on both ends so that the type number is always visible and readable no matter how the carton is stacked on the shelf.

Standard Transformer Corp.: The new 1949 catalog includes detailed electrical and physical specifications, including list prices of more than 400 items. Charts included show driver-modulator combinations, matched power supplies, output transformer-tube combinations, etc. Available at Stancor parts distributors free of charge.

Telrex Data Sheet: The data sheet treats the special requirements of TV antennas of all types, with special reference to band-width, gain, impedance matching, reactances at TV frequencies, the tuning effect of combining dipoles for low and high bands and similar data. Advantages of the conical design are detailed, with pertinent operating data. Copies are available without charge by writing Telrex, Inc., Rutherford at Neptune Ave., Asbury Park, N. J.

Sightmaster Corp.: A booklet on individualized television set installations has been printed by this manufacturer of TV sets. These custom television units are installed in a wall and the picture is seen in a decorative frame on the wall. Reception is controlled by a remote unit, and the viewing area looks like a mirror when the set is turned off. The book gives diagrams and specifications for such installations, and may be had direct from the firm, located at 385 North Ave., New Rochelle, N. Y.

Sams Photofact Manual: Howard W. Sams has prepared a special volume of Photofact folders on postwar automobile radio receivers containing complete service information on more than 100 sets. The Auto Radio Manual includes special sections which cover standard parts replacement information on vibrator buffer condensers, special purpose condensers, vibrators, speakers and transformers for auto receivers. The 392 page manual is priced at \$4.95.

General Electric Company: A training course is being offered to radio men on the installation and servicing of television receivers. The course, which can be undertaken either by correspondence or group study methods, consists of eight lessons. A graduation certificate is furnished upon completion. The course is being made available through G.E. and Ken-Rad tube distributors.

Sylvania Electric Products: Popular types of replacement tubes are now being supplied in a new 10-lot merchandising carton designed not only to simplify handling and order-checking but also to provide consumer appeal on shelf or counter.

Philco Corporation: "Mobile Merchandisers" is the name of a new fleet of specially designed trucks which resembles a super-market on wheels. The merchandisers will be used by Philco distributors to bring radio and TV tubes, parts, accessories and antennas directly to the servicemen in the field. Carrying over \$16,000 worth of merchandise, the truck will help eliminate costly trips by the serviceman to the warehouse, and enable him to operate with a smaller inventory.

Cleveland Electronics, Inc.: A new catalog has been issued on the Cletron replacement loud speaker line, including speakers for home, auto, FM, TV, and PA systems. Catalog may be had by writing direct to the firm at 6611 Euclid Ave., Cleveland, Ohio.

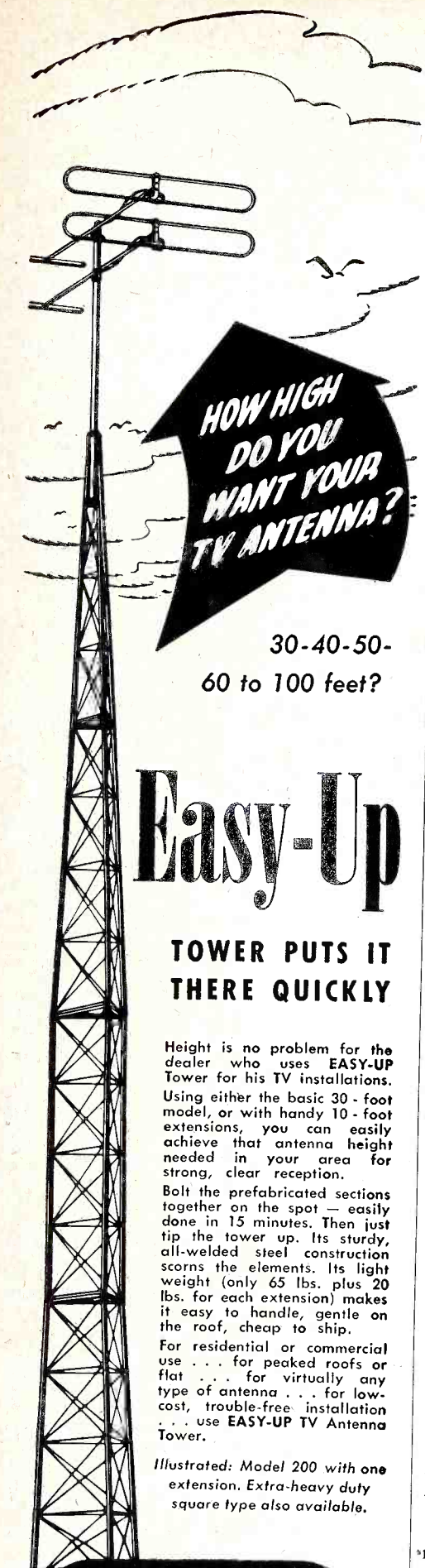

Easy-Up

TOWER PUTS IT THERE QUICKLY

Height is no problem for the dealer who uses **EASY-UP Tower** for his TV installations.

Using either the basic 30-foot model, or with handy 10-foot extensions, you can easily achieve that antenna height needed in your area for strong, clear reception.

Bolt the prefabricated sections together on the spot — easily done in 15 minutes. Then just tip the tower up. Its sturdy, all-welded steel construction scorns the elements. Its light weight (only 65 lbs. plus 20 lbs. for each extension) makes it easy to handle, gentle on the roof, cheap to ship.

For residential or commercial use . . . for peaked roofs or flat . . . for virtually any type of antenna . . . for low-cost, trouble-free installation . . . use **EASY-UP TV Antenna Tower**.

Illustrated: Model 200 with one extension. Extra-heavy duty square type also available.

Write for full details

Easy-Up Tower Co.

3800 Kinzie Ave.
Racine, Wis.

NO INCREASE IN PRICE for the new improved



MODEL 935

JEWEL
Wakemaster

with TELECHRON ALARM MOVEMENT

A wonderful JEWEL radio . . . now even GREATER! WAKE-MASTER now lulls the listener to sleep to his favorite music and TURNS ITSELF OFF AT A PRE-SET time, waking him to music or the early news and ringing an alarm 10 minutes later to make doubly sure. The wonderful, new LULLABY SWITCH is added at no increase in price! Accurate TELECHRON movement with sweep second hand operates with or independently of radio.

In Walnut
\$31.95*
in Ivory
\$33.95*

DISTRIBUTORS! FACTORY REPS!
Some good territories are open. Write for details.

Prices subject to change without notice. • Slightly higher west of the Rockies

NOW!
Go to sleep with **MUSIC!**
Wake up to **MUSIC!**
Wonderful, New **LULLABY**
SWITCH **DOUBLES** the **VALUE!**

JEWEL RADIO CORP.
10-40 45th AVE., LONG ISLAND CITY 1, N. Y.

22 Warren Coronets **SERVICING 150 APARTMENTS**
IN A MASTER INSTALLATION*



This is a cross-section of the Port Washington, Long Island, project at which the master installation was made using the **WARREN CORONET**.

* Installed by Field Service, Inc., Willis Avenue at Yale Street, Roslyn Heights, L. I., N. Y.

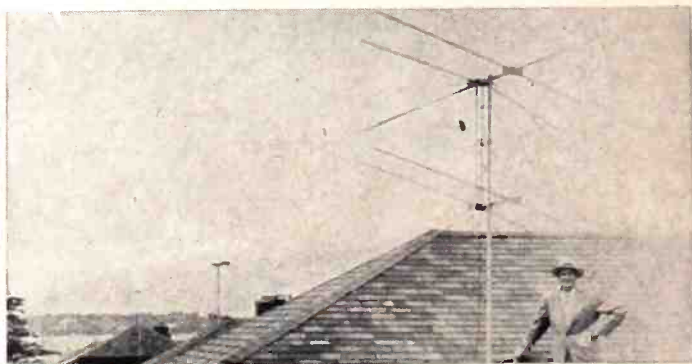

Actual photo of section of Port Washington installation. Mr. Fields, engineer in charge of installation is seen in lower right hand corner.

DEALERS:
For full line of television antennas and accessories buy direct from the manufacturer outlets. Save 40%.

WARREN MFG. CO., INC.

461 MAIN STREET

Outlets throughout U.S.A.

EAST HAVEN, CONN.



Model CT-101
16" TUBE

DEWALD

HIGH DEFINITION
TELEVISION

10" - 12½" - 16" MODELS

Quality—Performance—Value
... you'll find all the things
that make satisfied customers,
increase sales and profits, in
the new DeWALD Line of Tele-
vision and Radio.

**Quality Proven for More
Than a Quarter-Century**

JOBBERS — REPRESENTATIVES

Some choice territories now available.
Write for full information.

in
RADIO
and
TELEVISION

for
SOMETHING
BETTER,
it's

DEWALD

DEWALD RADIO MFG. Corp. 35-15 37th Ave., Long Island City 1, N. Y

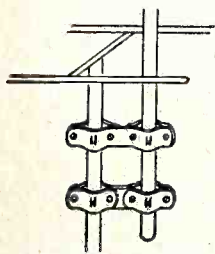
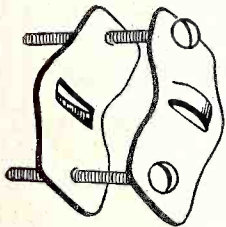
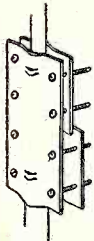
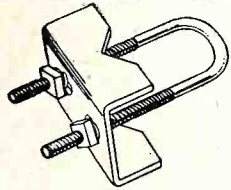

DON'T OVERLOOK THE SMALLER TYPES OF MOUNTING EQUIPMENT

Each product is designed to solve a different problem... to make the job of antenna installation a simpler and speedier one. Each product, though small and inexpensive, is equally as important as any of the 24 different models which now constitute our full line. Don't overlook such time-savers as these (in order shown):

U-BOLT EXTENDER—4" long with 1⅜" opening for joining masts, adding Hi-Freq., mounting antenna elements or attaching a mast to any small diameter pipe, pole or angle iron. MODEL UB-4... 50c list.

MAST EXTENDER—to hold any two masts of equal or unequal diameter with 4" bite on each mast. Six guying points. MODEL ME-8... \$1.45 list.

GUYING CLAMP—for fastening guy wires at any point on a mast. MODEL GC-4... 55c list.

MAST JOINER—for joining masts of equal or unequal diameter or adding Hi-Freq. With four guying points. MODEL MJ-2... 90c list.

WRITE FOR NEW FOLDER SHOWING ALL 24 MODELS.

Metalace CORP.

DEPT. 106

2101 GRAND CONCOURSE

NEW YORK 53, N. Y.

Jewel Radio Officials



Don Ferraro, president, and Leonard C. Welling, general sales manager, Jewel Radio & Television Corp., New York City, confer during recent Chicago Show. Mr. Welling has reorganized the Jewel sales staff to assure effective coverage on the company's television line.

New Manuals, Catalogs

Rider Manuals—Three new books are now available: Rider Manual #19, covering AM, FM, auto and communications receivers, \$19.80; TV Manual #2, \$18.00; and a new book, TV Picture Projection and Enlargement by Allan Lytel, 250 pages, \$3.30. The latter covers the optical elements of such systems. John F. Rider Publisher, Inc., 480 Canal St., New York 13, N.Y.

Electro-Voice Mikes—Bulletin #144 describes the new "650" and "645" mikes for broadcast use. Bulletin #148 describes mike stands, the Banquet and Floor stand. Electro-Voice, Inc., Buchanan, Michigan.

Merit Coil and Transformer—New catalog shows complete line of transformers, including the new series of TV transformers and a new line of transformers designed especially for outdoor sound use. Merit Coil and Transformer Corp., 4427 N. Clark St., Chicago, Ill.

Frank A. D. Andrea Honored



Frank A. D. Andrea, right, president Andrea Radio Corp., manufacturers of "Sharp-Focus" Andrea television sets, receives the 1949 Award of Achievement from Lyle K. Engel, of "Song Hits" magazine. Left is Pat Barnes, of the WJZ radio show on which Mr. Andrea received the award for his contributions to radio and television.

Rauland 16" TV TUBE

Development has been completed on a new 16" metal-glass TV picture tube designated type 16EP4. The overall length is 19 $\frac{3}{4}$ ", which is 2 $\frac{3}{8}$ " shorter than the 16AP4. Because of the shorter length, the deflection angle has been increased to 60 degrees. The tube requires the use of an external ion magnet. The Rauland Corp., 4245 No. Knox Ave., Chicago 41, Ill.—RADIO & TELEVISION RETAILING.

Motorola PORTABLE COMBINATION

Model 59F11 is a small, light-weight, portable radio-phonograph designed around the 45 RPM changer. The luggage-type case measures 12 by 13 $\frac{1}{2}$ by 7 inches. Set is priced at \$69.95. Motorola, Inc., 4545 Augusta Blvd., Chicago 51, Ill.—RADIO & TELEVISION RETAILING.

Simplophone AMPLIFIER

The Simplophone is a small desk telephone amplifier, designed to provide telephone conversation with hands free to make notes, and to provide group listen-



ing facilities. The telephone is placed in a molded cradle on top of the amplifier, and voices come out of the loudspeaker. Simplophone is priced at \$39.95. Simplophone Corp. of America, 303 Fifth Ave., New York, N. Y.—RADIO & TELEVISION RETAILING.

Industrial TV RECEIVERS

The "Century" model 221 "teleceiver" console set with 85-square inch picture is designed for home use and features simplified "visual tuning." Set lists for \$429,

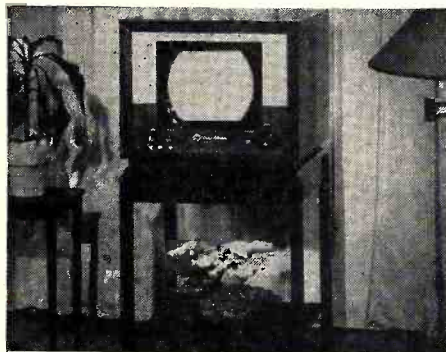

and in bleached mahogany at \$449. The 521 table set with 85-square inch screen lists at \$379. Industrial Television, Inc., 359 Lexington Ave., Clifton, N. J.—RADIO & TELEVISION RETAILING.

Four of a Kind!

Phoenix Stand-off Insulators

- FAST INSTALLATION
- TOP QUALITY—
- DEPENDABLE —
- LOW - PRICED!

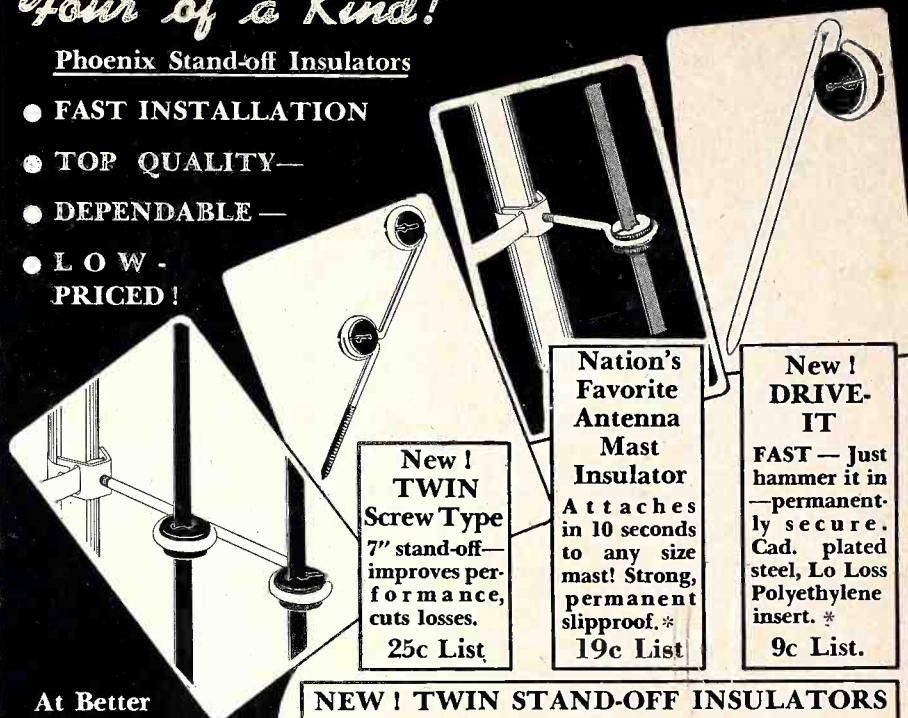

New! TWIN Screw Type
7" stand-off—improves performance, cuts losses.
25c List

Nation's Favorite Antenna Mast Insulator
Attaches in 10 seconds to any size mast! Strong, permanent slipproof.*
19c List

New! DRIVE-IT
FAST—Just hammer it in—permanently secure. Cad. plated steel, Lo Loss Polyethylene insert.*
9c List.

At Better Jobbers!
Order Today!

Send for Catalog R

NEW! TWIN STAND-OFF INSULATORS

Holds two twin lead conductors 7 $\frac{1}{2}$ " from mast. Fast, one man installation.*

35c list

* Pat Pend

PHOENIX ELECTRONICS, INC.

LAWRENCE, MASS.

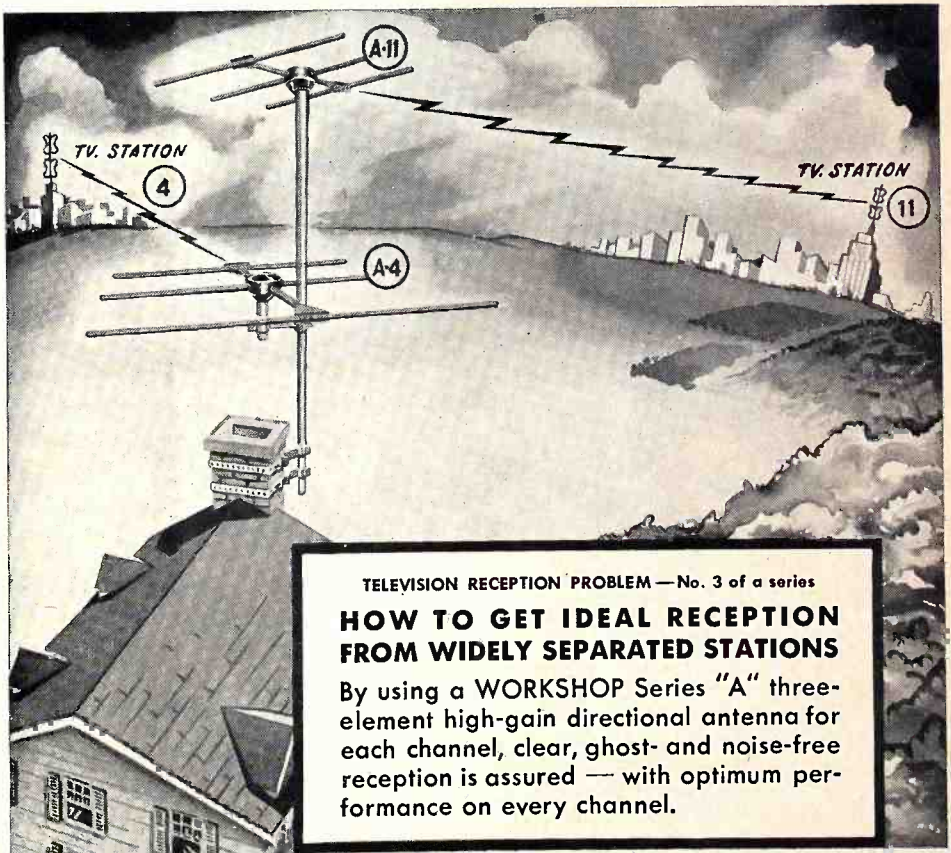

TELEVISION RECEPTION PROBLEM—No. 3 of a series

HOW TO GET IDEAL RECEPTION FROM WIDELY SEPARATED STATIONS

By using a WORKSHOP Series "A" three-element high-gain directional antenna for each channel, clear, ghost- and noise-free reception is assured — with optimum performance on every channel.

Send for the new Workshop TV Catalog (No. 49)

THE WORKSHOP ASSOCIATES, Inc.

Specialists in High-Frequency Antennas

57 NEEDHAM STREET, NEWTON HIGHLANDS 61, MASSACHUSETTS



ASK THE MAN ON THE ROOF WHY HE PREFERS SOUTH RIVER MOUNTS

The New South River
**DUO-MOUNT
ANTENNA BASE**
Model No. DM 37
(Pat. Pending)

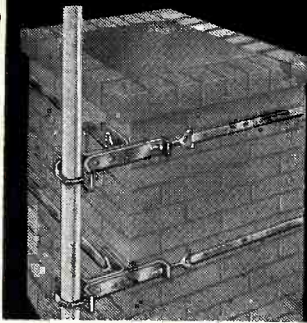

Holds tubing from 5/8" to 1 1/2" O. D. Made of riveted steel in hot dipped, everlasting galvanized finish. Features special "U" bolt.

NEW List Price **\$4.25**
Individually Boxed

★
Installation men will always specify South River because on the job their Exclusive, Quality Features save time and work. This means low cost installation. The man on the job knows and cares about quality. That's why he insists on South River Mounts.

The Original South River
**CHIMNEY MOUNT
ANTENNA BASE**
Model No. SR10
(Pat. Pending)

The Aristocrat of Antenna Bases

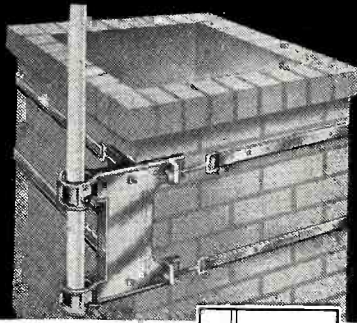

Holds tubing from 1/2" to 1 1/2" O. D., pipe from 1/4" to 1 1/4". Exceptionally durable. The four eye bolts enable straps to be tightened evenly. Also available in two sections if requested.

List Price **\$7.50** Individually Boxed

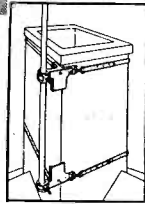

Both mounts can be installed in minutes by one man with no special tools.

Write for full information on our line of wall brackets, vent pipe mounts and accessory supplies.

**SOUTH RIVER
METAL PRODUCTS COMPANY, INC.**
SOUTH RIVER, NEW JERSEY

News of Jobbers And Representatives

Trans-Vue Corp., Chicago, Ill., manufacturers of multiple remote control commercial television systems, announces the appointment of the Hall-Jones Co., as their representatives in Connecticut.

A sales meeting for 125 of their dealers was conducted recently by Taylor Electric Co., Milwaukee, Wis., distributors of Hamilton Automatic Clothes Dryers. The meeting was held at Two Rivers, Wis., home of the Hamilton Mfg. Co., enabling the dealers to tour the new Hamilton dryer plant and see the dryers actually being built.

Having made a radical change in their method of distribution by appointing exclusive distributors, and exclusive dealers, in various territories now covered by television, Transvision, Inc. of New Rochelle, N. Y., reports increasing numbers of dealers now entering the scene. Intensive cooperative newspaper advertising, as well as semi-consumer and trade paper schedules are backing up this new program.

The Major Appliance Corp., 11 Deerfield St., Boston, has been appointed as Duchess washing machine distributor for eastern Massachusetts and southern New Hampshire. The announcement was made by F. W. McGrath, vice-president in charge of sales, Appliance Manufacturing Co., Alliance, Ohio.

Morley Brothers, Saginaw, Mich., has been appointed exclusive distributor for American Kitchens throughout the lower peninsula of Michigan. Morley Brothers, with general offices and warehouses in Saginaw, also have extensive branch operations and warehouses in Detroit and Grand Rapids. All three branches will carry a complete line of American Kitchens. Twenty-five Morley Brothers' executives and salesmen have made a special visit to the American Kitchens plant, at Connersville, Indiana, for a training program and tour of the facilities.

Merit Coil & Transformer Corp., 4427 N. Clark St., Chicago 40, Ill., through its sales manager, W. J. Barron, has announced the appointment of Bruce Cumming & Associates of 228 N. LaSalle St., Chicago 1, as representatives for the states of Illinois and Wisconsin.

D. R. Payne, manager of sales, Air King Products Co., Inc., Brooklyn, N. Y., announces the appointment of the All States Distributors as an exclusive distributor of Air King Products in northern New Jersey. All States Headquarters are located at 30 Warren Place, Newark 2, N. J. The company also announces the appointment of the Allied Electric Supply Company, as exclusive distributor of Air King Products in western Pennsylvania, and the pan handle of West Virginia.

Ward Leonard Electric Co., Mt. Vernon, N. Y., announces the appointment of Central Station Engineering Co., 2817 Croyden Drive, Tucson, Arizona, as sales representative in the state of Arizona.

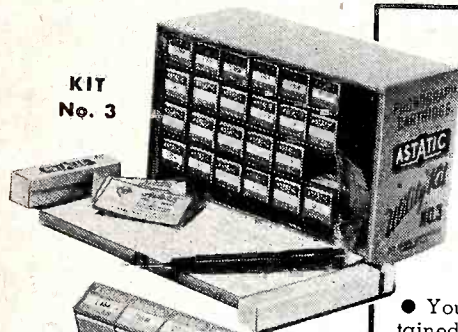

KIT No. 3



KIT No. 2

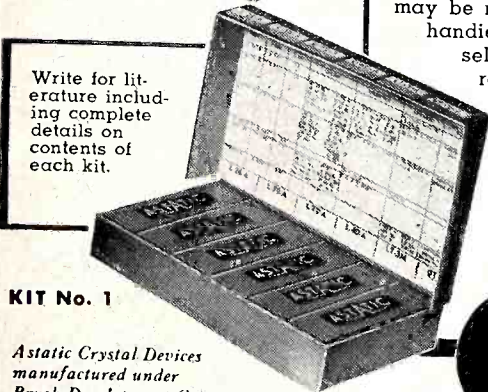

KIT No. 1

Astatic Crystal Devices
manufactured under
Brush Development Co. patents

Three Astatic UTILITY KITS

To help sell, service, maintain
inventories **FREE**
with your purchase of
ASTATIC CARTRIDGES

● You pay only for the Astatic Cartridges contained—and included in these new kits are only those types you are regularly called upon to furnish. You receive, at no additional cost, important new facilities. Astatic Utility Kit No. 3 is a sturdy, handsome wood cabinet. Inside, individual compartments house 24 boxed and labeled cartridges. Each compartment is also labeled to show what cartridge should be replaced in it. Other compartments hold six Astatic matched needles; pen-size needle pressure scale; an assortment of cartridge mounting screws, needle screws, terminal clips. Inside the lid is a chart showing cartridges which may be replaced by those in the kit. One of the handiest items a serviceman can carry . . . to sell and service 95 percent of cartridge replacement jobs.

Kit No. 2 is a heavy cardboard carton, holding 12 Astatic Cartridges and corresponding replacement charts, and will fill at least 85 percent of all replacement needs. Kit No. 1 contains six cartridges and replacement chart, and will fill a majority of phonograph requirements.



News About Jobbers And Representatives

Pioneer Appliance Co., San Francisco, has been appointed Coolerator distributor of refrigerators and freezers in northern California, it has been announced by William C. Conley, Jr., Coolerator sales manager.

Two new Tennessee distributors have been appointed to handle Arvin radios and electrical appliances in that state, Gordon T. Ritter, director of sales for the Arvin division of Noblitt-Sparks Industries, Inc., announced recently. **Moore-Handley Hardware Co.**, Craighead Street and the L & N tracks, Nashville, will distribute Arvin products in that metropolitan area and 38 counties in central Tennessee. Neill Jones is general manager of the organization and Woodrów P. Wilson is sales manager. Western Tennessee distribution of Arvin radios, electric irons, heaters and Lectric Cooks will now be handled under the supervision of **Woodson & Bozeman, Inc.**, 482 Union Ave., Memphis, Mr. Ritter's statement said.

E. B. Lucas, general sales manager of Walco, East Orange, N. J., has announced the appointment of factory representatives in seven cities. The following will handle Walco lenses, filters and needles: **Gianas Sales Agency**, 2345 Devon Ave., Chicago, Ill.; **Haggerty Sales Co.**, 10226 Woodward Ave., Detroit, Mich.; **Jack Bean**, 2901 Crockett St., Ft. Worth, Texas; **Michael Scott Co.**, 8 Todd Rd., Cohasset, Mass.; **Morris F. Taylor Co.**, 8416 Georgia Ave., Silver Spring, Md.; **Minor Jones**, 114 Sayre St., Horseheads, N. Y. Lenses and Filters: **Jerry Kaufman Sales Agency**, 631 Penn Ave., Pittsburgh, Pa. Needles: **James H. Podolny**, 5844 Beacon St., Pittsburgh, Pa.

International Harvester Co., announces the appointment of **David Kaufman's Sons, Inc.**, 2015 Washington Blvd., Baltimore 30, as distributors of Harvester refrigerators and freezers in the Washington, D. C.; Baltimore, Maryland; and Richmond, Virginia, territories. **Bickford Brothers**, 1209 Broadway, Buffalo 12, have been appointed distributors for the firm's line in the Buffalo and Rochester, N. Y. territories. Rochester headquarters is at 51 Litchfield St., Rochester 7.

Appointment of **Moto Radio Distributing Co., Inc.**, 5732 Baum Boulevard, Pittsburgh 6, Pa., as sole DuMont television receiver distributor in the Pittsburgh area, is announced by Ernest A. Marx, general manager of the television receiver sales division, Allen B. DuMont Laboratories, Inc. The appointment is effective immediately.

A. J. Lindemann & Hoverson Co., Milwaukee, announces the appointment of **Northwest Appliance Distributors, Inc.**, Spokane and Seattle, Washington, as distributors for L&H electric ranges and water heaters in that territory. The **Mills-Morris Co.**, Memphis, Tenn., will distribute the same line in the Memphis trading area.

BIGGER DEALER DISCOUNTS and TERRIFIC PERFORMANCE with *Videola* TELEVISION



Videola A Symphony of Sight and Sound!

COMPLETE LINE OF 91 AND 135 SQ. INCH TV RECEIVERS

From any angle you're on top with Videola. Bigger dealer discounts — no tie-in deals — exclusive advanced R.C.A. electronic features . . . all helping you sell more and more Videola sets!

Write to Dept. E for new brochure of our complete line. Distributors: Some territories still open. Wire—Write today.

Video Corporation of America
229 WEST 28th STREET • NEW YORK 1, NEW YORK

Here's TACO DIVISION

FROM CARTON
TO INSTALLATION

FAST!

*TACO now gives you all those features that have made it outstanding plus the JIFFY-RIG feature. TACO JIFFY-RIG antennas come completely assembled—just pull them out of the carton, tighten up the nuts, and you're ready for the roof. No mechanical or electrical characteristics have been sacrificed to bring this serviceman's-dream-come-true. This is it! Compare TACO for everything desirable in an antenna. Then . . .

ASK OUR JOBBER FOR THE CORRECT TACO ANTENNA FOR ANY TV, FM, AM, OR SW INSTALLATION. CATALOG ON REQUEST.

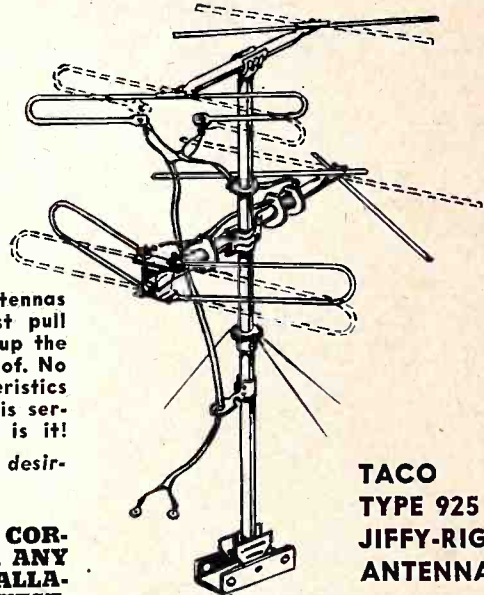

TACO
TYPE 925
JIFFY-RIG
ANTENNA

TACO

RADIO & ELECTRONIC
EQUIPMENT
TECHNICAL APPLIANCE CORP.
SHERBURNE, N. Y.

IN CANADA: STROMBERG-CARLSON CO., LTD., TORONTO 4, ONT.

NEW-IMPROVED

JERROLD

The Only TV-FM
Booster With The
AMAZING NEW
BUILT-IN

MATCH-A-TRAN



MORE TV SALES

You can now step up TV sales in a big way. The new improved Jerrold TV-FM Booster with Match-A-Tran improves reception in critical areas. Helps give sharper, clearer pictures with no loss of definition for longer distances.

THE SECRET OF LONG DISTANCE RECEPTION

Jerrold TV-FM Booster with Match-A-Tran is the secret of good distance reception. This high gain, tuned-grid, tuned-plate RF amplifier boosts the entire TV 6 megacycle bandwidth from 20 to 30 times and provides complete coverage of FM band.

The Match-A-Tran is a variable step-impedance transformer that provides a perfect match between booster output and TV receiver—any receiver. It makes certain that the entire gain of the booster is delivered into the receiver. Match-A-Tran is an exclusive feature of the Jerrold TV-FM Booster.

See the improved Jerrold TV-FM Booster at your parts-jobber or radio wholesaler. Or, write us for further information.

\$37⁵⁰
List

JERROLD ELECTRONICS CORP.
121 N. BROAD ST. PHILA. 7, PA.

Philco Distributor Advisory Committee Meets with Officials

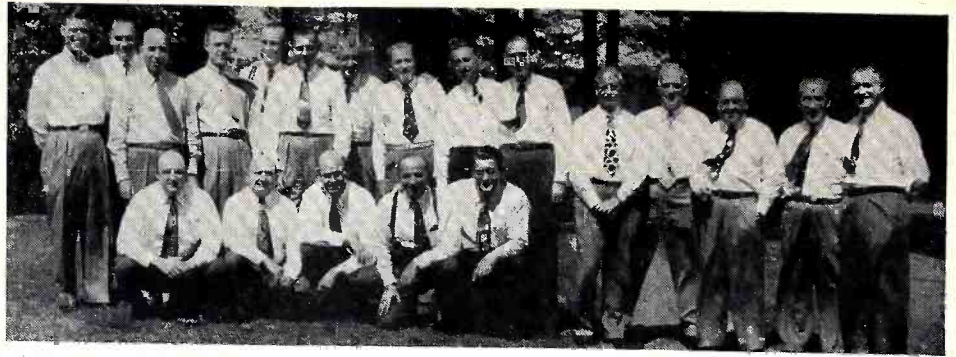

Relaxing between sessions of the Philco Distributor Advisory Committee and Philco executive meetings at Huntington Valley Country Club, Philadelphia, are left to right: Standing: James M. Skinner, vice-president, service; Wm. Kress, sales manager of the Mid-West; James H. Carmine, vice-president, Distribution; Raymond B. George, sales promotion manager; A. Van Antwerpen, Radio Specialty Co., Milwaukee, Wis.; Harold Sheer, vice-president of Philco Distributors, Inc.; A. J. Rosebraugh, manager home radio sales; C. R. Williams, C. R. Williams and Sons, Winston-Salem, N. C.; Ed Berg, Philco Distributors Inc., Phila.; John Ramsey, sales manager of the South; Herb Schiele, Artophone Corp., St. Louis Mo., Fred Ogilby, manager of television sales; John F. Gilligan, advertising manager; Cal Zamoiski, The Jos. M. Zamoiski Co., Washington, D. C.; Larry Hardy, vice-president, Radio and Television Div. Kneeling left to right: Stuart Falk, East-Central sales manager; C. C. Walther, Walther Bros., New Orleans, La.; John M. Otter, vice-president and general sales manager; Sam Roskin, Roskin Bros., Middletown, N. Y.; C. E. Lindstrom, East Coast sales manager.

"No TV for Auto Driver," States Motorola Official

Walter H. Stellner, vice-president of Motorola, Inc., Chicago, Ill., manufacturers of television and mobile communication equipment, declared that his company is "firmly opposed to installation of automobile television sets which can be seen by the driver."

"Experiments made by Motorola," Mr. Stellner went on to say, "have shown that, while television installations in private automobiles are entirely feasible, receivers visible to the driver constitute a serious new menace to highway safety. In an effort to cooperate with the National Safety Council and other interested agencies, Motorola is recommending installation of television sets for rear-seat passengers only."

Names in the News

The appointment of H. A. Brewer as northwestern district manager for the Westinghouse Home Radio Division has been announced by F. M. Sloan, division manager. Mr. Brewer, who will make his headquarters in Chicago, was formerly with the Sentinel Radio Corporation in charge of sales training and promotion.

Leslie J. Woods and Courtney Pitt, vice-presidents of the Philco Corporation, have been elected to the board of directors.

Kenneth C. Meinken, president of National Union Radio Corporation, announces the appointment of Emil J. Maginot, as sales manager in charge of distributor sales, for the company.

The resignation of Jason G. Hurley as a vice-president of Thor Corporation has been announced by Raymond J. Hurley, chairman of the board. Mr. Hurley, who has headed Thor's central sales division for the last year, resigned to return to his Chicago electrical appliance distributing firm at 5415 West Madison Street.

Service "Gripes" at Town Meetings

Suggestions by radiomen made at the Town Meetings of Radio Technicians on how to keep the TV set-owner satisfied and reduce the number of "nuisance" calls were directed at the dealer, the manufacturer and distributor, and to the broadcaster, pointing the way toward better TV public relations.

1. The Dealer:

- Don't oversell on "all 13 channels"
- Don't oversell on fringe reception or indoor antennas
- Don't fail to explain unavoidable reflections, diathermy, etc.
- Don't fail to mention extra charges for "non-standard" installations
- Don't fail to give customer instruction in set operation

2. The Mfr. & Distributor:

- Give freely and promptly of servicing information and helps to technicians
- Aid in instructing the public what to expect from TV through advertising

3. The Broadcaster:

- Promptly announce transmission failures, be frank about transmission weaknesses so that the set owner will know that the trouble is not in his set.

Broadcast test patterns during all daytime hours that no programs are scheduled (except Sunday) for the convenience of the installer-servicer.

SALES Tip

When new merchandise arrives, use the telephone to tell some of your good customers that such-and-such has just come in. "I think you will be interested to learn that we have just received a shipment of" is a good way to put it, after having identified yourself to the person on the other end.

New Du Mont Distributor for Southern California



Dr. Allen B. Du Mont, president of Allen B. Du Mont Laboratories, Inc., signs the contracts franchising radio and screen comedian Bob Hope (right) as exclusive distributor for Du Mont television receivers in the Southern California area. At the left is Ernest A. Marx, general manager of Du Mont's receiver sales division. Standing is Richard Gibson, president of Quality Television Corporation, Los Angeles.

Crosley Introduces New Line in New York



More than 11,000 New Yorkers attended "Crosley Day" in the Plaza Hotel, marking the introduction of new Crosley television receivers and Shelvador refrigerators. Shown at the television exhibit are l. to r.: John W. Craig, vice-president Avco Mfg. Corp., and general manager of its Crosley Division; Bert Cole, vice-president and general manager of Crosley Distributing Corp., sponsors of the show and Irving Sandberg, general sales manager of the same company.

Girls Publicize Vue Scope Product



Attention-getting stunt employed by Celomat Corp., New York City, in displaying its TV enlarger.

N. M. Mintz and Associates, 7357 Cottage Grove Ave., Chicago, are continuing to represent the power factor division of Cornell-Dubilier Electric Corp., according to announcement from Octave Blake, President. The new sales office opened by Cornell-Dubilier at 605 West Washington Blvd., Chicago, will represent the company in all other products except power factor.

The Electronic Supply Corporation, 40-14 Greenpoint Ave., Long Island City, N. Y., has been appointed distributor for the Radio Division of Sylvania Electric Products, Inc.,

Industrial Television, Inc., Clifton, N. J., has appointed the Penn-Jersey Tele Company of 146-A Broadway, Paterson, N. J., its distributor for the northern New Jersey area.

Sensational New
universal clamp

BACK STRIP
REMOVABLE FOR
CHIMNEY
MOUNT

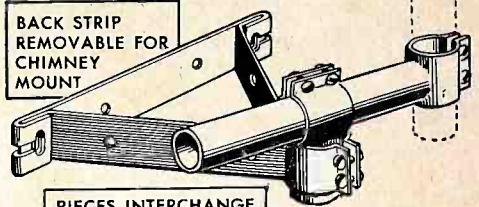

PIECES INTERCHANGE
SWIVEL, SLIDE, LOCK

**Licks EVERY
antenna mounting
problem!** **\$8.25**

LIST
LESS REGULAR
DEALER DISCOUNTS

UNIMAC is an installer's dream come true! This one unit completes your kit. UNIMAC mounts anywhere, in any position, handles all 1 to 1 1/4" masts, and swings them free and clear to perfect, upright position. NO GUY WIRES REQUIRED.



Clears overhanging eaves on gables... masts need not be bent... mount fastens directly to house without extension blocks. NO GUY WIRES.

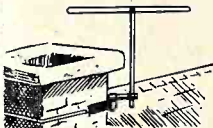

Clears lips on chimneys... choice of lag screw or strap mounting provided on part... NO GUY WIRES.



Base mounts easily on pitched surfaces... full adjustment for erecting mast and orienting antenna. NO GUY WIRES.



Mounts on horizontal or vertical window sash... swings antenna clear of obstructions. NO GUY WIRES.

UNIMAC is constructed of heavy steel throughout, with all joints welded, eliminating part failures. Sturdy, clean-cut appearance pleases customers, increases business. ONE-MAN CREWS NOW PRACTICAL.

There's no call back when you use Unimac



MARVIN RADIO-TELEVISION
Buckeye at East 89th St., Cleveland 4, Ohio

- Enclosed find \$5.10 (\$4.95 plus postage) for one sample.
- Enclosed \$..... for..... boxes of UNIMACS at \$29.70 per box of 6.

Name.....

Address.....

The Maytag Company of Newton, Iowa, recently appointed two new regional managers who will serve on the Kansas City Branch under C. G. Ely. The new regional sales managers are Charles G. Frederick, who will be in charge of 34 counties in Kansas and 3 counties in Oklahoma, and William L. "Doc" Lockridge, who will manage 3 counties in Missouri and 2 in Kansas.

Announcement of the retirement of three veteran officials of Landers, Frary & Clark after many years of service was made recently by Richard L. White. The three men relinquishing their posts are Will H. Rattenbury, vice-president and secretary; Albert G. Anderson, assistant treasurer and William E. Baker, assistant treasurer.

Edward G. Brierty has been appointed equipment sales representative for the Radio Division of Sylvania Electric Products, Inc., according to an announcement by C. W. Shaw, general sales manager. He will operate out of the company's Chicago office at 20 North Wacker Drive.

N. H. Terwilliger has joined Motorola, Inc., as assistant advertising and sales promotion manager, it has been announced by Ellis L. Redden, advertising and promotion manager.

Howard R. McClosky has been appointed vice-president in charge of manufacturing of Webster-Chicago Corp. Mr. McClosky's duties will include the correlation of the manufacturing functions of the two Webster-Chicago plants.

Names in the News

Leetate Smith has been appointed general sales manager, Palmer Manufacturing Corp., Phoenix, Arizona, according to an announcement by Oscar C. Palmer, owner-president.

Robert Gayle, veteran in the household appliance field, has been made vice-president in charge of sales in the central and southwestern areas, for the McAllister-Ross Co., Chicago, manufacturer of household vacuum cleaners, according to announcement by Charles Ross, president.

Three appointments to supervisory positions in the Tube Division of the General Electric Company have been announced by J. M. Lang, manager of the Tube Division. Those named to new posts are G. W. DeSousa, R. V. Bontecou, and L. E. Record. Mr. DeSousa has been named manager of sales administration for the Tube Division. Mr. DeSousa, prior to his appointment, was staff assistant to Mr. Lang. Mr. Bontecou has been named staff assistant to the manager of the Tube Division.

Kenneth C. Meinken, president of National Union Radio Corporation, has reluctantly announced the resignation of George A. Bodem, vice-president in charge of sales for that company. Mr. Bodem is retiring from the radio-tube manufacturing business to enter the field of radio set distribution in the Midwest.

F. W. McGrath, vice-president in charge of sales for the Appliance Manufacturing Company, Alliance, Ohio, announces the appointment of two additional district managers for Duchess Washers. Glenn O. Pippert, 49 Central Ave., Cincinnati, Ohio, is appointed for southeastern Ohio. E. C. Sharrow, 1571 Pontiac Road, S.E., is appointed for western Michigan, and northern border counties in Indiana.

Deepfreeze Division, Motor Products Corporation, North Chicago, Ill., has announced the appointment of John P. Strange as regional sales manager for the Southern region. He succeeds Thoben F. Elrod, recently resigned.

Frank W. Guthrie has been appointed sales manager of The Rauland Corporation, manufacturers of Visitron aluminized television picture tubes, according to an announcement made by E. N. Rauland, president.

Max Abrams, secretary-treasurer of the Emerson Radio and Phonograph Corporation, received the annual gold medal of the Men's League of Brooklyn as "outstanding citizen of the Borough" at a dinner held at the Hotel St. George. The award is given annually to a Brooklynite who has served his community for a period of ten years.

The Tele King Corporation, New York, has announced the appointment of Sydney Jurin as sales and sales promotion manager to handle the sales of the Tele King line of quality television sets. Mr. Jurin was previously sales manager of the Pilot Radio Corp.

New! highest efficiency of any known D.C. power supply in the 3 to 9 volt range

ELECTRO
ELECTRICAL AND RADIO EQUIPMENT

MODEL "B" D.C. POWER SUPPLY



Never before has there been a power supply like the ELECTRO Model "B". Radically new in design—trouble-free in operation—most efficient direct current source of power known.

ELECTRO PRODUCTS MODEL "B"—THE ONLY D.C. POWER UNIT USING CONDUCTION COOLING

LOOK AT THE FEATURES!

- ✓ New heavy duty selenium rectifiers.
- ✓ Eight power tap adjustments.
- ✓ 1 to 20 amperes at 6 volts continuous duty.
- ✓ Less than 3% A.C. ripple or hum.
- ✓ Damped volt and am-meters (no wiggling) Voltmeter 3% accuracy.
- ✓ Heavy duty tap switch.
- ✓ The RIGHT price.

Shows less heating than any other known type. Gives instant readings. Has exclusive new heavy duty selenium rectifiers—step power switch—transformer—choke—and condenser.

The 20 ampere 6 volt continuous rating provides more than enough power to operate any receiver. Peak instantaneous current rating of 35 amperes, (from 50 to 60 cycle 115 V power source), permits operation of two receivers with push button solenoids.

Use it for testing auto radios, faulty vibrators, push button solenoids, over and under voltage operating conditions on any size radio, and many other applications.

WRITE TODAY FOR COMPLETE DETAILS

ELECTRO PRODUCTS LABORATORIES, INC.
Pioneer Manufacturers of Battery Eliminators
549 W. RANDOLPH ST. CHICAGO 6, ILL.

SWEEPING the COUNTRY!



"TELE-SPEX"
TELEVISION SPECTACLES

It's sensational. A fast-selling, low-priced INDIVIDUAL GLARE FILTER that FILTERS THE PICTURE, NOT THE SCREEN. Permits natural black and white viewing for those who prefer it. Distortionless lenses. Optical frames.



Eliminate glare, Provide new eye-provide greater comfort in watch-definition, reduce ing night base-TV eye-strain. ball, boxing, etc.



Low priced for fast turnover.
Model No. TX (Ill. above)
List, **\$1.95** per pr.
Model No. CL-2 (Adjustable clip-on type)
List, **\$1.75** per pr.

SOLD ONLY THROUGH JOBBERS

RADIO MERCHANDISE SALES, INC.
550 WESTCHESTER AVENUE NEW YORK 55, N. Y.

**Are You
in this
GROUP?**



MANUFACTURERS
DISTRIBUTORS
WHOLESALEERS
RETAILERS
INDIVIDUAL USERS

Then you'll want to know today's facts about RAILWAY EXPRESS high-quality rail or air service, designed to meet your shipping needs—and why this complete service for one, all-inclusive charge offers the most value for your shipping dollar.

Write FOR YOUR COPY

of booklet "Complete Service for A Single Charge", please address: Railway Express Agency, Inc., Dept. 28, 230 Park Avenue, New York 17, N. Y.



NATION-WIDE RAIL-AIR SERVICE

GE Lowers TV Set Price



Lower picture tube costs and TV production economies are credited by General Electric for a new list price of \$369.95 in the east (formerly \$399.95) for Model 817 shown here being operated by Claire O'Keefe.

Group Endorses New Radio Parts Show Plan

The Association of Electronic Parts and Equipment Manufacturers went on record at its June meeting at Chicago as endorsing a plan to open the annual Radio Parts Show to all manufacturers who sell through distributors, regardless of association membership, and recommended that no attendance restrictions be imposed during Show hours. Present Show rules require membership in one of the five co-sponsoring groups to exhibit, and this year restricted attendance time was allotted in several categories.

Jewell in New Post

James M. Jewell, for the past three years copy chief in the advertising department of the Kelvinator division, Nash-Kelvinator Corp., Detroit, has been appointed advertising manager of Noblitt-Sparks Industries, Inc., Columbus, Ind., it has been announced by Glenn W. Thompson, president of the company.

Named by National Union



Kenneth C. Meinken, president of National Union Radio Corp., Newark, N. J., has announced the appointment of Emil J. Maginot, above, as sales manager of the distributor division of the company.

Telrex INC.
CONICAL ANTENNAS
*America's Outstanding
Television Beam*

- ★ The ONE antenna for ALL channels (no high-frequency head needed)
- ★ Maximum efficiency on ALL channels
- ★ Better than 12 DB front to back ratio on all frequencies

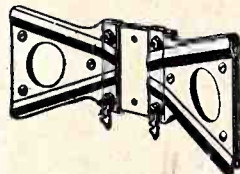

TELREX Conical Antennas provide the highest possible gain to the receiver — since the full strength of the signal (as received at

the antenna) is carried to the set with negligible loss—and with a definite reduction in the strength of ghosts or reflections. TELREX Conical Antennas are built better. Note this center clamp which provides such a strong grip over better than 3" of each rod surface. It is both a mechanical support and electrical contact second to none. And is only one of the features which result in improved and steadier pictures — from a better antenna—a TELREX antenna.

4X-TV
CONICAL "V" BEAM

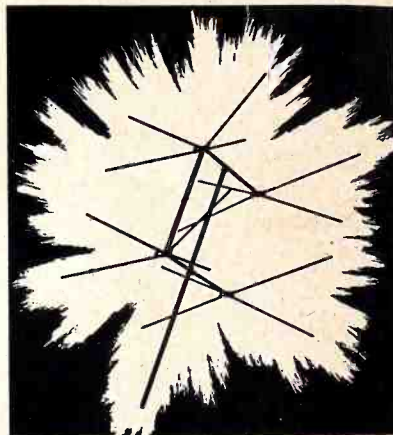

- Hi-Gain Stacked Conical "V" Beam—Channels 2 to 13
- Broad Band—Full Audio and Video Band Pass
- Low Inception Angle, Minimum Reflections
- Maximum Signal to Noise
- Better than 12 DB Front to Back Ratio All Frequencies
- 150 Ohm Non-Varying Center Impedance
- Use 72, 150 or 300 Ohm Transmission Lines
- Universal Mounting Clamp

Telrex Conical Antennas are available in a variety of models to meet any need.

© 1949 Telrex, Inc.

At your distributor or write

TELREX, INC.
ASBURY PARK 2, NEW JERSEY

Letters from Readers

Big TV Service Outfit

Editor,

RADIO & TELEVISION RETAILING

Liberty Television Corp., incorporated under the laws of the State of New York, is a consolidation of Paramount Television Corp. and Melody Mfg. Co. Consolidation made necessary by increased scope of activities and a desire to render better service.

We have one of the pioneer television service organizations on Long Island. We have at present well over 6000 television sets under yearly service, in Queens and Nassau Counties. A fleet of fourteen trucks and six passenger cars blanket the area and are able to give 24 hour service. Included in their equipment, all installation and service men carry a survey receiver.

We operate our own service school twice weekly, under the supervision of Louis Asheroff, chief engineer.

We believe that we are the first and only company of its kind that has "bonded television service." Each one of our men is bonded for added protection to manufacturer, dealer and consumer.

William V. Rudy is president and sales manager; Louis Asheroff, vice-president and chief engineer, and Florence Bettendorf is office manager.

We trust that this information will be of interest to you and your readers. We also take this opportunity of telling you that RADIO & TELEVISION RETAILING is our most important trade paper and has become very valuable to us in many ways.

William V. Rudy, President,
Liberty Television Corporation
Franklin Square, N. Y.

Another TV Distance Record Broken?

Editor,

RADIO & TELEVISION RETAILING

In line with your note in a recent issue of RADIO & TELEVISION RETAILING about long distance TV reception please note the enclosed copy of a letter to WMAR Baltimore, probably 1200 miles from here.

M. G. Goldberg
Beacon Radio Service
130 East Fourth St.
St. Paul, Minn.

Station WMAR-TV,
Baltimore, Maryland.

Gentlemen:—

Several times in the past month we have had occasion to note the presence of a TV signal on Channel 2 though no station in this vicinity is assigned this channel. Last evening the writer deliberately set out to determine just what station carrier this was and was rewarded with almost a half hour of top grade entertainment from a station

on the above mentioned channel which turned out to be WMAR-TV.

We are writing this letter for verification from you direct and list below sufficient evidence of reception which should leave no doubt of its accuracy. The reception was on a pilot TV-37 model which we were checking at the time, and we were using a standard folded dipole without reflector approximately 20 feet above ground. Now that we have had such good results we expect to install a reflector with motor-driven arrangement so that we may orient the system for best results.

Kindly acknowledge receipt of this letter and information contained as listed below:—

WMAR-TV Baltimore, Channel 2.

Time—6:45 to 7:00 p.m., C.S.T.

Program—"Toast of the Town"

Sponsor—Lincoln-Mercury

Master of Ceremonies—Alex Leftwich

Guest Stars—1. Girl Singer

2. Golfers. Craig Wood and one other

3. Acrobat with male audience participant doing stunts, especially with chair on bottles on table, etc.

4. Ventriloquist, Winchell and Jerry Mahoney

All guest stars appeared in grand finale.

Music—Ray Bloch

This program was followed at 7 p.m. by GE's Fred Waring Show.

We think the above information is sufficient evidence that the reception was authentic.

Beacon Radio Service,
Per M. G. Goldberg

VUE-SCOPE
TELEVISION MAGNIFYING LENS
MAGIC MOUNT

Write Today For
VUE-SCOPE'S
1949 MERCHANDISING PROGRAM

See Vue-Scope Before You Buy
CELOMAT CORP., 521 West 23rd St.,
New York 11, N. Y.

At Last - A New Practical
INDOOR TV ANTENNA

Small
Compact

The
"Vidiette"
Tricraft
Model
"700"

No pushing or pulling
of rods to adjust

- Low-priced
- Simply move knob to channel desired and you are "on the beam" — automatically electrically adjusted
- Under 2:1 standing wave ratio in all bands
- Small and compact — attractive appearance
- For portable units can be placed inside cover of set
- Individually boxed — packed 24 to a shipping carton — wt. 31 1/2 lbs. per carton

WRITE FOR YOUR COPY OF OUR NEW CATALOG!



Tricraft Products Co.

1533 North Ashland Ave., Chicago 22, Ill.

Manufacturers of complete line of Television, FM and AM antennas and accessories

ADVERTISERS' INDEX — JULY 1949

Aberdeen Auto Parts	125	National Merchandise & Sales Co.	111
Admiral Corp.	86, 87, 88	Nielsen Television Corp.	17
Air King Products Co., Inc.	12	Noblitt-Sparks Industries, Inc.	19, 45
American Television, Inc.	109	North American Philips Co., Inc.	50
Anchor Radio Corp.	126	Olin Industries, Inc.	10
Andrea Radio Corp.	99	Peerless Album Co.	126
Astatic Corp.	89, 132	Philco Corp.	5
Bakelite Corp.	70, 71	Phoenix Electronics, Inc.	131
Belden Mfg. Co.	21	Pioneer Scientific Corp.	140
Bendix Radio Div., Bendix Aviation Corp.	14, 15	Presto Recording Corp.	82
Boetsch Brothers	98	Radiart Corp.	121
Brach Mfg. Corp., L. S.	123	Radio Apparatus Corp.	127
Burgess Battery Co.	139	Radio Corp. of America:—	
Caldwell-Clements, Inc.	8	Tube Department	16, Cover 4
Cantor, Fitzgerald & Co., Inc.	140	Victor Division	20, 47, 65-69, 108
Capitol Records	91	Radio Merchandise Sales, Inc.	136
Celomat Corp.	138	Railway Express Agency	137
Columbia Records, Inc.	55	Ray-Dyne Corp.	104
Commercial Credit Corp.	54	Recoton Corp.	93
Cornell-Dubilier Electric Corp.	24	Reeves Soundcraft Corp.	140
Crescent Industries, Inc.	92	Rider Publisher, Inc., John F.	112
Crosley div., AVCO Mfg. Corp.	2, 3, 105	Shure Brothers, Inc.	95
Decca Records	111	Simpson Mfg. Co., Inc., Mark	103, 140
DeWald Radio Mfg. Corp.	130	Sonotone Corp.	110
DuMont Laboratories, Inc., Allen B.	39, 117	South River Metal Products Co., Inc.	132
Easy-Up Tower Co.	128	Sparks-Withington Co.	9
Electro Product Laboratories	136	Standard Transformer Corp.	125
Electro-Voice, Inc.	106	Starrett Television Mfg. Corp.	78, 79
Emerson Radio & Phonograph Corp.	76, 77	Stromberg-Carlson Co.	28
Fada Radio & Electric Co., Inc.	22	Sylvania Electric Products, Inc.	119
Federal Television Corp.	83	Symphonic Radio & Electronic Corp.	101
General Electric Co.	7, 11, 35	Technical Appliance Corp.	133
General Industries Co.	100	Tele-King Television Corp.	4
General Instrument Corp.	102	Tele-tone Radio Corp.	25
Graybar Electric Co., Inc.	13	Telrex, Inc.	137
Hearst Advertising Service	18	Trans-Vue Corp.	49
Industrial Television, Inc.	72, 73	Tricraft Products Co.	138
International Resistance Co.	127	Triplett Electrical Instrument Co.	6
International Telephone and Telegraph Corp.	26, 27	Video Corp. of America	133
Jerrold Electronics Corp.	134	V-M Corp.	94
Jewel Radio Corp.	129	Walco Sales Corp.	96
Mahogany Association, Inc.	43	Warren Mfg. Co., Inc.	129
Mallory & Co., Inc., P. R.	Cover 2	Waters Conley Co.	107
Marvel-Lens Industries	23	Webster-Chicago Corp.	90
Marvin Radio-Television	135	Webster Electric Co.	80, 81
Metalace Corp.	130	Workshop Associates, Inc.	131
Milwaukee Stamping Co.	84	Zenith Radio Corp.	85
Motrola, Inc.	97, Cover 3		

It's Another BIG BURGESS Portable Battery Season!



Make your store headquarters for popular Burgess radio batteries. Get new free counter and window displays—enclosures—streamers. Ask your jobber or write to Burgess.

HERE'S WHY

BURGESS
is the *Money-Making*
Portable Battery Line!

A COMPLETE LINE

★ ... of quality batteries. All sizes and voltages for all portable radios ... simplifies ordering and stock!

★ SUPERIOR QUALITY

... made even better by new engineering principles that increase the service life of dated, fresh Burgess Batteries!

★ NATIONAL DEMAND

... stimulated by advertising in nationally famous magazines read by more than 70 million battery buyers every month!

★ MORE PROFITS

... through the gaining popularity of this sales-winning, complete line of better dry batteries!

IF YOU'RE NOT ALREADY enjoying all the sales-winning, profit-making advantages of the Burgess battery line, write or phone your Burgess jobber; or for the name of your nearby Burgess distributor write to

BURGESS
BATTERY CO. FREEPORT, ILL

MERCHANDISING EXPERT, HARRY STEIN

RADIO AND TELEVISION MANAGER

DAVEGA STORES . . . says:

NEW YORK, N. Y.

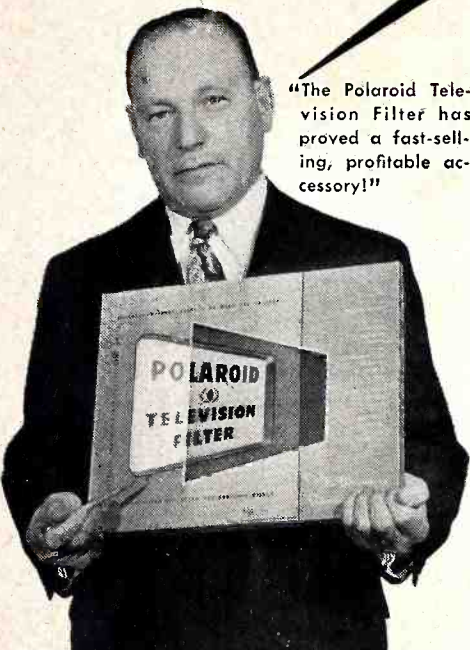

"The Polaroid Television Filter has proved a fast-selling, profitable accessory!"

Product created by **PIONEER SCIENTIFIC CORP.**
 © by Polaroid 295 LAFAYETTE STREET, NEW YORK 17, N. Y.

RCA 16" TV TUBE

The 16" tube designated type 16AP4 consists of a metal cone with glass face-plate and glass neck. Overall diameter at the face is 16 inches, overall length is 21 1/4 inches. Screen diameter is 14 3/8



inches. The screen is relatively flat, and the tube utilizes magnetic focus and magnetic deflection to provide a 10 by 13 1/4 inch picture. Second anode voltage recommended is from 9000-12,000 volts. The booklet, "Television Components for the kinescope RCA-16AP4," is available at jobbers or from the Tube Dept., RCA, Harrison, New Jersey.—RADIO & TELEVISION RETAILING.

New TMA Officers

Officers of the Television Manufacturers' Association for the 1949-50 term have been announced by the Association. Michael L. Kaplan, who has been acting president for the recently incorporated association, was named president for the coming year. Vice-president elect of TMA is Robert G. Kramer, president of Remington Radio Corp. Acting secretary-treasurer of the organization is A. E. Kessler, head of his own public relations firm.

Norge Price Reductions

As a result of increased demand, Norge division, Borg-Warner Corp. has announced greatly increased production schedules and sharp price reductions from \$10.00 to \$40.00 on current domestic refrigerator models.

Motorola Appoints Dick

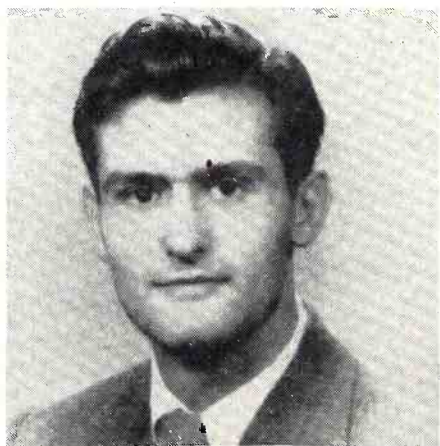

Joseph C. Dick, above, has been named to the newly created position of "supervisor of dealer material" at Motorola, Inc., Ellis L. Redden, advertising and promotion manager, has announced.

SENSATIONAL! NEW!

MASCO All Channel T.V.

ANTENNA BOOSTER
WITH FINE TUNING CONTROL

FOR
CLEARER
BRIGHTER
SHARPER
PICTURES



LIST
PRICE

\$42.50

It helps with roof top installations! It's the answer! For apartment house TV set owners!

Mr. Serviceman, it's YOUR HELPER for trouble shooting!

A sales aid for TV set demonstrations. The antenna may be rotated completely to any position desired to obtain maximum signal. Gripping action holds dipoles in pre-set position.

Swivel based antenna plugs into jack on top of booster cabinet

HELPS TO!

- Minimize ghost shadows
- Eliminate noise interference
- Eliminate interference from FM, amateur and standard broadcast

ALSO AVAILABLE

MODEL MTB-13X
All Channel Booster
Less Antenna - List Price **\$35.00**



Write for Descriptive Literature

MARK SIMPSON MANUFACTURING CO., Inc.
32-28 49th Street, Long Island City 3, N.Y.

HOW TO
CRACK the IRON CURTAIN
OF LANDLORD RESISTANCE TO
ROOF TOP ANTENNA CHAOS

KILL THIS

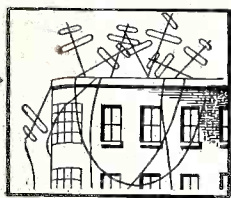

USE THESE



SOUNDCRAFT
Multivideo Connectors

Any good antenna and 300 ohm feedline will operate many TV receivers with the same performance as if using separate antennas. Non-cumulative insertion loss of only 4 db. No cutting or baring of feedlines.

List Price \$12.85

REEVES **Soundcraft** CORP.
10 EAST 52nd STREET - NEW YORK 22, N. Y.

To REEVES SOUNDCRAFT CORP.
10 EAST 52nd ST., NEW YORK, N. Y.

PLEASE SEND STORY AND DISCOUNTS . . .

NAME _____

ADDRESS _____

INDIVIDUAL

DEALER

HOTELEVISION

INC.

Class A Stock
(A Participating Stock)

\$1 per share

Offering Circular on Request

CANTOR, FITZGERALD & CO., INC.

61 Broadway

New York 6, N. Y.

ggest
news
of 1949

**11 NEW
INVENTIONS**
by Motorola

Coming soon
in the 1950 line

**watch-wait-
you'll whistle**
when you see them!

Motorola Inc. 4545 AUGUSTA BLVD., CHICAGO 51, ILLINOIS



RCA has pioneered the development of miniature tubes

One high quality—for TV-FM-AM —at no extra cost

● In TV and FM—where tube quality counts—RCA tubes more than meet the critical requirements. That's because the quality level of RCA tubes has been continually advanced in step with circuit progress. Improved design... more rigid control over manufacture and inspection... and more exacting tests, account for these higher quality standards. They apply to *all tubes* of a type... at no extra cost.

This *single standard* quality benefits all users. This extra quality cuts down costly service call-backs... builds customer confidence... brings you *more business*.

When you push RCA tubes you're selling the brand that holds top customer acceptance. So—*push RCA tubes and watch your business grow!*



NEW... handy miniature package

Now RCA miniatures come neatly packaged, five of a type, in attractive, expendable cartons. They're easier to handle, easier to stock, and a great aid in keeping track of your inventory. No extra cost... but plenty of extra convenience!

ALWAYS KEEP IN TOUCH WITH YOUR RCA TUBE DISTRIBUTOR



RADIO CORPORATION of AMERICA
ELECTRON TUBES
HARRISON, N. J.