

NOV 48

# RADIO & TELEVISION RETAILING

CALDWELL-CLEMENTS, INC.



Sell

a

Radio

for

Every

Room

- AM, M, TELEVISION
- ELECTRICAL APPLIANCES
- RECORDS & PHONOGRAPHS
- SERVICING & SOUND

RMA-NAB NATIONAL RADIO WEEK Nov. 14-20

**NOVEMBER** 1948



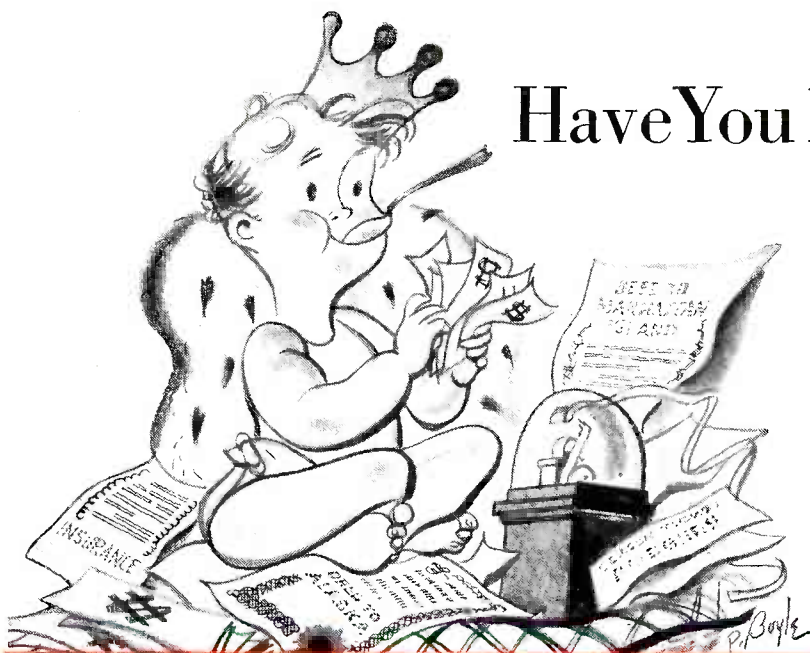

# Have You Met the Little Fellow with the **BIG** Advantages?

## The All New Mallory Midgetrol

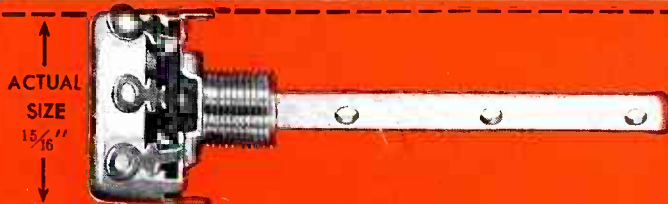

## Offers These BIG Advantages...

### BIGGER MARKET

The small size of the Mallory Midgetrol lets you service portables, auto radios and small AC-DC receivers which require  $1\frac{5}{16}$ " controls.

### SIMPLER INSTALLATION

The unique shaft design of the Mallory Midgetrol saves installation time with *all* types of knobs.

### SIMPLER STOCKING

Electrical characteristics let you use the Mallory Midgetrol to replace  $1\frac{1}{8}$ " as well as  $1\frac{5}{16}$ " controls. Stocks are further reduced because no special shafts are needed.

The Mallory Midgetrol is unusually quiet, both mechanically and electrically—and tests prove it *stays* quiet. In addition, the Mallory Midgetrol has nine *all new* features.

- NEW SIZE
- NEW DESIGN
- NEW SHAFT
- NEW EXTENSION
- NEW SWITCH
- NEW ELEMENT
- NEW CONTACT
- NEW TERMINAL
- NEW TWO-POINT SUSPENSION

*It's the NEW Standard in Carbon Controls. See your Mallory distributor.*

P. R. MALLORY & CO. Inc.  
**MALLORY**

CAPACITORS... CONTROLS... VIBRATORS...  
SWITCHES... RESISTORS... RECTIFIERS...  
VIBRAPACK\* POWER SUPPLIES... FILTERS  
\*Reg. U. S. Pat. Off.

**APPROVED PRECISION PRODUCTS**

P. R. MALLORY & CO., Inc., INDIANAPOLIS 6, INDIANA

# RADIO & TELEVISION RETAILING

Including "Radio & Television" and "Radio & Television Today"

IN THIS ISSUE

NOVEMBER, 1948

**ORESTES H. CALDWELL**  
Editorial Director

**M. CLEMENTS**  
Publisher

**JOHN L. STOUTENBURGH**  
Executive Editor

**RUTH MORRIS**  
Records Editor

**M. R. LABATT-SIMON**  
Assistant Editor

**ROBERT HERTZBERG**  
Contributing Editor

**EDWARD A. CAMPBELL**  
Technical Editor

**CHARLES F. DREYER**  
Art Director

**BUSINESS DEPARTMENT**

**M. H. NEWTON**  
Sales Manager

**EDWIN WEISL, JR.**  
**JOHN ROMANCHAK**

**BETTY HALL**  
Production

**BRANCH OFFICES**

CHICAGO 6  
**R. Y. FITZPATRICK**, Manager  
**S. GASKINS**  
201 N. Wells St. RAndolph 6-9225

**DUANE WANAMAKER**  
610 S. Broadway  
Los Angeles 14, Calif.  
Mutual 2161

**CIRCULATION DEPARTMENT**

**B. V. SPINETTA**  
Circulation Director

**W. W. SWIGERT**  
Credit Manager

November 1948, Vol. 48, No. 5, 35 cents a copy. Published monthly by Caldwell-Clements, Inc., 480 Lexington Ave., New York 17, N. Y. M. Clements, President; Orestes H. Caldwell, Treasurer. Subscription rates United States and U. S. Possessions \$2.00 for one year, \$3.00 for two years, and \$4.00 for three years. Pan American Countries \$4.00 for one year, \$5.00 for two years, \$6.00 for three years. Canada \$3.00 for one year, \$4.00 for two years, \$5.00 for three years. All other Countries \$5.00 for one year, \$7.50 for two years, \$10.00 for three years. Printed in U.S.A. Entered as second class matter April 9, 1948 at the Post Office, at New York, N. Y., under the act of March 3, 1879. Member of Audit Bureau of Circulation. \*Trade-Mark Reg. U.S. Pat. Off. Copyright 1948 by

**CALDWELL-CLEMENTS, Inc.**  
Publishers also of TELE-TECH.

★ *AM, FM, Television*

**COVER**—Sell a Radio for Every Room! RMA-NAB National Radio Week starts November 14.

<b>EDITORIAL</b> —Increase Your Buying Power .....	29
<b>WHAT'S AHEAD</b> —In Radios, Appliances, Records & Television .....	30
<b>HOW TO MAKE COLD TURKEY CANVASSING YOUR DISH</b> .....	34
<b>PROFIT POSSIBILITIES SHOWN SERVICERS</b> .....	36
<b>NEW RADIO MERCHANDISE FOR DEALER SELLING</b> .....	38
<b>BOOSTING SALES OF TV IN HIGHER INCOME AREAS</b> .....	40
<b>SELL MORE SETS AS CHRISTMAS GIFTS</b> .....	42
<b>SYSTEMS OF CONTROL PROTECT TV INSTALLATION PROFITS</b> .....	44

★ *Records, Phonographs, Accessories*

<b>COVER</b> —Top Platter Favorites .....	49
<b>HOW WE ADVERTISE TO BRING THE CUSTOMERS IN</b> .....	50
<b>CHILDREN'S RECORDS FOR CHRISTMAS</b> .....	52
<b>NEWS OF THE RECORD INDUSTRY</b> .....	Begins on page 54

★ *Electrical Appliances*

<b>COVER</b> —Have a LARGE Enough Stock of SMALL Appliances .....	59
<b>BUYING BEHAVIORISM IN THE HUMAN CUSTOMER</b> .....	60
<b>ELECTRICAL HOME APPLIANCES</b> .....	62
<b>CHRISTMAS DISPLAY IDEAS</b> .....	63
<b>DISHWASHERS MUST BE SOLD</b> .....	64
<b>NEW APPLIANCE PRODUCTS</b> .....	68
<b>NEWS OF THE INDUSTRY</b> .....	Begins on page 70

★ *Servicing and Sound*

<b>COVER</b> —About the New LP Records .....	71
<b>NEW AIDS TO EASIER SERVICING</b> .....	74
<b>NEW PRODUCTS HELP TO SELL SOUND</b> .....	78
<b>SERVICING RADIOS IN THE NEW CARS</b> .....	76
<b>TECHNICAL NEW PRODUCTS</b> .....	72
<b>NEW TOOLS, PARTS, PA EQUIPMENT</b> .....	80

Photo Credits

Ewing Galloway .....	Cover, pages 34, 60, 64
Allentown Call-Chronicle .....	page 59

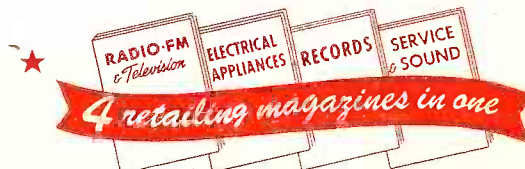

Member of  
**AUDIT BUREAU  
OF CIRCULATIONS**

**CALDWELL-CLEMENTS, INC.**  
480 Lexington Ave., New York, N. Y.



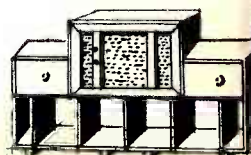
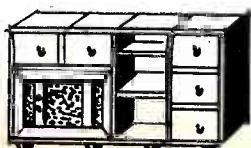
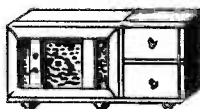
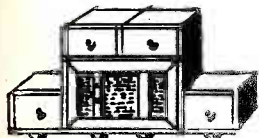
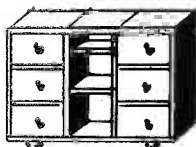
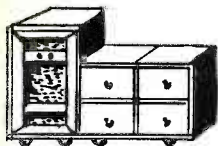
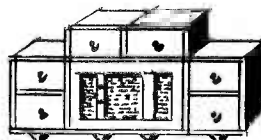
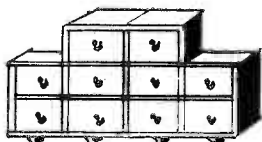
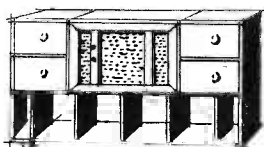
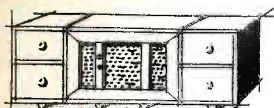
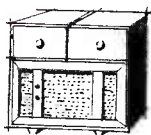
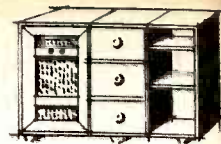
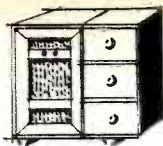

# Jensen Customode

*It's your move!* You are assembling a Home Entertainment Center or a Ham Shack and need fine loud speaker performance and cabinets for the ever expanding requirements of audio-video equipment. Designed by leading furniture stylists and electronics engineers, Customode's "building block" versatility enables you to create thousands of cabinet variations as you wish—when you wish. *It's your move!* Write today for literature and scale cut-up illustrations. Jensen Manufacturing Co., 6625 S. Laramie, Chicago 38, Ill.



There's still time to cut in on  
**ARVIN HOLIDAY PROFITS**  
 with these popular gift numbers



**Colorful! Compact! Top Value!**

**ARVIN MODEL 240P** \$19<sup>95</sup>\*  
*Pacemaker in Portables*

Here's a smart battery portable that's a natural for holiday sales. Display them, advertise them—watch crowds buy them up for Christmas gifts. Smart ruby-red plastic! Excellent tone and performance. Good profit margin!

**ARVIN MODEL 241P** \$29<sup>95</sup>\*  
*3 Way Portable Value*

Arvin-built 3-way model in three eye-catching colors—red, brown and ivory. Arvin engineered for top performance. Priced for extra holiday profits.

**ARVIN MODEL 244P** \$32<sup>95</sup>\*  
*The "Jeweler's" Model*

Three-way portable in America's luxury color—special jade green. Ideal for gift promotions, account openers. Extra profit margin, too!



**ARVIN MODEL 242T** \$14<sup>95</sup>\*  
*In Red, Yellow, Green or Ivory*

Newest Arvin AC/DC superhet. Smart styling. Non-breakable cabinet. In colors all America wants. Underwriters' listed. A sensational leader for the holidays.

**ARVIN MODEL 160T** \$34<sup>95</sup>\*  
*The Big Value Set* Walnut

Radio's biggest value! Packed with eye and ear appeal, engineered for peak performance. Five tubes plus rectifier. Three gang condenser, tuned r.f. stage, 5/4 in. Alnico speaker. Underwriters' listed.



**NATIONALLY  
 ADVERTISED**

Life—Country Gentleman  
 Saturday Evening Post

**NOBLITT-SPARKS INDUSTRIES, INC.**

Columbus, Indiana

\*Slightly higher in Zone 2. Portable's price less batteries.





# Pilot RADIO PICKS PROTELGRAM



**FOR BEST TELEVISION  
PROJECTION!**

The Pilot Model TV-42 incorporates the PROTELGRAM projection system and 16" x 12" viewing screen in a console cabinet measuring 39 1/4" x 28" x 22".

## *Quality* **THE ULTIMATE CHOICE OF TELEVISION MANUFACTURERS**

PILOT RADIO CORPORATION, one of America's pioneers and a leader in the production of high quality radio receivers, has chosen NORELCO PROTELGRAM to supply superior video projection to PILOT sets . . . with a large distortion-free 16" x 12" picture, a full 192 square inches.

NORELCO PROTELGRAM reproduces picture tones in true black, gray and white . . . completely free from discoloration and without glare or eyestrain. NORELCO PROTELGRAM large-screen projection permits normal viewing at less than 5 feet and upwards . . . the perfect medium for small or large group video viewing.

PILOT engineers selected NORELCO PROTELGRAM because of its dependable, large-screen, clear-view projection.

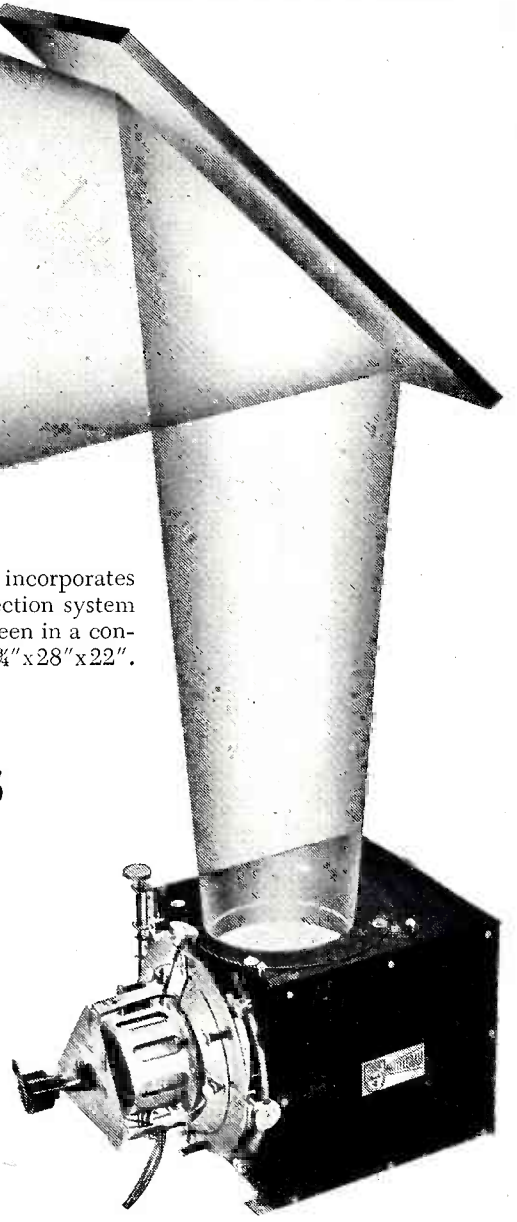

- The PROTELGRAM projection system consists of a specially developed 2 1/2" projection tube, optical box with focus and deflection coils, and a 25-kv regulated high-voltage unit. Compactness and flexibility make possible large-picture television in average size radio-phonograph consoles, consolettes and table model television receivers.

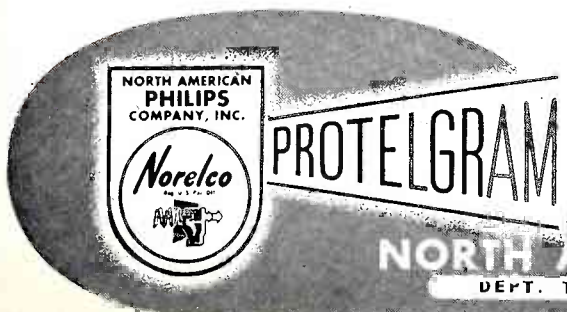

Other NORELCO products include standard 10" direct-viewing tubes and special-purpose cathode-ray tubes for many applications.

**IS PICTURE PERFECTION IN PROJECTION**

**NORTH AMERICAN PHILIPS COMPANY, INC.**  
DEPT. TR-11, 100 EAST 42ND STREET, NEW YORK 17, N. Y.

IN CANADA: PHILIPS INDUSTRIES LTD., 1203 PHILIPS SQUARE, MONTREAL \* EXPORT REPRESENTATIVE: PHILIPS EXPORT CORPORATION, 100 EAST 42ND STREET, NEW YORK 17, N. Y.





# ONLY PHILCO HAS IT!

## THE *Balanced Fidelity* REPRODUCER



Specially developed by Philco in collaboration with the engineers who created the amazing

# *Long Playing Record*

The Philco Balanced Fidelity Reproducer is the remarkable result of long research in the Philco laboratories and close collaboration with the engineers who developed

the revolutionary new 45 minute record. It is specially constructed and precisely balanced to stay in the record's unique microscopic grooves. It avoids distortion and wear. And, through proper balance and proportion, it permits *fullest enjoyment* of the wide range of tone and "concert hall" realism which distinguish this new type of recording. *There's nothing else like it on the market!*

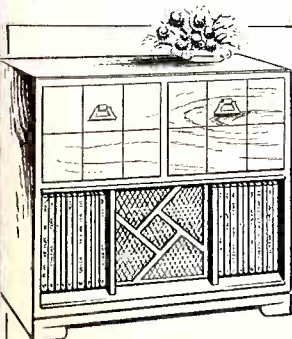

**PHILCO 1609.** Stunning Double Tone Arm Console. FM-AM . . . \$259.50

**PHILCO 1405.** Smart table combination for LP and Standard records . . . . . \$129.95

The exclusive Philco Balanced Fidelity Reproducer is yours to sell in a wide range of new Philco Double Tone Arm Radio-Phonographs covering every price bracket.

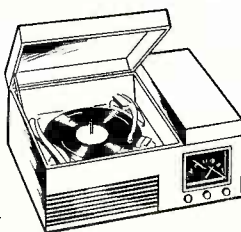

**PHILCO M-15.** Album-Length Record Player. Equips any radio or phono, old or new, to play LP records. \$29.95

## PHILCO

*Famous for Quality the World Over*



# Sparton

## "SHOOTS THE WORKS"

### in big fall ad program

Yes . . . Sparton is going all out with a powerful fall advertising drive to get extra sales and profits for you, the Sparton dealer, by featuring the tremendous values you offer under the time-tested SCMP—Sparton Co-operative Merchandising Plan. There's no other Sparton dealer down the street to ride along with you . . . you get the full benefit in your community.

If you aren't a Sparton dealer, better write today and see if the exclusive Sparton franchise in your community is still open.

### HERE'S THE FALL LINE-UP



1

Full-page ads in Saturday Evening Post—Farm Journal—Country Gentleman, consistently reaching over 8,900,000 families in city and country markets



2

Full-page rotogravure ads in Sunday Magazine sections of 21 METROPOLITAN GROUP newspapers, hitting nearly 8,200,000 families in big-city areas



3

ALSO, big 1,000-line ads in 26 leading metropolitan newspapers with a circulation of over 8,600,000



4

Plus ads every other week in 2229 small-town papers, coast to coast, of WESTERN NEWSPAPER UNION, reaching 1,700,000 families per insertion in grass-roots areas

### Dealers agree it's a sensation . . . a Console Combination and with FM—

Sparton Model 1059 . . . gorgeous Sparton AM-FM radio-phonograph with fast, silent, automatic record-changer; 10-inch, permanent magnet speaker; built-in loop antenna for AM and internal power line antenna for FM. In cabinet of rich, matched mahogany veneers, it's a challenging value that saves buyers up to \$50.00 over comparable radio-phonograph models. And you sell it for only

**\$144.95**

ALL PRICES SLIGHTLY HIGHER WEST OF ROCKIES



**ONE Sparton Dealer in each community**  
Check these profit-increasing features

- One exclusive dealer in each community
- Direct factory-to-dealer shipment
- Low consumer prices
- National advertising
- Factory prepared and distributed promotional helps
- Seasonal promotions
- Uniform retail prices
- Cabinets from Sparton's own plant

# Sparton

RADIO-TELEVISION'S RICHEST FRANCHISE  
THE SPARKS-WITHINGTON COMPANY • JACKSON, MICHIGAN



SERVES AND PLEASES MILLIONS!



**GENERAL**  **ELECTRIC**

176-847-0000

FIRST AND GREATEST NAME IN ELECTRONICS



# FADA TELEVISION IS TOPS

with Leading Dealers Everywhere!

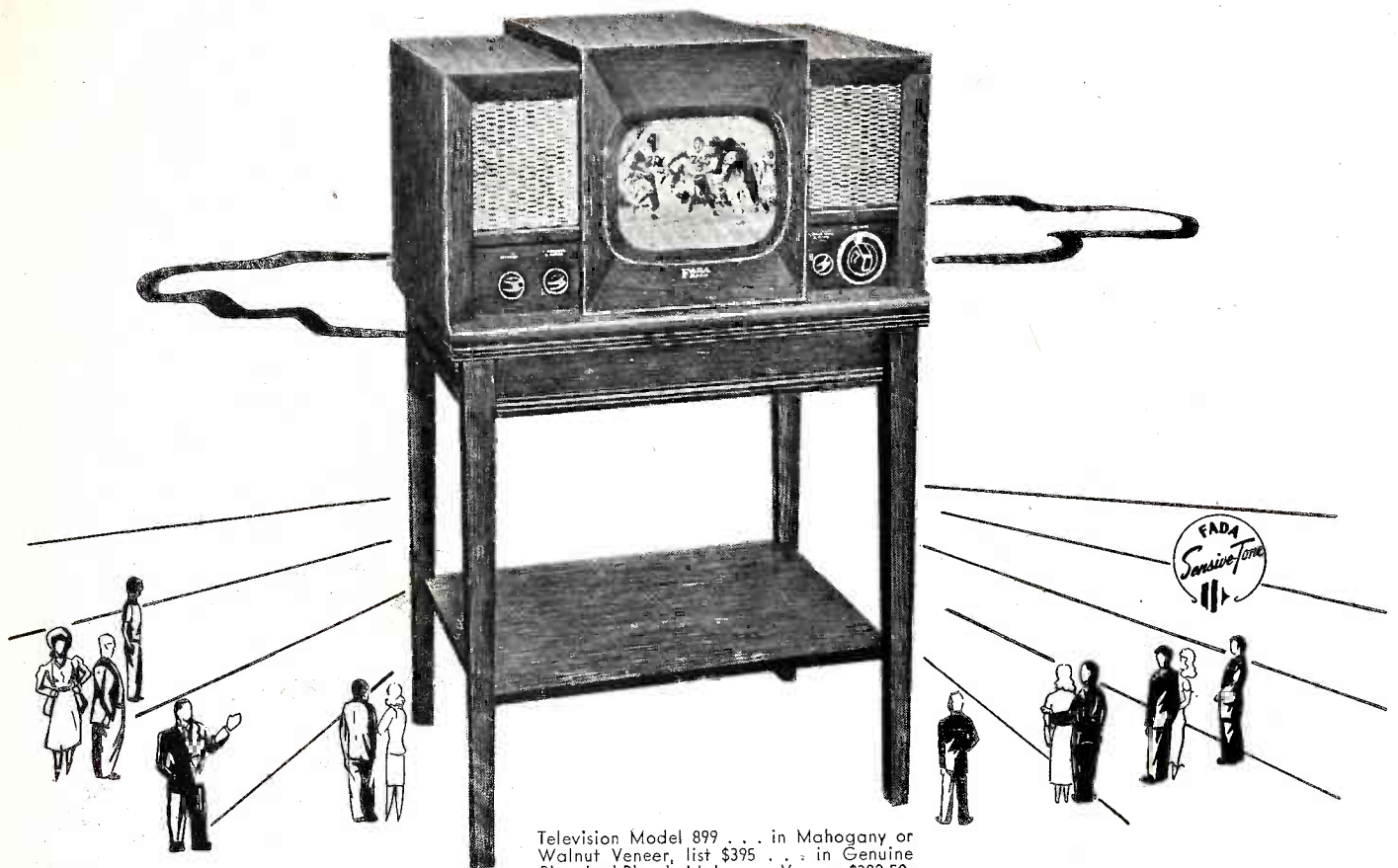

Television Model 899 . . . in Mahogany or Walnut Veneer, list \$395 . . . in Genuine Bleached Blonde Mahogany Veneer, \$389.50, plus tax and installation. Matching tables extra.

In every important Television market, FADA is boosting sales records of its franchised dealers! With aggressive newspaper advertising, with an unbeatable merchandising program, catalogs, handfolders, colored easled priced or slogan cards, window streamers, Neon Clocks, signs, newspaper mats, etc. Everything you need as leader in Television selling. Join the bandwagon of progressive, profit making FADA dealers.

MODEL 899 has large 10 Inch Tube . . . 52 Square Inch area. Full 12 Channel coverage. 30 Tubes including 4 Rectifiers and Kinescope tube.

*"FAMOUS SINCE BROADCASTING BEGAN . . . TELEVISION OF TO-MORROW . . . TO-DAY"*

**FADA RADIO & ELECTRIC COMPANY, INC.**

1920

BELLEVILLE, NEW JERSEY

1948



# Meet your prospects HALFWAY!

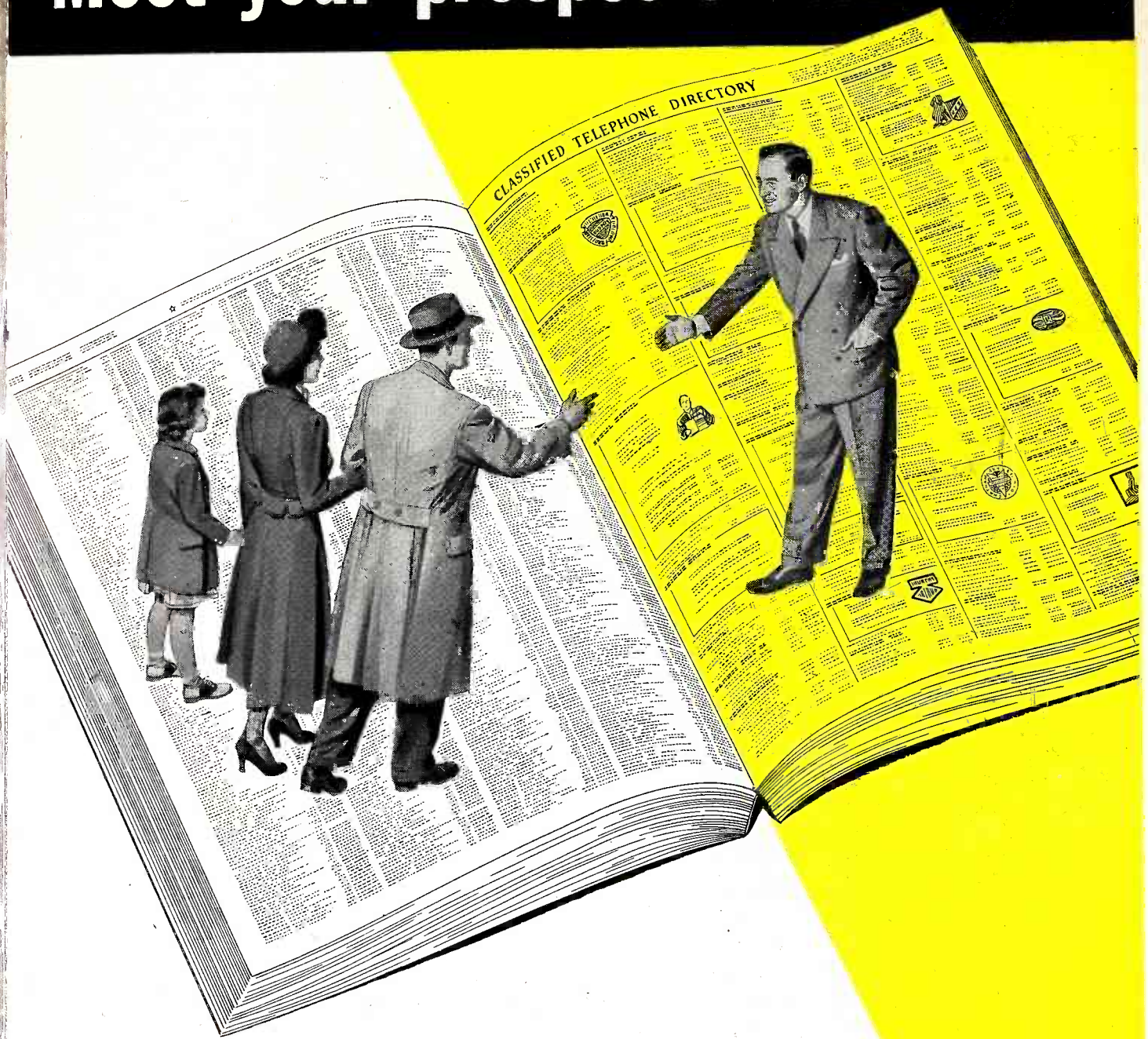

Most of your best prospects are listed in the alphabetical section of your telephone directory (the white pages).

Are you meeting these prospects...when they turn to the 'yellow pages' (classified section)? Every day, many thousands of telephone subscribers refer to the 'yellow pages' for the buying information they want.

When you use the 'yellow pages' to tell your community about your business—what merchandise and advertised products you sell, what services you offer—you'll find the 'yellow pages' of your telephone directory ideal for meeting prospects face-to-face...for turning more prospects into customers.



**For further information, call your local telephone business office.**





**HOTTEST NEW AUTO RADIO  
ACCESSORY IN YEARS!**

*New! Universal!*

**PHILCO**

**REAR SEAT SPEAKER**

**FOR ALL MAKES  
OF AUTO RADIOS**

**DOUBLES THE ENJOYMENT  
OF ANY AUTO RADIO AT...**

*Small Cost!*

Every passenger in the car enjoys finer reception when the radio installation includes a Philco Rear Seat Speaker. It brings new easy listening to rear seat riders—new freedom from blare up front. Yes, front and rear, here's new, clear, comfortable "living room" sound quality for all.



**MILLIONS WANT IT! DON'T MISS THESE BIG PROFITS!**



You've wanted a hot deal like this for years . . . one that you can sell to *present* auto radio owners, as well as new owners . . . easy to demonstrate . . . offering value far beyond its moderate price . . . yes, and profitable! Don't wait for the big Christmas rush—start now! Install a Philco Rear Seat Speaker in your *own* car and see how it *sells itself* to any customer who hears it.

**ASK YOUR PHILCO DISTRIBUTOR ABOUT IT TODAY...**



# More for your customers'

# Christmas Money



Model 376

### Your customers will want THIS!

FM-AM automatic radio-phonograph. *Natural color tone.* Amazing G-E Electronic Reproducer. 12" speaker. Mahogany veneered console. Model 376. NEW LOW PRICE **\$249.50\***

*Available with G-E electronic LP (long playing) record player—at slight extra cost.*



Here are gifts *your* customers will want for Christmas giving—gifts that offer them *more* for their Christmas money—gifts that are *performance-engineered* at Electronics Park for *value*, for *tone*, for *power*—for all around *acceptance!* Call your G-E radio distributor for complete details and prices, or write *General Electric Company, Receiver Division, Electronics Park, Syracuse, New York.*



Model 62

### Your customers will want THIS!

G-E "Wake-up-to-music" Clock-Radio. It's a fine-toned radio, an accurate G-E electric clock and an electronic reminder—all in an ivory plastic cabinet. Model 62. **\$41.95\***

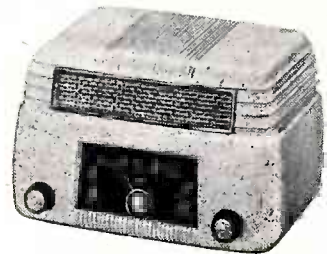

Model 201

### Your customers will want THIS!

De luxe AC-DC superheterodyne table radio. G-E *natural color tone.* 5 1/4 inch G-E Alnico 5 speaker. Big performance—extra big value. Full-size ivory plastic cabinet. Model 201. **\$37.95\***



Model 150

### Your customers will want THIS!

G-E 3-way portable. AC, DC, or batteries. Exceptional power, tone and performance. Maroon, ivory or light gray plastic cabinet. Simulated leather handle. Model 150. **\$39.95\***  
(less batteries)



Model 145

### Your customers will want THIS!

It's new! It's *different!* It's exquisite! Very thin personal portable—a slender 2 3/4 inches. Weighs only 7 1/2 lbs. AC-DC-batteries. Stunning maroon plastic case. Model 145. **\$44.95\***  
(less batteries)

*\*Western prices slightly higher. Prices subject to change without notice*

### For greater Christmas Sales

... push and sell General Electric's complete line:

- FM-AM Radios
- Radio-Phonographs
- Table Models
- G-E Daylight Television
- Portables
- Clock-Radios
- Farm Sets

# GENERAL ELECTRIC

175-G10



# THE CHICAGO STORY

## EXPENDITURES FOR ADVERTISING OF HOME FURNISHINGS, HOUSING EQUIPMENT AND ELECTRICAL APPLIANCES INCLUDING RADIO AND TELEVISION IN EACH CHICAGO NEWSPAPER, RETAIL AND GENERAL COMBINED

FIRST 8 MONTHS 1948

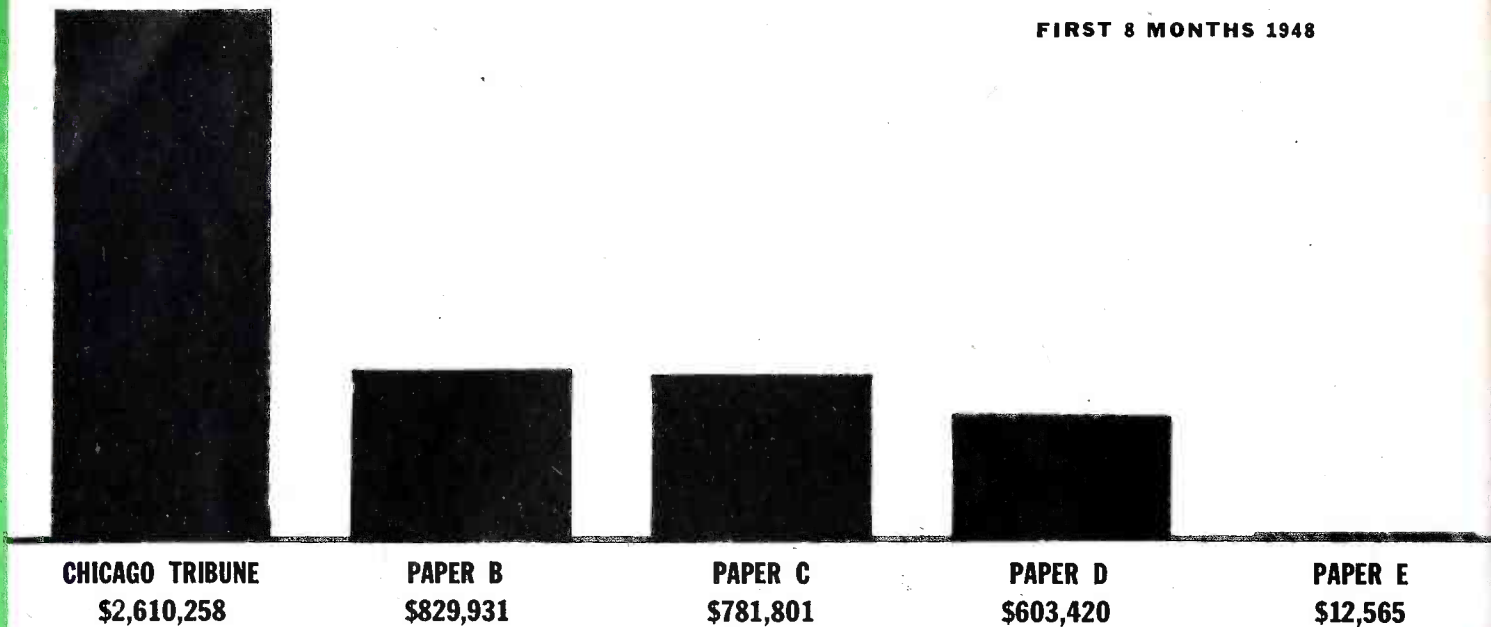

Placing more of their promotion funds in the Chicago Tribune than in all other Chicago newspapers combined, retailers and manufacturers as a group testify to this newspaper's ability to provide Chicago's biggest and best market for home furnishings, housing equipment and electrical appliances including radio and television.

## PERCENTAGE OF EXPENDITURES FOR ADVERTISING OF HOME FURNISHINGS, HOUSING EQUIPMENT AND ELECTRICAL APPLIANCES INCLUDING RADIO AND TELEVISION PLACED IN EACH CHICAGO NEWSPAPER, RETAIL AND GENERAL COMBINED

FIRST 8 MONTHS 1941 AND 1948

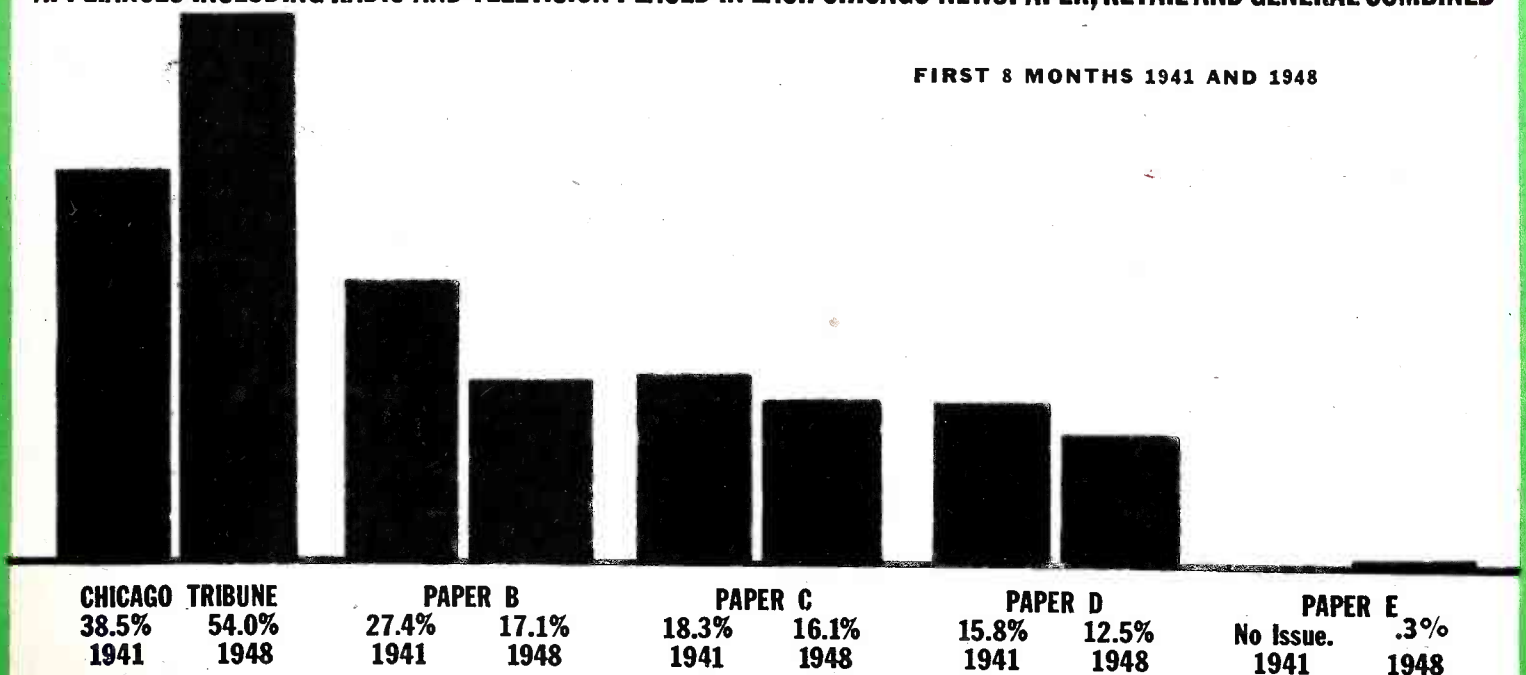

As the trend above makes plain, you sell more today and you build solidly for the future when you build your Chicago advertising program around the Tribune—the newspaper more home-minded families read and want. During the first 8 months of 1941, the Tribune's lead in expenditures over the next Chicago newspaper was \$245,148, or 39.9%. During the similar period this year, the Tribune's lead was boosted to \$1,780,327, or 214.5%.



# UP-TO-DATE!

## Facts to help you sell with greatest effectiveness in Chicago

**T**HE story these charts tell about advertising productivity is too important to be ignored by any retailer or manufacturer determined to make the most of his sales opportunities in the important Chicago market for home furnishings, housing equipment and electrical appliances including radio and television.

These charts reflect the unique community position of the Chicago newspaper read every day of the week by the families who account for the bulk of the consumer durables sold in every neighborhood and suburb of Chicago.

In addition, they testify to the regional effectiveness delivered by the Tribune in hundreds of cities and towns thruout the heart of the central states which contribute an important share of the total national sales volume.

With hundreds of thousands more total circulation, daily and Sunday, than other Chicago newspapers, the Tribune is the newspaper bought, read and *bought from* as is no other medium here.

To sell with greatest economy and effectiveness in the important Chicago territory, be sure your Tribune campaign is an adequate one. Rates per line per 100,000 circulation are among America's lowest.

# Chicago Tribune

THE WORLD'S GREATEST NEWSPAPER

CHICAGO TRIBUNE REPRESENTATIVES: A. W. Dreier, 810 Tribune Tower, Chicago 11; E. P. Struhsacker, 220 East 42nd St., New York City 17; W. E. Bates, Penobscot Bldg., Detroit 26; Fitzpatrick and Chamberlin, 155 Montgomery St., San Francisco 4; also, 448 S. Hill St., Los Angeles 13.

MEMBER: AMERICAN NEWSPAPER ADVERTISING NETWORK, INC., FIRST 3 MARKETS GROUP, AND METROPOLITAN SUNDAY NEWSPAPERS, INC.

SEPTEMBER AVERAGE NET PAID TOTAL CIRCULATION: DAILY, OVER 985,000 — SUNDAY, OVER 1,575,000



# Concentrated Distribution

...in  
the  
Radio  
Field



## You can sell more RCA Batteries because—

1. RCA Batteries are sold primarily through radio dealers and servicemen—this means more *repeat* business for you.
2. RCA provides the greatest array of selling aids in battery history . . . all geared to the *radio trade!*
3. Eight warehouses are strategically located to assure you of quick delivery on fresh stocks of RCA batteries through your local RCA Distributor.
4. RCA's completely rounded line covers virtually all of the requirements of the radio and electronics field.
5. Smart packaging, competitive prices, and "the greatest name in radio" add up to overwhelming customer acceptance.
6. RCA batteries are *radio engineered* for extra listening hours.

See your RCA Distributor about RCA Batteries today.

SELL RCA BATTERIES—THE COMPLETE LINE FOR THE RADIO AND ELECTRONIC TRADE

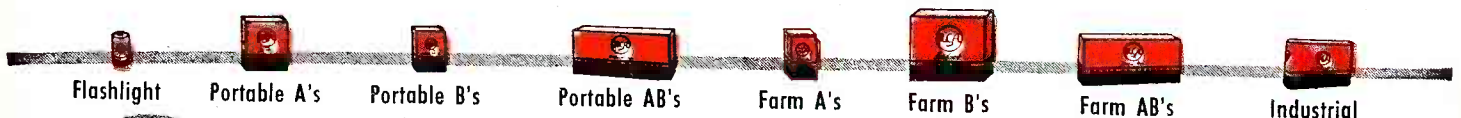

**RADIO CORPORATION of AMERICA**

**HARRISON, N. J.**





**NEW 3-WAY PORTABLE**

# "4 New Tops" IN YOUR TOP PROMOTION LINE

In every category—from Compacts to Consoles—Emerson gives you product and price LEADERS to SELL AT A PROFIT—with "step ups" all along the line... On every count, Emerson Radio and Television is the industry's No. 1 Promotion Line!

**Model 568.** Plays on AC-DC and self-contained Single Battery Pack... Alnico 5 PM Speaker... Handsome maroon plastic cabinet with weave-type grille, sliderule dial and integrated control knobs. 11½ in. wide. *Less batteries,* **\$29<sup>95</sup>**

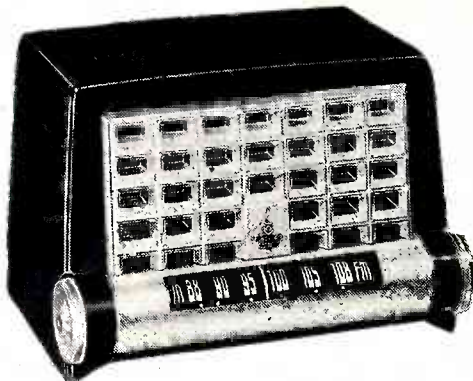

## **FM SENSATIONAL EMERSON "CONQUEROR"**

**Model 602.** Genuine (NOT "Superegen") Frequency Modulation. The great new performance, promotion and price leader. **\$29<sup>95</sup>** Only



## **PHONORADIO MODEL 579**

*Biggest Selling "Combination"*

AC—Automatic—a COMPLETELY SATISFYING Phonoradio with superb performance features and superb TONE. A great SELLER—a great LEADER for **\$49<sup>95</sup>** your combination business. Only



# Emerson Radio and Television

## **"IMAGE PERFECTION" TELEVISION**

**Model 606** with BIG 52-sq.-in. screen—Miracle Picture Lock—FM Staticlear Circuit. All advanced features. One of a GREAT line at popular prices. **\$349<sup>50</sup>**

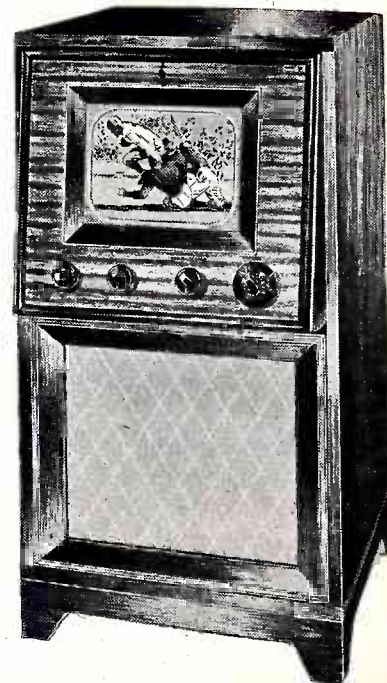

**EMERSON RADIO AND PHONOGRAPH CORPORATION • NEW YORK 11, N. Y.**



Look to the Leader...

for the best in  
tape recording!



MODEL 8U12

NEW  
MAGNETIC  
*tape*  
**Recordio**  
T.M. REG. U.S. PAT. OFF.  
by **WILCOX-GAY**

*Full Half-Hour  
of Continuous Recording!*

In the new Tape RECORDIO, Wilcox-Gay precision and research give you another outstanding instrument. Here is the answer to the demand for a tape recorder that is easy to operate, strongly built, and, at the same time, light enough to carry anywhere. It is the perfect instrument for all types of speech study and educational work.

**AMAZING FEATURES OF THE TAPE RECORDIO**

- Full half-hour of continuous recording on one tape.
- Frequency response beyond 7000 cycles assures brilliant reproduction.
- High speed wind in either direction without rethreading.
- Tape easily spliced with cellulose tape for editing purposes.
- Storage compartments for spare tape and microphone.
- Records either from microphone or from radio.

**PORTABLE!**

Tape RECORDIO weighs only 25 pounds. Closed view at right shows attractive carrying case covered with long-wearing airplane luggage type finish.

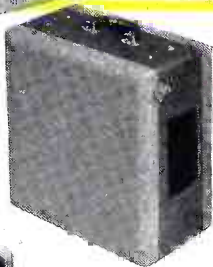

**AUXILIARY  
SPEAKER**

... shown at left, is available as an accessory for use in large auditoriums, etc. Has 12" PM dynamic speaker. Carrying case matches Tape RECORDIO. Weighs only 11 pounds.

**W I L C O X - G A Y**  
CHARLOTTE, MICHIGAN



Look to the Leader...

for the best in

long-playing record players!



MODEL 8F30

WILCOX-GAY

wireless

RECORD PLAYER

by the makers of Recordio

45 Minutes of Music from One Record!

No Connections Required!

\$29.95 RETAIL

Wilcox-Gay, first in 1938 with the original wireless record player, is first again in 1948 with a wireless player for the new long-playing records. Plays through any radio!

Easy to demonstrate, easy to sell—because no connections are necessary.

Featherweight pickup, especially designed for new microgroove records, saves wear on records and gives wide-range, high-fidelity response. Weighs less than six pounds. An amazing buy at \$29.95—and a sure seller to the thousands of people who want to enjoy the many advantages of long-playing records.

C O R P O R A T I O N

[In Canada: Canadian Marconi Company]



# NOW...Zenith Presents TWIN COBRA Tone Arms!



for both  
**STANDARD**  
and new  
**LONG-PLAYING**  
**RECORDS**

**AVAILABLE NOW IN ALL  
ZENITH\* CONSOLE RADIO-PHONOGRAPHS**

## THE COBRA\* TONE ARM REPRODUCES LONG-PLAYING RECORDS AT THEIR BEST

Yes, the famous Zenith Cobra Tone Arm, which makes any record, *old or new*, sound better, is particularly suitable for the new Microgroove Long-Playing Records. That is because of the Cobra's exclusive design. There is nothing but the tiny cartridge and receptacle on the end of the tone arm. As a result, the Cobra tracks perfectly in the tiny microgrooves and reproduces every note that went into the record.



Now, Zenith's leadership in radio-phonographs is more definite than ever with the new Twin Cobra Tone Arms, which insure the finest in reproduction from both standard and the Long-Playing Records. The Cobra Tone Arm for standard records is maroon; the Cobra for the new Long-Playing Records is green. A two-position switch is marked in color to correspond with the Twin Cobras.

**Keep An Eye On**



## LONG-PLAYING COBRA ADAPTOR

Here's extra business and goodwill from old customers, too. Present owners of Zenith radio-phonographs can enjoy the new Long-Playing Records with this compact adaptor.

\*Reg. U. S. Pat. Off.



**ZENITH RADIO CORPORATION • 6001 W. DICKENS AVENUE • CHICAGO 39, ILLINOIS**



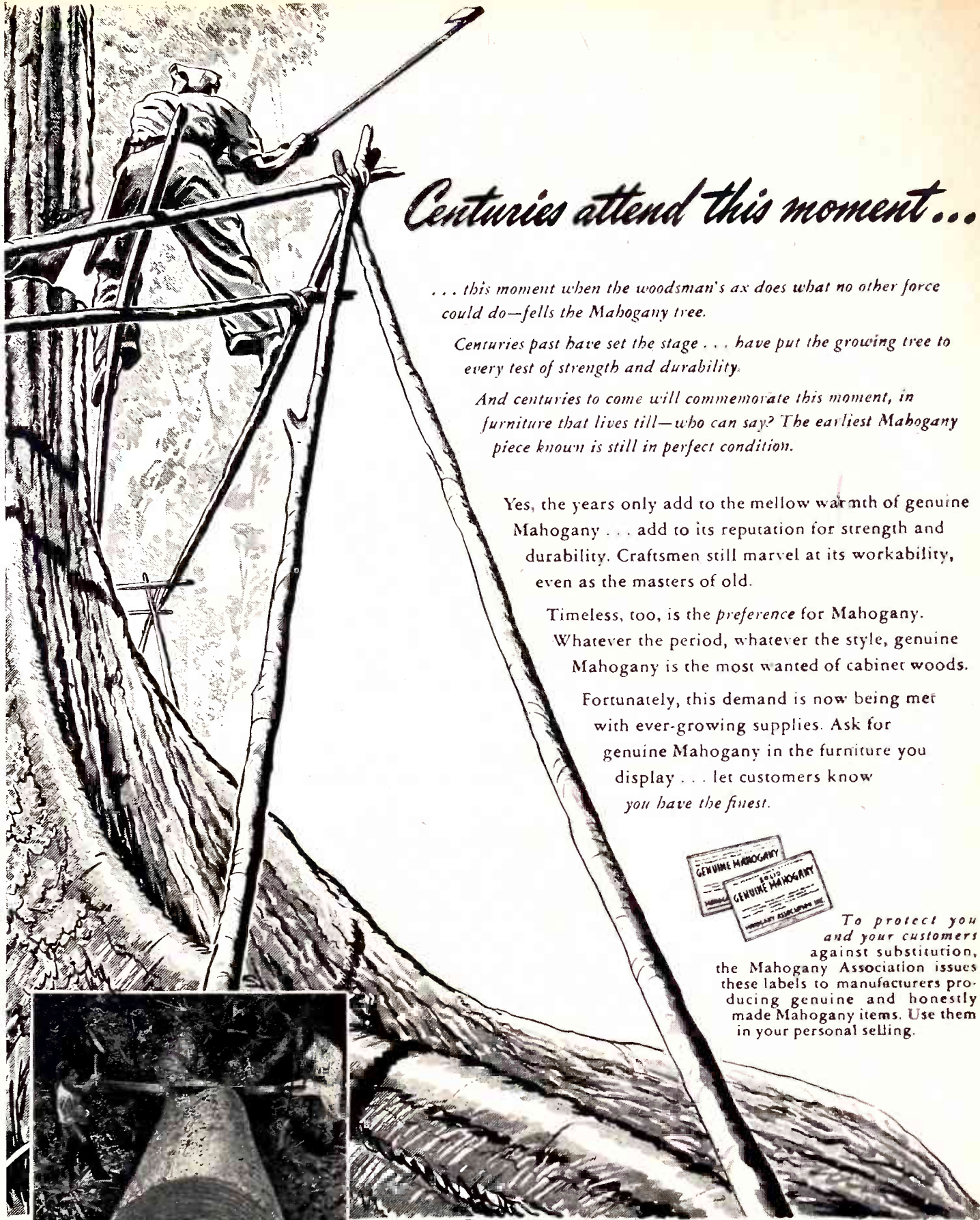

## Centuries attend this moment...

... this moment when the woodsman's ax does what no other force could do—fells the Mahogany tree.

Centuries past have set the stage... have put the growing tree to every test of strength and durability.

And centuries to come will commemorate this moment, in furniture that lives till—who can say? The earliest Mahogany piece known is still in perfect condition.

Yes, the years only add to the mellow warmth of genuine Mahogany... add to its reputation for strength and durability. Craftsmen still marvel at its workability, even as the masters of old.

Timeless, too, is the preference for Mahogany. Whatever the period, whatever the style, genuine Mahogany is the most wanted of cabinet woods.

Fortunately, this demand is now being met with ever-growing supplies. Ask for genuine Mahogany in the furniture you display... let customers know you have the finest.



To protect you and your customers against substitution, the Mahogany Association issues these labels to manufacturers producing genuine and honestly made Mahogany items. Use them in your personal selling.



SECRETS BARED... the tree is down, and now the saw reveals the first clues to the pattern of the grain. Always different, yet always beautiful, genuine Mahogany shows the greatest variety of all cabinet woods.

**"After All... there's nothing like MAHOGANY"**



## MAHOGANY ASSOCIATION, INC.

Suite 803-C, 75 East Wacker Drive  
Chicago 1, Illinois  
Please send new 7th edition of the 74-page Mahogany Book.

Name.....  
Address.....  
City and Zone No.....  
State.....





# Never before



Just plug it in, push a button, and get a great picture right away. That's the matchless demonstration you can make with this closed-front beauty with built-in antenna and push-button tuning. And it retails for about \$75 less than comparable models!

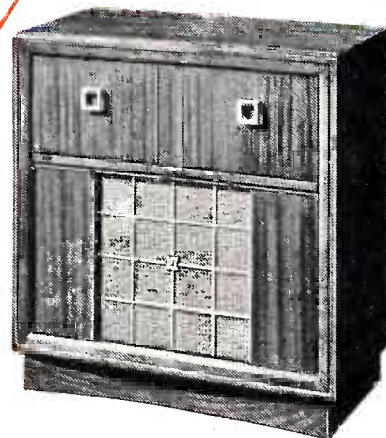

Side-by-side comparison with models costing \$50 more proves this the easiest selling AM-FM radio-phonograph for price and quality-conscious buyers. Its low price includes a plug-in attachment for long-playing records—or, at low-cost, the changer below.

## Big Christmas Advertising Program sends all prospects to your door

Advertising-wise, Bendix Radio is "pouring it on" during the Christmas buying season. And here's what that means to you. As the only Bendix Radio dealer in your community you will get *all* the benefit of our national advertising. Every prospect interested in these matchless 1949 models is directed straight to *you*.

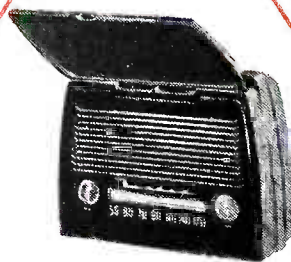

Wouldn't it be wonderful to offer gift buyers a small, long-range 3-way portable in jewel-like plastic at the price of an ordinary table model? Here it is—for plug-in or battery or AC-DC current—a self-selling "natural" for the Christmas trade.



All consoles will have it. Single-arm changer plays long-playing or standard records inter-mixed, shuts off current after last record.

**SEND THIS COUPON TODAY, REMEMBER—THIS FRANCHISE IS AVAILABLE TO ONLY ONE SELECT DEALER IN EACH COMMUNITY**



# Christmas Merchandise

with such **"Buy-Now" Appeal**

**BIG NAME—TOP QUALITY**

## Radio and Television

**PRICED TO MEET ANY COMPETITION**

It's a neat trick—but Bendix Radio dealers can do it! They offer nationally advertised radio and television—backed by a famous self-selling name and reputation and built to Aviation Quality standards—at figures competitive with price-built private brands. *And they can do it at a fine profit that's protected in every*

*way.* These are only the highlight advantages of our new, power-packed direct-to-dealer merchandising plan. There's still time to get in on it and capitalize on the big Christmas search for better values. But hurry—this protected-profit franchise is available to only one select dealer in each community.

**HOW CAN YOU MISS WITH A PROGRAM LIKE THIS!**

- The appointment of only one dealer in each community
- Direct factory-to-dealer shipments
- Freight prepaid to destination
- Low consumer prices competitive with national chains and mail order houses
- Liberal dealer discounts
- Nationally advertised retail prices protected by your exclusive franchise
- Radio and television built to Bendix Aviation Quality standards
- A complete line of radios and radio-phonographs including famous Bendix Long-Range FM
- The most advanced television created by the acknowledged leaders in radar and radio engineering
- Consistent national advertising that builds store traffic for you
- Compelling point-of-sale promotion helps
- Special promotion models to meet competitors' "off-season" distress sales
- Plus many new profit-building features soon to be announced.

# Bendix Radio

AND TELEVISION

DIVISION OF  
BALTIMORE 4, MARYLAND  
DEPT. I



Please send me all the facts about your new direct-to-dealer,  
radio-television merchandising plan.

MY NAME \_\_\_\_\_ MY FIRM \_\_\_\_\_

MY ADDRESS \_\_\_\_\_





Why Your RAYTHEON Tube Distributor\* Recommends

# The New RAYTHEON BANTAL TUBE



## It's Easier to STOCK

At the same price as ordinary tubes one Raytheon *Bantal* takes the place of *two*—cuts your stock problem in half! The Bantal 12SK7GT, for example, replaces, without shielding, either the GT or metal equivalent. Fast turnover, less money tied up in stock, more profit on your investment.

\*Your Raytheon Distributor sponsors the famous Bonded Dealer-Service Program. Ask him for full details on this business building plan.

## It's Easier to SELL

All these advantages at  
NO EXTRA COST

**Rugged Eight-Pillar Construction** — Short pillars direct to elements; low grid-plate capacitance—greater stability.

**Completely Shielded Internally** — No external shielding hardware or installation labor. Increases your service profit.

**Glass Button Stem** — Low Loss.

**Glass-To-Glass Seal** — Permanent Vacuum.

**Wide Lead Spacing** — No Electrical Leakage.

**Strong Non-Flexible Leads** — No Base Shorts.

**Glass-To-Dumet Vacuum Seal** — No Air Leaks.

**EIGHT POPULAR TYPES** — 6SA7GT — 6SJ7GT — 6SK7GT — 6SQ7GT — 12SA7GT — 12SJ7GT — 12SK7GT — 12SQ7GT.

**SUPERIOR FOR HEAVY DUTY SERVICE** — Recommend Raytheon Bantals particularly for replacements in sets or equipments requiring tubes of long life and greater dependability. Their superior performance assures customer satisfaction and repeat business.



**RAYTHEON MANUFACTURING COMPANY**

RADIO RECEIVING TUBE DIVISION

NEWTON, MASSACHUSETTS • CHICAGO, ILLINOIS • LOS ANGELES, CALIFORNIA

RADIO RECEIVING TUBES • SUBMINIATURE TUBES • SPECIAL PURPOSE TUBES • MICROWAVE TUBES



# 400,000 Admiral

## RADIO-PHONOGRAPHS NEED THIS



Comes smartly packaged in transparent plastic container



### \$1,500,000 REPLACEMENT BUSINESS FOR ADMIRAL DEALERS



No matter how sturdy a precision instrument may be, constant abuse is bound to impair its efficiency. The snap-in cartridge housed within ADMIRAL'S Miracle Tone Arm is a sensitive mechanism, and repeated dropping of the tone arm will cause damage.

Today 400,000 ADMIRAL radio-phonographs with Miracle Tone Arm are a year old or older. Each one of these should have a NEW snap-in cartridge if the ultimate in tone fidelity is to be maintained.

Here is a potential market for over 400,000 replacement cartridges. At \$3.95 each, this means a total of \$1,500,000 in sales reserved exclusively for ADMIRAL dealers.

### GET YOUR SHARE OF THIS PROFITABLE REPLACEMENT BUSINESS

How many of your customer's own ADMIRAL radio-phonographs with Miracle Tone Arm that are a year old or older? Every one is a sure-fire prospect for the snap-in cartridge. Here is YOUR OPPORTUNITY for quick, profitable sales.

Attractive display carton (left) placed in your service department or with fast-moving traffic items will mean FAST SALES and SATISFIED CUSTOMERS. Your ADMIRAL distributor has available a supply of hard-selling, compelling penny post cards which you may send to customers. Take advantage of this fast, inexpensive and easy way of letting your customers know the replacement snap-in cartridge is now available. PHONE OR WRITE YOUR ADMIRAL DISTRIBUTOR TODAY.



*Just ask yourself*

# Who gets the Blame for High Prices?

It's over your counters that your customers shell out those high prices that hurt so much. They don't pay the manufacturer. They can't pay labor. They pay you!

And so they blame you!

You can fight this stigma, and at the same time strike a major blow at the inflation that threatens your entire business, when you advertise U. S. Security Bonds.

Purchase of Security Bonds by your customers reduces the potential for credit inflation, stabilizes business, keeps money in your community, makes better customers for you.

To restore the confidence of your customers in you, to demonstrate that you are side-by-side with them in the same battle, advertise and display this symbol and slogan!



*"America's Security is Your Security"*

This campaign will be nationally advertised, nationally broadcast, nationally displayed. Customers will look for the slogan and symbol in *your* advertising, in *your* store.

You benefit yourself and your country by making this plan work. If you haven't yet received your complete Advertising and Promotion Kit, write to Retail Consultant, Advertising Section, U. S. Savings Bonds Division, Treasury Department, Washington, D. C.

*The Treasury Department acknowledges with appreciation the publication of this message by*

## RADIO & TELEVISION RETAILING





# ONE

stands out...



## OAK RIDGE ANTENNAS!

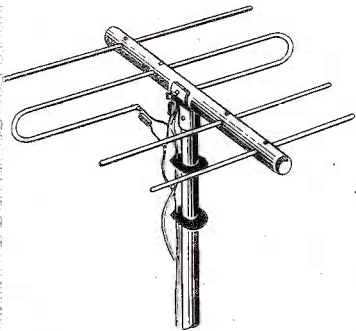

There's good reason why Oak Ridge **STANDS OUT** as a leader in the field of antennas and antenna accessories. For when sound, practical engineering, the best materials and sturdy construction go into a product the result is outstanding performance. Such is the quality and craftsmanship of every Oak Ridge product.

Oak Ridge is constantly developing new products to make TV and FM antenna installations easier, quicker and better! Whatever your antenna requirements are — see Oak Ridge products first . . . they're the finest! *Send today for your Oak Ridge catalog!*

Write Dept. 105.

### ANTENNAS

In TV and FM, for high or low frequencies . . . in good or bad reception areas — there's an Oak Ridge antenna to bring in the maximum signal. Models range from single dipoles to High-Low Wavemasters.

### ACCESSORIES

- 4-Way Clamps
- Chimney Wall Mounts
- Flat and Coaxial Cables
- Steel and Rubber Stand-Offs
- Wall Mounts (6" and 12" sizes)
- Chimney Mount Conversion Units
- Telescopic Masts (24 ft. and 36 ft.)

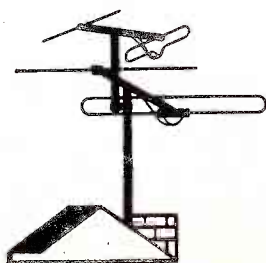

## OAK RIDGE ANTENNAS

239 East 127th Street, New York 35, N. Y.  
Manufacturing Division of Video Television, Inc.



# NEW! G-E TELEVISION CONSOLETTA

*Built right... Looks right... Priced right!*



MODEL 811

OUT of famous Electronics Park comes a wonderful new G-E Television consolette—Model 811. *It's built right*—for picture clarity, for realism, for natural tone and power. *It looks right*—it's a lovely, lasting, solidly built piece of fine furniture. *It's priced right!* Think of it—a full-size, enclosed, floor-model consolette—not just a table model on a stand—that costs your customers only \$359.95\* plus installation! 52 sq. in. direct-view screen. G-E automatic clarifier for sharp, clear pictures. All active U. S. channels. Mahogany veneered cabinet. *Get in your order now!* For full information call your G-E radio and television distributor or write *General Electric Company, Receiver Division, Electronics Park, Syracuse, New York.*

**\$359.95\***

*(installation extra)*

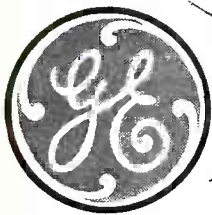

# DAYLIGHT TELEVISION

## SELLS ITSELF ON SIGHT!

Now you can sell your customers G-E *Daylight* Television—the brightest picture under the sun—in a sensationally low-priced table set—General Electric Model 810. 52 square inch direct-view screen. Same bright picture that 'til recently was available only in a console costing hundreds of dollars more. Compact, space-saving mahogany cabinet. Sells for only

**\$325.00\***

*(installation extra)*

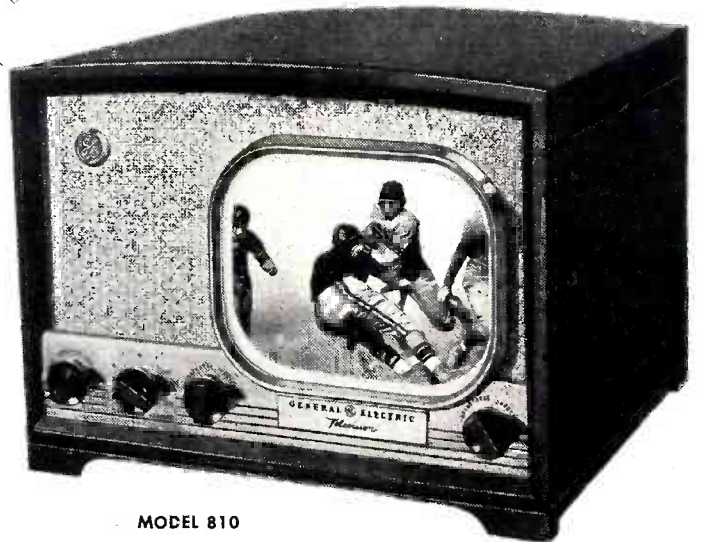

MODEL 810

*\*Western prices slightly higher. Prices subject to change without notice.*

*You can put your confidence in—*

**GENERAL**



**ELECTRIC**

180-G11



# TV and HYTRON go together!

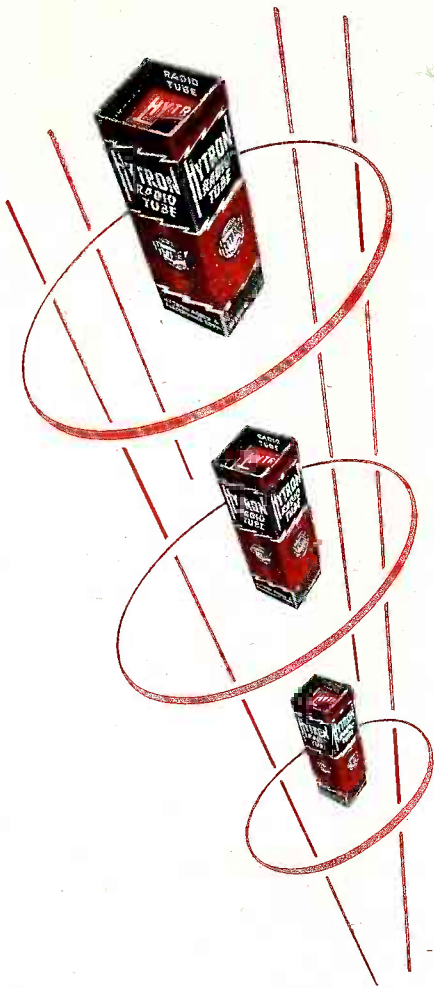

## GOING...GOING...GONE!



Last prizes in your Hytron service-man's contest going-gone. Grand prize winner soon to be announced. Contest over. *BUT* the

results are just beginning. We are now up to our necks in "hot" ideas. Two swell new shop tools are already scheduled for production. Many more coming. Don't miss a single one. And thanks a million for your cooperation in the contest. We are doing our darndest to make your efforts pay off for you.

TV and tubes go together. A heck of a lot of tubes. Lots of kinds of tubes. Miniature, GT, G, metal, and lock-in. In TV you find all varieties of receiving tubes.

To replace them, you need dependable tubes and a wide range of types. Dependable—because the complex TV tube chain is no stronger than its weakest link. A wide choice of types—to match the ingenuity of TV set designers.

Hytron gives you both. All kinds of tubes—and the same dependable Hytron tubes which keep company with the best of TV set makers. Service *your* TV sets with Hytron tubes; you'll find that TV and Hytron go well together.

SPECIALISTS IN RADIO RECEIVING TUBES SINCE 1921

# HYTRON

RADIO AND ELECTRONICS CORP.

MAIN OFFICE: SALEM, MASSACHUSETTS





**SMART NEW STYLING**  
that every woman wants!



Mr. Chippendale would have said:

*"One of my masterpieces!"*

Mrs. Customer will say:

*"Wonderful for my living room!"*

And you'll say: *"Best seller!"*

The new Stromberg-Carlson Chippendale is exquisitely designed, proportioned and executed in hand-rubbed matched mahogany veneers.

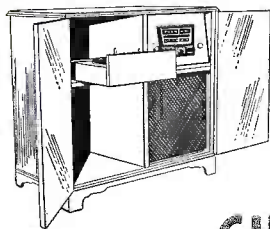

*The*  
**CHIPPENDALE**

#1407-PFM

FM-AM Radio-Phonograph

The Chippendale #1407-PFM is one of many superb new Stromberg-Carlson instruments that are destined to write salesbook history for franchised Stromberg-Carlson dealers. Available for early delivery, for Christmas profits.

**GREAT NEW FEATURES**  
that every man will go for!

- 1** **New Chromatic Tone Selectors**—visual color guides to fine blending, with separate treble and bass controls
- 2** **New Rocket Tuning for FM and AM**—a flick of the finger to select any station
- 3** **New Velvet-Action Record Changer**—with automatic stop and Hushed-Point "LT" pick-up
- 4** **New Signal Maximizer**—adjustable antenna circuit increases signal strength, reduces noise and interference
- 5** **New Finger-Touch Service Selectors**—instant choice of services: FM, AM, record player
- 6** **Exclusive "Full-Floating" 12" Alnico V Speaker**—for superlative tone quality

**STOP!—LOOK! and LISTEN!**  
There is nothing finer than a  
**STROMBERG-CARLSON**

Stromberg-Carlson Company, Rochester 3, N. Y.  
—In Canada, Stromberg-Carlson Company, Ltd., Toronto



# RADIO & TELEVISION RETAILING

Including Radio and Television Today

O. H. CALDWELL, Editorial Director



M. CLEMENTS, Publisher

## Increase Your "Buying Power!"

One of the most profit-promising resolutions the merchant can make for the coming New Year is the determination to make himself a better buyer.

No matter how efficient his salesforce is he must first *buy right* in order to operate a successful business.

Right now there are two most important reasons why the dealer needs to exercise greater-than-ever vigilance in performing the buying chore. First, he's in the midst of a changing market. There's a growing resistance to price, and customers are growing more "choosy" by the day. Competition is increasing, and market saturation continues to grow.

The second important reason why the retailer needs to explore all angles of the buying end of his business may quite accurately be termed a psychological one. For a long time the merchant has been grabbing up everything he could lay his hands on. He not only bought scarce products, he begged for them. He took on "assortment" deals and tie-in transactions. And all the time that this was going on, wild-eyed customers besieged and beseeched him. They were willing to take substitutions. They put their names on priority lists. All this is past history. But it has left its mark.

As a result of such feverish activity two things happened at the retail level. First, salesmanship came apart at the seams, dropping down lower than a snake's hips. This we all know about. But something else crept in that may not be quite so apparent, and that was the general relaxation at the buying end.

Just as it is vitally necessary now to re-vamp salesmanship it is certainly equally important to turn over a new leaf in buying. Every merchant must breathe new life into this phase of his business. He must weigh each purchase, consider the quantity, and measure the potential customer acceptance. To buy right he must be familiar with his inventory and with his turn-over rates.

"Buying power" means more than the mere ability to pay. It means the ability to buy right. Someone once said that "the buyer needs a hundred eyes." So far as this market is concerned, that someone is a hundred per cent right!



# What's Ahead!—in Radio,

**BECAUSE OF THE FACT** that almost everyone in the country is talking about the high cost of living, merchants in this field should advertise the price of products in Christmas window displays. Even on low-cost items, most window-shoppers will believe they are expensive in cases where prices are not shown. All too many people will think such price information is being deliberately withheld from them.

**THOUGH SOME MANUFACTURERS** are maintaining present list prices, and a few have announced reductions, look for more or less widespread increases throughout the radio-appliance industry within the next six months. Responsible factors include wage increases and upped material costs.

**RUMORS CONCERNING LAUNCHING OF** more new slow-playing records flying thick and fast. In the meantime, dealers and their customers are showing plenty of interest in the new Columbia product.

**GREAT INCREASE IN THE NUMBER** of trucks being used by independent retailers noted. Attractively lettered, such vehicles are being used for delivery and servicing purposes.

**DU MONT HAS ANNOUNCED TWO NEW TV** receivers in its line of sets. The "Meadowbrook" is priced at \$525; has 25 tubes plus 3 rectifiers, and comes in 18th Century English design with mahogany finish. The "Sutton" is styled in functional modern design and is finished in blond hardwood. It sells for \$540. Both sets have 12" tubes.

**LAUNDRY EQUIPMENT DEALERS,** jobbers and manufacturers paying a lot of attention to the need for soft water in doing a good job of clothes washing. In a survey, one manufacturer, General Electric, found that 84 per cent of a group of users were satisfied; that the majority of the balance claimed that hard water was responsible for some loads being unsatisfactory. When a softening agent was used, or when a water softener unit was installed, satisfactory results reached nearly 100 per cent.

**ORGANIZATIONS COOPERATING** with RMA-NAB to put over National Radio Week, Nov. 14-20, include: National Retail Furniture Association, FM Association, American Association of Advertising Agencies, Association of Women Broadcasters, Electric Institute of Washington, Electric League of Indianapolis, Electrical Association of New Orleans, Electric Institute of Boston, St. Louis Electrical Board of Trade, Nebraska-Iowa Electrical Council, Essex Electrical League of Newark, N. J., Electrical and Gas Association of New York, Electric League of Chattanooga, Inter-Mountain Electrical Association of Salt Lake City, The National Electrical Wholesalers Association, and the Southern California Radio and Electrical Appliance Association.

**THE NATION'S ESTABLISHED** radio-appliance retail stores have increased greatly in value. Offering prices are just about double prewar.

**HEAVY OVERHEAD KEEPING DEALER** profit rates low. One merchant, who employs an accountant, and who knows where he stands, examined the whole picture and found that if he tried reducing such overhead to any great extent, he would reduce his annual volume. This retailer does about \$120,000 a year, with a net profit of one per cent, after paying himself a salary of less than \$8,000. His overhead is about \$105 per business day.

**THE TV "FRINGE" MOVES FARTHER AWAY.** Philco's Philadelphia station, WPTZ programming was received at a point 383 miles distant. A resident of Thompson, Ohio saw WPTZ flash on the television screen around 7:45 P.M. when he flicked his set to channel 3. Floyd Murphy was so excited about this reception phenomena that he wrote a letter to the Philco station with full descriptions of the sequence of entertainment up until 8:30 P.M. To make certain that his report would be official, Murphy had his guest sign the letter as witness to a history making evening of home televiewing.

**VACUUM CLEANER SALES SLIGHTLY** below those of last year. 2,270,124 sold during first eight months of this year comes within 5.1 per cent of equalling 2,391,535 units sold in the first eight months of 1947, all-time high year, according to figures announced by C. G. Franz, secretary-treasurer of the Vacuum Cleaner Manufacturers' Assn.

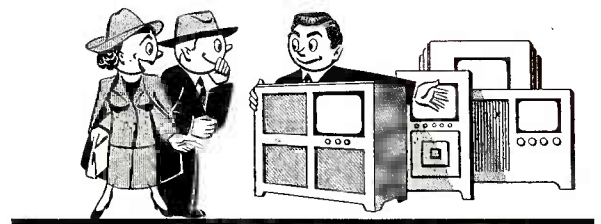

**THE DEALER'S ALL-IMPORTANT** position as the last-word authority in influencing consumer choice is more than apparent in the TV industry. Talks with numbers of retailers reveal that would-be purchasers are following a common pattern in asking about makes. "Which is the best television set, in your opinion?" is the way customers are expressing their appreciation of the fact that the local dealer is the local expert as far as they are concerned.

**FIRST-PRIZE WINNER OF THE July Hytron contest** is Sydney C. Patrette, San Jose, Calif., who has been engaged in radio experimental and service work for many years.

# Appliances, Records and Television

85 PER CENT OF DEALERS questioned in a survey made by this magazine revealed that their customers believe that prices of radios and electrical appliances are too high. Such results serve to prove further the necessity for merchants to compare prices in this field with those in other industries in order to satisfy buyers that outstanding values are still being offered.

ONE OF THE LARGEST RADIO-APPLIANCE retailers in the East uses Regulation W to feature decreased down-payment requirements. Prior to the re-enactment of the law he was asking a 25 per cent down payment. Now he has reduced it to 20 per cent.

A HOME RECEIVER OF FACSIMILE transmission was demonstrated by Stewart-Warner at the annual FMA convention. According to an official, the set will sell "for approximately one-half the price of receivers now on the market."

ONE OF MAIN PROBLEMS confronting TV dealers who do not make their own installations is the practice on the part of their customers to call them, instead of the contracting agency, when in need of service. It's a ticklish proposition from the good-will aspect, since most of the calls dealers get are requests asking when service will be rendered or complaints having to do with what customers consider slow service. For years established retailers have "educated" customers to expect calls to be made on appointment bases, an arrangement often impossible for the agency set-up to comply with.

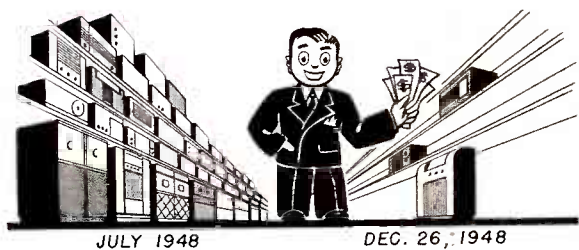

"THE TEMPORARY SLUMP IN SET SALES" was the title of an editorial run in this magazine last July. It was pointed out that the slow-down was a temporary, seasonal affair, and, as the situation now shapes up, it appears that the analysis was correct. Though there is considerable price-cutting, the sales situation has improved. Numbers of manufacturers have curtailed production of radios, and the way things look now, inventories will be sharply reduced after Christmas at all levels of the industry.

DEEFPREEZE ACQUIRES DOMESTIC refrigerator. G. H. (Rock) Smith, Deepfreeze VP and general manager, announces the purchase of the Frostair Duplex refrigerator from the General Tire & Rubber Co. Frostair, a combination freezer-refrigerator, will be added to the firm's extensive line of home freezers.

A WESTERN MERCHANT WHO USES PORTRAITS of his male and female sales personnel in his newspaper advertising, finds that numbers of total strangers come in and ask for certain members of the sales staff by name.

AN INCREASE IN RADIO OWNERS in downstate Illinois was revealed with the issuing of the 3rd annual Illinois Consumer Markets Analysis, released by Illinois Daily Newspaper Markets at Springfield. Interviews were conducted simultaneously in 40 daily newspaper cities outside Chicago. An increase of .8% or 18,183 family owners of one or more sets was shown when all 40 markets were compiled together. Of all the owner families 9.4% or 39,320 families answered "Yes" to the question "Do you own a radio that can receive FM broadcasts?"

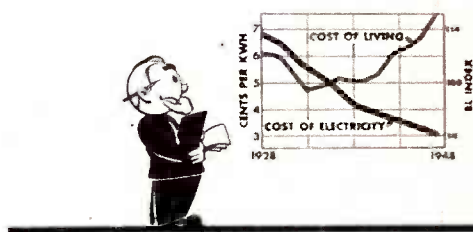

THE ECONOMIC MARVEL OF our times is certainly electricity, particularly when contrasted with the rising cost of living in these inflationary times. At the pay window of the electric company, the consumer's 1939 dollar will now buy him \$1.29 worth of electricity. See chart, above, prepared by U. S. Bureau of Labor Statistics.

PRESENT-DAY "MORTALITY RATE" of stores better described as a turnover proposition. Because of the sharply increased value of good-will, location, etc., numbers of establishments which might otherwise have folded due to financial difficulties, have changed hands with new owners carrying on, usually without interruption.

NEW TELEPHONE ANSWERING device now being marketed by Wire Recording Corporation of America, makers of "Wireway" recorders.

"WHILE THE COMPOSITE BASE PRICE of other metals is up more than 125%, the new base price for aluminum is still 20% below prewar," says David P. Reynolds, vice-president and general sales manager, Reynolds Metal Co.

A LEADING AUTHORITY ON ANTENNAS, Gardiner G. Greene, of Workshop Associates, Massachusetts manufacturers has branded as "utterly fantastic and ridiculous" a purported statement by a Chicago real estate man that "indoor television antennas" are adequate in 95 per cent of the Chicago area.



*The present  
that brings the present  
into your home*

Merry Christmas! Sing it, sing it, SEE it, with this EVERYTHING-in-one console, the "Monticello." Here's "Eye Witness" television PLUS a luxurious AM-FM Victrola radio-phonograph! A season ticket for complete home entertainment! 52 sq. in. screen. Walnut, mahogany or blond finish. AC. RCA Victor 8TV323.\*



9 ways to play the perfect

**EYE WITNESS  
TELEVISION**



For Santas with modest incomes, millionaire tastes! A brand-new table television set—the "Onlooker"—with the best pictures in "Eye Witness" television history! 52 sq. in. pictures that are locked in time! Automatic Multi-Channel Station Selector! It's a value you'll have to SEE to believe! Mahogany, walnut or blond finish. AC operation. RCA Victor 8T243.\*



"I'd give the world..." and you can! With the "Bystander," RCA Victor takes television out of the luxury into the "let's-get-it" class! And it's full-size. "Eye Witness" television in a cabinet that itself is a pleasure to see! 52 sq. in. screen. Multi-Channel Station Selector. Walnut, mahogany or blond finish. AC. RCA Victor 8T241.\*



Greetings for every season—the "Globe Trotter," in its weatherized aluminum and plastic case, is a summer-time outdoor playmate with its long-lasting RCA battery. Indoors, it's a powerful table set any time of the year—plays on AC or DC with the wonderful tone of the "Golden Throat." RCA Victor 8BX6.

For the one on your list who "has everything"—this brand-new beauty with AM and FM radio—Frequency Modulation at its finest through the exclusive "Golden Throat" tone system. Antique ivory-finish case or in plum-colored plastic. Exceptionally selective and sensitive, it's one of the choicest "plums" in Santa's pack! AC operation. RCA Victor 8X71.

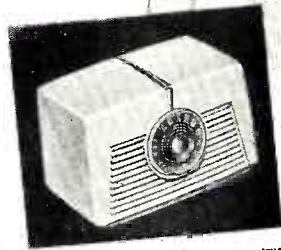

For a White Christmas, this dream-come-true value—a world-famous RCA Victor at a new low price. Marvelous tone—the exclusive "Golden Throat"—selective, plenty of power. RCA Victor 8X542, antique ivory-finish or maroon plastic.



"Happiest Ch who's satisfied RCA Victor's 1 of the "Golden Throat" AM, the New ALL-Aut cabinet finish or in modern "Victrola" T. M. 1

See this advertisement yourself and you'll agree that it's a sure sales-catcher. It will be in:  
LIFE . . . . . December 6th  
COLLIER'S . . . . . December 11th  
SATURDAY EVENING POST  
December 11th

**RCA VICTOR**



DIVISION OF RADIO CORPORATION OF AMERICA

"Victrola"—T. M. Reg. U. S. Pat. Off.

ONLY RCA VICTOR MAKES THE VICTROLA

RADIO & TELEVISION RETAILING • November, 1948









The canvasser can carve himself a slice of profits if he works hard and uses the right technique.

# How to Make **COLD TURKEY** Canvassing Your **DISH**

● They say that one can get used to anything—even a broken leg.

While all the country's greatest merchandising experts agree that door-to-door selling is most effective, they likewise join in admitting that it's a tough task. As tough as they come.

But it is a fact that in spite of its more or less grim aspects, the right kind of man can not only become used to cold turkey canvassing, but can make it his favorite dish.

And the person who is temperamentally suited to door-bell pulling today doesn't have to be a case-hardened guy either. Some years ago when the foot-in-door method was in vogue, canvassers were, for the most part, crass individuals who could shrug off an insult with the same ease with which they could bulldoze a woman into buying something she didn't want.

Now all this has changed. Frankenstein monster manners are out, as are spellbinding tactics. Salesmanship of the same kind employed in the better

stores is the brand the canvasser must bring to the front door. The finer the salesman's personality, the better his appearance, and the more acceptable his speech, the greater his sales results will be. He has no more in common with the old-time spieler than he has with the peddler being chased around by the dog in the back yard.

Today's cold-turkey canvasser carries himself with dignity. He is an expert who sells products on their merits; offers the backing of a reputable firm and its servicing facilities. Equally important, and worthwhile, he is following a method offering limitless sales possibilities. He is intrigued with the challenge of the unknown. The salesman following a lead has, to use a most hackneyed phrase, more or less of an

*entrée*. But the cold canvasser doesn't have the way paved for him. His approach to the front door is made in a spirit of adventure. He remembers what he's heard about the sale that's always waiting in the *next house*.

One of the first things the would-be canvasser needs to learn is the necessity for "regimenting" his calls. This means that he must map out a particular locality in advance, and work such area thoroughly. The efficient canvasser doesn't skip houses, nor does he jump from one section of the town to another on the premise that he'll find better pickings some other place.

In a way, canvassing is a lot like fishing. The fisherman who spends all of his time changing from one likely place to another usually comes home with an

***There's Gold in Them Thar Homes, But It Takes Intestinal Fortitude to Go Prospecting for It***

empty creel. The fellow who gives each spot a thorough going-over increases his chances for success.

Following are a couple of corner-cutting practices the inexperienced canvasser is likely to adopt, and the reasons for so doing:

1. He "skips houses in a street he has already laid out for the day's work. The reasons are, (a) he "sizes" up certain residences; gives them a mental "no good" rating, or, (b) he puts space in between calls because he doesn't want everyone in the block to know that he's canvassing.

2. He leaves a vicinity because some of the first few calls were "unsatisfactory"; because he ran into some discourtesy, or has discovered competition in the shape of other canvassers.

The would-be canvasser who wants to succeed must steel himself against falling into habit patterns like those just outlined. They lead to eventual dislike for the job since they upset one's mental equilibrium.

So far as the actual "approach" is concerned, numerous articles in this publication have urged to canvasser to make his introduction *direct*. Beating about the bush immediately sets up a feeling of distrust on the part of the resident. The honest, and most effective method is that which immediately makes known the name of the salesman and the name of the firm. This should be followed immediately by an explanation of the purpose of the visit. Radio-appliance canvassers will find it wise to offer either some specific product, such as a television receiver, or to describe briefly the entire line.

### **The "Approach"**

An introduction should run something like the following: "Good morning. I am John Harrison (not "Mr. Harrison"—that's silly, and too formal) of the Smith Electric Company. You probably know our store, on Main Street?" (This latter is put in the form of a question, and will be answered orally, or by a nod of the head.) "I am calling to offer to let you try one of our famous—television receivers in your own home, without any obligation."

Or: "I'm calling to ask what radios or appliances you are planning to buy. We have a complete line of—washers and ironers; —refrigerators, and food freezers. —vacuum cleaners, and leading small small appliances, as well as —, — and — radios."

The reader will note that the "approaches" are simple, direct and honest. Also, they are not "negative." When the canvasser asks, "are you interested in buying a —?" he usually receives "no," or "not at the present" as an answer. Most of us automatically say "no" or "not now" in answer to such questions even in cases where we are

actually contemplating a purchase. This is a sort of defense mechanism we employ to prevent making hasty decisions.

Every experienced salesman knows that it usually takes some time to "qualify" a prospect, and that the poorest sort of technique to use is that which produces a "no" before the salesman has had time to even begin to roll.

Though it "usually" takes time to ascertain whether a person is a prospect or a suspect, some amazingly contradictory things happen now and then to add zest to the chore of house-to-house work. Some of these amazing episodes are truly out of this world. The writer once knew a sales manager

## **Surprises**

### **Await the Door-to-Door Salesman**

★ Read in this article what happened when the proponent of the more-calls-more-sales idea greeted the housewife with, "You don't want to buy a vacuum cleaner, do you, lady?"

who was a firm believer in the law of averages idea. "It's not so much what you say as how many you say it to" was his main sales gimmick. At one meeting an argument over the workability of his plan arose, with one salesman describing the technique with a couple of forceful, unprintable words.

"All right, wise guy," said the sales manager. "You come with me, and I'll prove I'm right. I'll ring a flock of doorbells and say, 'you don't want to buy a vacuum cleaner, do you, lady?'—and I'll sell at least one job, too."

The men set out, but the "law of averages" idea couldn't be tested because on the very first call, in answer to the question, "you don't want to buy a vacuum cleaner, do you, lady?", the housewife threw a monkey wrench into the works by replying, "Yes. As a matter of fact I do."

### **Flexible Call Schedules**

House-to-house selling is like that. It's full of surprises—some pleasant, some unpleasant, and the episode proves that one never knows just where a set-up sale may be lying in wait for him.

As a general rule, the canvasser must make numbers of calls to make a satisfactory number of sales, but in cases where he is invited into a home by a person interested in something he sells, he should stick with the prospect as long as is necessary. After all, the sale's the thing that counts, and the employer of the canvasser who sets up call quotas should always make them flexible. The canvasser who sits on pins and needles in the home because he fears that he'll get bawled out for not

making enough calls, is doing himself and his employer a disservice.

Employers who set up inflexible requirements concerning the number of calls the canvasser should make each day are just making things tough for themselves and for their salesmen. And in connection with this it needs to be pointed out that the most suitable plan of operation calls for two things, as follows: First, that the canvasser be required to file sales reports, listing the names, addresses and results, and, second, that the employer study such reports carefully, and discuss them with the canvasser.

Under such plan if a "flexible" quota of say twenty calls has been set up, and a salesman's report shows that he made but ten, and lists several good interviews resulting in some "live" prospects, or perhaps a sale, then the day's work should be considered to be satisfactory.

From the viewpoint of both employer and employe the before-mentioned report is better than that of the man who brings in a sheet of paper with forty calls on it, all of them unproductive.

Scheduled for publication in the near future is an article entitled, "In Favor of the Sales Report." This RADIO & TELEVISION RETAILING feature will tell just how to successfully operate the sales report, why it will appeal to conscientious salespeople, and other relevant information.

Another angle to canvassing is the proven efficacy of having something to hand to the doorbell answerer. This "something" can well be one of those circulars that have been piling up in the store, or it may be an advertising souvenir, such as a pencil or a blotter. In the past, numbers of independent dealers offered premiums a la the Fuller Brush Man. In some cases, such premiums were sewing kits, hang-up fuse holders and other "door-openers." Even today when competitive conditions are not as severe as in the good old days, "door-openers" can be profitably employed provided they are wisely given.

A business card, bearing the names of the firm and the salesman should be left at each house. Under no circumstances should the canvasser depend upon his oral introduction to make a permanent impression.

Because the gentle art of canvassing hasn't been done to death since the war, the man who goes out to work the field today will find it to be a much easier job of work than it ever was before.

He'll find that there's much business to be had if he works hard, and systematically. There are plenty of hot leads in store for the cold turkey canvasser. He can make this business his dish if he is able to withstand its rigors and enjoy its challenge to seek profits in such an adventure-filled field.



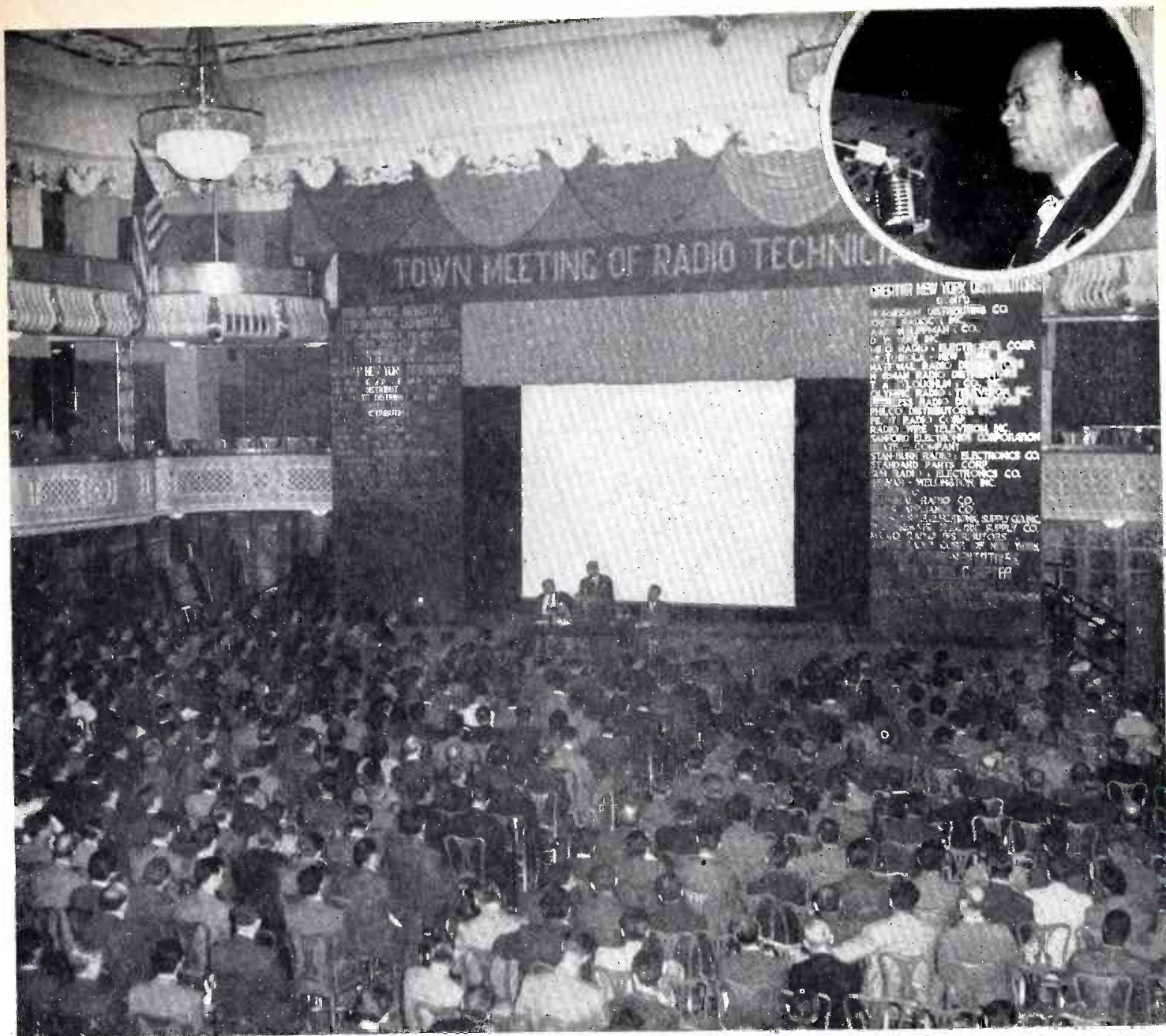

RMA president Max Balcom giving keynote address to more than 1300 at the first session of the New York Town Meeting September 27. Inset: Harry A. Ehle, Chairman of the Town Meeting.

## Profit Possibilities Shown Servicemen

### Better Business Methods and Opportunities in Television Keynotes of N. Y. "Town Meeting"

• "No competent radio technician today need have any fear that television or any other new broadcasting service will put him out of business. On the contrary, his chances for increasing his profits and making his economic position more secure were never so good as they are today," Max F. Balcom, president of the RMA declared at the Town Meeting of Radio Technicians held at the Astor Hotel in New York City September 27-29.

The Town Meeting was the first of five to be held in different cities during

the next few months as part of a drive by the entire radio manufacturing and distributing industry to convert the radio service industry to the demands of television. The next meeting will be held in Boston November 15-17, and subsequent meetings will be in Atlanta, Los Angeles and Chicago.

"Television service is now in the transition period going from the control of the manufacturer, to the wholesale distributor, to the dealers and back where it belongs in the service industry," said W. L. Parkinson, chairman of

the RMA service committee. To apprise the servicemen of the steps necessary to make this transition, and to help them with technical and business information, an impressive panel of experts addressed the New York dealers and answered the many questions put to them by the audience. A total attendance of almost 4000 dealers and technicians took part in the four sessions of the Town Meeting.

The profitable future ahead of the service industry due to the growth of television was highlighted by Harry A.



Ehle, chairman of the Town Meeting subcommittee of the Radio Parts Industry Coordinating Committee. This committee is sponsoring the series, along with the Electronic Parts & Equipment Manufacturers, the RMA, the Sales Managers Club (Eastern Division) and the West Coast Electronic Manufacturers Association, while local sponsors of the New York meeting included almost 60 manufacturers and distributors of Greater New York, and also the representatives of the Associated Radio Servicemen of New York, Inc.

Mr. Ehle pointed out that a projection of present TV set production and servicing figures indicates 14 million sets in use by 1952, with an average of from 4 to 6 service calls per year on each one. Conservatively estimated, this means a service bill for the nation of a quarter of a billion dollars for labor alone, compared with the \$75 million spent in 1947.

### Needs Stressed

But to participate in this bonanza, the serviceman must work hard to equip himself with the technical knowledge that TV circuits and servicing techniques demand, must lay out money for the absolutely necessary test equipment, must operate his business efficiently and aggressively and must co-

operate to avoid the smear of unethical practices which has plagued segments of the radio industry in the past.

Technical subjects were covered at the Town Meeting in a down-to-earth, practical manner from the personal experience of the speakers: Antenna installation by Ira Kamen, Commercial Radio Sound Corp.; TV installation in the home by Marvin Kaplan of Video Television Inc., Errol Jones of Amie Associates and Irving Winston of Winston Radio & Television Co.; Television servicing in the home by Eugene Ecklund, Bergen-Passaic Electronics, Inc.; Television service in the shop by Carl Quirk, Allen B. Dumont Laboratories; FM Detector systems by Murray Goldstein of Emerson Radio & Phonograph Corp.; and Sweep Generators by John F. Rider.

As Mr. Ehle said, "television has put us back in the home" . . . many more service calls will be made in the home than has been the case with radio in recent years, and a new importance attaches to the servicer—his appearance, his conduct, his workmanship and his ability. In effect, he represents the television industry when he steps into the customer's home.

On the other hand, servicing which must be done in the shop makes new

demands on the technician as to methods and equipment. The speakers pointed out that visual alignment is mandatory on TV, and that this requires a scope, a sweep generator, a calibrated marker generator and a VTVM. The technical specifications of these instruments must fulfill the requirements of TV frequencies, bandwidths, etc.

Servicing as a business enterprise was treated in talks by John Nuffort, creditman of American Cyanamid; Samuel W. Lerer, CPA; William J. Boyle of the Franklin Square National Bank; Austin C. Lescaboura, advertising executive; George H. Dennison of the Association of Better Business Bureaus; and Harold Suss of Blooming-

tions were ably answered by Mr. Parkinson of the RMA service committee, and by Jack Poppele, president of the Television Broadcasters Association.

They pointed out that the television boom we know today dates back only to March 18, 1947. Although the war had been over for some time, strikes, shortages of materials, and the confusion about color had kept the industry to substantially its prewar limits . . . there were about 17,000 receivers and 9 broadcasting stations.

The FCC decision on that date to postpone color for several years gave the industry the green light to go ahead on mass production of black and white sets. By the beginning of 1948 it has produced about 175,000 sets. It had gone ahead, however, with what Mr. Parkinson described as "educated guesses" as to how the sets would work, how much service they would require, how to charge for them.

### Trends Outlined

The radio service industry could not be handed the job initially, not only because there might not be enough men with sufficient experience, but also because the "bugs" had to be worked out of the sets, the servicing requirements had to be computed from experience rather than theory, the warranty

policy and charges had to be re-evaluated, and (by no means least) sufficient test equipment had to be produced to supply the industry. Mr. Parkinson pointed out that the charges are going up, the trend is away from the 2nd year warranty, and the time is not distant when all manufacturers and distributors will gladly turn the business over to the service industry.

Summing up, Max Liebowitz, president of the Associated Radio Servicemen of New York told the meeting that they must start immediately to learn all they can, and acquire all the necessary equipment, in order to participate in the future of the radio service industry, which is television.

That the New York Town Meeting was enthusiastically received by the dealers and technicians who attended was well demonstrated by their keeping the speakers far beyond the scheduled time with stimulating questions and group discussions, for which the speakers gave generously of their time. This was especially true of technical subjects. The sessions will undoubtedly act as a spur as well as a guide to a more intense application to the problems of television in the future, and as such can be considered a decided success.

**Tremendous expansion faces the service industry in income and personnel, Harry A. Ehle pointed out in projecting present production figures to 1952. At that time there will be 14 million receivers, requiring an average of from 4 to 6 service calls per year, or well over 100 million man hours. This will call for at least 60,000 servicemen, and an annual service bill for labor alone of over a quarter of a billion dollars!**

dale Bros. Mr. Boyle pointed out that although many businesses are started with only courage and knowledge, it takes more than these virtues to stay in business. Valuable advice was given by Mr. Boyle and the other speakers on keeping books, on granting and obtaining credit, on maintaining good relations with the public, and on sales promotion.

### An Article

on how to use the "TOWN MEETING" idea to better business conditions—enhance the standing of the radio technician in YOUR OWN TOWN OR CITY will appear in the December 1948 issue of RADIO & TELEVISION RETAILING.

Two of the questions which seemed most important to the New York dealers were: "Why has the radio industry waited until now to let us in on television, and why have they established yearly warranties at prices which would make it difficult if not impossible for us to operate at a profit?" These ques-



# New Radio Merchandise

## Zenith TABLE RADIOS

Three new table model radios introduced in Zenith line. Each of units combines Zenith's long distance broadcast reception and exclusive Consoltone circuit. Incorporated is the "Alnico 5" PM speaker. All sets are AC-DC. "Zephyr" model shown, has 5 tubes plus power recti-

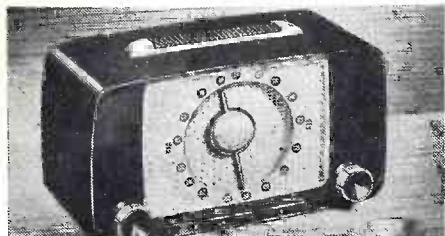

fier, automatic volume control, "flexo-grip" handle; cabinet fitted with jewel-glow indicator; cabinet shock-resistant; trimmed in Roman gold. Size: 8 inches high, 12 7/8 inches wide, 6 7/8 inches deep.

The "Pacemaker" and "Tournament" models have large tuning controls, "Alnico 5" speaker, 4 tubes plus power rectifier and automatic volume control. The "Tournament" has a flexo-grip handle, trimmed in Roman gold, and is 7 1/4 inches high, 12 1/8 inches wide, 6 inches deep. "Pacemaker" is 6 inches deep, 6 7/8 inches high, 12 1/8 inches wide. Zenith Radio Corp., 6001 W. Dickens Ave., Chicago 39, Ill.—RADIO & TELEVISION RETAILING.

## Capehart TELEVISION RECEIVERS

Model 461P, shown, lists at \$645 plus installation. Set provides 75-square-inch image; picture tube of mirror-backed type. Has 31 tubes

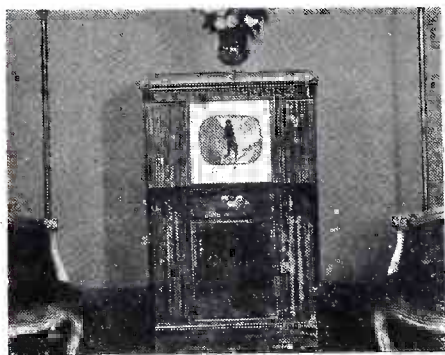

and five rectifier tubes. Finished in matched mahogany; cabinet of traditional design for use with Capehart phonograph-radio instruments.

Another Capehart television console, model 661P, retails for \$445 plus installation, and gives a 55-square-inch image. This set utilizes mirror-backed, flat-faced picture tube, and includes 24 tubes and four rectifier tubes. Mahogany cabinet is of 18th century English design, and is suited as a companion piece to the phono-radios in the line. Capehart Div., Farnsworth Television & Radio Corp., Ft. Wayne, Ind.—RADIO & TELEVISION RETAILING

## General Electric RADIO-PHONO

Table model radio-phonograph equipped with automatic record player, model 118, designed



to sell in, the East for \$99.95. Mahogany cabinet has full-length lid, metal grille. Unit has 5 tubes plus rectifier. Record changer automatically plays twelve 10-inch or ten 12-inch records. General Electric Co., Electronics Park, Syracuse, N. Y.—RADIO & TELEVISION RETAILING

## UST TELEVISION CONSOLE

12-inch direct view television-radio-phonograph console, priced at \$795 features: AM-FM radio, automatic record changer; attractive mahogany cabinet. Size of console: 39 3/4



inches high, 33 3/4 inches wide, 21 1/2 inches deep. Utilizes Zetka 12-inch tube and ion trap. Set has 31 tubes, plus four rectifiers and a crystal detector. U. S. Television Mfg. Corp., 3 W. 61 St., New York 23, N. Y.—RADIO & TELEVISION RETAILING

## National TELEVISION SET

Model TV-7M table television set features: bright pictures; dual-speaker; automatic station selector; 21 tubes, including 3 rectifier tubes; 7-inch picture tube. Sells for \$189.50. (Model in mahogany cabinet retails for \$199.50.) National Co., Inc., 61 Sherman St., Malden, Mass.—RADIO & TELEVISION RETAILING

## Wilcox-Gay RECORD PLAYER

Wireless record player, model 8F30, for use with microgroove recordings. Electronic instrument plays through any and all home radios without connecting cables. No radio



wiring or installation problems are involved. Instrument features wide range response. Unit priced at \$29.95. Wilcox-Gay Corp., Charlotte, Mich.—RADIO & TELEVISION RETAILING

## Ansley TELEVISION SETS

"Bellevue" model, shown, lists for \$995.00 plus excise tax and installation. Cabinet is 42 1/2 inches wide, x 23 1/4 inches deep, x 40 1/2

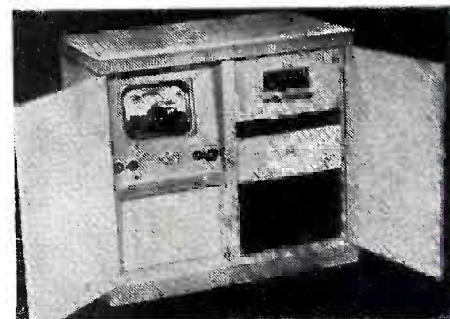

inches high. Cabinet ribbon striped mahogany. 12-inch picture tube, 77 sq. in. screen. Webster record changer. Also available in bisque finish at \$40 additional.

"Somerset" television set, has 12-inch picture tube, Webster record changer, traditional cabinet, lists at \$995.00 plus excise tax and installation. Modern styled television set, the "Salisbury" also has 12-inch picture tube, Webster record changer, and lists at \$995.00. Ansley Radio & Television, Inc., Trenton, N. J.—RADIO & TELEVISION RETAILING

## Cornell TELEVISION RECEIVERS

New line of television receivers supplementing present models. Features: automatic synchronizer, automatic gain control and inter-modulation system that minimizes drift and keeps picture locked with the sound. Set housed in "picture frame" cabinet of light and dark woods. Ten-inch model priced at \$349.00; 12-inch model at \$395.00. Cornell Television, Inc., 385 Flatbush Ave., Brooklyn 1, N. Y.—RADIO & TELEVISION RETAILING

## New Appliance Products in Appliance Section



# for Dealer Selling

## Sentinel PORTABLE TELEVISION SET

Portable television receiving set features: eye level vision, portable antenna; 4-knob control of channel, brightness, off-and-on volume and contrast. Case is imitation grain



leather, and is equipped with luggage type carrying handle. Sentinel Radio Corp., Evanston, Ill.—RADIO & TELEVISION RETAILING

## Air King WIRE RECORDER

Portable wire recorder, model A-725, includes amplifier and speaker, immediate playback, records from microphone, radio, phonograph or telephone, automatic shut-off at end of play or rewind of wire. Crystal microphone for hand, table or stand with plug-in mike cord, makes permanent recordings or

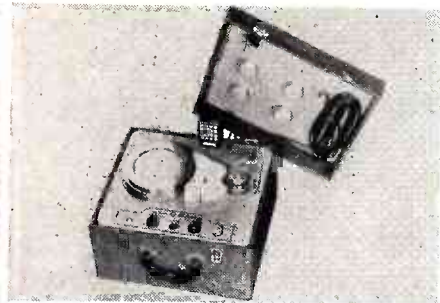

erases automatically when recording over used wire. Has plug for cable to record from radio or phonograph, utilizes 4 tubes plus selenium rectifier. The set sells for \$99.95. Carrying case is of blue grey leatherette. Weighs 21½ pounds, and measures 13¾ inches long x 12 inches wide x 9 inches high. Air King Products Co., Inc., 170 53 St., Brooklyn 32, N. Y.—RADIO & TELEVISION RETAILING

## Webster-Chicago RECORD CHANGERS

Models 246 and 256 dual speed, dual groove automatic record changers provide automatic or manual play of standard or long playing microgroove records at 78 or 33-1/3 r.p.m. Both changers feature: tilt-o-matic tone arm; pick-up cartridge equipped with tandem tip needle; simple switching arrangement brings either regular tip needle or microground tip into play at proper needle pressures. No lateral pressure in the tone arm; exclusive velocity trip mechanism brings changer into cycle with a lateral pressure of less than 1 gram; home recordings cut inside-out or outside-in up to 12-inch size can also be played on units. Webster-Chicago Corp., 5610 W. Bloomingdale Ave., Chicago 39, Ill.—RADIO & TELEVISION RETAILING

## Starrett TELEVISION SETS

"The Adams," model shown, sells for \$795.00. Hepplewhite styled console cabinet, 12-inch tube; mahogany or walnut finish.

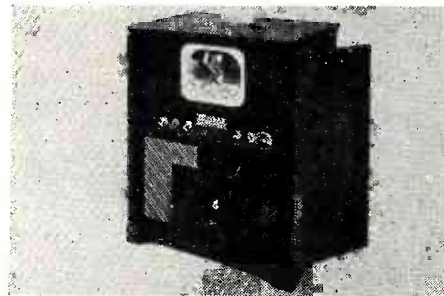

Set has 30 tubes and 1 rectifier; separate AM-FM, Webster phono changer. Cabinet is 37¾ inches high, 30¾ inches wide, 22¼ inches deep. Starrett Television Corp., 601 W. 26 St., New York 1, N. Y.—RADIO & TELEVISION RETAILING

## Industrial TELEVISION VIEWING UNIT

Model Sussex-10 viewing unit designed for remote control applications. May be added to existing ITI remote control installations or

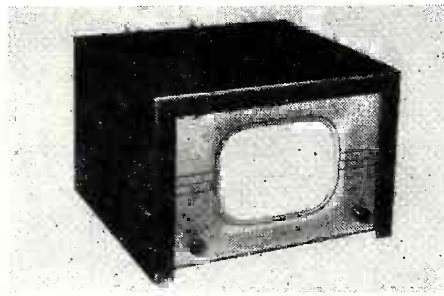

used in conjunction with a wide variety of standard television receivers. Utilizes 10BP4 cathode-ray tube with a metal and plastic cabinet. Industrial Television Inc., 359 Lexington Ave., Clifton, N. J.—RADIO & TELEVISION RETAILING

## Califone RECORD PLAYER

Record player for use with 33-1/3 r.p.m. recordings. Unit has specially designed and patented features including "feather" pick-up which exerts needle pressure of less than 6

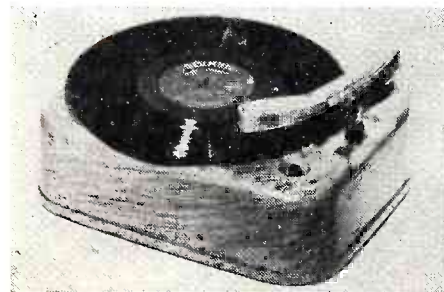

grams. Matched base and pick-up available in blonde or dark walnut finishes. Califone Corp., 1041 North Sycamore Ave., Hollywood 38, Cal.—RADIO & TELEVISION RETAILING

## De Wald PHONO-RADIO COMBINATION

Dual-speed phonograph and radio combination plays recordings of both 33-1/3 and 78 RPM operation. Features: self-starting motor, large turntable; five tubes plus rectifier.

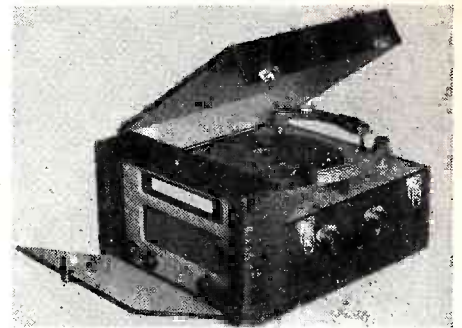

Cabinet is compact, luggage construction. Dimensions: 17 inches long, 8½ inches high, 14 inches deep. List price \$69.95. De Wald Radio Mfg. Corp., 35-15 37 Ave., Long Island City 1, N. Y.—RADIO & TELEVISION RETAILING

## Sparton TABLE RADIO

Model 121 table AM-FM radio priced at \$59.95 East of the Rockies. Cabinet finished in mahogany veneers, with ebonized front



trim, contrasting with metalized grille. Features: built-in loop antenna, internal power-line antenna, slide-rule illuminated dial; Sparks-Withington Co., Jackson, Mich.—RADIO & TELEVISION RETAILING

## Tele King TELEVISION RECEIVER

Table model television receiver features 10-inch picture tube, and designed to retail for \$199.95. Set has 19 tubes plus cathode ray tube. Tele King Corp., 601 W. 26 St., New York 1, N. Y.—RADIO & TELEVISION RETAILING

More New Radio  
Products  
Elsewhere in this Issue



# BOOSTING SALES

## of TV in the Higher-Income Areas

### Specialized Selling Methods Needed, Garden City Dealers Point Out

• The reputation of your store is a specially important sales factor, if you are trying to do a merchandising job on radio and appliances among the folk of the higher income brackets.

This is the conclusion reached by the proprietors of Gore & Hoppen. The store is a trim new retail establishment at 174 7th St., Garden City, L. I., N. Y. It's an area where a lot of well-heeled people live. Not the fabulously wealthy ones, but the "executive" group with the more-than-average incomes. W. Gore and R. F. Hoppen, the proprietors, have figured out how to do successful selling in the territory, and they say that one of the chief things to remember is how word-of-mouth advertising operates in this class of buyers.

This store has found that the well-fixed prospects are the ones who do the most talking among themselves about what the local dealer has to offer. Many dealers might assume that among the families of vice-presidents and executives, the "community spirit" is altogether casual and not very local in nature. Gore & Hoppen have found that such is not the case. The people of this income group, in a given community, seem to get acquainted quickly, and are definitely inclined to exchange notes on where to shop.

#### Good Service Expected

What these people expect of a dealer is extra good service, and good product styling, according to the Garden City dealers. These buyers reject the trick designs in home furnishings, and are likely to shy away from novelties. In Garden City, for instance, these folk are buying their new television sets in period style cabinets, and they want immediate installation. They like extra, individual attention and they're used to getting it. They are aware that their purchases are large ones in comparison with most sales made by the average dealer. They expect him to show his appreciation.

To handle all this service efficiently, Gore & Hoppen use the entire basement

of the store for repair work. They have equipped it and lighted it and staffed it so that they can do 100% maintenance and installation work for the fussiest customer.

It is pointed out, however, that this business among the higher incomes is enormously worth the trouble. Many new television installations run over a thousand dollars. Most of them pay cash. A retailer has very few collection

a person of judgment, and you watch your manners.

Gore & Hoppen make a point of working with all the local civic or social groups they can contact. They supply music or public address equipment for these organizations, and find that it is an ideal way to make contacts without using more impersonal forms of advertising. A dealer should not tackle any of this work, however, unless he is

---

### HOW TO TREAT 'EM

Don't try to sell in your shirt sleeves.

Watch your manners.

Remember you will be talked about.

Be prepared to offer personal service.

Go easy on the high pressure.

---

problems, and the whole thing goes more smoothly because one is dealing with high quality merchandise. Failures, and complaints about performance are 'way below those met by a dealer who specializes in cheap merchandise.

Another thing to remember in dealing with this class of customers is that high-pressure sales methods are out. These prospects don't mind a fellow exhibiting some energy and enthusiasm for the product he's selling, but the trick methods and the fast-talking tactics are no good. It simply means that you always wear a jacket when you sell, and that you proceed with dignity and sense. You assume that the prospect is

fully prepared to let his reputation stand or fall by the performance of his equipment, they assert.

Finally, a dealer should not be hesitant in selling a high-class piece of merchandise, to touch on the matter of value. If the retailer can point out any financial advantage, he should, depending of course on the particular prospect, emphasize the point in spite of the fact that the prospect has plenty in the bank. Gore & Hoppen have noticed that some of the \$25,000-a-year families are definitely more price-conscious lately because they are faced with extremely high costs of living and their salaries have not been boosted.



# Reason #9

*why—Du Mont is the most sought after franchise in television*

---

Du Mont is in *all* of television—and *only* in television. With Du Mont, television is no sideline—it's our entire business, and has been ever since Dr. Du Mont started his pioneer work in television research way back in 1931.

**DUMONT**

*First with the Finest in Television*

---

TELEVISION RECEIVER SALES DIVISION

Allen B. Du Mont Laboratories, Inc. • 515 Madison Avenue, New York 22, N. Y.

# Sell MORE Sets as Christmas Gifts!

## National Radio Week Starts Ball Rolling.

### Chance to Reduce Stocks of Small Receivers

● Merchandising promotion centering about the "Radio-in-Every-Room" theme will be featured during National Radio Week, Nov. 14-20. The event, sponsored by the Radio Manufacturers Association and the National Association of Broadcasters, will stimulate sales of receivers all over the country.

Coming just ahead of the Christmas season, National Radio Week will touch off a series of activities by dealers who are out to do a land-office business in the selling of radios. More than a dozen trade groups have pledged their aid to put radio's 28th birthday over with a bang.

Promotion material includes posters for display by high schools, radio dealers, and others in connection with the "Voice of Democracy" script contest for high school students; advertisements for joint cooperative sponsorship by dealers and distributors. A

series of radio spot announcements will be provided all broadcasting stations.

Widespread publicity will be given the "Radio-in-Every-Room . . . Radio-for-Everyone" slogan. The alert merchant will want to cooperate in bringing this theme into every home in his community. He should plug it for all it's worth during Radio Week, and use it to help him sell more sets as Christmas gifts—and the year 'round for that matter.

Furthermore, the idea back of the whole thing can be employed to spur sales of table models for the dealer who is presently carrying a large inventory of small sets and is not satisfied with the rate of turnover.

There are several methods the merchant can use to up sales of small receivers. The most obvious way to call attention to such radios as ideal Christmas gifts is to set up a display, labeling

each set, "for brother", "for sister" etc. Or, such sets can be suggested for various rooms via the use of attractively-lettered cards. One merchant has been very successful in keeping the small radios moving by setting up a special department where they are shown as "unusual radios."

It goes without saying that the merchant needs to promote all of his radio merchandise with equal enthusiasm. There's real profit in those expensive sets, and many will be bought as Christmas gifts.

In some localities dealers have been experiencing a slow-up in sales of certain high-priced consoles, and in such cases they need to make an all-out effort to sell them as holiday gifts. There are always those who want such sets, and are willing to buy them provided the store finds such people and then puts the necessary sales effort into the sales presentation.

### Early Start for Promotion

Christmas sales promotion should begin early, and National Radio Week is a natural starting point. This year's radio merchandise is outstanding in appearance, performance and in value. In TV localities the video set will be one of the most sought-after of all gifts, and it stands to reason that because of spotty supply, and installation problems, the dealer who gives out with the "shop early" advice is doing his customers a genuine favor.

(Continued on page 95)

## 25th Board of Directors, RMA, 1948-49

Ray H. Manson	Ernest Searing	E. A. Nicholas	J. J. Kahn	R. E. Carlson Vice President Chairman, Tube Division	W. J. Barkley Vice President	G. M. Gardner Vice President Chairman, Set Division	Frank M. Folsom	R. C. Sprague	Larry F. Hardy	Benjamin Abrams	
H. C. Bontig	W. A. MacDonald	Joseph Gerl	Walter Evans	W. R. G. Baker Director Engineering Dept.	Max F. Balcom President	Leslie F. Muter Treasurer	Paul V. Galvin	E. Aischuler	F. R. Lack	G. W. Thompson	
H. C. Mattes	Thos. A. White	Ray F. Sparrow	J. H. Stackpole	Allen Shoup Vice President	A. D. Plamondon, Jr. Vice President Chairman, Parts Division	W. P. Hilliard	Allen B. DuMont	G. Richard Fryling	H. L. Hoffman		
H. J. Hoffman	Herbert W. Clough	S. Insull, Jr.	A. Blumenkrantz	John W. Craig	Bond Geddes Executive Vice Pres General Manager	John W. Van Allen General Counsel	George Lewis	Lloyd H. Coffin	David Wald	George R. Haase	Harry G. Sparks



# New! 2-Speed Fully Automatic

## RECORD PLAYER

### in Stewart-Warner Radio-Phonographs!



**Plays ten 12" or twelve 10" Long Playing records automatically... Intermixed**

**Fully Automatic—Single Tone Arm for both standard and LP records**

*The new "micro-groove" record has revolutionized the radio-phonograph . . . made it almost overnight into a great new instrument.*

And once more it's Stewart-Warner that gives you all its benefits with PLUS value. The new Stewart-Warner 2-speed changer gives you up to 4 hours of continuous entertainment from the new records . . . yet is quickly and easily changed to play standard discs in the usual way.



Stewart-Warner 2-speed changer replacement units will be available for Stewart-Warner combinations now equipped with single-speed changers. Ask your distributor for full information.

# Stewart-Warner

FM • Radios • AM • Radio-Phonographs • Television

Chicago 14  Illinois

*Wonder Window*  
**TELEVISION**  
by Stewart-Warner

- New Instant Tuning!
- New Wider Pictures!
- New Home Styles!

Companion-Styled to  
Stewart-Warner  
Radio-Phonographs

•  
Gives you a New Picture  
of Television Sales

# Systems of Control Protect TV Installation Profits

By Samuel W. Lerer, C.P.A.,

Samuel W. Lerer & Co., New York City.

---

Condensed from a talk made to dealers attending one of the sessions of the Town Meeting of Radio Technicians, Hotel Astor, New York.

---

• The elements of control of any business may be simple or they may be highly intricate but they depend for their success or failure on one basic requirement: Management must use them.

Systems don't work by themselves. It takes people. For the element of control in a system to deliver its full benefits it must be used by the people most directly interested, the owners and managers of businesses.

## Profit Angles

Now what does management want from its television service business? Well, obviously it wants business and profit. It wants to assure that work is done when and as required. It wants to assure itself and its customers that service obligations are carried out in full in accordance with factory agreements, service contracts, at fair profits and on a business-like basis. In short the installation and service departments now rapidly growing in the

average dealers' business is looked upon as an increasingly vital section of the business.

Time and materials are what the radio-appliance dealer sells. These are the elements upon which he projects and collects his profits. Obviously then these are the two things which must be controlled through proper systems designed to the business, installed and then enforced for results. Since most dealers of television receivers are doing a large volume of business in other radio products and appliances the service order shown has been designed so that it will accommodate service on all appliances and be equally applicable to any service operation.

## A Check on Service

The forms are prepared in triplicate and are called "Service Order forms." Their chief function is the handling of customer's calls for service from the time it is received until after the work requested has been scheduled, exe-

cuted, collected and billed, verified, and filed for audit. Here's how it works:

1. The three copies are written at the same time on a Standard type register which will perform this function exclusively. The need for this type of device becomes apparent in the steps outlined below.

2. Two copies of the forms are ejected by operating the handle after the full information as to customer's name, address, telephone number, nature of complaint, type of transaction (cash, C.O.D., service contract, etc.) are written on the forms.

3. Copies 1 and 2 accompany the service man to the job where he fills in the details of the work done. The third copy is locked in the register where it remains in numerical sequence, thus providing a basis for audit and reference.

On the job the serviceman fills in on the first two copies the actual facts of the service call he made.

A. Serial number of the TV set or appliance

B. Time

C. Disposition of the receiver or appliance as to replacement parts installed or additional parts attached

D. Computes charges for materials and time, if C.O.D.

E. Receives customer's signature certifying that work has been done satisfactorily.

## Multi-Use Forms

In the event that cash is paid by the customer, the service man provides the customer with a receipt which is the upper part of the same register form (second copy). If it is a charge, the customer's signature authorizes the billing. In the cases where the appliance has to be removed from the premises of the customer, the second copy of the form becomes a claim check with a preprinted serial number. The same form also becomes an identifying tag for the appliance itself.

After the call has been completed, he returns the first copy to the office where his cash is checked in. Full control over the entire operation is estab-

(Continued on page 46)

**FORM "A" - SERVICE ORDER**

WITH SERVICEMAN TO JOB

COMPANY

3rd COPY

LOCKED

1. TO JOB- RETURNED  
2. TO CUSTOMER  
3. LOCKED-VERIFIES BOTH

The diagram illustrates the 'Form A' Service Order process. It shows a large form on the left with a 'COMPANY' header and a 'WITH SERVICEMAN TO JOB' label. An arrow labeled '3rd COPY' points from the form to a 'LOCKED' box. From this box, an arrow points to a mechanical register device. Below the diagram, a list specifies the destinations for the three copies: 1. TO JOB- RETURNED, 2. TO CUSTOMER, and 3. LOCKED-VERIFIES BOTH.



# Buyers agree ON THE 203

The new Westinghouse 203 is a triple-threat set with the finest of all three sales-winning features:

1. **Improved AM reception** gives super-sensitive, noise-free reproduction of the full tonal range.
2. **Genuine Westinghouse Rainbow Tone FM** . . . the quietest, most sensitive FM ever developed.
3. **Superb automatic record changer** plays 10 twelve-inch, or 12 ten-inch records with smooth, silent operation and quick 4-second changing speed.

. . . all this performance packed into an excitingly styled cabinet of rare beauty . . . and priced to convert shoppers into buyers.

## NOTE TO DEALERS:

This is one of the many new feature-packed Westinghouse radios that build sales and profits for Westinghouse dealers. If you don't handle Westinghouse radios, get on the bandwagon now!

HOME RADIO DIVISION  
WESTINGHOUSE ELECTRIC CORP.  
SUNBURY, PA.

## MODEL 203

AM/FM radio-phonograph  
in a striking modern cabinet  
of blonde frosted oak or  
dark mahogany.



*You can be sure . . . if it's*

# Westinghouse

RADIO TELEVISION



# Control System for TV Profits

(Continued from page 44)

lished by the locked-in audit copy which has remained in the register. The unbroken continuous forms provided with the registers thus become the keystone of the entire service organization while in field or in the service department.

While the before-mentioned register system has been designed for all appliances including television receivers, another system embodying the same principle of locked-in audit records is especially useful to the television sales department and the management of a modern business.

This system is called the Television Installation Order. It, too, is written on a register which produces five copies in the single writing. While four of the copies are with the servicemen on the job, the fifth copy remains locked in the steel compartment and is the office control. Because information will have to be duplicated on all four copies at the point of the installation the forms are manufactured so that they hold together by staples which are inserted during the manufacturing process. Carbons are interleaved between the four copies. This feature eliminates shuffling of carbons and aligning the forms by hand which can cause difficulty and customers' misunderstanding. Information on the different parts of the forms set is basically the same, but through blocked out sections of the second to the fifth copy, only necessary facts appear on each copy.

Here is a brief account of how this system works:

1. The five part form is written on the register. Four copies are ejected. These being stapled together with car-

bons interleaved will accompany the serviceman or installing team. Of course, this operation is initiated by the service department on advice from the sales floor that a television receiver has been sold.

2. All information about the installation before it is made is written on the register form. Basically, this will be customer identification, time promised and other general information. When properly filled in, the forms will then become:

First copy—Installation order—to serviceman and to be returned to bookkeeper when all details are completed.

Second copy—Manufacturers' or dealer's copy of the installation order.

Third copy—Service renewal contract—filed by dates so that solicitation of renewals can be efficiently handled.

Fourth copy—Service contract and warranty.

Fifth copy—Remains in register and verifies action taken by the installation team when they report job completed. Is then bound for permanent reference.

The accompanying forms for both of these register systems, as previously stated, can, of course, be changed to suit the individual situation. As a matter of fact, the above system, where heavy volume of installations require it, can be adapted to typewriters rather than registers. However, irrespective of the feeding method used, numerical control of continuous forms seems to be the best type of application.

Contrary to popular belief, the service contract does not have to be prepared individually. It can be efficiently combined with the television installation order as indicated above, written

and produced at the very instant that the other basic records concerning the installation are being made. When left with the customer, because of its number which corresponds exactly with the installation order itself, it is even more foolproof than most other methods of warranting service.

One of the simplest ways of accomplishing control of installing teams and/or servicemen is through a simple, two-part form which analyzes man's operation and tells where he is at all times. The form is prepared in two parts and details the serviceman's name, dates of work assigned, work completed, service order numbers handled by him, customers served, and the TV, radio or appliance serial number.

This is a form which should be geared to the individual's operation and handled by the service manager and the bookkeeping department which can "cost" each service job upon completion.

## Control of Parts

Control of parts is another place where a properly designed system can do much to reduce loss and protect profits. Indeed, if it's not done here, it may as well not be done anywhere. The loss of two viewing tubes can wipe out the profits on a good many installations and sales.

For this purpose, too, a register system should be used, since loose unnumbered slips may cause the same situation recently reported where it actually took over 2,500 antennae to complete over a period of time, exactly 1892 installations. Of course, some of this type of loss can't be helped, but "shrinkage" of expensive parts can be brought to a halt if the writing method for withdrawing those parts provides locked, tamper-proof records.

Generally, then, it is possible to control the important items of the service business through controls at the proper points.

RADIO, TV OR APPLIANCE SERVICE ORDER—3 part register forms for every service call. One locked-in to verify all work and monies handled. Basis for customer history.

TELEVISION INSTALLATION ORDER—5 part register form. One locked-in to verify all work. Basis for notifying dealer or manufacturer of installation. Provides warranty, solicits renewal.

WORK CONTROL SCHEDULE—2 part loose form controls all work of service men or teams. Basis for "costing", basis for important statistics.

PARTS REQUISITION—Multiple copy register form. Basis for controlling all parts withdrawals.

With these elements of control properly designed and installed, it is possible to hold every operation of the service department under tight control. The system outlined above is a fast growing one and is receiving acceptance among many TV dealers.

## FORM "B"-TV INSTALLATION ORDER

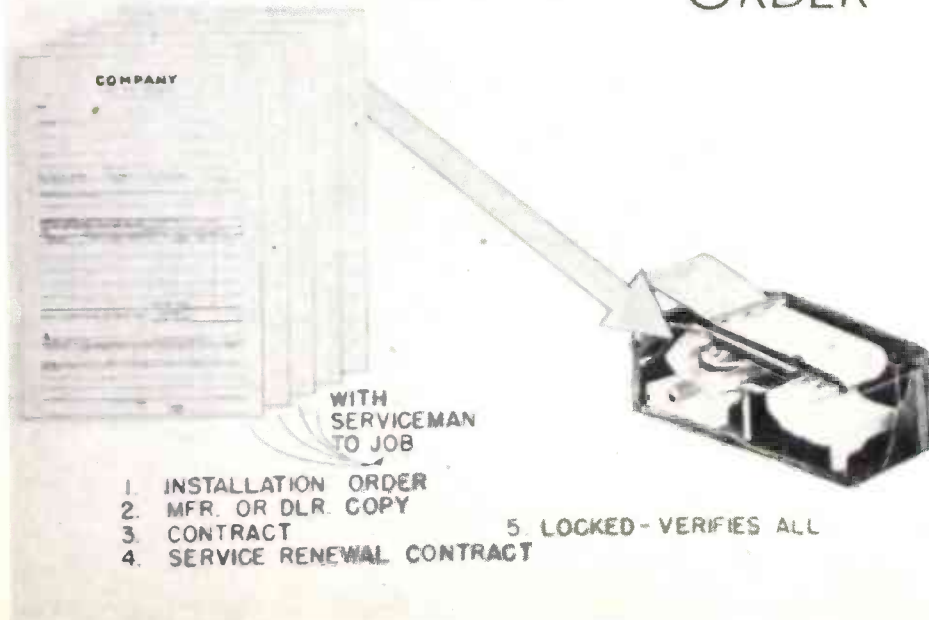



# UNITED STATES TELEVISION

presents

## "The Giant Twelve" Consolelette

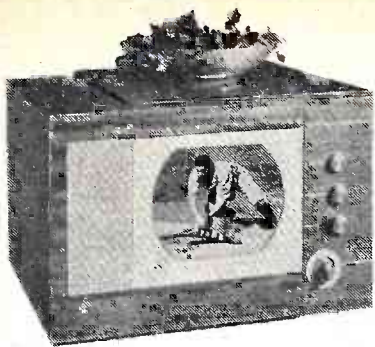

### "The Giant Ten"

Table Model

Model T-10823, a picture almost 9" x 7", featuring Syncro-lok.

**\$375\***



### "The Giant Twelve"

Console Combination

Model KRV-12831P with radio and record changer, featuring Syncro-lok, and a 75 square inch screen.

**\$795\***



### "The Giant Fifteen"

Table Model

Model T-15823, featuring Syncro-lok, and a 121 square inch screen.

**\$895\***

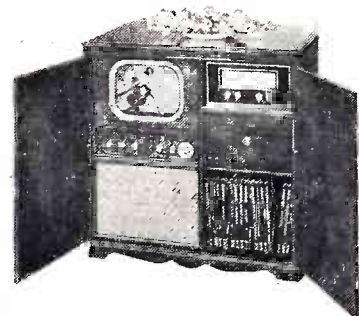

### "The Giant Fifteen"

Console Combination

Model KRV-15831P, with radio and record changer, featuring Syncro-lok, and a 121 square inch screen.

**\$1495\***



"The Giant Twelve" Consolelette, CFM-12823P, featuring Frequency Modulation, Syncro-lok, and a 75 square inch screen. **\$524.95\***

★ After ten years of research in UST's great laboratories, the UST "Giant Twelve" Consolelette is ready! Here at last is the perfect solution for the average consumer who wants the "Best of the Biggest Pictures" at a moderate price. You'll find it a deeply satisfying experience to relax before its comfortable 75 square inch screen and enjoy UST "No Fog" Contrast, UST Automatic Syncro-lok, UST Crystal Picture Detection, UST Tele-Symphonic Tone System and UST "Fused Circuit Safety". Mr. Average Consumer, without an FM radio, will appreciate this added feature in the new consolelette. The famous UST "Tele-Symphonic Tone System" assures perfect enjoyment of the fine UST high-fidelity FM circuit incorporated in this model. Available in period mahogany or modern finish.

**Important!** Deliveries . . . because UST owns Zetka Television Tubes, Inc., leading quality producer of 12" and 15" tubes, we can guarantee prompt delivery of Big-Picture sets. Write us for further information.

\*Federal Excise Tax and Installation, extra. Prices slightly higher west of the Rockies.

"Ten Years in Television"

**UNITED STATES TELEVISION MFG. CORP.**  
3 W. 61st St., New York 23, N. Y., Tel.: Circle 6-4255

# It's here!

## The NEW General Electric Variable Reluctance Cartridge for Long Playing Records

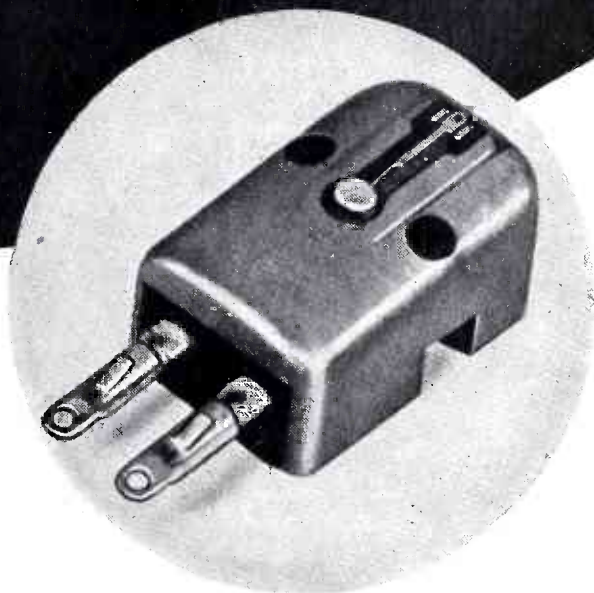

- Specifically designed for the new long playing records...high compliance...low mass stylus assembly
  - Equipped with 1 mil tip radius sapphire stylus
  - Can be used with standard G-E preamplifiers
- Place your order today!

*General Electric Company, Electronics Park,  
Syracuse, New York*

*You can put your confidence in —*

**GENERAL**  **ELECTRIC**

68-610



# RECORDS

## Top Platter Favorites



**ARNAZ, DESI:** "Perhaps, Perhaps, Perhaps"—"The Matador." RCA Victor 20-3113

Novelty and romantic ballad, with Arnaz doing both vocals.

**BENEKE, TEX:** "Poinciana"—"The Man I Love." RCA Victor 20-3112

Two familiar tunes get top treatment. "Poinciana" lyrics done by Garry Stevens with smooth mellow backing; Gershwin tune "The Man I Love" done as a straight instrumental.

**CLARK, BUDDY:** "Rendezvous with a Rose"—"I Still Get a Thrill." Columbia 38314

Crooner Clark has a way with a song that is clearly evident on this pairing of a fast-rising ballad, with the sentimental oldie, "I Still Get a Thrill."

**CROSBY, BING:** "Lily Marlene"—"A Bluebird Singing in My Heart." Decca 24508

A new bit of Crosbyana for his innumerable fans. . . . "Lily" gets good handling.

**DAMONE, VIC:** "His Fraternity Pin"—"At Half Past Seven." Mercury 5194

Aimed at Damone's teen-age following, this coupling is in the groove.

**DAY, DORIS:** "Pretty Baby"—"Just Imagine." Columbia 38302

The thrush has been getting good movie build-up, which will help sell these tunes—and the record.

**ELLINGTON, DUKE:** "My Honey's Lovin' Arms"—"Suddenly It Jumped." RCA Victor 20-3135

"Lovin' Arms" a solid jump number,

with vocal; "Jumped" an Ellington instrumental that is torrid.

**FIELDS, HERBIE:** "John, John"—"In a Persian Market." RCA Victor 20-3052

Good orchestra work, featuring the leader on alto sax and clarinet, sparks both sides.

**GARRET, BETTY:** "I'm Strictly on the

(Continued on page 56)

### VOCAL ARTISTS



**MELCHIOR, LAURITZ:** "Spring Came Back to Vienna"—"Helan Gar." MGM 30136

The tenor does two songs from film in which he is featured, "Luxury Liner." "Spring" a romantic tune; other side a Scandinavian drinking song.

**"EZIO PINZA IN POPULAR ITALIAN SONGS." Columbia MM-768**

The Metropolitan opera basso has recorded six favorites from his concert repertoire.

**"ELEANOR STEBER SINGS FAVORITES FROM 'THE FIRESTONE HOUR'." RCA Victor MO-1243**

Metropolitan opera soprano has built up a big listening audience through her weekly broadcasts. This collection features eight of her most popular interpretations.

**WARREN, LEONARD:** "On the Road to Mandalay"—"Until." RCA Victor 10-1447

These two popular songs by baritone Warren are an excellent follow-up to enthusiastic response which greeted the artist's "Sea Shanties" album.

### CLASSICAL WORKS

**BERLIOZ:** "Requiem," Emile Passani Choir and Orchestra conducted by Jean Fournet. Columbia MM-769

Performance recorded several years ago in Paris, this choral work is presented in its entirety on eleven 12-inch records, boxed in one volume, with explanatory booklet. Dealers who did well with "Messiah" and other full-length recordings, will find this a good prestige item for a select clientele.

**BRAHMS:** "Sonata No. 3, in D Minor, Op. 108, Mischa Elman, violinist, with Wolfgang Rose at the piano. RCA Victor DM-1232

Mischa Elman's virtuosity is well-known to music lovers. The veteran performer's recent releases are giving many people the opportunity to hear him, though, for the first time.

**DVORAK:** "Symphony No. 4 in G Major, Op. 88," Bruno Walter conducting the Philharmonic-Symphony Orchestra of New York. Columbia M-MM-770

Lilting folk music themes and "Bohemian" feeling of music makes this Dvorak work a good bet to suggest to customers who know and like the more familiar "New World Symphony."

**HEIFETZ, JASCHA:** "Banjo and Fiddle"—"Garden Scene." RCA Victor 12-0430

"Banjo and Fiddle" a popular Heifetz concert encore—and as such very familiar to his admirers.

**MOZART:** "Quartet No. 1 in G Minor for Piano and Strings." George Szell, piano with members of the

(Continued on page 57)



Store name is prominently displayed on the sleek looking front of this Oklahoma dealer's establishment. Large plate glass windows give excellent views of merchandise shown. Of particular interest as other means of advertising, are the three PA speakers, circled, atop the building.

# Advertise

## *to Bring the Customers In*

Jenkins Music Store, Oklahoma City, Okla., takes full advantage of the possibilities afforded through liberal use of newspaper advertising to bring additional customers into the store. "Eye appeal" is another factor upon which the manager relies. A sleek modern store front, three sectionalized full glass show windows, and electrically lighted signs command attention from passers-by.

Regular newspaper advertising schedules are maintained. The store found, through trial and error, that this was the right medium to "reach into their customers' homes," and pre-sell merchandise to the greatest extent. Intelligent, clever newspaper ads are Jenkins Music specialties. And they bring back old customers, as well as pull in some new ones.

Special attention is given to layout and display of the ads. Special sales, and "leader" items are frequently featured, and with outstanding success. "People who come in seeking bargains

frequently spend more money than my regular customers," says Ed P. Horne, appliance manager.

Other local newspapers are constantly examined for novel and original ideas of presentation and format.

Ads that pulled for Jenkins Music contained copy that was crisp, to-the-point, and honest. Stress is laid on maintaining reader interest so that customers will be impressed by the advantages of the merchandise illustrated in regard to both quality and comparative cost. Ads that proved unsatisfactory contained too much detailed copy

accompanied by illustrations that appeared complicated to the casual reader.

Although emphasis is placed on newspaper advertising to bring customers into the store, the job does not end there. Particular emphasis is placed upon the job of the salesperson once the prospect is in the store. The in-the-store selling job is given the same careful attention as is the effort to obtain customers' point-of-sale.

### **Role of Sales Staff**

"Salespeople are going to play a larger part in the turnover of all types of merchandise than most store managers and owners are willing to believe," cautioned Mr. Horne.

"We have had trouble in obtaining competent salespeople. Clerks don't



seem to have the knowledge or know-how required to sell their merchandise. I know that other proprietors have been plagued with this lack of interest on the part of their sales staff.

### Training Important

"With the renewed emphasis on selling, it is up to store managers to teach intelligent, comprehensive selling methods to employees. The old ideal of group discussions, clinics, and get-together talks should be taken out and dusted off. It is important to talk over selling problems encountered on the floor. The quality of the merchandise and its value to a potential owner should be stressed more and more as the market becomes more competitive and selective," Mr. Horne advises other dealers.

In addition to utilizing advertising and good selling to their fullest degree, Jenkins Music places good service high on the list of good customer relations. "Our repair department is the best salesman we have ever had, or expect to get," states Ed Horne.

"All our merchandise is guaranteed and serviced by the store for the length of the warranty. Rendering satisfactory service over a long period of time has assured us of keeping our old customers and of constantly gaining new prospects and friends.

### Service Counts

"A successful service department," he continued, "goes a long, long way in maintaining the proper public relations necessary to stay in business. Our customers know they can always have an item serviced with complete confidence at our store. They are usually pleased with the job, and nine times out of ten tell their friends about it. A satisfied service customer is another good salesman for Jenkin's Music Store."

"We are optimistic about the next 12 to 18 months future in radio and television sales," he continued. "We have been voluntarily trying to keep our inventory down. We now work on a budget each month, so much money



Ed Horne, left, appliance manager, looks on as Johnny Wall, member of the radio sales staff, demonstrates a new receiver.

being allocated to each department. At the end of 30 days after orders are placed, any un-filled orders are cancelled, regardless of the merchandise ordered.

### Future Looks Good

"I've found," he says, "that the best season for large radio combinations sales is from September through December. However, we do sell a large quantity of portables and small radios during the summer months.

"Home recorders sell well through the winter month with tape and record recorders running well ahead in that field. Wire recorders," he adds, "have recently been running a stout second in the amount we have sold in this line.

"I've found that there is a good selling field in this area, but I've also dis-

covered during the last 12 or 18 months that our buyers do not have as much money as they had previously. They still have the buying habits formed during the lush war and postwar days . . . however, they don't have the ready cash.

"Increased credit sales indicate that a radio and television retailing outlet need not fear that business will drop 'way off. Closer attention to credit references and knowing your customer will keep your sales volume high without having to mark off too many bad debts," Mr. Horne advises.

"More and more," he continues, "we find that our customers are demanding that we sell more of our merchandise on credit. This can easily be done by any established retailer who keeps a careful eye on the customer to whom he gives credit."

## ATTRIBUTES SUCCESS OF NEWSPAPER ADVERTISING TO:

- Attractive layout of copy and illustrative material
- Consistent use of the medium
- Featuring "leader" sales items to bring 'em into the store
- Training sales staff to be effective in backing up advertising

# Children's Records for Xmas

• Dealers who get out and beat the drum for children's records this year will find a willing public, ready to hop on the "kiddie disc" bandwagon. With more than 10% of total record sales this year calculated to be chalked up by children's records, manufacturers and dealers are making an all-out effort to cash in on the sales during the profitable Christmas period. A variety of promotional material, advertising aids, and display pieces have been prepared to assist retailers.

A "record-wise" public has been well educated regarding the merits of children's records thanks to the excellent job done by the disc makers, favorable comments in press, radio and encouragement from leading educators. The "kiddie disc" deserves a place in the Christmas stocking. It is up to dealers to see that it gets there.

## Artists Featured

On the Decca label, such artists as Bing Crosby, Loretta Young, Fred Waring, Frank Luther, and Danny Kaye have made several children's albums into best-sellers. Peter Lind Hayes' version of "Genie, the Magic Record," (C. U. 102), has been one of the label's top-sellers during the year. The delightful story has full orchestral background, and is suited for children up to 8 years old.

Other albums, which are tops in the Decca catalog, and which feature excellent presentation of story as well as rich musical backgrounds, include: Frank Luther's, "Mother Goose Songs" (C. U. 100); Danny Kaye's version of "Tubby the Tuba" (C. U. 106); Peter Lind Hayes, "The Little Tune that Ran Away," (C. U. 108); Bing Crosby, "The Small One" (DA 553) and "Merry Christmas" (A-550); Frank Luther, "The Three Billy Goats Gruff" (C. U. 113); Ray Bolger, "The Churkendoose," (C. U. 103). Fred Waring's "Nutcracker Suite," with original songs is another good seller. "Little Orley" (C. U. S. 7) stories told by Uncle Lumpy of the Fred Waring glee club, is a newcomer that shows great promise, too.

Columbia Records, Inc., has announced a series of Long Playing Micro-groove records for children, made of nonbreakable Vinylite, and retailing for \$2.85. The initial LP issues for children have been chosen with the four to nine year old group in mind. The releases include two volumes of "Nursery Songs" with Gene Kelly; sev-

eral selections of which are new; "Many Moons," an original story by James Thurber released for the first time, coupled with "The Eager Piano," a fantasy of a piano which wanted to play in Carnegie Hall; "Goldilocks and the Three Bears," coupled with "The Gingerbread Boy," both narrated by David Allen; "Rhumpy the Rhino," a new release, is a lively story of jungle animals, coupled with another animal story, "Kankie and the Concertina." All the aforementioned records have also been released by Columbia in non-breakable Vinylite albums to be played on regular 78 rpm. machines.

Columbia also has a non-breakable "Playtime" 7-inch record series that retail for 25c. Other Columbia catalog items of interest to dealers include: "Alice in Wonderland," sung by Jane Powell (MM-713); "The Adventures of Oliver Twist and Fagin," (also available on LP discs) with Basil Rathbone (MM-700); "Bongo," told by Dinah Shore (MJ-41); "The Eager Piano," (MJ-43); "Songs from 'When We Were Very Young'," Gene Kelly (MJ-42).

## Popular Titles

Featured in RCA Victor's new fall line of children's records for "the very young," are the following albums, all issued on non-breakable material: Jack Arthur's "Adventures in Mother Goose," "Songs of Raggedy Ann," "Holidays in Song," (Y-30, Y-27, Y-31); "Christopher Robin Songs," Alec Templeton (Y-26); "Sylvester the Seal," Eddie Mayehoff, (Y-373); "St. Catherine and the Miraculous Medal," Ted Malone (Y-367); "Lore of the West," Roy Rogers (Y-394); "Billy-on-a-Bike" Vaughn Monroe (Y-366); "The Wedding of the Princess," Paul Wing (Y-374); "Bambi," Shirley Temple, (Y-395); "Happy the Humbug Has a Birthday," David Wayne, (Y-370).

Capitol Records is offering the following albums on a new, virtually unbreakable material, which the company calls, "Superflex"; "Nursery Rhymes," sung by Ken Carson (DBS-90); "Bozo Sings," (DBS-840); "King Cole for Kids," (DC-89); "Bible Stories, Vol. I, Vol. II," told by Claude Rains (DBS-92, BB-94); "Little Toot," told by Don Wilson (DA-80); "Songs for Children," with Tex Ritter (DC-91). Colorful record readers are included with "Bugs Bunny and the Tortoise," (DBS-93) and "Bozo Under the Sea," (DBX-99.)

Other Capitol albums of interest include "Bozo Sings," (DBS-84); "Rusty in Orchestraville," (BC-35); and "Tales of Uncle Remus," (CC-40.)

Just in time for Christmas selling, MGM announces the release of non-breakable kiddie records on "Metro-lite." Included are: "Horton Hatches the Egg," "Tugboat Danny," "Pride of Kentucky," and "Songs of Health." Two of last year's favorites, "Irving the Unemployed Horse," and "Mother Goose Parade" are also available on this unbreakable material.

Lionel Barrymore as Scrooge in "A Christmas Carol," is another good seller for MGM. (16-A.)

Continental Records, New York City, has an original series of records featuring a child character named "Edna." On unbreakable colorful discs retailing at 79c some of the stories are: "Edna and the Magic Cereal," (203); "Edna in the Animal Mix-Up" (206); and "Edna in Bunnytown" (205).

Remington Records, Inc., New York City, is featuring its "Junior" line of records which are made of colorful, transparent plastic and packaged in attractive envelopes. The 1000 series, retailing at 75c features special songs and nursery medleys. The 100 series which sells for 98c utilizes full orchestra, and other musical backgrounds, with original lyrics and stories written especially for standard and folk music tunes.

Several titles from the Remington catalog include: "It's Santa Claus"—"Jingle Bells" (J-1001); "Time to Get Up"—"Sleepy Time"; "Nursery Tune Tale"—"Up, Up, Up"; "The Animal Parade"—"The Little Brown Duck" (J-107); "Bon Bon Street"—"The Story of Narcissus" (J-109); "The Train Ride"—"Sven Svenson's Tree" (J-110.)

## Variety of Selections

Signature Recording Corp., New York, is featuring a new non-breakable line of children's releases on "Signaflex." Available are: "The Story of Celeste," (C-1); "David and Goliath," (C-2); "Paul Bunyan" (C-3); "Little Stories for Little People," (CF-1); "Wild Bill," (CF-2); "A Trip to France," (CF-3); "A Trip to New York" (CF-4.)

Mercury Records has introduced a 7-inch non-breakable record designed to sell for 29c, with a variety of titles. The 10-inch unbreakable disc series, attractively packaged feature several popular albums including: Two Ton



Baker in "Lonely Little Petunia"—  
 "Laughing Place" (MMP-25); "Boomer  
 the Bass Drum" (MMP-11); "Christ-  
 mas Party" (MMP-5); "Dick Tracy"  
 with Jim Ameche (MMP-10); Jack  
 Carson's, "Willie and Hannibal in  
 Mouseland."

The Musicraft catalog contains sev-  
 eral albums with wide appeal, in-  
 cluding: "Peter and the Wolf," (M-65);  
 "Tweedle De Dee and Tweedle De  
 Dum" (N-11); "Hansel and Gretel"  
 (RRT-3.)

Allegro Records, a label which is  
 comparatively new to independent re-  
 tailers, features child participation re-  
 cords for youngsters under 6 years of  
 age. "A Child's Garden of Manners"  
 with Tommy Riggs, (Deluxe 19), has  
 been popular in the past. Mayfair Rec-  
 ords' story-teller, The Lady in Blue,  
 does a series of albums which make  
 pleasant listening. The Vox catalog in-  
 cludes the Music Master series on the  
 lives of composers, which are especially  
 good for elementary school children,  
 as well as additional albums for a  
 younger set.

A glance at the recently issued RA-  
 DIO & TELEVISION RETAILING DI-  
 RECTORY (August 1948) will give in-  
 terested dealers a complete listing of  
 all children's record manufacturers.



The Christmas stocking this year should be  
 chock full of songs, stories and "good listen-  
 ing." The record makers are offering prospec-  
 tive purchasers a wide choice of selec-  
 tions, with children's records catalogs  
 greatly expanded.





## FEATURES OF ASTATIC'S FL-33 PICKUP

1. Five-Gram Needle Pressure.
2. Permanent Sapphire Needle with .001" Tip Radius.
3. Approximately One-Half Volt Output.
4. Frequency Range 30 to 10,000 c.p.s.
5. Novel Design at Base Eliminates Tone Arm Resonances and Assures Perfect Tracking.
6. LP-33 Cartridge for Microgroove instantly replaceable in FL Arm with LP-78 Cartridge having .003" radius needle for playing 78 RPM Records. Both simply slip into position, no tools needed, **NO CHANGING OF NEEDLE PRESSURE.**

### Astatic FL-33 PICKUP

FOR COLUMBIA MICROGROOVE RECORDS

Here is no mere version of what a pickup for use with Columbia Microgroove Records should be—but the actual playing arm designed to meet the precise requirements of Columbia's new recordings. This new Astatic Pickup is manufactured to meet the specifications by Columbia, to insure maximum quality performance of the Columbia LP Microgroove Record. Available, then, in the Astatic FL-33 Pickup and LP-33 Crystal Replacement Cartridge, is the ultimate of Microgroove companion equipment . . . alone capable of getting the most out of LP Records.

FL FILTER: For best performance with high quality speakers. Controls high frequency response.

LISTED IN RADIO INDUSTRY RED BOOK

Astatic Crystal Devices Manufactured Under Brush Development Co. Patents



## Columbia LP Ad Campaign

A national magazine advertising campaign, supported by a strong merchandising plan, has been launched by Columbia Records, Inc., in behalf of the new Long Playing Microgroove records, announced Paul E. Southard, vice-president in charge of merchandising. Plans call for simultaneous participation in a 9-point merchandising plan by distributors and dealers. This includes a dealer presentation, cooperative newspaper advertising, radio chain breaks, window display contest with prizes for best "tie-in" window displays, direct mail campaign, telephone solicitation, point-of-sale material, free service from magazines and trade journal advertising.

## Decca Distributors

S. N. Goldberg, sales manager Decca Records, Inc., announces the following distributors for the company: Nelson & Small, Inc., Portland, Me.; Leo Maxwell Co., Inc., Oklahoma City, Okla.; General Appliance Co., San Antonio 6, Tex.; Reader's Wholesale Distributors, Inc., Houston, Tex.; Momsen-Dunnegan-Ryan Co., El Paso, Tex.; Salt Lake Hardware Co., Salt Lake City, Utah; Republic Dist. Co., Grand Rapids, Mich.; Stratton Warren Hardware Co., Memphis; Hawaiian Electric Co., Ltd., Honolulu; Post & Lester Co., Hartford.

## Sell Books Through RCA Victor Retailers

RCA Victor is merchandising two Simon & Schuster books, "The Victor Book of the Opera," and "The Victor Book of the Symphony." These are extremely timely for Fall symphony and opera activities.

## Dual Webster Needle

The Webster-Chicago Corp., Chicago, has developed a new nylon "Knee action" phonograph needle, which plays the conventional and microgroove records. Known as the "tanden-tip," the needle has a one mil diameter tip of osmium alloy, with qualities particularly suited to fine tonal reproduction, long needle life, and protection of records.

## Named by Buffalo Dealer

D. Bernard Simon, proprietor Music House, Buffalo, N. Y., announces the appointment of J. Frank McDonnell as assistant sales manager. Mr. McDonnell was formerly record sales manager of Bickford Bros., local RCA Victor distributor, and recently won the James Murray \$1000 award for the best sales promotion effort of the year among the RCA Victor distributors.

## Capitol Appointment

William R. Hill has assumed the duties of executive in charge of the New York offices, 250 W. 57 St., of Capitol Records, announced Glenn S. Wallich, president of the firm. Mr. Hill is Eastern division sales manager for Capitol.

## Introducing A NEW KIDDIE RECORD LINE

Smart dealers don't stock KIDDIE RECORDS—until they've seen the multicolor, unbreakable

**JUNIOR**

KIDDIE LINE

Distributor Territories Available—Write or Wire

**REMINGTON RECORDS, INC.**

254 W. 54th St., New York 19, N. Y. - Phone CI 6-5227

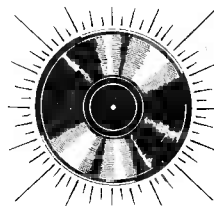

RETAILING AT

**79c**

AND

**98c**

## CLOSING DATES FOR

**RADIO & TELEVISION RETAILING**

**5th** of preceding month for all ads requiring proofs, composition, foundry work, key changes, etc.

**10th** of preceding month for complete plates only—no setting.

**1st** of month—Publication Date.

Cancellations not accepted after 5th of preceding month.

**CALDWELL-CLEMENTS, INC.**

480 LEXINGTON AVENUE, NEW YORK 17, N. Y.



# Recording Wire

is the Life Line of Good Recording

**WEBSTER-CHICAGO**

*Electronic Memory*

**RECORDING WIRE IS THE**

**Profit Line FOR YOU!**



It's easy to sell Webster-Chicago *Electronic Memory* Recording Wire because your customers will quickly detect its better performance. They will depend upon you for continuing supply...meaning repeat business and quick turnover for you NOW when profit margin counts!

Webster-Chicago *Electronic Memory* Recording Wire is bright, smooth, uniform. It handles easily and records faithfully ALL the sound impressed upon it. These are features which Wire Recorder owners appreciate.

## Here's why customers prefer Electric Memory Recording Wire

Webster-Chicago *Electronic Memory* Recording Wire is made from non-rusting stainless steel. Through the more than twenty manufacturing operations it is tested and retested for high standard and uniform magnetic, physical and chemical characteristics. Diameter is held to within plus or minus .0001 inches. Tensile strength is 245,000 p.s.i. (pounds per square inch) for a single strand, or better, for safe breakage factor, yet it is ductile enough for square knotting where junctions are required. Signal output and modulation levels are controlled at values which assure superior performance.

If you do not stock it now, get in on this profit-building opportunity today.  
Ask your nearest Webster-Chicago distributor, or write direct for full information.



FAMOUS, TOO, FOR QUALITY RECORD CHANGERS AND MAGIC NYLON PHONOGRAPH NEEDLES

**WEBSTER-CHICAGO**

5610 WEST BLOOMINGDALE AVENUE • CHICAGO 39, ILLINOIS



# NEW SHURE "900MG"

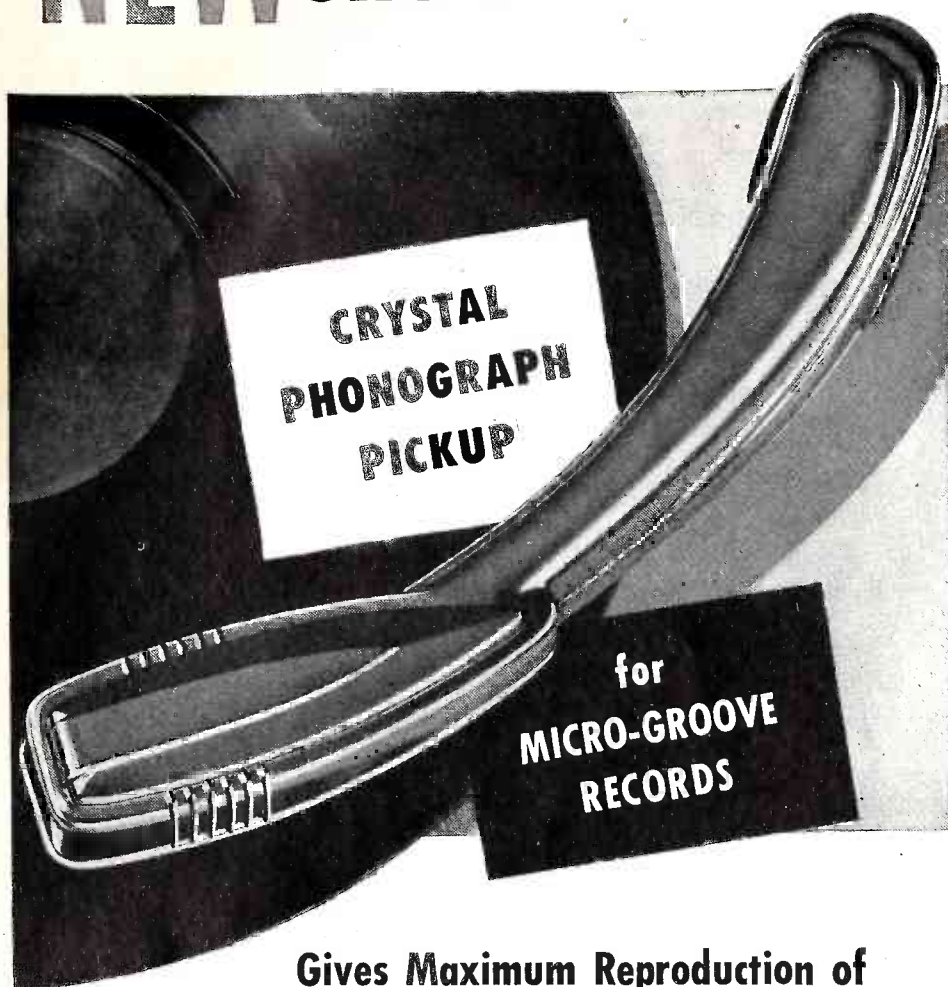

## Gives Maximum Reproduction of Micro-Groove Record Fidelity

The Shure "900MG" Pickup is an ideal instrument for tracking on the new micro-groove records. It tracks at 6 grams . . . uses a special offset osmium-tipped needle with a point radius of only .001" . . . and has an output of 1 volt! The Shure lever system has been adapted in the development of this new pickup—providing a high needle compliance. Listen to it—you will be thrilled with the results!

**Model "900MG"**

**Code: RUZUZ**

Shure Patents Issued and Pending. Licensed under the Patents of the Brush Development Co.

**SHURE**

**SHURE BROTHERS, Inc.**

*Microphones and Acoustic Devices*

225 W. HURON ST., CHICAGO 10, ILL. • CABLE ADDRESS: SHUREMICRO

## Popular Music

(Continued from page 49)

*Corny Side*—"It's A Quiet Town." MGM 10288

The Garrett gal can put her humor across the way few female singers can. . . good coupling for listening and chuckling.

GODFREY, ARTHUR: "Take 'Em to the Door"—"Waiting at the Church." Columbia 38322

Godfrey's legion of admirers will go for these waxed in the same pattern as his previous successes.

HAYMES, DICK: "Anytime"—"Bouquet of Roses." DECCA.

"Roses" tune definitely going places. Under the Haymes treatment the former hill-billy tune becomes a top popular ballad.

HERZON, HAL and his Septette: "Morton Gould's Musical Fantasies." MGM 31

Modern music in the modern manner presented in this sprightly collection of Gould compositions.

JAMES, HARRY: "September Song"—"Ab-Mur." Columbia 38300

A pair of instrumentals. . . standard "September Song" given James solid beat, while flip is an original with a brassy rhumba beat.

JONES, HANK: "Be Bop Piano," Mercury A-61

Authentic piano Be Bop. . . songs are: "Tea for Two," "Night We Called It a Day," "Blue Room," and others.

KELLY, GENE: "Song and Dance Man." MGM 30

Kelly sings and dances his way through this nostalgia-packed album with charm and talent. Included are "You're a Grand Old Flag," "Let Yourself Go," and "Yankee Doodle Boy."

KING COLE TRIO: "Lillette"—"A Woman Always Understands." Capitol 15224

A pair of slow, rhythmic ballads, with piano and guitar work between choruses.

LEE, PEGGY. "So Dear to My Heart"—"Love Your Spell Is Everywhere." Capitol 15232

"Dear to My Heart," is title song from Walt Disney production, a slow romantic tune. Reverse is old standard. Dave Barbour guitar passages provide fine backing.

"JOHNNY MERCER SINGS," Capitol CC-101

Six top Mercer song hits, including: "Strip Polka," "Candy," "On the Atchison, Topeka and the Santa Fe."

MILLS BROTHERS: "Gloria"—"I Want to Be the Only One." Decca 24509

"Gloria" tune gaining hit proportions.

McKINLEY, RAY: "What Did I do"—"The Morning Glory Road." RCA Victor 20-3124



Bandleader does vocals on first side "What Did I Do"; reverse "Morning Glory Road" is from film "If This Be My Destiny." Artie Malvin sings the song.

**MONROE, VAUGHN:** "In My Dreams"—"The Chocolate Choo-Choo." RCA Victor 20-3133

Langorous "In My Dreams" perfect for dancing; "Choo-Choo" side somewhat of a lullabye.

**MURPHY SISTERS:** "To Make a Mistake Is Human"—"Whose Heart Are You Breaking Now." Apollo 1128

A pairing of sentimental, slow, and sob-sisterish ballads.

**PASTOR, TONY:** "You Started Something"—"The Click Song." Columbia. 38297

Rosemary Clooney does first side vocal; flip is dedicated to Philadelphia night spot—with special appeal for dealers in that area.

**SCOTT, RAYMOND:** "You'd Be Surprised"—"Rub-Dub." MGM 10282

First side gets good handling, making pop novelty something to listen to; flip a bouncy instrumental.

**SHORE, DINAH:** "So Dear to My Heart"—"Lavender Blue." Columbia 32899

Both tunes from Disney film "So Dear to My Heart"—and like other Disney film-music, are delightful.

**STAFFORD, JO:** "By the Way"—"In the Still of the Night." Capitol 15218

"By the Way" from the film "When My Baby Smiles at Me." Other side is old standard ballad.

**STARR, KAY:** "You Were Only Fooling"—"A Faded Summer Love." Capitol 15226

A rhythm ballad and popular standard performed by this fast-rising girl singer. Miss Starr has been signed for some big network shows, so look for requests for her records from now on.

**THE CHARIOTEERS:** "It's Too Soon to Know"—"Until." Columbia 38329

Both songs have been getting a good all-around play. "Too Soon," a melancholy blues number with special appeal.

**THE THREE SUNS:** "I Go In When the Moon Comes Out"—"Canadian Capers." RCA Victor 20-3134

Artie Dunn does first side vocals; flip an instrumental.

**WARING, FRED:** "Winter Wonderland"—"All of a Sudden My Heart Sings"—"White Christmas"—"Twelve Days of Christmas." Decca 24501, 24500

This modern "Minstrel Man" does some smooth talking and singing on these couplings—especially for the seasonal trade. Good tie-ins with Waring personal appearance tour possible.

## Classical Works

(Continued from page 49)

**Budapest String Quartet.** Columbia MM-773

Good tie-in albums with Szell's previously released recording of the Mozart E. Flat piano quartet.

**PROKOFIEFF:** "Classical Symphony in D, Op. 25." Boston Symphony Orchestra, Serge Koussevitzky, conductor. RCA Victor DM-1241

A welcome addition to the RCA Victor catalog is this revitalized interpretation by Koussevitzky of a past best-seller.

**STOKOWSKI, LEOPOLD:** "Intermezzo, from 'Goyescas'"—"Sensemaya." RCA Victor 12-0470

Lush "Intermezzo" has been gaining new popularity among music lovers, and this version a welcome addition. Other side features a composition by Mexican Revueltas, that is relatively unfamiliar—but equally picturesque.

**WAGNER:** "Prelude and Love-Death." Chicago Symphony Orchestra. Artur Rodzinski, conductor. RCA Victor DM-1230

Wagner fans will welcome this stirring musical presentation for their collections. Rodzinski gives a symphonic touch to the music-drama.



# It is the BIGGEST-SELLING CHRISTMAS ALBUM OF ALL TIME

(and just one of DECCA'S many great ones)



**MERRY CHRISTMAS.** An all-time favorite that always leads in sales. Bing Crosby, the Andrews Sisters, Max Terr's Mixed Chorus and the Ken Darby Singers in this wonderful collection of Christmas songs, including White Christmas, Silent Night, and other favorites. 8 sides. 10 inch. No. A-550. \$3.75 (plus taxes)

THE BIGGEST-SELLING CHRISTMAS RECORDS OF ALL TIME ARE

ON

ORDER TODAY AND BE SURE OF DELIVERY!

**DECCA RECORDS**

Check your DECCA catalog to make sure your Christmas stock is complete!



# AN OPEN LETTER TO NORGE RETAILERS

Concerning the  
Appointment of  
Harry L. Spencer  
Director of  
Manufacturing



It's a real pleasure to have Harry Spencer back in the Norge organization, working again for "the best dealers in town" from coast to coast.

We at Norge know his abilities, and we know that he will put everything he has into the job of providing you with products of traditional Norge quality in the quantities you require.

During the sixteen years he was associated with Norge, consumer acceptance of Norge products increased tremendously.

There were many reasons for this, and Harry Spencer's "quality-makes-sales" philosophy was not the least of these. For he has an abiding faith in the basic Norge policy of building extra value into every product we manufacture.

For Harry Spencer, upholding Norge quality is more than a duty... it is his greatest pleasure. He will be in there pitching with the rest of the Norge team to give you the kind of merchandise that spells continued success for you.

*Howard E. Beed*  
President

SEE  
**NORGE**  
BEFORE YOU BUY

Norge Division, Borg-Warner Corporation  
Detroit 26, Michigan  
In Canada: Addison Industries, Ltd., Toronto, Ontario

A BORG-WARNER INDUSTRY



# ELECTRICAL APPLIANCES

Section of **RADIO & TELEVISION RETAILING**

## Have a **LARGE** Enough Stock of **SMALL** Appliances

**No Percentage in Being "Fresh Out of" Fast-Moving Christmas Gifts**

• There's nothing more exasperating to salesman and customer alike than the "fresh out of" situation during the peak of the Christmas gift-buying season.

Since most of the small appliances the merchant moves in great numbers during the holidays are good, year 'round staple sellers, he is wise to stock them right now in fairly large quantity. Such method will help speed sales, since products can be sold in original cartons, and will not have to be removed from holiday decorated windows or from in-store displays.

Most customers dislike having to take small appliances which have been on display, and this is particularly true in cases where such products are to serve as gifts.

But, of course, there's more to the need for adequate stock than the mere saving of time, however important a consideration that is during the rush season. There's the loss of sales to consider. All over the nation, retailers will sell millions of traffic appliances. It appears to be certain that Christmas, 1948, will be a record-breaker, all of which points up the real necessity for buying enough of each item to meet the demand.

Because of the spotty supply situation, plus what certainly will be an extremely active Christmas market, many a merchant who plans to attempt buying at the last minute, gauging *his purchases* by the demands in his own locality, will be disappointed.

Last Christmas thousands of dealers "ran out" of fast-moving items, and the same thing will happen this year to those who buy *too little* or *too late*.

There's very little time now for the buying of small products to be sold as Christmas gifts. The time for a careful examination of the inventory is at hand.

As pointed out earlier in this article, the stocking of *staple* appliances in sufficient quantities in anticipation of the Christmas business is sound merchandising. It is sound provided, of course, that the products are priced right for the community, and are of types and makes which are known to be acceptable to local customers.

The main things the dealer has to guard against in his last minute selection of Christmas merchandise is the possibility of over-stocking of specialty items which he does not normally sell at other times during the year.

Great care needs to be exercised in selecting such products and in estimating the sales potential for them. An exception, however, may be noted in the stocking of Christmas tree lights and sets. Many a dealer who does a big job each season in tree lights and sets finds that he always could have done a bigger one if he had bought in large enough quantities. But, here again, he must guard against too heavy over-buying because of the money he must tie up in sets he is forced to carry over.

Accompanying this article is a list of some small appliances to help the dealer in his last-minute buying for the folk in his community. Comment in the chart deals with availability of the merchandise, and with certain sales features.

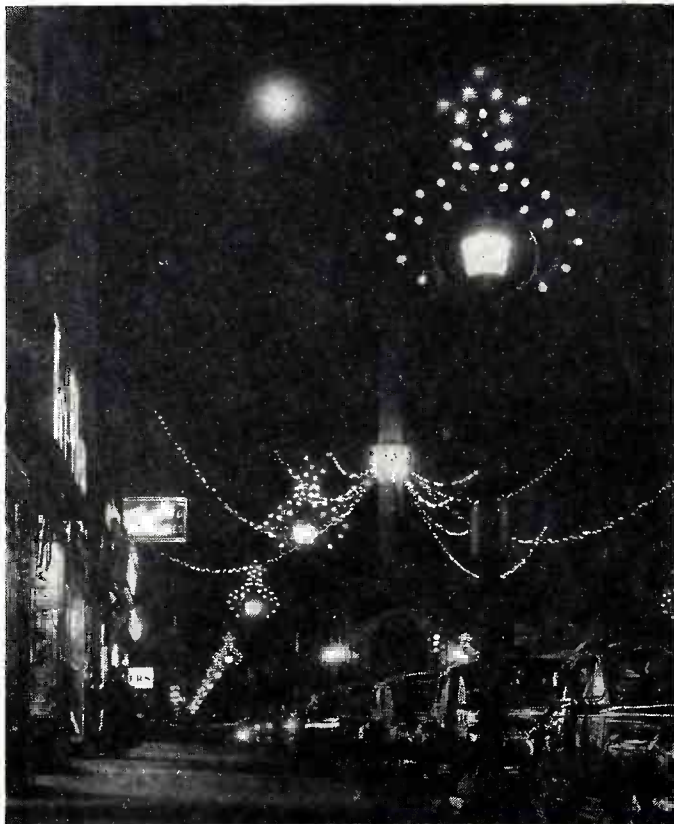

(Photo Courtesy of Allentown Call-Chronicle)

The dealer's community expects him to know its wants, and to maintain a sufficient stock during the Christmas rush.

(Listing of Small Appliances on page 104)



"NO" (BUT I REALLY MEAN "YES")

"NOTHING I LIKE BETTER THAN A GOOD ARGUMENT- I'LL STICK IT OUT A WHILE"

"I DON'T WANT ONE IF IT'S THE SAME MAKE AS THE JONES' HAVE"

"I'VE DECIDED TO BUY BUT I'LL MAKE BELIEVE I HAVEN'T"

"I DON'T LIKE THE NAME OF THE PRODUCT"

"I'VE A MIND OF MY OWN. NO SALESMAN CAN DO MY THINKING FOR ME!"

## BUYING BEHAVIORISM in the Human Customer

• The salesman who has learned a lot about human nature doesn't give up hope when an out-and-out belligerent customer attacks his every statement. Neither does such salesman consider an order as being in the bag when the prospective purchaser agrees with him at every turn.

For he has discovered that in selling, more successful transactions start with "no" than with "yes." Moreover, he has found all too many people seizing with favor upon some picayune remark he has made, the while blissfully ignoring what the salesman considers to be salient features of his presentation.

Almost any merchandiser one can mention will express himself as a firm believer in the efficacy of the satisfied-user list as a sales getter, and ninety-nine times out of a hundred it will prove to be just that. But sometimes it will kick back. While the writer was reading off a list of pleased users to the prospective purchaser of a large-cost unit, and calling the latter's atten-

tion to the fact that all resided in his immediate neighborhood, he noticed a flush of anger spread over the man's face at the mention of a certain name. "If that so-and-so has one of your products, I don't want it!" he cried, and the sale was lost.

The wise salesman has found it risky to accept the old saw, "ask for the order early and often" too literally. He knows that such technique when employed without regard to the immediate status of the transaction, has wound up more deals with a final "no" than with the desired "yes." Most buyers dislike being rushed just as much as they hate to be pushed. However, in cases where the customer is "pre-

sold" before he comes into the store he will often sign on the dotted line without wasting a minute.

While it is true that most purchasers who are more or less unfamiliar with a product need time enough in which to satisfy themselves that the choice is a wise one, every now and then a man or woman makes a split-second decision to the utter amazement of even the veteran salesman.

### Psychological Moments Help

Sometimes the "lightning" decider is wealthy, and considers the purchase too small to fiddle around about, but this is by no means true of all such people.

Now and then a salesman happens along just as one of these trigger-action buyers is in the right mood.

During a scorching hot day in late



August (just before the peak of the buying season) the writer was doing some cold canvassing on oil burners. On one call he found the man of the house resting under a tree in the yard. This in itself was a good sign, because men are the prime buyers of home heating equipment, and on daytime calls one encounters few of them.

"Believe it or not, I'm selling oil burners," the writer said, wiping the sweat from his brow.

"Believe it or not, I'll buy one from you," said the man. Just like that. Without batting an eye. Later on this man said, "It was so damn hot that day you dropped in that when you said 'oil burner' it hit me right between the eyes. You see I realized that cold weather wasn't far away, and it made me feel cool even thinking about it. I'd been considering installing automatic heat for a long time, but had never even inquired about it till you came along. You caught me in a weak moment," he concluded.

One of the prime reasons why prospects say "no" when they either mean "yes" or are on the fence, is because we inherently dislike having other people make decisions for us. In many, the thought of being swayed by a sales talk represents an affront to the intelligence; a signal of "weak-mindedness."

Other reasons why would-be buyers "stall" include those associated with the natural desire to make sure before taking the final step that the purchase is a wise one, and now and then the salesman encounters an individual who just loves to stage a delaying action. Too, there are those who are out to drive a bargain. They say "no" early and often because they hope to induce

the salesman to throw in something extra.

One of the most difficult tasks facing the salesman is to figure out how he stands at any stage of the game. If all human beings followed a similar pattern of buying behaviorism, this would be a cinch. But it just isn't that way. It is entirely possible that the prospect who commences to fidget dur-

and the one who begins to look out the window, are generally being subjected to a too-long sales talk, or may have reached a decision not to buy, and are anxious to get out of the store, or get the salesman out of the house, as the case may be.

Buyers prick up their ears at the strangest things, and react favorably or unfavorably to them. Sometimes the mention of a product name may call to mind some pleasant or unpleasant association. It may be that the maker's name is the same as that of a favorite aunt, or worse, the same as that of the old skinflint uncle who left all his dough to a pet cat.

Because so many seemingly trivial statements actually spell the difference between success and failure in selling the salesman who wanders away from strictly relevant facts often finds himself in deep water. A salesman seated in the luxurious home of an elderly prospect tried to justify the price of his product, when objection to it arose, by making a comparison between a Rolls-Royce and a famous low-priced American car. The elderly prospect assumed a somewhat grim look. "Come here," he said, "I want to show you something." Pointing out of a window he showed the salesman a brightly polished "T" model Ford!

Previous articles in this magazine have described certain "whims" and emotions which needle many persons into buying action. Sales have been made on such amazing bases as sympathy for the salesman; some appealing part of the salesman's attire, and even as a result of dreams the prospect has experienced.

(Continued on page 96)

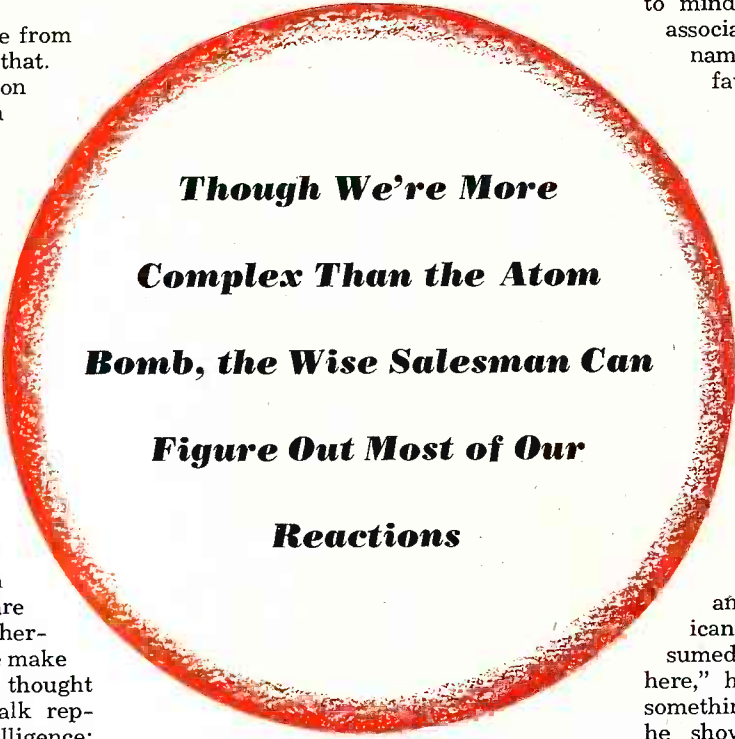

**Though We're More  
Complex Than the Atom  
Bomb, the Wise Salesman Can  
Figure Out Most of Our  
Reactions**

ing a sales presentation isn't bored at all, but is nervously approaching a decision to buy.

The individual who stares at a salesman with a dead-pan expression, may be absorbing the fine points with much greater interest than the prospective buyer who is all eyes and ears.

Fortunately, though, most "signals" are accurate. The fidgeting customer,

- Is there a **"psychological moment"** at which they ask for the order?
- Is the **"fidgeting" customer** always being bored, or is he just anxious to sign on the dotted line?
- How can the salesmen avoid taking part in **family arguments?**
- Do more successful sales transactions start **with "no" than with "yes?"**
- Is it always good policy to ask for the order **early and often?**

The foregoing are some of the points covered in this article on salesmanship.



# Electrical Home Appliances

## Westinghouse FAN

Model 10PHV, "poweraire" 10-inch, home ventilating fan, designed for installation in the wall of a kitchen or a home laundry. Fan sells for \$34.95. Features: Increased air movement, redesigned motor, three-ring air in-



jector grille. The white plastic grille snaps off for easy cleaning. Fan weighs 18 lbs. Adjustable wall sleeve of heavy sheet steel, with aluminum finish. Westinghouse Electric Corp., East Springfield, Mass.—RADIO & TELEVISION RETAILING

## Hoover VACUUM CLEANER

"Junior" model vacuum cleaner designed for smaller homes and apartments, and to serve as a supplementary cleaner to standard-size models. Unit retails for \$59.95; with cleaning tools \$10 extra. Unit weighs 13 3/4 lbs., and styled in beige and brown. Features:



foot switch behind the motor; converter attachment mechanism at the front. When the hosing is attached to the converter, the cleaner is easily moved around while the operator uses the cleaning tools. Hoover Co., North Canton, O.—RADIO & TELEVISION RETAILING

## GE CLOCKS

"Heralder" alarm clock, comes in ivory or brown plastic case. Retail for \$4.95.

"Informer" electric alarm clock, sells for \$6.95, and features soft, melodious bell alarm. Slim ivory plastic case is approximately 5 inches wide, 4 1/2 inches high and 3 inches deep. Hour and minute hands are luminous; second and alarm hands sea-green. General Electric Co., 1285 Boston Ave., Bridgeport 2, Conn.—RADIO & TELEVISION RETAILING

## Toastmaster WATER HEATER

40-gallon table-top automatic electric water heater. Designed to harmonize with modern kitchen equipment, unit is finished in baked white enamel. Top surface is finished in chip-resistant, strain-resistant white porcelain

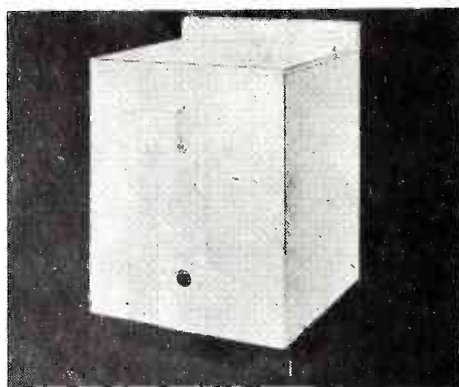

enamel. Equipped with finger-tip water temperature control. Features "life-belt" external heating element and the "ionodic" rod. Clark Div., McGraw Electric Co., 5201 W. 65 St., Chicago 38, Ill.—RADIO & TELEVISION RETAILING

## Everhot BLANKET

Model 922 electric blanket, shown, features dual comfortrol. 72 x 90 inches, available in blue or rose. Each comfortrol regulates warmth on one-half of the blanket. Comfortrols are

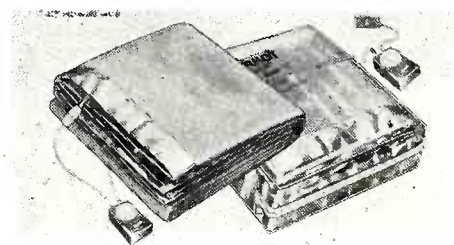

mounted on shock-proof metal chassis, encased in plastic shell, with pilot light illuminating setting. Packaged in clear plastic zipper bag.

Electric blanket, model 923 is 66 x 90 inches, has single control; model 921, is 72 x 90 inches, and has single control. Swartzbaugh Mfg. Co., Toledo 6, O.—RADIO & TELEVISION RETAILING

## Swiftly IRON

Iron weighs 2 3/4 lbs.; comes in flame proof travel case, making it useful for double duty.

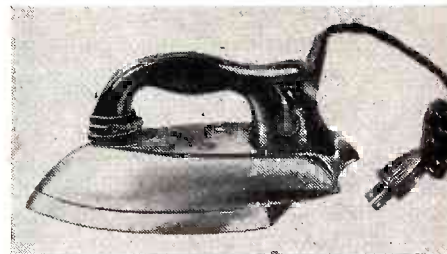

Features: automatic heat, instant heating, finger-tip control. Retail for \$7.95. Eastern Products Co., Empire State Building, New York 1, N. Y.—RADIO & TELEVISION RETAILING

## Palmaire HUMIDIFIER

Automatic humidifier is a complete unit which may be humidistatically controlled; employs rain-drop dripper system to filter, wash and moisturize air. Water is continuously re-



circulated from a three gallon reservoir by centrifugal direct-driven pump. Unit is 11 inches high, 9 1/2 inches deep, 16 inches long. Weighs 20 lbs. packed for shipment. Palmer Mfg. Corp., Phoenix, Ariz.—RADIO & TELEVISION RETAILING

## Paragon DEFROSTING CONTROL

"De-frost-it" domestic refrigerator defrosting control converts refrigerator to fully automatic nightly defrosting in less than a minute. Easy to install. Refrigerator cord plugs into the unit, and the "de-frost-it" cord into convenient receptacle. Automatic nightly defrosting does away with hand defrosting. Cycles can be set for refrigerator, taking into consideration age, climate and humidity. Refrigerator temperature is not raised excessively, and usually does not exceed thermostat setting. Unit is 3 1/2 x 2 1/4 x 5 1/2 inches, and is finished in white enamel. Lists at \$9.95. Paragon Electric Co., Two Rivers, Wis.—RADIO & TELEVISION RETAILING

# Christmas Display Ideas

● Many colorful and attention-getting displays for in-store and show window use can be made in the radio-appliance dealer's own shop. Such displays give the store the right sort of Christmas atmosphere, stimulating business, and, at the same time creating a spirit of good will. On this page are some interesting and novel pieces which can be used in the store, in show windows, and on doors and windows. The ideas were prepared by the Commercial Engineering Department of the Lamp Division of Westinghouse.

## Construction of Candles

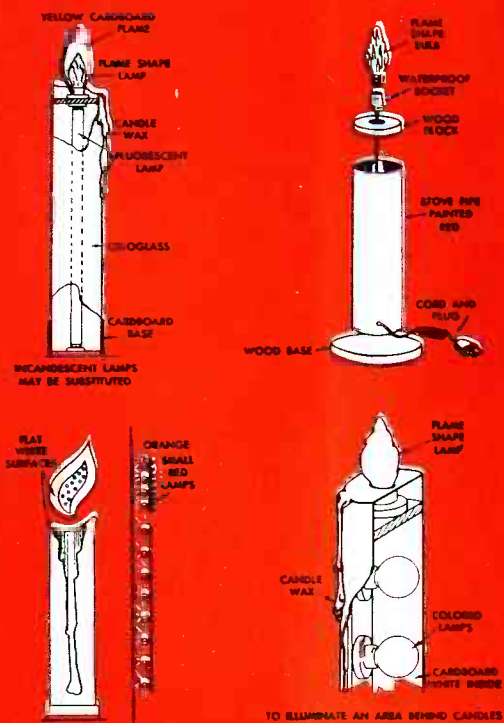

## Construction of Medallions

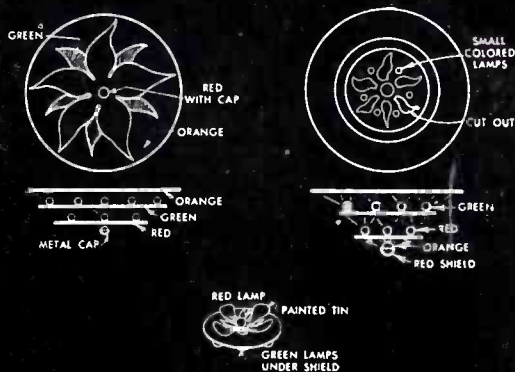

## Illuminated Designs & Letters

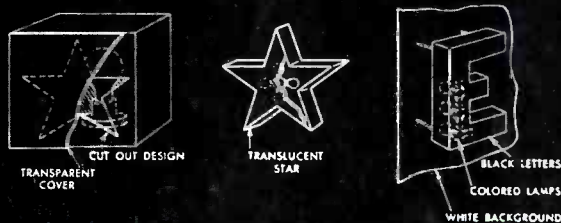

## Door or Window Decorations

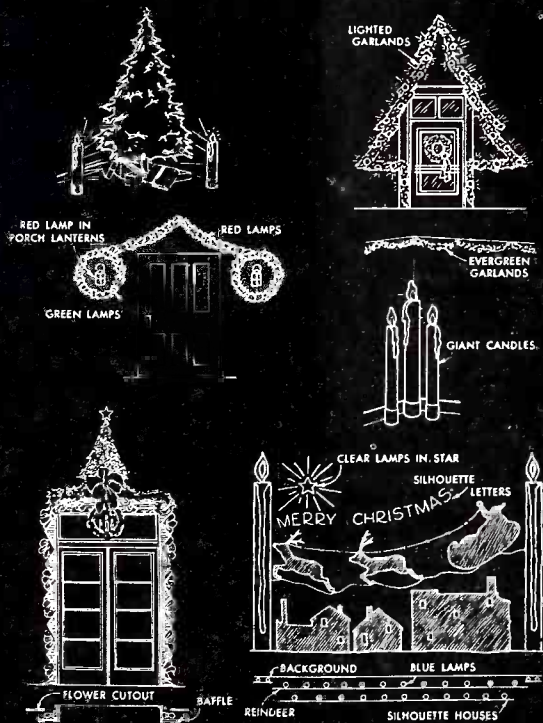

## Construction of Tree Silhouettes

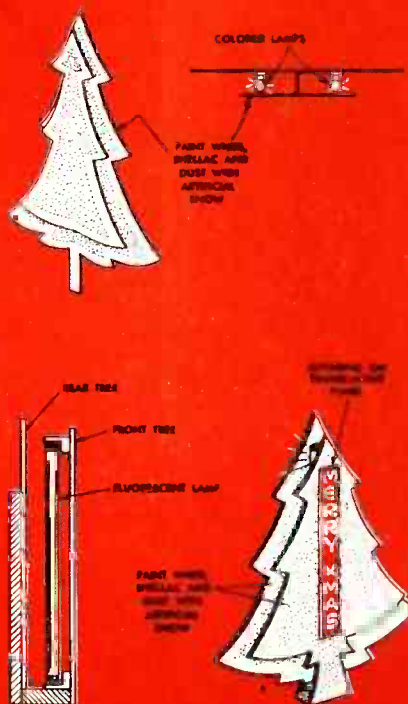





# Dishwashers Must Be SOLD!

## Specialized Effort Needed Despite Product's Great Appeal

● Dishwashing is one of the most unpleasant and boring chores the housewife is called on to perform. Almost every woman will go along with this statement, and almost every woman one questions will agree that she "wants" or "would like to have" an electric dishwasher.

But getting the prospective purchaser's name on the dotted line is something else again, for in spite of their terrific appeal, the electric dishwasher just won't sell itself. It *must be sold*. This doesn't mean that it's extremely difficult to merchandise dishwashers, but it does mean that unless the salesman uses specialized selling techniques he cannot expect to rack up a high batting average.

In instances where a merchant continues to employ half-baked demonstration set-ups and weak salesmanship the results so far as dishwasher sales are concerned will always follow a familiar pattern. He'll find that he's had a whole flock of would-be buyers in to see him and his products, but that in spite of the extreme interest on the part of the lookers the actual buyers are few and far between.

One of the deceptive things about selling dishwashers is the very great interest almost every store visitor shows in the product. This fact plus the high rate of expressed desire to own one, throws many a dealer into a dither when he finds that so many people will balk when he tries to close a sale.

One merchant reports that he has

never received a single refusal of an invitation to demonstrate this appliance, nor had he ever heard a woman say that she *did not want a dishwasher*.

The before-mentioned retailer, intrigued by the high-interest-low-sales aspects of the dishwashing machine business as he had experienced it set out to try and find some answers. First, he discovered that his "live" demonstration model was "dead" most of the time. On all too many occasions he would see one of his salesmen apologizing for the absence of hot water, or fumbling around to find an electric outlet after the machine had failed to start when the switch was turned on.

### Sales Drives Increase Volume

Next, this merchant found that no one, including himself, was doing a real selling job. When a customer would refuse to buy on the grounds that the dishwasher was "too new", and might be improved upon later, the salesman would take this lying down, instead of explaining that the dishwasher is actually an old and time-tested appliance, simple in operation, and one of the most durable of all products in this field.

After setting up the right kind of demonstration facilities, the dealer who had really *looked into* this business, began an extensive and highly effective sales drive on dishwashers, resulting in sharply increased volume, much of it coming from customer-recommended prospects.

Sales features being stressed in the successful merchandising of dishwashers include such angles as sanitation, elimination of "dishpan" hands, labor-saving, low initial cost, long life of equipment, low cost of operation, reduction in breakage of dishes and glassware, simplicity of operation, etc.

Since dishwashing is the most disagreeable task in the kitchen, and certainly the most obvious one, any woman will agree with the salesman who tells her that no *modern kitchen* is complete unless it is equipped with a dishwashing machine.

An important point to remember in selling dishwashers is that the servant-staffed home is just as much in need of this product as is the one where the woman of the house does her own work. In such a tight labor market modern appliances, including the dishwasher, can often be used to attract and hold suitable help.

For the woman who does her own work, the dishwasher can prove to be the great emancipator. It can remove the bugaboo of the thoughts of that big stack of dirty dishes waiting in the kitchen to spoil all the fun in having dinner parties. It will provide a cleaner, safer method of dishwashing, and it will save time, water, money and patience. In addition to its functional features, the modern electrical dishwasher will enhance the appearance of the kitchen.

There's real money to be made in selling electrical dishwashers for the dealer who is willing to do a first-rate sales and demonstration job in selling these great "naturals" for the modern

(Continued on page 96)

Rheem  
brings you the "New Look"  
in Water Heaters!



**Everything about it  
means profit for you!**

Streamlining is part of the Rheem "Design for Better Business." That is Rheem's program . . . better business and more profit for the plumber-dealer. Good looks in a water heater can help you sell, so we make our Royal Deluxe the smartest looking heater in America.

Part of the Rheem "Design for Better Business" you'll find underneath the heater's beautiful exterior. Sound engineering, new methods. The inner tank is processed by a *patented*\* Rheem automatic galvanizing method. Dow Magnesium Anode further prevents corrosion. Fiberglas Insulation. Grayson Control. Guaranteed by Good Housekeeping as well as by Rheem.

Easy installation, quick inspection and adjustment, fast factory shipments to your wholesaler . . . all are part of Rheem's "Design for Better Business."

**"DESIGN FOR BETTER BUSINESS"  
spells profits, too!**

Rheem brings you the most progressive program in the industry. It's aimed at moving heaters off your show floor. It includes every form of sales promotion, backed by national advertising. Rheem dealers get thousands of live leads from coupons every month.

Ask your wholesale supplier for RHEEM'S  
"Design for Better Business" \*Pat. No. 2444838

**RHEEM MANUFACTURING COMPANY**

570 Lexington Ave., New York 22, N. Y.

**AUTOMATIC WATER HEATERS  
ALL SIZES FOR ALL FUELS**

**SOFT WATER APPLIANCES  
HEATING APPLIANCES**

**DOMESTIC STORAGE TANKS**

Foreign affiliated companies in Brisbane, Melbourne, Sydney, Amsterdam, Rio de Janeiro, Singapore, and Hamilton, Canada.

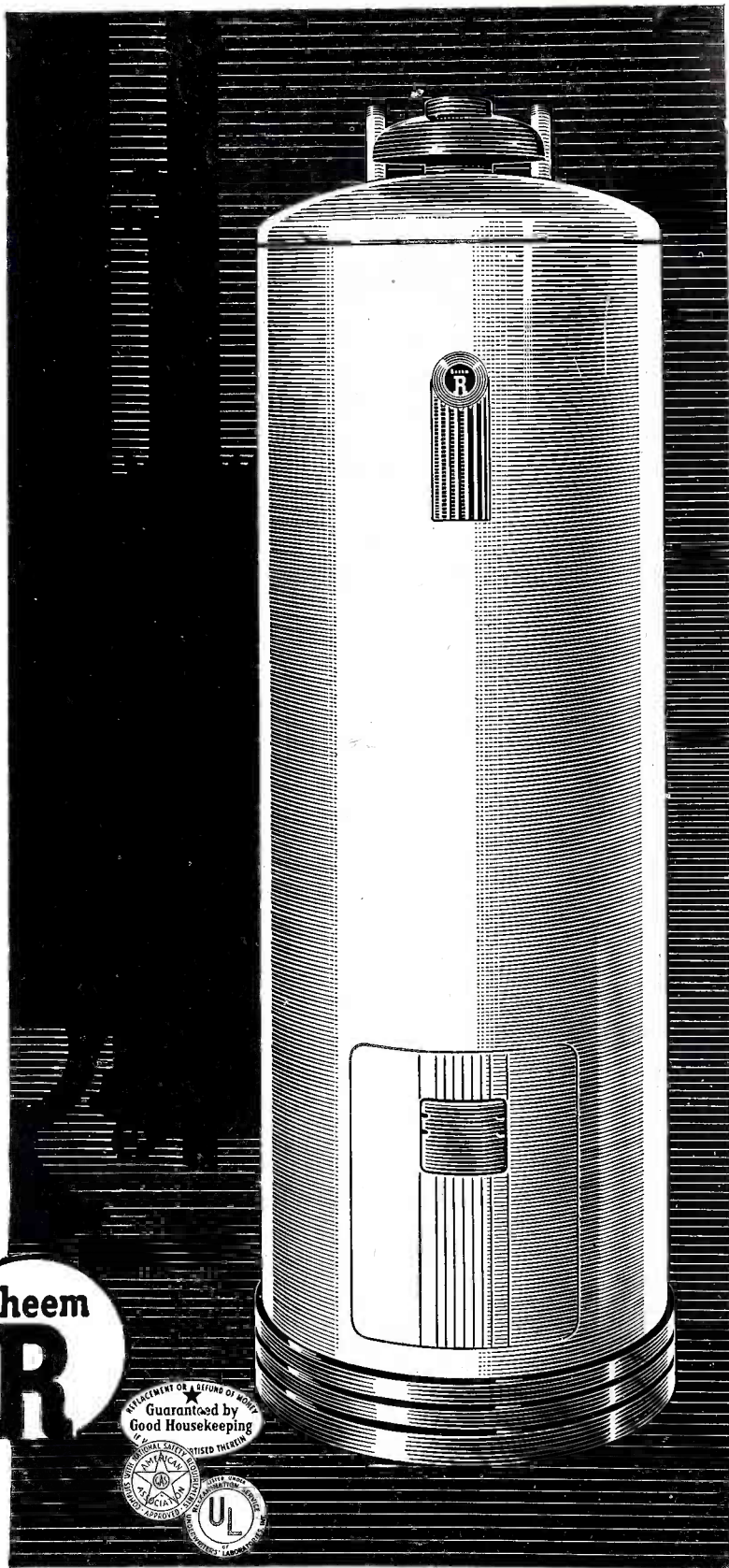



# FOR FAST TURNOVER

YOU HAVE NOT JUST ONE...NOT TWO...BUT  
**SIX SENSATIONAL SALES-CLINCHERS**  
IN UNIVERSAL'S No. 7808  
**"SPEEDLINER" ELECTRIC RANGE**

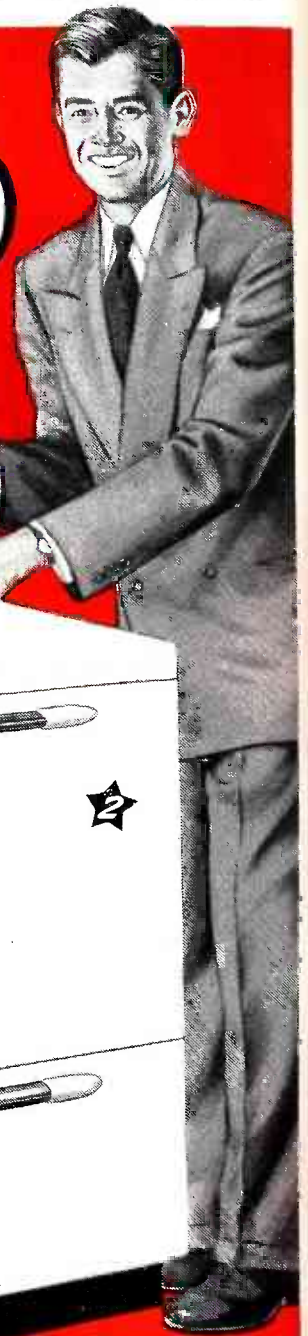

**1 FASTEST COOKING SPEED**  
and better control.  
With new Super-Heat,  
easy-to-clean, Monotube  
Thrift Units.

**2 LARGE TRU-BAKE OVEN**  
with new Push-Button  
Automatic Pre-Heat  
Cut-Out and Automatic  
Recessed Flood Light.

**3 THERMO-CHEF AUXILIARY  
OVEN** with automatic  
time-and-temperature  
control for baking,  
roasting and stewing.

**4 AMAZING  
AUTOMATIC COOK**  
for "absentee"  
cooking and baking.

**5 OVERSIZE, THERMOSTAT-  
CONTROLLED WARMING  
CABINET**—the only cabinet  
large enough for both  
food and dishes.

**6 TEL-A-SWITCH PANEL  
WITH SIGNALITES**  
simplifies selection  
of proper control,  
avoids wasted current.

## FOR QUICKER TURNOVER—TURN TO UNIVERSAL

*For hard-hitting, competitive selling,* you've never had an electric range in your store that gives you so much "reserve" selling power, such a wealth of sales ammunition. With just three sensational features . . . its super-fast "Super-Heat" Units, its time-and-temperature-controlled "Thermo-Chef" and

large "Tru-Bake" Oven . . . you'll have competition on the run. Then, you can really "pile up the score" with one sensational feature after another. Push this sales-making Universal Speedliner Electric Range—in your ads, in your windows, on your sales floor—and "out-feature" your competition.

**IT'S THE NATION'S FASTEST RANGE!**



# ... FEATURES TALK!

## IN RANGES...IN WATER HEATERS FOR "PLUS" FEATURES IT'S UNIVERSAL ALL THE WAY!

MODEL FOR MODEL, you're way out in front with Universal. In every range, from the sensational Bantam "Plug-In" Range right through to the big Universal de luxe Two-Oven Range, you have more quality, more value, more

features to talk about. You have the one line and the only line that enables you to sell *all of the market*... nine feature-packed ranges that meet the demands of every customer, every home, every pocketbook!

UNIVERSAL BANTAM  
PLUG-IN RANGE  
No. 6615

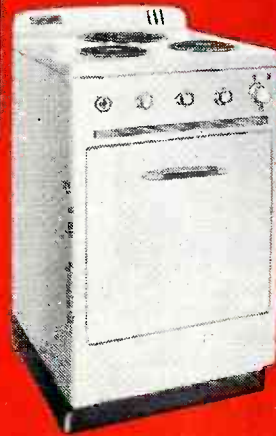

UNIVERSAL SPEEDLINER  
APARTMENT RANGE  
No. 6801



UNIVERSAL SPEEDLINER  
HEATER END RANGE  
No. 8801



UNIVERSAL SPEEDLINER  
TWO-OVEN RANGE  
No. 7809

### ... You'll Be Way Ahead In Selling Power, Too, With AMERICA'S MOST COMPLETE WATER HEATER LINE!

PROVE IT TO YOURSELF. Compare Universal's Automatic Electric Water Heater Line with any line on the market. Compare it for length. You have Round and Square types, High Boy and Table Top Models, Capacities from 20 to 86 gallons. You really have the features, too... rustproof,

streamlined cabinets... 300 lb. test Monel Metal tanks... cost-saving heat trap... immersion type Super-Heat Elements... cold water baffle plate... and for longer life, Universal Water Heaters equipped with the *sensational new rust-preventing Magnesium Anodic Rod* carry a 10 year Warranty.



### ... And Universal backs you year 'round with HARD-HITTING CAMPAIGNS AND PROMOTION THAT REALLY WORKS!

- Big, Attention-Pulling Ads in Top National Magazines
- Broad, Strong Newspaper Coverage
- Consistent, Penetrating Radio Advertising
- Complete, Full-Powered Point-of-Sale Support

# UNIVERSAL

LANDERS, FRARY & CLARK • NEW BRITAIN, CONN.



# New Appliance Products

## Cory BREWING SYSTEM

Push-button automatic coffee brewing system, model C500-A provides constant control over the variable factors in coffee brewing, and thereby assures uniformity of brew. The unit controls coffee measurement by providing a dispenser which measures coffee quantity automatically; controls water measurement by a

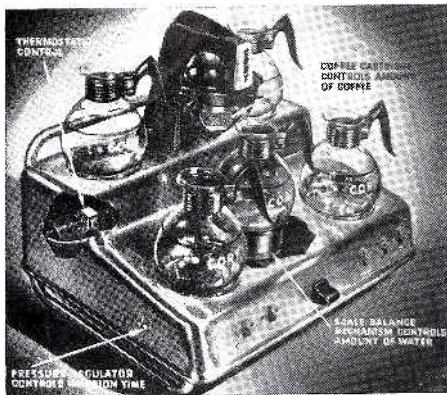

fixed orifice and by a balance-weight scale cut-off mechanism; controls water temperature by a specially adapted thermostatic control, assuring the best temperature range; controls infusion time by a pressure regulating device that governs the rate of flow of the water. Cory Corp., 221 North La Salle St., Chicago 1, Ill.—RADIO & TELEVISION RETAILING

## International Register RADIO CLOCK TIMER

RC-1021 timer for radios; an "on" and "off" timer. When radio is off, can be set to turn on at a later time; when radio is on,

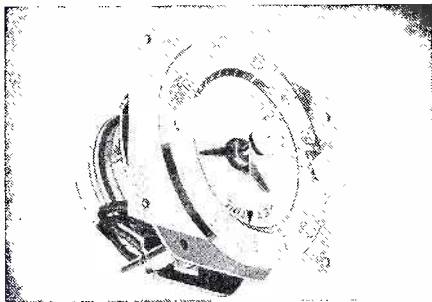

timer can be set to turn the unit off. International Register Co., 2614 W. Washington Blvd., Chicago 12, Ill.—RADIO & TELEVISION RETAILING

## Tri-Boro COOLER BAR

Electric cooler bar, "The Executive" combination bar-beverage cooler. Cooling department has storage capacity of over 4 cu. ft. Accommodates all size bottles. Lined with stainless steel; freezes and stores more than 100 ice cubes. Provides storage space, rack for glasses, and serving tray which slides forward. Cabinets are available in mahogany, walnut or blond wood. Unit is 40 inches high, 40½ inches wide. Retail for \$495.00. Tri-Boro Enterprises, Inc., 102-15 44 Ave., Corona, N. Y.—RADIO & TELEVISION RETAILING

## Tracy SINK-CABINET UNIT

Deluxe porcelain sink and cabinet unit, features: 54-inch double drainboard sink top in white porcelain enamel; complete with

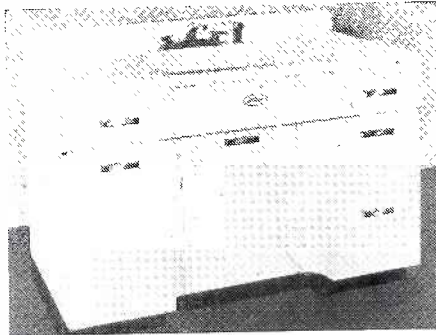

steel undersink cabinet; recessed center section; stainless steel handles; insulated doors and drawers; extra storage space. Other units available to provide complete kitchens for any desired arrangements. Suggested retail price for the sink and cabinet combination is \$149.50. Tracy Mfg. Co., Pittsburgh, Pa.—

## Mix-Whip MIXER

Unit whips cream, beats eggs, mixes batters, malteds, etc. Sells for \$8.95. Motor is encased in white enamel case, has self-lubricating

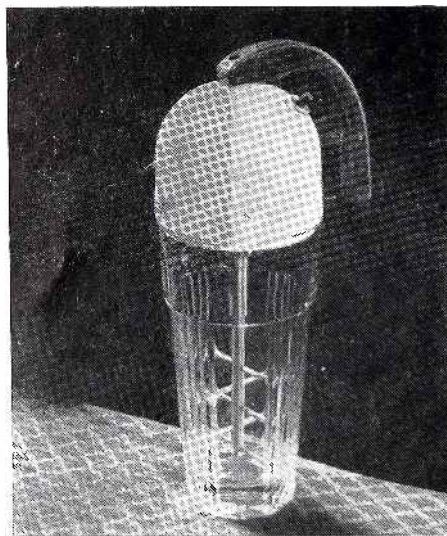

bronze bearings and built-in oil reservoirs. Agitator rod is 5/16 inch stainless steel and rinses clean easily and quickly. Electro Engineering Products Co., Inc., 4824 W. Kinzie St., Chicago 44, Ill.—RADIO & TELEVISION RETAILING

## Tele-Heat ELECTRIC HOTPLATES

Model R-46-A is a 6-heat, 2-burner stove; has pilot light assembly controlled with switches. Length 18 inches, width 9 inches, height 5 inches. Retail at \$13.00. Model R-3-A is a single burner, 3-heat unit, with rotary switch. 9 inches long, and 9 inches high. Retail price is \$7.50. All models finished in baked white enamel. Standard-Hygrade Electric Co., Inc., 1372-39 St., Brooklyn 18, N. Y.—RADIO & TELEVISION RETAILING

## Mitchell SUN RAY LAMP

Sun or heat unit, "Sun Ray" model 1914, made entirely of metal, finished in white baked enamel. The lamp uses either an RS sun lamp with built-in transformer or an R-40 infra red heating and drying lamp.

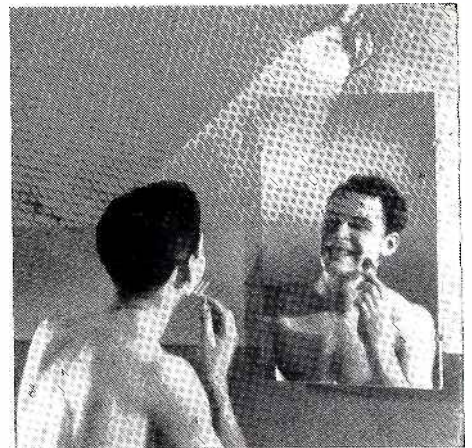

Lightweight and portable, can be slipped onto a hook over bathroom mirror. Has adjustable friction swivel. Comes with built-in switch, 6 ft. cord and plug. Mitchell Mfg. Co., 2525 Clybourn Ave., Chicago 14, Ill.—RADIO & TELEVISION RETAILING

## Remington SHAVER

Electric shaver, "Contour 6" features: three Blue Streak twin shaving heads mounted on a contour plate. Efficiency of the Blue Streak head improved by increased cutting surface and by submitting inner cutters to "Diamond-



Honing" process for keener edges. Improved motor, operates quietly. Modern plastic case, trimmed with chrome side strips and matching chrome hair pockets houses the shaver. Presentation case has antique tan leather color. Remington Rand, Inc., Electric Shaver Div., Bridgeport, Conn.—RADIO & TELEVISION RETAILING

Radio New Products  
Elsewhere in Issue



# LAST-MINUTE TIPS ON TRAFFIC APPLIANCES!



Looks like a big Xmas-gift rush ahead -- the biggest since the war. Pay-checks are high. More merchandise is available.

We said "more" merchandise. **That doesn't mean enough for everybody.** SOME dealers are going to get caught with their plans down!

So, tip number 1 is: **Get your orders in now** for everything you think you'll need -- **especially traffic appliances**, because this is the biggest season for them.

Tip number 2: **Place your orders with GRAYBAR.** The appliances that will sell most between now and Christmas are the ones for which there's the biggest **desire**. Desire created by quality plus powerful advertising -- which means the **top lines**. They're the lines Graybar distributes.

Tip number 3: **Use the help of your local Graybar Appliance Specialist** in balancing your inventory, coaching your personnel, and putting extra "juice" into your displays and promotion.



NATIONALLY ADVERTISED  
APPLIANCES AND RADIOS

*recommended by*  
**Graybar**

CALL THE GRAYBAR OFFICE NEAR YOU  
OR USE THE COUPON!

4883

Appliance Department  
Graybar Electric Company, Inc.  
Graybar Building, New York 17, New York

Tell me what lines you distribute in my community. I am interested especially in:

major appliances     traffic appliances     radios

Name \_\_\_\_\_

Store \_\_\_\_\_

Address \_\_\_\_\_

City \_\_\_\_\_ Zone \_\_\_\_\_ State \_\_\_\_\_



Merry  
Christmas

with

**AEROLUX  
FLOWERLITES**



**Beautiful  
and Original**

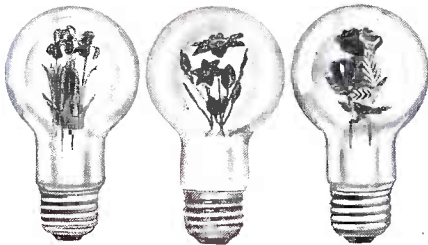

**Smartest Gift  
of the Year**



**You'll Love Them  
EASY TO SELL TOO!**



Write for  
Catalogue

**AEROLUX  
LIGHT CORP.**  
653 — 11th AVE.  
NEW YORK

**New Hotpoint Range Produced in Chicago Plant**



The new Hotpoint push button double oven electric range, model RD-5, shown, is being shipped to dealers from the world's largest electric range plant, which occupies more than one million feet of manufacturing space. The push button electric range shown has two ovens, each with its own temperature control and set of push buttons, "sealed heat", and interchangeable shelves for flexible arrangement of foods. (See article below.)

James J. Nance, president, Hotpoint, Inc., presided at the Chicago dedication ceremonies of the world's largest electric range plant, incorporating revolutionary mass production techniques, and occupying one million square feet of manufacturing space. Mr. Nance said that the new plant has a rated capacity of 600 thousand ranges a year. The beginning of formal production in the plant marks the completion of "the greater Hotpoint program," which required an investment of more than \$20 million in new manufacturing facilities.

All machinery is single-purpose type designed to speed production in assembly line operations. The new plant is a model of streamlined production flow with seven miles of conveyors which channel range sub-assemblies and parts to four main range assembly lines. Finished ranges, after passing inspection stations on the final assembly lines, are lifted by elevator to overhead conveyors, and then proceed to the warehouse for crating and shipping.

**Rheem Promotion Package**

A sales promotion package planned to help dealers cash in on its national consumer advertising campaign built around the new Rheem oil and gas console heaters, has been prepared by Rheem Mfg. Co. The "Rheem console heat" sizzling sales package comes in a red accordion-type folder. Pictures of oil and gas consoles alternate on the six inside surfaces of the folder. It is equipped with pockets containing complete product literature, and information about cooperative and local advertising campaigns.

**Hamilton Dryer Feature**

Hamilton automatic clothes dryers are now equipped with a germicidal sanitizing light, according to an announcement by Chas. H. Rippe, sales director, home appliance division, Hamilton Manufacturing Co., Two Rivers, Wis.

**GE Miniature Appliances**

A complete set of miniature plastic appliances is being made available by the General Electric Company to assist retailers, power companies, architects, builders, financial institutions and schools in planning kitchens and laundries.

Called the Appliance set, the kit consists of 77 major and traffic appliances, cabinets and kitchen furnishings scaled one inch to the foot and made of light, durable polystyrene by the G-E plastics division. Also included are four metal walls, four windows, two doors, a 16-page instruction book and a specially scaled measuring ruler.

**Westinghouse Factory Reps**

Frank J. Van Pelt has been appointed factory representative in the Central district for household refrigerator sales of the Westinghouse Electric Appliance Division, Mansfield, Ohio. Joseph C. McCarron has been appointed factory representative for laundry equipment in the same district.

**Wilson to Assist Sayre**

Filling a new position at Bendix Home Appliances, Inc., South Bend, Ind., Fred D. Wilson has assumed his duties as assistant to the president, Judson S. Sayre. Mr. Wilson has been vice-president in charge of operations for Radio Corporation of America, RCA Victor division, since April, 1947.

**Lewyt Features New Nozzle**

The Lewyt Corp., Brooklyn, N. Y., has staged a series of dealer meetings in cooperation with distributors, introducing the new Lewyt No. 80 carpet nozzle, and the latest advertising and merchandising programs. Distributors gave prepared talks, were provided with props, and a movie showing the operation of the new No. 80 carpet nozzle.



# SERVICE & SOUND

## Section of RADIO & TELEVISION RETAILING

# About the New LP Records

### Information on Conversion of Units. Data on Motors, Pickups and Phonograph Needles

• The recent appearance of Columbia Long-Playing microgroove records naturally gives rise to several questions in the minds of the dealer and his customer as to the utilization of these records on existing playback equipment. The question, "How can present equipment be modified?" is best answered

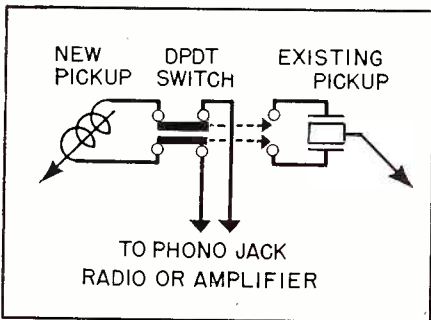

Fig. 1

by examining the requirements of the new record.

The problem was not merely to get a little additional playing time on the new records, but to get enough time to permit long musical pieces such as symphonies to be pressed entirely on one record. This involved the number of grooves as well as the speed: grooves were increased from the average 90 per inch to from 224 to 300 per inch, and speed was slowed down from 78 RPM to 33 $\frac{1}{3}$ . The groove width, naturally, had to be made smaller.

Thus we find that the requirements are: The turntable speed must be 33-1/3 RPM; the stylus or needle point must have a tip radius of .001 inches (1/3 the size of previous needles); and the pressure of the needle on the record, in order to track such a tiny groove, must be 6-7 grams (about 1/5 ounce—see chart fig. 2).

First in importance because it presents the greatest problem in conversion is the needle pressure. Existing players are designed for a particular pressure, usually between 3/4 and 2 ounces. While the pressure on some is adjustable, the limit is usually reached long before 6 grams.

A few very light pickups were already on the market before the appearance of microgroove records (around 1/2 ounce) but of 15 popular types checked, ten were 1 ounce or more, while the other five were 3/4 ounce. These cannot be utilized by inserting a new needle. Special tone arms featuring the required light weight, non-resonance, and proper stylus size are on the market and can be installed in place of existing pickups where only microgroove records will be played, or on the opposite side of the turntable where both 78 and 33-1/3 RPM types will be used. Since the needle for long-playing records is too small for regular records, it will be necessary to have both types.

An additional new product which can

1 gram (metric)	— .035 oz.
	(av.)
6 grams	— .21 oz.
	(approx. 1/5)
7 grams	— .245 oz.
	(approx. 1/4)
15 grams	— .525 oz.
	(approx. 1/2)
22 grams	— .77 oz.
	(approx. 3/4)
28.35 grams	— One ounce

Fig. 2

be utilized in this case, however, is a cartridge with two needles. These are on the market and are also being used on the new two speed changers.

Since it is unlikely that an existing cartridge can be used, the question of substituting the new smaller needle does not arise. Separate needles will be available, too, however, for replacement, including some with jewel tips.

The second problem involved is the motor speed. A few record players in

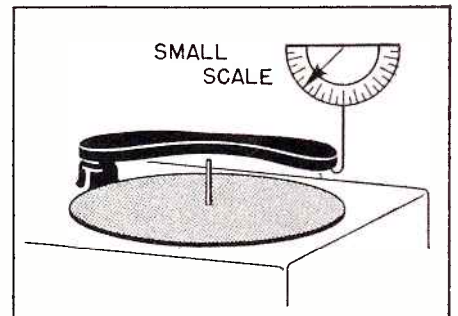

Fig. 3

homes now have two speed motors. The tone arm mentioned above with the special cartridge and needle can be added to this type and the job is done. Most players, however, have only 78 RPM motors. Single record players can be modified by installing a 33-1/3 RPM motor or a dual speed motor. Both of these types are on the market now. It is not advisable to change the motor on a record changer because of the difficulty of adapting it to the changer mechanism, fitting it into the available space, etc. In this case, single record players and changers are available which may be used in addition to present equipment (suggest installing a selector switch see fig. 1). Dual speed changers are also available, and may be suggested for replacing the entire changer used at present.

Where it is desired to know the pres-

(Continued on page 95)



# Technical New Products

## Eastern TV ANTENNA

The "Double U" antenna has been designed to improve TV reception in fringe areas without a high tower by a combination of two dipoles with two director elements and three reflector elements to produce high gain. Parasitic elements are cut to several different

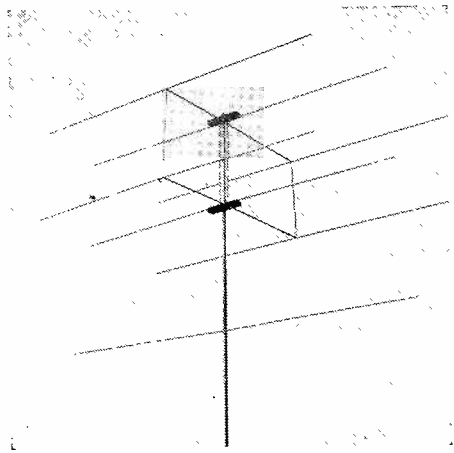

lengths appropriate to TV channels operating in various geographical areas. Impedance is 300 ohms for use with twin-lead ribbon, but 72 ohm output will be available for use with coax. The antenna is said to feature ease of assembly and erection. Eastern Transformer Co., Inc., New York City.—RADIO & TELEVISION RETAILING

## Ward TV ANTENNA

Field tests of the new TVH-9 have demonstrated superior gain characteristics on all channels, according to the manufacturer. This

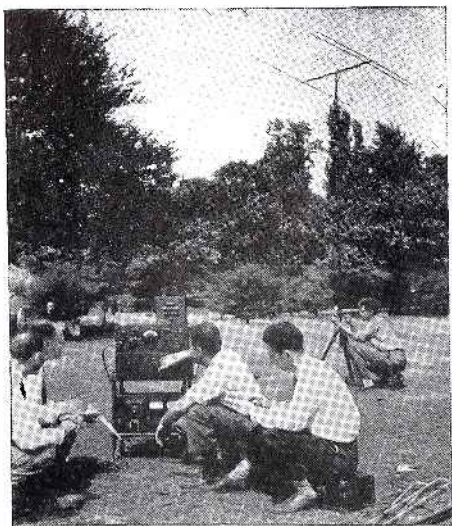

model is designed with a low-band folded dipole and reflector, and a high-band folded dipole and reflector on the same mast. Ward Products Corp., 1523 E. 45th St., Cleveland 3.—RADIO & TELEVISION RETAILING

## Ebert MERCURY RELAY

Especially adaptable to flicker-proof performance in sign-flashing operations, this new relay features silent operation on loads up

to 35 amperes. Claimed dust and moisture proof, and designed for easy installation, the relay will operate on  $\frac{1}{2}$  wave unfiltered current. Ebert Engineering & Mfg. Co., Hollis, L. I., N. Y.—RADIO & TELEVISION RETAILING

## VEE-D-X TV ANTENNA

The "Sky Monitor" is a low-cost, broad-band antenna for use in prime and near fringe TV areas, with good performance claimed on all channels. A tunable "Q" section facilitates

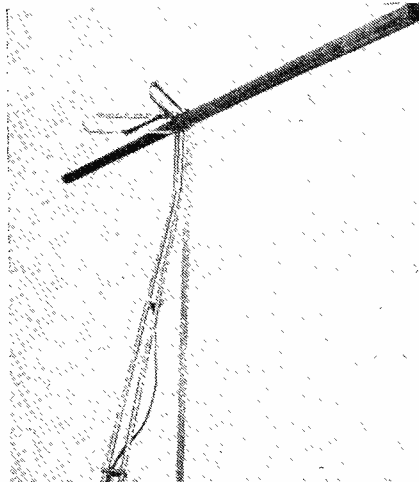

matching the line impedance, and provision is made for orientation of either the low-band straight dipole or the high-band folded "V." La Pointe Plascomold Corp., Unionville, Conn.—RADIO & TELEVISION RETAILING

## University POWER MIKE

This unusual microphone will, when supplied by a 6-volt battery, deliver  $1\frac{1}{2}$  watts of audio power to a loudspeaker without the aid of any electronic amplification. Frequency response is 300-5000 cps, and maximum transfer of power is effected to a speaker impedance of 2 ohms. The unit is capable of combination

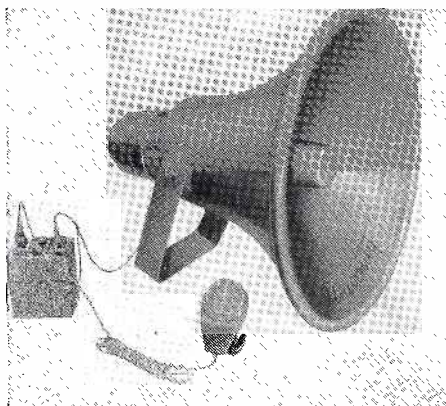

with a loudspeaker in several forms and is especially adapted to indoor and outdoor paging, political rallies, police traffic control, coaching, etc. Combination of three power mikes, one as a microphone and two as line amplifiers, results in a "tubeless" power amplifier of 20 watts output. University Loudspeakers, Inc., White Plains, N. Y.—RADIO & TELEVISION RETAILING

## Raytheon TUBE

The type CK5702/CK605CX is a subminiature tube with the same electrical characteristics as the 6AK5 and is designed to miniaturize equipment utilizing the larger tube.

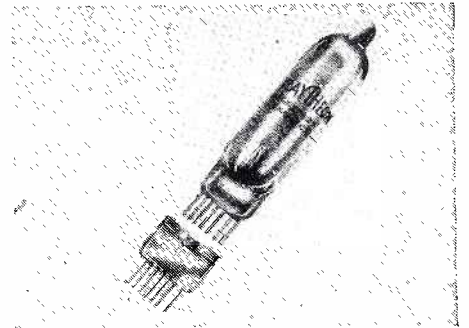

The two types are identical except for a slight difference in heater current. Raytheon Mfg. Co., Newton, Mass.—RADIO & TELEVISION RETAILING

## RCA TUBES

The 2K26 and 2K56 are klystron oscillators of the single resonator, reflex type intended primarily for use as local oscillators in microwave receivers. Frequency ranges are 6250-7060 mc

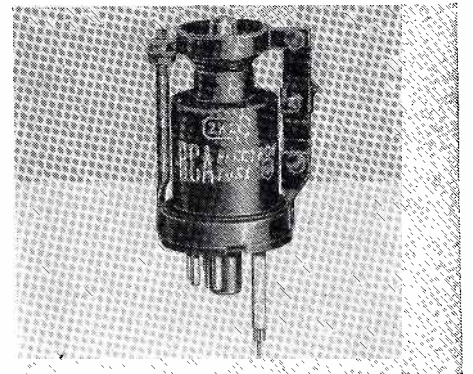

and 3840-4460 mc respectively. Both tubes have a useful power output in the order of 100 milliwatts. Tube Department, RCA, Harrison, N. J.—RADIO & TELEVISION RETAILING

## Struthers-Dunn RELAY

This DPDT control relay features small size and operation from either AC, DC or half-wave rectified AC. Rated at 2 amperes on 115 v. AC, the open type relay weighs only 2 ounces. Facilities for enclosure and for hermetic sealing are available. Struthers-Dunn Inc., Philadelphia.—RADIO & TELEVISION RETAILING

## Oil burner CONTROL

Fireye systems FF-2 and FF-6 afford flame failure safety control for oil burners by electronic means. The two systems provide adaptability to oil burners which use gas as an alternate fuel, and gas burners which use oil as an alternate fuel. Systems provide for automatic shut-off of fuel system when flame fails. Combustion Control Corp., Cambridge, Mass.—RADIO & TELEVISION RETAILING



# Another **UNIVERSAL** first!

**NEW SIMPLIFIED ALL-CHANNEL ANTENNA  
... CAN BE INSTALLED IN MINUTES!**

Eliminate all your installation headaches with this revolutionary ALL-CHANNEL UNIVERSAL ANTENNA. You can make any array for both Low Frequency and High Frequency reception by a simple twist-of-the-wrist, because of UNIVERSAL'S U-Bolt and Aluminum Block construction. The U-Bolt and Aluminum Block hooks into position instantly! It makes possible full 360° orientation and strengthens the image in "fringe" areas. The UNIVERSAL U-Bolt TV Antenna is a must for happier television reception — and a profit-maker for you!

**Write for prices and descriptive literature.  
DISTRIBUTORS INVITED  
TERRITORIES NOW BEING ALLOTTED**

**NO LOOSE  
HARDWARE**

**NO  
SPECIAL TOOLS**

**NO  
DRILLING**

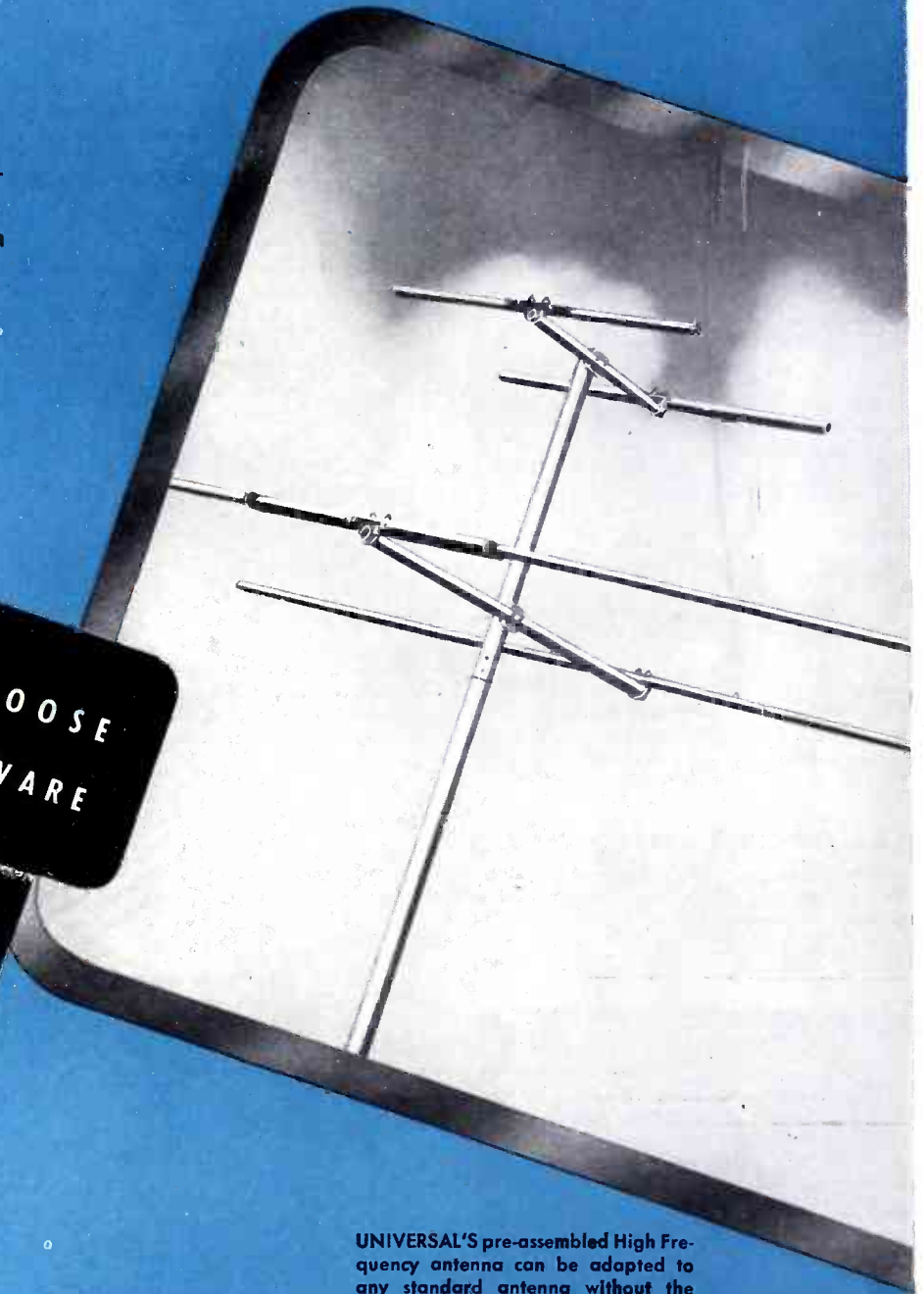

UNIVERSAL'S pre-assembled High Frequency antenna can be adapted to any standard antenna without the use of special tools.

**VERI-BEST TELEVISION PRODUCTS, INC. · 8-10 FORREST ST., BROOKLYN, N. Y.**

**Manufacturers of the UNIVERSAL Antenna**



# New Aids to Easier Servicing

## Ohmite RESISTOR CABINET

The five-drawer plastic cabinet is stocked with 125 resistors in 40 resistance ranges from 10 ohms to 10 megohms, with resistance

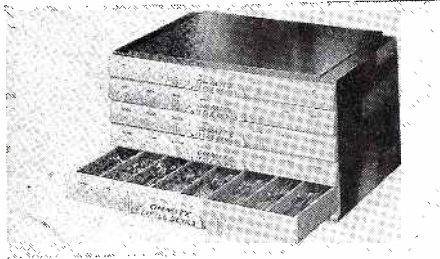

values printed in front of each compartment. The complete package is priced at \$10. Ohmite Mfg. Co., 4835 Flournoy St., Chicago, Ill.—RADIO & TELEVISION RETAILING

## Hickok TUBE TESTER

The 533 DM is a dynamic mutual conductance tester with a 9" illuminated scale so customers may read the condition of their tubes in terms of "Replace, Doubtful, Good," while micromho scales are provided for the

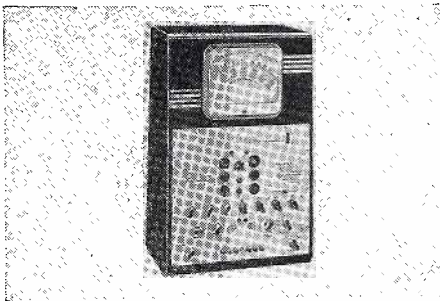

servicer. A roll chart, and a variety of tube bases and selector switches facilitate operation. Hickok Electrical Instrument Co., 10523 Dupont Ave., Cleveland 8, Ohio.—RADIO & TELEVISION RETAILING

## Vaco REVERSIBLE SCREWDRIVER

Accommodating both slotted and Phillips head screws, the Duplex Reversible screwdriver is designed to save time in a wide variety of radio and appliance servicing. The sturdy Amberly handle is provided with a reversible



blade which is easily removable but stays in place firmly when in use. Available in two sizes: No. 1 Phillips point and 3/16" regular at 85 cents, and No. 2 Phillips point and 1/4" regular @ \$1.00. Vaco Products Co., Chicago.—RADIO & TELEVISION RETAILING

## Precision HIGH VOLTAGE PROBE

The Series TV high voltage test probe provides a safe means of making direct readings of TV 2nd anode voltages up to 30kv DC by connecting to existing test equipment. Multi-

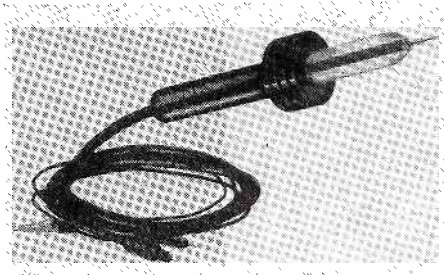

plier cartridges of different values are available to match the probe to various test sets. Precision Apparatus Co., Inc., Elmhurst, L. I., N. Y.—RADIO & TELEVISION RETAILING

## Philco METAL CUTTER

Designed especially for the installation of rear seat speakers for auto radios, the Philco metal cutter can be used with a 1/4" chuck

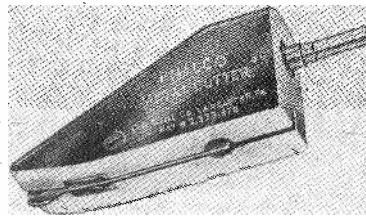

electric drill for cutting circles or curves in metal, wood and plastics up to .04 inches thick. Philco Corp. Accessory division, Philadelphia.—RADIO & TELEVISION RETAILING

## Metalace CHIMNEY MOUNT

Mounting of 3/4 to 2 inch TV, FM or ham antenna masts on chimneys is provided by this steel antenna base, which is clamped in

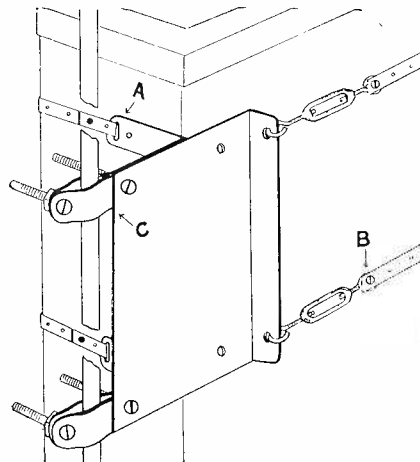

place with steel strap and turnbuckles. Vise-type clamps on the plate hold the mast. The complete mount lists at \$7.50. Metalace Corp., 2101 Grand Concourse, Bronx, N. Y.—RADIO & TELEVISION RETAILING

## Wilton POWRARM

Powrarms assure speed and convenience to benchwork by firmly holding work in place while at the same time permitting the work to be tilted at any desired angle. Two models make the powrarm adaptable to a wide

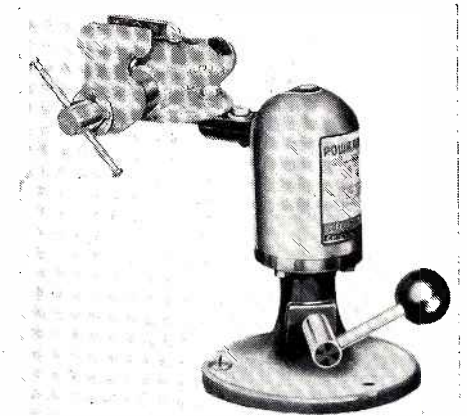

variety of machine shop, factory and service bench work. Powrarms can be conveniently fitted to radio and phonograph repair work. Wilton Tool Mfg. Co., Chicago.—RADIO & TELEVISION RETAILING

## Ad-a-Vox SPEAKER

An auxiliary speaker with its own cabinet and volume control for easy connection to existing sound equipment, the Ad-a-vox is designed to provide additional outlets for radio, TV, or phono equipment in bars, restaurants, clubs, hospitals and homes. The 4"

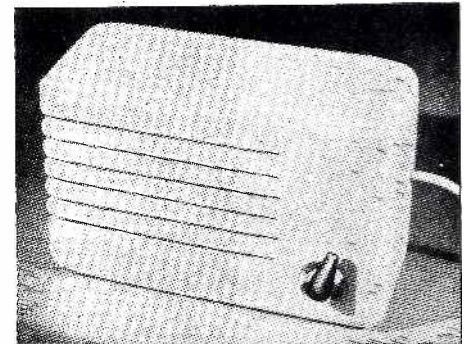

PM speaker is enclosed in an aluminum case available in seven colors, priced at \$5.75 for open-back and \$6.95 for closed-back models. Tarrytown Metalcraft Corp., Tarrytown, N. Y.—RADIO & TELEVISION RETAILING

## Carter SUPER CONVERTER

This wide variety of rotary converters for supplying 115 v 60 cycle AC current from DC sources of 6 to 115 volts to high power factor loads ranging from 40-250 watts offers a specific machine for each individual use. Designed to power radios, wire and tape recorders, amplifiers and other electronic equipment, the line is supplemented with accessory filters and frequency controls for special applications. Carter Motor Co., Chicago.—RADIO & TELEVISION RETAILING



# RIGHT . . . FOR SERVICING HOME RECEIVERS

## Now, A Replacement Line of Chicago Transformers & Reactors

Now available in principal cities, this new replacement transformer line fits a wide range of the service man's most frequent power and audio requirements and fills, as well, the needs of the amateur and experimenter for efficient, standard-type ratings at low cost.

Here's transformer design and construction you can rely upon to give accurate, dependable performance. Every unit is backed by Chicago Transformer's reputation for quality . . . established in over 20 years of designing and producing original equipment transformers for the nation's leading set manufacturers.

RMA color-coded leads, tinned lead ends, and compact, standard-dimension mountings make for easy installation at the service bench. Included in the line are power transformers and chokes, filament, driver, speaker matching, interstage, and output transformers in a range of carefully chosen, practical ratings.

Ask for *Chicago Replacement Transformers* the next time you call or visit our parts jobber. *In the meantime . . .*

WRITE FOR CATALOG

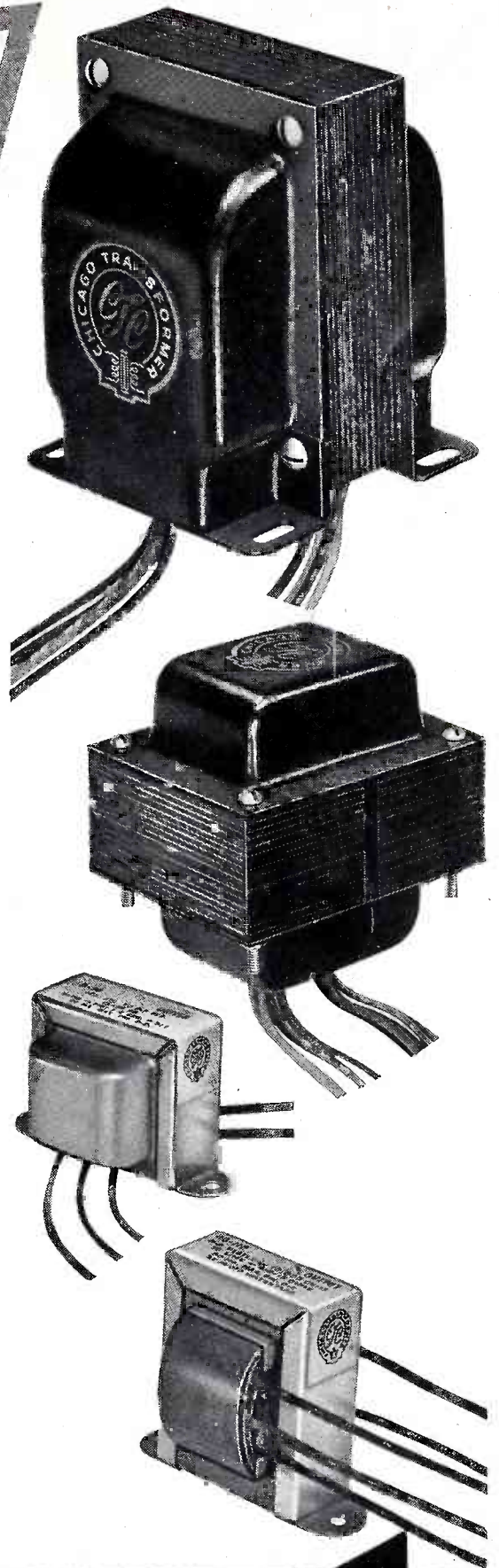
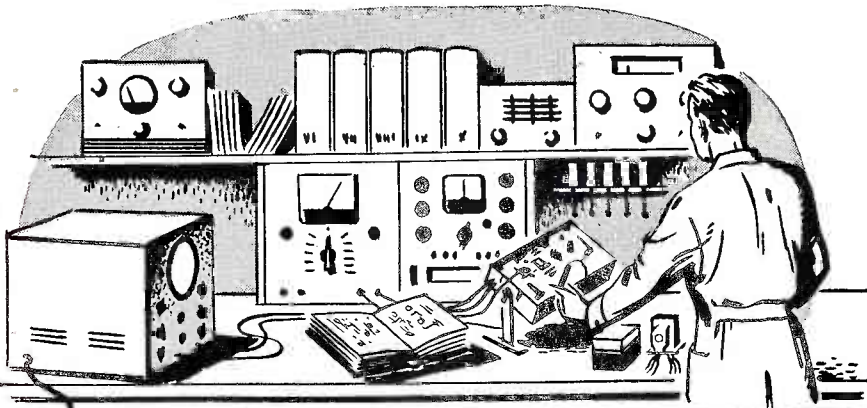

# CHICAGO TRANSFORMER

DIVISION OF ESSEX WIRE CORPORATION

3501 ADDISON STREET • CHICAGO 18, ILLINOIS





# Servicing Radios in the New Cars

## Where to Find Trouble

### and How to Remedy it.

## Checks on Electrical Systems

• With more auto radios produced during 1947 than any pre-war year, and with most new cars coming through with radios, servicing of car radios tends to assume increasing year-round importance to the dealer. Before going into the particular features of the new cars and radios, therefore, it might not be amiss to run over the general principles of auto radio servicing.

The logical starting point is to consider what we have here that we don't have in home receivers. The most obvious feature is the car itself! This manifests itself in three ways: the car as a source of line voltage, the car as a source of static, and the car as a source of mechanical vibration and shock.

To do a complete job of auto radio servicing, the servicer must be familiar with the general principles of auto electrical systems. Figure 1 shows a basic layout of such systems, with the important parts in heavy lines: the battery, the generator and voltage regulator, the ignition coil, and the ammeter—which is a convenient tie-point where battery voltage is available.

The electrical system may be a source of too-low or too high line voltage, and it may be a source of noise from sparking, poor grounds, corroded connections, etc.

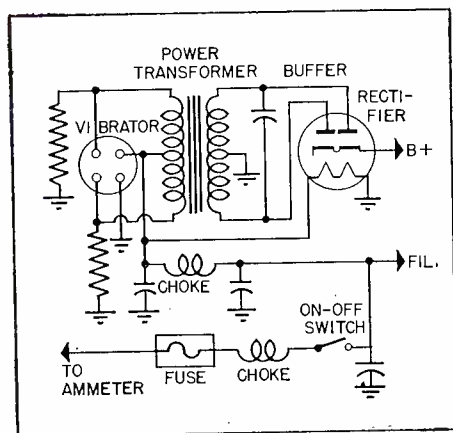

Fig. 2—Typical auto radio power supply.

The mechanical part of the car can be a source of trouble due to improper or incomplete bonding, wheel static, and vibration.

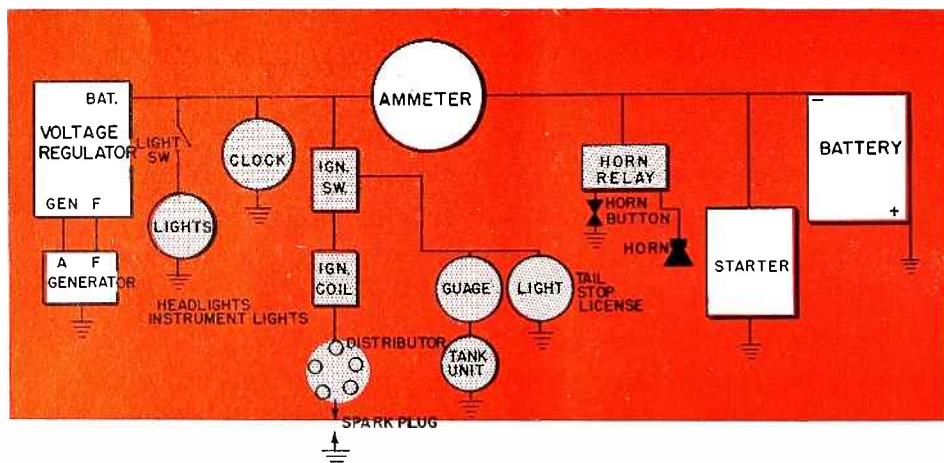

Fig. 1—Basic car electrical system.

The radio itself is distinguished by its power supply, which utilizes the battery for "A" and a vibrator pack for "B" voltage. Figure 2 shows a typical power supply of this type. Buffer condensers and vibrators are familiar trouble spots in this section.

### Remote Tuning Units

Auto radios are also distinguished by the fact that they frequently have remote push button tuning, often with solenoids or motors, and usually there are shielded cables connecting the receiver to the speaker and the antenna. These cables may be disconnected, may have poor connections, or be open or shorted. The push button solenoid draws so much current that a low line voltage (under 5.5) may not operate it.

In this connection it is important to know that a high voltage (over 7.4) will shorten the life of tubes, vibrator and circuit elements.

Isolating sources of noise (static) can be simplified by observing the condition present when the noise occurs. That is, does it occur with and without

an antenna, does it occur only when the car is in motion, or will it occur when the car is standing still and the motor idling? RF noise inside the car when it is not in motion is obviously not wheel static, and more probably indicates the need for bypassing and filtering.

A check list for isolating car radio troubles is reproduced below, followed by specific trouble shooting tips.

### 1. AUTOMOBILE

- Battery: Weak, water low, cables or terminals loose, corroded.
- Ignition system: Voltage and/or current regulation improper. Static noise from generator, ignition coil, points, plugs.
- Car parts and wiring: Mechanical noise—vibrating parts. Static noise—shielding, bonding, tube static powder, etc.

### 2. RADIO

- Antenna: Disconnected, open, short, grounded, joints corroded.
- Tubes and receiver circuits: Usual radio servicing procedure, and in

addition look for loose tubes and joints from vibration.

- Loudspeaker: Usual servicing procedure and in addition check connecting cable and plugs.
- Rectifier and Filter system: Line fuse, vibrator, transformer, chokes and filters.
- Remote tuner: Alignment of push buttons, burnt out or sticking solenoids.

Most modern car radios in up-to-date cars require only the familiar bypass condenser on the generator and the suppressor on the distributor. If noise is heard with the set on, the motor running and the antenna disconnected, try additional bypass caps on ammeter, ignition coil, dome light, gauges, etc. Bonding may be necessary . . . or any of the existing condensers may be open.

Engines "floating" on rubber mounts may need to be bonded to the chassis for noise reduction. The motor can be bonded on both sides by a length of flexible metal shielding running from an engine stud to the fire wall. Enough slack is left to permit the engine to

(Continued on page 97)



*Tube Testers for Today and Tomorrow...*

SPECIFY  
**TRIPLETT**

**UP  
and  
DOWN**

**Lever Switching Connects Each Tube Pin to Proper Circuit**

1. **ALL ELEMENT CHECK** — Thorough conclusive test of tube elements, shields and taps. The only commercial tester to get at each tube pin and make an open and short check.
2. **NO HUNTING FOR SOCKETS** — No plugging into wrong socket. Circuit flexibility requires only one socket for each type of tube base.
3. **CIRCUIT CLARITY** — Lever switch numbering corresponds to RMA tube pin numbers, connected to bring out each active tube element. A simple up or down motion of the lever instantly makes the connection.
4. **OPERATION SIMPLICITY** — Minimum of control settings plus straightforward arrangement of this outstanding emission circuit. Generally not more than five of the 10 lever switches need be set.
5. **"PICTURE" YOUR CIRCUIT** — Assures confidence in tests and enables special tube checks for balanced circuits, special loads, etc. "Trick" switching circuits make it more difficult for the serviceman to "picture" his test circuit.
6. **SET UP YOUR OWN TEST FOR NEW TUBES** — The "pictured" circuit and straightforward test procedures enable the user to set up data for new tubes. A feature rarely found in commercial type tube testers.
7. **INDIVIDUAL CONTROL FOR EACH TUBE ELEMENT** — Takes care of roaming elements, dual cathode structures, multi-purpose tubes, etc., in addition to standard value tests.

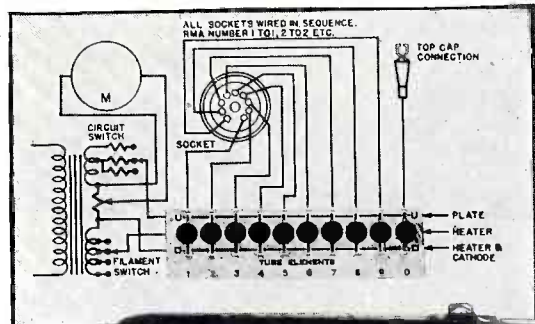

**TUBE TESTER MODEL 3413**  
Triplet lever switching circuit arrangement has 7 distinct advantages contributing to maximum flexibility, simplicity of operation and anti-obsolence.  
**NET DEALER \$66.75**  
**PRICE**

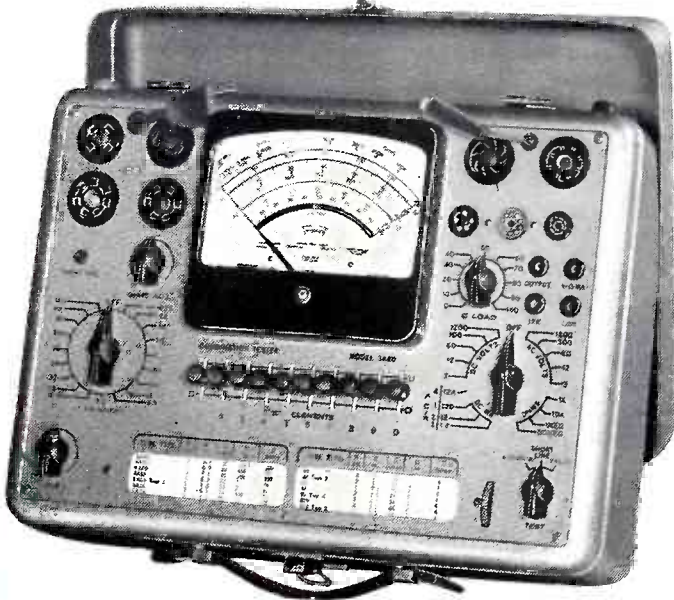

**... Combination  
Volt-Ohm-Mil-Ammeter Model 3480**

This tester combines the Tube Tester Model 3413 with complete facilities for voltage current and resistance analyses . . . a real economy for those shops requiring a combination tube tester and volt-ohm-mil-ammeter . . . Attractive two tone metal case with detachable hinged cover . . .

**TECH DATA**  
D. C. Volts: 0-3-12-60-300-1200, at 10,000 Ohms/Volt.  
A. C. Volts: 0-3-12-60-300-1200, at 2,000 Ohms/Volt.  
D. C. Amps: 0-12, at 250 Millivolts.  
D. C. Milliamps: 0-1.2-12-120, at 250 Millivolts.  
Ohms: 0-1000-10,000 (10-100 at center scale).  
Megohms: 0-1-50 (10,000-500,000 Ohms center scale).  
Output: Output Jacks, Condenser in series with A. C. Volt ranges.  
Scale: 5.6" long on top scale arc. 0-1000 Ohms and 0-50 Megohms on top arc. 0-12-60-300 A. C. and D. C. Volt figures are on four separate arcs. Scale markings are black on white except A. C. are red on white; 0-1K Ohms scale is green on white.

MODEL 3480 **\$98.75** . . . U.S.A. Dealer Net

SEE AT YOUR RADIO PARTS DISTRIBUTOR OR FOR MORE INFORMATION . . . WRITE  
**TRIPLET ELECTRICAL INSTRUMENT COMPANY • BLUFFTON, OHIO, U.S.A.**  
In Canada: Triplet Instruments of Canada, Georgetown, Ontario





# New Products Help Sell Sound

## GE PHONO CARTRIDGE

Designed especially for the new long-playing records, a new GE variable reluctance cartridge is now available which is smaller and lighter than previous models, and is equipped with a sapphire stylus one mil in diameter as required by the microgroove re-

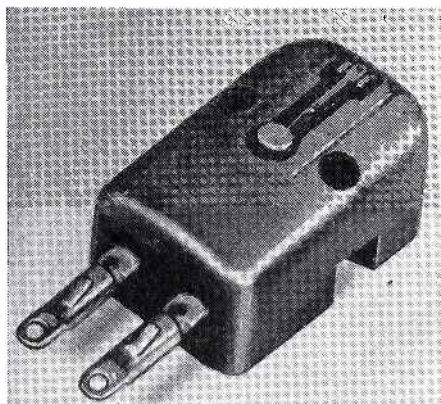

cordings. The improved shape of the cartridge makes it more universally adaptable to various tone arms, while superior features of previous variable reluctance cartridges are maintained. These include negligible needle scratch, wide frequency response, and freedom from resonance peaks. Receiver Division, General Electric, Electronics Park, Syracuse, N. Y.—RADIO & TELEVISION RETAILING

## Webster LP TONE ARM

The new lightweight "Featheride" tone arm for use with microgroove records is of stamped aluminum construction and is correctly balanced to maintain precise 7 gram tracking pressure for LP requirements. It can be equipped with either of two new

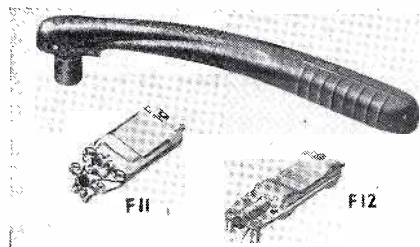

crystal cartridges: model F12 for exclusive playing of LP records at 33-1/3 RPM, or the F11, which is a double needle combination cartridge that plays either microgroove or standard records. Webster Electric Co., Racine, Wisconsin.—RADIO & TELEVISION RETAILING

## Scott NOISE SUPPRESSOR

A new low cost dynamic noise suppressor to minimize background noise on phonograph records, the 110-A is supplied with a matched pickup and a variable control to limit its action. The unit is small in size and is supplied with prepared leads for ease of installation. Herman Hosmer Scott, Inc., Cambridge, Mass.—RADIO & TELEVISION RETAILING

## GI DUAL SPEED MOTORS

The DR and DM are new phono turntable motors with external shift control operating at either 78 or 33-1/3 RPM, for use with standard or the new long-playing records.

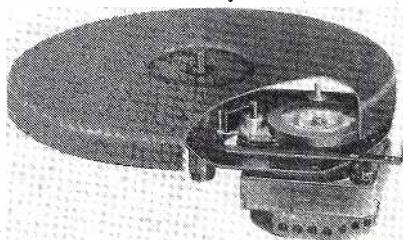

Voltages range from 110-220, 50-60 cycles. Manufacturer claims low rumble and good speed regulation. General Industries Co., Elyria, Ohio.—RADIO & TELEVISION RETAILING

## Brook AMPLIFIER

Model 12A3 is a new 10-watt all-triode amplifier for which the manufacturer claims virtually flat response from 20-20,000 cycles with negligible distortion. Step-type bass and treble controls permit selection of response

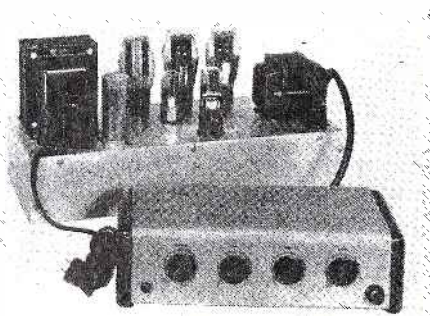

equalization, and two inputs are provided for low and high level pickups or tuners. Output impedances range from 2-500 ohms. Brook Electronics, Inc., 34 DeHart Place, Elizabeth 2, N. J.—RADIO & TELEVISION RETAILING

## RCA PORTABLE AMPLIFIER

The BN-2A is a lightweight, portable remote amplifier designed to furnish high fidelity audio pickup facilities at sporting events, street programs, political and social meetings. The 3-channel amplifier has a self-con-

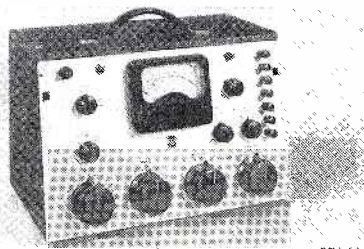

tained 115 v. AC power supply, volume indicating meter, and versatile controls for switching, monitoring, cueing, etc. RCA Victor Division, Camden, N. J.—RADIO & TELEVISION RETAILING

## Bogen DELUXE AMPLIFIER

The new HX50 is a 50 watt amplifier for high power public address requirements. Four input channels have separate volume controls, while master bass and treble controls provide considerable variation of the amplifier's fre-

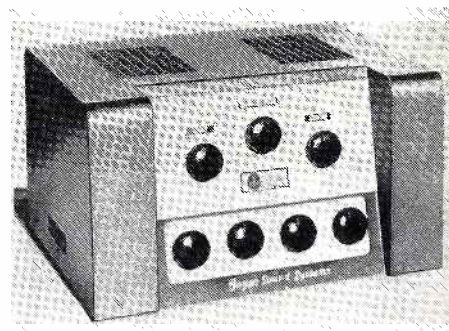

quency response of from 60 to 10,000 cps. A special feature is a variable control said to eliminate acoustic feedback without affecting fidelity. David Bogen Co., Inc., New York.—RADIO & TELEVISION RETAILING

## Operadio INTERCOM

The new Flexiphone line of intercom equipment includes a three-station master and two speaker stations providing sturdy, low-cost units suitable for small businesses, doctors,



dentists, farms, homes, etc. The simple, metal-housed units will sell for less than \$40. for a two-way system. Operadio Mfg. Co., St. Charles, Illinois.—RADIO & TELEVISION RETAILING

## Utah SPEAKERS

Two new speakers for use in outdoor theatres, the 4 inch SP4CO and the 5 inch SP5CO have proven waterproof under test conditions

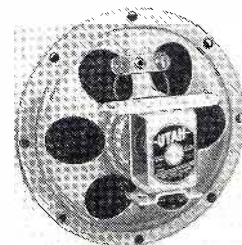

more severe than actual climatic conditions, the maker states. Both are 1.47 oz. PM speakers. Utah Radio Products, Huntington, Indiana.—RADIO & TELEVISION RETAILING





# MADE TO SELL YOU AND YOUR SERVICE

## 3 NEW SYLVANIA AIDS!



Big, handsome, eye-catching! That's the new Sylvania 38 $\frac{3}{4}$ " high and 8 $\frac{1}{4}$ " wide metal thermometer! Put this green, black and white business aid outside your shop—call attention to the service you offer and the merchandise displayed in your windows!

You can obtain this sales-catcher from your Sylvania Distributor! See him today!

only **\$2<sup>95</sup>**

Here's the new Sylvania Service Kit now available to service dealers—a prestige-building and practical addition to your service business!

Made of laminated plywood covered with brown plastic fabric with the appearance of fine leather, this kit has a tube capacity of over 75 tubes. The interior measures only 18" x 11 $\frac{1}{4}$ " x 5 $\frac{1}{2}$ ". The tool section in the lid is designed to hold the most commonly used tools for on-call service. Ask your Sylvania Distributor for this wonderful new, low-priced Service Kit. Get that added professional touch that means so much.



(Tools shown not included)

only **\$9<sup>95</sup>**



only  
**\$4<sup>50</sup>**

And here's the new Sylvania illuminated shadow box sign that's ready for hanging in your window, on your wall, or on any strategic flat surface in your window. Two eyes in the top of the sign are for hooks or chains.

The big, bright red letters "Radio Service" tell your message in no uncertain terms to every passerby. The sign's face is glass; the background translucent yellow. The red letters are outlined in black, while the bottom half of the sign is black with yellow lettering. The brown metal case is chrome trimmed. Size: 18 $\frac{1}{4}$ " long, 8 $\frac{1}{4}$ " high, 3 $\frac{1}{4}$ " deep. Seven-foot cord provided.

At Sylvania Distributors everywhere! Sylvania Electric Products Inc., Advertising Department, Emporium, Pa.

# SYLVANIA ELECTRIC

RADIO TUBES; CATHODE RAY TUBES; ELECTRONIC DEVICES; FLUORESCENT LAMPS, FIXTURES, WIRING DEVICES; PHOTOLAMPS; ELECTRIC LIGHT BULBS



# New Tools, Parts, PA Equipment

## Pioneer CHASSIS PUNCH

This device cuts square holes in sheet metal and simplifies the job of attaching otherwise "hard to mount" parts, allowing this work to be done in a rapid and easy manner. The Pioneer Chassis Punch method is not limited to square holes. In addition, angular, rectangular, L-shaped, or any square corner pattern type hole can be cut with precision and ease. It is merely a matter of making combination cuts (if necessary) to achieve the desired pattern which simplifies an otherwise hard job. At the present time the Punch is made in two square sizes,  $\frac{5}{8}$ " and  $\frac{3}{4}$ ", and for a considerable time past, the Pioneering Broach Company has been supplying the trade with thirteen sizes of round hole chassis punches which range in size from  $\frac{1}{2}$ " to  $1\frac{1}{2}$ ". Pioneer Broach Co., Los Angeles, Calif.—RADIO & TELEVISION RETAILING

## Electro-Voice MICROPHONE

New impedance selector instantly gives high or low impedance. New external shock mount provides double shock absorber action. Acoustalloy diaphragm withstands severest service. E-V broadcast cardyne 11. Model 731: Frequency response substantially flat 30-12,000 c.p.s. Output —50 db. Includes external shock mount. High-low impedance selector. Cannon XL-3 connector. "On-Off" switch. List Price . . . \$80.00 (Also available without "On-Off" switch or with 50-250 ohm impedance selector.) E-V cardyne 1. Model 726. Performance characteristics similar to Model 731. Has impedance selector, but does not include external shock mount. Frequency response substantially at 40-10,000 c.p.s. Output —53 db. "On-Off" switch. Amphenol MC-3 connector. List Price . . . \$59.50 E-V Model 345 external shock mount also available separately. Fits models 731 and 726. List Price . . . \$11.50. Electro-Voice, Inc., Buchanan, Mich.—RADIO & TELEVISION RETAILING

## Vibracloc LOUDSPEAKER BAFFLE

A new general purpose loudspeaker baffle adaptable to table, wall or corner mounting. Being of sector design, grouping is simplified. Constructed of heavy masonite and wood these new baffles are sturdy and attractive. The

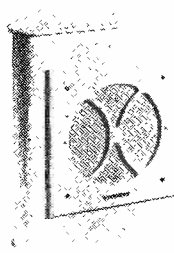

acoustic quality is excellent. Supplied in natural masonite at \$8.00 list or finished in ivory or brown wrinkle at \$10.00 list. Will accommodate any 6" speaker. Size 12" x 12" x 8". Vibracloc Mfg. Co., 3597 Mission St., San Francisco, Calif.—RADIO & TELEVISION RETAILING

## EMCO SPECIALTY TOOL

A specialty tool for hard-to-reach parts and places, has just been put on the market. It is a quality piece of equipment, precision made, acid proof, cadmium plated and can be taken apart to be cleaned. The shaft is flexible cable such as is used in speedometers and dental

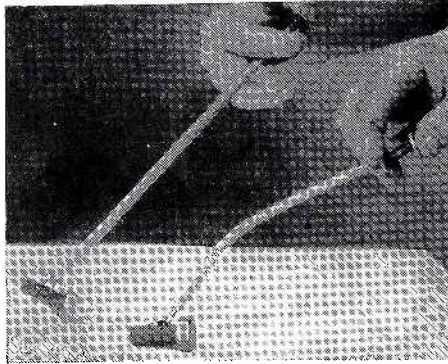

equipment and is encased in a flexible housing with expanding and retracting fingers which enable it to reach in and grab a tight hold on anything . . . with enough flexibility to work around corners or S-turns. EMCO Enterprises, 6750 Stony Island Ave., Chicago 49, Ill.—RADIO & TELEVISION RETAILING

## Unicon TELEVISION CONDENSERS

Capacities from .00025 to .25 MF in working voltages of 2,500, 3,500, 5,000, 7,500 and 10,000. Suitable for 60 cycle and RF power supplies. Manufacturer stresses use of heavy insulating paper with low voltage stress on each sheet. Sizes rated at 5,000 volts or more are made with two or more units connected internally in series to provide against corona or breakdown. United Condenser Corporation, 422 East 138th St., New York 54, N. Y.—RADIO & TELEVISION RETAILING

## Stevens-Arnold CHOPPER

DC-AC choppers are used with thermocouples, strain gauges and other low level equipment to convert pure DC into either pulsating DC



or AC so that the output of these devices may be amplified with AC amplifiers rather than DC amplifiers. By using information gained in

the field of ultra-high-speed relays the firm is now able to announce a chopper which will cover all frequencies from 10 to 500 cycles making it possible to use these new choppers either on 60 cycles, as previously, or on 400 cycles in aircraft. Complete details are given in Catalog 232 furnished upon request. Stevens-Arnold, Inc., 22 Elkins St., South Boston 27, Mass.—RADIO & TELEVISION RETAILING

## RCA PORTABLE SOUND SYSTEM

A new "deluxe" portable sound system, which employs a 15-watt amplifier and high-efficiency components to provide acoustical output equivalent to that of a 30-watt portable sound system incorporating two average permanent-magnet speakers, is now ready for shipment. This compact, portable sound system, designated as RCA Type SP-15A, consists of an aerodynamic microphone, a low-distortion, high-output amplifier, a heavy-duty alnico permanent magnet-type loudspeaker, and a two-tone luggage-size carrying case. It is designed for use in such locations as moderate size auditoriums, bus terminals, night clubs, taverns, restaurants, auction rooms and conference rooms. Two loudspeakers can be attached to the SP-15A amplifier to give the same high output for large auditoriums or locations requiring greater coverage than can be provided

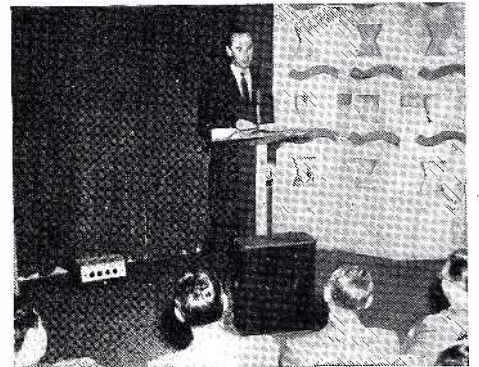

by one loudspeaker. The equipment is provided with a handsome steel-band, reinforced plywood carrying case, finished in gray and black durable Du Pont Fabrikoid, and measuring 8" deep, 17" wide, and 21" high. The complete system weighs 45 pounds. Radio Corp. of America, Engineering Products Dept., Camden, N. J.—RADIO & TELEVISION RETAILING

## "Quick Strip" WIRE STRIPPER

A simple twist and a pull are all that are required to strip insulation from No. 12 to 22 solid or stranded wire with the new "Quick-Strip" wire stripper. The tool consists of a round, hardened blade attached to a plastic handle of various colors. The blade contains four calibrated slots. Three slots accommodate and strip various size wire and the fourth cleans the wire. The tool removes not only the rubber, fabric or plastic insulation but cuts and removes braided wire shielding, such as that used on "mike" cable. The device is small, sturdy and compact, ideal for use in close quarters. Blade may be resharpened or is easily replaced. The "Quick-Strip" is valuable to radio and television men, electricians, auto mechanics, industrial maintenance men and telephone men. Jaco Products Co., 6408 Euclid Ave., Cleveland, Ohio. — RADIO & TELEVISION RETAILING



8740

8743

8734

8735

8738

8739

8747

8433

8799

8752

**INTERCOMMUNICATION  
AND SOUND SYSTEM  
CABLES**

*Every Type for Every Service*

Sold Exclusively Through Recognized Wholesale Distributors

**Belden**  
*Radio* **WIRE**



WHERE QUALITY  
AND RESULTING PRESTIGE ARE  
PARAMOUNT, LEADING MUSIC  
MERCHANTS PROFITABLY  
FEATURE THE INCOMPARABLE  
**CAPEHART**

**BIRKEL-RICHARDSON**

Proudly present on our 67th anniversary  
another great First!  
The incomparable  
new 1949 **Capehart**

Truly the "World's finest instrument  
for musical reproduction."

Capehart's world-renowned turn-over  
record changer. Capehart's incom-  
parable tonal perfection, cabinets by  
Capehart's artist craftsmen . . . an  
achievement you must see . . . you  
must hear to believe.

With the introduction of the new  
1949 Capeharts . . . there is a Cape-  
hart for every home . . . every hudget  
—whether it be French Provincial,  
Early American, Modern, 18th Cen-  
tury. Priced from \$295.00 to \$1595.00.  
Our 67 years of dependable—reliable  
service are your guarantee of com-  
plete satisfaction. Investigate before  
you invest!

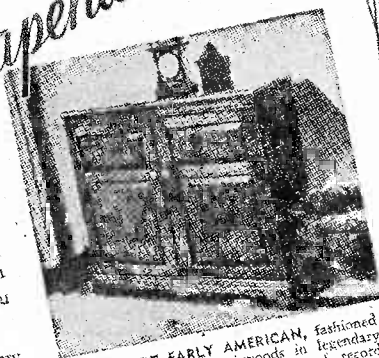

**CAPEHART EARLY AMERICAN**, fashioned  
from untouched hardwoods in legendary  
elegance. Exclusive new foolproof record  
changer, new silent pick-up—frequency range  
far exceeds any available recordings.

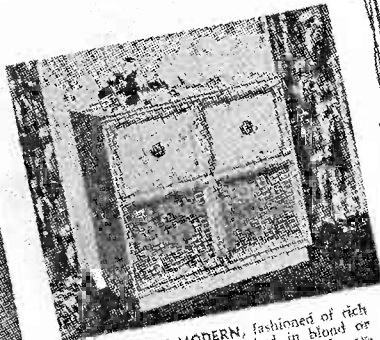

**CAPEHART MODERN**, fashioned of rich  
Mahogany veneers finished in blond or  
ebony. "True-Timbre" tone with the ex-  
clusive Capehart turn-over changer. AM,  
FM and short-wave radio, 23 tubes plus  
rectifiers.

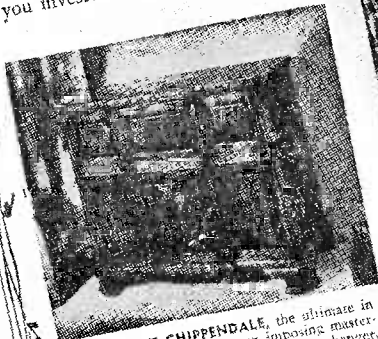

**CAPEHART CHIPPENDALE**, the ultimate in  
Radio-Phonographs . . . an imposing master-  
piece of beauty, exclusive turn-over changer,  
AM, FM and short-wave radio reception, 23  
tubes plus rectifiers.

Music Dept.  
**ASHBURN'S**  
420 E. Main St.  
Alhambra

730 WEST 7TH ST.  
Phone VAndika 1241  
LOS ANGELES

OPEN MONDAY EVENING



Reproduced from a recent  
issue of "The Los Angeles Times"

**Farnsworth** TELEVISION & RADIO CORPORATION,  
FORT WAYNE 1, INDIANA

## Universal Personnel



Richard L. White, president, Landers, Frary & Clark, New Britain, Conn., announced the ap-  
pointment of R. N. Campbell, as vice-president  
in charge of manufacturing operations. Mr. White  
also announced the promotion of Charles Cook  
to be manager of the main plant of the company,  
and assistant to Mr. Campbell.

Mr. Campbell has been in the manufacturing  
end of the business for more than 22 years. He  
has a broad knowledge of the manufacture of  
electrical products.

## Arthur Ansley Launches Firm

Arthur C. Ansley announces the forma-  
tion of a new company, Arthur Ansley  
Mfg. Co., Doylestown, Pa. The first prod-  
ucts of the company are three portable  
phonographs and four models of record  
playing equipment designed especially for  
use by schools.

Portable phono prices range from \$29.95  
to \$49.95, the latter being for an automatic  
record changing model with a 6 x 9-inch  
speaker. The school models include a  
portable unit, high fidelity table model,  
and a high fidelity console for large class-  
rooms and auditoriums.

## Bond Gift Package

Two popular flashlights in the Bond  
line are contained in a moderate-priced  
gift package, No. 1152, in which the  
flashlights are sold. The package is lith-  
ographed, and can be used as a counter  
display. A home flashlight in the new  
Bond luminous-case, and a second flash-  
light, for the car, equipped with a trans-  
lucent red warning lens ring, are featured.  
The package is designed for Christmas  
selling by the Electrical Divisions of  
Olin Industries, Inc.

## New Stanco Catalog

Standard's new catalog gives detailed  
descriptions of its line of high fidelity  
transformers, aimed to satisfy the needs  
of designers of audio equipment where a flat  
response covering the entire audio range  
with a minimum of distortion is required.  
Each of the ten models is designed for  
specific application in one type of circuit:  
low impedance to grid, push-pull input,  
mixing, or output. Different weights are  
provided so that size and space require-  
ments may be considered. Available on re-  
quest to Standard Transformer Corp.,  
Elston, Kedzie and Addison, Chicago 18.





Model 266  
Vacuum Tube  
Voltmeter  
for TV, FM, AM

- RANGES: Volts: (A.C. and D.C.) 0-1, 5, 10, 50, 100, 250, 500, 1000, 5000  
 Milliampers: (D.C.) 0-1, 5, 10, 50, 100, 250, 500  
 Amperes: (D.C.) 0-10  
 Ohms: 0-100 (10 ohms center)  
 0-10,000 (100 ohms center)  
 0-100,000 (1000 ohms center)  
 0-1 megohm (10,000 ohms center)  
 0-10 megohms (100,000 ohms center)  
 0-100 megohms (1 megohm center)  
 0-1000 megohms (10 megohms center)

Size: 8 1/2" x 9 1/2" x 8". Dealer's Net Price complete with Operator's Manual.....\$94.50

for  
**TV, -FM, and AM**  
servicing

— your 3 finest basic testers

On Model 266 Vacuum Tube Voltmeter, note these distinguishing Simpson features: the 1 volt range, for full scale deflection, necessary in low R.F. voltage measurements; the zero center switch provided for discriminator circuit alignment, a feature which embraces all D.C. voltage ranges. D.C. volt input resistance ranges from 50 megohms to 200 megohms; A.C. volt input impedance at 60 cycles is 40 megohms. The low input capacitance of the probe (approximately 4 micro-microfarads) insures the accuracy essential for the high frequencies encountered in servicing FM and television receivers.

Ask  
your  
jobber  
or send for  
literature.

SIMPSON ELECTRIC COMPANY  
5200-5218 W. Kinzie St., Chicago 44, Ill.  
In Canada: Bach-Simpson, Ltd., London, Ont.

**Simpson**  
INSTRUMENTS THAT STAY ACCURATE

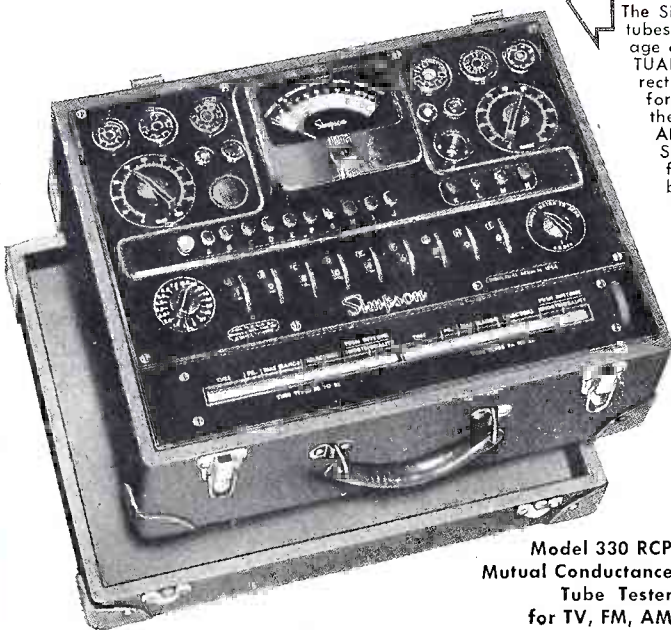

Model 330 RCP  
Mutual Conductance  
Tube Tester  
for TV, FM, AM

The Simpson Model 330 tests tubes in terms of PERCENTAGE of rated DYNAMIC MUTUAL CONDUCTANCE, a direct indication of tube performance with reference to the manufacturer's STANDARD MICROMHO rating. Shows tubes as good, fair, weak or definitely bad. When you have finished a tube test ONE BUTTON returns all switches to the normal position ready for the next test.

Size: 15 1/2" x 9 1/2" x 6 1/4".

Dealer's Net Price, complete with Operator's Manual. \$132.50



Model 415-A Signal Generator for FM and AM. Incorporates built-in sweep circuit for modern FM servicing. Frequency modulated signal with a sweep of 1 megacycle, more than adequate for all FM alignment. Internally modulated at either 60 cycles or 400 cycles or modulated from an external source. A 120 cycle saw-tooth voltage is available as scope synchronization or as actual scope sweep. AM bands cover complete frequency range from 75 KC to 130 MC. For 105-130 volts, 50-60 cycle  
 Size: 5 5/8" x 11 3/8" x 15 1/8"  
 Dealer's Net Price, complete with Operator's Manual..... \$145.00



## New Products

# SELL *the*

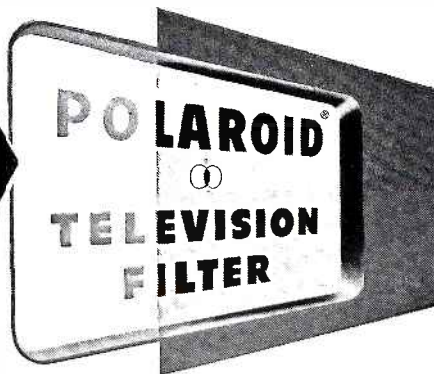

### Sell the Polaroid Television Filter

The filter that does what no other can do! Not just colored plastic, it's Polaroid—the greatest name in glare control . . . brings genuine visual comfort! Your customers know and want the Polaroid Television Filter. They've been pre-sold by hard-hitting advertising and promotion.

### Sell the Polaroid Television Filter

— the television filter your customers know and want! Sell one with every set. It's a fast-moving profit maker.

### Sell the Polaroid Television Filter

and you tie-in with its overwhelming consumer acceptance. Smart merchants everywhere report the Polaroid Television Filter an excellent seller! It brings new visual comfort! Contrast without glare! There's a Polaroid Television Filter for every set — sensibly priced within reach of all:

- No. 700—for all receivers with 7" tubes \$ 6.50
- No. 1000—for all receivers with 10" tubes \$10.00
- No. 1200—for all receivers with 12" tubes \$12.50
- No. 1500—for all receivers with 15" tubes \$16.00
- No. 2000—for all receivers with 20" tubes \$25.00

® by Polaroid Corp.

#### EXTENSIVELY ADVERTISED!

Television Programs



Like Dennis James Wrestling



Like Bob Smith "Howdy Doody"

Minute Spots



Following top rated shows

Newspaper Ads



Like this in leading papers

Magazine Ads



Like this in the New Yorker

A Product Created By

**PIONEER SCIENTIFIC CORPORATION**  
295 LAFAYETTE STREET, NEW YORK 12, NEW YORK

## PINPOINT YAGIBEAM

- Compact 5-element Yagi; thin hard brass SILVER PLATED for hi-Q, hi-gain.
- EVERY CONNECTION SOLDERED; no nuts, bolts, parts to loosen, corrode. Cross-bars insulated. Perfect impedance match. Hurricane-proof construction. Steel masts.
- 300a type has line attached. 73a type has coaxial plugs. See at local distributor's or write:

**ROGER Television Inc., 366 Madison Ave., New York 17**

EXTREME DIRECTIVITY gives Roger Yagi-Beam highly focused gain, obsoletes "stacking". Sharp 20° beam pinpoints desired signal, rejects reflected ghosts, noise, FM and reradiation. Perfect for multiple installations, dealer store setups, "fringe" areas. Popular with TV station engineers.

TUNED TO YOUR SPECIFIED CHANNEL.

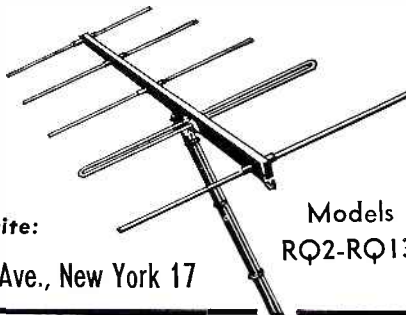

Models  
RQ2-RQ13

### GE TOY RECORD PLAYER

Console model electronic toy record player built into a pastel-ivory painted cabinet, decorated with decals. Designed to withstand rough handling. Speaker is protected by a multiweave metal grille which guards against poking objects through the speaker. Unit has two tubes,



an amplifier and a rectifier; has a combination on-off switch, and volume control. Plays 10, 12-inch and smaller sized records. Size: 14½ inches square, 24½ inches high. General Electric Co., Electronics Park, Syracuse, N. Y.—RADIO & TELEVISION RETAILING

### Howard TV SET

The 475TV is a 3-chassis, 30 tube (including 10" picture tube) TV package which is combined with the model 481 AM-FM-SW radio (14 tubes) and a record changer in a contemporary style console cabinet. The radio-phonograph set is also available in the same cabinet,

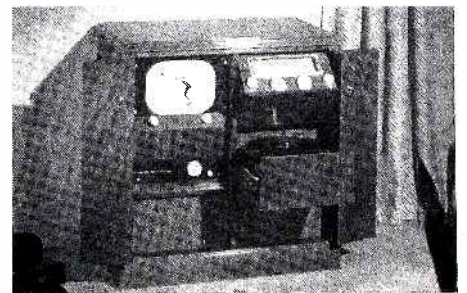

the TV set being replaced by a record storage compartment. The optional factory service plan provides for replacement by the dealer of the defective sub-chassis, so that it may be returned to the factory for repair. Howard Radio Co., 1735 Belmont Ave., Chicago 13, Ill.—RADIO & TELEVISION RETAILING

### Philson ANTENNA KITS

Television antenna kit designed for easy attachment to any existing low frequency antenna, to tuning range up to channels 7 through 13. Philson Mfg. Co., Inc., 156 Chambers St., New York 7, N. Y.—RADIO & TELEVISION RETAILING



**HERE IS HEAVEN SENT HELP**



**Says LYMAN A. ABBOTT**  
 THE IOWA FLYING SERVICEMAN  
 "To any organization such as ours, installing  
 and servicing PA systems, the new Rider PA  
 Manual is heaven sent help. It is a typical  
 Rider Manual. What more  
 need be said."

"... of course we have  
 all 17 RIDER MANUALS."

"... and attribute a good bit of our success in  
 producing a quantity of work in a minimum of  
 time to their always dependable, complete,  
 factory information. We will have Volume XVIII  
 as soon as it is published."



**You, TOO—NEED ALL 17 RIDER MANUALS**

Volume XVII . . . . .	\$16.50	Abridged Manuals I to V (one volume) . . . . .	\$19.80
Volume XVI . . . . .	8.40	Record Changers and Recorders . . . . .	9.00
Volume XV . . . . .	19.80	Master Index, covering Manuals, Vols. I to XV	1.50
Volume XIV to VII (each volume) . . . . .	16.50		
Volume VI . . . . .	12.50		

**VOL. I RIDER Television MANUAL**

1400 Pages, PLUS separate "HOW IT WORKS" and Index, \$18.00.  
 Everything that must be known about the 1946-47 television  
 receivers (complete and kit) of 34 manufacturers.

Separate "How It Works" covers theory of television; trans-  
 mission and reception, frequency standards, antennas, various  
 portions of receivers.

**Television "HOW IT WORKS" Available Separately**

If television is not yet in your area, it will be soon. Here is  
 theory you want. 208 pages . . . . . \$2.70

VOLUME I

**RIDER PA MANUAL**

*Just Out*

**Covers 145 Manufacturers'  
 Amplifiers, from 1938 to Date**

Bigger and better than even we had anticipated, the scope and thoroughness of this first industry-wide PA service manual makes it an essential piece of equipment for any shop doing PA work. It covers public address systems, outdoor announcing, musical instruments and phonographs, theatre and church hearing aids, electronic megaphones, intercommunications systems, theatre and home motion pictures, school, hotel and hospital sound systems, mobile and portable sound systems. ● It provides schematics, voltage and resistance tables, tube and chassis layouts, installation notes, operational instructions, impedance matching. ● Separate "HOW IT WORKS" book explains the theory of various designs employed in different types of amplifier systems, the servicing of PA systems, using the sine wave and square wave means of checking, methods of rapidly locating faults. Everything you need.

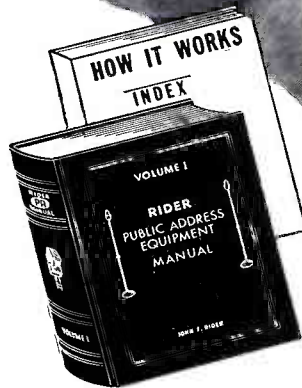

**2000 Pages in this new  
 RIDER FIRST plus separate  
 "HOW IT WORKS" and  
 INDEX . . . . . \$18.00.  
 ORDER YOURS TODAY!**

**RIDER MANUALS  
 MEAN SUCCESSFUL SERVICING**

**JOHN F. RIDER, PUBLISHER, Inc., 404 Fourth Avenue, N. Y. 16**  
 Export Agent: Rocke International Corp., 13 E. 40th St., N.Y.C. Cable ARLAB

NOTE: The Mallory Radio Service Encyclopedia, 6th edition, makes reference to only one source of radio receiver schematics—Rider Manuals.

ANOTHER NOTE: The C-D Capacitor Manual for Radio Servicing, 1948 edition No. 4, makes reference to only one source of receiver schematics—Rider Manuals.



## Remington Ad Mats

Remington Radio Corp., White Plains, N. Y., manufacturers of the Rembrandt television line, have readied ad mats for dealer use, with space for dealer imprint. The theme of the ad is "Perfection in Television," and models 180 and 1950 are featured in the copy.

## Fowler Distribution

The Fowler Mfg. Co., Portland, Ore., manufacturers of water heaters, has announced it will use Nash-Kelvinator distribution in Oregon and Washington.

## Admiral Regional Manager

George Malsed has been appointed regional sales manager for Admiral radios, radio-phonographs, television sets, electric ranges and refrigerators in Oklahoma City and the states of Texas and Louisiana according to W. C. Johnson, general sales manager of Admiral Corp., Chicago.

## Sylvania Names Hopkins

William J. Hopkins has been appointed eastern division manager for renewal tube sales department, Radio Tube Division, Sylvania Electric Products Inc., according to an announcement by C. W. Shaw, general sales manager.

## New Products

### Television Assembly TELEVISION RECEIVER

Model P-520 projection custom-built television receiver shows a 20 x 26 inch picture. The receiver requires an 18-inch depth for installation at its deepest point. Unit covers all



the television bands. Custom-built by the radio serviceman to the customer's specifications, and installed to suit individual needs. Suggested list price is \$1299.00. Television Assembly Co., 540 Bushwick Ave., B'klyn.—RADIO & TELEVISION RETAILING

### Micro RADIO

Comparable in size to a pack of cigarettes, the Micro radio is a 3-tube set which weighs 5½ ounces including self-contained batteries. It has a combination volume and sensitivity



control, and a station selector covering 550-1700 KC. The radio comes with a receiver which fits into the ear similarly to a hearing aid. It is designed to retail for \$39.95 including batteries. Micro-Electronic Products, Inc., Peru, Indiana.—RADIO & TELEVISION RETAILING

### Speed XMAS SELLING

The dealer who insists upon having every item price-ticketed will save a lot of time. First, such information is valuable to shoppers, helping them to make up their minds so far as cost is concerned, and second, it eliminates need for salespeople to depend upon memory. Some dealers use codes along with prices, while still others keep a sort of perpetual inventory on the tickets, showing at all times the amount of stock on hand.

**Sell**  
The Only  
**Low-Priced**  
**7 TUBE AC**  
inc. rect.  
**Wire Recorder**

**NEW**

**Wiremaster**  
by PRECISION AUDIO PRODUCTS Inc.

- Lifelike Reproduction (50-10,000 cycles)
- 2 Eyecatching Models
- Most Easily Operated

**Sell WIREMASTER**—the *only* low-cost, high-fidelity wire recorder on the market. Customers marvel at its brilliant true-to-life reproduction of all musical instruments—from bass drum to fiddle. And it incorporates many features of WIREMASTER'S famous "Professional" model, including improved wireless oscillator and built-in phonograph.

Beautifully styled in 2 models to attract twice as many prospects—priced for action—backed by extensive advertising and merchandising—WIREMASTER is the recorder that builds you PROFITS!



**WOOD CABINET MODEL H**  
An exquisite article of furniture that is at home in the most luxurious surroundings. Beautifully encased in compact, hand-finished mahogany, walnut, or bleached cabinet. Built-in Jensen 4" speaker.

Retail Price . . . \$142.50  
In Bleached wood \$5.00 extra

**2 MODELS FOR DOUBLE PROFITS!**

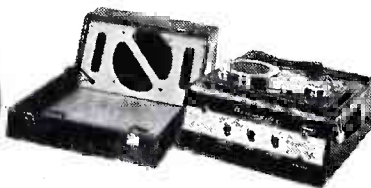

**PORTABLE MODEL P**  
Sturdy carrying case in rich, maroon multi-tone leatherette. Has tone control. 8" Jensen high-fidelity, extended range speaker separately housed in cover. Ample storage space for wire, microphone and cable. 37 lbs.

Retail Price . . . \$169.50

All recorders complete with crystal microphone, cable, wire, and phone needle.

Dealers, Distributors: Get Full Profit-Making Details Today. Phone or Write:

**PRECISION AUDIO PRODUCTS, INC.**  
1133 BROADWAY NEW YORK 10, N. Y. CHelsea 2-2429



# Why play "PENNY-ANTE" . . . when your business is at stake?

A good reputation, like good-will, is built by many deeds, but may be destroyed by a single dissatisfied customer. Your reputation is too valuable to risk for the few pennies "saved"

by buying inferior or unknown "bargains." That's why we keep repeating "Your Reputation and your customers deserve the best!" And the best means Sprague.

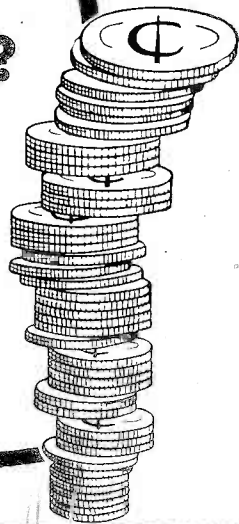

SPRAGUE TM TUBULARS—The first truly practical MOLDED Paper Tubular Capacitors!

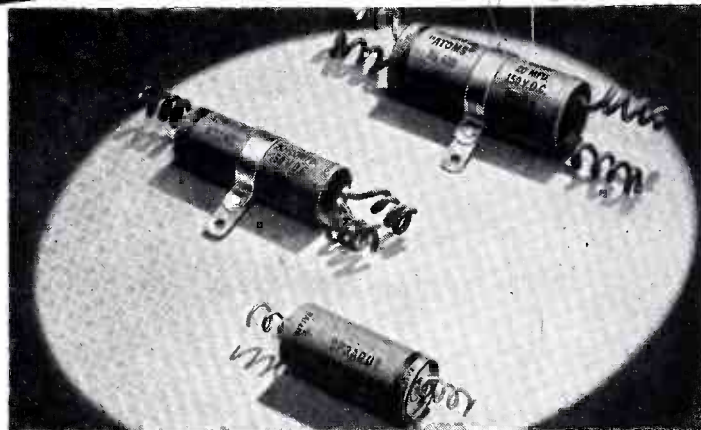

SPRAGUE ATOMS—Universal Midget Dry Electrolytics!

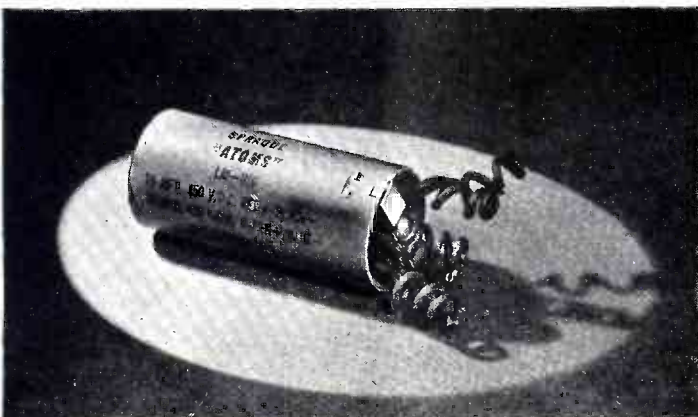

SPRAGUE LM—Universal Mounting Replacements!

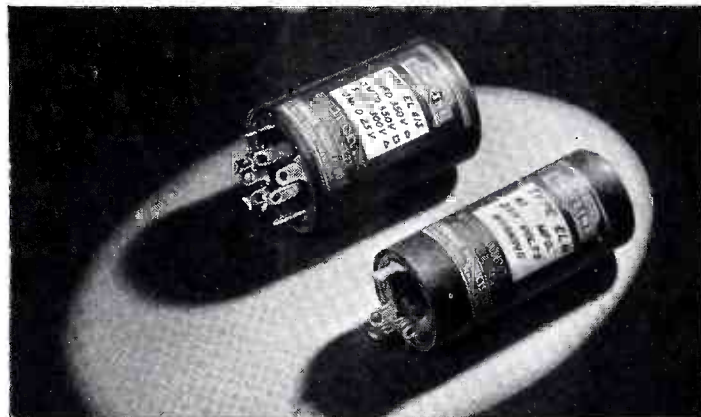

SPRAGUE EL—Self-Mounting Midget Can Type!

Reach for a **SPRAGUE**  
and Know **You're Right!**



## THESE SPRAGUE PRODUCTS ARE UNCONDITIONALLY GUARANTEED!

When used at their capacitance and voltage ratings, these Sprague Products are unconditionally guaranteed to render satisfactory performance.

CAPACITORS

\*KOOLOHM  
RESISTORS

# SPRAGUE

\* T.M. Reg.  
U.S. Pat. Off.

SPRAGUE PRODUCTS COMPANY, North Adams, Mass.

(JOBING AND DISTRIBUTING ORGANIZATION FOR THE PRODUCTS OF THE SPRAGUE ELECTRIC COMPANY)



# NEW TORQUE DRIVE KIT

*Makes Sales and Service Easy!*

**3 TYPES  
REPLACE OVER  
150 STANDARD  
MODELS**

*Lightest, Most Efficient,  
Crystal Pickup Cartridge  
Ever Produced!*



## SELL MORE CARTRIDGES

It's a colorful display . . . creates interest . . . and action . . . helps you sell *more* replacements to old and new customers.

## SATISFY MORE CUSTOMERS

You give *faster* replacement service. Your customers get *more* pleasure and *more* good plays . . . *even from old, worn records!*

## SIMPLIFY YOUR SERVICE JOB

It's a complete *service* Kit, too. Contains everything for time-saving, labor-saving replacement. Gives you 3 basic models that replace over 150 standard types.

## MAKE MORE MONEY

Saves ordering time and service time. Cuts overhead. You make a good profit on every cartridge sale . . . and every service job. Builds needle sales, too! *Put the Kit on display . . . take one with you on your service calls.* Available in Kit "A" (Osmium) and Kit "B" (Sapphire). Each Kit contains 6 cartridges, 4 extra needles, mounting plates, replacement chart.

Order from your E-V Distributor or write for Bulletin No. 142

**ELECTRO-VOICE, INC., BUCHANAN, MICH.**

Export: 13 East 40th St., New York 16, N. Y., U. S. A. Cables: Arlab

E-V Pat. Pend. Licensed under Brush Patents.

NEW MODEL L14 MICROGROOVE CRYSTAL CARTRIDGE AND NEW MODELS 20 AND 22 MAGNETIC CARTRIDGE FOR REGULAR AND MICROGROOVE ALSO AVAILABLE

IT PAYS TO REPLACE WITH

**Electro-Voice**

## Rozette REFRIGERETTE

Porcelain table top electric refrigerator, has capacity of 3½ cu. ft. It is 34¼ inches high, contains two shelves and cutaway for storage of tall bottles. Frozen food packages can be

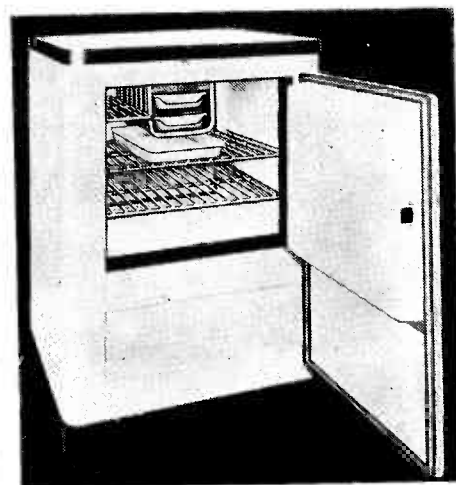

stored in ice tray compartment. Porcelain top is stainproof, baked porcelain interior; hermetically sealed power plant. I. R. Rozette & Associates, Merchandise Mart, Chicago 54, Ill. —RADIO & TELEVISION RETAILING

## Electromode HEATER

Built-in wall, down-flo heater with automatic thermostat, shown. Featured is a new silver-gray finish, designed for greater sales appeal. The neutral gray color is easily cleaned, and presents a richly textured hammered ap-

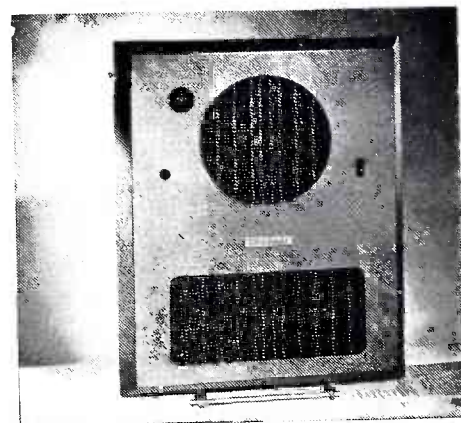

pearance. All Electromode models circulate heated air with a fan. Heat is generated by a patented cast-aluminum heating element which contains no exposed wires or glowing coils. Electromode Corp., 45 Crouch St., Rochester 3, N. Y.—RADIO & TELEVISION RETAILING

## New Hotpoint Dishwasher

A completely redesigned automatic electric dishwasher which will incorporate a new drain system to simplify installation has been developed by Hotpoint, Inc., Ralph C. Cameron, manager of the dishwasher-Disposal department, disclosed.

The new drain system was characterized as "a great step forward in cutting installation costs and establishing the dishwasher as a high volume appliance." Cameron said that company engineers expect to reduce the number of parts on the new models by 30 per cent.



## New Products for Dealers

### Indiana TAPE RECORDING HEAD

Model TD-704 is a magnetic tape recording head for use by manufacturers of home recorders, broadcasting equipment, business dictating machines, and test equipment utilizing

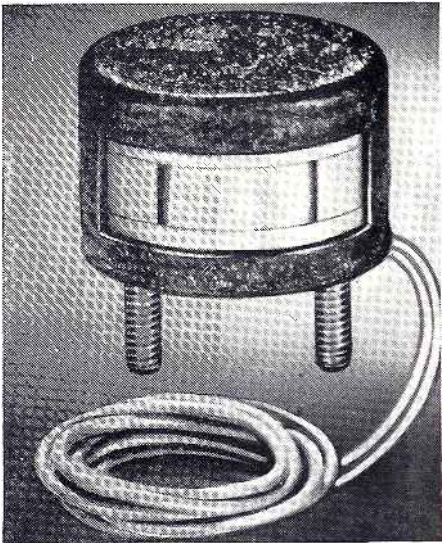

quarter-inch tapes. For use in high impedance circuits, it features high output and compact size, measuring  $\frac{7}{8}$ " x  $\frac{3}{8}$ " x  $\frac{5}{8}$ " deep. Indiana Steel Products Co., 6 N. Michigan, Chicago 2, Ill.—RADIO & TELEVISION RETAILING

### Speedex SPRING MAKER

The Spring Maker is recommended by the manufacturer as a bench tool for radio men, auto mechanics, experimenters, engineers, etc., to make springs of any desired diameter, pitch, number of coils and size of wire. Both compression and extension springs can be made, and a supply of assorted piano wire is provided with it. General Cement Mfg. Co., Rockford, Illinois.—RADIO & TELEVISION RETAILING

### TV INDOOR ANTENNA

Tel-Tenna is a compact, tubular indoor antenna of unique design, said to give high gain on all channels with directional characteris-

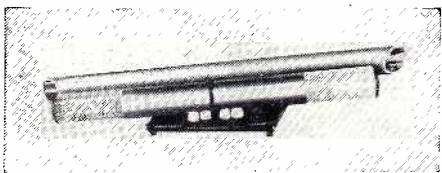

tics. Model 1, the simple antenna, lists at \$19.95, while model 2, which includes a booster with tuning features, lists at \$49.95. Precision Plastic Products, Inc., Chicago 6, Ill.—RADIO & TELEVISION RETAILING

# FLEXTRON MAGNIFYING LENS

adds that **plus**  
to your tv sales

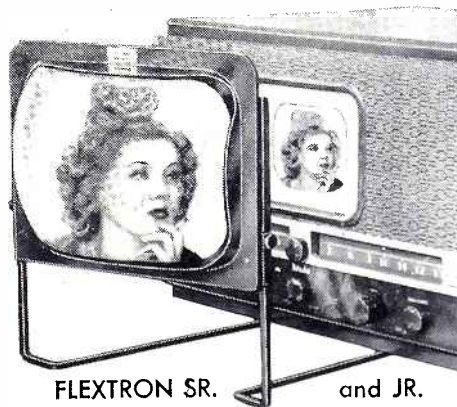

FLEXTRON SR. and JR.



FLEXTRON #3 (ROUND)

## AMAZING FLEXTRON LENS FITS ALL SETS—GETS BIG CUSTOMER RESPONSE

Sell to all your TV customers! Gives them more real 'seeing pleasure'—clearer, sharper, extra-large image. No glare or distortion. With Blue FLEXTRON, customers view pictures in normal room-light. A handsome FLEXTRON style for every TV set—each perfectly adjustable, beautifully engineered.

**FLEXTRON SENIOR.** 10" or 12" screens.  
List—CLEAR, \$34.95—BLUE, \$39.95.

**FLEXTRON JUNIOR.** 5" or 7" screens.  
List—CLEAR, \$19.95—BLUE, \$21.95.

**FLEXTRON #3 (ROUND).** 7" or 10" screens.  
List—CLEAR, \$27.50—BLUE, \$29.95.

**FLEXTRON DE LUXE.** Console style.  
List—CLEAR, \$39.95—BLUE, \$44.95.

Five other models available in low-price range.



FLEXTRON  
DE LUXE

Make extra profits on every TV sale! Send today for descriptive circular containing complete information and distributors' prices. A few distributorships still available—write at once for information.

MANUFACTURERS OF

**ELECTRO-STEEL  
PRODUCTS, INC.**

112-14 N. SEVENTH ST. PHILA. 6, PA.

**FLEXTRON**





**THE FASTEST TV ANTENNA ASSEMBLY**

**YOU + JFD "QUIK-RIG" = 30 SECONDS!**

*As Simple  
As Opening  
An Umbrella*

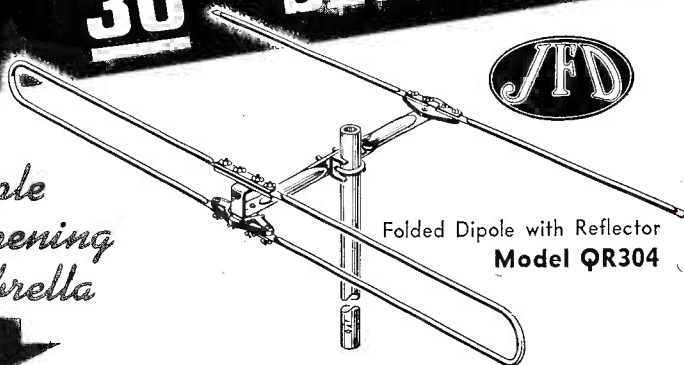

Folded Dipole with Reflector  
**Model QR304**

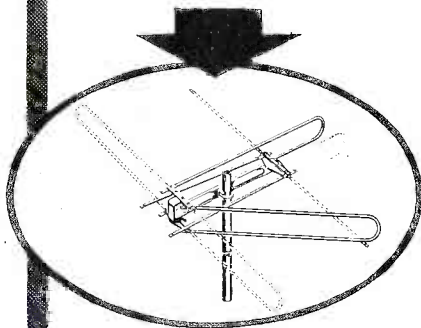

- ★ The simplest—fastest—easiest antenna assembly on the market today!
- ★ Completely pre-assembled.
- ★ No special tools or knowledge required.
- ★ Cuts installation time to the bone.

JFD Super-Beam Quik-Rig Antennas are available in a wide range of models to fit all requirements. Write for complete Quik-Rig catalog.

Ask your jobber to show you the new JFD Quik-Rig Antenna line.



**MANUFACTURING CO. Inc.**

**VISION does it again!**

**TELE-**

Model TVA  
Channels 2-13



**BOOSTER**

A Preamplifier for  
Better  
Television Reception

**\$28.50**  
LIST

Prices slightly higher  
on the West Coast.

*At a New Low Cost!*

**FEATURES**

- A two tube booster.
- Simple to install and operate.
- Efficient operation on all TV Channels.
- Exclusive "switch-through" circuit which allows normal antenna operation when booster is turned off.
- Excellent adjacent channel rejection, with sufficient bandwidth to preserve normal picture resolution.

**A NEW MODEL**

- Specifications —
- A three tube booster.
  - Two stages R.F. for super gain on high and low channels for the difficult areas.
  - Plus all the other VISION features.

**\$37.50**  
LIST

Prices slightly higher on the West Coast.

Also Complete Line of Television  
Test Equipment.

WRITE FOR PARTICULARS

**VISION RESEARCH LABORATORIES**  
87-50 Lefferts Blvd., Richmond Hill, N. Y.

Sold through leading  
jobbers in all pres-  
ent television areas.



**Tele-tone AC-DC Video Set**

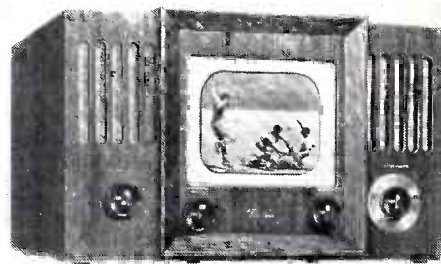
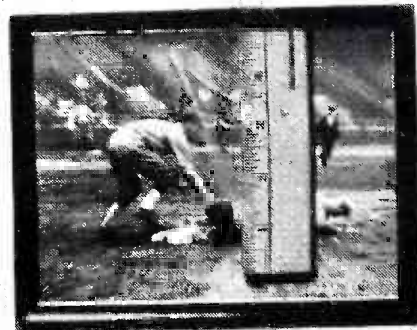

Table model AC-DC television set, with 7-inch screen, retails at \$199.95. S. W. Gross, president of Tele-tone Corp., points out that there is a big demand for television sets which are capable of operating on direct current as well as on alternating.

**Tele-Scope MAGNIFIER**

This new magnifier, or lens, is said to be the first flat, plastic, non-liquid lens developed for television use. Weighing less than three pounds, the magnifiers are available in three sizes: 9x12", 8x10" (for 7" sets) and



12x16" (for 10 or 12" sets). The maker states that it is possible to increase the size of 10" tube pictures 3 to 4 times without distortion. Tele-Scope is furnished in walnut or mahogany finished frames, complete with mounting brackets. The Wavell Corp., S. E. Corner Broad & Chestnut Sts., Philadelphia 7, Pa.—**RADIO AND TELEVISION RETAILING**

**Hy-Lite WINDOW ANTENNA**

Providing folded dipoles for both low and high bands, the HY-80-40 TV antenna may be mounted on wall, roof, in attic or out the window, and is especially adapted for use in

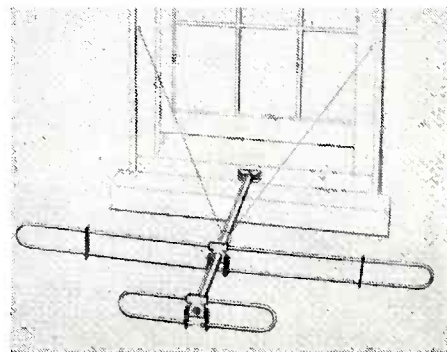

cities. The kit includes a 4' mast and provisions for mounting. Hy-Lite Antennae, Inc., 528 Tiffany St., Bronx 59, N. Y.—**RADIO & TELEVISION RETAILING**



## Jester Joins Ross Mfg.



K. B. Ross, president Ross Mfg. Co., Chicago, announced the appointment of Oden F. Jester, above, as general sales manager.

### Atlas TV MAGNIFIER

The Tel-Optic lens for use with 7, 10 or 12" picture tubes measures 12x17", and enlargement up to three times is stated by the maker. The lens is framed with a shield designed to

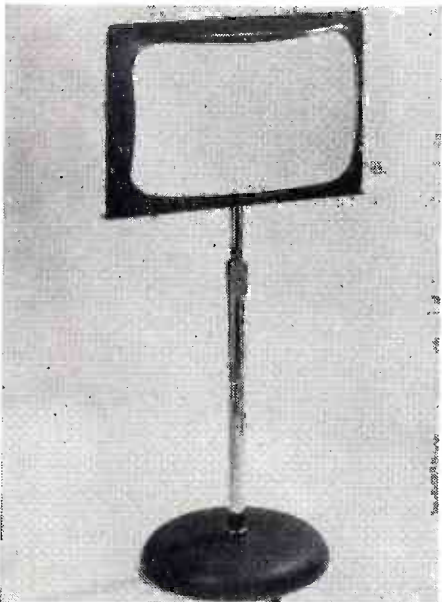

keep out room lighting reflections, and an adjustable floor stand is provided. The list price is \$49.95. Atlas Sound Corp., 1449—39th St., Brooklyn 18, N. Y.—RADIO & TELEVISION RETAILING

### Vision TV BOOSTER

The new TVZ Telebooster features continuous vernier tuning over all thirteen channels and a four position gain control, utilizing three 6AK5's to boost weak TV signals in fringe areas or indoor installations. List price is \$54.50. Vision Research Laboratories, 8750 Lefferts Blvd., Richmond Hill 18, N. Y.—RADIO & TELEVISION RETAILING

### Yuletide TIP

Most stores lengthen operation hours, and keep open additional evenings during the holiday season. It is extremely important to post notices calling attention to such changes on front doors and interiors of establishments.

## BIGGER HOLIDAY PROFITS

with new

## 4-IN-1 GIFT COMBINATION



UNMATCHED QUALITY!

List **\$199.50**

Slightly higher west of Rockies

PORTABLE

HIGH FIDELITY

WIRE RECORDER

RADIO

PHONOGRAPH

P.A. SYSTEM

**Four gift buyers instead of one!** Only Pentron offers you this amazing four-way sales value, in its wonderful new combination wire recorder, radio, phonograph and public address system!

**Another big sales appeal** a sensational synchronized timing meter exclusive with Pentron, never before offered in any wire recorder under \$500!

**Unequaled customer satisfaction.** In actual daily testing, Pentron instruments measure up to highest precision standards... insure trouble-free operation.

**Tested dealer helps and selling aids.** Mats for your advertising, envelope enclosures, counter cards, general literature... and Pentron's own advertising campaign that constantly creates new prospects!

**Profits from accessory sales and wire...** Pentron Recording Wire is "tops" in quality, builds repeat business. Extra profits in needles, speakers and baffles, headsets, telephone pickups, etc.

### A Few of PENTRON'S Sales Values

- Precision-built, 7-tube, high fidelity wire recorder, records and plays back its own radio, phonograph or microphone.
- Highly selective superheterodyne radio, built-in antenna.
- Tru-tracking phono arm, plays 10" or 12" records, Astatic L70 Cartridge.
- Medium gain public address system.
- Approved by Underwriters' Lab., Inc.



RADIO-PHONOGRAPH  
**PENTRON**  
*Astra-Sonic*  
**WIRE RECORDER**  
PUBLIC ADDRESS SYSTEM®

THE PENTRON CORP.  
611 West Division Street  
Chicago 10, Ill. RTR-118

Kindly send full details on dealer-distributors' profit opportunity.

Dealer  Distributor

Name.....

Company.....

Street.....

City..... State.....

**TODAY—WRITE FOR NEW DEALER, DISTRIBUTOR PROFIT PLAN**



# FULFILL THE DEMAND

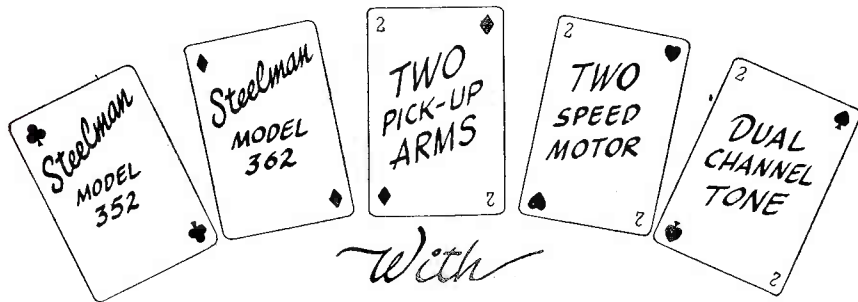

*With*

## THIS FULL-HOUSE HAND



Model 352—List Price \$49.95

Two pick-up arms (plays LP and standard records), two speed motor, power transformer, three tubes, 5 watt output, 6 1/2" Alnico speaker, dual channel tone control, inverse feedback for maximum volume with minimum distortion. Size: 14 1/4 x 15 3/8 x 7 1/4.



Model 362—List Price \$59.95

"Featheride" Tone Arm for LP records, special "Retractable" Tone Arm for standard records, two speed motor, power transformer, three tubes, 5 watt output, 6 1/2" speaker, dual channel tone control, inverse feedback, deluxe case superbly designed for style and durability.

*"The Tone Quality is Better"*

### STEELMAN RADIO CORP.

742 EAST TREMONT AVENUE

BRONX 57, N. Y.

**HY-LITE** presents . . .  
the new - all channel  
**LOW COST TV ANTENNA**

FULLY ADJUSTABLE

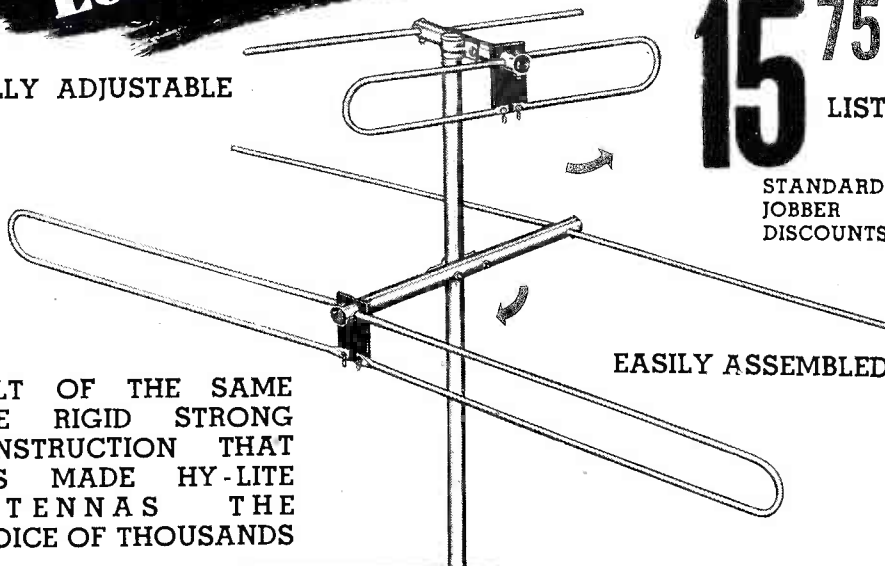

EASILY ASSEMBLED

BUILT OF THE SAME FINE RIGID STRONG CONSTRUCTION THAT HAS MADE HY-LITE ANTENNAS THE CHOICE OF THOUSANDS

ONLY  
**15<sup>75</sup>**  
LIST

STANDARD  
JOBBER  
DISCOUNTS

**HY-LITE Antennae** INC.  
Makers of Fine Antennas for AMATEUR · FM · TELEVISION  
528 TIFFANY ST., BRONX 59, N.Y.

IF YOUR JOBBER CAN'T SUPPLY YOU, SEND US HIS NAME. WRITE FOR NEW FREE CATALOG TV118

## New Appliances

### Westinghouse WARMING PAD SWITCH

New braille, or "touch type" control switch featured on Westinghouse warming pad is shown. Made of black plastic and small enough to fit into palm of the hand. Dial carries the visual markings of off, low, medium



and high heats. In addition, a series of small metal "dots" appear as the dial is moved from setting to setting. On the low setting, one "dot" appears, two for medium and three for high. All "dots" disappear on the off setting. Westinghouse Electric Corp., Appliance Div., Mansfield, O.—RADIO & TELEVISION RETAILING

### Haydon DEFROSTER CLOCK

Defroster control clock incorporates hour, minute and sweep-type second hands, and an automatic control for refrigerator defrosting. The knob for the clock hands is located at the top of the dial, away from the defrost con-

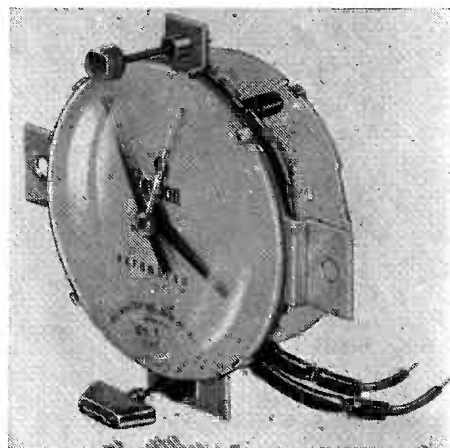

trol. The defrosting cycle is variable from 3 to 4 hours by means of an "on" time adjustable, through the defrost control knob. The control may be left "off" at intervals, or may be set for regular nightly operation. Haydon Mfg. Co., Inc., Torrington, Conn.—RADIO & TELEVISION RETAILING

### X-Pelzit EXHAUST FAN

Exhaust fan for window mounting. Has sliding side panels adjusted to permit mounting in windows from 22 inches to 33 inches in width. Extra long panels to fit 36 inch windows available. Ten-inch blades, 60 cycle AC shaded pole induction motor expel fumes and odors at the rate of 600 cu. ft. per minute. Entire unit is coated with cream colored baked on enamel finish. Retail for \$13.95. Thomson & Bishop, 910 Larch Ave., Takoma Park, Md.—Radio & TELEVISION RETAILING



**Federal TELEVISION RECEIVER**

Model 30, "The Kimberly," shown has 30 tubes; uses 15-inch direct view picture tube;

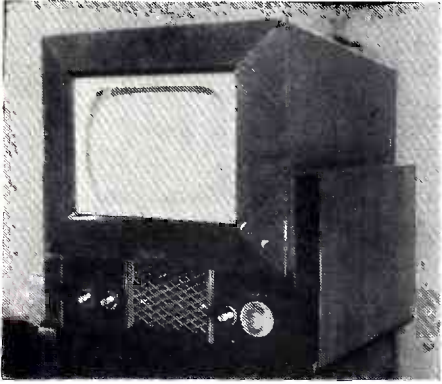

picture size approximately 140 square inches. Mahogany cabinet. Suggested list price \$795.00. Federal Video Corp., 108-10 Jamaica Ave., Richmond Hill 18, N. Y.—RADIO & TELEVISION RETAILING

**Sateen TELEVISION TABLE**

Model T 10 table shown is 27 inches high, has a "swivel" top that is 20 x 26 inches. Model T 11 has a swivel top that is 14 x 20 inches with openings for ventilation. The tables



are especially designed so that the television set can be turned in the direction of existing seating arrangements. Tables finished in walnut or mahogany. Sateen Products Co., Inc., 264-6 47 St., Brooklyn 20, N. Y.—RADIO & TELEVISION RETAILING

**UST Television Console**

A 15-inch television console model is being produced by the United States Television Mfg. Corp., New York City, announces Hamilton Hoge, president. The unit is priced at \$1495, and has AM and FM radio reception, Webster automatic phonograph, attractive mahogany cabinet, 31 tubes plus four rectifiers.

**Champagne Bottle Radio**

Lawrence Welk, orchestra leader, known for his "champagne music," is introducing a receiver called "champagne radio", which is to be built into a bottle. The set is a five tube AC-DC radio with dial on the cork and a 4-inch speaker. Welk is wholesaling the item from 1140 Lake St., Oak Park, Ill.

**Tele King Appointments**

The Tele King Corp., New York City, manufacturers of 10, 12, and 15-inch direct view television receivers, has announced the appointment of E. G. Arnold, Glendale, Calif., as the firm's district manager for the states of Cal., Ore., and Wash. Zenith Home Appliance Co., Brooklyn, N. Y., was named as the firm's distributor for northern New Jersey.

**Farnsworth Promotes Sevy**

William Sevy has been promoted to district manager in the East Central region by the Farnsworth Television & Radio Co., Ft. Wayne, it was announced by Lee Hadin, regional manager.

**Changes Name to Vidcraft**

Colonial Television Corp., announced that the company's new name is Vidcraft Television Corp., according to its president, Alfred Emerson. Offices are at 780 E. 137th St., New York City.

**Now Starrett Television**

General Television Corporation has announced a change in its name to Starrett Television Manufacturing Corporation. The company will continue to manufacture its complete line of television receiving sets, emphasizing 15" and 20" direct view picture tubes at its factory, 601 West 26 St., New York City.



**MODERN  
5 INCH  
Scopes  
for  
TELEVISION  
and FM  
by**



**MODEL 505 (Illustrated Above)**

The unexcelled instrument in its class. Permits a complete visual analysis of the electrical and electronic circuits of the I.F. and R.F. bands as well as the audio frequency stages. Quickly determines the effectiveness of a tube or circuit as an amplifier, rectifier or source of special wave shapes. 115 VAC. 19" x 11 1/2" x 14". Steel carrying case.

**MODEL 195B for Television**

Another popular HICKOK Cathode Ray Oscillograph. With this instrument you can align IF transformers, trouble shoot, analyze wave shape of signal, determine unknown frequencies, amplify and view very weak signals. An ideal companion for the HICKOK Model 610 T.V. Generator and 288X FM-AM Generator. 105-125 VAC. 8 3/16" x 18 1/2" x 13".

**Sensitive, accurate . . . for stage-by-stage alignment**

**The only COMPLETE Cathode Ray Oscillograph. Built with the famous HICKOK quality and accuracy, and providing the following exclusive HICKOK features:**

- **Wide band amplifiers—20 cycles to 1 m.c.**
- **Extremely sensitive vertical amplifiers**
- **Demodulators**
- **Phasing control**
- **Built-in FM oscillators (505 only)**
- **Return eliminators**
- **Sinusoidal and linear sweep**



For over 35 years . . . the finest in electrical and electronic instruments

**THE HICKOK ELECTRICAL INSTRUMENT COMPANY**  
10523 DUPONT AVE. · CLEVELAND 8, OHIO



## New Products

### Howard PULSAIRE

Combination warm or cool air circulator plugs into any outlet. Flip of a switch converts unit from cool air to warm air circulator. Unit constructed so that it is impossible for children's fingers to contact blades or heated coils. Broad base to prevent tipping. Top knob for easy portability. Styled in copper, green or blue Hammerloid. Howard Industries, Inc., 231 S. LaSalle St., Chicago 4, Ill.—RADIO & TELEVISION RETAILING

### Odor-Master DEODORIZER

Electrically heated domestic-type unit can be used to deodorize, medicate or perfume the atmosphere. Unit measures 1½ inches x 2 inches x 2½ inches, and incorporates a built-in electric plug. Compressed wafers which emit vapors under the force of heat are placed in the unit as needed. Odor-Master Corp., 1800 E. Forest Ave., Detroit 7, Mich.—RADIO & TELEVISION RETAILING

### Cir-Kit EDUCATIONAL TOY

The set include ear-phones, buzzer, switch, carbon rod, iron core, masonite mounting board, crystal detector, 25 feet of cotton insulated wire, 200 feet of enamel covered wire, and a 1½ volt dry cell. Directions contain numbered steps, and simple diagrams. Child can build buzzer sets, telegraphs, magnets, burglar alarms, crystal radio set, etc. Boxed, with battery, retails at \$6.95. Central Novelties, Inc., 315 W. Van Buren St., Chicago.—RADIO & TELEVISION RETAILING

### Step-Saver TABLE

Model 49T porcelain steel table has rustproof porcelain finish. It is 12½ inches x 22 inches, and it is 25 inches high. Priced at \$6.95. A slightly larger size available at \$8.95. Asquith Associates, Inc., 131 State St., Boston 9, Mass.—RADIO & TELEVISION RETAILING.

### RMA Names Racine



L. S. Racine, sales manager, Chicago Transformer Division, Essex Wire Corp., has been appointed chairman of the Transformer Section, RMA Parts Division, for the year 1948-1949.

# 5 MINUTE INSTALLATIONS GYRO-TENNA\*

**NO TOOLS  
NAILS  
BOLTS  
SCREWS  
GLUE OR  
CEMENT**

**1675 LIST**

**The Television-FM Antenna of a 1,000 Positions**

- A removable window antenna
- Covers all frequency ranges 44-216 mc, channels 1 to 13 and FM
- Non-directional Provides reception from all points of the compass
- Expandable to full folded dipole or straight dipole and reflector
- Secured firmly by expansion bolt principle.
- Designed for maximum broad band performance.
- Strong, lightweight aluminum with genuine lucite insulation.
- Sells right across the counter TV-FM buyers can install easily.

Manufactured by  
**PUBLIC OPERATING CORP.**  
100 West 42nd St., N. Y. 18, N. Y.

National Sales Representatives  
**APEX ELECTRONICS SALES CORP.**  
192 Lexington Ave., N. Y. 16, N. Y.

\* Trade Mark - Patent Applied for



MODEL  
RC-47

Another BELL First  
**Disc Recorder**  
now equipped for  
playing LP records

## BELL Dual Speed RE-CORD@fone DISC RECORDER

Now this popular Bell seller is also available (as Model RC-47LP at slight extra cost) equipped to play LP Microgroove and all 10" and 12" commercial records

Depend on this multi-purpose Bell unit of wide appeal to earn a big profit slice in your potential market this Fall and Holiday Season. Its high quality is *unmatched at so low a price!* It records sound from *any source* (radio, phono, microphone) at 78 and 33-1/3 RPM, plays back immediately, and is also a public address system. A single control permits instant selection of recording, playback, or PA function. Other choice features include: sloping control panel, visual level indicator, ample tone control, "dubbing-in" and monitoring facilities. Completely self-contained in a single carrying case, covered in tan leatherette.

\*LIST PRICES: Model RC-47 is \$150 and Model RC-47LP is \$165.  
(prices slightly higher west of Rockies)

BE SURE YOUR STOCK IS AMPLE • SEE YOUR BELL DISTRIBUTOR OR WRITE



**BELL SOUND SYSTEMS, INC.**

552 MARION RD., COLUMBUS 7, OHIO  
EXPORT OFFICE: 4900 EUCLID AVE., CLEVELAND 3, OHIO



## Christmas SALES-MAKER

When displaying products requiring considerable installation time, be sure to point out such fact via lettered cards. Such technique will encourage early buying of TV sets, automatic washers, door chimes, electric ranges, disposal units, etc.

## Sell Sets for Xmas

(Continued from page 42)

In every dealer's store, whether he has television or not, there are plenty of new and exciting things to sell—FM, with its static-free operation and greater tone quality; record-players, recorders, and, of course, those portables which should be completely sold out when December 26 rolls around.

Yes sir, there's plenty of inspiration in the theme relating to the desirability of having a radio in every room, and a radio for everyone. There's inspiration for the consumer because he can get more enjoyment out of life. There's inspiration for the merchant because he can make more money.

Now is the right time to get started on a real campaign to sell more sets for Christmas!

## On LP Records

(Continued from page 71)

sure of the pickup on the record, an ordinary letter scale such as is used to weigh an envelope for postage may be used, suspending the pickup from it at the needle end. The suitability of existing motors may be checked with a stroboscopic disc. Stability is an essential factor, since wow would be more noticeable at the slow speed. Some phono motors have a speed adjustment but either will not go down to 33-1/3 RPM or will not be stable at that speed.

Invariably, where conversion involves an expenditure of money, the customer will want to know if it is worth while. This, of course, is a case for demonstration, but a few additional facts may be highlighted: first, the price in terms of minutes of playing time . . . second the space requirements for record storage . . . third, the records are of vinylite, which is unbreakable, contains no abrasive filler and so has low surface noise. The light needle pressure also makes for less wear, less needle noise, less attenuation of high frequencies, and less danger from accidentally scratching the needle across the record. Finally, more playing time is provided without the interruption of changer cycles or the labor of feeding the changer.

Approached with the proper knowledge and stock, Long Playing records can provide additional volume for the dealer in the sale of new equipment and the modification of existing equipment, as well as the sale of records.

# CURRENT CONVERSION

## ATR "A" BATTERY ELIMINATORS



### for DEMONSTRATING AND TESTING AUTO RADIOS

New Models . . . Designed for Testing and Operating Auto Radios and D. C. Electrical Apparatus from 110 Volt A. C. Lines. Equipped with Meter, Voltage Control, and Selenium Rectifier, Assuring Noiseless, Interference-Free Operation, and Extreme Long Life and Reliability.

**ATR**

New Models

**AUTO RADIO VIBRATORS**

A Complete Line of Vibrators . . .

Designed for Use in Standard Vibrator-Operated Auto Radio Receivers. Built with Precision Construction, featuring Ceramic Stack Spacers for Longer Lasting Life.

**ATR VIBRATOR GUIDE**  
a complete line

New 32 page VIBRATOR GUIDE FREE

**ATR**

New Models

**STANDARD AND HEAVY DUTY INVERTERS**

For Inverting D. C. to A. C. . . .

Specially Designed for operating A. C. Radios, Television Sets, Amplifiers, Address Systems, and Radio Test Equipment from D. C. Voltages in Vehicles, Ships, Trains, Planes and in D. C. Districts.

**NEW MODELS**  
**NEW DESIGNS**  
**NEW LITERATURE**  
See your jobber or write factory

**AMERICAN TELEVISION & RADIO Co.**  
Quality Products Since 1931  
SAINT PAUL 1, MINNESOTA-U.S.A.





**VISION... proudly presents**

**the first SUPER DE LUXE BOOSTER**

Three stages of high-gain, broad band amplifiers, adjustable gain and smooth continuous tuning... that is what makes the VISION TELEBOOSTER MODEL TVZ the finest in its field.

**Check These Features**

- Continuous tuning over all tv channels, no bandswitching.
- Helps overcome noise and interference conditions.
- Vernier tuning makes the hairline adjustment easy and accurate.
- Gain control permits just the right amount of gain for each station.
- Eliminates need for outdoor antenna in many locations.
- Use three (3) type 6AK5 tubes in stable, high-gain circuit.
- Self contained power supply using long life selenium rectifier.
- Easy to install, just plug into AC outlet and connect to set and antenna.



MODEL TVZ **\$54.50** LIST

Prices slightly higher on the West Coast.

**NEW! TELEVISION FRONT END TUNER MODEL TF**

Vision Television Front End Tuner Model TF contains an RF Stage, Mixer and Oscillator incorporating an ingenious continuous tuning mechanism to provide stable and sensitive performance over all 13 channels.

Technical Information Supplied on Request

**NEW! THE FM TUNER FOR TELEVISION**

A new money maker in the television accessory field is the VISION FM-TELE-TUNER. Just connect the same way as a Booster, turn TV set channel selector to an unused channel and tune in FM during the hours when TV is not being broadcast.

**\$29.95 List**



**VISION RESEARCH LABORATORIES INC.**

87-50 Lefferts Blvd., Richmond Hill, N. Y.

**SENSATIONALLY DIFFERENT...**

**SLIM JIM**

A revolutionary development in soldering irons is the inter-changeable Thermo-Cel head. These heads not only simplify difficult operations but also are available in different wattages, thus giving the operator a flexibility of many irons in one. Our fifty-watt head will do the work of any ordinary 100-watt standard iron. **SAVE MONEY — SAVE TIME — LESSEN FATIGUE — INCREASE SPEED AND EFFICIENCY** — try the SLIM JIM and you'll never go back to old, heavy, hot-handled antiques. **THE SLIM JIM IS MADE TO STAND UP UNDER THE MOST EXACTING, CONTINUOUS 24-hour DUTY REQUIREMENTS.**

WEIGHT OF IRON **3 1/2 oz.**

WRITE DEPT. TR-11 FOR DETAILS

Note how specially developed sturdy Current Conductors are plugged into iron. Heat is thereby concentrated in Thermo-Cell. Air space minimizes back-flow of heat, thus assuring a cool handle at all times.

For: General Servicing Jewelry Instruments

SLIM JIM Thermo-Cel heads are equipped with the new "Filmized" tip — a special process developed by us — to prevent scale from oxidation, from "freezing" the tip in the head. This added feature also increases the life of the tip from 5 to 10 times longer. The SLIM JIM has never "broken down," either in the "field" or under the rigid test conditions in our laboratory.

The SLIM JIM is ideal for use in emergency. The iron can be purchased without the transformer, and with battery clips, for use on any 6-watt battery. Write for details to Dept. BB.

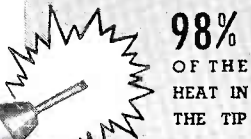

**98% OF THE HEAT IN THE TIP**

CHOOSE YOUR THERMO-CEL for the JOB — Easily Changed

**L-RAMJET—1/2" or 3/16"**

FOR: RADIO ASSEMBLY — SWITCH BOARDS — REPAIRS — METERS

**Z-BULLET—1/4" — 3/16"**

FOR: HIGH SPEED ASSEMBLY — VOICE COILS — PICKUPS — METERS — HEARING AIDS

**U-HEAVY OBLIQUE—3/16" — 1/8"**

FOR: TERMINAL BOARDS — RELAYS — CONTACTS

**A-LIGHT OBLIQUE—1/4" — 3/16"**

FOR: PRECISION SOLDERING — OFF ANGLE JOBS — INSTRUMENTS

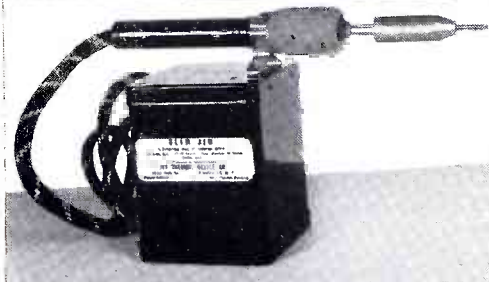

SLIM JIM with Transformer

**A SOLDERING IRON OF SUPERIOR MERIT**

**JET THERMAL DEVICE CO.**  
2173 86th STREET BROOKLYN, N. Y.

**Holiday WARNING**

Great care needs to be exercised during holiday rush hours in making change and in cashing checks. In addition to the possibility of themselves making errors, salespeople have to guard against those made by customers, and against deliberate swindle propositions engineered by a few sharpers who seek to take advantage of the abnormal conditions.

**Buying Behaviorism**

(Continued from page 61)

One of the most common yet least publicized phases of behaviorism by buyers is the inter-family "competition" over the choice of products. Such "competition" often develops into a battle royal, in which the unwary salesman may find himself very much in the middle.

Not long ago a salesman succeeded in "narrowing down" a family to a choice between two top-price television sets only to find what amounted to bitter controversy running wild throughout the household.

The man of the house, and his sister, who resided there, were dead set on Receiver A., while his wife and son expressed themselves as ready to hold out till the hot place froze over for Receiver B. Angry discussions ran the gamut from cabinet design to picture clarity; from sound quality to what make the Jones' had. The salesman almost ran himself ragged trying to listen with equal courtesy to the views of each of the squabblers, at the same time being most careful not to "take sides."

Because this salesman kept neutral and kept his head, he came out of the before-mentioned deal with *two sales*, one a table model for the basement playroom, and the other, a console chosen by Mrs. Buyer!

The salesman who loves his work can get a big bang out of the study of human buying behaviorism. He'll learn lots of things, among them the fact that while most normal people react along similar lines, plenty of others do not. And, so far as the latter group is concerned, he's in for some surprising revelations!

**Sell Dishwashers**

(Continued from page 64)

American home. This job consists of taking the mystery out of one of the simplest of all appliances, and selling it to the public on its merits, stressing its low cost, along with the numerous other features pointed out in this article.

The demand so far as want is concerned is phenomenally large. The profit-minded dealer is finding ways to cash in on such terrific interest.



## Servicing Auto Sets

(Continued from page 76)

roll on its mounts. The bond is soldered to the fire wall with a large enough iron to insure a hot joint—at least a 500 watt iron. The same may have to be done to the hood and/or fenders.

Many new cars, especially 1947 and '48 models, have their generator voltage regulators set too high (8 and 8½ volts), or have defective regulators (where the voltage may run as high as 10). As stated earlier, this may cause premature tube or part breakdown, or it may result in a whistle in the set when the car goes over a certain speed. Usually such matters are referred to an auto ignition man, but if they are handled at the radio shop, the regulator should not be touched until it has been ascertained that the battery voltage is normal, and not low, for in the latter case the regulator would and should send the charging voltage up. The manufacturer's rating on the generator should be checked, also.

Some sets have plastic push buttons and these occasionally stick in a depressed position. Since this draws a high current for a longer time than usual, the fuse may blow (the solenoid is likely to have been overheated before it blew) or the solenoid burned out, or both.

Many new sets have miniature tubes, and these have a habit of making poor contacts at the socket, especially if the set is on its side. Occasionally one of the pins will short out to the center post.

Some push button units utilize a separate set of coils for each station, and these tiny coils often open up due to car vibration and shock.

New sets should be given a bench pre-flight of an hour or so before installation, as many are coming through with microphonic tubes, shorted tubes, rattling speakers, defective vibrators and OZ4's. The latter tube often operates satisfactorily for 15 minutes to an hour, then fades abruptly only to resume the cycle after the set has been turned off a while. It's also wise to see if all the joints were soldered at the factory even if the set operates.

To locate wheel noises, operate the car and depress the brakes. If noise increases, the trouble is probably in the brake assembly (possibly rivets exposed on worn shoes). If the noise increases when the car is driven over a macadam or dirt road, or when it rains, the trouble is due to some tire and tube combination.

It is important to use an exact replacement of the buffer condenser, since one too small will endanger power transformer and rectifier while one too large shortens vibrator life. If a bad buffer is found, therefore, it is wise to check the condition of the other three components (vibrator, Xformer, rectifier).

# Winner by a Landslide!



**The TURNER  
MODEL 20X**

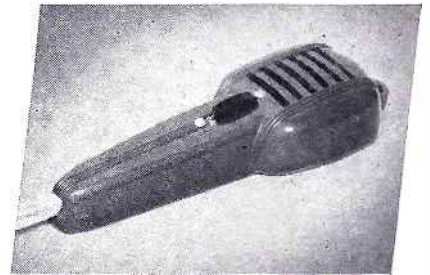

**MODEL S20X**

*Equipped with convenient slide-lock switch for on-off operation.*

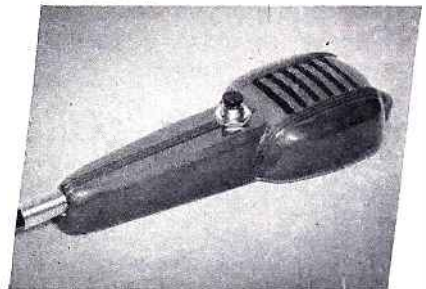

**MODEL SR20X**

*Equipped with built-in push-to-talk relay switch and cable.*

## High performance at low cost

On every count the new Turner Model 20X has won the vote of users. Response to voice and music pickups is smooth and even over a desired range of frequencies. Output level is remarkably high. Engineered for dependable service indoors or out with high quality moisture sealed crystal circuit. Light in weight, natural to hold, and most convenient to use. It is equipped with hook ring for hanging. Attractive case is finished in rich baked brown enamel. And the price, complete with 7 ft. cable is exceptionally low.

*Write for Complete Microphone Literature*

**THE TURNER COMPANY**  
903 17th Street N. E.

Cedar Rapids, Iowa

Crystals licensed under patents of the Brush Development Co.

*Microphones* **BY TURNER**





# RMS

Your  
Dependable  
Source of  
Supply

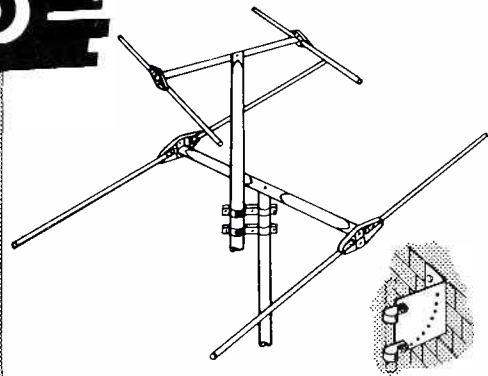

## TELEVISION ANTENNAS and ACCESSORIES

Here's your plentiful, reliable source of supply for fast-selling television antennas and accessories. RMS has a complete line—all types of antennas, including straight and folded dipoles, stacked arrays, high-frequency attachments, mounting brackets, extension masts, etc.

See your nearest Jobber for these fast-sellers, and new RMS Complete Catalog of Television Accessories.

**RADIO MERCHANDISE SALES, Inc.**  
550 WESTCHESTER AVENUE NEW YORK 55, N. Y.



**WEBSTER-CHICAGO**  
**Pre-tested**  
**RECORDING**  
**WIRE**

See Page 55  
for the important full  
page advertisement



**WEBSTER-CHICAGO**

**NEW! Your Lighted  
Christmas Tree  
in MOTION...**

**KASSON ELECTRIC  
CHRISTMAS TREE TURNER**

Revolves  
3 Times  
a Minute

Adjustable  
to most  
Tree Sizes!



Ideal for your Christmas displays. . . .  
Sturdy, dependable self-starting A.C.  
motor. Write for complete **ROTO-**  
**PRODUCTS** catalog and price list.

Introducing . . . Model "712"  
Movement  
with Lights!

• Model "712" turns  
3 RPM while per-  
mitting novel, self-  
contained lighting  
effects, or operation  
of electric devices—  
by means of sliding  
contacts. Capacity  
200 lbs., 18" dia.  
table.

**KASSON**  
**Roto-Sho**  
ELECTRIC TURNABLES



**GENERAL DIE & STAMPING CO.**  
Dept. TV, 262 Mott St., New York 12, N. Y.

# 1949!

RMA's 25th Year

TELEVISION's 10th Year

**CALDWELL-CLEMENTS'**

28th Year in radio-TV  
Publishing

### TV CHIMNEY MOUNT

The JFD adjustable chimney mount is designed to support antenna masts of ½" to 1½" OD without the use of guy wires. Steel bands around the chimney hold the vise-type mast clamps in place, and the adjustable spacing between the bands permits positioning the points of support according to the length of mast used. J.F.D. Mfg. Co., Inc., 4120 Ft. Hamilton Pkwy., Brooklyn 19, N. Y.—RADIO & TELEVISION RETAILING

### Bendix Display Piece



Designed for window or floor, this display exhibits three new models of Bendix automatic washers. It is lithographed in full colors. The "stage" is 47 inches wide, 54 inches high. The cut-out figures are free standing and about 20 inches high. Easel at left features Bendix automatic soap injector.

### LYTE TV ANTENNA (Channels 7-13)

The Skybeam is an array for the high band (TV channels 7-13) consisting of two folded dipoles, each with reflector, to provide increased gain and directivity in that band.

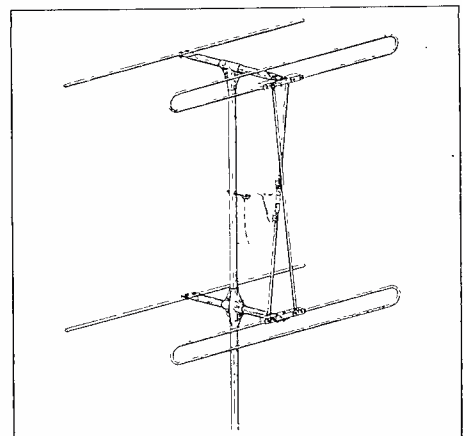

Designed for use either separately or with an existing low band antenna, model LHF comes with necessary mounting brackets and equipment. Retail price is \$15.50. Lyte Parts Co., Inc., Plainfield, N. J.—RADIO & TELEVISION RETAILING



## Promotes Tele-tone Sets



Tele-tone Radio Corp., New York City, participated as one of the donor's in the radio quiz show broadcasts of "Winner Take All." Model shown above in front of theatre display which featured the Tele-tone table model sets, which were given as prizes to contestants.

## Dealer Group Brings Suit

The Queens, N. Y. Electrical Appliance Merchants Assn., Inc., was advised by its attorney Gerard I. Nierenberg, that a law suit has been instituted in the Queens Supreme Court against a New York City retail dealer for violation of the Fair Trade Law connected with the sale of a television set. All other complaints of this type of violation will be turned over to the association in the future for immediate consideration.

## Ansley Appointment

Ansley Radio & Television, Inc., Trenton, N. J., has announced the appointment of Kenneth Pelham as chief of production engineering. He will supervise all production of television and radio made by the company.

## Sams Redbook

Howard W. Sams Radio Industry Redbook is a 440 page book presenting in tabular form the correct replacement parts for approximately 17,000 sets made from 1938 to 1948. Parts are listed under nine major components: capacitors, transformers, controls, IF coils, speakers, vibrators, phono cartridges, tube and dial lights, and batteries. Replacement data for 17 different parts manufacturers are included. The Redbook lists at \$3.95 and may be obtained from Howard W. Sams & Co., Inc., 2924 E. Washington St., Indianapolis 7, Indiana.

## Xmas WINDOW DISPLAYS

Use mass displays of small appliances, together with price cards and descriptive material. Such set-ups help convey the idea that the store offers a wide variety of Christmas gifts, and also offer valuable ideas to the window shopper. If you sell products from the windows make certain that displays are arranged so that such items may be obtained without disturbing the general effect.

# TRANSVISION

## NEW Television Kits, and Equipment

Important Advances in TV Reception and Servicing!

### NEW 10" TV KIT at amazingly LOW PRICE!

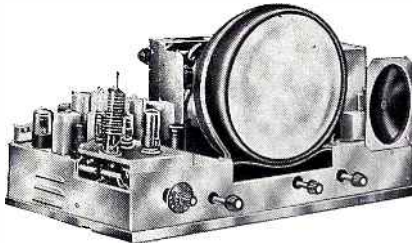

MODEL 10A TV KIT

The new Transvision Model 10A electromagnetic TV Kit gives a bright, stable 52 sq. in. picture. Has 10" picture tube, and CONTINUOUS TUNING on all 12 channels. Its high sensitivity makes for improved long-distance reception; especially good on high channels. Complete with all-channel double-folded dipole antenna and 60 ft. of lead-in wire. MODEL 10A TV KIT, less cabinet...Net \$199.00  
MODEL 12A TV KIT, same as above,  
but has a 12" picture tube...Net \$263.00

### NEW STREAMLINED CABINETS

for Transvision Model 10A or 12A TV Kit. Made of select grain walnut with beautifully rubbed finish. Fully drilled, ready for installation of assembled receiver.

Walnut Cabinet for 10A or 12A  
(Specify) .....Net \$44.95  
Mahogany and Blonde slightly higher.

### TRANSVISION ALL-CHANNEL TELEVISION BOOSTER...

To assure television reception in weak signal areas, or areas which are out of range of certain broadcast stations, Transvision engineers have designed this new booster. It increases signal strength on all television channels. Tunes all television channels continuously. Can be used with any type of television receiver. Unusually high gain in upper television channels.

Model B-1 .....List \$39.95

### TRANSVISION REMOTE CONTROL UNIT KIT...

Will operate any TV receiver from a distance. Turns set on, tunes in stations, controls contrast and brightness, turns set off. Ideal for installations where the television receiver is inaccessible. Tuner unit is a high gain, all-channel unit with about 50 micro-volt sensitivity. Easy to assemble in about an hour.

Model TRCU, with 25 feet of cable....Net \$44.50  
Without cabinet .....Net \$42.50

### NEW...TRANSVISION SWEEP SIGNAL GENERATOR

for Television and FM

OUTSTANDING FEATURES: (1) Frequency range from: 0-227 MC. . . . (2) Dial calibrated in frequency. . . . (3) Sweep width from 0-12 MC completely variable. . . . (4) Self-contained markers readable directly on the dial to .5% or better. (No external generator required to provide the marker signals). . . . (5) Crystal controlled output makes possible any crystal controlled frequency from 5-230 MC. . . . (6) Plenty of voltage output—permits stage-by-stage alignment. . . . (7) Output impedance 5-125 ohms. . . . (8) Directly calibrated markers, 20-30 MC for trap, sound and video IF alignment. . . . (9) RF for alignment of traps for IF channels when a DC volt meter is used as the indicating medium. . . . (10) Unmodulated RF signal to provide marker pips simultaneously with the main variable oscillator. . . . (11) Markers can be controlled as to output strength in the pip oscillator. . . . (12) Power supply completely shielded and filtered to prevent leakage. . . . (13) All active tubes are the new modern miniature type. . . . (14) Phasing control incorporated in the generator.  
MODEL No. SG .....Net \$99.50

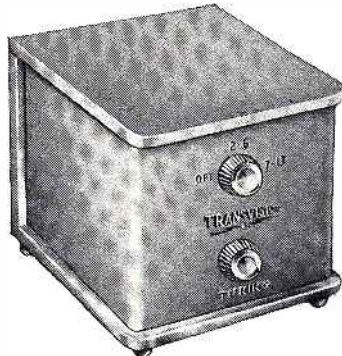

ALL-CHANNEL BOOSTER

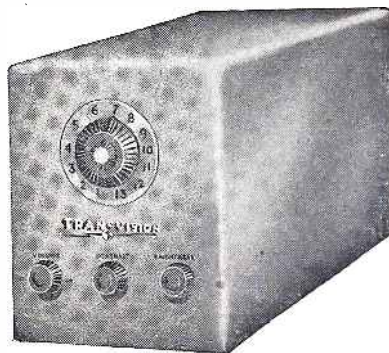

REMOTE CONTROL UNIT KIT

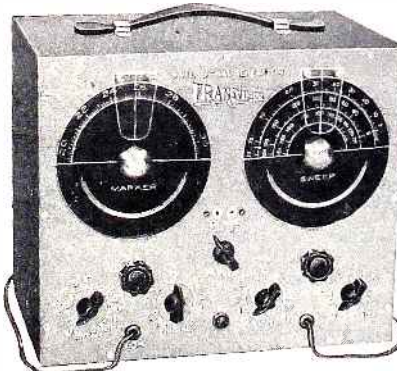

SWEEP SIGNAL GENERATOR

Radiomen . . . You Can Get into the  
**TELEVISION BUSINESS**  
In a **BIG WAY** with the  
**TRANSVISION DEALER PLAN**  
Write for Folder D-1

NEW 8-PAGE CATALOG of Transvision line available at your distributor, or write to:

**TRANSVISION Inc.**

Dept. RR

**New Rochelle, N. Y.**

In Calif: Transvision of California, 8572 Santa Monica Blvd., Hollywood 46

All prices 5% higher west of Mississippi; all prices fair traded. All Prices Subject to Change.



## THIS SIMPLE BENCH TEST

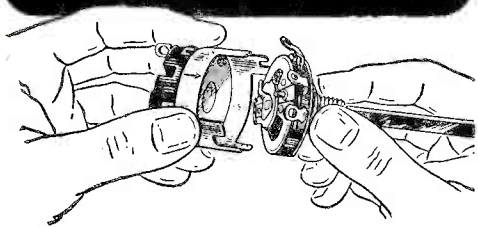

### proves you're right

Remove the cover from an IRC control, and from any other reputable control. You'll immediately see the superior IRC construction. Features that insure long dependable performance. Point by point, compare IRC's design to that of any other control and you'll know you're right when you ask for IRC!

Notice—the terminals are riveted assuring *positive* electrical contact. Gliding "5-finger" contactor provides *smooth gradation* of volume. *Silent* Spiral Spring connector eliminates principal source of control noise. Resistance material bonded to bakelite base gives an even, *long wearing* element.

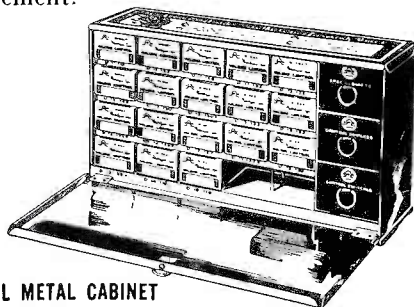

ALL METAL CABINET

Add *time-saving convenience* to the other features of IRC controls by buying a practical stock in this handsome all-metal cabinet. With this minimum investment of 18 Type D Controls plus switches and special shafts, the sturdy cabinet is furnished at no extra charge. You pay only the standard net price of the merchandise. Fast moving control stock in this IRC cabinet services 90% of the Howard Sams RED BOOK listings.



**INTERNATIONAL  
RESISTANCE CO.**

401 N. Broad St., Phila. 8, Penna.  
In Canada: International Resistance Co., Ltd.  
Toronto, Licensee

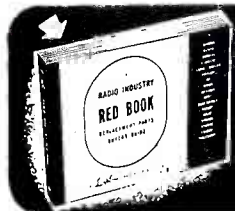

Yes! We're listed in the **RED BOOK**

Looking for the correct IRC replacement controls for any receiver manufactured from 1938 to 1948? Just refer to The Radio Industry RED BOOK.

## New Recorders

### Harrison WIRE RECORDER

Portable wire recorder phono-combination features: record player for 10 and 12-inch records; six tube performance; radio attachment; records from phono, record or mike;



attractive leather-bound carrying case; roll out control panel; public address system; tone control. Weighs 23 lbs. Dimensions: 8½ x 10 x 14 inches. Harrison Mfg. Co., 1426 N. St. Louis, Chicago 51, Ill.—RADIO & TELEVISION RETAILING

### Tapetone TAPE RECORDING KIT

Kit includes all amplifier components, including tubes and drilled chassis, all wire, connectors plugs, cables, screws and nuts. Mechanism components include turntable and motor, record pickup, erase and record-play

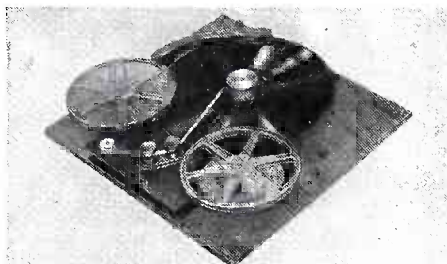

heads, tape propelling mechanism, mounting board, one ½ hour roll scotch recording tape, one takeup reel and complete instruction sheets. Kit priced at \$98.50. Tapetone Mfg. Corp., 37-06 36 St., Long Island City, N. Y.—RADIO & TELEVISION RETAILING

### Twin-Trax RECORDER

Portable magnetic tape recording equipment, model 710-B two-section portable magnetape recorder. The portable recording and playback unit is comprised of two matching cases, which are easily attached to make one compact single unit. One case contains the tape handling mechanism and speaker. The second case houses the 10-tube recording and playback amplifiers. Metal snaps fasten both together. Model features: one continuous hour of play; tape threading simplified; inputs provided for microphone and radio-phono; either sound track can be erased independently while a new recording is being made. Complete recorder available at \$335.00, less microphone. Amplifier Corp. of America, Magnephone Div., 398 Broadway, New York 13, N. Y.—RADIO & TELEVISION RETAILING

## THE MOST DESIRABLE ANTENNA MOUNT EVER MADE!

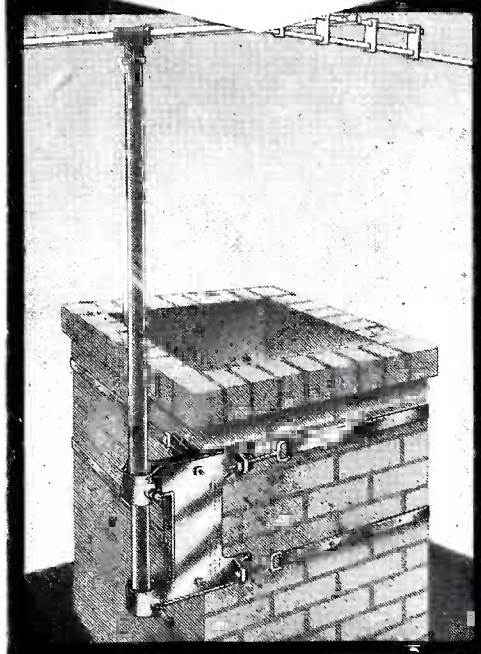

Pat. Pending

## Chimney Mount Antenna Base

- for TELEVISION
- FM • AMATEURS

List Price: **\$7.50**

Cost to Retailer: \$4.50

Installed in 10 minutes • Permits Use of Several Mounts on One Chimney

Chimney Mount is by far the fastest selling product of its type in the radio and television fields. It can be installed in ten minutes without the use of special tools or drilling of holes. Several mounts can be strapped to one chimney—to pole, 2 x 4, side of house or to any rectangular roof extension. Fastens aerial to highest point with galvanized steel bands having a combined tensile strength of more than 3,000 lbs. Made of corrosion-resistant aircraft-type aluminum alloy. Weight: 3 lbs.

Available Through All Leading  
Jobbers and Dealers or Write to:

**South River Metal Products Co.**  
South River, New Jersey



## Decca Subsidiary

Decca Records, Inc., New York City, has announced the formation of a subsidiary record company, Coral Records, Inc., with distribution planned through independent distributors. Coral has available all of the recording, manufacturing, promotional and credit facilities of Decca Records, Inc.

The first release included twelve records in the popular category and some country and sepiia releases. The Coral label has been publicized to dealers by means of direct mail, trade paper advertisements and distributor contact. Michael Ross has been named as general sales manager of Coral, with headquarters at 48 W. 57th St., New York City.

## ITI Sets for World Series

J. L. Dittman, Cleveland representative for Industrial Television, Inc., Clifton, N. J. firm, reported that all available ITI units were in use during the three days the World Series played in Cleveland. Dittman, who also operates the House of Television, said that in tours of the city while the series was being televised, he observed large crowds getting a view of the series on ITI's 15 and 20-inch direct view models.

## New Stewart-Warner Sets

Three new television sets, a table model and two consoles, providing 10% larger picture area than former models utilizing 10-inch tubes, have been announced by the Radio Division of Stewart-Warner Corp. The sets are designed as "companion pieces" and are "The Washington," "The New Yorker," and "The Wakefield." Channel selector tuning is a feature of the new television sets.

## Brunswick TV Sets go to Emerson Distributors

The Brunswick Div. of Radio & Television, Inc., New York City, has concluded an arrangement with Emerson Radio & Phonograph Corp., whereby Emerson's distributors will handle complete distribution of the Brunswick television line. Distribution of the sets in Boston, Providence, Hartford, New York, Newark, Philadelphia and Washington is already under way, with distribution to be extended to the rest of the country as soon as production warrants.

## Webster-Chicago Fans



Santy Runyon, left, saxophone instructor, utilizes a Webster-Chicago wire recorder in teaching students how to play musical instruments. Professional musician Elwood Carl, right, finds the wire recorder useful in perfecting musical techniques.

WHERE QUALITY

AND RESULTING PRESTIGE ARE  
PARAMOUNT, LEADING MUSIC  
MERCHANTS PROFITABLY  
FEATURE THE INCOMPARABLE

CAPEHART

THE *Capehart*

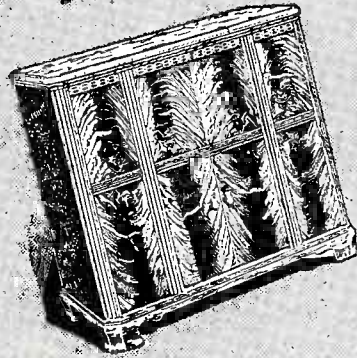

*One of the great luxuries of life*

Those who are in a position to gratify their desire for the very best in everything, including the world's great music—superbly reproduced—naturally choose the DeLuxe Capehart for their homes. It costs more, yes—but it is one of the world's finest instruments for musical reproduction.

You can explore the world with its powerful radio receiver—offering standard broadcast and FM reception—or provide supreme reproduction of the music in your record library.

Hear it at

**KNABE'S**

584 FIFTH AVENUE  
AT 47TH STREET BRYANT 9-0700

Reproduced from a recent issue  
of "The New York World-Telegram"

*Farnsworth* TELEVISION & RADIO CORPORATION,  
FORT WAYNE 1, INDIANA



# BURGESS

*Best bet  
for more  
business*



This perfect pair for personal portables, the new No. 2R "A", (left) made expressly for personal portables and No. XX45, 67½ volt "B" battery, give more listening pleasure and mean more sales and profits for you. Order your stock today.



**Bright  
New  
Package**

This bright, new package of 12 2R "A" batteries does its own selling. Carton fits into small space on your counter. Remember, Burgess recognized quality is preferred by 2 out of 3 electronic engineers. Push Burgess—for more sales and profits!

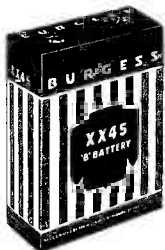

**Check Your  
Supply of Burgess  
Portable Batteries  
NOW!**

Be ready for the big fall portable battery demand. Football games, hunting trips, and the holiday season create peak usage for this item. Cash in on this seasonal business. Ask your distributor.

**BURGESS**  
IS THE COMPLETE LINE OF  
**BATTERIES**  
BURGESS BATTERY COMPANY  
FREEPORT, ILLINOIS

### Holiday HINT

The dealer who sells merchandise directly from displays can save a lot of time and grief by maintaining an orderly arrangement of empty cartons, each having instruction and warranty sheets. Such procedure will cut down returns due to failure of purchaser to understand how to run the product. Too, in cases where the carton is immediately available, customers are not as likely to demand item in original package as they are in instances where there's a long delay in searching for the box or carton.

### Big TV Set Production

Production of television receivers in the United States will reach the 100,000 a month mark by the last quarter of 1948, it has been predicted by James H. Carmine, vice-president, distribution, Philco Corp.

### Chicago Transformer Line

Newton Cook, jobber sales manager, Chicago Transformer Div., Essex Wire Corp., Chicago, announced the addition of a replacement transformer line to his company's stock transformer business. The new replacement line fits a range of the serviceman's most frequent power and audio requirements, and fills the needs of the amateur for efficient, standard-type ratings at low cost. Included in the line are power transformers, and chokes, driver, speaker matching, inter-stage and output transformers in a range of practical ratings.

### FM Assn. Convention

The second Annual Convention of the FM Association was held at the Hotel Sheraton, Chicago. Marion Claire, convention chairman presided at the opening meeting. Other speakers included, Wayne Coy, chairman FCC, J. N. Bailey, Executive Director, FMA, and Thomas F. McNulty, chairman RMA Liaison Committee.

### Hytron Contest Winner



Sidney C. Patette, left, radio serviceman of San Jose, Calif., receives the July prize in the Hytron serviceman's contest from Russ Hines, Hytron representative, (on right). Frank Quement of Frank Quement, Inc. looks on with approval.

FORECAST:

**Clear  
and  
Steady**

THAT IS

**ATLAS SOUND  
PERFORMANCE**



On land or sea . . . wherever Atlas Sound is used, you can count on unblemished, faithful performance. For a decade Atlas Sound has been noted for better Sound Equipment . . . now, the extra Alnico V Plus feature gives extra clarity, extra power, extra long-life.

**ATLAS  
SOUND CORP.**

1447-39th Street  
Brooklyn 18, N. Y.



## Special Arvin Display



Newly designed island floor display available through Arvin distributors to dealers. A four shelf streamlined floor piece the display has a special scratch preventative covering and is chrome trimmed. It is approximately four feet high, 4 1/2 feet long and the shelves are 19 inches wide.

## RCA TV Service Now Optional to Consumers

RCA Victor has announced that effective October 15 purchase of its television owner contract will be optional to the customer buying an RCA TV set. The firm will continue to render service on contracts still in force, and to purchasers of owner contracts in subsequent TV sales. The modification of the existing sales policy, it was announced, is in conformance with the original plan to continue factory-sponsored service only as long as necessary to insure dealer and manufacturer protection of customer good-will.

## Flextron TV Lenses

Electro-Steel Products, Inc., Philadelphia, Pa., manufacturers of Flextron magnifying lenses, announce the addition of five new suspending lenses to their line. Available in clear or blue, the lenses adjust either up or down for proper focus. Eight television magnifying lenses in a variety of price ranges are available.

## Zenith L-P Record Players

H. C. Bonfig, vice-president, Zenith Radio Corp., Chicago, announced the production of a new Zenith silent-speed record changer with "twin Cobra" tone arms. One Cobra is for standard records, the other was designed exclusively for use with Long-Playing records. A dual speed turntable functions with them and can be set for both speeds. This unit is operated by a simple hand switch. The green tone arm, for L-P discs, is lighter in weight than its twin. The twin Cobra arms are available on the Zenith combinations.

Zenith has also announced a Long-Playing record adapter for use by present owners of Zenith combinations. The adapter attaches to the audio system of the radio by a plug-in arrangement.

## Jobber Sponsors TV Show

In cooperation with one of its local dealers, C. V. Stackpole & Son Co. in Lynn, Mass., the General Electric Supply Corp., contracted for the sponsorship of the televising of high school football games for the 1948 season over a local station.

## Bendix Names Hassard



C. J. Hassard, above, has been named district merchandiser for the Philadelphia territory, by E. C. Bonia, general sales manager for Bendix Radio and Television. Bendix is now operating under the new direct factory-to-exclusive-dealer merchandising plan.

## Jobber Expands Offices

H. U. Mann Co., Inc., Chicago, electrical appliance distributors are now located at 1230 West Jackson Blvd. The new offices are housed in a modern, four story building and provide greater space and parking facilities.

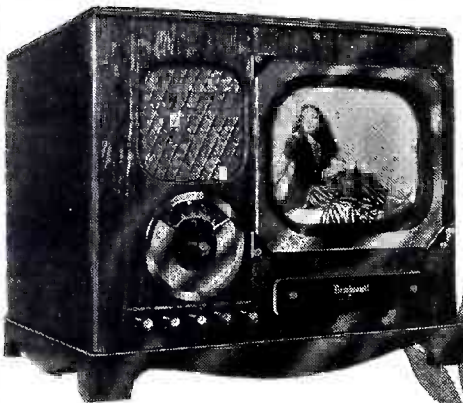

Model "1950" Television Receiver with 12" Picture Tube and FM Radio...\$495 List

**Y**OUR prospective television customers want a set that will give them perfect reception. Now at last they can have it...exclusive with Rembrandt. For Rembrandt offers reception never thought possible in present day television. It is truly tomorrow's set TODAY! Large, picture-clear reception to make your customers rub their eyes in disbelief. The Rembrandt is now available for immediate delivery in four luxurious models.

ALL REMBRANDT TELEVISION RECEIVERS CONTAIN FM RADIO

**REMINGTON RADIO CORPORATION**  
White Plains, N. Y.

RADIO & TELEVISION RETAILING • November, 1948

# Rembrandt

master  
in the art of  
television



Model 130  
Television  
Receiver  
with 15"  
Picture Tube  
and FM Radio  
...\$895 List



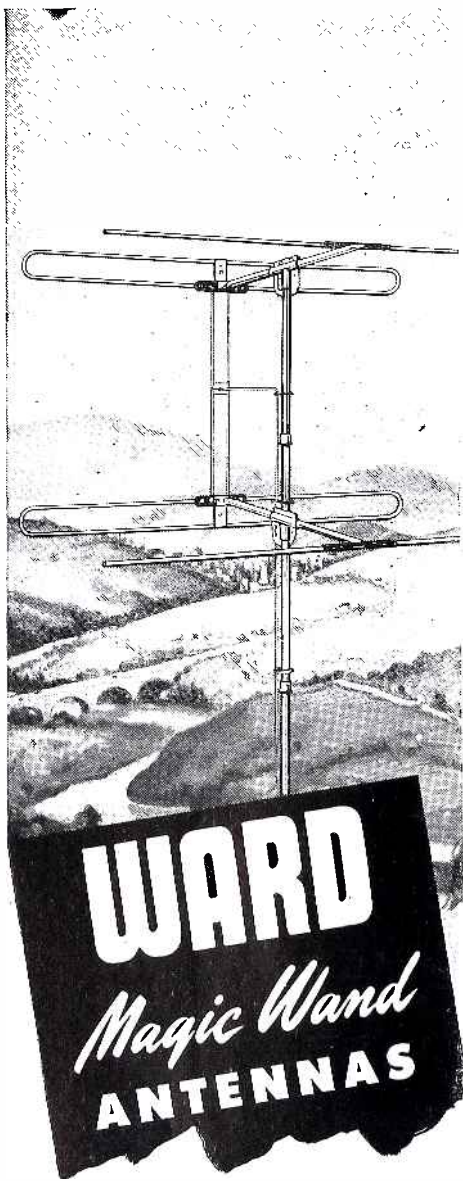

**THE ONLY BROAD BANDED,  
HIGH GAIN, STACKED ARRAY  
ON THE MARKET**

Many times more sensitive for TV reception in fringe areas and poor signal locations, the WARD TVS-6 STACKED ARRAY achieves maximum forward gain by stacking two high gain folded dipoles and reflectors with effective 1/2 wave spacing rather than the ordinary 1/8 or 1/4 wave which materially reduces sensitivity. THE ONLY STACKED ARRAY ON THE MARKET THAT IS BROAD BANDED, it will give excellent results with MANY CHANNELS where others are too selective. The advanced engineering and PRE-ASSEMBLED design of the WARD TVS-6 is only one of the reasons why WARD is the largest exclusive manufacturer of antennas in the world. See any leading parts distributor or write for catalog.

**THE WARD PRODUCTS CORPORATION**  
1523 E. 45TH STREET, CLEVELAND 3, OHIO.

**Admiral Regional Head**



Appointment of Phil G. Kerr, above, as regional sales manager for the Admiral Corp. was announced by W. C. Johnson, general sales manager. Mr. Kerr's headquarters are in Minneapolis, Minn.

**Small Appliances**

*(Continued from page 29)*

**Blankets, Electric**

Together with "sheets" and "foot-warmers", many will be sold as gifts. About 490,000 will be sold in '48. List-prices holding up well, and supplies are good. Require specialized sales effort.

**Broilers, Electric**

Supply good. Should sell as *multi-purpose units*, not merely as "broiler." Watch prices as some are being cut.

**Chimes, Door**

Large supply and selection. Dealers who do own work should urge early purchase to allow time for installation. Last-minute buyers can be sold on after-Christmas installing. Prices holding.

**Clocks, Electric**

Good supply, wide price range. "Natural" as Christmas gift. Can sell every day in the year. List-prices holding up.

**Coffee-Makers; Glass, Metal**

Will solve many a gift problem. Adequate supply of almost all makes. Number of new models on market. Prices quite reasonable. Good, steady seller.

**Dryers, Hair**

Great gift for any woman. A good item to suggest to the male shopper. Supply satisfactory, though some makes not back on market.

**Fans, Exhaust**

Practical gift for kitchens, rumpus rooms, etc. Window types good package sellers. Supply good: steady list prices.

**Grills, Sandwich**

Old, reliable appliances will solve many a gift problem. Sell as multi-purpose jobs, since they're fine for cooking chops, steaks, hot dogs, hamburgers, etc. Most makes available.

**Heaters, Space**

Lots of "combinations" and straight jobs available. Ideal for inter-family

**FOR THAT "FRINGE" AREA**

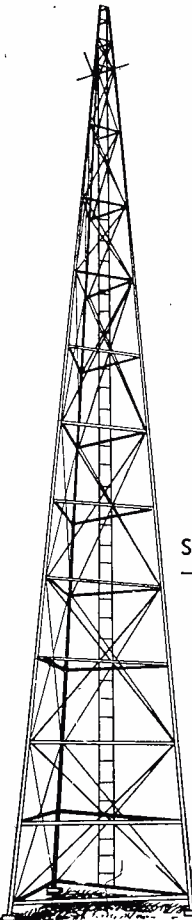

**A Better Picture  
and a  
Good Profit, Too!**

with  
**CHAMPION  
Television Towers**

**Guyed Towers**  
45', 65', 85'

**Self-Supporting  
Towers**  
40', 53', 67', 80'

Make Your  
Television Sales  
Stick

**Use Champion  
Steel Towers**

Strong  
—and Easy  
to Erect

Sold Through  
Dealers and Jobbers  
Write for Literature

**Norman M. Sewell  
Inc.**

Susquehanna Ave.  
at Derstine  
LANSDALE, PA.

**FREE  
ALLIED'S  
NEW 1949  
RADIO  
CATALOG**

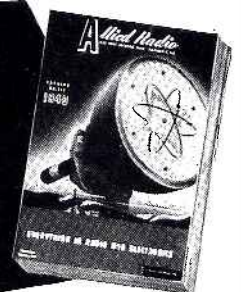

**Everything for the  
Radio Service  
Technician . . .**

**SEND FOR THIS  
180-PAGE BUYING GUIDE NOW**

Radiomen! Here's the new 1949 ALLIED Buying Guide that brings you everything you need in radio and electronic equipment. Get everything that's newest and finest from the world's largest stocks—test instruments, sound systems and P.A. equipment, thousands of parts, tubes, tools, books—all at lowest money-saving prices, ready for instant expert shipment. Send for your FREE copy of the new 180-page ALLIED Catalog—today!

**ALLIED RADIO**

ALLIED RADIO CORP., DEPT. 25-L-8  
833 W. Jackson Blvd., Chicago 7, Ill.

Send FREE New ALLIED Catalog.

Name.....

Address.....



**RUGGED! DURABLE!**

**A POWER SUPPLY THAT CAN REALLY "TAKE IT"**

**Electro**  
ELECTRICAL AND RADIO EQUIPMENT

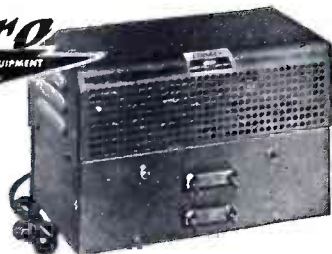

**MODEL "A"**

6V or 12V DC filtered from 110/115V 60 cycle power line.

This model has proper rectifier, choke coil, condenser and transformer to provide heavy instantaneous output and still maintain rated output under unusual load and heat conditions.

Ideal long life power supply for testing auto radios with solenoid tuning and tone controls; 12 volt marine and aircraft radios; telephone circuits, laboratory apparatus, etc.

*Write for complete information*

**ELECTRO PRODUCTS LABORATORIES**

Pioneer Manufacturers of Battery Eliminators  
549 W. RANDOLPH ST. CHICAGO 6, ILL.

**Multiply Television Profits!**

*Taybern* **T-V** *Duplicators*

"TELEVISION EVERYWHERE"

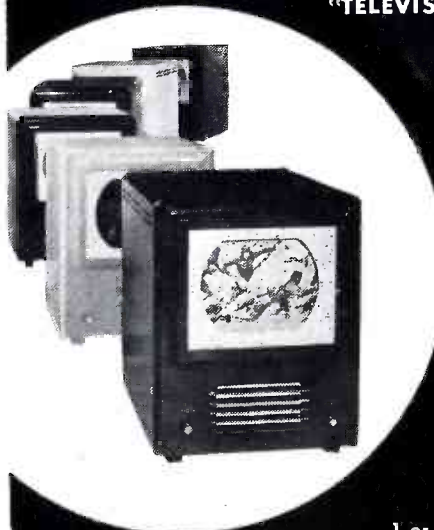

FOR

- ★ HOTELS
- ★ BARS & TAVERNS
- ★ HOSPITALS
- ★ SCHOOLS
- ★ HOMES
- ★ CLUBS
- ★ INSTITUTIONS
- ★ RESTAURANTS
- ★ AUTO COURTS
- ★ THEATRES
- ★ RESORTS

1 or 100 may be attached to any standard television set . . . Economical installation . . . Simple to operate . . . Superb performance.

Exclusive territories still available —  
*Write for Literature Today!*

**TAYBERN EQUIPMENT CO., INC.**

120 GREENWICH STREET • NEW YORK 6, N. Y.



**Solved!**  
Where Roof Installations Cannot be Made

**Use the "500"**

Does everything roof antennas will do!

New All-wave Television-FM Antenna — Model 500

The Model 500 solves the problem . . . for use where roof installation cannot be made . . . a full size antenna so designed that it may be used out-the-window and outside the porch and in various other ways . . . easily installed.

**CHECK THESE FEATURES:**

- ✓ Both Television and FM Bands
- ✓ For standard 300 ohm input
- ✓ Low standing wave ratio-increased signal strength
- ✓ Striking appearance . . .
- ✓ Light weight (net wt. 2-1/2 lbs.)
- ✓ Does not protrude excessively
- ✓ Complete with all mounting hardware and 35 ft. 300 ohm line
- ✓ Individually packed

"Tricraft" antennas are available at leading jobbers. If your jobber cannot supply you, write us for nearest jobber.



**Tricraft Products Co.**

1533 North Ashland Ave., Chicago 22, Ill.

Manufacturers of complete line of Television, FM and AM antennas and accessories

**NEW LEAD-IN SUPPORTS THAT GIVE BETTER TELEVISION and FM RECEPTION!**

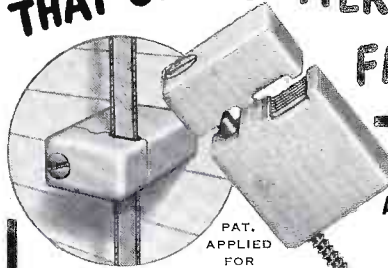

PAT. APPLIED FOR  
No. 9418

**OTHER ANTENNA AND LEAD-IN ACCESSORIES**



No. 1925 Insulated Screw Eye, Overall length 7-1/4", 5/16" insulator hole.



No. 1961 Split Bridge Ring Insulated Screw Eye, Overall length 3-5/8", 5/8" insulator hole, 1/4" diagonal slot.



No. 500 Antenna Strain Insulator, Brown glaze porcelain, size 2-1/8" x 1-9/16", 3/8" hole.

Two major causes of TV Black-out, FM Fadeout are eliminated with Porcelain Products' exclusively designed lead-in supports. They give rigid support preventing lead-in wire from twisting in wind or going slack; short circuits are stopped by giving quick moisture drainage at support yet wire is held firmly without injury to insulation. Made of highest quality porcelain, resistant to weather extremes, factory assembled, screws rust-proofed, no maintenance, low initial cost. For all popular types of lead-in cables.

WRITE TO DEPT. 6 FOR FOLDER

**Porcelain Products, Inc.**  
FINDLAY, OHIO





★ Here's the antenna that meets your electrical and mechanical requirements. Really good TV reception on all 12 channels. Also excellent FM reception. High-frequency top section may be oriented independently from low-frequency bottom section. High or low section automatically comes into operation through use of matching network. All-aluminum construction. Extremely rugged. Stays put through all kinds of weather. Quick and easy assembly. Comes complete with aluminum sectional mast and mounting clamps. List price only \$26.00.

★ **ASK OUR JOBBER . . .**  
Get this or any other TACO antenna that best suits your TV, FM, AM, or SW needs. Ask for latest TACO catalog—or write us.

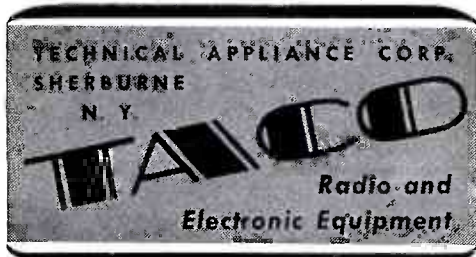

In Canada: Stromberg-Carlson Co., Ltd.  
Toronto 4, Ont.

## Small Appliances

(Continued from page 104)

gift-giving. A few being cut, but most being sold at list. (Oil and gas jobs sell well in some localities.)

### Heat Pads

Good supply of these quick-selling package items, with prices holding firm, and a steady demand during all seasons.

### Hot Plates

Single and double units can be suggested for use at tables, in game rooms.

### Irons, Hand

Be sure to have enough on hand, as they are big sellers at Xmas to husbands and youngsters as presents. Wide variety of models available in unlimited quantities. Good year 'round items, too. Very few being cut, and they're mostly early postwar jobs.

### Lamps, Health

Infra-reds and ultraviolets make ideal gifts. Plenty available. Stress their many uses. A few early postwar complete units still being offered at cut prices: are not important factors.

### Liquefiers

Lots of sales appeal if properly presented. Tie in well with vitamin popularity, and for the making of soups, beverages, etc. Good profit items, and are being sold at list prices.

### Mixers, Food

Sell all year, of course, but one of the best Xmas gifts. A few makes available in fair supply, but some others still under-counter items. Prices holding.

### Roasters, Electric

Supply fair. Good sellers when sold right. Features must be stressed. Extremely popular in some localities, slow-movers in others. Prices maintained.

### Shavers, Electric

Supply good. Some dealers do a big job with them, though they're sold by everybody and his brother. Almost any dealer can move some during Xmas.

### Sterilizers, Electric

These, with bottle warmers, are fine gifts for the couples with infants. Good, steady demand for them, with prices stable. When displaying, be sure to explain what they are via lettered cards.

### Toasters, Electric

One of the leading gift items, with very few being cut. Supply is spotty. Big production by a number of makers, but some famous brands aren't around.

### Vibrators, Electric

Supply satisfactory. A good specialty item for the dealer who pushes them. Need suggestive selling, and demonstration. Prices holding well.

### Waffle Makers

Straight, or as combination sandwich grills, they are ideal presents. Supply good; prices stable.

## Industrial Teleceivers

For Public Viewing in  
TAVERNS - HOTELS  
INSTITUTIONS  
SCHOOLS  
CLUBS

Featuring—  
SIMPLIFIED  
CENTRAL CONTROL  
with any number of  
viewing screens

**INDUSTRIAL TELEVISION, INC.**  
359 LEXINGTON AVE., CLIFTON, N. J. GREGORY 3-0900

## WATCH FOR *The New Additions*

TO THE  
*Acro*  
LINE OF  
QUALITY  
TELEVISION  
TABLES

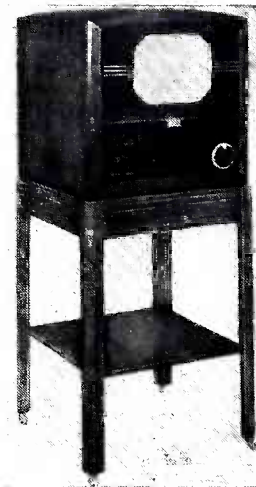

See  
*Acro*  
for the

### Latest in Television Tables

- Fully Assembled and Individually Boxed.
- Made of Choice Maple and Birch Hardwoods.
- Available in a Walnut or Mahogany finish.

Cash in on our new direct to dealer policy on a competitively priced, high quality line of television tables. Priced right, built right. There is an Acro table to fit every existing television set.

Dealer Inquiries Invited.  
**ACRO WOOD PRODUCTS CORP.**  
47 Watkins St., Brooklyn 12, N.Y. Dickens 2-0222



## A Remarkable NEW LINE



Espey Model 511

### High QUALITY • High POWER Custom Built AM-FM Chassis

Like every other model in the complete ESPEY line of replacement receivers, and FM Tuners, the Model 511 AM-FM chassis (illustrated) is the last word in modern engineering in the electronics field. Featuring 12 tubes plus Rectifier and Tuning Indicator, it is Drift Compensated, and is supplied complete with all antennas, 25 watt speaker, and all hardware. Its low price assures high profits for you in the growing replacement field. Write today to Dept. K-11 for complete details of this expanding profitable market!

**ESPEY MFG. CO., INC.**

528 EAST 72nd ST., NEW YORK 21, N. Y.

"Established—1928"



World's finest radio-phonograph —that's what experts and owners alike say of the Scott 800-B (shown here in one of the many cabinet designs available—the Chippendale). Elegantly engineered, beautifully housed, here is an instrument to be sold—and owned—with pride.

Not just television . . . but Scott Television. Here are Scott precision engineering, sensitivity, selectivity translated into exciting television. Big 16 x 12 screen (192 square inches of screen surface) folds into top of cabinet when not in use. A receiver for those who want the finest in video entertainment.



## Good Company

Retailers who hold the Scott franchise are the leaders in the whole field of radio and television.

They offer—and with considerable pride—the world-famous Scott radio-phonographs and the new Scott Projection Television Receiver.

Naturally, the number of Scott dealerships is restricted, but a few may now be granted to retailers who meet Scott's high standards.

You will find yourself in "good company" with the Scott franchise. For details, write Scott Radio Laboratories, Inc., 4541 Ravenswood Ave., Chicago 40, Illinois.



**Deluxe Communicator  
for 1 to 5 Sub Stations**

MASTER STATION MSS **\$37.50** List Price

## CONVERSA FONE

makes your "INTERCOM" Sales  
**PROFITABLE...**

Versatile new Pushbutton System sells on demonstration . . . and it's PRICED RIGHT — for dealer profits and customer goodwill!

These Features sell CONVERSA FONE for you:

- 5 Selector Push Buttons
- Operates 1 to 5 Sub-stations
- 4 Powerful Tubes for Amplification
- "Silent Feature" Eliminates Sub-station Hub-bub
- Modern Styled Cabinet — Walnut Finish

Sub-Station Model SSS  
List Price 11.95



Complete Literature on Request

**AUDIO COMMUNICATION MFG. CO.**

108-10 Jamaica Avenue  
Richmond Hill 18, N. Y.



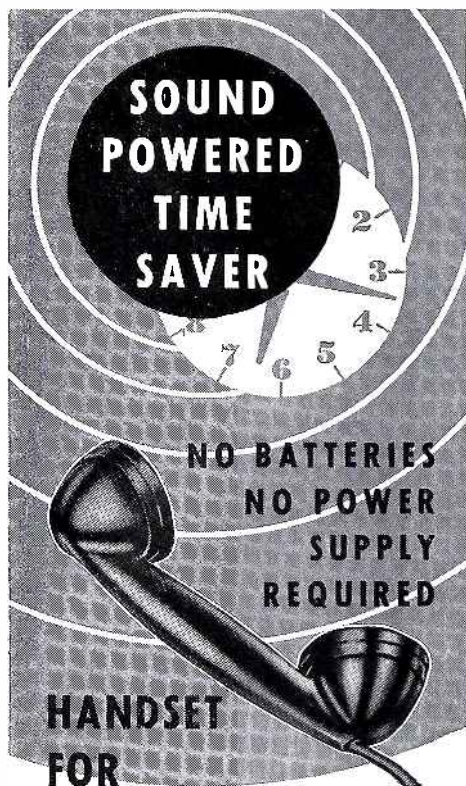

- TV & FM INSTALLERS
  - TELEPHONE,
  - TELEGRAPH and
  - POWER LINEMEN
- and wherever  
**EMERGENCY SERVICE**  
is required

The Wheeler Sound-Powered handset — complete within the single instrument — is a new development of an old principle. It's a step and time saver on any job where temporary, convenient and inexpensive telephone service is needed. No power source, no batteries to bother with. Operates over two conductor full metallic or single wire, ground return circuit. Safe, tough, quick, dependable. Efficient talking up to 25 miles. See your local jobber or write, wire or phone Waterbury for complete details.

MAGNET WIRE • COILS • BALLASTS

**THE  
WHEELER  
INSULATED WIRE CO., INC.**  
2411 EAST AURORA STREET

WATERBURY 91,



CONNECTICUT

DIVISION OF THE SPERRY CORPORATION

### RCA Tube Official



Edwin A. Freed, above, whose appointment as manager of electronic component sales to equipment customers has been announced by L. S. Thees, equipment sales manager, RCA Tube Department, Camden, N. J.

### Dates Ahead

*Future Events of Interest to Readers*

- Nov. 4-6: National Electronics Conference, Edgewater Beach Hotel, Chicago
- Nov. 7-12: National Electrical Manufacturers Assn., Annual Meeting, Hotel Traymore, Atlantic City, N. J.
- Nov. 8-10: RMA Engineering Dept.—Institute of Radio Engineers, Fall Meeting, Sheraton Hotel, Rochester
- Nov. 14-20: National Radio Week
- Nov. 15-17: Radio Parts Industry Coordinating Comm., Radio Technicians Educational Meeting, Hotel Bradford, Boston
- Jan. 19-20: National Assn. Music Merchants, Regional Conference, Hotel Biltmore, Los Angeles
- Jan. 26-27: National Assn. Music Merchants, Northwest-Pacific States, Regional Conference, Seattle
- Feb. 21-22: National Assn. Music Merchants, Southwest States Regional Conference, Dallas
- Mar. 21-22: National Assn. Music Merchants, Southern States Regional Conference, Atlanta
- Mar. 14-15: National Assn. Music Merchants, Central States Regional Conference, Cincinnati
- Apr. 4-5: National Assn. Music Merchants, West Central States Regional Conference, Minneapolis
- May 15: Radio Manufacturers Assn., 25th Silver Anniversary. Convention & Annual Radio Parts Industry Trade Show, Stevens Hotel, Chicago

### Christmas HINT

Plan now to set up adequate and efficient wrapping facilities for the holiday rush. Arrange wrapping centers so that more than one person can work there at the same time. Demands for gift-wrapping are on the increase, so provision should be made to take care of such requests, and this means that he should stock gift wrapping paper, ribbons, cards, etc.

**SHOOTS TROUBLE  
FASTER!** Makes more money for you on job or at service bench!



**PRICE  
\$9.95**

at distributor or postpaid, direct. Sorry, no COD's. Ohioans add 3% State Sales Tax.

## Signaletto

**MULTI-FREQUENCY GENERATOR**

In radio service work, time means money. Locate trouble faster, handle a much greater volume of work with the SIGNALETTE. As a trouble shooting tool, SIGNALETTE has no equal. Merely plug in any 110V. AC-DC line, start at speaker end of circuit and trace back, stage by stage, listening in set's speaker. Generates RF, IF and AUDIO Frequencies, 2500 cycles to 20 Megacycles. Also used for checks on Sensitivity, Gain, Peaking, Shielding, Tube testing. Wt. 13 oz. Fits pocket or tool kit. See at your dist. or order direct.

**Clippard** Instrument Laboratory, Inc.

Dept. R 1125 Bank St., Cincinnati 14  
Qualified Jobbers write, wire for details.



**WEBSTER-CHICAGO  
PRE-TESTED  
RECORDING  
WIRE**

**Makes News**

Don't miss the full page advertisement on page 55 of this issue



**WEBSTER-CHICAGO**



... if  
you  
want  
something  
better  
*demand*

R A D I O  
**DEWALD**  
T E L E V I S I O N

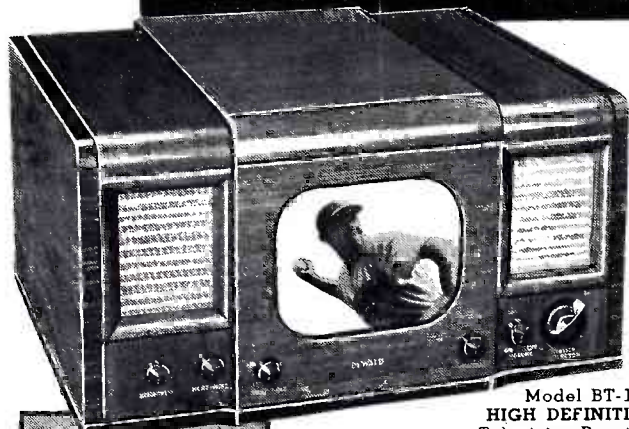

Model BT-100  
HIGH DEFINITION  
Television Receiver

Backed by Over  
a  
Quarter-Century  
of  
Proven Quality

DEWALD offers a complete line  
... from Portables to Television!  
Write for Complete Information.

**JOBBERS—REPRESENTATIVES**  
Some choice territories still available

**DEWALD RADIO MFG. Corp.**  
35-15 37th Ave., Long Island City 1, N. Y.

**PRINT YOUR OWN  
POST CARDS**

**COMPLETE OUTFIT**  
only \$750

Amazing results in sales, inquiries and contacts . . . saves time and money . . . very easy to use. **GEM STENCIL DUPLICATOR** is ideal for Advertising, Announcements, Notices, Labels, Forms, Price Lists—hundreds of

uses for every type of business and organization. Comes complete with all supplies, instructions and 60-page Book of Ideas.

**FREE TRIAL OFFER:** Try it before you buy it! Write and a **GEM OUTFIT** will be sent you postpaid. After 10 days, send only \$7.50 or return the GEM, no questions asked. The GEM must sell itself; you be the judge.

**BOND EQUIPMENT CO.**

DEPT. 125 — 6633 Enright  
St. Louis 5, Mo.

**SEND NO MONEY • FREE TRIAL OFFER**

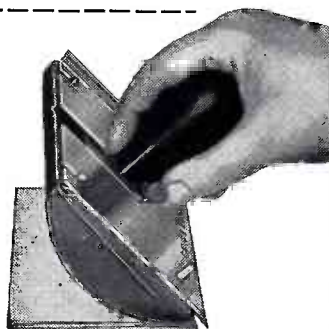

**PHILCO PARTS and TUBES  
HEADQUARTERS**

REPLACEMENT PARTS FOR RADIO models 1928 thru 1949. Tubes, Needles, Accessories, Refrigerator and Air Conditioner Parts, and Service Manuals.

Send 25c or stamps for 225 page, **PHILCO PARTS DIRECTORY**, or order items you need by part number. Wholesale Prices. Minimum order \$2.00. Shipments, Parcel Post or Express C.O.D.

**PHILCO DIVISION, WILLIAMS, INC.**  
830 South Adams St., Peoria 2, Illinois

**db GAIN + + +**

more signal strength for greater  
distance and the *best picture*

with **AMPHENOL**

**STACKED ARRAY**

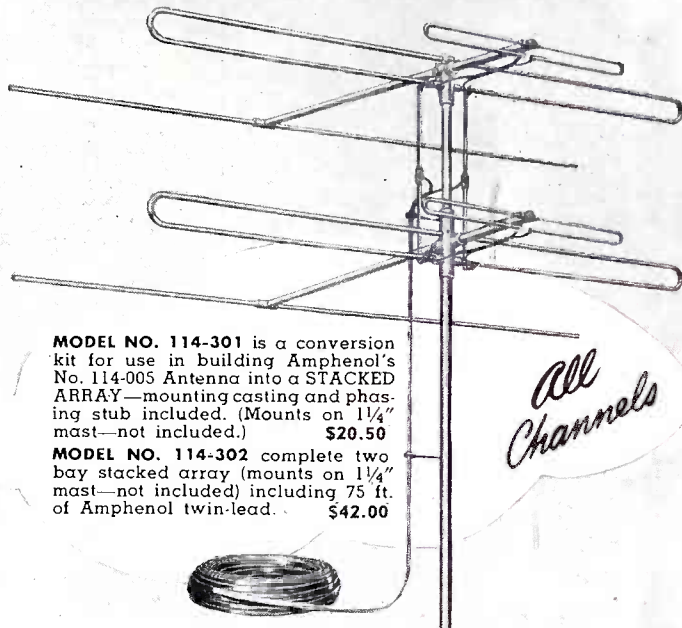

*All  
Channels*

**MODEL NO. 114-301** is a conversion kit for use in building Amphenol's No. 114-005 Antenna into a **STACKED ARRAY**—mounting casting and phasing stub included. (Mounts on 1 1/4" mast—not included.) **\$20.50**

**MODEL NO. 114-302** complete two bay stacked array (mounts on 1 1/4" mast—not included) including 75 ft. of Amphenol twin-lead. **\$42.00**

Stacked Array multiplies the universally acknowledged features of the Amphenol All-Channel TV Antenna (No. 114-005). Stack to provide reception at greater distances—Stack for picture brilliance and clarity—Stack for controlled TV reception. Provide the *TV Receiver* with the *Best Antenna* to Produce the *Best Picture*. Amphenol's Stacked Array is your assurance of top TV picture quality.

**Performance Charts Available**

If you are not now receiving the monthly **AMPHENOL ENGINEERING NEWS**—you will want to request the September issue which included pattern and gain charts for the Stacked Array. We will be glad to mail it and to place your name on our list to receive future issues—write Dept. 13D.



**AMERICAN PHENOLIC CORPORATION**

1830 SOUTH 54TH AVENUE, CHICAGO 50, ILLINOIS  
COAXIAL CABLES AND CONNECTORS • INDUSTRIAL CONNECTORS, FITTINGS AND CONDUIT • ANTENNAS • RADIO COMPONENTS • PLASTIC FOR ELECTRONICS



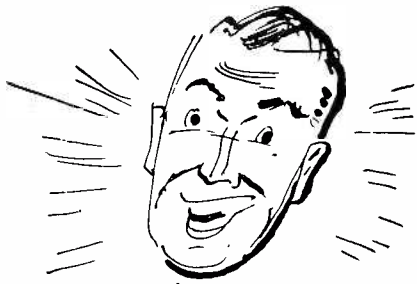

# WEBSTER-CHICAGO RECORDING WIRE IS Pre-tested

See page 55  
for full details

**WG** WEBSTER-CHICAGO

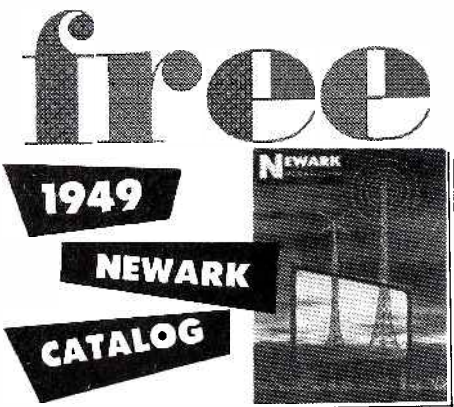

For EVERYONE interested in  
**TELEVISION • RADIO • ELECTRONICS  
SOUND SYSTEMS • INDUSTRIAL EQUIPMENT**  
EVERYTHING in standard brand equipment!

Professionals! Radio Hams! Television Enthusiasts!  
Beginners! Oldtimers! Amateurs! Hobbyists! Here's  
one book that's a MUST for you! Our FREE 148 page  
catalog jammed with over 20,000 different items.  
The smallest part to the most complete industrial  
system from one dependable source!

**24-HR. MAIL ORDER SERVICE • ONE YEAR TO PAY**

**3 GREAT STORES:** Uptown at 115 West 45th St.  
and Downtown at 212 Fulton St. in **NEW YORK**  
323 W. Madison St. in the heart of **CHICAGO**

**MAIL ORDER DIVISIONS:** 242 W. 55th St., N. Y. 19  
and 323 West Madison St., Chicago 6, Illinois



**MAIL COUPON NOW**  
Newark Electric Co.  
Dept. K-3 242 W. 55th St.  
New York 19, N. Y.

Please send me FREE the Newark 1949 Catalog  
NAME \_\_\_\_\_  
ADDRESS \_\_\_\_\_ CITY \_\_\_\_\_ STATE \_\_\_\_\_

## Whitney Wire Dealer Aid

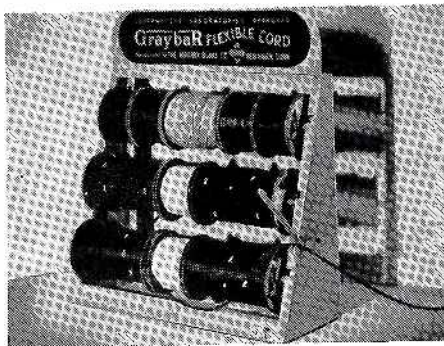

The Whitney Blake Co., wire manufacturers of Hamden, Conn., is offering through the Graybar Electric Co., a new wire display-dispenser for retail stores. The wire rack is 28 1/4 inches wide, 11 inches deep and 21 1/4 inches high. It carries 11 spools of wire in a variety of popular types.

STATEMENT OF THE OWNERSHIP, MANAGEMENT, CIRCULATION, ETC., REQUIRED BY THE ACT OF CONGRESS OF AUGUST 24, 1912, AS AMENDED BY THE ACTS OF MARCH 3, 1933, AND JULY 2, 1946.

OF RADIO & TELEVISION RETAILING, published monthly at New York, N. Y., for Oct. 1, 1948.

State of New York, N. Y., County of New York, N. Y.

Before me, a Notary Public in and for the State and county aforesaid, personally appeared Orestes H. Caldwell, who, having been duly sworn according to law, deposes and says that he is the Editor of RADIO & TELEVISION RETAILING and that the following is, to the best of his knowledge and belief, a true statement of the ownership, management (and if a daily paper, the circulation), etc., of the aforesaid publication for the date shown in the above caption, required by the Act of August 24, 1912, as amended by the Act of March 3, 1933, and July 2, 1946 embodied in section 537, Postal Laws and Regulations, printed on the reverse of this form, to wit:

1. That the names and addresses of the publisher, editor, managing editor, and business manager are: Publisher, M. Clements, Rumson, N. J. Editor, Orestes H. Caldwell, Catrook Road and Bible St., Cos Cob, Conn. Managing or Executive Editor, John L. Stoutenburgh, 564 Riverside Dr., New York, N. Y. Business Manager, M. H. Newton, 583 W. 215th St., New York, N. Y.

2. That the owner is (if owned by a corporation, its name and address must be stated and also immediately thereunder the names and addresses of stockholders owning or holding one per cent or more of total amount of stock. If not owned by a corporation, the names and addresses of the individual owners must be given. If owned by a firm, company, or other unincorporated concern, its name and address, as well as those of each individual member, must be given.) Caldwell-Clements, Inc., 480 Lexington Avenue, New York 17, N. Y. M. Clements, O. H. Caldwell, Charles A. Petersen, Trustees, 480 Lexington Ave., N. Y. C. M. Clements, Trustee, Rumson, N. J. O. H. Caldwell, Trustee, Catrook Rd. and Bible St., Cos Cob, Conn. Charles A. Petersen, Trustee, 474 Senator St., Brooklyn, N. Y.

3. That the known bondholders, mortgagees, and other security holders owning or holding 1 per cent or more of total amount of bonds, mortgages, or other securities are: (If there are none, so state.) None.

4. That the two paragraphs next above, giving the names of the owners, stockholders and security holders, if any, contain not only the list of stockholders and security holders as they appear upon the books of the company, but also, in cases where the stockholder or security holder appears upon the books of the company as trustee or in any other fiduciary relation, the name of the person or corporation for whom such trustee is acting, is given; also that the said two paragraphs contain statements embracing affiant's full knowledge and belief as to the circumstances and conditions under which stockholders and security holders who do not appear upon the books of the company as trustees, hold stock and securities in a capacity other than that of a bona fide owner; and this affiant has no reason to believe that any other person, association, or corporation has any interest direct or indirect in the said stock, bonds, or other securities than as so stated by him.

(Signed) Orestes H. Caldwell

Sworn to and subscribed before me this 21st day of September, 1948.

W. Kenneth Reynolds,  
Notary Public New York County.

(My commission expires March 30, 1949.)

*telex inc.*  
**CONICAL ANTENNAS**

BOX 879, ASBURY PARK, N. J.

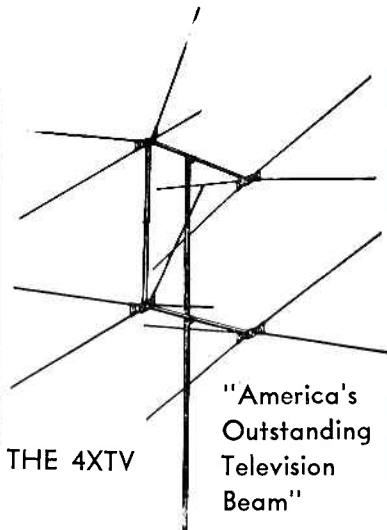

THE 4XTV

"America's  
Outstanding  
Television  
Beam"

Conical "V" beam. Unidirectional pattern 2-to-13 — 14 DB F to B ratio all channels — Total weight 6 3/4 lbs.

AT YOUR JOBBER OR WRITE US

## FASTER TRACING!

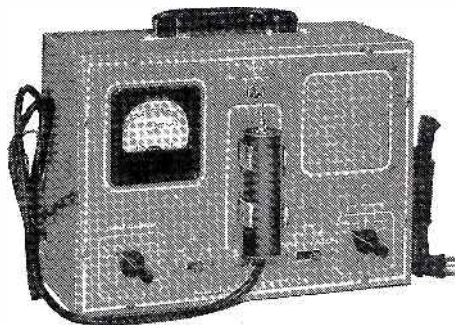

Model No. 777

### R.C.P. DYNATRACER for AM-FM-TELEVISION

You'll be amazed how fast receiver trouble is located with this *high* sensitivity, low-input Dynatracer. You can handle more service jobs and increase your daily profits. Extremely simple to operate—so sensitive it picks up broadcast signals with an antenna of only 18"! Detects signal variations directly from antenna through r.f., i.f., and a.f. without switching or changing channels. Order this low cost, precision instrument today . . . only \$41.50 net.

\* \* \*

- Negligible disturbance • Attenuation of 10,000 to 1 with ladder type step attenuator, vernier control
- 10,000 microvolts full scale • Traveling detector • Frequency up through 150 mcgs.
- Self-Contained meter • Versatile meter-speaker switching • Size, 6 5/8" x 8 1/8" x 11 3/4". Tests microphones and pick-ups.

SEE R.C.P. — BEST FOR EVERY TEST

**RADIO CITY PRODUCTS CO., INC.**  
152 West 25th St.  New York 1, N. Y.



## Admiral Jobber Names Carey

Clarence S. Tay, branch manager Appliance Distributors, Admiral jobbers in Chicago, has announced the appointment of Thomas C. Carey as sales manager. Carey was former district sales manager for Philco in the Missouri region. He has many years experience in the radio and appliance industry.

## New Allied Catalog

Allied Radio Corp. of Chicago has brought out a new comprehensive catalog presenting its complete line of communication and sound equipment, including parts and associated supplies and accessories. The 180-page buying guide is completely indexed for easy reference, and is presented in organized sections of broad, related lines such as public address and intercom equipment; recorders, communications type receivers, phonographs, kits, technical books, and many others. Newly available items such as low-cost TV sets, and playback equipment for LP microgroove records are included. Copies may be obtained without charge from Allied Radio Corp., Chicago.

## Stromberg-Carlson Jobber

R. F. Trant, Inc., Norfolk, Virginia distributing organization, has been appointed by Stromberg-Carlson to serve the company's authorized dealers in 53 counties in Virginia and 22 in North Carolina, according to C. J. Hunt, Stromberg-Carlson radio and television sales manager.

# YOUR BEST BUY

## T-VEE SIGNAL AMPLIFIER

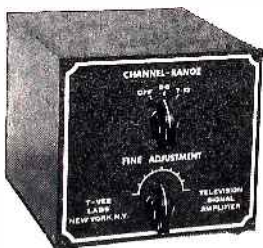

Made by  
Expert  
Engineers

# \$1370

Your Cost

A booster for all television channels. Self contained power supply—length of lead supplied for quick simple installation. Permits use of window and indoor antenna. Reduces off channel interference. Handsome wooden cabinet. FULLY GUARANTEED.

25% with order. Bal. C.O.D.

## NORTHERN SALES CO.

63 East Broadway, N.Y.C. CO 7-5425

## INDEX TO ADVERTISERS NOVEMBER 1948

Acro Wood Products Corp.....	106
Admiral Corp.....	23
Aerolux Light Corp.....	70
Allied Radio Corp.....	104
American Phenolic Corp.....	109
American Telephone & Telegraph Co.....	9
American Television & Radio Co.....	95
Astatic Corp.....	54
Atlas Sound Corp.....	102
Audio Communication Mfg. Co.....	107
Belden Mfg. Co.....	81
Bell Sound Systems, Inc.....	94
Bendix Radio div., Bendix Aviation Corp.....	20, 21
Bond Equipment Co.....	109
Burgess Battery Co.....	102
Caldwell-Clements, Inc.....	24, 112
Chicago Transformer div., Essex Wire Corp.....	75
Chicago Tribune.....	12, 13
Clippard Instrument Laboratory, Inc.....	108
Decca Records, Inc.....	57
DeWald Radio Mfg. Corp.....	109
DuMont Laboratories, Inc., Allen B.....	41
Electro Products Laboratories.....	105
Electro-Steel Products, Inc.....	89
Electro-Voice, Inc.....	88
Emerson Radio & Phonograph Corp.....	15
Espey Mfg. Co., Inc.....	107
Fada Radio & Electric Co., Inc.....	8
Farnsworth Television & Radio Corp.....	82, 101
General Die & Stamping Co.....	98
General Electric Co.....	7, 11, 26, 48
Graybar Electric Co., Inc.....	69
Hickok Electrical Instrument Co.....	93
Hy-Lite Antennae, Inc.....	92
Hytron Radio & Electronics Corp.....	27
Industrial Television, Inc.....	106
International Resistance Co.....	100
Jensen Mfg. Co.....	2
Jet Thermal Device Co.....	96
Jewel Radio & Television Corp.....	Cover 3
J.F.D. Mfg. Co., Inc.....	90
Landers, Frary & Clark.....	66, 67
McGee Radio & Electric Co.....	111
Mahogany Association, Inc.....	19
Mallory & Co., Inc., P. R.....	Cover 2
Newark Electric Co.....	110
Noblitt-Sparks Industries, Inc.....	3
Norge div., Borg-Warner Corp.....	58
North American Philips Co., Inc.....	4
Northern Sales Co.....	111
Oak Ridge Antennas.....	25
Pentron Corp.....	91
Philco Corp.....	5, 10
Pioneer Scientific Corp.....	84
Porcelain Products, Inc.....	105
Precision Audio Products, Inc.....	86
Public Operating Corp.....	94
Radio City Products Co., Inc.....	110
Radio Corp. of America:	
RCA Victor Division.....	32, 33
Tube Department.....	14, Cover 4
Radio Merchandise Sales, Inc.....	98
Raytheon Mfg. Co.....	22
Remington Radio Corp.....	103
Remington Records, Inc.....	54
Rheem Mfg. Co.....	65
Rider Publisher, Inc., John F.....	85
Roger Television, Inc.....	84
Scott Radio Laboratories, Inc.....	107
Sewell, Inc., Norman M.....	104
Shure Brothers, Inc.....	56
Simpson Electric Co.....	83
South River Metal Products Co.....	100
Sparks-Withington Co.....	6
Sprague Products Co.....	87
Steelman Radio Corp.....	92
Stewart-Warner Corp.....	43
Stromberg-Carlson Co.....	28
Sylvania Electric Products, Inc.....	79
Taybern Equipment Co., Inc.....	105
Technical Appliance Corp.....	106
Telrex, Inc.....	110
Transvision, Inc.....	99
Tricraft Products Co.....	105
Triplett Electrical Instrument Co.....	77
Turner Co.....	97
U. S. Television Mfg. Corp.....	47
Veri-Best Television Products, Inc.....	73
Vision Research Laboratories, Inc.....	90, 96
Ward Products Corp.....	104
Webster Chicago Corp.....	55, 98, 108, 110
Westinghouse Electric Corp.....	45
Wheeler Insulated Wire Co., Inc.....	108
Wilcox-Gay Corp.....	16, 17
Williams, Inc.....	109
Zenith Radio Corp.....	18

## ★ BIG SALE ★ on GENERAL ELECTRIC Test Equipment — Save Up to 2/3

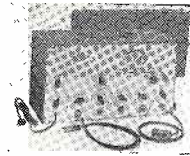

G.E. YGS-3 AM/FM  
\$195.00 VALUE  
Oscillator  
Sale Price **\$99.50**

The widely advertised and nationally known General Electric YGS-3, 11 tube FM/AM Oscillator was designed to sell for \$195.00. We offer you this brand new factory cartoned signal generator for only \$99.50. Covers up to 200 megacycles, 3 FM sweep widths, crystal controlled. Variable audio oscillator for 100 to 12,000 cycles. This is the finest signal generator ever built. We purchased G. E.'s entire stock. Place your order now. Priced with tubes, ready to operate. Shipping weight 43 lbs. Net price \$99.50.

## GENERAL ELECTRIC CRO-3A 3-INCH Oscilloscope

\$98.50 VALUE

Sale Price **\$49.95**



Brand new General Electric 3" Test Oscilloscope. The companion unit to the YGS-3 shown above (Made to sell for \$98.50) Now McGee's sale price only \$49.95. This is a complete 3" test scope, sweep from 0 to 30 kc. Priced complete with tubes; packed in original factory cartons. We suggest you order with the YGS-3 Signal generator, to have a matched set of laboratory test equipt. Shipping weight 35 lbs. Net price \$49.95.

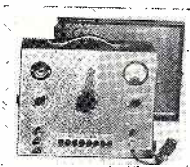

## GENERAL ELECTRIC YCW-1 CAPACITANCE Resistance Bridge

\$59.50 VALUE

Sale Price **\$29.95**

General Electric YCW-1 is a \$59.50 value. Wein bridge type capacitance-resistance bridge. Offered to you, brand new for only \$29.95. An indispensable item for every service bench. A few YCW-1 are available for 110 or 220 volts, 60 cycle operation; net \$34.95 each. Capacity range, .000005 to 200 mfd. in 3 steps. Resistance range, 5 ohms to 20 megohms in two steps. Insulation resistance bridge 0 to 2500 megohms. Dimensions 9 3/4 x 12 x 7 inches. Weight 20 lbs. Net price \$29.95.

## GENERAL ELECTRIC YGA-4 AUDIO OSCILLATOR

\$49.50 VALUE

Sale Price **\$29.95**



Brand new G. E. YGA-4 Audio Oscillator. Made to sell for \$49.50. McGee's scoop price only \$29.95. You have no doubt always wanted one, but before they were too expensive. Now offered at a price you can afford to pay. VFO 50 to 15,000 cycles. Stable BFO circuit. Weight 31 lbs. A super value at our sale price of \$29.95.

## YGA-2 SINE OR SQUARE WAVE G.E. OSCILLATOR \$150.00 VALUE Sale Price **\$59.95**

A \$150.00 value Sine or Square wave generator for only \$59.95. Brand new, complete with tubes. Similar in appearance to the YGA-4 pictured above. YGA-2 for 110 or 220 volts, 60 cycle current. Net price \$64.95. Frequency 20 to 20,000 cycles sine or square wave. Output power 400 milliwatts. Sine wave 20 volts, Square wave 60 volts peak to peak. Attenuator continuously variable. Hum 60 db below maximum output. Accuracy plus or minus 1 cycle below 33 cycles, plus or minus 3% above 33 cycles. Shipping weight 43 lbs. Net price each \$59.95.

If the above information does not convince you, write for our GE catalog.

Send 25% deposit with order. Bal. sent C.O.D. No. full C.O.D. orders. Prices F.O.B. K.C.

**McGEE RADIO COMPANY**  
1225 McGee St., Kansas City, Mo.



# 25<sup>th</sup>

## **SILVER ANNIVERSARY** **of the RADIO MANUFACTURERS ASSOCIATION** **1924...RMA...1949**

Radio's premier organization of set and parts manufacturers will celebrate its 25th anniversary during the week of May 15 in Chicago, in conjunction with the annual RADIO PARTS SHOW. Entering formally or informally into the celebration will be such industry organizations as the Sales Managers Club, the National Electronic Distributors Association, the Representatives of Radio Parts Manufacturers and the radio trade press.

### **OTHER MILESTONES IN 1949**

**29**<sup>th</sup> anniversary of CALDWELL-CLEMENTS activity in radio-television publishing, beginning at the time of KDKA's first broadcast in Pittsburgh in 1920.

**27**<sup>th</sup> anniversary of RADIO & TELEVISION RETAILING, founded in 1922 as Electrical Retailing and purchased from McGraw-Hill Publishing Company in 1940.

## **ANNIVERSARY & SHOW NUMBER** **May 1949**

Observing radio's first quarter-century of manufactured receivers, RADIO & TELEVISION RETAILING will salute the R.M.A. with a memorable May issue. Editorial features and advertisements will take you back through 25 years of industrial romance and then project you into the fantastic future of radio, FM and television — a feature issue that will be read from cover to cover and saved for posterity by veteran radio men and newcomers alike.



**MANUFACTURERS**—In your 1949 advertising budgets, make provision for your greatest advertisement in this Anniversary & Show Number. A cooperative insert with your old-time distributors would be appropriate.

**CALDWELL-CLEMENTS, Inc., 480 LEXINGTON AVE., N. Y. 17, N. Y.**



WAKE UP THOSE RADIO SALES with the wonderf

# JEWEL Wakemaster

RADIO with TELECHRON alarm



ANOTHER GREAT JEWEL VALUE ACHIEVEMENT!

TWO GREAT NAMES linked together to bring you ONE great RADIO! And it's a sure-fire seller and profit-maker for you! This splendid set has features galore in addition to low selling price and beautiful styling. It's a real achievement in radio merchandising and another great JEWEL triumph!

IN WALNUT MODEL No. 920

**\$29<sup>95</sup>**

5% Higher West of Rockies

## Wakemaster

Turns itself on in the morning. Acts as a subtle, pleasant awakener.

Doctors acknowledge the advantage of awakening gently, especially to music. WAKEMASTER won't let you oversleep. A buzzer sounds automatically 10 minutes after the pre-set awakening time.

## Wakemaster

has a TELECHRON alarm movement that can operate independently.

Whether the radio portion of your WAKEMASTER set is turned on or not, the TELECHRON alarm movement runs while the set is plugged in. Has sweep-second hand. Will start the radio at any time.

## Wakemaster

has a superheterodyne JEWEL circuit

JEWEL is fast becoming one of the best-known names in specialty radios and JEWEL circuits are winning fame for performance and dependability. This set is an outstanding example.

## Wakemaster

is Nationally advertised in

SAT. EVE. **POST LIFE Collier's**

The consuming public is being told about the JEWEL WAKEMASTER through the pages of America's "big 3" magazines. It's destined for big sales and we back that confidence with greater advertising than ever.



Made by the makers of these famous best-sellers!



JEWEL PIN-UP Electric Clock and Radio Combination

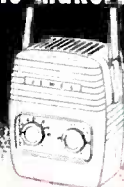

JEWEL TeeNee Portable Battery-Powered Radio

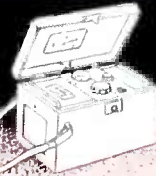

JEWEL TRIXIE 3-Way Portable A.C.-D.C. and Battery Radio



JEWEL Table Model Plastic Cabinet Radio

EXPORT ADDRESS: JEWEL INTERNATIONAL RADIO CORP.

**JEWEL RADIO CORPORATION**  
583 Ave. of Americas, New York 11, N. Y.

CABLE ADDRESS: JEWELRAD, N. Y. C.





of the



*Push RCA Tubes, Batteries, Parts and Test Equipment  
—and watch your business grow!*

## **Radio's greatest line . . . backed by the greatest name in radio**

© RCA and *only* RCA, brings you this preferred line of related products for greater sales volume throughout the year.

You benefit by handling RCA Tubes, Batteries, Test Equipment, Parts and Accessories . . . because you can concentrate your requirements with *one* dependable source of supply . . .

because the RCA monogram on *any* product gives it immediate customer acceptance.

What's more, you'll save time and give greater customer satisfaction using the outstanding new line of laboratory-engineered RCA Test Equipment in your service shop.

See your RCA Distributor today for full details.



**RENEWAL SALES**

**RADIO CORPORATION of AMERICA**

**TUBE DEPARTMENT**

**HARRISON, N. J.**