

# RADIO & TELEVISION RETAILING

C A L D W E L L - C L E M E N T S , I N C .

OCTOBER 1947

## ● *Radio, FM & Television*

"MIRACLE ON MAIN STREET" — WHAT'S AHEAD — WHERE IS YOUR TERRITORY? — BIG-FOUR DEALER — SALESFLOOR BEHAVIORISM — TELEVISION SALES AND SERVICE — FM FOR XMAS — NEW PRODUCTS

## ● *Electrical Appliances*

GET XMAS WINDOWS IN EARLY — WHERE TO GET LEADS — DOLLARS IN XMAS TREE SETS — APPLIANCE SERVICE — SELL MORE CLOCKS — QUARTER-MILLION DOLLAR GOAL — NEW PRODUCTS — LIGHTING NEWS

## ● *Records & Phonographs*

SALES TIPS — ACCESSORIES FOR GIFT-GIVING — PROFIT KEYNOTES PENNA. RETAILER'S METHODS — REVIEW OF LATEST RECORDS — COVERAGE OF NEWS EVENTS of the INDUSTRY — NEW PHONOGRAPH PRODUCTS

## ● *Service & Sound*

TIPS FROM SERVICE MANAGERS — PA SYSTEMS IN CHURCHES — FM TUNER CIRCUITS — MARKETS FOR INTERCOMS — INSTALLING TAVERN TELEVISION SETS — WHAT'S NEW IN SERVICE AND SOUND EQUIPMENT

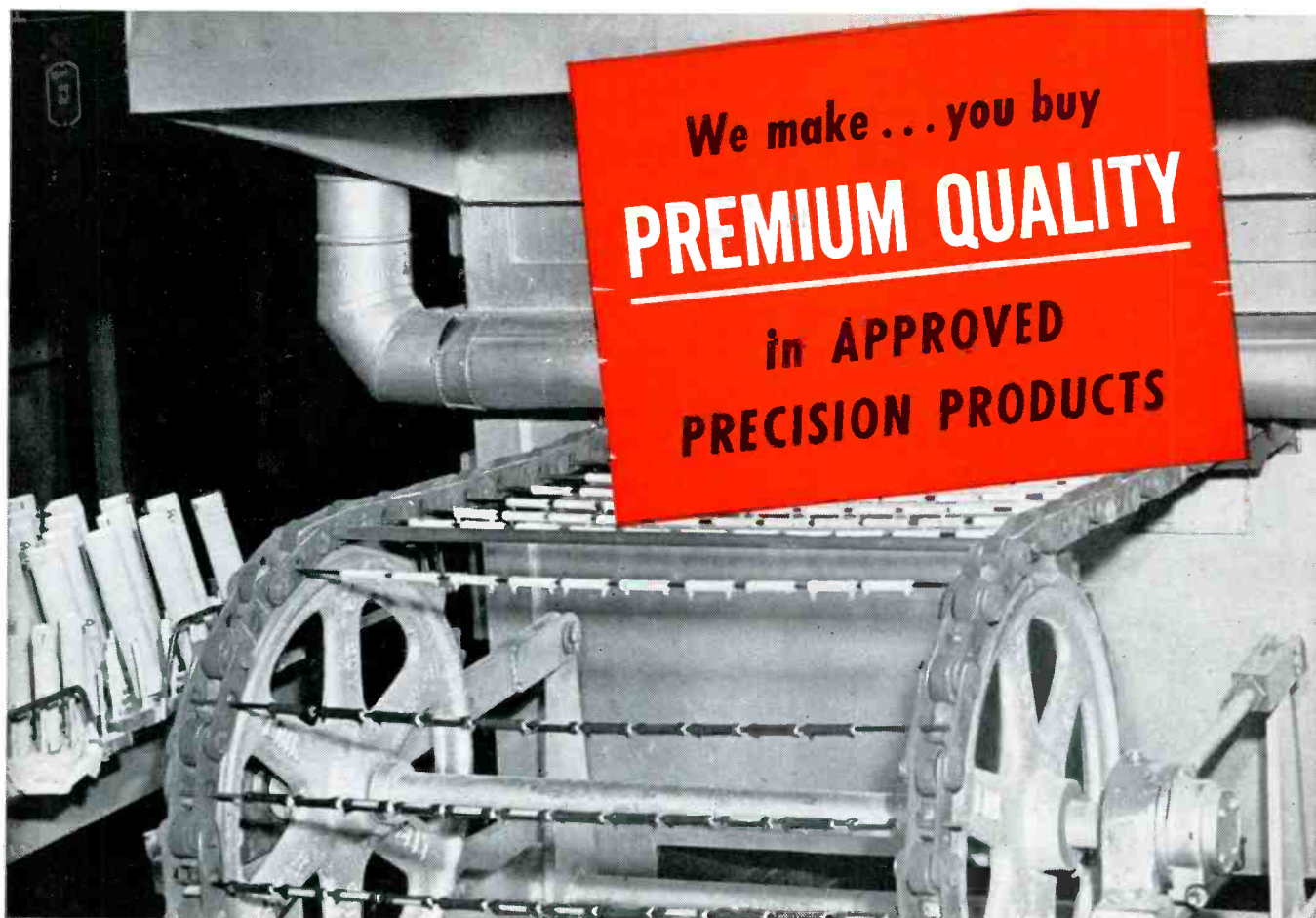

**T**HE Vitreous Enamel Resistors emerging from these huge Mallory baking ovens are famous everywhere for fine performance. Wound with an accuracy of  $\pm 5\%$ , they are coated with a high grade enamel, evenly applied, which gives them maximum protection from moisture and corrosion—assures uniform heat distribution too.

You can depend on these resistors to dissipate heat rapidly, to withstand tough atmospheric conditions, to remain free from failures, to stay accurate — to be everything implied in an Approved Precision Product. You pay no more for this premium quality.

Available in fixed and adjustable types, Mallory Vitreous Enamel Resistors run from 10 watts to 200 watts and have a wider range of convenient stock resistance values. You'll find them at your Mallory distributor—a distributor ready to give you detailed information about prices and catalog numbers, and willing to serve you in any other way.

**YOU EXPECT MORE AND GET MORE FROM MALLORY**

P. R. MALLORY & CO. Inc.  
**MALLORY**

VIBRATORS . . . VIBRAPACKS\* . . . CAPACITORS . . .  
 VOLUME CONTROLS . . . SWITCHES . . . RESISTORS  
 . . . FILTERS . . . RECTIFIERS . . . POWER SUPPLIES.  
\* Reg. U. S. Pat. Off.

**APPROVED PRECISION PRODUCTS**

*National Radio Week*  
 Oct. 26—Nov. 1

**P. R. MALLORY & CO., Inc., INDIANAPOLIS 6, INDIANA**



# RADIO & Television RETAILING

Including RADIO & Television TODAY

**ORESTES H. CALDWELL**

Editorial Director

**M. CLEMENTS**

Publisher

**JOHN L. STOUTENBURGH**

Executive Editor

**DARRELL BARTEE**

Managing Editor

**HAROLD R. ELLIS**

Technical Editor

**RUTH MORRIS**

Records Editor

**M. R. LABATT-SIMON**

Assistant Editor

**CHARLES F. DREYER**

Art Director

**BUSINESS DEPARTMENT**

**LEE ROBINSON**

Sales Manager

**M. H. NEWTON**

Business Manager

**EDWIN WEISL, JR.**

F. A. WHITE

**A. R. FISKE**

Promotion Manager

**BETTY HALL**

Production

**BRANCH OFFICES**

CHICAGO 6

R. Y. FITZPATRICK, Manager

S. GASKINS

201 N. Wells St. RAN. 9225

LOS ANGELES 5

THE ROBERT W. WALKER CO.

683 S. Lafayette - Park Pl.

Drexel 4-88

SAN FRANCISCO 4

68 Post St. SUtter 1-5568

**CIRCULATION DEPARTMENT**

**B. V. SPINETTA**

Circulation Director

**W. W. SWIGERT**

Credit Manager

**RADIO & Television RETAILING**

October 1947, Vol. 46, No. 4, 25 cents a copy. Published monthly by Caldwell-Clements, Inc. Publication Office 1309 Noble St., Philadelphia 23, Pa. Editorial, Advertising and Executive Offices 480 Lexington Ave., New York 17, N. Y. M. Clements, President; Orestes H. Caldwell, Treasurer. Subscription rates United States and Latin American countries \$1.00 for one year, \$2.00 for three years (Canada \$1.50 for one year, \$3.00 for three years). All other countries \$2.00 for one year, \$4.00 for three years. Printed in U.S.A. Entered as second class matter March 20, 1947, at the Post Office at Philadelphia, Pa. under the act of March 3, 1879. Member of Audit Bureau of Circulations. Copyright by Caldwell-Clements, Inc., 1947.

\*Trade-Mark Reg. U. S. Pat. Off.

**IN THIS ISSUE**

**OCTOBER, 1947**

★ *Radio, FM, Television*

|   |    |
|---|----|
| COVER—The Big Four                            | 35 |
| EDITORIAL—Miracle on Main Street              | 36 |
| RADIO, APPLIANCES, RECORDS & TELEVISION TODAY | 40 |
| WHERE IS YOUR TERRITORY?                      | 42 |
| STOLFI'S—Television Headquarters for Stamford | 44 |
| PROMOTION WITH PURPOSE AND PUNCH              | 46 |
| NEW SETS FOR THE XMAS SEASON                  | 48 |
| NEW RADIO LINES FOR XMAS SELLING              | 50 |
| SALESFLOOR BEHAVIORISM                        | 52 |
| SELL FM FOR XMAS                              |    |

★ *Records, Phonographs, Accessories*

|  |                   |
|--|-------------------|
| COVER—Platter Profit Pointers          | 55                |
| GIFT DISC ACCESSORIES                  | 57                |
| RADIO PROMOTION BOOSTS PLATTER PROFITS | 59                |
| DISCS FOR XMAS BRING DOLLARS           | 61                |
| NEW PHONO PRODUCTS                     | 64                |
| NEWS OF THE RECORD INDUSTRY            | Begins on page 66 |

★ *Electrical Appliances*

|   |                   |
|---|-------------------|
| APPLIANCE COVER—Early Christmas Business          | 77                |
| WHERE TO GET LEADS                                | 79                |
| QUARTER-MILLION \$\$\$\$\$ BUSINESS-DEALER'S GOAL | 80                |
| NEW ELECTRICAL HOME APPLIANCES                    | 82                |
| \$\$ IN DECORATIVE MATERIAL                       | 84                |
| NEWS ABOUT LIGHTING                               | 86                |
| APPLIANCE SERVICE NEWS                            | 88                |
| UP ELECTRIC CLOCK SALES                           | 90                |
| NEWS OF THE INDUSTRY                              | Begins on page 91 |

★ *Service and Sound*

|                                    |     |
|------------------------------------|-----|
| COVER—Tips on Easy Circuit Changes | 95  |
| SOUND FOR CHURCHES                 | 97  |
| LATEST FM TUNER CIRCUITS           | 98  |
| PLACING TELEVISION SETS IN TAVERNS | 100 |
| MARKETS FOR INTERCOMS              | 104 |
| NEW SERVICE PRODUCTS               | 108 |
| NEW SOUND PRODUCTS                 | 110 |

|                      |     |
|----------------------|-----|
| TELEVISION TOPICS    | 112 |
| WITH THE WHOLESALERS | 116 |

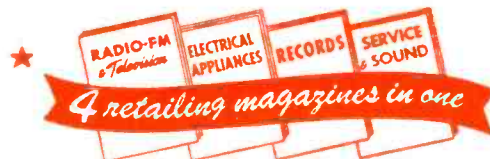

**29,000 COPIES  
THIS ISSUE**

Member of  
AUDIT BUREAU  
OF CIRCULATIONS

**CALDWELL-CLEMENTS, INC.**

Publication Office ..... 1309 NOBLE ST., PHILADELPHIA 23, PA.  
Editorial, Advertising & Executive Offices .... 480 LEXINGTON AVE., NEW YORK 17, N. Y.



# YEA MAN

## YOU'RE GONNA NEED A **strong line**

There's no choice in the matter . . . today you have to play ball with your prospects. And if you think modern gals aren't the shiftiest open field runners that ever headed for the goal of easier homemaking . . . well, you've got another think coming! They'll shift from product to product, from dealer to dealer, until they run into a line that will hold 'em. That's why we suggest this:



## LET'S GO INTO A **huddle**

If you don't want to get thrown for a loss it's time to plan sales strategy right now. And one of the first steps is to look over the field . . . and check your line-up against one that's built to be a winner. Check it, for example, against this CROSLY team:

## HERE'S THE **center** OF ATTENTION



® \*TRADE MARK REG. U. S. PAT. OFF.

## CROSLY *Shelvador\**

It's the Crosley Shelvador\* . . . the snappiest number that ever held down the pivot position on any line! One glance at all that extra front-row food space (in the big model it's 28 feet) stops any woman in her tracks. A close inspection of all the additional features (including mechanical refinements and styling) and she's on *your* side . . . leading cheers for the smartest idea in the refrigerator field.

Women know the score, all right, when it comes to kitchen efficiency. That's why the Crosley Shelvador\* consistently chalks up bigger and bigger sales gains for Crosley dealers . . . why it will continue to gain more ground in the rough 'n tumble competition ahead.



CROSLY RANGES

## SAFE **guards** FOR SALES

It's final results that count . . . on gridiron or griddle. So women rally 'round Crosley ranges and learn that THE BASIC 4 mean as much to easier, better cooking as the Four Horsemen did to Notre Dame!

They do! The (1) OVERSIZE OVEN, (2) WAIST - HIGH BROILER, (3) KALORIE KEEPER INSULATION and (4) SPEED-UP SURFACE UNITS, features of both gas and electric models, go triple-threat units one better! Yes, and they not only safeguard meal-making for women . . . they safeguard sales for dealers.



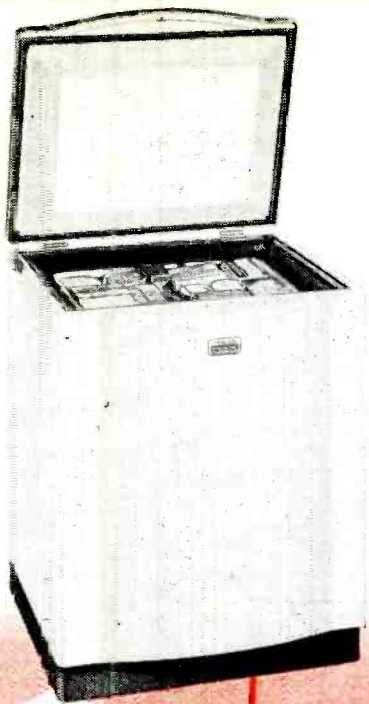

## LET'S **tackle** FROZEN FOODS

There's no better way to do that than with the Crosley Frostmaster, the thrifty, kitchen-size frozen food cabinet that holds 100 pounds of frozen foods. With the big shift to frozen foods, dealers caught napping without such a handy unit will be penalized. Talk about extra points . . . the Frostmaster has 'em! It freezes family quantities of meat, poultry

and properly processed fruit or vegetables. Its 36" x 29<sup>3</sup>/<sub>4</sub>" x 26<sup>1</sup>/<sub>4</sub>" dimensions are designed to fit any kitchen. It fits flush to floors . . . close fit all around. Toe space is recessed; gleaming finish cleans as easily as a china dish. Quiet, super-efficient Crosley Electro-saver mechanism is built for years of economical, trouble-free operation.

## AN **aerial attack** IS MIGHTY IMPORTANT



And again Crosley is ready with merchandise that can't be passed up. A smart console that's engineered for outstanding reproduction of AM-FM radio or recorded music? That's the Crosley Carrollton . . . a superb instrument with that famous feature—the Crosley Floating Jewel Tone System. A Television set incorporating improvements that make telecast reception practical for everyone? That's the Crosley Spectator . . . a real leader in its class.

A small table model radio that combines beauty and performance at a moderate price? That's the Crosley Rondo . . . smart and new from every view, a mellow-toned performer, too!

Of course there are many more models that make for out-standing radio sales gains . . . and minimum interference from competition.

## YOU'RE THE **quarterback!**

If your line is a strong one, no one is going to run over you . . . and at the same time you're going to win a lot of customers. And in your backfield of course you need your manufacturers' engineering skill . . . their standards of quality production . . . and their promotion efforts. That's where Crosley will star for you.

But you're the quarterback. *You make the decisions.* Make the right ones NOW . . . you'll be a sure winner tomorrow.

*Say . . .* **HOW STRONG IS your LINE ?**



THE CROSLY RONDO

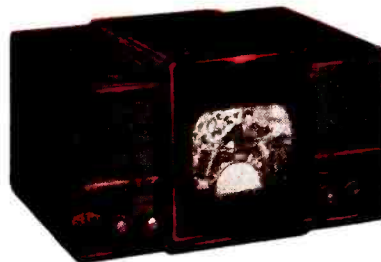

THE CROSLY SPECTATOR TELEVISION SET



THE CROSLY CARROLLTON

† PATENTED.

© 1947 CROSLY DIV. AVCO MFG. CORP.

# CROSLY

Division—**AVCO** Manufacturing Corporation  
Cincinnati 25, Ohio

Shelvador\* Refrigerators — Frostmasters — Kitchen Cabinets and Servisinks — Ranges — Radio — Radio - Phonographs — FM — Television Short Wave — Home of WLW





Transformers of even a few years ago are not the transformers of today. Engineering advances! Know the factors of transformer efficiency today — with Merit Quality. Consult Merit.



**MERIT COIL & TRANSFORMER CORP.**

TELEPHONE

4427 North Clark St. Long Beach 6311 CHICAGO 40, ILL.

## The Publishers Sound Off . . .

**RADIO SERVICE** men throughout the country sharpened their pencils and filled in questionnaires not so long ago for John F. Rider, dean of radio servicing.

**THE SURVEY** got right down to basic fundamentals and, thanks to the helpfulness of radio service people everywhere, comes up with a lot of basic facts that shed plenty of bright light on every significant trend and statistic in the technical and business end of the radio servicing industry.

**YOU'LL GET IT** beginning in the November issue of Radio & Television Retailing. It will all be spread out in black and white and dressed up with easy-to-digest charts. It's an *exclusive first* for Radio & Television Retailing, a genuine "scoop," which, we are certain, will prove to be eye-opening and of genuine value to every mortal interested in the service business.

**YOU'LL LEARN** how many dealers operate their own service departments and how many do not. Also, what electrical appliances and allied lines are being sold by service outlets. You'll get a line on the variety and types of equipment used by service men. You'll discover what sort of equipment is on the schedule for early purchase. From all this and much more, you will be able to take a good look at yourself and see how you stack up.

**THESE DATA**, used in planning your business, should be worth many dollars in the cash register to you. Because today is the day of hand-springs in the radio industry—when television and FM are bursting into the nation's parlor and are making unprecedented demands upon the service man. This is the day when you have to run to keep in step with new ideas, new designs, new developments. The horizons of the radio service industry are beautifully decorated by dollar signs. This survey should go far to help you reap the harvest.

**PUBLISHERS** sometimes throw their arms completely out of joint in their enthusiastic efforts to pat themselves on the back. This is one time, however, when we have an honest-to-gosh right, we believe, to say, "Yes, indeed, Radio & Television Retailing has really got something there."

**YOU'LL AGREE**, we think, when you've had a chance to study the survey in next month's issue.

—THE PUBLISHERS



# NEWS FOR PHILCO DEALERS

About the Greatest Advertising and Promotional Campaign the Industry has ever seen!

To increase your radio sales and profits during the all-important fall season Philco, the leader, has gone into action with the greatest advertising and promotional campaign the industry has ever seen. Nothing like it for power, size, cost and sheer impact on the buyers of your locality has ever happened before. And it doesn't cost you a cent to share in the tremendous harvest of new business resulting from this staggering program, as it builds increasing momentum in the weeks ahead. Philco is doing its part to provide everything you need to make this promotion yield record returns in sales and profits. Now is the time to tie-in and cash-in with Philco. Concentrate your efforts where they will yield the biggest results. Get going today with your Philco Distributor.

-and this is Only the Beginning

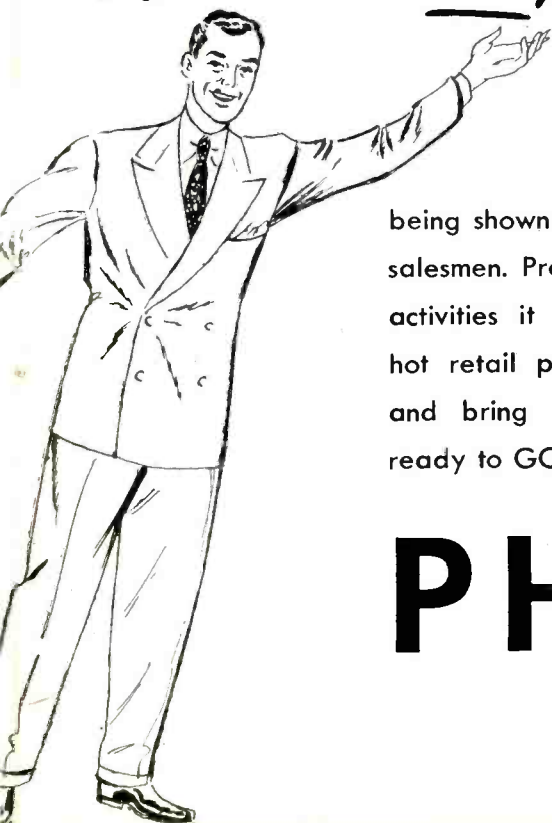

Here's the big campaign portfolio now being shown in every territory by Philco Distributor salesmen. Prepare for the rapid-fire merchandising activities it tells about...the continuous flow of hot retail promotions to stimulate your salesmen and bring traffic and sales to your store. Be ready to GO... WITH PHILCO!

# PHILCO

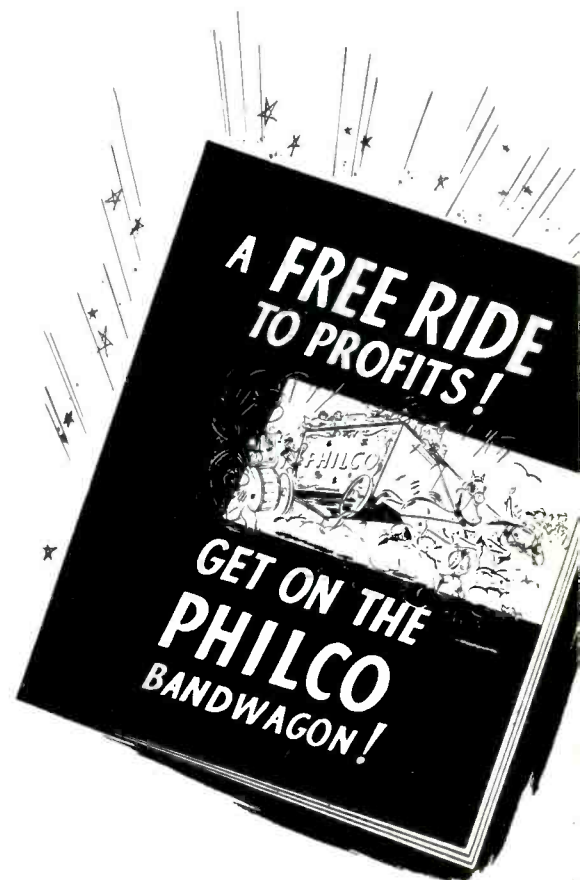

# Here's how to sell home recording...

WITH  
**Recordio**



**Visualize** for your prospect how RECORDIO ... the world's finest home recording instrument ... becomes their "life of the party" and capture its care-free merriment for future enjoyment.

**Show** your customer how to record his favorite radio shows, symphony orchestras, or historical events ... just as they were broadcast.



**Recall** the many happy family get-togethers that deserve to become family mementos ... instantly available in sound.



**Demonstrate** how easy it is for anyone to make a personal "voice letter" to send to absent family members or friends ... a four-minute letter with personality.



**Dramatize** the wide variety of events that can be recorded and kept indefinitely for future enjoyment down through the years.

## SELL ENTERTAINMENT... SELL **Recordio!**

Increasing publicity for home recording in all its forms is arousing public interest. Here is a brand new, uncrowded market for your sales efforts. Make sure, however, that you choose a home recorder with an experienced past and a promising future ... RECORDIO by Wilcox-Gay. Every RECORDIO sale brings you at least *twelve additional sales a year* of RECORDIO Discs and Needles.

**PUT YOUR MONEY ON  
A PROVEN WINNER ...**



**Recordio**  
T. M. REG. U. S. PAT. OFF.  
by **WILCOX-GAY**

**WILCOX-GAY CORPORATION • CHARLOTTE, MICHIGAN**

135 A4



**KEN-RAD TUBES  
BUILD BUSINESS FOR MY  
RADIO REPAIR SHOP!**



You hear that statement from service-men who've learned that at all times they can count on Ken-Rad tube quality, stamina, and long playing life.

**Ken-Rad double acceptance—by dealers and users  
—means a doubled sales-and-profit potential!**

As a radio-repair specialist or tube dealer you can "cash in" on the twofold popularity of Ken-Rad tubes—their acceptance by service experts because they're *good tubes*, and the favor they enjoy with radio owners based on their fine performance and long life.

Profits can come not alone from your growing volume of Ken-Rad tube business, but by selling more parts and repair time to owners who seek the superior service you offer your clients. *For Ken-Rad tubes are your*

*most effective advertisement of this service.*

Here is a splendidly engineered *modern* line of receiving tubes, backed by great facilities in research and manufacture, with a brand name deservedly popular and growing more so daily. Here too is OPPORTUNITY to increase your sales, boost your income, underscore with the Ken-Rad good name your own fine local reputation.

Put Ken-Rad double acceptance to work for you . . . profitably!

**SPEAKING FOR APPRECIATIVE  
OWNERS, KEN-RAD TUBES  
BUILD GOODWILL!**



Customers soon discover that Ken-Rad tubes give a "lift" to radio performance. Advanced tube design and precision manufacture are responsible.



Write for Ken-Rad Booklet ETR-16, "Essential Characteristics". This well-known publication contains the technical data you need to select Ken-Rad tube types for sets being repaired. The three "C's" apply throughout: Convenient, Concise, Comprehensive. Just one of many Ken-Rad helps—including the trade's *finest display, advertising, and promotion material*—available to radio service-men and tube dealers!

178-F9-6850

**KEN-RAD** *Radio Tubes*

PRODUCT OF GENERAL ELECTRIC COMPANY

Schenectady 5, New York

ARVIN  
ARVIN  
ARVIN  
ARVIN  
ARVIN  
ARVIN  
ARVIN  
ARVIN  
ARVIN  
ARVIN  
ARVIN  
ARVIN  
ARVIN  
ARVIN  
ARVIN  
ARVIN  
ARVIN  
ARVIN  
ARVIN  
ARVIN  
ARVIN

**FEATURES THAT STOP 'EM . . .**  
**AND PRICE THAT *Sells-em!***



Model 150TC Mahogany Veneer  
Model 151TC Walnut Veneer

**150<sup>TC</sup>**  
COMBINATION RADIO  
AND RECORD CHANGER

**\$ 89.95**  
LIST

Prices slightly higher in Zone 2



The Arvin 150TC is an achievement in designing for smallest table space with no sacrifice in performance. And production-planning for mass market pricing has been brilliantly accomplished without compromising quality and beauty. Has selenium power-rectifier for greater, undistorted output. You'll sell these Arvin 150TC's fast . . . your customers will buy them with pride and satisfaction. They're nationally advertised, and they really move. Order yours today!

**HAS ALL THESE FEATURES YOUR CUSTOMERS WANT!**

- New compactness, fits on smaller tables, easy to carry!
- Time-proven automatic record-changer for trouble-free operation
- Single button control of automatic changer
- Easier accessibility for operation of changer control
- Full RF stage
- Choke filter for additional power output
- Outstanding tone qualities
- Continuously variable tone control
- Adjustments and repairs easily made without removing chassis

... the name on many profit-building products from  
**NOBLITT-SPARKS INDUSTRIES, INC., Columbus, Indiana**



# READY

For immediate delivery

# AIR KING WIRE RECORDER

and RADIO-PHONO COMBINATION

**AIR KING OPENS AN EXCITING NEW FIELD IN HOME ENTERTAINMENT.**

Air King was the first radio manufacturer to successfully combine the Wire Recorder, Radio and Phonograph into a smooth functioning, foolproof, home entertainment unit that even a child can operate. Another out-growth of Air King's Engineering "Know-How".

Consumer acceptance of the Wire Recorder, in combination with a radio phonograph at no extra cost has been sensational! It has proven itself in thousands of American homes and is considered by top merchandisers to be the hottest item of the year.

Smart dealers will insist upon the Wire Recorder in all future radio-phonograph combinations.

**FIRST AID PROGRAM for HEALTHY BUSINESS**  
Air King places its Advertising and Sales Promotion Department at your disposal. Write today for information on our First Aid Program to help you promote the Air King line in your community. A new idea in manufacturer-dealer cooperation.

Air King believes that progress makes sense and dollars too. Here is your opportunity to get on the Air King bandwagon and be the first to sell the Air King Wire Recorder Radio-Phono Combination in your community.

★ WE HAVE A LIMITED NUMBER OF DISTRIBUTOR AND DEALER TERRITORIES OPEN ★  
Write or wire (New Address): Air King Products Co., Inc., 170 53rd Street, Broomlyn 32, N. Y.  
Export Address: Air King International, 75 West Street, New York 6, N. Y.

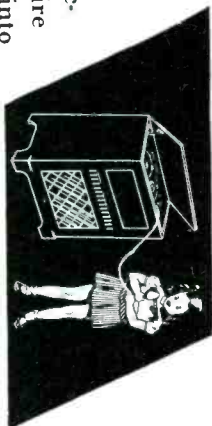

Records your voice. Disc Records or Radio Programs. simple, finger-tip controls.



The music lovers' dream comes true. Amazing high fidelity noise free recordings.

It's a Radio, Phonograph and Wire Recorder all in one!



One hour of recording on a small spool of wire. Replay or erase for new recording.

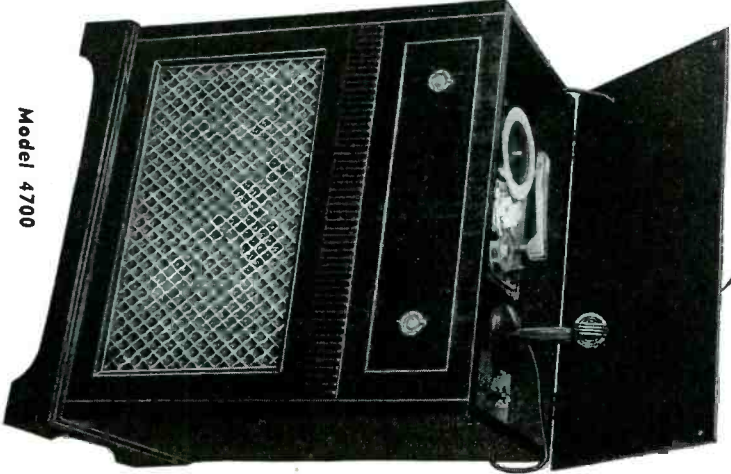

Model 4700

**FEATURES YOU CAN SELL!**

- Records Voice on Wire, through Microphone.
- Records Phonograph Records on Wire.
- Records Radio Broadcasts on Wire.
- Powerful Super-Sensitive Radio.
- High Quality Phonograph.
- Amazing Air King "Wirestone" Reproduction.

*The Story of Radio Since 1920*

# AIR KING RADIO

Division of HYTRON RADIO & ELECTRONICS CORP.

more  
sales  
for  
you!

**Better Dealer Support**

Highly productive advertising, prepared by you or your agency, issued at the dealer level. Dealer willingly pays but 2 1/2¢ a line. Your cost is proportionately low.



**Increased Product Prestige**

Large-space advertisements convey your sales message to people interested in home appliances throughout the Great Chicago Market.



**Better-known Retail Outlets**

Each dealer gets selective coverage of his local market . . . prominent identification in his own trading area.

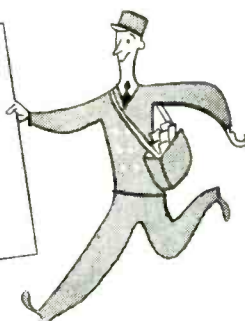

**Faster Results**

Because dealers back up this advertising more enthusiastically, it pays off right away! More sales for your dealers, more profit for you!



from the  
**Chicago Tribune's  
Selective Area  
Advertising Plan**

Identifying your local outlets — prominently — can pay big dividends, help you build a stronger selling organization. Use the Tribune's Selective Area Advertising Plan to do this!

Each of your dealers gets a campaign directed specifically at the market he serves. Each gets highly localized selling pressure directed at his own prospects. And you get total coverage of the entire Chicago Market . . . a market large enough to take all or

the greater part of many manufacturers' production.

This is possible because the Tribune gives you *five separate Sunday sections* in which to list your non-competing dealers. You get selective coverage with five advertisements for the price of one — further, you share the costs with your distributors and dealers. Result: more sales for you in the rich Chicago Market.

To learn how the Plan fits *your* needs, write your nearest Tribune representative as shown below.

**PLAN IS PAYING OFF FOR USERS**

More than a dozen radio and appliance manufacturers are using the Tribune's Plan. Included in this group are Bendix washer, Eureka vacuum cleaner, and Bendix and Admiral radios. *You and your dealers* can profit from this Plan, too. Tribune line rates per 100,000 circulation are among America's lowest.

**Chicago Tribune**

*The World's Greatest Newspaper*

July average net paid total circulation:  
Daily, over 1,030,000 • Sunday, over 1,500,000



- A. W. Dreier, Chicago Tribune  
810 Tribune Tower, Chicago 11
- E. P. Struhsacker, Chicago Tribune  
220 E. 42nd St., New York City 17
- Fitzpatrick & Chamberlin  
155 Montgomery St., San Francisco 4
- W. E. Bates, Chicago Tribune  
Penobscot Building, Detroit 26

MEMBER: AMERICAN NEWSPAPER ADVERTISING NETWORK, INC., FIRST 3 MARKETS GROUP, AND METROPOLITAN SUNDAY NEWSPAPERS, INC.



DEALER AFTER DEALER SAYS:

*Greatest Performance*

*in Phonograph History*

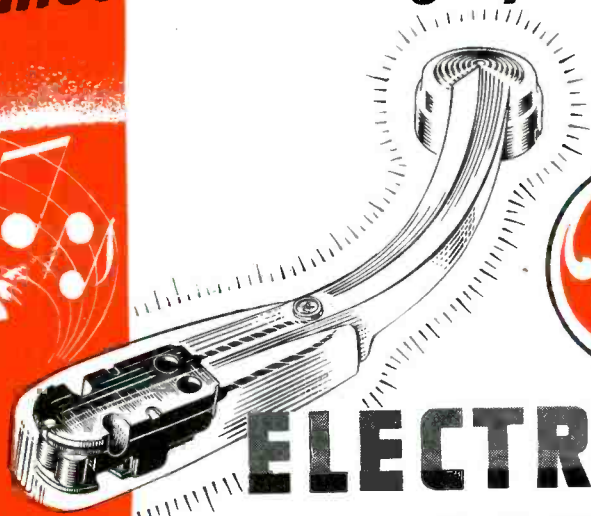
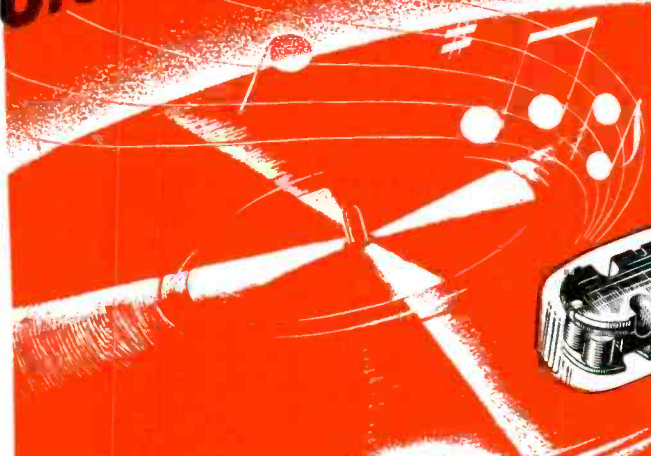

# ELECTRONIC REPRODUCER

Powerful sales feature of the sensational General Electric radio-phonographs

"Out of this world" say the teen-agers. "Magnificent" say the older folks. "Best sales closer any phonograph ever had" say dealers. It's yours for bigger business in General Electric automatic radio-phonographs. For full information write your General Electric radio distributor or General Electric Company, Receiver Division, Electronics Park, Syracuse, N. Y.



*"I heard a Miracle!"*

Says MARGARET WHITING, star of Capitol Records, heard on the Franco-American Club 15 Program over CBS

**GENERAL  ELECTRIC**

175-P10

LEADER IN RADIO, TELEVISION AND ELECTRONICS

PORTABLES • TABLE MODELS  
CONSOLES • FARM SETS  
AUTOMATIC PHONOGRAPH  
COMBINATIONS • TELEVISION



Model 354. Fast selling automatic combination. Standard broadcast, FM (both bands). G-E Electronic Reproducer. Stores 120 Records.



Model 502. 6 band automatic combination with standard radio, short wave, and genuine FM. G-E Electronic Reproducer.



Model 417A. 5 band automatic combination with genuine FM. G-E Electronic Reproducer.



Model 304. G. E.'s finest automatic table combination. G-E Electronic Reproducer.

**... GOING TO CHICAGO? Visit General Electric's permanent radio and radio-phonograph showrooms, 11th Floor, Merchandise Mart. Be sure to see the new models—new features—new selling ideas.**

*Could this  
be your town?*

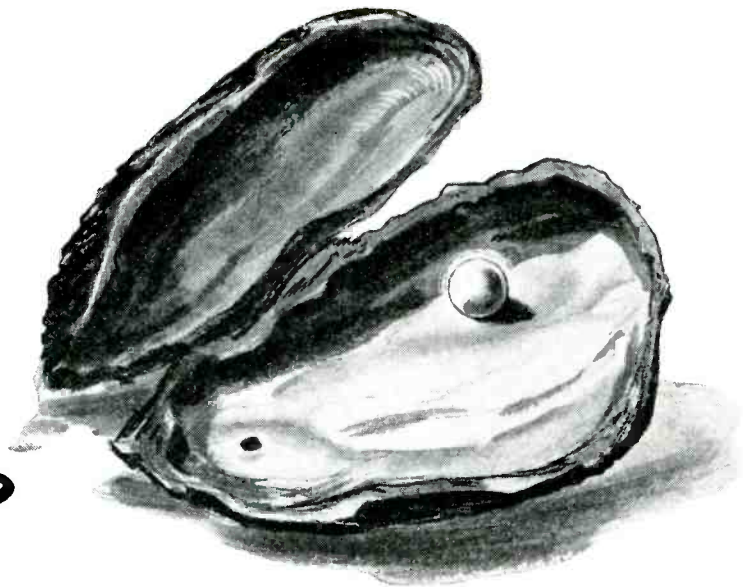

**N**OT EVERY radio retailer can call the whole town his oyster.

But Sparton dealers can. And do!

They're protected by the SCMP—Sparton Co-operative Merchandising Plan. They're spared the grief of camouflaged discounts, price cutting, circus promotions, dumping and all the rest of the competitive hoop-la!

Under SCMP only *one* dealer in each community holds the Sparton franchise. All of Sparton's punch-packing national advertising and promotion work locally for him alone.

Under SCMP shipments are made directly from factory to dealer. The savings go into the radios and into the Sparton price, which can compete even with the mail order houses—at a profit!

Right now the new Sparton Challenger line is the sensation of the radio world, for beauty, performance and value. And SCMP helps make it possible.

Yes, the whole town's your oyster when you hold the Sparton franchise. Why not write us today and ask whether the franchise is still available in your community?

**THE SPARKS-WITHINGTON COMPANY**  
JACKSON, MICHIGAN

*Sparton* **Radio's Richest Franchise**

**ONE** *Sparton*  
**DEALER**

**in each community**

*Check These  
Profit-Increasing Features*

- One exclusive dealer in each community
- Direct factory-to-dealer shipment
- Low consumer prices
- National advertising
- Factory prepared and distributed promotion helps
- Seasonal promotions
- Uniform retail prices
- Products styled by outstanding designers

**A HOT, SHORT LINE AT LOW PRICES**



**MODEL 7-BM-46-PA**—Automatic radio-phonograph in blended walnut or mahogany veneers. With 10" speaker, "roll-out" phonograph drawer. Has three wave bands.

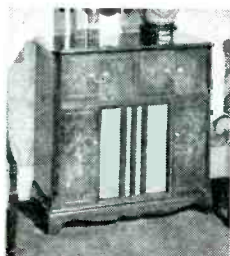

**MODEL 10-BM-76-PA**—Automatic radio-phonograph with FM. "Roll-out" phonograph drawer, 10" speaker. Finished in choicest mahogany or walnut veneers.

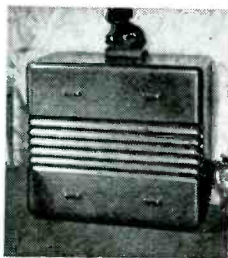

**MODEL 10-AM-76-PA**—Automatic radio-phonograph with FM. "Roll-out" phonograph drawer. Modern design cabinet of natural or blonde mahogany veneer.



**PERIOD MODEL—No. 1007**—Automatic radio-phonograph with FM, in mahogany veneer. Also the Modern Model in Golden Wheat finish; Contemporary Model in mahogany veneer.

**SMALL SET  
WINNERS, TOO!**

See the new Sparton portable (Model 606) for battery, AC/DC current.

See the new Sparton utilities (Models 100 & 101) in ivory or ebony finish.

See the new Sparton table automatic (Model 201) with big set performance.



*Only a few can own it...*

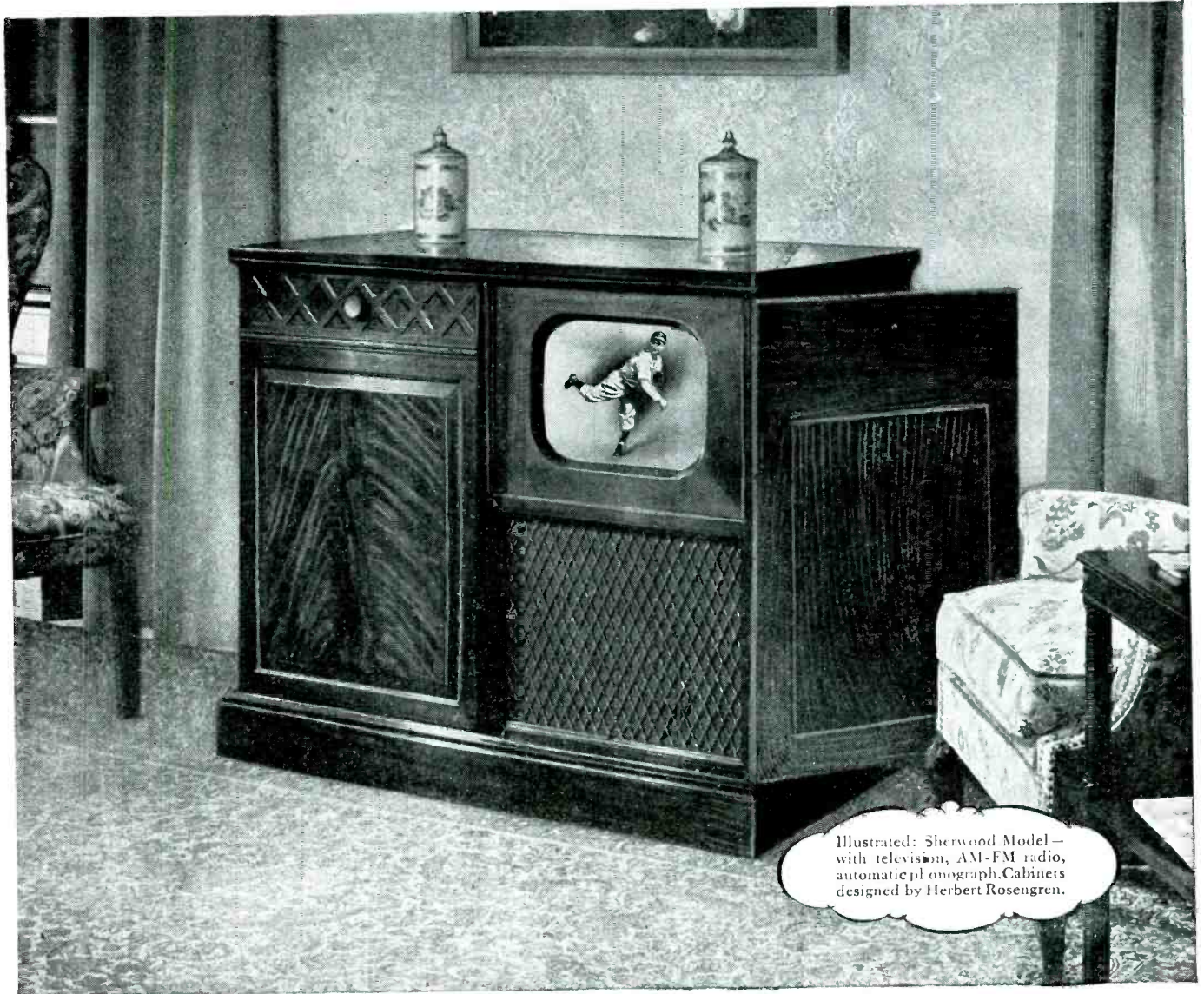

Illustrated: Sherwood Model—  
with television, AM-FM radio,  
automatic phonograph. Cabinets  
designed by Herbert Rosengren.

*but* everyone should see this superb Du Mont Teleset\*

Du Mont consumer advertising does more than build Du Mont prestige... it makes Du Mont the standard of comparison and the Du Mont dealer first point of call for the television prospect. Leadership in television merchandising goes hand in hand with the leading line. That's why the Du Mont dealership is the most-sought franchise in the field today.

ALLEN B. DU MONT LABORATORIES, INC. • GENERAL TELEVISION SALES OFFICES AND STATION WARD,  
515 MADISON AVENUE, NEW YORK 22, N. Y. • HOME OFFICES AND PLANTS, PASSAIC, N. J.

**DU MONT** *First with the Finest in Television*

\*Trade-mark

Copyright 1947, Allen B. Du Mont Laboratories, Inc.

*Christmas is Coming*

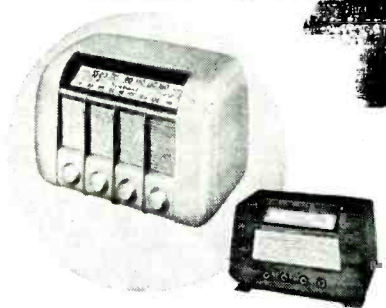

The last word in FM-AM Table Models.



FM-AM; Phono-combination lined oak or regular mahogany.

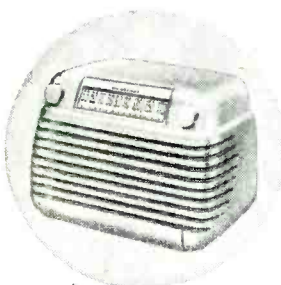

AC-DC Superhets. Compact, powerful, efficient, beautiful.

**AND THE Sentinel LINE IS  
HERE NOW**

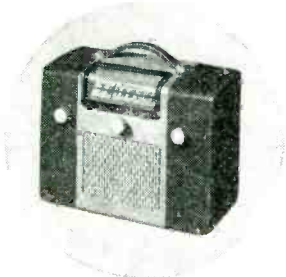
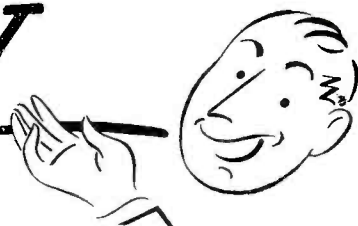

AC-DC and Battery Portables, Super performing.

And NOW is the time to get set for the biggest Christmas selling in all radio history! Sentinel is ready—ready with the finest, most complete line ever offered—a radio for every room in every home; for every purse and purpose . . . AM and FM, Battery and Electric—Consoles and Portables, Table Models and Radio Phonographs, backed by full-color, full page advertisements in leading national magazines.

**CASH IN ON RADIO'S BIGGEST SELLING SEASON—CONTACT YOUR SENTINEL DISTRIBUTOR TODAY!**

SENTINEL RADIO CORPORATION • EVANSTON, ILLINOIS



The "Treasure Chest" Sensation of the industry. AC-DC and Battery Superhet. 8¼" x 5" x 4½". Weighs only 5½ pounds with batteries.

FOR STUDIO TONE IN YOUR HOME

**Sentinel** *Radio*



# everybody wants...backed by a

and all thru the **HOUSE**  
 the RADIO they want is  
**Westinghouse**

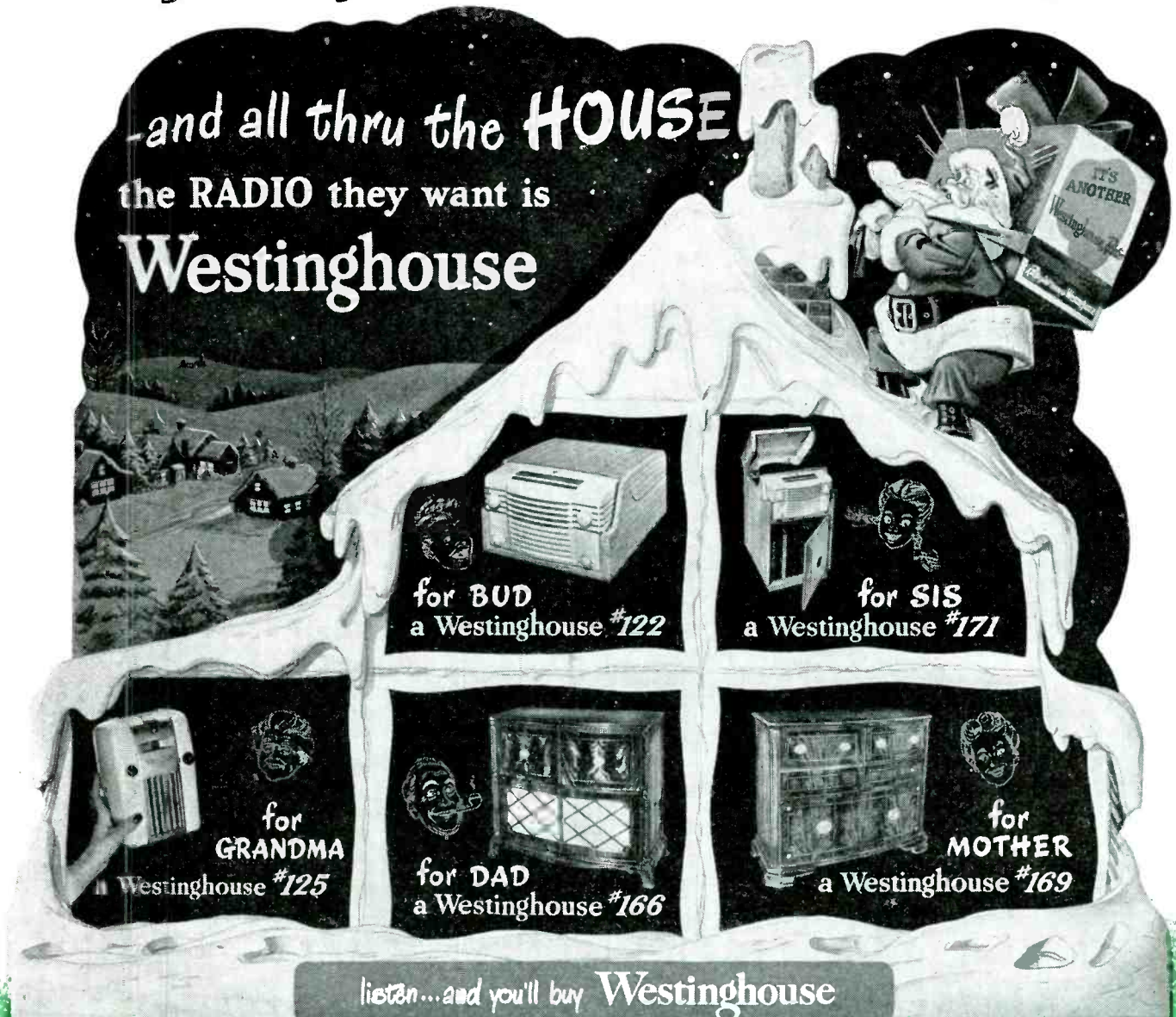

listen...and you'll buy **Westinghouse**

This window display uses the same illustrations and the same theme as the national magazine ad. Size 40" high by 45½" wide by 8" deep.

### Powerful Retail Selling Helps

A broadside and stuffer, each in two colors, which sell the Christmas gifts that everyone wants — Westinghouse Radios. Models 122, 125, 166, 168, 169 and 171 are featured.

### Traffic-Stopping Window Display

This full-color display features five important Westinghouse sets as Christmas gifts. In full color plus glittering snow... can't be missed in your store or window.

Your Westinghouse distributor has this promotional material now. Order from him today without delay so you can be ready in November.

**FIRST NAME IS** **Westinghouse**  
 RADIO TELEVISION



# Another Smash Hit

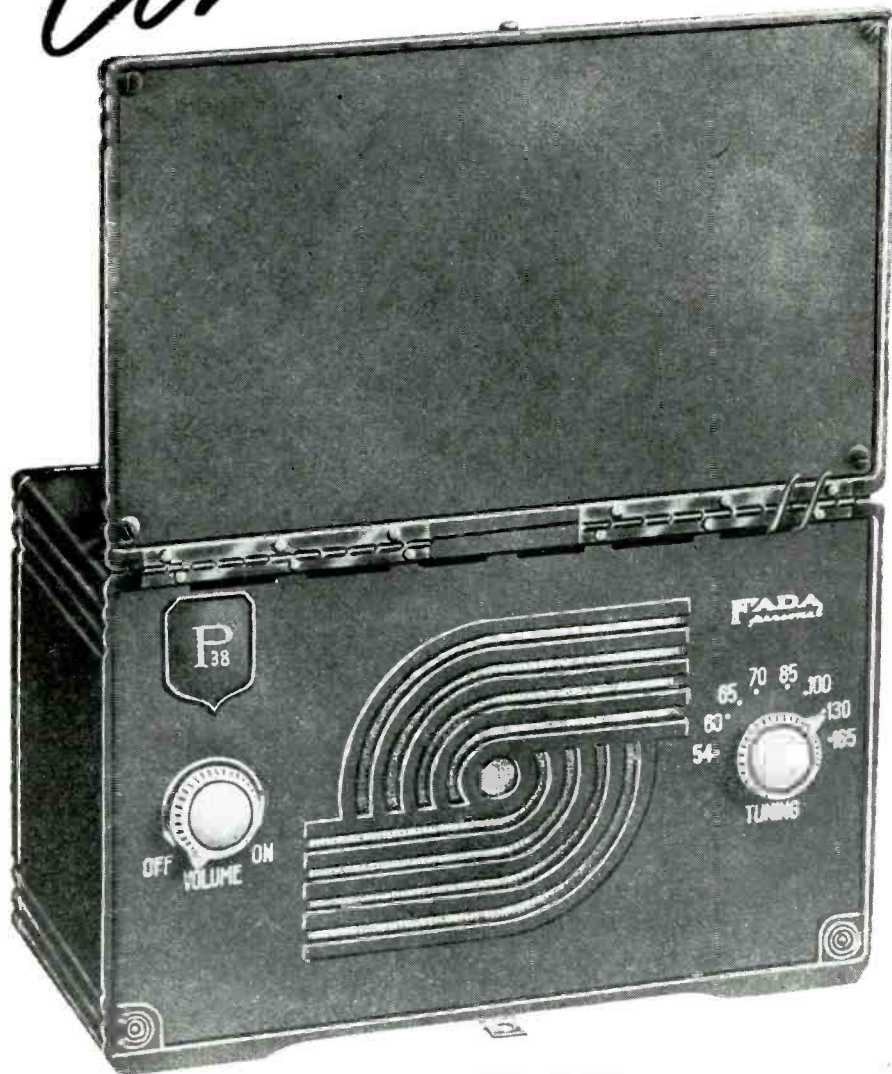

by

## FADA Radio

*The Radio of To-  
Morrow . . . To-Day!*

**H**ERE'S the last word in Battery Operated Personal Portables. The new FADA Model P38 is a gem for compactness, beauty and performance. Plays anywhere! It comes in four alluring color plastic cabinets. Like all FADA products Model P38 is a masterpiece without peer in its class, certain to find acceptance everywhere.

**\$24<sup>95</sup>**

List

Less Batteries  
(In Ebony Plastic)

\* Sensitive! Selective! \* Four inch 'Alnico' V Magnet Speaker  
\* Iron Core I.F. Transformers and as oscillator coil \* High Q Loop Antenna \* Weighs only 5<sup>1</sup>/<sub>4</sub> lbs. with batteries \* Genuine leather carrying handles.

### • MODEL P38 •

Battery Operated Super-heterodynes in Choice of Sparkling Ebony, Walnut, Translucent Maroon or Genuine Ivory Bakelite Cabinets.

THE RADIO OF TOMORROW — TO-DAY

# FADA RADIO & ELECTRIC COMPANY, INC.

## BELLEVILLE, NEW JERSEY

"SINCE BROADCASTING BEGAN"



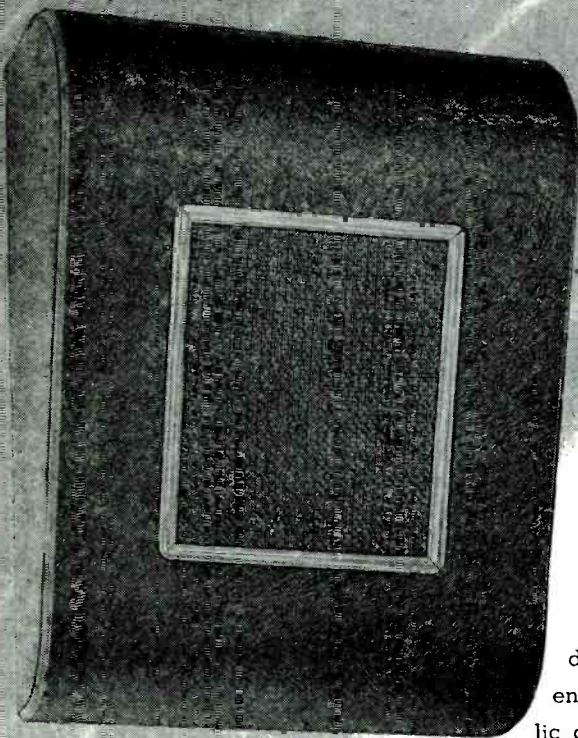

# Jensen

*Model J-61*

## WALL CABINET

Model J-61 Wall Cabinet, employing the Peridynamic principle, is another new JENSEN enclosure, destined for wide use in such public address installations as hotels, factories, schools, airports, railroad stations and offices.

It may also be used to enclose extension speakers in homes. It can be used with any 6-inch speaker.

Model J-61 Wall Cabinet is of durable construction and beauty of design and finish and is formed of attractively textured brown composition wood over solid wood frame. The grille is of matching brown fabric with chrome trim around aperture. Brackets for wall mounting are furnished. On the back is mounted a 5-lug terminal strip. Height, 16-2/3 inches; width, 12 3/4 inches; depth, 6 1/4 inches.

Model J-61 Wall Cabinet (ST-751) . . . \$14.50



OFFICES



AIRPORTS

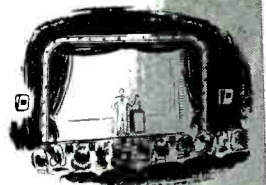

SCHOOLS



RAILROAD STATIONS

### JENSEN BASS REFLEX CABINETS

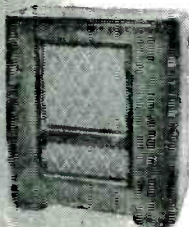

TYPE D

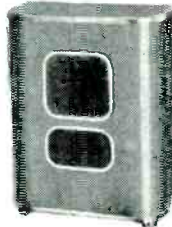

TYPE B

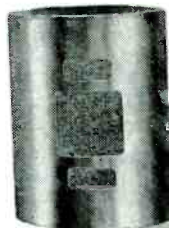

TYPE H

*Designers and Manufacturers  
of Fine Acoustic Equipment*

JENSEN  
MANUFACTURING CO.  
6625 S. LARAMIE, CHICAGO 38, ILL.

Please send me a copy of the 1947 Jensen catalog.

Name .....

Address .....

City..... Zone..... State.....



# Here are the Christmas Gifts

# Walloping

# Westinghouse Radio

## PLANNED PROMOTION

Every one of these Westinghouse radios is perfect for a personal or family gift. Each has sales advantages that you can demonstrate to your customers . . . real advantages that will help you sell more radios. These sets are backed by a colorful, powerful advertising and sales promotion package.

### THESE ARE THE SETS . . .

**THE 125**—Beauty, performance and utility packed into 9¼" x 6" x 6". It's a console radio in capsule form.

**THE 153**—The automatic radio-phonograph with the revolutionary LIFT-OUT, carry about radio. Has TWICE the utility of ordinary radio-phonographs!

**THE 166**—Concert hall performance in a masterpiece of cabinet craftsmanship. Your customers can see and hear the difference.

**THE 168**—A smartly styled, modern radio-phonograph that's packed with features for you to sell.

**THE 169**—A magnificent radio-phonograph that offers the ultimate in performance. 13 genuine features that you can demonstrate!

**THE 171**—The only 3-in-1 instrument on the market! A LIFT-OUT radio, an automatic record changer and more record storage space than most big consoles.

HOME RADIO DIVISION, WESTINGHOUSE ELECTRIC CORPORATION  
SUNBURY, PA.

### Dominating National Ads

POST Oct. 29 & Nov. 12  
COLLIER'S Oct. 24 & Nov. 7  
LIFE Nov. 7 & Nov. 21

December issues of:  
COUNTRY GENTLEMAN  
PROGRESSIVE FARMER  
CAPPER'S FARMER

### Free Ad Mats and Radio Spots

8 tie-in mats and 12 radio spots. Hard-working local advertising that will move merchandise off your floor.

### Eye-Catching 4-Color Billboard Insert

Features the 169—in full natural color—it will remind prospective customers of the finest family gift of all.

Tune in Ted Malone, Monday through Friday, 11:45 A. M., E. S. T., A. B. C. Network

## RADIO'S



# Over 90% OF NEW MOBILE TRANSMITTER DESIGNS USE **HYTRON**

## THE ORIGINAL INSTANT-HEATING TUBE



HY69 — the original instant-heating tube.

Because they fill a real need for conserving filament power, Hytron instant-heating tubes are in. Yes, the 2E25, 2E30, HY69, HY1269, and 5516 are in the new mobile transmitter designs of many famous friends—too many to thank in this small space. The 2E25 and 2E30 also appear on the Army-Navy Preferred List. Why so popular? With no standby current, battery drain can be cut to 4% of that with cathode types—attainable power output and range increase. Potentials of rugged filaments are centered for battery operation. Beam pentode versatility simplifies the spares problem—one type can power all stages. To you the distributor, the overwhelming popularity of Hytron instant-heating tubes means more profits. Make sure *you* get them by maintaining adequate replacement stocks.



Bendix MRT-3A, 152-162 mc f-m taxicab transmitter uses 2E30's generously.



Federal's 25-watt, vhf Model FMTR-25-VC. Note emphasis on 2E30 and 5516.



Harvey Laboratories chose 2E30's, 5516's for its Model 542 f-m transmitter.



Jefferson-Travis Model 351, 35-watt marine radio-telephone employs HY69's.

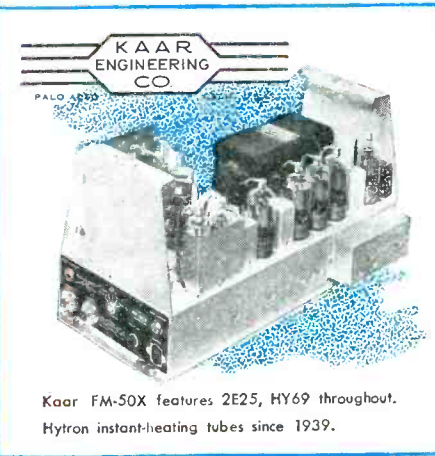

Kaar FM-50X features 2E25, HY69 throughout. Hytron instant-heating tubes since 1939.



5516's power both driver-doubler and final of Motorola's Model FMTRU-30D.

WRITE FOR FREE NEW DATA SHEETS:  
2E25, 2E30, HY69,  
HY1269, 5516.

SPECIALISTS IN RADIO RECEIVING TUBES SINCE 1921

# HYTRON

RADIO AND ELECTRONICS CORP.



MAIN OFFICE: SALEM, MASSACHUSETTS

# NEW LOW PRICES ON UST 1948 TELEVISION LINE

## Plus ATTRACTIVE NEW DISCOUNT PLAN MEANS QUICKER EARNINGS FOR YOU!

Now you'll sell more UST television sets than ever and make quicker profits too because of the new improved 1948 models combined with lower prices and the attractive new discount plan.

Months of planning made it possible. New set designs! New engineering techniques! New production efficiencies! Increased manufacturing schedule!

Get ready for the big fall and winter television demand. It's going to be a "Television Christmas" this year. Take advantage of UST's hard-hitting advertising campaign. Right now newspaper, trade journal, magazine and direct-mail advertising is taking effect everywhere from coast to coast in television areas.

**DOWN \$400**

Model T-525; Screen size 25" x 19"!—3½ Sq. Ft.!

1947 Price—\$1995  
New Improved 1948 Model

ONLY  
**\$1595\***

**DOWN \$450**

Model T-530; Screen Size 22½" x 30"!—5 Sq. Ft.!

1947 Price—\$2245.  
New Improved 1948 Model

ONLY  
**\$1795\***

**DOWN \$450**

Model T-521; Screen Size 21¼" x 16"! Almost 2½ Sq. Ft.!

1947 Price—\$1745.  
New Improved 1948 Model

ONLY  
**\$1295\***  
(Limited Stock Available)

**DOWN \$480**

Model T-507, beautiful 5-in-1 console with FM, AM, Shortwave, Automatic Phonograph and Television. Screen size, 21¼" x 16" (almost 2½ sq. ft.!) 1947 Price \$2275.  
New Improved 1948 Model ONLY **\$1795\***

**ONLY \$895**

Model T-502, brilliant 10" direct view console with FM, AM, Shortwave, Automatic Phonograph and Television. Available in exquisite period or distinguished modern cabinetry. Standard home installation, \$89. Commercial installation, \$139.

\*Plus standard installation charge (\$150 for commercial establishments) (\$125 for home installations) with three-month service guarantee. All prices include Federal Excise Tax and three-month parts guarantee. Prices 5% higher West of Rockies. All prices are or will be fair traded and price-protected in your area.

*MY CUSTOMERS WANT TELEVISION NOW—IN TIME FOR HOCKEY, BASKETBALL, FOOTBALL AND BOXING THIS FALL AND WINTER. THEY'LL GO FOR THESE NEW LOW PRICES!*

*I'M STOCKING UP! UST'S NEW LOW PRICES ARE TERRIFIC! AND JUST WHEN EXPERTS SAY INCREASED COSTS WILL DRIVE PRICES UP!*

*MY CUSTOMERS WILL LIKE THE NEW UST TIME PAYMENT PLAN... WITH SO LITTLE CASH DOWN!*

*NEW DISCOUNT PLAN GIVES ME QUICKER PROFITS THAN EVER BEFORE\**

Send for copy of free booklet "How to Sell Television Sets Profitably". A must! Write Box J, United States Television Mfg. Corp.

Tavern Sets: Models T-530, T-525 and T-521  
Home Sets: Models T-507 and T-502

# ★ UNITED STATES TELEVISION ★

MFG. ★ CORP.

3 West 61st Street, New York 23, N. Y.

Telephone Circle 6-4255



IT'S NEW! IT'S SENSATIONAL!

*The* **MECK**

**FM  
CONVERTER**

LIFELIKE FM ON ANY RECEIVER!

LIST \$ **19** 95

JOHN MECK INDUSTRIES, INC. PLYMOUTH, INDIANA, U.S.A.

**The Lowest Priced Nationally  
Advertised Radio-Phonograph  
Console on the Market!**



This is the most phenomenal radio-phonograph value in America today! You'll give it an "Oscar" for being so thrillingly smart, so compact! Costs less than many table models, yet it has the sensational Miracle Tone Arm which is standard equipment on Admiral's highest-priced consoles. What an edge you've got with this set!

- New Miracle Tone Arm
- High-speed changer plays up to 12 records automatically
- High fidelity audio system
- Variable tone control
- Alnico No. 5 dynamic speaker
- Storage space for 108 records
- Available in walnut, mahogany, or blonde veneers

MODEL 7C60-6M1 (Walnut)

**\$99<sup>95</sup>**

**"hot ones"**

**TWO NEW**

**ORDER NOW! IMMEDIATE DELIVERY**





*The greatest improvement in RECORD PLAYING  
since the invention of the phonograph*

A startling achievement! Admiral's new Miracle Tone Arm uses no coil, no crystal, no filament, no special tubes! These are *prime causes* of distortion. The new Miracle Tone Arm *eliminates them entirely!* Even oldest records come to life with vivid brilliance unmarred by needle scratch or other disturbing surface noise. Complete with ultra-sensitive pickup point.

Now... an exquisite period console radio-phonograph at a price anyone can afford! Engineered and styled in the Admiral tradition that says every purchaser must get the most for his money. With period consoles enjoying greater favor than ever before, you'll be in the black with this fast moving, mass-market profit maker. Judge its quality for yourself!

**NEW PERIOD STYLE CONSOLE  
AT SENSATIONAL LOW PRICE!**

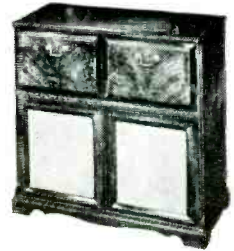

- New pull-out phonograph for easy record loading
- High-speed changer plays up to 12 records automatically
- "No blast" push-pull output
- Variable tone control
- Large Alnico No. 5 speaker
- Walnut, mahogany, or blonde in top-grade, selected veneers

MODEL 7C65-7E1 (Walnut)

**\$ 169<sup>95</sup>**

Prices slightly higher  
in South and West



FROM

*Admiral*

*America's Smart Set!*

display 'em for easy sales, big profits

# BRIGHT STAR

## BATTERIES



- ★ Quality-built cells preferred by millions from coast to coast.
- ★ "Give More Bright Light Longer" — proved by actual test.
- ★ Extra, easy profits whenever displayed to store traffic.
- ★ Pop-up container self-sells 2 dozen standard metal top batteries.

## FLASHLIGHTS



- ★ New design, sturdy construction appeal to widest consumer market.
- ★ Big profit margins protected by fixed price policy.
- ★ Colorful cut-out display nestles 3 No. 216 Prefocused Metal Flashlights.
- ★ Fast sellers at \$1.45 retail, complete with cells.

NATIONALLY ADVERTISED TO 51,771,633 READERS

See Bright Star's value-packed merchandise display deals. Your local jobber can give you full details.

**BRIGHT STAR BATTERY CO.,**  
 main office and factory: CLIFTON, N. J.  
 branches: CHICAGO • SAN FRANCISCO



# Tele-tone presents the traffic builders

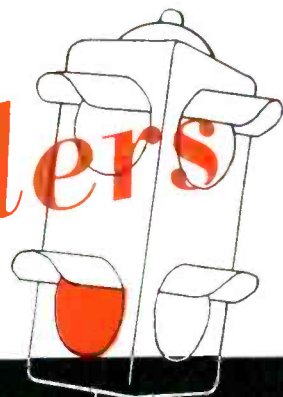

**TELE-TONE — Table Model #150** — Super HETERODYNE with slide rule dial, streamlined plastic case . . . at a price that means sales, sales, sales. In ebony.

To retail at **\$12.95** —Ivory \$13.95



**TELE-TONE — Table Model #160** —Powerful SUPER-HET circuit, for AC or DC. Slide rule dial, automatic volume control. Full tube complement. Built-in antennae. Available in colorful plastic cabinets.

To retail at **\$17.95**

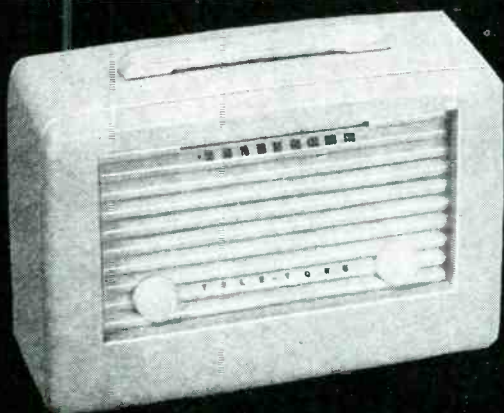

**TELE-TONE Self Powered Portable — Model #156** — Handsome portable with SUPER-HET circuit, cased in post-war flexible plastic and available in mcroon, sand, cream or ebony. One of the "hot-test" numbers ever presented.

To retail at **\$17.95** —less batteries.

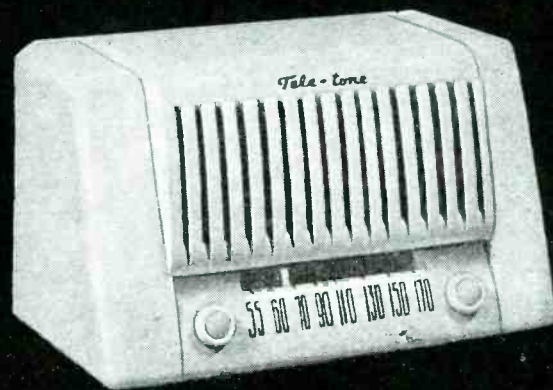

**TELE-TONE — Table Model #159** — Here's the set that puts the green light on real profits. SUPER HETERODYNE circuit with slide rule dial and streamlined plastic case. Available in brown or ivory.

To retail at **\$19.95**

**styled for sales . . . in sparkling colors  
priced for profits**

Here's the radio news you and your customers have been waiting for. Here are four new TELE-TONE models that will have them storming through your doors . . . building profitable traffic that results in extra sales, extra profits.

Order the new TELE-TONES today . . . display them on your shelves . . . in your windows . . . and watch them sell and sell and sell!

**Tele-tone**  
RADIO CORPORATION  
540 West 58th Street, New York, New York

America's Leading Small Radio Specialists



FIRST NEW MODELS — REMLER 1948 LINE

**REMLER SCOTTIE** ... *Pups and Juniors*

**PROFIT LEADERS  
READY NOW**

**19<sup>95</sup>** up



**SCOTTIE PUPS**

List Prices

WALNUT PLASTIC . . . **19<sup>95</sup>**

WHITE . . . **22<sup>95</sup>**



Here is an answer to the dealers' demand for *full-sized* personal radios, priced for the buyers' market. Excellent tone. Tested and proved in "tough spots" where reception is difficult. 5 tubes AC-DC; superheterodyne circuit with dual purpose tubes. Automatic volume control; full vision slide dial; vernier tuning. Enclosed back; built-in antenna and features not available in other sets at less than \$35.00. Approved by Underwriters Laboratories. Ready now for immediate delivery.

*Scotties step up Profits*

- ★ Prices in step with buyers' market
- ★ Attractive Discounts — MORE PROFIT
- ★ Full size cabinets. Solid plastic . . . not sprayed
- ★ Tested and proved in localities where reception is difficult
- ★ Fine tone . . . easy to demonstrate . . . easy to sell

**CHOICE TERRITORIES**

**AVAILABLE FOR DISTRIBUTORS**

Complete line from \$19.95 table models to \$300.00 combinations with all features including F.M.

For information write or wire

**REMLER COMPANY LTD.**  
2101 Bryant Street San Francisco 10



**SCOTTIE JUNIORS**

DeLuxe Models. Additional refinements. Carrying handle . . . portable for room-to-room entertainment. List prices

WALNUT PLASTIC . . . . . **24<sup>95</sup>**

WHITE . . . . . **27<sup>95</sup>**

*Remler*

1918 — 1948 **30<sup>TH</sup>** ANNIVERSARY **RADIOS**





WITH ME

*Tone*

IS TOPS

I like my music rich and natural—the way it comes in at home. My Motorola Auto Radio brings it to me that way on the road. I don't like to be confined to nearby big-power stations. My Motorola brings in more stations, clearer and sharper—wherever I drive. That's why I'm sold on

*Motorola*

WITH ME

*Style*

IS THE THING

I like a radio that fits and matches the car I'm driving. My Motorola is specifically designed for my car. And when my new car comes, it will be an easy matter to have my Motorola transferred to it. A new control head will make it a part of that car too! Me, I would never take less than a



*Motorola*



IT'S

*Sales*

THAT COUNT

WITH ME

As a car dealer I know the value of a name like Motorola—a name that packs plenty of prestige and gets immediate consumer acceptance. I like the way Motorola backs me up with full scale national advertising and powerful point of sale material. That's why I feature

*Motorola*



**We're all  
sold on**



**MOTOROLA Inc. CHICAGO 51, ILLINOIS**

# Zenith Gives You More Real **DEMONSTRABLE VALUE**

*First in Style, Performance, Features... That's why it's the industry's most copied line!*



Model 9H088R

It's *value* that counts in radio sales today . . . and that's why Zenith radios and radio-phonographs are so easy to sell.

Zenith gives you *features* you can actually demonstrate . . . *tone* and *performance* prospects can hear for themselves . . . *style leadership* proved by the industry's many copies and adaptations of Zenith design.

Yes, compare them all, and you'll agree that Zenith is first in *salability* . . . with features, performance, styling and downright value made possible only by the knowledge and experience gained in 31 years of Radionics Exclusively.

## Here Are Style and Value Sales Features Zenith Gave You First

- **THE COBRA TONE ARM . . .** Perfected record tone. The tiny filament gently floats in the record grooves, reproducing every note, every shading.
- **SILENT-SPEED INTERMIX CHANGER . . .** Changes both 10 and 12 inch records intermixed, so as to provide an almost continuous flow of music.
- **TILT-OUT CONTROL PANEL . . .** This Zenith design, now widely copied, brings the entire control panel into an accessible, easily viewed position.
- **GLIDE-OUT PHONOGRAPH . . .** A touch of the phonograph door glides the entire record-changer unit out within easy reach.
- **2-BAND ZENITH-ARMSTRONG FM . . .** FM at its best—wide-band, true fidelity, static-free FM as developed by Major Armstrong and Zenith Engineers.
- **THE RADIORGAN . . .** Radio's most demonstrable tone control. 64 different tonal effects provide just the tone emphasis desired.
- **AMPLE RECORD STORAGE SPACE . . .** The big storage compartment in the Zenith Console combination cabinets is an important feature. Show it to your prospects!
- **FLAT-TOP CABINET . . .** The entire top may be used for flowers, vases, books or decorative pieces. There are no lids to lift to operate either the radio or the phonograph.

Keep An Eye On



*Zenith Radio Corporation • 6001 Dickens Ave • Chicago 39, Ill.*



# Caught in a Tidal Wave of Batteries?

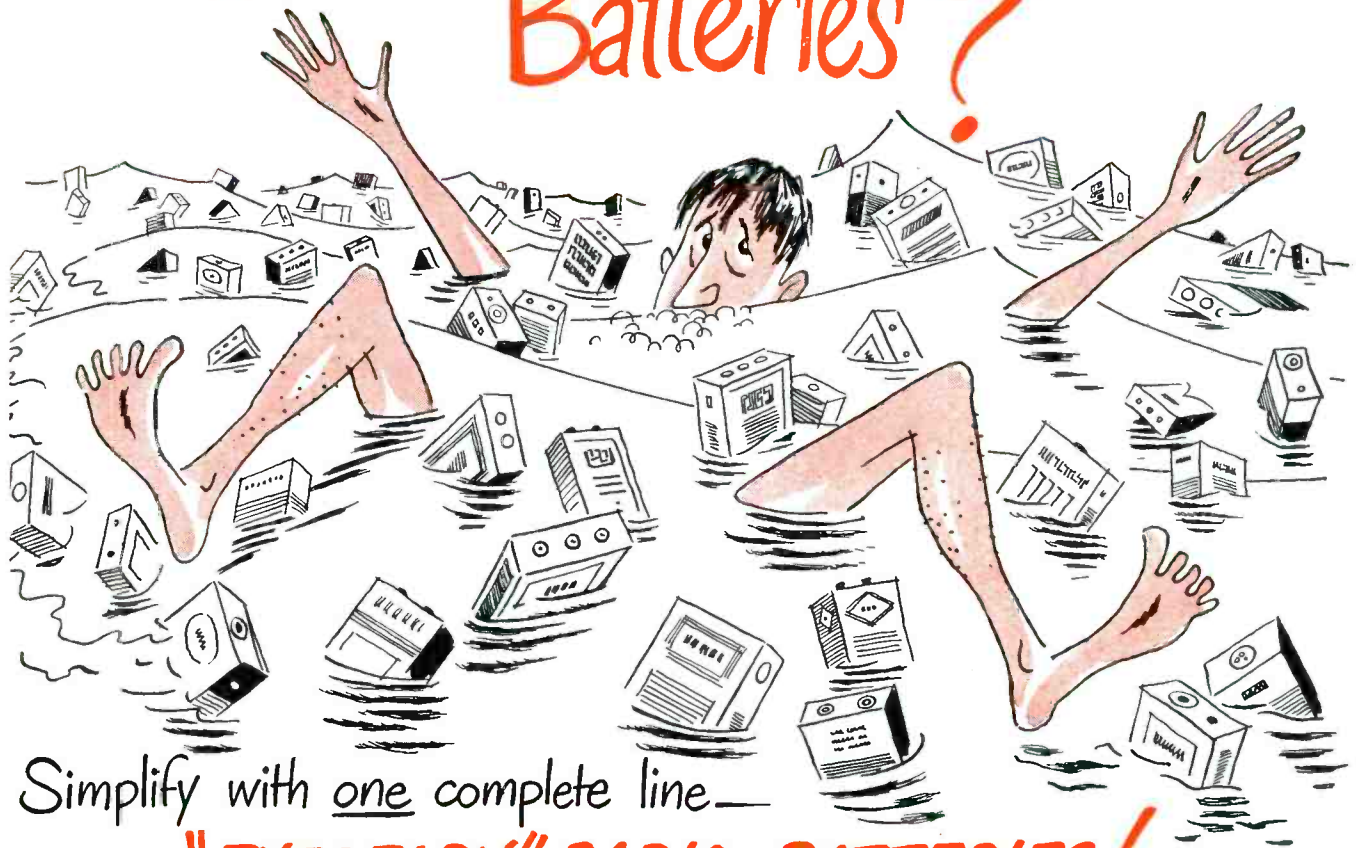

Simplify with one complete line—

## "EVEREADY" RADIO BATTERIES!

IF YOU feel you're being swamped by shelves full of odd brands, war babies, and newcomers to the radio-battery field, here's a life preserver for you: "Eveready" radio batteries will fit virtually *all* makes of sets. They're a *standard value* from coast to coast... you don't have to *turn on the heat* to sell them. Instead, you can set them out before your customers and say, "This is IT!"

*The registered trade-marks "Eveready" and "Mini-Max" distinguish products of National Carbon Company, Inc.*

And the customers KNOW it!

Why waste time, and money, and valuable shelf space with slow-moving odd-brand batteries? Sell the batteries that *sell themselves*; and remember, "Eveready" "Mini-Max" batteries outlast any other "B" batteries of comparable size.

They're available in quantity NOW. And you don't have to buy anything else to get them!



**NATIONAL CARBON COMPANY, INC.**  
30 East 42nd Street, New York 17, N. Y.  
Unit of Union Carbide and Carbon Corporation



**Go to a Radio Manufacturer for Radios—a Battery Manufacturer for Batteries!**



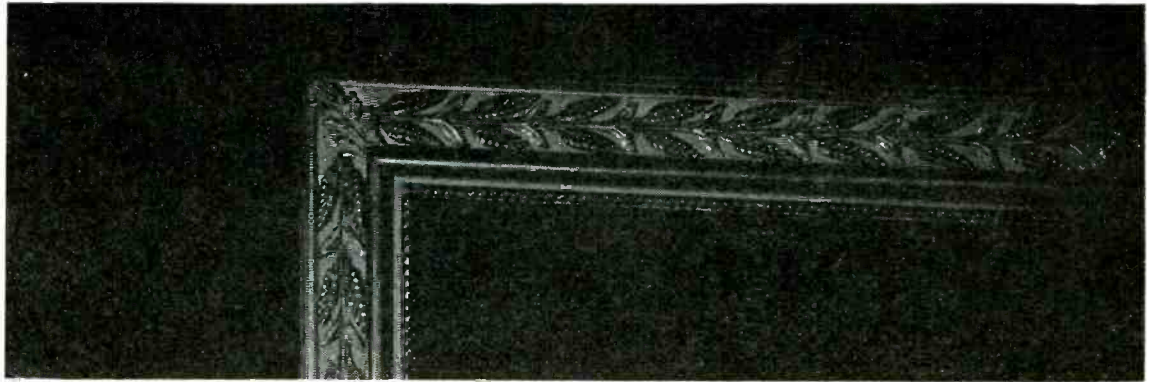

Set it in front of a mirror—just to see more of it—and let the handsome tuning chassis of the Scott radio-phonograph remind you that every Scott instrument, always, whatever its particular function or cabinet style, is elegantly engineered . . . to enhance the reputations of those who handle Scotts . . . Scott Radio Laboratories, Inc., 4450 Ravenswood Avenue, Chicago 40, Ill.

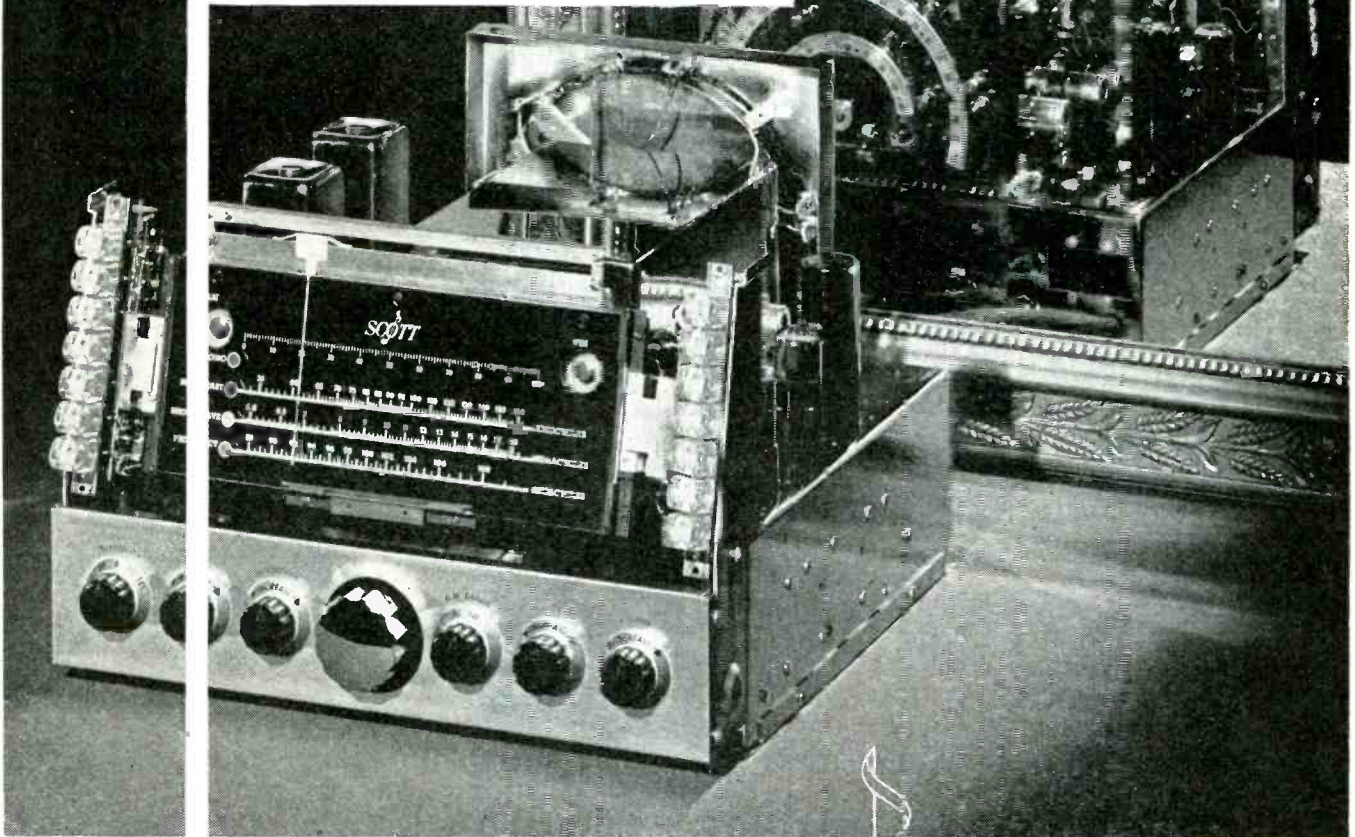
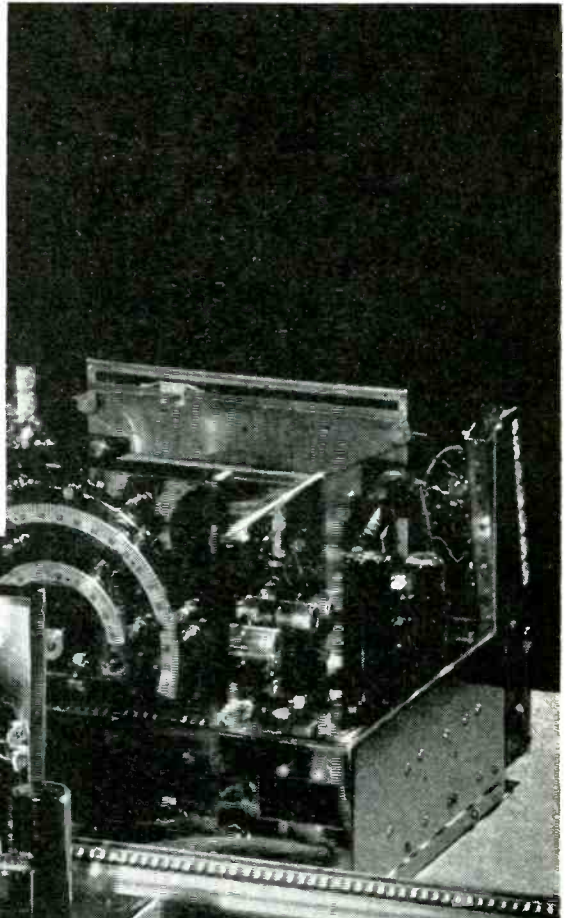



**"Where FM also means Finest Made"**

**NOT ONLY "FINEST MADE"  
BUT ALSO**

*Biggest  
Value!*



Retail  
for Only  
**\$169.95**

TEMPLE MODEL G-725

## The Sensational Temple FM Radio-Phono' Console

"Where FM also means Finest Made." Yes, you'll find we meant every word of our slogan—and more—when you see, hear and inspect this outstanding Temple FM set. For here are the last words in tonal perfection, operating efficiency and cabinetry. Temple built inside and out—all *qualified and priced* to outsell any FM Console on the market. Be the first to show this sensational set in your community. Order NOW — today.



Just a few of the many features that make this a "stand-out" among FM sets.

- High sensitivity and selectivity on both AM and FM.
- Freedom from drift on FM eliminating necessity for retuning.
- Automatic volume control.
- Colorful luminous pointer with three dimensional dial scale.
- Fast acting automatic record changer plays 10 twelve-inch or 12 ten-inch records at one loading.
- Hard alloy tipped permanent-type needle.
- Pull out record changer. No lift lid, no need to disturb lamps or other articles placed on radio.
- Built-in sensitive high gain AM and FM antenna, eliminating need for external antenna in most locations.
- Beautiful hand-rubbed Temple-built cabinet of fine woods.
- Armstrong licensed.
- Engineered by Temple, symbol of fine craftsmanship.

**TEMPLE TONE RADIO MFG. CORP.**

NEW LONDON, CONN. • Exec. Offices: 220 East 42nd Street, New York, N. Y.

RAYTHEON TUBES...  
MASTER'S ORDERS

YOU'RE ALWAYS RIGHT  
WITH RAYTHEON



BUY RAYTHEON TUBES!



*Excellence in Electronics*

- RADIO RECEIVING TUBES
- SPECIAL PURPOSE TUBES
- TRANSMITTING TUBES
- HEARING AID TUBES

*Designed to give years of service*

*Plenty of Distributors to assure you service*

*Essential to perfect radio service*

**RAYTHEON MANUFACTURING COMPANY**  
RADIO RECEIVING TUBE DIVISION  
NEWTON, MASSACHUSETTS      CHICAGO, ILLINOIS





# Clear as a Bell

## NEW AM AND FM-AM Radio-Phonographs

by

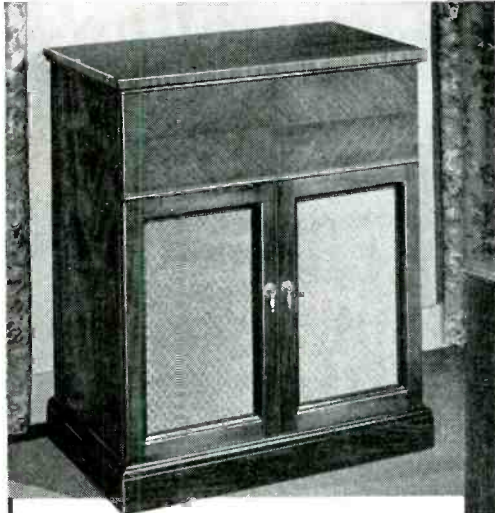

**MODEL WTRU-254.** The hottest selling console on the market! Priced from \$50 to \$75 below any comparable model! Complete home entertainment—Standard Broadcast, Short Wave, Automatic Phonograph! A top quality console, fine furniture in choice mahogany veneers. With album storage space. Today's biggest console value—gives you the edge on combination sales! . . . . . **\$149.95**  
**Model WKRU-254.** With FM-AM, **\$179.95**



**MODEL RMR-245.** You'll do a big console business with this magnificent model! It's big (two record storage compartments)—it's fine furniture in rich mahogany—it's complete—Broadcast, Short Wave, Automatic Phonograph! And it's sensibly priced—within the budget of the mass market buyer. It's the model that means volume combination sales! . . . **\$240.00**  
**Model WLRU-245.**  
With FM-AM . . . . . **\$275.00**

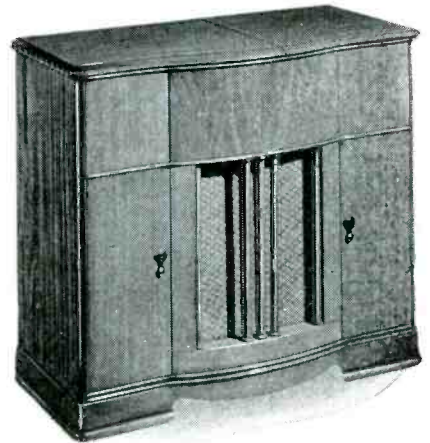

**MODEL RMR-219.** Top-quality combination at an unchallenged price! Luxurious proportions, SONORA-crafted in choice mahogany veneers. Two album storage compartments. Broadcast, Short Wave, Automatic Phonograph. Complete home entertainment, priced to draw in your trade, designed to sell! . . . . . **\$235.00**  
**Model WLRU-219.** With FM-AM, **\$270.00**  
**Model WLRU-220.** With FM-AM in the beauty of rare Primavera woods, **\$280.00**

*(Prices slightly higher in the Far South and West of the Rockies.)*

### SENSATIONAL FM-AM PLASTIC TABLE MODEL

**MODEL WEU-262.** Brighten your sales with SONORA'S table model masterpiece! Here's thrilling FM reception and "Clear as a Bell" standard broadcast in a plastic table model cabinet that deserves an "Oscar" for its brilliant styling. Timed right, priced right to take your trade by storm. They want FM. They want fine styling and quality. Give them this SONORA sensation and watch them buy! In Mahogany, **\$59.95**  
**Model WEU-240.** In Ivory . . . . . **\$62.95**

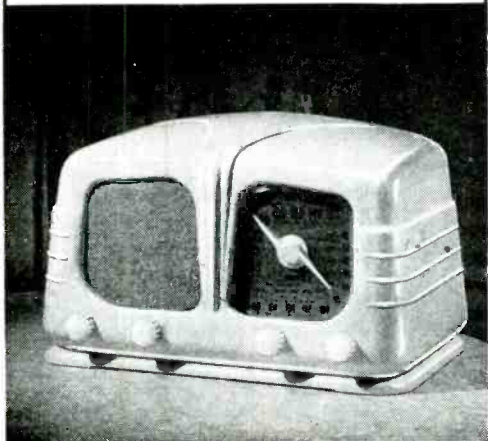

### SONORA—YOURS FOR STEADY, GOOD BUSINESS

SONORA Franchised Dealers are backed by a 3-Point Policy that has for its goal continuous sales and customer satisfaction—the requirements for steady good business:

**QUALITY**—Every SONORA model is designed and built to deliver "Clear as a Bell" tone. SONORA styling is market-conscious. SONORA produces fine furniture—crafted in its own wood factory.

**DEPENDABLE DEALING**—SONORA plays squarely with its Dealers. There's no obsolescence in SONORA merchandise. SONORA helps you move merchandise—protects your investment.

**SENSIBLE PRICES**—Each and every SONORA model is priced to appeal to mass market buyers—pledged to give more value, more quality, more enduring satisfaction for your customers' money.



**COMPLETE HOME ENTERTAINMENT AT ITS BEST**

**SONORA RADIO & TELEVISION CORP.**  
325 NORTH HOYNE AVE., CHICAGO 12, ILLINOIS

**STOP!- LOOK!- and LISTEN! to**  
**STROMBERG-CARLSON'S** challenging  
 radio advertising and sales promotion  
 campaigns



First of the new series.  
 Full color spread in the  
 POST and LIFE—  
 asking 39,000,000 readers to  
 STOP!—LOOK!—and LISTEN!

Nothing vague here! This is down to earth selling. It helps your prospect make up his mind. It makes him want to *Stop!—Look!* and *Listen!* to a Stromberg-Carlson. It sends customers *your way!*

**PLUS-** a hard-hitting newspaper campaign in key cities



Big space advertisements localize the excitement of Stromberg-Carlson's *Stop!—Look!* and *Listen!* theme—dramatize the 12-Minute Demonstration—turn interest into action that leads to *sales!*

**PLUS-** a complete new sales-closing package built around

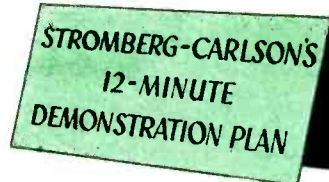

No gaps here! No step has been overlooked to carry the full force of this challenging theme through to your floor. Each piece has been designed to lead the prospect into a convincing, clinching 12-minute demonstration!

This complete program is geared to a highly competitive market—to help you make money as a Stromberg-Carlson dealer! Your distributor has full details.

THERE IS NOTHING FINER THAN A

**STROMBERG-CARLSON**

Stromberg-Carlson Company, Rochester 3, N. Y.— In Canada, Stromberg-Carlson Co., Ltd., Toronto



Established in 1922 as ELECTRICAL RETAILING

# RADIO & Television RETAILING

Including Radio and Television Today

O. H. CALDWELL, Editorial Director

★

M. CLEMENTS, Publisher

## "Miracle on Main Street"

Not quite a *miracle*, perhaps, but the coming Christmas season is going to be something for the book—and in black ink! More money, more merchandise and more sales than any Christmas the country's ever seen!

And the smart merchant will not only *take*, but will *give*.

He won't *give* away his merchandise. He won't pose as Santa Claus like the benevolent old gentleman in the current movie, "Miracle on 34th Street," but he *will give*—*give* intangible, worthwhile things, which cost him nothing.

He will, for instance, *give* cheerful, courteous service. He will *give* good honest values. He will *give* the people of his community sparkling show-windows and other displays which will serve to engender the Christmas spirit in addition to featuring his wares.

He will *give* out with the sort of salesmanship which is just what the doctor ordered to make the customer forget the days when he was pushed around in all too many stores.

The radio/appliance dealer will *give* many, many things this Christmas without sacrificing a penny of his profits. In return, he will obtain priceless gifts, in the form of good-will, from the customers who support his business.

With the great flood of money in hand to buy the mountainous stocks of Christmas merchandise, Main Street, U. S. A. can view this coming event as a near miracle—coming as it does after years of shortages and anxiety.

But, so far as it concerns the merchant's *giving* an extra measure of customer-winning courtesy with each and every transaction, it isn't a miracle at all. It's just common sense business, with the sort of spirit designed not only for the Christmas season, but for the whole year 'round.

**NATIONAL RADIO WEEK, OCT. 26 --- NOV. 1 --- RADIOS FOR EVERYONE . . . EVERYWHERE!**

Dealers—Distributors . . .

Get in on this **DOUBLE-BARRELED PROMOTION CAMPAIGN!**—Tie it in with your Christmas activities!

Cut yourself a big piece of RADIO'S 27th BIRTHDAY CAKE.

**BOOST SALES THROUGH**

Show-Window Displays . . . In-Store Exhibits . . . Newspaper Ads . . . Direct-Mail . . . Local Radio Stations . . . Cooperation With Local Civic Groups . . . Salesmanship . . . Showmanship . . . and **THROUGH ASKING EACH CUSTOMER TO BUY MORE RADIOS.**

For promotion material write to Radio Manufacturers Association, 1317 F Street, Washington 4, D. C., or to National Association of Broadcasters, 1771 N Street, N.W., Washington 6, D.C., sponsors of the big two-way event.

# What's Ahead!—in Radio

**THIRD ANNUAL NATIONAL RADIO WEEK**, October 26 to November 1, is a three-way cooperative campaign designed to keep retailers' sales volume high, to increase radio listening audiences, and to maintain steady and full employment by the radio industry. The dominant theme is: "Radios for Everyone . . . Everywhere."

**ORDER THOSE STANDARD XMAS TREE LAMP sets early.** Manufacturers and jobbers predict that many a merchant who puts off ordering until "some other time" may find that "some other time" is too late. Standard sets will probably be in short supply. However, some of the new novelty numbers will probably be available in sufficient numbers to meet the demand.

**GIFT CERTIFICATES THIS CHRISTMAS** on scarce items will be issued by many a radio appliance retailer. It doesn't seem possible that such situation could exist this long after V-J Day, but it's a fact, nevertheless.

**TELEVISION A BILLION DOLLAR INDUSTRY** in the next five years. That's the prediction of J. R. Poppele, president of Television Broadcasters. Mr. Poppele is also a Mutual Broadcasting System vice-president.

**A SIMULTANEOUS MERCHANDISING PRESENTATION** throughout the United States was carried out in one day when 486 electrical appliance distributors in 232 cities received via Western Union messenger service a sample of the Proctor Electric Company's first postwar product—a new automatic toaster that reheats cold toast.

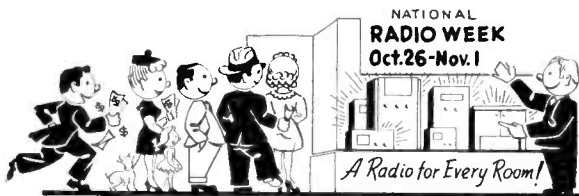

**ONE WHALE OF AN OPPORTUNITY!** National Radio Week, Oct. 26 to Nov. 1, an event geared up to sell more radio receivers, is a "natural" for a tie-in with Christmas sales activities. To RMA's slogan, "Radios for Everyone . . . Everywhere," the progressive dealer can add the phrase, "For Christmas," implement such slogan with some hot-as-a-pistol promotion, and make himself some real money.

**NEW SUNLAMP, DESIGNED TO FOLD AWAY UNDER THE BED** and featuring a built-in automatic timer being marketed by Westinghouse at \$29.95, (with bulb).

**JUSTICE DEPARTMENT EXPLORING FM SITUATION** regarding Petrillo's refusal to rescind his ban against simultaneous broadcast of live music over AM and FM outlets unless musicians receive double pay for such performance.

**RADIO INDUSTRY ACTION TO OPPOSE** recent restrictions by several Latin American countries on importation of receiving sets is being taken by the RMA export committee. Nine countries, headed by Mexico, Argentina and Chile, have restricted American set imports, largely because of U. S. Dollar shortages.



**"THEY LOOK IN YOUR SHOW-WINDOWS** to get ideas for Christmas gifts, and they start this procedure early," says a progressive New York merchant, who gets his Yule displays in right after Thanksgiving. This, he says, is one good reason to identify your store as Xmas headquarters well in advance. Another good reason is that each season finds the gift-shoppers buying the bulk of their purchases earlier than they did the preceding years.

**NORMAL DEMAND FOR RADIO-PHONO COMBINATIONS** will soon be three to four times the pre-war level, according to R. A. Graver, vice-president of Admiral Corporation. While only 6,000,000 families now have facilities for playing records, an Admiral survey reveals, there probably will be 18,000,000 radio-phonograph sets in use within a few years, said Graver.

**SCRANTON, PA., DEALERS DO SOMETHING ABOUT** the rebuilt vacuum cleaner business. Merchants, in the Pennsylvania city, working with the local Better Business Bureau and the local newspapers, have adopted a code aimed to prevent the use of misleading advertising in the sale of rebuilt household cleaning equipment.

**CHICAGO'S INTERNATIONAL LIGHTING Exposition**, November 3 to 7, to be headquartered in the Stevens Hotel. Among the speakers will be D. G. Mitchell, president Sylvania Electric Products, Inc.; E. C. Huerkamp, Westinghouse lighting division sales manager; C. G. Pyle, managing director, National Electric Wholesalers Assn.; H. P. Litchfield, assistant general sales manager, Graybar Electric Co.; Ward Harrison of General Electric's lamp department.



# Appliances, Records, and Television

**NEW ELECTRICAL WASTE-FOOD DISPOSAL UNITS** being announced by a number of manufacturers with prices starting at approximately \$125, installation extra. At the present time about five major cities have ordinances which either prohibit or control installation of garbage eliminators.

**DURING THE FIRST SIX MONTHS** of this year, the electric industry added 1,102,000 new customers to power lines, of which 929,000 were urban and rural residential users. This is an average of 183,000 new customers per month. Figures were obtained by Edison Electric Institute.

**ELECTRICAL JOBBER SALES LED** all other trades percentage-wise in gains for the first half of this year, according to the Department of Commerce. Electrical distributors' sales were 119 per cent over the comparable period last year, ringing up an estimated total of \$1,544,000,000.

**SPONSORSHIP OF THE FIRST COMMERCIAL** program on the newly-formed Continental FM network has been bought by Stromberg-Carlson. Stanley H. Manson, Stromberg manager of advertising and public relations, said that it represents the largest individual sale of time in the history of FM broadcasting. At least 22 stations in six states and the District of Columbia are participating. The program originates in Station WHFM, the company's own outlet in Rochester, N. Y.

**NEW COMPETITIVE TREND IS AWAY** from combatativeness. Noted with pleasure is the total absence of "hurt-the-other-fellow" tactics in show-window signs and in ad copy, even in the toughest merchandising spots in the big cities. Plenty of competition exists, but it's all remarkably clean.

**ELECTRIC "FOOTWARMER,"** RETAILING AT \$7.75, has been announced by General Electric's automatic blanket and sunlamp division. The new device is designed to bring an even warmth of 105° F. to the foot of the bed throughout the night.

**IT'S NO WONDER RETAIL SALES HAVE BEEN ERRATIC** when one considers the way things have been going. Only a few months ago, Mr. and Mrs. Public who'd just gotten over roaming about with pockets full of money drinking coffee sweetened with saccharine or rock candy, and on the prowl for men's white shirts and good, red meat, believed prices were going down. So many held off buying radios and appliances. Now the consumer's sure prices are going up, and as soon as he can get his mind oriented, and the vacation vagaries out of his thoughts, watch for a big buying splurge . . . and before the end of 1947!

**A SALES TRAINING COURSE DESIGNED** to cut down the increasing merchandise "bouncing-back" rate being launched by one of the largest department stores in the U. S. Store tycoons claim most of the returns for refund or exchange are due to the wrong sort of salesmanship.

**THE FARTHEST NORTH ANY TELEVISION** program has been received west of the Mississippi is at Port Hueneme, California, fifty air-miles from Los Angeles, according to the Port Hueneme "Herald Express." The big-screen receiver, made by New York's United States Television Mfg. Co., was installed in a local tavern by U. S. T. of California, a Los Angeles firm.

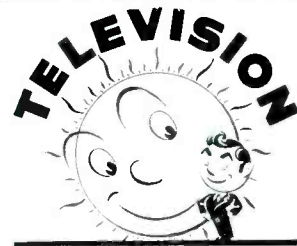

**GOING PLACES — FAST!**  
**READ ALL ABOUT —**  
**HOW RAPIDLY TELEVISION IS GROWING**  
**HOW BIG TELEVISION WILL BE**  
**HOW TELEVISION COVERAGE IS SPREADING**  
**HOW TO GET ABOARD THE TELEVISION BANDWAGON**  
**WHO'S WHO IN TELEVISION**  
. . . and many other features in  
**RADIO & Television RETAILING'S**  
**BIG TELEVISION ISSUE**  
**DECEMBER 1947**

**DON'T MISS IT! GET A LOOK-IN**  
**ON THE GROUND-FLOOR OF TELE-**  
**VISION — AMERICA'S NEXT BILLION-**  
**DOLLAR INDUSTRY!**

# RCA Victor "Golden Throat"

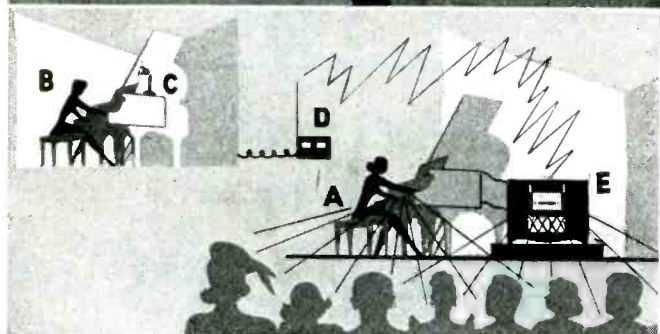

## Two pianos demonstrate perfect tone reproduction of the "Golden Throat"

The two-piano team of Carlile and Wayne performed in the dramatic "Golden Throat" Demonstration. The diagram above shows the setup used. Audiences were amazed as they heard the "Golden Throat" reproduce the tones of the piano with such perfect fidelity.

Miss Carlile played piano (A) on the stage before the audience. Miss Wayne played piano (B) in a studio in another part of the building. Microphone (C) picked up the sound from piano (B) and fed it to a transmitter (D) which broadcast to the RCA Victor "Crestwood" (E).

The two pianists played alternately . . . passing the melody back and forth so that the audience heard continuous music. *But only part* of it came from the piano on the stage . . . the rest was heard through the "Golden Throat" sound system of a stock model of the RCA Victor "Crestwood."

## Critical listeners amazed at "Golden Throat" perfect tone reproduction

and this means even more RCA Victor sales for you!

The word of this thrilling demonstration of perfect tone reproduction is spreading! Perhaps *you* saw the "Golden Throat" Demonstration at the NAMM Convention in Chicago . . . perhaps some of *your* customers saw it at the RCA Victor EXHIBITION HALL in New York City.

The results of this two-piano demonstration are always the same! Audiences are thrilled as they hear the "Golden Throat" reproduce tone so perfectly they cannot correctly identify the source of the music . . . the piano on the stage before them or the piano heard through the "Golden Throat" tone system of the RCA Victor "Crestwood."

*And*, we're sending the "Golden Throat" Demonstration around the country. Soon you and your customers will be able to see and hear this thrilling performance. Contact your distributor or write directly to us for information on when the "Golden Throat" Demonstration will reach *your* area.



**ONLY RCA VICTOR MAKES THE VICTROLA**

"Victrola"—T. M. Reg. U. S. Pat. Off.



# Demonstration a smash hit!

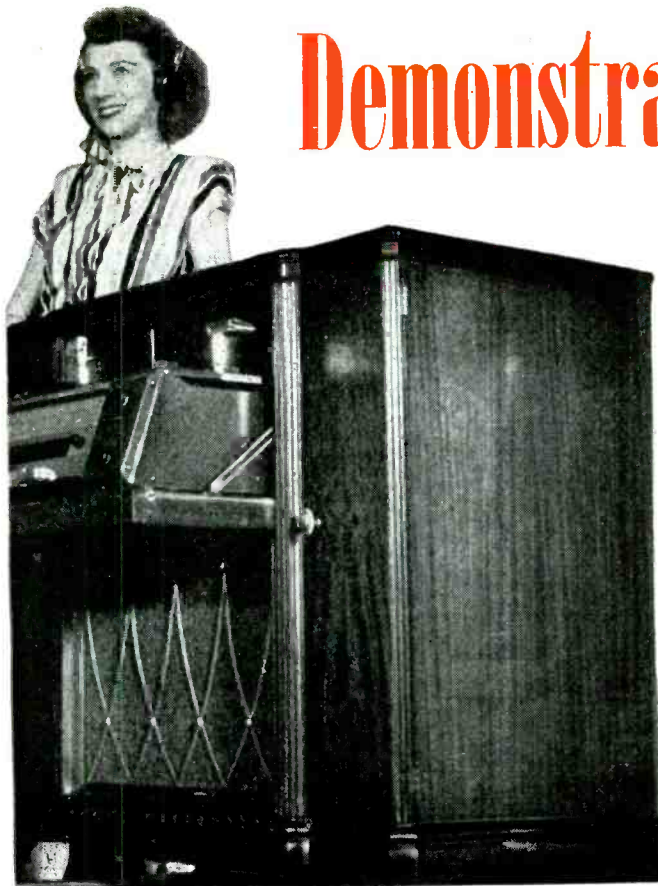

The RCA Two-Piano Team, Miss Carlile, seated, and Miss Wayne, standing, greet the audience before performing in the "Golden Throat" demonstration.

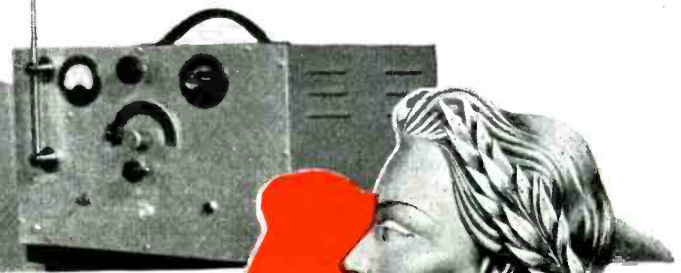

## Read these typical reactions . . .

some of these people may be friends of yours

I have never been so thrilled. I just heard the "Golden Throat" reproduce the very tone of the piano so perfectly, I could not tell the broadcast from the original.

Signed: *Aaron Cohen*  
Brooklyn, N. Y.

This dramatic demonstration proves the "Golden Throat" reproduces music just as played by the artist. This RCA Victor acoustical system is the finest I have ever heard.

Signed: *Stephen Bambas*  
Simpson, Pa.

This demonstration proves the "Golden Throat" reproduces even the tone of the piano perfectly. This is the type of radio we have all been waiting for. Now, we can hear only sound as produced by the artist.

Signed: *Mrs. Robert D. Woelk*  
Billinlo, Ill.

The RCA Victor has produced a sound system that reproduces the original tone exactly. I was absolutely unable to find a difference between the piano on the stage and the piano broadcast through the "Golden Throat."

Signed: *Irwin Weitz*  
Pittsburgh, Penna.

The "Golden Throat" reproduces sound exactly as produced. Try as I would, I could not detect a difference between the original and the broadcast.

Signed: *Alan Rea*  
Kew Gardens, N. Y.

I think the RCA Victor "Golden Throat" is the greatest thing in modern radio. Now, we can hear pure tones exactly as produced.

Signed: *Donald A. Boone*  
East Hartford, Conn.

## "Golden Throat"

All RCA Victor instruments, from the popular 65X1 to the superb "Crestwood," have the "Golden Throat" Tone System. Dollar for dollar, RCA Victor instruments give your customers greater brilliance, higher fidelity . . . a more perfect performance. The "Golden Throat" is the exclusive new RCA Victor sound system . . . produced by RCA's 27 years of electronic skill and Victor's 48 years of leadership in the reproduction of sound.

Listen to RCA Victor create sales for you on the RCA Victor show — "Music America Loves Best" over your NBC station every Sunday 2:00 P.M., E.S.T.

# RCA VICTOR



DIVISION OF RADIO CORPORATION OF AMERICA

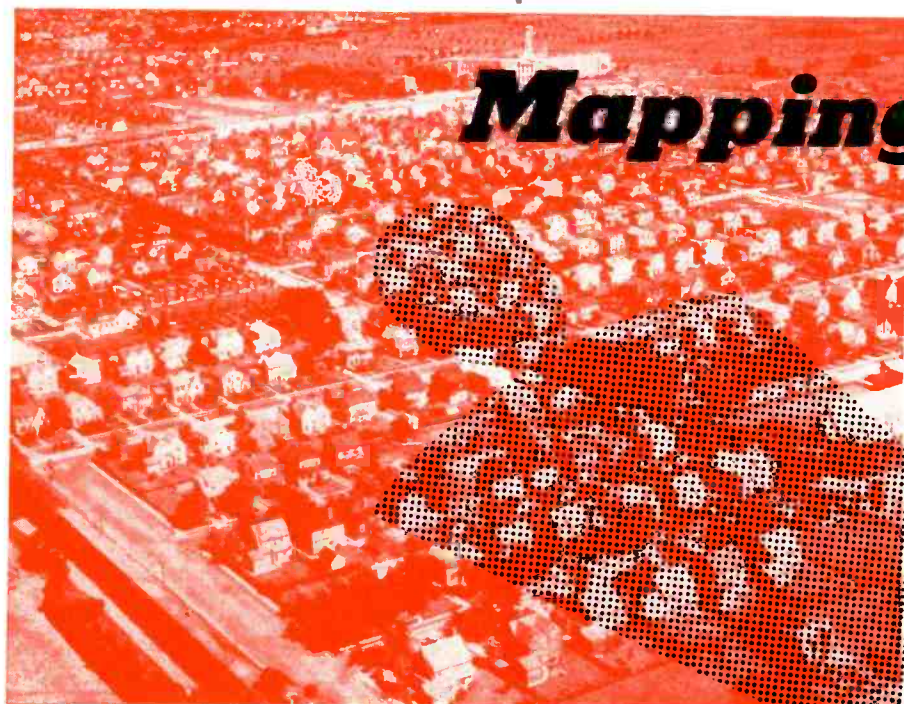

# Mapping Out the

*Many Factors Govern*



● Some radio/appliance retailers have found that the trading area they attempt to cover is too large to be profitable. Still others consider their territories too small, and are planning to expand them.

Now that outside selling is coming back merchants are re-examining their merchandising fields with new interest. They know that the highly concentrated, compact area, having a large number of residences is the least expensive one to sell and service in, but many are not situated in such advantageous locations, and are thus forced to cover large territories which often have "blank" spaces which must be traversed in order to reach the towns where "pay dirt" may be found.

To the dealer who is planning active outdoor selling, and consequently will increase the size of his sales force, the trading area becomes a very real thing, both from the aspects of being able to cover it adequately, and from the point of view of allocating territory to salesmen.

## **How Far to Go**

Somewhere between the two extremes of too small and too large an area lies the happy medium for every merchant. The dealer situated in a small city, say one of 18,000 population, which is surrounded by farms, and is quite far distant from the next city or town, may feel it is good business to concentrate his efforts on his city, and upon neighboring farms.

Another merchant, similarly situated may, because he has a large

business set-up, and a number of salespeople, feel justified in including a couple of other cities in his newly-planned territory, even though they are far away.

Certain dealers have found through bitter experience that sales made in fringe territories have eaten up profits in cases where but few were made, because of the fact that it cost them too much to render service.

One dealer describes his experiences in selling oil burners just before the war. Because his salesmen had done intensified canvassing in the city itself, they became imbued with the feeling that they had satu-

ritory they were working, his salesmen were unable to do a good job.

They did sell a very few oil burners, and, as luck would have it, each installation seemed to be jinxed. Numbers of free service calls resulted, and the dealer lost money on each installation.

The old saying about the grass looking greener in the next pasture has applied to all too many dealers who've spread out so far that they

---

## **YOU NEED A LARGER SALES FIELD IF—**

**Your business is set up to handle more volume than your present area can afford. . . .**

**You can take on more work without neglecting the customers in your own front yard. . . .**

---

## **YOU NEED TO DECREASE PRESENT TERRITORY IF—**

**Distant selling and servicing is proving unprofitable to your organization. . . .**

**You cannot take care of the potential sales and service business in your immediate location.**

---

rated possibilities of the place. A plan was made which permitted them to cover a couple of distant cities. "If they had made no sales at all," this dealer says, "I would have been better off." He states that because of the stiff competition offered by the established merchants in the new ter-

have been unable to take care of any of the area efficiently.

On the other hand, the large dealer who is able to cover his own immediate territory adequately often finds it necessary to expand in order to increase business. However, it must be borne in mind that expansion



# Sales Territory

## Need for Increasing or Decreasing Size of Trading Area

is always expensive. The dealer who plans to take in a great big new chunk of sales field finds that he must increase his advertising budget; he must take on more salesmen, and he is going to have to fork over more money for transportation.

All over the United States retailers have expanded their territories by opening branch stores, and many have been extremely successful. But the fact remains that it costs twice as much, often more, to run two stores than it does to run one, and by the same token one can lose money twice as fast in two stores.

### Door-to-Door Sales

In order to branch out into two or more stores, the merchant must have adequate capital, a thorough knowledge of the sales potentials of the new fields and have at his command the executive personnel needed to supervise all of the stores.

The expansion of a business through the opening of additional stores is well-known to retailers, and many have such ideas as a goal to shoot at, but those who cannot, or do not wish to go into this now are faced nonetheless with the territory problem as viewed from their headquarters.

For the merchant who has money to spend for advertising and products which appeal to the buyer, expansion from a central point is not only possible but is frequently a good move. In his trading area right now the dealer can look about him and see door-to-door outfits selling products out of some distant headquarters. Such organizations do not depend upon a showroom or a store, but maintain what is nothing more or less than a sales office where outdoor crews are trained; then turned loose on communities far and wide.

The established retail merchant can follow the example of the door-to-door outfit and go out far and wide in search of business only if he can do this without neglecting his own immediate territory. His territory

is as large as he can profitably make it. It does not pay to attempt to bite off more than he can chew.

Outdoor selling follows a more or less familiar territorial pattern. While there is some canvassing done in the heart of our great cities, most of the dealers in such locations who have outdoor salesmen make most of their calls in the suburbs. The dealer whose store is in the suburbs rarely travels his men in the city.

Instead of turning a lot of salesmen loose in a territory whose confines are imaginary, the good businessman will sit down with a map and do some careful planning.

He will see how many in-between calls his salesmen and servicers can make between this place and that place. He will take into considera-

refrigerator servicer stop on the way to a "no-ice" call and take care of other kind of appliances, or is he a "specialist" who'll only be able to take care of the one customer—at a loss to the firm? Will the salesman you select for a certain territory get along well with the people there who may be quite different from those in the home town? Being used to city and suburban selling, how will he make out calling on farmers?

### Sales Sources

In order to do a profitable business the merchant must have customers. The larger his overhead, the more customers he must have. Some dealers do a remarkably large sales volume in a very small town by

---

## BEFORE YOU GO INTO A NEW FIELD BE SURE THAT

You know the buying habits of the residents

The average income of the inhabitants

The number and standing of competitive stores

If new area is quite far distant, whether there are in-between calls which can be made profitably

---

tion the buying habits of the people in the prospective territory; their average incomes, and the number of competitive dealerships he will have to buck if he plans to try for some of the business.

### Size Up the Area

The first step in the plan to develop new territory is certainly the acquisition of knowledge about the new terrain. Because working a territory costs money, it is just as important to size up the new field first as it is in the case where a new store is to be opened.

In making long trips away from the store both for making sales and rendering service, consideration also must be given to the sort of men who will perform these duties. Can your

counting almost every resident a customer. Certain other merchants do land-office businesses almost entirely with persons from outside their immediate locations. But by and large, most "local" merchants do most of their business with the local people, and all, of course, have some distant customers on their books.

It is important to allocate a definite field to do sales work in. It is important too that this territory be the right size. Not so large that it will be too costly to cover—not so small that potential sales possibilities just don't exist.

As stated before, territorial expansion should never be undertaken by the merchant if it means that potential local business will be neglected as a result.

# Stolfi's

# Television

Expert Knowledge of Merchandise

Retail Business in



Note large plate glass windows, which afford passers-by good view of store interior.

● "Expert service is the key to an expanding merchandise business."

This maxim is well illustrated in Stamford, Conn., by the rapid growth of Michael Stolfi's former radio repair shop into one of the largest retail radio-appliance operations in this thriving industrial community of 50,000 population.

For Mike Stolfi is the acknowledged outstanding radio-service ex-

pert of the community. It is to Mike that the other radio servicers in town invariably go for help and guidance. And Mike, who is a keen student of circuits, as well as a good business man, usually knows the answer.

It was this thorough knowledge and repair of customers' sets and appliances which from the beginning built confidence and loyal patronage in a rapidly growing clientele for the Stolfi business.

But Stolfi has not been content with this solid if limited foundation of his business. To win new friends and customers he has constantly sought to keep his store and service shop before an expanding local public. To this end, he has used sign-board advertising, paying \$80 per month per display board, half of which cost is borne by the manufacturer of the product also featured on the sign. Also he has kept his name, address and phone number in the classified section of the local daily newspaper. And he has liberally used radio time on the local broadcasting station.

### New Store in Busy Location

Two years ago Stolfi moved to the handsome commodious building in downtown central Stamford, on the much-travelled Post Road, as shown on these pages. A former automobile display room, this new store provides large plate-glass windows for Stolfi's stocks of radios, consoles, phonograph combinations, and major electrical appliances. In the rear is ample space for the radio service department, a separate washer-refrigerator repair department, small

appliance repairs, and automobile-radio installation and repairs. Alongside the building, is a large parking space for customers' cars.

The boss's own private office is in the front and also admits to the "Television Theatre", seating 75 people which is Stolfi's own special pride and joy.

### Pioneering Television

Mr. Stolfi has been the television pioneer of the Stamford-Greenwich area, and even before World War II was actively selling, installing and servicing television sets. In fact, when television was still merely a strange word to most people, Stolfi had 15 to 20 pioneer TV sets in use by his customers around Stamford. In those days, television sets required a lot of "nursing," and his unerring diagnosis and quick restoration of service when any of these sets got out of order, built the reputation that "Stolfi's Is Television Headquarters" in Stamford—a reputation on which the business is still cashing in.

For with his pioneering experience in television, it is not surprising that already Stolfi has sold far more television sets than any other Connecticut dealer, and has indeed handled most of the television sales going into the Stamford area. Orders for television sets pour in upon him, and his only difficulty has been in getting the necessary sets to take care of

Watch for the Important  
**TELEVISION ISSUE**  
of Radio & Television  
Retailing in December

Everything You Want to  
Know about the New Video  
Art Which Will Soon Be  
Bringing New Business and  
Profits in All Television-  
Served Areas

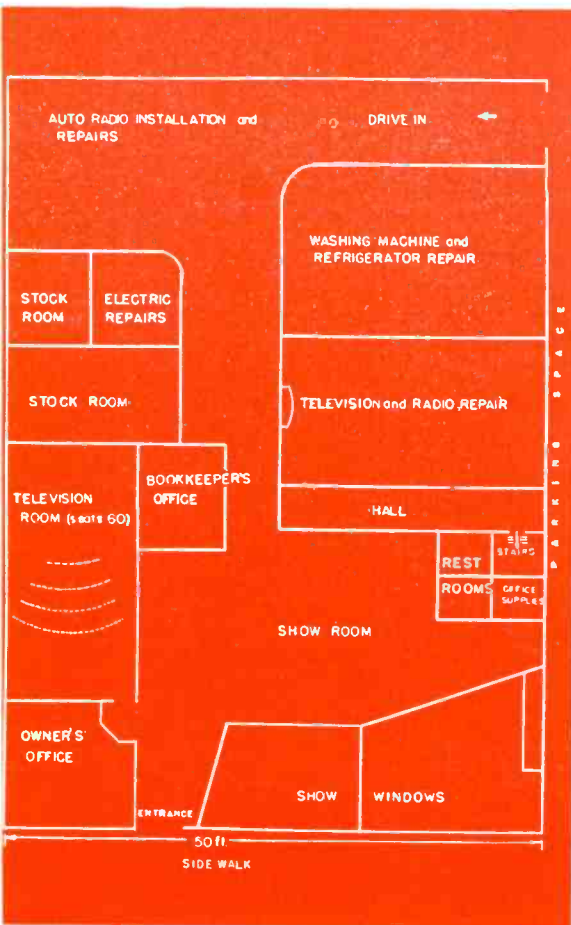



# Headquarters for Stamford

**and Servicing Has Built Outstanding  
Radio, TV and Appliances**

his customers. There is still a waiting list, with friends of present customers cheerfully delaying until Stolfi can personally certify that the set selected is OK and is installed right.

## Theatre Demonstration

Stolfi's "Television Theatre" has proven a valuable adjunct to his sale of TV sets. At first this demonstration room was kept open evenings for all comers to enjoy video programs. Later the open sessions were confined to Friday-evening boxing bouts, and always the big room was jam-packed. Now the television demonstrations are given chiefly by special appointment with serious prospects, so that intending buyers may have a comfortable place in which to relax and get a foretaste of the television enjoyment they are to enjoy in their own living rooms.

## Television Here to Stay

Active in television since 1939, when he built his first set, Mr. Stolfi has now had eight years experience in merchandising and servicing television. After selling, installing and repairing hundreds of TV sets, he has found that his television customers share his own vigorous enthusiasm for the new home entertainment art. "I am convinced," he says, "that television is here to stay."

Having trained several skilled servicemen to handle his radio, television and appliance repairs, Mr. Stolfi now rarely returns to the radio bench except when some particularly knotty technical problem shows up. Nowadays, instead, he devotes himself to supervising his complex and departmentalized radio-electrical business and contacting his customers over the telephone and in person.

But he recognizes that the continuing success of this growing retail business is based on the fact that the boss "knows his way around," as well as over and under, every detail of the construction, performance and repair of radios, television sets and appliances.

"Expert knowledge," Stolfi agrees, "is essential to an expanding business in radio-electrical devices for the home."

Radio service bench has equipment for handling any radio, FM or television job.



Owner Stolfi demonstrates a new TV receiver in his Television Theatre seating 60.



Corner of the radio and appliance showroom, with overlooking office for bookkeeper.

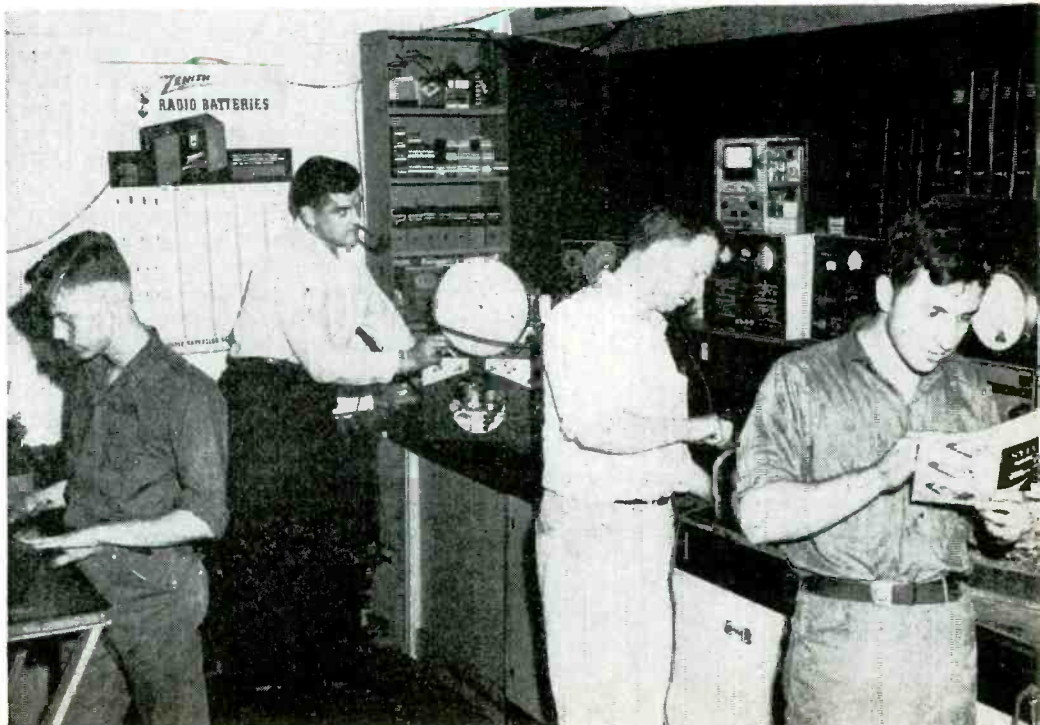





Store-front styling of this California establishment has pronounced "look-in" qualities. Repair department on the mezzanine can even be seen from the street.

## ***Promotion with Purpose and Punch***

***West Coast Retailer Has Learned How to Attract Buyers to His Striking New Store***

● Radio Margo, in its slick new store at 7415 MacArthur Blvd., Oakland, Calif., is staging promotions that draw 1,000 people in a single day.

It may be a store broadcast on local Station KRE, or it may be a recording star autographing records. Whatever the occasion, this hard-hitting retailer draws them in by the hundred—and sells them radios, records, appliances, or service. These four activities are building a flourishing business for M. A. Margossian, the proprietor, and make the store a successful example of "Big Four" merchandising.

Mr. Margossian, who is a college-trained communications engineer, came to this country from Turkey 17 years ago. After trying several locations in the area, he took a long-time lease on the present site, where local

architects built according to his plans and last year came out with a store front that soon became a show piece. Local jobbers often advise new retailers to see the place, to get ideas.

The plate glass area of the store's "visual front" give the house a general "show case" style. To one side of the store are radios, the other side, major appliances. The center of the floor is for traffic appliances and also for small radios, displayed on attractive islands. Both the fixtures and the general architectural designs were inspired largely from the store modernization booklets published by General Electric, Admiral, and Universal.

The rear of the store is for records and music. This department creates the largest traffic, and is placed toward the end of the building so that people will go through the maze

of appliances and radios before they reach their destination. Many sales are created in just this way.

### ***Visibility Unlimited***

A mezzanine floor provides room for the office and the repair department. The repair bench and an array of imposing instruments are visible from the front, even from the street. There is no unexcusable disorder apparent. It's clean and attractive. Behind a partition is a systematically arranged parts department, where repaired sets are kept. This repair department layout, specifically the work bench design, is an elaborate modification of plans in Sylvania's booklet on radio service bench design.

Proprietor "Margo" says that "The front of the store is the most im-



portant part of any retail merchant's firm. It must stop the traffic. With this in mind I have a European immigrant artist decorate my windows and front of store. Every month new designs and moods are created keeping the interest varied and fresh. The doors of the store are wide open, summer or winter, eliminating all resistance. The entire floor is kept meticulously clean. All this inspires confidence and reflects well on the character and personality of the operators."

The store is air conditioned. In cold weather room temperature is kept around 70 degrees, and in summer powerful fans blow filtered fresh air.

This dealer has a six-ply theory for successful business. He has outlined his rules as follows:

"First, *know your merchandise.* This knowledge can be secured through a trade magazine, such as **RADIO & Television RETAILING**, which we have read for many years. Attend sales and service meetings. Read sales pamphlets. And above all, if it's possible, own and use some of the articles you sell.

"Second, *know your customer.* Half of the battle is won when you know your customer, because you know his likes and dislikes. When a prospect walks in don't approach him with What can I do for you? or Can I help you? method. To break the ice, talk about anything at first but your merchandise. Selling then be-

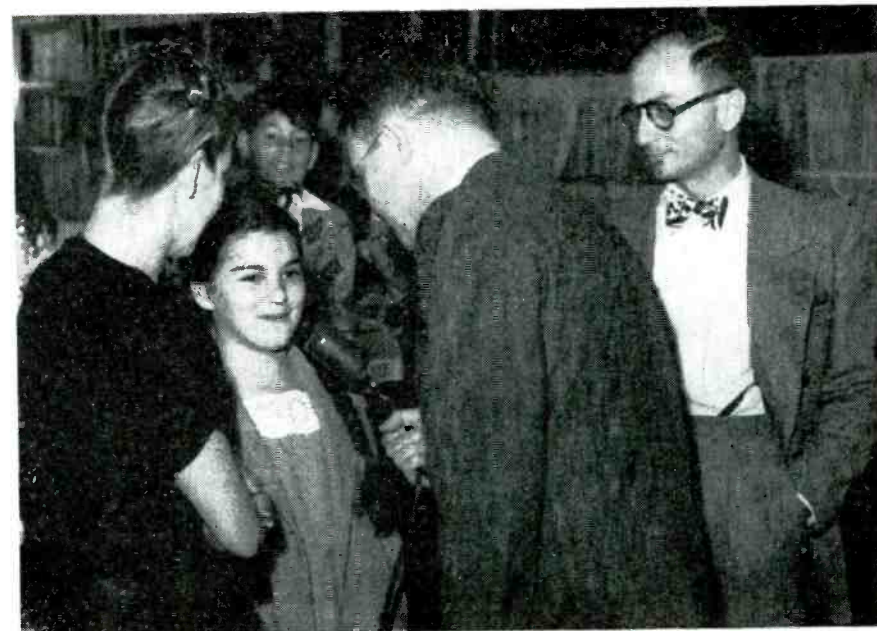

Radio Margo has a direct wire to local Station KRE and stages frequent interest-stirring broadcasts from the store. Here, the announcer interviews Mrs. Ruby, Miss Rose Anne and proprietor M. A. Margossian.

comes more pleasant and easier.

"Join some service group, social or church organization, fraternal or athletic club. The more people you know the more successful you will be. But do not become a joiner for the sake of joining. Take active interest in your community affairs and problems. Do hard work in some of the committees. It is relaxing, and invigorating if the cause is worthy. But again, do not overdo it to the extent of neglecting your business or family.

"Third, *let your customer know*

*you.* Advertise. Redecorate your windows often. Use the classified section of your telephone directory. If you are established in the central part of your town, occasional advertising both in newspapers and local radio stations will bring satisfactory results. Watch the effects of such efforts carefully but do not expect miracles overnight. Consistent and persistent advertising is the answer. We have been on the air daily with station KRE since 1941.

"Some months the results are very encouraging and some other months very discouraging. However, from

(Continued on page 139)



Typical crowd at the Oakland, Calif. store when recording artists make appearances. In this scene it's Hadda Brooks of boogie musical fame, helping to sell stocks of her discs.



## RCA Victor TV RECEIVER

Model 630-TCS console television set, with 10" picture tube, 52 sq. in. screen, 12" electrodynamic speaker. Golden Throat tone system, Eye Witness picture synchronizer, automatic station selector covering all 13 video channels. Twenty-six receiving tubes, plus 3 rectifier tubes in addition



to picture tube. Cabinet finished in selected walnut veneers with ornamental sliding tambour doors which closes over controls. Suggested retail price is \$450 plus \$65 for year's installation and maintenance as per "Owner's Policy". Radio Corp. of America, RCA Victor Division, Camden, N. J.—RADIO & Television RETAILING

## Garod CLOCK-RADIO

Model 5RC1 "Radalarm" superhet clock-radio combination with automatic on-off radio circuit governed by pre-setting spe-

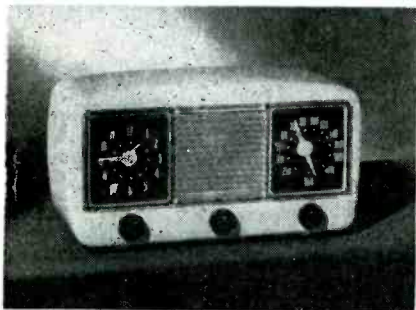

cially designed Telechron electric clock. Tunes 540 to 1650 kc, built-in loop antenna, simplified controls. \$39.95 in Zone 1. Garod Radio Corp., 70 Washington St., Brooklyn, N. Y.—RADIO & Television RETAILING

## Emerson RADIO

Model 547-A table superhet receiver, ac-dc, four tubes plus rectifier. Built-in super-loop antenna. 4" round Alnico 5 PM



dynamic speaker. Slide rule dial. Tunes 550 to 1600 kc. Cabinet is ivory plastic with gold trim. \$19.95. Emerson Radio & Phonograph Corp., 111 Eight Ave., New York, N. Y.—RADIO & Television RETAILING

## Westinghouse FM-AM COMBO

Model 167 bow-front console combination with standard broadcast, FM, and automatic phono. Full range tone and automatic volume controls, 12" electrodynamic



speaker, special easy-to-read dial. Ten tubes plus rectifier and phono amplifier. Automatic mix record changer, new electronic tone arm, record storage space. Cabinet finished in blonde palmavera or cordovan. \$379.95. Westinghouse Electric Corp., Sunbury, Pa.—RADIO & Television RETAILING

## Farnsworth RADIO

Model GT-051 table superhet with 180 degree airplane type dial, beam power output, Alnico 5 PM speaker. Tunes 540

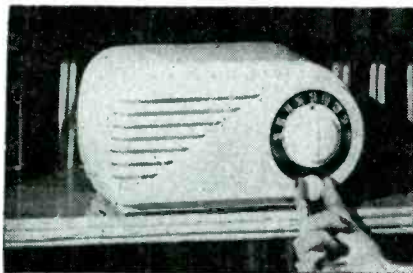

to 1620 kc, illuminated red plastic dial indicator. Built-in antenna, AVC, grip-sized controls. Cabinet of ivory plastic ultra-modern tear-drop design, styled for carry-

# New Sets for

ing handle facilities. Measures 11¼" wide by 5¼" deep by 6" high. (Model GT-050 is mahogany plastic) Farnsworth Television & Radio Corp., Ft. Wayne, Ind.—RADIO & Television RETAILING

## Admiral RADIO

Model 7T04-5N1 table superhet tuning 540 to 1630 kc. Five tubes, 5" PM Alnico 5 dynamic speaker. Beam power output, AVC, Aeroscope to eliminate aerial and ground wires. Solid wood cabinet in ultra

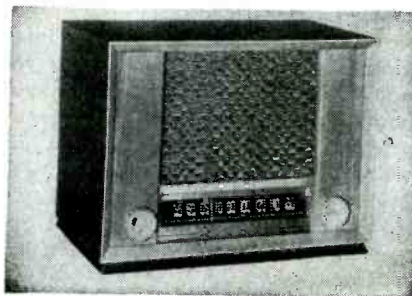

modern two-tone natural and walnut finish. Measures 12½" wide by 9¾" high by 7½" deep. Shipping weight is 10¾ lbs. \$29.95. Admiral Corp., Chicago 47, Ill.—RADIO & Television RETAILING

## Transvision TV RECEIVER

Table model video receiver with 12" direct-view picture tube, to be custom-assembled by the dealer. Covers all tele channels, 75 sq. in. of picture. Recom-

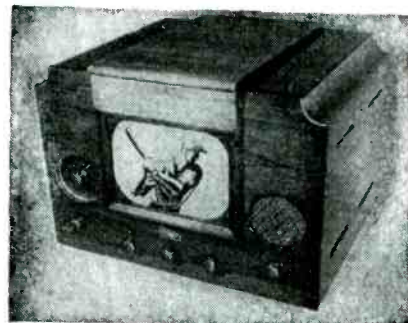

mended for taverns, restaurants, clubs, hotels, etc. Twenty-two tubes. Cabinet measures 24" wide by 18" deep by 17" high. Transvision, Inc., 385 North Ave., New Rochelle, N. Y.—RADIO & Television RETAILING



# Xmas Season

## Magnavox COMBO

Mayfair Model automatic radio-phonograph with optional (Armstrong) FM. Eight tubes plus rectifier, 10-watt power output, 12" Duosonic speaker. Automatic record changer has pianissimo pickup. Cabinet of simple, functional design, in mahogany

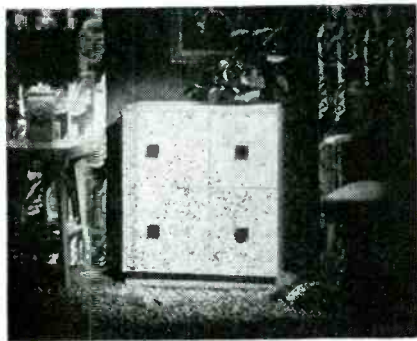

or white oak. Record storage space provided. \$198.50 (\$263.50 with FM, with 14 amplifier tubes, 2 rectifiers and one tuning tube—FM may be added at will). Magnavox Co., 2131 Bueter Rd., Ft. Wayne 4, Ind.—RADIO & Television RETAILING

## Majestic COMBO

Model 5AK780 "Commander" chairside automatic radio-phonograph combination. Alnico 5 PM speaker, ac only, tunes 535 to 1620 kc. Built-in directional antenna, bass boost circuit, large size horizontal exposed dial all miniature tubes. Lift top phono

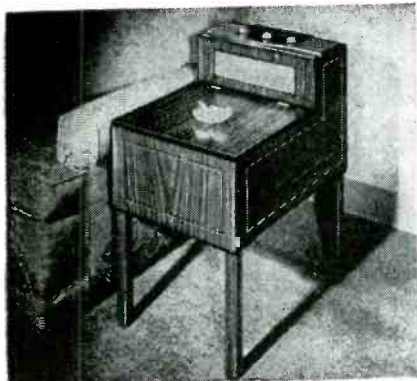

plays 10" or 12" discs automatically, tone compensated volume control. Crystal pickup, long-life Eagalloy-point needle. Modern design cabinet in mahogany, walnut and blonde finishes. Majestic Radio & Television Corp., St. Charles, Ill.—RADIO & Television RETAILING

## Motorola TV CONSOLETTTE

Model 547-A table superhet receiver, ac-receiver with 10" picture tube—picture area of 55 sq in. Pre-aligned at factory to cover all 13 channels, electromagnetic speaker, continuously variable tone control. Five operating controls on the front; eight service controls on left side of cabinet.



Specially designed pre-selector and r-f amplifier to eliminate interference. Modern design cabinet with matching overlays measures 22" wide by 40" high by 22" deep. Motorola, Inc., 4545 Augusta Blvd., Chicago, Ill.—RADIO & Television RETAILING

## Audar RECORDER-COMBO

Model RER-9 chairside recorder-radio-automatic-record-player, with 8 tubes including rectifier. Four-position switch for



radio, recording radio, playing records, or microphone recording. Special speaker baffle design to improve reproduction. Recorder will record up to 10" discs;

changer will handle twelve 10" records or ten 12" discs. Magic eye tube used as tuning indicator in "radio" position and as volume level indicator in radio-and-microphone recording positions. Modernistic design cabinet in fine-grain plastic coated fabric with hand-rubbed mahogany panels and trim. Measures 31" long by 20" high by 17" wide. Audar, Inc., Argos, Ind.—RADIO & Television RETAILING

## Sonora FM RECEIVER

Model WEU-240 table FM-AM superhet tuning 535 kc on standard and 87 to 109 mc for FM. Built-in loop for standard—connection for FM dipole. Full-vision dial, variable tone control, AVC. Eight tubes including rectifier. Ivory plastic-molded

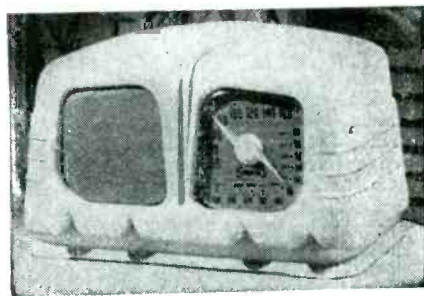

cabinet in contemporary styling. Measures 14" wide by 7 3/8" deep by 8 1/2" high. \$72.95. (Same model in walnut plastic \$66.95). Sonora Radio & Television Corp., 325 N. Hoyne Ave., Chicago, Ill.—RADIO & Television RETAILING

## Air King RADIO

Model A-512 "Prince" superhet table ac-dc unit, beam power pentode audio system, die-cut antenna. Five tubes including rectifier, 2-gang tuning condenser, illuminated airplane type dial. Alnico 5

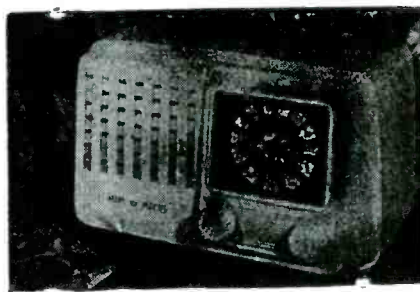

speaker. Plastic cabinet measures 9 1/2" long by 6" high by 5 1/2" deep. Ivory (illustrated) is \$21.95. Walnut Model A-511 is \$19.95. Air King Products Co., Inc., Division of Hytron Radio & Electronics Corp., 1523-29 63rd St., Brooklyn 19, N. Y.—RADIO & Television RETAILING

## Federal RADIO

Model 1040T table ac-dc receiver with four tubes plus rectifier. PM speaker, built-in loop antenna. Federal Telephone & Radio Corp., 591 Broad St., Newark, N. J.—RADIO & Television RETAILING.

# New Radio Lines for Xmas Selling

## GE COMBO

Model 802 console combination direct-view receiver. Separate circuit for each of 13 video channels, 10" picture tube. GE automatic picture clarifier. Automatic disc player. Regency period cabinet veneered with genuine Honduran mahogany. Retails at about \$750. Receiver Division, General Electric Co., Bridgeport, Conn.—RADIO & Television RETAILING.

## UST PUBLIC TV SET

"Pic" model video receiver designed for public places—screen 19" by 25". Includes FM and AM radios with two short wave bands, 35 tubes including 5 rectifiers, Bausch & Lomb lens used in refractive optical projection system. Screen set

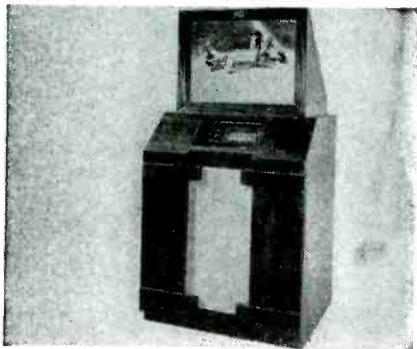

higher than on previous models. Improved centralized control panel with sliding doors equipped with lock. Cabinet of mahogany finish, 72" high. \$1995, tax included, installation extra. United States Television Mfg. Corp., 3 W. 16th St., New York 23, N. Y.—RADIO & Television RETAILING

## Modernair RADIO

Model 500 battery receiver "to fit the palm of the hand." Provides earphone reception for 540 to 1600 kc, antenna connection wire to be clipped to nearby metal object. Ground connection for use with outside antenna. Designed around

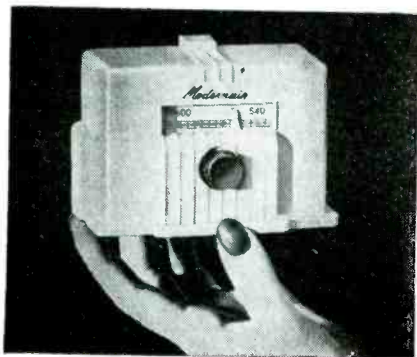

HI-MU 1L4 pentode receiving tube, uses standard midget type batteries. Cabinet molded from Tenite plastic, available in red, white or blue. Measures 4 3/8" by 3" by 3". \$5.98 without batteries. Modernair Corp., 952 S. Grand Ave., Los Angeles 15, Calif.—RADIO & Television RETAILING

## Lear PORTABLE RADIO

Model RM 402-C "Learavian" portable 3-band superhet receiver for aircraft users. Operates on ac-dc or self-contained batteries. Covers 195 to 410 kc for range and control tower reception, 500 to 1500 kc for standard, and 2.2 to 6.2 mc for aircraft communication. Built-in antenna for use when not in flight; plug-in connection for fixed aircraft antenna. Operates at loudspeaker level, 5" speaker, jack for headphones. Control panel on top of case. Compact cabinet of airplane luggage type, comes in beige tweed or wine color. Seven tubes including rectifier. \$75 retail. Lear, Inc., 110 Ionia Ave., N. W., Grand Rapids 2, Mich.—RADIO & Television RETAILING

## Autocrat COMBO

Model RPT-547 table combination with 5-tube (including rectifier) superhet radio and single record player playing 10" or 12" discs. Alnico 5 speaker, ac only, crys-



tal pickup. Plywood cabinet covered with 2-tone fabricoid, measures 12" by 12" by 5". Autocrat Radio Co., 3855 N. Hamilton Ave., Chicago 18, Ill.—RADIO & Television RETAILING

## Hoffman COMBO

Model B-1000, first of new Symphonic series, console radio-phono with 10 tubes. Two speakers—12" auditorium type plus "tweeter." Push-button tuning, three tone controls, "sound expansion" system. Webster automatic disc changer handling twelve 10" or ten 12" records, sapphire tipped nylon needles. Hoffman Radio Corp., 3430 S. Hill St., Los Angeles, Calif.—Radio & Television RETAILING

## R-K FM KIT

Model FM-7 table FM receiver kit, covering 86 to 110 mc range—can also be used as an FM tuner with good amplifier. Jacks for radio, phono or extra speaker. Comes

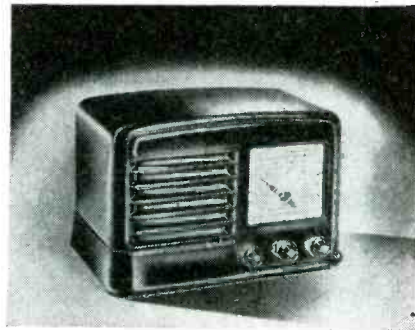

complete with speaker, tubes, bakelite cabinet—r-f section pretuned at factory. Miniature tubes; two i-f stages, one limiter stage and one discriminator. Full step-by-step wiring instructions, schematic and pictorial diagrams. \$29.95. Radio Kits, Inc., 120 Cedar St., New York, N. Y.—RADIO & Television RETAILING

## Pray DIFAN FM-TV ANTENNA

New type antenna for video and FM, folded "difan" style, covering frequency range of 48 to 108 mc. Substantially uniform impedance of 250 ohms over a 2.25/1 frequency range. Manufacturer

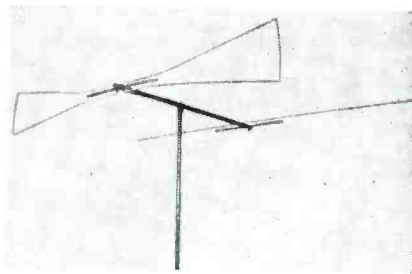

rates band width at "more than 5 times that of a folded dipole." Bears name of company's president, G. Emerson Pray. Tuck Electronic Corp., 76 Montgomery St., Jersey City 2, N. J.—RADIO & Television RETAILING

## Audax REPRODUCER

Model 74-A "tuned-ribbon" reproducer. Adequate output without preamplification. Jewel stylus can be replaced by user. Near-zero mass-linear responses to 10 kc., point pressure of 24 grams. No torsional action. Audax Co., 500 Fifth Ave., New York, N. Y.—RADIO & Television RETAILING.



# Don't Murder

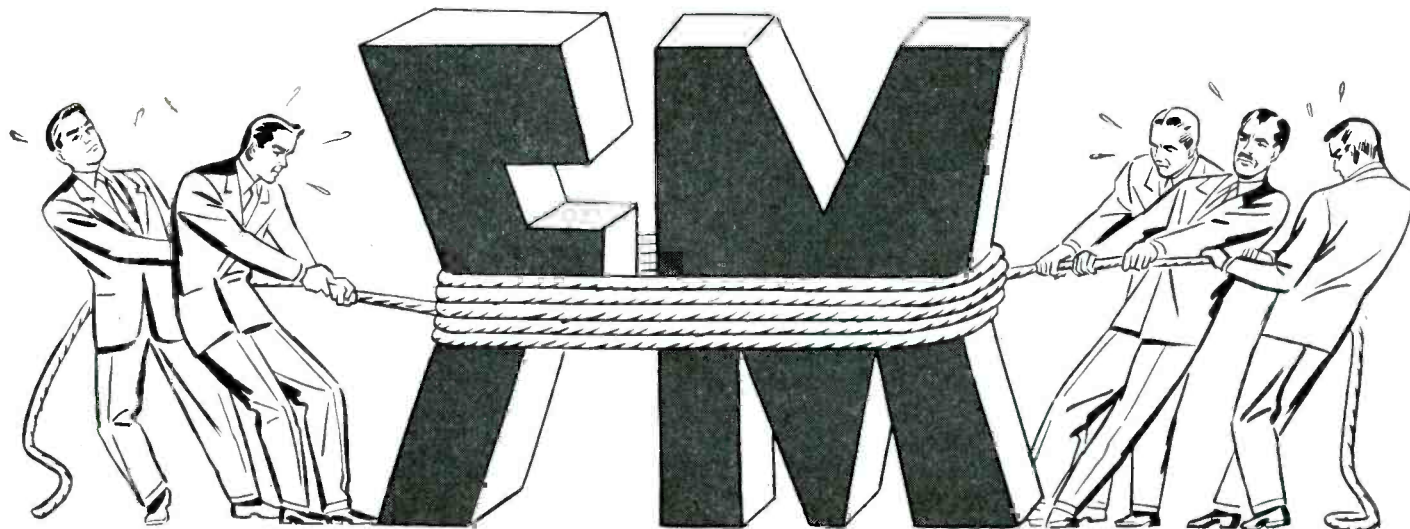

Don't mess around with second-rate FM gadgets  
... when FM DEMANDS the high quality of

## Pilotuner

Mr. Dealer! We earnestly urge: USE THE AMAZING FM PILOTUNER AS YOUR STANDARD OF COMPARISON, in testing ALL FM receivers and "tuners".

That's how you can avoid inferior, "rat-trap" equipment that simply *will not and can not* do justice to FM.

FM stations throughout America have acclaimed the PILOTUNER with all the raves in the book. It DOES THE JOB . . . because it's a QUALITY product, backed by Pilot Radio's unsurpassed practical experience in making FM sets.

Remember—we INVITE and WELCOME *legitimate* competition. We deplore ONLY that FM equipment which lacks integrity . . . which can do no good for the dealer, the consumer—or for FM itself.

The fate of FM—the glorious, most modern kind of broadcasting—is *in your trust*. Guard it well! Join the swing to the BEST FM . . . headed by the original PILOTUNER.

**PILOT RADIO CORPORATION**, 37-06 36th ST., LONG ISLAND CITY, N. Y.  
Makers of PILOTONE VINYLITE RECORDS • PIONEERS IN SHORT WAVE • FM • TELEVISION

# Salesfloor Behaviorism

The Clerk Doesn't Have to Look Like a Fashion-Plate or Kotow Like a Head Waiter, But He Must Toe the Line in Today's Market

● The kiss of death has already been bestowed upon the technique of take-it-or-leave-it selling. Merchandising is no longer a series of wrap-ups, pushovers and set-ups. The customer who formerly *apple-polished* around in search of scarce products, now *shops around* for the best and most for his money.

The wide-awake merchant is glad that normal selling conditions are about at hand. Genuine salesmen are itching to get back into harness, and consumers are glad once again to be riding high, wide and handsome up there in the driver's seat.

Aware of the changed conditions, progressive dealers all over the country, who worried through the famine-ridden market, doing their level best to hold the good-will of their customers, are paying more and more attention to all angles of salesmanship.

During tough times it was enough of a job to get salespeople to be merely courteous and helpful. Now, the retailer must probe into every minute detail of salesmanship if he wants to keep his place in the sun.

How salespeople act, and what they look like, are two things that will count heavily in this competitive market.

The dealer may have a bang-up, modern store, a well-rounded line of radios and appliances, and a staff of salesmen who are really hot after business, and still be missing a bet if he overlooks such seemingly small things as annoying and unattractive behaviorism quirks which could well be hangovers from the lush days.

Salesroom behaviorism must be studied. If the dealer can give his establishment a clean bill of health, all well and good, but if he finds that some of his salesmen are still indulging in certain careless habits, or that he himself isn't properly "policed" up, then it's time to clean house.

During the topsy-turvy days, the salesman could get away with talking to a customer with a cigarette dangling between his lips. If he needed

a shave, he could shrug it off with the old "too-busy" alibi.

If the customer was able to lay his hands on a precious radio or a toaster or an iron, he'd give the order to a guy wearing galluses just as readily as he would give it to a man in a frock coat.

Now things are different. A slightly objectionable mannerism on the part of a salesman, which could well have been glossed over during the pressure days, may stand out like a sore thumb now that toe-the-line sales tactics are the order of the day.



Today, a thorough salesman isn't merely a man who sells. He's the fellow who *looks* and *acts* like a salesman. This doesn't mean that he must dress like a tailor's dummy. Nor does it mean that he should bow and scrape like a Parisian headwaiter. But it does mean that he cannot afford to be careless in manner or dress in these days when we are on the threshold of a real struggle for survival in business.

This smoking in the showroom proposition, for instance, may seem like a minor thing, but it is a problem which has long worried the merchant. During slack periods, it looks more like a depression than a lull in business to the customer who peers in the window and sees several salesmen lolling about under clouds of smoke.

It's worse, of course, to permit salespeople to smoke while talking to

customers, or to scurry around looking for a place to lay a cigarette. Moreover, stale tobacco odors which permeate the store are objectionable not only to non-smokers, but to smokers themselves who come in from outdoors.

In most large stores, clerks are forbidden to smoke. In many small stores salesmen are permitted to smoke only during slow periods. A "no-smoking" in the showroom ban seems to be the best rule, leading merchants think, but they do agree that employes should be given time off to take a few drags now and then in places away from the salesfloor.

## "Shirtsleeve" Selling

"Shirtsleeve" selling is another problem. There are two schools of thought on this subject, but the group insisting that a jacket or an office coat is a must appear to lead in numbers.

We asked a leading small-city merchant about it. Said he: "Maybe a pipe-smoking chap, wearing red suspenders and no coat, can sell a couple a twelve hundred-dollar electric kitchen. It could be, but I wouldn't want to gamble on it, myself. I'll settle for the salesman who has a look of the successful businessman about him."

Customer Jones may go around Saturdays in loafing togs which make him appear to be a hobo, and still object to the too-casually dressed salesman.

Client Smith may come into the store smoking a calabash pipe as big as a squash, and feel deeply insulted if the salesman is puffing away on even a non-king-size cigarette. The chap who comes in with a breath that smells like a bar-rag will have no confidence in the clerk whose halitosis is the result of a short beer.

All in all, it's going to be the little things that will count in the tough selling days ahead, and, in addition to watching the big things in salesmanship, we'll have to be on guard against the seemingly small faults in action and in appearance.



AMERICA'S MOST POPULAR

Personal  
Portable



Note new full-vision slider dial and efficient tuning knobs.

NEW EMERSON RADIO  
MODEL 558

\$34<sup>95</sup>

(LESS BATTERIES)

Choice of Ivory,  
Black or Green

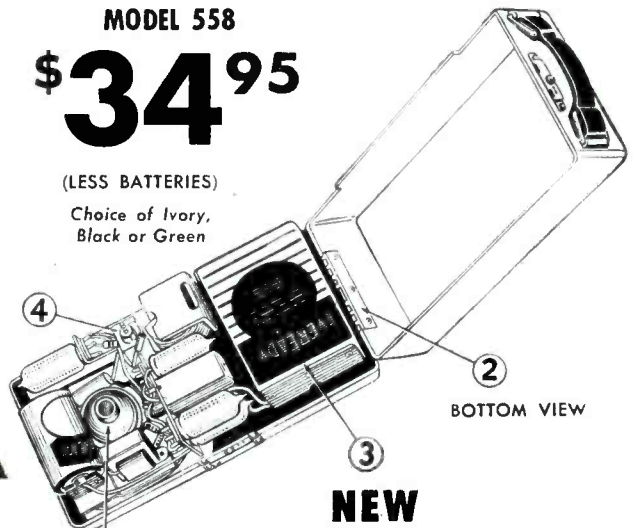

BOTTOM VIEW

NEW

IMPROVED FEATURES

1. New type — 60% LARGER — Alnico 5 Permanent Magnet Dynamic Speaker — greater sensitivity and power without distortion.
2. New hinged back for easy accessibility.
3. New provision for easy battery change.
4. Modern miniature iron core IF coils.

Increased acoustic power with advanced circuit design — High efficiency loop antenna located to eliminate chassis signal absorption — Automatic volume control — Exceptionally low battery drain.

Super-Powered 1948  
**Emerson  
Radio**

Every Emerson Radio dealer knows the sensational selling history of the former Model 508. Nationwide response PROVES that this new, improved version—Model 558—is destined to MULTIPLY that public demand!

Production of Model 558 — backed by tremendous promotion—is rapidly going ahead, but commitments must be filled in the order received. Anticipate your needs NOW for the coming FALL and WINTER BOOM.

Write, Wire or Phone Your Emerson Radio Distributor

EMERSON RADIO AND PHONOGRAPH CORPORATION • NEW YORK 11, N. Y.  
World's Largest Maker of Small Radio



# FM for Xmas

## **New Models Ideal for Holiday Promotions**

● One of the problems that radio-appliance retailers face during the holiday season is how to make their gift merchandise "different," spectacular and really interesting.

October and November will tell the story, on stocking the kind of gift merchandise that attracts special attention and SELLS. This is the time to make the plans in detail and decide what stocks will chalk up the most volume during the Christmas buying season.

One of the best possible merchandising bets for this period is FM. It has all the qualities of first-string holiday stuff—it's new, luxurious, long-lasting, and a source of high-level personal enjoyment. For retailers who are searching for something to take the "routine" out of a radio Christmas—if they want down-right novelty and appeal for their displays and demonstrations—FM is elected.

### **Wide Price Range**

At this point in the business, an all-out promotion of FM does not mean that a dealer must concentrate on the "upper half" of his customer list. There are plenty of moderately priced table sets—in addition to converters, adapters or tuners, now on the market.

The opportunities in FM, for a dealer to sell in the higher brackets and to make more money per sale, are, of course, one of its chief assets. However, everybody knows that when the annual Christmas spirit comes along, to say that it reaches into all income groups is to put it mildly, and a dealer should be prepared to sell the family of average

income to the very best of his talents. Right now, he has the right merchandise for all kinds of selling, because the FM equipment has reached down into the \$30 bracket.

It is sometimes hard for the average dealer to dream up holiday displays and promotions that have a plus amount of "come hither." More often than not, he tells his story of gift radio in a quiet and ordinary sort of way, using the point-of-sale materials supplied by the manufacturers, adding some trim of his own, and adapting the available materials to his individual set-up.

newest and most distinguished Christmas gift . . . available for the first time (if this is true locally) . . . the radio that makes this Christmas a memorable one. . . ." It provides a lively departure from the ordinary events in a dealer's promotion.

FM has a fine "quality" reputation which will appeal strongly to those thousands of folk who are looking for Christmas gifts of real style and stature. When a dealer suggests it to a customer, he compliments the prospect because FM has that kind of atmosphere. And the customer knows that when he uses it as a gift, it compliments the taste of those who receive it. The popular idea is that anybody who is interested in FM has a certain flair for finer things.

To get the most benefit out of the Christmas interest, the FM dealer needs a definite merchandising program planned around the status of FM broadcasting in his area. If the local transmitters are just getting started, the retailer should cooperate to the fullest extent with the stations in publicizing and promoting the new program service.

If FM broadcasting is already established in the area, the retailer leaves his "introductory" tactics behind and settles down to two-fisted store promotion. This may involve the staging of special store demon-

---

## **TWO-FISTED SALES ACTIVITIES WILL ROLL UP VOLUME**

Sell FM to all income groups—

*Now it can be done!*

FM's a natural for Yuletide merchandising—

*Get Busy!*

Display FM in show-windows—

*On showroom floors!*

Tell customers about FM's features—

*Ask 'em to buy!*

---

When you bring into this picture a radio product that's brand new and increasingly impressive, you improve the retailer's prospects in a very substantial way. Where the dealer had previously used a window display with a string of AM radios decorated for Christmas and the usual suggestion that the sets are exceptionally good gifts, he can now spark at least a part of the exhibit with banner headlines. With considerable "splurge" and vigor, he can announce something on the order of "radio's

strations at fixed and advertised times, or any number of promotional ideas. Some dealers will want to undertake "educational" programs, in which they help to show the whole community how FM works. Others will stage their own "radio shows" in which they make a special event out of the new variety of models and types of FM sets available.

In fact, where FM is concerned, the promotional possibilities are unlimited. And the holiday season is the time it pays off!



*Only* **Bendix Radio**

*has it!*

**Hush-O-Matic**

**THE REMARKABLE NEW DEMONSTRATION FEATURE  
THAT SUPPRESSES NEEDLE NOISE . . . BROADENS TONAL RANGE . . .  
GIVES RECORDS NEW LIFE!**



Here is the kind of selling advantage every radio dealer dreams about! Bendix Radio has at last made it possible to enjoy the full richness of records without audible needle noise even from old records! Needle noise is restricted in low level passages, and tonal range is automatically increased as the level increases. Yet this wonder-working device adds very little to the cost of the set! It's the kind of development you can expect *only* from Bendix Radio—one more reason why the Bendix Radio franchise is one of the most valuable in the industry!

← **45,000,000 WILL READ ABOUT  
HUSH-O-MATIC THIS MONTH!**

***A line of Leaders at Every Price Level!***



**BENDIX RADIO DIVISION of  
BALTIMORE 4, MARYLAND**



**NOW! Exclusive new features  
that sell!**

# Stewart-Warner Radio-Phonographs for 1948

**SHADOW-BOX DIAL**



With unique Wide-Angle Tuning! First major improvement in radio design in 15 years. Engineered to be seen clearly from all angles.



With new Electro-Hush Reproducer! The Dura-point retracts to guard records from accidental damage! Needle noises are banished.

**STROBO-SONIC TONE SYSTEM**

**THE INTERPRETER** blond mahogany crafted in the modern manner; also in rich old-world mahogany. Intermix record changer.

*...beautiful new cabinets, period and modern, style-proportioned for the home of today!*

Yes, for Stewart-Warner dealers, the really new radio-phonographs are here—acclaimed with enthusiasm by dealers everywhere! New in styling, new in radiant performance, new in the true-life beauty of their Strobo-Sonic Tone . . . in both radio and phonograph.

Perfectly proportioned for

today's home, these smart consoles blend harmoniously with all decorative styles. All the famous Stewart-Warner features, too—including built-in Radair Antenna; the fast, gentle-action record changer; PM dynamic speakers.

You can see the difference . . . and how you can HEAR it!

A Model for Every Purpose—A Radio for Every Room

## Stewart-Warner

AM Radios FM Radio-Phonographs Television

CHICAGO 14



ILLINOIS

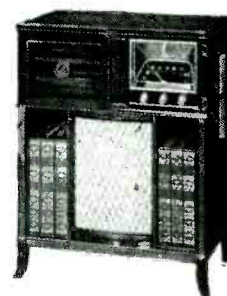

**THE SYMPHONIC** period-piece combination in old-world mahogany, with dimensional bronze grille. 34 1/4" high, 23 3/4" wide, 16" deep.

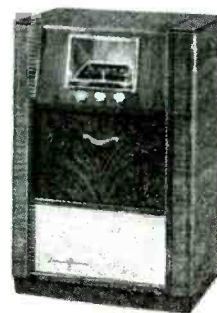

**THE NEW MINSTREL** handsome contemporary design; standard record changer. 34 1/2" high, 23 3/4" wide, 16" deep.



# RECORDS

Section of **RADIO & Television RETAILING**

## Platter Profit-Pointers

**\$** IT'S CHRISTMAS IN OCTOBER for dealers who have to do their stock ordering, plan window displays and holiday promotions this month. Last year's sales reports, coupled with sales figures for this year, should be utilized in placing Xmas orders. Manufacturers have already formulated plans for window posters, streamers, special display pieces and cooperative holiday advertising, and are ready to answer all inquiries.

**\$** PRE-HOLIDAY SALES of Christmas "mood music" like "White Christmas," "Santa Claus Is Coming to Town," and "Jingle Bells" are profitable factors in the seasonal sales picture. Push the sales of these platters by displaying them prominently, and keeping them together. Customers like to feel the Yuletide glow weeks before the 25th of December.

**\$** LOUDSPEAKERS carrying strains of "Jingle Bells" and other Christmas tunes to passers-by, a good idea, where local ordinances do not prohibit. Music serves as a continual reminder that "Records Make Excellent Gifts."

**\$** PLUGGING of "Records for Christmas" should be started early in holiday buying season and continued until December 24th. Last-minute-shoppers are enthusiastic platter purchasers, so dealers should prepare themselves to do a rushing business Christmas Eve.

**\$** COMPETITION for the record business will be particularly keen this Christmas season, and dealers should remember that customers will go to those retailers who offer that "extra something." Stores where people "won't have to wait," where the clerks are even-tempered, and which maintain a good gift-wrapping service, will be the establishments that will get the largest share of the trade.

**\$** ONE CLEVER IDEA used in a Christmas window display will attract shoppers and bring them into the store. A simple and effective focal point piece might

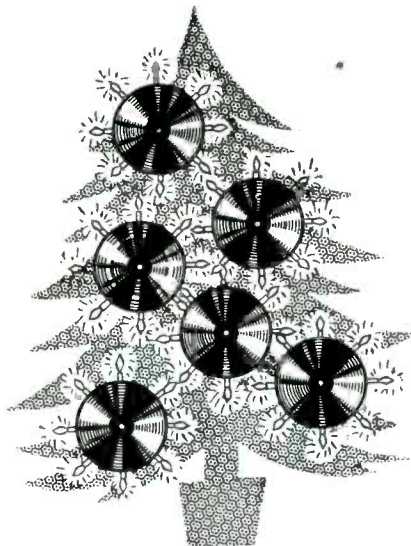

consist of a fire-proof tree, with discs hanging from the branches, and a circle of "on-off" Xmas bulbs surrounding each platter.

**\$** THE FASTER the service, the more customers can be accommodated, the more profits will accrue to the dealer during the Christmas selling rush. An enlarged selling staff, bigger wrapping facilities, and a speed-up system of taking cash should all be considered when planning for the holidays.

**\$** PERIOD between Xmas and New Year's Day a good selling time for pop dance records for New Year's Eve parties. Dealers who do not wish to change their windows the day after Christmas, will do well to plan displays that can be used until Jan. 1. In some instances, a sprinkling of confetti and a handful of colorful streamers strewn across the window will do the trick.

**\$** THREE-WALLED, sound-proofed record listening booth, with open end facing store interior, a new dealer idea to speed up disc sales, and combat juvenile capers. Youngsters are not inclined to "cut a rug" or deface walls while under watchful eye of proprietor.

**\$** DISC ASSORTMENTS, packaged by dealers in blank album covers, is another sales gimmick for getting those extra Christmas dollars. In some instances, customers can choose their own selections, and retailers offer to stamp "For Mom" or "For Mary" in gold letters on the album cover, making for a unique and personalized gift.

# Next month's headliners in your **RCA Victor** ads



Here are your three pop leaders for November, pre-sold for you in leading Sunday newspapers, in "LOOK," and 6 other national magazines. Have these moneymakers in sight when the ads appear!



*Glenn Miller*

*Sammy Kaye*

*Beryl Davis*

"Glenn Miller Masterpieces—Vol. II" by Glenn Miller and his Orchestra (Album P-189, \$3.15)

Turnover on Vol. II, containing 8 great prewar Miller numbers, should be even bigger than P-148!

"Year Round Favorites" (Album P-184, \$3.15)

The everlasting popularity of seasonal tunes will skyrocket Sammy Kaye's newest album—a collection of some of the best-loved music in the calendar!

"Pass that Peace Pipe" and "The Best Things in Life Are Free," with Russ Case and his Orchestra (20-2483, 60¢)

Another sensational Davis number, brimming with personality. Everybody . . . everywhere . . . is falling for Beryl!



Outstanding new recordings by three of the world's greatest artists . . . each to be featured full page in "TIME" next month. Well-timed reminder displays will get quick action.



**HEIFETZ**

**KOUSSEVITZKY**

**PEERCE**

Concerto in D Minor for Two Violins and Orchestra—J. S. Bach. RCA Victor Chamber Orchestra, Franz Waxman, Conductor. Both solo parts played by Heifetz. Album M/DM-1136, \$2.85. "TIME" Nov. 3.

(Prices shown are suggested list, excluding taxes)

Symphony No. 94, in G ("Surprise")—Haydn. Boston Symphony Orchestra. M/DM-1155, \$3.85. "TIME" Nov. 24.

Operatic Duets, with Leonard Warren. From *La Bohème*—Puccini, and *La Forza del Destino*—Verdi. RCA Victor Orchestra, Jean Paul Morel and Erich Leinsdorf, Cond. M/DM-1156, \$2.85. "TIME" Nov. 17.

# RCA Victor records



*Making more friends for you every week*

Robert Merrill, star of the RCA Victor show. Best sellers in your current stock get powerful plugging on this program—well worth cashing in with display! Tune in and tie in . . . 2 PM (EST), Sundays, over NBC Network.



# Gift Disc Accessories

Promote Sale of Phono Needles and Cabinets as Presents

● Dollar-wise retailers are well aware of the importance of stressing record accessories as extra money-makers. And just as needles and record storage units have their place in the year-round selling scheme, so do they have their place in the Christmas "giving" scene.

The disc accessory angle must be concentrated on during this season, no matter how heavy the rush is in other departments. Potential profits to be realized from these items are large, and dealers will be amazed at the comparative ease with which sales are consummated.

Customers welcome a chance to buy something that is "different" as a gift. Dealers should point out that Needle X is not only practical, but will increase the listener's enjoyment of the music; or that such a storage unit will please mother as well as the youngsters; or perhaps that an inexpensive record brush will help the children learn how to properly care for their collection of discs.

## Attractive Gifts

Many people who are out doing their Christmas shopping will not think of giving a phono needle as a gift, desiring something that may appear to be more glamorous or impressive. Packaging is important in this respect. The needle manufacturers are offering their product in expensive cellophane, plastic, velvet, and jewel-like cases that belie all doubts of the gift not being "elegant" enough.

On the other hand, needles are available in a wide price range, and the less expensive ones can be suggested as an "extra gesture," to be enclosed with an album gift.

Dealers should realize that many people who walk into stores to buy discs as presents for relatives and friends, may not own players themselves. These customers, in particular, welcome casual suggestions such as: "Are you sure your niece has an ample supply of needles?" or "If your niece really plays records so often, she can use a needle like this—do you know it plays 2000 times?" etc.

An intelligent sales talk, given at the right moment, stressing the fact that needles are not luxuries but ne-

cessities, may transform a fleeting impulse into a concrete sale. Needle and record manufacturers realize that a large percentage of record accessory sales are the result of a direct approach in the store, and have accordingly prepared an abundant variety of point-of-sale dealer display selling aids.

One of the most effective means of promoting needle sales has been to place a colorful display and needle dispenser on the counter, or under the glass of the counter. One manufacturer provides dealers with specially designed stands of metal and glass containing needles of various

Many record stores are planning original and lavish window displays for the holiday season. Packaged display material available from the manufacturers can be easily incorporated into any record window.

## Wrapping Important

The small boxes can be wrapped with gilt paper and ribbon, and slogans of the "Good Things Come in Little Packages," "Give 10,000 Record Plays for Xmas" variety, utilized with manufacturer's cards which describe the needle. Any angle which may appeal to customers and arouse

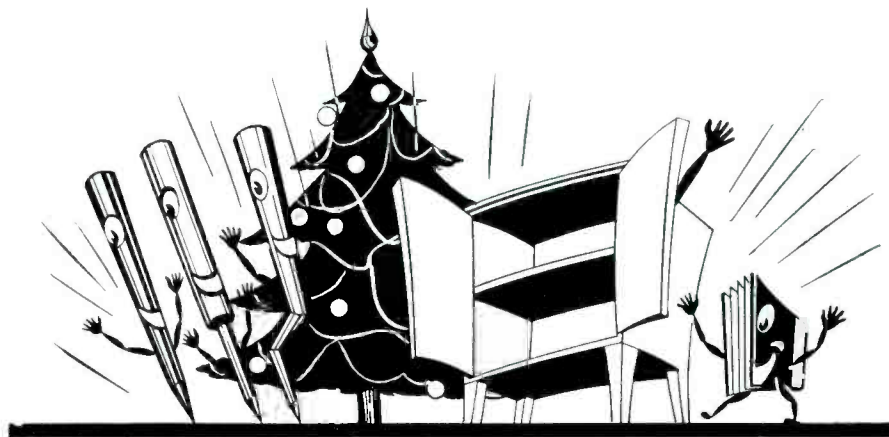

prices and quality. Another needle maker features a jewelry type counter show-case for display and selling purposes.

Whether the material which calls the customer's attention to the dealer's stock of accessories is on the counter, below the counter glass, on cards, or displayed on the shelves at eye level, it should be there for each and every customer to see, in addition to the useful Christmas trimmings.

## Advertising Pays

Needles should receive a proportionate share of the space in all dealer record advertising. In addition, many needle manufacturers, and record companies with their own brand of needles, offer retailers cooperative newspaper advertising, and engage in extensive consumer promotion of their product in national magazines.

their interest should be used to plant the idea of "Give a Needle for Christmas."

In the April, '47, issue of RADIO & Television RETAILING, methods of selling units of record storage space were discussed, and the various types of merchandise available on the market described.

Storage units are available in a multitude of price ranges and styles. The simple record album container may be price at 59c or less; the Hepplewhite styled furniture storage unit may sell for \$59 or more.

Expanding album racks, single shelves with scratch-proof coverings which can be placed on top of tables or desks, combinations of shelves which stand on the floor, as well as portable record holders of the hassock or loose-leaf binder types are all gifts which the dealer can suggest with assurance.

The type of storage unit which the dealer will recommend to prospective

(Continued on page 76)

# Radio Promotion Boosts

Pennsylvania Retailer Uses Air Show to Merchandise Records

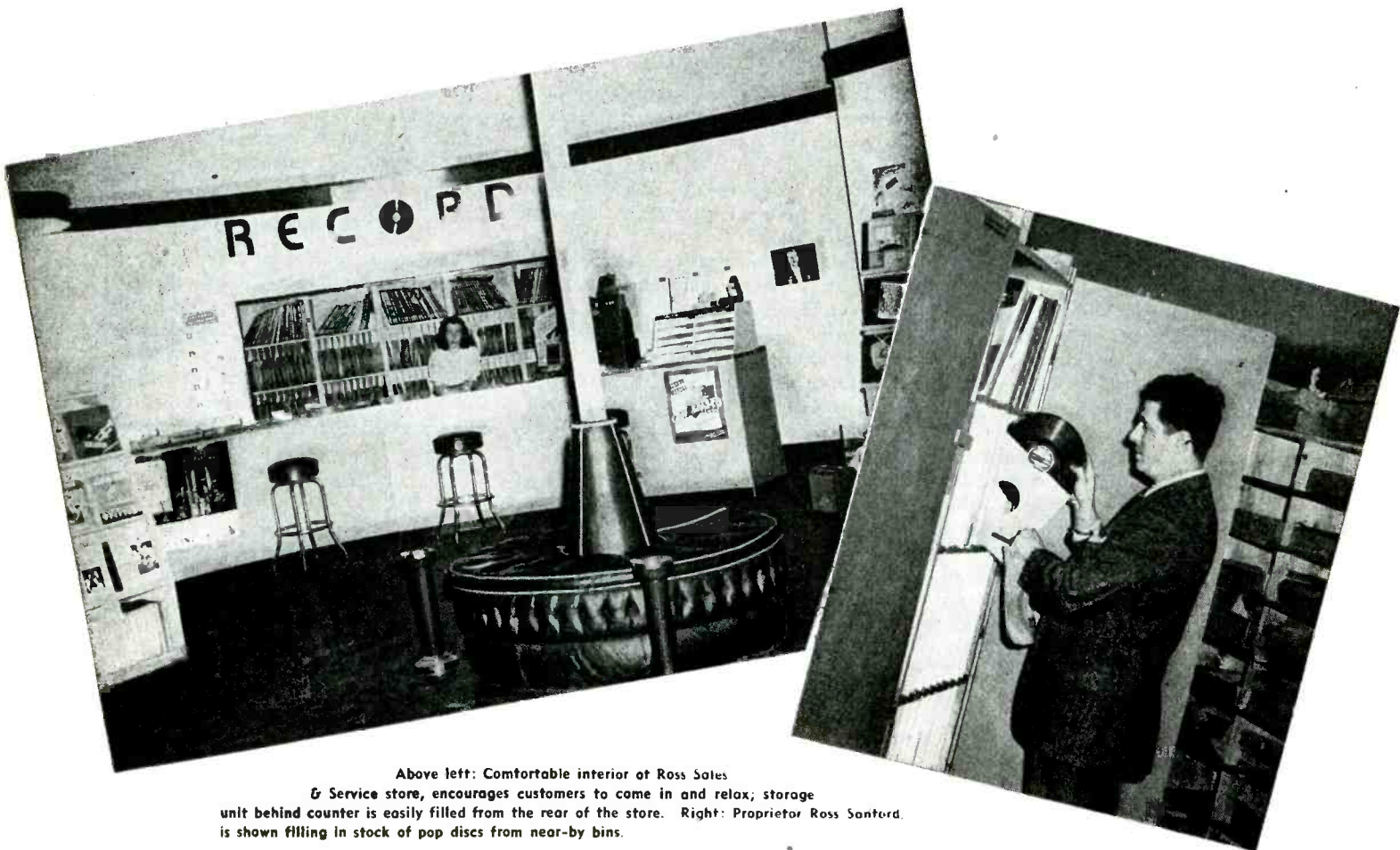

Above left: Comfortable interior of Ross Sales & Service store, encourages customers to come in and relax; storage unit behind counter is easily filled from the rear of the store. Right: Proprietor Ross Sanford is shown filling in stock of pop discs from near-by bins.

● Ross C. Sanford, owner of Ross Sales and Service, Warren, Pa., is utilizing radio advertising to obtain bigger and better disc sales from his trading area. Spot announcements, audience participation shows, and musical programs aimed at the teen-age and family audience, all go out over a local station.

## Discs Publicized

Records receive the benefit of most of the radio-time promotion, but appliances are currently coming in for their share of advertising recognition. Store remodeling, availability of more appliance products, and a family audience garnered by many of Ross' radio shows are accounting for the new appliance emphasis.

80% of Mr. Sanford's advertising expenditure is allotted to radio pro-

motion. Mr. Sanford explains, "the investment in air-time has more than paid off in increased record sales, and in maintaining a lively store traffic, which frequently results in sales of other merchandise."

Possibly the most popular of the Ross store's shows is the informal disc program "Platters and Chatters" which goes over the air at 3:30 p. m. daily during the school months. Youngsters crowd into the studio, jam the halls, and line-up to watch the show through an observation window.

Sanford, who incidentally designed his own store, has done so with an eye to customer appeal and working practicality. The record section of the store has comfortable seats and stools, and is large enough to accommodate a number of people. Record fans, consequently, have made the

Ross store a popular meeting place.

A unique display-storage piece located behind the sales counter was designed by Sanford to facilitate inventory and stock control. From the front, the customer sees an ordinary record rack built into the wall. This storage-wall is divided into five sections, each readily accessible from the rear of the store. The doors for each of the sections, which open into the record storage room, are made of simple wood panels, which have been hinged on to the racks.

## Facilitates Replacements

At regular periods, Sanford opens the record rack doors from the storage room, checks the quantity of records in the various bins, and refills the discs where necessary. The dual purpose rack is approximately



# Platter Profits

and Increase Sales in Other Departments

10 feet long, 5 feet high, 1½ feet deep.

Gay upholstered seats around a pillar in front of the record counter, and the leather stools add to customer comfort. During holiday record rushes, Sanford uses ear-phone plug-ins along this "RECORD" counter.

## Interior Decoration

In an effort to center attention on island displays of radios and appliances Sanford installed low, overhanging "canopies," bordered by fluorescent lighting. The ceiling is painted gray, walls are light blue. The floor was laid with a mottled linoleum, to provide good-looks without distracting from the displays. Columns located through the center

of the store were built into a circular display, incorporated into a seating arrangement in the record department, and otherwise blended into the decor of the store.

Additional remodeling plans call for more self-service record racks, and a greater concentration on merchandising home appliances. Sanford is planning a series of model rooms featuring electrical appliances. "For instance," he explains, "we intend to set up a kitchen and living room, separated by moveable partitions, equipped with furniture and appliances. Curtains and flower pots will be used to simulate a "homey" atmosphere, and make the merchandise as attractive as possible."

When merchandise becomes more plentiful, Sanford plans to convert the second floor of his building into

a small auditorium complete with a stage and an abundance of electrical outlets. Demonstrations of home appliances are planned to take place under the guidance of a home economist.

## Future Plans

"The whole front of the store will eventually be remodeled," Sanford continued. All interior renovations have kept the new store front in mind. Plans call for maintaining the store interior as a permanent display, with no "show windows" to block the view from the street. Huge curved display windows, bright interior lighting, gray vitrolite building, and huge, lighted lettering proclaiming the store's name, are highlights of Ross C. Sanford's future store modernization plans.

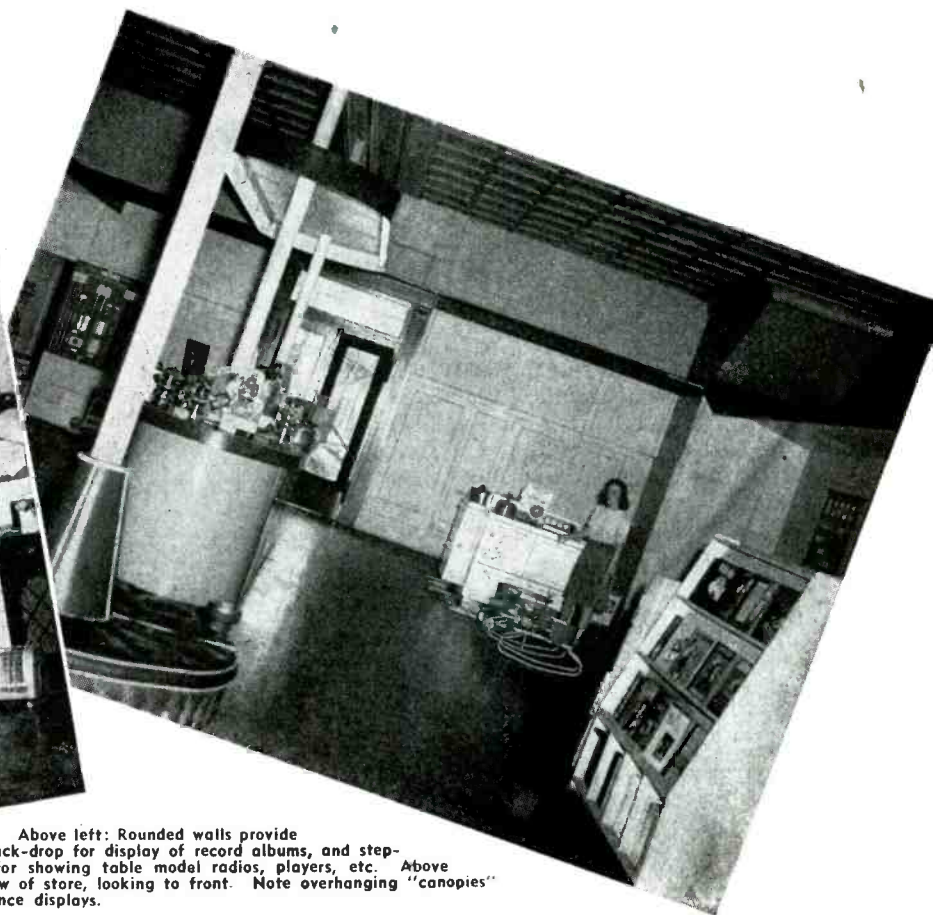

Above left: Rounded walls provide good back-drop for display of record albums, and step-up tiers for showing table model radios, players, etc. Above right: View of store, looking to front. Note overhanging "canopies" for appliance displays.



# Discs for Xmas

## CLASSICAL WORKS

**BACH, "Mass in B Minor,"** Robert Shaw conducting the RCA Victor Chorale and orchestra. RCA Victor M or DM-1145-1146

The first album contains nine 12-inch records, the second album contains eight 12-inch records in this complete recording of the Bach Mass. Seasonal interest should bolster sales.

**BACH, "Suite No. 2 in B Minor for Flute and Strings,"** Sebastian Caratelli, flute, with the Pittsburgh Symphony Orchestra, Fritz Reiner, conductor—"Fuge in G Minor." Columbia M-MM-695

Fritz Reiner interprets the Bach dance music with clear-cut vision and warmth.

**BEETHOVEN-LISZT, "Adelaide, Op. 108"** Egon Petri, piano. Columbia 72163-D

Lovely Beethoven song transcribed by Liszt, and played by Egon Petri.

**BERNSTEIN, "Facsimile,"** Leonard Bernstein conducting the RCA Victor Orchestra. RCA Victor M or DM-1142

This original composition for the Ballet Theatre is called a "Choreographic Essay" on the album cover. Mood of the piece is captured in the artistic "modern manner" of the dance illustrated on the album cover.

**"BRAZILIAN PIANO MUSIC,"** Guiomar Novaes, piano. Columbia M-MM-692

Music lovers, educators, and serious "folk music" adherents will find something to suit their respective interests in this collection.

**DEBUSSY, "Sonata No. 2 for Flute, Viola and Harp,"** Laura Newell, harp; Milton Katims, viola; John Wummer, flute. Columbia X-MX-282

Sensitive performance of Debussy sonata by three talented performers.

**DEBUSSY, "La Fille Aux Cheveux de Lin"—FALLA, "Jota."** Jascha Heifetz, violinist with Emanuel Bay at the piano. RCA Victor 10-1324

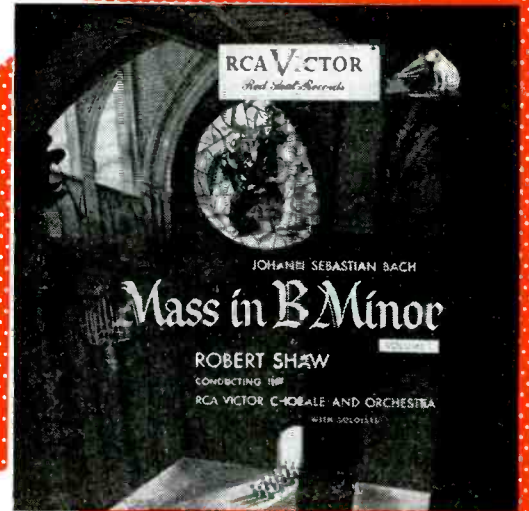

RCA Victor's two-volume recording of the Bach "Mass" is a memorable musical event.



Customers go for Dinah Shore's Columbia waltzes of tunes that are old and new, sweet n' swing.



"Benny Rides Again" is the title of a new album Benny Goodman recorded for Capitol, and which is getting a special consumer-clear promotion.



Frankie Laine's teenage following is still growing. Laine's latest Mercury discings are the reason.



# Bring \$\$ for Dealers

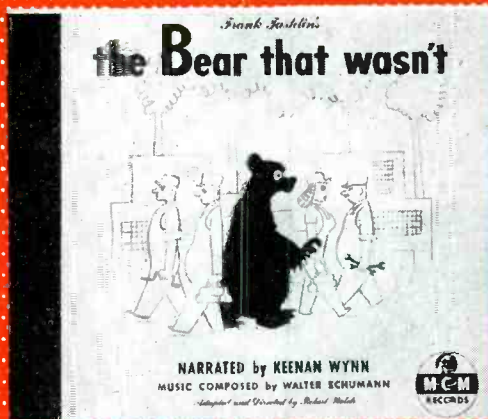

This MGM album is one of a group of children's sets released by the firm in time for Xmas.



Johnny Long's collection of "College Favorites" for Signature is aimed at the football fans and student crowds.



Roy McKinley, featured artist on the Majestic Records label.



Fans of Decca's Louis Jordan have catapulted his discs into the "best-seller" category.

Heifetz devotees are familiar with these two melodic compositions, through the concert hall and previous waxings. This is the first time the two have been plattered together, though.

FALLA, "Ritual Fire Dance,"—  
"Dance of Terror." Artur Rubinstein, pianist. RCA Victor 10-1326

Rubinstein has recorded the "Fire Dance" previously, but many new fans who heard the pianist's performance in the film "Carnegie Hall" will be good customers.

LISZT, FRANZ, "Concerto No. 1 in E Flat," Artur Rubinstein, pianist, Dallas Symphony Orchestra, Antal Dorati, conductor. RCA Victor M or DM 1144

Rich melodic interpretation by Rubinstein of Liszt concerto.

SCHUMANN, "Arabesque, Op 18." Jose Iturbi, pianist. RCA Victor 10-1325

Iturbi pianistics get full play in this Schumann recording.

## VOCAL ARTISTS

GIORDANO, "Come Un Bel Di Di Maggio," VERDI, "Di Tu Se Fidele." Jussi Bjoerling, tenor. RCA Victor 10-1323

The Metropolitan Opera star adds more favorite arias to his rapidly expanding "waxed" repertoire.

HUMPERDINCK, "Hansel and Gretel," Rise Stevens, Nadine Conner, Thelma Votipka, John Brownlee, Claramae Turner, and Lillian Raymond. Max Rudolph conducting the chorus and orchestra of the Metropolitan Opera Assn. Columbia MOP 26

This two-volume set contains twelve 12-inch records, and marks the premier issue of the first Metropolitan Opera recordings done by Columbia with the entire cast of the production and recorded on the stage of the "Met", with the regular orchestra in accompaniment.

"ROMANTIC ARIAS," Raoul Jobin, tenor, with the Metropolitan Opera Orchestra conducted by

(Continued on page 62)



## Xmas Discs

(Continued from page 61)

**Wilfred Pelletier.** Columbia M-MM-696

Six arias from French grand opera sung by the French-Canadian tenor. Start of winter opera season should create much customer interest.

**"SACRED ARIAS OF JOHANN SEBASTIAN BACH."** Carol Brice, contralto, with the Columbia Broadcasting Concert orchestra, conducted by Daniel Saidenberg. Columbia X-MX-283

Contralto Carol Brice performs the sacred oratorio arias with fervor.

## CHILDRENS

**"IRVING, THE UNEMPLOYED HORSE,"** Narrated by Allen Melvin. MGM L1A

The story of a horse, his efforts to keep a snowflake alive, and of his teaming up with Santa Claus is one that children will find delightful all during the year, but particularly so during the Holiday season.

**"KIDDIE KLASSICS,"** sung by Bob Hannon. Majestic M-19.

Orchestral accompaniment to songs of childhood like, "The Walrus and the Carpenter," and "The Frog Who Would A-Waltzing Go," plus ten other favorite tunes make good listening and learning for the youngsters.

**"LITTLE STORIES FOR LITTLE PEOPLE,"** told and sung by Monica Lewis, with Ray Bloch's orchestra. Signature CF-1

This 2-record album, features the songstress in a new, and pleasant role.

**"MOTHER GOOSE PARADE,"** Narrated by Betty Martin. MGM L2A

"Jack and Jill", "Simple Simon", "Little Miss Muffett", "Humpty Dumpty", "Dickory-Dickory-Dock," and eight other equally popular Mother Goose ditties are included in this outstanding album. The musical accompaniment has its "modern adaptations."

**"THE BEAR THAT WASN'T,"** Narrated by Keenan Wynn. MGM 12A

Bear's attempt to convince that he is not a man, plus "familiar sound" patterns of factory, carnival, phones, combine fantasy with realism to make a fascinating children's album.



Billy Daniels, newly signed on the Apollo label.

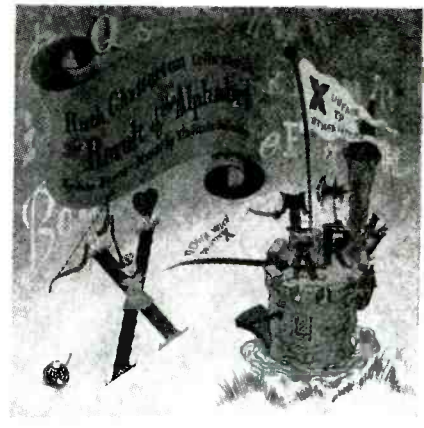

Tiffany Production's new children's album.



Featured quartet on Manor Records, the Four Tunes.



Vox duo-pianists Vera Appleton and Michael Field.

**"THE CHURCKENDOOSE,"** Ray Bolger. Decca CU 103

This barnyard story, sparked with Bolger's singing and dancing, comes on an unbreakable disc, packaged in a colorful folder; will give young listeners a good picture of the characters.

**"THE LAND OF THE LOST,"** Columbia J-MJ-38

Imaginative narration and story about the "Magic Sea Kingdom."

**"THE YOUNG PERSON'S GUIDE TO THE ORCHESTRA,"** Columbia M-MM-703

This album for children breaks down the various parts of orchestral music, shows how themes are developed and how instruments are used. It will find enthusiastic acceptance by home buyers as well as schools.



**"BENNY RIDES AGAIN,"** Benny Goodman, Capitol BD-57.

Natural for fans of B. G. Sides feature Goodman in a duo, to Goodman beating it out with a full orchestra. Part of a special promotion for season.

**"BESSIE SMITH, VOL. II,"** Bessie Smith, Columbia C-142

Former collector's items of blues singer's waxings, selected to make this outstanding album.

**"BORRAH MINNEVITCH FAVORITES,"** Borrah Minnevitich & His Harmonica Rascals. De Luxe.

"Donkey Serenade," "Lullaby," "September Song" and other standards included in album. Current popularity of harmonica music coupled with Minnevitich's past reputation, a point dealers should not overlook.

**"CAMPUS CLASSICS,"** King Cole Trio, Johnny Mercer, The Pied Pipers, Stan Kenton, Ella Mae Morse, Benny Goodman, Paul Weston, Matt Dennis, The Dining Sisters. Capitol BD-58

The album is, as the title implies, a collection of "request favorites" the artists have received during personal appearances. Extensive merchandising display material available.

**"DUKE ELLINGTON PLAYS THE BLUES,"** Duke Ellington orchestra. RCA Victor P-182

Blues in the modern jazz idiom,

(Continued on page 71; for listings of Light Concert Favorites, Folk Music, and Dramatic records see pages 74 and 75.)



# THESE COLUMBIA NEEDLES

Headed by the sensational

Columbia "Tailored-Tip"\* Sapphire

\*Trade-mark

All priced for fast profitable turnover

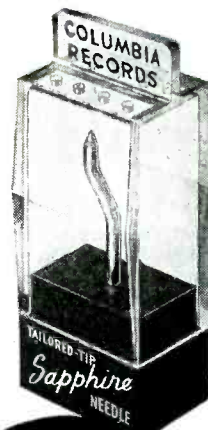

RETAILS FOR ONLY  
**\$1.50**

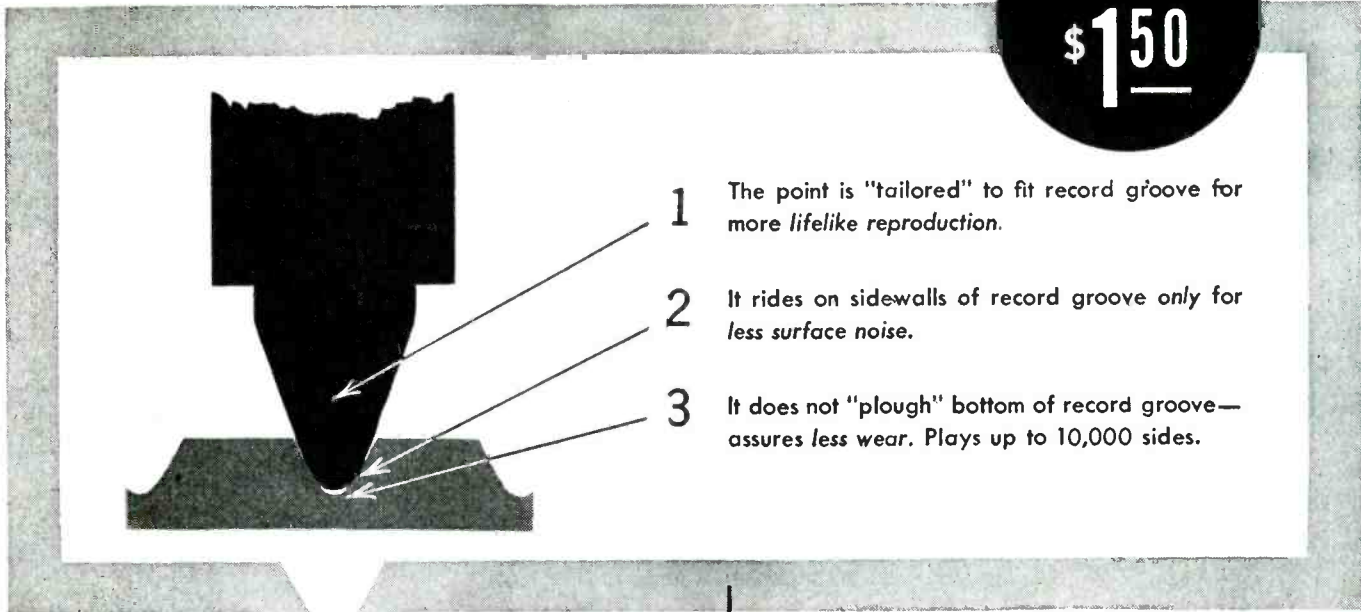

- 1 The point is "tailored" to fit record groove for more lifelike reproduction.
- 2 It rides on sidewalls of record groove only for less surface noise.
- 3 It does not "plough" bottom of record groove—assures less wear. Plays up to 10,000 sides.

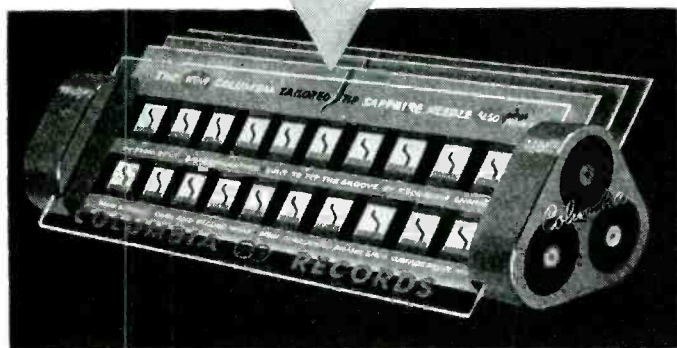

Sapphire Needle Display — Holds 60 Needles

A Columbia needle for every need! The "Tailored-Tip"\* Sapphire is microscopically shaped and designed for amazing clarity, brilliance, fidelity and long life. "Tailored" to fit the groove by master recording engineers—then Shadowgraphed for uniform perfection.

Backed by advertising in Life, Saturday Evening Post, Time, American Record Guide, and Saturday Review of Literature's supplement, "Recordings" . . . 500 radio stations!

## SELL FROM THESE 3 BEAUTIFUL DISPLAYS

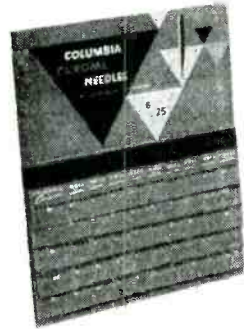

**COLUMBIA CHROMIUM NEEDLES**  
Packaged 6 to a card in clear plastic envelopes which are stapled to the handsome blue display card, 50 packages to each.  
Size: 12" x 15". Needles to package: 6.  
Packages to card: 50.  
Suggested List \$.25 per package



**COLUMBIA MASTERWORKS NEEDLES**  
Packaged 50 needles to a package, 50 of which are stapled to the eye-catching counter display shown at the right.  
Size: 12" x 15". Needles to package: 50.  
Packages to card: 50.  
Suggested List \$.25 per package

**Columbia Records INC.** 

Trade-marks "Columbia," "Masterworks" and  Reg. U. S. Pat. Off.

# New Phono Products

## GE RECORD PLAYER

Model 12 table phonograph, 4-tube amplifier, manually operated. Undistorted power output of 2.5 watts, 7½" Alnico PM speaker. Magnetic type pick-up. Wood cabinet, simply styled, contrasting control knobs. Measures 10¾" high by 15¼" wide by 13½" deep. Electronics Dept., General Electric Co., Bridgeport, Conn.—**RADIO & Television RETAILING**

## Farnsworth RECORD CHANGER

Model P-56 automatic record changer playing 10" or 12" discs automatically for nearly a full hour. Three-point record suspension, delayed drop to protect discs,

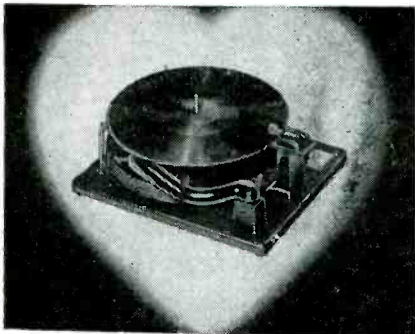

lightweight tone arm, sealed crystal pickup. Precious metal stylus, automatic stop, rim drive motor. Base dimensions are 12" by 14¼". Farnsworth Television & Radio Corp., Ft. Wayne, Ind.—**RADIO & Television RETAILING**

## Filmgraph RECORDER-REPRODUCER

Model HK portable permanent recorder and instantaneous reproducer, using two reels of 16 mm. 14" in diameter—capacity up to 5000' of M2 film with 100-sound-track width. (Each sound track has continuity up to 3 hours.) Features incorporated with each unit, and/or are available include

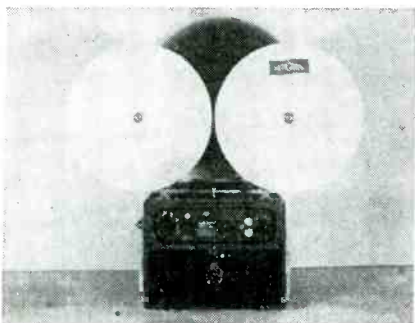

track and footage indicators; electric fast rewind; slow-down, start-stop by hand, foot, remote or voice control; monitoring during recording, neon volume level indicator, volume regulation from whisher to a roar. Weighs 30 lbs. Miles Reproducer Co., Inc., 812 Broadway, New York 3, N. Y.—**RADIO & Television RETAILING**

## Victrola SCHOOL PHONO

Classroom Senior model record player, table unit designed specially for school use. Amplifier power sufficient for auditorium, 12" speaker, separate bass and treble tone controls for reproduction demonstration by instructors. Recessed controls, pickup of special lightweight design. "Silent sapphire" soldered into place. Blonde hardwood cabinet measures 18½" wide by 14" high by 20½" deep. Suggested list price is \$99.50. Radio Corp. of America, RCA Victor Division, Camden, N. J.—**RADIO & Television RETAILING**

## Magnesonic TAPE RECORDER

Compact streamlined tape recorder for home and business use, to record radio programs, phono records, music and voice. Uses tape on reels with capacity up to one hour of recording. Can record new

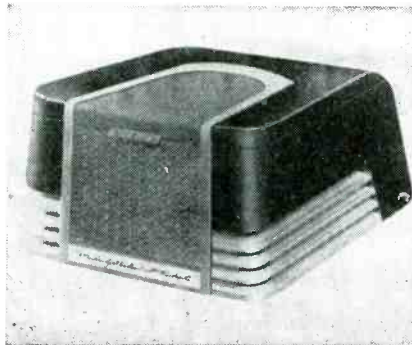

programs continuously on the same tape by automatic erasure as new material is recorded. Black ebony-finished wood cabinet. Sound Recorder & Reproducer Corp., 5501 Wayne Ave., Philadelphia, Pa.—**RADIO & Television RETAILING**

## Genex PORTABLE PHONOGRAPH

Model PE-2 portable a-c record player, manually operated, with 3-tube amplifier employing inverse feedback. Separate tone and volume controls, 5" PM dynamic speaker, tangent type pickup arm. Crystal pickup with 1¼ oz. pressure. Constant speed 75 RPM rim-drive motor. Operates on 110 v. 60 cycles. Lightweight carrying case covered with simulated leather, measures 6" by 13" by 17". Genex Corp., 663 Broadway, New York 12, N. Y.—**RADIO & Television RETAILING**

## Cardwood RECORD HASSOCK

Record hassock of solid wood construction, steel banded. Specially designed lid stop, heavy steel hardware. Model 1000 contains wire rack for 50 discs and is 14" by 14" by 17" high. Model 2000 has card index for 100 records and is 14½" by 18½" by 17" high. Model 3000 has space for eight 12" albums and is 18" by 18" by

17" high. Lined with alligator grain imitation leatherette; outside is padded leatherette of Python design in 5 colors. Seat of

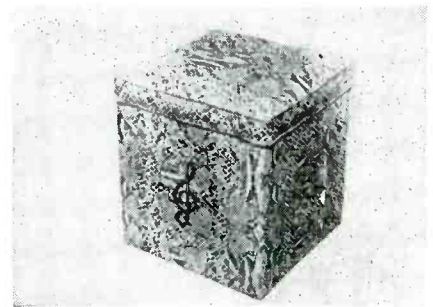

shredded rubber or rubberized hogs hair, unshiftable design so that no buttons are required for stability of padding. Cardwood Products Corp., 201-209 S. Second Ave., Mt. Vernon, N. Y.—**RADIO & Television RETAILING**

## Autocrat PHONOGRAPH

Model EPP-247 low-priced portable single record player handling 10" or 12" discs. Alnico 5 PM speaker, 2-tube amplifier including rectifier, ac only. Crystal



pickup, self-starting motor. Plywood case covered with fabricoid measures 14½" by 12¾" by 6". Autocrat Radio Co., 3855 N. Hamilton Ave., Chicago 18, Ill.—**RADIO & Television RETAILING**

## Record-O-fone PORTABLE RECORDER

Model RC-47 portable combination recorder, record player and PA system. Makes permanent recordings from any sound source at 33½ RPM or at 78 RPM. Easy connection to radio—provision for "dubbing in" while radio program being recorded. Amplifying and immediate playback features also make it useful as an instruction aid in all types of speech classes, voice and dramatics schools. Compact design. Bell Sound Systems, Inc., 1197 Essex Ave., Columbus 3, Ohio.—**RADIO & Television RETAILING**



NOW A WORTHY NEW TEAMMATE FOR THE WEBSTER • CHICAGO NYLON NEEDLE WITH JEWEL TIP



For Music Lovers Who Prefer the Playing Qualities of a Metal Tipped Needle.

Time-Tested—Sales Proved

WEBSTER • CHICAGO

*Ivory Nylon*

NEEDLE WITH THE JEWEL TIP \$3.50

**THE OSMIUM ALLOY TIP**

in the *Black Nylon* Needle is made of a rare alloy that is ideal for fine tonal reproduction, long needle and record life. It is formed by powdered metallurgy on a base of rare, expensive osmium. It is moulded under high pressure. Cintered at closely controlled temperature. And, with jewelers' precision standards, microground to a mirror-like finish. With its high polish and accurate finish, the alloy tip rides the record groove gently, smoothly, safely. It delivers a remarkably true reproduction and virtually eliminates needle scratch and record wear.

*More Sales—More Profits—More Satisfied Needle Buyers* when you sell *Both Black Nylon and Ivory Nylon PHONOGRAPH NEEDLES*. Now, for the first time, you can sell discriminating music lovers a Nylon Needle with either the Osmium Alloy Tip or Jewel Tip. Needle buyers who want the incomparable performance of "Knee-Action" can have it at their price preference—\$2.50 or \$3.50. And with either tip, and at either price, they can enjoy the finer record reproduction made possible by Webster-Chicago's introduction of the basic improvement of the "Knee-Action," nylon-cushioned playing tip.



Presented by the Makers of

**WEBSTER • CHICAGO**

RECORD CHANGERS and WIRE RECORDERS

**WEBSTER**  **CHICAGO**

5610 Bloomingdale Avenue, Chicago 39

*The Choice of Music Lovers*

**Back with  
a BANG!**

**Recoton  
RETAILER'S  
IMPRINTS**

Good news for RECOTON dealers! We are resuming our old policy of imprinting retail store names and addresses on needle packages. What better package to start with than that carrying the widely-famed and heavily-demanded SUPERTONE PHONEEDLE... With your order for 10 cards or 10 cartons, your name and address are imprinted FREE on every Supertone package.

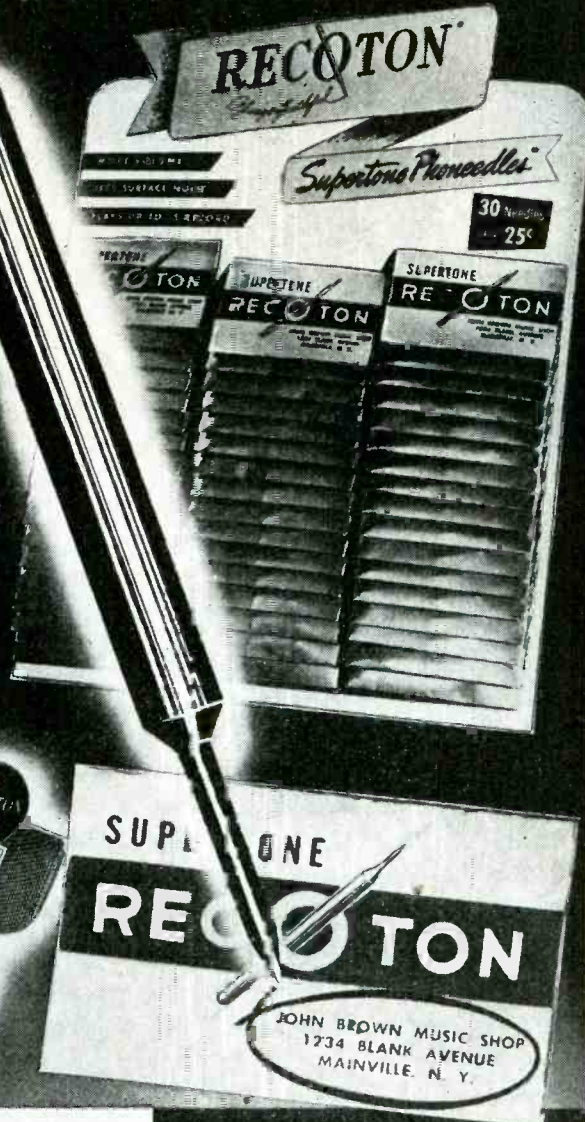

**HERE'S YOUR PROFIT**

|   |         |
|---|---------|
| LIST PRICE PER CARD<br>or PER CARTON..... | \$12.50 |
| YOUR REGULAR COST.....                    | 6.25    |
| Special Imprint Discount.....             | .62     |
| YOUR NET COST.....                        | \$ 5.63 |
| YOUR PROFIT.....                          | \$6.87  |

**IMMEDIATE DELIVERY!**

**RECOTON**

RECOTON CORPORATION  
251 North Avenue, New York 10

\*Reg. U. S. Pat. Off.

**Permo Selling Aid**



Premo, Inc., manufacturers of Fidelitone floating-point needles, is offering dealers a combination counter display-dispensing unit. The easel-display features an actual Fidelitone Master needle in its package, surrounded by a brilliant display background. The board carries a tamper-proof needle supply on its back.

**Columbia Disc Series**

Columbia Records' "Add-A-Part" series, is in production and will be available in record stores. These records provide an opportunity for aspiring instrumentalists and singers to practice in the company of well-directed and technically correct musicians.

On these records all of the parts of a chamber-music composition are recorded with the exception of one instrument. Thus in the chamber music selections an instrumental enthusiast may "sit in" with a highly skilled chamber music group and play his own instrument and, in others, sing to piano accompaniment. Add-A-Parts are divided into three groups, easy, medium, and difficult, so that the beginner may build an Add-A-Part library as his ability with his chosen instrument grows. Each album and record is accompanied by a complete musical score with the missing part written clearly and in full. It includes a running line of the music shown above the missing part so that the player can at all times have a picture of the interplay of the other instrumental parts with his own.

**Jubilee Record Firm**

Jerry Blaine, president of Jubilee Records, 760 Tenth Ave., New York City, announced that Cosnat Distributors will handle his firm's records in the New York, Conn., Mass., and New Jersey territories. Jubilee releases feature Lee Tully in "Essen, Parts I and II," and "Today I Am A Man" coupled with "Annie's Got A Fella."



THRU EXCLUSIVE ARRANGEMENT WITH THE

GOVERNMENT OF CZECHOSLOVAKIA

KEYNOTE

*Announces*



The Entire Collection  
of Symphonic Music  
Recorded by the  
World Famous

ULTRAPHON,  
ESTA and  
SUPRAPHONE Companies

Will Be Available to Your Customers on

# KEYNOTE RECORDS

*at popular prices*



## KEYNOTE MANUSCRIPT RECORDINGS

(Extended Frequency Range)

Now Available for  
Immediate Delivery

### STRAVINSKY:

Dumbarton Oaks Con-  
certo ..... \$3.75

### VIVALDI:

Concerto Grosso in D  
Minor ..... \$1.75

### SHOSTAKOVICH:

Opus 3, No. 73 ..... \$6.75

Now, for the first time, you can offer your customers the long hoped-for great symphonic music of such famous European artists as the Concertgebouw Orchestra under Mengelberg, the Czech Philharmonic under Kubelik, Oistrakh the great Russian violinist, Fritz Heitmann, Kleiber conducting the Belgian National Orchestra in works by Tchaikowsky, Prokofiev, Dvorak, Smetana, Bach and Hindemith and many other old as well as contemporary masters. Faithfully reproduced in America by Keynote from the superlative master recordings originally made by Ultraphon, Esta and Supraphone, these popular priced distinguished albums and records will create a sensation among music lovers and record collectors. Be sure of your share of this brand new profit opportunity... order the first 10 new albums in the Keynote-Czech series from your distributor now for guaranteed delivery before the Christmas season. \$1.25 per 12" record.

Watch for the First Dealer Promotion that "Promotes the Dealer"  
Soon to Be Announced by

## KEYNOTE RECORDINGS, INC.

Chicago • 522 Fifth Avenue, NEW YORK • Hollywood

## Keynote Dealer Help

Keynote Records, Inc., is supplying dealers with match covers, on a monthly basis. Depicted on the cover are miniature reproductions of two new Keynote album releases. On the inside of each cover is printed one letter of the word "Keynote." It is suggested that dealers enclose a pack of matches with each sale. When the customer collects the whole word, "Keynote," on separate covers, he will receive a Keynote album of his own choice free. Dealers will receive a full retail credit for each album given away.

## MGM Calif. Jobbers Have Dealer Pic Preview



Sues, Young & Brown, Inc., distributors for MGM records for the state of California, invited record dealers to a special preview of the film, "The Unfinished Dance," in connection with the new MGM album of the same name. Shown at the preview, looking at the album, are, l. to r.: E. E. Young, treasurer, Sues, Young & Brown, Inc.; Jesse Kay, MGM's western talent representative; N. Callicott, manager, MGM record department; Clarence Brown, producer-director; M. G. Sues, president, Sues, Young & Brown, Inc.

Up Profits! Boost Sales! Speed Turnover with



*A New Label*  
Specializing in  
**CHILDREN'S**  
*Non-Breakable*  
**RECORDS**

- Album 10 — PINOCCHIO
- Album 12 — SNOW WHITE
- Album 16 — SLEEPING BEAUTY
- Album 18 — CINDERELLA
- Album 20 — FAVORITE NURSERY SONGS & GAMES
- Album 22 — ALICE IN WONDERLAND

Album 14 — *Irving Caesar's*  
**SONGS OF SAFETY**  
(music and sound effects)

*Vinylite and*  
*Vinyl Plastic*  
*in Colors*

LIST \$ **2.95** PLUS TAX

Each Album  
Contains 2 Records

**Melodee**  
**RECORDS INC.**  
314 West 52 Street  
New York 19, N. Y.

Choice territories still available. Distributor inquiries invited.

## RCA Victor Music Books Promotion Folder Ready

Six books on music appreciation published by RCA Victor for use in schools and homes are promoted in a new folder offered to record distributors by the company's educational sales department.

The two-color folder, 3½ x 8¼ inches in size, opens to an 11 x 8¼ inch sheet on which are described six different music appreciation books. The cover features an original music signature design, and space is available on the back of the folder for dealer imprint. Suggested uses include distribution to summer schools, teachers' institutes, and general mailing as an envelope stuffer.

## Duotone "Sized" Needle

Stephen Nester, president of the Duotone Co., 799 Broadway, New York City, announces the production of a series of phonograph needles, to be sold according to size.

Mr. Nester stated that needles "in sizes" were necessary because those now in use are not successful on pre-war records, and on many European records. The sizes are as follows: .015, .020, .023, .025, .028, .030. Duotone is marketing the new needles in packages of six star sapphires for \$25.00, and individually for \$5.00 apiece.

## Atlas Disc Jobber

Raymond Gregori, vice-president, Atlas Record Co., Hollywood, Calif., had named the Midtown Distributors, 1674 Broadway, New York City, as its representative in that area.





Movable lever to demonstrate the needle's unique spring action

NOW—the Fidelitone SUPREME in a setting as artistic and brilliant as the needle, itself; as crystal-clear as its reproduction. This brand new Plexiglas Counter Display is available at your Fidelitone distributor.

**PERMO, Incorporated** CHICAGO 26  
More Permo Needles sold than all other  
longlife needles combined



## RCA Victor Presents "Airborne Symphony" to Army



The first RCA Victor album of records of Marc Blitzstein's "Airborne Symphony," written while the composer was a member of the U. S. Eighth Air Force in England, was presented for inclusion in Army Air Force's archives. Shown at the brief ceremonies, are (l. to r.): Lt. Gen. George E. Stratemeyer, commanding general, Air Defense Command; Mr. Blitzstein; Lt. Henry Kane; Maj. Gen. Charles B. Stone, III.

## Columbia Xmas Promotion

Columbia Records, Inc., has prepared a variety of material for dealer use in Christmas promotion planning. Included is a three dimensional Christmas tree with album illustrations, a mailing piece illustrating 34 albums in full color and listing 100; a children's catalog similar to a comic book; a Christmas supplement; 3 full-color hangers; 300 record merchandiser cards; cooperative ads; special Xmas issues of "Disc Digest" and "Promotion News."

## Continental Expansion

Donald Gabor, president Continental Records, New York City, and Anthony J. Dillon, sales manager, have completed a trip throughout the U. S., signing up many new distributors for the Continental line of foreign, popular and children's records. Mr. Dillon, on his return, remarked that the "Continental family of distributors has increased substantially."

## Vox President Tours

George H. Mendelssohn, president of Vox Records, is touring Europe, looking for new recording talent. He supervised recording sessions in France with Gaby Casadesus, pianist, and Otta Klemperer, conductor. Vox is the exclusive U. S. agent for Polydor records.

## Lissen Releases

James Brown, president, Lissen Records, 255 W. 43 St., New York City, has announced that Jimmy Foster, Lissen recording artist, has waxed two new releases: "Cuban Love Song" backed with "You're Not So Easy to Forget," and "Hold Me," flipover, "Still You're Mine."

## MGM Jobber Plans Album Contest

Gil White, MGM record manager, Northeastern Distributors, Inc., found that dealers and clerks were very interested in his firm's special MGM "Holiday for Strings" album contest. White offered \$100 to the record clerk who made the best showing in the sale of "Holiday for Strings," MGM album featuring David Rose. The success and interest shown in this contest indicates that there will be bigger and better contests in the offing, says White.



# The Revolt of the Alphabet

A really new and unique album of an original and delightful fantasy . . . . . narrated by

**RUTH CHATTERTON**

Famous screen and stage star

Music written and conducted by **VLADIMIR SELINSKY.**

Contact your nearest distributor or send coupon.

Garden State Distributing Co.  
98 Lock St., Newark 4, N. J.

Midtown Distributing Co.  
1674 Broadway  
New York, N. Y.

Scott-Crosse Co.  
1857 Spring Garden St.  
Philadelphia, Pa.

Barnett Distributing Co.  
15 East 21st St.  
Baltimore, Md.

Milhander Distributing Co.  
619 Atlantic Ave.  
Boston, Mass.

**UNBREAKABLE — UNBEATABLE — \$2.98 tax. incl.**



## Xmas Discs

(Continued from page 62)

sparked by Ellington's piano, gets full play in this collection.

"GENE KRUPA," *Columbia C-138*  
Instrumentals as well as vocals by Anita O'Day, Roy Eldridge and Irene Day included in this collection for Krupa fans.

"PROM DATE," *Tex Beneke with the Miller orchestra. RCA Victor P-183*  
Specially for college dates and

proms, dealers will find this collection of danceable arrangements of eight college favorites a good seller.

"THEME SONGS, Vol. II," *Columbia C-140*

Theme songs of Frankie Carle, Gene Krupa, Claude Thornhill, Les Brown, Xavier Cugat, Dick Jurgens, Elliot Lawrence and Ray Noble included in this album.

ANDREWS SISTERS, "Near You"  
—"How Lucky You Are." *Decca 24171*

"Near You" tune had been slated for "top tune" lists.

BAILEY, PEARL, "St. Louis Blues"  
—"Get It Off Your Mind." *Columbia 37570*

Pearl Bailey's unique talents are show-cased in these "different" pairings.

CARLE, FRANKIE, ". . . And Mimi"  
—"For Once In Your Life." *Columbia 37819*

Two lyrical sides for listening and dancing.

CLARK, BUDDY, "I Kiss Your Hand, Madame"—"They're Mine—They're Mine . . ." *Columbia 37592*

Old favorite, coupled with new love tune.

CROSBY, BING, THE ANDREWS SISTERS, "The Freedom Train"  
—"Star Spangled Banner." *Decca 23999*

"Freedom Train" is the new Irving Berlin song, especially written for the "Freedom Train" caravan which is touring the country, stopping at various towns, and presenting programs designed to encourage the spirit of democracy. Innumerable tie-in possibilities.

CUGAT, XAVIER, "Un Poquito de Amor"—"Rumba at the Waldorf." *Columbia 37829*

Rhythmic numbers, suited for Latin-American dancing.

DANIELS, BILLY, "Butterfly"—"Diane." *Apollo*

Billy Daniels' intro plattering for Apollo.

DAY, DENNIS, "Ya Shure You Betcha"—"Christmas Dreaming." *RCA Victor 20-2377*

Dennis' radio fans are well aware of his talents as a mimic, which he aptly demonstrates on the first side; reverse is a straight romantic tune.

DOREY, RAY, "Why Should I Cry Over You"—"Boulevard of Memories." *Majestic 7268*

Dorey does a bouncy disc coupled with a sentimental ballad.

ECKSTINE, BILLY, "The Wildest Gal in Town"—"On the Boulevard of Memories." *MGM 10069*

The blues baritone's following will go wild over these two tunes, especially suited to his style.

FOUR CHICKS AND CHUCK, "Kokomo, Indiana"—"The Turntable Song." *MGM 10070*

First side is from film, "Mother Wore Tights"; reverse is tune from "Something In the Wind."

HERMAN, WOODY, "Somebody

(Continued on page 73)

# RECORD Business! O P A S T U V W X Y Z

- So good it was recently broadcast live over the coast-to-coast network of the American Broadcasting Company.
- So good thousands of listeners have been asking their local dealers for the album.
- So good a first order will turn over immediately for you.
- So good Newsweek Magazine says of it: "... Due for the biggest play."
- Don't miss new business on the sensational new album.

## The Revolt of the Alphabet

tear off this coupon today

ORDER NOW! Use the coupon below. Albums will be shipped to you immediately.

TIFFANY PRODUCTIONS, Inc.  
200 W. 57th St., New York 19, N. Y.

Yes, I want a quick record turnover! Please rush to me—  
REVOLT OF THE ALPHABET Albums at \$2.98 incl. tax, less  
40% discount.

Dealer's Name \_\_\_\_\_  
Street Address \_\_\_\_\_  
City and State \_\_\_\_\_  
My Distributor's Name \_\_\_\_\_  
 Check Enclosed  Ship Collect

Distributors:  
Territories available. Write or wire today.

TIFFANY PRODUCTIONS, Inc., 200 W. 57th St., New York 19

## Melodee Distributors

Melodee Records, Inc., 314 W. 52 St., New York City, has named the following distributors for its line of records: Barnett Dist. Co., Baltimore, Md.; Chord Dist., Chicago, Ill.; Crowe-Martin Dist., Houston, Tex.; Kayler Co., Phila., Pa.; Merle Weiss Dist. Co., Pittsburgh, Pa.; Niagara Midland Co., Buffalo, N. Y.; The Parker Co., Dist., Denver, Colo.; Philippine Education Co., Inc., Manila, Philippines; Southland Dist. Co., Atlanta, Ga.; Thomas Music Supply, Detroit, Mich.; Melody Record Supply Inc., New York City; Pacific Jobbers, Honolulu, Hawaii; Seminole Dist. Co., Miami, Fla.

## RCA Victor Air Show

"Music You Want," the RCA Victor Records radio feature which is now being carried by 55 independent radio stations throughout the country as a five nights a week program devoted to classical music, celebrated its tenth anniversary on the air. The program, forerunner of many of the present-day recorded classical music shows, commemorated the event with a series of special programs.

## Keynote Appointee

Charles D. McKinnon has been placed in charge of eastern division sales for Keynote Recordings, Inc.

## Honor Columbia Artist



Dorothy Shay visited the town of Flat River, Mo., (topic of one of her most popular songs) and appeared in the local record shop to autograph her latest albums. In honor of "The Park Avenue Hillbillie" the day was proclaimed "Dorothy Shay Day."

## New MGM Artist

Evelyn Tyner, pianist, has been signed to record for MGM Records. Miss Tyner was featured as piano soloist with the Cleveland Symphony Orchestra.

## Recoton Dealer Aids Tie-In With National Ads

Recoton Corp., makers of Recoton supertone phonedneedles, announced that they are taking orders for dealer package imprints. Recoton will imprint dealer's name and address on individual packages of supertone needles with orders for 10 display cards or 10 cartons. Regular dealer's discounts prevail plus special discounts on imprint orders.

In addition, the company has prepared special newspaper ad mats for local dealer advertising, which have been timed to tie-in with national advertising.

## Vox Chicago Office

Vox Records has opened its third branch office, adding to the New York and Los Angeles branch set-up. The address of the new Chicago office is 605 W. Washington St.

## Apollo Sales Upswing

Henry Servais, general sales manager of Apollo Records returned from a survey trip through the south, and reported a reshuffling of Apollo branch management, with plans for added distribution in the South and West.

Apollo also reported an upswing in sales, partly due to clicking of Murphy Sister's recording of "Breaking In a New Heart."

**KEEPS DUOTONE UP FRONT EVERY MINUTE...  
GET YOURS NOW AND WATCH SALES SKYROCKET!**

Here's a counter card, storage bin and silent salesman all in one! The brand new Duotone "Show Window" is a smartly-styled counter display case of wood and lucite that features the fast-selling line of Duotone Needles. Each package in the "Show Window" nestles in a handsome blue plush lining. An attractive glass top protects the contents. It's only 29" high, 12" long — takes up little room on your counter.

Your customers will stop, look and buy when they see this handsome display. You simply serve them from the built-in stock compartment. Here's an easy way of selling that gives you quick turnover . . . and rings up more profits.

Phone or wire your distributor today (or inquire direct) for our Special Introductory Offer on the new Duotone "Show Window".



**DUOTONE**

**DUOTONE COMPANY**

799 Broadway, New York 3, N. Y.

Stephen Nester, President

Export Dept.: American Steel Export Company, Inc., 347 Madison Avenue, New York 17, N. Y.



## Capitol Promotions



Capitol's "Back to School" promotion package features merchandising aids for dealers, and special albums "Benny Rides Again," starring Benny Goodman, and "Campus Classics," starring a variety of Capitol artists.

## Xmas Discs

(Continued from page 71)

**LOVES ME**—"Baby, Baby All the Time." Columbia 37820

Tune from "George White's Scandals," still popular today, "Somebody" gets a good Herman treatment; reverse features Woody in a blues mood.

**HOLIDAY, BILLIE**, "Long Gone Blues"—"Am I Blue?" Columbia 37586

Traditional blues done in the inimitable Holiday styling.

**HUMES, HELEN**, "Be-Bop Bounce"—"I Don't Know His Name." Black & White 114

Be-Bop swing and a lusty blues ballad sung by Humes gal.

**JONES, SPIKE**, and his City Slickers: "Our Hour"—"The Pop Corn Sack." RCA Victor 20-2375

The humorous Jones effects, complete to popping paper bag, are heard on this coupling.

**JURGENS, DICK**, "When You Were Sweet Sixteen"—"On the Avenue." Columbia 37803

"Sweet Sixteen" is an everlasting favorite; reverse is a sparkling ditty in a cheerful tempo.

**MARTIN, TONY**, "Lazy Country Side"—"Too Good to be True." RCA Victor 20-2396

Martin warmly delivers two tunes from the latest Walt Disney production, "Fun and Fancy Free."

**MORALES, NORO**, "Wha' Hoppeen Baby?"—"Rumba Fantasy." Majestic 1166

(Continued on page 74)

## New Columbia Needle

Columbia Records Inc. has put on the market a new long-life phonograph needle which it is believed will last for approximately 10,000 plays. Called the "Tailored Tip" needle, it has been developed by Columbia Records engineers.

The design feature of the new long-life needle is the fact that it has been "tailored to fit the groove" by master recording engineers—in other words, that the point has been ground to an angle and tip radius so that the needle rests on both sides of the record groove, rather than on the bottom. Sapphire was chosen for

the tip, and each tip is microscopically ground and shadowgraphed to insure exact dimensions. The tip radius chosen is suited both to the wide grooves of older recordings and those of present day records. The needle is priced at \$1.50.

## New Victor Artists

James W. Murray, vice-president in charge of RCA Victor Record activities announced that Virginia MacWatters, coloratura soprano, Igor Stravinsky, composer and conductor, and George London, bass-baritone, have been signed to exclusive RCA Victor recording contracts.



## Your Steady Sales Builder All Year 'Round

Here's a fast-selling album that typifies the beauty of design and sturdiness of construction found throughout the entire UNITED line! With simulated leather backbone, strong leatherette cover and heavy kraft pockets, this album is built for long, hard use.

No. 412, for 12" records, retails around \$1.30. No. 410, for 10" records, retails around \$1.00. Either size in red or brown. Stock a complete line of UNITED Albums for steady, year 'round sales!

**UNITED LOOSE LEAF CORPORATION**  
233 Spring Street • New York 13

## Xmas Discs

(Continued from page 73)

"Fantasy" is a Morales instrumental, adapted from "Capricio Espanol." "Baby" side is an original with Bob Johnstone on the vocals, and bright Morales piano passages.

SHEBOBLOU TRIO, "What Is This Thing Called Love?"—"These Foolish Things." Chord 640

Piano, drum and bass trio recording.

SHORE, DINAH, "It Takes a Long Long Train with a Red Caboose"—"Do A Little Business On the

Side." Columbia 37840

"Train" side features a boogie woogie piano beat, with Dinah telling the lyrical blues story. Flipover is a straight ballad.

SHORE, DINAH, "The Stanley Steamer"—"I'm Out to Forget Tonight." Columbia

First side is from "Summer Holiday," with the Modernaires assisting.

SINATRA, FRANK and the CHARLOTEERS, "I've Got a Home In That Rock"—"Jesus Is a Rock in the Weary Land." Columbia  
Sinatra teams with the vocal group

to present two sides in a different vein.

SINATRA, FRANK, "The Stars Will Remember"—"Christmas Dreaming." Columbia 37809

Two new sentimental ballads, that the Sinatra fans will rush to buy.

SPIVAK, CHARLIE, "A Little Bit Longer"—"What Are You Doing New Year's Eve?" RCA Victor 20-2395

"Sweetest Trumpet" bandleader turns out two danceable discs.

SMITH, KATE, "God Bless America"—"Bless This House." MGM 30025

The first song needs no introduction to Americans. Both sides are particularly timely, especially during the Christmas season when thoughts of home, God and country are uppermost in people's minds.

THE THREE SUNS: "On the Avenue"—"Sentimental Souvenir." RCA Victor 20-2393

"Sentimental" side done in the familiar pattern of other Three Suns hits.

THORNHILL, CLAUDE, "Early Autumn"—"Oh You Beautiful Doll." Columbia 37593

Two contrasting sides, featuring Thornhill piano passages.

WAYNE, ARTIE, "That's What Your Heart Is For"—"One Little Tear Is an Ocean." Majestic 1168

Wayne's first Majestic waxing features the singer in a novelty-gimmick song and a slow ballad.

Continuing Our Fast-Moving Parade of

# MUSAGRAND

THE NEW 1948

## RECORD CABINETS

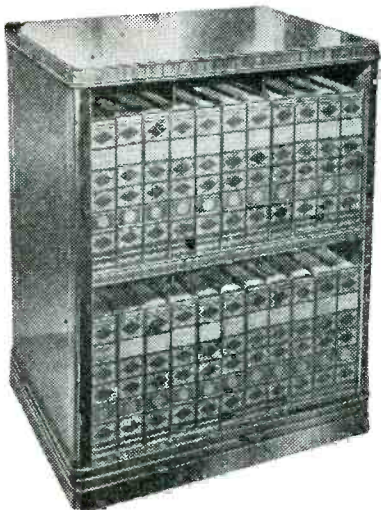

**6 TO SEE!  
TO SELL!**

3 Models with Doors  
3 Models without



- Spacious Top will Hold any Size Table - Model Radio - Phono Comb.
- Walnut and Mahogany Veneers, Superbly Finished.
- Packed in Air-Cushioned Cartons.

**MODEL #4850:**  
pictured above. Holds 22 albums, 264 records. Dimensions 31x18x23½

**MODEL #4875:**  
holds 20 albums, 240 records with doors. Walnut only. Dimensions 30x22x16

**MODEL #4845:**  
holds 11 albums, 132 records serpentine bow front. 25¾x23½x16½

**MODEL #4880:**  
holds 22 albums, 264 records with doors. Mahogany only. 32x16½x24½

**MODEL #4855:**  
holds 22 albums, 264 records. Serpentine bow front. 31x23½x16½

**MODEL #4885:**  
holds 22 albums, 264 records with doors. Blond only. 31¾x23¾x16½

**JOBBERS:**  
protected territory available. Inquiries invited. Write to

MANUFACTURED BY  
**ECKENROTH CO.**  
32-50 ROSS ST., BROOKLYN, N. Y.

## LIGHT CONCERT FAVORITES

"A PATRICE MUNSEL PROGRAM," Patrice Munsel, soprano, with Al Goodman and his orchestra, and the Guild Choristers. RCA Victor

Miss Munsel's first album features Spanish and Latin-American popular songs such as "Dark Eyes," "Estrellita" and "Cielito Lindo." Her large radio audience will like these songs.

"An IGOR GORIN PROGRAM," Igor Gorin, baritone. RCA Victor M-1125

Slavic Gypsy songs in the popular vein, "Dark Eyes," "The Volga Legend," and some light opera favorites are included in this album.

KULLMAN, CHARLES, "The Whiffenpoof Song"—"The Sweetheart of Sigma Chi." Columbia 4500-M

Tenor Charles Kullman performs two college favorites, recently re-popularized.

(Continued on page 75)



*In the Spotlight ...*

**Bagshaw**  
NEEDLES

World Famous  
Since 1892

*with National Advertising!*

Bagshaw Phonograph Needles are being advertised in Down Beat, Etude, American Record Guide, and 16 other publications most read by the record-buying public.

Capitalize on this concentrated advertising by continuing to feature Bagshaw's Needles — the world's most famous, most widely distributed phonograph needles!

Send for New Catalog "E" and Current Price Lists

**H. W. ACTON CO., INC.**  
Sole Distributor  
370 Seventh Ave., New York 1, N. Y.

**THE WHOLE COUNTRY'S**

**JUST BUSTIN' WITH** //

**"Essen"**  
(ENGLISH-JEWISH NOVELTY)

**JUST RELEASED**  
And Already Soaring  
in Popularity

Two New Hits by—  
**LEE TULLY**

**"TODAY I AM A MAN"**

**"ANNIE'S GOT A FELLA"**

Your territory may still be open  
for distribution.  
Write, Wire

**JUBILEE RECORDS**  
760 TENTH AVENUE, NEW YORK, N. Y.

(Continued from page 74)

"POPULAR ORGAN SOLOS, Don Baker. Columbia C-137

Don Baker has been heard by millions of people at the New York Paramount theatre, where he plays the organ. This collection contains a wide choice of songs selected for their popularity as well as for their ability to show off the deep and varied tones of the organ.

**DRAMATIC**

GIELGUD, JOHN, "The Importance of Being Earnest"—"Lady Windermere's Fan." Decca DU-90012

Two scenes from two popular plays of Oscar Wilde, were waxed in this recording by John Gielgud, who played the stage roles at various times. The witty lines are delivered crisply and clearly.

MOORHEAD, AGNES, "Sorry, Wrong Number." Decca DAU-2  
Dramatic radio play is recorded with all the suspense and thrill kept intact.

"BETWEEN AMERICANS," narrated by Kate Smith; written by Norman Corwin. MGM 7A

This album is notable for two reasons. One, it presents the first Corwin work ever written for records; and it affords Miss Smith an opportunity to draw at the heartstrings in the same way she does on her daily radio broadcasts. The album is a treatise on "the American way of life."



ACUFF, ROY, and his Smoky Mountain Boys: "Blue Eyes Crying in the Rain"—"The Devil's Train." Columbia 37822

A love ballad is coupled with a religious-type Western for an interesting disc.

BOND, JOHNNY, and his Red River Valley Boys, "Fat Gal"—"Too Many Years Too Late." Columbia 37856

"Fat Gal" a humorous tune telling virtues of a plump girl friend; reverse, a Western lament.

BILL BOYD, and his Cowboy Ramblers, "Now Or Never"—"Tellin' Lies." RCA VICTOR 20-2379

Tuneful electric guitars and banjos accompany the two song stories, of unrequited love.

(Continued on page 76)

**IT'S NIFTY...  
IT'S THRIFTY**

**IT'S THE**

**Worin**

**ONE-FIFTY**

**SAPPHIRE  
NEEDLE**

Dealers say . . . Nifty is the word for this new, balanced dural shank needle with sapphire tip precision polished for perfect record groove fit.

Thrifty? . . . your customers get thousands of pleasing plays for only \$1.50. At least twice the life of any metal needle at any price.

Top quality at a price patterned to sell and sell and sell.

Attractive self-selling display card carries clever sales shorts that pack a real punch.

Order a card now and receive 2 One-Fifties absolutely free! There's \$3.00 extra profit for you on each card purchased.

**INDUSTRIAL SAPPHIRE MFG. CO. INC.**  
131-35 AVERY AVENUE FLUSHING, N. Y.

SEND (at regular dealer list price) ( ) One-Fifties, mounted twelve per display card, plus my bonus, plus ( ) color brochures describing the entire *Worin* line.

Name \_\_\_\_\_

Address \_\_\_\_\_

**MAIL TO YOUR DISTRIBUTOR OR DIRECT TO INDUSTRIAL**

# MULTIPLY YOUR MOVES WITH alliance MOTORS



• Millions of Alliance Phonomotors made for the radio industry bring mass-production "know-how" to the manufacture of Alliance Powr-Pakt Motors . . . motors from less than 1-400th h.p. on up to 1-20th h.p.

And so, besides driving turntables, record changers and tuning devices, Alliance motors are vital power links in modern operations which call for more motion—remote control—automatic action!

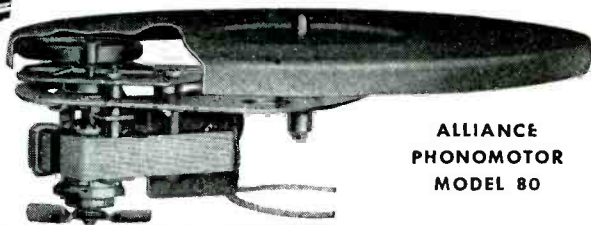

ALLIANCE PHONOMOTOR MODEL 80

WHEN YOU DESIGN ... KEEP

## alliance

MOTORS IN MIND

ALLIANCE MANUFACTURING COMPANY • ALLIANCE, OHIO

## Lissen LEADS THE WAY!

with

### JIMMY FOSTER

singing



You're Not So Easy to Forget } LR 1038  
Cuban Love Song }

Hold Me } LR 1039  
And Still You're Mine }

★ ★ ★ ★ ★ ★ ★ ★  
*Lissen!* We're giving the best in records—we want the BEST in DISTRIBUTORS

★ ★ ★ ★ ★ ★ ★ ★

### LISSEN RECORDS, INC.

255 W. 43rd St., New York, N. Y. LA 4-0120

## Xmas Discs

(Continued from page 75)

GUTHRIE, JACK and his Oklahomans, "Oklahoma's Calling"—"Please, Oh Please." Capitol A40032

Cowboy ballads with interesting instrumental backgrounds.

JOHNSON, ROME, "The Waltz of the Wind"—"Someday You'll Thank Me." MGM 10068

Western folk singer, accompanied by his Saddle Pals, does two love ballads of the hills.

LONZO and OSCAR, "My Adobe Hacienda"—"Cornbread, 'Lasses and Sassafras Tea." RCA Victor 20-2378

Adapting a popular tune to the Western way, is done on first side; flip is an original which is familiar to the team's radio fans.

"SQUARE DANCES," Riley Shepard, with Shorty Long and his Santa Fe Rangers. Signature F-1.

"Turkey in the Straw," "Sailors Hornpipe," and "Ta-Ra-Ra Boom De-Ay" included in this square dance collection, without calls.

"WESTERN POLKAS," Tex Williams and his Western Caravan. Capitol AD-56

Well-known polkas done with that "Western" accent on the right musical syllable.

## Disc Accessories Make Good Gifts

(Continued from page 57)

purchasers obviously depends on the customer and the recipient. Many of the portable record carrying cases are specifically designed for the teenage trade. These cases are equipped with indexed file holders, and are lightweight and good-looking enough to be carried with pride by girls as well as boys. Parents are "natural" prospective purchasers, along with school chums.

Youngsters can please the family by presenting them with a hassock-type unit, which Dad can use for comfort, and mother will enjoy for its good looks. A furniture-styled storage piece, which the dealer knows will blend with the home combo cabinet, can also be sold for the home.

There's more to the record business than merely selling records—and retailers have to concentrate on all the angles—if they want to realize the "great expectations" that are in store for the coming Christmas selling season.



# ELECTRICAL APPLIANCES

Section of **RADIO & Television RETAILING**

## Get **MORE** Christmas **Business!**

**The Dealer Who's Ready for the Early-Bird Customer Can Increase His Yuletide Sales Volume**

● The earlier the dealer surrounds his store with a Christmas atmosphere, the more large and small electrical appliances he can expect to sell as gifts.

Though numbers of "major" household products are bought upon a spur-of-the-moment impulse, and certainly even more small appliances are selected during the last minute rush, the fact remains that *most* are ordered only after careful consideration and deliberation on the part of the customer.

As a rule the customer requires "time" to think it over when he purchases an electric refrigerator, a range, or a piece of motor-driven laundry equipment. That's why it is important to keep suggesting such appliances as gifts long in advance of the peak buying period. The dealer who gets a down payment to "reserve" an article for Christmas delivery has the order in the bag.

### **Tune-In on Trend**

Since there is a definite trend on the part of the shopper to shop early, it is important also to keep up an advance suggestion barrage on small appliances as ideal gifts. Many Christmas gifts are purchased this month to be stored away by the customer as a means of avoiding the rush. Numbers of large appliances will be reserved—more than ever before—because buyers are still shortage-conscious, and most will be loath to take a chance on being disappointed.

Right now, most retail merchants are in a Christmas "rush" of their own. They are in the middle of their annual Yuletide buying. They are

selecting the products they feel will appeal most to the people in their respective communities.

### **"Stretch" the Season**

But they know that the only reason they're buying all these Christmas products is because they hope to sell them readily—and at a profit. Therefore they're keeping a weather eye on the selling end, too.

Right after Thanksgiving is not too early to get Christmas show-windows in, and to start making the inside of the store take on a Christmas look. Numbers of dealers start

promoting sales of Yuletide gifts even earlier.

The dealer who gets off to an early start in promoting his store as Christmas gift headquarters is in line to "stretch" the holiday buying period in his store. Such merchant's volume will be much larger than that of the one who puts off his own buying, and his own promotion to customers. "Too little and too late" will be the answer to an unsatisfactory volume in the store of the procrastinator.

Every man, woman and child in the United States believes that the  
(Continued on page 137)



Only **Gibson** Has

# UPS-A-DAISY

... **Greatest Selling Feature of them all!**

**4 SURFACE UNITS OR  
3 SURFACE UNITS PLUS  
DEEPWELL—All on  
the same Range!**

The Gibson Kookall Automatic is the high-profit item that out-features every other electric range on the market! In addition to UPS-A-DAISY, the innovation which all your customers will want, the Gibson has waist-high broiler; two complete ovens; easy-clean porcelain-on-steel finish; concealed oven vent for greater cleanliness; fluorescent lighting—features on features that add up to *sales appeal!*

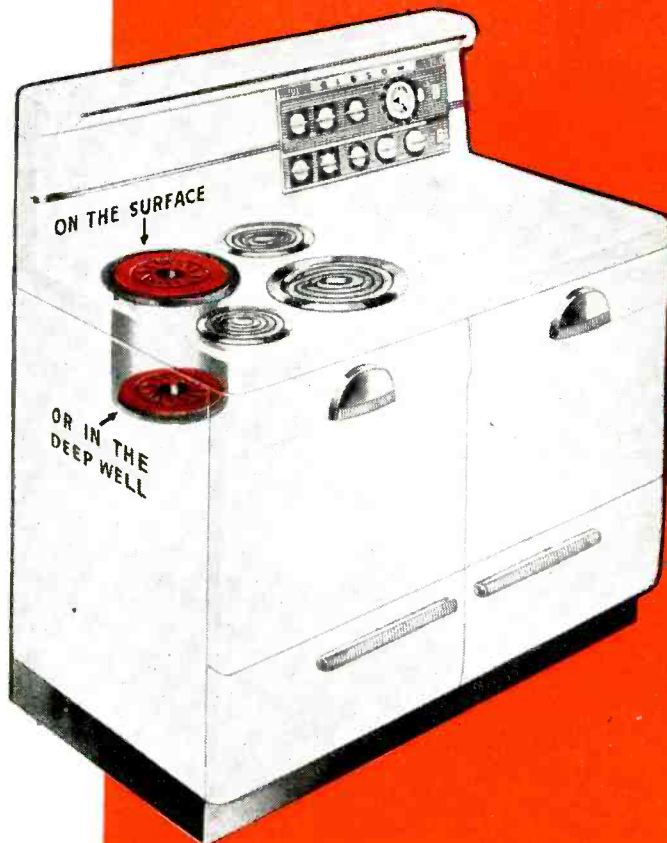

## GIBSON HOME FREEZER

Space-saving, upright design—no more diving and fumbling for frozen food packages. Five spacious lockers, each behind an individual, clear-glass door. Another Gibson profit builder for aggressive dealers.



## GIBSON FREEZ'ER LOCKER REFRIGERATOR

Keeps frozen foods at the peak of flavor perfection for months... Its spacious, wall-to-wall *Fresh'ner Locker* keeps fresh meats, fruits and vegetables vitamin-full and farm-fresh for days!



## GIBSON REFRIGERATOR COMPANY

GREENVILLE, MICHIGAN

Copyright 1947, Gibson Refrigerator Co.





# Where to Get Leads

## Names of Good Prospects Available from Local Sources

● Now that the go-out-and-sell days are here again, dealers will resume building up those "live" lists of prospects.

Many retailers have not thought about where to get "leads" since the high-competition days before the war. But now it is time to think energetically about this type of business-builder.

The process of collecting the names of the people who are possible customers has changed in recent months. It is now influenced by the enormous national activity in new homes—the building of new houses and the re-shuffle of living quarters until the thousands of unsettled families find a permanent place to live.

Consequently, in obtaining good leads, the radio/appliance retailer should begin by keeping a sharp eye on the real estate activities in his community. In prewar days, this was only one source of leads, but the "home" market is now so active that it deserves first importance in the dealer's line of action. There are so many thousands of families who are either making changes or hoping to do so, the retailer cannot afford not to know exactly what's going on.

### Utilize "Contacts"

To do this, the dealer should have contact with all building-permit services, real estate firms, and rental agents in his area. He should have his system organized so that he knows when all houses are sold, and when apartments are rented. He should be in position to know when building "developments" are scheduled, and should get advance, detailed information about what families are due to live in the community.

In most cases this kind of operation will require that the retailer do some kind of courtesy for the real estate agents, in order to enlist their cooperation. Dealers who have done this on a small scale report that it's worth it, in terms of the resulting sales. To establish contact with a new family in the community often means an immediate sale, but whether or not merchandise is actually bought, the dealer can figure that if he makes a solid, friendly contact with the newcomers, he will certainly benefit in the long run.

As far as building permits are concerned, there are organizations which make a business of selling these lists. Many retailers have found that it is a good idea to buy at least a sample of these; if the lists prove to be of limited value, the dealer can always drop his subscription.

The local newspapers are also sources of this information, but in the case of the new home news, by the time it appears in the paper it may be too late to be of maximum usefulness to a dealer. Such items in news columns are, of course, read by all business men, and the radio/appliance man may find himself to be only one of a group which takes action as a result of the news note.

Newspapers are, however, a highly valuable source of information on marriages, graduations, vacations, etc. These events all indicate that merchandise will be needed by the principals or their friends, and the mention of the news item is a good way to start a contact. And whether or not the people make purchases, still the store is advertised as a go-getter and the effect is generally a good one.

In these days when a dealer's lines are popularly diversified, he is able to offer merchandise appropriate for wedding gifts, graduation presents, vacation equipment, etc. And he will

get ideas for selling a great variety of home equipment to leads from the newspaper. Just how this works out depends greatly on the nature of the community.

On the subject of vacations, there is the case of the radio man who read the newspaper and as an experiment wrote down the names of five people who were scheduled for vacations. He phoned them all, for the purpose of selling portable radios. He found that one had already gone, and that none of the remaining four were interested in buying a portable. No immediate business resulted but later on he found that two of them had remembered the name of the store and had mentioned it to two friends.

### Bought Combos

Both friends were owners of portable combinations and bought records at a later date. The third vacationist became a prospect for a home set upon his return to town, and in the case of the fourth, the dealer never heard from him at all. As a general rule, a customer likes to be asked to give the names of friends who might be in the market for something. It implies that he is a respected man who is acquainted with respected people, and it involves him in the affairs of the store.

New home-makers on prospect lists will want to know about kitchens like Hotpoint's new "L" unit.



# Quarter-Million **\$\$\$\$\$\$**

*Plans to Hold Old Customers and to Attract New Ones.*

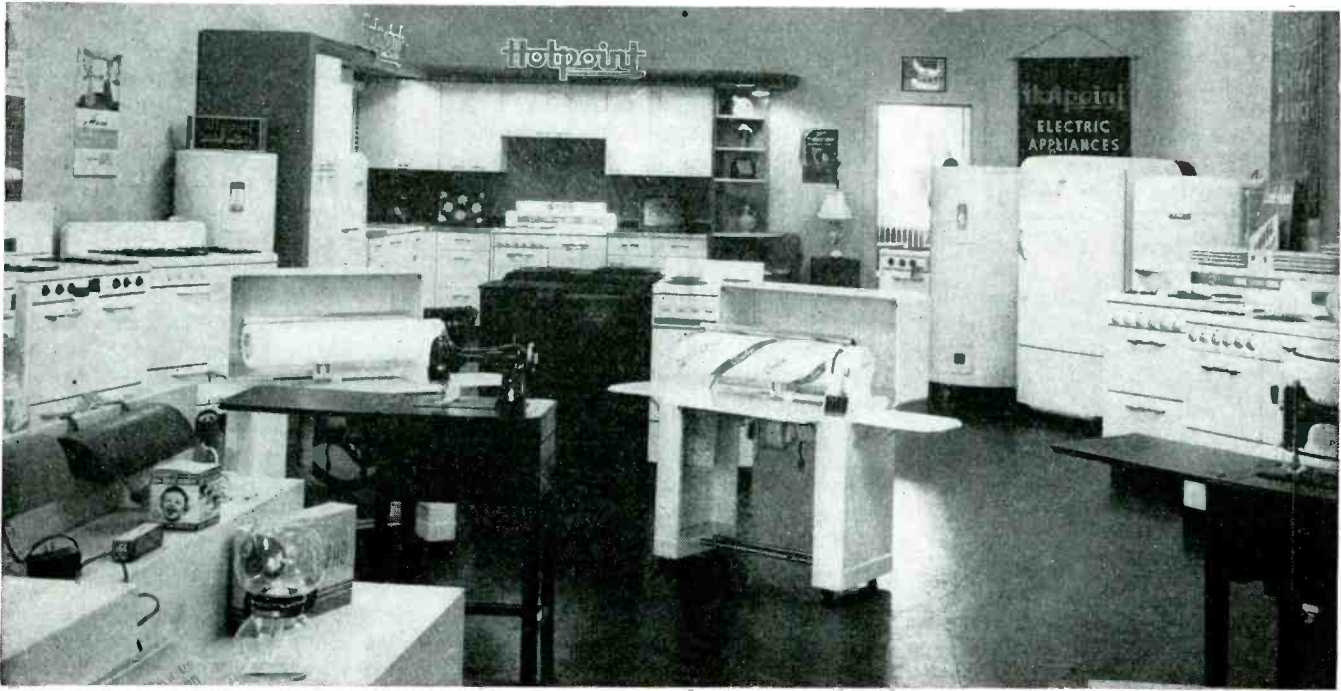

The display arrangement preferred at the Oak Park store is to show smaller items on tables and islands at the front; major appliances along walls.

"Meet the Mrs. at Maus's" is the slogan at the appliance and radio store of Elmer J. Maus at 15 Madison St., Oak Park, Ill., where for some time suburban housewives have met their husbands returning from business in Chicago on Saturday, Monday or Thursday nights.

Located in the newest shopping district of this better-class Chicago suburb of 100,000 people, this store is across the street from a row of groceries, next door to the newest, most modern bank in Chicagoland, and two doors from the corner drug-store—a chain which built up a huge business on the slogan "You're always welcome at Walgreen's."

The appliance store furnishes comfortable upholstered chairs and lounges, with plenty of ashtrays to invite tired customers to relax and make a leisurely approach to the buying of large appliances and complete kitchens.

Mr. Maus was not always fortunate enough to have a modern, comfortable store in which to interview his customers. When he first came to Chicago and entered the appliance business, he had only a corner space in a coal yard office in a Chicago industrial district. He went

out after his customers — ringing doorbells miles away from the coal yard. People liked him, and he got to know them well by calling at their homes. It was only after five years of this kind of selling that he was able to open the store in Oak Park in 1943.

"Personalized selling," says Mr. Maus, "cannot be overemphasized. I know nearly all my customers, and I

---

## THIS ILLINOIS MERCHANT STRESSES

- .. Personalized Selling
- .. Comfort for Customers

## AND HE

- .. Aims for High-Volume
- .. Knows How He's Going to Handle the Traded-In Products

---

know a lot about them. It pays to tie in personal things in your sales talks."

Ninety per cent of the business this store does — and last year it

grossed nearly \$100,000—is with the three thousand old customers who date from the coal yard days. They telephone the store to inquire about appliances in stock, then drop in to meet their wives, talk to Mr. Maus, and complete a purchase.

There were many vacant stores in this district when Mr. Maus bought his shop, but he observed that the chain stores were coming into some of them, and solid business, such as the bank, was also building there.

Only one appliance store existed in the district at that time. The store he bought had only a 30 foot frontage on the street, but the diagonal windows, sloping back to the entrance, had great possibilities for display, and a brilliant electric sign across the sidewalk was installed to call attention to the store.

### Store Dressed Up

The interior of the store was modernized with fluorescent lighting, gray walls, bright linoleum, and wall cabinets painted yellow, with the open shelves at the top lined with Swedish red. When the store was opened, in 1943, the stock consisted of \$500 worth of Christmas gift



# Business is Dealer's Goal

## Advertises His Store as a Meeting Place

novelties and one water heater.

In 1946 six hundred major appliances were sold, and the store has orders now for \$15,000 worth of dishwashers and a carload of clothes dryers, to mention only two items.

The floor is well supplied with display appliances, featuring Servel, Roper, Magic Chef, Hotpoint, Bendix, Deep Freeze and Conlon products. One wall is given to electric appliances, with a complete electric kitchen at the rear, where demonstrations are held on Saturdays and other days when traffic is heavy. Mr. Maus plans to put in a gas kitchen at the side lined with gas appliances.

In connection with the sale of water heaters, the store features a service which involves inspection of the customers' water supply. Those who have local artesian well water are advised to subscribe to a water softener service which displays its equipment on the floor of this store.

Located as he is on the fringe of Chicago, Mr. Maus had around 20 neighborhood publications to choose from for advertising. He selected the one with the highest rate and

standing in the community. Because the flow of appliances from distributors is still uncertain, Mr. Maus prefers to advertise his store as a meeting place, and make his name known to the people of the town, until specific merchandise can be mentioned in advertising.

### Contacts Continued

The search for new customers continues, although Mr. Maus does not ring doorbells in these prosperous days. He canvasses by telephone, and says that he can, with his present store, his "right hand," Mrs. Ward, part time clerks and a bookkeeper who comes in twice a month, handle the quarter-million dollar business he expects in the next few years.

Mr. Maus is planning for the future in using his commodious basement. He is going to install a complete line of commercial cooking equipment there soon. He predicts that by 1948 dealers will have to take trade-ins, and he is making plans now to have a used goods "bargain basement" as well.

Most dealers agree that the reason they so often come out behind the eight-ball in accepting trade-ins is not so much because they "buy" such used merchandise from the householder, but because the traded-in stuff is taken in, and then forgotten.

Dealer Maus knows that in order to operate profitably in the trade-in market, he must have a plan for doing something with the products he accepts from customers. Plans for follow-through on the disposition of used appliances should be on every dealer's agenda right now. A sure way to lose money is to throw traded-in merchandise into some obscure corner where it will accumulate nothing but dust.

When a merchant shoots at as high a goal as Maus does—a quarter-million dollar business—he must keep his eye on every angle of the operation. That's why this Chicagoland retailer keeps two jumps ahead of trends in his planning. He knows that while there isn't a lot of trade-in business being done now, the time is not far off when it will become once again a common procedure.

Elmer J. Maus has come to the range in this demonstration of a complete electric kitchen. Note artistic touches in corner shelf display at right.

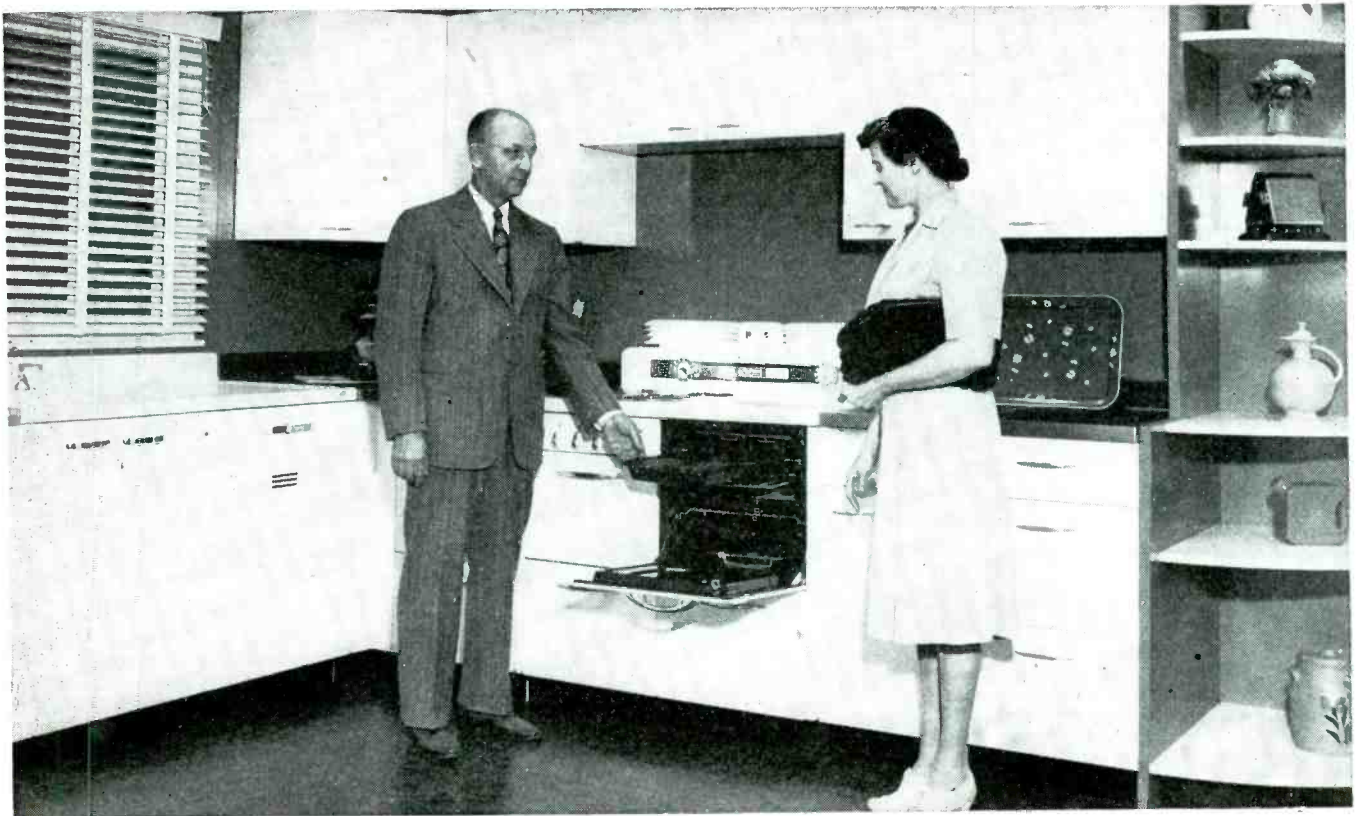

Refrigerators

Washers

Ironers

Ranges

Vacuum Cleaners

Food Freezers

# New Electrical

## Frigidaire ELECTRIC DRYER

Electric dryer will dry completely a whole washer load of clothing in 20 to

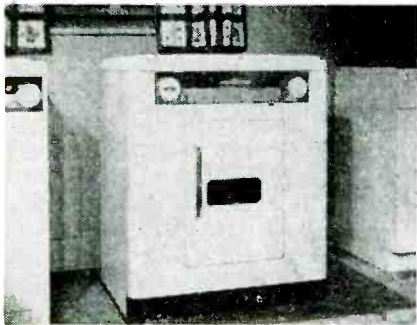

30 minutes. Only 15 to 25 minutes are required if the housewife desires to damp-dry clothing for ironing. Revolving drum inside "tumbles" clothes while circulating; hot air does the rest. Frigidaire Div., General Motors Corp., Dayton, Ohio—RADIO & Television RETAILING

## Vornado TWIN AIRE

Air circulator with built-in heating unit, for all-year comfort. Designed to provide an ample supply of well circulated air, conditioned for comfort. Fan features a three-bladed, vortex type propeller. Heat-



ing element features helical coil of nickel-chrome iron mounted in moulded ceramic porcelain supports. Housing of heavy-gauge steel mounted on tubular steel supports. Operates by flip of a switch. \$29.95. The O. A. Sutton Corp., Wichita, Kans.—RADIO & Television RETAILING

## Eureka DISPOS-O-MATIC

Cylindrical unit, mounted beneath and connected to drain opening in any standard sink. The main part of the unit serves as a reservoir for kitchen waste, which is fed in through the sink's drain. The unit is self-cleaning, accomplished by

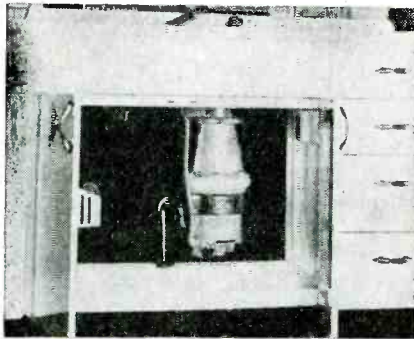

the flow of water and centrifugal force. A hidden electrical switch starts the unit automatically when the cover plate is firmly in place in the "on" position. Pulverizing section consists of the rotary impellers, the cutting ring and the radial agitators. Eureka Williams Corp., Bloomington, Ill.—RADIO & Television RETAILING

## Norge GAS RANGE

Two-broiler gas range, equipped with "concentrator" burner; hidden fluorescent light in back panel; built-in electric timer clock and appliance outlet; combination

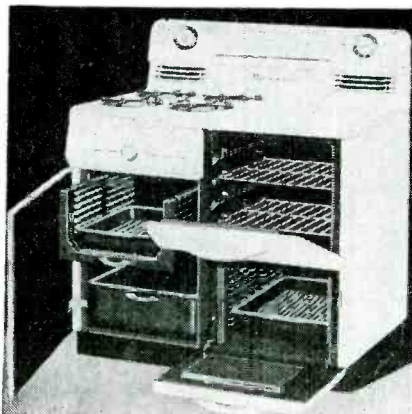

oven valve and heat control. Both broilers are deep to provide increased capacity. Norge Div., Borg-Warner Corp., Detroit, Mich.—RADIO & Television RETAILING

## Proctor IRON

Model No. 984, "roly-poly" (self-righting) never-lift iron. Features: single leg for stability and greater soleplate ironing sur-

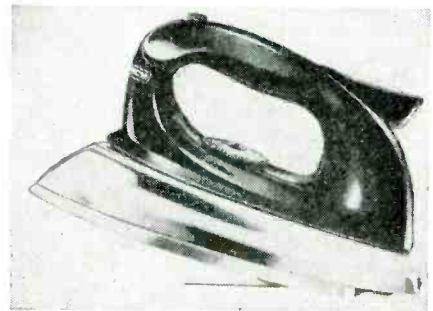

face; self-lifting; equipped with an always visible dial of fabrics which includes a nylon marking and a rayon signal which points to "green" when it is safe to iron rayons and nylons, and to "red" when iron is too hot for synthetic fabrics. Priced at \$14.95. Proctor Electric Co., Inc., Philadelphia, Pa.—RADIO & Television RETAILING

## Portman SEWING MACHINE

Lightweight, portable all-purpose sewing machine features: an open "lower arm" arrangement for darning and mending, built-in soft glow electric light, aluminum carrying case, variable speed electric drive motor, adjustable control for automatically regulating stitch length for forward

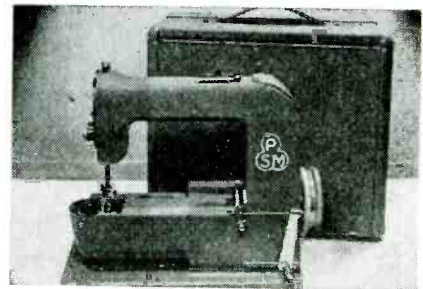

and reverse sewing, horizontally located bobbin. Various attachments are included with the machine. Complete weight approximately fourteen pounds. Portman Machine Tool Co., Inc., Portman Sewing Machine Div., 70 Portman Road, New Rochelle, N. Y.—RADIO & Television RETAILING



# Home Appliances

★ Toasters  
★ Roasters  
★ Hand Irons  
★ Mixers  
★ Clocks  
★ Coffee Makers

## Westinghouse PORTABLE HEATER

Lightweight home heater, made of aluminum with satin finish. Weighs less than 5½ lbs. Equipped with carrying handle, unit is 15¼ inches high, 10¾ inches wide,

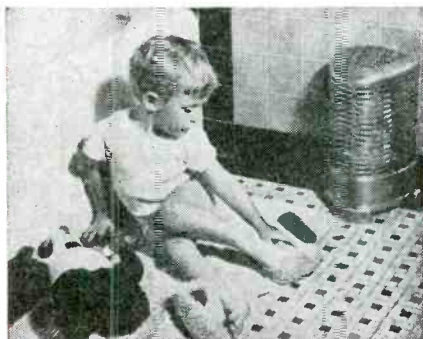

9½ inches deep. In operation, heater provides immediate heat by radiation, maintains room temperature by convection. Westinghouse Electric Corp., Emeryville, Calif.—RADIO & Television RETAILING

## Hoover VACUUM CLEANER

Model 50 cylinder type vacuum cleaner. Chief among features is the dirt ejector, which disposes dirt by a new easy method. Cleaner has two handles, one for carrying or storing in a horizontal

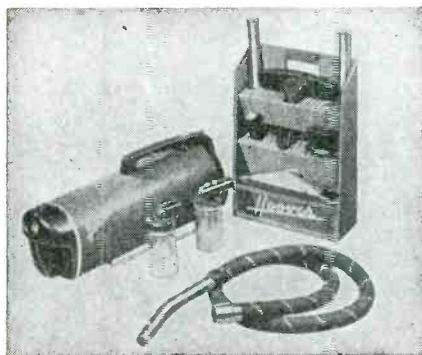

position and one for a vertical position. Power switch located on top of handle is hand or foot operated. Powerful suction. Comes complete with a kit of cleaning tools. The Hoover Co., North Canton, Ohio.—RADIO & Television RETAILING

## GE TRAVEL IRON

Streamlined travel iron, weighs two pounds. Broadbased handle is held securely in ironing position by simple locking



device and folds flat so iron may be slipped into zippered carrying case. Works on ac and dc. General Electric Co., Bridgeport 2, Conn.—RADIO & Television RETAILING

## Hotpoint FRY KETTLE

Electric commercial fry kettle is rectangular in shape, and features direct im-

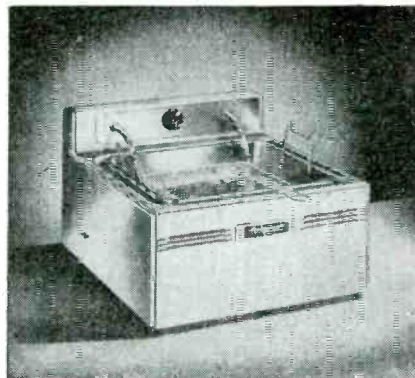

mersion of the Calrod heating element into the fat. One of five new matched counter cooking appliances announced by the company. Finished in nickel-chrome. Hotpoint, Inc., Chicago 44, Ill.—RADIO & Television RETAILING

## Everhot ELECTRIC BLANKET

Automatic electric blanket, Model 920. Blanket is 72 inches x 90 inches; 75% wool, 25% cotton. Safety thermostats guard against over heating. Available in rose

and blue. Each blanket is packaged in an attractive carton, with a clear plastic (polyvinyl chloride acetate), storage bag included. Control assembly is in white

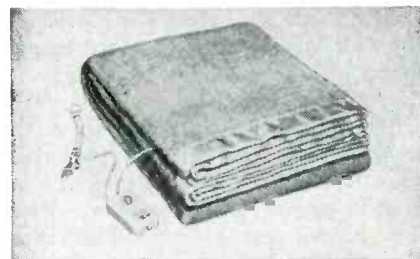

plastic box, having a temperature selecting dial and on-and-off switch. Retail list price, \$41.95 including tax. The Swartzbaugh Mfg. Co., Toledo 6, Ohio—RADIO & Television RETAILING

## RCA BATTERY FLASHLIGHT

Flashlight designed to meet need for a rugged hand light; features silver-plated zinc parabolic reflector, lacquered to re-

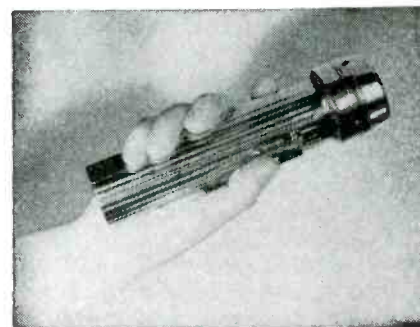

tain mirror finish. Rust-resistant barrel; 3-position coil-spring switch includes a flashing position for signaling. Radio Corp. of America, RCA Victor Div., Camden, N. J.—RADIO & Television RETAILING

## Silex MEASURING SCOOP

"Dippex" coffee measuring scoop, designed to use just the right quantity of ground coffee for each cupful of coffee brewed. Has a natural scoop shape, made of plastic, and is lightweight. Dippex is being packed with each Silex glass coffee maker as standard equipment. The Silex Co., Hartford 2, Conn.—RADIO & Television RETAILING

# \$\$ in Decorative Material

## Christmas Tree Set Sales Can Be Pushed Up Into the Higher Brackets Via Speed and Efficiency

• Adequate display, wide assortment, skillful salesmanship, and proper testing and demonstrating facilities are some of the more important ingredients needed to insure profitable sale of Christmas tree lighting sets and equipment.

Of course, too, the merchant must be able to get his hands on sufficient stock, and in order to do this he should place his orders early because the entire output of standard manufacturers will probably be allocated during the remainder of this year.

Though the supply situation on lighting sets has greatly improved over last year it is still not considered to be adequate on most numbers. The bottleneck is not in the wiring or sockets, but in the supply of "conventional" type bulbs, although some of the newer designs will be available in large quantities.

Lighted wreaths, and other decorative specialties, will be available in far greater numbers than last year's market afforded.

### How to Get Ready

The merchant who is able to get his hands on enough sets to take care of all or most of his potential sales, is next faced with the realistic proposition of selling the merchandise at a profit. Just because the supply isn't going to be too good doesn't mean that the buyer is likely to gobble up all of the tree sets without the necessity for being "sold."

Adequate display, started at an early date, is the first rule. Sets should be placed in windows and in strategic positions throughout the sales floor. It is important that numbers of strings should be lighted. In addition to showing the outfits as sets for the customer to buy, they should be employed by the dealer for store "dressing" decoration purposes. Strings can be run around display tables, wall moulding, etc. Such displays are powerful silent salesmen.

The merchant who wants to do a big job must have the proper assortment for the customers in his community. He must have enough outdoor sets, indoor sets, and enough of the newer novelty bulbs and outfits. Shoppers dislike having to buy some here and some there when it comes

to tree lighting sets, and they will often walk out of the store which has but *some* of the desired kind or quantity.

A dealer must sell a lot of sets in a short time in order to obtain profitable volume, and the experienced merchant knows that there are plenty of slow-up tactics which are demonstrated by some customers.

He must be equipped to handle both the fast-buying shopper who knows what he wants, orders it and gets out, and the other kind who frequently tries the patience of even the most experienced salesperson. Among the time-taking things some customers do in purchasing tree equipment are requests for special assortments of bulbs in a string, such as "all red" or "all-blue"; insistence that the dealer repair owner's old tree strings which are too far gone to justify an adequate price, and which, even if repaired, would be unsafe to use.

The smart salesman must know all the answers. If the firm has a hard-and-fast rule against selling "assortments" to order, then it should be enforced, and all customers should be treated alike. There should be some sort of policy on repairs, too, and this policy should be set up well in advance of the rush buying period.

One of the greatest factors in

speeding up sales of sets is the installation of a conveniently located, well arranged testing station. Such station should be in a place where the customer can see what is going on, and should be so arranged that more than one person can test at a time. If possible, wrapping facilities should be nearby.

### Speeding Up Sales

In speeding up sales of sets, the salesperson should be familiar with the merchandise so that he can describe the various features in order to help the customer to make a decision. However, adequate display, before-mentioned in this article, will eliminate the necessity for "sales talks" in most all transactions.

As soon as the customer makes a selection, the clerk should take the following steps: 1. Screw all lamps into sockets in sets. 2. Test entire set by plugging into conveniently located outlet. 3. Wrap.

The testing of "loose" Christmas tree bulbs can be accelerated via a sufficient number of handy sockets having correct voltage supply. If the dealer makes the sockets and test-board himself, he should be careful that they are sized right. For ex-

(Continued on page 140)

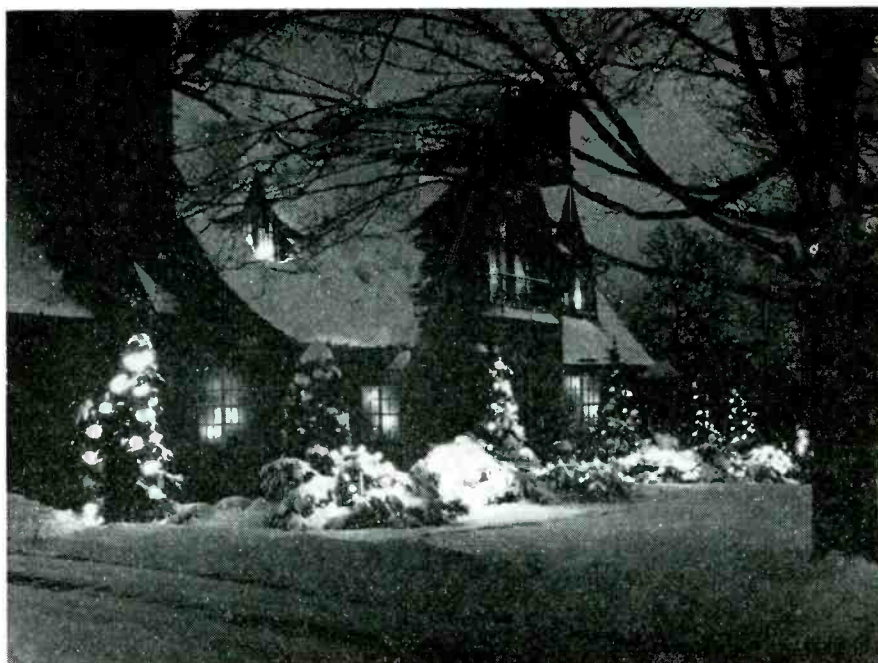



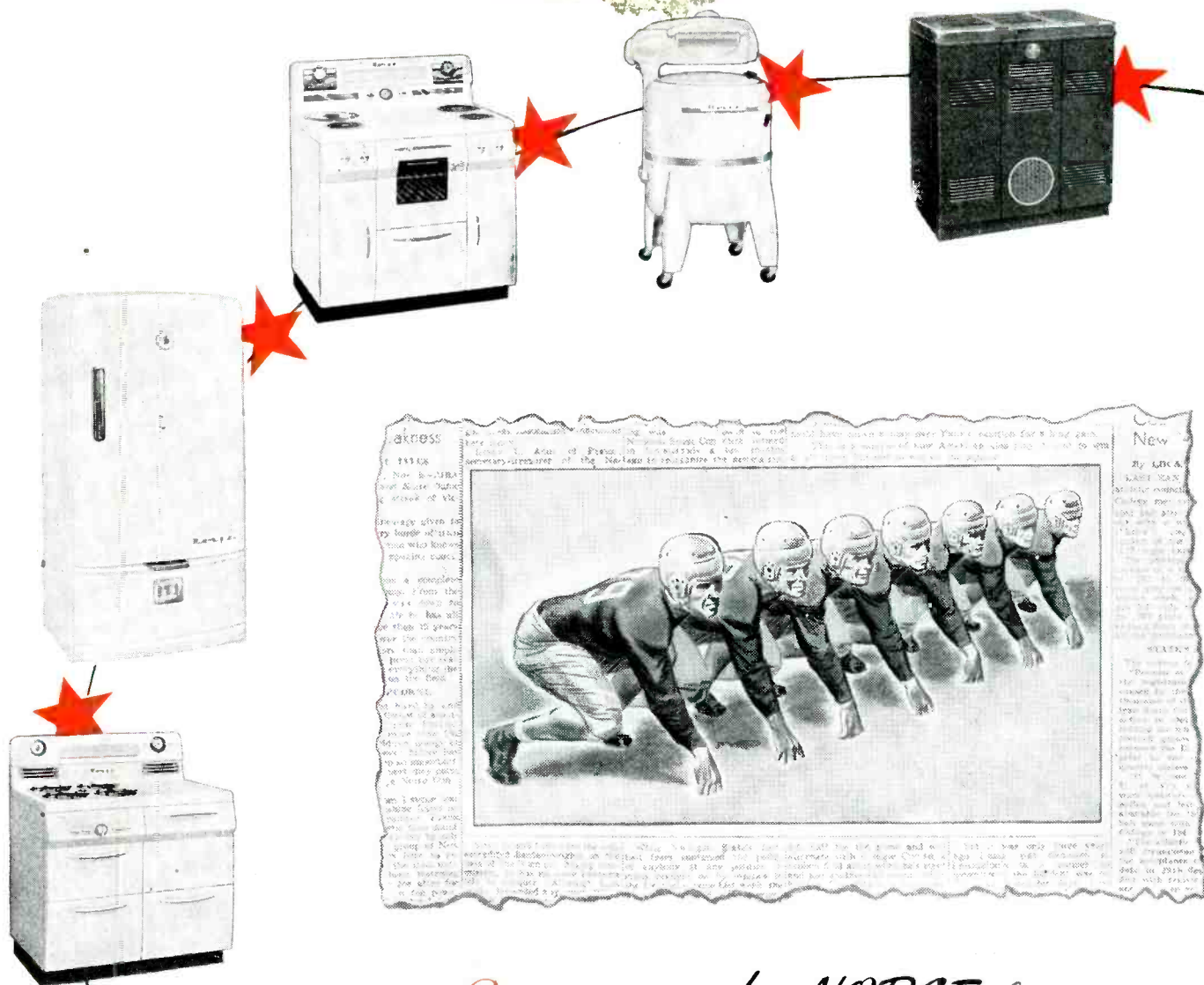

There are *Seven Stars* in the *NORGE* line, too!

Seven major appliances . . . each a big-ticket item—styled, engineered and priced to lead its field! Only Norgge, among all manufacturers, can offer you an all-star line-up like *this!*

But Norgge's "Big Seven" is, above all, a smooth-working *team*. Its members work together to produce more initial sales—more tie-in sales—more repeat sales. It is the winning combination for retailers who think not only of present profits, but also of future growth!

Norgge Division, Borg-Warner Corporation,  
Detroit 26, Michigan.

Products of  
BORG-WARNER



Norgge products, distributed world-wide, are typical examples of the values made possible by the American system of free enterprise.



**SEE  
NORGE  
BEFORE YOU BUY**

# News About Lighting

New Products Hit Markets for Home and Commercial Use

## New Phil-Mar Lamps

Phil-Mar Electric, Inc., Cleveland, Ohio, is showing a new line of pottery table lamps. The line features seven styles in five different glazes. The lamps are equipped with colorful opaque parchment shades with matching top and bottom fabric braid



The new "Plume" model.

trims. Three styles are shaded fabric over parchment shades, and include a highly-styled California-type cover. Shown in the illustration is one of the outstanding numbers. It has been named the "Plume."

## Sylvania Fluorescent Tree Lamps Plentiful

Fluorescent Christmas tree lights which can be used outdoors in cold weather as well as indoors have been announced by Sylvania Electric Products Inc., who introduced the round, pastel-colored bulbs two years ago for indoor use only. The new sets have waterproofed cords and are equipped with special gaskets to be placed inside the sockets for protection from the elements.

Both cord sets and individual fluorescent bulbs will be plentiful this year according to Sylvania Electric officials and both outdoor-indoor type strings and indoor type sets will retail at \$4.95, plus tax, with individual bulbs costing 45¢ apiece, plus tax, a reduction of more than 24% over last year's prices.

The fluorescent bulbs, which come in soft blue, green, coral, yellow and orchid colors, have a screw type

base, and are independently operated. Each lamp consumes about four watts of current and has an average life of 1000 hours. The strings need no special auxiliary equipment in order

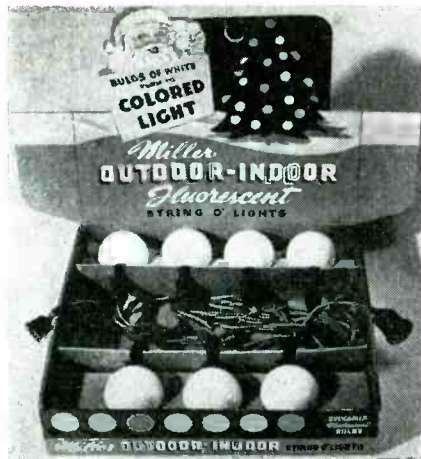

Sylvania fluorescent tree set.

to operate, although they are made with the same type of fluorescent powders that go into fluorescent tubes for regular residential and commercial use.



Lighted party centerpiece created by Sylvania and Dennison Mfg. Co., for children's party. New fluorescent bulbs used.

## Amplex Color Clips Now Available

New simple color clips, said to turn ordinary display and window lighting into sparkling color lighting quickly and easily, are now available. The color clip is made of lightweight spun aluminum into which is slipped a round, flat color filter made of natural-color glass segmented in four parts to permit heat escape. Clip

and filter slip over any standard reflector bulb to provide spotlighting and floodlighting in any of seventeen standard colors.

Circular No. 109 describing these accessories can be had by writing the manufacturer, Amplex Corp., 87 Columbia St., Brooklyn 2, N. Y.

## New Swivelier Units

A new line of adjustable screw-in hood-shade lighting units is announced by the Swivelier Co., Inc., of 124 E. 16 St., New York. The hood shades will accommodate up to a 300-watt Type R-40 bulb, and are available with or without removable louvers. Some of the features stressed by the manufacturer are: 1. Stays put at any angle—will not work loose or drop down, regardless of vibration or number of adjustments. 2. No wing nuts or screws to adjust. 3. Full universal adjustment—90 degrees vertical range, 350 degrees horizontal range. 4. Special "stop" prevents wires twisting.

## Noma Sets for Christmas

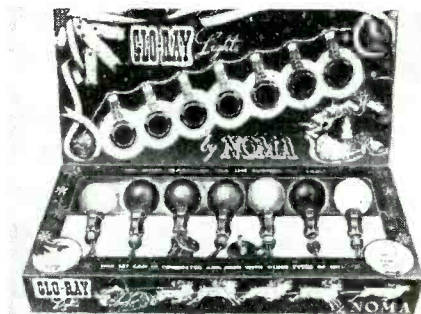

Noma Glo-Ray outfit No. 3017

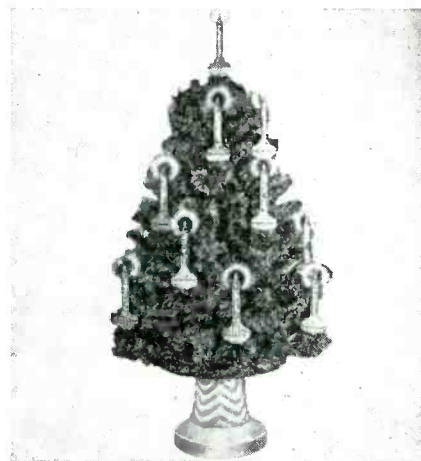

Noma's new Bubble-Lite Tree, No. 503-G., has 18 assorted color lamps, 6 "spare" lamps.



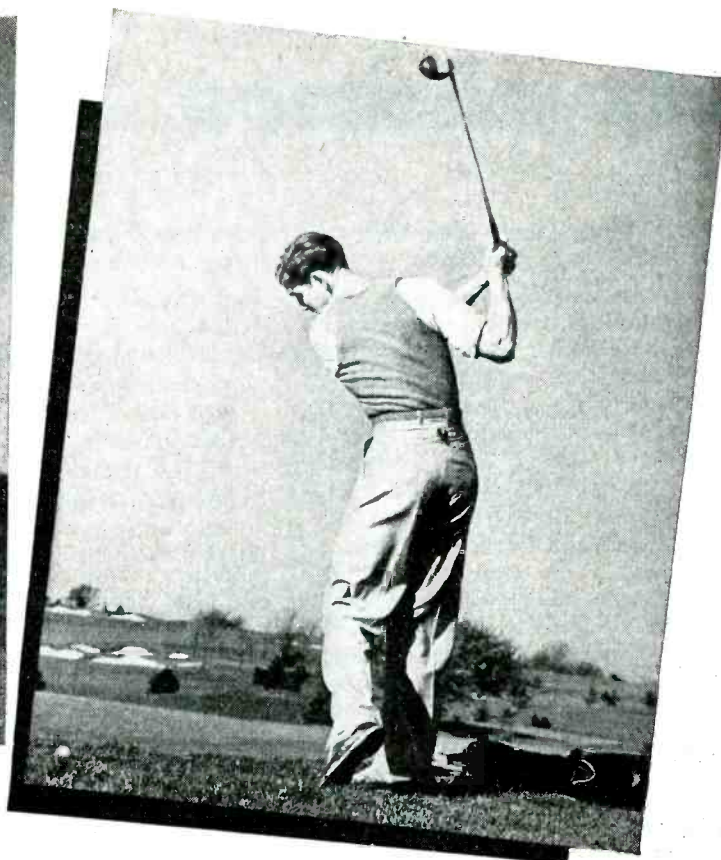
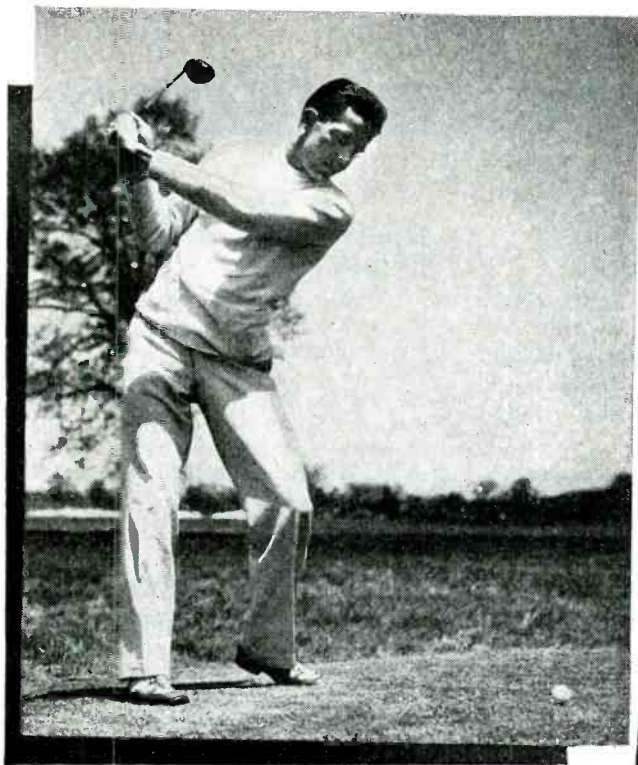

## Which one will be **TOMORROW'S CHAMP?**

Whether you're analyzing golfers or radios or appliances, you can easily spot the "duffers" — but, as the competition narrows down, you've really got to know the game to be able to predict the winner.

In this tough, exciting game which is your business and ours, market conditions are changing constantly. New products — and new features on well known products — are altering customers' preferences. Prices—manufacturers' advertising—dealer promotional helps . . . all these we must consider carefully in selecting the lines that will sell best — be most profitable — not just today, but long-range.

As a long-established national distributor of leading radios and appliances, Graybar has closely

studied hundreds of lines under all varieties of market conditions. As an independent, self-directing organization, Graybar is free to select and recommend lines on the basis of salability. At the same time, because of its proved ability to "move merchandise," Graybar enjoys the close co-operation of top-flight manufacturers.

There you have the basic reasons why Graybar dealers have faith in the recommendations of our Merchandising Specialists. Proof that these recommendations pay in practice is the success of Graybar dealers throughout the nation. *Merchandising Department, Graybar Electric Company, Inc. Offices and warehouses in over 90 principal cities.*

4794

When a product is recommended by Graybar, you can be sure it is (1) easy to sell, (2) honestly advertised, (3) backed by a warranty which protects both dealer and consumer.

*recommended by*  
**Graybar**

RADIOS

• MAJOR APPLIANCES

• TRAFFIC APPLIANCES

# Appliance Service News

## Motor Capacitor Service Kit Made by Aerovox

A motor-capacitor servicing kit that determines the right capacitance in the absence of such information or identification, and then provides that capacitance until standard replacements are available, is offered by Aerovox Corp., New Bedford, Mass., through its distributors.

The postwar kit features the Aerovox Capacitor Selector or compact instrument which clips in place of the defective motor-starting capacitor. Five toggle switches are flipped until the quickest start is obtained within safe voltage limits as indicated by the voltmeter. The correct capacitance value is read from the "On" switches.

In the absence of a universal or an exact-duplicate capacitor replacement, the Aerovox Emergency Unit is clipped in place temporarily. The corresponding leads are simply inserted in the terminal coupler to obtain the total required capacitance. Later, at the serviceman's convenience, the regular replacement is installed, but meanwhile the refrigerator has been "fixed in a jiffy." Two Emergency Units are in the kit.

## Solar Has New Solderless Connectors

The Solar Electric Corp., Warren, Pa., announces a recent improvement in its line of hot molded bakelite solderless wire connectors designed for quick and easy joining of standard gauge electrical wires.

The newly improved connectors, distributed under the trade name "Scru-Its," are manufactured in several sizes for connecting various combinations of solid and/or stranded wires.

According to the manufacturer, the connectors are not affected by heat, cold or moisture, and are used for permanent wire connections, as well as for "roughing-in" work, without tape, solder, heat or special tools. They are easy to use, safe and inexpensive. All sizes carry the UL label of approval.

Wire ends are stripped, and the "Scru-Its" screw right on. No twisting of wires is necessary. Their compact size permits their use in switch boxes, fixtures, fuse boxes, appliances, and many other applications.

## Service Code of the Proctor Electric Co.

Proctor Electric Company service stations are requested to adhere to the following minimum standards:

1. Appliances normally to be serviced and returned within twenty-four hours.
2. Repairs to be made carefully, appliances checked for other possible defects, thoroughly cleaned, and tested for satisfactory operation.
3. After inspection, appliances to be re-polished as nearly as possible to original finish and carefully re-packed.
4. Appliances again returned because of unsatisfactory servicing to be reserviced without cost to customer.
5. On the assumption that "the customer is always right," doubtful cases to be decided in favor of the customer.
6. Questionnaire (for report by customer of service irregularities and favorable or unfavorable comment) to be supplied free by Proctor and to be included in each wrapped package.

\* \* \*

## New Cold Zone Tester



To check refrigeration equipment operating temperatures, J-B-T Instruments, Inc., New Haven, Conn., offers the model 50-50.

## Camfield Service Manual

Camfield Manufacturing Company's service department, Fulton St., Grand Haven, Mich., has issued a 17-page service manual on its automatic toaster.

## How to Neutralize Sulphur Dioxide

Do not discharge sulphur dioxide where it will cause damage or harm to lawns, shrubbery, flowers, birds, pets, etc. If it is not possible to discharge into the outside air, a solution of thirteen ounces of lye to one and one-half gallons of water will neutralize the sulphur dioxide. The foregoing advice comes from the service department of Norge.

## Reading Home Meters

Servicers are frequently called upon to explain meter-reading to customers. Westinghouse offers the following information: There are two general types of home power meters . . . the type with four dials, and the more modern speedometer type. The dial type is read from left to right . . . first thousands, next hundreds, then tens, then ones. We read the figure nearest the needle on

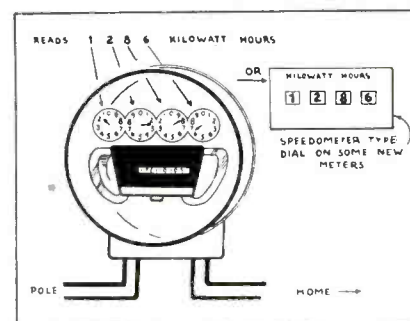

each dial. On the examples given in the illustration above, both meters register 1286 kwh. Last time the meter was read it registered 1186 kwh. Subtracting the latter figure from the former we find that 100 kwh have been used since the last reading. Therefore, the bill for the period is 100 times the local rate per kwh.

## Oil-Resistant Compound

An oil-resistant compound for splicing electrical wire has been announced by the United States Rubber Co. The new compound is made of neoprene rubber combined with special synthetics. It is recommended for use on any electrical circuit coming in contact with oil. It will be distributed in the form of tape 30 feet long, three-quarters of an inch wide and .030 inch thick.



# Simplify your BOOKKEEPING Job



**REGISTER every transaction by hand...**

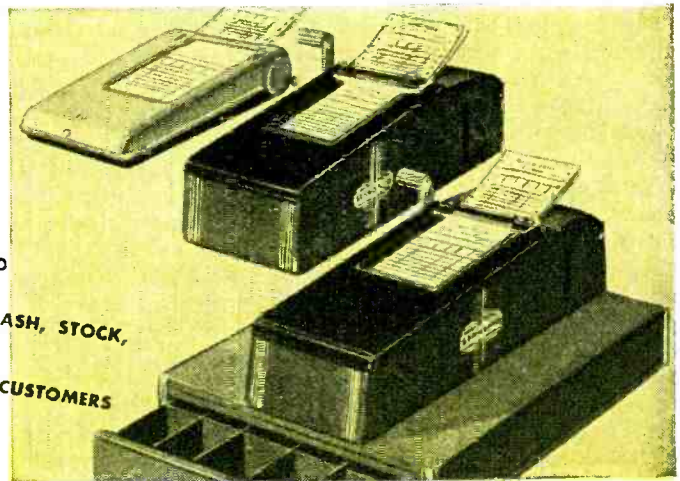
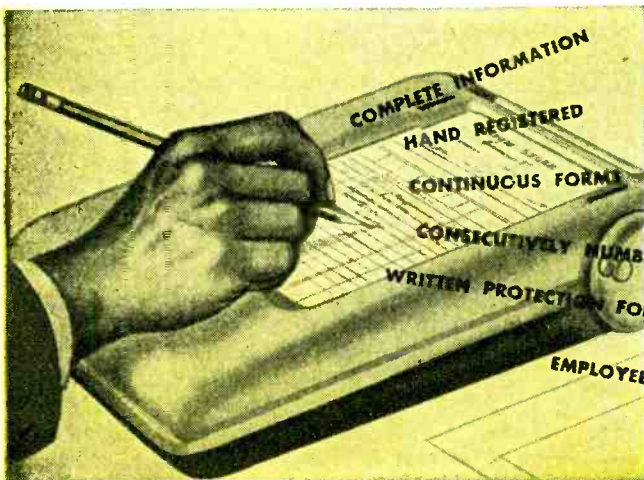

**the modern STANDARD REGISTER way!**

**D**ISCOVER how much easier, *faster*, you can make the records you need—with the Standard Form-Flow Register. Learn how it simplifies bookkeeping, tax and financial reports. See how it checks carelessness, misunderstandings, dishonesty...protects your cash, merchandise, *people* involved in every transaction. And see how it helps give you the fast, accurate picture of inventory you need, today. Mail the coupon, *now*, learn *all* the ways a Standard Register can help you operate more profitably.

**FREE!** WRITE FOR FOLDER which tells how Standard Form-Flow Registers and pre-tested Standard Register systems can give you more complete records with less writing, less work—in your particular business.

**THE STANDARD REGISTER COMPANY**  
Manufacturers of Registers and Forms  
for ALL Business and Industry  
DAYTON 1, OHIO

**Appliance Dealers**

**GET THESE SPECIAL BENEFITS**

- All records clear, legible at one writing.
- Copies for customer, office, delivery and locked-in audit records.
- Foolproof check against lost records.
- Fixed responsibility, including delivery receipt.
- No confusion on terms of sale, payment or delivery instructions.
- Complete legal contract and copies with one customer signature.

○ THE STANDARD REGISTER COMPANY ○  
 ○ Dept. 13-D, Dayton 1, Ohio ○  
 ○ Please send me Free Standard Register Business Digest which tells me how I can write better records in my business...easier...simpler...faster! ○  
 ○ NAME..... ○  
 ○ COMPANY..... ○  
 ○ STREET..... ○  
 ○ CITY..... ONE..... STATE..... ○

Pacific Coast: Sunset McKee-Standard Register Sales Co., Oakland 6, Calif. Canada: R. L. Crain Ltd., Ottawa. Great Britain: W. H. Smith & Son, Ltd., London



# UP *Electric Clock Sales!*

*A Little Extra Effort Can Mean a Lot More Business*

● In every community there are numbers of homes without electric clocks. Also, there are many homes having but one electric time-keeper.

The modern home needs not *one*, but a number of accurate, dependable clocks, and the electric type certainly fills the bill. Every dealer can view his own trading area as representing a very large potential for clock sales, and he can increase his volume surprisingly if he goes after this business the right way.

Selling features are numerous and appealing. Electric clocks cost little to buy, practically nothing to operate, and they last for many years. They are accurate to the n'th degree, are noiseless, and require no attention on the part of the owner. If he makes an out-and-out drive to sell more clocks, the dealer is bound to get satisfactory results. He can sell *more* clocks to the person who now owns *some*. He certainly should be able to obtain a sale from *almost* every non-owner who has AC current in his home.

### **Expert Advice**

Let's see what some of the expert clock merchandisers have to say. For instance, C. R. Thorson, sales manager of General Electric Company's clock division, offers the following advice to retail merchants:

"Families who have first hand acquaintance with the dependability and accuracy of General Electric clocks in the kitchen or bedroom have little patience with the variability of ordinary clocks and, increasingly, are buying G-E clocks for use throughout the entire house.

"Dealers should take advantage of the enormous acceptance of electrical living to sell clocks on a 'house-around' basis.

"The big jump in the marriage

rate and the resultant (in spite of difficulties) increase in new homes offer inviting pastures for greater clock business to the dealer who is alert enough to get aboard a long-distance bandwagon.

"These new homemakers are conditioned to electrical living and are thoroughly sold on the leisure and easier housekeeping that electrical appliances bring.

"Not only are they buying appliances themselves, but thousands of their friends and relatives are buying gifts for them.

"New couples, and the people who are buying gifts for them, represent an important market for General Electric clocks, not only in the traditional month of brides, but throughout the whole year. These people want gifts which are both attractive and useful." Thorson concluded.

### **More Suggestions**

A clock for every room in the house is stressed by the Ingraham people in the following statement prepared especially for RADIO & Television RETAILING:

"The electric clock section of the new Sentinel line of clocks and watches produced by The E. Ingraham Company of Bristol, Connecticut, has been specially designed so that home owners can have an appropriately styled electric clock for every room in the house.

"The Sentinel kitchen clock has a case which is easily cleaned and a dial which is easily readable in the kitchen. Modern cooks watch the clock carefully and cook not only by minutes but by seconds. The Sentinel electric alarm clock is styled for the modern bedroom with a pleasant 1-2-3 alarm. The absence of tick makes such alarm clocks increasingly popular in the bedroom.

"The Sentinel desk or table clock in rich walnut wood case is appropriately designed for this situation and blends with the modern note in furniture. Even the bathroom now has a clock so that mom and pop can get out of the shower in plenty

of time. The Sentinel 'Mural' in its wide 12-sided case harmonizes perfectly with the tile of the up-to-date bathroom.

"Sentinel electrics are so reasonably priced and so reliable with their motors completely sealed in oil that now, as the Ingraham people say, you can 'Guard Your Precious Time' under the trademark of the Ingraham Champion Shepherd in every room in the house."

Seth Thomas sales executives give the following advice to readers of this publication:

"The best way to either sell Seth Thomas clocks in groups or to get repeat business is—first—to have an adequate display. Then with this as a basis—*sell Seth Thomas styling*. It's smart, and a mark of efficiency as well, to have a Seth Thomas clock in every room—a clock always in sight—and at the same time accentuate the decorative setting.

"Then, tell your customers about Seth Thomas value, remembering that it takes a combination of both price and quality to make a value genuine.

"Finally, tell your customers about the wide variety of fittings offered in the Seth Thomas line. There are smart timepieces for the occasional table—alarm clocks—clocks that announce the hours and half-hours and full Westminster chimes. Their selection for personal use suggests good taste and, too, they are excellent for gifts.

"The message that we try to impart to our dealers is to sell Seth Thomas from the angle of the various features that the line carries. One thing that we have not mentioned before is the fact that our line has been consistently nationally advertised over a number of years and our program will be substantially accelerated this Fall."

Among the trade-names identified with the electric clock manufacturing field are General Electric, Gilbert, Hammond, Ingraham, New Haven, Revere, Sessions, Seth Thomas, Telechron, Waterbury, Westclox and Winslow.



## NEWA Campaign to Boost Sale of Appliances

To help the wholesaler's salesman help his customer and thereby step up sales volume, the National Electrical Wholesalers Association, New York City, has announced that it will publish a series of printed bulletins entitled the *Appliance Sales Booster* and the *Supply Sales Booster*.

This new promotional program for NEWA members was initiated by the store management and store arrangement committee of which K. G. Gillespie was chairman.

Charles G. Pyle, NEWA's managing director, views this promotional activity as one that is timely and will be effective in meeting the new problems of the buyers' market and the coming challenge to distribution. "The NEWA Sales Boosters," he said, "will cover a wide range of electrical appliance and apparatus and supply subjects, from time payment selling to lighting, using the user, store arrangement, product demonstration, control equipment and many others.

"We are designing this publication especially for the use of our member companies' salesmen. It will help them do a better selling job, help them serve their customers more completely. Our industry is about to come face to face with its greatest challenge to selling expertness. And that is a challenge we must meet successfully if we are to maintain volume production and jobs."

## Graybar Promotes Hayes

Norman A. Hayes has been advanced to the position of district merchandising manager for Graybar Electric Company at Seattle, Washington, according to an announcement made by C. S. Powell, vice-president in charge of radio and appliance sales. Mr. Hayes will supervise all Graybar merchandising activities throughout their Northwestern district, which includes the territories of their offices at Seattle, Spokane, and Tacoma, Washington; Portland, Ore., and Butte, Montana.

## Frigidaire Ups Prices of Some Products

A limited increase in the prices of some products, is announced by Frigidaire Division, General Motors Corporation. P. M. Bratten, general sales manager, pointed out that these increases reflect advancing costs in materials and losses caused by irregular production due to material shortages.

Frigidaire appliances affected by the price adjustment include electric refrigerators, showing an increase of \$5 to \$15, with no increase on three models; electric ranges from \$5 to \$10, with no increase on two models; and the automatic electric washer, which has been increased by \$15. There is no increase in the prices of Frigidaire home freezers, electric dryers and ironers.



## New 1948 PROCTOR Automatic Pop-up Toaster!

...and what they mean to you

### The Toaster

... Beautiful in appearance, remarkable in performance. The design was the unanimous first choice of women at design polls throughout the country.

And beneath the handsome exterior the Proctor contains a toasting mechanism of unusual accuracy, the exclusive Proctor "Color Guard".

Other important features are *silent operation*, cushioned pop-up, *sliding crumb tray*. The new Proctor is truly America's Most Distinctive Toaster.

### The Promotion

Proctor presents America's most distinctive advertising campaign ... A million ads a day.

Magnificent Full-color Spreads in The Saturday Evening Post: October 4 — Double page—November 22—Junior Spread—Dec. 6 — Another Double page.

PLUS Full-page, 4-color ads in Oct. and Dec. Ladies' Home Journal—Good Housekeeping — McCall's — True Story—American Home—Better Homes & Gardens.

PLUS ads in 11 other magazines.

Take a toaster rich in beauty and in features, a toaster that *by itself* will attract women to any window.

Add an advertising campaign to reach almost every woman in your town!

What's that mean to you?

**STORE TRAFFIC** and Store Profits every time you display the new Proctor on your counters, in your windows, in your ads.

Everything you'll need to build store traffic is in a Free Tie-In Package. See your Distributor now!

# PROCTOR

**NEWSMAKER  
IN APPLIANCE  
MERCHANDISING**

PROCTOR ELECTRIC COMPANY, PHILADELPHIA 40, PENNSYLVANIA

## IMMEDIATE DELIVERY

# 32 Volt Farm Appliances

### ◆ 32 VOLT ELECTRIC WAFFLE IRON

Modern. Beautiful chrome plated finish. Bakes large 8-inch Waffles. Imbedded durable element for faster baking. Mounted on attractive tray base. Cord included.—Retail \$16.95 each.

Dealers Cost including Excise Tax .....\$11.95 each

### ◆ 32 VOLT ELECTRIC TOASTER

Modern Cabinet Model. Brightly polished Aluminum Turn-over Style. Cord included.—Retail \$7.95 each.

Dealers Cost including Excise Tax .....\$4.95 each

### ◆ 32 VOLT ELECTRIC IRON

High—Medium—Low Heats for correct ironing temperatures. Streamlined 3½ lb. iron. Highly polished. Cord included. — Retail \$9.95 each.

Dealers Cost including Excise Tax .....\$6.95 each

### ◆ 32 VOLT HOT PLATE

Attractive all steel one Burner Stove, suitable for all general cooking. 550 Watts. Complete with cord. — Retail \$6.95 each.

Dealers Cost including Excise Tax .....\$4.25 each

### ◆ 32 VOLT HAIR CURLING IRON

All steel with sturdy wood handle. Chrome finish. Cord attached. — Retail \$3.95 each.

Dealers Cost including Excise Tax .....\$2.50 each

#### OTHER 32 VOLT APPLIANCES

Radios, Vacuum Cleaners, Coffee Makers, Etc.

**TERMS: Check with Order or  
C. O. D. Railway Express. F. O. B. Chicago.**

**HAINES MANUFACTURING CORPORATION**  
4754-56 N. CLARK STREET CHICAGO 40, ILLINOIS

# You too?

You too, like so many other dealers, may have had the disheartening experience of not being able to reap the fruits of your labor because a distributor or manufacturer has insisted upon opening other dealers in your territory after you have built public acceptance for his line.

#### A New Concept In Merchandising

This need never happen to you again on certain types of products; if it hasn't happened yet you can preclude such a business catastrophe by securing *while you can a lifetime franchise* on a line and trade mark of which you become the *conditional owner*.

#### Security In Lifetime Franchise

With this lifetime franchise goes a feeling of security for the future unmatched by any other business compensation—a definite knowledge that whatever you build will be yours, and your heirs, for all time—come depression and low volume, or boom and great volume that you need share with no one.

#### Wide Range of Products to Be Available

At present the line consists of oil burners, boiler-burner units and furnace air conditioning units. To be added soon, all under the same trade name, and available at the option of the dealer, are: kitchen cabinets, disposal units, dish

*Manufacturers—Have you a quality product that can be merchandised under private label?*

**FISKE PRODUCTS, INC.**

**BEDFORD, NEW YORK**

CLIP THIS COUPON TO YOUR LETTERHEAD AND MAIL AT ONCE.

FISKE PRODUCTS, INC., BEDFORD, NEW YORK

Without obligation, please send me complete details of your plan.

Name .....

Street Address .....

City .....

Zone .....

State .....

## Seen' is Believing!



Through a sight glass made by a power company serviceman, prospective purchasers of Bendix automatic washer can see the dirty wash water as it flows to drain and note that successive rinse waters become clearer.

## Philco Takes Over Refrigerator Plant

As a continued expansion of its refrigerator and freezer division, Philco Corp. has acquired the production facilities and all other assets of the Rex Mfg. Co., Inc., Connersville, Indiana. Philco has been purchasing the entire refrigerator output of the Rex plants for several years and has had an investment of \$973,000 in the preferred stock of that company. Operations of the Rex firm will continue without any change under the direction of the present executive management, with no changes in policies or personnel.

## "National FM Day" on Oct. 29

One of the big events of Radio Week—to be celebrated coast-to-coast from Oct. 26th to Nov. 1st—is "National FM Day" on Oct. 29. The special day has been set aside midway in the week for all the FM interests to celebrate the progress made in one of the fastest-moving branches of radio.

## "Garden" Fresh Air!

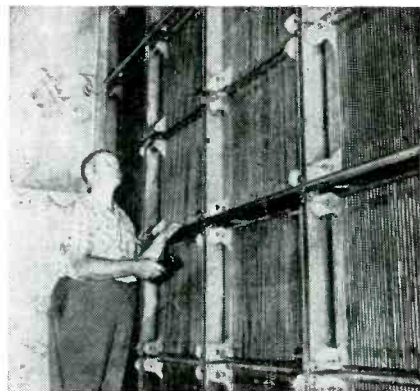

Howard Post, chief engineer of Madison Square Garden, New York, inspects the collector cells of the Raytheon precipitator recently installed in the new air-conditioning system in the garden.



# FACTS AT YOUR FINGERTIPS



Here are extra hands constantly ready to help you. Here is fingertip control of those many big and little problems that so unexpectedly call for instant solution during the course of your day's work.

Written recently by two practical, practicing engineers, these books are already working hand in hand with thousands of plant engineers, electrical engineers and engineering students.

So enthusiastic has been the applause from those who bought these books, we gladly assume all risk in placing them in your hands on a five day approval basis. Send the coupon today.



## ELECTRONIC CONTROL HANDBOOK

By Ralph R. Batcher, E.E. and William Moulic

Here are all the essential data necessary to determine the worth of an electronic control device; a dependable guide toward your taking advantage of the cost-cutting, production-speeding, quality-control possibilities of electronic devices. Section I, Basic Elements of Control; Section II, Conversion Elements; Section III, Electronic Modification Circuits; Section IV, Activation Elements; Section V, Control Applications.

350 Pages—Hundreds of Illustrations—\$4.50

## ELECTRONIC ENGINEERING HANDBOOK

By Ralph R. Batcher, E.E. and William Moulic

For radio-electronic specialists this Caldwell-Clements book provides a convenient, authentic source of formulas and principles, as well as the latest in electronic applications. Free from involved mathematical explanations. Section I covers Vacuum Tube Fundamentals; Section II, Electronic Circuit Fundamentals; Section III, Electronic Applications; Section IV, Vacuum Tube Data.

456 Pages—560 Illustrations—\$4.50

Both books 6 x 9 inches, bound in limp leatherette covers, open conveniently flat.

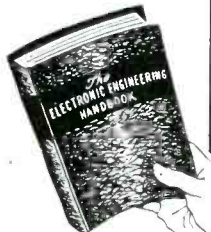

Once You Get These Books in Your Hands, You'll Always Have Them at Your Fingertips

No Risk—5 Day Approval

### CALDWELL-CLEMENTS, INC.

480-D Lexington Ave.  New York 17, N. Y.

Publishers to the electronics industries since 1925

Send books checked. If not satisfied, will return within five days. Otherwise will remit payment.

- ELECTRONIC ENGINEERING HANDBOOK \$4.50  
 ELECTRONIC CONTROL HANDBOOK \$4.50

Name.....

Address.....

City and State.....

Company Name.....

# Solved...

That Rainy Washday Problem! Now Anyone Can Dry Clothes Indoors, Thanks to Trilmont!

IT'S HERE! THE **FIRST Safety ELECTRIC CLOTHES-DRYING OUTFIT** Low-Priced for Volume Sales!

It's the FAMOUS **TRILMONT Safety\* Heater Complete** with a New Specially-Designed All-Metal Clothes-Drying Rack!

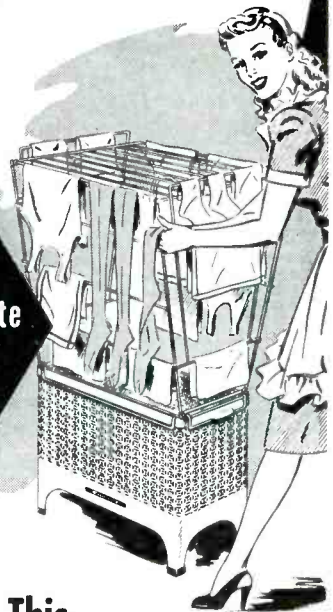

Cash in Now on This **Sure-Fire Profit Combination!**

Here's the first low-priced safety electric clothes-drying outfit for the mass market that can't afford expensive deluxe driers! It's a NEW, durable, easy-to-use all-metal rack . . . with over 35 linear feet of nickel-plated bars for clothes-drying . . . so compact it can be used in a corner space or small bathtub . . . collapsible so that it can be folded away for easy storage behind a door. PLUS the TRILMONT Safety\* Electric Heater . . . world famous for "warmth without worry" . . . now better than ever with the new TRILMONT Safety Cord Switch! Write today for name of nearest distributor! Ask your distributor or write direct about special plan to equip TRILMONT Heaters in your stock with TRILMONT'S new Drying Rack and Safety Cord Switch.

Heater and Drying Rack, List Price, \$39.50. Special Combination Retail Price . . .

**\$34.50** Incl. Fed. Tax Slightly Higher in Western Zone

Heater equipped with Detachable Cord Set and HEAVY DUTY Switch. Ivory or Brown Baked Enamel. Model A, 1200 Watts. Model AA, 1320 Watts. A. Cor D.C.

\*Winner, Lewis & Conger First Annual Home Safety Award

TRILMONT PRODUCTS CO., 24th & Walnut, Philadelphia 3, Pa.  
 Sales Agents: A. C. Sanger & Co., Inc., New York, Boston, Philadelphia, Atlanta, Cleveland, Chicago, Dallas. West Coast: Les Taufenbach & Co., Los Angeles, San Francisco, Portland, Seattle.

**When the Encyclopedia recommends  
a WIRE-WOUND control, remember...**



## Mallory is the Line That Gives You **ALL** Needed Values

A PROPER servicing job on old type radios often calls for a tapered wire-wound control. The Mallory Radio Service Encyclopedia will tell you just what's needed. And you'll find what you need in the Mallory Catalog—and at your Mallory Distributor's.

Fact is, Mallory is the manufacturer who has always made a *complete* line of wire-wound controls. There are thirty-three types covering every resistance value and taper . . . many with the exclusive Mallory adjustable bias feature . . . *all* equipped with the universal channel shaft and insert that fits all types of knobs.

Make it a Mallory wire-wound control, and you can't go wrong.

**You Expect More—and Get More—from Mallory**

**Insist on MALLORY—the  
Complete Control Line**

*Mallory is the manufacturer  
that offers:*

- 33 Correctly Tapered Wire-Wound Controls
- 31 Values in Single Tapped Controls
- 10 Values in Double Tapped Controls
- 12 Clutch Type Controls
- 10 Universal Dual Controls
- 92 Popular Special Controls

**P. R. MALLORY & CO. Inc.**  
**MALLORY**

VIBRATORS . . . VIBRAPACKS\* . . . CAPACITORS . . . VOLUME  
CONTROLS . . . SWITCHES . . . RESISTORS . . . FILTERS  
. . . RECTIFIERS . . . POWER SUPPLIES.

\*Reg. U. S. Pat. Off.

**APPROVED PRECISION PRODUCTS**

National Radio Week  
Oct. 26—Nov. 1

**P. R. MALLORY & CO., Inc., INDIANAPOLIS 6, INDIANA**



# SERVICE & SOUND

Section of **RADIO & Television RETAILING**

## Tips on Easy Circuit Changes

Service Notes from Set Makers Save Troubleshooting Time

• Nothing is more important to a troubleshooter than familiarity with a logical procedure in localizing trouble in a set. Often, however, a helpful hint to constantly recurring faults will permit a certain amount of

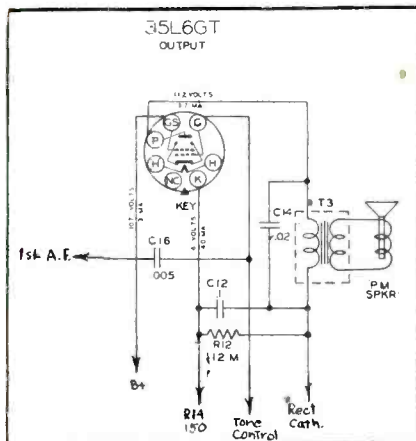

Fig. 1—Arvin Models 664, 664A, Chassis RE-206-1.

saving of time . . . provided the hint is authoritative. Here, then, are a few more tips right from the service departments of the manufacturers, to be added to those already discussed in previous issues.

Arvin models 664 and 664A, chassis RE-206-1, may have a hum which can be reduced by changing certain values in the hum-bucking circuit,

Figure 1. C12 is changed from .1 mf to .03 mf, and R12 is changed from 12,000 ohms to 15,000 ohms. On model 140P, chassis RE-209, if the antenna stage will not easily track with the oscillator at 600 kc, check to see that the loop is parallel with the aluminum plate. Bend it in or out slightly until the set aligns with good tracking.

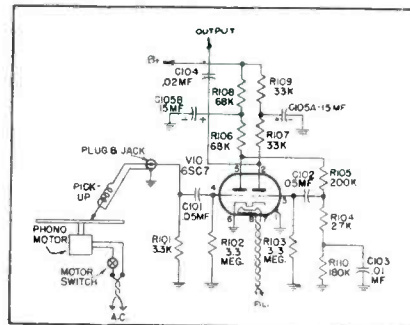

Fig. 2—General Electric Models, 12, 303, 326, 417.

General Electric models 12, 303, 326 417, Musaphonic (see Figure 2) high frequency response may be raised or lowered by changing the value of the resistor which connects directly across the reproducer unit. This resistor is usually contained in the preamplifier unit at the input jack. Making it a larger value or removing it will raise the highs. A compromise may be 10,000 ohms.

Zenith chassis 5C01- 6C01- 6C05 i-f amplifier circuit is shown in Figure 3. Uncontrolled oscillation in the set will sometimes arise in the circuit, and may be corrected by soldering a 470,000 ohm carbon resistor across the secondary of the first i-f transformer.

In the same chassis, distortion and poor sensitivity are usually caused by a short between turns on the wavemagnet, while if with poor sensitivity the set also fails to operate

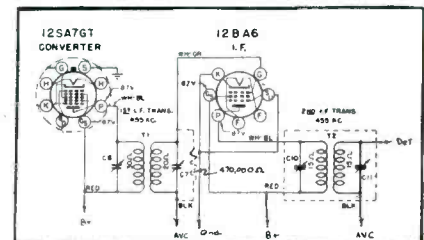

Fig. 3—Zenith Chassis 5C01, 6C01, 6C05.

on the low frequency end of the dial, the oscillator coil should be replaced.

In Zenith chassis 6C40, model 6G001, inserting the a-c plug into the battery saver switch socket while the off-on switch is on, may cause the set to block and become dead. Switching the set off and on will relieve this blocked condition and return the set to normal operation.

COMING IN NOVEMBER Issue of RADIO & Television RETAILING—

Results of the nationwide JOHN F. RIDER SURVEY outlining every significant trend and statistic in the technical and business end of the RADIO SERVICING INDUSTRY

AN EXCLUSIVE "FIRST" IN RADIO & Television RETAILING!

Rider spent thousands of dollars collecting and compiling this valuable material. The trade's leading magazine brings the important information to its readers as a "scoop"—as a GREAT SERVICE TO THE SERVICE BUSINESS.

# Revolutionary NEW RCA FARM BATTERY



## A full year's service...at less cost per hour

Now an "A-B" pack second to none... the RCA VS-099 Farm Radio Battery! Radio engineered for extra listening hours... with these *four points of superiority*—

**Superpowered** with RCA's special "Radio Mix"... the reason why there's a guaranteed 1500 hours—a full year's service—of dependable power in average use for an average 4-tube battery set. And at *less cost per hour!*

**Sealed-in-Steel** construction gives the RCA Farm Radio Battery greater mechanical strength...

protects individually tested cells against damage. **Leakproof.** Steel-sealed container makes battery leak-resistant and swellproof... protects radios and floors.

**Climate-Proof.** Container preserves power *wherever* battery is used... by sealing out dampness—protecting against desert dryness.

Get the details on this sensational new Farm Battery from your RCA Distributor. It's the hottest profit-maker in the field!



**TUBE DEPARTMENT**

**RADIO CORPORATION of AMERICA**

**HARRISON, N. J.**



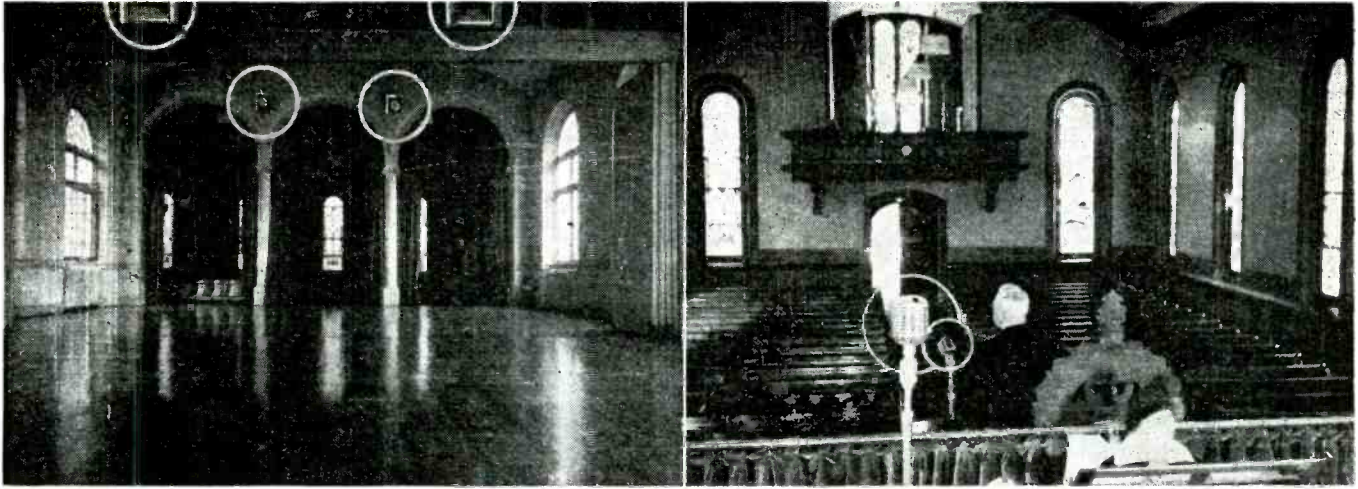

Left: From rear wing, pulpit is seen through right-hand arch. Four 12" PM speakers are controllable by T-pad hidden behind folding doors at left. Right: Rev. A. C. Wyckoff, D.D., familiarizes himself with the pickup pattern of one of the two mikes flanking the pulpit, while Miss Dorothy Howland sits at the organ. In foreground is seen one of the two mikes flanking the console, used for tower reproduction pickup. Balcony houses amplifier and controls.

# Sound for Churches

## Part II Offers Pointers for Installing Auditorium and Tower Systems

● The September issue discussed a number of factors entering into the selling and planning of a church sound system. This month we continue with more ideas for the sound dealer in this field, as seen by L. A. Randall, of Stromberg-Carlson Co.

The location of auditorium speakers usually present a problem, for not only are we concerned with proper coverage, but also with unobtrusive appearance. The loudspeakers should be located fairly high and with no obstructions between the reproducers and the areas to be covered.

The installation in The Reformed Church of Spring Valley, N. Y., pictured on this page, illustrates another principle as well . . . that of the sparing use of speakers and sound

reinforcement whenever possible, a very important factor.

The worshippers seated in the main auditorium can ordinarily hear the voice of Rev. Albert Clarke Wyckoff, D.D., minister of the congregation, without the need for amplification. Those in the added wing, however, would find this impossible, although they are able to see him sufficiently well. Hence only the wing required loudspeakers.

Speakers connected to the auditorium system are sometimes required in the choir loft to keep the choir posted on the progress of the service, in the entrance to the nave to inform the ushers when to seat the tardy worshippers and in rooms used for overflow purposes during services

when the auditorium is overcrowded.

Consideration must also be given to the number of microphones in the system, but as they are not used simultaneously in most forms of worship, it is not necessary to provide individual inputs for each microphone. Instead, their receptacles can be paralleled. The amplifier microphone inputs should be equipped with well shielded, low impedance 30- to 150-ohm input transformers so that long shielded input lines can be used to guard against noise pickup.

The usual precautions required in any good sound system installation of using high quality shielded microphone cable and keeping these cables away from power and loud speaker

*(Continued on page 106)*

Left: Mike for tower reproduction chime pickup, located in organ left, is placed two feet in front of the high-pitched end of the array, a location chosen on the basis of numerous trials. Right: One of the four trumpets in the tower, supported by pipes from wooden platform and guyed by two wires from pipe clamp to cleche frame, and four ropes from bell of horn to frame. At right are seen two more sets of units for two other trumpets.

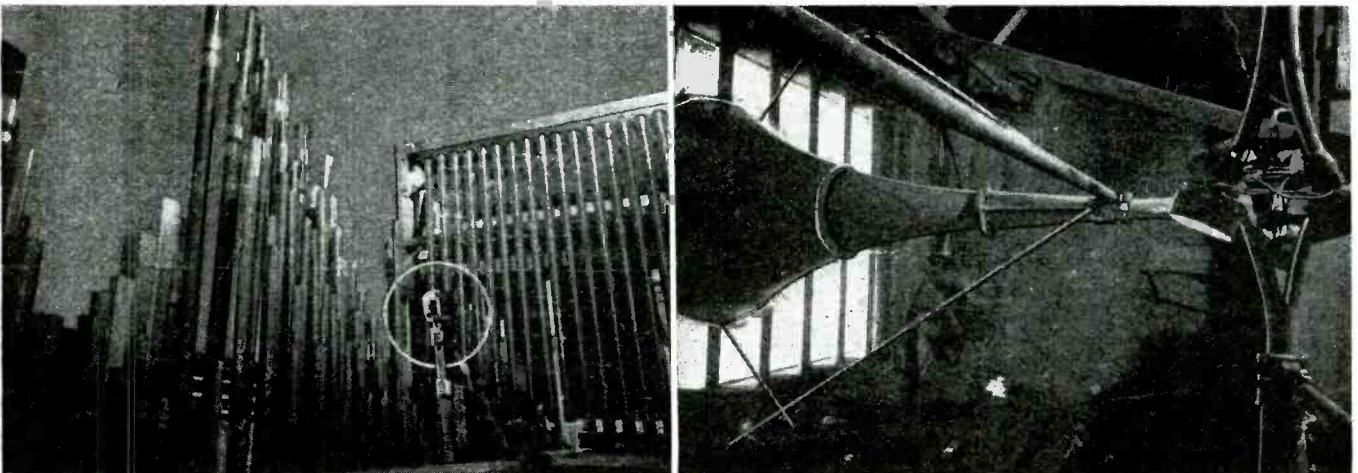

# Latest FM Tuner

Descriptions and Technical Details of the Newly-Marketed Units. Add Noise-Free

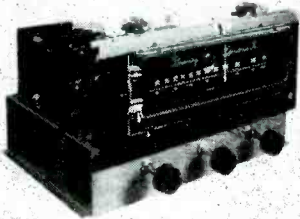

Browning RV-10 uses miniature tubes in tuned r-f and i-f sections, needs less than 10 uv input for optimum operation of 2-stage cascade limiters and Armstrong circuits. Tuning eye indicator, edge-lighted dial, phono switch, high impedance output.

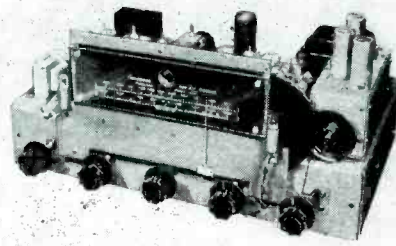

Meissner AM-FM tuner, No. 9-1091, uses miniature tubes for tuned r-f and i-f amplifiers, sensitivity under 10 uv. Response flat within 2 db, 30 to 15,000 cycles. Compensated volume control, bass and treble equalizers, tuning eye.

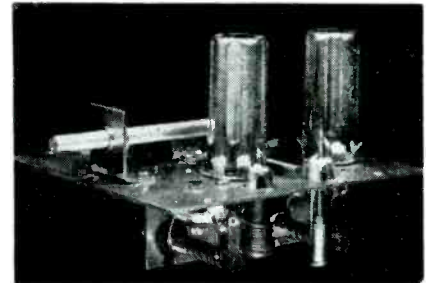

Radio Tuning Devices FM r-f tuner uses 6AK5 mixer, 6C4 oscillator, with 120-1 image ratio. 180° dial rotation with no backlash; less than 3 db tracking error, no perceptible frequency drift. Input 300 ohm line, output 10.7 mc.

● Although one of the greatest new markets awaiting the enterprising servicer, FM has until recently been relatively slow in getting started. That state of affairs belongs now with history, for in recent months FM has opened up with a great big bang!

This Fall, sensational announcements have been and are being made of new FM sets priced to reach every section of the public. New FM transmitting stations are going on the air by the hundreds, nationally, and scarcely a populous section of the land is without at least one today.

From all this activity, the alert servicer will reap a harvest. Possibly the earliest returns will be in the form of custom installation and servicing of the new FM and combination AM-FM tuners. These devices run from one-tube super-regenerative affairs to big, beautiful multi-tube chassis, having in common only the lack of a loudspeaker and audio amplifier channel, and the ability to tune

to the FM bands. They are designed to tie into the customer's present AM receiver audio section.

Some units are made to be mounted onto existing audio or AM radio chassis, others with cabinets of their own can be placed atop the existing AM receiver, while still others are mounted above or below the AM panel and chassis in commodious consoles or in rack-and-panel jobs.

## Latest Offerings

Shown on these pages are circuits of three new tuners, and pictures of four more. Other tuners, not shown, as well as low FM band to high FM band converters are also on the market. A full list of manufacturers making such devices appeared in the September 1947 directory issue of RADIO & Television RETAILING. In addition, some manufacturers are offering build-your-own kits of parts from which FM tuners may be built.

Edward's FM Radio Corp. FM tuner uses three high-Q silver plated tuned lines with miniature tubes in r-f section, and permeability tuned ceramic i-f transformers having separate primary and secondary windings. A 7½-1 tuning dial ratio is used. Less than 10 uv sensitivity for full limiting. 300 ohm input for twin lead line, tuning eye, front panel phono switch.

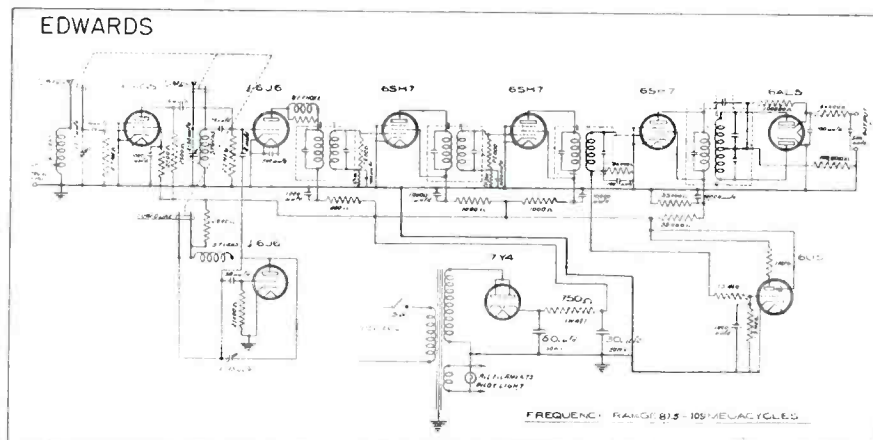

Browning Laboratories, Inc., 742 Main St., Winchester, Mass., announced their 13-tube RJ-12 and RJ-14 tuners some time back, and followed recently with their new 9-tube model RV-10 and RV-11. The newer models, compared with the older, show a self-contained power supply, greatly reduced size and weight, and coverage of the new FM band from 88mc to 108mc, without an AM range.

Maguire Industries, Inc., 936 North Michigan Ave., Chicago, Ill., plan to place a new Meissner FM tuner on the market soon. Their 18-tube AM-FM tuner pictured above has, however, become a familiar sight in many parts of the country. In addition to the new FM band, the standard broadcast range is covered, from 527 kc to 1620 kc.

## Separate Assemblies

Radio Tuning Devices, 392 State St., Stamford, Conn., make several FM r-f tuners and FM i-f strips, besides an audio section and FM-AM combinations. Pictured above is their model FMF-2 tuner, using two tubes and designed to work into a 10.7 mc i-f amplifier. The required amplifier could be a low-band FM receiver i-f amplifier, or another of the company's units, such as the model FM-107 6-tube strip with limiters, or the model 107R 3-tube strip with ratio detector. Model FMF-3 is a 3-tube tuner with r-f stage.

Collins Audio Products, Inc., 126 Park St., Westfield, N. J., have a 17-tube FM-AM tuner, illustrated above, and a straight FM tuner for rack mounting or assembly into existing consoles. The FM-AM tuner covers from 87.5 mc to 108.5 mc, and from



# Circuits

High Fidelity to AM Sets.

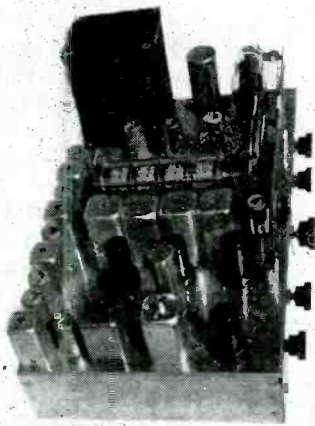

Collins Audio Products FM-AM tuner uses miniature tubes, 10.7 mc i-f with 3 db tracking error, 10 uv sensitivity. Regulated B supply to FM r-f circuits. 150-1 image ratio, tuning eye, no drift, 300 ohm input.

530 kc to 1650 kc. The AM section uses a 20-kc flat-top response curve, with a 10-kc interchannel whistle filter, four-gang tuning and delayed, amplified AVC.

Pilot Radio Corporation, Long Island City 1, N. Y., are the manufacturers of the widely-publicized Pilotuner. Listed as model T-601, this 5-tube (plus selenium rectifier) FM tuner covers the 88-108 mc band. Featured in the low price range, it is sold in its own small cabinet, from which it may be removed for mounting in small consoles or even table model phono-radio combinations.

### Some Unusual Features

As a result of early design experience with drift, copper tuning capacitors are used instead of the conventional aluminum. Among the several departures from usual component design, is the screw clamp mounted on the r-f coil, which by squeezing turns of the coil closer together pads the circuit. The oscillator padder consists of a disc mounted in relation to the silver plated coils. The circuit is shown at upper right.

Approved Electronic Instrument Corp., 142 Liberty St., New York 6, N. Y. uses a resonant-lines tuned

Approved Electronic Instrument Corp. FM tuner has resonant line tuning in r-f end, and iron-core ceramic 10.7 mc i-f stages. Has 2 volts output into high impedance, negligible frequency drift and 10 uv sensitivity for full limiting. The 6" pointer-travel slide rule dial has a 16-1 tuning ratio. 300 ohm input.

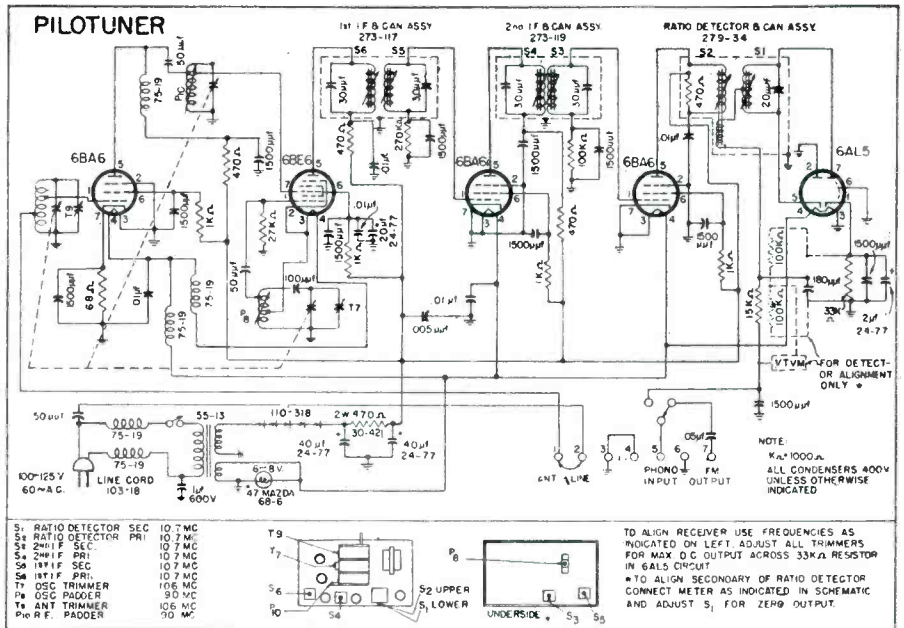

Pilot Radio Corp. Pilotuner uses negative temperature coefficient compensation in the tuned circuits. Five miniature tubes, selenium rectifier. For local reception, has r-f pickup filter on line, and 300 ohm input for outside dipole for low field strength areas. A tuned r-f stage and ratio detector, with high impedance output and slug-tuned i-f amplifier transformers.

front end, with the Armstrong FM circuit in its tuner model. Containing eight tubes, it covers the 88-108 mc tuning range. A complete diagram is shown at lower right.

Edward's FM Radio Corp., 168 Washington St., N. Y. 6, N. Y. market a popular FM tuner. An eight-tube unit, it tunes from 87.5 mc to 109 mc, and uses resonant-lines tuning in the r-f end. Its small size and compact tuning dial makes for convenience in installation. See diagram at lower left.

The Christmas buying season is close upon us. While complete radios are a favorite gift, folks with more than one receiver already in the home are apt to think in other directions for intra-family presents. An FM tuner, for attachment to the present AM receiver or phono amplifier

changes this "saturated" field into an "unscratched" market. Get literature and display samples, and promote them via the service department now! There's a unit to match any price requirement, style of installation or local reception condition.

SERVICE ties in with  
NATIONAL RADIO WEEK  
October 26 to November 1,  
Sell more SERVICE!  
Sell more SETS!  
Make more PROFIT!

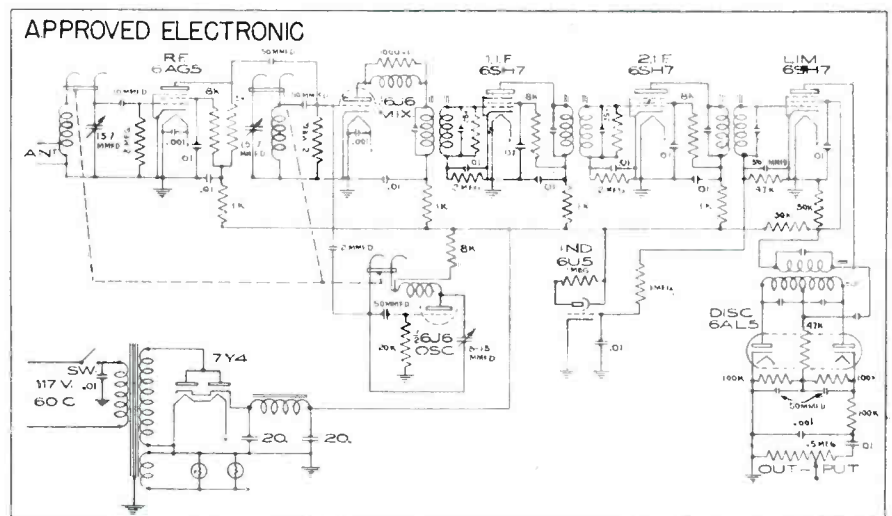

# Install

## Important Field for



Cecilia Carman's Telican receiver brought news reporters to her bar, Allen's Alley, in New York's Grand Central Palace, when Rosy, the trained 800-lb. 6-foot bear dropped in to watch the wrestling matches.



▲ The cocktail lounge of the Pal Mar Restaurant, Larchmont, N. Y., sports a model 130C Rembrandt Television receiver with 15" tube. In the restaurant proper, a console Rembrandt takes over.  
▼ Industrial Television series 1R installed at a low point, for "intimate" viewing by booth customers. Controls are remote, under the bar, and simultaneously tune other picture screens. See diagram at right.

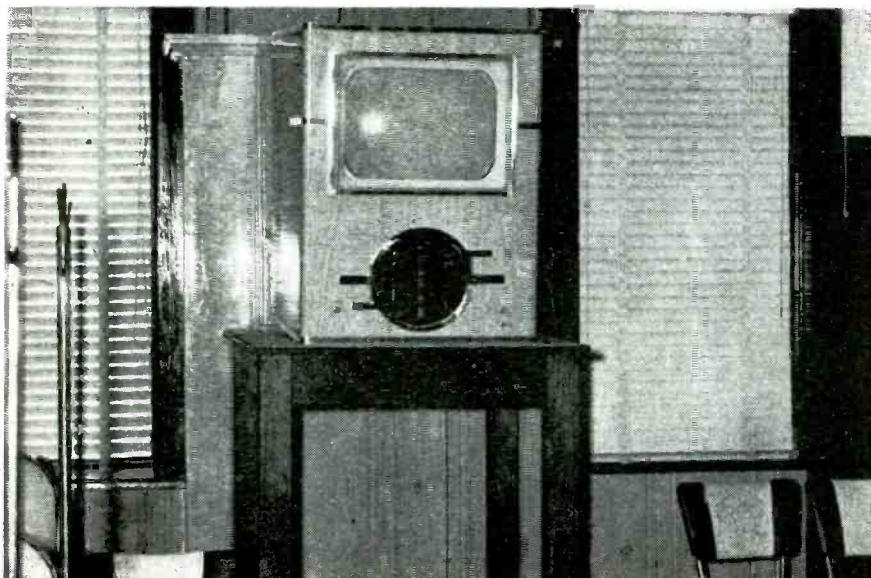

● The biggest thing that has ever hit either the tavern or the television industry has been the mass installation of television receivers in bars. Not only have bars with TV multiplied their business between 2 and 10 times, but Mr. Public has thereby been given his first real introduction to the new medium . . . and he's gone for it hook, line and sinker!

There's good money for the installing servicer in bar and tavern work . . . but to make it profitable, the man handling the job must be an honest-to-goodness expert. In this field nothing takes the place of experience. Much of that experience has been compiled, however, by the early birds in the field. Here are some pointers which they offer.

The purpose for which the bar owner spends big money for television is not to offer entertainment . . . it's to sell drinks. Therefore the receiver must be located where it will make people want to crowd around the bar or find seats in booths. Early mistakes in this direction made bars actually lose business. Correcting the mistake multiplied profits enormously.

### Some Good Examples

Look over the successful installations on this page. Note that the picture is high, and is generally most easily seen when standing right at the bar. Tippy customers, overly concerned with the receiver's tuning, have a bad tendency to fool with controls. For this reason, knobs should be on remote controls, or locked behind a door on the cabinet, or accessible only by the bartender, or so high up as to discourage tampering.

Since restaurant customers often begin watching a TV feature at the bar, and want to continue watching after being seated in the restaurant, the restaurant end of the business may require a separate set from the bar, or may use a type which has more than one picture tube tied into the same control unit, as featured by Industrial Television, Inc. When a separate receiver is used, it is often a standard type home set, either table or console, since restaurant customers are far less likely to play with



# Television Sets in Taverns

## Quick Service Profits.

controls. For this purpose, the receivers made by any of the well known manufacturers are often seen.

Some enterprising firms have begun to rent bar television sets by the month, with the rental fees applicable to the purchase price of the set within a certain period.

The sales problem is often complicated by arbitrary objections by the landlords owning the buildings in which bars are located. The installing dealer generally has the bar owner take care of all legal or code requirements, insurance, liability clauses against injuries to property or persons, etc. The dealer usually advises on steps and procedure, and certifies that his installation work is in accordance with local building and electrical codes.

## Avoid These Faults

Besides legal problems, psychological and technical worries beset the dealer. In the former, are especially found misconceptions which arise from the appearance of the multi-element antenna array. They range from folks who are afraid of the structure attracting lightning, to pigeon fanciers who believe the dipoles "sterilize" their pigeons.

Generally, however, the most important problems are technical. Since the correct operation of the television is directly tied up with profits, it is easy to see why the barkeeper is extremely touchy on the question of picture stability and quality. Poor line voltage regulation caused by a combination of mechanized bar equipment, cash registers, etc., and outdated, overloaded electric wiring are a reliable source of trouble. Even the annoying habit of transmitting stations adjusting their transmission or test pattern while radiating signals, will cause innumerable service calls to arise.

In poor locations, two or three separate antennas, with accompanying switches, may have to be used. In order to provide the optimum of reception on each and every station on the air, as demanded by the bar owner. Besides all this, of course, the main attendants must be well trained to tune the receiver.



Charles Wien's U. S. Television receiver at New York's Subway Inn, 143 W. 60th St., is placed for bar as well as booth viewing. Controls are locked behind doors, after adjustments are made.



▲ Dumont's new Custom model television receiver, seen currently in many taverns, is found here in a basement play room and private bar. Since no standing bar is provided, the screen is placed only slightly above the heads of the viewers. This type of private custom installation is growing in popularity. ▼ Industrial Television's hookup for several picture tubes operating off one control unit.

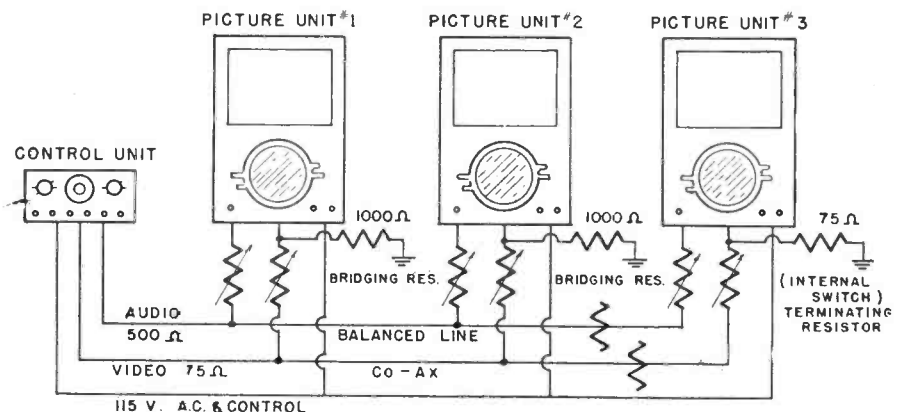



**ONLY \$139.50**

(F. O. B. Grand Rapids, Mich.)

**ORDER YOURS TODAY**

**FROM YOUR SYLVANIA DISTRIBUTOR**

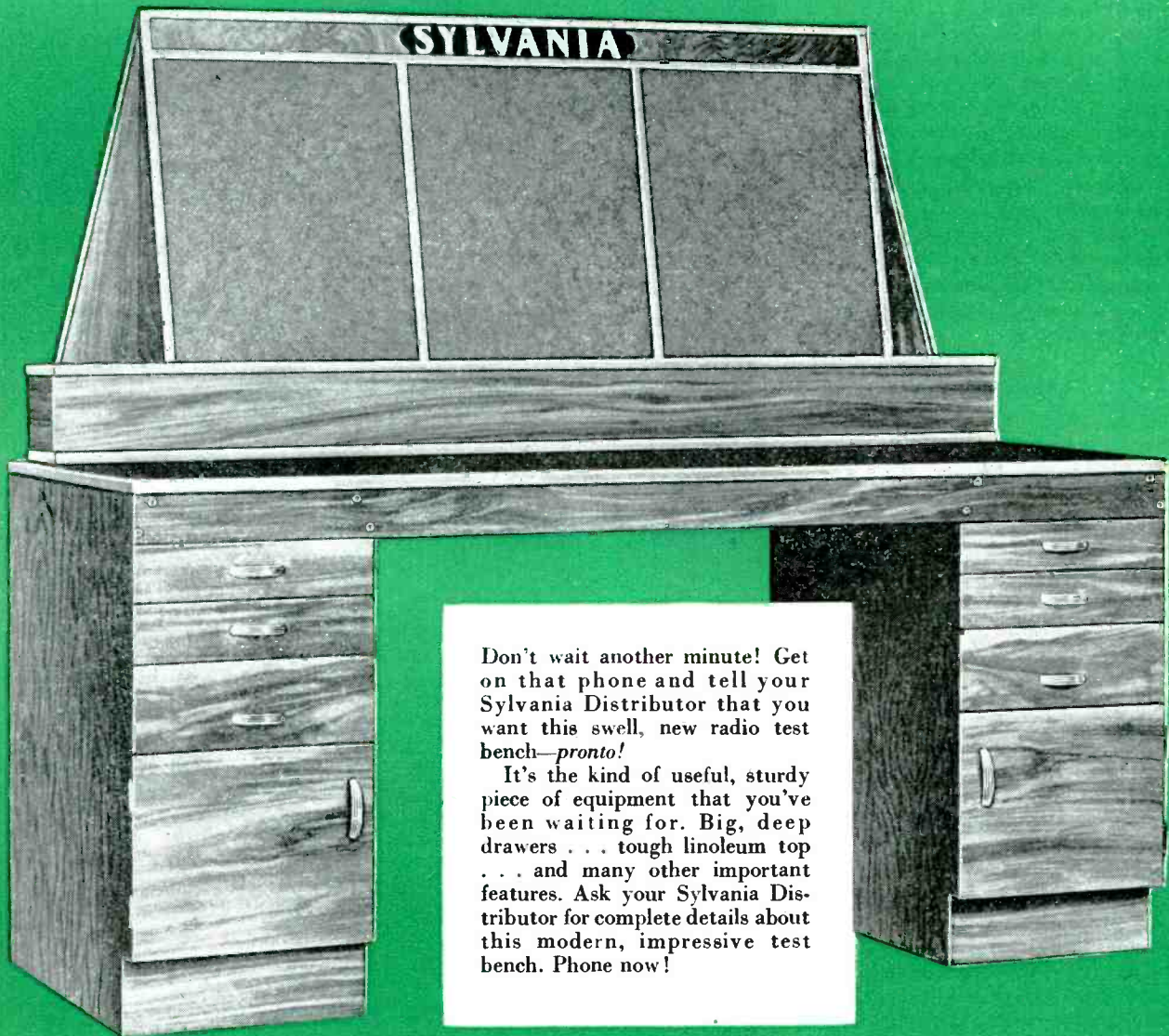

Don't wait another minute! Get on that phone and tell your Sylvania Distributor that you want this swell, new radio test bench—*pronto!*

It's the kind of useful, sturdy piece of equipment that you've been waiting for. Big, deep drawers . . . tough linoleum top . . . and many other important features. Ask your Sylvania Distributor for complete details about this modern, impressive test bench. Phone now!



**SYLVANIA**

MAKERS OF RADIO TUBES; CATHODE RAY TUBES; ELECTRONIC DEVICES



# THE BIG NEW SYLVANIA LOW-PRICED TEST BENCH

**COMPACT—YET ROOMY!  
COMES READY TO ASSEMBLE WITH  
FULL INSTRUCTIONS!**

**THREE-SECTION INSTRUMENT  
PANELS WITH AMPLE ROOM FOR  
A MULTIPLICITY OF INSTRUMENTS!**

Every radio service man has been clamoring for just such a big, rugged test bench as the one you see described on these pages!

Well, here it is! 7 feet long x 32 inches deep . . . 69 $\frac{3}{4}$  inches high! 36 $\frac{3}{4}$  inches from floor to working surface. Ample knee space! Ample toe space . . . (note recessed feature at each end). Gumwood front . . . plywood sides! Bench surface smooth, easy-to-clean tough linoleum! Six big drawers—two large

storage compartments! (Shipping wt. is 310 lbs.)

Yes sir, this is another Sylvania aid to better business for you! There's nothing on the market to match this rugged test bench for all-round serviceability and quality of construction. **ORDER YOURS TODAY! SOLD ONLY THROUGH SYLVANIA DISTRIBUTORS.**

*Sylvania Electric Products Inc., Radio Division, Emporium, Pennsylvania.*

**COMPLETE PREFABRICATED  
PARTS COME READY  
TO ASSEMBLE!**

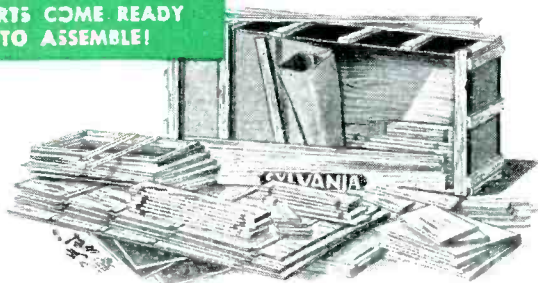

**RECESSED BASES  
FOR CLOSE WORK!**

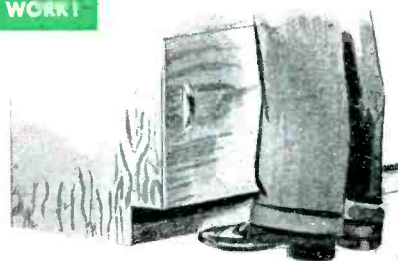

**ALL-METAL  
HARDWARE!**

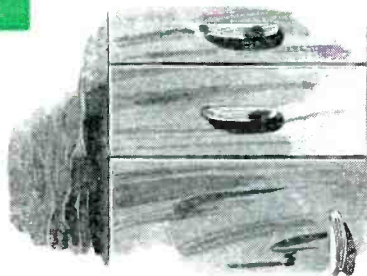

**STRONG WOOD  
AND MASONITE  
CONSTRUCTION!**

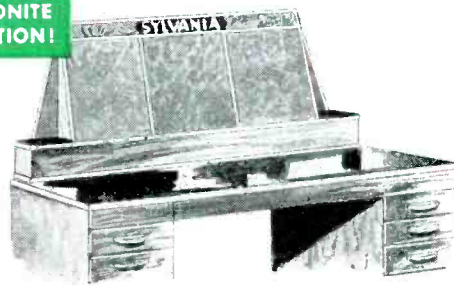

# ELECTRIC



FLUORESCENT LAMPS, FIXTURES, WIRING DEVICES; ELECTRIC LIGHT BULBS



Belfone "Maestro" series has a "Testalok" circuit to indicate when called line is busy. If not busy, it locks out other stations from breaking in. Stand-by unit draws plate current only when intercom is in conversation. Bell Sound Systems, Inc., 1183 Essex Ave., Columbus, Ohio.

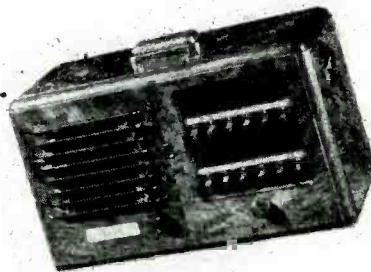

Webster Electric Deluxe Teletalk model 512 uses a separate microphone, mounted atop the unit, and separate speaker, thus eliminating the talk-listen lever. Webster Electric Co., Racine, Wis.

# Intercoms—Market

**Every Technician Should Become Familiar With**



Bogen Deluxe series have a "discrete busy signal system", in which steady and flickering glow lamps on caller's unit indicate when called station is talking, listening and free. Any or all stations can be called simultaneously. David Bogen Co., Inc., New York 12, N. Y.



Dictograph EL-201 Electronic master station can call up to 10 stations, individually or simultaneously if desired. A small light indicates incoming calls. Dictograph Products, Inc., 580 Fifth Ave., New York 19, N. Y.

● During the past 10 years, intercommunication has become a section of ever greater importance in the sound business. The radio dealer also views it as a developing part of his trade, as does the radio servicer.

The fact is, the intercom business has spread out quickly, and has reached the point where it is entitled to a special section or staff in any radio or sound sales or service setup. The intercoms shown on this page represent some of the manufacturers whose products are seen in the millions of stores, offices, factories, institutions and homes throughout the country. Each is sold through a distributor and dealer channel.

Virtually any business of two rooms or more can use an intercom. Any businessman with a secretary, any doctor or dentist with an assistant or technician, and any owner of a store with a stockroom, can save miles of steps and hours of time with an intercom.

These devices have many selling points in their favor. Easily adapted

to any business, they keep people at their desks, provide relief for the busy switchboard, increase productive capacity, secure better co-ordination, reduce delays, improve customer service, and foster better executive supervision. Master stations usually cost less than a cent a day to operate, while remotes may consume no power at all.

Other uses for the system are easily found. When the watchman has completed his rounds, he switches the system on so that all noises in the entire organization are picked up in the office. Should an emergency occur during the working day, special safety instructions could be given immediately to all branches.

A new and very quickly growing field for intercom is in the home. For listening in on the baby's nursery or play room, for hearing radio programs from another part of the house, for talking with callers through a closed front door, for quick contact between all family members, the home-style intercom is

E-L Radio Utiliphone is a 5-tube radio and a 3-tube intercom combined into one. This model 76RU has automatic break-in on radio receptions when a sub-station calls. Electronic Laboratories, Inc., Indianapolis, Indiana.

Kellogg Select-O-Phone is a private automatic telephone and paging system, with capacity to handle up to 36 lines. Sub stations use dial telephones, while master station can use speaker, part of selector box. Kellogg Switchboard & Supply Co., 310 W. 6th St., Kansas City, Mo.

Lyman "Baby Listener", developed from the Callmaster industrial intercoms, enables the mother to listen in on nursery and playroom from the kitchen, bedroom, living room or any other part of the house. Lyman Electronic Corp., 12 Cass St., Springfield, Mass.

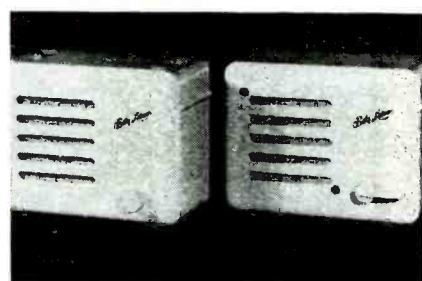
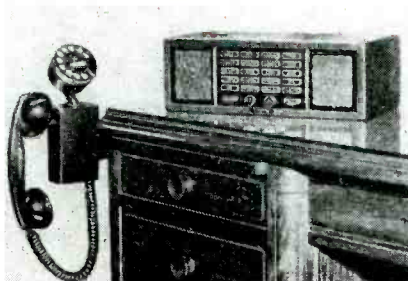
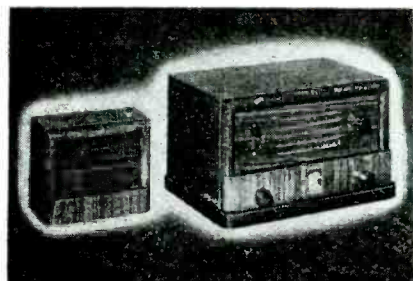



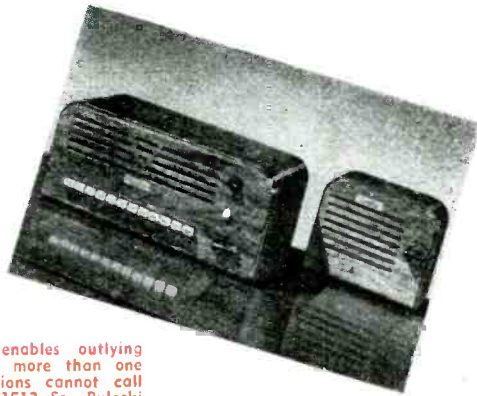

Talk-A-Phone "Chief" model enables outlying stations to originate a call to more than one master in a system. Staff stations cannot call each other. Talk-A-Phone Co., 1512 So. Pulaski Rd., Chicago 23, Ill.



Stromberg-Carlson models IM-507 (seven station) and IM-514 (fourteen station) intercoms have separate volume controls for setting outgoing and incoming volume levels. Incoming calls are heard even when power of called station is turned off. Stromberg-Carlson Co., Rochester 3, N. Y.

# for PA, Service

## the Leading Products in This Expanding Field

meeting with great acceptance, and a number of new units are being readied for announcement to the trade.

Contract installation and maintenance of intercoms has been frequently handled by the service department of the radio dealer, and today an increasing amount of business is coming from non-contract trade. Most frequent sources of trouble are found in the cording and cables between units, terminal strip connections, tubes, speakers, switches, electrolytics, and pilot lights.

The circuits employed within the units are ordinarily straightforward amplifier hookups, with either series filament ac-dc wiring or ac-only transformer types. The switching and cabling methods, however, vary widely from one make of intercom to another, and before soliciting trade from the public, the servicer should prepare by securing circuit diagrams of the most popular types to study and understand.

In a recent questionnaire sent to

a number of dealers, RADIO & Television RETAILING asked: to what type of firms have you recently sold intercoms? The partial list of customers below, may well be a guide around which to plan initial sales efforts.

### Recent Intercom Purchasers

Wholesale tobacco dealer, large armature works, garage, printer, bar, university, fish market, out-patient clinic, grain elevator, cafe, bakery, public utility, restaurant, doctor's office, steel company, motor transport company, business school, laundry, bottling plant, private home, beauty school, hotel, florist's greenhouse, cold storage locker, bank, auto supply store, bus line ticket office, retail super market, typographer, fire department, theatre, country club, tourist court, big business office, public school, railroad, variety store, mine, packing company, canning company, cleaning plant, paper warehouse, church, telegraph office.



Masco model JMK intercom is a two-unit system housed in cast aluminum cases. Press-to-talk switch on the remote station prevent unauthorized listening-in. Power output into the 4" speaker is 2.5W. Mark Simpson Mfg. Co., Inc., Dept. 2, 32-28 49th St., Long Island City 3, N. Y.



Raytone intercom is a master-to-master system used with up to ten stations, each containing a three-tube amplifier and 4" PM speaker. Distributed by Raytone Electronic Co., 25 Frankfort St., New York 7, N. Y.

Operadio Flexifone intercoms offer 10- and 20-station masters, with provision for loudspeaker paging and use of privacy handset. Press-to-talk bar can lock down. Operadio Manufacturing Co., St. Charles, Ill.

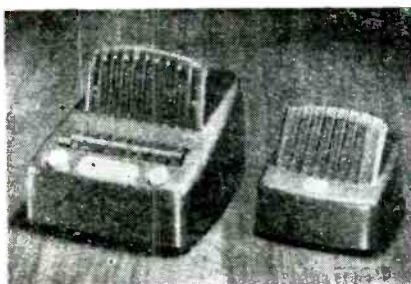

RCA has 5 models of intercoms, for 6- and 12-station systems, with and without privacy earphone. No eavesdropping is possible, although simultaneous group paging is simply accomplished. Sound Equipment Section, RCA, Camden, N. J.

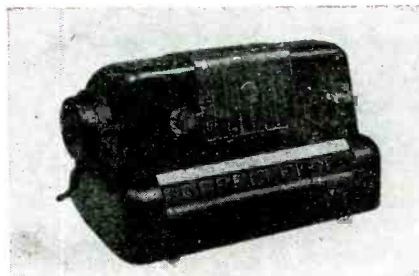

Rauland Amplicall of the 2400R series has 24 stations and handset for privacy as well as speaker. A neon bulb signal lamp indicates when the station being called is busy. The Rauland Corp., 4245 North Knox Ave., Chicago 41, Ill.



# Religious PA

(Continued from page 97)

lines, matching of speakers, etc., must be followed. A church installation offers more of a problem in wiring for it must be concealed and not detract from the beauty of the edifice. In the installation shown here, dealer Harvey H. Mellion, of Spring Valley, ran his shielded chime, organ, pulpit and spare mike cables over the rooftop, via small, sealed holes in the ceiling, leaving none visible.

Reproduction of chimes from the church tower is another fairly easy problem to solve. Quality of reproduction is the first consideration and not loudness. Due to exposure to weather, re-entrant horns and driver units having corrosion-resisting finishes are oftentimes selected for the speakers. To provide as good reproduction as possible, the re-entrant horns should be as large as the physical limits of the tower permit.

Usually four re-entrant horns with driver units are required for 360° coverage from the tower. Sell your prospect on quality of reproduction and not distance. Foliage, adverse winds and building obstructions will affect the distance carrying ability of

the reproduction and even cause spotty coverage.

Under normal or average conditions, a fifty watt amplifier is ample for the audio power requirements. Most driver units have a 16 ohm voice coil. If we connect two driver units in parallel to a speaker line our load impedance is 8 ohms.

If four line to voice coil transformers are used at the tower speakers, as in the pictured illustration, four 500 ohm lines can be run to connect the horns with individual 500 ohm amplifier outputs, or with a common 2000 ohm output tap. If it is desired to eliminate weather-protected line transformers at the tower, use No. 14 AWG twisted conductors as an 8-ohm line which can be run 190 feet with loss of 1 db.

### Precautionary Step

Careful adjustment of the bass suppressor control will be necessary to exclude frequencies below the cut off of the re-entrant horn being transmitted to the driver unit or a high pass filter installed. Distorted reproduction and damage to the driver units can be the result of not following this precaution.

There are several manufacturers

of electronic chimes whose output can be connected to the input of the amplifier. If a microphone is to be used to pick up the chime section from the organ another problem is involved. Usually a low impedance, broadcast type balanced line dynamic microphone or microphones are used and the amplifier equipped with low impedance input transformers.

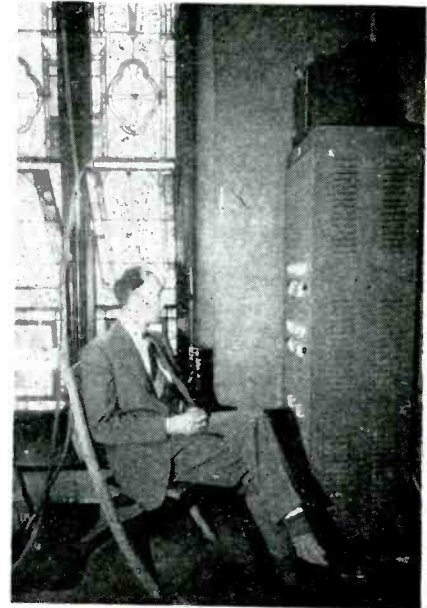

Heart of the system is the bank of Stromberg-Carlson amplifiers. On top is a monitoring speaker, at left a signal box. Phillip Inglis at controls.

Floor plan layout, showing mikes, controls and speakers. Note the two organ pickup mikes, placed in the chancel, outside the organ loft, to permit the sound to be modulated by the shades, simulating the effect actually heard by the audience. Block wiring diagram is seen at lower right.

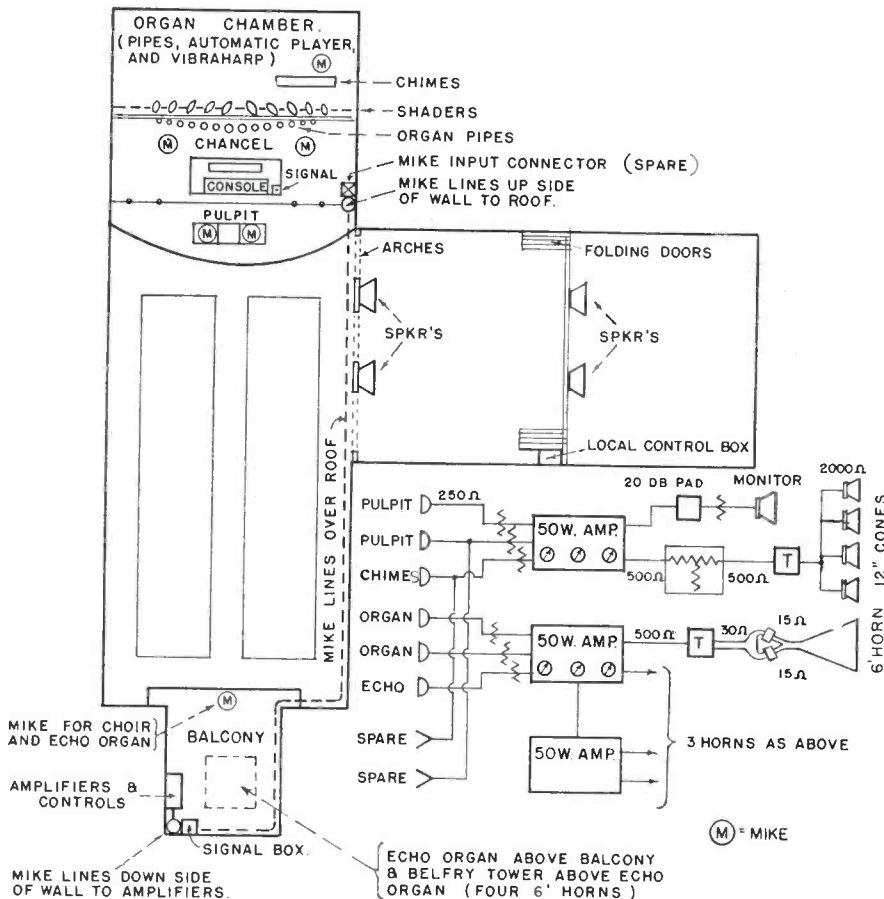

Considerable experimentation is usually necessary to find the proper microphone location where the sound from the individual notes of the chimes is picked up with even intensity. A monitor speaker connected to the amplifier should be used in conducting the test and the tower speakers cut off to prevent annoyance.

Recreational or social area systems present only the usual everyday problems to the sound equipment engineer of locating and selecting the proper speakers, amplifiers and microphones, minimizing acoustical coupling or feed back, and determining the proper wiring method.

It may be necessary for the church committee to decide on a long range program if their finances are insufficient to do the entire job at one time. Nothing hurts the sound industry quite as bad as when some institution wants a system to perform a lot of services and names an inadequate amount of money they can spend and have some sound engineer accept.

When a religious institution installs a number of independent systems, they can always be interconnected permanently or temporarily at a later date to serve those infrequent occasions when the need arises for the system to function as one.



**NOW**

# 625 NA\* VOLT-OHM-MIL-AMMETER

**RANGES**

- Six D.C. Volts to 2,500 at 20,000 Ohms per Volt.
- Six D.C. Volts to 5,000 at 10,000 Ohms per Volt.
- Six A.C. Volts to 5,000 at 10,000 Ohms per Volt.
- Six Current Ranges: 0-50 Micro-amperes to 0-10 Amperes.
- Three Resistance 0-2000-200,000 Ohms; 0-40 Megohms.
- Six Decibel Ranges: -30 to +69.
- Six Output Ranges to 5,000 Volts.

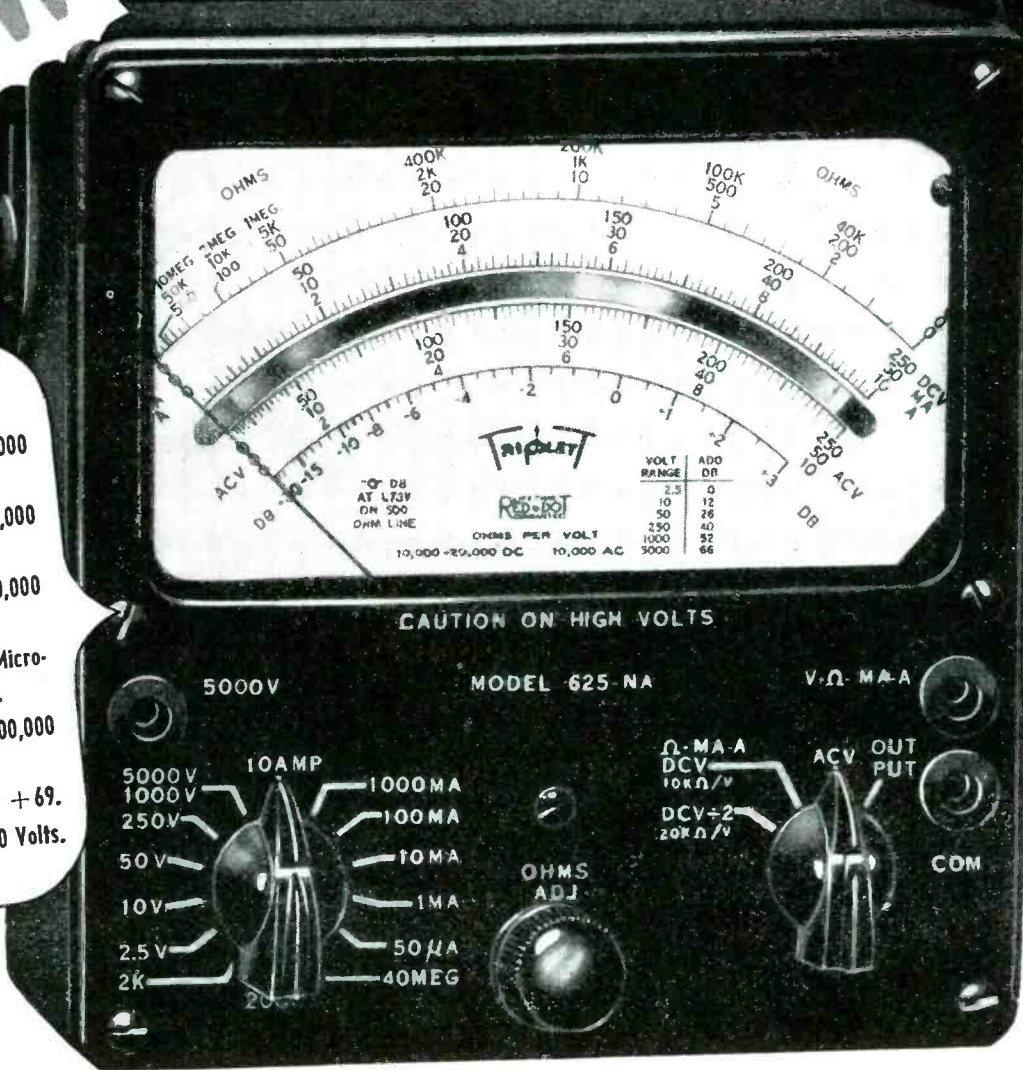

## \*High Ohms—Mirror Scale—Thirty-Nine Ranges

*For the Man Who Takes Pride in His Work*

The new Model 625NA, with 39 ranges and many added features, is the widest range tester of its type. Note the long mirror scale on the large 6" meter for easier more accurate reading. Resistance ranges to 40 megohms give you all the ranges

needed for general servicing, plus Television and FM. And with 10,000 ohms per volt A. C. you can check many audio and high impedance circuits where a Vacuum Tube Volt meter is ordinarily required. A proven super-service instrument.

Write for details today about Model 625NA and the many other new Triplet testers. Address Dept. Q107.

*Precision first  
...to last*



# Triplet



**ELECTRICAL INSTRUMENT CO. BLUFFTON, OHIO**

# New Service Aids Save Time

## RCP TUBE TESTER

Model 316DL uses a 7½" indicating meter with identical easy-reading good-bad scales on both sides, permitting the customer to see for himself the condition of his tubes. Using a "free-point" circuit as a preventative against obsolescence with the development of new tube types, the

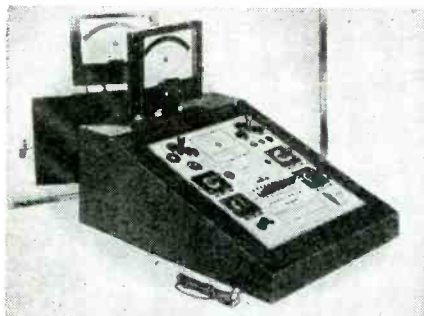

tester features as well a noise and microphonic detecting jack, a mechanical roll chart and the new 9- and 7-prong rectangular sub-miniature tube sockets. Model 316M, with the same basic circuit features and facilities, uses a 4½" meter mounted on the sloping front panel between the tube socket groups. Radio City Products Co., Inc., 127 W. 26th St., New York 1, N. Y.—RADIO & Television RETAILING

## Allied VTVM

Model 730 is a small, light and low-price vacuum tube voltmeter. Selling for \$34.50 net, 6 ranges cover up to 1000V d-c and 500V a-c, with accuracy within 3%. A polarity reversing switch is included. The probe contains one of the three miniature tubes, and has a response to 120 mc. Dimensions are 8½" x 5½" x 3". Allied Laboratory Instrument, Inc., 355 W. 26 St., New York 1, N. Y.—RADIO & Television RETAILING



## RCA BATTERY VOLTOHMYST

Type WV-65A is a self-contained VTVM requiring no external power source. Incorporating the features of the conventional model RCA VoltOhmyst, it can be used with the RCA Crystal Probe for testing voltages up to 100 mc. It weighs approximately nine pounds. RCA-Victor Co., Camden, N. J.—RADIO & Television RETAILING

## Hickok BATTERY VTVM

Model 214 is a self-contained battery-operated electronic volt-ohmmeter. Six a-c and six d-c ranges cover 0.3/12/30/120/300/1200 V with 15 megohms resistance

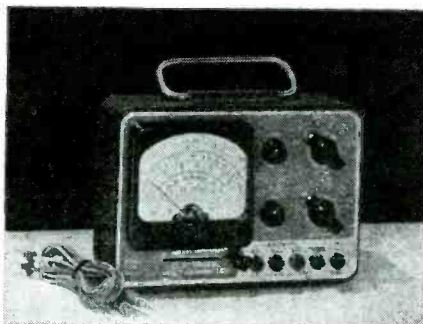

and 10 mmf capacity at the input. Six resistance ranges cover from 1 ohm to 1000 megohms. One 1S5 tube is used. The unit weighs 5¼ lbs. Hickok Electrical Instrument Co., 10523 Dupont Ave., Cleveland 8, Ohio—RADIO & Television RETAILING

## Speedway BENCH GRINDER

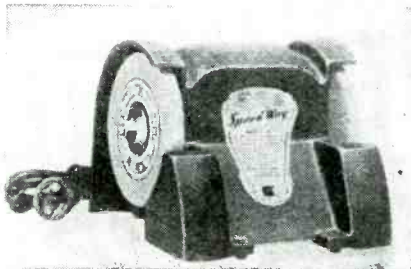

Type 117 portable bench grinder weighs 7½ lbs, and is rated at 1/15 horsepower. The two 4½" wheels and motor are completely enclosed in blue crackle finish one-piece molded housing. Speedway Mfg. Co., 1834 South 52nd Ave., Cicero 50, Ill.—RADIO & Television RETAILING

## Crystal Devices FM CONVERTER

Designed to permit old band (40—50mc) FM receivers to tune to the new band (88—108mc), the crystal FM converter is connected between the antenna and the receiver's input terminals. No power connections are necessary. While no alignment need be made in the receiver's if



section, some sets may require a slight r-f and oscillator trimming. Although already adjusted for best operation in the center of the new FM band, two screw driver adjustments on the side of the converter can permit adaptations to local conditions. Crystal Devices Co., P. O. Box 380, GPO New York 1, N. Y.—RADIO & Television RETAILING

## Sylvania OSCILLOSCOPE

Type 132 7-inch cathode ray oscilloscope uses push-pull 7C7 signal amplifiers. Provision is made for Z axis input with approximately ½ megohm, 30 uuf shunt capacity, impedance to ground. Weighing 37 pounds, the unit is 17" high by 11¾" long and 17¾" deep. Sylvania Electric Prods. Inc., Radio Tube Division, 500 Fifth Ave., New York 18, N. Y.—RADIO & Television RETAILING





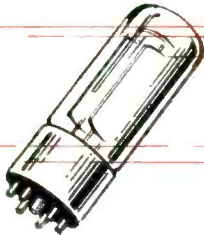
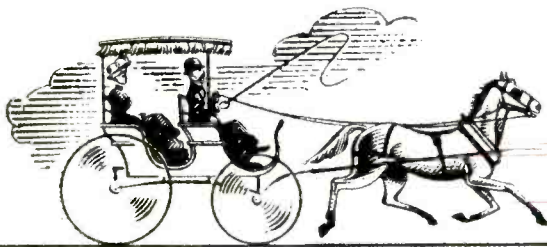

## STORY WITHOUT WORDS

...here's how it can boost *your* profits

AS SURELY AS the "gasoline buggy" replaced the horse-drawn carriage, the Miniature Selenium Rectifier—an original Federal development—is destined to take the place of the rectifier tube in AC-DC receivers. Already, more and more manufacturers are building it into their radio sets—and more and more maintenance shops are installing it in the sets they service.

What about *you*? Here is really a big chance for you to

make *extra money*—by *modernizing* AC-DC sets now using a rectifier tube—giving them faster starting, better all-around performance. And as new sets using the Miniature Rectifier as original equipment come to you for servicing, you'll want to be ready with replacements. It's your opportunity to be a *leader* by introducing this improvement *now*—by installing Federal's Miniature Selenium Rectifier in every AC-DC receiver you service.

Available through major jobbers from coast to coast—complete with detailed instructions.

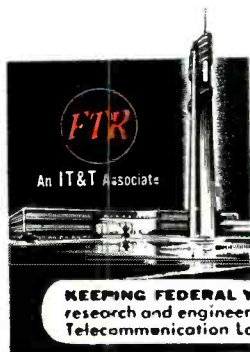

KEEPING FEDERAL YEARS AHEAD... is IT&T's world-wide research and engineering organization, of which the Federal Telecommunication Laboratories, Nutley, N. J., is a unit.

## Federal Telephone and Radio Corporation

SELENIUM and INTELIN DIVISION, 1000 Passaic Ave., East Newark, New Jersey

In Canada: — Federal Electric Manufacturing Company, Ltd., Montreal.

Export Distributors: — International Standard Electric Corp., 67 Broad St., N. Y. C.

# New PA Equipment for Sound Business

## Langevin WIRED MUSIC

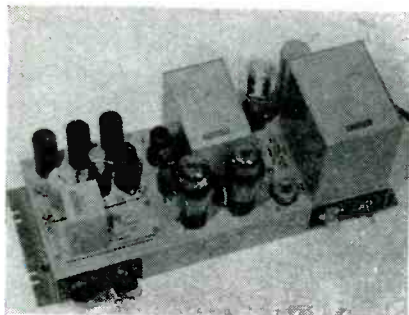

Model 610 amplifier, designed for wired music pickups, provides 20W with less than 2% total harmonic distortion from 100 to 7500 cycles, or less than 5% from 50 to 15,000 cycles (flat within 1.5 db) at 15W output, into 500, 125 or 4 ohms load with ungrounded output windings. A shielded, balanced, input transformer provides 150 ohm, 600 ohm, and bridging impedances, facilitating direct connection to telephone lines where permitted. A separate mike input channel for paging in plant installations, uses a 30 or 250 ohm input, and a remotely-controllable preamp, to provide 112 db gain. The Langevin Co., Inc., 37 W. 65th St., New York.—RADIO & Television RETAILING

## Jones FANNING STRIP

Terminal wiring for PA equipment is facilitated with the new harness or cable wiring aid. Designed for use with the same company's barrier strips, up to 20 terminals can be wired up on the fanning strip, the work being done on the bench, without the need to solder directly at the amplifiers being installed. Howard B. Jones Div., Cinch Mfg. Corp., 2460 W. George St., Chi. 8, Ill.—RADIO & Television RETAILING

## Audax REPRODUCER

Model STUDIO-81 of the new Audax Tuned-Ribbon family is fitted with a diamond stylus, and has a point pressure of 14 grams, with magnetic-cushion tracking. A linear response to over 10 kc is maintained. Audax Co., 500 Fifth Ave., New York City—RADIO & Television RETAILING

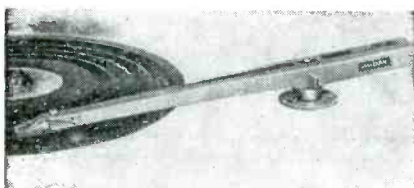

## E-V BUTTON CONTROL MIKE FLOOR STAND

Utility model 430 Button-Control floor stand has a single red button by means of which the shaft height can be instantly varied and relocked. Holding firm against the weight of the microphone, no screw adjustments are needed, although the shaft may be rotated easily without unlocking. Designed for 3-legged, solid support, as well as light weight, one bolt is used to lock all three legs into position, with a 17" spread. The height is adjustable from 36" to 65", with a net weight of 7½ lbs. Electro-Voice, Inc., Buchanan, Mich.—RADIO & Television RETAILING

## Portelec SYSTEM



Model 40M2 is a portable electrical phonograph transcription player and public address system. A 12 watt amplifier with crystal pickup and dual-speed turntable are combined with a dynamic mike. 25 feet of cable and a telescoping mike stand into one case. The top section of the case is removed to form two sections, each containing an 8" PM speaker with 50' of cable. Pacific Sound Equipment Corp., 130 North Beaudry Ave., Los Angeles 12, Calif.—RADIO & Television RETAILING

## Western Electric SPEAKER

Type 755A loudspeaker is a low-power counterpart of the W.E. 728B speaker. This 8-inch cone has a frequency response from

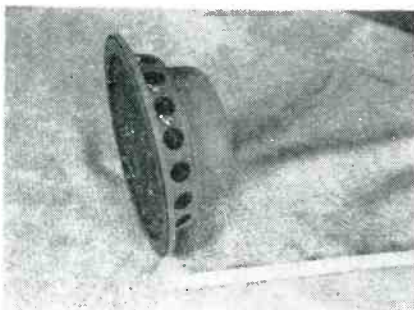

60 cycles to 13,000 cycles, handling 8W of audio. It is 3½" in depth, and requires a baffling enclosure of only two cubic feet. Western Electric Co., Inc., 195 Broadway, New York 7, N. Y.—RADIO & Television RETAILING

## University PAGING and TALK-BACK SPEAKER

Model MIL has a built-in hermetically sealed PM dynamic driver unit, and because of construction and corrosion proof

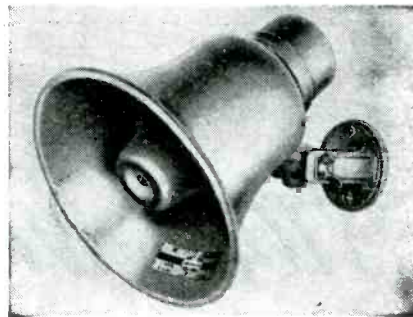

finish, is immune to moisture, salt spray, wind and vibration. With a continuous duty rating of 5W, the speaker has an adjustable bracket for simplified mounting and orientation, and can be used for talk-back intercom circuits. University Loudspeakers, Inc., 225 Varick St., New York 14, N. Y.—RADIO & Television RETAILING

## Permoflux SPEAKERS

High fidelity De Luxe model speakers range from 10" to 15", in both PM and EM types, with a power handling capacity up to 25W. The PM types feature a heavy

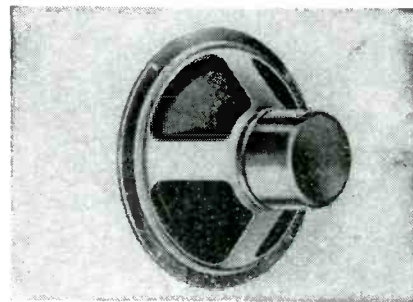

ring magnet and oversize dust-capped voice coil, and with suitable baffles the audio range is approximately 30 cycles to 12,000 cycles. Finish is corrosion resistant. Permoflux Corp., 4900 West Grand Ave., Chicago, Ill.—RADIO & Television RETAILING



# FREE

# to servicemen...



the magazine that makes your service jobs  
easier — faster — more profitable

tells you what to do  
— how to do it — chock  
full of FM and television  
servicing information — simplifies  
complicated jobs — tested ways of  
boosting shop traffic

Here's a magazine which can go a long way toward making your shop *the* radio shop in your community. Every month it is loaded with ideas — not impractical, day-dreamy schemes which look good only until you try using them—but down-to-earth, tested plans which have actually been used with success by other servicemen just like yourself. Its convenient, pocket-size pages contain valuable technical data — latest dope on new type tubes — notes on trouble shooting — yes, and dozens of helpful hints which will help you to repair any radio ever made easier, better and twice as fast. Accept "The Capacitor"—every month—with C-D's compliments. Put it to work in your shop speeding up repair jobs — building bigger profits. *Don't wait! Mail coupon below NOW so your FREE subscription will start at once.*

Read what these successful  
service men say about "the Capacitor"

**FROM MAINE:** "Your magazine carries much of interest to the serviceman. Keep up the good work."

**FROM MISSISSIPPI:** "The C-D Capacitor is a fine paper. My apprentice uses it to good advantage."

**FROM ILLINOIS:** "I think the C-D Capacitor is one of the finest and most complete publications I have ever had the pleasure of receiving."

**FROM KANSAS:** "Ads in The Capacitor saved me over one hundred dollars on test equipment. A great magazine."

### FREE ADVERTISING FOR SERVICEMEN

Looking for a new signal generator? Want to sell that spare 'scope? Interested in swapping some equipment with other servicemen? *The Trading Post* — which appears every month in "The Capacitor" will carry your ad FREE. Cornell-Dubilier Electric Corporation, Dept. JD-10 South Plainfield, N. J.

Mail This Coupon TODAY

1910 1947



MICA — DYKANOL — PAPER — ELECTROLYTIC

CORNELL-DUBILIER ELECTRIC CORPORATION, Dept. JD-10  
South Plainfield, New Jersey

Please enter my name to start receiving "The Capacitor"  
at once — absolutely free.

Name.....

Firm.....

Address.....

City..... Zone..... State.....

I own my own shop.  I am employed. (Please check one)

# TELEVISION TOPICS

## Motorola in Full Production of TV Sets

Motorola is reaching full production on its television receivers, according to a statement released by the firm. In a news release which announced a dividend of 30 cents per share of common stock, the organization also stressed the fact that its exclusive radar-type FM tuning device, used on all Motorola FM receivers, has been accorded wide acclaim in the industry. "This new type tuner represents a substantial departure from conventional outmoded methods of FM tuning and brings to the listening public for the first time a practical FM receiver with no-drift precision-peak tuning," the statement said.

## GI Research Aimed at Lower-Priced TV Parts

With the aim of putting television within reach of the average consumer, General Instrument Corporation has begun a half-million dollar research and engineering program designed to reduce sharply the cost of major components used by the television set manufacturers, it has been announced by Richard E. Laux, executive vice-president.

The program will be carried out in the Elizabeth, N. J., laboratory of General Instrument and in that of its wholly-owned subsidiary, the F. W. Sickles Company, Chicopee, Mass., of which Mr. Laux is president. Special attention will be paid to such currently expensive items as tuning heads, deflection coils and high voltage transformers, said Mr. Laux, expressing the hope that manufacturers of other television parts will embark on similar cost reduction research.

The reduction of 90 per cent in the cost of variable condensers effected by General Instrument since 1923 was cited by Mr. Laux as an indication of what such a program can ultimately accomplish.

## UST Launches Plan to Aid Television Dealers

A booklet, "How to Sell Television Sets Profitably," is a feature of the huge merchandising project undertaken by United States Television Mfg. Corp., 3 West 61st St., New York City, to help its dealers, it has been announced by Francis H. Hoge, vice-president in charge of sales. The twelve point dealer aid plan is being handled by Huber Hoge and Sons, advertising agency for UST.

Because UST's big-screen projection television sets reach the specialized public place market, a separate merchandising plan has been created to help owners of clubs, taverns and restaurants increase their revenue through use of the big picture sets. This direct mail project is also being handled by Huber Hoge and Sons.

The 16-page booklet on how to sell tele-

vision includes an analysis of the television industry, the opportunity to dealers, how to get prospects, how to demonstrate television, and has a list of question-and-answers that invariably come up for discussion. Other material for dealers include complete sales literature, point of sale displays, mat service, continuous direct-mail and trade advertising campaigns to public places, a periodical newsletter on sales tips, electric sign, window sticker, weekly television program service, complete promotion kit and consultation and lead service.

## New Philco TV Antenna

Construction has been started on a new 552-foot antenna tower at the transmitter of Philco television station WPTZ, Philadelphia, which will quadruple the area served by the station and bring clear television signals within reach of about 4,000,000 people, it has been announced by Ernest B. Loveman, vice-president of the Philco Television Broadcasting Corp.

The new tower will be the loftiest structure in the Philadelphia area and one of the highest antenna towers ever built for television. The tower will be so situated that one side faces the WPTZ studios in downtown Philadelphia and other important points from which television programs originate, such as Shibe Park and Franklin Field. Another side of the tower faces toward Mt. Rose, N. J., intermediate relay station for the Philco microwave television relay system linking New York with Philadelphia.

## GE Building Tele Transmitter for WOR

The General Electric Company is building a high-power television transmitter at its Electronics Park plant at Syracuse for WOR, New York, which will use it to operate a new television station to be established in that city with call letters WOR-TV. It will operate in channel 9 (nine) at a frequency of 186-192 million cycles per second.

In making this announcement, C. A. Priest, manager of the GE transmitter division, said the unit is expected to be delivered in March and WOR-TV personnel will have it on the air during the summer of 1948.

It will project programs into homes over a radius of 45 miles from its New York site and will bring this new service to from 15 to 20 million people.

Rated at 5-kilowatts, the transmitter's power will be increased to over 30-kilowatts by use of a high-gain GE television antenna. The transmitter will be designed so that higher-power stages can be added when needed without extensive changes to existing equipment, Mr. Priest said.

## New Booklets

RCA Victor Division, Radio Corp. of America, Camden, N. J., answers some frequently asked questions about television in "What's Your Television I. Q.?" a new two-color 16-page booklet for distribution to consumers through franchised RCA Victor television dealers.

Ward Leonard Electric Co., 35 South St., Mt. Vernon, N. Y., now has available for dealers a 6-page two-color booklet No. 100,000 on rheostats, resistors, relays, starters, switches, speed regulators, voltage regulators and dimmers. It's fully illustrated and all reps are listed.

Carter Motor Company, 2644 N. Maplewood Ave., Chicago, manufacturers of rotary electric power supplies for radio communications equipment, announce release of their latest sales bulletin, No. 447-J.

Metropolitan Electronic & Instrument Co., 6 Murray St., New York City, offers a catalogue describing and pricing testing equipment of all types, makes and brands which the firm distributes.

Jensen Manufacturing Co., Chicago, Ill., has available a new catalog, No. 1010, containing 24 pages of useful information and data.

The contents are arranged by groups for easy use by the reader and include Standard Series, Concert Series, Extended Range Single-Radiator Series, Coaxial Series, Bass Reflex Reproducers and Cabinets, and the Professional Series. The Professional Series includes such items as heavy-duty theatre equipment, Hypex and "S" Projectors, and the famous Speechmaster Reproducers. Three pages are devoted to a listing of impedance matching transformers in both fixed and adjustable impedance designs.

In the back of the book is a comparison chart showing all Jensen models in their relative gap energy levels. Each band of gap energy is separated from the next by 1.5 db. New Jensen models are shown side by side with their Alnico 3 predecessors to make selection easy for the purchaser.

Copies are obtainable from any Jensen Distributor or from the company at 6601 S. Laramie Ave., Chicago 38, Ill.

RCA Tube Department, Harrison, N. J., has available a new sales aid folder, illustrating and describing the complete line of promotional pieces and displays prepared for the dealer. This is a handy catalog from which the merchant can select store display material or mailing pieces, or otherwise plan a complete business-getting program. The booklet is available free from RCA distributors.



# Now...

## you can use it anywhere!

**Measures voltage  
resistance . . . and current**

**A**BOUT THE HANDIEST METER in the service field! In one instrument, for one price, you get an electronic voltmeter, ohmmeter, and ammeter . . . *battery-operated* to make it completely independent of power-line sources.

Use it to test car radios, farm sets, railroad signal equipment, aircraft radio, industrial electronic devices . . . opens up hundreds of profitable new opportunities beyond the limits of power lines.

With it you can measure both a-c and d-c voltages to 1000 volts, resistance to 1000 megohms, and direct current to 10 amperes. A new low-cost, RCA crystal probe can be attached if you want to make v-h-f measurements.

Most important, this instrument is easy on batteries. They last up to 10 months in normal service. A neon pilot light flashes when the instrument is on . . . serves as a reminder to turn the instrument off when not in use.

Linearity and stability are excellent.

Here is one of the best buys in test equipment on the market today. We'll be glad to send you complete descriptive and price information on this time and money saver. See it at your RCA Test Equipment Distributor.

**New BATTERY OPERATED  
RCA VOLTOHMYST**



**TEST AND MEASURING EQUIPMENT  
RADIO CORPORATION of AMERICA  
ENGINEERING PRODUCTS DEPARTMENT, CAMDEN, N. J.**

In Canada: RCA VICTOR Company Limited, Montreal

## New Manual on Farm Electrification

Practical information about profitable uses of electric service on the farm is the subject of a new training program just released by the Edison Electric Institute. Grover C. Neff, president has announced.

Among the subjects included are: the present status of farm electrification; basic fundamentals of electricity; wiring and re-wiring for the farm; lighting; water systems; home appliances; electric rates; freezing equipment; electrical equipment for poultry and egg production, dairying and feed and crop processing; electric motors.

Copies of the in-service training manual are being sent to state directors of extension activities, power companies, and others concerned with agriculture, by the Institute. Additional copies will be made available, at \$1.50 per copy.

## Silex Promotes Two

The Silex Co., has made known two new promotions in its sales force, according to J. M. Moore, general sales manager. Earl H. Barker, formerly Pacific Coast sales manager, was appointed Pacific Coast manager covering 11 western states. Robert J. Martin, formerly salesman in the Los Angeles area, has been promoted to district manager of the Los Angeles territory.

## Proctor Introduces New Toaster and Irons

Breakfast meetings for their distributor salesmen and executives in the New York City and New Jersey territories have been held by the Proctor Electric Company at the Hotel Commodore, New York, and the Military Park Hotel, Newark, to familiarize them with the promotional material available to their dealers when the company's new postwar toaster, which can reheat cold toast, is introduced to consumers early this month.

The distributors also saw for the first time the company's new Never-Lift and Champion irons, and the promotional package accompanying them which will be introduced to consumers in November, one month after the introduction of the new toaster.

A price of \$2.95 each has been set on Proctor's toaster and iron promotional packages to establish a value. They are, however, to be furnished free of charge to dealers who pledge themselves to cooperate with the premiere showing of these products. Proctor's sales strategy requires a window display featuring a cardboard model of the appliance, with the actual appliance on display inside the dealer's store being actively demonstrated. Local dealer advertising to tie in with the company's huge advertising campaign is being encouraged.

The meetings were jointly conducted by H. S. Perkins and Carl McLaughlin, New York and New Jersey Proctor district managers, respectively. Approximately 120 from New York attended the meeting at the Hotel Commodore which included representatives from the following distributor organizations: E. A. Wildermuth, Brooklyn; B. Davis, Mt. Vernon; Garfield Electrical Supply Co., Inc., Graybar Electric Company, Inc., Hirschfeld Electrical Supply Co., Inc., Joseph Kurzon, Inc., Lafayette Electric Corp., Lehr Distributors, Inc., L. Luria & Son, Inc., Masback, Inc., and Westinghouse Electric Supply Co., New York and Jamaica branches.

The Newark meeting was attended by approximately 60 salespeople from among the New Jersey distributors, among whom were representatives of the Rutkin Electric Supply Co., Asbury Park; Lehr Distributors, Inc., Jersey City; Morristown Electrical Supply Co., Morristown; C. M. Lantz, Inc., Orange; Beller Electric Co., Eastern Electrical Supply Co., Graybar Electric Company, Inc., Monarch Electric Supply Co., Inc., and T. A. O'Loughlin, Inc., all of Newark.

## Battery Consolidation Announced by Gould

The acquiring of the business and plant facilities of the storage battery division of Philco Corp., and their consolidation with the Gould Storage Battery Corp., a subsidiary of National Battery Corp., has been announced by A. H. Daggett, president of Gould and National Battery.

Gould and National Battery now have plants located "at all strategic points throughout the United States."

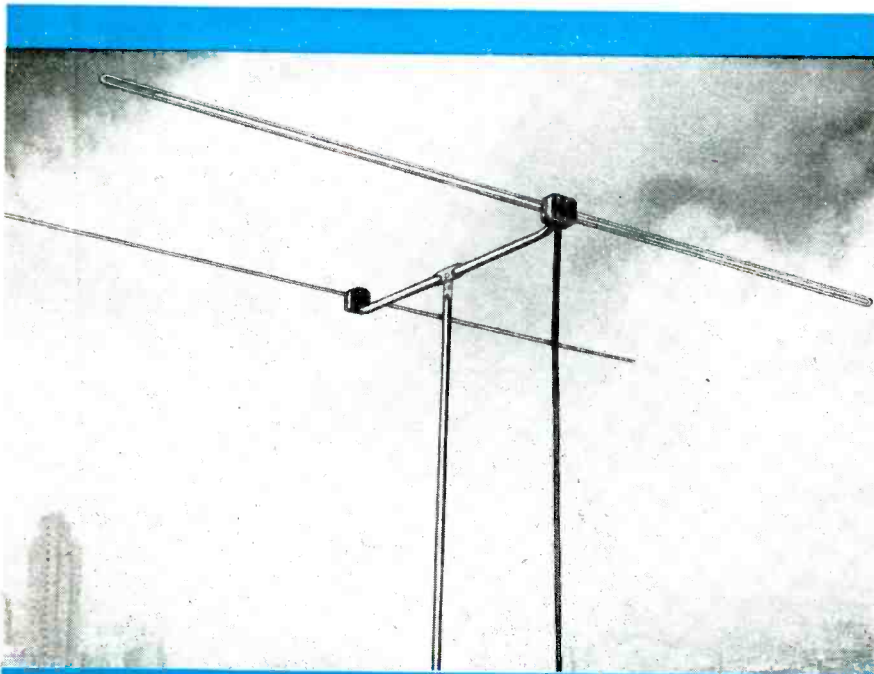

No. 8320

## FM ANTENNA

with Belden 8225 Parallel 300-OHM Transmission Line

FOR BETTER SERVICE

**Belden**  
Radio WIRE



# This Book Makes You a Record Changer Service Expert!



## Ready Now! Your Howard W. Sams 1947 Automatic Record Changer Service Manual

Hundreds of you have written to me personally in the past year, describing your crying need for reliable service data on Automatic Record Changers. Long before these letters began to come in, we foresaw the tremendous expansion of the Record Changer service field and began working on the problem. NOW—I am proud to announce the publication of the Howard W. Sams 1947 AUTOMATIC RECORD CHANGER SERVICE MANUAL. There is no other book like it. It makes you a service expert on Changers—helps you tackle and lick any kind of mechanical Changer problem. The Manual covers MORE THAN 40 POST-WAR MODELS—all of them DIFFERENT. The information is absolutely accurate, complete, authoritative—based on our actual study of the equipment. Everything you need to know is presented in giant-size exclusive "exploded" views, photos from all angles, completely keyed parts lists, and full text explaining disassembly, adjustments, change cycle data, service hints and kinks, and parts replacement. And for the FIRST time in any publication, you get complete, accurate data on leading WIRE, RIBBON, TAPE, and PAPER DISC RECORDERS! I honestly believe that no progressive Serviceman can afford to be without this Manual. Your copy is ready now—see it at your local jobber. Own it. Use it. It's the best investment you can make today to increase your earning power.

*Howard W. Sams*

- ★ **BIG PLUS VALUE**—the only single source of timely, accurate Service Data on leading Wire, Ribbon, Tape, and Paper Disc Recorders.
- ★ **DeLuxe Volume.** Hard Cover; opens flat. 400 pages of clear, accurate data that makes you a Record Changer Service Expert!

**THERE'S NOTHING LIKE IT! ONLY . . . . .**

**\$4.95**

## DON'T MISS PHOTOFACT SETS NOS. 23, 24 and 25!

PHOTOFACT Sets Nos. 23, 24 and 25 feature the exclusive new uniform "Standard Notation" schematics—the greatest service data development in 20 years! Each and every diagram is drawn to the same basic set of clear, uniform, easy-to-understand standards. Here's what the new "Standard Notation" Schematics mean to you: Makes circuit analysis simpler, quicker, fool-proof, more accurate! No more time wasted puzzling over odd-looking diagrams! No more trouble with varying symbols and confusing styles! Just ONE CLEAR STANDARDIZED STYLE FOR ALL CIRCUITS—SAVES YOU

TIME—HELPS YOU EARN MORE. Only PHOTOFACT offers you the "Standard Notation" Schematics. Order Sets Nos. 23, 24 and 25 today—and see the amazing advantages!

- FREE:** PHOTOFACT Cumulative Index—your guide to all post-war receivers.
- FREE:** How to File Folder—shows 5 good ways to file PHOTOFACT Folders. Get these PHOTOFACT Aids FREE at your parts jobber—or write us direct.

WITH EXCLUSIVE NEW  
**"Standard Notation"  
SCHEMATICS**

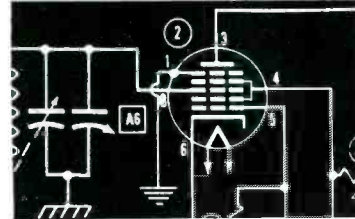

### NEW! Howard W. Sams DIAL CORD STRINGING GUIDE



There's only one *right* way to string a dial cord. And there's only one book that shows you how. It's the Howard W. Sams DIAL CORD STRINGING GUIDE. Here, for the first time, in one handy pocket-sized book, are all available dial cord diagrams and data covering 1938 through 1946 receivers. Licks the knottiest dial cord problem in a matter of minutes. This low-cost book is a "must" for servicing. You'll want two copies—one for your tool kit and one for your shop bench. Order them today. ONLY... **75c**

### BOOST YOUR EARNING POWER!

Mail This Order Form to Your Parts Jobber Today or send directly to HOWARD W. SAMS & CO., INC., 2924 E. Washington St., Indianapolis 6, Ind.

- My (check) (money order) for \$..... enclosed
- Send SAMS' 1947 AUTOMATIC RECORD CHANGER MANUAL(S) at \$4.95 per copy.
  - Send PHOTOFACT Set No. 23.  No. 24.  No. 25 (at \$1.50 per Set).
  - Send SAMS' DIAL CORD STRINGING GUIDE(S), at \$0.75 per copy.
  - Send PHOTOFACT Volume 1 (including Sets Nos. 1 through 10) in Deluxe Binder, \$18.39.
  - Send PHOTOFACT Volume No. 2 (including Sets Nos. 11 through 20) in Deluxe Binder, \$18.39
  - Send FREE PHOTOFACT Aids.

Name.....  
Address.....  
City..... State.....

**HOWARD W. SAMS & CO., INC.**  
INDIANAPOLIS 6, INDIANA

Export—Ad. Auriema—89 Broad St., New York 4, N. Y.—U. S. of America  
Canada—A. C. Simmonds & Sons, 301 King St., East—Toronto, Ontario

**PHOTOFACT SERVICE**

"The Service that pays for itself over and over again"

# With the Wholesalers

**HARRISBURG, PA.**—Purchase of offices, showrooms and warehouse buildings at 619-621 Walnut St., across from the Pennsylvania Capitol Building, has been announced by Jules Alexandre, Inc., Crosley distributors in Harrisburg, Pa. The buildings, consisting of approximately 30,000 square feet of floor space, were purchased from the Pennsylvania Railroad and were originally built by the International Harvester Company for storage of heavy tractors and farm equipment. Jules Alexandre, Inc., headed by Jules E. Alexandre, president and general manager, employs 34 persons in representing such lines as Crosley refrigerators, radios, electric and gas ranges and Crosley home freezers; Apex washers, cleaners and ironers; Coleman heating equipment; L & H electric ranges and hot water heaters; Oakland heaters and ranges, Grand ranges; Welbilt ranges; Quicfrez home freezers, and other major appliances. In addition to Alexandre, officers of the company are Ben Eby, vice-president and secretary; Samuel Prescott, vice-president and comptroller; and Otto Hepner, treasurer.

**GRAND RAPIDS, MICH.**—Radio Electronic Supply Co. has been appointed to be Emerson's western Michigan wholesaler. In charge of the sales activities for Emerson sets is Emil J. Rissi, vice-president of the distributor organization.

## Happy at the Prospects of Increasing FM Sales With the New Bendix Radio FactoMeter

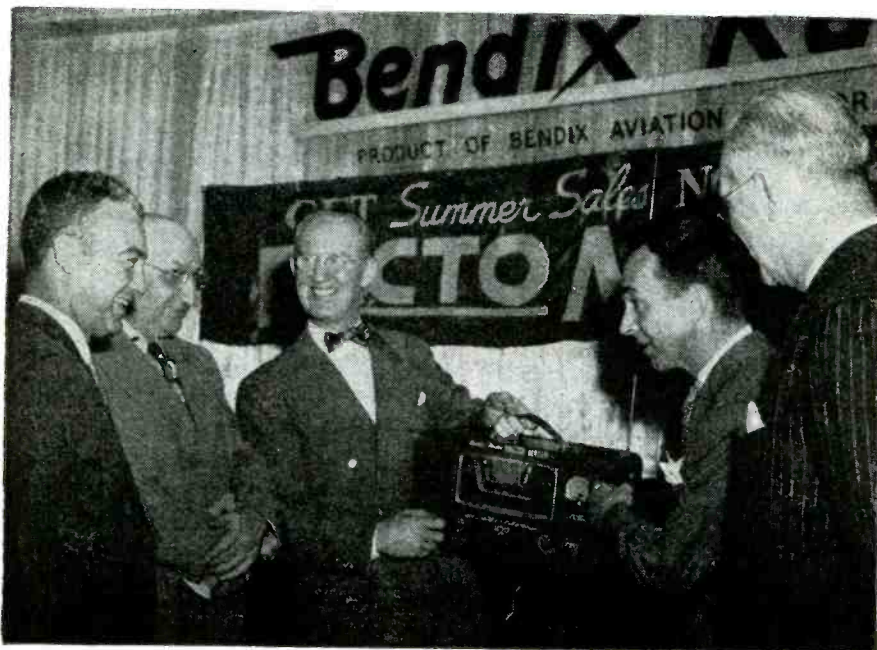

Enthusiastic over the Bendix Radio FactoMeter are Ted Goldenberg, American Sales and Distributors, Inc., Columbus, Ohio; A. Margolis, owner of Rex Radio, Dayton; and Bendix Radio district managers Sam Rochester, Middle Atlantic states; Paul J. Reed, New England states, and Russell Fryburg, northwest territory.

**MINNEAPOLIS, MINN.**—Butler Brothers major appliance division here will distribute Presteline home products in the Minneapolis and Duluth trading areas. W. Anderson is division manager.

**PHILADELPHIA, PA.**—Pierce-Phelps, Inc., distributor of Proctor products, recently played host to 50 of the Proctor Electric Company's various district managers and field representatives at a sales breakfast. The wholesale firm's traffic appliance sales manager, John T. O'Brien, and Newt Misell, director of sales training, addressed the meeting. Robert M. Oliver, Proctor vice-president, was one of the featured speakers.

**BIRMINGHAM, ALA.**—The appointment of Associated Distributors, Inc. as Zenith distributor for Alabama and western Florida has been announced by H. C. Bonfig, vice-president and director of sales for Zenith Radio Corporation. "The management and personnel of Associated Distributors, Inc., have built an enviable reputation as wholesalers in their territory, and we are happy to welcome them into the Zenith family," Bonfig said in his announcement. Luther S. Hart, president, and Wesley L. Greer, vice-president of Associated Distributors have long been active in the electrical appliance field in Alabama.

## New Sales Manager



Thomas C. Carey, above, has been appointed sales manager of Appliance Distributors, Chicago, Admiral wholesalers. Clarence S. Tay, branch manager of the jobber firm, made the announcement.

**CHICAGO, ILL.**—Stewart-Warner radios and television sets will be distributed in the Chicago trading area by Butler Brothers. The firm is also wholesaler for Gibson Refrigerator, Apex Rotarex Corp., and the Musitron Co. The appliance division is in charge of W. Kilmer.

**INDIANAPOLIS, IND.**—Radio Equipment Company has been named to distribute Bendix washers, dryers and ironers in the Indianapolis and Cincinnati territories. Hayes Hollibaugh is vice-president in charge of the firm. George L. Patterson has been named manager of the Cincinnati operation.

**SEATTLE, WASH.**—Appointment of F. T. O'Brien, well-known appliance merchandiser, as executive vice-president of Radio Television & Appliance, Inc., Philco distributor, has been announced by S. L. Savidge, president of the organization. The firm is western Washington and Alaska wholesaler for Philco products, Columbia records, L & H electric ranges and water heaters, Blackstone laundry equipment, Allen circulating heaters, Filter Queen vacuum cleaners, Knapp-Monarch products, etc.

**SAN ANTONIO, TEX.**—H. J. (Jack) Helliwell, widely-known for past association as divisional sales manager for such outstanding firms as Atwater Kent, Gibson Refrigerator Co. and Farnsworth Radio & Television Co., has announced the formation of a distributing organization to be known as the Jack Helliwell Co., 2805 Flores St.



# You Can Add Up Your Income with a SOLDERING IRON!



**Y**ES, it's a fact that you may not have realized . . . but every minute your soldering iron is busy, you are busy making money. *And you can make even more money if you will suggest to your customers a complete "FIND AND FIX" treatment for sets.*

A complete "FIND AND FIX" reveals parts about ready to go as well as those that are shot, saves your customers extra trips, prevents the embarrassment of parts going sour right after leaving your shop.

IRC's Volume Control Cabinet, Resistor Assortment Kits and Basic Kit cut down unnecessary trips to your distributor for parts, give you more time for soldering . . . for making your time *pay*. Order from your local IRC Distributor today. International Resistance Company, 401 N. Broad Street, Philadelphia 8, Pennsylvania. *In Canada:* International Resistance Company, Ltd., Toronto, Licensee.

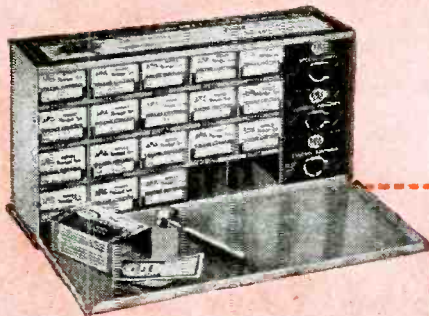

### The IRC Volume Control Kit

18 All-purpose controls, 6 switches and 5 special shafts in an attractive factory-packed steel cabinet.\*

### The 3 IRC Balanced Resistor Assortments in Resist-O-Cabinets\*

No. 1. 59 assorted insulated composition and power wire wound resistors, including adjustable types.

No. 2. 100 of the most used ranges in 1/2 watt insulated composition and insulated wire wound resistors.

No. 3. 83 top quality resistors in the 1-watt range.



### The IRC Basic Kit

471 "basic" resistors in a wide variety of types and ranges, plus 6 additional bands for adjustable types. All metal cabinet.\*

\*Cabinets are furnished at no charge, not sold separately.



## INTERNATIONAL RESISTANCE COMPANY

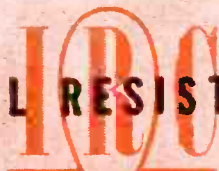

Wherever The Circuit Says  $\Omega$

Copyright, 1947, International Resistance Company



**AS GOOD  
AS IT LOOKS**



**MODEL S20X**

WITH SLIDE-LOCK SWITCH AS ILLUSTRATED AT SLIGHT EXTRA COST

**ALL THESE FEATURES AT LOW COST**

- ★ Metalseal crystal
- ★ High level: 54db below 1 volt/dyne/sq. c.m.
- ★ Smooth response:  $\pm$  5db from 50-7000 c.p.s.
- ★ Corrosive resistant aluminum diaphragm
- ★ Convenient, light weight
- ★ Modern styling
- ★ Turner quality

*Microphones* **BY TURNER**

It's the new Turner Model S20X Hand Microphone for home recording, public address and amateur work. Beautifully finished in rich baked brown enamel. Light in weight and convenient to use. Fits the hand perfectly, hangs on a hook when not in use.

Its performance is the kind you expect in a microphone costing three times as much. Response to voice and music pickups is smooth and flat over the most desired frequency range. Level is exceptionally high. The entire circuit is shock mounted to withstand rough treatment and is equipped with barometric compensator.

**SEND NOW FOR BULLETIN**

**THE TURNER COMPANY**

903 17th Street N. E. • Cedar Rapids, Iowa

**TURN TO TURNER FOR SOUND PERFORMANCE**

CRYSTALS LICENSED UNDER PATENTS OF THE BRUSH DEVELOPMENT CO

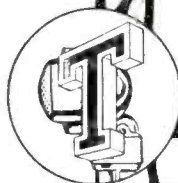

**Oden Jester Sales Head of Jensen Industries**

Peter L. Jensen, president of the Jensen Industries, Inc., manufacturers of the Jensen phonograph needle, announces that Oden F. Jester has been named general sales manager of the company. Mr. Jensen also announces that Phil M. Spink remains as general manager of the company.

Mr. Jensen says, "It is a pleasure to report to our distributors and dealers throughout the world that Mr. Jester has joined our organization. His wide ac-

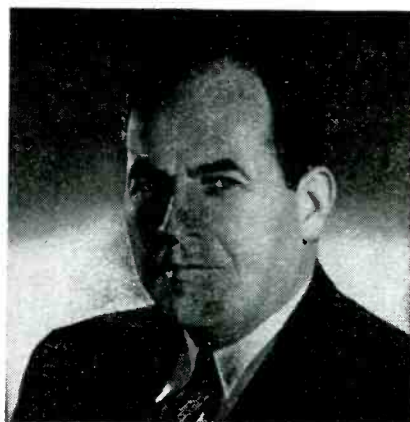

Oden F. Jester

quaintance in the music and radio trades and his thorough knowledge of effective promotion and sales technique will certainly reflect in steadily increased sales of the Jensen needle line." Mr. Jester recently resigned as vice-president in charge of sales for Maguire Industries, Inc. Jester, a well known veteran executive of the radio and phonograph industry, was formerly sales manager of the radio division of Stewart-Warner and held a similar position with Utah Radio Products Company for seven years before joining the Meissner Manufacturing Company which was subsequently taken over by Maguire Industries.

**Astatic Promotes Doyle**

The promotion of William J. Doyle to general sales manager has been announced by F. H. Woodworth, president of The Astatic Corp., Conneaut, Ohio, producers of microphones, phonograph reproducers and radio parts.

**Herzog Vice-President**

According to an announcement made by Theodore Apstein, president of Universal General Corp., 365 Canal St., New York 13, N. Y., distributors of radio and electronic parts and supplies, Robert G. Herzog has just been appointed vice-president in charge of engineering.

**NATIONAL RADIO WEEK**

**Oct. 26 to Nov. 1  
Participate and sell  
more sets!**





# SPEAKERS

## ALUMINUM FOIL BASE VOICE COILS PROVIDE

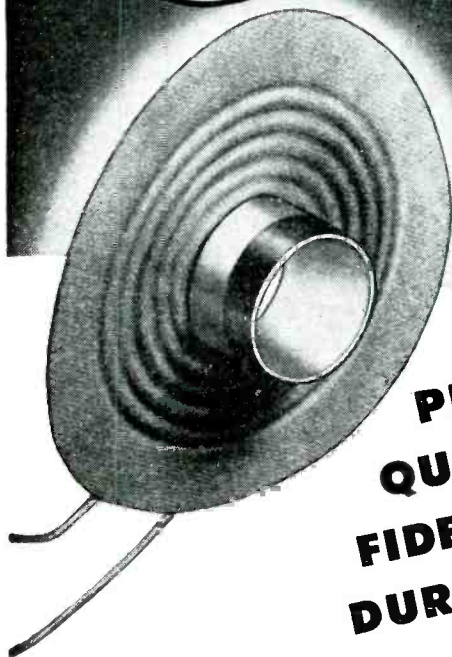

**PERFORMANCE  
QUALITY  
FIDELITY  
DURABILITY**

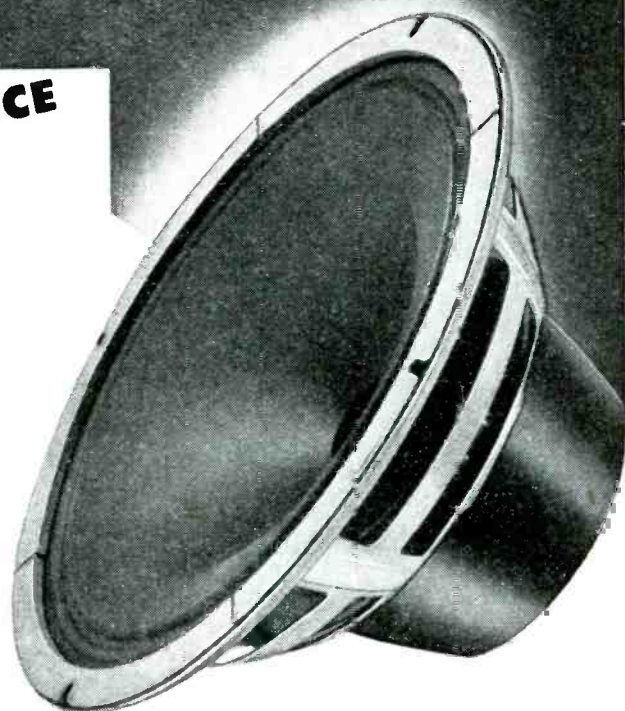

EVERY General Electric Speaker—from the smallest to the largest—has aluminum foil base voice coils. This G-E development makes possible their high quality performance, tone fidelity, and operating durability. Whether you use them by the hundreds of thousands in production lines, or purchase a single unit for an individual replacement, your customers will appreciate the extra quality performance of G-E Speakers.

**G-E Speaker construction gives you these excellent features which assure dependable performance and fine quality reproduction:**

- High wattage handling capacity. The metal construction provides much better heat dissipation. This permits operation of the speaker at increased wattages.
- No warping of voice coil. The metal base will not introduce internal stresses, and it is not subject to separation of laminations or to other adverse effects which might result in distortion.
- The aluminum foil base voice coil will not absorb moisture under high humidity conditions.
- Internal stresses which result in dimensional distortion are eliminated through the aluminum foil base voice coil construction.
- Metal construction assures better control of clearance between moving parts.
- Better tone quality and reproduction.

### PLUS...

● **ALNICO-5 PERMANENT MAGNETS FOR OVERALL EFFICIENCY AND SENSITIVITY.**



● **DURABLE CONSTRUCTION THROUGHOUT.**

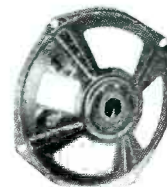

Write now for complete information on speakers to: *General Electric Company, Electronics Department, Syracuse 1, New York.*

# GENERAL ELECTRIC

169-F7



**Promoted by Crosley**



Norman C. MacDonald, formerly VP and general manager of Crosley Distributing Co., N. Y., is now general sales manager Crosley Division of Aveco Mfg. Corp.

**Stewart-Warner Executive**



Kenneth W. Sickinger, above, has been placed in charge of advertising for the radio division of Stewart-Warner Corp.

**They Travel to See the New Trav-ler Receivers**

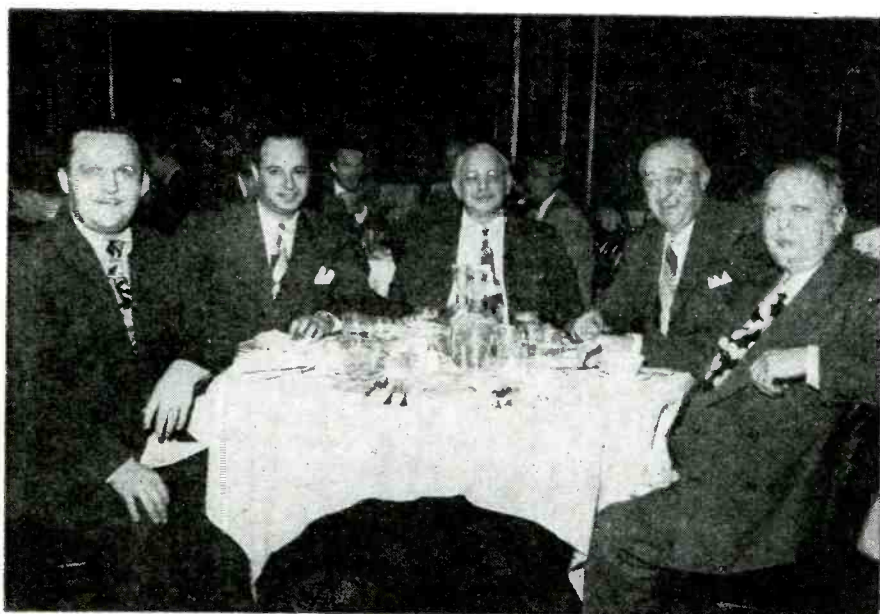

Over 100 Trav-ler Radio Corporation distributors saw the newest line of the firm's sets unveiled at French Lick, Ind. Left to right, Cal Jones, Wurlitzer Co., Chicago; D. Tavel, Indiana Radio Distributing Co., Indianapolis; M. Tavel, Indiana Radio Dist. Co.; D. Breen, Skelly Oil, Kansas City, Mo., and H. Fenberg, Colonial Dept. Stores, Detroit, Mich.

**General Electric Sales Heads Greeted by Manager**

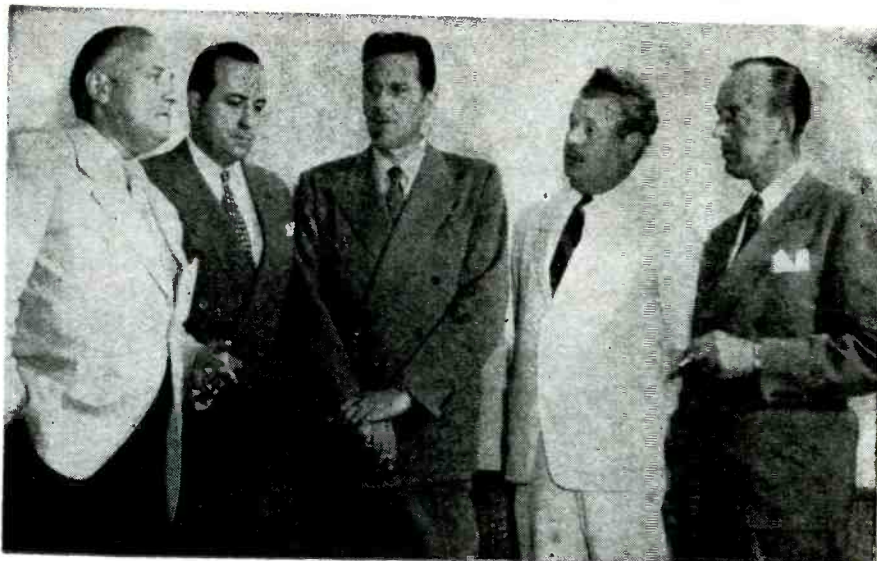

A. A. Brandt, general sales manager of General Electric's electronics department greets four receiver division sales heads transferred from Bridgeport to Electronics Park, Syracuse, N. Y. Left to right: E. P. Toal, sales manager of standard line receivers; Fred Ponnell, manager of sales promotion and advertising; Paul Chamberlain, sales manager for the receiver division and G. S. Perkins, sales manager for the Musaphonic line of receivers.

**Takes on a Big Job!**



G. T. Stevens, left, executive vice-president of Eureka division of Eureka Williams Corp., welcomes John B. Lattigan to Bloomington, Ill., and his new job as Eureka's sales manager.

**Sales Representative**



Jack F. McKinney, above, of Dallas, Texas, has been appointed as rep for Texas and Oklahoma by Standard Transformer Corp., Chicago. The announcement was made by James M. Blackledge, general sales manager of Standard.

**Names  
in the  
News**



In **December**...

## RADIO & TELEVISION RETAILING

will spotlight **TELEVISION**



This will be the industry's first **TELEVISION ISSUE** since the end of the war and represents a big step forward toward **TELEVISION'S** bigger tomorrows. Here will be timely, constructive merchandising and servicing features to prepare the retailer for a great merchandising opportunity.

For the **Advertiser** this issue will serve as a showcase for the newest developments in **TELEVISION**. It will present an unexcelled opportunity for manufacturers to advertise their products and identify themselves with **TELEVISION**.

*Phone, Write, Wire Space Reservations Today*  
*Closing Dates: 10th of November for complete plates,*  
*5th for copy and cuts.*



**Caldwell-Clements Inc.**

480 Lexington Ave., New York 17, N. Y.  
Chicago 6      Los Angeles 5      San Francisco 9



10-STATION  
MASTER UNIT

*Every Business  
is a Prospect!*

**FLEXIFONE**

INTERCOMMUNICATION  
SYSTEMS

**OPERADIO...THE  
OUTSTANDING SOUND  
EQUIPMENT LINE FOR  
YEAR 'ROUND SALES  
AND PROFITS!**

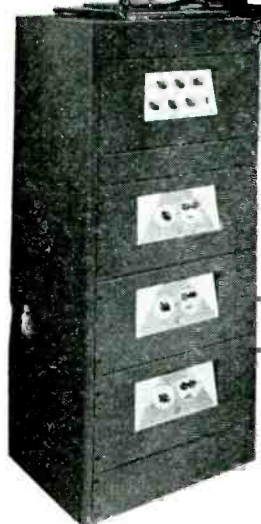

PRE-AMPLIFIERS — BOOSTERS  
AND MOUNTING RACKS

*Smart New Designs...  
New Features!*

Outstanding . . . that's the word for the new OPERADIO sound equipment line! Every unit is designed, engineered and constructed to OPERADIO-quality standards . . . with important new features and smart styling for added sales-appeal. OPERADIO sound equipment is nationally advertised to assure you of steady, successful sales.

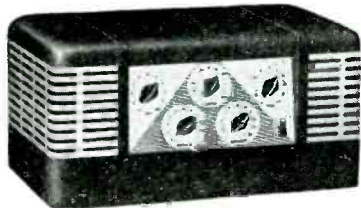

20-WATT AMPLIFIER

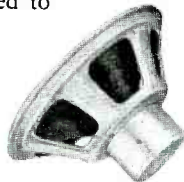

SPEAKERS

**OPERADIO**  
*Sound Equipment*

**SEND  
COUPON  
FOR  
COMPLETE  
DETAILS**

OPERADIO MFG. CO., Dept. RTR-14, ST. CHARLES, ILL.

Gentlemen:

Please send us free information on the items checked:

- Operadio Sound Equipment  
 FLEXIFONE Intercommunication

Name \_\_\_\_\_

Address \_\_\_\_\_

City \_\_\_\_\_ State \_\_\_\_\_

**New Garod Owner Names  
Silver Vice-President**

In his first official act as new owner of the Garod Radio Corporation, Brooklyn, N. Y., Leonard Ashbach announced the appointment of Lou Silver as vice-president and a director of that corporation.

Mr. Silver, who has been the Garod National Sales Manager for the past eight years, now assumes complete charge of all Garod sales throughout the world.

"In purchasing the company," Mr. Ashbach said, "I was as much concerned with retaining its entire key personnel as a functioning, well-coordinated team, as I was with tangible physical assets. Mr. Silver's splendid record with Garod, as well as his earlier years in the field, have convinced me that I could not possibly have made a better choice. Remember, Lou Silver has been selling radios to my distributing organization in Chicago for years, and any man that can sell me . . . can sell for me."



Lou Silver

Upon assuming his new post, Mr. Silver said: "With our sales organization now set up the way it is, with the new radio and television models that we are about to produce, plus the promotion budget which Mr. Ashbach has authorized, we're sure to show the greatest sales increase of any radio manufacturer this fall and winter."

Mr. Silver then added that production schedules on the new 1948 models had been upped considerably as a result of the enthusiasm displayed by Garod distributors at the recent convention in New York.

On these models particularly schedules have been more than doubled: The little "Starlet," a personalized portable weighing only 3½ lbs. with batteries; the "Rad-alarm," a combination clock-radio; and the new "Chairside" radio-phonograph. All of these, including the Garod Television receiver, are in production now. The Television set has a 10-inch screen, AM and FM radio, automatic record changer and record space in an attractive period console cabinet.

**Returns to Altec**

Frank H. Jennings, electrical engineer with Altec Service for many years before the war, has returned to Altec's New York district as a service engineer.



# A Sign of Successful Servicing

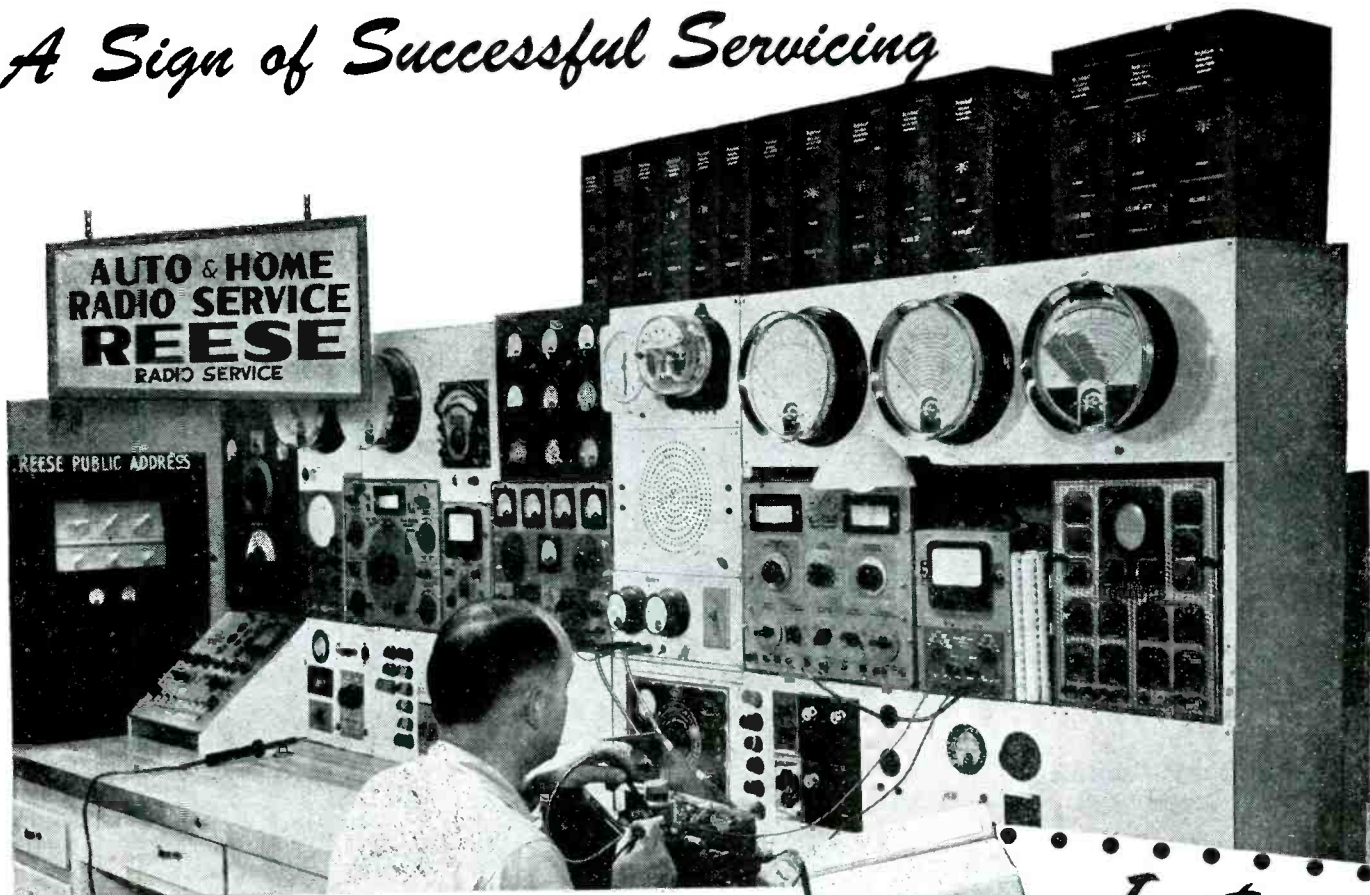

## Reese has all Fifteen RIDER MANUALS (and Volume XVI on order)

THE servicing shop of Francis Reese in Olean, N. Y. has been the subject of several success stories recently published in radio magazines. Shops so featured are significantly distinguished by a better-than-average profit and a complete set of Rider Manuals. Thus, at Reese you will find all volumes, kept conveniently handy for ready reference. For, no other single source of information supplies the essential data contained in Rider Manuals, and nowhere but in the first fourteen volumes can you find the material you must have to service 80% of the receivers now in American homes. (Those issued from 1920 to 1942.)

To those shops repairing any and all makes of receivers, sets of all ages, this pre-war data is absolutely essential for profitable operation.

—And, Rider Manual data is reliable, the OFFICIAL AUTHORIZED servicing data right from the service departments of the companies that make the sets. No one knows better than the

manufacturer what procedures are best for his products. This is the basis for the authority and success of Rider Manuals.

Volume XVI will be at your jobbers in October; order it today. Remember, Rider Manuals are investments; they keep pouring out profits for you. Copies of Volume I, bought over seventeen years ago, are still benefiting their owners. So, be sure your shop has the sign of successful servicing—be sure it has all sixteen Rider Manuals.

### RIDER MANUALS—16 VOLUMES

|   |         |
|---|---------|
| Volume XVI.....   | \$ 6.60 |
| Volume XV.....  | 18.00   |
| Volumes XIV to VII (ea. vol.)   | 15.00   |
| Volume VI.....  | 11.00   |
| Abridged Manuals I to V<br>(one volume).....  | 17.50   |
| MASTER INDEX, covering all<br>Rider Manuals except Vol.<br>XVI, which has its own index | 1.50    |
| Record Changers<br>and Recorders (a manual).....  | 9.00    |

JOHN F. RIDER, PUBLISHER, Inc., 404 Fourth Avenue, New York 16  
Export Agent: Rocke International Corp. 13 E. 40th St., N.Y.C. Cable ARLAB

**RIDER MANUALS**  
**MEAN SUCCESSFUL SERVICING**

*Just Out!*

**VOL. XVI**



**RIDER  
MANUAL**  
At your jobbers  
in October  
768 Pages  
PLUS SEPARATE  
'HOW IT WORKS'  
BOOK  
\$6.60

During "Seventeen Years of Continuing Service to the Servicing Industry" we have been anticipating its needs. So, because of the present high rate of receiver production, Rider Manuals are being issued three times a year, to give you complete, authoritative servicing data at the earliest necessary date. And, at the minimum investment; Vol. XVI is less than a cent a page. The binding is the same sturdy, custom-made, loose-leaf binder that matches your present Rider Manuals. And, the contents are the usual high standard, supplemented with "clarified-schematics" on multi-wave band sets and a separate "How It Works" book explaining the kinks of the newer receivers. We are proud to publish Vol. XVI, you will find it profitable to possess.

**PLACE YOUR ORDER TODAY**



# Sales Helps for Dealers and Jobbers

## GE Dealer Displays Viewed by Experts



R. W. Metzner, GE replacement tube sales manager shows new dealer helps to David L. Marks, head of Fort Orange Dist. Co., Albany, N. Y.

## To Help Sell Sets



New easel-backed display fits over RCA Victor's models 66X1 and 66K2. "Modeled" by Kay Callahan of the firm's Camden, N. J., staff.

## "Self-Service" Set-Up For Radio Chemicals



General Cement Co., Rockford, Ill., has a new chemical display available. Deliveries on the unit, shown above, are prompt to jobbers and dealers. The display is very sturdy, attractively colored and finished in beautiful natural color—easy to keep clean. A specific space is allotted for each chemical in the display and the part number is indicated in large clear figures. The approximate dimensions are 70 inches wide by 70 inches high by 21 inches deep at the base. It's easy too, to take inventory with this display, GC officials point out.

## New Battery Carton Holds 24 Cells



Offered by Ray-O-Vac Co., Madison, Wis., carton holds 24 D cells. Size of display unit 5" by 8". The red, yellow and blue display piece is designed for window or counter use.

## Doggone Long Dog!

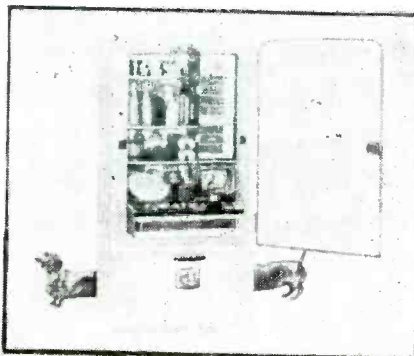

If you can't get along little doggie get two short ones, for trick shot, such as this. Ad men used two daschunds to gain impression of one long one for illustration. Idea was to dramatize large freezer storage capacity in new Norge refrigerator.

## Apex Package Promotion Offered Retailers

Latest thing in sales aids is the package promotional program announced to dealers in Apex home cleaners, washers and ironers by Frank S. Ryan, manager of advertising and sales promotion for Apex

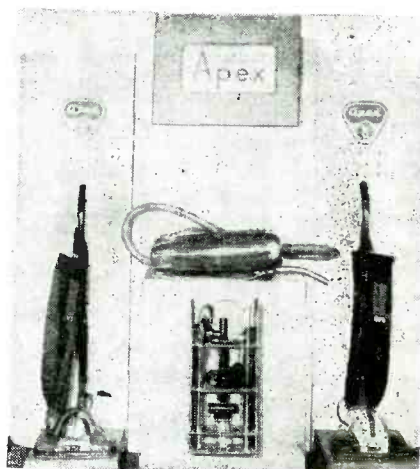

To boost cleaner sales

Rotarex Corp., sales organization for the nationally popular line of Apex appliances.

Mr. Ryan's announcement stressed how the package offers the dealer an opportunity to tie in with national and cooperative advertising and that it is designed to help him meet the highly competitive market which lies ahead.

Featured in the Apex package is a highly attractive triple-panel display unit flexible enough to fit any sales floor.

## Colorful Point-of-Purchase Set for Window or Counter



Designed in yellow and blue, the unit features International Resistance Company's volume control cabinets and resistor assortment kits. It is in three sections, easily erected; used individually or as a unit.



**HERE ARE SIMPSON'S  
PROFIT-MAKERS FOR  
SERVICEMEN...**

# "BASIC 3"

The serviceman who tries to "get along" with cheaply-made, run-of-the-mill test instruments is taking an outside chance on success. The business of radio servicing must be *built* from the bottom up on an endless succession of perfect jobs. Knowing what the trouble is, in a receiver, and knowing when that trouble is eliminated *can be no better than the test instruments that reveal them.*

The "Basic 3" Simpson instruments shown here are an extremely profitable investment for any serviceman. He needs all three and, in their price range, he cannot buy better anywhere else. In fact, in their price range they are unequalled. They will do more than many instruments selling for substantially more. These are facts easily demonstrable to any serviceman who will take the time to check up. And it is worth the time in the *cold cash of profits* to discover how Simpson engineering skill and uncompromising quality construction produce the *staying* accuracy for which Simpson instruments are famous.

**MODEL 315 SIGNAL GENERATOR.** Designed down to the most minute detail for highest accuracy, greatest stability, minimum leakage, and good wave form . . . . . **\$67.35**

**MODEL 305 RC TUBE TESTER.** Tests all tubes. Provides for filament voltages from .5 volts to and including 120 volts. Spare sockets for future tube developments . . . . . **\$59.50**

**MODEL 260 HIGH SENSITIVITY SET TESTER.** 20,000 ohms per volt.; D.C. Voltage ranges to 5,000 volts A.C. and D.C. Resistance ranges to 20 megohms. Current ranges to 500 milliamperes, also 10 amperes D.C. . . . . **\$38.95**

In New Roll Top Safety Case . . . . . **\$43.75**

**SIMPSON ELECTRIC COMPANY • 5200-5218 West Kinzie Street, Chicago 44**

In Canada, Bach-Simpson, Ltd., London, Ont.

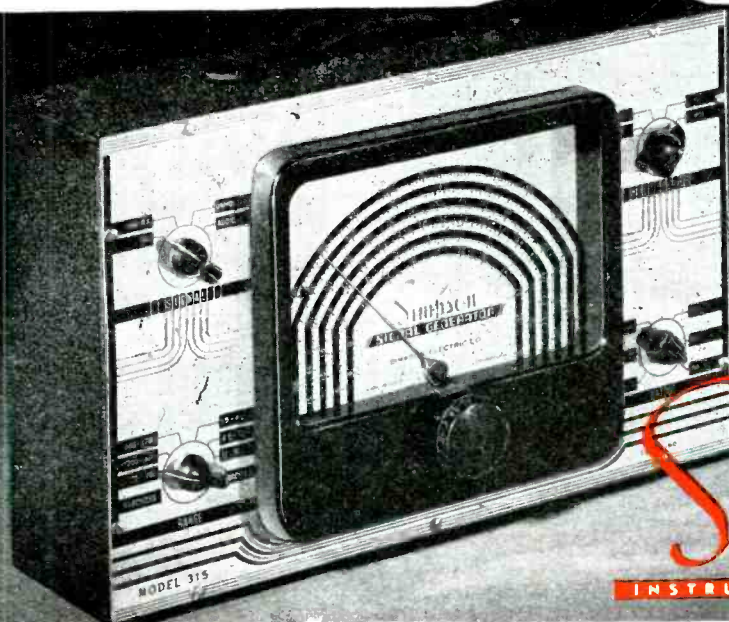

**Simpson**  
INSTRUMENTS THAT STAY ACCURATE



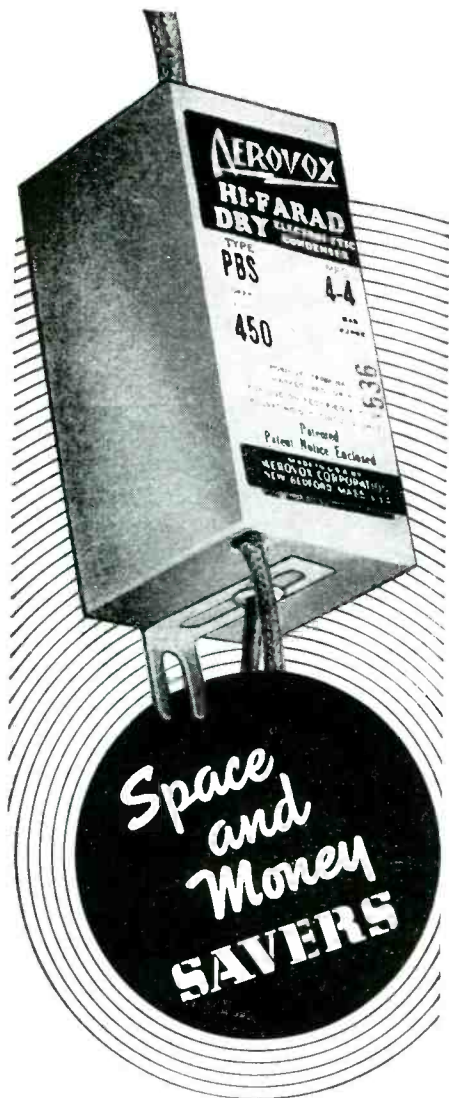

● Aerovox Type PBS space-saver midget capacitors are still the popular choice of servicemen. Units encased in heavy cardboard containers, thoroughly impregnated and sealed. Two color-coded wire leads for each section. Units mounted flat or upright; also two or three may be stacked by overlapping adjustable metal flanges. In 450 v. D.C.W., single, double and triple sections; 600 v. D.C.W., single section. All popular capacities.

● **Ask Our Jobber . . .**

He can supply these handy, inexpensive, general-purpose electrolytics. Keep a supply handy for rush jobs. Ask for latest catalog—or write us.



**FOR RADIO-ELECTRONIC AND INDUSTRIAL APPLICATIONS**

AEROVOX CORP., NEW BEDFORD, MASS., U.S.A.  
 Export: 13 E. 40th St., New York 16, N.Y. • Cable: 'ARLAB'  
 In Canada: AEROVOX CANADA LTD., Hamilton, Ont.

**Zenith Vice-Presidents**

Orrin E. Wolf has been elected vice-president of Zenith Radio Corp., in charge of the hearing aid division. J. E. Anderson, general purchasing agent, has been elected as Zenith vice-president in charge of purchasing, and Willy Dumke has also been elected a vice-president in charge of production of speakers, transformers and hearing aids.

**Langevin Devices to be Serviced by Altec Corp.**

All Langevin industrial control devices are being serviced by the Altec Service Corporation on a nationwide basis, the Langevin Manufacturing Corporation has announced.

The Altec Service Corporation maintains a staff of 250 electronic engineers, located in every major U. S. city, on constant call to service the new line of Langevin industrial controls, the first of which is a new photo-electric scanner and control-amplifier for registration processes.

**E. A. Miller Promoted**

The board of directors of Acme Electric Corporation of Cuba, New York, have unanimously elected Edward A. Miller to vice-president, in charge of engineering. Miller joined the Acme organization in 1930. His first project for the company was the improving of the design, performance and expanding the line of luminous tube transformers.

**Burgess Battery Honored**



L. H. Harris, sales manager of the battery division of Burgess Battery Company, Freeport, Ill., points out to F. J. Kirkman, vice-president and general manager, the statement of the basis for the recent award made to the Burgess firm by the New York Museum of Science and Industry. The award was accepted by Mr. Kirkman at a New York presentation.

**Plexiglas Pick-Up Heads**

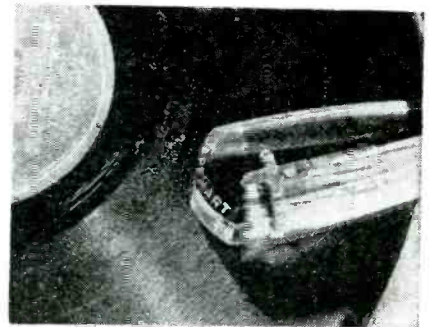

Unusually lightweight, Plexiglas is used for pick-up heads on New Capehart and Panamuse combinations. Less than one ounce of pressure is exerted on the record surface.

**\$3,000,000 Package!**

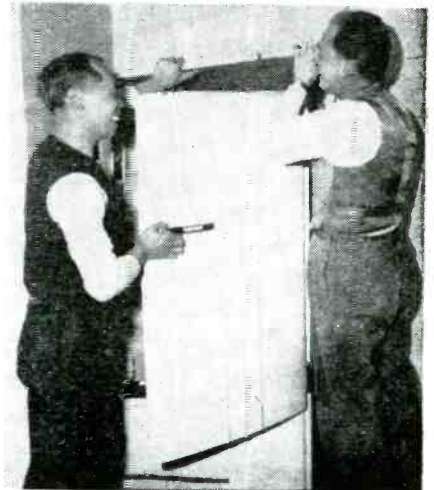

Shanghai delivery of this Gibson refrigerator cost Walter Rundle, right, \$3,378,000 in Chinese money, and many weary months of waiting. Hsing T'woSan helps uncrate it.





# Masco News

## NEW BIG VALUE INTERCOM. MODEL JMR MASTER AND REMOTE U. L. APPROVED!



### Opens Up New Markets



OFFICES



HOMES



DOCTORS

Stores, dentists, lawyers, merchants, farms all potential sales.

### Complete, Ready-to-Use

Model JMR consists of a packaged Master and Remote, including tubes and 50 feet of cable. Latest design! Top quality! Low priced! Simple to install. Easy to operate.

List Price..... **\$39.95**  
Add 5% West of Rockies

Contact your local Masco distributor for immediate delivery.

### Features of Model JMR

117 Volt AC or DC operation.  
2.5 watts of power.  
4 in. PM Alnico V Speaker.  
Volume control with on-off switch.  
Separate press-to-talk switch.  
Remote station has press-to-talk switch.  
Attractive cast aluminum housing. Hammertone finish.

ALSO AVAILABLE... A complete line of U.L. Approved Intercommunication Equipment.  
For descriptive literature or other information write directly to factory. Dept. D.

# MASCO

MARK SIMPSON MANUFACTURING CO., Inc.  
32-28 49th Street, Long Island City 3, N.Y.

## SOUND SYSTEMS and Accessories

RAvenswood 8-5810-1-2-3-4

## KAROLA PRESENTS ITS NEW MODEL 47602 UNIVERSAL CAR RADIO

featuring

Separate Custom Speaker, Baffles and Mountings  
6 Miniature Tubes High Sensitivity  
High Fidelity Tone Small Compact Size  
Adaptability to Any Car  
6" Heavy Duty Speakers

List **\$39.95**

KAROLA CORP., 922 Washington Ave. N., Minneapolis 1, Minn.

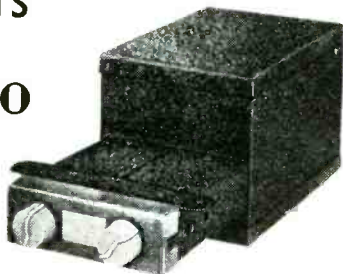

Some  
Distributorships  
still available.

## Emerson Announces Tele Service Policy

Installation of all Emerson television sets, including antennas and a year's warranty service at a cost of \$60 will be undertaken by the newly-formed subsidiary, the Emerson Television Service Corporation, according to Dorman D. Israel, vice-president in charge of engineering and production.

Mr. Israel indicated that the new organization is designed to service Emerson television receivers direct from the factory until such time as the trade itself can arrange to set up its own service units.

At the time of the delivery of an Emerson television receiver, Emerson Television Service Corporation will issue an "Emerson Television Owner's Service Contract" which assumes all responsibilities including the installation of an antenna, the television receiver, and the servicing of both for a period of one year.

Service covers the replacement of parts and tubes including the picture tube, as may be required to repair or maintain the receiver in normal working order for a period of one year. The cost of installation including a year's service is \$60 and is billed with each receiver by the dealer. This fee represents the net charge for the installation. When a dealer sells and delivers a set he notifies the Emerson distributor who in turn initiates the request on the service corporation for the installation.

## Snyder Mike Stand



"Pete" Roberts, ace announcer and Mary Lou Howard, popular singer, shown with a floor and desk model microphone stand, part of the Snyder Mike Stand line. Pete and Mary Lou are heard over Philadelphia's NBC outlet—50,000 watt KYW. Snyder Mfg. Company's headquarters are in Philadelphia.

## New Production Head

Arthur Koehler has been appointed production manager of Sorensen & Company, Inc., Stamford, Connecticut, manufacturers of AC and DC voltage regulators and electronic equipment, it was announced by Helen S. Sorensen, president.

Mr. Koehler was formerly with the Arma Corporation in Brooklyn, New York and with the Langevin Company of New York in a similar capacity.



## Hytron Names Boise

Vinton K. Ulrich, chief commercial engineer of Hytron Radio & Electronics Corp., national manufacturers of radio tubes, sun lamps and electronic equipment, announces the appointment of Everett B. Boise as Hytron's sales engineer in the New York and Mid-Atlantic area.

## Music Hath Charms—



... to soothe Ellen Fitzgerald, St. Paul, as she goes through tiresome job of getting her hair waved. The small radio is called the "Monoset," and it's made by Telex, Inc., Minneapolis, Minn.

## Gerl Sees Low-Cost FM Sets Marking New Era

At a ceremony attended by Mayor Kenelly of Chicago and Governor Green of Illinois, Joseph Gerl, president of Sonora Radio & Television Corp., presented these officials with the first two AM-FM table model radios to come off the Sonora line. These 8-tube sets, retailing at \$59.95, said Gerl, "herald the beginning of low-cost FM sets and mark a new era in the radio industry." Present were many members of the Chicago radio industry. Gerl is also a director of the Radio Manufacturers Association.

"The advent of FM broadcasting," Gerl told the assembled group, "means the reversal of a long-time trend. During the 1930's, as the quality of radio broadcasting went up, the quality of radio receivers went down. Manufacturers found that building a radio set which had sparkling-clear reception meant expensive speakers, many tubes and larger cabinets, all of which hoisted the price of a good radio beyond the income of the average family.

## New Karola Car Radio

The Karola Corporation announces its new model 47602 Universal Car Radio, which is contained in a sturdy crackle-finished steel cabinet and is replete with many improved features. Chief of these is its high sensitivity and high fidelity tone, the latter largely due to 6" heavy duty speakers.

This compact model, has 6 miniature tubes and separate custom speaker, baffles and mounting. It is adaptable to any make of car and lists at \$39.95. Distributors should contact the Karola Corporation at 922 Washington Ave. No., Minneapolis 1, Minn.

## Rider Survey Compiled

The first cross-compilation of 2,944 filled-out questionnaires on the radio service business, representing almost 15% of all those mailed, has been completed by John F. Rider, Publisher, Inc., 404 Fourth Ave., New York 16, N. Y.

With the tabulation process alone costing \$1400, a total of more than \$3000 has thus far been spent in arriving at authoritative figures on the radio service industry today. When the final analysis has been made, it is expected that every significant trend and statistic on the technical and business end of the nation's radio repair industry will have been charted.

Another separate survey conducted by John F. Rider among radio servicers

has also been completed. In the September issue of Rider's "Successful Servicing" publication will probably appear the results of the poll on the standardization of tube and parts schematic symbols, according to Mr. Rider. This latter survey was conducted on behalf of the RMA service committee.

## Kanaga, Vice-President

Lawrence W. Kanaga, who has been engaged in sales and merchandising activities for the past 13 years, has been appointed vice-president of the RCA Victor Distributing Corporation and general manager of the Company's Detroit branch, it was announced by Walter M. Norton, president of the distributing organization.

# MEISSNER

PRESENTS THE NEW *Brewster Line*  
OF TABLE MODEL RADIOS! . . .

Here at last is the outstanding line of table model radios you have been waiting for! Superbly designed, unmatched for sheer beauty of tone, these quality sets reflect the skill and craftsmanship that have made the name Meissner a byword for quality in the trade.

Smartly designed, quality engineered, these new Brewsters are being manufactured for exclusive distribution through parts jobbers only. No quotas, no high pressure tactics, no sales direct to dealers or special distributors . . . nothing that might interfere with your merchandising this exclusively-jobber line to the hilt. And Meissner unconditionally guarantees these new Brewsters against price reduction for the balance of the year.

*This line is available for delivery now. Write today for full information, catalog and prices.*



*Meissner*

ELECTRONIC DISTRIBUTOR AND  
INDUSTRIAL SALES DEPARTMENT

**MAGUIRE INDUSTRIES, INCORPORATED**

500 W. HURON ST., CHICAGO 10, ILLINOIS

**EXPORT-SCHEEL INTERNATIONAL INC.**

4237 N. LINCOLN AVE., CHICAGO 18, ILL. • CABLE-HARSCHEEL

**NOW!** in 1,000 pages

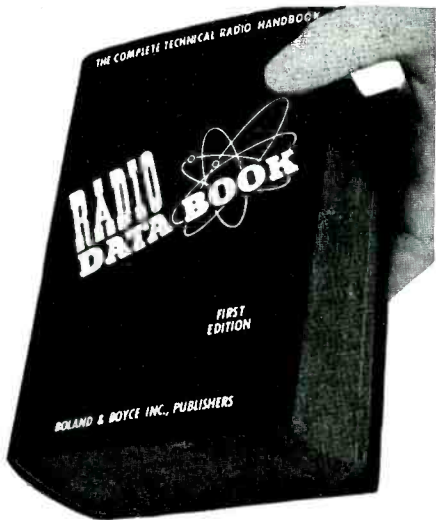

Handsomely bound in RED and GOLD

All data and basic knowledge in radio and electronics digested into 12 sections... in a complete, quick to find, easy to read, handbook form.

Plan every operation in radio and electronics with the *Radio Data Book*. This new radio bible will be your lifelong tool... you will use it every day, on the board, at the bench, in the field! Use it for construction, troubleshooting and testing. The *RADIO DATA BOOK* will be your invaluable aid in design, experiment and in layout. It will help make your production better, faster and easier. In any and every operation in radio and electronics, you will use the *RADIO DATA BOOK*!

The *RADIO DATA BOOK* is a work of complete authority, prepared by engineers with many years of practical experience. They have been assisted by the Boland & Boyce staff of editors skilled in preparing electronics manuals for the U. S. Signal Corps for many years. These men have worked for several years gathering material for this book... all the knowledge of radio principles and operation... all the statistics... all the newest developments in electronics... every possible angle and detail. Eighteen months were spent digesting this material into the most concise, the clearest, and the most readable form. The result is this invaluable manual... The *RADIO DATA BOOK*. Whether you use this book for general reference, for scientific instruction, or for education, one thing is certain—the practical help, the daily usefulness you will derive from it will prove to be worth many, many times its astonishingly low price!

Advanced Sale... first printing. Only 10,000 available... To make sure to get your *RADIO DATA BOOK*, mail your order **NOW!**

- 12 sections... 1000 pages... Completely Illustrated
- Section 1. THE 150 BASIC CIRCUITS IN RADIO.
  - Section 2. COMPLETE TEST EQUIPMENT DATA.
  - Section 3. TESTING, MEASURING AND ALIGNMENT.
  - Section 4. ALL ABOUT ANTENNAS.
  - Section 5. SOUND SYSTEMS.
  - Section 6. ELECTRICAL AND PHYSICAL CHARACTERISTICS OF RADIO COMPONENTS.
  - Section 7. COMPLETE TUBE MANUAL.
  - Section 8. CHARTS, GRAPHS AND CURVES.
  - Section 9. CODES, SYMBOLS AND STANDARDS.
  - Section 10. 50 TESTED CIRCUITS DESIGNED FOR OPTIMUM PERFORMANCE.
  - Section 11. DICTIONARY OF RADIO AND ELECTRONIC TERMS.
  - Section 12. RADIO BOOK BIBLIOGRAPHY.

12 complete books in one only \$5.00!  
Less than 42c per book!

**MAIL THIS COUPON TODAY!**

**BOLAND & BOYCE INC., PUBLISHERS**  
460 BLOOMFIELD AVE. MONTCLAIR 4, N. J.

Please send me a copy of THE RADIO DATA BOOK Enclosed is \$5.00

NAME .....

ADDRESS .....

CITY ..... ZONE .....

STATE .....

**BOLAND & BOYCE INC., PUBLISHERS**

### Golenpaul Heads Radio Parts Show Group

Charles Golenpaul, New Bedford, Mass., was elected president of the Radio Parts and Electronic Equipment Shows, Inc., sponsor of the national Radio Parts Show, at the Show Committee's annual meeting.

Golenpaul, who succeeds Jack Berman of Chicago, as president, represents the Sales Managers Club, Eastern Group, on the Show committee. Jerome J. Kahn, Chicago, representing the parts division, RMA, was chosen vice-president; R. J. Sherwood, Chicago, representing EP & EM, secretary, and W. O. Schoning, Chicago, (NEDA), treasurer.

The 1948 board of directors includes: J. J. Kahn and R. C. Sprague, representing RMA; Charles Golenpaul and W. W. Jablon, representing SMCEG; R. J. Sherwood and John L. Robinson, representing EP & EM, and W. O. Schoning and Aaron Lippman, representing NEDA.

Committees announced by President Golenpaul include:

Budget committee: W. O. Schoning, chairman; J. J. Kahn, R. J. Sherwood and Sam Poncher. Publicity committee: John L. Robinson, chairman; R. C. Sprague and W. W. Jablon. Housing committee: W. W. Jablon, chairman; J. J. Kahn and W. O. Schoning.

Arrangements committee: J. J. Kahn, chairman; R. C. Sprague, John L. Robinson, J. A. Berman, W. O. Schoning and L. B. Calamaras. Banquet committee: R. J. Sherwood, chairman; Sam Poncher,

W. W. Jablon and J. A. Berman. Credentials committee: R. C. Sprague, chairman; W. O. Schoning, R. J. Sherwood and Leslie DeVoe.

### Westinghouse Supports RMA Sales Program

Advertising and sales promotional plans of the Home Radio Division of Westinghouse Electric Corp. to support the new public relations and merchandising program of the Radio Manufacturers Association have been announced by J. H. Stickle, Westinghouse advertising manager. The program is now being presented at distributor meetings being held around the country.

### RCA Large-Screen Television

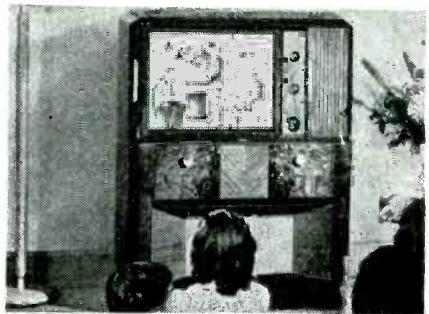

RCA Victor's new big-screen television receiver, Model 648 PTK presenting a 15 x 20 inch image with a brilliance of 50 foot-lamberts. The 300-square-inch picture is nearly as large as a newspaper page. Also includes a three-band radio, standard, FM, and short wave. Suggested retail price for the 648 PTK is \$1195, plus Federal Excise Tax and RCA Victor Television Owner's Policy fee.

### Universal's Large Line in One Window

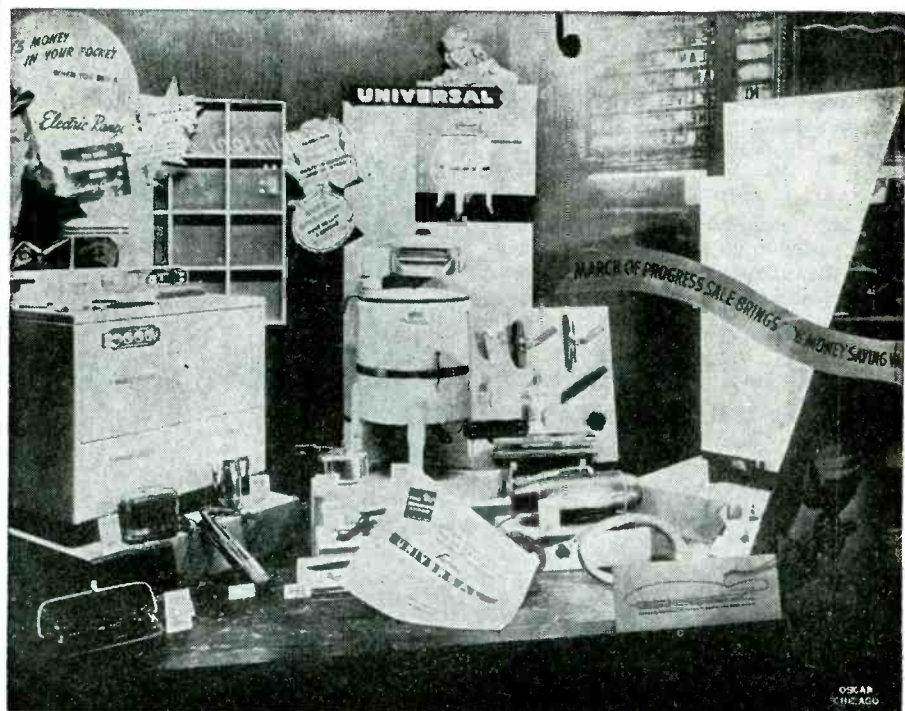

The Boston Store, Chicago, Ill., combines major and small appliances in an attractive display to show the vast extent of Landers, Frary & Clark's products in its march of progress sales held in the Windy City.



**Meck FM Converter  
Will Retail at \$19.95**

Within five months, thousands of additional homes throughout the country will be able to hear frequency modulation radio programs.

This was the prediction John Meck, radio manufacturer at Plymouth, Ind., as he revealed his firm had developed a revolutionary device called the Meck FM converter which will sell for \$19.95.

Meck's converter may be attached to any ordinary radio receiver in FM broadcasting areas, and makes it possible for the listener to hear FM programs.

The circuit for the new converter, which can be attached by any radio serv-



New Meck Converter

iceman in a few minutes, was worked out by Meck engineers in cooperation with the Hazeltine Laboratories. It uses a new regenerative circuit and a special new tube adapted from wartime radar equipment.

The converter, using the regular amplifying facilities of the AM broadcast receiver for volume, measures 9½ inches by 7 inches and is housed in an attractive plastic case. It tunes in all FM stations on the new wave band.

**Sams Books Meet Demand**

The two new service books published by Howard W. Sams & Co., Inc., Indianapolis 6, Indiana, are getting a strong response from radiomen across the country, report distributors. The Automatic Record Changer Manual, covering more than 40 different models with original data, has 416 pages in a hard cover, and sells for \$4.95, while the Dial Cord Stringing Guide, in a 96-page pocket size format, sells for 75¢, and will lick the "knottiest" dial cord problem. Sams is the publisher of the well-known Photo-fact Folders.

**"RADIOS FOR EVERYONE  
... EVERYWHERE!"**

**Tie in with NATIONAL RADIO WEEK, Oct. 26 to Nov. 1. Sell MORE SETS — Make MORE MONEY!**

**NATIONAL RADIO WEEK**

**Oct. 26 to Nov. 1  
Participate and sell  
more sets!**

**Cornish Wire Catalog  
Offered Dealers**

Cornish Wire Co., Inc., 15 Park Row, New York City, is now distributing its first postwar catalog of electrical, radio and industrial wires, cables and specialties. The illustrated folder may be had free by writing direct to the company.

**A "Sophisticated"  
Magnavox**

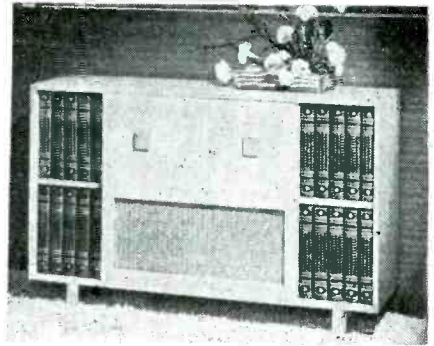

Magnavox Cosmopolitan, available in streamlined white oak; 18 watt undistorted power output, two 12-inch Duosonic speakers and precision automatic record changing with noiseless feather-touch pickup. It is listed at \$385. With FM, 14 amplifier tubes, two rectifiers and two tuning tubes, the Cosmopolitan is priced at \$450.

**NEW!  
TIME-SAVING!  
VERSATILE!**



**Sine or Square Wave  
at the Flick of a Switch!**

Now—the General Electric Sine-Square Wave Generator YGA-2 provides you with greater facilities for better, more efficient service work. A top quality equipment, it incorporates two units in one; a high quality, stable oscillator and a square wave generator. It features a low distortion sine wave, stable RC oscillator and instantly available square waves.

**SINE WAVE APPLICATIONS**

Testing and adjustment of audio amplifiers, transformers, phase inverters, audio filters, etc.

**SQUARE WAVE APPLICATIONS**

Two point testing of response and characteristics in audio devices. Checking frequency response of wide band amplifiers. Determination of phase shift, distortion and high frequency peaks in audio equipments.

For complete information on the Sine-Square Wave Generator and other General Electric Service Test units write today to:  
General Electric Company, Electronics Park, Syracuse, N. Y.

**GENERAL ELECTRIC**

Use...  
**OHMITE**

Replacements

**BROWN DEVIL RESISTORS**... Wire-wound, vitreous-enameled type. Now in compact 5-watt size. Also 10 and 20-watt units.

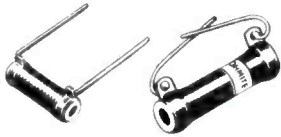

**LITTLE DEVIL RESISTORS**... Now 1/2 and 1-watt sizes in ±5% tolerances. Also 1/2, 1, and 2-watt sizes in ±10% tolerances.

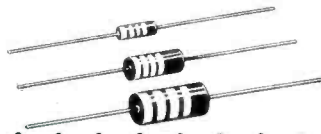

**TYPE AB POTENTIOMETER**... A new extremely high quality molded composition unit—rated 2 watts with a good margin of safety.

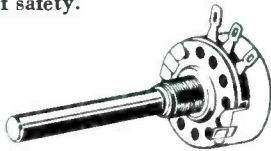

**DIVIDOHM ADJUSTABLE RESISTORS**... Wire-wound vitreous-enameled type—10 to 200 watts. Sturdy... dependable.

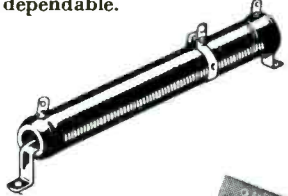

See Your Nearest  
Ohmite  
Distributor

Send for  
Catalog 19



**OHMITE MANUFACTURING CO.**  
4872 Flournoy St., Chicago



Be Right with...

**OHMITE**

RHEOSTATS • RESISTORS  
TAP SWITCHES

**New Low Prices on Bendix Radio Line**

Greater values and new low prices featured the new Bendix Radio models recently introduced to national distributing organizations. A new \$19.95 model marked the extension of the Bendix sets into a lower price bracket.

The model 110 utilizes the same cabinet previously found on the \$26.95 radio with a new high performance chassis with the same tube count. Like all other models in the line, this low cost set features a new bright dial lighting that is said to give the set both unusual charm and brilliance. This Bendix model features a one-piece enclosed plastic cabinet with a concealed molded-in handle.

Other prices dropped proportionately down the line of table models which, in turn, offer similar new treatments. The introduction of a five-tube wood model at \$32.95 and two six-tube wood models at \$39.95 marks the return of wooden table sets to the Bendix Radio line after a lapse of several months.

**New Features**

The model 1531, selling at \$179.95, in a mahogany cabinet, offers both pull-out drawer type automatic record changer and a door to the dial and controls. It is equipped with a twelve-inch speaker. This set also introduced Bendix Radio's Phantom Grille to popular price brackets. Hailed by J. T. Dalton, general sales manager for radio and television, as reflecting a new trend to authentic cabinet styling, this set fails to reveal any trace of grille, but nevertheless provides a rich outpouring of tone through a finely perforated panel of synthetic veneer. This feature also appears on the five-tube wooden table model and model 1521, a new radio-phonograph combination with FM at \$229.95.

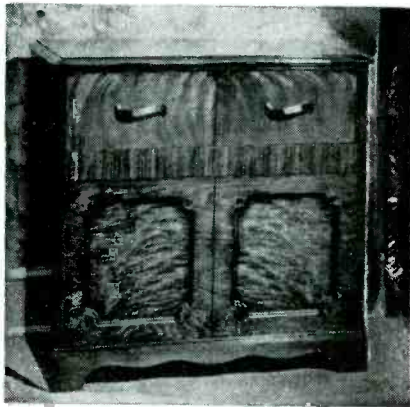

Model 1521

Hush-O-Matic, the new Bendix scratch eliminator, was dramatized by Dalton who pointed out that it provides all the beauty from a record with none of the scratch and who claimed a new tone life for old records. Featured on Model 1217-D at the top of the line, Hush-O-Matic comprises a switch control for a two-tube electronic circuit. In addition to the specific features announced

by Mr. Dalton, the line was said to be generally sharpened, both electrically and mechanically.

Among the Bendix officials who addressed the meetings were Malcolm Ferguson, president Bendix Aviation Corp., W. P. Hilliard, general manager of the radio division, and Earl L. Hadley, Bendix advertising manager.

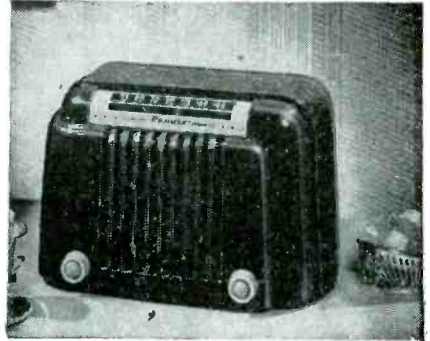

Model 110

**Stromberg Has New Paging-Intercom Unit**

The Stromberg-Carlson Company, Rochester, N. Y., has announced that, to meet business demands for quick communication between selected areas and a control center where the return message will be private, it has introduced the IM-3, a new paging and intercom system. It is a compact telephone-like master unit capable of directing outgoing messages to any one or all of three areas and of controlling the volume both ways. The incoming message is sent by the respondent's speaking directly into any one of the reproducers located in the areas addressed. A press-to-talk key on the telephone base controls the transmission and reception of messages.

The master unit of the new intercom is built into a telephone instrument base and handset and derives its power from a remotely located amplifier which it controls. The IM-3 is said to be especially adapted to executive offices where the privacy of an incoming message is desired.

**New Majestic Sets**



Two of the new Majestic table models, 8FM744—an eight tube (including rectifier) FM-AM receiver retailing for less than \$100.00 and the 5A410, a five tube (including rectifier) standard broadcast receiver retailing at \$29.95 in white, \$27.95 in black.



## NATIONAL RADIO WEEK

Oct. 26 to Nov. 1  
Participate and sell  
more sets!

### Low-Priced FM-AM Radio by Olympic

P. L. Schoenen, executive vice-president of Olympic Radio & Television, Inc., of Long Island City, N. Y., has announced that the company is producing an FM/AM table model radio receiver to retail at \$39.95.

Mr. Schoenen said, "Market research recently conducted, leaves no doubt that there is an enormous demand for a good, low-priced radio receiver that will enable its owner to listen to, and become familiar with FM broadcasts in his area. . . .

"In spite of the tremendous public interest in FM, the audience still remains small. Why is this? There are several reasons. First, over-all production of FM units is still small; second, the majority of models now offered are expensive consoles; third, FM table models available until now are not in the low price bracket, and such models as have been available in the medium price range are in exceedingly short supply.

"Olympic's FM/AM model 7-532 is of generous size with 6" dynamic speaker, a full range tone control and a power output of about two watts, in a beautiful streamlined plastic cabinet, having a large slide rule dial. The circuit used in this receiver is the result of over two years of research and development. It employs 5 tubes plus rectifier and operates on AC or DC current without the use of an outside antenna on either FM or AM. The effective range on FM is about 20 miles and on signals of good or moderate strength, noise rejection is very effective and provides reception remarkably free from natural or man-made static.

"Olympic is planning a daily production in excess of 1,000 sets but the initial output will be somewhat smaller."

### Air King Sales Reps

J. J. Clune, merchandise manager, Air King Products Co., Inc., 170-53rd St., Brooklyn, N. Y., manufacturers of Air King radios, announces the appointment of the following sales representatives:

John P. Ludgate Associates, 345 Fourth Ave., Pittsburgh, Pa., for western Pennsylvania, West Virginia, Kentucky, and Ohio with the exception of the Toledo trading area. The Haggerty Sales Co., 10226 Woodward Ave., Detroit, will represent the Air King line for Michigan and the Toledo trading area in Ohio. Sam Robbins of New York will represent Air King for New England and New York State except Metropolitan New York City, Long Island, Westchester and White Plains.

### Organizational Changes by Crosley Division

A series of organizational changes in the Crosley Division, the Avco Manufacturing Corporation, have been announced by R. C. Cosgrove, general manager.

Norman C. MacDonald, who has been vice-president and general manager of the Crosley Distributing Company, New York City, has become general sales manager of Crosley Division of Avco.

Bert Cole, who has served under MacDonald since October 1, 1944, as general sales manager, will become general manager of the New York firm.

Sydney D. Mahan, former head of both sales and advertising, will head up an expanded advertising, sales promotion, and

public relations department.

Corley W. Kirby has been appointed domestic sales manager of Crosley, Cosgrove announced. Kirby, a veteran of the major appliance and radio fields, has served Frigidaire as branch manager in Newark, New Jersey, sales manager of the New York branch, and in various capacities at headquarters in Dayton, Ohio.

Lee Stratton, whom Kirby succeeds, will head up a new section on home freezers. Stratton will promote the sale of the Crosley Frostmaster frozen food cabinet, and other developments in this field, as they are announced.

Stratton started with Crosley in 1944 as manager of refrigeration sales and has assisted in the development of new lines.

**THE NEW**  
*Rauland*  
**Omni-directional\***  
**FM**  
**ANTENNA**



Model 150      88 to 108 mc

- No Special Orientation Required
- Low Standing Wave Ratio
- High Sensitivity & Signal Strength
- All-Aluminum Construction

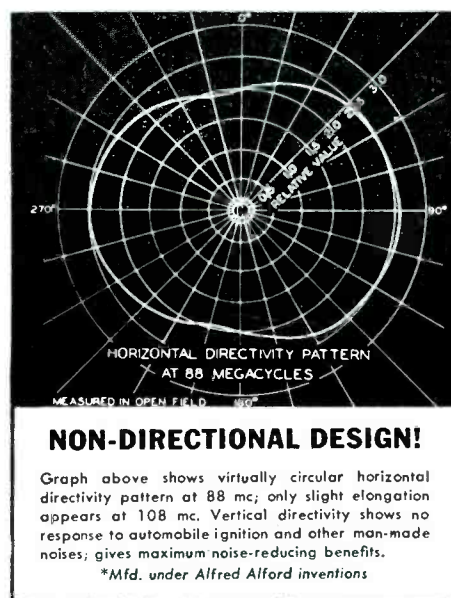

### The FM Antenna that Gives You a Big "Selling Edge"

It's new, different—far superior to the conventional FM antenna! Here is the *first* and *only* FM Receiving Antenna with *all* these features: Non-Directional Pickup over the *entire* FM band—for satisfactory reception from all stations in any location regardless of direction of signal. Higher gain improves reception at outlying sections of the effective station area. Stable-Omnidirectional characteristics—unaffected by rain, sleet, or age. Small, rugged, and supplied completely assembled—easy to install. Can be used in pairs for increased signal strength and lower noise. Can be permanently grounded for protection against lightning. Direct match to standard 300 ohm receivers (matching unit available to match other impedances). No other conventional antenna offers all the FM receiving advantages obtained from the exclusive design of the new RAULAND Model 150 FM Receiving Antenna. Give your FM business a real boost with the RAULAND FM Antenna!

SEE YOUR AUTHORIZED RAULAND DISTRIBUTOR for full information on the new RAULAND Model 150 FM Receiving Antenna. Don't miss out on this selling opportunity in the expanding FM market!

Electroneering is our business

SOUND TELEVISION      *Rauland*      INTER-COMMUNICATION

THE RAULAND CORP. • 4247 N. KNOX AVE. • CHICAGO 41, ILL.



# ATLAS

*The Seal of  
Sound Supremacy*



**REENTRANT PROJECTORS**



**DRIVER UNITS**



**BOOSTER UNITS**

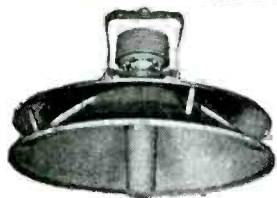

**RADIAL PROJECTORS**



**"MIKE" STANDS**  
Baffles  
Enclosures  
Desk Stands  
Speaker  
Stands  
Adaptors  
Wall Boxes  
Boom Stands

Write for illustrated catalog sheets

## ATLAS SOUND CORPORATION

1451—39th Street, Brooklyn 18, N. Y.

### Hallcrafters Line to Colen-Gruhn in N. Y.

The Hallcrafters Company, Chicago, announces the appointment of Colen-Gruhn, Inc., 387 Fourth Avenue, New York City, as distributors for the Hallcrafters console radio and television receiver line in the New York area.

M. Mitchel Gruhn is president and Col. Harold S. Glasser is vice-president of Colen-Gruhn.

In announcing the appointment, Wm. J. Halligan, president of The Hallcrafters Company, pointed out that in the past quarter of a century New Yorkers have bought over \$50,000,000 worth of radio and appliance products through dealers serviced by Colen-Gruhn. "This record of service, now coupled with the Hallcrafters line, assures New Yorkers of the best in quality and distribution," he said.

### Parts Show Starts May 9

The Radio Parts and Electronic Equipment Shows, Inc., sponsor of the electronics industry's annual national exhibit, has retained the S. I. Neiman organization, Chicago, as public relations counsel.

The date for the 1948 Show has been set for the week of May 9th at the Hotel Stevens, Chicago.

### Represents GE Products

Monte M. Wheeler has been appointed representative at San Francisco for General Electric heating devices and fans, it has been announced by B. M. Tassie, Pacific district manager of appliance sales.

### Hoffman Shows New Set Line to Jobbers

H. L. Hoffman, president of the Hoffman Radio Corp. of Los Angeles, has met with distributors from all eleven Western states and previewed Hoffman's plans for 1948.

A custom built quality line of radios, radio-phonographs and home-recording units was shown . . . models that are entirely new in design and engineering. One of the outstanding features of the meeting was the unveiling of Hoffman's latest achievement in the field of home-recording . . . the "Musicord." This radio-phonograph-recorder will be offered with or without FM and in both modern and period styles.

In announcing the company's sales promotion plans for the balance of the year, Mr. Hoffman emphasized that the advertising and merchandising program had been designed to give Hoffman dealers consistent backing.

### New JFD Chemicals

The JFD Mfg. Co., Inc., Brooklyn, N. Y., has announced the addition of four new items to its line of radio chemicals. These are Poli-Wax, used for polishing radio cabinets, etc., Contact and Crystal Cleaner for insuring clean, positive contacts and spotless crystals; JFD Bakelite Cement for securing plastic to plastic and to other materials, and JFD Liquid Non-Slip Compound for preventing dial belts and cables from slipping.

### Emerson Launches a Movie Tie-in Campaign



Leo Hahn (right), Emerson sales promotion manager, presents "Black Gold" radio to Steve Brodie (left), president of Monogram Pictures. Emerson's set will tie-in with movie "Black Gold," scheduled to appear in 16,000 motion picture theatres. Schedules of showings

will be sent to Emerson Radio Dealers to tie-in window streamers and radio-ad streamers for theatre lobbies. Co-operative ads are available. In larger cities, stars in picture will be available for personal appearances in leading stores, according to Emerson officials.



## Raytheon Shows New Products at Convention

The commercial products division of Raytheon Manufacturing Co., Waltham, Mass., exhibited its complete line of studio and transmitting equipment at the National Broadcasting Association Convention, Atlantic City, from Sept. 15 through Sept. 19.

## New Remler Receivers

Remler Company Ltd., 2101 Bryant St., San Francisco, is celebrating its 30th Anniversary with a complete new line of 1948 receivers. "Scottie Pups" and "Scottie Juniors," featured as popular price leaders in the new series, are now available for immediate delivery, according to an announcement made by Jack Totten, vice-president.

These new Remlers are full-sized personal table models with solid plastic cabinets. They are said to have excellent tone and have been tested in localities where reception is difficult. The receivers are 5-tube AC-DC superhets with dual purpose tubes.

"Scottie Pups" list at \$19.95 in walnut; \$22.95 in white. The "Scottie Juniors" are encased in a beautiful cabinet with carrying handles and have additional refinements. Walnut plastic list \$24.95; white \$27.95.

Remler is in the process of "going national" and distributors are being appointed throughout the country.

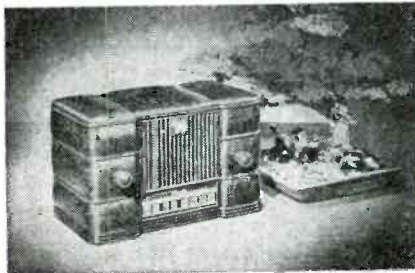

Scottie Pup

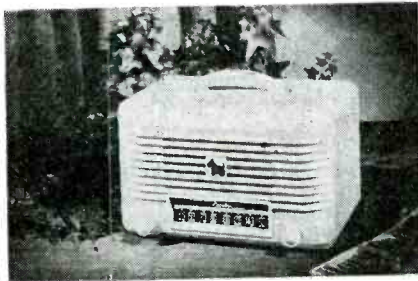

Scottie Junior

## New Emerson Sparkle Sets

Emerson Radio and Phonograph Corporation has released three new sparkling models, variations of the Emerson ivory plastic model number 511. The sets are molded in an emulsion of gold stamped on the cabinets in ivory bronze, green bronze, and red bronze. They retail for \$29.95. Another Emerson Radio "first" model 547, the transparent ruby, listing at \$19.95, also made its appearance.

## Sloan New Manager of Westinghouse Radio

F. M. (Todd) Sloan, a veteran of more than 20 years in the communications and radio industries, has been appointed manager of the Westinghouse Home Radio Division, Sunbury, Pa. He succeeds Harold B. Donley who resigned.

Mr. Sloan, formerly assistant general manager of Westinghouse Radio Stations, Inc., has been associated with Westinghouse radio activities for more than 15 years in technical and administrative positions.

In addition to laying the ground work for the nation-wide service organization of the Division which he now manages, Mr. Sloan served during the latter part

of the war as manager of the field engineering service department for the industrial electronics division at Baltimore. In this capacity he developed and supervised a world-wide engineering service organization that included operations in the distant theatres of operation where Westinghouse radar and allied electronic equipment were installed for the Navy.

## Hoffman Joins Admiral

Seymour Mintz, director of advertising and sales promotion for the Admiral Corporation, announces the appointment of Richard L. Hoffman, as assistant advertising director. Hoffman was formerly office manager, research department of Foote, Cone & Belding.

# TERRIFIC SAVINGS ON OLSON "AKRAD" CONDENSERS

Special Introductory Offer —  
**LIMIT: ONE KIT TO EACH CUSTOMER**

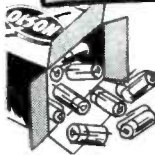

Why do we make this offer? First, remember, this is OLSON's and we're famous for BARGAINS. Second, we're busting to have you try our new "AKRAD" Condensers. They're absolutely TOPS: hermetically sealed in aluminum; tough insulating film resists shorts; will take surges without puncturing; extra-low leakage, super-long shelf life; fully resistant to temperature and humidity changes; leads can't loosen. "AKRADS" take plenty of overloading without breakdown. They last and last and LAST.

### GUARANTEE:

Use five Olson "AKRADS" on your toughest jobs. If not 100% satisfied, send back the remaining Condensers to OLSON RADIO WAREHOUSE, INC., 73 E. Mill St., Akron, Ohio—and we will refund EVERY CENT YOU PAID, and the postage too.

Look what you get!

| Quan. | Mfd   | Volts | List         | Total          |
|-------|-------|-------|--------------|----------------|
| 2     | 10    | 25    | .75          | 1.50           |
| 2     | 25    | 25    | .85          | 1.70           |
| 5     | 20    | 150   | .85          | 4.25           |
| 5     | 40    | 150   | 1.10         | 5.50           |
| 5     | 20-20 | 150   | 1.30         | 6.50           |
| 5     | 8     | 450   | .95          | 4.75           |
| 5     | 16    | 450   | 1.35         | 6.75           |
| 29    |       |       | <b>TOTAL</b> | <b>\$31.45</b> |

**A Regular \$31.45 List Value for only**

**\$9.95**  
POSTPAID\*

\*When Remittance is made with order, we pay postage.

**DON'T MISS IT! MAIL THIS COUPON TODAY!**

**OLSON RADIO WAREHOUSE INC.**

73 E. Mill St., Dept. 102, Akron, Ohio

Send me one Kit of 29 Olson Guaranteed "Akrad" Condensers. (Limit: One Kit to a customer.)  I enclose \$9.95; Olson pays postage.  Send my order C.O.D. I will pay postage.

NAME \_\_\_\_\_

ADDRESS \_\_\_\_\_

CITY \_\_\_\_\_ STATE \_\_\_\_\_

**FOR FASTER SOLDERING**  
**2 NEW WELLER**  
**SOLDERING GUNS**  
 with

*Solderlite*



The new Weller Soldering Guns with Solderlite plus the fast 5 second heating help make service work more profitable for radio, television and appliance service men, electrical maintenance men, electric motor rewinding and repair shops automotive electrical service. A useful and time-saving tool for laboratory workers, experimenters, hobbyists, telephone installation and maintenance men. See your radio parts distributor or write for bulletin direct.

822 Packer St., Easton, Pa.

**WELLER**  
**MANUFACTURING CO.**

In Canada: Atlas Radio Corp., Ltd., 560 King St., N. W., Toronto, Ont.  
 Export Dept.: 25 Warren St., New York 7, N. Y.

**Sparton Names Dyna**

The appointment of George Dyna, veteran radio and appliance sales executive, as western zone manager for Sparton radios, is announced by Sparks-Withington Company, Jackson, Mich. Mr. Dyna's headquarters will be in Los Angeles.

A well-known figure in West Coast radio distribution for the last twenty-five years, Mr. Dyna has been most recently the West Coast distributing manager for the Bendix Radio Division of Bendix Aviation Corporation.

**Nationwide Sales Coverage by Pilot**

The Pilot Radio Corporation, 3706—36th Street, Long Island City 1, N. Y., whose newest product, the FM Pilotuner, is receiving applause from retail dealers, consumers and dradio stations, announces the following territorial coverage for its home salesmen and sales representatives throughout the country:

Home office salesmen: New York City, Long Island, lower New York State (to Albany), New Jersey, Delaware, Maryland, Washington, D. C., and eastern Pennsylvania.

Anderson Sales Co., 148 State St., Boston, Mass., Maine, New Hampshire, Vermont, Rhode Island, Eastern Mass.; Bader & Fox Dist. Co., 625 N.W. Couch St., Portland, Ore., Idaho, Montana, Oregon, Washington; Glenn Burdick, 26 Summit Ave., Buffalo, N. Y., western and central New York State; Sol Chain, 157 Church St., New Haven, Conn., Connecticut and western Massachusetts; Golbus Sales Co., Western Merchandise Mart, 1355 Market St., San Francisco, Calif., northern California; Golbus Sales Co., 1217 S. La Cienega Blvd., Los Angeles, Calif., southern California; Mayray Company, 1500 Canal St., New Orleans, La., Louisiana, Alabama, Mississippi, Florida.

Also Allen D. McGehee, 5671 Indianola Ave., Worthington, Ohio, Ohio; James H. Podolny, 5844 Beacon St., Pittsburgh, Pa., West Virginia, western Pennsylvania; Arthur Rixon & Son, 209 W. Washington St., Greenville, S. C., South Carolina, North Carolina, Georgia; Ross Associates, Inc., 1156 National Bank Bldg., Detroit, Mich., Michigan; The Salescrafters, Inc., 510 N. Dearborn St., Chicago, Ill., Illinois, Indiana, Wisconsin, Missouri, Minnesota, Nebraska, Iowa, Kansas, North and South Dakota; The Texport Company, 304 E. Fifth St., Austin, Texas, Texas, Oklahoma; James C. Wilson, 604 Georgia Ave., Bristol, Tenn., Tennessee, Virginia.

**Estate Promotes Dunn**

The advancement of Cecil M. Dunn to the newly created position of director of sales and advertising has been announced by John A. Seubert, vice-president and general manager of the Estate Heatrola division, Noma Electric Corporation.



*The New Maestro*  
**BELphone INTERCOM**

Contact office-plant personnel instantly without leaving your desk. This better-than-ever BELphone system gives fingertip control over your voice messages. Amazingly flexible. Extra call-stations added easily. As little as 5¢ a month operates entire 15-station system. Uses electric current only when you talk. Compact cabinet is rich brown Durez plastic. Compare your intercom needs with the striking new BELphone Maestro.

SEND FOR ILLUSTRATED BULLETIN TODAY

**BELL SOUND SYSTEMS, INC.**  
 1187 Essex Avenue  
 Columbus 3, Ohio  
 Export Office: 4900 Euclid Ave., Cleveland 3, Ohio

**Profitable BOOKS**

- To sell to your customers
- For the use of your servicemen

**INTRODUCTION TO Practical Radio**

By Tucker. Unusually complete, clear explanations of all fundamentals, including the necessary math. Already a best-seller to hams, servicemen and radio fans. Illus. \$3.

**PRINCIPLES OF Radio for Operators**

By Asherton. 470 illustrations and very graphic, easy-to-understand explanations of the operating principles of every radio part, including antennas. \$4.

**INTRODUCTION TO Electronics**

By Hudson. A masterly exposition of the underlying theory, construction of basic devices, and multitudinous applications—both present and potential. Illus. \$3.30.

You will make a double profit on the sale of these excellent books. They are easy to sell, and they create the interest and knowledge that make your customers into steady buyers of radio supplies. Your service department, too, will find them a valuable aid in locating and repairing trouble quickly. Let us send you copies on approval.

The Macmillan Co., 60 Fifth Ave., N. Y. 11



## Early Sales

(Continued from page 77)

slogan, "Do Your Christmas Shopping Early," is good advice, and they earnestly mean to follow it. The merchant who starts plugging early shopping in his own store, and does it via advertising, through show-window and in-store display, is bound to start selling earlier, and for a longer period of time, than the fellow who just plans to do it *manana*.

All indications point toward a record volume of Christmas business this year, and, as stated before, there certainly has been a definite trend on the part of the American shopper to buy well in advance of Christmas. While it's true that the buying rate will be much higher during the last few days before Christmas Day, no dealer can do a satisfactory amount of business unless he gets rolling early, with the aim of doing business in terms of *months* rather than in terms of *days*, or even *weeks*.

## Langevin Sales Director



Ralph J. Hugh has joined the Langevin Mfg. Co., New York, as sales director of the industrial control division.

## UST Reduces Prices on Television Sets

Price reductions up to \$480 have been announced for United States Television receivers by Hamilton Hoge, President of UST. The lowered prices are now in effect.

The greatest price drop, \$480, was on UST's home projection television console which includes FM and AM radio as well as two short wave bands and automatic record-changing phonograph. This model, which has a 21 by 16-inch screen, previously sold for \$2275 and is now listed at \$1795.

United States Television's best seller, a public place model with a screen 19 by 25-inches (475 square inches), has been reduced \$400, from \$1995 to \$1595.

The set with the largest screen in mass production today, 30 x 22½ inches, has been lowered in cost to \$1795 from \$2245. This unit is in limited production at this time. A limited supply of one of UST's earliest models, a public place projection set with a 21 by 16-inch screen, has been dropped to \$1295 from \$1795.

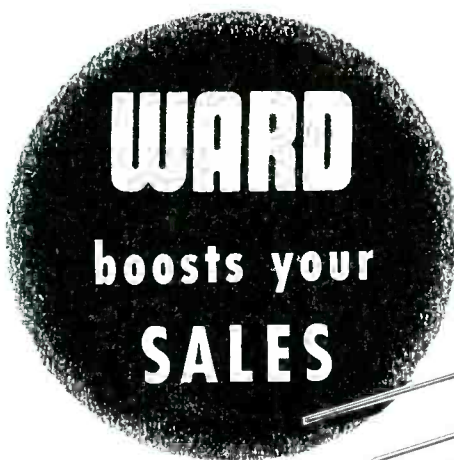

with All-out  
Consumer Advertising on  
*Magic Wand*  
FM AND  
TELEVISION AERIALS

This campaign, in the Saturday Evening Post and leading newspapers, is convincing millions of present and prospective FM and Television receiver owners that a good outdoor dipole antenna is a necessity. As a result you'll make more money selling "Magic Wand" FM and Television Aerials . . . and be able to promise, and deliver, finest reception no matter where your customers live. You'll make added profits from aerial installations, too. See your Ward distributor for details on how to assure your full share of the benefits of this major FM and Television Aerial campaign, or write:

**THE WARD PRODUCTS CORPORATION**  
1523 East 45th Street, Cleveland 3, Ohio  
DIVISION OF THE GABRIEL COMPANY

EXPORT DEPT.: C. W. Brandes, Mgr., 4900 Euclid Ave., Cleveland 3, Ohio  
IN CANADA: Atlas Radio Corp., 560 King St., W., Toronto, Ont., Canada

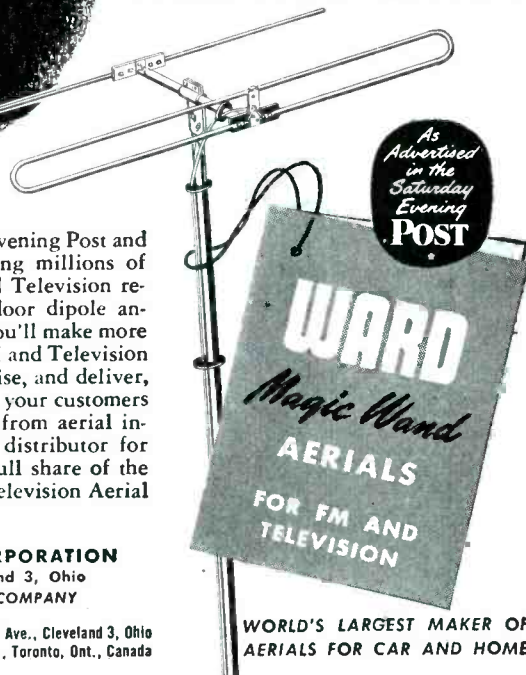

WORLD'S LARGEST MAKER OF  
AERIALS FOR CAR AND HOME



. . . with intercommunication that heads the list in *all* of the latest advancements . . . Talk-A-Phone . . . the World's Most Complete Line of Intercommunication.

Talk-A-Phone, a perfected product of the world's largest manufacturer specializing in intercommunication, comes complete . . . ready to install and is easily installed.

A unit for every requirement, large or small. Liberal profits. Attractively priced. Unbeatable performance. Nationally advertised.

For complete particulars, clip this ad and pin it to your letterhead . . . or write for Talk-A-Phone Catalog No. 47.

Establish yourself as intercommunication headquarters *NOW!*



## Talk-A-Phone Co.

1512 S. Pulaski Road Chicago 23, Ill.

# 30,000 RADIO SERVICE- TECHNICIANS READ

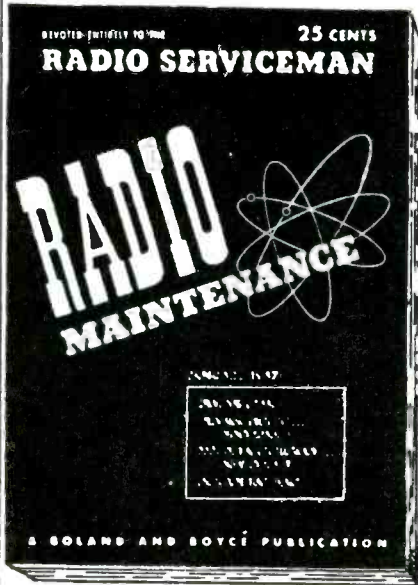

## EVERY MONTH

RADIO MAINTENANCE today fills a breach that has existed in the radio field for a long time. Already 30,000 servicemen read RADIO MAINTENANCE every month because it is devoted entirely to the radio serviceman.

The RADIO MAINTENANCE staff specializes in the preparation of articles on every phase of Radio Maintenance in series form which may be filed and used for reference. The leading articles cover everything for the radio serviceman on Television, FM and AM; Test Equipment; Electronic Appliances; Tools; Antennas; Alignment; Troubleshooting; Repair; Construction; Pick-Ups and Sound Amplification and Reproduction Equipment. Also, in RADIO MAINTENANCE each month there are departments on hints and kinks, the latest news of the trade, review of trade literature, radlomen's opinions, new products and news from the organizations. All articles are presented in a step-by-step precision style, clearly illustrated, with schematics, accurate photographs, specially prepared drawings, white on black charts, color diagrams, isometric projections and exploded views.

Tear off coupon below, and mail today. Your first issue will be mailed immediately on receipt of this coupon. One issue FREE if payment is enclosed.



**RADIO MAINTENANCE MAGAZINE**  
460 Bloomfield Avenue,  
Montclair 4, N. J.  
Please send me RADIO MAINTENANCE every month for

1 year at \$2.50       Payment enclosed  
 2 years at \$4.00       Bill me later

Name .....

Address .....

City—State .....

Occupation .....

Title .....

Employed by .....

\* Independent Serviceman—Dealer Serviceman—Service Manager—Dealer—Distributor—Jobber.

**BOLAND & BOYCE INC., PUBLISHERS**

## Zenith Takes a Bow!

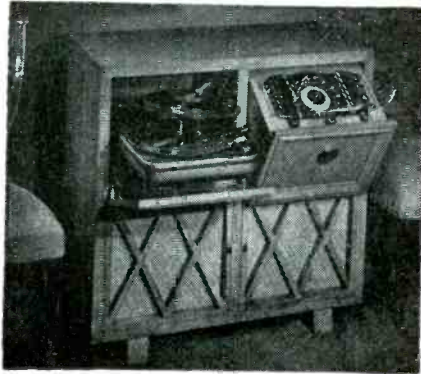

The Zenith combination radio, pictured here, appears prominently in MGM's movie hit, "The Hucksters," starring Clark Gable.

## Joins Sprague Electric



Carroll G. Killen, above, has been appointed to the field engineering staff of the Sprague Electric Co., North Adams, Mass., it has been announced by President Robert C. Sprague.

## New Olson Comic Poster



Olson Radio Warehouse, Inc., 73 E. Mill St., Akron 8, Ohio, offers to send its giant comic poster, lithographed in color, size 17" x 22", postpaid to radio servicemen. The poster's a painless method which can be used to educate the public on condensers, says Olson.



HERE'S a new and highly profitable business that's a dead natural for the radio-man who wants to supplement his income with a minimum investment in both time and money. Today, individuals like yourself, all over the country, are realizing big dividends with TRADIO, the radio functionally-designed for coin operation in hotels, tourist camps, hospitals, etc. And they're doing it right in their own backyards, too.

## • Big Earnings, Steady Income

TRADIO has pioneered in this new and flourishing post-war field. Get in on the ground floor and assure yourself of financial security for life.

## TRADIO ★ Tried ★ Tested ★ Proven

TRADIO sells to operators only through franchised distributors. No routes are sold. We'll put you in touch with the distributor in your territory if you'll phone Asbury Park 2-7447 or write

TRADIO, Inc.  
Dept. X-10,  
Asbury Park,  
N. J.

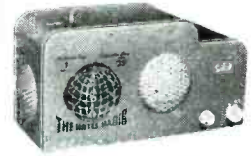

**TRADIO, Inc.** ASBURY PARK  
NEW JERSEY

# BELL Novelty Records

## Jewish & English Comedy

BY - BENNY BELL

- 120. Benny Bell Blesses A Bride
- 332. A Disgusted Millionaire
- 246. Oy Hut Air C'dah-vind
- 740. Eye-yi Yah-da-dye
- 531. Living and Laughing
- 638. Bar Mitzvah Speech
- 390. Yiddish Radio Broadcast

ALSO, ENGLISH COMEDY

- 523. PINCUS the PEDDLER
- 230. The Son of PINCUS
- 413. Pincus Went to the Mountains

New Release

## DR. YOOKIE KUPVAYTIG

(No. 963, Yiddish Laugh-Riot)

Dealers price ..... 49c, tax paid

—C. O. D. Until Established—

**IF YOU HAVE NO LOCAL DISTRIBUTOR, ORDER FROM**

## BELL RECORDS, Inc.

2382 PITKIN AVE.,  
BROOKLYN 7, N. Y.



## Promotion With Purpose

(Continued from page 45)

year to year the progress is apparent. For smaller stores, with neighborhood locations, flyers, personal contacts, mail advertising, and small neighborhood journals are more economical and effective.

"Fourth, *know your books*. Many apparently successful appliance dealers went out of business both during pre-war and postwar periods. A lack of analysis of monthly operations will cause more damage to the business than any other single factor. It is so easy to over-buy, so easy to find expenses out of control.

"Fifth, *know your help*. Unless you understand some of your help's problems, their needs, their temperament, their likes and dislikes, their hobbies, living habits, etc. it is rather difficult to expect maximum return for the money you have allocated for their services. Weekly early morning conferences, sales meetings will help you understand some of their problems as well as yours.

"It is employer's duty to see that the employe is adequately compensated. If a man is not making enough to support a family he is not doing his work efficiently. He is worried, and his mind seriously preoccupied. If his exigencies are beyond reason, let him go, and find somebody else whose living methods fit his earning power.

"Sixth and finally; *know your jobber*. Very little has been said about this phase of business by writers, but it is just as important to know your jobber as to know your customer, your goods, or your help. Small favors extended to them or to their salesmen will reflect unquestionably in your business development. Give their representatives, their salesmen, and other employes ample time to present their products and problems.

### New Webster Electric Unit

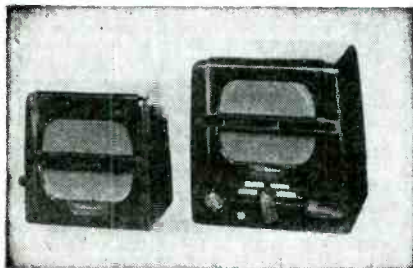

A new contribution to step-saving in the home is the electronic device called Telehome. It consists of a master station which can originate and receive response from as many as three stations. It's a product of the Webster Electric Co., Racine, Wis., for many years makers of business inter-communication systems.

**EXTRA Protection for EVERY Service Job!**

**FIXED OR ADJUSTABLE**

## VITROHM RESISTORS

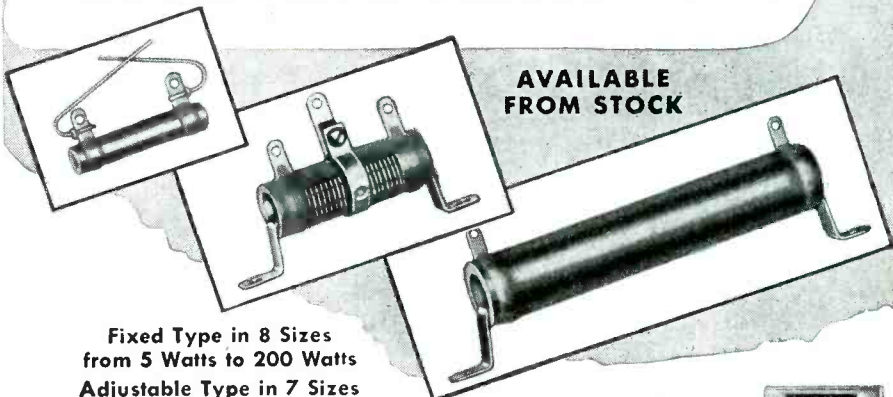

**AVAILABLE FROM STOCK**

Fixed Type in 8 Sizes  
from 5 Watts to 200 Watts  
Adjustable Type in 7 Sizes  
from 10 Watts to 200 Watts

You can guarantee dependable, trouble-free performance when you install VITROHM wire-wound resistors. Windings are held in place and protected by a special WL vitreous enamel which is tough, crazeless, moisture and acid-resistant. They give long service, avoid call-backs, build satisfied customers and greater profits. Available in wide range of resistance values.

Authorized Distributors Everywhere

WARD LEONARD ELECTRIC CO., Radio and Electronic Distributor Division, 53-H W. Jackson, Chicago 4

**SEND FOR FREE CATALOG**

Write for Catalog No. D-2. Gives complete data and information.



## WARD LEONARD

**RELAYS • RESISTORS • RHEOSTATS**

Electric control devices since 1892

### SENSATIONAL SELLER!



### LAKE DELUXE CHANGER

Revolutionizes the Industry!  
An Excellent Seller!

#### 11 Outstanding Features:

- Positive Intermix
- Service Adjustments Eliminated
- Minimizes Record Wear
- Single Knob Control
- Plays ALL Records
- Pick-up arm may be grasped at any time and changer will not be thrown out of adjustment
- Resonance-free ball bearing tone arm
- Easily operated—any child can do it
- Completely Jam-proof
- Records Gently Lowered on Spindle—not dropped
- Automatic Shut-off on last record

Dimensions: 13 13/16" W x 12 1/4" D x 7 5/8" H. **\$28.73**

No. 116A. . . . . YOUR NET  
SERVICEMEN—RETAILERS Write for our new, illustrated 16-page catalog NR-116. It's free. Get on our mailing list!

Write for our Special Catalog on Microphones, Amplifiers and Sound Equipment!

**Lake Radio Sales Co.**  
615 W. Randolph Street  
Dept. B  
Chicago 6, Ill.

Every Radio Serviceman Needs This **FREE**

68 PAGES

AC-DC

BALLAST

TUBE MANUAL

To get YOUR FREE COPY of this indispensable manual (value \$1.50) merely mail in to JFD Factory 12 flaps from JFD Radio Dial Belt envelopes; include 10¢ in postage to cover mailing cost. (Buy your JFD Dial Belts and Belt Kits from your nearest parts jobber.)

JFD's new 68-page Ballast Manual is a treasury of information for Radio Servicemen and Dealers — Lists more than 3000 radio ballasts — ACDC Ballasts for Fluorescent lights and electrical appliances — 220 volt to 110 volt Stepdown Ballasts.

Send 12 Envelope Flaps to:

**J.F.D. MANUFACTURING CO. INC.**  
4109-4123 FT HAMILTON PKWAY BKLYN 19, N. Y.





Here's the  
**INSIDE  
STORY**

★ Yes, this is that tube-type or plug-in resistor widely used in radios. Clarostat introduced and pioneered this item. Best of all—and most important to you—Clarostat has boiled down the essential replacement numbers to TEN. Yes sir, TEN Universal types replace practically all resistor tubes listed.

Furthermore, the Clarostat construction is unique. Mica support for windings; Glasohms for main loads; positively centered support; windings that cannot sag or short; positively char-proof; adequate safety factor—all that adds up to the well-known Clarostat reliability.

★ Order an assortment of those Clarostat Universal plug-in resistors from your jobber. Ask for latest catalog. Or write us.



CLAROSTAT MFG. CO., Inc. • 285-7 N. 6th St., Brooklyn, N. Y.

## Xmas Lights

(Continued from page 84)

ample, the "smooth-bore" sockets, so made for speedy operation, should be just a trifle larger than the outside dimensions of the base of the bulb. Some dealers paint high-voltage sockets red, and use green for marking sockets where current has been stepped down through use of transformers.

Numbers of dealers who do electrical work find that "outside" decoration services pay well. In many communities residents and business people go in for elaborate outdoor lighting of live trees, doorways, etc., in some cases spending thousands of dollars. To make the most money out of handling such work, the dealer should book orders as far in advance as he possibly can, in order to lay out the work and get an idea of how much material will be needed.

There's big business in Christmas decorative material in the offing, and the merchant can pile up a large volume of outside and small-ticket sales if he's equipped to sell the merchandise speedily and efficiently.

### Tele-tone Sales Manager



Benjamin H. Rice, who has been with the firm since July 1946, has been made sales manager for Tele-tone New York Corporation. His appointment was announced by John S. Mills, vice-president in charge of sales and advertising.

### Maseo Salesmen



Mark Simpson Mfg. Co., Long Island City, N. Y., makers of sound equipment and accessories, have appointed the W. H. Connors Co., 390 Ash St., Denver, Colo., as factory reps for Colorado, New Mexico, Utah, Wyoming and parts of Idaho and Montana. Above, left, Carl Connors; right, Bill Connors, founder of the firm.



REVOLUTIONARY NEW INSTRUMENT  
FOR COMPLETE RECEIVER TESTING!

## Signalette

MULTI-FREQUENCY GENERATOR

Generates R.F., I.F. and AUDIO Frequencies, 2500 cycles to over 20 megacycles, using new electronic multi-vibrator or radar principle. Completely self-contained—fits coat pocket or tool chest. Just plug into A.C. or D.C. LINE AND CHECK RECEIVER SENSITIVITY, AUDIO GAIN. R.F. and I.F. alignment, auto radio aerial peaking or shielding, breaks in wires, stage by stage signal tracing, tube testing by direct comparison, etc., etc. Sturdy construction, handsome appearance!

PRICE \$9.95  
See at your dealers or write for details:

at dealer CLIPPARD INSTRUMENT  
or F.O.B. LABORATORY, INC.  
Cincinnati, 1125 Bank St. Cincinnati 14, Ohio

VARIABLE CONDENSERS. 365 mmfd., 2 gang. Ball-bearing shaft, O.D.  $\frac{3}{8}$ " x  $\frac{1}{4}$ " .75

#### TUBE SPECIALS

Well known brands in perfect condition, but not in sealed cartons. Most types in stock at up to 80% off list. Every tube guaranteed 90 days.

|  |              |
|--|--------------|
| #20, 26, 27, 46 or 56  | .29          |
| #42, 45, 75, 76, 77, 78, 80, 89, 5Y3   | .39          |
| #52, 6F6, 6H6 or 6K7   | .39          |
| #35, 36, 37, 39, 84, 5Y4, 6AS, 6CS, 6D6, 6F5, 6J7, 6N7, 6U7, 6SA7, 6SK7, 12SA7, 12SK7 or 12SQ7 | .49          |
| #1A7, 1H5, 1N5, 1R5, 6A3, 6U5, 6X5, 7A7, 7C5, 7C6, 7Y4 or 50                                   | .59          |
| TUBE CARTONS: Plain white. CT size (1 1/4" sq x 3 3/4")  | Per 100 1.25 |
| Medium size (1 1/2" sq x 4 3/4")   | Per 100 1.48 |
| Large size (2" sq x 5 1/4")  | Per 100 1.79 |

PHONO MOTORS. Twin-coil, 110 V. A.C., quiet rim-drive. With 9" heavy duty turntable

|   |      |
|---|------|
| RCA Victor Power Transformer for models R-32, 45, 52 or 75. Unshielded  | 2.95 |
| UTC "OUNCER" INPUT TRANSFORMERS (7/8" x 1-3/16"). Dynamic Mike or low impedance pick-up to grid, .49; 12 for            | 5.95 |
| RADIO HARDWARE TREASURE. An indispensable asst. of approx. 1000 screws, nuts, lugs, washers, etc., for every radio need | .49  |

#### HANDY KITS FOR SERVICEMEN

|  |      |
|--|------|
| #2—SPEAKER CONES; 12 asstd. 4" to 12" moulded & free-edge (magnetic incl.). Less voice coils   | 2.00 |
| #3—MOULDED BAKELITE CONDENSERS; 50 asstd. .0001 to .2 mfd., 200-600 WV. Clearly marked   | 2.95 |
| #4—TUBULAR BY-PASS CONDENSERS; 50 asstd. X .001 to .25 mfd., 200-600 WV. Standard brands   | 2.49 |
| #20—SPEAKER REPAIR KIT. A real time & money saver. Contains: 25 asstd. paper rings, 10 spiders, 23 voice coil forms, 3 yds. felt strips, 20 chamois leather segments, kit of 16 shims & tube of cement | 2.49 |

PROMPT SERVICE ON ALL SPEAKER & PHONO PICK-UP REPAIRS

Minimum Order \$2.00—20% Deposit Required on All Orders. Please Add Sufficient Postage

**LEOTONE RADIO COMPANY**  
67 DEY STREET, NEW YORK 7, N. Y.



## SPECIALS FOR OCTOBER

### AERIAL WIRE

100 ft. coil, 7/23 tinned aerial wire ..... 69c each  
 50 ft. coil (same as above) ..... 36c each

### PUSH-BACK WIRE

Solid or stranded, tinned copper conductors with cotton serve and waxed cotton outer braid for easy push-back; available in all standard colors.

Per 100 ft. coil—22 Ga. Solid ..... 61c  
 22 Ga. Stranded ..... 68c  
 20 Ga. Solid ..... 71c  
 20 Ga. Stranded ..... 82c  
 Per 1000 ft. spool—22 Ga. Solid ..... \$5.72  
 22 Ga. Stranded ..... 6.45  
 20 Ga. Solid ..... 6.51  
 20 Ga. Stranded ..... 7.38

### 18 GAUGE SOLID FIXTURE WIRE

Solid, tinned copper conductor with weatherproof compound under lacquered braid; Type R.F. Underwriters Approved; a real buy at this low price: \$6.50 per 1000 ft.

We carry in stock for immediate delivery many types of wire and cable in gauges of from 23 to 2, in addition to various types of multi conductor cable for many uses. We also manufacture cord sets and cables to specifications. Send us your inquiries for prompt attention.

Our new catalog is now available for distribution. Write for your copy today.

**COLUMBIA WIRE & SUPPLY CO.**  
 5734 ELSTON AVE., CHICAGO 30, ILLINOIS

# Rembrandt

Reg. U. S. Pat. Office  
 THE FINEST IN

## TELEVISION-FM CONSOLE RECEIVERS

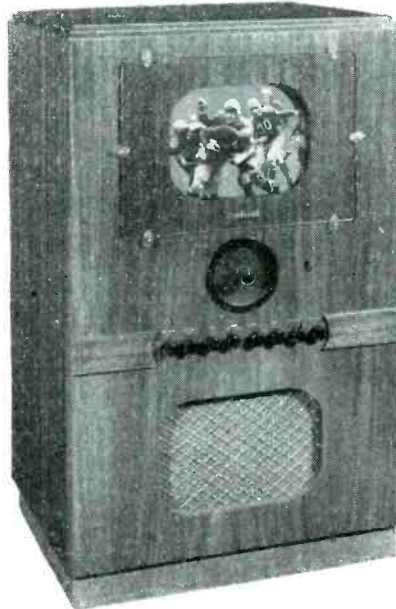

### MODEL 80

12" PICTURE TUBE  
 80 SQUARE INCHES  
 DIRECT VISION VIEW  
 SCREEN.  
 LIST: \$695.00

### MODEL 130

15" PICTURE TUBE  
 130 SQUARE INCHES  
 DIRECT VISION VIEW  
 SCREEN.  
 LIST: \$895.00

BOTH MODELS FEAT-  
 URE THE FAMOUS  
 DUMONT INPUTNER.  
 INCLUDES ALL 13  
 TELEVISION CHAN-  
 NELS AND FM BAND.

WRITE TODAY FOR  
 FREE ILLUSTRATED  
 FOLDER AND PAR-  
 TICULARS.

MANUFACTURED BY  
**REMINGTON RADIO CORPORATION**  
 WHITE PLAINS NEW YORK

# NOW!

END WORRY...MESS...  
 UNCERTAINTY OF  
 STORAGE BATTERIES!

*Enjoy*

**PERFECT** Radio Reception When Servicing  
 Car, Marine and Aircraft Radios!

**NEW** *Electro*  
 ELECTRICAL AND RADIO EQUIPMENT

Model "A"  
**POWER  
 SUPPLY**

DC Output

Operates latest type auto  
 radios with solenoid tuning  
 and tone controls . . . also 12 volt marine and aircraft radios.

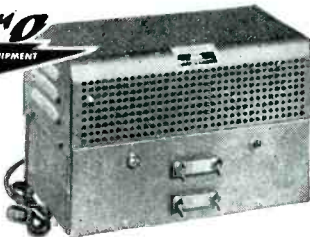

Height, 7 3/4"  
 Width, 7 3/4"

Length, 11 3/4"  
 Ship. Wt. 31 lbs.

Always dependable! Reserve power a-plenty! Big, heavy duty transformers and chokes — large capacity condensers, for exceptional voltage regulation — instantaneous power for solenoid operation. Two separately filtered DC output sources: in parallel supply 6V at 15 amps. series, 12V at 7 1/2 amps. Separately 6 V at 7 1/2 amps.

Compact. Sturdy. 18-gauge steel construction. Handsome blue Hammerloid finish. Comes completely equipped including 6' rubber cord and plug. Vastly superior and costs no more than batteries for equal service.

Send for complete description of this up-to-the-minute power supply.

**ELECTRO PRODUCTS LABORATORIES**

Pioneer Manufacturers of Battery Eliminators

549 West Randolph Street

Chicago 6, Illinois

## FINGERS are FASTER with VACO <sup>Break-Proof</sup> <sup>Shock-Proof</sup> Screw and Nut Drivers

Nimble fingers using precision built tools do all kinds of radio assembly or servicing work faster, save both time and money. That's one good reason why radio men everywhere prefer Vaco products. Precision built for precision work, these delicately balanced

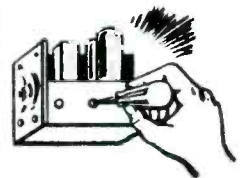

screw and nut drivers "handle" perfectly . . . speed up every type of operation. Break proof, shock proof Vaco drivers are your assurance of the right tool for the job. Write today for descriptive catalog.

173 TYPES AND SIZES

**NEW**... Colored Spin-Hex  
 Ambery! Handle Caps



Another Vaco extra! Color of removable cap indicates size of driver. No more hunting for the right size! Hollow handles hold reserve nut supply.

**VACO**  
 PRODUCTS CO.



317 E. Ontario St.  
 Chicago 11, Illinois

**NO MATTER WHAT YOUR REQUIREMENTS  
 . . . THERE'S A VACO TO FIT EVERY NEED!**

## Correction

Through an error, Clippard Instrument Lab., Inc., 1135 Bank St., Cincinnati, Ohio, was not listed in the September 1947 Directory Issue of this magazine. The firm manufactures testing equipment.

## Farnsworth Television Sets for N. Y. and Phila.

The Farnsworth Television & Radio Corporation's new 1948 table model television receivers have made their official debut in the New York and Philadelphia markets.

The event was heralded by a distributor-dealer noon luncheon at the Hotel Astor in New York and a distributor-dealer dinner in the evening at the Bellevue-Stratford Hotel in Philadelphia. Top officials of the Farnsworth company, headed by President E. A. Nicholas, attended both meetings.

The D. W. May Corporation is distributor of Farnsworth products in the New York metropolitan area, while Trilling & Montague is the Philadelphia wholesaler.

The Farnsworth table model receiver has a 10-inch direct-view tube providing a 52-square-inch picture and is housed in a modernly designed cabinet available in either mahogany or blonde finishes. The retail price is \$349.50.

Installation is being handled by approved

service depots, with the customer given a choice of two installation and service policies. A \$45 fee includes installation and service guarantee for 90 days, while a \$65 fee covers installation and service, if needed, for one year.

The Farnsworth table model set is said by officials of the company to be the most compact receiver of its type yet developed. The cabinet is only 16 inches wide, 18 inches high at the front tapering to 13 inches high at the back, and 22 inches deep.

The receiver has 22 tubes, including two rectifiers and a Visitron picture tube. This newly developed picture tube has a special aluminum back which increases picture brilliance and also prolongs the life of the tube.

Another exclusive Farnsworth development is the electronic beam relaxer which enables simplicity of the electrical circuit design and permits more economical receiver operation.

All controls are front-mounted, visible and individually labeled. Transparent plastic knobs are used for the controls which are new to most users—focus, fine tuning, contrast and brilliance. Opaque knobs are used for familiar controls—volume, tone, on-off switch and channel selector.

In speeches to the company's dealers in New York and Philadelphia, President Nicholas cited the rapid progress being made today in television. He pointed out that there are now 80 regular spon-

sors of television programs an increase of 70 percent over the number in March of this year, and that 75,000 receivers already are in operation.

## Majestic Reports Large Sales Orders

Executives of the Majestic Radio & Television Corporation returned from regional sales meetings held simultaneously in fifteen key markets, with orders totaling \$6,163,492.00 for August, September, October shipments of radios and radio combinations, according to an announcement made by Parker H. Ericksen, vice-president.

"These results are extremely satisfying," said Mr. Ericksen, "in view of the fact that Majestic took 5½ million dollars in orders from distributors during the national convention in Chicago May 2." Company officials emphasize that these orders are for delivery during the third quarter period, and that cabinet supply, now greatly alleviated, will enable the new Elgin plant to produce this volume.

## "RADIOS FOR EVERYONE

... EVERYWHERE!"

Tie in with NATIONAL RADIO WEEK, Oct. 26 to Nov. 1. Sell MORE SETS — Make MORE MONEY!





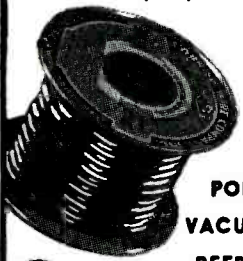



**the Service line**  
of **CORDS and CORD SETS**  
specified by top manufacturers of

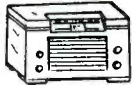

**LAMPS**  
**RADIOS**  
**IRONS**  
**FANS**  
**PORTABLE TOOLS**  
**VACUUM CLEANERS**  
**REFRIGERATORS**

**RANGES**    **WASHERS**  
**HEATERS**    **MIXERS**

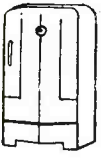
A full line of Flexible Cords for the repair and service industry, obtainable through jobbers and distributors.

**CORNISH WIRE CO., INC.**  
15 Park Row • New York City, 7

**Feature this Light**  
*For Fast Turnover - - Profits*



**Homecraft**  
**Fluorescent Overhead Light**

New—Sells on sight—

Modern, attractive, economical for kitchen, bathroom, basement, workshops, halls—complete illumination—no shadows. Available in white baked enamel or Triple Plated Chrome.

Send for FREE Radio Parts Bulletin      *Dealers—write today for prices and descriptive circular.*

**INTERSTATE RADIO & PARTS CO.**  
6357 South Ashland Avenue      Chicago 36, Illinois  
*Distributors of Homecraft Electronic Products*

**CLOSING DATES FOR**

**RADIO Television RETAILING**

**5th** of preceding month for all ads requiring proofs, composition, foundry work, key changes, etc.

**10th** of preceding month for complete plates only—no setting.

**1st** of month—Publication Date.

Cancellations not accepted after 5th of preceding month.

**CALDWELL-CLEMENTS, INC.**  
480 LEXINGTON AVENUE, NEW YORK 17



# INDEX To Advertisers

OCTOBER, 1947

|  |              |   |             |
|--|--------------|---|-------------|
| Acton Co., Inc., H. W. ....                                | 75           | Merit Coil & Transformer Corp. ....     | 4           |
| Admiral Corp. ....   | 22, 23       | Motorola, Inc. ....                     | 27          |
| Aerovox Corp. ....   | 126          | National Carbon Co., Inc. ....          | 29          |
| Air King Radio Div., Hytron Radio & Electronics Corp. .... | 9            | Noblitt-Sparks Industries, Inc. ....    | 8           |
| Alliance Mfg. Co. ....                                     | 76           | Norge Div., Borg-Warner Corp. ....      | 85          |
| Atlas Sound Corp. ....                                     | 134          |   |             |
|  |              | Ohmite Mfg. Co. ....                    | 132         |
| Belden Mfg. Co. ....                                       | 114          | Olson Radio Warehouse, Inc. ....        | 135         |
| Bell Records, Inc. ....                                    | 138          | Olympic Radio & Television, Inc. ....   | 32A         |
| Bell Sound Systems, Inc. ....                              | 136          | Operadio Mfg. Co. ....                  | 122         |
| Bendix Radio Div., Bendix Aviation Corp. ....              | 53           |   |             |
| Boland & Boyce, Inc. ....                                  | 130, 138     | Permo, Inc. ....                        | 69          |
| Bright Star Battery Co. ....                               | 24           | Philco Corp. ....                       | 5           |
|  |              | Pilot Radio Corp. ....                  | 49          |
| Caldwell-Clements, Inc. ....                               | 93, 121, 127 | Proctor Electric Co. ....               | 91          |
| Chicago Tribune ....                                       | 10           |   |             |
| Clarostat Mfg. Co., Inc. ....                              | 140          | Quam-Nichols Co. ....                   | 143         |
| Clippard Instrument Laboratory, Inc. ....                  | 140          |   |             |
| Columbia Records, Inc. ....                                | 63           | Radio Corp. of America: ....            |             |
| Columbia Wire & Supply Co. ....                            | 141          | RCA Victor Div. ....                    | 38, 39      |
| Cornell-Dubilier Electric Corp. ....                       | 111          | RCA Victor Records ....                 | 56          |
| Cornish Wire Co., Inc. ....                                | 142          | Tube Department ....                    | 96, Cover 4 |
| Crosley Div., Avco Mfg. Corp. ....                         | 2, 3         | Engineering Products Div. ....          | 113         |
|  |              | Rauland Corp. ....                      | 133         |
| DuMont Laboratories, Inc., Allen B. ....                   | 13           | Raytheon Mfg. Co. ....                  | 32          |
| Duotone Co. ....   | 72           | Recaton Corp. ....                      | 66          |
|  |              | Remington Radio Co. ....                | 141         |
| Eckenroth Co. ....   | 74           | Remler Co., Ltd. ....                   | 26          |
| Electro Products Laboratories ....                         | 141          | Rider Publisher, Inc., John F. ....     | 123         |
| Emerson Radio & Phonograph Corp. ....                      | 51           |   |             |
|  |              | Sams & Co., Inc., Howard W. ....        | 115         |
| Fada Radio & Electric Co. ....                             | 18           | Scott Radio Laboratories, Inc. ....     | 30          |
| Federal Telephone & Radio Corp. ....                       | 109          | Seeburg Corp., J. P. ....               | Cover 3     |
| Fiske Products, Inc. ....                                  | 92           | Sentinel Radio Corp. ....               | 14          |
|  |              | Simpson Electric Co. ....               | 125         |
| General Electric Co. ....                                  | 11, 119, 131 | Simpson Mfg. Co., Inc., Mark ....       | 128         |
| Gibson Refrigerator Co. ....                               | 78           | Sonora Radio & Television Corp. ....    | 33          |
| Graybar Electric Co. ....                                  | 87           | Sporks-Withington Co. ....              | 12          |
|  |              | Sprague Products Co. ....               | 144         |
| Haines Mfg. Corp. ....                                     | 92           | Standard Register Co. ....              | 89          |
| Hytron Radio & Electronics Corp. ....                      | 19           | Stewart-Warner Corp. ....               | 54          |
|  |              | Stromberg-Carlson Co. ....              | 34          |
| Industrial Sapphire Mfg. Co., Inc. ....                    | 75           | Sylvania Electric Products, Inc. ....   | 102, 103    |
| International Resistance Co. ....                          | 117          |   |             |
| Interstate Radio & Parts Co. ....                          | 142          | Talk-A-Phone Co. ....                   | 137         |
|  |              | Tele-tone Radio Corp. ....              | 25          |
| Jansen Mfg. Co. ....                                       | 15           | Templetone Radio Mfg. Corp. ....        | 31          |
| J. F. D. Mfg. Co. ....                                     | 139          | Tiffany Products, Inc. ....             | 70, 71      |
| Jubilee Records ....                                       | 75           | Tradio, Inc. ....                       | 138         |
|  |              | Trilmont Products Co. ....              | 93          |
| Karela Corp. ....  | 128          | Triplett Electrical Instrument Co. .... | 107         |
| Ker-Rad Div., General Electric Co. ....                    | 7            | Turner Co. ....                         | 118         |
| Keynote Recordings, Inc. ....                              | 67           |   |             |
| Lake Radio Sales Co. ....                                  | 139          | United Loose Leaf Corp. ....            | 73          |
| Leotone Radio Co. ....                                     | 140          | U. S. Television Mfg. Corp. ....        | 20          |
| Lissen Records, Inc. ....                                  | 76           |   |             |
|  |              | Vaco Products Co. ....                  | 141         |
| Macmillan Co. ....   | 136          |   |             |
| Maguire Industries, Inc. ....                              | 129          | Ward Leonard Electric Co. ....          | 139         |
| Mallory & Co., Inc., P. R. ....                            | 94, Cover 2  | Ward Products Corp. ....                | 137         |
| Meck Industries, Inc., John ....                           | 21           | Webster Chicago Corp. ....              | 65          |
| Melodee Records, Inc. ....                                 | 68           | Weller Mfg. Co. ....                    | 136         |
|  |              | Westinghouse Electric Corp. ....        | 16, 17      |
|  |              | Wilcox-Gay Corp. ....                   | 6           |
|  |              | Zenith Radio Corp. ....                 | 28          |

While every precaution is taken to insure accuracy, we cannot guarantee against the possibility of an occasional change or omission in the preparation of this index.

What

*Adjust a Cone*

Means to **YOU**

The Quam Adjust-A-Cone speaker has a construction which provides a method for *precision* centering of the voice coil in every Quam Speaker *before* it leaves the factory.

With ordinary speaker construction, such precision is almost impossible, even under the most ideal production methods, and, as a result, the slightest warping or expansion of the cone may produce a rubbing voice coil.

Rubbing voice coils, so frequent with speakers of conventional construction, are practically eliminated in Quam Speakers.

Always specify Quam Speakers for finest performance and long, trouble-free service.

Write for  
Catalog

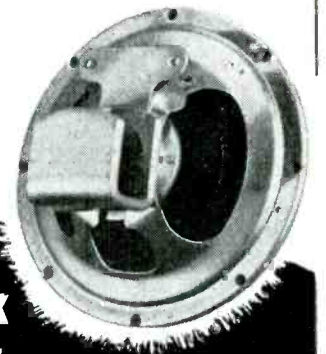

**LOOK**  
for the  
**'U'-SHAPED COIL POT**

**QUAM**  
*Adjust a Cone*  
**SPEAKERS**

**QUAM-NICHOLS  
COMPANY**

33rd Place and Cottage Grove  
Chicago 16, Illinois

# SPRAGUE TRADING POST

## SWAP-BUY OR SELL

**URGENTLY NEEDED**—Power transformer or complete power amplifier for RCA model 9-18 using 2, 81 and 1, 50 tubes. Don J. Baird Appliance Co., Brigham City, Utah.

**WILL TRADE**—Complete, up to date DeForest communications course. Want N.R.I. servicing course or up to date tube tester in good condition. Raymond D. Lintz, 77 Hamilton Ave., Lynn, Mass.

**FOR SALE**—All sizes and ranges of milliammeters and voltmeters, new. George Masiro, 1880 W. 12th St., Brooklyn 23, N. Y.

**SELL OR TRADE**—Conn \$100 cornet in good condition for Solar C-F exammeters. Paul Condry, Condry Radio Service, 604 Garfield, Springfield, Ill.

**WILL TRADE OR BUY**—12T8 radio tube. What do you need? Berry's Repair & Sales, 3402 Strong Ave., Kansas City 3, Kans.

**FOR SALE**—Hallcraft S-40 with universal transformer, used 3 months. \$70. Gerald R. Felver, 985 S. Arlington St., Akron 6, Ohio.

**FOR SALE**—Complete radio shop, 6 test instruments, 4 Riders manuals, 165 tubes; over 300 resistors, 163 condensers; volume control kit and 25 extra controls; 20 variables; speakers, transformers, dials, sockets, etc. Mostly new, list price over \$650, will sell for \$300 and postage. John F. Thiel, 1003 N. Denver St., Tulsa, Okla.

**WANTED**—Will borrow or buy RC-319Q Tech. manual. Robert B. Coble, 288 Pammel Ct., Ames, Iowa.

**FOR SALE**—KW phone transmitter, 2—2KV power supplies, n.p. 250th in final, HQ-129X-BC-21-T new signal shifter, BC 575 E and lots of extra parts. Write for list. C. C. Bryan, 1118 Broad St., Phenix City, Ala.

**SELL OR TRADE**—Electronics in Industry. Chute; High Frequency Measurements, Hund; Communication Engineering, Eyratt; National Electrical Code Handbook, Abbott. Need service equipment or any Riders manuals. Orrell Shields, 711 S. 11th St., Newark 3, N. J.

**WANTED**—Navy type signal generator OAN covers from 200 KC to 2 megs. M.O.P.A. complete with 15 ft. antenna, battery operated and manual. State price by mail. Walter O. Willeh, 1315 W. Martin St., Apt. 7, San Antonio 7, Texas.

**FOR SALE**—2" Waterman scope, new, \$50. J. R. Golden, Canton, Miss.

**WANTED**—Complete list of electronic equipment, used by armed services and description of each. R. J. Gill, 1760 Mullhobby Drive, Coronado, Calif.

**FOR SALE**—Equipment and stock of radio service and appliance store in town of 20,000. Write for information. Henry C. Buckins, Ottawa Home Appliances, 112 E. Main St., Ottawa, Ill.

**WANTED**—Schematic for RC-348Q receiver. State price. R. Koesling, 127 Sixth Ave., N. St. Petersburg, Fla.

**WILL TRADE**—Zenith 6 band trans-oceanic portable complete with wave rod and wave magnets in new condition. Want test equipment in same condition, particularly coltchmst, Vomax, VTM or what have you? Carl J. Stahnke, Alitka, Minn.

## A REAL LABORATORY INSTRUMENT

... Priced for the Service Market



**NEW De Luxe SPRAGUE TO-3 TEL-OHMIKE**

This new de luxe Tel-Ohmike is the ideal instrument for capacitance and resistance checking or analyzing. Smaller—easier to use than previous models. Checks capacitors and resistors **WITHOUT REMOVING THEM FROM THE CIRCUIT**. Has high-grade built-in D.C. volt-milliammeter.

Although designed and priced for servicemen, Tel-Ohmike is used in hundreds of laboratories where its accuracy and usefulness have been proved in the most exacting applications. It's a real *professional* instrument—for those who take real pride in their work.

See it today at your Sprague jobber's store. Write for copy of free Bulletin M-414.

**FOR SALE**—New Supreme 592 push button set tester, \$50, or will trade for photo enlarger of equal value. Hugh Pollard, Jr., 1022 McLean St., Greenwood, Miss.

**FOR SALE**—Brush Labs Navy wire recorder magazine, complete except for motor and amplifier, \$35 plus express. Howard Erickson, 725 S. Ashland, Chicago 7, Ill.

**FOR SALE**—General Electric TC3P mutual conductance portable and tube checker. New and perfect, \$45. J. Cooper, 445 E. Grand Blvd., Detroit 7, Mich.

**FOR SALE**—Comet electro-voice crystal microphone #902 built in on gray plastic stand, brand new, \$7.50. Eugene Marsaglia, 300 W. Madison St., Baltimore 1, Md.

**SELL OR TRADE**—Oscilloscope, facsimile printer and all kinds of radio equipment and books. Will exchange lists. Paul Brassard, Box 353, Brunswick, Me.

**WANTED**—Type 55E-2A5 tubes. Bernard T. Schmeidler, 515 S. Irving Ave., Scranton 5, Pa.

**FOR SALE**—Transmitter tuning cord, 3 gangs, 1 x 800 mmf, 4 x 100 mmf and 2 x 200 mmf; 3 power transformers, 2 ammeters, 5 tubes, variable condensers, mica condensers, relay, choke, resistors and switches for signal corps transmitter use. All new, \$25. Lance O'Neal, Neuse, N. C.

**SELL OR TRADE**—Echophone EC-1B used about 3 weeks, in good condition, \$30. Want 8-meter for S-201 Hallcrafters receiver and used N.R.I. Radio Course. Ernest Tucker, c/o Davis Hardware, Fayetteville, Tenn.

**WILL TRADE**—Tllok tube tester, Superior channel analyzer, signal generator, miscellaneous tubes, parts. Want 2 Haynes clippers or super-clippers, Ultra 4A or Ultra Stratosphere 10 in good

operating order. Hover, Box 8, Jamul, Calif.

**SELL OR TRADE**—3 band receiver R 100/URR—59/1.5 mc—3.6/8.5 mc—8.5/19 mc, 110 or 220 v ac-dc or batteries. Excellent condition, \$30. Also has speakers, condensers, antenna loops, volume controls, painter tube sockets, soldering irons, resistors, phono motors. What will you have? H. Kanter, 1301 E. 57th St., Brooklyn, N. Y.

**SELL OR TRADE**—Supreme tube tester, 504A; Jackson meter 665 J and Simpson 324 meter. All in good condition. Cash or what have you? Larry Day, 2231-A N. 21st St., Milwaukee 5, Wis.

**WANTED**—Power transformer for RCA Victor, R-32 receiver. Must be in good condition. State your price. George A. Lipanot, Box 22, Lansing, Kans.

**WILL TRADE**—Melsner 10 1199 2 band Superhet completely constructed, in excellent working condition. Want 4, 7 or 8 tube, 3 way portable with vertical antenna. Gene Mich, Star Rt., Pipersville, Bucks Co., Pa.

**FOR SALE**—Signal generator Superior 850, range 250 kc to 33 mc on fundamentals and 99 mc on harmonics; internal 400 cycle modulations and provision for external modulation. Good condition, \$30 including regional express. Martin Prager, 1288 St. Johns Place, Brooklyn 13, N. Y.

**SELL OR TRADE**—VMO modulation transformer for Stancor A398 or equivalent with SEC 400 to 500 ohms imp. Pri 400 to 450 ohm imp or will buy for cash. Frank Bou, c/o Bot Dept. F of Penna., 38th & Woodland Ave., Phila. 4, Pa.

**WANTED**—Signal tracing instrument and a capacity-resistance tester. State type and make of instrument. Edwin A. Grunelch, Box 236, Buffalo, N. Dak.

**FOR SALE**—Collins automatic tune AN/ART—13A in original condition with full calibration and tubes, \$120. Roy T. Merkel, 4220 Eighth Ave., Temple, Pa.

**SELL OR TRADE**—Seven tube Philco auto radio for Ford 1940 or model to fit panel of 1939 Ford Deluxe. R. J. Hess, 205 Ocean Parkway, Brooklyn 18, N. Y.

**FOR SALE**—Majestic, a-c power unit, #108, used on chassis model 90 and Majestic super dynamic speaker G-2 for use on models 70B, 90, 100 and 180. Both in good working condition. Joseph L. Krajewski, 330 Garfield St., Natick, Pa.

**SELL OR TRADE**—Wireless phono projector, guitar amplifier, movie projection course, 40 meter CW transmitter, auto 11" eliminator, tango charger, 50 watt ten meter R.F. section; Amerite ribbon microphone. Want enlarger camera, projector, testing equipment, welder or

what have you. Stanley, 2748 Meade St., Detroit 12, Mich.

**FOR SALE**—Million vacuum tube volt-meter XM, \$20; Clough Brenke signal generator OCN, \$25; Philco oscilloscope 022 complete, \$40; 10 station master intercom system with substitution, \$20; Collins ATC dynamos, \$10; 110v a-c, 20 amp. circuit breakers, new, \$5. Vernon Lustick, 1014—10th St., N. W., Cedar Rapids, Iowa.

**WANTED**—Technical manual including wiring diagrams, parts list and operating instructions for Colonial Radio Corp. T-67/ARC3 V.H.F. transmitter as manufactured for U. S. Government. Glen B. Barber, 3724 Darius St., Houston 5, Texas.

**FOR SALE**—Sigma sensitive relays, new 8000 ohm. Operate on differential of 5 mill. Perfect for electronic devices, \$2.25 ea., \$21.50 for 10, \$200 for 100. Also wire recorder kit, \$110. L. Seigle, 2215 N. Broadway, St. Louis, Mo.

**FOR SALE**—Melsner 3 tube battery regenerative receiver, 17 to 545 meters, complete with tubes. Excellent condition, \$12. Otto Poller, Jr., 2122 Edgeland Ave., Louisville, Ky.

**FOR SALE**—High fidelity Knight 6-tube, TRF broadcast tuner with matching 5 tube, 10 watt amplifier. Superb tone quality, \$50; brand new RCA 3-way portable radio, \$80. R. L. Horky, 2428 Channing Way, Berkeley 4, Calif.

**FOR SALE**—Radios, tubes, cabinets, gift items, music works, etc. Write for list. G. Samokofsky, 527 Bedford Ave., Brooklyn 11, N. Y.

**WANTED**—One or 2 Acoustimeter assemblies for 8-66 Motorolas—new or used, in good condition for auto sets. Kress Radio Service, P. O. Box 262, McDonald, Pa.

**FOR SALE**—Dual speed phonograph, 16" Astatic 8-12 pickup; Green flyer dual speed motor, 8 watt amplifier, 8" speaker with 40' of cable. Includes microphone input, crystal hi-impedance mic with 23' shielded cable complete in case. Hardly used, \$125. Also brand new multi-imp. Shure 55 microphone & 30' of 2 conductor shielded cable, \$50. Carroll Post, Angwin, Calif.

**FOR SALE**—Superior channel analyzer, complete with prods, instructions and diagram. Good working condition, \$25. Charles C. Butler, 616 E. 5th St., Cherrysvale, Kans.

**FOR SALE**—Jensen 8" pm speaker, 20 oz. magnet, model pm RC, \$4; G-E 12" pm speaker, alnico magnet 50-9000 cycles 25 watts, \$9.50; 6 watt, push-pull ac-dc amplifier, 5 tubes, tone control. High fidelity, \$10. and Astatic crystal pickup, \$1.50. Aaron Scheiner, 1361 Inwood Ave., New York, N. Y.

**WANTED**—Riders manuals 1, 2, 3 and 5—but the abridged book. State price and condition. Anderson Radio Service, 634 Tenny Ave., Kansas City 5, Kans.

### YOUR OWN AD RUN HERE FREE

The Sprague Trading Post is a free advertising service for the benefit of our radio friends. Providing only that it fits in with the spirit of this service, we'll gladly run your own ad in the first available issue of one of the six radio magazines in which this feature appears. Write CAREFULLY or print. Hold it to 40 words or less.

Confine it to radio subjects. Make sure your meaning is clear. No commercial advertising or the offering of merchandise to the highest bidder is acceptable. Sprague, of course, assumes no responsibility in connection with merchandise bought or sold through these columns or for the resulting transactions.

**DEPT. RRT-107, SPRAGUE PRODUCTS CO.**

North Adams, Mass.  
(Jobbing distributing organization for products of the Sprague Electric Company)

**ASK FOR SPRAGUE CAPACITORS and \*KOOLOHM RESISTORS by name!**

\*Trademark Reg. U. S. Pat. Off.





## Let the Changer

**HELP YOU SELL  
THE INSTRUMENT**

Records have never been more popular—among tots, teenagers, grown-ups. It's only logical then that radio-phonograph combinations will be judged by the quality and performance of the record-changer. That's why so many leading manufacturers equip their instruments with Seeburg Changers.

The Seeburg line includes three fine changers—each designed for receivers of varying price—all engineered to provide reliable, trouble-free performance.

Plan now to give your combinations every competitive advantage by using Seeburg Changers. Seeburg's long experience in the development and manufacture of all kinds of changing mechanisms is your assurance of satisfaction.

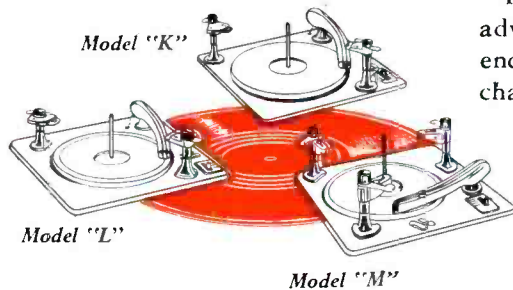

Model "K"

Model "L"

Model "M"

# Seeburg

RECORD CHANGERS ★ MUSIC SYSTEMS

J. P. SEEBURG CORPORATION  
1500 N. Dayton St., Chicago 22



**You're in the lead with RCA...here's why**



*RCA sales and business aids work for "you and RCA" day in and day out.*

## Teamwork... RCA backs your every play for better business

"YOU and RCA" form the hardest-hitting selling team in the field. And, as a member of your team, RCA runs interference for you with an array of dynamic sales and business aids that *identify, serve, and remind.*

RCA Direct Mail Postcards, Ad Mats, Imprinted Stationery, Packaging Tape, and other business aids, all work toward promoting your business and making "you and RCA" the most influential

names in radio in your community.

Ask your RCA Distributor for a copy of the new RCA Sales Aid Booklet. It illustrates the latest business aids and advertising promotions designed to meet your individual requirements.

Point-of-sale support by RCA sales and business aids is one more powerful reason why *you're in the lead with RCA.* So, push RCA tubes and watch your business grow!



**THE FOUNTAINHEAD OF MODERN TUBE DEVELOPMENT IS RCA**



**TUBE DEPARTMENT**

**RADIO CORPORATION of AMERICA**

**HARRISON, N. J.**