

1947 FEBRUARY

# RADIO RETAILING

*& Television*

CALDWELL-CLEMENTS, INC.

TELEVISION •

# RADIO-FM

ELECTRICAL

# APPLIANCES

PHONOGRAPHS &

# RECORDS

SOUND &

# SERVICE

Vol. 45 No. 2  
Caldwell-Clements, Inc.  
Retailing  
Caldwell-Clements, Inc.



# THESE WORDS MEAN PREMIUM QUALITY

APPROVED  
PRECISION  
PRODUCTS

... at no extra cost!

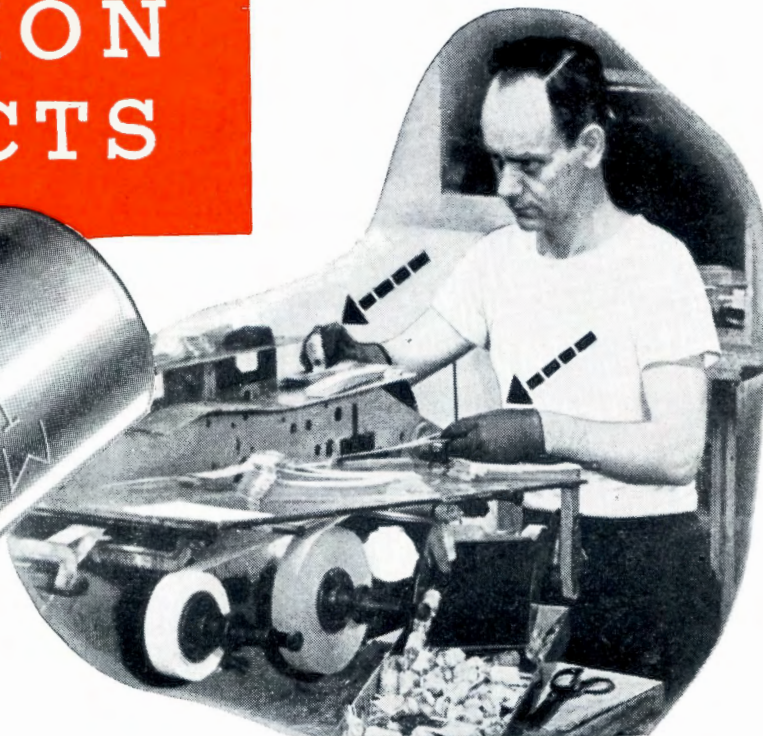

You don't *pay* more for Mallory parts—but you *expect* more and *get* more from them. That fact has been proved for over fifteen years—by performance that has constantly justified the Mallory slogan, "Approved Precision Products."

Why, for instance, have most servicemen found Mallory FP capacitors "tops" in quality? Because, for one thing, chlorides and other impurities are kept to *less than one-half of one part per million*. This is accomplished by a system of rigid controls that

insists upon capacitor gauze actually purer than hospital gauze... that compels plant operators to wear rubber gloves... that assures production under scientifically air-conditioned surroundings.

As a result, Mallory FPs are eminently dependable. They have a nationwide reputation for premium quality. Like other products sold by Mallory's carefully selected, conveniently located distributors, they really *are* approved... they really *are* precise.

**You Expect More and Get More From Mallory**

P. R. MALLORY & CO., Inc.  
**MALLORY**

VIBRATORS... VIBRAPACKS\*... CAPACITORS... VOLUME  
CONTROLS... SWITCHES... RESISTORS... FILTERS  
... RECTIFIERS... POWER SUPPLIES.

\*Reg. U. S. Pat. Off.

**APPROVED PRECISION PRODUCTS**

P. R. MALLORY & CO., Inc., INDIANAPOLIS 6, INDIANA



# RADIO & Television RETAILING

Including RADIO & Television TODAY

**ORESTES H. CALDWELL**  
Editor

**M. CLEMENTS**  
Publisher

**JOHN L. STOUTENBURGH**

Managing Editor

**DARRELL BARTEE**

News Editor

**HAROLD R. ELLIS**

Technical Editor

**RUTH MORRIS**

Records Editor

**CHARLES F. DREYER**

Art Director

**LUCILLE M. JONES**

Assistant Editor

**READER SERVICE**

JANE NORMAN

**BUSINESS DEPARTMENT**

**LEE ROBINSON**

Sales Manager

**M. H. NEWTON**

Business Manager

**EDWIN WEISL, JR.**

R. A. WHITE

BEN MORRIS

Promotion Manager

**BETTY HALL**

Production

**CIRCULATION DEPARTMENT**

**B. V. SPINETTA**

Circulation Manager

**W. W. SWIGERT**

Credit Manager

**BRANCH OFFICES**

CHICAGO 6

R. Y. FITZPATRICK, Manager

S. GASKINS THOMAS FAHEY

201 N. Wells St. RAN. 9225

CLEVELAND 14

DAVID J. O'ROURKE, Manager

Citizens Bldg., 850 Euclid Ave.

MAin 8270

LOS ANGELES 5

THE ROBERT W. WALKER CO.

684 S. Lafayette Park Pl.

Drexel 4388

SAN FRANCISCO 4

68 Post St. SUTter 5568

**RADIO & Television RETAILING**,  
February, 1947, Vol. 45, No. 2, 25  
cents a copy. Published monthly by  
Caldwell-Clements, Inc., 480 Lexing-  
ton Ave., New York 17, N. Y. M.  
Clements, president; Orestes H. Cald-  
well, treasurer. Subscription rates  
United States and Latin American  
countries, \$1.00 for one year, \$2.00  
for three years, Canada \$1.50 for one  
year, \$3.00 for three years. All  
other countries \$2.00 for one year,  
\$4.00 for three years. Printed in  
U. S. A. Re-entered as second class  
matter April 21, 1944, at the Post  
Office at New York, N. Y., under  
the act of March 3, 1879. Member  
of Audit Bureau of Circulation.  
Copyright by Caldwell-Clement  
Inc., 1947. \*Trade-Mark Reg.  
Pat. Off.

IN THIS ISSUE

FEBRUARY, 1947

## ★ Radio, FM, Television

COVER—The Big Four

EDITORIAL—What Price Radio, Appliance Products .....	37
RADIO, APPLIANCES, RECORDS & TELEVISION TODAY .....	38
SELL THE MODERN WAY .....	42
RETAILER'S WAY TO BIGGER PROFITS .....	44
DEALERS USE AIR-WAVES TO ADVERTISE THEIR PRODUCTS .....	46
SERVICE GUARANTEE SELLS MERCHANDISE .....	48
MAKE YOUR STORE SWINDLE-PROOF .....	50
NEW SETS FOR NEW PROFITS .....	52-56
LISTING OF RADIO MANUFACTURERS .....	58

## ★ Records, Phonographs, Accessories

COVER—Record News Flashes .....	61
A DAY WITH A DISC DISTRIBUTOR .....	63
RECORD MERCHANDISER .....	64
DISCS SPIN MORE PROFITS .....	66
LEADING SONGS OF THE DAY .....	70
DISPLAY UNITS THAT PAY .....	72
HOW TO SELL RECORD CHANGERS .....	74
NEW PHONO PRODUCTS .....	76
NEWS OF THE RECORD INDUSTRY .....	Starts on page 78

## ★ Electrical Appliances

COVER—Get Ready for Time-Selling .....	83
WHAT'S NEW IN LIGHTING .....	85
"COUNTRY-STYLE" APPLIANCE BUSINESS .....	86
HOW MUCH IS YOUR FLOOR SPACE WORTH? .....	88
NEW ELECTRICAL HOME APPLIANCES .....	90-92
APPLIANCE SERVICE HINTS .....	100
LISTING OF HOME ELECTRICAL APPLIANCE MAKERS .....	104

## ★ Service and Sound

COVER—Save Steps in the Service Department .....	107
SELLING AIRPORT PA .....	109
SERVICING NEWEST AUTO RADIOS .....	110
RECORD CHANGERS MAINTENANCE .....	112
ALIGNING LATEST RADIO RECEIVERS .....	116
IDEAS FOR THE TEST BENCH .....	118
SHORTCUTS IN SERVICE .....	122
NEW AIDS FOR BUSY BENCHES .....	124
PUBLIC ADDRESS SPURS SALES .....	128
NEW ITEMS FOR QUALITY "SOUND" JOBS .....	136
NEW EQUIPMENT CUTS REPAIR TIME .....	138

NEEDLING THE SLOW-PAYERS .....	140
SALES TIPS AND PROFIT-POINTERS .....	142
TELEVISION NEWS .....	144
DISTRIBUTOR ACTIVITIES .....	146
NEWS OF THE INDUSTRY .....	Starts on page 98



**29,000 COPIES  
THIS ISSUE**

member of  
**AUDIT BUREAU  
OF CIRCULATION**

WELL-CLEMENTS, INC.—TEL.: PLAZA 3-1340—480 LEXINGTON AVE., NEW YORK

#105  
\$5.00





# THE BIG "7"

The big Temple value parade is on the march—with new, fast-stepping models in every price range—with new advances in performance and cabinetry—with an eye to retail profit and turnover every Temple Dealer will welcome. Seven big money-makers—and more to come!

*Contact your Temple Distributor today  
— and join the Temple profit-parade!*

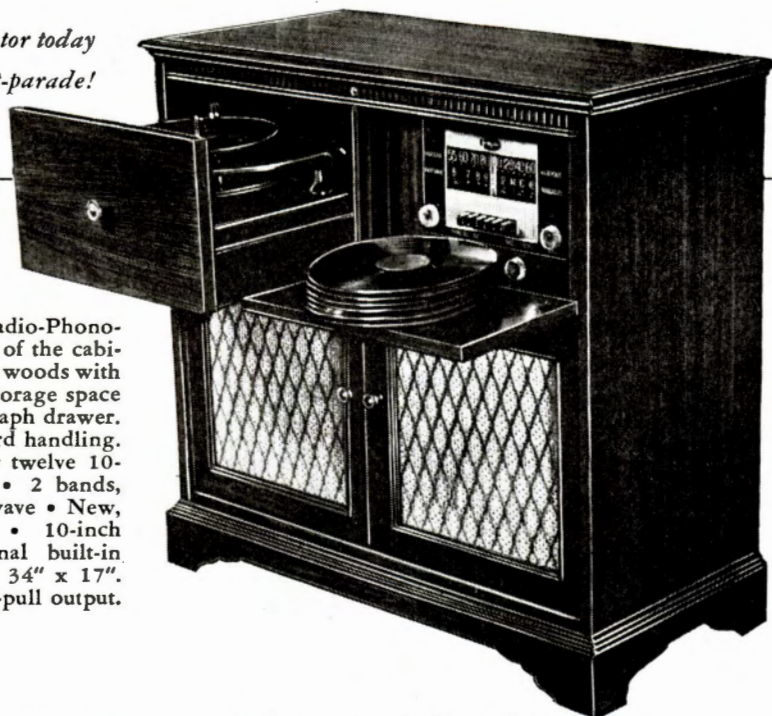

**MODEL G-722**—Magnificent Radio-Phonograph Console. A masterpiece of the cabinet maker's art — made of finest woods with mahogany veneers • Ample storage space for albums • Pull-out phonograph drawer. Easy-reach drop shelf for record handling. Automatic record changer for twelve 10-inch or ten 12-inch records • 2 bands, complete broadcast and short wave • New, uniform push-button tuning • 10-inch speaker • First all-directional built-in aerial • Cabinet size—34" x 34" x 17". AC operation—powerful push-pull output.

**MODEL G-618**—Table model in a uniquely handsome cabinet of mahogany or walnut veneers • Automatic bass-boost tone compensation • 3-dimensional illuminated dial scale • Radio frequency stage for maximum sensitivity • Built-in loop antenna • Automatic volume control • Alnico speaker.

**MODEL G-515**—Table model in an exceptionally beautiful cabinet of walnut or mahogany veneers • Built-in loop antenna. Automatic volume control • Latest type low drain tubes. Illuminated slide rule dial. Alnico speaker.



**"Where FM also**



# FOR '47...and more coming

*Sensational Value!*

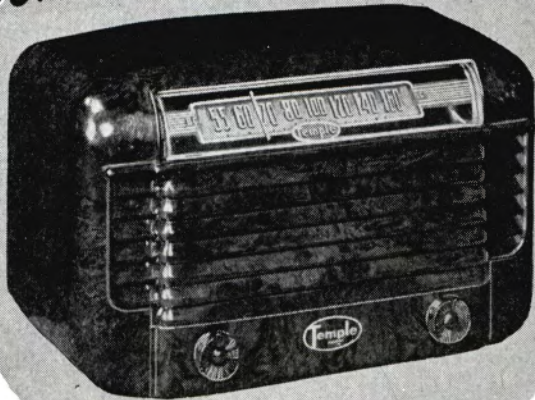

**MODEL G-513**—A matchless plastic table model that has no price competition • AC-DC • Illuminated 3-dimensional slide rule dial • Automatic volume control • Alnico speaker • Handsome walnut grain effect • Cabinet size—12 $\frac{1}{8}$ " x 7 $\frac{3}{8}$ " x 5 $\frac{5}{8}$ " • Today's biggest money's worth!



**MODEL F-617-S**—Outstanding table model radio-phonograph with highly perfected, superior automatic record changer • Radio frequency stage of maximum sensitivity. Replete with new engineering advancements • In especially beautiful cabinet of rare mahogany veneers.



**MODEL G-516**—Radio-manual phono combination in handsome cabinet of beautiful mahogany veneers • Continuously variable tone control • Light-weight crystal pick-up • 3-dimensional illuminated slide rule dial. Automatic volume control and bass-boost compensation.

**MODEL F-611**—The sensational Temple Portable. Ingeniously designed chassis construction providing for maximum power and long-life battery usage • Housed in handsome, smartly-grained fabricoid cover.



**TEMPLE TONE RADIO MFG. CORP.**

NEW LONDON, CONN.

Executive Offices — 220 East 42nd St., New York, N. Y.

**means Finest Made"**





**Transformers designed and fabricated by engineers of specialized experience, for service departments who make the most exacting requirements. This is Merit principle and practice.**

**EXPORT DEPARTMENT:  
1791 Howard St., Chicago 26, U. S. A.**

**Cable Address: MERIT**



**MERIT COIL & TRANSFORMER CORP.**

TELEPHONE  
**4427 North Clark St. Long Beach 6311 CHICAGO 40, ILL.**

## **FM Also Means "Fast Moving"**

We're seeing a harvest here in the dead of Winter. Something we started planting and nurturing way back in 1936 is now blooming with amazing rapidity in 1947. It's Frequency Modulation, and we're going to feature it in our March issue. That FM number will be far ahead of our previous FM special in 1941, and it will do a job in telling you how to sell and service FM.

Several weeks ago in Washington, the new FM Association (FMA) met. What was thought to be another routine meeting of broadcasters, manufacturers and other members of the trade now has started an avalanche of activity, and any number of predictions. Almost with the speed of electricity, the air is suddenly full of talk about FM—what it will do in 1947, what plans are shaping up, what sets will be sold, what it means in terms of retail sales. Look at some of the spokesmen's predictions:

3-4 million FM receivers are expected to be produced in 1947, and by the end of the year production may be at the rate of 5 million annually. (In 1941, the all-time prewar high of all types of sets was 13 million.)

FM stations on the air by the end of 1947 may be 700. Some 100 are broadcasting today. Ultimately, 5,000 may be required to cover the U. S. (And it has taken AM twenty-five years to develop 900 stations.)

With little or no dividends to date, venture capital for FM stations, and for FM set production, continues to grow. That's confidence with a capital dollar sign.

What it means for you: Of the 60 million-odd radio sets in the U. S., only one-half million include FM. All that new FM production, all those new FM stations mean heavy consumer promotion. Customers must buy their sets somewhere, and buy them they will—from you—increasing your unit sales, and your over-all volume. We'll tell you much more about FM as the biggest thing in 1947 radio next month. We, too, are keeping pace. Wait 'til you see our great FM issue in March. You'll be selling FM sets with that for months to come.

*The Publishers*



# Recordio

T. M. REG. U. S. PAT. OFF.

## Versatility

**REVEALS NEW**

**PROFIT HORIZONS**

Standing virtually alone in a vast, uncrowded sales field, RECORDIO — *the world's finest home recording instrument* — is your "Open Sesame" to a veritable storehouse of brand new profits. Fleeting pleasures, beloved voices, gay parties, great symphonic masterpieces, history-heralding events . . . all are captured forever, from radio or microphone, with this amazing RECORDIO — versatile Recorder-Radio-Phonograph Combination. Recording enthusiasts will soon establish your store as headquarters for regular repeat sales of RECORDIO DISCS and RECORDIOPOINTS.



RECORDIO *by* WILCOX-GAY CORPORATION • CHARLOTTE, MICHIGAN

105M



# NO WONDER STEWART-WARNER DEALERS CAN'T GET ALL THE SETS THEY WANT!

**T**HERE are all kinds of radios on the market today . . . but you'll still have a hard time finding a Stewart-Warner set on a dealer's shelf. And not because we aren't making them! It's because Stewart-Warner sets are *easier* to

*sell*. They'll be even *easier* to sell in 1947. And for a few good reasons why, look at these all-new models . . . including the finest in both FM and Television . . . a model for every purpose—a radio for every room.

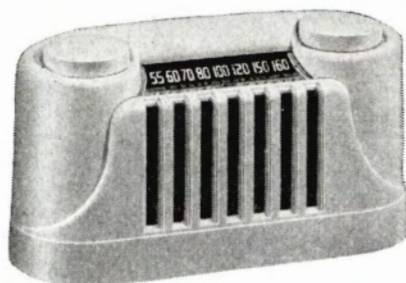

## THE AIR PAL—Console Performance in a Beautiful Jewel Case!

Performs with power and volume anywhere you can plug in AC-DC current . . . in trains, planes, hotels, at home . . . anywhere you connect it. Built like a watch, small as a cradle phone, yet it has 4 tubes plus rectifier, accurate slide-rule dial, planetary tuning, 3½-in. PM dynamic speaker, full AM band! Fits in a brief case, weighs only 3¼ lb.! Ebony, walnut, and ivory plastic.

*YOU CAN HEAR...AND SEE...THE DIFFERENCE!*



**AM-FM CONSOLE** in rich mahogany. AC, 8 tubes plus rectifier. Permeability tuning with 5 push buttons for AM band. Inverse feedback, RF stage for both bands. Two built-in antennae. Three-position tone control. Picture clear Strobe-Sonic Tone!

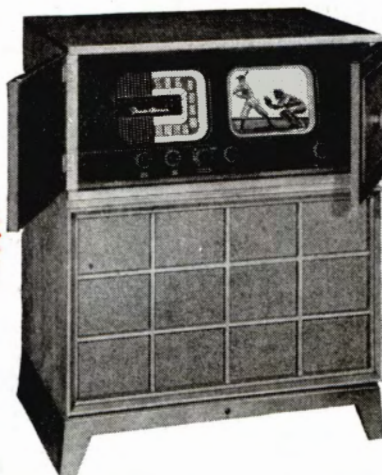

**DIRECT-VIEW TELEVISION** with FM sound and AM band. All 13 channels. Pictures sharp and clear under living-room lights! Ten-inch CR tube plus 21 tubes. Underwriters' Laboratory approved. Two custom-built cabinets, Modern and Georgian.

**FOR 1947—Easier Than Ever to Sell**

## Stewart-Warner

AM *Radios* FM • *Radio-phonographs* • *Television*

CHICAGO 14,  ILLINOIS





EXPERIENCED SERVICE-MEN SAY —  
"YOU CAN INSTALL KEN-RADS WITH  
**CONFIDENCE**"

# KEN-RAD RADIO TUBES



**R**ADIO OWNERS expect more from their tubes today . . . better tone-performance, longer life. They know electronics has progressed with giant strides, and count on buying a share of the benefits with their repair-dollars.

*Ken-Rads fulfill highest expectations.* These quality tubes match your quality service. Ken-Rads are advanced in design—lead consistently in performance. General Electric *continuous* research assures this.

G-E and Ken-Rad research works day-in, day-out to build greater shock-resisting

*strength* into tube design—toward more *rigidity* to prevent false responses from vibration and acoustical feedback—in the direction of improved *electrical constancy* throughout tube life.

To radio owners, such progress means better, more satisfying tone over a longer period of time. To you, it means *profits*, from a successful repair business based on a loyal, appreciative clientele.

Install Ken-Rads to reap the reward that comes from handling an up-to-the-minute **QUALITY** tube product!

176-11-3080

Write for Booklet ETR-16, "Essential Characteristics," the most complete digest of tube information available.

# KEN-RAD

DIVISION OF GENERAL ELECTRIC COMPANY  
OWENSBORO, KENTUCKY



# THE TRUSTY TRIO FOR

# *Tough Jobs*



**TURNER  
99**



**TURNER  
999**



**TURNER  
U9S**

Severe operating conditions are a "push-over" for Turner Dynamic mikes. Their accurate pickup and smooth natural response to voice and music is not affected by climate or temperature. Built-in ruggedness enables them to stand up and deliver under abuse that renders an ordinary microphone useless. Typical of Turner Quality are Models 99, 999, and U9S. Professionals both in appearance and performance they will give added efficiency to your operations. Find out more about these Turner Dynamics.

## MODEL 99 DYNAMIC

Used by broadcast stations, large city police departments, and specified as standard equipment by internationally known manufacturers. Will not blast from close speaking. Case fits any standard microphone stand and adjustable saddle gives semi- or non-directional operation. Response is flat within  $\pm 5$ db from 40-9000 cycles. Level: 52db below 1 volt/dyne/sq. cm. at high impedance. Gun metal type finish. Complete with 20 ft. removable cable set in a choice of 30-50 ohms, 200 ohms, 500 ohms, or high impedance.

## MODEL 999 <sup>BALANCED LINE</sup> DYNAMIC

Same style and finish as Model 99. Equipped with Balanced Line features for critical applications and professional results under all conditions. Has voice coil and transformer leads insulated from ground and microphone case. Line is balanced to the ground. Response is flat within  $\pm 5$ db from 40-9000 cycles. Level: 52db below 1 volt/dyne/sq. cm. at high impedance. Complete with 20 ft. balanced line low capacity removable cable set with 3-pin polarized locking connection in a choice of standard impedances.

## MODEL U9S DYNAMIC

### Four Impedances at Your Fingertips

Whatever impedance you need—50 ohms, 200 ohms, 500 ohms or high impedance—you can get it quickly and easily with the turn of the switch on Turner U9S. This flexible unit handles toughest jobs. Same precision engineering and rugged construction as Model 999 with built-in multi-impedance transformer. Response is flat within  $\pm 5$ db from 40-9000 cycles. Level: 52db below 1 volt/dyne/sq. cm. at high impedance. Complete with 20 ft. removable cable set.

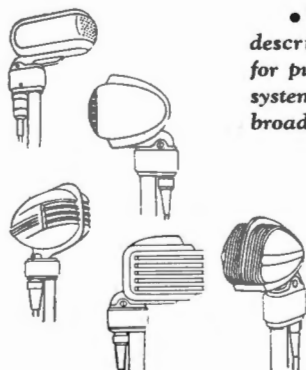

• Write for complete literature describing all Turner Microphones for public address, recording, call system, amateur and commercial broadcast, and special applications.



## THE TURNER COMPANY

903 17th Street N. E. • Cedar Rapids, Iowa

*Microphones* **BY TURNER**

Licensed under U.S. patents of the American Telephone and Telegraph Company, and Western Electric Company, Incorporated.



# Jack-Of-All-Trades?

## NO SIR! Zenith's Policy Is

# RADIONICS

# EXCLUSIVELY

### IT'S A POLICY That Means Better Radios . . .

Zenith's skills and efforts are geared entirely to Radionic development and progress. The scores of pace-setting sales features for which Zenith has long been famous have been a natural result of this concentration of effort. The New Way to

Play Records with the Cobra Tone Arm, Zenith's built-in FM antenna, the Radiorgan, the Consoltone circuit—these are but a few of the sales-making developments made possible by Zenith's policy of "Radionics Exclusively."

### IT'S A POLICY That Means Better Dealers . . .

Zenith dealers are not "bogged down" by unproved brands of refrigerators, washing machines or other items forced on them as part of their radio franchise. Zenith dealers are free to select the lead-

ing items they want in other lines to complement Zenith radios . . . they are known for the quality of *every* line they carry. Progressive dealers . . . *better* dealers . . . appreciate this independence.

### IT'S A POLICY That Means Better Business . . .

Zenith's pledge of rigid adherence to this policy of "Radionics Exclusively" in the future as in the past is your assurance that Zenith radios will continue to be "Always A Year Ahead." This su-

periority of product means better business now, and in the future . . . consistent, *profitable* business resulting from the good-will of customers who know the satisfaction of superior performance.

### The Day Is Coming . . .

when manufacturers cannot "force" unwanted merchandise on dealers. When that day arrives, the value of the Zenith franchise . . . the radio dealer's "Declaration of Independence" . . . will be greater than ever.



ZENITH RADIO CORPORATION

CHICAGO 39, ILLINOIS

30 Years of Radionics Exclusively



# Everybody's pleased



**MANUFACTURER**

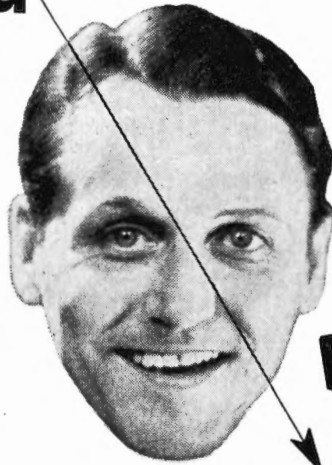

**DISTRIBUTOR**

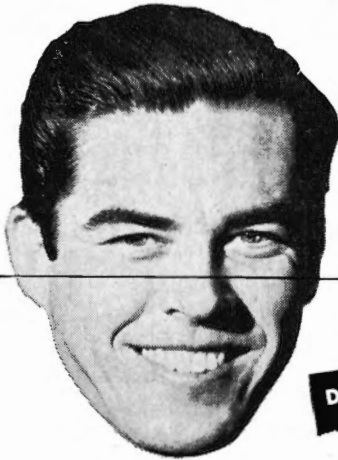

**DEALER**

with the **RESULTS** from  
the Chicago Tribune's  
new Coöperative  
Advertising Plan

Coöperative advertising dollars do a more effective job in the Great Chicago Market when they are earmarked for the Tribune's new Plan. Under this Plan—

**EACH DEALER GETS:**

1. Selective coverage of his local market
2. Prominent display of his name and location
3. The low rate of just 2½¢ a line!

**YOU GET:**

1. Better identification of your local outlets
2. Enthusiastic dealer support
3. Advertising that pays off right away!

Tribune families tell us that they will spend \$263,000,000 for home appliances the first year they are available. This is 63.4% of the total indicated volume in the Great Chicago Market. No other medium covers this staggering potential so effectively. Tribune rates per line per 100,000 circulation are among the lowest in America.

## Chicago Tribune

*The World's Greatest Newspaper*

December average net paid total circulation:  
Daily, over 1,040,000; Sunday, over 1,500,000

H. N. King, Chicago Tribune  
810 Tribune Tower, Chicago 11  
E. P. Struhsacker, Chicago Tribune,  
220 E. 42nd St., New York City 17  
Fitzpatrick & Chamberlin  
155 Montgomery St., San Francisco 4  
W. E. Botes, Chicago Tribune  
Penobscot Building, Detroit 26

MEMBER: AMERICAN NEWSPAPER ADVERTISING NETWORK, INC., FIRST 3 MARKETS GROUP, AND METROPOLITAN SUNDAY NEWSPAPERS, INC.



GENERAL ELECTRIC **FM**

*Triumphant Realism*



Glamorous **GINNY SIMMS**,  
star of the Borden show, every  
Friday night over CBS.

**SENSATIONAL G-E ELECTRONIC REPRODUCER . . .** for the most beautiful record reproduction you ever heard! No needles to change. Self-protecting genuine sapphire stylus normally is unharmed by accidental dropping or by sliding across record.



... in glorious natural color tone with this great new radio-phonograph

**LISTEN—COMPARE . . . AND YOU'LL BE PROUD TO SELL G-E MODEL 417**

♪ The first chance you get . . . hear this set perform! Listen to FM or AM or short wave. Of course the FM is wonderful. It's genuine Armstrong FM. But the AM and short wave too, sound better than ever. Listen to any record, old or new. Then you'll realize just how fine the G-E Electronic Reproducer really is! Look at the cabinet. That's styling your best customers will appreciate. And the price is well below what you'd expect for such a triumphant combination. For full details see your G-E Radio Distributor, or write today to: Electronics Department, General Electric Company, Bridgeport, Conn.

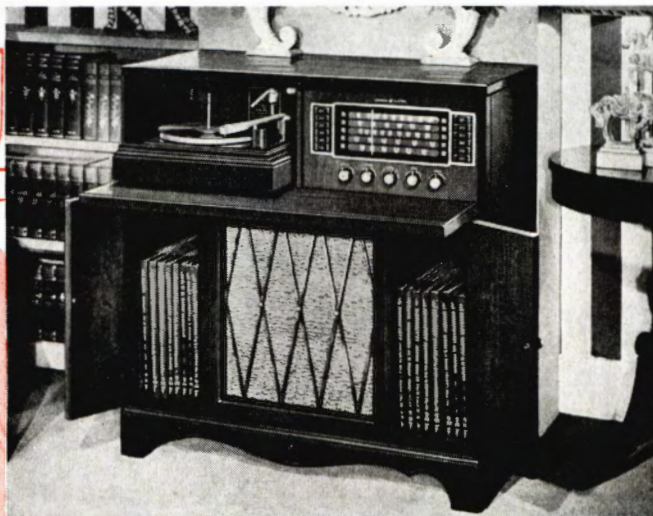

**SUPERB GENERAL ELECTRIC FM-AM RADIO-PHONOGRAPH MODEL 417**

Five Bands—AM, Short Wave and genuine Armstrong FM. 9 tubes plus rectifier. Sensational new G-E Electronic Reproducer reveals all the music on your records. G-E Guillotine Tuner. Oversized (12") Dynapower Speaker with magnet of G-E Alnico 5. Beautiful 18th Century-inspired mahogany cabinet. Storage space for approximately 120 records.

THE FIRST AND GREATEST NAME IN ELECTRONICS

**GENERAL  ELECTRIC**  
175-F2

PORTABLES • TABLE MODELS • CONSOLES • FARM SETS • AUTOMATIC PHONOGRAPH COMBINATIONS • TELEVISION



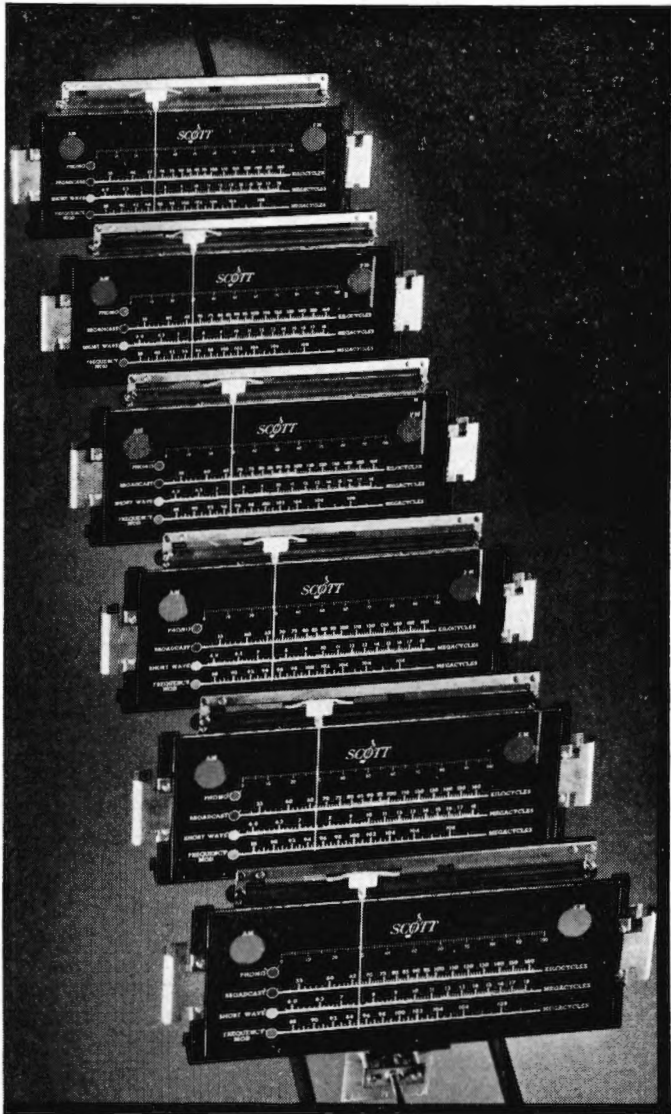

# Pride of Dealership

Six more of the "world's finest."

Scott radio-phonographs, like so many of the better things in life, come in small bunches. Scott dealerships, therefore, are necessarily limited to retailers serving those who simply *must* have—and who can afford—"the world's finest radio-phonograph."

Pardonable, certainly, the *pride of dealership* in the Scott franchise . . . in knowing your establishment caters to the "Scott type."

SCOTT RADIO LABORATORIES, INC.  
4450 Ravenswood Avenue, Chicago 40, Illinois

**SCOTT**  
RADIO PHONOGRAPH



The elegant engineering of the Scott radio-phonograph is reflected in superb cabinetry. Shown here is the Scott Regency cabinet.



# FADA



*The Radio of* **TOMORROW...TODAY!**

**THE LAST WORD  
IN  
3-WAY PORTABLES**

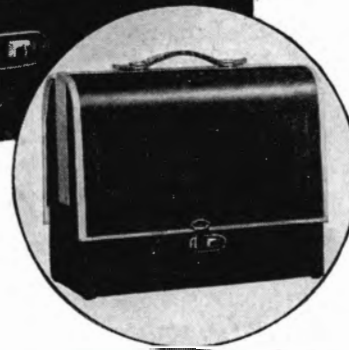

**MODEL P82**

Tri-power portable Superheterodyne with Hi-Gain tuned RF stage in rich two-tone simulated leather covered wood cabinet. 5 tubes plus rectifier tube.

**TOPS IN TABLE MODELS ...**

**YOU CAN ALWAYS DEPEND ON**

# FADA Radio

*Famous Since Broadcasting Began!*

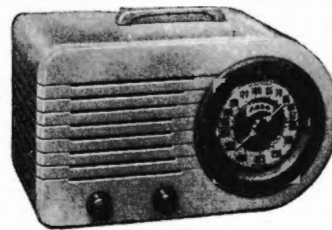

**MODEL 1000 - 6 TUBES**

AC-DC Superheterodyne in beautiful gem-like "Fada-lucent" cabinets. Five Tubes plus Rectifier Tube.



FADA 5-tubes — plus-rectifier-tube models are equipped with the new FADA "Sensitive-Tone" ... assuring greater sensitivity and clearer reception.



**MODEL 605 - 5 TUBES**

AC-DC Superheterodyne in modern walnut plastic cabinet. Four tubes plus rectifier tube.

**FADA RADIO AND ELECTRIC COMPANY, INC., LONG ISLAND CITY, N. Y.**



# Lead with the Leader in '47!



## "Perpetual Promotion" in 1947 in Behalf of ALL DEALERS Alike

"Lead with the Leader in '47!" With a continuous flow of sparkling new sets of every type—with greatly increased output—with outstanding promotion features to spotlight your store every month of the year.

Emerson Radio, in an unprecedented nationwide and local-wide advertising and sales promotion campaign — IN BEHALF OF ALL DEALERS ALIKE—will again LEAD in every progressive merchandising respect.

Watch for sensational broadside announcement. Ask your Emerson Radio distributor.



## World's Smallest AC-DC Superheterodyne

*Emerson Radio Model 540.* Never before anything like it—in compactness, in concentrated power, in all-embracing tone! A beautiful palm-of-your-hand receiver in plastic—in a range of colors, Featured model in nation-wide advertising.

**\$19<sup>95</sup>**  
*In Walnut*

EMERSON RADIO AND PHONOGRAPH CORPORATION • NEW YORK 11, N. Y.  
*World's Largest Maker of Small Radio*



# THE NEW 1947 Emerson Radio



## Better Style, Tone, Performance, Value

Here are just a few typical models in a DEMAND  
LINE For Every Purpose and Every Purse.

*Emerson Radio 3-Way  
Portable Model 536.* One of a distinguished  
group of portables with  
super-power and out-  
standing style and per-  
formance features. Less  
batteries.

**\$49<sup>95</sup>**

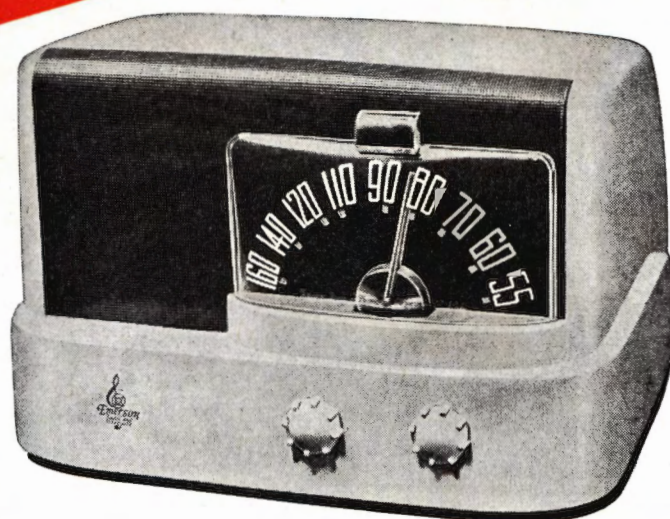

*Emerson Radio "Moderne" Model 511.* 1947  
style innovation in a series of color combinations.  
Plastic cabinet with metal grille, modern dial  
with crystal facing. A superb performer.

**\$29<sup>95</sup>**

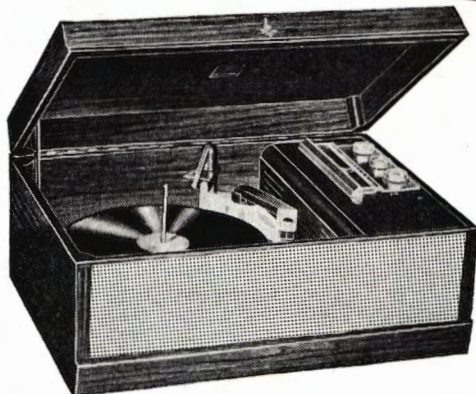

*Emerson Phonora-  
dio Model 506.* All  
advance design,  
automatic operation  
and superlative per-  
formance features in  
exquisite cabinet.

**\$119<sup>95</sup>**

*Lead with the  
Leader  
in '47!*

EMERSON RADIO AND PHONOGRAPH CORPORATION • NEW YORK 11, N. Y.  
*World's Largest Maker of Small Radio*



# ALTEC LANSING

*presents*

**A UNIQUE LINE OF LOUDSPEAKERS  
UNEXCELLED IN ANY FIELD...FOR ANY USE**



604 Duplex 15-inch



603 Multicell Dia-Cone 15-inch



600 Dia-Cone 12-inch

**THE MODEL 604 DUPLEX** fulfills professional requirements for a full 2-way speaker, reproducing the entire FM range without intermodulation or distortion. It provides the ultimate in sound quality . . . unsurpassed by any unit at any price.

**THE MODEL 603 MULTICELL DIA-CONE** meets the tremendous need for ultra high-fidelity sound that approaches the Duplex in quality, but is more economical in price. This speaker incorporates all the advantages of a 2-way multicellular speaker system.

**THE MODEL 600 DIA-CONE** is priced within the range of all connoisseurs who demand faithful reproduction of tone. It can be offered as a replacement for speakers in existing sets or as an auxiliary speaker.

**To Dealers and Servicemen—***There's a profitable new selling slant in presenting Altec Lansing speakers to your customers as extra or replacement speakers. Cash in on it now! Write for details.*

Cabinetry designed to enhance sound reproduction and harmonize with interiors is available for Models 604 and 603.



**ALTEC**  
LANSING CORPORATION

1161 N. Vine St., Hollywood 38, Cal.  
250 W. 57th St., N. Y. 19, N. Y.

The Models 603 and 600 both employ the exclusive Dia-Cone construction principle, reproducing low frequencies and high frequencies from separate diaphragms.

**" KEEP ADVANCING WITH ALTEC LANSING "**



It's a fact! Confirmed by Dealers all over AMERICA

...the **ECA** RADIO DEALER FRANCHISE

"pays off" in...

**PROFITS...  
PRESTIGE...  
GOOD WILL**

The consumer has become "selective". He looks for quality . . . demands value . . . wants radios that will give high quality, dependable performance. And that is precisely what the ECA Radio line provides—*plus a merchandising program that is custom-tailored for the benefit of the Radio Dealer.*

- **ECA RADIO DIRECT-to-DEALER SALES POLICY**—Means greater value for your customer.
- **DEALERS ARE SELECTED—AND LIMITED.** That means protected territories and higher sales potential for *your* store.
- **RETAIL PRICES MAINTAINED:** Freedom from price-cutting competition, and *protected profits* for you.
- **FREIGHT PAID TO YOUR CITY**—another big help in boosting your profit percentage.
- **ECA RADIOS ARE QUALITY BUILT**—Better, costlier components—newest electronic features—rigidly inspected and thoroughly tested—built to a quality standard . . . not down to a price.
- **NATIONAL ADVERTISING**—Reaching millions of prospects and pre-selling them for you.
- **COOPERATIVE NEWS-PAPER ADVERTISING**—To help you bring 'em into *your* store.
- **SALES-CLINCHING WARRANTY TAG**—The first "informative label" on radios . . . makes a powerful sales tool for you, builds customer confidence and good will.



Limited number of territories still open . . .

Write for Information on the ECA Radio Dealer Franchise—**NOW!**

**ELECTRONIC CORP. OF AMERICA**  
170 53rd STREET • BROOKLYN 32, NEW YORK  
RADIOS • RADIO PHONOGRAPHS • PORTABLES • FM • TELEVISION • RECORD PLAYERS

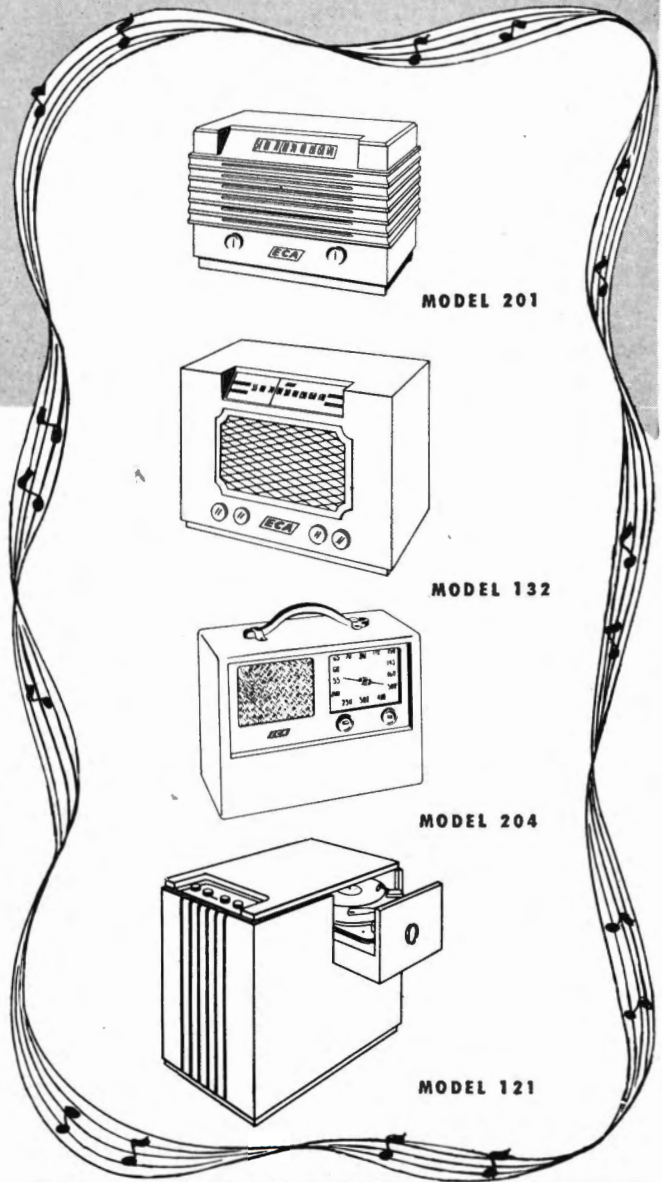

ELECTRONIC CORP. OF AMERICA  
170 53rd St., Brooklyn 32, N. Y.

R-2

I am interested in the ECA Radio Dealer Franchise.  
Please send details.

Name \_\_\_\_\_

Store Name \_\_\_\_\_

Address \_\_\_\_\_

City \_\_\_\_\_ Zone \_\_\_\_\_ State \_\_\_\_\_



ANNOUNCING THE

# Symphonette



IMPROVED CLARI-TONE CHASSIS \*

275% MORE POWER

GREATER SENSITIVITY

LESS DISTORTION

BETTER TONE QUALITY

LONGER SET LIFE

LONGER TUBE LIFE

In the SYMPHONETTE radio-phonograph table combination with automatic record changer, CLARION has achieved another masterpiece of compact efficiency. By means of the revolutionary and exclusive CLARI-DISC rectifier, a reserve of power up to 275% allows undistorted tone from a whisper to symphonic volume.

\*Patent Applied For

*"Calls the world to your door"*



# Clarion

AMERICA'S FIRST  
AUDIBEL RATED

# RADIO

WARWICK MANUFACTURING CORPORATION • 4640 WEST HARRISON  
CHICAGO 44, ILLINOIS





**A** fine watch—delicate Italian lace—these are synonymous with superb craftsmanship. But imagine such hand-to-eye co-ordination at mass production speeds. The mount operator who assembles with a small spot welder the tiny internal parts of your Hytron tubes displays just such craftsmanship. Despite painstaking engineering and intricate machinery, it is finally her accuracy, speed, perseverance, and appreciation of fine tolerances which build Hytron quality. Assembly mistakes once sealed within a tube cannot be corrected.

That is why Hytron is so fussy about selecting and training its mount operators. Each applicant must pass exacting tests for eyesight and for finger and tweezer dexterity. Then begins a long training cycle: two months to master a single constructional step; up to two years to

oversee the versatility of the expert mouter.

Every possible aid is given to the Hytron mount operator. Work simplification helps her co-ordinate smoothly and efficiently motions of eyes, hands, and feet. Parts design is simplified; supporting micas serve as templates. Welding is automatically timed. Tight spacing tolerances (.003") and frequent engineering changes prohibit widespread use of jigs and fixtures. Magnification is impracticable, because of width and depth of field. Major effort must always be to train the mouter's keen eyes and nimble fingers to assemble delicate parts to fine tolerances, despite varying materials and machine set-ups.

Yet the Hytron mouter works so effortlessly that it all looks easy. It is easy only because she has the know-how. Next time you pick up a Hytron tube, examine her handiwork.



SPECIALISTS IN RADIO RECEIVING TUBES SINCE 1921

# HYTRON

RADIO AND ELECTRONICS CORP.

MAIN OFFICE: SALEM, MASSACHUSETTS





# This "Post-War Wonder" is a Selling Reality!

National advertising campaign opened in Saturday Evening Post, Time, New Yorker, etc. The Mail-A-Voice will stay "News" for a long time!

The Saturday Evening Post

**IT'S ABSOLUTELY NEW!**  
Here's one of the most sensational benefits of war-time electronic research... a brand new way of corresponding!

## Now... MAIL YOUR VOICE!

Send your spoken message, recorded electronically... folded into any letter envelope... mailed for a three cent stamp!



**YES, THROUGH THE MAGIC** of the new electronic wonder—Magnetic Recording—you can record your voice on a small paper disc... fold it and mail it! The new MAIL-A-VOICE® records your words and plays them back... with every personal meaning you gave them!

MAIL-A-VOICE recordings have no grooves—no scratches. There are no "tricky" gadgets to fuss with... no skill needed to make excellent "voice letters". Each recording holds three minutes of your voice... costs only a few pennies... can be "erased" and used over... or filed for permanent record.

### FOLDABLE "VOICE LETTERS" REVOLUTIONIZE CORRESPONDENCE!



1 They fold into ordinary envelopes... nothing to break... but your voice is there... placed there by a post-war electronic "magic"!



2 Send them anywhere... your "personality" in the mail! How much more intimate than the written word of pen and ink.



3 Unfolded they play back just as you recorded them... the folds don't harm them—because they are recorded magnetically. Mail them anywhere!

- Here are just a few ways you can use the MAIL-A-VOICE!
- Bring your loved ones closer through intimate "voice letters"!
  - Make business correspondence quick, confidential, emphatic!
  - Open new worlds to handicapped persons!
  - Holiday Greetings
  - Children's Messages
  - Letters between Students and Parents
  - Salesmen's Reports
  - Inter-office Memos
  - "Vocal Sketch Pad"
  - Correspondence
  - Aged
  - Blind

## Mail-A-Voice®

"The Letter with a Personality"

THE BRUSH DEVELOPMENT CO. • 3405 Perkins Ave., Cleveland 14, O.

See and hear the amazing MAIL-A-VOICE... Fill out this coupon and mail it TODAY for a free booklet on MAIL-A-VOICE and for a demonstration at no obligation!

Name \_\_\_\_\_  
Address \_\_\_\_\_  
City \_\_\_\_\_ State \_\_\_\_\_

Mail it to The Brush Development Co.  
P. O. Box No. 5344, Cleveland 1, Ohio



Trade Mark

Brush Mail-A-Voice® magnetic recorder—reproducers represent the skill and research of America's pre-war and post-war leader in electronic recording. You will want to be among the first with this revolutionary correspondence instrument. Inquiries are pouring in... this is an electronic wonder people can actually see, hear, and buy! Write



with accent on

# Furniture Styling

they're at home in every room of the house

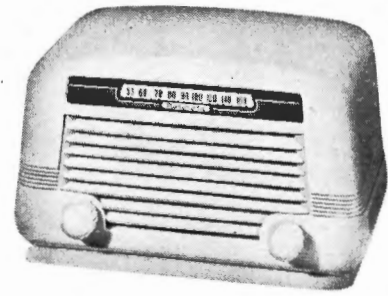

## In 1947 SELL an EXTRA RADIO

And this is your golden chance: No customer is content with just *one* Motorola radio when he sees the unbelievably varied range of other Motorolas. A cabinet customer is a "portable potential" . . . and vice versa. In either case, he's sold . . . completely . . . on *Motorola Radio*.

## Feature Radios as *Gifts* for ALL OCCASIONS

Motorola is the Perfect Gift. Your customer will be best satisfied with the choice of a Motorola . . . whether it's an elaborate console combination or a palm-size portable.



**GALVIN MFG. CORPORATION • CHICAGO 51, ILLINOIS**



# Westinghouse Radio

**A NEW 3 WAY PORTABLE WITH**

*Twice the sensitivity*

**OF COMPARABLE PREWAR MODELS**

Westinghouse Radio originality gives you another big sales leader that is designed right, built right, and priced right to provide you with a real *competitive* sales advantage.

**It has looks!** A smart luggage type design in two-tone simulated leather with a special bumper-frame construction to protect knobs and dials . . . a gold finished metal mesh and leather front that is beautifully styled.

**It has features!** A special switch and plug-in arrangement for easier swing-over between A-C, D-C or battery operation . . . **INSTANT**

operation at the turn of the switch . . . a tell-tale off-and-on indicator . . . a newly perfected selenium rectifier for **DOUBLE** the sensitivity of similar prewar sets.

**It has utility!** A powerful 3 way portable that is light in weight . . . only 13 lbs. including batteries . . . and a smart brown plastic handle that makes it easy and convenient to carry anywhere, indoors or outdoors.

Looks, features and utility . . . all wrapped up into a better value for you to sell!

Home Radio Division, Westinghouse Electric Corporation, Sunbury, Pa.

✓ **NO WAIT • NO WARM-UP • AC OR DC**  
✓ **BIG IN SIZE • BIG IN PERFORMANCE**  
✓ **LIGHT IN WEIGHT**  
**YOU GET MORE STATIONS**  
**YOU HEAR THEM BETTER**

**RADIO'S FIRST**



# Releases the *H-148*



Another  
Sales Leader  
added to the  
outstanding  
radio line in  
the industry

**NAME IS**

# Westinghouse

RADIO TELEVISION



AM-FM Console Combinations  
 Television Consoles  
 Television Table Models  
 Table Model Phono-Radios  
 Table Model Radios  
 3-Way Portables  
 Wire Recorders

AM Phono-Radio Model RMR 219



*The Spotlight is on Sonora for '47*

with a COMPLETE LINE of "Clear as a Bell" tone radios

This AM combination radio-phonograph, Model RMR 219, is one of the highlights of SONORA's complete line for '47. Lightning fast record changer plays twelve 10-inch or ten 12-inch records. Full range short wave band and standard band, large dynamic speaker, ample record storage compartments on both sides of cabinet. Variable tone control gives any variation of treble or bass tones with a simple twist of the wrist.

And remember, when it comes to a choice in

radios, it's tone, superior tone, that makes the sale—and that's where SONORA, famous for "Clear As A Bell" Tone, gives you a big plus in radio sales. And for the style-conscious customer, there's SONORA's distinctive styling in plastic and shaped wood cabinets that answer the demand for modern, flowing lines.

Watch for SONORA's complete line for '47 . . . and watch the increased consumer preference for SONORA in '47!

**Sonora**   
*Clear as a Bell*

HOME ENTERTAINMENT AT ITS BEST  
 SONORA RADIO & TELEVISION CORP.  
 325 North Hoyne Avenue • Chicago 12, Illinois

RADIOS • FM • TELEVISION SETS • RECORDS • PHONOGRAPHS • RECORDERS



*Get the most out of Television with Du Mont Prestige*



The Du Mont WESTMINSTER combines superb large-screen television, standard radio, FM, shortwave and automatic record player in a distinguished cabinet designed by Herbert Rosengren. Six other models.

## THE DU MONT FRANCHISE PROTECTS YOUR PROFITS

Du Mont offers a liberal discount on the world's finest television receivers—the new Du Mont Telesets\*—plus the rank of "Television Headquarters" in your community—an honor which grows naturally from handling receivers that are accepted as the yardstick by which the public may judge this great new art.

# DU MONT

*First with the Finest in TELEVISION*

### FEATURES OF THE DU MONT *Dealer Franchise*

1. Limited to community leaders.
2. Liberal discount.
3. Strong 1-year picture tube warranty.
4. Training program for dealer salesmen and servicemen.
5. Extensive magazine and newspaper advertising.
6. Effective dealer helps.
7. A prestige-building product  
... the world's finest  
television receivers.

ALLEN B. DU MONT LABORATORIES, INC. • GENERAL TELEVISION SALES OFFICES AND STATION WABD, 515 MADISON AVENUE, NEW YORK 22, N. Y.  
DU MONT'S TELEVISION STUDIOS, WANAMAKER PLACE, NEW YORK 3, N. Y. • HOME OFFICES AND PLANTS, PASSAIC, NEW JERSEY  
Copyright 1947, Allen B. Du Mont Laboratories, Inc. \*Trade-mark



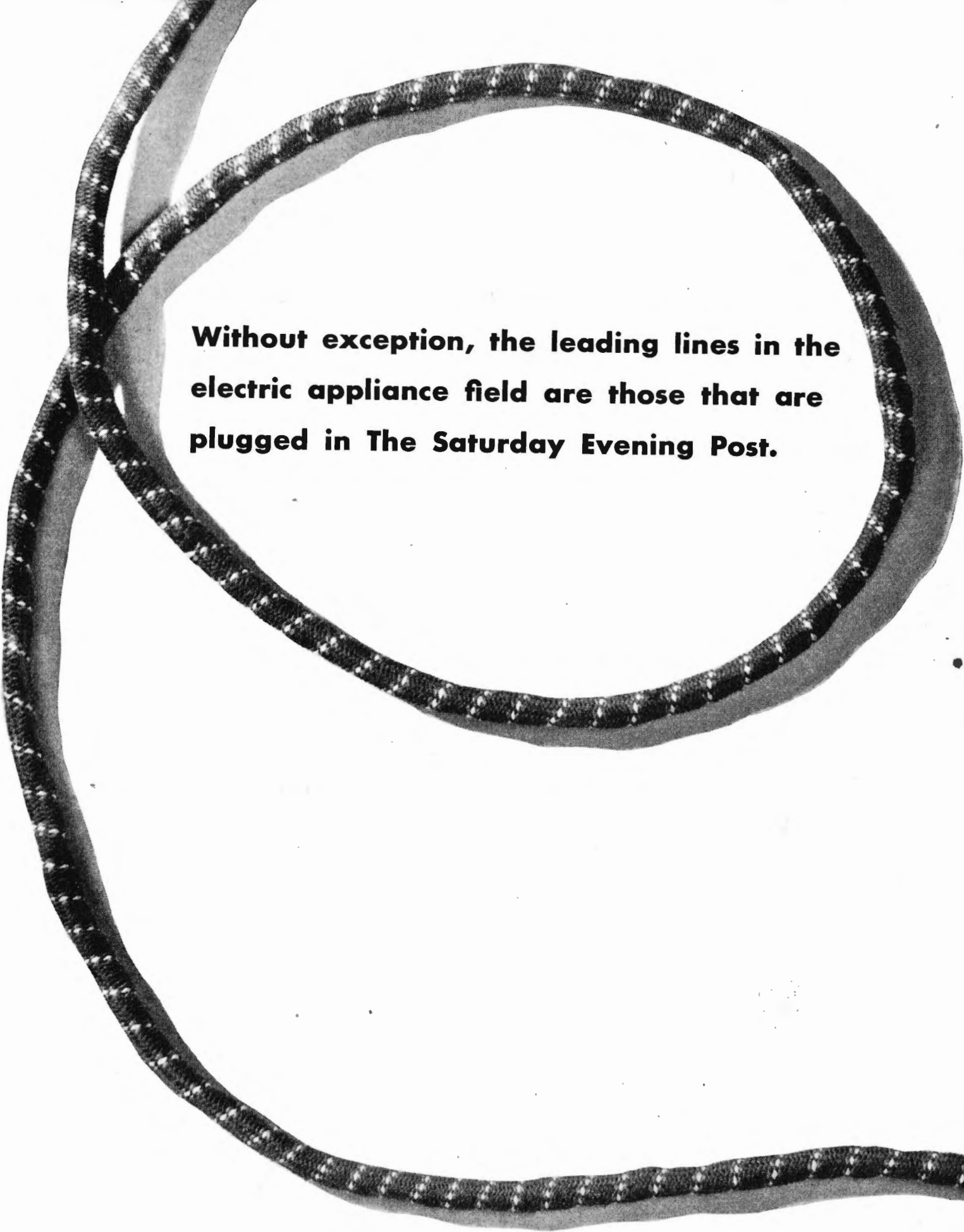

**Without exception, the leading lines in the electric appliance field are those that are plugged in The Saturday Evening Post.**



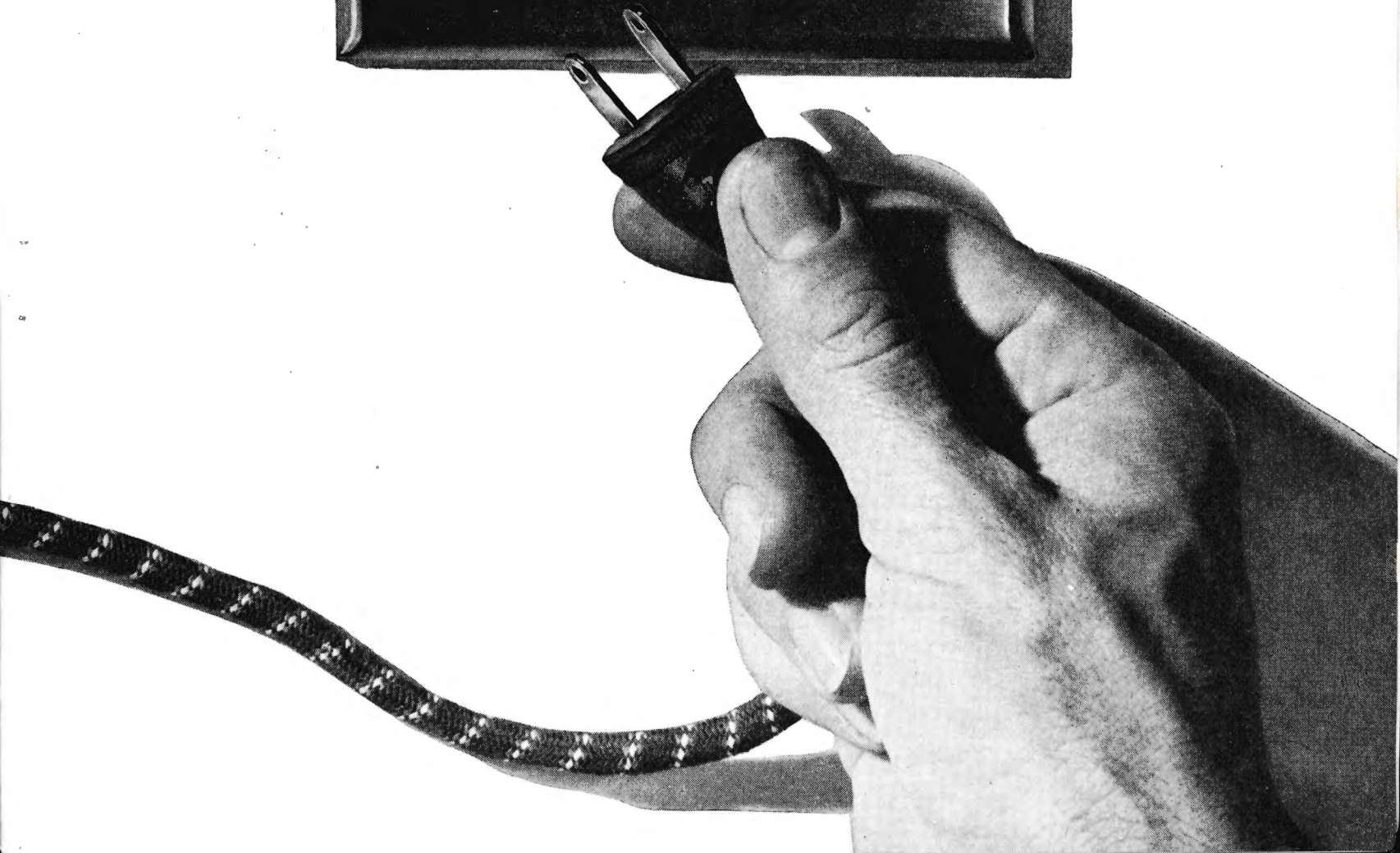



# THE FARNSWORTH DEALER WILL PROFIT FROM THIS PICTURE!

Appearing in the March 17 issue of Life magazine

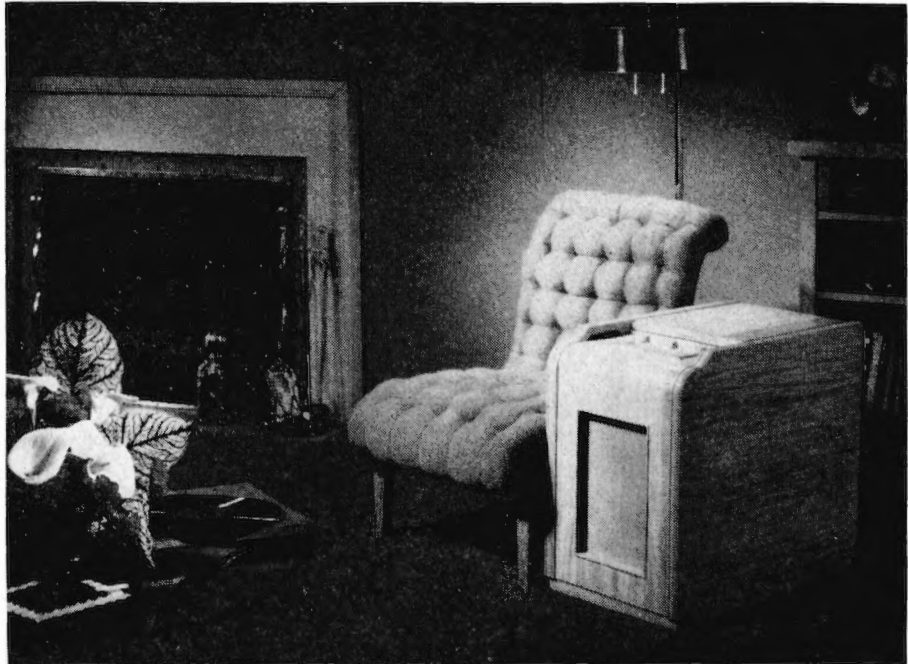

THE FARNSWORTH CHAIRSIDE • Flagship convenience—all phonograph and radio controls accessible from your easy chair. The compact, modern cabinet provides ample record storage—full, faithful tonal reproduction. Available in walnut and genuine South American prima vera.

Millions of readers will see this powerful full-color, full-page national advertisement next month. They will see and read about the famous Farnsworth Chairside Model EK-264, the set that sells them sitting down. They will identify Farnsworth quality phonograph-radios, table models and television sets. And they will read that the Farnsworth dealer "is one of a limited number carefully selected because of his integrity, his willingness and ability to render proper service."

In this way, Farnsworth backs up every Farnsworth dealer, not only with consistent, attention-getting national advertising for Farnsworth products, but with a strong reference to the reliability of the Farnsworth dealer himself.

Farnsworth Television & Radio Corporation, Fort Wayne 1, Ind.

*Farnsworth for Fidelity*

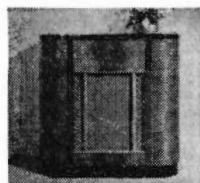

MODEL EK-102 • Modern, beautifully styled phonograph-radio. Brilliant FM (Frequency Modulation) and AM performance. High-fidelity tone. 3-point suspension record changer plays 12 ten-inch or 10 twelve-inch records. Choice of walnut or blond oakgrain cabinet.



MODEL ET-061 • Smart, handsome table radio. Lustrous ivory plastic cabinet with contrasting grille in blue, maroon or black. Features brightly illuminated Farnsworth travelite dial. Standard and foreign reception. Built-in loop antenna. Set operates on either AC or DC current.



TELEVISION TABLE MODEL • The hit of the New York Television Show, brilliantly engineered by Farnsworth, television's pioneer. Sharp, clear pictures on 16-inch direct-view, semi-flat face tube. A.M. radio also available. Compact, modern cabinet in regular, or blond oakgrain.

WHETHER you enjoy the sparkle and drive of today's popular music, or the flooding richness of the symphony, you'll like the way each is re-created in your home by the new Farnsworths. These truly post-war instruments are endowed with a full, vibrant tone that brings you recorded and broadcast music of surpassing clarity. All incorporate new electronic advances, and the phonograph-radios are equipped with an improved automatic record changer that is quick, quiet and gentle. Cabinets range from smart portables to luxurious phonograph-radios—all combining quality with modest price (ranging from \$25 to \$400). Hear the new Farnsworth today at your nearest Farnsworth dealer. He is one of a limited number carefully selected because of his integrity, his willingness and ability to render proper service. You'll find him friendly and informed, and anxious to help you in every way.

FARNSWORTH TELEVISION & RADIO CORPORATION

*Farnsworth*  
Television • Radio • Phonograph-Radio

Farnsworth Radio and Television Receivers and Transmitters • Aircraft Radio Equipment • Farnsworth Television Tubes • Mobile Communications and Traffic Control Systems for Rail and Highway • The Farnsworth Phonograph-Radio • The Capehart • The Panamuse by Capehart





# You Can Add Up Your Income with a SOLDERING IRON!

**Y**ES, it's a fact that you may not have realized . . . but every minute your soldering iron is busy, you are busy making money. *And you can make even more money if you will suggest to your customers a complete "FIND AND FIX" treatment for sets.*

A complete "FIND AND FIX" reveals parts about ready to go as well as those that are shot, saves your customers extra trips, prevents the embarrassment of parts going sour right after leaving your shop.

IRC's Volume Control Cabinet, Resistor Assortment Kits and Basic Kit cut down unnecessary trips to your distributor for parts, give you more time for soldering . . . for making your time *pay*. Order from your local IRC Distributor today. International Resistance Company, 401 N. Broad Street, Philadelphia 8, Pennsylvania. *In Canada: International Resistance Company, Ltd., Toronto, Licensee.*

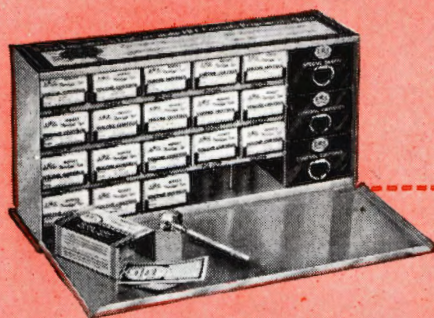

**The IRC Volume Control Kit**  
18 All-purpose controls, 6 switches and 5 special shafts in an attractive factory-packed steel cabinet.\*

**The 3 IRC Balanced Resistor Assortments in Resist-O-Cabinets\***

- No. 1. 59 assorted insulated composition and power wire wound resistors, including adjustable types.
- No. 2. 100 of the most used ranges in 1/2 watt insulated composition and insulated wire wound resistors.
- No. 3. 83 top quality resistors in the 1-watt range.

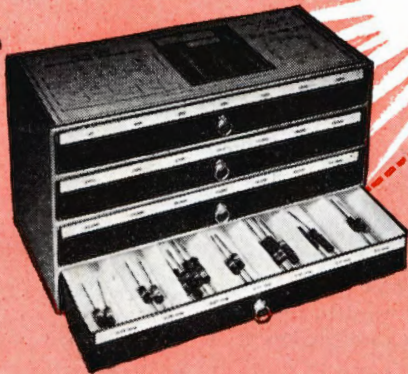

**The IRC Basic Kit**  
471 "basic" resistors in a wide variety of types and ranges, plus 6 additional bands for adjustable types. All metal cabinet.\*

\*Cabinets are furnished at no charge, not sold separately.



## INTERNATIONAL RESISTANCE COMPANY

Wherever The Circuit Says  $\Omega$

Copyright, 1947, International Resistance Company



HOLD IT!



WATCH THE BIRDIE!

SURE. WE'RE TAKING YOUR PICTURE...

... your sales picture... into consideration. Here's the angle: It'll pay you to keep an eye on that eagle now. Dollars will come harder tomorrow. You'll be shooting for faster turnover, greater sales volume. And one way to hit 'em will be to stand right up in the front row with a line

of merchandise that fits your picture because it fits your customers' picture.

That makes sense, doesn't it? All right... keep an eye on that birdie for a few minutes while you check off the sales advantages you get with the Crosley line. First..

POSE BESIDE THIS SHELVADOR\* A MINUTE, PLEASE

Picture yourself standing beside this good-looking refrigerator while you demonstrate it to a shopper. What catches your eye? Right... the Shelvador\* does! And believe us, it catches the eyes of buyers, too.

It demonstrates itself... shows at a glance how it puts twice the food to the front, makes everything handy for

housewives. That's *exclusive*. After a decade it's still the *newest* feature in home refrigeration... one that means most to smart women. You don't have to draw a diagram to explain that; a woman sees it in a flash. Her eyes light up, her hands start to twitch... and mister, you're well on your way to a sale!

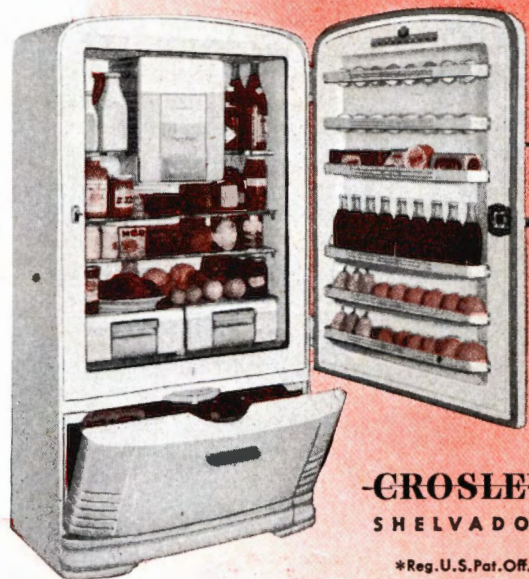

CROSLY SHELVADOR\*

\*Reg. U.S. Pat. Off.

AND HERE'S ANOTHER QUICK DOUBLE-EXPOSURE



Here's the setting: That nice lady (there are millions like her!) wants a range, too. She's in your shop—looking around—undecided. Enter the hero (that's you, IF you're a Crosley dealer). And what a picture you can give her! Of course you have range models with be-kind-to-women features that characterize all Crosley kitchen

appliances. Advantages galore, in gas or electric; over-size ovens, waist-high broilers, four fast surface cooking units... plus the famous Crosley one-piece core construction, extra thick insulation, and beauty to spare.

And you aren't finished yet! There's...



## ONE MORE SHOT FOR THE MODEL KITCHEN

Check the Shelvador\*, check the range, and now complete the picture with the Servisink. That really *furnishes* a kitchen . . . to a queen's taste. Sure and every shopper is a queen when it comes to demanding the finest for her kitchen!

Crosley supplies it—right down to the sink. The Servisink is sleekly beautiful in gleaming porcelain; it has oodles of built-in space for utensils; it's knee-recessed so someone's best gal can sit down while she works; it has a handy garbage container; it has companion cabinets. Could any woman who has slaved at a conventional "water and waste" sink keep from making the Servisink a "must" on her shopping list?

That completes a quick trip with Mrs. Shopper through a Crosley kitchen. But don't *you* stop here; keep an eye on that eagle!



## NOW FOR SOME CANDID VIEWS OF RADIOS



It isn't far from the kitchen to the rest of the home . . . not for a Crosley dealer. For he has a complete line of radios—a model for any room in the home.

From the Crosley Floating Jewel† Tone System (the permanent sapphire stylus that plays on *sides* of record grooves, virtually eliminates s-c-r-a-t-c-h-i-n-g) exclusive feature of the radio-phonos, down to the tuning knob

on the smallest table model, the line is typical of Crosley engineering. Every electronic improvement . . . the smartest styling . . . quality craftsmanship throughout—those are basic sales advantages highlighted in the too-many-to-mention-here specific features.

These few models give you an idea:

### THE CROSLY CARROLLTON

The Floating Jewel† Tone System, Crosley FM (frequency modulation) and the Crosley Master Tone Control (giving 64 different tonal combinations for radio or records) make this instrument a favorite of those who love fine music. A luxurious satin-finished mahogany or walnut cabinet puts appearance on a par with performance . . . completes a distinguished model that complements the finest home.

### THE CROSLY DEBUTANTE

Here are big console features in an attractive cabinet that occupies no more floor space than a dining room chair. Ideal for smaller homes and apartments, it offers such outstanding features as the Floating Jewel† Tone System, Crosley FM (frequency modulation), Continuous Tone Control, Fast Jam-proof Automatic Record Changer.

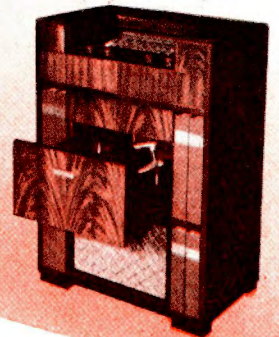

### THE CROSLY RONDO

Appearance tells this story . . . and it's just as good from the back as from the front! The Rondo is as compactly powerful and clear-throated as you'd guess from its sleek lines and smart plastic mahogany color cabinet. It's right at home atop any end table. Features include Enclosed Loop Antenna; Slide Rule Dial; Continuous Tone Control.

\*Reg. U.S. Pat. Off.

†Patented

NOW **YOU TAKE OUR** PICTURE



In taking your picture with the Crosley line grouped around you, we've given you a pretty good picture of that line itself.

Take that picture. Think it over. Consider some of the easy-to-demonstrate Crosley features we've mentioned. Look ahead to the competitive days tomorrow when it's going to take more sales punch to punch those cash register keys. And finally . . . **watch that birdie!**

Shelvador\* Refrigerators •  
Home Freezers •  
Kitchen Sinks and Cabinets •  
Ranges • Laundry Equipment •  
Radios • Radio-Phonographs—FM • Television •  
Short Wave • Radar • Home of WLW, "The Nation's Station"

# CROSLLEY

Division—The Aviation Corporation

Cincinnati 25, Ohio





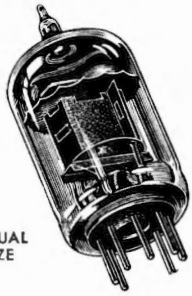

ACTUAL SIZE

# TUNG-SOL DEALERS

*can't help talking about it!*



"Hope you don't mind my talking shop, Joe, when we are out for fun, but in my radio business I push the lines that pay fair profits.

"Tung-Sol Tubes are a fine example. I don't know how they do it but those Tung-Sol people seem to be able to restrict their distribution to dealers

who want to make money. It must be the result of their sales policy ... sell only to good jobbers and you get only good dealers.

"People like Tung-Sol Tubes. You see when you put in a Tung-Sol Tube it will stand up. And we don't have call backs because of

tube failures. That uniform high quality of Tung-Sol Tubes means a lot to us dealers.

"Sure they have a full line of miniatures, G-GT's, metal and large glass tubes so I can service old as well as new sets and equipment."



**TUNG-SOL**  
*vibration-tested*  
**ELECTRON TUBES**

**TUNG-SOL LAMP WORKS, INC., NEWARK 4, NEW JERSEY**  
Sales Offices: Atlanta • Chicago • Dallas • Denver • Detroit • Los Angeles • New York  
Also Manufacturers of Miniature Incandescent Lamps, All-Glass Sealed Beam Headlight Lamps and Current Intermittors



# The New DELCO RADIO Combination

For those  
who demand  
the *Best*



**T**his handsomely styled, engineered-for-tomorrow radio-phonograph combination features the finest in AM and FM reception, with fourteen tubes plus rectifier, and a mammoth 15-inch speaker for full tone range. It provides push-button tuning—not only on the standard AM broadcast bands but on FM as well!

And the phonograph? Here again Delco offers the best of all that's new! A special lightweight tone arm, with sapphire permanent-point pick-up, gives amazing fidelity and tone quality . . . but that's not all! Its advanced design eliminates needle changing, makes records last years longer.

Add to these great features a smooth-action record changer with the extra capacity of fourteen 10-inch records or ten 12-inch records—an automatic shut-off that goes into action when the last record is played—and you realize that this instrument has *everything!*

To put this magnificent Delco combination in anything but the finest cabinet would be unthinkable. Expert craftsmen have produced cabinets of grace and distinction to give it the proper setting. Model R-1251 in walnut, and Model R-1252 in mahogany, are masterpieces of fine furniture.

Like other Delco portables and table models, this fine new Delco combination brings new honors to the trusted Delco name of General Motors. United Motors Service, General Motors Building, Detroit 2, Michigan.



#### Production is Improving

But there are still many shortages of materials and component parts which make it impossible to meet the large demand for Delco radios at this time. If your distributor is unable to fill your order for Delco radios promptly, keep trying. You can count on it that he's doing his best, and that we're doing ours to speed production.

## DELCO RADIO A GENERAL MOTORS PRODUCT

*Delco radios are distributed nationally by United Motors Service. See your United Motors distributor about the Delco radio line.*





## ...but, how about the 2nd act?

**I**T'S BEEN a wild 1st Act for radioretailers, plagued by a combination of delivery delays and the clamor of a radio-hungry public.

But now the curtain is down on Act I—when selling radios was largely a matter of getting *enough* recognized radios to keep anywhere near even with demand.

Will increased production straighten out these troubles in Act II, or are you in for the madhouse of disguised discounts, slugs, price cutting, and the chaos of dumping? Will you be swamped with super-promotions stacked precariously on top of last week's super promotion?

No predicting if the old dog-eat-dog days will return—or when—but for Sparton dealers it's definite. These practices are *completely out*.

Sparton dealers can enjoy the show—protected by S.C.M.P.\*—despite any general return of old distribution bugaboos.

Full production is under way in Sparton's

big plants. And what a job Sparton craftsmen are doing! Never were radios and combinations more beautifully cabined. Listen to a Sparton and you'll know these models merit the expression, "Radio's richest voice since 1926!"

And never before was *such value* offered to the public. Through the extra-efficiency of S.C.M.P.\*, the beautiful new Spartons sell *profitably* at prices that compete with mail order house competition.

How can it be done?

Under S.C.M.P.\* there is *one*, exclusive Sparton dealer in each area. Direct factory-to-dealer shipment brings the cost of distribution down to earth. All Sparton national advertising reaching an area works exclusively for the one Sparton dealer. See how it all adds up?

It *pays* to be a Sparton dealer!

THE SPARKS-WITHINGTON CO., JACKSON, MICH.  
Radio and Appliance Division—Plant 5

ONE  
*Sparton*  
DEALER  
in each community

Check These  
Profit-Increasing Features

- One exclusive dealer in each area
- Direct factory-to-dealer shipment
- Low consumer prices
- National advertising
- Factory prepared and distributed promotion helps
- Seasonal promotions
- Uniform retail prices
- Products styled by outstanding designers

# Sparton

Radio's Richest Voice Since 1926

\* **S·C·M·P·** SPARTON CO-OPERATIVE MERCHANDISING PLAN. A proven exclusive method of profitably retailing radios and home appliances that has been and is being advertised regularly to consumers in leading magazines.



**LIFE TESTED\* TO ASSURE THAT**

**YOUR *first* PROFIT IS**

**YOUR *Net* PROFIT!**

Each Sentinel radio you sell represents more than just another sale. It represents unqualified customer satisfaction and good will, for every Sentinel set is Life-Tested\* to insure longer radio life, fidelity of tone and elimination of service costs, thereby assuring that your first profit is your net profit.

Sentinel makes a radio for every customer that walks into your store . . . for every purse and purpose, for every room in every home. AM and FM, AC and DC, battery and electric, table models and portables, consoles and combinations . . . Sentinel radios are Life-Tested\* . . . for utmost customer satisfaction, for maximum dealer profits.

SENTINEL RADIO CORPORATION  
EVANSTON, ILLINOIS



\* Life Testing of every part in advance ascertains that every Sentinel radio set will prove superior to any stress or strain, any wear or tear to which they will be subjected short of absolute abuse. This testing and retesting is applied, not alone to the complete radio but to all electrical and mechanical parts, to cabinets as well—even to tuning knobs!

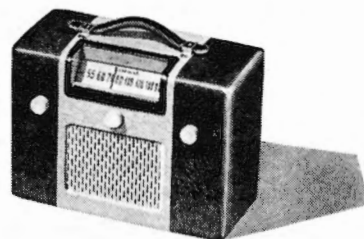
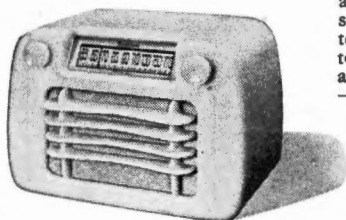
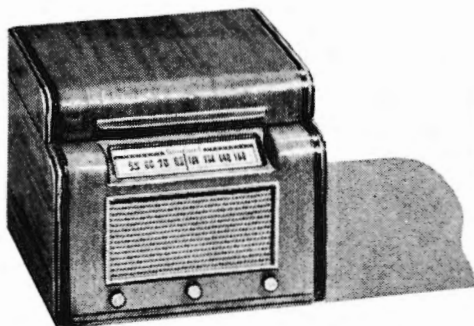

*for Studio tone  
in Your Home*

**Sentinel**  
*Radio*



**The AUTOGRAPH, Model 1135 PL** — This magnificent radio-phonograph in its classic 18th Century cabinet is available in either mahogany or walnut veneers, carefully matched and rubbed to emphasize the natural beauty of the rare woods. Reception is deep, brilliant and true with the famous exclusive "Acoustical Labyrinth" and matchless Carpinchoe Speaker. Automatic range switch gives push-button control of both AM or FM programs. Record changer plays 10 and 12 inch records intermixed. Feather-light crystal pick-up provides extreme fidelity of reproduction. "No-lift" drawer-type changer leaves cabinet top clear for decoration. Engineered for wire recording.



# The Finest Stromberg-Carlson in History

It's the biggest radio news in years.

Yes, the two famous models of the Stromberg-Carlson 1135 series... "The Georgian" and "The Autograph" ... are here!

The most brilliantly conceived Stromberg-Carlsons ever!

More than any other radio-phonographs, these two give you an opportunity for prestige... for profit. They're your most brilliant sales performers.

*For the main radio in your home...*

**THERE IS NOTHING FINER THAN A  
STROMBERG-CARLSON**

ROCHESTER 3, N. Y.

*Radios, Radio-Phonographs, Television, Sound Equipment, and Industrial Systems, Telephones, Switchboards, and Intercommunication Systems.*

**The GEORGIAN, Model 1135 PF** — Impressive in every detail, a distinctive addition to any home. Without doubt, the finest automatic radio-phonograph console Stromberg-Carlson has ever made. It combines every advance in electronic engineering in an exquisitely rich cabinet of matched African swirl mahogany veneers. Utmost fidelity in all tonal ranges, at any volume level, with the patented "Acoustical Labyrinth" and exclusive Carpinchoe Speaker. Automatic range switch gives push-button control of both AM and FM programs. Record changer plays 10 and 12 inch records intermixed. Feather-light crystal pick-up provides extreme fidelity of reproduction and long record life. Engineered for wire recording.





# RADIO *& Television* RETAILING

Including Radio and Television Today

O. H. CALDWELL, Editor ★ M. CLEMENTS, Publisher ★ 480 LEXINGTON AVENUE, NEW YORK 17, N. Y.

## **What Price Radio and Appliance Products!**

The retail pricing picture is fast assuming the appearance of a crazy-quilt pattern. Prices are going up and prices are going down, and the merchant who doesn't keep himself and his staff posted day-by-day may find himself losing money and customers.

Unfamiliarity with today's prices may result in the merchant charging too much or too little for his products. The retail prices on some products now on his floor have risen since he purchased them. Others have dropped. Some are changing en route to his store.

Today's customers are a price-conscious lot and are suspicious of the motives of any salesman who fumbles with price quotations. They have no confidence in the dealer who is unable to advise the prospective purchaser whether the appliance or radio has been advanced or reduced in price—or whether no price change has taken place.

Nowadays, the dealer needs to go over his stock frequently in order to keep his merchandise properly priced. He and his salespeople should know what comparable models retailed for before the War, what the OPA price was and why the product is worth what it sells for today.

By making price comparisons with products in many other fields, the clever dealer will be able to prove conclusively that radios and appliances still represent great value for the prices asked.

The progressive merchant, who realizes that the lush selling days are over, keeps abreast of price changes because he wants to get his full profit and because he wants his customers to have full advantage of savings through any price reductions. He endeavors to keep posted on present retail prices, and if there is any doubt in his mind, he gets in touch with his supplier.

The merchant who *guesses* what prices are in this chaotic market may gain nothing more than the dubious honor of being known as a Mortimer Snerd type of merchandiser—in the red, financially, and in the doghouse with his customers.



# RADIO, Electrical Appliances,

**FACTORIES BUSY; PURCHASING POWER UP** compared with a year ago when a million persons were on strike. As we go to press the roll of strikers is down to a mere 50,000, and production is mounting daily. Dealers are hoping that they will have adequate supplies of "seasonal" merchandise, such as portable radios, fans and room coolers with which to meet the steady demand.

**DEALER "SAMPLING" STILL GOING ON** despite upped output. Refrigerators, laundry equipment, many small appliances, television sets, portables and high-priced combinations are still scarce because of the large pent-up demand. Easing up of the steel situation will soon be reflected in greater quantities of electrical appliances, large and small.



**NO "RUNAWAY PRICES" IN THIS FIELD.** Leading men in the industry, mindful of the highly competitive nature of their business, kept predicting that when OPA folded up for keeps prices in radio, appliance and record fields wouldn't run wild. Viewing the present market, we see that the statements of these men were a hundred per cent correct.

**THE EIGHT MILLIONTH REFRIGERATION** product, an electrical household unit, recently rolled off the assembly line at Frigidaire's giant Moraine City plant in Ohio.

**MORE AND MORE CONSUMER CREDIT BUYING** is a noteworthy trend. One expert predicts that by the middle of 1947, time-buying volume should reach about twelve billion dollars compared with present level of eight billion, 700 hundred million dollars.

**HINTS ON SELLING FOOD FREEZERS** and larger refrigerators from U. S. Dept. of Agriculture: (1) Frozen foods easy to buy and carry home. (2) They're easy to prepare. (3) They keep well in the freezing compartment of the average refrigerator. (4) They have superior flavor. (5) They have higher vitamin content.

**ONE-MAN PUBLIC ADDRESS SYSTEM** has been devised by the Signal Corps. A voice amplifier is worn slung around the neck. It is powered by a storage battery and weighs less than three pounds.

**"GO ALL-ELECTRIC" CAMPAIGN** launched by National Electrical Mfrs. Assn., tells dealers that "Every family has its choice between 'going All-Electric—the Modern Way' or using electricity and one or more of the flame fuels." To date, says NEMA, LP-gas competition alone has cost the electrical industry over a billion dollars in gross revenues. Whether these losses will continue to mount, NEMA continues, depends upon the attitude of the electrical appliance dealers.

**WHEN IS THIS "BUYERS' MARKET" COMING?** Well, one prominent industry figure, R. Stafford Edwards, president of the National Electrical Manufacturers Association, in speaking about household electrical appliances said that pent-up demand would be tempered by the purchaser's ability to buy and the competition for the consumer dollars offered by other durable goods industries. "In this respect," said Mr. Edwards, "a buyers' market was generally predicted by the middle of the year."

**"NOW THAT PRODUCTION OF LARGER SETS** and combinations is under way, in the quality brackets, we are entering the new year in a climate far more promising, from the standpoint of both the producers and the consumers, than prevailed a year ago."—Frank A. Hiter, vice-president Stewart-Warner Corporation, Chicago.

**PHONO RECORD SALES** in 1946 more than doubled those of 1945 made by Columbia Recording Corporation. Edward Wallerstein, Columbia president, sets the possible output of his firm for 1947 at double its present production rate.

**WASHER MANUFACTURER CONTINUES** strict allocation. Barlow & Seelig Manufacturing Company, through its director of sales, P. J. Daniels, announces that it expects to be confronted with production problems well into the first quarter of 1947. "If no further handicaps develop, our production should steadily increase to maximum plant facilities during the second quarter," says Mr. Daniels.



**NEW INTEREST IN HIRING SALESMEN** as production goes up in many plants. Manufacturers, wholesalers and dealers hand-picking staffs for the coming buyers' market. 1947 will see more salesmen working on the "outside" than had been employed at any time since the start of the War.



# Records, and Television, **TODAY**

"NOW AS WE MOVE INTO 1947, OPA price controls have been lifted. However, freedom to raise prices does not of itself assure prosperity either for companies or their employes. Westinghouse is convinced that it must keep prices as low as possible, to maintain sales and employment in a competitive market."—Gwilym A. Price, Westinghouse president.

*VOTE OF CONFIDENCE* has been given radio by millions of outspoken Americans who were asked, in another survey, to describe effectiveness of institutions affecting their lives. No less than 86% of them said that radio was doing a good or excellent job; 76% said the same thing about churches; 62% for schools and 45% for local governments.

VIDEO VOLUME to jump into the big time during 1947, says president Hamilton Hoge of U. S. Television Mfg. Corp., who estimates that production of television receivers this year will be around 360,000. He has it figured that 30,000 will be made by the industry during the first quarter, and that 60,000 to 80,000 will be the total for the second quarter. Count on 200,000 to 250,000 for the last half of 1947, predicts the UST executive.



RMA'S RADIO IN EVERY ROOM campaign being readied. Retailers can jump right into this drive and make more money. An all-out attempt to sell each customer more than one receiver will bring extra profits to the merchant.

BAN ON COIN-OPERATED PHONOS in Beardstown, Ill., didn't stop one tavern keeper from entertaining his patrons. He installed a radio-phono changer combination (a Farnsworth) which has been operated by the public an average of 12 hours a day for the past six years. The machine has been serviced only two times during this period.

THE HEAD OF A BUSY WHOLESALE FIRM is always a busy guy. He has so much detail and managerial work to do that it's next to impossible to greet all of his customers or to handle their complaints personally. "Bill" Harrison of Harrison Radio, New York, has installed a telephone in his sales department for the convenience of any customer who has something to complain about. A lettered card tells the customer that the phone connects directly with the office, and urges that it be used in any instance where the buyer is dissatisfied with any transaction.

"THERE WILL ALWAYS BE A PLACE FOR independent distributors who will work together to provide higher standards for their business and the American way of living."—R. P. Almy, manager distributor sales, Sylvania Electric Products Co.

ITS NEW ELECTRIC RANGES for 1947 will feature "Defrost-All", a new "double-quick" means of thawing quick-frozen foods, according to an announcement made by Estate-Heatrola division of Noma Electric Corp.

SWIVEL-TUBE MOUNTING, which pivots over a 60 degree angle and thus permits viewing from either right or left as well as straight on, is a feature of Crosley's new television receiver. An aluminized-screen cathode-ray tube, claimed by the maker to produce a "two times brighter picture," is used.

NEW PRODUCTS FOR EUREKA WILLIAMS include a new and improved home cleaning system and an automatic food waste disposer to fit standard kitchen sinks, according to Henry W. Burritt, president of the firm.

THEY'VE GOT AN AWFUL LOT of coffee, as songsters have yelped for weeks, in Brazil. First beans will reach this magazine via a desperate but gallant offer from B. P. Briganti, big radio distributor of Sao Paulo. Banks in Brazil will allow no remittance under \$1,000 and as much as Senor Briganti likes RTR, he countered: "Could we send a kilo of coffee in exchange for subscription?" Coffee-drinking circulation manager B. V. Spinetta said yes, and will save a cup for Audit Bureau of Circulations.



MORE MONEY is being spent, and less stacked away in savings, was a major point in President Truman's economic report to Congress. Current rate of savings is about 10% of income, which is prewar style—but in 1944 the rate was about 30%. Many retailers thereupon decided to watch these trends with eagle eye during 1947.

GROSS TIME SALE OF AMERICAN Broadcasting Company for 1946 amounted to \$40,617,130, an increase of \$571,164 over the previous year. General Mills bought \$2,916,752 worth of time, leading the list. Firms in this field advertising over the air included Philco, Westinghouse and Lear.



ONLY RCA VICTOR MAKES THE VICTROLA



Two beautiful styles...the 612V3 in Period design and the 612V1 in Modern design. Both are available in carefully selected Blonde, Walnut and Mahogany veneers.

# RCA VICTOR's dramatic advertising



Sales and profits from RCA Victor! The finest instruments in the history of RCA Victor—the exclusive "Golden Throat" tone system—an unequaled advertising campaign—keep RCA Victor radios and Victrola\* radio-phonographs moving out of your salesrooms faster than we can supply them.

See the striking four-color full-page advertisement in: Life—Feb. 10 Saturday Evening Post—Feb. 8 Collier's—Feb. 8 featuring the famous "Crestwood" series.

Listen to them—compare with any other radio-phonograph in or near their price class—and you'll see why customers are asking for—*waiting for*—an RCA Victor "Crestwood."

"GOLDEN THROAT"...Exclusive acoustical system brings out the full, mellow tones of sound reproduction at its finest.

ALL-IN-ONE CONTROL UNIT, introduced in this "Crestwood" series, brings the complete radio chassis and automatic record changer into convenient playing position at a touch. Plays in both open and closed positions.

"SILENT SAPPHIRE" pick-up... a tiny point of genuine sapphire—light as a feather on records, adds years to their life. No needles to change, no needle chatter!

RCA VICTOR FM (Frequency Modulation) assures static-free FM reception. For full performance—both the Standard (AM) and the International Short Wave broadcast bands.



\*"Victrola"—T.M. Reg. U. S. Pat., Off.



ONLY RCA VICTOR MAKES THE VICTROLA



The 68X1, in antique-finish ivory plastic. The 66X2 (not shown) is cased in glowing Walnut plastic.

# builds sales for you!

The exclusive "Golden Throat" gives superior tone even to less expensive RCA Victor radios!

Dominant advertising creates an overwhelming demand NOW—assures continuing sales long after the market is flooded with radios of all kinds—at all prices!

Watch for the second full-page February advertisement in full color—featuring the 66X1 and 66X2 in:

Life—Feb. 24 Saturday Evening Post—Feb. 22 Collier's—Feb. 22

These are compact, easy-to-carry sets—designed for those who want radios modern in appearance *and* performance! They'll soon be reaching you in ever-increasing quantities.

"GOLDEN THROAT" acoustical system reproduces radio programs with amazing richness and fidelity. RCA VICTOR ENGINEERING for distinctive performance includes: five RCA Preferred Type Tubes and rectifier tube, 2-point tone control, selective superheterodyne circuit, and connections for an additional antenna for reception in weak signal areas.

"MAGIC LOOP" built-in antennae (two of them) "pull in" foreign as well as domestic programs with thrilling clarity.

MODERN DESIGN . . . gleaming plastic with the sweeping lines of functional simplicity that fit into any room. Convenient built-in handle . . . allows easy carrying from room to room as desired. Two-band dial permits new, easier tuning.

# RCA VICTOR

DIVISION OF RADIO CORPORATION OF AMERICA

"Golden Throat"  
finest tone system  
in RCA VICTOR history!

Outstanding over all other tone systems tested—the exclusive "Golden Throat" has made the new RCA Victor radios and radio-phonographs *your* customers' choice.

This exact co-ordination of cabinet, loud-speaker and electronic amplification is the triumph of 27 years of RCA's electronic engineering achievements and Victor's 48 years of leadership in sound reproduction.

Listen to the "Golden Throat" give new life to radio programs and records—and you'll know why the *insistent* demand, all across the country, is for RCA Victor radios and Victrola\* radio-phonographs!





The good salesman is resilient-minded. He doesn't use "canned" formulas, but fits his presentations to meet the situation at hand.

## **A General Speed-Up and Overhauling of Salesmanship is Needed in this Merchandising Era**

● The need for a new type of salesmanship is at hand.

Retailers of radios, records, electrical appliances and service will find that selling is bound to become more and more competitive and that the successful survivor of the competitive era will be, after all, the dealer who's built up a large backlog of customer good-will.

While it is true that the merchant in this field has had to put up with a lot from "fill-in" employes in the past, he is now in a position to pick and choose the selling personnel he needs, and to "get shed" of the weak sisters, gripers and goldbricks both in his sales and service departments.

The new merchandising trend

seeks to syncretize all departments of the independent dealer's organization into one smoothly operating, profit-paying operation. In order to do this, the retailer realizes that he must spark his selling methods with a modern brilliance that will appeal to customers so favorably that they will keep coming back to the store—and will bring others with them.

The modern salesman must be able to sell merchandise the **right** way. He cannot be merely an order-taker. He cannot be an eager-beaver or an "after you, my dear Alphonse" guy.

He must be able to speed up a sale's conclusion without appearing to be over-eager. He must be able

to take disappointments without batting an eye and he must have that certain something which makes customers like him, trust him and depend upon his judgment and expert knowledge.

How you train your salesman has everything to do with how they will eventually act as salesmen.

The dealer who pushes his salesmen too hard, crying and griping over every lost sale, will find that he's built up a bunch of merchandising wolves who approach a customer like a predatory animal stalking its prey.

The dealer who feeds a lot of hogwash to his salesforce, such as exaggerated claims about how much they can earn, or how some fair-haired boy of the past knocked 'em dead by yanking out order blanks or by elbowing his way into homes, is going to find himself with a disillusioned, disloyal bunch of characters on his hands.

### **Get New Outlook**

The old "here's the way we used to do" stuff is a lot of malarkey in selling just as it is in any other business. World War One soldiers get fed up to the hilt on bragging by companions who fought in previous military operations. GI's in the latest conflict certainly resented the gum-beating of certain "re-treads" out of World War One who bragged about the hardships they had, the dangers they faced, or about the great ability they possessed.

No matter how long a dealer or a salesmanager has been in business he should forget the "good old days" in his sales training program. He should operate on the level of today's business—and tomorrow's.

### **Buying Group is Younger**

Old-timers are all right if they are capable of being modern-minded in their sales operations. Old-timers become "old-fashioned" and foggy when they refuse to accept good new ideas from new salespeople. A well-known psychosis associated with senility, among other things, causes its victims to remember with clarity events of long ago—causes them to forget re-



# the Modern Way!

cent happenings. Too much "the way we used to do it stuff," will help age a business just as the before-mentioned psychosis marks mental decadence in an individual.

Age of the individual, however, has nothing to do with this picture. Plenty of old fogies are young; plenty of young fogies are old.

The main thing for the old-established dealer to realize today is that the average age of the people he will hire now to do his selling is *much lower* than that of the group who did his selling for him before the war. The age-average is a *great deal lower* than it was during the Depression when his most active sales measures were being undertaken.

The long-established retail merchant and the long-experienced salesmanager and salesman all have heads full of old saws about selling. Ancient, moth-eaten, worn-to-a-frazzle methods are stored away in the brain pockets of the veteran merchandisers along with a bunch of outmoded "rules" about "successful" salesmanship.

## Modern Customer Pattern

It's all right to permit such cobwebby memories to remain in one's gray matter area, because, it isn't likely that the old-timer can very easily ban them, but it's another thing to drag 'em out to be used as selling examples for the "enlightenment" of the young person who hopes to become a first-rate salesman.

New-day selling calls for diplomatic, honest and interest-intriguing techniques, with successful culmination being, as it always was, the goal to shoot for.

The modern customer will expect direct, unhesitating and clear answers to his questions. He will expect the modern salesman to know all about the product he sells as well as all about competitive makes. Today's buyer will resent efforts to high-pressure him into making a decision before he's found out all he wants to know about the radio or appliance. Yesterday's buyer was so frequently exposed to high-pressuring that he almost expected it; certainly was used to it, and frequently was willing to laugh it off or even to succumb to it.

Now, however, the modern buyer is a bird of a different feather. He's been pushed around, insulted, and sometimes merely tolerated in all sorts of stores.

This modern customer, is commencing to find out that he's in a position to **choose** what he wants and from whom. He will appreciate courtesy, intelligent demonstration and assurance that his patronage is valued by the merchant. He will not fall for the tactics of the high-pressure artist whose actions cry "hurry, hurry, hurry! Buy and get out." He will not fall for the groveling type salesman whose mental attitude is disliked by men and women customers alike.

The modern customer wants modern treatment, and it's up to the established dealer to give them just that, and to encourage his salespeople to act as individuals and to let them have all necessary leeway in developing themselves as personalities.

Right now we're dealing with a **younger** group of salespeople, with a group of buyers too who are younger, on the average, than any we've had before, and with modern equipment which doesn't need any hokum in selling it.

The thing to do is to keep young.

Don't let's sell ourselves the notion that everything that worked in yesterday's selling field will necessarily work today.

Let's retain the fundamentals that we know will be effective right now, and be willing to discard those

methods which the modern-minded salesman and customer alike consider to be passé.

Experience is a dear teacher but some of the things we learned about selling at its hands no longer prove to be effective merchandising implements.

So let's take a new, bright view of salesmanship; and keep our businesses flexible enough to change with the times.

We'll never be old fogies in merchandising as long as we are willing to accept new ideas which seem to be promising.

As time goes on and competition increases, as it is bound to do, salesmanship will once again occupy its rightful place in the American selling scene. We know that the seller's market is on the way out, but fast. Soon the buyer will be shopping around for merchandise of his own *choosing*—not just anything we can lay his hands on. As a matter of fact, buyer-resistance and buyer-choosing is already here and it is certain to increase in intensity.

The merchant who gears his business to have that certain something that sets his establishment out from the crowd is the fellow who's going to survive and make money.

New ideas in selling will appeal to the regular customer and to the prospective ones who visit the store where sparkling methods have been provided for a shortage-weary public.

---

## Train Salesmen for the New-Day Selling!

**Don't give 'em a lot of hogwash about "the good old days"—instead, portray the glamorous picture of TODAY!**

**The dealer who gripes over each and every lost sale builds up a bunch of merchandising wolves and eager-beavers. Be reasonable in your demands.**

**Be a "Modern Old-Timer" and you'll cash in on the prestige of old establishment plus the reputation for being up-to-the-minute.**

**Make salesmen conscious of the fact that today's customer is DIFFERENT, and that the shopper age-group is younger than ever before.**

---





# Retailer's Way to

**Behind That Spectacular Glass of the Haynes Store Front—a Lot of Careful Planning and Hard Work**

• The partners of the big store at 403 W. Washington St., Charleston, W. Va., mean business when they call it a "Music and Appliance Center."

The Haynes Co., in the modern new store opened last summer at the edge of the city's main shopping center, is attracting wide notice by its brisk, three-ply policy involving (1) Emphasis on the four-star-merchandising combination of radio, appliances, records and service. (2) Advertising on local Station WGKV on two different programs every day, and (3) Making the store a giant "show place" that buyers will like and remember.

## **Whole Town's Talking**

The impressive array of Haynes radios, records and appliances can be seen from some distance, because of the striking design of the front windows. The plate glass installation runs the full length of the 60-ft. front, and is the blue-tinted, heat-resistant type of glass featured by the Libbey-Owens-Ford Glass Co. The extraordinary areas of tinted glass are themselves an eye-catcher, as the windows look distinctly "different" and form an unusual "front" for the mass of brilliantly lighted merchandise in-

side the Haynes Showroom.

Prospects are "steered" through the floor displays of radios, record-players and appliances to the record department and the managers report that eight out of ten of them stop to have a look at new models. That is, even the most casual and hasty of the disc buyers take a look at the floor displays, partly because the merchandise is placed directly in their path, and partly because these units are some distance away from any counter or desk where the store personnel is ordinarily stationed. Prospects feel that they can at least take a passing interest in the merchandise without getting involved in a sales discussion with attendants.

Partners in the Haynes store are Sam Haynes and his son, Ralph. Mrs. Haynes is the office manager and takes an active part in the ordering of merchandise. The store, however, has the "strictly business" as well as the "family" atmosphere, and functions as a big-scale operation streamlined for volume.

More attention has been given to the record department than to any other single section in the Haynes store. Almost half of the 3,100 sq. ft. of the sales floor has been given to demonstration and sale of all types of discs. The fea-

ture of the section is a custom-built record counter, table-height, with chrome-trimmed stools and a string of earphones. Counting the booths, which are jumbo size and are conspicuously labelled "Classics", there is room for seven customers to try records simultaneously.

## **Blonde Preferred**

The island displays for albums are the conventional type with the slanted shelves, except that these shelves are actually a series of shallow bins. Each bin holds six albums. The entire department is finished in blonde wood and has an extremely modern appearance.

The emphasis on records was one

Bosses of the big store are father and son—Samuel H. Haynes, seated, and Ralph Haynes.





# RECORDS SERVICE

The "double" store of the Charleston, W. Va., dealer has only one entrance, so that customers who come in for one item do a lot of "circulating" among other items.

## Bigger Profits

\* "Big 4 Dealer Sells All 4"

reason why Haynes wanted a heat-resistant glass installed in the windows; records may be displayed in the sunlight without the usual "melting" difficulty and this has proved to be a distinct advantage.

On station WGKV each morning, Haynes sponsors a "Ham 'N Eggs" show, and each evening the store is on the air with five minutes of "West Virginia's New News" plus a "Top Tunes" feature which involves a record contest.

### Disc Fans Gather

Haynes describes the latter feature as follows: "Each night, we present clues in the form of biographical briefs towards the identity or a popular artist in the record field. The first two successful guessers in the store on Saturday morning receive albums of the artist's records FREE."

Ralph Haynes reports that record fans have started lining up at the store as early as 5:30 a. m. on Saturday, and that the stunt has been generally successful.

Mr. Haynes supervises the mailing of a mimeographed listing of some 200 different records of current interest, headed "Record Notes from Your Music Center." These are sent monthly to a prospect list

of 2,500, with the notation "Subscription Price—Just an occasional purchase of records."

The company believes in diversification and has a compact "paint corner" on the first floor. The space on the second floor is now being

used for smaller showrooms, storage and service. The handsome and spacious store is scheduled for even further advances as more merchandise becomes available. Haynes has the space, the confidence in the business and the go-getter attitude.

Haynes went all-out for disc-selling equipment, and they kept it cheerful, modern and useful throughout. The department is larger than many record stores. Note listening posts at right.





# Dealers Advertise

## Survey Reveals Results, Costs, Kinds of Programs Used.

● The nation-wide survey made by RADIO & Television RETAILING on the use of broadcast advertising by radio - appliance - record - service dealers, continued from the preceding issue, reveals that retailers, by and large, have found radio a profitable medium through which to merchandise their goods.

Of the merchants polled, 60% indicate that broadcasting has been successful in selling the goods advertised; 8% have found taking to the air unprofitable; 32% were undecided or did not indicate results of their broadcast advertising.

But in view of the fact that only 9.8% of those broadcasting have discontinued using this medium altogether, it can safely be assumed that the bulk of the 32% who were non-committal received satisfactory results from going on the air. Fur-

thermore, about one-third of the 9.8% who quit this form of advertising were forced to do so because of a lack of merchandise. These retailers will resume buying time on the air after their stocks are replenished.

Much of the broadcast advertising done during the last few years has been institutional; that is, because of war-time scarcities dealers plugged their stores in order to build prestige in preparation for "real" selling. Now that goods have become more abundant retailers are featuring radios, refrigerators, or other appliances.

Most of the time bought on the air has been used to push the sales of radios. This may be attributed to the fact that receivers were among the first items to become available in any appreciable quantity. Of the retailers buying pro-

gram time of five minutes or more, 24% stressed radios; of those who used spot announcements, 16% emphasized sets. General or institutional advertising was used by 14% of the dealers who ran programs and by 9.5% of those preferring spot announcements.

Phonograph records also account for a sizable share of specific goods advertised on the air. Discs were featured by 14% of those supporting programs; and by 13% of the merchants using "spots". Washing machines were stressed by 5% of the dealers with programs and by 7% of those reaching the public through spot announcements. Major appliances including refrigerators, ironers, vacuum cleaners and others which were available in sufficient quantities to warrant advertising accounted for 10% of the merchandise promoted on programs; these appliances were also pushed by 9% of retailers with spot announcements.

### Use Recorded Music

Of all the dealers using broadcasting to sell their wares, 64.5% bought time of five minutes duration or longer while 62% paid for spot announcements. The percentage of retailers using programs and "spots" amounts to more than 100% since many retailers are using both types of advertising.

Most of the programs of five minutes to a half-hour in length featured recorded music. Of those sponsoring their own programs, 65% used records. Newscasts fig-

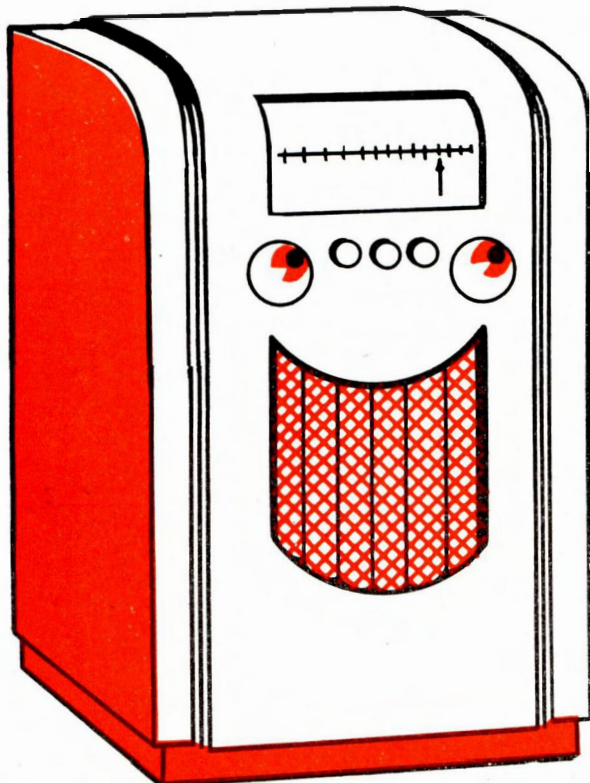

Dealers' messages go direct into the home to sell radios, discs and electrical appliances.

### NUMBER OF DAYS PER WEEK PROGRAMS SPONSORED

30%	of stores on air	1 day weekly
3%	" " " "	2 days weekly
11%	" " " "	3 " "
4.5%	" " " "	4 " "
25%	" " " "	5 " "
6.5%	" " " "	6 " "
5.5%	" " " "	7 " "

14.5% not specified

100%



# Via the Air-Waves

## Overall Picture Seen Profitable to Merchants in U.S.

ured prominently on programs with 18% of radio-appliance advertisers using this type of broadcast. The balance of air time buyers used such programs as man-on-the-street, old-time music quartets, sports broadcasts and others.

Interesting features used on programs to hold the listener's attention include playing records broadcast directly from the dealer's store; quiz contests; public service programs which run a lost and found column of the air; contests which require participants to register their names and addresses at the retailer's establishment and tips on the uses of appliances for maximum household comfort.

The survey reveals that 30% of program sponsors had one program a week; 25% had programs 5 days a week; 11% broadcast 3 days a week; 6.5% were on the air 6 days weekly; 5.5% broadcast every day; 4.5% broadcast 4 days each week; and 3% were on the air 2 days out 7. The balance polled did not indicate program frequency.

### Coordinate Promotion

Analysis of the number of times per week merchants ran spot announcements indicates that 17% of all "spots" for each store were broadcast 3 times or less weekly; 34% were on the air 4 to 6 times a week; 26% 7 to 10 times; and 17% ran announcements 11 times or more each week. The balance of 6% of merchants polled did not specify.

Less than half of the dealers us-

ing broadcast advertising (47%) kept records on the results of this advertising on sales of particular items. But merchants have found that they can evaluate the worth of a program or spot announcement by the store's patronage following a broadcast.

Many retailers coordinated their

games, concerts, street cars; and distributing handbills.

While most dealers preferred not to use their broadcast advertising as a substitute for outside salesmen many of them did. The survey indicates that 22% took to the air instead of employing men to sell outside the store. Of those

### ITEMS MENTIONED ON AIR BY DEALERS BUYING RADIO TIME

Items Advertised	Percentage of Merchants	Items Advertised	Percentage of Merchants
Radios .....	80	Mixers .....	3.5
Refrigerators .....	65	Sewing Machines .....	1.5
Washers .....	66	Broilers .....	2
Records .....	44	Clocks .....	2
Radio Service .....	35	Music Goods .....	2
Appliance Service .....	34	Water Heaters .....	9
Freezers .....	3	Space Heaters .....	6
Steel Kitchens .....	1.5	Vacuum Cleaners .....	12.5
Irons .....	6	Sun Lamps .....	1.5
Ironers .....	7	Other Appliances .....	19
Ranges .....	15	P. A. Systems .....	1.5
Toasters .....	3.5	Miscellaneous .....	10

\*Totals more than 100% since dealers advertise more than one item.

\*430.5

radio advertising with other forms of sales promotion. Newspaper ads were used chiefly to tie in with announcements over the air. Local newspapers were employed by 30% of the broadcast advertisers to call attention to the broadcasts, or to supplement them.

Window and interior displays were utilized by 14.6% of the merchants to coordinate their on-the-air advertising; 5% used direct mail. Other means of promotion that tied in with the broadcasts included personal appearances at the retailer's store of artists recorded; advertising at local theaters, ball

who used radio for this purpose, 57% have found broadcasting a successful substitute for outside salesmen at this time.

A breakdown of the length of time these air advertisers have been in business shows interesting results. Retailers who have been established 5 years or less composed 30% of this group; from 6 to 10 years, 19%; from 11 to 15 years in business, 9%; from 16 to 20 years, 6%; from 21 to 25, 7%; from 26 to 35 years, 7%; those who have been operating for more than 35 years composed 15% of the total, but

(Continued on page 102)

### ANNUAL EXPENDITURES ON ALL TYPES OF ADVERTISING

18%	of stores spent	\$1,000 or less
28%	" "	1,000-2,000
16%	" "	2,000-3,000
8%	" "	3,000-4,000
9%	" "	4,000-5,000
5%	" "	5,000-6,000
16%	" "	over 6,000

100%

### SPOT ANNOUNCEMENTS BROADCAST EACH WEEK

17%	of stores had	3 or less
34%	" "	4-6
26%	" "	7-10
17%	" "	11 or more
6%	not specified	

100%

### ANNUAL SALES OF STORES USING RADIO ADVERTISING

7%	had sales of	\$25,000 or less
12%	" "	25,000-50,000
29%	" "	50,000-100,000
19%	" "	100,000-150,000
12%	" "	150,000-200,000
6%	" "	200,000-300,000
15%	" "	over 300,000

100%





# Their Guarantee

**Bradley's Three Stores Are Building Up On Reputation of "A Warranty that Counts"**

Bradley's signs are familiar to N. J. drivers.

• Keeping on the alert for new sales and service ideas is bringing added profit to co-owners William D. Bradley and Bernard A. Dupree.

For example, these merchandisers took a tip from the *Tune - Up! Tube-Up! Check-Up!* article which appeared in the November, 1946 issue of RADIO & Television RETAILING and capitalized on this theme. Their main store at 1 Newman Springs Rd., Red Bank, N. J., displays this slogan prominently in

its windows, bringing new business to the store.

Another illustration of smart merchandising is shown by the store's cashing in on the advertising and promotions of key manufacturers. By timing their window displays to tie in with the promotion of Federal's selenium rectifier these retailers are currently boosting their service business. Large streamers in the establishment's windows keyed to this maker's advertising campaign have attracted much attention from passers-by.

"New ideas are the life-blood of our business," explains co-proprietor Bradley. "One of these sales ideas was the adoption of our present slogan, 'Service with a Guarantee that Counts'. This has paid off in increased sales of radios and electrical appliances and in greater volume of service business.

"When we say that we guarantee a radio or refrigerator, we mean exactly that. We adopted our slogan after hearing customers complain against a few dealers who did not guarantee their work or did not

Two of the three bench positions in the Newman Springs Road store that back up the Bradley guarantee. Fluorescents provide strong glare-less light. An 18-foot bookshelf holds all service literature, while below is a small-parts cabinet. Tubes are under the counter, and tools are hung on bench.

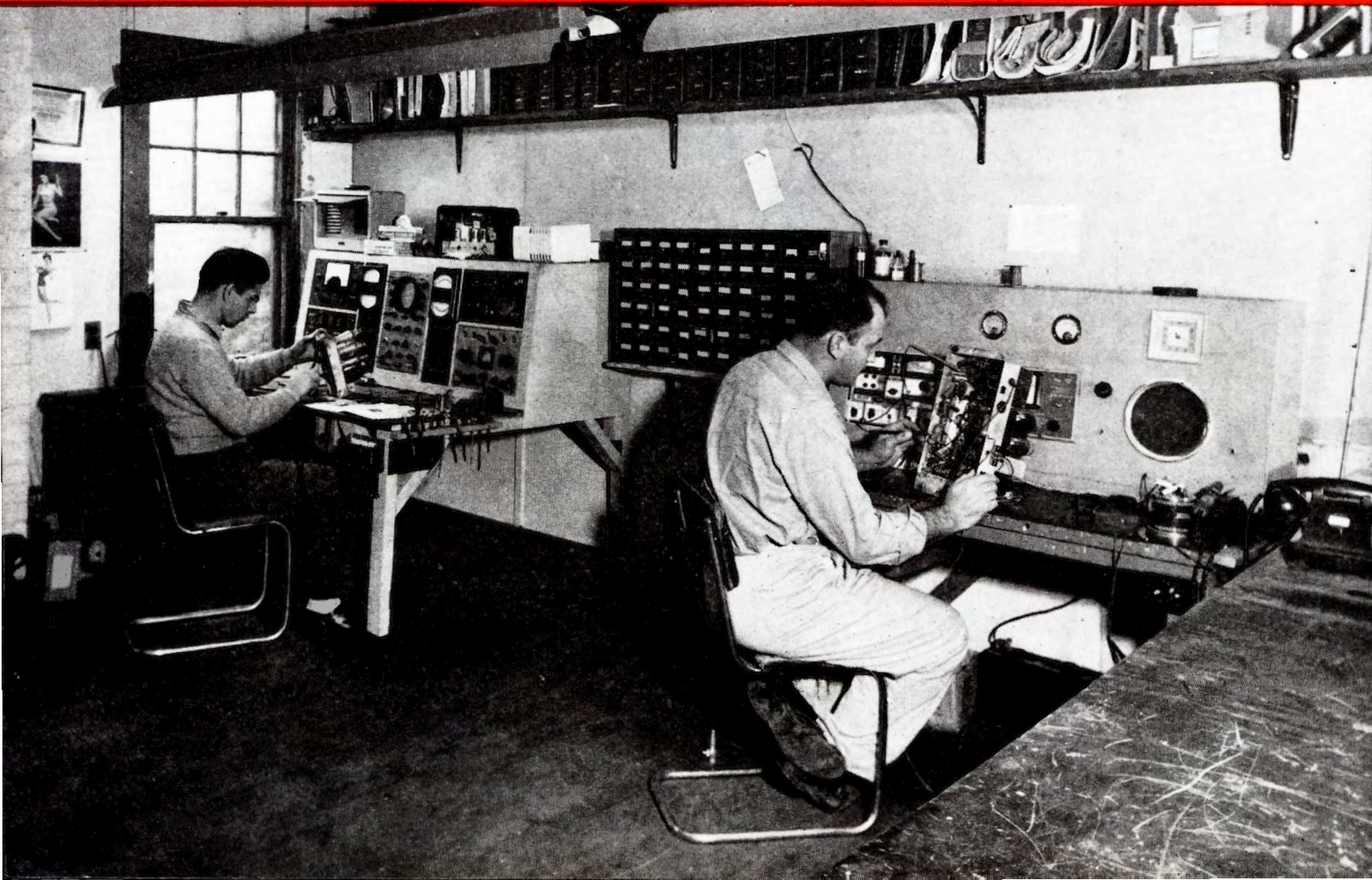



# Sells Radios

live up to their promises. By constantly plugging our slogan and promoting the well-known brands of sets and appliances we carry, we are building a sizeable volume of business."

The firm is succeeding in increasing its sales on the principle expressed in its slogan by the use of outdoor advertising. As the headquarters store is situated on the main artery leading in and out of town, several large signs are strategically placed off the highway to advertise the establishment "with a guarantee that counts". The store itself carries prominent signs to catch the eyes of passing motorists.

"We constantly promote our slogan and then live up to it," Bradley says. "Our principle would be meaningless if we didn't let customers know about it. That's why we advertise it widely."

## Value of Records

The firm keeps a written record of every repair job, commencing with 1932. Accurate data on work performed, parts replaced, etc. provides a "history" of every radio or appliance "doctored" by the company's technicians. Aside from providing practical information on a particular set when it returns for additional servicing, these records are also used as a strong merchandising point to help clinch the sale of a receiver, appliance or repair job.

Prior to the war the establishment operated as a radio sales and service organization only. But when customers began to demand appliances the co-owners took on electrical appliance lines.

The sales and service departments in the store are segregated, thus enabling the firm's four expert technicians to work undisturbed by customers on the sales floor. Three of the radiomen devote their time to in-store repair work, while the fourth utilizes the company's truck for outside service calls.

The maintenance department is geared for high speed servicing with a minimum of time-wasting effort.

The corner displays of Bradley's six front windows shine their service-merchandising message out on two main travel arteries. Auto radio drive-in facilities will be next promotion subject.



The layout is so designed as to avoid lost motion, thereby cutting costs of operation.

The service bench is laid out neatly and comfortably in order to

lessen fatigue. As the technician is seated when at work he is more capable of concentrating on his work. All items necessary for the

*(Continued on page 105)*

Doors at rear of store lead to office, repair shop, stock room, and space for additional show-rooms. Beyond office is salesroom for service jobber activities, also rapidly expanding.





# Make Your

## Counterfeiters and Other Gyps May Be Eying Your Place Right Now; Here's How to Protect Your Business

● Dealer Smith has a right to scowl when he finds among his day's receipts a Federal Reserve note bearing the portrait of Lincoln; a bill which has been raised from a "five" to a "twenty" by a sharper who pasted the numerals "20" on the corners...

Or he may be just as angry to find that he lost eighteen bucks to the glib, well-dressed stranger who came in during a rush period and finagled around with a change-making transaction...

Or it could be that check in his hands which makes Dealer Smith see red (red in the ledger, too) because it's just come back from the bank as NG. He remembers the whole thing now. A stranger presented a check made out to him (on the face of it) by one of Smith's very best customers.....

### 10 Ways to Forestall the Crook

1. Realize that there are three kinds of "bad" bill-passers.
2. Scan all bills for evidence of "raising." Learn which picture is on which bill.
3. Unfold all banknotes before putting them in cash register.
4. Compare "suspected" counterfeits with genuine ones before making change.
5. Don't give strangers "change" from check larger than amount of purchase.
6. Don't take check with signature you know from a person you don't know.
7. Suspect strangers who request unusual change transactions, especially during rush hours.
8. Don't give your checks to strangers.
9. Scrutinize out-of-store deliveries involving change or check-cashing.
10. Don't give cash or checks to strangers soliciting for "benefits" or "drives" or to salesmen who offer to sell "samples."

He feels no worse, however, than his brother dealer who paid out forty-five dollars to a strange solicitor for an ad in a program "for the benefit of the local police department". This proved to be as phony as the smile on the face of a clip-joint hostess.

Because he never knows when his store is being "cased" by the nimble-witted crook, the merchant must keep on his toes.

The dealer who makes an all-out effort to swindle-proof his store is a smart operator. He's the sort of merchant who realizes that the gyp artist is just as dangerous as the hold-up man, the burglar or the kleptomaniac.

Some merchants lay all sorts of elaborate traps to thwart efforts of out-and-out thieves but neglect to gear themselves to cope with counterfeit money passers, check finaglers, short-change artists, skip-buyers and the like.

### Forewarned Is Forearmed

The cagy dealer doesn't keep large sums of money in cash registers and safes. He does all he can to keep small articles out of reach of the kleptomaniac and he erects efficient barriers against those who try to break into his store.

And the wise retailer does other things, too, in a genuine effort to keep at a minimum his losses from those who are out to swindle him. He weighs each transaction carefully so that he will not be likely to fall for the element of surprise angle that the gyp uses to implement his chicanery.

Nor will the clever merchant permit himself to be fooled by the respectable appearance of the crook or by the gyp artist's assumed financial stability. Glib mention by the crook of his supposed intimate friendship with customers well-known to dealer will always be taken with a grain of salt by the

careful store operator.

The merchant may well consider the "queer" currency danger as ranking first in importance. Moreover, the process of changing money is a fast operation as compared with the handling of checks, when the dealer has more time to think.

In addition to the "speed" angle associated with making change, the dealer is further exposed to the "bad money" menace because there are *three sorts* of "passers" to contend with. These are: 1. The professional "shover." 2. The "honest" person who, having been "stuck" with spurious dough, seeks to "pass it off on" someone. 3. The innocent possessor of counterfeit or "raised" money.

### Watch All Money!

In view of the foregoing, the merchant should scan all bills and coins with the utmost care, even when offered by well-known customers. It is not good business to examine *carefully* all money tendered by strangers on the one hand, and to accept without scrutiny that handed out by established clients of the store.

"Raised" bills are just as dangerous and tricky as the counterfeit ones. Since the former are usually

shoved during rush periods, and because they are made up of *genuine* parts of banknotes, the dealer and his salespeople should be especially alert.

The "feel" of a bill and a quick glance on the part of the person accepting it is not enough of a safeguard. The merchant should look at the portrait on the bill and then see if it "matches" the amount.

The bill raiser is often a skilful "artist" who does a good job of



# Store Swindle-Proof!

pasting or otherwise fitting in on a smaller bill numerals, etc., cut from a banknote of a larger denomination. Bill raisers also make a practice of "shoving" half-and-half notes, for instance a bill made up of halves of a ten and a one dollar note, folded so that the unwary clerk sees only the ten dollar section.

The merchant and all of those who handle money in his organization should know *whose* portrait is on *which* bill. To combat the efforts of the bill-raiser, be able to immediately associate the portrait with the amount, and unfold all

The three main types of bills in circulation are: Federal Reserve note, with green seal and serial number; U. S. note, with red seal and serial number and the Silver Certificate with blue seal and serial number.

There is a ten dollar bill in circulation at the present time that the dealer should be on the lookout for. It has the check letter (I) and check plate number 18. The right eye of Hamilton on this counterfeit ten is too narrow, giving a squinting appearance. Shading on the upper left jaw and right side of nose is too light. Serial numbers are print-



clerk. On bills, the portraits are not "life-like"; the colors are "off" and the texture of the spurious bill is sleazy and lacks the interwoven colored silk threads of the genuine. Counterfeit coins do not "ring", feel greasy to touch, are "off-color" and the milling around the edges is not cleancut or durable.

Even during these prosperous times, gyp artists prevail in numbers and their ranks will swell as financial conditions in the country commence tightening up.

The "short-change artist" makes his living by a fast-moving, bewildering technique which he has developed to a high degree. Most of the short-changers operate during crowded hours, but some of the cleverer and more personable individuals are able to ply their complicated "pitches" even when there are no other customers in the store.

Since the short-change artist comes into the store with a thoroughly prepared step-by-step plan and a disarming manner, he often catches the proprietor or a clerk napping.

In order to protect himself against unscrupulous men and women who seek to come out on the long end of a change-making transaction, the dealer should be skeptical of all strangers who follow a purchase with unusual or obviously complicated requests for making change.

"Remote-control" gypers usually operate in cities. Such characters place orders in person or over the telephone. The "remote-control"

(Continued on page 97)



The clever crook takes pains not to look the part. Don't be fooled by appearances or glib speech. Weigh each deal carefully. The gyp's routine is well rehearsed; the "surprise" element's in his favor.

banknotes before making change. "Pictures" and denominations as they appear on United States bills are as follows:

- \$1 Washington
- \$2 Jefferson
- \$5 Lincoln
- \$10 Hamilton
- \$20 Jackson
- \$50 Grant
- \$100 Franklin
- \$500 McKinley
- \$1000 Cleveland
- \$5000 Madison
- \$10,000 Chase

ed in pale olive green. The back of the bill is darker than a genuine and the design is coarser in detail.

Merchants may obtain up to the minute information which will help them detect counterfeit money by requesting that they be placed on the Secret Service's mailing list. There is no charge. Address the nearest office of the organization, or Chief, U. S. Secret Service, Washington, D. C.

Fortunately, there are few counterfeit bills and coins which cannot be readily detected by the alert





## Rejuven-Air PORTABLE RADIO



Model BP-500 lightweight 3-way portable receiver with new type battery rejuvenator, an indicator showing condition of battery, and special dial illumination circuit showing when set is operated on ac or dc. Simple and convenient battery terminals, single switch to change from ac to dc. PM speaker. Built-in loop antenna, iron core transformer. Two-color leatherette carrying case. Measures 10½" by 12½" by 4½"; weighs 11 lbs. Electromatic Mfg. Corp., 88 University Place, New York 3, N. Y.—RADIO & Television RETAILING

## Delco RADIO

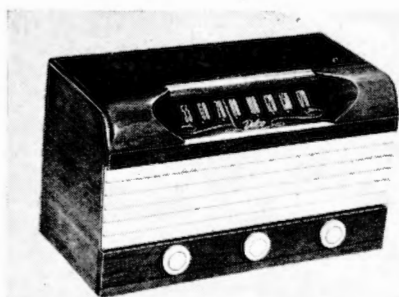

Model R-1229 table receiver tuning 550 to 1700 kc. Five tubes plus rectifier, tone control, two tuned stages, built-in loop antenna. Modern straight-line cabinet design, with light mahogany finish and natural maple grille—burgundy red dial back-plate and matching control knob trim. Delco Radio Division of General Motors Corp., Kokomo, Ind.—RADIO & Television RETAILING

## Panamuse FM-AM COMBO

Model 25N2—the "Sheraton Upright" Panamuse by Capehart—automatic radio-phonograph with shortwave, FM and standard. Radio tuner has 15 tubes plus cathode ray tuning indicator and



# New Sets for

one amplifier tube. Military type wiring; call letters in face of dial. Amplifier unit has 8 tubes including two rectifiers—18½ w undistorted output. Two speakers—15" for bass and 5" for treble coaxially mounted and balanced. Visual indication of bass and treble tone—bevelled plate glass on front of control panel. Built-in antenna. Panamuse disc changer plays twelve 10" or ten 12" records—automatic cutoff, long life needle. Cabinet has bowed and figured front of swirl mahogany or walnut. Tambour doors, inlaid lines. Measures 37⅞" high by 33½" wide by 19⅞" deep. Farnsworth Television & Radio Corp., Capehart Sales Division, Ft. Wayne, Ind.—RADIO & Television RETAILING

## RCA FM-AM RADIO

Table model 68R series with FM and AM bands—the FM designed on the Seeley "radio detector" principle. Seven tubes plus rectifier, "Golden Throat" tone system, 3-point tone control. Two built-in antennas—one for each band.

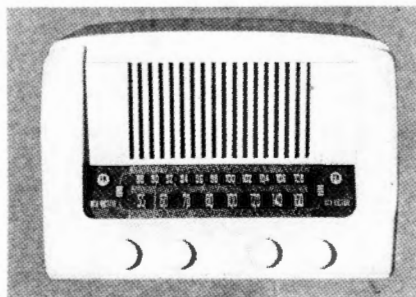

Automatic volume control, phono input jack for record player with switch on front panel. Built-in ground. Model 68R1 is brown plastic and 68R2 (illustrated) is ivory plastic, priced at about \$70. Model 68R3 has cabinet of walnut and other woods—at about \$85. RCA Victor Division, Radio Corp. of America, Camden, N. J.—RADIO & Television RETAILING

## Orthosonic COMBO

Chairside radio-phonograph combination. AM-FM, automatic record player—largest of new "Orthosonic" line of receivers. Twelve tubes, dual tone controls for operation of twin speakers; bass and treble boost. Motor-driven "lift" mechanism electrically raises and lowers entire top of receiver, to provide access to record changer—top of receiver always remains level. Electronic Laboratories, Inc., 122 W. New York St., Indianapolis 4, Ind.—RADIO & Television RETAILING

## Zenith PORTABLE-TABLE RADIO

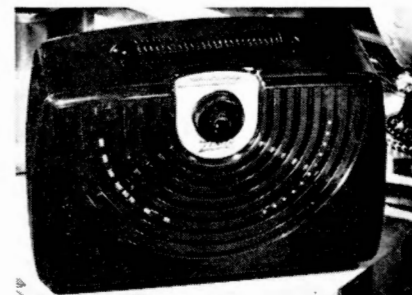

Model 5G003 "Holiday" portable designed also for use as table model. Operates on ac or dc, with long-life self-contained battery pack, jumbo semi-traverse dial for easy tuning—535 to 1620 kc. Superhet circuit has safety switch to cut out battery automatically when electrical plug is removed. Concentric control tuning and volume controls. Alnico 5 speaker, built-in antenna. "Permo-Stretch" handle fits flat when not in use. Cabinet of modern design—maroon plastic with Roman gold trim. Measures 8-21/32" high by 13-1/16" wide by 5¼" deep. Lists at \$39.95 without batteries. Zenith Radio Corp., 6001 W. Dickens Ave., Chicago 39, Ill.—RADIO & Television RETAILING

## Bendix COMBO

Model 667-A table ac radio-phonograph with single-button-control automatic record changer. Push-pull beam power pentode output, long-life selenium non-tube rectifier, 6" Alnico 5 speaker. Two-position tone control, slide rule dial, tunes 540 to 1620 kc. "Super Signal" built-in antenna, "Supertone" feedback circuit. One-ounce crystal tone arm, permanent type needle of precious alloy. American walnut cabinet of compact design measures 16"



wide by 10⅞" high by 15⅜" deep. Bendix Radio Division of Bendix Aviation Corp., Baltimore, Md.—RADIO & Television RETAILING



# New Profits

## Fada RADIO

Model 659 (short wave version of Model 652) with two wave bands—528 to 1640 for broadcast and 5.7 to 18.3 mc for international short wave. Superhet with 6 tuned circuits, ac-dc, automatic

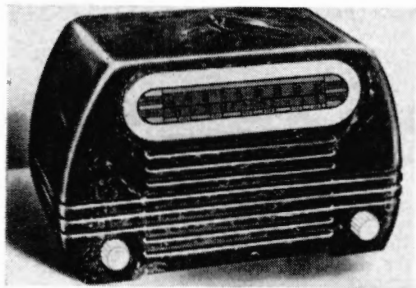

volume control. Five tubes plus rectifier, diode low distortion detector. Reduction drive tuning (ratio 6 to 1), horizontal dial, beam power output system, power output of 2 watts. Alnico 5 dynamic speaker, built-in Fa-Da-Scope loop antenna, noise-reducing RF stage. Measures 11" wide by 6 $\frac{3}{4}$ " high by 6 $\frac{1}{4}$ " deep; weighs 6 lbs. Fada Radio & Electric Co., 30-20 Thomsen Ave., Long Island City, N. Y.—RADIO & Television RETAILING

## Apex COMBO

Model 8146-AC console superhet radio-phonograph with three bands—standard tunes 535 to 1680 kc; short-wave includes 2.2 to 7.2 mc and 6.9 to 23.5 mc. Push-pull amplification. 10" auditorium type PM speaker with Alnico 5 magnet, 8 tubes—two of them dual purpose. Automatic full range volume control. 3-position tone control. Built-in loop antenna plus provision for external aerial. Slide rule dial—high ratio drive on tuning condenser. Automatic changer plays twelve 10" or ten 12" records.

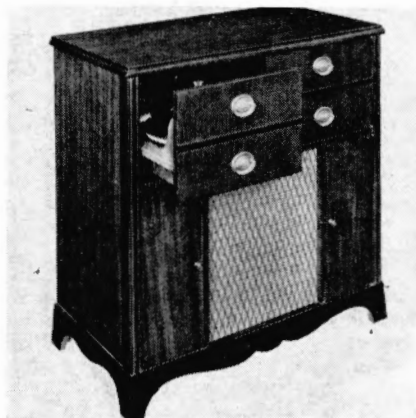

Sheraton cabinet of mahogany veneers. Apex Radio & Television Corp., 192 Lexington Ave., New York 16, N. Y.—RADIO & Television RETAILING

## Browning AM-FM TUNER

Model RJ-12 radio tuner unit receiving the FM band (87 to 109 mc) plus standard broadcast (530 to 1650 kc). Uses Armstrong FM circuit, two-stage cascade limiting. Separate RF and IF systems on both bands. High impedance output for connection to amplifier. Phono position included in channel selector switch to provide volume control directly on the tuner. FM antenna also serves AM. Tuning eye shows either

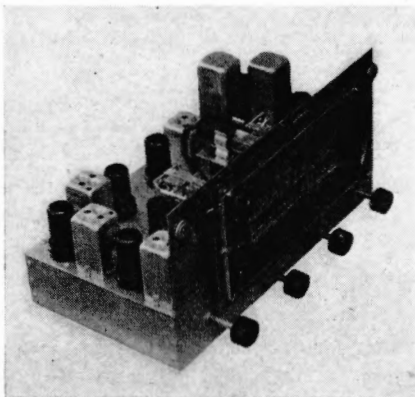

band. Designed for easy mounting in drawers, cabinets, shelves, etc., es-cutcheon supplied with unit, slide-rule edge-lighted dial. Available with or without power supply. Measures 7 $\frac{3}{8}$ " high by 13 $\frac{1}{2}$ " wide by 9" deep; weighs 12 lbs. Browning Laboratories, Inc., Winchester, Mass.—RADIO & Television RETAILING

## Viewtone TELE SET

"Futura" model straight video receiver, table unit with 7" screen. Mahogany veneer cabinet, hand-rubbed finish. Measures 21" wide by 21" deep by 19" high. \$225 plus installation. Viewtone Television & Radio Corp., 81 Willoughby St., Brooklyn, N. Y.—RADIO & Television RETAILING

## Air King RADIO

Model 4706 "The Regent" table superhet, ac-dc, six tubes including rectifier. Beam power pentode audio system, speaker of Alnico 5 alloy. Die-cut antenna enclosed. Illuminated white-on-black airplane dial, contrasting with cabinet color. Modern and simple lines

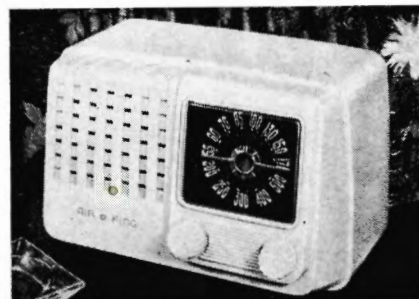

in cabinet—plastic case available in ivory (illustrated) or walnut. Air King Products Co., Inc., Division of Hytron Radio & Electronics Corp., 1523-29 63rd St., Brooklyn 19, N. Y.—RADIO & Television RETAILING

## ECA COMBO



Model 131 portable automatic radio phonograph—the "Holiday"—tuning 540 to 1700 kc, delivering 1.7 w undistorted power output. Uses selenium rectifier. Alnico 5 speaker, slide rule dial, 5 tubes plus rectifier. AVC, built-in antenna. Covering of weather-proof plastic-treated alligator grain leatherette. Plays ten 12" or twelve 10" records with lid closed. Measures 20 $\frac{3}{4}$ " by 15 $\frac{1}{8}$ " by 8 $\frac{3}{4}$ ". Electronic Corp. of America, 170 53rd St., Brooklyn, N. Y.—RADIO & Television RETAILING

## Aviola COMBO

Model 518 table combination with Aviola automatic record changer, 5 tubes, 5" Alnico 5 dynamic speaker. Plays twelve 10" or ten 12" discs, via streamlined, warp-proof die-cast changer with only 7 moving parts. Lifetime needle, bearings oiled for life; plays



home recordings. Cabinet with desert blonde finish, 5-ply oak louvred grille. Aviola Radio Corp., Phoenix, Ariz.—RADIO & Television RETAILING



# More New Lines Ready

## Crosley RADIO

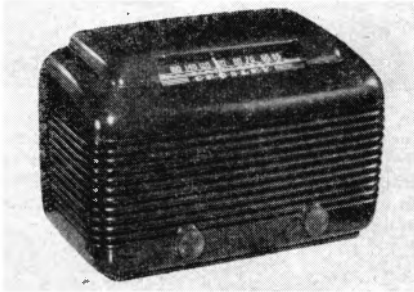

Model 56 TG "Minuette" table unit, ac-dc, tuning 540 to 1600 kc. Beam power output, PM speaker, automatic sensitivity control, enclosed loop antenna, 5 tubes including rectifier. Slide rule dial. Brown plastic cabinet measures 7" high by 10 $\frac{3}{4}$ " wide by 6 $\frac{3}{4}$ " deep. Crosley Corp., Manufacturing Division, Cincinnati 25, Ohio—RADIO & Television RETAILING

## Workshop ROTATOR

Antenna rotating device with sturdy rotating mechanism operated from indicator control box. Designed for the manufacturer's beam aeriels, but can be adapted to antennas of other designs and will support several at once. Allows use of low loss coaxial line direct from antennas to set. Rotates full 360 degrees at 1 RPM, in either direction—stops automatically at North position. Rugged construction—geared electric motor housed in aluminum casting. Quiet operation emphasized throughout design. The Workshop Associates, 66 Needham St., Newton Highlands 61, Mass.—RADIO & Television RETAILING

## Motorola RADIO

Model 65X15 table receiver, ac-dc superhet tuning 540 to 1720 kc. Five tubes plus rectifier, RF stage, 5" speaker, wave trap. Built-in Aero-Vane loop

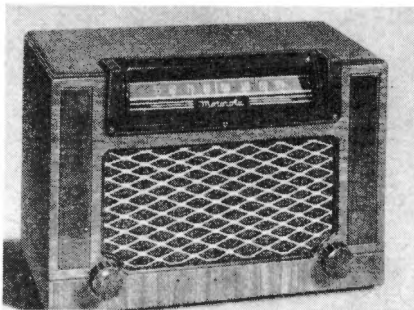

antenna. Walnut veneer cabinet measures 13 $\frac{1}{4}$ " by 8 $\frac{1}{2}$ " by 7 $\frac{1}{8}$ ". Galvin Mfg. Corp., 4545 Augusta Blvd., Chicago, Ill.—RADIO & Television RETAILING

## Mystery RADIO

Electronic toy radio receiver requiring no tubes, no battery, no electricity. Brings in strongest local station anywhere in broadcast band when clipped to some form of antenna and ground. Uses radar type crystal detector, and rubber fitting for ear. Can be used as microphone when clipped to phono terminals of most radio sets. Or two of the units clipped together will act as batteryless telephone over several hundred feet. Comes complete with instructions, packed in colorful display box with total weight of 1 lb. \$2.45 retail. Tabyrinth Equipment Co., 120 Greenwich St., New York 6, N. Y.—RADIO & Television RETAILING

## Ampro SLIDE PROJECTOR

Model 30-D dual purpose "Ampro-slide" for both 2" by 2" slides and 35 mm strip film—for homes, classrooms, churches, clubs, etc. Curved film guide-ways, for easy threading and speed in operation. Patented automatic snap-action self-centering slide carrier—projector can be operated with one hand. No additional units needed for

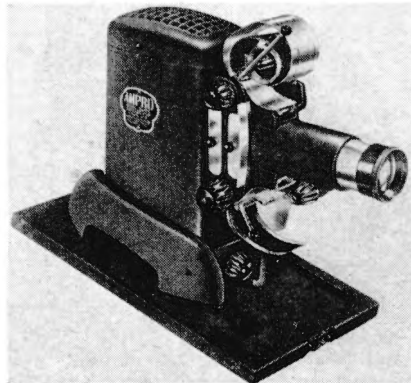

changing from slides to strip film. Anastigmat 3.5 projection lens, 300 w lamp—operates on 105 to 125 volts ac or dc. Comes complete with lift-off case. Ampro Corp., 2835 N. Western Ave., Chicago 18, Ill.—RADIO & Television RETAILING

## Frawley HOTEL RADIO

Coin-operated chairside ac or dc receiver designed for hotel use. Dial-operated shielded loop antenna for adjusting reception to each room. Station selector, tone and volume controls, 6" dynamic speaker. Gives 2 hrs. of reception for 25c. Built-in slug rejector. Walnut veneer cabinet. Hotel Radio Corp., 3000 E. Jefferson Ave., Detroit 7, Mich.—RADIO & Television RETAILING

## Ferrar RADIO

Model T-60 table superhet, ac-dc, six tubes including rectifier. Tunes 535 to 1650 kc, two-gang variable condenser,

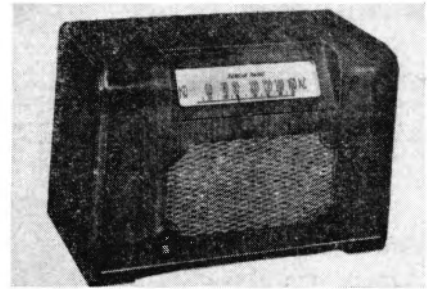

5" Alnico 5 speaker. Power output of 1.5 watts. Walnut cabinet, wide grille, two controls. Measures 15" long by 9 $\frac{1}{2}$ " high by 7 $\frac{1}{4}$ " deep. Weighs 13 lbs. Ferrar Radio & Television Corp., 55 W. 26th St., New York 10, N. Y.—RADIO & Television RETAILING

## Vertrod ANTENNA

Model 444 combined FM and television "Continental" dipole-reflector type antenna with frequency range of 44 to 106 mc. Dipole elements of hard aluminum alloy, marked and calibrated in megacycles—adjustable with set screw to desired bands for FM or video. Support built of patented water-repellant porcelain insulator. Five-foot enamelled steel mast, with plated steel guy wire brackets and universal base mounting brackets. \$23. (When furnished with 75 ft. of 300-D polyethylene-covered lead-in wire, \$27.50) Vertrod Corp., 60 E. 42nd St., New York 17, N. Y.—RADIO & Television RETAILING

## Lear CHAIRSIDE COMBO

Console radio-phonograph with 3 bands, chairside style (31" high). Automatic record changer, 6 tubes, ac. Cabinet available in blonde (shown) or

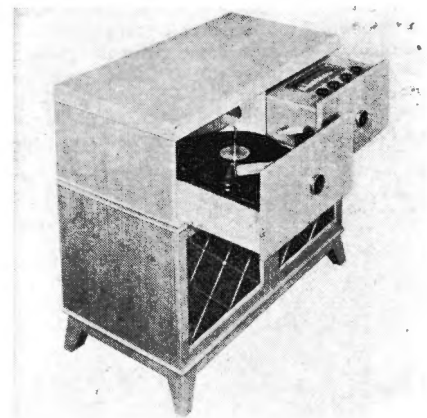

mahogany finish, Sheraton design. \$185.60 for the blonde; \$176.60 for mahogany. Lear, Inc., Home Radio Division, 110 Ionia Ave., N.W., Grand Rapids 2, Mich.—RADIO & Television RETAILING



# This *New* Promotion Re-affirms an *Old* Policy

**F**ROM the first announcements of the new Meck plan for producing "Trail-Blazer" radio receivers, one theme has dominated our merchandising:

"Radio specialists have the leadership now—you deserve to keep it continuously through the post-war period. We will do everything possible to maintain the public's acceptance of the dealer—because we know that the best sets will be sold by these 'men who know radio best'."

Check the engineering—you'll find "Trail-Blazer" sets live up to this standard.

Check this new SERVICE promotion aimed to maintain public confidence in YOU. This whole program—national and local advertising, posters, direct mail, and sales helps—is built for YOU. Ask your Meck "Trail-Blazer" jobber about it today.

*John Meck*



Advertising in the Saturday Evening Post



Tie-in Ad Mats for Meck Dealers



Counter Cards



Window Posters



Mailing Cards



Neon Signs



# MECK RADIOS

John Meck Industries, Inc., Plymouth, Ind., U. S. A.



# New Lines Offered

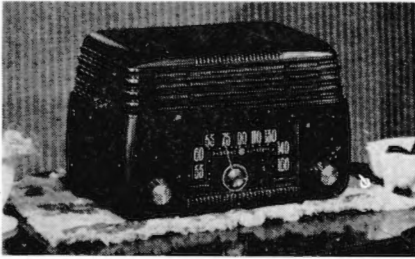

## GE RADIO

Model 200 table receiver tuning 540 to 1600 kc, six tubes including rectifier. Undistorted power output of 1.2 watts. Automatic volume control. 5 1/4" Alnico 5 PM speaker. Two controls. Brown plastic cabinet featuring modern simplicity in design. Measures 7 1/2" high by 12" wide by 7 1/2" deep. General Electric Co., Bridgeport, Conn.—RADIO & Television RETAILING

## Electro-Tone COMBO

Model 706 portable automatic combination radio-phonograph with 6-tube ac radio, 6" PM Alnico 5 speaker. Enclosed loop antenna, iron core coils, full-vision slide rule dial, tapered tone control. Shock-mounted; automatic volume control. Automatic changer plays 10" or 12" discs. Featherweight crystal pickup. Cabinet in two-tone color combination. Electro-Tone Corp., 221 Hudson St., Hoboken, N. J. — RADIO & Television RETAILING

## DynaTone ELECTRONIC PIANO

"Modern" model electronically amplified instrument combining radio, phonograph, piano and harpsichord. Radio tuner in right hand drawer compartment brings in FM, standard broadcast, and shortwave. Automatic record changer in other drawer compartment has regulator for playing record slightly above or below normal speed, so that discs can be played with piano. Dyna-



tone piano has strings and tones of regular piano, but electrically amplified tones replace sounding board. Volume control for piano as well as for radio & records. Ansley Radio Corp., 41 St. Joes Ave., Trenton 9, N. J.—RADIO & Television RETAILING

## Taco FM and TELE DIPOLES

New line of dipole FM and television antennas, designed of aluminum tubing to avoid rust and corrosion. Supporting members of enamel-finished steel tubing; former wooden spreaders or mount-members have been replaced by insulating materials such as bakelite or polystyrene. Standard download is now ribbon transmission line comprising two stranded conductors insulated by band of polystyrene—resulting in loss per 100 ft. of only .02 db at 10 mc; 1.25

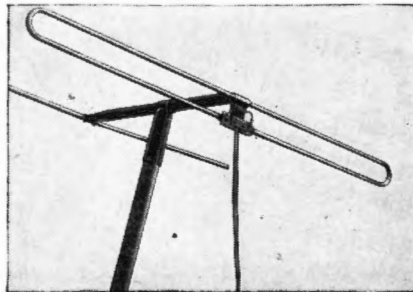

db at 50 mc; and 2.1 db at 100 mc, with 300 ohm surge impedance. Special low-loss splicing tape available to avoid losses at high frequencies. Complete components shipped in flat carton—easily assembled. Technical Appliance Corp., 41-06 De Long St., Flushing, L. I., N. Y.—RADIO & Television RETAILING

## Emerson PORTABLE RADIO

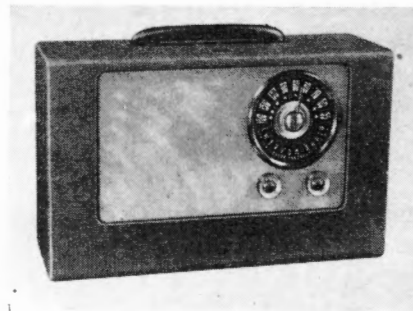

Model 523 three-way portable unit operating on ac-dc and battery, tuning 550 to 1600 kc. Alnico 5 PM dynamic speaker and Miracle Tone feature. Automatic power shift and automatic volume control. Lightweight and weatherproof cabinet, luggage style. Lists at \$47.20 less batteries. Emerson Radio & Phonograph Corp., 111 8th Ave., New York, N. Y.—RADIO & Television RETAILING

## Plicote TRANSPORTATION FINISH

New outdoor paint coating chemically engineered to resist heat, cold, vibration, marring, grit and grime. Tested for autos, outdoor furniture, bicycles, trucks, boats, buses etc. available in 10 colors including black and white. Designed to stand constant and hard wear as well as exposure to weather. Plicote, Inc., 664 N. Michigan Ave., Chicago, Ill.—RADIO & Television RETAILING

## Ward ANTENNAS

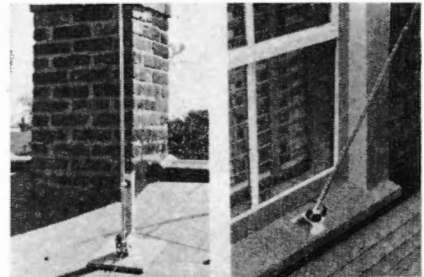

New line of house and window radio masts, vertical type, telescopic design. Weather proofed with heavy cadmium plating. House mast, with built-in lightning arrester, built for easy mounting in variety of roof positions—extends to 12 ft. and collapses to 4 ft. Window mast built for 3-minute installation on window frame or sill of home apartment or office—extends to 8 ft. and collapses to 40 inches. The Ward Products Corp., 1523 E. 45th St., Cleveland, Ohio—RADIO & Television RETAILING

## Coronet RADIO

Two-band superhet table receiver with 5 tubes and 5" Alnico speaker tunes 550 to 1700 kc for standard broadcast and 6 to 17 mc for shortwave. Built-in loop antenna, illuminated slide rule dial, automatic volume control. Tropicalized construction. Wood cabinet of walnut measures 14" by 8" by 9". Coronet Radio & Television Corp., 1083 Bergen St., Brooklyn 16, N. Y.—RADIO & Television RETAILING

## Stromberg-Carlson.AM-FM

Model 1121-LW—the "Imperial"—console superhet with two FM bands, standard broadcast and spread-band shortwave band. Eight station push buttons for both standard and shortwave, all-wave built-in loop antenna, 12" electrodynamic speaker, automatic volume control, tone control. Convenient con-

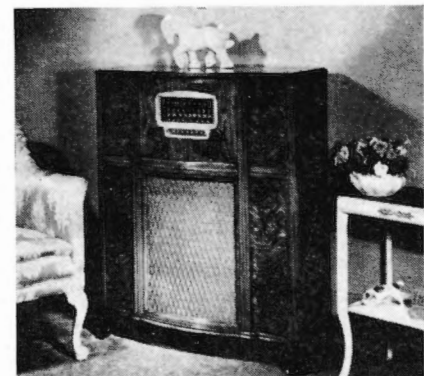

nection for phono, plus circuit for quick connection of S-C wire recorder. Contemporary style walnut cabinet measures 38" high by 32 1/2" wide by 14 1/2" deep. Stromberg-Carlson Co., Rochester 3, N. Y.—RADIO & Television RETAILING





MODEL 4604F



## The Baron

### Now! A 2-Band, Table Model with Console Features — Standard and Short Wave Reception with Interference Eliminator

Here's the kind of price-quality feature which brings extra business into a fine radio shop. Air King precision craftsmanship enables you to present to your most appreciative customers a 2-Band, high performance radio finished in rich American walnut. The set has superb good looks and exceptional tone. When you see how brilliantly it demonstrates and remember that it offers fine radio reception on both standard and short wave, anywhere in the country, you can see its great possibilities as a stepper-up of immediate sales income.

**Note this combination of Air King Features—**

Interference eliminator that blocks out code telegraph. Built-in Phonograph Jack to accommodate

automatic record changer. Convenient panel control for phonograph connection. 6 Tubes (including rectifier) with Superheterodyne circuit. 7 inch Selectorloop. Alnico #5 "Tone King" speaker.

Air King Products Company, Inc.  
1523-29 63rd Street, Brooklyn 19, N. Y.

*The Royalty of Radio Since 1920*

# AIR KING RADIO

Division of HYTRON RADIO & ELECTRONICS CORPORATION, Brooklyn, N. Y.

Export Address: Air King International, 75 West Street, New York 6, N. Y.

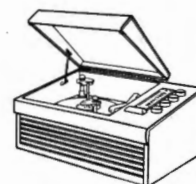
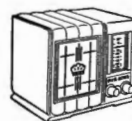
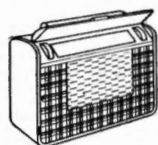

★ WE HAVE A LIMITED NUMBER OF DISTRIBUTOR AND DEALER TERRITORIES OPEN ★







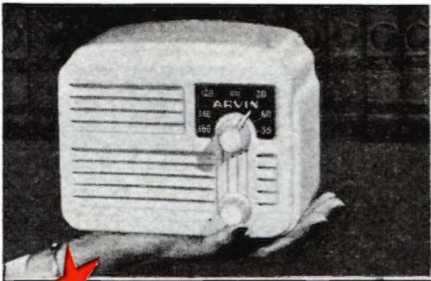

★ ARVIN Money Maker 444A

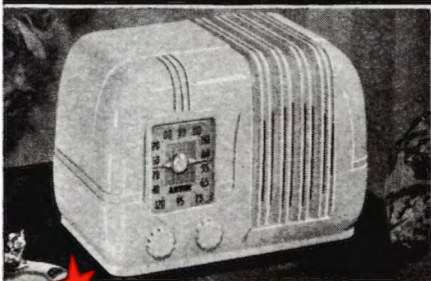

★ ARVIN Money Maker 544A

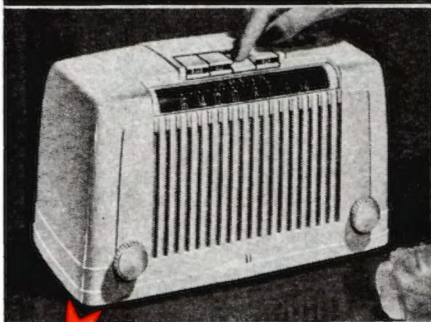

★ ARVIN Money Maker 555A



★ ARVIN Money Maker 664A

# THEY'RE MONEY-MAKERS

IN A

# Big way

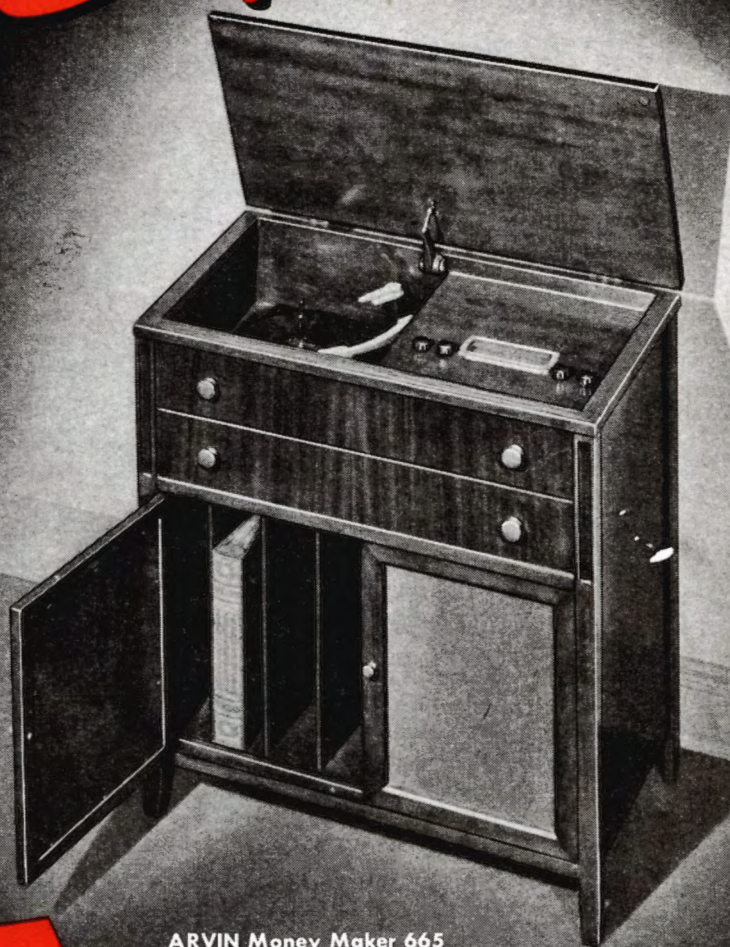

ARVIN Money Maker 665

**ARVIN**  
*Top Flight*  
**RADIOS**

★ So well known for dependable quality at prices people like to pay, these Arvin models are making money for dealers in a big way.

**ARVIN** ... the name on many profit-building products from  
**NOBLITT-SPARKS INDUSTRIES, INC.**  
Columbus, Indiana



# What you should know about **sex** to sell Radios



**People and rabbits** have this much in common: they both consist of *males* and *females*.

But unlike rabbits, who thrive on a diet of carrots and companionship, male and female *people* must shell out the shekels for numerous worldly goods.

One of the first things they'll likely shell out for is a radio—and who can predict the sex of a radio sale? *He* may buy *her* one, *she* may buy *him* one, or they may go out and buy one *together*.

Whether you deal in radios or record changers, electric heaters or electric icemakers, you've got to sell *two sexes* . . . *males* and *females*. Either *together* or *separately*.

And who can woo *males* and *females* like *The American Magazine*!

Dollar for dollar, page for page, *no other* magazine can match the multimillion circulation delivered by . . .

*The American  
Magazine*



# RECORDS

## Section of RADIO & Television RETAILING

SUNSHINE, HEAT, AND RESULTANT WARPAGE take their toll each year of record dealer's profits. Disc clerks sometimes place albums in the store window, and leave the records in the pockets. Care can be taken to avoid these "little" mistakes which cost money.

*HANDLE WITH CARE*, says well known disc dealer, commenting bluntly on the expanding market in phonographs for youngsters. Reproduction must be good, or the kids will have their tastes and their "ear" ruined at a critical time in their musical experience. Besides that, children are more sensitive to tinny reproduction than most adults think, and they're likely to lose interest in the whole thing; the least that a parent can do is to provide first-rate players with skilled artists on quality discs.



RECORDS CAN PROVIDE A FLOOR SHOW AT HOME—Enterprising retailers are taking advantage of the lean days in the night-clubs and bistros, and the tightening of "easy spending" on the part of the public. Entertaining at home is becoming more and more the order of the day. Outstanding personalities in the entertainment field have recorded albums and singles that are perfect for group listening. Comedians and crooners, dramatic plays and vocal novelties are all available on wax. In fact, a new record company has announced its intention of recording only original comedy scripts featuring noted comedy teams. Dealers with foresight are playing up the idea of spending "an evening at home with records."

"SEASONAL LULLS" in record sales are expected by some retailers at this time of the year. More often, however, these dull expectations are a "state of mind" rather than an actual fact. Records are a "glamour" item, and people seek diversion at all times of the year.

*CAPITOL RECORDS TO PREVIEW* forthcoming platters for dealers two weeks before release date. Attempts are being made to supply salesmen with records at this early date to help dealers eliminate "blind" ordering.

*PLATTERS FOR PRESENTS* is an angle enterprising dealers cannot afford to overlook with St. Valentine's Day coming up this month. Discs of the "swoon, moon, I love you" variety will go over big. Suggestion: Compile a listing of recordings with the word "love" in title, and post prominently in the store. Albums of "Love Songs" have been recorded by several artists, and a large selection of serious "love" music albums are available, such as "Love Music From Tristan Und Isolde," "Love Music from Boris Godounoff", and "Songs Of Love Waltzes," etc.

MUSIC LOVERS WHO ANXIOUSLY await the playing of American compositions in the concert halls, can find most of the outstanding American composers listed in the record catalogs. James W. Murray, vice-president in charge of RCA Victor record activities declared, "While it is true that concert audiences rarely hear American compositions in their own concert halls, this situation does not exist in the recording field, where American compositions are given more consideration as possible recording material than the works of European composers." Dealers can capitalize on the fact that works by Americans are readily available on records.

*COLUMBIA RECORDS IS PLANNING* a series of "tour" folders for all artists who will make nationwide personal appearances during 1947. The first of these is the dealer sheet giving the itinerary of the Pittsburgh Symphony Orchestra.



FOREIGN LANGUAGE DISCS MADE in the U. S. are sold in the U. S.—very few are exported. This fact points up the importance of "foreign markets" in the disc dealer's locality. Parents and youngsters in these national groups buy language records and allied sheet music. In fact, if there is a predominantly large Polish, Russian, or Scandinavian, etc., group in the vicinity it will pay the dealer to hire a clerk who speaks the language.

PRICE OF SHELLAC reported dropping. This, however will have no effect on the price record structure, with most manufacturers intending to hold the line at peak '46 levels.



# Next month's RCA VICTOR advertised features!

*for "POP"*

in "LIFE" and "LOOK"  
in 6 fan & teen-age  
magazines

Get set for the coming promotion on the King of the Concerto! Freddy Martin's new album, "CONCERTOS FOR DANCING," will be advertised across the board next month in RCA Victor's gigantic new "pop" record campaign...reaching everybody . . . selling everybody! It's a sure case where *display will pay!* (Album No. P-169, \$3.15.)



*for Red Seal*

in "LIFE"—and  
2 full-pages in "TIME"



**MELTON**, Tenor: *Irish Songs*—RCA Victor Orchestra, David Broekman, Conductor. Album M-1090, \$3.85. To be featured in "LIFE," March 3.



**RUBINSTEIN**: *Concerto No. 2, in F Minor, Op. 21, and Berceuse in D-Flat, Op. 57*—Chopin. NBC Symphony Orchestra. Album M/DM-1012, \$4.85. In "LIFE," March 3.

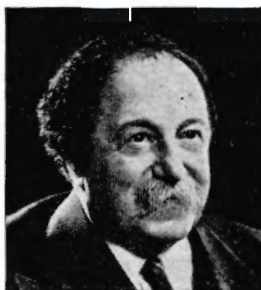

**MONTEUX**: *The Rite of Spring*—Stravinsky. San Francisco Symphony Orchestra. Album M/DM-1052, \$4.85. Full page in "TIME," March 24.



**STOKOWSKI**: *El Amor Brujo*—de Falla. Hollywood Bowl Symphony Orchestra, solo by Nan Merriman. Album M/DM-1089, \$3.85. "LIFE," March 3.



**WARREN**: *Pari Siamo and Cortigiani, Vil Razza Danata, Rigoletto*—Verdi. Record 11-9413, \$1.00. "TIME," March 10th issue.

Prices are suggested list prices, exclusive of taxes.



ALSO . . . your entire Red Seal release for March will be listed in the "LIFE" page . . . a service of big interest to your customers . . . of big value to you!

*Your RCA Victor Distributor*





▲ Customers utilize the bar box selector in the company's modern record division showroom. Stanley Kopicki, counterman, takes the orders.



Harvey Leist, manager of the order service department of the Ludwig Hommel Company's record division (left) takes stock of the record situation with Phil Muse, floor supervisor. Note shielded fluorescent lights which cut down eyestrain among department employees.



▲ Semi-annual inventory record reports are kept on electric accounting machines. ▼ Dealer looks at display of "how records are made."

## A DAY with a Disc Distributor

Ludwig Hommel Co., Pittsburgh, Pa., Columbia record distributors, celebrated its 40th anniversary recently. The firm services 600 record dealers in four states and thirty-eight counties, who in turn serve a consumer market of over four and one half million.

Part of staff of the record division shown using roller conveyor systems to fill orders promptly, and speed movements from filler to packer to shipper. The conveyor system is a new approach to the task of filling and shipping dealer's orders. Note fluorescent lighting.





# Record Merchandiser

**William Barrow Has Made Records Pay the Way by Ingenuity, Good Sales Sense and Smart Technique in His Long Island Store**

● William Barrow, proprietor of Barrow Music Shops, 25 Middleneck Rd., Great Neck, L. I., has made his original investment of \$378 for record stock pay off. His business today is in the \$50,000 sales yearly category.

His first stock of records was bought in 1927 and 1928. By 1935 the record sales began to make their mark on the profit side of the ledger. During the next three years business doubled each succeeding year and continued to increase at the sure and steady rate that prevails today.

The Long Island community in

Every available nook and cranny is used to best advantage in the Barrow's establishment. Note display and storage space.

which the Barrow store is located is composed of families in the above-average income group. Therefore, this dealer has been able to concentrate on the merchandising of classical music and albums, until these sales account for the greatest percentage of his business. Youngsters, however, find all the popular records they desire at the store. By attracting this "family" trade, Barrow has developed a good set of steady second and third generation customers.

The biggest jump in record sales occurred immediately after the manufacturers started to push the sale of combinations during the 30's. Barrow's present disc inventory is approximately \$20,000. He has a very satisfactory yearly turnover.

This dealer finds it necessary to keep a heavy slow-moving stock. Record connoisseurs, Barrow says, "want what they want when they want it." Since his store leans heavily on this trade, it has been worthwhile to keep quantities of chamber music and 18th century selections on hand. Mr. Barrow and his clerks continually strive for more of these sales. The record collector is looked on as a friend of the establishment's, and frequently follows suggestions that are offered.

## Self-Selection

Barrow has always been a firm believer in the value of open display. The first counter and display racks he ever used were built to order—designed with an eye to what Barrow calls, "keeping an open face to the public."

Clever planning of the physical layout of the store makes the most of the space available. Record racks and other display material are arranged on the oblong floor (22 feet x 55 feet), in a compact, efficient manner, giving an air of spaciousness to the surroundings. The outstanding display piece is a four-sided interlocking unit, with ample facilities for storage of records and albums, and with two record players and two sets of ear-phones for the customer's use. (See p. 72 for

detailed drawing of this outstanding unit designed by Mr. Barrow.)

Seven of these adaptable units are lined up in approximately the center of the store making an excellent "line of sight" display. The younger set, especially those who buy pop records, use these center aisle display-booths to best advantage. Popular selections are all stacked in such a way that self-service is no problem. The pockets are cut for 10 and 12 inch discs and are separated by a thin material. The disc titles are placed to the left. Breakage through mis-

Proprietor Barrow demonstrates his unique ear phones and record player set-up, combined with record storage display piece.

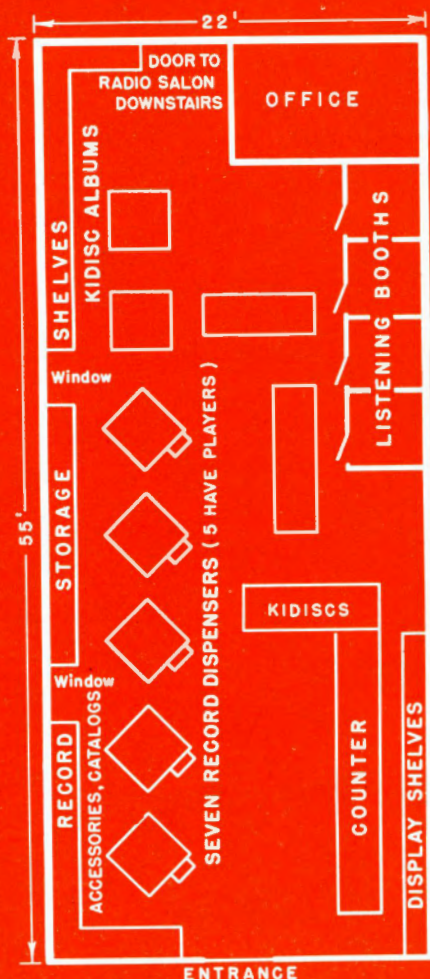
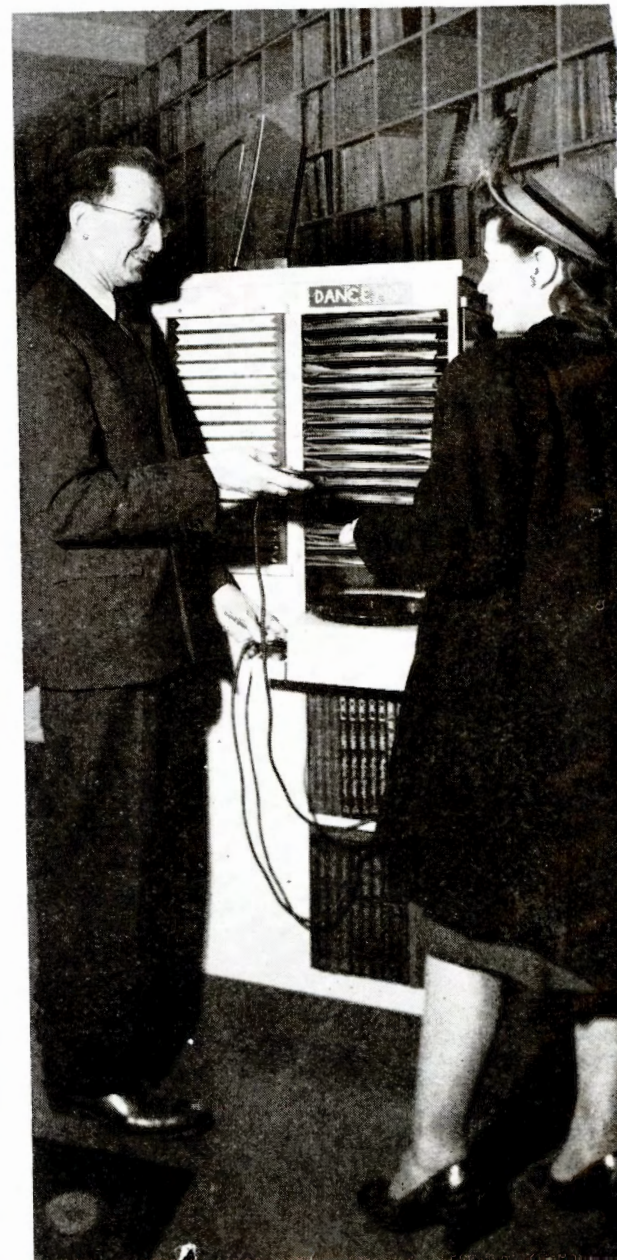





The younger set crowds into Barrow's store as soon as school lets out in the afternoon. Cultivating customers is an old Barrow's stand-by, and the youngsters are catered to as well as their parents. Mary Piskula, record manager, is in the immediate foreground.

handling is minor; and there are no teen-age hi-jinks and other capers.

The record players, also especially designed for Barrow, are placed at a convenient waist-high level. A non-kinking cord, heavy headphones, excellent motors and pickups are features of this installation. Barrow found that the best equipment gave the least trouble, and was cheapest in the long run.

The record player is installed on the front and back of the unit, and either one or two people can listen to each player. The other sides provide extra storage and display space.

#### Display Categories

Albums are placed in the open display sections on the left side of the store. These are grouped together according to subject matter, and vary according to season and stock on hand. Some typical Barrow groupings include: 1) Modern—jazz classics, jazz groups 2) Square dances, Westerns 3) Musical comedies 4) New classical recordings 5) Waltzes—concert, popular 6) Modern compositions and readings 7) Vocals 8) Children's. In the two window niches along this wall Mr. Barrow places albums which may need some pushing or highlighting.

To the right, as one enters the store, is a counter-display unit concentrating on pop records. Also

along this wall are four record booths, two for classical listeners, and two for popular listeners. The literature adorning the walls in these booths is in keeping with the types of records demonstrated. The booths are clean, large, and are equipped with amplifiers.

#### Storage System

A perpetual inventory is maintained on albums, and the less active records; "hot" records are counted daily. The pop discs are classified on the shelves according to manufacturer, and as soon as a platter goes out, it is immediately replaced. The reserve storage is kept numerically. Mr. Barrow estimated that a customer can walk into his store, and provided he has the record requested in stock, the purchaser can walk out with the disc under his arm in less than two minutes.

Three girl clerks comprise the record department, headed by Mary Piskula, assistant to Mr. Barrow. Barrow believes that women are better record sales clerks than men.

A staircase in the rear of the store leads to the downstairs Radio Salon. These rooms are carpeted, have walls of knotted pine, and utilize lamps and built-in bookcases to maintain a "homelike" atmosphere in which to show the floor models. Large combinations

are displayed in this main room, while an adjoining space is used for table model displays.

Barrow Music engages in local newspaper advertising and direct mail promotions. An open book on the counter invites interested customers to leave name, address, phone number and the type of music they prefer. Mr. Barrow sends out personal letters, monthly manufacturer bulletins, music reviews, and other popular disc reviews that appeal to the younger set. He finds that the resulting prestige and institutional advertising is well worth the original cost.

As for the future, Barrow is looking forward to days of expanding radio business and record success.

The main room of the radio salon below the record department is carpeted, has paneled walls, and is used to display console sets.

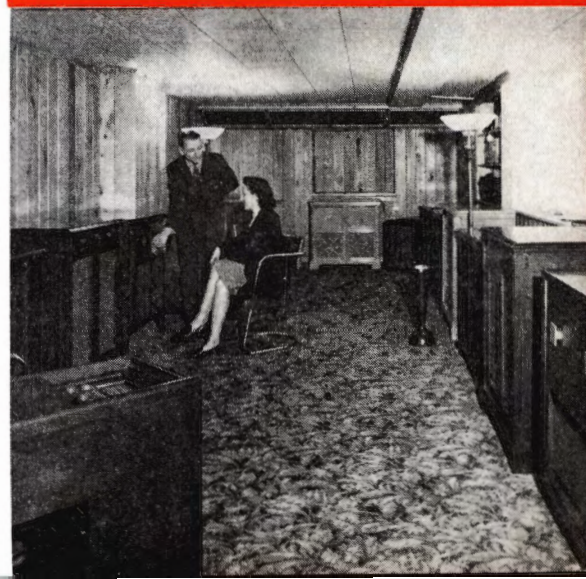





Fritz Reiner is leading the Pittsburgh Symphony Orchestra in its Columbia Records sponsored tour of the nation's cities.

## Discs Spin More

• "Super" promotions for the month of February have been planned by the record manufacturers to give selling that extra impetus and sparkle. In addition, a flock of new discs have been released that will undoubtedly catch the public fancy.

RCA Victor is engaged in an extensive tie-in promotion on the nationwide tours of the San Francisco Symphony Orchestra, under the direction of Pierre Monteux, the Minneapolis Symphony Orchestra with Dimitri Mitropolous conducting, and the Boston Sym-

phony Orchestra, Serge Koussevitzky wielding the baton.

### Publicity Offered

Promotional activities in connection with the three tours will include point-of-sale dealer aids, a tie-in merchandising program, on-the-spot advance exploitation, and consumer and trade publicity and advertising. Each orchestral tour will be backed by dealer kits, preparatory press books, containing photographs and ad layouts, and window tie-in merchandise displays.

The advertising and field sales heads at Victor have envisioned a completely packaged sales presentation for dealers and distributors.

The Minneapolis Symphony left from Milwaukee, and will arrive in Toledo, O., Feb. 3. From there it will cover cities in Pennsylvania and upper New York State, Ohio, Indiana, Illinois, Missouri, Iowa, Minnesota, S. Dakota, Montana, Washington, Idaho, Oregon, Utah and on through the states back to Minnesota.

The San Francisco Symphony Orchestra tour gets underway in March, from California, and then starts a cross-country trek that will take the group through Arizona, Texas, Alabama, Virginia, Maryland, Washington, D. C., New York, Massachusetts, Canada, and then on its way back to the Coast through Chicago, Iowa, Colorado, Utah, Oregon, Washington, Vancouver and California.

The Boston Symphony Orchestra will play in various cities along the eastern seaboard, and in Boston.

Featured on Victor's red seal list is a new Toscanini album containing Mozart's "Symphony No. 41 in C Major," and the "Air" from Bach's "Suite No. 3 in D-Major." Arthur Rubinstein has done an album of Chopin's "Sonata in B-Flat Minor." Sir Thomas Beecham has recorded Beethoven's "Symphony



A promotional campaign with many ramifications has been launched by Capitol Records to publicize "Tales Of Uncle Remus," the album which combines music and stories from the Walt Disney feature picture, "Song Of The South."



Dealers are encouraged to take advantage of the tours of three outstanding symphony orchestras that record for Victor. Shown are conductors Pierre Monteux, Serge Koussevitzky, and Dimitri Mitropoulos who will lead the various groups.

**Manufacturers Back Plans to Push Record Sales; Promotions Off to Big Start—Good Platter Pickings**

# Profits

No. 4 in B-Flat Major" in another outstanding Victor album.

**Additional Albums**

Other Victor red seal albums are: "Symphony No. 2 in D-Major," Brahms, with San Francisco Symphony, Pierre Monteux, conductor; Schubert's "The Maid Of The Mill, op. 25" featuring tenor Richard Crooks. Red seal singles include: Mozart's "Symphony No. 26 in E-Flat Major," Boston Symphony, Serge Koussevitzky, conductor;

Licia Albanese, in two Verdi arias.

Columbia's Pittsburgh Symphony has also started its great tour, under the direction of Fritz Reiner. Columbia promotion backing this tour includes complete coverage in each city the Pittsburgh Symphony hits. Publicity kits and photographs promoting the orchestra and its personnel are available, and have been designed to include natural Columbia tie-ins.

Promotional kits sent to distribu-

(Continued on page 68)



George Gershwin's immortal "Rhapsody In Blue" is Paul Whiteman's first release under his recently signed recording contract for Signature.

Katherine Dunham does an album of authentic music native to the Caribbean islands in her debut for Decca, entitled "Afro - Songs And Rhythms."

Deems Taylor, inset, does the commentary for Pilotone Records Academy of Music series, which will be a continuing succession of classical albums.





# Discs Spin More Profits



(Continued from page 67)  
 tors for dealers use to contain a 38 x 50-inch window display; six-album merchandiser card exploiting recent albums; tour folder; 2-color poster (6 feet x 18 inches); program ads and co-op ads to be made available.

Under the direction of Fritz Reiner (Vladimir Bakaleinikoff, associate conductor) the Pittsburgh Symphony gave its first concert in Ohio. In February the group hits Mexico City, Texas, Louisiana, Alabama, Georgia, Tennessee, Kentucky, West Virginia, and finally Ohio.

## New Releases

Releases of Columbia Masterworks feature a selection of vocal, operatic, and symphonic recordings. Included in the albums are: "Songs By Charles Trenet," sung in French; Artur Rodzinski, conducting the Philharmonic-Symphony of New York in Prokofiev's "Symphony No. 5"; Liszt's "Hungarian Rhapsody No. 2," Eugene Ormandy conducting the Philadelphia orchestra; Ezio Pinza with the Metropolitan Opera Orchestra in "Mozart Operatic Arias," sung in Italian; Robert Casadesus at the piano in "Preludes" by Debussy; Oscar Levant's recordings of the two pieces he performs in the film "Humoresque," the "Black Key" Etude of Chopin, and "Malaguena" by Lecuona. Also on the disc are Chopin's "Revolutionary Etude," and Poulenc's "Pastourelle." Frank Sinatra also does a piece of the Masterworks label, the "Soliloquy" from "Carousel."

"Woody Herman And His Woodchoppers" is the title of a new

Woody Herman album. Gene Kelly narrates "The Pied Piper of Hamelin" on a children's set.

Popular singles issued by Columbia include: Harry James' waxing of "Jalousie" and "The Man With The Horn"; The Modernaires with Paula Kelly "My Heart Goes Crazy" backed with "Connecticut"; Frank Sinatra's rendition of "That's How Much I Love You" flipover "I Got A Gal I Love"; Elliot Lawrence's orchestra in "They Can't Convince Me" and "Let's Put Our Dreams Together."

Capitol Records has issued the "Tales Of Uncle Remus" album, from Walt Disney's "Song Of The South," featuring Johnny Mercer, the Pied Pipers, and the original cast. This album is receiving tremendous manufacturer-backing. More than 4,000 window displays have been issued, magazine, newspaper, and dealer ads have been published, radio and movie tie-ins as well as other promotional helps have also been utilized to give the album every publicity benefit possible.

## Pop Singles

New Capitol singles have been recorded by Andy Russell, Peggy Lee, Clark Dennis, Jesse Price, Wingy Manone, and Merle Travis. The Pied Pipers have waxed, "You Can't See The Sun When You're Crying," "Make Me Know It."

Other Capitol singles include: Martha Tilton, "Connecticut" backed with "How Are Things In Glocca Morra"; Margaret Whiting warbling "Beware My Heart" and "What Am I Gonna Do About You?"; Jo Stafford's "September

(Continued on page 73)

Reading from the top, down, and over to the right we find the following artists featured on some of the current recordings: Diamond's virtuoso of the keyboard, Jan August; King of Calypso, Wilmouth Houdini, who has recorded a new album for Apollo; basso Adia Kutznetzoff, Disc Co.'s singer of "Gypsy Songs of Russia"; Martha Raye recently signed with Cardinal Records; Tommy Riggs and little Betty Lou, of De Luxe's "A Child's Garden of Manners" album.



68



# HERE'S THE BUILD-UP

in  
LIFE  
THE SATURDAY EVENING  
POST  
TIME

**RECORD NEWS!**

10 performances to be remembered! 10 great interpretations of popular classics by the leading artists of our day... artists and orchestras who like scores of others now are recording exclusively for Columbia Masterworks Records!

**FRITZ REINER**  
conducting the Pittsburgh Symphony Orchestra  
Symphony No. 2 in B Major  
Columbia Masterworks Set M-108-517 \$4.50\*

**EDDO PINZA** with **BRUNO WALTER**  
conducting the Metropolitan Opera Orchestra  
Hector Berlioz: Te Deum  
Columbia Masterworks Set M-108-518 \$4.50\*

**ROBERT CASADESUS**  
Debussy: Prelude—Book II  
Columbia Masterworks Set M-108-544 \$3.25\*

**Charles Trenet**  
with orchestra conducted by M. D. D. D.  
Songs by Charles Trenet  
Columbia Masterworks Set M-108-519 \$3.75\*

**MORTON GOULD**  
and his Columbia  
Masterworks  
Columbia Masterworks Set M-108-545 \$4.50\*

**LILY PONS** with orchestra  
conducted by  
André Malancol  
Paris  
Columbia Masterworks Set M-108-520 \$3.50\*

**ALEXANDER SCHNEIDER** and **RALPH KIRKPATRICK**  
Hector: Double for Violin and String Quartet  
Columbia Masterworks Set M-108-521 \$3.50\*

**NELSON EDDY**  
singing in four-part harmony, with Trenton Pettit, soprano  
Opera: The Lark  
Columbia Masterworks Set M-108-522 \$3.50\*

**Maryla Jonas**  
Piano Music of Chopin  
Columbia Masterworks Set M-108-523 \$3.50\*

**MAURICE EVANS**  
Shakespeare: Hamlet—On Cassio  
Columbia Masterworks Set M-108-524 \$3.50\*

\*Hear these five late releases at your Columbia dealer's today. Then turn to the new Columbia Record Catalog for thousands of other wonderful interpretations of great music by these and many more distinguished Columbia artists.  
\*Set prices shown are estimates of issue.  
Distributed by Columbia, "Masterworks" and CBS Reg. U. S. Pat. Off.

FRITZ REINER . . . one of the great conductors of our time, inspired leader of the famous Pittsburgh Symphony Orchestra.

He wants you to enjoy great music recorded at its best....so **FRITZ REINER**  
is recording exclusively for **Columbia Records**  
MASTERWORKS

## FOR YOUR FEBRUARY *Masterworks* BUSINESS

Another great list of new Columbia Record releases—as presented to an audience of more than 23,000,000 readers—*thousands in your immediate neighborhood!* Check through the "Playbill" above.

contact your  
**COLUMBIA RECORDS**  
DISTRIBUTOR  
for stock



# Leading Songs of the Day

Tune Surveys, Radio Programs and Current Movies Show Dealer What Public Wants

• Changes in the popularity of the tunes the nation is humming are continually taking place. New songs appear on the scene, those that have run their gamut drop out, while a few perennial favorites linger melodiously on.

Top tuner, "A Gal In Calico," from the motion picture, "The Time, The Place, And The Girl" is available on platters featuring Bing Crosby, Johnny Mercer and the Pied Pipers, Benny Goodman, Tex Beneke and Louis Prima.

Some songs making their debut on RADIO & Television RETAILING's popular song survey for the first time are from popular movies; others have caught the public's fancy because of an exceedingly good score or set of lyrics.

## Top New Numbers

"Sunset To Sunrise" has been heard on the air waves frequently these past few weeks. "Uncle Remus Said," that novelty ditty from Walt Disney's "Song Of The South," is catching on fast, along with other bit songs from the film. Woody Herman, Tex Beneke and Monica Lewis have recorded this tune on single discs, while albums of music from the cartoon-picture are available from Capitol, (featuring Johnny Mercer, the Pied Pipers, and the original cast), as well as from Cosmo.

"Years And Years Ago" has been waxed by Les Brown's orchestra, Dick Haymes, Tony Martin, Bob Chester and Phil Brito. "And So To Bed," another newcomer, has been done on wax by Artie Shaw and Skitch Henderson. Freddy Martin, Kay Kyser, and Guy Lombardo have recorded "Managua Nicaragua."

Also new this month is "You'll Always Be The One I Love" which

songbirds Dinah Shore and Betty Rhodes warble on Columbia and Victor discs respectively. Betty

## THE NATION'S FIRST 50 TUNES ON THE AIR

Listed in Order of Their Popularity  
(RADIO & Television RETAILING'S Own Survey)

Current Ranking		Trend of Popularity
1	A Gal In Calico	↗
2	The Old Lamplighter	↗
3	Ole Buttermilk Sky	↗
3	Zip-A-Dee-Doo-Dah	↗
4	Oh, But I Do	↗
5	The Whole World Is Singing My Song	↗
6	For You For Me Forever More	↗
7	The Things We Did Last Summer	↗
8	For Sentimental Reasons	↗
9	It's All Over Now	↗
10	Rumors Are Flying	↗
11	You Keep Coming Back Like A Song	↗
12	It's The Talk Of The Town	↗
13	September Song	↗
14	Sooner Or Later	↗
15	Either It's Love Or It Isn't	↗
16	I Guess I'll Get The Papers	↗
17	Five Minutes More	↗
17	I'll Close My Eyes	↗
18	In The Blue Of Evening	↗
19	Same Time Same Place	↗
20	I'll Never Love Again	↗
20	Sunset To Sunrise	↗
20	Uncle Remus Said	↗
21	Coffee Song	↗
21	In My Merry Oldsmobile	↗
22	Smoke Dreams	↗
22	This Is Always	↗
23	Years And Years Ago	↗
23	And So To Bed	↗
23	Blue Skies	↗
23	This Time	↗
24	The Best Man	↗
24	Anybody's Love Song	↗
25	Passé	↗
25	Rickety Rickshaw Man	↗
25	You Are Everything To Me	↗
26	Flying Home	↗
26	Managua Nicaragua	↗
26	South America, Take It Away	↗
27	Twilight Time	↗
28	Kaye's Melody	↗
28	The Night Shall Be Filled With Music	↗
29	Everybody Loves My Baby	↗
29	Somewhere In The Night	↗
29	Twilight Song	↗
29	You'll Always Be The One I Love	↗
30	Pretending	↗
31	On The Other End Of A Kiss	↗
32	Save Me A Dream	↗

Hutton and Buddy Clark have both made platters of "On The Other End Of A Kiss." "The Night Shall Be Filled With Music" and "Flying Home" are other new tunes.

Going strong on the popularity

polls, with some promising to get better are: "The Old Lamplighter"; "Ole Buttermilk Sky"; "Zip A De Do Dah"; "Oh But I Do"; "For Sentimental Reasons"; "Either Its Love Or It Isn't"; and "Sooner Or Later."

Coming up fast from the bottom of the list of "top tunes" are: "Pretending"; "Everybody Loves My Baby"; "You Are Everything To Me"; "The Rickety Rickshaw Man"; "Anybody's Love Song"; "The Best Man"; "This Time"; "I'll Never Love Again"; "In The Blue Of Evening"; and "I'll Close My Eyes."

## HIT PARADE TUNES

(Songs Featured on Lucky Strike Air Show)

A Gal In Calico  
For Sentimental Reasons  
For You, For Me, Forever More  
Ole Buttermilk Sky  
Rumors Are Flying  
The Old Lamplighter  
The Things We Did Last Summer  
The Whole World Is Singing My Song  
You Keep Coming Back Like A Song  
Zip-A-Dee-Doo-Dah

## MOTION PICTURES PROVIDE AMPLE DEALER TIE-INS

Films listed all feature outstanding hit tunes which have been recorded by a variety of artists. Watch for movies to hit local theatres—then cash in on added box-office appeal:

Blue Skies  
Canyon Passage  
Carnival In Costa Rica  
Dead Reckoning  
Down To Earth  
Duel In The Sun  
I'll Be Yours  
I've Always Loved You  
Jolson Story  
Knickerbocker Holiday  
Humoresque  
My Heart Goes Crazy  
Margie  
New Orleans  
Night And Day  
Smash-Up  
Song Of Scheherazade  
Song Of The South  
Sweetheart Of Sigma Chi  
Till The Clouds Roll By  
The Best Years Of Our Lives  
The Shocking Miss Pilgrim  
The Fabulous Dorseys  
The Time, The Place, And The Girl  
The Thrill Of Brazil  
Three Little Girls In Blue

## NAMM Trade Show

The National Association of Music Merchants (NAMM) 1947 Convention and Trade Show will be held June 1-5, at the Palmer House, in Chicago.

The management is considering giving a special radio-phonograph show at the Stevens Hotel, featuring phonograph-radios, phonograph records and accessories.

## Haynes-Griffin Store Names Fred Kolmetz

Just appointed by Haynes-Griffin, prominent New York radio-appliance store, is Frederick Kolmetz, as advertising manager to head up the concern's new promotional and expansion department. Mr. Kolmetz was formerly general manager of Liberty Music Shops, New York City, where he was for 12 years.

George P. Lohman, the Haynes-Griffin president, said that the firm is planning an energetic expansion program, and will shortly take over additional space in the same building at 391 Madison Ave. He said the firm will enlarge its activities in the record and radio field, and that Mr. Kolmetz will direct the expanded departments as promotional head of the company. Haynes-Griffin is now 24 years old.



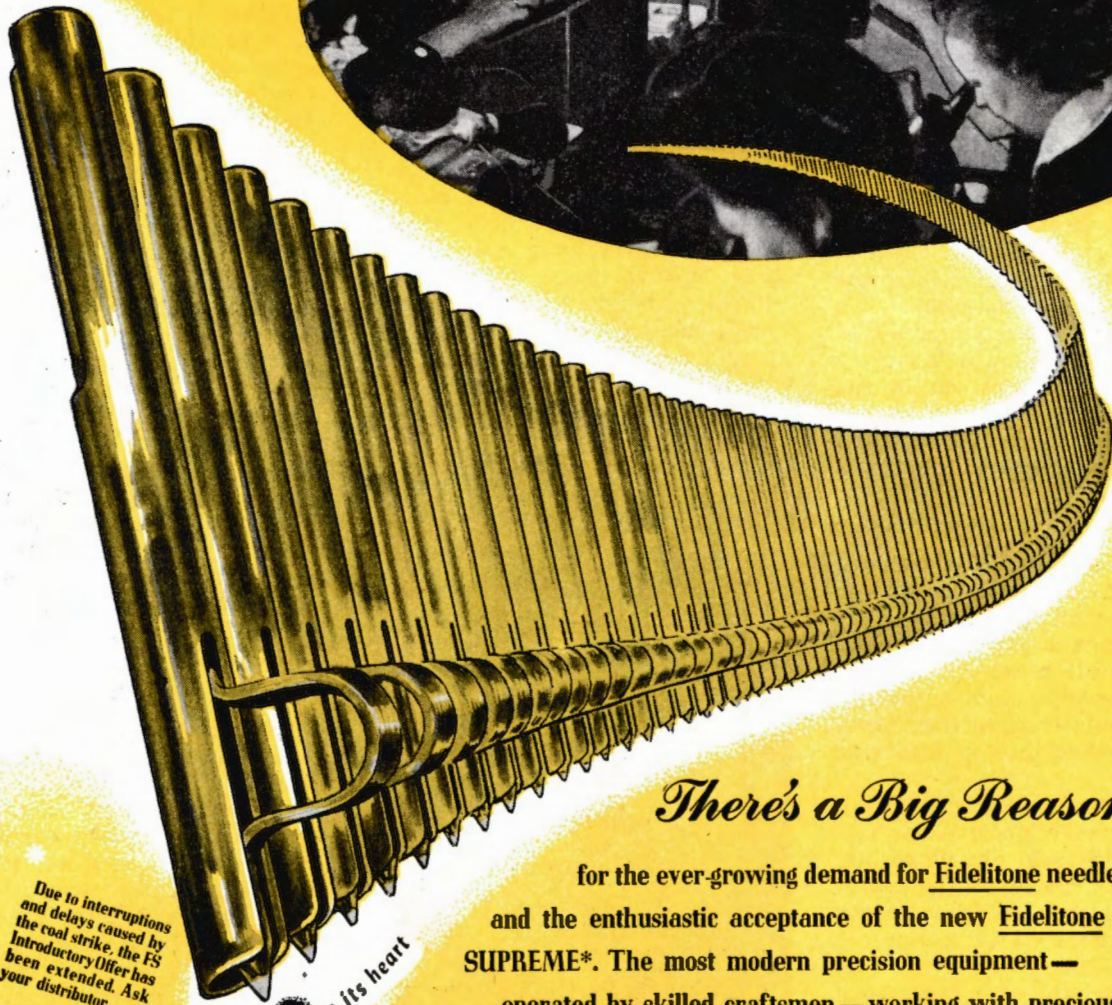

Due to interruptions and delays caused by the coal strike, the FS Introductory Offer has been extended. Ask your distributor.

the needle with  Spring in its heart

**\$250**

Beautifully packaged in a useful record brush



**PERMO, Incorporated**  
CHICAGO 26

More Permo Needles sold than all other longlife needles combined

## *There's a Big Reason*

for the ever-growing demand for Fidelitone needles and the enthusiastic acceptance of the new Fidelitone SUPREME\*. The most modern precision equipment—operated by skilled craftsmen—working with precious metals—producing patented designs—regularly inspected during and after manufacture—is the answer.

All this assures the finest needles—of unvarying uniformity—the most for the money; assurance to you of repeat patronage.

The greatest needle of them all is

# Fidelitone Supreme

FLOATING  
POINT  
NEEDLE



# Display Units That Pay

**Proper Use of Record Racks Can Speed Selling, Save Energy, and Reward Dealer with Extra Cash**

• Time saved is profit gained for the record retailer. Any selling device that will enable the dealer to take a short cut to that ultimate objective—the sale—is well worth thinking about.

In this respect the introduction of "self-service" to disc sellers proved a boon. Supplemented by "suggestion" when necessary, open displays are still the most effective and quickest means of selling the bulk of record merchandise.

The problem of keeping stock as part of display, of showing a variety of singles and albums out in the open, and of maintaining an attractive store interior, is a situation that every dealer has to cope with.

## Various Models

Record racks have been designed in large and small models, and in conservative and ornate styles. Some dealers plan their own, others order those suggested by the record manufacturers, and still others go to private construction companies who specialize in this type of work.

To show the largest selection in the least possible space is the aim of most retailers in choosing their display racks. Some of the better known styles include: The revolving rack on a metal stand. Sometimes with storage space around the core of the display; the easel type (good for windows, and in narrow spaces); the "V", with strips nailed across the front to hold the albums

or singles. This display is built on a step-up basis and holds approximately 6 records per shelf.

Other popular models are: Album display stands. These have straight backs for placement flat against wall, slanting fronts, and several ledges. Compartments are usually found on the bottom for storage space; single displays which can be placed at several key spots in the store, and which are designed specifically to "push" items. Stock racks, counters and show-cases are

also made to combine any of the aforementioned features.

In designing his own fixtures, the dealer must keep the needs of his own particular store uppermost at all times. Retailers have taken a basic type of display piece and added a record player, or additional storage space; some have built sides and a top to simulate a "doll house" around a fixture to promote kid-discs.

The various record manufacturers have been very enterprising in this matter of helping the dealer save time in selling records. "Record merchandisers" for storing single records, albums, or both are readily available. Floor plans illustrating store layouts, and the ways and means for handling display and storage problems are the dealer's for asking. Jobbers' salesmen are equipped with pictures of the record racks to simplify dealer orders.

## Many Advantages

In addition, certain private companies specialize in the construction of record racks and feature patented innovations which aid in the display and sale of records.

Time-saving devices which the record retailer employs to help him speed the sale of his merchandise need only be limited by his own ingenuity, the time required to "suggest a sale", and the actual physical effort involved in getting the record, wrapping it and collecting the cash.



▲ Wm. D. Barrow (see story p. 64) designed this unique display-storage-record player piece.

Alma D. Kraushaar, disc sales manager for Haynes-Griffin, New York City retailers, designed this display stand for children's records. Total capacity, 500 albums. Each side shows 48 titles, holds 96; bottom of stand has capacity of 308 albums. The piece is 6 ft. long, 2½ ft. wide, 5 ft. 3 in. high.

▼ RCA Victor has available for interested dealers a complete variety of display racks. A "scale model" suggested floor plan is shown.

The A. Bitter Construction Co., New York City, manufactures a variety of display pieces for records. Shown is a standard unit, model 115, especially designed for open display and self-selection. The unit is 60 in. wide, 55 in. tall, contains 25 pockets, each holding 15 records. Capacity is approximately 600 records.





## To Capitol Records Post



George W. Oliver, who has been named head of Capitol's advertising and promotion division, succeeding H. W. Woodmansee.

## Disc Profits

(Continued from page 68)

Song" flipover "It's As Simple As That."

Making her debut on Decca Records is Katherine Dunham, in a unique album of "Afro-Caribbean Songs and Rhythms." Another new Decca album is Carmen Cavallo's "All The Things You Are."

Decca singles feature: Hildergarde's warbling with Guy Lombardo on "Sidewalks Of New York" and "Sweet Rosie O'Grady"; two other Lombardo singles couple "The Anniversary Song" with "Uncle Remus Said" and "All The Things You Are" flipover "Long Ago"; Bing Crosby's styling on "Who Threw The Overalls In Mrs. Murphy's Chowder" backed with "It's The Same Old Shillelagh"; Judy Garland vocalizing "It's A Great Day For The Irish," and "A Pretty Girl Milking Her Cow."

Signature Records announces that Paul Whiteman has been signed to do a series of works on the Signature label. Mr. Whiteman's first album will be the "Rhapsody In Blue" with Earl Wilde featured on the piano in this Gershwin score. Johnny Long has renewed his Signature contract with first scheduled platters, "Life Can Be Beautiful" flipover "How Are Things In Glocca Morra" and "Paradise" backed up by "Hawaiian War Chant."

Signature's Skinnay Ennis has recorded "Oh, But I Do" with "So Would I" on the reverse side.

Pilotone Records has invaded the classical disc field with a continuing succession of albums to be known as the Academy Of Music series. The first two albums to

(Continued on page 77)



Model MX Smooth Power Motor

ENCLOSED FIND

# Smooth Power

The new die-cast bearing brackets on *Smooth Power* MX Phonomotors make them all 'round better motors. They allow more accurate centering of the motor in the field, which results in an even torque and aids in the elimination of vibration.

This improvement is typical of the advanced engineering that features our complete line of motors, recorders and combination record-changer recorders. Their quick pick-up to full, constant speed, their quietness and freedom from vibration and wow . . . all will delight you and your customers.

Your own fine products will give *smoother* performance when they're equipped with *Smooth Power* mechanisms.



THE GENERAL  
INDUSTRIES CO.

DEPARTMENT MX

ELYRIA, OHIO



# Selling Disc Changers

Product Knowledge a Must With the Retail Merchant

This interesting article on record changers was written especially for RADIO & Television RETAILING by Lee Bunting, sales manager, Garrard Record Changers.

• The record changer is a mechanical device which requires your most careful consideration. Dozens of mechanisms designed to change records automatically are now available. Some of them ought never to reach your sales floors, while others are potential sources of countless service calls, dissatisfied customers and intangible losses for some time to come. Of course, there are others that give excellent service, and therefore are a tremendous asset to the retailer. The wise dealer will become schooled in what constitutes a really good changer, so that he can counsel his customer, backing up his recommendations with sound, logical reasoning.

The major part of your reputation depends on the type of equipment you sell, and it goes without saying that one important determining factor in a modern combination is a "better-than-average" automatic record changer.

## Must Do Three Things

Any record changer must, obviously, perform three functions in addition to rotating the turntable:

(1) At the completion of each record the arm must be moved *completely* clear of the record stack.

(2) The next record must be brought into playing position on the turntable.

(3) The tone arm must swing in and contact the new record at the beginning of the record grooves.

The three functions listed above are fundamental, so we will not discuss them to any extent other than to caution that the tone arm must be dealt with *gently* at all times; that it should be lifted *vertically* from the record after the *entire* record has been played; and that it is moved out well beyond the radius of the following record. This is extremely important, because some changers have the tendency to get slightly out of timing or adjustment, with the result that the next record lands on top of the tone



Lee Bunting

arm. In addition, when the arm moves into position to play the following record, it is important to note whether it is gently lowered into position straight down to the music grooves, or whether it is simply allowed to drop down.

Other points of importance are listed below, for a check-off and will be discussed hereafter:

1. Correct motor speed
2. Motor rumble
3. WOWS
4. Record slippage
5. Record squeak
6. Number of controls
7. Automatic Stop
8. Trip mechanism
9. Stylus used
10. Change cycle time
11. Pick-ups
12. Capacity for records
13. Tone arm resonance
14. Longevity

**CORRECT MOTOR SPEED:** Since all records are cut at an exact, established, fixed rate of speed, it is essential that the record changer operate at exactly the same rate of speed if the reproduction is to sound like the original. An excellent changer is one that *can be* adjusted to an exact speed of 78 r.p.m., under any condition of line voltage, and that will maintain this correct speed whether the turntable is carrying one record or the entire load.

There are some changers manufactured to specifications which allow a wide variance in turntable speed, so that the one-record speed

is considerably above 78 r.p.m. in order to compensate for the 8 to 10 r.p.m. reduction in speed resulting from a full load. In other words, the changer may run at 84 r.p.m. with one record on the turntable, but slow to 75 r.p.m. under a full load of records.

**RUMBLE**—Rumble (or the grinding sounds frequently heard during pianissimo sections of recordings) is usually the result of poor motor design, or inferior shock mounting, so that all the vibrations of the motor are passed on to the pick-up.

**WOWS**—A wow is that wavering effect which is so noticeable and objectionable when listening to sustained notes. It is caused by even the slightest change in turntable speed. Wows can be caused by many things, including poor motors which simply are not capable of the work required of them. One way to minimize wow is to get a lot of flywheel action into the turntable, so that the tiniest difference in the power transmitted from motor to turntable does not become evident.

**RECORD SLIPPAGE**—Record slipping or skidding while on the turntable is fairly common to some changers, and results in wavy reproduction even though the turntable may be revolving at a proper rate of speed. Some manufacturers are now considering the use of felt or anti-slip rims for records to eliminate this. Special spring grips right in the spindle also reduce the possibility of slippage.

**RECORD SQUEAK**—If the record spindle rotates in the center of the stacked records which are waiting to be played, or if the records on the turntable rotate around a stationary spindle, squeaking may occur. Some of the more expensive mechanisms are equipped with a spindle which has a rotating collar for the records on the turntable, or provide for the entire spindle to rotate.

**NUMBER OF CONTROLS**—The new trend in design has been simplicity of controls and many manufacturers today plug the fact that *only one control is required*; this is called a start-reject knob. Where two or more controls are used, it is

(Continued on page 80)



# WEBSTER NYLON PHONOGRAPH NEEDLE

*Nylon*

A New and Revolutionary Idea  
in Needle Design, Construction and Performance

... with the *Knee-Action* Nylon Cushioned Jewel Tip!

- ★ Nylon knee absorbs distracting needle scratch and surface noises.
- ★ "Knee-action" permits jewel tip to ride record groove in a gentle, floating motion.
- ★ Floating action of nylon knee improves needle tracking at both low and high frequencies.
- ★ Self-damping property of nylon knee reduces harmonic distortion.
- ★ Nylon knee creates vertical cam action of the tip which eliminates groove slapping.



Nylon knee absorbs vertical shocks caused by the pinch effect of the record grooves; it levels out horizontal shocks of needle "bounce." Nylon "knee-action" creates a gentle, floating needle ride—in effect like the smooth ride of the modern motor car.



**1** A revolutionary nylon knee that produces a floating "knee-action" which absorbs and reduces needle scratch and surface noises and prolongs record life.

**2** A top quality, hand-polished sapphire jewel tip, precision-machined to an extremely close tolerance to assure consistency of product and the complete satisfaction of discriminating music lovers.

**3** A light-weight, great-strength aluminum shaft that fits securely in the pickup without danger of twisting or loosening.

## *Incomparable Results...*

FOR MUSIC LOVERS... FOR INCREASED SALES

Protects valuable records from unnecessary wear... gives greater effectiveness to the superior playing qualities of the jewel tip... virtually eliminates breakage of sapphire tip by accidental dropping... greatly lengthens needle life... produces a pleasing, harmonious tonal balance... yields a minimum of needle talk... delivers a remarkably authentic record reproduction.

### Nationally Advertised!

Watch for national advertising for the Webster Nylon Phonograph Needle. And ask your distributor for free advertising cooperation.

### A DISTINCTIVE JEWEL CASE FOR THE INDIVIDUAL WEBSTER NEEDLE



You'll like this completely different, vest-pocket size jewel case, smartly styled of lustrous, clear plastic. A compact container for pocket or purse. And a handy, permanent case in which to keep an extra needle.



**WEBSTER**



**CHICAGO**

5610 Bloomingdale Avenue, Chicago 39

Now... as always... Webster means finer record reproduction



# New Phono Lines

Latest Disc-Playing Equipment & Accessories

## Jackson PHONOGRAPH



"The Jiver" Model 4001 electric portable ac phonograph, playing 10" or 12" records manually. Audio power output of 2 watts, self-starting 78 RPM constant speed noiseless synchronous motor with 9" flock-sprayed turntable. Astatic crystal pickup, 5" PM dynamic speaker. Tapered volume control. Flush mounted needle cup; extra long line cord. Case of 3/8" plywood with rounded corners, streamline design with two-tone covering of brown Levant and eggshell leatherette. Measures 12" by 12 1/2" by 7"; weighs 12 lbs. Jackson Industries, 1708-16 S. State St., Chicago 16, Ill.—RADIO & Television RETAILING

## Peerless HAS-O-RAK

Hassock-and-record-rack combination providing for storage of fifty 10" or 12" discs. Hinged drop-front door has Peerless Junior Record Rack attached, so that rack slides out when door is opened and records are easily accessible without operator rising from hassock seat. Sturdy construction with rounded sides and 3" padded seat; covered with simulated leather in variety of colors. Rack has disc index for easy identification. Offered as space-saver and an aid in avoiding breakage and dust. Suggested

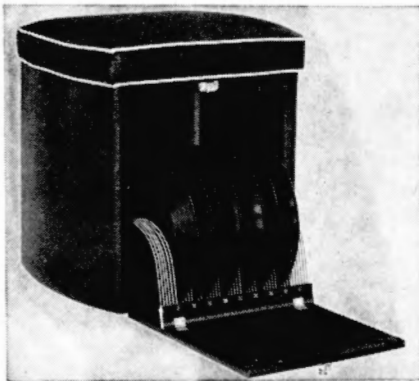

list price is \$22.95, slightly higher west of Rockies. February deliveries. Peerless Album Co., Inc., 352 Fourth Ave., New York, N. Y.—RADIO & Television RETAILING

## Kiddi-Trola PHONOGRAPH

"Carousel" model electric record player designed especially for youngsters. Lightweight acoustic tone arm, needle cup with two needles, on-off switch, 6-ft. rubber line cord. Engineered for simple and fool-proof operation; large tone chamber. Will handle any size record. Circular case decorated with carousel designs—available in several

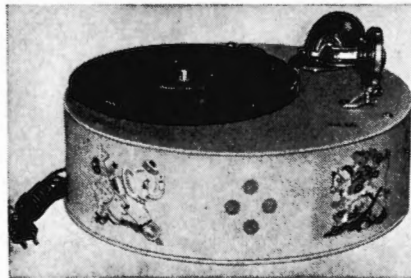

color combinations—pink & blue, silver & blue, and gold & red. Lists at \$18.95. Herold Mfg. Co., Inc., 1 Romney Place, Scarsdale, N. Y.—RADIO & Television RETAILING

## Webster PHONOGRAPH



Model 60 table phonograph unit with automatic record changer. Full range tone control; master switch for "warm-up" of amplifier before starting of amplifier. Equipped with new Webster Nylon sapphire-tipped needle. Housed in all-metal cabinet of hammered gold finish. Lightweight design for easy carrying from room to room—weighs 16 1/2 lbs. Retail at \$49.50. Webster-Chicago Corp., 5610 Bloomingdale Ave., Chicago 39, Ill.—RADIO & Television RETAILING

## Birch PHONOGRAPH

"Nottingham" Model 308 portable electric record player, with 8" speaker built into cover. Hand-rubbed hardwood motorboard and speaker housing; heavy plush lining for record storage compartment. Three tubes, Astatic tangent pickup, rim-drive motor. Flocked grilles front and back of speaker, needle cup with snap-tight cover, sturdy



lid stay. Embossed catalin plate, plastic switch knobs, genuine leather handle, ultra-modern design grille set into cover. Tailored luggage-style case covered with heavy simulated leather. Measures 20 1/4" by 6 3/4" by 13". Boetsch Bros., 221 E. 144th St., New York, N. Y.—RADIO & Television RETAILING

## Mutual RECORD PLAYER

"Kiddy phonograph" produced especially for youngsters comes with 8" or 9" turntable, mechanical tone arm. Needle cup with snap lid. Entire design presented as electrically safe and fool-proof. Packed individually in air cushioned cartons. Retail at \$18.50 including tax. Mutual International Corp., 11 W. 42nd St., New York, N. Y.—RADIO & Television RETAILING

## Capitol 3-WAY PHONOGRAPH

Model U-24 portable record player, with amplifier operating on either ac or dc or on battery. Has both electric and spring-wound motor. High-gain amplifier, Alnico 5 magnet type speaker, constant-speed electric motor. Crystal pickup, protection fuse, continuous var-



iable tone control, needle with osmium alloy tip. Capitol Records, Inc., 1483 Vine St., Hollywood, Calif.—RADIO & Television RETAILING



## Wallerstein Sees Boom Record Sales Year

Edward Wallerstein, president of Columbia Recording Corp., Bridgeport, Conn., was elected to the board of directors of the Columbia Broadcasting System, Wm. S. Paley, the board chairman announced. Mr. Wallerstein has been head of Columbia Records since its organization in 1939.

On the basis of results achieved in 1946 and plans already set for

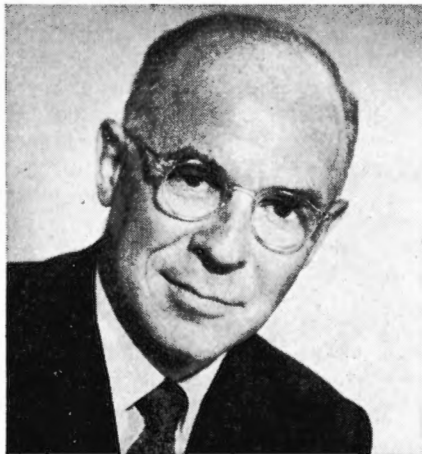

Edward Wallerstein

1947, Mr. Wallerstein expects the coming year to be the greatest in Columbia's history.

Because phonograph records are low-priced products sold to the mass market, representing a basic cultural desire of the American people, Mr. Wallerstein believes that the state of the record industry is also a barometer of general business trends. "As such, the increase in the sale of records, both Masterworks and popular, is a reflection of a vast reconversion of our people to peacetime buying habits," he said.

## Disc Profits

(Continued from page 73)

reach the market featured Edvard Grieg's "Holberg Suite," with Rudolph Ganz conducting the Metropolitan Symphony Orchestra, and Franz Joseph Haydn's "Farewell Symphony," with Erich Leinsdorf.

The album sets of four Vinylite discs each have explanatory comment by Deems Taylor on the first side.

Diamond Records has issued a new Jan August album entitled "Piano Magic." Selections included are: "Make Believe"; "Some Of These Days"; "Tea For Two"; "Melancholy Baby"; "Ol' Man River"; "A Pretty Girl Is Like A Melody."

(Continued on page 78)

**KEEP DUOTONE UP FRONT...**

**FOR GREATER SALES AND PROFITS!**

**HERE'S THE DUOTONE DIAMOND, NUMBER ONE NEEDLE IN THE DUOTONE PARADE!**

**F**OR customers who want the best, recommend the unchallenged leader among all jewel-tipped needles. The Duotone Diamond makes music sparkle with full-range beauty . . . every voice and instrument recreated in golden tones. It performs superbly for years and years—the only needle that plays shellac and Vinylite records interchangeably without wear.

So, spotlight the Duotone Diamond. Keep it up front and cash in on Duotone's reputation for quality products and fair prices. Unconditionally guaranteed. \$50 retail. Write direct for the name of your distributor. Other Duotone Needles from 10¢ to \$5.

The Duotone Line includes the world's largest variety of phonograph needles, Duodisc recording blanks, cutting needles and recording accessories.



**DUOTONE**

DUOTONE COMPANY

799 Broadway, New York 3, N. Y.  
Stephen Nester, President



EXPORT DEPARTMENT: American Steel Export Co., Inc., 347 Madison Ave., New York 17, N. Y.

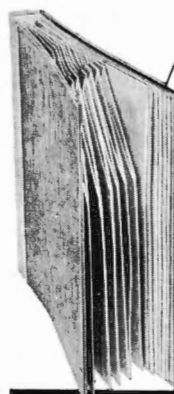

REG. U. S. PAT. OFF.

with

**"TIP LOC"**

THE SLIP PROOF, BREAK PROOF SAFETY FEATURE

Exclusive with REC-ALBUM, Records won't fall out. Most advanced type DISK-ALBUM made. 10" & 12" storage, package type from 2, 4, 6, 10 or 12 heavy Kraft envelopes which lay flat with edges recessed. Merchandise your album space with NEW, FRESH & SMART REC-ALBUMS. The album they're all talking about. See your jobber or Write . . .

**L. H. SYMONS ASSOC.**

345 HUDSON STREET,  
NEW YORK 14, N. Y.



## Pittsburgh Symphony Display Material



The above display material has been sent to Columbia Records dealers for use in conjunction with the nationwide tour of the Pittsburgh Symphony Orchestra. The kit consists of a yellow and black streamer measuring 65" x 14", a picture of the entire orchestra 50" x 20" and smaller cards listing different Columbia recordings by the orchestra.

### New Prices for Record Dealers' Booklet

Record Sales Service Co., 33 Coulter Ave., Ardmore, Pa., announces its new price list for its booklet, "Record of the Month," published monthly and sold to one subscriber only in each city.

Lots of 1000 per month, standard edition, blank back cover, \$23.85 per M; 2000 per month, \$22.90 per M; 3000 per month, \$22.10 per M; 4000 per month, \$21.50 per M; 5000 per month, \$21 per M. Prices include store name, address, etc. Prices are also available for special printings.

### Permo Executive on Tour

Trade showings of the Fidelitone moving picture, "Points of Distinction" have recently been staged among dealers, distributors and salespeople in California, Colorado, Arizona and Texas by E. C. Stephens, vice-president and general sales manager of Permo, Inc., 6415 Ravenswood Ave., Chicago 26, makers of the Fidelitone phonograph needle.

Mr. Stephens made an extended tour through numerous cities in those areas, exhibiting the talking movie and noting widespread applause from the trade.

### Famous Voices on Heritage Series



J. L. Hallstrom, general merchandise manager, RCA Victor, makes presentation of the firm's initial set of Heritage Series discs to the Metropolitan Opera Guild. With him, l. to r., are Mme. Frances Alda, Mrs. John Bradley, and Mrs. William Gibbs of the Guild.

## Disc Profits

(Continued from page 77)

Other Diamond albums, (discs of which are also sold singly) are: "Samba Album" with Jose Cortez and his orchestra; "Hillbilly Album" featuring Ed Yates and Caleb Coy and the Bush Mountain Boys.

Wilmouth Houdini, the King of Calypso, has signed an exclusive recording contract with Apollo Records. His first release is "Moan, People, Moan," backed by "Bobby Sox Idol." His first album is "King Houdini & His Calypso Parliament." Pancho and his orchestra, and the Murphy Sisters have waxed "Miami Beach Rhumba," "La Mulata, Arrebata," and "Hey Ai Yea." Other Apollo singles have been made by Ann Bond, Bobby Gregory and his Cactus Cowboys, Willie Bryant, Ben Smith, Babe Wallace and Artie Sims.

Disc Co. of America's album of "Gypsy Song Of Russia" features the basso, Adia Kutznetzoff, accompanied by Basil Fomeen orchestra. Adelaide Van Wey, contralto, sings "Creole Songs" in the authentic Creole patois in another Disc album. Another in the series of Disc jazz albums is "Muggsy Spanier And Orchestra."

Mercury Record releases feature Frances Langford warbling "I Haven't Got A Worry In The World," and "Time On My Hands"; Harry Cool's orchestra in "It's Dreamtime" backed by "Cecilia"; Albert Ammons and his Rhythm Kings doing "Deep In The Heart Of Texas Boogie" and "Sweet Patooty Boogie"; and Tiny Hill's version of "Somebody Stole My Gal" backed by "Aintcha' Tired."

### Plans Series

Sonora is planning a new black label record to retail for 39c. Artists on this new label will include George Towne, Roberta Lee, Gerry & Sky, Snub Mosley and Roy Smeck. Others will be added to the roster from time to time.

New Sonora releases are by the Gordon Trio, "Managua Nicaragua" flipover "Jealous"; and "Caravan" backed with "Lullaby Of The Leaves"; Maya and his rhumba Ambassadors do "Gu-Tu-Ru-Gu" reversed by "Por Causa De Las Mujeres" and "Mi Bumba Ne" backed with "Rumbomba"; Eddie Barefield, Jesse Rogers, and Joe Biviano and quintette are featured on other Sonora singles.

(Continued top of next page)



Cardinal Records, a new recording firm, has announced its first release to be Charlie Barnet's rendition of his two hits "Cherokee" backed up by "The New Redskin Rhumba." The company has signed a three-year deal with Martha Raye and will release an album entitled "Martha Raye Visits Charlie Barnet And His Orchestra In Hollywood."

Other Charlie Barnet singles recorded by Cardinal are "Juice Head Blues" backed by "Darktown Strutters Ball"; "Caravan" and "I've Got It Bad"; "Charleston Alley" flipover "Bunny."

#### New Sides

Duke Ellington has recorded two new sides for Musicraft entitled "Tulip Or Turnip" and "It Shouldn't Happen To A Dream." Other Musicraft singles are Artie Shaw's "Connecticut" and "Don't You Believe It, Dear"; Sarah Vaughan's vocalizing on "September Song" and "Moonlight On The Ganges"; Dizzie Gillespie plays "Emanon" and "Things To Come"; Phil Brito sings "They Can't Take That Away From Me" and "Far Away Island"; Mel Torme renders the ballads "It's Dreamtime" and "You're Driving Me Crazy."

DeLuxe Records announces the release of children's album "A Child's Garden Of Manners" featuring Tommy Riggs and Betty Lou. Fourteen verses about "lessons in manners" are woven together in this album. New DeLuxe singles include: "Bear Creek Hop" and "You've Had A Change In Your Heart," Whitey & Hogen; "Anniversary Song," backed by "Bayou Mood," Russ David; and two new Denver Darling releases, "A Dollar Ain't A Dollar Anymore" backed with "Ding Dong Polka" and "Cool Water," flipover "My Little Buckeroo."

National Record releases include:

(Continued on page 82)

#### Cardinal President



Harry W. Bank announces the formation of a new recording company, Cardinal Records, Inc., New York City. Mr. Bank founded Cosmo Records, Inc.

*Eye Appeal* THAT ATTRACTS  
— PERFORMANCE THAT SELLS



MODEL 60



W E B S T E R

## Phonograph WITH AUTOMATIC RECORD CHANGER

Your customers will buy — and enjoy — this phonograph the year 'round. Newest member of the Webster family, Model 60 is built with the famous Webster care. Performance sells it — quality keeps it sold. Model 60 features the popular Webster Model 50 record changer, 3-tube amplifier with full compensating tone control, and a 5-inch permanent magnet speaker. Here's tone quality usually found only in much larger, expensive phonographs. See your distributor today.



Moves right off your counter

WEBSTER  CHICAGO

5610 Bloomingdale Avenue, CHICAGO 39, ILLINOIS  
33 years of Continuous Successful Manufacturing



## RCA Victor's 1947 Ad Budget Hits Record High

RCA Victor Record's 1947 national advertising—based on the largest budget allocation for this purpose in company history—will pioneer in new fields of record exploitation and media, according to J. W. Murray, vice-president in charge of RCA Victor record activities.

National ad schedule as released by J. M. Williams, advertising manager, calls for invasion of newspaper comic supplement field with color insertions regularly scheduled for a Sunday newspaper group embracing combined circulation in excess of 30 million. New twist to the comic supplement ads, scheduled to run throughout 1947, will be cartoon dramatization of RCA Victor popular record personalities, among them Tommy Dorsey, Freddie Martin, Perry Como, Vaughn Monroe, as an added filip to popular record advertising in

consumer magazines and the heaviest trade-paper campaign undertaken to date.

## Album-of-the-Month Club

A "packaged" record-album-of-the-month club is being made available to dealers throughout the country. The detailed mechanics of the plan are centrally handled for franchised dealers by the Record-Album-of-the-Month Associates Inc., 250 W. 57th St., New York City. Customer-members are procured for dealers through national advertising.

Selections - of - the - month are chosen from among the releases of the major record companies and announced in the club's Record Review. When orders are tabulated, they are sent to the various regional associate dealers for filling from their own stock via their regular delivery service.

## Walco Dealer Aids

Electrovox Co., Inc., 31 Fulton St., Newark 2, N. J., has issued a new folder describing its Walco "400" series phonograph needles. Also mentioned is its complete kit of sales stimulators for dealers including literature, newspaper mats, displays, and other promotional aids. A copy of the folder can be obtained by writing to the company.

## Design New Disc Labels

A new "spinning" design for its record label is announced by Black & White Recording Co., Inc. The record label is being produced in black on white for the company's popular lines and in silver on black for its higher priced line. Children's discs will carry a special silver on dark blue.

Bruce Altman is director of sales promotion, advertising and publicity.

## Selling Changers

(Continued from page 74)

important that the customer be schooled in their proper manipulation.

**AUTOMATIC STOP**—The automatic shut off after the last record, has been used on the more expensive mechanisms for several years. This is a definite feature, since the tone arm always stops in its correct resting position.

**METHOD OF TRIP** — There are two general types of trip, the velocity and the ratchet. The velocity trip seems to be preferred, since it trips only on completion of the music grooves and depends upon an accelerated movement of the tone arm and not on the eccentric groove, found on most records. This velocity trip will trip immediately upon the completion of the music grooves without waiting on the long spirals found on many 12-inch records leading into the center eccentric. Thus they give a more rapid change cycle.

### Permanent Needles

**PERMANENT vs. REPLACEABLE NEEDLES**—All changers should use a permanent point needle so the selection really becomes one of whether the needle can be replaced without changing the entire cartridge. The advantage of the replaceable needle is its cheaper replacement cost. On the other hand, the advantage of the permanent needle stylus is that a worn needle

causes the customer to replace the entire cartridge, which may have been damaged by rough handling or excessive heat. The disadvantage is, of course, the increased cost of replacing the cartridge.

**METHODS OF CHANGING NEEDLES**—Where the replaceable needles can be used see if means are provided for easily changing the needle. This is accomplished by allowing the tone arm to be raised to a complete vertical position or by a "swivel" head which will bring the cartridge and needle into full view.

**PUSHER vs. KNIVES**—The slicer or knife type that pioneered the industry, damaged some records and built up a certain amount of sales resistance. Customers who have experienced difficulty with the knives or slicers, can be sold the newer pushers instead. It should be added here that the newer design of the knife type is greatly improved over the early methods and should do a satisfactory job, providing it is well designed and produced under rigid inspection.

**CHANGE CYCLE TIME**—The new trend is toward a rapid change cycle with many manufacturers claiming 4 and 5 seconds. This fast change cycle is definitely a selling point. However, see that gentle handling of the tone arm and records is not sacrificed in order to speed up the cycle.

**PICK UP USED** — Many paragraphs can be written on the pick-up, since there are many types and

models made by the different manufacturers. We will not try to list and discuss all of these as to frequency response, durability etc., but suggest that you check the pick-up used to see that the weight of the needle on the record is not excessive. It should be in the range of ½ to 1½ ounces. Frequency response curves can be supplied if desired from the manufacturers, but most customers will depend on the listening test. At any rate, the cartridge or pick up is considered separate from the mechanism. Some changers can be supplied with a selection of cartridges. This is a good feature, for it allows you to cater to a prospective customer's personal preferences.

### Record Capacity

**CAPACITY OR NUMBER OF RECORDS**—The capacity to handle a large number of records is desirable only if other equally important points are not sacrificed. Most machines carry a capacity of 8 to 12 records and the points to watch are:

(a) Excessive weight that increases center hole wear or pusher type machines where the records rest on the spindle shelf or step.

(b) As the stack increases, the needle angle must change more and more from one record to 12, and hence the angle becomes worse at the extreme limits.

(c) As the capacity and weight of the records increase, a greater

(Continued on page 160)



## "Nylon Knee" Phono Needle Now Ready

A new type phonograph needle, with its knee-section made of nylon, has been introduced by Webster-Chicago Corp., 5610 Bloomingdale Ave., Chicago 39, Ill. The nylon,

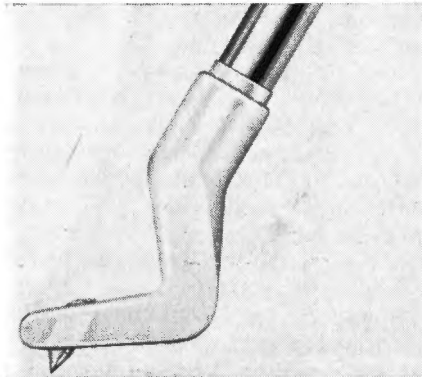

Webster-Chicago Needle.

which has valuable self-dampening qualities, is used between the aluminum shaft and the sapphire tip as a special "knee" to absorb vertical shocks and horizontal bounce.

The needle is designed to suppress mechanical resonance, needle scratch and surface noise—also to improve tracking at low needle pressure. Webster says that it also prolongs the life of the sapphire

tip, and emphasizes high fidelity. It's packed in a clear plastic jewel case; the firm also has a permanent plastic display case.

## Concert Hall Albums

Concert Hall Society, Inc., has announced a new series of general release albums. The first three releases, on Vinylite, are: Grieg's "Sonata In A Minor For Violoncello and Piano"; Prokofieff's, "Music For Children," featuring pianist Ray Lev; Beethoven's "Irish Songs" with Richard Dyer-Bennet as soloist.

## 1947 Winner



Stephen Nester, Duotone Co. president, and director of International Sound Research Institute, presents latter group's annual diction award to actress Ingrid Bergman.

## Crown Publishers Offer Living Language Records

Crown Publishers, Living Language division, 419 4th Ave., New York 16, N. Y., have available for retailers complete language courses in French and Spanish. The 20

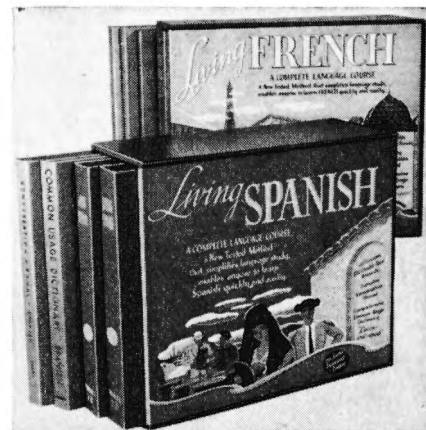

Albums and books came attractively packaged.

double faced records contain 40 lessons. The records can be played on any phonograph. The complete unit contains two books—a conversation manual, and a common usage dictionary. The entire set fits any record shelf. The course retails for \$29.50.

# NEW... Improved Model 355A-1



## PORTABLE PHONOGRAPH

with all the features your customers are looking for!

- Smallest AC automatic record changer phono with 3 tubes energized by power transformer. 5 watt output.
- Improved portability. Special grip clip to prevent damage to tone arm while carrying.
- New "phantom" pilot light.
- Inclined sounding board improves reception.
- New trouble-free, foolproof automatic record changer. Careless handling won't throw tone arm out of adjustment.
- Dual Channel Input . . . two separate amplifiers blended by electronic tone control for perfect record reproduction.
- 6 1/2" Alnico Speaker. Minimum AC hum.
- Attractive leatherette covered case.

Made by America's oldest manufacturer — devoted exclusively to the creation of electric phonographs.



A model to suit every music lover's preference . . . every purse.

- #301—Portable —\$39.95
- #302—Table Model—\$43.95
- #350—Portable —\$47.85
- #351—Table Model—\$51.95

**\$69<sup>95</sup>**

Inc.  
Fed. Tax

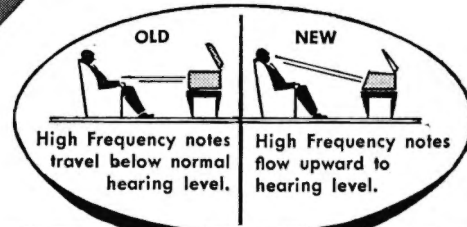

**STEELMAN RADIO CORP.**

742 EAST TREMONT AVENUE  
BRONX 57, NEW YORK

(Big producer for U. S. Army during war years)



# MULTIPLY YOUR MOVES WITH alliance MOTORS



• Millions of Alliance Phonomotors made for the radio industry bring mass-production "know-how" to the manufacture of Alliance Powr-Pakt Motors . . . motors from less than 1-400th h.p. on up to 1-20th h.p.

And so, besides driving turntables, record changers and tuning devices, Alliance motors are vital power links in modern operations which call for more motion—remote control—automatic action!

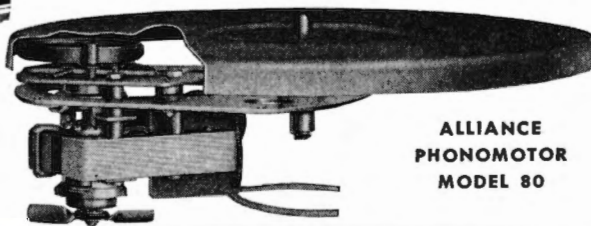

ALLIANCE PHONOMOTOR MODEL 80

WHEN YOU DESIGN ... KEEP

## alliance

MOTORS IN MIND

ALLIANCE MANUFACTURING COMPANY • ALLIANCE, OHIO

### PHONO and CHANGER CABINETS



Changer Cabinet ..... \$11.95  
Phono Cabinet ..... \$8.95

Assemble your own phonographs and changers and make that extra profit. Vaughan's cabinets are the finest you can buy. Attractive and well built they are quickly sold when displayed. Cabinets are covered with heavy Levant leatherette (washable) and trimmed with latest hardware and fittings.

Motor board 14 x 14½. Will play 12" records with lid closed. Also room for small radio or amplifier. Speaker opening takes 5" or smaller. Overall 14½ x 15½ x 9 high.

Changer board 15½ x 15½ large enough for any changer. Large compartment for amplifier radio or both. Overall 20 x 16 x 10. Speaker opening takes 6" or smaller.

Order Today — Cash or C.O.D.

**VAUGHAN CABINET CO.**  
3722 N. Clark St. Chicago 13, Ill.

### R-L SPECIALS for IMMEDIATE delivery

#### WIRELESS PHONOGRAPH WITH AUTOMATIC RECORD CHANGER



No wires to connect. Just plug in and play through radio. 45 minutes of uninterrupted plays of 10 or 12 inch records without reloading. For 110V. 60 cycle operation. Complete with open type walnut veneer cabinet. Shipping weight 14½ lbs. B6200 Net, each \$27.06

#### RADIO—PHONOGRAPH COMBINATION

Includes 5 tube Superhet Radio Single Post Automatic Record Changer which will play either ten 12" records or twelve 10" records, continual action. Forty-five minutes of solid entertainment housed in choice of Hardwood Walnut



finish Cabinet or beautiful light Swedish Modern Wheat color.  
B6204—Walnut Finish—Net each ..... \$54.50  
B6203—Wheat Finish—Net each ..... \$55.50

Write for Free Parts Catalog



731 West Washington Boulevard  
Dept. R. CHICAGO 6, ILLINOIS

### Disc Profits

(Continued from page 79)

Joe Turner and his Boogie-Woogie Boys, "Miss Brown Blues," "I'm Sharp When I Hit The Coast," Dick Thomas & Santa Fe Rangers, "Rose Of The Alamo" flipover "A Lonely Cowboy's Dream"; Amory Brothers, "There Is No Breeze," backed with "Caravan."

New Cosmo releases feature: Tony Pastor doing "You Should Have Told Me" and "Whispering"; Larry Clinton's versions of "Three O'clock In The Morning," backed with "Poor Butterfly," Gertrude Niesen's warbling of "Temptation" flipover, "Gee It's Good To Hold You"; and the Sleepy Valley Five in "You're My Last Sweetheart Darlin'" and "Prairie Polka."

Two new Key Note albums are: "Piano Contrasts" featuring Bernie Leighton and "Magyar Gipsy Melodies" with Alexander Haas and his Budapest Gipsy Ensemble. Key Note singles are by George Barnes, Joe Thomas, and Sir Lancelot.

Stinson Trading Co. has announced the release of a new album of Hebrew liturgical music "Cantorial Songs," sung by the South American Cantor Pincas Borensztein.

#### Add Tunes

Modern Music releases in the blues and boogie field include: "Just In Case You Change Your Mind" by Jim Wynn backed with "Organ Grinder Swing"; "No—Name Jive Part I and II" done by Jerry Brent; "Temptation" and "Roll Em" another Jerry Brent waxing; Hadda Brooks vocalizing "You Won't Let Me Go" flipover "Basin Street Blues."

Annette Warren has signed an exclusive Black & White recording contract. Her first release is "Am I Blue," "Lots Of Luck To You." Other Black & White discs feature Helen Humes & All Stars "Be Ba Ba Le Ba Boogie," "Married Man Blues"; Jack McVea & his all stars "Open The Door Richard" and "Lonesome Blues"; Earle Spencer's "Bolero In Boogie" and "Production On Melody" and Phil Moore's "Mood Indigo" flipover "Ain't Misbehaving."

Releases by Vogue, the picture record, are: "A Man, A Moon And A Maid", and "The Cuban Yodelin' Man" with Enric Madriguera; "I Love You In The Daytime Too" backed by "Clementine"; "All By Myself" flipover "Sniffle Song", Frankie Masters; "If That Phone Ever Rings," backed by "The Whif-fenpoof Song", Art Kassel.



# ELECTRICAL APPLIANCES

Section of **RADIO & Television RETAILING**

## Get Set for "Time" Sales

**Ready Credit Arrangements for Increase in Instalment Selling**

• Instalment selling on a large scale is coming back. Although Regulation "W" is still in effect imposing restrictions on down payments and repayment time, the return of unrestrained credit dealings draws nearer as supply catches up with demand. The end of the sellers' market will see the elimination of credit controls and a large increase in instalment transactions.

About 75 to 80 per cent of all pre-war radio-appliance purchases were on a credit basis. An equal volume of "time" sales (if not more) is expected after restrictions are withdrawn. It is therefore necessary for the retailer to get ready now

Appliance buyers will shop for attractive credit terms. Be ready with finance plans.



to handle instalment selling.

The planning of the merchant's instalment set-up should be clear to him. He should:

1. Know his credit requirements based on the anticipated sales volume.

2. Decide upon the type of institution which will finance him (finance company or local bank).

3. Provide facilities for interviewing customers buying "on time".

4. Provide for follow-ups or collections (if necessary).

Conditions under which instalment sales were arranged have changed since pre-war years. The radio-appliance dealer should familiarize himself with the revised contracts, new lending agencies, different rates, and new features which may affect him or his customers. Keep abreast of finance changes.

### **Inductments Sew Up Sales**

Expanded instalment selling will see a revival of finance plans, in new or altered form, which the retailer should know in order to clinch credit sales. Three of these among others, are: "Add-on" plans whereby customers may buy additional appliances without further down payment; farm plans, especially tailored for rural folk; "skip-payment" feature whereby the first instalment is due long after the signing of the contract.

Tactful handling of patrons buying on the instalment plan is necessary in order to avoid offending them, and to protect the merchant. Courteous treatment of customers is a "must" not only for selling on credit but for all sales.

A secluded place on the sales floor

or, best of all, a separate office should be available where patrons can divulge their financial status in private.

It is important that the dealer or his salesman get all the necessary credit information from the customer. Having to contact the patron for additional data after an interview may prove embarrassing to him as well as the retailer.

### **Keep Eye on Salesmen**

Overselling a radio or appliance may prove to be a boomerang to the dealer. Exaggerated claims may "bounce" the appliance back to the merchant and leave an irate prospective buyer instead of a satisfied customer.

Care should be taken to guard against unwarranted changes in the contract made by over-anxious salesmen intent on making a sale. This type of "editing" may cost the retailer much money.

In arranging for instalment sales with an institution, the dealer should be able to stock, display and demonstrate in his store, enough merchandise without tying up his capital. Terms often permit him to place a radio or appliance in a prospective buyer's home even though it hasn't already been paid for.

The merchant should be sure that his lending agency can offer him the same attractive terms which his competitors' have, and that his contracts are intelligently administered. He must deal with a finance company (or bank) which will consult him first in all cases of repossession, payment delinquencies, etc., in order to protect himself and to maintain good customer relations.



Now! Sperti switches on the advertising power for you

... ON THE SENSATIONAL SUPER-POWERED 575-WATT

# Sperti 2-in-1 ULTRA-VIOLET-INFRA-RED LAMP!

MODEL S-200

**USE SPERTI'S GENEROUS COOPERATIVE ADVERTISING PLAN TO CASH IN ON THIS BIG NATIONAL ADVERTISING**

Join the thousands of dealers who are running local tie-in advertising on this cooperative plan . . . let your customers know your store is local headquarters for this sensational lamp.

**A sure best-seller for the worst-of-winter months ahead. More than 15 million people will read about it regularly in The Saturday Evening Post, Collier's and Time**

Big, dramatic advertising in America's most widely-read weekly magazines will be selling your customers this sensational Sperti 2-in-1 Lamp that provides ultra-violet or infra-red at the turn of a switch.



Route those customers into *your* store by tying-in with this tremendous national advertising campaign. Plan your own campaign on the Sperti 2-in-1 Lamp in your local newspaper. Use the generous Sperti Cooperative Advertising Plan that makes your advertising dollars do double duty. For full details, write, wire or phone your distributor. If you don't know his name, write Sperti, Inc., Cincinnati 12, Ohio.

**2-IN-1 FEATURES MULTIPLY SALES!**

- Super-powered, 575 watts • Operates on AC or DC • Genuine mercury arc • Separate infra-red • Streamlined stand adjusts to any height or position • Designed by a world-famous scientist • Approved by Underwriters' Laboratories

**RETAIL \$48.50 complete with scientifically-tested goggles and instruction book**

PRODUCTS OF **Sperti Inc.** CINCINNATI 12, OHIO • RESEARCH • DEVELOPMENT • MANUFACTURING

**Also stock the new super-powered 600-watt Sperti Sunlamp (Model H-300)**

One of the fastest-tanning sunlamps ever made for home use. Operates on AC or DC, genuine high-intensity mercury arc. Completely adjustable stand. Retail \$64.50 complete with scientifically-tested goggles and instruction book.

Also display the sensational Sperti 560-watt Portable Sunlamp. Compact as a camera. Tans fast. Retail at only \$37.50





# What's New in Lighting

Specialty Lamps Being Actively Promoted by Nation's Leading Manufacturers

• Though the shortage of popular size incandescent electric light lamps continues, the manufacturers are keeping up their large-scale advertising campaigns. Copy featuring good lighting as a health necessity, stressing the low cost of replacement bulbs and current to operate them, as well as plugging new type and new purpose bulbs is being used.

The something new in the lamp picture today is the all-out drive to sell more therapeutic bulbs to the public, and to educate them to the proper use of baking and sunlamps.

General Electric has cut the price of its infrared bulb from \$1.60 to \$1.25, and is featuring the reduction in copy in consumer magazines. GE also sells a new safety type heat lamp for \$2.95. Advertising to consumers stresses the fact that there are dozens of other uses for infra-reds besides their health purposes. For example, GE points out that they can be used to dry nail polish, hair, paint, glue and small laundered articles. GE has also readied a new 7 ounce infrared which it will sell at \$2.25.



General Electric continues to plug the sale of infra-red lamps, stresses various uses.

Dealer helps on GE's infrared campaign include an attractive four-color counter display piece, a window streamer, a consumer folder, newspaper mats and an envelope stuffer.

The "don't be a bulb-snatcher" angle is being continued by GE for its incandescent line. Latest dealer material on bulbs for the home includes a colored feature display, a streamer, bulb basket and a counter bulb holder.

A couple of new special purpose Westinghouse lamps are attracting wide attention. One of these is the bacteria-destroying Sterilamp, a type which is designed to be suspended on the wall by picture hooks. Another is the midget ultra-violet bulb which is mounted inside the cabinet of the household refrigerator. The lamp emits bacteria-killing rays and emits ozone. Pulling three and a half watts, the lamp operates only when the compressor is running.



Rigid testing of Westinghouse sunlamps insures uniformity and efficiency.

Westinghouse has been actively promoting sales of its infrared line too. The spatter proof lamp sells for \$2.95; the regular, \$1.25. Consumer advertising in all sorts of mediums is being used by the company and a number of new dealer helps have been released, among them a sign and merchandiser for fluorescents and a basket for displaying both incandescent and fluorescent lamps. The before-mentioned pieces are all-metal.

The Verd-A-Ray Corp., Toledo, Ohio, is helping its dealers in selling its new Penetray line of infra-reds. The pyrex model sells at \$3.50; No-glare ruby at \$3.60; amber at \$2.00. Other types retail for \$1.60 and \$1.25. Promotion material available for dealers consists of a counter merchandiser, folders, window streamers and advertising mats. The company is offering to pay half the cost of advertising the dealer runs—any size.

The campaign on Verd-A-Ray's insect-repellant lamp commences this month.

A new type of electric light bulb which promises to revolutionize the use of portable lamps and double the amount of useful light distributed by them, as well as provide added reading comfort, has been announced by B. K. Wickstrum, sales manager of the lighting division of Sylvania Electric Products

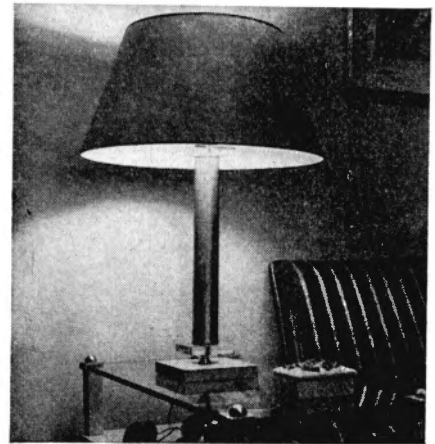

Easy to demonstrate and easy to sell is the new Sylvania Bolite bulb. It converts lamp to indirect light.

Inc., at opening of the Sylvania lighting center in New York City.

Every portable floor and table lamp can be made an indirect lighting unit by replacing the conventional globe-shaped bulb with the new Sylvania 200-watt Indirect Bolite bulb. Moreover, because the new bulb provides its own diffusion, the need for bulky and heavy diffusing bowls used with some present indirect type lamps will be eliminated.





# "Country Style"

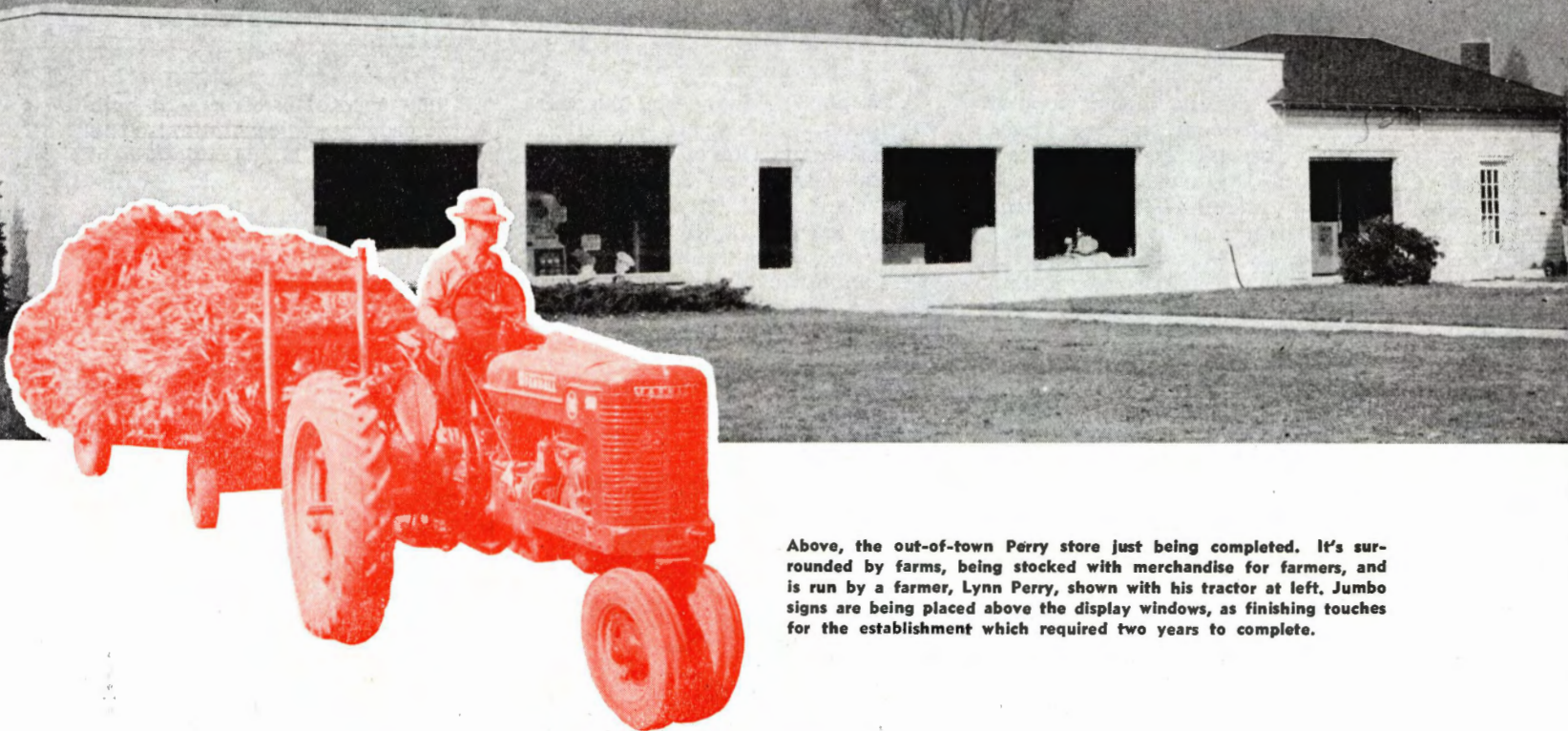

Above, the out-of-town Perry store just being completed. It's surrounded by farms, being stocked with merchandise for farmers, and is run by a farmer, Lynn Perry, shown with his tractor at left. Jumbo signs are being placed above the display windows, as finishing touches for the establishment which required two years to complete.

## **Ohio Retailer Has Developed Facilities and Methods for a Money-Making Emphasis on Farm Merchandising**

● South of Ashtabula, Ohio, on Route 46, is a modern, showy brick building with big plate glass windows—an unusual sight among the many farms of the area. The newest electrical appliances are visible behind the glass front, even from the highway.

This appliance store, "stuck right out in God's country," is the work of Lynn Perry, owner-manager, who also runs a 350-acre farm on the other side of the rural black-top. Sound merchandising principles have already given this business, recently housed in the gleam-

ing, tile-brick structure, a rousing send-off.

"I've at last got the store and show room that I've always wanted," smiles Mr. Perry, taking off from filling a silo to comment on his appliance business, "but I've hammered away for years to get my name well known in this area as someone who knows electrical appliances and how to service them. Direct, personal contact is the most valuable point in selling yourself to rural people.

"I've gotten extra help on the farm when special calls came in

for service on appliances, and I've gone out myself all hours of the day and night to put something right so that those living away from the city can have their appliances working right."

### **In Step With Neighbors**

This policy is based on the principle that the farmer can't wait very long for things to be done for him. He must plant his crops at a certain time, milk cows daily at the proper time interval, harvest the wheat when it is ripe and not later. That's the kind of work he does, and he likes to have that kind of work done for him.

"Also, I let well-known brands work for me," continued Mr. Perry. "I'm now carrying a complete line of nationally advertised appliances, for instance, and of course these products are being promoted day and night, in newspapers, magazines and on the air. This way I keep the name of my main line of products constantly in front of my buyers, and it is done rain or shine, whether the products are immediately available or not."

---

## **Farmers Need These Electrical Products**

**Germicidal Lighting**

**Fence Controllers**

**Animal Clippers**

**Barn Ventilators**

**Milking Machines**

**Stable Cleaners**

**Grinders**

**Brooders**

**Churns**

**Pumps**

**Motors**

**Welders**

**Seed Cleaners**

**Hay Dryers**

**Water Heaters**

**Milk Coolers**

**Egg Candler**

**Soil Heaters**

*Plus Complete Home Appliances*

---



# Appliance Business Pays

Mr. Perry figures that he will be successful in selling many rural people, largely because of handling reputable merchandise and understanding the farmers' needs. He feels so strongly that the farmer needs his electrical equipment as soon as it can possibly be given to him, that his showroom is practically empty. One of his advertisements in a nearby community newspaper put it this way:

**"Why Our Showroom Is Nearly Empty—**We believe in the business principle of selling every item we get as soon as we can sell it. Therefore, we usually do not have a showroom full of merchandise. Instead, our items are out working for our customers. General Electric Appliances. Farm and Dairy Equipment. Lynn M. Perry. State Route 46—New Lyme."

## Careful Planning

Work was completed on the store last spring, after about two years of painstaking planning and gathering of materials. Some of the glazed-face bricks which line both the exterior and interior of the

walls were gathered piecemeal and stored in a hen-house until work could begin.

Mr. Perry hired some expert labor, but did much of the construction himself. Sales floor space, measuring 30' x 70', is entirely of concrete and was laid in a from-morning-till-midnight operation. The ceiling was constructed of especially strong timbers with no interior pillar supports. The timbers will hold up under the heavy snows known to this part of the country. Celotex on the ceiling is insulated with rock wool to aid in economical heating.

## For Local Selling

The basic structure of the building is one which features strength and simplicity, and Mr. Perry had enough of a personal hand in it to keep the quality uniform, in these days of material shortages. And the interior plan is appropriate to the location—a pleasant showroom without too many frills.

Heating will be done through hot-air vents in the ceiling, fed from an oil-fired furnace in a

stockroom to the side of the sales room. Large fluorescent lights give the interior a striking appearance after dark. The color trim of the interior brick walls is in white, green and black, in that order, from the ceiling down.

The private offices and sales counter on the end of the sales room are constructed of walnut and mahogany timber that lay in a nearby forest for a number of years. It now has a high glossy finish and draws many favorable comments from customers.

## Specialties Stocked

Among the lines handled are water systems, low vacuum milkers, automatic water heaters, portable compressors, food freezers, oil stoves, milk coolers, hand trucks (used primarily for moving heavy appliances but also for sale), barn equipment and electrical stable cleaners.

"We've found that the farmer who buys some of our merchandise and then gets good, personalized follow-up interest and service can be developed into a customer who will come again and again and tend to buy everything needed on the farm right here from our lines," said Mr. Perry. "That's the kind of business we are cultivating and that will keep us going."

## More Lines Coming

"We are thinking of adding a model kitchen in a complete unit, taking up a large portion of our sales room. Although sales of this won't be very frequent, it seems to us that the margin of profit and the tie-in sales will more than make up for the time and space used."

The exterior of this store, to be known as Perry Electric, Sales and Service, is rapidly becoming a show place in its own right. Shrubbery of various kinds, flowers and evergreens are included in the landscaping around the building, and a large front lawn (the store sets back from the highway about 50 feet) bisected by a neat concrete walk seems very inviting to passing motorists.

Although most of the space in the Ashtabula, Ohio, store is used for floor display of a great variety of bulky farm equipment, some counter room has been provided for smaller items.





# Cut Costs of Display

**Get More Profit from Sales Floor; Here's a Simple Way to Analyze Store Area, Chop Selling Expense of Each Section**

• Few dealers are going "broke" today. But as they view the ever-increasing space their display lines are taking up, and begin to think what they are paying their landlord or tax collector, they say they are getting "bent"—by rent.

Because of the competition for stores and storage space, dealers report they are paying substantially higher rentals. This is especially the case with new dealers in the larger shopping centers.

This condition makes it imperative for the dealer to analyze every bit of space in the store to see that it pays its way. His most pressing problem is to decide how much space to allot to his growing appliance displays, since they are bulky items, but he may be dubious about displays of other products as well.

Most dealers throw up their hands at any such analysis. They pay rent for the store as a whole, but do not relate the cost of that rental to any special area in the store. Too much computation is involved.

## How to Use Chart

Yet if the dealer could do this in some easy way, it would help greatly to decrease his costs. He could virtually eliminate unprofitable displays and increase the efficiency of his store as a selling tool.

To reduce the work of figuring costs of rental, RADIO & Television RETAILING has prepared a chart, accompanying this article, that gives the answers to anyone who merely draws two straight lines. With this chart, the dealer can read his costs for any department or section of his store.

The chart shows the cost per square foot of any area where the dealer knows the total cost of that area. For example, suppose the dealer is paying \$1,000 a year for some floor space that measures 8 feet wide and 20 feet long.

This is not an uncommon situation, although the dimensions might vary from the example. Deal-

ers often have separate leases for various sections of their store, or if they do not, they have a clear idea of the rental value of some special part.

With this chart, they can reduce the total cost for any such area to terms of cost per square foot. In the example mentioned, the dealer uses the chart as shown by the dotted lines.

He draws the first line through the 8 for the width and the 20 for the length, carrying it across with a ruler to the area scale, which it crosses at 160 square feet.

He then draws a second straight line beginning at this 160 point and running through the \$1,000 mark on the "total cost" scale. When he carries this line across to the last scale, he reads from the scale the

cost per square foot at \$6.25.

The dealer can then relate this to the store as a whole on the basis of comparing costs per square foot. This comparison will tell him if the cost of the area is out of line.

To compute the cost per square foot for the store as a whole, the dealer can use the same chart, no matter how large the store is. The chart will take care of any problem of this store, regardless of width, length or cost.

This is because although the scale of width runs from "1" to "10", it may also be used from "10" to "100" or "100" to "1,000" merely by adding ciphers. The same thing applies to the other scales.

To use again the dotted lines on the chart to show this, assume that the store is 80 feet wide instead of

Apply this easy-to-use chart to find whether store space is paying its way.

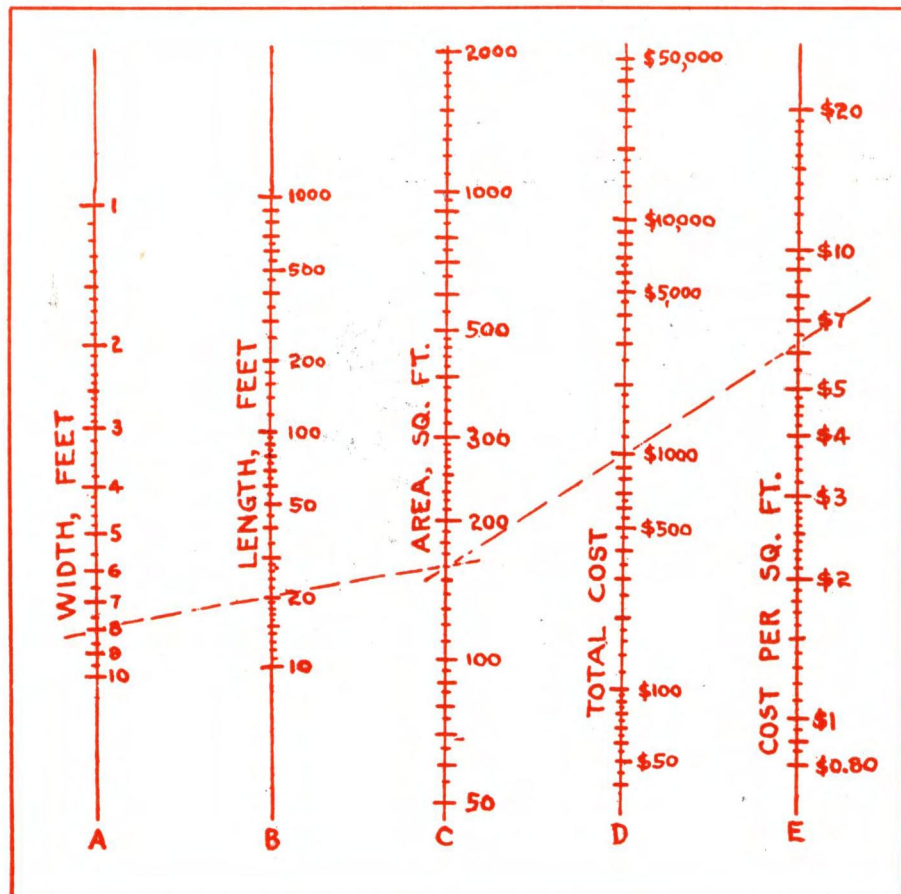



# Space

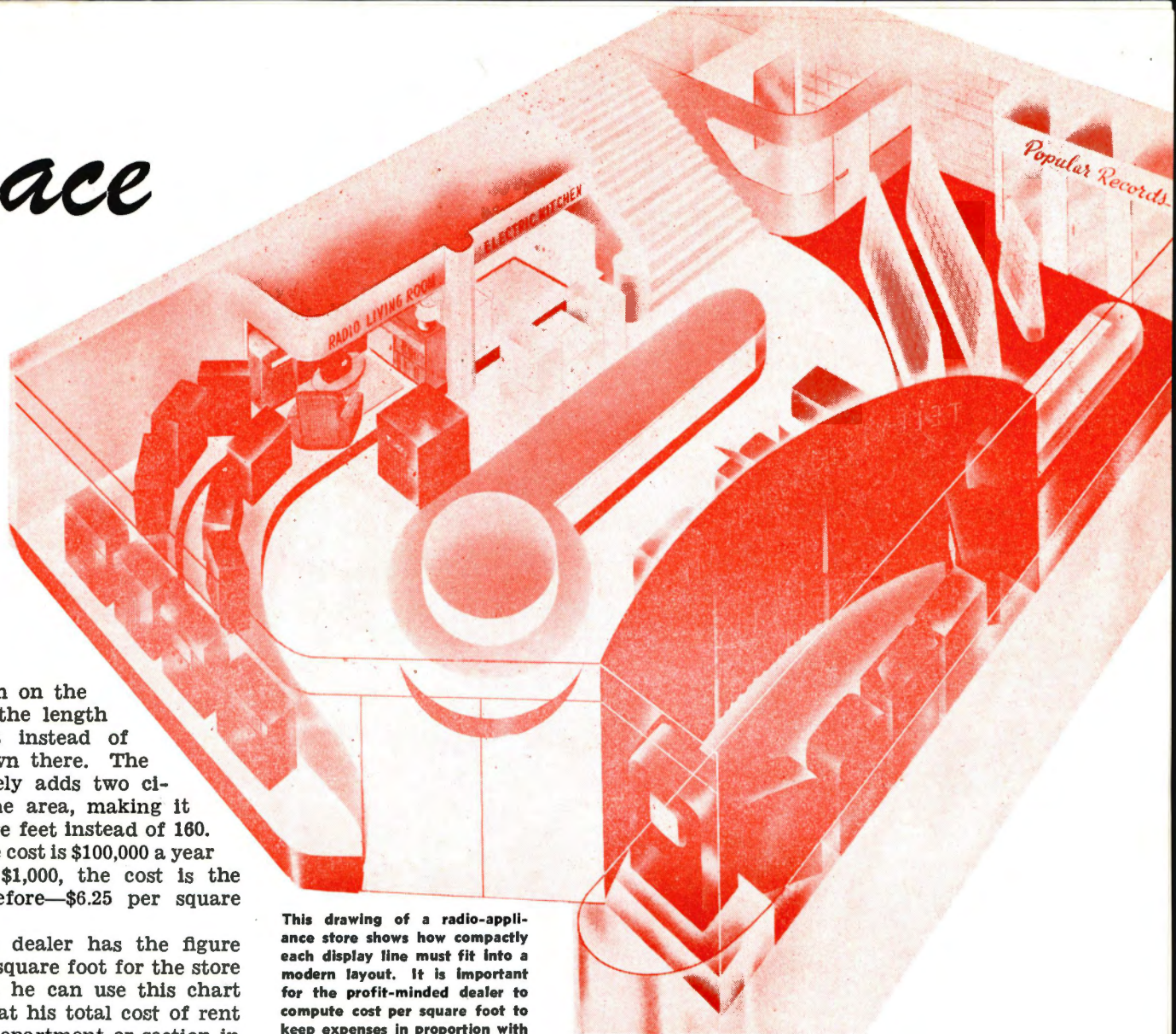

the 8 shown on the chart and the length is 200 feet instead of the 20 shown there. The dealer merely adds two ciphers to the area, making it 16,000 square feet instead of 160.

And if the cost is \$100,000 a year instead of \$1,000, the cost is the same as before—\$6.25 per square foot.

Once the dealer has the figure of cost per square foot for the store as a whole, he can use this chart to show what his total cost of rent is for any department or section in his store.

For example, suppose he does not know how much rental his major appliance department is costing him, and he wants to find out. He has learned that his cost per square foot per year for his store as a whole is \$6.25. He measures the major appliance department and learns that it is 8 feet wide and 20 feet long.

## Appliance Section Rental

He extends the line from 8 through 20, just as before, to get 160 square feet. But for the second straight line, he lines up this 160 with \$6.25, in the last column, and reads off his total cost for the department, which is \$1,000 a year.

Now the dealer knows how much his sales volume of major appliances is. He also knows how much his total sales volume for the store is. It is a simple matter to make comparisons, by reducing both of the rental values to percentages of net sales.

The way to think of rent is always as a percentage of net sales,

This drawing of a radio-appliance store shows how compactly each display line must fit into a modern layout. It is important for the profit-minded dealer to compute cost per square foot to keep expenses in proportion with sales.

not in dollars and cents. Even if a dealer owns his store location, he should compute his "rent" cost just as if someone else owned it.

It is easy to get the percentage of rent to net sales for the store as a whole. All that is necessary is to divide the rent by the sales.

But for individual parts of the store, there must be two steps. First figure the cost of rental for the department. Then divide it by the sales of the department to get the profit.

In the mythical store we are dealing with here, the rental was \$100,000—not because that is typical but because it showed how to operate the chart. Now if the annual sales of such a store were \$2,000,000, the rent would be 5% of the sales.

Let us say that the sales volume of the appliance department in this imaginary store amounts to \$20,000 a year. In that case, the rent for that section is also 5% of the sales volume, and the department is occupying its fair proportion of the

total space of the store.

But if the sales volume of electrical appliances in that hypothetical store was only \$10,000 a year, then the appliance department rental would be 10% of sales instead of 5%. And the wise dealer would reduce the space devoted to his major appliance department so as to bring its rental cost in line with that of the store as a whole.

## Method Saves Time

By using this chart, the dealer can in a few minutes solve many of the problems of allotment of space that may have been bothering him. He should first become familiar with it by doing a few problems he can do in his head. He can then apply it to problems that he *cannot* do in his head.

He can answer some questions by learning the cost per square foot, first of the store as a whole and then of special areas. One such problem arises whenever he plans

(Continued on page 98)



Refrigerators ★

★ Washers

Ironers ★

★ Ranges

Vacuum Cleaners ★

★ Food Freezers

# New Electrical

## Lewyt VACUUM CLEANER

Cleaner and attachments fit into hexagonal container measuring 14" across the top and 21" in height. Cleaner weighs 16 lbs.; pearl gray finish with red nameplate medallion and chrome



trim. Triple-filter action; 3 separate filters. Universal ac-dc motor. Complete set of attachments. Lewyt Corp., 60 Broadway, Brooklyn 11, N. Y.—RADIO & Television RETAILING

## Silex COFFEE MAKER

"Sheraton" model. Equipped with highly polished chromium plated self-timing electric stove and neckband, white or black moldex collar, handle, upper bowl cover, decanter cover, and



dippex coffee measurer. Model available in 4 to 6 cup, 8 cup and 12 cup sizes. Also available without electric stove. Silex Co., Hartford 2, Conn.—RADIO & Television RETAILING

## Casco HEATING PAD

Casco 57, 3-speed electric heating pad. Features: cushion-heat construc-

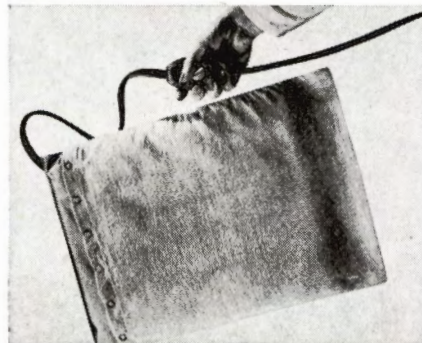

tion; moisture-resistant cover can be wiped clean; further protected by fabric cover which is removable for washing. Each of the 3 speeds have two thermostatic controls for added safety. Casco Products Corp., Bridgeport, Conn.—RADIO & Television RETAILING

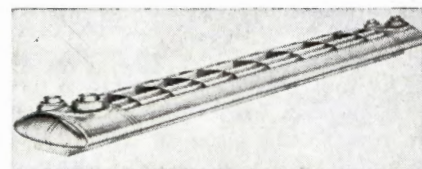

## Westinghouse MERCHANDISER

Two or four-light fluorescent luminaires for general illumination and matching, and adjustable incandescent spot lights for highlighting. Both available for surface and pendant mounting. Units can be combined into an illumination system planned to fit the lighting problem of any particular kind or size of store. Spot lights can be aimed to highlight displays located anywhere within large areas under the actual fixtures. Westinghouse Electric Corp., Mansfield, O.—RADIO & Television RETAILING

## Montgomery PROGRAM CLOCK

Synchronous program clock automatically controls all types of signals used in schools, industry and business. Once set, the clocks continue to follow an exact schedule until reset. Feature: standard 12 hour full vision dials; mech-

anism can be set to close an electrical circuit at any desired 2½ minute interval in the 12 hour disc or 5 minute interval in the 24 hour disc; available in 6 models; self-starting motor. Overall dimensions: 11 inches high, 8 inches wide, 4 inches deep. Case finished in old ivory baked enamel, dial lettering

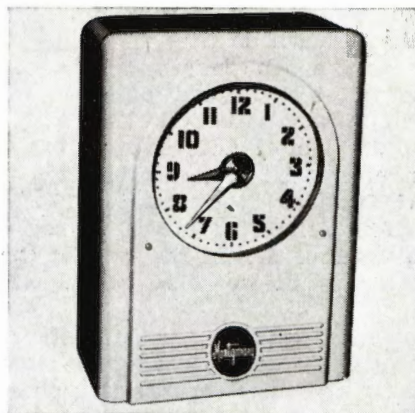

in Chinese red. Montgomery Mfg. Co., Dept. 283, 549 W. Washington Blvd., Chicago 6, Ill.—RADIO & Television RETAILING

## Handyhot TOASTER

Model 5809-H, turn-over oven type toaster. Bright chrome with ebonized finish handles and carrying side rails. Matching chrome tray permanently attached. Spring tension doors hold two slices of bread in correct upright posi-

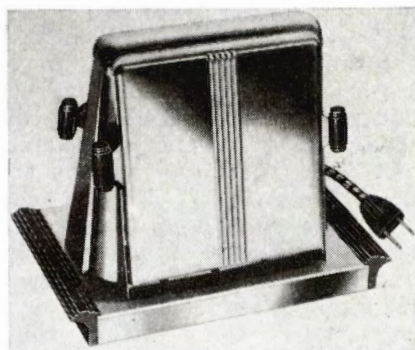

tion. Mica type heating element for fast, uniform heating. Permanently attached 6 ft. heater cord. Chicago Electric Mfg. Co., 6333 W. 65 St., Chicago 38, Ill.—RADIO & Television RETAILING



# Home Appliances

★ Toasters  
★ Roasters  
★ Hand Irons  
★ Mixers  
★ Clocks  
★ Coffee Makers

## Tanlux HEALTH LAMP



Lamp produces two-fold effect of suntanning skin, and acting as a germicidal or healing agent. Lux Craft Corp., 28-30 South Day St., Orange, N. J.—RADIO & Television RETAILING

## Mertland WATER HEATER

10 gallon automatic electric hot water heater, storage type, plugs into any 110 volt electrical outlet. Chromalox quick heating immersion type heating unit. Requires minimum space. Automatic



snap action temperature control. Blanket type Fiberglas insulation, 3 inches thick. M. M. Hedges Mfg. Co., Chattanooga, Tenn.—RADIO & Television RETAILING

## Andrews COMBINATION GRILL

Performs functions as a grill, toaster and broiler. Retail for \$12.50. Andrews Industries, Inc., Stamford, Conn.—RADIO & Television RETAILING

## Pennsylvania Aircraft HOT PLATE

Electric hot-plate of highly-polished all-aluminum alloy with screw fastenings; 6 ft. cord with plug attached. Heating element of nickel chromium, supported in a ceramic insulator with a protective steel plate over the element to

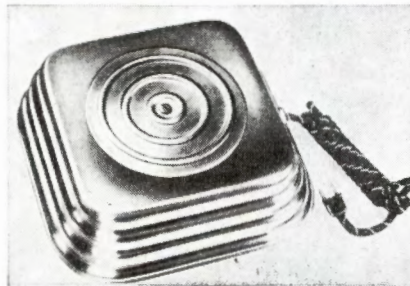

prevent breakage of the ceramic or spillage penetrating it. Size 3 3/8 inches; weight: 2 lbs. 14 oz. Pennsylvania Aircraft Works, Inc., 611 N. 40 St., Philadelphia 4, Pa.—RADIO & Television RETAILING

## Sno-Breze COOLER

Air-stream, fan-type, evaporative cooler, available in 14 in. and 16 in. models. V-design permits rapid fan suction, both sides removable for quick pad change; dripper feeds water through metal tube to metal wick across pad; 22-gauge, rust-resistant steel cabinet; blue baked enamel finish. Palmer Mfg. Corp., Phoenix, Ariz.—RADIO & Television RETAILING

## Coronet BEAUTY PATTTER

Electric massager for skin and scalp. Composed of a roller accessory for

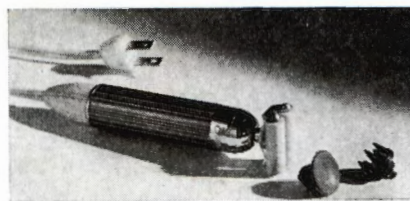

complexion; scalp accessory for invigorating scalp; disc accessory for massaging muscles. Weighs 6 oz.; 5 inches long. Retail at \$8.95. Lektron Corp., 525 W. 45th St., New York, N. Y.—RADIO & Television RETAILING

## American STOVE

No. 1001 R. Single burner stove; dial selector switches; fine nichrome heating element; safety plates. Made of highly



polished chrome. Size: 9 in. long x 9 in. wide x 5 in. high. American Electrical Appliances Corp., Brooklyn 19, N. Y.—RADIO & Television RETAILING

## Laundry Master IRON

Three-heat iron with high, medium and low heats for various fabrics. Op-

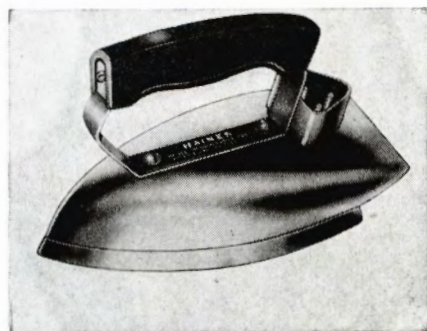

erates on ac-dc. Haines Mfg. Corp., 4754 N. Clark St., Chicago 40, Ill.—RADIO & Television RETAILING

## Handi Glow TEST LIGHT

Plug-in pilot light for standard electric outlet or socket. Neon-light indicator takes usual plug prongs slipping through its slots and into standard outlet. Bulb is over the head of plug, in full sight at all times. Red glow also convenient for locating outlets in dark places. Industrial Devices, Inc., 22 State Road, Edgewater, N. J.—RADIO & Television RETAILING



# New Appliance Products

## Kleen-Air VENTILATOR

Motor driven fan forces fresh air through a fiberglass filter, eliminating

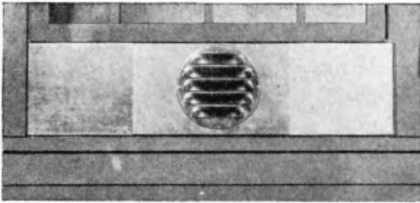

pollen, dust and soot from the air. Packed with 10 extra filters. Kleen Air Corp., 60 E. 42nd St., New York, N. Y.—RADIO & Television RETAILING

## Mastercraft BED LAMP

"Repose" model. Fluorescent lamp constructed of sturdy pressed steel. Inside reflector surface finished with a special chip-proof white enamel. 15



inches long, 4 $\frac{3}{4}$  inches deep, 3 inches high. Finished in aqua, beige, walnut, rose, powder blue and brown crackle. Mastercraft Electric Co., 181 Bruce St., Newark 3, N. J.—RADIO & Television RETAILING

## Ranger INVERTER

Electronic inverter changes ac into dc, increasing electric shaver cutting efficiency and power. Styled of ivory plastic and are available in two models, one a cordless type for direct plug-

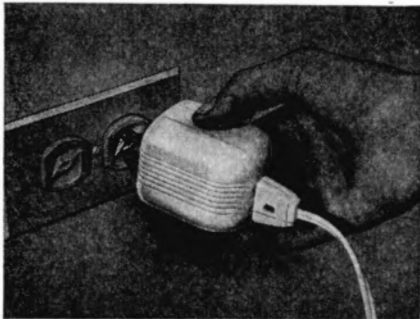

ging into an outlet, and the other with a cord and male plug. Both models retail for \$4.95. Electronic Specialty Co., 3456 Glendale Blvd., Los Angeles 26, Calif.—RADIO & Television RETAILING

## Universal FLOOR POLISHER

Floor polisher with finger tip switch, tough bristle brush, light weight. Powerful motor, supported by felt roller. Finished in baked blue crackle enamel.



polisher is constructed with pressed steel frame and steel handles to stand hard usage. Landers, Frary & Clark, New Britain, Conn.—RADIO & Television RETAILING

## Ajax BARBEQUE

Portable electric barbeque. Dimensions: 18 in. x 24 in. x 24 in. Made of stainless steel; a stainless steel spit. Solid inch of asbestos around three sides and bottom; three arm adjust-

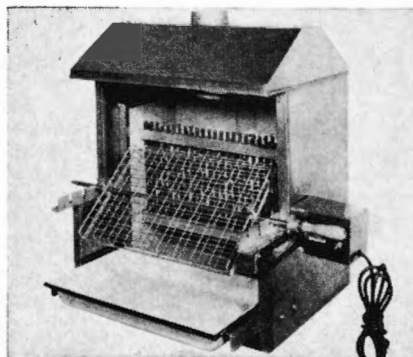

ments. Removable top for easy installation in brick. Priced at \$199.50. Steak grill attachment is \$8.95. Seabreeze Engineering Co., 834-836 S. San Pedro St., Los Angeles 14, Calif.—RADIO & Television RETAILING

## Aeroil FLAME GUN

Weed burner patented tool. Tank made of welded steel, and tested to 100 lbs. pressure. Size of flame can be regulated with valve. Portable Aeroil Products Co., Park Ave. at 57 St., West New York, N. J.—RADIO & Television RETAILING

## Heat King RANGETTE

Model 222-C. Two burner electric plate mounted on metal utility cabinet. Burner section has two 3-heat burners. Overall height 35 inches, width 18 inches, depth 9 $\frac{3}{4}$  inches. Unit finished



in white baked enamel. Retail at \$29.98. M & J Products, Inc., 3730 N. Southport Ave., Chicago 13, Ill.—RADIO & Television RETAILING

## Gemco AIR CONDITIONING UNIT

Compressor unit features: aluminum semi-hermetically sealed compressor unit and motor housing; oil separator and automatic oil return; two-staging, for savings in water consumption; peak performance under varying water temperatures and supply; can be plugged in; light in weight; modern in style and appearance. Electrical controls assembled in one cabinet. General Engineering & Mfg. Co., 4417 Oleatha Ave., St. Louis 16, Mo.—RADIO & Television RETAILING

## Steady-Glo ELECTRIC STOVE

Deluxe unit, model M-102, table top electric stove. Black bakelite heat resistant handles in combination with

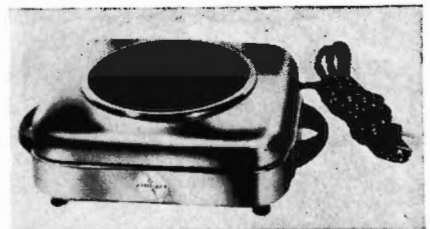

chrome finish; one-piece base; available in three models. Size: 11 $\frac{1}{4}$  in. x 8 $\frac{3}{4}$  in. x 5 $\frac{3}{4}$  in. Appliance Industries of America, Chicago, Ill.—RADIO & Television RETAILING

FOR LATEST RADIO MERCHANDISE, SEE PAGES 52 TO 56.





ELECTRIC RANGES

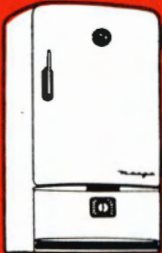

"ROLLATOR" REFRIGERATORS



GAS RANGES

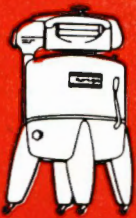

"ED-TA-TOR" WASHERS

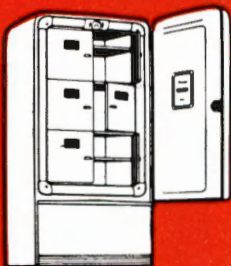

HOME & BARN FREEZERS

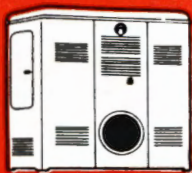

HOME HEATERS

SIX LINES...  
SIX LEADERS

# NORGE

HOUSEHOLD APPLIANCES  
ARE BUILT TO BE THE

GREATEST VALUES  
IN THE FIELD

Each Norge product is a leader in its field.  
Each is easy to sell. Each brings pleasure to  
the buyer and profit to the dealer.

### A BORG-WARNER INDUSTRY

Norge is the trade-mark of Norge Division, Borg-Warner Corp., Detroit  
26, Michigan. In Canada: Addison Industries, Ltd., Toronto, Ontario.

SEE  
**NORGE**  
BEFORE YOU BUY





... the name that became a company!

FOR 43 YEARS the "Hotpoint" trade name has been the byword for the finest in electrical household equipment. It has grown in stature with each passing year — thanks to a policy of "quality first," to consistent advertising, to the careful development of an outstanding dealer organization.

Today the Hotpoint line consists of electric ranges, refrigerators, freezers, dishwashers, disposalls, water heaters, complete home laundry equipment, and a variety of commercial cooking equipment. Today, too, Hotpoint stands for "America's Foremost Kitchen Planners."

Recognizing the increasing value of identifying itself with its trade name, Edison General Electric Appliance Co., Inc., announces that hereafter it will be known as Hotpoint, Inc., a General Electric Affiliate.

HOTPOINT *Inc.*

*A General Electric Affiliate*

5680 WEST TAYLOR STREET • CHICAGO 44, ILLINOIS

**Hotpoint**  
ELECTRIC APPLIANCES







## "More customers, sir?"

"Yes indeed, sir, it was a wonderful party. But if you'll pardon my suggesting it, sir, I'd say that a few more customers wouldn't hurt. They'll do much to ease the change from a sellers' market.

"Oh yes, sir, I've been serving them this way for years. Right in the 'yellow pages' of the Telephone Directory. It follows quite naturally, sir, that since shoppers do go to the 'yellow pages' first for buying information, your advertising there will turn ordinary shoppers into *your* customers.

"And they may become harder and harder to get.

"*More* customers, sir?"



*For further information call your  
local telephone business office.*



*The Swing is to Home Freezers!*



**JOIN THE  
PROFIT  
PARADE**

Home-frozen foods are fast becoming an integral part of American life and home planning . . . the trend toward home freezers becomes more profitable every day. The Gibson Home Freezer is the unit you'll want displayed on your floor. Its upright construction means downright sales action . . . eliminates diving for food and provides more storage space. Five generous, unobstructed shelves for easy, accurate selection and ample room for every kind of frozen food. Join the profit parade early while the market possibilities are still almost unlimited.

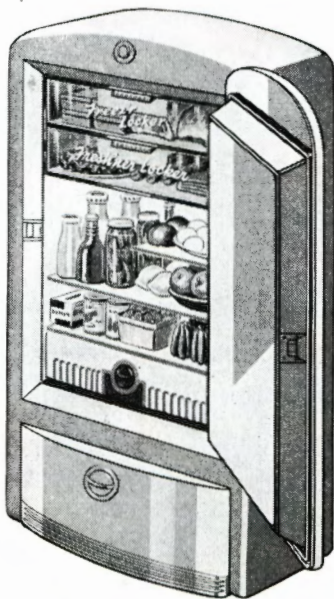

**GIBSON REFRIGERATOR**

Here's the refrigerator with two "easy-sale" features everyone wants. Freez'r Locker, a Gibson original, provides separate storage space for frozen foods. The Fresh'ner Locker has just the right temperature and humidity for salads, fruits, and vegetables.

**Gibson**

**GIBSON REFRIGERATOR CO.  
GREENVILLE, MICHIGAN**

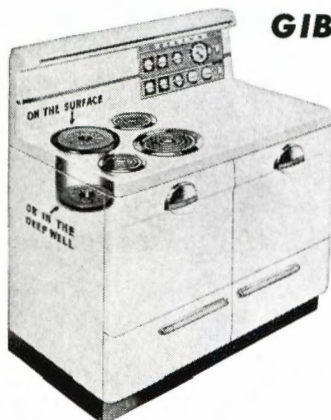

**KOOKALL AUTOMATIC ELECTRIC RANGE**

Dealers and consumers alike are talking about UPS-A-DAISY, the Gibson feature that gives 4 surface cooking units or three surface units and a Deepwell Kookall. Other features include waisthigh broiler, banquet-size oven, simple and convenient automatic operation.



## Toast of the Family

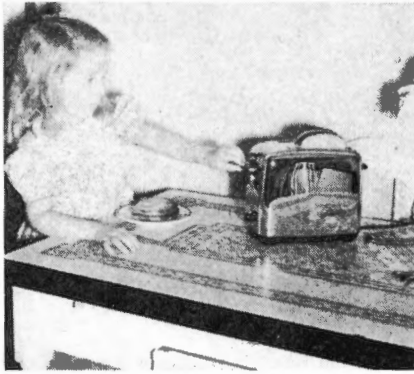

Four year old Joan Calverly uses the "Toast Timer" on Landers, Frary & Clark's new automatic toaster which permits inspection of toast without interruption of current cycle.

## Swindle-Proof

(Continued from page 51)

crook or an accomplice lies in wait for the delivery man for the purpose of "pulling" a fast one on the unsuspecting merchant. He may have arranged in advance to give the deliverer a check or a large bill for which he wants change, or he may pay for the article with a counterfeit bill.

In some cases "remote-control" gyps use the phone to impersonate customers known to the dealer; order some article to be sent "with change", etc., then intercept the delivery man near the genuine customer's home, take the package and the change from a check—and vamoose.

The dealer is perfectly justified in questioning deals with strangers or their claims that they were recommended or sent "by" someone the dealer knows.

There are few established merchants who haven't at one time or another lost money in check transactions which could not be classed as swindles, there are also numbers of others who have been taken over the hurdles by check forgers, check-raisers and "bum" check-passers.

The following check-transaction "don'ts" have been prepared by the editors of RADIO & Television RETAILING for the benefit of the dealer:

1. Don't give any stranger *change* from a check made out for more than purchase amount.
2. Don't accept check in exchange for merchandise from any stranger unless person is able to identify himself.
3. Don't accept a check bearing a signature you *know* from a person

you *don't know*. It may be a forgery. You *may*, however, take an *unknown's* check from a customer you know to be honest and financially sound.

4. Don't give your checks to strangers who come in soliciting funds for alleged "drives" etc., or to strange salesmen who offer to sell "samples" they carry with them.

5. Don't accept a check just because it happens to be issued by government, state or municipal agency or by a well-known, large firm. It may be stolen.

6. Don't leave your own signed checks lying about where others may see them.

The dealer has plenty of check problems in dealing with honest people. He has had to do with checks that "bounced" and with post-dated ones, etc., all of which is the more the reason that he should do all he can to steer clear of being victimized by dyed-in-the-wool check "artists."

While it can be assumed that most "skip-buyers" are honest in the sense that they are not bent on deliberately swindling the merchant, there are a few who are out-and-out thieves.

Most dealer losses to the deliberate skip-buyer are accounted for by the person who carries his purchases, such as minor appliances or portable radios out of the store after establishing a fictitious credit standing which the dealer failed to investigate.

Promoters who collect in advance for non-existent charity drives, fake benefits and the like take their toll among unwary merchants throughout the land. Such gyps often suggest by implication that they represent local police, fire or other organizations.

The wise dealer who believes that the "cause" he is asked to support is a worthy one, will, in all cases, agree to send his payment direct to the organization, and will never give money or checks to a soliciting stranger.

And so it goes. The dealer has problems enough with "honest grafters" such as were described in an article in the December, 1946, issue of this magazine, entitled, "Let the Seller Beware!", which dealt with *customers* who are out to rook him. Such "conniverers" give him plenty of headaches. In addition to the few crooked customers he must cope with the dealer needs to be on his guard against *real racketeers* by making his store as *swindle-proof* as he possibly can.

# Here's a NEW Revolutionary MONEY MAKER FOR YOU

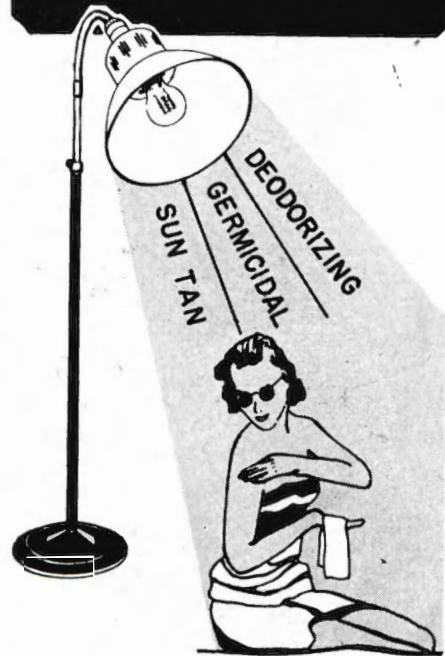

It's New  
**TANLUX**

## HEALTH LAMP

NO OTHER LAMP gives your customers as much for their money. . . . They get a lamp that can be used for

1. SUNTAN, without danger of severe burning.
2. KILLING GERMS and therefore helpful in treatment of many diseases.
3. DEODORIZING room air and purifying it.

That's why the TANLUX HEALTH LAMP is revolutionary. Now look at the retail price . . . \$39.95. Next visualize a good profit in it for you . . . then act to find out how you can get this profit. . . . Write us.

Retails \$39.95

INQUIRIES INVITED

LUX CRAFT CORPORATION

28 S. DAY ST., ORANGE, N. J.



# Are your ears burning?



**Do you have these profitable symptoms?**

**A burning sensation around the ears?** People are saying nice things about you for reserving them o Proctor Never-Lift.

**A crowded sensation about the counters?** People are interested in a display and demonstration of the iron that lifts itself.

**A full, satisfied sensation in the cash register?** You've got a backlog of actual orders for Proctor Never-Lift irons plus the profitable good will of people who now associate your store with the best.

**Profit with Proctor...make this easy Never-lift demonstration**

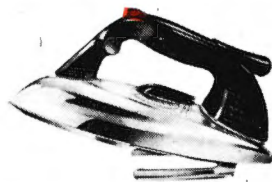

**Iron** as you would with any good automatic iron. You'll find that Proctor's Even-Heat on the iron sole-plate makes ironing smoother and faster, without drag or wrinkling. The Fabric Dial gives correct heat for every type fabric.

**Glide** iron off material without lifting. Press the red button forward—and legs automatically lift iron. The legs will not scorch or burn... they hold the iron safe from tipping or falling. The Never-Lift action is built for 250,000 operations.

**When** ready to resume ironing just press heel of handle. Click signals that legs are recessed... will not catch on fabric. Ordinary ironing calls for lifting 2½ tons in an average ironing day. The Never-Lift eliminates this tiresome lift-work.

# PROCTOR

**NEWSMAKER  
IN APPLIANCE  
MERCHANDISING**

PROCTOR ELECTRIC COMPANY, PHILADELPHIA 40, PENNSYLVANIA

## New Universal Blanket



Landers, Frary & Clark's new electric blanket featuring "Slumber Sentinel" temperature control. Blanket is made in two colors—cedar or blue; it has 6 safety thermostats.

## Cost of Store Space

(Continued from page 89)

If he is thinking about leasing adjoining space, he should first learn what will be the cost per square foot per year of the proposed additional space. If it is far out of line, he should search actively for other ways to expand his space, perhaps by moving to another location.

The same thing applies to modernizing. How much will new display fixtures add to the cost per square foot of a department? A large jump in this figure is an immediate caution signal.

Finding the total cost of a given space, by applying the cost per square foot of the store as a whole to its area, is still more revealing. It will do far more than merely show the proper size of a department. It may be applied to individual store fixtures as well.

An ordinary selling table with the space around it may be found to occupy space whose total cost is, say, \$200 a year. If it sells only \$1,000 worth of merchandise a year, the rental cost is obviously 20%. To bring the space into line with a 5% average rental, the dealer must find some product that will sell \$10,000 worth in a year.

Moreover, the space toward the front of the store is worth more, and must sell more goods, than the space in the rear. The dealer should, of course, make allowance for this fact.

But despite these qualifications, this chart can be a most valuable rule of thumb. With it, the dealer can go over his store "with a fine-tooth comb," find and eliminate dead spots in his layout that he never knew existed, and in this way get fullest possible return from his rental dollar.



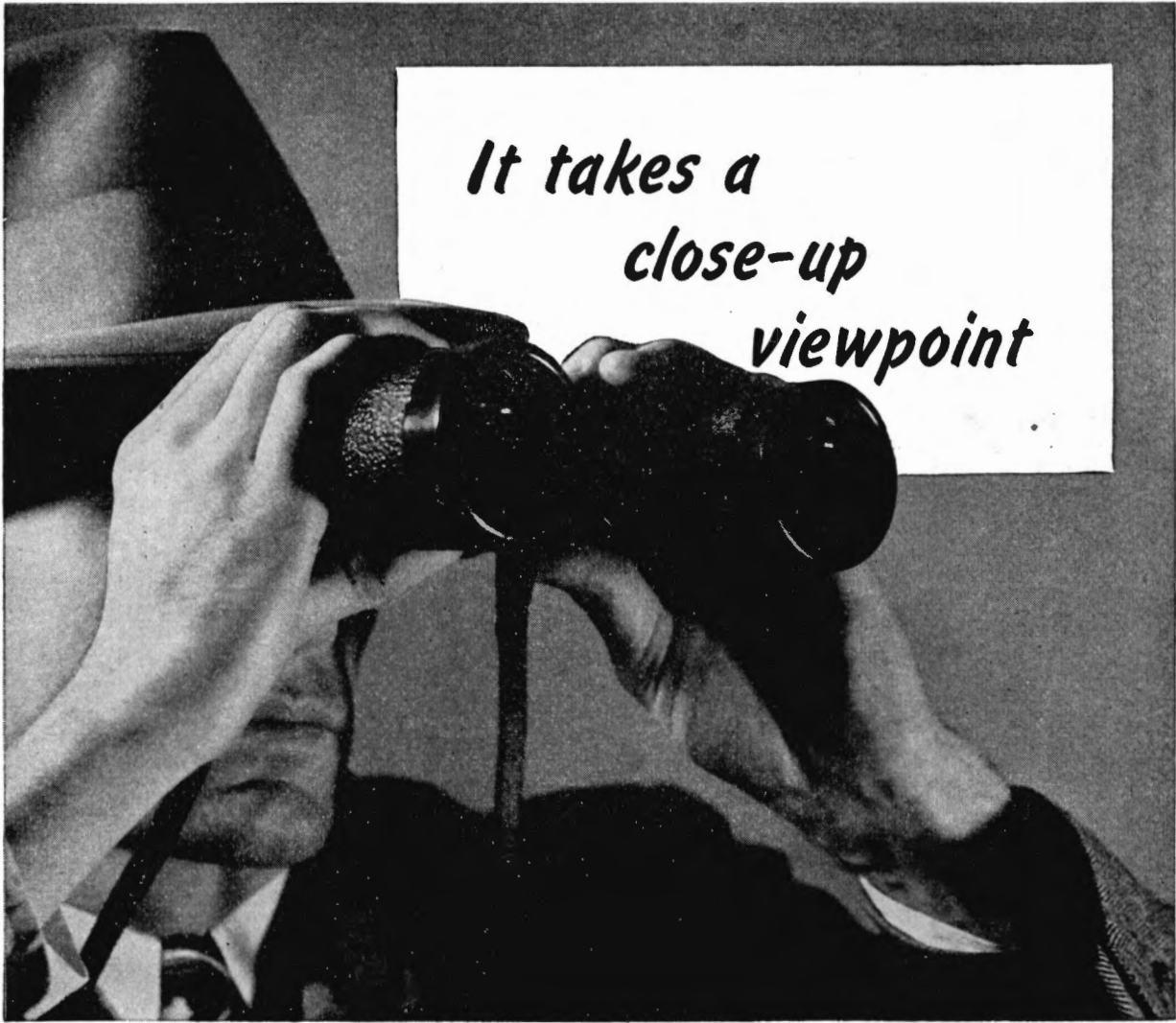

*It takes a  
close-up  
viewpoint*

**... to pick tomorrow's champs**



*... and to compare the profit potentials of different lines of appliances or radios.*

To be able to pick the best lines for its dealers, a distributor has to be really close to the radio-appliance business . . . has to have the kind of judgment that you find only in a thoroughly experienced organization — like Graybar. To merit the confidence of manufacturers, a distributor has to be solidly established — like Graybar. To be able to make the best merchandising recommenda-

tions in the interest of its dealers, a distributor should be an independent, self-directing organization — like Graybar.

From the district Graybar organization which serves them, Graybar dealers in every section of the nation get time-saving deliveries of expertly selected lines — plus a wealth of profit-building merchandising ideas. For information about a Graybar dealership, write *Merchandising Department, Graybar Electric Company, Graybar Building, New York 17, N. Y.*

4722



**..... an independent distributor  
with a talent for picking best sellers**

**HOME RADIO • MAJOR APPLIANCES • TRAFFIC APPLIANCES**



# Appliance Service Tips

## Money-Saving Short-Cuts and Ideas on Repairing and Testing

### Inexpensive Appliance Tester, Iron Holder

Proctor Electric Co., Philadelphia, Pa., suggests herewith an inexpensive way to make a test board for checking any electrical appliance circuit. Shorts may be tested by inserting test leads in plug 5 and snap switch button 8 placed in "off" position. An accompanying illustration also shows how to construct a holder for hand irons.

Here's what's needed to make the tester: (see diagram)

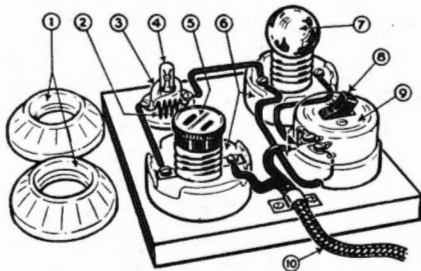

1. Covers for screw type receptacles. 2. Shunt coil (18 gauge nichrome No. 3 wire). 3. Miniature porcelain socket. 4. Pilot lamp (2.5 volts). 5. Female screw plug. 6. Screw type receptacle. 7. Lamp  $7\frac{1}{2}$  watts). 8. Snap switch button. 9. Single pole snap switch. 10. Wires going to source of current.

To test for circuit: (A) Connect wires going to source of current (No. 10). (B) Insert male plug of appliance to be tested in plug No. 5.

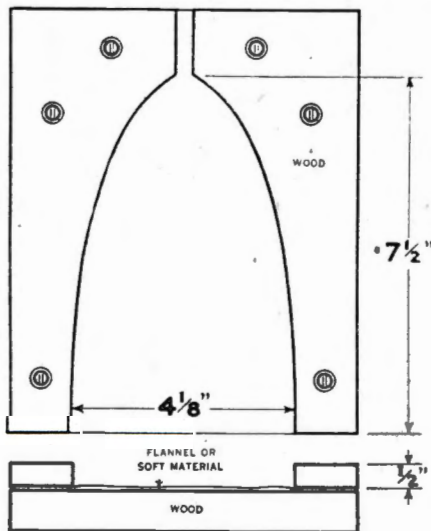

Easy-to-make iron holder.

(C) Turn toggle switch, No. 8, to "off" position. (D) If there is a circuit through appliance lamp No. 7 will light. (E) Test leads may be used by inserting the male plug of the leads into plug No. 5.

To use as a signal when thermostat contacts open or close: First: turn button No. 8 on switch to "on" position. Second: insert appliance plug in plug No. 5 (switch on). Third: when switch button No. 8 is in this position there will be no circuit through lamp No. 7. Pilot lamp No. 4 will light as it is connected in series with appliance on test. Fourth: when the pilot light goes out it is a signal that thermostat contacts have opened, thus breaking the circuit. Maximum rating 1500 watts.

### Headache-Preventer

The ac-dc bugaboo has plagued many a dealer in communities where both currents are scattered about. Customers will bring back burned-out new appliances, insisting that dealer make good under guarantee. One servicer fastens a small red tag, lettered, "Warning-Do Not Use on Direct Current!" to cord set just back of male plug. Urges customer not to remove tag.

### Restaurant Service Pays On-the-Job Dealer

Dealers who solicit repair business from restaurants of all sorts find that they can build up a steady flow of business at profitable prices. Speedy service is a must with eating place owners and the merchant who is equipped to turn out the work rapidly will find plenty of work.

Some of the appliances the restaurant owner needs to keep in top-notch condition include, exhaust and circulating fans, drink and food mixers, multi-slice automatic toasters, electric stoves and ranges, clocks, waffle irons, roasters, etc. The dealer who is also an electrical contractor can find new outlet and lighting fixture business in the eating establishments too.

Syndicated stores having lunch counters who may never buy a single dollar's worth of new products locally, do, in many instances,

pay good money out to local technicians for repair services.

### Converting Fluorescent Lighting Fixtures

Conversion of fluorescent fixtures from ac to dc or vice-versa is a simple matter of providing the proper ballast. The reactors used in fluorescent ballasts have a dual function—to provide a quick pulse of voltage when the starter opens circuits, and to limit the current through the tube.

#### Must Add Resistor

While both these functions are taken care of in ac circuits, the negligible impedance of a reactor to dc makes necessary the addition of a current-limiting resistor when an ac to dc conversion is made. For 15-watt desk type fixtures, for example, a 190-ohm line resistor is needed. For two-lamp fixtures, two resistors are used, as indicated by the double-resistance line cord.

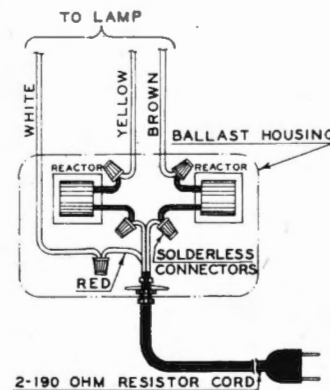

Above, dc current circuit. Below after conversion to ac current. Dazor fixtures shown.

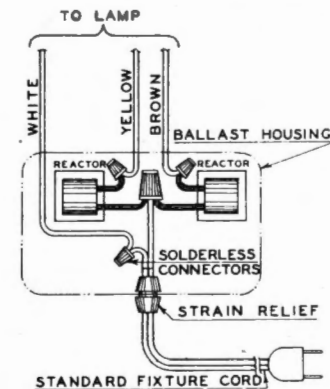



# PRACTICAL WORKING TOOLS FOR THE ENGINEER



## ELECTRONIC CONTROL HANDBOOK

Here are all the essential data necessary to determine the worth of an electronic control device; a dependable guide toward your taking advantage of the cost-cutting, production-speeding, quality-control possibilities of electronic devices. Gives you facts to intelligently balance the advantages of electronics against mechanical and other methods of control. Easily understood without advanced knowledge of electronics. Section I, Basic Elements of Control; Section II, Conversion Elements; Section III, Electronic Modification Circuits; Section IV, Activation Elements; Section V, Control Applications.

350 Pages • Hundreds of Illustrations • \$4.50

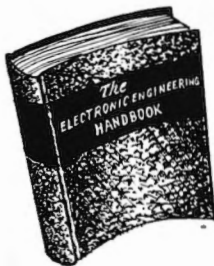

## ELECTRONIC ENGINEERING HANDBOOK

For radio-electronic specialists this Caldwell-Clements book provides a convenient, authentic source of formulas and principles, as well as the latest in electronic applications. Electrical operating and executive engineers will find here the solutions to many production problems. Easily understood by anyone with a knowledge of basic electrical principles and simple circuits. Free from involved mathematical explanations. Section I covers Vacuum Tube Fundamentals; Section II, Electronic Circuit Fundamentals; Section III, Electronic Applications; Section IV, Vacuum Tube Data.

456 Pages • 560 Illustrations • \$4.50

Both books 6x9 inches, bound in limp leatherette covers, open conveniently flat.

Once You  
Get These  
Books in  
Your Hands  
You'll Always  
Have Them  
at Your  
Fingertips

No Risk—  
5 Day  
Approval

### CALDWELL-CLEMENTS, INC.

480-D Lexington Ave.  New York 17, N. Y.  
Publishers to the electronic industries since 1925

Send books checked. If not satisfied, will return within five days. Otherwise will remit payment.

ELECTRONIC ENGINEERING HANDBOOK \$4.50  
 ELECTRONIC CONTROL HANDBOOK \$4.50

Name.....

Address.....

City and State.....

Company Name.....

On the  
**WHITE CROSS** record  
55 years running . . .

Quality Products  
make profits!

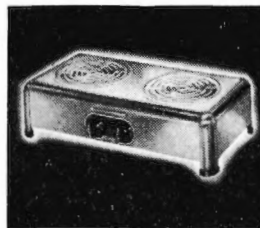

No. 114—Satin Chrome 6-Heat Hot Plate—Two 7-inch, 3-heat elements. Left, 1000-500-250 watts; right, 650-325-165 watts. Reciprocating switches with indicating plate.



No. 351-A—1000-Watt Lightweight Automatic Iron—Specially designed thermostat maintains proper temperature accurately on heavy or light material, as shown on indicator.

Ahead of the times at all times—that's White Cross! There's a kitchen-full of White Cross products with the same durable quality that has made profits for retailers for more than half a century now!

The big reason behind today's White Cross success is the farsighted design of each appliance—functional for efficiency yet matched with the others for modern style and beauty. And backing up every White Cross sale are strict standards of skilled workmanship which assure top-notch performance. That's why customers count on White Cross for lasting value. Retailers, too! They know that White Cross quality keeps stocks moving for faster turnover and steady profits!

*Sold Only Through Leading Distributors*

**NATIONAL STAMPING AND ELECTRIC WORKS**  
3220 WEST LAKE STREET • CHICAGO 24, ILLINOIS

MAKERS OF

**WHITE CROSS**  
PRODUCTS

SUBSIDIARY OF

**EUREKA WILLIAMS**  
CORPORATION

PLANTS IN DETROIT, MICH. • BLOOMINGTON, ILL. • CHICAGO, ILL.



# AT LAST! A FOOLPROOF *Electric Iron!*

## THE LAUNDRY MASTER with 3 HEAT CONTROL



Operates on  
AC-DC Current

**\$9.95**  
RETAIL

★ ★ ★  
**DEALERS  
COST**

**\$6.50 ea.**  
Incl. FED. TAX

★ ★ ★  
**IMMEDIATE  
DELIVERY!**

- Revolutionary New Heat Control Principle
- Holds Heat at Temperature Chosen
- No Thermostats, Moving Parts, or Gadgets to Get Out of Order

The Laundry Master provides Low-Medium-High heat without thermostatic control. Correctly engineered for top ironing efficiency for years of trouble-free service. Full size, lightweight (only 4 lbs.), beautifully streamlined. Get Extra Volume, Bigger Profits with this sensational new seller. Send your order today!

**3**  
PLUG-IN  
POSITIONS FOR  
LOW: for silk, rayon,  
or nylon  
MED: for wool  
HIGH: for cotton  
and linen

*Also Available:*

One Heat Irons in 220-110 and 32 volts. Waffle Irons, Toasters and Room Heaters.

TERMS

Check with order or C.O.D. Net Railway Express F.O.B. Chicago.

**HAINES MANUFACTURING CORP.**  
4754-56 N. CLARK ST. CHICAGO 40, ILLINOIS

**All over the U. S. Dealers Report:**

## APPLIANCE Sales Mount in "Big Four" Selling

Electrical appliance sales by independent retailers continue to increase when they are merchandised together with related products like radios and phonographs, records, and servicing. That's the continuing result of the "Big Four" plan of selling, introduced last year by RADIO & Television RETAILING. Promoted each month on the front cover and in a magazine sectionized with related editorial and advertising material, more and more dealers are cashing in on local opportunities by offering full merchandising and servicing to their communities. In our 27,000 ABC Paid circulation 22,000 appliance dealers read RADIO & Television RETAILING because it is the only publication offering them, within the covers of a single monthly issue, information on all their chief retailing activities. For this reason, appliance manufacturers can sell an important market here that is unreachable otherwise.



**CALDWELL-CLEMENTS, INC.**  
480 Lexington Avenue • New York 17 • Plaza 3-1340

## Radio Advertising

(Continued from page 47)

many of those established this period of time were department stores. The balance of those surveyed did not specify length of establishment.

The annual sales volume of those advertising on the air varied from \$5,000 to over a \$1,000,000 for the large store doing a heavy volume of sales in receivers, electrical appliances, records, and related merchandise.

Of those supplying information on their yearly volume, 7% reported sales of \$25,000 or less; 12% up to \$50,000; 29% up to \$100,000 annually; 19% not exceeding \$150,000; 12% up to \$200,000; 6% not over \$300,000; 15% over \$300,000. Here again, those in the very high sales volume range comprised large department stores.

The sums of money spent on all types of advertising, including broadcasting, ranged from 2% to 5% of each dealer's annual sales volume. Of those reporting their total annual advertising appropriations, 18% allotted \$1,000 or less; 28% up to \$2,000; 16% not over \$3,000; 8% not over \$4,000; 9% up to \$5,000; 5% spent up to \$6,000; and 16% had advertising budgets of \$6,001 or more.

The location of a store, in addition to its size, also plays a part in determining the amount of business done by a firm, and consequently the amount of advertising it is prepared to do.

### Stores On Main Stem

Most of the dealers doing broadcast advertising were located in the high traffic sections of their communities, the survey reveals. A breakdown of locations indicates that 68% of the merchants polled were situated on main streets; 26.5% were located on side streets or away from main arteries. The balance of the merchants surveyed were unclassified.

Some of the establishments with a large annual sales volume attained this great business by operating from more than one store. About 15% of the dealers on the air had more than one location.

The overall picture given by the survey indicates that broadcast advertising is profitable in selling merchandise and in building prestige. Provided that merchants have sufficient quantities of goods to sell and allot a reasonable part of their expenditures for radio, profits can be gained by the intelligent use of this medium.



# Now! Get records that do these 9 vital jobs... easier, simpler, faster!



- ✓ **DEPENDABLE TAX INFORMATION**
- ✓ **DETAILED SALES ANALYSIS**
- ✓ **PROTECTION OF MERCHANDISE**
- ✓ **INFORMATION ON PROFITABLE LINES**
- ✓ **CONTROL OF CASH**
- ✓ **ACCURATE INVENTORY CONTROL**
- ✓ **RECEIPTS FOR CUSTOMERS**
- ✓ **COMPLETE CUSTOMER LISTS**
- ✓ **ADEQUATE INFORMATION**



- A. Marginally punched Standard Register forms can't slip.
- B. Pin-wheel feed means extra speed, extra carbons, perfect alignment.
- C. Locked-in copies provide extra protection, positive control.

## **Radio and Appliance Dealers** **GET THESE SPECIAL BENEFITS**

All records clear, legible, at one writing. Copies for customer, office, delivery and locked-in audit records. No copying errors. Foolproof check against lost records. Fixed responsibility, including delivery receipt. No confusion on terms of sale, payment, or delivery instructions. Complete legal contract and copies with *one* customer signature.

## **THE STANDARD REGISTER COMPANY**

**Manufacturers of Registers and Forms  
for ALL Business and Industry**

**DAYTON 1, OHIO**

**Write for FREE folder! Discover how Standard's pre-tested Formcraft continuous forms and STANDARD'S FORM FLOW REGISTERS give you more complete records with less writing, less work**

Many a record system that was "good enough" a few years ago is totally inadequate for the job it must do, today. That's why thousands of firms have adopted Standard Register's modern, exclusive, pre-tested systems and Form-Flow Registers. Standard Register systems help you get better, more useful records *faster*—records that conform to government regulations, income tax reports, and at the same time protect cash, merchandise and consumer good will. Get all the facts. Mail the coupon, today. There's no obligation.

**The STANDARD REGISTER Company**  
Dept. 1302, Dayton 1, Ohio

Please send me Free Standard Register Business Digest which tells me how I can write better records in my business . . . easier . . . simpler . . . faster!

NAME \_\_\_\_\_

COMPANY \_\_\_\_\_

STREET \_\_\_\_\_

CITY \_\_\_\_\_ ZONE \_\_\_\_\_ STATE \_\_\_\_\_

Pacific Coast: Sunset McKee-Standard Register Sales Co., Oakland 6, Calif. Canada: R. L. Crain Ltd., Ottawa. London: W. H. Smith & Son, Ltd.



# PRODUCTS OF ELECTRICAL APPLIANCE MANUFACTURERS

Listing the companies whose lines cover one or more of the seven groups of greatest importance to retailers and distributors.

The following manufacturers of electrical appliances returned our editorial questionnaire giving the information needed for these listings	Refrig.-Freezers	Laundry Equip.	Vac. Cleaners	Elec. Ranges	Gas Ranges	Space Heaters	Traffic Appl.	Manufacturers not listed may furnish data for the next issue. No advertising obligation. Additions or revisions will be made monthly.	Refrig.-Freezers	Laundry Equip.	Vac. Cleaners	Elec. Ranges	Gas Ranges	Space Heaters	Traffic Appl.
Adel Precision Products Co., No. Hollywood, Calif.								Koral Elec. Mfg. Co., 43-22 Van Dam St., L. I. City, N. Y.							
Admiral Corp., 3300 W. Cordland St., Chicago								Laifer Refrigerators, Rochester, N. Y.							
Altorfer Bros. Co. (ABC), East Peoria, Ill.								Landers, Frary & Clark, 47 Center St., New Britain, Conn.							
Amann Society, Refrigeration Division, Amanna, Iowa								Lewyt Corp., 60 Broadway, Brooklyn, N. Y.							
American Electrical Appl. Co., 5014 Ft. Hamilton Pkwy., Bklyn.								A. G. Lindemann & Hoverson Co., Milwaukee, Wis.							
American Electrical Heater Co., Detroit, Mich.								Lovell Mfg. Co., Erie, Pa.							
American Ironing Machine Co., Algonquin, Ill.								Lowell Mfg. Co., 589 E. Illinois Ave., Chicago, Ill.							
American Stove Co., 4301 Perkins Ave., Cleveland, Ohio								McAllister-Russ Corp., 135 So. La Salle St., Chicago							
Apex Electric Mfg. Co., Cleveland, Ohio								MacArthur Products, Inc., 34 Front St., Springfield, Mass.							
Appliance Indus. of Amer., 666 Lake Shore Dr., Chicago 11, Ill.								Magic-Aire, Inc., 1730 Ivanhoe Rd., Cleveland, Ohio							
Appliance Mfg. Co. (Duchess), Alliance, Ohio								Majestic Electric Appliance Co., Inc., Galion, Ohio							
Arista Associates, 446 Dean St., Brooklyn, N. Y.								Malleable Iron Range Co. (Monarch), Beaver Dam, Wis.							
Armstrong Products Co., Huntington, W. Va.								Manning Bowman & Co., Meriden, Conn.							
Atlantic Mfg. Co., Hamburg, Pa.								Marlin Mfg. Co., 37 E. 21st St., New York, N. Y.							
Automatic Washer Co., Newton, Iowa								Martin-Parry Corp., York, Pa.							
Barlow & Seelig Mfg. Co. (Speed Queen), Ripon, Wis.								Mat Matic Home Ap. Corp., Div. Matam Corp., 45-18 Ct. Sq., LIC							
Barton Corp., West Bend, Wis.								Maytag Co., Newton, Iowa							
Beam Mfg. Co., Webster City, Iowa								Mell-O-Chime & Signal Corp., 119 S. Jefferson St., Chicago 6							
Bell Appliance & Radio, 125 E. 46th St., New York, N. Y.								Menasco Mfg. Co., Burbank, Calif.							
Bendix Home Appliances, Inc., South Bend, Ind.								Merit-Made, Inc., 94 Elm St., Buffalo, N. Y.							
Ben-Hur Mfg. Co., 634 E. Keefe Ave., Milwaukee, Wis.								Herman Miller Clock Co., Zeeland, Mich.							
Berger Electric Co., 109-01 72nd, Forest Hills, N. Y.								Miracle Electric Co., 36 So. State St., Chicago, Ill.							
Bersted Mfg. Co., Fostoria, Ohio								Modern Maid Co., Inc., 122 S. Michigan Ave., Chicago 3, Ill.							
Birtman Electric Co., 4140 Fullerton Ave., Chicago, Ill.								Monitor Equipment Corp., 640 W. 249th St., Riverdale, N. Y.							
Blackstone Corp., Jamestown, New York								Montag Stove Works, 2011 N. Columbus Blvd., Portland, Ore.							
Buffalo Forge Co., 205 Mortimer St., Buffalo, N. Y.								Morton Appliance Co., 666 Lake Shore Drive, Chicago, Ill.							
Burkaw Electric Co., 105 E. 29th St., New York, N. Y.								Morton Mfg. Co., 5105 West Lake St., Chicago, Ill.							
Calkins Appliance Corp., South Bend, Ind.								National Acoustic Products, 120 N. Green St. Chicago 7, Ill.							
Cameo Products, Inc., 57 William St., New York, N. Y.								National Die Casting Co., Touhy & Lawndale Ave., Chicago, Ill.							
Camfield Mfg. Co., Grand Haven, Mich.								National Stamping & Elec. Wks. (White Cross), W. Lake, Chicago							
Carrier Corp., Syracuse, N. Y.								Naxon Util. Corp., 2101 W. Walnut St., Chicago, Ill.							
Caseo Products Co., 512 Hancock Ave., Bridgeport, Conn.								New Haven Clock Co., 133 Hamilton St., New Haven, Conn.							
Central Rubber & Steel Corp., Findlay, Ohio								Nineteen Hundred Corp., St. Joseph, Mich.							
Century Precision Works, Inc., 503 West 56th St., New York								Noblitt Sparks Industries (Arvin), Columbus, Ind.							
Chicago Dryer Co., 2210 No. Pulaski Road, Chicago, Ill.								Noma Electric Corp., 55 W. 13th St., New York, N. Y.							
Chicago Electric Mfg. Co., 6333 W. 65th St., Chicago, Ill.								Norge Div., Borg-Warner Corp., E. Woodbridge, Detroit, Mich.							
Clements Mfg. Co. (Cadillac), Chicago, Ill.								Nu-Tone Co., 321 E. 3rd St., Cincinnati, Ohio							
Rex Cole Inc., 21-05 51st Ave., Long Island City, N. Y.								One Minute Washer Co., Kellogg, Iowa							
The Coleman Co., Inc. 248 N. St. Francis St., Wichita 1, Kan.								Panelclectric Products Div., Gen. Aire, Eq., South Norwalk, Conn.							
Conlon Bros. Mfg. Co., 4512 W. Fillmore St., Chicago, Ill.								Phileo Corp., Tioga & C Sts., Philadelphia, Pa.							
Conlon Corporation, 1824 So. 52nd Ave., Chicago, Ill.								Pleasantaire Corp., Tower Bldg., Washington, D. C.							
Cooler Corp., Duluth, Mich.								Portable Elevator Mfg. Co., Refrig. Div., Bloomington, Ill.							
Copeland Refrigeration Corp., Sidney, Ohio								Portable Products Corp., 420 Blvd. Allies, Pittsburgh, Pa.							
Copeland Heater Corp., Hanna Bldg., Cleveland, Ohio								Precise Electronics Co., 614 W. 49th St., New York, N. Y.							
Cory Glass Coffee Brewer, 221 N. LaSalle St., Chicago								Premier Vacuum Cleaner Div., General Electric Co., Cleveland, O.							
Cribben & Sexton Co., 700 No. Sacramento Blvd., Chicago								Pressed Steel Car Co., 122 S. Michigan Ave., Chicago, Ill.							
Crosley Corporation, Cincinnati, Ohio								Prevore Elec. Mfg. Co., 122 18th St., Brooklyn, N. Y.							
Dalbair Mfg. Co., 1314 Forest Ave., Dallas, Tex.								Proctor Elec. Co., Philadelphia							
Deepfreeze Division, Motor Products Corp., N. Chicago, Ill.								Radiant Heater Corp., 521 Fifth Ave., New York, N. Y.							
Detroit Michigan Stove Co., 6900 E. Jefferson, Detroit								Ray-Dyne Co., 141 W. 24th St., New York, N. Y.							
Dexter Company, Fairfield, Iowa								Redi-Electric Co., 141 W. 24th St., New York, N. Y.							
Dominion Electric Mfg. Co., Mansfield, Ohio								Refrigeration Corp. of America, 225 W. 57th St., New York, N.Y.							
F. A. Dormeyer Mfg. Co., 4316 N. Kilpatrick Ave., Chicago								Regina Corp., Rahway, N. J.							
Duo-Therm, Div. of Motor Wheel Corp., Lansing 3, Mich.								Revere Clock Co., McMillan at Dover, Cincinnati, Ohio							
Easy Washing Machine Co., Syracuse, N. Y.								Revere Inc., Fisher Bldg., Detroit, Mich.							
Economaster Products Co., 9th Ave., Nashville, Tenn.								Reynolds Electric Co., 2650 W. Congress St., Chicago, Ill.							
Edison C. E. Appliance Co. (Hotpoint), Chicago, Ill.								Reynolds Metals Co., Louisville, Ky.							
Edwards Company, Norwalk, Conn.								A. E. Rittenhouse Co., Inc., Honeoye Falls, N. Y.							
Electric Steam Products Corp., Detroit, Mich.								Robbins & Myers, Inc., Springfield, Ohio							
Electrical Industries, Inc., 42 Summer Ave., Newark, N. J.								Roberts & Mander Stove Co., Hatboro, Pa.							
Electro-King Mfg. Co., 503 N. LaSalle St., Chicago, Ill.								Robeson-Royal Corp., 176 Anderson Ave., Rochester, N. Y.							
Electromaster, Inc., 1803 E. Atwater St., Detroit, Mich.								Geo. D. Roper Corp., Blackhawk Div., Rockford, Ill.							
Electromode Corp., 45 Crouch St., Rochester 3, N. Y.								Round Oak, Dowagiac, Mich.							
Electronic Enterprises, Inc., 1312 Forest Ave., Dallas, Tex.								Rutenber Electric Co., Marion, Ind.							
Emerson Electric Mfg. Co., 1324 Washington Ave., St. Louis, Mo.								Samson United Corp., 1700 University Ave., Rochester, N. Y.							
Empire Appliance Co., 480 Lexington Ave., New York								D. E. Sanford Co., 331 Madison Ave., New York, N. Y.							
Eureka Vacuum Cleaner Corp., 6060 Hamilton Ave., Detroit								Sanitary Refrigerator Co., Fond du Lac, Wis.							
Evanair Division, Evans Products Co., 15310 Fullerton, Detroit								Schelm Bros., East Peoria, Ill.							
Faraday Electric Co., 11 S. LaSalle St., Chicago, Ill.								Seelt & Reiser, 11441 Locust Ave., Cleveland, Ohio							
S. W. Farber, Inc., 141 S. 5th St., Brooklyn, N. Y.								Seeger Refrigerator Co., Arcade & Wells Sts., St. Paul, Minn.							
Featherline Corp., 299 Madison Ave., New York, N. Y.								Seeger Sunbeam Elec. Mfg. Co. (Goldspot), Evansville, Ind.							
Finders Mfg. Co., 3669 S. Michigan Ave., Chicago								Servel, Inc., Evansville, Ind.							
Florence Stove Co., Gardner, Mass.								Sessions Clock Co., Forestville, Conn.							
L. K. Franklin Co., 1241 So. Hill St., Los Angeles 15, Calif.								Sheridan Electronics Corp., 2850 S. Michigan Ave., Chicago, Ill.							
Fresh-nd Aire Co., 210 N. Clinton St., Chicago, Ill.								Signal Electric Mfg. Co., Menominee, Mich.							
Frigidaire Div., General Motors Corp., Dayton, Ohio								Silex Co., 80 Pliny St., Hartford, Conn.							
Froster Div., General Tire & Rubber Co., 332 S. Mich. Ave., Chicago								F. A. Smith Mfg. Co., 801 Davis St., Rochester, N. Y.							
P. A. Geier Co. (Royal), 540 E. 105th St., Cleveland, Ohio								Son-Chief Electric, Inc., Winsted, Conn.							
General Consumer Prods. Inc., 4610 N. Western Ave., Chicago								Sparks-Withington Co., Jackson, Mich.							
General Die & Stamping Co., 262 Mott St., New York, N. Y.								Sperti, Inc., Beech & Kenilworth Sts., Cincinnati, Ohio							
General Electric Co. Appl. & Merch. Dept., Bridgeport, Conn.								Standard Gas Equip. Corp., Bayard & Hamburg, Baltimore, Md.							
General Mills, Inc. Chamber of Com. Bldg., Minneapolis, Minn.								Stem Electric Co., Grand & Potomac, St. Louis, Mo.							
Getz Power Washer Co., 1025 Walnut St., Morton, Ill.								Stern Brown, Inc., Long Island City, N. Y.							
Gibson Refrigerator Co., Greenville, Mich.								Stiglitz Furnace & Foundry Co., Portland Ave., Louisville, Ky.							
A. C. Gilbert Co., 319 Peck St., New Haven, Conn.								Sunbeam Corp., 5600 Roosevelt Blvd., Chicago, Ill.							
William L. Gilbert Clock Co., Winsted, Conn.								Sun Kraft, Inc., 213 W. Superior, Chicago, Ill.							
Gillfillan Bros., Inc., 1815 Venice Blvd., Los Angeles								Superior Electric Prod. Corp., Cape Girardeau, Mo.							
Gill Electric Mfg. Co., Redlands, Calif.								Swartzbaugh Mfg. Co. (Everhot), 1336 W. Bancroft St., Toledo							
Glenwood Range Co., Taunton, Mass.								Tappan Stove Co., Inc., Mansfield, Ohio							
Globe-American Corp., 101 E. Broadway, Kokomo, Ind.								Teleshon Corp., Ashland, Mass.							
G-M Laboratories, Inc., 4326 N. Knox Ave., Chicago, Ill.								Tepper Appliance Co., Cincinnati, Ohio							
Go Electric Corp., 200 William St., New York, N. Y.								Thermador Electric Mfg. Co., S. Riverside Dr., Los Angeles, Cal.							
Grand Home Appliance Co., 2323 E. 67th St., Cleveland, Ohio								Thermo-Boiler Co., 23 Flatbush Ave., Brooklyn, N. Y.							
Gray & Dudley Co., 222 3rd Ave., Nashville, Tenn.								Seth Thomas Clock Co., Div. Gen. Time Inst. Corp., Thomaston, Ct.							
Haines Mfg. Corp., 4754 No. Clark St., Chicago, Ill.								Toastmaster Prod. Div., McGraw-Electric Co., Elgin, Ill.							
Hamilton Beach Co., Div. of Seovill Mfg. Co., Racine, Wis.								Toast-O-Lator Co., Inc., 10-23 Jackson Ave., L. I. City, N. Y.							
Hamilton Mfg. Co., Two Rivers, Wis.								Toastwell Co., 620 Tower Grove Ave., St. Louis, Mo.							
Hammond Instrument Co., 2915 N. Western Ave., Chicago, Ill.															



## Fair Guarantee

(Continued from page 49)

completion of a job within arms reach; tools are neatly arranged on the bench, parts cabinet is within easy reach at one side, and service books are overhead. Adequate fluorescent lighting keeps eyestrain at a minimum.

"Our service department not only brings us profit, but it is also the solid foundation upon which we are building our sales volume," Bradley declared. "During the competitive period, which we are already facing, servicing more than ever before will play an important role. Customers will buy from the store which can not only sell nationally-known makes, but which can also maintain their radio or appliance in the most efficient manner.

### Service Is the Key

"Our repair section is the backbone of our business. We will continue to stress it in order to win new customers and to hold on to our regular ones.

A large part of the firm's business is devoted to the sale and servicing of auto radios. About 40 per cent of the man hours spent on repair work prewar were on car radios. Anticipating an expansion in the mobile field, the co-proprietors have built an addition to their building. This expansion provides complete facilities for servicing auto receivers and room for two cars. A parking lot outside the shop is also provided.

### Boom Is Coming

"We are making a special bid for the auto radio business in our trading area," Bradley asserted. "We expect a boom in this field which should be very profitable to us. We have our facilities readied for it."

When the company began to merchandise electrical appliances it established its own appliance service department. Much profit has come to the firm from this source. The fine reputation the co-owners established on radio repair has been instrumental in bringing in new appliance maintenance business.

Another profit-making function is the sale and maintenance of public address systems. As a result of searching out new ideas for sales, the store has done a large business in PA equipment and servicing.

Rounding out the firm's activities is its wholesale parts department

which caters to the needs of local technicians. This section carries a large stock of tubes, radio cabinets, testing devices etc., and adds to the profitable operation of the store.

### Four Rules Followed

Summing up the management of the store, the co-owners state, "We are building our sales volume by constantly being on the lookout for new ideas and then following them up aggressively. First, we have a

good location which is not in the high rent section of town. Second, we handle lines of goods which already have created a great amount of public acceptance. Third, we sell service and promote good-will at the same time by promoting our slogan. Last, we believe in making a fair profit and giving the customer his money's worth."

The company's two other stores are located at 3 E. Front St. in Red Bank, and at 34 E. Front St., Keyport.

# Something NEW in WATER HEATING

## Dudley HOT WATER HEATER ASSEMBLY

ATLANTIC MFG.  
HAMBURG, PA.  
Patent Pending

Convert your present Boiler in 30 Minutes with this Complete Kit to an Electric Water Heater

"The heater with a BRAIN"

IMMERSION HEATER AND THERMOSTAT  
The new Dudley



combined automatic immersion heater and thermostat—approved by Underwriters Laboratory.

BANDING  
5 Rust Proof Bands — easily applied — Hold Insulation Jacket securely — Pack-



age of Fiberglass Cement included in kit.

SAFETY PRESSURE AND RELIEF VALVE Assures complete safety.

Galvanized T joint, nipple and plugs.



FIBERGLAS INSULATION



The modern insulation in a wire mesh jacket. Will not rot, decay or absorb moisture.

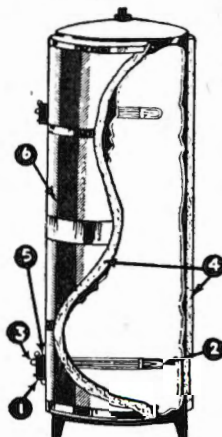

- 1 Accurate Thermostat operates attention free on low cost basis.
- 2 Immersion type heater, insuring instant heat, without delay.
- 3 Pilot Indicator shows immediately when heater is in operation.
- 4 Fiberglass insulation jacket holds heat inside tank—Modern and extra long-lasting.
- 5 Immersion Heater and Thermostat carries complete UL approval.
- 6 Jacket may be painted with any type of paint for special color schemes.

Safe...

To convert any STANDARD RANGE BOILER

Automatic

### IMMEDIATE SHIPMENT

A new phase in electric water heaters, never before available. Complete assembly for use with any type range boiler. Assures plenty of hot water at all times. Equipped with the new Dudley combined automatic immersion heater and thermostat which has proven under test to be economical, efficient and long-lasting.

Thermostats are set for 150° temperature and are equipped with an adjusting screw to raise or lower the temperature.

DEPENDABLE CONVENIENT  
HOT WATER WHEN YOU WANT IT!

### SPECIFICATIONS

Catalog Number	Size in Gals.	No. of Heating Elements	Standard Wattage—Bottom Element	Top Element	Voltage	Retail Price
M-20 A	20	1	1000	.....	110	34.95
M-20 B	20	1	1000	.....	220	34.95
M-30 A	30	1	1500	.....	110	39.95
M-30 B	30	1	1500	.....	220	39.95
M-30 B-D	30	2	600	1000	220	49.95
M-40 A	40	1	1500	.....	220	44.95
M-40 B	40	1	2000	.....	220	44.95
M-40 B-D	40	2	750	1250	220	54.95
M-50 A-D	50	2	1000	1500	220	59.95

**ATLANTIC MANUFACTURING CO.**  
HAMBURG 2013 HAMBURG, PENNA.



## What Kind of Tubular Paper Capacitor Do You Need?



## The MALLORY Line of capacitors is really complete

MALLORY makes 75 different paper tubular capacitors to supply your "every need" and for your convenience. They range in rating from 400 volts to 1600 volts—and in size from  $\frac{3}{8}$ " x 1" to  $1\frac{1}{4}$ " x  $2\frac{1}{2}$ ".

These paper tubulars are divided into two broad categories—wax impregnated and oil impregnated. Both are hermetically sealed to provide against atmospheric penetration. Both are carefully factory-tested so you get *all* the quality that Mallory puts into them.

Get the complete story from your Mallory Distributor or from the Mallory Catalog.

You save a lot of time if you check the Mallory Catalog for replacement parts as you need them. Do you have a copy? If not, see your Mallory Distributor.

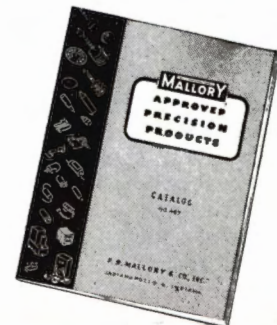

**YOU EXPECT MORE AND GET MORE . . . FROM MALLORY**

**P. R. MALLORY & CO., Inc.**  
**MALLORY** VIBRATORS . . . VIBRAPACKS\* . . . CAPACITORS . . . VOLUME CONTROLS . . . SWITCHES . . . RESISTORS . . . FILTERS . . . RECTIFIERS . . . POWER SUPPLIES.

\*Reg. U. S. Pat. Off.

**APPROVED PRECISION PRODUCTS**

**P. R. MALLORY & CO., Inc., INDIANAPOLIS 6, INDIANA**



# SERVICE & SOUND

Section of **RADIO & Television RETAILING**

## Take Time to Save Time

Prepare Your Service Department Now for Economical Operation

● Take all the man-hours lost through accidents, wars, national calamities and depressions, add them up and multiply by a telephone number picked at random . . . and the total will be but a drop, as compared to the vast ocean of time wasted in the day-to-day repetition of useless motion.

Especially for the service department is wasted time a critical item . . . for time is the servicer's stock-in-trade. And now, with trade getting tighter, the clock begins to tick louder.

### Where Your Hours Go

Since we all waste time in one way or another, let us ask ourselves this question: How is some of *my* time being wasted? If you, as a servicer, will stop to answer that question truthfully and searchingly, chances are the answer will be one of these:

- 1—Pickup and delivery time
- 2—Preparation time
- 3—Troubleshooting time
- 4—Storage time

Let us illustrate these points more fully. Do you know, for instance, that one of the largest chain of radio service shops in the country averages only 10 minutes travel time per outside job? Perhaps your territory is so dispersed that you'd need jet propulsion to match that 10-minute figure . . . but on the other hand, perhaps it's only a matter of sloppy routing, poorly-stocked tool-kits, indefinite appointments or lack of an incentive bonus plan.

It is a good idea to divide your outside man's day into time units. In large cities, a ½-hour unit allows for travel time and inspec-

tion call. Additional ½-hour units are used up on actual home repairs. If the necessary replacement parts are missing, the servicer should estimate the number of time units needed for the follow-up call and the complete repair, or yank the set.

The first procedure is followed by the largest service organizations, which get enough calls to keep a man busy in one large neighborhood on any one day, and have him work on foot. The individual servicer with car, of course, does better to take the set to the shop for any repairs requiring complete disassembly.

To be able to figure on a half-hour per inspection call, the servicer must, of course, be an excellent technician. This is a matter of preparation. Preparation time is always well spent, whether for outside jobs or inside jobs. Prepare

by mastering the latest radio circuits no less than basic theory. Prepare by watching your own wasted motion.

For instance, how do you keep your replacement parts? In a cigar box . . . with every value of resistor or capacitor all jumbled together? Or are all of the most-frequently-needed values within arms reach, separated in instantly-identified containers?

### Suggested Methods

Small glass jars make excellent holders, for they can be screwed into their caps mounted to the underside of the shelf immediately in front of the workbench, while their transparent quality permits instant inventories to prevent the stock from getting dangerously low.

The March issue of RADIO & Television RETAILING will treat this subject further, offering many ideas.

X marks the spots where time is lost in poorly-arranged service shops. Keep stock, diagrams and phone within reach of bench. Keep repair jobs in rack, well identified, easily located.

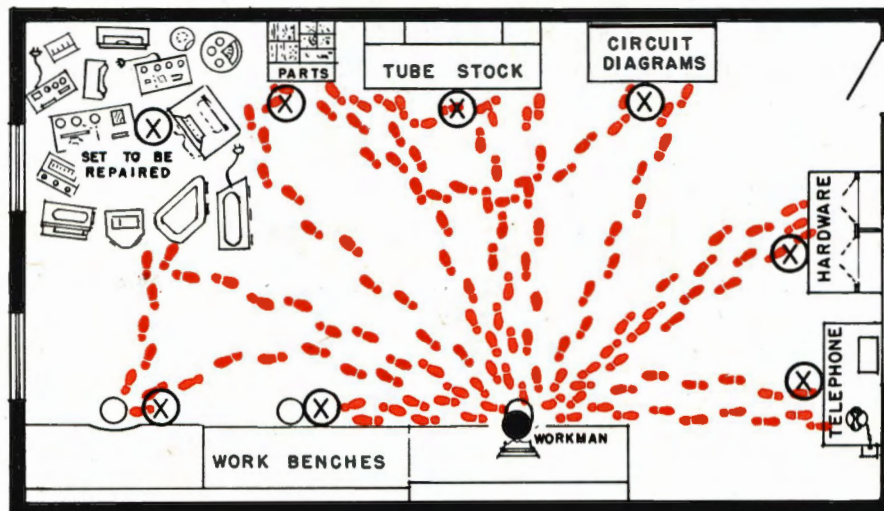



**OVERWHELMING  
ACCEPTANCE...**



**because they're  
Radio-Engineered for  
Extra listening hours**

**T**HE VERY FACT that RCA Batteries are designed *for radio by radio engineers*, is the reason why dealers and servicemen everywhere are turning to RCA *Preferred Type* Radio Batteries for greater profit and customer satisfaction.

Each radio-engineered battery type has the right capacity for the current drain of the sets it is designed for. And all "A-B" types are engineered so that *both* sections

deliver effective voltage for the *full* life of the battery pack.

Add this to the fact that RCA is the greatest name in radio, and you'll understand why the smartly packaged and competitively priced RCA Radio Batteries lead the way today. You can get your stock conveniently and quickly from the same RCA Distributor who supplies you with RCA tubes, parts, and test equipment.

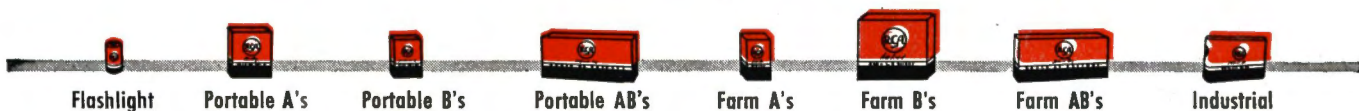

**TUBE DEPARTMENT**

**RADIO CORPORATION of AMERICA**

**HARRISON, N. J.**



# Call for Airport PA

**The Ceiling's Unlimited in This Fast-Moving Industry. Every Field Needs More Sound Now.**



University B6 loudspeaker pumps 150 watts of audio through parking area to far runway.

• One of the most important of the new fields for PA installations has to this day been little noticed by many sound dealers. It has been roughly estimated by at least one leading PA equipment manufacturer that no less than 6,000 sound systems will be installed in Class I and Class II airfields during the next two years.

Of approximately 3,900 airfields in the country, 2,600 are in Classes I & II, suitable for small planes. At these airfields are found from one to five or more independent companies engaged in the business of passenger "thrill" flights, instruction of amateur pilots, rentals for "solo" use, and charter flights.

While a sizeable number of these companies already have some sort of paging or announcement system, virtually every one will purchase new systems or new equipment for their existing installation.

The systems are used for the broadest variety of purposes, ranging from entertainment to advertising, and from personnel direction to

traffic control of taxiing aircraft.

Shown on this page is a typical small installation at Morristown, N. J. Municipal Airport. Along with other companies at this field, the Hilton Flying Service, Inc., is expanding its use of PA apparatus by the addition of 200-watt equipment designed to carry down the entire length of the runway.

While the larger Class III and Class IV airports use radio control towers and two-way airborne radio sets for traffic and runway control, the smaller fields accomplish the same objectives without radio. Warnings, also, can be forcibly directed to emergency crews, parked cars, spectators, passengers and waiting parties by the use of powerful sound amplifiers.

## More Uses for PA

Installations in hangars are also very popular, since office quarters are often apart from the hangars to which information must be gotten expeditiously. For those airports which make tie-ins with carnivals, fairs, and sports events, high-power PA installations are an essential element.

Amplifiers for small airfield work vary greatly in power-handling ability. For simple communications with a hangar, often only a strong

intercom hookup is needed. For general paging in the immediate vicinity of the office, a group of speakers can be driven from a 25-watt amplifier. On the other hand, an all-around useful system is a small investment compared to its cost, and 200-watt jobs are very popular for powering a complete network of horns.

## Why Sound Is Needed

It should be remembered that airplane services have a great deal of capital invested in a business which is still partially dependent upon a novelty appeal. The service shown on this page, for example, owns and operates 12 planes, including 1 super cruiser.

To make such a great investment profitable, every channel for attracting business must be exploited, and one of the important means is the high-power, high-fidelity sound system. With higher standards of sound reproduction gradually coming to dominate the industry, older installations are due for revamping.

Because small airports are generally a bit off the beaten track, few sound dealers make it a point of concentration. However, the enterprising PA department will find many a hot prospect in this field, once he begins to make selling calls.

University PH horn with 5AH driver unit covers ramp area, with smaller side speakers.

Muriel Shaffer dispatches Hilton planes over the PA, keeping pilots and field personnel notified on weather; PA system is used to attract business through advertising announcements.





# Big Boom Reported in

**Specific Troubles to Look for in the New 6-Volt Sets.  
Troubleshooting Tips Include Details for Easy Repairs.**

● Of all the sets used by the consuming public, automobile radios undoubtedly take the worst beating. Being subjected to relatively monstrous voltage overloads, underloads, moisture, heat, vibration, mechanical shock and retuning, only years of continuous designing and meticulous attention to field service-reports have brought them to the point where, before the war, auto radios withstood years of daily use.

The auto sets produced during the past year suffered, however, from faulty or expedient parts and lack of vital field service experience. It is not surprising, then, to find a relatively high percentage of troubles appearing.

While these bugs have already mainly been engineered out of the latest production runs, the huge demand for auto radios which keep apace with the likewise great percentage of new cars desired, will inevitably indicate a boom of several years in auto radio servicing.

The slug-tuning coils have been one major source of trouble. Basically this unit is not new, having already been used prewar. It seems to be here to stay, and no doubt the current weaknesses will soon be eliminated.

The tuning slugs or cores often

break off from the plunger shafts or springs to which they are affixed, in the magnetic solenoid-driven assemblies. Weak solenoids sometimes give trouble when the car battery is somewhat low, and should be replaced. One manufacturer, Zenith, gives servicers a service manual for these automatic tuning units alone. The illustration at right is typical of this manual.

In Zenith sets, trouble has been experienced with ratchet gears made of softmetal. If the mechanism fails to change from one station to the next, or jams between two stations, yet works perfectly by hand, the trouble is probably with the ratchet gear. If, after checking for obvious troubles such as loose, missing or binding parts, and cleaning and lubricating the gear, turret ratchet and turret shaft, the condition is still present, replace the soft gear with one of the newer steel units.

Sometimes it will be found that the gear is good, and sufficient lubricant is present, and that the mechanism still jams when changing from manual tuning to the first pushbutton position. This is especially liable to happen when the manual tuning indicator is at the high frequency end of the band.

Zenith 1946 permeability tuning unit showing position of ratchet gear and muting switch spring.

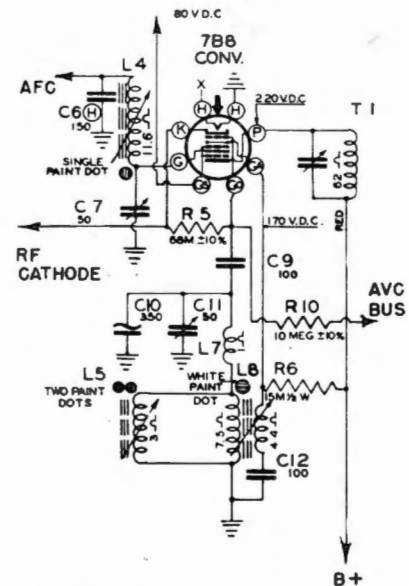
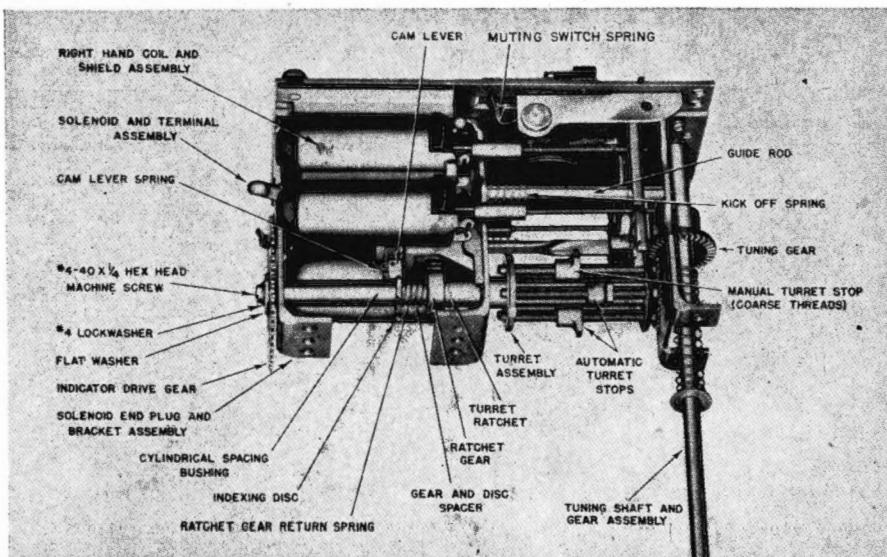

Ford 6-tube model 6MF080 typifies sets using a 7B8 converter. Dead or intermittent oscillators are traceable to off-standard tubes, capacitors C-9, C-10, C-11, and off-value coils.

If the solenoid hasn't enough pep to make a complete cycle, the slug mounting assembly gets caught on the muting switch, which is supposed to put a momentary 6-volt bias on the first a-f tube.

This is unfiltered battery voltage, and produces a loud hum in the speaker. The trouble can sometimes be cured by smoothing down the switching lever surface, or loosening the lever spring tension, with replacement of the solenoid as the final resort.

The Philco pushbutton mechanism may be found not to track, as a result of incorrect installation, because the control cable that pushes the rotating wafer switch is not tied down well enough. This cable must be taped down very tight.

Motorola permeability-tuned assemblies are occasionally found jammed as a result of misalignment of the plungers in the coils. This results in the cores breaking away from the plungers, as well as off-tracking. No car radio seems to be completely free, as yet, from some sort of trouble along these lines.

In the Motorola sets, for example,



# Auto Radio Servicing

in which the tone control also works on a solenoid relay operated by pushing the volume control knob, the car owner sometimes keeps the control pressed without releasing it for a time long enough to ultimately burn out the solenoid.

## Look for These Faults

Another important point to check is the dial and pointer mechanism, which may bind. On the Lincoln, for example, the Lucite dial scale may warp, causing the pointer to bind on the upper edge. To remedy, install a reinforcement strip under the upper edge of the dial scale.

Other mechanical troubles pop up in the new auto sets also. The Motorola volume control shaft, for instance, may be pulled out of the set by an inexpert servicer using insufficient care in removing the flexible drive, which is designed to expand when plugged into the shaft. This requires a wasteful dismantling job as penalty.

Weak sides of grooved volume control shafts are still breaking off as they did in prewar sets. Since there is no room for adding bushings or collars in many receivers, the entire control must sometimes be replaced. Others, however, will take a replacement shaft.

The Zenith station selector touch bars are hinged on a pin held by crimped-over slots cut into tongues on the escutcheons assembly. These slots were originally too shallow, and the pins sometimes pulled loose from the crimp. For a simple remedy, take an additional slight cut into the slot, and re-crimp the metal over the pin.

Most of the new auto radios have recurrent troubles of an individual nature aside from control assemblies. For example, the RCA receivers used a power transformer which occasionally shorted to the case, or developed a breakdown in the high voltage winding.

Older Sonomatic models had poor bypass capacitors in the SK7 r-f and i-f cathode and screen grid circuits, while loose terminal leads frequently developed in the .2 mf a-f coupling capacitor between the 6SR7 and the 6V6. The same kind of trouble has occurred in the .005 mf capacitor connected from the a-f tap on the diode i-f coil to the top end of the volume control.

Philco sets have revealed some vibrator defects, while excessively high battery voltage seems to be bad for the Motorola vibrators. The latter set used an OZ4 rectifier at first, which was changed later to a 6X5.

OZ4 rectifiers (sometimes called "money tubes" because of a tendency to go bad after about 5 months of service . . . comfortably clearing the guarantee period) have traditionally been finicky on battery voltage regulation, and the trend today is toward hot cathode types, such as the 6X5 or the 7Y4.

The electrolytic capacitors of many receivers are of the can type; at times, the electrolyte leaks, and forms a current path between terminals, resulting in a hum. As a check, move the can slightly with a screwdriver. This may reduce the hum temporarily. Rather than clean the can, replace the part, for the likelihood is that the leak will reappear shortly.

## A Frequent Offender

In many cases, intermittent operation of Zenith car radios are caused by sharp edges, burrs and cracked surfacing of the metal trimmer leaves in the i-f transformers. The 2nd i-f transformer's secondary winding has a fixed tab capacitor for the detector diode return which shorts to produce this symptom, while the first i-f trimmer, when shorting, causes a no-signal condition with normal d-c voltages at all socket connections.

Simplified diagram of Motorola Model 405 shows permeability tuning unit as well as slug-tuned shunt-type oscillator padder and i-f coils.

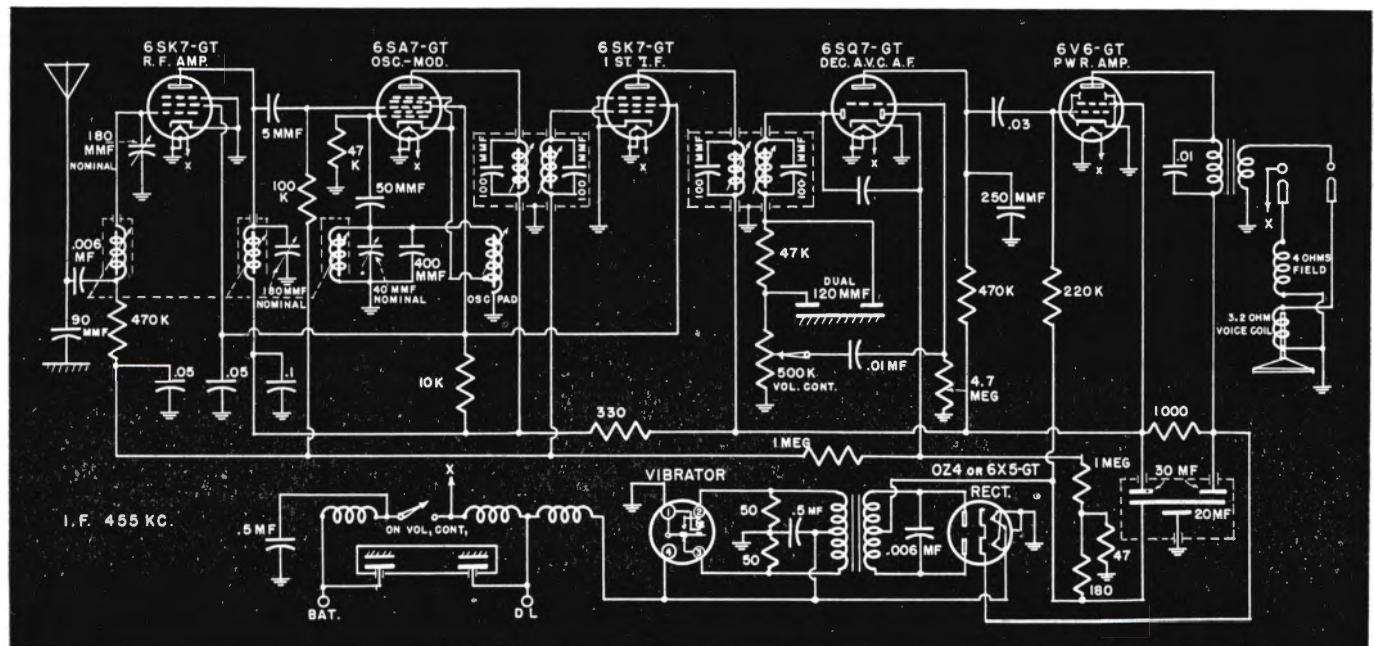



# Record Changer Speed

**Trouble Points in Specific Motor Assemblies Listed.**

**Cut Service Costs by Studying These Tricky Features.**

• While no record changer problem can always be labeled "easy" those involving variations in turntable speed are generally in the "hard" category. The first article on this subject appeared in the January issue. Now Louis Loshak goes more deeply into the not-so-apparent causes of speed troubles, discussing some particular cases by way of example.

In using replacement motors to replace a manufacturer's type care should be taken that the motor spindle or drive bushing is of the same thickness. If the spindle is thinner, speed will be slower. During the war, the author undertook a small contract to repair some phono demonstrators that had burnt out Alliance motors.

## When Standard Vary

Upon inspection it was found that the drive mechanisms were not standard, but were built by the manufacturer of the machine specially around what appeared to be a fifty cycle motor spindle. The problem was solved by using the only procurable type of motor at that time, a straight sixty cycle job and a standard fifty cycle conversion spring, which was obtainable from another set manufacturer.

If an assortment of springs is on hand, the servicer can do wonders in substituting one rim drive motor for another. Servicers whose customers live in those parts of the country having direct as well as alternating currents will especially

RCA RP-151 motor cradle and drive wheel.

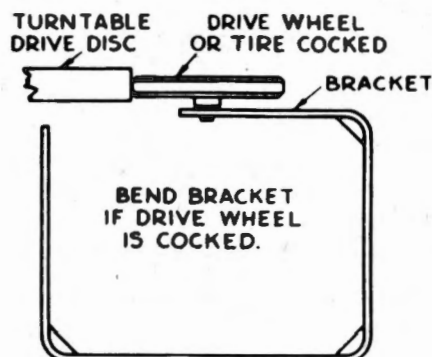

appreciate these suggestions.

With so many of our table model combinations using ac-dc chassis it is only natural for the consumer to turn on his phonograph motor when he moves into a d-c apartment. For when the receiver is plugged in and reception is achieved, the consumer unwittingly expects the turntable to work since his radio is bringing in stations. This fact alone accounts for a large percentage of motor replacements in d-c areas.

When a motor spindle spring is installed, care must be used to make sure that the turns are laid down closely together, with no sharp edges or ends to chew up the idler or turntable rubber tire.

Often a way can be found to adjust speed by loosening the motor from its mounting or platform and by shifting the mounting angle. This brings the drive wheel up or away from the turntable and can be counted upon to make some difference in rotating speed.

In doing this, remount the motor spindle in such a manner that it is perfectly parallel to the turntable spindle, and with the driving surface perpendicular to the driven surface of the turntable.

## Spindles Give Trouble

Bent motor spindles are another cause of varying and slow speed. Even a slight "wobble" in a motor spindle is sufficient to slow down the motor appreciably. Bent turntable spindles, on the other hand, produce varying speed effects, or wows.

Also take a moment to straighten the fan on models employing them. While the later production units do not have felt washers, a few drops of oil should be squirted into the bearings just the same.

Our discussion of speed problems has been limited to those taking place at the primary source, the motor. To examine every speed problem and its cause would take volumes. However it will be worthwhile to go into a brief analysis of three popular RCA mechanisms

and the unusual speed problem encountered in these changers.

The first mechanism is RP-139, used in such models as the U125, U129, U130 etc. This mechanism is familiar to the servicer as the unit which has a Black Flyer motor

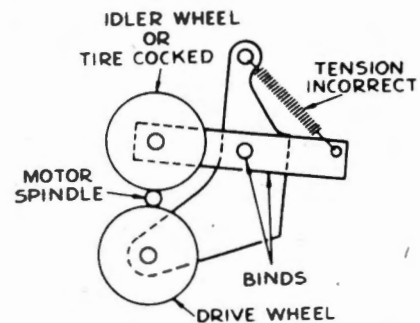

Check tension of RP-151 idler wheel spring.

mounted separately below the mechanism itself. The phono panel is connected to the motor by means of a flexible coupling.

Complaints of wow and slow speed are quite generally traceable to motor trouble the service of which we shall not discuss here. However many a servicer has replaced or repaired the motor on this machine only to find that the trouble reappears in a short time.

To discover the reason for repeated motor trouble, disconnect the flexible coupling between the motor and turntable. Place a marker on the turntable. Spin the turntable by hand sharply. Count the ensuing revolutions. The turntable should rotate freely and twelve complete revolutions should result.

In the case of changers RP-158, -160, -161 and -162, the same procedure can be followed by applying power until the turntable has reached full speed, and then pulling the motor and idler away from the turntable. As before, twelve complete turns should be made. If this does not happen, then rest assured that repeated motor trouble has a cause. Proceed as follows.

Remove the changer panel and place it on a bench. Disassemble the turntable by knocking out the pin that holds the copper coupling below. Now you may find difficulty



# Faults—II

RCA thrust bearing assembly, part 38568, utilizes a ball bearing washer to replace the older turntable bearing of RP-139.

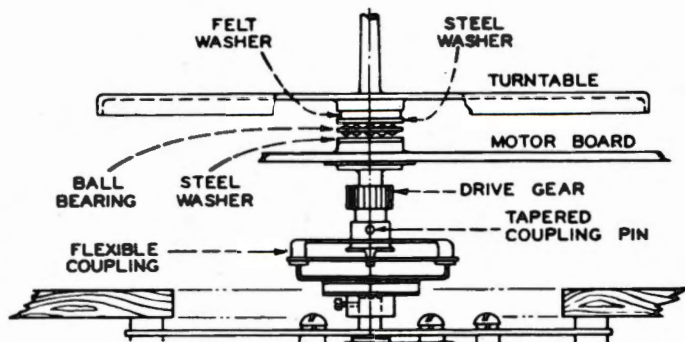

in removing the turntable as it seems to be frozen to the bearing. Tap the sides of the turntable sharply and pull up. Once the assembly is apart you have two choices as to the method of repair.

The first, is to sandpaper down the lower spindle, clean out the bearing, oil, grease and reassemble. Very fine crocus cloth or emery cloth should be used, if available. If not, use a fine grade of sandpaper. Clear out any foreign particles, such as bearing metal, watching for set screw burrs as well.

Bevel the top edge of the top bearing slightly, with a knife or scraper. Clean the shaft and the bearing with carbon tetrachloride, removing oil and grease, being certain to clean out any chips which may have dropped into the bottom bearing. Before reassembling, lubricate all moving surface with a light coating of STAPUT 512, which can be purchased from E. F. Houghton & Co., Third St., and Lehigh Ave., Philadelphia, Pa., or their distributors.

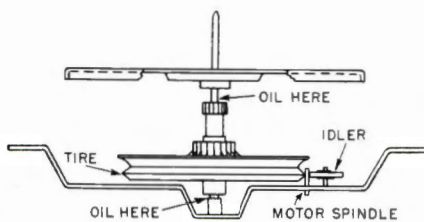

Inspect large drive tire of RCA RP-145.

Another method entails the purchase of RCA part number 38568 thrust bearing assembly. Install this ball bearing washer in place of the original unit and reassemble. Illustrated, are the position of the various parts going into this assembly. The second method is recommended but the first is adequate if the 38568 kit is unobtainable.

Insufficient lubrication of the motor bearing will also result in slow speed and lack of torque. Remove the armature and clean it and the bearing with carbon tetrachloride. Judicious polishing with

crocus cloth may be advisable as well.

Then use a good lubricant, proper for the job it has to do. Standard Oil Co. of Indiana puts out a Special Oil number 11326 while Singer Sewing Machine oil is also a good lubricant.

The RCA record changer model RP-145 and similar model changers were used by a great many manufacturers other than RCA. Speed troubles in these mechanisms are generally traced to the large drive tire. This unit looks like a tricycle tire and often appears to be perfectly firm and not worn. However by all means change this part when trouble appears. The author has seen these tires give trouble although they appeared healthy enough to be mistaken for a new unit.

## Symptoms of Trouble

If further speed trouble is encountered, service the motor by using the method described above. Other symptoms that are the result of this tire trouble, are failure of the mechanism to complete the cycle and even jamming of the changer due to the fact that torque is insufficient to help the changer go through the difficult portion of the change cycle.

Now look at the illustration of the motor cradle and drive tires that are part of the V225 RCA phonograph mechanism. This is the RP-151 changer that plays both bottom and top of a record.

The motor used here is the General Electric rim drive with a field tapped for a reverse winding. Service procedure is the same for this unit as for the conventional model. Assuming that motor and tires are in good condition, look for the cause of slow speed in the cradle itself. Make sure that the shape of the cradle matches that of a new changer. The cradle is of light gauge steel and is easily bent, thus a serviceman or a consumer may throw it out of line when working

on the changer. This results in improper contact between drive tire and turntable.

The final illustration is that of the turntable employed in the V225 mechanism. Note the screw and nut on the bottom. If speed is still slow or wavering after you have checked all other causes, turn the mechanism upside down. Now loosen the nut and take out the screw. Inside the bearing you will find a felt washer. Dollars to doughnuts, you find this washer dry and curled up thus causing an internal bind in the turntable.

Pull out the washer, pour a little carbon tet into the bearing and wash it out thoroughly. Dry, insert the washer, and lubricate with a light oil. Wash the turntable rim, tires, etc., with a little carbon tet to remove any oil film that may accumulate as the result of lubrication. Also check the suspension spring that holds up the motor cradle. In time this spring loses tension. Snip off a few spirals; this should do the trick.

In general, it may be said that the modern phono changer is not difficult to service. Analytical patience and a few parts will take care of the bulk of service problems. These machines nowadays are not heavy, parts are inexpensive, and the number in use is growing all the time. The service of these units is proving to be a highly lucrative phase of the radio servicer's business. Is that true of yours?

V225 mechanism of RP-151 has felt washer, reached for oiling by removing bottom screw.

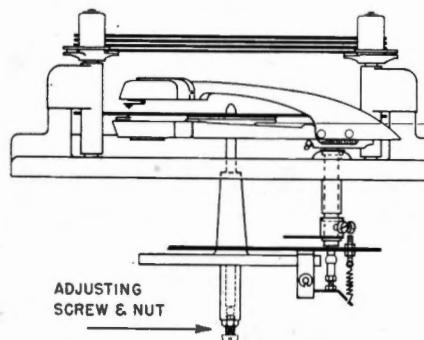



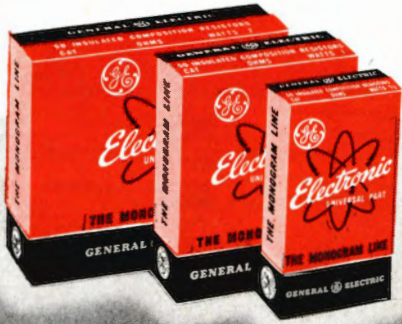

*Quality*  
across the board

# IN THIS GENERAL ELECTRIC LINE OF UNIVERSAL PARTS



**H**ERE'S A LINE of top quality parts that every distributor can be proud to handle—the General Electric line. This is not "just another line" but one of the most outstanding groups of units in the field. Designed, tested and produced with only one thought in mind—quality—every item will add to your prestige, profit and sales.

The General Electric line of universal parts is going to be easier to sell because it carries a name known everywhere. It is going to be easier to sell because the service man who replaces worn components with General Electric parts makes an immediate impression on the customer which can bring him greater returns. It is going to be an easier

line to sell because it is a complete line and you can supply most of the service man's needs, saving him valuable time.

Packaged conveniently in bright orange and blue cartons, every item is its own silent salesman. Backed by colorful window and counter displays, sales promotion aids and business forms for the service man's use, you have a complete follow-through for boosting sales and profit.

Send your order in at once. Remember—the General Electric line of Universal Parts is—Desirable—Profitable—and Complete.

Write for full details to: *Electronics Department, General Electric Company, Syracuse 1, N. Y.*

FIRST AND GREATEST NAME IN ELECTRONICS

**GENERAL**  **ELECTRIC**





SPEAKERS



ATTENUATORS

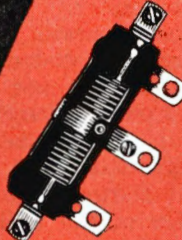

ADJUSTABLE  
WIRE-WOUND  
RESISTORS



FIXED  
WIRE-WOUND  
RESISTORS



RHEOSTATS



COMPOSITION  
CONTROL



T PAD



2 WATT  
WIRE-WOUND  
CONTROL



L PAD

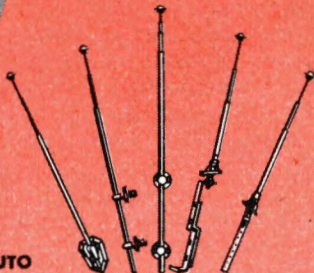

AUTO  
ANTENNAS

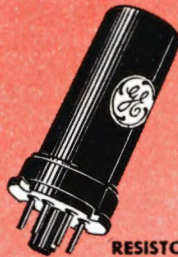

RESISTOR  
TUBES

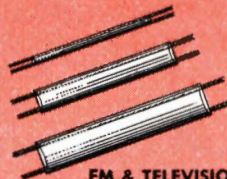

FM & TELEVISION  
LEAD-IN CABLE



ADJUSTABLE  
SWITCHES

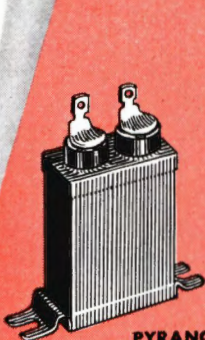

PYRANOL  
CAPACITORS



PORTABLE  
INSTRUMENTS



PANEL METERS

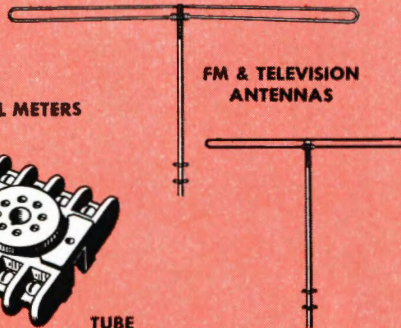

FM & TELEVISION  
ANTENNAS



TUBE  
SOCKETS

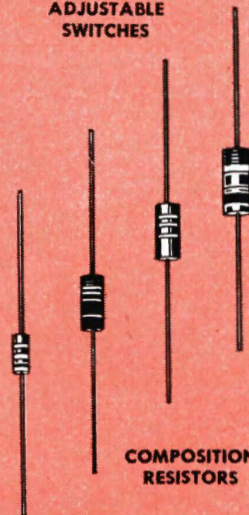

COMPOSITION  
RESISTORS

FIRST AND GREATEST NAME IN ELECTRONICS

GENERAL



ELECTRIC







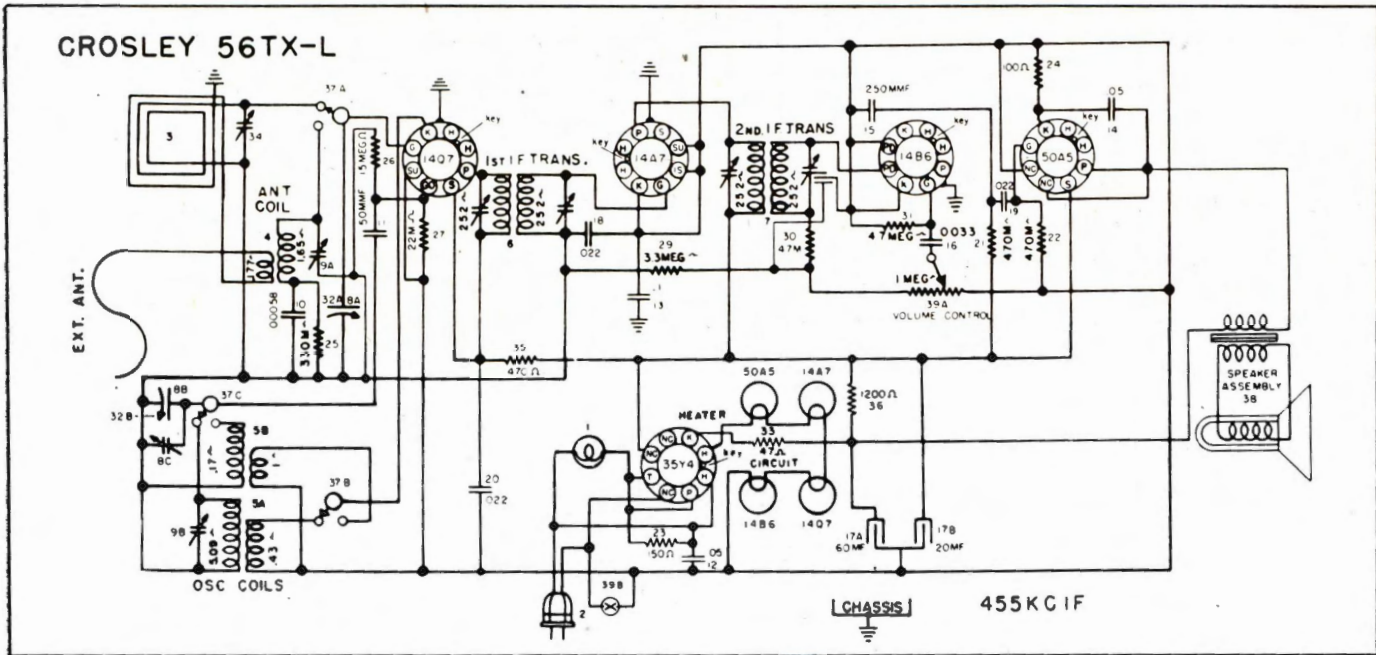

Crosley 56TX-L uses a floating ground which connects to the chassis through .1 mf capacitor 13. Make voltage checks to the common B—.

HOWARD MODEL 920 is a four-tube battery radio, using audio bias developed in the r-f oscillator stage. An outside antenna and ground should be used with this receiver, enabling the employment of an iron core high impedance antenna coil.

A conventional alignment serves to adjust the tuned circuits, with the slug-tuned i-f transformers adjusted both above and below the chassis on a 455 kc signal fed directly into the outside antenna lead. The r-f alignment is made at 1500 kc, with the generator coupled through a 200 mmf capacitor to the same point.

The oscillator trimmer located

on the side of the rear section of the variable capacitor is aligned first, followed by the antenna trimmer, found on the front section of the gang. No low frequency adjustment is provided, since cut plates are used in the oscillator section.

Voltages given in the diagram will be found accurate only when a VTVM is used in making the measurements. The receiver's on-off switch has three positions. The first is the "off" position, the second is the "battery saver" position, for use on strong local stations, and the third is the "full power" position, identified by a red flag or tab

which shows in front of the dial when full power is used.

Both the plate and screen returns of the 1R5 tube are made through the oscillator primary coil for greater stability, while the automatic type of bias used in the 1U4 grid circuit produces high sensitivity and prevents overloading.

A portion of the audio bias for the 3Q4 second audio amplifier is secured from a voltage divider arrangement in the oscillator grid circuit, while the bias for the 1S5 first audio amplifier is achieved by virtue of the "gas" current through the 10 megohm resistor in its grid circuit, an increasingly popular device.

Howard Model 920 is a new battery farm radio using a battery-saver switch and two stages of audio pentode amplification with a 5" PM.

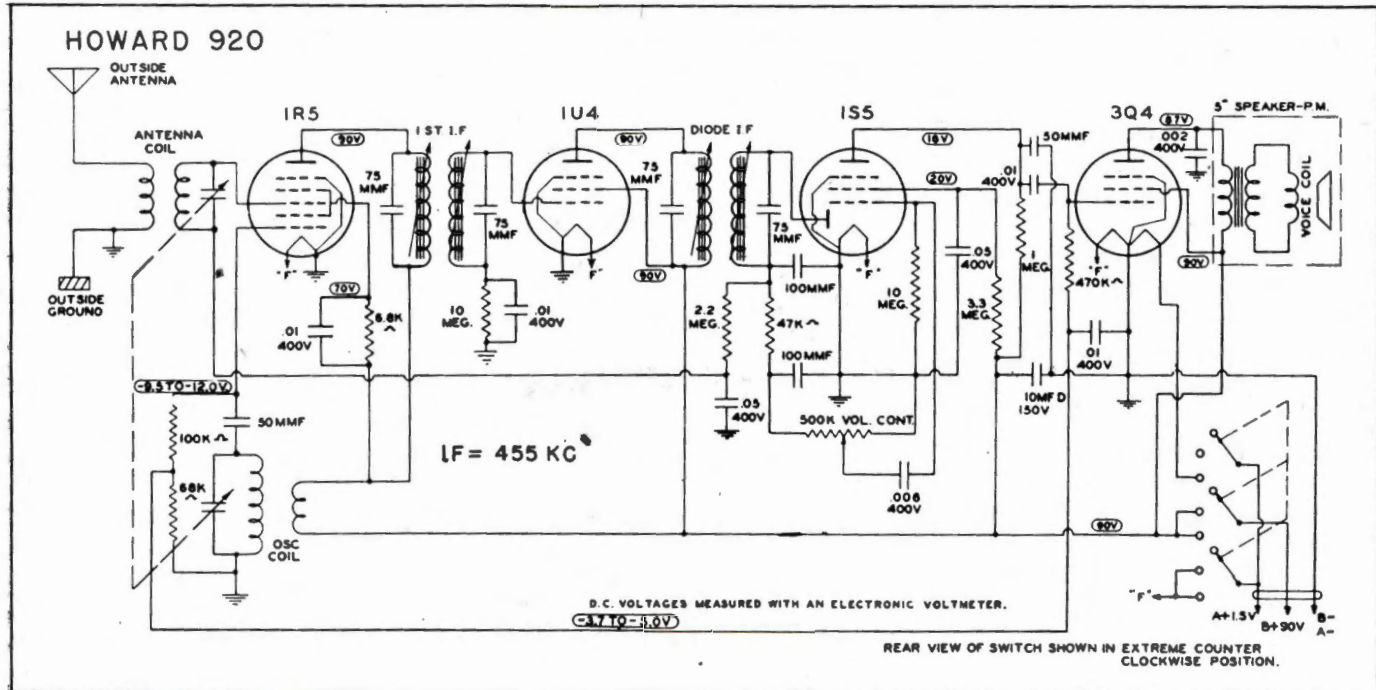



# Ideas for the Test Bench

Easy-To-Use Accessories Save Valuable Service Time

## Measure AC Amperes With Your Voltmeter

It is often desirable to know the approximate power input to a radio or low-current appliance, as this knowledge may indicate the source of trouble.

While a-c wattmeters are expensive and easily damaged, an approximation of the watts input to a radio may be arrived at by using your a-c voltmeter to measure the

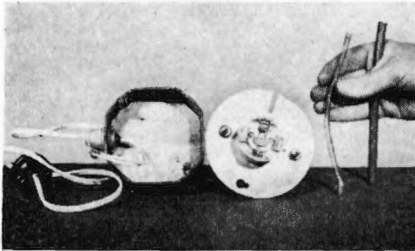

First assembly stage of input-power meter.

voltage drop across a known resistance which is in series with the radio power supply or appliance.

Knowing the exact resistance of the series resistance unit and the voltage drop across it, the amperes flowing are easily calculated. To make such measurement quickly, a resistance unit was constructed as shown, using a metal outlet box having a standard receptacle mounted in the cover.

Two pin jacks were mounted on the box cover. Also shown in the first illustration is the resistance

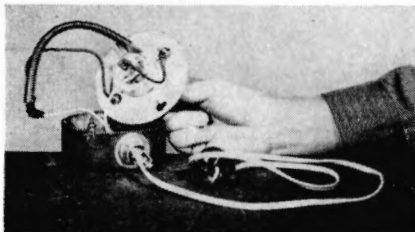

Resistance wire is run through fibre sleeve.

wire and a piece of fibre sleeving which was used for insulation. The resistance wire was of the type used in electric range units and was cut so that its resistance was four ohms.

The second photo shows the wiring completed, with the outlet box cover ready to fasten into place. Note the diagram for wiring arrangement and connection of voltmeter. The third photo illustrates the unit in use on a small set.

If the radio had no power transformer, the volt-amperes drawn by it could be considered watts, and the marking on the radio nameplate checked against this value.

Since this radio had a power transformer, a small allowance for some reactive load must be made in considering the volt-amperes as watts. In this set, the voltmeter reading is 4 volts. Using Ohm's law:

$$I = \frac{E}{R} = \frac{4}{4} = 1.0 \text{ A.}$$

Multiplying the line voltage of 115V by this 1A current, a volt-

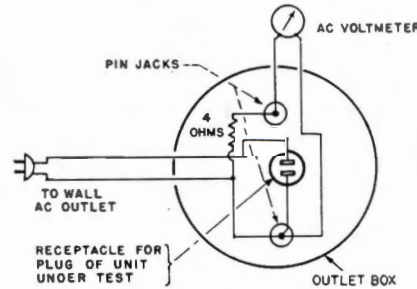

Circuit diagram of the current quick-tester.

ampere rating may be computed:  
 $115V \times 1.0A = 115 \text{ VA}$

Since the nameplate on the radio listed the watts as 75, it was evident from the 115 volt-ampere figure that too much current was being drawn from the line. A check of the radio condensers resulted in finding a shorted by-pass condenser.

Upon disconnection of this faulty condenser the voltmeter pointer dropped to a reading of 3 volts. Repeating the steps as above, this



Outlet box is permanently connected to wall receptacle. To eliminate meter and shunt, use a jumper with pin jacks at either end.

reading results in .75 amperes and 86 volt-amperes.

This last reading is close enough to the nameplate rating to assume that there are no more major defects which are causing excessive

current to be drawn. Upon the installation of a new condenser the radio operated satisfactorily.

The above voltmeter readings were taken on a 10 volt scale. However, it is wise to use a higher scale when first connecting the voltmeter to the test unit as a defective power transformer or like trouble might draw sufficient current to cause a high voltage drop, with possible damage to the meter.

The resistance of the wire used in the test unit should not be too high, as the voltage drop to the radio will then be excessive. With a voltmeter having a lower scale a resistance of two ohms or less could be used.

This unit is also useful in checking for possible grounds in the radio after making repairs. That is, with a ground wire connected to the chassis (sets requiring ground connections) voltage drop readings are taken with the line plug connected in both possible positions.

## Rewinding Damaged R-F Solenoid Coils

Sometimes r-f coils are found with shorting turns and scorched windings, requiring replacement. If the manufacturer's part is not available, and the size and insulation type of the original wire is known, a quick rewind will generally give good results.

If necessary to figure out the correct number of turns, use a simplified calculator such as the "Calcula-ide" pictured below. Produced by the American Hydromath Co., 145 W. 57th St., New York 19, N. Y., the computer requires no arithmetic, giving necessary coil details directly from values of circuit capacity and coil form size.

Knowing form diameter of damaged coil, find wire size and spacing to match capacitors.

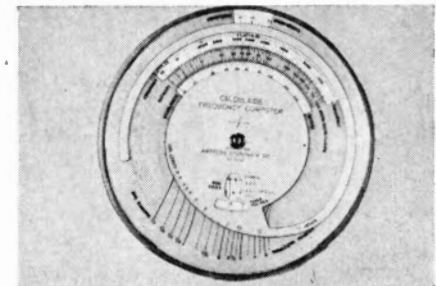



# Listen ... IT'S A Jensen SPEAKER!

**4** COAXIAL SPEAKERS  
**8** REPRODUCERS  
**3** BASS REFLEX\* CABINETS  
**REPRODUCERS**

## COAXIAL SPEAKERS



**MODEL HNP-51 COAXIAL (ST-122).** A 15-inch articulated Coaxial with cone-type h-f unit and horn-type h-f unit. Alnico 5 PM design throughout. Dividing network gives two-way performance. Wide-range response and excellent polar pattern. Ideal for FM receivers, high quality phonographs and similar applications, including monitoring. In Bass Reflex cabinet, response ranges from 50 to 15,000 cps. H-F Range Control lowers cut-off in four steps to suit program quality. Input impedance, 500-600 ohms. Maximum power rating in speech and music systems, 25 watts. List Price, \$125.00.



**MODEL JAP-60 COAXIAL (ST-600).** A 15-inch cone-type Coaxial with PM design. Furnished with H-F Range Control. Nominal input impedance, 500-600 ohms. Maximum power handling capacity in speech and music systems, 20 watts. List Price, \$96.00.

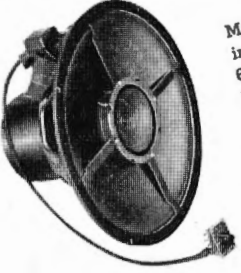

**MODEL JHP-52 COAXIAL (ST-601).** A 15-inch cone-type Coaxial like Model JAP-60 with efficiency approximately 4 db less. Furnished with H-F Range Control. Input impedance, 500-600 ohms. Power handling capacity in speech and music systems, 15 watts. List Price, \$65.00.



**MODEL ICP-40 COAXIAL (ST-603).** A 12-inch Coaxial at low cost. Ideal replacement and modernizing unit where 12-inch speaker is required. Simplified low-cost bridging network inbuilt. Terminals provided for addition of ST-606 Level Control. Nominal input impedance, 6-8 ohms. Power rating, 10 watts in speech and music systems. List Price, \$35.

UTILITY DESIGN (Brown Opaque Lacquer)

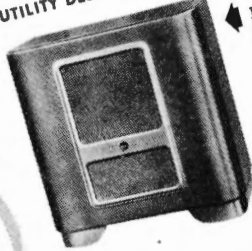

**MODEL RA-151.** Complete with Model HNP-51 Coaxial and H-F Range Control installed. List Price, \$181.15.

**MODEL RD-151.** Complete with Model HNP-51 Coaxial and H-F Range Control installed. List Price, \$201.00.

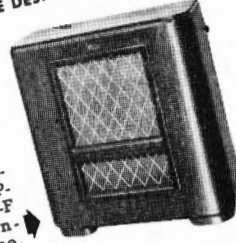

**MODEL RA-153.** Complete with Model JAP-60 Coaxial and H-F Range Control installed. List Price, \$142.15.

**MODEL RD-152.** Complete with Model JAP-60 Coaxial and H-F Range Control installed. List Price, \$162.00.

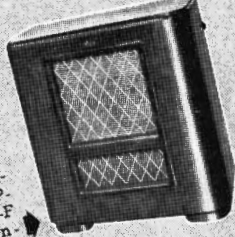

**MODEL RA-154.** Complete with Model JHP-52 Coaxial and H-F Range Control installed. List Price, \$121.15.

**MODEL RD-153.** Complete with Model JHP-52 Coaxial and H-F Range Control installed. List Price, \$141.00.

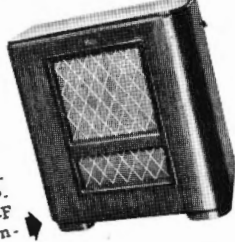

**MODEL RA-124.** Complete with Model ICP-40 Coaxial installed. List Price, \$94.15.

**MODEL RD-122.** Complete with Model ICP-40 Coaxial installed. List Price, \$114.00.

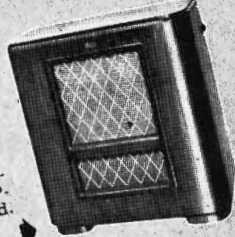

DELUXE DESIGN (Satin Finish Walnut)

**JENSEN MANUFACTURING COMPANY**  
6625 S. Laramie Ave., Chicago 38, U. S. A.  
In Canada: Copper Wire Products, Ltd.,  
11 King St., W., Toronto, Ont.  
\*TRADE MARK REGISTERED



**Jensen**  
SPEAKERS WITH ALNICO 5  
Designers and Manufacturers  
of Fine Acoustic Equipment



**NOW!** FOR A COMPLETE  
THE BEST IN RADIO TUBES—

**RADIO RETAILER'S SERVICE  
DEPARTMENT CAN OFFER BEST  
AND MOST COMPLETE SERVICE  
THROUGH PRODUCTS**

**MADE BY SYLVANIA**

When you sell Sylvania Radio Tubes, you're building customer good will — because you *know* you can count on Sylvania quality to assure customer satisfaction.

Sylvania Quality Control keeps the closest check on every tube . . . from the raw materials stage right through to finished product. Sylvania produces many of its own tube parts — maintains its own tungsten plant where the fine wire filaments for Sylvania Tubes are made.

When tubes are completed, Sylvania ages them to stabilize their characteristics . . . *then* subjects them to rigid tests. When a Sylvania tube reaches you, you're *sure* it's right . . . an assurance you can pass on to your customer.

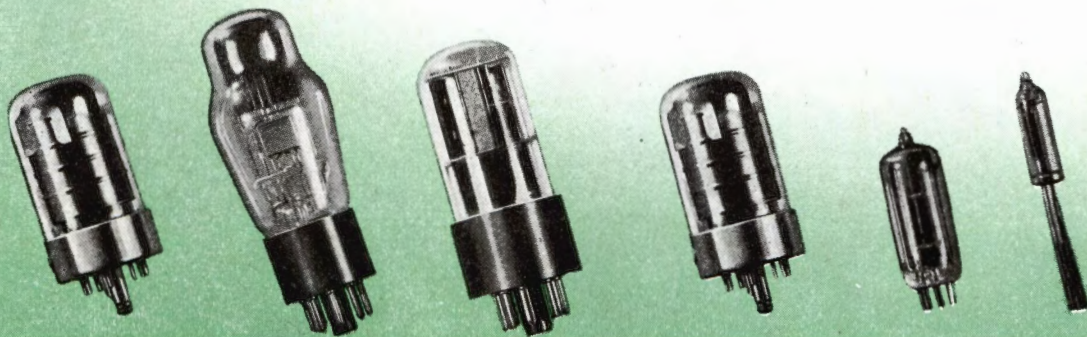

**SYLVANIA**

**MAKERS OF RADIO TUBES; CATHODE RAY TUBES; ELECTRONIC DEVICES;**



# SERVICING JOB . . .

## PLUS THE LATEST IN TESTING EQUIPMENT!

### Counter Tube Tester

Here's the last word in counter testers—made by the men who have tested tubes by the million. Not only does it test every radio tube in common use today, but provision has been made to permit quick adaptation to new types that may be developed.

The Sylvania Counter Tester Model 139 is styled as carefully as it is engineered. Its smart two-tone green panel, with its white dial markings, is in harmony with the surroundings of the most progressive radio store.

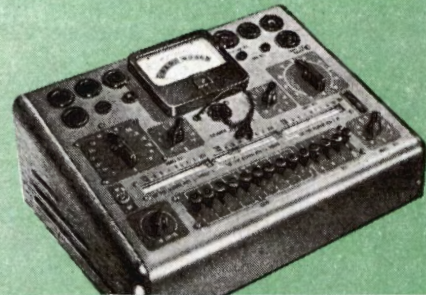

### Poly (MULTI-PURPOSE) Meter

The Sylvania Poly (MULTI-PURPOSE) Meter Model 134 provides, in a single compact instrument, the means of making a multitude of electrical measurements and tests. Quantities measured include, audio, A.C. and R. F. voltages (up to 300 mc); D.C. voltages from 0.1 to 1,000; direct currents from 0.1 milliamperes to 10 amperes; resistances from  $\frac{1}{2}$  ohm to 1,000 megohms.

Instrument is compactly built, attractively styled, includes all essential accessories.



### 3-Inch Cathode Ray Tube Oscilloscope, Type 131

This instrument is especially useful in rapid receiver alignment and trouble-shooting. Controls are easily accessible. Light-weight visor permits use of instrument in well-lighted room. The cathode ray tube is shock-mounted and shielded against stray fields.

Cabinet is steel constructed, ventilated with louvers, and finished in attractive pearl-gray baked enamel. Strong leather handle is securely fastened to top of cabinet, to permit easy carrying of instrument, which weighs only 18 pounds.

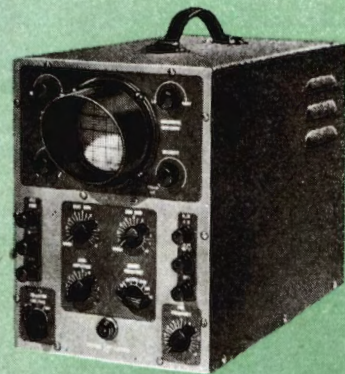

SEE YOUR SYLVANIA DISTRIBUTOR!

# ELECTRIC



FLUORESCENT LAMPS, FIXTURES, WIRING DEVICES; ELECTRIC LIGHT BULBS



# Short Cuts in Service

Tricks of the Trade Used by Active Repairmen

## Clamp Type Test Probe Starts Nuts

A spring or clamp type test probe as shown may be used to advantage for other purposes than that of attaching test instruments.

Small nuts may be placed in the spring jaws of the test prod and started in cramped places. Nuts

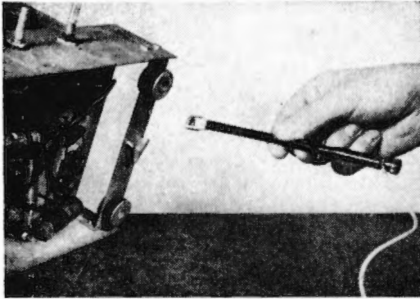

Many a scratched finger is avoided here.

and bolts or washers, pieces of solder etc. may likewise be removed with such a prod.

While the attaching wire is shown for identification purpose, the wire may be disconnected for ease of handling.

## Spring Shield Wire May Lose Tension

Short circuits sometimes occur in the radio when shield wire loses its tension and expands with the result that it contacts a bare terminal.

When such occurs, the condition may be remedied by unwinding several turns of the wire and cutting off the excess, as illustrated. The last turn should be soldered to the chassis to prevent further trouble.

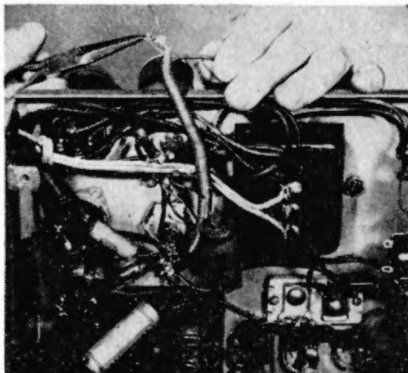

A common trouble found in older radios.

## Philco 39-119

An unusual cause of off-calibration was discovered in this receiver to be caused by a deteriorated 370 mmf mica capacitor used as a fixed padder in the oscillator circuit. Identified as number 9 on the schematic, it threw the low frequency end of the band off by about 150 kc, losing part of the band.

## Razor Cleaning Brush Is Convenient Service Tool

Small brushes used for cleaning electric razors are available at low cost in stores handling razors and supplies. The small size makes the brush suitable for applying non-slip compound to dial cords without waste or application to other parts. A second such brush may be carried in the tool kit for cleaning contacts.

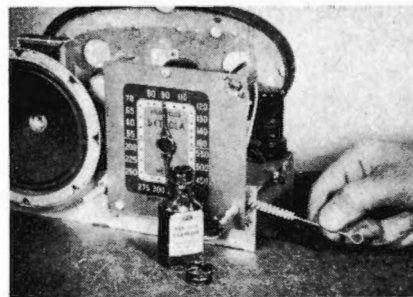

Dusting and cleaning in hard-to-get-at regions is made easy with this little tool.

The brush illustrated is about three inches overall and the bristle end is less than one-quarter inch in diameter.

## Setchell-Carlson 55

After bouncing around half a dozen repair shops throughout the country, the well-traveled owner of one of these predecessors of the 3-way portable set finally got his set's modulation hum cured by C. O. Thurlow of Wilder, Vt. Thurlow discovered a leaky 75 mmf by-pass capacitor C7, which acted as common coupling between an i-f grid and the filament circuit operating off a 6X5-rectified b-plus.

## Mark Generator Plug for Signal Stability

Signal generators usually operate most accurately with the ground or chassis lead of the generator connected to the grounded terminal of the lighting circuit at the wall outlet.

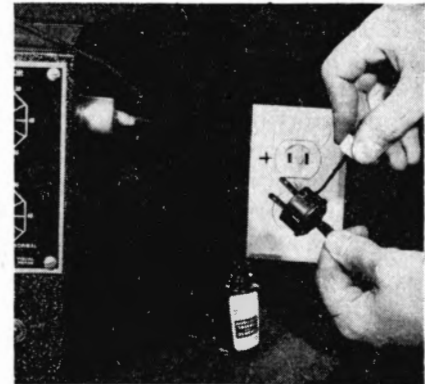

Mark the cord and outlet for quieter operation, and identification in d-c districts.

After determining the position of the generator plug in the outlet is required to obtain this condition, the plate of the wall outlet and the plug of the generator may be coded or marked with nail polish as shown. This will assure the insertion of the plug in the same position at time of each test.

## Faucet Washers Insulate Chassis Screw Heads

A receiver was found inoperative due to a burned open "On-Off" switch.

This defect was caused by the owner placing the radio on a grounded machine, where the uninsulated chassis screw heads contacted the grounded metal machine frame. With one position of the radio line cord plug a short circuit occurred.

After replacing the switch, the screw heads were insulated by the use of fibre faucet washers as shown. These washers were drilled out so that the screw heads were recessed in the fiber and could not touch any table or frame upon which the fiber feet might rest.

It may be necessary in some cases to grind off part of the screw heads to provide more clearance.



# Don't Waste Time Figuring How to Take It Apart

## PHOTOFACT\* FOLDERS

give you complete  
disassembly  
instructions

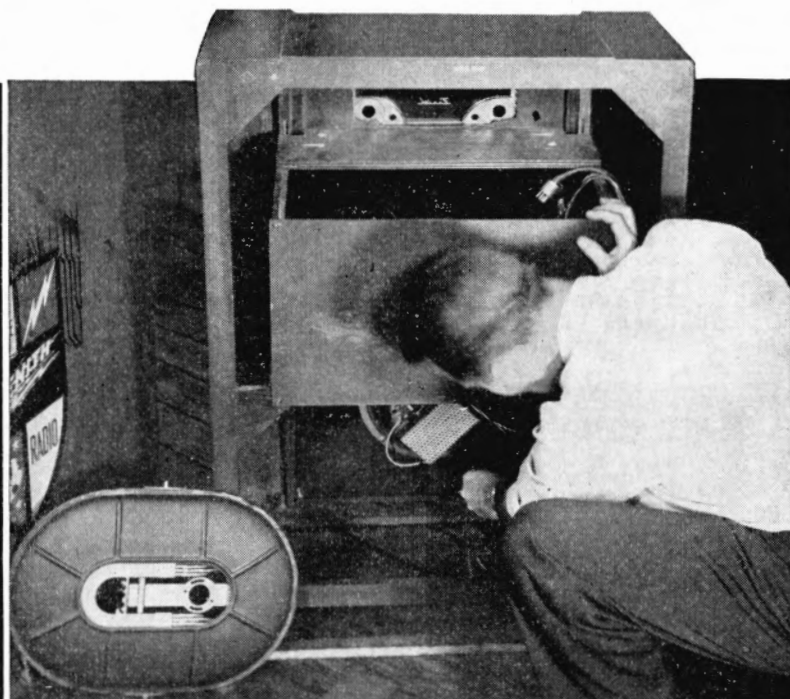

Do you lose valuable time discovering how to take out chassis, speakers and record changers from some of the new combinations? Are you familiar in all cases with *the proper sequence of removal*? Whenever the procedure is complicated, PHOTOFACT FOLDERS give you complete disassembly instructions—enable you to do an efficient job without damaging panels, dials, grilles or any other parts of the set. Better still, you're sure of getting them back together again in the quickest possible time.

That's not all PHOTOFACT FOLDERS do. They make it easy to diagnose trouble, locate defective parts, decide on adequate replacements and *get them in a hurry*. They do this by means of exclusive numbered photographs, full-page easy-to-read schematics, complete parts listings, record changer anal-

yses and many other helps that assist you in making *up to twice as many repairs a day*.

PHOTOFACT FOLDERS are the result of actually examining and testing the instruments covered. They are based on *original research*—not on "canned" or copied information. They cover *all* the latest radios, phonographs, record changers, recorders, communications systems and power amplifiers. Sent to you in sets of 30 to 50 folders, they cost only \$1.50 a set. This includes membership in the Howard W. Sams Institute. Actually they cost you nothing for they pay for themselves over and over again in time saved.

Over 25,000 radio service engineers use and depend on them! Give servicing worries the go-by! Spend less time, do better work—and more of it—by seeing your distributor or by using the convenient coupon.

### PUBLICATION DATES

Set No. 13 . . . February 10  
Set No. 14 . . . February 25

Cut this out and MAIL OR TAKE IT TO YOUR DISTRIBUTOR. If you do not know his name and address, send it directly to Howard W. Sams & Co., Inc., 2924 East Washington Street, Indianapolis 6, Indiana, and we will see that your nearest distributor gets it. In Canada, write to A. C. SIMMONDS & SONS, 301 King Street East, Toronto, Ontario. Canadian Price, \$1.75.

- Send Set No. 14 (Feb. 25)
  - Send Set No. 13 (Feb. 10)
  - Send Set No. 12 (Jan. 25)
  - Send Set No. 11 (Jan. 10)
  - Send me Volume 1 (including Sets Nos. 1 to 10) with De Luxe Binder, \$18.39. Individual Sets Nos. 1 to 10, \$1.50 each.
  - Send me a De Luxe Binder (at \$3.39)
- My (check) (money order) (cash) for ..... is enclosed. (If you send cash, be sure to use registered mail.)

PLEASE PRINT

Name \_\_\_\_\_  
Address \_\_\_\_\_  
City \_\_\_\_\_ Zone \_\_\_\_\_ State \_\_\_\_\_  
Company Name \_\_\_\_\_  
My Distributor's Name \_\_\_\_\_  
City \_\_\_\_\_

\*Trade Mark Reg.

## HOWARD W. SAMS & CO., INC. RADIO PHOTOFACT SERVICE

In Canada—write to A. C. SIMMONDS & SONS, 301 King Street East, Toronto, Ontario



# New Aids for Busy Benches

## Bliley Electric Co. TEST OSCILLATOR

Type CCO is a new crystal controlled oscillator featuring a highly accurate selection of five common i-f frequencies—175 kc, 262 kc, 370 kc, 455 kc and 465 kc. Direct crystal control is also provided at 200 kc for r-f alignment and

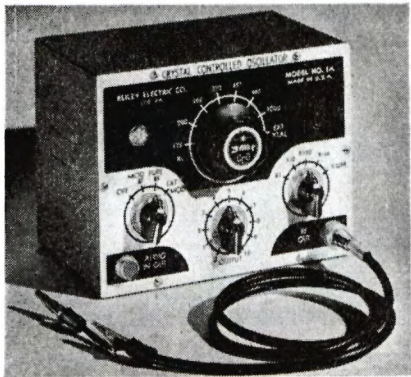

at 1,000 kc for short wave alignment. An external socket accommodates crystals of other frequencies. A 3-position modulation selector and 5-position attenuator with vernier output control are on the panel. Bliley Electric Co., Erie, Pa.—RADIO & Television RETAILING

## Weston DYNAMIC TUBE TESTER

Model 798 is a new mutual conductance tube tester, with separate adjustments for plate, screen, grid bias and signal voltages. A modulated 5 kc signal is used, for three micromho ranges as well as a good-bad scale. A multi-meter section permits three ranges of a-c and d-c measurements to 750 volts, two d-c current ranges to 150 ma., and two resistance ranges to 1 megohm. Weston Electrical Instrument Corp., Newark 5, N. J.—RADIO & Television RETAILING

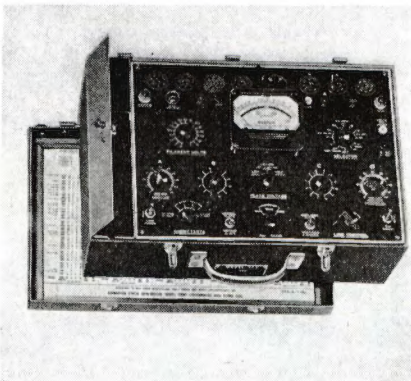

## Cherry Rivet HAND GUN

Designed especially for small-quantity users of the larger sizes of Cherry blind rivets, model G-55 Hand Gun is a lightweight unit operated manually by the use of a ratchet principle. Cherry Rivet Co., 231 Winston St., Los Angeles 13, Calif.—RADIO & Television RETAILING

## RCA AUDIO VOLTMETER

Type WV-73A audio voltmeter is a VTVM of extremely high sensitivity for measuring a-c voltages from 1 millivolt to 1000 volts in 11 ranges. The electrical conductivity of switches, circuit breakers, buses and grounds, as well as

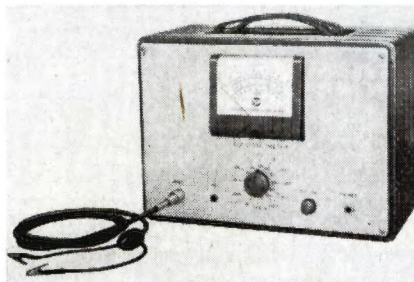

transmission losses in lines and circuits, and the response of special filters and compensators may be found. Especially useful in high fidelity audio circuits, the meter has a range of 20 to 20,000 cycles. RCA Victor Division, Camden, N. J.—RADIO & Television RETAILING

## Electronic Measurements VOLOMETER

Model 101A Volometer is one of a new line of volt-ohm-milliammeters and bridges. Four resistance ranges to 20 megohms, three current ranges to 600

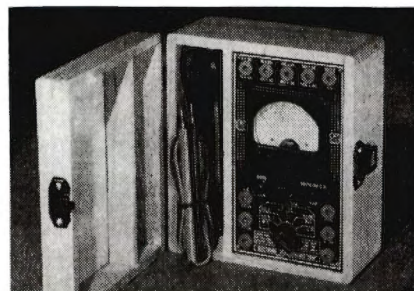

ma., four a-c voltage ranges to 1200 volts, and five d-c ranges to 3000 volts at 1000 ohms per volt are covered. Electronics Measurements Corp., 114 Liberty St., New York 6, N. Y.—RADIO & Television RETAILING

## Speco SIGNAL TRACER

The portable battery operated signal tracer is housed in a steel case, with carrying handle and cover, weighing only 4 lbs. 10 oz. To prevent accidental battery drain, the main switch must be

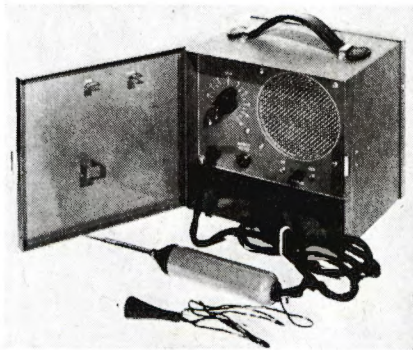

turned off in order to close the cover. An extra long probe lead is used, to permit placing the tracer on an automobile seat when checking the car radio. Special Products Co., Silver Springs, Md.—RADIO & Television RETAILING

## C-D CAPACITORS

Type ZN midget capacitors are designed for work with hearing aids and pocket radios, where space is at a premium. Non-inductive and impregnated, the units range in thickness from  $\frac{3}{32}$ " to  $\frac{3}{16}$ ", and in value from .0001 mf to .1 mf at dc rated voltages from 150 v. to 600 v. Cornell-Dubilier Electric Corp., South Plainfield, N. J.—RADIO & Television RETAILING

## National Union UNIVIBES

Univibes are universal auto radio vibrators, standardized to a minimum of 8 types serving as replacement units for over 2500 different models of auto radio receivers. Individually packaged, they are distributed nationally. National Union Radio Corp., Newark, N. J.—RADIO & Television RETAILING





**For the Man Who Takes Pride in His Work**

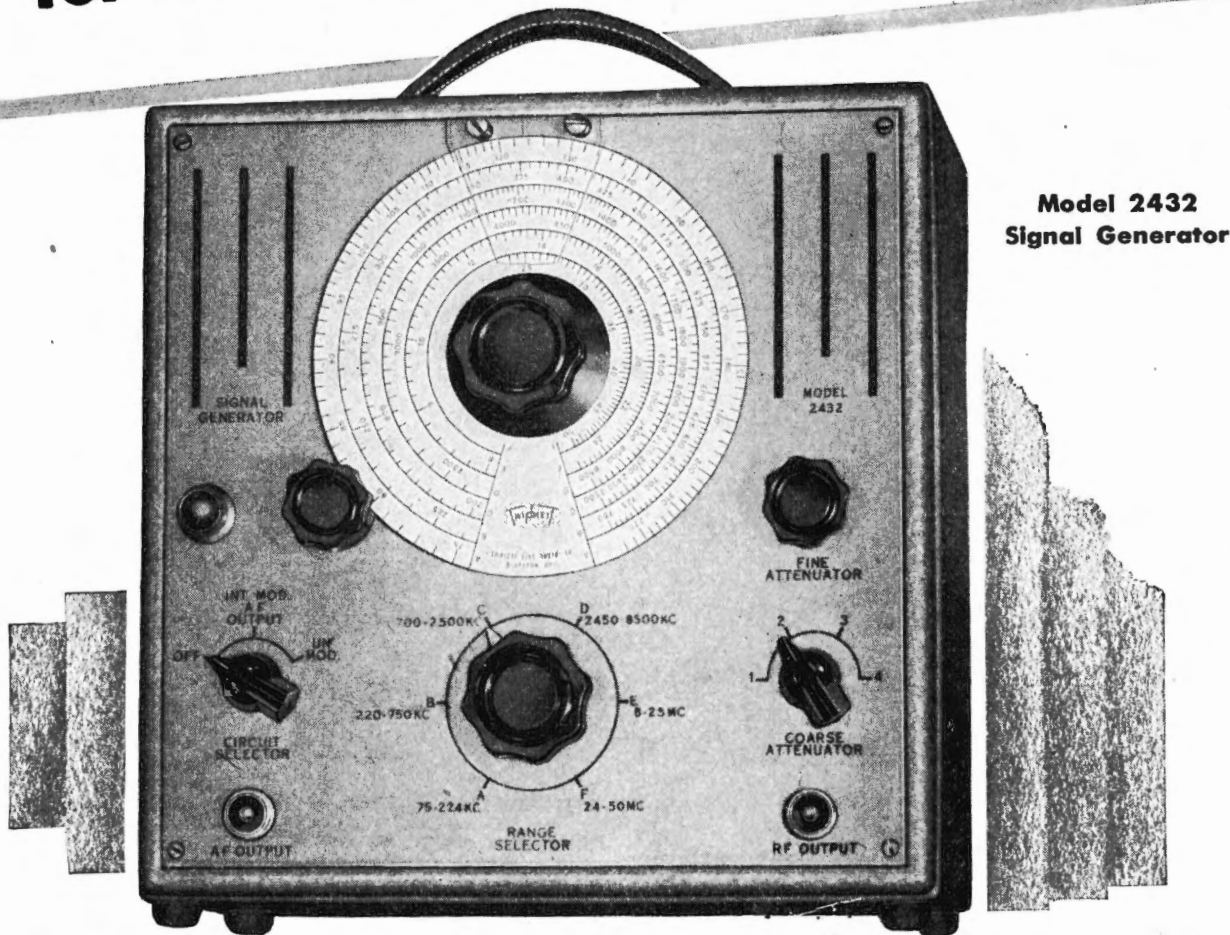

**Model 2432  
Signal Generator**

**FM AND TELEVISION BAND COVERAGE ON STRONG HARMONICS  
STRONG FUNDAMENTALS TO 50 (MC)**

Another member of the Triplet Square Line of matched units this signal generator embodies features normally found only in "custom priced" laboratory models.

**FREQUENCY COVERAGE**—Continuous and overlapping 75 KC to 50 MC. Six bands. All fundamentals. **TURRET TYPE COIL ASSEMBLY**—Six-position turret type coil switching with complete shielding. Coil assembly rotates inside a copper-plated steel shield. **ATTENUATION**—Individually shielded and adjustable, by fine and course

controls, to zero for all practical purposes. **STABILITY**—Greatly increased by use of air trimmer capacitors, electron coupled oscillator circuit, and permeability adjusted coils. **INTERNAL MODULATION**—Approximately 30% at 400 cycles. **POWER SUPPLY**—115 Volts, 50-60 cycles A.C. Voltage regulated for increased oscillator stability. **CASE**—Heavy metal with tan and brown hammered enamel finish.

There are many other features in this beautiful model of equal interest to the man who takes pride in his work.



**Triplet**

**ELECTRICAL INSTRUMENT CO. BLUFFTON, OHIO**







**"...ELEVEN YEARS  
OF TROUBLE-FREE  
PERFORMANCE"**

**A typical RADIART VIBRATOR TESTIMONIAL**

A typical example of the testimonials to Radiart performance which come in to us regularly from Radiart users everywhere is contained in a recent letter from a Mid-Western service man, Mr. W. E. Hopper, of North Vernon, Indiana.

Back in 1935, Mr. Hopper purchased and installed a Radiart Vibrator, type 3315. On October 14, 1946, eleven years later, Mr. Hopper wrote in to order a new Radiart to replace the original which had finally worn out AFTER ELEVEN YEARS OF TROUBLE-FREE PERFORMANCE!

This amazing record is only one of the many in our files attesting to the superiority of Radiart products. Designed to exacting specifications, of the highest quality materials, Radiart Vibrators, Vipowers and Aerials are as perfect as modern manufacturing methods can make them.

Ask to see these quality lines at your jobbers today or write for new illustrated Vibrator Guide and Catalog.

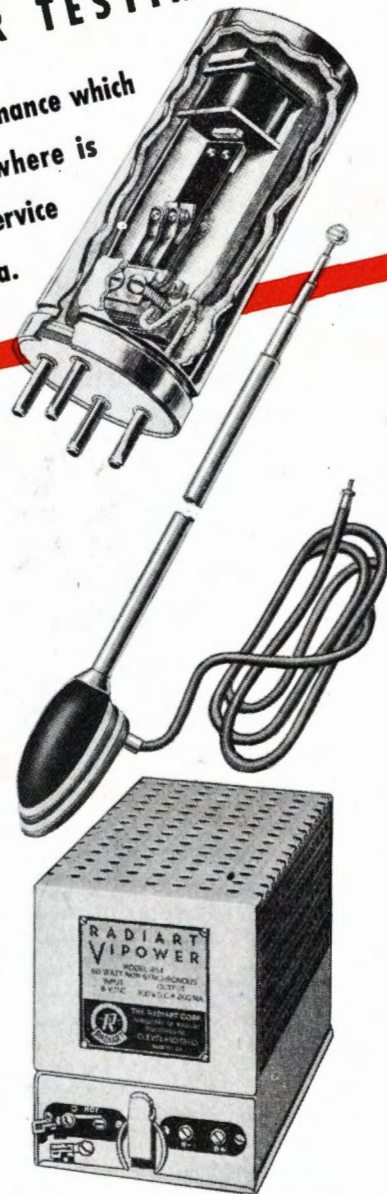

**ELECTRONIC DISTRIBUTOR**

**MAGUIRE**

9 3 6 N. M I C H I G A N



# THORDARSON

## AMPLIFIERS

Here is an amplifier line designed for true, brilliant sound reproduction. The last word in amplifier quality, these precision-built units are backed by 52 years of transformer manufacturing experience and 31 years of audio pioneering . . . See them at your jobbers today.

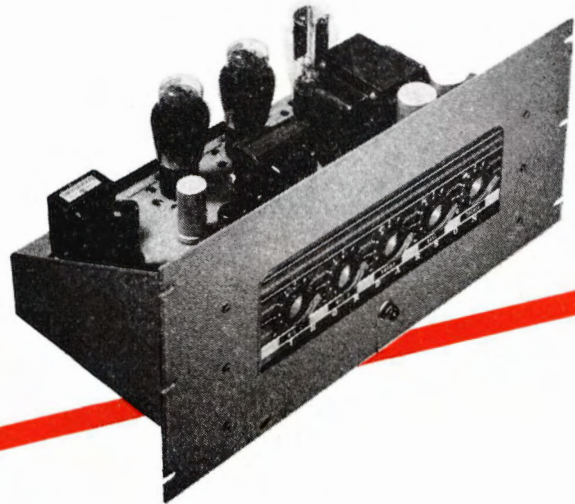

# MEISSNER

## ANALYST

The modern service instrument. Designed to handle the receivers of today, yesterday and tomorrow with equal facility. Tests by the signal-tracing method . . . fastest, most reliable method to date . . . See it at your jobbers today.

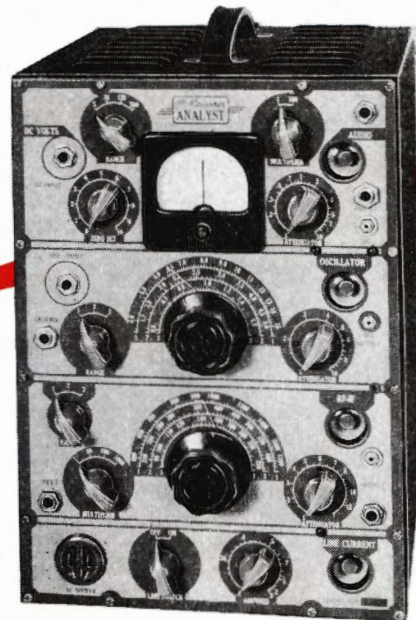

MEISSNER-THORDARSON RADIART  
PRODUCTS IN PHOTO-FACT FOLDERS

EXPORT ADDRESS, SCHEEL INTERNATIONAL, INC.  
4237-39 N. LINCOLN AVENUE, CHICAGO 18, ILLINOIS  
CABLE HARSCHEEL

AND INDUSTRIAL SALES DEPARTMENT

# INDUSTRIES inc.

AVENUE, CHICAGO 11, ILLINOIS



# PA "Spark-Plugs" Sales



## Texas Brand of Sound Service Helps to Develop Radio Sales and Maintenance

With carefully designed sound equipment, Mr. Vogt started specializing in public address for rodeos, soon extended the service to other community jobs. It was one "opener" for his general radio business.

● Herbert L. Vogt of Victoria, Tex., is a hard-hitting radio man who started a set repair business 15 years ago, and has now developed it into a full-scale sales-and-service outfit operated in an impressive new home. The new building was designed specially for radio sales and service, and it is easily the equal of many "big-city" lay-outs.

Mr. Vogt's town is located in rodeo country. These bronc-ridin' events are held regularly and often throughout the area. In this connection, Mr. Vogt realized a long time ago that there was a definite need for sound equipment, portable and fool-proof, to announce the various rodeo events and the results of each. The Victoria country has some leather-lunged cowmen who can make themselves heard above the confusion of a bawling herd, but even that sort of voice was not adequate to reach rodeo crowds.

So Mr. Vogt set up his sound service and "spark-plugged" it with rodeos.

Today, no rodeo would be complete in the Victoria area without Vogt's sound truck to carry the many announcements connected with the modern rodeo show. Sound equipment and sound service have been vital factors in building up Mr. Vogt's approximately \$30,000 annual service volume, he declares. He is looking to his sound service to add even more to his volume as soon as new merchandise is available in quantity.

The sound truck, with its four powerful speakers, stands where the entire audience can see it. The company name on both sides of the vehicle gives the Vogt shop a lot of advertising.

Although Mr. Vogt purposely cut his sound service fee low for rodeos, because they provided him with an

opportunity to start the sound service and also with an excellent advertising medium as well, he does not use the microphone for his own advertising. The announcer never mentions that the sound service is provided through the courtesy of Mr. Vogt. He leaves it to the signs on the truck to do that.

From rodeos it was easy for him to extend the service to other regular or one-time events. Political rallies, outdoor gatherings of all kinds and large meetings indoors use his sound service as a matter of course, because he has been able to establish himself, and make it "the thing to do", wherever large gatherings assemble.

Mr. Vogt watches the local papers for news of forthcoming events which will bring a lot of people together. If the paper gives names of persons in charge of such an event, he clips the item and contacts the persons mentioned.

### Clinchers That Work

Contacting these persons, he offers his sound services and quotes a definite price. If any sales argument is needed, he points out the obvious advantage of providing proper facilities so that all people may hear the speakers and stresses the unfairness to speakers of failure to provide adequate public address hook-ups. He also stresses the fact that his sound units are double, so that if one falls at a crucial moment, the other may be plugged in immediately.

As a public service, and at the same time obtaining some excellent goodwill advertising for his shop, Mr. Vogt offers his sound service free to all special church events where large crowds are expected, and to special meetings of women's clubs and other purely religious or civic gatherings.

Rendering this service free does not cost a great deal and it has

(Continued on page 143)

Radio repair jobs and sound service practically built this new home for the Texas retailer.





# For Better Testing!

## NEW GENERAL ELECTRIC SERVICE TEST EQUIPMENT FOR UP-AND-COMING SERVICE MEN

**I**T'S NEWS—and good news for service men who want to see work move into the shop fast—and out again. The new line of General Electric service test equipment has been designed to do just that. Quick, accurate, efficient service work means more dollars, more satisfied customers and more business.

First in this list of fine equipment is the Capacitance-Resistance Bridge, YCW-1. Check the jobs it can do to make your job easier.

- Measures capacitance from .000005 to 200 microfarads  $\pm 1\%$  in three convenient ranges.
- Measures resistance 5 ohms to 20 megohms  $\pm 2\%$  in two convenient ranges.
- Power factor is measured on the high capacitance range by a potentiometer in series with the standard which has a scale of 0 to 50 percent.
- Insulation resistance is indicated directly by a panel meter. A 0 to 2500 megohm range is covered with a dc voltage supply of 500 volts.
- Electrolytic leakage test is provided which will indicate whether the leakage is excessive.
- Polarizing voltage — a continuously variable dc voltage supply from 0 to 500 volts is available for polarizing the electrolytic condensers.
- Turn ratio of transformers is measured by switching one coil or section of a coil into the Wein bridge circuit and the other section of secondary coil is compared with it.

The YCW-1 is compact, portable and needs only to be plugged into any 115 volt 50 or 60 cycle line to operate.

### GENERAL ELECTRIC ELECTRONIC VOLTOHMETER

The Type PM-17 permits measurement of actual operating voltages without excessive circuit loading or detuning. In addition to dc voltages, both audio and radio frequency voltages may be measured from 200 cycles to more than 100 megacycles. An ohmmeter circuit is included for convenience in measuring high and low ohmic values of resistance. Fluctuations in line voltage and changing of tubes have little or no effect on calibrations. Entirely portable, it can be carried anywhere and can be plugged into any 115 volt 60 cycle line. Supplied with the Electronic Volt ohmmeter are two alligator clips, two pairs of leads, and an r-f probe.

### GENERAL ELECTRIC OSCILLOSCOPE

The CRO-5A is really a laboratory quality unit for service work. Accurate and rapid, it was designed primarily for studying voltage and current wave-forms, but it also can be used to study any variable which may be translated into electrical potentials by means of associated apparatus.

All amplifier and sweep d-c potentials are electronically regulated to give a stable trace even under adverse power line variations. The unit is compact, portable, and sturdy in construction so that ordinary jars and vibration will not damage it. Completely self-contained, it will operate on any 115 volt, 60 cycle ac power source.

For complete information on these General Electric Service Test instruments, write to: *General Electric Company, Electronics Department, Syracuse 1, New York.*

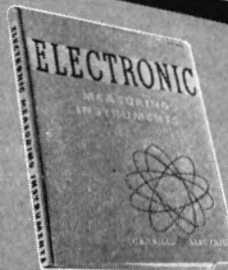
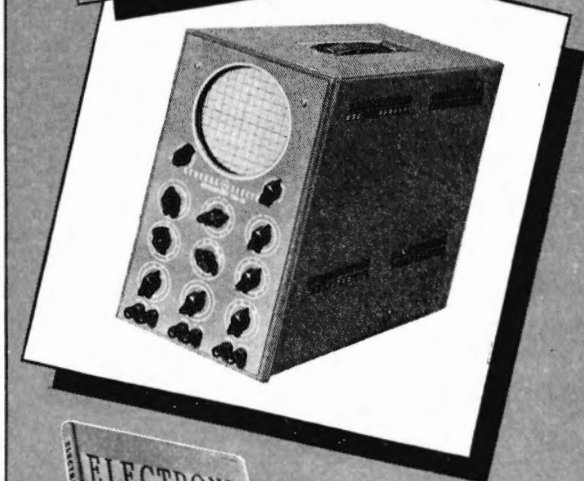
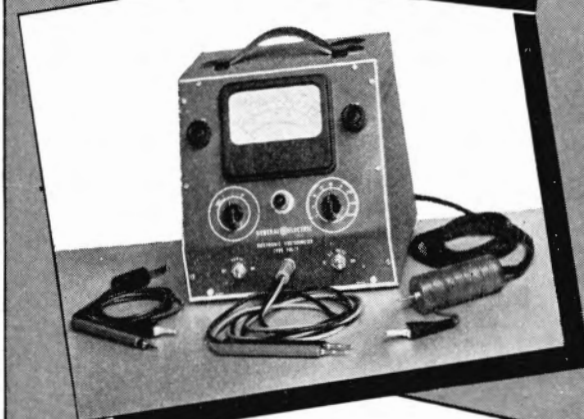
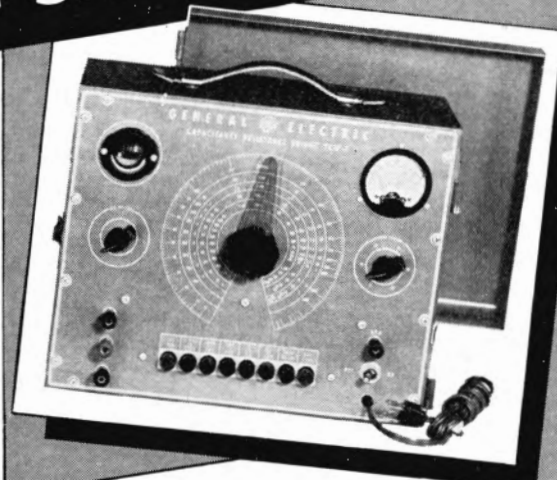

● Write for your copy of General Electric's Electronic Measuring Equipment Catalog. IT'S FREE!

**GENERAL  ELECTRIC**  
164-F2



**PUTTING ELECTRONICS TO WORK**  
**with**  
*Government Owned Surplus*

To help you incorporate the many advantages of electronics in your business, the War Assets Administration is making available its enormous inventory of tubes and equipment now.

Qualified distributors all over the country have been appointed by WAA to represent it. In every field where electronic application has proved its worth, these distributors maintain inventories and have the technical "know-how" to service your needs.

Get in touch with your nearest distributor and see how government-owned war surplus can help you—electronically. Or—if it is more convenient—write to

**ELECTRONICS DIVISION**  
**OFFICE OF AIRCRAFT DISPOSAL**

**WAR ASSETS ADMINISTRATION**

425 Second St., N.W.

Washington 25, D. C.

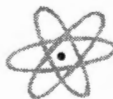



Millions and millions of electronic tubes are at your disposal. Pictured are some of the types which are available to you.

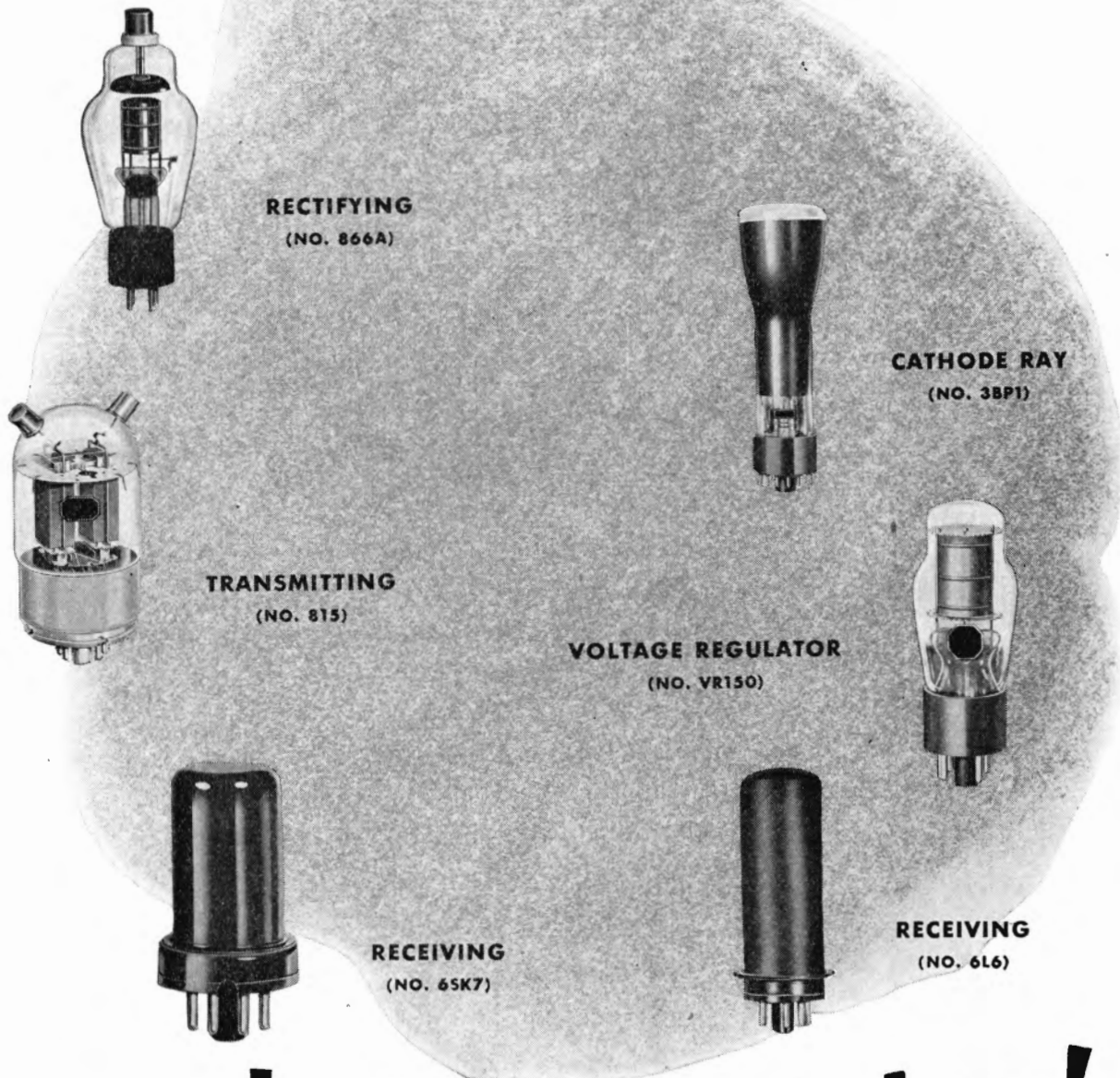

**tubes! tubes! tubes!**

**"NO ELECTRONIC DEVICE IS BETTER THAN ITS TUBE"**

880



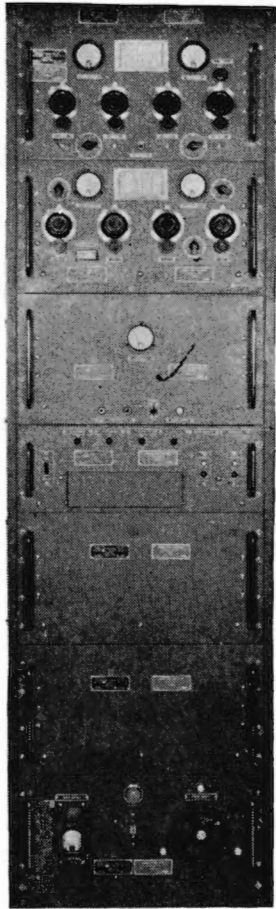

Transmitter

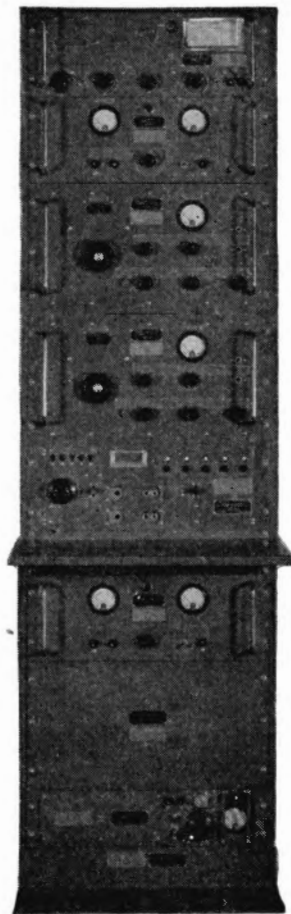

Receiver

# MODERN COMMUNICATION and PRODUCTION

depend on

*Electronics*

Today—virtually all methods of high-speed communication use electronic tubes. In the industrial field, heating, welding and various methods of control are being done better and faster because of electronics. From big broadcasting stations to tiny hearing aids—from induction heating to voltage regulation—the science of electronics is playing a major role in industry.



Microphone

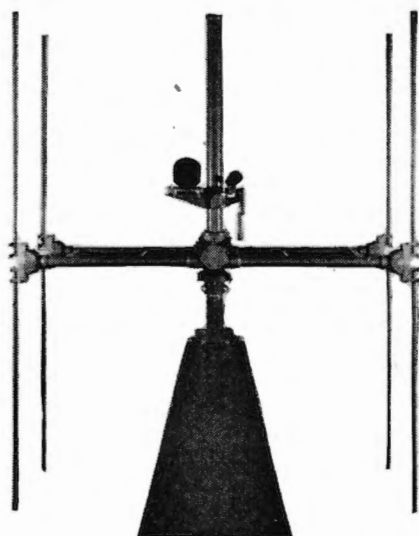

Matching Stub and Antennae

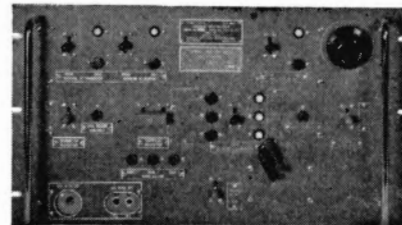

Control Unit

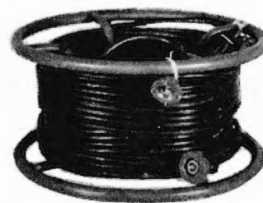

Headset



## these Authorized Distributors will serve you:

Listed here are the names and locations of WAA appointed distributors. Not all of them will have complete stocks but it will pay you to consult them on your electronic problems.

Automatic Radio Mfg. Co., Inc.  
120 Brookline Avenue  
Boston 15, Massachusetts

Communication Measurements Laboratory  
120 Greenwich Street  
New York 6, New York

Tobe Deutschmann Corporation  
Canton, Massachusetts

Electronic Corporation of America  
353 West 18th Street  
New York 19, New York

Electro-Voice, Inc.  
Buchanan, Michigan

Emerson Radio & Phonograph Corporation  
123 Duane Street  
New York 7, New York

Essex Wire Corporation  
1601 Wall Street  
Ft. Wayne 6, Indiana

General Electric Company  
Building 267-1 River Road  
Schenectady 5, New York

Hammariund Mfg. Company, Inc.  
460 West 34th Street  
New York 1, New York

Hoffman Radio Corporation  
3741 South Hill Street  
Los Angeles 7, California

Hytron Radio & Electronics Corporation  
76 LaFayette Street  
Salem, Massachusetts

E. F. Johnson Company  
206 Second Avenue S. W.  
Waseca, Minnesota

Newark Electric Co., Inc.  
242 West 55th Street  
New York 19, N. Y.

Majestic Radio & Television Corporation  
125 West Ohio Street  
Chicago 10, Illinois

Raytheon Manufacturing Company  
60 East 42nd Street  
New York 17, New York

Smith-Meeker Engineering Company  
125 Barclay Street  
New York 7, New York

Sylvania Electric Products, Inc.  
Emporium, Pennsylvania

Technical Apparatus Company  
165 Washington Street  
Boston 8, Massachusetts

Tung-Sol Lamp Works, Inc.  
95 Eighth Avenue  
Newark 4, New Jersey

American Condenser Co.  
4410 Ravenswood Avenue  
Chicago 11, Illinois

# WAR ASSETS ADMINISTRATION

A UNITED STATES GOVERNMENT AGENCY  
FOR THE DISPOSAL OF SURPLUS PROPERTY

880



To our friends in the industry

## A MESSAGE FROM

**RAYTHEON**

**THE WAR ASSETS ADMINISTRATION** has inaugurated a new program for the disposal of electronic equipment, as announced in the foregoing pages.

Raytheon is privileged to be associated with this program and is dedicated to its successful completion in the interests of the government and the electronic industry which it is proud to have served so long.

Just as Raytheon served the armed forces during the war, so it again serves a national effort—with integrity and competence.

The Raytheon name is your guarantee for both. The company is at your service. Write, wire or telephone so Raytheon may act in your behalf.

**Raytheon Manufacturing Company**

(WAA Contract #WAS (P) 7-231)

60 E. 42nd St., New York 17

Vanderbilt 6-3608

### FM Will Boost Set Sales, Bonfig Tells Retailers

The sales honeymoon in AM radio is just about over, and the radio industry to maintain future volume must look to FM, phonograph combinations, and specialties, according to H. C. Bonfig, vice-president of Zenith Radio Corp. Mr. Bonfig spoke to 300 electrical appliance dealers of Tennessee at their second annual convention held in Nashville.

Table model AM sets of unknown brands are already beginning to back up on dealer shelves, Mr. Bonfig said, and predicted a tough competitive sales market this year. He said that FM was the big hope of the future because its superior service will enable it to supersede AM and render the public a much better radio service than now enjoyed. This in turn will open a tremendous market for the sale of radios.

Mr. Bonfig was introduced by Ben Gambill, president of the association, and president of Braid Electric Co., Zenith distributor in Nashville. The meeting was also attended by James H. McKee, Zenith district manager, and Cy Shobe, the firm's distributor in Memphis.

### Garod Shows 1947 Sets at Chicago Sales Meeting

Garod Radio Corp., Brooklyn, N. Y., commencing activities for its "Silver Anniversary Year," called a meeting of all its national distributors and sales representatives in Chicago recently.

At this three-day meeting, conducted by Louis Silver, Garod sales manager, the new 1947 line of Garod radio receivers was exhibited for the first time. New models include an all-plastic table model radio-phonograph combination, a brand new 3-way portable and—the new Garod television set. The latter features a direct-viewing receiver with bright projection which will make it possible to view the image in a lighted room. This new television receiver also has an entirely new feature which will offer great flexibility and convenience. It has a 10-inch cathode ray tube and occupies a minimum of floor space. Cabinets will be available in a number of period styles, to fit all types of home decor.

### Last Request Is Gift to the Blind

Scores of radio men have sent condolences to Jerome J. Kahn, widely known radio executive whose wife died recently in Evanston, Ill. Mr. Kahn is president of Standard Transformer Corp., Chicago.

At the time of his wife's death, Mr. Kahn revealed that she had made an exceptional request—that her eyes be donated to an Eye Bank, in order to benefit some unknown person who required new corneas to restore sight. Her eyes were therefore sent to the Eye Bank for Sight Restoration, Inc., in New York City, where it was said that the remarkable donation will grant new life to an eye patient.

**Start Your Own Service Shop**  
WITH  
**LITTLE MONEY**  
NEW BOOK TELLS YOU HOW  
Only \$1.75 Postpaid  
Starting and Operating a Profitable ELECTRICAL or RADIO BUSINESS  
New 1947 Edition

Brand new—nothing like it. Here are full facts about starting with small capital full or part time. Tells how to finance a business, select location and lay out store, buying and what to charge, advertising, salesmanship, legal angles, record keeping, etc. Information you need to run a good paying shop of your own, written in easy to understand language, fully illustrated.

**Send Coupon for 10 Days FREE TRIAL**  
Get this sensational new book, "Starting and Operating a Profitable Electrical or Radio Shop" on 10 days' FREE TRIAL. 240 pages, only \$1.75 postpaid. Order your copy today. Fill out and mail coupon NOW.

**COYNE ELECTRICAL SCHOOL**  
Technical Book Div. Dept. 27-K4  
500 South Paulina Street, Chicago 12, Illinois

**RUSH THIS 10 DAY FREE TRIAL COUPON**

TECHNICAL BOOK DIVISION  
COYNE ELECTRICAL SCHOOL, Dept. 27-K4  
500 S. PAULINA ST., CHICAGO 12, ILL.  
O.K.—rush my copy of "Starting and Operating a Profitable Electrical or Radio Shop." I am enclosing \$1.75 remittance (Coyne pays postage). I understand I may return book in 10 days for full refund if I'm not entirely pleased.

NAME \_\_\_\_\_ AGE \_\_\_\_\_  
ADDRESS \_\_\_\_\_ ZONE \_\_\_\_\_  
CITY \_\_\_\_\_ STATE \_\_\_\_\_

Check here if you prefer to have book sent C. O. D. Pay postman \$1.75 plus small C.O.D. fee upon delivery. Same 10 DAY SATISFACTION GUARANTEE.

**NEWARK NOW AGENTS OF WAA**

**HUGE STOCKS OF TRANSMITTING AND SPECIAL PURPOSE TUBES at amazingly low prices**

Make Newark your first stop for all the tubes you need. As agents of War Assets Administration, Newark has huge stocks of government surplus tubes, priced at a fraction of their original cost. WRITE NOW FOR NEWARK'S COMPLETE TUBE LISTING. YOU'LL SAVE TIME AND MONEY BY COMING TO NEWARK FIRST.

- Mail or Phone Orders Filled Promptly
- Write: 242-V W. 55th St., New York City

NEW YORK Telephone  
Offices & Warehouse Circle 6-4060  
242 W. 55th St., N.Y. 19  
**NEWARK**  
ELECTRIC COMPANY, INC.

New York City Stores: 115-17 W. 45th St. & 212 Fulton St.

ACTING AS AGENTS FOR WAR ASSETS  
ADMINISTRATION UNDER CONTRACT WAS(p) 7-167



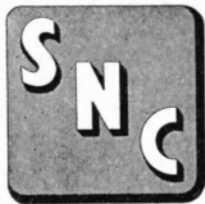

**transformers**

**PROTECT**

**radio service profits**



*Uniformly high SNC quality prevents extra servicing costs due to replacement transformer failure*

Mr. Service Dealer—Transformer replacement jobs that come back for further servicing quickly eat away repair work profits . . . damage your reputation and lose you customer good will.

S N C transformers *protect* your service profits because they're trouble-free. Made to rigid engineering specifications by expert workmen using only the finest materials, they're your assurance of a perfect installation every time.

Avoid troublesome complaints and increase your profit margin by specifying S N C! Full information concerning S N C transformers available on request . . . just write for catalog.

*The partial list of output transformers given below indicates the wide variety of S N C units now being made.*

**S N C O U T P U T T R A N S F O R M E R S**

Type Number	Primary Impedance	Secondary Impedance	Pri. Ma.	Power Watts	Wt.	Mtg.	Dimensions				
							A	B	C	D	E
6P701	2500-7500 Sgl. Plate	500	45	10	1¼	B	2¼	2⅞	1⅜	2⅜	
6P710	7500-15,000 P.P. Plates	500	45	10	1¼	B	2¼	2⅞	1⅜	2⅜	
6P714	Universal Sgl. or P.P. Pl.	500	45	10	1¼	B	2¼	2⅞	1⅜	2⅜	
6P717	250-500	4-8-16	0	35	2¼	B	2⅞	3⅝	1⅞	2⅞	
6P722	500-3000	2-16	0	10	1¼	B	2¼	2⅞	1⅜	2⅜	
6P726	3300CT and 3800CT	4-8-16-250-500	90	60	5¼	G	3½	2⅞	2¼	2¼	1⅞
6P731	4500CT and 6600CT	4-8-16-250-500	90	60	5¼	G	3½	2⅞	2¼	2¼	1⅞
6P736	5000CT	4-8-16-250-500	70	25	2½	D	2⅞	3⅝	1⅞	2⅞	
6P740	4300CT	4-8-16-250-500	70	25	2½	D	2⅞	3⅝	1⅞	2⅞	
6P743	6600CT	4-8-16-250-500	70	25	2½	D	2⅞	3⅝	1⅞	2⅞	

**Remember! S N C gives MORE applications with SMALLER inventories for GREATER profit!**



*Manufacturing Company, Inc.*  
**WEST LAKE AVE., AT LEHIGH GLENVIEW, ILLINOIS**



# New Items for Quality PA Jobs

## Operadio AMPLIFIER

Model 1A35 is an 8-watt amplifier with one microphone input using 4 amplifier stages, and one phono input using 3 stages. Both inputs as well as a 3-step tone control are varied from the front panel, while the single 6L6GA delivers its output at 3-5, 6-8 and 400-600 ohms. Operadio Mfg. Co., St. Charles, Ill.—RADIO & Television RETAILING

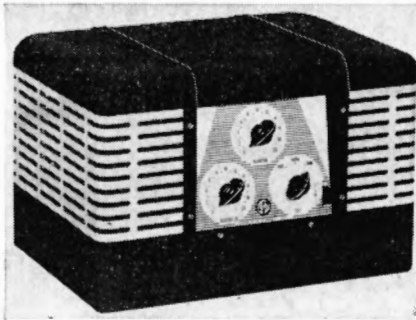

## Brush CRYSTAL MIKE

The BA-106 Acoustical microphone is a new crystal type using the Brush sintered bronze damping design, to provide essentially flat response from 40 to 6,000 cycles, at high impedance and output. The satin chrome finish shaft of

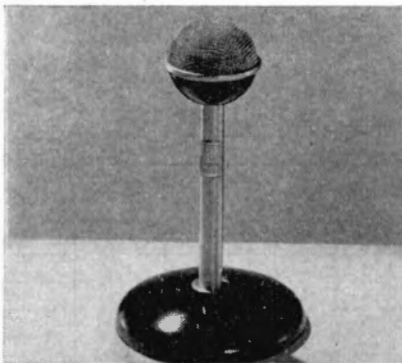

the stand plugs into the blank molded base, and pulls out to be used as a hand-held microphone. Supplied with an eight-foot cable and plug. The Brush Development Co., 3405 Perkins Ave., Cleveland 14, Ohio—RADIO & Television RETAILING

## Seletron BATTERY BOOSTER

The lightweight Seletron battery booster is an automatic constant voltage charger for plants using single 6-volt storage batteries for operating alarm or signal systems, control apparatus, or for use in service shops repair-

ing auto radios. Using a selenium rectifier and automatic circuit breaker, the charger delivers 4-2 amperes continuously. Radio Receptor Co., Inc., 251 W. 19th St., New York 11, N. Y.—RADIO & Television RETAILING

## Cardwell REPRODUCER

Model CE-26 Sound Reproducer consists of a high-fidelity amplifier and heavy 10-inch speaker in a grey, silver trimmed metal case. 8 watts of undistorted output are delivered by the push-pull 6V6 tubes into the PM speaker, with provision made for attaching 4 ad-

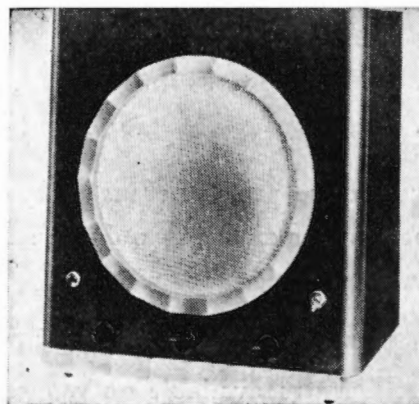

ditional speakers. Separate phono and microphone gain controls, as well as tone control, are mounted on the front panel. Allen D. Cardwell Mfg. Corp., 97 Whiting St., Plainville, Conn.—RADIO & Television RETAILING

## Bogen BOOSTER AMPLIFIERS

Models GO50 and GO125 are two new booster amplifiers delivering 50 and 125 watts respectively. Two transmitter type 807 tubes in push-pull with multi-stage inverse feedback provide a response flat within 1 db from 20 to 20,000 cycles. The 1/2-megohm input can be used for balanced telephone line applications. David Bogen Co., Inc., 663 Broadway, New York 12, N. Y.—RADIO & Television RETAILING

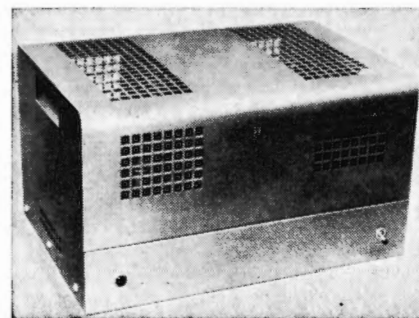

## Rauland Corporation PORTABLE AMPLIFIER

Model PD-812 is a portable system using a single-unit split-type case. The 14-watt amplifier has two microphone inputs and a phono input, with mixer control of each, and a double attenuating tone control on the illuminated front

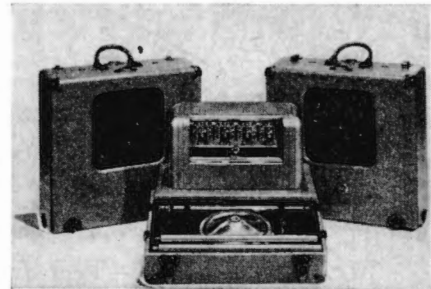

panel. Two 12" dynamic speakers, a dynamic mike, demountable floor stand and all necessary cables and plugs complete the system. Other similar systems are available in 20 watts and 35 watts. The Rauland Corporation, 4245 No. Knox Ave., Chicago 41, Ill.—RADIO & Television RETAILING

## Electro-Voice MIKES

Model 610 Dynamic and model 910 Crystal microphones are mounted in similar, functionally streamlined cases. For general purpose use, indoor and outdoor, their polar pattern is non-directional at low frequencies, becoming directional at high frequencies, and



covering the range from 50 to 8,000 cycles. The 610 Dynamic, with an output level of -53 db, is available in hi-z (25,000 ohms) and 50, 250 or 500 ohms impedance, while the 910 Crystal has a hi-z output of -48 db. Electro-Voice, Inc., Buchanan, Mich.—RADIO & Television RETAILING



# SPRAGUE TRADING POST

## SWAP—BUY—SELL

**WANTED**—Gernsback service manuals 1-3-5. For sale, a Superior BR-44 resistance-capacity bridge; one 3" Westinghouse 0-50 micro-ammeter and assortment of other meters. John L. Campbell, 2034 E. 26th St., Brooklyn 29, N. Y.

**FOR SALE**—Slightly used Silver Vomax #900 in excellent condition, \$50 cash. Ralph J. Watkins, 120 Center St., Bangor, Mich.

**WANTED**—Good used communication receiver such as National FB7A, Howard 436 or 437, Hallicrafters S19R, S20R, SX23, SX24, etc. Have many non-radio items for trade. Write for list. Bud Woida, 2315 Monroe St., Two Rivers, Wisconsin.

**FOR SALE**—Hickok dynamic mutual conductance multi-tester #510-X, \$30; Million tube tester model DD, \$20; 6-tube Spartan auto radio, \$23.50; N. R. 1. kits #2 and 6 less tubes, \$12.50. Dale A. Hahn, 224 N. 20th St., East Moline, Illinois.

**WANTED**—Will pay \$40 for BC-312, 342, 348 or other reliable communication receiver. Power supply and speaker unnecessary. J. L. Clark, 903 Clinton St., Philadelphia 7, Pa.

**FOR SALE**—Pulse transmitter, 500mc, four Elmac 15E's in p.p. parallel, 15R rectifier. Antenna switching unit with RCA 1960. Both from ASB-4 radar. 600 cycle, 110v. a-c operation. Both for \$18 f.o.b. N. G. Plattner, 7143 Stockley Road, Upper Darby, Pa.

**FOR SALE**—Hallicrafters S-29 in good condition. Want SX-24, SX-25, HQ-120, HQ-129 or similar receiver. Describe fully. Arlo Herrick, Box 485, Milbank, S. Dakota.

**WANTED**—Good 12" turntable and motor. Have following tubes for sale: 6J6; 6AG5; 9001; 9002; 9003; 6SL7; 6SN7; 12SL7 and 12SN7. 39c ea., fully tested, shipped in bulk pack. R. L. Wenk, 2714 Valley Pike, Dayton, Ohio.

**WANTED**—Good communication receiver. Have tubes for sale (boxed) at 40%-50% off, also power transformers, ham gear transmitting miniature and acorn tubes, etc. Write for list. Harry Gurschwitz, 147 Chester St., Brooklyn, N. Y.

**FOR SALE**—2-meter Abbott TR4A transmitter-receiver with set of tubes, \$55. Also have vibrator power supply 500V-200 ma., \$12. D. B. McLennan, 1550 Hayes St., San Francisco 17, Calif.

**WANTED**—Television receiver or kit, shortwave receiver and test eqpt. Will swap Argus A2F F4, Robot II, Zeiss Tessar F. 2.8 etc. H. Gursch, 1481 Shakespeare Ave., Bronx 52, New York.

**FOR SALE**—Four tube Motorola radio, A and B bat. power pack required, less battery and 1Q5GT tube, \$10; 5-tube elec. signal tracer, home-made, but works fine, \$35. Carl Bombal, Shobonier, Ill.

**WANTED**—Neon radio repair service sign. Send photo, specifications, price, etc. Will pay cash or trade Simpson #305 tube tester, Feiler TS-1 signal tracer, or Triplett 1175-B sig. generator and v.t.v.m. combination. Draughn Radio Service, P. O. Box #77, Hindman, Ky.

**WANTED**—Rider manuals, especially 1 through 5. Cash. John T. Lipani, 157 Leverett St., Boston 14, Mass.

**FOR SALE**—G. E. CR05 oscilloscope with extra tube—new, \$150 cash or will trade. H. K. Miller, 623 N. Court, Whittier, Calif.

**URGENTLY NEEDED**—12AP4 television picture tube. Will trade new Hallicrafters S20R for one. Also need a 9AP4 tube. Will trade 20-watt modulator and power supply for either tube. Donald Russell, 221 W. Allen Lane, Philadelphia 19, Pa.

**WANTED FOR CASH**—Small portable combination tube checker and v-o-m. Describe fully, state price. O. Richardson, Ozzie's Radio Service, 634 St. Nicholas Ave., Dept. C-4, Ed 4-5085, New York 30, N. Y.

**WANTED**—Good automatic record changer. Will swap ¼" electric hand drill, Weston 0-10v d-c 3" meter and Shure xtal hand mike. Jos. J. Buckley, Arrott Arms, Apt. D12A, Arrott & Leiper Sts., Philadelphia 24, Pa.

**FOR SALE**—Radio servicing business complete including tubes, parts, supplies, test eqpt. Good discounts on everything. Buyer must take all or nothing. Approx. \$1,000 will cover. Write for details. P. O. Box 15, Lebanon, Pa.

**FOR SALE**—Radio City signal generator #701. A-1 condition. \$30. Have many new tubes. Write for list. J. Domino, 58-81 Maspeth Ave., Maspeth, N. Y.

**FOR SALE**—We have many scarce radio tubes. Write for list. Bill's Radio, 2038 Washington St., Boston 19, Mass.

**JOB WANTED**—Radio & sound technician, 18 yrs. experience. Know test eqpt. maintenance and construction. Best of references. All letters answered promptly. R. F. Johnson, 706 Tennessee Ave., Pineville, Ky.

**FOR SALE**—1946 Philco UN6-400 auto radio. Brand new with 6 tubes, \$40 takes it. Aulthouse Radio, 3006 Pine Ave., Altoona, Pa.

**SWAP**—One GE 814 tube, brand new, surplus. Want pair of VT-127-A's or one 829B. Must be new. Russell McGhee, Girtler, Pa.

**FOR SALE**—Hard-to-get radio tubes, 10% off list. Write for list. Henry Kolk, Washingtonville, N. Y.

**FOR SALE**—Stancor 20-watt phone-CW exmitter, complete with 80-meter crystals, coils and final Ip meter. Vibroplex bug key and single button carbon mike included. Essex Radio, 8 Osgood St., So. Lawrence, Mass.

**FOR SALE**—Following brand new tubes in cartons, mailed prepaid, \$17.50 for the lot: 1-83; 2-80; 1-6H6; 1-6A7; 1-35Z5; 1-1R5; 1-1S4; 1-1D8; 1-1G4; 1-41; 1-1C5; 3-12SA7; 1-6W5; 1-6SA7; 2-1Q5; 2-1T4; 1-85. C. W. Zanner, 102 Grosvenor St., Athens, Ohio.

**POSITION WANTED**—Radio technician. 1st class radio telephone license, experienced in aircraft radio wants position. Near Chicago preferred. B. F. Peyton, 1034 W. 61 St., Chicago, Ill.

**FOR SALE**—RCA 167 sig. generator with new leads, in A-1 shape, \$40. Hamilton Radio Clinic, What Cheer, Iowa.

**FOR SALE**—Radio tubes: 1A7; 6A7; 25L6; 35L6; 50L6; 42, 6A8, 35Z5. Radio parts, one phono motor with turntable; Simpson #260 VOM, \$38.95. Want new Sylvania tube tester, or Triplett 2H25. W. L. Mason, 820 Graham St., Alhambra, N. C.

**WANTED**—Television receivers in any condition, especially RCA TRK-5 TT-5 TRK-9-12. Write giving details and price asked. Columbia Radio Service, 237 Broadway, Newburgh, N. Y.

**WANTED**—1939 Chevrolet 10:1 ratio panel mounting (dash) radio control. Also a 6N6 tube. Albert C. Hart, 4848 Linden Ave., Hammond, Ind.

**WANTED**—Raco-Super-Clipper or Sky Champion S20-R. State price and condition. Edward Horch, Plain City 3, Ohio.

**WILL TRADE** BC-375, BC-223, BC-406-A and cash for BC-610 or equal. Late N.R.I. radio course for sale, \$100 or trade for television set. Multimeter \$10; signal generator and capacitor bridge, \$50. W6VTC, P. O. Box 1298, Hollywood 28, Calif.

**FOR SALE OR TRADE**—Amplifier, 20-watts, needs some repairs, \$5. Tubes: 81, 50, 53, 2A6, two of each, \$1 each or all for \$6.75. Will trade for recording eqpt. Robert Paxton, 10110 Hereford Place, Silver Spring, Md.

**FOR SALE**—Speakers: 8" magnetic, 6" Quam PM, 4" PM with output trans.; 1-5016 output trans.; tuning condensers and various tubes. Write for list. Stanley K. Wilkinson, Larwill, Ind.

**NOT A SUBSTITUTE!**



### Replace Wet Electrolytics with Sprague Type RW

When replacing wet electrolytic capacitors, use Sprague Type RW. They're not substitutes! They're dry electrolytics of very high voltage formation specifically designed for use as wet replacements or for other difficult applications. Due to their extremely low power factor, lower capacity values give you better filtering. For instance, Type RW-25 rated at 25 mfd. is at least the equivalent of a 40 mfd. wet electrolytic. They'll stand high peak surges. They'll handle a-c ripples—and they fit the standard mounting holes. Ask your jobber for Sprague Type RW.

Write for the complete Sprague Catalog listing Capacitors and \*Koolohm Resistors for every radio service, amateur and experimental need.

Send your ad to: Dept. S-27

# SPRAGUE PRODUCTS COMPANY

NORTH ADAMS, MASS.

JOBBER DISTRIBUTING ORGANIZATION FOR PRODUCTS OF THE SPRAGUE ELECTRIC CO.

## YOUR OWN AD RUN HERE FREE!

Sprague will gladly run your own TRADING POST ad free of charge in the first available issue of one of the six radio magazines in which this feature appears. WRITE CAREFULLY or print. Hold it to 40 words or less and confine it to radio subjects. Sprague reserves

the right to rewrite ads as necessary, or to reject any that do not in our estimation fit in with the spirit of this service.

*Harry Nathan* Sales Manager

ASK FOR SPRAGUE CAPACITORS and \*KOOLOHM RESISTORS by name!

\*Trademark Reg. U.S. Pat. Off.



# New Equipment Cuts Repair Time

## Feiler STETHOSCOPE

Model TS-3 is an a-c signal tracing Stethoscope. The 1" diameter aluminum probe contains a miniature tube in a detector-amplifier isolating circuit, while the larger case houses 3 more tubes, including a power output which drives the 5" PM speaker for audible signal



tracing. An a-c voltmeter may be connected to front panel jacks which terminate VTVM and output meter circuits, while earphone jacks are also provided for extremely sensitive work. Model TS-2 is a similarly constructed Stethoscope for portable battery operation. Feiler Engineering Co., 803 Milwaukee Ave., Chicago 22, Ill.—RADIO & Television RETAILING

## Philco Corp. DYNAMIC TESTER

Model 7030 uses a searchlighted probe head with a lucite lens. A wide choice of input impedances is provided, enabling the tester to operate at high r-f frequencies. The speaker delivers 2 watts at less than 10% distortion. Philco Corp., Philadelphia, Pa.—RADIO & Television RETAILING



## Clarostat CONTROL KIT

Serviceman's kit No. 4 contains an assortment of 17 controls, 8 switches and 4 glass-insulated flexible resistors, packed in a neat hinged-top steel cabinet devoid of advertising and labels. Upwards of 95% of standard replacement needs are covered in this stock-saving assortment, offered at a considerable saving. Clarostat Mfg. Co., Inc., 130 Clinton St., Brooklyn 2, N. Y.—RADIO & Television RETAILING

## Perco REPLACEMENT COIL

A new miniature oscillator coil is designed for use as a replacement unit for prewar and postwar receivers. Measuring 9/16" x 3/4", the coil has movable iron core which makes its inductance variable in order to match any oscillator

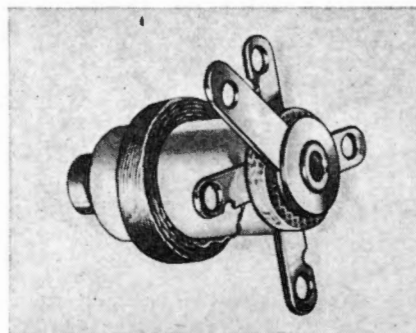

coil that needs to be replaced. A bifilar winding acts as the grid coupling capacitor when required. The coil is useful in radios employing a pentagrid converter and 455-456 kc i-f transformers. Pioneer Electric & Research Corp., 7212 Circle Ave., Forest Park, Ill.—RADIO & Television RETAILING

## Workshop Associates STAND-OFF INSULATOR

A molded polystyrene insulator for running balanced 300 ohm television and FM transmission line is being sold through dealers. Designed to keep both conductors rigid and parallel, out of proximity to grounded pipes or building walls, the insulator is attached with a single wood screw, and the line is snapped securely in place, with slippage eliminated. The Workshop Associates, Inc., 66 Needham St., Newton Highlands 61, Mass.—RADIO & Television RETAILING

## Solar Mfg. Corp. CAPACITOR ANALYZER

Model CBB is a small, light-weight improvement over the earlier model CB. A range of capacity from 10 mmf to 800 mf can be measured by means of a "magic eye" tube in a Wein bridge balance, while simplified neon lamp

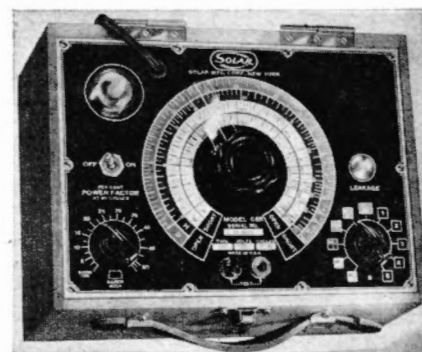

test circuits are used for visual checks of insulation resistance and leakage currents of electrolytic capacitors. The instrument can also be used as a line frequency resistance bridge covering a range from 50 ohms to 2 megohms. Solar Mfg. Corp., 285 Madison Ave., New York 17, N. Y.—RADIO & Television RETAILING

## Sylvania Electric OSCILLOSCOPE

Type 131 Oscilloscope stresses portability, weighing 18 lbs. and measuring 10 3/4" high by 8 1/8" wide by 13 3/4" deep. The 3" cathode ray tube is swept from 15 to 40,000 times per second by a saw-tooth wave generated by a type 884

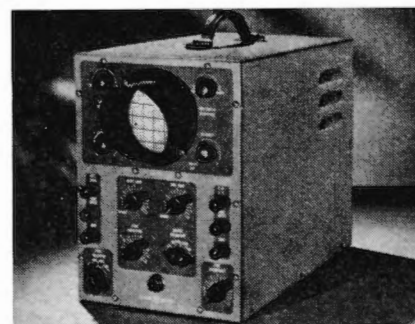

gas triode oscillator. Type 707 amplifiers provide vertical and horizontal gain. Sylvania Electric Prods. Inc., 500 Fifth Ave., New York 18, N. Y.—RADIO & Television RETAILING

NEW ELECTRICAL APPLIANCES, PP. 90 TO 92.

NEW RADIO SETS, PP. 52 TO 56.



## Named by Presteline



Paul H. Eckstein, who has been appointed assistant general sales manager of Pressed Steel Car Co.'s domestic appliance division.

## Emerson Presents 1947 Models and Sales Plans

The national sales organization of Emerson Radio and Phonograph Corp. met recently for a two day session in New York for a presentation of the company's new radio models for 1947 and to hear the details of the greatly accelerated sales program for 1947.

Dorman Israel, vice-president in charge of engineering and production, demonstrated the firm's latest developments in electronic improvements and styling. Charles Weisser, national sales manager, commented on the policies of the organization and elaborated on the advertising program which is underway in newspapers throughout the nation.

President Benjamin Abrams revealed that 1946 was the largest year in Emerson's history both from unit volume and dollar volume. "Judging from orders already on hand the year 1947 will see all previous sales records broken," Mr. Abrams stated.

## "20th Anniversary" Line Shown by Norge

A new "20th Anniversary" line of household appliances has been presented by the Norge division of Borg-Warner Corp., according to M. G. O'Harra, vice-president and director of sales.

The new line will be named in commemoration of the firm's 20th year of existence and will consist of new products and improved models of existing ones. These include refrigerators, freezers, gas and electric ranges, washing machines, home heaters, water coolers, and other refrigeration specialties.

## Rexon Ad Manager

Jacques Schwalbe, president of Rexon, Inc., general distributors in the United States for Swiss-made Thorens lighters, phonographs and record changers, has announced the appointment of Howard Liebl as advertising manager.

Performance curves like this prove the superiority of Newcomb Amplifiers...

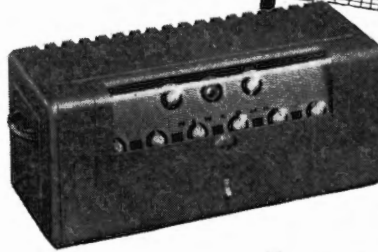

Deluxe Model KX-60

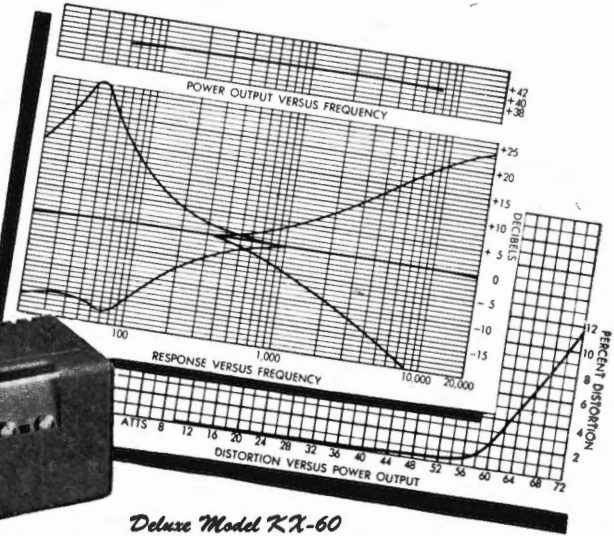

For the most faithful reproduction of music or speech at any volume level, the KX-60 is unexcelled. It is unique among high powered amplifiers. Its superiority is complete from every angle, whether it is frequency response, distortion at low or high outputs, power at all frequencies, tone control action, mixer response, operational features, portability or any other factor.

### NOTE SPECIFICATIONS

**POWER OUTPUT:** 60 watts at less than 5% distortion with wide flat power output versus frequency curve and extremely low distortion at any volume level. **FREQUENCY RESPONSE:** 20 to 20,000 cycles within 1 d.b. **INPUTS (5):** 3 for mikes, 2 for phono. **INPUT IMPEDANCES:** Mikes 2 meg.; phono ½ meg. (Microphone inputs instantly convertible to low impedance by use of TR-91 plug-in transformer). **OUTPUT IMPEDANCES (6):** 3, 4, 6, 8, 16 and 250 ohms to terminal strip and four bakelite molded sockets. **GAIN:** Mike inputs: 126 d.b. Phono inputs: 78 d.b. **TONE COMPENSATION:** Bass range from -17 to +24 d.b. Treble range from -24 to +24 d.b. **CONTROL PANEL:** Etched metal, fully illuminated. **CONTROLS (9):** 3 mikes, 1 phono fader for 2 pickups; 1 master, 1 bass, 1 treble, 1 volume indicator,

1 power switch. **CONTROL COVER:** Thru- vision plastic keylock cover protects controls from misadjustment. **VOLUME INDICATOR:** Electron Ray tube coupled to calibrated control provides full scale deflection from 2 to 60 watts. **OVERLOAD INDICATOR:** Electron Ray tube indicating slightest overload of output tubes. **MISC. FEATURES:** All resistance capacity coupling; multi-stage inverse feedback; plug-in filter condensers; electronic type dual tone controls with resonant bass and special shaped curves; crystal pickup equalizing networks in each phonograph input; regulated screen power for output tubes; accessible fuse in insulated post type holder; AC outlet socket connected with main switch; thoroughly impregnated heavy duty transformers; multiple winding output transformer with uniform output from all taps; heavy gauge welded steel chassis and cabinet; cabinet finished in durable, easily cleaned baked enamel, gray Hammeroid finish. **DIM.:** 8 3/4" x 8 3/4" x 2 1/4".



AUDIO PRODUCTS CO.

Dept. A, 6824 Lexington Avenue • Hollywood 38, California

AMERICA'S TOP QUALITY AMPLIFIER



FOR IMMEDIATE SHIPMENT

No. 353 Crystal Pickups .....	\$3.53
No. 395 Crystal Pickups .....	3.82
No. 289 Vibrator Transformers for 6 to 8 tube radio....	2.89
No. 295 Power Transformer—650V 90 m 5V 2 amp. 6.3V 3 amp. Giveaway price .....	2.95

Thousands of bargains in tubes, parts, amplifiers, radios, etc.  
Write for bulletins.

LIFETIME SOUND EQUIPMENT CO.

DEPT. TV-14

TOLEDO 2, OHIO



# Needle the Slow-Payers

**How to Get Your Money From People Who Have Your Merchandise.**

• Every merchant likes to feast his eyes upon a nice, fat bank balance. He enjoys looking about his store, seeing the stocks of this and that he has on hand; the modern fixtures, the service equipment and perhaps out in front his "rolling" stock, a lettered truck or two.

He likes to see all of these things because they are *his*. Or, if he's a part of a retail corporation or partnership, because they're partly his.

But far too many dealers who are so well pleased with the possessions they can *see* and *feel* right under their noses, and who guard each piece, parcel and penny with meticulous care, overlook the fact that large sums of *their money* is not in their custody, not in their tills and not in their banks. It's in the *hands of customers*—and it represents actual hard-cash.

In his "accounts receivable" ledger, the dealer can see *his* money. Certain of his customers have this money now. Some will pay without question when the account becomes due, but there are others who have not paid bills *long past due*, but who might settle up if urged to do so. There are still others who hope to evade paying.

The dealer himself has already

**Make collection efforts consistently and regularly. If you can't get all of the money due you, try to get some of it. No account is "hopeless" until you've really tried to collect it.**

*paid* his suppliers for the merchandise his accounts receivable customers have. He's already paid his servicers for maintenance work provided for the benefit of customer who owes him money.

In other words, the accounts receivable ledger lists the names of people who have both the dealer's *merchandise and his money*. The retailer knows that it's next to impossible to get the merchandise back from those who persistently refuse to pay. Therefore, with the "bum" and doubtful accounts staring him in the face, he can foresee nothing but loss of money and time if he fails to act.

## Classifying Credit

In looking over his accounts receivable ledger—a chore which he should indulge in frequently, he can see three sorts of classifications for the persons listed therein:

1. The pay-on-time group. Nothing to worry about until any change their present habits.
2. The slow-pay group. The kind that "need needling to nudge."
3. The hopeless group. Those who ignore dire warnings and are more often than not judgment-proof.

The dealer should go right after that slow-pay group and keep after them. Such customers can be *made* to pay all or some of the amounts they owe if the dealer will keep at them. Members of the slow-pay group are usually careless folk; or folk who like to "work on other people's money"—or a combination of both.

The dealer should follow collection work on the slow-pay group by mail, telephone and by personal call. Where the entire amount cannot be collected, the dealer should make a plea for at least some of the money owed, and, at the same time exact a statement as to when another payment will be made. When the promised date falls due, the dealer should be right on the spot to remind the customer of his self-made obligation.

Every dealer has a certain number of good customers who are erratic in their payment methods. Some dealers fail to keep ahead of such folk because they do not want

to antagonize them, losing perhaps not only the slow-payer's patronage but that of friends or relatives of the delinquent one.

In such cases, the dealer who uses *tact* usually gets results. No customer will take umbrage at the dealer who calls because he has a few "financial problems" to take care of and, therefore finds it necessary to "bother" the customer with a request for payment in part or in full.

The main thing to do in the successful handling of slow-pay accounts is to keep everlastingly on top of such situations. Collection attempts must be made regularly and consistently.

There's another angle to collecting from the slow-payers, too, and that is the technique of "switching" collectors. Too often the "putter-offer" becomes so familiar with the dealer or with a certain salesman that it becomes easy to say "no" and to get away with it. For this reason it's better to send collectors such customers are not acquainted with.

Strangers give an impersonal touch to this business of collecting as witness the amazing way that most people—even the dead-beats—will pay the small loan companies promptly, and via the postoffice. Since it is true that "familiarity breeds contempt", the dealer shouldn't overlook the "stranger" angle in chasing his own money.

"Hopeless" accounts should be wiped off the dealer's book for his own peace of mind if for no other reason. However, an account should never be classed as "hopeless" upon any other basis than a *definite* knowledge that it is uncollectible.

*(Continued on top of next page)*

## \$ From "Putter-Offers"

**Follow up frequently—such folk need needling to nudge them.**

**"Switch" collectors — send a stranger and beat the old "familiarity breeds contempt" angle.**

**Exact promises — make the slow-payer say "when" and be there when "when" arrives.**





Heresay, presumption or guesswork should never be employed. Instead, a genuine, all-out effort to collect must first be made. After this has been done, the dealer is in a position to judge the case.

Where "hopeless" account amounts are low, nothing much can be done. Where the won't-pay customer's bill is large, it sometimes pays the dealer to take legal action, though some merchants dislike going to court with collection matters because they feel that it injures their good-will structure.

All in all, though, no matter what methods he pursues after looking at his receivables ledger in the light of representing his own money being held by others, drives to get in the money should be frequent and well-planned.

Whenever the dealer is tempted to look around him at his possessions as a whole he shouldn't forget that there's a share of them—often too big a share—lying right in that book listing names of customers and amounts they owe the merchant's business.

### Toastmaster Fair Trade Contracts

Fair trade contracts have been executed in all states having fair trade laws, establishing both minimum wholesale prices and the minimum retail price on the Toastmaster automatic pop-up toaster, Model 1B12, according to a recent announcement from the Toastmaster products division, McGraw Electric Co., Elgin, Ill.

In the announcement, W. E. O'Brien, general sales manager, pointed out that the contracts were as binding upon those who do not sign contracts as upon those who do. A slight increase in the Toastmaster toaster list price from \$18.55 to \$18.75 designed to eliminate the OPA price in favor of one conforming to customary practice, was also made effective with Mr. O'Brien's statement. McGraw Electric Co., however, has not increased its price to distributors and the entire benefit of the increase will be passed along to both distributors and retailers in slightly increased profit margins.

Prices are established under the fair trade laws of the 45 states having them. Missouri, Texas, Vermont and the District of Columbia are the only areas in which there are no fair trade laws.

### Finders Sales Meeting

Inaugurating a new sales educational program on its "Hollywood" electric table broilers, Finders Mfg. Co., Chicago, entertained salespeople of State St. outlets at a series of breakfasts conducted here. Guests were given complete selling points and consumer usage of this appliance. The company plans to repeat this program in key cities throughout the country.

### Chicago Markets Draw Crowds of Buyers

Some 240 manufacturers of appliances and radios exhibited their products for peak crowds at the Chicago Markets—Jan. 6th to 18th, at the Furniture Mart and at the Merchandise Mart. Many of the newest lines were shown here for the first time, both in the radio and appliance fields, and some of the showings created a real stir among the mobs of buyers at the event.

In most instances where new items made their debut, it was a case of manufacturers adding a new model to major lines that had already been shown. And nearly all of the suppliers were still

dogged by shortages to the extent that they could only promise deliveries later in the year.

Absent from the scene this year was the National Housewares Show, which has been delayed until April 27 to May 2. It will be held in Philadelphia.

### New Mastercraft Chiefs

Mastercraft Electric Co., Newark, N. J., announces the election of Irving Skolnick, formerly vice-president in charge of sales and advertising, as president and general manager. Sidney Blackman is now vice-president and will coordinate sales promotion, market research and production schedules.

... Revolutionary

## RADIO SENSATION

Already famous in many parts of the world, the ultra modern Emor Radio is causing a sensation in the United States. Its unusual new design affords simplicity of operation as well as marking a new step in streamlined radio beauty. Patented all over the world, the Emor Radio is made by Artist Craftsmen and is an exquisite addition to any style of interior decoration. Sturdy in construction . . . superior in quality of materials . . . this five tube, all wave Super-heterodyne set is outstanding for its clarity of reception and excellence of tone as well as for its appearance.

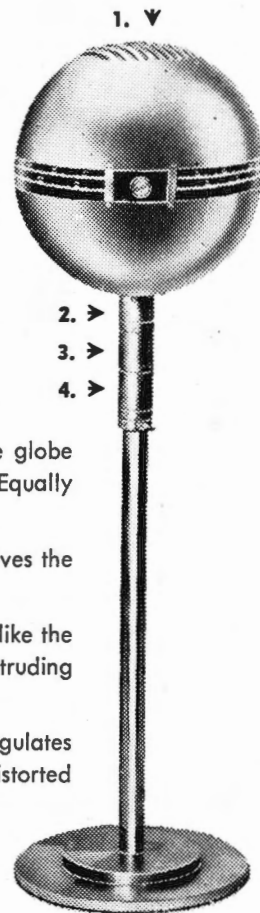

1. **LOUD-SPEAKER GRID** at the top of the globe provides even distribution of sound waves. Equally clear and distinct in any part of the room.
2. **TUNING CONTROL** in top sleeve. Revolves the globe for reception on all bands.
3. **WAVE LENGTH CONTROL** is in sleeve like the other controls. Easily accessible with no protruding knobs.
4. **VOLUME CONTROL**, also in a sleeve, regulates the reception from a whisper to an undistorted fortissimo.

No table necessary. Stands on the floor, 4½ feet high and is adjustable up to 6 feet.

**EMOR RADIO, LTD.** 400 EAST 118TH STREET  
NEW YORK CITY  
Tel. SACramento 2-3374-5-6



# Sales Tips and Profit-Pointers

If his service department is kept clean and attractive looking it lends itself well to visits by customers. Personally-conducted tours through the maintenance section create a most favorable impression of the dealer in the eyes of the consumer.

"Shirtsleeve Diplomacy" may have served us well in our international affairs, but shirtsleeve-exposing salesmen never lend dignity to a store. In cases where ordinary business jackets are too warm, or may become soiled, "office coats" can be worn.

Personal sales factors help to carry the sales message into the mind of the customer. A smile is the chief element in a winning personality. Others are enthusiasm in showing the product and tact in overcoming objections.

Go over each salesman's sales record with him periodically to show him where he stands. Compute his percentage of pay to sales volume. Analyze also the number of presentations and the amount of the average sale.

Follow through on your sales training program by day-to-day supervision of your sales force. Give them store-developed leads, help them organize their day's work, and furnish them with the advice and encouragement they need.



The good salesman knows when and to whom to extend credit. It is embarrassing to himself and his customer this going to "check up," leaving the would-be buyer standing around. A "credit" rating list should be available to the sales staff at all times.

Take your staff into your confidence. Show them by concrete figures they are with an organization that is "going places." This will build their morale and make them anxious to succeed.

Let's avoid using clichés—stilted, hackneyed and moth-eaten phrases—in greeting customers. "Can I help you?" is as monotonous and unimaginative as "are you being waited on?" Anything's better than these. Call attention to some new merchandise, give the visitor a circular or a pleasant nod, but be sure to tie a can to such questions as "is anyone taking care of you?" or "are you interested in seeing something?"

To handle the matter of price successfully, first become acquainted with your customer. Learn his needs and living standards. You can then confidently suggest the size and model of radio or electrical appliance which is best suited to his needs and ability to pay.

Frequent sales meetings keep your staff on their toes. Go over with your men in detail all price and model changes. Analyze reasons for past successes and failures. Formulate future plans.

Your *servicers* should be agreeable chaps as well as capable technicians. Lots of householders believe explicitly in the servicer's opinion of products because "he's not trying to sell me something," they say.



Don't underestimate the intuition of the juveniles when it comes to waiting on them. Whether they're just on an errand for mother or in your store to purchase something, they will resent losing their "turn" to some adult; harbor a grudge against the dealer who is impatient or condescending in his manner toward them.

The radio/appliance salesman shouldn't confuse courteous salesmanship with kowtowing servility. There is no need for any merchandiser in our field to put on the Gaston and Alphonse act with customers, nor to bow and scrape like a Parisian perfume vendor. Such actions, along with eager-beaverishness, nauseate most shoppers.



Restrict the reports your salesmen must write to those which you actually need to control their activities. Unnecessary reports distract a salesman and may hamper his ability to sell.



## PA Spurs Sales for Vogt

(Continued from page 128)

done a lot toward publicizing not only the sound service of the company but the shop itself.

"I don't think I have donated my sound services a single time," Mr. Vogt declares, "that some person—usually a woman—does not come in shortly afterwards, bring her radio or some appliance for repair and mention that she appreciated my providing the sound service at their gathering. That's how I know definitely that it pays."

Charge for the other service naturally varies according to the length of time and the size of the crowd. It runs from a minimum of \$5 to several times that figure.

### Constructive Publicity Helps

"Although the service itself pays a profit, I do not operate it primarily for that purpose. The town needed it, and it pays its way many times over through the constructive publicity it gives the shop and radio store. It will pay even better when I have adequate merchandise for sale."

Also, it has paved the way for the sale of public address equipment and installations in business houses large enough to require such service, Mr. Vogt points out. The equipment on the truck may be quickly removed and placed inside a building.

### Mail-A-Voice Recorder and Reproducer



Made by the Brush Development Co., Cleveland, Ohio, this widely advertised Model BK-501 magnetic recorder is a self-contained recorder-reproducer. Recordings are made on paper suitable for mailing.



*A Topnotcher of the Lear Line*

Table model radio-phonograph in handsome cabinet of hand-rubbed mahogany veneer. AC superheterodyne, 5 tubes plus rectifier. Automatic record-changer plays 10" and 12" records consecutively or intermixed. Beautiful tone and volume with Alnico PM speaker.

This lovely of the Lear line is getting more than its share of popular approval. We knew it had eye-appeal because our research and tests said it had fine design. We knew its tone would be rich and full and fine because of the materials and workmanship we lavished on it. So after all we shouldn't be surprised that the smart American buyer should pick it out as a ripping value. So this set, plus all the other Lear

Radios, is building good will and high reputation for Lear Dealers everywhere. Together they're showing that people appreciate radios fashioned with skill developed over our seventeen years of building aircraft radios.

Thus you see the Lear Franchise, while full of other advantages, is based upon sound, appealing products that will attract buyers and fulfill every promise.



# LEAR RADIO

LEAR, Incorporated, Home Radio Sales and Merchandising Division, 110 Ionia Avenue, N.W., Grand Rapids 2, Michigan.



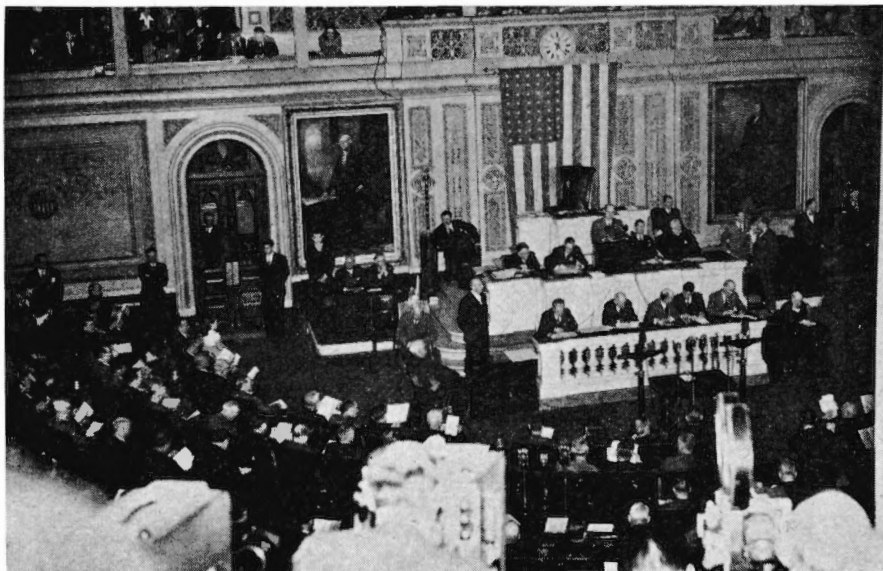

In the foreground are the video cameras from the three studios which picked up the events at the opening of Congress. From this scene in the House of Representatives at Washington, D. C., some experts concluded that a new era in politics was opening—an era in which John Q. Citizen is taken "inside" the legislative processes via television in the nation's capital.

## Citizens of 3 Cities See Congress Open

In a dramatic "first" for television, the opening of the 80th Congress in Washington, D. C., on Jan. 3 went on the air in pictures, and fans in New York, Philadelphia and Washington saw the momentous proceedings in detail.

The National Broadcasting Co., the Columbia Broadcasting System and the Allen B. DuMont Laboratories pooled their resources to televise the session for viewers in the three cities. The telecast was seen in New York over Stations WNBT (NBC), WCBS-TV (CBS), and WABD (DuMont); in Philadelphia over Station WPTZ (Philco), in Washington over Station WTTG (DuMont), and on specially-installed television receivers in NBC's Washington radio Station WRC.

The occasion marked television's first broadcast from Congress. A minimum of six image orthicon cameras were used for the coverage. The three stations co-operated in manning the equipment and producing the pool pickup, which was transmitted over the intercity coaxial link of the A. T. & T.

# TELEVISION TOPICS

## Broadcast Pictures in Politics

One of the key factors in the coming development of television, according to a statement by Brig. General David Sarnoff, president of Radio Corp. of America, will be the role of the video art in the political scene.

The RCA head said that "Although the television camera already has scanned national political conventions and presidential candidates, it will be ready to play its first big role in the 1948 campaign. That year will be to television what 1924 was to broadcasting, when Coolidge, Davis, Dawes, Cox, Bryan and other orators picked up the microphone for the first time in a national campaign and marveled at its ability to reach the people. Political techniques were vastly changed in that era of the headphones and goose-neck loudspeaker horns. Similarly, in 1947, television will be studied as a new factor in politics as plans are laid for the '48 campaign of radio sound and sight. In 1948, it may be expected that in the United States there will be several hundred thousand television equipped homes, possibly as many as 500,000."

### Thousands of Sets

The RCA production schedule for this year calls for 25,000 receivers in the first quarter, 25,000 in the second quarter, 50,000 in the third quarter, and 60,000 in the fourth quarter, or a total 1947 production of 160,000 instruments. These re-

ceivers will have a retail value of approximately \$65,000,000, according to a company statement.

## Television Courses in DuMont-NYU Tieup

In cooperation with DuMont Laboratories, New York University will be giving a series of courses on television commencing February 5, 1947. While the evening technical courses are non-credit types, no academic prerequisites are needed.

Covering practical theory and operation of television receivers, transmitters and UHF television, some of the classes will be held at DuMont studios and laboratories, under the instruction of Western Electric's Morris Nelson and DuMont's S. R. Patremio. Other courses of the series are being given under George C. Christ of the N. Y. Telephone Co.

## Production of "Big Picture" Sets

In reviewing the progress of the UST "Big Picture" television receiver, Hamilton Hoge, president of United States Television Mfg. Corp., said that many of the sets with the 21 $\frac{1}{4}$ " by 16" picture already installed in bars "are being seen nightly by audiences ranging from several dozen to several hundred, depending upon the program offered . . ."

Mr. Hoge reported that production is now at the rate of five per day and is expected to go to 300 a month in February

and 500 a month in March. UST feels that it is good policy to concentrate most of its attention on its 'Tavern Tele-Symphonic' at \$2350 and on its 'Tele-Symphonic' for the home at \$2400, at least for the next few months. Both these units feature AM broadcast and two short wave bands, FM, and a record changer, as well as television. Later, when parts are more readily available, UST plans to deliver popular priced sets.

## Pictures Seen as Topflight "Salesmen"

Praising the value of television as an advertising medium because it permits a sponsor to show a product and to demonstrate how it operates and how it is used, Joseph Gerl, president of Sonora Radio & Televisio Corp., in an address to the Charlotte (N.C.) Chamber of Commerce, said that "any good electrical appliance store, any good furniture store, any good department store, or any good clothing specialty shop, will find such an advertising medium of great value."

Mr. Gerl pointed out that "instead of demonstrating a new washing machine to three or four customers at a time, television would permit demonstration to thousands of potential customers at one showing. The same would hold true for every variety of merchandise that had eye-appeal or 'use-appeal.' Customers can be encouraged to view the merchandise over their television sets, and then order by mail or phone.



## Video Kit Ready for Retailers

The merchandising plans of Transvision Inc., 144 Union Ave., New Rochelle, N. Y., producers of television construction kits originally planned for individuals with a technical background, have undergone a quick change according to Herbert D. Suesholtz, general manager.

With the first large-quantity production in the stores, the unit has been bought by an unexpected number of non-technical persons, including housewives. As a result, national distribution is being organized for sales through radio and appliance dealers. Incoming orders are being filled with at least sample shipments.

The kit uses a 7" screen tube, and is supplied complete in every detail including an already-wide r-f amplifier unit. Since this r-f unit is pre-tested and pre-aligned in the Transvision factory, and the i-f transformers are fixed-tuned, no test equipment is needed in building the set.

Since a full list of purchasers of the build-your-own television kits is being kept, additional notes, corrections and literature can and will be sent by Transvision Inc., directly to the user.

Retail price of the Transvision kit is \$159.50 with front panel, while an additional rubbed wooden cabinet of pickle pine, walnut or mahogany veneer is sold for \$35 extra.

## Philco Video Station Covers Basketball

Thirteen of the home basketball games played by the University of Pennsylvania basketball team this season will be seen by the television audience in the Philadelphia area under the sponsorship of The Atlantic Refining Co. over Philco television station WPTZ.

With two new image orthicon cameras, used by Philco and Atlantic to televise all the Penn Home football games last fall, the local audience will have "centercourt seats" for each basketball game. The cameras are placed on a special constructed platform, midway between the baskets, and pivot around to follow every play.

## Radio School Sponsors Showings of New Ideas

New York's Delehanty Institute will sponsor a series of eight demonstrations of the latest technics and developments in radio, television and FM, according to Monroe M. Freedman, principal of the school of radio, electronics and television.

Starting in February and continuing into June, the first group of demonstrations will include one by CBS on color television, and others by RCA, U. S. Television Co., Precision Instrument Corp., John F. Rider, Col. Burlingame, distributor of Supreme instruments, and others.

Theatre facilities for 850 radio servicers, dealers and manufacturers have been set aside.



*Chairside Charm*

Radio-Phonograph with  
Pull-out Automatic  
Record Changer

# HOWARD RADIO

*Noted for tone*

Famed for Performance  
and Value

**HOWARD RADIO COMPANY**  
CHICAGO 13, ILLINOIS

*America's Oldest  
Radio Manufacturer*



# JOBBER'S IN ACTION

## Coast-to-Coast Review of Distributor Activities

LOS ANGELES, CAL.—A handsome new building, comprising more than 40,000 square feet of floor space, has been opened to the trade by *Century Distributing Co.*, Emerson radio jobber in this area. The modern architecture and interior layout of the new building provide not only for dramatic display of the products handled, but also provide conveniences for the firm's customers. Shipping and service facilities have been arranged for high efficiency, also.

NORFOLK, VA.—C. R. Taylor, former apparatus and supplies salesman of this branch of the *Westinghouse Electric Supply Co.*, has been named branch manager of this office.

PHILADELPHIA, PA.—Appointment of Victor G. Brobst as credit manager of *Peirce-Phelps, Inc.*, of this city and Harrisburg, wholesalers of appliances, has been announced by W. G. Peirce, president.

CHARLOTTE, N. C.—*Williams & Shelton Co., Inc.*, has opened its new establishment at 801 South Tryon St., in the famous old Williams Mansion, in the heart of Charlotte's business district. After the grand opening, "open house" was held



C. A. Williams, Jr., and J. Lauer Williams greeting dealers over radio station WSOC.

with over 1,500 persons associated with North and South Carolina appliance dealers attending. Featured at the event was the premier showing of Presteline electric ranges manufactured by the Pressed Steel Car Co. Among those participating were C. A. Williams, president, and J. Lauer Williams, vice-president of the distributing firm, and A. Raysson, sales manager of Pressed Steel Car.

CHICAGO, ILL.—Announced as a recently appointed distributor for The Silex Co. is the prominent distributor, *Hibbard, Spencer, Bartlett & Co.* of this city. The jobber is one of the largest and oldest distributing firms in the country.

## Wholesaler Looks to the Future



Radio Distributing Co., Detroit, recently moved into this large new warehouse on a 2-acre site outside downtown area. It has 22,000 sq. ft. of floor space and room for expansion.

NEW YORK, N. Y.—The new self-service radio parts department of *Bruno-New York, Inc.*, metropolitan distributors, is now handling the products of 40 nationally known parts manufacturers, in addition to RCA Victor tubes, parts, test and sound equipment. The manager of the department is Sid Pressler, whose appointment was recently announced by Gerald O. Kaye, general sales manager of the firm. Mr. Kaye also announced the appointments of Richard Harris as assistant to Phil Silverman, record dept. manager, and David Oreck as assistant to Dave Wagman, radio and television sales manager. Department manager for Bendix Home Appliances is Ira M. Schwartz, and the sales manager for Eureka products and traffic appliances is Jack Urove.

MIAMI, FLA.—Walter D. Rowlands, president and general manager of *Major Appliances, Inc.*, announces the completion of two new branch offices in Jacksonville and Tampa, Fla. These buildings incorporate the latest modern equipment to increase efficiency in serving dealers, the company states. The showrooms have been designed to assist retailers in proper methods of display, and complete auditoriums will be available with modern kitchens to facilitate sales training.

MINNEAPOLIS, MINN.—Carl O. J. Peterson has joined the *General Corp.* here as appliance and radio sales manager. Mr. Peterson will supervise the sale of Farnsworth radios, Calcinator garbage disposal units, Plicote finishes, and other products. The new appointee is well known in this area, having spent a number of years as field representative for the Frigidaire Division of General Motors, both in the Twin Cities and Des Moines territory.

CINCINNATI, OHIO—L. A. Iserman has been appointed manager of the Cin-

cinnati branch of *General Electric Appliances, Inc.*, it has been announced by P. A. Tilley, president of the corporation. He succeeds P. C. Wilmore, who has resigned.

SAN FRANCISCO, CAL.—After 18 months in retirement from his former wholesale radio parts business which he operated for 25 years, Ira L. Offenbach has become active in the new organization, *Offenbach & Reimus Co.*, in co-partnership with Robert A. Reimus. The company has opened new and elaborate quarters at 372 Ellis St. The same business policies which prevailed in preceding years will continue in the future.

The scope and policies of the new wholesale organization have been broadened so that new channels of trade may be served. For example, the firm will specialize in radio dealer, service, amateur, industrial, and coin machine accounts; diversification of merchandise and larger stocks of widely used components are also planned to accommodate the large increase in population in the area served.

HARRISBURG, PA.—Appointment of Samuel Prescott as general office manager, credit manager and controller of *Jules Alexandre, Inc.*, distributors of Crosley products, has been announced by Jules Alexandre, president.

SEATTLE, WASH.—*F. B. Connelly Co.*, Norge distributor in this area, announces the opening of its new and enlarged quarters. The firm is also expanding at present its Portland location. Frank Porter, vice-president, states that the showrooms have been expanded and modernized, and counters and shelves have been planned so that merchandise is attractively shown and easily examined. The showroom layout is designed in order that dealers can obtain suggestions for their own store arrangements.



**Mallory Wholesale Head**



Walter E. Harvey, who has joined P. R. Mallory & Co., Inc., Indianapolis, Ind., as manager of the company's wholesale division.

NEW YORK, N. Y.—“The World at Your Fingertips” was the theme of the recent exhibit of *Niagara Radio Supply Co.* at the National Crafts and Science Show held here. The exhibit featured a live short wave station (W2BNW) operated by Sy Denby of Niagara, N. Y. Contact was made with both local and distant stations as far away as Cuba.

Main idea of the performance was to show the general public how to become a short wave “ham” as an interesting and valuable hobby. Supporting literature was distributed tracing the history, growth and development of amateur short wave radio.

BALTIMORE, MD.—A. J. McGettrick has been appointed general sales manager of *Mid-Atlantic Appliance Distributors*, wholesalers of Bendix radios in this city and Washington, D. C., according to Samuel Cohen, co-owner of the firm. Mr. McGettrick was until recently sales manager of the company's Baltimore operations. In his new capacity he assumes full direction of Mid-Atlantic's distribution policies and selling activities on its many nationally advertised products.

**Mobile FM Unit**

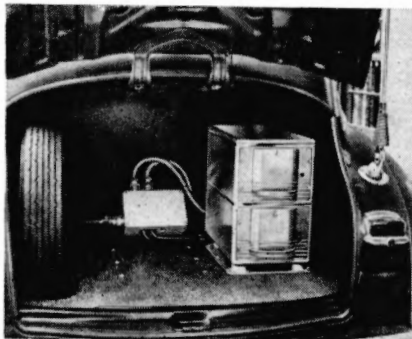

The new FM mobile radio-telephone equipment made by Kellogg Switchboard & Supply Co., Chicago, shown in rear deck installation in '46 Plymouth. Receiver includes a selective signal circuit, set to respond to pulses sent out from dial-operated calling unit at telephone company.

# New 1947 profit makers

## PROVED BY THE '46 LINE

**YES, PROFIT MAKERS—BECAUSE...**

Stromberg-Carlson's is a complete, broad line, with all the latest scientific features that sound equipment customers are looking for.

experience in the production of fine radios, telephones, and telephone switchboard equipment—equipment with records of years of dependable service.

**BECAUSE—**

These sound systems meet every standard in every situation—from the most elaborate of industrial requirements to the simple room-to-room installation.

**BECAUSE—**

Stromberg-Carlson Sound Systems have *proved* to be sound sales builders and sound profit makers with scores of satisfied dealers, in 1946...

**BECAUSE—**

“Manufactured by Stromberg-Carlson” means designed and engineered by matchless skills and

**AND BECAUSE—**

The 1947 market for this quality equipment promises to be the biggest, brightest ever!

*Here are a few typical products*

**PORTABLE SOUND SYSTEM, MODEL P532**

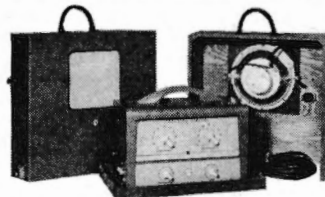

Portable system in a three-section, compact case. 15 watt amplifier with one phonograph and two microphone inputs, two heavy duty Alnico V reproducers, and 25 feet of durable cord with connectors attached. One case acts as the reproducer receptacle for connecting in cascade.

**AMPLIFIER, MODEL AU 35**

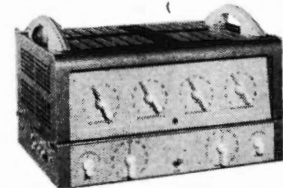

One phonograph and three microphone high impedance inputs, separate base and treble controls, 50 watt divided output with separate master volume control. Additional amplifier jack for tandem operation. Hum adjuster, resistor board construction and rugged copper plated steel chassis. Underwriters approved.

**AMPLIFIER, MODEL AR 37**

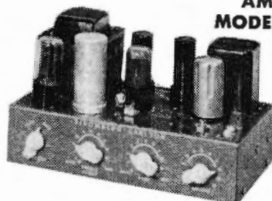

Two input jacks, one provides equalization network for crystal pick up, the other may be bridged across 500-600 OHM circuits, without change in level. Treble attenuation and boosts, base boost, base compensator volume control, separate gain control and fidelity control give the finest in record and wired-music reproduction.

**SOUND SYSTEM, MODEL SS 750**

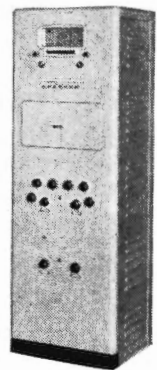

A completely pre-engineered system. Incorporates AM-FM radio tuner, record changer, controls, and 90 watts of audio-power divided into four output circuits. Wired for optional remote control turret. Rugged all-metal cabinet with glacier-grey finish. Underwriters approved.



**STROMBERG-CARLSON**

STRAIGHT-LINE



COMMUNICATION





# Better Instruments

*improve your profits*

WITH DYNAMIC MUTUAL CONDUCTANCE  
ORIGINATED AND PRODUCED EXCLUSIVELY BY HICKOK

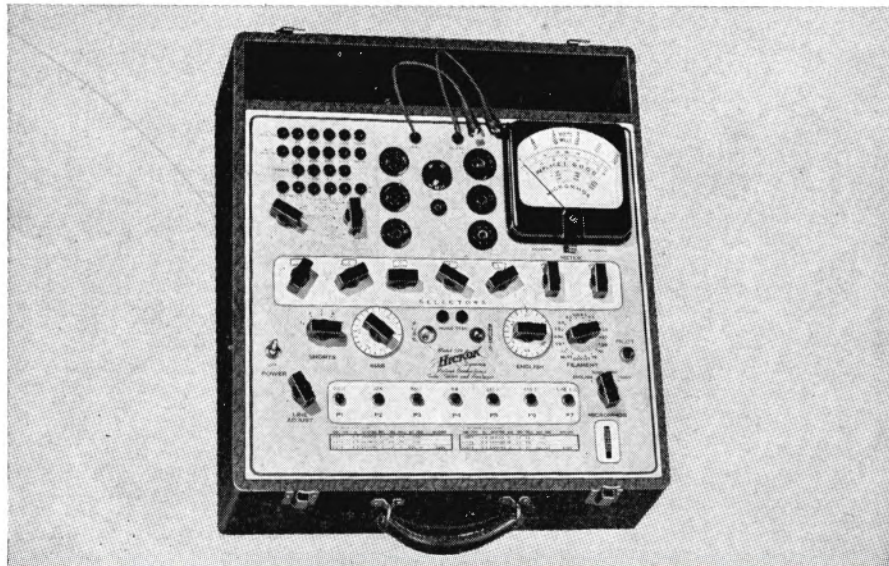

**TRULY, THE HICKOK 534 IS SOMETHING  
ANY SERVICE MAN CAN BE PROUD OF...**

1. Faster testing saves time for you.
2. Greater accuracy with HICKOK Tube and Set Testers assures better satisfied customers.
3. These test instruments cut down your customer calls for rechecks.
4. Better quality instruments increase your profits.

Model 534—all purpose Tube and Set Tester illustrated above meets all requirements of the exacting service man. It has everything you will need—even including a complete High Sensitivity Analyzer Unit.

★ ★

Write for catalog today listing all technical characteristics and you will choose—**HICKOK**—the finest in Radio Test Equipment for more than a third of a century.

**THE HICKOK ELECTRICAL INSTRUMENT COMPANY**  
10523 DUPONT AVENUE • CLEVELAND 8, OHIO

**HICKOK**  
INSTRUMENTS

## International Harvester Exhibits New Lines

A new line of International Harvester refrigerators and freezers, some now in production, others soon to be, was dramatically presented before a large sales convention at the company's Evansville, Ind., refrigeration plant.

The meeting, which included more than 300 Harvester branch managers, assistants and other sales executives, was shown the nucleus of a line so complete that it will meet every domestic refrigeration preference. Refrigerators, single and two-temperature; freezers, chest and vertical, all in complete size and price ranges, were shown Harvester refrigeration dealers.

Also unveiled to the organization for the first time were displays dramatizing selling features. These will be available to International Harvester refrigeration dealers, a part of a complete program of national advertising and sales promotion.

## Jefferson-Travis New Emerson Subsidiary

Jefferson-Travis Inc., manufacturer of marine radio and radiotelephone equipment, has become a wholly owned subsidiary of the Emerson Radio and Phonograph Corp. Jefferson-Travis will operate as a separate company and will have at its disposal the facilities and counsel of Emerson personnel.

Robert C. Berner, an official of the parent company, has been elected president of Jefferson-Travis and Col. Harold Lloyd, formerly with Emerson, has been named general manager. Ray Friedman continues in charge of sales, and Joseph Mas is chief engineer.

## Represents Weston Corp.

A. R. Hough, who has been manager of government and utility sales for Weston Electrical Instrument Corp., has been named by Weston to succeed Arthur L. Pollard as its manufacturer's representative with headquarters at 15 Nokomis Circle, Knoxville, Tenn. Mr. Pollard has announced his retirement as a manufacturer's representative.

In addition to representing the Weston Corp., Mr. Hough will also represent Reliance Electric & Engineering Co., Meriam Instrument Co., Cornell Dubilier Electric Corp. (power factor improvement division), and Superior Electric Co.

## Heads Kellogg Division

F. M. Parsons, sales manager of the Kellogg Switchboard and Supply Co., announces the appointment of Col. Edgar L. Love as manager of the Coiled Kord division.

In his new position, Col. Love will direct national distribution of all Coiled Kord division products, with particular emphasis given to a new retractable electrical utility cord adapted to industrial purposes following wide wartime use.



## Expect Record Crowds at Chicago Radio Show



Charles Golenpaul (seated) of Aerovox, Sam Poncher of Newark Electric, and Margaret McGowan draw slips for assignment of space.

Advance registration for the Radio Parts and Electronic Equipment Show to be held at Hotel Stevens in Chicago from May 11 to 16, 1947, indicates that show attendance will break all records, Kenneth C. Prince, show manager, states. Drawings for booths at the show were held in New York recently, with 158 manufacturers' booths and ten half-booths for guest exhibitors assigned, a complete sell-out of all available space.

NEDA Day, Monday, May 12, will be featured by a breakfast for manufacturer guests of National Electronic Distributors Assn. members, and a lunch for sponsoring organizations (Radio Manufacturers Assn., Sales Managers Club Eastern Division, Assn. of Electronic Parts and Equipment Manufacturers, and National Electronic Distributors Assn.). All meetings originally scheduled for Monday will be held earlier in the week or after Friday. The exhibition hall will open on Tuesday, May 13, for member exhibitors, their booth attendants, members of the press, sales representatives and distributors only, with open house scheduled for Friday. Radio amateurs and the general public will be admitted on that day only.

## Tele-tone Elects Mills



John S. Mills, named vice-president in charge of sales and advertising of the Tele-tone Radio Corp., New York City. He's been in radio 23 years—a Tele-tone director since the firm started.

## Meck Promotes Local Radiomen; New Sales Aids

An advertising campaign that features a series of half-column ads which suggest that radio owners patronize their local radio repairmen, has been launched by John Meck Industries, Plymouth, Ind., to help out the servicemen in a series started in a current issue of Saturday Evening Post. No suggestion is made that a new radio should be purchased, or that the technician chosen should be associated with the firm's dealers, John Meck, president, stated.

"The radio repairman who managed to survive the difficulties of the war years

deserves all the help that can be given him by radio manufacturers," Mr. Meck said. "He is an essential part of the radio business. Aside from that, he has a thorough knowledge of radio from the consumer's viewpoint."

In connection with the series of ads, the Meck company is preparing a dealers' kit which will be distributed through jobbers. The kit will consist of counter display cards, window posters, ad mats and mailing cards, all of which will utilize the cuts and heads featured in the ads. In addition, dealers may purchase a special neon sign from the company at cost. Any Meck dealer may obtain the kit free of charge. There is no sales tie-in.

# Success Formula OS/AJC\*

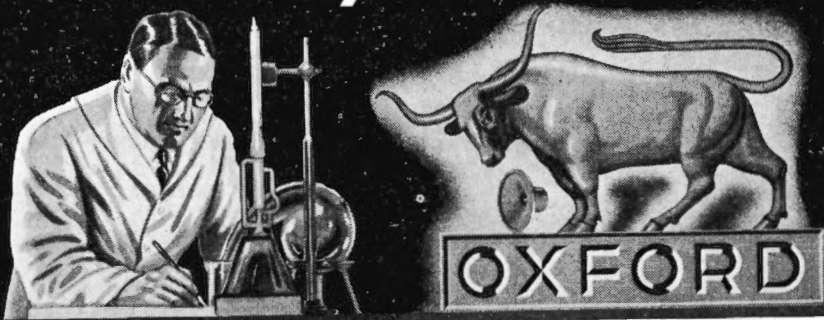

## \* OXFORD SPEAKERS / ALL JOBBERS' CHOICE

In producing the OXFORD SPEAKER, every effort has been taken to make it the most outstanding unit of its field. That these efforts have been crowned with success is attested to by the fact that over 77 radio manufacturers have used more than 1,500,000 OXFORD SPEAKERS in their 1946-1947 line of receivers.

Successful merchandising for the jobber must consist of plentiful sales at a profit. Dissatisfied customers or poor products do not encourage jobber sales. When offering OXFORD SPEAKERS, the jobber is positive that the product meets exacting specifications and that he will have a well-satisfied customer.

The versatility of the OXFORD SPEAKER line assures that a jobber can fill nearly every order for a replacement or public address system installation unit. And he can do this without a "special" speaker. That is why it can be truly said of OXFORD SPEAKERS that they are the ALL JOBBERS' CHOICE.

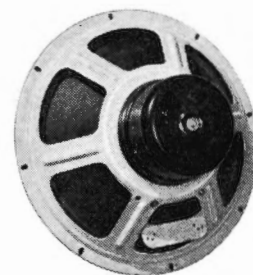

By consistent and continuous research into new materials and production methods, the OXFORD SPEAKER has been perfected to a high degree. This, coupled with wartime-developed modern manufacturing processes and careful quality control checks, assures the buyer of an OXFORD SPEAKER that he has a superior unit.

Copyright, 1946, Oxford Radio Corporation

**OXFORD RADIO CORPORATION**  
3911 SOUTH MICHIGAN AVE., CHICAGO



# NEW BOOKLETS

Sylvania Electric Products Inc., Emporium, Pa., is distributing three new bulletins describing the equipment manufactured by their electronics division, including full information on the Polymeter, the portable and counter type tube testers, and the modulation meter.

Cannon Electric Development Co., 3209 Humboldt St., Los Angeles 31, Cal., has published a bulletin XL-SC2 describing their new line of microphone connector plugs.

Kellogg Switchboard and Supply Co. has issued a new 24-page booklet in color, an "X-Ray Story of the Kellogg Masterphones." A feature of the booklet is its method of analyzing and sectioning the construction of the Masterphone by means of a series of four transparent overlay "windows." This new visual design enables the reader, simply by turning the pages of the book, literally to take a telephone apart.

Free copies are available by writing to the company at 6650 S. Cicero Ave., Chicago 38, Ill.

St. Louis Microphone Co., 2726-28 Brentwood Blvd., St. Louis 17, Mo., has released a new catalog on its line of dynamic microphones. The illustrated listing includes all types of mikes, including high fidelity, amateur, outdoor, standard broadcast, cardioid, aircraft, differential, etc., as well as the "Colormike" and the St. Louis line of mike accessories. Included is a folder on "What You Need to Know About Microphones."

General Cement Mfg. Co., 919 Taylor Ave., Rockford, Ill., announces a new catalog which is available free. The firm produces such items as dial cables, test lights, alignment tools, etc.

General Electric Co., Bridgeport 2, Conn., predicting that "the same extraordinary change, which took place in American kitchens, bathrooms and basements under the stimulus of modern ideas and production, is about to take place in the laundry," has issued a new 24-page booklet encouraging the establishment in the home of a planned utility area in which all occasional activities, such as laundering, sewing and hobbies, may be carried on. The booklet, entitled "Does Your Home Have a Place for Living?" points out that, while the modern home is well planned for routine functional activities, it makes no provision for miscellaneous part-time activities.

JFD Mfg. Co., 4109 Ft. Hamilton Parkway, Brooklyn 19, N. Y., has completed arrangements for the publication of its 1947 catalog. The new catalog will be distributed among radio servicemen when ready. The company states that its new line is approximately 40% larger than ever before.

The Solar Electric Corp., Warren, Pa., is offering a new catalog No. 209-A, describing their new "Scru-Its." Solderless wire connectors for fast set-up and knock-down of rental sound and temporary demonstrations or permanent installations are available for joining all gauges of wire. Small, safe and inexpensive, they work without tape, and are known as "Scru-Its" because they make the connection simply by a fast screwing motion of the connector onto the wires.

General Transformer Corp., 1250 W. Van Buren St., Chicago 7, Ill., is ready with a new, complete service manual and parts list for all models of Porta Power ever made. Servicing of all the units is simplified in this manual—one or more copies will be sent free to any serviceman or dealer who sends a request.

The Silex Co., Hartford 2, Conn., makers of the "Duolectric" steam iron, are offering the popular booklet, "French Hand Laundering Secrets" free to readers of current Silex ads in national magazines. It contains hints and instructions for the laundering of all types of fabrics and clothing, and includes proved tips and rules of ironing suits and skirts, pressing lace, steaming velvets, etc., plus "a hundred other useful hints on skillful laundering" with hand finishing stressed.

JUST  
OUT

## VOLUME XV

**ONE FEATURE ALONE  
WILL REPAY THE ENTIRE  
COST TO YOU...TIME, AND  
TIME, AND TIME AGAIN!**

For years and years on end—for as long as 1946 receivers are in use—Volume XV will continue to pay you annual cash benefits by providing authorized time-saving servicing data complete and bound in a systematic form. The owners of Volume I, purchased 16 years ago, are still deriving benefits from it. A library of Rider Manuals is a lifetime, profit-paying investment.

Volume XV incorporates the latest Rider "first"—"clarified schematics," a plus service on which we have spent tens of thousands of dollars in order to save you hundreds upon hundreds of hours each year. Also, with each copy of Volume XV is the separate book "How It Works," a practical guide to the theories of operation of the new technical features of latest receivers.

Many post-war sets are equipped with record players and changers; these are covered in Volume XV. All the popular brands of "Ham" communication receivers are included. You are brought up to date on all Scott receivers.

Yes, on the 1984 pages of Volume XV, covering the sets of 121 American Manufacturers and the 150 pages of "How It Works" you will find the data and services that will make it pay its profitable way for years to come. Order from your jobber today.

### OTHER RIDER MANUALS

Volumes XIV to VII, each volume.....	\$15.00
Volume VI.....	11.00
Abridged Manuals I to V (1 vol.)....	17.50
Record Changers and Recorders.....	9.00

### "clarified schematics"

"Clarified schematics" do a job which you have had to do on every multi-band receiver and combination set coming into your shop. They break down composite diagrams of hundreds of complicated multi-band receivers into individual schematics of each circuit as it exists with each turn of the wave band or equipment switch. With a "clarified-schematic" you save the time heretofore spent tracing out an original schematic to find which components are in operation under different positions of the wave band switch. Alone, this one feature will repay the entire purchase price of Volume XV year after year.



PRICE  
\$18.00

**YEAR AFTER YEAR AFTER YEAR  
RIDER MANUALS  
Keep pouring profits for Servicemen**

**JOHN F. RIDER PUBLISHER, INC.**

404 FOURTH AVENUE, NEW YORK 16, N.Y.

Export Division: Rocke-International Corp., New York 16, N.Y. 13 E. 40th Street, Cable ARLAB



RCA Tube Department at Harrison, N. J., has published a new 16-page booklet, "Receiving Tubes for Television, FM and Standard Broadcast (Form 1275C)," which charts the characteristics and socket connections of their extensive line of receiving tubes including kinescopes. The chart, which is a complete revision of a similar booklet, "RCA Receiving Tubes and Allied Types (Form 1275B)," is sold for 10 cents.

Scenic Radio & Electronics Co., 53 Park Place, New York 7, N. Y., are distributing a new 16-page catalog of test equipment of many well-known makes, stressing immediate delivery from stock. Amplifiers, automatic record-players, microphones, speakers and replacement parts are also listed.

Wells Sales, Inc., 4717 W. Madison St., Chicago 44, Ill., has just released an illustrated manual covering a wide variety of relays available for immediate delivery from stock. Complete technical information and prices are included.

Lustra Corp. of America, 40 West 25th St., New York 10, N. Y., has issued a four-page illustrated bulletin, No. 103, which discusses four types of light bulbs designed for rugged-duty service. The bulletin describes vibration service lamps, traffic signal lamps, milltype lamps, and rough-service lamps.

Appliance Corp. of America, 430 E. Silver Spring Drive, Milwaukee 11, Wis., has issued a 24-page booklet, "Technical Data on the Akka Top Flow Automatic Washer" completely illustrated with photos and diagrams. Under the head of "Operation" of the washer, it deals with such topics as cabinet assembly, components, sphere assembly, transmission and control assembly, soap, starching, motor, pump assembly, etc. Other main sections of the booklet deal with the function and the advantages of the washer, with detailed drawings showing the action of the unit.

Astatic Corp.'s new catalog No. 46 is a colorful 24-page, stiff-cover booklet which tells the story of the growth and present facilities of the Astatic Corp. at Conneaut, Ohio, and explains the increasing field of applications for their products. Complete specifications of all their microphones, phono pickups, recording heads and accessories as well as a separate four-color folder on the new Nylon 1-J crystal pickup cartridge are included.

Holub Industries, Inc., Sycamore, Ill., have made available a new 10-page illustrated catalog which is aimed as an aid during the scarcity of electric motors and generators. It describes motor maintenance tools which conserve the available equipment. Included are such items as commutator and slip-ring re-surfacing stones, carbon brush seaters, voltage and circuit testers, blowers and vacuum cleaners for removing dirt from motor windings, 14 types of wire insulation strippers, fuse reducers, etc.

# EVERY BUSINESS IS A PROSPECT!



## FLEXIFONE

INTERCOMMUNICATION SYSTEMS

**10-STATION MASTER UNIT**



**PRE-AMPLIFIERS — BOOSTERS AND MOUNTING RACKS**

**20-WATT AMPLIFIER**



**SPEAKERS**



**OPERADIO... THE OUTSTANDING SOUND EQUIPMENT LINE FOR YEAR 'ROUND SALES AND PROFITS!**

*Smart New Designs...  
New Features!*

Outstanding . . . that's the word for the new OPERADIO sound equipment line! Every unit is designed, engineered and constructed to OPERADIO-quality standards . . . with important new features and smart styling for added sales-appeal. OPERADIO sound equipment is nationally advertised to assure you of steady, successful sales.

# OPERADIO

## Sound Equipment

**OPERADIO MFG. CO., Dept. RTR-10, ST. CHARLES, ILL.**  
Gentlemen:

Please send us free information on the items checked:

Operadio Sound Equipment  
 FLEXIFONE Intercommunication

Name \_\_\_\_\_

Address \_\_\_\_\_

City \_\_\_\_\_ State \_\_\_\_\_

**SEND COUPON ABOVE FOR COMPLETE DETAILS**



# OHMITE

## Little Devil

INSULATED  
COMPOSITION  
RESISTORS



Resistance  
and Wattage  
marked on  
**EVERY UNIT**

Here is a new composition resistor—tiny but exceptionally rugged. Not only color coded, but individually marked for quick identification. *Little Devils* are sealed and insulated by molded plastic. They dissipate heat rapidly, have a low noise level and low voltage coefficient, are light, compact, and easy to install. Millions of these units have proved their value in critical war equipment. Available from stock in Standard RMA values from 10 ohms to 22 megohms. Tolerance  $\pm 10\%$ .

Available only from Ohmite Distributors  
**OHMITE MANUFACTURING CO.**  
4871 Flournoy St., Chicago 44, Ill.

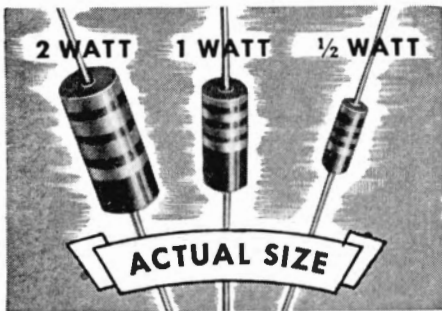

Send Now for  
Bulletin No. 127

Gives complete data and list of RMA values. Includes dimensional drawings and handy color codes.



*Be Right with...*

# OHMITE

RHEOSTATS  
RESISTORS • TAP SWITCHES

## Norge Men in Washer "School"

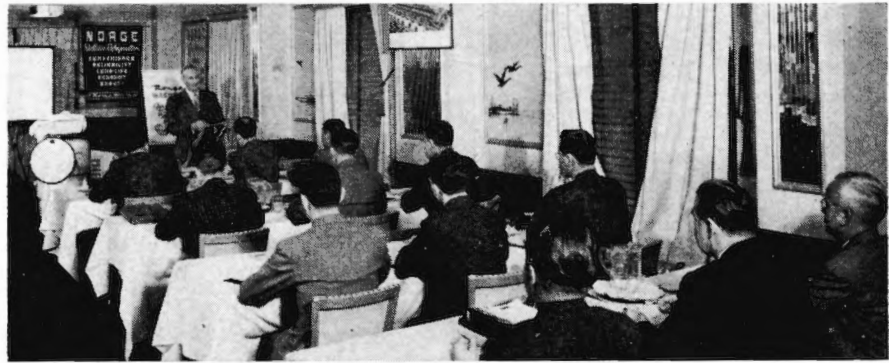

Newly-appointed district sales representatives for the Norge division of the Borg-Warner Corp. listen to R. H. Pizor, manager of laundry equipment sales, as he explains features of firm's new washing machine. Trainees attended six-week course before contacting dealers.

## Gibson Moves to Improve Steel Supply

Supplies of sheet steel for the Gibson Refrigerator Co., Greenville, Mich., have been greatly improved by a step in which Frank S. Gibson, secretary and treasurer of the firm, has become vice-president of a new company which will take the entire output of the Appolo Steel Co., Appolo, Pa.

The Pennsylvania steel mill, with a monthly capacity of 10,000 tons, was bought by a Detroit group who leased it to the new firm of which Mr. Gibson is vice-president. Gibson will share the Appolo output with others, but expects that its steel shortage will now be materially alleviated. The firm's output of refrigerators and ranges is already ahead of prewar, and the upright home freezer units are being spurred.

## JFD Sales at Peak

Julius Finkel, president of the JFD Mfg. Co., Brooklyn, N. Y., announces that radio dial belt sales during 1946 reached

a new high. Mr. Finkel disclosed that over 2,500,000 of the firm's dial belts were sold during the past year. He attributed this sales volume partly to the company's jobber display stands and wall racks of belts which have been distributed to the trade.

## Tele-tone Rep on Tour

Robert Schasseur, sales representative of Tele-tone International Corp., New York, has returned from a trip to major South American countries.

The purpose of the trip was to display the new "Dyna-mite" table model radio and the eight-tube radio-phonograph combination made by Tele-tone.

## Porta Power Parts

An announcement by General Transformer Corp., 1250 W. Van Buren St., Chicago 7, Ill., says that "parts which are special to our Porta Power units are now available through the jobber who may not have them in stock but will be able to secure them promptly."

## Radio Associations Get Together



Members of Chicago radio groups, including NEDA members there, met in that city for a feature inter-association dinner. Shown in good-natured hands-in-neighbors'-pockets pose are, l. to r., Matt Heinz, Hallicrafters; Kenneth Prince; Jack Berman, Shure Bros.; William Schoning, Lukko Sales; Whipple Jacobs, Belden; and Sam Poncher, Newark Electric. In charge of the party were Mr. Prince, Mr. Berman, and Sol Burke of Concord Radio.



## Gets Heavy Delivery on New Profitable Lines

Ferretting out new lines and favoring them with strong promotion—that's the key to how one fast-growing jobber has been able to secure good delivery of some highly desirable lines. This is the philosophy of Milton A. Putterman and Louis H. Grossberg of Milo Radio & Electronics Corp., 200 Greenwich St., New York 7, N. Y.

National trade magazine advertising, over-the-counter promotion and displays, and the use of publicity, has often swung appreciative manufacturers to large scale deliveries, and rolled up high sales, say these progressive merchandisers.

At a recent national science show, held in New York, crowds jammed the Milo booth where two postwar "firsts,"—the new Federal selenium rectifier and the St. George wire-recorder,—were dem-



Showroom of Milo Radio & Electronics Corp., which changes promptly with new developments in radio.

onstrated. "In the first two months of promoting the selenium rectifier, thousands of mail orders were received for our special deal on 6 units. Almost all of these buyers are writing, phoning and telegraphing for larger lots today", say the Milo men.

## Sylvania Elects Vice-Presidents

Robert H. Bishop, director of sales, and Conda P. Boggs, director of manufacturing, have been elected vice-presidents of Sylvania Electric Products Inc., according to an announcement by Don G. Mitchell, president.

Mr. Bishop joined the company as a member of its New England sales force in 1936, and Mr. Boggs, who had been with GE and RCA, joined Sylvania in 1932.

## Federal Appoints Two

Two new vice-presidents have been elected by the Federal Electric Products Co., Newark, N. J., it is announced by L. W. Cole, president. They are W. H. Lantz, Jr., of Hartford, Conn., and Rey F. Frenger of St. Louis, Mo.

# Astatic Microphones



*Used Extensively*

**FOR PAGING AND COMMUNICATING SYSTEMS**

Among the countless applications for which Astatic Crystal and Dynamic Microphones are used, none is more general than paging and inter-communicating systems. Office, factory and hotel paging, the exchange of departmental messages, communications between ships and shore, planes and airfields, cabs and dispatchers... all employ types of microphones manufactured by Astatic... microphones with clear cut, voice-range characteristics, long used and favored for dependable service and high operating efficiency.

See your Radio Parts Jobber  
or write for new Catalog

Model T-3  
Crystal  
Microphone  
Mounted on  
Grip-to-Talk  
Desk Stand



"Conneaut"  
Model 600  
Crystal  
Microphone



Dynamic  
Model DN  
Microphone



JT-Series  
Crystal  
Microphone





# WARD

WORLD'S FINEST  
AND FASTEST SELLING

*Aerials*

Here's Your Newest Profit Builder!  
A striking, three-dimensional display which catches the eye of every customer. It's completely assembled, ready to place on your counter and bring in easy, extra sales. You pay only for the four fast moving models mounted. The display itself is FREE!

**Model 61-7  
PROFIT BUILDER**

LIST \$22.00

Each of these models is engineered and equipped to fit every car!

# WARD

*Aerials*

Every Ward model has been tested and approved by car and radio set manufacturers — your proof of quality inside and out.

THE WARD PRODUCTS CORPORATION • 1523 E. 45th STREET, CLEVELAND 3, OHIO  
EXPORT DEPARTMENT: C. O. BRANDES, MGR., 4900 EUCLID AVENUE, CLEVELAND 3, OHIO  
IN CANADA: ATLAS RADIO CORP., 560 KING STREET, WEST, TORONTO, ONTARIO, CANADA



## Sales Helps for Dealers

Wall Chart in Colors



Zenith Radio Corp. has made available to its dealers this attractive wall chart showing its entire line in full color.

## Large Cory Display Holds Entire Line

Cory Corp., Chicago, has made available a new and attractive floor-type display made of cardboard and of sufficient strength to hold the entire Cory line. Distribution of this sales help is on a co-operative basis at a cost of \$10 to the retailer.

The display is printed in a dark red and brilliant yellow. Effective use of



Corrugated construction adds strength.

white vertical stripes on the base provides a 3-color effect with 2-color printing.

Display stands 62 in. high and is 42 in. wide. It provides two 24 in. wide shelves on the left and two 16 in. shelves on the right. To provide complete flexibility of use, the three shelves are all easily removable, thus giving the dealer any combination of shelves he desires.

## Rendezvous Display

Columbia Records has made available a large cardboard display piece, suitable for window or sales floor, featuring its new Morton Gould album "Rendezvous." Printed in four colors, this attractive dealer help promotes such numbers as "Stardust," "Tea for Two," "Night and Day," and others. Display measures 3½ by 4½ feet.

## HAVE YOU RECEIVED YOUR SUPREME?

While our production has not yet caught up with the heavy demand for SUPREME Testers, it is steadily increasing.

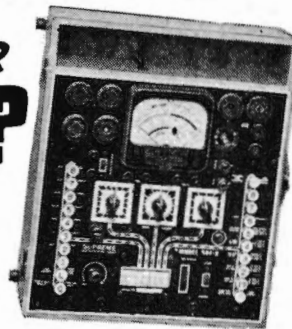

If you have not received your SUPREME Tube Tester, Set Tester, Oscillator, Oscilloscope, Multi-Meter, check with your Authorized SUPREME Distributor.

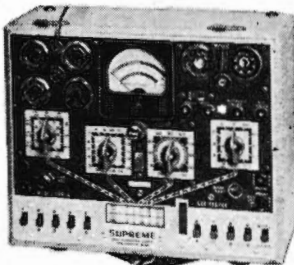

Big new catalogue now ready. For complete description of all SUPREME Testers, and Panel Meters, write today.



EXPORT DEPT. THE AMERICAN STEEL EXPORT CO., INC.  
374 MADISON AVE., NEW YORK 17, N.Y.

SUPREME INSTRUMENTS CORP., GREENWOOD, MISS., U.S.A.





**Phil-Mar Wall Lamp  
in Self-Display Package**



Lamp with new carton.

A new wall lamp package designed to serve as an attractive gift carton as well as a self-display unit for counters and windows was introduced to buyers and dealers at the lamp show in Chicago by A. S. Kosser, president of Phil-Mar Electric, Inc.

The new package, titled "A Package of Light," is designed to contain a wall lamp, shade, reflector bowl—and if the retailer chooses—a 100-watt incandescent lamp. It is one of the main features of the company's 1947 sales program.

"Introduction of this carton will help retailers to get their wall lamps out of the stock room and onto the counters," said Mr. Kosser.

**New Cartons for Parts**

A new standardized metal-edged carton is being used by Burndy Engineering Co., New York 54, N. Y., for their Hydent electrical connectors, in a move to make stocking simpler. Within each carton are 10 small metal-edged packages which makes selling quicker. Complete announcements on prices and quantities are being made by Burndy.

**Official Poster**



This striking poster in four colors can be obtained for dealer display at a low price. The National Father's Day Committee has its headquarters at 50 E. 42 St., N. Y.

**FOR '47** **Portable P.A. Profit-Package!**

**PD-835  
35-WATT  
PORTABLE  
SYSTEM**

**SELL THE COMPLETE  
PORTABLE P.A. LINE!**



RAULAND helps you fill the big demand for Portable Sound with three new perfect P.A. packages for '47: 14 Watts, 20 Watts, and 35 Watts (illustrated). Each is a smartly styled RAULAND-designed-and-built package, ready to plug in and operate. Perfectly-matched components assure top performance—full rated output, superb tonal fidelity, maximum flexibility, and trouble-free operation. Cash in on the reputation and acceptance of RAULAND Electronic Sound. Sell all your prospects for Portable P.A. with this complete, profitable line. Write today for full details.

**PD-835 PORTABLE SYSTEM**

The RAULAND 35-Watt PD-835 Portable System illustrated will cover approximately 20,000 people indoors, or 50,000 square feet outdoors. Two sturdy carrying cases house entire system: 35 Watt Amplifier, 2—12" PM Dynamic Speakers, Dynamic Microphone, mike floor stand, all necessary cables and plugs. Features: 4 Microphone Inputs; 2 Phono Inputs with Dual Fader; Separate Bass and Treble Tone Controls; illuminated amplifier panel. (Optional: remote mixing of 3 microphones.)

*Electroneering is our business*

**RADIO • RADAR** **COMMUNICATIONS**  
**SOUND** **TELEVISION**

**Rauland**

THE RAULAND CORPORATION • CHICAGO 41, ILLINOIS

**BARONETTE is coming!**

Watch for BARONETTE in the next issue  
announcing a full line of

- RADIOS
- RADIO-PHONOGRAPH COMBINATIONS
- ELECTRICAL HOUSEHOLD APPLIANCES

**BARONETTE RADIO & TUBE CORP., 220 5TH AVE., NEW YORK 1**



**RAYTHEON**  
MANUFACTURING COMPANY

*Excellence in Electronics*  
RADIO RECEIVING TUBE DIVISION  
NEWTON, MASSACHUSETTS CHICAGO

"...and put Raytheon tubes in my set please." That's the customer specifying "Raytheon"—a name he knows to be synonymous with quality and dependability. Stock Raytheon tubes to keep your customers happy; to keep your business growing.

## E-L Plans New Features for 1947 Radio Models

Electronic Laboratories, Inc., Indianapolis, Ind., will offer new radio receivers incorporating a number of new features in an expanded radio production program scheduled for 1947, according to William W. Garstang, president.

"We are not planning our 1947 program with just a view to producing more radios," said Mr. Garstang. "Each of these new models has been designed to meet a specific need in the industry and will offer the consumer features never before available. And although production of our 6-tube receiver, currently offered, will continue, our main emphasis will be placed on the 8 and 12-tube models."

"Orthosonic" has been selected as the brand name of these new receivers which are keyed around a twin amplifier-speaker system permitting the listener to adjust the ratio between high and low notes in reception to suit individual taste.

Largest of the new radios will be the chairside combination AM-FM radio (see this issue's "New Lines" section) with automatic record player. Incorporating a 12-tube chassis housed in a chairside type cabinet, this model features a motor-driven "lift" mechanism which electrically raises and lowers the entire top of the radio receiver at the touch of a button.

## Ohio Retailers Elect Officers

Lew Riebel of Riebel's Appliance Shop, 1190 N. High St., Columbus, Ohio, has been elected president for 1947 of the Associated Radio Service Dealers of Columbus. Other officers elected include:



Lew Riebel

Bill Hetrick of Gus Grener's, vice-president; Dave Sears of Sears Radio Service, secretary, and Charles Dykes of Buckeye Radio Laboratory, treasurer.

New members of the board of directors are: Jim Long of Long & Stouder Co.; Gordon Barber of Linden Radio Electric; Charles Heldreth of General Radio & Television, and Floyd Martin of Martin Sound. The new jobber representative on the board is William Wilson, president of Hughes-Peters, Inc.

**FOR VOLUME -- PROFITS, TOO --**  
*Sell all 3!*

**Lenk**

Experienced dealers know there is only one way to make the most profit out of 28 years' preference for Lenk quality—sell all three.

The big reason for the popularity of Lenk Soldering Equipment is the uniform quality that's built into every item. The mechanic who has used any Lenk Product is a ready customer for the rest of the line. The missionary work has already been done. Get the full benefit from this rapidly accumulating tide of preference—sell all three!

**THE Lenk MFG. COMPANY** ★ ★ ★  
Dept. S., NEWTON LOWER FALLS 62, MASS.  
★ ★ Manufacturers of Soldering Equipment Since 1919

BLOTORCHES

ELECTRIC SOLDERING IRONS

SOLDER



# NEW

## Simpson Model 305RC Tube-Tester with

### "No Backlash"\* Roll Chart



With the addition of the new Simpson "No Backlash"\* Roll Chart to the 1947 version of our Model 305, this famous instrument becomes beyond question the finest tube-tester on the market in its price range. Read the description of this new Roll Chart in the panel below.

Model 305RC provides for filament voltages from .5 volts to and including 120 volts. It tests local, single ended tubes, bantams, midgets, miniatures, ballast tubes, gaseous rectifiers, acorn tubes, Christmas tree bulbs, and all popular radio receiver tubes.

Like other Simpson tube-testers, the Model 305RC incorporates 3-way switching which makes it possible to test any tube regardless of its base connections or the internal connections of its elements. This method, the result of exhaustive research and expensive construction, protects the Model 305RC against obsolescence to a degree not enjoyed by competitive testers. No adapters or special sockets are required. In addition to having a complete set of sockets for every tube now on the market, this tester has a spare socket, to provide for future tube developments.

The Model 305RC has provision for testing pilot lamps of various voltages as well as Christmas tree bulbs. It tests gaseous rectifiers of the OZ4 type—also tests ballast tubes direct in socket for burnouts and opens. Has neon bulb of proper sensitivity for checking shorts. This tube-tester is fused, and has the latest improved circuit. It provides for line adjustment from 100 to 130 volts, with smooth vernier control.

Model 305RC is distinguished for its beautiful exterior. It has a two-tone metal panel in red and black on a satin-finished background. Sockets and controls are symmetrically arranged for quick operation. The large, modern, fan-shaped instrument has an exceptionally long scale. It has "good" and "bad" English markings, also a percentage scale for matching and comparing tubes. Cases, both portable† and counter style, are made of strongly built hardwood, durably and beautifully finished.

Size, 11"x11"x6". Wt. 10 lbs. Shipping wt., 15 lbs.  
Dealer's net price, portable or counter model.....\$59.50  
For 60 cycle 115 volt current only.

For 220 volt or 60 cycle, add..... 7.50  
Standard Model 305, with book-type speed chart 49.50

**Counter Model 305RC.** Same instrument as portable model, but set in fine walnut finished hardwood case, with tilted, easy-to-use panel.

†Finished hardwood cases are standard on portable models. When these are not available, the instrument is housed in attractive simulated-leather covered case.

**SIMPSON ELECTRIC COMPANY**  
5200-5218 W. Kinzie Street, Chicago 44, Illinois  
In Canada, Bach-Simpson, Ltd., London, Ont.

### \*6 Exclusive Features Make This the Finest Roll Chart Ever Designed for Tube-Testers . . . . .

- "No Backlash" feature of this Roll Chart automatically takes up all slack in the paper chart and, by keeping it in constant tension, makes it impossible to turn the selector wheel without turning chart. Gives precision selection at all times. Also prevents chart from tearing or getting out of alignment.
- Gearing is such that only 6 turns of selector wheel will run the entire length of the 12½ ft. chart.
- Easy to read. The clear Lucite window is just wide enough to show 2 tube settings, or both settings on a multi-purpose tube.
- Entire unit removable by taking out four screws. Just lift from receptacle to make new entries or install new chart.
- Chart ingeniously fastened to rollers, affording easy replacement and constant alignment.
- Rigid, light-weight construction. Gear driving mechanism incorporates heavy-duty precision brass gears and parts.



# Simpson

INSTRUMENTS THAT STAY ACCURATE



# TRUE QUALITY VALUE DEPENDABILITY

## IN INTERCOMMUNICATION EQUIPMENT



### MASCO GIVES YOU ALL 3 Plus These Outstanding Features

- 1 Feather touch station selection.
- 2 Each master is equipped with a wired junction box and on-off indicating light.
- 3 Line impedance of 13 ohms allows for longer cable runs than found in the average intercommunication equipment.

Model	Description	List Price
Model 76	Master-to-remote master, 5 positions; with tubes.....	66.25
Model 711	Master-to-remote master, 11 positions; with tubes.....	75.00
Model RS	Remote station, less switch.....	15.00
Model RS-1	Remote station, with switch.....	17.50
Model 86	Master-to-master, 6 positions; with tubes.....	70.00
Model 811	Master-to-master, 12 positions; with tubes.....	80.00

Contact your local Masco distributor for immediate delivery on this and all other Masco equipment.

# MASCO

MARK SIMPSON MANUFACTURING CO., Inc.  
32-28 49th Street, Long Island City 3, N.Y.

### SOUND SYSTEMS and Accessories



RAvenswood 8-5810-1-2-3-4

## Big Drive for "Radio in Every Room"

First steps are now being taken by the trade in the \$50,000 all-industry sales promotion, "A Radio in Every Room—A Radio for Every Purpose," sponsored by the Radio Manufacturers Association. All types of retail outlets, as well as several retail trade associations and the broadcasting interests, are active in the campaign.

Edward G. Taylor, of Zenith Radio Corp., has pointed out that almost half of the radio homes in the country have only one radio set. Mr. Taylor reminded the industry that a large variety and volume of receivers, far greater than the prewar capacity of the trade, can now be offered to the public, and that the more-radios-per-home theme was the important one.

New radio-phonograph combinations, along with FM and television (where transmitting facilities are available) are being emphasized in the drive.

### New Members

RMA has named ten new members to the organization. These are American Radio Hardware Co., Inc., Mt. Vernon, N. Y.; Brook Electronics, Inc., Newark, N. J.; Dormitzer Electric & Mfg. Corp., Boston 15, Mass.; The Hickok Electrical Instrument Co., Cleveland 8, Ohio; The James Knights Co., Sandwich, Ill.; Mi-Radio Corp., Cleveland 9, Ohio; Petersen Radio Co., Inc., Council Bluffs, Iowa; Precision Apparatus Co., Inc., Elmhurst, N. Y.; Standard Piezo Co., Carlisle, Pa., and John Volkert Metal Stampings Inc., Brooklyn 5, N. Y.

### Join Motorola Club

Paul Galvin, president of the Galvin Mfg. Corp., recently welcomed 156 members of the Motorola Service Club to a dinner and ceremony in their honor. Thirty-one new members were admitted to the Service Club, organized for those who have completed more than ten years in the employ of the firm.

### In Eastern Sales



Lou Alexander has joined the eastern sales force of the Cornell-Dubilier Electric Corp., South Plainfield, N. J., according to announcement from Octave Blake, president.



## Sensational, Amazing

NO ELECTRICITY — NO TUBES  
NO BATTERIES — NO TUNING

## MYSTERY RADIO

Yes, this new MYSTERY RADIO provides instant reception from the nearest broadcasting station—just put little ear piece into your ear and attach wire clips to aerial and ground, presto—you have reception.

- So small, it will fit in the palm of your hand.
- Usually works swell by just attaching clip to aerial, bed spring, screen door or wire fence, etc.
- Nothing to wear out—no parts to replace.

FREE—Display material provided with order.  
Dealers—write for special discount.

\$245  
List Price



### TAYBERN EQUIPMENT COMPANY Dept. RR-2

120 GREENWICH STREET

NEW YORK 6, N. Y.



## Admiral Names Johnson General Sales Manager

Ross D. Siragusa, president of Admiral Corp., Chicago, has announced the appointment of Wallace C. Johnson as gen-



Wallace C. Johnson

eral sales manager for the company. Mr. Johnson for the past two years has been manager of field activities on all Admiral products.

In making this announcement, Mr. Siragusa said, "Admiral is now producing at the rate of 47 million dollars per year. Dual-Temp refrigerators and electric ranges are now being sampled to distributors and dealers, and radio production has hit an all time peak."

### Sams Begins on Vol. 2

With the distribution of Set No. 10, Howard W. Sams & Co., Inc., Indianapolis 6, Indiana, have completed Volume I of their Photofact Folders, and have begun production of Volume 2 with more new features added.

In preparation for the new volume are 37 automatic record changer folders, a trade directory giving the names and addresses of all principle component parts manufacturers, and hundreds of Photofact Folders on the new receivers, amplifiers and phono players.

### Juice King Salesmen

G. W. Haney, vice-president and general sales manager of the National Die Casting Co., Chicago, announces the following additions to the present Juice King sales force. Art Evans, who will contact dealers and jobbers in the Illinois, Michigan, Minnesota, Wisconsin, North and South Dakota areas, and Cliff Glader will travel in the Ohio, Indiana and northern Kentucky districts.

### Proctor Stresses Ads

Expenditures made by the Proctor Electric Co., Philadelphia, for national magazine advertising on irons for the first nine months of 1946 was 50 per cent more than the next largest advertiser, according to Charles G. Duy, Jr., advertising manager. Heavy demand for the company's irons can be traced to the firm's war-time advertising program, Mr. Duy states.

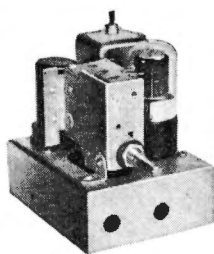

Upright model.

## SET BUILDERS—2 Tube Super Het Kit

Completely wired ready to connect into any AC-DC or 6 volt filament with 125 V or more B supply—plate current drains—2 mls.

High gain and selectivity—plays with 6 ft. of wire—excellent for PA systems, radio tuners and for making combination kits for set builders—tunes police calls.

**\$795** ea.  
unwired

**\$995** ea.  
wired

Laydown model where space is essential.

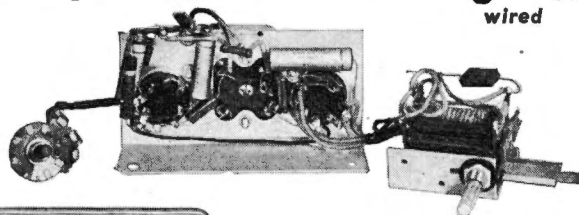

Escutcheon plate with knobs as illustrated goes with each unit—wired or unwired.

1	312-1 Perm. Tuners	Consists of:	2	558-1 Octal Sockets
1	322-2 I.F. Coils		2	727A-1 Tube Shields
1	263-5034-4 Tub. Cond. .05 mfd.		1	571-3 Tube Clips
2	263-1034-5 Tub. Cond. .01 mfd.		1	Chassis
1	232-2515-2 Mica Cond. 250 mmf.		1	12SA7
1	232-5015-4 Mica Cond. 470 mmf.		1	12SQ7
1	232-5015-3 Mica Cond. 500 mmf.		1	Vol. Control
1	111-22312 1/2 W. Carb. Resistor, 22K		1	Phono Switch
1	111-33512 1/2 W. Carb. Resistor, 3.3M		1	On-off Switch
1	111-10612 1/2 W. Carb. Resistor, 10M		2	Knobs
1	111-27412 1/2 W. Carb. Resistor, 270K		1	Escutcheon Plate

Quantity unlimited  
20% deposit with  
orders

**UNION Radio Corporation**

328 S. Pauline • Chicago 12, Ill.

**IMMEDIATE  
DELIVERY**  
Dept. C



Align Yourself  
with

**ARCTURUS**

—The Oldest Name  
in Radio Tubes!

Here is your chance to secure those hard-to-get tubes you need. STANDARD ARCTURUS places at your disposal a diversified supply of tubes of every type and description—both War Assets Administration surplus and regular stock. Every tube is subjected to rigid testing and servicing, including packaging.

The supply of some types is limited. To get the STANDARD ARCTURUS monthly announcements of available types of War Assets Administration surplus tubes, clip the coupon below and mail it *at once* with a complete list of your requirements.

**FILL IN & MAIL TODAY**

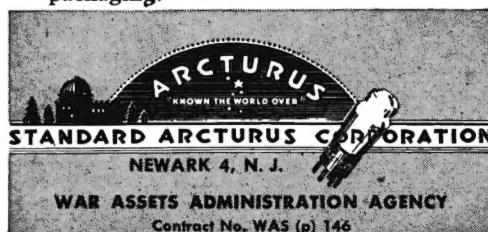

Standard Arcturus Corp., 101 Sussex Ave., Newark 4, N. J.  
Please send me monthly lists of available W.A.A. tubes.

Name .....

Company .....

Address .....

R.R.2

A few STANDARD ARCTURUS distributorships are still available. Write for Details!



## Another BELL SOUND Standard Bearer out front with sales appeal!

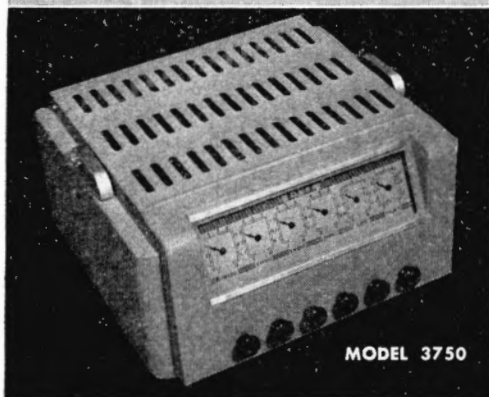

MODEL 3750



### STAY A STEP AHEAD IN PROFITS WITH BELL SOUND SELLERS

Here's power-packed, high-fidelity performance in a smart, compact 50-Watt Amplifier with remarkably extensive coverage. The new "Sound-Master" has wide-range bass and treble controls, plus volume controls for 3 mikes and 1 phono, all handily arranged for easy, precise adjustment. Check the "specs" on this up-to-the-minute Model 3750 for other outstanding features.

This is only one of many BELL "best sellers," for all commercial and industrial sound needs. Ask about BELfone "intercom" systems, recording and disc-playing units, P.A. systems, permanent and portable amplifiers, industrial voice-paging and broadcasting equipment, and other electronic sound devices. Satisfy market demands and boost your profits with these advanced BELL Sound Systems. Your nearby BELL distributor has details. See him today.



**BELL SOUND SYSTEMS, INC.**  
1202 ESSEX AVENUE COLUMBUS 3, OHIO  
Export Office: 4900 Euclid Ave., Cleveland 3, Ohio

## Selling Changers

(Continued from page 80)

variance in speed will occur from one record to full load. In some machines this is great enough to cause real annoyance.

• **TONE ARM RESONANCE**—Tone arm resonance is very important to the design engineer, and causes a crystal which may have very good frequency response to have pronounced peaks when used in a tone arm having bad resonance characteristics.

**LONGEVITY** — Watch out for the mechanism that wears out quickly and will not stand up under continued use. Your customer spends real money for a combination, and will find it difficult to forgive his dealer if his changer fails or wears out prematurely.

Usually a visual inspection of the mechanism (particularly *under* the unit plate) will give a fair indication of the expected life. However, we suggest that you satisfy yourself by running one of each model several hours on the floor. Start a life test on your display floor and tell your customers that this changer has operated 8 hours a day for X days, which is equal to years of home use without breaking any records or breaking down. This display is a real sales-maker.

### Recognizing Types

Another important point in selling combinations is to question the customer as to the type of music he likes. A jazz-hound or jitterbug who listens to fast tempo jive records will be quite happy with a cheaper mechanism, for many small defects can get by without serious complaint. But the customer who enjoys symphonies, dinner music, concerts, etc., should be persuaded to spend a few more dollars for a machine which is free from wow; that can be adjusted to the correct speed (78 r.p.m.) and which meets the qualifications of a better than average unit.

Yes, Mr. Dealer, you are headed for real profits selling the new combinations and we again caution you, "DON'T OVERLOOK THE RECORD CHANGER". Sell only those that are better than average, be familiar with the features that make it better than average, and take plenty of time being sure that your customer thoroughly understands the proper operation. A few moments spent pointing out the features and superiorities of a good changer at the time of sale, can save you hours of explanation at a later date.

## Radio PILLOW SPEAKER



"Here's the swellest  
**EXTRA-PROFIT** item  
you've ever seen!"

- It's a "natural" for tie-in sales with small radios . . . ups your unit of sale.
- It's "just the ticket" for thousands of individuals who want to enjoy the news and other favorite programs by themselves *anytime without disturbing others*. The TELEX Radio PILLOW SPEAKER placed *under a pillow* permits one person—and one alone—to hear his radio.
- It "sells like hotcakes" as a *gift* for convalescents, hospitalized veterans, "shut-ins", and others. (The TELEX Magnetic Radio *Pillow Speaker* was originally designed for Army hospitals to replace uncomfortable head-phones, and is now being used as standard equipment.)

Don't pass up this "hot-selling" radio specialty. Write Dept. I or see your radio jobber. Complete merchandising helps to help you display and sell. *Immediate delivery.*

Complete with 10 foot plastic cord, plug, jack and mount, and instructions.

**TELEX INC.**

ELECTRO-ACOUSTIC DIVISION  
Minneapolis, Minn.

Canadian Distributors:  
ADDISON INDUSTRIES, LTD., Toronto



# RADIO TUBES

MANUFACTURERS  
SERVICEMEN • DEALERS

Large Stock • Complete Line • Standard Brands Only

**50% off** on tubes including

50L6, 35Z5, 12SA7, 12SK7, 12SQ7, 50A5, 35Y4, 14A7, 14Q7, 14B6, 1LE3, 1LA6.

40% off on all other radio tubes not listed

**\$3.50** 5 TUBE KITS  
(50L6—35Z5—12SA7—12SQ7—12SK7)

**\$3.50** 5 TUBE KITS  
(50A5—35Y4—14A7—14Q7—14B6)

Manufacturers write for special prices on large orders

**\$2.75** MINIATURE KITS  
(50B5—35W4—12AT6—12BA6—12BE6)

CONDENSERS  
20-20 Mfd and 50-30  
(150 volts)—.50 each

RECORD CHANGERS  
Famous makes including  
2 post automatic  
\$15.95 and up

CRYSTAL PICKUPS  
Complete with hardware  
— \$1.98 each

SPEAKERS  
5", 6" and 8" PM  
Alnico heavy slug as  
low as \$1.60

All items listed are standard brands. 20% deposit with all orders

Written requests for items not listed will receive prompt attention

**VOGUE RADIO COMPANY**  
1470 Coney Island Avenue, Brooklyn, N. Y.

*We Cut Open an Electone*

Hi INTENSITY PILOT LIGHT  
SMOOTH PLANETARY TUNING 5 to 1 RATIO Hairline accuracy  
ANTENNA COIL for Distant and Weak Stations  
ENGRAVED PLEXIGLAS DIAL Edge lighted  
SPEAKER AND TRANSFORMER MOUNTED ON THE CABINET Improved tone  
SELENIUM RECTIFIER long life - higher gain

*to Show you the EXPENSIVE REFINEMENTS unique in a low priced table model*

**NE** NORTHEASTERN ENGINEERING, INC  
MANCHESTER NEW HAMPSHIRE  
ENGINEERS AND MANUFACTURERS OF THE BEST IN ELECTRICAL AND ELECTRONIC EQUIPMENT

MR. PEANUT

*Large Vacuum-Packed Tin of Delicious*  
**PLANTERS PEANUTS**  
**ABSOLUTELY FREE!**

*Olson's New "Gift-of-the-Month"*

The treat's on Olson—and what a treat! A big Half-Pound Tin of Planters famous Jumbo Peanuts—fresh, plump and tender! It's FREE to Olson customers. Why not be an Olson customer and get our free gifts, as well as really good radio parts?

Just fill out and mail the coupon below, and you're a member of Olson's FREE Gift-of-the-Month Club. No dues, we pay the gift bill! No obligation. This month, a \$10 purchase brings you one half-pound tin of Planters Peanuts FREE; a \$20 purchase brings you TWO tins, etc.

If you do not have our latest Bargain Catalog, paste this coupon on a postcard and mail today!

**OLSON** RADIO WAREHOUSE, INC.  
73 E. MILL ST., DEPT. 70, AKRON, OHIO

Please enroll me in Olson's Gift-of-the-Month Club and send me your catalog. If I order this month, I will receive free Planters Peanuts as offered above.

NAME \_\_\_\_\_  
ADDRESS \_\_\_\_\_  
CITY \_\_\_\_\_ STATE \_\_\_\_\_

CLIP and MAIL



**NOW! FOR TOP SALES IN '47!**



**\$84.50**  
list price

Wavemaster TOWN & COUNTRY Combination with split top — opens completely for the fully automatic record player.

New! Latest innovation—the Wavemaster TOWN & COUNTRY Combination. Tilt-top opening for radio only.

**Wavemaster Automatic Combination TOWN & COUNTRY Model**

It's the new Wavemaster TOWN & COUNTRY Combination for top selling! Tilt-top opens separately for radio, completely for the record player with fully automatic, foolproof record changer. Plays ten 12" or twelve 10" records. Completely portable.

Fine, attractive, two-tone leatherette covered all-plywood carrying case. Reinforced fittings, double locks on both sides. Just like fine luggage!

For full, rich tonal reproduction, it's the TOWN & COUNTRY Combination! Five tube Superhet radio, Alnico V Speaker, large baffle area for resonant tone. Chassis and changer sturdily mounted. Lightweight crystal pickup, permanent needle.

**DEALERS! WRITE US FOR YOUR NEAREST JOBBER! JOBBERS! TERRITORY AVAILABLE — WRITE NOW!**



**The HAROLD Co.**

96 Fifth Avenue  
New York 11, N. Y.



**Phono Needle • Grille Cloth  
Cabinet Repair Kit • Spray Kits**

**G-C RADIO CABINET SPEAKER GRILLE CLOTH**

High quality speaker grille cloth that will blend with any cabinet. Also light color cloth for Plaskon and Ivory Cabinets.

No. 940—18" x 20".....List \$1.00



**G-C MASTER POINT "SYMPHONIC" PHONO NEEDLE**

Quality needle, over 5,000 plays because of special perfectly formed tip of precious metal. Excellent reproduction.

Easy on the record. List each.....\$1.00  
No. 1435-D Display 13 needles (1 free) List .....\$12.00



**G-C FELT-KOAT FLOCK FINISH SPRAY KITS**

Now it's easy to supply flock for refinishing turntables, cabinets, grilles, etc. Kit contains specially designed spray gun, 2 colors flock, undercoats, thinner, brush, instructions, etc.

No. 180-2 .....List \$10.75

**G-C DELUXE CABINET REPAIR KIT**

Comes in handy black leatherette finish box. Contains shellac sticks, stain, varnish, polish, alcohol lamp, spatula, brushes, wiping cloth, directions, etc.

No. 901 .....List \$3.50

ORDER FROM YOUR JOBBER

Write for your G-C Catalog today

RADIO DIVISION DEPT. G

**GENERAL CEMENT Mfg. Co., Rockford, Ill., U. S. A.**

Manufacturers of over 3,000 products • Sales offices in principal cities

**Cessation of FM in 42-44 Mc Band**

In order to clear the band of 42-44 mc for use by the non-government fixed and mobile services to which that band has been allocated, the FCC has announced temporary assignments for FM stations now operating in the 42-44 mc region. They are as follows:

Station W2XMN, licensed to Edwin H. Armstrong, Alpine, N. J., formerly on 42.8 mc now shifts to 44.1 mc and its regular assignment is 98.9 mc.

WINX-FM, licensed to WINX Broadcasting Co., Washington, D. C., formerly on 43.2 mc now shifts to 44.7 mc—its regular spot is 92.9 mc.

WMNE of the Yankee Network, Boston, Mass., previously on 43.9 mc, now goes to 45.1 mc and its regular place is 98.1 mc.

WBEZ, Board of Education, Chicago, formerly on 42.5 mc now shifts to 44.3 mc and is regularly at 91.7 mc.

WBKY, University of Kentucky, Lexington, Ky., leaves 42.9 mc and goes to 44.3 mc. Its regular assignment is 91.3 mc.

WBOE, Board of Education, Cleveland, formerly at 42.5 mc, goes to 44.3 mc and its regular position is 90.1 mc.

KALW, Board of Education, San Francisco, previously at 42.1 mc, changes to 44.3 mc and the regular assignment is 91.7 mc.

WNYE, Board of Education, New York City, which has been at 42.1 mc, changes to 44.9 mc and will regularly be at 91.7 mc.

WIUC, University of Illinois, previously at 42.9 mc, goes to 44.7 mc and its regular place is 91.5 mc.

Stations WNYE and WIUC have indicated that they propose to cease operation until their equipment is ready for operation on their regular assignment.

FCC has not yet fixed the date when all FM operation in the 44-50 mc band must cease and all FM operation be confined to the 88-100 mc band. As previously announced, the Commission "will endeavor to continue the temporary operation of stations in the lower band until FM receivers for the higher band are generally available."

**"Miracle" Exhibits at Chicago Markets Show**

Nineteen electric household appliances were featured by the Miracle Electric Co., Chicago, at the Chicago Markets Show, according to George A. Boivin, sales manager and director of advertising. "Included in our complete line of appliances," stated Mr. Boivin, "was the new Miracle electric portable food mixer, an all-purpose mixer with many features."

**Tradio Executives**

Tradio, Asbury Park, N. J., has announced the appointments of Nathan Hellman as chief engineer, and William Casano as head of the drafting department.



# GRIP

*without the "GRIP"*

## VACO screw driver handles

of gleaming Amberyl plastic have gracefully fluted sides, but fluting stops sufficiently far from rounded butt to insure a firm, smooth grip...thus, hands and tempers are protected, lessening danger of accidents, too! Vaco handles are shock-proof and break-proof.

There are **173** types of Vaco screw drivers. Type shown above is especially designed for certain industrial jobs.

**VACO PRODUCTS CO.** 317 E. ONTARIO ST. CHICAGO 11, ILL.  
CANADIAN WAREHOUSE: 560 KING STREET WEST - TORONTO 2, ONT.

## Radio Books For Radio Servicemen

**"INSIDE THE VACUUM TUBE"**  
 A goldmine of information for the student, amateur, serviceman or engineer.  
 425 PAGES PRICE \$4.50

**"UNDERSTANDING MICROWAVES"**  
 Provides a foundation from which the reader can proceed to understanding of various micro-wave developments of the past five years.  
 400 PAGES PRICE \$6.00

**"RADAR"**  
 For students, hobbyists and laymen . . . . \$1.00

and THESE STANDARD WORKS

The Cathode Ray Tube at Work . . . \$4.00	An-Hour-a-Day-With-Rider Series -
Frequency Modulation . . . \$2.00	on "Alternating Currents in Radio
Servicing by Signal Tracing . . \$4.00	Receivers," on "Resonance & Align-
The Meter at Work . . . \$2.00	ment," on "Automatic Volume Con-
The Oscillator at Work . . \$2.50	trol," on "D-C Voltage Distribu-
Vacuum Tube Voltmeters . . \$2.50	tion." Hard bindings . \$1.25 each
Automatic Frequency Control \$1.75	

**JOHN F. RIDER PUBLISHER, INC.**  
 404 FOURTH AVENUE, NEW YORK 16, N. Y.  
*Specializing in books for advancement of the radio servicing industry.*

## SCARCE RADIO TUBES

DISCOUNTS UP TO 60% OFF

- ALL POPULAR STANDARD BRANDS
- NEW, GUARANTEED
- SEALED CARTONS

024, 1LA6, 1LN5, 1P5, 2A3, 5Z4, 6A8, 2A5, 2A6, 6E5, 6F5, 6J8, 6K5, 6K8, 6P5, 6Q7, 7A8, 7B4, 7B8, 7B5, 7B7, 7C5, 7F8, 7G7, 12A8, 12F5, 12J7, 12K7, 12Z3, 14Q7, 14R7, 25A7, 25L6, 25Y5, 25Z5, 25Z6, 30, 32L7, 33, 35, 35A5, 35Y4, 35Z3, 43, 45, 47, 50A5, 50Y6, 55, 57, 58, 59, 70L7, 71A, 84, 117L7, 117M7, 117N7, 117P7, 117ZB, 117Z6, XXL.

### 6 SPECIAL OFFERS 6

1. 5 Tube All-American Kit (50L6, 35Z5, 12SA7, 12SK7, 12SQ7) . . . . . \$3.65
2. 25Y5 (Exact replacement for 25Z5). List price \$3.20. Your cost . . . . . .85
3. ACORN TUBES, Guaranteed 954, 955, 956, 957, ea. .49
4. 6AK5 Tubes, Guaranteed . . . . . .75
5. HEARING AID TUBES—all types 501ax-509ax, ea. .49
6. 6AH6 TUBES . . . . . .49

SPECIAL DISCOUNTS ON ALL LARGE ORDERS  
 Wire or Write for Catalog—We Ship Anywhere  
 RICHmond 6951

**COMMERCIAL RADIO**  
 36 BRATTLE ST., BOSTON 8, MASS.  
Department T

## NO-OX WILL NOT GUM!

THE MIRACLE FLUID

**CLEANS PRESERVES RENEWS DISSOLVES LUBRICATES**

NO-OX the "magic" ELECTRICAL CONTACT CLEANER. The answer to radio and electrical technician's need for an efficient cleaner to dissolve corrosion and prevent oxidation. No pre-cleaning required! Works instantaneously. Preserves surface up to one year! 1 oz. bottle 50c net; 2 oz. bottle 95c net. Satisfaction guaranteed or money back.

AVAILABLE THROUGH YOUR RADIO AND ELECTRICAL PARTS DISTRIBUTOR

Manufactured by NO-OX LABORATORIES  
 1517 W. Pico Blvd.  
 Los Angeles 15, Calif.

**DISSOLVES CORROSION PREVENTS OXIDATION**



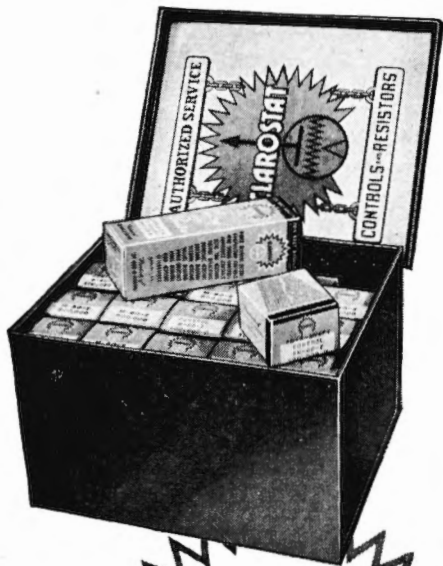

*You asked for it!*

**SERVICEMAN'S  
KIT No. 4**

★ With this kit you're ready to service upwards of 95% of the standard radios. And you can keep the kit complete by re-ordering individual items.

**CONTROLS and SWITCHES**  
Kit contains 17 selected volume and tone controls. Most popular ohmages and taps. Also 8 Ad-A-Switches—both s.p. and d.p. types. Plus 4 Glasohms (glass-insulated flexible resistors).

**PLUS — DATA and PLAQUE**  
Packed in a neat, sturdy, green-lacquered steel cabinet (no advertising or outside label). Kit includes Clarostat Volume Control Selector and Authorized Service plaque. A big \$32.15 value; "special" to you at only \$17.79!

★ **Ask Our Jobber . . .**  
Ask for this "special"—get yours before the supply runs out. If you're not acquainted with the nearest Clarostat jobber, write us and we'll bring you together.



CLAROSTAT MFG. CO., Inc. • 285-7 N. 6th St., Brooklyn, N. Y.

**20 Years Ago**

From the February, 1927, Issue of Radio Retailing

ANNUAL CHECK-UP shows how one dealer did \$40,901 worth of business but operated at a loss—how a careful monthly inventory can help to keep the business out of the red.

CABINET DESIGN TREND centers on new positions for radio reproducers—the problem has the designers puzzled.

PRICE CUTTING DEALER admits that he failed at the low-price game, but he turned to servicing and he made it pay.

RADIO LEGISLATION now in sight in Congress as Dill-White Compromise Bill (for station wavelength control) is reported out of committee. Editor O. H. Caldwell of RADIO RETAILING named to radio committee of American Engineering Council.

TELEVISION DEVICE invented by Dr. E. F. W. Alexanderson, providing for picture projection, makes telecasts possible.

SOME CUSTOMERS TALK idly to radio salesmen in the store, but neglect actual buying—an Oregon dealer provides a special "Information Booth" for this type of customer.

MERCHANDISING PROGRAMS works well for retailers who promote public listening to broadcast sports events and concerts.

WHAT THE INDUSTRY NEEDS—Misleading radio ads should be stopped; too many parts jobbers and manufacturers indulge in back-door deals; radio retailers should get together in local associations.

**Open Sylvania Electronic Service Station in NYC**

The appointment of Home Radio Service, Inc., 253 E. 72nd St., New York 21, N. Y., as Electronic Service Station for repairs and parts on any Sylvania device produced by the electronics division has been made, according to officials of both companies.

Tube testers, modulation meters, Polymeters, oscilloscopes and Wabash-Sylvania Electroflash instruments may be sent to its electronic service stations for every type of repair, and through them replacement parts may be obtained by independent radio servicers.

**JOBBERS! QUANTITY BUYERS!  
SAVE MONEY**

with MID-AMERICA'S Sensational Values!



You can't beat Mid-America's rock-bottom prices for top-quality radio parts and electronic equipment! MID-AMERICA has 70,000 square feet of warehouse space jam-packed with relays, chokes, tubes, condensers, resistors, meters, plugs, jacks, wire, cable, sockets, switches, generators, dynamotors, volume controls, knobs—all new, unused and in perfect condition—AND ALL AT THE LOWEST PRICES YOU'VE EVER SEEN! And every month, month after month, we keep adding to our tremendous stock. Write today for MID-AMERICA'S big, complete catalog—and get your name on the list to receive our FREE MONTHLY

BULLETINS which list the latest, greatest buys in radio parts and electronic equipment that will make you more money. Mail requests to MID-AMERICA'S store address, attention Dept. RT-27.

**MID-AMERICA CO. Inc.**

STORE: 2412 S. MICHIGAN AVE. CHICAGO 16, ILL.  
WAREHOUSE: 2307 S. ARCHER AVE. CHICAGO 16, ILL.

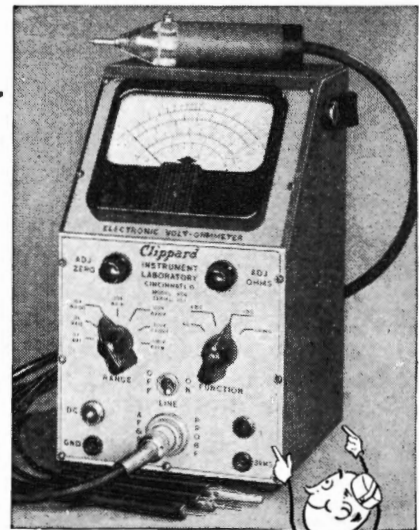

**Clippard  
ELECTRONIC VOLT-  
OHMMETER, MODEL 406**

We invite comparison of this instrument with any at any price for appearance, ruggedness, accuracy, stability. 0-1 to 1,000 volts U.H.F., A.C., D.C. 0-1,000 megohms. Pen-type dual diode A.C. probe. No extras to buy. Send for details or order today.

**CLIPPARD INSTRUMENT LAB., Inc.**  
1133 Bank St., Dept. 4, Cincinnati 14, Ohio

**\$89.50**  
from jobber or F.O.B. Cin.



**Electro**  
ELECTRICAL AND RADIO EQUIPMENT



**BATTERY  
ELIMINATORS**

MODEL "P"

Sell Them Now for Winter Use With Portable Radios

**A Complete Line for Every Requirement!**

Models to convert dry battery radios to efficient AC receivers. Other models to convert dry battery radio for use only with 6 volt storage battery.

Cost but a few cents per hundred hours of operation. Completely filtered—hum free—silent and efficient. Sturdily constructed—no liquids or moving parts—operate in any position.

MODEL "Q"—Operates any 1.4 volt 4, 5 or 6 tube radio from 6 volt storage or dry battery, or Wincharger. Ideal for farms, camps, autos, boats, etc.

MODEL "R"—Operates 2 volt 4, 5, 6 or 7 tube radio from 6 volt storage or dry battery, or Wincharger. (0.5 Amp. filament max.)

MODEL "P"—Operates any 1.4 volt 4, 5 or 6 tube radio from 110 volt 60 cy. source. Cuts down current use and saves batteries for portable use.

MODEL "F"—Operates any 2 volt 4, 5, 6 or 7 tube radio from 110 volt, 60 cy. source. (0.5 Amp. filament max.)

Canadian representative, ATLAS RADIO CORP., Toronto, Canada

**ELECTRO PRODUCTS LABORATORIES**

Pioneer Manufacturers of Battery Eliminators

549 WEST RANDOLPH STREET CHICAGO 6, ILL.



the *Service* line  
of **CORDS and CORD SETS**  
specified by top manufacturers of

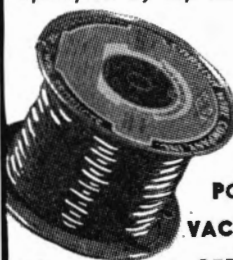

LAMPS  
RADIOS  
IRONS  
FANS  
PORTABLE TOOLS  
VACUUM CLEANERS  
REFRIGERATORS

RANGES WASHERS  
HEATERS MIXERS

A full line of Flexible Cords for the repair and service industry, obtainable through jobbers and distributors.

**CORNISH WIRE CO., Inc.**

15 Park Row • New York City, 7



**FEBRUARY SPECIALS**

14 GA. BRAIDED ANTENNA WIRE

Consists of 16 Strands of 26 ga. bare copper wire made into an extra strong flat braid.  
Per 100 ft. coil .....\$ .85

IMMEDIATE DELIVERY FROM STOCK ON THE FOLLOWING TYPES OF ELECTRICAL CORD

18 GA. TWO CONDUCTOR TYPE P.O.S.J.

Parallel all rubber cord for small appliances such as lamps, radios, small fans, etc. Available in black, brown or ivory.  
Per 250 ft. spool .....\$ .70

18 GA. TWO CONDUCTOR TYPE S.V.

Ideal for larger appliances, vacuum cleaners, food mixers, etc. All rubber round cord. 1/4" diameter. Black only. Per 250 ft. spool .....\$ .95

18 GA. TWO CONDUCTOR TYPE S.J.

For small equipment, washing machines, portable tools, etc. All rubber round cord, approximately 5/16" diameter. Black only.  
Per 250 ft. spool .....\$ .60

We also carry in stock many other types of cords and multi-conductor cable in addition to single conductor wire from #23 to #2 gauge.

See your local jobber or write direct.

**COLUMBIA WIRE & SUPPLY CO.**

5740 ELSTON AVE., CHICAGO 30, ILLINOIS

**JFD NEW "BIG 4" SERVICEMEN'S BASIC KIT!**



A Great New  
TIMESAVER  
For Radio Servicemen!  
FOUR Basic Radio Service  
Kits in ONE Package

**SPECIAL!**  
SERVICEMEN'S COST

\$ **18.00**  
LIST PRICE \$33.35

These 4 Popular JFD Kits have everything needed for 25% of all radio service work!

1. **B25A BELT KIT** assortment of 25 Dial Belts in Metal Container.
2. **5C25 DIAL CABLE & CORD RACK**, Contains 5 metal spools of fast-moving dial cables and cords.
3. **770 BALLAST KIT** contains 5 JFD improved Air-cooled ADJUSTABLE Ballasts.
4. **BP-100-MC PLUG ASSORTMENT** contains 100 radio battery plugs in 25 different popular types.

Above kits include much valuable radio service data



Write for Literature

J.F.D. MANUFACTURING CO.  
4109-4123 FORT HAMILTON PARKWAY, BROOKLYN 19, N. Y.



# —LAKE— Amplifying Systems

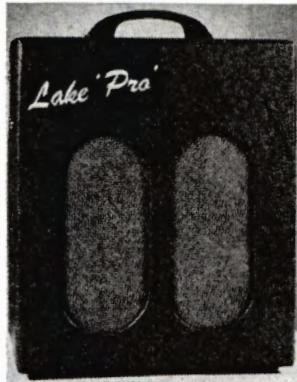

Excellent designed, compact amplifiers, ideal for students, professional entertainers, homes, factories, schools, etc. Perfect for voice, musical instruments, pickups and contact microphones; clear, rich tone; heavy plywood in luxurious leatherette covered, streamlined portable cabinets.

AS LISTED BELOW:				
No.	Watts	Inputs	List	Your Cost
A16	16	4	\$110.00	\$64.68
A15	15	3	97.50	52.86
A12	12	2	87.50	51.45
A8	8	3	87.50	51.45
A6	6	2	75.00	44.10
A5	5	2	60.00	35.28
ACDC	8	3	75.00	44.10

Model

**HAWAIIAN ELECTRIC GUITAR**  
Beautiful black plastic, trimmed with chrome  
23" scale, 4 1/2 octaves of playing range  
List—\$50.00—Your Cost....\$29.40



## De Luxe PHONO CABINET

Covered in luxurious, genuine brown leatherette, has deluxe brass hardware throughout, made completely of plywood with brown plastic handle, has padded top and bottom. Motor board 14" x 14 1/2". Overall dimensions 16" L x 15" W x 8" H.  
Your special net price ..... **\$8.95**

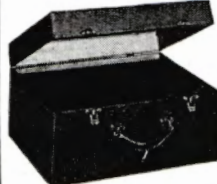

Portable Phonograph case, of sturdy durable plywood in handsome brown leatherette finish. Inside dimensions 16 1/2" long, 14" wide, 9 1/2" high. Has blank motor board. As illustrated specially priced at **\$6.95**

Also blank table cabinets of walnut veneer in the following sizes, with speaker opening on left front side:  
(\*Note: \*7 has center speaker grill)  
#1 — 8 1/4" L x 5 1/2" H x 4" D \$1.95  
#2 — 10 1/4" L x 6 1/2" H x 5" D \$2.75  
#3 — 13 1/2" L x 7 3/4" H x 6 1/4" D \$3.25  
#7\* — 10 1/4" L x 7" H x 5 1/2" D \$2.50

\*Speaker Opening in center of front side  
All types of radio cabinets and parts are available at Lake's Lower prices. A large stock is listed in our catalog.

**SERVICEMEN—RETAILERS**  
Write for our new, illustrated 16 page catalog NR-116. It's free. Get on our mailing list! Write for our special catalog on microphones, amplifiers and sound equipment.

**Order from Lake!**  
**You'll make no mistake!**

Dept. B

# Lake Radio Sales Co.

615 W. Randolph Street  
Chicago 6, Ill.

## DATES AHEAD

### Future Events of Interest to Readers

- Feb. 3-8: Home Furnishings Winter Market, Western States, Western Merchandise Mart, San Francisco
- Feb. 9-12: Housewares & Appliance Show, Municipal Auditorium, San Antonio
- Feb. 9-13: Western Gift, Toy & Housewares Spring Show, Civic Auditorium, San Francisco (Feb. 23-27: Seattle, New Washington and Olympic Hotels)
- Feb. 10: Fourteenth Annual New England Housewares Show, Parker House, Boston
- Mar. 3-6: The Institute of Radio Engineers, Annual Radio Engineering Show, Grand Central Palace, New York City
- Apr. 5-12: Electric Home Show, Municipal Auditorium, Birmingham, Ala.
- Apr. 19-26: Metropolitan Home Show, Grand Central Palace, New York City
- April 27-May 3: Nat'l Housewares Show, Conventional Hall, Philadelphia, Pa.
- May 5-11: National Plastics Exposition, Coliseum, Chicago
- May 11-16: Radio-Electronics Parts Show, Hotel Stevens, Chicago
- June 1-5: National Association of Music Merchants (NAMM) Trade Show, Palmer House, Chicago
- June 12-22: Second Annual Construction Industries Exposition & Home Show, Pacific Auditorium, Los Angeles
- Sept. 8-12: Second National Instrument Conference & Exhibit, Hotel Stevens, Chicago

### Markets 6-Tube Kit

A two-band receiver covering 550-1750 kc and the 19, 25, 31 and 49-meter bands is being offered in kit form by Grossman Radio & Electric Co., 120 Cedar St., N. Y., wholesale distributors. Model SWK is a 6-tube ac-dc superhet in walnut plastic cabinet with 5" Alnico 5 PM speaker. Also being offered by the same firm is the RK-100 resistor replacement kit of 100 assorted IRC units in popular values from 1/2 to 2 watts.

### Ohm's Law Calculator

A new pocket-size Ohm's Law calculator incorporating many new features in a pocket size "slide rule" construction, has been announced by Ohmite Mfg. Co., 4937 Fluornoy St., Chicago, manufacturers of rheostats, resistors and tap switches. The calculator sells for 25c.

### "House of Frisby"

Now doing business in its elaborate new store at 315 W. Sunrise Highway in Freeport, L. I., N. Y., is the "House of Frisby," a radio-appliance-record concern described as one of the most modern in the country. The store, which was designed by the noted expert, Lurette Guild, features Westinghouse appliances.

## SPECIAL SALE!

### R.L.T. TUBE TESTER

Priced  
at only

**\$49.95**



- Tests all tubes up to 117 V.
- Tests shorts & leakages
- Tests individual sections
- Works on 90-125V 60 Cycle AC

Comes in portable cabinet complete with all operating instructions

No. 60A—6F6—5 General Universal  
A & B Battery, 7.5V, 9V, 90V B..... **\$1.49**

Write for **FREE** Bulletin

## HERSHEL RADIO COMPANY

5249 Grand River Detroit 8, Mich.

**SURPLUS SPECIAL!**—2 conductor (#21 gauge) transmission cable. Flexible stranded, tinned, twisted, rubber covered. Outside VINYLITE jacket. Ideal for P. A., communication & light electrical work. 1/4" O. D. 3 1/2 ft.; 250 ft. .... 4.95

16" N.B.C. RECORDINGS. For home, P.A. systems, demonstration etc. Each contains 2 complete, different 15 min. "Voice of the Army" dramatic programs with music. Over 60 different titles, such as: Aerial Gunner, etc. 33-IRPM. 5 asstd. records..... 1.49  
Plastic Handles for portables; 6" mtg. White, blue or brown..... 15¢ ea.; 7" for..... 1.00  
TUBES: Perfect condition. But not in sealed cartons. Guaranteed for 90 days. #26, 27 or 56, 29¢; #24, 42, 77, 80, 89, 6A7, 6D6, 6H6, or 6K7, 39¢; #50, 75, 78, 6A3, or 6A3..... 59

### SERVICEMEN'S KITS

- #1—R.F., Antennæ & Osc. coils, 10 asstd. .98
- #2—Speaker Cones; 12 asstd. 4" to 12" moulded & free-edge (magnet included). 2.00
- #3—BAKELITE MICA CONDENSERS; 50 asstd. .0001 to .25mfd. 200-600V. 2.95
- #4—Tubular By-Pass Condensers; 50 asstd. .0005 to .25mfd. 200-600V..... 2.49
- #6—Dial Scales; 25 asstd. airplane & slide rule (acetate & glass included).... 2.98
- #7—Escutcheon Plates; 25 asstd. airplane, slide rule & full-vision types ..... 2.95
- #8—Knobs; 25 asstd. wood & bakelite including setscrew & push-on types ..... 1.00
- #9—Wafer Sockets; 12 asstd. 4 to 7 prong .25¢; or 50 for ..... 1.00
- #11—Shield cans; 15 asstd. for coils, tubes, transformers, etc. .... 1.00
- #12—Mica Padders & Trimmers; 15 asstd. incl. multiple & ceramic base types..... .69
- #14—Volume & Tone Controls; 10 asstd. wire-wound & carbon. Less switches..... 1.49
- #15—Wire-Wound Resistors; 15 assorted ohmmes. 5 to 50 watts ..... .98
- #16—IF Coils; six asstd. including shielded & slug tuned. Peaks unmarked ..... 1.95
- #17—Dial Windows; 12 asstd. sizes, incl. flat & moulded acetate & convex glass.... 1.29

PROMPT SERVICE ON ALL SPEAKERS AND PHONO PICK-UP REPAIRS

Min. Order \$2.00—20% deposit required on all Orders. Please add sufficient postage. Write Dept. RT-1

**LEOTONE** RADIO COMPANY  
65-67 DEY STREET, NEW YORK 7, N. Y.



# INDEX To Advertisers

FEBRUARY 1947

	Page		Page
Air King Radio Div.,		Newark Electric Co., Inc.	134
Hytron Radio & Electronics Corp.	57	Newcomb Audio Products Co.	139
Alliance Mfg. Co.	82	Noblitt-Sparks Industries, Inc.	59
Altec-Lansing Corp.	16	No-Ox Laboratories	163
American Magazine	60	Norge Div., Borg-Warner Corp.	93
American Telephone & Telegraph Co.	95	Northeastern Engineering, Inc.	161
Astatic Corp.	153		
Atlantic Mfg. Co.	105	Ohmite Mfg. Co.	152
		Olson Radio Warehouse, Inc.	161
Baronette Radio & Tube Corp.	155	Operadio Mfg. Co.	151
Bell Sound Systems, Inc.	160	Oxford Radio Corp.	149
Brush Development Co.	20		
		Permo, Inc.	71
Caldwell-Clements, Inc.	101, 102	Proctor Electric Co.	98
Chicago Tribune	10		
Clarostat Mfg. Co., Inc.	164	Quam-Nichols Co.	167
Clippard Instrument Lab., Inc.	164		
Columbia Recording Corp.	69	Radio Corp. of America	
Columbia Wire & Supply Co.	165	RCA Victor Division	40, 41
Commercial Radio	163	RCA Victor Records	62
Cornish Wire Co., Inc.	165	Tube Division	108, Cover 4
Coyne Electrical School	134	Rauland Corp.	155
Crosley Div., The Aviation Corp.	30, 31	Raytheon Mfg. Co.	
		Receiving Tube Division	156
Delco Radio Div., General Motors Corp.	33	War Surplus Electronic Equipment	134
DuMont Laboratories, Inc., Allen B.	25	Rider Publisher, Inc., John F.	150, 163
Duotone Co.	77	R-L Electronic Corp.	82
Electro Products Laboratories	165	Sams & Co., Inc., Howard W.	123
Electronic Corp. of America	17	Saturday Evening Post	26, 27
Emerson Radio & Phonograph Corp.	14, 15	Scott Radio Laboratories, Inc.	12
Emor Radio, Ltd.	141	Seeburg Corp., J. P.	Cover 3
		Sentinel Radio Corp.	35
Fada Radio & Electric Co., Inc.	13	Simpson Electric Co.	157
Farnsworth Television & Radio Corp.	28	Simpson Mfg. Co., Inc., Mark	158
		SNC Mfg. Co., Inc.	135
Galvin Mfg. Corp.	21	Solar Capacitor Sales Corp.	168
General Cement Mfg. Co.	162	Sonora Radio & Television Corp.	24
General Electric Co.	11, 114, 115, 129	Sparks-Withington Co.	34
General Industries Co.	73	Sperti, Inc.	84
Gibson Refrigerator Co.	96	Sprague Products Co.	137
Graybar Electric Co.	99	Standard Arcturus Corp.	159
		Standard Register Co.	103
Haines Mfg. Co.	102	Steelman Radio Corp.	81
Harold Co.	162	Stewart-Warner Corp.	6
Hershel Radio Co.	166	Stromberg-Carlson Co.	36, 147
Hickok Electrical Instrument Co.	148	Supreme Instruments Corp.	154
Hotpoint, Inc.	94	Sylvania Electric Products, Inc.	120, 121
Howard Radio Co.	145	Symons Assoc., L. H.	77
Hytron Radio & Electronics Corp.	19		
		Taybern Equipment Co.	158
International Resistance Co.	29	Telex, Inc.	160
Jensen Mfg. Co.	119	Templetone Radio Mfg. Corp.	2, 3
J.F.D. Mfg. Co.	165	Triplet Electrical Instrument Co.	125
		Tung-Sol Lamp Works, Inc.	32
Ken-Rad Div., General Electric Co.	7	Turner Co.	8
Lake Radio Sales Co.	166	Union Radio Corp.	159
Lear, Inc.	143		
Lenk Mfg. Co.	156	Vaco Products Co.	163
Leotone Radio Co.	166	Vaughan Cabinet Co.	82
Lifetime Sound Equipment Co.	139	Vogue Radio Co.	161
Luxcraft Corp.	97		
Maguire Industries, Inc.	126, 127	War Assets Administration	130, 131, 132, 133
Mallory & Co., Inc., P. R.	106, Cover 2	Ward Products Corp.	154
Meck Industries, Inc., John	55	Warwick Mfg. Corp.	18
Merit Coil & Transformer Corp.	4	Webster Chicago Corp.	75, 79
Mid-America Co., Inc.	164	Westinghouse Electric Corp.,	
		Home Radio Div.	22, 23
National Stamping & Electric Works,		Wilcox-Gay Corp.	5
Div., Eureka Williams Corp.	101	Zenith Radio Corp.	9

While every precaution is taken to insure accuracy, we cannot guarantee against the possibility of an occasional change or omission in the preparation of this index.

LOOK  
FOR THE  
'U'-SHAPED  
COIL POT

THE MARK OF  
**QUAM**  
QUALITY

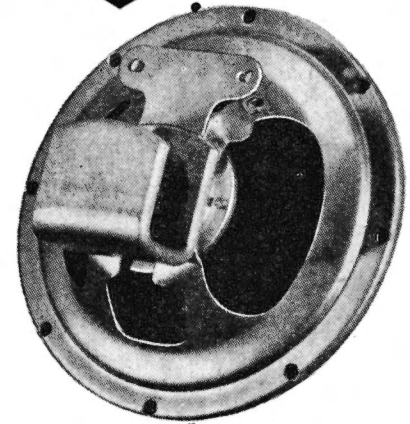

**QUAM**  
*Adjust-a-Cone*  
**SPEAKERS**

**QUAM-NICHOLS  
COMPANY**

Builders of Quality  
Speakers Since 1923  
33rd PLACE AT COTTAGE GROVE  
CHICAGO 16, ILL.





## CROSS-SECTION of a SUCCESS STORY

### "SEALDTITE" BY SOLAR

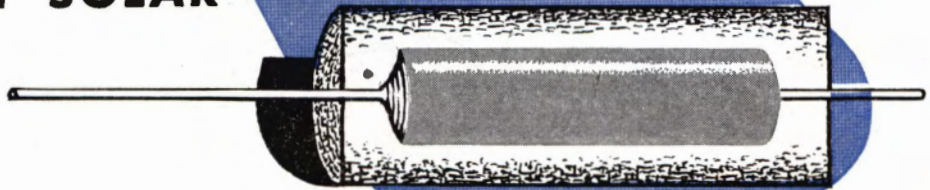

**I**N 1939 Solar pioneered the first wax-molded paper capacitor—the now famous "Sealdtite". Its success was immediate. Manufacturers, servicemen, amateurs everywhere acclaimed the new, solid, tough, MOISTURE-PROOF "Sealdtite"—the capacitor with the truly protective molding. Since then the demand for Solar's "Sealdtite" has spread like wildfire. Thousands of capacitor users have found it best by test. Today, "Sealdtite" capacitors rank first with engineers; for engineers don't guess — they know.

*P. S. Do you read The Solar System for regular news on developments in the capacitor field? If not, drop us a note to place your name on the mailing list without charge.*

⊕ SO 1681 A

**SOLAR CAPACITOR SALES CORP.**  
285 MADISON AVENUE • NEW YORK 17, N. Y.  
ELECTROLYTIC, PAPER and MICA CAPACITORS





# the New Seeburg "M"

... the three-post, intermix changer



## A CHANGER WITH NEW APPEAL FOR MANUFACTURERS, DEALERS, MUSIC LOVERS

Announcing the new Seeburg Model "M" . . . a record changer to add appeal to even the most glamorous radio-phonograph combinations.

Outstanding among the many fine features of the "M" is its exclusive three-post construction which brings these important record playing advantages:

1. **INTERMIX** playing of 10 and 12-inch recordings.
2. **INCREASED RECORD LOAD.** The "M" has a capacity of fourteen 10-inch records, twelve 12-inch records or twelve 10-inch and 12-inch records intermixed.
3. **LONGER RECORD LIFE.** Multiple post construction assures gentle handling, minimum spindle hole wear.

But more than this the Model "M" possesses all the engineering refinements that have made Seeburg changers the favorites of manufacturers, sellers and buyers alike.

## FEATURES OF THE NEW SEEBURG MODEL "M"

- **THREE-POST CONSTRUCTION** that lengthens the life of precious discs, increases record load.
- **INTERMIX PLAYING** of both 10 and 12-inch recordings.
- **SIMPLE MECHANISM** that gives long, trouble-free operation.
- **SWIFT, QUIET OPERATION** that means minimum time between changes—assures pleasurable listening.
- **CONSTANT SPEED MOTOR** that brings turntable up to speed quickly—holds it there.

**Seeburg**  
RECORD CHANGERS ★ MUSIC SYSTEMS  
J. P. SEEBURG CORPORATION  
1500 N. DAYTON ST. • CHICAGO, 22





**You're  
in the lead  
with RCA...**  
*here's why*



*Prestige...* the best-known name is your best stock-in-trade

Towering 70 stories above Radio City, in New York, the RCA Building fittingly symbolizes the greatest name in radio. Atop this skyscraper are the letters RCA—three letters that have come to be recognized throughout the world as the symbol of quality and integrity.

That is why, today, the RCA name is a household word and the best-known, and most respected name in radio.

People naturally seek out the products of earned reputation. No wonder, then, that RCA Tubes en-

joy such wide customer acceptance.

Your identification with RCA lends prestige to your business—brings more people to your shop for other things, too. RCA *prestige* is another reason why—*You're in the lead with RCA!*

**THE FOUNTAINHEAD OF MODERN TUBE DEVELOPMENT IS RCA**



**TUBE DEPARTMENT**

**RADIO CORPORATION of AMERICA**

**HARRISON, N. J.**