

Radio Retailing

The Business Magazine of the Radio Industry

A McGraw-Hill Publication

SEPTEMBER, 1929

STARTLING RESULTS ASSURED . . .

WITH THE

EVEREADY RAYTHEON

SCREEN-GRID TUBE ER 224



**INCREASED STABILITY, COMPLETE
UNIFORMITY, QUICK ACTION**

THE EXCLUSIVE, patented Eveready Raytheon 4-Pillar construction is of vital importance in the screen-grid tube, which has four heavy elements requiring rigid support.

Eveready Raytheon Tubes come in all types, each with this sturdy 4-Pillar construction which prevents distortion of tube elements.

Eveready Raytheons, *only*, have all the advantages of this patented construction. Turn their superlative performance into profits—sign up for them now.

NATIONAL CARBON CO., INC.

General Offices: New York, N. Y.

Branches: Chicago, Kansas City, New York, San Francisco

Unit of Union Carbide  and Carbon Corporation

For the *really* NEW
in DYNAMIC
SPEAKERS

SEE and HEAR

the

NEW *Farrand*

ELECTRO DYNAMIC

the

NEW *Farrand*

INDUCTOR DYNAMIC

DEALERS get in touch with your Distributor.
MANUFACTURERS get in touch with us.

FARRAND MANUFACTURING CO. INC. LONG ISLAND CITY, N. Y.

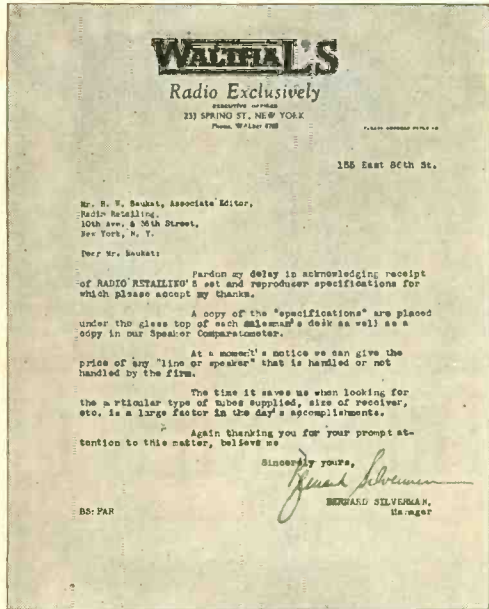

How do You Use the Listings?

HERE is a letter which tells frankly just how the members of a great New York chain radio outlet use the receiver and speaker specifications compiled and published by *Radio Retailing*. Our editorial pages are designed to be used as *tools*, in promoting and aiding every branch of this great industry. It certainly does our hearts good to have someone thoughtful enough to write in and tell us just how these lists are put to work helping the salesman ring the cash register.

What are you doing with them?

Radio Retailing

The Business Magazine of the Radio Industry

O. H. CALDWELL, *Editor*

RAY V. SUTLIFFE,
Western Editor, Chicago
S. J. RYAN
Merchandising Counsellor
HENRY W. BAUKAT,
Associate Editor
M. E. HERRING
Publishing Director

September
1929

Vol.10—No.3

Editorial Staff
HARRY PHILLIPS
T. H. PURINTON
C. GRUNSKY,
San Francisco
PAUL WOOTON,
Washington

CONTENTS

Copyright, 1929, by McGraw-Hill Publishing Company, Inc.

Management	
<i>What it Costs to Sell Radio, Part I</i>	52
<i>Meeting the Competition of the Chain Store</i>	58
<i>If I Were Boss</i>	64
<i>Tracing the Skip</i>	76
Sales	
<i>Selling the Farmer</i>	56
<i>Canvassing for Customers</i>	62
<i>With the Co-operators</i>	66
<i>Cashing in on Radio Week</i>	70
<i>Best Sales Ideas of the Month</i>	82
<i>Every Store a Radio Show</i>	61
Service	
<i>How the Screen-Grid Tube Affects Service</i>	74
Store Layout	
<i>Artistic Treatment of Narrow Store</i>	69
Broadcasting	
<i>Oh, What a Winter for Radio!</i>	55
Window Display	
<i>The Four Principles of Good Window Display</i>	77
The Editors Say	
<i>Radio's Big Year</i>	51
<i>Rural Radio Due for a Boom!</i>	78
Educational	
<i>Radio Will Speed These Lagging Little Feet</i>	68
News	
<i>This Month in the Radio Industry</i>	88
<i>New Products to Sell</i>	84
Manufacturing	
<i>The Inductor Dynamic Speaker</i>	97
Listings	
<i>Phonograph Record "Best Sellers"</i>	93
<i>Parts Directory</i>	99
Technical Advances	
<i>Facts About Remote Control and Automatic Tuning</i>	72

McGRAW-HILL PUBLISHING COMPANY, INC., Tenth Ave. at 36th St., New York, N. Y.

Cable Address: "Machinist, N. Y."

JAMES H. MCGRAW, Chairman of the Board
MALCOLM MUIR, President
JAMES H. MCGRAW, JR., Vice-Pres. and Treas.
EDWARD J. MEHREN, Vice-President

MASON BRITTON, Vice-President
EDGAR KOBAK, Vice-President
HAROLD W. MCGRAW, Vice-President
H. C. PARMELEE, Editorial Director
C. H. THOMPSON, Secretary

NEW YORK District Office, 285 Madison Ave.
WASHINGTON, National Press Building
CHICAGO, 520 North Michigan Ave.
PHILADELPHIA, 1600 Arch Street
CLEVELAND, Guardian Building

ST. LOUIS, Bell Telephone Building
SAN FRANCISCO, 883 Mission Street
BOSTON, 1427 Statler Bldg.
GREENVILLE, S. C., 1301 Woodside Bldg.
DETROIT, 4-257 General Motors Bldg.

LONDON, 6 Boulevard St., London, E. C. 4

Member A.B.P. Member A.B.C. Printed in U.S.A.



RADIO'S · SUPREME · ACHIEVEMENT

At the Radio Shows

THE difference between "good" and "very good" isn't a matter that can be put exactly into words. Specifications do not make a radio any more than dimensions make a Parthenon.

The quality of the music which pours from a receiver is determined by the *spirit* which goes into the making of the instrument. All the world's knowledge of radio design is in a Stromberg-Carlson—of course. But there is more. There is the eagerness to take pains—to put here a little stronger piece of material, to shield there with a heavier plate of copper, to wind this coil just a bit more thoroughly, to make that wire connection a degree more solid.

And the result is the Stromberg-Carlson Receiver of today; *decidedly* better in giving your customers the true enjoyment that radio can afford because of that idea of "just a little better" which has gone into every single operation of its making.

STROMBERG-CARLSON TELEPHONE MFG. CO.,
ROCHESTER, N. Y.



NO. 846 STROMBERG-CARLSON. Equipped with every practical development known to leading engineers in the radio art. Three Screen Grid Tubes, in radio frequency stages "totally shielded," affording high amplification, improving Selectivity and Sensitivity and adding a new brilliance to Tone. Built-in Electro-Dynamic Speaker; Automatic Volume Control; Meter for Visual Tuning; Phonograph Jack; Walnut finished cabinet with six legs. Uses 3 UY-224 Screen Grid, 3 UY-227, 2 UX-245 in "push pull" and 2 UX-280 Radiotrons. Price, without tubes, East of Rockies, \$347.50.



NO. 642 STROMBERG-CARLSON. Three Screen Grid tubes in radio frequency stages; "totally shielded;" Built-in Electro-Dynamic Speaker; Phonograph Jack; Walnut finished cabinet. Uses 3 UY-224 Screen Grid, one UY-227, one UX-245 and one UX-280 Radiotrons. Price, without tubes, East of Rockies, \$247.50.

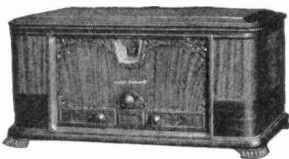

NO. 641 STROMBERG-CARLSON. A Screen Grid Treasure Chest table model Receiver. Three Screen Grid Tubes in radio frequency stages; "totally shielded;" Phonograph Jack; Walnut finished cabinet. Uses 3 UY-224 Screen Grid, one UY-227, one UX-245 and one UX-280 Radiotrons. Price, without tubes and speaker, East of Rockies, \$155.00.



NO. 25 ELECTRO-DYNAMIC SPEAKER. Scientifically baffled. Operating power supplied by UX-280 Rectifier Tube. Walnut finished. Price, without Rectifier Tube, East of Rockies, \$85.00.

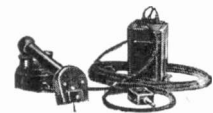

NO. 3-A MAGNETIC PICK-UP OUTFIT. Makes possible electrical reproduction of records. Price, East of Rockies, \$30.00.

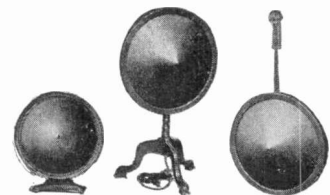

STROMBERG-CARLSON CONE SPEAKERS. Noted for their exceptional fidelity of tone. Prices, East of Rockies. No. 16 Cone Speaker, \$40; No. 17 Cone Speaker, \$35; No. 14 Cone Speaker, \$22.50.

NOTE—There are other models of Stromberg-Carlson Receivers for use in Direct Current areas.

Stromberg-Carlson

MAKERS OF VOICE TRANSMISSION AND VOICE RECEPTION APPARATUS FOR MORE THAN THIRTY FIVE YEARS

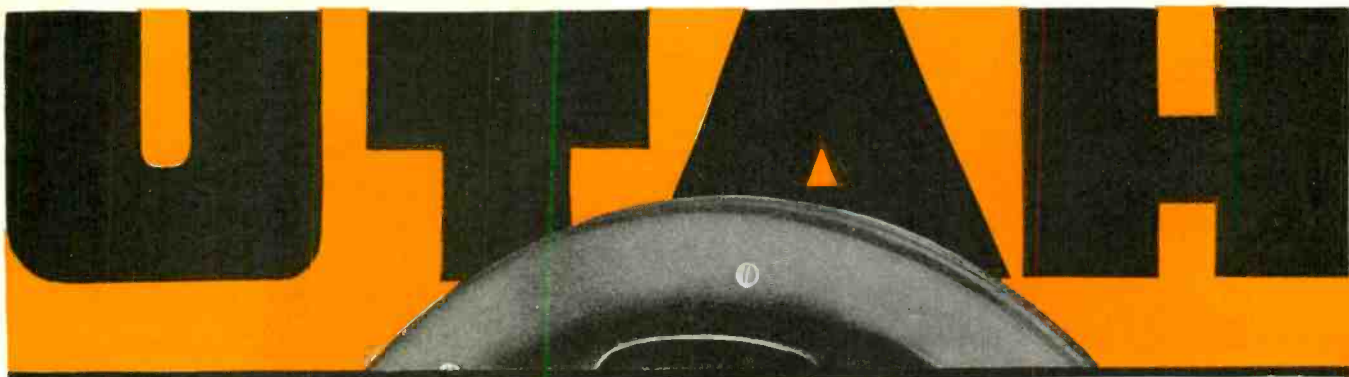

A Smashing Success

... Proved by Tremendous Sales ...



Utah Stadium
Model 66-A

110 A.C. Operation. Diameter over-all 12 1/4". Cone 10 1/2". Equipped with full wave high voltage rectifier—eliminating step down transformer—can be used on 25 to 60 cycles. No hum. Ideal for largest output—a superior speaker for home, theatre, large hall and outdoor use.

\$45⁰⁰

Behind the smashing success of the Utah Large Stadium Dynamic is the soundest reason in the world—precision manufacture—superlative quality. Astounding sales have followed. This means higher buying power and increased manufacturing facilities—benefits we pass along to you.

..... Utah Speakers are furnished as standard equipment by many leading 1930 Radio set manufacturers.

Send now for complete details of complete line—table models and chassis.

UTAH RADIO PRODUCTS CO.
1737 South Michigan Ave. Chicago, Ill.

**KEN-RAD
NOW BROADCASTING
OVER NATIONAL BROADCASTING COMPANY'S
BLUE NETWORK >>> EVERY MONDAY NIGHT**

10 PM EASTERN DAYLIGHT TIME.. 9 PM CENTRAL DAYLIGHT TIME.. 8 PM CENTRAL STANDARD TIME

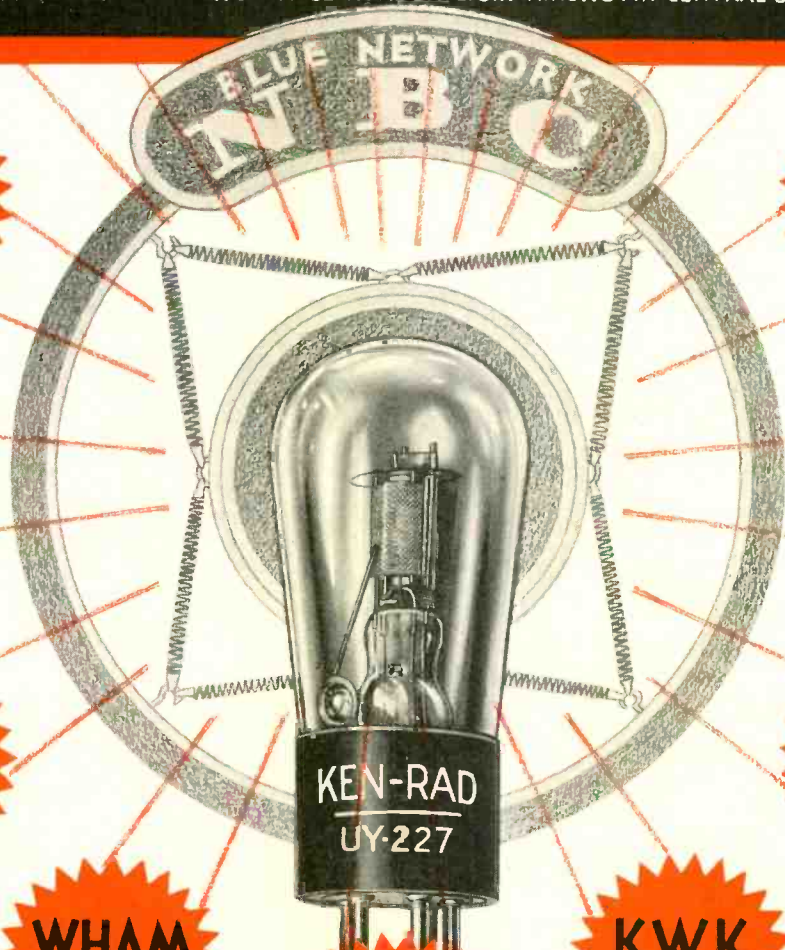

WJZ
NEW YORK

KDKA
PITTSBURGH

WBZA
BOSTON

WJR
DETROIT

WBZ
SPRINGFIELD
MASS.

KYW
CHICAGO

WHAM
ROCHESTER

WREN
KANSAS CITY

KWK
ST. LOUIS

A unique and tuneful program—Ken-Rad's «CABIN NIGHTS.» Haunting melodies, dusky voices and lilting tunes. Ken-Rad invites you to listen in every Monday evening.

—AND a Ken-Rad advertisement appears in The Saturday Evening Post and Collier's Weekly every other week, reaching over 5,000,000 tube prospects.

THE KEN-RAD CORPORATION
Incorporated
OWENSBORO, KENTUCKY
A DIVISION OF KEN-RAD TUBE & LAMP CORPORATION

KEN-RAD
RADIO TUBES

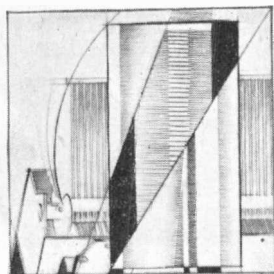

The only Screen Grid radio incorporating the Equalized Band Pass Filter

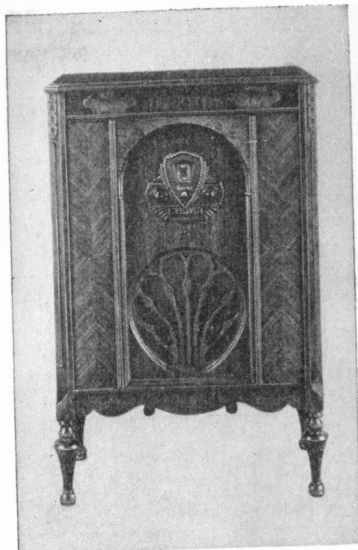

● Model 21950. Excellent lines and compact design. Ideal for apartments. Price \$219.50

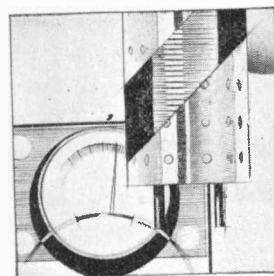

Life extension for tubes! Automatic voltage regulator on every New Grebe

THE NEW GREBE

HERE are the four models which compose the 1929 Grebe line. In each model the chassis is the Grebe Super-Synchrophase, with the Grebe Equalized Band Pass Filter. Radio merchandising experts from all parts of the country picked these numbers as being certain to appeal to the better class of radio purchasers this year. Orders now on our books prove the experts were correct. A. H. Grebe & Company, Inc., Richmond Hill, New York. Western Branch: 443 So. San Pedro St., San Francisco, Calif.

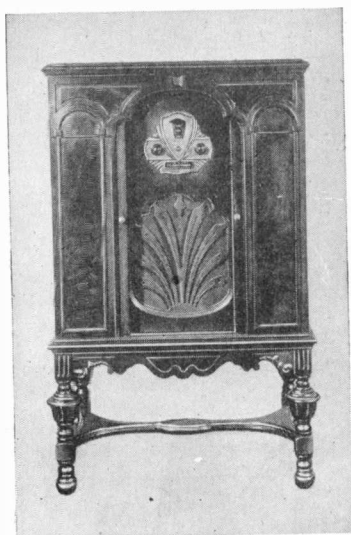

● Model 270. Modern lines of unusual charm and choice wood unite to make this a very popular model for the larger apartments and for houses of medium size. A most worthy cabinet for the Super-Synchrophase. Price \$270.00

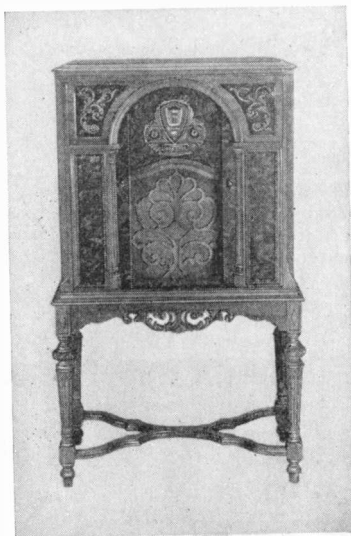

● Model 285. Walnut and mahogany are combined in this design. The wood has been chosen for its grain and finished for permanent beauty. This cabinet is selling to some of the finest homes in the country. Price \$285.00



● Model 450. This is a combination of the Super-Synchrophase with an electrically operated phonograph and magnetic pick-up. The final word in complete musical equipment for home, club or restaurant. Price \$450.00

LEUTZ



Leutz Seven Seas Radio Phonograph Combination

3 Screen Grid Tubes
 12-in. Dynamic Speaker
 Electric Phonograph
 Adjustable Selectivity
 Push Pull 2/250 Tubes
 Single (Split) Dial
 Panel Illumination
 Unit Construction
 all
 LEUTZ QUALITY

WRITE, WIRE OR CABLE TODAY

C. R. LEUTZ INC.

ALTOONA, PA., U. S. A.

Cables Experinfo N. Y.

WEST COAST

B. J. Howdershell
 Detwiler Bldg.
 412 West Sixth St.,
 Los Angeles,
 California

FRANCE

Baldwin M. Baldwin
 1 Boulevard Haussman,
 Paris, France
 Cables Experinfo Paris



Close-up of Phonograph

SEVEN SEAS

THE TUBE LINE OF THE FUTURE

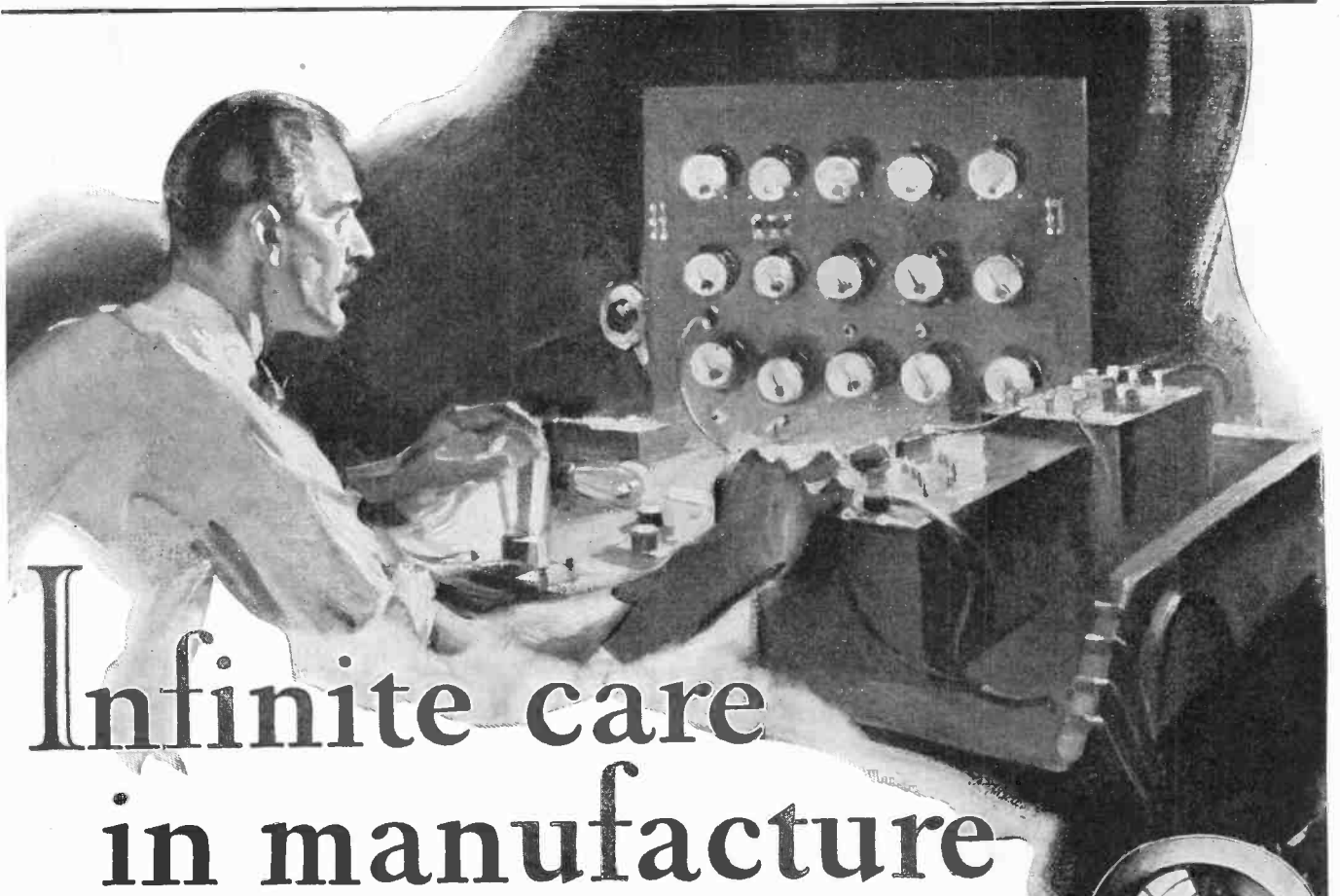

Infinite care in manufacture

TEST follows test in rapid succession in the making of each Sonatron tube—and each test must be passed with flying colors! The highest standards in the industry are enforced in the Sonatron factories, with the result that Sonatrons render superlative service to the millions who buy them. And dealers who sell them are reaping a rich harvest of profits, untroubled by calls for service.

▽ ▽ ▽

Have you listened to the Sonatron program recently? Every Sunday evening from 8:30—9:00 o'clock Eastern Time.

SONATRON TUBE COMPANY
Chicago, Illinois Newark, New Jersey

NEW and IMPROVED
SONATRON
RADIO TUBES



THE
WORLD'S
LARGEST
RADIO TUBE
LINE

Recognized



Fobbers:
Are "come-backs" on tubes seriously affecting your net profits? Returns on LA SALLE High Vacuum Tubes are less than half that of any known tube. Protect your profits with LA SALLE quality. . . . Write for our proposition.

Leadership

☐ EVERY LA SALLE TUBE is made, complete, in our own plant under license of R. C. A.

☐ Consistent quality, based on highest possible vacuum, has won highest recognition, with trade and public.

☐ Scientific principles and careful factory management make it possible to sell LA SALLE for the price of ordinary tubes. This gives LA SALLE Dealers the double benefit of good profits and quick turnover of stock. We shall be glad to send full information.

LA SALLE RADIO CORPORATION

Division of Matchless Electric Co.

1500 North Ogden Avenue, CHICAGO, ILL.

LaSalle

HIGH VACUUM RADIO TUBES

Licensed Under RCA, General Electric Co and Westinghouse Electric & Manufacturing Co. Radio Tube Patents



*The Royalty
of Radio*

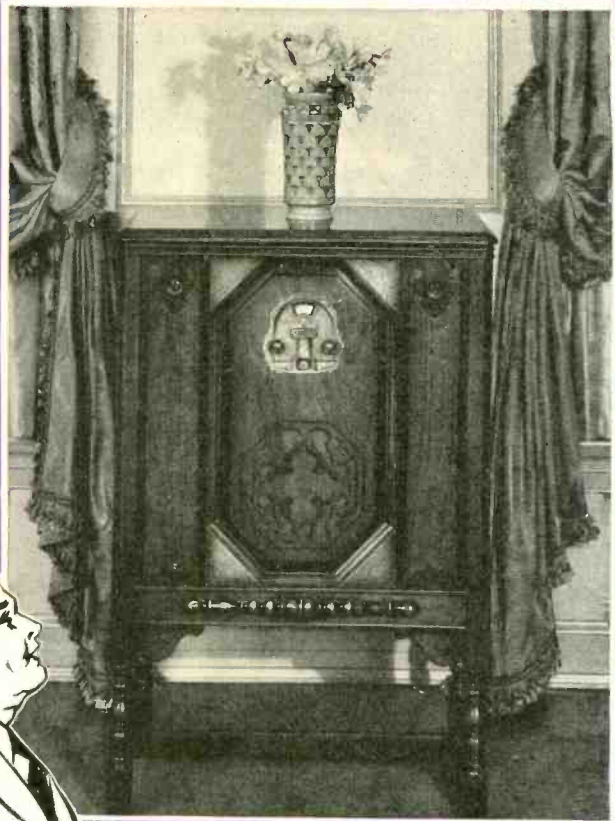

Royal Model 210 (Neutrodyne) Royal Model 220 (Screen Grid) The High Gain Neutrodyne Circuit employs 227, 245 and 280 type tubes (8 tubes are used in all). This popular and economical combination of time-tried tubes assures long life and low upkeep.

Why Kennedy Dealers are Enthusiastic

THE enthusiasm of Kennedy Dealers and Dealer Salesmen is genuine and spontaneous—all over the United States! Naturally! Exquisite cabinetry that instantly appeals to those who love the finer things of life—Chassis (either High-gain Neutrodyne or Power-detection Screen-grid) that fully utilizes every known advance in radio science. . . . Life Tone performance that surpasses any standards of mere reproduction, because it is the tone of life itself—All combined to merit the distinction of “The Royalty of Radio” at prices within easy reach of the millions!

KENNEDY

KENNEDY

In addition: A protective franchise that really protects and earns profits a most elaborate merchandising program that carries a punch the leadership of leaders in radio and industry tremendous financial resources straight-line production facilities to meet tremendous demands!

Talk to Kennedy Dealer Salesmen and you will learn the reason for their enthusiasm. They will tell you why Kennedy is a self seller that stays sold. They know the instant appeal of the product—from furniture elegance to Life Tone performance!

Whether or not you are one of the Kennedy Family, send for the Kennedy Gold Book. It is an intimate story of success. . . .

**COLIN B. KENNEDY CORPORATION,
SOUTH BEND, INDIANA**



Royal Model 310 (Neutrodyne) Royal Model 320 (Screen Grid) The Power Detection Screen Grid circuit employs 224, 227, 245 and 280 type tubes (8 tubes are used in all). The extreme amplification obtained from the Kennedy method of employing the new Screen-Grid tubes is utilized through Power Detection.

Dealers!

Dealers — Send for the Gold Book. Use the coupon.



**COLIN B. KENNEDY CORP.,
South Bend, Ind.**
Please send the Gold Book to

I am a Distributor; Dealer; Salesman.

"THE SET WITH THE PUNCH"

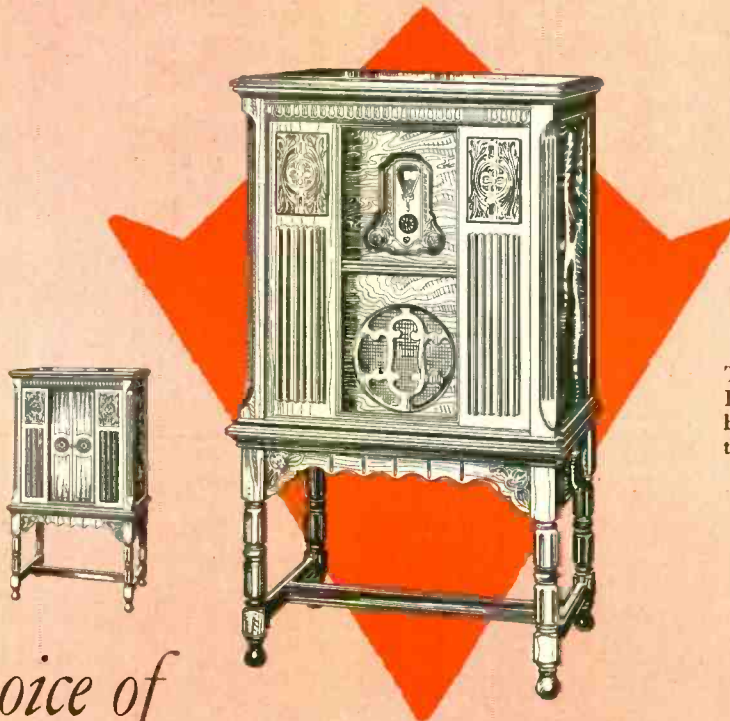

The New 17th Century English Console now being introduced. Rivals the beauty of a costly antique.

Your Choice of 2 NEW POWERFUL CIRCUITS

Screen Grid! Balanced Bridge! Both now available in the New Stewart-Warner—

New laurels for the Champion of the Air! New and increased efficiency for the "Set with the Punch"—the new Stewart-Warner! New opportunities for sales by every Stewart-Warner Dealer!

For now you can secure any Model Stewart-Warner Radio with either Screen Grid or Balanced Bridge Circuits. Before you complete plans for this fall and

\$154⁵⁰*

less tubes

Approved 17th Century English Console Number 47 with Model 900 Stewart-Warner Electro-Dynamic Reproducer. Cabinet of American Walnut with silent sliding doors. Height 44 in., width 26½ in., depth 16¾ in.

**All prices slightly higher west of Rockies*

Christmas business, compare this year's Stewart-Warner with other makes. The New Series "900" Stewart-Warner is utterly unlike the set of former days. And it is just as far in advance of any of the latest sets of other makes.

Send for our money-making plan—our sales winning dealer helps and our franchise proposition—the fairest in the radio industry.

STEWART-WARNER CORPORATION, CHICAGO, ILLINOIS, U. S. A.

STEWART-WARNER RADIO

Screen Grid Circuit or Balanced Bridge Circuit

Note Features!

Screen-Grid Circuit: Uses three of the new 224-type Screen-Grid tubes; two 227-type heater tubes (one as the power detector); two new 245-type tubes in a powerful new "push-pull" hookup; and one 280-type rectifier tube. Resistance-coupled audio frequency. Three stages of screen-grid amplification. Completely shielded variable condensers. No AC HUM—yet 100% sensitivity!

"Balanced Bridge" Circuit: Uses five 227-type heater tubes, one serving as detector; two new 245-type tubes in a powerful new "push-pull" hookup; and one 280-type rectifier tube. This improved circuit completely eliminates oscillation; yet it is extremely sensitive. It brings distant stations booming with all the punch of a "local" and with almost uncanny realism of tone.

Plug-in for Television: equipped to receive these signals when popular in broadcast range.

Air-Cooled Power Transformer: more efficient performance through positive cooling of coil.

Plug-in for Phonograph: reproduces any phonograph record with standard pickup attachment.

Automatic Voltage Control: delivers uniform power to set regardless of line voltage.

4-in-line Variable Condensers: most accurate condenser gang made: completely shielded.

Extremely Accurate Tuning Coils: scientifically space wound and crystal tested to exact capacity.

Built-in Aerial: ground wire only required for local reception and home demonstrations.

Completely Shielded Chassis: one-piece drawn copper coil shields; shielded condensers; power detector and power transformer units.

Aerial Compensator: 3 taps provide adjustment to any type aerial and local conditions.

Gold-Plated Connections Throughout: lasting and non-corrosive; the supreme radio refinement!

Cabinets by Louis Hanson Co., Chicago
and Burnham Phonograph Corp.,
Los Angeles



\$142.50*
less tubes

Approved Jacobean Cabinet No. 35 as shown above with Stewart-Warner Model 900 Radio and Electro-Dynamic Reproducer. Cabinet of American Walnut with enclosed back and hinged top. Height 38 in., width 27 in., depth 15 in.

*West of Rockies, \$147.00 less tubes

Approved Sheraton Cabinet No. 58 with Model 900 Stewart-Warner Radio, *\$165.50 less tubes. New Stewart-Warner Electro-Dynamic Reproducer. Cabinet of American Walnut and Australian Lacewood with silent sliding doors—height 52½ in., width 25½ in., depth 17 in.

The Console Ensemble in hammered gold bronze or jade green and black. Electro-Dynamic Speaker. \$123.25 less tubes. West of Rockies, \$128.50. Table Models in same finishes as Console Ensembles, \$89.75. West of Rockies \$92.25.

Complete line of A. C. and D. C. models, 60 cycle or 25 cycle.

*West of Rockies, \$170.50 less tubes

STEWART-WARNER
R A D I O
Screen Grid Circuit or Balanced Bridge Circuit

<p>Model No. 101 Dimensions, 42-in. H. x 25 1/2-in. W. x 15 1/2-in. D. Set Compartment, 10 3/4- in. x 24-in. x 14-in. Space for Dial Control 12 1/2 in.</p>	<p>\$16.50 Net F.O.B. York, Pa.</p>	<p>Model No. 801 Dimensions, 40-in. H. x 25 1/2-in. W. x 14 3/4-in. D. Set Compartment, 9 3/4- in. x 22-in. x 13-in. Space for Dials, 10 3/4-in.</p>	<p>\$13.50 Net F.O.B. Phila. Pa.</p>	<p>Model No. 301 Dimensions, 46 3/4-in. H. x 27-in. W. x 15 1/2-in. D. Set Compartment, 11-in. x 24 1/2-in. x 14-in. Space for Dials, 12 1/2-in.</p>	<p>\$16.50 Net F.O.B. Hanover, Pa.</p>
					

Radio cabinet

BUY DIRECT - and make

THE cabinets shown above are only five of the sixteen "GENERAL" Models. The prices and descriptions tell their own story. Fine quality of construction and finish AT ROCK BOTTOM PRICES . . . because our direct from factory to dealer method eliminates selling and handling costs to jobbers and eliminates jobbers selling and shipping costs to you.

You get the benefit of at least nine different savings. Prices to you are NET. You determine your own profit—and you MAKE it because everyone of these cabinets hits the public where it lives—in the pocketbook!

10% discount when purchased in quantities consisting of any assortment of models shown in our general catalog.

N. Y. Radio Show
 Section T—Booths 4 and 5

Chicago Radio Show
 Section U—Booth 4



WOOD CABINET

T. J. Molloy, Pres.

196 Lexington Avenue, New York.

Model No. 103
 Dimensions 42-in. H. x 25-in. W. x 5 1/2-in. D. Set Compartment 10 1/2-in. x 24-in. x 12 1/2-in. Space for Dials, 12 1/2-in.

\$20.50
 Net F.O.B.
 York, Pa.



Model No. 302
 Dimensions, 46 1/2-in. H. x 27 1/2-in. W. x 15 1/4-in. D. Set Compartment, 11-in. x 25 1/4-in. x 14-in. Space for Dials, 12 1/4-in.

\$19.50
 Net F.O.B.
 Hanover, Pa.



VALUE

from the **FACTORY**
more money!

Cabinets to fit all standard make sets, including the new Atwater Kent and Crosley Screen-grid receivers. Speaker brackets supplied with all models for Atwater Kent chassis.

The combination of woods is so forcibly brought out as to render each model unusual "eye value." Choice walnut veneers and maple overlays used throughout. Each cabinet is hand rubbed and lacquer finished.

Don't buy any radio cabinets until you get full particulars on the entire "GENERAL" line. Write today for illustrated literature giving the full facts.

10% discount when purchased in quantities consisting of any assortment of models shown in our general catalog.

Cabinet designs by
 Hammarstrom

Salesmen—Valuable
 Territory Still Available



CORPORATION

T. J. Molloy, Pres
 196 Lexington Avenue, New York

BY AUTHORITY OF THE UNITED STATES GOVERNMENT

THERE IS
ONLY ONE
DYNAMIC
SPEAKER

MAGNAVOX

THE ORIGINAL

WITH THE CAN'T-BE-COPIED

REALISM



Models 401, 403 and 405
12¼" high, 12" wide, 8¼" deep
10½" cone

The U. S. Patent Office has granted to the Magnavox Company exclusive use of the word "DYNAMIC" in connection with radio loud speakers.

Patents may be infringed, trademarks may be borrowed, but performance quality cannot be

copied. The making of a dynamic speaker is an art that was started by the Magnavox Company in 1911 and carried on since that time.

THE MAGNAVOX COMPANY

Factory and Pacific Sales: OAKLAND, CALIF.
Factory and Sales East of the Rockies: CHICAGO, ILL.

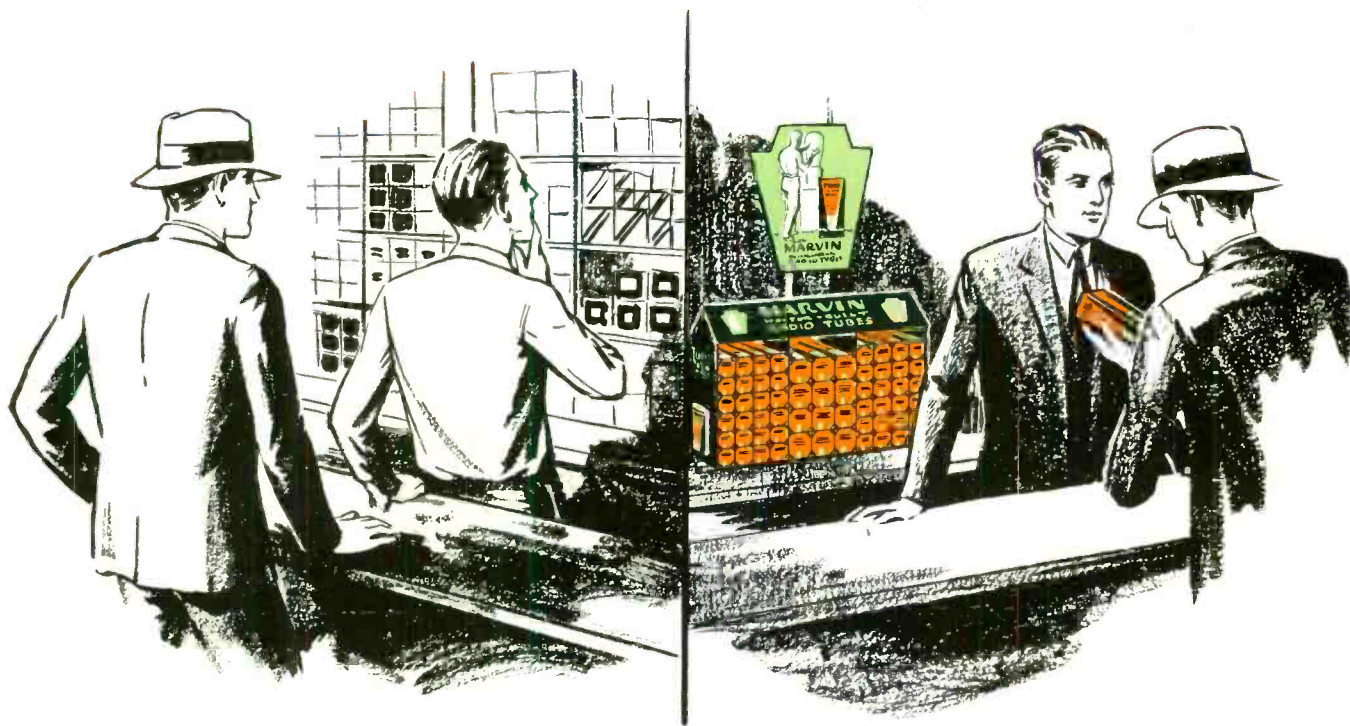

*You can handle some of every kind
— or make maximum profits
by concentrating on MARVIN*

DROGRESSIVE dealers are finding it *more profitable* to concentrate on one quality line of independent tubes. Simplified inventory, better stock control, increased turnover—and maximum profits—are the inevitable results of such a long-headed policy.

The new MARVIN Metal Display Cabinet, lithographed in full colors, holds the number of tubes the average dealer should display. It insures you complete stock control, increased turnover—and more profits.

Make your tube department pay you *maximum profits* by installing this sales-making display cabinet. Your MARVIN distributor will tell you how you can get it *free*—or write us.

MARVIN RADIO TUBE CORPORATION
IRVINGTON, NEW JERSEY

General Sales Office: 225 BROADWAY, NEW YORK



The MARVIN MUSICIANS

Each Saturday night over Station WJZ and Associated N. B. C. Stations, the MARVIN Musicians are making friends of millions and millions of radio tube users for the tubes that "serve better and live longer." Extensive and continuous newspaper advertising will also be directing consumers to the stores of dealers who sell MARVIN Master-Built Tubes.



This attention-compelling window and counter display material insures MARVIN dealers of maximum display value and identifies them as agents for Master-Built Radio Tubes.

These MARVIN displays supplement the radio broadcasting and newspaper advertising and are the basis for many a sale. Your distributor will gladly furnish you with any of this material.

MARVIN RADIO TUBE CORPORATION
IRVINGTON, NEW JERSEY

General Sales Office: 225 BROADWAY, NEW YORK

...and now
the whole country has
“Gone
Kylectron!”



THE first public demonstration of Peerless and Courier Radios was held in Chicago early in July. Two hundred and fifty thousand people a day heard—and marveled. All Chicago was talking Kylectron.

At that time we prophesied that the whole country would marvel at the magic of Kylectron just as Chicago had. But even we did not foresee the wave of enthusiasm that these Kylectron-equipped radios would cause throughout the country. People seem to have been waiting for Kylectron. Dealers everywhere say that never before has anything in radio caused such a sensation. The nation has “gone Kylectron!”



the “reasons why” are on the next two pages . . .

▶▶▶ Never before have Radio

Peerless and Courier Radios equipped with Kylectron take country by storm!

What is Kylectron? The engineers say it is the "most direct conversion of electrical energy into sound."

Musicians and music lovers say it is the "most perfect method of reproducing vocal or instrumental music." Radio dealers say it is "the most sensational means of stimulating sales and profits."

And all of them are right. For Kylectron is the most revolutionary development in radio since the first tube set. Kylectron isn't radio—it's the human voice!"

Here is radio without hum, without distortion, without mechanical sound of any kind. Here is distance, selectivity, volume. Here is light-socket operation.



Backed by a Gigantic Advertising Campaign

The story of Kylectron and of Courier and Peerless Radios is being told to the people of America through a tremendous advertising drive.

Following is a brief outline of the advertising and merchandising program behind these two Kylectron-equipped radios:

Newspaper Advertising
Radio Broadcasting
Outdoor Display
Window Display
Store Display
Direct Mail Literature
Special Selling Helps of every description

THE COURIER

Here's value that *shows*. Screen grid, of course, three tubes; power detection; selectivity that delights the most critical—distance that will bring joy to the hearts of the "DX fans"—tone that *everyone* will enjoy. Cabinets of enduring beauty. The radio "shoppers" will never find another such radio value at such a price.

... and they both

Dealers been so *enthusiastic*

**Already these two lines have become
the season's most valuable franchises**

No wonder radio dealers are enthusiastic. No wonder they're clamoring to get in on the ground floor . . . to get the franchise for Peerless and Courier radios before they find themselves obliged to compete with this fast selling line.

This is, without doubt, going to be the biggest radio year in history. And the

dealer that offers his customers Peerless and Courier radio, equipped with Kylectron, is going to get the lion's share of the profits. For the biggest name in radio this year is Kylectron.

Now is the time for *action*. Write or wire your distributor or get in touch with us direct.

All Selling Efforts Concentrated in Dealer's Territories

Our merchandising and advertising plans are designed to do a concentrated selling job in every dealer's own territory. That's what is going to make sales for Peerless and Courier dealers. *Each territory will be intensively covered.* Every possible customer will be told and re-told the story of Kylectron and of Peerless and Courier Radios. Every medium that will bring about *direct results—immediate sales—* will be used in cities and towns where there are Peerless and Courier dealers.

In short, we are not content merely to sell the dealer. We consider that our selling job is not finished until the radio is *in the home*.

Get in touch with your distributor or wire us today for full details.

THE PEERLESS

Every Peerless cabinet is a real masterpiece of the cabinet-maker's craft. Every Peerless set is a real achievement in radio engineering. This radio has *everything*. Every new development that has proved to be good has been incorporated into this new Peerless. *Nothing* has been spared to make it the finest radio on the market.



have Kylectron!

Peerless

Dynamic Reproducers

THE Peerless Dynamic Reproducer is a revelation. Attached to any radio receiver, it produces a quality of tone and a volume that is as far above the ordinary speaker as the tone of the modern electric phonograph is above that of the old-fashioned talking machine that used a horn.

The Peerless startled the world with its new and better construction. It is truly "built like a battleship" and because of this, gives every Peerless owner many years of care-free service.

That's why dealers like it, too . . . service calls are practically eliminated.

Peerless Dynamic Reproducers are made in a number of models and for use with any type of electric current: 25 and 60 cycle, 110 volt, A.C.; 6 to 8½ volt, D.C. storage battery; 32 volt D.C. farm lighting; and 110 volt D.C. house lighting current. Completely equipped with cords, ready to attach.

New low prices this year—from \$14 to \$50 retail.

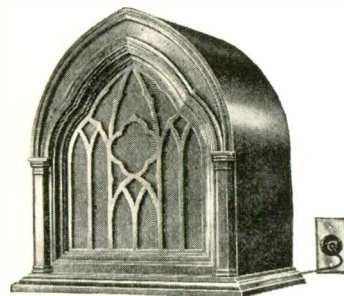

PEERLESS MODEL 19-A

One of the most popular of the Peerless line of Dynamic Reproducers. Encased in a beautiful carved walnut cabinet of Gothic design. Equipped with nine-inch dynamic speaker, it delivers volume enough to fill a hall if desired, with a quality and sweetness of tone that is truly wonderful.

Newcombe-Hawley

Speakers

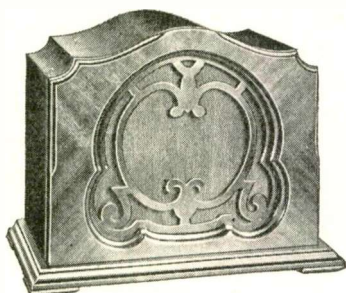

NEWCOMBE-HAWLEY
MODEL N. II. 37

This is a portable reproducer with Newcombe-Hawley dynamic cone unit of the most improved design. It comes in a beautiful cabinet of grained walnut which carries an instant appeal because it harmonizes so perfectly with the furnishings of any living-room. Used with a good receiving set it produces a marvelous quality of tone and ample volume.

WHEN you sell a Newcombe-Hawley—you've sold it, and it stays sold. It's a quality product, always has been, ever since it was first put on the market. And now, with one of the country's largest radio-producing companies back of it, even better quality will go into these speakers. Everything will be done to make Newcombe-Hawley the outstanding line of speakers in their field—both as to quality and sales volume.

Prices, too, will be more attractive. They are lower this year, ranging from \$12 to \$45 retail.

Newcombe-Hawley Speakers are made in a variety of models in both the dynamic and magnetic cone types. And in the case of the dynamic types,

there are models for use with any kind of electric current. Fully equipped with attachment cords.

Write for Details Today

Already the United Reproducers' franchise is becoming the most valuable one in the radio business. Dealers everywhere are taking on one or more of its lines. Decide now to get in on the ground floor of what is certain to be the greatest money-making proposition in radio. United Reproducers' products are not only going to be unusually profitable for dealers, but they are going to do a real job of building good-will. The products are right.



UNITED REPRODUCERS CORPORATION

Rochester, N. Y. and Springfield, Ohio

Full license protection under RCA, Hazeltine and Meissner patents and applications. © 1929 U.R.C.





A VITAL MESSAGE . . .

**to Radio Dealers Who
are Financially Responsible
and Technically Qualified**

THE Pilot Radio and Tube Corporation, world's largest radio parts plant, announce a new policy of direct-to-dealer distribution of its full line of radio parts, complete radio kits and the newly developed Pilotron radio tubes.

Inasmuch as Pilot radio parts, kits and tubes are bought by custom set-builders, advanced radio experimenters and others who know the technical side of radio, it is essential that the Pilot dealer be well informed technically. He must be able to talk intelligently to the type of fan who builds his own and therefore knows what it is all about. That there is a great and rapidly growing market for radio parts is amply attested to by the constant growth of the Pilot organization, now the world's largest radio parts plant.

*{ The Pilot Policy Protects the Dealer by
assuring him a legitimate profit at all times. }*

PILOT RADIO & TUBE CORP.

WORLD'S LARGEST RADIO PARTS PLANT

323 BERRY STREET, B'KLYN, N. Y., DEPT. U. S. A.



CORWICO VULCAN

LIGHTNING ARRESTER

Price and Performance Make It a Big Seller

\$1.00
LIST



The Corwico Vulcan Lightning Arrester not only protects the radio receiver against damage by lightning but also dissipates accumulated static charges. This is a feature that will appeal to your customers and one that makes the Vulcan the biggest selling lightning arrester on the market.

\$100 GUARANTEE

We guarantee to repair up to a cost of \$100, any radio receiver, protected by a Corwico Vulcan Lightning Arrester, that has been damaged by lightning.

If your jobber cannot supply you with Corwico Vulcan Lightning Arresters, order a sample carton of six direct.

CORWICO ANTENNA KIT

Insure your customers better reception and an aerial equipment that will last longer and give the best results by selling them the Corwico Antenna Kit No. 4. It contains everything for a complete aerial and lead-in equipment together with a Corwico Vulcan Lightning Arrester.



\$2.50
LIST

If your jobber cannot supply you with Corwico Antenna Kits order a sample carton of ten direct.

QUALITY  SERVICE

RADIO'S BEST-KNOWN WIRES
"BEST FROM THE GROUND UP"

Write for Complete Catalog.

AT THE RADIO WORLD'S FAIR

Madison Square Garden, New York, Sept. 23 to 28.
See the Corwico Display, Booth 5, Section 2.

CORNISH WIRE CO.
28 Church St., New York City

MAKERS OF
CORWICO BRAIDITE HOOK UP WIRE

**It isn't how many we make..
but how good we make them**

VAN HORNE

Radio Tubes

Quality for 15 Years

YOU know that quality will never be sacrificed to quantity in making Van Horne Tubes. For 15 years the name Van Horne has been synonymous with quality. This year will be no exception. Van Horne Radio Tubes are the handiwork of tube carftsman with years of experience building quality tubes only. This custom-building is responsible for Van Horne's unvarying uniformity, and low replacement ratio.

Van Horne production however will always be sufficient to supply Van Horne distributors and dealers. Van Horne is limiting its distribution. It is selecting its dealers. Thus, regardless of any shortage in the industry this season, Van Horne dealers will always be assured an ample supply of uniform high quality tubes to meet their needs. You want to look into the profitable Van Horne proposition for this year. VAN HORNE TUBE CO., FRANKLIN, OHIO.

All Van Horne Tubes, including the new screen-grid tubes, are manufactured under exclusive Van Horne patents.

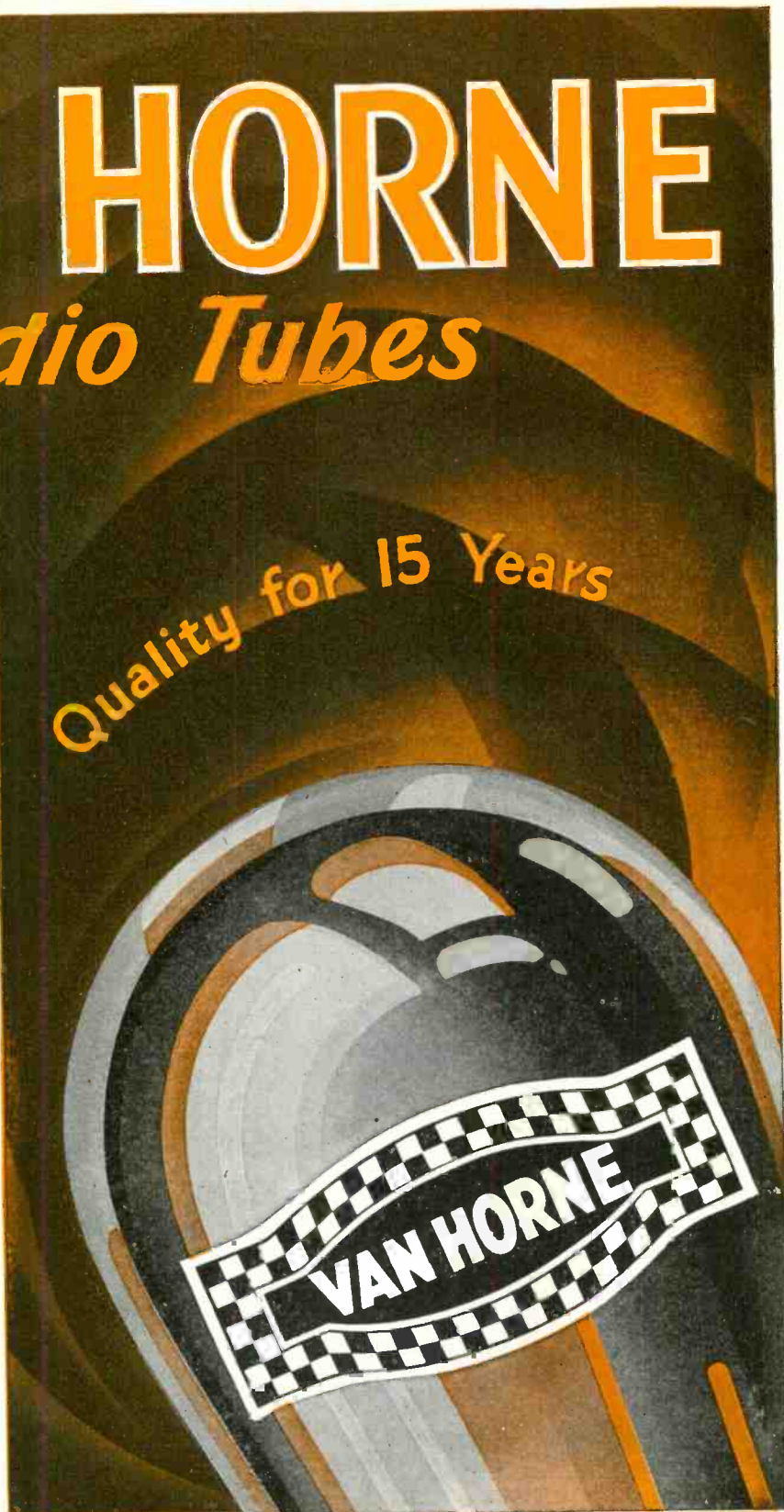

A 30 YEAR DEVELOPMENT

BOHNALITE



CHAS. B. BOHN
The authority who
developed Bohnalite

Bohnalite, the new light alloy, took 30 years of patient study and constant research to perfect.

Bohn metallurgists, having experimented with thousands of "heats" for various purposes, can now recommend the precise alloy to cover your requirements.

Bohn special heat treating processes are exclusive with this organization. And you know the great commercial value of scientific heat treatments.

Remember Bohnalite, in addition to being 62% lighter than iron, has high uniform hardness—great density—fine grained structure—unusual strength—excellent bearing qualities—and is ductile.

Write us today. Send your samples and blue prints. Let us show you the economical advantages of Bohnalite. Send for literature.

BOHN ALUMINUM & BRASS CORP., DETROIT, MICH.
New York Chicago Philadelphia Cleveland Pittsburgh

62% LIGHTER THAN IRON



AIR COLUMN
CONAMIC
DYNAMIC



OPERADIO SPEAKERS

THE LINE COMPLETE



The JUNIOR

Beautiful in appearance and performance. Handles satisfactorily the output of any set up to and including five and six-tube Neutrodynes, Super-heterodynes, etc., using the 201-A type tubes. A 30-inch exponential air column. Total height of Speaker 8 1/2 inches.
Price..... List \$15.00



The SENIOR

Operates efficiently on the same type of sets and tubes as the Junior, but is more sensitive to weak signals. Capable of great volume with a remarkable acoustical range. 34-inch air column—14 inches high. The Junior and Senior Operadio Speakers are finished in either gold or maroon.
Price..... List \$19.50



LITTLE JACK HORNER

Here is Jack Horner's small brother—with all of his characteristics except his big voice. Will handle the output of any radio set up to and including 17 type tube—either singly or in push-pull. Driven by a magnetic unit same as all Operadio Conamic models.
Price..... List \$35.00



The Jack Horner Speaker

THE new Operadio Electrodynamic Chassis, rugged in construction, magnificent in performance has made possible many revolutionary improvements in Operadio Speakers. Because it is so different it permits the construction of many types of cabinets never before thought of in radio engineering.

Equally outstanding with the unit itself is the new Jack Horner wall model which permits reproduction of fundamental frequencies as low as 90 cycles. This design utilizes the two walls of the room as sounding surfaces to focus the sound. Although these new Operadio Speakers are unique in their idea and beautiful in design, of far greater importance is the remarkable performance which the new Electrodynamic Speaker makes possible.

The Jack Horner Speaker reproduces the complete musical range with absolute fidelity. It will stand up under continuous operation with sets using the most powerful tubes, such as the Type 250. It is extremely sensitive and responsive to the lowest impulses.

A tone control is included which permits adjustment of pitch to suit the user's taste. 20 foot cord for both power and set connection with through switch and plug. Size 15 inches wide by 36 inches high, taking 12 inches of wall space on each side.

- LIST
- No. 23060—110 V. 50-60 Cycle A.C. \$55.00
 - No. 25060—110 V. 25-40 Cycle A.C. \$57.50
 - No. 21060—110 V. D.C. \$45.00

OPERADIO

MANUFACTURING CO.

ST. CHARLES, ILL.



The ALGONQUIN

This speaker has an 11 inch cone driven by a powerful magnetic cone unit. It has response on reasonable volume equal to the average electrodynamic speaker. It will handle the output of audio tubes up to 171 in push-pull.
Price..... List \$32.50



The PARISIENNE

A handsome console of modern French design. It has an 11 inch cone driven by a powerful magnetic cone unit. Will handle the output of audio tubes up to 171 in push-pull. 22 1/4 inches long x 31 inches high x 13 1/4 inches wide . . . top will accommodate table type radio sets. Price List \$41.00



The ST. CHARLES

An electrodynamic speaker that gives tremendous volume with undistorted tone fidelity. Cabinet is 32 inches high, 16 inches deep, 24 inches wide. List No. 23061—110V. 50-60 Cycle A.C. \$75.00 No. 25061—110V. 25-40 Cycle A.C. \$77.50 No. 21061—110V. D.C. \$65.00

NEW REVOLUTIONARY PRODUCTION SYSTEM



Profit With GULBRANSEN On the Air!

MILLIONS of listeners will have Gulbransen Precision-Built Radio firmly in mind when the Gulbransen Symphony Orchestra under Dr. Henry Hadley, foremost American composer-conductor, goes on the air over the Columbia Chain Saturday Night, October 5th at 9:30 P. M. Eastern Standard Time. With this great merchandising help as a basis, Gulbransen is presenting its dealers with a powerful and complete sales plan using every known means for influencing buyers. Every display—every printed piece all links up in a powerful selling campaign. Alert dealers everywhere are grasping it. Ask for the complete plan—it means a greater sales volume for you.

Newspaper Advertising

The general newspaper advertising campaign which Gulbransen will conduct on a large scale is thoroughly linked up with a series of distinctive dealer advertisements. These in turn tie-up perfectly with the basic Gulbransen sales features.

Window Display

Colorful and effective display material, both for the window and inside the store, is furnished. These displays will attract passers-by, will aid in building up popular interest, and will point out the unusual advantages of the Gulbransen Radio.

Cuts Dealer Service Cost!

A PRODUCTION system entirely new in radio manufacturing, is setting records for service-free radio. Every operation in building the Gulbransen chassis is electrically timed and recorded—all coils, condensers and resistors are grouped into ten classifications and each set is built from these finely matched parts. With this precision in the making, there is no wonder that of all the Gulbransens shipped during a specific period 99-3/5% were in perfect condition, were sold into homes and gave faultless reception. Think what this relief from burdensome service means to a dealer's net profit. Get the details of the Gulbransen Precision-Built Radio and the profit making sales plan behind it.

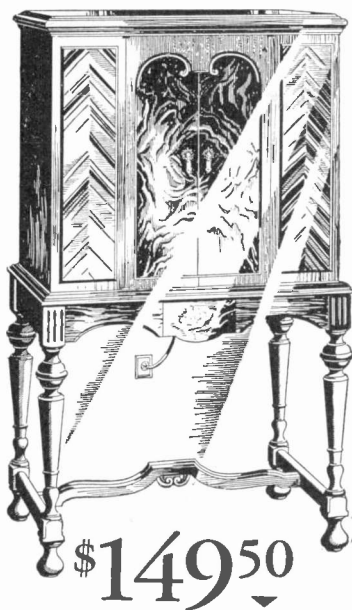

The beautiful Gulbransen high-boy console of fine walnut and rich veneers—product of piano craftsmen.

Smart lowboy console at \$139.50, less tubes.

Check These Features!

1. Efficiency of each set must measure within four millionths of a volt of master laboratory model.
2. Double Primary Circuit.
3. Push-Pull Amplification using 245 tubes.
4. Screen-Grid Power Detection.
5. 10-inch Dynamic Speaker.
6. Phono-Radio Switch.
7. Local-Distance Switch.
8. 9 Tubes in Line.
9. Equal Amplification—High and Low Waves.
10. Cabinets by piano craftsmen.
11. Chassis and power pack in one unit.
12. Completely Shielded.
13. Oversize Audio Transformers.
14. Accurately Matched Radio Transformers.

GULBRANSEN COMPANY, Kedzie, Sawyer, Spaulding and Chicago Aves., CHICAGO, ILL.

GULBRANSEN

PRECISION-BUILT RADIO

Manufactured Complete by the World's Largest Maker of Pianos

... designed much as other tubes

but -



the DUOVAC factory was designed as no other tube plant ever has been ... to achieve uniformity in every operation to maintain uniformity in every DUOVAC, to let no tube be called a DUOVAC which is not uniform.

The DUOVAC PROCESS which makes DUOVAC uniformity possible will be advertised widely before set owners everywhere. The dealer who serves this enlightened clientele by featuring DUOVACS will not only be assuring his trade greater tube satisfaction ...

He will also be reducing his service problems because of the uniformity of DUOVACS ...

DUOVAC RADIO TUBE CORPORATION
360 Furman Street
Brooklyn, N. Y.

The DUOVAC package—(shown here in 2 colors) is actually printed in four colors, shaded from deep blue to deep red in a gorgeous rainbow effect, an ideal combination for effective window, counter or shelf display.

DUOVAC

The * Precision Radio Tube

*PRECISION—The quality of being precise, strictly accurate—identical. Standard Dictionary

At the R. M. A. Show in New York visit our display at booth 6, section B. B

Televocal

Quality Tubes

No. AC 224
Screen Grid

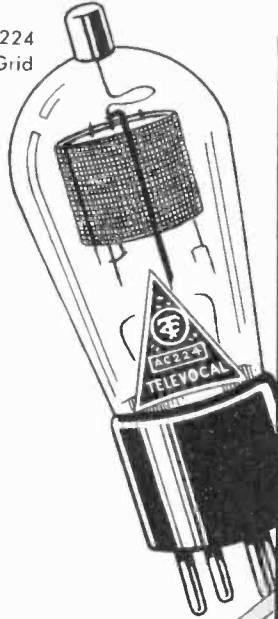

No. AC 227
Quick Heating

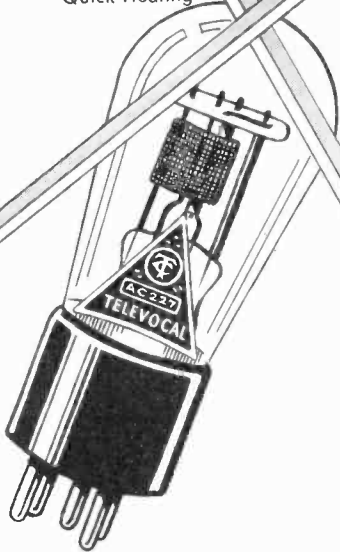

Volume

The increasing popularity of
TELEVOCAL TUBES
is due to a number of things.

- First: Greater Volume without distortion.
- Second: Perfect Fidelity of Tone Quality.
- Third: The AC 227 is Quick Heating—almost instantaneous.
- Fourth: Clear, Humless Operation.
- Fifth: Uniformity—every tube the same as its brother.
- Sixth: Greater Sensitivity insuring further range.
- Seventh: Sturdy Construction—built to stand any strain.
- Eighth: Liberally Guaranteed.

Televocal Tubes are superior because the materials used are the finest that money can buy; the engineering talent is the best obtainable at any price; the machinery used is the latest and most modern; inspections and tests are carried far beyond the usual limits and an integrity in workmanship based on making tubes as well as we know how, regardless of conditions.

No. TC 245
Power Tube

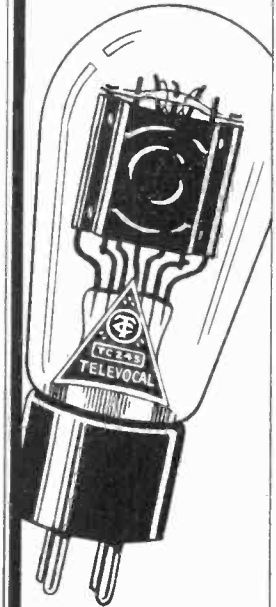

Televocal Corporation
Televocal Building, Dept. B-9
588 12th Street, West New York, N. J.

Prepare against a possible shortage by ordering now.

Televocal Tubes are made in all standard types.

The Listening Test

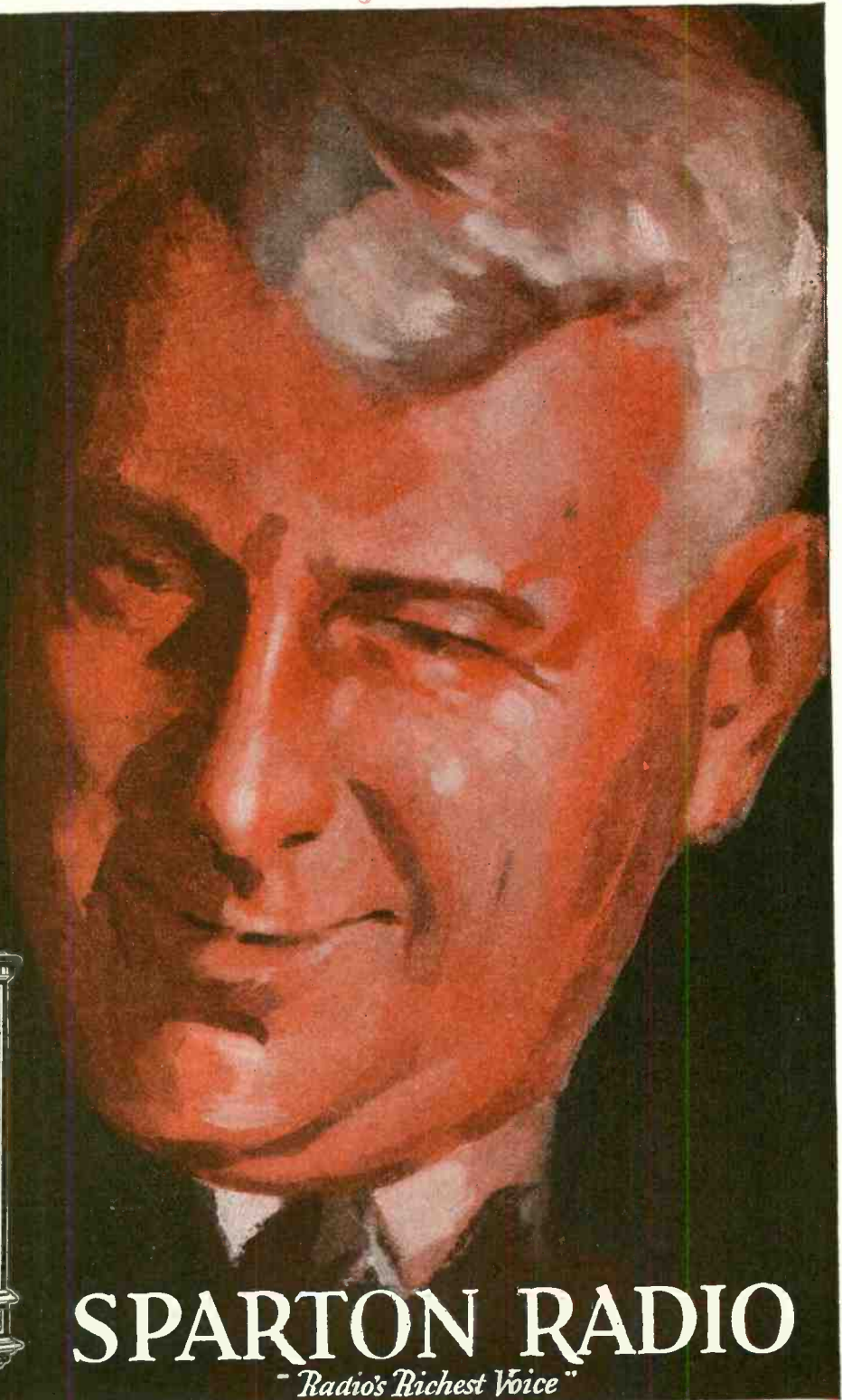

The NEW SPARTON
EQUASONNE



Model 301

SPARTON RADIO

"Radio's Richest Voice"

FACE-TO-FACE REALISM

RADIO'S NEWEST AND MOST THRILLING SENSATION
Once more Sparton has presented an outstanding radio development . . .
FACE-TO-FACE REALISM. Developments for this year have been as great
as Sparton's other achievements . . . the revolutionary *EQUASONNE* circuit and
Radio's Richest Voice. To hear the new Sparton instruments is to hear
HUMANIZED radio reception so amazing that you almost FEEL the living
presence of your entertainers. This remarkable quality is maintaining the
Sparton dealer organization as the most prosperous in the industry.

THE SPARKS-WITHINGTON COMPANY (Established 1900), JACKSON, MICHIGAN, U. S. A.
Pioneers of Electric Radio without batteries of any kind (354)

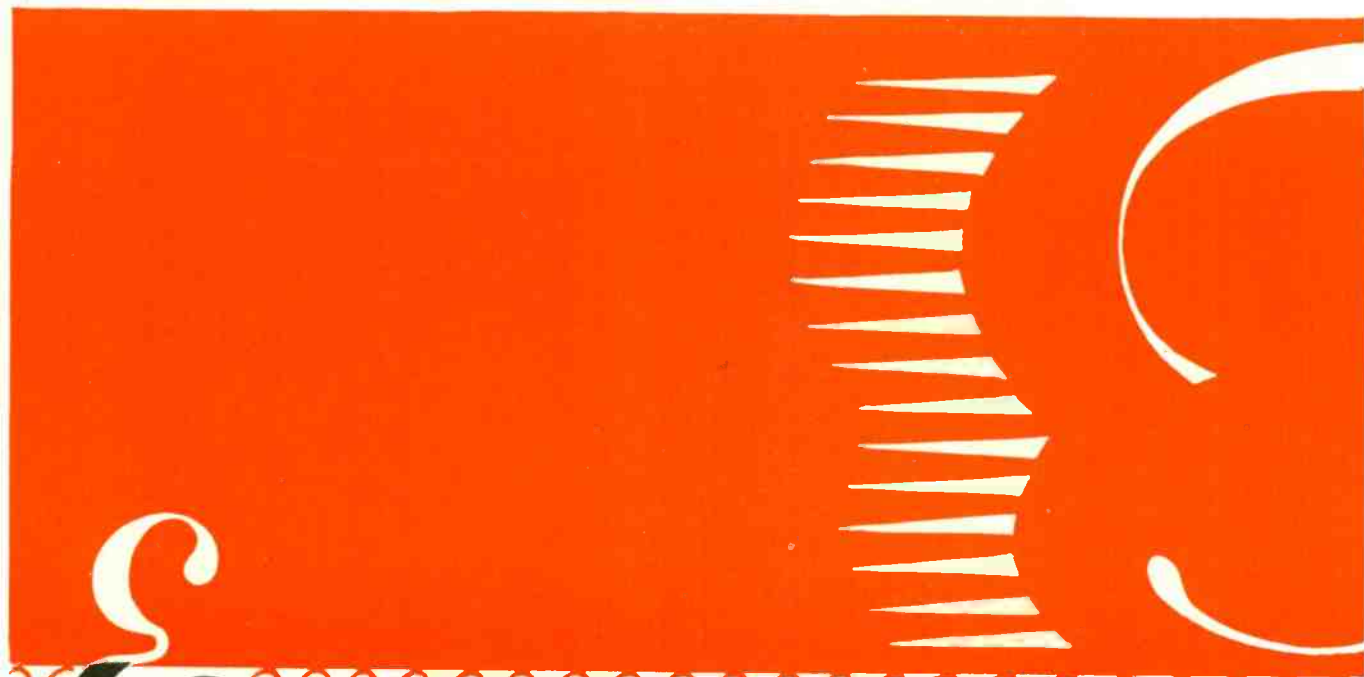

Every Sterling concertone is SCREEN GRID

THE Sterling Concertone was never "converted" to screen grid. THE VERY FIRST CONCERTONE EVER MADE WAS SCREEN GRID. In the Concertone screen grid is not a "feature"—it is a basic principle.

The Concertone is manufactured and marketed by one of the oldest and largest American makers of delicate electrical instruments. More than a generation of experience and experiment backs the Concertone. We delayed production of the Concertone until each of its features was PROVEN. Thus the Sterling Concertone represents the very latest developments of the industry, intelligently synchronized to produce a Tone so superior that the most casual listener exclaims, "Here, indeed, is Radio's most golden voice!"

The Sterling franchise, with complete sales and advertising cooperation, is available to reputable, progressive dealers everywhere.

Electrical Manufacturers for 23 years. Sterling Chargers, Eliminators, Tube Testers and Set Testers are known the world over.

The Troubadour

The ideal set for small homes or apartments. Finished in beautiful matched Walnut. 3 screen-grid tubes, with every proven modern feature. A wonderful 8 tube set, with much more power than its size suggests. Less tubes \$129.50



Sterling
CONCERTONE
RADIO

Home

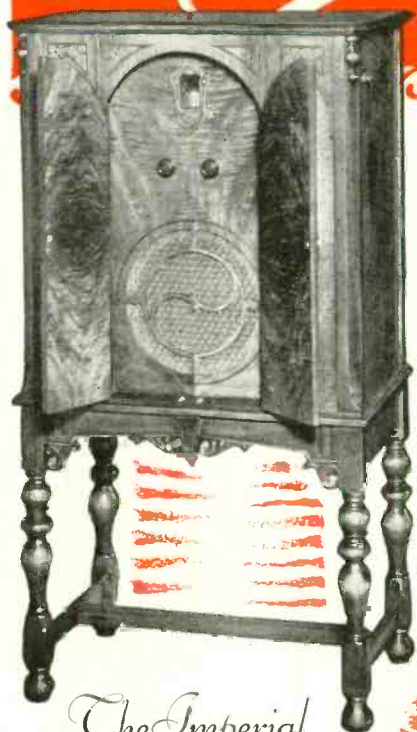

The Imperial

Beautiful Walnut high-boy; 3 screen-grid tubes, with each stage completely shielded. 2 stages of audio frequency, with push-pull amplification. One control each for tuning and volume regulation. Less tubes \$187.50

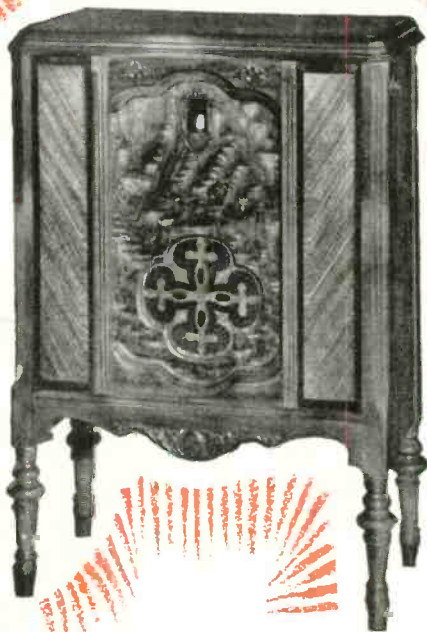

The Serenader

A handsome, medium sized Walnut low-boy houses this remarkably selective and sensitive set. 3 screen-grid tubes afford perfect long range tuning; each stage completely shielded. A set of outstanding beauty and utility. Less \$149.50 tubes

Prices slightly higher far West

Radio

THE STERLING MANUFACTURING CO.
CLEVELAND, OHIO

THE BIG THREE OF RADIO



227

The most perfect detector made — that's why SPEED 227's cost more for us to make, but not for you to buy. Burn-out proof! Fast heating — 5 seconds flat (not by words—by test!)

224

New? Not to us. In production in 1928 when demand was only experimental. While others have been announcing, we have been improving. That's what foresight and tube-making experience were able to do.

245

Perfected and in production weeks ahead of others. Very rigidly constructed — extra bracing of the elements and special anchoring of filament in the SPEED 245 give added volume and finer tone quality.

THE SPEED Tube line is, of course, complete*. But these are the "Big Three" now—the ones you're interested in particularly, because they're the ones your customers want. Carry the quality 227's, 224's, 245's,—SPEED—and your tube business is assured.

The SPEED proposition demands the consideration of every wide-awake jobber and dealer as a matter of good business. Work fast—write at once—franchises are going fast.

* The SPEED line also includes the 201A, 199, X140, WD11, WD12, 200AA, 112A, 171A, 171AC, 210A, 250, 226, 280, 281.



SPEED

CABLE RADIO TUBE CORPORATION

84-90 No. Ninth St., Brooklyn, N. Y

MAKERS OF RADIO TUBES SINCE 1924

Mighty Monarch
of the Air



Majestic dealers . . .

will break all former
sales records with this
big Majestic idea

THE SIDE-BY-SIDE TEST OF RADIO VALUE!

Here's what we're telling the public in our nation-wide advertising:

Go to any good radio dealer. Have him place the new Majestic *side-by-side* with the most expensive set in the store—both sets connected to the same aerial—with a two-way switch to operate each set in turn. Check each against the other on these seven vital points:

✓TONE ✓SELECTIVITY ✓SENSITIVITY ✓EASE OF CONTROL
✓BEAUTY ✓RELIABLE PERFORMANCE ✓QUIETNESS

Majestic . . . Mighty Monarch of the Air . . . will *out-perform* any set at any price put *side-by-side* with it.

When prospects come to the store to make the *side-by-side* test they are given every help. It is made easy for them.

Watch Majestic sales climb yet higher!

Dealers who haven't yet acquired a Majestic franchise: get in touch with a Majestic distributor—by wire or phone—and see if he cannot give you one of those few desirable territories still open.

GRIGSBY-GRUNOW COMPANY
CHICAGO, U. S. A.

Majestic

RADIO

Licensed under patents and applications of R. C. A. and G. E. Co., also by telephone, Lowell & Drumore and Hogan License Associates.

WORLD'S LARGEST MANUFACTURERS OF COMPLETE RADIO RECEIVERS



Quality in Manufacture Creates Quality in Reception

HYGRADE RADIO TUBES are made by men with years of experience in handling the problems connected with vacuum tubes.

Add to this the Hygrade developed method of testing which has maintained the high standard of Hygrade Lamps and you will understand why these tubes are living up to this same standard.

Selling Hygrade Tubes means selling better reception. Your customers will discover that the red triangle means "You Cannot Buy a Better Tube."

HYGRADE Radio Tubes

Made in Salem, Massachusetts by
HYGRADE LAMP CO.

For twenty-eight years makers of Hygrade Lamps



LIVE DEALERS EVERYWHERE...

are taking advantage of
This Money Making Franchise

EXCELLENT reasons why they want this franchise! The Mills Automatic Phonograph brings quick, sure, easy profits — more than \$500 on every sale — the best money-maker for dealers produced in our 40 years experience! Modern, all-electric, equipped with *exclusive record selector*, ornamental in appearance, perfect in performance! Our cooperative dealer plan includes factory sales help; a big national advertising program; and real profit-making discounts. What more could be desired for sure-fire profits and sales!

You Make Over \$500 Profit per Sale!

To the progressive dealer this wonderful ultra modern instrument opens a selling field of astonishing size and buying power. Every restaurant, confectionery, drug store, etc. needs The Mills Automatic Phonograph. Remember only *one* easy sale a week means over \$26,000 profit a year!

The MODERN Money Maker for Dealers

Mills Automatic Phonograph is backed by a big national advertising campaign, convincing your prospects — helping you sell! Liberal finance plan! Small wonder that live dealers everywhere are taking advantage of this money-making franchise! You too may have this same cooperation . . . WE GO THE WHOLE WAY WITH YOU!



MILLS NOVELTY CO.

4100 Fullerton Ave. Chicago, Illinois

"Makers of over 450,000 successful coin-operated instruments"

We are now making a new line of automatic electric phonographs for the home—with radio combination if preferred. Write for details.

Selective
Automatically
plays any record
you select!



Note These Sensational Selling Points

1. Earns up to \$150 cash a month or more for the people you sell!
2. Increases their trade 20% to 50%!
3. Has many *exclusive* features, including record selector!
4. 100% electric, completely automatic!
5. Needs no attention or mechanical service!
6. Has special volume control!

Mills Automatic Phonograph

Prompt decision will
bring prompt profits.
Send coupon below
TODAY!

MILLS NOVELTY CO.
Dept. A5-S, 4100 Fullerton Ave., Chicago, Ill.

With no obligation to me, send at once big free 24-page book in colors, and full details of how to make these cash profits!

Name.....
Street.....
Town.....



4 ways to insure best Results

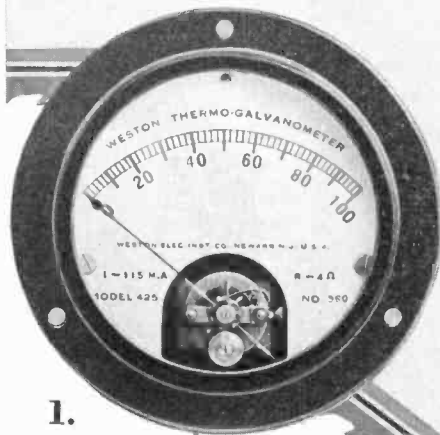

1.

1. $3\frac{1}{4}$ " diameter panel—D. C., A. C. and thermo-couple instruments for the dealer or anyone who is building up panel test equipment.

2. A. C. Model 528 Portable Ammeters and Voltmeters.

Adapted especially for testing A. C. operated radio sets. Alike in size and shape to its companion D. C. instrument (Model 489). Pair of 30" cables supplied with voltmeters.

3. Model 547 Radio Set Tester.

A. C. Voltmeter—750/150/16/8/4 volts. D. C. Voltmeter. High range increased to 750 volts. Other ranges 250/100/50/10/5 volts D. C. Milliammeter double-range—100/20 M. A.

4. Model 533 Counter Tube Checker.

Requires no batteries, operates direct from any A. C. light socket or any other A. C.—60 cycle—90 to 130 volts source of supply. Will test every type of tube, A. C. or D. C. having filament voltages of 1.5, 2.5, 3.3, 5 or 7.5 volts, including rectifying type tubes.



2.

Testing Equipment That Assures Reliability

Weston instruments, the standard of the world, emphasize the fact that reliability pays dividends. Forty-one years of constant effort to improve and perfect the art of electrical measurement has resulted in the production of instruments upon which dealers can depend to protect their financial investments.

The supreme test of every radio receiver comes after the installation is completed—but every dealer and service man can guard against inferior results by making a careful check-up at the time of the sale.

Testing equipment which insures reliability increases the efficiency of servicing work and is a factor in securing business—for the ability to quickly and accurately diagnose set troubles in a customer's presence instills confidence and makes every purchaser a booster.

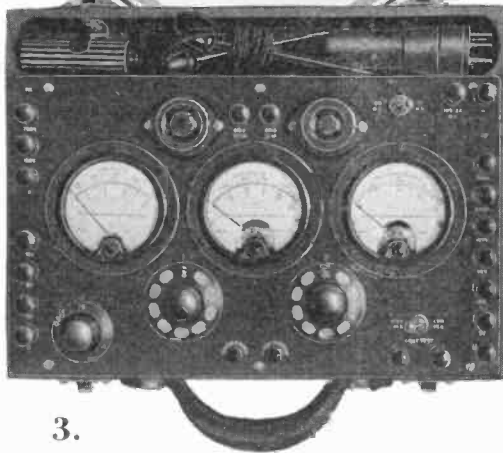

3.



4.

A Vital Part of Every Radio Installation

The Model 547 Radio Set Tester, for instance, not only locates "shorts" between grid and plate, but also discovers distortion in the audio system due to tube overloading. It also provides for filament circuit and general continuity tests and serves as a rapid tube checker.

The counter tube checker—Model 533—makes it possible to obtain with great speed the proper voltage regulation, by means of a voltage adjusting dial and voltage indicator.

The A. C. and 3-range voltmeters, like all Weston instruments, command the attention of all who appreciate the finest workmanship and demand unflinching reliability.

Weston instruments absolutely eliminate all guess work. They give the service man an immediate and accurate answer to every question he may ask, enabling him to diagnose quickly and surely every trouble.

Each instrument is handsome in appearance, light but rugged, made for long service and unflinching dependability. They will increase your profits.

Weston
PIONEERS
SINCE 1888
INSTRUMENTS

**WESTON ELECTRICAL
INSTRUMENT CORP.**
581 Frelinghuysen Avenue
Newark, New Jersey

**THERE IS
ONLY ONE
CHAMPION**

TUBES FOR EVERY RADIO



*Swing into the Season —
profiting with Champions*

CHAMPIONS represent everything the name stands for . . . Champion Radio Tubes not only have that superior quality and long life which is so necessary in building and sustaining reputation, but they also have unusual salability. Champion daily broadcasts, through the great Westinghouse Stations KDKA, KYW, WBZ and WBZA, are constantly placing this name of prestige before millions of people. Newspaper advertising is also telling the story of Champion performance, and last but not least is the very sales atmosphere which surrounds the Champion merchandise itself.

Fine Radio Tubes can only come from fine factories and long experienced organizations. This is another reason why Champions offer perpetual profit and satisfaction.

Champion broadcasts programs daily and weekly through Westinghouse Stations KDKA, KYW, WBZ and WBZA, and through Columbia Stations WNAC and WEAN



TEST THEM IN THE BOX

You know the Champion by its unique package. Each tube can be quickly tested without removal from the package. But, if the test alone is not enough, remember that every Champion is guaranteed to give perfect satisfaction to the user and any just claim by a Champion tube user will be promptly allowed.

Champion
RADIO TUBES



LICENSED UNDER R.C.A. PATENTS
CHAMPION RADIO WORKS, INC., OF DANVERS, MASS.

PERRYMAN

RADIO TUBES

for **MORE PROFITS**—Show your customers the patented **PERRYMAN BRIDGE** and **TENSION-SPRING**

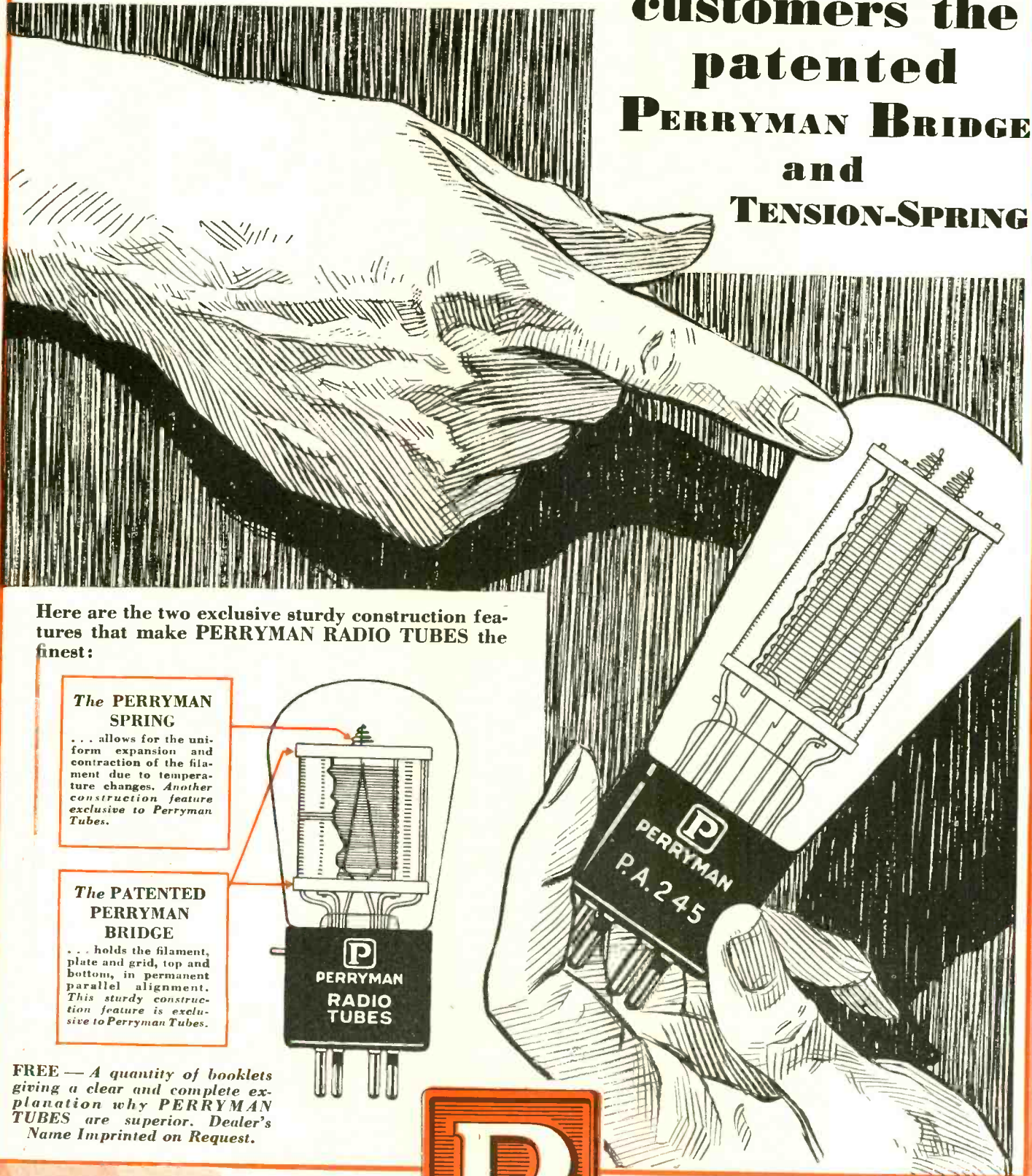

Here are the two exclusive sturdy construction features that make PERRYMAN RADIO TUBES the finest:

The PERRYMAN SPRING

... allows for the uniform expansion and contraction of the filament due to temperature changes. Another construction feature exclusive to Perryman Tubes.

The PATENTED PERRYMAN BRIDGE

... holds the filament, plate and grid, top and bottom, in permanent parallel alignment. This sturdy construction feature is exclusive to Perryman Tubes.

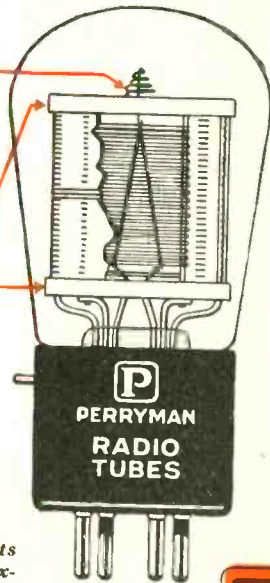

FREE — A quantity of booklets giving a clear and complete explanation why PERRYMAN TUBES are superior. Dealer's Name Imprinted on Request.



PERRYMAN ELECTRIC COMPANY, INC.

4901 HUDSON BOULEVARD, NORTH BERGEN, N. J.



TEST WITH ACCURACY

The **NEW 3-METER**

MODEL 245

**SET AND TUBE
TESTER**

Tests Screen-Grid

Particularly designed for the new sets using the 245 power tube. Tests are made by inserting plug in socket from which tube has been removed. Extra cords and tip jacks permit the use of meters individually. Checks line voltage. Strong seamless metal cover. Beautiful baked enamel finish. Leather handle. Simple. Accurate. Supremely practical.

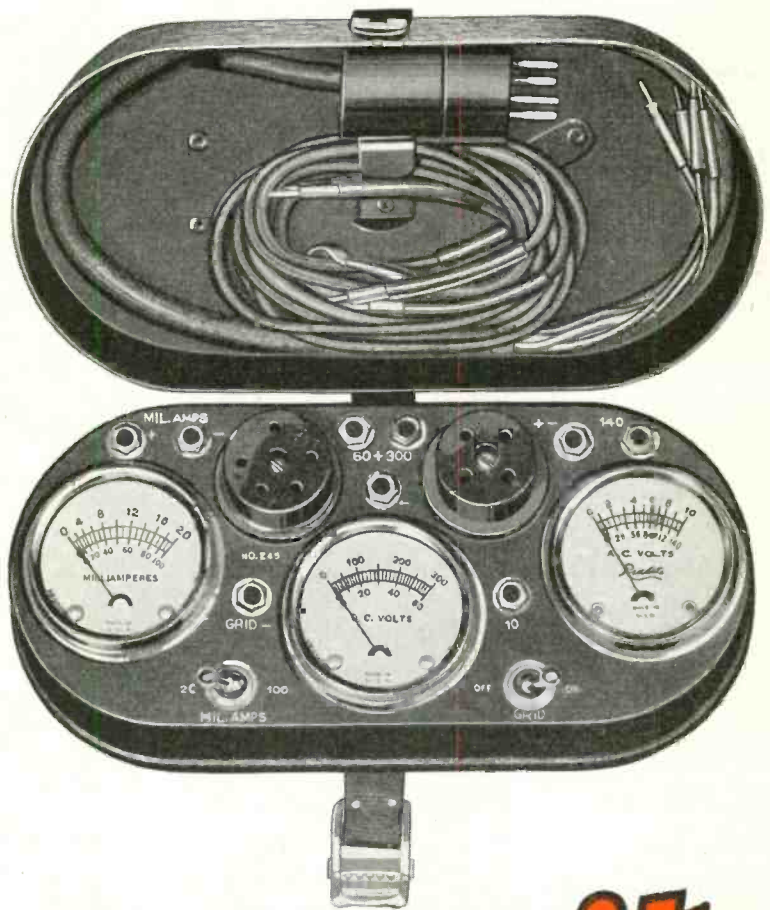

NET **\$12**

Your jobber can supply you. If ordered direct, remittance must accompany order.

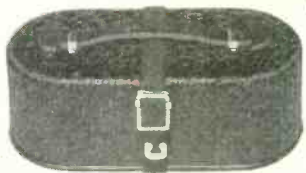

Readrite

ESTABLISHED 1904

READRITE METER WORKS, 6 College Ave., BLUFFTON, OHIO

A Perfect Combination

FOR THE PRICE OF A RADIO ALONE

SENTINEL introduced *sensibly priced radio* at the Trade Show . . . Dealers, quick to see *real profit opportunity*, entered orders far beyond our fondest hopes!

Today . . . Sentinel offers you as fine an electrical combination as you've ever seen, for you to sell at the price you ordinarily have to ask for a good radio . . . and right now there's a tremendous market for a popularly priced combination!

Modern Screen Grid Plus

Screen grid—of course—but please read the description. Note what an “edge” this model gives you over any competition. Wire us for your first shipment. You'll appreciate that orders have to be filled as received . . . and we want to serve you! Action now will prove profitable!

“You're Safe with a Sentinel!”

SENTINEL MANUFACTURING COMPANY
9715 Cottage Grove Avenue, Chicago, Ill.
Division of United Air Cleaner Company



Model No. 666-C

This marvelous combination has an ultra-modern nine tube radio, using 4 screen grid tubes plus the new 227 tubes and two 245 tubes in push-pull, and famous Quam Dynamic Speaker . . . electric phonograph of course uses the same radio circuit and speaker, the United Electric Motor, and United Pick-Up. . . cabinet finish similar to Model 668 described below. Your sales of this combination will be tremendous.

\$149⁵⁰
LIST PRICE
Less Tubes

Prices are slightly higher in Colorado and the West

Model No. 444

An ultra-modern screen grid set, with rich five-ply walnut cabinet and two-tube maple overlay. Modern and attractive in every detail, and equipped with the Famous Quam Dynamic Speaker.



\$89⁵⁰
LIST PRICE
Less Tubes



\$99⁵⁰
LIST PRICE
Less Tubes

Model No. 666

A splendid nine tube set, using 4 screen grid tubes plus the new 227 tubes and two 245 tubes in push-pull . . . a handsome five-ply walnut cabinet with two-tone maple overlay . . . and equipped with the famous Quam Dynamic Speaker!

Every important part of Sentinel Radio is made right in our own plant.



ALUMINUM

for finer reception



BBETTER tone timbre, greater selectivity, closer tuning, are highly desirable qualities that Aluminum shields bring to radio reception.

Aluminum shielding reduces interference. It eliminates electrostatic and electro-magnetic interaction.

It makes possible more compact design and adds less weight to the set than any other metal. It is very workable and presents few limitations of sizes and shapes.

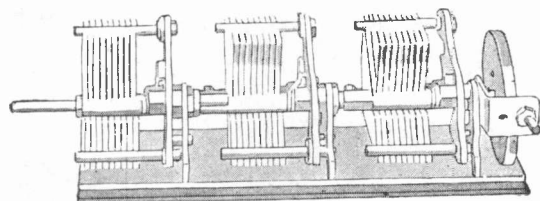

Accuracy and uniformity beyond anything ever previously attained can be secured in variable condenser blades by the use of Aluminum.

The Company produces a special sheet Aluminum for this purpose with gauge tolerance of .001 in thickness, and with the total variation within one sheet limited to .0005 inch.

This material is available to Radio set manufacturers either in sheet or in finished form.

Aluminum Die Castings combine lightness, strength, accuracy and high conductivity. They have equal strength with less than half the weight of other casting materials.

Inquiry is solicited concerning the use of Aluminum Die Castings for loud speaker frames and bases, condensers and condenser frames, drum dials, chassis and cabinets, and for Aluminum in any other form.

ALUMINUM COMPANY OF AMERICA

2462 Oliver Building, Pittsburgh, Pa.

Offices in 19 Principal American Cities

Tie up to this

Your Ship is in—

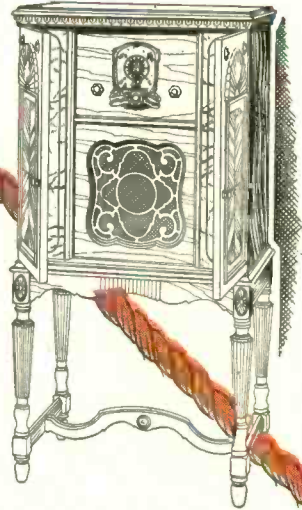
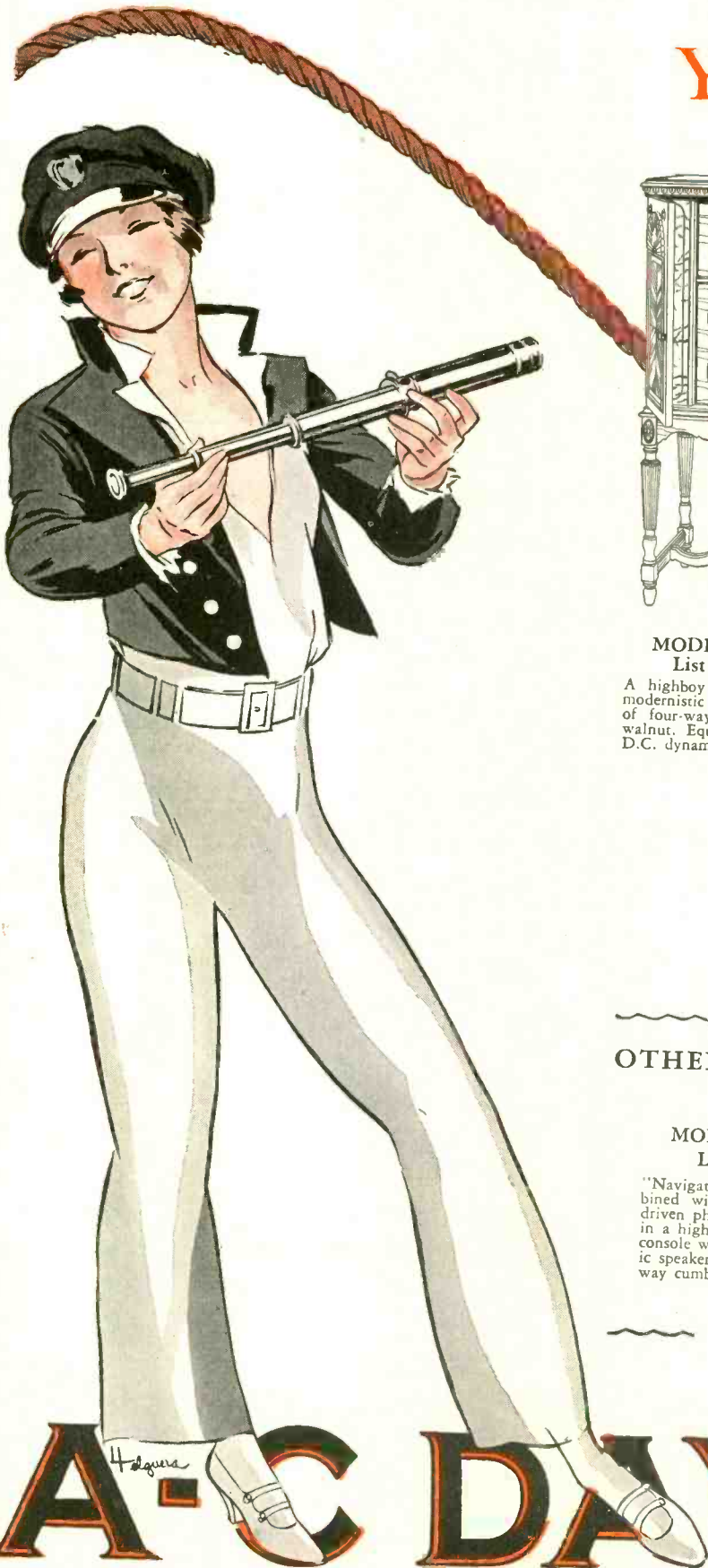

MODEL AC—9990
List Price, \$188

A highboy console of faintly modernistic design with doors of four-way matched Oriental walnut. Equipped with Jensen D.C. dynamic speaker.

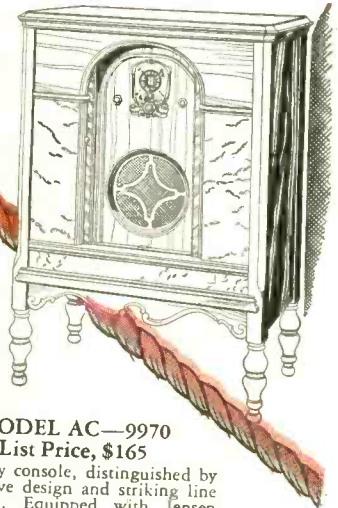

MODEL AC—9970
List Price, \$165

A lowboy console, distinguished by its massive design and striking line treatment. Equipped with Jensen D.C. dynamic speaker.

~~~~~  
**OTHER MODELS, NOT ILLUSTRATED**

**MODEL AC—99100**  
List Price, \$267

"Navigator" radio receiver, combined with a high-class motor-driven phonograph, and installed in a highly polished burl walnut console with Jensen D.C. dynamic speaker. Impressive, but in no way cumbersome.

**MODEL AC—9980**  
List Price, \$185

A radically individualized lowboy console of Moorish design. Those desiring something off the beaten path will be especially pleased with its different treatment of the speaker grill. Jensen D.C. dynamic speaker.

~~~~~  
Table models, including those battery-operated, are described under Model AC-98, illustrated on the facing page.
~~~~~

**A-C DAYTON**

# Fleet of Winners!

with—Dolly Dayton at the helm!

LET Dolly Dayton pilot you to bigger profits this year. Tie up with the jolly crew that is riding the "Navigator" to radio sales records this season. The A-C. Dayton "Navigator" is the prize craft of all radio!

Look into the "Navigator" yourself. Let your own knowledge of engineering tell you that few receivers on the market today can match this trim craft. *Nine tubes* in all, five of them in the radio frequency circuit! *Power Detection* that eliminates the noisy intermediate stage! *Push-Pull Audio*, using two of the new 245 type tubes! Jensen Electro-Dynamic Speaker—the big 11" size, to take the tremendous power of the "Navigator"

circuit, and reproduce everything, bass or treble, music or voice, in the true, realistic tone re-created by the instrument itself! Here you have *Power . . . Range . . . Tone!*

The "Navigator" is new to radio this year. Employing the Selectaphase system of complete tuning under the Technidyne circuit, it gives a new meaning to *Selectivity!* The "Navigator" actually "pre-selects" the signal and filters out interference and noise before amplification begins.

Where other consoles are just furniture, the "Navigator" cabinets are Romance. Instead of an escutcheon plate, a mariner's compass. Instead of a tuning control, a ship's wheel. The "Navigator" is the radio with a personality! All furniture, consoles and table models, are by Globe-Wernicke, the finest work of furniture craftsmen for fifty years. Prices range from \$69 to \$267, less tubes, a range to meet all competition. Heavily advertised, the "Navigator" is a line that will make new profits for you this season.

Look over the line here. Then get all the facts. Write—now—to the A-C. Dayton Company, Dept. 15, Dayton, Ohio.

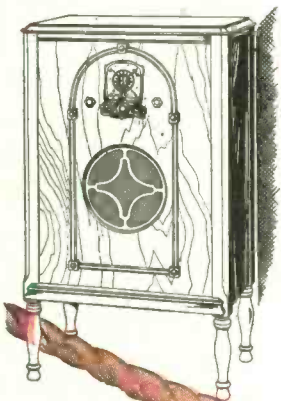

MODEL AC—9960  
List Price, \$148.50

A compact walnut lowboy console finished richly in a dull lustre. Equipped with Jensen D.C. dynamic speaker.

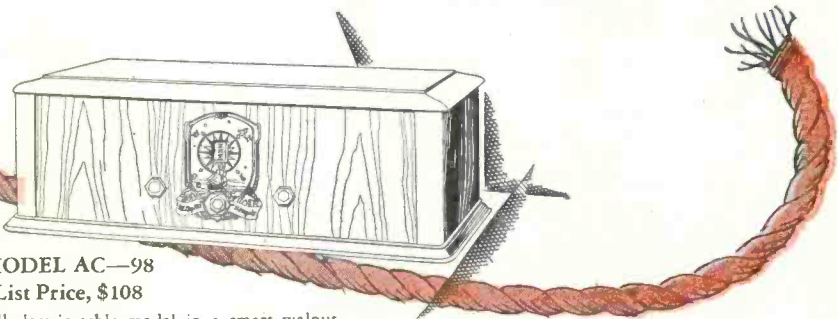

MODEL AC—98  
List Price, \$108

All-electric table model in a smart walnut cabinet with four-way matched burl walnut lid. Same model in slightly smaller walnut finish cabinet, list price, \$98. Corresponding battery models, list prices, \$79 and \$69.

“FOR THE MAN WHO BELIEVES HIS OWN EARS”  
**NAVIGATOR**”

A SCREEN-GRID RECEIVER THAT  
MONTHS OF DESIGN AND TEST PROTECT

# EVEREADY

## RECEIVERS ARE



\$185 MODEL 52 console, in a cabinet of rich walnut finish that fits in any decorative scheme whatever. Electro-dynamic speaker built in. Chassis has eight tubes, including rectifier.

LIST \$185 without tubes

### *Screen-Grid Receivers have been added to the Eveready Line!*

UNDER the designation of Series 50, Eveready dealers now have the advantage of the latest type of tube, in a chassis that is Eveready in every essential of construction, performance, reliability and dependability. Three console cabinets are offered, known as Models 52, 53 and 54, using the identical perfected Eveready Screen-Grid Chassis. Models are available in both 60 and 25 cycle, making this new all-electric screen-grid receiver available in all sections of the country.

The new Series 50 uses three screen-grid tubes as radio frequency amplifiers. So exactly and perfectly has this receiver been designed and built that the tremendous capabilities of these tubes are used to the full. Sensitivity is ten times that of last year's Evereadys and six times that of the next most sensitive modern receiver we have been able to measure. This is a real feat in receiver construction and is evidence of the high quality of Eveready Series 50.

### *Protection for Eveready dealers*

A mighty important feature of Eveready Screen-Grid Series 50 Receivers is this—cabinets preserve the same design as in Series 30 and Series 40.

The same handsome grilles that have caused so much enthusiasm in the 30 and 40 Series are retained. Eveready beauty is a tremendous, outstanding asset, and you and we capitalize it to the fullest degree.

**EVEREADY**  
TRADE MARK REGISTERED  
**RADIO RECEIVERS**



MEASURES UP TO EVEREADY STANDARDS  
ITS COMPLETE DEPENDABILITY

# SCREEN-GRID

## NOW READY!

This unique cabinet policy means freedom from style depreciation. Dealer stocks retain their value, and customers continue to be satisfied with their purchases.

This is *news* of prime importance to all those who have been shivering in their boots, fearing that screen-grid receivers would make everything else hopelessly obsolete.

Eveready knows how to build for permanence!

NATIONAL CARBON COMPANY, INC.

General Offices: New York, N. Y.

Branches: Chicago Kansas City New York San Francisco

Unit of Union Carbide  and Carbon Corporation

Licensed under patents and applications of RCA and RFL



\$235 MODEL 54, a de luxe console in the grand manner, for the most luxurious homes. Will harmonize with any background. Walnut finish in rich grain, with delicate carvings. A triumph of craftsmanship.

LIST \$235 without tubes

\$220 MODEL 53, a larger and more luxurious console, in walnut finish with decorative carvings. Same all-electric chassis as Model 52. All cabinet designs are exclusive with Eveready.

LIST \$220 without tubes

\*THE MOST SENSATIONAL EVENT  
OF THE YEAR!



**BOND**  
ELECTRIC

OPENS THE 1929 FALL SEASON WITH A RECORD-BREAKING

**\$500,000**  
**SELLING DRIVE**

And Points the Way for All its Dealers to  
**RIDE TO GREATER PROFITS!**

\*SEE OPPOSITE PAGE FOR FURTHER FACTS

# Here's why BOND ELECTRIC is your ONE BEST BET in the Race for BIGGER BUSINESS:



1. BOND will spend \$500,000 in promoting a Great Nation-Wide PRIZE CONTEST to make October, November and December record-breaking profit months for its dealers.
2. BOND will offer **\$10,000.00** in Prizes to the **Public** for the best answers received in its nationally advertised "PICTURE PUZZLE" Contest!
3. BOND will offer **\$2,500.00** in Prizes to the **Trade** for the best merchandising co-operation extended during the Contest by its Authorized Dealers!
4. BOND will offer **\$2,500.00** in Prizes to **Jobbers' Salesmen** for their share in making the Contest an overwhelming success!
5. BOND will advertise the \$10,000.00 "PICTURE PUZZLE" Contest with large-space announcements in the SATURDAY EVENING POST and COLLIER'S—in a list of the nation's leading FARM PAPERS—and in over 200 important CITY NEWSPAPERS, which will feature the names and addresses of all Authorized BOND Dealers located in those cities and their trading areas!
6. BOND will give its dealers FREE of Charge the most dramatic and compelling Window Display material it has ever put out!
7. BOND will give its dealers another irresistible magnet which will draw millions of people into their stores!
8. BOND will introduce two vitally new and different features in its line of Flashlights and offer special advantages to all dealers handling BOND Radio Batteries and Tubes!
9. BOND will focus the entire force of its Fall Campaign upon its dealers to speed up sales and increase their store traffic!

Everything's Set for a Record-Smashing Drive

LET'S GO!!



## BOND ELECTRIC CORP

JERSEY CITY, N. J.

Chicago      San Francisco      Kansas City

Makers of Radio "A", "B" and "C" Batteries,  
Storage and Dry Batteries, High-Vacuum Radio  
Tubes, Flashlights and Mono-Cells.

BOND ELECTRIC CORP., Jersey City, N. J.

Gentlemen:

Please send us full information about the \$15,000 BOND "PICTURE PUZZLE" CONTEST and the way in which we can derive the greatest benefit from it.

Name \_\_\_\_\_

Address \_\_\_\_\_

City \_\_\_\_\_ State \_\_\_\_\_



## Two Things Sylvania Dealers Won't Worry About.

Every Sylvania Dealer will get all the tubes he needs. Yet Sylvania Tubes won't be dumped on the bargain counters.

Throw *those* two worries out!

Plenty of Sylvania Tubes of Sylvania Excellence to go 'round. But not to go 'round the corner to the push-cart store.

For we still insist on fifteen tests of every Sylvania Tube. And tubes that don't make good go into the scrap heap.

Ask a Sylvania Jobber about Sylvania Tubes. But get the first hand facts from some Sylvania dealer.

See our exhibit at the  
Sixth Annual Radio  
World's Fair. New  
Madison Sq. Garden,  
N. Y., Sept. 23-28,  
Inc. Booth 7, Sec. V.

SYLVANIA PRODUCTS COMPANY  
EMPORIUM, PENNSYLVANIA

# Sylvania

## RADIO TUBES

Licensed Under RCA Patents

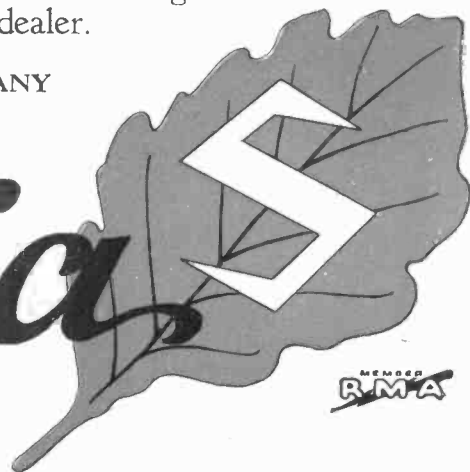

MEMBER  
RMA

❖

## “Radio’s BIG Year”

**A**LL signs point to great things ahead, this season—for the radio public, the radio industry, and the radio trade. With September, the curtain rises on an unparalleled combination of circumstances favorable to radio business.

1. **The Public is Receptive** to radio as never before. It has full confidence in today’s sets, and wants the latest and best.

2. **Wonderful Broadcasting is Ahead.** Regular programs will be better than ever, more headliners and feature events will be on the air, sports and national occasions will compel attention, and, capping the whole, a series of trans-oceanic programs from Europe and from the South Pole, is assured this season.

3. **The Potential Audience** for radio *is now doubled.* The system of “cleared” broadcasting channels instituted late last season by the Washington authorities insures that every village and cross-roads, every farm house, ranch home and island dwelling will this Fall be reached with a choice of good programs. Every home, every farm, is today a prospect for radio sales.

\* \* \*

**B**UT selling must start early this season. And it must go on vigorously every minute of the working day, if the radio trade is to take advantage of the opportunity before it.

Sales volumes must go up, if last year’s dollar totals are to be repeated—for individual sales this season will be conducted at lower unit prices in the popular lines.

Sales volumes must go up, also if the production schedules of optimistic manufacturers are to be absorbed by healthy selling.

Wise manufacturers will, of course, guide their production orders by sales results, even in this favorable year, and undoubtedly, plans laid last spring for an output of some 6,000 sets this season, will be modified in the direction of a normal increase over last year’s actual sales figure of 2,600,000 sets.

\* \* \*

**F**ROM now on, the situation is in the dealer’s own hands. He will have to **SELL** as he has never sold before.

He will have to scour his territory for prospects and *go after every prospect in sight.* He will need to institute aggressive telephone canvassing and house-to-house specialty sales methods. He must give home demonstrations. He must advertise. He must tie in his own local publicity with national campaigns. He must make his show windows and his store interior become effective tools in his campaign. And having landed his customer, and collected his money, that customer must then become the center of a new series of campaigns to equip the customer’s friends with up-to-date radio sets.

Moreover, every man and woman on the dealer’s payroll must this season become imbued with the sales purpose—service men and delivery drivers, as well as floor sales people and office employees. Each can help produce prospects or sales.

Every ounce of man power, every last degree of sales purpose will be needed between now and Christmas to fulfill the 1929 radio opportunity, and make this “Radio’s Big Year.”

# 109 Radio Merchants Answer the Question—

# What

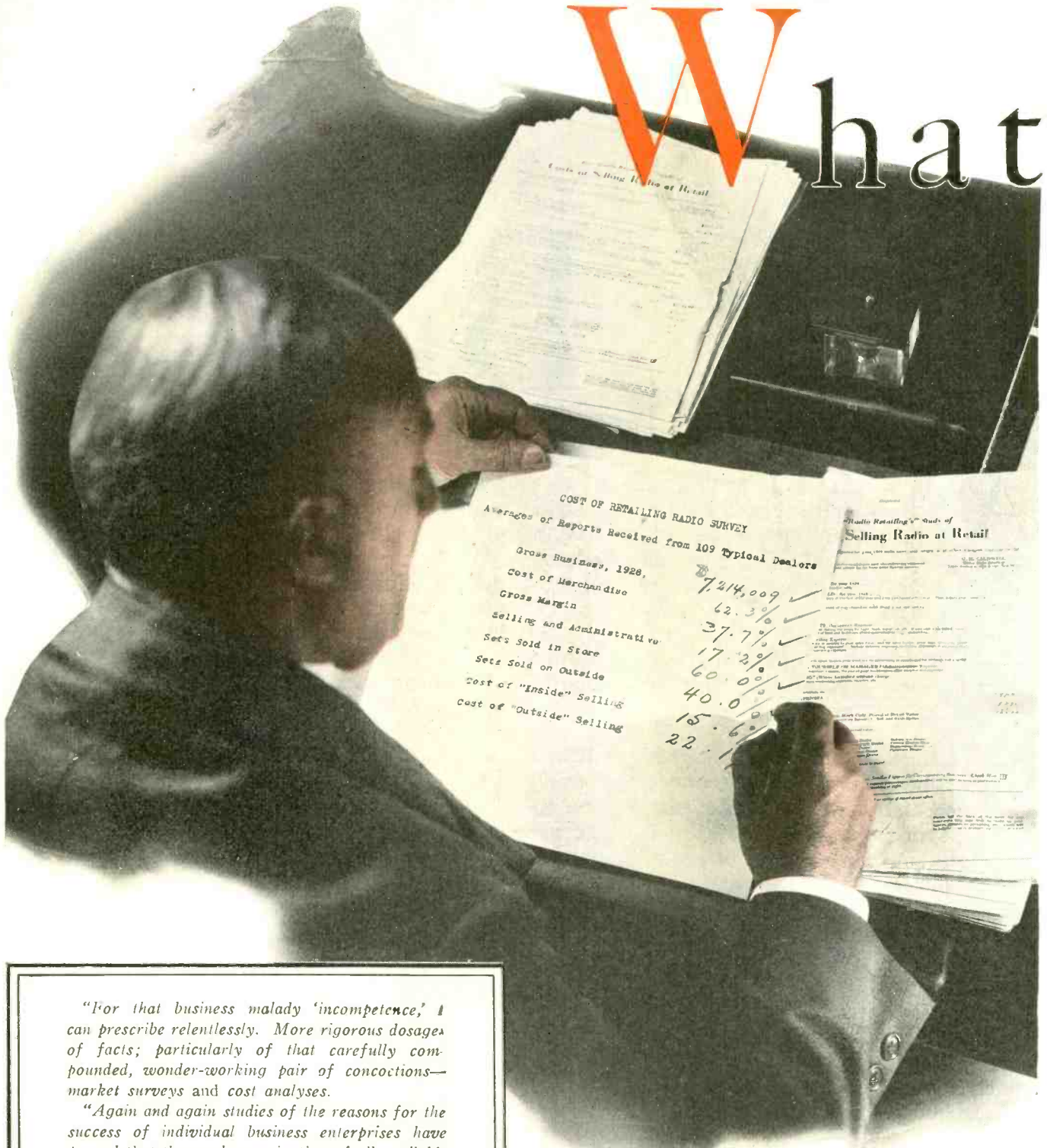

**COST OF RETAILING RADIO SURVEY**  
Averages of Reports Received from 109 Typical Dealers

|                            |               |
|----------------------------|---------------|
| Gross Business, 1928,      | \$7,214,009 ✓ |
| Cost of Merchandise        | 62.3% ✓       |
| Gross Margin               | 37.7% ✓       |
| Selling and Administrative | 17.2% ✓       |
| Sets Sold in Store         | 60.0% ✓       |
| Sets Sold on Outside       | 40.0% ✓       |
| Cost of "Inside" Selling   | 15.6% ✓       |
| Cost of "Outside" Selling  | 22.1% ✓       |

**Radio Retailing's Costs of Selling Radio at Retail**

"For that business malady 'incompetence,' I can prescribe relentlessly. More rigorous dosages of facts; particularly of that carefully compounded, wonder-working pair of concoctions—market surveys and cost analyses.

"Again and again studies of the reasons for the success of individual business enterprises have proved that thorough examination of all available data as to the actual cost of doing business, item by item, and as to the specific sources of profit, develop the most potent weapons against commercial weaknesses. A mastery of all of the facts on any given retailing problem generates self-reliance, stimulates true competence—and competence is the most effective offensive in combating competition."

Dr. Julius Klein, Assistant Secretary of Commerce.

**T**HE "returns" are in on *Radio Retailing's* study of the costs of selling radio at retail. This research was conducted in conjunction with the Federated Radio Trade Association and the National Association of Music Merchants. It makes mighty interesting reading.

Seven thousand confidential questionnaires were mailed to selected lists of merchants in every state in the Union. These retailers were asked basic questions as to their business experience in 1928. From the mass of returns there has been compiled the vital statistics

# of Selling Costs?

PART I of a series of analytical studies of retailing expenses and management based on a joint survey of the industry conducted by this magazine, the Federated Radio Trade Association and the National Association of Music Merchants.

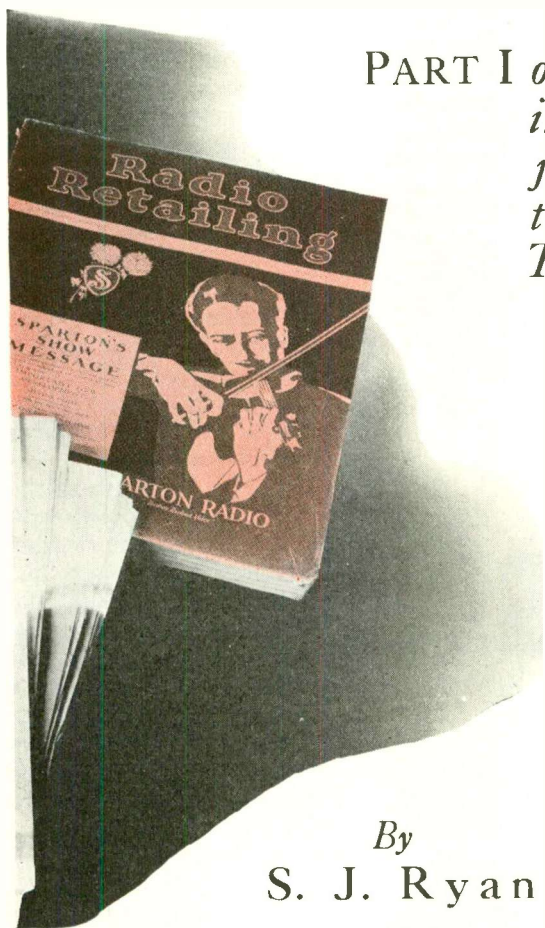

By  
S. J. Ryan

of 109 typical retail radio operations. These range from the little "side line" business of \$900 to those exceeding \$400,000. Their total was \$7,214,009. Scattered geographically, as they are, they present a splendid cross section picture of conditions as they actually exist in the radio retail trade. They cover all types of outlets, specialty, music, hardware, furniture, department store and central station.

What is the *actual cost* to the radio merchant of the merchandise he sells? How does gross volume affect this cost? Has the "big" dealer a greater margin advantage than the little fellow? How much does the man doing a \$50,000 business pay out in salaries? The fellow that does \$200,000? What percentage of radio is sold in the store? How much outside? Which method is more costly?

These, and other questions equally important, no man living has been able to answer conclusively—but in this, and succeeding issues, we will present *facts* which will serve as a basis for deductions probably as accurate as anywhere obtainable.

To other retailers of radio products these facts offer a definite standard of comparison by which they may measure their own operations. To the wholesaler and the manufacturer they suggest means for being of greatest service to their customers.

In this issue we present group figures on sales volumes, the cost of merchandise sold, gross operating margins, costs of selling and administration (the largest single factor in the cost of doing business) and the percentage of inside and outside sales and their relative costs.

YOU A DIRECTOR

Now let us suppose, Mr. Reader, that these 109 stores compose the Retail Radio Company. Assume that you are a member of its board of directors and that the operating statement of these stores, in detail and in total, is before the Board for its consideration.

You will find that some of the stores have made a profit and that others have incurred a loss; some show a balanced operation but the majority alternate strength and weakness. After a study and discussion of these figures would you not set up standards of operation based on the revealed *facts*? That is the purpose of this survey.

The \$7,214,009 of radio sold last year by these 109 stores cost \$4,492,661, or 62.3 per cent. This left a gross operating margin of 37.7 per cent. Out of this latter amount all expenses had to be paid.

There is a lot of talk about discounts in the radio field, but in retailing the discount is just the *starting point*. Obviously these merchants received a larger discount than 37.7 per cent on their *purchases* because they realized that amount on what they *sold*.

The cost of merchandise sold was arrived at by putting down the amount of inventory at cost at the beginning of the year, adding to this the amount of purchase at cost during the year and subtracting the inventory at cost at the end of the year. The *cost* of merchandise is an unvarying factor, but retail prices are not necessarily so as we all know to our sorrow.

Various factors naturally operate to increase the cost

of merchandise sold and reduce gross margin available. For example, these inventories include all trade-ins. It is a common practice to sell trade-ins at the allowance price—its cost to you—plus reconditioning expense (when you can get it). Such merchandise is sold at a loss of course. Likewise you might buy a set at a discount of 50 per cent from list and eventually sell it at a discount of 25 per cent from the list to get rid of it, and be doing a smart merchandising job to get it off your hands. But your margin on sale is then only 33½ per cent. It has even been known to happen that the manufacturer has reduced the list price while you still have merchandise at the old list in stock. The cost hasn't changed however. All this runs up the cost of selling.

*Do the larger stores have a greater gross margin upon which to operate than the smaller ones?* Yes. Twenty-two stores doing a volume of \$100,000 or over and with total sales of \$4,194,760 show a gross margin of \$1,642,431 or 39.2 per cent. Twenty-five stores with volumes ranging from \$50,000 up to \$100,000, whose total sales volume amounted to \$1,726,829, had a gross margin of \$629,577 or 36.4 per cent. Sixty-two stores with volumes ranging from \$900 up to \$50,000 sold \$1,292,420 of radio last year and retained a gross margin of \$449,340 or 35.5 per cent.

Here is a progressive decline in gross margins by groups, but while it is quite probable the larger stores received somewhat larger initial discounts, that would not necessarily account for the larger gross margins on merchandise sold. Possibly they merchandised their businesses better. We can find out a bit more about that when we see their stock-turnover figures and detailed operating costs.

Naturally there are violent fluctuations in gross margins in the individual stores in each group. Group A with an average gross margin of 39.2 per cent, shows variances from a low of 26.5 per cent to a high of 43.9 per cent; group B (average 36.4 per cent) runs from 17.7 per cent (ouch!) to 43.2 per cent; group C from 18.7 per cent to 44.1 per cent, with an average of 35.5 per cent. As stated, the gross margin for the 109 stores was 37.7 per cent. This is not a bad showing.

*Does it cost the large radio store less for salaries in proportion to sales than the small one?* No! Before giving the explanatory figures by groups I might mention that while our questionnaire requested two sets of figures on this expense, sales clerk hire (including delivery and supplies) and administrative expense (including management and office salaries and supplies) we found that in the small business these expenses were not usually segregated. Frequently the owner or manager devoted part of his time to selling, etc. For purposes of comparison therefore we have grouped all selling and administrative salaries and supplies. Detailed figures, where furnished, will appear in the individual tabulations in the October issue.

It cost the 22 stores in Group A 17.7 per cent for

selling and administrative expense last year; the 25 stores in group B paid 17.6 per cent and 62 stores in group C got by with 15.1 per cent. There were the usual variations in the individual operations, of course, but averages are pretty good indexes in a list as widely scattered as this one. The cost to the 109 stores was just under 17.2 per cent. This figure, by the way, compares very favorably indeed with other lines of retailing.

*Is more radio sold today inside the store or out?* In this group of 109 stores the volume ran about 60 per cent inside and 40 per cent outside. We say "about" because it all depends upon the definition of outside selling. A great many dealers did not answer our inquiry upon this point because they were undoubtedly uncertain in their own minds. For the purposes of this survey we define outside selling as sales made on "cold-canvass" or leads by outside crews. A sale closed on a home demonstration which originated by the customer coming into the store and selecting a set, subject to a satisfactory demonstration in the home, is classified as an inside sale. It is unfortunate we could not secure more extensive information on this point but there is no question that the percentage of outside selling has increased since *Radio Retailing's* survey of 1925.

*Is outside selling responsible for the larger volumes of bigger stores?*

In order to arrive at the relative costs of inside and outside selling we divided the stores into five groups, and we will answer the above question in that manner. The largest group volume was done by the stores whose sales were 65 to 80 per cent outside; the second largest group volume by stores whose sales were 90 to 100 per cent inside; the third largest volume by stores whose sales were 65 to 80 per cent inside; the

fourth by stores whose sales were fifty-fifty and the smallest group volume of stores reporting by those whose sales were 90 to 100 per cent outside.

Another angle: The sales of the two groups, 65 to 80 per cent outside and 90 to 100 per cent outside were very slightly larger than the two respective groups of inside selling stores. The fifty-fifty group held the balance of power. We found, however, that some merchants classified as outside sales all sales closed outside the store.

#### OUTSIDE SELLING

*Is outside selling more costly or does the increased volume reduce the percentage so it is comparable with inside selling costs?*

We will go back to the groups again for our answer. Please bear in mind these figures are total salaries and supplies, in order to get an accurate comparison with all sizes of stores.

The group of stores doing 65 to 80 per cent of inside selling had the lowest expense, namely 13.9 per cent; the next lowest was the 50/50 group with 14.5 per cent; then followed the 90 to 100 per cent outside group

(Please turn to page 92)

#### Comparison of Gross Margins by Amount of Business

| No. of Stores | Annual Volume              | Total Sales | Gross Margin | Per Cent |
|---------------|----------------------------|-------------|--------------|----------|
| 22            | \$100,000 or over.....     | \$4,194,760 | \$1,642,431  | 39.2     |
| 25            | \$50,000 to \$100,000..... | 1,726,829   | 629,577      | 36.4     |
| 62            | \$900 to \$50,000.....     | 1,292,420   | 449,340      | 35.5     |
| 109           |                            | \$7,214,009 | \$2,721,348  | 37.7     |

*Gross margins decline as volume decreases.*

#### Comparison of Sales and Administration Expenses

| No. of Stores | Annual Volume              | Percentage for Sales and Administration |
|---------------|----------------------------|-----------------------------------------|
| 22            | \$100,000 or over.....     | 17.7                                    |
| 25            | \$50,000 to \$100,000..... | 17.6                                    |
| 62            | \$900 to \$50,000.....     | 15.1                                    |
| 109           |                            | 17.2                                    |

*The smaller store has a slight advantage with respect to the cost of selling and administration.*



# What a *W*inter for Radio!

Coming "Epochs of the Air"  
That will Boom Business

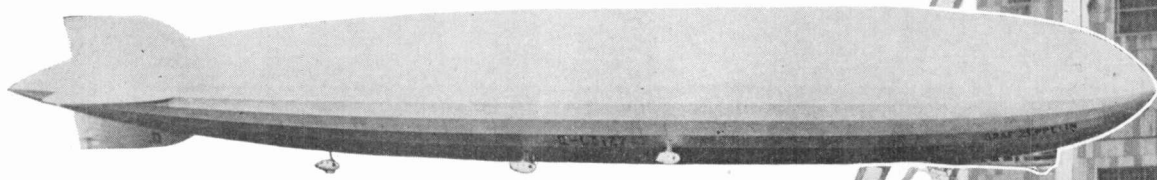

"PROGRAMS that will far surpass in attention and entertainment value anything heretofore heard!" That's the boil-down of the opinions of top-executives with the National Broadcasting Company, Columbia and American chains, concerning their plans for Fall and Winter air events, as personally stated to a representative of this magazine.

Master programs will mean a greater public interest in radio—and more business for the alert dealer. Plan to turn every outstanding broadcasting event into dollars during the coming season.

Space permits only the briefest outline of just a few of the "high light" epochal events scheduled for the coming months. Here they are:

*Trans-oceanic Broadcasting* — Just around the corner. Tentatively scheduled for October, during the celebration, by the electrical industry, of Light's Golden Jubilee. National hook-up. Some of the most noted personages of the old world will speak. Interchange of programs between U. S. and Germany to begin immediately, according to official release from NBC.

*Entertainment* — The appearance of Sir Harry Lauder the other night, over a special NBC chain, is indicative of the headlines that will be signed for 1929-30. Others are: Mr. and Mrs. Sketches, by Briggs (Graybar Hour, Columbia); Paramount-Publix Hour. Paramount artists will be available for chain programs (Columbia) and for local stations; A "bigger and better" General Motors Family Hour (NBC); Brunswick Recording Artists (Columbia)—this company also will run feature programs during the "off" or demonstration hours;

*Sir Harry Lauder is one of the latest notables to be signed up for the super-entertainment of the radio listener.*

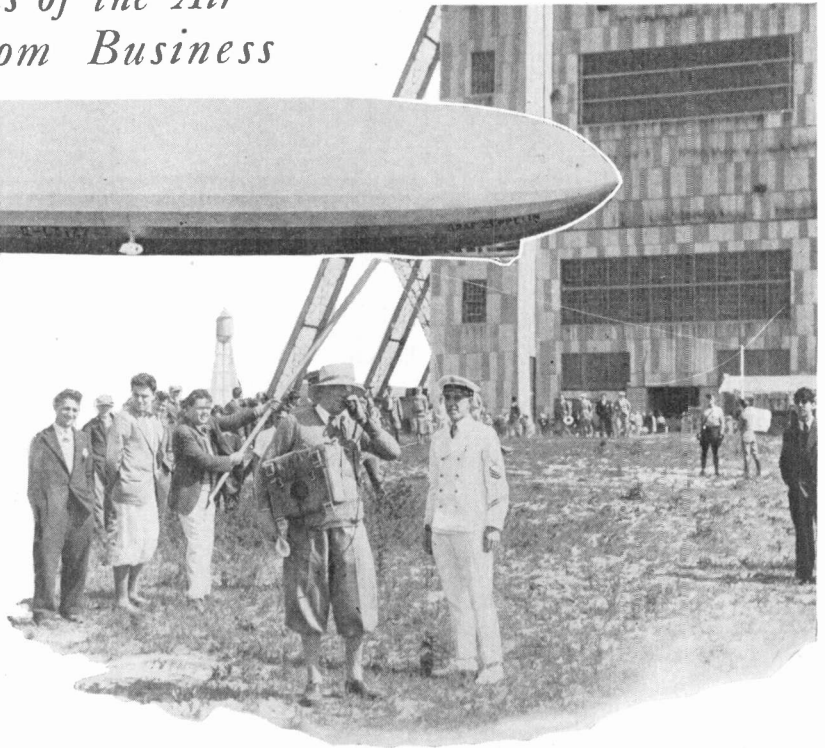

Floyd Gibbons and staff broadcasting the arrival of the Graf Zeppelin. A special portable transmitter and a mobile, 30-foot antenna was used. This illustrates how every effort is being used to provide the American public with unique air entertainment.

"RKO Radio Hour," Radio-Keith-Orpheum over NBC chain every Tuesday at 10:30 a.m. Also RKO weekly matinee Thursdays at five.

*Educational*—"Timely Topics," N. Y. Herald (NBC); National Farm and Home Hour, Dept. of Agriculture, 31 stations; rapid extension of radio in the schools (see article in this issue); the "Byrd Tests," from the bottom of the World; analysis of International Events by Dr. Julius Klein, and Col. Lindbergh, who will talk for the Ohio School of the Air.

*Of Special Interest to Women*—The National Woman's Party weekly talks to women.

*Promotional*—The creation of a foundation to "stimulate program artistry and focus public attention on radio stations, chains, and artists presenting worthwhile broadcasts," by the Freed-Eisemann Radio Corporation; the Atwater Kent Auditions.

*Bringing Radio, Stage and Screen Together*—As a result of recent mergers between broadcasting corporations, theatrical interests and Hollywood magnates, radio set users, this winter, will have the pleasure of hearing such celebrities as: Clara Bow, Nancy Carroll, Ruth Chatterton, Maurice Chevalier, Dennis King, Evelyn Brent, William Powell, Richard Arlen, George Bancroft, Charles (Buddy) Rogers, Gary Cooper, Gertrude Lawrence, Hal Skelly, Charles Ruggles, Helen Morgan, Eddie Cantor and Rudy Vallee.

Due to this same reason outstanding musical talent, formerly unavailable, will now be "on the air."

# Selling *the* FARMER

*Why* Jerry Taylor

*Sold 400 Farm Sets in 30 Months*

1. Allotted territory based on productivity.
2. Remuneration plan that "clicked".
3. Picked men who understood the farmer.
4. Demanded daily reports and strict discipline.
5. Not afraid of the mail order houses.

SELLING the farmer boils down to a question of territorial planning plus certain clear-cut control policies, according to Jerry Taylor, of the Kipp Music Company, Manhattan, Kansas. Based on an active experience of 30 months of intensive merchandising, during which period he sold 400 battery-operated radio receivers, Taylor advocates the application of "the rule of 4" to this problem.

"Four district representatives, each operating in 400 square miles of territory can cover a total market of approximately 4,000 farm houses," he declares. In Kansas there is an average of 2.5 well-to-do farmers per square mile.

Carrying this rule a step further, he advocates an objective of four calls per day. If this latter plan is faithfully practiced sales will average not less than two a week.

When this simple formula is put up to a likely rural representative it becomes, he says, a comparatively easy matter to obtain, and retain, the right type of men for this work.

## CONTROL ESSENTIAL

But division of territory is simply the beginning. The real nub of successful farm operation, it appears, lies in the proper formulation and rigid application of certain definite sales policies—best presented by a description of what Taylor actually did.

He hired men who were "farm minded." They talked like farmers and dressed like them; they knew the farmer's problems—in truth, they *were* farmers to all intents and purposes, but they were not afraid to apply a little high-pressure stuff if the prospect was a good risk.

He paid these men 15 per cent on all original rural orders.

His contract with these men provided that they must own and operate their own cars and attend to all deliveries, installations and minor servicing requests as well as assuming half the loss on any trade-in transactions or bad accounts. He sugared this pill, however, by an ar-

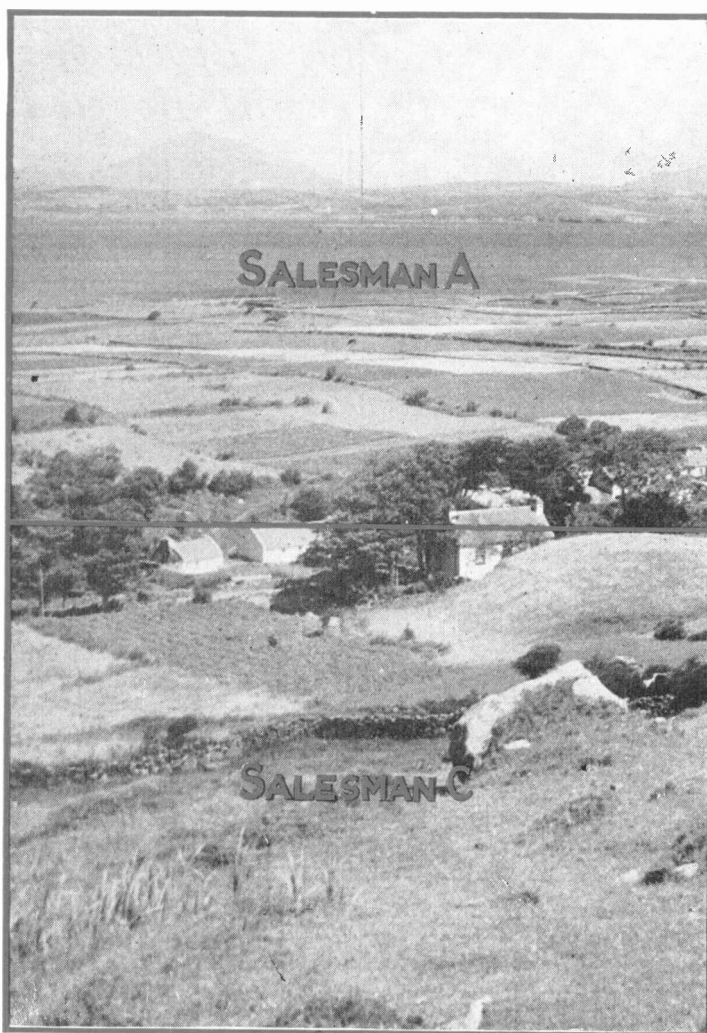

range where by half of the \$5 aerial equipment and installation charge found its way into the salesman's pocket. Furthermore, as was no more than fair, the salesman shared equally in the profits from trade-in resales.

Sharply at 9 o'clock *every morning*, each representative was required to report in person or by telephone.

A liberal portion of each man's sales training was devoted to meeting that bug-a-boo, mail-order house competition. Taylor saw to it that his men were supplied with mail-order catalogs—and that they could quote on a set whose value was commensurate with the product offered by this type of competition. Commensurate value, in this instance, meant personal service and battery-charging facilities as well. As soon as the farmer's interest was sufficiently aroused and he was convinced that the Kipp Music Company could more than meet the mail-order or chain-store proposition, an effort was made to sell him a better grade outfit. During 1928, the average price for a complete installation, including storage battery, was \$136.

# by the Rule of 4

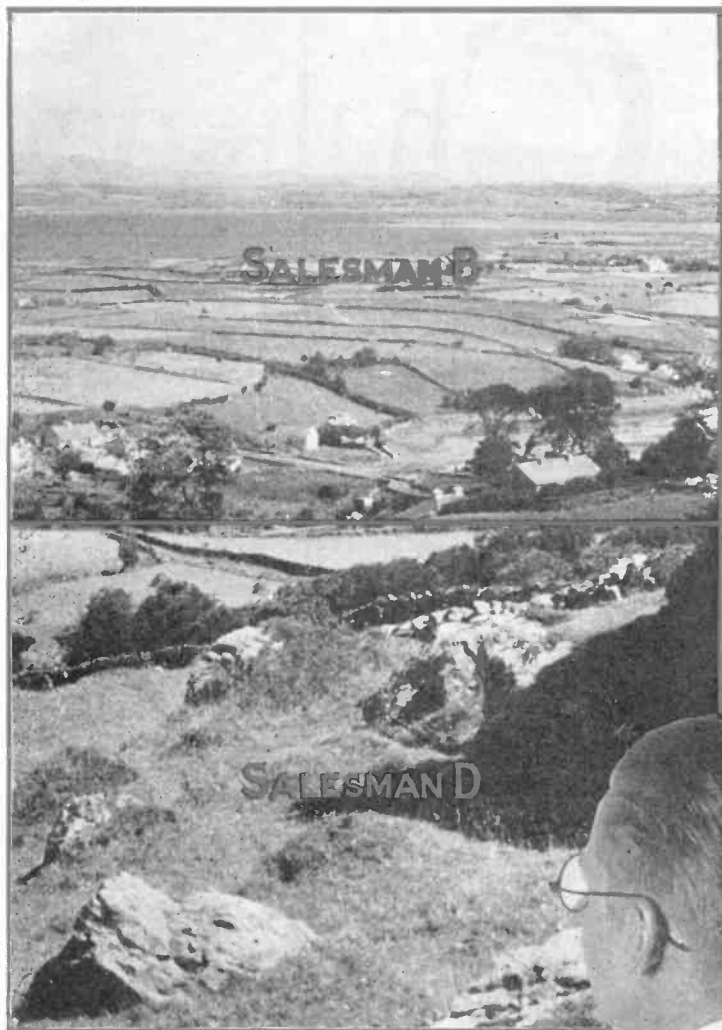

MILES

## CUTTING SERVICING COSTS

Another point that was emphasized during this training period was to sell the user on the wisdom of bringing in his battery for recharging at least every three weeks.

"Such a policy," states Mr. Taylor, "not only insures satisfactory service but it gives me an opportunity to nip service troubles in the bud. To encourage this practice, we charge the battery the first time free. After that the price is fifty cents. A full battery and frequent store contacts with customers will reduce service calls 70 per cent. It is an easy matter to prove that a storage-battery equipment for the A circuit is not only best but costs less in the long run."

Visualizing the unusually potent value of good will advertising among those whose social life is as neighborly as that of the farmer, Taylor keeps his customers'

4 Salesmen  
40 Miles Square  
400 Radio Sales  
4000 Farmer Prospects

sets in efficient operating condition during the summer months. For the past two years he has paid a rural representative a moderate drawing account to contact users from June to September. The leads acquired because of this special service were turned into sales during September and October and more than repaid him for seeing to it that the sets were kept operative during the off season.

It has been stated that Taylor's profit from rural selling was equivalent to that from a like amount of city

business. He attributes this to the preceding policies and also to the fact that many farmers want good sets and generally complete their time payment obligations within four months from date of purchase. As he checks each risk with the local bank before delivering the material his losses have been less than one per cent.

"Keep your eye on the farm market," he declares. "With the coming of high efficiency tubes and batteries it won't be long

now before this business will be classed, by an increasing number of dealers, as one of their best bets."

The prophetic wisdom of this observation is verified by news, elsewhere in this issue, of sets especially suited to farm requirements, and by the changing attitude of many dealers toward the ruralite.

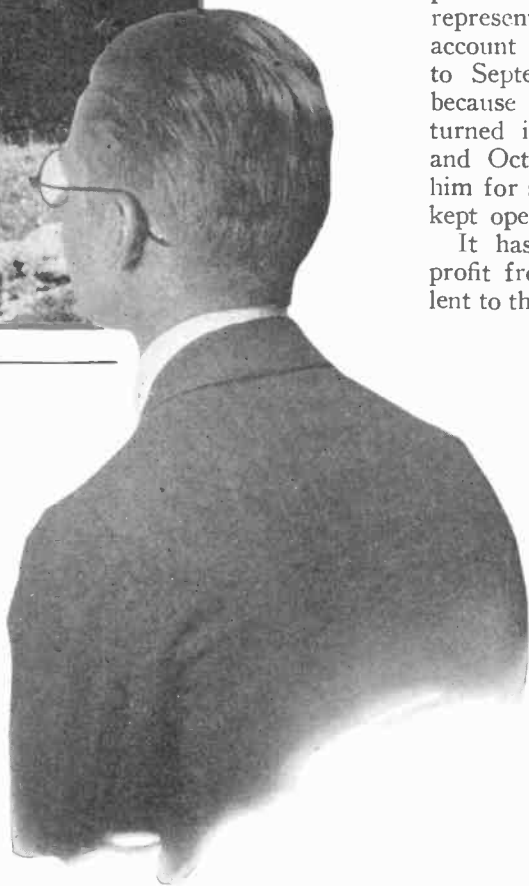



# Meeting the Challenge

MAX SHORE,  
the motivator of  
this idea.

Gross sales, since Radio Vision's incorporation, are from 20 to 40 per cent greater than the combined business of its twenty-three dealer members for the corresponding months of 1928. Here are the 1929 figures:

|                |           |
|----------------|-----------|
| February ..... | \$111,503 |
| March .....    | 158,441   |
| April .....    | 156,783   |
| May .....      | 192,778   |
| June .....     | 158,000   |
| July .....     | 143,900   |
| <hr/>          |           |
| Total .....    | \$921,405 |

Note the consistent gains,  
despite the hot weather.

Look them over! Square  
jawed business men; linked  
together they are proving  
the profitableness of the  
adage: "United we stand."

THIS is the story of a dealer who looked ahead-- and, being fore-minded, met *chain store competition*. In doing so he *tripled net profits*, not alone for himself but for 24 associated retailers of radio equipment.

It is the story of how these 25 merchants pooled their assets and their liabilities, formed a co-operative company and, from date of organization, February 9, 1929, to August 1, (six months), grossed \$921,405 and showed a net profit, after taxes, of close to \$148,000.

It is, in brief, the story of a new type of "merger" merchandising operation whose success to date has exceeded the most optimistic expectations of its founders.

The concern is the Radio-Vision Stores, Inc., and the location, Chicago, Ill.

Max Shore, president of this corporation, and the originator of the project, for fifteen years has been recognized as a leading radio-music merchant. He is a self-made man in every sense of these words—a product of Halsted Street. He also is a consistent advocate of ethical trade practices.

"Why should I wait until chain store double-truck advertising and chain store methods

put me in the red?" declared the irrepressible "Max" to the writer. "So one day this January I was thinking about these matters," (Mr. Shore long ago formed the habit of taking time off for thinking occasionally), "you know, combines, new chains being organized, and I said to myself, 'Why can't a number of dealers get together and do some of the things these other boys are doing?' So I called a meeting of nine of my successful dealer friends—and that's how it started."

Note that Mr. Shore said, "successful" dealers. Herein lies one of the chief reasons for the amazing results which Radio-Vision Stores, Inc., is obtaining. Only *successful* retailers were approached—established, "seasoned" prosperous merchandisers. There is not a "weak sister" in the organization. The idea blossomed January tenth. By February ninth the businesses of all

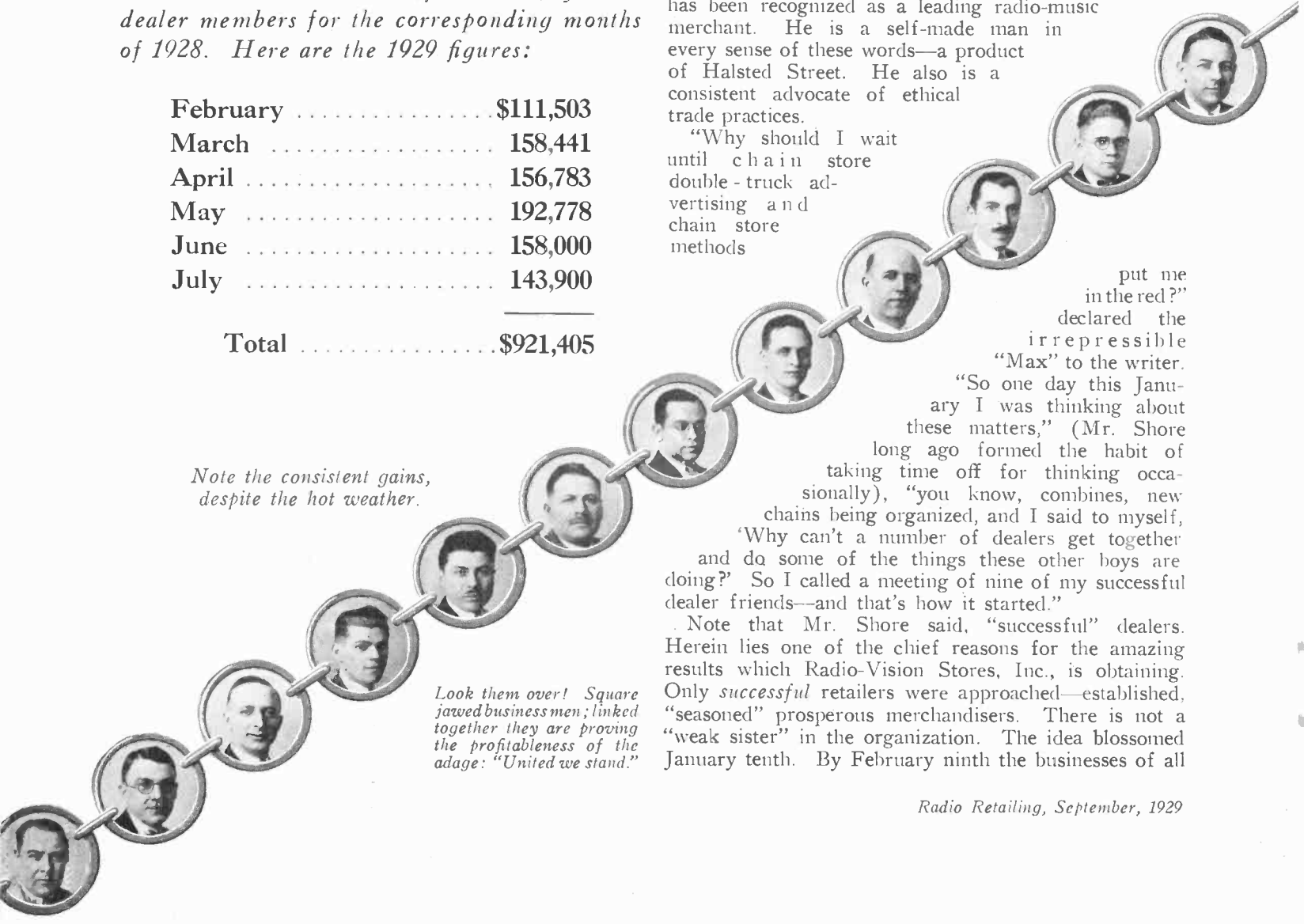

*How 25 Chicago dealers, through co-operative action, are cutting costs and increasing net profits.*

# of the Chains

By  
Ray V. Sutcliffe

25 dealers selected by common consent of the original nine, had been audited and appraised by a firm of expert accountants; 78,000 shares of stock had been issued, pro-rata according to assets, and Radio-Vision Stores, Inc., was a going concern. This capitalization of \$1,560,000 represents approximately the net worth of the business.

The speed with which this unfamiliar task was accomplished is indicative of the interest manifested in it.

### *The Essence of the Plan*

The plan, in brief, was to form a corporation for the purpose of taking over and operating the existing independent businesses of its originators. The nubbin of this plan was the fact that the net worth of the stores taken over was the only consideration for which stock was issued—promotional profits constituted no part or purpose of this new set-up. No associated dealer has received stock for anything other than actual assets contributed to the common pool. Furthermore, no stores whose business might be classed as a liability rather than an asset, were included.

The plan of operation centralizes the functions of buying, accounting, credit and collections, advertising, service and warehousing. The store owner who, in the past, has spent much of his time buying, supervising service, dealing with his advertising problems, trying to get credit and make collections, can now devote most of his time to the all-important matter of selling.

Voting power is based on the number of shares

of stock held. The customary corporation officers and seven additional directors are elected by the stockholders. To date the 25 store managers and those officers of the company, serving in executive capacities at the headquarters place of business, are the only stockholders. Max Shore was unanimously elected president at the first meeting of the stockholders—a tribute to his character, and to his business ability and leadership.

### *The Advertising Angle*

This activity had its inception in the realization, by Mr. Shore and his associates, of their growing inability, as individual dealers, to cope with advertising conditions and with chain store competition in the Chicago area.

"Advertising space within the budget of a single dealer no longer was paying its way," Mr. Shore explained. "Prominent displays were necessary in order to meet the 'copy spreads' of competitors enjoying city-wide distribution outlets."

In this respect, under the new alignment, Radio-Vision Stores has been most successful. Its present publicity budget of \$3,800 a month, plus manufacturers' allowances of at least an equal amount, permits the weekly insertion of full page advertisements in both morning and evening newspapers, and, because it now has a resale outlet in a majority of the trade centers throughout the greater Chicago district, it is in a position to cash in on the pulling power of its dominant copy. Incidentally, this sum is approximately 30 per cent less than was the aggregate of the individual expenditures of these 25 dealers prior to their recent affiliation—and the inquiries, per store, have been twice as heavy.

The present copy features one set at a time, and carries the signature of all stores. The name "Radio-Vision Stores," is prominently displayed.

As a matter of fact increased advertising efficiency, although substantial, represented but a small part of the benefits of co-operative retailing.

Each store manager and stockholder, formerly the store owner, because of the inter-competitive nature of his new task—sales and earnings for each store being reported and commented on at the monthly meetings of stockholders—was put on his mettle. It was, and is, distinctly up to him to increase promotional



*Headquarters store and office on Jackson Ave.*

efforts and to submit favorable earnings reports to his fellow partners.

Furthermore, his immediate personal income is based on 12½ per cent of *net* profits for his branch, as well as 2 per cent of his gross sales. He also participates, of course, in dividend earnings.

Here, then, we find a clearly defined quadruple incentive for managerial efficiency—and a distinct safeguard against petty jealousy or self-seeking. The latter have wrecked many previous ventures of this nature, and the former (managerial efficiency) is one of the weak spots of the closely held chain store companies.

Other material economies which have developed in connection with this aptly-named "Vision" plan are found in the operation of the buying, stockkeeping, accounting, credit, and service departments. These will be fully covered further on in this article.

### *The Mechanics of R-V*

But what of the mechanics of such an original venture?

How was this "put over" without one cent of outside capital?

How were the "insurmountable" obstacles overcome?

Why is this activity, which was declared by many as "doomed to failure," earning almost twenty per cent on gross sales?

The first step was to appraise, equitably, the true worth of each individual retail concern. Accounts receivable were listed at face value, collection losses to be charged back to the dealer. Liabilities were assumed by the new corporation and subtracted from the assets of the petitioner. Merchandise, fixtures, equipment and supplies were valued—by the expert accountants, mutually agreed upon—at current worth. Good will was appraised at the estimated normal increase of business for a period of one year from date. These factors, therefore, were held within moderate limits.

So far current assets, plus routine bank borrowings, have been sufficient to finance the organizational expenses and the opening of executive and warehouse headquarters at 618 West Jackson Boulevard.

Another reason for this accomplishment is that, under the central warehouse plan, only "sample" stocks are maintained in the stores. As the total warehouse stock is less than half the former total, this rearrangement released a considerable amount of stock which did not have to be replaced. Duplicate equipment, particularly automobiles, also was liquidated.

"But Max, you'll never in the world get twenty successful dealers to submerge their store identities and turn over their business to a Board of Directors. They just simply *won't* pull together," said many of his sincere friends.

The answer is that they did, and still are.

They did because, like Max, they thought they saw an answer to the problem of the little dealer in the big city. They are because they were picked in advance as tried and true team men—fellows big enough to sink petty motives for the commonweal.

### *Increased Volume and Startling Economies Through the R-V Plan*

The answer to the last of these four questions, the tripling of net earnings, will be found in the sum total of the following facts, the first three of which have been explained:

Dominant publicity, tied to 25 local distribution points, tripled the worth of each advertising dollar.

Friendly, inter-organizational, competition between store managers—former owners who now can devote their entire time to selling—have markedly improved sales.

Total inventories materially reduced. Stock turns are twice last year's averages.

Discounts somewhat better due to volume buys and discounting of invoices.

An expert accountant and credit manager holds "leaks" and collection losses to a minimum.

Last, but not least, a central service and delivery department have made possible a 70 per cent saving in these major activities.

### *Operation Economies*

Unusual economies have been effected in operation. The plan of centralizing the administrative functions of these 25 stores means fewer employees to each outlet, and these for selling purposes only. Direct overhead averaged 18.44 per cent for the first three months of operation. This includes rent, heat, light, salaries and commissions. Warehousing, deliveries, advertising and other general administration expenses were estimated by Mr. Shore at 11 per cent; or a total overhead slightly under 30 per cent.

Servicing costs, in particular, have shown striking reductions. Whereas, these dealers formerly required 80 to 90 service men, 18 now handle the total requirements of 25 stores quicker and more satisfactorily than did the eighty. Live Chicago dealers sell radio sets to persons located miles from the buying point. Consequently their servicers must spend time and money covering their farflung calls.

Centralized service solved this difficulty. Under the "Vision" plan the city is divided into 18 service zones. Calls are received and dispatched at the main office. Each service man has his own accessible territory, and now can cover it without undue loss of time.

### *Buying Economies*

Naturally certain purchasing economies, inherent in the buying capacity of a 25 store unit, are possible. While this pooled financial strength has placed much power in the hands of the executive in charge of purchases no effort to disregard the wholesaler, on lines thus distributed, has been made. Purchasing is through the orderly channels already established. Obviously favorable "buys" are often made—an inherent advantage of chain operation.

Again, the policy of Radio-Vision Stores is to maintain prices. There will be special sales on obsolete merchandise, of course, but the basic idea is to sell standard and accepted makes of radio receivers at recommended prices.

### *Outside Selling Systematized*

Systematic outside selling also has been made practical under this plan. The company operates five sales trucks, with seven men to a crew. These crews are scheduled, in advance, for a day a week with each store manager. A crew reports at a store, takes aboard 12 sets—and the local manager—and locates in a district previously selected by the store manager. Before the sun sets these 12 sets generally have been placed on demonstration. This process, however, is not merely a "shove-in" as the wagon crews are paid their 7½ per cent commission only when the sale has been consummated. The crew manager and the local man see to it that these sets are properly placed.

The follow-up and closing is left to the local store organization. The store salesman gets 5 per cent if he makes the sale.

In our August issue, S. J. Ryan pointed to the growing menace of the chain store and suggested that only through co-operative action with fellow-dealers could the independent operator combat certain economic factors which favor the chains. Ryan supported his contention by quoting the following utterance of E. A. Filene, internationally known economist and one of our greatest merchants:

"Individual merchants," Mr. Filene declared, "can form themselves into associations which will perform all the functions of the present chain and still retain their individual ownership and management. Thus they can meet the chain menace at its weakest point—for the average chain store manager does not have the same personal interest in his business as does the individual owner."

Radio-Vision Stores, Inc., was conceived and executed without the benefit of a prior knowledge of the economic philosophies of the great Bostonian, but it is operating almost in exact accordance with Mr. Filene's theory.

Retailers without the industry, as well as within it, will follow with keen interest the business fortunes of Mr. Shore and his band of co-operators.

# Every Store a Radio Show

**A**N ARTICLE in our October, 1928, issue told how the Dayton Radio Trade Association held a successful exposition in a hotel. Here's another idea, from Battle Creek, Mich., for a local show. It is based on the principle that people want to hear as well as see the set and the dealer's store is the logical place to stage a "show week" exhibition.

The local radio association, co-operating with the leading newspaper and station WKBP, issued a ten-page supplement to the *Evening News*. This special insert announced "Three Glorious Nights for Radio." Explanatory copy stated that all members of the Battle Creek Radio Association would hold open-house the following Thursday, Friday and Saturday evenings. "An opportunity," it continued, "for you to visit radio dealers and their stores and hear specially arranged programs from our local station without obligation or without being asked to buy."

#### COST BUT \$50 PER MEMBER

Each member contributed \$50 to the jack-pot and also dolled up his establishment. The common fund (\$550) covered the cost of the front page spread in the supplement, the special talent for each of the three evenings and the series of special broadcasts. In addition, each dealer agreed to take not less than one quarter-page advertisement in the special edition. The newspaper co-operated by providing suitable radio "filler" copy and numerous news items explaining the proposition to the public.

The local broadcasting station announced the coming event by a series of short talks during the preceding week.

The underlying object was to get the worthwhilers to the store. In this it was signally successful. With but

CHARTER MEMBER AND  
HONORARY CIRCULATION  
OFFICER OF THE DAYTON  
RADIO TRADE ASSOCIATION

**The Battle Creek Enquirer, and —  
THE EVENING NEWS**

DAILY AVERAGE NET PPM  
CIRCULATION 13,581  
FOR AUGUST, 1928

BATTLE CREEK, MICHIGAN, WEDNESDAY, SEPTEMBER 19, 1928      PRICE THREE CENTS

## Be There When it Happens!

### The Battle Creek Radio Association Presents Radio Nights in Battle Creek

*Three Glorious Nights of Particular Interest to You*  
In Cooperation with  
**The Enquirer and News and Station WKBP**

**Thursday, Friday and Saturday, Sept. 20, 21, 22**

An Opportunity for you to visit Radio Dealers at their own stores and studios to see the latest that radio affords and to test tone quality and convenience while WKBP, Battle Creek is bringing you entertainment.

**Your Home Dealers, Your Home Radio Station Seeking to Make Your Reception the Best Possible**

|                                                                                                                                                                                                                                                                                                                                                                                                                                                                                                                                        |                                |                |                      |             |              |                      |                      |               |           |                        |                     |  |                                                                                                                                                                                                                                                                                                                                                                                                                                    |
|----------------------------------------------------------------------------------------------------------------------------------------------------------------------------------------------------------------------------------------------------------------------------------------------------------------------------------------------------------------------------------------------------------------------------------------------------------------------------------------------------------------------------------------|--------------------------------|----------------|----------------------|-------------|--------------|----------------------|----------------------|---------------|-----------|------------------------|---------------------|--|------------------------------------------------------------------------------------------------------------------------------------------------------------------------------------------------------------------------------------------------------------------------------------------------------------------------------------------------------------------------------------------------------------------------------------|
| <p><b>The Battle Creek Radio Association Is<br/>Composed of the Following Dealers</b></p> <table border="0" style="width: 100%;"> <tr> <td>Battle Creek Auto Electric Co.</td> <td>Roat Music Co.</td> </tr> <tr> <td>Central Electric Co.</td> <td>Spartan Co.</td> </tr> <tr> <td>Guy E. Crane</td> <td>Wattles Hardware Co.</td> </tr> <tr> <td>Hubbard Electric Co.</td> <td>Whalen &amp; Rice</td> </tr> <tr> <td>Jury-Rowe</td> <td>Wireless Equipment Co.</td> </tr> <tr> <td>Radio Equipment Co.</td> <td></td> </tr> </table> | Battle Creek Auto Electric Co. | Roat Music Co. | Central Electric Co. | Spartan Co. | Guy E. Crane | Wattles Hardware Co. | Hubbard Electric Co. | Whalen & Rice | Jury-Rowe | Wireless Equipment Co. | Radio Equipment Co. |  | <p><b>Over WKBP, Battle Creek</b></p> <p><small>1415 Edwards</small></p> <p>THURSDAY 7 TO 10 P. M.<br/>Bruce Watkins' Orchestra and other radio artists</p> <p>FRI DAY FORENOON<br/>10 to 11 a. m.—Visiting Stars Hour</p> <p>FRI DAY EVENING<br/>7 to 10 p. m.—Chicago Nightingales</p> <p>SATURDAY FORENOON<br/>10 to 11 a. m.—Comedy Hour</p> <p>SATURDAY EVENING<br/>7 to 10 p. m.—Cosmo Orchestra and other radio artists</p> |
| Battle Creek Auto Electric Co.                                                                                                                                                                                                                                                                                                                                                                                                                                                                                                         | Roat Music Co.                 |                |                      |             |              |                      |                      |               |           |                        |                     |  |                                                                                                                                                                                                                                                                                                                                                                                                                                    |
| Central Electric Co.                                                                                                                                                                                                                                                                                                                                                                                                                                                                                                                   | Spartan Co.                    |                |                      |             |              |                      |                      |               |           |                        |                     |  |                                                                                                                                                                                                                                                                                                                                                                                                                                    |
| Guy E. Crane                                                                                                                                                                                                                                                                                                                                                                                                                                                                                                                           | Wattles Hardware Co.           |                |                      |             |              |                      |                      |               |           |                        |                     |  |                                                                                                                                                                                                                                                                                                                                                                                                                                    |
| Hubbard Electric Co.                                                                                                                                                                                                                                                                                                                                                                                                                                                                                                                   | Whalen & Rice                  |                |                      |             |              |                      |                      |               |           |                        |                     |  |                                                                                                                                                                                                                                                                                                                                                                                                                                    |
| Jury-Rowe                                                                                                                                                                                                                                                                                                                                                                                                                                                                                                                              | Wireless Equipment Co.         |                |                      |             |              |                      |                      |               |           |                        |                     |  |                                                                                                                                                                                                                                                                                                                                                                                                                                    |
| Radio Equipment Co.                                                                                                                                                                                                                                                                                                                                                                                                                                                                                                                    |                                |                |                      |             |              |                      |                      |               |           |                        |                     |  |                                                                                                                                                                                                                                                                                                                                                                                                                                    |

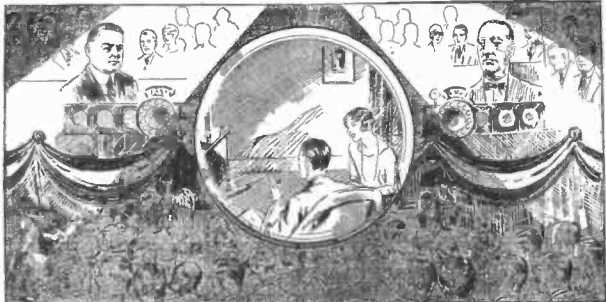

*A special 10-page supplement, issued by the local newspaper, was the backbone of this idea.*

few exceptions each participating dealer reported a complete "sell-out" of his immediate stock. Spot sales averaged six sets per store and live prospects 27 per store.

Quoting President Hubbard: "The plan got rid of the 'drifters.' The dealers served light refreshments and some gave the ladies flowers for souvenirs. The artists made personal appearances, being systematically routed from store to store when not busy at the studio. It brought seriously interested prospects right to the point of sale and at a total expenditure of less than \$100 per dealer."

Because the special local broadcast programs were sponsored and financed by the dealers' association, their scheduling and character was such as to be ideally suited for store reception and

demonstration purposes. Fine reproduction was the rule.

#### UNIFIED EFFORT AND "RADIO WEEK"

"The attraction value of unified effort," concludes Mr. Hubbard, "was obtained by the co-operative advertising in the special supplement and by our store-to-store entertainment tie-up. At the same time the individual advantage of being able to actually demonstrate the set in one's own store, and talk to prospects without the confusion and distraction occasioned when a competitor is exhibiting within earshot, persuades me that such a plan is the answer to the problem of staging a radio show in a medium sized city."

With "Radio Week" in the immediate offing this plan suggests itself as an admirable way for co-operatively featuring this event locally. Write H. G. Erstrom, of the Federated Radio Trade Association, 32 W. Randolph St., Chicago, for special advertising and display materials. These now are available for those who wish to tie-in with National Radio Week, Sept. 23-28.





# Customers

By  
Henry W.  
Baukat

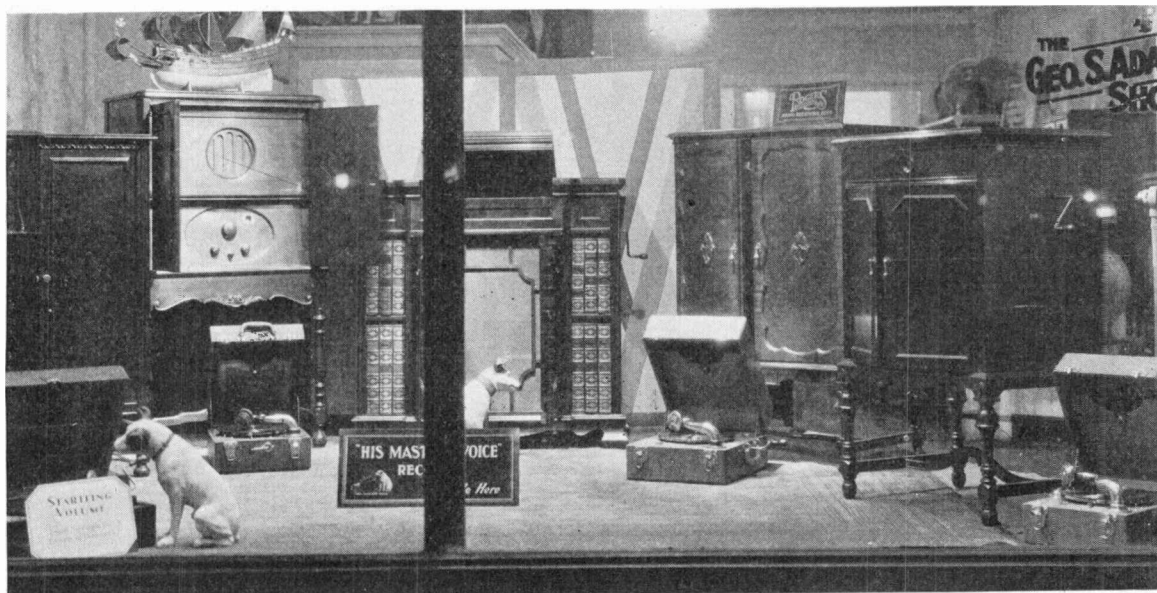

*Adams' well-lighted and attractive window is located in Hamilton's business center.*

instance, as a set comes from the manufacturer in the store, immediately after it is uncrated a small decalcomania bearing Adams' name is placed within the cabinet in some inconspicuous but yet not hidden place. On this is printed Adams' own serial number which corresponds to the number of sets he has sold since he has been in business. In other words, the first set that came into his place is numbered 1 and so on up to date. This number, together with the manufacturer's serial number, is then entered in a large book. The type of set is also entered here.

If the set is sent out on demonstration this is at once noted. If the set is brought back in the store, this is also entered in the book. When the set is sold the owner's name is recorded and that page is finished. This gives Adams a very valuable history of all the merchandise that he has sold as well as the exact status of all sets on hand. Not only that but it gives him an excellent record of his customers and by going back over the pages of this book he can see whether or not they are again to be potential customers for any additional equipment—if their sets have become obsolete, or just what attention they probably will need. The advertisements which Adams runs in local newspapers are also rather unique as at the bottom of each one is a little map of the section of the city in which he is located.

He has found that this is very helpful in getting customers acquainted with the fact that he is in a very accessible downtown location.

Direct mail pieces are also sent out at intervals. This, together with the sign board advertising and newspaper ads, absorbs a \$3,000 appropriation yearly.

Another very unique idea is the way in which free service is given. After the sale has been completed and the set installed, a short letter is sent inclosing five service contract cards. This letter explains that each card

is good for one service call. The make, model number and serial number of the set is on each card. These are good for one year. Adams finds that sending these out *after* a sale is made impresses the customer and also makes him wary about calling up for free service when he sees he is using up the tickets. Adams employs three service men practically all the time. They are paid an average salary of \$30 a week.

As far as trade-ins go no definite policy has been set down, as circumstances alter cases. Each trade-in is considered entirely upon its own merits and factors such as the time of season, class of people, condition of business, etc., all have their effect.

Quite a few phonographs are taken in trade for radio sets around this section of the country. These are sold to immigrants, as it has been found that they will buy these together with records in their own language. Therefore this is a fairly good business not only from the standpoint of getting rid of the old phonographs but of establishing prospects for buying phonograph records.

A custom has also been established to give everyone in the store a bonus at the end of each year depending upon the amount of work ~~they have~~ done and its importance to the business. It has been found that this is a most excellent way to keep them keenly interested in the welfare of the company.

During the summer slump season this year, Adams conceived the idea of offering a prize of a chest of silver to the salesman who had the best sales record for the months of April, May and June. This kept them all on the jump and resulted in a very definite flattening out of the sales curve. For instance, 60 sets were sold in April, 30 in May, 30 in June and in July they started going up, ending at about 45. There is no reason why a similar scheme cannot be used by other dealers every summer in order to keep the sales force interested.

# If I were

By C. Grunsky

"IF I were the boss," said the Star Salesman, "there are a number of things I would do differently." "What are they?" I asked, because I value the opinion of this man. He is employed by the radio department of a good sized store in a southwestern city and has made a name for himself through several successive seasons. He has been favorably mentioned by manufacturers and by customers who will buy from no one else. He would, in fact, make a good retailer himself.

"I don't mean to criticize the boss," my salesman hastened to add. "I think we have as enlightened a policy on most things as any radio merchant in town. But you can't come in contact with customers day after day without discovering several things which would make it easier to sell them radio.

## HOW KNOWLEDGE HELPS THE SALESMAN

"For instance," he went on, "take the matter of hiring and maintaining the sales force. This undoubtedly has more to do with the success of a radio enterprise than any other one factor. My experience is that the store with the enthusiastic active salesman is the store which is making money. And yet how many radio merchants really set about obtaining the right kind of man in the first place and how many know how to keep him on his toes after they get him? I think the department stores are perhaps the worst offenders in this regard. To the general store manager, the radio department is just another division of his main problem and he sees no reason for treating it differently. He looks upon radio salesmen as being just another variety of clerks—to be obtained in much the same way and to be compensated on a scale comparable to the salary of the man in the knit goods department. The result is that salesmen are drawn from other fields with no background at all of radio training. They carry out their work as order takers, not salesmen in the best sense of the word.

"I do not believe that it is possible to overestimate the importance of radio training for the salesman in this field. By this I do not mean a two weeks' course of an hour or two evenings, but a thorough understanding of the field comparable with an engineering training. If a salesman has had such a thorough technical background he can examine any new set which comes on the floor, study it a little and thereafter speak with authority in regard to it.

"This does not imply that the salesman should address his customers in technical language or bother them with a discussion of the intricacies of design, but that he will

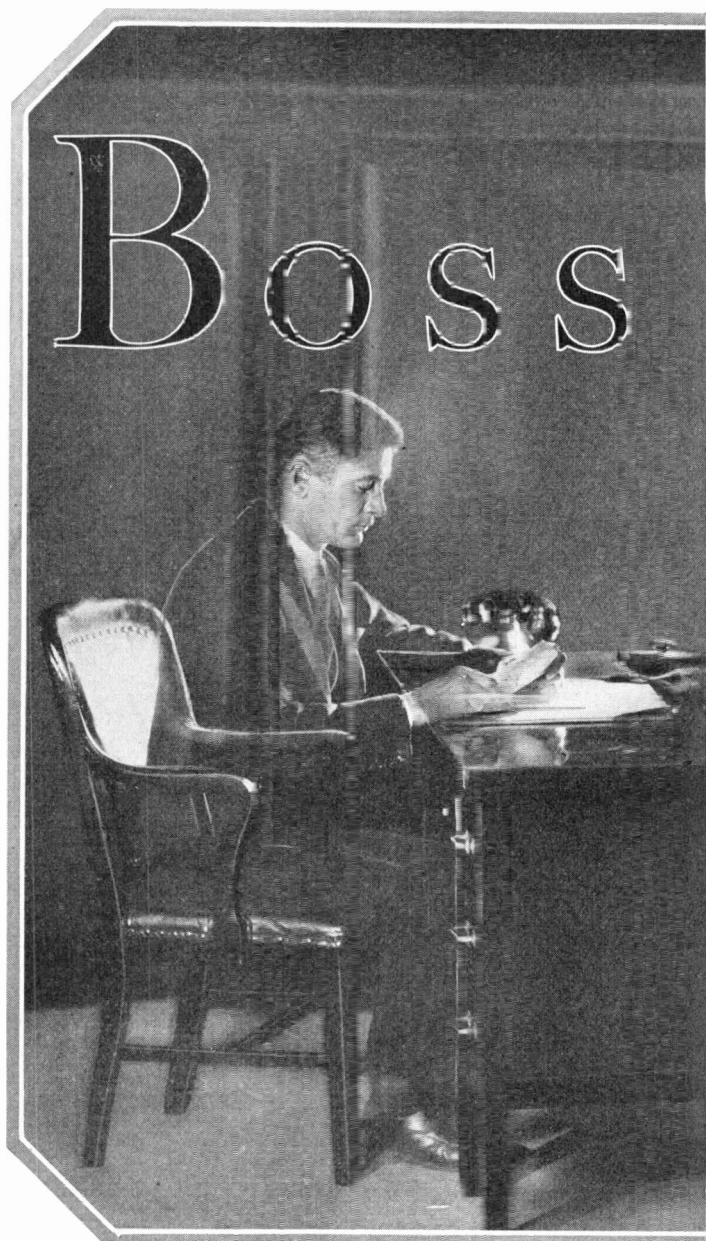

show, unconsciously, that he understands what he is talking about. The customer will soon acquire a respect for his opinion. The fact that the salesman understands the new set will have great influence in bringing about a sale.

"Let no one believe," he went on to say, "that the public is as ignorant as it is painted. There are hundreds of well posted fans who must be sold radio and whose intelligent questions on the subject must be answered if their respect is to be kept. Moreover, these fans are just the ones whose opinion is sought by their friends and whose influence in bringing in later prospects is most valuable. If the salesman is not in the position to meet any inquiry without hesitation it counts against him tremendously. On the other hand, the enthusiasm of a real expert is contagious and makes sales as nothing else can.

"Of course, not every man with technical training is a good salesman, but if I were choosing men, I would look for the salesman among the experts, rather than to choose a good man with selling ability in another field and hope to train him to understand radio. I have seen



## *The "STAR" salesman passes on some suggestions gleaned from a firing line experience.*

"I believe also that a difference should be made between commissions allowed on sales originating in the store and those on which the salesman discovers the prospect himself on the outside and follows it up at the expense of several calls.

"To be successful, in other words, I believe that the radio department of large stores must be conducted almost as a separate business. The radio instrument is certainly the most highly specialized and probably the most expensive individual item sold by the department store.

### DEPARTMENTAL CO-OPERATION

"Another thing, regular meetings between the service and sales departments would, it seems to me, prove to be of the utmost value. As always where the two are kept separate (a good thing, in my opinion) there are differences of opinion which arise.

"The salesman who feels that lack of attention on the part of the service department has lost him the friendship of a customer and gives the store a black eye from which it is difficult to recover will feel better if he can pass along his complaint and knows that something is being done to remedy the fault. Again, the conditions which the service man comes across in his experience furnish the most valuable of lessons to the salesman.

"Absolute co-operation between all departments is essential. More than once a sale has been endangered by the failure of a credit department to act promptly or by delays in delivery which make it impossible for the salesman to make even the most reasonable promise with any certainty that it will be carried out. And certainly a little extra money spent upon a high class personnel in the billing department would be worth the expense. Nothing is so productive of ill-will as a mistake in a bill. Here again, it would be good policy for the larger stores to separate their radio department as much as possible from the red tape of their other work so that the same prompt action would be possible or in the case of the small merchant to whom the sale of a radio set is a real event.

### SEGREGATE COMPLAINANTS

"The small retailer has the advantage in many respects, it seems to me, but he too, I think, could profit by separating his service and sales departments at least to the point where the customer who came in with a complaint and a request for service would not broach it on the sales floor. Not only does such a disgruntled one take the time of the salesman, but he spreads his dissatisfaction in all directions.

"Another thing which both the small merchant and the large store can do is to size up the class of customers in the neighborhood and carry stock appropriate to that class of trade. Our own store, for instance, attracts the

*(Please turn to page 92)*

more than one of these star salesmen in other lines fall down in radio.

### MUST BE PROPERLY REMUNERATED

"Another thing," said my star salesman, "given a man with the proper technical background, he must be paid commensurately. In my opinion the commission basis is the ideal method of recompensing salesmen—allow each man to reap the full benefit of his labors. Yet I have seen store after store attempt to build up a sales force while economizing on the payroll. And when it became apparent that by active effort a salesman could actually earn a little more than the men in other departments of the store, the commission was cut down.

"A satisfied salesman will devote his full enthusiasm to the interest of his employer. If he feels underpaid, on the other hand, he will be keeping one eye open for other opportunities and will inevitably slight the finer arts of salesmanship. In case a cheaper set does not bring complete satisfaction, for instance, and must be resold, the underpaid fellow will let it go to follow up a new account. Here is a distinct loss to the store.



# With the Co-operators

*Merchandising Benefits Enjoyed by Dealers  
Who are Solving Some of Their Problems  
Through Local Trade Association Effort*

**B**ECAUSE of the unusual number of situations in the retail radio business which can best be met by co-operative action, many dealers are finding, through the organization of a live local trade association, the answers to such problems as: credits, demonstrations, local interference, local broadcasting programs, grading and compensating service men, shows, trade-in policies and terms. For example:

## **Adopt Modern Accounting Methods**

The intricacies of correct business accounting are smoothed out for 35 participating members of the St. Louis Radio Trade Association by its formulation of a set of "standard" bookkeeping forms. The service and advice of an expert accountant is available for this group. Each member submits a monthly statement, on these forms, to the association office. These reports are analyzed and compared for the purpose of locating losses and checking excess expenditures.

## **Checks Credits Through Clearing House**

The Columbus Radio Trade Association, Columbus, Ohio, has an arrangement with the Ohio Bureau of Credits whereby its members first secure a credit report on all prospects whose standing is the least bit doubtful. Naturally each retailer is supposed to assist the Bureau by reporting each customer who has failed to live up to the terms of his agreement. Repossessions and demonstration hounds also are reported.

## **Buy Air Time Together**

A distributor in Wheeling, W. Va., arranged with a group of dealers for the co-operative purchase of weekly "air time" from the local broadcasting station. Each participant is credited, in the announcements, on a pro-rata basis.

## **Tulsa Holds "One-Day" Show**

The worth of a radio show, conducted entirely through the co-operative energy of local dealers, is demonstrated by the successful culmination of an affair of this nature recently held at Tulsa, Okla.

An elaborate 10-page radio supplement, issued by a local newspaper, was credited as the main reason for an attendance of 5,600 persons.

Two unique ideas distinguished this show. It was open for three hours only—from 8 to 11 p.m. Thursday, April twenty-fifth. Second, the exhibits were grouped according to the make of sets and not by individual dealers.

"These features," declared M. L. Poundstone, secretary-treasurer of the Tulsa Radio Dealers Association, "insured a maximum of buying activity with a minimum of lost time on the part of the exhibitors. The show was more than self-supporting because we secured such a large attendance with but a one-day overhead. Sales were twice those of our last year's affair."

## **Charlestown Standardizes Trade Practices**

While the dealers of Charlestown, W. Va., are not officially organized, they meet frequently, and, through co-operative action and sincerity of purpose, enforce the following sales policies: a maximum trade-in allowance of 7½ per cent of the selling price on old phonographs or battery operated sets; a ten per cent carrying charge figured on the total quotation; ten dollars for an aerial installation; a 30-day limit for free servicing.

"These rules," states S. H. Galperin, one of the outstanding radio dealers in the Mountaineer State, "have practically doubled our net profit since we decided to put them into effect. The results certainly prove its value to all concerned."

## WRTA Checkmates Adverse Legislation

The frequent introduction of ill-advised legislation, proposed state laws directly inimical to the interests of radio retailers, requires constant watching by the industry and best can be fought by presenting a united front.

Because a delegation of radio men, who appeared before the Radio Laws Committee at Madison, Wis., were supported by practically every radio merchant in the state the Wisconsin Radio Trade Association nullified a proposal to levy a tax on radio sets and another vicious piece of legislation which provided that the time-payment purchaser could retain sufficient merchandise to cover his or her financial interest in a purchase, the payments on which had been defaulted. It secured the passage of a bill exempting one radio set in every home from personal property tax and of another with reference to serial numbers.

Nationally, dealer-jobber associations have been requested, by the Radio Manufacturers Association, to appoint key contact men to watch local legislation and to support the latter's efforts to prevent the passage of adverse laws at Washington.

## Kenosha Cleans Up Interference

The cleaning up of local interference calls particularly for united action. Kenosha is but one of many examples where dealers, who club together, are able to provide the funds and equipment to locate and clear many cases of sales destroying local interferences.

An expert, with an automobile and special apparatus, spent three weeks in this Wisconsin city. With the assistance of the lighting company, he ran down and remedied 80 per cent of the cases reported.

## Code of Ethics Booklet

Detroit dealers have issued a booklet which sets forth a suggested code of business ethics and recommended trade practices. Cleveland also has taken steps to curb unwise price cutting, terms and "trial" offers.

## Pacific Coast Has "Blue Book" of Trade-in Allowances

Under the guidance of A. G. Farquharson, secretary of the Pacific Coast Radio Trade Association, dealers are provided with a "blue book" in which are listed all models of well-known sets together with a suggested allowance price. Monthly supplement sheets keep this valuable aid to the trade-in problem up to date.

## School and Ratings for Servicemen

A co-operative movement, which has gained much momentum among radio associations during the past six months, is that of training, examining and grading service men. This plan provides a check on actual ability, it heightens the morale of the servicemen and it strengthens customer confidence in the dealer.

Through an arrangement with a reputable radio school, whose training course and examination methods have been approved by the local radio organization, servicemen obtain special instruction at reasonable rates. Those who feel that their technical knowledge is already sufficient are required to take an examination and to obtain a rating card.

Those who pass these oral and written tests are given a card which not only identifies its owner as a graduate

servicer but serves as an official identification credential for the customer.

## Chicago Organized for Defence

While the Midwest Radio Trade Association, Chicago, is successfully carrying out many constructive policies, a situation, savoring of "racketeering," has banded together over 300 of the most substantial dealers and wholesalers in the Great Lakes city. A move to unionize service men and dealers is successfully being fought. Midwest is taking the offensive by examining and grading its members' service men.

It is also utilizing the facilities of a local credit bureau to check doubtful applicants for terms accommodations.

Although most of these ideas may be successfully applied by any group of local dealers, greater benefits will follow if such groups organize and affiliate with the national, dealer-distributor, body. The Federated Radio Trade Association maintains permanent offices at 32 West Randolph St., Chicago. Executive-Secretary, H. G. Erstrom, will gladly consult with any body of radio dealers desiring detailed information relative to organization matters and the possibilities of success through co-operative effort.

## Reveals the Demonstration Hounds

Demonstration "joy riders" are broadcast to the retailers of Dayton, Ohio, by means of a simple little card which is filed with the secretary of the Merchants Association. Dayton Chamber of Commerce. If a dealer has any doubts about the sincerity of a prospect's demand for a lengthy "trial" he phones the Chamber and ascertains whether or not the man in question has been reported by other dealers.

The success of this plan hinges on the care exercised by each radio merchant in reporting all demonstration hounds. To date it has cut cases of this nature fifty per cent.

| RADIO RETURN CARD                         |                                                                          |
|-------------------------------------------|--------------------------------------------------------------------------|
| (Send this record to Chamber of Commerce) |                                                                          |
| We have today taken back a radio from     |                                                                          |
| NAME                                      | Hemmingway, John T.                                                      |
|                                           | Last (Print, Don't write) First                                          |
| ADDRESS                                   | 625 So. Joyce St.                                                        |
|                                           | Number Street                                                            |
| Date Installed                            | June 5, 29                                                               |
|                                           | Day Month Year                                                           |
| Date Removed                              | July 8, 29                                                               |
|                                           | Day Month Year                                                           |
| Remarks:                                  | Wife remarked "no intention of buying"<br>Two other sets had been tried. |
| Sign Here:                                | Hudson Radio Shop                                                        |

---

| KEEP THIS CARD FOR YOUR RECORD        |                                                        |
|---------------------------------------|--------------------------------------------------------|
| We have today taken back a radio from |                                                        |
| NAME                                  | Hemmingway, John T.                                    |
|                                       | Last (Print, Don't write) First                        |
| ADDRESS                               | 625 So. Joyce St.                                      |
|                                       | Number Street                                          |
| Date Installed                        | June 5, 29                                             |
|                                       | Day Month Year                                         |
| Date Removed                          | July 8, 29                                             |
|                                       | Day Month Year                                         |
| Remarks:                              | No intention of buying. Two other sets had been tried. |

This card is the peg that pins Dayton demonstration "joy riders" to the masthead. One copy goes to the association secretary, the other is retained by the dealer. •

How

# Radio

*Will Speed*

*these*

*Lagging*

*Little*

*Feet*



*To provide better educational programs for school children, such as these, three agencies are hard at work.*

**T**O INVESTIGATE the possibilities of education by radio, Secretary Wilbur, of the Department of the Interior, has appointed a special committee of fourteen prominent educators and radio personages. Its chairman is United States Commissioner of Education, Wm. John Cooper. Its radio members are: Judge Ira E. Robinson, chairman of the Federal Radio Commission; Merlin H. Aylesworth, National Broadcasting Company; William S. Paley, Columbia Broadcasting System, and Miss Alice Keith, Radio Corporation of America.

This committee will conduct a thorough study of the present application of broadcasting to educational usage and will make recommendations to Secretary Wilbur this December as to its future possibilities.

Another noteworthy effort to extend the practical use of radio in the schools is that of the Rural Education Department of the Teachers College, Columbia University, New York City. There, under the direction of Margaret Harrison, detailed "laboratory" studies of the use of radio receiving sets in rural schoolhouses are now being conducted. These will be practical rather than theoretical in nature.

The country schools co-operating in this study will be notified regularly of the special educational programs scheduled by national broadcasting systems or local stations. Thus the teachers will be able to fit these programs in their curriculum. A check will be made of the



*The principal also uses the radio equipment. For room-to-room communication it is invaluable.*

programs used, the number of pupils listening, the kind of reception, and of the many other practical problems involved.

"At the present time there are eight million farm children enrolled in the one-teacher hamlet, two-teacher or the consolidated schools of the United States," declares Miss Harrison.

"These constitute practically one-third of the total public school enrollment of the United States; nearly one-half the public school teachers are engaged in instructing farm children."

The third agency studying this question is the Department of Education, Cleveland, Ohio. After two months of experience with the radio as a factor in classroom instruction, the school officials of Cleveland are beginning to draw conclusions which promise to be favorable to the continued and extended use of radio instruction there.

So impressed were the directors of the Radio Manufacturers Association with this idea, which has been so frequently advocated by *Radio Retailing*, that they voted, at their August meeting, to extend the full and active co-operation and resources of their organization to Secretary Wilbur and to further the work of the Governmental Advisory Committee on Education by Radio.

Live dealers will acquaint their local school boards with these matters, and will sell them, *now*, complete installations so that the children will not miss these educational treats.

# Artistic Treatment of Narrow Store

*How it helps the Hancock Music Company of Pasadena capture the "carriage trade."*

TO INSURE the creation of that all important "first impression" Newton Hancock, owner of the Hancock Music Company, Pasadena, Calif., places an unusually ornate radio set, grand piano, rug and formal reception bench in the fore part of his store.

The demonstration rooms, which line the left side of this quite narrow showroom, are finished in different Period styles.

An ornamental stairway leads to a series of radio rooms on the second floor.



*The men behind the sets.*

To further attract a quality clientele Hancock specializes in the building of cabinets to order. He also caters to those who wish to incorporate the radio chassis in some piece of furniture already in their possession. This service has found a decidedly responsive cord from the well-to-do. The average price for work of this former nature is well over \$700. While not every dealer is in a position to do things of this nature, some special activity is advisable, according to Hancock.

An electrically actuated turntable and pick-up, mounted on a mahogany table and connected with a combination set, serve the double purpose of record demonstration and of illustrating the musical merit of modern radio-phonograph cabinets.





# CASHING IN

# on "Radio

THE experience of the Schwabacher-Frey Company, radio dealer of San Francisco, has shown that the period immediately following a radio show is apt to be a quiet one from a sales standpoint. The public is still confused as to the significance of what it has seen. In consequence, this is a period of shopping, when people come into the store and make inquiry, look at sets, listen to demonstrations and sales talks—and then walk out again.

Last year this concern determined to *crystallize* public opinion, to turn shoppers into buyers without the usual intermediary period of hesitation.

National "Radio Week" was the peg chosen on which to hang an intensive publicity campaign.

Plans were made to stage a week of events which would call attention of the public to the store and which would quicken sales. These plans included no policies of reducing prices or offering special terms of any kind. In fact, no inducement whatsoever was offered to customers for buying that particular week. *Advertising may be credited with the sole responsibility for having brought them to the store and for having kept them there to buy.*

The advertising took various forms. In the first place, a conspicuous announcement was made in the Sunday papers. This was followed by a daily bombardment of small ads in all papers throughout the week. The first announcement was one column in width and 20 inches in length, while the teaser ads were of 2-inch dimensions and said simply: "*It is Radio Week at Schwabacher-Frey.*" Mr. Nash prefers the second or third page for major advertisements rather than the radio page, feeling that here competition is less and that news matter is a better neighbor than the publicity stories which too often make up alleged radio news. The small ads occurred at

intervals throughout the paper, no section being overlooked, so that there were few readers, however casual, who could fail to know that the week marked something special in the radio line at Schwabacher-Frey.

IN ADDITION, Nash effected some excellent tie-ins with his manufacturer's advertisements. Here, too, the policy of this store is a little different from the ordinary. Mr. Nash prefers to run his ad on a different page from that on which the manufacturer's copy appears, using a cross-reference to stimulate interest. "For further information about this instrument (or this line)," runs the Schwabacher-Frey advertisement, "see the manufacturer's advertisement on page . . ." This, it is felt, produces better results than the name of the firm crowded in with that of twenty others on the same page with the advertisement itself.

In addition to the newspaper space, 100,000 handbills were printed and distributed early in the week.

The store, of course, was decorated for the occasion. Banners and signs were prominently displayed across the front of the building. *Inside, strings of small orange-paper banners announcing "Radio Week" literally outlined every architectural feature of the main floor and balcony.* No one entering the store—indeed, no one passing in the neighborhood—could overlook the fact that a radio event of some importance was being staged.



## A Sales Opportunity

The week beginning Monday, Sept. 23, will be designated by the industry as "Radio Week." During this same period will be held the Radio World's Fair at Madison Square Garden, New York City.

Here, then, is an excellent opportunity to capitalize, locally, on a special sales opportunity.

Last year Schwabacher-Frey of San Francisco, quadrupled its sales because it featured its store during Radio Week.

Publicize Radio Week, co-operatively and individually, prior to and during the week ending Sept. 28. Actual experience says that it will pay.

# W E E K

As part of this display, the show windows were entirely turned over to radio and two young women were hired to display show cards and to keep the attention of the crowds directed to the material displayed. These women were not mere window demonstrators but were hired through a theatrical agency for their stage presence and their ability to carry through the little drama which was enacted. Some 90 show cards had been worked out in sets of 15 to 20, completely covering the story of the sets featured, including price and service arguments. The price card was always the topmost of the set, so that it faced the public when not in use, all the cars being stored on the floor of the window directly in front of the set to which they applied until lifted to the easel by the demonstrator. It was the province of the young woman to lift these cards in succession, call the attention of the public to the message and point out the particular feature mentioned at the same time.

THE girls had been thoroughly rehearsed in their work, but as it was impossible to remember all the stage directions, the action to accompany each card was plainly printed on its rear surface. When the card reading "This set sells for \$85" was lifted up, for instance, the girl could read "Point to the set on the table" and did so without awkwardness.

In the same way, she turned the dials to illustrate its

## It's **RADIO WEEK** at **SCHWABACHER- FREY**

Special Demonstration and Display of the greatest aggregation of radios—representing every price class—ever assembled in California

**\$64.50 to \$1575.00**

*Sold on the Budget Plan*

It's **RADIO WEEK** at  
**Schwabacher-Frey**  
Market opposite Grant Avenue

simplicity, or demonstrated the combination phonograph feature at the appropriate moment. This window demonstration was so popular that it kept a constant crowd in front of the store and the very fact of the blockade impressed many people with the importance of the event.

INSIDE the store few special changes were made. An adequate supply of attendants were on hand and an almost continuous concert was kept up in an area of the sales space somewhat cut off from the rest of the floor. Here chairs were arranged, with a demonstrator always on hand to control the set. As the public had been invited to attend the musical concert in the balcony, from 10 to 6, many who came to listen to this feature made no purchases. These visitors were not pestered with sales talk, although it was explained that should they have any questions to ask, some one would be there to answer them.

No trade-ins were taken, no special terms were offered, no price reductions featured—the only difference between this week and the one preceding it was in the advertising which was done, so that the difference in sales may fairly be credited to that source.

The records show a four-fold increase in volume during "Radio Week" as compared with the previous year, during the same period.

But the importance of this week by no means ceased on Saturday night. The store, through this event, has been placed on San Francisco's map as an important radio center. People who had never heard of that fact before now know that Schwabacher-Frey carries radio. In the minds of those who knew it, its importance has been increased. The prediction of Mr. Nash is that radio sales for the coming season will be double those of the previous year, the increase being credited largely to the impetus given this business by making the most of "Radio Week."

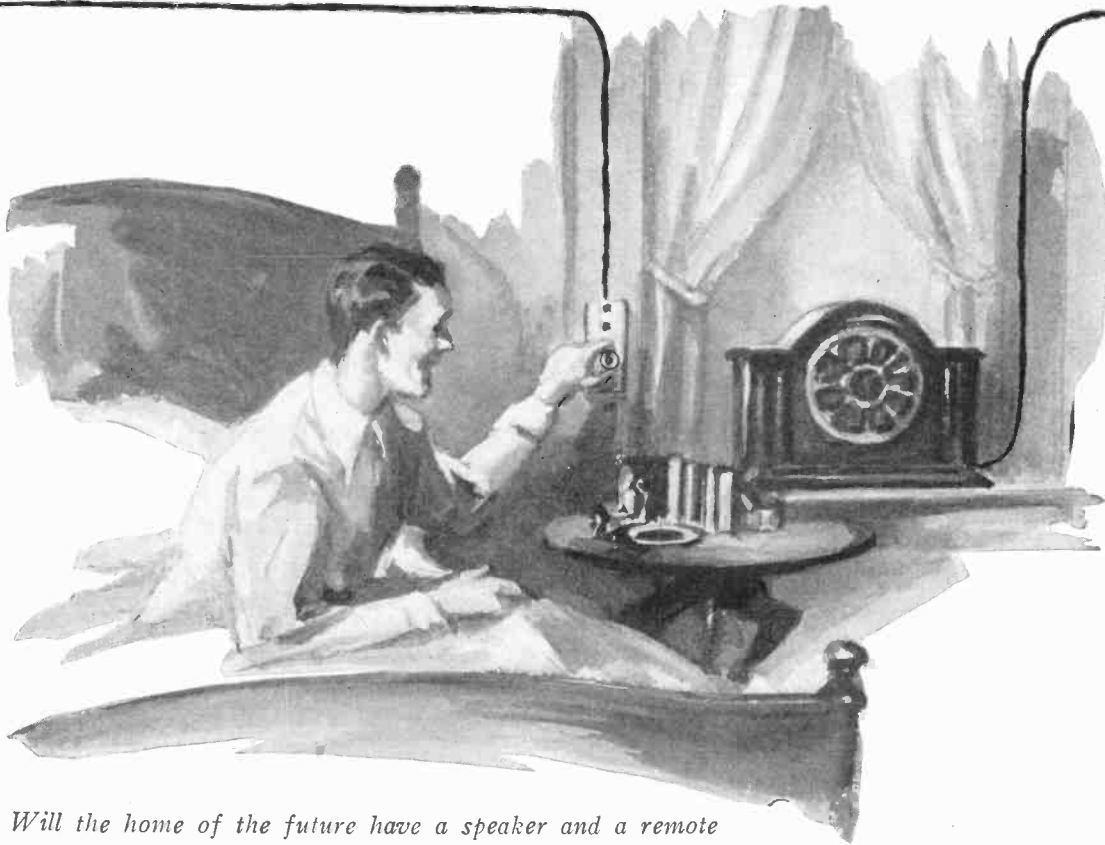

*Will the home of the future have a speaker and a remote control device in every room?*

What  
Prepare  
yourself  
now so you  
will be able  
to answer  
intelligently  
your  
customers'  
questions.

**R**EMOTE control and automatic tuning apparatus, while now considered as *convenience* accessories, bid fair to be rated as radio necessities in the near future. When perfected they will fill a specific demand from a certain class of radio user. Practically every set manufacturer is devoting much time and thought to their development. Already a number of these devices are on the market.

With the availability and the use of these added conveniences will come questions from the public as to their selection, use and maintenance. The dealer, therefore, will need to be well posted in order to best merchandise remote control or automatic tuning. For this reason the following has been written to help our readers properly formulate their opinions with respect to these new devices which they soon will be called upon to merchandise.

#### REMOTE TUNING AND PRE-SELECTION

There are two ways in which a radio receiver can be electrically controlled—remote tuning and remote pre-selection (automatic tuning). The former generally is applied to systems in which the control box has a standard dial and vernier knob. A dial is synchronized with the dial of the set. Thus the remote tuning control becomes an extension of the tuning knob, the on-and-off switch, and perhaps the volume control, to several remote points.

Remote pre-selection refers to systems by which, from several remote points, the radio set can be tuned to specific stations for which the mechanism has been previously adjusted.

Which system will meet greater popularity no one can tell at this time, although, among thirty-six manufacturers, the majority seem to favor remote tuning in preference to remote pre-selection.

#### HOW MUCH WILL THE TRAFFIC BEAR?

Some engineers would like to combine the two methods. Others would like to do a number of marvelous things, but always there are two factors which must be balanced against each other—cost vs. convenience.

Remote control, of either type, should not increase the cost of a hand-tuned set so as to take the set out of its price class. Consider two equivalent sets: the one hand-tuned, at \$125, and the other equipped for remote control, at \$135. A customer can be pushed up a \$10 step, but if remote control affects the price to the extent of \$50, it's a tough job to sell merely on the strength of remote control.

In other words it would appear that remote control should be made a convenience available for every set owner, rather than a luxury for a few. This is most important to dealers, because *every remote control set sold carries with it the potentialities of a profitable installation of several remote control boxes.*

In making new plans for bigger profits from remote control sets, the dealer must use the utmost discrimination in choosing sets that are equipped with truly perfect devices.

Sets that have remote control which is anything less than perfect are just another leak for profits. It is better to lose a sale than to sell a set equipped with a type of remote control that will call for repeated service and repair.

In judging such devices, the dealer must satisfy himself as to these general points concerning remote tuning or remote pre-selection:

1. Is any 110-volt current carried in the leads to the control boxes?
2. Will the control make any appreciable difference in the electric light bill?

Dealers *Should Know About*

# Remote Control

## and Automatic Tuning

3. Are there relays to get out of adjustment, contacts to clean, lamps or resistors to burn out, or any uncertain electrical devices to require repair or replacement?
4. If it is operated incorrectly by servants or children, can it be put out of order? Can anyone, unfamiliar with the control, operate it without instruction?
5. Are there delicate mechanical parts which will become uncertain when subject to use and wear, or is everything simple, strong, and rugged enough to stand up under all emergencies?
6. Will dampness cause rust and corrosion, interfering with the mechanical functions?
7. Can two or more control boxes be used, for multiple control?
8. Is there a simple way to turn the set on and off from the remote control boxes?
9. Is it noiseless in operation?

With regard to remote control devices the following specific questions should be thoroughly considered:

1. If the dial of the control is out of step with the dial on the condensers, can they be synchronized by some elementary, single adjustment that does not make it necessary to go to set to see where the dial was left?
2. Does the dial control operate at approximately the same speed as the tuning knob at the set? And can the set be tuned at the control box in the same casual way that people are accustomed to handle the ordinary tuning knob?
3. Is the setting obtained from the control box as close and accurate as with hand tuning?

If it is remote pre-selection that is being considered see if the apparatus fulfills these requirements:

1. Can the adjustments of the mechanism for settings of different stations be accomplished in a simple manner, without special tools by persons who have no mechanical skill?
2. Does the mechanism bring the condensers to the exact tuning point—right on the nose—every time for each station?
3. Is the mechanism protected from damage if, by mistake, two separate control boxes are operated at the same time?
4. Can the selector mechanism be adjusted from the front of the set, so that it is unnecessary to pull the set out and turn it around?

These are broad questions, carefully chosen from the fundamental specifications of thirty-six manufacturers. When you examine any type of remote control, check

over these questions. Unless you can answer "Yes" to every single one of them, after careful consideration, watch out for customer dissatisfaction and service troubles.

Remote control must make good as useful service, satisfactorily performed, and as such will be a profitable development to the manufacturers and to the trade.

The general plan seems to be that sets will be priced to include the built-in driving mechanism, but the list price will not include the control boxes. That is to give the dealers a chance to sell as many control boxes as possible for each installation.

Again, a set may be sold with only one control box installed initially. This gives a dealer a chance to follow up for the installation of additional controls.

Remote control, of either type, is a habit-forming convenience, like a telephone extension. Thus it is very likely that once a customer gets into the habit of using a control box at one point, he will soon wish to have further controls at convenient points around the house.

The next problem in connection with remote control is the use of several reproducers around the house. The dynamic speakers now being produced are not well suited for installation at points remote from the set. However, that is an engineering detail that can be met easily when the problem is brought to the attention of the engineers. The necessary changes in the speaker design can be made readily and matched transformers supplied for distribution, just as is done for installations in theaters or public-address systems.

Some manufacturers whose plans for remote control are well advanced have prophesied that remote control will be a sales factor, by Jan. 1, 1930, as important as single dial tuning, or a.c. operation.

It is possible that that is overstating the case, but it is certain that remote control will have a most important effect upon the plans of manufacturers and the trade when the new models are brought out after the first of the coming year.

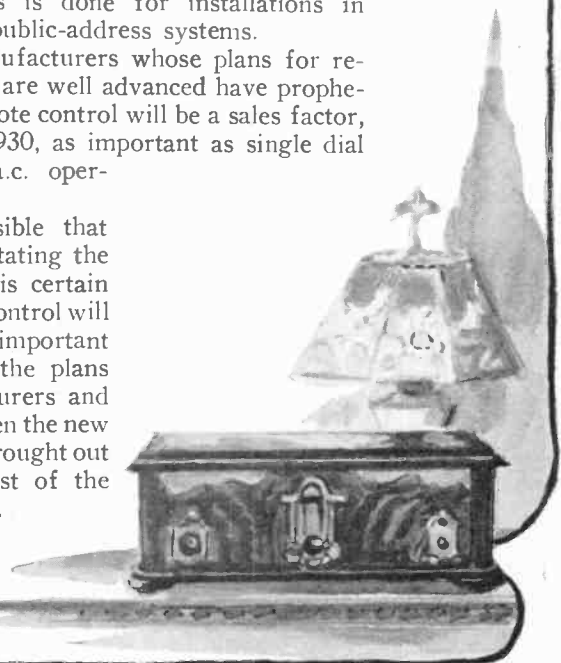

# How Does Screen-Grid Affect SERVICE?

*A discussion of the influence of radio's latest development on the question of service. Will it increase or decrease the service problem? Read this article and find out.*

*Conducted by*  
**H. W. Baukat**



**N**OW that the screen-grid tube is definitely among us, how does it influence radio service. That is the all important question. At first glance, it appears to be a simple problem, very easily solved. Let us see.

Suppose we start at the reason for the use of the tube, and see how it is allied with the service man. The basic reason for the use of the tube is additional sensitivity. Now we are not arguing pro or con on this score. It is not up to us to condemn or approve. We are simply stating facts. The radio receiver manufacturer claims that the use of the tube provides increased sensitivity, better distance-getting ability. The prospective owner reads the ad and buys a set; perhaps trades in an old set for one with screen-grid tubes. What now . . . . ?

If the receiver is actually more sensitive than his old set, he is satisfied, but if it is not up to expectation, the service man appears upon the scene. The receiver is not performing in normal manner, is the complaint. Now what is the criterion for normal manner? What is the basis to show normal or subnormal operation? The public as a whole expects too much from a radio receiver; never attempts to realize that the average sensitivity of a radio receiver is definitely limited by one factor which he himself is producing, man-made static. The extensive exploitation of the screen-grid tube, in commercial and experi-

mental radio receivers has led many to believe that phenomenal and astounding results are to be expected with screen-grid receivers. Now we are not gainsaying the fact that additional amplification is available with the screen-grid tube, but the paramount item is satisfaction on the part of the customer. It is dangerous to herald astonishing results, if only because receiving conditions differ in localities.

The use of the screen-grid tube permits fewer tubes to accomplish a certain sensitivity level. The use of less tubes means more economical operation and the slogan should be altered to read accordingly. Many manufacturers are producing radio receivers with the screen-grid tube which employ the same number of tubes as were used in the previous year's model. Marvelous sensitivity is claimed for the receiver. It is true that the receiver is more sensitive than the previous model, but the service man will be called in to explain why 5,000 and 6,000 mile reception is not being accomplished.

**I**T IS only human when we possess a sensitive receiver to adjust it to maximum sensitivity, just to see what it will do. It performs best by permitting reception of every form of electrical disturbance present in the neighborhood and even in adjacent neighborhoods. The result is a call for the service man to eliminate "clicks and sputtering sounds which I never heard with my

other receiver. The tubes must be defective or this receiver is not performing in normal manner"—ad infinitum. Complaints relative to electrical disturbances will be increased because of the use of screen grid tubes and greater amplification.

With respect to actual trouble in the radio receiver, the item is allied with the number of tubes in the receiver. Comparing the average screen-grid receiver employing fewer tubes than the average standard tube receiver, we are prone to believe that service troubles will not increase, because the additional elements in the tube and the additional elements required to provide satisfactory operation with the screen-grid tube are offset by the fact that fewer tubes are used.

If, however, the number of tubes remain the same, service troubles will increase. Not because the tubes are defective, or because the tubes require a change in design which results in a more complicated installation, but because the number of components in the receiver are increased, and the number of components in the tubes are increased. Each and every part in a radio receiver is allied with service and is a potential source of trouble.

**F**URTHERMORE, the fact that the amplification available with each tube has been increased is sufficient in itself to aggravate trouble. As an example, we have the condition of excessive regeneration

in the radio frequency amplifier. . . . The use of the screen-grid tube permits the elimination of definite neutralizing and stabilizing systems—*providing* the signal input or amplification is not raised beyond a certain level. An erroneous impression is prevalent that neutralization is not necessary when the screen-grid tube is employed. Ask the man who has adjusted his receiver to maximum volume. Now, we do not mean to imply that the average screen-grid tube receiver is afflicted with "uncontrollable regeneratititis." Far be it from us to say such a thing, but how can we convince the radio receiver owner that he can secure sufficient signal output without increasing the amplification to the point where regeneration becomes excessive, despite the fact that the statement is absolutely true.

The additional element in the tube is of little consequence because manufacturers are making rugged tubes, but standardization in the manufacture of screen-grid tubes is a wee bit in the offing. Our experience has proved to us that it is not very advantageous to interchange all makes of screen-grid tubes, as may be done with the standard 201A, the 226 and the 227 types of tubes. . . . Results differ and appreciably so. Time will alleviate this condition, but until such time, it will mean additional work for service men and dealers alike.

The additional voltage necessary for the screen-grid is of little consequence because the same voltage is applied to other tubes in the receiver and special taps are not required. However, the need for perfect shielding and the need for perfect contacts to all of these shields offsets the fact that the neutralizing system has been removed from the receiver. As a matter of fact, it is very likely that these shields and ground will offer a little additional work along servicing lines. Not that the use of these shields is detrimental or is indicative of poor electrical design, but rather that such items have a faculty of becoming loose during transit and of raising "velly muchee" trouble in a screen-grid receiver.

Now, we do not mean to paint a picture of despair because of the introduction of the screen-grid tube, but we might just as well look the truth in the face. New developments of this nature cannot be introduced without some additional difficulty.

#### TESTING MORE DIFFICULT

Receiver testing with the screen-grid tube is going to be more difficult than receiver testing with the conventional type of tubes. First, because of the additional control grid lead, which wire is not found in the average installation. Additional time must be consumed to connect this lead to the tester cable and then to connect the contact to the tester. The additional length of leads will interfere with the normal operation of the set when being tested to an extent greater than that encountered with the conventional tube. We are not referring to the measurement of the operating voltages, but to the actual performance of the receiver when the tester is applied.

Then, again, many men are not equipped with testing devices suitable for application to the screen-grid tube, and such condition cannot expedite service. 'Tis true that time will remedy matters in every direction but service men in general may be prepared for a little additional work because of the screen-grid tube. It cannot be avoided. Just remember the transition from the battery set to the B-eliminator, from the battery set and B-eliminator to the A-eliminator, from the eliminator combination to the a.c. tube . . . now the screen-grid tube.

## Radio Data Sheets

The National Radio Institute, 16th and U Sts., N. W., Washington, D. C., as part of its course for radio service men, publishes a most complete data book covering all the circuits of the various commercial broadcast receiving sets, together with instructions as to how to test these circuits and all the necessary constants. Also contained in these books is much useful information on fundamental design and construction of various types of units, coils, power packs, eliminators, etc., that are in common use today. Supplementary pages are made up from time to time as new sets and circuits make their appearance on the market.

### The Screen-Grid Tube Permits—

1. Greater R.F. gain.
2. Less A.F. amplification.
3. Elimination of neutralization.
4. Bias type detection.
5. Lower ratio R.F. transformers.
6. Use of resistance A.F. coupling.

### Which Result in—

1. Uniform gain and selectivity over the entire broadcast band.
2. Better tone quality.
3. One less winding on R.F. transformers.
4. More efficient set.

## The Service Man's Manual

Two new books have been written by John F. Rider for the radio service man is the announcement received from the Radio Treatise Co., 1440 Broadway, New York City.

These two treatises constitute a two-volume series entitled "The Service Man's Manual." The first volume entitled "The Mathematics of Radio" explains radio phenomena in a practical manner, with examples of all calculation, so that the service man may be in a position to solve all technical problems. This book leads up to the second volume. An idea of the contents of Volume 1 is "Ohm's Law, Resistances, d.c. Filament Circuits, a.c. Filament Circuits, Capacity, Voltage Divider Systems for B Eliminators, Inductance, Reactance and Impedance, Resonant circuits, Iron core chokes and transformers, Vacuum Tubes, Three Element Tubes, Power Amplification, Graphs and Response Curves, Multiple Stage Amplifiers, Alternating Current Tubes, Screen grid tubes, A and B Eliminators."

The second volume entitled "The Trouble Shooting Manual" is written to fill a long-felt want. It contains the diagnosis of receiver systems, RF amplifiers, AF amplifiers, Eliminators, etc. Trouble shooting in these systems with commercial set testers and analysis of symptoms. Wiring diagram of Weston and Jewell set testers, application of these testers and about 150

wiring diagrams of old and modern commercial receivers. A few of the receiver manufacturers represented in this volume are Radio Corp., of America, Fada, Freed-Eismann, Kolster, Federal, Zenith, Crosley, Stromberg-Carlson and others. The books are 8½x11 in. and the price is \$5 for the two volumes; \$2 for Vol. 1 and \$3 for Vol. 2.

## The Power Detector

Lately we have been hearing a lot about power detection. Perhaps this term is somewhat new to many although the method is by no means new. There are two methods of detection, one *with* grid leak and condenser and the other *without* grid leak and condenser but using a "C" battery.

The grid leak and condenser method is the one which has been popular in the past mainly for the reason that louder signals could be had this way. This method of detection, sometimes called grid rectification, gives results equal to that of a detector and a stage of audio amplification. This is because the radio frequency voltage applied to the input is changed to audio frequency in the grid circuit and the audio frequency variations are amplified into the plate circuit.

Now however we hear more about the other method called plate rectification. This is what is being called power detection. The advantage of this system is that no current flows in the grid circuit because the average value of the grid voltage is maintained negative with respect to the filament. Therefore no power is taken from the tuning circuits and no damping effect is exerted on them. It is necessary to use a "C" battery which of course is a simple matter in an a.c. set. Because of the increased sensitivity of sets today this later method, which allows greater signal strength to pass undistorted through the detector tube will be the popular one to be used from now on.

## Radio Service Course

The first radio course for service men has just been compiled by the Radio Division of the National Electrical Manufacturers Association in co-operation with the Radio Institute of America, as the answer of national set manufacturers to the service problem.

The course comprises four textbooks. Four examination papers are offered during the course which may be submitted to the Radio Institute of America for correction and rating.

Technical language has been avoided as much as possible but fundamental principles, receiving circuits and circuit diagrams, receiving set components, definitions and ethics of servicing have been treated in sufficient detail to give the radio dealer and his service man an accurate understanding of all essential information required in practical service work.

The complete course will cost \$12. Copies may be obtained from the Radio Institute of America, 326 Broadway, New York City.

## Television Booklet

A small booklet containing information on audio resistance amplifiers and their application to television has been issued by the International Resistance Company, Philadelphia, Pa., and may be had for the asking.

# Tracing the

# “SKIP”

## *How to Get Information from Relatives—Tracing “Skips” Through Their Children—Ownership of An Automobile as a Clue—Real Estate Firms as Good Prospects*

**M**ANY times the retailer can get information concerning the whereabouts of the “skip” from the latter’s relatives and friends, provided, of course, due care and proper judgment are exercised in the quest.

1. One investigator poses as a life insurance representative. First he finds out whether the “skip” carried life insurance, and if so, with which company. After securing this information the investigator visits relatives of the person, who under ordinary circumstances would be averse to revealing the whereabouts of the “skip.” The investigator informs the relatives that he has a cash surrender on the policy, which the company has instructed him to deliver to the rightful owner only. To strengthen this, the investigator may show the relative a bogus check as evidence of cash dividend due the “skip.” This will always make the relative “open up” and reveal the whereabouts of your man. Another way still is to represent yourself as a life insurance agent and tell the relative that the policy is going to lapse unless action is taken by the “skip.” This is bound to bring action.

2. When interviewing friends and relatives of the “skip” you may make the statement that the party in question gave their names as references. Or, you may play another card. Tell the relatives that you represent some firm and that you have in your possession a check for “back pay” for the party. Or better still, you may tell them that you have in your possession a “dividend check” for the man on an insurance policy, and that the check must be delivered to the person designated only.

3. Some investigators will even resort to the practice of compensating friends in the neighborhood to secure the necessary information from relatives of the “skip.”

4. Often you can secure the necessary information through the person’s children. Thus, the children may belong to an athletic club, such as bicycle, baseball, or any other sports’ club, and the names and addresses of the juvenile members will appear on the rolls of memberships or an athletic programs. That is why, when extending credit to a customer it is often best to state on the application blank the names and ages of children and their places of employment, if any. Also, you may

obtain the desired information by interviewing the principal of the school.

5. Ownership of an automobile by the person wanted may give a good clue to his latest whereabouts. It is best to try the Motor Vehicle Department in the state, or any other official registry department, as this office should have record of the license number and the owner’s address.

**I**F, however, the automobile was disposed of before removing, you would do well to write to the State Registry Department, where record of all second-hand sales is filed before a license can be issued to the new owner of the car. As a general rule, before a license is issued to the new owner, a clearance card or certificate is issued in about two weeks to the party who sold the car. Meanwhile the old owner may have left his forwarding address with the department.

6. Real estate firms are good sources of information. See as many as possible, and form good connections with their representatives. Cultivate especially the real estate firms that make a specialty of renting homes. If you have reason to believe that the man wanted had just moved into a certain neighborhood you can inquire at the real estate office for a list of homes they had just rented in that neighborhood, and by a process of elimination you can worm out the house in which the man now resides.

7. Go to the place where the “skip” was last employed. He may have presented references by several business men before finally securing employment. The firms may have these names on file, and it is up to you to interview them. Perhaps the “skip” had been sent to his last place of employment by an employment agency, and there his new address may also be registered.

8. Veteran investigators interviewed by the writer recommend the following as good information sources to cultivate: Chief of police, union officials, newsdealers, local banker, gas and electric meter readers, dentists, doctors, tailors, American Legion post, deliverymen, policemen, mailmen, Chamber of Commerce, local credit bureau, voters’ lists and tax collectors.

# Illustrating The 4 P rinciples of Good Display



## 1. ATTENTION!

Stop 'em! The genuine Indian in this window (above), Robertson Music Company, Lawrence, Kan., has attention value but no sales appeal.



## 2. INTEREST, and 3. DESIRE (above)

Stern and Company, of Philadelphia, show us how effectively to combine interest and desire through the use of descriptive window cards.



## 4. ACTION!! (left).

Get 'em in. A mighty hard thing to do. Generally accomplished by price or special "limited time" appeals. This window of Alexander Revell, Chicago, stresses tone as well as value.

# Radio Retailing

A McGraw-Hill Publication

SEPTEMBER

1929

# Rural Radio

## The Waiting Farm Market

OF THE 28,500,000 homes in the United States 5,861,000 are on farms which have no electricity supply. Indeed, less than 7½ per cent of our total of 6,315,000 farms are serviced by the lighting companies.

But for the American farmer the sun is coming out. The Federal Farm Board, with its \$500,000,000 fund for co-operative marketing, will be a contributing factor to this optimistic outlook. Greater tariff protection, now in the offing, is another. Furthermore, indications are that the farmer certainly will obtain equal treatment with the industrialist in regard to federal legislation from now on. Rural credits are improving. Whereas there were 122 farm bankruptcies per 100,000 farms in 1924, the ratio has lately dropped to sixty. Farms are more accessible to trading centers, and farm work is more attractive.

All these things will enhance the number, and the purchasing power, of the farmer's dollars.

It is high time, therefore, that the radio industry evaluate this waiting farm market for its true worth.

Because of the factors just enumerated it is a safe assumption that a majority of these 5,861,000 families (20 per cent of the total number of households in the United States) will be excellent prospects for battery operated radio sets.

What is the manufacturer and the dealer doing about this opportunity? Investigation discloses that selling the farmer can be made a profitable business for merchants in many lines—including radio. But the latter activity during the past 15 months, has been sadly neglected. This has been due to the more alluring market for the new a.c. receiver. This year certain manufacturers and many farseeing dealers will meet this challenge by recultivating this profit-bearing soil. Apart from this incentive, such a policy in many cases, will be necessary to maintain last season's sales record.

And *Radio Retailing* proposes to do its full share to revivify this tremendous demand for radio reception on the farm. It will publish, frequently, "dealer method" stories of successful excursions into this field—see, "Selling the Farmer by Rule of 4," in this issue. It also will report fully the industry news of this activity.

## Broadcasters Getting Out of the Red

OF INTEREST to radio dealers is the news that many broadcasting stations are beginning to return substantial profits not only to their owners but to the manufacturers of radio equipment who buy their air time. This statement comes from Radio Commissioner Harold A. Lafount who recently returned from a month's survey of the fifth radio zone, which embraces the Pacific Coast territory.

This opinion is confirmed by many radio concerns

and by the fact that the better stations now have "waiting lists" of prospective advertisers whom they are unable to accommodate.

Inasmuch as the prosperity of the broadcasting unit is the prosperity of the radio retailer, this news is most welcome.

## Public Anticipates Home Talkies

IN THE September issue of *Harper's* magazine is an article by Gilbert Seldes, that well-known critic of the screen, entitled, "Talkies Progress." In it he describes the latest developments in this new form of cinema enterprise and points out that soon Home Talkies will prove to be serious competitors to the public theatres. We quote the following paragraph because of its extreme significance to the radio industry.

"Within twelve months—eighteen months at the latest—the talkies will have to meet the competition of the talkie-projector in the home—something resembling the popular amateur movie projector, but equipped with synchronized sound. And within another year we shall probably have the simple and comparatively inexpensive mechanisms, now being perfected, which will throw on a small screen set up beside the home radio set a moving picture projected from a central broadcasting station. Thus two separate ways of having the talkie, without going to the theater, will challenge the talkie which stays in the theater."

Coming, as this does, from one outside the confines of the radio industry, increases its importance to all within the industry. We know there are many manufacturers burning the midnight oil in the development of Home Talkies. It is also rumored that within a very short time actual models will be on the market. And, Mr. Radio Dealer, if you are preparing yourself for this new trend now, it will be you who will cash in on it.

## Let's Have No More Commissions

APROPOSAL to expand the powers, staff and operating expenses of the present Radio Commission, while at the same time diminishing its usefulness to radio, is contained in a bill now before Congress to form a Federal Communications Commission which would have charge of all communications, both wire and wireless, in addition even to the supervision of the distribution of electricity for lighting and power purposes.

Those who know Washington intimately, see in this attempt one more effort to fasten the control of the politicians on great industries, while at the same time, creating jobs for political appointees.

The regulation which radio requires is essentially that of *traffic control*. The regulation demanded by the wire utilities is purely that of *rate fixing* and *plant evaluation*.



# Due for a Boom!

Between the two there is no common denominator. Experience in one field is no preparation for the other.

At the present time, the interstate regulation of the telephone and telegraph companies is in the hands of the competent Interstate Commerce Commission, which is a rate-fixing body.

The sooner the Radio Commission, or any such control body like it, can be eliminated from the Washington picture, and radio traffic control once more restored to the hands of experts in the Department of Commerce, the better will it be for the radio trade and the vast army of radio listeners.

## Basic Business Conditions Better

THE month just closed found the volume of general business on a plane about 2 per cent above that witnessed at the opening of July, and on a plane about 4 per cent above that reported at the opening of August last year. General business in the Chicago and East North Central sections was currently slightly under that of a month ago, but every section except the East South Central reported a volume of current business materially over that witnessed in August last year.

The 90-day outlook is good throughout the country, the expected volume of business averaging about 4 per cent above that at the opening of August, and about 6 per cent above the volume witnessed during the same period last year.

Radio manufacturing companies appear to be enjoying a volume of business greater than ever before experienced at this time of year. Competition, however, among the producers of receivers is extremely severe, and while total profits from this division of the business will undoubtedly establish new records over the previous record year, yet it is impossible to determine as yet which companies will be the major beneficiaries. It appears that tube concerns are faced with the same general situation.

## Closer Co-operation Needed

THERE is still too little preliminary contact between tube and set engineers. We find that in practically every case of a new tube being developed, the tube engineers "had the idea" first, then they built the tubes which were ultimately used by the set engineers.

Of course there have been times when set development became sufficiently influential to create a tube to meet its need. But generally the tube engineers first had in mind a use for a tube, built it, and then,—and only then,—have the set engineers taken the tube and engineered its use.

The ideal condition will come when the two branches of engineers consult together in advance of a desired

development; define their problem together and work to meet it together. For just as a set can be no better than the tubes that are in it, by the same standard the tubes cannot give their full value if the set engineering fails to best utilize the tube's characteristics.

Closer co-operation on both sides will result in a saving of time and money and in better merchandise.

## Illegal to Fix Service Prices

THE federal anti-trust laws apply to a service business as well as to the manufacture and distribution of merchandise, the Supreme Court of the District of Columbia has ruled, following a motion for dismissal of the Government's petition for an injunction to prevent 13 master cleaners and dyers doing business in the District of Columbia from entering into agreements on prices and the division of business. The Government filed its suit in February, 1929, charging the defendants with conspiracy to raise prices to be charged for cleaning and dyeing. The defendants moved to dismiss the proceedings on the ground that the Sherman Act does not apply to the particular business in which they are engaged. With reference to the applicability of the anti-trust laws to price agreement or other understandings in restraint of trade made by persons or companies engaged in purely service business, Justice Jennings Bailey said:

"I think that the bill in this case will lie, both under the statute and the principles of common law."

## Who is Master—You or the Dog?

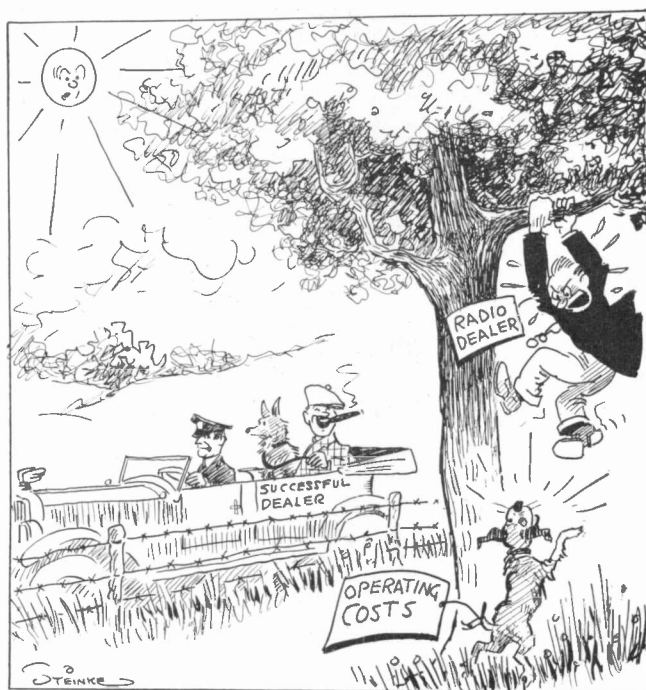

# 1919 - 1929

## Ten years of

# RCA

# LEADERSHIP

## and now

## the greatest of all RCA lines

*"Music from the air  
or record  
with the realism  
of the  
RADIOLA"*



*This sign marks the leading  
dealer in every community*

RADIOLA DIVISION  
RADIO-VICTOR CORPORATION OF AMERICA  
NEW YORK CHICAGO ATLANTA DALLAS SAN FRANCISCO

# RCA RADIOLA

MADE BY THE MAKERS OF THE RADIOTRON



**RCA Radiola 67**

The new Super-Heterodyne combination with RCA Electro-Dynamic loudspeaker giving electrical reproduction of records. The complete home instrument brings to you a will "Music from the air or record."  
\$690 (less Radiotrons)



**RCA Radiola 64**

RCA Super-Heterodyne receiver de luxe. Super-sensitive and super-selective. Remarkable tone realism made possible by improved RCA Electro-Dynamic reproducer.  
\$550 (less Radiotrons)



**RCA Radiola 66**

A new improved RCA Super-Heterodyne with RCA Electro-Dynamic reproducer. Built with master craftsmanship throughout. The finest Super-Heterodyne ever offered at this price.  
\$225 (less Radiotrons)



**RCA Radiola 60**

Beautifully designed table mode of the Radiola Super-Heterodyne, the most selective circuit known in the radio art.  
\$130 (less Radiotrons)



**RCA Radiola 47**

The newest RCA "all-electric" development in Screen-Grid radio combined with the phonograph. Radio and phonograph utilize the same improved built-in Electro-Dynamic reproducer. "Music from the air or record."  
\$275 (less Radiotrons)



**RCA Radiola 44**

Utilizing the sensational new Screen-Grid Radiotrons. Circuit incorporates latest engineering refinements. High amplification, great selectivity and sensitivity.  
\$110 (less Radiotrons)



**RCA Radiola 46**

Cabinet Radiola with the new Screen-Grid Radiotrons. Built-in RCA Electro-Dynamic reproducer. A powerful, efficient receiver of most modern design. \$179 (less Radiotrons)



**RCA Radiola 33**

The rationally famous "all-electric" console type Radiola. Realistic reproduction of music and the voice from nearby or distant stations. A quality instrument at a low price.  
\$54 (less Radiotrons)

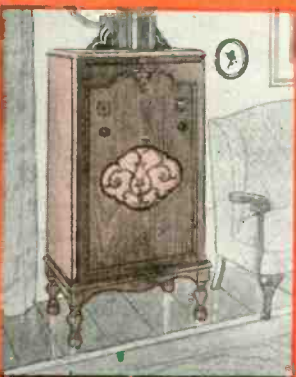

**RCA Radiola 22**

RCA Screen-Grid Radiola for battery operation, with RCA loudspeaker enclosed. Reproduces voice or instrument with great fidelity.  
\$135 (less Radiotrons)



**RCA Loudspeaker 106**

Electro-Dynamic speaker of amazing range, capacity and tone fidelity. Operates from A. C. house current.  
\$49.50



**RCA Loudspeaker 103**

The leading magneto-type radio reproducer. Designed to harmonize with home furnishings.  
\$22.50



**RCA Loudspeaker 100-B**

With the rich, mellow tone characteristic of the popular "100" type of reproducer. The design matches Radiola 33.  
\$17.50

# RCA RADIOLA

MADE BY THE MAKERS OF THE RADIOTRON

# Sales Builders

## "Honor Roll" Paves the Way

### This Month's Prize Winner

THE continuous showing of the names of all purchasers of radio sets has increased the business of Henderson and Parker, Warsaw, Ind., an estimated 20 per cent. "Our 'Honor Roll,'" this firm calls it, and hangs these names in the store window as well as displaying them on the side wall of the salesroom.

The public's interest in the Honor Roll increases in proportion to the growth of the list. This impressive array of names also acts as an excellent advertisement of the popularity of this concern.

Furthermore, the presence of the names of the purchasers in the display window increases the ties of friendship between the customer and Henderson and Parker.

Near the Honor Roll in the window is a chart of station dial numbers, as reported by a number of the Honor Roll who has located the largest number of stations. This display also builds confidence and publicly proclaims the co-operation that exists between dealer and customer.

## Painting "White Elephants" in Their True Color

DISARMING frankness upon the part of the advertisement writer, like the style used for this Pittsfield, Mass., store, is a big asset in getting attention to the White Elephants that may be on hand. It's what somebody has called "Supertruth in Advertising."

### We Are Just Tired of Seeing These Radios Around—Don't You Want One?

That's "Truth in Advertising" says our radio buyer, and he's for the truth every time, every day. About these radios he says he is "fed up" with them—wants to get them off his chest and out of the store—quick!

This four-tube Atwater Kent has been gathering dust long enough. It belongs to a gentleman who wanted a Fada more. It will not get Europe often but is a good set for a man who is satisfied with big stations. His neighbors would like it better because it wasn't made to hear a mile but gives results in the owner's house and neighbors can sleep. Four good tubes and a cone speaker with the set. If you can raise the money it's yours for \$29.50.

Not many people ever heard of a Wolper—we never did until this came. The speaker built-in and batteries all in the cabinet, hid from view. The maker thought he ought to get \$100 for this model. Well, for the man who likes three dials, it would be a corking good deal at \$50, but we'll say \$35—take it for that.

In our way is a six-tube Radiodyne that gets Denver, California, Cuba and other distant points, they say. A doctor owned it and paid \$135 for it. His wife preferred the Fada and so the Radiodyne is waiting here for someone. If you have patience, don't mind two dials and a whistle or two, this set would be a "wow" for you to own. \$25 for it—what do you say?

A Radiodyne five-tuber in a console, just as good looking as when it cost \$125. We are offering it to you for just \$75, a good fifty underprice.

Two Music Master Cone Speakers that were O.K. at \$35 a while ago—listen, we've marked them ten each.

HOLDEN & STONE Co.  
Radio Department

## Cuts Tube Losses at Both Ends

BY TESTING every tube as soon as it is received from the manufacturer or jobber and then pasting the following notice on all found satisfactory, the Wichita, Kan., branch of J. W. Jenkins Sons Music Company is reducing tube losses at both ends. Defective ones are discovered at once, and returned to the source from whence they came, while complaints from users have been cut in half.

Oscillation Test O. K.  
Not Subject To  
Replacement

**TESTED**

J. W. JENKINS SONS  
MUSIC CO.

This Work was done by the  
A B Electric Co.

MAR 1 8 1929

122 WEST THIRD STREET  
Carthage, Missouri

## Sticker Serves as Reminder

"ON all our repair jobs, we make use of this sticker. (Illustrated above.) It makes it easy for the customer to call us again and also serves as a reminder when he discusses radio with his friends," says A. G. Adams, of the A B Electric Company, Carthage, Missouri. "They are very inexpensive and are very easy to attach to convenient places, either in the set or on parts, as well as on packages and bundles."

## The Milk Bottle Carries the Message

Octagonal stickers which bear the radio advertising message of the Sunset Electric Company, Portland, Seattle, and Spokane, are affixed to the milk bottles of several of the leading milk companies in these cities. When the housewife takes in the bottle, this is the message that greets her: "When you buy Pine Creek, you get the finest milk—let your Atwater Kent dealer show you the finest in Radio."

Sunset reports a very decided increase in sales and inquiries.

## Contacts Each New Customer

EVERY new customer of Simcoe & Sommer, 34 Somerset Street, Plainfield, New Jersey, receives a printed statement which explains the company's service policy in detail.

All questions regarding tube replacements, service calls, repairs, and time limits during which service calls will be made are taken up. This statement brings about a closer understanding between customer and dealer on the question of service. It also nips in the bud most cases of misunderstanding or thoughtless complaints.

ALL STANDARD MODEL OF RADIO SETS  
TRADEMARK REG. U. S. PAT. OFF.

**SIMCOE & SOMMER**  
"RADIO - PLUS EXPERIENCE"  
34 SOMERSET ST., PLAINFIELD, N. J.

**WE THANK YOU**  
Please accept our sincere thanks for your order. We will do our best to get your set in a hurry and in perfect condition.

**OUR SERVICE POLICY**  
Satisfying and fair claims on service are one of our chief aims with you. Therefore you are entitled to a frank and full statement of our service policy so that there will be no misunderstanding about what the "best" service means to both of us.

**TUBES**  
Tubes are not guaranteed by any of the manufacturers but any tube bought from us which is defective will be replaced free of charge within thirty days from date of purchase. Any defect in a tube will show up within that period.

For every day more, defective tubes will be substituted by the manufacturer for adjustment and any tubes which are replaced to us by the maker will also be replaced by us in the time of charge. Pending the manufacturer's decision, new tubes will be paid for by the user. We will make an immediate refund if and when the manufacturer's tubes are replaced to us.

This arrangement constitutes a NINETY DAY service policy on tubes but we can give the policy only on tubes which are not defective or which have become defective through some external cause not on the tubes themselves.

**RADIO SETS AND SPARE PARTS**  
All members of the Radio Manufacturers Association have adopted a policy similar to that of the makers of automobiles—Ninety Day Warranty, which means when radio manufacturers have assumed their responsibility to their Dealers. Our policy with our customers is to meet their needs and to be fair.

For three months from date of purchase we will repair or replace at our option any radio set or speaker which is defective, free of charge. There will be no charge for express bills during this period. Make us aware of this benefit as soon as possible.

For more additional months we will repair any impedance or any speaker making no charge whatever for the labor involved in the actual repair. During this period the owner pays for parts only. However, there will be a material charge of \$1.00 for each month's operation of service call made when the actual repair is made. This policy covers only defective merchandise and does not apply to internal switch boxes, compressors, through phone lines, or other external electrical accessories used. This arrangement constitutes a ONE YEAR service policy on sets and speakers.

**TERMS**  
All requests, orders and repair work is cash upon completion and delivery to the owner.

Make Type No. Day Call  
We appreciate your patronage. Will you recommend us to your friends?

WE SELL ONLY THE BEST IN SETS AND ACCESSORIES

# For Live Dealers

## His Best Advertiser Is Lowly Postal Card

**B**ELYING the testimony of many dealers that "doesn't pull any longer" is the experience of the Modern Electric Company, St. Louis, Mo. Using the ordinary garden variety postal card as its chief publicity medium, sales during Oct., Nov. and Dec. averaged three to every 1,000 printed messages sent to a list of unknown prospects selected from the telephone directory. As the total cost per thousand of this publicity was but \$15.50 (included typing of names and addresses) the cost per live lead was \$5.17.

"This promotional 'stunt' is so obvious and simple that it is, for these very reasons, overlooked by the average dealer," declares President C. O. Burklin. "Yet, in addition to its low cost, it enables me to contact thousands of prospects personally unknown to me and otherwise not directly reachable.

"The Modern Electric Company is a neighborhood store. The typist is instructed, therefore, to select, in alphabetical order, only the names of persons on a given list of streets within a radius of three miles from 3641 So. Grand Boulevard. She devotes approximately four hours a day to this work. I try to circularize each prospect once a month."

The message on these cards stresses value and terms. Inquiries are followed up the day received with a personal call from the outside salesman. The postal card, as employed by Burklin, gives him maximum direct contact coverage at minimum cost.

## Printed Notices Speed Time Payments

**T**HREE days before "due date," every customer on the credit list of the Hardsocg Manufacturing Company, Ottumwa, Iowa, receives a 5x5-inch printed slip which notifies him the day on which the next payment on the radio contract will fall.

Three days after "due date," delinquent customers receive a second notice of similar size, but on different-color paper, calling their attention to the overdue account and concluding with this

**HARDSOCG MANUFACTURING CO.**  
RADIO DIVISION  
117 SOUTH COURT STREET  
Ottumwa, Iowa, March 18 1922.

Thomas Taylor  
105 Main St  
Ottumwa

A payment on your Radio Contract will become due,  
March 22, 1922.

We will appreciate your attention.

To avoid additional interest charge, payments should be made promptly.

HARDSOCG MFG. CO.  
PER L. Lucas

OPEN SATURDAY EVENINGS UNTIL 9:30 O'CLOCK.

☞ RADIO RETAILING will pay \$5 every month for the best sales idea and \$3 for every sales idea accepted for publication in this department.

☞ All you have to do is to write us a letter telling us about it. If possible, send along a photo or diagram.

☞ Address: Sales Idea Editor, Radio Retailing, 36th Street and Tenth Avenue, New York City.

warning: "Payments should be made promptly to avoid additional interest charges."

It costs the Hardsocg Manufacturing Company four cents a month per customer to print and mail a "payment due" or "overdue" notice. "But this gentle reminder has speeded collections so that now seventy per cent of the credit customers pay promptly and eighty per cent of the remainder come across in response to the second notice," declares an official of this concern.

"The average delinquent is not crooked; just careless or forgetful. Reminder notices are well worth their cost and should form a regular part of the collection machinery of any dealer's book-keeping system."

## If You Close the Store Evenings, Try This

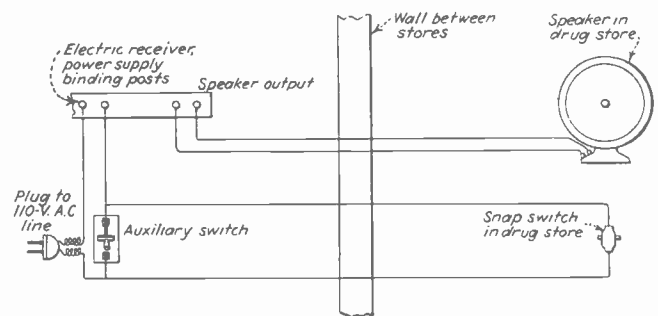

**L.** BLEECKER, owner of Fiery's Electric Shop, Maplewood, N. J., has placed an electrically operated set in his store window, wiring its power leads through the adjoining drug store owned by his friend, George D. Foster. A push-type switch has been inserted in series with one of these supply leads just back of a counter in the drug store. A small cabinet speaker has also been placed in the drug store its output leads wired back to Fiery's Shop.

When Bleecker closes his shop for the evening he closes an auxiliary switch in the set's power line, tunes the set in on a large local station and then opens the auxiliary switch, turning the current off again.

Foster, who keeps his store open until late at night, has only to press the switch behind his counter, closing the power line, and the set broadcasts Bleecker's publicity to his drug customers.

The co-operative scheme is the result of Foster's request during the broadcasting of a football game last fall. Bleecker intended to install the speaker temporarily but it has increased the sale of Foster's cigars and candy and supplied him with a number of good leads—so it remains. A small sign over the loudspeaker bears the name of the set in operation next door.

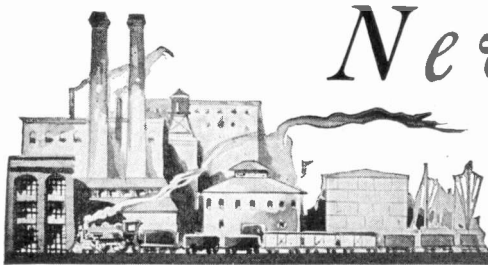

# New Products for

This editorial section is prepared purely as a news service, to keep readers of "Radio Retailing" informed of new products.

## New Radiolas for Farm Use and An A.C. Set

To bring the latest developments in radio to homes not served by electrical power lines, The Radio Corporation of America, 233 Broadway, New York City, has brought out Radiolas 21 and 22. The circuit in each is identical and uses two UX-222 tubes together with either three UX-112A's, or two UX-112A's and one UX-171A, depending upon whether the owner wishes to use three or four 45-volt B-batteries. Both receivers have a local-distance switch, and the new stencil-cut illuminated selector dial.



Model 22

Radiola 21 is a table set in a walnut veneer cabinet.

Radiola 22 has a built-in 103 reproducer. The console cabinet is of Queen Anne design and is designed to house all batteries. The intended retail price of the 21 and 22 will be announced later.

A new model with the super-heterodyne circuit is the Radiola 66. This has not been specially designed for farm use as have Models 21 and 22. It has a tuned antenna coupling circuit, one stage of r.f. amplification,



Model 66

oscillator, first detector, two stages of intermediate frequency amplification, second (power) detector and one stage of a.f. amplification. The elimination of one stage of a.f. materially increases tone fidelity and reduces possibility of distortion, according to R.C.A. Six UY-227's, a UX-245 and a UX-280 tube are used. Facilities are provided for attaching a phonograph pick-up. The cabinet is two-tone walnut veneer with burl maple overlays. The speaker opening and control panel are covered with cut velours. Price, \$225.—*Radio Retailing*, September, 1929.

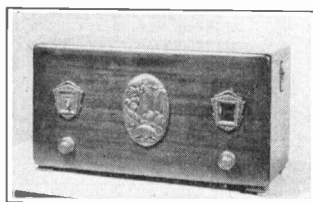

Model 21

## 32-110-Volt D.C. Converter

A converter of the inverted synchronous type which will change 32 volts of direct current to 22 volts alternating current and then step it up through a booster winding to 110 at 60 cycles is announced by the Kato Engineering Company, Mankato, Minn. All windings are on one armature which is suspended between two bearings.

A specially designed filter system brings to the radio set smooth even current. This has been specially built for use with all 32-volt d.c. farm lighting systems. According to the manufacturer this converter uses approximately 2½ to 3 amp. at 32 volts. The intended retail price is \$70. Other models are being developed.—*Radio Retailing*, September, 1929.

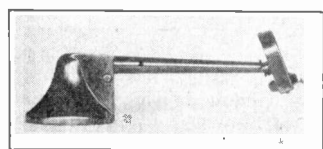

## Electric Pick-Up with Non-Set Stop

An electric pick-up with automatic non-set stop is announced by the American Sales Company, 932 Wrightwood Ave., Chicago, Ill. By means of a series of levers in the base of the tone arm, this device will automatically operate all types of records, without setting, says the maker. It comes with a 16 in. arm for commercial installations in moving picture theatres.—*Radio Retailing*, September, 1929.

## Graybar "600" Set

A new seven-tube console set, designated as Model 600, employing an improved super-heterodyne circuit, has just been introduced by the Graybar Electric Company, 1735 Grand Central Terminal, New York City. The tubes used are six 227's, one 245, and one 280.

The circuit includes an antenna coupling circuit, one stage of t.r.f., a power detector, oscillator, two stages of intermediate frequency, a second power detector and one power output stage. The electro-dynamic speaker obtains its field excitation directly from the socket power unit of the receivers instead of from the customary rectifier stacks. The cabinet features a highly colored, tapestry grille of unusual design. The intended retail price is \$2.25.—*Radio Retailing*, September, 1929.

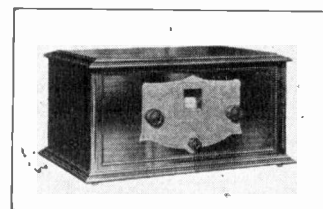

## Fada Battery Set

To meet the demand in rural areas for a battery operated receiver, F.A.D. Andrea, Inc., Long Island City, N. Y., has bought out a six tube Neutrodyne set, employing five 112A's and one 171A power tube. The circuit consists of three stages of t.r.f. amplification. The antenna compensator is operated from the front panel. Model 22, as it is called, is especially designed for use with the Fada 4 magnetic speaker, and operates from a 6-volt storage battery, plus 135-180 volts of B-batteries. It is a table model in a cabinet of mahogany with duo-tone finish. The intended retail price is \$55.—*Radio Retailing*, September, 1929.

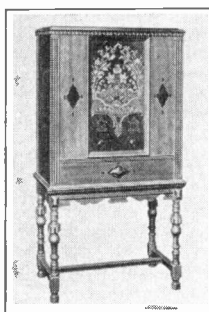

## "Golden Voiced" Table

A new development in the radio field is the "Golden Voiced" table just announced by the Kiel Furniture Company, Milwaukee, Wis. It is designed for acoustic properties with dynamic speaker, permitting full and undistorted tone reproduction, the manufacturer says. All wood parts are of a proper thickness to prevent tone-distorting vibration. The wiring for aerial, ground and power connections is concealed in the table legs and there is no exposed wiring above the floor. This table is made especially for the new Atwater Kent screen-grid set and has been officially approved by the Atwater Kent Manufacturing Co. The chassis is installed under the table top, which lifts up, so that all parts are accessible for servicing. A panel on one side of the table lets down, exposing the tuning panel. The over-all dimensions are 24½ in. x 36 in. x 31 in. high. The intended retail price is \$45.—*Radio Retailing*, September, 1929.

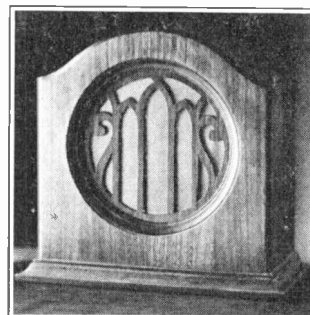

## Dynamic Speakers

Two cabinet model speakers, one called a "superdynamic" and the other known as a "ferro-dynamic," have been developed by Valley Appliances, Inc., Rochester, N. Y. They are licensed under Lektophone patents. The super-dynamic chassis for 60 cycles, a.c. operation, with 7½ in. cone, is \$26; in the illustrated cabinet, \$40; with 10 in. cone, \$27.50. For 60 cycles, d.c. operation, with 7½ in. cone, the price is \$18; with 10 in. cone, \$19.

The ferro-dynamic in a cabinet similar to the one illustrated, with 7½ in. cone, is \$21. Chassis only, 7½ in. cone, \$11.50; 10 in. cone, \$12.—*Radio Retailing*, September, 1929.

# Dealers to SELL

All announcements appearing on these pages are published without advertising considerations of any kind whatsoever.

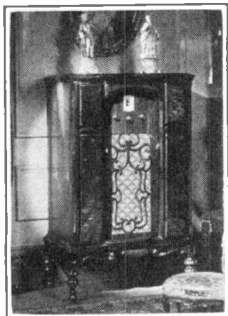
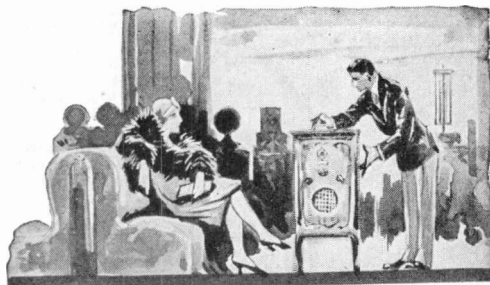

Courier Model 653

## Peerless 25 and Courier 653

The line of Peerless and Courier receivers, made by the United Reproducers Corporation, Rochester, N. Y., has been extended to include two new models.

Peerless 25, the larger of the two, uses three screen-grid tubes in conjunction with newly developed low-loss, uniform-gain, r.f. transformers, to give maximum selectivity, a 227 detector, a 227 in the first audio, two 245's in push-pull in the second, and a 280 rectifier. It is also equipped with an improved automatic volume control, with a 227 as a control tube. This model, as well as the Courier receiver, has the "Kylotron" reproducer. The cabinet has matched butt walnut doors and center panel, with sides of diamond matched walnut. The intended retail price is \$600.

Courier 653 has the "65" chassis which employs three screen-



Peerless Model 25

grid tubes, one 227 detector, a 227 in the first audio, two 245's in push-pull in the second and a 280 rectifier. The cabinet is 46 in. high and has front and doors of matched burl walnut, overlaid with burl maple. Price, \$165.—*Radio Retailing*, September, 1929.

## Portable Set Analyzer

The Jewell Electrical Instrument Company, 1650 Walnut Street, Chicago, Illinois, announces that its pattern 199 set

analyzer is now available in a portable cabinet which has a drawer and compartment for tools and extra tubes.—*Radio Retailing*, September, 1929.

## Browning-Drake Set

Two table sets and two consoles are offered by the Browning-Drake Corp., 226 Calvary St., Waltham, Mass. Model 54, illustrated, has five tuned circuits using nine tubes, including two 245's in push-pull. With screen-grid circuit, the intended retail price is \$142.50; with heater type tubes, \$137.50. The table model with screen-grid circuit is \$102.50; with the heater type tubes, \$98.—*Radio Retailing*, September, 1929.

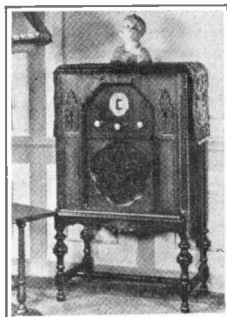

## Dynamic Speaker Chassis

The Trimm Radio Manufacturing Co., Chicago, Ill., has developed a dynamic speaker chassis that combines wide range with tone fidelity.

Model D100 is an a.c. chassis, the energy for which is supplied by the conventional type of power amplifier tubes in push-pull, or from a power pack supplying d.c. for energizing the field coil.

DV102 is provided with an output transformer which matches the power amplifier tubes and voice coil.—*Radio Retailing*, September, 1929.

## Convenience Outlets

Radio convenience outlets for practically every need are offered by Bud Radio, Inc., Cleveland, Ohio.

Model 105B for aerial and ground connections, is \$1.25; 106B for speaker or head phone connections, \$1.15; 158B for aerial, ground and electrical connections, \$2.40; 168B for speaker and electrical outlet, \$2.30; 156B for serial, ground and speaker connections, \$2.40; 157B for speaker outlet and volume control, \$3.00; 166B for two speaker connections, \$2.30, and 183B, which contains a duplex receptacle for supplying electric current to the set and speaker and a three-way toggle switch so that the receiver can be turned on and off at two places distant from it. Price, \$2.50. *Radio Retailing*, September, 1929.



Model 292

## New Gulbransen Sets

Two screen-grid sets, one a highboy and the other a console, are now being made by the Gulbransen Co., 3232 W. Chicago Ave., Chicago, Ill.

Model 291 uses two 245's in combination with the screen-grid tubes. The radio-phonograph switch is operated by the knob that controls the a.c. switch. The intended retail price is \$139.50.

Model 292 has a 10 in. dynamic speaker. The cabinet is built of walnut with walnut veneers. The intended retail price is \$149.50.—*Radio Retailing*, September, 1929.

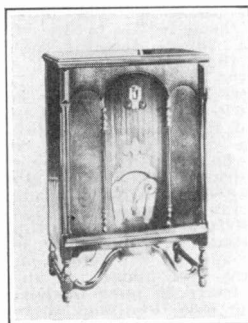

Model 291

## Trav-Ler Portable Sets

Three new models of portable radio receivers, all using a new and radically different type of circuit, have been perfected by the Trav-Ler Manufacturing Corporation, St. Louis, Mo. They have only four tubes, with a screen-grid tube used in the r.f., a 199 as detector and in the first audio stage. A 120 is used in the last audio stage.

Each model is made to operate with batteries, or on 110 volt, a.c. or d.c. The power packs and batteries are easily interchangeable, so that the dealer need carry only a minimum stock as he can stock the two styles of power pack and equip the model according to the buyer's demand. A built-in loop

is used. Binding posts for antenna and ground are provided. The "Standard" is the smallest model and lists at \$65. The case is covered in black Mocotan with the panel in black, green and gold crackle finish.

The "De Luxe" is a larger set and retails at \$75. This model when closed measures 14 1/2 in. x 9 in. x 13 1/2 in. The weight when fully equipped is 30 lb.

The "Aristocrat" has a 7 in. cone speaker of a new type especially developed for it. The case is covered in brown Mocotan. When closed it measures 15 1/2 in. x 9 in. x 15 1/2 in. The weight is 39 lb. Price, \$100.

The above prices cover the speaker but do not include power packs, batteries or tubes. The a.c. power pack lists at \$35; while the d.c. unit is \$30.—*Radio Retailing*, September, 1929.

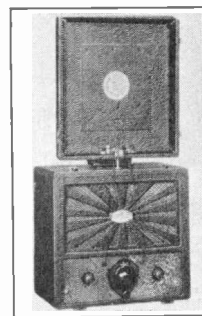

## Electric Phonograph Motor

A neat and compact electric phonograph motor, known as the "Black Flyer," has been developed by the General Industries Company, 2913 Taylor Street, Elyria, Ohio. It is of the standard power-motor type. Sufficient power is provided for instantly starting the largest records under the heaviest needle pressure, according to the manufacturer. It operates on 110 volt, 60 cycles, a.c., and picks up under load to 80 r.p.m. within two revolutions.

The finish is black crackle enamel with hardware in nickel, brass, antique copper or statuary bronze finish. The turntable may be had covered in standard shades of felt or velveteen. Silk velvet coverings are available at a slight extra charge.

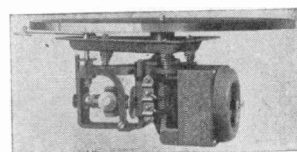

The "Blue Flyer," illustrated, is a "super-electric" motor particularly suited for portables because of its smaller size. It is of the induction type and is built on the same principles as the larger model.—*Radio Retailing*, September, 1929.

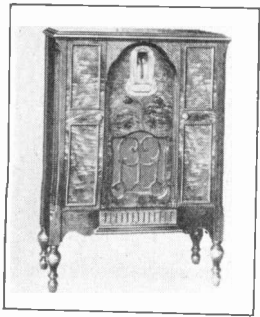

Model 52

## New Zenith "50" Line

Four new models make up the "50" series just brought out by the Zenith Radio Corp., 3620 Iron Street, Chicago, Ill. The sets use the following tubes: three 224's, three 227's, two 245's and a 280 rectifier. A feature of these receivers is the double push-pull amplification using two 227's and two 245's, providing tremendous output. A 12-in. super electro-dynamic speaker; automatic volume control, automatic station silencer and indicator, and phonograph pick-up connection are among

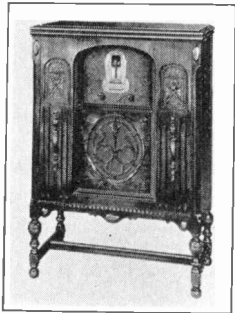

Model 53

the other features. All have the Zenith automatic tuning device.

Model 52 is inclosed in a cabinet which is an American adaptation of a Gothic cabinet. This model does not have the automatic control and station indicator and silencer. The intended retail price is \$175.

Model 53 comes in a Jacobean period console, decorated with carving. Price, \$275.

Model 54, in a Charles II period cabinet, has an intended retail price of \$395.

Model 55 features remote controlled automatic tuning and has a built-in loop antenna. With remote control, the set may be operated from any part of the house. As many as four tuner units may be connected to the set. The device is 6½ in. by 3 in. and comes in a walnut case with bronze plate top and felt covered bottom. The intended retail price is \$700.—*Radio Retailing*, September, 1929.

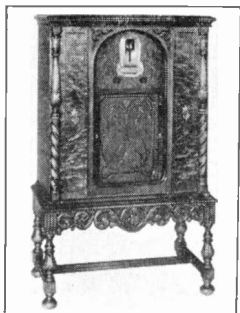

Model 54

## Steinite 60 and 70

The Model 60 set being made by the Steinite Radio Co., Ft. Wayne, Ind., employs five 227's, two 245's and one 280 rectifier. It is equipped with a super electro-dynamic speaker. The doors are made of matched walnut and are of the half swinging type.

Model 70, illustrated, utilizes three screen-grid tubes, two 245's, one 227 and a 280. An electro-dynamic speaker is also used in this model, which is inclosed in a walnut cabinet. The intended retail price is \$118.—*Radio Retailing*, September, 1929.

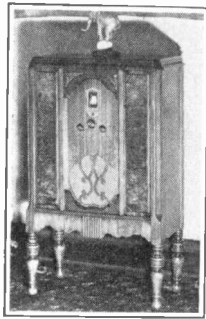

## New Sentinel Line

A radio-phonograph combination with a United electric pick-up and electric motor, and a Quam dynamic speaker, is one of the outstanding features of the line being made by the Sentinel Manufacturing Co., 9705 Cottage Grove Ave., Chicago, Ill. The intended retail price of this model, which is illustrated above, is \$149.50.

Among the radio receivers offered are model 666, a nine tube set using 227's and two 245's, and equipped with a Quam dynamic speaker, \$99.50; and model 414, a screen-grid receiver, \$89.50.—*Radio Retailing*, September, 1929.

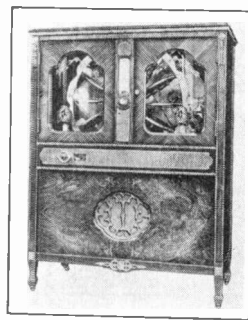

## Mills Automatic Phonograph

A new automatic phonograph with several improvements is now a part of the line made by the Mills Novelty Company, 4100 Fullerton Ave., Chicago, Ill. Chromium finished parts are now used and they are visible through the etched plate window. When in operation colored lights illuminate them. The cabinet is made of burl walnut. This model has, of course, the record selector device and special volume control.—*Radio Retailing*, September, 1929.

## Electric Portable Phonograph

A recent addition to the line of Stevens Manufacturing Corporation, 44 Spring Street, Newark, N. J., is a small, portable phonograph turntable with electrical pick-up, operating on the regular light socket. It is based on an entirely new type of electric motor measuring only 4 in. in diameter and with a speed governor carried by the rotor inside the housing. The motor operates in conjunction with a small transformer and special rectifier which supplies 4½ volts at 180 milliamperes. This electric portable phonograph is mounted in a small walnut finished wooden suitcase. The list price is \$42.50 complete.—*Radio Retailing*, September, 1929.

## Console Cabinets

The line of the American Furniture & Cabinet Co., Inc., Scott's Lane and Ridge Ave., Philadelphia, Pa., embraces three models.

Model 211 is an English lowboy of walnut with open face front. The set compartment measures 8 in. x 21 in. x 12 in. Price, \$23.

Model 215 is a Louis XVI highboy of walnut with French doors. The set compartment is 10 in. x 23 in. x 12 in. Price, \$48.

Model 216, illustrated, is a lowboy of Renaissance design with open face front. It is made of walnut and will accommodate a set 9 in. x 21 in. x 12 in. Price, \$33.—*Radio Retailing*, September, 1929.

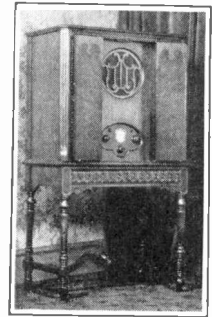

## New Operadio Speakers

The "Jack Horner" wall reproducer, illustrated, has the new electro-dynamic chassis and is made by the Operadio Manufacturing Co., St. Charles, Ill. It hangs in a corner of the room, using two walls as sounding surfaces. The dimensions are 15 in. wide x 36 in. high. The intended retail price for 110 volt, 50-60 cycle operation is \$55; for 25-40 cycle operation, \$57.50; and for 110 volt, d.c. operation \$45. A smaller model known as the "Little Jack Horner" is \$35.

The "Junior" speaker, with 10 in. exponential horn, is \$15. The "Senior" with a 54 in. air column is \$19.50. The "Algonquin" has an 11-in. cone driven by a magnetic cone unit and retails at \$32.50. The "Parisienne" is a console of French design and will accommodate a table set on top. The price is \$41. The "St. Charles" is a console with the electro-dynamic chassis. For 110 volt, 50-60 cycle operation the price is \$75, for 25-40 cycles, \$77.50; and for 110 volt, d.c. operation, \$65.—*Radio Retailing*, September, 1929.



## Voltage Regulator

The Webster Company, 850 Blackhawk Street, Chicago, Ill., is making a voltage regulation device called the "Auto-Potentialator." It contains no moving parts, liquids, ballast resistor or tubes, and is easily installed. The intended retail price is \$15.—*Radio Retailing*, September, 1929.

## "Transitone" Receiver for Autos

A radio receiver for installation on the dash-board of an automobile has been developed by the Automobile-Radio Corporation, 4311 Thirty-second Place, Long Island City, N. Y.

It consists of a six-tube, six-volt radio receiver completely enclosed and properly shielded by a copper box behind the dash. The tubes are mounted in cushioned base sockets to absorb the vibration. It has three stages of t.r.f., detector and two stages of transformer coupled audio amplification. The tubes used are three 201A's in the r.f. circuit, a 200-A detector, one 201A in the first audio and a 112A in the last audio stage.

The aerial for closed cars is copper wire netting concealed in the top of the car out of sight. For open cars, the aerial is made of heavy flexible copper cable woven criss-cross into heavy canvas which is made into the top of the car. This aerial will function with the top up or down. A reproducer is mounted over the windshield on closed cars and under the instrument board in open models. A speaker may be plugged in and used at any distance from the car. The tubes are run from the regular storage battery of the car. Ignition noises have been eliminated by a sound filter system, according to the maker, and reception is satisfactory at all speeds.—*Radio Retailing*, September, 1929.

## D.C. Interference Devices

The Dubilier Condenser Corporation, 10 E. 43rd Street, New York City, has introduced two types of D.C. interference devices. One has 4 mfd. by-pass condensers, and the other has 2 mfd. by-pass condensers, both intended for a 400-volt D.C. working voltage. There are three leads for the necessary connections across the line or power equipment, with the center lead to ground.—*Radio Retailing*, September, 1929.



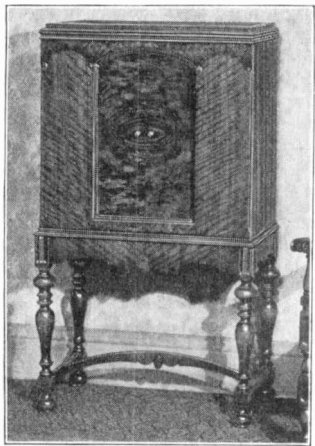

Model 70

## Two New Bush & Lane Receivers

The "de luxe" chassis is used in models 70 and 34, recently placed on the market by the Bush & Lane Piano Company, Holland, Mich. It consists of three stages of tuned and neutralized radio frequency amplification, tuned detector and grid-leak condenser method of rectification. The audio stage uses two 245's in push-pull. Eight tubes, including rectifier, are employed. A phonograph attachment is provided.

Model 34 has a recessed center panel framed by a front of figured butt walnut, with an overlay of maple burl. The intended retail price is \$187.50.

Model 70 is a highboy with figured sliding doors of butt walnut with panels of lighter Australian walnut on either side. Price, \$207.50.—*Radio Retailing*, September, 1929.



Model 34

## Dynamic Air Column Units

The Miles Mfg. Corporation, 31 W. 21 St., New York City, is marketing electro-dynamic reproducer units designed for air column work.

The Miles dynamic air column unit is put up in conjunction with a special output transformer in the following combinations of unit, transformer and horn.

The M 3½ Combination (3½ ft. trumpet, unit and output transformer) lists at \$170.

The M9 combination is the same as the above only with a large 9 ft. theatrical horn and lists at \$230.

The M10 is the same as the above with a giant ten ft. horn

*Radio Retailing*, September, 1929

having a 40 in. bell, listing at \$275.

These reproducers are designed to operate any output of 10 to 30 watts of undistorted power. Field supply 1.1 amp., at 6 volts d.c. (also can operate direct from a.c. by means of rectifier).—*Radio Retailing*, September, 1929.

## Metal Stands

Metal stands to accommodate Atwater Kent and Crosley sets and speakers are offered by the A. L. Smith Iron Works, Chelsea, Mass. They are lacquered and available in either antique brown or black. Each has a speaker clearance of 17 in.

Model H-1 is made for A-K model 40, 42 or 46 and the Crosley Show Box and Gem Box; model H-2 for A-K models 44, 45, 47, and 55; and model H-3 accommodates the Crosley Jewel Box and the Apex model 36. Any set of the same dimensions will also fit these stands. The intended retail price is \$4.75.—*Radio Retailing*, September, 1929.

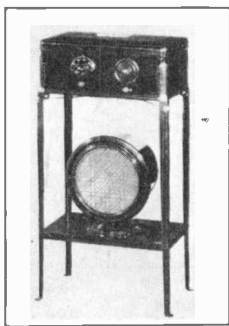

## Combination Antenna and Clock

The Aerial Insulator Company, Inc., Green Bay, Wis., is offering its inside aerial in combination with the Gardner "Around the World" clock, by which time in various parts of the world can be told at a glance. It will operate on either A.C. or D.C., is made of cast aluminum and retails for \$9.50, complete.—*Radio Retailing*, September, 1929.

## Stromberg-Carlson Electric Pick-Up

A new magnetic pick-up unit, known as the 3-A, has been designed by the Stromberg-Carlson Telephone Manufacturing Company, Rochester, N. Y., for use with its new line of screen-grid receivers and other sets using power detection and requiring that the pick-up circuit work directly into the grid of the amplifying tube.

The pick-up unit or head is of the low impedance flexible armature type. The step-up transformer is provided to raise the voltages to a value suitable for operating the audio amplifier. A flexible arm reduces wear on the record. The intended retail price is \$30.—*Radio Retailing*, September, 1929.

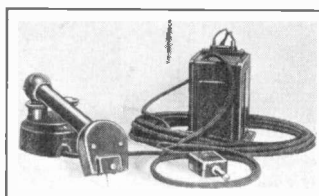

## Seven Tube Sets

Of particular interest to radio dealers in California and surrounding territory is the announcement by Barker Bros., Seventh Street, Flower and Figueroa, Los Angeles, Calif., of two radio receivers enclosed in cabinets especially made for typical California interior. In addition to these models, two other styles are available. The chassis used has six 227, one 245 and one 280 rectifier tube. The line, known as the "Invincible" line, is made under RCA, Latour and Hazeltine patents.

The "Monterey" model comes in a "peasant-type" cabinet with aged wood finish, in straw or Spanish Green, decorated. The intended retail price is \$224.

The "La Mesa" is made especially for Spanish interiors. It is of the table type and lists at \$198.

The "Albion" is a walnut lowboy in the English cottage design. \$225.

The "Hadlow" has sliding doors and comes in both walnut and mahogany. With plain panel, the price is \$198; with decorated \$207.—*Radio Retailing*, September, 1929.

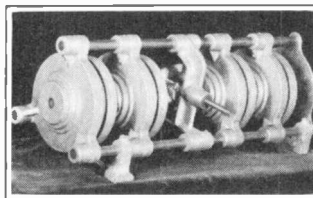

## Die Cast Condenser

The Furnell Die Cast Condenser Corp., 16 Hudson St., New York City, is placing on the market a new type of condenser. It eliminates entirely plate construction, the stator and rotor units being composed of one piece castings each—using a special alloy which will not warp. Stations are spaced over 360 degrees of dial motion. Any curve may be had by means of the design of the actuating cams.

The elements, being thick, avoid all vibration. According to the maker it is impossible to short the condenser. At maximum capacity a .02 in. air-dielectric is maintained. This increases to .05 in. at minimum capacity. Bakelite is used for insulation.—*Radio Retailing*, September, 1929.

## A Sensitizer

The Sunset Manufacturing Company, 7471 Melrose Avenue, Los Angeles, Calif., is making what it calls the Sunset "sensitizer" for use on any tuned radio frequency set. It is in the form of a band which slips over the detector tube, with a wire for connection to the antenna post. The intended retail price is \$1.—*Radio Retailing*, September, 1929.

## A.C. Portable Phonograph

A portable a.c. phonograph which incorporates a number of unusual features is announced by the Stevens Manufacturing Company, 44 Spring Street Newark, N. J. This portable includes the new Stevens silent motor and miniature rectifier, operating directly from a.c. current supplying power for the motor. A phonograph sound box and arm deliver the music to a built-in horn which utilizes the curve of the carrying case cover as a sound rectifier. A



phonographic pick-up and outlet are also included.

One of the important features of this machine is the small compartment to carry batteries so that it may be automatically wound when used where a.c. current is not available. A small switch disconnects the a.c. rectifier and substitutes the battery source. The case is covered in black imitation leather with all metal parts heavily nickeled.—*Radio Retailing*, September, 1929.

## Readrite Tube and Set Tester

Screen-grid sets can be analyzed and tested with the new device put out by the Readrite Meter Works, Bluffton, Ohio. A grid bias and three double reading meters are provided. Extra cords with tip jack connections are supplied to permit use of each meter individually. It is self-contained and comes with a seamless drawn metal cover, with leather handle. The intended retail price is \$20.—*Radio Retailing*, September, 1929.

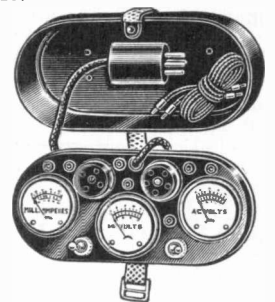

## Replacement Resistors

A resistance unit, known as Durham type MF4-2, may now be obtained from the International Resistance Company, 2206 Chestnut Street, Philadelphia, Pa., in all ranges of from approximately 250 ohm to 10 megohms. It is ruggedly made and is especially useful to manufacturers, jobbers and service stations for use in replacing resistors in power packs and a.c. sets.—*Radio Retailing*, September, 1929.

# THIS MONTH in the Radio Industry

## To Guard Against Overproduction

### RMA Board Also Votes to Resume Broadcasting Plan This Fall

Immediate action to prevent possible overproduction of radio products this season was agreed upon by the board of directors of the Radio Manufacturers Association at its recent meeting, held in the Clifton Hotel, Niagara Falls, Ontario.

The merchandising department of this organization was instructed to recommend to radio manufacturers, acting strictly within the limitations and in observance of the law, that their production schedules be carefully checked against present and prospective business. This in order to guard against undue expansion.

For the radio public, and in support of broadcasting also, the board of directors decided to undertake to present another series of special RMA programs next fall. These will be contributed by various manufacturers and broadcast on national chains. This activity will be in charge of B. G. Erskine of Emporium, Pa., chairman of the Broadcasting Committee. It follows the successful series of nearly a score of RMA programs presented last spring.

C. C. Colby of Canton, Mass., chairman of the association's legislative committee, reported complete organization in the east and substantial progress in other sections of the country in the establishment of a new legislative information service. Local radio leaders are being appointed to cooperate with the RMA in local and state radio legislative affairs, to protect all radio interests against harmful legislation.

Next month the Patent Committee, headed by Le Roi J. Williams of Cambridge, Mass., will undertake an intensive campaign in furtherance of the RMA patent interchange plan.

### For West to East Broadcasting

James A. Frye, sales manager of the Earl Radio Corporation, finds West Coast facilities for transmitting radio broadcasts to the East quite inadequate as compared with those available for east to west programs. Mr. Frye, on a recent trip through his western territories, interviewed radio enthusiasts with the object of arranging for a two-way wire which would enable worthwhile western programs to be broadcast in the east as regularly as Atlantic Coast broadcasts are now sent to California.

The Radio Wholesalers Association has elected Fred Wiebe as vice-president from the central zone. Zone 3 will be represented by G. N. Provost of the Doubleday-Hill Electric Company, Pittsburgh, while C. C. Matthews of the Capital Electric Company, Indianapolis, Ind., has been elected to fill the vacancy from Zone five.

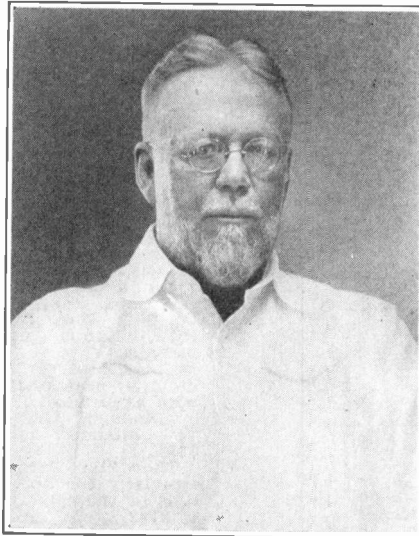

### R. A. Fessenden, Pioneer

Professor R. A. Fessenden, radio pioneer and early "wireless" inventor, in whose Brant Rock, Mass., laboratories some of the present radio leaders, while still in knee pants, received their first radio instruction. Professor Fessenden was recently retained by the Grigsby-Grunow Company, Chicago, for special consulting work.

## Bond Runs Second Prize Contest

So successful was the first prize contest, run last year by the Bond Electric Corporation, Brooklyn, N. Y., that this concern has now launched a second contest to publicize and popularize its line of batteries, flashlights and radio parts.

This new "stunt" will take the form of a series of six picture-puzzles. Prizes, aggregating \$10,000, will, it is believed, cause in the neighborhood of 100,000 persons to participate. It will be necessary for those entering the contest to go to the local dealer in order to carry out the terms of this idea.

### Marvin Designs New Fixture

To help the dealer maintain a continuous and accurate check on his supply of tubes and at the same time display them attractively, the Marvin Radio Tube Corporation has designed a handsome display cabinet in green, orange, and black, the Marvin colors. Various tube assortments are available to fit individual needs.

### Dilco Expands

The Dilco Radio Corporation announces that it will exhibit a new line of vacuum tubes at the Radio World's Fair at Madison Square Garden which will bear the Dilco trade mark. Dilco has recently completed a factory in Harrison, New Jersey.

## Harbord, RCA, Comments on Dubilier Decision

Responding to an inquiry concerning the recent decision of the United States District Court of Delaware, Federal Judge Morris presiding, in the case of Francis W. Dunmore, P. D. Powell and the Dubilier Condenser Corporation, plaintiffs, against the Radio Corporation of America, General James G. Harbord, president of the latter concern, advised that four claims of one patent were held not to be infringed by the Radio Corporation, and that three claims of two other patents were held to be infringed by certain receiving sets heretofore sold by it. It was stated that an appeal will be taken from the adverse portion of the decision.

The decision is the outgrowth of a suit brought in 1927 against the Radio Corporation of America, alleging infringement on patents owned by plaintiffs for the manufacture of instruments for radios which eliminated the necessity of storage batteries and made it possible to operate from the standard residence lighting systems.

The decision does not involve the suit of the Radio Corporation of America against the Dubilier Condenser Corporation on the Hull patent, covering alternating current power supply for radio sets, which suit is still pending.

## Atlas, Davega and City Radio Stores Merge

A merger agreement which welds into one unit three large chain store operations, was announced the fore part of August. The subscribing parties are the Atlas Stores Corporation of Chicago, the City Radio Stores, Inc., and Davega, Inc., the latter two of New York City.

These stores will handle phonographs, musical instruments, cameras and sporting goods, as well as complete stocks of radio equipment. It is expected that each chain will continue to operate under its own name.

## "Skipper" Hahn of Amrad



In spite of his military title, Major James E. Hahn, president of the Amrad Corporation, Medford Hillside, Mass., can qualify for the nautical title of "skipper." Here he is with Mrs. Hahn enjoying the salt breezes at Marblehead Neck, Mass.

# National Union Radio Corp. Name of New Tube Merger

Nathan Chirlestein and E. A. Tracy Slated for High Executive Positions—Initial Capitalization, \$16,000,000

The National Union Radio Corporation is the name chosen for the four recently merged concerns manufacturing Sonatron, Marathon, Televocal and Magnetron tubes respectively.

The Honorable Joseph E. Davies, chairman of the Federal Trade Commission during the Wilson administration, has been elected chairman of the board of directors. Paul M. Mazur and Sylvester W. Muldowny of Lehman Brothers, bankers, were also elected to the board.

It is announced that Nathan Chirlestein, who was president of the Sonatron Company, will be executive vice-president of the National Union. Another important executive from one of the constituent companies will be E. A. Tracy. He was vice-president of the Northern Manufacturing Company, maker of the Marathon tube, and is to be vice-president in charge of sales and advertising in the new corporation.

The creation of the National Union is based upon reciprocal licensing contracts with the Radio Corporation of America, as reported in last month's issue. Under this agreement each company is authorized to make tubes covered by the others' patents.

Under its licensing agreement with the Radio Corporation of America the new

company will also enjoy the advantages in the tube field of all laboratory developments and research of the General Electric Company and the Westinghouse Electric and Manufacturing Company, with which RCA is affiliated. In addition, however, it will create its own research and scientific department.

National Union also has entered into an agreement with RCA by which the latter loans the new company \$2,000,000, secured by notes, and receives in return an option to buy 40,000 shares of stock in the new corporation within five years. It is stated that this transaction has been completed and that the new concern is therefore able to go ahead promptly in its merchandising and advertising programs.

One million shares of common stock are authorized by the new company's charter, which was secured in Delaware, but only 400,000 will be issued at this time. As this issue will be given a value of about \$40 per share, the National Union will thus begin operations with a capitalization of \$16,000,000.

The daily production capacity of the combined companies is stated as from 75,000 to 100,000 tubes. These are made in five plants located at Chicago and Newark, Hoboken and Union City, N. J.

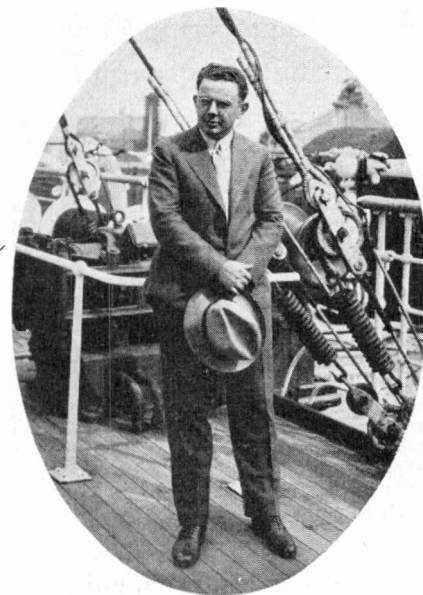

## White in Europe

While this is being penciled, Tom White, "dynamic" sales manager for Jensen, is figuring how he is going to get back from Europe—including the Scandinavian.

## \$100 for Best Program Suggestion

Idea Sponsored by Radio World's Fair to Popularize "Radio Week"

The radio listener or dealer with the best plan for a one-hour broadcasting program will receive \$100 from the management of the Radio World's Fair, which opens at Madison Square Garden, New York, Sept. 23. The idea, or program continuity outline, must be sufficiently comprehensive for the judges to interpret clearly its meaning.

This is but one of many "stunts" which will be employed to popularize the concurrent holding of this event with that of National Radio Week. Another will be the network broadcastings from a specially constructed crystal studio at the Garden. Six consecutive days of attractive programs are planned. Announcements to the listening public throughout the United States also will be made.

Here, then, is an excuse for dealers to contact their customers as well as an opportunity to make a special drive on set sales.

Entries in the program contest should be mailed before Sept. 14 to G. Clayton Irwin, 1904 Times Building, New York City.

## Get Together

A meeting of the eastern distributors of the Silver-Marshall Company and its salesmen was held at the Hotel Commodore, New York City, Thursday, Aug. 15, under the direction of Harold C. Bodman, sales manager.

L. T. Breck, sales manager of Kolster Radio Corporation, and Robert C. Hopkins, eastern manager, presided at a joint sales meeting of the Roberts Electrical and Auto Supply Company and the Trilling and Montague Company in Philadelphia recently.

Electrical Distributors, Ltd., Vancouver, B. C., recently entertained its dealers at a banquet in the Hotel Vancouver. Bob Hindle, sales manager, presided. Conrad B. Strassner, president of the A. C. Dayton Company, Dayton, Ohio, was the chief speaker.

## Inca Locates at Ft. Wayne

George A. Jacobs, founder and former president of the Dudlo Manufacturing Corporation, and associates has organized the Inca Manufacturing Corporation at Fort Wayne, Ind. This concern will manufacture copper wire products for the electric, radio, automotive and kindred industries.

## Lukko Opens New Branch

The Lukko Company, distributor for the Colin B. Kennedy Corporation, opened its new main office and show rooms at 910 West Jackson Boulevard, Chicago, on August 16. John M. Redell will be in charge for Lukko.

## The Cup That Cheers



One of those cups that cheer, but do not inebriate, recently was presented to C. A. Earl, president of the newly named Earl Radio Corporation, by thoughtful associates. This act was to commemorate the change of firm name from that of the Charles Freshman Company to the title which carries the Earl identification.

## Apex Shows New Models

At a meeting of the Apex distributors of the United States Radio and Television Corporation, held in Chicago on Aug. 12, first showing was made of the new Apex screen-grid set and the new high-gain neotrodyne set. Some fifty-five distributors from all sections of the country were in attendance.

## General Electric Organizes Supply Corporation

Effective Oct. 1, the fourteen wholesale distributing corporations owned by the General Electric Company will be consolidated into the General Electric Supply Corporation (of Delaware). These companies have for many years distributed General Electric products and the plan involves no change of ownership.

The consolidated corporation will be in a much better position to offer nation-wide service through its control of seventy-six houses, through interchangeability of stocks, and speedier and more economical operation, it is claimed.

## Amer. Engineering Council to Study Legislation

A committee of experts has been named by the American Engineering Council to study legislation involving radio and wire control now pending in Congress. Among those who have agreed to serve are Edwin Wendt, of Washington, D. C., who will act as chairman, and O. H. Caldwell, editor of *Radio Retailing* and former Radio Commissioner.

"Fundamental questions are involved in the bills of Senators Watson and Couzens," declared Arthur W. Berresford, president of the Council. "Their ultimate purpose is to establish an all-embracing commission somewhat like the present Interstate Commerce Commission, but which would have supervision of all means of communication. Is it in the public interest to create another such commission?"

## Oxford Issues Speaker-Chassis Chart

The Oxford Radio Corporation, 3200 West Carroll Ave., Chicago, has prepared a timely chart showing the proper speaker for use with each chassis manufactured by the leading set and chassis manufacturers. This chart is prepared for jobbers and dealers, as well as the cabinet concerns who buy individual units and assemble them into a complete console set.

## Radio Shows and Conventions

**September 9-15:** First Annual International Radio Exposition, Olympia, Detroit, Mich.

**September 10-13:** Annual Radio Trade Show, Ballroom of the Mosque, Richmond, Va.

**September 16-21:** Fifth Annual Southwest National Radio Exposition, New Coliseum, St. Louis, Mo.

**September 16-21:** Fifth Annual Rochester Radio Show, Convention Hall, Rochester, N. Y.

**September 16-21:** Fifth Annual Cincinnati Radio Show, Music Hall, Cincinnati, Ohio.

**September 18-25:** Cleveland Radio Show, Public Auditorium, Cleveland, Ohio.

**September 23-28:** Sixth Annual Radio World's Fair, Madison Square Garden, New York City.

**September 23-28:** New Haven Radio Show, Arena, New Haven, Conn.

**September 23-28:** Sixth Annual Radio Exposition, Convention Hall, Kansas City, Mo.

**September 24-28:** Eighth Annual Northwest Radio and Electrical Show, Minneapolis Auditorium, Minneapolis, Minn.

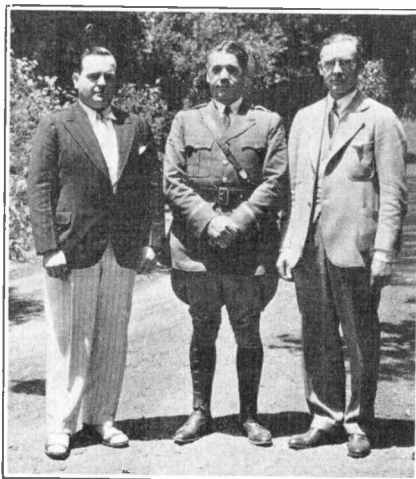

*Captain Sparks and Aides*

The camera catches Captain William Sparks in full military regalia—aided and abetted in his recent conventioning tour of the Pacific coast, by Messrs. Walter Fagan and C. W. Griffin, president and sales manager, respectively of the Pacific Wholesalers, Inc., of Los Angeles, Calif.

## Marvin On the Air

The Marvin Radio Tube Corporation of Irvington, N. J., went on the air August 31, over station WJZ and ten other associated NBC outlets with a program entitled, "The Marvin Musicians."

## American Piano Co. to Sell Sets Through Own Outlets

Robert B. Rose Directs Operations

The American Piano Company will distribute a complete line of radio receivers through its own chain of retail outlets operating under the name "Ampico Hall." These stores cover such important trading areas as New York City, Brooklyn, Fordham, N. Y., Jamaica, L. I., Newark, N. J., Chicago, Milwaukee, Cleveland, St. Louis, Boston, Philadelphia, and Atlanta, Ga.

Robert B. Rose has been appointed vice-president in charge of Radio Promotion. Mr. Rose has had an extensive experience with R. H. Macy and Company, and recently was general manager of Landay Brothers.

The American Piano Company will carry makes of radios in each price level. Among the piano lines controlled by this concern are: the Mason and Hamlin, the Knabe, official piano of the Metropolitan Opera Company; the Chickering, America's oldest piano; the J. and C. Fischer and the Marshall and Wendell.

## Columbia Adds Seven Stations to Chain

The new Far West group of the Columbia Broadcasting System, comprising seven stations, will be opened September 1, according to William S. Paley, president.

The stations added are KLZ, Denver; KDYL, Salt Lake City; KVI, Seattle; KOIN, Portland, Ore.; KFPY, Spokane; KFRC, San Francisco; and KHJ, Los Angeles.

Stations KHJ, Los Angeles, and KFRC, San Francisco, known to West Coast listeners as the "Don Lee Chain," are owned and operated by Don Lee, prominent radio chain operator, while the other five stations have long been outstanding in their respective localities.

## Radio Concerns Broadcasting

The Bremer-Tully Manufacturing Company and the Ken Rad Corporation are among the latest radio manufacturers to inaugurate weekly entertainment programs on the air. The former broadcasts every Friday at 10 p.m. over the Columbia system. Ken Rad goes on Mondays at 10 over the NBC Blue Network with a feature called "Cabin Nights."

## Executive Appointments

HOWARD W. SAMS has resigned his position as New York district sales manager of E. T. Cunningham, Inc., to become director of territorial sales for Silver-Marshall, Inc., of Chicago.

SAMUEL S. SANFORD, formerly with Victor and RCA, has recently been appointed sales manager of the Triad Tube Co. His new duties will take him to every state in the Union.

DONALD J. PIETI, widely known in radio-music circles, has recently joined the Allen-Hough Carryola Company as chief sales engineer.

The Steinite Radio Co. of Ft. Wayne, Ind., announces the appointments of O. R. COBLENTZ as assistant sales manager; S. J. HELSPER as sales promotion manager; HAROLD WEISLOW as advertising manager; and FRED IGGBERG as factory manager.

# What the Wholesalers are Doing

## Stanley and Patterson Absorb Sterling in New Radio Set-up

A gesture of unusual significance is noted in the recent action of Stanley and Patterson, Inc., a leading jobber of radio and electrical products in New York City, when, on August 15, it announced its retirement from active participation in jobbing radio apparatus. This end of its business will be assumed by a new organization called, George L. Patterson, Inc. The latter concern will be headed by Irving Sarnoff, formerly president of the Sterling Radio and Electric Company.

Under this new arrangement Sterling ceases to exist and Stanley and Patterson's line of radio receivers (Radiolas) will be distributed by its subsidiary, George L. Patterson, Inc.

The significance of this move lies in the fact that, for the first time, an electrical jobber has voluntarily parted with its radio activities in favor of a specialized, allied, distributing organization.

"We feel that this is a wise and proper thing to do," stated Mr. George Patterson, to a representative of *Radio Retailing*, "because the nature of the radio business and the diversified character of its primary retailing outlets call for a specialized type of distributing administration."

## RWA Elects Three New Directors

The Radio Wholesalers Association has elected Fred Wiebe as vice-president from the central zone. Zone 3 will be represented by G. N. Provost of the Doubleday-Hill Electric Company, Pittsburgh, while C. C. Matthews of the Capital Electric Company, Indianapolis, Ind., has been elected to fill the vacancy from Zone five.

The work of the Tube Committee has resulted in a great deal of good will being created for the association and it is believed that the organization's membership will increase materially therefrom.

## Distributor Appointments

THE PLANT COMPANY, Minneapolis, Minn., is now distributing Fada sets and speakers in North Dakota, the greater portion of Minnesota and parts of Wisconsin and Michigan.

THE ECONOMY ELECTRIC COMPANY, Fort Worth, Tex., which has recently been made Steinite distributor in 99 counties of north Texas, has appointed J. Moore Green as general sales manager of the radio division.

THOMAS J. NORTHWAY, INC., Rochester, N. Y., has been appointed distributor for the Zenith Radio Corporation in Rochester and surrounding territory.

KELLEY, HOW, THOMSON, of Duluth, Minn., one of Grebe's oldest distributors, has taken over the states of North and South Dakota and the eastern half of Montana, in addition to its original territory of Minnesota and northern Wisconsin. A branch office has been opened at Minneapolis.

H. C. SCHULTZ, INC., Sonora distributor in Detroit and Cleveland, Ohio, has had its territory extended to cover Cincinnati. A showroom and branch office has been established in that city.



## Heads Three Companies

D. W. May is the founder of the May Distributing Corporation, the May Radio Corporation, and D. W. May Inc. He represents Crosley, Amrad, and Philco in New York and Newark.

## Nelson With Gertler

R. M. Nelson is leading the sales organization of the Gertler Electric Company, New York. This concern is distributing the Colin B. Kennedy receiver.

THE KIMBERLY RADIO CORPORATION, Chicago, has appointed G. P. Gunther as general sales manager. He has been connected with the Zenith Radio Corporation, Chicago, for the past ten years.

THE SPENCER COMPANY, of Memphis, Tenn., has been appointed factory representative for Triad tubes. It will cover the entire southern territory.

## More News About Wholesalers

Reibold, Inc., of Bismark, N. D., announce its appointment as distributor of the Kennedy receiving sets. The product is manufactured by the Colin B. Kennedy Corporation of South Bend, Ind.

The Acme Electric and Manufacturing Company announces the appointment of the following representatives: G. Benn Montgomery, New York City; G. Spencer Pritchard, Chicago; Fraser Sales Company, Detroit.

The Colin B. Kennedy Corporation has authorized the Carroll Electric Company, Inc., in Washington; the Northland Electrical Supply in Minneapolis; and the Hafer Supply Company in Joplin, Mo., as distributors of its line.

George S. Snyder has just been appointed western Pennsylvania representative for the Balkeit Radio Company.

A. H. Grebe and Company, Inc., have added Stewart-Downey, Inc., of Boston, to the roster of their distributors.

The A. C. Dayton Company, of Dayton, Ohio, has appointed the Ideal Radio Cabinet Manufacturing Company of New York as distributor for its line of receiving sets.

The Kellogg Switchboard and Supply Company has authorized the following distributors to handle its products:

The Flee-Petty Auto Supply Company in St. Louis, the L. and L. Tire and Battery Company in Louisville, Universal Motor Company in Richmond, and the Raub Supply Company, Lancaster, Pa.

The Martin-Murphy Company, Inc., of Atlanta, has received an appointment as distributor for the American Bosch Magneto Corporation.

## Father and Son Which Is Which?

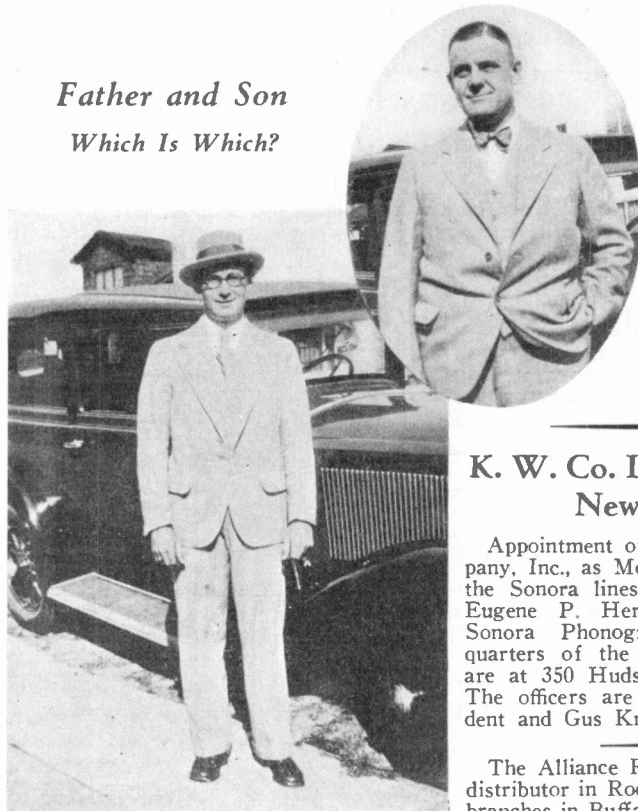

The answer is that George H. Curtiss, Senior, is the one in the oval, without the hat. He recently was appointed secretary of the Pacific Radio Trades Association, with headquarters in San Francisco. "Junior" has just taken over the task of representing the De Forest Radio Company on the Pacific Coast.

## K. W. Co. Is Sonora New York Distributor

Appointment of the K. W. Radio Company, Inc., as Metropolitan distributor for the Sonora lines has been announced by Eugene P. Herrman, president of the Sonora Phonograph Company. Headquarters of the K. W. Radio Company are at 350 Hudson St., New York City. The officers are Leonard Welling, president and Gus Krouse, treasurer.

The Alliance Radio Corporation, Edison distributor in Rochester, N. Y., has opened branches in Buffalo and Syracuse.

## *If I Were Boss* (continued from page 65)

lower and medium class of trade, rather than the well-to-do. Nevertheless, our department has always carried a heavy stock of expensive cabinet type machines of the upper price ranges which we are expected to dispose of. We would show a much better turnover figure, I am sure, if all but a sample line of these fancy sets were eliminated so that our attention could be directed almost exclusively to the popular numbers.

"An idea which I have found productive of satisfactory results in making console sales, is to point out to the customer who buys such a set, that provision can be made for plugging in a second loudspeaker, so that the use of the set may be enjoyed in the kitchen or elsewhere in the house. I find a lively demand, also, in connection with table models, for a long cord connection for the loudspeaker so that it may be transported from one part of the house to another. Undoubtedly the possessor of a console set would like to enjoy the same flexibility. Here is a good chance to sell a second loudspeaker, of which few salesmen take advantage.

"Another piece of good advice which I would pass on to my salesmen, if I were boss, is always to start at the top of the list in displaying sets. If the customer demands a particular make, show it to him, but in the most expensive model on the floor. It has been worth a great deal to me in increased commissions to follow this little rule—and certainly it must have increased my value to the boss. Never underestimate the buying ability of the customer because he does not happen to look prosperous. Show him the best. This will accomplish two things. It will flatter him and it frequently will result in the sale of a high-priced set. By going down from the top you find the highest possible level at which the customer will buy, whereas starting from the less expensive models results in hitting his lowest price level.

"Our store carries specials occasionally for advertising purchases, but I am not sure that it does not overlook their chief purpose—which is to bring the customer into the store where he can be sold something else. The 'special' is a good point of departure, but it is really

almost as easy to sell a better model at a higher price if you just take the trouble. *If I were salesmanager I should feel anything but happy over too good a sales record in disposing of 'specials.'*

"I have theories too about time payments, home demonstrations, service contracts and trade-ins, but in none of these fields does the individual merchant stand alone. If I were boss, therefore, I would go in for building up whatever co-operative organization existed in my own town between my fellow radio merchants. Then, through by local trade association, I would advocate educating the wobbly dealer to the advantages of a sound and conservative policy in all of these fields.

"In the matter of trade-ins, as I see it, we are now passing through the most difficult period. When people cease to bring in battery sets, or when the last battery set sold becomes so old that even its owner does not expect it to bring much return, half the grief from this source will be over. As it is now, the greatest loss comes from the current feeling that it does not pay to put much money into a radio set because it becomes obsolete in a few months and you can never hope to get anything back on it—a widespread belief due to the small trade-in value for even the most expensive of battery type sets.

"During this interval, I think that the most important part of the radio merchant's allowance trade-in policy should be the explanation which precedes the naming of the allowance. The customer should be led to appreciate the situation and to feel that he has gotten full value out of his set during its use and that therefore he should not expect a very large return.

"What would I do if I were boss?"

"Not so differently, I suppose, from what my boss is doing now. I would purchase a stock appropriate to my trade and then I certainly would set out to obtain the very best sales force possible, seeing to it that they had an adequate technical training and paying them accordingly. *And then I would concentrate on getting the largest possible return from every customer.*"

## *What of Selling Costs?* (continued from page 54)

with an expense of 15.4 per cent. The fourth highest cost, 16.7 per cent, was incurred by the group whose sales were 90 to 100 per cent *inside* and the highest percentage of all was in the 65 to 80 per cent *outside* group who have a figure of 23.5 per cent.

### Relative Costs of "Inside" and "Outside" Selling

| Volume                              | Inside     | Outside   | Sales<br>Expense |
|-------------------------------------|------------|-----------|------------------|
| Group doing the largest volume..... | .....      | 65 to 80% | 23.5             |
| Second largest.....                 | 90 to 100% | .....     | 16.7             |
| Third largest.....                  | 65 to 80%  | .....     | 13.9             |
| Fourth largest.....                 | 50         | 50        | 14.5             |
| Smallest Volume.....                | 10%        | 90%       | 15.4             |

*"The combined 65 to 100 per cent "inside" groups show a cost of 15.6 as against an expense of 22.1 per cent for the respective combined "outside" groups. Total average selling and administrative expense, 17.2 per cent."*

These percentages appear almost contradictory when taken individually. There is the startling difference of almost ten per cent between the 65 to 80 per cent *inside* and the 65 to 80 per cent *outside* groups, whereas the 90 to 100 per cent *outside* group are right in the middle with an expense of 15.4 per cent. The combined 65 to

80 per cent and 90 to 100 per cent *inside* groups show a cost of 15.6 per cent as against an expense of 22.1 per cent for the respective combined *outside* groups. As I said before, however, group figures are pretty good indexes, and taking into consideration the average salary expense of the entire 109 stores of 17.2 per cent, it is definitely established that *outside* selling is more costly to the merchant and that its percentage cost is not reduced through increased volume to a figure comparable with the cost of *inside* selling.

This should not be construed as an argument against *outside* selling. It simply means that the total sales expense per transaction is increased. However, it is perfectly possible—and very often happens—that the total net dollars profit is greater due to a larger gross volume.

We have found, so far, what the merchandise he sells costs our Retail Radio Company, what its gross margin is at varying volumes what its costs for sales and management, what the volume and trend of *inside* and *outside* selling is and about respective costs. In the next issue we will present the *complete* operations of these 109 stores, with comments upon salient features of the tabulated figures.

# Phonograph-Record "BEST SELLERS"

Recorded selections that recently have been in greatest demand or that are recommended to dealers by leading record manufacturers as "safe bets."

## Victor

- 22047-A Moanin' Low
- Ain't Misbehavin'—Leo Reisman and Orchestra
- 22029-A Heigh-Ho! Ev'rybody
- Miss You—Vallee's Connecticut Yankees
- 21931-A Pagan Love Song—The Troubadours
- The One Girl—Shilkret and Victor Orchestra
- 22004-A Am I Blue?—Shilkret and Victor Orchestra
- Let Me Have My Dreams
- 21977-A My Sin—Waring's Pennsylvanians
- When My Dreams Come True
- 22033-A Maybe! Who Knows?—Gene Austin
- I've Got A Feeling I'm Falling
- 21961-A Breakaway—Olsen's Music
- Big City Blues
- 22032-A Peace of Mind—Pancho's Orchestra
- Good Morning, Good Evening, Good Night
- 21959-A I Get the Blues When It Rains—Marvin and Smalle
- Down Among the Sugar Cane
- 21967-A I'm Just a Vagabond Lover
- I'm Still Caring—Vallee's Connecticut Yankees

## Brunswick

- 4400 Little Pal
- I'm in Seventh Heaven—Sung by Al Jolson
- 4401 Why Can't You—From motion picture "Say It With Songs" as sung by Al Jolson
- Used to You
- 4402 One Sweet Kiss
- Liza—See 4401
- 4375 Singin' in the Rain—Earl Burtnett and His Los Angeles Biltmore Hotel Orchestra
- Orange Blossom Time
- 4376 Low Down Rythm—See 4375. These four from the motion picture "Hollywood Revue of 1929"
- Feelin' for You
- 4378 Your Mother and Mine
- Singin' in the Rain—Nick Lucas in "Hollywood Revue"
- 4383 Or What Have You—Al Goodman and Orchestra from "The Little Show"
- I've Made a Habit of You
- 4445 Moanin' Low
- Am I Blue?—Libby Holman, comedienne
- 4476 Do What You Do—Ziegfeld's "Showgirl"
- I've Made a Habit of You—Zelma O'Neil
- 4452 Don't Hang Your Dreams on a Rainbow—From Carroll's "Sketchbook"
- Song of the Moonbeams

## Edison

(Needle Releases)

- 14041 Smiling Irish Eyes—Levitow's Orchestra
- Where the Sweet Forget-Me-Nots Remember
- 14040 Pagan Love Song—Violin and Ensemble
- Don't Hang Your Dreams on a Rainbow—Waldo Mayo
- 14035 I Want to Meander in the Meadow—Phil Spitalny
- Someday Soon—Mel Morriss' Piccadilly Players
- 14036 Breakaway
- Maybe, Who Knows?—Mel Morriss' Piccadilly Players
- 14012 Am I Blue?—Rolfe and Lucky Strike Orchestra
- Birmingham Bertha
- 14003 Fioretta—Rolfe and Lucky Strike Orchestra
- Dance of the Paper Dolls
- 20006 Barnacle Bill the Sailor
- How To Make Love—Frank Luther and His Pards
- 14016 Wedding of the Painted Doll—California Ramblers
- Heigh-Ho! Ev'rybody, Heigh-Ho!—The 7 Blue Babies
- 14029 S'posin—Tenor Solo—J. Donald Parker
- Where Are You, Dream Girl?
- 14037 Little Pal—Baritone Solo—Phil Dewey
- I'll Be a Pal to Your Boy—Baritone Solo—Bob Pierce

## Columbia

- 1882-D I'm the Medicine Man for the Blues
- Wouldn't It Be Wonderful?—Ted Lewis and His Band
- 1877-D Little Pal
- Seventh Heaven—Paul Whiteman and Orchestra
- 1888-D I Get the Blues When It Rains
- Kids Again—Guy Lombardo and His Royal Canadians
- 1883-D I Want to Meander in the Meadow
- Now I'm in Love—Ruth Etting
- 1900-D Am I Blue?
- My Song of the Nile—Ben Selvin and His Orchestra
- 1837-D Am I Blue?
- Birmingham Bertha—Ethel Waters
- 1891-D Moanin' Low
- Ain't Misbehavin'—The Charleston Chasers
- 1853-D Pagan Love Song
- With a Song in My Heart—James Melton
- 1854-D I'm Walkin' Around in a Dream
- Maybe—Who Knows?—Ted Lewis and His Band

### Retail Credit Practice

John T. Bartlett and Charles M. Reed, with the co-operation of the National Retail Credit Association, have made a nationwide study of credit as a function of modern retailing and have compiled a comprehensive manual of practice in their book "Retail Credit Practice."

The book shows how credit can be made a productive device increasing sales volume and reducing overhead. The full credit and collection process is unfolded, beginning with the credit application, and continuing with the investigation, risk analysis and decision, finally following the account through its store history. Various collection methods are covered in detail.

The book is published by Harper and Brothers, 49 East 33rd Street, New York City. Price: \$4.

### Federated Issues Two Booklets

"How to Organize a Local Radio Trade Association," and "Radio Wholesalers Association" are the titles of two interesting booklets recently compiled by the Federated Radio Trade Association. Either booklet may be obtained for the asking by addressing H. G. Erstrom, executive-secretary, The Federated Radio Trade Association, 32 West Randolph Street, Chicago, Ill.

### Radio Receiving Tubes

The McGraw-Hill Book Company, 370 Seventh Avenue, New York City, has just published a 297-page book entitled "Radio Receiving Tubes," by James A. Moyer and John F. Wostrel. The essential principles underlying the operation of vacuum tubes

are explained in as non-technical a manner as is consistent with accuracy. Also interspersed are illustrations and diagrams. The retail price is \$2.50.

### Textbook for Radio Operators

The second edition of "Radio Operating Questions and Answers," formerly published under the title of "Radio Questions and Answers," by Arthur R. Nilson and J. L. Hornung, has just come from the press. It is published by the McGraw-Hill Book Company, 370 Seventh Ave., New York City, and is written especially for students and operators who are about to take the government examination for an operator's license. The material contained is drawn from many sources and compiled from the commercial operator's standpoint. The price is \$2.



C.A. Earl Radio



MODEL DELTA

22  
\$ 99.<sup>50</sup>

(less tubes)

Only a Sensational Set could have attained such sensational success! Six months ago unknown—today a best seller. Only outstanding performance and unparalleled value could have done it. ♦ ♦ ♦ ♦

*There may be a C. A. Earl franchise still available in your territory*

♦ ♦ Write or wire ♦ ♦

**EARL RADIO CORPORATION**

C. A. EARL, President

122 East 42nd Street, New York City

Branch Offices: Chicago - San Francisco - Kansas City



# Eliminating Interference

LOCAL radio trade associations should consider the need for an ordinance to minimize radio interference, such as the one already in force in Portland, Ore., Los Angeles, Cal., and other cities.

According to this ordinance, violet ray machines, machines using the Tesla coil or principle, X-ray machines, open or quenched spark machines, or any apparatus which produces high-frequency oscillations, can be operated only with the permission of the electrical division of the Bureau of Buildings. An amendment to the ordinance excepts radio stations from these provisions.

Furthermore, even with a permit, it is unlawful to operate such machines between 7 p.m., and 11 p.m., except by a registered practitioner in the practice of his profession in emergency cases. Violations are punishable by a fine not exceeding \$500 or by imprisonment for not more than six months, or both. This ordinance should go a long way toward minimizing, if not eliminating radio interference, especially during the hours when it is most annoying.

This is the ordinance:

## ORDINANCE NO. 51269

An ordinance to provide for minimizing radio interferences, providing a penalty, and declaring an emergency.  
The City of Portland Does Ordain as Follows:

Section 1. UNLAWFUL TO OPERATE APPARATUS THAT INTERFERES WITH RADIO BROADCASTING OR RECEPTION: It shall be unlawful for any person to operate in the City of Portland any apparatus generating or causing high-frequency oscillations which interfere with radio broadcast transmitting or receiving apparatus, without a permit to use the same.

Section 2. DEFINITION OF TERMS: The following electrical apparatus shall be considered as coming within the meaning of this ordinance, namely: violet ray machines, machines using the Tesla coil or principle, X-ray machine, open or quenched spark machines, or any machine including or incorporating a device producing high frequency oscillations.

Section 3. APPLICATION FOR AND ISSUANCE OF PERMITS: Any person desiring to operate any apparatus in the City of Portland coming within the terms of this ordinance shall file a written application therefor with the Bureau of Buildings (Electrical Division). The Bureau of buildings (Electrical Division) shall prepare a form of application. If the information in the application be indefinite or incomplete, the Bureau of Buildings (Electrical Division) shall refuse to issue a permit until sufficient information shall have been submitted. If an application be rejected the applicant, upon request, shall be entitled to receive a definite statement in writing setting forth the reasons for the rejection. If the application conforms to the provisions of this ordinance and to the form prepared by the said Bureau a permit shall be issued, to the applicant conditioned that all requirements of the Building Code, Fire Code and other ordinances of the City of Portland have been complied with. Each applicant to whom a permit is granted shall pay a fee of one dollar for one machine and fifty cents for each additional machine. It shall be unlawful to operate any apparatus permitted under the terms of this ordinance, and for which a permit has been issued, between seven o'clock p.m. and eleven o'clock p.m. of any day, unless the operation be by a practitioner duly licensed by the State of Oregon, or under his or her direction in the regular course of practice of his or her profession in emergency cases.

Section 4. PERMIT PERSONAL—NOT TRANSFERABLE, EXPIRING ON THE 31ST DAY OF DECEMBER OF EACH YEAR: Each permit shall be personal and not transferable. All permits shall expire on the 31st day of December of each year.

Section 5. RIGHT OF INSPECTION—UNLAWFUL TO INTERFERE WITH the Inspector of Buildings (Electrical Division), or any of his authorized deputies or assistants, shall have the right to enter upon any premises at all reasonable hours for the purpose of inspecting the installation and the working of all

through

Local

Legislation

*The text of the Portland ordinance regulating the operation of oscillating apparatus during hours of broadcasting.*

apparatus coming within the terms of this ordinance, and it shall be unlawful for any person to interfere with the Inspector of Buildings (Electrical Division) or any of his authorized deputies or assistants in making said inspection or to refuse to permit the said inspector or his deputies or assistants to enter the premises for such purposes. The inspector or his deputies or assistants before entering any premises shall exhibit to any person there in charge his authority as inspector.

Section 6. PERMIT SUBJECT TO REVOCATION. All permits shall be subject to further regulations that may be imposed by the Council, and nothing in this ordinance contained shall be construed to create any vested right in any person to the assignment, renewal, reissuance or continuance of any permit, and the right shall be and remain at all times vested in the Council, and the Council may as hereinafter provided revoke and cancel any permit for fraud or misrepresentation in its procurement or for a violation of any of the provisions of this ordinance, or any other ordinance of the city, or for a violation of any state or federal statute, or for any conduct or act on the part of the person to whom the permit is issued, or the employees of such person, or permitted by him or them, on the premises where such apparatus is used, or in connection therewith, or adjacent thereto, tending to render such premises where the same is used as a public nuisance, or a menace to the health, peace or general welfare of the city.

Section 7. NOTICE AND HEARING. Whenever information shall come to the Inspector of Buildings, or the Chief of the Electrical Division, that any person to whom a permit has been granted under the terms

*Violet ray machines, X-ray machines, open or quenched-spark machines, or any apparatus producing high-frequency oscillations can be operated only with the permission of the local electrical department.*

of this ordinance has committed any act rendering the permit subject to revocation, it shall be the duty of the officer having such information forthwith to submit the facts in writing to the Council and at the same time serve upon the person to whom a permit has been granted thereof, together with a notice citing such person to appear before the Council for investigation or said complaint at a time and place stated in such notice. In case service cannot be had upon said person, the same shall be mailed to his last known business address. No further pleadings shall be necessary. Such hearing or investigation shall be informal. If on such hearing or investigation the Council shall find that cause exists for the revocation of such permit the same may be revoked by a majority vote of the Council.

Section 8. Any person who violates any of the provisions of this ordinance shall, upon conviction thereof, be punished by a fine not exceeding five hundred dollars (\$500), or by imprisonment in the city jail for a period not exceeding six (6) months, or by both such fine and imprisonment.

Section 9. Inasmuch as this ordinance is necessary for the immediate preservation of the public health, peace and safety of the City of Portland, in this: that there are no adequate regulations in the City on this subject, therefore an emergency is hereby declared to exist and this ordinance shall be in force and effect from and after its passage by the Council.



# Research

A complete production laboratory is devoted to the development of transformers and other items for general production as well as sample transformers for set manufacturers' requirements and special transformers for various purposes. Factory testing, service and drafting are controlled by the production laboratory.

An elaborately equipped research laboratory is maintained as an individual department totally independent of the production laboratory. In the field of independent research Thordarson is far famed. Not only is the research laboratory abreast of the trends in radio engineering, but is recognized in transformer circles as outstanding in its leadership.

# THORDARSON

*Transformer Specialists Since 1895*

**THORDARSON ELECTRIC MANUFACTURING CO.**  
Huron, Kingsbury and Larabee Streets, Chicago, Ill.

1931



# Keeping in touch with RADIO MANUFACTURING



1931

## The Inductor Dynamic Speaker

Explanation of the Latest Type of Speaker That Combines Simplicity and Economy with a New Standard of Tone

Two types of speakers are in common use today, namely, the magnetic type and the dynamic type. The former, while inexpensive and simple to apply, is limited in volume and tone range. The latter, while costly and complicated to apply, is capable of remarkable volume and tone range. The radio designer or manufacturer, as well as the radio buyer, has heretofore had to decide between the two extremes.

However, for some three years past C. L. Farrand has been working on a compromise type. He has sought to combine the simplicity and economy, on the one hand, with ample volume and full tone range on the other. As a result an entirely new type of speaker has been developed which he has named the *inductor dynamic* because of its resemblance in principle to the conventional induction motor, together with its dynamic power.

In external appearance, the inductor dynamic appears to be an enlarged and refined magnetic type. It employs two powerful permanent magnets, and therefore does away with the necessity of an external power supply for energizing the field windings of the magnet, usually required in powerful speakers such as the dynamic type. Its application to any radio set or amplifier, consequently, is quite as simple as the magnetic type. Only two connections are required—those for the signal current. Again, in bulk and weight, it compares favorably with the magnetic type. Meanwhile, in the matter of volume as well as range of musical frequencies reproduced, it is decidedly in a class with the best dynamics. If anything, it is capable of a better low-frequency response than the usual dynamic of moderate size, because of the greater swing or amplitude of motion given to the diaphragm, due to the lighter mass of moving parts and its freedom of motion.

Obviously, and despite its external resemblance to the magnetic type, it must be different. And so it is, decidedly different.

To begin with, the inductor dynamic speaker is based on the principle of the a.c. induction motor, the rotor of which revolves under the influence of changing magnetic flux in many pole pieces. Here the motion is a rotating one. In the inductor dynamic motor, the changing magnetic flux, due to the effect of the current on the fixed magnetic field, actuates a pair of armature bars connected by tie rods, each bar working between its respective pole faces. The gaps between armature and pole faces remain constant, but the area by which the armature and pole face overlap is varied as the armature is set in motion by flux changes. The two light bars, with their tie rods, are supported between the two sets of pole pieces by means of exceedingly light strip springs, whose function is to hold the gaps constant and *not* to supply the restorative force which is left entirely to the magnetic force.

Referring to the accompanying diagram which tells the story of the inductor dynamic principle, it will be noted that the

armature assembly rides freely between the pole pieces P-1 and P-2. The coils C-1 and C-2 are connected in series. A current flowing through the windings in the direction indicated will increase the flux through the pole legs P-1, and decrease the flux through the pole legs P-2. The flux, seeking the path of least reluctance, exerts a greater force on the armature bar A-1 than on the armature bar A-2, thus moving the armature in the direction indicated. On the reverse of the cycle the armature moves in the opposite direction in the same manner. The pole legs are cut to the shape indicated to reduce the leakage flux and to bring the greatest flux density to the desired point. The opposite forces on the two armature bars cause the armature to rest at a middle position which may be termed the "magnetic center." The flow of voice current in the coils causes this

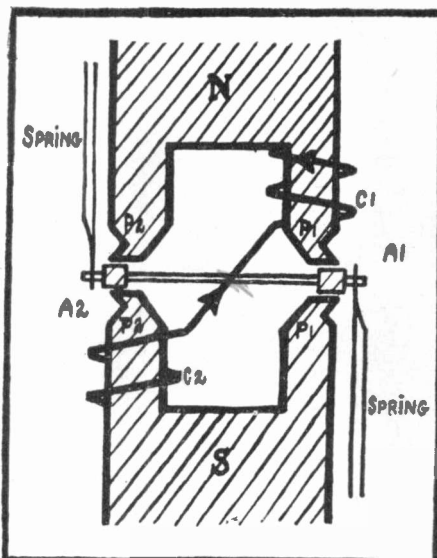

Cross section of inductor speaker

magnetic center to shift, and the armature moves along with the magnetic center.

Compared with the magnetic type, the obvious advantage is that the armature in the inductor dynamic is placed sufficiently close to the pole pieces to gain the necessary sensitivity and power, yet, moving in the plane of the pole faces, there is no danger of pole slap or again there is no cramping of swing or amplitude of motion due to limited pole spacings. Also, there is no necessity for the stiff springs which must be employed for the balanced armature of the magnetic type in gaining minimum magnetic gaps for sensitivity and power yet avoiding pole slap. The stiff spring tension seriously impairs the operation of the usual magnetic type at the lower frequencies. The spring resonances also introduce distortion. The apex of the cone is driven in an arc motion, rather than a straight line, introducing distortion.

These limitations have all been eliminated in the inductor dynamic type.

Compared with the dynamic type, the inductor dynamic requires no separate field excitation current. It therefore makes for a simpler and less expensive assembly. Also, there is no a.c. background due to a pulsating d.c. magnetizing force. The inductor dynamic is applied in the same simple way as the magnetic type. It requires only an output transformer or choke and condenser combination, so as to keep d.c. out of the speaker windings. If the speaker is to be applied to a push-pull amplifier, a third lead may be taken from the windings at the point where the two coils are joined together, and used as the mid-point of the windings. This corresponds to the mid-point in the primary of the usual output transformer or choke, which is thus dispensed with.

The inductor dynamic must be carefully matched to the impedance of the amplifier. This feature is not as essential in the moving coil type of dynamic, but it is of greatest importance with the inductor dynamic, which is made in four different impedance values, distinguished by a disk of one of four colors placed on the chassis, to facilitate the matching of impedances.

The inductor dynamic is capable of producing all the volume desired for home entertainment. Because of its high electrical efficiency, it will provide as much volume with a given input as the moving coil dynamic using from ten to fifteen watts in its field. In tone quality, the inductor dynamic reproduces the full musical frequency range. It requires no box resonance for the bass. The entire armature assembly, including springs, weighs 4.5 grams, as compared with 8 to 15 grams for the moving coil dynamic and it is capable of excellent low-frequency response, in which it exceeds the dynamic. With an input of 15 T.U. at 30 cycles, the inductor motor moves a 10-inch cone one-eighth inch.

The inductor dynamic speaker marks a decided step in the direction of simplicity and economy of radio sets, yet it introduces a power and a tone quality that leave little to be desired.

## Foreign Stations

Surprising as the information may be to the average broadcast listener, still it is a fact that there are more stations in France than in England.

France heads the list in company with Sweden, each with thirty-one stations, reports the export department of Fada Radio. Germany is second with twenty-six and England is third with twenty-one.

Greece, Bulgaria and Portugal have no central broadcasting organizations.

According to the Prague Plan, Europe may now listen to broadcast entertainments on as low as 200 meters.

The high power stations operated by the Soviets in Leningrad and Moscow are now using 20 to 30 kilowatts.

The highest powered station in England is Daventry (5XX), 25 kilowatts, which is the power also used by Langenberg in Germany, now using 473 meters. Motala, Sweden, is operating on 1,348 meters with 30 kilowatts.

# TONE

*Tone depends on many things, but above all, on the design and construction of the audio end of the set. In this department of radio, T·C·A engineers are specialists, serving with matchless production facilities many of the leading set manufacturers in the country. Uniformity, authentic design, perfected construction detail, and dependable deliveries are inherent characteristics in T·C·A products.*

**TRANSFORMER CORPORATION OF AMERICA**  
2301-2319 SOUTH KEELER AVENUE, CHICAGO, ILLINOIS  
*Sales Offices in Principal Cities*

Output Transformers  
Input Transformers  
Audio Transformers  
Dynamic Speakers  
Power Packs  
Chokes

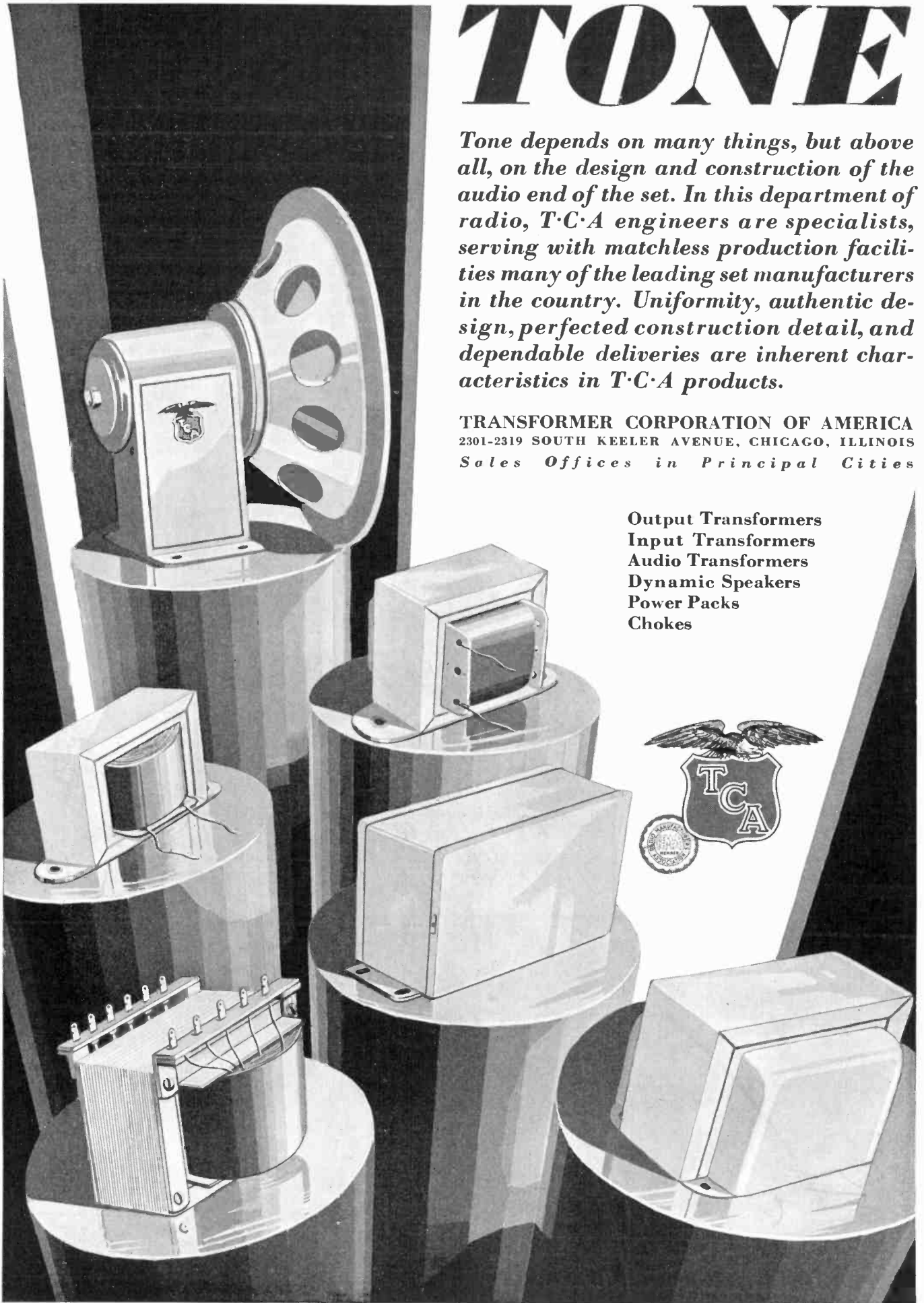





What is the practical effect of all this experimentation, this protracted striving for scientific accuracy in the pick-up? Simply that it shall PERFORM properly . . . responding to the minutest demands of the record and faithfully reproducing those chromatic shades without which there can

be no real music. The handsomest pick-up in the world would be useless if it were not sensitive as a seismograph . . . and it is well to observe that the Electro-Chromatic PICK-UP caps its truly fine performance with an appearance that does credit to any machine with which it is allied.

**The AUDAK COMPANY, 565 Fifth Avenue, New York**

In Canada—The Canadian National Carbon Co., Ltd., Toronto

"Creators of High Grade Electrical and Acoustical Apparatus Since 1915"

# GET ALL THE BUSINESS

## These Popularly Priced New Products Sell Hand-in-Hand with Radio



### THE ROTROLA

List \$45 Price

Every radio owner on your books is an instant prospect. It plays phonograph records right through their radio—electrically—with full volume and finest tone. The Rotrola is equipped with the Webster Pick-up, and the famous Rotor 80 cycle A.C. Motor. Send today for your sample!

### CARRYOLA No. 125

List \$25 Price

Think of selling an excellent portable, equipped with famous Rotor electric motor, at the same price you have been selling ordinary portables. This opportunity is before you with the Carryola No. 125! Every dealer will want this portable because it sells on sight—send for your sample—step ahead of all competition!



### MODEL No. 175

List \$75 Price

The finest radio-phonograph combination cabinet you've ever seen. Completely equipped with Rotor electric Motor and turntable. Webster Pick-up, and compartment for records. Place any radio and speaker you desire in this cabinet, and think of the compelling price at which you can sell the complete combination! It means quick profit and business for you! Send today for sample! Usual trade discounts.

**Y**OUR big selling season is just about to open . . . so make your plans to get all the business due you. Be sure to take advantage of the popular market, by selling these sensational new Carryola products . . . they give you a price range low enough to attract a fine volume of profitable business, and sell hand-in-hand with radio.

Alert radio-music Dealers and Jobbers are choosing these outstanding Carryola products for this fine *additional business* . . . so we urge that you too step out today . . . send your initial order for the new models . . . take the profit which comes through quick easy sales to the popular market . . . action now will get you all the business . . . complete free catalog sent gladly on request!



# Allen-Hough Carryola Co.

279 Walker Street, Milwaukee, Wis.

EXPORT OFFICES

225 W. 34th St., New York City

FACTORIES: Milwaukee and New York

World's Largest Makers of Portable Musical Instruments.

# Your best merchandising bet

**100%** service from the sets sold is every dealer's best merchandising bet. Assures turn-over, not turn-backs. Service of the type that necessitates several calls—maybe finally a trip to shop or factory—is worse than none at all. It undermines confidence in all the lines you sell, and suggests incapacity to stand back of a pledge of unhampered, efficient operation. The day of guessing and groping in radio service work is done. The Radio public has no patience with half-way results. They junk the set, damning dealer and manufacturer, that interferes with their precious hours of pleasure over the air.

And because of the constantly increasing number of

**SUPREME DIAGNOMETERS** in use, daily more Radio fans are learning that there is *one* Radio testing apparatus that, with almost uncanny precision, puts the service-man's finger, *instantly*, on every trouble, and enables him to give relief, eliminating the bother, the expense, the time and the distasteful suggestion of taking the set out of the home.

Besides keeping your sets sold, the **SUPREME DIAGNOMETER** puts the Service Department on a money-making basis, creating a double-edged profit. 1. By conserving the service-man's time which means money to you. 2. By creating enthusiastic customer good will, which means increased sales.

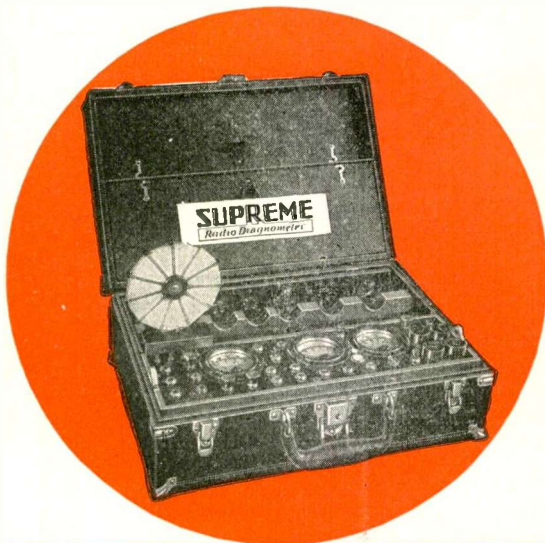

## The Only Complete Portable Radio Testing Laboratory

No other radio testing device can anywhere near approach the range, completeness and flexibility of the **SUPREME DIAGNOMETER**. A test will show you. Send for ours which is confidently called "A Test that Challenges Attention." Some of the outstanding features of the **SUPREME** are:

- All tubes tested under actual operating conditions.
- Screen grid socket analysis without oscillation.
- 750 Volt 4 scale A.C. and D.C. meters, 3 scale milliammeter.
- Self-contained power plant.

- Modulated radiator for testing, synchronizing, neutralizing.
- External connections to all apparatus. Test both plates '80 type rectifiers.
- All continuity tests without batteries.
- Universal analyzer plugs.

**"Set Testers" prove only 29% to 40% efficient in comparison with the SUPREME DIAGNOMETER**

---and a request for complete specifications will reveal numerous other superiorities.

### Supreme Service League

To Radio Owners: Look for this emblem in your radio shop, on the lapel button or card of your service man. It is your guarantee of dependable radio service.



### Order NOW

Present production permits immediate deliveries but the momentum of sales is such that buyers are cautioned to place their orders now. Reservations will be made against all orders placed for future delivery on specified dates. Make use of this plan to avoid disappointments.

(Most good distributors carry the **SUPREME DIAGNOMETER** in stock. If yours cannot supply you, send order direct on form to the right.)

# SUPREME

## Radio Diagnometer

Makes every <sup>conceivable</sup> test on any Radio Set-

Supreme Instruments Corp.  
340 Supreme Bldg.  
Greenwood, Miss.

Please ship **SUPREME DIAGNOMETER Model 400-B** on basis checked below.

- Net cash \$139.50.
- Time payment plan—\$33.50 cash and 8 monthly payments of \$15.00 each.

All prices are F.O.B. Greenwood, Miss. No dealer's discount.

Date shipment desired.....  
Signed.....  
Firm Name.....  
Street Address.....  
City.....  
State.....

Please give three or more bank or trade references and names of distributors from whom most purchases are made.



# EDISON LIGHT-O-MATIC RADIO

FLASH!

THERE'S YOUR STATION

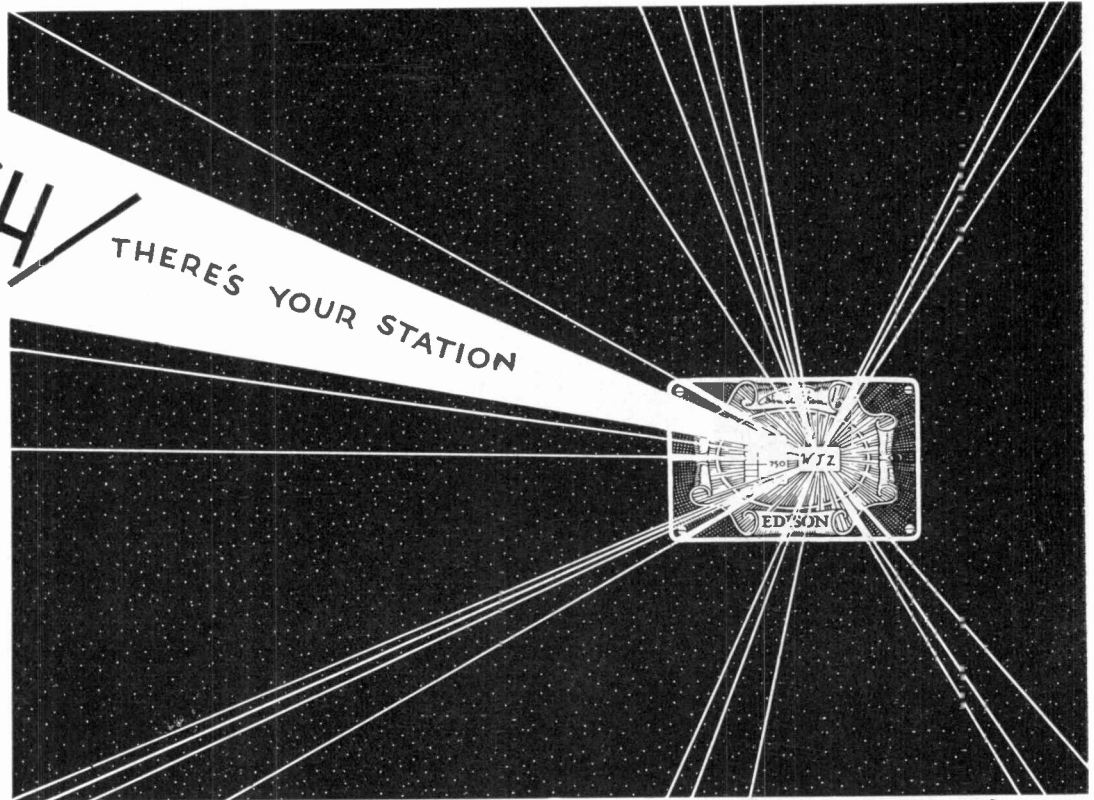

new!

dramatic, intriguing!

NEW—with a freshness of idea characteristically Edison... DRAMATIC—with an eye-compelling focus for public attention... INTRIGUING—people flock to see it—they gather in crowds wherever it is shown... That's Edison Light-O-Matic Tuning!

Many are the splendid new features, Light-O-Matic Tuning is but one, on this new Edison Radio. People like it—they talk about it—they BUY IT.

Manufactured in the famous Thomas A. Edison Laboratories at Orange, N. J., the new Edison Radio is worthy of the great name it bears.



### EDISON DISTRIBUTING CORPORATION

ATLANTA, 155 So. Forsyth St. ... BOSTON, Statler Bldg. ... CHICAGO, 3130 So. Michigan Ave. ... DALLAS, Santa Fé Bldg. ... DENVER, 1636 Lawrence St. ... KANSAS CITY, 1215 McGee St. ... MINNEAPOLIS, 608 First Ave., N. ... NEW ORLEANS, 128 Chartres St. ... ORANGE, N. J. ... PITTSBURGH, 909 Penn Ave. ... RICHMOND, 1204 East Main St. ... SAN FRANCISCO, 1267 Mission St. ... SEATTLE, Volker Bldg.

CLEVELAND, B. W. Smith, Inc., 2019 Euclid Ave. ... DETROIT, E. A. Bowman, Inc., 5115 John R. St. ... LOS ANGELES, H. R. Curtiss Co., 727 Venice Blvd. ... NEW YORK, Blackman Distributing Co., 28 West 23rd St. ... OGDEN, Proudfit Sporting Goods Co., 2327 Grant Ave. ... PHILADELPHIA, Girard Phonograph Co., Broad & Wallace Sts. ... ROCHESTER, Alliance Motor Corp., 727 Main St., East ... SAGINAW, Morley Bros. ... ST. LOUIS, Silverstone Music and Radio Co., 412 N. 12th St. ... DUBUQUE, Renier Bros. ... CINCINNATI, Edi-Radio Mart, 622 Broadway Ave. ... BINGHAMTON, Alliance Motor Corp. ... BUFFALO, Alliance Motor Corp., 1460 Main St. ... SYRACUSE, Alliance Motor Corp., 1045 South Salina St.

# There's a Big Opportunity

## Sell a Belden Aerial Kit with Every Set

Practically every customer who enters your store is a prospect for one of the popular Belden Radio Wire Accessories. A Beldenamel Aerial Kit should be as much a part of every receiver sale as tubes. The customer who buys a Beldenamel Aerial Kit and installs it according to directions, has settled the aerial question for all time. The most satisfactory results obtainable from his receiver are assured. He will more than likely become a better booster for the receiver you sell him.



## The Double Aerial System Is Again Popular

With the new wave lengths and new high power receivers, long distance reception is rapidly coming back into favor. Set owners like long outdoor aerials for bringing in distant stations with comfortable volume and short aerials for eliminating interference of local stations. Indoor aerials are popular for the latter purpose.



## Sell Aerials and Accessories to Increase Service Profits

Every service kit should include a complete assortment of wire accessories, such as indoor aerials and extension cords. Accessory wire sales of servicemen should not be overlooked.

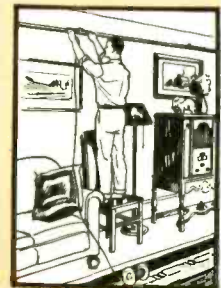

# in Belden Kits & Accessories

## Every Worth While Accessory in the Belden Line



The Complete Belden Line contains aerial equipment, cords, and practically every radio accessory needed by set owners and servicemen. Here are radio wire accessories of the best quality, backed by a name well and favorably known throughout the industry, that meet every requirement of radio. You can sell these products with every assurance of effective performance.

### More Saturday Evening Post Advertising

Because of their innate quality, Belden Radio Products have become popular with radio users everywhere. This popularity has been increased by a consistent advertising program which has reached radio buyers from year to year. An extensive program in the Saturday Evening Post this year will carry the story of Belden Quality Radio Products to millions of readers.

### Get this Sales Builder

Display Belden Kits and Accessories to increase your accessory sales. The attractive three color counter card, shown at the left (size 12x18 inches), is yours for the asking. Mail the coupon.

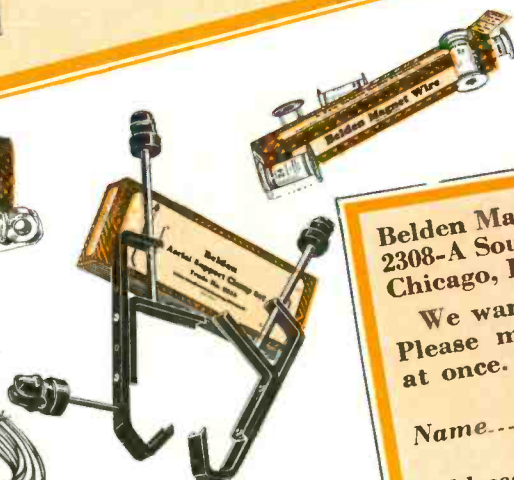
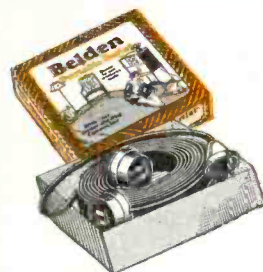
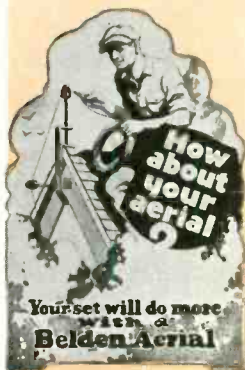

Belden Manufacturing Company  
 2308-A South Western Avenue  
 Chicago, Illinois

We want to increase our accessory sales.  
 Please mail your attractive display card  
 at once.

Name.....

Address.....

*Mail the Coupon*



## 23 years of leadership

Only De Forest Audions bear the name of the inventor, Dr. Lee De Forest, and include all the latest developments of the De Forest Laboratories.

All other radio tubes no matter what they are called, are made under the invention and basic patents of Dr. Lee De Forest.

DE FOREST RADIO CO., JERSEY CITY, N. J.

*Branch Offices located in*

|              |            |             |             |         |
|--------------|------------|-------------|-------------|---------|
| Boston       | Atlanta    | Minneapolis | Denver      | Detroit |
| New York     | Pittsburgh | St. Louis   | Los Angeles | Dallas  |
| Philadelphia | Chicago    | Kansas City | Seattle     |         |

*de Forest* AUDIONS

**ATWATER  
KENT  
RADIO  
SCREEN-GRID**

**Whatever they want—  
You have it in  
Atwater Kent Radio**

*Suit them with Atwater Kent Radio !  
and suit yourself with extra profits •*

# ATWATER KENT RADIO SCREEN-GRID

*Whatever they want—*

**"Let me see the latest in radio."** You have it! In Atwater Kent Screen-Grid Radio, with all the *proved* improvements. Here is true performance . . . needle-point selectivity . . . distance-getting . . . tremendous power . . . genuine Electro-Dynamic tone. It's a winner! Tens of thousands are buying it!

**"But I have direct current."** You have it! In the Atwater Kent Screen-Grid direct current set. Perfected . . . tested . . . right!

**"I must use a battery set."** You have it! In the up-to-date Atwater Kent Screen-Grid battery set. All the improvements of the all-electric Atwater Kent. Electro-Dynamic, of course. Ideal for unwired homes . . . the last word in battery sets.

## MORE SALES . . . MORE PROFITS



**The Table Model**—Model 55—Screen-Grid receiver.  
Without tubes, \$88.

Model F-4—Electro-Dynamic table speaker, \$34.

**On the Air**  
Atwater Kent Radio Hour  
Sunday Evenings, 9:15 (Eastern Daylight Time)  
WEAF network of N. B. C.

*Prices slightly higher  
west of the Rockies and in Canada*

# ATWATER KENT RADIO

## SCREEN-GRID

*you have it!*

**"I want a cabinet radio."** You have it! In simple designs, elaborate designs. To suit any taste . . . Cabinets made by America's leading designers for Atwater Kent Screen-Grid Radio.

**"I want a small set."** You have it! In smart, compact, table models for the smaller apartments . . . or for people who naturally prefer this style of radio.

**"And the price?"** You have it! In Atwater Kent Radio at prices to suit the thrifty or those who need not count the cost . . . to suit any pocket-book.

*Meet the demand of your customers and get*

### MORE SALES . . . MORE PROFITS

**In Cabinets**—The best of American cabinet makers—famous for sound design and sincere workmanship—are cooperating to meet the demand for Atwater Kent Screen-Grid Radio in fine cabinets like these.

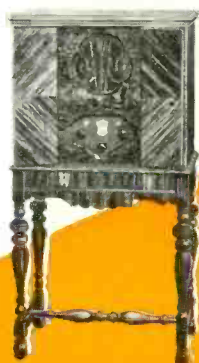

#### On the Air

Atwater Kent Mid-Week Program  
Thursday Evenings, 10:00  
(Eastern Daylight Time)  
WJZ network of N. B. C.

# ATWATER KENT RADIO

## "Most in Demand"

*because*

it is made by a maker famous for turning out radio that keeps on working.

*because*

it has the good will of more than 2,550,000 owners.

*because*

it is brought to people's minds through three broadcasting programs every week—Sunday night, Thursday night and Wednesday morning.

*because*

it is backed by radio's greatest advertising campaign—newspapers, magazines, posters.

*because*

it is the best-known radio.

*because*

the Atwater Kent factory, doubly the largest radio factory in the world, has the facilities for making fine radio which can be sold at a moderate price.

*feature it!*

**ATWATER KENT MANUFACTURING COMPANY**

4733 Wissahickon Avenue

A. Atwater Kent, President

Philadelphia, Pa.



## Beauty that's more than skin deep

**T**RANSCENDENT beauty of Radio Master Cabinets is far more than sheen of varnish—

It is beauty of graceful design by one of America's foremost furniture designers, whose services for radio furniture we have exclusively—

It is beauty of rare, lovely woods for which we search the earth to the far corners—

It is beauty of honest skillful craftsmanship in making and finishing. Radio Master has one of the finest cabinet shops in the country.

This beauty of solid quality is enduring value—it enhances the desirability of the set to the buyer—brings you two profits instead of one and—

Radio Masters are cabinets you take prideful delight in selling.



**Model 170—A "Creation" in Wood**

Splendid with the mellow beauty of matched walnut — Mexican and French Burl — Spindle carved ornaments.

Will take nearly all table sets but is especially adapted for Atwater Kent—ample space for Dynamic Speaker. Smooth action sliding doors.

**Model 171—Splendid in Line and Material**

Matched oriental walnut doors with Mexican burl panel. French burl pilasters. Spindle carved ornaments—Half doors.

Fits nearly all table sets—especially Atwater Kent. Interior panel may be bored to order when necessary.

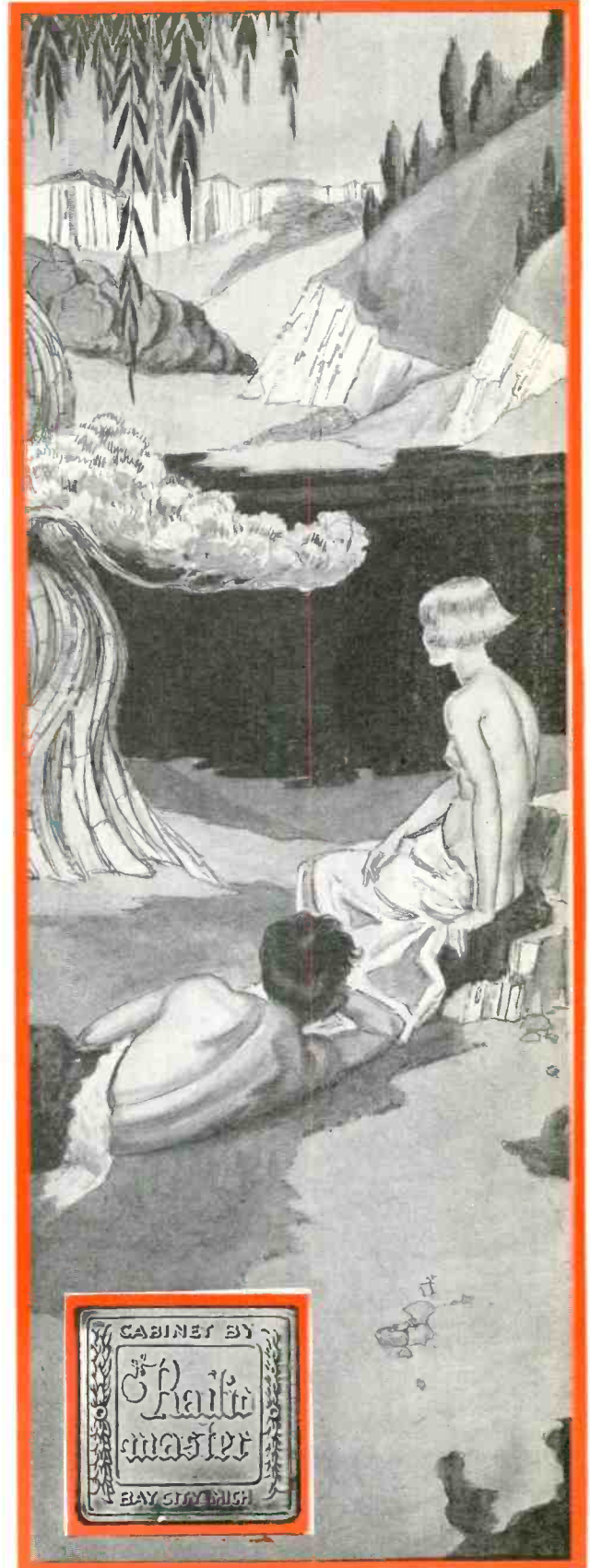

# Radio Master Cabinets

**THE SETTING BEAUTIFUL FOR ANY RADIO**

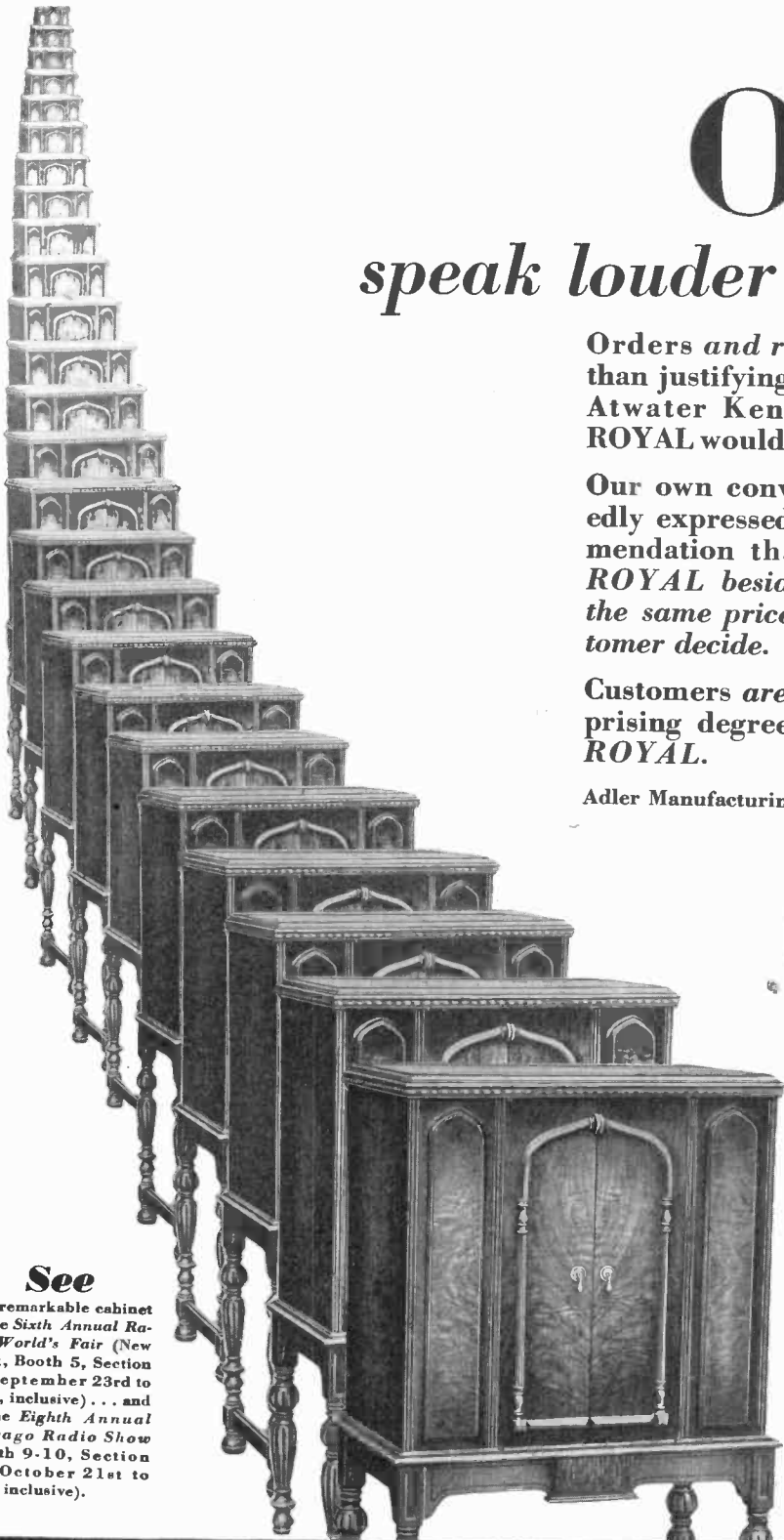

# ORDERS

*Speak louder than words*

Orders and repeat orders are more than justifying the prediction that the Atwater Kent Cabinet by ADLER-ROYAL would be exceedingly popular.

Our own conviction has been repeatedly expressed in the sincere recommendation that you place ADLER-ROYAL beside any other cabinet in the same price class and let your customer decide.

Customers are deciding and, to a surprising degree, in favor of ADLER-ROYAL.

Adler Manufacturing Co., Incorporated, Louisville, Ky.



**See**

this remarkable cabinet at the Sixth Annual Radio World's Fair (New York, Booth 5, Section N; September 23rd to 28th, inclusive) . . . and at the Eighth Annual Chicago Radio Show (Booth 9-10, Section EE; October 21st to 27th inclusive).

Note: ADLER-ROYAL flush-with-side doors fully protected by design patents.

# ATWATER KENT Cabinet by ADLER-ROYAL

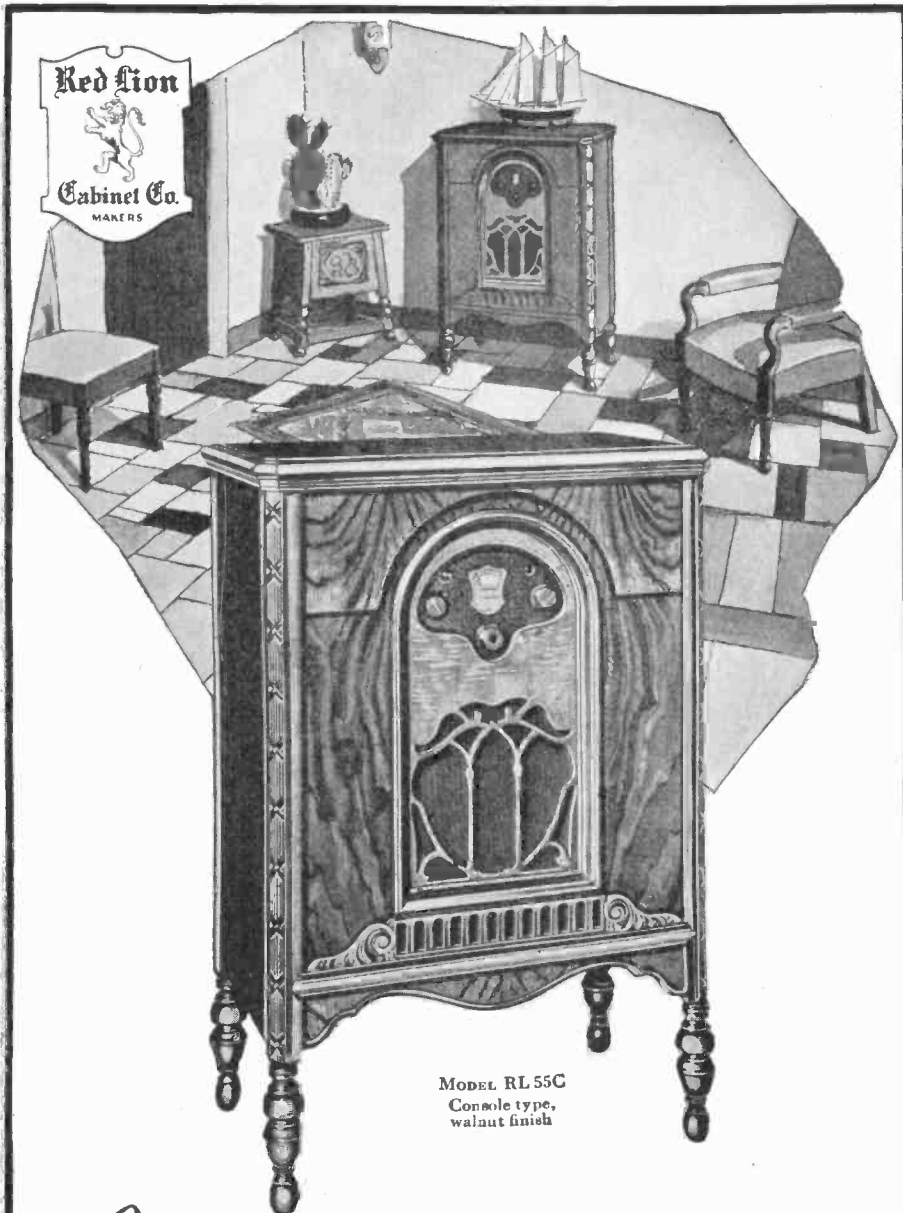

MODEL RL 55C  
Console type,  
walnut finish

*Outstanding achievements  
in radio furniture  
the New 1929*

# Red Lion CABINETS

**FOR ATWATER KENT RADIOS**

CHARMING simplicity which has  
ings—gracefully balanced de  
to whatever room you m  
walnut finish which blen  
or denotes the individu  
in present day decor

*This advertisement appears in the  
September 21st issue of  
The Saturday Evening Post*

**RED LION CABINET COMPANY • RED LION • PA.**

*Makers of the Famous Red Lion Furniture*



*as advertised in  
The Saturday Evening Post*

Red Lion advertising in *The Saturday Evening Post* ties right up with the Atwater Kent message. It will reach millions of readers—many of them your customers, your prospects—and is bound to increase the demand for and the sales of Red Lion Cabinets for Atwater Kent Radios.

*Write for full particulars*



MODEL RL 5500

Exceptionally good-looking highboy model. Finished in walnut. Designed for the new Atwater Kent Screen-Grid Sets.

**W**ITH competition growing keener every day, the shrewd dealer seeks a line of distinctive Quality—and Kellogg offers exactly that, in—

# SCREEN-GRID RADIO

## PLUS..

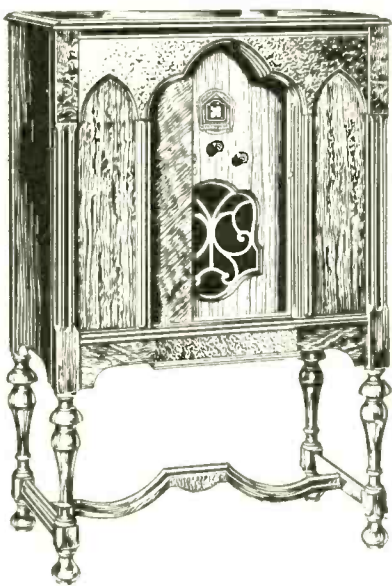

Distinctive quality at only a slight advance over "price" radio! Quality not only in performance but in cabinets as well! A typical example is Model 523, shown above. Priced at only \$250, less tubes! Another style at \$295; and a combination radio and phonograph at \$395. Unusual advertising and sales support! Franchises are closing rapidly, so communicate at once if interested.

*Prices slightly higher west of Rockies*

• [ *Not one or two, but—*  
**3 Screen-Grid Tubes** ] •

**PLUS**

**Power Detector**

**PLUS**

**Powerful Push Pull**

**Audio** 3 Tubes including  
two 245 or 250 type tubes

**PLUS**

**Automatic Volume**

**Control** Kellogg Exclusive  
1929 Design

**PLUS**

**Kellogg Tone Balanced  
Dynamic Speaker**

**KELLOGG**  
*Cathedral Tone*  
**RADIO**

*Licensed Under R. C. A. Patents*

KELLOGG SWITCHBOARD & SUPPLY CO.  
CHICAGO

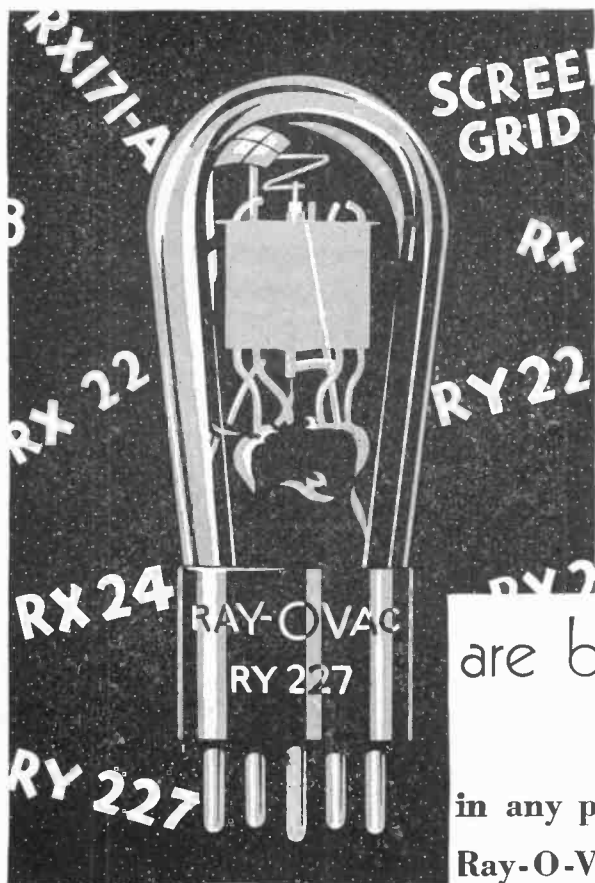

# THESE *Tubes*

are built to a reputation

There can be no compromise with quality in any product that bears the Ray-O-Vac name. Ray-O-Vac Radio Tubes were designed to match the Ray-O-Vac reputation; what more can anyone—dealer or user—ask? Your jobber will supply you.

There is a Ray-O-Vac Tube for every type of radio set, old or new. And when you consider that this good name has stood for excellence in batteries for so many years, you find that you really have *something to sell* when Ray-O-Vac Tubes are on your counter. Consult the list at the right for details.

### FRENCH BATTERY COMPANY

Factory: Madison, Wisconsin  
Sales Office: 30 N. Michigan Ave., Chicago

Makers also of Ray-O-Vac "A," "B," and "C" Radio Batteries, Ray-O-Vac Ignition, Telephone, and Flashlight Batteries, Ray-O-Vac Standard Flashlights, and the Ray-O-Vac Rotomatic Searchlight (in colors).

# RAY-O-VAC *Tubes*

## *Ray-O-Vac* RADIO TUBES

- RX-199** Detector Amplifier
- RV-199** Detector Amplifier
- RX-120** Power Amplifier
- RX-200A** Detector
- RX-201A** Detector Amplifier
- RX-201B** Detector Amplifier
- RX-112A** Power Amplifier
- RX-171A** Power Amplifier
- RX-240** High Mu Detector Amplifier
- RX-222** Screen Grid Radio Audio Amplifier
- RX-226** A. C. Amplifier
- RY-227** Detector Amplifier
- RY-224** A.C. Heater Type Screen Grid Detector Amplifier
- RX-245** A. C. Power Amplifier
- RX-210** A. C. Power Amplifier and Oscillator
- RX-250** A. C. Power Amplifier
- RX-280** Full-Wave Rectifier
- RX-281** Half-Wave Rectifier

# SCREEN-GRID BOSCH RADIO

The new Screen-Grid Bosch Radio more than justifies its leadership. Dealers have found that to be so. The buying public has discovered it, too. Bosch Radio is correctly engineered to the new screen-grid tubes. Dealers are finding it easy to sell. They are doing a volume business. Bosch Radio is creating profits now. Bosch Radio is outstanding in tonal quality, in selectivity, sensitivity, simplicity of operation and controllable power. It is priced right. The cabinets are built right and are beautiful. The Bosch Dealer franchise is fair and square with price advantages and a flexibility that will interest you. Bosch factory-to-dealer cooperation, Bosch advertising are factors worth considering. Write for details if you would be included in this season's activities.

Bosch Radio licensed under patents and applications of R.C.A., R.F.L. and Lektophone. Prices slightly higher west of Rockies and in Canada.

**AMERICAN BOSCH MAGNETO CORPORATION**  
Springfield Massachusetts

**Branches:** New York Chicago Detroit San Francisco





The new Bosch Radio Table Model 48 illustrated above contains the perfectly shielded chassis with seven tubes, three of which are the new Screen-Grid amplifier type, housed in handsome table cabinet of richly grained walnut veneers. Sliding doors are introduced in a table mode, with a distinct sales appeal. List price, less tubes ..... \$119.50

The Bosch Radio Combination Receiver and Speaker Console illustrated on left will be in great demand because it embodies Screen-Grid quality radio in an inexpensive combination of charming individuality. Perfectly chosen woods and veneers combined with rich carving make this console one of beauty. It has the electro-dynamic type speaker. List price, less tubes ..... \$168.50

The new Bosch Radio De Luxe Console at right is truly the last word in radio. The chassis, employing the most modern scientific developments in radio engineering, uses seven tubes, three of which are the new Screen-Grid type, and two of which are the large new audio amplifiers arranged in push-pull. The cabinet, with tall sliding doors concealing both dial panel and electro-dynamic type speaker, is strikingly different. The finish is antique in Old English line and set off with well selected walnut veneers. List price, less tubes ..... \$240.00

Bosch Radio Tubes add a new quality of performance to any radio receiver.





# Silver Radio

## 4 Tests that ANYBODY Understands

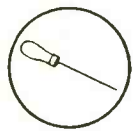

The Ice Pick  
Test



The Vanishing  
Antenna Test



The Hair Pin  
Test



The "Four Bits"  
Test

SILVER RADIO is, before all else, a radio to be sold directly on the strength of its demonstrably superior performance as compared with any other set on your floor, no matter what its price.

SILVER RADIO dealers are encouraged by the factory to actively seek competitive tests against any and all other radios.

These four startling new tests, applied in any store or location, summer or winter, rain or shine, will show to the most un-radio-minded customer the absolute superiority of SILVER RADIO. Big words these, but . . .

Silver-Marshall will use large space in newspapers throughout the country in September and October to bring people into your store to see these simple tests performed.

And in the hard-fought radio market which will prevail this fall, the safest investment that any dealer can have is a receiver which will consistently out-perform all others—SILVER RADIO.

SILVER - MARSHALL, Incorporated, 6421 West 65th Street, Chicago, U. S. A.

SILVER · ON · RADIO · IS · LIKE · STERLING · ON · SILVER



# Capehart Paved the Way to Bigger Music Profits

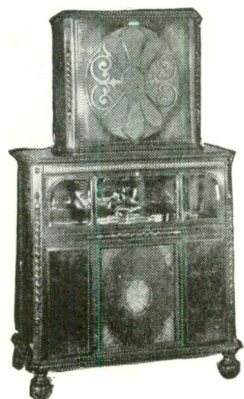

**AUDITORIUM MODEL**  
Recommended for public auditoriums, dancing academies, etc.

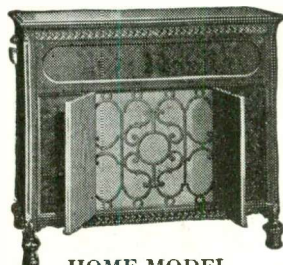

**HOME MODEL**  
Exquisitely designed for use in the finest clubs and homes.



**OUTDOOR MODEL**  
Specially built to meet great volume outdoor requirements. Fireproof and weatherproof.

**C**APEHART has revived the commercial musical instrument business. He came into the field 18 months ago with a product that was instantly recognized as the first dignified, practical and profitable automatic instrument that had ever been offered to public establishments. He established the policy of selling exclusively through dealers—the first time that up-to-date merchandising methods had been used in the industry.

With what results? A dormant industry has been brought to life. A mere idea has grown in 18 months to a business running into the millions! Capehart dealers are

making such profits as were never known to them before—\$2000 to \$5000 a month. Capehart users report business increases of as high as 75%, coin box receipts averaging \$25 a week. The market has become so attractive that even imitators have entered the path that Capehart has paved.

But only the surface of this rich new market has been touched. With the completion of a greatly enlarged new factory, Capehart is now prepared to offer new dealers the same opportunity for really big profits that was given to those who pioneered with it in the early days.

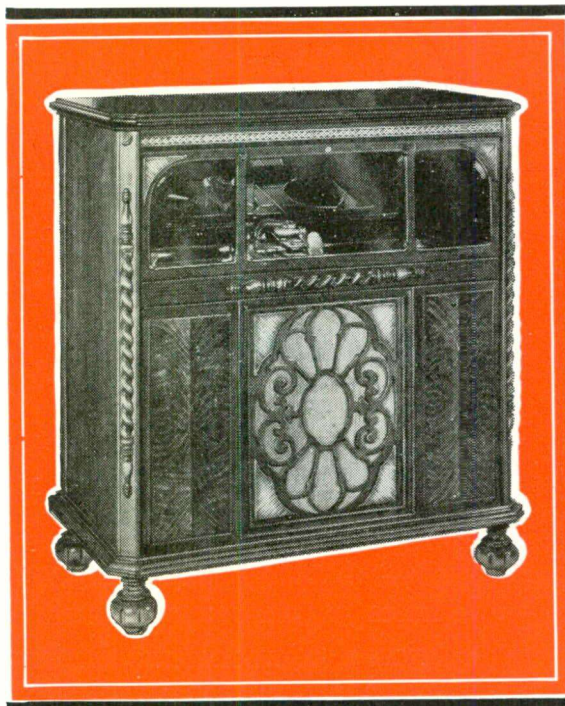

## Write for Details!

We invite correspondence with dealers who can measure up to the possibilities of this new opportunity. Valuable franchises are available now in several territories. The coupon below will bring full details without obligation. Please mail it today.

### Saturday Evening Post Advertising Campaign Starts This Month

On September 14th, Capehart begins a big advertising campaign which will appear every two weeks in the Saturday Evening Post. The general public will be educated to the advantage of patronizing the establishment that offers Capehart entertainment. Bigger profits for Capehart owners. And even a bigger opportunity for Capehart dealers. Investigate now.

The *Capehart*  
**ORCHESTROPE**  
CONTINUOUS AMPLIFIED MUSIC FOR ALL PURPOSES

## Plays 56 Selections

The Capehart actually offers more than has ever been possible before in a commercial musical instrument. Plays 56 selections, 28 records on both sides, changing and turning the records automatically. Operates 24 hours a day, if desired, without even a moment's attention. The tone, brought through 3 stages of audio amplification and a dynamic speaker, is startlingly true to life.

The volume is adjustable to any requirement. Supplied with or without coin-operating attachments. Also with as many as five auxiliary speakers. Cabinets of dignified and attractive design. And—for the first time in the industry—a complete line: a model for every purpose.

**THE CAPEHART CORPORATION**  
Fort Wayne, Indiana

The Capehart Corporation,  
Dept. 4856, Ft. Wayne, Ind.

Please send me, without obligation, descriptions of all Capehart models and details of the Capehart Dealer's Franchise.

Name .....

Address .....

City .....

State .....

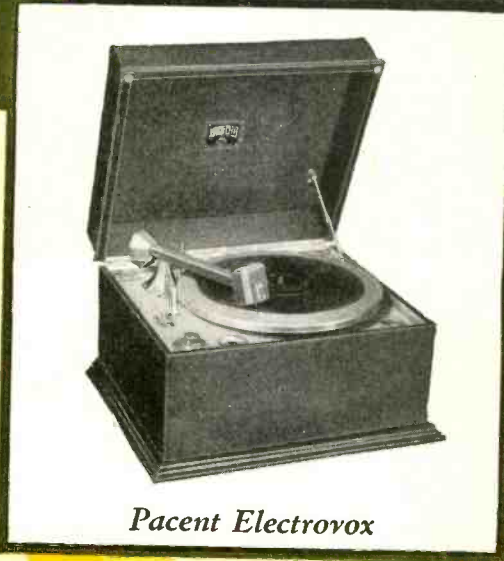

*Pacent Electrovox*

### *The Super Phonovox*

The finest pick-up to be had—and the fastest selling. Has balanced tone-arm for correct noiseless needle pressure, supremely sensitive English 36% Cobalt Magnets, no rubber bearings to harden and cause grief through wear.

### *Pacent Electrovox*

The Electrovox is a complete, beautifully finished electric phonograph—ready to play records through radio. Its reproduction of tone is amazingly rich and life-like—and it is a ready, profitable seller.



## *Super Phonovox*

List Price

**\$15.00**

*Prices slightly higher  
west of the Rockies*

*These PACENT  
build profits*

Pacent phono-radio accessories lead the field in sales volume just as they lead in quality. And this leadership means a great deal to Pacent dealers—in quicker easier sales, in greater profits and in the hosts of pleased customers who gladly tell their friends. Demonstrate the Super Phonovox and the new Pacent Induction Type Motor for every Radio and Phonograph customer. Show them how easily and how *economically* an old phonograph can be made to perform like the costly electric instruments. People today have learned to be discriminating about tone quality and the wonderfully *lifelike*

# PACENT

## Induction Type Motor

List Price

**\$25.00**

Prices slightly higher  
west of the Rockies

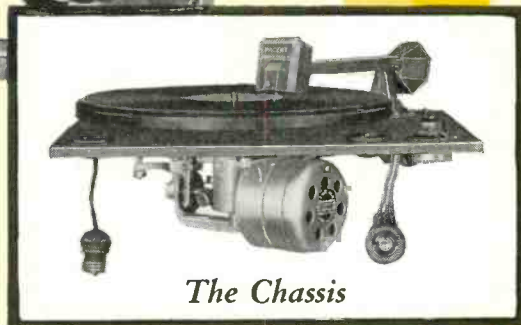
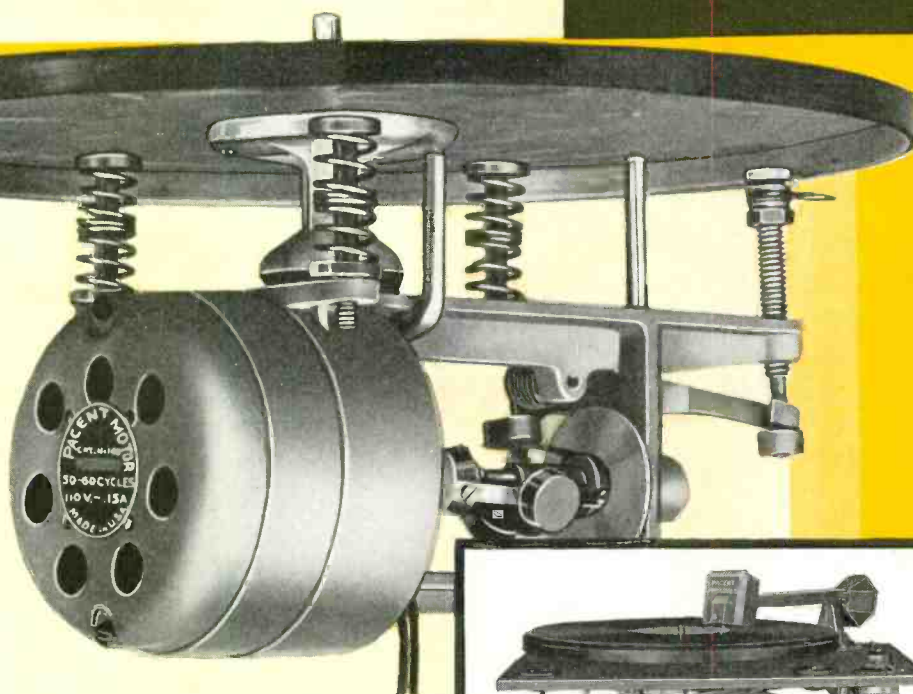

The Chassis

# achievements for Dealers...

voice of the Super Phonovox literally sells itself. People likewise insist upon flawless mechanical efficiency and the Pacent phonograph motor is unequalled for smooth, silent, trouble-free operation. Feature these dependable products consistently and you will find that you can substantially increase your Sales Volume—with very little effort.

Dealers—be sure to visit our exhibit at the New York Radio Show at Madison Square Garden, September 23rd-28th. Booth CC-10.

**PACENT ELECTRIC Co., Inc., 91 Seventh Ave., N.Y.**

*Pioneers in Radio and Electric Reproduction for Over 20 Years*  
Manufacturing Licensee for Great Britain and Ireland: Igranic Electric Co., Ltd., Bedford, Eng.  
Licensee for Canada: White Radio Limited, Hamilton, Ont.

### Induction-Type Motor

Dealers everywhere feature this silent new induction-type motor to cash in on the fast-growing popularity of phono-radio combinations. Completely insulated against noise and made vibrationless by dynamically balanced rotor. Operates on 110 Volts, 50 or 60 cycles A.C.

### The Chassis

The Pacent Electrovox Chassis comes completely mounted with The Super Phonovox and the Pacent Induction-Type Motor, including automatic stop and radio-record switch.

# ACCESSORIES

# P resenting the 1930 APEX line

The New

**APEX SUPER-SCREEN-GRID** \$115

and the New

**APEX HIGH-GAIN  
NEUTRODYNE** \$115

List  
(Less tubes)

List  
(Less tubes)

Each with APEX New Multi-Phase Circuit and APEX  
New Full Tone-Color Electro-dynamic Speaker.

Dominating in value, the 1930 APEX line is sweeping onward to a tremendous success. Check this great line for the four factors that sell Radio: (1) Eye-appeal, (2) Ear-appeal, (3) Purse-appeal, (4) Continuous, satisfactory performance in the home. Convince yourself! Order now and start APEX profits your way—or apply today for your APEX franchise, one of the most valuable profit opportunities in Radio!



**THE UNITED STATES RADIO & TELEVISION CORPORATION**  
1340 Michigan Avenue, Chicago, U. S. A.

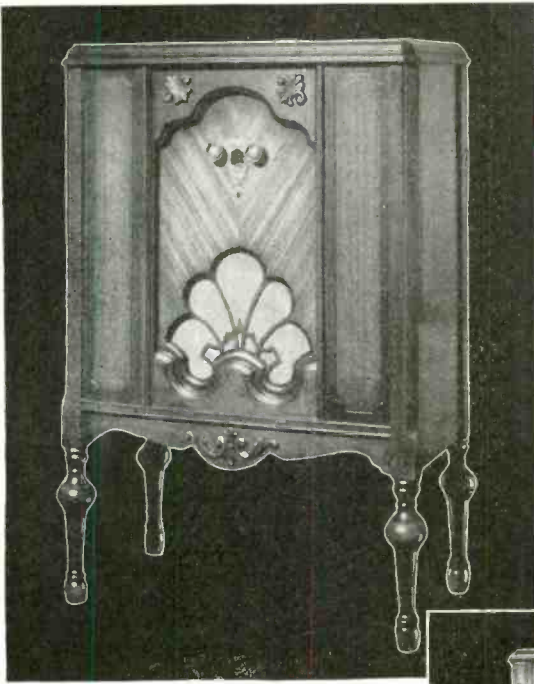

At right: Model 14  
SUPER-SCREEN-  
GRID  
(110 volt, 60 cycle)  
List \$140  
(less tubes)

*Cabinet:* Full American Walnut veneer, 47 1/4" x 25 1/2" x 16 1/2". *Chassis:* Simple and compact. 3 stages tuned radio frequency, 2 stages audio with last stage using 2-245 tubes in push-pull. *Speaker:* 12-inch Stadium Model Apex New Full Tone-Color Electro-dynamic. *Tubes:* 2-224 screen-grid, 2-227 heater, 2-245 power amplifiers, 1-280 rectifier.

Model 14A—Same as Model 14 only for 110 volts, 25 cycle current. List \$144 (less tubes).

Model 140 — HIGH-GAIN  
NEUTRODYNE (110 volt,  
60 cycle) List \$140  
(less tubes)

*Cabinet:* Full American Walnut veneer, 47 1/4" x 25 1/2" x 16 1/2". *Chassis:* Compact. 3 tuned stages radio frequency, 2 stages audio with last stage using 2-245 tubes in push-pull. *Speaker:* 12-inch Stadium Model Apex New Full Tone-Color Electro-dynamic. *Tubes:* 5-227 heater, 2-245 power amplifiers, 1-280 rectifier.

Model 140A—Same as Model 140 only for 110 volts, 25 cycle current. List \$144 (less tubes).

**TABLE MODELS**

Model 60—HIGH-GAIN NEUTRODYNE  
(110 volt, 60 cycle) List \$60 (less tubes)

*Cabinet:* Beautifully finished metal cabinet 18 1/2" x 13 1/2" x 7 1/2". *Chassis:* Compact. 3 tuned stages radio frequency, 2 stages audio with last stage using 2-245 tubes in push-pull. *Tubes:* 5-227 heater, 2-245 power amplifiers, 1-280 rectifier.

Model 60A—Same as Model 60 only for 110 volts, 25 cycle current. List \$64 (less tubes).

Model 45—APEX BATTERY SET  
List \$45 (less tubes)

*Cabinet:* Beautifully finished metal cabinet: 17" x 9 1/4" x 6 3/4". *Chassis:* 3 tuned stages radio frequency, two audio, last stage with power amplifier. *Tubes:* 5-201A, 1-171A power amplifier.

Can such values be matched? Can you doubt the dominance of Apex in 1929-30? Get in line for Apex profits right now! Order today, or apply for your Apex franchise.

**THE UNITED STATES RADIO AND  
TELEVISION CORPORATION**  
1340 Michigan Avenue, Chicago, U. S. A.



Model 11—SUPER-SCREEN-GRID (110 volts,  
60 cycle) List \$115 (less tubes)

*Cabinet:* Full American Walnut veneer, 40 1/4" x 27 1/4" x 14 1/2". *Chassis:* Simple and compact. 3 Stages tuned radio frequency, 2 stages audio with last stage using 2-245 tubes in push-pull. *Speaker:* APEX New Full Tone-Color Electro-dynamic. *Tubes:* 2-224 screen-grid, 2-227 heater, 2-245 power amplifiers, 1-280 rectifier.

Model 11A—Same as Model 11 only for 110 volts, 25 cycle current. List \$119 (less tubes).

Model 115—HIGH-GAIN NEUTRODYNE (110  
volts, 60 cycle) List \$115 (less tubes)

*Cabinet:* Full American Walnut veneer, 40 1/4" x 27 1/4" x 14 1/2". *Chassis:* Compact. 3 tuned stages radio frequency, 2 stages audio with last stage using 2-245 tubes in push-pull. *Speaker:* APEX New Full Tone-Color Electro-dynamic. *Tubes:* 5-227 heater, 2-245 power amplifiers, 1-280 rectifier.

Model 115A—Same as Model 115 only for 110 volts, 25 cycle current. List \$119 (less tubes).

Below: Model 24  
SUPER-SCREEN-  
GRID with RE-  
MOTE CONTROL  
(110 volt, 60 cycle)  
List \$240 (less tubes)

*Cabinet:* Full American Walnut veneer, 47 1/4" x 25 1/2" x 16 1/2". *Chassis:* Simple and compact. 3 stages tuned radio frequency, 2 stages audio with last stage using 2-245 tubes in push-pull. *Speaker:* 12-inch Stadium Model Apex New Full Tone-Color Electro-dynamic. *Tubes:* 2-224 screen-grid, 2-227 heater, 2-245 power amplifiers, 1-280 rectifier.

Model 24A—Same as Model 24 only for 110 volts, 25 cycle current. List \$244 (less tubes).

Model 160—SUPER-HIGH-  
GAIN NEUTRODYNE  
(110 volt, 60 cycle)  
List \$160 (less tubes)

*Cabinet:* Full matched American Walnut veneer, 50 1/4" x 27 3/4" x 18 1/4". *Chassis:* Four tuned stages radio frequency, 2 stages audio, last stage using 2-245's in push-pull. *Speaker:* 12-inch Stadium Full Tone-Color Electro-dynamic. *Tubes:* 6-227 heater, 2-245 power amplifiers, 1-280 rectifier.

Model 160A—Same as Model 160 only for 110 volts, 25 cycle current. List \$166 (less tubes).



# THE NEW SONORA RADIO

WITH

## SYNCHRO-TONE MODULATOR and SCREEN GRID TUBES

**NOW... a Radio by SONORA at popular prices!**

**D**ESIGNED by SONORA . . . built by SONORA . . . backed by the SONORA reputation of 18 years in the production of fine sound-reproducing instruments.

Manufactured in their entirety by SONORA in SONORA plants located at Saginaw, Mich., Buffalo, N. Y., and Bridgeburg, Ont., Canada.

Especially designed for screen grid operation in order to realize the tremendous sensitivity and selectivity of which these tubes are capable.

Equipped with the New Synchro-tone Modulator that reproduces, with marvelous fidelity, every note in the musical scale *exactly* as it is broadcast.

And . . . for the first time, in the *popular price range!*

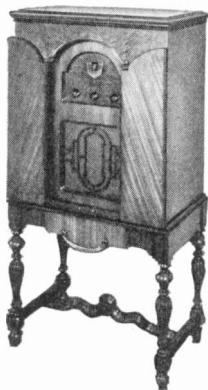

**Model A-33 Screen Grid**  
Cabinet by Sonora

Highboy: Highest quality, extra large power dynamic speaker. Cabinet of selected walnut with attractive overlays. French Chateau doors. New SONORA Screen Grid Chassis.

**\$179<sup>50</sup>** Less tubes Price slightly higher in Far West

### SONORA Screen Grid Chassis

Six tubes and rectifier; three 224 R. F.; one 227 power detector; two 245 audio amplifiers in push-pull system; one 280 rectifier; power supply integral. Extremely simple and especially designed for easy accessibility. Extreme sensitivity and selectivity with stability; completely shielded, including new inter-stage condenser isolation. A real screen grid job.

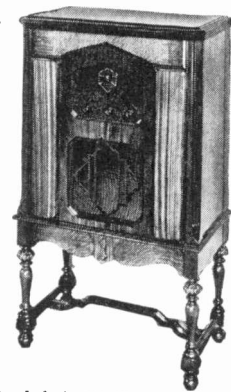

**Model A-31 Screen Grid**  
Cabinet by Sonora

Lowboy: Highest quality, extra large power dynamic speaker; genuine walnut cabinet with selected veneer trim. New SONORA Screen Grid Chassis.

**\$149<sup>50</sup>** Less tubes

Price slightly higher in Far West

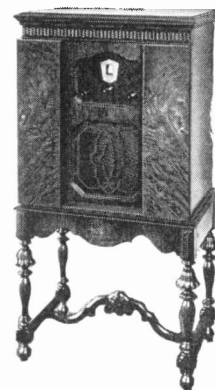

**Model A-35 Screen Grid**  
Cabinet by Sonora

Highboy: Highest quality, extra large power dynamic speaker. Cabinet of rare beauty in full accord with SONORA standards. New SONORA Screen Grid Chassis.

**\$235<sup>00</sup>** Less tubes

Price slightly higher in Far West

# "CLEAR AS A BELL"

## SONORA Studio Chassis



**Model A-32 Studio**  
Cabinet by Sonora

Highboy: Specially designed power dynamic speaker. Beautifully designed cabinet with selected butt walnut doors and satin-wood overlays. SONORA Studio Chassis.

**\$250<sup>00</sup>** Less tubes

Price slightly higher in Far West



**Model A-30 Studio**  
Cabinet by Sonora

Horizontal: Specially designed power dynamic speaker. Attractive cabinet of modern trend, with carefully matched walnut, satin-wood and rosewood overlays. SONORA Studio Chassis.

**\$190<sup>00</sup>** Less tubes

Price slightly higher in Far West



**Model A-40 Studio**  
Cabinet by Sonora

Melodon Combination. Specially designed power dynamic speaker. Cabinet of beautiful modified Hepplewhite design; Australian walnut and satin-wood. Includes splendid reproducing phonograph. Electrically operated, with no-set automatic stop. SONORA Studio Chassis.

**\$375<sup>00</sup>** Less tubes

Price slightly higher in Far West

# You will want the SONORA Dealer Franchise

## SONORA De Luxe Chassis

Eight tubes, plus rectifiers and ballast lamp; four radio amplifiers type RA-1; one detector type DE-1; one audio amplifier type DE-1; two audio amplifiers type SO-2 in push-pull system; two rectifiers type RE-2; one 150 ballast lamp. Extremely sensitive. Ultimate power output combining auditorium volume with the utmost in tonal refinement from concert volume to a whisper, at will. Circuit especially designed to provide constant amplification over entire wave band. Careful matching of speaker with chassis output gives exceptional tone quality.

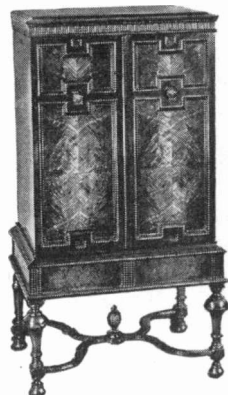

**Model A-36 De Luxe**  
Cabinet by Sonora

Upright: Specially designed power dynamic speaker. Local reception without antenna. Beautifully designed cabinet of William and Mary period, in charming combination of American and crotch walnut. Famous SONORA De Luxe Chassis.

**\$470<sup>00</sup>** Less tubes

Price slightly higher in Far West



**Model A-44 De Luxe**  
Cabinet by Sonora

Melodon Combination: Specially designed power dynamic speaker. Local reception without antenna. Unusually attractive cabinet. English Renaissance style. American and crotch walnut with oak burl overlays. Famous SONORA De Luxe Chassis.

**\$695<sup>00</sup>** Less tubes

Price slightly higher in Far West

**First:** because the New SONORA Radio undoubtedly will be the season's best-selling radio.

**Second:** because of the liberal SONORA Authorized Dealer Policy.

**Third:** because the spectacular, nationwide SONORA advertising campaign sponsors new sales ideas.

**Fourth:** because SONORA embodies a simplicity of construction that eliminates all unnecessary parts, and makes every remaining part easily accessible.

**Fifth:** because of a co-ordinated SONORA sales policy of closest cooperation between the factory and you.

**Sixth:** because a SONORA dealer has a sales franchise of permanent value, increasing year by year.

Responsible dealers everywhere will find it to their advantage to know more about the New SONORA Radio and the profitable SONORA Sales Plan.



A trade-mark of distinction that has been synonymous with fine music for 18 years

(Licensed under patents of Radio Corporation of America and Canadian Radio Patents, Ltd.)

# SONORA PHONOGRAPH COMPANY, INC.

Main Offices: SONORA BUILDING,  
50 West 57th Street, New York City

Factories: Buffalo, N. Y.; Saginaw,  
Mich.; Bridgeburg, Ont., Canada

## A picture-book study of growing dollars



90% of service calls that are received after a set is originally installed are caused by defective tubes.

# Who pays for the service of a service man?

You do, of course. And it comes out of the profit you make on sets.

How many service calls do you make on each set you sell? How much would it be worth to you if you could reduce this number by one call?—by 2 or 3 calls?

Experts say that 90% of service calls on sets after they have been installed are due to defective tubes.

This should cause you to sit up and take notice.

It should make you keen to find the most dependable line of tubes on the market and furnish them as original equipment on all sets as well as for replacements.

Here are some of the benefits you will derive from handling high quality, well known tubes:—

1. Reduced number of dissatisfied customers
2. Reduced number of unprofitable service calls
3. Reduced cost of returning tubes to factory
4. Higher reputation of the sets you sell
5. Higher reputation for your dependability

# CeCo



## in tube sales . . . for live dealers

6. Repeat business insured
7. Increased sales of other items in your store

Possibly you do not have the facilities for making exhaustive tests of tubes for all important characteristics and length of life. But other large dealers and radio manufacturers have made these tests for CeCo.

### 4 great companies proved that Ce Co tubes have 30% to 50% longer life

Two of the foremost set manufacturers and the two largest tube distributors in America tested CeCo tubes. These companies have their own precious reputations to protect. They *had* to know the *best* tubes.

So, in their own laboratories, *without our knowledge*, they made exhaustive tests of all the better tubes on the market.

In making their tests, they afterward told us, they found that CeCo tubes tested highest in the important tube characteristics. As one of the outstanding facts, their experiments proved that *CeCo tubes outlasted other tubes tested by 30% to 50%*.

As an outcome of their tests these four companies alone have contracted for over 4,000,000 CeCo tubes during the coming season.

### Every Ce Co tube is dated

This will be found a great aid to cutting down the number of service calls. Each CeCo tube is stamped on the base with its date of manufacture. The date on CeCo tubes is to help you in making satisfactory adjustments on any complaints you may receive.

Licensed under patents and applications of the Radio Corporation of America, the General Electric Company, and the Westinghouse Electric and Manufacturing Company

**Ce Co Manufacturing Co., Inc.**  
PROVIDENCE, R. I.

# tubes

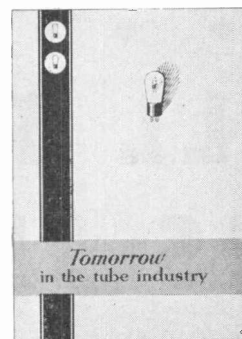

This book tells of the ever-increasing importance of tube sales to radio dealers. Among others, here are some of the things it discusses:—

1. The size and development of the radio market
2. The percentage of profit in tubes
3. The growing replacement market for tubes
4. How quality tubes cut losses on set sales and service
5. Will there be a tube shortage in 1929?
6. Price cutting
7. Turnover
8. An impartial analysis of the radio market by Dr. H. K. Nixon, Professor of Marketing and Advertising at Columbia University.

Send for this book. It contains many helpful suggestions for building up tube sales and shows what progress other dealers are making along this line.



The A. C. 224 Screen Grid Tube was developed and perfected by CeCo over a year and a half ago.

CeCo Manufacturing Co., Inc., Dept. 209,  
1200 Eddy Street, Providence, R. I.

Send me a copy of the dealer book, "Tomorrow in the Tube Industry."

Name \_\_\_\_\_

Company \_\_\_\_\_

Address \_\_\_\_\_

# ... AND THEY'RE STILL RUBBING THEIR EYES IN AMAZEMENT!

## MODEL 52

... Employs nine tubes, including rectifier. Specially designed Screen-Grid circuit... DOUBLE Push-Pull audio amplification. Genuine Automatic Tuning. Super-size Zenith Syntonic Dynamic Type Speaker. Linear Power Detection. Self-Healing Filter Condenser. Simple Selectivity Adjustment. Automatic Phonograph switch. Charming low-boy console of Butt Walnut with overlays of English Satin Oak.

**\$175**

LESS TUBES

Western U. S. price slightly higher



Up went the curtain...and Zenith's 15th Anniversary Models stunned the radio world. Here, at last, was modern achievement, superb, unexpected—that far *outstripped* everything else in quality and *outvalued* them at popular prices. Instant success was apparent—dealers enthusiastically grasped the opportunity. Zenith quality now at popular prices — irresistible! Get in touch with your Zenith distributor now.



ANNIVERSARY

**ZENITH**  
**AUTOMATIC**  
**RADIO**  
 → LONG DISTANCE ←  
TRADE MARK REG.

ZENITH RADIO CORPORATION · 3620 IRON STREET, CHICAGO  
 WORLD'S LARGEST MAKERS OF HIGH GRADE RADIO

"Automatic Radio" Owned and Controlled by The Zenith Radio Corp., Chicago, U. S. A., under the following patents—Vasselli 1581145, Re-issue 17002, Heath 1638734, Marvin 1704754, Canada 264391, Great Britain 257138, France 607436, Belgium 331166. Also under other U. S. and foreign patents pending. Licensed only for Radio amateur, experimental and broadcast reception. Western United States prices slightly higher.

# *the* PERFECT Proposition

**Priced to Sell Profitably**

**Built to Command the Price . .**

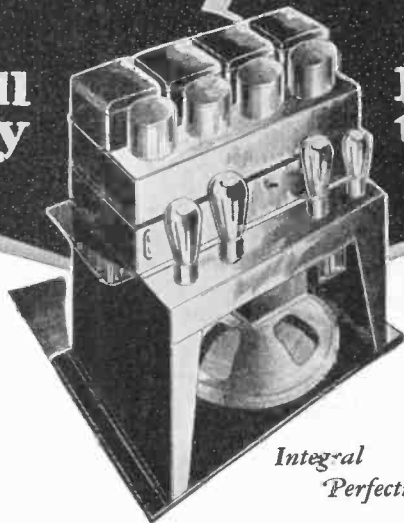

*Integral Perfection*

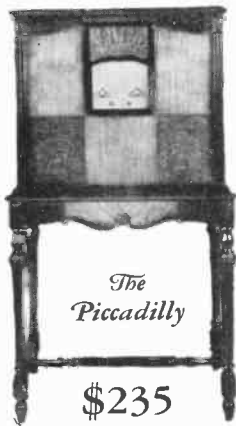

*The Piccadilly*

**\$235**



*The Moderne*

**\$270**



*The Cavalier*

**\$235**

CUTTING DYNAMIC SPEAKER

CUTTING SOUND RADIATION

FOUR SCREEN-GRID TUBES  
(EIGHT TUBES IN ALL)

*These exclusive features...* combined with rare beauty, superb performance, outstanding value...are winning public preference for Colonial everywhere.

## To a few **Jobbers**

COLONIAL offers a chance to surpass its great Eastern success!

Jobber and dealer commitments have far exceeded our highest hopes, but our tremendous new manufacturing facilities make it possible for us to designate a few more capable distributors. If you have no comparable line...if you want to reinforce a low-priced line of sets with a higher-priced line which will SELL...get in touch with us at once.

**WRITE OR WIRE**

# COLONIAL Radio



"RADIO'S CLEAREST VOICE"

COLONIAL RADIO CORPORATION, LONG ISLAND CITY, N. Y.



The Set of the Future  
Now!

The Set of the Future  
Now!

The Set of the Future  
Now!

**DEALER HELPS**

with  
Balkeit Radio

The new  
Balkeit Radio

**U**NIFORMED in "Balkeit Blue" the Balkeit advertising and merchandising program for the season is distinctive and complete.

Tying-in directly to national and local newspaper advertising Balkeit offers its dealers a line of window trim material and literature which is unusually effective.

Posters, cards, large muslin backgrounds, Balkeit Blue streamers, and electric signs form the nucleus of this dealer help material.

The "Balkeit Blue Book of Radio Talent" has taken a position of leadership among the Radio literature of the season. This, of course, will be distributed only through Balkeit dealers.

Write to the Balkeit Radio Company, North Chicago, Illinois, for complete details regarding Balkeit Radio, Model C, the advertising-merchandising plan behind it and the Balkeit Dealer Franchise.



The Blue Book of Radio lists the broadcasting talent of the country alphabetically — when and where to find them. A national demand is growing for this book.

**Balkeit Radio**  
*Model C*

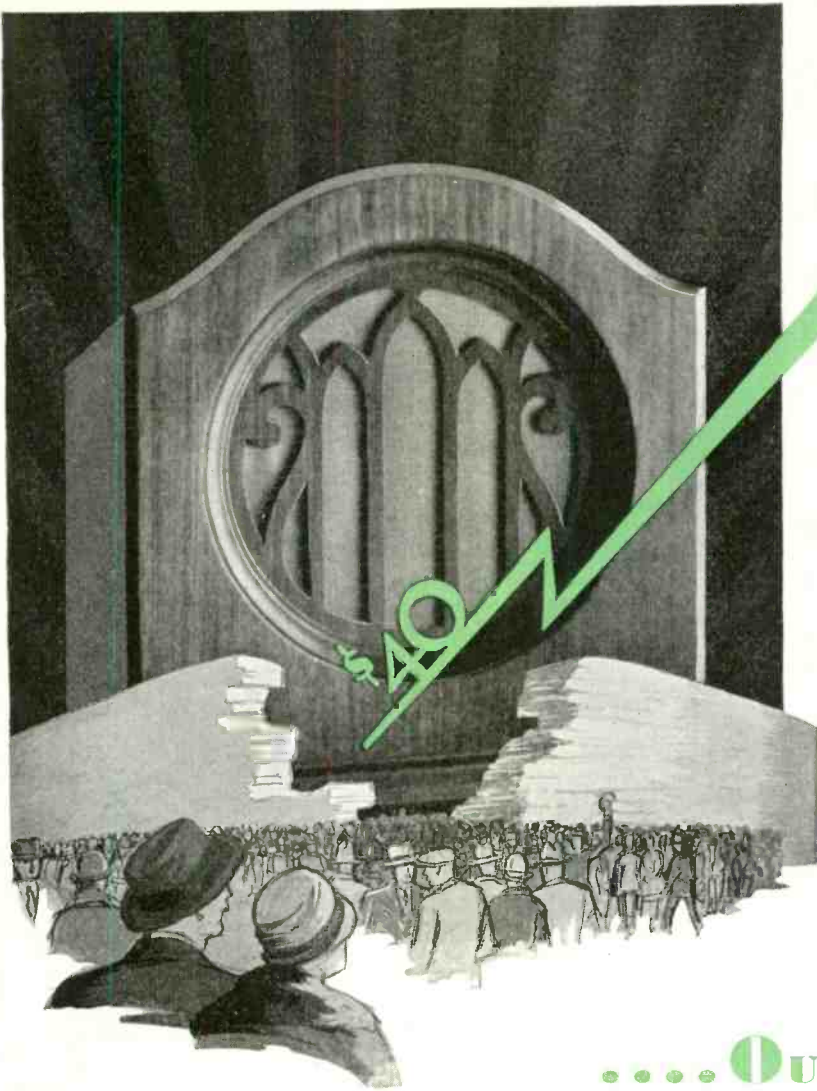

... OUR  
**ONE PROFIT POLICY**

*has battered down the*  
**HIGH-PRICE WALL**

**E**VERY radio dealer can now offer super-dynamic quality at a low price. For the new Symington Reproducer, made in the factory of the Valley Appliances Company, where almost half a million radio speaker parts have been built during the past two years, offers amazing purity of tone, the very peak of reproductive quality, at a list price of \$40.00.

There were 11,000,000 radio sets in use in the United States on January 1, 1929. Less than a million and a half of

**Symington**

Licensed Under Lektophone Patents

Ferro-Dynamic and Super-Dynamic  
**REPRODUCERS**

these will be replaced by new sets this year. This leaves over 9,000,000 radio sets—the owners of which are interested in buying a good super-dynamic speaker at a price they can afford.

And they can afford the Symington price of \$40.00. Particularly when they hear the remarkable purity of tone which the Symington design makes possible. When they hear the volume, the true-to-life quality of this speaker—they will say, "That is the speaker we want!"

Ever since the Power Speaker came out the radio set-owning public has been waiting for a speaker of this quality at this reasonable price.

Dealers and jobbers who have not yet examined samples of the new Symington Super-Dynamic are invited to write at once. The time is growing short.

**Valley Appliances, Inc.**  
 Rochester, New York

# The

# TOMAN SUPER PICK-UP

Now Standard  
Equipment  
with Better  
Manufacturers.

**GREATER VOLUME  
FINER TONE  
ADDED BEAUTY**



Until you have *seen* and *heard* the new TOMAN Super Pick-up you cannot begin to realize its amazing merits. That is why we want to send **YOUR SAMPLE** today!

**A SINGLE TEST AND  
YOU'LL RECOGNIZE  
ITS IMPORTANCE!**

**U**NUSUAL beauty of design, adding distinction to any instrument, together with wonderful volume and richest tone, accounts for the recognition the TOMAN Super Pick-up has received from highest radio-music authorities. To the Jobber and Dealer its exclusive advantages offer the first great profit-making opportunity in this line. Like all TOMAN products the Super Pick-up is reasonably priced. It offers a great chance to make quick sales and to earn the enduring goodwill of your customers. Let us send your Sample today. *Test it in private first!* That's your privilege—without the slightest obligation. Write us now!

**PERFECT FOR THEATRICAL USE**

## TOMAN

REPRODUCERS  
PICK-UP ARMS



TONEARMS  
PICK-UPS

### E. TOMAN & CO.

2621 W. 21st Place,  
Chicago, U. S. A.

Cable—SIVAD—Chicago  
Established 1914

Bankers—1st National Bank of Chicago

"In view of the many wonderful things I've heard about the Super Pick-up

**I WANT TO TEST IT!**

You may send a sample today, without obligation on my part to buy."

Name .....

Address .....

City .....

Executive .....

# Wanted:

*a dealer  
who wants the facts!*

**B-15** Console receiver in walnut cabinet. Seven heater type tubes and rectifier tubes. Four tuned circuits. 9½ in. dynamic reproducer operating from 2 type 345 power tubes in push-pull. Selector tuning. Price, less \$125.50 tubes.....

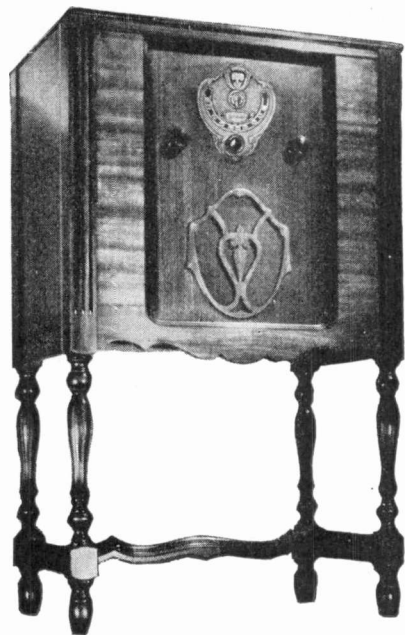

That's exactly what we mean! We want a dealer who's got that "show me" frame of mind—who says, "Forget this talk about 'sweeping the country' and 'ringing the cash register!' Give me the facts!" ¶ Right!—here are your facts! ¶ The Brandes offers 4 tuned circuits, dynamic reproducer and push-pull amplification. ¶ The Brandes is the *only* set on the market with a 21 year *wireless* background. ¶ The Brandes is the *only* set in the field to carry the *written* O. K. of world famous experts! ¶ And with all these features, the Brandes console models are priced at only \$125.50 and \$165 . . . *It's your move now!*

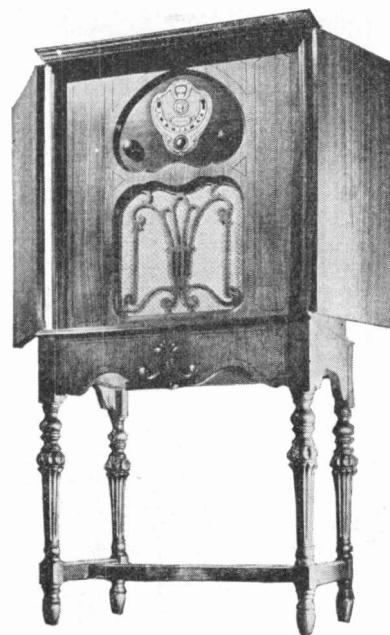

**B-16** Brandes de luxe model using seven heater type tubes and rectifier tube. Decorative grille. Four tuned circuits. 11½ in. reproducer operating from 2 type 345 power tubes in push-pull. Selector tuning. Price, less tubes, \$165.00

*The* **NEW**



Wireless  
1908

# Brandes Radio

Copyright 1929, by The Brandes Radio Corp.

(A DIVISION OF KOLSTER RADIO CORPORATION, NEWARK, N. J.)

RADIO  
WORLD'S FAIR  
Madison Square Garden  
September 21st to 28th  
Booths #BB18 and 20

**SEE**  
**and compare these**  
**cabinets at the Shows**

Then place them, on your own floor, beside any others in the same price class . . . and let your customer decide.

*That's all we ask.*

This suggestion has been repeatedly made because of our own unqualified confidence in the captivating charm and exquisite workmanship of all ADLER-ROYAL Cabinets; the wisdom of our advice is now being confirmed by a continually increasing volume of orders.

Adler Manufacturing Co., Incorporated, Louisville, Ky.



ADLER-ROYAL  
 Model No. 324



ADLER-ROYAL  
 Model No. 325



ADLER-ROYAL  
 Model No. 322



ADLER-ROYAL  
 Model No. 323



**AT THE**  
 Sixth Annual Radio  
 World's Fair, New  
 York, Booth 5, Section  
 N; September 23rd to  
 28th inclusive . . . At  
 the Eighth Annual  
 Chicago Radio Show,  
 Booth 9-10, Section  
 EE; October 21st to  
 27th inclusive.

All ADLER-ROYAL Cabinets  
 fully protected by design  
 patents.

**ADLER-ROYAL** *Radio*  
*Cabinets*





Star-Raider R-20, nine tube radio. \$435.00 (less tubes)



Star-Raider R-25, nine tube radio. \$475.00 (less tubes)



Star-Raider R-30, nine tube radio. \$525.00 (less tubes)



Star-Raider RP-40, radio-phonograph combination, nine tubes. \$725.00 (less tubes)



# STAR-RAIDER is the Release from a Competitive Market

Star-Raider opens the gate to new sales lands—filled with bigger-profit sales, freed from price-tag competition.

Mr. Public now picks his radio by the Ear and Eye . . . as well as Price. And that fact makes Star-Raider the industry's opportunity.

For Star-Raider is built to be as fine an instrument as humans can achieve. Each one has the care of

a custom-made model. Each cabinet is a proud example of the old-world woodworkers' art.

There are now five Star-Raiders—the R-20, R-25, R-30, RP-40, and latest of all, the (electric) Phono-Tabouret that plays records over any radio with a pick-up jack.

The industry's opportunity is five-fold. Are you in?

CONTINENTAL RADIO CORPORATION  
FORT WAYNE, INDIANA

(Successor to The Single Radio Company)

# the STAR-RAIDER

America's Finest Radio Made Finer

# The Giant of Dynamics

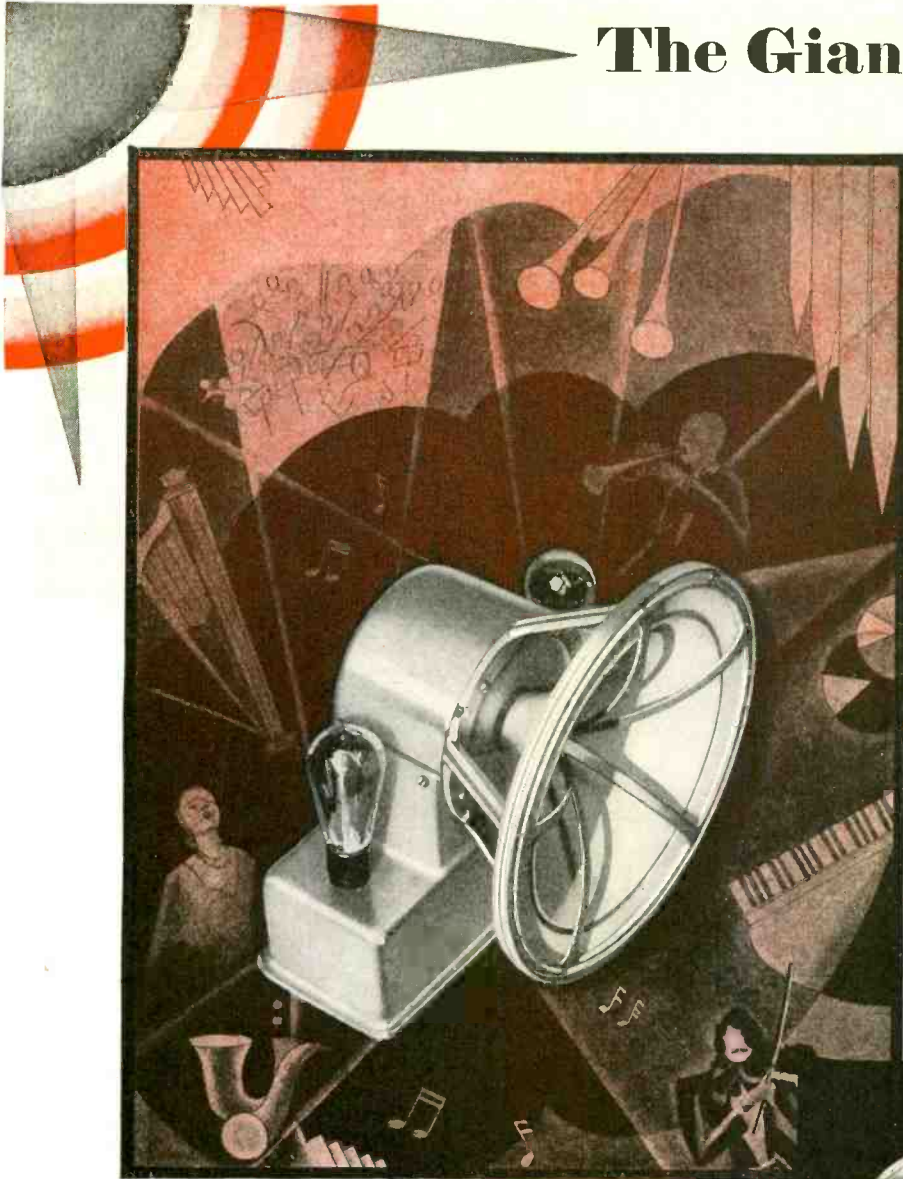

The  
**BEST**  
Theatre  
**DYNAMIC**

**FOR HOME  
AND THEATRE**

Never in the history of radio has there been such a speaker. Huge... heavy...unequaled for beauty.....dwarfing all others in size and performance, the Best Theatre Dynamic is the sensation of the Radio Season.

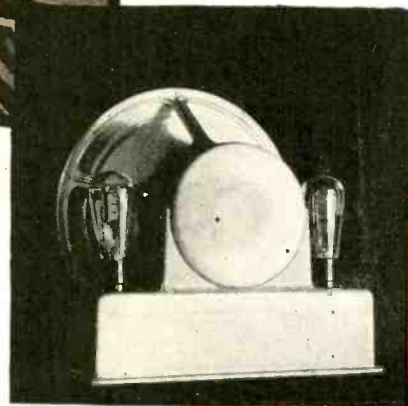

This is the first dynamic that gets the high notes as well as the low, for the Best Theatre Dynamic accurately reproduces every sector of the musical scale. It was designed with but one idea in mind—to make the finest dynamic speaker possible. Never before has there been such undistorted output—and so free from troublesome hum.

For operation on 105-120 volts A.C. 50 to 60 cycles. List price, Theatre Model, chassis only \$125.00 less the two 281 rectifier tubes. Home Model—\$95.00 (chassis only—less tubes.)

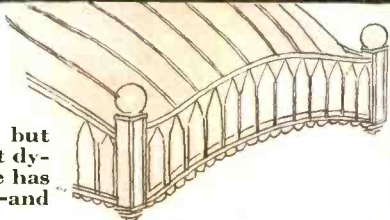

### Have you heard the BBL Electric Motor Speaker?

Wonderfully sensitive, better than the ordinary dynamic. No moving coil, no rectifier, no condenser, no hum—just perfect satisfaction. List price Chassis only 9" diaphragm \$20.00. 12"—\$22.50. Complete in beautiful walnut cabinet with 12" diaphragm \$35.00.

### The Improved Best Theatre Pick-up

The largest, heaviest and most powerful pick-up on the market—yet the Best Suspension Bridge Counter balance makes it possible to use this great weight with but the weight of a feather on the record. No needle scratch—no wearing of records. Price—Theatre model (with extra long tone arm) \$35.00. Home model \$17.50.

See our exhibit Booth H118 Radio World's Fair New York Sept. 23-28

### Best Manufacturing Company

Makers of the famous BBL Speaker Units

1200 Grove Street Irvington, N. J.

Canada

445 King St., West; Toronto.

If you are going to sell the finest speaker it is possible to make it would be wise for you to send the coupon for complete information so that you can get your sample order in at once.

Best Manufacturing Company  
1200 Grove Street, Irvington, N. J.

Please send me complete information on the

- Best Theatre Dynamic
- BBL Electric Motor Speaker
- Best Theatre Pick-up

Name .....

Address .....

# YEAR ROUND SALES AND UTILITY

*The Performance of the New Trav-Ler Receivers assure year 'round sales for the dealer and year 'round utility for the buyer.*

## ✓ Check\*

The practical uses to which the new Trav-Ler Receivers may be put are almost endless. With their increased range and tone quality their utility is increased many fold. Check those listed here and see how many people come into your store every day who are prospects for a New Trav-Ler for one or more of these uses.

- For Motor Trips.
- As the Second Set in the Home.
- For Week-end Outings.
- In Small Apartments or Hotels.
- For Hunting or Fishing Trips.
- In the Office.
- For Daily Stock Markets Reports.
- For Sport Event Broadcasts.
- For the Traveling Man.
- For Invalids or Shut-ins.
- The Ideal Gift for any event.
- On Motor Boats or Cabin Cruisers.
- For College Students.
- For the Summer Home or Cottage.
- \* The New Trav-Ler Receivers may be operated either 110 volt AC or DC current or with batteries. The Power Packs and batteries are instantly interchangeable.

You know what the public has been demanding in a portable radio receiver—"give us a receiver comparable with the larger sets" in range, sharpness of tuning, and tone excellence and volume. Trav-Ler engineers have designed a new type portable employing the latest proved developments of the radio art, incorporating every feature and advantage which the public now demands and expects.

### *New Shielded Circuit*

The new Trav-Ler Portable Receivers obsolete all previous sets of this type with their perfected shielded circuit employing screened grid and power tubes. One dial tuning—the stations click in sharp and clear on all broadcast channels—startling day and night time range, cone speakers, fixed filament voltage control ending tube paralysis, and instantly interchangeable power supply for operation either with light socket 110 volt AC or DC power or batteries.

The new Trav-Ler Portable Receivers point the way to added profits for the

dealer and distributor. Trav-Ler sales *do not* interfere with your regular lines. They *do bring* added business from present and prospective customers, and do not conflict with sales of regular receivers. The performance of these new receivers mean year round utility for the buyer and year round business and profit for you.

### *New Trav-Ler Prices*

With many improvements in the circuit and in the appearance of the cases Trav-Ler prices remain at low and competitive levels. The New Standard Model, \$65; the New DeLuxe Model, \$75; the New Aristocrat, \$100. All prices less tubes, power packs and batteries. AC Power Pack, \$35; DC, \$30. Prices slightly higher west of Rockies.

Only by actual test can you appreciate the ability of these new portable receivers. Order one from your jobber today or write

us for complete details of the new Trav-Ler sales plan and bigger trade discounts.

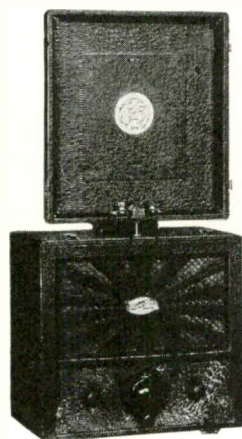

*The  
TRAV-LER  
DeLuxe  
Model*

**DISPLAYS AT THE NEW YORK AND CHICAGO RADIO SHOWS**

*Make it a point to visit the Trav-Ler Exhibits at the Sixth Annual Radio World's Fair, New Madison Square Garden, and Eighth Annual Radio Show, Coliseum.*

# TRAV-LER PORTABLE RADIO RECEIVERS

TRAV-LER MANUFACTURING CORP'N.

NEW YORK CITY

ST. LOUIS

CHICAGO

General Office and Factory: 1818 Washington Ave.

# 200 Cities and 28 Stations Taken In Advertising Sortie

The aspirations of a generation have been reached in the new Brunswick Radio. There only remains the dissemination of this knowledge to everyone throughout the length and breadth of the Nation. This, Brunswick has arranged for in a big way. To date we have taken 200 cities and 28 Broadcasting Stations for this purpose. The broad significance of this statement as it reflects on our dealers' sales and profits will be apparent to all.

The publications with the greatest circulations will carry the Brunswick message of "Tone Triumph" to the reader. The preferred, high-powered broadcasting stations will tell the story to all radio listeners.

High class newspapers will be used in one endeavor. Such artists as Al Jolson, Belle Baker, Nick Lucas, Ben Bernie, etc., in the other. Write for schedule and program. You will need it.

**"The Tone Test  
Tells the Tale"**

Every Brunswick dealer is equipped to prove "Studio Quality" of Brunswick Radio Reception in his own store. He can demonstrate the Brunswick Radio as no other set can or will be demonstrated.

He can re-create a Broadcast made at 12:11 midnight, May 4th last, at the Studio of WABC, New York City.

Once a prospect hears this Broadcast, just as though in the Studio of Station WABC on that date, and at the same time the same program received through a stock model of the NEW Brunswick Radio, he will need little encouragement to decide on a Brunswick. And he has three popular-priced models from which to choose.

Brunswick dealers, everywhere, use this "test" to close sales. If you are not already a Brunswick franchise holder, we invite you to participate in the benefits to be derived from such an association.

Of  
Easier  
Sales  
and  
Longer  
Profits

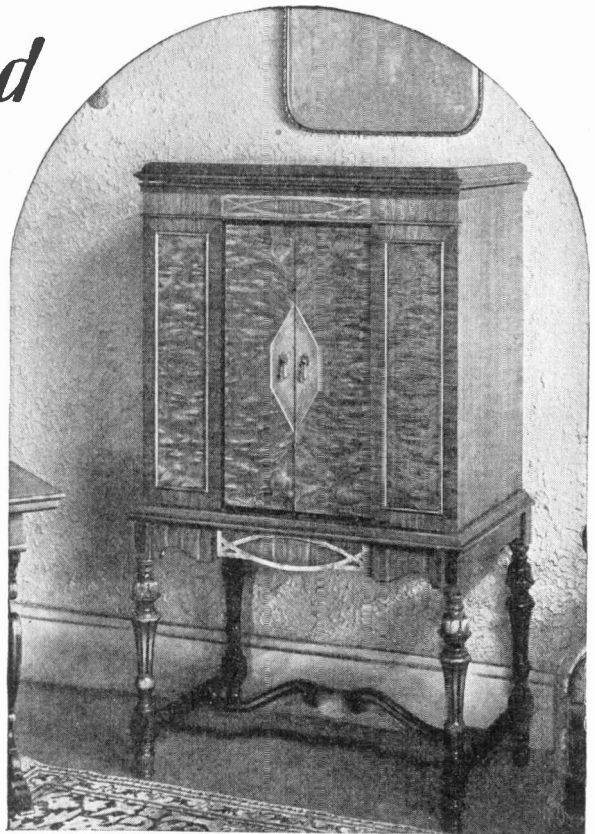

Brunswick Combination Panatrobe  
with Radio. Model No. 31  
Price \$272 Tubes Extra

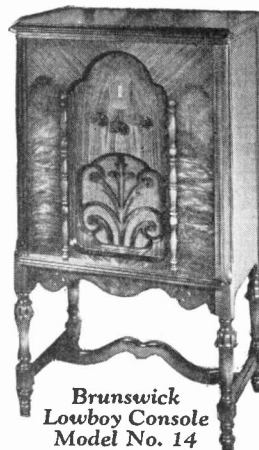

Brunswick  
Lowboy Console  
Model No. 14  
Price \$148  
Tubes Extra



Brunswick  
Highboy Console  
Model No. 21  
Price \$174 Tubes Extra

# Brunswick

Radio — Panatrobe with Radio — Records

THE BRUNSWICK-BALKE-COLLENDER CO., New York, Chicago, Toronto  
Branches In All Principal Cities

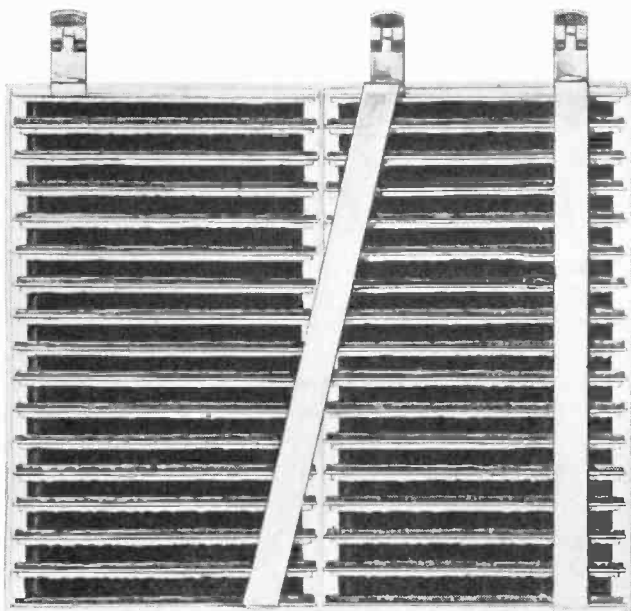

**EVEREADY LAYERBILT CONSTRUCTION**

Here is the inside story of the Eveready Layerbilt—flat, space-saving cells making connections automatically. Only five solderings, only two broad connecting bands. Maximum reliability, maximum active materials, greatest life. Layerbilt construction is an exclusive Eveready feature. Only Eveready makes Layerbilt Batteries.



**CYLINDRICAL CELL CONSTRUCTION**

Here is the inside story about every "B" battery assembled of separate, individually sealed cells—29 fine connecting wires, 60 solderings, and lots of waste space between cells.

This is the **LARGE SIZE** Eveready Layerbilt "B" Battery for heavy duty.



No. 486, the longest lasting, most economical of all Evereadys. List \$4.25. There is also another Eveready Layerbilt, Medium Size, No. 485, listing at \$2.95.

EVERYBODY KNOWS THE  
**TRUTH**  
ABOUT  
"B" BATTERIES

FOR years we have been hammering into the consumer's mind the facts about Eveready Layerbilt superiority. The diagrams on this page have been given a tremendous circulation, probably larger than ever was given to any similar story. This advertising has been the most discussed of all "B" battery advertising, for it tells the truth, and tells it hard and fast.

If you are now selling Eveready Layerbilts you know how effective our advertising has been. If you do not handle Eveready Layerbilts you are in the minority. Our suggestion is that you talk to a dealer who sells these batteries and get his opinion of them as profit-makers. Then the next time a jobber's salesman calls, ask him about them. You'll find there is a sound business basis for the dealer preference for these best of all "B" batteries.

**NATIONAL CARBON COMPANY, INC.**

General Offices: New York, N. Y.

Branches: Chicago Kansas City New York  
San Francisco

Unit of Union Carbide **UCC** and Carbon Corporation

● **IN VITAL SERVICE** ●

Eveready Batteries are being used in automatic train control, aircraft beacon receivers, talking motion pictures, short wave transmission, picture transmission, television, for the protection of life and property, and to secure instant, unflinching, noiseless, perfect electrical power.

# ELECTRAMUSE

*Really New - Actually Better*

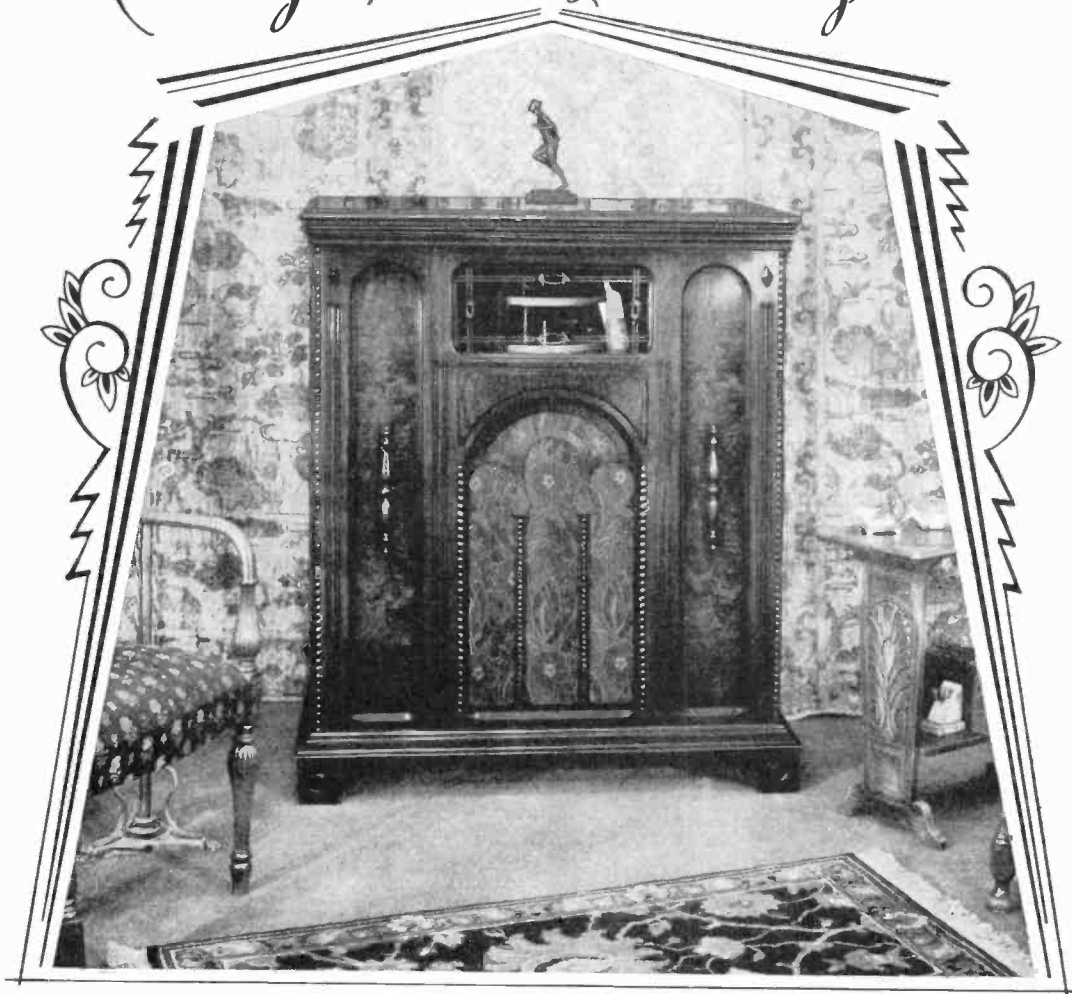

**T**HE new Club Model Electramuse, just announced, is a beauty and bound to be a leader. The low, well-proportioned lines of the beautiful satin finish walnut cabinet

appeal to the most discriminating buyer. It's the greatest achievement ever known in a continuous-playing, automatic musical instrument.

### *Tremendous Market Now Waiting*

Clubs, resorts, cafes, confectioneries, large auditoriums offer a new and tremendously large market for this new model. There is nothing that will meet their requirements like the new model Electramuse.

The same Electramuse mechanism that has proven so satisfactory for over three years has been retained in this new model.

Superb tone is accomplished by using a brand new type of amplification and a combination of other superior features. A highly perfected type of speaker especially designed to produce tremendous volume with-

out distortion is perfectly balanced with the pick-up and amplification. Electramuse thrills wherever it is heard—it has a tone quality you've never heard before.

#### *This Genuine Money-Making Opportunity Now Offered to Responsible Dealers*

The movies, clubs, hotels and other business institutions are replacing orchestras. In Electramuse, dealers are face to face with an amazing profit-making opportunity. Electramuse is the best known mechanical musical instrument; thousands in use producing

highly pleasing results. This new model may be operated by remote control or in conjunction with the fool-proof H&H patented coin box.

Lose no time in investigating the money-making possibilities open to responsible dealers. Choice territories still open to dealers who can qualify. Write today—use the coupon, or, better still, wire us.

**HOLCOMB & HOKE MFG. CO.**

Indianapolis, Ind., U. S. A.

| Holcomb & Hoke Mfg. Co.,  
 | Dept. R-9, Indianapolis, Ind.  
 | Please tell me all there is to know about your new  
 | Club Electramuse and Dealer Plan.  
 | Name .....  
 | Address .....  
 | City ..... State .....

# UP to a High Standard

## NOT DOWN TO A PRICE!

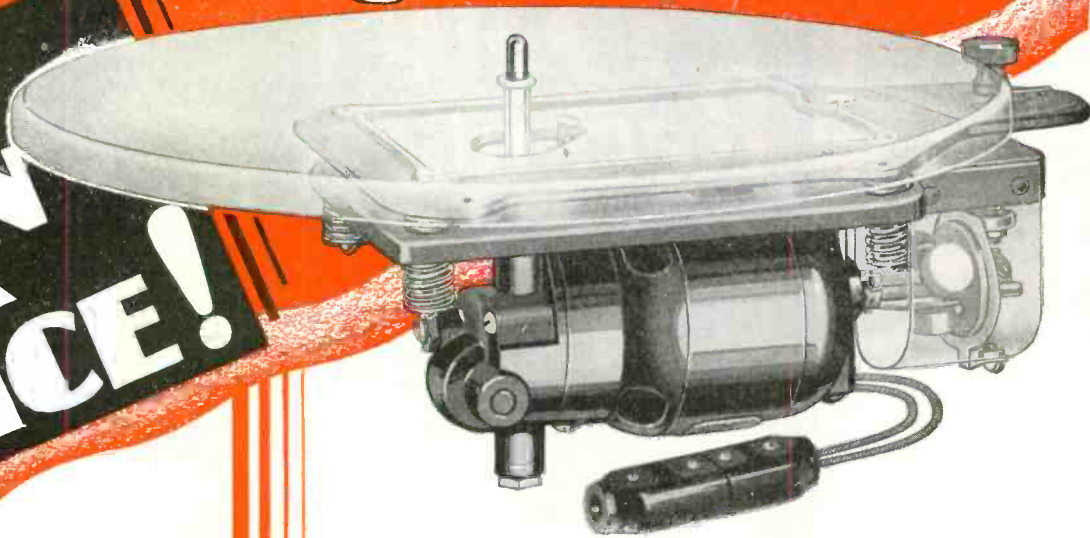

FOR DEMONSTRATING  
A. C. SETS

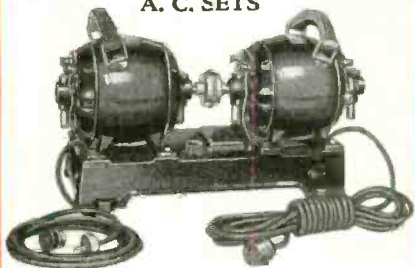

Bodine Model 1031 R Motor Generator Set is ideal for demonstrating A. C. sets and phonographs in D. C. districts. Two-unit construction eliminates hum. Produces 110-volt 60-cycle current. Units available for 110-115-volt or 32-volt D. C. Circuits. Built-in filter.

FOR THE TALKIES AND  
TELEVISION



Bodine Model AE Synchronous Motor from 1/20 to 1/4 H. P. for television experimental work, or driving motion picture projectors and mechanical turntables synchronously for talking pictures. Speed absolutely constant at 1800 R. P. M.

## that explains the fine quality of Bodine Turntable Units

HERE are some of the exceptional features built into the Bodine Units that make them outstandingly successful:

- Bakelite gears (instead of fibre gears)
- Baked enamel finish (not sprayed lacquer)
- Double contact self-aligning governor brake (not single contact)
- Enclosed governor (no exposed parts)
- Ventilating fan on motor (no overheating)
- Double mounting plate with 4-point spring suspension (no noise)
- Ground shafts to .00025 in. tolerance, minus only (no bearing trouble)
- Running test of 24 hours for each unit (no service annoyance)
- Powerful motor (no delay in acceleration of turntable)

There are many other extraordinary features that will interest you.

### Mail the Coupon for these details

# BODINE

SMALL-MOTOR SPECIALISTS FOR 24 YEARS

**BODINE ELECTRIC CO.,**  
2242 W. Ohio St., Chicago

Please send us information and prices on items checked below.

Bodine RC-10 Electric Turntable Unit  
 Bodine 1031 R Motor Generator Set  
 Bodine Synchronous Motor

Name.....  
 Address.....

"The rough-and-ready aerials seen on housetops contribute to poor reception," says Mr. Clough.

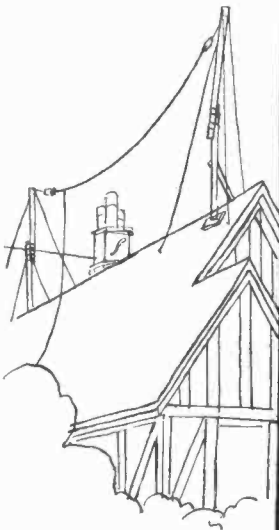

# "Better Reception Always Assured

"When a GOOD OUTDOOR AERIAL is used"

Says

KENDALL CLOUGH  
Chief Engineer

## SILVER-MARSHALL INC.

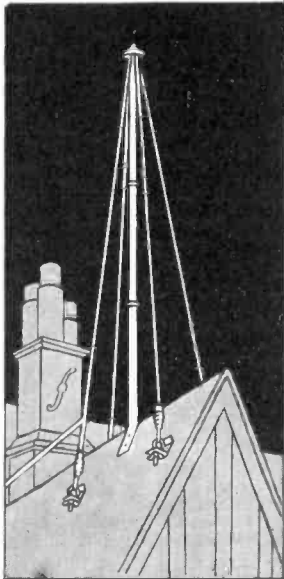
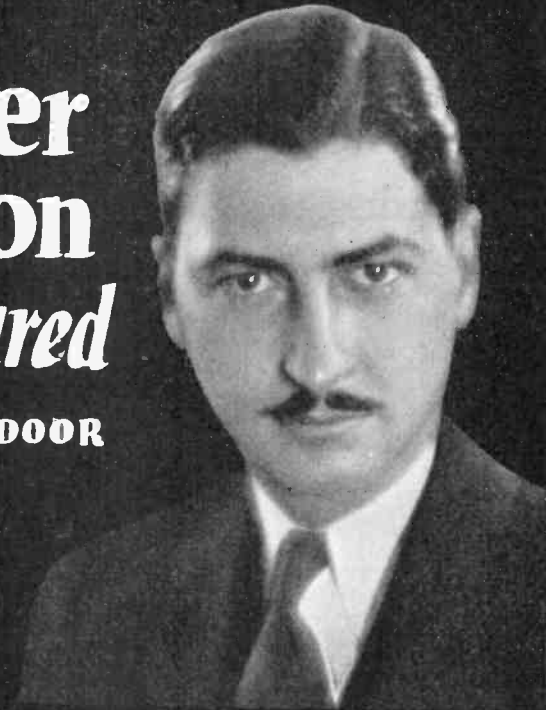

Showing typical installation of Premax Standard Umbrella-type Aerial Assembly recommended by many Engineers. Complete kit, including Ground Rod, ready to install. List, \$5.95. Skeleton kit, including Premax Masts and Ground Rod but without wire, insulators, etc. List \$4.00. Either kit packed complete in carton.

**R**ADIO Engineers unanimously oppose slouchy aerial and ground installations. Set owners resent them. Short sighted dealers who make them soon lose customer's confidence.

A New York report shows 50% of all service calls are the *direct result of unsuitable or inadequate accessories or their improper installation.* Says the report: "Only fifty dealers out of a hundred have learned the simple truth that good salesmanship requires more than the sale of a good receiver; it means suitable high grade accessories, careful installation and adequate instruction as to use and maintenance. Such dealers are gradually winning a reputation which is weakening the position of their short-sighted competitors!"

Premax Standard Aerials meet every need. They are collapsible—*attach and anchor them*—then raise to desired height and lock! You'll say it is the *safest—and quickest* erected

aerial you ever installed! Premax Aerials are wind-, storm- and rust-proof. Start your new set-purchasers right—with the life-time Premax Aerial installation.

### Helpful Book on Aerials FREE

Hundreds of Service Men are using the new Premax Book as standard instructions for aerial installation. It is called "*THE RIGHT AERIAL—and Easy Ways to Erect It!*" as a guide to correct antenna installation. This book tells: *How to get DX with the Right Aerial; How Long Should My Aerial Be?; What Has Aerial Height to do With Good Reception?*

*The book is free!*

Send your name and address—get this book and name of nearest Premax Jobber. PREMAX PRODUCTS, Inc., Niagara Falls, N. Y.

Jobbers: Send for free Aerial Book and Profitable Premax Proposition.

# PREMAX AERIALS AND GROUND RODS

**THERE IS A STANDARD PREMAX AERIAL FOR EVERY JOB!**



# The CROSLLEY UNITRAD

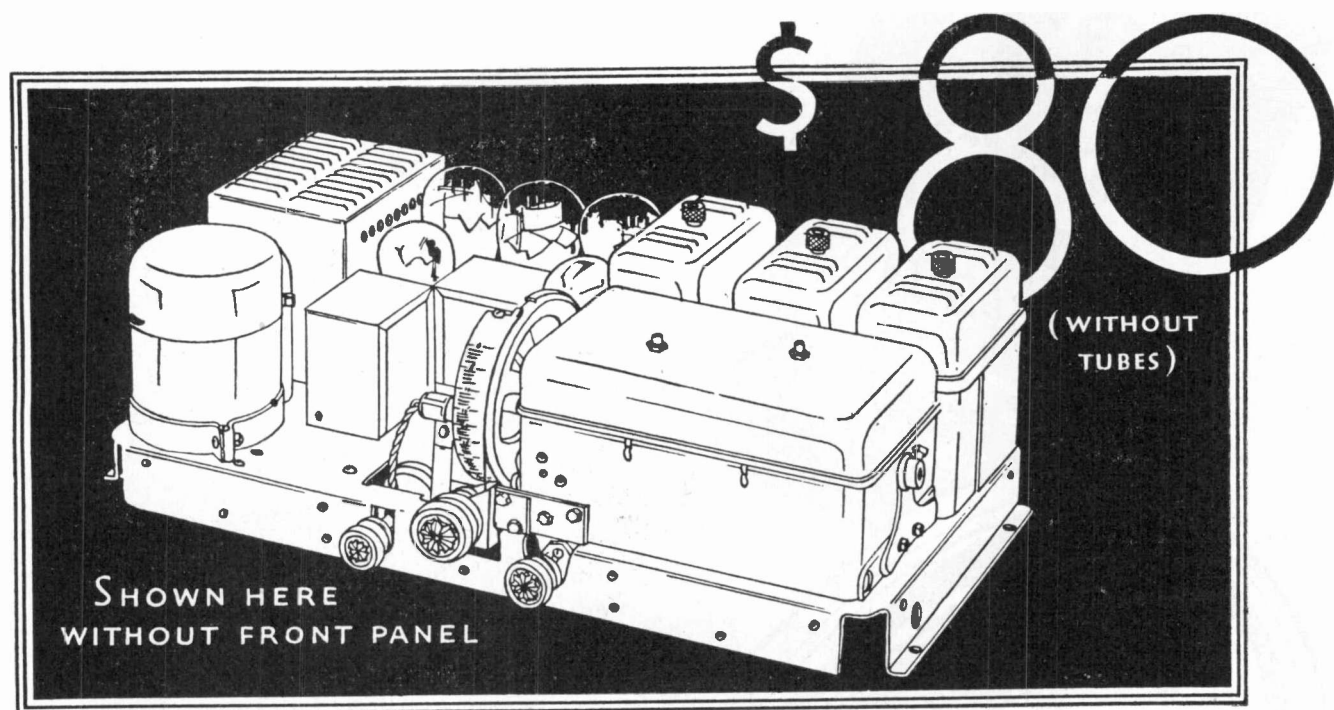

## —the “big news” in SCREEN GRID RADIO!

**O**NCE more, Crosley engineering skill and Crosley straight-line mass production score! This time with a radio set not only sensational in price, but matchless in performance. For engineers have pronounced the new Crosley Screen Grid Unitrad the finest A.C. radio ever produced. And only \$80, without tubes!

See for yourself . . . note the circuit listed here: It utilizes **THREE** 224 Screen Grid R. F. tubes; one 227 power detector tube; one 227 heater-type first audio tube, resistance coupled; two 245 power output tubes in push pull; one 280 rectifier tube—eight in all!

Deep, natural tone is the result—razor-edge selectivity—instant

response with volume *plus* on the slightest turn of the dial. Complete elimination of howls and squeaks, too, even at the highest amplification. No wonder the new Crosley Unitrad is the radio sensation of the year!

Orders for the Unitrad are already flooding the factory. And from every section of the country, dealers are reporting lively sales. Better look into it now—call the nearest Crosley distributor *today!* Or write us direct for complete information.

The Crosley Radio Corporation  
Powel Crosley, Jr., Pres.

Cincinnati, Ohio  
Home of WLW

*In  
handsome console  
models, too!*

*While the new Crosley Screen Grid Unitrad may be used as a simple table model, for bookshelves or other out-of-the-way places, it is also available in an extensive line of Crosley consoles. Or it may be had in cabinets produced by seven of the leading cabinet manufacturers of the country—all in the widest possible range of prices.*

*You're there  
with a*

# CROSLLEY

# Cut your

**137**  
**FACTORY**  
**INSPECTIONS**  
**GUARD**  
**ARCTURUS**  
**QUALITY**

*only*  
**ARCTURUS**  
*gives you all these*  
**EXTRA FEATURES**

- 1 Acts in 7 seconds.
- 2 Immune to line surge.
- 3 Arcturus Quality cuts service calls more than 50%.
- 4 Exclusive construction at every vital point.
- 5 Liberal replacement policy.
- 6 World's record for long life.
- 7 Endorsed by 29 set manufacturers.
- 8 Sold by reliable jobbers and dealers.
- 9 Superiority easily demonstrated.
- 10 Improvements protected by patents.
- 11 137 inspections keep quality high.
- 12 New features constantly pioneered.
- 13 Colored blue for positive identification.
- 14 Millions of Arcturus Tubes now in use, giving unusual service.
- 15 Name and trade mark well known to the radio trade and the radio public throughout the country.

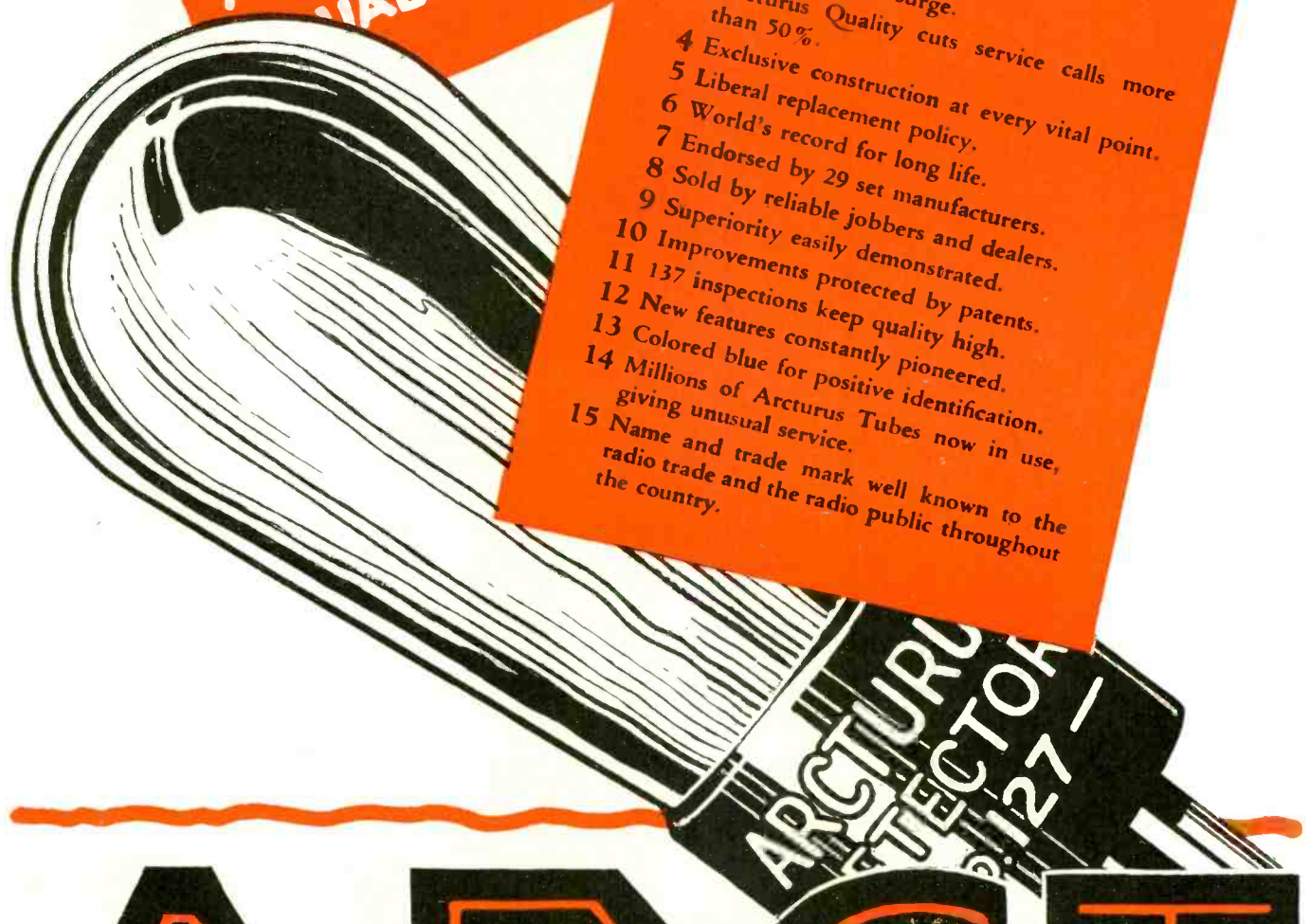

# ARCT BLUE

# service calls in half . . . . . sell **ARCTURUS Tubes**

**S**ERVICE calls cost money. Many of them are due to burnt out tubes...noisy tubes...tubes that soon lose their efficiency. Good tubes help keep service overhead down.

Arcturus *Blue* A-C Tubes are so well designed and carefully built that they cut costly tube trouble to the minimum. Dealers who equip all their A-C sets with these exceptional tubes have found by actual experience that *Arcturus Tubes cut service calls 50% or more.*

This means greater profits from set sales, and thoroughly satisfied customers. Arcturus *Blue* Tubes make any A-C set do its best because they act in 7 seconds, do away with hum, give true tone, and hold the world's record for long life.

If you are not now selling these perfected tubes write us for all the facts and join the ranks of satisfied retailers who are making more money with Arcturus.

ARCTURUS RADIO TUBE COMPANY, Newark, N. J.

# URRUS

**A-C  
LONG LIFE**

# TUBES

# *indisputable* EVIDENCE

**T**HE demand for radio receivers equipped with Jensen Electro-Dynamic Speakers confirms the judgment of America's leading set manufacturers who early in 1929 proved to their satisfaction the superiority of the new Jensen Concert Speaker. These manufacturers' sets are known today as the industry's "best sellers". This new Jensen Concert Speaker with ten inch cone and many other exclusive features has been specifically designed to meet the individual requirements of these manufacturers who know the value of offering to their trade the finest possible tone quality. Each of them found this new reproducer to interpret into sound more faithfully and brilliantly the energy delivered by their receiver. Jensen Electro-Dynamic Speakers are offered in three models, with eight, ten and twelve inch cones, each size available for operation with either 110 volt AC or 110 or 220 volt DC current. Jensen Concert and Auditorium models are also available in the Imperial Cabinet, America's finest and most beautiful reproducer. Radio dealers are finding a ready market and attractive profits with Jensen Dynamic Speakers either sold separately or installed in radio furniture.

*Licensed under  
Lektophone  
Patents*

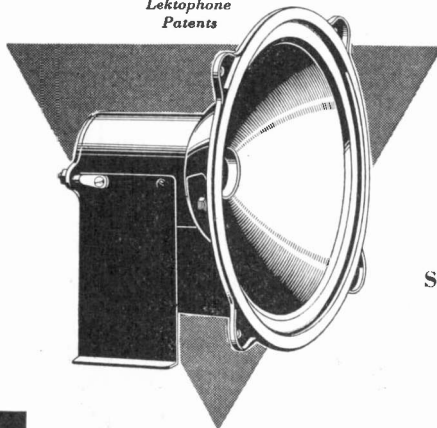

*See Our Exhibit at the  
SIXTH ANNUAL RADIO WORLD'S FAIR  
Madison Square Garden  
NEW YORK CITY  
BOOTH 20, SECTION CC*

**Jensen**  
**ELECTRO-DYNAMIC SPEAKERS**

JENSEN RADIO MANUFACTURING COMPANY

6601 South Laramie Avenue, Chicago, Illinois

212 Ninth Street, Oakland, California



# Gold Seal's Contribution to Perfect Reproduction *The Biggest 4 in Radio*

HUMLESS TUBES of Gold Seal uniform quality for SCREEN GRID and A. C. SETS. The selection of leading set makers who want their own product to perform most satisfactorily.

Price range and discount policy information from

There is a Gold Seal Tube for every set and every socket.

Gold Seal Electrical Co., Inc.  
250 Park Ave., New York

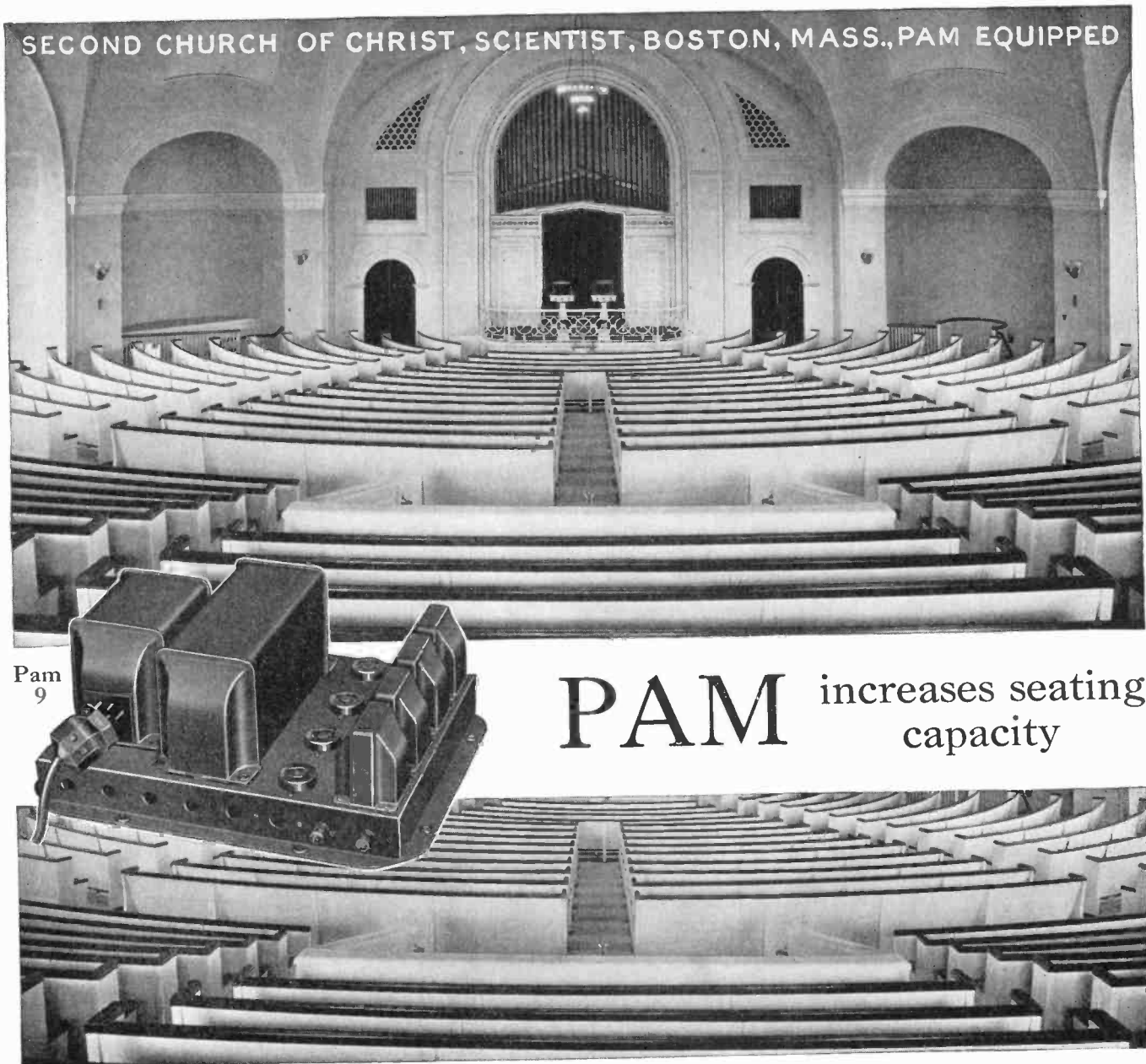

## PAM increases seating capacity

Because of the Pam installation no one need stand or be turned away for lack of seats at the Second Church of Christ Scientist, Boston, as long as there is a seat available in the Sunday School Room or other parts of the church.

Every word of the speaker is picked up by microphone and PAM-amplified for the loud speakers, which deliver it crystal clear to the overflow assemblages.

Every church or parish house is a logical prospect for PAM equipment for this or entertainment purposes, and every radio dealer should see to its installation.

A new 16-page bulletin giving mechanical and electrical characteristics, representative installations and many new PAM amplifiers will be sent upon receipt of 10c. in stamps to cover postage. When writing ask for bulletin No. RR12.

*Samson Electric Co.*

MEMBER  
**RMA**

Manufacturers Since 1882

Main Office:  
Canton, Mass.

Factories: Canton  
and Watertown, Mass.

# Why the New Browning-Drake Is a Good "Buy" for You

**H**ERE is a set which enables you to offer your customers considerably more "radio" than they can buy at anywhere near the price—a set which provides a degree of selectivity, distance-getting and tone-quality unsurpassed by receivers costing fifty per cent more.

In addition, Browning-Drake cabinets are so attractive in design and so well built and finished that they will instantly appeal to your feminine trade—our small cabinet models (54 and 64), particularly, will find enthusiastic acceptance.

Browning-Drake *construction*, backed by a reputation for quality second to none, assures you of freedom from excessive servicing which eats into profits. Six models, table and console, heater and screen-grid types.

*Send for information and territories still open.*

**Browning-Drake Corporation,**  
226 Calvary Street, Waltham, Mass.

*Builders of quality radio for five years.*

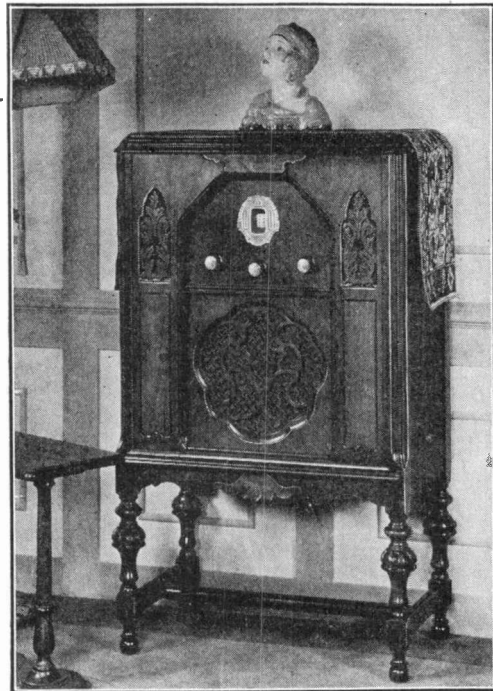

**Model 54**—(Screen grid) small console, (38x26x14) (less tubes.) \$142.50

**Model 64**—(Heater Type) small console, (38x26x14) (less tubes.) \$137.50

*Prices slightly higher west of Rockies.*

**Model 53**— \$102.50  
Table Model. Screen grid type. (less tubes.)

**Model 63**— \$98.00  
Table Model. Heater type. (less tubes.)

*Prices slightly higher west of Rockies.*

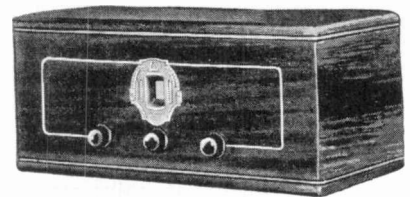

1. Semi-automatic tuning—both kilocycles and call letters on dial.
2. Five tuned circuits—nine tubes.
3. Tuned antenna.
4. Push-pull audio (245 power tubes).
5. Power detection (plate rectification) optional.
6. Hum eliminator.
7. Band-pass filter effect (10 KC selectivity).
8. Mer sion trouble-proof condenser.
9. Voltage regulation adjustment.
10. Power unit integral part of chassis.
11. Large size dynamic speaker.
12. Phonograph, short wave and television connections.
13. Selected walnut and American gum wood cabinet.
14. Hand-rubbed satin Duco finish.

# Browning-Drake

## RADIO

Nearly 1,500,000 people are using Browning-Drake Sets

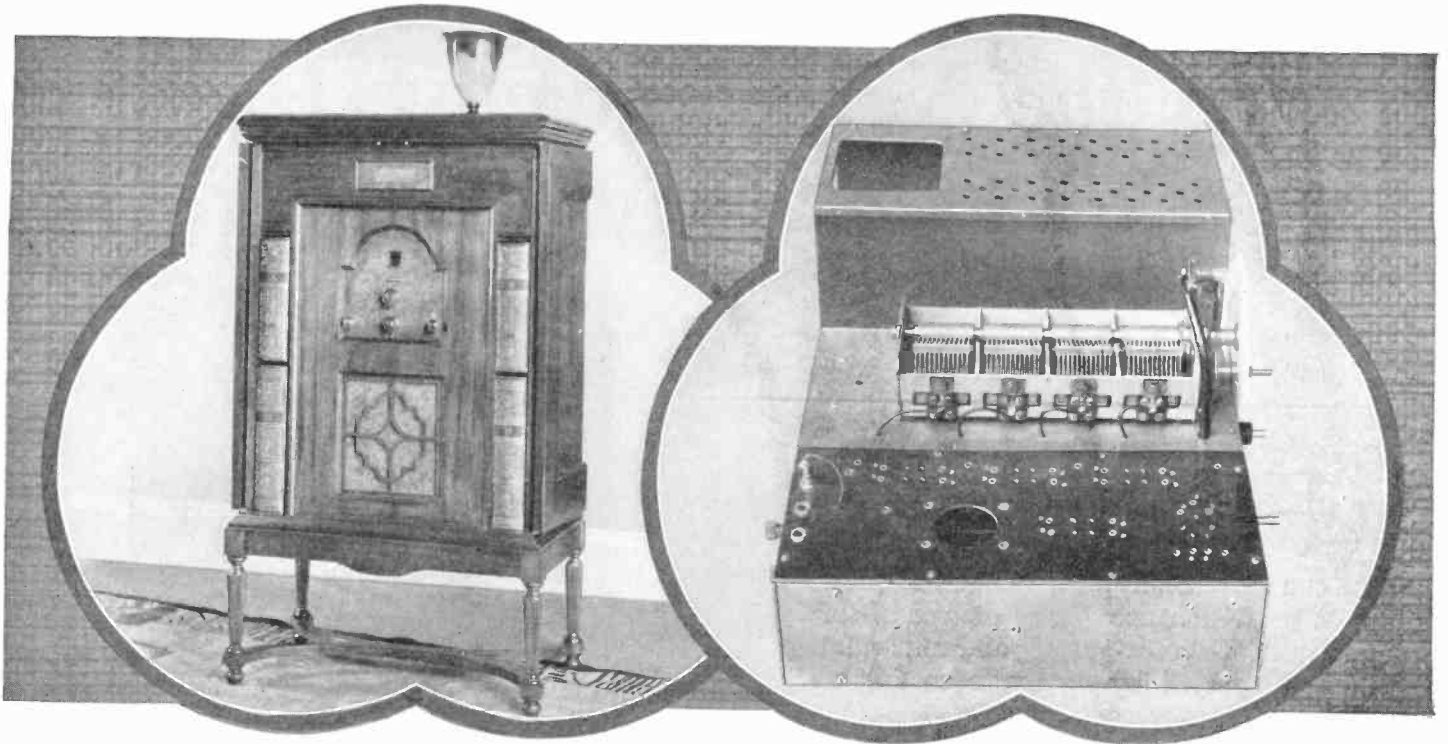

Edison Radio-Phonograph, and chassis showing tube shelf of Bakelite Laminated. Made by Thomas A. Edison, Inc., Orange, N. J.

## Edison Radio protects a famous name by using dependable *Bakelite Insulation*

When a product is branded "Edison", it may be safely assumed that no stone of research has been left unturned. In developing the Edison Radio, experiments demonstrated the importance of selecting a dependable insulating material for the tube mounting shelf. To provide complete insulation from interference, the engineers of this company adopted a shelf of Bakelite Laminated. Mechanically strong, this tube shelf is accurately machined to provide the unvarying uniformity required for accurate assembly. Sharp, clean drilling is easily accomplished and metal bushings are

securely inserted without danger of chipping and cracking. The smooth, lustrous finish requires no protective coating, and lasts indefinitely.

Bakelite Laminated is non-hygroscopic, non-deteriorating, and does not become impaired from climatic changes. Buyers of radio recognize Bakelite Insulation as the accepted standard, and dealers, throughout the country have been quick to use this as a sales appeal.

Write for a copy of our Booklet No. 39, "Bakelite In Radio".

### BAKELITE CORPORATION

247 Park Avenue, New York, N. Y. Chicago Office, 635 West 22nd Street  
BAKELITE CORP. OF CANADA, LTD., 163 Dufferin St., Toronto, Ontario, Canada

# BAKELITE

REGISTERED

U. S. PAT. OFF.



THE MATERIAL OF A THOUSAND USES

"The registered Trade Mark and Symbol shown above may be used only on products made from materials manufactured by Bakelite Corporation. Under the capital "B" is the numerical sign for infinity, or unlimited quantity. It symbolizes the infinite number of present and future uses of Bakelite Corporation's products."



# Do You Like Pie?

**A**T dinner—a juicy, luscious pie is put before you: you cut it, serve it and crave a piece for yourself—then you find that none of it is for you—not enough to go around—and you're disappointed.

Just so with national advertising. When a manufacturer's representative puts before you a "pie" of great national advertising—a long list of media, six figure appropriations, and adds a tempting selling talk—that's the time to ask "how big a piece of that pie am I going to get?"

Ask him "Is this advertising going into the homes in *my* town? Is it going to reach the people that *I* want it to reach? Is it going to move merchandise out of *my* store, and leave *hard, cold dollars* in its place?"

The American Weekly is the one publication that cuts the pie so that there's plenty for all. It is the one publication that combines *national* coverage with *local* effect—the one magazine that does just as much for *you* as it does for the manufacturer.

## What is The American Weekly?

The American Weekly is the magazine distributed through seventeen great Hearst Sunday newspapers from seventeen principal American cities.\* It concentrates and dominates in 485 of the Nation's 784 towns and cities of 10,000 population and over.

- In each of 153 cities, it reaches one out of every two families.
- In another 119 cities, it reaches from 40 to 50%.
- In an additional 108 cities, it reaches from 30 to 40%.
- In 105 more cities, it reaches from 20 to 30%.

And in thousands of other populous areas, almost 2,000,000 additional families buy and read The American Weekly—making a colossal national total circulation of 5,646,898, the greatest and the most responsive circulation of any publication in the world!

### THE AMERICAN *Greatest Circulation in the World* A WEEKLY

Main Office: 9 EAST 40TH STREET, NEW YORK CITY

\*Albany  
Atlanta  
Baltimore  
Boston  
Chicago  
Detroit  
Los Angeles  
Milwaukee  
New York  
Omaha  
Pittsburgh  
Rochester  
San Antonio  
San Francisco  
Seattle  
Syracuse  
Washington

BRANCH OFFICES:  
Wrigley Bldg., Chicago  
5 Winthrop Square, Boston  
753 Bonnie Brae, Los Angeles  
222 Monadnock Bldg., San Francisco  
1138 Hanna Bldg., Cleveland  
101 Marietta Street, Atlanta  
12-231 General Motors Bldg., Detroit

The American Weekly  
9 East 40th Street  
New York City

Please send me a copy of the American Weekly and a statement of its circulation in my trading territory.

MAIL THIS COUPON

Name.....

Address.....

Town..... State.....

# ERLA

SCREEN GRID RADIO

THE ERLA SCREEN GRID RECEIVER is an 8-tube set utilizing three 224 screen grid tubes, one 227 power detector tube, one 227 resistance coupled audio tube, two 245 power tubes in push-pull and one 280 rectifier tube.

CONSOLE MODELS in distinctive cabinets, priced from \$134.50 to \$189.50.

Manufactured under licenses of Radio Corporation of America.



Type 30  
DeLuxe Model Console  
\$169.50 (less tubes)

## SELLS BECAUSE--

It sells on sight. By sheer force of merit! That's why you will want to know about the remarkable Erla dealer franchise. Here is merchandise whose performance will win the preference of your customers.

Write us today!

**ELECTRICAL RESEARCH LABORATORIES, Inc.**  
22nd at Paulina Street  
CHICAGO



## Unequaled Value in the Jewell Pattern 199

EVERY test necessary for effective radio servicing, including screen grid receivers, is met perfectly by the Jewell Pattern 199, the lowest priced, high quality set analyzer on the market.

Pattern 199's are built to the most exacting standards. The large  $3\frac{3}{4}$  inch Jewell Instruments have been proved on thousands of exacting industrial applications. The bakelite panel and silver contact switches indicate the high quality of construction throughout.

In addition, the Pattern 199 is backed by the most complete and thorough radio data service available, including complete test data on sets of leading radio manufacturers. Jewell Analysis Charts make it easy to record test data systematically for convenient comparison and analysis.

Thousands of dealers are converting service liabilities into profits through use of the Pattern 199. Order one from your jobber today.

List price, \$97.50 Dealers' net price, \$73.12

29 YEARS MAKING GOOD INSTRUMENTS  
**JEWELL**  
 JEWELL

# 199 Set Analyzer

Write for catalog sheet which describes the Jewell Pattern 409, a four-instrument set analyzer for expert servicemen, the Jewell Pattern 210 Tube Checker, and complete line of Jewell Radio Instruments.

**Instructions for Servicing Radio Receivers**

Jewell Electrical Instrument Company  
 1650 Walnut Street, Chicago, Illinois

Please send us your booklet, "Instructions for Servicing Radio Receivers," and literature covering Jewell High Grade Radio Service Instruments.

Name.....

Address.....

*It's the talk of the  
Radio World—*

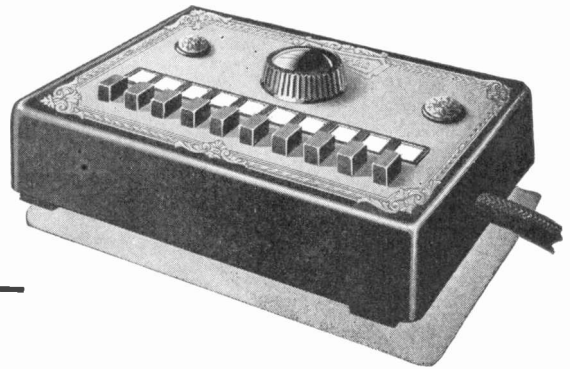

**KOLSTER REMOTE CONTROL**



RADIO  
WORLD'S FAIR  
Madison Square Garden  
Sept. 21st to 28th  
Booth No. K-1

**K-45**—Richly grained walnut cabinet—unique and exquisite in appearance. Remote control. Electrical tuning. Nine tubes and two rectifiers. Screen grid R. F. tubes. Equipoised dynamic reproducer. Three stages of audio . . . second and third stages push-pull, using type 327 . . . \$500.00.  
tubes and type 350. Price, less tubes . . . . .

Out of the confusion of claim and counter-claim—dealers instantly recognize ONE FACT! —the Kolster K-45 with remote control is a sensation wherever it's shown!

People call it an amazing development! It permits the owner to start the radio from a remote point in the house—choose any one of his favorite stations—and make the volume

louder or softer as he pleases!

But this de luxe K-45 is only one model of the Kolster line for 1930! See the other two —K-43 and K-44—both featuring screen grid tubes, Selector Tuning and equipoised dynamic reproducer! In 1930—more than ever before—one neighbor will tell another, "Kolster is a fine set."

**KOLSTER  
RADIO**

# WIRT VOLTAGE REGULATORS

## —“SAFETY VALVES”

### for all A. C. radio sets

The Wirt Voltage Regulator has been on the market but a short time—and yet already thousands of them are now in use, protecting tubes and sets, and increasing radio enjoyment.

There is one good reason for the success of the Wirt Voltage Regulator—it fills *well* the need of variable voltage regulation for A. C. radio sets. It doubles the life of tubes—it completely protects delicate parts against current “surges”—it increases selectivity, and cuts down bothersome line noises. Two sizes—No. 211 (list, \$2.25) should be used with sets drawing not more than 65 watts. No. 211-B (list, \$3.25) is for sets consuming in excess of 65 watts and not more than 150 watts, sets using seven tubes or more, and sets that are equipped with a dynamic speaker.

Of course, dealers find the Wirt Voltage Regulator a quick, easy seller. And an exceptionally profitable item! You will, too. Mail the coupon now, we'll bill through any jobber you name.

Here's a suggestion—and a good one, too. Many radio dealers are getting added profits through handling Dim-a-lite, the little device that fits into any socket and makes possible any intensity of light. Dim-a-lites sell quickly in conjunction with radio equipment. They give to household lighting just the added touch of beauty and comfort that is needed. Every home is a market for many Dim-a-lites. Why not sell them? Space is reserved for your Dim-a-lite order in the coupon. Be sure to mail it in today!

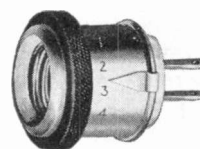

No. 211

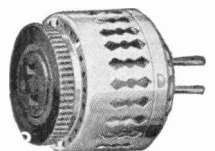

No. 211-B

# WIRT COMPANY

522½ Greene Street

Philadelphia, Pennsylvania

WIRT COMPANY  
522½ Greene Street, Philadelphia, Pa.

R. R. 9-29

Please ship me by return mail:

- ..... Display cartons of 10 Voltage Regulators, No. 211.
- ..... Display cartons of 10 Voltage Regulators, No. 211-B.
- ..... Display cards of 10 Dim-a-lites, No. 23.
- ..... Display cartons of 10 Dim-a-lites, No. 23-A.
- ..... Display cartons of 10 Wirt Lightning Arresters, No. 200. (List price, \$1.00)

Bill Through ..... Jobber

Name .....

Address .....

# UNIFORMITY

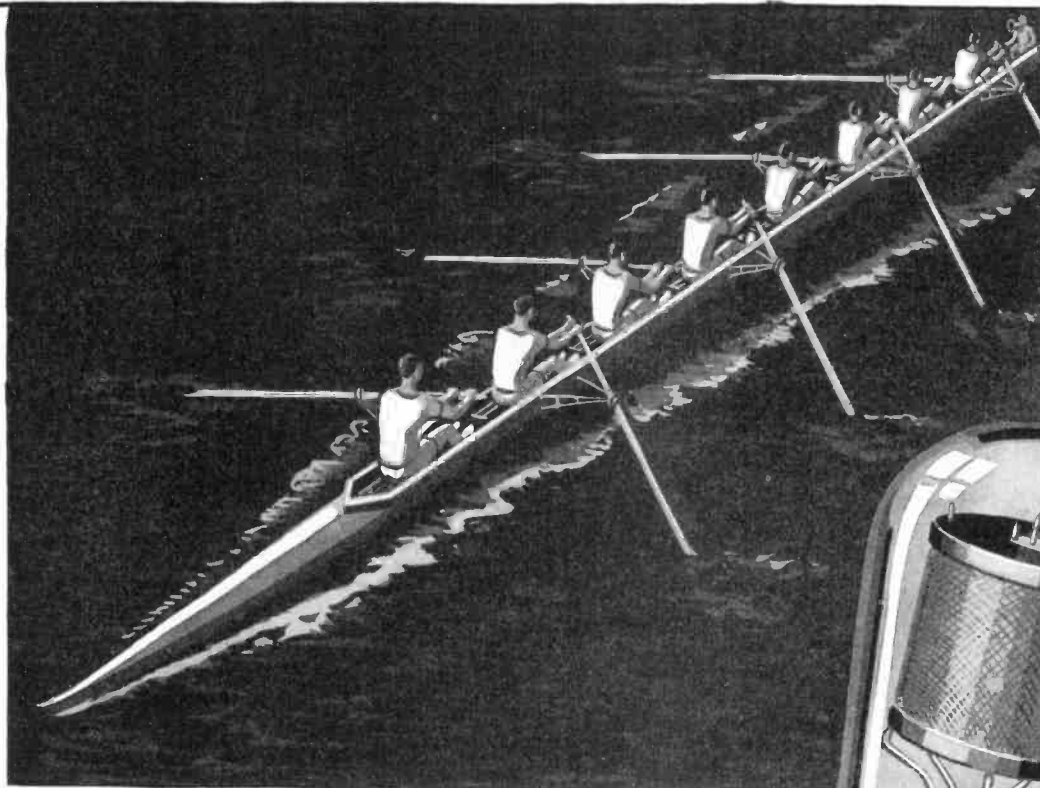

**W**HETHER in cartons or carloads, you will find TRIAD quality absolutely uniform! UNIFORM because the complete materials for TRIAD Tubes (except glass and base) are made right in the TRIAD plant; UNIFORM because the manufacturing process, from first to last, is personally supervised by world-famous radio engineers; UNIFORM because TRIAD Tubes are subjected to nine exhaustive tests for vital characteristics before ever reaching the packing department—and even there they are sorted for uniformity and *again* inspected before shipment! Even the testing machines themselves are made by the TRIAD Company, and are built to the U. S. Bureau of Standard Specifications. TRIAD Tubes are “honor-built” — throughout! That is why TRIAD *alone* can *insure* every tube for six months’ perfect service—and it is exactly the reason why *you* can win (as thousands of other dealers are now doing) far greater tube sales and profits with TRIAD than you have ever enjoyed before!

*Call your jobber or write us direct for complete TRIAD dealer information.*

**TRIAD MANUFACTURING COMPANY, .INC.**

Triad Building — Blackstone, Middle and Fountain Sts.  
PAWTUCKET, R. I.

**TRIAD**  
INSURED  
**RADIO TUBES**



Above is shown TRIAD  
T-24 — Screen Grid Tube  
for AC use.



Tune in on the “Triadors”  
— every Friday evening  
8 to 8.30 Eastern Daylight  
Time — on WJZ and as-  
sociated NBC Stations.

# AMRAD PRESENTS THE BEL CANTO SERIES

## Triple Screen Grid

The advantages of the Screen Grid Tube are fully recognized by Amrad which has built its 1929 chassis especially for Screen Grid operation and utilizes THREE Screen Grid Tubes.

The demand of the public for *beautiful tone* is recognized by Amrad in its use of the finest electric speakers made, mounted on baffle boards and attuned to the receiver.

The necessity for *real furniture* was recognized when Amrad employed one of the outstanding furniture artists of America to design the Bel Canto Series.

And most important of all, Amrad sets are produced at a price which makes them readily salable and wonderful value—BUT they are not in the class of low price competition. The consumer is glad to pay a little more for beautiful furniture, superior engineering, sturdy construction and *the finest tone in radio!*

Write for details as to open territory. Address

Sales Desk AA  
THE AMRAD CORPORATION  
Medford Hillside, Mass.

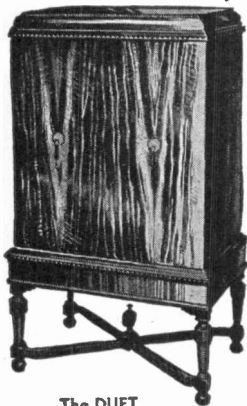

**The DUET**  
Magnificent electrical radio and phonograph combination in console of East Indian Laurelwood with inside panel of fine Oriental Walnut.  
Price, \$495 (less tubes)

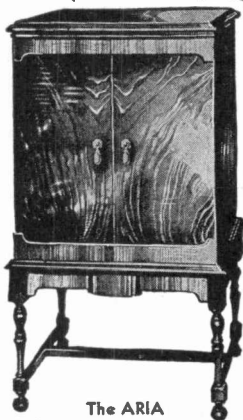

**The ARIA**  
Beautiful console of American and African Walnut. Standard Amrad Screen Grid Chassis with built-in speaker.  
Price \$198 (less tubes)

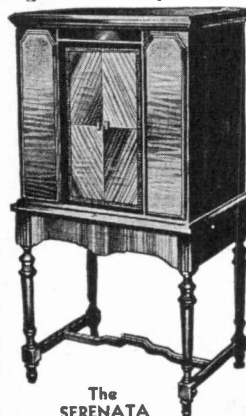

**The SERENATA**  
Sliding door cabinet of Walnut with panels of curly maple and ebony inlays. Built-in speaker.  
Price, \$245 (less tubes)

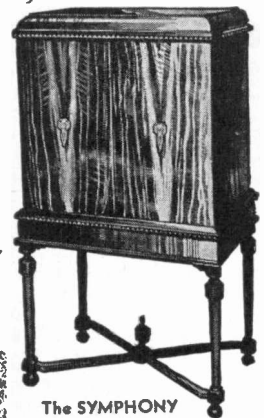

**The SYMPHONY**  
Cabinet of Laurelwood, Macassa Ebony and fine Walnut veneers. Eight tube chassis with superb dynamic speaker built in.  
Price, \$295 (less tubes)

FROM THE FAINTEST WHISPER...

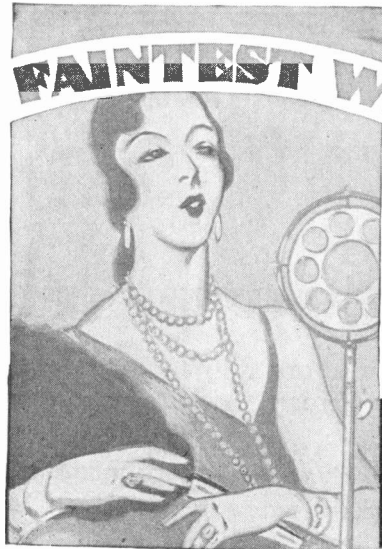

TO THE  
MIGHTIEST  
VOLUME

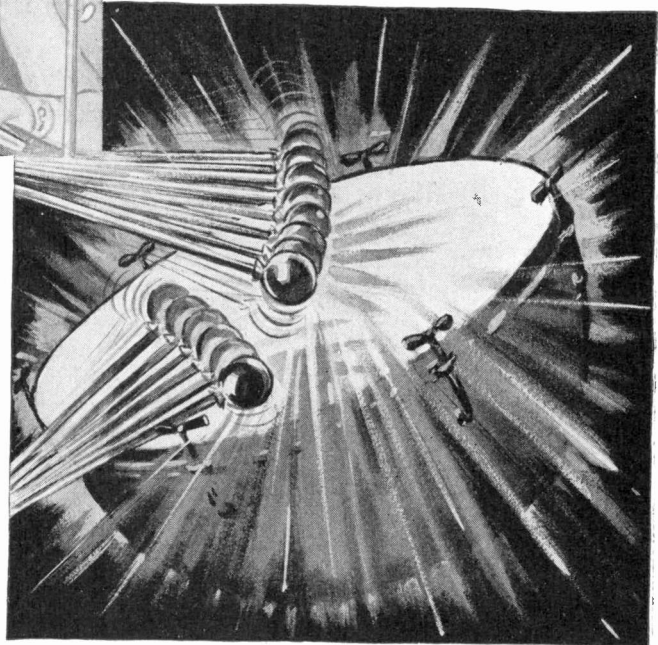

*the Webster Electric Pick-up Reproduces Perfectly!*

OVER the entire range of recorded music . . . from the faintest soprano inflection to masterful passages on the tympany . . . the Webster Electric Pick-up reproduces faithfully. This fidelity of tone, this ability to capture the most delicate harmonies and intonations of voice and instrument, has won for the Webster supremacy in its field.

As a result of Webster's supremacy in everything that counts in an electrical pick-up, its dealers have enjoyed a profitable success with it everywhere . . . a success based on tremendous public demand.

The public wants the Webster Pick-up because it alone embodies all those fea-

tures that mean true tone quality. Every part in its construction is perfectly matched and balanced. Greatest travel freedom of the needle is assured by a frictionless stylus bearing. The built-in volume control in Model 2-A is a distinct Webster feature, making the unit extremely compact and easy to install.

If you have not yet investigated the sales possibilities offered by the beautiful appearance, matchless tone qualities, and precision workmanship so evident in the Webster Electric Pick-up, do so today. Many leading jobbers have already placed orders for their stocks.

Order direct if your jobber has not received his.

WEBSTER ELECTRIC COMPANY, Racine, Wisconsin

**Webster**  
**W** Electric Pick-up

The New Webster Model 2-A includes Pick-up head, supporting arm, built-in volume control and adapters. List Price \$17.50.

The Webster Electric Theater Pick-up for use with 16" records. Two Models—Standard and Low Impedance. Model 2-D \$25.00. Model 2-D-1 \$30.00. Matching Transformer \$6.50.

Pick-up head, Model 2-B. Both models readily adaptable to either battery operated or A. C. sets.

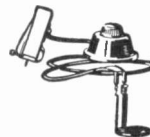

Model 2-B includes Pick-up head, separate volume control, and necessary adapters. List Price \$13.00.



# BREMER-TULLY RADIO SCORES ITS

*Greatest Success*

in eight years of Fine Instrument Building

Bremer-Tully has sold more instruments and franchised more dealers since the introduction of the new DeLuxe Console Models, numbers 81 and 82, than ever before. Why? New low prices, powerful nationwide broadcast and newspaper advertising, convenient financing, and our new profit-protective franchise plan are all partially responsible. But the fundamental reason is the

overwhelming superiority of the new Bremer-Tully *Micro-Balanced* Chassis in every phase of performance. Compare it in *tone, selectivity* and *distance* side-by-side with any other 1929-30 radio—bar none—and you will join the thousands of dealers who are flocking to Bremer-Tully for worth-while “quality” profits and lasting success in radio.

**BREMER-TULLY MANUFACTURING COMPANY**  
656 Washington Boulevard, Chicago, U. S. A.

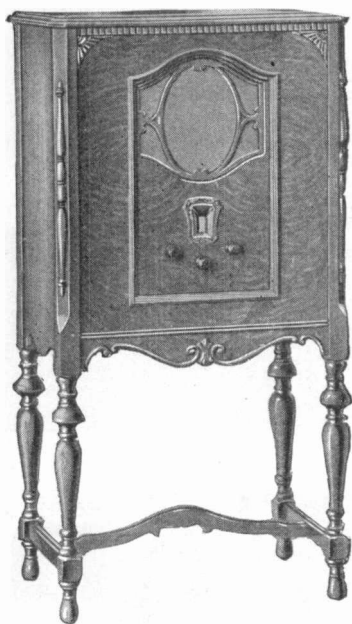

*At Left:* MODEL 81 DeLuxe Open Console; \$164, less tubes.

*At Right:* MODEL 82 DeLuxe French Door Console; \$195, less tubes.

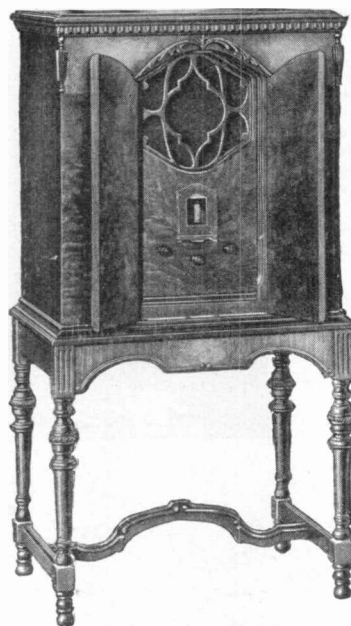

**Tune In!**  
Bremer-Tully Time  
10 P. M.  
Eastern Standard Time  
Every Friday  
Over  
Columbia Network  
*Special Pacific Coast Program*

A P E R M A N E N T N A M E I N R A D I O



Day-Fan  
delivers the  
**NATURAL TONE**

[[ *A Message that the Nation is Reading* ]]

In August, broad-scale-advertising began to tell the American public a story of radio tone as it should be. Collier's, reaching 2,000,000 readers, is inviting them to hear Day-Fan Radio, distinctively different in tone simply because it delivers the *natural* tone, as never before.

All sound frequencies are recreated in the audio-amplification system of the Day-Fan just as they are originally created before the microphone, by voice or instrument. No attempt to "improve" upon the original, by over-emphasizing low notes. Instead . . . the true richness and resonance of the actual broadcast . . . with a new and remarkable brilliance added by the silvery clear presentation of high notes.

This is the story being told in a series

of national advertisements during the Fall, assisting every Day-Fan dealer. Local newspaper advertising—direct mail campaigns—displays—support his merchandising effort. Let us tell you fully what the Day-Fan Franchise means to you today. Write at once.

DAY-FAN ELECTRIC CO.  
1109 Wisconsin Blvd. Dayton, Ohio



Day-Fan Radio was developed with a sound, proved design as its basis. 9-tube matched unit set with a perfected electro-dynamic speaker is standard in each model.

Model 69, less tubes \$225.00.

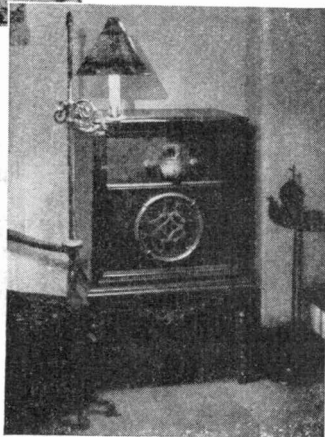

Day-Fan employs two 245 tubes in push-pull in the power output stage, for wonderful volume without distortion.

(Left) Model 72, less tubes \$175.00.

Accurate matching of impedances, stage by stage, produces a smooth flow of effective power. Day-Fan is surprisingly sensitive, and responsive to tuning.

(Right) Model 68, less tubes \$169.50.

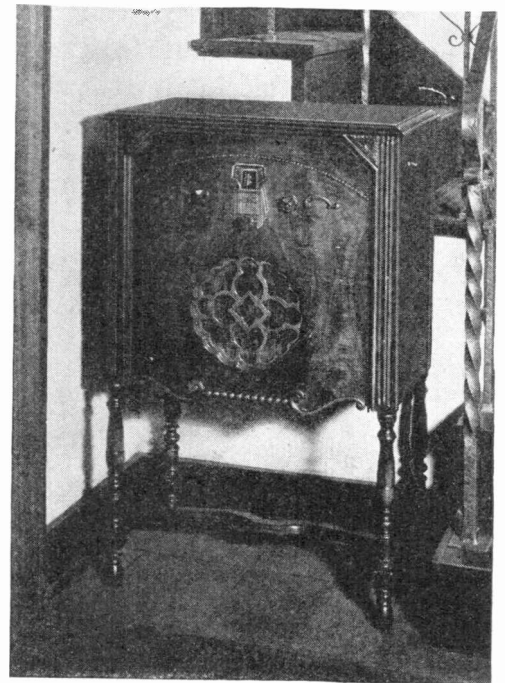

**Day-Fan**  
RADIO

# An entirely new idea in Lightning Arresters

1. Ground Terminal shielded to prevent flow of electro-static field to set, thus reducing noise.
2. Choke coil and condenser built in to filter static noises.
3. Special winding of choke acts as fuse to save the set from harm.

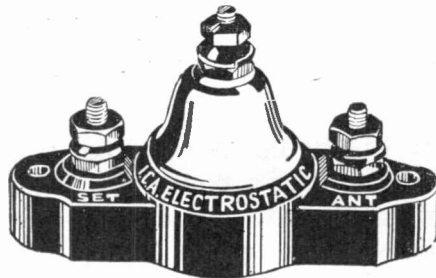

4. Condenser insulation protects set should aerial accidentally fall on a power line.
5. Complete and dependable protection to house and set.
6. A \$100.00 insurance bond backs the guarantee of the Electro-static.

**The I. C. A. Electro-static *Shielded*  
Lightning Arrester affords complete  
protection plus a definite reduction  
of static. \$1.00 list price makes it a big seller**

The I.C.A. Electro-static is the last word in lightning arresters for safety, static reduction and improvement of radio reception. It is a scientific instrument in every sense of the word, incorporating the silicate carbon, high-resistance principle, plus a special choke and condenser filter system and a by-pass shield that shields the set from the usual electro-static field set-up between the aerial and ground connections.

The I.C.A. Electro-static is handsome in appearance, black porcelain with heavily nickelplated hardware. It looks like a big dollar's worth—and it is.

No installation—old or new—is complete without an I.C.A. Electro-static. Make the extra profit there is in selling this better lightning arrester.



## Two other winners Selectuner — Resistovolt

List—\$1.50

List—\$1.75

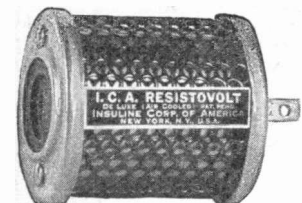

The Selectuner is a new principle station selector and static reducer that in nearly every case greatly enhances the radio reception of any type of set. It cuts out unwanted stations over the whole wave band, gets better distances, reduces static and enhances tone quality.

And from the dealer's point of view, the good looks and low price of Selectuner make it a very popular item.

Resistovolt is breaking even last year's record for big sales, and will be increasingly in demand during the 1929 and 1930 season.

Besides protecting regular AC tubes from blow outs caused by line surges and overloading, Resistovolt gives equal protection to the new 224 Screen Grid Tubes.

Every installation should include a Resistovolt to eliminate the hazard and expense of tube blow outs.

Also available combined with light socket aerial—Antennavolt, list price \$2.25.

**INSULINE CORP. of AMERICA, 78-80 Cortlandt Street, New York, N. Y.**

# The LINE that's EASIER to SELL and we'll tell you why

In every price-class there is a Freed model priced just a shade or two below the list of other makes of anything like equal quality.

This combination of Price with Freed Performance and Appearance—backed by the strongest kind of newspaper and magazine advertising, broadcasting, sales helps and co-operation with the dealer—makes your selling problem easier.

*Ask the local Freed distributor if he has any available franchise, or write us.*

FREED-EISEMANN RADIO CORPORATION • 122 East 42nd Street, New York City

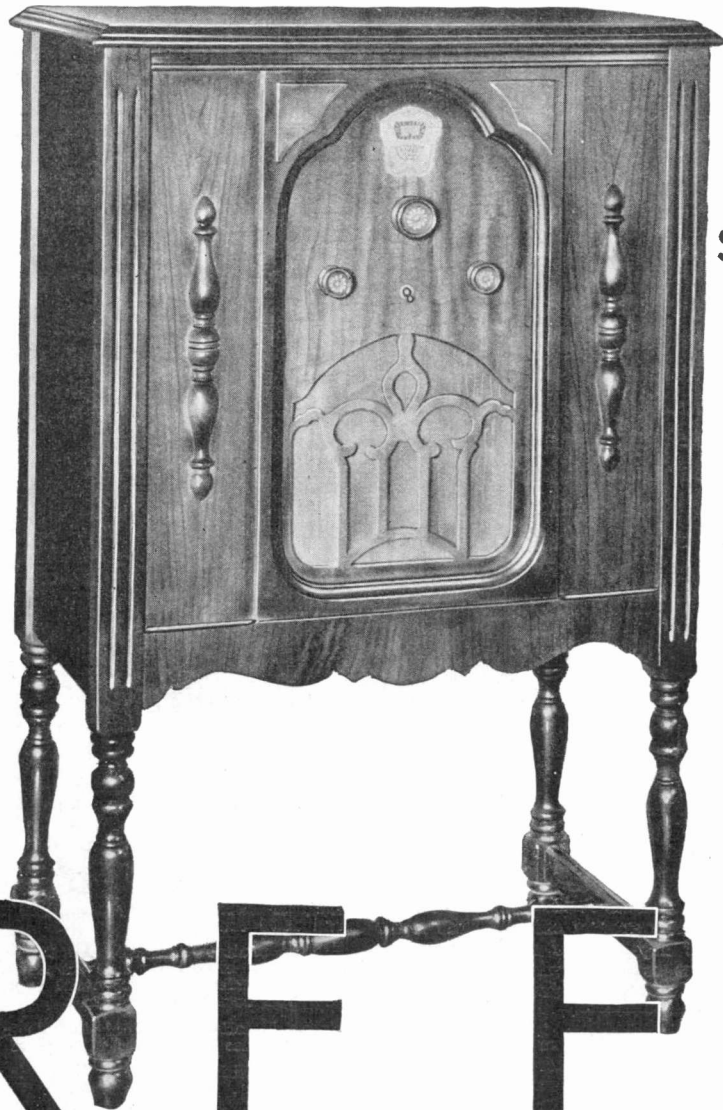

\$ **99**<sup>50</sup>  
(less tubes)

#### MODEL NR-55

8-Tube NEUTRODYNE for light socket operation.  
Push-Pull amplification.  
Inductor Dynamic Speaker.  
Cabinet of Walnut veneer.  
Other models up to \$225  
Prices slightly higher in Canada.

# F R E E D

## R A D I O

**GAS** is ALL RIGHT in a Zeppelin . . . .  
but it's ALL WRONG in a **RADIO TUBE**

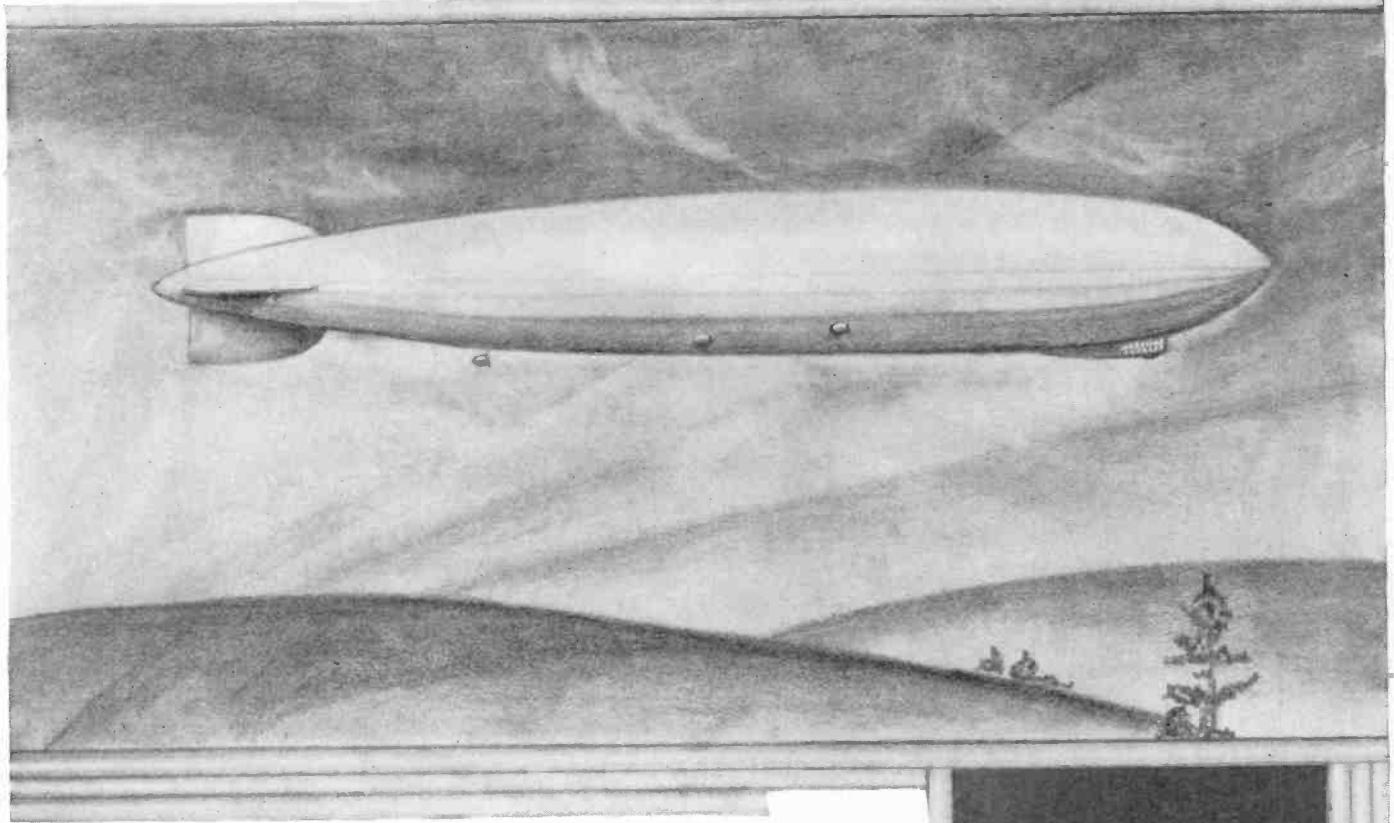

RADIO  TUBES

*are absolutely FREE from GAS*

**G**ASES, such as hydrogen, helium and others—vital to dirigibles—have made possible such achievements as the Zeppelin.

Cases also play an important part in the manufacture of radio tubes, BUT, in striking contrast to the Zeppelin, they must be completely ELIMINATED before each tube is sealed.

HYVAC RADIO TUBES are free from hum and give long life, because of the "degree of high vacuum" made possible by the Hyvac process of gas evacuation, modern methods of manufacture and up-to-date equipment.

To assure your customers the ultimate in radio reception, plus liberal profits for you, stock HYVAC RADIO TUBES.

*DISTRIBUTORS: Guaranteed exclusive distribution only. Write at once for full information on this outstanding tube proposition in the radio industry.*

**HYVAC RADIO TUBE CO.**

86 Shipman Street      Incorporated 1926      Newark, N. J.



# KINOMATIC TUNING means

**Remote:** Vernier control of tuning and volume, and switching on or off at distances of 200 ft. or more.

**Multiple:** Any number of control boxes — Twenty or more if desired. The more boxes sold, the greater the dealer's profit.

**Safe:** No underwriters violations. Controls operate from 14-volt step-down transformer. Wiring can be run anywhere, out of sight.

**Low Cost:** New sets with Sleeper Kinomatic tuning cost little more than old-fashioned, hand-tuned sets. No expense for service.

The convenience of Sleeper Kinomatic tuning is making hand tuning a mark of obsolescence.

Aggressive set manufacturers are planning to put Kinomatic even on their lowest-priced models.

Attach to  
Any Set  
in  
60 minutes  
!

SEE THESE SETS EQUIPPED WITH KINOMATIC  
At the New York Radio Show, Sleeper Research Booth, DD-5

CROSLEY — MAJESTIC  
PHILCO — ATWATER KENT

Also, Be Sure to See Sleeper Kinomatic Devices at the National Company's  
Booth, FF-5

The Kinomatic Tuning device is so small that it can be installed in practically any set. Dealers and service men can get full information at the New York Radio Show from experts who will be in attendance at the Sleeper Research Booth.

## KINOMATIC—Double Profits

Kinomatic acts as the extension of the vernier dial, volume control, and on and off switch to one or a dozen control boxes. All stations, local and distant, can be tuned in from any Kinomatic control box, as accurately as by hand tuning at the set.

FIRST DELIVERIES of KINOMATIC tuning devices are coming from the National Company, Malden, Mass.

National KINOMATIC made under the Sleeper Research license, can be attached to all new or old radio sets.

FOR COMPLETE INFORMATION, write to the National Company, Inc., Malden, Mass., or to the

Sleeper Research Laboratories, Inc.

M. B. SLEEPER

416 WEST 33rd STREET

NEW YORK CITY

Costs less than  
a new set  
of Tubes  
!



It goes without saying that the class of people attracted by the rich beauty and lifelike tone of Bush & Lane Radio are those who make up your most profitable market. "Built Like a Fine Piano" is more than a slogan to this market; . . . it's their reason for buying the aristocrat of radios.

**Bush & Lane Piano Co.**  
*Holland, Mich.*

An Exclusive  
Agency Franchise Assures  
Maximum  
Profits.

## Built Like a *fine* Piano



# Bush & Lane RADIO

A Complete Line—With Prices that Start Where Profits Begin

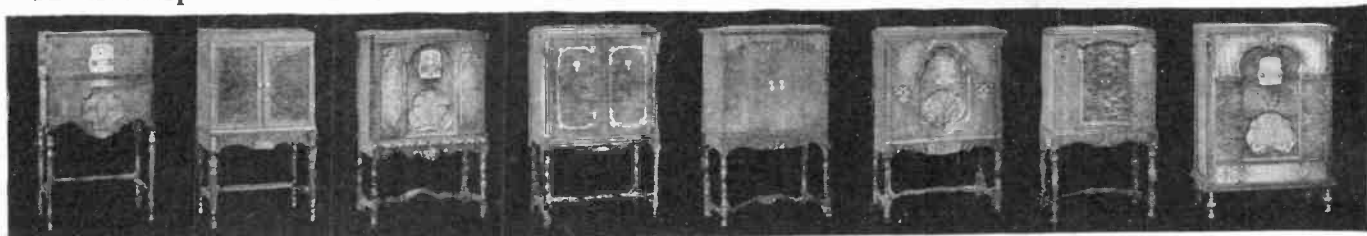



# Name your own profits

with the new

## ACME

### SCREEN GRID

### RADIO

**I** NSTALL the new ACME Screen Grid Chassis in your own furniture combinations—create your own eye appeal—and sell the complete sets at *your own* mark-up. You can't lose money that way—and you *can* insure yourself ample profits!

The new ACME has the "IT" that radio fans demand—performance that spells profits. Wonderful tone—selectivity to hair-line precision, volume to wake the neighbors, if you want to.

You can sell these sets under the ACME name, or we will stamp your own name or trade label on the panel escutcheon plate. Escutcheon plates furnished to harmonize with all furniture finishes.



But don't wait. Fall is coming—fall that will bring a greater demand than ever for ACME. Be ready to make *insured* profits. We will gladly send further information and arrange a demonstration. *Write or wire today.*

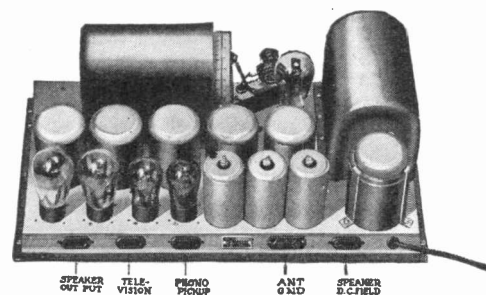

Type 88 SG  
8 Tube Chassis — \$77.00

#### FEATURES OF THE NEW ACME SCREEN GRID RADIO

A.C. . . . . and Screen Grid, of course . . . . . four gang condenser, tuning four circuits, for sharper selectivity . . . . . perfect shielding . . . . . push pull amplification . . . . . built-in provision for magnetic pick-up and television . . . . . built-in antenna . . . . . all these, and more, you'll find in this finest Acme.

**THE ACME ELECTRIC & MANUFACTURING CO.**  
1440 Hamilton Ave.

Cleveland, Ohio

*Representatives in principal cities*

Established 1917

Member R.M.A.



# New Profits from Old Customers!

## REPLACE THOSE OLD SPEAKERS

with the New 1930

## MUTER ULTRADYNAMIC SPEAKER



The MUTER speaker may be had in either the hand-some table model, or con-solette shown. Artistic in design, beautifully finished walnut.



| Description                           | List    |
|---------------------------------------|---------|
| Table Cabinet Only                    | \$15.00 |
| Console Cabinet only                  | 25.00   |
| Table Cabinet with 110 V. A.C. Unit.  | 42.50   |
| Console Cabinet with 110 V. A.C. Unit | 52.50   |

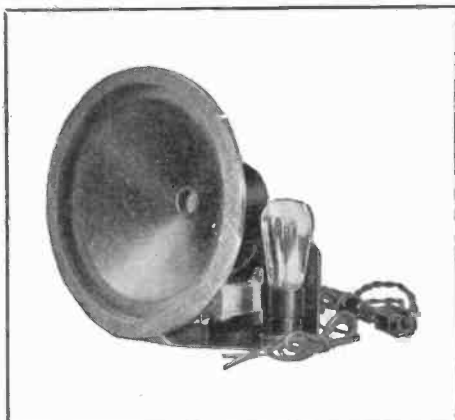

### THE REPLACEMENT SPEAKER SUPREME!

Every one of your customers who has a magnetic speaker or an out-dated dynamic is a logical prospect for a replacement sale—with the new MUTER Ultradynamic! A simple demonstration is enough—the quiet, humless operation of this great speaker, its freedom from excessive “drumming” on low notes, and its glorious, rounded tone—sells it instantly! Here is a great new market opened up for you by the speaker which in quality, background and price leads its field! Write for details—and do it now!

| Description—Units Only                   | List    |
|------------------------------------------|---------|
| 110-Volt 60 Cycle A. C. Unit (less tube) | \$27.50 |
| 90-Volt Direct Current Unit              | 25.00   |
| 6-Volt Direct Current Unit               | 22.50   |



### RADIO PARTS OF FAMOUS MUTER QUALITY

- Kit containing essential parts for highly efficient aerial, complete . . . . . \$1.75
- Instant adjustable ground clamp . . . . . .15
- Muter Replacement Transformer . . . . . 2.00
- Muter Knife Throw Switches . . . .60 to 2.00
- Muter Fixed Condensers — .00015 to .01 . . . . .25 to .85
- Muter Fixed Grid Leaks and Special Resistances, all capacities . . . . . .25
- Muter Filter Condensers of very finest construction . . . . .1.25 to 9.00
- Replacement Condenser Cartridges for repairing condenser blocks..40 to 3.00

#### Muter Dependable B Power Units

- Rectifier List (without Tube)
- 280 Type, 180 volts at 30 miles . . . . . \$22.50
- 280 Type, 220 volts at 40 miles . . . . . 25.00
- Raytheon Type, 180 volts at 30 miles.. 22.50
- Raytheon Type, 220 volts at 40 miles.. 25.00
- Muter Complete AC Power Unit—for use with 280 tube . . . . . 30.00

**LESLIE F. MUTER COMPANY**

8440 South Chicago Avenue . . . . . Chicago

READS VOLTS    FILAMENT HERE    READS VOLTS    PLATE HERE    READS GRID    CONTROL HERE

Announcing  
THE  
NEW  
Type SG  
4600  
RADIO  
SET  
TESTER

Radio's  
Most  
Complete  
Servicing  
Equipment

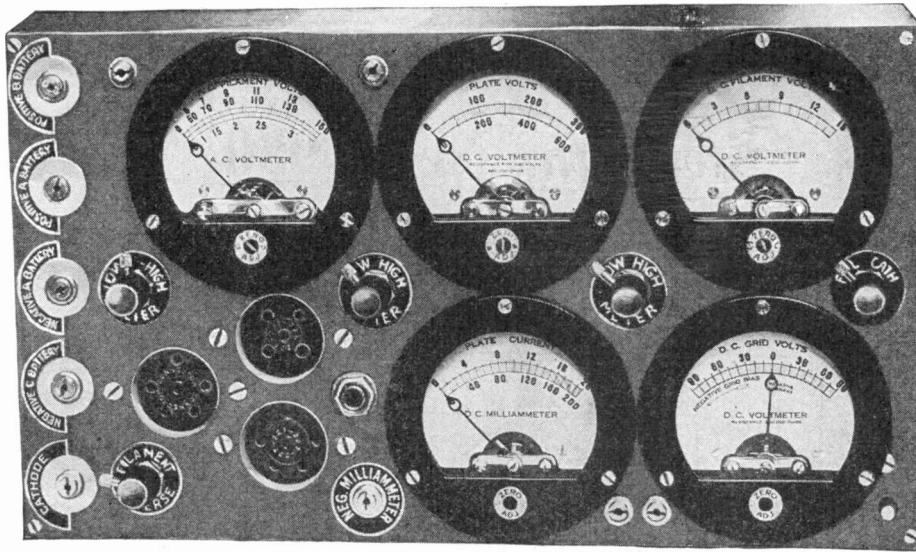

Dealers' net price complete with carrying case  
**\$90.00**

Write for  
FREE  
Bulletin  
No. 26

READS PLATE    READS    SCREEN  
CURRENT HERE    GRID VOLTS HERE  
INDICATES SIMULTANEOUSLY ALL THE ABOVE VALUES

The HICKOK ELECTRICAL INSTRUMENT CO., Cleveland, Ohio

## DOUBLE DANGER DEMANDS DOUBLE PROTECTION

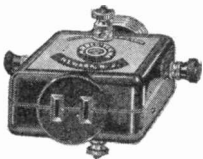

for ELECTRIC RADIO SETS

A lightning arrester installed on the outdoor antenna alone is NOW insufficient protection. TODAY two arresters are necessary—one for the outdoor antenna and one for the electric light circuit.

### Brach Arres-Tenna Gives COMPLETE Protection

by combining TWO Lightning Arresters in one small unit. In addition to giving maximum protection it IMPROVES reception, INCREASES volume and REDUCES interference. A necessity for all electric sets.

Lists at \$2.50. Carries \$100 Free Insurance.

### For Outdoor Antennae STORM KING Lightning Arrester

Universally Recommended by Leading Radio Engineers as World's QUALITY Lightning Arrester.

Over 3,500,000 in Use.

Carries \$100 FREE Insurance  
Lists at \$1



L. S. BRACH MFG. CORP.  
Newark, N. J., U. S. A.      Toronto, Can.

**ELECTRAD**  
Quality  
Builds  
REPEAT  
Sales

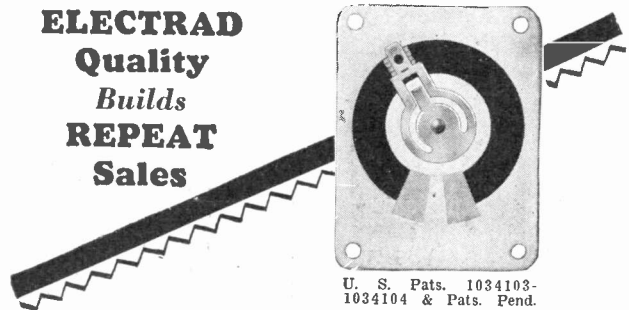

U. S. Pats. 1034103-1034104 & Pats. Pend.

Constant pioneering research, high standards and the most modern manufacturing facilities enable ELECTRAD to produce a line of resistances and voltage controls which have increased its own sales year after year — and WHICH WILL INCREASE YOURS, TOO.

### The Super-TONATROL An Example of Electrad Pioneering

The perfected result of extensive research in anticipation of today's need for a long-lasting, high-voltage volume control. Laboratory tests have shown its normal life to be more than ten years of average usage. All-metal construction, with a special resistance element fused to an enameled steel plate. Pure silver floating contact of new design provides a velvet control which grows smoother with use. See illustration. Made in seven ratings with uniform or tapered curves. List \$2.40 to \$3.50.

**ELECTRAD**  
INC.  
Dept. RR9, 175 Varick Street, New York, N. Y.

Please send copy of Super-TONATROL folder, showing recommended hook-ups.











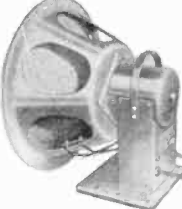

Name .....

Address .....

# OXFORD

## Electro-Dynamic Speaker

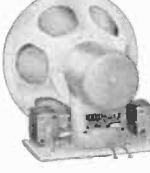
Licensed Under Lektophone Patents

|                                                                                                                                                                                                                                                                    |                                                                                                                                                                                                                                                                   |                                                                                                                                                                                                                                                                         |                                                                                                                                                                                                                                                         |                                                                                                                                                                                                                                                             |
|--------------------------------------------------------------------------------------------------------------------------------------------------------------------------------------------------------------------------------------------------------------------|-------------------------------------------------------------------------------------------------------------------------------------------------------------------------------------------------------------------------------------------------------------------|-------------------------------------------------------------------------------------------------------------------------------------------------------------------------------------------------------------------------------------------------------------------------|---------------------------------------------------------------------------------------------------------------------------------------------------------------------------------------------------------------------------------------------------------|-------------------------------------------------------------------------------------------------------------------------------------------------------------------------------------------------------------------------------------------------------------|
|  <p>D. C. Speaker with 2500 ohm field coil. Model 37—10 in. metallized cloth cone. Model 45—8 in. metallized cloth cone.<br/>List \$33.00</p>                                     |  <p>D. C. Speaker with 2500 ohm field coil. Model 24—10 in. metallized cloth cone. Model 30—8 in. metallized cloth cone.<br/>List \$31.50</p>                                    |  <p>D. C. Speaker with 2500 ohm field coil. Model 38—10 in. metallized cloth cone. Model 46—8 in. metallized cloth cone.<br/>List \$33.00</p>                                          |  <p>D. C. Speaker with 2500 ohm field coil. Model 36—10 in. metallized cloth cone. Model 44—8 in. metallized cloth cone.<br/>List \$25.00</p>                         |  <p>D. C. Speaker with 5000 ohm field coil. Model 39—10 in. metallized cloth cone. Model 47—8 in. metallized cloth cone.<br/>List \$32.50</p>                            |
|  <p>D. C. Speaker with 2500 ohm field coil. Model 67—12 1/2 in. metallized cloth cone.<br/>List \$39.50</p>                                                                     |  <p>D. C. Speaker with 5000 ohm field coil. Model 40—10 in. metallized cloth cone. Model 48—8 in. metallized cloth cone.<br/>List \$26.00</p>                                  |  <p>For operation with 6 volt battery. Model 22—10 in. metallized cloth cone. Model 28—8 in. metallized cloth cone.<br/>List \$29.50</p>                                             |  <p>D. C. Speaker with 1000 ohm field coil. Model 55—10 in. metallized cloth cone. Model 56—8 in. metallized cloth cone.<br/>List \$33.00</p>                       |  <p>A. C. Speaker for 110 volt A. C. complete with Kuprox Rectifier. Model 23—10 in. metallized cloth cone. Model 29—8 in. metallized cloth cone.<br/>List \$39.50</p> |
|  <p>Auditorium — Tube type speaker — for 110 volt A. C. with No. 280 tube. Designed for theatre use. Model 70—12 1/2 in. metallized cloth cone.<br/>List, less tube \$45.00</p> |  <p>Tube Speaker for 110 volt A. C. with No. 213 or No. 280 tube. Model 31—10 in. metallized cloth cone. Model 43—8 in. metallized cloth cone.<br/>List, less tube \$37.50</p> |  <p>Auditorium — A. C. Speaker — For 110 volt A. C. complete with double Kuprox Rectifier. Designed for theatre use. Model 71—12 1/2 in. metallized cloth cone.<br/>List \$70.00</p> |  <p>A. C. Speaker for 110 volt A. C. complete with B-L Rectifier. Model 59—10 in. metallized cloth cone. Model 60—8 in. metallized cloth cone.<br/>List \$33.00</p> |  <p>Auditorium — A. C. Speaker — For 110 volt A. C. complete with Kuprox Rectifier. Model 72 12 1/2 in. metallized cloth cone.<br/>List \$45.00</p>                    |

## OXFORD RADIO CORPORATION

Successors to Joy-Kelsey Corporation



G. A. Joy, President

Roy W. Augustine, Sec'y & Treas.

Frank Reichmann, Gen'l. Sales Mgr. and Chief Engr.

3200 W. Carroll Ave.

Chicago, U. S. A.



# But

## “WHO WON?”

Sport for sport's sake? Of course, and more power to it, But sooner or later, after any contest, athletic or otherwise, comes the inevitable question, “Who won?”

Radio men lately staged five contests. Each contest had the laudable aim of finding out the reading habits of radio dealers, jobbers and manufacturers.

1. One large radio set maker in the East put on the first event. He asked 300 of his dealers what business magazine they read. The magazine most dealers picked received 740% more votes than the second magazine.
2. Three hundred dealers were picked by a Middle Western set manufacturer for the second contest. The question was, “What trade paper do you read?” The magazine in first place received 930% more votes than the magazine in second place.
3. Another Eastern set manufacturer conducted the third test among 355 of his dealers. The question was the same. The results showed the winning magazine with 230% more votes than the second place winner.
4. An advertising agent figured in the fourth contest. He asked key jobbing houses handling radio what magazines they read. The winning magazine collected over 100% more votes than the second publication.
5. The fifth contest was conducted among a very critical part of the industry—the radio manufacturers themselves. The question asked was the same as in the other four tests—“What is your favorite business publication?” The winning radio business paper polled 489% more votes than its nearest competitor . . . if 400% difference is near.

That is the story of the five “favorite magazine” contests. “But who were the five winners?” perhaps you ask.

There weren't five winners! There was only one.

One magazine won all five contests.

That magazine, most useful to radio dealers, jobbers and manufacturers (as well as *advertisers*), is

### RADIO RETAILING

*a McGraw-Hill publication*



Screen Grid Fada 25 highboy—all electric—uses new 245 type power tubes in push-pull amplification—Fada full power dynamic speaker—single illuminated dial—equipped for phonograph attachment. All Fada prices are slightly higher west of the Rockies and for export.

# Sales resistance gives way before the tone of the **Fada 25**

When a prospective customer hears the full, rich voice of its Fada dynamic speaker—the lovely perfection of tone and shading in the music reproduced by the Fada 25 . . . when he sees the beauty of its cabinet work—pictures it in his home . . . then he finds *it's only \$165!*—that prospect becomes a *customer*.

Fada dealers are profiting by the public's

surprise at being able to buy so fine a radio at so low a price. For Fada quality is famous wherever radio is known . . . and the Fada line is complete—a radio for every purse.

Write or wire for information regarding a Fada franchise in your territory.

F. A. D. ANDREA, INC.

LONG ISLAND CITY, NEW YORK



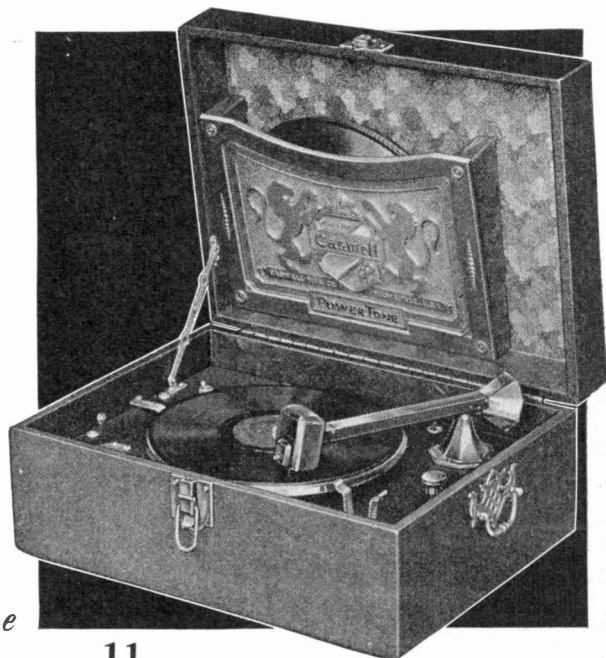

The  
**Caswell  
POWERTONE** ///

Another Caswell achievement has proved one of the hits of the trade show—the new, all electric Caswell PowerTone. A treasure chest in appearance, it combines those elements of precision, compactness and beauty most desired in a portable pick-up.

**\$49<sup>50</sup>**

**[ All  
Electric ]**

In value, the PowerTone is the wonder of the industry. It is equipped with a General Electric Synchronous type motor—a power plant whose performance and dependability is world famous. It incorporates the Patent Phonovox—a pick-up device of exceptional tone quality, roundness and precision assuring the faithful reproduction of every type of phonograph record. It is fitted with antique brass effect hardware and a built-in, art-crafted record album, making it a thing of beauty for any home. When placed on top of the radio cabinet, the Caswell PowerTone becomes an individual part of the musical equipment—its soft brown coloring blending perfectly with any wood finish.

**JOBBER!**

Consider the profit possibilities of this item from all angles—then write us for our jobber's proposition, keeping in mind the fact that Caswell does not compete with you in selling to the trade—but sells only through recognized jobbers.

**Caswell Manufacturing  
Company**  
St. Paul Avenue at Tenth Street  
Milwaukee, Wisconsin

**CASWELL** |||

**THERMATROL  
FILTROLS**

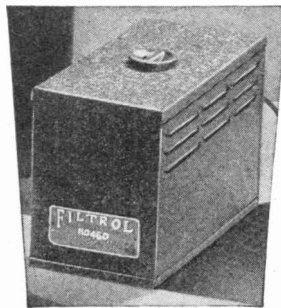

For quieting AC line noises

and  
**Line Voltage Controls**

For protecting AC TUBES are standard service items with dealers everywhere.

They are worthy of the best set you sell, and help to make service calls pay a profit. **ORDER NOW**

- FILTROL** No. 460  
Plugs ahead of the set . . . \$12.00
- MOTOR FILTROL** No. 458  
For direct application to oil burners, etc. . . . \$15.00
- FILTROL, JR.** No. 450  
Plugs ahead of small household appliances . . . \$3.50
- VOLTAGE CONTROLS**  
No. 200 Light Duty. For sets up to 6 tubes . \$1.75  
No. 210 Heavy Duty. For all larger sets . . . \$2.00

THERMATROL MANUFACTURING CO., Springfield, Mass.

SHIP AT ONCE TO— Name \_\_\_\_\_  
 ---No. 460 ---No. 200 Address \_\_\_\_\_  
 ---No. 458 ---No. 210 \_\_\_\_\_  
 ---No. 450 Jobber \_\_\_\_\_

CAPS MADE OF LEAD ONLY METAL USED FOR XRAY AND RADIUM SHIELDS

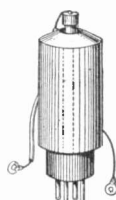

TYPE 224

**SCREEN GRIP TUBE SHIELD WITH SHIELDED LEAD**

List Price 60c.  
Net Wt. about 4 ozs.



TYPE 227

**SHIELD TYPE NOPHONIC TUBE CAP**

List Price 35c.  
Net Wt. 5 ozs.



TYPE 200

**PLAIN TYPE NOPHONIC TUBE CAP**

List Price 25c.  
Net Wt. 5 ozs.



TYPE 199

**NOPHONIC TUBE CAP FOR 199 TUBES**

List Price 25c.  
Net Wt. 2½ ozs.

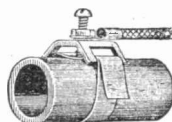

**"SADDLE"** Approved Mertz Spec. Co.  
Ground Clamp 13065 Stockton St.  
1", 2" and 3" sizes Wilmington, Del.

## Your Coil Problem Solved!

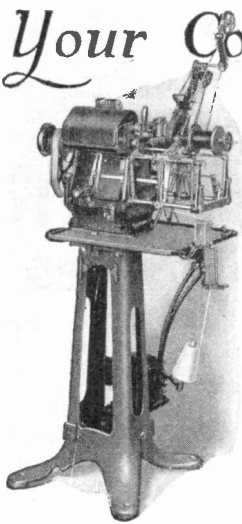

Install a group of "Universal" Coil Winding Machines

and insure uniform production of dependable coils at surprisingly low cost

or

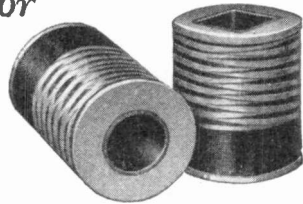

Purchase these same coils from us, carefully wound to your specifications and ready for application to your product

UNIVERSAL WINDING COMPANY  
*LESSON*  
BOSTON

## CAN YOU SELL THE HIGHEST CLASS RECEIVER IN THE WORLD?

*Here Is the Perfect Broadcast Receiver!*



The Console

**T**HE New Admiralty Super-10 is the very apex of Modern Research Engineering.

It is a brand new receiver for the radio connoisseur which we believe represents final superiority over any broadcast receiver now being manufactured or contemplated.

Strictly custom-built, this new model meets the requirements of those that want the best. It is in fact, the Highest Class Receiver in the World.

### SUPER FEATURES

10 Radio Tubes—Superior Power—Complete self-contained electric operation—exceedingly compact—Simplified controls—Full Vision Tuning Indicators—Uses Heater type AC Screen Grid and Power Tubes—Super Selective—Band Pass Filter Effect—Hum Eliminator—Line voltage regulation—Scientifically correct shielding—Great range with sensitivity control—Minimum antenna requirements—Improved push-pull audio system—Perfect reproduction with great volume—Arranged for Electro-Dynamic Loudspeaker—Adaptable for short-wave television work—Universal wave-length range for use in any part of the world—Phonograph pickup connection—Special Weston Meters for Voltage and tuning resonance—Protected against moisture for tropical and marine installation—Built strictly according to U. S. Navy Standards—Cabinets of finest selected Mahogany and Walnut—Exquisite console combinations available—Entirely custom built—Thoro air test by receiving engineers on all classes of reception for range and quality of reproduction—Sold direct from factory and thru selected franchise dealers in the principal cities of the United States and foreign countries—Unconditionally warranted against defects.

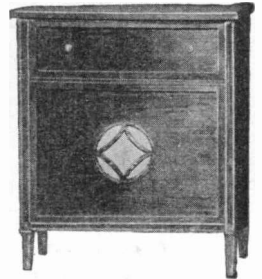

The Highboy

A few additional representative dealers now being appointed in selected territories.

*Write, Telegraph or Cable Today  
Attractive illustrated literature on request.*

**NORDEN-HAUCK, INC., ENGINEERS**  
Marine Building, Delaware Avenue and South Street  
Philadelphia, Pa., U. S. A.

Cable: NORHAUCK

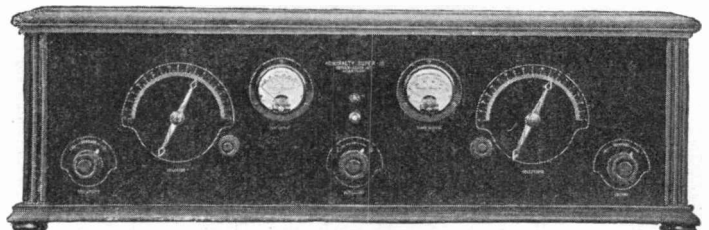

## Cunningham RADIO TUBES



Quality safeguarded from within

Where Tube Similarity Ends

Leading dealers and jobbers realize that outside appearances may be similar or even identical between various makes of radio tubes.

It is the accuracy with which the parts are precisely manufactured and tested that gives Cunningham Radio Tubes their remarkable outstanding quality and long life.

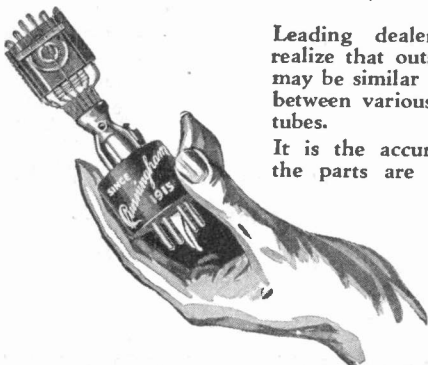

E. T. CUNNINGHAM, INC.  
New York Chicago San Francisco Dallas Atlanta

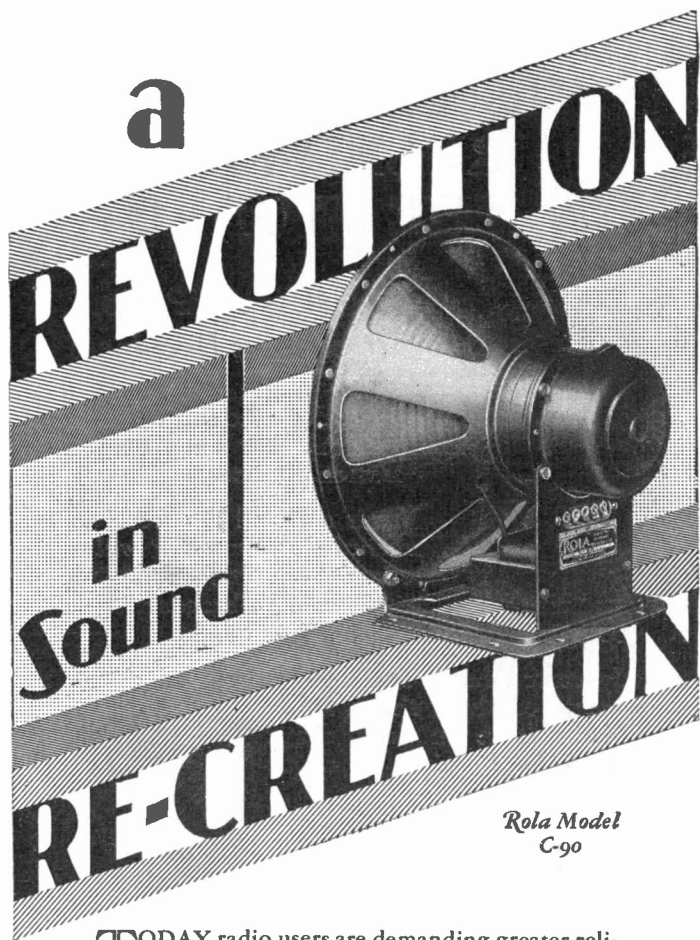

Rola Model C-90

TODAY radio users are demanding greater reliability—more consistently fine performance—from radio sets. Alert dealers are particularly careful as to the loudspeakers installed in their merchandise. They realize that the loudspeaker is the heart of the radio set—that it is *the speaker that tells the story*.

Dealers find Rola electro-dynamics brilliant in performance—rugged and dependable under the most exacting conditions. They realize that Rola reproducers best meet present-day demand for quality reproduction—that a set equipped with Rola is a set that is easiest to sell.

Make sure that Rola electro-dynamic reproducers are in the sets you sell. Install Rola units in your customers' present sets—this is a lucrative source of additional business.

The larger Rola "Series C" and "Series R" electro-dynamics find a ready market for installations in talking pictures, auditoriums, schools, and all types of public address systems. There are Rola quality loudspeakers for every type of sound-reproducing installation. *For further information, write*

The  
ROLA  
COMPANY

ROLA

CLEVELAND, OHIO  
2570 E. Superior Avenue  
OAKLAND, CALIFORNIA  
Forty-fifth and Hollis Streets

# NOW

The Great Farm

## Market is Opened for A.C. Radio Sales

The JANETTE 32-Volt Rotary Converter enables the radio dealer to count every farmer with a 32-volt D.C. lighting plant as a first-class A.C. radio prospect. Go after this big new market NOW!

JANETTE Rotary Converters have been the standard of the A.C. radio and talking machine industries for years. Scientifically built filter cuts out all D.C. hum. Equipped with starter and voltage regulator. Voltmeter obtainable if desired.

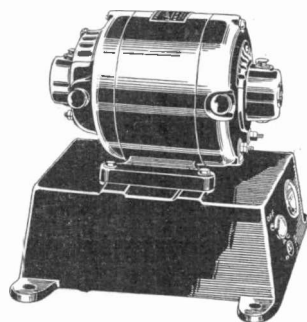

Write for Bulletin 729-C.

JANETTE MFG. CO.  
555 West Monroe St.,  
Chicago

|                                            |                                             |
|--------------------------------------------|---------------------------------------------|
| Singer Bldg.,<br>140 Broadway,<br>New York | Real Estate<br>Trust Bldg.,<br>Philadelphia |
|--------------------------------------------|---------------------------------------------|

Type C-16-F. Capacity 110  
watts. Shown equipped with  
Filter Starter and Voltage Regu-  
lator, and Voltmeter.

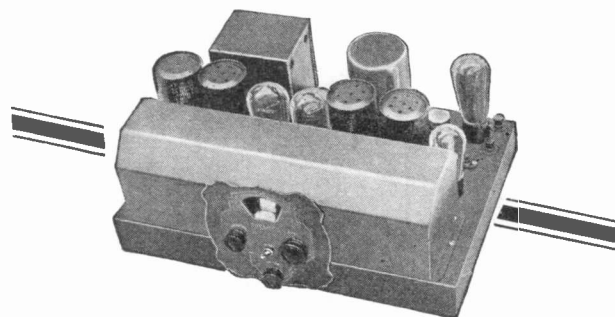

## LOOK! Screen-Grid plus Power Detection—Under Your Own Brand

Cash in big this season by offering radio's newest and most modern development—using your own brand name. You set your own resale price to meet every market condition—you banish the bugaboo of one-sided contracts and restricted territories, and by purchasing direct from factory, you get every possible price concession. Most important, you preserve your greatest asset—your trade identity and good will.

This Premier Has Every Needed Feature

The new Premier screen-grid chassis, Model 724, 7 tubes (8 with rectifier), is illustrated. A great performer. Full tone, volume, pleasing eye value. Many features—power detection, 100% shielded, all metal, D.C. dynamic speaker terminals, phonograph pickup, safety fuse and latest tube combination using four 221's, one 227, two 245's in push-pull and one 280 rectifier.

Write for full details

PREMIER ELECTRIC COMPANY

1814 Grace Street, CHICAGO

Established 1905



# Check these 3 sales points of Simplex Screen Grid Radio

- 1—Three Screen Grid Tubes ✓
- 2—Super-Power Dynamic Speaker ✓
- 3—Beautiful appearance ✓



**Model F Lowboy**  
 Retail \$139.50 less tubes. 23 1/2 in. high, 23 in. wide, 13 in. deep. Shipping weight 80 lbs.



**Model F Highboy**  
 Retail \$169.50 less tubes. 26 1/2 in. wide, 47 in. high, 15 3/4 in. deep. Shipping weight 125 lbs.

HERE is the radio receiver for the man who *looks ahead*. The chassis is provided with jacks for readily connecting television apparatus.

Simplex High Power, too, pioneers in the field of amplification—about four times that of ordinary sets—finer tone, deeper volume—greater range—greater selectivity.

Period cabinets in figured walnut. High-boy has sliding doors of matched burl walnut. Lowboy ideal for small homes, apartments. Both have same chassis.

Never before so fine a radio at so small a price. A forerunner of tomorrow's trend in radio. Five minutes will convince the customer of the difference.

*Write for Details Today.*

**THE SIMPLEX RADIO CO., Sandusky, Ohio**

### Specifications

Tubes—three 224, one 227, one 245, one 280. Four tuned stages. Power detector with automatic grid bias, detector directly coupled to output stage; illuminated dial, kilocycle calibration, completely shielded. Automatic voltage regulation; safety fuse, built-in light socket antenna, phonograph connection. Super Power dynamic speaker.

## LIKE A CAR WITH A BALKED GAS LEVER IN HEAVY TRAFFIC

Your foot on the gas brings a jerky response . . . you're holding up traffic that's anxious to move.

Your variable resistance feeds the "gas" to your radio receiver . . . and there's all the difference in the world if its a CENTRALAB.

Quiet, even flow of current without a crackle or a sputter . . . that's CENTRALAB performance. . . . a scientifically constructed percision resistance control for the modern radio receiver.

*Write for Free Booklet on "Volume Controls—Voltage Controls and their uses"*

# Centralab

CENTRAL RADIO LABORATORIES

20 KEEFE AVE., MILWAUKEE, WISCONSIN

THIS shows the exclusive rocking disc construction of Centralab volume control. "R" is the resistance. Contact disc "D"

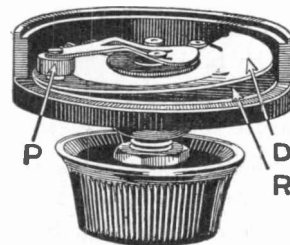

has only a rocking action on the resistance. Pressure arm "P" together with shaft and bushing is fully insulated.

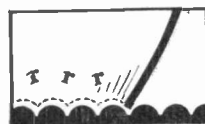

This is the action of the usual wire wound control after it has been in use for some time . . . like dragging a stick over a cobblestone pavement.



The tailor uses the same principle as Centralab. He does not want to ruin the garment by placing the iron on it so he places a cloth in between. Centralab controls can not ruin the resistance because the rocking disc is in between the pressure arm and the resistance.

## For Electrical Contractors who really KNOW radio

**I**T IS amazing the money that can be made by installing sound systems. The business is everywhere. But you must know how to look for it and how to handle it after you get it in order to profit by the great opportunity of today.



**I**n every territory  
Broadcasting Sound Systems  
are required for . . .

- |                  |                 |                  |
|------------------|-----------------|------------------|
| Amusement Parks  | Dance Halls     | Riding Academies |
| Aviation Fields  | Factories       | Sanitariums      |
| Band Stands      | Gymnasiums      | Skating Rinks    |
| Base Ball Parks  | Hospitals       | Sporting Arenas  |
| Camps            | Hotels          | Stadiums         |
| Churches         | Playgrounds     | Steamships       |
| Circuses         | Public Parks    | Swimming Pools   |
| Civic Centers    | Race Tracks     | Theaters         |
| Convention Halls | Railroad Depots | Yacht Clubs      |
|                  | Restaurants     |                  |

Powerizer Amplifier Panels for Every Installation Need

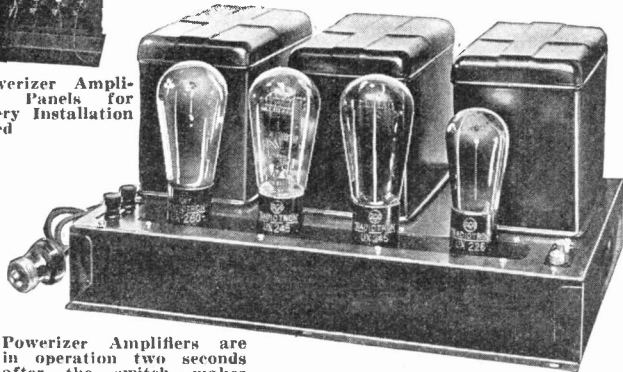

Powerizer Amplifiers are in operation two seconds after the switch makes contact

Many alert contractors have allied themselves with POWERIZER, the amplifier of perfect tonal power. With it as the heart of a Sound System, better installations are made and the services of the contractor who made them are sought after.

We want to talk brass tacks with contractors who can see the possibilities in Sound Installations. We are ready to help them and to protect them in their territories. A lifetime of amplifying and control mechanisms bearing our trade mark is at your disposal . . . if you are ALIVE to the opportunity we are offering. Get in touch with us at once.

Literature and Questionnaire on Request  
Service Agencies in Important Cities  
Write for bulletin RR-1028

Radio Receptor Company, Inc.  
106 Seventh Ave., New York City  
Licensed by Radio Corporation of America  
and Associated Companies

# POWERIZER

## SOUND SYSTEMS

Oldest Tube Manufacturer in  
New England

Hytron  
Tubes

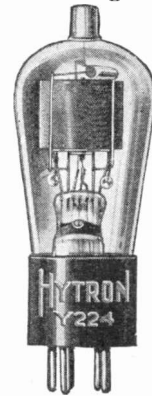

Best By  
Every Test

Highest Quality  
Years of Experience  
Tested by Latest Methods  
Record for Performance  
Offer Greater Profits  
Now Write for Proposition

HYTRON CORP.  
SALEM, MASS.



## WRIGHT-DeCOSTER REPRODUCER

*"The Speaker of the Year"*

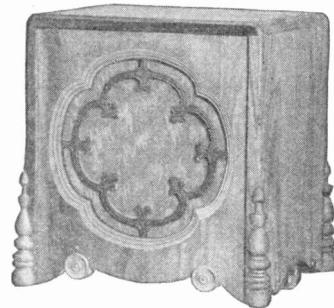

*Your Radio Can Be Only  
As Good As Its Speaker*

Install a Wright-DeCoster

Write for descriptive folder,  
and address of nearest Dis-  
trict Sales Office.

WRIGHT-DeCOSTER, INC.  
St. Paul, Minnesota

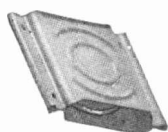
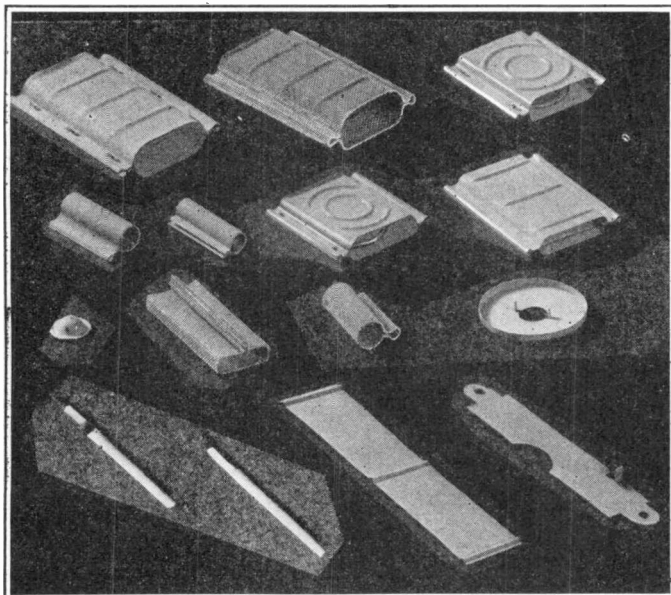

201-A (Round)

The 201-A can be furnished in 3 different sizes—.177-in., 3/16-in., .198-in. inside diameter—both degasified and carbonized.

## Finest Quality Tube Supplies

We are equipped to furnish tube parts in any size or in any quantities—molybdenum filament hooks, tungsten filament hooks, screens,—in fact all of the various stampings used in the assembly of better tubes.

These tube supplies are manufactured from superior materials and with the utmost care and precision. Tubes that are assembled with Juno parts will stand the test of quality and service in any competition.

*We will gladly meet your specifications or send any further information you wish.*

**Juno Fasteners, Inc.**  
Hillside, New Jersey

## New Self-Feeding Electric Soldering Iron

THE EVER-FLO Fountain Soldering Iron saves time and eliminates waste. Solder melted within the iron. Flow to point controlled by valve. From tiny drop to steady stream. Made in three sizes. Cost but little more than ordinary electric iron.

EVER-FLO is the only self-feeding soldering iron.

**DISTRIBUTORS WANTED!**  
Mail coupon today.

National Self-Feeding Iron Co.  
1204 Chester Williams Building,  
Los Angeles, California  
Send information about EVER-FLO Fountain Soldering Iron and exclusive plan for distributors.

Name .....

Street .....

City .....

RR .....

**ANACONDA**  
MAGNET WIRE

Plain Enameled  
Cotton Covered  
Silk Covered

**ANACONDA WIRE & CABLE CO.**  
Magnet Wire Dept.  
MUSKEGON — MICHIGAN.

## CANNON-BALL

Is the Sales Winning Name

For popularly priced Magnetic Cone, Air Column Speakers and balanced Armature Units for Cone, Air Column Speakers and Phonograph, made by the largest manufacturers of

HEADSETS

All Sales Makers. Write for Details.

**Cannon & Miller Company, Inc.**  
SPRINGWATER, N. Y.

# 6<sup>th</sup> ANNUAL RADIO WORLD'S FAIR MADISON SQ. GARDEN NEW YORK SEPT. 23<sup>RD</sup> TO 28<sup>TH</sup> INCLUSIVE

The Trade and Public of the two most important buying territories will be there.

**ALL THE NEWEST DEVELOPMENTS!**

The newest developments in radio, designed as a result of the many trends and ideas brought out at the June Trade Show will be on display. New models of receivers, speakers, tubes, furniture, prepared since June, will be among the displays of the 217 prominent exhibitors. The newest in TELEVISION will head the many feature attractions! See the evolution of radio: past, present and future.

## 550,000 PEOPLE

Will Attend These Two Largest

### RADIO EXPOSITIONS!

217 Leading Radio Manufacturers Will Exhibit!

The Only Official Shows of the Radio Manufacturers' Association



# 8<sup>th</sup> ANNUAL CHICAGO RADIO SHOW COLISEUM CHICAGO OCT. 21<sup>ST</sup> TO 27<sup>TH</sup> INCLUSIVE

It's the Roll Call of the Radio Industry! You cannot afford to miss it. **PLAN NOW TO GO.**

**PARTS MATERIALS BUYING GUIDE!**

This year, for the first time, both shows will include a Parts and Raw Materials Directory. With the official approval of the Radio Manufacturers Association it will be used as a buying guide by the industry's chief engineers, sales executives and purchasing agents. Every manufacturer who supplies material to the radio manufacturing industry should be represented.

## RADIO MANUFACTURERS' SHOW ASSOCIATION

G. CLAYTON IRWIN, Jr., General Manager

U. J. HERRMANN, Managing Director

## Potter Filter Condensers

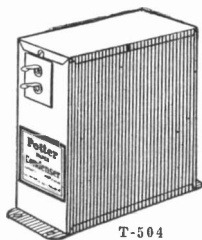

T-504

| Code        | Cap. Working Voltage D. C.                                                  | Size                           | Price   |
|-------------|-----------------------------------------------------------------------------|--------------------------------|---------|
| RR-245      | Condenser Block for single and push-pull 245 type tube amplifiers . . . . . |                                | \$19.75 |
| T-2900      | Condenser Block for the single 210 type tube amplifier . . . . .            |                                | \$20.00 |
| T-2950      | Condenser for the push-pull 250 type tube amplifier . . . . .               |                                | \$22.50 |
| T-2098      | Condenser Block for single 210 type tube amplifier . . . . .                |                                | \$20.00 |
| T-280-171   | Condenser Block for power pack with 280 type tube rectifier . . . . .       |                                | \$18.00 |
| T 307-2-104 | { 1. Mfd. 200<br>1. Mfd. 200<br>4. Mfd. 400                                 | 1 7/16" x 4 1/2" x 4 3/4" high | \$8.50  |
| T 307       | 1. Mfd. 200                                                                 | 1 7/16" x 4 1/2" x 4 3/4" high | 6.25    |
| T 405       | 2. Mfd. 400                                                                 | 1 7/16" x 4 1/2" x 4 3/4" high | 3.75    |
| T 407       | 4. Mfd. 600                                                                 | 2 1/8" x 4 1/2" x 4 3/4" high  | 6.75    |
| T 504       | 1. Mfd. 1000                                                                | 1 7/16" x 4 1/2" x 4 3/4" high | 2.75    |
| T 505       | 2. Mfd. 1000                                                                | 1 7/16" x 4 1/2" x 4 3/4" high | 5.25    |
| T 506       | 3. Mfd. 1000                                                                | 2 1/8" x 4 1/2" x 4 3/4" high  | 7.75    |
| T 604       | 1. Mfd. 1250                                                                | 1 7/16" x 4 1/2" x 4 3/4" high | 3.50    |
| T 605       | 2. Mfd. 1250                                                                | 2 1/8" x 4 1/2" x 4 3/4" high  | 6.75    |

### Replacement Blocks

For All

"B" Eliminators and Power Supply Units

Write at once for information

**The Potter Co.**

North Chicago, Illinois

A National Organization at Your Service

## WASMUTH-GOODRICH COMPANY



Fine Radio Cabinets  
fashioned by  
Master Craftsmen

103 Park Ave., New York  
Peru, Indiana

## Broadcast Your Message With Showcarder Signs

Attractive signs will sell more radio sets and supplies. Increased volume means greater profits. SHOWCARDER produces "signs that sell."

Never mind a long letter. Just say:  
"Send me details Free."



A complete sign department for you. With SHOWCARDER you can easily make all the signs you want.

SHOWCARDER, INC. 2312 University Ave.,  
ST. PAUL, MINN.

# ANNOUNCING —

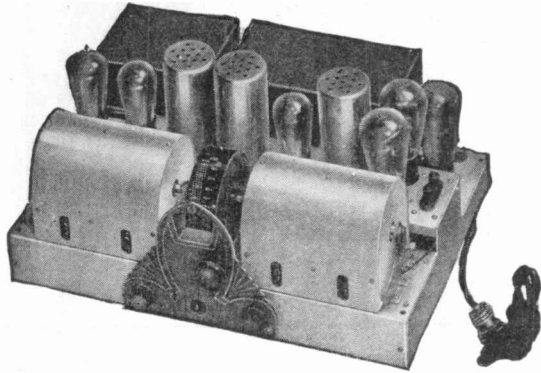

*Antenna-less*  
**MANDEL Screen Grid Chassis**

**T**HE first radio that satisfactorily receives distant stations *without an aerial, loop, or ground.* In the Mandel Screen Grid Chassis atmospheric static is greatly reduced, and distortion is totally absent. No other radio possesses these outstanding qualities. Those who recognize fine construction in radio, will turn to the MANDEL.

*Built for those who wish to increase their profits by marketing a fine radio under their own name.*

**Mandel Electric Co.**  
 2157 N. California Ave., Chicago, Ill.

*Makers of Fine Radio Apparatus Since 1920*



**MANDEL Electro-Dynamic Speaker**

Made to match the fine quality of the MANDEL Chassis. Wired for 90 to 125 volts, 50 to 60 cycles, alternating current, or for direct current operation in connection with the MANDEL Chassis. Also made to operate from a 6-volt battery.

# EBERT

OF RED LION, PA.

## RADIO CABINETS

*exclusively manufactured to meet the exacting requirements of the*

## ATWATER KENT MANUFACTURING COMPANY

Designed and built by a quality cabinet making organization of 75 years' experience.

EBERT FURNITURE CO. of Red Lion, Pa. *Established 1854*



**MODEL 77**

Height, 43". Width, 28". Depth, 15 1/2". Five-ply veneers throughout. Top and sides of straight walnut. Front is laid with plain American Walnut, Burl Walnut, and genuine Bird's Eye Maple . . . . .

**\$33.25** List

**A. Irving Witz**

**Martin J. Polikoff**

*National Sales Agents*

611 Widener Bldg., Phila.



MANY OF YOUR CUSTOMERS  
NEED NEW **B-H**  
**RECTIFYING**  
**TUBES**  
FOR "B" ELIMINATORS!



Carton of four  
Eveready Raytheon B-H Tubes

# EVEREADY RAYTHEON B-H

MANY of your customers are using "B" eliminators built for the original gaseous B-H rectifying tube. Millions of such units were sold during the past few years. Tell these customers what a big improvement in reception a new Eveready Raytheon B-H Tube will make. The replacement market for these tubes is enormous.

Eveready Raytheon B-H Tubes come in handy cartons of four tubes each. Always keep at least one full carton on hand.

NATIONAL CARBON COMPANY, INC.

General Offices: New York, N. Y.

Branches: Chicago Kansas City New York  
San Francisco

Unit of Union Carbide  and Carbon Corporation



TRADE-MARKS

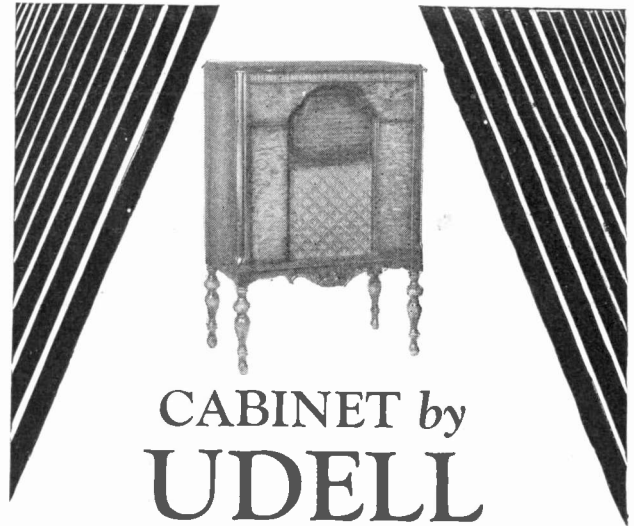

## CABINET by UDELL

Fifty-six years of fine cabinet making are back of the Udell name.

New model and new designs are now being offered, but the same fine workmanship that has characterized the product of the Udell Works for a generation still segregates its product from the ordinary.

Now ready—in convenient brochure—beautiful set of gravure printed photographs of the complete new Udell line of cabinets. A set will be sent free to distributors and dealers upon request.



THE UDELL WORKS

28th St. at Barnes Ave.

Indianapolis, Ind.

## ACME WIRE PRODUCTS

Parvolt Filter and By Pass Condensers  
Coils—Magnet Wire Wound  
Varnished Insulations

Magnet Wire . . . All Insulations

All products made to Recognized Commercial Standards, including those of:

National Electric Mfrs. Assn.  
Radio Manufacturers' Assn.  
American Society for Testing Materials

For 25 years manufacturers and suppliers to the largest and most discriminating users.

THE ACME WIRE CO.  
NEW HAVEN, CONN.

Branch Offices

New York  
52 Vanderbilt Ave.

Chicago  
842 N. Michigan Ave.

Cleveland  
Guardian Bldg.

# Leadership

In the field of strictly chassis manufacturers, Audiola, by virtue of the unquestionable quality of its product, has assumed definite leadership.

This position has been attained through the inherent quality of the Audiola chassis. The engineering skill represented in its design, the superior workmanship and the quality of its component parts combine to make it the outstanding product in its class.

TOTALLY ENCLOSED CHASSIS

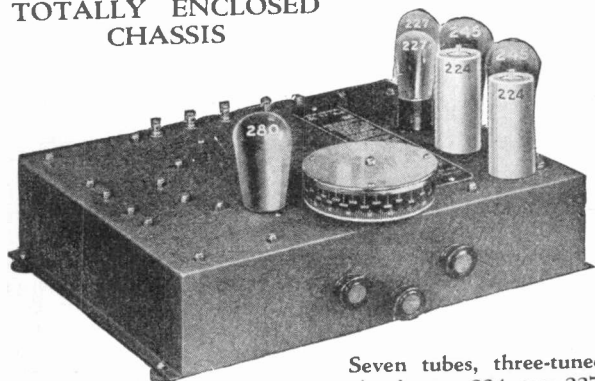

MODEL 7330

Seven tubes, three-tuned circuit, two 224, two 227, two 245 and one 280 tube.

The faithful tone reproduction and high degree of selectivity ensure satisfaction to your customers.

Screen Grid Tubes  
Power Detector—No Hum  
245 Tubes in push pull at full recommended voltage.

# AUDIOLA

## RADIO COMPANY

430 So. Green St., Chicago, Ill.

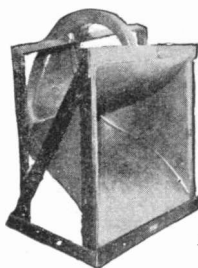

Miles 10 ft. Horn  
No. M 10

A New Electrodynamic Speaker made along entirely different lines—getting away from antiquated concepts and methods.

Loud... Clear... Life-like  
—that's

# MILES



Type M 100  
Dynamic Unit  
5 1/2 x 5 1/2.

New heights of reproducing power and realism, based on years of intensive research and development. Performance that has won leading manufacturers and dealers of Synchronous, Non-Synchronous and Public Address Equipment . . . that will win you by a single trial.

- M 9 Combination Unit and 9 ft. Horn . . . . . List \$230.00
- M 10 Combination Unit and 10 ft. Horn . . . . . List \$275.00
- M 12 Combination Unit and 9 ft. Junior Horn . . . . . List \$185.00
- M 3 1/2 Combination Unit and 3 1/2 ft. Trumpet . . . . . List \$170.00

Write for special discounts.

MILES MANUFACTURING CORP.

"Builders of Acoustical Reproducers Since 1923"

31 West 21st St. Phone GRAmery 5081 New York City

Cable Address: "Milesman" N. Y.

## TRIMM Dynamic Chassis

Model D100

\$20

Model DV102

\$24

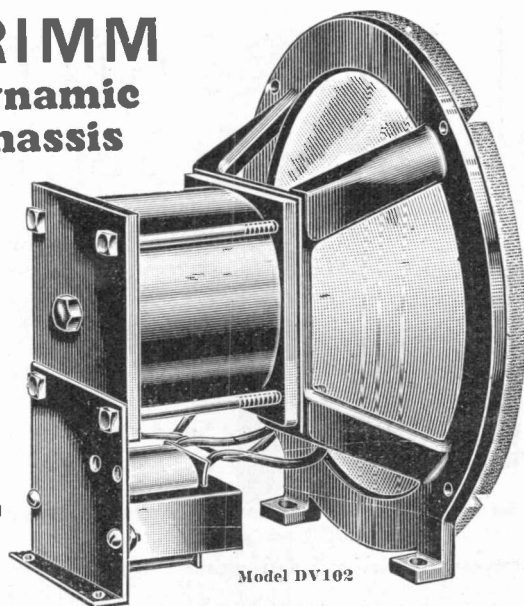

Model DV102

Model D100 operates from a chassis of the alternating current type where the output energy is supplied by the conventional type of power amplifier tubes in push-pull, this energy being fed through an output transformer which matches the voice coil and where the power pack supplies direct current for energizing the field coil.

Model DV102, illustrated above, is provided with an output transformer which matches the conventional type of power amplifier tubes and the voice coil.

Send for full information on wide range, true fidelity, extreme volume with mellowness and entire absence of blasting or distortion.

TRIMM RADIO MFG. CO.

847 W. Harrison Street, Chicago, Illinois

Examine these McGraw-Hill  
**Radio Books**  
for 10 Days **FREE!**

**Moyer and Wostrel**  
**Practical Radio Construction  
and Repairing**

By JAMES A. MOYER and JOHN F. WOSTREL.  
319 pages, 5½x8, 157 illustrations, \$2.00.

A practical book for the amateur constructor who wishes to make his own receiver; for the person who buys a commercially built receiver and wants to know how it operates, how to improve it and how to repair and keep it in repair; and for the radio dealer and his assistants who are called upon to test and repair radio broadcast receivers.

**Moyer and Wostrel**  
**Practical Radio—New Third Edition**

By JAMES A. MOYER and JOHN F. WOSTREL.  
300 pages, 5x8, illustrated, \$2.50.

A thoroughly revised edition of this practical book on radio fundamentals. The book gives a clear explanation of the essential information needed by students preparing to become licensed amateur and commercial radio operators.

**Nilson and Hornung**  
**Radio Operating Questions and  
Answers**

By ARTHUR R. NILSON and J. L. HORNUNG, Second Edition.  
267 pages, 5½x8, 91 illustrations, \$2.00.

This book, and its companion volume, Nilson and Hornung's *Practical Radio Telegraphy*, contain the essential information needed by students preparing to become licensed amateur and commercial radio operators. This second edition of *Radio Operating Questions and Answers* covers the latest laws and regulations governing radio operators and the operation of radio stations.

**Moyer and Wostrel**  
**Radio Receiving Tubes**

By JAMES A. MOYER, Director of University Extension, Massachusetts Department of Education and JOHN F. WOSTREL, Instructor in Radio Engineering and Supervisor in Charge of Industrial Subjects, Division of University Extension, Massachusetts Department of Education.  
296 pages, 5½x8, 181 illustrations, \$2.50.

In this book the essential principles underlying the operation of vacuum tubes are explained in as non-technical a manner as is consistent with accuracy. The book covers the construction, action, reactivation, testing and use of vacuum tubes as well as specifications for vacuum tubes and applications for distant control of industrial processes and precision measurements.

**Lauer and Brown**  
**Radio Engineering Principles**

By HENRI LAUER and HARRY L. BROWN.  
301 pages, 6x9, 227 illustrations, \$3.50.

A thorough revision and amplification of this standard work on the underlying principles of radio engineering. In addition to all that material contained in the first edition which applies to modern practice, much new material has been added.

Send the  
coupon today!

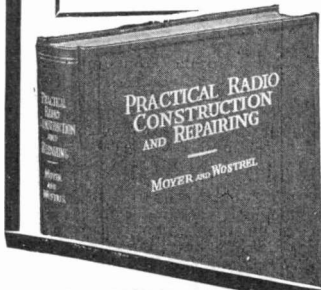

**McGraw-Hill**  
**FREE EXAMINATION COUPON**

McGraw-Hill Book Co., Inc., 370 Seventh Avenue, N. Y.  
Send me the books checked. I agree to either return the books in ten days or send my remittance at that time.

- ... Moyer and Wostrel—Radio Receiving Tubes, \$2.50.
- ... Nilson and Hornung—Radio Operating Questions and Answers, \$2.00.
- ... Lauer and Brown—Radio Engineering Principles, \$3.50.
- ... Moyer and Wostrel—Practical Radio, \$2.50.
- ... Moyer and Wostrel—Practical Radio Construction and Repairing, \$2.00.

Name .....  
Address .....  
Position .....  
Company .....

(Books sent on approval to retail purchasers in U. S. and Canada only.)

R. R. 9-29

**Now!**  
**—An Improved Beede  
Combination Tube and Set Tester**

No. 250  
With Screen  
Grid Test

List Price  
\$25.00

Dealer's  
Price  
\$15.00

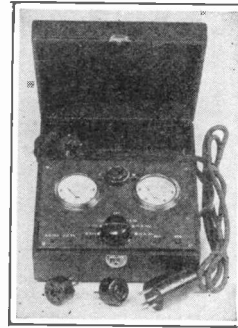

No. 20  
Without  
Screen Grid  
Test

List Price  
\$20.00

Dealer's  
Price  
\$12.00

**It Tests Screen Grid Tubes**

The advent of the screen grid set prompted the development of a new and better combination tube and set tester, with special attachment to test screen grid tubes. It makes all ordinary tests on A.C. and D.C. tubes and receiving sets also.

Every service-man, set builder, radio store and radio fan—should have this improved instrument. It has a large market—it offers a profit.

Get one for your own use. Write for details.

**Beede Electrical Instrument Co.**  
Manufacturers of Quality Battery Meters, Meters for Radio Use, Etc.  
PENACOOK, NEW HAMPSHIRE

You are reading  
**the Only**

radio or music trade publica-  
tion that has been admitted in-  
to membership of the Audit  
Bureau of Circulations and  
the Associated Business Pa-  
pers.

*Radio Retailing* has meas-  
ured up to unusually exacting  
standards of reader-selection,  
reader-interest and reader in-  
fluencing.

—a McGraw-Hill publication, to be sure.



# SEARCHLIGHT SECTION

EMPLOYMENT and BUSINESS OPPORTUNITIES—SURPLUS STOCKS—DISCONTINUED MODELS

**UNDISPLAYED—RATE PER WORD:**

*Positions Wanted*, 8 cents a word, minimum \$1.25 an insertion, payable in advance.  
*Positions Vacant* and all other classifications, 12 cents a word, minimum charge \$2.50.  
*Proposals*, 40 cents a line an insertion.

**INFORMATION:**

*Box Numbers* in care of any of our offices count 10 words additional in undisplayed ads.  
*Discount* of 10% if one payment is made in advance for four consecutive insertions of undisplayed ads (not including proposals).

**DISPLAYED—RATE PER INCH**

1 inch .....\$7.50  
 2 to 3 inches..... 7.25 an inch  
 4 to 7 inches..... 7.00 an inch  
 Rates for larger spaces, or yearly rates, on request.  
*An advertising inch* is measured vertically on one column, 3 columns—30 inches—to a page.  
 Radio Retailing

## RADEX

doubles the enjoyment of a radio set. That's why

**WE SELL**

**80,000**

**MONTHLY**

Alphabetical and Hour-by-hour Index to all Chain Programs.

Complete list of stations, alphabetically, geographically and by frequencies.

Merely entering a few dial readings calibrates any set.

*One reader writes: "Radio without RADEX is like a blind date in a flivver—you don't know where you're going or what you'll get when you get there."*

25c. the copy. \$2.00 a doz.

### THE RADEX PRESS

1367 E. 6th St., Cleveland, Ohio

### Sales Manager Available

Through an unusual circumstance, a rather widely known Sales Manager in the radio-music industry will be available September 1st. This man has a record of service with the Manufacturer, Jobber and Retailer. His experiences, over a period of years, have covered all these fields, and his record of accomplishment in each will prove most interesting to the proper party. Financially responsible, married, forty, and in excellent shape to do a real "job" for a good sound organization. Just address "Box K." PW-102, Radio Retailing, 520 N. Michigan Ave., Chicago, Ill.

**SPECIAL NOTICE:**

### To the Radio Industry

*Advertising in connection with legitimate offers of surplus stocks and discontinued models of radio merchandise is acceptable in this section of "Radio Retailing."*

*Extreme care will be exercised by the publishers to prevent the use of advertising in the Searchlight Section to encourage price cutting on current models of merchandise or equipment. Nor will advertising which invites violation of the dealer's contract with the manufacturer be acceptable.*

*All merchandise offered in the Searchlight Section must be accurately and fully described and must be available on order.*

**POSITIONS WANTED**

**RADIO** department manager, now employed, desires to make change. Capable taking charge sales, service and repairs. Excellent references. PW-96, Radio Retailing, Southwestern Bell Tel. Bldg., St. Louis, Mo.

**OFFICE** managers and other men fully experienced in Radio; capable of taking charge of sales, service and repair, can readily be obtained through an advertisement in the Searchlight section of Radio Retailing. Send your adv. today to Searchlight Department, Radio Retailing, Tenth Ave. at 36th Street, New York.

**SALESMEN WANTED**

**Salesmen On Commission**  
 To sell line of radio benches. Lowest prices for quality merchandise. Good territory open. Tillman Bros., La Crosse, Wis.

**SALESMEN AVAILABLE**

**IF YOU** are looking for salesmen to sell Radio or represent your complete line, insert an advertisement in the Searchlight Section of Radio Retailing for quick results. Radio Retailing's circulation is in excess of 25,000. Send your adv. today to Searchlight Department, Radio Retailing, Tenth Ave. at 36th St., New York.

### Surplus Stocks

When you have surplus stocks of radio equipment to sell—coils, tubes, sets, speakers, cabinets, insulators, etc., or when you are in the market to purchase such surplus stocks of other dealers—

Use a "Searchlight" Ad.

*Mr. Manufacturer and Mr. Jobber!*

How much money and space have you tied up in surplus stocks?

Turn them into working capital! We pay cash for surplus stocks of standard radio merchandise in any quantity.

Get our cash bid first! Write, wire or phone details today.

**AMERICAN SALES COMPANY,**

19-21 WARREN ST.  
 NEW YORK CITY

# SEARCHLIGHT SECTION

September, 1929  
Radio Retailing

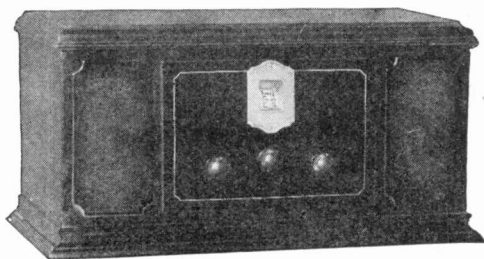

Electric CHELSEA Radio

Uses New 245 Power Tube  
Automatic Pick-up Jack  
Built-in Socket Antenna  
Provision for A.C. Dynamic  
Uses 4—226 1—227 1—245 1—280 Tubes

Four tuned Circuits  
Binocular Coils  
Illuminated Drum Dial  
Aluminum Shielded Chassis

Direct to Dealer  
from Manufacturer **\$35.00**

**CABINET** Made of selected woods with genuine Maple Burl panels, overlaid on four-way matched veneer. Hand-rubbed in dark brown Mahogany with glass-like lacquer finish. Massive and extremely beautiful, a true product of the cabinet maker's art. Size 24¼-in. x 12¼-in. x 12¼-in.

TERMS:—25% with order, balance C.O.D. 2% discount full cash remittance.

## BARTY RADIO COMPANY

11-42 31st Ave., Long Island City, N. Y.

Quantity mfrs. of Radio Receivers under private brands.

Cable Address—BARTYRAD EST. 1920 Tel. Astoria 5492



List Price \$30.00 ea.  
Reduced to \$15.00 ea.

## New *Algonquin* CONE SPEAKERS

Will stand powerful or weak volume equally well and reproduce with wonderful tone quality and volume.

Has a full-floating large 18-in. Cone, brought to the highest point of perfection. Made of a special impregnated fabric (not paper) which is absolutely unaffected by moisture or atmospheric conditions.

Equipped with an extremely sensitive electro-magnetic Cone unit with direct drive to Cone and is exact to highest degree. A beautifully designed Speaker with art metal scroll. Ship model. Finished in polychrome gold stipple.

Special **\$3.70** ea. Lots of 5 or more **\$3.25** ea.

American Sales Co., 19-21 Warren St., N. Y.

Over  
25,000  
other  
men  
in the  
Radio  
Industry  
will see  
this page—

Then isn't this the logical place to advertise any business wants you may have of interest to men in the Radio Industry? Employment — Business Opportunities — Surplus Stocks, etc.

# BUSINESS OPPORTUNITIES—

WHEN—

—You have surplus stocks of radio equipment to sell—coils, tubes, sets, speakers, cabinets, insulators, etc.

—You are in the market to purchase such surplus stocks of other dealers.

OR IF —

—There is anything you need now—dealers, salesmen, capital, etc.

—There is anything you want to sell—surplus stock, a complete business, a factory site—

THEN —

—Advertise in the Searchlight Section of RADIO RETAILING.

Address:

Searchlight Department

Tenth Ave. at 36th St., N. Y.

# We're running a Night Shift that Benefits your Day Shift

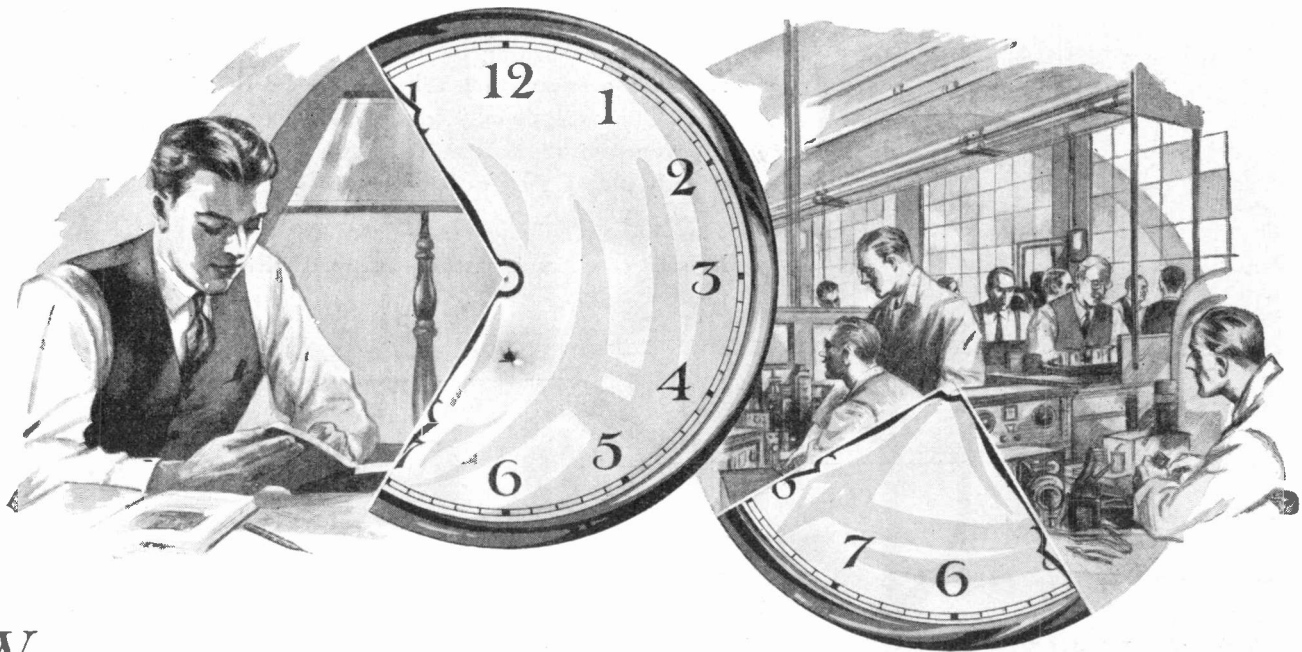

**W**HEN the world puts down its tools and turns to rest and pleasure, we carry on. When the shops are emptying, the study-lamps are lighted, and the great night shift of the N.R.I. buckles down to work.

Our raw material is ambition. Our process is education. And our product is trained men.

First the Process: It is a Radio Course of six construction sets, fifty lessons, and a number of extra texts. It teaches in a practical, down-to-brass-tacks way, the theory and practice of Radio Communication. It covers servicing of all the major circuits and sets—Atwater Kents, Radiolas, Crosleys, Grebes, Super-Zeniths, Philcos, Amrads, Freed-Eisemanns, Freshmans, Majestics, Stromberg-Carlsons . . . in all their various models. It teaches how to build, and sell, and install, and service, Receivers and Transmitters. It covers Radio from one end to the other.

And the Raw Material: Ambition must be made of lasting stuff to finish a year of work on the night shift. The men who complete our course must have grit and determination. It takes real grit to work during pleasure hours—

takes real determination to stick it out—and the man who has both is worth his salt.

Now the Product: N.R.I. graduates have made good and are making good in hundreds of important capacities in the Radio Industry—as engineering directors and managers, as chief service men, as sales managers, as short wave experts, as chief operators, as salesmen, as technicians, as executives, with large corporations and smaller concerns. Our men are making enviable records for themselves, for us, and for their employers.

N.R.I. men are ready to work for you—there are hundreds of them in all parts of the country.

Through our headquarters here in Washington, you can reach these men. They will bring to your day-shift the experience and training of our night-shift. They will give you more in honest, intelligent, ambitious effort than many of the men on your pay roll now.

When you need men, call on us for Trained Men—there is no cost, no obligation. We seek only your good will.

**N. R. I. Men are Making Good with:**

- Atwater Kent
- Amer. Bosch Magneto
- Brunswick
- Crosley
- De Forrest
- Freed-Eisemann
- Firestone
- General Electric
- Jenkins Television
- Sears Roebuck
- Stewart Warner
- Stromberg Carlson
- Victor Talking Mach.
- Westinghouse
- Western Electric
- Thos. A. Edison, Inc.
- R. C. A.
- and many more.

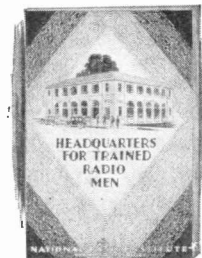

"Headquarters for Trained Radio Men" is a booklet for employers. We have spent hundreds of thousands of dollars equipping ourselves to help you. Our assistance costs you absolutely nothing—it can be worth a great deal.

The National Radio Institute  
Dept. S-RR  
16th and U Sts., N. W.,  
Washington, D. C.

Gentlemen:  
Please send me your Free Booklet, "Headquarters for Trained Radio Men."

Name .....  
Address .....



**NATIONAL RADIO INSTITUTE**  
16th and U Streets N.W.  
WASHINGTON, D.C.

**HEADQUARTERS FOR TRAINED RADIO MEN**



# NOW—cash in on fall buying

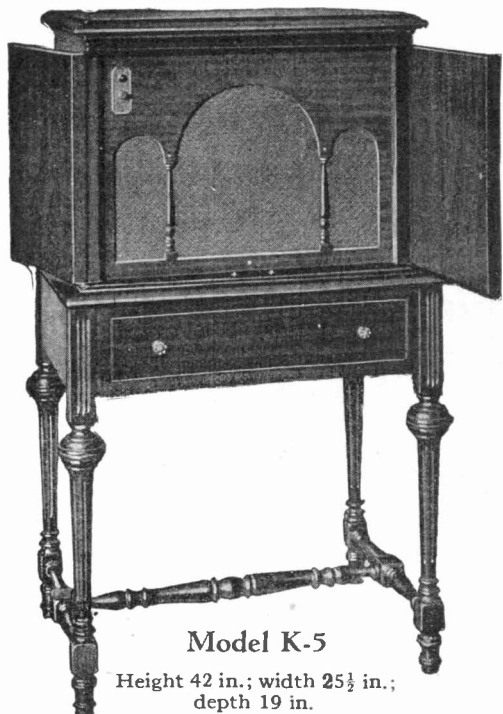

Model K-5

Height 42 in.; width 25½ in.;  
depth 19 in.

List Price \$175.00  
(without tubes)

**\$33.50!**

Lots of 5  
or more **\$29.50** Ea.

## FEATURES

1. Electro-Dynamic Reproducer (10¼-in. dia.).
2. 210 Power Amplifier. Fine tone quality.
3. Supplies "B" voltage, if desired.
4. Can be used with any electric or battery set.
5. Complete A.C. Electric operation.
6. Beautiful pencil-striped walnut cabinet.

## NOTE

All units offered in this advertisement are BRAND NEW, packed in original factory sealed carton and fully guaranteed.

TERMS: 20% cash with order, balance C.O.D. f.o.b., New York. (2% Discount for Full Remittance with order.)

Thousands of these famous KOLSTER sets were sold during the slack summer selling period. Now, with the added activity of the fall buying season they will be easier to sell than ever before! Stock up! Our exceptionally low prices mean sure sales and good profits for you—an ideal item to feature this fall. Many dealers have already placed their orders—get yours in today!

This radio equipment is KOLSTER built, packed in the original Kolster cases and cartons, shipped direct to us from the Kolster factory.

## K O L S T E R ELECTRO-DYNAMIC REPRODUCER

Combined with 210 Power Amplifier and "B" Supply Unit

**T**HIS finely matched, rugged unit comprises a complete heavy duty Electro-Dynamic Reproducer, including a 210 Power Amplifier with "B" supply unit, all self-contained on a steel frame. It weighs 45 pounds without the cabinet. The cabinet itself is of pencil-striped walnut, beautifully designed with Cathedral grille. It is equipped with switch for control of house current to reproducer, power unit and amplifier. A pilot light indicates when the Reproducer is in operation.

If desired the 210 Power Amplifier will also supply 22, 67 and 90 volts "B" current, sufficient for any set using up to 8 tubes. An automatic voltage regulator tube, UX-874, maintains the "B" voltage silent and steady.

This Electro-Dynamic Reproducer can be used with any battery or A.C. set, replacing the last audio stage or be used with all tubes of the set. Wherever used, it will bring out every shading and range of tone; every note is reproduced with utmost faithfulness, pure and undistorted. It will modernize any radio receiver.

The following tubes are required for its operation: 2-UX-281 (for full-wave rectification); 1-UX-210 (for super power amplification); 1-UX-874 (for voltage regulation). For use with phonograph pick-up, one additional audio stage is recommended between the pick-up and this Reproducer.

A 20-ft. cable is included with each instrument. Operates direct from 50-60 cycle, 110-120 volt A.C. current.

Licensed Under Patents of the Radio

**AMERICAN SALES COMPANY**

# with these low-priced KOLSTERS!

Every Set and every Electro-Dynamic Reproducer is BRAND NEW; each bears the Kolster guarantee tag and original serial number.

Our ability to buy these world-famous KOLSTER RECEIVERS and REPRODUCERS for cash, enables us to offer them at remarkably low prices, a fraction of their original cost.

And we control the exclusive sale of this merchandise as we have bought the entire stock.

Even special lower prices are offered on purchases of these sets in lots of five or more—Think it over!

## K O L S T E R SIX TUBE CONSOLE RECEIVER

With Built-in Kolster Electro-Dynamic Reproducer

**T**HE entire set can be operated direct from the A.C. light socket, 50-60 cycle, 110-120-v., by simply adding any "A" supply unit and a small  $4\frac{1}{2}$ -volt "C" battery. The built-in Electro-Dynamic Power Reproducer furnishes the "B" supply current to the set. A switch snaps the receiver in or out of operation and a pilot light tells instantly when set is in operation. The single dial control makes this the simplest of receivers to operate.

This receiver employs the famous Kolster T.R.F. circuit. It operates on either indoor or outdoor antenna using three stages of R. F., detector and two stages of A. F. The three point tap switch aerial adjuster operated from panel gives hairline selectivity. A loose coupled coil in conjunction with tap switch increases the distance getting value of the receiver. In addition, the 210 power amplifier built into the model K-5 Dynamic Reproducer, achieves remarkable tone quality. In this receiver is embodied everything looked for in modern radio.

The combination Kolster Set and Electro-Dynamic Reproducer is housed in a beautiful console of burled walnut with maple overlay. Full swinging doors found only in the finest cabinets add to its beauty.

The receiver uses 6-UX 201-A tubes and the Electro-Dynamic Reproducer uses 2-UX 281, 1-UX210, and 1-UX 874 tubes.

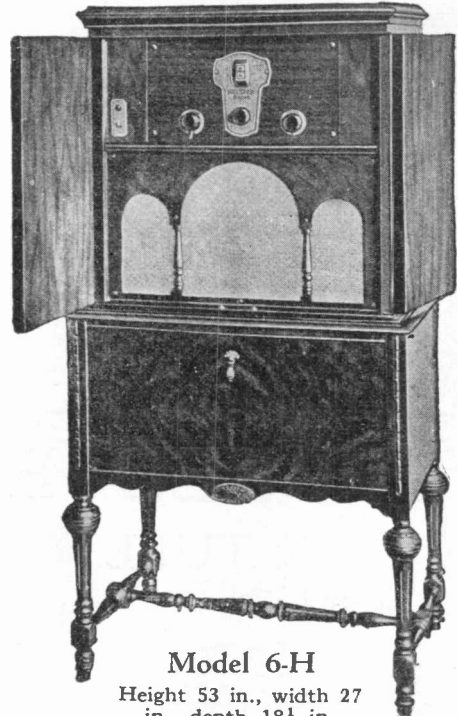

Model 6-H

Height 53 in., width 27  
in., depth  $18\frac{1}{2}$  in.

List Price \$295.00  
(without tubes)

**\$48.50!**

Lots of 5  
or more **\$44.50** Ea.

### FEATURES

1. Beautiful highboy console of burled walnut with maple overlay.
2. Kolster K-5, Electro-Dynamic Reproducer with built-in 210 Power Amplifier included for fine tone quality (see opposite page).
3. Famous Kolster 6-tube T.R.F. circuit.
4. Hairline selectivity. Distance Reception.
5. Single dial control—simple to operate.

### MANUFACTURERS AND JOBBERS

We are prepared to offer cash for surplus stocks of Radio Merchandise. This means of course stock in first class condition and in such volume that insures a good value to our many established buyers. Send details of your offerings for quick action.

Corp. of America and Lektophone Corp.

19-21 Warren St., New York City



Size 6"x5"x3 1/2"

# AEROVOX or Dubilier

## High Voltage Filter Condenser Blocks

Finest non-inductive High Voltage Filter Block. Made to be used with UX-250 Power Tubes but can be used safely in filter circuits of eliminators or high power Amplifiers in any combination of capacities desired.

Each Unit is equipped with long, heavy, flexible insulated leads, convenient for easy wiring, and also has mounting brackets. Latest design.

The insulation resistance of these Condenser Blocks is in excess of R.M.A. and N.E.M.A. standard requirements.

Due to the request of the manufacturers of these Condenser Blocks we cannot divulge the high list price of same.

| RATED D. C. CAPACITY |        | WORKING VOLTAGE |
|----------------------|--------|-----------------|
| 2.0 mfd.             | 1000 V |                 |
| 1.0 "                | 800 V  |                 |
| 1.0 "                | 800 V  |                 |
| 3.0 "                | 400 V  |                 |

**Special \$2.50**

per block

# FREED-EISEMANN

## SIX TUBE NEUTRODYNE RECEIVER

(For Battery Operation)

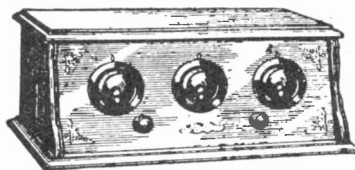

Model No. 130

List Price **\$80.00**  
(less tubes)

Size  
18 1/2" x 10 1/2" x 9 3/4"

### Features:

- Completely Shielded
- 3 Stages R.F., 1 Detector,
- 2 Audios (1 Power Tube)
- Stippled Panel
- Genuine Mahogany Cabinet—
- Cable Attachment

An excellent number for customers preferring an inexpensive set. This Freed-Eisemann Set is ideal for portable use.

Built of the finest of parts. Uses 5—UX-201A tubes and 1—UX-171A tube. Wired for "C" Battery.

**Special \$9.50**

Lots of 5 or more **\$9.00 ea.**

### The New Gould Kathanode

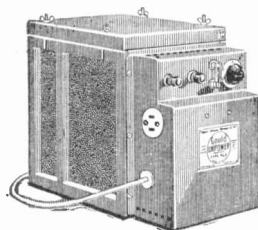

List Price \$39.50

# Unipower

GOULD PRODUCT  
(With Built-in Relay)

Automatic Radio "A" Power From Light Socket

Model A.C.—6 K (Six Volt)  
Furnishes rich, smooth, unflinching "A" current, without any trace of hum. No rewiring necessary in your set. Equipped with a new noiseless Balkite Charging Unit which has four graduated charging rates and in addition one booster rate (1 1/2 amperes) for an emergency charge, which enables it to properly take care of all sizes of sets and conditions of operation. Operates on 110-120 V., 50-60 cycle A.C. current. Complete with extra fuse.

**Special \$9.75**

Lots of three—**\$8.50 ea.**  
Lots of six—**\$7.50 ea.**

### Genuine RCA UX200 Radio Tubes



List Price \$1.75 ea.

Bakelite UX face detector tube drawing one ampere.

Due to the extreme low prices of these tubes, we cannot allow replacements. However, every tube is brand new and packed in the original factory sealed carton, we having purchased them direct from the Radio Corporation of America.

**Special 13c ea.**

\$6.50 Per Carton

Sold only in Carton Lots of 50.

### POWERIZER



PXY-1 MODEL R-20

Complete "A B & C" Eliminator and 210 Power Amplifier

It is a "B & C" Eliminator furnishing "B & C" current to the entire Radio Set, also a Super Power Amplifier furnishing "A, B & C" current to the 210 power amplifying tube. Simple to connect, no rewiring necessary in the set. Comes equipped with an adapter plug which is inserted in the last audio tube socket. Has filament windings which will also supply A.C. current for the A.C. tubes, if desired. Uses the UX-210 super power and the UX-280 full wave rectifying tubes. Using this Powerizer with any Battery or Electric Set will bring out the finest tone reproduction and volume, comparable with the results obtained from any of the best modern receivers. Operated direct from light socket: 110-120 V., 50-60 cycle, A.C. current.

LIST PRICE \$59.00 EA.

**Special \$15.00**

(Complete with Harness)

### Manufacturers and Jobbers !

We are prepared to offer cash for surplus stocks of Radio Merchandise. This means of course stock in first class condition and in such volume that insures a good value to our many established buyers. Send details of your offerings for Remittance with order.

American Sales Company, 19-21 Warren St., New York

**EAGLE** Power • Clarity • Tone Volume **EAGLE**  
Audio Transformers Audio Transformers

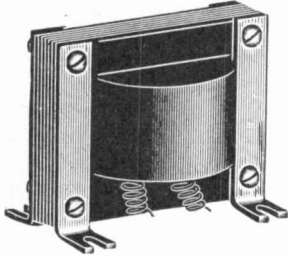

**Eagle Type U**

An excellent replacement transformer, will fit into any convenient place in set. Loose leads facilitate easy wiring.

The repair man's utility trans. Ratios: 3-1; 5-1.

**NET 65c ea.**

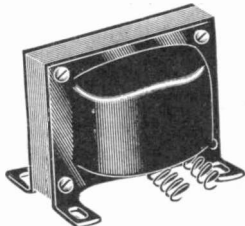

**Eagle Type L**

Highly finished black japan, with loose leads, very convenient for set builders and replacements because of its compactness and size.

Ratios 3-1; 5-1.

**NET 75c ea.**

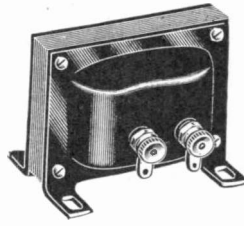

**Eagle Type H.B.**

Highly finished black japan — small, compact, ready to replace in any set. With binding posts.

Ratios 3-1; 5-1.

**NET 85c ea.**

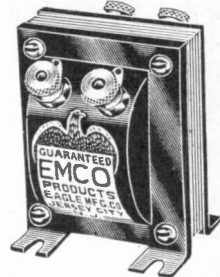

**Eagle Type V.B.**

Highly finished in black japan. Ratios 3-1; 5-1.

**NET 95c ea.**

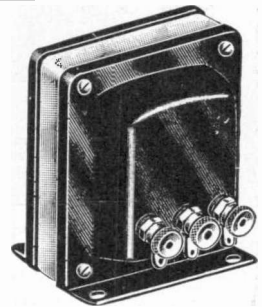

**Push-Pull**

Input and Output

Use of these two highly advanced transformers in the last stage audio amp. in conjunction with two 245 or UX171A will give maximum volume and clarity.

**NET \$3.00 per pr.**

The "EAGLE" transformers cover the entire audible scale of frequencies. Reproduces both the high and low notes equally and with natural fidelity. They are low priced, and you cannot obtain better transformers for more money. Stock these transformers and double your investment.

A TRANSFORMER FOR EVERY NEED



**Mayola Replacement Block (Zenith)**

Designed for replacements in all Zenith electric sets that use a 280 rectifier tube. These units are composed of high voltage condensers throughout. Will stand more current than any Zenith set can give it. Flexible wire leads off each tap. Complete hook-up instructions with every block. This unit will serve for a good many other purposes. Put a Mayola Block in the set and forget about future troubles. Net \$5.50 Lots of six \$29.00

**Dry "A" Eliminator Replacement Condenser (Dubilier)**

Serves as a universal replacement condenser in all "A" eliminators. Majestic, Kodak, Fada, Knapp A Power, Greene-Brown, Sterling, etc. It will also eliminate hum from dynamic speakers. The Dubilier "A" after detailed analysis and tests, is rated by the laboratory of the world's largest communication corporation as superior to every other make. Its features of construction insure the user of long, satisfactory service. 2000 mfd., polarized electrolytic dry "A". Dealers Net Price \$2.70 each. 4000 mfd. \$1.50 net. 6000 mfd. 6.60 net.

**Mayola Majestic Eliminator**

Replacement Condenser Block

A replacement block for Majestic eliminators, which is guaranteed by the Mayola Laboratories for a period of one year.

The condensers in this block are all composed of high voltage condensers, and you can be assured that once this block is installed it will last indefinitely.

For Majestic Special B Net \$4.65

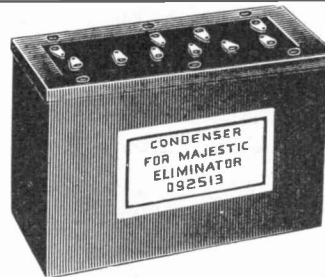

**Net \$4.50**

In lots of 6 \$25.00

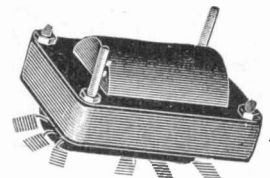

**Eagle (Unshielded) Push-Pull Transformers**

Designed for set manufacturers and set builders.

It also makes an excellent replacement Push-Pull Transformer.

**NET 95c ea.**

**Variable Wire Wound Resistance on Baked Lava Tube**



0 to 25000 ohms Variable Resistance

Variable wire wound, heavy duty, used on any radio circuit, B eliminators, amplifiers, electric sets, etc. When the desired voltage is obtained it can be set and it will not vary due to the positive contact. It will take the place of 2 to 4 variable resistances. Net 65c.

| DUBILIER FILTER CONDENSERS |        |         |
|----------------------------|--------|---------|
|                            | List   | Net     |
| 1 mfd.                     | \$2.00 | \$ 1.40 |
| 2 mfd.                     | 2.25   | .60     |
| 4 mfd.                     | 3.50   | 1.00    |
| 6 mfd.                     | 5.00   | 1.50    |

| DUBILIER BY-PASS CONDENSERS |        |        |           |
|-----------------------------|--------|--------|-----------|
|                             | List   | Net    | Doz. lots |
| .1 mfd.                     | \$1.00 | \$ .25 | \$2.61    |
| .25 mfd.                    | 1.10   | .28    | 3.00      |
| .5 mfd.                     | 1.25   | .30    | 3.36      |
| 1. mfd.                     | 2.00   | .35    | 3.65      |

Dubilier By-Pass 1 mfd., Type 656 \$3.10 per doz.

Polymet Filter Condensers 1/10 mfd. 15c. each.

**RESISTANCES, Fixed Wire Wound Baked on Lava tubes**

18,000 ohms (Total)  
With fixed taps as follows:  
1500—4500—3300—6500—  
2200 ohms.

11000 ohms with fixed taps as follows:  
300—1300—4300—3000—  
2100 ohms.

These resistances can be used for a thousand purposes. In view of the low price we cannot sell less than 12. Every repair man should have them in stock. 12 for \$3.60.

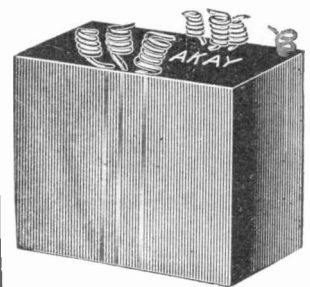

**Atwater Kent Replacement Unit**

(For Atwater Kent Electric Set Model No. 37)

This unit contains the proper chokes and high voltage condensers. All flexible wire colored leads identical to the original. Fully guaranteed.

**NET \$7.50**

**Federated Purchaser**

A National Organization Serving Over 10,000 Retail Merchants

16-22 Hudson Street, New York, N. Y.

Telephone Barelay... 7583  
7584

If you have not received our "Radio Bargain News," send for FREE copy today. It contains \$100,000 worth of radio merchandise at prices more than 75% off the regular list. Permit us to place your name on our mailing list.

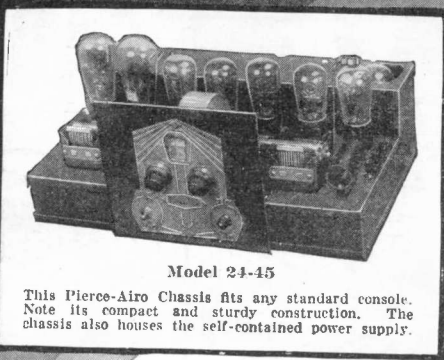

Model 24-45

This Pierce-Airo Chassis fits any standard console. Note its compact and sturdy construction. The chassis also houses the self-contained power supply.

# UNDISPUTED LEADERSHIP!

## PIERCE AIRO

The NEW SCREEN-GRID: Model 24-45 is, justly termed the "PERFECT RADIO" Chassis. Jobbers and dealers—well informed in Radio, have chosen this new job in preference to all others: *Truly an Undisputed Leader*, surpassing all others for—construction, performance, price.

### The Modern Way to Sell Radios

More and more radio dealers realize that the Pierce-Airo way is the logical way to sell radios today. With a super-performing chassis like the Pierce-Airo, and a variety of consoles for the prospect to choose from, sales are not only more easily made but they are more profitable because you can set your own selling price and make your own profit. Sell the Pierce-Airo way. Make the Pierce-Airo your leader. It will make you more customers and boost your profits.

See our exhibit at N. Y. Radio World's Fair, Booth Z, Sec. 1

Samples are ready for delivery. Write for net prices and full particulars.

PIERCE-AIRO, INC., 113R Fourth Ave.  
New York City

### Pierce-Airo Chassis Features

1. Employing the new 224 Shield Grid Tube.
2. Uses the new 245 tube, insuring increased volume without the consequent distortion.
3. Provision is made for regulation of line voltages in various localities, insuring longer life of tubes.
4. With a Pierce-Airo Chassis either an A.C. or D.C. dynamic speaker can be used.
5. Has automatic phonograph pick-up.

|                               | Page               |
|-------------------------------|--------------------|
| A-C Dayton Co.                | 44-45              |
| Acme Elec. & Mfg. Co.         | 166                |
| Acme Wire Co.                 | 180                |
| Adler Mfg. Co.                | 112-134            |
| Allen Hough-Carryola          | 101                |
| Aluminum Co. of America       | 43                 |
| American Bosch Magneto Co.    | 116-117            |
| American Weekly               | 151                |
| Anrad Corp.                   | 157                |
| Anaconda Wire & Cable Co.     | 177                |
| Andrea, F. A. D.              | 171                |
| Arcturus Radio Co.            | 144-145            |
| Atwater Kent Mfg. Co.         | 107-108-109-110    |
| Audak Co.                     | 100                |
| Audiola Radio Co.             | 181                |
| Bakelite Corp.                | 150                |
| Balkeitt Radio Co.            | 130                |
| Beede Elec. Instrument Co.    | 182                |
| Beiden Mfg. Co.               | 104-105            |
| Best Mfg. Co.                 | 136                |
| Bohn Aluminum Corp.           | 26                 |
| Bodine Electric Co.           | 141                |
| Bond Elec. Corp.              | 48-49              |
| Brach Mfg. Corp., L. S.       | 168                |
| Brandes Corp., The            | 133                |
| Bremer Tully Mfg. Co.         | 159                |
| Browning-Drake Corp.          | 149                |
| Brunswick-Balke-Collender Co. | 138                |
| Bush & Lane Piano Co.         | 165                |
| Cable Radio Tube Corp.        | 34                 |
| Cannon & Miller               | 177                |
| Capehart Auto. Phono. Corp.   | 119                |
| Caswell Mfg. Co.              | 172                |
| Ce Co Mfg. Co.                | 126-127            |
| Central Radio Lab.            | 175                |
| Champion Radio Works, Inc.    | 39                 |
| Colonial Radio Corp.          | 129                |
| Continental Radio Corp.       | 135                |
| Cornish Wire Co.              | 24                 |
| Crosley Radio Corp.           | 143                |
| Cunningham Inc., E. T.        | 173                |
| Dayton Co., A. C.             | 44-45              |
| Day Fan Elec. Co.             | 160                |
| DeForest Radio Co.            | 106                |
| Duovac Radio Tube Corp.       | 29                 |
| Ebert Furn. Co.               | 179                |
| Edison Co., Inc., Thos. A.    | 103                |
| Electrad, Inc.                | 168                |
| Electrical Research Lab.      | 152                |
| Farrand Mfg. Co.              | Inside Front Cover |
| Freed Eisemann Radio Corp.    | 94-162             |
| French Battery Co.            | 115                |
| Freshman Co., Inc., Chas. H.  | 94-162             |
| Gold Seal Elec. Co., Inc.     | 147                |
| Grebe & Co., Inc., A. H.      | 5                  |

### ALPHABETICAL INDEX TO ADVERTISEMENTS

|                                    | Page              |
|------------------------------------|-------------------|
| Grigsby-Grumow Co.                 | 35                |
| Gulbrandsen Co.                    | 28                |
| Hickok Elec. Instr. Co.            | 168               |
| Holcomb & Hoke Mfg. Co.            | 140               |
| Hygrade Lamp Co.                   | 36                |
| Hytrol Corp.                       | 176               |
| Hyvac Radio Tube Co.               | 163               |
| Insuline Corp. of America          | 161               |
| Janette Mfg. Co.                   | 174               |
| Jensen Radio Mfg. Co.              | 146               |
| Jewell Elec. Instrument Co.        | 153               |
| Juno Fasteners, Inc.               | 177               |
| Kellogg Switchboard & Supply Co.   | 114               |
| Kennedy, Inc., Colin B.            | 10-11             |
| Ken-Rad Corp., Inc.                | 4                 |
| Kolster Radio Corp.                | 154               |
| La Salle Radio Corp.               | 8-9               |
| Leutz, Inc., C. R.                 | 6                 |
| Magnavox Co.                       | 16                |
| Mandel Elec. Co.                   | 179               |
| Marvin Radio Tube Co.              | 17-18             |
| McGraw-Hill Book Co.               | 182               |
| Mertz Specialty Co.                | 172               |
| Miles Mfg. Co.                     | 181               |
| Mills Novelty Co.                  | 37                |
| Muter Co., Leslie F.               | 167               |
| National Carbon Co.                | 46-47-139         |
| National Carbon Co., Raythcon Div. | Front Cover 180   |
| National Self-Feeding Iron Co.     | 177               |
| Norden-Hauck, Inc.                 | 173               |
| Operadio Mfg. Co.                  | 27                |
| Oxford Radio Co.                   | 169               |
| Pacent Elec. Co.                   | 120-121           |
| Perryman Elec. Co.                 | 49                |
| Pierce Airo, Inc.                  | 190               |
| Pilot Radio & Tube Corp.           | 23                |
| Potter Co.                         | 178               |
| Premax Prod. Inc.                  | 142               |
| Premier Elec. Co.                  | 174               |
| Radio Corp. of America             | 80-81, Back Cover |
| Radio Master Corp.                 | 111               |
| Radio Mfrs. Show Ass'n.            | 178               |
| Radio Receptor                     | 176               |
| Readrite Meter Works.              | 41                |
| Red Lion Cabinet Co.               | 113               |
| Rola Co.                           | 174               |

|                                      | Page              |
|--------------------------------------|-------------------|
| Samson Electric Co.                  | 148               |
| Sentinel Mfg. Co.                    | 42                |
| Showcarder, Inc.                     | 178               |
| Silver-Marshall, Inc.                | 118               |
| Simplex Radio Co.                    | 175               |
| Sleeper Research Lab.                | 164               |
| Sonora Phono. Co., Inc.              | 124-125           |
| Souatron Tube Co.                    | 7                 |
| Sparks-Withington Co.                | 31                |
| Steinite Radio Co.                   | Inside Back Cover |
| Stewart-Warner                       | 12-13             |
| Sterling Mfg. Co.                    | 32-33             |
| Supreme Instruments Corp.            | 102               |
| Stromberg-Carlson Tel. Mfg. Co.      | 2                 |
| Sylvania Prod. Co.                   | 50                |
| Televoical Corp.                     | 30                |
| Thermatrol Mfg. Co.                  | 172               |
| Thordarson Elec. Mfg. Co.            | 96                |
| Tomari & Co., E.                     | 132               |
| Transformer Corp.                    | 98                |
| Trav-Ler Mfg. Corp.                  | 137               |
| Triad Mfg. Co.                       | 156               |
| Trimm Radio Manufacturing Co.        | 181               |
| Udell Works, Inc.                    | 180               |
| United Reproducers Corp.             | 19-20-21-22       |
| United States Radio & Television Co. | 122-123           |
| Universal Winding Co.                | 173               |
| Utah Radio Prod. Co.                 | 3                 |
| Valley Appliances                    | 131               |
| Van Horne Tube Co.                   | 25                |
| Wasmuth-Goodrich Co.                 | 178               |
| Webster Elec. Co.                    | 158               |
| Weston Elec. Instrument Co.          | 38                |
| Wirt Co.                             | 155               |
| Wood Cabinet Corp.                   | 14-15             |
| Wright De Coster, Inc.               | 176               |
| Zenith Radio Corp.                   | 128               |

### SEARCHLIGHT-SECTION

|                          |             |
|--------------------------|-------------|
| Classified Advertising   |             |
| BOOKS                    |             |
| Radex Press              | 183         |
| BUSINESS OPPORTUNITIES   | 183         |
| EDUCATIONAL              |             |
| National Radio Institute | 185         |
| EMPLOYMENT               | 183         |
| RADIO STOCKS             |             |
| American Sales Co.       | 183-4-6-7-8 |
| Barty Radio Co.          | 184         |
| Federated Purchaser      | 189         |



# Steinite

**SUPER SCREEN-GRID RADIO**

The Set *and* the Price that are *thrilling* America

Again—Steinite thrills America with a great new set—and a startling price! The set is the product of a research department years ahead; of an organization which has the ability and experience to anticipate public preference in radio—and meet it at a price!



LESS TUBES



THE price is the result of tremendous facilities, of modern mass production methods made possible by an overwhelming public demand... a demand which grows and grows because Steinite has consistently offered America's greatest value! And the price is, also, the result of one-profit manufacture—from cabinets down to the smallest unit, the Steinite is made *completely* in Steinite's own factories!

Steinite presents a SUPER screen-grid radio with all that is new combined with a rich, full tone.

This Full Page Ad Appears in the Saturday Evening Post of September 21<sup>st</sup> —AND MORE TO COME!

Now—MORE THAN EVER—  
"AMERICA'S GREATEST VALUE!"

1. Linear power detection with automatic grid bias.
2. Push-pull audio power stage, using the newest "245" tubes.
3. Real humless reception.
4. "Battleship" chassis construction; completely shielded.
5. ELECTRO-Dynamic speaker.
6. Glorious tone.
7. Magnificent consoles.

(Licensed under the patents and patent applications of Radio Corp. of America and associated companies and the Radio Frequency Laboratories.)

The Steinite organization is tuned to achievement. Years ago, it gave the first low-priced electric set to America. Today, Steinite's new set—and Steinite's amazing price—are flashing, brilliant stars in the radio sky. Go to a nearby Steinite dealer at once—and accept the verdict your sense of values will render. Learn the thrill which comes with Steinite ownership—a thrill which millions have discovered!

**DEALERS!** Protect yourself now by making application for your franchise at once

**STEINITE RADIO COMPANY**  
Fort Wayne, Indiana

**A Radiotron  
for every purpose**

- RADIOTRON UX-201-A**  
*Detector Amplifier*
- RADIOTRON UV-199**  
*Detector Amplifier*
- RADIOTRON UX-199**  
*Detector Amplifier*
- RADIOTRON WD-11**  
*Detector Amplifier*
- RADIOTRON WX-12**  
*Detector Amplifier*
- RADIOTRON UX-200-A**  
*Detector Only*
- RADIOTRON UX-120**  
*Power Amplifier*
- RADIOTRON UX-222**  
*Screen Grid Radio  
Frequency Amplifier*
- RADIOTRON UX-112-A**  
*Power Amplifier*
- RADIOTRON UX-171-A**  
*Power Amplifier*
- RADIOTRON UX-210**  
*Power Amplifier Oscillator*
- RADIOTRON UY-224**  
*Screen Grid Radio  
Frequency Amplifier  
(A.C. Heater)*
- RADIOTRON UX-240**  
*Detector Amplifier for  
Resistance-coupled  
Amplification*
- RADIOTRON UX-245**  
*Power Amplifier*
- RADIOTRON UX-250**  
*Power Amplifier*
- RADIOTRON UX-228**  
*Amplifier  
(A.C. Heater)*
- RADIOTRON UY-227**  
*Detector Amplifier  
(A.C. Heater)*
- RADIOTRON UX-280**  
*Full Wave Rectifier*
- RADIOTRON UX-281**  
*Half Wave Rectifier*
- RADIOTRON UX-874**  
*Voltage Regulator Tube*
- RADIOTRON UV-878**  
*Ballast Tube*
- RADIOTRON UV-886**  
*Ballast Tube*

The standard by  
which other vacuum  
tubes are rated



Look for this mark  
on every Radiotron



**CHARLES EDISON**

President THOMAS A. EDISON, Inc. 1929

"Before releasing them to our dealers we test the performance of Edison receiving sets with RCA Radiotrons. We do this because they do full justice to a product of which we are proud. So that purchasers may receive maximum satisfaction from our instruments we recommend to our dealers RCA Radiotrons for initial equipment and for replacement."

*Charles Edison*

The leading makers of radio sets hold on a quality basis and recommend RCA Radiotrons for tests, initial equipment and for replacement. If you wish to get the finest performance of which your receiving set is capable, replace all of your vacuum tubes once a year at least. Old tubes left in with new ones impair the efficiency of the others.

**RCA RADIOTRON**

RADIOTRON DIVISION  
RADIO-VICTOR CORPORATION OF AMERICA NEW YORK CHICAGO ATLANTA DALLAS SAN FRANCISCO

**RCA Radiotrons are recognized by manufacturers and the public alike as the finest quality of vacuum tubes that can be produced. Because of their national acceptance they are the easiest radio merchandise to sell. The dealer who carries a complete line of them, and has them always in stock, is assured of a profitable tube business the year around.**

Superior resources of research and manufacturing guarantee to RCA Radiotrons the finest possible quality in vacuum tubes. They are the standard of the industry—and so accepted by both the trade and the public.



The national magazine advertisement reproduced at the left is one of the 1929 Radiotron series, each of which carries the signature of a leading radio manufacturer.

RADIO-VICTOR CORPORATION OF AMERICA · NEW YORK · CHICAGO · ATLANTA & DALLAS · SAN FRANCISCO  
RADIOTRON DIVISION

**RCA RADIOTRON**

RADIOTRONS ARE THE HEART OF YOUR RADIO SET