

A McGraw-Hill
Publication

January
1927

Radio Retailing

The Business Magazine of the Radio Industry

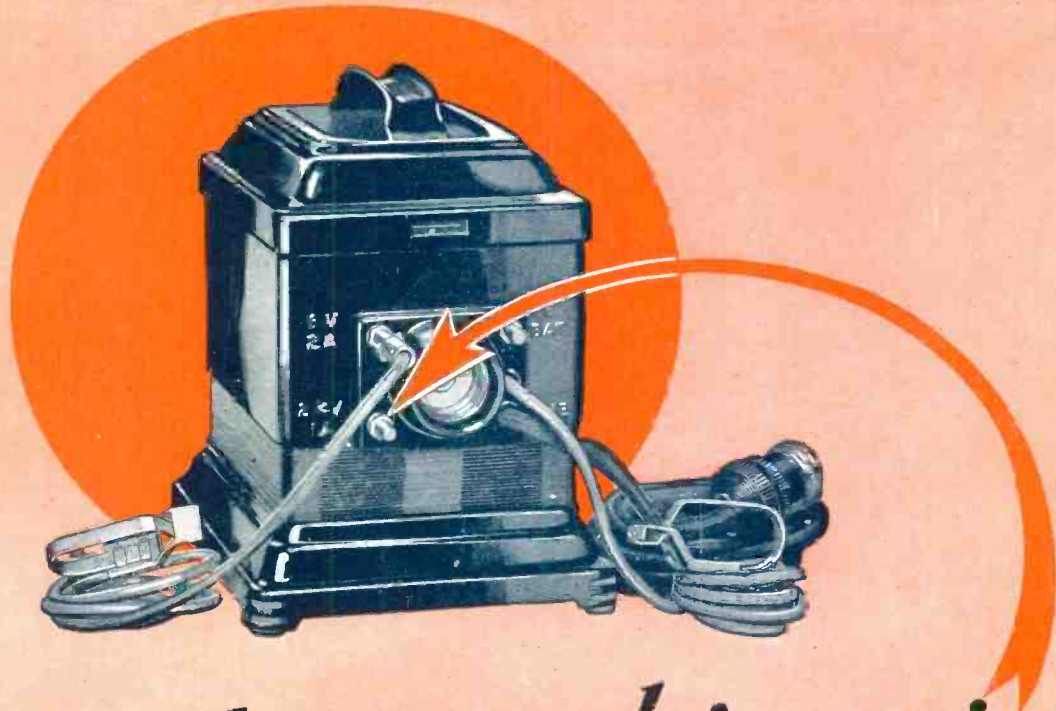

Do you know *this point*

The G-E 2 ampere Tungar battery charger will *trickle charge* a 6 volt battery from its 2/4 volt tap. Think of it! A trickle charge or a full 2 ampere boost when needed.

This is one of the points that makes Tungar a "best seller." Emphasize it and increase your profit.

 **Tungar**
REG. U.S. PAT. OFF.
BATTERY CHARGER

Merchandise Department
General Electric Company
Bridgeport, Conn.

*Tungar—a registered trademark—is found only
on the genuine. Look for it on the name plate.*

GENERAL ELECTRIC

Cunningham

RADIO TUBES

Since 1915
Standard for all sets

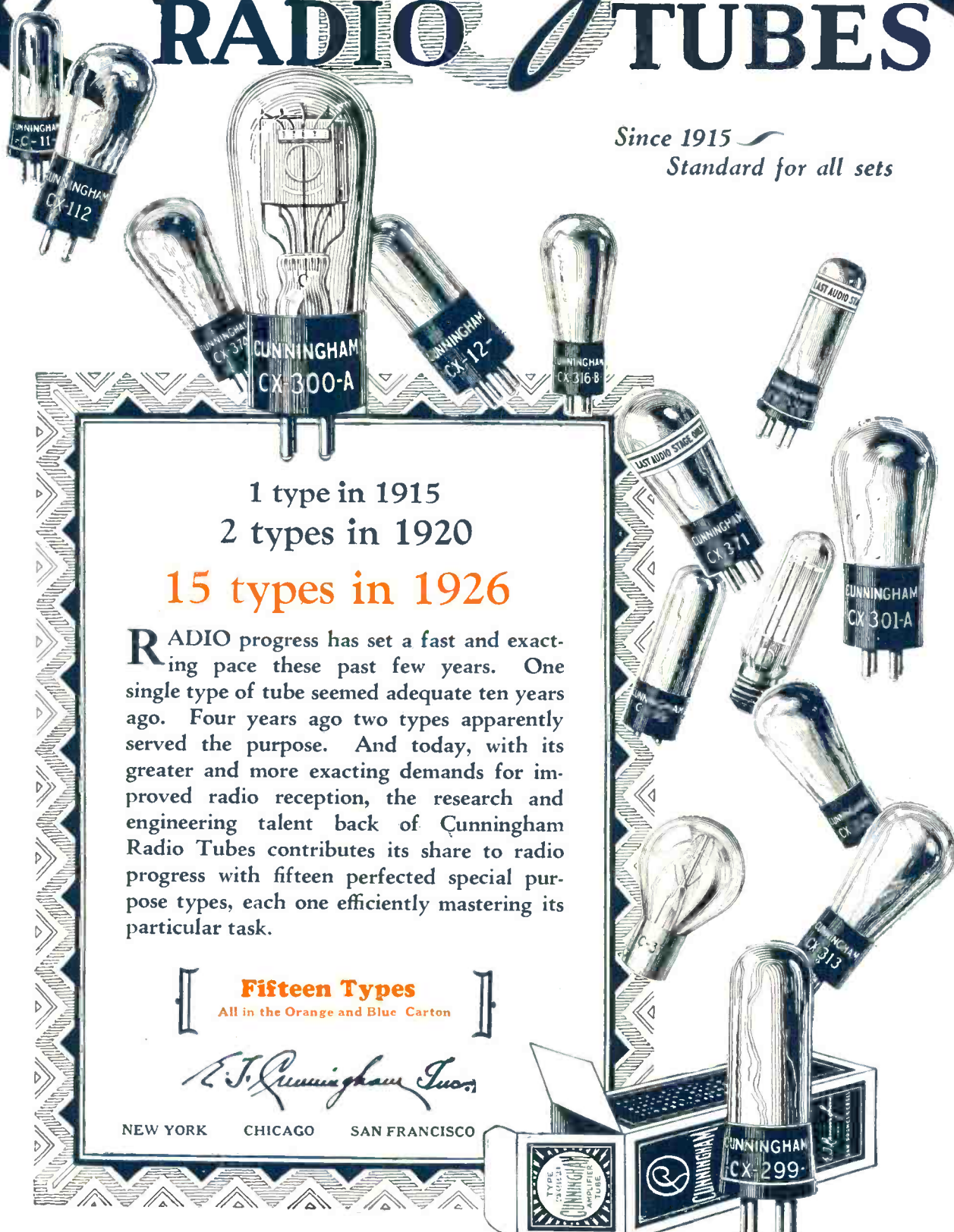

1 type in 1915
2 types in 1920

15 types in 1926

RADIO progress has set a fast and exacting pace these past few years. One single type of tube seemed adequate ten years ago. Four years ago two types apparently served the purpose. And today, with its greater and more exacting demands for improved radio reception, the research and engineering talent back of Cunningham Radio Tubes contributes its share to radio progress with fifteen perfected special purpose types, each one efficiently mastering its particular task.

Fifteen Types

All in the Orange and Blue Carton

E. J. Cunningham, Inc.

NEW YORK CHICAGO SAN FRANCISCO

GUARANTEE

Buy a **Utah** and use it for two weeks. Compare its tone with the best the others are able to produce. **If the Utah does not give better reception** return it to your dealer and **he will refund your money.**

IT'S HERE

The Sensation of 1927

The Newest Addition to the World's Most Complete Line of Speakers.

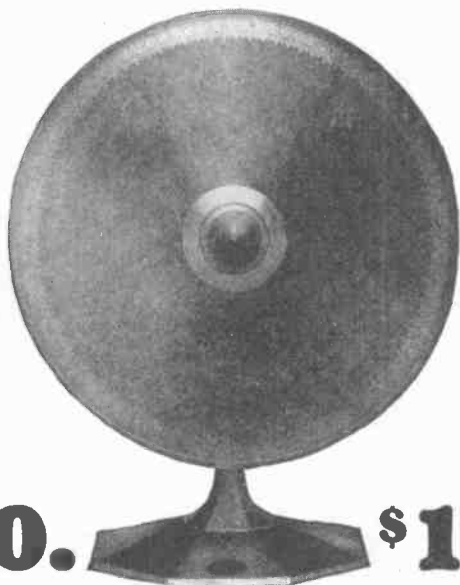

\$10. \$10.

The New

UTAH CONE SPEAKER

14½ in. high

Also Utah Cone Speaker

Free Edge **\$16.00**
17½ in. high

UTAH STANDARD

14-in. Bell

\$22.50

The Speaker with the Golden Throat

UTAH JUNIOR

11-in. bell

\$12.50

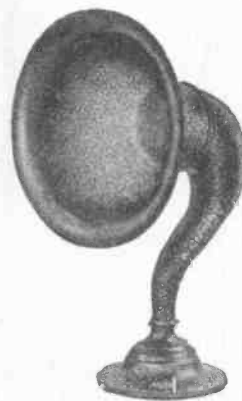

UTAH SUPERFLEX

Reg. U. S. Pat. Off.

\$10.00



UTAH BOOK SPEAKER

Looks like an open book 17x13½

\$19.00



The only complete line of speakers on the market.

We are manufacturers—not assemblers.

Trade Mark Registered

Utah Radio Products Co., 1421 So. Michigan Ave., Chicago



No. 502 Receiver, Art Console. Price, less accessories but including external Cone Speaker, East of Rockies \$325; Rockies and West \$355; Canada \$380.

No. 602 Universal Receiver, Art Console. Price, without accessories but including external Cone Speaker, East of Rockies \$365; Rockies and West \$400; Canada \$475.

Receivers that SELL and STAY SOLD

Stromberg-Carlson Receivers Sell, because—

They have been associated in the public mind for three years as Receivers of outstanding excellence. They possess striking beauty, the result of masterly cabinet designing. They have the impetus of an intensive, well-organized advertising campaign.

Stromberg-Carlson Receivers Stay Sold, because—

In Tone, Volume, Range and Selectivity the performance fulfills the expectations of the most exacting buyer.

Stromberg-Carlson Dealers are Assured Good Profit, because—

The use of high grade materials, carefully assembled, and rigidly inspected, protects the dealer from profit-eating service calls. The guarantee which only an authorized dealer can issue, makes it advantageous for purchases to be made only from such a dealer. The factory guarantees not to reduce prices.

STROMBERG-CARLSON TELEPHONE MFG. CO.

Rochester, N. Y.

Stromberg-Carlson

Makers of voice transmission and voice reception apparatus for more than thirty years.





The Synchrophase a One-Dial Receiver

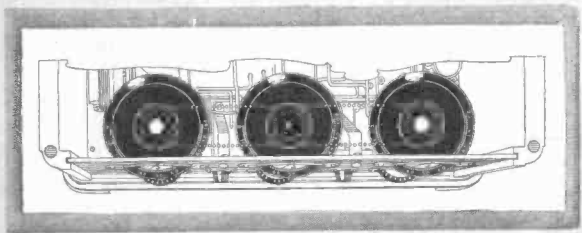

Grebe Flexible Unit Control
makes the Synchrophase a set of one, two or three dial control at your option.

THE demand for simplicity of control is met by the Synchrophase with its *Flexible Unit Control*.

This makes the Synchrophase a one-dial control receiver. But it does not destroy the great advantage of individual dial setting for very fine tuning, especially for distance reception.

This valuable quality, supplemented by the double range of the *S-L-F Condensers*, offers you a most convincing selling point.

But do not forget the other exclusive Grebe advantages — *Binocular Coils*, *Colortone*, *Low-Wave Extension Circuits*.

Send for Booklet RR which fully explains them and shows how they produce the reception for which Grebe sets are noted.

A. H. Grebe & Co., Inc., 109 W. 57th St., New York
Factory: Richmond Hill, N. Y.
Western Branch: 443 So. San Pedro St., Los Angeles, Cal.

This Company broadcasts through stations WAHG and WBOQ

All Grebe apparatus is covered by patents granted and pending.

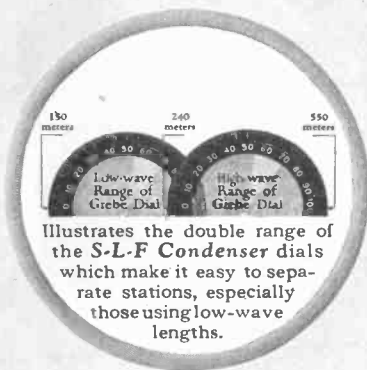

Illustrates the double range of the *S-L-F Condenser* dials which make it easy to separate stations, especially those using low-wave lengths.

The GREBE SYNCHROPHASE

TRADE MARK REG. U.S. PAT. OFF.



There's **POWER** behind the **Gold Seal** Line

Get the benefit of the powerful selling factors that aid Gold Seal dealers—

- quality product, finest of materials, design and workmanship
- backed without quibbling by a strong company whose success is based on a square deal policy to all
- national advertising which makes customers and satisfied dealers
- dealer cooperation of every type

And there are many other reasons why Gold Seal dealers are enthusiastic about this fast selling line.

*Better get full particulars
now—mail coupon today*

GOLD SEAL ELECTRICAL CO.
INCORPORATED
250 PARK AVE., NEW YORK

Gold Seal
Radio Tubes

Jobbers—A few attractive territories still open—write for details at once.

All Standard Types



Type GSX-112
High power tubes for use in last stage of audio amplification give increased volume.
List price \$4.50

**Types GSX-201a
and
Gs-201a**

The popular general purpose type, for amplifier or detector. Long life and high efficiency.
List price \$2.00



Type GSX-216B
For use in battery eliminators to rectify alternating current—advantageous in supplying the higher current required by power tube equipped sets.
List price \$7.50

Type GXS-200A
For use as detector only, giving superior strength on weak signals—especially desirable for distance.
List price \$4.00



COUPON R.R. 1-27

GOLD SEAL ELECTRICAL CO., Inc.
250 Park Avenue, New York, N. Y.

Gentlemen:—

Please send me full particulars of the Gold Seal line and your attractive proposition

Name _____

Address _____

City _____

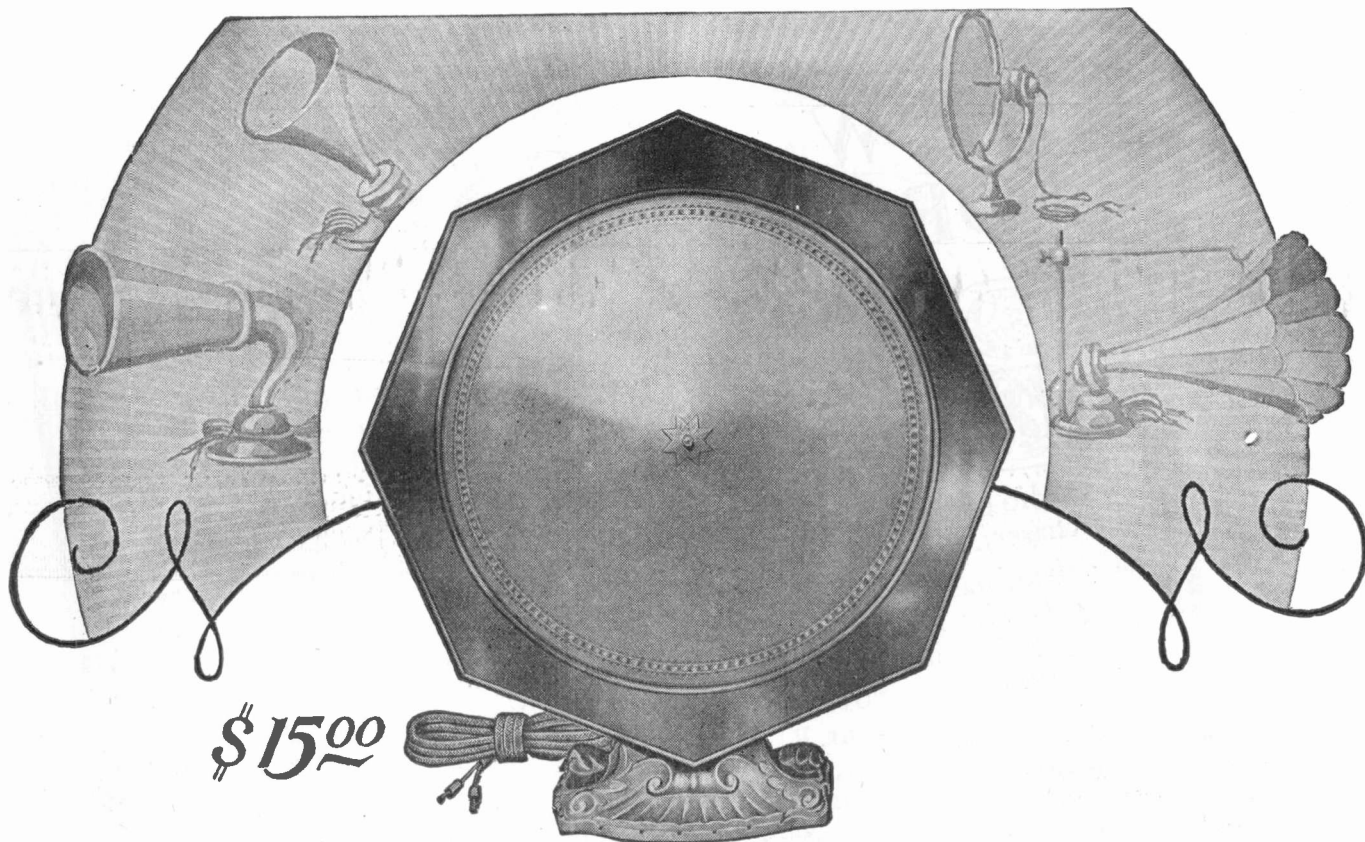

PROGRESS

REMEMBER the first loudspeakers?—they looked like megaphones and sounded worse. And remember the prices. Oh boy!

Certainly, tremendous strides have been made in radio acoustics as well as in appearance. Yet most prices remain entirely too high—at least they did until Tower entered the field.

Now, you can offer a speaker of highest quality, such as the New Meistersinger for only \$15. This cone may be used as a Wall or Table model, according to taste or space requirements. Its powerful direct-drive unit with *eight* connections to cone (*patented*) delivers a tone quality and volume usually associated only with speakers much higher in price. Other speakers—each a leader in its class—from \$4.95 to \$9.50.

TOWER MFG. CORP.
Boston, Mass.

If you want to make money with Tower, write us today.

Tower

Meistersinger



CONE

NEW PROSPECTS FOR B-POWER UNITS

BEGINNING with the January 29th issue of the *Saturday Evening Post* Raytheon will conduct an educational campaign to convince the general public of the advantages of light-socket B-power. At the present time only one out of every six radio receiving sets is equipped with B-power units. Think what that means to you—five out of every six radio owners in your community are prospects, not to mention new purchasers. Raytheon will help you sell them.

Raytheon has been a very vital factor in the development of the B-power market. The Raytheon rectifying tube made light socket B-power thoroughly reliable, and the phenomenal publicity on Raytheon which followed, spreading over the country, aroused the interest of radio fans in this new development. Raytheon advertising in radio magazines made the new story complete. All this time, Raytheon Engineers, working in co-operation with manufacturers, made sure that the complete units gave satisfaction. As a result, the demand for Raytheon-equipped B-power units has been such that of all B-power units now in use, approximately one half are Raytheon-equipped.

Now Raytheon takes the next big step in the creating of more prospects for B-power units. Through the use of the *Saturday Evening Post*, millions of set owners, hitherto hardly conscious of the existence of B-power units, will become active prospects for them. This will mean more business for you.

Your co-operation is desired. Keep Raytheon-equipped units on display. Recommend them. When sales are made, see that the installation is correct, with voltage properly adjusted. Make sure that the owner appreciates the advantages of improved quality in reception, and freedom from attention, which this remarkable advance in radio power supply makes possible. Co-operate with Raytheon in adding to the large number of satisfied users of reliable B-power units, and your business will prosper.

RAYTHEON MANUFACTURING COMPANY
Cambridge, Massachusetts

If you desire any information regarding the Raytheon rectifying tube, Raytheon-equipped units, their installation, or any other phase of the B-power problem, write to the Service Department, Raytheon Manufacturing Company, Cambridge, Massachusetts.

Raytheon
LONG LIFE RECTIFYING TUBE

THE SATURDAY EVENING POST

22 leading manufacturers and Raytheon solve the problem of radio light socket power

Now you can have unfailing
reliable radio B-power
direct from your
home light socket

**CROSLEY
RADIO**
CROSLEY-RADIO CORPORATION

**SPARTON
RADIO**
SPARTON-WASHINGTON COMPANY

**Burns
B-Battery Eliminator**
AMERICAN ELECTRICAL COMPANY

**BT
B-POWER UNIT**
BREMEN TRADING COMPANY

**ZENITH
B-Eliminator**
ZENITH RADIO CORPORATION

**Kinston
B-Battery Eliminator**
KINSTON ELECTRIC COMPANY

**Majestic
B-Current Supply**
Majestic Electric Company

**APCO
Raytheon Rectodyne**
APCO MANUFACTURING COMPANY

**GENERAL RADIO
Plate Supply**
GENERAL RADIO COMPANY

**ELECTROY
B-POWER UNIT**
ELECTROY COMPANY

**ALL-AMERICAN
B-POWER UNIT**
ALL-AMERICAN RADIO COMPANY

**ACME
B-POWER SUPPLY**
ACME APPARATUS COMPANY

**EREA
Hum-free B-Eliminator**
EREA ELECTRIC COMPANY

**STORAD
POWER UNIT**
STORAD ELECTRIC COMPANY

**Nayolium
B-POWER UNIT**
NAYOLIUM COMPANY

**Sterling
B-POWER**
STERLING ELECTRIC COMPANY

**TIMMONS
BLIM**
T. TIMMONS

**MODERN
B-POWER**
MODERN ELECTRIC COMPANY

**Cornell
Voltage Supply**
CORNELL ELECTRIC COMPANY

**Valley
B-POWER UNIT**
VALLEY ELECTRIC COMPANY

**WFCO
B-POWER UNIT**
W. F. COLEMAN

These radio manufacturers, foremost in their field, endorse the Raytheon Long Life Rectifying Tube for use in their B-power supply units. They have accepted Raytheon as THE HEART OF RELIABLE RADIO POWER.

WHAT the manufacturers whose names appear on this page were quick to standardize on the **RAYTHEON LONG LIFE RECTIFYING TUBE** for use in their B-power supply units is a tribute to the Raytheon research organization.

The development of the Raytheon rectifier from a mere idea to a remarkable scientific achievement has made possible the sale of nearly 300,000,000 worth of B-power units, Raytheon-equipped, in the comparatively short time since it was first announced to the radio world.

This means that there are already more than 750,000 satisfied users of B-power units, Raytheon-equipped.

These B-power units utilize the electric current which is furnished by the ordinary domestic lighting system. They do away entirely with B-batteries.

The manufacturers who are listed on this page

have built B-power units to suit various types and styles of radio receiving sets, according to their own individual designs and the specifications of their own engineers.

All of these supply units, however, have this one thing in common—they use the **RAYTHEON LONG LIFE RECTIFYING TUBE**, the perfection of which was made possible by the development of the principle of gaseous conduction. The Raytheon rectifier has no filaments or liquid solutions. It has no parts to be replaced, and nothing which requires attention.

When you buy a Raytheon-equipped B-power unit you will get not only the most reliable rectifier that scientific methods can produce, but you will also have absolutely reliable, unfailing B-power, improved reception, and freedom from the annoyance of run-down B-batteries. You can dispense with B-batteries entirely.

For your protection, the **RAYTHEON LONG LIFE RECTIFYING TUBE** is sold only to those manufac-

turers whose B-power units have passed the rigid laboratory tests of the Raytheon engineers. Look for the Raytheon trade-mark. It is used by the manufacturers whose names appear on this page on their B-power supply units. The Raytheon trade-mark is the symbol which guarantees unfailing, reliable radio power direct from your light socket. Ask your radio dealer for a B-power unit, Raytheon-equipped. He has them—or can get one for you.

Raytheon
LONG LIFE RECTIFYING TUBE

Raytheon Manufacturing Company
Department 52, Cambridge, Massachusetts
Examine the Raytheon Long Life Rectifying Tube and compare the quality of reception from one radio. What is the unit that makes better socket power available for my radio?
Name _____
Street No. _____
City & State _____
(PLEASE CHECK THE QUALITY THAT INSPIRES YOU)

RAYTHEON IS THE HEART OF RELIABLE RADIO POWER

The development of the B-power market by Raytheon will continue on a comprehensive basis. Advertisements are appearing regularly in the radio magazines. Publicity is being sent to the press frequently. With the addition of the "Saturday Evening Post" the program becomes complete.

Raytheon
LONG LIFE RECTIFYING TUBE



CLEAR GLASS
DEMONSTRATING
TUBE.



TYPE P. D.
200-A
SUPER-SENSITIVE DETECTOR

Three Points of Superiority.

1. The Patented Perryman Bridge.
2. The Double Filament.
3. The Tension Springs.

Remember the story of the little girl who was suspected of being a Princess. To make certain they placed a bean under the mattress in her bed and sure enough she was so uncomfortable she couldn't sleep.

That's pretty sensitive—but it's a long way from equalling the sensitivity of P.D.200-A, the Perryman Super-Sensitive Detector. This tube penetrates a mattress of air a thousand miles wide and delivers the station you want—and only that station. It annihilates distance and confusion.

P.D. 200-A makes local stations out of distant stations and brings in all stations clearly and distinctly with minimum tuning. Demonstrate by alternating P.D. 200-A with ordinary detector-amplifiers and your customers will take all of them you can deliver.



Super-sensitive Detector

Perryman Radio Tubes offer you a substantial and permanent profit. All Perryman Tubes are carefully made, rigidly checked and merchandised under common sense methods. Perryman Distributors are prepared to cooperate with all dealers on advertising displays, newspaper mats and prompt deliveries of tubes. There is a Perryman Radio Tube for every purpose.

PERRYMAN ELECTRIC CO., Inc.

Executive Offices:
33 West 60th St.
NEW YORK CITY

Laboratories and Plant:
North Bergen, N. J.

PERRYMAN

RADIO **P** TUBES

"DISTANCE WITHOUT DISTORTION"

Adopted by Radio Leaders



New, Practical-Free!

WRITE FOR YOURS TODAY

THIS new Durham Display Cabinet is the most practical sales-producing device ever designed for radio dealers. Very compact . . . only 9 in. by 7 in. by 7 in. . . solidly made in mahogany with glass top . . . changeable upright display tells the Durham story . . . holds a complete stock of Durham Resistors and Mountings . . . handy on counter . . . saves time in selling.

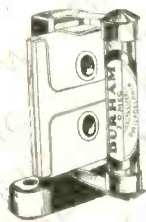

RESISTOR MOUNTING

Made of moulded insulation of exceptionally high resistance. Only upright mounting on the market and occupies but little space in set. Single mounting, 50c. For condenser, 65c.

In quantity this cabinet costs nearly \$5.00. As long as they last we are supplying them FREE to dealers who order complete stock—50 assorted Resistors, 5 Single and 5 double Mountings. Total list \$30.75 less regular discounts. Order direct, give us name and address of your jobber, and display cabinet will be sent immediately.

DURHAM METALLIZED RESISTORS

Selected as standard by leading Radio Engineers

INTERNATIONAL RESISTANCE CO., Dept. J, 1936 Market Street, Philadelphia, Pa.



The Outstanding Radio Line for a Profitable 1927

The ERLA SUPER-SIX [RFL] RECEIVER

The crowning achievement in radio for 1927 is the new Erla RFL Super-Six—a six-tube completely shielded receiver with true one-dial control. Reproducing units perfected to the highest limit which deliver broadcast entertainments so faithfully that all former standards of reception have been revised. Surpasses any new type phonograph in quality of reproduction and volume. To appreciate how far advanced this new receiver is over other types, we invite you to compare the Erla Super-Six with any other receiver or phonograph.

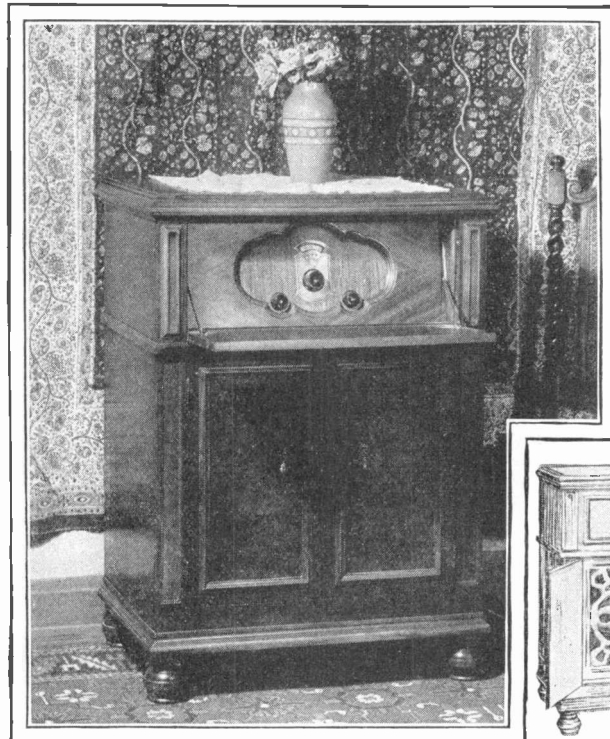

Erla cabinets are true art objects, worthy of a distinguished place in the finest drawing room. The Super-Six shown here is of dark American Walnut, trimmed in Satinwood with panels of matched Burl Walnut. This set is \$285.00. The six-tube table cabinet is \$210.00. Slightly higher west of Rocky Mountains.

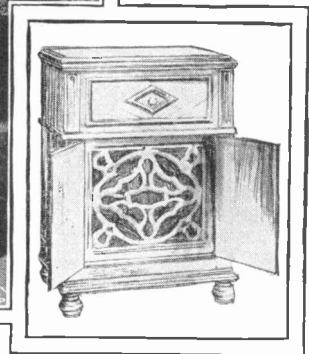

OFFERS YOUR CUSTOMERS ADVANTAGES THAT ARE YEARS AHEAD

Here is your chance to "scoop" your competitors and "cash in" on this new receiver; a chance to get in on the ground floor and take out the big profits while others are getting ready to follow our lead.

The Super-Six operates on an antennae from one foot to 100 feet in length, or on a loop. In its ability to bring in distant stations, it eclipses any receiver ever made. It is super-sensitive yet simple to tune, and squeals and howls are banished forever. It is not critical. The RFL circuit has been perfected to its highest efficiency by Erla engineers and this new receiver is so easy to tune that a child can get distant stations with greatest ease.

In the reproducing elements the Erla engineers have outdistanced the entire radio field. The new Erla Omnitonic

unit reproduces all tones of the musical scale. The Erla Concert Grand Audios are the most costly instruments of their kind ever used in any receiver. These in combination with a 92" air column horn will reproduce any instrument, note or harmonic that the human ear has ever heard and reproduce them with volume and faithfulness.

Here is the simplified radio that thousands have been waiting for; as easy to tune as winding a watch—a receiver that makes the novice an expert in getting distant stations. Here is a rare opportunity—a receiver that is so outstandingly superior that it makes others obsolete and opens new fields for sales development—an opportunity that will put you a year ahead of competition if you take advantage of it now.

Sign and mail the coupon and let us tell you about the most valuable sales franchise in radio. But don't put it off. The established Erla policy is to give dealers restricted territories. Only one dealer in each community will have this opportunity; so if you are interested in making more money, sign and mail the coupon for full particulars today.

YOUR OPPORTUNITY

ELECTRICAL RESEARCH LABORATORIES
Dept. J50, 25th St. and Cottage Grove Ave., Chicago
Gentlemen: Please send me complete literature and details on your new 6-tube, Monod-ic Receiver with True single dial control.

Name.....

Firm Name.....

Address.....

(I understand this does not obligate me in any way)



Delta

Offers this Combined Trickle Charger
and Full Capacity Charger

The No. 12
HI-LO "A"
BATTERY
CHARGER

A TRICKLE CHARGER that can be transformed into a full capacity charger by the turn of a switch! A price that defies all competition! That's the new Delta HI-LO Battery Charger.

There are no moving parts in HI-LO. It's noiseless, and can be used while the set is in operation. A drawn metal case protects bulb and coils. Leads, both to light socket and to battery terminals, are generous in length.

HI-LO uses the new "Superatled" Bulb—guaranteed by Delta—the new style Tungar Bulb No. 277465 or any other bulb of similar style. The "HI" charging rate is about $1\frac{3}{4}$ ampere; the "LO," about $\frac{1}{2}$ ampere.

The rich mahogany baked enamel finish of Delta HI-LO will attract buyers. It's versatility—and price—will sell it. Performance? Delta guarantees that.

Write · Phone · Wire your jobber · or
DELTA ELECTRIC COMPANY
Marion, Indiana

A Sure Profit Maker at **\$10⁰⁰**
List Price
Less Bulb

The sign of the
Designated Federal Retailer



Your franchise . . . what is it really worth?

Does it give you neighborhood protection against "next door" competition on the same line—a territory all your own?

Does it bring you the benefits of sound merchandising plans which lead buyers into your store, speed up turn-over, and make possible a profit-building business?

Does it have behind it a product that is non-competitive in itself—that differs so radically from all others that comparisons invariably mean sales?

Does it support a complete line of such radio, a set to meet practically every price requirement?

Does it carry with it a fixed policy of national advertising supplemented by local newspaper advertising which brings demand to a focus on your store?

Does it involve business dealings with an organization of square shooters—men long in the business—successful—here to stay? With a manufacturer who has confidence in you, requires no signed agreement, expects your co-operation only in so far as they themselves merit it?

* * * *

Designated Federal Retailers work under a policy, fair in every detail. Their service maintenance on Federal Ortho-Sonic sets is down to the very minimum of expense to them. They enjoy a quality of co-operation heretofore unknown in this industry.

Federal Ortho-Sonic Radio, dominant in beauty and performance, has created its own individual market in the eyes of the buying public. It is represented by a splendid class of retailers and wholesalers. Write the Federal Wholesaler in your territory. If you don't know who he is, write us.

FEDERAL RADIO CORPORATION, Buffalo, N. Y.

Division of Federal Telephone and Telegraph Co.

Operating Broadcast Station WGR at Buffalo

Federal ORTHO-SONIC*

Reg. U. S. Pat. Off.

Radio

The fundamental ex-
clusive circuit making
possible Ortho-sonic
reproduction is pat-
ented under U. S. Let-
ters Patent No. 1,682,470

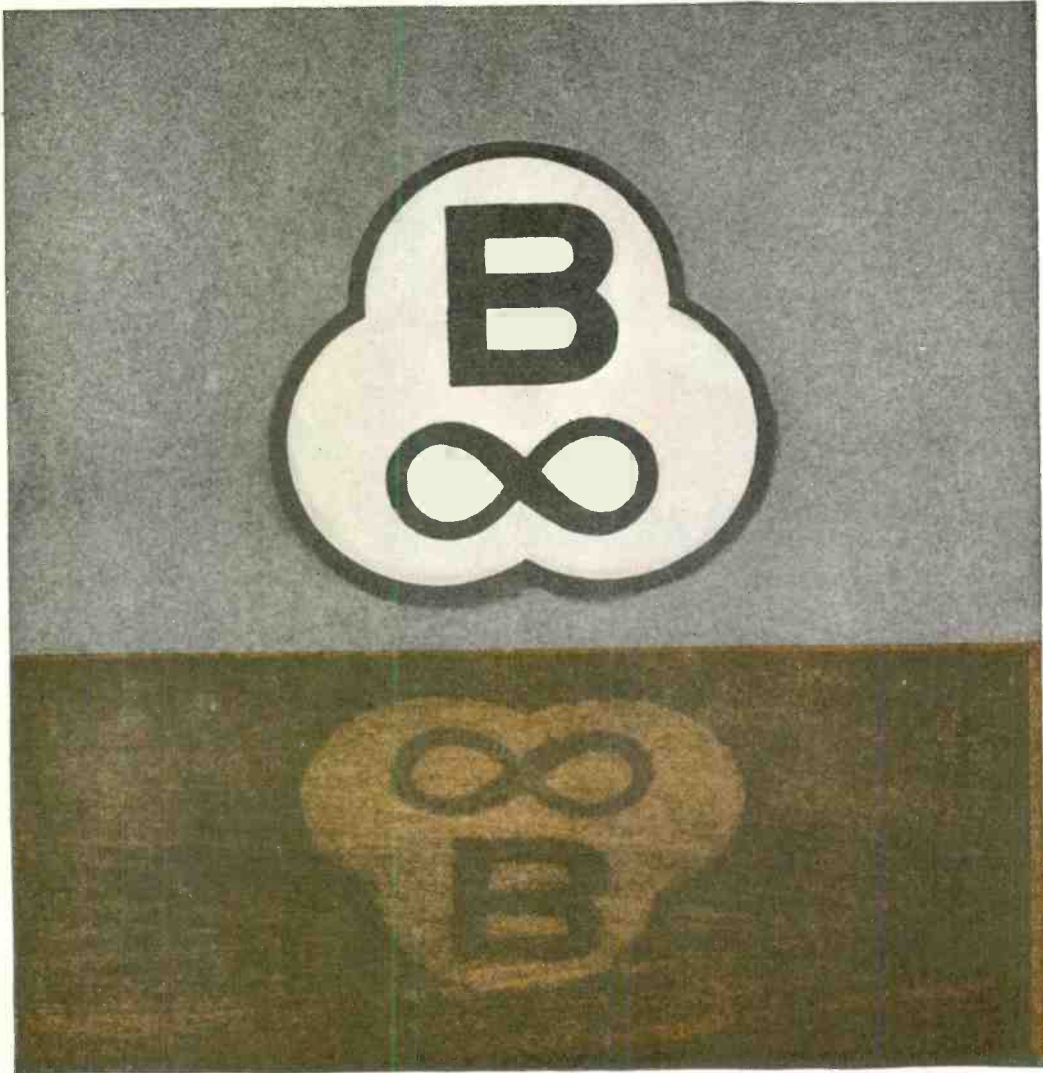

L U S T R E

How very important to the radio dealer is the lasting lustre of Bakelite. Sets, parts and panels may be displayed to tempt the public, with no fear that exposure or handling will mar their newness or impair salability.

The use of Bakelite is standard practice in the better class of radio equipment.

BAKELITE CORPORATION

247 Park Ave., New York, N. Y. Chicago Office: 636 W. 22nd St.
BAKELITE CORP. OF CANADA, LTD., 163 Dufferin Street, Toronto, Ontario

BAKELITE

REGISTERED

U. S. PAT. OFF.



THE MATERIAL OF A THOUSAND USES

"The registered Trade Mark and Symbol shown above may be used only on products made from materials manufactured by Bakelite Corporation. Under the capital "B" is the numerical sign for infinity, or unlimited quantity. It symbolizes the infinite number of present and future uses of Bakelite Corporation's products."

Value

**makes it
America's Fastest
Selling Cabinet!**

*Beautifully Made . . . Beautifully Finished
Popular Design Enduring Construction
Wonderful Volume . . Natural Tone Qualities*

THE PERFECT CABINET FOR
ATWATER KENT COMPACT
AND OTHER MODELS

THIS new Royal Blue Model, designed by Irving, has been intelligently produced to meet the growing demand for a thoroughly high quality cabinet at a low price. Absolutely nothing has been sacrificed in construction, finish or tone quality. Examination will prove it has no superior in quality from ANY point of view. And as it CAN BE RETAILED AT \$10 to \$20 LESS THAN SIMILAR CABINETS, it has no equal in price. Value alone makes it the biggest buy in its field. Order direct or from your jobber.



**ROCKFORD SALES
CORPORATION**

(Division of Federal Furniture Factories, Inc.)
206 Lexington Avenue, New York

Cabinets

Alone!

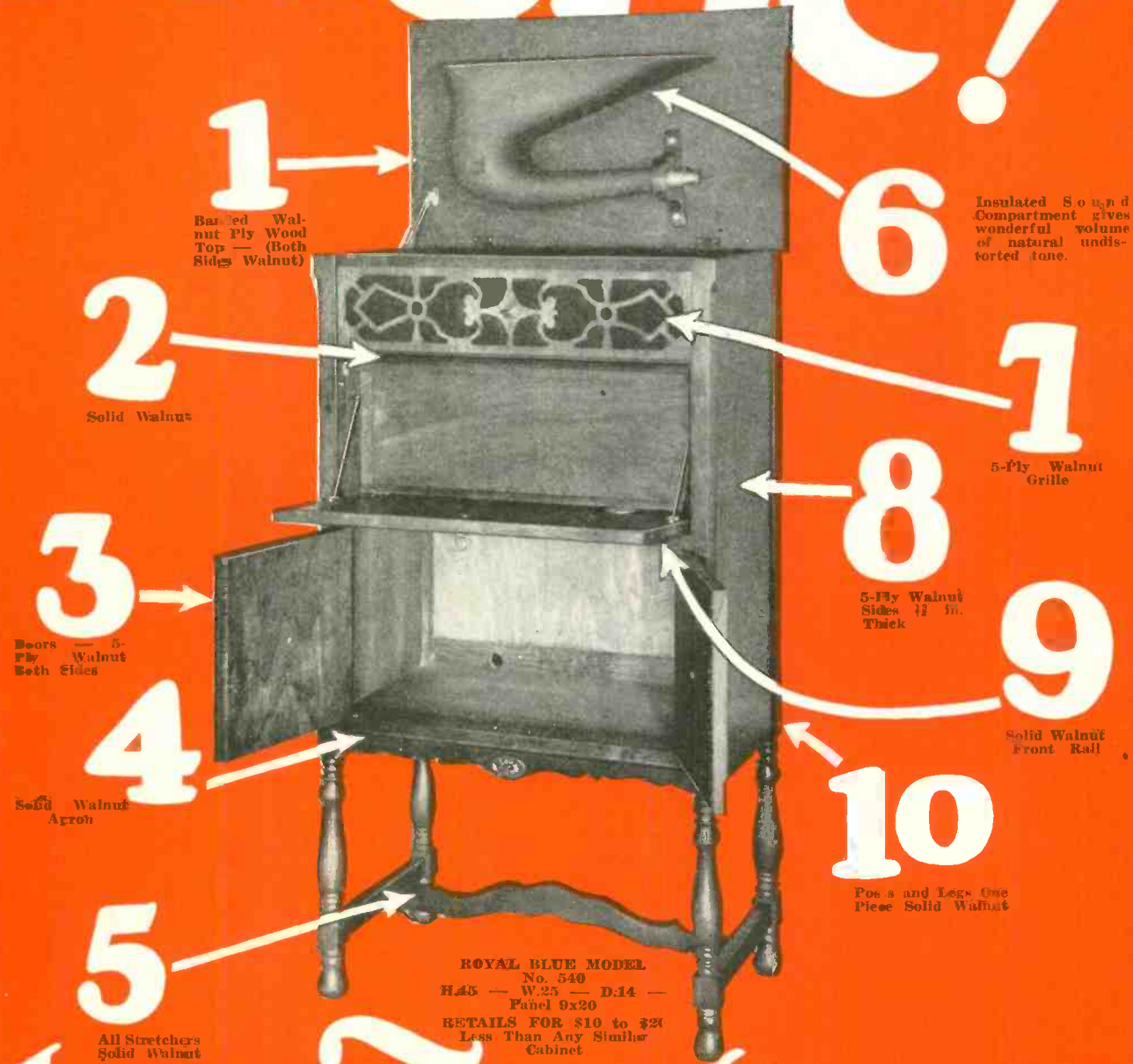

by Irwin

Hook Up With This!

SUPERB! "A" ELIMINATOR

Tune in on These!

1. Comes ready to use—just attach to light socket.
2. Hooks up like ordinary battery.
3. No change in wiring needed.
4. Operate automatically with switch on set. No extra wiring or change in wiring already in use.
5. Operates any standard set including Resistance and Impedance Coupled types. Loop or outside aerial.
6. Not a trickle charger.
7. Perfectly quiet. No audio frequency whistles.
8. Absolutely dry, nothing to spill.
9. No delicate parts whatever to get out of order.
10. Also supplied in combination with "B" and "C" units if desired, making one complete power outfit.



A Nation-Wide Consumer Good Will has already been purposely created for you by our widely-distributed and nationally-advertised Superb "B" Eliminator.

For special price offer on one sample outfit to Bona-fide Dealers, tear off and send the coupon attached below.

SUPERB
ELECTRIC
COMPANY
220-222 N. State St.,
CHICAGO, ILLINOIS

Gentlemen:—Please send me full information on your special offer to Dealers.

SUPERB ELECTRIC CO.

"Makers of Goods That Make Good"

220-222 N. State St., Chicago, Illinois

Name

Address

City

Dave Grimes' hat is in the radio ring to succeed—He will!

KIMBALL HOUTON STARK, the general manager of my organization, wrote that headline. It's my story in a sentence. Certainly I'm going to try to live up to it. Here are the details:—

The Grimes Radio Engineering Co., Inc. is the sole owner of United States Patents Nos. 1,517,057 and 1,517,058—British Patents Nos. 204,301 and 225,579—Canadian Patent Nos. 241,602 and 260,787—and Australian Patent No. 20,813.

All these patents cover basic improvements and inventions of radio receivers using the important principles of inverse duplex circuit arrangements.

I am happy to announce that my research work during the past two years has resulted in improvements that now give the "inverse duplex" principle advantages not possessed by any other amplifier receiver circuit.

My present organization (which has always been the patent holding company and which has today no other connection more than that of licensor with any company bearing or using my name or inventions) has been expanded to immediately manufacture and market both the necessary

and special parts needed in the new and improved GRIMES RADIO inverse duplex circuit arrangement, as well as complete radio receivers. I have been fortunate in bringing into my present organization a group of men whose past experience in the radio industry leads me to believe that a successful future is assured.

A simple, substantial and honest research, production, sales and advertising policy has been arrived at and we are now building up a group of jobbers and dealers who are happy to sell products of my manufacture and who are enthusiastically sold on the merit of GRIMES RADIO products.

Our company is also interested in granting licenses to companies—particularly in Canada,

Great Britain, and Australia—to manufacture and sell radio apparatus utilizing the inverse duplex arrangements.

I shall be happy to tell you in detail about our future plans and products. Just ask your secretary to use the memo below, or better still dictate to me your own personal letter.



President.

GRIMES RADIO

products that earn "profits" and
are a "service to the customer"

GRID RF CHOKES

FILTER RF COILS

ILLUMINATED VERNIER
DIAL CONDENSERS

SHIELDED
ILLUMINATED VERNIER
DIAL CONDENSERS

GRIMES I. D. S. KIT-SETS

Arrange to sell
GRIMES RADIO

GRIMES RADIO ENGINEERING CO., INC. — GRASMERE - STATEN ISLAND - NEW YORK.

GRIMES RADIO

[*Memo to Secretary:* Please write to the Grimes Radio Engineering Co., Inc.,
Grasmere, Staten Island, New York, and ask for complete trade proposition.]

KELLOGG

Flawless Reproduction

Radio

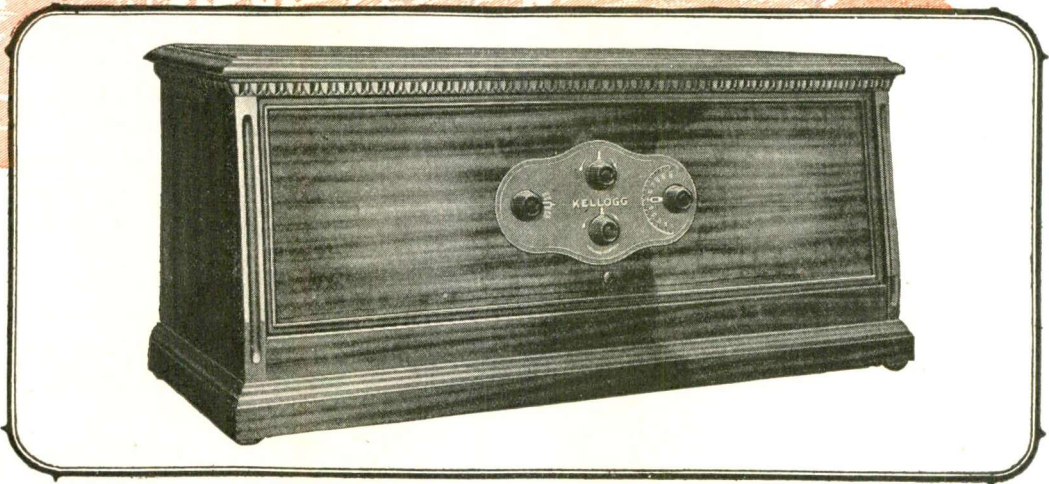

Licensed under application for letters patent of Radio Frequency Laboratories, Inc. [R. F. L.]

Backed by 29 Years' Telephone Experience

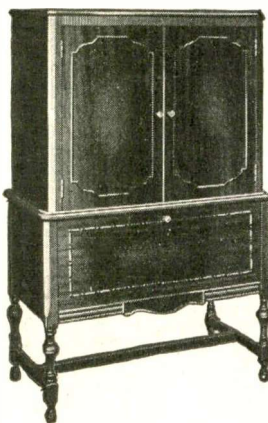

Model 508 includes the apparatus of the table model and the famous Kellogg speaker, with ample space for all batteries or power supply units.

FLAWLESS, faultless radio reproduction such as Kellogg has attained can come from experience alone. In radio set building, nothing—absolutely nothing—matches experience.

Model 507 receiver is the finished result of our 29 years' experience in voice transmission—a set that cannot squeal or howl—that brings them in with a "punch" to delight the most critical radio fan.

Heavy shielding around and between the coils prevents interference, and three stages of radio frequency give maximum range and selectivity. Take our word for it—here's a receiver that's as perfect as can be made.

This splendid set backed by Kellogg's aggressive merchandising plans, make an ideal proposition for the far-sighted dealer who looks not only to today's profits, but also to the future. Our 1927 plans cannot help but interest you. Mail the coupon and let us show you the exceptional profit-making opportunity open to dealers who can qualify for the Kellogg franchise.

Mail the Coupon Today



Dept. 12-A

Kellogg Switchboard & Supply Co.

1066 West Adams St. Chicago, Illinois

Please tell us of your plans that will make money for us in 1927.

Name

Address

Kind of business

Kellogg Switchboard & Supply Co.
1066 W. Adams St., Dept. 12-A, Chicago

STEWART-WARNER

Enters 1927 with

Record of Achievement

THE YEAR 1926 has again proven conclusively to the makers of the Stewart-Warner Matched-Unit Radio that reliable merchandise manufactured by a concern of good reputation and distributed on a clean-cut basis is the one certain means of obtaining success in present day marketing.

Into the ranks of Stewart-Warner Blue Ribbon Dealers have come concerns who have wished to identify themselves with a manufacturer on whom they could depend—large music and furniture dealers, department stores, public utility companies and many others.

One big reason why these houses have shown preference for the Stewart-Warner line is the distributing organization. Stewart-Warner Products Service Stations handle Stewart-Warner products exclusively. Their activities are directed by the factory to a large extent. They have at all times lived up to Stewart-Warner policies and

standards, always maintaining list prices and establishing dealers with territorial rights. They have not attempted to obtain distribution at every street corner; Stewart-Warner Blue Ribbon Dealers are given an opportunity to build a successful business on Stewart-Warner Matched-Unit Radio in their respective localities because of our protective franchise.

If you, too, wish a radio dealership that will be successful and permanent, if you wish to have back of you a manufacturer with twenty years of experience, with the facilities for large production and prompt delivery, then we suggest you investigate our proposition.

Stewart-Warner welcomes as a dealer representative any concern of financial responsibility that will honestly and actively engage in the merchandising of Stewart-Warner Matched-Unit Radio. The success of other Stewart-Warner Blue Ribbon Dealers can be your success.

STEWART-WARNER SPEEDOMETER CORPORATION
1820 DIVERSEY PARKWAY, CHICAGO, U. S. A.

|| *Stewart-Warner manufactures a complete line of cabinet and console models ranging from \$50 to \$400, somewhat higher west of the Rockies.* ||

The Stewart-Warner Air Theatre is conducted over WBBM [226 meters], for your entertainment, and for demonstrating purposes, every afternoon and evening.

Advertising Department
STEWART-WARNER SPEEDOMETER COR'N
1820 Diversey Parkway, Chicago, U. S. A.

Please request your nearest representative to get in touch with us about _____ (give date)

Your firm name _____

Address _____

Town _____

Would you like Some of this \$2000.00?

Do you own or operate a store selling radio supplies? Given all material, can you trim a window so that it will make folks stop, look and listen? If so, you are eligible to join this

Awards

- First Prize:
\$500.00 in Gold
- Second Prize:
\$250.00 in Gold
- Third Prize:
\$200.00 in Gold
- Fourth Prize:
\$150.00 in Gold
- Fifth Prize:
\$100.00 in Gold
- Sixth Prize:
\$100.00 in Gold
- Seventh to Twentieth Prizes:
14 Gold Awards
\$50.00 each

\$2,000.00 PRIZE CONTEST

for winning window displays of
advertising material featuring the



It howls!

Mc DONALD HOWL ARRESTER

"It Stops that Howl"

TRADE MARK

Patented Dec. 7, 1926. No. 1,610,208

Infringers will be vigorously
proceeded against.

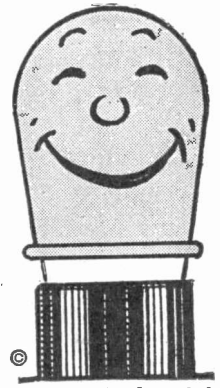

Now it doesn't!

From now until February 15th, 1927

the contest is on. You don't have to buy a thing. We furnish without charge complete advertising material for your windows and give you suggestions for displaying it to best advantage.

Fair Play for All

Each display will be judged as to its Originality, Effectiveness and Good Taste by the Committee of Five disinterested judges well known in the radio field. Your opportunity is as good as any.

Let your window bring you tangible profit!

All ABOARD! 
Cut me out and
mail me Right NOW!

SPARTAN ELECTRIC CORP., 350 W. 34th St., N. Y. C.

Kindly send, without obligation to me, full particulars about your \$2000.00 Prize Contest for Best Window Displays of Advertising Material featuring the McDonald Howl Arrestor.

Name and Title.....

Name of Firm.....

Address.....

VESTA

Quality Radio Units

Meeting a Wide Spread Popular Demand



Vesta Trickle Charger

\$10—Pacific Coast \$10.50

Because of the millions of radios using batteries, this is, perhaps, the largest selling radio unit today. Owners may buy the Radio "A" Unit when the time comes to replace their old battery but while their present battery is efficient they can just as well use the trickle charger.

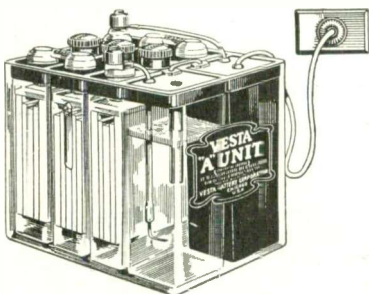

Vesta Radio Light Socket "A" Unit

Three-in-one—"A" Battery, Trickle Charger and Built-in Hydrometer

The very height of efficiency in Radio "A" Power. All in a clear glass case—condition of battery and trickle charger always in plain view.

2 Capacities:
25 Amp. \$25.00 50 Amp. \$27.50
Pacific Coast Add \$1.50

WFKB

Tune in Vesta Broadcasting Station—WFKB—on 217.3 Meters—Chicago—7:00 to 8 and 9 to 11:00 every weekday evening—EXCEPT MONDAY. Sundays 2:30 to 4:00 P.M. (Central Standard Time).

Makers of Vesta Automobile Batteries—Quality Products for Over 29 Years

THE remarkable opportunity offered in the Complete Line of Vesta Radio Products is without a parallel in the industry.

1—They are of the utmost quality.

2—They are the products of an organization of 30 years' experience in electrical units.

3—The line embraces the essentials for complete radio satisfaction in reception and service.

4—The nation-wide distributor organization perfected by Vesta gives the dealer a near-by source of supply. Join the Vesta organization and enjoy a prosperous 1927!

There's a Vesta Central Near You

VESTA BATTERY CORPORATION
2100 INDIANA AVENUE, CHICAGO



VESTA X-201-A
\$2.00



VESTA 199
\$2.25

Vesta Quality Tubes

A remarkable improvement in Tube Construction. A quality that cannot be questioned.

Vesta Radio "A" Battery

The Highest Quality for Radio

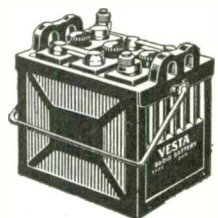

Vesta Vaco Radio "A" Battery

Conforms to Vesta high standards of material and construction at lowest prevailing prices. 80, 100 and 120 amp. hour sizes.

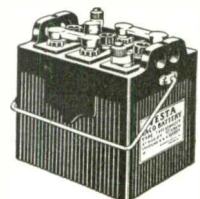

Send This Coupon to the Nearest Vesta Central or to VESTA BATTERY CORP., 2100 Indiana Ave., Chicago, Ill. Please have your Central Distributor near me present the Vesta Radio Line.

R. R.—Jan.

Name

Address

City State

Bosworth! — A name you can safely rely on

This company realizes fully the importance of maintaining a good name. To keep its record spotless, it takes precautions that have gained for it a substantial following of proud Bosworth owners and of new Bosworth jobbers and dealers.

The Bosworth Radio is made to meet the widespread demand for an extraordinary radio—for a radio that combines flawless performance with a beautiful appearance.

The men who build the Bosworth have that objective constantly before them—and they must come up to their mark. Bosworth stand-

ards of manufacture are rigid; compromises are unknown.

To prove their sincerity in the belief that the Bosworth *is* flawless, the makers of Bosworth Radio back it up for a whole year with an unequivocal guarantee.

The result—Bosworth does not sell the greatest number of radio sets, but does sell radio sets to the most discriminating buyers.

Dealers who believe that the Bosworth idea of business reflects their own attitude, will find much to interest them in the Bosworth booklet entitled "Product and Policy." A copy will be sent on request.

THE BOSWORTH ELECTRIC MANUFACTURING COMPANY
3754 Montgomery Avenue, Cincinnati, Ohio

Type B-2, a 5 tube set. The tubes are two radio, one detector, and two audio. Two dials provide modern, simple control. Equipped for power tube. Price, east of Rockies \$115.00.

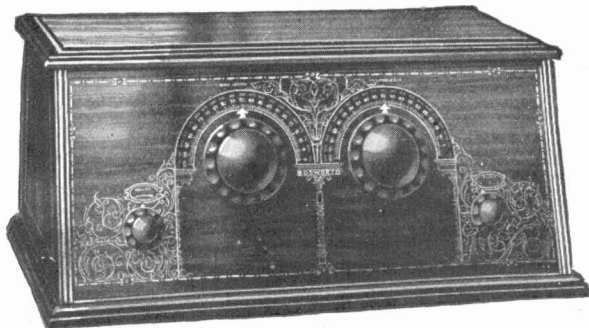

Type B-3, a powerful, easily controlled six tube set with a beautiful natural tone. It has three stages of tuned radio frequency, detector and two audio. This model has two dials which operate together as a single control. Equipped for power tube. Price, east of Rockies, \$155.00.

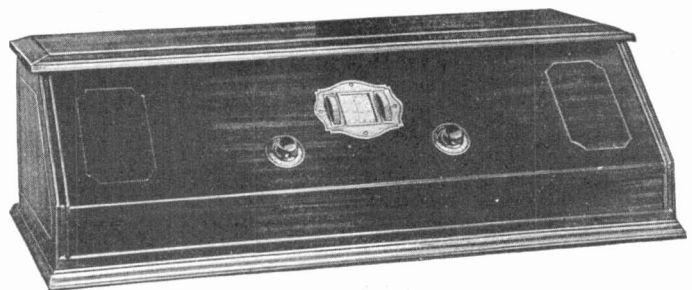

A few jobber locations are still available. Write for booklet — "Product and Policy."

BOSWORTH RADIO



Maximum
Reception
Always

Not a
Combination
Trickle Charger
and Battery

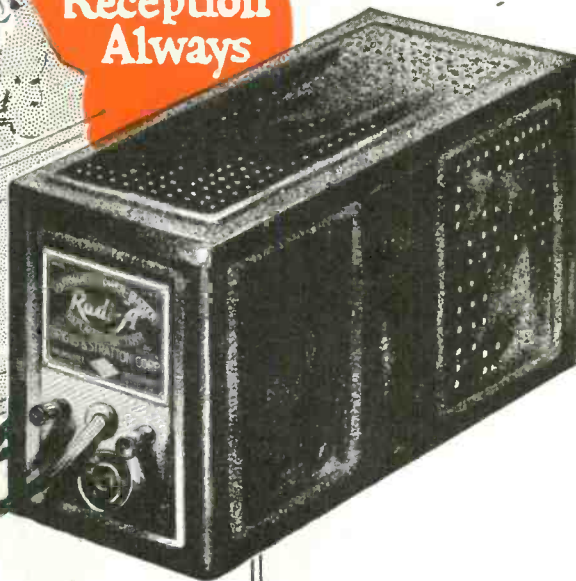

97 Radi-"A"
Dealers in Chicago
78 in Detroit
62 in Cleveland

AND the list grows day by day because the radio public has discovered Radi-"A" and is now buying this instrument in volume.

Whether you are located in Minneapolis or Buffalo, Kansas City or Frisco, Memphis or Boston, Butte or Baltimore, the same kind of a market exists for Radi-"A" where you are as where "the fellow is who is selling Radi-"A".

Here, at last, is the long awaited light socket "A" power unit that is not a combination "A" battery and trickle charger. Radi-"A" replaces both the "A" battery and charger—and every sale pays you a better profit than the combined profit from the two units Radi-"A" replaces! Entirely automatic in operation. Makes "B" eliminator automatic, also. No hum or distortion. Never runs down. No installation difficulty; no service trouble.

Ask your jobber about Radi-"A"—
or write us direct for additional data.

BRIGGS & STRATTON CORPORATION
MILWAUKEE WISCONSIN

Radi-"A"
Replaces
"A" Battery and Charger

Radi-"A" may be operated from any 110-volt A. C. 50 or 60 cycle electric power line.

Radi-"A" 6 Volt Standard is for use with radio receivers of 4 to 8 quarter-ampere tubes inclusive. It develops a 6-volt direct current of 2 to 2-3/10 amperes.

Radi-"A" 6 Volt Special is for use with sets of 8 to 10 quarter-ampere tubes inclusive only, and develops a 6-volt current with a maximum output of 3 amperes.

Radi-"A" 4 Volt is made for any set using up to 12 No. 199 UV tubes inclusive.

No Hum
or
Distortion

Fully
Automatic
in
Operation

New ~



Kolster 6-G Closed

The latest addition
to the Kolster line.

Dimensions

Height, 50 inches
Width, 26 inches
Depth, 17 inches

A BEAUTIFUL, new cabinet model, in genuine mahogany with walnut finish, highlighted, and with decorative overlays—modern design of conservative dimensions—housing a Kolster 6 tube set with inbuilt Special Cone. Antenna operation. Ample space for all batteries. List, \$185.

Kolster

Hear It



Kolster 6-G Open

The doors told all the way back. No unsightly "wing" effect.

AS with other Kolsters, we urge you to let this winning set demonstrate its own superiority. It satisfies the most exacting demands—a super-fine instrument in a beautiful cabinet at a popular price. Ask your distributor for a demonstration or mail the coupon.

Kolster

FEDERAL-BRANDES, Inc.
 Woolworth Bldg., New York, N. Y.
 Please arrange a Kolster-Brandes demonstration.
 It is understood that this does not obligate me.
 Name
 Street
 City
 State

23

Farrand

B

ELIMINATOR



~~\$\$\$~~ 48⁵⁰
 {without tube}
 Slightly higher
 West of Rockies

- made by the makers
 of the famous
Farrand
 Speaker

KNOWN QUALITY

FOUR months ago a new product—TODAY the accepted standard of "B" battery elimination. There's a Farrand distributor near you. Capitalize on the ever-growing demand by ordering NOW!



FARRAND MFG. CO., INC., LONG ISLAND CITY, N. Y.



Who will tell you the real truth about radio tubes?

A ticklish proposition—tubes. Well, now, they have been, haven't they?—almost a blind article. But that's all past. At last the dealer can be absolutely certain as to how the best-known makes of radio tubes compare. He doesn't have to listen to this tube manufacturer and that. Now he has absolute **PROOF**.

Here's how. One of the leading electrical laboratories of the country recently concluded a severe comparative test of the best-known radio tubes on the market. This laboratory has no interest in the manufacture or sale of any tube. The object of the test was merely to arrive at the scientific truth about radio tubes.

And here's what happened—*URECO Radio Tubes proved best.*

This scientific report will clear up all your doubts about radio tubes

Of course, in order to keep up with the times, a dealer should know about every detail of this report. We can let you have an exact copy of it. Just write and ask for it, or send the coupon below. And when you get it, be sure to study it carefully.

You'll probably be amazed to find how far

URECO tubes surpass all others in all important respects.

Also, if you wish we'll be glad to tell you all about how authorized URECO dealers work—and about the most unusual helps they receive to promote the resale of URECO tubes.

*Fill out and mail
the coupon TODAY!*

United Radio & Electric Corp.

418-420 Central Avenue, Newark, N. J.

Ureco Radio Tubes

"More sensitive than a musician's ear"

United Radio & Electric Corp.,
Newark, N. J.

Gentlemen:

I am interested in the comparative test given the best-known radio tubes in a leading electrical laboratory recently. Please, without obligation on my part, send me an exact copy of the report made by the laboratory on this test.

Name

Address

City State

ATWATER KENT RADIO

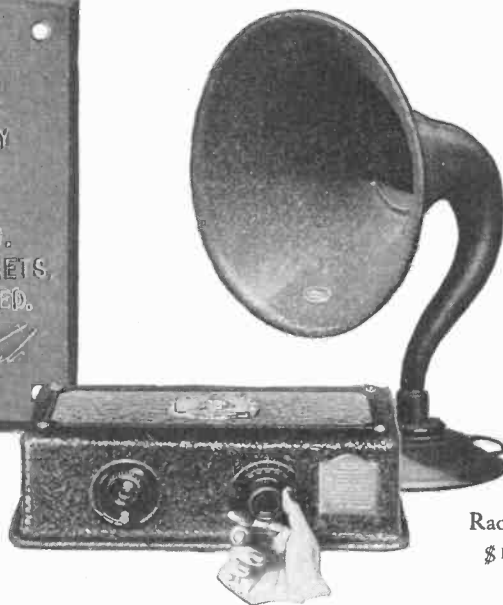

MODEL 35, illustrated, 6-tube ONE Dial Receiver, less tubes and batteries, but with battery cable attached, \$70. Other ONE Dial Receivers, \$85 and \$140.

Radio Speakers
\$16 to \$23

The first receiving set sold by the Atwater Kent Manufacturing Co. was shipped from the factory November, 1922.

Figures for the intervening years, showing the increasing demand for Atwater Kent Sets, are:

1922-1923 6,628	1925-1926 . . . 311,208
1923-1924 58,927	PRODUCTION OF SETS FOR:
1924-1925 . . . 175,461	1926-1927 . . . 600,000

EVERY SUNDAY EVENING:
The Atwater Kent Radio Hour brings you the stars of opera and concert, in Radio's finest program. Hear it at 9:15 Eastern Time, 8:15 Central Time, through:

WEAF	New York
WJAR	Providence
WEEI	Boston
WRC	Washington
WSAI	Cincinnati
WTAM	Cleveland
WTAG	Worcester
WGN	Chicago
WFI	Philadelphia
WCAE	Pittsburgh
WGR	Buffalo
WOC	Davenport
KSD	St. Louis
WWJ	Detroit
WCCO	Minneapolis-St. Paul

ATWATER KENT MANUFACTURING COMPANY

A. Atwater Kent, President

4733 Wissahickon Ave., Philadelphia, Pa.

Write for illustrated
booklet of Atwater Kent Radio

Prices slightly higher
from the Rockies west, and in Canada

EARL E. WHITEHORNE,
Contributing Editor
S. J. RYAN,
Merchandising Counsellor
L. E. MOFFATT,
Associate Editor
H. S. KNOWLTON, *Boston*
PAUL WOOTON, *Washington*

Radio Retailing

The Business Magazine of the Radio Industry

O. H. CALDWELL, *Editor*

WILLIAM C. ALLEY,
Acting Managing Editor
RAY V. SUTLIFF, *Chicago*
HENRY W. BAUKAT,
Technical Editor
WILLIAM W. McDONALD,
Assistant Editor
C. GRUNSKY, *San Francisco*

Table of Contents, January, 1927

Statistical Survey of the Industry.....	30	Eliminating Demonstrations	53
What Industry Leaders Say About 1927....	32	The 1927 Average Set	55
Trade Looks Forward to 1927 with Confidence	36	For the Service Man.....	56
Budgeting Sales and Expenses for the New Year	38	Dealers Co-operate on "Radio Bungalow" ..	59
Interference Blanks to Help the Dealer....	41	Your Editors Have This to Say—.....	60
Choosing the Right Location	42	New Radio Products for the Dealer to Sell.	64-69
"Human Interest" in Window Displays....	45	Specifications of Radio Batteries	70
Selling 85 Trickle Chargers in Two Months	46	What the Trade Is Talking About.....	71
Nation Demands Congress Enact Radio Relief	48	News of Jobbers and Distributors.....	76
The "Secrets of Success" in Reaching the Rural Market	50	New "Dealer Helps" the Manufacturers Offer	78
		Merchandising Radio Parts	81
		Review of New Circuits	85
		New Radio Parts Announced This Month.	87-89

Industries Honor Publisher on His 66th Birthday

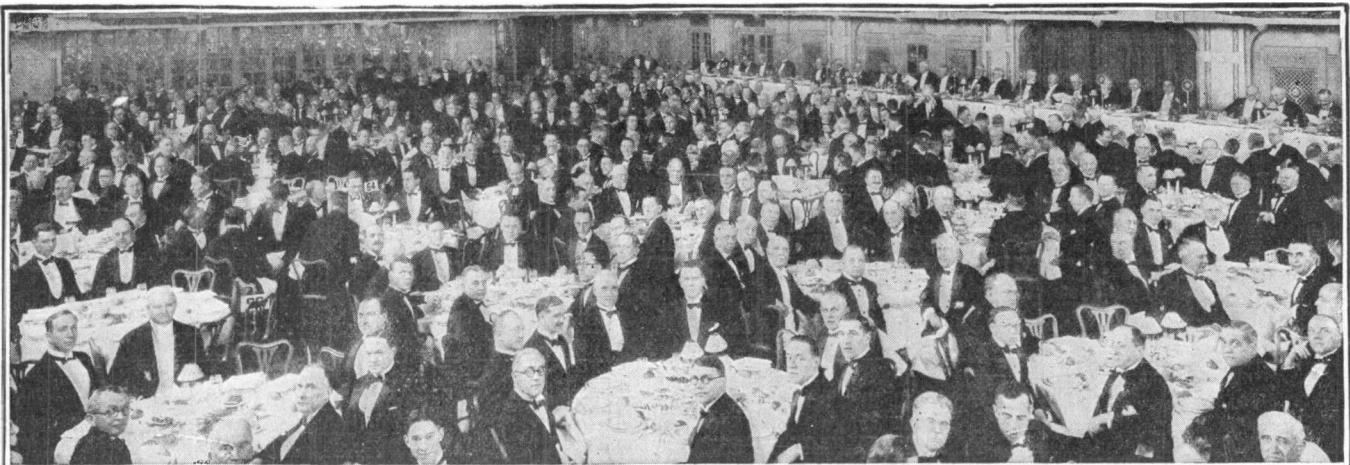

James H. McGraw, president and founder of the McGraw-Hill Publishing Company, was the guest of honor at a dinner December 17, given at the Hotel Astor, New York City, to commemorate the publisher's 66th birthday. The dinner was arranged by a committee of leaders of industry and business, and marked the completion of Mr. McGraw's 41st year as a publisher of business and technical magazines.

From a humble beginning, with one struggling publication, Mr. McGraw guided his organization through years of hardship and adversity to its present high position among the leading publishing houses of the world.

More than 1,000 friends of the guest of honor attended the dinner. Arthur Williams, vice-president of the New York Edison Company, was chairman of the committee, of which Thomas A. Edison was honorary chairman. Others serving

on the committee included M. H. Aylesworth, Bruce Barton, Newcomb Carlton, Barron Collier, H. M. Edwards, Charles L. Eidlitz, Dudley Farrand, Dr. Livingston Farrand, General George W. Goethals, Simon Guggenheim, John Hays Hammond, Hon. Herbert Hoover, Clarence L. Law, Clarence H. Mackay, Adolph S. Ochs, William Barclay Parsons, Dr. Calvin W. Rice, Charles Scribner, Gerard Swope, and Owen D. Young.

John W. Lieb was master of ceremonies and the speakers were: Willits H. Sawyer, president of the American Electric Railway Association; General Guy E. Tripp, chairman of the board, Westinghouse Company; Charles L. Edgar, president of the Boston Edison Company; Dean Dexter S. Kimball, of Cornell University; Edward J. Mehren, vice-president of the McGraw-Hill Company, and the guest of honor.

Member Audit Bureau of Circulations

Circulation of This Issue, 80,000 Copies

McGraw-Hill Publishing Company, Inc., Tenth Ave. at 36th St., New York, N. Y.

JAMES H. MCGRAW, President
JAMES H. MCGRAW, JR., Vice-Pres. and Treas.
MALCOLM MUIR, Vice-President
EDWARD J. MEHREN, Vice-President
MASON BRITTON, Vice-President
EDGAR KOBAK, Vice-President
C. H. THOMPSON, Secretary

Electrical World Electrical West Ingenieria Internacional
Industrial Engineer Engineering and Mining Journal
Chemical & Metallurgical Engineering American Machinist
Electrical Merchandising Power Electric Railway Journal
Bus Transportation Engineering News-Record
Coal Age Successful Methods
Copyright, 1927, by McGraw-Hill Publishing Company, Inc.
Cable Address: "Machinist, N. Y."
Annual subscription rate is \$2 in United States and Canada.

WASHINGTON, D. C., Colorado Bldg.
CHICAGO, 7 South Dearborn St.
PHILADELPHIA, 1600 Arch St.
CLEVELAND, Guardian Bldg.
ST. LOUIS, 713 Star Bldg.
SAN FRANCISCO, 883 Mission Street
LONDON, E. C., 8 Boulevard St.

Statistical Survey of the Radio

Estimated figures pertaining to the radio industry from 1922 to date, compiled by *Radio Retailing* from sources as authentic and accurate as it is possible to obtain

Number of Sets in Use (As of Jan. 1)

Including both factory-built and home-made,
after accounting for obsolescence

1922.....	60,000
1923.....	1,500,000
1924.....	3,000,000
1925.....	4,000,000
1926.....	5,000,000
1927.....	6,500,000
1928..... (Estimated)	7,700,000

Radio Audience (As of Jan. 1)

Number of people listening
to sets in use

1922.....	75,000
1923.....	3,000,000
1924.....	10,000,000
1925.....	15,000,000
1926.....	20,000,000
1927.....	26,000,000
1928..... (Estimated)	30,000,000

Total Radio Sales

(At retail, in numbers and dollars, during the year)

	1922	1923	1924	1925	1926	Total to Date	Estimated 1927
Radio Sets No.	100,000	250,000	1,500,000	2,000,000	1,750,000	5,600,000	1,700,000
(Factory-built)	\$5,000,000	\$15,000,000	\$100,000,000	\$165,000,000	\$200,000,000	\$485,000,000	\$215,000,000
Speakers No.	25,000	500,000	1,500,000	2,000,000	2,000,000	6,025,000	1,500,000
(Separate units)	\$750,000	\$12,000,000	\$30,000,000	\$32,000,000	\$30,000,000	\$104,750,000	\$30,000,000
B-Battery Eliminators No.			10,000	100,000	500,000	610,000	600,000
(Separate units)			\$400,000	\$4,000,000	\$18,000,000	\$22,400,000	\$21,000,000
Dry Batteries, A, B and C	\$4,500,000	\$6,000,000	\$55,000,000	\$66,000,000	\$80,000,000	\$211,500,000	\$85,000,000
Storage Batteries and A-Power Units No.		650,000	2,000,000	1,700,000	2,100,000	6,450,000	1,900,000
(Separate units)		\$7,000,000	\$25,000,000	\$26,000,000	\$37,000,000	\$95,000,000	\$30,000,000
Receiving Tubes No.	1,000,000	4,500,000	12,000,000	20,000,000	30,000,000	67,500,000	35,000,000
	\$6,000,000	\$17,000,000	\$36,000,000	\$48,000,000	\$58,000,000	\$165,000,000	\$65,000,000
Other Accessories (Including headsets, separate cabinets, aerial equipment, etc.)	\$3,750,000	\$4,000,000	\$11,600,000	\$24,000,000	\$33,000,000	\$76,350,000	\$44,000,000
Parts	\$40,000,000	\$75,000,000	\$100,000,000	\$65,000,000	\$50,000,000	\$330,000,000	\$45,000,000
Totals							
Sets	\$5,000,000	\$15,000,000	\$100,000,000	\$165,000,000	\$200,000,000	\$485,000,000	\$215,000,000
Parts	\$40,000,000	\$75,000,000	\$100,000,000	\$65,000,000	\$50,000,000	\$330,000,000	\$45,000,000
Accessories	\$15,000,000	\$46,000,000	\$158,000,000	\$200,000,000	\$256,000,000	\$675,000,000	\$275,000,000
Grand Total	\$60,000,000	\$136,000,000	\$358,000,000	\$430,000,000	\$506,000,000	\$1,490,000,000	\$535,000,000

Retail Sales Curve

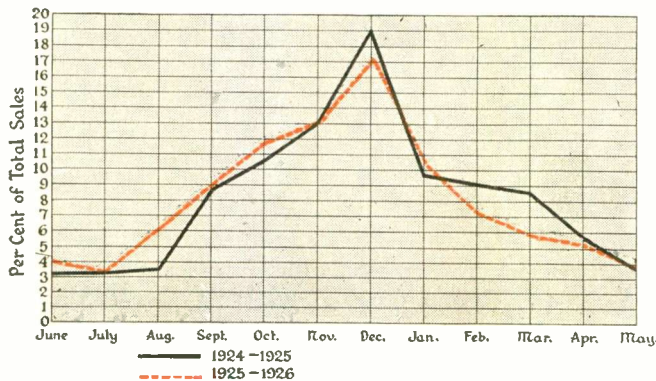

Survey made among a number of retailers shows sales curve slowly straightening out, as indicated by red line above.

No. Sets on Farms (At end of year)

1922.....	10,000
1923.....	145,000
1924.....	360,000
1925.....	550,000
1926.....	1,350,000

Radio Retailing acknowledges the aid of the following companies in preparing these statistics—Hazeltine Corporation, Radio Corporation of America, Martin-Copeland Co., Raytheon Manufacturing Co., Federal-Brandes, Inc., Gould Storage Battery Co., National Carbon Co., Charles Freshman, Inc., Tower Manufacturing Corp., Radio Master, Inc., and others.

Business, as of January 1st, 1927

Figures appearing on these pages are fully protected by copyright. Permission to reproduce is gladly granted if credit is given this publication

Rank of States as Radio Markets

Rank	State	Per Cent Business Done Each State*	No. Sets in Use Each State
1.	New York	10.09	655,850
2.	Pennsylvania	7.74	503,100
3.	Illinois	7.20	468,000
4.	California	6.34	422,100
5.	Ohio	5.59	363,350
6.	Texas	4.27	277,550
7.	Michigan	4.18	271,700
8.	Massachusetts	3.68	239,200
9.	Missouri	3.10	201,500
10.	New Jersey	2.98	193,700
11.	Iowa	2.80	182,000
12.	Indiana	2.72	176,300
13.	Wisconsin	2.60	169,000
14.	Minnesota	2.29	148,850
15.	Washington	1.85	120,250
16.	Kansas	1.55	101,000
17.	Oklahoma	1.55	100,750
18.	Nebraska	1.55	100,500
19.	Tennessee	1.50	97,500
20.	Georgia	1.41	91,750
21.	North Carolina	1.41	91,550
22.	Virginia	1.40	91,000
23.	Louisiana	1.28	83,200
24.	Colorado	1.27	82,550
25.	Maryland	1.26	81,900
26.	Connecticut	1.23	79,950
27.	Kentucky	1.20	78,100
28.	Florida	1.20	77,900
29.	Oregon	1.10	71,500
30.	Alabama	1.05	68,250
31.	West Virginia	.93	60,450
32.	Arkansas	.80	52,000
33.	Mississippi	.76	49,400
34.	South Carolina	.74	48,100
35.	Maine	.68	44,200
36.	Rhode Island	.67	43,550
37.	District of Columbia	.66	42,900
38.	Utah	.63	40,950
39.	South Dakota	.60	39,150
40.	North Dakota	.60	38,850
41.	Montana	.48	31,200
42.	Idaho	.42	27,300
43.	New Hampshire	.41	27,650
44.	Arizona	.38	24,700
45.	Vermont	.33	21,550
46.	New Mexico	.33	21,350
47.	Wyoming	.23	14,950
48.	Delaware	.21	13,650
49.	Nevada	.08	5,200

*Factors used—Passenger Auto Registrations, Broadcasting Stations, Income Tax Returns, Population.

Radio Exports (At end of year)

1922	\$2,800,000
1923	\$3,450,000
1924	\$6,000,000
1925	\$9,900,000
1926	\$8,500,000

Industry Census (To date)

Manufacturers	2,550
Wholesalers and distributors	985
*Retailers	29,000
a. Primary	5,800
b. Electrical	7,850
c. Music	3,950
d. Automotive	4,550
e. Hardware	1,900
f. Sporting goods	800
g. Department	1,250
h. Furniture	800
i. Electric light companies	600
j. Miscellaneous	1,500

* Carrying full stock of sets and accessories

Saturation Comparison

(To date)

No. Homes in U. S.	26,800,000
No. Phonographs	11,000,000
No. Passenger Autos	18,000,000
No. Telephones	17,000,000
No. Homes wired for electricity	15,900,000
No. Farms	6,370,000
No. Homes without radio sets	20,300,000
Radio Saturation	24%

Growth of Retail Radio Trade

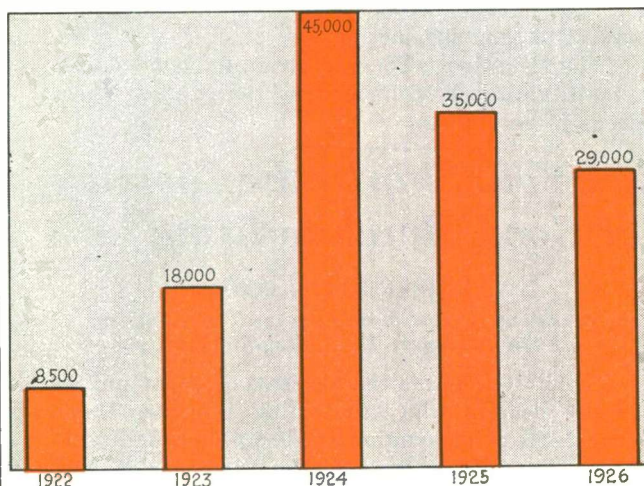

Chart above indicates number of dealers decreasing, with the peak number, 45,000, reached in 1924.

Dealers Who Do a *SELLING* JOB

1926 was a year of progress which will be reflected by greater public interest in radio during year to come

"In Service Lies the Greatest Promise of Progress"

By LOUIS B. F. RAYCROFT
*Chairman, Radio Division, National Electric
Manufacturers' Association
Electric Storage Battery Company*

RADIO has passed its introductory period and today is accepted as a popular necessity. The more popular radio becomes, the more need there is for competent merchandisers to act as purchasing agents, as storekeepers, and particularly as ensurers of proper service to the public. It is in the service which the radio retailer gives to his customers that the greatest promise of progress lies in the coming year.



Louis B. F. Raycroft

Service in radio is not only technical but is peculiarly personal and intimate. Its very difficulty makes more certain the need for high-grade retailers and more sure the larger profit which comes from the satisfied customer. The radio retailer of 1927 will find greater success in the field as he emphasizes the advantages of quality reception ensured by quality service, and thus builds the substantial basis for a permanent business.

The year 1927 will be our best year in radio. There need be no doubt on that point. Nothing can stop the progress of radio. Adversity may even speed it on its way to greater heights. Regardless of politics or piracy at their worst, radio broadcasting will continue and radio invention and production will meet the requirements of the situation. The radio retailer must do his part in maintaining the confidence of the public. There is no profit in pessimism.

"Steer Your Ship by the Compass of Good Merchandising"

By HERBERT H. FROST
*Past President, Radio Manufacturers' Association
General Sales Manager, E. T. Cunningham, Inc.*

THE YEAR 1927 offers the greatest of opportunities to those dealers who are willing to grasp them. Clear your decks of unsound methods and look the radio business square in the eye—realize that the "boom" days of "any old thing" are over, that dead inventory is lost profit, that you cannot handle everything on earth and that your lines for 1927 will be made by manufacturers in whom you have confidence. Insist on

the kind of support that will best enable you to take advantage of a year of unprecedented business in radio and, in turn, support the manufacturer in his efforts to educate the consumer, broaden your market and build for the future.

Manufacturer and dealer will be closer than ever in 1927. Both parties must enter the year with the determination to make the words "Service" and "Co-operation" mean something. The successful dealer of 1927

realizes right now that the buying public, his customers, are demanding the fullest value for every dollar spent—in fact, where once they were willing to accept what was offered, they are now demanding even more than the industry is prepared to give. To meet this situation the dealer must select his merchandise from the standpoint of quality, present it honestly and service it conscientiously. All of which will inspire the entire industry to greater things.



Herbert H. Frost

"Future of Radio Is Clearer, Brighter and Bigger"

By HAROLD J. WRAPE
*President, Federated Radio Trade Assns.
President, Benwood-Linze Company*

THE radio industry is rapidly progressing—it is becoming more stabilized, sounder, and less hazardous. We have some history behind us to guide us, and the principles of successful operation are becoming more apparent.

Many of the undesirables are passing out of the picture and their places being taken by practical, hard-headed business men.

The better organizations are forging ahead on a definite plan of operation, carefully executed. People are critical of the character of those who serve them; better merchandise and more reliable service are demanded. Particularly in the retail field is this true, where, for the first time, many records of unusual success are shown and the great opportunities in this field

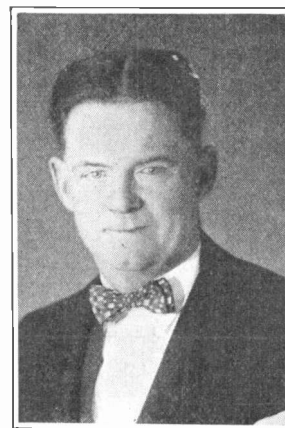

Harold J. Wrape

Will Prosper in 1927, Leaders Say

BUT—retailers will have to *sell* their merchandise to the public if radio is to expand in 1927, it is declared

forcibly emphasized. The price pendulum has swung too low and there is a reaction for better values. The future of radio is clearer, brighter and bigger in every way, to my way of thinking.

"Every Branch of Radio Has Set New Mark of Progress"

By DAVID SARNOFF

Vice-President, Radio Corporation of America

IN reviewing the achievements of radio during 1926, the distinction must be clearly drawn between radio as an art and radio as an industry. Taken from the perspective of the past twelve months, nearly every department of radio activity has set some new mark of progress. Insofar as progress in the radio industry is dependent upon progress in the radio art, the year 1926 marks definite upward improvement. The higher types of receiving sets now in the market represent the best that the art has been able to achieve, in sensitivity, selectivity and tonal quality.

With higher standards in the art and a more critical listening public, have come better standards of merchandising and more thorough standards of service, although both these latter problems are far from exhausted.

The character and scope of radio programs in the Fall and Winter months of 1926 are sufficient indications of the high standard of excellence reached in broadcasting.

Broadcasting is now developing upon an organized basis, and it is not too much to expect that as its economic foundations become firmer, the service will become greater and better.

"Selling Policy as Important as Good Merchandise"

By ALEX EISEMANN

Treasurer, Freed-Eisemann Radio Corp.

THE most reassuring factor in the radio industry is the fact that the important elements are boiling down to fewer set manufacturers. The consciousness of this fact alone enables dealers to choose their suppliers with much greater certainty and satisfaction than was possible heretofore.

In past years one would find many lines in dealers'

stocks; now one finds only a few and in many cases in the outlying districts, dealers find it to their interest to handle but one line.

From a merchandising standpoint under the new conditions of radio marketing, a manufacturer must have sufficient facilities to produce lines at a wide range in price to meet the various price markets to be supplied by his dealers.

From another standpoint, patent protection will be found to be a factor to which dealers are giving more and more attention. The situation is still somewhat complicated, but is fast being ironed out.

The business is becoming more and more comfortable as trade practices become crystallized. The entire industry has learned that a good and well-defined selling policy from which there are no deviations is just as important as good merchandise.

"Many Factors Will Make 1927 A Great Year"

By HUGH H. EBY

Chairman, Membership Committee, Radio Manufacturers' Association

President, H. H. Eby Manufacturing Co.

ALL of the available statistics point to the fact that there is no saturation point for radio products in this country. The radio industry, in spite of its enormous growth, is still in its infancy and from every standpoint, 1927 looks as though it would be the biggest and most profitable radio year ever.

Because of its rapid growth and the tremendous opportunities for its future, radio has attracted the greatest advertising and merchandising brains in the United

States. They are concentrating their thought and effort on the problems of widening the market and of helping the retailer resell the goods.

Everywhere, magazines and newspapers, recognizing the possibility of greatly increased advertising are contributing editorially to the development of the industry.

Advertisers themselves have been quick to see the tremendous amount of good-will which could be created by financing the broadcasting of good programs with the result that broadcasting is steadily improving.

By tying up their sales efforts to all of these constructive influences, the radio retailers have an opportunity for profitable business in 1927 which has never been equalled before.



David Sarnoff



Hugh H. Eby

"The Future of Radio Depends on the Quality of Broadcasting"

By M. H. AYLESWORTH

President, National Broadcasting Company

UNDER proper legislation the radio industry should advance very rapidly in 1927. Better broadcasting to more people will produce satisfactory results.

It will be the purpose of the National Broadcasting Company during 1927 to carry high grade programs to more and more people in the United States. I think everyone in the industry will admit that the future of radio depends upon quality of broadcasting and the number of people reached.

The National Broadcasting Company owns only one station and that is WEAJ in New York City. It will manage Stations WJZ in New York and WRC in Washington. Using Stations WEAJ and WJZ as centers of distribution, we are able to provide at least two networks of associated broadcasting stations throughout the United States and so insure a wide diversification of programs. Our object is to provide these stations with programs of national scope and to distribute them to such other broadcasting stations as may wish to take them.

The National Broadcasting Company expects to cooperate fully with the radio industry in order that we may, all working together, furnish the best possible broadcasting.

"Broadcasting Will Reach New High Point of Attainment"

By PAUL B. KLUGH

Executive Chairman, National Ass'n of Broadcasters



Paul B. Klugh

WITH the change of the year, broadcasting in America perhaps stands at another one of its transition periods.

Our members have been working diligently for many weeks, exchanging ideas and building programs for 1927 which, it is hoped, will reach a new high point of attainment. The only shadow of doubt that is cast over these splendid plans for the new year is the question of whether or not Congress is going to adequately protect radio.

At the moment of writing, the industry itself has accomplished a great objective through the medium of the National Radio Co-ordinating Committee. It is another chapter in the colorful history of radio that eight men, authorized by as many national associations and possessed of many diversified opinions, could subordinate all personalities and minor problems and unambiguously endorse what they believed to be fundamental requirements in the enactment of radio legislation by the House and Senate.

Congress has worried over these perplexing problems for three years, the results of their efforts being now

under consideration by the Congressional Conference Committee. If those conferees have a will, and I believe they have, to work as did the men of the various radio associations, by the time these words are on the press, they too may have brought out an adequate recommendation for legislation.

"Closer Tie Between Dealer and Manufacturer Essential"

By W. ROY MCCANNE

President, Stromberg-Carlson Tel. Mfg. Co.



W. Roy McCanne

WE OF the Stromberg-Carlson Company feel that 1927 holds more in store for the radio retailer as well as the manufacturer than any year experienced heretofore. This statement is not made thoughtlessly or superficially, but as a result of a careful study of the trends and the tendencies of the market.

In the first place, we believe that as a result of better education of the public along radio lines there will be an increased demand for better and higher quality radio receivers. Through the sale of higher class receivers and accessories the dealer will be able to make more profit, not alone because his bills of sale will be larger but because service costs will be greatly lessened.

Finally, we believe that 1927 will be marked by new advances in radio merchandising, that manufacturers will come to realize, to a greater extent than ever before, that the industry rests upon the dealer for its support, and that a close relationship between manufacturer and dealer is essential.

"Better Merchandising Will Play an Important Part in 1927"

By MILTON ALDEN

President, Alden Manufacturing Co.

AS I try to see into 1927 I think I can visualize three things: First—that the radio season will last longer than previous seasons. This opinion is based on some very definite facts as well as a number of more or less intangible reasons.

Second—The public is very much interested in radio and is willing to be sold. However, as the easy market has already been sold, better, more sincere and thorough selling must come into play if the sales volume of 1927 is to equal or pass that of 1926.

Third—That we are arriving or are in a quality era—cheaply and poorly constructed radios do not sell readily. Radio value is measured by reproduction. Perfect reproduction is of paramount importance and because steps in this direction show such a great advance over what the public is used to—1927 offers unlimited possibilities for the equipment that definitely shows the fullest possible advances along this line.

"Definite Trends in Circuit and Cabinet Design Seen for 1927"

By POWEL CROSLLEY, JR.
President, Crosley Radio Corporation



Powel Crosley, Jr.

PRESENT indications point to an increased demand for tuned radio frequency, with two or perhaps three stages of radio frequency amplification, detector, and ordinarily two stages of audio frequency. Use of power tubes in the output stage or stages also is growing in popularity, while another very definite trend is toward the elimination of batteries through the use of power units which take the current direct from the light socket.

Popularity of console designs is certain to increase, although there will be a large number of table type receivers sold. The indication now is that the public has come to regard radio as a permanent fixture in the home and therefore feels that the receiving set should be properly housed in its own individual cabinet of the console or furniture type.

Opening of lower broadcasting wavelengths for new stations is essential. The pioneer operators who have developed the higher waves are entitled to recognition by Congress. The latest reports from Washington are to the effect that immediate action is to be taken to relieve the congested conditions in the air and to permit the older stations to continue the good work they have been doing without molestation by new-comers.

"Radio Industry Will Prosper in Spite of Its Many Ills"

By E. N. RAULAND
President, All-American Radio Corp.

RADIO is passing through the most critical period in its history. Crowding of wavelengths, lack of legislative control, uncertain patent situation, lightning-like changes in designs, a buying public largely misinformed and unacquainted with what may reasonably be expected of radio, too many fly-by-night manufacturers, too many poorly qualified dealers and jobbers, lack of uniformity in terms and discounts, unfair trade prices, varying standards, misleading advertising — all these factors, and others too, add to the seriousness of the situation.

But in spite of its many ills, the radio industry will



E. N. Rauland

prosper. No doubt about that. It is just about over the peak of uncertainty right now. The foundation of the industry is its personal interest for every man, woman, and child, which in turn, is assured for all time by reason of the entertainment and educational value of radio.

The year 1927 will bring more economical methods of distribution, still further improvements in receiver and transmitter design, better values for the ultimate purchaser, even higher type of broadcast programs, more thorough understanding of radio by the layman, some adequate form of legislative control. Briefly, the year 1927 will bring much progress and attractive profits to the radio industry.

"Future Integrity of Parts Business Is Assured"

By H. B. RICHMOND
Treasurer, General Radio Co.

JUST one short year ago dealers looked with question on any optimistic statement regarding the future of the radio parts business. Many of these very dealers just now enjoyed a Merry Christmas because of the additional profit made from carrying a line of parts during 1926. Sales during 1926 have astounded even the most optimistic among us. 1927 has every indication of outdoing the past year!

Why? Because radio is advancing more rapidly than ever and the average American is a notoriously lavish spender for new devices — witness the automobile accessory trade. A year ago speaker filters were almost unknown; hundreds of thousands are in use today. "B" battery substitutes have forged to the front in a single year. Next year will see a vast improvement in "A" supply sources, and the addition of other useful devices that in turn will mean more profit to the dealer than have those of the past year.



H. B. Richmond

"Aggressive Selling Methods Must Be Used This Year"

By FRANK REICHMANN
President, Reichmann Company

THE outlook for the radio business in 1927 is very bright. Our business for 1926 was far greater than the year previous, and we look to 1927 for a still better year.

The day is past, however, when the public in their eagerness will just step in and buy. Radio dealers, jobbers and manufacturers are realizing that radio apparatus must have aggressive selling methods behind it. This makes for a sounder and healthier business. It is eliminating the irresponsible maker of radio sets and forcing manufacturers to produce real quality products. Clean competition makes for better business.

Radio Trade Greet 1927

San Francisco Outlook Promising on West Coast

"Great possibilities in store for 1927" is universal opinion in Bay District. Prospects better than last year at this time. Christmas season generally much better than 1925, although some lines quiet. No post Christmas slump anticipated. Active selling predicted for January and February. Shortage of sets this season starts year with clean slate in contrast to last year when over-production hindered market. No summer depression next year is prediction owing to fact that emphasis in selling is being placed on local reception rather than distance. Local broadcasting greatly improved over year ago and expected to show steady gain following precedent started by arrangement with San Francisco symphony. Great local interest shown in national legislation situation in hope that distance reception conditions can be cleared. Fewer manufacturers, better dealers and better understanding of merchandising methods all expected to mean better business for 1927.

San Antonio "Predict Excellent Year"

Stabilizing of industry, acceptance by public of radio as the ultimate instrument of entertainment and general business situation lead radio trade here to predict excellent business during 1927. Sales during past few weeks show decided trend toward better sets.

There is also large demand for loop sets and consoles. Believed these types will have increasing demand next year. Trade-ins not expected to exceed 20 per cent of total set sales. Rural territory offers rich field in this section and may be depended on for large volume. Public demand is toward good sets merchandised by reliable dealers and made by reliable manufacturers.

Los Angeles "25 per Cent Increase Expected"

Conservative predictions place 1927 sales 25 per cent greater than 1926. Bank clearings and retail sales showed substantial increase. Dealers and jobbers watching stocks closely so are not loaded up. Present healthy condition of stock will prevent dumping and credit difficulties next summer. Broadcasting causing some concern. Elimination of interference by proper radio

legislation strongly desired. Encouraging indication is alertness of some jobbers and dealers to summer situation. Radio Trades Association taking active interest in broadcasting and plans effort to secure good programs afternoons and evenings. Replacement business becoming big item in retail sales. More than half retailers' income is derived from service and accessories. Battery eliminator sales exceptionally large.

New Orleans "Sales Are Stabilizing"

1926 radio sales fell short of four million dollar quota for this market set at beginning of year but sales are believed to be material increase over three million dollars worth sold 1925. There was no slump but last three months of year were comparatively quiet. Trade does not expect great increase in activity for 1927 but at same time it is believed sales will continue for next three months at present rate. General impression is radio sales stabilizing and that sales for 1927 will be little greater than last year. Trade says public no longer interested in distance reception. Sets must now compete with new phonographs in perfection of tone quality. Music stores gave more attention to phonograph

sales during holidays than to radio. There is growing demand here for local broadcasting equal to that offered by Eastern stations. This together with more intelligent merchandising by radio stores will increase sales.

Slightly lesser number of actual sales but larger dollars and cents volume is expected in 1927.

Chicago "10 per Cent Increase Anticipated"

Dealers in this territory anticipate ten to twenty per cent increased volume and even better ratio of profit for next twelve months. Prediction based on expected further stabilization of sets, reduction of demonstration and service costs through co-operation, and clearing up of station interference. Jobbers think character and proportion of retail outlets will remain about as at present. Set manufacturers contemplating no radical changes in design or circuits but working closer with accessory makers to insure perfectly balanced ensemble. Looking to June trade show here to advance season and permit dealers order in plenty time for early fall business. All classes of trade confident 1927 will be active and profitable year with industry on firm and healthy basis.

Portland, Ore. "Trade Optimistic"

Dealers and jobbers optimistic as to business in 1927, expressing belief it should continue to increase compared with year just ending. Christmas buying reached expectations of dealers. Estimates place December sales this year at 20 per cent over last December, although dealers generally have not bought heavily for needs after Christmas. Battery eliminators still in large demand and jobbers anticipate being short after holidays. Two new broadcasting stations have recently come in and third is approaching completion. This will make nine local stations and some confusion has already been experienced with more anticipated. In spite of this, the new stations have had favorable effect on business mainly through improvement in quality of programs presented. Broadcasting of symphony concerts locally as well as from San Francisco has furnished dealers with excellent sales arguments.

With Complete Confidence

New York

"Fewer Sales but Greater Profit for 1927"

Dealers, manufacturers and jobbers look for considerable increase in 1927 sales of better grade receivers and accessories. Actual number of sets sold will probably not exceed 1926, but dollars and cents figure expected to show 15 to 20 per cent increase due to sale of higher priced merchandise. Higher priced set sales will naturally mean increase in time payment business and decrease in service costs. Trade-ins assuming larger proportions and expected to be 1927 factor. Some early dumping of B eliminators and cones probable, due to concentration of many manufacturers of these accessories on local market. Business between November 15 and December 15 fell short of expectations. Movement of accessories particularly slow, although several jobbers of well known sets report demand holding up well. On average October and early November business exceeded December sales. January and February business expected to bolster up December quota.

Detroit

"Fall Season Disappointing"

Both wholesale and retail radio trade here declined considerably during second half November and last month ran behind record set in October and early November. Local trade uncertain about 1927 but sentiment on whole cheerful. Interest in radio keen. Radio sales will depend on general business conditions, particularly automotive industry, which is declining somewhat. Industries now at about sixty per cent capacity. Belief is business will improve after first of year and that 1927 will be good year. Radio legislation expected to help.

Pittsburgh

"Good After Slow Start"

Radio business Pittsburgh rapidly gaining headway after slow start. Holiday months, which in former years were barometers of seasonal rush, did not display same conspicuous strength this year. In spite of this, present movement very healthy and feeling for continuation during at least first quarter of new year is general. There is no marked increase in volume of business and in general runs about same

Telegraphic reports by direct wire to "Radio Retailing" from all sections of the country agree that

The New Year will bring fewer sales but in larger units—and hence greater profits

as year ago. Activity centers about sets with some interest in kits and passing demand for parts. The set field favors console and furniture models more than former years. Running close second is the demand for electrical supply devices. Greater interest displayed in tone quality while range is secondary consideration. This doubtless due to new schedule of large broadcasting company in New York now including both local stations in program network. Some little uneasiness displayed by chaos propaganda but this is much in minority.

Boston

"Sales Will Continue Well Into Spring"

December sales from a quarter to one-third better than November. Opinions on early 1927 sales vary. Appears safe to conclude that while some slackening is to be expected, sales this district will continue well into spring. As interest is greater than last year and programs infinitely better, buying will be more active. All agree accessories will continue strong until June.

Philadelphia

"Spring Sales Will Hold Up"

Although holiday sales this territory experienced slight check it is believed volume of sales in January, February and March will be at least fifty per cent greater than last year. Better grades of sets have more popular demand owing to necessity of selectivity. Dealers and jobbers report sales check due to heterodyning stations. With many stations delivering better programs it is believed greater part of

sales conditions will depend upon decision made for control of wave-length situation. B power supply units have topped the list for accessory sales with cone speakers next in line.

Sets which operate with simplicity and have automatic power supply are placing radio in good position. With wave-length situation under government control, present year will be one of best in history.

Toronto

"Aggressive Dealers Report Gains"

Radio trade entering new year in optimistic spirit. Increases of twenty-five to fifty per cent looked for. It is pointed out that besides appealing to bigger market unit sales are larger. Many new stores have been opened and these are getting their share. Among aggressive dealers a considerable gain was noted in 1926 sales and a proportionate increase is looked for in 1927. Market resilient as full page advertising of cut prices had little effect on general sales. Due to hand-to-mouth buying no orgy of price cutting is expected unless manufacturers release distress merchandise. Dealers reluctant to stock large quantities but placing small orders in fair volume. Collections reported good but there is a general tightening up on expenditures. Strong selling still obtains on some medium priced receivers of good performance. There is flush of parts buying apparently by fans who held off till after Christmas. Reception weather continues good but heterodyning kills many sales.

St. Louis

"35 per Cent Increase Expected"

After careful study of 1926 business as compared to 1925, coupled with analysis of prospective conditions among manufacturers' trade and buying public for 1927, consensus of opinion in St. Louis trade is radio business 1927 will show increase approximately 35 per cent over 1926. Some large jobbers state there will be average yearly increase of 25 per cent for many years to come. This opinion is based on much earlier start of consumer buying in 1926 which will start earlier in 1927 due to manufacturers' announcements of models and trade show in June. Also St. Louis Radio Show will be held full month earlier than 1926 show. Radio Trade Association in St. Louis proposes campaign in 1927 to start consumer buying in June and July. With full support of local trade, will have good effect.

Please turn to Page 58

Here's a Dealer Who Has Set a Sales Quota and Expense Budget for 1927

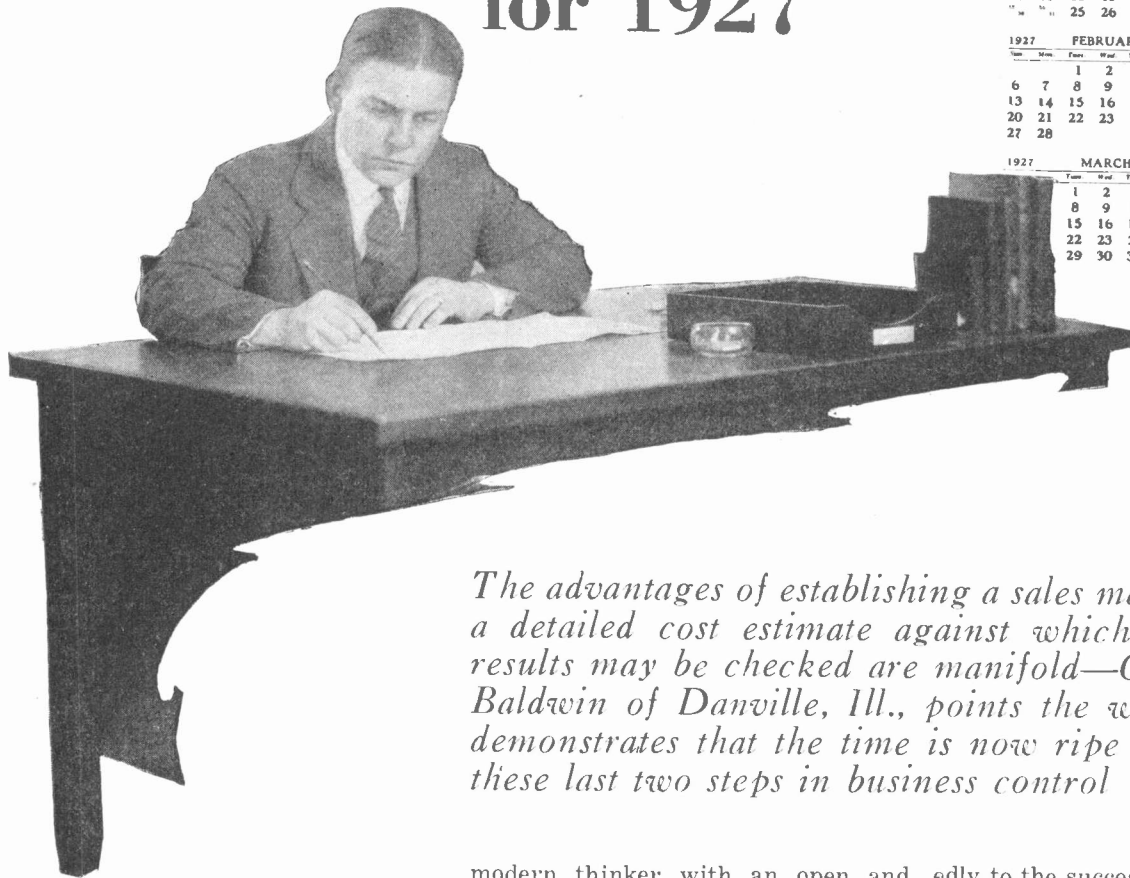

1927							1927							1927															
JULY							AUGUST							SEPTEMBER															
Sun.	Mon.	Tue.	Wed.	Thurs.	Fri.	Sat.	Sun.	Mon.	Tue.	Wed.	Thurs.	Fri.	Sat.	Sun.	Mon.	Tue.	Wed.	Thurs.	Fri.	Sat.									
2	3	4	5	6	7	8	9	10	11	12	13	14	15	16	17	18	19	20	21	22	23	24	25	26	27	28	29	30	
1	2	3	4	5	6	7	8	9	10	11	12	13	14	15	16	17	18	19	20	21	22	23	24	25	26	27	28	29	30
1	2	3	4	5	6	7	8	9	10	11	12	13	14	15	16	17	18	19	20	21	22	23	24	25	26	27	28	29	30

The advantages of establishing a sales mark and a detailed cost estimate against which actual results may be checked are manifold—Glidden Baldwin of Danville, Ill., points the way and demonstrates that the time is now ripe to take these last two steps in business control

By RAY V. SUTLIFFE

GLIDDEN BALDWIN introduced himself to me at the first annual banquet of the Indianapolis radio dealers last October—during that period of noisy good fellowship which occurs just before the banquet-hall doors are opened. "I came half way across the state of Indiana for the primary purpose of meeting, face to face, a member of the editorial staff of *Radio Retailing*," he said (which added two inches to the size of our hat).

"I want to talk to you about this matter of business control," he hastened to add, "and to tell you how I have profited by my adaptation of an article on expense break-down which I read in your magazine last June."*

It wasn't long before I discovered that Mr. Baldwin was an extremely keen and progressive young man, a

modern thinker with an open and investigative mind. As is frequently the case with those who seek knowledge he was able to impart fully as much information as he received during the course of that delightful evening.

Baldwin, it appears, attended Leeland Stanford University and the University of Illinois. He started in the radio business in Danville, Illinois, with a capital of \$700, in March, 1924. When he first met me the net worth of his business was \$8,600. But it was his next remark that fixed my attention.

"I am now working on my 1927 sales quota and expense budget," he declared in a matter-of-fact tone.

"Would you mind repeating that last statement?" said I. "It sounds a bit too good to be true."

I had interviewed literally thousands of the fraternity these last two years and never before had encountered a radio man who was taking these latest and most constructive steps in the scientific control of retailing steps which are recommended by merchandising experts and which have contributed so mark-

edly to the success of other and older businesses. Here at last, at the Hotel Claypool's festive board I had found my man, or rather he had found me. I arranged at once to beard the lion in his Danville den.

Before presenting this modern merchant's system for stimulating sales and checking expenses may I explain that budgeting is simply the estimating of probable expenses, based on a forecast of the business, month by month, that should be done in the coming fiscal year. Heretofore this has, admittedly, been beyond the ken of the average radio dealer. Public demand and manufacturer's policies have been too uncertain. But radio merchandising is becoming stabilized. For 1927 it will be both possible and expedient to base expenditures on a planned sales volume. Baldwin's example will serve to point the way. He has been operating it long enough to demonstrate its advantages and to permit the drawing of certain conclusions.

In mid-December I went to Danville and reviewed Mr. Baldwin's business systems. I checked them

*"The Difference Between Loss and Profit."

To Operate a Quota-Budget Sheet

1. Keep a monthly record of sales, cost of merchandise and itemized expenses.

2. Provide a suitable quota-budget form or key-sheet.

3. Estimate your possible sales, by months, for the coming fiscal year.

4. Allocate operating and sales promotional expenses

according to the sales estimate.

5. Enter these forecasts in their proper places on the key-sheet.

6. Each month compare actual sales and expenses with your estimate of what conditions should have been. If there is a marked divergence ascertain the reasons and plan accordingly.

the year and a half just past.

His system for costing and recording sales and for tabulating expenses, according to their eleven natural classifications, was most admirable. (See footnote.)

From these foundation facts he had prepared a combined quota and budget sheet for his next fiscal year which was unusually complete and enlightening. It is serving, in fact, as a complete control record, a perfect picture, of his entire business.

The Control Sheet

This record is reproduced herewith. It measures twenty-one inches long by ten high. It is divided, horizontally, in two parts. The upper for expenses, the lower for sales—past, present and estimated. It was compiled in the following order: First—the actual sales and total expenses, by months, for the fiscal year ending August thirty-first, 1926, were entered—horizontals (F) and (C). Second—from this data, plus a consideration of possible public demand and next year's local business conditions, Baldwin set an ambitious—but possible—monthly sales goal to shoot at. This is horizontal (D). Next he estimated, in the order given, the costs of doing this amount of business—merchandise (10); fixed expenses (1, 5, 7, 8, 9, 11). Subtracting all the preceding items from estimated sales (D) gave him the monthly amount available for sales promotional efforts and for net profit. These are horizontals (2, 3, 4 and 6).

In planning a control sheet it is essential that expenses be broken down into their component parts. It is the only way in which this subject can be analyzed and anticipated with

any degree of accuracy. Furthermore the chief value of a study of this nature lies in the consideration of the individual expense factors. If these are submerged in one grand total how can the guilty item be discovered or the weak link strengthened?

It takes Mr. Baldwin's efficient assistant about three hours each day to cost sales and to segregate and enter expenses. It took the two of them three days, intermittent work, to prepare the quota and budget sheet. Was it worth it? The following analysis will enable each reader to judge for himself.

In 1925-26 Baldwin made a clean net profit of seven per cent on a gross volume of \$22,752. An excellent showing for such a modest business. Now comes the rub. Note that in order to obtain that added \$6,448 volume (D) minus (F), he must, according to his expense budget, sacrifice 1.3 on his net profits. In other words, selling cost increases when business is forced.

"Should I try to expand under the circumstances?" he said to me.

"By all means," I replied and justified my answer somewhat like this:

He Should Try to Expand

"Your business right now is on the danger line. If you do any less it will be at a loss. To stand still is to go backwards. Further it is quite possible that you will be able to cut down, when the time arrives, some of your estimates. Any saving will go directly into added net profit. As it is, your control sheet shows a slight increase in actual dollars profit over last year. Another thing—increased volume will mean increased stock turns. This, together with your ability to reduce your average inventory for the next twelve months, hence your invested

capital, spells a much higher return on your money. For example, your stock, fixtures and bank loans last year amounted to \$6,400. Your net profit was \$1,605. Your earnings on capital therefore was 25 per cent. Cut your capital \$700 (due to preceding reasons). Your profit is estimated at \$1,652. Your earnings on capital would thus jump four points, namely to 29 per cent."

This Goal Acts as a Spur to Greater Effort

Of greater value, however, than that of providing a tangible thing which may be studied for the betterment of the business is the inspiration, the *spur*, that such a visible goal is bound to produce. Baldwin told me that his men are as impatient as he is for the end of the month to arrive in order that they may compare actual attainment with estimated ability to produce. He posts the "bogey" the first of each month and gives each employee a small bonus if the business exceeds it.

Another thing Baldwin discovered was the seriousness of his summer "slump." While it is true that the percentages tend to exaggerate his losses in actual dollars at that time, still it is apparent that he should increase his off-season volume or take on some "fill-in" line.

The foregoing will serve to indicate some of the facts available from a record of this nature. Is the maintenance of a "key" sheet worth while? Listen to Glidden Baldwin. He summarizes the matter in these words:

"Key" Sheet Enables Dealer to Review Business Monthly

"Once a month it enables me to review the business in a business-like manner. To determine the actual degree of profit, or of loss, I am sustaining. It leaves nothing to the imagination. It presents in the clearest possible form all the vital statistics that one must know if he would steer his ship of trade by chart and not by guess. It is the key to past facts, present performances and anticipated attainments. If the only thing it gave me was the satisfaction of knowing that my business accounting was in accord with modern methods I would consider the slight amount of time and of added expense required to operate this quota and budget sheet indeed well spent."

An article describing this "Costing" system is being prepared for publication in an early issue.

"Interference" Blanks Help the Dealer

*Pacific Radio Trade Association
dealers build new friendships and
increase business through assist-
ance given customers*

MANY a man has complained against static, or the power lines in his neighborhood, whose entire trouble is traceable to a loose connection in his own set. On the other hand, there are many who make no complaints, but who charge up their failure to get good results against radio itself, thus not only eliminating themselves from the field, but influencing others, throwing in an element of resistance difficult for the salesman to overcome.

The importance of eliminating these two types of malcontents, and of aiding in cleaning up the sources of radio interference as well, has led the Pacific Radio Trade Association to issue an "Interference Data Blank," which is furnished to members for distribution to customers bothered by interference of any kind, on which they may explain fully their troubles.

Blanks Kept on Counters

These blanks are kept on the counters of radio shops and passed out to all who make inquiry. When returned, filled out, they are used as the basis of a preliminary investigation by the power company radio interference experts. They are carried by service men in their rounds, so that every opportunity shall be had to reach all complainants.

The set owner is asked to fill in the blank, giving his name and address and phone, the type and make of set and the nature of the trouble experienced, as well as the time when the interference occurs. Many other questions designed to locate possible sources of trouble, are asked.

A statement at the bottom of the blank requests the owner of the set in question to fill it out completely

and to return it to the dealer from whom it was obtained. It is obvious that if he has really ascertained the facts called for, he will, in many cases, eliminate his own trouble without further action. If he has not, the data given, particularly relative to the type of interference experienced, combined with the presence of possible contributing causes, will enable the dealer, in most cases, to make a fair guess as to the source of the trouble. If it is anything which he can cure, his service man calls to look over the set or to make such suggestions as are desirable.

This gives him an opportunity not only to enter the home where trouble is being experienced, but also in many cases neighboring homes—and not infrequently suggests opportunities for the sale of better class radio to the owner of a home-made set.

Trouble Reports are Sent to Offender

Where the trouble is readily assignable to some outside source, such as the power lines or the street cars, the report is forwarded to the company concerned, which is usually very glad to get the accurate information as a basis for their own investigation. In the case of interference which is not handled through one of these channels, the report is

forwarded, as a last resort, to the U. S. Supervisor of Radio for the district, who sees that the condition is cleared up.

Business Getters

These blanks have already shown themselves to be business getters for the dealer, as well as builders of friendship. The owner of a set appreciates that his troubles are being looked after and even if the interference is not removable, he will feel better about it if he knows that it has at least been diagnosed. In addition, it is hoped, as time goes on, to locate the trouble points in the community, so that a picture of the city from the standpoint of its weak spots in radio reception may be formed. In this way it will be possible to acquit certain popularly accepted culprits and, perhaps, to show that others are responsible for the interference. Once the situation is clear, it should not be difficult to find its permanent solution.

PACIFIC RADIO TRADE ASSOCIATION INTERFERENCE DATA BLANK	
From	(Name)
.....	(Phone)
..... (Address)	
Type and make of set	
Kind of interference: Hum (.....), Hiss (.....), Roar (.....), Squeal (.....), Tap (.....), Buzz (.....), Crash (.....), Surge (.....).	
Time that interference occurs.....a.m.p.m. Day.	
Does it cover entire dial? (.....) or near what stations on dial (.....)	
Is it continuous? (.....) or intermittent? (.....). When first noticed? (.....)	
Does it continue when you pull the main service switch supplying your home with light and power? (.....) or when your neighbors pull their switches? (.....)	
Has anyone who understands radio sets and circuits examined your batteries and your set? (.....). If so, to what did he assign trouble? (.....)	
Do you, or does anyone in your neighborhood operate oil-burning furnaces, elevators, small motors, violet ray or X-Ray machines, or other electro-mechanical appliances? (.....) Ever turn them off to see if they might be causing the trouble? (.....)	
State type of batteries (A, B, and C) used, and B Eliminator if no batteries. (.....)	
Aerial height Length Parallel to other wires?	
Where is ground connection made?..... Is lead-in a separate wire? (.....). Is it soldered? (.....). Is aerial insulated from trees and other grounded material? (.....). Is it fastened at either end to lighting or telephone poles? (.....). How many blocks from the nearest street car line? (.....)	
With aerial and ground wires disconnected and their binding posts connected with a wire, do you still get the interference? (.....)	
What other listeners in your vicinity are having the same trouble?	
What is the best time of day to call?.....	
<small>These questions should be answered by the person bothered by the interference and this sheet then returned to the Dealer from whom it was obtained. His service man can determine whether the trouble is within the set or whether it comes from an outside source. In the latter case, he should refer it to the local radio club, or power company for investigation. Should they be unable or unwilling to locate the noise source, this report, as a last resort, may be forwarded to the U. S. Supervisor of Radio, Custom House, San Francisco, for such action as he deems necessary.</small>	
Furnished by (Dealers' Name)	

This is the interference data blank used by the Pacific Radio Trade Association to help radio "listeners" to find the actual sources of their interference. The blanks are kept on the counters of radio shops and have shown themselves to be business getters and builders of friendships.



Choosing the for a Radio Store

The strategic point for a retail store or a branch sales office is on the fringe of a business district, on a main thoroughfare leading to a residential section, says merchandising authority.

THE exact location of the "busiest corner in the world" is still somewhat in dispute, with this, that, and the other city claiming the honor. Personally, I can think of half a dozen that have enough traffic going by to suit anybody; so dense is the stream of humanity in any one of these places that relative supremacy is not of the slightest consequence.

But, comes the question, if it could be determined, wouldn't that corner be the ideal spot for a radio store or branch sales office?

The answer is, emphatically, No!

It happens that I have had to answer this question many times in a practical way in determining the value of locations in several cities, and during the course of these investigations I have had ample opportunity to view and review the errors in judgment made by hundreds of merchants. There is more to picking out a profitable site for a retail radio shop than the usual observation: "A lot of people go up and down this street; it ought to be a good place for a radio store or sales office." Yet that is often the principal, if not the sole, reason given by a proprietor for setting up in the place where he is doing business. It appears therefore that there is some useful purpose to be served in a discussion of the considerations that should govern a decision of such vital importance to the future prosperity of the business, with a view to setting up guideposts for newcomers

By
**J. ANDREW
WHITE**
*Vice-President,
Haynes-Griffin Radio
Service, Inc.*

and standards for those who have taken the plunge blindly.

Strange as it may seem, the number of people who pass a given location every day is relatively unimportant in choosing a site for a radio store or branch; on the other hand, a store's easy accessibility to customers who travel by the car lines is of basic importance.

In picking a street or corner where pedestrian traffic is heaviest the primary purpose is to do the largest possible volume of business. Obviously, the larger the crowd the greater the number of prospective purchasers. But volume of business is not the whole story. The guiding essential is not to reach out for the highest total of gross sales possible, but to weigh the question: "How large a business can be done here, profitably."

Radio requires large floor space;

so the question of rental has first of all to be watched closely. In the central business district the price per square foot ordinarily runs too high to make occupancy of space there profitable.

There are other considerations, also. Normally, in every town the central business district caters largely to transients. Hotels and theatres, banks and department stores belong there, and probably would not prosper anywhere else. But the radio store is a different proposition, as will be disclosed in a study of the motives that govern the intending purchaser and the probable frequency of visits with intent to buy.

Practical planning for retailing radio in any given location requires,

Right

or

Branch

Sales

Office

Location



or a combination of the three; the main point is, that the quality is easily recognizable and a small amount of money is involved in each purchase and that such buying is a daily occurrence. While such a store can prosper in a "neighborhood" location, it is obvious that the volume of business to be done is directly proportionate to the density of pedestrian traffic, and there can be no argument that the ideal location lies within the central business district.

chasing. It compares quality, style and price in various stores and defers the purchase until such comparisons have been made. Dry goods, wearing apparel, toys and novelties belong to this class.

The third type of goods, "specialties," comprises those which call for less comparison and are purchased ordinarily at a store which has been determined upon in advance, the determining factors being a favored brand and the quality and reliability reflected in the store's reputation.

There is some overlapping of these three classes, but the distinctions are clear enough to aid in proper planning for selling radio at retail. It is obvious, for instance, that the best location for a cigar store, which handles "convenience" goods, is a point where there is the greatest number of passersby who are ready to buy the desired article of small unit price at the instant the desire makes itself felt, and who can be served quickly with merchandise that requires relatively small floor space for handling. The appeal can be either price, style or quick service,

Basically, although in somewhat lesser degree, the same considerations apply to merchandise which comes under the "shopping" goods classification.

But radio belongs in the division of "specialties." If it seems to have overlapped into the class of "shopping" goods, that is merely an unfortunate circumstance occasioned by the rapidity of the industry's growth; under the impetus of a hectic buying demand radio stores were opened in any and all neighborhoods, without regard to suitability of the site or the proportionate expense of maintaining the location.

Proper planning for the retailing of radio, however, calls for its consideration as a "specialty" that is not normally a price proposition, nor is it—like wearing apparel, for instance—subject to the buying motives which are governed by quality and style comparisons.

Examined in the light of merchandise to be sold as a "specialty," it is clear that a radio store is handicapped if its location is in the heart of the central business district. The

first, a classification of radio as merchandise by determination of the public's purchasing motives and buying habits. Three fundamental divisions to cover all products have come to be recognized; these are (a) convenience goods; (b) shopping goods; (c) specialties.

Radio does not fit into the first classification, for "convenience" goods are those which the customer buys as soon as the need is felt. Drugs, groceries and household articles fall under this classification, where convenience in purchase is the standard, not convenience in use. Articles which are in constant use and sold at a unit price too small to justify going out of the way to trade at a particular store make up this division.

"Shopping" goods, the second classification, are bought differently. These are the things which the public uses deliberation and care in pur-

When Selecting a Site for a Radio Store or Branch Sales Office

Remember—

“The best location for the radio store, or branch sales office, is on the fringe of the central business district.”

“The number of people who pass a given location every day is relatively unimportant.”

“Easy accessibility to customers who travel by the car lines is of basic importance.”

“Prosperity rests on basing the selling appeal on quality, both in merchandise and service.”

passersby are governed by two main buying motives while there—receptivity to the convenience of buying familiar products of daily use and minor cost, or intent upon comparisons of style, quality and price of needed articles that are bought with less frequency but with a certain regularity. The purchase of a radio set or its accessories is somewhat in the nature of an event; scarcely ever is it mere routine; it is something to be thought over and talked over in advance at home. Hence, the intending buyer is not likely to be drawn into a store on the impulse of the moment, solely because a window display has caught his eye. Buying radio is very different from buying a hat, for example; it is not a matter of instantaneous decision or whim.

Radio Is Outside the Household Budget

Moreover, the financing of the purchase is outside the budget for necessities. Surrounded by the displays and the appeals to buy accustomed “convenience” or “shopping” goods, and very probably having come to that district for the express purpose of renewing some article of general necessity, the consumer in the dense pedestrian traffic of the central business district is not likely to be seized with a sudden impulse to buy a radio set, no matter how skillful the window appeal.

The best location for the radio store is on the fringe of the central business district. There is no error involved in the choice of a site in outlying residential districts, but where so-called neighborhood trade is his sole source of income the store proprietor must be content with a smaller volume of business.

The selection of a place of business

somewhere on the fringe of the central business district having been made the next consideration is the choice of the section. Radio stores and branch sales offices, like furniture and music houses and automobile showrooms, would gain considerably by clustering in a distinctive neighborhood or street, if the locality is or can be established as one where goods of like kind and quality are to be found. Clustering to begin and keep up a price warfare has been a more familiar procedure in radio than the other, but this is obviously only a temporary or transitory condition. Indications seem to predict that radio retailers will soon awaken to the business value of establishing a street or a section of the town which will be known as the radio district, where the public can expect to see extensive stocks of wide variety and good quality. In many towns such a neighborhood already exists, and the proved successes of such sections have firmly established the fact that prosperity rests on basing the principal selling appeal on quality, both in merchandise and service.

Very often a single store can become the nucleus around which the radio group can successfully gather. One of the stores with which I am associated, for example, took up a location on the fringe of a city's dense pedestrian district with the specific idea of catching the backwash of the shopping horde, and operating on a quality basis solely, became an immediate success. Several other stores which established themselves in the heart of the shopping commotion did not fare so well; gradually, newcomers took up locations on the quieter street and nearby, as stores became available—and those which maintained the quality

policy built up a good business; the price slashers who invaded the district expecting to take a “free ride” on the neighborhood's growing reputation for reliability in radio have long since put up the shutters and silently stolen away.

The character of neighbors in terms of quality is then another primary consideration in the selection of a store.

A further governing factor, worthy of equally careful study, is the character of the people who usually patronize the district. According to the class of business which the radio retailer intends to do, he must secure definite knowledge of whether the clientele he can expect to draw will be high, low or middle class, and in what proportions. In some towns and some sections it is also of importance to note the tendency of occupational groups to seek certain localities, and to give thought to the buying habits and the relative proportions of business to be done with office and factory workers, the professional class, the farmers, and so on.

An Important Consideration

Again, the dealer should ask himself, Does the town or the locality need another radio store? This is a question which I feel has little engaged the attention of radio retailers, and yet there is nothing more important and requiring closer scrutiny, by both the man who expects to open a new store and the retailer already in business who is seeking the reason why he has been unable to drive his sales up to the point where he thinks they should be.

Basically, there are two things to determine: the purchasing power of the average individual locally, by town, city or county; and the number of families within easy reaching distance of the store. The first figure can be obtained ordinarily from the local Chamber of Commerce or business men's organization, or from the public statistics recorded at the county seat. It makes a big difference how much money the local people earn, for radio is a luxury, and unless the majority or at least a large proportion of the prospective customers have good incomes there will be a dearth of radio sales. To show how widely incomes vary, let me make just passing reference to the extremes shown in the reports of the effective income of \$123 per person per year in the case of Itwamba County, Mississippi, and \$1,107 per

(Please turn to page 54)

"Human Interest" in Radio Displays

Radio Keeps Jiggs at Home

"Jiggs and Maggie" of the popular comic strip are used to emphasize the home appeal of radio by the Crouch Radio Company, Oneonta, N. Y. The figures are made of beaver board and cost less than \$5. They were drawn by a local artist.

"Even a Child Can Tune It"

The simplicity of control of the new set models is inexpensively played up in this Washington, D. C., window by the use of a dealer's help placard.



Radio Cheers the Tired Hunter



This hunter's scene showing radio bringing entertainment at evening in the camp was featured by the Radio Sales Corporation, Seattle, and won a \$50 prize in a recent window contest.

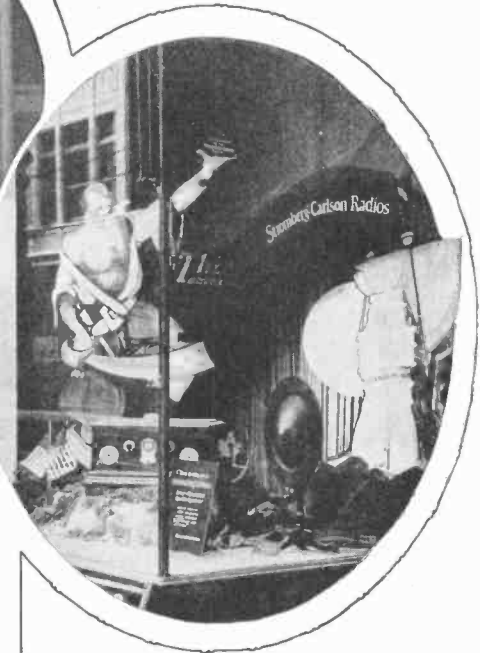

The Shielded Set Finds a New Champion

Attention is focussed on total shielding in this display by the Thiebes Music Company, St. Louis. A fierce-looking pirate, sword in hand, and his ship in the background, stand ready to protect the set.

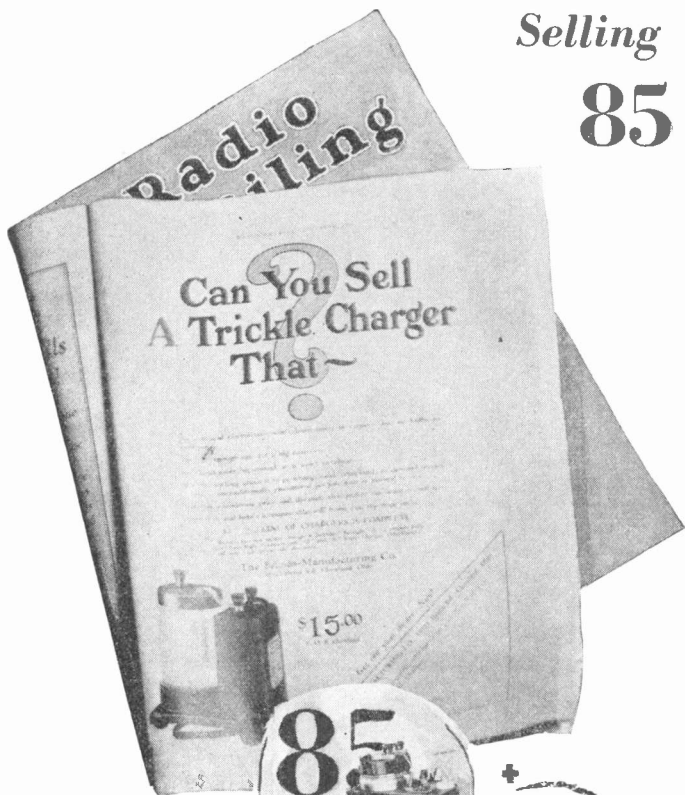

Selling

85 Trickle Chargers in Two Months

Here's a little example in arithmetic—

- One ad in "Radio Retailing"*
- + One phone call to jobber*
- + 85 trickle chargers*
- + Window displays*
- + A few hundred circulars*
- + Store and home demonstrations*
- + Two months*
- = \$510 gross profit*

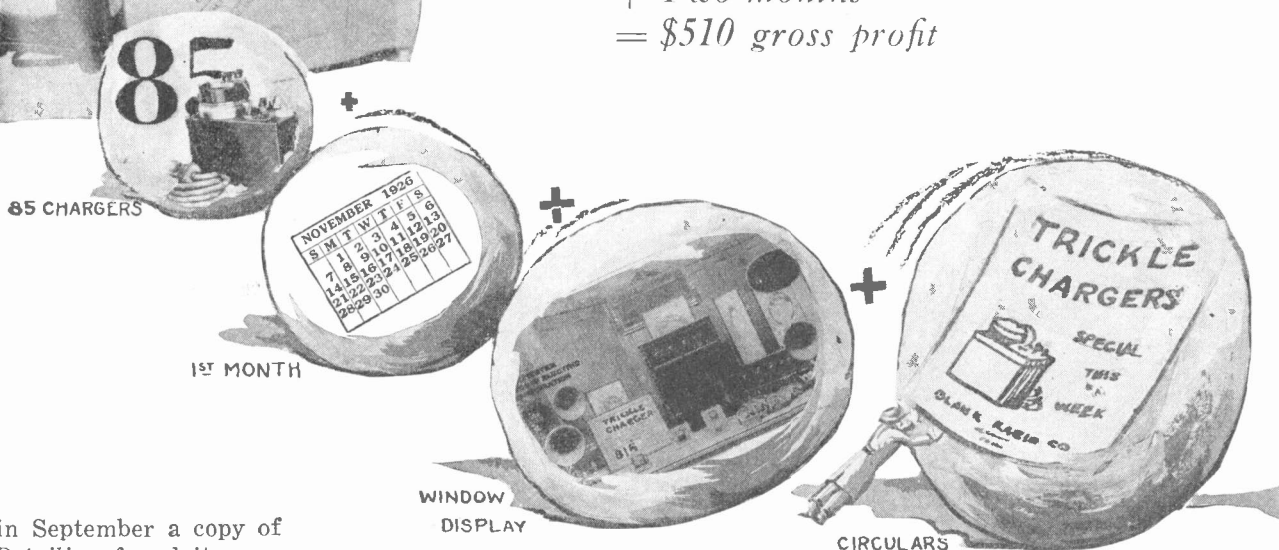

EARLY in September a copy of *Radio Retailing* found its way into Willie's Radio Shop, 23 Willoughby Street, Brooklyn, N. Y. The postman tossed it to the counter where it opened to an advertising page.

N. Willie, the shop proprietor, glanced at the issue casually, then stopped and examined the "ad" at which it had accidentally opened. It apparently carried an interesting message, for a moment later he stepped to the telephone. That same afternoon a sample shipment of A battery trickle chargers left the stock room of a local jobber for delivery at Willie's Radio Shop via fast express.

The "ad" had suggested an idea. The trickle charger was obviously an accessory which could be used to convert storage batteries already in operation in the homes of many of his customers into battery eliminators. Just the thing for the novice. No battery wires to disconnect every

week or so, no need to carry a heavy storage battery from one room to another to be charged. Just the thing to keep a battery in fully charged condition all the time without special attention.

Accessory Sales Campaign

The item could be sold to all his old customers. Why not concentrate on the sale of an accessory, just as he had often done on a "pet" receiver?

No sooner thought of than put into execution. The chargers arrived. Willie tested them thoroughly. No hum with the set in operation, with the battery being charged. Fine! A meter was inserted in one of the charger leads. The "trickle" charged the set's battery at about $\frac{1}{2}$ ampere per hour. If the battery were almost totally discharged the accessory would automatically increase its

charge rate to $\frac{7}{8}$ amperes and as a charge was accumulated the "trickle" would taper the current down to practically zero. Left connected with the battery and the light line, the set would be at peak efficiency at all times so far as filament supply was concerned. "The average 5 tube receiver is in use about 3 hours per day," Willie ruminated. "Great! The charger will keep a battery at maximum efficiency when the days the receiver is not in use are allowed for."

The Opening Gun

The window display was promptly changed to feature the trickle charger. The accessory was connected to a popular receiver on display and its features outlined by means of small pasters on the inside of the pane. The plug and cable ran out of sight behind the receiver,

presumably to the base plug. Each paster was "tied" to the charger by means of a colored ribbon, thus the display radiated facts to the neighborhood set owner. "Convert your A battery into an eliminator," the main centerpiece read.

Next, a charger was placed on the store counter. Every customer who entered the store had his attention called to it. Every package that left the store when opened was found to contain a descriptive circular. Every old customer was mailed a circular.

Then for the keynote of the campaign. Willie offered to demonstrate the trickle charger in the home of a prospect without charge. He had demonstrated complete receivers in this manner for several years and in the case of the receiver there was always that odd chance that the weather might be unfavorable for a

How Willie Conducted His Sales Campaign

1. He featured the accessory in his window for two weeks;
2. Mailed descriptive circulars to all his old customers;
3. Explained the merit of the article to every customer who entered the store;
4. Enclosed a circular in every package of goods;
5. Gave free home demonstrations of the trickle charger throughout the neighborhood.

the connection of two wires to the storage battery, a plug inserted in the base receptacle and the charger went to work. An ammeter inserted in the line convinced the prospect that the accessory was delivering the

current without an objectionable hum.

Willie's intensive advertising campaign created interest in the neighborhood. "Half a dozen or more people a day have entered the shop to inquire about the charger since I have advertised it," he tells us. The result of concentration on a single accessory is the sale of 85 trickle chargers in two months. List price \$15, gross profit approximately \$510.

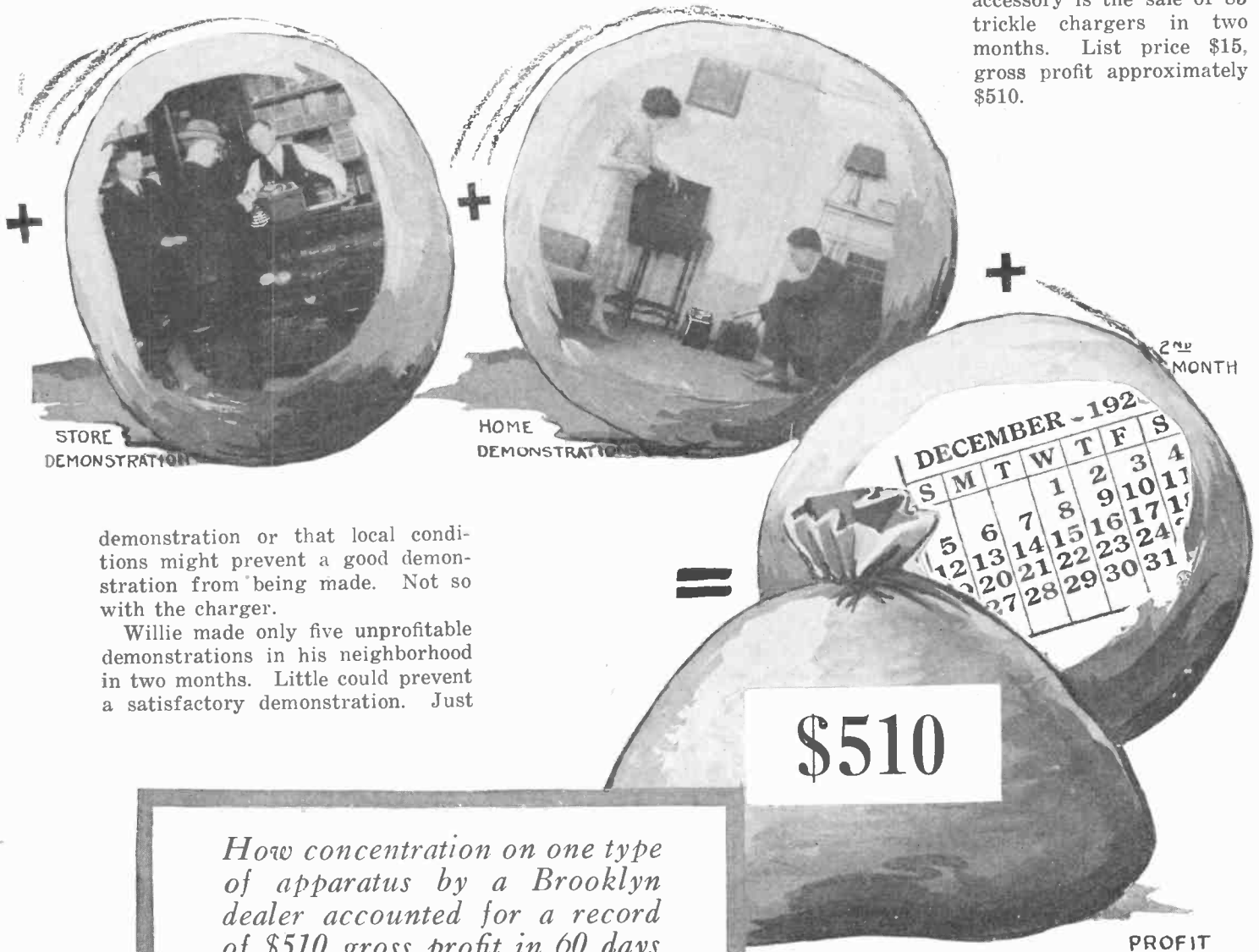

demonstration or that local conditions might prevent a good demonstration from being made. Not so with the charger.

Willie made only five unprofitable demonstrations in his neighborhood in two months. Little could prevent a satisfactory demonstration. Just

How concentration on one type of apparatus by a Brooklyn dealer accounted for a record of \$510 gross profit in 60 days

Nation Calls on Congress to

Enact Radio Relief

Strong support of provisions of White Bill given in President Coolidge's Message, and by Radio Co-ordinating and Bar Committees.

Emergency resolutions before both Houses

RELIEF! Give us relief! Relief through emergency Congressional resolution or relief through permanent legislation—but above all, relief! Radio chaos has gone on long enough!

That is the message that has poured in upon Washington from all sides these past few weeks—from the radio industry itself, from the listening public who find the ether a scrambled mess, and from the farmers who find market reports impossible to receive. Directly up to Congress, responsibility is being put by citizens and constituents.

Even from the White House itself, came ringing injunctions to Congress to agree upon and pass promptly, radio legislation for which the country has long waited. In his official message, read at the opening of Congress, December 6, President Coolidge said:

"The Department of Commerce has for some years urgently presented the necessity for further legislation in order to protect radio listeners from interference between broadcasting stations and to carry out other regulatory functions. Both branches of Congress at the last session passed enactments intended to effect such regulation, but the two bills yet remain to be brought into agreement and final passage.

"Due to decisions of the courts, the authority of the department under the law of 1912 has broken down; many more stations have been operating than can be accommodated within the limited number of wavelengths available; further stations are in course of construction; many stations have departed from the scheme of allocation set down by the department, and the whole service of this most important public function has drifted into such chaos as seems likely, if not remedied, to destroy its great value. I most urgently recommend that this legislation should be speedily enacted.

"I do not believe it is desirable to set up further independent agencies in the Government. Rather I believe it advisable to entrust the important functions of deciding who shall exercise the privilege of radio transmission and under what conditions,

the assigning of wavelengths and determination of power, to a board to be assembled whenever action on such questions becomes necessary. There should be right of appeal to the courts from the decisions of such board. The administration of the decisions of the board and the other features of regulation and promotion of radio in the public interest, together with scientific research, should remain in the Department of Commerce. Such an arrangement makes for more expert, more efficient, and more economical administration than an independent agency or board, whose duties, after initial stages, require but little attention, in which administrative functions are confused with semi-judicial functions and from which of necessity there must be greatly increased personnel and expenditure."

"Emergency Resolutions" to Stop Further Licensing of Stations

Recognizing that a deadlock existed between the two Houses of Congress on the subject of permanent radio legislation, attempts were made to secure temporary protection of the ether channels by preventing the licensing of any more stations, through introducing joint resolutions before Congress on the opening day.

The "emergency" resolution presented by Congressman White, Republican, author of the House radio

bill, would prohibit the granting of any licenses for broadcasting stations except renewal of unexpired licenses, from December 6 until otherwise provided by law. The second resolution, presented by Representative Samuel Dickstein, Democrat, of New York City, in the House, and Senator Copeland of New York in the Senate, would give Secretary Hoover complete authority over radio operation, licenses, and wavelengths until Congress has decided on a permanent plan for control. Mr. Dickstein's resolution constituted virtually a short "radio law in two paragraphs," setting up complete control of radio and leaving full discretion and administration with the Secretary of Commerce. Since the passage of such a resolution would leave little or no necessity for a permanent radio law to be enacted, opinion in Washington generally favored the White resolution, which contented itself with definitely instructing the Secretary of Commerce merely to issue no more licenses, pending permanent legislation.

Meanwhile a very complete statement of the needs of radio legislation had been drawn up by the Co-ordinating Committee of the Radio In-

Your Plea for Early Sound Radio Legislation Has Been Presented to the Congressional Committee

If you signed the coupon in November *Radio Retailing* and mailed it to the Editors, as suggested, your appeal for early legislation along the principles of the White Bill, with certain amendments, has been formally laid before the Conference Committee.

Copies of the petition, with names and addresses of all signers, were during

December delivered to each individual member of the Conference Committee, and to other leaders in Washington. All other information and statistics collected by *Radio Retailing*, including its unique complete survey of "ether confusion" conditions throughout the country, have also been made available to all officials interested.

dustry, a body made up of representatives of the two manufacturer associations, the two broadcaster groups, the retail trade, and the amateurs. The program outlined by the Co-ordinating Committee followed closely that appearing on page 33 of *Radio Retailing* for December. The statement read:

It is the opinion of the Co-ordinating Committee that it is highly essential to secure legislation controlling radio during this session of Congress. To this end it appears that two distinct steps are necessary.

1. The enactment of an emergency control measure, which will prevent the further complication of an already complicated situation by prohibiting the issuance of any more licenses for the operation of radio broadcasting stations after December 6, 1926.

2. The bringing out of conference of a comprehensive and adequate general law governing the whole radio industry.

The emergency control measure is necessary, in our opinion, because broadcasting stations are now increasing at such a rate—to be specific, one a day—as to cause not only confusion on the air but the possibility of even greater confusion. It is estimated reliably that there are now more than 20,000,000 citizens of the United States who are enthusiastic listeners to radio programs; that more than 5,000,000 citizens of the United States are the owners of radio receiving sets; that the investment of these citizens as individuals in radio is upwards of \$1,500,000,000, to say nothing of the investment which broadcasting companies and commercial operators have in the industry.

Unless immediate steps are taken by Congress to prevent confusion in the air, this great radio listening public, together with its large investment in radios, is likely to suffer a tremendous injury.

Equally important is the threatened interruption of the flow of information regarding agricultural and market reports, upon which our farmers have come to depend, through the medium of the radio.

We assume the Conference Committee realizes that it cannot permit further delay to jeopardize a national industry involving six hundred million dollars per year, and, more important, the disappointment of twenty million people in a very vital and personal family interest.

Having made our position clear in its intent and purpose, the committee, eliminating all considerations except those for the good of the radio listener and the industry, and the existing subject matter in the Senate and House bills, favors a control consisting of two bodies—a Federal Radio Commission and the Department of Commerce, whose functions shall be as determined in the House bill. These functions should be so adjusted in the administrative powers as to clearly determine the standards

used in cases for decisions as herein-after recommended, and to define and clarify large discretionary powers and control in the commission.

This committee believes that any limitation, in addition to the fact that a man must not be financially interested in radio at the time he is serving on the Commission, restricts the number of men from whom selection can be made to serve ably on the Commission because of their current knowledge of radio problems.

It is the opinion of the Co-ordinating Committee that it is fair, just and reasonable, and in confirmation of the interpretation of the common law, that there be provided in any radio law a recognition of rights as between individual broadcasters as distinguished from the vested rights of the United States which will be in

effect at the time and in the form prescribed in the legislation following your conference report.

We believe that the theory, of the right of priority of operation, should be thoroughly defined. In effect this means that the allocation and use of wavelengths shall be determined on the basis of these factors:

1. The length of time during which stations, existing at the time this Act becomes law, have operated.

2. The character of service rendered by them.

3. The requirements of their zones and communities for radio service.

The above principles should be so written into the law that there will be no limitation of the effect thereof.

Bar Assn. Advises Cut in Number of Stations

A new and unique legal point of view was interjected into the legislation situation by the Air Law Committee of the American Bar Association, of which Chester W. Cuthell, a Washington attorney, is chairman. This committee urges that in the interest of good radio reception the number of stations licensed be considerably cut down in number, by putting certain stations off the air, but proposes that the stations thus shut down be compensated for both the physical value of their equipment and good-will. It explains:

"To close stations in which large sums of money have already been invested is obviously a drastic provision. We do not believe that the courts would hold Constitutional legislation which permitted such closing, either directly or indirectly by way of declining to issue new licenses, unless just compensation were paid.

"The opinion of our committee, which we believe is shared by a very large percentage of the bar, is that the creation of more and more commissions, which are merely appointed by the President and which thereafter do not report to the President, is not the form of organization that tends to the greatest efficiency.

They rarely work harmoniously because their members are chosen from different parties. They are slower to act and slower to deal with new problems than an individual Cabinet officer."

In discussing proposed anti-monopoly provisions of radio legislation, the report says:

"The committee believes that it is not the best legislative policy to incorporate in a radio regulatory measure provisions that either parallel or duplicate the Sherman and Clayton laws with respect to monopoly or limitation of competition. Those laws have been on the books for a good many years. They have been litigated perhaps more fully than any other group of statutes, and they seem to us adequate to deal with any tendency toward monopoly."

Air Chaos



—N. Y. Daily Mirror

Analyzing the Secrets of Success

RADIO renders its greatest and most acceptable service in the rural community. Yet city dealers outsell their country brethren two to one, according to the most reliable estimates from set manufacturers. With a view to finding out why most rural dealers do not get their natural share of radio business, I questioned dealers in a score of representative buying centers.

There is no simple formula for selling radio in rural districts, I discovered. What succeeds in one community fails in another. Aggressive

Active interest in community affairs and unfailing service pave the way to a lasting, prosperous business, interviews with leading country merchants reveal

dealers attain this enviable position of leadership?

K. W. Fritts of Fritts & Corey, Newton, N. J., was one of these dealers. When I called on him, he had just completed a radio show all

with those who later became the established leaders of the industry. In fact, some of his competitors gained a temporary advantage by securing franchises on sets which later became national selling successes.

Fritts, however, stood back of every set he sold with an active and sympathetic service. By this he gained both a reputation for integrity and a knowledge of which receivers gave trouble and which gave satisfaction.

Little by little, he has thus developed a line which meets every price and service need of his community. Today he can secure almost

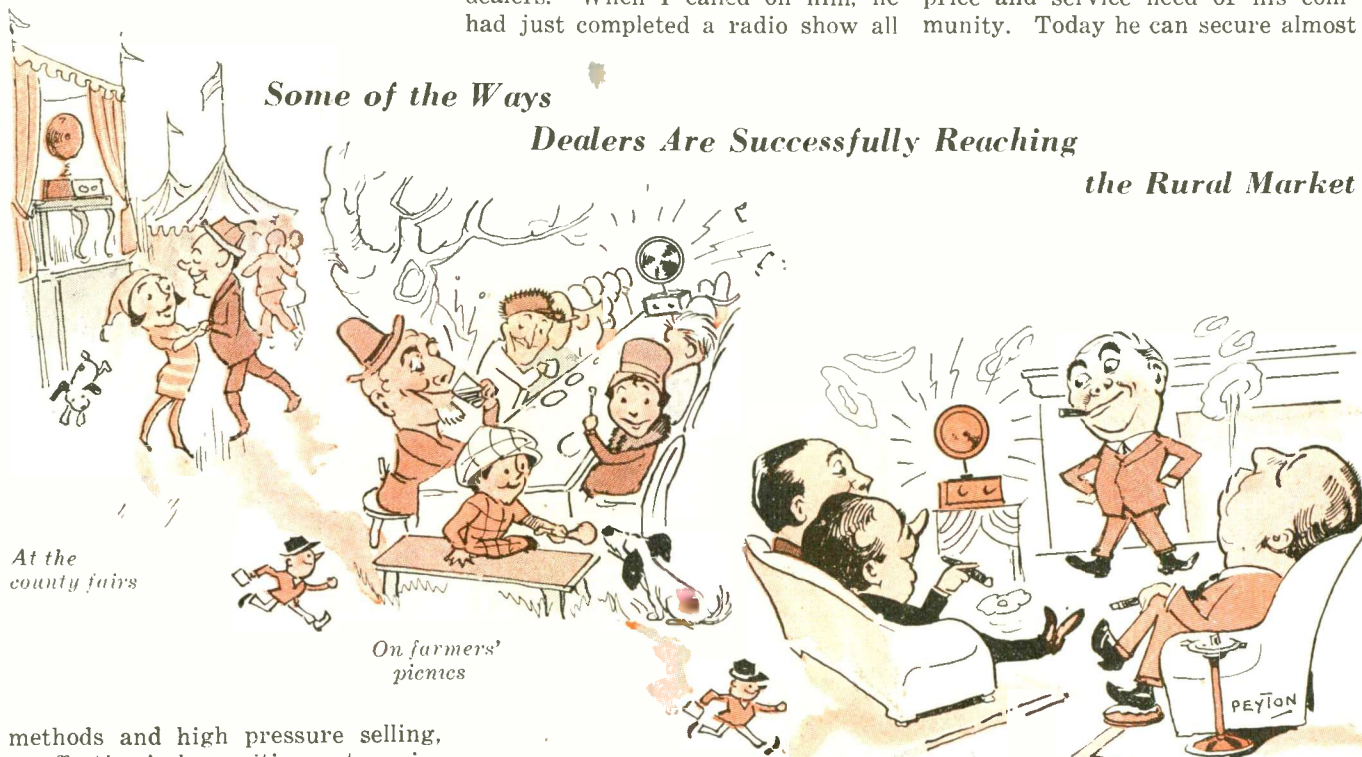

At the county fairs

On farmers' picnics

At the farmers' clubs

methods and high pressure selling, so effective in busy cities, antagonize conservative country buyers. House-to-house selling and home demonstrations get over in one town and fall down in the next.

During the first few weeks of investigation, I was more confused than when I began. Here and there I found dealers doing a surprisingly large and active business over a wide area. They were selling more sets than their five or six competitors put together. Inquiry of anyone in their town—the postmaster, the hotel keeper, the idler on the street corner—for the best radio store proved that each was recognized by the citizens of his community as the local radio authority. How did these

his own in the Town Hall of a nearby community having a population of less than a thousand. The show had started the night of the Dempsey-Tunney fight. Within the week he had closed twenty sales between \$100 and \$350 and, he assured me, from previous experience, that his little show would net him at least thirty more sales before Christmas.

Fritts did not gain his position as a leader in the radio business in Sussex County without a struggle. He started from scratch with six competitors. Lacking technical knowledge at first, he did not tie up

any franchise he seeks because he is the leader in the radio business.

Another example is that of Charles Kerr, in charge of the radio department of the only department store in a small town in Vermont. Two years ago he sold 150 sets from his cramped space under the stairs of the store; last year he sold nearly 200 sets.

He is a busy man because he spends his evenings installing sets, servicing them and instructing owners how to get the most out of them. He, too, has only satisfied customers and some of them, learn-

in Selling Radio to the Farmer

ing of his reputation, come a score of miles to do business with him.

To the dealer in the large city, selling twenty-five or thirty thousand dollars worth of sets a year does not seem like a big business. But the small town dealer sells at list prices; he pays small rent and low salaries and he advertises in newspapers having low advertising rates. It is not unusual to make three times more profit on a given volume in the small town than in large cities.

The Hoover Shop, a progressive electrical concern of Kansas City, Kansas, and an outstanding success in selling radio to rural communities, carries on an inexpensive but complete mail campaign by a very simple method. It obtains from the postmasters of neighboring towns the numbers of the R.F.D. routes and of the post office boxes on each route. A rubber stamp, illustrated on the next page, is used for addressing the envelopes, and the route and box numbers are filled in by hand. In this way hundreds of prospects are

BY EDGAR H. FELIX

reputation for unfailing service and, for a period of years, has satisfied every customer, no matter what the cost in effort and time.

(3) Each has studied radio receivers and local conditions thoroughly, so that he can recommend the best set suited to his customer's pocket-book and needs with certainty and positiveness.

There is nothing startlingly new in these principles. They are widely recognized. Nevertheless, five out of six country dealers still wait behind their counters for customers to drop in and buy.

Being active in the community means more than going to church

because he knows that is what he must do to sell the conservative buyers of his community. And he is ever alert for new opportunities to make radio sell itself.

It was interesting to note how different dealers responded to suggestions. To each dealer whom I called on I suggested that he loan a receiving set to every newly married couple in the community. Most of the dealers laughed off the idea with

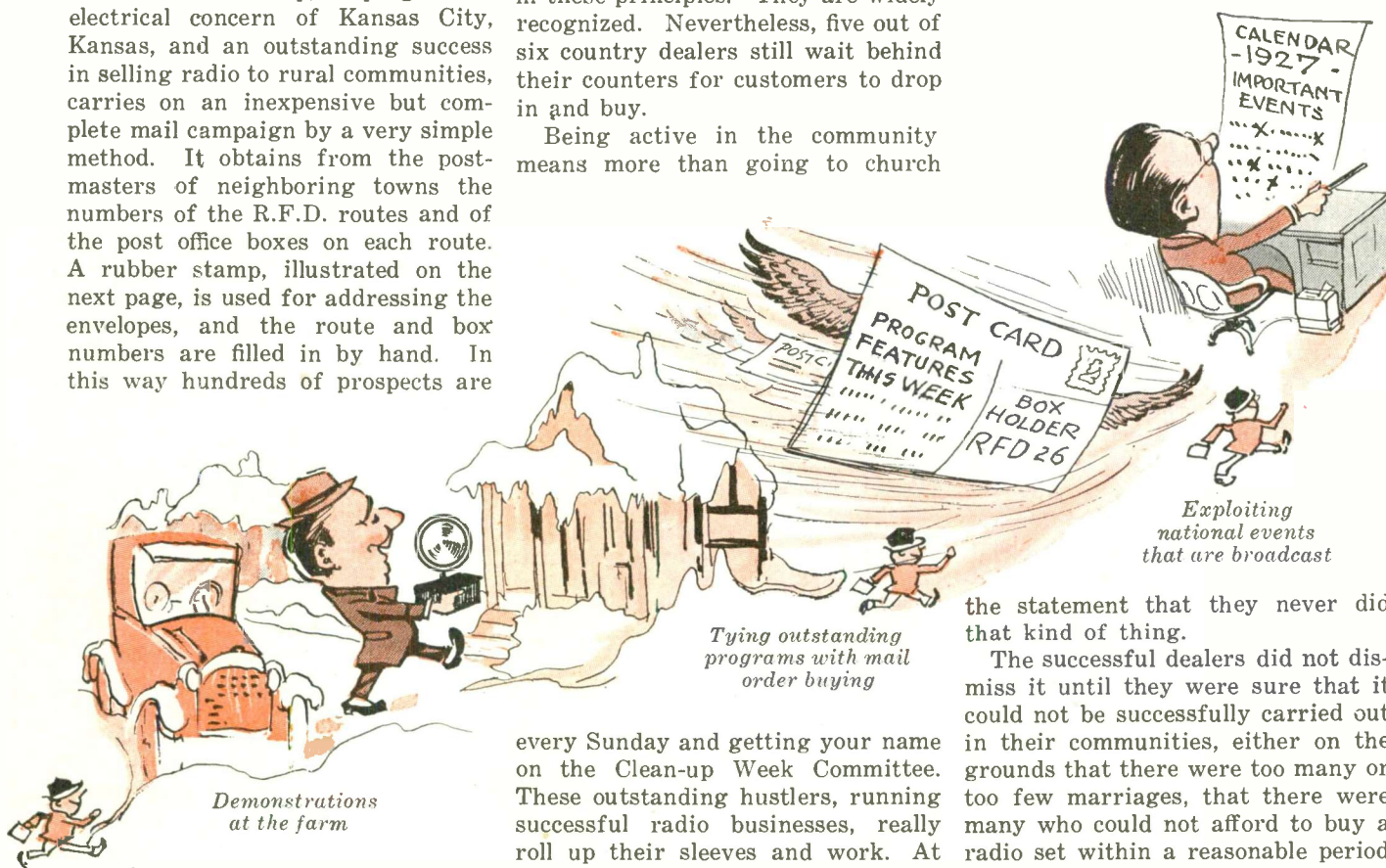

Demonstrations at the farm

Tying outstanding programs with mail order buying

Exploiting national events that are broadcast

reached by circulars, and a notable proportion of sales follows.

To cite individual instances of successful rural selling is interesting, but conditions vary so that it is more profitable to consider the fundamental principles upon which rural selling is based. Three cardinal points stand out in the policies of those whom I classified as successful rural dealers:

(1) Each is an active leader in the affairs of his community and he uses every opportunity which his activities afford to make the services of radio known.

(2) Each has won a widespread

every Sunday and getting your name on the Clean-up Week Committee. These outstanding hustlers, running successful radio businesses, really roll up their sleeves and work. At the Sunday School picnic, the folks dance to music from a radio which the dealer transports and sets up with considerable effort and trouble.

At the American Legion Carnival and at the Farmers' picnic, he is on deck as usual, with his radio doing a goodwill job. He posts the market reports in his store window so that the farmers will better appreciate the service of radio. During the World's Series and the Football season, his loudspeaker is working in the village square. He even lends radio sets to homes where there is illness. He overlooks no opportunity to demonstrate the service of radio

the statement that they never did that kind of thing.

The successful dealers did not dismiss it until they were sure that it could not be successfully carried out in their communities, either on the grounds that there were too many or too few marriages, that there were many who could not afford to buy a radio set within a reasonable period or that the offer would be otherwise abused. My object was not to learn whether the suggestion was feasible or not, but to note the difference in attitude toward suggestions between the successful and unsuccessful dealer.

Winning a reputation in a small town where everybody knows everybody else is a slow process. But the dealer who wins a place of obvious leadership by constant and constructive activity and unfailing service has paved the way to a lasting and prosperous business. The personal element is everything in the small town. And you can't get your per-

sonality across a show case; you've got to get out and get busy in the affairs of the community.

My second point is the old story of service. The purchase of a radio set at a cost of \$100 to \$200 is often the largest single expenditure for a non-essential made by a farmer over a period of several years. If it is a source of constant trouble and expense, his neighbors will soon know about it. To quote the words of Mr. Fritts, "Many times we have replaced sets for customers even though their complaints were quite unreasonable, because we cannot afford to have a single dissatisfied customer."

Some of the dealers I called on rendered no service whatever. One electrician whom I met on my wanderings had sold a five tube receiver of well known make to the local Men's Club. (What an ideal place to make a sale for winning a reputation for service!) He said the set had been giving constant trouble for a year. He asked me to step over and look at it. Under the table were four "B" batteries, connected in series. The electrician explained that the trouble couldn't be batteries because he had recently added two new ones, which brought the voltage of the four batteries to nearly 100 volts! But he could not understand why the set gave forth a continuous whistle.

There has been some difference of opinion among retailers about charges for service calls. Most of the good dealers I called on render free service on all sets which they sell for an indefinite period, charging only for materials supplied and for

TO discover why most country dealers do not get their share of radio business, the author interviewed successful retailers in 20 rural centers. His observations and recommendations set down in this article throw new light on this important problem and will prove helpful to dealers everywhere.

repairs resulting from abuse. The profit on tubes and batteries sold through service calls is sufficient to meet the cost of rendering it. With the increased reliability of radio receivers, it seems likely that this will become generally accepted practice because practically every service call now results in a sale of maintenance accessories.

Judicious Set Buying

The third point is judicious buying of receiving sets. The lessons learned through service calls are a valuable aid in securing data as to the most satisfactory receivers. I found a number of considerations in set selection of particular importance to dealers serving rural districts:

(1) Sets must be sufficiently sensitive to bring in at least a dozen stations with loudspeaker volume. Many makes of receivers, excellent for city use, fail to meet this requirement, in spite of claims to the contrary.

(2) Simplicity of control is a selling factor of paramount importance in rural districts.

(3) The stocking of only one good line in each price class is all that is necessary if the dealer has won the confidence of his community; otherwise he must be prepared to supply what his customers ask for. Varied stocks confuse buyers and increase the investment.

Radio Retailing has presented several excellent articles on instalment selling; it would be mere repetition to go into it again. Comparatively few rural dealers are selling receivers on the instalment plan. In agricultural communities, instalment buying seems to be limited to purchases running into larger amounts.

House to house selling is sometimes recommended as the ideal method of building up sales in the rural community. But door to door selling has no place with a commodity as high priced as radio. The progressive dealer who utilizes community activities to bring attention to radio will be quick to recognize those who are interested among persons he instructs or entertains. He concentrates his personal selling on the listeners who evidence some interests and relies upon his sustained public service to build up, by constant stimulus, the desire to buy radio. He lists these buyers in his prospect list. He invites them to all important demonstrations. He sends them postcard notices of all outstanding radio events; he invites them to listen in his store, if they do not own radio sets.

As evidence that this service method of selling gradually builds up prospects, dealers will recognize the fact that few people come into their stores to be convinced that they want a radio set. They do not subject themselves to direct sales effort until they have decided to buy a radio. Actual selling is largely a matter of deciding which radio set they wish. Public demonstrations and listening service hasten the day they arrive at that point. They contribute more to the actual sale than the final selling talk which leads to the choice between one set or another.

The Value of Home Demonstrations

Home demonstrations are valuable in closing sales, but discrimination should be used in giving them. Too liberal a policy with home demonstrations leads to abuse of the privilege by those who are not bona fide prospects. Of 20 active small town dealers questioned, 12 stated they give home demonstrations only if a cash deposit was paid by the prospect.

Please turn to page 58

THE HOOVER SHOP

752 MINNESOTA, AVE.
KANSAS CITY, KANSAS
PHONE - DREXEL 0464

BOX HOLDER

R.F.D. _____
KANSAS CITY, KS.

How a Kansas City, Kansas, dealer addressed his envelopes for a successful, inexpensive direct mail campaign in the rural districts. The address is made by a rubber stamp; the number filled in by hand. The Post Office Department permits this form of address when names of box-holders are not known.

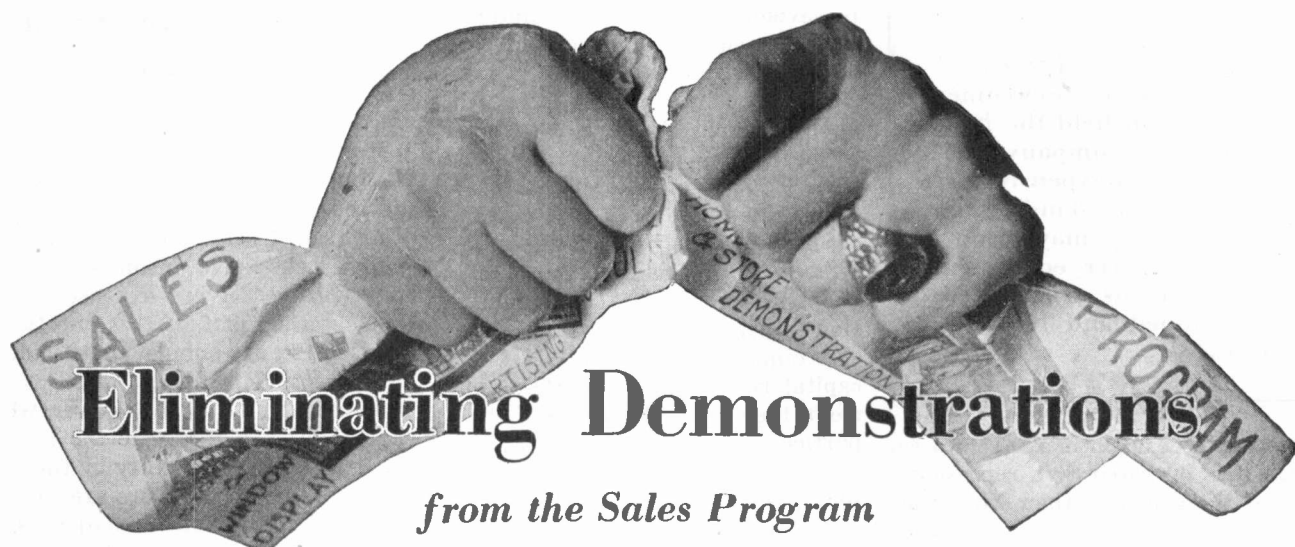

Eliminating Demonstrations

from the Sales Program

MOST radio dealers are ready to admit that the retail radio business suffers from an unusually heavy overhead necessitated by the conditions of the business—demonstrations, installation, servicing. Each of these takes time and, even if it involves no further expense, demands the carrying of a larger sales force than would be ordinarily required to handle the same volume of business in an article which was sold purely as a store product.

The Ernst Hardware Company, of Seattle, which carries radio as a special department of some importance, believes that much of this overhead is unnecessary. So far as possible they have endeavored to place radio on a par with any other store merchandise, selling it on its merits over the counter, without demonstration and without servicing.

Goods Sold on Store's Reputation

"Practically all merchandise is sold on the reputation of the store in any case," the manager of the department declares. Few customers have sufficient knowledge of any field to tell quality by appearance. In the same way, the customer who is purchasing radio must rely in large measure on the statements of the salesmen and the faith which he has in them. A demonstration can give only a very general idea of the performance of the equipment, and if comparisons are being made, the demonstration may do an injustice because it comes at a time when reception may not be so favorable. As for the wearing qualities of the set and its future performance over a

Radio can be sold over the counter on its own merits, just like other merchandise, a Seattle hardware company has found.

By C. GRUNSKY

period of time, this is altogether taken on trust.

The Ernst company, therefore, has taken the stand that the set may be sold in the first place on the basis of its appearance and the statements made in regard to its performance. These statements, incidentally, are made extremely conservative so that the customer's surprise comes rather from the better results obtained than from any failure of the set to live up to specifications. Quality merchandise and a recognized standing for the store are, of course, the essentials upon which this procedure is based.

Will customers purchase radio sets without hearing them? Well, the extent of the radio business done by the established mail order houses is proof of the fact that, under certain circumstances, they do. When you add to that a personal inspection of the set, plus the knowledge that the firm with which they are dealing is one of long standing, with the very highest of reputations and that if

anything should be wrong it would not hesitate to make it right, the demonstration becomes a secondary matter.

There is, in the first place, nothing in the surroundings of the department which would suggest a demonstration in the store. The sets are attractively displayed with an effective background, but entirely in the open, in the midst of store traffic, with no demonstration booth available. The customer does not think of asking to hear the radio under these conditions. When a request is made for a house demonstration, as frequently happens because the public is trained to expect this by other dealers, the customer is told that this is not the policy of the store, but that if he wishes to purchase the set, of course anything which is not according to the claims made for it will be taken care of.

Lessens Servicing

Does this lead to excessive servicing? On the contrary, according to the manager of the department, one of the reasons for adopting the "no demonstration" policy has been the fact that servicing under this system is considerably less. Whether the customer studies the subject of radio more thoroughly when placed "on his own" and in consequence is able more intelligently to operate the set, or does not think of asking for help because it is not offered, at any rate the service calls on sets sold in this way have been only about one-fourth as many as those required when home demonstrations were given.

The explanation given for this by the Ernst company is that cus-

Trains Beginners

To educate newcomers in the radio field the Ernst Hardware Company sells them an inexpensive set with the understanding that later on they may trade it in on a better equipment. The trade-ins are then reconditioned and sold at a profit.

tomers expect much more from a set when it is operated by a representative of the company than when they are operating it themselves. If they turn the dial on their own initiative and thereby get the local Seattle station, or if they bring in San Francisco, they are delighted. When the demonstrator is handling the set, on the other hand, they expect to get Chicago at the least. This expectation is then continued on into the future. Moreover they have the feeling in many cases that they had better monkey with the set as little as possible.

In consequence if the slightest thing goes wrong they call up and ask for help. When they have operated the set from the first, on the other hand, they feel the confidence of the old hand at the game and do not ask for unnecessary help. The Ernst Company announces no definite policy in the matter of rendering service, but as a matter of fact they make no service calls except in unusual cases.

Installs All Sets It Sells

The only exception to the policy of confining the sale to the store is in the installation of sets. The company always installs any set sold. This insures its being done correctly and starts the customer out right. If he were left to himself, in all probability he would get the hook-up wrong and then return the set the next day with the tubes burned out, expecting a fresh set in exchange.

Next to cutting down the cost of selling, the Ernst company believes that buying is most important. A "sense of the market" which enables the buyer to foresee changes in the trend of purchasing will prevent the department from being loaded up with obsolete equipment. There is no economy in stocking up with a model which is cheap because it is out of date. This is the greatest bugbear of the dealer and can only

be avoided by a close familiarity with the entire radio field. To end a season with clean shelves ready to stock up on the new styles as they appear should be the aim of every buyer under present radio conditions. Much of the success of the Ernst Hardware radio department is credited to a study of this one subject.

Because of the system of selling adopted, the absence of demonstration expense and the reduction in servicing, as well as the fact that no capital is tied up in obsolete equipment, the overhead expense of the department is low. This is a legitimate basis, the company believes, for selling some of their merchandise at a slightly reduced price. In no sense do they sanction price cutting, but they believe that the customer should be given some advantage in price because he has foregone demonstrations and servicing. This, they believe, is on a par with the electrical contractor who, because he has reduced his business to a system, can operate at a lower cost than his competitor, and so can afford to take jobs at a lower rate. Undoubtedly they lose some sales because they do not offer the service offered by other stores; they believe, however, that they gain more because of their lower costs of doing business.

Beginners Trained

One of the interesting practices of the store is to train beginners in the use of radio. This they believe it is possible to do by selling them low-priced sets and later on more expensive ones. A low-priced set selling for \$29.50 has been chosen for this purpose and this is featured in advertising, a special effort being made to sell this set to those who have not hitherto enjoyed the use of radio and who do not wish a more expensive set. The set is definitely sold as a "come-on" proposition, being accepted as a trade-in on the purchase price of a larger set later on. This is made one of the arguments in negotiating the sale, so that the mind of the customer is already directed toward the time when a larger set will appear desirable. As a matter of practice, it is found that a large number of these sets are actually turned in after a month or two for the more expensive set with the wider radius of reception. The small sets are so simple in construction that they can easily be reconditioned and resold, generally for the full amount allowed on the trade-in, plus a reasonable profit.

"Choosing the Right Location"

(From Page 44)

person per year in Los Angeles County, California. Even on the deferred payment basis, it is obvious that radio sets cannot be sold to people who have incomes sufficient only to meet living expenses.

The other half of this question is a matter of simple mathematical division. Population statistics are conveniently available everywhere and it is easy to divide the number of families in the locality by the number of radio stores there are to serve them. Radio, as merchandise, is not like groceries or drygoods—the public can get along with far less radio stores than with either of the others. It may be of interest to know that, by and large, averaged all over the United States, there is a grocery store to every 73 families; a dry goods store to every 691 families, and about the same number of hardware stores. This does not mean necessarily that this is the number the public requires—the business failures indicate rather the contrary, in fact—but that is the proportion as it exists. And there are said to be about 30,000 retail radio stores throughout the country nowadays; that is, one to every 900 families—that may be of some use in determining the possibilities for profitable business in any given location. Common sense is the main ingredient for the solving of this problem, but the attempt to set up standards with the foregoing figures is of some use in at least establishing warning signals.

In fine, a location that may be ideal for one type of business may be altogether unsuitable for radio. And one that may be unsuitable for one particular radio store may be good for another, depending upon the size and quality to the business. Consideration of the factors so far given in this article may be found useful and profitable therefore—particularly if the location looks "good" when the following questions can be answered favorably:

Can I do here a volume of gross business 25 times the amount of the rent?

Can it be done at prices which will show me at least 34 per cent gross profit?

If the location does not measure up in all the essentials which have been here outlined, let me advise you, from experience—watch out!

The Year's Trend in Set Design

Composite views of 1927's table and console model sets based on a survey of the products of 200 manufacturers in *Radio Retailing's* July and August set listing

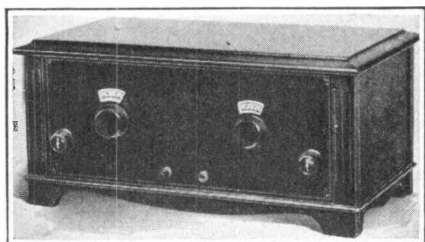

\$101

1927's average table type set lists at \$101, weighs 31 lb. and is 9 in. high, 23 in. wide and 12 in. deep. Only 8 per cent of the types manufactured are equipped with built-in loudspeakers.

INCREASING interest in highboy and console type receiving sets is reflected this year in the catalogs of principal radio manufacturers. Seventy per cent of the types offered by manufacturers are of the console variety. In 1926 so few consoles were sold in proportion to the number of table models disposed of, that this larger type of receiver had little bearing on the specifications of the year's average receiver.

This year the situation is entirely altered. So many consoles have appeared on the market that an average set figure including this type would be misleading. If this were done, for instance, the list price of the average receiver would appear as \$151, its weight would be given as 56 lb., and every other figure presented would be out of proportion to the same degree. For this reason the average console receiver and the average table model are pictured separately.

Tuned Radio Frequency Predominates

More than 80 per cent of the various lines offered by manufacturers this year are of the T.R.F. variety. Approximately 6 per cent of the sets offered by manufacturers employ the Neutrodyne principle, while regenerative circuits are used in another 6 per cent of the types offered.

Though the average set employs 2 dials, 41 per cent of the sets available provide for three-dial control, 34 per cent use two tuning dials and 23 per cent are equipped for single-control operation.

The figures used on this page are based on the number of models offered by manufacturers, and not on the number of sets actually produced.

The 1927 Average Set

(both table and console) has—

- 5 Tubes—40 per cent of the types made accommodate either dry cell or storage battery tubes.
- 2 Stages of Radio Frequency—Very few sets employing less than this number and many manufacturers swinging to multi-stage r.f. sets.
- 2 Stages of Audio Frequency—With an average slightly higher than last year due to the development of resistance and impedance coupling methods.
- 2 Tuning Controls—Simplified control rapidly becoming a necessity in the higher priced models.



\$202

The season's composite console model lists at \$202, weighs 82 lb. and is 37 in. high, 30 in. wide and 12 in. deep. 52 per cent of the types manufactured contain built-in speakers.



For the
S
E
R
V
I
C
E
Man

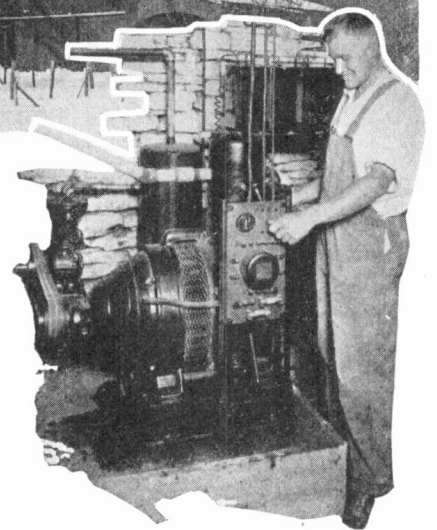

Using Farm Lighting Batteries for A, B and C Radio Current

Editor's Note—This article by A. S. Clarke of the Clarke Electric Company, Danville, Va., gives in detail his method of adapting the farm electric plant to supply current for the radio set. This is a very practical plan and an easy one for the ordinary dealer to use.

THE 110 volt storage batteries of the larger size farm lighting plants may be used, without undue strain on the batteries, for both the A and B batteries of a radio installation provided the precautions, given in this article are observed. The total current drawn by the average 5 tube tuned radio frequency set for filament lighting is 1½ amp., which is approximately the current drawn by a 32 volt 40 watt lamp. The use of 3 cells for filament lighting will not run these cells down appreciably faster than the others in the series.

The general scheme for getting both A and B current from a 56 cell battery is shown in Fig. 1.

A tap is taken off the battery at the jumper connecting the third and

fourth cells from the negative end and this tap becomes both the positive A and negative B terminal. It is an almost universal custom now to make these two a common terminal. A tap can be taken off at any point desired from the positive A and negative B terminal for one or more intermediate voltages as shown.

Fig. 2 shows the method of obtaining A, B, and C voltages from a 56 cell battery. The leads from the battery should be fused at the battery using 3 amp. fuses and then cabled together and run to the set

where by-pass condensers of at least ½ mfd. should be provided as shown. These are for the purpose of overcoming the effect of the long leads upon the operation of the set. When these schemes are used we have observed no injurious effect due to the existing wiring in the house acting as a counterpoise, especially if one side of the filament is grounded as shown in the other accompanying sketches.

If the negative side of the filament is grounded as is almost always the case in the average 5-tube tuned radio frequency set, it is advisable to disconnect the ground from the filament wiring. If this is impracticable, due to unbalancing of the set, or to the fact that the antenna is run to a tap on the first R.F. transformer, a .001 mfd. or larger condenser capable of standing 100 volts continuously, should be inserted in the ground lead of the set. Also a separate driven pipe ground should be employed instead of the farm

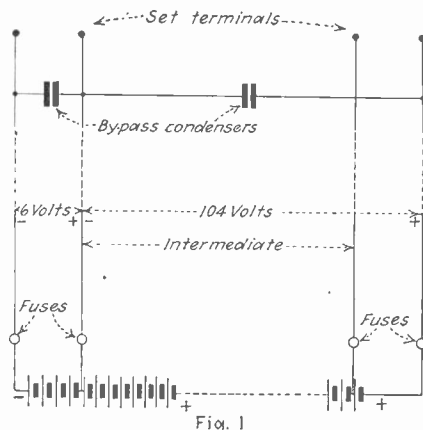

Fig. 1

water supply piping as is usually done.

The reason for these precautions is that practically every farm lighting system we have ever tested has a ground somewhere. Sometimes this occurs on the generator or ignition system of the engine. Then also the pump motor on the automatic water supply, which is usually located in a very damp place, becomes grounded, making the whole water piping system electrically alive.

Testing for Ground

To see if the system is grounded start the water supply motor and all other motors used on the system that might possibly cause a ground, and test using a voltmeter. One terminal of a 0-100 volt voltmeter is connected to a good ground and the other touched to one or the other side of the lighting system. If the voltmeter indicates a difference in potential when the test clip is on the positive wire then the negative side is grounded, and vice versa. If the test shows a grounded positive and there are no devices on the line that require a definite polarity, change the wires feeding the house system so that the negative is grounded rather than the positive. This, of course, is not feasible if the generator and ignition are purposely grounded.

Results of Neglecting Precautions

Supposing then, one side of the line is grounded and we are taking filament current only from our 32 or 110 volt battery, let's see what happens if we do not observe the precautions such as a ground lead condenser and the change of ground outlined above.

In Fig. 3 we have the condition where there is a ground on the negative side of the line, but we have started to take our taps down from

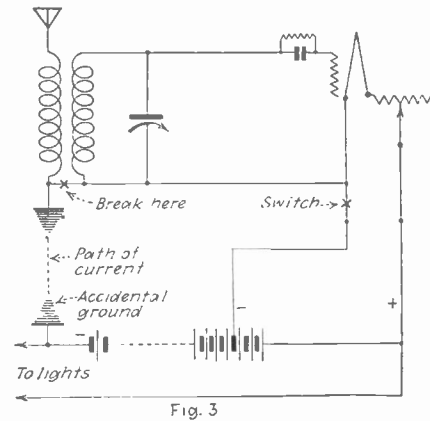
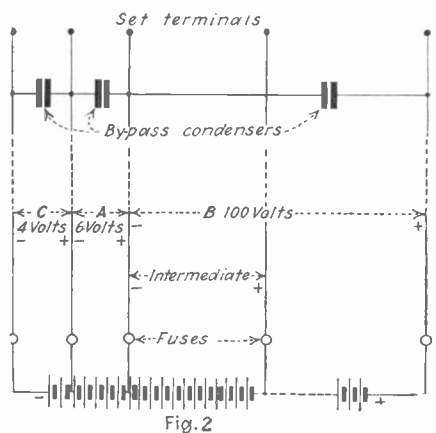

the positive end of the battery instead of up from the negative end. When the switch is turned on at the set we shall have a flow of current between the two grounds as shown by the dotted line. If this path is of

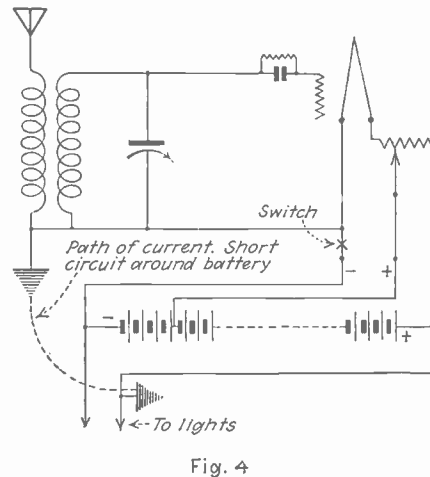

low resistance, as would be the case if the water piping was grounded and our radio ground made to it, we would have a short circuit around the battery and the resultant heavy current would blow the tubes, burn up rheostats and cause other similar troubles. If the battery switch on the set was in the negative lead, smoke would be rising even before the switch was moved to the "on" position, as can be seen from tracing the path of the current.

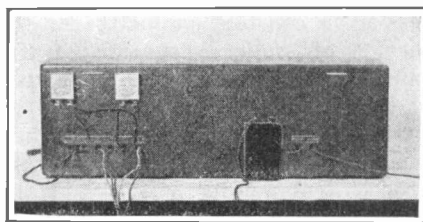

Above is shown how Clark installs by-pass condensers at the rear of the radio set to overcome the detrimental effect of the long leads from the batteries.

If we had the positive side grounded, the effect would be simply shorting the 3 cells of the battery used.

In Fig. 4 we have started off right by taking 3 cells from the negative end but we have our positive grounded, the result being the same as that of Fig. 3—blown tubes and fireworks.

The Correct Hook-Up

If, however, the negative is the grounded side and we start at the negative end and tap 3 cells towards the positive for our positive lead, all is well. Ground is connected to ground as in Fig. 5 and no harm results. This is the correct hook-up. Now look back at Fig. 4 and it will be seen that by simply changing the two wires feeding the house lighting system we could get the condition shown in Fig. 5 and avoid this trouble.

The safest thing to do, however, is to insert a condenser in the ground lead which will effectually block all direct current but allow ready passage to radio frequency current. A condenser of the size specified or larger will have no effect on the tuning of the aperiodic primary circuit since it is in series with the antenna capacity and is very large compared to this capacity.

If the precautions outlined are observed any owner of a 32 volt farm lighting outfit can enjoy complete freedom from the nuisance of having to recharge his A battery. If a 110 volt storage battery system is available he can be forever freed from radio battery troubles. Of course when motor driven devices are operating on the system they will cause considerable interference with reception due to brush sparking, etc., but the trouble is usually present whether or not the power battery is used to supply current for the radio receiving set.

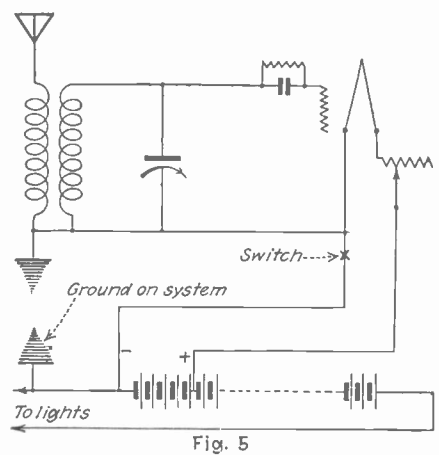

Circuit Tester Combined with Tube Reactivator

Speed being one of the requisites of the modern service man, L. A. Lagasse, Beverly, Mass., offers the following suggestion as an aid in this direction. A small portable case, a double-pole, double-throw switch, two standard, keyless, light sockets, and any good tube reactivator are necessary to make up the outfit shown in the illustration.

"Then," Lagasse tells us, "the sockets and switch are mounted on a bakelite panel, which is placed by the side of the reactivator in a case. From the center blades of the switch and coming from one side of the case are flexible leads with a plug on, which may be used to connect to the house-lighting circuit. This supplies current for both the tester and the reactivator. Ten-watt lamps should be used in the test sockets, otherwise damage may result to the parts under test. The two wires coming from the other side of the case, connected to the test lamp, may be equipped with clips if desired. It is to be noted that when the tester is used on the receiver all the tubes should be removed and also the battery and outside wires disconnected.

"When testing audio frequency transformers a cheap voltmeter is to be used in series, otherwise due to the resistance in the windings, the lights will not show as they should.

"The tester works in the following manner: When both lights remain lit the circuit tested is open. If one light goes out and the other lights very bright the circuit under test is closed. When it is desired to use the tube reactivator, merely throw over the switch as this provides current for the transformers."

Lagasse says that by use of this testing device many short circuits caused by defective fixed condensers have been found that other service men have missed due to lack of means of testing.

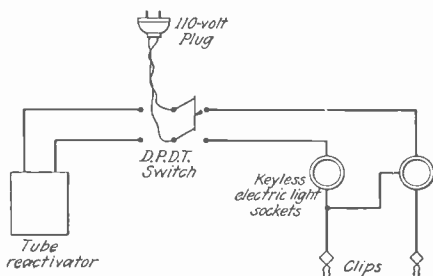

Use of the above testing circuit greatly aids Lagasse, Beverly, Mass., in servicing

GUARANTEE! ○ Keep in a Convenient Place

R. & R. RADIO CO. Inc.

1418 BROADWAY 1410 MYRTLE AVE.
Bushwick Theatre Bldg. Cor. Greene Ave.
Tel., Foxcroft 5512 Tel., Foxcroft 8360

ESTABLISHED 1921

... *J. Jones* ... *any 10. 1926.*

Type or Name of Set ... *Blair - 5* ...

No. ... *100* ...

THE above radio set is guaranteed for one year from date. If it should not operate properly, phone our nearest store and representative will call.

Our representative will also call at regular periods for the purpose of inspecting your set, testing your batteries, etc.

R. & R. RADIO CO., INC.

BY ... *M. J. R.* ...

RECORD OF INSPECTIONS			
DATE	BY	DATE	BY
<i>1/15/26</i>	<i>RJR</i>		

NOTICE! DO NOT ADMIT REPAIR MAN WITHOUT PROPER IDENTIFICATION

A record card such as this is supplied by the R. & R. Radio Co., Brooklyn, with each set sold. As service calls are made, the dates and the name of the service man are recorded.

Rural Radio Selling

From Page 52

pect. The home demonstration is given in those cases with the object of finding the set which suits the prospect.

Four others give home demonstrations but do not leave the sets for trial after the demonstration. Their policy was based on the experience of novice radio users, who, when left alone with the set, could not tune in stations satisfactorily and then decided against purchase because radio was too complicated. These dealers found, after demonstrating a set for an evening in the home, that the psychological effect of removing it often led to a closing of the sale. The remaining dealers had no definite policy on demonstrations or insisted on store demonstrations only.

Rural selling depends for its success upon constant publicity for the service of radio. Location of the radio store and fancy window displays, dominant factors in large cities, are of minor importance when compared with the influence of aggressive community activity. Make yourself liked and your competitors are at a tremendous disadvantage. Look over the calendar of coming events and see in how many you can make radio participate.

Barometer of the Market

From Page 37

Cleveland

"Will Surpass 1926"

Radio business 1927 will surpass 1926 is agreed among practically all Cleveland distributors.

Power supply for popular priced receivers essential if business is to increase. Too many eliminators, but not enough which are adaptable to all types of sets. One pioneer jobber predicts ten to twenty per cent drop in total sales for 1927 but explains that stabilization is cause and good organizations will keep their sales above 1926 figure. Market for expensive sets fair and for popular priced lines considerably better. Set sales in 1926 have created good market for 1927 sales of accessories and replacement equipment which is expected to keep business moving at all seasons.

Denver

"Business Will Hold Up"

Christmas buying of radio showed increase over 1925 approximately fifteen per cent and is well distributed. Survey of trade indicates business in early months 1927 is expected to continue on even tenor. Reports from both wholesale and retail trade show tendency to reduce stock too radically which may have effect on activity although some merchants report they expect January business will almost equal December. However, consensus is that January will drop between twenty-five and thirty per cent from December and will then taper off slowly to a late Spring as contrasted with fifty per cent drop in January last year and an additional forty per cent in February.

Atlanta

"Trade Expects Banner Year"

Radio sales during last weeks of December reported heavy which lends encouragement to retailers and distributors especially after lull in October and November. Trade expects banner retail sales January and February with nominal decrease through May but with steady sales throughout summer. Informing public of improved broadcast facilities and programs and possibility Congress will enact law governing interference will play important parts in keeping radio sales on par if not considerably in excess 1926. Increase approximately twenty per cent predicted for 1927. Sales will undoubtedly be handled by fewer manufacturers and distributors but additional dealers. Conditions in South show sales spotted indicating poor dealer representation in places. On other hand territories not fruitful to any other line of business produce radio sales. Activity on part of small town dealers indicates interest among farm trade which is apparently virgin market. Favorable action by Congress and continuance of present interest cannot produce other than increase over 1926.

Dealers Establish "Radio Bungalow"

SIX retailers of San Antonio, Texas, have opened the radio-equipped bungalow illustrated on this page as demonstration headquarters for the Freed-Eisemann receivers which they handle. This small house, located in one of the exclusive residential sections of the city, easily accessible by automobile or trolley, was purchased and furnished by the dealers on a co-operative plan. An expert demonstrator is in attendance at all times, and the expenses of upkeep are shared by the co-operating dealers.



The bungalow is advertised extensively by means of a co-operative advertising program. Banners are displayed in the store windows of the dealers and on their delivery trucks and a leading newspaper carries an advertising box on its radio page calling attention to broadcast features which may be heard any evening at the cottage.

Its attractive furnishings, which may be seen in the rooms here shown, were supplied at a reasonable price by a local furniture dealer who is given a line calling attention to that fact in the group's advertising in the local paper.

Most of the ordinary demonstration difficulties experienced by retailers are eliminated through this plan at an outlay within the means of each of the dealers. The expense of transporting equipment to the homes of prospects and the cost of making numerous installations are done away with; the chance of striking a location where good reception might be hard to obtain is obviated.

Though it is intended primarily as a demonstration bungalow for prospects brought by the dealers where sales may be closed, an attendant, on duty between 7:30 and midnight each evening, operates sets for any visitors who may drop in.

The six dealers sponsoring this innovation in retail co-operation are: Radio Engineers, Royal Radio Sales, Gene Roth & Company, Joske Brothers, Liberto Radio Sales and the Praeger Hardware Company, known as the Freed-Eisemann Dealers' Association of San Antonio.

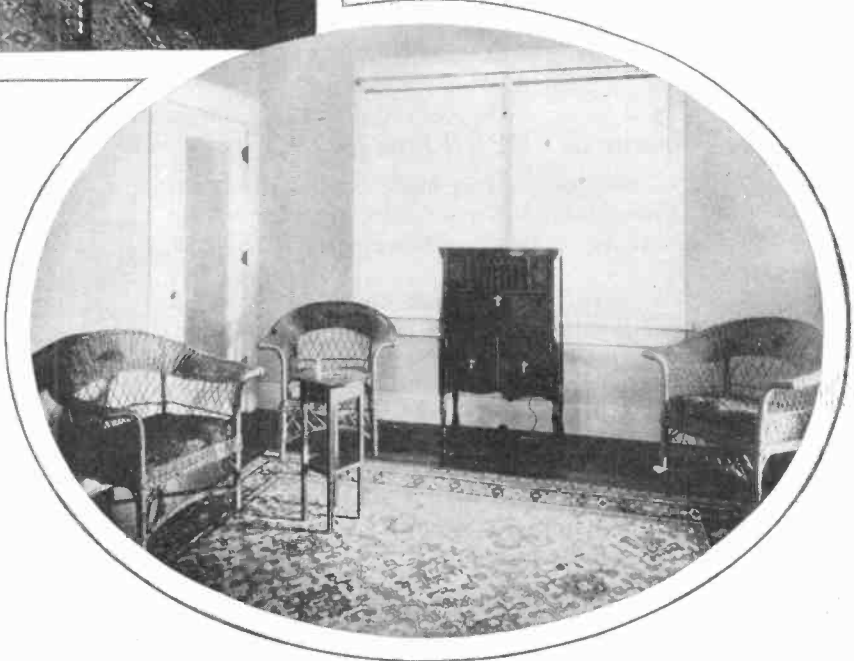

San Antonio radio bungalow, owned co-operatively by six Freed-Eisemann dealers, and two of its demonstration rooms

Distinguished Support for our Position on Legislation

WITH its November issue, *Radio Retailing* initiated a legislative program for radio, embodying some definite recommendations not wholly popular either in the radio industry or at Washington. Indeed, from certain spokesmen of the radio art, we received the advice (both publicly and privately) that we had better "leave well enough alone" and entrust the future of radio legislation to their own capable hands without kicking up a hullabaloo about the shortcomings of the laws before Congress.

Since the November and December issues, when *Radio Retailing* frankly told its readers about the legislation situation, some distinguished support has come to our position. The views stated editorially concerning emergency legislation, priority, administration by commission, right of radio men to serve, etc., have been, in part or wholly, restated with approval by the following:

President Coolidge in his Message to Congress, and in interviews;

The final report of the Co-ordinating Committee of the Radio Industry;

The radio-law report of the American Bar Association; Distinguished members of both Houses of Congress;

Numerous public addresses by thoughtful industry leaders;

Hundreds of personal letters of approval from all branches of the trade;

Hundreds of newspaper editorials and articles.

Radio Retailing believed from the beginning that the industry and Congress would respond to right thinking and sound reasoning in this legislation matter, and that there was no need for gum-shoeing.

The distinguished support now being given our original position makes us feel fully justified in our course of "speaking right out in meeting" when the future of the industry was at stake.

* * *

Failures Fewer in 1926 Than in 1925

ACCORDING to a report just made by the Electrical Credit Association, the year 1926 was far better than 1925 so far as electrical and radio retail failures are concerned.

In the New York, Middle and Southern Atlantic States, the Central States and the Pacific Coast States, there was a decrease of "accounts delinquent." But there was a sharp increase in the New England territory, indicating a financial stringency there that does not exist in the rest of the country.

The best market for radio and electrical goods at this time seems to be the Pacific Coast section, the next best in the Middle and Southern Atlantic States, and the third best in the Mississippi Valley. New York ranks fourth.

"Hand-to-mouth" buying is on the decrease, however, in the New York territory and also on the Pacific Coast, these two territories showing the strongest disposition to buy in larger average amounts than other sections of the country.

Here's Praise for the Good Work of the Co-ordinating Committee

THE National Radio Co-ordinating Committee has done a commendable piece of work in its recommendations to Congress regarding radio legislation. As a group and as individuals, the Committee should receive the highest praise for a good job well done.

Particularly creditable is the thoroughness with which their study has been conducted. Careful analysis quickly revealed the many points at which the radio bills before Congress needed to be strengthened. The Co-ordinating Committee's final report goes exhaustively into these various situations, and presents actually some twenty-seven different constructive suggestions concerning fundamentals which should underlie sound radio legislation.

Recalling that only a few weeks ago, radio executives were addressing trade meetings advising resigned acceptance of any kind of radio laws that the Senate and House seemed disposed to pass, we think the radio industry is now to be congratulated on having at last waked up, stiffened its backbone, and determined to speak its mind constructively concerning the legislative needs of radio, the listening public, and the radio industry.

* * *

Were We Right or Wrong?

THE exposé of the actual degree of broadcasting confusion prevalent throughout the country and published in *Radio Retailing* last month brought forth more commendatory comment from men in all branches of the radio trade than any other single article this magazine has ever published, with the sole exception, perhaps, of the legislation analysis presented in the November number.

These two editorial services have been termed, time and again—to quote from one letter from a prominent manufacturer and member of the RMA, "the greatest steps that have yet been undertaken by anyone to secure adequate radio legislation."

But—a little rain with the sunshine—there was one rebuke—courteous, but earnest—from a group of gentlemen whose standing lends authority to their views. They said we were unwise in giving to the trade this authentic report of radio reception conditions.

So, the editors leave it up to their readers—was it right or wrong to publish that "ether confusion" article last month? Give us your opinion.

The score now stands—Right, 118; Wrong, 1.

* * *

A Healthy Sign

THE fact that the peak business of radio manufacturers was reached in October last year, instead of November, should be construed as a good sign, rather than "viewed with alarm." It heralds, to our editorial mind, the advent of several desirable conditions—the straightening out of the yearly sales curve, greater stabilization, and the possibility of a more even production schedule.

It shows, also, that dealer and consumer buying is

This to Say—

Radio Retailing
Vol. 5, No. 1

slowly spreading itself out over twelve months of the year, rather than being concentrated in a few rush months. Manufacturers' sales and production peaks should be several months ahead of consumer absorption. Next year, the manufacturers' peak may be reached in September, and, in years to come, perhaps in August or July. Certainly, all branches of the trade should work with that goal in view.

* * *

Radio is "Sitting Pretty"

EXPERT economists predict there will be a slowing up in business generally during the first half of 1927—due to a temporary tightening up of money after a protracted period of prosperity. This is deemed a natural reaction but is not expected to assume serious proportions. In fact, it is believed the last quarter of 1927 will witness the inauguration of an even greater era of prosperity than we have yet experienced.

But if a period of depression does come, no matter how long or how intense, it may be that it will prove a benefit rather than a detriment to radio. Consider the thing from this angle—while everyone is prosperous, radio gets its share along with other lines, but if a financial tautness occurs and people are forced to curtail their expenditures on amusements and theaters, they will turn, naturally, to radio as the cheapest and most desirable form of entertainment. Thus radio will hold up while other lines slump.

Radio, therefore, is "sitting pretty," no matter what may come in our national economic affairs.

* * *

Sales Curve Straightening Out

A STUDY of retail selling costs in radio stores just completed by the editors discloses the fact that the yearly sales curve is straightening itself out. Business done during the summer months of 1926 increased two to three per cent over 1925, and likewise, the business done during the fall months just past, was about one per cent below 1925.

This is another desirable and healthy condition. The new year seems full of good signs if one stops to analyze the situation. To help the dealer's sales curve further in the straightening out process, the subject of sidelines again comes to the fore. It is undoubtedly sound business practice to sell some supplementary line during the months when radio slumps, without, of course, lessening the sales pressure on radio. A sideline this coming summer is an investment to which every radio merchant should give some serious thinking during the next few months.

* * *

Government Need Not Pay Damages for Broadcast Stations Shut Down

THE Air Law Committee of the American Bar Association has proposed that the Government, in shutting down broadcasting stations beyond the number which can be accommodated on existing wavelengths, shall compensate the owners of the stations thus shut down.

Radio Retailing, January, 1927

Radio Retailing cannot agree with this proposal.

Owing to the fact that no license has ever been granted or renewed for a period longer than 90 days, it appears to us that no vested right in any wavelength has ever been created. Hence we are inclined to believe that the Government may shut down any station by refusing a license and that when it does, the owner of the station will have no claim for damages against the Government.

A somewhat analogous situation occurred recently when the Constitution was amended, the Volstead Act passed and the sale of intoxicating liquor prohibited in this country. By these Acts and changes in the fundamental law of the country undoubtedly a great many persons were deprived of an opportunity to make money in the same manner as they had previously enjoyed. There were a number of attempts to pass legislation providing that the Government should compensate those persons then in the liquor business for the enforced stopping of their business. But none of these attempts succeeded.

When an investor puts his money in a business that is dependent upon a Government license he can secure no guarantee that the Government will not revoke or change the license, because it is not a contract between the Government and the owner of a station, but more in the nature of a permit. Under the common law, moreover, and in the absence of statutes there is no reason why the Government should pay compensation to persons who have invested in this business under those conditions. Therefore, we do not see how the owner of a station can expect to recover damages.

The Wavelength Entanglement What's Congress Going to Do About It?

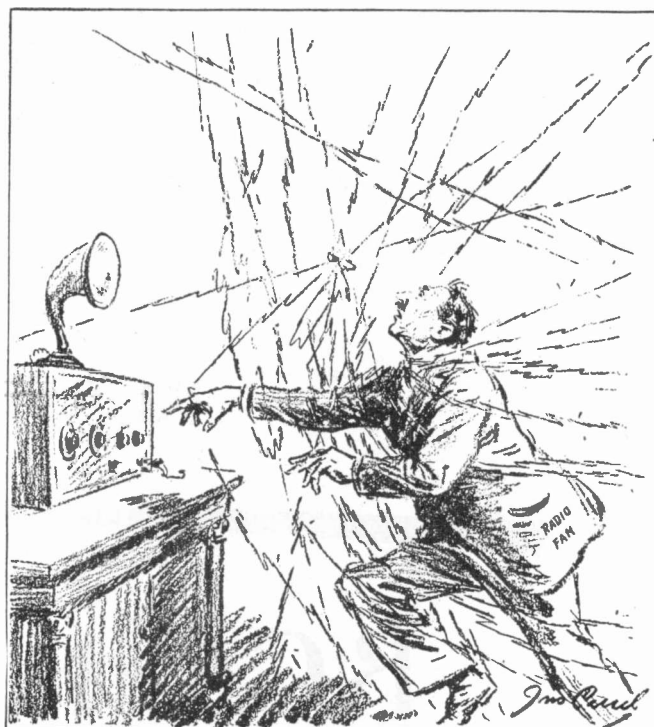

N. Y. Evening World

Page 61



Gay blue seas of the south... rippling jazz rhythms from far-away orchestras... don't travel this winter without a Radiola!

Great at home or on the open seas - this double purpose Radiola

Resting under the palms—rouring the sunny states—sailing the seas on two sides of the equator . . . take along a portable Radiola. Or up where the snows are thick and the bob sleds fly—where the ice is glassy and the skaters call for music—swinging, rhythmic, waltzy music . . . take along a portable Radiola. One of those cleverly planned and remarkably capable super-heterodynes fitted into the smartest portable case. Pick it up—carry it off—take your music with you!

Radiola 26 has proved its sturdiness on mule-back trails up roughest mountains. It has proved its dependability in balloon races, helping the winning ship to victory. It has capped the climax of every sort of in or outdoor sport in every sort of season.

Smartly attractive at home—completely portable out-o'-doors—always a fine performer



Radiola 26 is a double-purpose six-tube super-heterodyne. Completely and compactly portable. But with a fine looking walnut battery box, for home use, with space for larger batteries, and an antenna coupler for hooking up an extra antenna, if you wish it. Or loop may be fastened on the back. With 6 Radiotrons, . . . \$225

For out-o'-doors, Radiola 26 leaves its regular batteries at home in their walnut cabinet. Just neat—complete—compact—it hides its loudspeaker inside—its loop in the cover—and smaller portable batteries inside the back. Then, home again after a gay trip, it slips inconspicuously back into place in the smartest corner of the living room—attractive in its finely grained walnut cabinet—pleasing to look at—great to listen to!

It is not just a portable radio set, but a real six-tube super-heterodyne with the fine tone and the *proved* quality for which the Radiola is famous. And it adds to its desirability the compactness of a portable, too!

Buy with confidence  where you see this sign.

RADIO CORPORATION
OF AMERICA

RCA Radiola
MADE BY THE MAKERS OF THE RADIOTRON

NEW YORK · CHICAGO
SAN FRANCISCO

RCA Radiola

MADE BY THE MAKERS OF THE RADIOTRON

This advertisement is scheduled to appear in full color in the following list of magazines: Vogue, Vanity Fair, House and Garden, Country Life, Spur, and Asia, and in two colors in Time Magazine and in black and white in Quality Group list.

Sell performance — at a price

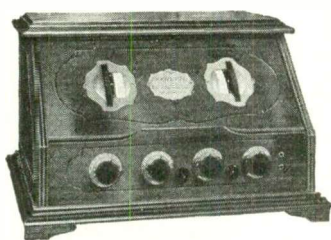

Radiola 20,
list, . \$115

Radiola 20. Challenging the tone quality and performance of its bigger and higher priced competitors! Twenty times as selective as the average antenna set, and therefore replacing thousands of other sets in the congested broadcast areas. One of the finest values in radio today!

Sell *now* to the traveler

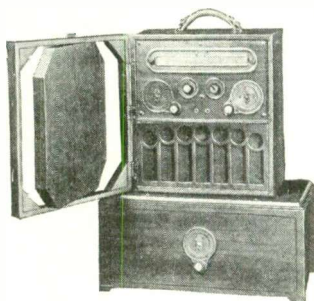

Radiola 26,
list, . \$225

Radiola 26. A double-purpose set. Portable—easy to carry—completely self-contained—for the winter vacationist going south. And a very attractive home set finished in walnut that is richly grained. For the living room now—and out-o'-doors next summer, for those who are spending the winter at home.

Sell *battery* or "*light socket*" operation

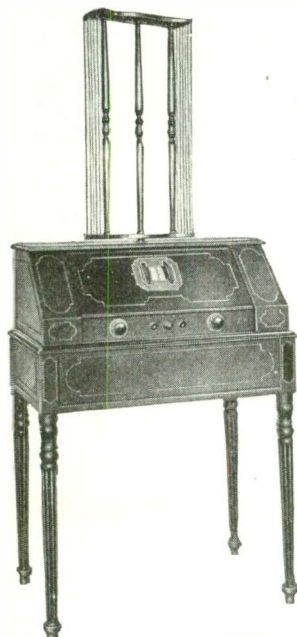

Radiola 28,
list, . \$260



This sign marks
the leading dealer
in every community.

Radiola 28. Eight tube super-heterodyne—known for the finest performance in radio. For battery operation. Or for complete A.C. operation, as when it is combined with RCA Loudspeaker 104.

RADIO CORPORATION OF AMERICA
New York Chicago San Francisco

RCA Radiola

MADE · BY · THE · MAKERS · OF · THE · RADIOTRON



What's New in Radio and

This editorial section is prepared purely as a news service, to keep readers of "Radio Retailing" informed of new products.



Console Type Batteryless Receiver

Radio Retailing, January, 1927

The Standard Radio Mfg. Corp., Ltd., 90 Chestnut St., Toronto, Canada, makes the illustrated "Rogers" Type No. 200 Console Cabinet with built-in reproducer. It is equipped as are all the sets made by this company, with A.C. tubes, including a power tube in the last audio stage, has an illuminated dial, and comes complete, ready to operate, on 110-volt, 25 or 60 cycle current, with an intended retail price of \$395. The cabinet is made of walnut with Butt veneer panels, giving a two-tone effect. Other models made are Type 150, a table model with five tubes, complete except for the loud speaker. This is a three-dial control receiver. Intended retail price \$220. Type 235, which is a two-dial control, three-tube set, table model, comes complete with power unit and tubes. Intended retail price, \$140. Type 220 is also a table model, housed in a walnut cabinet with Butt veneer, oval panels, having one-dial control. The dial is graduated in wave-lengths as well as degrees. The set comes complete, ready to operate, except for loud speaker. Intended retail price of \$275.



Compensator for Microphonic Tubes

Radio Retailing, January, 1927

A short rubber ring designed to be placed around microphonic tubes is being made by the Premier Radio Corporation, Defiance, Ohio. This can be so adjusted that microphonics caused by vibration of the tube are prevented. The intended retail price is 75c.

Battery Cord

Radio Retailing, January, 1927

For the set having batteries in the cabinet, and protected by fuse, the Belden Manufacturing Co., 2300 South Western Ave., Chicago, has developed a short battery cord. This cord consists of five conductors of No. 18 Belden Colorubber insulated stranded copper wire 4½ ft. long. The Colorubber insulation is not affected by battery acids. Intended retail price, 50c.

Six-Tube Receiver

Radio Retailing, January, 1927

The illustrated six-tube receiver is being made by the Standard Radio Corporation, 41 Jackson Street, Worcester, Mass., and is known as the "Standardyne B 6." The circuit consists of two stages of tuned radio frequency detector and two stages of transformer coupled audio amplification with the sixth tube in parallel with the last audio. Straight-line wave-length condensers behind a metal panel of morocco effect with brass highlights afford a pleasing design as well as shielding. Universal sockets for use with both UV and UX type tubes are incorporated. The audio frequency transformers are made by the above company and are of special design. The receiver tunes from 200 to 550 meters. Intended retail price of Model B 6 is \$45. Intended retail price of Model 600, a console, \$100.

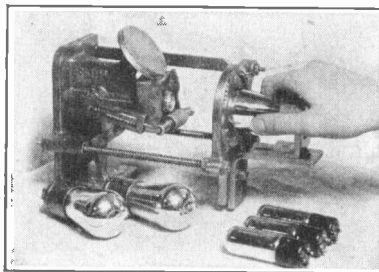
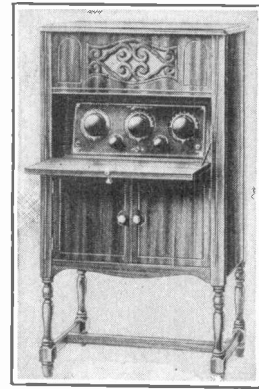

Bulb Stamping Machine

Radio Retailing, January, 1927

Illustrated is the new bulb stamping machine being made by the Eisler Engineering Company, 750 So. Thirteenth St., Newark, N. J. With this the apex of the bulb may be marked with gold or silver ink. It is adaptable for marking either 3 or 5-volt tubes or any type of incandescent lamp. To operate, the bulb is placed in the adjustable holder, pushed forward, the result being an impression on the glass. The ink on the rubber die is constantly renewed by means of a rubber roller which carries the ink from a rotating ink plate.

Five-Tube Receiving Set

Radio Retailing, January, 1927

The Western Coil & Electrical Company, Racine, Wis., is making a compact five-tube receiving set known as WC-15. The circuit is composed of two stages of radio frequency, detector, and two stages of audio frequency amplification. A 2-dial control is used and the over-all dimensions of the set are 15 in. x 8½ in. x 8 in. Intended retail price, less accessories, \$49.50.

Another new model is the WC-19 E, which is also a two dial control receiver, using six tubes. This circuit comprises three stages of tuned radio frequency, detector, one straight audio, and one power audio. Over-all dimensions are 8 in. x 8½ in. x 22 in. and the intended retail price is \$110.

Receiving set WC-20-G is a two-dial

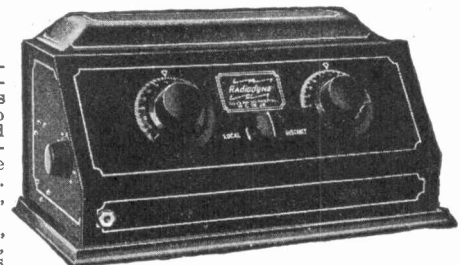

control nine-tube receiving set having drum controls. Over-all dimensions are 24½ in. x 11¼ in. x 15¼ in. This circuit incorporates five stages of radio frequency amplification. The intended retail price is \$225.

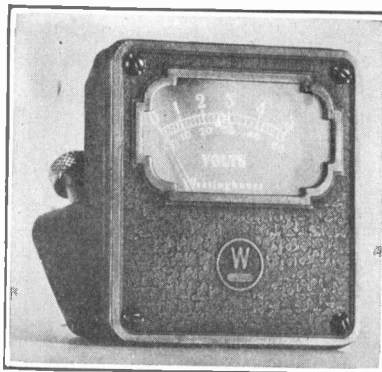

Cabinet Portable Voltmeter

Radio Retailing, January, 1927

The Westinghouse Electric & Manufacturing Company, Plane and Orange Streets, Newark, N. J., is manufacturing the illustrated cabinet portable voltmeter which is adaptable to Radiolas 20, 25 and 28 and also to Brunswick and Victor radio combinations. It is incorporated in a beautifully designed case which at once makes it part of the radio set. It is so made that tip jacks can be inserted and there is also a special lead equipped with a resistor in order that B battery voltages may be read on the high scale provided. An angle is also provided to take care of any type of mounting. The instrument is furnished in two ranges, 0-5 and 150 volts or 0-5 and 50 volts, both instruments having intended retail price of \$6.50.

Where to Buy It

For Information on New
Parts See Pages 87 and 89



All announcements appearing on these pages are published without advertising considerations of any kind whatsoever.

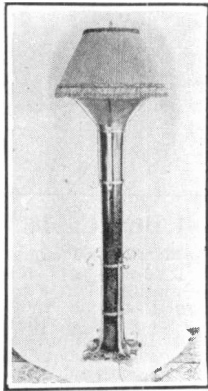

Decorative Lamp Radio Reproducer

Radio Retailing, January, 1927

The illustrated reproducer, known as "Speak-O-Lamp," is made by the G and C Radio Co., 3312 Lisbon Ave., Milwaukee, Wis. The shade is 14 in. in diameter, 11 in. deep, hand painted or silk covered. It is furnished with a 20 ft. cord. Intended retail price is \$45. Another model known as the "DeLuxe," has a silk pleated shade over a double silk lined shade, trimmed with lace to match and comes in two colors, orange and gray. Intended retail price, \$65.

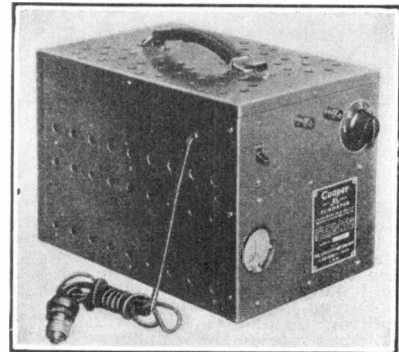

A Battery Eliminator

Radio Retailing, January, 1927

The Cooper Corporation, Cincinnati, O., is manufacturing the illustrated A battery eliminator. Full wave rectification is obtained and a ballast unit keeps the output voltage uniform at 6 volts independent of line voltage variation. According to the manufacturer, the filter system eliminates all hum and ample current is supplied to operate as many as ten $\frac{1}{4}$ amp. tubes.

Six-Tube Receiver

Radio Retailing, January, 1927

The New Idea Radio Co., 123 West Madison St., Chicago, Ill., makes the illustrated receiver. The cabinet measures 45 in. high x 20 in. wide x 22 in. deep. It is finished in brown mahogany, golden oak, or French gray. As can be seen, it contains a special drawer for papers, etc., and ample space for batteries and accessories. The six-tube unit which fits in the top of the cabinet has an intended retail price of \$75. A portable case may also be had for this unit for \$25. The cabinet with a full set of panels has an intended retail price of \$125. The circuit used is tuned radio frequency.

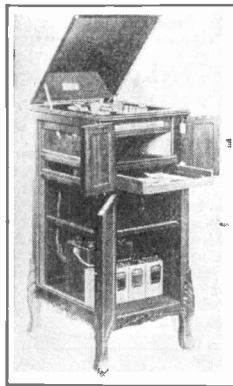

Six-Tube Receiver

Radio Retailing, January, 1927

The National Radio Co., Forest Lake, Minn., is making a six-tube receiver consisting of two stages of tuned radio frequency, detector, and three stages of low ratio transformer coupled audio amplification. Total shielding is used with single dial control. Sets are wired for the new type of tubes. Over-all dimensions of Models 202 and 203 are 42 in. high, 16 in. deep, and 36 in. wide. These are Console models of different design, having intended retail price of \$190 each. Other models range in price from \$85 to \$600.

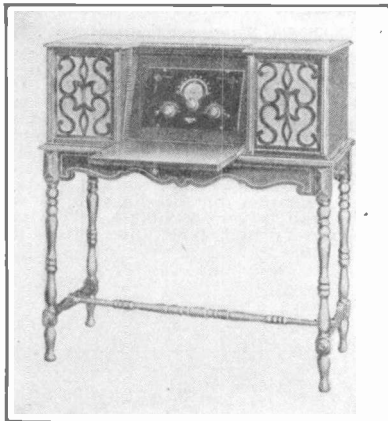

Five-Tube, One-Dial, Batteryless Receiver

Radio Retailing, January, 1927

The illustrated "Falck" consolette, which is a 5-tube, batteryless, self-contained receiving set with one-dial control, is made by the Advance Electric Company, Los Angeles. It is contained in a mahogany, period cabinet, in which is also a loud speaker. This receiving set operates from the electric light line, eliminating all A, B, and C batteries. All parts are manufactured by this company, and the set is guaranteed for one year. Intended retail price complete \$189.

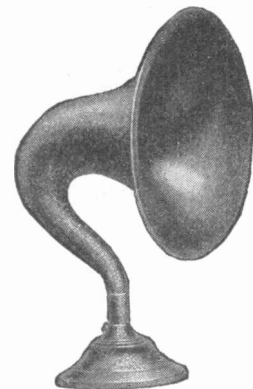

Horn Type Reproducer

Radio Retailing, January, 1927

The Model 500 horn type reproducer is being made by the Spartan Electric Corporation, 348 West 34th St., New York City. This is equipped with the Spartan balanced armature unit and its over-all dimensions of 23 in. high, with a 15 in. bell. It is finished in antique bronze. The intended retail price is \$18.50.

Crystal Receiving Set

Radio Retailing, January, 1927

The Carter Manufacturing Company, Cleveland, is making what is known as the "Carco" crystal receiving set. This is intended to receive stations of from 50 to 100 miles distant. A variometer is used in the set and the "cat's whisker" is gold tipped to prevent oxidation.

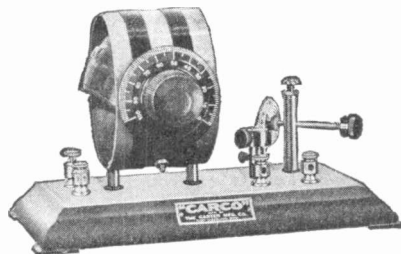

What's New in Radio and Where to Buy It—

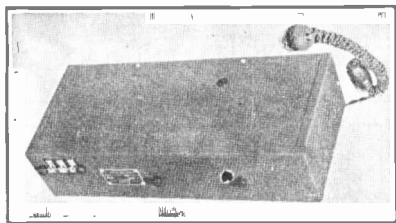

B Battery Eliminator

Radio Retailing, January, 1927

The illustrated "Rogers" B battery eliminator is being made by the Standard Radio Manufacturing Corporation, Limited, 19 Chestnut Street, Toronto, Canada. This is made in two models, the first being a 90-volt model which will supply B battery voltage for sets using up to five and six tubes and requiring 22½ and 45 volts on the detector and 90 volts on the amplifier. The second or 134 volt model supplies B battery voltage for the new power tubes and sets using over six tubes. Both models are designed to operate on 110 volt, 25 or 60 cycle current. Intended retail price of the first model is \$49.50; of the second model, \$52.50.

Truphonic Amplifier

Radio Retailing, January, 1927

Illustrated is the new amplifying system unit being manufactured by the Alden Manufacturing Company, Springfield, Mass., which is known as "Truphonic." The complete unit, which can be attached to any radio receiving set, includes three Truphonic couplers and a Truphonic output unit in a lacquered steel catacomb, polished Bakelite socket strip for the three tubes, connecting adapter for attaching to the set, and battery cables and rheostat. The overall dimensions are 12½ in. long, 2½ in. wide, and 2½ in. high. It is known as No. 304, and has an intended retail price of \$20.

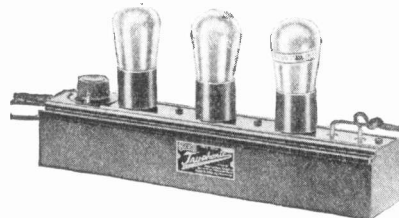

Wall Box Cable Plug

Radio Retailing, January, 1927

Howard B. Jones, 614 So. Canal St., Chicago, is making a new type of multi-plug designed to be mounted in a switch box installed in the base-board. The bracket is mounted on a switch box covering, and consists of a standard seven-contact socket with a regular plug and cable. With this in the base-board, the batteries can be placed in the basement or adjoining closet. The intended retail price, complete with 4-ft. cable, is \$3.50.

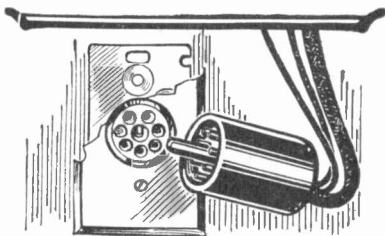

Trickle Charger

Radio Retailing, January, 1927

The "Electron" trickle charger is made by the King Electric Manufacturing Company, 1681 Fillmore Ave., Buffalo, N. Y. It is completely encased in a rigid metal box about the size of a medium-sized 45-volt B battery. A standard 2½ amp. rectigon bulb is used and the charging rate is from .8 to 1 amp. The finish is royal blue and the charger is intended to function on 110 volt, 50-60 cycle current. The intended retail price, complete with tube, is \$14.25.

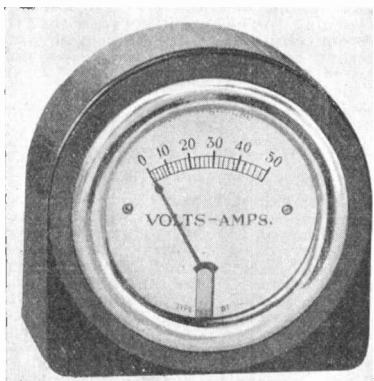
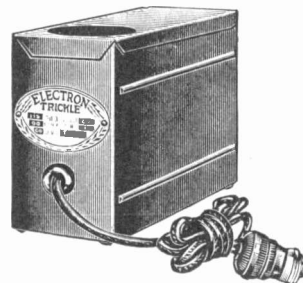

Portable Volt-Ammeter

Radio Retailing, January, 1927

The Westinghouse Electric & Manufacturing Company is making the illustrated type P. A-2, volt-ammeter (50 volts and 50 amperes) for radio use. This instrument has no movable coils or springs to get out of order and is provided with a special testing lead and mounting bracket which may also be used as a terminal. The intended retail price is \$5.

Cabinet Reproducer

Radio Retailing, January, 1927

The Globe Phone Manufacturing Co., Reading, Mass., is marketing a new cabinet type reproducer, known as the "Technolian." This contains a new type of unit, together with the company's patented fused metal and wood laminated diaphragm. A duplex tone chamber is used.



Antenna Lead-In

Radio Retailing, January, 1927

No. 750 antenna lead-in is made by the Ajax Electric Specialty Co., 1926 Chestnut St., St. Louis, Mo. This is made 12 in. long of pure copper strip in one piece, insulated by braiding and varnished over entire length excepting the Fahnestock clips located at each end. Intended retail price 12c.

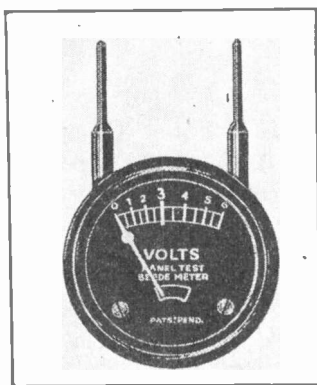

Midget Pin Jack Voltmeter

Radio Retailing, January, 1927

A midget pin jack voltmeter with a diameter of 1½ in. has just been perfected by the Beede Instrument Company of Penacook, N. H. This meter meets the need for a compact voltmeter to be used on Radiolas. The meter is small enough not to interfere with the tuning dials and is quite inconspicuous at the bottom of the set. The dial is white enamel on black with a white hand and is very readable. This meter has a very high resistance. It is listed at \$2.50.

B Battery Eliminator

Radio Retailing, January, 1927

The Auto Vacuum Products Company, New York City, is making the illustrated B battery eliminator known as "Auto-B." This is designed for operation on a 110 volt, 50-60 cycle current, and uses for a rectifying element the "Recto-Cell." This cell, according to the manufacturer, contains the neutral salt solution which is harmless to fabrics. The only attention the eliminator needs is a little water now and then. Four output terminals are provided which are negative B, plus detector, plus 90 volts, and plus 135 volts. This Type 14 eliminator complete, has an intended retail price of \$38.50. The Recto-Cell unit which has to be replaced after several years use has an intended retail price of \$6.

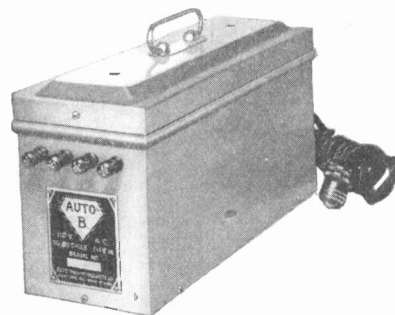

News of Latest Products Gathered by the Editors



All-Wood Cone Reproducer

Radio Retailing, January, 1927
The C. W. Smith Company, 1125 Wall St., Los Angeles, Cal., is distributor for the "Woodlark" reproducer. From the base to the outer sound board there is no metal whatever, and this, it is claimed, gives excellent tone quality. The speaker itself, known as Model A, has an intended retail price of \$15. A wood pedestal designed to be used with the loud speaker may be had for \$6.50 additional. Another speaker is the "Woodlark Concert Grand" which has a triple harmony chamber with four points of contact. The speaker is of the reflex type and has an intended retail price of \$25.

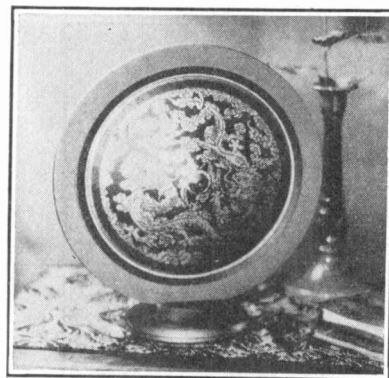

Cone-Type Reproducer

Radio Retailing, January, 1927
American Bosch Magneto Corp., Springfield, Mass., offers the illustrated "Library Ambotone" model, cone-type loud speaker. This is a decorative radio reproducer, designed to be used in the library. It is finished in black and gold. Wood is used in its construction to get mellowness of tone, according to the manufacturer. The intended retail price is \$12.50.

Cone Reproducer

Radio Retailing, January, 1927
The O'Neil Manufacturing Company, 715 Palisade Ave., West New York, N. J., makes the illustrated cone reproducer. According to the manufacturer, the electrical unit is very sensitive and rugged, permitting the use of power amplifiers without damage. The 14-in. frame is laminated wood, mahogany finish, which acts as a resonator. If the user desires, the base may be removed by taking two screws out from under the shelf and placing eyelets in the same holes for picture cords, then the cone may be hung on the wall. The intended retail price is \$12.

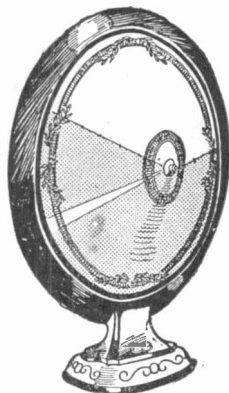

Short Wave Adapter

Radio Retailing, January, 1927
The J-M-P Manufacturing Company, Milwaukee, Wis., is making the illustrated short wave adapter, known as the "Submariner." This device can be attached to any vacuum tube receiving set and will allow operation of the set on 30 to 75 meters. It is said to work with any type of circuit. Further information may be had by writing the above company.

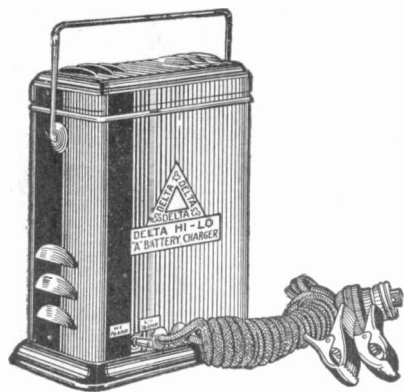

High and Low Rate Battery Charger

Radio Retailing, January, 1927
The Delta Electric Co., Marion, Ohio, is making the illustrated two-rate battery charger, known as No. 12 Delta High-Low. The low or trickle charge rate is approximately $\frac{1}{2}$ amp. while the high is 1 1/2 amp. The charger is designed to operate on a 110-volt, 60 cycle current. Pressed steel is used for the container which is finished in a rich mahogany baked enamel. The bulb and all mechanism are completely inclosed and the complete charger measures 7 1/2 in. high x 5 1/2 in. wide x 3 in. thick.

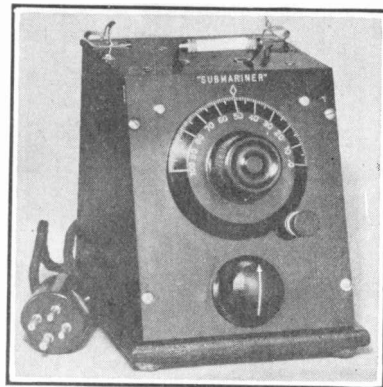

Double Range Voltmeter

Radio Retailing, January, 1927
A double-range voltmeter is being made by the Westinghouse Electric & Manufacturing Company, East Pittsburgh, Pa. The scale ranges are 5 and 50 volts and is recommended for use in checking A, B and C batteries. This is a dependable voltmeter operating without moving coils or springs and is provided with three foot lead and special pin-jack terminals. These pin-jack terminals may be used with all the sets now on the market possessing voltmeter jacks. The intended retail price of this meter type P.T. is \$5.

B Battery Eliminator

Radio Retailing, January, 1927
The Cornell Electric Manufacturing Corporation, 135 East 58th Street, New York, is in production on the "Cornell Voltage Supply," a B battery eliminator. Type "B" will operate receiving sets using from 1-10 tubes and it has a variable radio frequency voltage range of from 50 to 150 volts. The audio amplifier voltage is from 100 to 180 volts. Intended retail price complete including Raytheon tube, \$39.50. Type "CB" is the same as type "B" with the addition of a variable "C" battery voltage supplying from 1 to 50 volts. Intended retail price of this model complete with Raytheon tube \$49. According to the manufacturer the filter consists of two 100 heavy low resistance chokes with 12 mfd., of high voltage condensers.

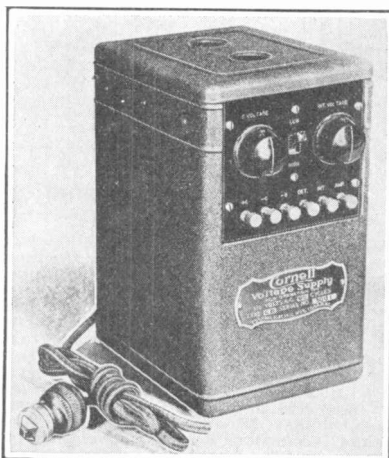

Gold Plated Aerial Wire

Radio Retailing, January, 1927
The B & B Engineering Co., Chicago, Ill., is making gold plated aerial wire known as "Halo" which consists of seven strands of No. 22 gage, hard drawn copper wire with a 25 karat gold plating. Each aerial comes packed in an individual carton and has an intended retail price of \$3.50.

What's New in Radio and Where to Buy It—

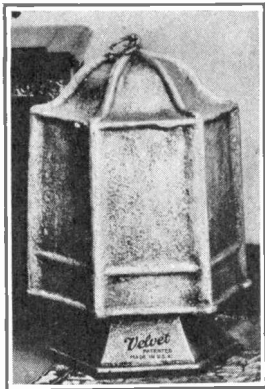

Lantern Shape Reproducer

Radio Retailing, January, 1927

The illustrated lantern reproducer is being marketed by The Zinke Company, 1323 Michigan Boulevard, Chicago, Ill. It is said that a double stylus bar prevents free-end movements of the armature and eliminates unit noise. The diaphragm is of thin aluminum alloy corrugated in two directions. It has 33 in. of horn of the orthophonic type. Over-all dimensions of the reproducer are 12½ high and 7½ inches wide. Intended retail price, \$12.50.



B Eliminator With Three Variable Voltages

Radio Retailing, January, 1927

Grigsby-Grunow-Hinds Company, 4540 Armitage Avenue, Chicago, Ill., makes the illustrated "Majestic Master-B" unit. This has a rating of 60 milliamp. at 150 volts. This model has three adjustable resistances controlling all voltages. The maximum voltage output is sufficiently high to operate any of the power tubes now on the market. The intended retail price complete with Raytheon tube is \$43.50.

B Battery Eliminator Using Raytheon Tube

Radio Retailing, January, 1927

The Electrical Research Laboratories, 500 Cottage Grove Avenue, Chicago, is making the Erla "Big Ten" B battery eliminator. This is for operation on 110 volt, 60 cycle current and will operate any set of from 1 to 10 tubes. The case has an olive green enamel finish and its over-all dimensions are 6½ in. x 4½ in. x 10½ in. The voltages are as follows: detector variable from 22½ to 45, intermediate variable from 67½ to 90 volts and 135 volts. A small toggle switch in the lower right hand corner controls the line current. The intended retail price, complete with extension cord and tube, \$45.

Radio Tube Tester

Radio Retailing, January, 1927

The illustrated model B-47 tube tester is made by the Hickok Electrical Instrument Company, Cleveland, Ohio. The over-all dimensions are 16½ in. x 14 in. x 4 in. and the weight is 15 lb. The finish is polished Bakelite. This is a very delicate instrument for measuring all tube characteristics. The standard model has an intended retail price of \$350 and the laboratory model that of \$400. The laboratory model is provided with a plate voltmeter switch for connecting the grid and plate together, a double scale range and switch for the plate milliammeter for changing the scale range from 15 to 150 milliamp. and a special switch for changing the scale range of the filament-ammeter from 500 milliamp. to 5 amp.

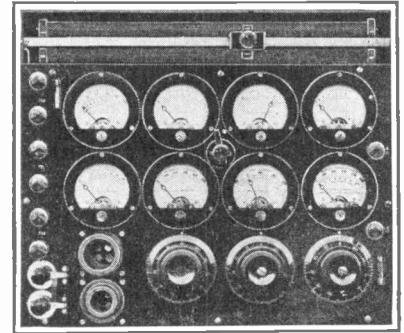

Resistance Coupled Amplifier

Radio Retailing, January, 1927

The Sonatron Tube Company, 108 W. Lake St., Chicago, is making the illustrated resistance coupled amplifier for use with either dry cell or storage battery tubes. This amplifier comes complete with tubes which are colored in order, red, white, and blue. It is equipped with a switch for turning filaments on and off. The base is of polished Bakelite and all parts are heavily nickel-plated. Mounting holes permit the unit to be fastened in any position. The intended retail price complete is \$20.

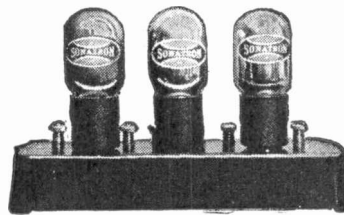

A Battery Power Unit

Radio Retailing, January, 1927

The Electric Storage Battery Co., Philadelphia, Pa., is making both a four and six volt A battery Power Unit. Each of these types in turn may be obtained in two models. Model 2-A has a self-contained switch, while Model 3-A has not. The latter may, however, be operated with a remote control switch especially designed for the purpose. Model 3-A, (4-volt supply) has an intended retail price of \$28. Model 3-A, (6-volt supply) has an intended retail price of \$38. Model 2-A, (4-volt supply) has an intended retail price of \$27. Model 2-A, (6-volt supply) has an intended retail price of \$36. Used with certain types of receivers a slight hum may be perceptible, but can be overcome through the use of the master control switch which has an intended retail price of \$4.50.

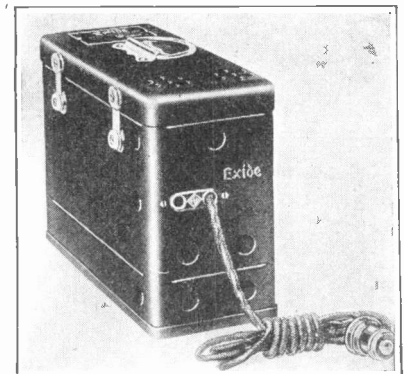

Aerial Mast

Radio Retailing, January, 1927

The "M-T Airmast" made by the Mitchell-Taylor Company, 1601 So. Michigan Ave., Chicago, Ill., may be adjusted to any angle through 180 deg. The poles are impregnated with electrolytic varnish and the bases and spearhead tops are made of steel, weather-proofed with black enamel. The base is punched to span two bricks and the tops are punched for three guy wires and aerial wire. The complete unit includes two bases, two spearhead tops, two five-foot poles, screws, guy wires, staples, etc. Intended retail price complete, \$5.

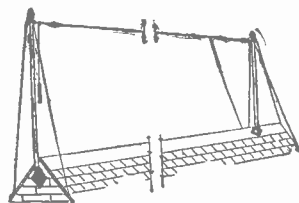

Battery Charging Panel

Radio Retailing, January, 1927

A battery charging panel for dealers' use is being made by Hobart Brothers Co., Troy, Ohio. This panel is equipped with jacks and plugs somewhat after the manner of a telephone switchboard, thus eliminating all knife switches. One line carries the regular charging rate. The second line gives the ammeter reading of any battery plugged in on it. The third line provides 5 amp. resistance for batteries that need it and the fourth line provides 10 amp. resistance. Furnished complete with special plug

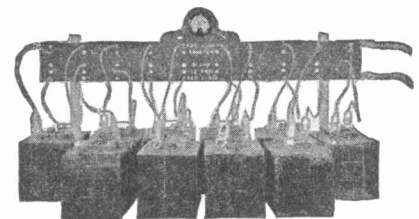

equipped leads. The capacity is 10 batteries at one time. Intended retail price, \$35.

News of Latest Products Gathered by the Editors

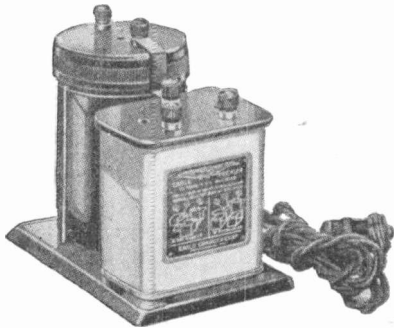

Trickle Charger

Radio Retailing, January, 1927

The Eagle Charger Corporation, 121 North 8th Street, Philadelphia, is making the illustrated trickle charger. It will charge A batteries at the rate of $\frac{1}{2}$ amp. and B batteries at 250 milliamp. According to the manufacturer, A batteries may be charged while being used with the set, there being no objectionable hum. This charger is shipped dry, and to put it in operation it is necessary but to add water. It has a crackle finish. Intended retail price, \$10 complete.

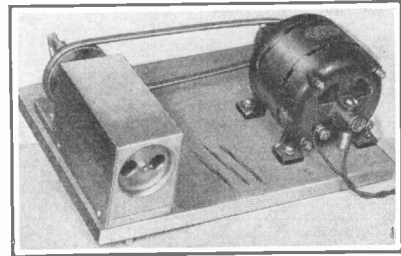

Wire Stripping and Twisting Machine

Radio Retailing, January, 1927

A motor-driven machine for wire stripping and twisting is made by the F. R. Zierick Machine Works, * Howard St., New York. The machine is mounted on a base measuring 12 in. x 18 in., driven by a one-quarter horse power motor and the process of stripping and twisting is done at one operation. The moving parts are properly guarded and there are adjustable knives to take care of various sizes of wire. These can be removed to be re-sharpened and replaced. According to the manufacturer, an operator can strip two to three thousand wires an hour.

B Battery Eliminator

Radio Retailing, January, 1927

The "Filtrex" B battery eliminator, model 500, is being made by the Conner Crouse Corporation, 52 Vanderbilt Ave., New York City. It is said to furnish 180 volts at 60 milliamp., and is supplied with voltage taps at 22, 45, 90 and 180. An on and off toggle switch is located at the top of the eliminator. The finish is Duco midnight blue, and a 216B Rectron is used for rectification. It can be used with 110 volt, 50 or 60 cycle current. The intended retail price is \$47.50.

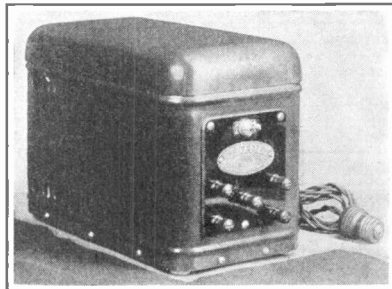

Glass Insulators

Radio Retailing, January, 1927

The Ajax Electric Specialty Co., 1928 Chestnut St., St. Louis, Mo., makes the illustrated No. 36 crystal glass insulator. This is a five-ring insulator, $3\frac{1}{2}$ in. long by $1\frac{1}{2}$ in. in diameter. These come packed one gross to the package and have an intended retail price of 10c. each.

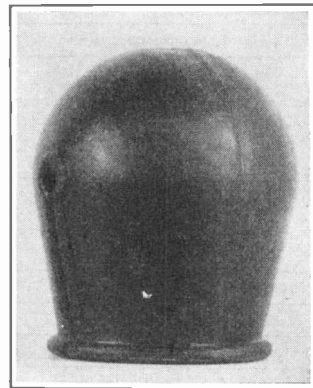

Eliminator for Tube Microphonics

Radio Retailing, January, 1927

The Spartan Electric Corporation, 348 West 34th St., New York, is marketing the illustrated "McDonald Howl Arrestor." This is a cap made of soft rubber designed to put over the top of a receiving tube, in order to dampen microphonic vibrations that may occur. These caps are made in different sizes to fit the various tubes. They are designed to be used primarily on the detector tube but have been found useful anywhere in the circuit where vibration on the tubes causes microphonics.

Impedance Amplification Unit

Radio Retailing, January, 1927

Illustrated is one of the units of the new "Rauland-Trio" combination, being made by the All-American Radio Corp., 4201 Belmont Ave., Chicago. Two of these units are to be used in conjunction with a Rauland-Lyric audio frequency transformer, which allows greater volume than may be had by the use of two stages of transformer-coupled audio frequency amplification, at the same time maintaining high quality of reproduction. These units are of the same design but somewhat smaller than the transformers made by this company. Each unit contains an inductance, a resistance, and a capacity.

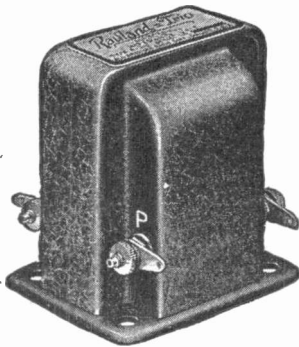

Mantel Type Reproducer

Radio Retailing, January, 1927

The illustrated reproducer is being manufactured by the Gemco Manufacturing Co., Milwaukee, Wis., makers of "True-tone" speakers. This is finished in walnut mahogany; and is 18 in. high, 7 $\frac{1}{2}$ in. wide, and 5 $\frac{1}{4}$ in. deep. The amplifying chamber is an all-wood horn, the outlet of which is covered with gold cloth over wire mesh. Equipped with a semi-floating armature type, giant loud speaker unit. The intended retail price is \$32.50. This can also be had in a green or a red finish. Other decorative types of loud-speakers made by this company are Model 20, a pedestal type, which has an intended retail price of \$45; pedestal type No. 21 has an intended retail price of \$37.50; and mantel drum type Model No. 25 has an intended retail price of \$25.

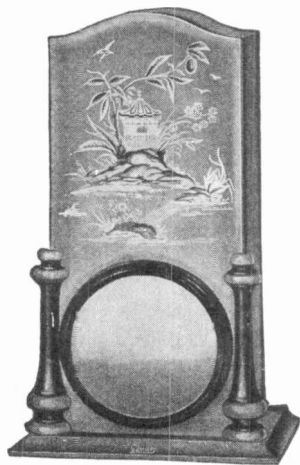

Fixed Condenser with Paper Dielectric

Radio Retailing, January, 1927

A paper dielectric fixed condenser is manufactured by the Dubilier Condenser and Radio Corporation, 4377 Bronx Boulevard, New York City, for use in filter and other similar circuits. This condenser is made in three types, type 901 with a rated d.c. working voltage of 160. Type 902 is tested at 400 volts d.c., and type 903 made to withstand voltages up to 600 volts d.c. The units are made in standard capacities from 1 to 6 mfd., and are equipped with soldering lugs. Intended retail price, in 1 mfd. size, type 901, \$1.50; type 902, \$2; type 903, \$3.

Dry and Storage Radio Batteries

Listing of radio products is a monthly feature of *Radio Retailing*.

For audio and power amplifiers see the February issue

Dry Batteries, A, B and C

Manufacturer's Name and Address	Trade Name	Number of Models of A Batteries Made	List Price Range		Number of Models of B Batteries Made	List Price Range		Number of Models of C Batteries Made	List Price Range	
			Min.	Max.		Min.	Max.		Min.	Max.
Advance Battery Corp., Brooklyn, N. Y.	Advance ABC				7	\$1.50	\$4.75	1		\$0.60
Bright Star Battery Co., Inc., Hoboken, N. J.	Bright Star	1	\$.45		8	1.75	4.75	1		.60
Burgess Battery Co., Chicago, Ill.	Burgess	1	.50		9	1.50	5.50	4	\$.40	1.75
Burn-Boston Batt. & Mfg. Works, Boston, Mass.	Addwater, Burn-Boston	3	1.25	2.50	1		3.75	1		.75
Carbon Products Co., Lancaster, Ohio	ACE	1	.50		8	1.50	4.75	3		.60 2.00
Champion Carbon Mfg., Co., Cincinnati, Ohio	Champion	1	.50		6	1.75	4.75	3		.60 3.75
Diamond Elec. Specialties Corp., Newark, N. J.	Diamond	2	.26	.26	7	1.50	4.75	4		.60 1.75
French Battery Co., Madison, Wis.	Ray-O-Vac	1	.50		7	1.75	5.00	3		.40 1.75
General Dry Batteries, Inc., Cleveland, O.	Kleartone	1	.50		6	1.75	4.75	1		.60
Marathon Battery Co., Wausau, Wis.	Marathon	1	.50		8	1.50	4.75	3		.60 1.50
National Carbon Co., Inc., New York City	Eveready	1	.50		9	1.50	5.50	2		.60 1.75
Stuart Prod., Corp., Chicago, Ill.	Stuart	1	.50		6	1.75	5.50	1		.60
Underwood Battery Co., Cleveland, Ohio	Underwood				5	2.00	4.75	2		.60 .85
Volton Battery Co., Inc., Brooklyn, N. Y.	Volton-Queenbee				10	1.50	4.75	2		.60 1.75
Wireless Dry Cells Ltd., Niagara Falls, N. Y.	Maximite, Reliance	2	.45	.50	9	1.50	4.75	3		.45 1.20
Yale Electric Corp., Brooklyn, N. Y.	Yale, Franco	3	.45		8	.60	4.75	1		.60 .60

Storage Batteries, A and B

Manufacturer's Name and Address	Trade Name	Number of Models of A Batteries Made	List Price Range		Range in Capacity (Amp.-Hr.) Min. Max.	Number of Models of B Batteries Made	List Price Range		Range in Capacity (Milliamp.-Hr.) Min. Max.	
			Min.	Max.			Min.	Max.	Min.	Max.
Am-Plus Storage Batt. Co., Chicago, Ill.	Am-Plus	6	\$17.50	\$45.60						
Arco Batt. & Plate Co., Ft. Wayne, Ind.	Arco	5	11.00	19.00						
Baldwin Batt. Shop, Baldwin, Mich.	Baldwin	5	10.00	30.00	60 80					
Consolidated Batt. Co., Philadelphia, Pa.	Consol	7	15.90	24.60						
Cooper Corp., Cincinnati, O.		5	13.00	25.00						
D. A. Radio Co., Buffalo, N. Y.	Darco					3	\$20.00	\$32.50		1,600
Dry Storage Batt. Corp., Philadelphia, Pa.	Tab					1		\$4.50		
Edison Storage Batt. Co., Orange, N. J.	Information not received at time of going to press.									
Electric Storage Battery Co., Philadelphia, Pa.	Exide	9	5.30	25.50	12 150	2	10.15	18.30		6,000
Englert Mfg. Co., Pittsburgh, Pa.	Dragon		16.05	29.15	90 215					
General Lead Batt. Co., Newark, N. J.	Titan	2	13.40	39.60	80 165	1		19.00		6,000
Gilbert Battery Co., Bridgeport, Conn.	Gilbert					6	25.00	45.00	1,250	2,500
Globe Electric Co., Milwaukee, Wis.	Globe, Geo	10	10.60	25.00	40 150	1		6.25		3,000
Gould Storage Battery Co., New York City	Gould	4	13.25	22.50	50 120					
Grayne Corp., Chicago, Ill.	Grayne					3	19.85	36.25	3,000	3,000
Hartford Batt. Mfg. Co., Milldale, Conn.	Hartford	4	12.00	22.00	35 130	1		20.00		4,000
Hellos Battery Co., Boston, Mass.	Joyce Bros		15.00	30.00	40 190	1		4.00		20,000
Henderson Battery Co., Spokane, Wash.	Aladdin	3	12.50	18.50	60 120					
Kalsh Electric & Mfg. Co., St. Louis, Mo.	Keo	7	10.50	52.00	40 175					
Marko Storage Batt. Co., Brooklyn, N. Y.	Marko "A"	5	11.00	25.00	60 150	2	9.50	18.50		6,000
McLean Storage Batt. Co., Cleveland, O.	McLean, Speed	9	16.00	28.00	50 120					
Lyons Storage Batt. Co., Belleville, N. J.	Lyons	5	9.75	15.00	50 125					
National Lead Batt. Co., St. Paul, Minn.	National	6	10.50	21.85	60 140					
Oxidite Batt. Co., St. Paul, Minn.	Oxidite, Compact	2	84.00	87.00		4	28.00	44.00	440	1,100
Perrine Quality Prod. Corp., Boston, Mass.	Perrine Quality	3	14.50	23.00	65 135	2	25.00	37.50	1,500	1,500
Philadelphia Storage Batt. Co., Phila., Pa.	Information not received at time of going to press.									
Prest-O-Lite Co., Indianapolis, Ind.	Information not received at time of going to press.									
Royal Batt. Co., New York City						2	11.00	15.00		3,000

What the Trade is Talking About

License Applicants Must Waive Rights to Wavelength

President Coolidge on December 8 signed a joint resolution of Congress requiring all applicants for radio station licenses to execute a waiver of any claim of right to a wavelength as against the United States. The Department of Commerce yesterday instructed its Supervisors that no further station licenses be issued unless applications for those licenses are accompanied by a waiver in the following form:

"As required by the joint resolution of Congress approved December 8, 1926, and as a part of the application for license for a (Class of station) radio station at (Location of station) hereto attached, the applicant hereby waives any right or any claim of right, as against the United States, to any wavelength, or to the use of the ether in radio transmission, because of previous license to use the same or because of the use thereof."

This waiver must be dated, signed and submitted with the application.

There are now 133 applications on file. Action has been suspended upon all of them and will be withheld until the waivers are submitted. Twenty-three of these applications are for broadcasting stations.

The same action will be taken as to all applications hereafter received.

To Build Radio Equipped Modern Homes

The importance of radio equipment as part of the construction of the modern home is acknowledged by the Home Owners Service Institute, New York City, under whose supervision 360 model houses will be built in 28 "key" cities of the United States during the next year. Thirty-six of these houses will be finished, equipped, and opened to the public for four weeks. Crosley Radio Corporation receiving sets and equipment have been specified for each of these houses which will be located in the market centers of the United States from coast to coast.

The Home Owners Service Institute, composed of non-competitive national interests in the building and allied trades is undertaking this campaign to show the advantages of using standard, nationally advertised materials and equipment in residence construction and the importance of correct construction procedure. The Crosley Radio Corporation is a member of the Institute.

British Broadcasting on Paying Basis

Under the supervision of the new British Broadcasting Corporation, licensed by the post office department of Great Britain, nearly \$3,750,000 will be available during 1927 for broadcasting purposes. Of this sum, \$1,125,000 is retained by the government which



Caught in the Act

Louis Pacent, head of the Pacent Electric Company, New York, is here shown at his favorite hobby—testing various Pacent radio devices. Mr. Pacent needs only two things to make him completely happy—a Pacent instrument and something to test it with.

must expend only \$500,000 issuing licenses to set users.

An annual license fee of ten shillings is to be paid annually by 2,097,000 listeners to the government. Of each ten shillings obtained in payment of a license fee, six shillings three pence is turned over to the British Broadcasting Company for programs and general maintenance expenses.

Showers Brothers, Chicago, has moved the sales offices of its radio division from the Tribune Tower building to 914 South Michigan Boulevard.

Victor Company Changes Hands in \$40,000,000 Deal

The largest concern of its kind in the world changed hands December 8 when the banking firms of J. & W. Seligman & Company and Speyer & Company acquired control of the Victor Talking Machine Company. Eldredge R. Johnson, president, issued a statement on that date that he had given an option on the purchase of all his stock at \$115 per share. His holdings will call for a cash payment of more than \$28,000,000 it is estimated, and a similar purchase offer is to be made to all other stockholders.

In this transaction, involving the transfer of \$40,000,000 or more, the Victor Talking Machine Company, with headquarters at Camden, N. J. and branches throughout the world, is expected to change from a close held corporation to one directed on a public ownership basis. The purchasing companies are to offer securities to the public shortly.

Due to the production of the Orthophonic reproducer in 1925 the company regained much of the business it lost because of the tremendous inroads of the radio business. The company's assets at the present time are \$19,529,911 and its current liabilities are \$5,090,069. A cash balance on hand of \$3,694,527 is recorded.

The I. R. Nelson Company, Jersey City, N. J., is now manufacturing the Furnell variable air condenser for the Furnell Manufacturing Corporation. The former company owns and operates broadcast station WAAM.

Twin Cities Stage Radio Exposition



St. Paul and Minneapolis radio fans jammed the Kenwood Armory, Minneapolis, during the week of the Fifth Annual Northwest Radio Show. Manu-

facturers' exhibits held the attention of thousands of radio prospects as well as the many visiting retailers and jobbers who attended.

National Broadcasting Co. to Have Own Building

Unique in the annals of radio broadcasting is a 15 story building, being erected at 711 Fifth Avenue, New York City, designed primarily to suit the exacting requirements of a broadcasting station. Four entire floors of the building are to be given over to the activities of the National Broadcasting Company when it is completed in May or June.

The building will contain eight fully equipped studios from which the company's programs will be relayed by land wire to transmitters located in many central cities. Thus the building, while in a sense housing a super-broadcasting station, will not be topped by the enormous steel towers which usually distinguish such structures.

Merlin H. Ayiesworth, president of the company, has announced that programs broadcast by the New York station, WJZ, will henceforward be under the supervision of the company though directed by its present personnel. The station will continue to serve listeners as a single unit and will not form part of the N.B.C. chain of which WEAJ is the nucleus.

\$250,000 Factory Marks Magnavox Expansion

Four acres of ground in the industrial section of Emeryville, Calif., adjoining Oakland, have been purchased by the Magnavox Company. Plans are being made for the immediate erection of buildings to contain over 100,000 sq.ft. of floor space. The latest available machinery for the manufacture of radio apparatus and electrical devices is to be installed in the new plant.

E. H. Schwab Heads Splitdorf

E. H. Schwab, formerly president of the Bethlehem Spark Plug Company, which merged with the Splitdorf Electrical Company of Newark, N. J., two

years ago, has been elected president of the latter company, succeeding M. W. Bartlett who has retired from the business. With Mr. Schwab's appointment and the advancement of R. W. Porter from the position of radio sales manager to that of general sales manager it is the intention of the company to go in for the development of its radio division on a greater scale than heretofore.

W. F. Barrett has been elected to a vice-presidency of the Union Carbide and Carbon Company. Mr. Barrett has been associated with the company and its subsidiaries since 1913 and is president of the Prest-O-Lite Company, Inc., and a number of other corporations as well as a director in the National Carbon Company, Inc. G. W. Mead, chairman of the board of directors of the Linde Air Products Company, Prest-O-Lite Company, Inc. and several other associated concerns, has been elected a member of the board of the Union Carbide and Carbon Company.

The Atlantic Broadcasting Corporation, a newly formed organization of which Alfred H. Grebe is president, Douglas Rigney, treasurer, and Fay L. Faurote, vice-president and general manager, has purchased the group of stations formerly controlled by A. H. Grebe and Company, Richmond Hill, N. Y., including station WAHG and WBOQ. The company's initial program was radiated on the evening of December 17, direct from Steinway Hall, New York City, in which its offices and studios are maintained. All transmitters are located in Richmond Hill.

The Willoughby Music Store, Willoughby, Ohio, has been chartered with a capital of \$25,000 by R. A. Semrad and R. O. Semrad, Cleveland; J. A. Bechtol, C. A. Reeve and A. L. Madow of Willoughby. J. A. Bechtol, former Painesville, Ohio retailer, has been elected general manager. The company has opened a complete radio and music store in the McTodd Theater Block. A full line of accessories is stocked.

Behind Day-Fan Guns



W. E. Baker, left, general manager, and Charles T. Lawson, sales manager of the Day-Fan Electric Company, are largely responsible for the precision and regularity with which the big Dayton, Ohio, plant ticks. Lawson bosses the salesmen and Baker bosses Lawson. Between the two they are putting over a mighty good job in single control radio sets this year.

Switzerland Has Touring Radio Show

Switzerland is running a close second to the Northwest Radio Trade Association for supremacy in new merchandising ideas. Paralleling the trade tour or traveling radio exposition staged by Twin City dealers and jobbers, the Radio Genossenschaft of Zurich, Switzerland, is sponsoring a radio show now visiting all the small towns and villages within the area covered by the Zurich broadcasting station.

The show has been on the road since October, stopping for two or three days in each locality, usually on Saturday, Sunday and Monday, and will continue spreading radio propaganda until the end of January. Exhibitors are displaying radio receiving sets of all kinds, from simple crystal receivers to the highest-priced tube sets, and a considerable increase in radio listeners is anticipated as a result.

Whose Dinner Was This, Anyway?

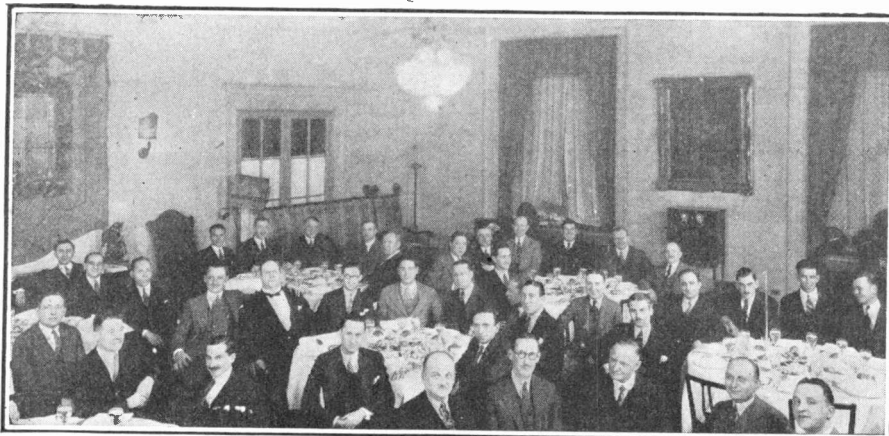

Thirty-six New York City retailers postponed starvation late in November, attending a dinner at the Hotel Pennsylvania in response to the Radio Circular Company's invitation to give the new Grimes-Viking receiver the "double-O". Radio Circular Company

distributes the latest product of David Grimes, Inc. As the evening progressed half the dealers waxed eloquent about the set while the other half celebrated Mac Levy's association with its manufacturer. Whose dinner was this anyway—Grimes' or Mac Levy's?

1925 Phonograph Output Sixty Per Cent Lower

The manufacture of phonographs and phonograph parts and accessories in 1925 decreased about 60.4 per cent from 1923 production, according to the Department of Commerce. Production for 1925 was placed at 642,015 phonographs, including dictating machines, valued at \$22,613,909. Parts and accessories valued at \$33,111,780 were manufactured, these two classifications representing decreases of 60.4 per cent and 31.7 per cent respectively as compared with \$57,037,060 and \$48,474,264 in 1923, the last preceding census year. In 1923, 997,459 phonographs were produced.

The items entering into the valuation for parts and accessories for 1925 were: records and blanks, 82,125,060 valued at \$26,790,847; needles, valued at \$960,831; cabinets, \$2,316,718; and other parts, \$2,543,384. The figures cover the production of 58 reporting establishments.

Proportion of Radio Listeners Among Substantial Families in 25 Cities

The magazine-reading and domestic habits of substantial families in twenty-five cities of the United States were the subject of an extensive inquiry made recently by the Bureau of Business Research of New York University, New York City. Many facts of scientific value in advertising were developed.

Questionnaires were sent out to 25,000 telephone subscribers in twenty-five cities; the names being taken at random.

At least one magazine was read by 97 per cent of the families; only 3 per cent read no magazine whatever. The range of the number of magazines read was from 1 to 20. The largest number of families read 4 magazines.

That the families interviewed represented in general a group of high purchasing power was established by the high percentage of home-ownership, 62 per cent of them being home-owners. Further data revealed that 97 per cent of those who were interviewed were automobile owners. The makes of automobiles owned were largely in the medium-priced group. In order, the leading makes were: Ford, Chevrolet, Dodge, Studebaker, Nash, Cadillac, Hudson, Hupmobile, Packard, Willys-Knight and Oldsmobile.

Of importance to radio manufacturers was the percentage of families owning radio sets. Of the families interviewed, 50 per cent owned sets. It is quite evident that well-to-do urban dwellers of the United States are still far from having all the radio apparatus they can absorb. Analysis of the figures for different sections of the country also shows great variation in the percentages, which may indicate that selling pressure has been applied unevenly.

Radio Center Dissolved

Radio Center, an organization renting space in the Bush Building, New York City, and re-renting compartments or booths to radio manufacturers, thus endeavoring to establish a central showroom in which out-of-town radio buyers might view the products of various manufacturers, has been dissolved. Colonel S. Herbert Mapes, former president of the project, has established offices at 437 Fifth Avenue, and intends to distribute a \$195 all-electric set, an electrical refrigeration system known as the Mapes system, and an oil-burning heater.

New Priess Appointments

Sales of the Priess Radio Corporation, New York City manufacturer of the Priess Straight Nine Receiver, have been placed under the supervision of William R. Davis, who has been appointed vice-president. Mr. Davis was formerly sales manager of the Magnavox Company, Pacific coast manufacturer of loudspeakers. Prior to his connection with Magnavox he devoted his time to government radio experiments. He was associated with Prof.

Fessenden in work of this nature back in 1906.

Julius V. Cremonim becomes assistant to the vice-president and manager of Priess' export sales department. He has been connected with the company for several years and has had considerable experience in the sale of various commodities in South America and Europe.

Victor Sponsors a New Broadcast Series

Beginning with a two hour program by world famous artists on New Year's night, January 1, the Victor Talking Machine Company is to sponsor a new series of bi-monthly broadcasts. Programs, to be broadcast between 9 and 10 p.m. on Fridays, will be relayed simultaneously to various sections of the country as the result of an arrangement completed with the National Broadcasting Company. In addition to this latter company's chain of stations, WBZ, Springfield, KDKA, Pittsburgh, and KYW, Chicago, will be employed with WJZ, New York, serving as the central or key station.

The Farrand Manufacturing Company, manufacturer of Farrand cone speakers and battery eliminators, has elected A. D. Silva vice-president. Mr. Silva was for some years chief engineer for the Atwater Kent Manufacturing Company.

Diamond T Holds Sales Convention

Diamond T Radio Manufacturers, South Bend, Indiana, manufacturer of five and six tube receiving sets, held its semi-annual sales conference at its factory, 526 Niles Avenue, Nov. 20. The company's entire sales staff attended a series of meetings addressed by C. L. Smith, president; H. J. Tweed, eastern sales manager, and B. J. Schmidt, western sales manager, outlining the reasons for the company's past success and its plans and policies for the year.

A number of retail customers attended the company's banquet held in the evening at the Oliver Hotel and witnessed a demonstration of the latest "Diamond T" models.

Harold R. Fletcher has been appointed director of sales and distribution of the Algonquin Electric Company, Poughkeepsie, N. Y. Mr. Fletcher was formerly associated with the Amsco Products Company. He will maintain offices at 120 Broadway, New York City, where the executive offices of the concern manufacturing Thermodyne radio receivers are located.

The Dongan Electric Manufacturing Company, 3001 Franklin Street, Detroit, Mich., has appointed R. L. Bradbury its New York sales representative. Mr. Bradbury, who was formerly associated with the R. J. Smyth Sales and Service of that city, will maintain offices at 154 Nassau Street.

Has the Crime Wave Reached 'Frisco?



Plenty of pomp and ceremony attended the presentation of the millionth Atwater Kent receiver to Mayor James Rolph, Jr., of San Francisco by Mary Lewis, Metropolitan Opera star, in behalf of A. Atwater Kent. The set was shipped via air mail to the

company's San Francisco distributor, Ernest Ingold, who apparently has caught a crime wave complex some where. A young army of guards surrounded him en route to the Mayor's office. Left to right in the oval, Mr. Ingold, Miss Lewis and Mayor Rolph.

Radio Advertising Standards Issued by Bureau

In co-operation with a number of individuals and groups in the radio industry, including various steps in merchandising from maker to consumer, the National Better Business Bureau, 383 Madison Avenue, New York City, has prepared tentative standards of radio advertising and selling.

Advance copies of these standards were first circulated in mimeograph form throughout the industry with the request that fallacies and shortcomings of any kind be pointed out. The circulation of this material resulted in such widespread commendation and agreement that the standards have been set up in printed form for national distribution, now going into the mails.

79% of City Dealers Sell on Time Payments

The percentage of radio stores that sell on the installment plan has long been an important question. So far as New York City is concerned, a check has just been made by the New York University Bureau of Business Research, in co-operation with F. A. D. Andrea, Inc. The inquiry was directed on five-tube receivers as a standard. The survey of the bureau, during which 209 stores were called on, showed that 79 per cent sold on the installment plan and 21 per cent for cash only. This refers to radio receiver sales. Other facts brought out in the survey are—

Fifty-six per cent of those selling on partial payment make no interest charge.

Forty-four per cent make specific charges, averaging 8 per cent of the cash price, on the basis of one year to pay. However, six months is the average in most cases.

The Glenn L. Martin Company, Radio Division, Cleveland, Ohio, has reduced the list price of its Aero-B Power unit, formerly retailing at \$50, to \$35.



Lettering on a door in the Woolworth Building, New York City, in the suite occupied by the Radio Corporation of America, reads, "Mr. Bucher, Sales Manager." Here's a big job, handled in a big way by a man who has proven himself big enough to do it. And, sh— his favorite recreation is to collect all the burnt-out tubes he can find, bust 'em up and watch the vacuum escape.

British Tubes Reduced

A general reduction has been made in the retail price of vacuum tubes throughout Great Britain, according to a dispatch from the Valve Manufacturers' Association. Prices range from 1s. 6d. to 4s. 6d., according to type, or from \$0.36 to \$1.08 in American money at the present exchange rate.

The Minerva Radio Company, 154 East Erie Street, Chicago, has leased an additional floor in the building it now occupies to facilitate the assembly of Minerva console receivers. The company's main plant is located at Plano, Ill.

Ernest S. Hilber has been appointed assistant sales manager of the Federal Radio Corporation, Buffalo, N. Y. Mr. Hilber formerly represented the company in Canada.

Radio Broadcasting Merger in Japan Reported

The broadcasting companies of Japan have decided to join interests in the formation of one company which will control all broadcasting in the country, according to a report to the Department of Commerce from Commercial Attaché Charles E. Herring in Tokyo.

A number of those in Japan who are interested in radio are of the opinion that the move was directed and guided by the Government, thus signifying the desire of the Communications Department to control radio broadcasting in Japan.

Minneapolis Dealers Prevent Demonstration "Joy-Riding"

Twin City members of the Northwest Radio Trade Association, Minneapolis, Minn., have agreed to use the association offices as a clearing house through which the "joy-riding" demonstration customer may be apprehended. This type of customer makes the rounds of radio stores and secures a set "on demonstration," retaining it for several days without intention to purchase. Association members will record customers who have secured demonstrations and not bought, mailing these records each day to the association offices to be filed. Thus dealers may phone the association and check up on proposed demonstrations, using their own judgment if the customer appears to be a chronic offender. It is expected that this system will save thousands of dollars in the course of the year.

Members of the association, both wholesale and retail, have also adopted the following policy in relation to returned merchandise:

"Merchandise is not returnable without written consent; is not sold on consignment; may not be returned on salesman's authorization and damaged returned goods will be repaired—not replaced. Transportation charges must be prepaid and will be adjusted if merchandise is found defective."

Storage Batteries, A & B (concluded from page 70)

Manufacturer's Name and Address	Trade Name	Number of Models of A Batteries Made	List Price Range		Range in Capacity (Amp. Hr.)		Number of Models of B Batteries Made	List Price Range		Range in Capacity (Milliamp.-Hr.)	
			Min.	Max.	Min.	Max.		Min.	Max.	Min.	Max.
Smith, B. H., Danbury, Conn.	Hawley "A"	2	\$12.50	\$16.00	80	110	5	\$2.65	\$32.00	1.25	2,500
Standard Batt. Mfg Co., Ft. Worth, Texas	Standard	3	13.65	19.50	70	120					
Star Storage Batt. Co., Muncie, Ind.	Star	9	17.00	24.00	60	150	1		8.00		6,000
Storad Mfg. Co., Cleveland, O.	Storad	4	14.00	19.50	60	120	2	7.50	14.00		4,500
Thornton & Everest, Inc., Los Angeles, Cal.	Thor	5	7.75	14.50							
Todd Electric Co., Inc., New York City	Wizard, Perpetule, Todd						3	20.00	46.00		1,250
Universal Batt. Co., Chicago, Ill.	Universal	12	3.60	43.40	15	160	3	.60	15.00		3,500
U. S. Light & Heat Corp., Niagara Falls, N. Y.	USL	9	8.00	21.00	21	131	2	13.75	21.50		2,500
Vesta Battery Corp., Chicago, Ill.	Vesta	8	9.75	19.80	25	125	4	7.75	22.50	2,500	5,000
Victor Storage Batt., Rock Island, Ill.	SOS	4	13.00	19.50	60	120					
Western Batt. & Supply Co., Denver, Colo.	Westric	5	13.80	20.50	65	130	1		17.50		2,500
Westinghouse Union Bat. Co., Pittsburgh, Pa.		7	12.50	18.50	40	110	2	6.50	9.00	3,500	6,000
Willard Storage Batt. Co., Cleveland, O.	Willard	8	13.40	27.00	35	120	4	15.00	26.50	3,000	6,000
Witherbee Storage Batt. Co., New York City	Witherbee	5	9.75	15.00	50	125					
Yale Electric Corp., Brooklyn, N. Y.	Yale Franco, Elay	5	13.45	19.90	60	120					
Zied, J., Philadelphia, Pa.	Everlast						4	15.00	28.00	300	3,000

The Status of Canada As a Market for Radio Apparatus

Exports of radio apparatus from the United States to Canada reached \$3,682,928 in 1925, compared with \$2,413,687 in 1924, the increase being 53 per cent, compared with 203 per cent increase in 1924 over 1923. Imports from Great Britain totalled \$264,455, of which \$51,520 was for tubes.

According to a survey recently made by The Canadian Business Research Bureau of Toronto, the increase in the number of radio receiving licenses issued by the Dominion Government in 1925 was 42,179, or 45.85 per cent, over 1924, which year beat its predecessor by 191.04 per cent. It is now possible to compare the issue of licenses for three years and the survey in question shows that the growth of the trade in Canada closely parallels that of the United States, but falls behind that of Great Britain, which country increased its licenses last year by 502,500, or three times the rate of increase in ratio to population in Canada. The British authorities complain that a large number of fans operate without a license, but the number of licenses actually taken out on January 1, 1926, equals one to every five families.

The number of sets in Canada today is estimated at 536,700 or one set to every 4½ families. Distribution varies very greatly in various provinces, 39 per cent of the population owning 52 per cent of the total sets and 55 per cent of passenger cars.

The Dominion Government sells radio licenses through the post offices and through responsible radio retailers. Licenses are issued only to persons giving name, address and other requisite information.

Analysis of the figures suggests that conditions in Canada differ materially from those in the U.S.A. About 62 per cent of all Canadian licenses are held in cities large enough to support a daily newspaper, possibly rural fans are more addicted to "building their own" and they doubtless are not so careful in the matter of obtaining a license but still the figures suggest a better urban than rural market.

Conditions vary greatly in various provinces, areas containing 45 per cent of the total population own 75 per cent of the total number of sets. Canadian radio sales in 1925 followed closely the sales of motor cars and electrical appliances. A feature of the season was the rapid increase in the sales of British-made tubes. Although British manufacturers of tubes (they call them "valves" over there) do the bulk of the trade in Europe and the Eastern Hemisphere, they had not previously done much in Canada.

Canada promises to prove a fine market for makers of lamp-socket radio sets. It leads all countries in the proportion of population living in electrically lighted abodes, and 60 per cent of the total population live in areas in which power costs less than 1c. per kw.-hr.

The volume of radio business done in Canada in 1925 is estimated at \$27,000,000.



"Fishing" Trip?

The letter that accompanied this photo of George A. Scoville, vice-president and sales manager of the Stromberg-Carlson Company insists that next to receiving orders for telephone and radio equipment Mr. Scoville enjoys nothing better than a "fishing" trip. The gentleman at his left is Clyde Jones, former patent attorney of the company. Mrs. Scoville appears to be admiring the quality of the china.

British India Finances Broadcast Stations

Broadcasting in India, under the supervision of the Indian Broadcasting Company, Ltd., Bombay, is to be financed by an annual listeners tax of ten rupees—approximately 37 cents at present exchange values—and popular subscription to common stock in the company. 150,000 shares of common stock, at ten rupees each have been authorized, of which 60,000 will be offered to the public. 2,500 shares are reserved for importers of radio apparatus, who must be stockholders in order to secure an import license in India.

The company intends to establish high-powered stations in the Bengal and Bombay presidencies, according to a Department of Commerce report. Additional stations at suitable centers are to be erected at a later date.

Fort Wayne Dealers Stop Free Demonstrations

"Two months ago one of our dealers, while giving a demonstration in a prospect's home, discovered that there were four other sets, also 'on trial,' tucked away in that same house at the time," stated H. C. Wall, president of the Fort Wayne Radio Trade Association, a few weeks ago to a representative of *Radio Retailing*.

"This 'free demonstration' privilege has been so abused here in Fort Wayne," he continued, "that a contract was finally drawn up and submitted to our dealers at a recent meeting. In addition to stating the terms of payment this form contained the following clauses:

"This is to authorize the (name of dealer inserted here) to retain the sum of \$10 to pay for the expenses of demonstrating, provided the set is not accepted by me upon delivery after demonstration has been made. Title to remain in (dealer's name) until fully paid for and said Company is given permission to remove the instrument and accessories at any time if there is refusal on my part to comply with the terms of the above order. This does not include cost of erecting aerial. Signed, etc."

"I admit that this is pretty strong medicine," Mr. Wall remarked, "but certain diseases require drastic remedies. At the meeting of our association when the contract was presented for approval twenty-one voted for its adoption and but two voted against it."

Ralph A. Sayres has been appointed vice-president of Grant & Wadsworth, Inc., New York City advertising agency located at 342 Madison Avenue. Mr. Sayres will devote his entire time to radio promotion work. He has been connected with the manufacturing firm of J. B. Ferguson for some time as advertising manager.

The Talking Machine Company, 1618 Third Avenue, Birmingham, Ala., has been appointed exclusive distributor of Fada products in Alabama and western Florida.

Radio Shows and Conventions

January 19-21: Annual Convention, Radio Division N.E.M.A., Old Colony Club, Waldorf-Astoria Hotel, New York City.

June 6-11: R.M.A. Convention and Radio Show, Hotel Stevens, Chicago.

June, 6-11: Music Industries Chamber of Commerce Convention, Hotel Stevens, Chicago.

August 20-27: Fourth Annual Pacific Radio Exposition, Civic Auditorium, San Francisco.

September 19-24: Third Annual Southwest National Radio Show, Coliseum, St. Louis.

September 19-24: Fourth Annual Radio World's Fair, New Madison Square Garden, New York City.

September 26-October 1: Sixth Annual Northwest Radio Show,

Kenwood Armory, Minneapolis.

October 3-8: Salt Lake City Radio Show, Salt Lake City, Utah.

October 3-8: Third Annual Indianapolis Radio Exposition, State Fair Grounds, Indianapolis.

October 3-8: Pittsburgh Radio Show, Duquesne Gardens, Pittsburgh, Pa.

October 4-9: Fifth Wisconsin Radio Exposition, Auditorium, Milwaukee, Wis.

October 10-16: Sixth Annual Chicago Radio Show, Coliseum, Chicago.

October 24-29: New Orleans Radio Show, "States" Building, New Orleans.

October 24-29: Dayton Radio Show, Dayton, Ohio.

News of Jobbers and Distributors

Bosworth Appoints Three New Jobbers

The Manufacturers Sales Company, eastern representative of the Bosworth Electric Manufacturing Company, Cincinnati, has appointed three new jobbers, all covering eastern New York, New Jersey, and the metropolitan district. The new distributors of Bosworth products are: the Wholesale Radio Service Company, 6 Church Street; Radio Jobbers, Inc., 142 Liberty Street, and J. H. Bunnell & Company, 34 Park Place, New York City.

St. Louis Jobber Forming Dealer Association

Mayer & Company, Inc., St. Louis, Mo., jobber of radio apparatus, has formed an association of its retail customers known as the "Red-M" Dealer Association. Through this new organization it is the aim of A. B. Mayer to bring retailers of Red-M products to the attention of buyers. The association contemplates co-operative advertising and has already furnished identification stickers for the windows of members. The "Radio-caster," official organ of the new local association, will contain service and sales helps as well as news of merchandise available.

Sporting Blood



R. N. Swanson, secretary and buyer of the Vreeland Radio Corporation, Denver jobber, spent a hard earned vacation roughing it with rod and reel in the wilds of British Columbia. This snapshot shows him about to cast viciously into a murky pool in quest of a fighting denizen of the deep.

The Sutcliffe Company, 220 South Fourth Street, Louisville, Ky., has been added to the distributor list of the All-American Radio Corporation of Chicago. The company is exclusive distributor of All-American and Rauland products in the state.



On Top of the World

Leland Williams, left, secretary, and Fred D. Wilson, president of E. M. Wilson & Son, Newark, N. J., jobber, found that a sojourn in the wide open spaces improved the morale of the sales force. Accordingly a camp was established this fall at Lake Hopatcong. Mr. Wilson tells us that a good time was had by all. Dressed like this who wouldn't have had one.

The Corlaer Radio Corporation has been formed with headquarters at 123 Wall Street, Schenectady, N. Y., and will distribute radio apparatus throughout the Mohawk Valley and outlying areas. The company will also distribute electrical apparatus.

The Welco Storage Battery Company, Flint, Mich., has been appointed a distributor of Hyatt portable receivers by the Electrophone Corporation of Chicago. The company also maintains offices in Detroit and Kalamazoo and has been granted exclusive distribution rights in the state of Michigan and nearby Ohio territory.

The Burmac Company, Quincy, Ill., has available an illustrated catalog of the various products which it distributes throughout the state. The catalog contains photographs, list prices and complete specifications of these products.

C. B. Cooper, 154 Nassau Street, New York City, has been appointed New York sales representative for the Shramrock Manufacturing Company, Newark, N. J. The company manufactures single dial receivers under patents of John V. L. Hogan.

Brown & Caine, radio jobber, 2317 Calumet Avenue, Chicago, has released a new circular of the products it distributes. The booklet is illustrated and contains full specifications and list prices. Several Bee Cee products which the company manufacturers are also listed.

Pacific Wholesale in New Quarters

Pacific Wholesale Radio, Inc., San Francisco distributor of Freed-Eise-mann radio apparatus, has found it necessary to enlarge its quarters. Located at Folsom and Seventh Streets, the company now occupies two floors and 7,000 sq.ft. of floor space. The main floor is fitted out as a sales and show room, while the second floor serves as a service department, store-room and shipping section. Adequate provision has been made for the accommodation of customers. Headquarters of the company is at 1310 San Pedro Street, Los Angeles. A branch office is also maintained at Oakland.

Tait Radio Sales, Bay and Wellington Streets, Toronto, Canada, has been appointed exclusive distributor of Ortho-sonic radio receivers in the marketing area of Toronto. Ortho-sonic radio is the product of the Federal Radio Corporation of Buffalo, N. Y.

The Specialty Service Corporation, 575 Atlantic Avenue, Brooklyn, N. Y., has prepared a catalog for the use of retail customers. The catalog contains a list of all merchandise which the company stocks with full list prices. Net prices are also quoted in code. A deciphering card is mailed with each catalog.

Arthur I. O'Kanst has been added to the sales force of the Wholesale Radio Equipment Company, 115 Leonard Street, New York City, and will cover upper New York City retail trade.

Exit Housing Problems

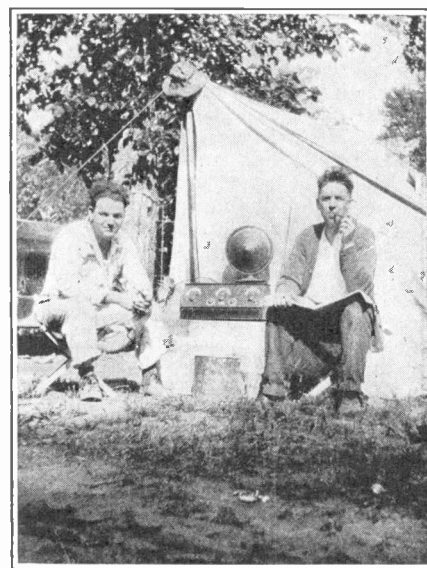

George W. Livingston and B. K. Bunch, Northern Kansas and Missouri salesmen for the Sterling Radio Company, Kansas City, Mo., ducked local landlords over a week-end and set up this "lean-to" beside Linn Creek. Livingston fished for DX, while Bunch fished for fish.

CROSLLEY

BETTER COSTS LESS

RADIO

CROSLLEY RADIO INSTRUMENTS
Each item the utmost in radio at its price. All prices slightly higher west of the Rocky Mountains. Prices without accessories.



THE "PUP" \$9.75
This little double-circuit one-tube set has brought happiness to thousands and made records for long distance receiving.



THE "4-29" \$29
A 4-tube receiver of amazing efficiency, Crescendon & Quality D. E. D. Everywhere considered marvelous at its price.



THE "PORTABLE" \$33.00
The 4-29 in portable form, handy, compact, efficient.



THE "5-38" \$38
A five-tube tuned radio frequency set, with two stages of non-oscillating radio frequency amplification, Crescendon controlled, two stages of audio frequency amplification.



"RFL-75" \$65
5-tubes. True cascade amplification, non-oscillating, non-radiating even under any mishandling. Its perfect balancing achieved by Wheatstone bridge in each stage of amplification. Exceptional selectivity and tone.



THE "MUSICONSOLE" \$32.00
Embodies the Musicone in a beautiful console of two-tone mahogany finish and provides room for batteries and accessories; 24 inches high inside.



6-TUBE "RFL-90" CONSOLE \$90
Introducing the double drum station selector! Includes Musicone in exquisite console. Room for batteries and all accessories; 40 inches high by 30 1/2 inches wide.

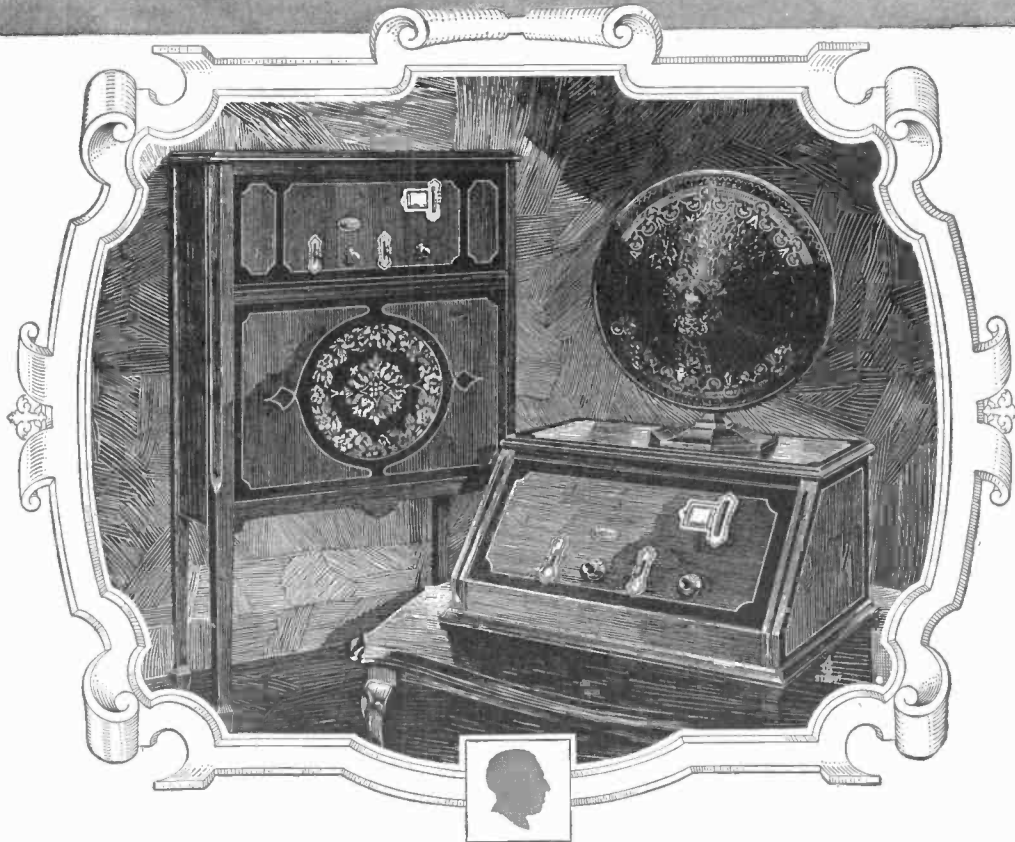

CROSLLEY 1927 FEATURES
Many exclusive-features found only in highest priced radios.

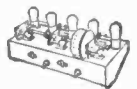

ALL-METAL SHIELDED CHASSIS
This truly great radio achievement, found in several Crosley sets, furnishes a substantial frame for mounting elements, produces excellent alignment of condensers, shields the units from each other, prevents interstage, improves the stability of the circuit, increases selectivity and a standard saves cost by standardizing this phase of manufacture.



THE "ACUMINATORS"
Crosley Acuminators permit tuning in—loud and clear—weak stations passed over and entirely missed by ordinary single dial radios. In tuning high powered and local stations they are not used. They are an exclusive Crosley feature.



THE "CRESCENDON"
When, on ordinary radios ears must strain to catch a station miles away, a turn of the Crescendon on Crosley radios instantly swells reception to room-filling volume. An exclusive Crosley feature.



THE SINGLE-DIAL STATION SELECTOR
Nothing in radio equals the joy or the convenience of single dial control. Crosley's single drum control enables you to find the stations sought without log book or "tuning."



POWER TUBES
Power tube adaptability marks the Crosley "5-50", "5-75" and "RFL" sets. This feature typifies Crosley provision for best radio reception at moderate cost.

Amazing single dial control and reproduction

THE 5-50

Such a success! Enthusiastic owners report amazing performance—a drum dial delivering stations loud, clear, sharp; each an almost imperceptible turn of the drum apart. Write station letters on the drum; return to them at will. This marvelous receiver containing these advanced ideas in radio (some of them exclusive to Crosley), including metal shielding and power tube adaptability indicates Powel Crosley, Jr.'s genius in lowering prices by mass production methods.

THE SUPER MUSICONE

Listen to this wonder reproducer of broadcasting! Then you'll understand why it is the biggest selling loud speaker on the market EVERYWHERE, and the most imitated. Its shape, however, is NOT the secret of its wonderful performance. Its delightful tone and the fidelity of its reproduction is achieved solely through the Crosley patented actuating unit. Avoid imitations. There is only one genuine MUSICONE. Smaller model, 12-inch cone, \$12.50.

THE 5-75 CONSOLE

This set includes ideas for radio reception perfection NOT found in any other radio. Marvelous exclusive Crosley "Crescendon" and "Acuminators" increase volume on distant stations and bring in programs entirely missed by and missed on ordinary one dial control radios. Console is 40 inches high with ample room for batteries and a genuine Crosley Musicone is built in. Radio chassis same as in the 5-50 receiver. Beautifully finished two-tone mahogany cabinet, rose gold fittings.

\$50.

\$14.75

\$75.

Prices slightly higher west of the Rocky Mountains

Write Department 130, for Illustrative Literature

Crosley manufactures radio receiving sets, which are licensed under Armstrong U. S. Patent No. 1,113,149, or under patent applications of Radio Frequency Laboratories, Inc., and other patents issued and pending.

THE CROSLLEY RADIO CORPORATION

CINCINNATI, OHIO. POWEL CROSLLEY, Jr., President

New Dealer Help Material

Aids to greater profits provided by radio manufacturers for their dealers

Universal Dealer Helps Now Available

Merchandising aids for the use of retailers of Universal apparatus manufactured by the Universal Battery Company, Chicago, Ill., are now ready and are available on request. The material consists of a generous supply of small illustrated catalogs, stuffers for mailing campaigns, large lithographed window posters in 6 colors, window transfers of an attractive nature, moving picture slides featuring Universal batteries and electros which may be used in local newspaper advertisements.

The company's entire line of dealer helps is available to authorized retailers without charge and will be shipped immediately upon receipt of a signed requisition.

The Radio Corporation of America has prepared a limited number of display cartons designed to stimulate the sale of sets of three and four tubes where one is ordinarily sold. Cartons accommodating either three or four Radiotrons may be obtained. The company's literature states that the cartons' attractive coloring, red, white and black, combined with their rigid construction is intended to put over the idea of keeping several spare tubes next to the radio receiver for emergency replacement.

The Stewart-Warner Speedometer Corporation tells the world what users think of "Matched Unit" radio in a new 14 in. x 25 in. wall poster containing enlarged facsimile copies of letters of approval from users in Tennessee, New Mexico and Canada. Testimonials have always been a good method of stimulating sales and these plain, uncolored statements released by the Chicago company are rapidly finding their way on to the walls of retail stores.

The Borkman Radio Corporation, Salt Lake City, Utah, is sending out a broadside of circulars to retailers, advertising its speakers. Each illustrated circular is devoted to one of the company's four models, also mentioning one of the other speakers. Thus the "Jewel Case" circular bears a photo of the "Chinese Cone-Flex" on its back, the circular describing the "Cone-Flex" calls attention to another model, the "Lantern," etc. A larger dealer help contains photos of all the models. The circulars, printed in brown and yellow, and giving list prices, may be stamped with the dealer's imprint and are available without charge.

The Ward Leonard Electric Company, Mount Vernon, N. Y., lists its entire line of "Vitrohm" wire-wound resistances for radio in circular 507, just released. Dimensions, weight, power rating, etc., together with list prices are given in the circular.

Celebrating the "Millionth"

This is a duplicate of the 1,000,000th Radio Receiving Set made by the Atwater Kent Manufacturing Company in its 15-acre factory at Philadelphia, Pa. on Friday, December 3rd, 1926.

On the same day 5317 Sets (11 per minute) were completed.

Placed beside an Atwater Kent "compact" receiver this 11 by 14 inch sign furnished by the Atwater Kent Manufacturing Company is imposing. There is just enough of the news element in the passing of the one-million mark in the production of these receivers and enough of a novelty about the comparison to make window shoppers stop, look and listen. A companion display piece quotes the production figures of the company since 1922.

Philharmonic Featured in New Fada Display

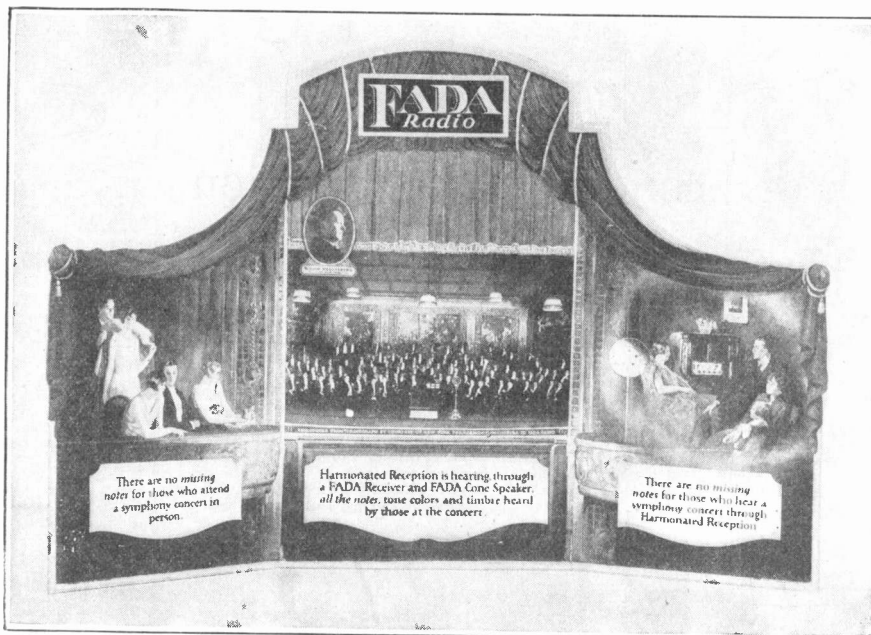

F. A. D. Andrea's latest window display centerpiece, featuring the New York Philharmonic Orchestra, directed by William Mengelberg, calls attention to the fact that the pleasure of a concert received in the home via Fada

"Harmonated" radio may be equalled only by attending the performance. The display is in several colors and the attractive interior of Carnegie Hall, New York City, in the center panel enhances its appearance.

The Music Master Corporation, Betzwood, Pa., of which David S. Ludlum is trustee, is furnishing for use as a dealer-help a small two-page folder containing colored illustrations of the speaker which it is marketing. The folder is 3½ in. x 5½ in. in size and is printed in several conservative colors.

The Charles Freshman Company, Inc., New York City, has published a forty-seven page catalog and instruction book. The company's sets are photographically illustrated as are individual parts such as coils, dials, transformers, sub-panel assembly etc. Trouble shooting methods and other Freshman products are also listed.

J. B. Ferguson, Inc., 225 West 57th Street, New York City, offers a small two-page folder, containing photographic illustrations of its Model 10 receiver, and a 10 x 14 inch easel-backed counter card as merchandising aids to its dealers. The small pamphlet is equipped with an attractive blue cover, space for the dealer's imprint, and may be inserted in a standard envelope for mailing purposes. The counter-card is printed in blue on a gold background, featuring the tone quality of this same receiver.

Degasifying Radio Tubes by the New Arch Method

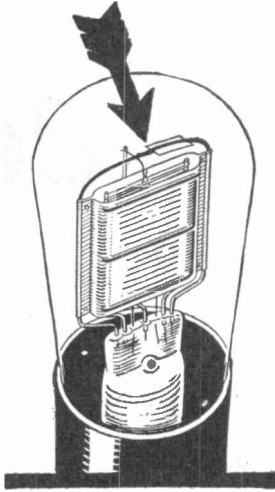

A common fault found in radio reception today is the noticeable receding of quality in any set—regardless of its make or cost, after it has been subjected to several hundred hours use.

This condition causes unending disappointment to the user and expense to the dealer who either finds the set back on his hands or is burdened with useless service calls.

The source of such trouble can, in 90% of the cases be traced to poor tubes largely due to the wrong practice of degasifying metal parts at time of manufacture.

Ken-Rad engineers successfully solved this problem by the invention of the famous arch principle of construction—now incorporated in the complete line of Archatron tubes.

The Old Method

The standard practice used by others of clearing the tubes interior of gas is to exhaust it at a temperature of 600 degrees centigrade. In the assembling of the parts a small piece of metal material called the "getter" is welded to the plate and "flashed" when the plate reaches this temperature.

This flashing supposedly clears the elements of gas besides giving the tube its mirror-like appearance.

But this method does not completely remove all of the objectionable gases from the tube.

A New Discovery

The new ARCHATRON discovery places the "getter" supported in a position above the plate by an "arch" so that the heat does not readily reach this material and the temperature of the thus isolated "getter" is not affected during the degasification process.

This procedure results in more perfect degasification because the elements can be heated to a much higher degree—even to a bright red heat—without flashing the "getter." At this temperature the tube is thoroughly evacuated, hermetically sealed and based, the "getter" being flashed electrically just before the final test.

Perfect Degasification

Through the application of this Ken-Rad discovery all injurious gases are liberated from the elements in advance, and the tube has an absolute pressure which is equal to the vapor pressure of the "getter." This method insures permanent degasification and gives the longest obtainable filament life to the tube.

Another advantage is in causing the metallic deposit to appear at the top portion of the tube, leaving the stem free of it. Most of the inter-element capacity trouble with other radio tubes is traceable to a metallic deposit upon the stem where the lead-in wires are grounded. This fault is overcome through our "arch" principle and insures a uniform capacity so important in the new balanced receivers.

Best by Test

ARCHATRON tubes have been tested in most leading laboratories and also by well-known radio authorities.

They have passed every known test with a fine superiority rating.

Don't hesitate to recommend them to your customers. The UNCONDITIONAL GUARANTEE FOR ONE YEAR protects you.

THE KEN-RAD CORPORATION, Inc.
Owensboro, Ky.

GUARANTEED for ONE YEAR

Any ARCHATRON not subjected to excessive voltage is unconditionally guaranteed for one year.

"Too many service calls"—is the complaint of radio dealers everywhere. Put a stop to them!

How many times have you answered a call only to find that the receiving set you had sold was in perfect condition but that its tubes had given out after only a few weeks' use.



Type UX-199

Sell the only INSURED radio tube on the market—one year guaranteed ARCHATRONS.

An Archatron for Every Need

- UX 201-A Detector-Amplifier
- UX 199 Detector-Amplifier
- UX 112 Power Amplifier
- UX 120 Power Amplifier
- UX 216-B Single Wave Rectifier
- UX 213 Double Wave Rectifier
- UX 200-A Super Detector
- UX 100-A High-Mu Resistance Coupled Amplifier



Type UX-201-A

Tested 7 Ways Ken-Rad ARCHATRONS

A new standard of perfection resulting in a new performance. No ARCHATRON is packed in its carton until it has first been subjected, not merely to one or two or three but SEVEN Efficiency Tests.

1. Amplification
2. Capacity
3. Volume
4. Filament Life
5. Vacuum
6. Uniformity
7. Co-ordination

"The Secret is in the Wonderful Arch."

Mail This Coupon

for complete simple explanation of the new improved ARCHATRONS.

THE KEN-RAD CORPORATION, INC.,
316 West Second St., Owensboro, Ky.

Please send information about ARCHATRON One-Year Guaranteed tubes, sales helps, and name of your nearest distributor.

Name

Address

City State.....

Hermetically Sealed!



ALL-AMERICAN AUDIO TRANSFORMER

*"fits any circuit—
does a better job"*

Every All-American Audio Transformer you sell means a satisfied customer as well as the profit you make. It's a fine quality product—with satisfactory results built into it.

After assembly, the heavy steel shell is filled with a moisture-proof compound which seals it forever; no chance of break-down from rust or electrolysis; climate and humidity cannot affect the delicate wiring and other vital parts.

We're advertising the All-American Audio Transformer aggressively to the radio public. You can sell many of them—better be ready. Ask your jobber; or write us.

A helper that really helps

"The Indian Guide" is one of the means by which we help our dealers sell more merchandise. You'll find it worth reading; chuck-full of real merchandising facts and ideas. Issued monthly. Write us to put you on the mailing list.

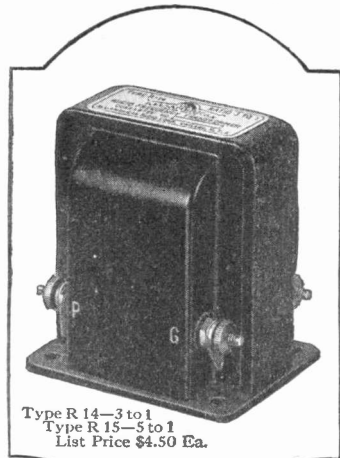

Type R 14—3 to 1
Type R 15—5 to 1
List Price \$4.50 Ea.



This full page advertisement will appear in February 1927 issues of Radio News and Popular Science Monthly. Total class circulation more than 750,000 copies.

ALL-AMERICAN RADIO CORPORATION

4223 Belmont Avenue, Chicago, U. S. A.

STATION WENR (266 METERS) IS OWNED AND OPERATED BY ALL-AMERICAN RADIO CORP.

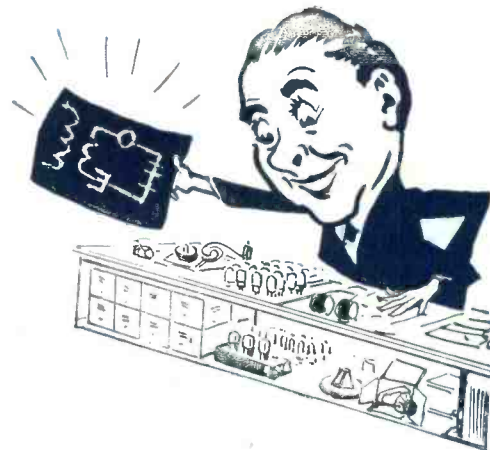

Merchandising Radio Parts

A Section of *Radio Retailing*

January, 1927

Elliott says:

“Parts Fill
the
Sales Gaps”



In addition to its value as a stimulant to set sales Elliott's small parts stock netted him approximately \$300 last year.

Shreveport, La., dealer supplements his set business with a small stock of radio parts, using them as stepping stones to receiver sales

MOST retailers in lines other than radio have not found it good business to specialize in the sale of highly profitable items to the exclusion of all others. In practically every line a small “extra” is carried as a logical and profitable adjunct to the sale of “bread-and-butter” items.

The average phonograph dealer, for instance, finds the sale of sheet music profitable, while relying principally on the sale of instruments to pay expenses. Electrical contractors stock small accessories, fuse plugs, batteries, etc., though revenue from the sale of wiring is really what makes the wheels go 'round.

In both instances the “extras” are profitable items, though secondary to a better line. They serve the double purpose of establishing the retailer's

store as headquarters in his field, thus attracting customers who may later be sold larger items and providing a steady flow of business through periodic sales gaps which occur in connection with standard lines.

Parts Involve Small Expenditure

Approximately \$1,000 is invested in radio parts by the Elliott Electric Company, Shreveport, La. Yet in a town with a total population of 60,000 the company turns over its parts stock four times a year at a net profit of 7 per cent.

As an adjunct to set business, parts are highly profitable, according to R. H. Mayer, radio department manager of the company. Not only are they in demand two months or more earlier in the year than complete receivers, but people still ask

for apparatus with which to construct their own receivers far into the summer months.

It has been the company's experience that the confirmed parts buyer may usually be developed into a prospect for a high priced factory receiver. Very often sales graduate from a rheostat or a condenser one year to an inexpensive set the next and the best obtainable receiver the following year. Many customers enter the shop to buy a small item, become regular patrons and are later developed into prospects for larger receivers.

Limits Advice to 15 Minutes

Mayer overcomes the principal difficulty experienced by parts dealers by limiting conversation with customers to 15 minutes if the store is

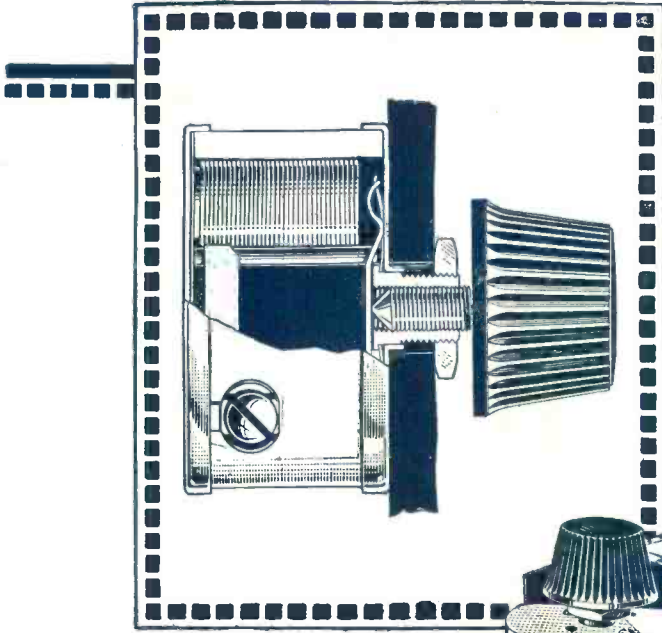

Bradleyohm-E

PERFECT VARIABLE RESISTOR

This new oversize resistor is used as standard equipment by leading B-Eliminator manufacturers such as Acme, All-American, Majestic, Philadelphia Storage Battery, and Willard. It is the ideal variable resistor for controlling plate voltage output. The scientifically-treated discs in Bradleyohm-E provide stepless, noiseless, plate voltage control, and the setting will be maintained indefinitely.

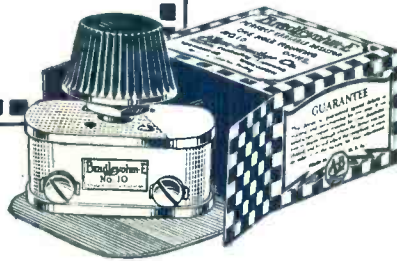

Sell Allen-Bradley Resistors for B-Eliminator Hook-Ups

RADIO dealers and jobbers are enjoying a continuous sale of Allen-Bradley variable and fixed resistors, because these important units are specified for most B-Eliminator circuits published in radio magazines and newspapers. Capitalize on this continuous demand and insure a uniform turnover of your radio stock by standardizing on Allen-Bradley variable and fixed resistors for your radio trade.

A new folder giving seven popular B-Eliminator hookups will be sent you at your request. Have it handy for reference purposes.



Bradleyunit-A

PERFECT FIXED RESISTOR

The Bradleyunit is used extensively by B-Eliminator manufacturers as standard equipment. It is recommended by leading radio writers as the ideal fixed resistance unit for B Eliminator kits. Send for latest price sheet giving complete details and ratings of Bradleyunits for every application.

**Send for Illustrated Folders
Use the Coupon!**

ALLEN-BRADLEY COMPANY
489 Clinton St., Milwaukee, Wisconsin

Please send me by return mail your latest folder of Allen-Bradley perfect radio devices.

Name

Address

.....

How Elliott's Divides Its \$1040 Parts Investment

Article	\$—at Retail	Per Cent of Total	Proportionate investment of \$38,000 stock (Dec. issue)
Binding posts.....	35	3	0.2%
Condensers, variable moderately priced.....	35	7	11.3
best quality.....	40		
Condensers, fixed.....	140	14	2
Coils, tuning.....	75	7	1.5
Diagrams and booklets.....	20	2	0.1
Dials.....	25	2	2
Dials, vernier.....	25	2	3.1
Grid leaks.....	20	2	1.3
Jacks.....	25	2	1.8
Meters, 0-8 volt type predominates.....	50	6	2
Novelties, special coils, etc.....	70	7
Panels, sizes longer than 26 in.....	20	5	2
sizes smaller than 26 in.....	30		
Potentiometers.....	50	5
Resistances, variable from 6 to 30 ohms.....	20	2	2.3
Switches, panel.....	25	2	0.9
Transformers, medium and quality priced Low ratios in demand.....	200	20	30
Wire, heavy connection.....	25	2
Wire Double-Silk Magnet. 18 to 36 gauge.....	100	10
	\$1040	100	

This division of stock is the result of Elliott's three-year study of the parts business in Shreveport. The two columns at the right contrast his percentage of investment in various items with that of the Yorkville Radio Company listed in December.

at all busy. He has found it necessary to take this step in order to save time and discourage chronic "question and answer" men who invariably depart without making a purchase.

Customers are without exception discouraged from bringing home-built sets to the store for examination unless it is distinctly understood that a charge will be made for advice. The principal factor in favor of the sale of parts is the absence of trouble and service and Mayer intends to keep it that way.

He has found it absolutely essential that a man with sound technical knowledge be employed to sell parts. Authentic advice before a purchase averts the return of merchandise.

"There should be no greater difficulty with the granting of special discounts in connection with parts business than that experienced with factory made receivers," says Mayer. "Of course we have many requests for courtesy discounts but have found it profitable to extend this service only after checking our list of professional set builders. Business of this kind, usually repeat, is profitable."

Parts Dealer Features Replacement Service

There is more than one way to sell parts, according to W. Byrne, of Byrne's Auto - Electric Company, Portsmouth, N. H. In some localities it is impossible to interest people in the home-construction of radio receivers and power supply devices. They simply are not mechanically inclined and decline to buy apparatus of this type. It is possible, however,



An Advertising Pennant



A yellow felt pennant, furnished without charge by Amsco Products, New York City, to its dealers advertises the retailer rather than a particular line of apparatus. Large black letters and radio's symbol, forked lightning in brilliant red, calls attention to the fact that the store in which it hangs is "Radio Headquarters." Amsco parts are identified with the display only in small unobtrusive lettering at the bottom of the pennant.

to do an appreciable business in the replacement line.

Byrne goes after parts business from this angle. He does not attempt to sell parts over the counter but bends every effort toward inducing people who already own receivers to have him install new transformers or audio amplifying systems in order to improve tone quality. His advertising advises set owners that he carries a complete stock of parts and is in a position to replace broken units in all standard receivers. Apparently he has a "corner" on the local repair market. In this way a greater stock of parts is disposed of than would be possible if he tried to sell them to "fans."

The idea might be carried further by an enterprising retailer. In the sale of high-grade equipment it should be possible in many instances to install new parts without extra charge, depending entirely on the profit from the sale for remuneration.

A New Parts Display Idea

The illustrated method of packing "Ensign" binding posts, a product of The H. H. Eby Manufacturing Company, Philadelphia, is conclusive evidence that the modern "parts" manufacturer as well as the wide-awake retailer of such radio apparatus realizes the importance of proper display and the capitalization of public demand for popular circuit material. Complete equipment for the construction of a popular receiver grouped in a similar manner by the retailer will do much to stimulate trade. The company can also supply posts boxed for other circuits including the Lynch Amplifier, LaCault LR 4, Harkness KH 27, Madison Moore, St. James and Varion.

from Franklin to Faradon

Compare Franklin's crude Leyden Jar with the compact, efficient Faradon Capacitor of modern radio.



Model WS By-Pass Unit

Made in
½ MFD
1 MFD
and 2 MFD
Units

The Wireless Specialty Apparatus Company, established in 1907, manufactures Faradon, specializes in electrostatic condensers for all purposes.

Your Customers

know and depend upon Faradon equipment for their radio sets and battery eliminators. Make sure your stock is complete.

Wireless Specialty Apparatus Company

Jamaica Plain, Boston, Mass., U. S. A.



Made in
U. S. A.

Price \$10.50

Model WS-3750 "Universal" Filter Capacitor Block

Other models in blocks or individual units with
any desired capacities and voltage ratings.

Faradon By-Pass and Filter Capacitors

Reviewing the New Circuits

A forecast of construction articles which will appear in February 'fan' magazines



A QUALITY audio amplifier which may be incorporated in old receivers or used in connection with radio-frequency and detector units is the subject of the feature article in *Popular Radio* for February.

The amplifier, designed in the

It is designed to operate on 110 volt, 60 cycle a.c. from which it obtains its A, B and C battery voltages.

The receiver is of the four tube type, with one stage of tuned radio-frequency, regenerative detector and two stages of transformer coupled audio frequency amplification. Tun-

the last audio stage. The filament supply to the 199's is d.c. and a 200 ohm resistance is shunted across the filament terminals of each of these tubes to by-pass plate current and improve tone quality. A milliammeter is included in the filament circuit.

The current supply unit, employing two thermionic tubes of the 213 type as rectifiers, supplies 157 volts of d.c. at 80 milliamps. This current is filtered through a series of three iron-core choke coils and a bank of condensers totaling 10 microfarads. The high voltage transformer is provided with a separate filament winding for the 213's.

The parts employed in the construction of the complete receiver and power supply are as follows:

- C—.00035 mfd. variable condenser
- C2—1 mfd. by-pass condenser
- C3—Small by-pass condenser
- C5—High voltage filter condensers
- L—Tapped antenna coil
- L1—R.F. transformer with primary spaced over entire length
- L2—Radio-frequency choke coil
- L4, L3—Iron core filter chokes
- MA—0-100 d.c. milliammeter
- R—Fixed resistance, 200 ohms
- R1—1,200 ohm rheostat
- R2—High resistance potentiometer
- SW—Switch
- T—Audio transformer
- T1—Audio transformer
- T2—Power transformer
- T3—Bell ringing transformer, 6 volt
- W—25 watt electric light lamps, Tungsten filament
- W1—15 watt electric light lamp, Tungsten filament

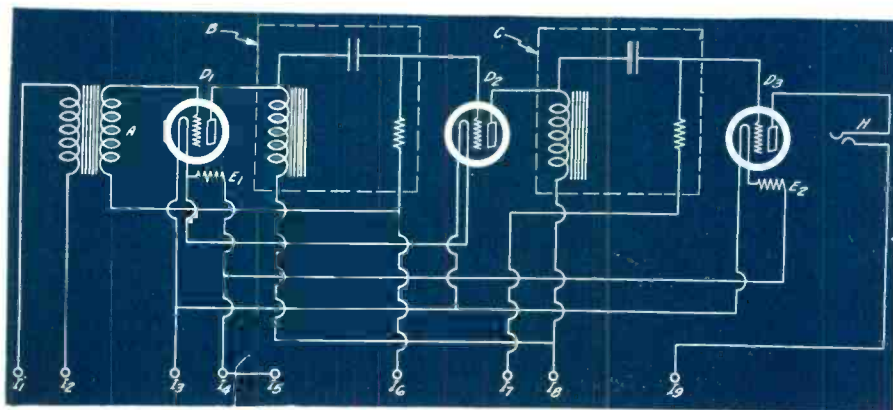

Popular Radio's Three Stage Amplifier

A list of the parts used in the construction of this three-stage amplifier may be found on this page with key letters

Popular Radio laboratory, consists of one stage of transformer coupled amplification, employing a quality transformer of low ratio and two stages of impedance coupling. It is said to provide excellent tone quality and accurate reproduction of both high and low notes, when used with a cone speaker or other type of reproducer capable of operating efficiently at all frequencies.

ing is accomplished by means of two wavelength controls and a regeneration resistance which is not critical.

Three UX 199 type tubes are used with a UX 112 power amplifier in

- A—High quality audio transformer of low ratio.
- B, C,—Impedance amplifying unit containing a choke coil, blocking condenser and grid leak.
- D1, D2, D3—Vacuum tube socket.
- E1, E2—Filament resistance of self-adjusting type, 1/2 ampere size.
- H—Open circuit jack.
- I1-I9—Binding posts.

"Radio News" Batteryless Receiver

McMurdo Silver writes the feature "How to Build" article for *Radio News'* February issue entitled the "Radio News Batteryless Receiver."

The set, designed in two separate units—radio receiver and power supply—is said to provide excellent selectivity, tone and volume without noticeable hum from the light lines.

The "Radio News" Batteryless Receiver

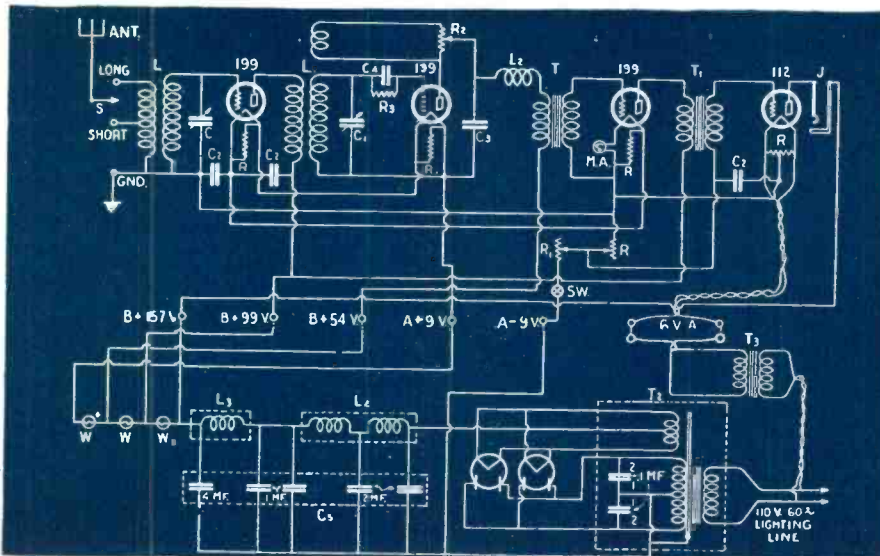

The receiver and current supply units shown in the above diagram are constructed in separate compartments. The lower half of the diagram, below the binding post connections, is the power supply section.

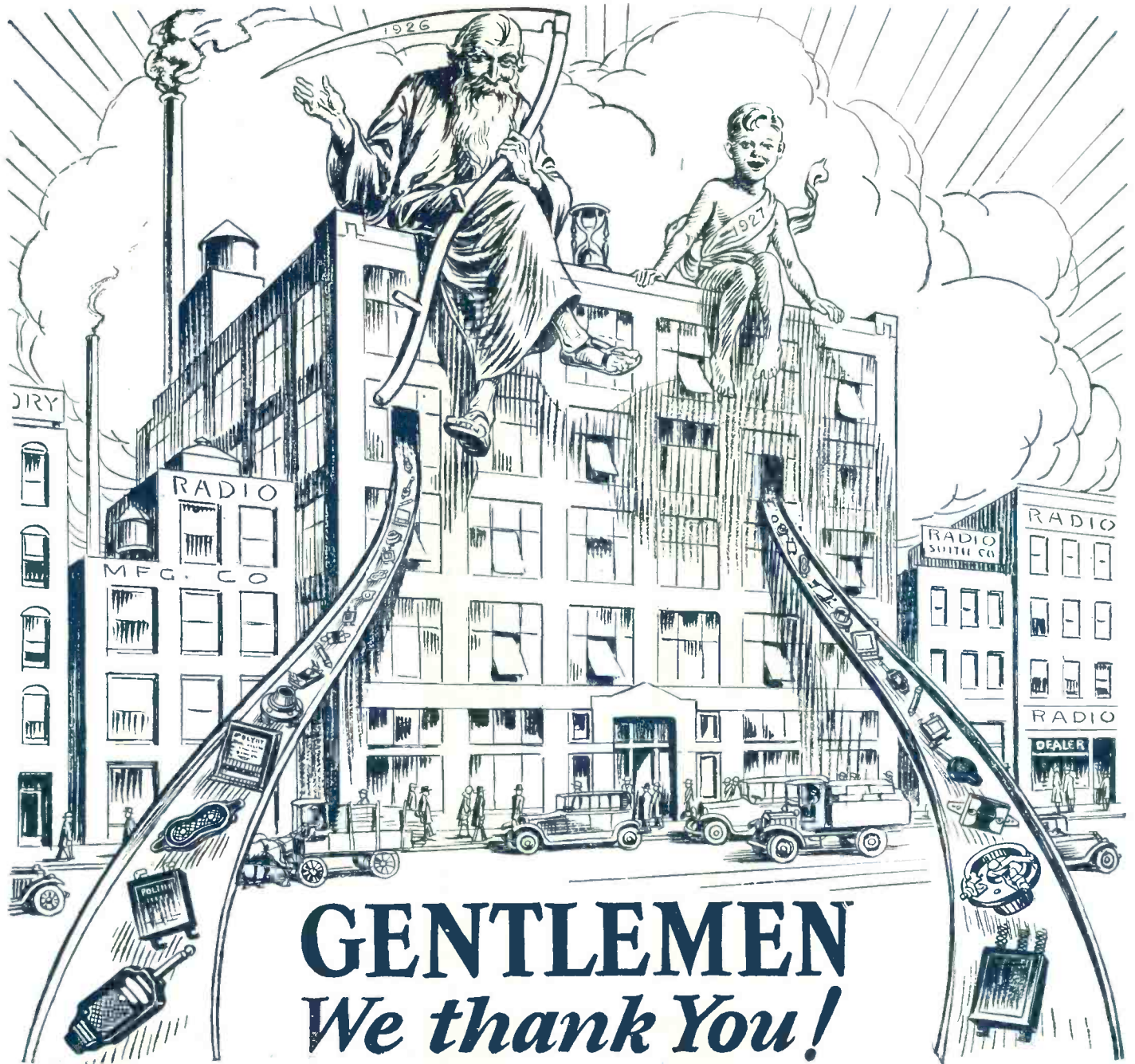

GENTLEMEN

We thank You!

MANUFACTURERS, DISTRIBUTORS, DEALERS—your splendid patronage has made for us a wonderfully successful year. Polymet has grown during 1926; expanded until today we face the new year stronger than ever before, the "World's Largest Manufacturers of Radio Essentials", indeed!

We take this opportunity of renewing our pledge of conscientious, personal service and the painstaking production of the highest quality merchandise. And we wish you all a very happy, prosperous New Year.

POLYMET MANUFACTURING CORPORATION

599 K Broadway, New York City

"World's Largest Manufacturers of Radio Essentials"

POLYMET PRODUCTS

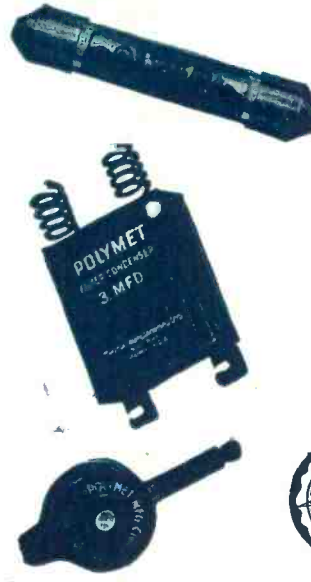

New Parts Announced This Month

New apparatus produced by manufacturers is listed in this section without advertising considerations of any kind. For the month's new sets and accessories see pages 64-69



Twenty Henry Choke Coil

Radio Retailing, January, 1927

The Jefferson Electric Manufacturing Company, 501 South Green Street, Chicago, is making a choke coil known as No. 358, designed to keep the B battery potential out of the loud speaker windings when used in connection with a two to six mfd. condenser. This choke has an extremely low d.c. resistance and ample current carrying capacity, according to the manufacturer. Its over-all dimensions are 2 1/4 in. high, 2 3/8 in. wide, and 2 3/4 in. long, including the terminals. Mounting holes on 1 1/8 in. x 1 1/4 in. centers. Weight 1 1/4 pounds. Intended retail price \$5.

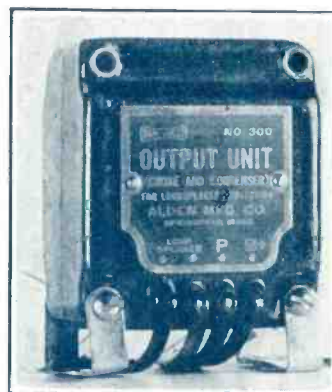

Output Transformer

Radio Retailing, January, 1927

The Alden Manufacturing Company, Springfield, Mass., is manufacturing the illustrated "Truphonic" output unit designed to be placed between the output of the last audio frequency tube and the loud speaker. This will improve quality and protect the speaker against burning out and demagnetizing. It is especially recommended where power tubes are used. Supplied in cases similar to individual Truphonic couplers. It is known as No. 300 and has an intended retail price of \$5.

Filter Condenser Block for B Battery Eliminator

Radio Retailing, January, 1927

The "Igrad B Unit" illustrated, is manufactured by the Igrad Condenser & Manufacturing Company, Inc., 26 Avenue D, Rochester, N. Y. It contains two .1 mfd., two 2 mfd., two 1 mfd. and one 8 mfd. condensers, and is encased in a metal container 3 3/4 in. x 2 1/4 in. x 5 in. over-all. All condensers with the exception of the .1 mfd. size which is used across the transformer output, and tested at 1,500 volts a. c., are made to withstand voltages up to 750. The unit is intended to retail for \$11.

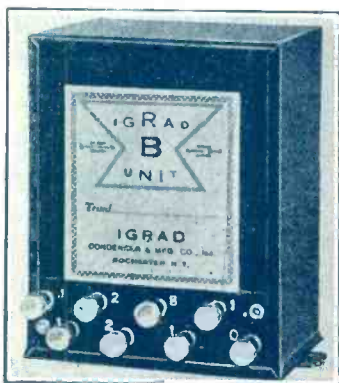

By-Pass Condenser Block for BH Raytheon

Radio Retailing, January, 1927

The Tobe Deutschmann Company, Cornhill, Boston, Mass., manufactures the illustrated filter condenser block, called the "Tobe BH Block," for use in eliminators employing the new BH Raytheon rectifying tube. The unit contains one 6 mfd., and two 4 mfd. condensers designed to operate at a normal voltage of 300. The condensers are contained in a silvered metal case and all terminals are brought out through an insulation strip at the base. Intended retail price \$11.

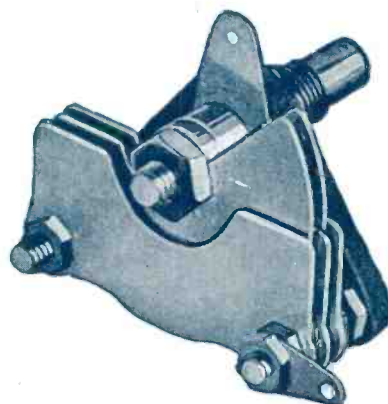

Balancing Condenser for Matching Dial Settings

Radio Retailing, January, 1927

The Daven Radio Corporation, 160 Summit Street, Newark, N. J., manufactures a small balancing condenser called the "Daven Balancer" designed to be attached to the framework of the first radio frequency condenser in receivers employing tandem tuning in the second and third stages. Variations in the wiring of successive stages and the damping effect of the antenna-ground system in the first stage often make the matching of tuning dials difficult in such sets. The Balancer compensates for this condition.

B Eliminator Kit with Variable C Voltages

Radio Retailing, January, 1927

The illustrated B and C battery eliminator kit, called the "L. C. Intermediate Power Pack," is sold by the Conner Crouse Corporation, 52 Vanderbilt Avenue, New York City. In addition to the 180 volts of plate potential which this unit supplies, C battery voltages variable from 20 to 50 volts are available. The kit is complete, containing one .1 mfd. high voltage condenser, a 14 mfd. filter condenser block and necessary chokes, transformer, tube socket, wire, etc. The intended retail price of the assembly is \$42.50. The kit may

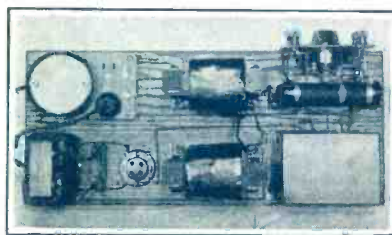

also be obtained equipped with a relay automatically controlling its operation for \$5 extra.



Types 901, 902 and 903. All purpose condensers with working voltages* of 160; 400; and 600 volts respectively. Capacities: 1, 2, 4 and 6 mfd.



Type 907. An improved and compact condenser replacing the old "by-pass" type with a working voltage* of 160 volts. Capacity: .1 to 2.0 mfd.

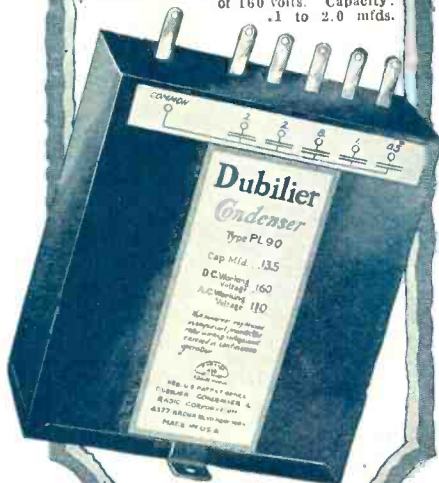

Type P. L. 90. The Dubilier Raytheon Block. Working voltage* 160 volts. Tans at 2, 2.8, 1, and .5 mfd.

COMPACT CAPACITY

Putting capacity into a paper condenser is comparatively simple. Providing for unvarying capacity in a paper condenser of small size, and building it to withstand high voltages in continuous operation—this required years of work in Dubilier research laboratories.

In Dubilier paper condensers only the finest of linen paper and tin foil are used. But it is the Dubilier process used in making them; the exacting standards set by Dubilier tests—that give to Dubilier Condensers the kind of quality demanded by the greatest radio stations in the world.

Efficiency and a liberal margin of safety are never sacrificed for size or appearance—where a reputation such as that held by Dubilier must be maintained in every country in the world. You sell compact capacity and safety when you sell condensers made by Dubilier.

Dubilier

CONDENSER AND RADIO CORPORATION

4377 Bronx Blvd., New York, N. Y.

*Working voltage is the voltage at which a condenser may be safely used in continuous operation.

New Parts Announced This Month

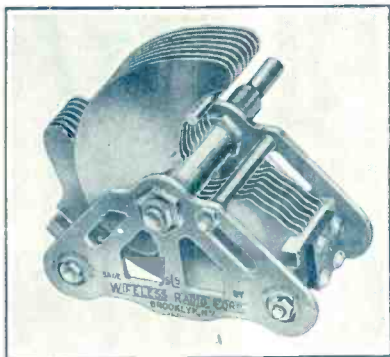

Straight Line Separation Variable Condenser

Radio Retailing, January, 1927

The illustrated variable condenser, manufactured by the Wireless Radio Corporation, Varick Avenue and Harrison Place, Brooklyn, N. Y., is said to space stations evenly on its dial throughout the entire broadcast band. The plate construction of the unit, manufactured in three standard capacities, .00025, mfd., .00035 mfd., and .0005, mfd., is a combination of straight line frequency and straight line wavelength design. The condenser is made of brass, with Radion insulation. Bearings are of bronze and hardened steel. Condensers are also obtainable with aluminum plates.



Vernier Dial with Logging Tabs

Radio Retailing, January, 1927

The Westerland Super-Vernier Dial, combines the advantages of a 150 to 1 vernier ratio and simple operation. As illustrated, each dial is supplied with a number of small tabs on which the call letters and wavelengths of stations are listed. These small tabs may be inserted in the face of the dial itself. Rough tuning may be done by lifting the dial knob away from the panel, the same knob providing finer adjustment when dropped back into the gear teeth on the dial face. A worm gear is said to provide smooth operation without backlash. The dial may be mounted without drilling additional holes in the panel. Intended retail price, \$2.50. Gold plate, \$3.50. Statuary bronze \$3.

Space Wound R. F. Coil

Radio Retailing, January, 1927

Type S2 radio frequency coil, manufactured by the Feri Radio Manufacturing Company, 1167 Bedford Avenue, Brooklyn, N. Y., is 2 in. in diameter and space wound on a thin film of transparent insulating material. The coil is equipped with a mounting strip and may be obtained in sizes suitable for use with standard tuning condensers. The primary coil is inserted in one end of the secondary. Intended retail price, in sets of three, \$4.50.



Variable Condenser with Grounded Rotor

Radio Retailing, January, 1927

The rotor plates of the illustrated variable condenser manufactured by the De Jur Products Company, 199 Lafayette Street, New York City, are grounded to the frame, thus minimizing hand capacity effects. The end plates of the unit are of nicked brass and a tie-bar connecting all rotor plate ends insures uniform and rigid spacing. Direct electrical connection is made from the rotor to the frame by means of a phosphor bronze pig-tail. Made in three capacities: .00025 mfd., \$3; .00035 mfd., \$3.25; and .0005 mfd., \$3.50.

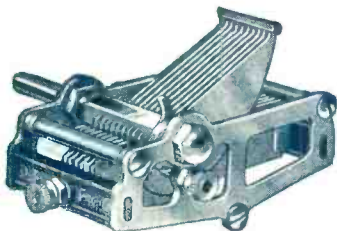

Transformer and Choke Unit for B Eliminator

Radio Retailing, January, 1927

The Ford Radio & Mica Corporation, 111 Bleeker Street, New York City, manufactures the illustrated choke coil and transformer assembly for use in B battery eliminators. The unit contains a transformer designed to supply 132 volts at 60 milliamp. and two filter choke coils. At 20 milliamp. 212 volts may be obtained. A Raytheon tube is supplied with each unit.

A, B and C Eliminator Transformer and Choke Unit

Radio Retailing, January, 1927

No. 2565 B-Power Unit, manufactured by the Dongan Electric Manufacturing Company, 3031 Franklin Street, Detroit, Mich. contains a 700 volt, center-tapped transformer and two 25 henry choke coils. The high-voltage transformer is rated at 35 milliamp. and is designed for use with the new Raytheon BH rectifier. Intended retail price, in metal container, \$17.50.



B Eliminator and Power Amplifier Kit

Radio Retailing, January, 1927

The General Radio Company, Cambridge, Mass., manufactures two complete B eliminator and power amplifier kits known as the Rectron type 390 kit and the Raytheon type 395 kit. Both outfits are equipped with positive

B voltage taps for 40 and 90 volts while in both cases 170 volts is applied directly to the plate of the single UX-171 power tube in the amplifier. The Rectron type employs a UX-213 full-wave rectifying tube while the Raytheon unit employs the full-wave, non-filament tube of the same name. Both kits are complete with drilled baseboard, screws, nuts, wire, etc. Type 390 is intended to retail for \$47.50 and type 395 for \$50 both without tubes.

Bakelite Binding Post with Non-Removable Head

Radio Retailing, January, 1927

Style T, "Morse-Eureka" binding post, manufactured by the F. W. Morse Company, Boston, Mass., is made of Bakelite. Lettering cannot be turned out of line, remaining in the position in which the post is mounted. The head, with which phone tips or wire connections are tightened, turns on the stationary center. The posts are available in all lettered types.

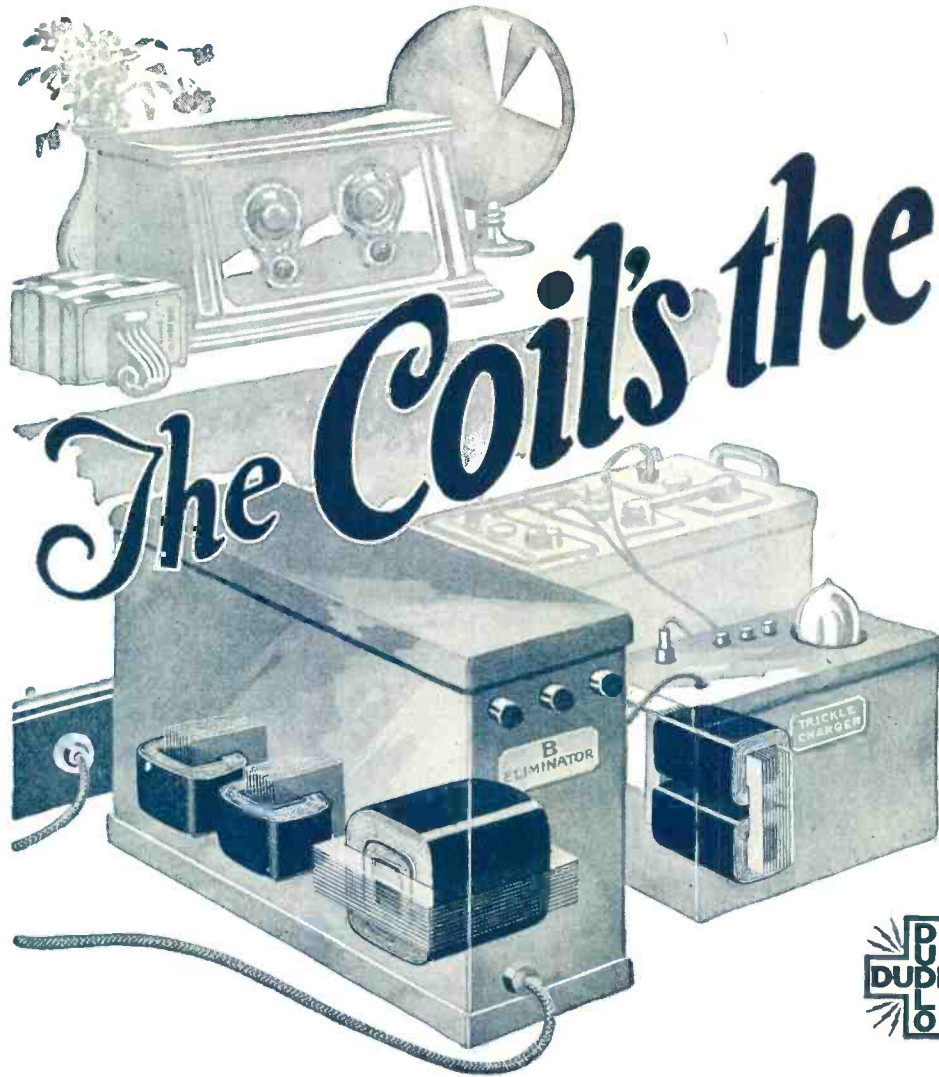

*that
makes
Radio*

*No Radio Unit is
any better than its
coils--true of all
electrical appara-
tus where coils are
used, but most
true of Radio.*



EVERY step of Radio progress calls for more and better coils. The strong trend this year toward "B" power units, "A" battery chargers and other devices to use light socket power, makes the coil of greater importance than ever. Ordinary coils produce only ordinary quality of reception and make a mediocre out of an otherwise fine set.

It is therefore important for radio manufacturers to buy the *best coils* wound from the *best magnet wire*.

It is equally important for every jobber and dealer to *know* what kind of coils are used in every radio unit he sells to his customers. In other words,

Good Coils Make Good Radio Units

DUDLO

DUDLO MANUFACTURING CORPORATION, FORT WAYNE, INDIANA

412 Chamber of Commerce Bldg.
NEWARK, N. J.

160 North La Salle Street
CHICAGO, ILL.

4153 Bingham Ave.
ST. LOUIS MO.

274 Brannan St.
SAN FRANCISCO, CALIFORNIA

Quality

The Key to the 1927 Buying Trend

NOW, more than ever before, radio fans are realizing that it is false economy to skimp when buying transformers. On transformer quality depends the quality of the entire set—and that's why critical radio buyers are swinging around to Ferranti. The few extra dollars they pay for Ferranti come back to them a hundred-fold in enhanced radio enjoyment. Incidentally this means more money for you.

Ferranti is a transformer that any engineer will pick for its permanent reliability and sound construction—a transformer that a musician will select for its true rendering of all notes in the scale—a transformer that the fan wants because the engineers and musicians tell him that it is the *best!*

The solid, straight forward and honest merchandising policy back of Ferranti, coupled with co-operative advertising, will take these transformers off your shelves and *keep* them in the buyers' sets.

When a fan walks into your store and asks for the best, give him the best—Ferranti! It means a handsome profit and increased prestige for you!

FERRANTI



\$12 A. F. 3—The best transformer at any price.

FERRANTI, Inc.

130 West 42nd Street, New York, N. Y.

Ferranti, Ltd.
Hollinwood, England

Ferranti Electric, Ltd.
26 Noble St., Toronto, Canada



EBY

BINDING POSTS

*Specified
In Best Selling Circuits*

And now a complete set of the posts required for each circuit is packaged separately.

Each carton contains five complete sets of all the markings necessary to build the receiver.

Saves your clerks' time, keeps stocks down and makes inventories easy.

At your jobber's.

Complete Sets Ready for

Browning-Drake
Cockaday LC 27
Hammerlund-Roberts
Infradyne
LaCault LRA
St. James
Varion
Kenneth Harkness KH 127
Victoreen



NEW!

Completely shielded by an all-metal back, the sensitive, accurate dial minimizes the effect of body capacity. Set is not detuned when hand is removed. Friction drive. No backlash. One hole mounting.

The shielded feature, the Eby name and our national advertising are all in your favor for volume sales.

One model—one stock—one price \$2.50.



A Scientifically Perfect Contact

After all, it's only a matter of common sense. Everybody knows that a three point wiping contact is the most scientifically perfect type known.

That's the type of contact the Eby Socket delivers at all times. And when the tube moves the contact actually gets tighter and checks the jar.

Specified for Madison Receiver and Lynch Amplifier. Retailers quickly and profitably at the advertised list price—50 cents.

*For Convenient Buying Reference see the
McGraw-Hill Radio Trade Catalog.*

THE H. H. EBY MANUFACTURING CO.

4710 Stenton Ave., Philadelphia, Pa.

RMA



You can insure perfect operation of sets you sell

YOU are making certain that your customer's set will always operate at its highest efficiency when you sell a Reliable Automatic Power Control Switch with every Trickle Charger and B Eliminator.

These switches do *automatically* the things the set owner frequently forgets to do — *turns on or off either or both* Trickle Charger and B Eliminator as required. A set owner who uses a Reliable Automatic Power Control Switch knows that his charger and B Eliminator are always in the correct operating positions.

Besides building the good will of customers, the Reliable Automatic Power Control Switch gives dealers a decided price advantage against competition and reduces service calls.

What It Does

As soon as the switch on a radio set is turned on, the Reliable Automatic Power Control Switch connects the B Eliminator with the 110 volt house lighting circuit. As soon as the set switch is turned off, the Reliable Switch automatically shuts off the current to the B Eliminator at the same time turning on the Trickle Charger. This keeps the A Battery always at full working capacity. The Reliable Switch will operate the Trickle Charger alone or the B Eliminator alone, or both at the same time.

Reliable Automatic Power Control Switch



Utility Models

Model 13—For use with sets having from 3 to 8 type 201 A tubes or their equivalent in amperage drain, i. e. — between .75 and 2 amperes. *List Price \$2.00.*

Model 14—For use with sets having from 5 to 10 type 199 tubes or their equivalent in amperage drain, i. e. — between .3 and .6 amperes. *List Price \$2.50.*

Convenience Models

Model 23—Complete with cord and plug and receptacles for connection with Trickle Charger and B Eliminator cords. Electrically identical with Model 13. *List Price \$3.50.*

Model 24—Same construction as Model 23 but intended for use with sets using from 5 to 10 type 199 tubes or their equivalent in amperage drain. *List Price \$3.75.*

The Reliable Parts Mfg. Co.
2821 Prospect Avenue :: Cleveland, Ohio

The Reliable Parts Mfg. Co.
2821 Prospect Avenue, Cleveland, Ohio

Please send me more complete information, dealers' prices, etc., on your Reliable Automatic Control Switches.

My Jobber is _____

Name _____

Address _____



SM

One Four-Thousandth!



A record has been established for S-M audio and output transformers—they have given satisfaction to one four-thousandth of a per cent.

Each type has been sold with a guarantee that it would give better quality of reproduction than the buyer had ever before heard. With such a guarantee thousands of doubting Thomases rushed to buy, confident that they would simply try the new transformers and then return them for a refund. They were fully confident that their sets could not be beaten; but they were game to try since they were sure a trial would cost nothing.

How did the story end? Like all big things, very simply! Among all the free trial buyers, less than one transformer from every four thousand sold was returned for a cash refund as "unsatisfactory."

Have you ever heard of a record like this—of a factory claiming its products to be the "best," then backing that statement to the limit, selling thousands of transformers, and having a return percentage of less than one four-thousandth of one per cent?

Can you ask for any better reason to justify your selling S-M audios and outputs when you have the factory's proven guarantee that they will give your customers a perfection of tone obtainable in no other way?

Do you know that you can make a friend of the dissatisfied customer with last year's set by putting in a pair of S-M audios for him? Or simpler yet—when you find a man with an old set—get him to invest \$6.00 in an S-M 221 output. When he connects it between his set and speaker, he'll find out what real quality is. Then give him a copy of "The Secret of Quality"—it's free—and he'll come back for the audios after reading it.

SILVER-MARSHALL, INC.
870 West Jackson Blvd., CHICAGO, U. S. A.

ELECTRAD

Radio Frequency Oscillations Conquered

Again science and radio engineering skill have triumphed over an obstacle in the path of radio development. A new and efficient method of controlling oscillations in radio frequency circuits has been developed and it is with special pleasure, therefore, that Electrad, Inc., presents

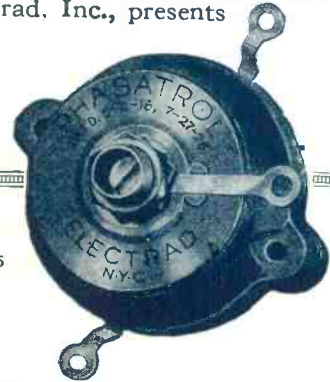

Pat'd
5-2-'16
7-27-'26

Licensed by
Rider Radio
Corporation

"PHASATROL"

*A true balancing device
for radio frequency amplifiers*

THIS new accessory is so simple it can be installed in any set in a few minutes—no expert knowledge or skill being required—and a marked gain in efficiency and performance is immediately noted.

PHASATROLS are being given wide publicity through write-ups in news and consumer publications and our extensive advertising campaign. This will unquestionably create a big demand for this product and, once introduced, *it will sell itself.*

Wide-awake dealers will be ready to meet this demand when it begins. Send your order to your jobber today in order to insure prompt delivery. Packed six individual cartons to a display container, and retailing at \$2.75 each, you will find the new PHASATROL one of your best sellers.

ELECTRAD, INC.
428 Broadway
New York, N. Y.

ELECTRAD

A New *and* Essential Radio Accessory

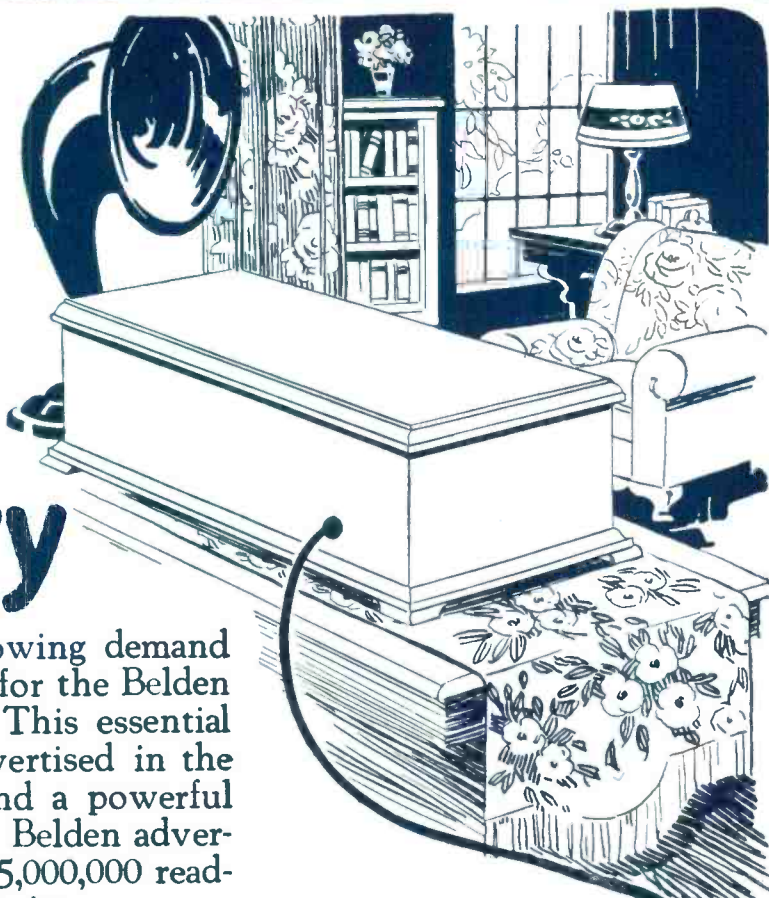

CAPITALIZE on the growing demand which has been created for the Belden Fused Radio Battery Cord. This essential radio accessory is widely advertised in the leading radio publications and a powerful campaign in Liberty Weekly. Belden advertising is reaching more than 5,000,000 readers interested in radio accessories.

Line up with the Belden line by placing your order today for a complete stock of Belden Radio Accessories, including the new Belden Fused Radio Battery Cord. Jobbers and dealers everywhere are enthusiastic about the Belden Line because it is a fast moving profitable line of accessories.

Rapid turnover and sure profits come to the radio dealers or jobbers who standardize on widely advertised radio items manufactured and backed by prominent radio manufacturers. The Belden line is going stronger this year than ever. Are you getting your share of this attractive business?

The A-Battery and B-Battery fuses are enclosed in a neat bakelite cover that is easily opened to permit inspection of the fuses. The fuses are not interchangeable with each other, nor with automobile fuses, so wrong fuses cannot be used accidentally. New fuses are sold through dealers and jobbers.

LOOK FOR THE STRIPED CARTON

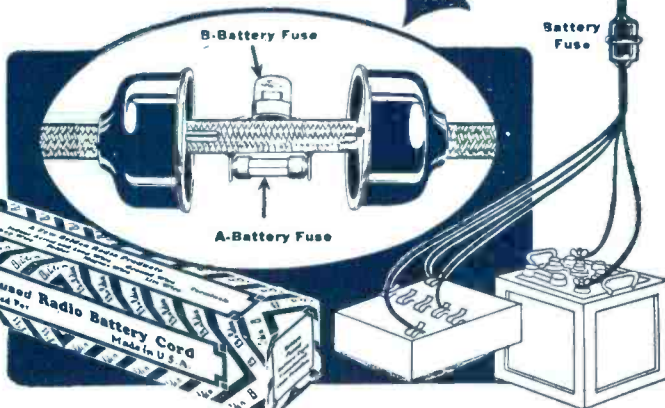

Belden Manufacturing Company
2308-A S. Western Avenue, Chicago, Illinois



Belden Fused Radio Battery Cord



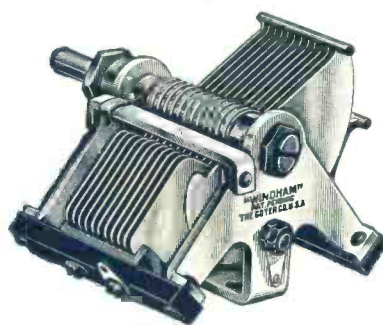

The "Windham"
Station
Separating
Condenser

The Condensers In Your Set Carry a Heavy Burden This Season

The Radio Public is rapidly acquiring experience. It now keenly appreciates more than ever the tone and quality of radio reception, and is becoming very critical regarding appearance, ease of operation and durability.

Retailers insistently demand a set that makes no annoying inroads on their valuable time, especially during the busy season. They want a set that stays sold. A set that requires the minimum of service and adjustments.

Manufacturers of radio sets will have to use better parts in their products. With stations crowded together utmost selectivity is essential, and those parts subject to continual use must have smooth, lasting qualities. Surely the condensers you adopt will bear a large share of this burden.

"Windham" condensers have a high standing in the trade. They are small, rugged and efficient, of uniform quality, and the price is right.

*We are now taking orders for next season's delivery.
How about yours?*

THE GOYER COMPANY

Willimantic, Conn.

FROST-RADIO

Ask Your Neighbor

Type 880 Super Variable Resistance

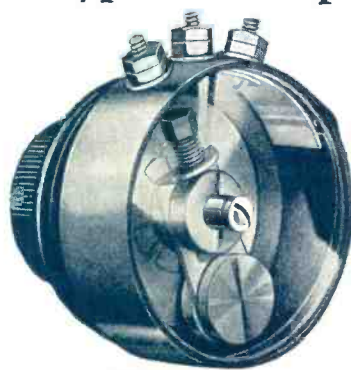

FROST-RADIO

A new **FROST-RADIO** precision unit made to meet the demand for variable high resistance in receiving sets. Works smoothly and noiselessly. Does not heat up to any extent due to large area of resistance element. Movable arm makes smooth, positive contact without causing wear. It is finely made, like a good watch, and all metal parts are nickel plated and hand buffed. Knob is genuine Bakelite.

HAS MANY USES

FROST-RADIO Super Variable Resistance is used for: (1) Volume control, (2) Controlling grid bias in R. F. circuits, (3) Improving tone by placing across audio transformers, (4) Resistance coupled amplification. It is used wherever a variable high resistance is called for. Supplied in the following resistances: 50,000, 100,000, 200,000 and 500,000 ohms. We guarantee this unit to be the most accurate and serviceable resistance unit on the market. List price: \$1.25.

HERBERT H. FROST, Inc.
160 North La Salle Street

New York

CHICAGO

Los Angeles



Set Manufacturers!

Standards of radio reception are becoming higher with each new year. 1927 models must be an improvement over those of 1926, and they will be.

Correct coils are vital to good reception. We specialize in such coils. We are producing regularly the most advanced types, built with the famous "Diamond-weave" construction.

Write us concerning your own requirements. We are prepared to furnish better coils for the new sets.

THE F. W. SICKLES COMPANY
110 Union St., Springfield, Mass.

SICKLES DIAMOND-WEAVE COILS



The St. James Transformer

The highly efficient vacuum-treated, dehydrated air core transformer which has been so successfully used in the well-known St. James Super-Het.

A mighty good article with good profits for parts dealers. Very complete and simple working plans available.

Send for our Folder

St. James Laboratories, Inc.
845 Washington Blvd., Chicago, Ill.

Your Coil Problem Solved!



Install a group of "Universal" Coil Winding Machines

and insure uniform production of dependable coils at surprisingly low cost

or



Purchase these same coils from us, carefully wound to your specifications and ready for application to your product

UNIVERSAL WINDING COMPANY

Lessor
BOSTON



Radio's Best Wire
"FROM THE GROUND UP"

The Choice of Amateurs and Experts

Through consistent advertising, backed by the sheer merit of the product itself, "Corwico" sales are increasing by leaps and bounds. If you are not a "Corwico" dealer, you are missing steady sales and daily profits.

TO DEALERS

Corwico is the branded and advertised line of radio wire that outsells the unknown lines. Order Corwico through your jobber.

TO JOBBERS

Write us for full particulars regarding the Corwico proposition.

TO MANUFACTURERS

Let us quote on your wire requirements.

CORNISH WIRE COMPANY
30 CHURCH STREET, NEW YORK CITY

BOSTON CHICAGO KANSAS CITY
50 Federal St. 337 W. Madison St. 208 Baltimore Bldg.
SAN FRANCISCO: 585 Mission Street



New Products

Tinytobe Condensers

You can now fill your customers' demands for small, as well as large-capacity TOBE Condensers, with the new TINYTOBES. Shown in actual size in the cut at the right. They are so small that they take up practically no room in the set, yet they can be used at operating voltages up to 500 v. D.C. and can be secured in capacities from .0001 Mfd. to .02 Mfd. Write us for new pamphlet and price list RR.



Tobe 600 Line

A new tested really high-voltage condenser, for use with the AmerTran and similar high-voltage power packs. Made to stand the heat. The only condenser for that use with safety terminals—a unique TOBE feature.

PRICES:

No. 650. 0.5 mfd. \$1.75
No. 601. 1.0 mfd. \$2.50
No. 602. 2.0 mfd. \$4.00
No. 604. 4.0 mfd. \$7.00



If you are not already a TOBE dealer, write us for name of nearest jobber handling this standard line of condensers and technical apparatus, —used by Philco, Modern, National Co., Inc., General Radio and other leading manufacturers.

Tobe Deutschmann Co.

Engineers and Manufacturers of Technical Apparatus
Cambridge, Mass.

Efficient Service on Molded Parts



BAKELITE AND MOLDED MATERIAL
MADE TO YOUR SPECIFICATIONS

American Insulator Corp.

52 Vanderbilt Avenue, New York City

Goodrich Silvertown

The Radio Panel Supreme!

- 1 Easier to drill and machine.
- 2 Better color, lasting lustre.
- 3 Lower free sulphur — no discoloration.
- 4 Higher softening point—no warping.

Goodrich V.T. Sockets Spaghetti Tubing
Radiophone Ear Cushions
Battery Mats
Hard Rubber Tubes for Coils

The B. F. Goodrich Rubber Company
Established 1870 Akron, Ohio



THE PANEL OF BEAUTY AND SERVICE

No Finger Prints or Smudges.
Distinctive Appearance—Very Popular.
Plain Finish on Reverse Side.

Quick Turnover—Highest Quality—Low Price

HOOD RUBBER CO., WATERTOWN, MASS.

CLIP TIME OFF WIRING JOBS
BY USING



Approved by the Underwriter Lab.
Cartons of 100 — Standard Package 1000

For Free Working Samples Sign Below and Mail

Name _____

Address _____

COLT'S PAT. FIRE ARMS MFG. CO., HARTFORD, CONN.

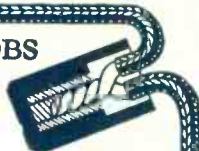

An Insulating
Cap with a split
screw that bites
twisted wire ends.

Helping Manufacturers to Serve You More Efficiently

Through McGraw-Hill questionnaires we have been able to give manufacturers facts which have helped them standardize on sizes most acceptable in a particular industry.

We have also through McGraw-Hill questionnaires been able to convince manufacturers that they have been delinquent in rendering service.

So when you receive a McGraw-Hill questionnaire you can fill it out, confident that it will return to you in the form of better service to your business.

THE PUBLISHERS

ELECTRAD^{INC.}

A Lightning Arrester Your Customers Can Depend On



Here's another Electrad Certified seller—an essential on every set. Completely sealed and moisture proof. Listed by National Board of Fire Underwriters. Indoor type, illustrated, list 50c.—in Canada, 75c. Packed 6 to attractive display carton. Outdoor bell type, individually boxed, list \$1.50—in Canada \$2.00.

ELECTRAD Metallic Leaks and Resistors



The perfect grid leak—noiseless, non-inductive, constant under any weather, temperature or working conditions. Permanently accurate. Non-hygroscopic. Great current-carrying capacity without overheating. Resistance element is fused to the inside of a glass tube. No carbon, paper, varnish, fiber. Paraffined under high vacuum. Capped with the exclusive Electrad ferrule. Sizes 1 to 10 megohms—list 60c.—in Canada 85c.

The Lamp Socket Antenna That Gets Results

Those who don't want to climb up on the roof to put up an aerial will be delighted with the Electrad Certified Lamp Socket Antenna. Plugs in on any light socket—gives volume, distance, clearness, smotheres static and interference. Uses no current. Absolutely safe. Tested dielectric strength. List 75c.—in Canada \$1.10



Write for details on our square dealer proposition, that helps you sell and protects your profits.

Write for information on the Electrad 500,000 ohm compensator for perfect control of tone and volume.



428 Broadway, N. Y. City.

ELECTRAD^{INC.}

Manufacturers:

Your Selling Season Has Advanced!

The radio trade show to be held in June has quickened the tempo of the whole industry. Manufacturers of sets and accessories, such as eliminators, chargers, loud speakers, etc., must have their new models ready by June instead of September or October as in previous years.

This means that manufacturers must place in February to May their commitments for raw materials, parts, cabinets and other supplies.

If your prospective customers are radio manufacturers, you can reach them all and reach them effectively through these advertising pages. "Radio Retailing's" February, March, April and May issues are four particularly necessary sales tools.



Radio Retailing

—a McGraw-Hill publication

473 Tenth Avenue, New York City

P. S. Of course, "Radio Retailing" reaches all worthwhile wholesalers and retailers of radio, in addition to manufacturers.

There is no Substitute for a Good "B" Battery in Radio

45 VOLTS
30 CELLS
\$4.50



In addition to having a longer original life, TAB batteries can be recharged at home to full voltage 6 to 8 times with any standard "B" battery charger or chemical rectifier.

The Battery Sensation of Radio History

TAB—the one and only Dry "B" Battery which can be recharged. TAB, which sells at practically the same price as any other dry "B" battery, yet gives six to eight times more service than the ordinary kind. No wonder it has been acclaimed by trade and radio public alike as the most sensational battery development in the entire history of radio.

TAB batteries have been approved by the foremost testing laboratories in America. What the public thinks of TAB is best shown by the constantly increasing demand. Write for literature and discounts.

As Many Lives as a Cat

For Convenient Buying Reference See the McGraw-Hill Radio Trade Catalog

Patented and Manufactured Exclusively by
DRY STORAGE BATTERY CORPORATION, 213 South Broad St., Philadelphia, Pa.

TAB—the Rechargeable Dry "B" Battery



Radio Products ARE OF National Repute

The Public prefers them because of their excellent performance.

The Trade pushes them because of their easy selling, and attractive profit features.

ACME Products Are Good Will Producers

They are extremely reliable and efficient because they are built by engineers long experienced in radio.

ACME Universal "B" Supply Unit

Four-tap type. Gives excellent performance up to and including 6 and 8 tubes, including radio frequency sets.

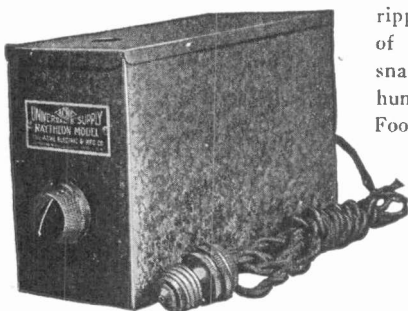

30 Milliamperes @ 135 v.
25 Milliamperes @ 150 v.
15 Milliamperes @ 180 v.

110 volts a.c., 60 cycles.

Smooths out every trace of ripple. Quality and volume of tone improved. No snap, crackle, noise or hum. Easy to operate. Fool-proof. Cannot burn out tubes in set or "B" supply unit. Has variable control and removable fixed resistance. Very compact. Any standard filament tube for rectification purposes may be used.

List Prices, East of Rockies

Type BE-30, without tube.....\$32.00
Tube..... 3.00

ACME Radio Control Switch

This switch is entirely automatic in its operation. Positive in action, functions properly, is compact in design, neat, attractive, nothing complicated in its construction to cause trouble.

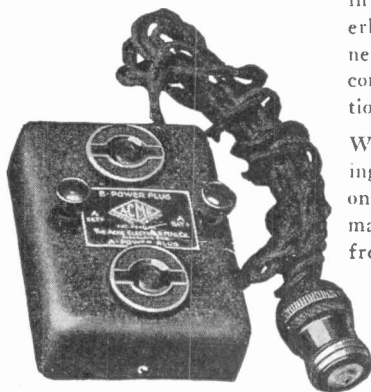

When connected to receiving set, and set is turned on, the trickle charger automatically disconnects itself from A battery and the B power unit is connected to the set. When the set is turned off, the trickle charger is connected to the storage battery and immediately starts charging A battery; also the B eliminator is disconnected from the set and line.

May be used with any set regardless of type of charging equipment. Patented. Guaranteed. Cost of operation negligible. Should be a part of every set sold or now in use.

List Price, complete East of the Rockies.....\$5.00

ACME Trickle Charger

This trickle charger uses a 2-ampere tungar bulb in its operation with a specially designed transformer with independent windings. The charging current delivered ranges from 1/2 to 3/4 amperes and consumes 25 to 40 watts of energy. Supplied with extension cord attachment.

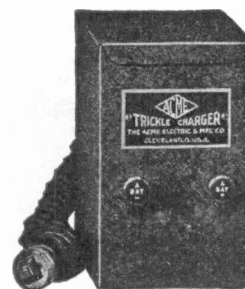

The case is made of sheet steel finished with crystallizing lacquer, mounted on rubber feet, and presents a neat appearance.

List Prices, East of the Rockies

Type AT-1, without bulb.....\$6.00
2-ampere bulb..... 4.00

The ACME Two Rate Trickle Charger

Type AT-2. Designed to serve the larger radio receiving sets. With this charger two charging rates may be obtained by simply throwing the Toggle Switch on the outside of the charger, from one position to the other. Delivers 1/2 amperes and 1 1/2 amperes. Uses a 2-ampere tungar bulb with a specially designed transformer.

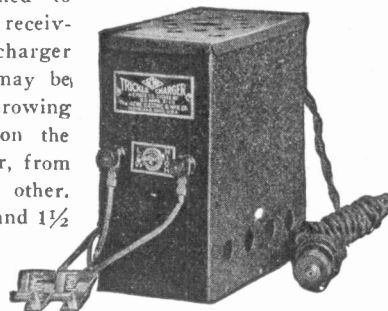

List Prices, East of the Rockies

Type AT-2, without bulb.....\$11.00
2-ampere bulb..... 4.00

ACME Universal Charger

With this ACME Universal Charger, a 4 or 6-volt battery may be charged, also 48 cells of radio B battery. There are two independent windings on this charger and the batteries may be charged with the radio set in operation which, in many cases, is quite advantageous.

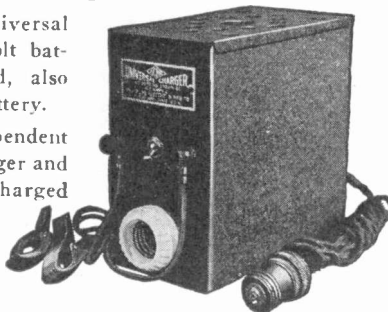

List Prices, East of Rockies

Type AU, without bulb.....\$12.00
2-ampere bulb..... 4.00

MANUFACTURED BY

THE ACME ELECTRIC AND MANUFACTURING CO.

1435 Hamilton Avenue

Cleveland, Ohio



The New Balkite Charger

MODEL J. Has a low trickle charge rate and a high rate for rapid charging and heavy duty use. Can thus be used either as a trickle or as a high rate charger and combines their advantages. Noiseless. Large water capacity. Visible electrolyte level. Rates: with 6-volt battery, 2.5 and .5 amperes; with 4-volt battery, .8 and .2 amperes. Special model for 25-40 cycles with 1.5 amperes high rate. Price \$19.50. West of Rockies \$20. (In Canada \$27.50.)

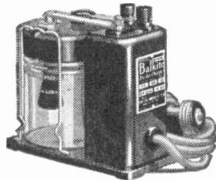

Balkite Trickle Charger

MODEL K. For those who require a charger of limited capacity only. Can be left on continuous or trickle charge thus automatically keeping the battery at full power. Converts the "A" battery into a light socket "A" power supply. Charging rate about .5 ampere. Over 300,000 in use. Price \$10. West of Rockies \$10.50. (In Canada \$15.)

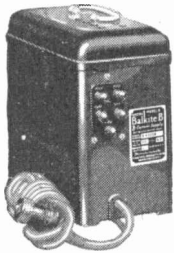

Three New Balkite "B"s

Balkite "B" eliminates "B" batteries and supplies "B" current from the light socket. Noiseless. Permanent. Employs no tubes and requires no replacements. Three new models. The new popular priced Balkite "B"-W at \$27.50 for sets of 5 tubes or less requiring 67 to 90 volts. Balkite "B"-X, (illustrated) for sets of 8 tubes or less; capacity 30 milliamperes at 135 volts—\$42. Balkite "B"-Y, for any radio set; capacity 40 milliamperes at 150 volts—\$69. (In Canada "B"-W \$39; "B"-X \$59.50; "B"-Y \$96.)



Balkite Combination

When connected to the "A" battery supplies automatic power to both "A" and "B" circuits. Controlled by the filament switch on the set. Entirely automatic in operation. Can be put either near the set or in a remote location. Will serve any set now using either 4 or 6-volt "A" batteries and requiring not more than 30 milliamperes at 135 volts of "B" current—practically all sets of up to 8 tubes. Price \$59.50. (In Canada \$83.)

All Balkite Radio Power Units operate from 110-120 volt AC current with models for both 60 and 50 cycles. The new Balkite Charger is also made in a special model for 25-40 cycles.

Now push the line that sells after January 1st

*Balkite sales during the
1925-26 season were 15% greater after
than before January 1st*

You know from your own experience in past seasons that most radio lines do not sell as well after January 1st as before. You also know that to maintain the greatest possible volume of sales during the coming months you must push the lines that sell after January 1st.

Balkite is one of those lines. You have the proof in this fact: *The sales of Balkite Radio Power Units during the 1925-26 season were 15% greater after January 1st than they were up to January 1st.*

Such a record is to be expected. Every sale of a radio set creates a new Balkite prospect. In many cases a Balkite sale is made at the same time. But in many more the sale follows a month or two later. That is why Balkite sales continue to mount after the peak of the selling season for sets is over. That is why Balkite is one of the lines you ought to push now. Jobbers and dealers who concentrated their efforts last year on a few live lines secured a much larger volume of sales than those who scattered their efforts on many items, most of which were practically unsalable at this time of year.

When you push Balkite you profit by Balkite broadcasting and by one of the greatest advertising campaigns in radio. This campaign goes right on after January 1st. It is behind you when it can do you the most good.

This is the greatest of all seasons for light socket radio power devices. Make the maximum profit out of this demand by pushing Balkite, the standard line in the field.

FANSTEEL PRODUCTS COMPANY, Inc.
North Chicago, Illinois

Balkite Radio Power Units

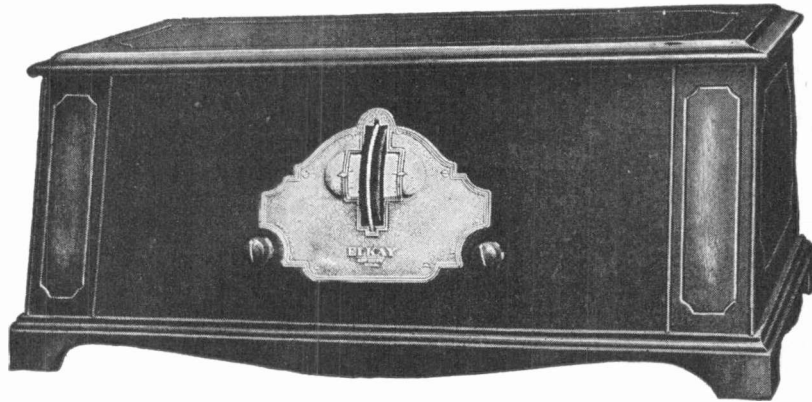

(Licensed Under Patents Granted and Pending)

Six Tubes—\$125 List

SELECTIVE TRUPHONIC

Designed for the New Conditions in Radio

STATIONS are getting closer together. The lower wave bands, where tuning on the old sets was difficult, are crowding up. The public feels the effect of this, and is no longer attracted to a receiver that is unable to meet this changed order of things.

The new condition calls for (1) Pleasing, natural tone in good volume (2) Ability to tune out the local stations (3) Even tuning over the whole band (4) Good sensitivity for DX.

That the public really wants a receiver with these advantages, and will pay the price, is only too evident from the fine success Elkay dealers are having with the Senior Truphonic Six shown above. Here are the reasons for it:

Truphonic Audio System—This remarkable discovery produces a complete range of the most beautiful tones we have yet heard in radio. If there is good music on the air, Elkay owners will get it.

Needle-point Definition—Here is something that has gained the warmest kind of welcome for the Elkay in the large broadcasting centers. Its extreme selectivity under the very eaves of the big broadcasters, is truly remarkable.

Smooth Tuning—With most of the old receivers, and with many of those of 1927, tuning down into the low waves without readjusting the filaments is rough going. The Elkay Synauto R. F. design smooths this all out, giving you free sweep from 200 to 580 meters.

Complete Shielding—The Elkay is practically isolated from the influence of "strays," and there is no interstage coupling.

Uni-Control—Note the panel. You have the flexibility of three dials, but all under the thumb.

Other refinements are: "floating" sockets mounted on Bakelite sub-panel; Bakelite for all important insulated and wearing parts; beautiful, slope-front cabinet of antique, natural-grain mahogany, Duco finished.

The Elkay is the product of radio *engineers*. It is technically right. It will do everything that modern radio conditions call for. You can safely and enthusiastically put your name behind it and rapidly build up a business that will mean something to you. Ask your jobber for the details. If he can't help you, write us, giving us his name.

Under Way Now the new JUNIOR SIX

—for the man who wants Elkay engineering standards, but is unable to pay the price it is necessary to ask for the Senior. The Junior will retail for considerably under a hundred dollars, and will fit our dealers to take fuller advantage of the very live demand centering around the name ELKAY. Details later.

The Langbein-Kaufman Radio Co., Dept. M., 62 Franklin St., New Haven, Conn.



Greater Selectivity

Makes CASE Radios Easiest to Sell

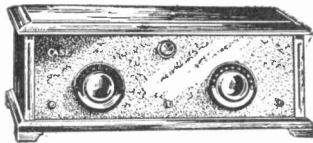

MODEL 00A
6 Tubes, 2 Controls only \$75.00
3/4-in. Solid Mahogany Cabinet
WITHOUT ACCESSORIES

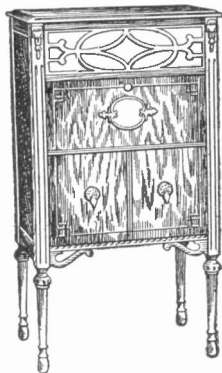

No. 60C, \$125

New Cabinets

Above is shown one of the several new cabinets we just introduced. Better—more attractive—than ever before. All CASE Radios are built complete in one factory (for a lifetime of service) by a well established, strongly-financed organization with over 500 jobbers throughout America. National advertising, dealer help, complete sales co-operation—all help CASE dealers to sure profits.

One of the strongest arguments today in selling *any* radio set is *selectivity*. *You* know that—and so does everybody else. That's where CASE dealers are "sitting pretty." In spite of the present jumbled condition of broadcasting—nearly 700 stations, with many changing back and forth on wave length and sending time—CASE Radio pulls in enough stations *clearly* at all times to satisfy any reasonable person.

ALL Good Features—At Low Prices!

CASE Radios have the reception and precision qualities of high-priced sets—but at popular prices. There's a model for every purse and taste—all built around a standard circuit; six tubes; dial or vernier control; remarkable power and clearness as well as selectivity. No wonder CASE has been forging steadily ahead for five successive years! *You* can profit by tying to this proven line of fast sellers *now*.

Write Today for Complete Information

Indiana Mfg. & Electric Co.

Marion, Indiana

CASE

RADIO PRODUCTS



The Highest Efficiency + Greater Beauty
make

ORCHESTRION

The year's greatest speaker value

To the already famous tone quality and radio efficiency of the Horn Type Orchestrion Speaker, has been added the beauty of a finely made, five-ply, sliced Walnut or Mahogany Console Table. It stands 30 inches high, 36 inches long and 15 3/4 inches wide. Designed by musical instrument makers, it incorporates the famous ORCHESTRION TONE ARM and unit, so that true tones are reproduced with sweetness and clarity, together with ample volume. Top space is large enough for practically all table-type receiving sets. Priced at \$35.00 the Orchestrion Console type is indeed the greatest value yet offered.



The Orchestrion Pedestal Speaker is 29 inches high and nine inches square. It may be had in either solid walnut or mahogany; also in a variety of lacquer and paint finishes.

Price \$24.50

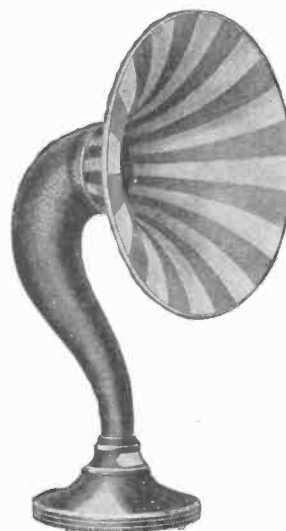

The Horn Type Orchestrion Speaker—known all over the world for Clarity of Tone.

Now priced at
\$29.50

The RADIO CABINET CO.

2118 Gale Street, Indianapolis, Ind.

Pacific Coast prices slightly higher

ORCHESTRION

LOUD SPEAKER

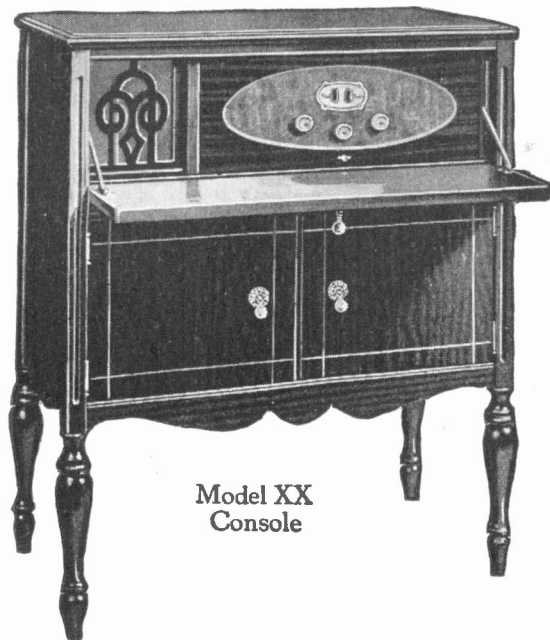

Model XX
Console

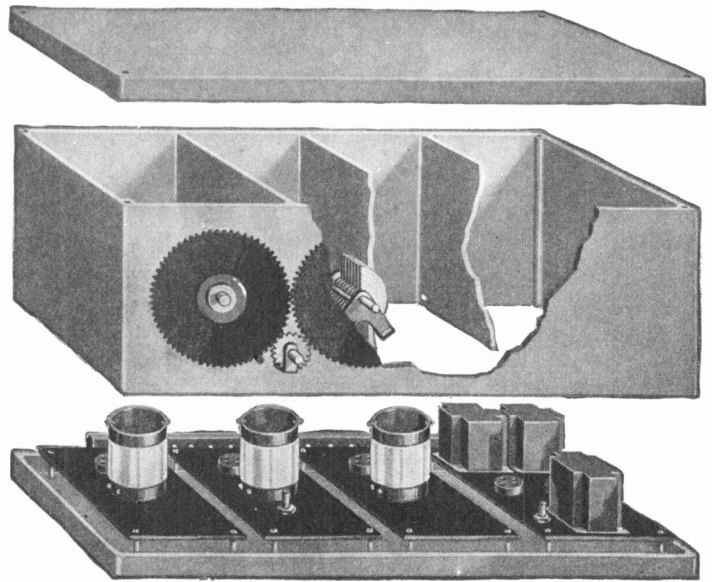

You Can Sell this Set with Complete Assurance

SLAGLE RADIO SETS are good. Thousands of our old and new customers have told us so. We do everything that 14 years has taught us about building good sets. Every set is carefully tested "on the air." It gives perfect reception when it leaves our plant.

Note the thick, cast-aluminum shielding used by Slagle. Each unit completely protected from the others and from the outside. Cleaner, sharper tuning; purer tone values; more satisfactory operation all around. This

beautiful job is thoroughly characteristic of Slagle workmanship.

The Slagle "hook-up," complete internal shielding, plus careful work and expert inspection guarantee extremely smooth, quiet operation, and perfectly natural tone with any desired volume.

Because it's built right, it works right, and gives your customers a brand of service that keeps them loyal to you. We have a real proposition for energetic dealers. Let us tell you all about it.

SLAGLE RADIO COMPANY, Fort Wayne, Indiana
High Grade Sets Since 1911

TRADE MARK
Slagle Radio

NEUTRODYNE

approaches its fourth birthday
in 1927

It has proved itself fittest to survive

LOOK back over the last five years of radio history. What have you seen? First, the public success of the three pre-broadcasting receiving circuits—a success due to circumstances rather than merit. They were all there was, until Neutrodyne entered the field in 1923 with the first method of reception devised solely for home radio, for the faithful reproduction as well as selective and sensitive selection of programs.

Neutrodyne's success was immediate. Never had the public had such magnificent radio results, such supremely easy operation.

Came the flood, as the movie people say. A flood of imitators, of dynes this and that. The name was copied, simulated, imitated. But without the Neutrodyne principle, any imitation of the name was and is worthless. The name and the fundamental principle are one and inseparable. Only the fourteen licensed manufacturers named below make Neutrodyne receivers.

Today, when the fourth anniversary of the Neutrodyne receiver approaches, Neutrodyne is in a stronger position than ever in public favor, in the sales asset it puts in dealers' hands. During nearly four years, scores of imitators have come and gone, leaving dealers and users holding the bag for these manufacturers, some of whom were merely ignorant of the patent situation, while others were plainly piratical.

Nearly four years have demonstrated Neutrodyne's inherent merit, its permanence and profitableness. Ask yourself if you can afford to do business without a line of Neutrodyne receivers.

Look for this trade-mark

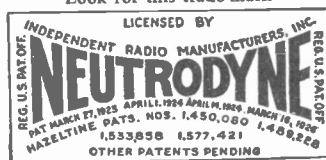

It is your protection against patent infringement liability

The following fourteen manufacturers are the only ones licensed to make Neutrodyne receivers and the protection of distributors and dealers against patent infringement liability, maintained by the Hazeltine Corporation and Independent Radio Manufacturers, Incorporated, applies to none other than Neutrodyne receivers.

THE AMRAD CORPORATION, Medford Hillside, Mass.

F. A. D. ANDREA, Inc., New York City

CARLOYD ELECTRIC & RADIO COMPANY, Newark, N. J.

EAGLE RADIO COMPANY, Newark, N. J.

FREED-EISEMANN RADIO CORPORATION
Brooklyn, N. Y.

GAROD CORPORATION, Belleville, N. J.

GILFILLAN RADIO CORPORATION, Los Angeles, Cal.

HAZELTINE CORPORATION

(Sole owner of "Neutrodyne" patents and trade-marks)

HOWARD RADIO COMPANY, Inc., Chicago, Ill.
KING-HINNERS RADIO COMPANY, Inc., Buffalo, N. Y.

WM. J. MURDOCK CO., Chelsea, Mass.

STROMBERG-CARLSON TELEPHONE MANUFACTURING COMPANY, Rochester, N. Y.

R. E. THOMPSON MANUFACTURING CO.
Jersey City, N. J.

WARE RADIO CORPORATION, New York City

THE WORK-RITE MANUFACTURING CO.
Cleveland, Ohio

INDEPENDENT RADIO MANUFACTURERS

(Exclusive licensee of Hazeltine Corporation)

Unipower's special advantages are easily sold to customers

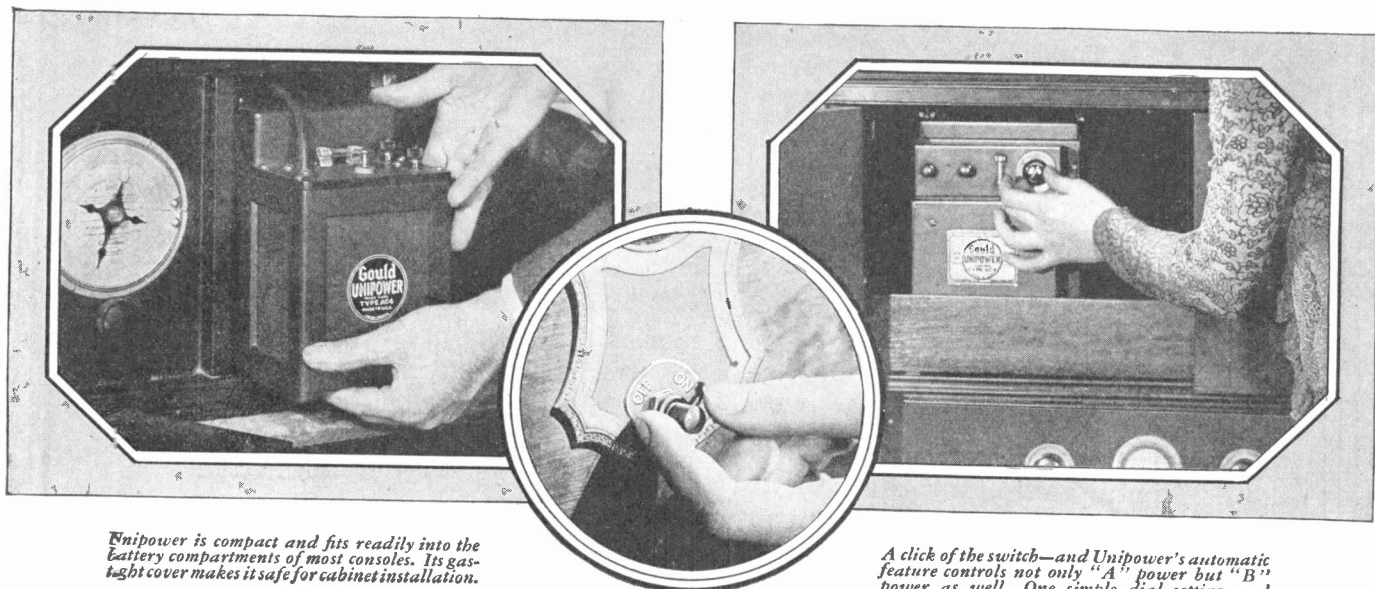

Unipower is compact and fits readily into the battery compartments of most consoles. Its gas-tight cover makes it safe for cabinet installation.

A click of the switch—and Unipower's automatic feature controls not only "A" power but "B" power as well. One simple dial setting and Unipower gives the exact "A" power charging rate needed by any particular set.

YOUR radio "A" power customers are in two groups—those who know so little that they must depend on your advice—or those who know so much that they must be convinced on every point.

Let Unipower help you with both. Its simplicity of operation—all power control! from the set switch—will appeal to the novice, while the more experienced "fans" will appreciate Unipower's other special features.

For instance—Unipower employs the proven principle of trickle charge plus an indispensable rapid charge rate. Four trickle rates, operated by one dial, can be applied to give just the right power adjustment for the heavily worked multi-tube sets now in use. Only Unipower is protected by automatic cut-off in the rectifying cell!

Unipower construction makes it fool-proof. There are no parts that need adjustment or replacement during the normal life of the product.

Write us for the complete story of Unipower's Automatic "A" power. The Gould Storage Battery Company, Inc., 250 Park Avenue, New York.

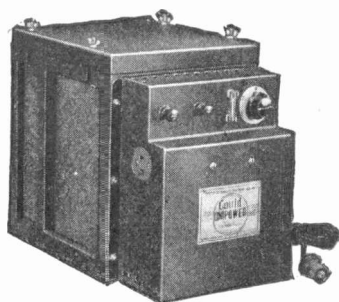

*For 201-A tubes or equivalent
AC-6HA \$42.50*

Unipower contains a Balkite charging unit of Gould design. It operates from alternating current 110-125 volt—60 cycle. Special models, 25-50 cycle, at slightly higher prices.

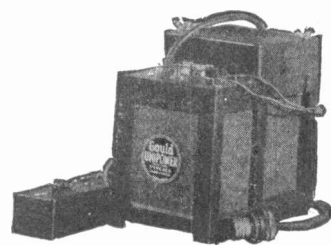

*For 199 tubes or equivalent
AC-4 \$33.00*

Proven quality!

Unipower is manufactured by the makers of the famous Gould Batteries for automobiles, submarines, railroads, farm-lighting, vehicle and fire-alarm service.

Unipower

A GOULD PRODUCT

AUTOMATIC "A" POWER WITH "B" POWER CONTROL

**3 Things That Make
A-C Dayton Owners
Happier—**

Selectivity Control that really selects,

Compensator that keeps perfect tuning balance.

Duophonic Reproduction based on the pipe organ principle.

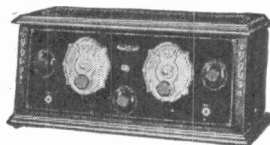

XL-25 Standard
\$79

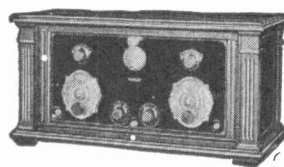

XL-30 Standard
\$135

When you sell a man THIS Radio—
you give him MORE than he expects!



XL-25 Con-
sole \$139



XL-30 Console
Grand \$255

SELL a man a good radio and he's probably satisfied; sell him an A-C DAYTON and he's surprised, delighted, actually loud in his praise.

A-C DAYTON'S highest reputation hasn't been made in the magazines where it advertises—it's been made in thousands of homes from New York to Los Angeles by people who paid up to \$255 for their A-C DAYTON'S and got

more than they expected.

That's the kind of radio to sell, if you are going to build a sound radio business—a business that will grow!

A-C DAYTON has been successful for six years. This year it is scoring one of the big triumphs of the industry. There never was a better time to hear what A-C DAYTON offers reliable dealers.

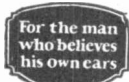

Write us today! We'll put the full facts in your hands by return mail.

THE A-C ELECTRICAL MFG. CO.
DAYTON, OHIO

Makers of Electrical Devices for More Than 20 Years

A-C DAYTON
RADIO

Six Models (5 and 6 tube) priced from \$56 to \$255. Western and Canadian prices are slightly more.

TEAR OFF AND MAIL

The A-C
Electrical
Mfg. Co.,
Dayton, O.

Gentlemen: I am interested in your exclusive franchise. Send full details at once.

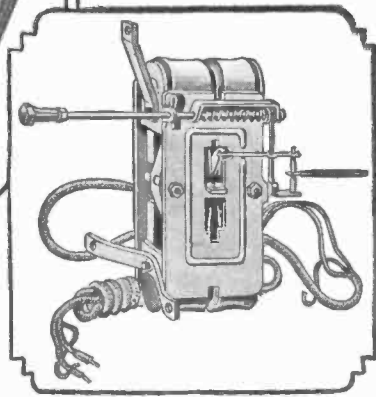
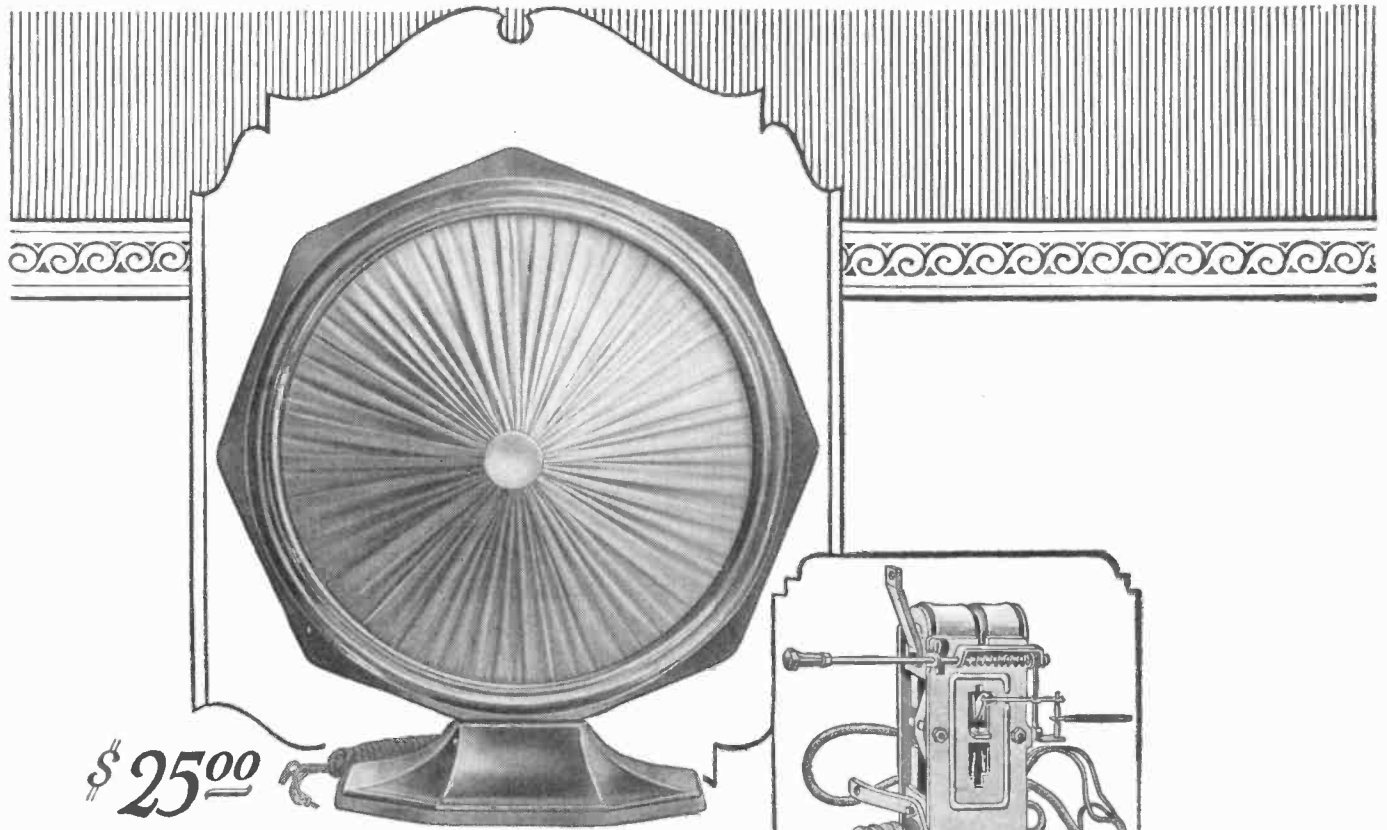

The matchless Sonochorde Unit with its four super-powered magnets capable of lifting over 10 lbs.

A difference you can see and hear

SONOCHORDE is held in high regard by manufacturers of other speakers. Why! Because of its downright quality—both in appearance and tone. At a glance you see the unrivaled beauty of Sonochorde design—the mahogany finish, non-breakable frame and base, the rich wine-colored front of silk, the protected back, the impressive craftsmanship in every detail. But you do not easily see the marvellous Sonochorde Unit. You *hear* it. Its wealth of tone—deep, rich and clear—never fails to convert doubters into enthusiastic buyers.

Try Sonochorde! Compare it. But order now for prompt delivery

BOUDETTE MFG. CO., Chelsea, Mass.

Factory Sales Agents:
Hastings Elec. Sales Co., 42 Binford St., Boston, Mass.

The New
SONOCHORDE
CONE



Wall Model
Includes all features that distinguish Sonochorde.
\$27.

Floor Standard Model
\$35.

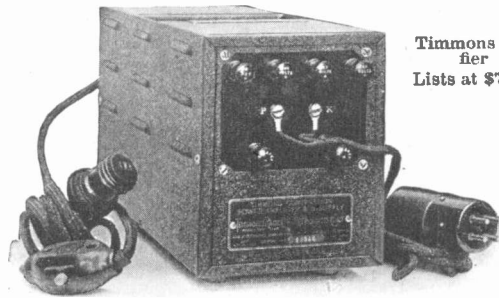

Timmons Combination Amplifier and B Supply
Lists at \$70.00 without tubes.

*The way to make a good fat profit and
make it quickly is—*

DEMONSTRATE A TIMMONS POWER AMPLIFIER *on sets in your neighborhood*

After your customer hears a Timmons Power Amplifier hooked up to his set, he is sold *absolutely*. The reproduction is perfect—flawless—and so natural that it is startling. This same customer will never be satisfied until he owns a Timmons Power Amplifier. Then watch him strut—and listen to him talk about it. He will sell a couple to friends, too. We know of one dealer who took up the demonstrating idea and increased his sales \$600 in a week. He sold not only Timmons Amplifiers during this week, but a lot of

other radio apparatus to people who were attracted to his store.

We will be glad to help you plan a demonstration week. Think of the nice profit the other dealer had on his \$600 increased sales.

Remember, too, that Timmons Power Amplifiers also sell power tubes. And that they require no servicing and can be attached to any set now operating a loud speaker. Let us know if you need folders or other literature on Timmons Power Amplifiers, Timmons B-Liminators or Timmons Cones.

And now the new
Timmons B-Limator
\$28.50

greater voltage—more milli-
amperage. Has power tube
tap — trouble-proof — once
sold — stays sold.

Timmons Raytheon B-Lim.
Lists at \$47.50 with B H
Raytheon tube.

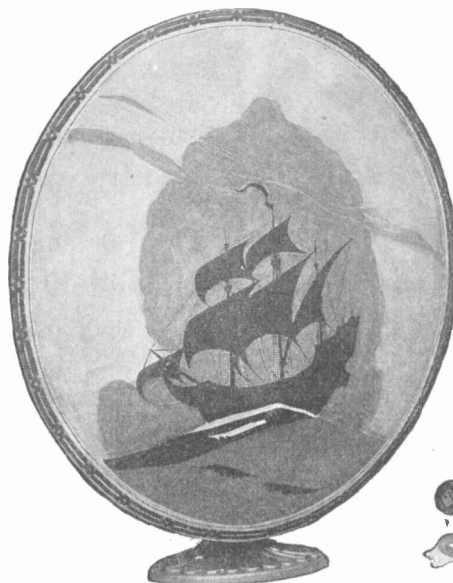

Timmons new Concert Grand Cone. Lists
at \$56.00. The greatest loud speaker that
Timmons has ever produced.

Timmons Amplifier without
B Supply
Lists at \$45.00 without tubes.

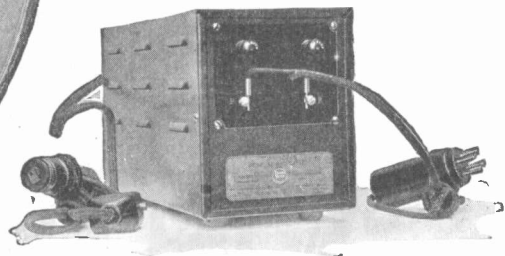

TIMMONS RADIO PRODUCTS CORPORATION
Germantown, Philadelphia

On the Crest!

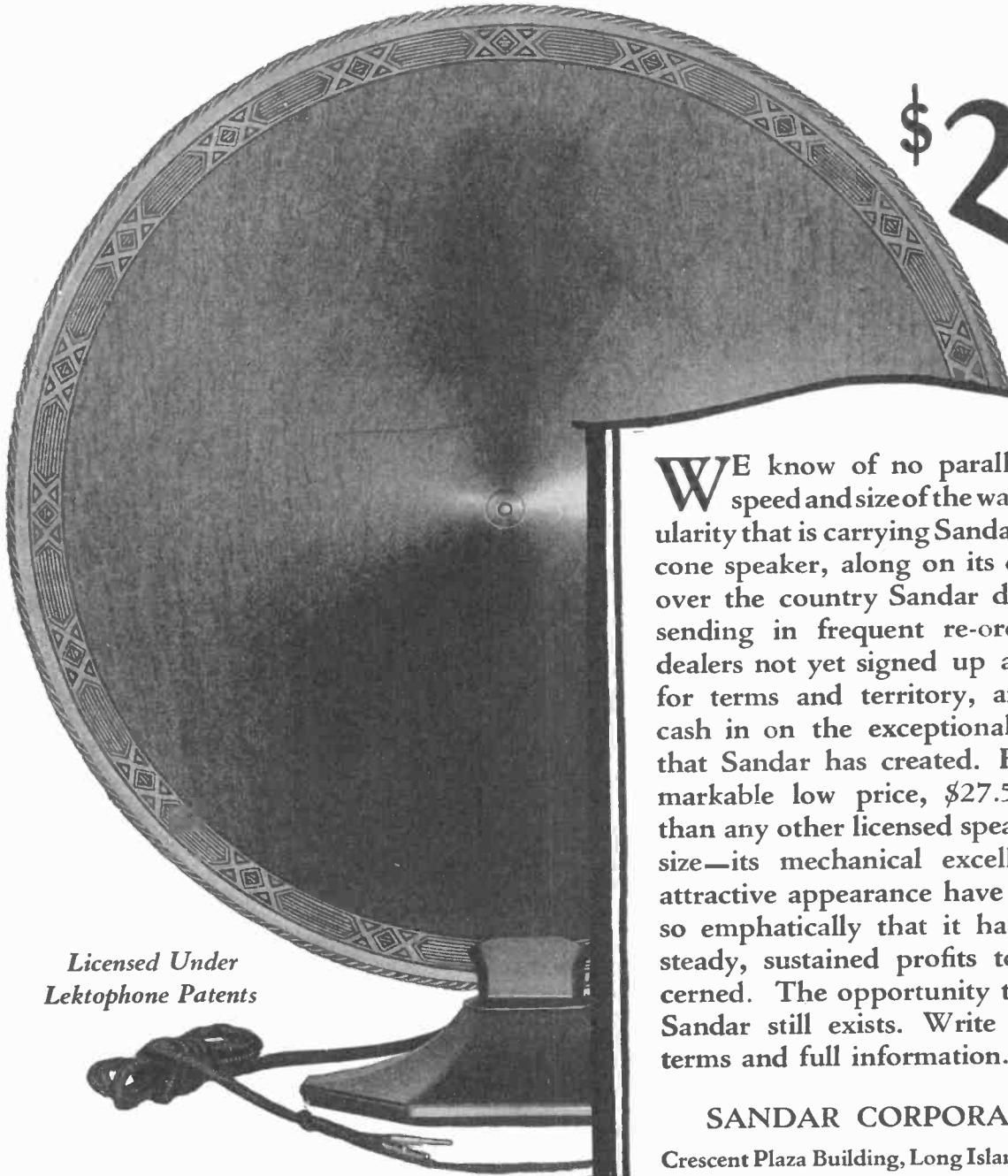

*Licensed Under
Lektophone Patents*

\$ 27.50

WEST OF THE
ROCKY MOUNTAINS
\$30.00

WE know of no parallel to the speed and size of the wave of popularity that is carrying Sandar, the new cone speaker, along on its crest. All over the country Sandar dealers are sending in frequent re-orders, and dealers not yet signed up are asking for terms and territory, anxious to cash in on the exceptional demand that Sandar has created. For its remarkable low price, \$27.50—lower than any other licensed speaker of its size—its mechanical excellence and attractive appearance have registered so emphatically that it has brought steady, sustained profits to all concerned. The opportunity to take on Sandar still exists. Write today for terms and full information.

SANDAR CORPORATION
Crescent Plaza Building, Long Island City, N.Y.

SANDAR SPEAKER

It's Here!

**A New SHAMROCK
at a New *Low* Price**

Shamrock scores again by making it possible for every home to own a fine perfection-designed radio set, *built up* to the high SHAMROCK standard and *brought down* to the price of ordinary receiving sets.

This new Model—called the “B” Model—has the same perfect performance and carries the same guarantee as every higher-priced SHAMROCK product. It produces the same clear, resonant, mellow *TONE*—has the same marvellous *Selectivity*. Yet the price is only \$115!

**Priced to fit
the Moderate Income**

The young married couple—the man on a moderate salary who has longed for a radio but held off until he could afford a *good* one—the business girl with a one-room apartment—these are the people who seize upon the new SHAMROCK—

Get in touch with your jobber and ask him to show you this new SHAMROCK “B” Model—it's creating quite a stir!

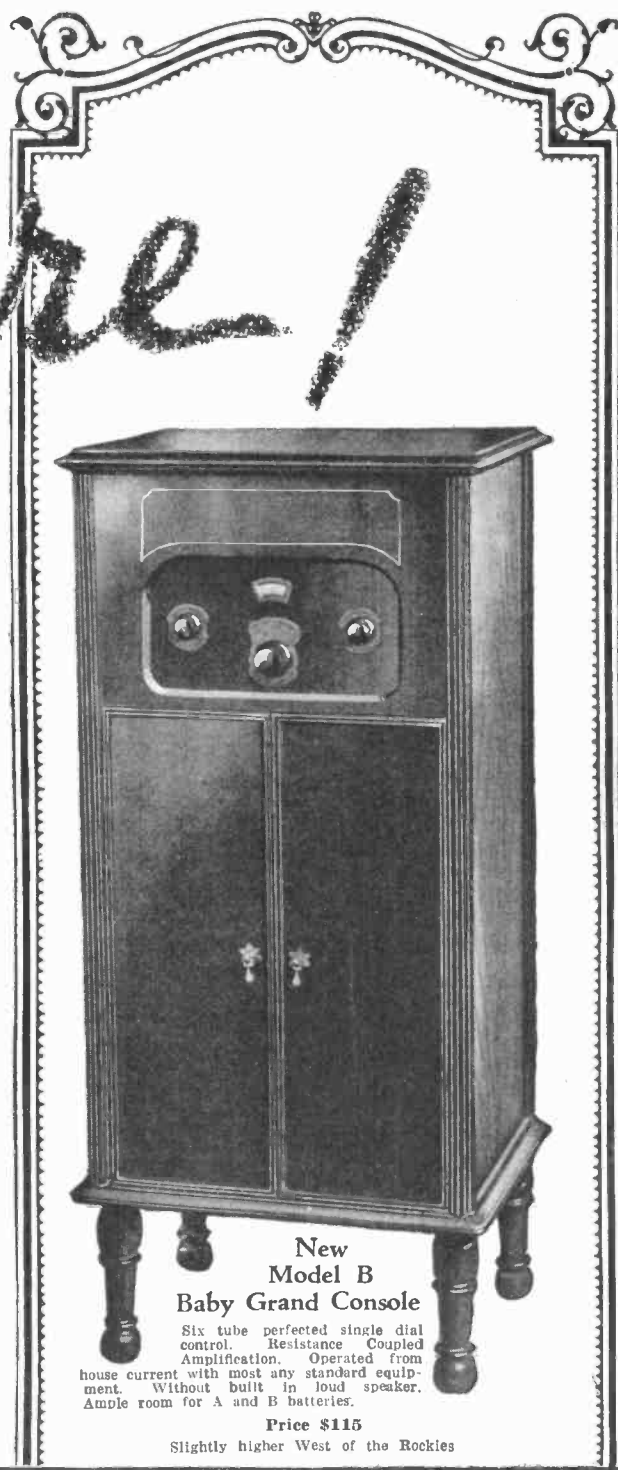

**New
Model B
Baby Grand Console**

Six tube perfected single dial control. Resistance Coupled Amplification. Operated from house current with most any standard equipment. Without built in loud speaker. Ample room for A and B batteries.

Price \$115
Slightly higher West of the Rockies

SHAMROCK
RADIO SETS

Makers of Famous SHAMROCK STANDARD PARTS

SHAMROCK MANUFACTURING CO.
196-204 Waverly Avenue, Newark, New Jersey

Test "B" Power Output Voltages—this New Sterling Way!

The Sterling R-410 "B" Power Tester Answers These Vital Questions:

What is maximum voltage output of the "B" Power—its total capacity to deliver at no load?

What voltage will it deliver at say, 20—40—60 mills, or at any load up to 100?

How many milliamperes will any particular receiver pull when in operation?

Which kind of "B" Power gives sufficient plate voltage at that load? How much to spare, if a power tube were added?

Is any tube socket not receiving plate voltage due to trouble in the circuit? Which one is "open"?

What plate volts in the detector, Amplifier or Power tube?

What voltage has any dry or storage "B" battery or combination of them up to 300 volts?

In addition you can check the output of any D. C. generator such as is used in transmitting sets; find out the load in any circuit or determine battery polarity.

New!

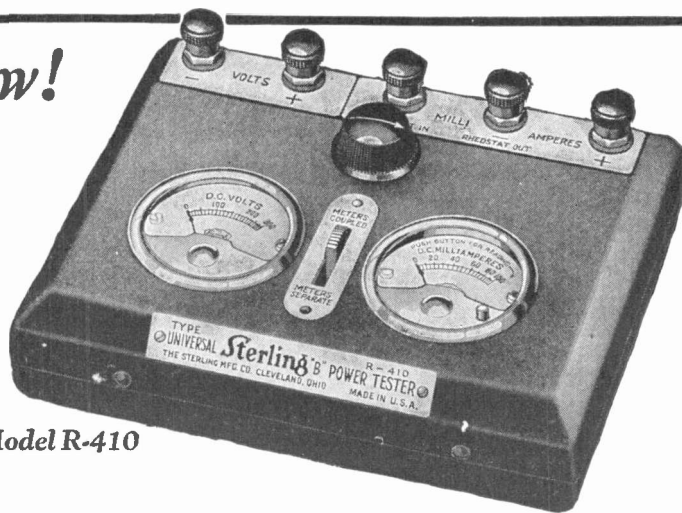

Model R-410

Promote Store Sales and Reduce Service Costs

"B" Powers—Eliminators—are here to stay. The dealer's problem is how to judge them and how to service them.

With this new device you are in a position to show the total voltage output of any "B" Eliminator—to show its voltage at any given load. This means not only more sales—*safer sales*—but it is your protection against stocking "B" Power Units which are below standard.

List Price . . . \$40.00

The Companion piece to Complete Radio Testing Service



Model No. R-408

STERLING TUBE TESTER and SERVICER No. R-408

More complete than ever, this improved model now tests power tubes and grid circuits.

Built especially for testing the plate current of vacuum tubes in milliamperes—the real amplification value. Equipped with a combination voltmeter, 0-150 volt scale for plate voltage, and 0-6 volt scale for filament, this instrument offers a ready means for testing "A" and "B" battery voltage supply to any tube socket. Also invaluable for making many other tests. — List Price, \$22.00.

Sterling

"B" POWER TESTER

THE STERLING MFG. CO.
Electrical Manufacturers since 1906



CLEVELAND, OHIO
2847 Prospect Avenue

APPROVED BY 18 MONTHS OF PUBLIC USE
NO OTHER BATTERY IS LIKE IT

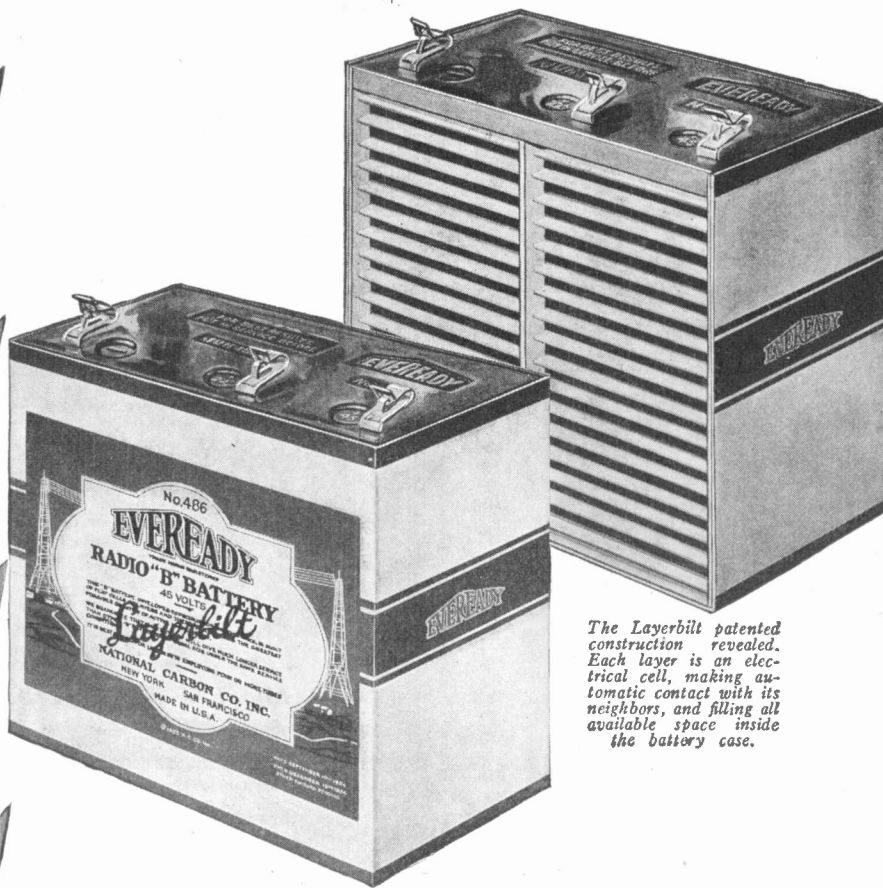

The Layerbilt patented construction revealed. Each layer is an electrical cell, making automatic contact with its neighbors, and filling all available space inside the battery case.

Eveready Layerbilt "B" Battery No. 486, the Heavy-Duty battery that should be specified for all loud-speaker sets.

This is the most satisfactory and profitable "B" battery to sell, because it is the most economical to use

IN DAILY use in the home, Eveready Layerbilt "B" Battery No. 486 has fulfilled all the promises ever made for it. You can tell your customers that it is beyond all doubt the most economical "B" battery ever built; that it will serve them longer, and thus cost less to use. All loud-speaker sets require Heavy-Duty batteries, and the Eveready Layerbilt is absolutely the best of all.

To those who are now using the smaller Light-Duty batteries on such sets, the Layerbilt will give twice the service though they do not cost anything like twice as much. Unless your customers are using Eveready Layerbilts, they are spending more on "B" batteries than they should, and sooner or later will find it out. Forestall their

dissatisfaction by selling them Layerbilts now.

Eveready Layerbilt's unequalled service is due to its unique construction. All other dry cell "B" batteries are assembled of cylindrical cells, with many soldered connections and much waste space. The Layerbilt is built up in layers of flat current-producing elements, that make connection with each other automatically and that fill all available space inside the battery case. This battery has more active materials than any other "B" battery, and the Layerbilt construction makes those materials more efficient current producers.

During 1927 this story is being told the public in smashing, convincing advertisements in leading national magazines and radio papers. Double-

page spreads in two colors in *The Saturday Evening Post* form the keystone of the biggest advertising program ever planned for Eveready Radio Batteries. For "B" battery profits, put your sales effort on the Layerbilt.

Manufactured and guaranteed by
NATIONAL CARBON CO., INC.
New York San Francisco
Atlanta Chicago Kansas City
Canadian National Carbon Co., Limited
Toronto, Ontario

Tuesday night is Eveready Hour Night—
9 P. M., Eastern Standard Time, through
the following stations:

- | | |
|------------------|------------------|
| WEAF—New York | WTAM—Cleveland |
| WJAR—Providence | WWJ—Detroit |
| WEEI—Boston | WGN—Chicago |
| WTAC—Worcester | WOC—Davenport |
| WFR—Philadelphia | WCCO—Minneapolis |
| WGR—Buffalo | WLS—St. Paul |
| WCAE—Pittsburgh | KSD—St. Louis |
| WSAI—Cincinnati | WRC—Washington |

Read what these "Repeat Order" Customers say of Watson town Radio Tables

"The shipment recently received is very satisfactory."
"Order arrived in fine condition and very much admired."

"We received a few days ago our shipment of cabinets No. 924 and are very much pleased with them."

"We have uncrated these tables and set them up. We like them and desire to place another order as follows."

"Tables O.K. and arrived in first class order."

"We have received the Radio Tables and Cabinets and are well pleased with them, therefore, we are sending in another order."

"Have had some of your tables and liked them very much."

"Your tables are the finest we have ever handled and at the price, they are ahead of anything in the line of Radio Furniture."

"The tables you sent me were O.K. in every respect."

"At the price these cabinets were beyond my expectation. I was most agreeably surprised."

"We were very well pleased with the cabinets already received."



Model 923

Solid Mahogany. Dull lacquer finish.
Top 20-in. x 38-in. Height 30-in.
Two ventilated standard size battery cabinets
Drawn for headsets, log, etc. Gliding casters
Shipped KD one in Plywood case.

Christmas paved the way

Now is your opportunity for profitable Radio Table sales

Radiola, Atwater-Kent, Crosby, Bosch,—many of the best sellers in radio this Christmas were table models. Now is the time to check over your list of customers who bought these sets. They'll all be good prospects for a finely built and moderately priced radio table,—designed to match the set and hold all batteries or eliminators.

In the famous Watson town line you'll find just the tables you'd want to sell,—really fine furniture, built by an old furniture house with a first hand knowledge of modern radio needs.

Prices are specially attractive. Dealer proposition is "four-square." Service on the dot, and all shipments made in plywood boxes to assure perfect condition on delivery.

Write at once for fully illustrated leaflet and prices for immediate delivery.

**Watson town Table
& Furniture Company**
Watson town, Pa.

AERIAL KITS

Style "A"
\$3.50

Style "B"
\$2.00

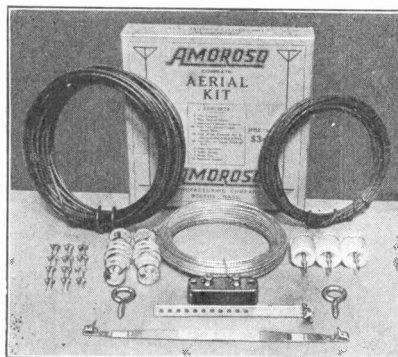

Everything that is necessary for the installation of an efficient aerial and ground system. Easy to install. Easy to buy. Easy to sell.

Attractively packed in display box

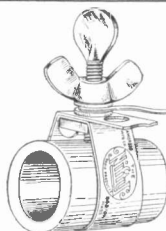

Nifty Ground Clamp (shown at left) requires no tools and is easily adjusted to commonly used pipe. Made of tinned copper and brass. No soldering necessary.

Nifty Lead-in (shown below) completely weatherproof, pliable, and insulated. No holes to bore. Fits easily under window or door tightly closed.



AMOROSO

MANUFACTURING COMPANY
60 India St. BOSTON, MASS.

ACME FLEXIBLE CELATSITE

Flexible, stranded wire for point-to-point and sub-panel wiring. Non-inflammable "spaghetti" covering. In black, yellow, green, red and brown; a color for each circuit. Put up in 25-foot coils.



The Original Celatsite

—a tinned, copper bus bar wire with non-inflammable "spaghetti" covering, for hook-ups. 5 colors; 30-inch lengths.



Celatsite Battery Cable

—a silk covered cable of vari-colored Flexible Celatsite wires, for connecting batteries to set. Prevents "blowing" of tubes; gives your set an orderly appearance. We also offer the highest grade of "spaghetti" tubing for Nos. 10 to 18 wires. 5 colors; 30-inch lengths.



Stranded Enameled Antenna

Best outdoor antenna you can buy. 7 strands of enameled copper wire; maximum surface for reception. Prevents corrosion and consequent weak signals.



Dealers Write for Acme Wire Products Folder E
THE ACME WIRE CO. - New Haven, Conn.

ACME WIRE
MAKES BETTER RADIO



New and Improved
**FRESHMAN
 MASTERPIECE**

**Quality with 100% reserve power—
 Genuine Mahogany Cabinet—All Metal
 Shielded front and sub-panel—power
 tube amplification—"C" Battery con-
 nections—Non-microphonic sockets**

Freshman Masterpiece products comprise a complete line of distinctive radio receivers—table models—many beautiful consoles with built-in cone speaker—trickle charger—power amplifier—"ABC" power supply unit—loud speaker, etc. It is one of the most complete lines in radio.

Sold to Authorized Freshman Dealers Only

Write for complete information about the Freshman Authorized Dealer Franchise—the most profitable in radio.

CHAS. FRESHMAN CO., Inc.

Freshman Bldg., New York

2626 W. Washington Blvd., Chicago

The World's Greatest Radio

There's Money for you in putting Radio Batteries in the cellar



PREMIER EXTENSION CORD and CABLE sells easily and fast because it enables radio owners to do what they want:—hide their batteries in the cellar and extend the loud speaker onto the porch or into the next room. "Standard New Code" Insulation

used exclusively. Cord and cable comes in all lengths, standard and special. Jobbers everywhere. Low prices with attractive dealer discounts. Act now for biggest season just ahead. For nearest jobber's name, write to Crescent Braid Co., Providence, R. I.

The advent of the power tube makes an Extension Cord necessary to preserve true tone.

If your jobber can't supply you, write us for name of nearest on our list. Quick service guaranteed.



Premier
**Extension Cord
and Battery Cable**

Crescent Braid, Inc.,
289 to 297 Thurber Ave., Providence, R. I.

The Enchanter Radio Cone Speaker

A RICHLY decorative radio cone speaker capable of reproducing the entire tonal scale with true, full fidelity. Operates equally well without or with power tube.

*T*HIS strikingly beautiful radio cone speaker makes an instantaneous appeal to the eye. The cast metal galleon is hand decorated in polychrome colors of silver grey, green, yellow and red.

Sells at \$30 list.

National Distributors

Baker-Smith Co., Inc.
Call Bldg.,
San Francisco, Calif.



Height 15 in., Diameter 13 in.

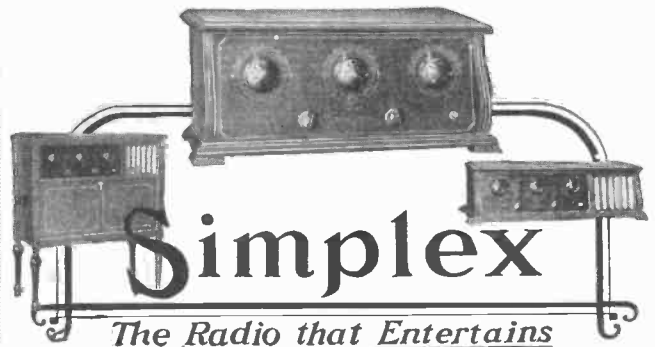

Simplex

The Radio that Entertains

They Stay Sold

No troublesome come-backs when you sell them Simplex. It is so well built and of such simple construction that it gives satisfactory service over a long period of time.

The popular 5 tube tuned radio frequency receiver in its tasteful walnut finish cabinet makes an instant appeal.

Simplex SR 9	\$ 65
Simplex Console	95
Simplex Console	125
Simplex Console Grande	185

Write today for Liberal Dealer Proposition

35 years' experience behind these sets.

Simplex Radio Company
Main and Rector Streets
Philadelphia, Pa.

The MERSHON Condensers

smooth out tone through B eliminators as
a plane smooths the rough surface of a board

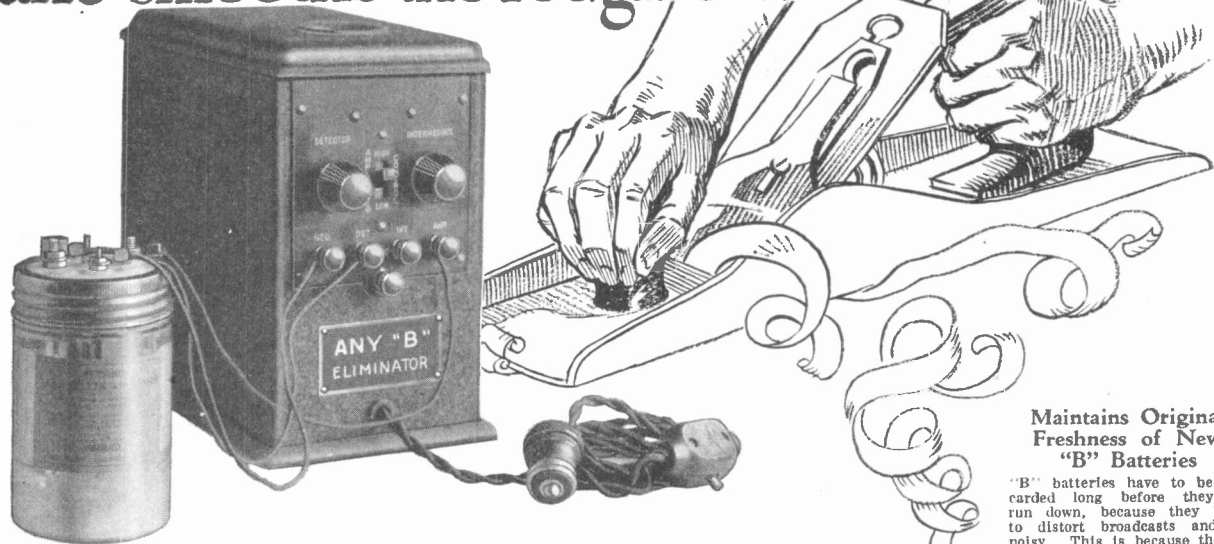

Maintains Original Freshness of New "B" Batteries

"B" batteries have to be discarded long before they are run down, because they begin to distort broadcasts and get noisy. This is because the internal resistance of the batteries increases as they age. Connecting a Mershon across your "B" batteries (with a disconnecting switch) overcomes this high internal resistance and so greatly prolongs the useful life of dry cell batteries. The Mershon itself does not wear out or run down. It may be used continuously with endless sets of "B" batteries.

Makes old "B" eliminators ever fresh like brand new "B" batteries!

Connecting a Mershon condenser to your "B" eliminator vastly improves the tone quality from your receiving set. The famous Mershon's action is two-fold. First, it assists in more perfect filtering (straining) of the uneven current supplied by the Lamp Socket. Second, it acts as a reservoir to store a large amount of energy which is fed to the Receiver in a continuous smooth flow as called for by incoming broadcasts. This action may be considered the same as the result of using a plane for a rough board. Most "B" eliminators use a good filter which can be noted by the lack of any AC hum. But for perfect results and tone quality comparable to that which is obtained from the use of new "B" batteries, it is essential that a sufficient amount of energy be stored directly back of the receiving set. This energy must be on tap to instantaneously supply current for loud or long sustained musical notes. The famous Mershon enables this storage of energy to be accomplished electrically rather than chemically. The result is a great improvement in tone quality. It is particularly noticeable on low notes which require a large amount of current for proper reproduction.

To connect a Mershon is as simple as connecting a battery to your Receiver. Three lead wires are provided attached to the Mershon, the positives being colored red and the negative black.

Caution: Of course it must be realized that a Mershon added to a "B" eliminator will not improve tone quality; or the use of any other tone improvement device; if the design of a receiving set or loud speaker is such that the tubes or loud speaker are overloaded.

There are many other uses for Mershon condensers. Write Dept. 8A7 for descriptive folder.

AMRAD CORPORATION
Medford Hillside, Mass.
Harold J. Power, Pres.

\$ 8.

AMRAD

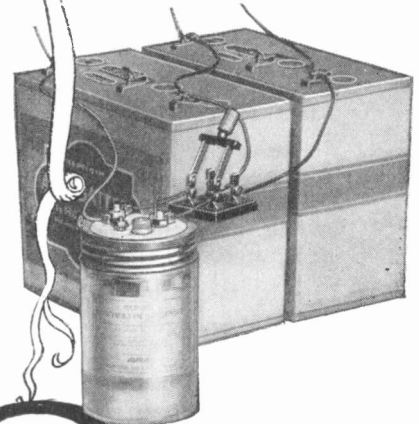



Pat. Applied For

A new accessory with a rich profit behind it

Its double purpose should attract tremendous sales. A decorative silk cord for hanging Cone Speakers, making it possible to eliminate all unsightly wires.

The copper wires to the speaker are concealed in the silk cord. They are equipped with phone tips for connecting the speaker, and provision is made behind the rosette for making connection to the wire from the set itself.

Women will like it because it is decorative and keeps all wires out of sight. It is furnished in several colors to suit every taste.

It prevents accidents to the speaker.

And, in many cases, by enabling the speaker to be located more advantageously in the room, it improves reception.

We are offering speaker manufacturers, jobbers and dealers a proposition that is a real inducement.

It is standard equipment on many speakers.

Jobbers—Let us send you samples, with full particulars about the attractive counter display, and the proposition behind it.

LIST \$1.00

allowing you a good profit

Dealers—If your jobber doesn't carry this patented cord write us!

Cone Speaker Manufacturers
It will add another feature to your speaker and help sell it. Write for particulars.

Rosenblum & Co., Inc.
11 West 19th St., New York City

Particular People Who Insist on the BEST are Asking for

The New MU-RAD SUPER-SIX RECEIVER



ONE DIAL CONTROL

MU-RAD
RADIO CORPORATION
Dept. R
Asbury Park, N. J.

Embodying the most efficient features of radio as it is known today. Assembled with care and precision and inspected with the utmost pains. A set that has proven itself popular with customers who appreciate radio's real prowess. Mu-Rad will bring to your store prestige and additional sales and to yourself a real margin of profit. Investigate these profits today!

Write for Proposition!

A SENSATION!

Electric Window Flasher

with Changeable Letters



SPECIFICATIONS

Price Letters—6 in. high
Reading—1 1/2 in. high

Opal Glass Background. Beautifully Framed. Antique Finish. Light flashes on and off without motor.

—DAY and NIGHT SIGN—

Brilliant by Day — Startling at Night

Only \$15.00 [100 Letters and 22 Numerals FREE with each sign if you order from this advertisement.]

Fully Guaranteed

CHANGEABLE LETTERS enable this sign to be used for any purpose—to say anything—at all times.

Other signs up to \$45.00

WRITE FOR DETAILS

NATIONAL SIGN CO.
124 West 18th St., New York City



*Father bought the
Radio for Christmas—
Now
Mother's Ready
for the Cabinet*

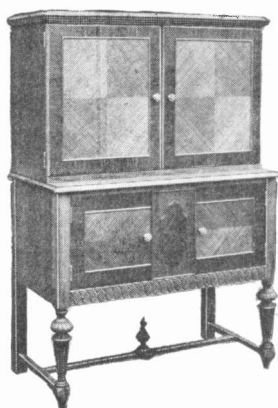

YOU KNOW how it is with father—when he buys a radio he is so intent on quality of tone, distance, selectivity, etc., he never thinks of such a thing as a cabinet. Hundreds of thousands of fathers did just that this Christmas.

But mother wants a cabinet. Her feeling for beauty—which has lifted the home out of the ugly, out of the commonplace—brought it to present high standards of eye appeal—leans her toward the handsome Radio Master Cabinet.

When you tell her that Radio Master Cabinets fit any table set—show her their beauty and convenience—she is going to want one.

It only takes a few minutes to install a Radio Master Cabinet—it conceals all wiring, batteries, etc. There is a wood horn speaker above arranged to receive your favorite speaker unit.

Workmanship is splendid—material perfect—prices moderate, and profit good.

Get after mother—there are plenty of them who have the price, or can make father see the light. Every radio that was sold at Christmas increased the potential market. It is business to help fill the past Christmas slump.

If you are not selling Radio Master Cabinets—don't fail to write us for our proposition.

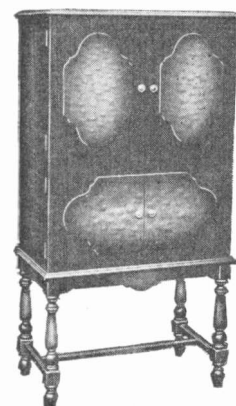
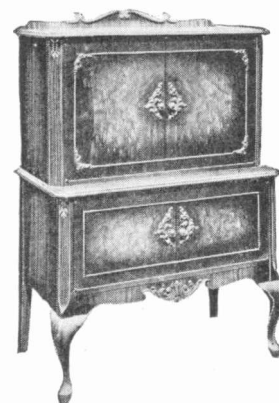

Radio Master Corporation
Bay City, Mich.

O N E O F T H E W A R D I N D U S T R I E S

AMPLION

distribution is country-wide

Distributors are especially enthusiastic about the two Amplion innovations for this season, the Amplion Cone and the Amplion Patrician.

Important Announcement to the Trade

The Amplion Patrician new list price is \$50.00.

The Patrician assembles an Amplion unit and a 48-in. air-column in a handsome hand-carved mahogany cabinet 18 in. x 12 in. x 9 in. Do not fail to see this new model.

The secret of the fine performance of every Amplion model lies of course in the matchless Amplion unit.

Whatever type of reproducer your customers prefer, whether it be horn, air-column, cone or phonograph attachment, the Amplion unit which is the heart of all Amplion reproducers will help any set to give its best performance.

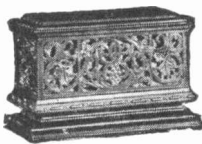

Amplion Patrician AA 18
\$50



Amplion Cone AC 12
\$30

THE AMPLION CORPORATION OF AMERICA

Suite E, 280 Madison Avenue, New York City
The Amplion Corporation of Canada Ltd., Toronto.



Sell Tubes that Make Good!

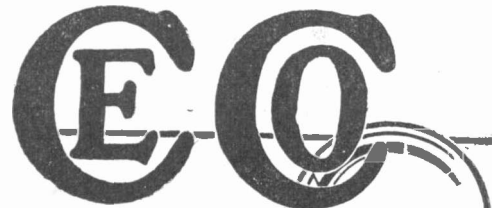

Type "H"
Special Detector

Will give improved reproduction and avoid the usual rushing and hissing sounds of the "soft" detectors.

Using a higher plate voltage than previous types, it will handle powerful signals with less overloading. Average mutual conductance 940. Voltage Amplification factor 14.4.

List Price \$2.50

The Tube of Longer Life

A Type for Every Radio Need

Makes a Good Receiver Better

Write for Complete Data Sheet

C. E. MFG. CO. Inc. . . . PROVIDENCE . R. I.



Sales—

—good sales—insure the success of your business. Watch your merchandise closely and choose only nationally advertised products to stock.

Jewell instruments are nationally advertised and are constant profit builders. Your customers will ask for them. Write for our radio catalog No. 15-C and ask for our discounts.

Jewell Electrical Instrument Co.
1650 South Walnut St., Chicago
"26 Years Making Good Instruments"

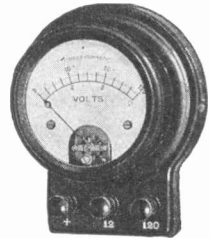

Pattern No. 57—double reading (0—7.5—150) portable radio voltmeter for testing batteries, circuits, filament, voltage, etc.

More Radio Cabinet Sales

This Standard No. 401 Radio Cabinet was designed to be highly attractive and to be most practical. Users find that it fully meets their needs.

A number of features including wood horn, make this a cabinet you should consider at once.

Made in Antique Brown Mahogany or Antique Burl Walnut finish. Write for dealers' transportation allowance and discount list.

STANDARD PIANO BENCH MFG. CO.
1221-1227 W. Lake St.
Chicago, Ill.

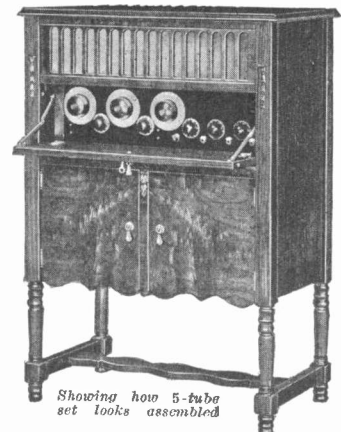

Showing how 5-tube set looks assembled

If It Stood This—

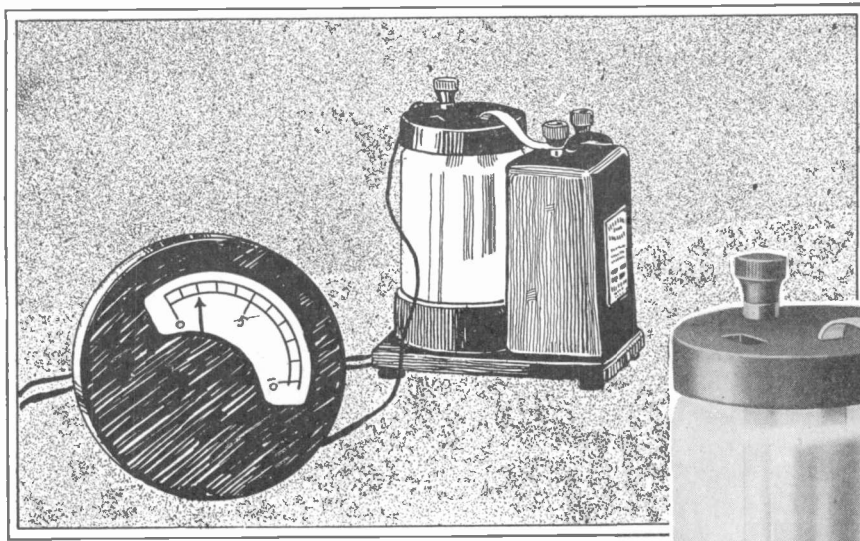

It Will Stand Regular Service for Years

Running continuously for months—delivering 2 amperes (permitted by use of special transformer—regular transformer is wound to limit rate to .5 to .75 ampere)—nearly three times normal rate—there seems to be no limit to the France Trickle Charger's endurance.

Still going strong—electrodes show not a sign of corrosion—no loss in weight.

We meant this to be a breakdown test—but the France Trickle Charger just won't break down.

If they will stand this, you know they will serve your customers for years—you won't get them back for servicing.

Non-acid fumeless electrolyte—high rate—.5 to .75 ampere—moderate price—good profit—it is the charger to sell, and dealers are selling them by the hundreds.

Don't miss using the coupon below, to get more information. It's the greatest thing which has struck the charger market.

The France Manufacturing Co.
10325 Berea Road, Cleveland, Ohio



Rate .5—.75 Amp.

List Price
\$10⁰⁰

Get out your Shears—Now

France Mfg. Co.
10325 Berea Rd.
Cleveland, O.

Name

Address

Please send me your
proposition on your
Trickle Charger.

THE TALKING BOOK

A Novel and Efficient Radio

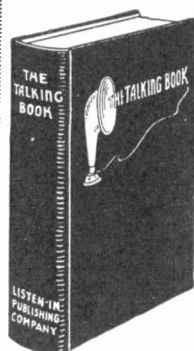

A wonderful radio detector set, complete with aerial and ground leads, antenna and pair of standard ear phones, self-contained in attractive leather-bound book. Set is finely constructed with soldered connections and is equipped with the new

Celerundum Rectifying Unit

Better Reception. Greater Distance.

No Batteries Required.

The Talking Book is the best selling crystal detector set on the market.

LIST—3.50

With Phone, \$6.00.

Dealers—Jobbers—Write for discounts.

THE LISTEN IN CO.

115 Federal St., Boston

THE HYATT 6-TUBE PORTABLE RADIO RECEIVER

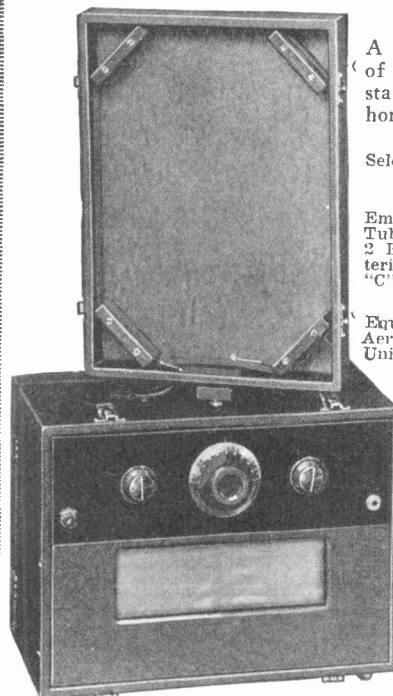

A portable radio receiver of highest quality and substantial construction for the home, hotel, club, hospital.

Selective, Long Range, Tone Quality and Volume.

Employing 6-C 299 or UV 199 Tubes, 3 Standard Dry Cells, 2 Burgess No. 4308 "B" Batteries and 1 No. 5360 Burgess "C" Battery.

Equipment includes Loop, Aerial, Inbuilt Speaker with Unit, Single Dial Control.

Enclosed in Black Leatherette Covered and Well Built Cabinet 15-in. wide, 11½-in. high and 9½-in. deep. Wt. 14 lbs. less tubes and batteries, 28 lbs. fully equipped.

LIST PRICE

Less Accessories

\$75.00

F.O.B. CHICAGO, ILL.

LIST PRICE WITH FULL EQUIPMENT

\$95.00

Jobbers and Distributors Join us in the distribution of this Wonderful Receiver. Write for our Plan and Discounts

Dealers

If your Jobber can not serve you, write us for our Circular and Discounts.

THE ELECTROPHONE CORPORATION

109 NO. WABASH AVE., CHICAGO, ILL.

ELECTRICAL SUPPLIES — RADIO

For speedy service on guaranteed Radio and Electrical goods, send your orders to Harry Alter. I make it my business to give you Same Day Delivery.



Harry Langer mgr. Order Dept.

If you are not on our mailing list write today for our catalogs.

The Harry Alter Co.

ELECTRICAL and RADIO SUPPLIES
Ogden at Carroll Ave. CHICAGO ILL.

Sell Udell Radio Cabinets

A good example of our stock line of Radio Cabinets and Tables is No. 746 illustrated at left.



UDELL covers a complete range in design, finish and price. See our permanent displays—spaces 1029-31 American Furniture Mart, Chicago; space 314, New York Furniture Exchange, 206 Lexington Ave. Write for complete catalog R-86 and dealer's discounts.

We also build special Radio Cabinets under contract.

Write your requirements.

THE UDELL WORKS, INC.

28th Street at Barnes Ave.,
INDIANAPOLIS, IND.

Your Name

in this space in all issues where larger display space is not used backs up your advertising campaign and keeps your name in the alphabetical index.

THANK You!

The wholesome recognition accorded statistical data prepared by McGraw-Hill Publications is due in large measure to the readers of McGraw-Hill Publications, who reply with painstaking care to McGraw-Hill questionnaires.

This is a word of appreciation to you readers who are called upon from time to time to give McGraw-Hill basic information of a more or less confidential nature.

THE PUBLISHERS

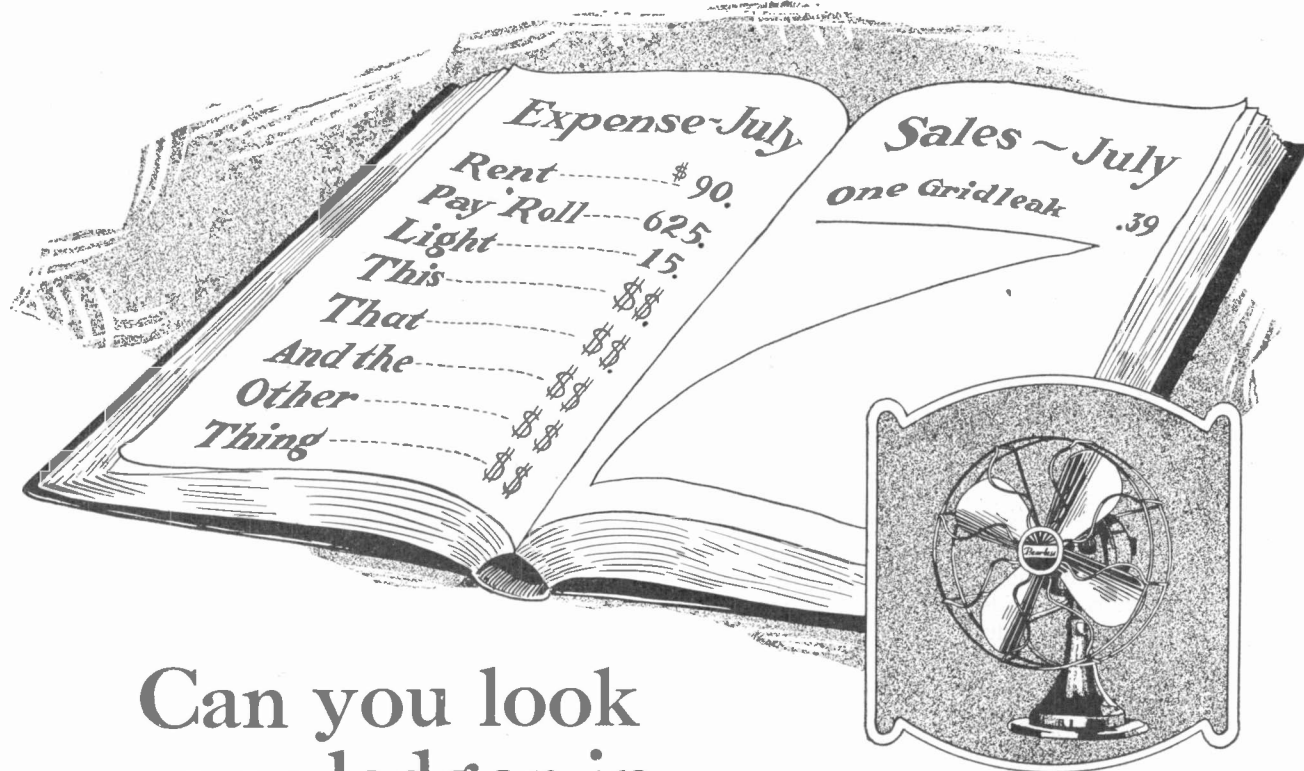

Can you look your ledger in the face—in summer?

Whether dealer or jobber, you don't like to look at your ledger in the summer time, when radio business melts in the blazing sun.

Expensive floor space producing nothing—windows worthless—sales force eating money or else wrecked to be expensively rebuilt when the season opens—its a situation crying for action.

Sell Peerless Fans. There is a line that loves the sun. The hotter Ole Sol gets, the more fan sales flourish and bloom into profits.

Your regular force can sell them in volume to regular radio prospect lists. In addition, every time you work new lists, you can create good will for future radio business.

It's a fan just made for the business—silent, powerful, reliable, requires negligible service, qualities that appeal to buyers—reasonable price—good profit.

Send for more information, and meet the summer slump with a smile.

The Peerless Electric Company
WARREN, OHIO

Peerless The Silent Fan

Radio for Winter—

Peerless Fans for Summer

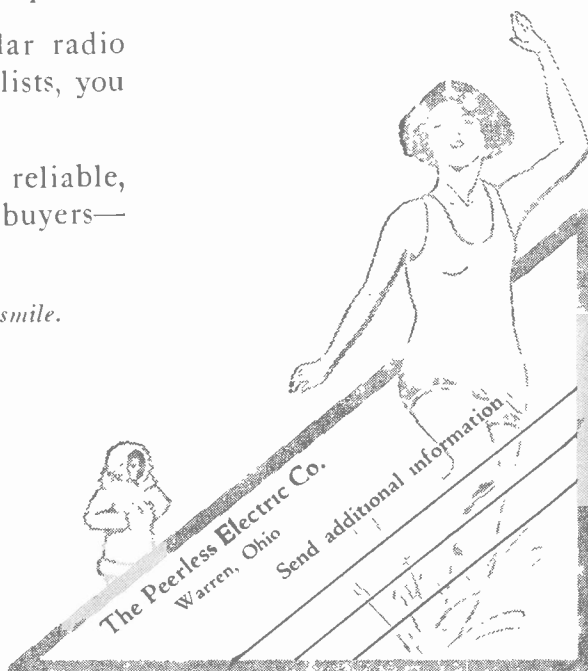

Two types fill every need in "A" power units

THE Prest-O-Lite Trikl-Automatic "A" Power Unit is now made in two types that enable you to meet absolutely every customer's requirements and at prices that are materially under the current market.

Each contains a specially designed Prest-O-Lite radio battery, full 40 ampere-hour capacity, with a large volume of electrolyte, thus eliminating the necessity of frequent watering. Special built-in hydrometer. Silent, full-wave charger, without liquids, bulbs or moving parts, indestructible and highly efficient. Charging rate adjustable. Everything in a small, compact metal case with handle, and extension cord. Cost of operation, about 1 cent a day.

Type A—supplies "A" current only and has automatic relay, turning charger off when set is turned on.

Type AX—In addition has connections for "B" power, making the radio receiver 100% automatic power operated.

Prest-O-Lite also makes standard radio "A" batteries, 60, 80, 100, 120 ampere-hour capacities. The addition of these Trikl-Automatic "A" Power Units to the standard

TRIKL-AUTOMATIC "A" POWER UNIT

\$29⁵⁰
TYPE A

\$34⁵⁰
TYPE AX



Prices slightly higher west of Rockies

line now makes the Prest-O-Lite contract even more valuable than ever before. Write us for full details.

THE PREST-O-LITE CO., INC., INDIANAPOLIS, IND.
New York San Francisco
Unit of Union Carbide and Carbon Corporation



Prest-O-Lite

A Real Sales Maker

Made of selected genuine Mahy. or Amer. Walnut Plywood. Finished two tone Antique Brown Mahy. or American Walnut. Battery Compartment. High grade Loud Speaker Wood Horn and UTAH LOUD SPEAKER UNIT COMBINED. 30-in. High, 32-in. Wide, 15-in. Deep. Average shipping weight 62 lbs. Price Antique Brown Mahy. \$36.00. Price, Antique Amer. Walnut \$36.75. Write for liberal jobber and dealers discounts.



Radio Console No. 505

Exclusive United States Sales Representatives

SANFORD BROS.

CHICAGO, ILL. 30 W. Walton Place
CHATTANOOGA, TENN. 615 Broad St.
SAN FRANCISCO, CAL. 311 Minna St.
SEATTLE, WASH. Amer. Bank Bldg.

Hommel refers all users' inquiries to his Dealers!

Every HOMMEL Dealer cashes-in on the many user inquiries resulting from HOMMEL'S National Advertising

HOMMEL NEVER RETAILS

Strict adherence to this fundamental Hommel Policy has established Hommel as one of the fairest and squareest jobbers in the radio field

WHOLESALE EXCLUSIVELY
LUDWIG HOMMEL & CO
929 PENN AVENUE PITTSBURGH, PA.

Business Wants

THE *Searchlight* Section of this paper represents a meeting place for men and concerns who have immediate business "wants" to fill—the section covers

- | | |
|------------------------------|---------------------------------|
| Agencies Wanted | New Industries Wanted |
| Agents Wanted | Office Space for Rent or Wanted |
| Books and Periodicals | Partners Wanted |
| Business Opportunities | Patent Attorneys |
| Civil Service Opportunities | Patents for Sale |
| Contracts Wanted | Plants for Sale |
| Desk Room for Rent or Wanted | Positions Vacant |
| Educational | Positions Wanted |
| Employment Agencies | Property for Sale |
| Employment Service | Representatives Wanted |
| Foreign Business | Salesmen Available |
| For Exchange | Salesmen Wanted |
| For Rent | Spare Time Work Wanted |
| For Sale | Sub-Contracts Wanted |
| Franchises | Tutoring |
| Labor Bureaus | Vacation Work Wanted |
| Miscellaneous Wants | Work Wanted |

"SEARCHLIGHT"

Yourself?

Have You Experienced
This New Radio
ASSURANCE?

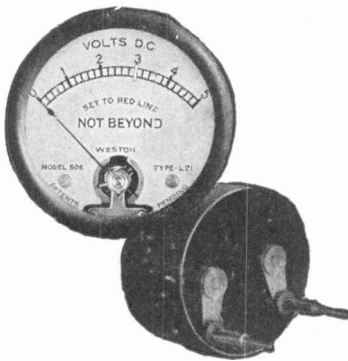

WESTON MODEL 506 "PIN-JACK" VOLTMETER, plugs directly into filament pin-jacks now provided on Radiola, Victor, Brunswick-Balke and Bosch sets. All other sets can be so equipped by installing pin-jacks which accompany each instrument. Gives longer tube life, best possible reproduction and eliminates 90% of the troubles of radio reception.

TWO Weston instruments applicable to any make or type of radio set which enable the operator to closely regulate tube filament voltage and get the best results from his set. Dealers are selling these instruments because they cut their servicing overhead on the sets they sell, because they insure the purchaser's set satisfaction, because they find it profitable. Try them on your own personal set and see the difference.

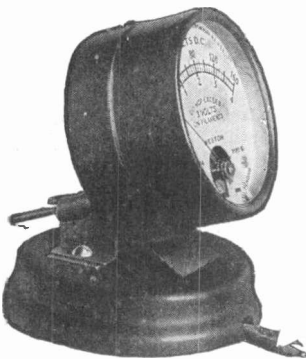

WESTON MODEL 506 CONVERTIBLE "PIN-JACK" VOLTMETER

A "Pin-Jack" Voltmeter as shown above, but with the additional unique feature—a High Range Stand—which allows you to remove the voltmeter from the set. Plug it into the High Range Stand to get accurate information on battery voltages or for making circuit tests, or locating grounds and faults.

WESTON ELECTRICAL INSTRUMENT CORPORATION
25 Weston Avenue, Newark, N. J.

STANDARD THE WORLD OVER
WESTON
Pioneers since 1888

ANY HYDROMETER CAN TEST YOUR BATTERY — BUT ONLY THE "Break Not" TESTS IT RIGHT!

THAT'S WHY YOU WANT THE "Break Not"

NO GUESSING
Positively Tells
The Condition
Of Your Battery

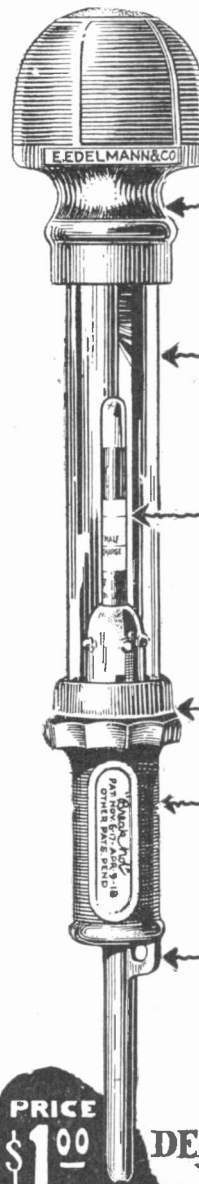

- **BULB**
OF FINEST RED RUBBER
MADE TO FIT THE HAND
CAPACITY JUST RIGHT
- **JAR**
CUSHIONED BETWEEN THE BULB AND
TIP—PREVENTS BREAKAGE
AN EXCLUSIVE FEATURE
- **FLOAT**
WONT STICK TO THE SIDES
PRINTED IN THREE COLORS
EASY TO READ
- **KANT-ROLL**
THE HEXAGON HOUSING COLLAR
KEEPS IT IN PLACE
AND PREVENTS BREAKAGE
- **FLOAT HOUSING**
KEEPS THE FLOAT FROM BREAKING
MADE OF THE
FINEST RED RUBBER
- **HANG IT UP**
WHEN YOUR THROUGH USING
ACID WONT DRIP OUT
KEEPS IT OUT OF THE WAY

OVER 4,500,000
IN USE

DEALERS: HOW'S YOUR STOCK?
YOUR JOBBER CAN SUPPLY

PRICE \$1.00
EAST OF THE ROCKIES

"Break Not's"

MADE BY
E. EDELMANN & CO.
2332 LOGAN BLVD. CHICAGO ILLINOIS



ACME ENAMELED ANTENNA



Best outdoor antenna you can buy. 7 strands of enameled copper wire; maximum surface for reception. Prevents corrosion and consequent weak signals.

The Original Celatsite

—a tinned, copper bus bar wire with non-inflammable "spaghetti" covering, for hook-ups. 5 colors; 30-inch lengths.

We also offer the highest grade of "spaghetti" tubing for Nos. 10 to 18 wires. 5 colors; 30-inch lengths.

Flexible Celatsite



Flexible, stranded wire for point-to-point and sub-panel wiring. Non-inflammable "spaghetti" covering. In black, yellow, green, red and brown; a color for each circuit. Put up in 25-foot coils.

Celatsite Battery Cable

—a silk-covered cable of vari-colored Flexible Celatsite wires, for connecting batteries to set. Prevents "blowing" of tubes; gives your set an orderly appearance.



Dealers Write for Acme Wire Products Folder E

THE ACME WIRE CO. • New Haven, Conn.



HARTUNG CLIPS

Continuous Circuit - Bulldog Grip

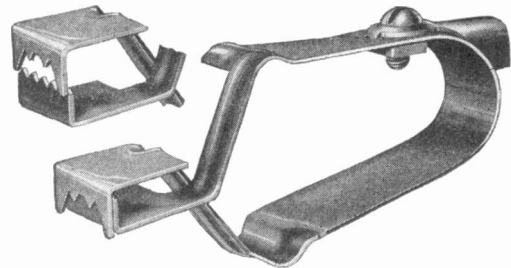

A COMPLETE assortment of sizes and capacities is offered you in the Hartung line of battery, radio, and test clips. Long life and efficient operation is assured by the one-piece design, the careful selection of materials, and the heavy lead coating of these superior clips.

Order from your jobber or write us for samples!

C. F. HARTUNG CO.
728 E. 61st St., Los Angeles, Calif.

Hitch Your Sales Wagon To These Fourteen HAMMARLUND STARS

Hammarlund Precision Products are officially specified in fourteen of the season's featured circuits.

- | | |
|--------------------|---------------------|
| COCKADAY "LC27" | SARGENT "INFRADYNE" |
| BROWNING-DRAKE | PACENT "ULTIMAX" |
| LACAULT "LR4" | HENRY-LYFORD |
| VICTOREEN SUPER | ST. JAMES SUPER |
| LOTTIN & WHITE | MORRISON "VARION" |
| HARKNESS "KH-27" | CARBORUNDUM SUPER |
| POPULAR SCIENCE | HAMMARLUND |
| MONTHLY "POWERFUL" | ROBERTS "HI-Q" |

This means that radio fans all over the country, who want quality results, are buying Hammarlund Condensers and Coils for their favored circuits—a fact evidenced by the largest volume of business in Hammarlund history.

Are you getting your full share of this radio parts harvest? If not, better write to us at once.

HAMMARLUND MFG. CO.

424-438 W. 33rd St., New York



Business Wants

THE *Searchlight* Section of this paper represents a meeting place for men and concerns who have immediate business "wants" to fill—the section covers

- | | |
|------------------------------|---------------------------------|
| Agencies Wanted | New Industries Wanted |
| Agents Wanted | Office Space for Rent or Wanted |
| Books and Periodicals | Partners Wanted |
| Business Opportunities | Patent Attorneys |
| Civil Service Opportunities | Patents for Sale |
| Contracts Wanted | Plants for Sale |
| Desk Room for Rent or Wanted | Positions Vacant |
| Educational | Positions Wanted |
| Employment Agencies | Property for Sale |
| Employment Service | Representatives Wanted |
| Foreign Business | Salesmen Available |
| For Exchange | Salesmen Wanted |
| For Rent | Spare Time Work Wanted |
| For Sale | Sub-Contracts Wanted |
| Franchises | Tutoring |
| Labor Bureaus | Vacation Work Wanted |
| Miscellaneous Wants | Work Wanted |

"SEARCHLIGHT"

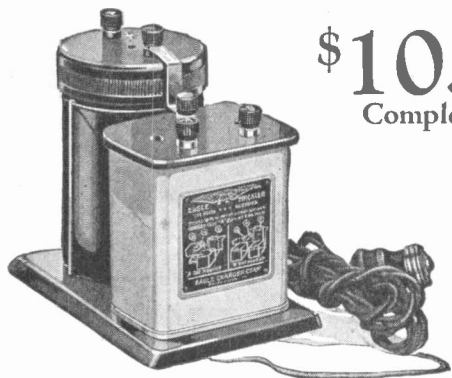

\$10.00
Complete

Eagle "TRICKLER" is The Biggest \$10. Worth in Radio

With this Eagle "TRICKLER" you can offer your customers practically a complete power unit for the price of an ordinary trickle charger.

It will charge an "A" battery at half ampere rate while listening in and will also charge storage "B" and rechargeable dry "B" batteries.

Eagle "TRICKLER" is shipped dry, no liquid chemicals are necessary. The terminals won't corrode and it costs less than 2 cents a day to operate this efficient unit.

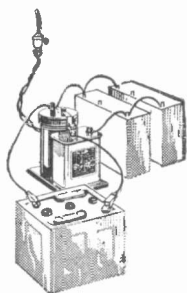

This shows how Eagle "TRICKLER" is hooked up to charge an "A" battery at half ampere rate and two 45 Volt rechargeable dry "B" batteries at 250 milliamperes. Eagle "TRICKLER" is the only trickle charger that will charge storage "B" or rechargeable dry "B" batteries.

Where is there a bigger \$10.00 worth in radio for your customers than this Eagle "TRICKLER"?

If your jobber can't fill your order, write to us for the nearest Eagle jobber's name.

Eagle Charger Corporation
121 North 8th St., Philadelphia, Pa.

Manufacturers of
EAGLE CHARGERS



Priess Straight Nine
List Price with-
out accessories \$335.00

Write for name of our distributor in your territory [*We have a most unusual opportunity for the right man*]

SOME very desirable territory is still open. We give exclusive representation and a dealer franchise.

Our line includes a sufficiently wide price range to meet all requirements of a high-class dealer.

Priess Straight Nine. List Price, in handsome figure mahogany cabinet, without accessories (not illustrated) **\$195**

Priess Straight Eight, especially adapted for rural localities. List Price, without accessories **\$175**

Priess
TRADE MARK
STRAIGHT 9 NINE

Priess Radios are nationally advertised
Write for full information.

PRIESS RADIO CORPORATION
693 BROADWAY NEW YORK

SEARCHLIGHT SECTION

SURPLUS STOCKS—BUSINESS OPPORTUNITIES

UNDISPLAYED—RATE PER WORD:
 Positions Wanted, 6 cents a word, minimum \$1.25 an insertion, payable in advance.
 Positions Vacant and all other classifications, 10 cents a word, minimum charge \$2.00.
 Proposals, 40 cents a line an insertion.

INFORMATION:
 Box Numbers in care of any of our offices count 10 words additional in undisplayed ads.
 Discount of 10% if one payment is made in advance for four consecutive insertions of undisplayed ads (not including proposals).

DISPLAYED—RATE PER INCH:
 1 to 3 inches.....\$6.65 an inch
 4 to 7 inches..... 6.40 an inch
 8 to 14 inches..... 6.20 an inch
 Rates for larger spaces, or yearly rates, on request.
 An advertising inch is measured vertically on one column, 3 columns—30 inches—to a page.

Radio Retailing

POSITIONS WANTED

RECTIFIER specialist. Electro-chemical engineer, six years' training. Research experience with many current rectifiers. experience with battery elimination problems in general. Also has patents for licensing. PW-26, Radio Retailing, Tenth Ave. at 36th St., New York.

BUSINESS OPPORTUNITY

To Lease
 In a popular priced department store, radio department. Address all communications to, The Mint, Des Moines, Ia.

Radio Department to Lease In Providence, R. I., Dept. Store.

Located on one of the busiest streets in the center of the city. Live wire concern; financially responsible. Can make exceptional arrangements. For full details, address Alwin's, one of New England's Great Stores Providence, Rhode Island

POSITION VACANT

RADIO BUYER AND MANAGER WANTED

One of Detroit's largest stores wants a high class man to take full charge of their Radio Department beginning January 1st. Must understand Radios from A to Z, be a good buyer and organizer of both the selling and service ends of the business. Steady position and good salary to the right man.

Address

P-25, Radio Retailing, Guardian Bldg., Cleveland, O.

SURPLUS STOCKS WANTED

Largest and oldest surplus Radio Buyers in America. Cabinets, Consoles, Sets, Loud Speakers, Eliminators, etc. Also open for Electrical and Hardware Stocks. We are not interested in any offerings if submitted to others at the SAME TIME.

Resident Radio Buyers,
 82-84 W. Broadway, New York City
 Walker 1778

W E P A Y Liquidate Your Surplus **C A S H**
RADIO STOCK
 Highest prices paid for surplus radio cabinets, sets and parts. Any quantity.
 What have you to sell?
GENERAL RADIO SET CO.
 74 Cortlandt St., N. Y. C.

TO HELP YOU

LOCATE COMPETENT MEN
 "Searchlight" Advertising

G-3

The advertisements in the SEARCHLIGHT SECTION of this paper

constitute the most comprehensive group of "live" opportunities to be found in any publication serving this industry.

Each announcement represents a current Want of a concern or individual in the industry with some element of profit in each for whoever can fulfill the need. Some have money saving possibilities, others are opportunities for more business; many are employment opportunities while still others offer chances to buy going businesses, plants, property, etc.

"Searchlight" advertisements are constantly changing. New opportunities find their way into this great Want medium each issue. Regular consultation of the "Searchlight" pages should be as important to the careful reader as reading editorial articles of his particular liking. One is news of the industry, the other, the NEWS OF OPPORTUNITIES being offered in the industry. No one can afford to overlook opportunities.

For Every Business Want
"Think SEARCHLIGHT First"

ALPHABETICAL INDEX TO ADVERTISEMENTS

	Page		Page
A-C Electrical Mfg. Co.	109	Ferranti, Inc.	91
Acme Elec. & Mfg. Co.	101	France Mfg. Co.	123
Acme Wire Co.	116-128	Freshman Co., Inc., Chas.	117
All-American Radio Corp.	80	Frost, Herbert H., Inc.	96
Allen-Bradley Co.	82		
Alter, Harry Co.	124	General Electric Co.	Front Cover
American Insulator Corp.	97	General Radio Co.	99
Amoroso Mfg. Co.	116	Gold Seal Electrical Co.	4
Amplion Corp. of America	122	Goodrich Tire & Rubber Co.	98
Amrad Corp.	119	Gould Storage Battery Co., Inc.	108
Atwater Kent Mfg. Co.	28	Goyer Co.	96
		Grebe, A. H. & Co., Inc.	3
		Grimes Radio Eng. Corp.	17
Bakelite Corp.	13		
Baker-Smith Co., Inc.	118	Hammalund Mfg. Co.,	128
Belden Mfg. Co.	95	Hartung Co., C. F.	128
Bosworth Elec. Mfg. Co.	22	Hazeltine Corp.	107
Boudette Mfg. Co.	110	Hommel & Co., Ludwig.	126
Briggs & Stratton Corp.	23	Hood Rubber Co.	98
C. E. Mfg. Co.	122	Indiana Mfg. & Electric Co.	104
Colt's Pat. Fire Arms Mfg. Co.	98	International Resistance Co.	9
Cornish Wire Co.	97		
Crescent Braid, Inc.	118	Jewell Elec. Instrument Co.	122
Crosley Radio Corp.	77		
Cunningham, Inc., E. T. Inside Front Cover			
		Kellogg Switchboard & Supply Co.	18
Delta Electric Co.	11	Ken-Rad Corp., Inc.	79
Deutschmann Co., Tobe	97		
Dry Storage Battery Corp.	100	Langbein-Kaufman Radio Co., The	103
Dubilier Condenser and Radio Corp.	88	Listen In Co.	124
Dudlo Mfg. Corp.	90	Ludwig Hommel & Co.	120
Eagle Charger Corp.	129	Mu-Rad Radio Corp.	120
Eby Mfg. Co., H. H.	92		
Edelmann & Co., E.	127	National Carbon Co., Inc.	115
Electrad Inc.	94-99	National Sign Co.	120
Electrical Research Laboratories	10		
Electrophone Corp.	124	Peerless Electric Co.	125
		Perryman Elec. Co.	8
Fansteel Products Co., Inc.	102	Polymet Mfg. Corp.	86
Farrand Mfg. Co., Inc.	26		
Federal-Brandes Corp.	24-25	Positions Wanted	130
Federal Radio Corp.	12	Prest-O-Lite Co., Inc.	126
		Priess Radio Corp.	129
		Radio Cabinet Co.	105
		Radio Corp. of America 62-63-Back Cover	Cover
		Radio Master Corp.	121
		Raytheon Mfg. Co.	6-7
		Reliable Parts Mfg. Co., The	93
		Rockford Sales Corp.	14-15
		Rosenblum & Co., Inc.	120
		Sandar Corp.	112
		Sanford Bros.	126
		Searchlight Section	130
		Shamrock Mfg. Co.	113
		Sickles Co., F. W.	96
		Silver Marshall	94
		Simplex Radio Co. (Philadelphia, Pa.)	118
		Slagle Radio Co.	106
		Standard Piano Bench Mfg. Co.	122
		St. James Lab. Inc.	96
		Sterling Mfg. Co.	114
		Spartan Electric Co.	20
		Stewart Warner Speedometer Corp.	19
		Stromberg-Carlson Tel. Mfg. Co.	2
		Superb Electric Co.	16
		Sylvania Prod. Co.	Inside Back Cover
		Timmons Radio Products Corp.	111
		Tower Mfg. Corp.	5
		Udell Works, Inc.	124
		United Radio & Electric Corp.	27
		Universal Winding Co.	97
		Utah Radio Products Co.	1
		Vesta Battery Corp.	21
		Watsonville Table & Furniture Co.	116
		Weston Elec'l Inst. Corp.	127
		Windsor Furniture Co.	132
		Wireless Specialty Apparatus Co.	84

McGraw-Hill has your viewpoint

THEREFORE, before sending you a questionnaire to fill out, McGraw-Hill editors and investigators study it carefully to make certain that it conforms to the following requirements:

I. Make the purpose behind the McGraw-Hill questionnaire perfectly clear to the person from whom we solicit information.

2. Restrict our questions to vital matters and express them in simple terms.

3. Recognize all answers as strictly confidential when requested.

4. Make the completed compilations available to all ramifications of industry and trade which can put them to profitable use.

THE PUBLISHERS

**Windsor Wall or Table
Type Cone Speaker
Amazes Radio World**

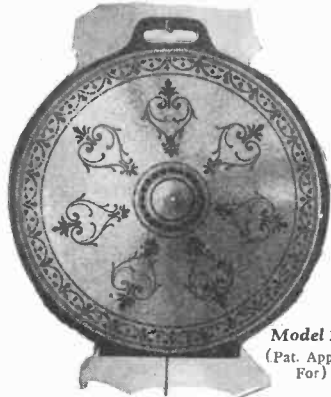

Model 210
(Pat. Applied For)

The latest model Windsor Cone Loudspeaker has astonished the world of radio. In convenience, quality of reception, and extremely low price, it far surpasses anything yet offered. The cone is 22 inches in diameter and is supported by an easel back. It can be hung up on the wall, as in the picture above, or stood upon any flat surface as shown in the picture below. It contains the famous Windsor loudspeaker unit noted for its extreme clarity and fidelity of reproduction.



Model 210
22-inch Cone Loudspeaker
with easel back

\$15.00
(West of Rockies \$18)
(Pat. Applied For)

Model 302 (Shown below)
With Moulded Composition Horn Loudspeaker and 18-inch Cone Loudspeaker.



(Pat. Applied For)

In this Windsor Console is combined both the Windsor Moulded Composition Horn Loudspeaker and the 18-in. Windsor Cone Loudspeaker. The top is 30 in. x 17 in. and stands 29 in. high. Plenty of battery and equipment space is provided by large shelf in rear. Price, finished in Mahogany or Walnut **\$48.00**
(West of Rockies, \$55)

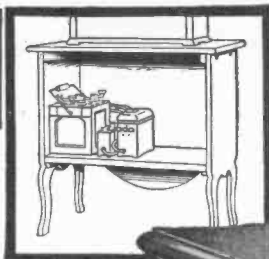

Rear view at left shows large compartment with ample space for batteries, battery charger, or battery eliminator, which are entirely concealed from view. Back is open for ventilation of batteries.

At right is shown the Cone Loudspeaker, with its panel, which is quickly and easily removable, allowing instant access to all batteries, battery charger, battery eliminator or other equipment and wiring.

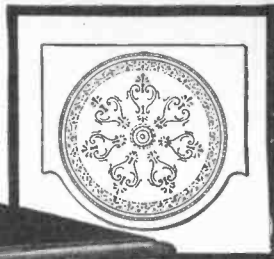

(Pat. Applied For)

Model 200—with 22-inch Cone Loudspeaker

This Windsor Cone Loudspeaker Console is equipped with a 22-inch Windsor Cone Loudspeaker. Its top is 30" x 17" and is 29" high. The battery shelf provides ample space for batteries, charger, battery eliminator and other equipment. Beautifully finished in either Mahogany or Walnut.

Model 200

\$29

Console with Cone Loudspeaker Ready for Set and Batteries
(West of Rockies, \$35)

This is the Fastest Selling Line of Loudspeakers and Loudspeaker Consoles in the Radio World Today

The quality of radio reception made possible by Windsor Cone and Horn Loudspeakers and Loudspeaker Consoles so far surpasses anything heard heretofore that it amazes and delights every radio enthusiast. The Windsor Line is so complete that everyone can find in it a loudspeaker, loudspeaker table, or loudspeaker console exactly to fit their particular needs.



Model 100
with Moulded Composition Horn Loudspeaker or 16-inch Cone Loudspeaker
(Pat. Nov. 18, 1924)

Above is shown a beautiful Windsor Loudspeaker Console, finished in either Walnut or Mahogany, which provides ample space on top for any radio set. The battery shelf beneath will accommodate all necessary equipment. Equipped with either Moulded Composition Horn or 16-inch Cone Loudspeaker. Size: 38 in. x 18 in., and 29 in. high. Price **\$40.00**
(West of Rockies, \$42.50)

To the right is shown the newest Windsor Loudspeaker Console. It is equipped with a 22-inch Cone Loudspeaker and cabinet suitable for 7-inch radiopanel up to 26 inches in length. Battery shelf provides ample space for all equipment. Beautifully finished in either Walnut or Mahogany. Price (without receiving set) **\$44.00**
(West of Rockies, \$52.00)



(Pat. Applied For)

Model 1000
with 22-inch Cone Loudspeaker

Note to Dealers: Write or wire today for details of the highly profitable Windsor line.

Electrical Department

WINDSOR FURNITURE COMPANY

1436 Carroll Avenue • CHICAGO, ILLINOIS

Los Angeles Branch—917 Maple Avenue



THE Sylvania Radio Tube Franchise is meant for the dealer who knows how to build good will by selling complete satisfaction. Sylvania tubes and selling methods make friends all along the line. Write for details.

SYLVANIA PRODUCTS COMPANY · EMPORIUM, PENNA.

This ad is one of the brilliant color-pages running every month all the year round in a long list of the most important national magazines. Can you afford to be without the one heavily advertised vacuum tube, when customers demand it?



HEATING METAL INSIDE OF GLASS

Everyone knows that glass melts easily, and metal requires a high temperature. Yet, at the Radiotron laboratories, the experimenters can put a Radiotron in the coil of a "high frequency furnace" and melt the metal inside without melting the glass. This is done by an electric current that is induced inside the glass bulb, right through the glass.

This extraordinary furnace is not only used for experiment. In manufacture, every single Radiotron goes for a moment through such a furnace, just after the air has been exhausted out of it. The inside metal is heated, the tiny air bubbles boil right out of the metal and the glass, and are pumped away. Never before could such an exhaust be obtained.

This means real performance when the Radiotron gets into your set. And it adds another reason for insisting on a genuine RCA Radiotron base and the glass. There are Radiotrons for every purpose.

more distance on the same set

Want more stations on that storage battery set of yours? Want the far-away ones you get now to come in more easily and regularly? The Radiotron laboratories have developed a *super-detector* that slips right into the socket where you have a Radiotron JX 201-A now. Just change that one to a Radiotron UX-200-A.

It makes your set sensitive to fainter signals—tunes out no fainter stations—picks up weaker ones you couldn't get before. It makes a big change for a very small cost!

Bring your storage battery set up-to-date with a genuine RADIOTRON UX-200-A or UX-201-A.

Bring your dry battery set up-to-date with a genuine RADIOTRON UX-200-A or UX-201-A.

RCA

RADIO CORPORATION OF AMERICA
New York Chicago San Francisco

RCA Radiotron

MADE BY THE MAKERS OF THE RADIOLA

RADIOTRON UX-50-A	Detector Amplifier
RADIOTRON UX-100	Detector Amplifier
RADIOTRON UX-100	Detector Amplifier
RADIOTRON UX-111	Detector Amplifier
RADIOTRON UX-112	Detector Amplifier
RADIOTRON UX-200	Detector Only
RADIOTRON UX-200-A	Detector Only
RADIOTRON UX-120	Power Amplifier Last Radio Stage Only
RADIOTRON UX-117	Power Amplifier
RADIOTRON UX-111	Power Amplifier Last Radio Stage Only
RADIOTRON UX-210	Power Amplifier Oscillator
RADIOTRON UX-713	Full-Wave Rectifier
RADIOTRON UX-216-B	Half-Wave Rectifier
RADIOTRON UX-816	Voltage Regulator Tube
RADIOTRON UV-978	Ballast Tube
RADIOTRON UV-808	Ballast Tube
RADIOTRON UX-877	Rectifier Tube



If you are not handling RCA Radiotrons you are missing a source of steady, never-failing all-year profit ~ ~ ~

RADIO CORPORATION OF AMERICA
New York Chicago San Francisco

RCA Radiotron

MADE BY THE MAKERS OF THE RADIOLA