

Radio Retailing

The Business Magazine of the Radio Industry

THE only permanent goal is public confidence—expressed, as it is, by preference for trademarked merchandise which has been measured by the yard-stick of quality. Negative quality never brings permanent profit, whether the commodity is a set of silverware or a set of radio tubes. Since 1915 Cunningham Radio Tubes have been sold by an ever-increasing number of dealers, the vast majority of whom realize that quality is the basis of business integrity.

R. J. Cunningham, Inc.

New York

Chicago

San Francisco

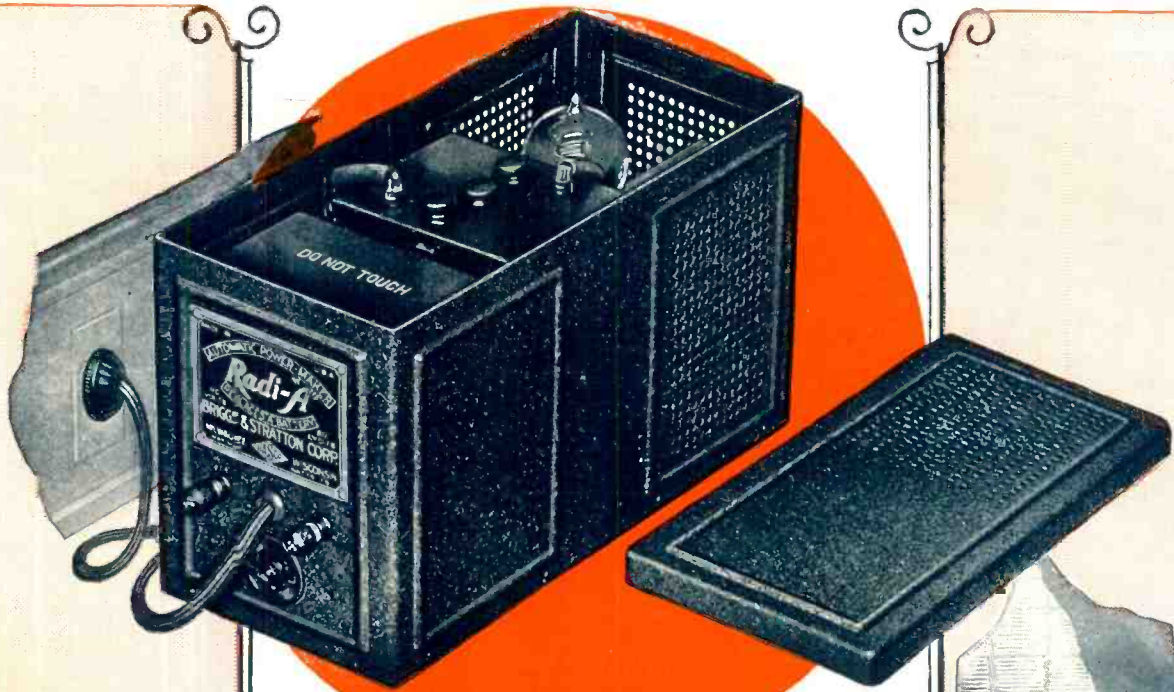

**Uniform Power
— No Hum —
No Distortion**

...
**Maximum
Reception
Always!**



Radi-"A" can be sold to present owners of radio sets — at a good profit to you.

Cash In On This Double Market

THERE are two large groups of people that are Radi-"A" prospects — folks who are going to buy radio sets and those who have them. Both want the finer reception Radi-"A" provides — without any battery troubles.

The nuisance of an "A" battery and charger has kept many people from buying a radio. Now you can sell them a set and a Radi-"A". You will sell more radio sets and make a larger profit on Radi-"A" than you would on an "A" battery and charger.

Present set owners who know what battery grief is are all interested in a light-socket "A" power unit that uses no battery or charger. Radi-"A" is what they have been waiting for.

Radi-"A" is a complete light-socket power unit that operates without a battery. It converts 110-volt, 50 or 60 cycle alternating current into a uniform, constant, 6-volt direct current of from 2 to 2 3/10 amperes, capable of handling radio sets up to and including 8 tubes, using standard 1/4 ampere tubes. Operates without hum or distortion! It has no delicate or complicated parts—nothing to adjust or get out of order. Radio set switch automatically controls both Radi-"A" and the "B" Eliminator (if a "B" Eliminator is used), which is operated directly through Radi-"A".

Write for full details and name of nearest distributor.

BRIGGS & STRATTON CORPORATION, Milwaukee, Wis.

Radi-"A"

Replaces
"A" Battery and Charger



Radi-"A" helps you sell more radio sets and nets you a Double Profit on each sale.

"A"
Power
from Light Socket
Without
Battery

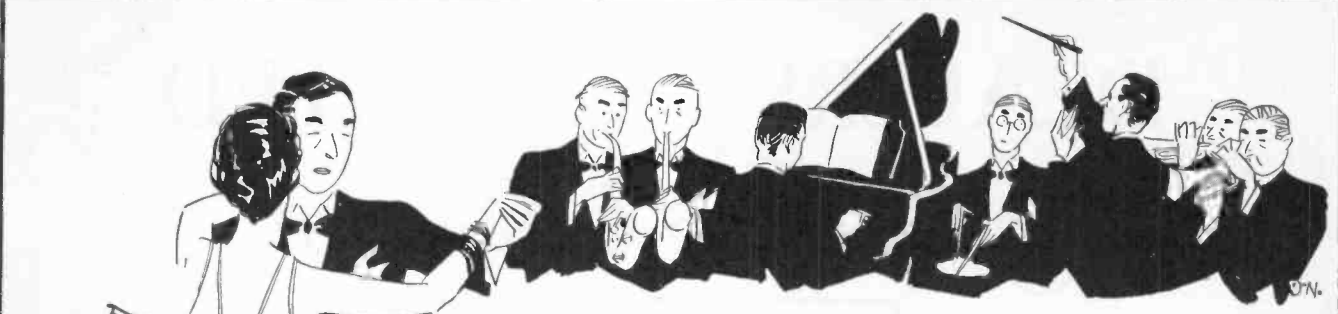

REMEMB'RING

the others...
then listen to a

UTAH

Made in Salt Lake City
Trade Mark Registered

UTAH STANDARD

14" Bell

22⁵⁰

(The Speaker with the Golden Throat)

Utah Junior

11" Bell

12⁵⁰



UTAH BOOK

Exceedingly
Decorative
Finest
Reproduction
Size 17½" x 13½"

19⁰⁰

Utah Super-Flex

10⁰⁰



Reg. U. S. Patent Office



The only complete line of speakers on the market

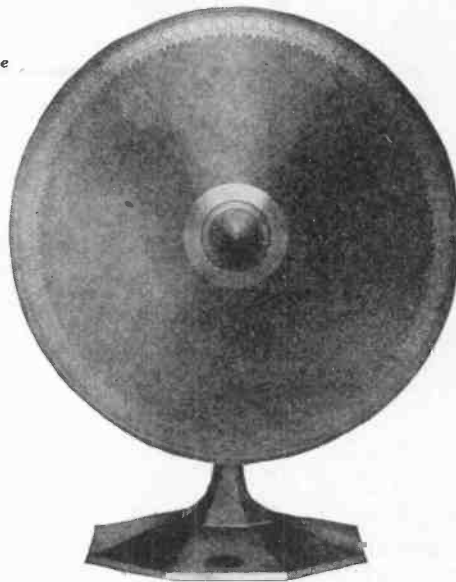

We are manufacturers, not assemblers

GUARANTEE

Buy a **Utah** and use it for two weeks. Compare its tone with the best the others are able to produce. **If the Utah does not give better reception** return it to your dealer and **he will refund your money.**

UTAH CONE SPEAKER

Free edge—17½" high

16⁰⁰

UTAH RADIO PRODUCTS CO.

1421 S. Michigan Ave., Chicago

DEALERS DELIGHTED WITH *New 5-Tube Receiver*

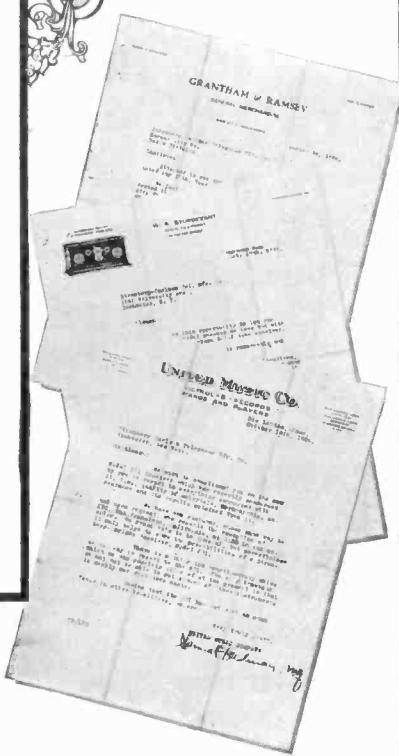
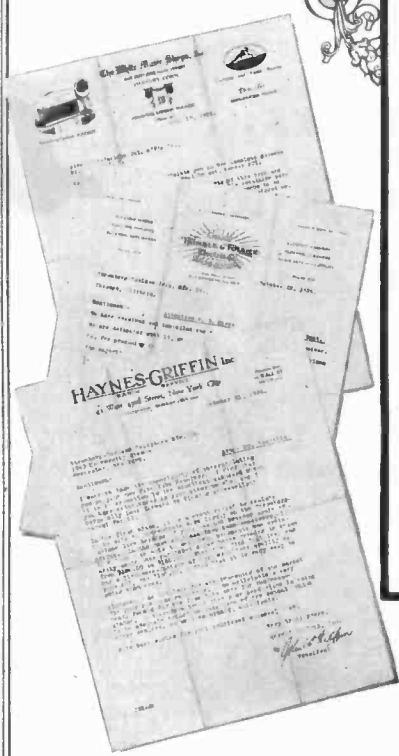

No. 502 Receiver. Art Console. 5-tube; coils shielded; operates from house current or batteries; space for socket power units or batteries. Price, less accessories but including external Cone Speaker.

East of Rockies	Rockies and West	Canada
\$325	\$355	\$380

No. 501 Receiver, same operating unit as No. 502. Price, less accessories without Cone Speaker

East of Rockies	Rockies and West	Canada
\$180	\$192.50	\$225

I find the No. 501 Receiver is no exception to the excellent standards which you have established in your other models it is a great relief to dealers to be able to concentrate more firmly on the Stromberg-Carlson line because of your new and broader scale of prices.

I anticipate a very heavy demand for these Five Tube sets, and trust that your production is going to be adequate enough to take care of the demand.

Haynes-Griffin, Inc., New York City.

We have received and installed the new 5-tube Treasure Chest Receiver. We are delighted with it and wish to compliment the Stromberg-Carlson Co. for producing this model, as we find it to be very suitable for the majority of homes.

Gray, Trimble & Smith Electric Co., Bloomington, Ill.

We wish to compliment you on the new Model 501 Receiver in regard to everything connected with it, i.e., quality of materials, workmanship, appearance and the results obtained from it.

There is nothing too complimentary which we can say in regard to the 501. The only drawback which we can possibly think of is that we may not be able to get enough of these instruments to supply our customers wants.

United Music Company, New London, Conn.

We have just received the new No. 501-Receiver and having tested it out will say that it is certainly a step forward in radio. We never yet have seen a set so powerful and selective when used with a Stromberg-Carlson Cone Speaker it has the finest tone we have ever heard.

Grantham & Ramsey, Kaw City, Oklahoma

INFLUENCED by the flood of public approval, Stromberg-Carlson dealers in every section of the country are voicing their enthusiasm over the new 5-tube Receivers.

For these dealers are reaping increased profits from this broadened Stromberg-Carlson field of radio merchandise—and are enabled to concentrate more firmly on a line which represents permanence of value.

Stromberg-Carlson Telephone Mfg. Co., Rochester, N. Y.



Stromberg-Carlson

Makers of voice transmission and voice reception apparatus for more than thirty years.

This Christmas Offers You a Real Opportunity

DEALERS who chose the Synchronphase made money this year. They will make much more this Christmas, for the public is getting radio wise.

This Christmas offers *you* a real opportunity to start a stream of sales that will grow stronger as the months pass. For the Synchronphase gives more than satisfaction—its performance delights its owner; it needs little or no servicing; it stays sold and each sale brings others.

Don't put it off—investigate *now!*

Write at once for Booklet RR and prices

A. H. Grebe & Co., Inc., 109 West 57th St., New York
Factory: Richmond Hill, N. Y.
Western Branch: 443 So. San Pedro St., Los Angeles, Cal.

This Company owns and operates stations WAHG and WBOQ.



"If you wish to know the road before you, ask of those who have traveled it".

If you wish to know the opportunity the Synchronphase offers, ask those who have sold it.

Doctor H. Grebe

The GREBE SYNCHROPHASE

TRADE MARK REG. U.S. PAT. OFF.



The Synchronphase is also supplied with battery base and in five console models.



All Grebe apparatus is covered by patents granted and pending.

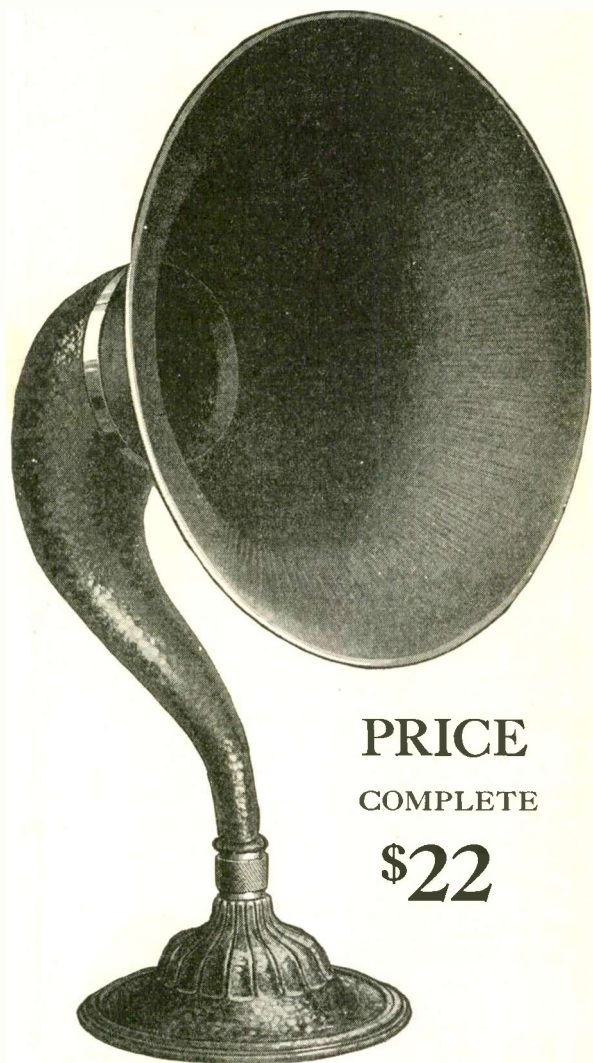

PRICE
COMPLETE
\$22

when you handle
what the public
demands—

Music Master

HORN SPEAKER

Cater to public choice in your Christmas stocks and watch sales grow. Now is the time to insure increased holiday sales and turn them into profits.

Thousands of radio dealers and consumers recognize the superior qualities of Music Master Horn Speakers. They demand the reproducer of excellent tone qualities with resonance and unequalled power.

The amplifying bell is the distinguishing feature. Seasoned selected wood lends a rich, mellow sweetness as conceived by the master violin makers of old.

Consider public demand carefully. Music Master is stronger and better able to serve at this time than ever before.

There are no substitutes in performance.

Music Master Corporation

David S. Ludlum, Trustee,
Betzwood, Pa.
(Port Kennedy P. O.)

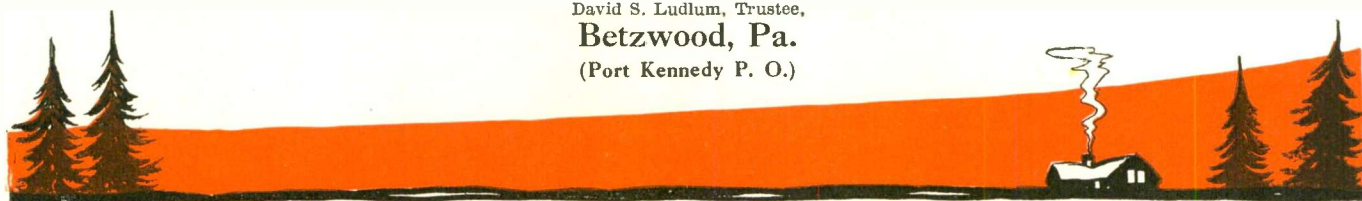

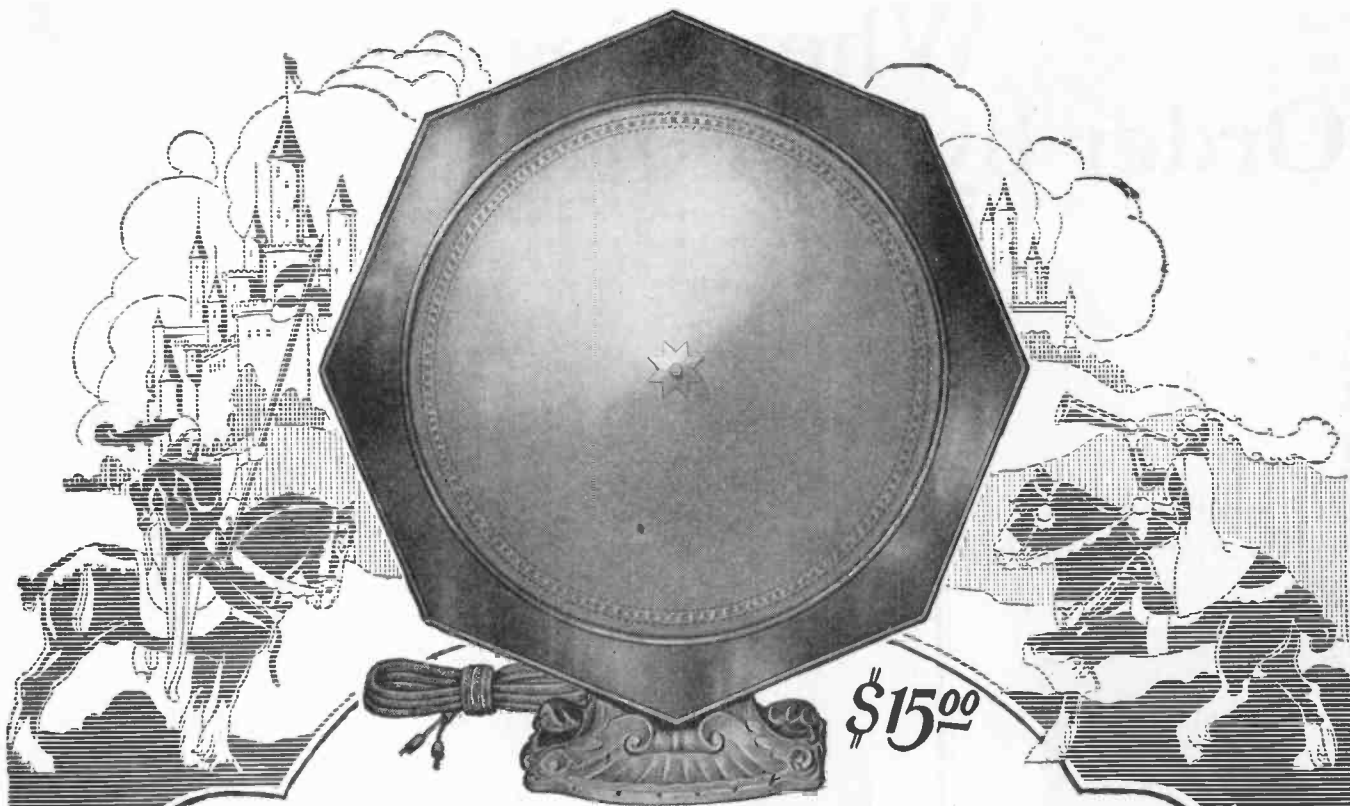

PRESENTING ~
Tower
 Meistersinger
 CONE

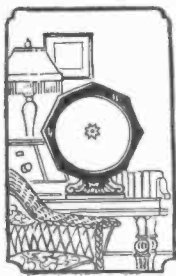

2 Models in 1
 No longer is it necessary to buy a special type of speaker limited to only one use.

ANOTHER Tower Sales Leader—the new Meistersinger Cone for those who demand highest quality both in appearance and performance. Unlike the average model, the Meistersinger serves a double purpose—it may be employed as a table model or hung on the wall by simply detaching base. Why not profit by this exclusive Tower feature!

The powerful direct-drive unit is protected by a beautiful mahogany finish frame with ply-wood sound-board back. Art metal base, free-edge construction and many other features.

With the introduction of the Meistersinger, the Dealer now may offer a non-competitive Tower value in every price class.



Tower Has It.
 The Meistersinger may be used either as a table or wall model — according to taste or space requirements.

Write us for your Distributor's name

TOWER MFG. CORP., Boston, Mass.

When Dealers Order by Hundreds at Sight—They Believe

Others of the France family

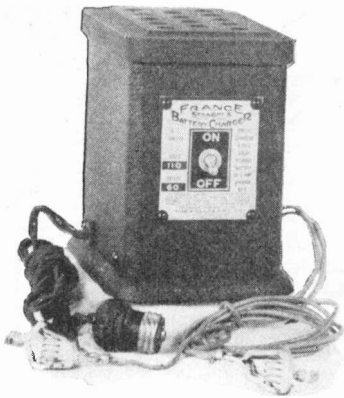

France Straight A Charger

Charges 4-6 or 8 Volt Radio A or Automobile Batteries at 2 amp. rate. Single bulb—plenty of capacity. List price \$12.50 without bulb F.O.B. Cleveland.

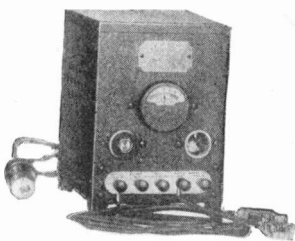

France Super-Charger (Mechanical)

Charges 4-6 or 8 Volt Radio or Automobile Batteries at 5 to 7 amperes. Also up to 120 Volts B batteries. Unusually efficient, quiet, economical, simple, durable. Will charge dead batteries. List price \$22.00 F.O.B. Cleveland.



\$10⁰⁰
List
 Charging Rate
 .5 to .75 Amp.

WHEN we first placed this Trickle Charger on the market—before we had time to advertise it—we showed it to several radio dealers and jobbers in and around Cleveland.

We expected a few scattering trial orders, because anybody is naturally careful about a new product.

Not so—we immediately began to receive orders for hundreds—they saw and were convinced.

They said that the year guarantee—the high rate—the funeless, harmless electrolyte—and the liberal design were enough for them.

We believe it will be enough for you, and the coupon below will bring you our proposition.

Price—\$10 list, with liberal discount. We have the production to make prompt shipment of your orders, however large.

France Manufacturing Co.
 10325 Berea Rd.
 CLEVELAND, OHIO

Trouble-Free Service and Long Life Are Built Into Every France Charger.

Get out your Shears—Now

France Mfg. Co.
 10325 Berea Rd.
 Cleveland, O.

Please send me your Proposition on your Trickle Charger.

Name

Address

The NEW Seven-Test

RADIO TUBES



Type UX-201-A

Tubes of a quality and uniformity heretofore believed impossible. A new tube free for any Archatron that fails to give perfect satisfaction for one year. No other manufacturer has dared to offer such a guarantee.

KEN-RAD

ARCHATRON

The most rigidly inspected and severely tested radio tubes ever produced. Each and every ARCHATRON, before it is packed, is subjected to SEVEN exhaustive tests to prove its—

1. Amplification.
2. Capacity
3. Volume.
4. Filament Life.
5. Vacuum.
6. Uniformity.
7. Coordination.

Put an end to complaints from purchasers of short-lived tubes of widely different electrical characteristics. Sell them ARCHATRON with this protection:

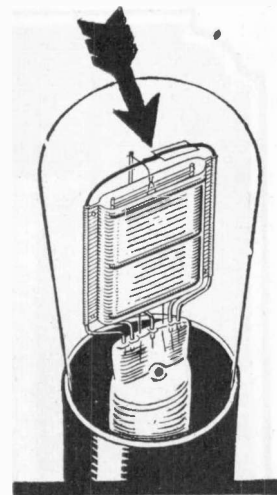

THE ARCH DOES IT

Perfect degasification, made possible by Ken-Rad's entirely new and exclusive "arch" principle of construction is the secret of the ARCHATRON'S amazing sensitivity, uniformity and longer life.

ARCHATRON for EVERY NEED

- UX-201-A Detector-Amplifier
- UX-199 Detector Amplifier
- UX-112 Power Amplifier
- UX-120 Power Amplifier
- UX-216-B Single Wave Rectifier
- UX-213 Double Wave Rectifier
- UX-200-A Super Detector
- UX-100-A Hi-Mu Type
- UX-Resistance Coupled Amplifier
- UX-210 Super Power Amplifier



Type UX-199

Any Ken-Rad Archatron not subjected to excessive voltage is

Guaranteed Unconditionally FOR ONE YEAR

Bear in mind that ARCHATRON cost no more than unguaranteed radio tubes, yet give unbelievably more service and better service.

Write quick for name of our nearest distributor and illustrated folder explaining the only real improvement in radio tube design since DeForest invented the Grid.

THE KEN-RAD CORPORATION, Inc.
Owensboro, Ky.

MAIL THIS COUPON

THE KEN-RAD CORPORATION, INC.,
314 2nd St., Owensboro, Ky.

Please send information about ARCHATRON One-Year Guaranteed tubes, sales helps, and name of your nearest distributor.

Name

Address

City State

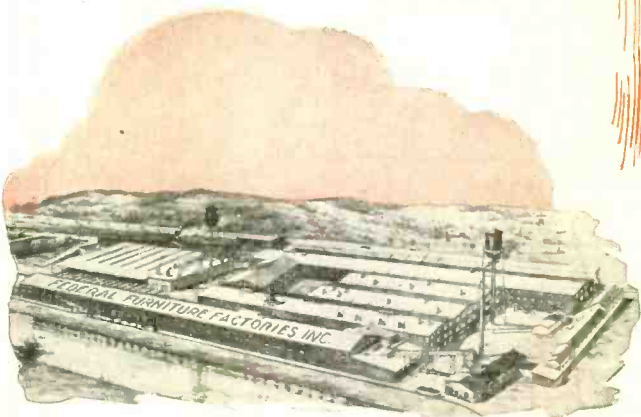
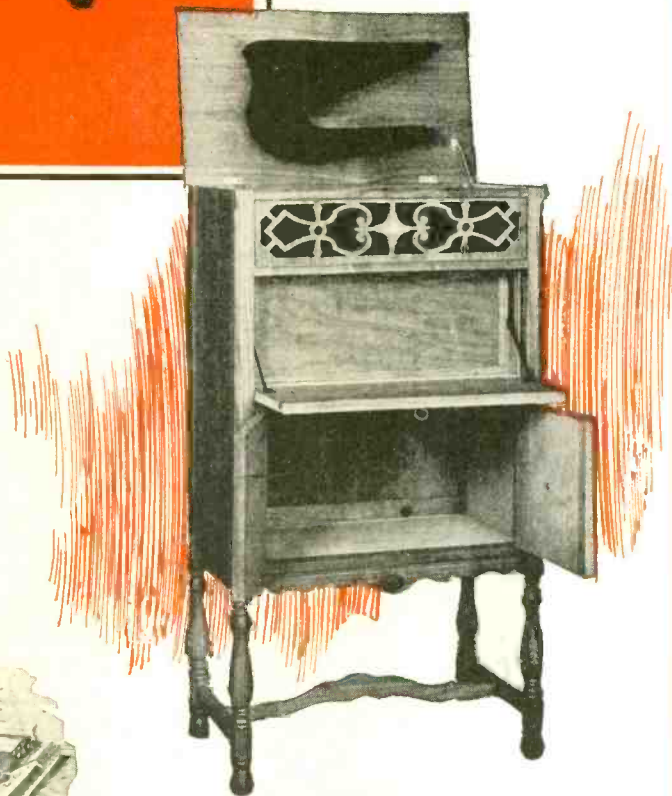

One of the giant plants of the Federal Furniture Factories, Inc. Your guarantee of uninterrupted production of Cabinets by Irving.

ROYAL BLUE MODEL—No. 540
H, 45; W, 25; D, 14. Panel 9 x 20.

A magnificent cabinet. Walnut only. Substantial construction. Beautiful dull-rubbed finish. Hinged, silk-lined loud speaker grill. Receiver compartment fits any standard set. Roomy lower compartment for batteries, accessories, etc.

The Cabinet Sensation of the 1927 Season

*Beautifully Made . . . Beautifully Finished
Popular Design . . . Enduring Construction*

GUARANTEED BY
THIS RESPONSIBLE ORGANIZATION

The Perfect Cabinet for the
ATWATER KENT COMPACT—And Other Models

THE New Federal Radio Cabinet is one of those rare pieces of merchandise in which every single detail dovetails so perfectly that tremendous sales can be the only outcome. Design is one of those happy combinations of line and form which instantly hits a widespread popular chord.

Appropriate for the Atwater Kent Models and practically all other makes. Size exactly meets popular demand. Finish harmonizes with the prevailing furniture mode of today.

It comes to the market at just the moment when the highboy type of radio cabinet has won the attention of millions of people.

IN QUALITY IT HAS NO SUPERIOR.

And because it is produced on a *quantity production basis* IT CAN BE SOLD FOR AT LEAST \$10 to \$20 LESS THAN ANY SIMILAR CABINET PRODUCED TODAY.

BIGGER PROFITS—Start Making Them Now!

The New Federal Radio Cabinet is making new sales records because it represents EXCEPTIONAL VALUE. The consumer knows VALUE. He WANTS value. Put it on display in your store and watch your sales GROW!

Order from your jobber or write us direct to-day.

ROCKFORD SALES CORPORATION

Division of Federal Furniture Factories, Inc.

206 Lexington Avenue | . . . New York City

Cabinets by Irving

LOGIC

ANY radio retailer able to confine his dealings to one large and responsible concern which manufactures a complete line of receiving sets that will meet all his requirements is indeed in a fortunate position. Federal Designated Retailers, operating on this basis, are enjoying bigger and better returns than otherwise possible. And for these reasons:

- 1 The Federal Plan gives the retailer an opportunity to concentrate on fewer lines, and in his advertising and selling statements to be consistent in his recommendations to his customers.
- 2 The general Ortho-sonic Line through its all-satisfying range of models and prices, simplifies ordering and inventorying, and results in faster turn-over and better profit margins.
- 3 The Retailer realizes that a manufacturer, willing to forego maximum immediate profits for the sake of perfecting and producing *simultaneously* a varied line, must be inspired by a grim determination to build and to *hold* a respected position throughout the years.

The advantages offered by the Federal Plan are too unusual ever to be overlooked by the retailer who is sincerely ambitious. Write your Federal wholesaler for full details. If you don't know his name, write us.

ORTHO-SONIC[★] Federal Radio

Reg. U. S. Pat. Off.

★The fundamental exclusive circuit making possible Ortho-sonic reproduction is patented under U. S. Letters Patent No. 1,582,470.



The sign of the Designated
Federal Retailer

FEDERAL RADIO CORPORATION, Buffalo, N. Y.

(Division of Federal Telephone and Telegraph Co.)
Operating Broadcast Station WGR at Buffalo



Resonant Wood Construction finished in Six Colors

The NEW VASSAR Cone Speaker

**\$30
VALUE**
in
**Everything
But Price!**

NOW that radio is better understood and people know what to expect of a cone speaker, sales will be made on the basis of *real*—not supposed—value. Right here is your and our opportunity.

Large scale production and manufacture of every part in our own factories explain the low price of the Vassar Cone Speaker.

The reproducing unit is equal in design and construction to that of any \$30 speaker on the market. Let us prove this to you. Extremely sensitive, it responds to the faintest impulses, catching each delicate modulation and elusive expression of human voice or musical instrument. And yet, when volume is desired—for dancing or a large room—the full, sweet tones pour forth in such rich resonance and volume that distortion is unknown.

Write today for our complete proposition. Every day you delay you are losing money.

List Price **\$12.50**

ALGONQUIN ELECTRIC COMPANY, INC.

Leo Potter, President

Main Office: 120 Broadway, New York, N.Y.

Factories: Poughkeepsie, N. Y.

Why Is This Man Standing on a Kolster Chassis?

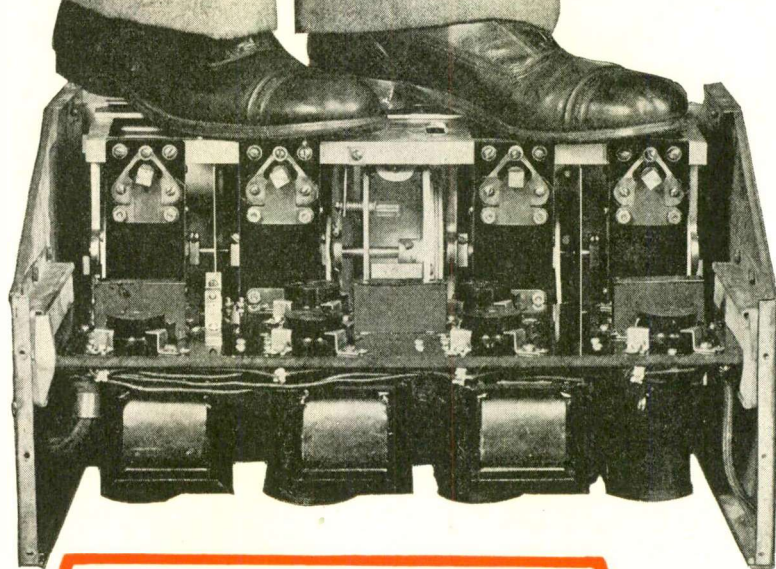

This sturdy chassis is housed in a metal box, keeping all dust and dirt away from the condensers.

This 203 pound man standing on the condenser chassis of a Kolster is pictured to emphasize the super-strength of Kolster construction.

Kolster Radio is built to stay in working order for years. Such design insures perfect alignment and permanent balance.

Every demonstration proves Kolster's superiority in performance. Every examination of its design and construction proves it will continue to give constant satisfaction to the customer.

In selling a Kolster, you're winning a friend—he'll recommend it to others.

Kolster Radio

“Triple Strength”

Dr. Kolster Insisted

“Now that the set is electrically correct, make it triply strong,” said Dr. Kolster.

See the tuning condensers and cradle of a Kolster Set—how sturdy: Note how strongly the stator plates are fastened.

There’s a quarter inch die cast aluminum support between each condenser.

There is one of many examples of Kolster fine engineering. Examine the Set for yourself—note its rigidity and permanence.

Of course your customers want a convincing demonstration. Kolster gives it—in addition it insures constant satisfaction.

Send for complete technical description of the Kolster line.

Fill in the coupon below for a demonstration. It costs you nothing.

If you can balance a golf ball on the eraser of your pencil, you will have achieved the perfect balance found in a Kolster Set.

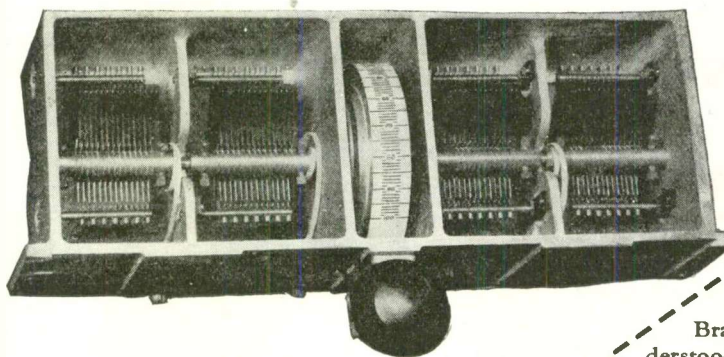

FEDERAL-BRANDES, INC.

Woolworth Bldg.
NEW YORK, N. Y.

Please arrange a Kolster-Brandes demonstration. It is understood that this does not obligate me.

Name.....

Street.....

City..... State.....

Brandes Speakers

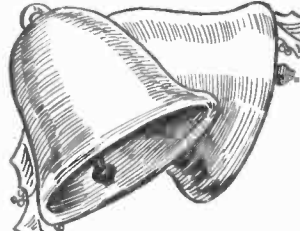

When Chimneys

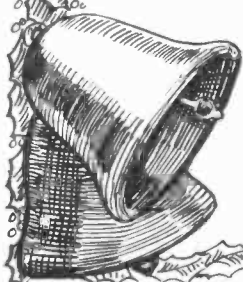
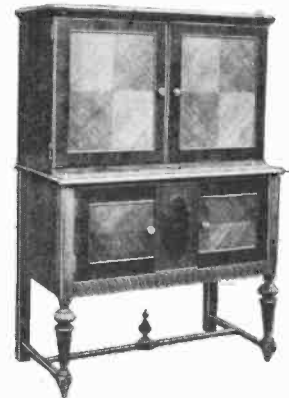
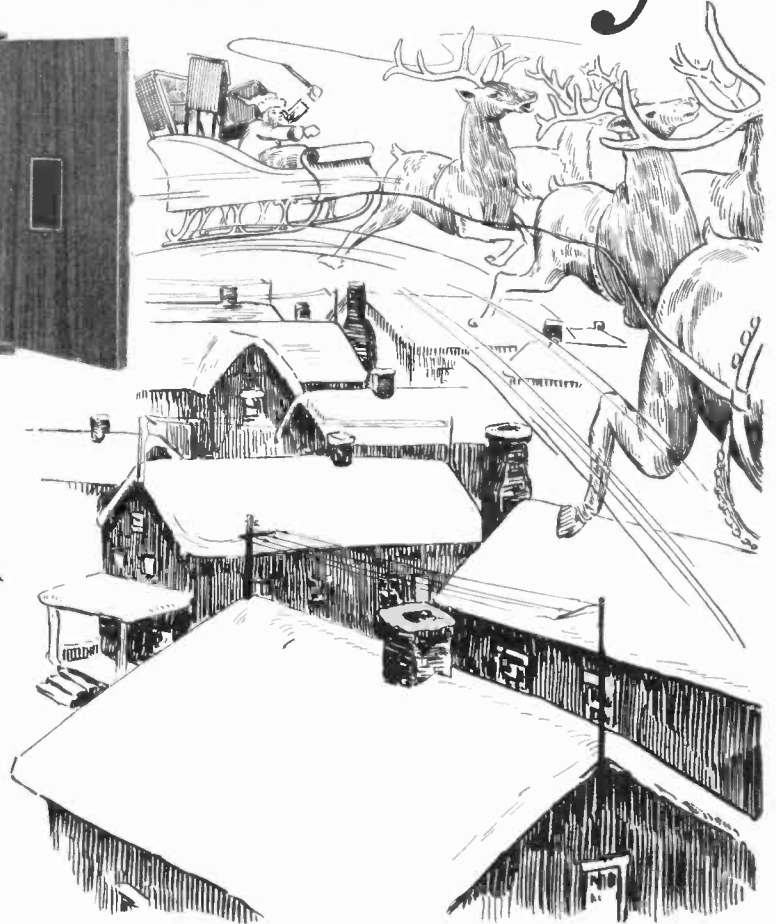
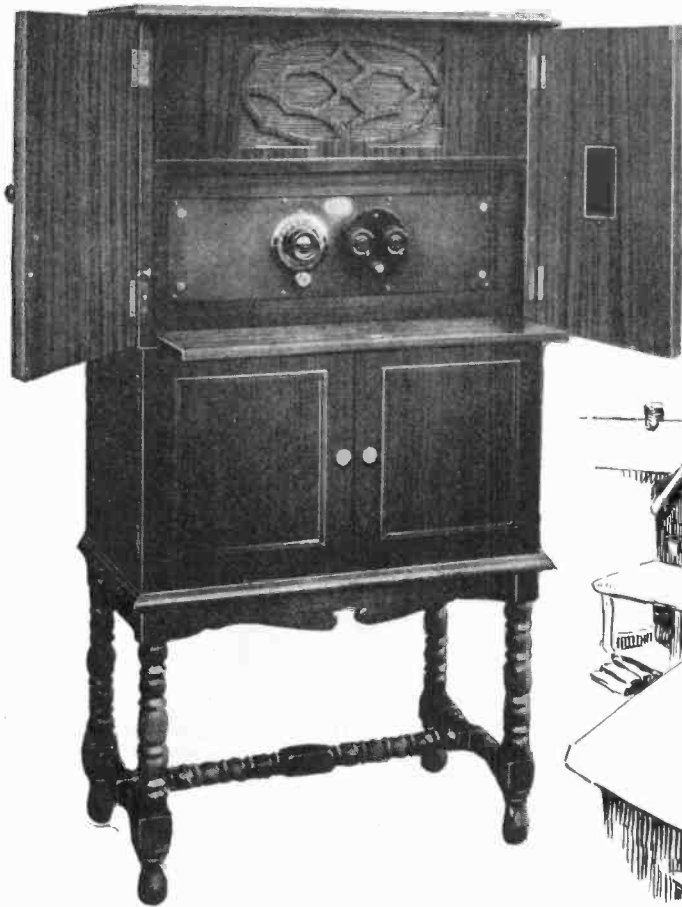

Radio Master Corpo
ONE OF THE WARD
BAY CITY,



Mean Profit



SANTA will soon be ready to make his annual journey from chimney to chimney, gladdening the hearts of young and old. He is even now looking around for things to put into his pack.

See that his pack contains lots of Radio Master Cabinets—they are splendid Christmas gifts, and very profitable to sell.

Fit any table set—installation is a matter of a few minutes. Install the customer's old set, or a new set—the field is enormous—a market without saturation—the time is ripe.

Eight beautiful models in walnut and mahogany. Some have striped walnut or burl overlays.

Pull out radio frame makes tubes easy to reach—disappearing arm rest—plenty of battery space below—wood horn above arranged to receive your favorite speaker unit—all wiring concealed.

Cabinet work of beauty and sturdiness that is not excelled anywhere.

Our settled dealer and jobber policy, moderate list prices, and liberal discounts make them a good proposition for permanent business.

Order plenty of these Cabinets for Christmas buyers—If you are not acquainted with our proposition, the coupon below will bring information.



ration of America

INDUSTRIES
MICHIGAN

RADIO MASTER CORP.
Bay City, Michigan

Please send me your proposition on Radio Master Cabinets.

Name _____

Address _____

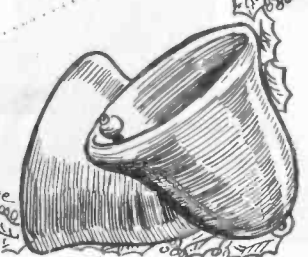

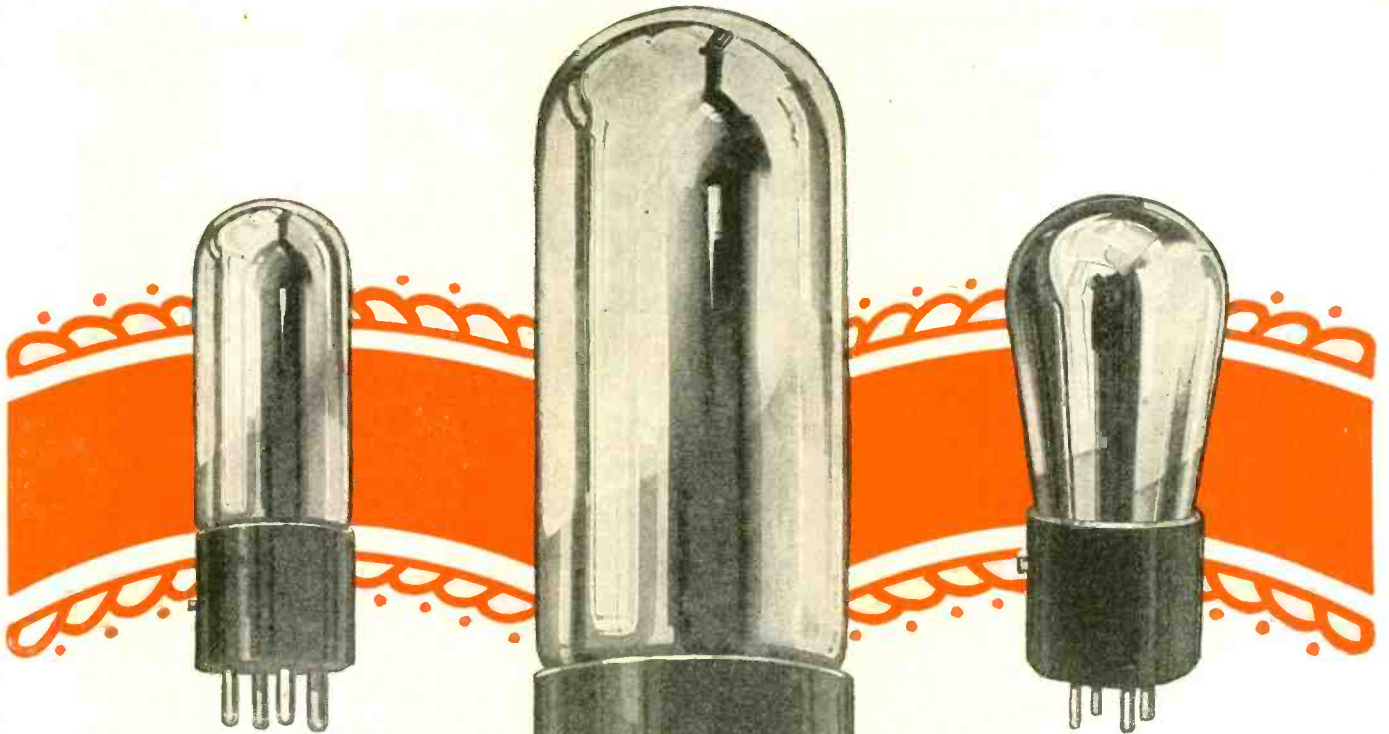

Sylvania
TUBES

Every dealer who sells Sylvania Radio Tubes gets these double barreled selling advantages—

1. Consistent advertising and complete dealer cooperation.
2. A quality tube that has created a new high standard in clear radio reception and is unconditionally guaranteed.

An unbeatable combination that means a steady turnover and profits to every Sylvania dealer.

Write for the Sylvania Proposition

**SYLVANIA PRODUCTS COMPANY
EMPORIUM, PENNA.**



At last you can be sure about tubes

So much of consumer satisfaction depends on tubes that it is hard to understand why some dealers are willing to send out radio sets equipped with any but the best.

The difficulty used to be that even a man in the radio business could not be sure

about tubes. There was nothing to go by. But now you can be in a position to give customers honest advice on tubes. For one of the leading electrical laboratories recently tested the best-known tubes on the market and compared them in various ways.

Win the friendship of your customers with these tube facts

The results of this comparative test have been included in a report. You will be amazed at the tube facts revealed. You will probably change your mind about more than one tube.

The report places URECO radio tubes above all others. But you cannot possibly appreciate the superiority of URECOs unless you read the entire report.

As a radio dealer, you should know all these tube facts as quickly as possible. We can let you have an exact copy of the report if you will fill out and mail the coupon below.

And we will be glad, also, to tell you at the same time about unusual helps furnished URECO dealers to promote the resale of URECO tubes.

*Fill out and mail
the coupon TODAY*

United Radio & Electric Corp.

418-420 Central Avenue

Newark, New Jersey

United Radio & Electric Corp.,
Newark, N. J.

Gentlemen:

I am interested in the comparative test given the best-known radio tubes in a leading electrical laboratory recently. Please, without obligation on my part, send me an exact copy of the report made by the laboratory on this test.

Name

Address

City State.....

THE NEW SHIELDED HAMMARLUND~ROBERTS HiQ* RECEIVER

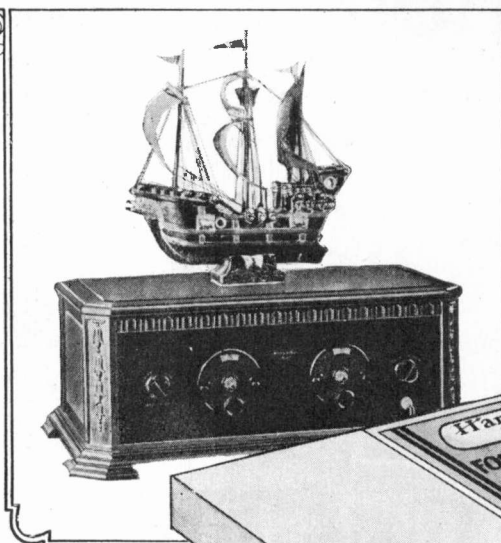

The Book That Sells the Idea!

Written by the Hammarlund-Roberts Board of Engineers. Interesting as fiction. Thoroughly practical. Complete in description, picture and diagram. And simple as A.B.C. It sells the idea. 25c.

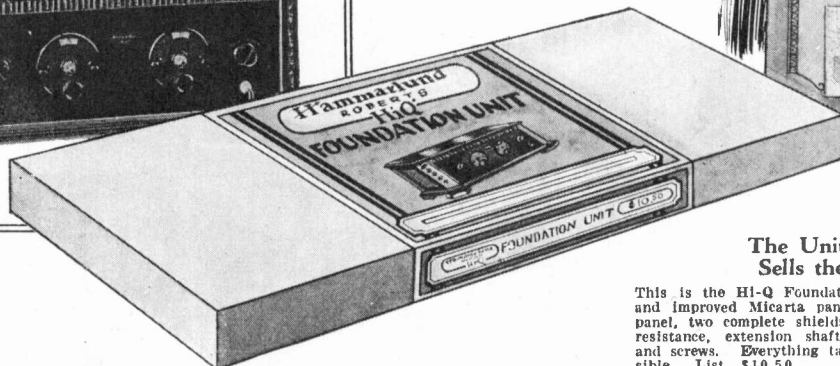
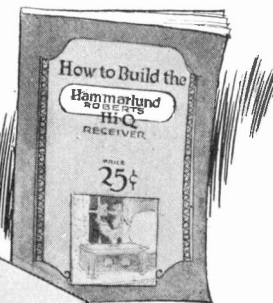

The Unit That Sells the Set!

This is the Hi-Q Foundation Unit. Has drilled and improved Micarta panel, drilled Micarta sub panel, two complete shields, two equalizers, fixed resistance, extension shaft, hardware, wire, nuts and screws. Everything tagged. Mistakes impossible. List, \$10.50.

This \$10.50 Unit Sold \$400,000 Worth of Parts Last Month!
[Biggest Months Yet to Come]

IT IS an accepted fact that the Hammarlund-Roberts Merchandising Plan has given the parts business the greatest stimulus in radio history.

Last month sales of parts for the New Hi-Q* Receiver totalled nearly \$400,000. Accessories sold to the extent of another \$300,000. Dealers have reordered many times!

Remember the New Hi-Q* is even better than the Hammarlund-Roberts of last year. A thoroughly modern receiver in every respect. Incorporates newest features. Keener selectivity, greater power, finer tone. Easy to build. The fullest value in its field to-day. Backed by powerful national advertising.

Start getting your share of these extra profits to-day. Don't forget that the biggest months are yet to come and the New Hi-Q* idea is just gathering headway. Write or telegraph your jobber to-day for a supply of "How to Build" books and a quantity of the Foundation Units.

All parts are standard. You should have them in stock. Each sale amounts to \$63.05. Accessories and cabinets extra. All EXTRA profits!

Hammarlund

BENJAMIN



MAR-CO

EBY

Samson

DURHAM

Carter



MICARTA

AMPERITE



*High Ratio of Reactance to Resistance. High Ratio—Great Selectivity—Loud Signals.

HAMMARLUND-ROBERTS, Inc., 1182-J Broadway, New York

Mass Production

methods and tremendous purchasing power brought to Amrad and applied to building Neutrodynes a year ago by Powel Crosley Jr. make available to the public a 5 tube Neutrodyne at \$60.

In this 5-tube battery type Neutrodyne at \$60 great engineering skill is manifest in the splendid performance of the set. Cabinet and trimmings are all any purchaser could ask—beautifully finished and appointed. Recessed dials behind windows and delicately adjusted vernier controls are distinctive features.



Model S-522



Cone Table

for table models S-522 and AC-5 with Crosley Musicone Built in. Ample room for batteries or power unit. \$32

—and a light socket operated Neutrodyne at \$150

This is Amrad's crowning achievement. A power unit, using a current direct from your light socket on wall or from table lamp furnishes A, B and C current direct to the 5-tube Neutrodyne pictured at the right. This power unit is pictured directly behind the set.

No batteries—nothing to charge. An entirely new development in power supply. Amazing Mershon Condensers contribute to its great efficiency and compactness. TESTED BY CONSTANT USE IN HOMES FOR OVER A YEAR. Price of receiver \$65. Price of power unit separately \$85.



Model AC-5

Add a Mershon Condenser to your B eliminator for super-B current supply

30 MFD DUOTYPE



Filtering out light socket current hum is but part of the job. Eliminators must have STORAGE capacity to prevent "chopping off" of loud or sustained notes. The Mershon Condenser acts as a reservoir and STORES energy for sudden heavy drains on plate current. Does the work of expensive storage battery electrically rather than chemically. B eliminator connected with this condenser gives the excellent tone reproduction of fresh B batteries.

Mershon Electric Condenser 15 mfd's capacity each half. 30 mfd's total capacity. Type D-15-30. Maximum rating 300 volts D.C. If punctured can be repaired and need not be thrown away.

\$8

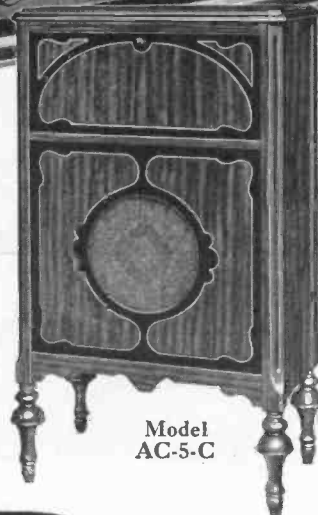

Model AC-5-C

Light Socket Operated 5 Tube Console

A beautiful cabinet in two-tone finished mahogany. Stands 40 inches high. Genuine Crosley Musicone built-in. Equipped with 5 tube battery type set \$110— with lamp socket set and power unit \$200.

AMRAD

NEUTRODYNES

AMRAD CORPORATION
Medford Hillside, Mass.
HAROLD J. POWER, Pres.

Write Dept. 8L6 for descriptive literature

Announcing Another

New and Improved
**FRESHMAN
MASTERPIECE**

*Console with Built-in
Cone Speaker!*



\$79⁵⁰

Model 6-F-16

Made of the Finest
**Genuine
Mahogany**

this Freshman Console contains the new Quality Freshman Masterpiece radio receiver.

A Large Cone Speaker is embedded in the center of the compartment immediately below the set—providing ample room for all accessories on either side. Sturdy and compact, this console measures 36 in. high and 31 in. wide.

Sold to Authorized
FRESHMAN Dealers Only

Write for complete information about the Freshman Franchise—the most valuable in radio.

CHAS. FRESHMAN CO., Inc.
FRESHMAN BLDG., New York
2626 W. Washington Blvd.
Chicago

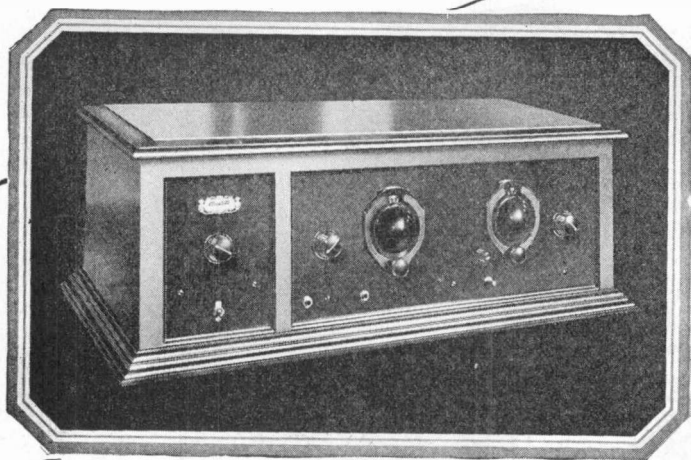

\$ 231

with 5 McCullough AC
Tubes and Rectron 213
without Loud Speaker

Clearartone LEADS THE WAY

FOR a long time dealers have awaited the coming of a radio set that would enable them to make sufficient profit on every sale. They have grown tired of transactions in which they *seem* to enjoy a fair margin only to lose it all in service costs. The solution to this great problem has arrived at last. And it is the new Clearartone Radio Electric Model 110, the first in the field, which does the trick.

The Clearartone Radio Electric Model 110, operates from the house current. It eliminates "A" and "B" Batteries and uses instead five of the famous McCullough AC Tubes. No fluids or acids. It sells for only \$231 including the five tubes and Rectron 213 (no loud speaker).

The Clearartone Radio Electric Model 110, considering all its advantages, is an unusually low-priced set and, therefore, especially attractive to the radio fan. Nevertheless, there is a good margin of profit to the dealer. And the elimination of battery service costs helps him to retain that profit.

This set is really a remarkable creation. The convenience of operation is obvious. The price can not be beaten. Add to this the exceptional tone quality and volume, the high class of workmanship which insures years of satisfactory service and you have a combination of advantages not found anywhere else today.

Write for full details and discounts.

THE CLEARARTONE RADIO COMPANY

2432 Gilbert Avenue
Cincinnati, Ohio

CLEARARTONE *Complete* RADIO SETS



Why Eveready Layerbilt is the most economical "B" battery ever built!

HERE, in the radically different Eveready Layerbilt, is the "B" battery which tops them all. Instead of the usual assembly of round cells, it is built of flat layers of current-producing materials. This construction, exclusive to Eveready, makes use of the spaces now wasted between the round type cells and avoids the usual soldered wires.

Test after test has proved that this battery is the most economical "B" battery ever built, and you can make that flat-footed statement to all your customers. Tell them that

on all loud speaker sets the Eveready Layerbilt will give twice the service of the smaller Light-Duty batteries. It is far and away the most

economical source of "B" power obtainable. It is also the most reliable and dependable. It delivers pure D. C. (pure direct current) which is essential to true tone reproduction. This is the best "B" battery we have ever built, and we firmly believe that it is the best "B" battery available on the market today. Order from your jobber.

Tuesday night means Eveready Hour — 9 P. M., Eastern Standard Time, through the following stations:

WEAF—New York	WTAM—Cleveland
WJAR—Providence	WWJ—Detroit
WEEI—Boston	WGN—Chicago
WTAG—Worcester	WOC—Davenport
WFI—Philadelphia	WCCO—Minneapolis
WGR—Buffalo	WCCO—St. Paul
WCAE—Pittsburgh	KSD—St. Louis
WSAI—Cincinnati	WRC—Washington

EVEREADY
Radio Batteries
—they sell faster

Manufactured and guaranteed by

NATIONAL CARBON CO., INC.
New York San Francisco
Atlanta Chicago Kansas City
Canadian National Carbon Co., Limited
Toronto, Ontario



Registered!

Licensed under the
Lektophone
patents

\$ 27.50

Slightly higher
west of the Rockies

EMPHATIC success has attended SANDAR, the new cone type speaker, ever since its arrival in the field of radio several months ago. Instant and widespread approval greeted its unparalleled receptive accuracy and tone-retaining ability, its downright good looks which enhance appearance of a set, and its surprisingly moderate price—\$27.50—lower than any other licensed speaker of its size! Fans everywhere are installing Sandar as their favorite speaker, dealers are naturally hustling to meet the demand, and the manufacturers are working at high pressure to keep ahead on production. Sandar spells profits in big red letters these busy days. There's still time for you to get aboard if you act promptly. Write us for terms and full information.

SANDAR CORPORATION

Crescent Plaza Building, Long Island City, New York



SANDAR SPEAKER

Radio keeps its "spot-light" on Bakelite

Bakelite is so universally used for radio sets, parts and accessories, that it is always in the "spot-light." Only a material of exceptional merit, of unfailing performance, could have become so firmly entrenched in the favor of both radio manufacturer and radio public.

Radio dealers can benefit through this high reputation of Bakelite, by making sure that the radio sets, parts and accessories that they sell are Bakelite insulated. They will find that radio equipment bearing the trade-mark "Bakelite" is more readily sold.

Write for Booklet 39

BAKELITE CORPORATION

247 Park Ave., New York, N. Y. Chicago Office: 636 W. 22nd St.
BAKELITE CORPORATION OF CANADA, LTD., 163 Dufferin St., Toronto

BAKELITE

THE MATERIAL OF  A THOUSAND USES

The registered Trade Mark and Symbol shown above may be used only on products made from materials manufactured by Bakelite Corporation. Under the capital 'B' is the numerical sign for infinity, or unlimited quantity. It symbolizes the infinite number of present and future uses of Bakelite Corporation's products.



REGD. U.S. PAT. OFF





and out comes
the lost bass,—
*Giving you that
Thousand Dollar
Tone ~ ~ ~*

AN Aero B Amplipower will make any standard radio set a real musical instrument. With a good loudspeaker, the Amplipower will bring out every note with its original clarity—rich mellow bass and shrill vibrant high notes, each true and clear.

The Amplipower supplies all of the "B" current for any type of set, and also operates a built in high voltage power tube which replaces the last audio tube of the set by merely inserting an adapter plug into this tube socket.

The Amplipower brings out every note with its true broadcasted value and furnishes a dependable lifetime "B" current supply as well. It is attached to any set in the same manner as B batteries, can be adjusted in a few minutes and improves tone quality to such an extent that a demonstration is almost invariably a sale.

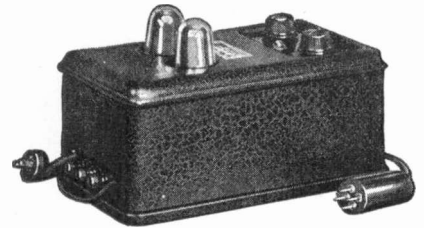

The Aero B Amplipower is a "B" power unit with a built in high voltage power tube which replaces the tube in the last audio stage of the set. Price \$65.00 without tubes.

Aero B is also built as a "B" power unit without the power tube—now reduced to \$35.00 complete (formerly \$50.00).

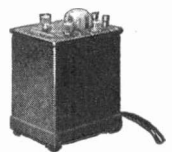

THE GLENN L. MARTIN COMPANY
Radio Division CLEVELAND, OHIO

AERO B
Amplipower
and "B" Power Units

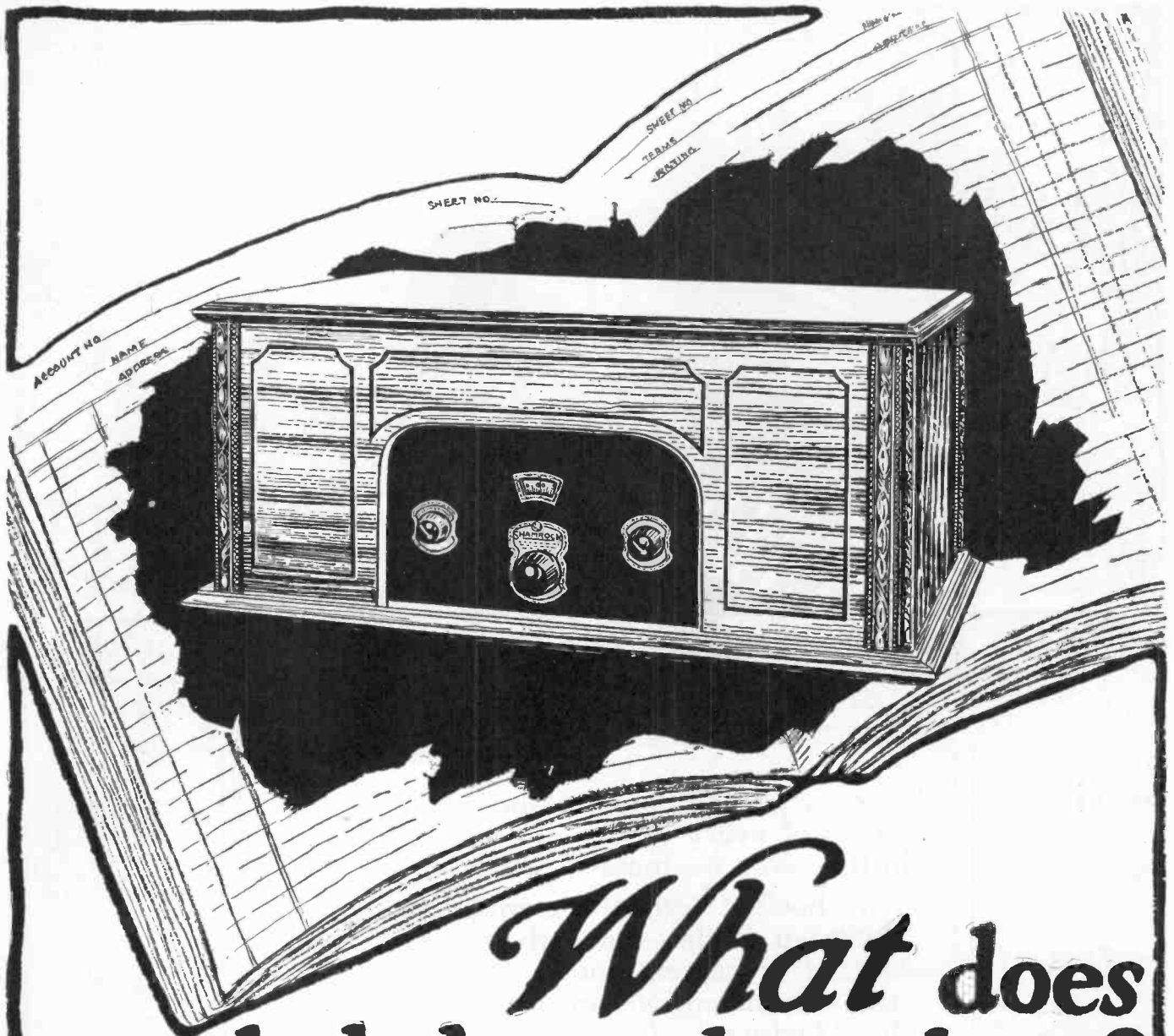

What does the balance-sheet show?

Are you just getting by, or are you in the red figure class? In either case Shamrock invites your inquiry because most Shamrock Dealers are in the other class—they make money!

They have every reason to. Shamrock is an attractive set that has eye-compelling features. It is selective and sensitive with a perfected one-dial control—it has volume and tonal qualities quite out-of-the-ordinary and it is priced reasonably. When it is sold it *stays* sold!

When a set possesses all of those features

sales are bound to result—it sells on merit alone. Coupled with the aggressive Shamrock advertising policy it is only reasonable to expect Dealers to show profits. And they do!

Write in for details if you would like to join the happy throng.

SHAMROCK

RADIO SETS

SHAMROCK RADIO COMPANY

Pioneers in building Perfected One Dial Sets

196 Waverly Avenue, Newark, N. J.

HARTMAN RADIO Perfectly Syntonized* HARTMAN RADIO Perfectly Syntonized* HARTMAN RADIO Perfectly Syntonized*

TMAN RADIO Perfectly Syntonized* HARTMAN RADIO Perfectly Syntonized* HARTMAN RADIO Perfectly Syntonized*

HARTMAN RADIO Perfectly Syntonized* HARTMAN RADIO Perfectly Syntonized*

TMAN RADIO Perfectly Syntonized* HARTMAN RADIO Perfectly Syntonized*



TMAN RADIO Perfectly Syntonized*

HARTMAN RADIO Perfectly Syntonized*

TMAN RADIO Perfectly Syntonized*

HARTMAN RADIO Perfectly Syntonized*

A copy of this booklet should be in the hands of every jobber and dealer who is in the radio business *to stay*.

This booklet tells the complete story of Hartman Radio—the only *perfectly syntonized** receiver made. It explains the two new inventions incorporated only in the Hartman. It outlines our unusual sales policy and gives our aims. It is the *complete story*.

Hartman Radio has set a new high standard in radio reception. *You* ought to know its story. Write for your copy of the booklet.

It is yours without obligation.

HARTMAN RADIO Perfectly Syntonized*

MAN RADIO Syntonized

HARTMAN RADIO Perfectly Syntonized*

HARTMAN RADIO Perfectly Syntonized*

SYNTONIZED

means "perfectly in step in tone," or perfect unison of operation in the receiver, freedom from distortion and oscillation, pure tonal quality, maximum volume and distance, regardless of wave length, with the ideal degree of selectivity for all conditions

The HARTMAN ELECTRICAL MFG. Co.

Mansfield, Ohio.

Coshocton, O.

Chatham, Ont.



VESTA

Quality
TUBES



X-201-A
\$2.00
LIST

You will find in Vesta Tubes a new idea of quality. Even though the tubes you have been handling may be good tubes, improvements have been so rapid in the Radio industry that new qualities present themselves to take the place of the old.

Vesta Tubes are several steps forward in quality construction. You have only to put a set of these tubes to the test to note their superior qualities.

They will practically eliminate the tube grief which you have had. They will win friends for you wherever sold. It is typical of Vesta quality so substantial for over 29 years.



199
\$2.25
LIST

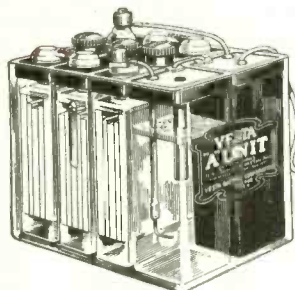

Vesta Light Socket
"A" Power Unit
2 Capacities: 25 amp., \$25 (List)
50 amp., \$27.50 (List)
Pacific Coast, add \$1.50



VESTA BATTERY CORPORATION
2100 INDIANA AVE. CHICAGO, ILL.

VESTA

AUTO-RADIO PRODUCTS

Vesta for Vitality

Makers of Vesta Automobile Batteries—Quality Products for Over 29 Years

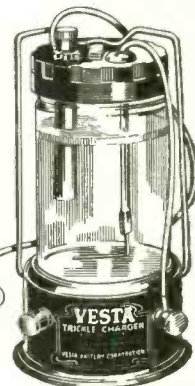

VESTA TRICKLE
CHARGER—A
Big Seller—List \$10
Pacific Coast \$10.50

WFKB

Tune in Vesta Broadcasting Station—WFKB—on 217.3 meters—Chicago—7:00 to 8 and 9 to 11:00 every weekday evening—EXCEPT MONDAY. Sundays 2:30 to 4:00 P.M. (Central Standard Time).

VESTA BATTERY CORP., 2100 Indiana Ave., Chicago, Ill.

Please have your Central Distributor near me present the

Vesta Radio Line Auto Battery Line

Name

Address

City State

R.R.

ATWATER KENT RADIO

Letting you in on the secret...

How is it that Atwater Kent ONE Dial Receiving Sets can bring in all broadcasting stations within range without the use of additional adjustments?

The answer is: *Care in manufacture.*

Almost any radio engineer can make a true ONE Dial set *in the laboratory.* But to keep the costs down by manufacturing in quantity—that is a different story.

The Atwater Kent factory, with its 159 tests, its painstaking workers, its automatic machines turning out parts accurate to one five-thousandth of an inch, has learned how to make a multitude of things with the same care that is bestowed on one.

And this—the secret of many a renowned product—is the secret of the success of Atwater Kent ONE Dial control.

EVERY SUNDAY EVENING:—The Atwater Kent Radio Hour brings you the stars of opera and concert, Radio's finest program. Hear it at 9:15 Eastern Time, 8:15 Central Time, through:

WEAF . . . New York	WTAM . . . Cleveland	WGN . . . Chicago
WJAR . . . Providence	WCCO . . . Mpls.-St. Paul	WGR . . . Buffalo
WEEI . . . Boston	WTAG . . . Worcester	WOC . . . Davenport
WRC . . . Washington	WCAE . . . Pittsburgh	KSD . . . St. Louis
WSAI . . . Cincinnati	WFI . . . Philadelphia	WWJ . . . Detroit

Write for illustrated booklet of Atwater Kent Radio

ATWATER KENT MANUFACTURING COMPANY

A. Atwater Kent, President

4733 WISSAHICKON AVENUE, PHILADELPHIA, PA.

Prices slightly higher from the Rockies west, and in Canada

MODEL 35, six-tube ONE Dial receiver, less tubes and batteries, but with battery cable attached, \$70. Model H Radio Speaker, brown crystalline finish, \$21. Model G, same as Model H, but in amber-buff and sage-green, \$23.



E. E. WHITEHORNE,
Contributing Editor
S. J. RYAN,
Merchandising Counsellor
L. E. MOFFATT,
Associate Editor
H. S. KNOWLTON, Boston
PAUL WOOTON, Washington

Radio Retailing

The Business Magazine of the Radio Industry

O. H. CALDWELL, Editor

WILLIAM C. ALLEY,
Acting Managing Editor
RAY V. SUTLIFFE,
Western Editor, Chicago
H. W. BAUKAT,
Technical Editor
WILLIAM McDONALD,
Assistant Editor
C. GRUNSKY, San Francisco

Table of Contents December, 1926

Frontispiece—"The Supreme Christmas Gift"	32
A Program for United Industry Action on Legislation	33
Radio Has a Dollars and Cents Value to the Farmer	34
The Present Status of Radio Legislation ..	37
Broadcast Situation Serious	40
Ideas that "Came in Fine" Last Christmas	43
"Avenues of Approach" in Selling Radio to Women	44
Radio Happenings Recorded by the Camera	47
What This Industry Needs	48
Planning for 1927	49
Specifications of Variable Condensers.....	52
Some Display Ideas for Christmas Windows	54
Your Editors Have This to Say—.....	56
For the Service Man	59
New Radio Products	64
What the Trade Is Talking About	72
News of Jobbers and Distributors.....	76
New Dealer Helps the Manufacturers Offer	78
Merchandising Radio Parts	81
Specifications of Knockdown Sets	87
Specifications of Rectifying Tubes.....	89

President Coolidge Interprets Advertising as the Life of Trade

Before the American Association of Advertising Agencies meeting at Washington in October, President Coolidge said:

WHEN we stop to consider the part which advertising plays in the modern life of production and trade we see that basically it is that of education. It informs its readers of the existence and nature of commodities by explaining the advantages to be derived from their use and creates for them a wider demand. It makes new thoughts, new desires, and new actions. By changing the attitude of mind it changes the material condition of the people.

SOMEWHERE I have seen ascribed to Abraham Lincoln the statement that "In this and like communities public sentiment is everything. With public sentiment nothing can fail; without it nothing can succeed; consequently he who molds public sentiment goes deeper than he who enacts statutes or pronounces decisions. He makes statutes and decisions possible or impossible to be executed."

ADVERTISING creates and changes this foundation of all popular action, public sentiment, or public opinion. It is the most potent influence in adopting and changing the habits and modes of life, affecting what we eat, what we wear, and the work and play of the whole nation. Formerly it was an axiom that competition was the life of trade. Under the methods of the present day it would seem to be more appropriate to say that *advertising* is the life of trade.

Member Audit Bureau of Circulations.

Circulation of This Issue, 30,000 Copies.

McGRAW-HILL PUBLISHING COMPANY, INC., Tenth Ave. at 36th St., New York, N. Y.

JAMES H. MCGRAW, President
JAMES H. MCGRAW, JR., Vice-Pres. and Treas.
MALCOLM MUIR, Vice-President
EDWARD J. MEBBEN, Vice-President
MASON BRITTON, Vice-President
EDGAR KOBAK, Vice-President
C. H. THOMPSON, Secretary

Electrical World Journal of Electricity Ingenieria Internacional
Industrial Engineer Engineering and Mining Journal
Chemical & Metallurgical Engineering American Machinist
Electrical Merchandising Power Electric Railway Journal
Bus Transportation Engineering News-Record
Coal Age Successful Methods
Copyright, 1926, by McGraw-Hill Publishing Company, Inc.
Cable Address: "Machinist, N. Y."
Annual subscription rate is \$2 in United States and Canada.

WASHINGTON, D. C., Colorado Bldg.
CHICAGO, 7 South Dearborn St.
PHILADELPHIA, 1600 Arch St.
CLEVELAND, Guardian Bldg.
ST. LOUIS, 713 Star Bldg.
SAN FRANCISCO, 883 Mission Street
LONDON, E. C., 8 Boulevard St.

"The Christmas Gift Supreme"

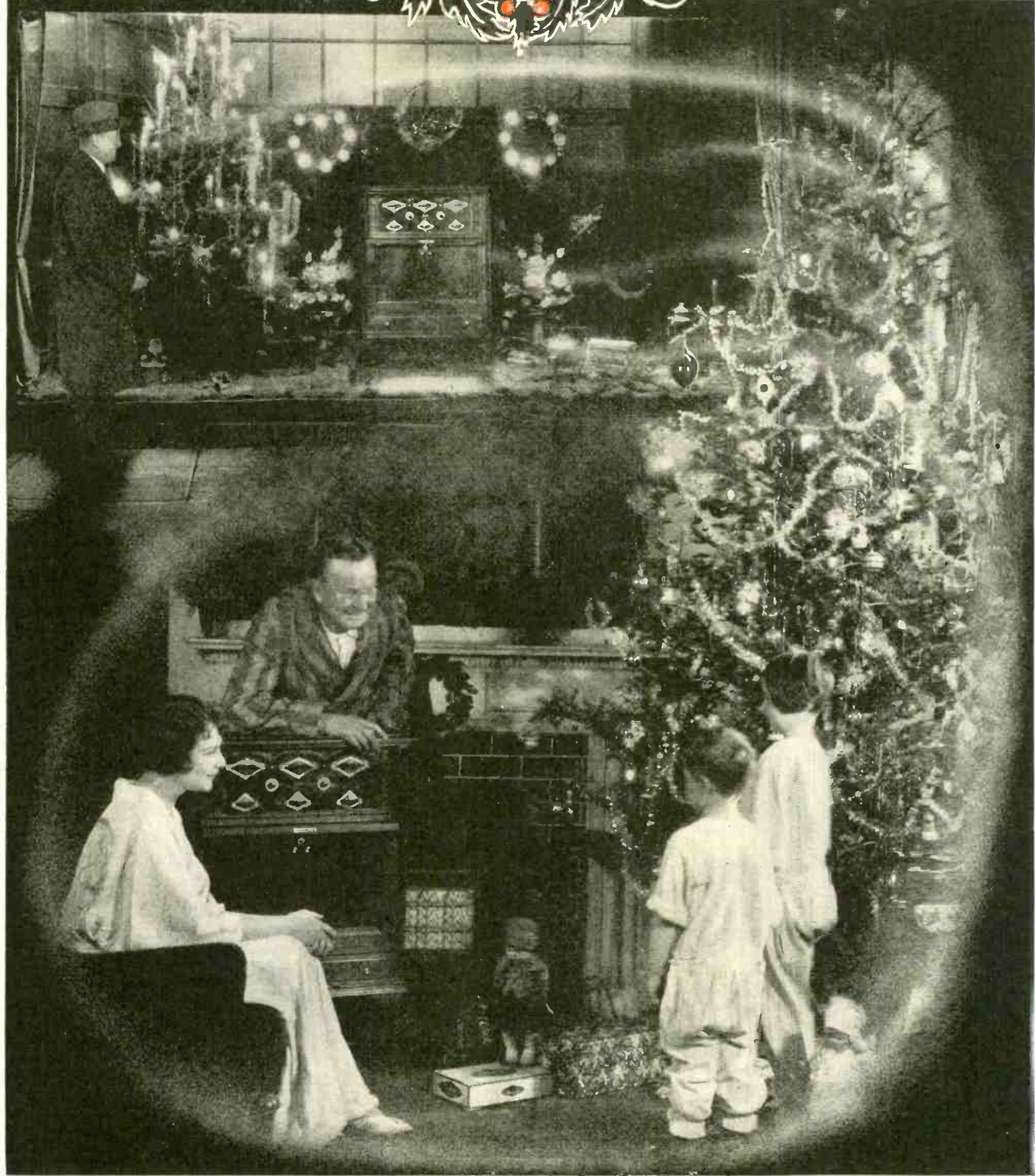

THROUGH window displays and every other means possible, get across the message that a radio set makes an ideal gift for the family.

Radio Retailing

With Which Is Incorporated *Electrical Retailing*

VOLUME 4

DECEMBER, 1926

NUMBER 6

The Present Radio Legislative Deadlock—and a Program for United Industry Effort

RADIO legislation today faces a deadlock—a triple deadlock. First: there is the deadlock between the two houses of Congress, the Senate having passed one bill, the House another, and each refusing to accept the other's radio legislative program.

Second: there is the deadlock between the authors of the two bills. These two gentlemen met for a conference late in November, and found themselves still "very far apart" in their views. The Congressional Conference Committee, of which they are both members, did not meet during November as planned, and will not meet until after Congress convenes, December 6.

Third: A deadlock has developed between the views of two sections of the radio industry itself. One group, viewing with alarm the increasing "ether chaos," is demanding radio legislation at once, even if not the best legislation from the standpoint of radio and radio listeners.

The other group, looking ahead, and knowing the difficulty of getting changes in laws once passed, urges that no radio law be passed at this time unless it be sound legislation, providing fully for the future of the radio art. This latter view has been somewhat strengthened by the WGN decision handed down in Chicago, Nov. 18, upholding the granting of an injunction against a station interfering with an older station, and so giving broadcasting stations protection in the use of their own wavelengths against interfering stations, under the common law.

BUT most serious in this situation of deadlocks, is the radio industry's own failure to arrive at a united position with respect to what legislation it wants. Two widely divergent points-of-view are now being presented to Congressmen and others at Washington, one set demanding legislative action, the other urging no action—until Washington in exasperation asks: "What does the radio industry really want? Does it know, itself, what it wants? Has it any united program?"

With Congressional opinion divided and deadlocked, as it now is, this lack of unity in the radio industry involves the serious danger that Congress, finding no industry program, may pass wholly inadequate, compromise legislation, "in order to be rid of the dern problem." On the other hand, a clear-cut legislative plan backed by the entire radio industry and trade right now would have the best possible chance of breaking the Congressional deadlock.

As a way out of the present situation, *Radio Retailing* offers the following compromise program, as meeting the practical and imminent necessities of the situation, as well as securing the demands of both sides.

FIRST: To keep ether conditions from getting any worse, and to simplify the problem of the future controlling authority, which will be faced with the necessity of shutting down stations above the number of 250 to 500, wiping out investments of \$25,000 to \$75,000 apiece, since 800 stations will shortly be operating—

Secure at once the passage of a joint resolution by Congress instructing the Secretary of Commerce to issue no more broadcast-station licenses until new legislation is passed.

SECOND: Effect in the Conference Committee a compromise embodying provisions from both the Dill Bill and the White Bill, as follows:

- a. Put full discretionary powers for the allocation of wavelength and the location of stations, in a Radio Commission, meeting part-time as needed, and instructed by law to give consideration to both public service rendered and priority of service, in the granting of licenses and the limiting of stations to the facilities of available wavebands.
- b. Put administration of licensing and station operation in the hands of the Secretary of Commerce, thus securing a continuing executive control of the situation, responsible to the Government.

THIRD: Draft into the proposed radio law provision for

- a. The right of radio men to be admitted to membership on the Radio Commission, under the same provisions as other part-time employees of Government departments.
- b. Control of non-radio electrical interferences not now provided for in either bill.

UNITED and immediate action is needed on the part of the radio industry. Absence of unity of opinion may result in the passage of mere politically-expedient radio laws, totally inadequate for the best interests of radio. A united industry program—either the above, or some other—has every chance of breaking the lawmakers' deadlock, and securing sooner or later, the really constructive legislation demanded by every radio man and every radio listener.

For present status of radio legislation; WGN decision, etc., see page 36

For results of nation-wide survey of ether-chaos conditions, see page 40

Radio Has a Dollars and Cents

Noted farm expert tells what radio has done for the farm owner and outlines three effective ways of reaching this vast class comprising nearly half the population of this country

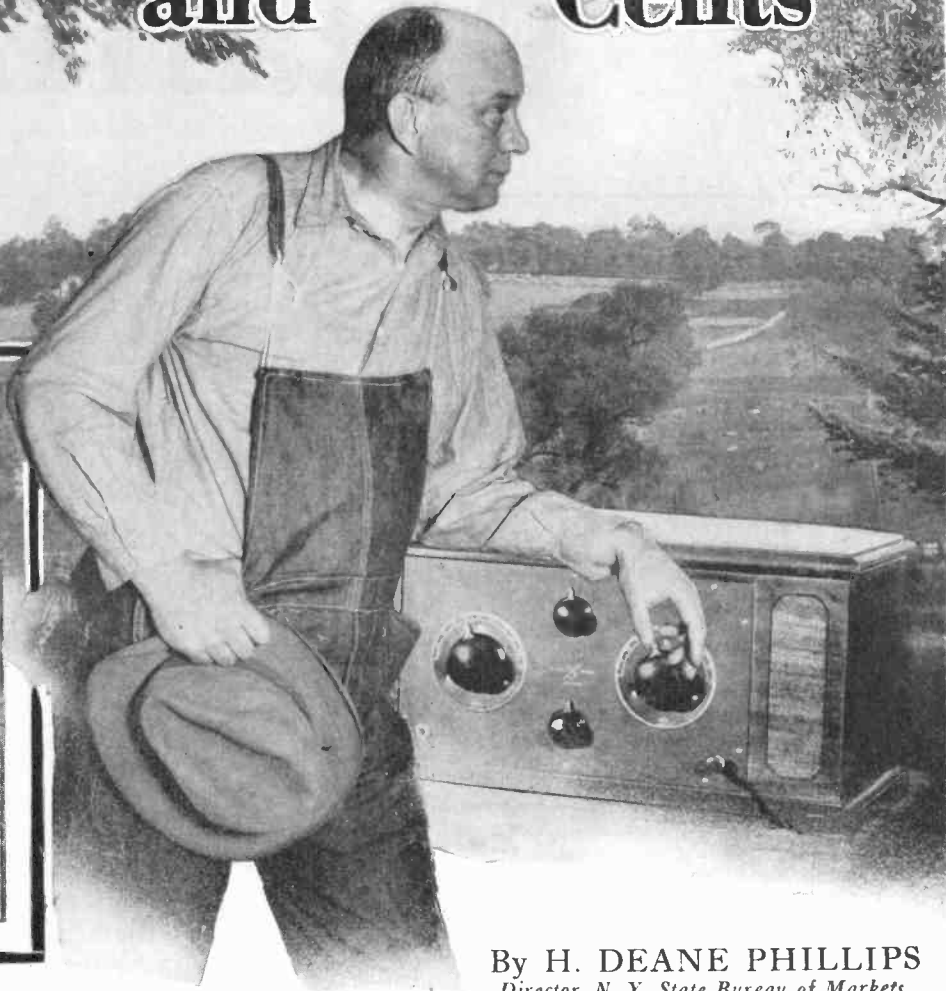

By H. DEANE PHILLIPS
Director, N. Y. State Bureau of Markets

CERTAINLY, the farmer, of all people, should have a radio set. To him the dealer can make the most effective of all sales talks, the combination of personal enjoyment with actual financial advantage. It seems odd to me that more dealers do not recognize this fact and that this great potential market for radio equipment is being so little cultivated by the average retailer.

Perhaps one reason for this is that few people concerned with the selling end of radio fully realize the extent of the broadcasting of weather reports, market news, and other features intended especially for farmers, which now goes on from the various stations or, if they are aware of its extent, they fail to realize of how great importance and practical value these reports are to the farmer.

The entertainment feature of radio, of course, has been welcomed

by enough people to result in one of the most rapid developments of any industry that we have ever seen. I wonder, however, if it is as well recognized by radio dealers as it should be that there is one great class of listeners to whom radio means most of all in the way of entertainment and education and who at the same time are practically the only group to whom it also means an actual money gain to have a radio set? I refer to the farmer—the class which makes up nearly half the population of the United States.

The one great practical use of radio so far developed, at least from the listener's standpoint, is the dissemination of weather reports and market reports on farm produce. In this respect, moreover, radio is superior to any other possible means of dissemination because of its speed, the need for which is evident

if this information is to be used to advantage by those who receive it.

Adequate knowledge of the markets and advance information on the weather mean money in the farmer's pocket—a great deal of money, in the aggregate. In addition, because they are more out of the world than town and city people, the educational and entertainment features of radio are a special boon to farmer folk and are appreciated by them to an extent not matched by any other group of radio listeners.

Reports Bring Farmer Money

Many instances of the actual use made of radio market and weather reports by farmers might be given. As my work takes me around our state of New York, I am continually running across new examples of how these reports have saved some farmer money.

Value to the Farmer

Yet He is a
Neglected
Prospect

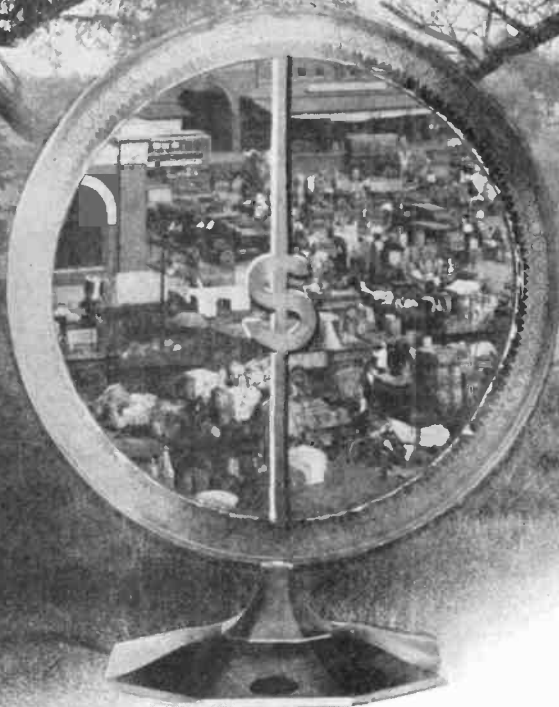

One such example is that of a cabbage grower whom I met early last December. He was especially happy over the price he had received for a car of cabbage—practically his entire crop. It seems that he had been planning to load and ship this car a few days earlier than he did, but decided to wait a bit when he heard in the weekly radio summary of the cabbage market, sent out from WGY, the statement that southern cabbage was coming to market very slowly and that unusually cold weather in Wisconsin was preventing shipments from that section. The light supplies caused a reaction in the market and the price jumped from \$23 to \$30 per ton. The grower made enough to pay for his radio set many times over.

Instances of this sort could be multiplied indefinitely. Many potato growers, for example, have told me that because of the special summary of the potato situation given by radio from WGY, Schenectady, N. Y., early last Fall they had decided to

MOST dealers realize the extent of the market for radio among the farm population, but are at a loss as to how to reach this vast field. In this article H. Deane Phillips, director of the New York State Bureau of Markets, tells what his experience has shown to be the best methods of interesting and selling the farmer.

hold their potatoes until late in the season. As a result, some of them were able to sell their crop at \$3 per bushel compared to the 90c. or \$1.00 they were offered at the start of the season.

Market Summaries Score Heavily

These special market summaries from WGY have undoubtedly scored heavily in the way of securing increased financial returns for some farmers; yet it is after all the daily market reports and the daily weather reports which in the aggregate ac-

count for the greatest savings which can be attributed to radio.

The examples of this sort which I run across are especially numerous. One such was that of a lettuce shipper, who on learning via radio that an unusual number of cars of lettuce had been started to market on one particular day, put his day's cutting into the local cold storage warehouse instead of shipping it. He thereby avoided one of the worst market gluts of the season, which made a difference to him of several hundred dollars in the returns received for his lettuce.

In this particular case it was not merely the completeness of the information which saved the lettuce grower from loss, but, especially, the speed in getting it to him which the radio made possible. No other means of disseminating market information is so effective in this respect and with the markets and the weather, speed is the vital thing.

And so it goes—radio has clearly opened a new era for the farmer. No longer need he be completely isolated and out of touch with current doings in the world, no longer need he sell his produce blindly and in the dark. Radio is the miracle worker which has completely changed the situation.

The farmer then is obviously one

of the best of all prospects for the sale of radio equipment. Furthermore, this rural field is so far almost untouched, for although there are already a great many radio sets owned by farmers, the actual owners are only a small percentage of those who are still potential buyers.

Ways to Reach Farmer

Now just a word as to how to reach these farmer prospects.

Window displays obviously do not help, because the farmer is not apt to see them or even if he does, he is apt to be timid about entering the store.

Newspaper advertising in city papers also is obviously not very effective, because most farmers do not read any city paper. Advertising in small country papers is better and that is already being used to some extent to sell radio equipment to farmers by mail.

Remember, the farmer is a confirmed mail-order buyer. This is the real tip for the local retailer who wishes to reach the surrounding farm territory. A little expenditure of postage stamps and printers' ink or typewriter ribbon and the use of a selected list of farmers' names which can readily be secured from the local farm bureau manager, will

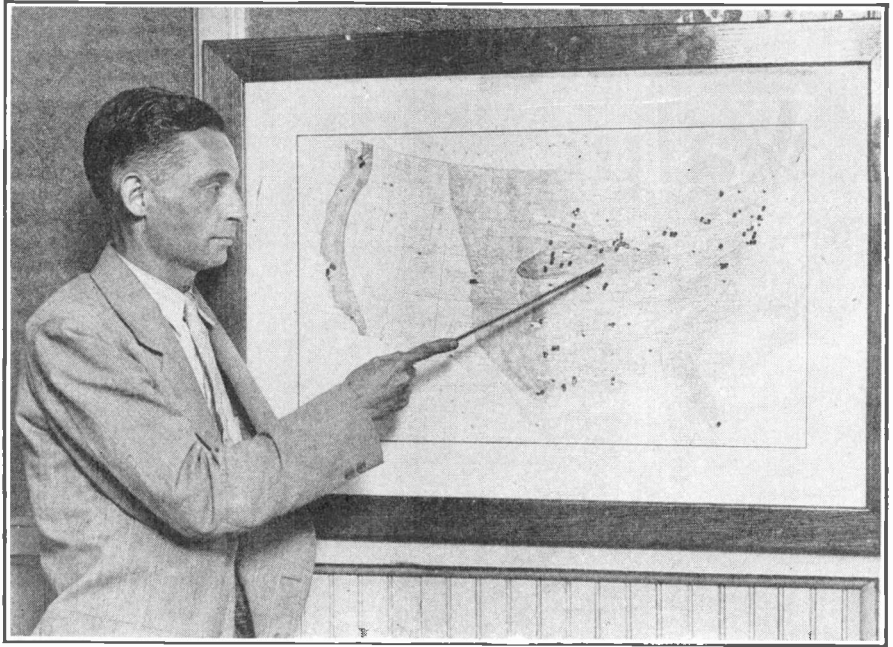

The U. S. Department of Agriculture conducts farm school on the air, using forty broadcasting stations throughout the country. In this photograph Sam Pickard, chief of Radio Service, is shown pointing out on a map the locations of these radio "schoolrooms."

bring in many farmer prospects to visit the store. Once there the selling is not so difficult because the possession of a radio set actually means more to the farmer than to any other prospect you can find.

Lastly the opportunity to attend farmers' meetings of one kind or another should not be overlooked. I personally have seen six sets sold at one such meeting where a demonstration was given, and they were not cheap sets either.

In conclusion it might be pointed out that service, the bugbear of present day retailing, is not such a problem in the case of the farmer as it might appear because of his distance from the store.

Farmer His Own "Trouble Shooter"

In the first place the farmer is by habit and necessity a pretty good all-round mechanic. He is used to being his own "trouble shooter" on many different kinds of farm machinery and his ingenuity has been developed by constant practice.

With adequate directions he is quite competent to go ahead and make his own installation with, perhaps, a little help over the telephone. Nor is he apt to pester a dealer afterward to fix his set when all he needs is a new tube or battery. He is the type which will discover this sort of trouble for himself.

All things considered, therefore, the farmer is a prospect well worth more attention than he is now receiving and the potential sales possibilities in the surrounding farm section are well worth the careful consideration of every live radio dealer.

Stations Broadcasting Farm Features

Following is a partial list of the 110 stations which are broadcasting the Department of Agriculture's farm features:

WAAM, Newark, N. J.; WWJ, Detroit, Mich.; WHAS, Louisville, Ky.; WLW, Cincinnati, Ohio; KFKX, Hastings, Nebr.; WKH, Cleveland, Ohio; WOC, Davenport, Iowa; KSL, Salt Lake City, Utah; WHEC, Rochester, N. Y.; KFAU, Boise, Idaho; KFDY, Brookings, So. Dak.; KOB, State College, N. M.; KQW, San Jose, Calif.; KTHS, Hot Springs, Ark.; WBAP, Fort Worth, Tex.

WCCO, Minneapolis, Minn.; WDAY, Fargo, No. Dak.; WHB, Kansas City, Mo.; WLBL, Stevens Point, Wis.; WOS, Jefferson City, Mo.; WRVA, Richmond, Virginia; WGAL, Lancaster, Pa.; KTCL, Seattle, Wash.; WMAK, Buffalo, N. Y.; KHQ, Spokane, Wash.; WOAN, Lawrenceburg, Tenn.; WAPI, Auburn, Ala.; WRC, Washing-

ton, D. C.; WSB, Atlanta, Ga.; WCSH, Portland, Me.

WEAO, Columbus, Ohio; WKAR, East Lansing, Mich.; KWCR, Cedar Rapids, Iowa; KOIL, Council Bluffs, Iowa; WHO, Des Moines, Iowa; KMA, Shenandoah, Iowa; KOA, Denver, Colo.; KFBB, Havre, Mont.; KFXF, Colo. Springs, Colo.; KWWG, Brownsville, Tex.; WLS, Chicago; WMC, Memphis, Tenn.; KFOA, Seattle, Wash.; KOAC, Corvallis, Ore.; KPO, San Francisco, Cal.; WDAF, Kansas City, Mo.

WDBO, Winter Park, Fla.; WGBS, New York City; WHK, Cleveland, Ohio; WAMD, Minneapolis, Minn.; KFJF, Okla. City, Okla.; WBAK, Harrisburg, Pa.; WBAW, Nashville, Tenn.; WCAD, Canton, N. Y.; WEBH, Chicago; WENR, Chicago; WFI, Philadelphia; WGR, Buffalo; WMAC, Cazenovia, N. Y.; WOAX, Trenton, N. J.; WSMB, New Orleans; WTAM, Cleveland; WMCA, New York City; and KSO, Clarinda, Iowa.

The Status and Prospects of Radio Legislation

*Congress conference committee holds no meetings until Dec. 6.
The WGN decision at Chicago. Radio Co-ordinating
Committee adopts "priority" recommendation*

OWING to the death of one of its members, Senator Cummings, no meeting of the Congressional Conference Committee on Radio Legislation was held at Washington during November, although it had been hoped and planned that at such a meeting, convened in advance of Congress, the committee might effect a compromise between the White and Dill bills, and be ready to go before Congress with a recommended program of action that might be accepted by both houses. The nearest thing to such a conference, up to the time *Radio Retailing* went to press was a meeting between the authors of the two bills, Senator Dill and Representative White. While both authors manifest a broad and open-minded view of the situation, they found themselves as a result of their meeting, still widely apart, so far as arriving at any compromise legislation with the principles on which both can agree.

The first meeting of the Conference Committee will be held following the convening of Congress, Monday, December 6.

Radio Control by a General "Communications Commission"?

In certain quarters in the Senate, there is growing a demand to put the control of *all means of interstate communication*, in the hands of a Federal Communications Commission, transferring to this commission regulation of both telephone and

telegraph lines now imposed on the Interstate Commerce Commission. The last-named body would then become primarily a transportation commission, with the new Communications Commission exercising control over all means of transmitting intelligence, including wire lines, telephone and telegraph, and radio.

In supporting the Dill Bill plan of a full-time commission of five members at \$10,000 a year, many members of the Senate have in mind really creating a future Communications Commission, to whose responsibilities control of wire lines can afterward be added. These Senators see the proposed Radio Commission as a nucleus for the working out of

this future Communications Commission plan, and are therefore committed to the full-time commission idea, well beyond any mere considerations of radio itself.

Since the Conference Committee under the rules of Congress cannot inject "new legislation" into its recommendations, there is little chance of a full Communications-Commission plan being worked out at this session, but it will undoubtedly be attempted later.

Meanwhile there has developed within the radio industry itself, a sharp difference of opinion as to whether radio legislation is wanted at the present time and under present conditions. With interfer-

790 Broadcast Stations in Sight, Right Now!

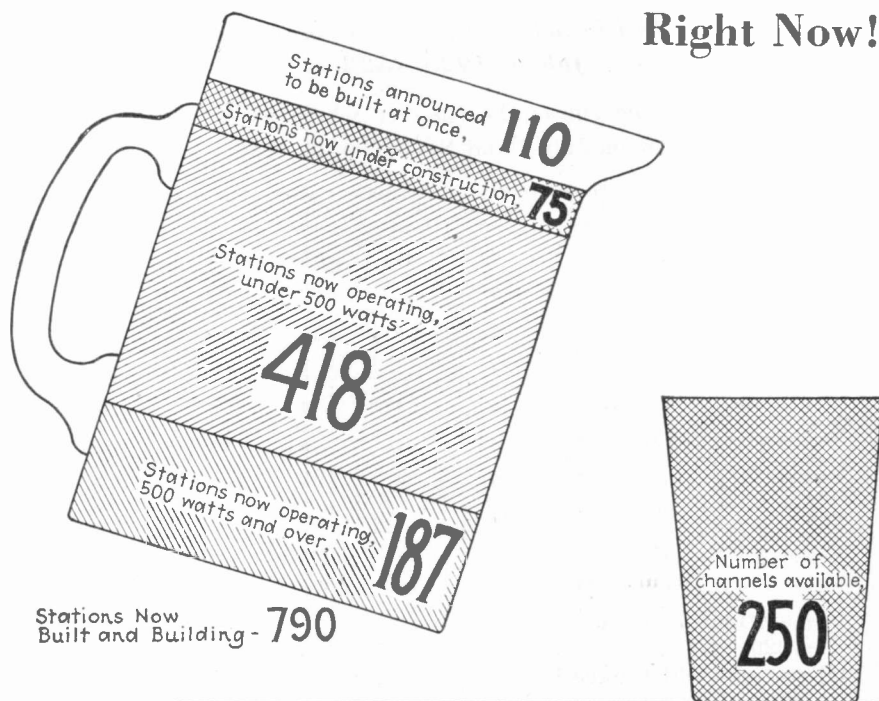

This diagram pictures the broadcast-station situation today. The output of all these stations—now built and building—will have to be poured through 89 wave bands. Allowing for simultaneous operation of geographically-separated stations below 500 watts, not over 250 stations can broadcast at the same time without interference. Hence, if the good stations are not to have their time seriously cut down, hundreds of present stations will have to be told to "get off the air," involving cancelling of investments of \$25,000 to \$75,000 per station.

To keep the situation from becoming any worse than it now is, *Radio Retailing* urges the immediate passage of a resolution by Congress directing the Secretary of Commerce to issue no more licenses until the passage of fundamental radio legislation later.

How can they be poured into 89 wavelengths without splitting up the time of "good stations" which the public wants to hear?

ence and heterodyning increasing, and reports coming in of "ether chaos" in various parts of the country (See *Radio Retailing's* telegraphic survey of ether conditions for the whole country, page 40), one group is vociferously demanding relief at once, through the passage of Federal laws, without particular concern as to the provisions of those laws. "Give us any kind of a law, but give it to us at once," is their motto.

Another group, more conservatively-minded, is disposed to look carefully into the laws now before Congress, and seriously questions whether out of the present bills there can be effected a compromise measure that will serve the best interest of radio. "Better no legislation at this time, than bad legislation" is the way they sum up their position.

"We expect to be in radio a long time, and we do not want to see short-sighted and insufficient laws passed, which will put a burden on the development of this wonderful new art," they explain. "Laws once on the statute books are hard to amend or change. We can get along for the present without any law

covering interference, other than the basic common law, the application of which to radio wavelengths is now sustained in the WGN decision at Chicago. This decision considerably strengthens the position of existing broadcasters, protecting their rights to their wavebands, without any special radio legislation."

WGN Decision Upholds Priority of Use of Wavelength

The decision by Judge Francis S. Wilson of Chicago, handed down on Nov. 18, may have a profound influence on the rights of broadcasters to protect themselves from later interfering stations, by securing in-

junctions under the common law of the land. The suit was brought by the Chicago *Tribune* Company, operating stations WGN and WLIB, against the Oak Leaves station, owned by the Coyne Electrical School and J. L. Guyon, dance-hall proprietor.

This decision, which has been awaited with keen interest by radio broadcasters and lawyers all over the country, enjoins the Oak Leaves station from broadcasting over a wavelength sufficiently near to the *Tribune* stations to interfere with programs. A motion to dissolve the temporary restraining order was denied, and pending appeal and the hearing of the permanent injunction case, the court stated that a distance of fifty kilocycles in frequency from the wavelength of the *Tribune* stations safely might be used by the Oak Leaves station, and that if they came any closer it would be at the risk of the defense in the cause before the court.

New Principle Set Up

The new principle set up here is that priority of time in the use of certain wavelength in broadcasting, the building of property on this basis, and the education of the receiving public to it, creates a superiority of right in that particular part of the ether.

"We are of the opinion," wrote Judge Wilson, "that under the circumstances in this case priority of time creates a superiority of right, and the fact of priority having been conceded by the answer it would seem to this court that it would be only just that the situation should be preserved in the status in which it was prior to the time that the defendants undertook to operate over or near the wavelength of the complainant.

"It is difficult to determine at this time how a radio station should be properly run, but it is also true that the science of broadcasting and receiving is being subject every day to change and it is possible that within a short time this may be accomplished, although it is the opinion of the court from an examination of the affidavits and exhibits in the case that 40 kilo-

**Board Jurisdiction With Department Administration
—Secretary Hoover's View**

"I have said consistently for the last four or five years that the location of stations and the allocation of wavelengths should not be in the control of any one man, that it should be in the hands of a board, but that once such stations are established and wavelengths allocated, the administration of the law should be vested in the Department of Commerce. On that I stand now. That is my view of the matter briefly."

No Wonder the Air is Cluttered!

*Number of broadcasting stations in operation
July 1, 1926—528*

The following table shows the changes which have taken place between July 1 and November 22, 1926

District	New Stations	Changed Location	Changed Power	Changed Wave-length	Under Construction	Preparing Power Increase	Plans Indefinite
First Boston.....	8	1	4	10	6	..	6
Second New York.....	15	2	7	10	2	11	20
Third Baltimore.....	..	1	2	4	..	5	..
Fourth Atlanta.....	7	..	5	3	..
Fifth New Orleans....	11	1	6	4	10	11	12
Sixth San Francisco...	3	8	4	15	6	..	7
Seventh Seattle.....	12	3	9	9	6	3	11
Eighth Detroit.....	9	6	11	4	3	1	36
Ninth Chicago.....	27	6	26	24	32	16	18
Total.....	85	28	76	80	70	50	110

New stations licensed to use 500 watts or over since July 1, 1926..... 17

Old stations which have increased power to 500 watts or over since July 1..... 13

Total increased power 30

Total stations, November 22, 1926—613

cycles is not at this time recognized as a safe limitation for the prevention of interference between stations located in the same locality."

Members of "Radio Co-ordinating Committee" Issue Statement

On Nov. 19, a meeting of all except one member of the National Radio Co-ordinating Committee was held at the Hotel Washington, Washington, D. C., to discuss radio legislative policies. This committee, although designed to be the central mouthpiece of the radio industry on radio legislative matters, is headed by a Chicago newspaper man as chairman, Walter A. Strong, of the Chicago *Daily News*.

Other members of the Co-ordinating Committee present and signing the statement below, were: Paul B. Klugh, executive chairman, National Association of Broadcasters; A. T. Haugh, president, Radio Manufacturers Association; R. W. DeMott, president, Radio Magazine Publishers Association; Charles H. Stewart, vice-president American Radio Relay League; and Harold W. Wrape, pres-

ident, Federated Radio Trade Association. The statement reads:

Radio legislation which will establish Federal control over broadcasting is highly essential. If it is impossible to secure the enactment of permanent legislation in the immediate future, Congress should pass an emergency measure which will prevent further confusion in the ether.

In the enactment of legislation it is the recommendation of the Committee that whatever authority is placed over broadcasting should be required to make determination of who shall broadcast by giving consideration to the length of time stations have operated; the character of service rendered by them, and the requirements of their States and communities for radio service. This principle is not intended in any way to create a vested right as against the United States, but asserts that there is a distinction between vested rights and the rights of individuals against each other.

The Co-ordinating Committee of the Radio industry is not taking the part of proponents of either bill, but instead is insistent that the bills be regarded from the standpoint of public service, which in the final analysis will redound to the greatest benefit not only of the public but to the manufacturer, dealer and broadcaster.

It is the belief of the Committee that the administration of radio can be adequately handled by either the Department of Commerce or a separate radio Commission. The determination of which authority shall administer radio is exclusively a matter for Congress; a compromise of the proposed methods may offer the most satisfactory solution.

Pending the time that Congress meets and is able to give consideration to radio legislation, the Co-ordinating Committee urges broadcasters who had been rendering effective service to the radio public prior to the breakdown of authority, to protect their interests, and hence the interests of the public, by recourse to State courts in the event of interference from stations in the same locality where the conditions are identical or favorable.

Chicago Decision Expected to Check Further Interference

The decision of the Chicago courts in the case of WGN vs. WGES sheds a ray of hope. The local court held that a separation of 50 kilocycles is necessary between stations in the same community. Confirmation of the Chicago decision in other State courts will do much to check the invasions of the

(Please turn to Page 58)

A Lot of Broadcasters Will Have to "Get Off" Before Those Left Can Get Anywhere

On What Basis Will Selection Be Made?

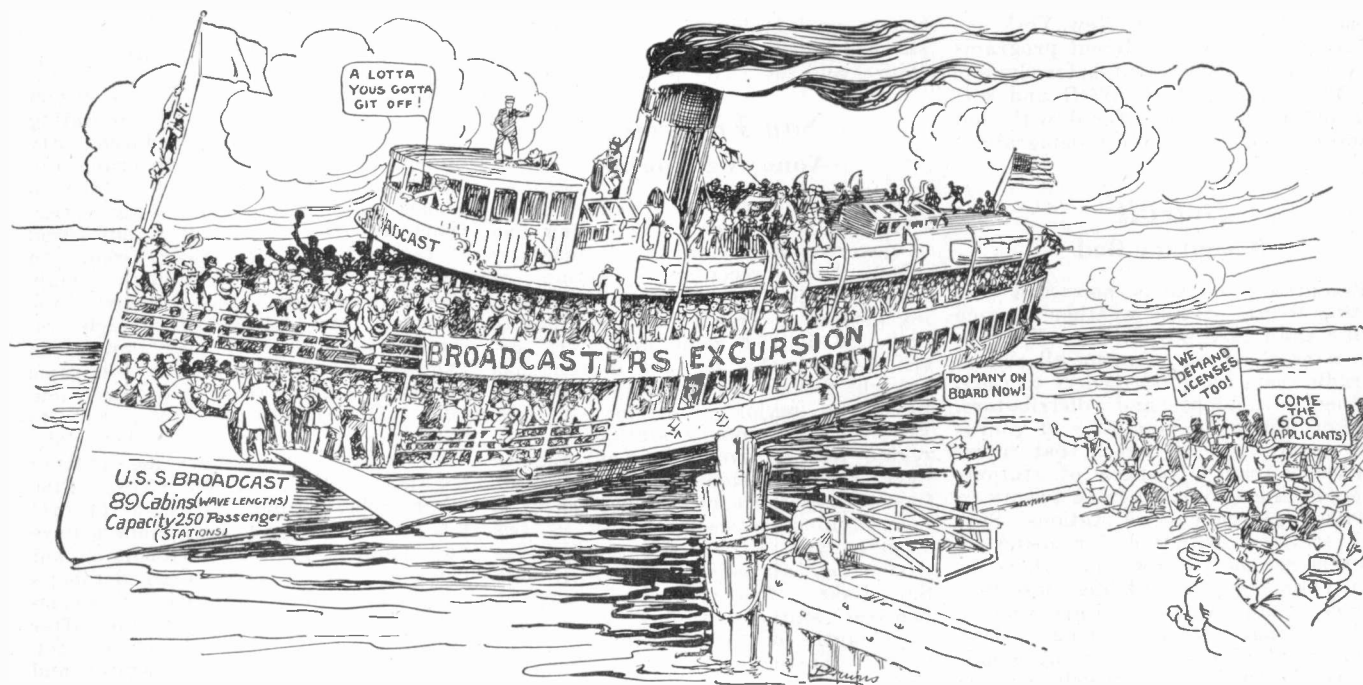

With 790 broadcasting stations now built or building, it is clear that a large number of broadcasters will have to be ordered "off the air" by the supervising authority, if good reception by the listening public is to result.

On what basis can this selection of stations be made? Tastes differ on program values. Who can say what class of program renders the greatest "service to the public"? Technical excellence of station equipment alone is not an adequate criterion.

The only definite measuring-stick left to guide the supervising authority in ordering stations to close up, is length and character of past service to the public. However inequitable the application of this priority rule may seem in special cases, it remains as the only definite basis on which selection can be made without endless litigation and argument. Hence *Radio Retailing* urges consideration of "priority" as well as good service, in determining who shall be ordered to shut down.

Radio Retailing's Representatives Report

"Ether Confusion" Is Widespread

All sections of the country encounter heterodyning and station interference. Trade demands Congress limit number of broadcasters

New York **Interference General**

Broadcasting situation rapidly nearing crucial point in New York and vicinity. Appearance, below 400 meters, of many new stations using low power prevents satisfactory reception of old standbys broadcasting worth while programs. Several poorly equipped stations have increased power, blanketing dials of local receivers. Heterodyne whistles and inter-station interference particularly noticeable in Brooklyn and Long Island where new small stations are causing considerable disturbance. Condition, prevalent for month, though not yet seriously affecting retail sales, is causing concern in trade. Unless clarified business depression is inevitable. Dealers report difficulty in making satisfactory demonstrations. Public, long skeptical but gradually being convinced of radio's practical value, in danger of being again lost as prospects. Old customers insistent that dealers get together and bend efforts toward elimination of 50 per cent of stations. Clearly seen that most new "ether busters" have poor modulation, worse talent and operate to detriment of established broadcasters. At most, New York has 8 stations from which decent programs may be received without heterodyning. WNYC, WEAJ, WJZ, WOR and several other seldom interfered with, but situation below 380 meters deplorable.

Detroit **Reception Bad**

Reception conditions here bad and getting worse. While weather is much better than last season, actual reception is much worse. Among all classes of radio men, from set owners to radio engineers, dealers and distributors, opinions differ as to degree of confusion in air, but all agree that interference is bad. Number of stations heterodyning estimated from twenty to sixty-five per cent of all stations. Several stations criticized for using so much power as to drown out others on nearby wavelengths. Fading more pronounced than formerly. Impossible to hold Chicago stations long. Distributors of high price sets say condition is affecting sales seriously, as it is impossible to escape heterodyning and confusion, even with best. Big dealers who carry variety of sets also having trouble, characterized as noisy reception. Dealers report taking back many sets they sell because they cannot give customers satisfactory recep-

tion. Service calls have also increased greatly because of this noisy reception. Consensus is that condition is hurting business already and will shortly become serious unless corrected.

Atlanta **Interference Widespread**

Reception throughout the entire southern territory reported considerably improved since Oct. 15 in increased volume and lack of static. Confusion below three hundred sixty and above four hundred forty meters is prevalent and makes receiving at these points practically impossible except on the most selective instrument available which does not clarify the situation to a satisfactory degree on test. Under best conditions actual number of stations received three hours operating time was thirty-six, only nine of which came in without being heterodyned. Receiver used eight tube superheterodyne on loop. Many of larger stations heterodyned each other especially above four hundred fifty-five meters. Considerable interference also around 300 meters. Interest in radio in the south waning on account of confusion and inability to separate the stations except with high priced machines, and then only to a fair extent.

San Francisco **Annoying Conflict**

Reception fair on Pacific Coast. Changes in wavelength following end of government control do not seriously affect local reception. Action of Pacific Radio Trade Association in asking pledges of broadcasting stations to abide by district radio inspectors' decision when changes are desired has brought pledges from all important stations and majority of smaller ones. However three minor stations in bay region and as many in Los Angeles have adopted wavelengths which interfere with distance reception. Result is heterodyning between station in Los Angeles and KGO; also conflict between bay stations and Seattle and Salt Lake. Twenty-five per cent of midwest stations conflict with local wavelengths on set of average sensitivity. Eastern stations conflict but situation better because of three-hour time difference. San Jose station KQW broke agreement for silence between seven-thirty and eight. Dealers who sell on local programs content with situation, but general feeling that action should be taken to clear distance reception.

Minneapolis **Reception Very Poor**

Radio reception conditions in Northwest territory very poor from standpoint of heterodyning by stations in other territories. From standpoint of normal interference, static and fading we are enjoying best period in two years. Plenty of stations any place in country can be picked up, but practically all are heterodyned by other stations on approximately same wavelength. Only two or three stations with which no other stations are interfering. Illustration, WCCO at Minneapolis operating on 417 meters is overlapped by WCRW, Chicago, WBBR, Rossville, New York, and KGDI, Seattle, on approximately same wavelength. Every day sees new stations coming on air and old stations changing wavelengths. Special programs from number of large Eastern stations valueless as majority of prominent stations have others interfering with them. Few listeners can pick desired programs with certainty.

New Orleans **Serious Confusion**

Radio men and retailers here report heterodyne squeals on all broadcasting stations up to three hundred fifty meters, at times making programs unintelligible. This condition is true on almost all occasions; the only exceptions are the super-power and local stations which generally come in clearly through interference. Only two super-power stations below three hundred fifty meters are clearly received here. Sales for first ten months this year less than for same period in 1925, according to three jobbers. One jobber attributes this to new models reaching market late. Two others say retailers are putting too much effort on trade-ins. Five other jobbers report increases for first ten months of year. All jobbers have had trouble getting accessories, but November sales larger than October's and largest sales expected for December. No one looks for slump after holidays. Conditions of cotton crop may affect buying late in winter and spring. Percentage of sales in country better than in city. New Orleans market signally free from price-cutting. A radio trades association was formed in November by jobbers and retailers to encourage good merchandising practices and to secure greater co-operation.

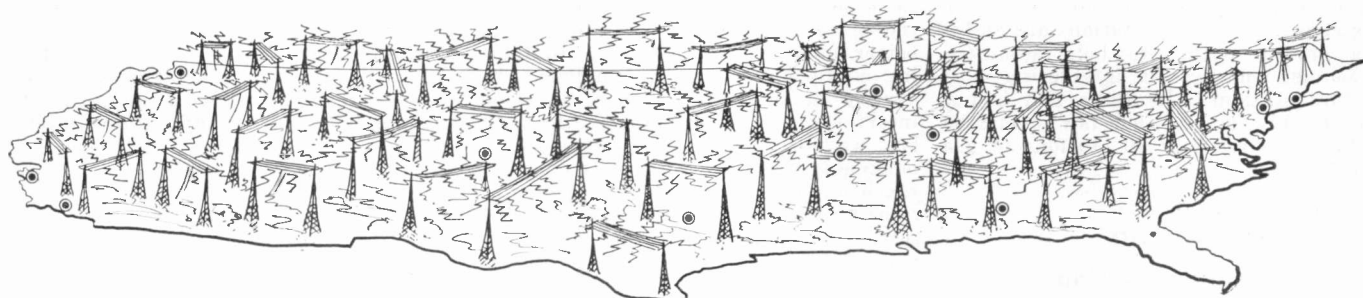

Telegraphic reports giving last-minute details of radio reception conditions. By direct wire to *Radio Retailing's* private telegraph office

Philadelphia

Programs Drowned Out

Interference caused by heterodyning stations creating considerable trouble has been prevalent for past three weeks. Super-power stations among those being heterodyned. Programs from at least eight of thirty stations made useless. Weather conditions very favorable for perfect reception. Condition general throughout section. At least thirty-two stations affected by this disturbance. Dealers report slight decrease in sales owing to pre-holiday conditions as well as unsatisfactory demonstrations caused by the heterodyning of stations. Many listeners complain about the logging of stations as these vary almost every night. Greatest changes noticed below 350 meters. There has been no change in wavelengths in this territory and from latest reports there is no tendency for same. Static level very low and many distant stations received with ease. Receivers which tune broadly are of little value at present time. Loop type receivers becoming more popular due to prevailing conditions. Considering all this disturbance, sales are still far ahead compared to the past season.

Washington, D. C.

Better Than Other Sections

Reception conditions Washington better than in most localities. This territory fortunate in experiencing little or no heterodyning on local stations, but distant stations almost impossible to hear because of squeals. Dealers report there are only one or two receivers on the market which can be demonstrated satisfactorily on other than local stations. Reception conditions considered good compared to rest of country, in that at least local stations can be heard.

Congress realizes situation and is expected to act promptly on radio legislation. It is said one Congressman attempted to tune in home town station and found it impossible. He then expressed himself forcibly on the subject and said "such conditions must be remedied." A certain Senator received a letter from a constituent congratulating the Senator on a recent radio speech and saying that undoubtedly it was a very fine speech, but he couldn't

hear a word of it because of a heterodyne howl from another station broadcasting on same wavelength. This Senator, hitherto an obstructionist on radio legislation, may now change his mind.

Cleveland

Squeals Spoil Programs

Approximately 75 per cent of stations received in Cleveland are interfered with by others on same wave causing squealing, although in some cases whistle is so light it does not mar reception for average listener. Leading station here, WTAM, is received in city itself with strong heterodyne whistle which is serious as far as music lovers are concerned. Improved radio weather has subjected many good stations to interference from broadcasters formerly not heard. Detroit and Pittsburgh programs often ruined by interference from New York, Buffalo and Shenandoah, the offender in each case being a new broadcaster or a recent wave jumper. Increase in Chicago stations added a few clearly received stations, but blanked out as many or more formerly popular stations. A great deal of interference results from stations not being on assigned or chosen wavelength, this applying to jumpers and standpatters alike. Another serious offender is the station choosing a hybrid wave, half way between two standard channels, thereby ruining two transmissions besides its own. This has hurt reception from Kansas City, Detroit and other points recently. Radio fans are able to identify large numbers of stations without difficulty but majority who purchased radio for entertainment have found that many local programs and most of the outside ones are not enjoyable on account of heterodynes.

San Antonio

Condition Deplorable

Radio situation in San Antonio in deplorable condition due to heterodyne squeals. At regular meeting of San Antonio Radio Trades Association Nov. 11, resolution passed to place petition in stores of all members and to solicit signatures and forward petitions to Congress. Season has been retarded, if not greatly damaged, by interference. Extensive advertising of

programs arouses interest of fans, while squeals cause keen disappointment and demoralize radio. Fact that cheaper sets can pick up programs has had serious reaction on sale of better class merchandise. Demonstrations are difficult. Dealers' integrity questioned when new owner tries to tune in and gets loud squeals or several programs at the same time. Several instances where actual sales have been lost due to dissatisfaction on part of customer. S. G. Blanchard, president of association, reports dealers and fans aroused over situation and all demanding immediate action. Very few stations received clearly, because channel is crowded with many stations of approximately same wavelength. Usual holiday orders very slow in coming in.

Chicago

Situation Serious

Heterodyne squeals from interfering stations very serious here, particularly on lower wave-bands. Since October 15th has been rapidly growing worse. At least seven Chicago stations are heterodyning each other. Many Chicago stations and distant outfits also interfering. Dealers say twenty-five per cent of local stations heterodyning. Listeners inured to interference conditions and buying, but not as readily as forecasted early this season. Two eastern stations which use crystal control come in on definite dial settings and are favored by western fans. Crystal control therefore recommended for all stations. Dealers say expert tuner can get many distant stations but not loud and accompanied by whistling. Average owner can get few outside stations. Hand-to-mouth buying by dealers is marked on this territory.

St. Louis

Many Whistles Developing

Need of radio legislation felt very keenly in St. Louis territory due to ever-increasing interference caused by number of new stations. Old stations increasing power also adds to confusion. Dealers find many new carrier whistles have developed and St. Louis located in middle of country finds these whistles all over the dials. Local stations are giving good programs and

trade is urging listeners not to try for distance. Some local stations are building crystal outfits to help eliminate broadness and prevent interfering with distant stations. If Radio Bill is not passed this session some law should be enforced compelling all stations to use crystals.

Boston **Stations Overlap**

This section records uneven conditions in reception. Average clear nightly reception with moderate priced machine set at six stations. With special high power sets forty-five stations covering East and Central States can be recorded. Average receiver experiencing trouble in bringing in stations clearly. Two local stations, WEEI and WBX with nearly equal wavelengths, overlap, and operators constantly complain to broadcasters. Some reflection here in sales of filters but most jobbers declare good sets, properly installed and operated, tune out ordinary interference. With WNAC much trouble is reported. Attempts made to agree on schedules so far a failure. Outside Boston area situation is perplexing. Northern district blanketed from Boston during operation of WEEI and WBZ and receives mostly New York and Canadian stations. Southern Massachusetts has dead zone. South of Boston has trouble getting WEEI, due to bad air racket from southerly points. Unless best sets used, operators must expect squeals in this district from three local stations. Many dealers, broadcasters, and operators interviewed lean strongly to legislation which will insure better air conditions. As compared with last year conditions worse.

Kansas City **Serious Interference**

Radio business here exceeding all expectations despite serious station interference. But dealers claim they could surely sell additional thirty per cent of demonstrations if it were not for heterodyning. No more than eight stations are received clearly over entire dial. One nearby station reported particularly objectionable. Has jumped its original wavelength, is broad on the air, often has mediocre and self-seeking programs and blankets three popular stations. People buying in face of adverse reception but angry that station interferences are permitted to exist. All dealers interviewed in seven southwestern states want fewer and better stations.

Los Angeles **Too Many Stations**

Due to large number of broadcast stations in and about Los Angeles only very selective receivers are salable to any degree. DX reception poor in the metropolitan area, although receivers twenty miles outside the city have fair success in bringing in distant stations. There are fourteen broadcasting sta-

tions here. Dealers are generally of the opinion that eight or nine would better suit the needs of public, eliminating confusion and giving sufficient diversity of programs. There is some interference between local stations on low wavelengths, although it is more noticeable when an attempt is made to reach outside of this area. Eight stations broadcasting between 235 and 340 meters cause confusion with the average set. No more than nine local stations and three outside stations are clearly received on the average set. Dealers and fans eager to secure proper legislation regulating broadcasting. Radio trades association of Southern California at a meeting here November 15, attended by 350 dealers, jobbers and manufacturers agents committed itself to support the co-ordinating committee in Washington and to contribute financially. White Bill with priority rights provision is favored.

Toronto **Demonstrations Menaced**

Interference caused by heterodyning stations becoming serious menace to demonstration in Toronto and district. Extent of trouble may be gaged from fact that on some nights it is impossible to get anything lower in wavelength than KDKA at three hundred and nine meters. Heterodyning in this district is particularly noticeable from Chicago stations, some of which are now on the wavelengths of Canadian stations. Some low power stations are particularly objectionable and are cutting each other's broadcast to pieces. One station appears to sit on CKCL wavelength of 356.9 meters. There is another noticeable disturbance between Buffalo and Miami Beach. On some nights heterodyning occurs in six or eight places on the dials. Difficult to detect heterodyning stations except with wave meter because the broadcast is so badly chopped. Dealers when demonstrating endeavor to tune between squeals. In some cases by slightly detuning the stronger station will come in. Broadcast men point out that the trouble is aggravated by some stations not having harmonic suppressor and not using crystal oscillator to keep to exact wave length.

Pittsburgh **Outlying Sections Suffer**

No considerable amount of comment in local district on present chaotic broadcasting condition. Occasional criticisms are made by fans who want distant stations. This lack of complaint here is due to the presence of two high class stations, whose programs are rapidly becoming metropolitan by continual linking with New York and other stations. Such broadcasting satisfies the local fan giving better reception than by trying to get distant stations direct. In outlying districts there are numerous complaints of heterodyne interference from the eastern stations. Western interference is

conspicuous by its absence which in turn may be due to fact that eastern stations in this district are more popular. All in all the fact remains that listeners can get only about a dozen stations with clarity and without interference.

Denver **Confusion Cuts Sales**

Interference is prevalent in this territory, but dealers' reports as to the degree of confusion vary. Some report as high as 75 per cent of stations received cannot be cleared of heterodyne squeals. This condition seems to be more common in the mountain districts. It reaches its highest point in the large cities, and within fifty miles of local broadcasting stations. Consensus of reports indicates stations located on the Pacific Coast can be received with much less interference than those located east of Denver. Very few reports received that do not complain of heterodyning in all eastern stations except one or two very low on the dial. Dealers feel that this condition is reflected unfavorably on retail sales, which in the last month have not been quite up to expectations based on early indications.

Portland, Oregon **Better Than Average**

Broadcasting situation in Portland territory is a little better than average in comparison with other districts. Two out of the six broadcasting stations here have heterodyne squeals.

Business appears to be about 10 per cent better than last month and 20 to 25 per cent better than November last year. Increasing difficulties are being experienced in getting shipments from the factories and some jobbers report many back orders on hand. Cone speakers and battery eliminators are still big sellers, with increasing demand for high-grade sets.

Oklahoma City **Southwest Hard Hit**

Station interference can no longer be disregarded. It is a detriment to radios progress in Southwest. Conclusion of seventy dealers in Missouri, Arkansas, Oklahoma, Texas, and Louisiana, is that they would do fifteen per cent more business if air lanes were cleared of present congestion. Despite heterodyning sales twenty per cent ahead of last season in this territory. Dallas dealer says "local stations come in all right but frequently impossible to get certain important Eastern and Northern points. This interferes severely with the complete enjoyment of radio, consequently with sales. Believe I could increase gross volume ten per cent if wave bands were properly allotted and certain unimportant and objectionable stations eliminated." A leading dealer in Oklahoma City selling superheterodynes states he has not lost sales, but knows

he would do more if he could assure prospects that there would be no interference. In Texarkana, Arkansas, dealers say "interference has helped sell better sets but hurt low priced ones. Even quality outfits have trouble at times especially around 263 meters." Another dealer in Shreveport, La., declares condition is "worse now than a month ago." Five dealers in Tulsa say, "the explaining we have to do hurts the game." Consensus of opinion is

that from 258 to 280 meters interference is worst but many complain of conditions between 247 and 254 meters.

The Dakotas

Air Crowded

Air badly crowded in North and South Dakota between 210 and 310 meters. Bad spot around 460 meters

due to KFNF and KMA and KMMJ on pirate wave lengths interfering with all good stations near their wave-lengths. Situation getting worse as reception improves, but not enough to retard set sales, causing dissatisfaction among present set owners. Receiving conditions in Dakotas extraordinarily good last two weeks hearing both coasts easily. Dealers in territory favor *Radio Retailing's* recommendation on legislation November issue.

Ideas That "Came in Fine" Last Christmas

HERE are some good radio advertising phrases "picked up" when dealers were broadcasting in the newspapers to the public last Christmas:

The Key to Happiness

"Let your family be supremely happy during this joyful season and during the cold, snow-bound days to come. The key to this happiness is Radio—one of our radio installations."—Lotter Machine Company, Seymour, Wis.

"A Radio in Every Home on Christmas Day."—Wanamaker's, New York.

"Scores and scores of fine radio sets in the Hahne radio section. Sets of a humble, inexpensive variety—sets of luxurious excellence."—Hahne's, Newark, N. J.

"Get the Christmas Wave-Length—. . . A world joins hands in celebrating this Christmas."—Lyon & Healy, Chicago.

A Great Gift

"Radio cabinets—A great gift surely for some radio enthusiast you may know whose unsightly assortment of batteries and ambling wires are a constant eyesore to the orderly housewife. All the disturbing untidy battery and wire display can be hidden away inside this attractive console."—Loeser's, Brooklyn, N. Y.

"Don't Be Radio Sorry—The purchase of a cheap set is only a stepping stone to a better one. Wear your seven-league boots today."—The Silverstone Company, St. Louis, Mo.

Getting the World's Best

"And then, in the evening, tuning in with the radio you've selected at Tull & Gibbs—listening in with the others to entertainment from far away! Getting

the best there's to be had in this old world! Right on Christmas Day! And enjoying it more than all the year's other days combined. And everything. It's Gold! The alchemy which will transmute things into thrills. The reward for the year's past efforts. And that's what Christmas should be."—Tull & Gibbs, Spokane, Wash.

Prepared for the Rush

"Still plenty of time to get that Christmas Radio for the folks. Even though it is late you don't need to disappoint them. Our men are ready for the usual 'eleventh hour' rush. Come in today—or tonight—select your set and Reed will install it for the Christmas Day programs; ready for the whole family to enjoy. And enjoy it they will—Christmas Day, New Year's Day and all the other days for years to come."—Reed Radio & Electric Co., Uniontown, Pa.

Reviving a War Phrase

The war made "14 Points" well known. W. F. Craig, R. D. Montgomery and twelve other concerns in Woodstock, Ontario, divided a page into fourteen sections, under the banner of "14 Gift Suggestions for Everyone 14," the two merchants named featuring radio gifts.

A Page on Hobbies

A radio set was given ample illustration and description on a page "For the Games They Play and the Hobbies They Ride," run by the T. Eaton Co., Ltd., Toronto, Can.

Featuring the Exclusive

"Wanamaker Exclusivities," an advertising spread by John Wanamaker, New York, included an advertisement of a radio set which the store alone handled in the city.

For Under the Tree

"Put These Gifts Under the Tree" was the caption of a page run by the Davis Company, Chicago, with the introduction, "Christmas morning dawns, and piled high under the tree aglint with tinsel and aglow with color are the Christmas packages! Here, below, are a few of the things that will be found in them." Items like radio sets for men were illustrated and described separately.

Radio in "Quick Guide"

Three days before Christmas, Marshall Field & Co., Chicago, ran a page "Quick Guide for Christmas Shopping." Classifications were made for all kinds of persons — women, girls, boys, men, elderly women, babies and children. Sub-classifications were made under these headings. Radio sets were recommended under "Something for Recreation" for elderly women, boys, children and men, and "For the Home."

Christmas Club Savers

"More Christmas Club Checks Out!—And Not One to Be Wasted on Trivial Things" was the caption that the C. F. Wing Company of New Bedford, Mass., ran over a fac-simile of the club check issued by a local savings bank. The advertisement led up to the suggestion of investment in a radio set.

Aims at Lodge Members

One-inch single column advertisements with the heading "Good Morning!" in handwriting, run by Fifield's, Augusta, Me., had such messages as:

"Give her a radio so she can have some fun while you are ranting 'round the lodges, clubs, or otherwise out."

What Are the Avenues of Approach

By
C. GRUNSKY

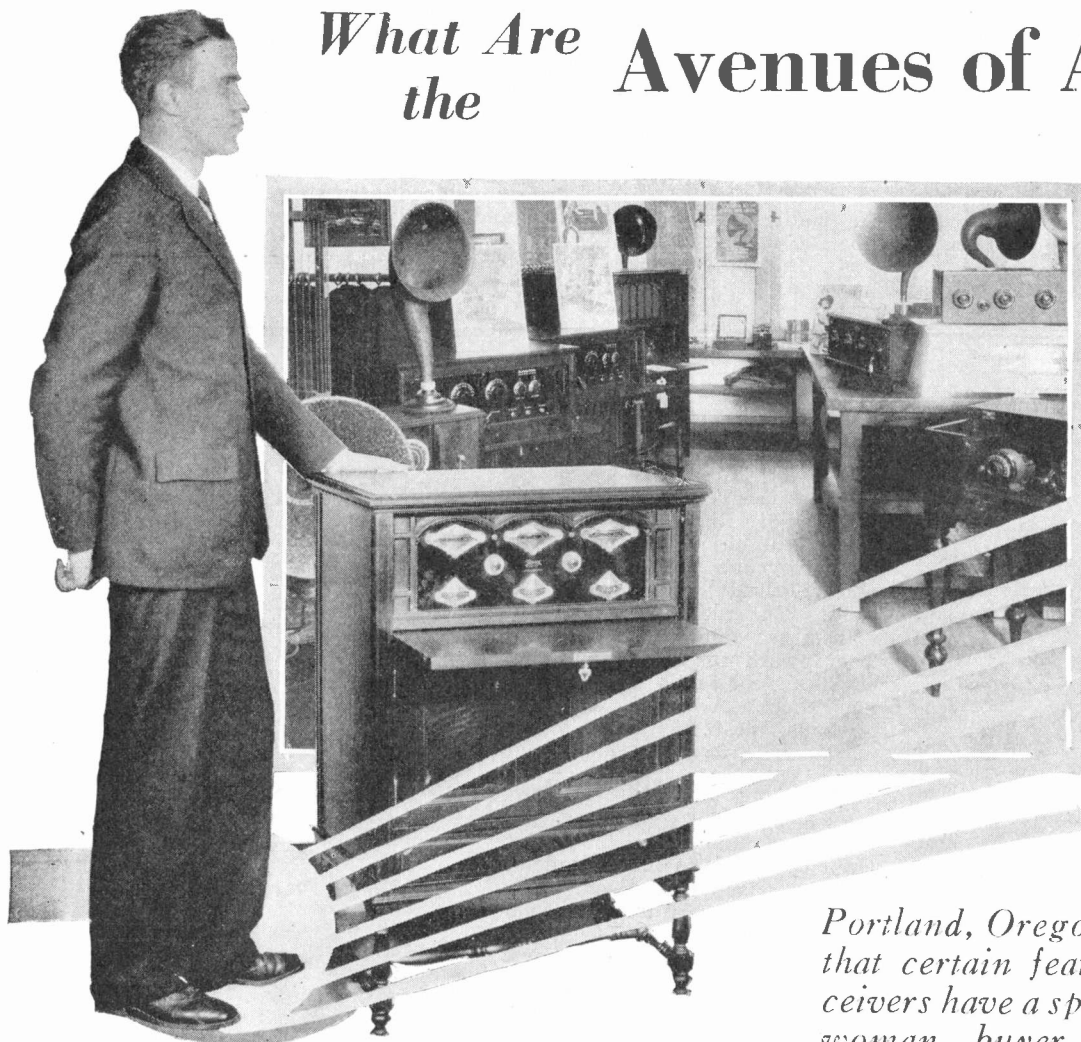

Portland, Oregon, company finds that certain features of radio receivers have a special appeal to the woman buyer. Sales talks to feminine customers should be far different from those made to men

RADIO may be sold to the woman prospect just the same as any other product in which she is interested, the J. K. Gill Company of Portland, Oregon, has found. Methods of window display, store furnishing and the very sales talks employed in selling other commodities to women are just as successful in the sale of radio sets.

Retailers of goods that appeal directly to the female shoppers naturally know the likes and dislikes of women. The Gill company has been in the leather goods, book, stationery, and novelty business for a long time, and its clientele is made up largely of women. Recently it installed a radio department, which has already proved a huge success simply because the firm has employed the experience of years of dealing with women in other lines, to the sale of radio.

Regardless of the product, success in any line sold to women depends largely on the way she is approached,

according to H. P. Harrison, manager of the J. K. Gill Company's radio department. "Women want good material," he explains, "and are willing to pay for it, if they are convinced that the value is there. They are not so cocksure of their opinions in regard to radio as men are, and are more open to persuasion. They like to buy from a dealer in whom they have faith, whose reputa-

WOMEN prospects are just as easy to sell radio as men, if they are approached properly. That is the conclusion of H. P. Harrison, manager of the radio department of the J. K. Gill Company, Portland, Oregon, whose clientele is made up largely of women. In this article he explains the best methods for building up women's trade.

tion is well established, and who is known to stand behind the goods he sells. So it is through this avenue that we generally first approach the woman prospect. When we have put this idea over, we proceed to talk up the set in detail."

Among the first obstacles the salesman encounters is the matter of servicing. The possibility of failure of the set, of repairs and adjustments makes the average woman buyer hold back. To overcome this natural hesitancy, the J. K. Gill Company has adopted a very generous service policy.

Goods Are Guaranteed

Satisfaction is guaranteed and the customer thoroughly understands that if the purchase does not live up to what was claimed for it, the company will take it back at any time. This may sound as if a large percentage of the profits would be swallowed up in refunds and exchanges, but actually this is not the case.

in Selling Radio to Women?

- ♦ SIMPLICITY OF CONTROL ♦
- ♦ ECONOMY OF OPERATION ♦
- ♦ PLEASURE OBTAINED ♦
- ♦ TONE QUALITY ♦
- ♦ APPEARANCE ♦
- ♦ EASY PAYMENTS ♦



The fact that the woman knows that she may return a radio set if it proves unsatisfactory is all that is necessary and she has no desire to return it. If it really is unsatisfactory, she will attempt to return it in any case and good business policy will suggest some adjustment which will make her contented. A dissatisfied customer can do more damage in a few minutes than can be remedied in a year's advertising.

The J. K. Gill Company is an old established firm in Portland with a reputation for dignity and stability; its good-will would be valued at a very high figure, and anything which is in the nature of the reasonable maintenance of this good-will is justified.

This assurance of satisfaction has other sides as well. It is not necessary to sell the customer so much in detail before delivery, if she knows that the set can be returned if she is not satisfied. The guarantee means to her that the claims of the salesman are justified, otherwise he would not dare put them to the test. She is more likely to accept the word of the dealer and to make the purchase without such extensive demonstrations and comparisons as are otherwise usual.

This, of course, means a saving in overhead on the selling cost of the individual transaction. A slightly increased service cost would then be justified. As a matter of fact, the

records show that the cost of servicing under such a liberal policy is not materially greater than with a more restricted plan.

Home Demonstration Necessary

Where both a man and a woman are involved in the transaction, as is generally the case where the radio is to be purchased for family use, the approach is usually made through the woman. In these cases, the J. K. Gill Company has found, it is almost necessary to give a home demonstration and to leave the set in the home on trial over night or for two nights.

Mr. Harrison states that in his experience the demands made by a woman and a man from a radio set are different. The woman asks for clear tone, ease of operation and good programs from her local station. She is content to tune in on one station and, if she likes what is being offered, to listen in for the evening. Not so her husband. He likes to turn the dials and to bring in distance. For

this reason, it is almost impossible to satisfy both at one sitting.

The best policy, in the experience of the company, is to leave the set in the home for a sufficient amount of time for both to try it out according to their own ideas. Of course this is never done before the transaction has advanced to the point where a sale is almost a certainty.

Do women buy cabinet sets? Not always. They like a set to be neat and compact and to fit inconspicuously into the furnishings of their rooms; they appreciate not having awkward batteries and other accessories to dust and care for and to keep from injuring the carpets. Of course they like beautiful pieces of furniture if these fit into their homes and into the possibilities of their purses. Such arguments as compactness, ease of operation, quality of tone, simplicity of maintenance, sightliness and guarantee of satisfaction generally sell the woman customer.

Here is another argument which is

not so frequently heard, but sells sets nevertheless. Radio furnishes a hobby for the tired business man. It will keep him at home evenings; it will rest him and it will mean better health and better tempers in the household. Why? Because outside of the automobile, radio is the one mechanical invention of the modern age which appeals to the business man. It has caught his attention and it has the right appeal to hold it.

The moving picture and the theater are not always successful in taking a man's mind off his business; his thoughts wander while he watches, for instance, the S-51 rise from a watery grave, and focus themselves again on the problems of the day. He does not, for some reason or other,

remain at home putting records on the phonograph or running the player piano. He will sit down at a radio, however, and spend the entire evening absorbed in trying to get a distant station.

Radio Brings Recreation

This means recreation of the best kind because it takes the man completely out of himself and rests him by giving him a different personality for the time being. Every one knows that the man with a hobby is usually the man who lives to a ripe old age; he is never troubled with nerves, because he does not use the same set all the time; he changes into another suit of interests, as it were, and keeps both wearing longer.

The wife knows this and so is open to approach on the ground that radio will be a good thing for her husband. Do not try this argument on the man, however; he will resent the insinuation that he needs anything and will close his mind against your efforts. But it is a good woman's reason for buying radio, which might be employed more often than it is.

Two makes of sets are carried by the J. K. Gill Company, one in each price range. Mr. Harrison does not believe in carrying a large number of makes which serve merely to confuse the customer. The average woman finds it difficult to judge between two sets on demonstration and in most cases considers just two factors in reaching her decision—the price she is able to pay and the advice of the dealer. And if the dealer is going to recommend one set rather than another, why should he not carry that set in the first place and let all the others go?

Salesman Handicapped by Too Many Sets

The average salesman speaks convincingly only when he thoroughly believes in his goods. It is too much for any one man to believe that all the sets on the market are the best. How can he argue for any one set, even the one he believes in, with enthusiasm, if he knows that what he says is an implied criticism of some other ware which he will be called upon to sell the next day?

If you set a customer to shopping about from make to make in your own store, you lead her to go out into the field and try out still other sets before she is satisfied. In any case the sale is unduly prolonged and expensive.

An interesting angle of radio merchandising from the standpoint of a stationery and book store, is the natural tie-in between the two. The J. K. Gill Company quickly grasped this fact, and arranged to give weekly book reviews over one of the local radio stations. The book department reports an immediate reaction in the sale of the books reviewed. Just as phonograph records of a well known singer are in demand when the artist is to give a recital in town, so books are asked for while they are in the public's mind. At the same time, the fact that these talks are given by the company over the radio naturally redounds to the advantage of the radio department, giving it excellent publicity, and a high rating.

Pulling Together for Christmas Sales



You give ALL this when you give Radio!

No other single gift has stored within it such tremendous possibilities as has a Radio Receiver! When you give RADIO—you give not simply a beautiful piece of Furniture—but you give contact with and access to ALL that is happening in the World today—tomorrow—and forever! Truly—no other Gift can even COMPARE to Radio! These five things we would have you remember!

- 1 With the Gift of one GOOD Radio Receiver you give Entertainment and Education for years to come!
- 2 ALL of the latest models of the World's LEADING Radio Receivers are NOW available to you!
- 3 You should take great CARE in the selection of your Radio! Buy ONLY from REPUTABLE houses.
- 4 Radio takes time to install. Order YOUR Christmas Radio by December 19 to insure installation!
- 5 You can purchase your Radio on EASY TERMS from any of the Southland's Radio Dealers!

RADIO is indeed the Gift SUPREME!
It is the PERFECT Gift for your Family—
bringing to EACH MEMBER of it—
WHATEVER that member desires!

RADIO TRADES ASSOCIATION
of Southern California

This advertisement is published in the interest of the radio buying public and the trade.

Advertisements similar to this increase the business of Southern California radio dealers during the Christmas holidays. A small footnote in the lower left corner calls attention to the fact that the advertisement is published in the interest of the general trade.

Recording the Month's Radio Activities

The First Beam Wireless Station

The towers at the right belong to the first beam wireless station just erected at North Petherton, Somerset, England. The peculiar shaped tops allow the waves to be sent in any desired direction with increased power and less interference.

Radio Aids Harbor Craft

The skipper of the official "welcome boat" of New York City, Captain William S. Hamilton, below, receives radio reports from the shore and from incoming vessels, greatly expediting harbor traffic.



Radio Connects All Parts of Vast Building

The loudspeakers in the circle in the picture at the right are part of a permanent radio and public address system in the great auditorium of the new Shriners' temple, Los Angeles. All parts of the building are connected. The installation also includes a receiver for amplifying radio programs.

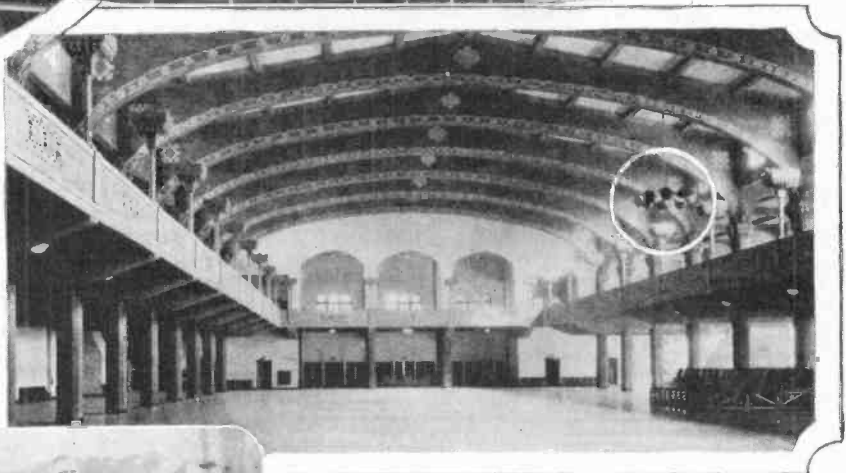

Hogs Hear Their "Master's Voice" Miles Away

Radio was used to broadcast the "Hog Calls" sent out by contestants for the national championship during Radio Show Week at Omaha, Nebraska, recently. The broadcast calls brought the porkers running from all over a 160-acre farm right up to the set, as seen in the picture. The contestants competed in a studio seven or eight miles away.



Mary Garden Sings for Radio Fans

Above: Mary Garden, famous opera prima donna, before the microphone on the inaugural program of the National Broadcasting Company, Nov. 15. This photograph was received by land wire in New York fifteen minutes after it was taken in Chicago.

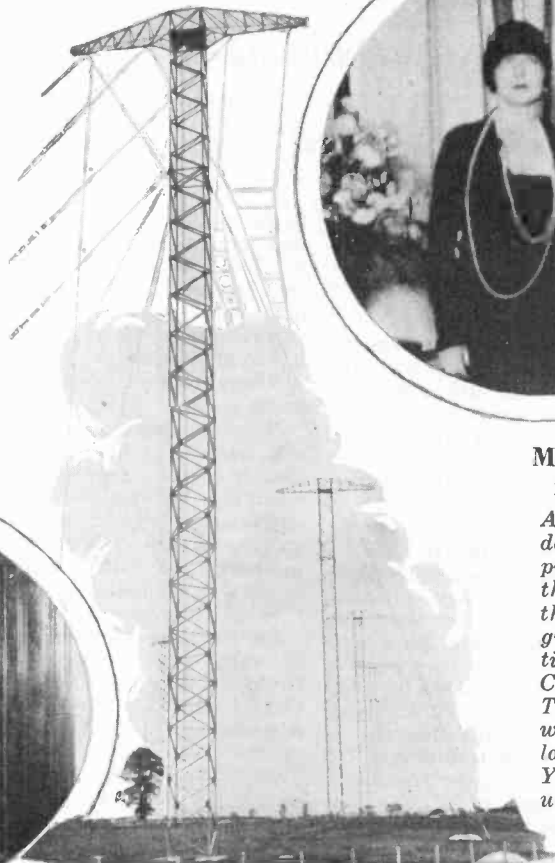

What This Industry Needs

A policy of "No Dumping of Sets" by responsible manufacturers would mean greatest progress radio has yet seen, executive says.

The Greatest Promise of the New Year

Editor, *Radio Retailing*:

It is my opinion that the biggest thing that the radio industry can expect for the New Year just about to make its bow is that there will be "No Dumping of Radio Sets by Responsible Manufacturers."

This means a big step in advance for the protection of the dealer.

No careful student of the manner in which radio receiving sets are sold to the public by the dealer can doubt that by far the largest percentage of radio receiving sets are sold on the deferred payment plan. It is highly necessary for all concerned in the radio industry that these instalment payments be met. It is as much the manufacturers' and jobbers' concern as it is the dealers'.

With the dumping of radio sets by responsible manufacturers entirely eliminated, a clear horizon is in view for the stabilizing of the radio industry and it is my opinion that 1926 will see healthy steps of progress towards stabilization.

MYRON GOLDSOLL,
Vice-President, Chas. Freshman
Co., Inc.,

New York City.

Your Future Lies in "Service"

Editor, *Radio Retailing*:

Some radio dealers have the idea that when the price of the set has been rung up in the cash-register and the receiver delivered, the sale is closed! But, that's when it has only begun. It's just a repetition of the old adage that "It isn't the amount of sales you make, it's the amount of repeat business you can realize from that sale that makes for success!"

Are you closing the sale when the contact is over? Or are you the clever man who gives service and earns his repeat business?

There you have two questions the answers to which will decide your future in the radio game.

There are a thousand and one ways to the consumer's heart and pocket-book. But the soundest way to both is by giving him something that he doesn't actually expect: That's what I mean by "service."

When you go to a clothier to buy a suit and you do find something that pleases you, you don't expect that man

to be calling on you every so often to find out whether the pants are holding out, or the vest is drawing up or the coat is tight under the armpits! Surely not; clothing isn't necessarily a service game. But radio is! And don't forget it for an instant.

When that set leaves your door, your work starts.

Because there are so many things that have to be hitting just right to get the reception, and get it where and when the customer wants it. Batteries, antennae, tubes, condensers, power units, speakers and what-not all have to check O. K. before you're through.

Let's look ahead three or four years. What do we see?

Do we have to be expert economists to realize that the accessory end of the business is going to be the biggest thing? In time to come the country is going to approach a saturation point as far as sets are concerned. Then what will you sell? Accessories! And plenty of accessories! To every man who buys a set, you'll have 100 customers who want tubes, batteries, new power units, new speakers, new this and new that being brought out daily by the radio engineers.

By giving service NOW you'll be on the ground floor THEN. And there'll be greater profits then, too. Being a wide-awake dealer just means that you are giving the customer something he doesn't expect — "service." And the dealer who gives him the most and the best service is going to be remembered when he wants accessories in the future.

I speak from experience. The jobber's problem is exactly the same as the dealer's. We have built The Roycraft Company on the solid foundation of "Service to the Dealer." And we're going to keep on giving this service until they can't think of radio without immediately associating Roycraft with it.

ROY B. COHEN,
President, The Roycraft Co.,
Minneapolis.

Guessing Has Gone Out of Fashion In Radio

Editor, *Radio Retailing*:

There are three legs on which every manufacturing structure must stand. They are the knowing how to manufacture—that is the physical process itself; the knowing how to finance; and the knowing how to sell. Each is equally important. Each must yield

adequately on what it costs. If any one of the three is extravagant, the cost will show up in the price of the product, making that price higher than it fairly should be. The manufacturers in radio who have disappeared were wobbly on one or more of these three legs. Those who were well grounded are looking forward to better and more prosperous radio.

Successful radio manufacturers, particularly those who have had electrical experience before radio came on the scene, realize the vital need of continuous research. The successes of the future—for there is no doubt the weeding out process will go on—will be those who most quickly and efficiently adapt themselves to needed change. There will always be change; there is nothing final in such an elusive proposition as manufacturing a radio receiver. Sensing this changing demand and studying to meet it is far different from guessing what the public wants and trying to supply it. It is the difference between success and failure.

W. E. BAKER,
General Manager,
Day-Fan Electric Co.,
Dayton, Ohio.

Three-Dial Control Sets Still Popular

Editor, *Radio Retailing*:

Regardless of what Mr. M. J. Ryan claims, we have been unable so far to find a one-dial control receiving set that will in any way approach the performance of our three-dial control Neutrowound Receiving Set. It is only natural that this gentleman would take the attitude he does as he is doubtlessly putting his efforts behind a so-called one-dial control receiver.

We are sending our New Hampshire representative a copy of Mr. Ryan's letter and are instructing him to make it a point to call on this dealer and prove to him that Neutrowound will out-perform any one-dial control set that he may have in stock. We notice that Mr. Ryan contends that the public in general will not bother with three-dial control. The fact remains that Neutrowound, being a three-dial control set, is enjoying a very extensive distribution throughout the United States and our dealers are reporting that they experience less difficulty in selling Neutrowound than they do in any other set they handle.

Mr. Ryan is correct in his assertion that performance tells the tale. Performance is just what is selling Neutrowound. A single dial control set cannot possibly bring in the stations that an efficient three-dial control set will get.

W. W. MURRAY,
Sales Department
Neutrowound Radio Mfg. Company
Homewood, Ill.

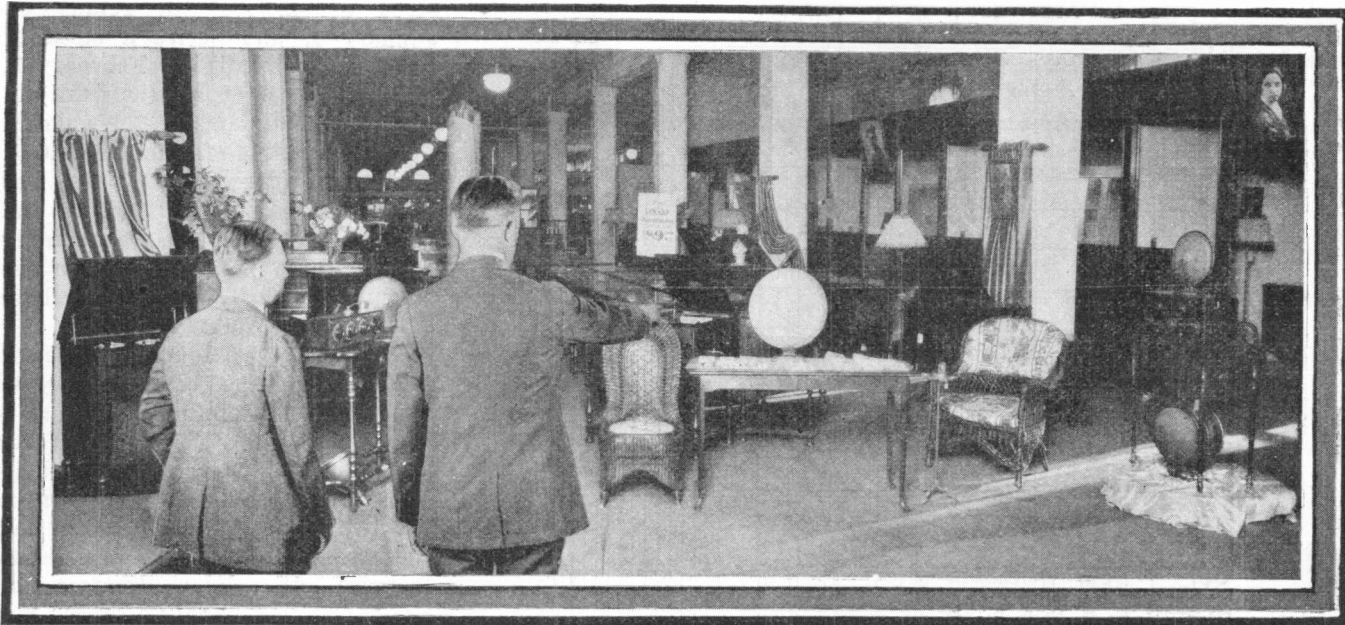

Planning for 1927

Looking ahead into the new year—laying out monthly stock requirements and purchases—how and what to buy—aim for small stocks and quick turnovers—a few disturbing factors

By S. J. RYAN*

THE editors have asked me to write on, "How the Radio Merchant Must Plan Ahead for 1927."

The following are my *personal* views—they are not those of this publication, nor are they based on anything that has appeared in this publication, beyond what impressions I have formed from reading, observation and experience in retailing.

This is written in the first week of November and the next seven weeks' business will have a distinct bearing on how the radio merchant will plan for 1927, but it is vitally important that he does plan ahead.

Radio business is good *now*. It is sound and the demand for standard merchandise is strong, and will, I believe, be sustained over the holidays. I have planned my stock, therefore, so that I'll have *plenty of merchandise to sell up to January 1*—this includes not only sets and

combinations, but accessories as well.

So far as detailed planning is concerned—newspaper advertising, window displays, direct mail publicity—we have only laid these out to February 1. By the time this appears in print our detailed plans will be worked out to March 1.

These plans include, of course, our daily sales. Our "promotions" (advertising, windows, etc.) are designed to get us at least the planned sales. Our purchases are always

based on our estimated sales. If, for example, we do not secure our planned sales in November and December, automatically our "open to buy" (purchasing allowance) is cut down proportionately, so as to balance our stock on hand at the end of a given period. As a further measure of safety, we never (except in most unusual circumstances) spend all of our purchase allowance in advance for any given month. One of these exceptions is the holiday business. Experience has taught us

In 1927, Mr. Ryan says, the radio merchant should—

Reduce inventory slowly from Jan. 1 to April 1.

Make small purchases each month, but not as much as is sold.

Arrive at start of summer in as liquid condition as possible.

Then replenish depleted

stock with summer radio items and, possibly, a small sideline.

Keep an eye on the radio legislation situation, and its possible effect on trade.

Keep both eyes on the possibility of new developments making present stock obsolete.

*Merchandising counsellor, *Radio Retailing*, and merchandise manager, B. Nugent & Sons, St. Louis, Mo. Former general merchandise manager Kresge Department Store Corporation, and merchandise manager, J. L. Hudson Company, Detroit, and J. & N. Adam, Buffalo.

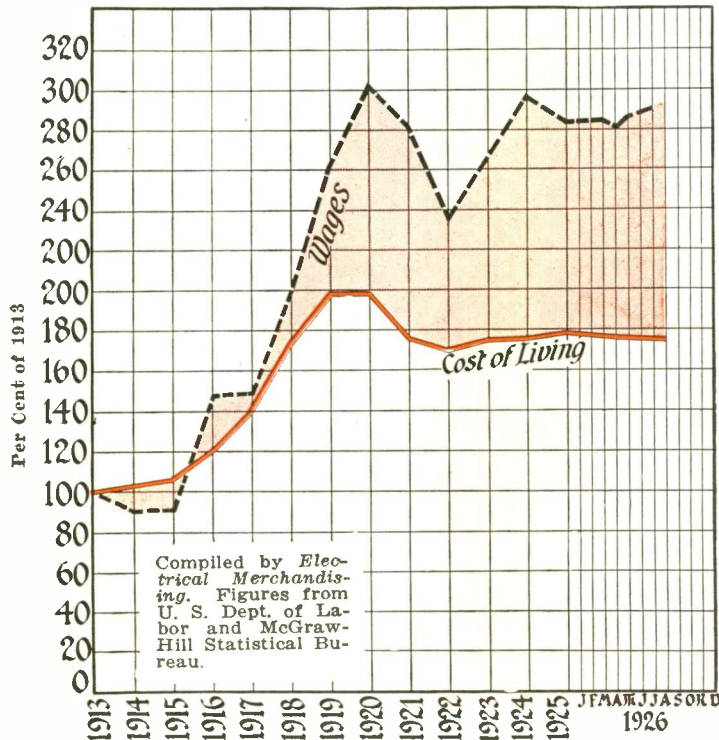

The earned income in the United States is increasing and the cost of living going down, creating a larger spending surplus than the American family has ever before enjoyed. It is this margin between living cost and income that the radio man competes for.

that this is one time of the year when we are uncertain of being able to "fill in" promptly, so that our shelves are well filled early in November for the Christmas season. At the same time, we have still a moderate sum left out of our purchasing allowance for whatever rush orders we may have to make for the holiday buying in December.

Another word about December business. Collections have already slowed up. I would, therefore, be conservative in granting time payment privileges, making certain my customer can and will pay as due, even though his income is reduced. And I would not *oversell* him for the same reason. When the merchandise goes out, it should stay out. Long term paper probably will not be so good an asset in 1927 as it has been. It is only common prudence, therefore, to increase your caution regarding long term paper as the season advances.

Our purchases for Christmas business are practically all made now, and the entire thought of our organization is devoted to selling. Our stocks on January 1 must be at the figure planned for that date.

This stock figure is always as low as, in our judgment, is consistent with what we believe the demand will be.

From January 1 to April 1, the radio stock will be gradually reduced. (I say *will* be, not *may* be.) On April 1, our stock will be just as low as possible and still have a radio store. It will remain in this position until September 1, rise in September and October, reaching its peak again on November 1.

Stock Will Be Heavy on January First

There is nothing in the present situation that will affect the demand for radio merchandise up to January 1, but on that date, if our plans work out, our radio stock will still be heavier than at any time of the year until the following September or October.

The method used by most stores in controlling stocks is to take, first, the stock on hand for a given date—let us say, in this instance, January 1; then set a stock figure for February 1, which, in our opinion, will be sufficient to meet fully the demands of our customers. We then estimate the amount of sales we shall secure in the month of January and subtract this amount from the January 1 stock figure. The difference between the result and the February 1 stock figure is the "open to buy," or purchasing allowance.

For instance, suppose we have a

stock of \$20,000 (at retail) on January 1, and desire a stock of \$17,000 (at retail) on February 1, and plan to sell \$6,000 (at retail) in the month of January. We would proceed in this fashion: \$20,000, minus \$6,000, equals \$14,000. The difference between this figure and the \$17,000 which we are planning for February 1 is \$3,000, or the amount we shall have to purchase during the month of January.

This same procedure is followed each month of the year, and the year itself is divided into two seasons—spring and fall. The stock figures are influenced by the rate of turnover which experience has shown us that we can, or should, secure and the constant effort is, of course, to increase our volume, decrease our stock, and accordingly increase our net profit.

This system is a very simple one, and could easily be adopted by any radio merchant. I am certain he would find it helpful in the merchandising of his business.

In addition to the measure of safety which a low stock always carries, one of the prime reasons why a radio stock should be at its lowest point around April 1 is because of the very great advantage of the merchant's having funds available which he can invest in some other type of merchandise to tide him over the inevitable "summer slump." The radio merchant is constantly tempted to get into other lines of merchandise during this period of the year. I do not think anyone is competent to make any general recommendations, but it seems to me that the radio merchant should have at least one other line that is seasonable to that period of the year, and what may be even more important, he should endeavor to build up the finest service department in his community.

Good Service Man Great Asset

One of the weaknesses of the present radio merchandising structure is the quality of the service. There are too many incompetents masquerading as service men. An intelligent, diplomatic service man who really knows his business is, in my opinion, the greatest asset that any retail radio store can have, and such a man, or organization, will not only pay expenses but will yield a handsome profit to the radio merchant during the summer season. If, however, the radio dealer himself is not thoroughly conversant with the

merchandise he sells, it is going to be rather difficult for him to maintain the quality of his service.

A Few Disturbing Factors

There is no question about the stability—the permanence—of radio. I believe we are on the threshold of inventions and improvements that will soon make it as essential to our existence as the telephone and the automobile are today.

But there are a few disturbing factors that may or may not influence radio business in 1927. These must be carefully considered in next year's plans.

First, the radio legislation now pending before Congress. Any serious disturbance to the present

set-up of broadcasting will cause a public reaction. Manufacturers and dealers will feel this first, but any readjustment that is not an improvement on the existing situation will, without doubt, work harm to the retail radio business.

It will be necessary, therefore, for the radio merchant to watch this very closely—and do his bit to see that his Congressional representatives handle the matter intelligently.

Second, new inventions. Still the bug-a-boo of radio! I am without any definite information on this point, but this is a merchandising hazard always with us in a rapidly-advancing field.

Thinking that way, I'm going to cut down my stock of such mer-

chandise below 1926 figures, at least until I'm sure.

Third, the trade-in problem. Personally, I am violently opposed to trade-ins, because you cannot control the thing once it gets a hold in a community. The market is always "made" by the dumbest dealer, and if you follow him you'll have all your profits tied up in obsolete merchandise. Let's take a lesson from the auto dealer with his terrific mortality, largely caused by a mistaken trade-in policy. I'd rather do *less* business and make *more* money.

Now, these are the specific radio factors that may or may not prove disturbing to retail trade. In addition, my own opinion is that business
(Please turn to page 58)

Newspaper Advertising in Twenty-seven Cities by Four Competing Trades*

IN DOLLARS

City	Radio	Electrical Appliances	Automotive	Music (includes piano and phonograph)
Chicago.....	\$1,346,000	\$250,000	\$2,600,000	\$770,000
Detroit.....	291,996	216,510	1,050,000	291,400
Indianapolis.....	76,315	71,941	333,006	115,143
Philadelphia.....	445,000	310,000	1,510,000	460,000
Peoria.....	12,740	29,749	46,000	5,000
Rochester.....	76,860	170,000	270,000	50,000
Schenectady.....	3,500	32,000	64,000	13,000
St. Louis.....	185,200	153,500	876,500	195,400
Spokane.....	12,810	36,000	142,000	16,300
Minneapolis.....	118,604	69,232	419,387	117,891
Boston.....	566,520	90,815	1,251,631	156,505
Totals.....	\$3,135,545	\$1,429,747	\$8,562,524	\$2,190,709

IN AGATE LINES

Los Angeles.....	964,264	621,950	5,607,052	1,403,444
Portland.....	403,290	423,346	2,213,568	504,240
Cincinnati.....	675,443	648,937	1,826,136	688,312
Columbus.....	485,726	331,745	1,252,286	543,173
Flint.....	56,714	164,108	1,034,820	253,204
Dayton.....	288,423	352,570	2,046,752	761,124
Milwaukee.....	790,061	499,905	2,134,028	402,916
Omaha.....	374,080	308,049	1,240,155	557,862
St. Paul.....	279,636	323,050	1,218,896	365,134
Toledo.....	344,536	701,807	1,740,955	582,250
Washington, D.C.....	515,073	220,396	2,978,434	618,619
Louisville.....	205,709	446,938	1,699,002	443,728
Oklahoma City.....	79,130	68,488	504,574	53,942
San Antonio.....	184,436	198,968	1,496,969	325,860
Albany.....	396,480	170,163	1,320,644	251,562
Des Moines.....	284,812	147,771	1,295,713	113,037
Total lines.....	6,327,813	5,628,194	29,609,984	7,868,415
Per Cent of Total.....	14.6%	10.7%	58.8%	15.9%

* Does not include foreign language newspapers.

Variable Condenser Specifications

(For specifications of knockdown sets, see page 87 and for B battery eliminator rectifying tubes see page 89)

INFORMATION concerning radio products, with the name and address of the manufacturer, is a feature of *Radio Retailing's* editorial service published from time to time as market conditions warrant.

This service is wholly for the benefit of the readers and is without charge of any kind whatsoever to the manufacturer listed. Forms are mailed out with return envelopes well in advance of these listings and those manufacturers wishing to be represented must fill out the forms as indicated and return

them to us within the time specified. It is *Radio Retailing's* desire to make these pages a representative directory of radio products, so that, by following them as they are published, the dealer will always have at hand the information he wants about any radio set, reproducer, accessory or parts. For receiving sets see the July issue, pages 35-46, and the August issue, page 66. For loud speakers, head sets and phonograph units see the August issue, pages 58-61. For battery chargers, battery eliminators and power units see the

September issue, pages 78-81, also page 107. For receiving set chassis and cabinets see the October issue, pages 65-71. Also on pages 74-5 are (illustrated) socket power receivers. For receiving tubes see the November issue pages 69-70-106. Complete listings of all radio manufacturers and their products appear in the *McGraw-Hill Radio Trade Catalog*, which is published three times a year by the McGraw-Hill Publishing Company, Incorporated.

For specifications of Dry and Storage Batteries, see the January (1927) issue.

Name and Address of Manufacturer	Trade Name and Model Number	List Price	Capacity in Microfarads		No. of Plates per Unit	Type	Is Vernier Built-in	Method of Mounting	Diam. of Shaft (in Inches)	Overall Dimensions at Min. Cap. (in Inches)	Material of Plates	No. of Units on Shaft	
			Max.	Min.									
Alden Mfg. Co. Springfield, Mass.	Na-ald Localized Control Tuning Unit												
	Double	\$8.00	.000375	.000012	17		No	Special		6 1/2 x 5 x 4 1/2	Nickled Brass	1	
	Double	10.00	.0005	.000015	23		No	Special		7 x 5 x 4 1/2	Stator Plates	2	
	Triple	10.00	.000375	.000012	17	SLF and SLW	No	Special		9 1/2 x 5 x 4 1/2	Aluminum	1	
	Quadruple	15.00	.000375	.000012	17		No	Special		13 1/2 x 5 x 4 1/2	Rotor Plates	1	
Amsco Products, Inc., Broome & Lafayette Sts. New York City	Amsco Allocating 1211	2.75	.00025	.00001	11	SFL		3 hole		2 1/2 x 4 1/2	Brass	1	
	Amsco Allocating 1213	2.75	.0003	.00001	13	SFL		3 hole		2 1/2 x 4 1/2	Brass	1	
	Amsco Allocating 1217	3.00	.00035	.000012	17	SFL		3 hole		2 1/2 x 4 1/2	Brass	1	
	Amsco Allocating 514	3.00	.00025	.00001	14	STL		1 hole		2 1/2 x 3 1/2	Brass	1	
	Amsco Allocating 516	3.00	.0003	.00001	16	STL		1 hole		2 1/2 x 3 1/2	Brass	1	
	Amsco Allocating 518	3.25	.00035	.000012	18	STL		1 hole		2 1/2 x 3 1/2	Brass	1	
	Amsco Allocating 1223	3.50	.0005	.000012	23	SFL		3 hole		2 1/2 x 4 1/2	Brass	2	
	Amsco Allocating 526	3.75	.0005	.000012	26	STL		1 hole		2 1/2 x 3 1/2	Brass	1	
	Amsco Allocating 1222	5.50	.00025 ea.	.00001	11	SFL		3 hole		2 1/2 x 4 1/2	Brass	2	
	Amsco Allocating 1226	5.50	.0003 ea.	.00001	13	SFL		3 hole		2 1/2 x 4 1/2	Brass	2	
	Amsco Allocating 1234	6.00	.00035 ea.	.000012	17	SFL		3 hole		2 1/2 x 4 1/2	Brass	2	
	Amsco Allocating 1014	6.00	.00025 ea.	.00001	14	STL		1 hole		2 1/2 x 3 1/2	Brass	2	
	Amsco Allocating 1016	6.00	.0003 ea.	.00001	16	STL		1 hole		2 1/2 x 3 1/2	Brass	2	
	Amsco Allocating 1018	6.50	.00035 ea.	.000012	18	STL		1 hole		2 1/2 x 3 1/2	Brass	2	
	Amsco Allocating 1246	7.00	.0005 ea.	.000012	23	SFL		3 hole		2 1/2 x 4 1/2	Brass	2	
	Amsco Allocating 1026	7.50	.0005 ea.	.000012	26	STL		1 hole		2 1/2 x 3 1/2	Brass	2	
	Amsco Allocating 1514	12.00	.00025 ea.	.00001	14	STL	Yes		For drum dial		2 1/2 x 3 1/2	Brass	3
	Amsco Allocating 1516	12.00	.0003 ea.	.00001	16	STL	Yes				2 1/2 x 3 1/2	Brass	3
Amsco Allocating 1518	13.00	.00035 ea.	.000012	18	STL	Yes				2 1/2 x 3 1/2	Brass	3	
Amsco Allocating 1526	15.00	.0005 ea.	.000012	26	STL	Yes				2 1/2 x 3 1/2	Brass	3	
Benjamin Electric & Mfg. Co. 120 So. Sangamon St., Chicago, Ill.	8660	4.50	.00025	.000013	13	SLW	No	3 hole		2 1/2 x 2 1/2 x 1 1/2	Brass Silver Plate	1	
	8661	4.75	.00035	.000015	17	SLW	No	3 hole		2 1/2 x 2 1/2 x 2	Brass Silver Plate	1	
	8662	5.00	.0005	.000017	23	SLW	No	3 hole		2 1/2 x 2 1/2 x 2	Brass Silver Plate	1	
	9060	5.00	.00025	.000016	13	SLF	No	3 hole		4 1/2 x 2 1/2 x 1 1/2	Brass	1	
	9061	5.25	.00035	.000017	17	SLF	No	3 hole		4 1/2 x 2 1/2 x 2	Brass	1	
	9062	5.50	.0005	.000018	25	SLF	No	3 hole		4 1/2 x 2 1/2 x 2	Brass	1	
Bruno Radio Corp. 40 Paynter Ave. Long Island City	101	3.50	.00027		11	SLF	No	1 hole		4 1/2 x 2 1/2 x 2 1/2	Brass	1	
	101	3.75	.00038		17	SLF	No	1 hole		4 1/2 x 2 1/2 x 2 1/2	Brass	1	
	101	4.00	.00053		23	SLF	No	1 hole		4 1/2 x 2 1/2 x 2 1/2	Brass	1	
Caldbeck Tool & Mfg. Co., 307 E. Third St. Des Moines, Iowa	Demcal 11	3.50	.00025	.000007	11	SLW	No	3 hole		2 1/2 x 4 x 3 1/2	Brass	5	
	Demcal 23	4.50	.0005	.000012	23	SLW	No	3 hole		3 1/2 x 3 1/2 x 4	Brass	11	
	Demcal 111	5.00	.00025	.000012	23	SLF	No	1 hole		3 x 3 1/2 x 4	Brass	12	
	Demcal 41	5.50	.001	.000016	41	SLW	No	3 hole		4 1/2 x 3 1/2 x 4	Brass	20	
	Demcal 123	5.50	.00035	.000014	31	SLF	No	1 hole		3 1/2 x 3 1/2 x 4	Brass	16	
	Demcal 141	6.00	.0005	.000016	41	SLF	No	1 hole		4 1/2 x 3 1/2 x 4	Brass	21	
Cardwell Mfg. Corp., Allen D. 81 Prospect St. Brooklyn, N. Y.	Taper Plate 191-E	4.00	.000075	.000005	3	SFL	If desired	3 hole		4 x 4 x 2 1/2	Aluminum	1	
	Taper Plate 167-E	4.00	.00015	.000007	5	SFL	If desired	3 hole		4 x 4 x 2 1/2	Aluminum	1	
	Taper Plate 168-E	4.25	.00025	.000008	7	SFL	If desired	3 hole		4 x 4 x 2 1/2	Aluminum	1	
	Taper Plate 169-E	4.75	.00035	.000013	11	SFL	If desired	3 hole		4 x 4 x 2 1/2	Aluminum	1	
	Taper Plate 192-E	5.00	.0005	.000015	15	SFL	If desired	3 hole		4 x 4 x 3 1/2	Aluminum	1	
	191-C	4.00	.00005	.000005	3	SLW	If desired	3 hole		4 x 4 x 2 1/2	Aluminum	1	
	167-C	4.00	.0001	.000006	5	SLW	If desired	3 hole		4 x 4 x 2 1/2	Aluminum	1	
	168-C	4.00	.00015	.0000065	7	SLW	If desired	3 hole		4 x 4 x 2 1/2	Aluminum	1	
	169-C	4.00	.00022	.0000095	11	SLW	If desired	3 hole		4 x 4 x 2 1/2	Aluminum	1	
	170-C	4.25	.00025	.000011	13	SLW	If desired	3 hole		4 x 4 x 2 1/2	Aluminum	1	
	192-C	4.25	.0003	.000008	15	SLW	If desired	3 hole		4 x 4 x 2 1/2	Aluminum	1	
	171-C	4.75	.00035	.000012	17	SLW	If desired	3 hole		4 x 4 x 2 1/2	Aluminum	1	
	172-C	4.75	.0004	.000014	21	SLW	If desired	3 hole		4 x 4 x 2 1/2	Aluminum	1	
	173-C	5.00	.0005	.000015	25	SLW	If desired	3 hole		4 x 4 x 2 1/2	Aluminum	1	
	174-C	5.00	.0007	.000018	33	SLW	If desired	3 hole		4 x 4 x 4	Aluminum	1	
	194-C	6.00	.0009	.000021	41	SLW	If desired	3 hole		4 x 4 x 4	Aluminum	1	
	175-C	7.00	.001	.000022	47	SLW	If desired	3 hole		4 x 4 x 4 1/2	Aluminum	1	
	176-C	15.00	.0015	.000032	71	SLW	If desired	3 hole		4 x 4 x 5 1/2	Aluminum	1	
	203-C	5.50	.00005	.000005	3	SLW	If desired	3 hole		4 x 4 x 2 1/2	Aluminum	2	
	205-C	6.00	.0001	.000006	5	SLW	If desired	3 hole		4 x 4 x 2 1/2	Aluminum	2	
	207-C	6.50	.00015	.0000065	7	SLW	If desired	3 hole		4 x 4 x 2 1/2	Aluminum	2	
	211-C	7.00	.00022	.0000095	11	SLW	If desired	3 hole		4 x 4 x 2 1/2	Aluminum	2	
	215-C	7.50	.00025	.000011	15	SLW	If desired	3 hole		4 x 4 x 2 1/2	Aluminum	2	
	217-C	8.00	.0003	.000008	17	SLW	If desired	3 hole		4 x 4 x 4	Aluminum	2	
	221-C	8.00	.00035	.000012	21	SLW	If desired	3 hole		4 x 4 x 4 1/2	Aluminum	2	
	225-C	9.00	.0004	.000014	25	SLW	If desired	3 hole		4 x 4 x 4 1/2	Aluminum	2	
	303-C	7.00	.00005	.000005	3	SLW	If desired	3 hole		4 x 4 x 4	Aluminum	3	
	305-C	8.00	.0001	.000006	5	SLW	If desired	3 hole		4 x 4 x 4	Aluminum	3	
	307-C	9.00	.00015	.0000065	7	SLW	If desired	3 hole		4 x 4 x 4	Aluminum	3	
	311-C	10.00	.00022	.0000095	11	SLW	If desired	3 hole		4 x 4 x 4	Aluminum	3	
	315-C	11.00	.00025	.000011	15	SLW	If desired	3 hole		4 x 4 x 5 1/2	Aluminum	3	
	317-C	12.00	.0003	.0000085	17	SLW	If desired	3 hole		4 x 4 x 5 1/2	Aluminum	3	
321-C	13.00	.00035	.000012	21	SLW	If desired	3 hole		4 x 4 x 5 1/2	Aluminum	3		

Name and Address of Manufacturer	Trade Name and Model Number	List Price	Capacity in Microfarads		No. of Plates per Unit	Type	Is Vernier Built-in	Method of Mounting	Diam. of Shaft (in Inches)	Overall Dimensions at Min. Cap. (in Inches)	Material of Plates	No. of Units on Shaft
			Max.	Min.								
DeJur Products Co., 199 Lafayette St. New York City	180-A	3.00	.00025	.00005	15	SLF	No	1 hole	$\frac{1}{4}$	$4\frac{1}{2}$	Brass	
	180-B	3.25	.00035		21	SLF	No	1 hole	$\frac{1}{4}$	$4\frac{1}{2}$	Brass	
	180-C	3.50	.0005		27	SLF	No	1 hole	$\frac{1}{4}$	$4\frac{1}{2}$	Brass	
Federal Radio Corp. Buffalo, N. Y.	Federal Type 48	1.10	.00007	.00001	3	SLC	No		$\frac{1}{4}$	2	Aluminum	1
	Federal Type 45	4.00	.00027		11	SLC	No		$\frac{1}{4}$	$3\frac{1}{2}$	Aluminum	5
	Federal Type 46	5.00	.00055		21	SLC	No		$\frac{1}{4}$	$3\frac{1}{2}$	Aluminum	10
	Federal Type 47	6.00	.0011		43	SLC	No		$\frac{1}{4}$	$3\frac{1}{2}$	Aluminum	21
Furnell Mfg. Corp. 24 Scott St. Newark, N. J.	Furnell 3	5.00	.0003	.000015	2	SLF	No	1 & 3 hole	$\frac{1}{4}$	4×3	Aluminum	1
	Furnell 3A With Electro Static Shield	5.25	.0003	.000021	2	SLF	No	1 & 3 hole	$\frac{1}{4}$	$4 \times 3\frac{1}{8}$	Aluminum	1
	Furnell 35	5.25	.00035	.000015	2	SLF	No	1 & 3 hole	$\frac{1}{4}$	4×3	Aluminum	1
	Furnell 35A With Electro Static Shield	5.50	.00035	.000021	2	SLF	No	1 & 3 hole	$\frac{1}{4}$	$4 \times 3\frac{1}{8}$	Aluminum	1
	Furnell 5	6.00	.0005	.000015	2	SLF	No	1 & 3 hole	$\frac{1}{4}$	$4 \times 3\frac{1}{8}$	Aluminum	1
Furnell 5A With Electro Static Shield	6.50	.0005	.000021	2	SLF	No	1 & 3 hole	$\frac{1}{4}$	$4 \times 4\frac{1}{8}$	Aluminum	1	
Gardner & Heppburn, Inc. 2100 Washington Ave., Philadelphia, Pa.	Quaker	1.00	.0005	.0001	23	Mod. SLF	No	1 hole	$\frac{1}{4}$	$4\frac{1}{2}$	Brass	1
	Quaker	1.00	.00035	.0001	17	Mod. SLF	No	1 hole	$\frac{1}{4}$	$4\frac{1}{2}$	Brass	1
	Quaker	1.00	.00025	.000095	13	Mod. SLF	No	1 hole	$\frac{1}{4}$	$4\frac{1}{2}$	Brass	1
	Continental	2.50	.0005	.00011	30	SLFW	No	3 hole	$\frac{1}{4}$	4	Aluminum	1
	Continental	2.50	.00035	.000009	21	SLFW	No	3 hole	$\frac{1}{4}$	4	Aluminum	1
	Continental	2.50	.00025	.000009	15	SLFW	No	1 hole	$\frac{1}{4}$	4	Aluminum	1
	L. C.-27 Special	3.50	.000275	.000009	17	SLFW	No	3 hole	$\frac{1}{4}$	4	Aluminum	1
	Bruno	4.00	.0005		23	SLF	No	1 hole	$\frac{1}{4}$	$4\frac{1}{2}$	Brass	1
	Bruno	4.00	.00035		16	SLF	No	1 hole	$\frac{1}{4}$	$4\frac{1}{2}$	Brass	1
	Bruno	4.00	.00025		13	SLF	No	3 hole	$\frac{1}{4}$	$4\frac{1}{2}$	Brass	1
	Continental	5.00	.0005	.00011	30	SLFW	No	3 hole	$\frac{1}{4}$	4	Aluminum	2
	Continental	5.00	.00035	.000009	21	SLFW	No	3 hole	$\frac{1}{4}$	4	Aluminum	2
	Continental	5.00	.00025	.000009	15	SLFW	No	3 hole	$\frac{1}{4}$	4	Aluminum	2
	L. C.-27 Special	7.00	.000275	.000009	17	SLFW	No	3 hole	$\frac{1}{4}$	4	Aluminum	2
	Continental	7.50	.0005	.00011	30	SLFW	No	3 hole	$\frac{1}{4}$	4	Aluminum	2
	Continental	7.50	.00035	.000009	21	SLFW	No	3 hole	$\frac{1}{4}$	4	Aluminum	3
	Continental	7.50	.00025	.000009	15	SLFW	No	3 hole	$\frac{1}{4}$	4	Aluminum	3
	Infradyne Special	9.50	.00035	.0000095	23	SLFW	No	3 hole	$\frac{1}{4}$	4	Aluminum	3
	Ambassador		.0005		23	Mod. SLF	No	1 hole	$\frac{1}{4}$	$4\frac{1}{2}$	Brass	1
	Ambassador		.00035		17	Mod. SLF	No	1 hole	$\frac{1}{4}$	$4\frac{1}{2}$	Brass	1
Ambassador		.00025		13	Mod. SLF	No	1 hole	$\frac{1}{4}$	$4\frac{1}{2}$	Brass	1	
General Instrument Corp. 477 Broadway, New York City	0-50 Degree on 100 Degree Dial SLF	Ranging from \$4.25 to \$5.50	.0001	.000009	7			1 or 3 hole	$\frac{1}{4}$		Brass	1
			.00015	.00001	9							
			.00025	.000014	15						$3\frac{1}{2} \times 3 \times 1\frac{1}{8}$	
	50-80 SLW and 80-100 Degrees S.L.C.		.0003	.000016	17							
			.00035	.000018	19						$3\frac{1}{2} \times 3 \times 2\frac{1}{4}$	
		.0005	.000021	27								
		8.00	.00035		19					$3\frac{1}{2} \times 3 \times 3\frac{1}{4}$		2
Hammerlund Mfg. Co., Inc. 424 West 33rd St. New York City	Midline	4.25	.0001	.000007	5				$\frac{1}{4}$	$4 \times 3\frac{1}{2} \times 2\frac{1}{2}$	Brass	1
		4.50	.00025	.000009	11				$\frac{1}{4}$	$4 \times 3\frac{1}{2} \times 2\frac{1}{2}$	Brass	1
		4.65	.000275	.00006	13	Between SLF and SLW.	No		$\frac{1}{4}$	$4 \times 3\frac{1}{2} \times 2\frac{1}{2}$	Brass	1
		4.75	.00035	.000011	17		No		$\frac{1}{4}$	$4 \times 3\frac{1}{2} \times 2\frac{1}{2}$	Brass	1
		5.00	.0005	.000013	23		No		$\frac{1}{4}$	$4 \times 3\frac{1}{2} \times 2\frac{1}{2}$	Brass	1
	Improved SLF	4.25	.0001	.000007	5	SLF	No	1 or 2 hole	$\frac{1}{4}$	$5\frac{1}{2} \times 3\frac{1}{2} \times 3\frac{1}{2}$	Brass	1
		4.50	.00025	.000009	11	SLF	No	1 or 2 hole	$\frac{1}{4}$	$5\frac{1}{2} \times 3\frac{1}{2} \times 3\frac{1}{2}$	Brass	1
		4.65	.000275	.00001	13	SLF	No	1 or 2 hole	$\frac{1}{4}$	$5\frac{1}{2} \times 3\frac{1}{2} \times 3\frac{1}{2}$	Brass	1
		4.75	.00035	.000011	17	SLF	No	1 or 2 hole	$\frac{1}{4}$	$5\frac{1}{2} \times 3\frac{1}{2} \times 3\frac{1}{2}$	Brass	1
		5.00	.0005	.000013	23	SLF	No	1 or 2 hole	$\frac{1}{4}$	$5\frac{1}{2} \times 3\frac{1}{2} \times 3\frac{1}{2}$	Brass	1
	Junior	1.80	.000016	.000003	5	SLC	No	1 hole	$\frac{1}{4}$	$1\frac{1}{2} \times 1\frac{1}{2} \times 1\frac{1}{2}$	Brass	1
		1.80	.000032	.000003	9	SLC	No	1 hole	$\frac{1}{4}$	$1\frac{1}{2} \times 1\frac{1}{2} \times 1\frac{1}{2}$	Brass	1
		1.80	.00005	.000003	11	SLC	No	1 hole	$\frac{1}{4}$	$1\frac{1}{2} \times 1\frac{1}{2} \times 1\frac{1}{2}$	Brass	1
		2.00	.000065	.000006	15	SLC	No	1 hole	$\frac{1}{4}$	$1\frac{1}{2} \times 1\frac{1}{2} \times 1\frac{1}{2}$	Brass	1
Equalizer	.50	.00005	.000003	2	SLW	No	Base	Screw	$1\frac{1}{2} \times 1\frac{1}{2} \times 1\frac{1}{2}$	Brass	1	
Hart & Hegeman Mfg. Co. 342 Capitol Ave. Hartford, Conn.	W-607	1.00	.00005	.000006	3	SLC	No	1 hole	$\frac{1}{4}$	$3\frac{1}{2} \times 3\frac{1}{2} \times 2\frac{1}{2}$	Aluminum	1
	W-3	2.25	.00004	.000005	3	SLF	No	3 point	$\frac{1}{4}$	$2\frac{1}{2} \times 4\frac{1}{2} \times 2\frac{1}{2}$	Aluminum	1
	W-606	2.25	.000125	.000008	5	SLC	No	3 point	$\frac{1}{4}$	$3\frac{1}{2} \times 3\frac{1}{2} \times 2\frac{1}{2}$	Aluminum	1
	W-5	2.50	.00008	.000007	5	SLF	No	3 point	$\frac{1}{4}$	$2\frac{1}{2} \times 4\frac{1}{2} \times 2\frac{1}{2}$	Aluminum	1
	W-610	2.60	.00025	.000015	11	SLC	No	3 point	$\frac{1}{4}$	$3\frac{1}{2} \times 3\frac{1}{2} \times 2\frac{1}{2}$	Aluminum	1
	W-11	2.85	.00021	.00001	11	SLF	No	3 point	$\frac{1}{4}$	$2\frac{1}{2} \times 4\frac{1}{2} \times 2\frac{1}{2}$	Aluminum	1
	W-617	3.00	.00035	.000015	17	SLC	No	3 point	$\frac{1}{4}$	$3\frac{1}{2} \times 3\frac{1}{2} \times 2\frac{1}{2}$	Aluminum	1
	W-17	3.25	.00032	.000012	17	SLF	No	3 point	$\frac{1}{4}$	$2\frac{1}{2} \times 4\frac{1}{2} \times 2\frac{1}{2}$	Aluminum	1
	W-624	3.40	.0005	.000018	23	SLC	No	3 point	$\frac{1}{4}$	$3\frac{1}{2} \times 3\frac{1}{2} \times 3\frac{1}{2}$	Aluminum	1
	W-622	3.60	.00025	.000015	11	SLC	Yes	3 point	$\frac{1}{4}$	$3\frac{1}{2} \times 3\frac{1}{2} \times 2\frac{1}{2}$	Aluminum	1
	W-23	3.65	.0004	.000014	23	SLF	No	3 point	$\frac{1}{4}$	$2\frac{1}{2} \times 4\frac{1}{2} \times 2\frac{1}{2}$	Aluminum	1
	W-644	4.00	.001	.000021	43	SLC	No	3 point	$\frac{1}{4}$	$3\frac{1}{2} \times 3\frac{1}{2} \times 4\frac{1}{2}$	Aluminum	1
	W-43	4.25	.0009	.00002	43	SLF	No	3 point	$\frac{1}{4}$	$2\frac{1}{2} \times 4\frac{1}{2} \times 3\frac{1}{2}$	Aluminum	1
	W-634	4.40	.0005	.000018	23	SLC	Yes	3 point	$\frac{1}{4}$	$3\frac{1}{2} \times 3\frac{1}{2} \times 3\frac{1}{2}$	Aluminum	1
W-654	5.00	.001	.000021	43	SLC	Yes	3 point	$\frac{1}{4}$	$3\frac{1}{2} \times 3\frac{1}{2} \times 4\frac{1}{2}$	Aluminum	1	
Imperial Elec. Mfg. Co. 50 Columbia St. Newark, N. J.	Puradyne	2.25	.0002		11	SLF		3 hole	$\frac{1}{4}$		Aluminum	1
	Puradyne	2.50	.00031		15	SLF		3 hole	$\frac{1}{4}$		Aluminum	1
	Puradyne	2.75	.000351		17	SLF		3 hole	$\frac{1}{4}$		Aluminum	1
	Puradyne	3.00	.00051		23	SLF		3 hole	$\frac{1}{4}$		Aluminum	1
Karas Electric Co. 19 S. La Salle St. Chicago, Ill.	Karas Orthometric	6.50	.0001	.00001	5	SLF	No	1 hole	$\frac{1}{4}$	$6\frac{1}{2} \times 3 \times 4\frac{1}{2}$	Brass	1
		6.50	.00014	.000011	7	SLF	No	1 hole	$\frac{1}{4}$	$6\frac{1}{2} \times 3 \times 4\frac{1}{2}$	Brass	1
		6.50	.00025	.000012	11	SLF	No	1 hole	$\frac{1}{4}$	$6\frac{1}{2} \times 3 \times 4\frac{1}{2}$	Brass	1
		6.75	.00037	.000014	17	SLF	No	1 hole	$\frac{1}{4}$	$6\frac{1}{2} \times 3 \times 4\frac{1}{2}$	Brass	1
		7.00	.0005	.000018	23	SLF	No	1 hole	$\frac{1}{4}$	$6\frac{1}{2} \times 3 \times 4\frac{1}{2}$	Brass	1
Geo. Morton Stockton, Cal.	Morton V.C. 1	5.00	.0005		23	SLF	No	3 point	$\frac{1}{4}$	$3\frac{1}{2} \times 3\frac{1}{2} \times 3\frac{1}{2}$	Aluminum	1
	V.C. 2	7.00	.001		43	SLF	No	3 point	$\frac{1}{4}$	$4\frac{1}{2} \times 3\frac{1}{2} \times 3\frac{1}{2}$	Aluminum	1
	V.C. 3	15.00	.0005		23	SLF	No	3 point	$\frac{1}{4}$	$1\frac{1}{2} \times 3\frac{1}{2} \times 3\frac{1}{2}$	Aluminum	3
Philmore Mfg., Co. 106 Seventh Ave. New York City	Philmore Straight-Line Separation	2.00	.00025		13	SLS	No	1 hole	$\frac{1}{4}$		Al. or brass	1
	No. 210	2.00	.00035		17	SLS	No	1 hole	$\frac{1}{4}$		Al. or brass	1
	Philmore Midget	.84	.00004		7	SLS	No	1 hole	$\frac{1}{4}$		Al. or brass	1
Rathbun Mfg., Co., Inc. Jamestown, N. Y.	ESLC-10	3.50	.00015	.000005	10	SLC	No	1 hole	$\frac{1}{4}$	$3\frac{1}{2}$	Aluminum	1
	ESLC-12	3.50	.0002	.000005	12	SLC	No	1 hole	$\frac{1}{4}$	$3\frac{1}{2}$	Aluminum	1
	ESLC-14	3.60	.00025	.000006	14	SLC	No	1 hole	$\frac{1}{4}$	$3\frac{1}{2}$	Aluminum	1
	ESLC-16	3.75	.0003	.000008	16	SLC	No	1 hole	$\frac{1}{4}$	$3\frac{1}{2}$	Aluminum	1
	ESLC-18	3.85	.00035	.000008	18	SLC	No	1 hole	$\frac{1}{4}$	$3\frac{1}{2}$	Aluminum	1
	ESLC-26	4.00	.0005	.000009	26	SLC	No	1 hole	$\frac{1}{4}$	$3\frac{1}{2}$	Aluminum	1

Windows With a



A home scene like the one above, of the Hellberg and Crimm Company, St. Louis, is easily adaptable to a Christmas window display.



The Texas Radio Syndicate, San Antonio, used this neat corner setting to carry its Xmas message.

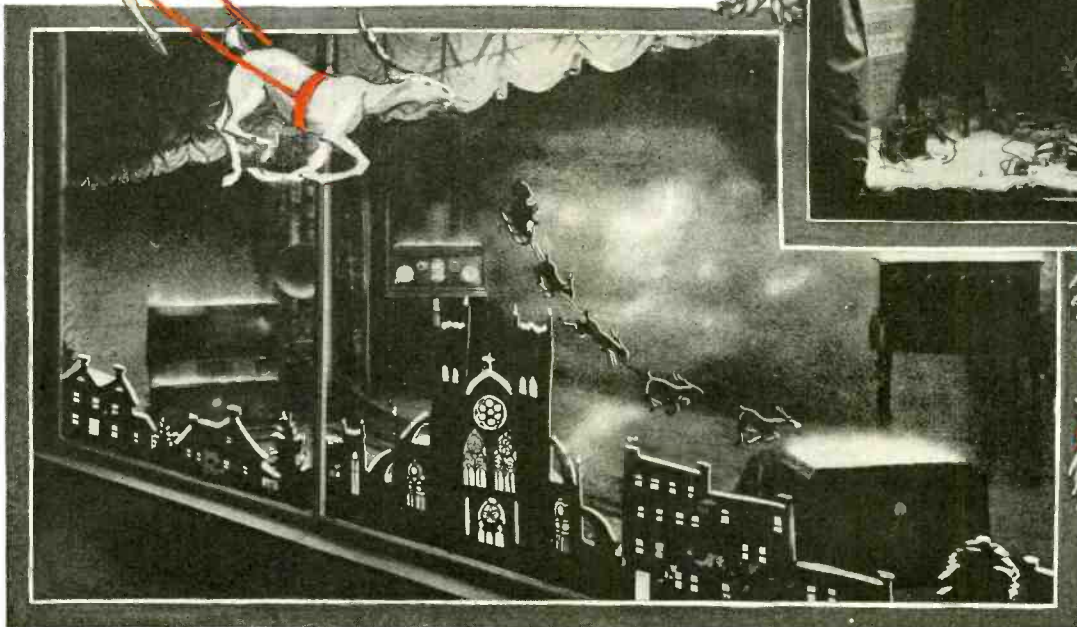

Radio and Christmas Eve cheer are joined effectively in this window of a California music company. The silhouettes were pasted on the window and made an attractive night scene.

Christmas Appeal



"Reserve yours now for Christmas" says one sign in this radio window, left. "You fill in the chair—we will fill in the radio," the other sign reads.

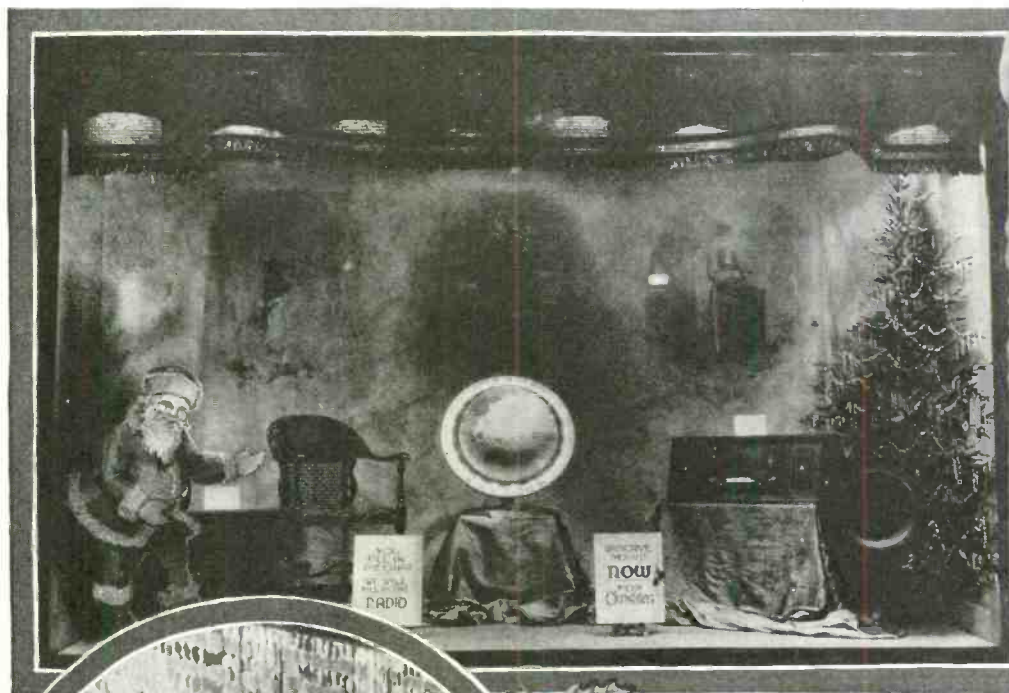

The beautiful in radio furniture is emphasized in this display, left, of the Airphone Radio Company of Chicago.



The Christmas gift list should include radio, is the sales note of this fireside scene, right, in a New York store.



One of the Reasons Why the White Bill Is Better

THE radio bill as written by Congressman Wallace H. White is more satisfactory in many respects than Senator Dill's measure. One instance of this will suffice.

The Dill Bill specifically states that the licensing authority "shall * * * issue to *each* applicant therefor a station license * * *." On the other hand, the White Bill states the licensing authority "MAY issue to ANY applicant therefor a station license * * *." In the case of the Dill Bill, as can readily be seen, authority is granted to issue a license, BUT NONE IS GRANTED TO REFUSE A LICENSE other than the very broad and wholly inadequate phrase, "if public interest, convenience or necessity be served," which could never hold up if put to test in a court of law.

Some legal reason for refusing a license such as the priority of stations that had an *adequate and efficient* service to the public as of some past date, such as July 1, 1926, should be part of the radio bill.

For the protection of *good broadcasting*—this publication will fight until every last hope is exhausted.

* * *

Good Legislation the Primary Requirement

THE policy of this publication in the matter of radio legislation is inalterably to

(1) Secure good legislation, and (2) Secure it *as soon as possible*.

The editors are wholly out of sympathy with the hue and cry to accept any kind of a bill Congress wants to foist on us so long as it gives us legislation quickly. Legislative protection is greatly needed. But *good* legislation is the greater need.

A joint resolution in Congress withholding further station licenses will prevent the present situation from growing worse, and will give Congress and the radio industry time to work out a really adequate law.

Good legislation, we repeat, is the primary requirement.

* * *

An Effective Legal Stop-Gap

RADIO legislation will probably not be passed by Congress until after the Christmas recess. At this time it seems humanly impossible to do it. But that is no reason for the radio industry to tear its hair and shout "Calamity."

It has been proved by the WGN case in Chicago that the courts will recognize that "possession is nine points of the law" regarding broadcasting and the right to use wavelengths. That station, as you undoubtedly know, secured an injunction against a station which appropriated a wavelength near enough to WGN to cause interference. The offending station was effectively AND LEGALLY stopped from interfering with WGN, and that meant, of course, that it could not broadcast

on that wavelength. AND IT DID NOT BROADCAST.

Here, then, is a legal precedent for other stations to follow. If a new station interferes with an older station, or if an old station jumps its wavelength so as to interfere with any other station, injunctions against the offending station can be secured and the interfering station legally stopped from broadcasting on any wavelength which interferes with another station. Until legislation is passed, then, interference between stations can be stopped if the injured station sees fit to follow the course set by WGN. It is up to the broadcasters themselves to protect their listeners in that way.

* * *

Radio Helps the Farmer— and the Farmer's Wife

HOW radio helps the farmer in dollars and cents and closely links the agricultural sections of the United States with the rest of the world is graphically revealed by participants in a recent contest conducted by a broadcasting station. To find out just how radio benefits the farmer, this station asked farm listeners to write a letter telling their individual experiences. Replies were received from twenty states. These letters showed about an equal division between the popularity of the strictly entertainment features of radio and its economic and service uses.

"We're farmers by day and radio fans by night," was the note that ran through most of the contest letters. Some said they considered radio more valuable to the farmer than the automobile.

"There is no drudgery to dishwashing, dusting or patching, if there is music to work by and the livelier the music the faster you work. Radio has brought this music into our homes," wrote the first prize winner.

"As a business proposition the radio has been a great asset through market and weather reports," wrote the winner of the second prize.

Both the first and second awards went to women. Don't overlook the value of radio to the woman on the farm, when selling radio sets in the rural districts.

* * *

Recent article in this publication said, "In selling radio to the farmer, don't talk down to him." That's a pretty good axiom for selling radio to anybody.

* * *

Christmas Business Continues Through January

A REVIEW of 1925-26 retail store financial statements indicates that last year's Christmas business lapped over well into January. Dealers should not allow their stock to become depleted immediately after the holidays, for this reason. January is becoming a good month for radio sales, and business is expected to keep up well into the new year.

This to Say—

**Radio
Retailing**
Vol. 4, No. 6

The Electric-Light Companies Want to Help

INDICATIVE of the importance which the electric lighting companies are now placing on the subject of radio interference originating from their lines or apparatus was the action of the middle-west division of the National Electric Light Association in extending its Des Moines convention one entire day in order that a full session could be devoted to radio interference, its effect on public relations, and how to co-operate with listeners' leagues and radio dealers to eliminate these interferences.

This meeting verified, in no unmistakable manner, the fact that the central station is not only ready and willing to co-operate with the radio fraternity in the elimination of electrostatic disturbances but that it is already doing so. It was also brought out that many of the interference complaints by owners against the lighting companies were unjustified.

Enlist the co-operation of your local lighting company if local conditions are troublesome—you will find the company more than willing to do its full share.

* * *

It is reported Red Grange is to enter the radio business. He's so good at breaking up interference.

* * *

The Public Is Patronizing the Reliable Dealer

THE dealer who has built his business on a square deal policy reports that sales are good right now—better than last year.

The irresponsible dealer—of the price-cutting gyp type—is complaining bitterly about lack of trade and that business can't compare with this time last year.

And that is not editorial theorizing. It is absolute fact, gleaned on a trip just made by one of the editors of *Radio Retailing* through the smaller towns of New England.

In almost every case the legitimate dealers, the ones who have given their customers service and a square deal, declare sales are going along satisfactorily. The ones who have not kept their merchandising ethics as clean as they might be are wondering why their customers seem to have vanished.

* * *

Service Must Be Sold— Not Given Away

HOW many people would have nerve enough to call on a doctor or a lawyer and expect to get advice without paying for it? It is generally recognized that the men in these professions are selling service, which is the result of long study and experience.

It is high time for radio merchants to show their customers that radio service must be recognized in the same manner. The best service men are those who have

studied the technicalities of radio and have coupled with it long and costly experience. This should be paid for, and it is up to every dealer in the radio business to see that it is.

* * *

Give a Thought to Better Windows

TWO kinds of people stop and look in radio show-windows. (1) People who already have radio sets but who are interested in seeing what's new since they bought theirs. (2) People who are thinking about buying a set, and are "looking around."

Both classes have money in their pockets for the radio dealer. Group 1 needs parts and accessories, and eventually will buy better sets. Group 2 is made up of select prospects, ready to be closed.

Your windows are your introductions to this ready money that daily passes your store. Are the displays fresh, clean and attractive? And have you laid plans to have them kept so by regular and frequent changes during the months ahead?

"The March of the Lame Ducks"

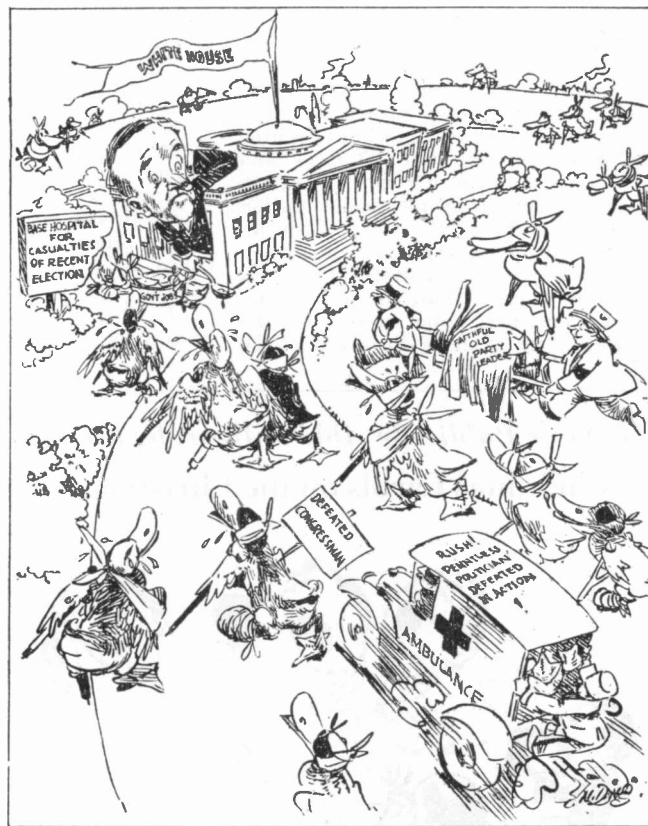

"Ding," in the *N. Y. Herald-Tribune*, hits the nail on the head when he says, in this cartoon, that President Coolidge will have a lot of casualties from the last election to take care of. And what could be simpler than "taking care" of some of these political "lame ducks" by putting them on a radio commission that excludes qualified radio men from membership? A commission of radio men co-operating with the Department of Commerce will prevent the possibility of political control of radio.

The Status and Prospects of Radio Legislation

(From Page 39)

ether channels, which are being planned by more than seventy stations which are now under construction.

On July 3, the day that Congress adjourned, there was enacted a joint resolution known as the radio "stop-gap" measure. Its purpose was to bring to light any claims of "vested rights" in the air and to fix irrevocably the United States Government's exclusive rights to the wavelengths over its territory at home and overseas. Through some cause, the resolution failed, in the closing "jam" of the session, to secure the signatures of Vice-president Dawes and Speaker Longworth. It is intended now to obtain them as soon as Congress is convened and then to send the resolution to the President for his signature. Both Representative White and Senator Dill consider the enactment of the "stop-gap" resolution an important condition precedent to radio legislation. It reads as follows:

That until otherwise provided by law no original license for the operation of any radio broadcasting station and no renewal of a license of an existing broadcasting station shall be granted for longer periods than 90 days and no original license for the operation of any other class of radio station and no renewal of the license for an existing station of any other class than a broadcasting station shall be granted for longer periods than two years, and that no original radio license or the renewal of an existing license shall be

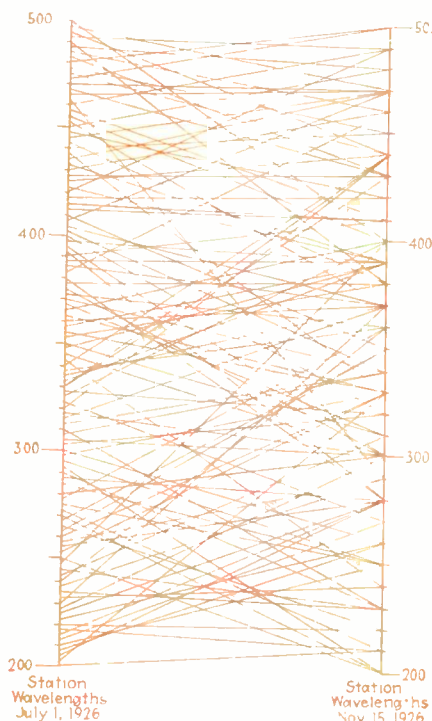

This chart shows the confused condition of wavelengths after the 75 present changes have been made. If every station had adhered to its assigned wavelength, the lines would go straight across from column to column. It demonstrates how completely the careful allocation of wavelengths by the Department of Commerce has been muddled.

granted after the date of the passage of this resolution unless the applicant therefor shall execute in writing a waiver of any right or of any claim to any right as against the United States to any wave length or to the use of the ether in radio transmission because of previous license to use the same or because of the use thereof.

It will be noted that the above resolution as passed by both houses,

relates only to the "waiving of vested rights" in wavelengths, and in no sense *limits the number of stations* privileged to broadcast. It is this latter provision for limiting the number of stations which is now so important to radio listeners. To accomplish station limitation will necessitate the passing of an additional Congressional resolution instructing that no more licenses be issued until the new fundamental radio law is passed. Such a resolution will hold the situation *in statu quo* until adequate controlling legislation can be enacted, as pointed out in the leading editorial of this issue.

Planning for 1927

(From Page 51)

in general will not be so responsive in the spring of 1927, as it was in 1926 and 1925. This may be aggravated by local conditions, such as, in the South, the cotton situation.

Many excellent authorities, in a much better position to know than I am, do not feel this way—but I am going to be a bit conservative and keep my assets as liquid as I can.

Re-reading the foregoing, I am struck with its gloomy aspect; but I don't mean it that way. We expect to sell radio in 1927, more of it than we have in 1926, but I feel we'll have to work harder and more intelligently to do so. *This calls for the greatest care in planning.*

As usual, we'll not make any large commitments in advance. We'll follow a "hand-to-mouth" buying policy. Some manufacturers and jobbers mistakenly criticize this policy. They are wrong. The only retailer that is an asset to them is a financially sound retailer—and "hand-to-mouth" buying makes for financially sound merchants by enabling them to keep their stocks in as liquid a condition as possible. "Small stocks and quick turnover" should be the radio policy for 1927.

Radio Ad on Bottle Cover

The E. G. McKinney Hardware Company, Durant, Oklahoma, has hit upon a good plan for keeping its name before the public. It purchases milk bottle caps in large quantities and on them has printed an ad for the McKinney Company. It purchases these milk bottle caps in lots of 50,000 and is able to sell them to dairymen and milk dealers at a price just enough to cover the cost of printing. —*Atwater Kent Dealers' Bulletin.*

Will Your Public Be Able to Hear, by Radio,

Christmas Carols on the Christmas-Morning Air?

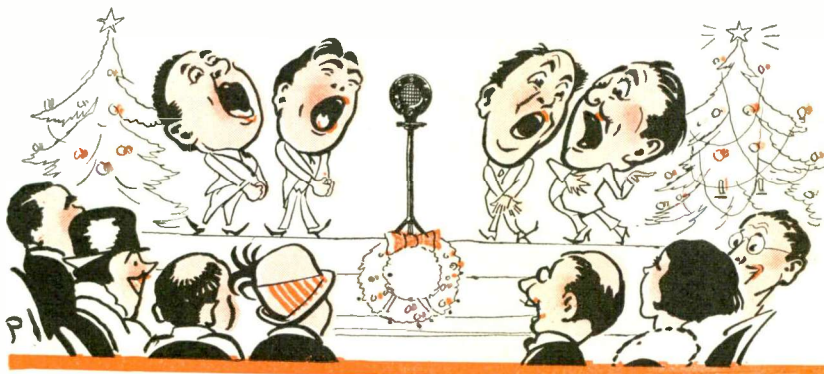

If you have influence with your local radio station, urge its management to arrange a special program of Christmas carols for Christmas morning, Dec. 25. This will give recipients of new radio sets a thrilling experience in trying out their new gifts. Announcement of such a program will also encourage tardy purchasers to buy

in time for the Christmas morning carols.

If you operate your own station, invite a quartet of well-known church singers to sing the carols into the microphone in your store or show window. And get the newspapers to announce this unique Christmas-carol service on the Christmas-morning air.

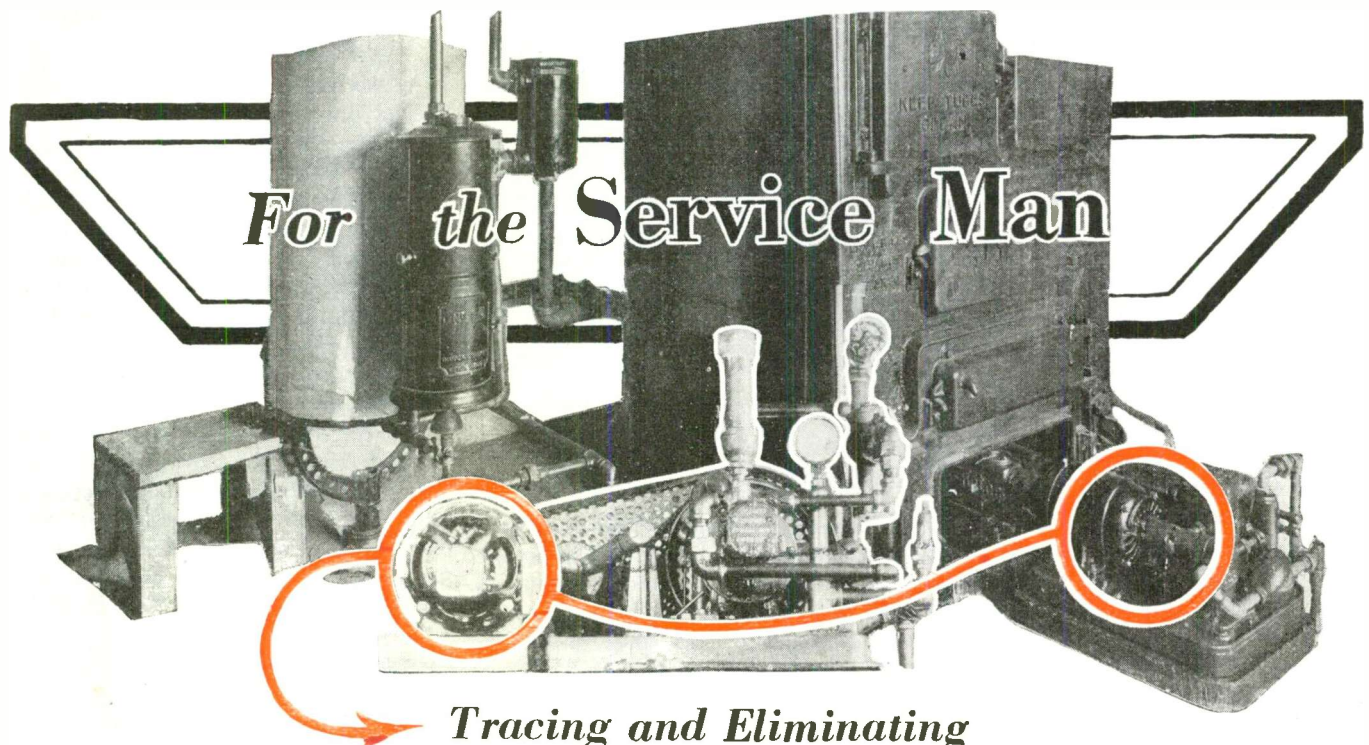

Tracing and Eliminating

Oil Burner Interference

WITH the colder weather come better radio reception and less static. But man, as usual, steps in and disrupts the natural course of events, so that as nature eases up on the static he proceeds to make some.

In this particular case we refer to oil burners for the furnace which have come into very popular use within the past few years. Trouble from this source is evidenced by a continuous frying or crackling noise in the radio set, which may continue for thirty or forty minutes at a time, and sometimes longer. There are a number of oil burners now on the market that use a universal type motor connected to a blower or centrifugal sprayer device. This type of motor uses a commutator with brushes continually bearing down upon it. After a short time this commutator becomes dirty and much sparking occurs at the brushes. Even a new motor will sometimes spark quite a bit. The result is interference to all close-by radio receivers. It has been found that the interference will at times travel for a block or more each way from its source.

Oil burners which use a repulsion induction motor do not cause radio interference.

After finding this source of interference, the next step is to clear it up. On offending series

A Department of Service Helps
Conducted by
H. W. BAUKAT

motors it has been found that the filter shown in the accompanying sketch will usually entirely eliminate the interference.

To construct filter such as this take two porcelain tubes approximately 1 in. in diameter and 12 in. long, and on each of these wind 175 turns of No. 16 D.C.C. wire. This size of copper wire will pass all the current necessary for the operation of a ¼-hp. motor, the size most commonly used in oil burners. The number of turns, as well as the size of the by-pass condenser, will have to be determined by experiment for each job, since, experience shows, no set rule can be laid down that will be equally effective on every motor.

However, the figures given here can be used as a basis in most cases. After the coils are wound, they should be mounted on a 7 in. x 14 in. bakelite panel and the whole device put in a metal service box measuring 10 in. x 16 in. x 4 in. The two by-pass condensers, whose capacities may vary anywhere from 1 to 8 mfd., can also be put in this box and their mid-point grounded. Sometimes it is necessary to shunt an additional condenser as shown on diagram below.

Where the interference is not too bad, an 8 mfd. condenser shunted directly across the brushes of the motor often will effectively stop the interference. Put the condensers and chokes as near the brushes as possible.

Base Receptacle For Aerial and Ground

An ordinary base receptacle and a plug make a very excellent method of entrance for the aerial and ground. The receptacle placed in the base-board facilitates quick disconnecting of the set. Both the plug and receptacle should be marked in such a way as to make reversal of the leads impossible.

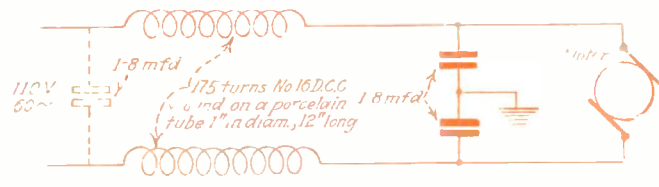

Above is the wiring scheme for checking interference from universal type oil burner motors.

Re-magnetizing Phone and Speaker Units

Many old headphones and horn type speakers now in the possession of radio fans can be made to operate as they did when new, by the simple process of re-magnetization.

Possibly the diaphragm may have a dent in it which means that this should be replaced, or at some time or other the cords were connected in such a way that the field of the electro-magnets opposed that of the permanent magnets, thus weakening the permanent magnet. J. A. Aniba, Delmar, Del., recognized this fact and is re-magnetizing phones in the following manner:

"All that is necessary," he tells us, "is a magnetic compass, a stock of diaphragms, and an electro-magnetic field. When a pair of phones or a loud speaker is brought to me, I proceed as follows: First, the unit is connected to a working set. If the signal is feeble I try a new diaphragm. If this does no good, the magnets are next tested. I find that a good magnet should hold a twenty-penny nail on either pole. If it does not, a compass is then used to determine the poles, remembering that the north pole of the compass needle will be attracted to the south pole of the unit. Having determined this, the next step is to re-magnetize the magnets through an electro-magnet which can be run from a 6-volt storage battery. After energizing the electro-magnet, place the poles of the unit against those of the magnet, making sure that the unlike poles are together. From 15 minutes to half an hour will re-magnetize them fully."

Overcoming Interference from Electric Heating Pads

Users of very sensitive radio receiving sets have perhaps noticed that when an ordinary electric heating pad, having an automatic

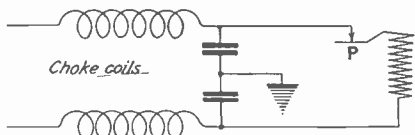

Fig. 1

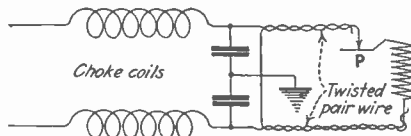
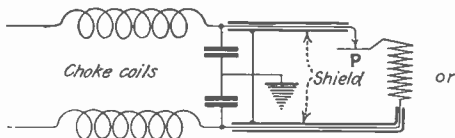

Fig. 2

thermostat control, is used anywhere in the house, a click is heard in the receiving set every time the contacts make and break. This is very annoying as these breaks come quite frequently while the device is in use.

W. L. Hodges, of the Wireless Specialty Apparatus Company, Boston, Mass., has found that the insertion of choke coils and condensers in the ordinary manner is not possible due to their size and that placing them further back in the supply wires does not stop all the noise.

"Therefore," he tells us, "we have narrowed the matter down to cutting out the disturbance radiated from that portion of the wire between the heating pad and the point where condensers and choke coils may be conveniently located in the supply circuit. Shielding the wires between these two points provides a partial, if not total, solution. In the case of a heating pad this wire must be flexible and the shield, therefore, must be a woven covering or a wrapped flexible covering, to give complete coverage. Some improvement will result from paralleling each of the carrying conductors as for instance, by using twisted pair wire for each lead and utilizing the capacity, one wire of each pair would have with it an accompanying current conductor, as indicated in the sketch."

Fig. 1 shows the manner in which choke coils and condensers should be inserted in power lines where radio interference is being caused by heating pad P.

Fig. 2 shows two methods by which the wires leading to the pad may be shielded.

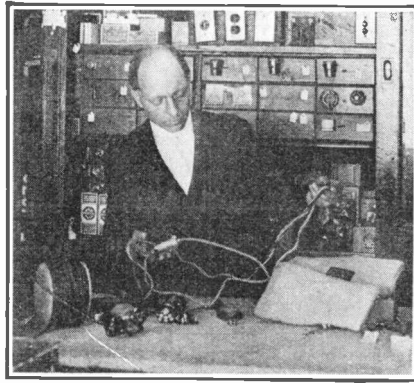

To shield heating pad wires is not a very difficult job and one which will bring extra dollars to the dealer's pocket.

Soldering-Iron Pilot Lamp Plug Saves Power

A skyrocketing electric light bill caused one western radio dealer to keep his "weather eye" open for power waste. Sure enough, he found that electric soldering irons were connected and often forgotten. Accordingly, the illustrated combination pilot lamp and base-plug connector found its way into the shop to check carelessness and it has incidentally proved to be an attractive side-line article.

One of the dealer's service men carried a soldering iron and one of these pilot lamps off to a customer's home some time ago and it so happened that the housewife saw him use the iron, with its glowing reminder that the current was still on. Immediately, she saw its possibilities in connection with her electric iron and bought it. Now several of these plugs are part of the equipment of every service man, and many have been sold outright without any particular effort.

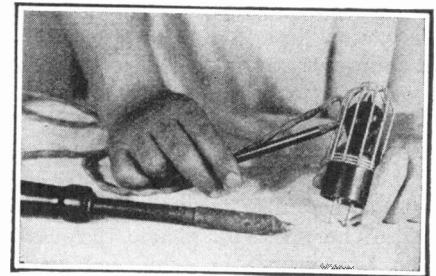

This pilot lamp plug, not much larger than an ordinary plug, insures against forgetfulness.

Resistance Value

The value of the resistance and the size of battery to be used in the circuit published on page 87 of the November issue of *Radio Retailing* relative to a Universal Testing Machine were purposely left out as any desired values can be employed. However, as there have been several inquiries about these values it may be well to explain this point a little further.

The sole purpose of the fixed resistance is to keep the needle of the meter on scale to any predetermined reading desired by the builder. A 4½ volt C battery will probably be the handiest to use here, and in this case the approximate value of the resistance will be 50 ohms. This can be made up by winding some fine wire on a spool and testing until the proper value has been arrived at.

Test for Defective Resistors

It sometimes happens in a resistance coupled amplifier of the audio frequency type that trouble is experienced in the resistors burning out after a certain period of use. The usual indication of this state of affairs is a gradual decrease in volume or else a decrease accompanied by a lot of "static" in the speaker.

The decrease in volume is caused by the resistance of the unit going up to a value where the voltage impressed on the tube is not enough to make it function properly. One way of testing, and it is particularly handy where the resistors are not mounted in plain sight above the sub-panel, is to have a standard resistor with a piece of flexible wire soldered to one end. The other end of the wire may have an ordinary battery clip fastened on it.

The procedure is to turn on the receiver, connect up the flexible wire to the B battery, and then touch each of the plate connections at the tube socket in turn. The volume should come back almost to normal if the resistor has become defective through burning out and, when connected to the resistor which happens to be O.K., the volume will decrease.

Heating Stops Lamination Hum in Transformers

While every effort is made on the part of transformer manufacturers to supply the popular B-power-eliminator transformer free from mechanical or electrical noises, it

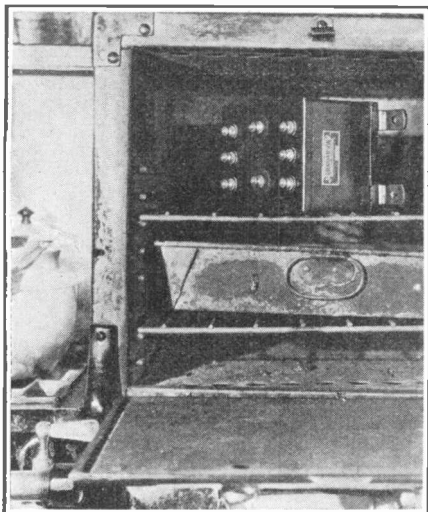

Small transformers sometimes hum objectionably due to a loose lamination. Remelting the compound inside will usually stop the noise.

sometimes happens that the compound, used to seal the core laminations inside the case, works loose. When this happens the magnetic field causes the loose lamination to set up quite a hum.

A simple treatment to overcome this consists of baking the transformer in an oven, as shown in the photograph, and allowing it to get just warm enough to soften the compound. Change the position of the case every few minutes so that the compound will not run to one side, but will run evenly and fill up the space where the loose lamination is, and prevent it from vibrating.

Correct C Battery Voltage

It is a known fact that the B battery voltage which is normally 90 on a receiver may fall to 67 volts or possibly lower before the operator begins to notice any radical change in the volume of the music obtained. The voltage of the battery gradually falls off with age and the loss is so little each day that it is hardly noticed. Lately several cases have come up where the C battery was causing trouble due to natural falling off of plate voltage.

There is a certain amount of C battery to use for any given plate voltage and tube. If the plate voltage is decreased without a corresponding decrease in the C battery voltage, distortion will be evident even before the battery is completely exhausted. If it is desired to continue the use of the B battery after the voltage has fallen to a considerable extent, it is well to reduce the C battery voltage or else remove the C battery entirely until new B batteries are obtained.

Portable Battery Cabinet

A Brooklyn radio dealer, in order to demonstrate expeditiously the various sets about his store without going to the trouble of wiring up the entire store for batteries, conceived the idea of having a small mahogany cabinet mounted on wheels, such as one finds in the home on tea wagons.

In this cabinet all A, B and C batteries are conveniently located, the entire output being connected to a Jones Multi-Plug. As the sets come in the store they are equipped with the other half of this device so that whenever a set is to be demonstrated it necessitates only pushing the wagon to where the set is located and

Condenser Blocks Interference

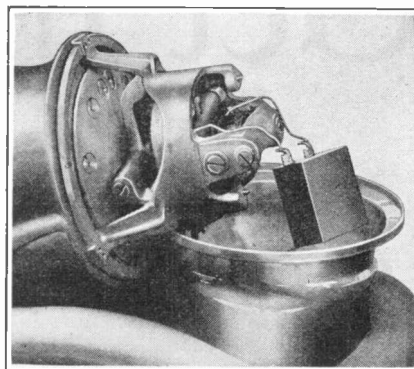

The vacuum cleaner motor is one of the worst sources of local interference. Shunt the brushes with a two mfd. condenser. This will eliminate the interference entirely.

connecting the plug. At night this cabinet can be wheeled to the rear of the store and the storage battery charged up for the next day's work.

Fada Neutralizing Tool

F. A. D. Andrea, Inc., announces a new tool for service jobs designated as the Fada neutralizing tool. The development of the Fada 6 and 8, embodying a special type of neutralizing condenser, led to the designing of this tool for adjusting them. The engineering department explains that while these condensers seldom need adjusting, the new tool gives the service men of distributors and dealers a handy means to make readjustments when they become necessary.

Capacity Click Deceptive

If you are using the 'phone and battery method of testing for short or open circuits in radio apparatus, be careful that you do not get fooled by the low click given out due to the slight charge which may have collected in the instrument under test, particularly condensers. This click will be heard in parts at times when they are defective, thus giving the service man a false impression as to the electrical soundness of the device in question. The light bulb in series with the power line is the only reliable method.

Batteries Should Be Protected

Don't forget the fire underwriters' rules which provide that all storage batteries shall be protected by fuses or circuit breakers rated at not more than 15 amp. and located preferably at or near the battery.

Get the whole range



RCA Radiola

MADE · BY · THE · MAKERS · OF · THE · RADIOTRON

RADIO · CORPORATION · OF · AMERICA · NEW YORK · CHICAGO · SAN FRANCISCO

of Christmas sales - with the *complete* line of Radiolas



Sell to the man who wants the finest radio—at a moderate price

Radiola 20, list, \$115

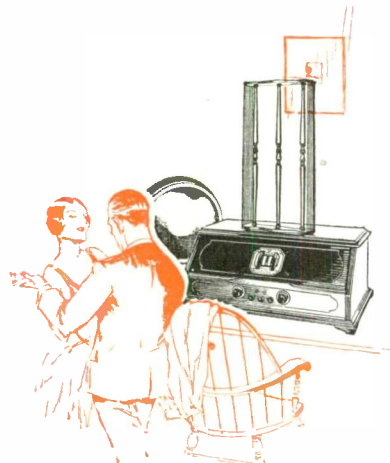

Sell to the man who wants the superlative quality of the super-heterodyne.

Radiola 25, list, \$165



This sign marks the leading dealer in every community.

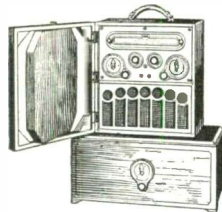

Radiola 26, list, \$225

DON'T let a single sale go by! With the complete line of RCA Radiolas, and the Radiola Time Payment Plan to back him up, the RCA Authorized Dealer can sell to every radio prospect... from the man who can buy only the smallest model "on time"... to the man who can pay cash for the finest of all.

RCA dealers themselves predict that this will be their greatest year. Sales are rising to a new peak, for the public has absolute confidence in the *tried, tested* and *perfected* Radiolas. The public knows that they will continue to perform as they do on demonstration—superbly!



Sell to the man who wants lighting socket radio.

Radiola 28, list, \$260. RCA Loudspeaker 104, list, \$275. A. C. Package, for adapting Radiola 28 for use with Loudspeaker 104, without batteries, list, \$35.

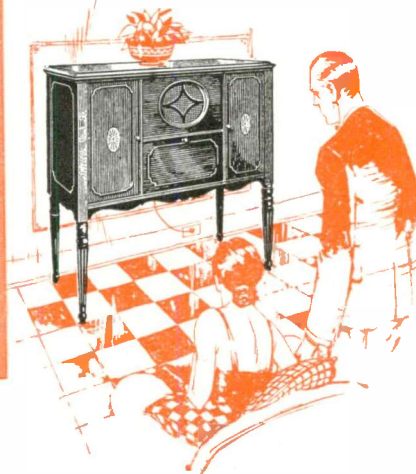

Sell to the man who wants the great electrical and musical achievement of the Radiola 30.

Radiola 30, list, \$575

RCA Radiola

MADE · BY · THE · MAKERS · OF · THE · RADIOTRON

RADIO · CORPORATION · OF · AMERICA · NEW YORK · CHICAGO · SAN FRANCISCO





What's New in Radio and

This editorial section is prepared purely as a news service, to keep readers of "Radio Retailing" informed of new products.

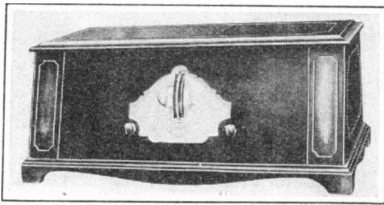

Six-Tube Uni-Control Receiver

Radio Retailing, December, 1926

The Langbein-Kaufman Radio Company, 62 Franklin Street, New Haven, Conn., is making the illustrated 6-tube "Elkay" receiver. This embodies the Donle Truphonic system of audio frequency amplification and both the radio frequency stages and the detector are entirely shielded. The uni-control has a flexibility of three dials; is very simple to tune, with no sub-controls. The sockets are of the "floating type" mounted on a Bakelite sub-panel. All connections are taken from a common cable. The receiver is installed in a sloping-front cabinet of brown, antique Duco finished, natural grain mahogany. The intended retail price is \$125.

Cone Loud Speaker Console

Radio Retailing, December, 1926

The Windsor Furniture Company, 1420 Carroll Avenue, Chicago, Ill., is making a cone loud speaker console. This measures 30 in. long, 17 in. wide, and 29 in. high. The cone itself is 22 in. in diameter and the console may be had with either mahogany or walnut finish. A spruce sounding board is used and an added feature is the battery shelf which measures 26 in. by 10½ in. This is known as Model 200 and has an intended retail price of \$29.

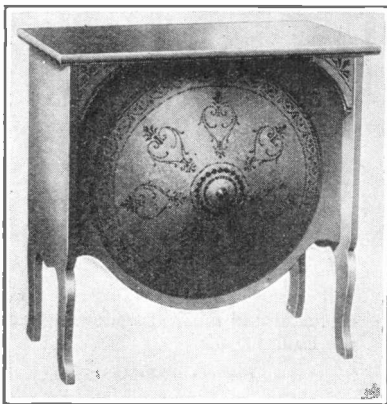

B Battery Power Unit

Radio Retailing, December, 1926

The Precision Electric Manufacturing Corporation, 1020 Santa Fe Avenue, Los Angeles, Cal., is making a B power unit designed for sets using from 1 to 12 tubes. The output is said to be 120 milliamp., and condensers of a capacity of 100 mfd. are used. Model M which furnishes up to 135 volts and has one variable voltage, has an intended retail price of \$42.50, complete. Model L which furnishes up to 90 volts, also having one variable voltage, has an intended retail price of \$37.50 complete.

Six-Tube Console Receiver

Radio Retailing, December, 1926

The Simplex Radio Company of Sandusky, Ohio, presents a new Console Model to sell at \$165. It is a single dial six tube set having three stages of audio amplification. The two radio frequency and detector stages are individually equipped with separate condensers and the three condensers are connected in units to a single control by a series of grooved pulleys. The tie between the pulleys is made with spring wire under tension. Provision has been made so that the first and third condensers may be adjusted to the phase of the second if necessary. Primary or antenna inductance of the first stage is tapped to accommodate different length aerials. The cabinets are of genuine mahogany, hand rubbed in two-tone Duco finish. Provision has been made to accommodate all batteries and accessories, including charger, in cabinet compartments.



Seven-Tube Receiver in All-Metal Cabinet

Radio Retailing, December, 1926

The new Thermiodyne "Treasure Chest" 7-Tube receiver, as illustrated, is being made by the Algonquin Electric Company of Poughkeepsie, N. Y. This is included in a hammered, all-metal cabinet and will cover a wave band of from 190 to 550 meters. The circuit incorporates three stages of tuned radio frequency, detector, and three stages of audio frequency amplification (one transformer coupled and two resistances coupled). The set is equipped with vernier controls for fine tuning. The receiver has an intended retail price of \$180 and the table shown, \$40. This set is also being put out in red plush to retail for \$200, and the table for \$55. A cone-type loud speaker is also being made which has an intended retail price of \$40 and is finished to go with the set just described. This same speaker in ordinary finish will have an intended retail price of \$30.

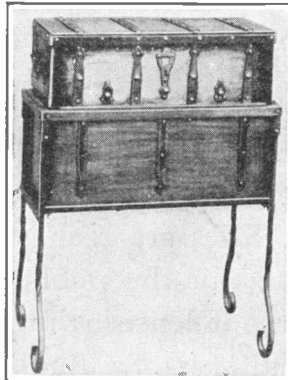

Six-Tube, One-Dial, Shielded Receiver

Radio Retailing, December, 1926

The illustrated six-tube, one-dial control receiver is being made by the Electrical Research Laboratories, 2500 Cottage Grove Avenue, Chicago. It is completely shielded and, according to the manufacturer, will operate on an antenna of from 1 to 100 ft., or a loop. Erta concert grand audio frequency transformers are used, and also a 92 in. air column horn. The cabinet is of dark American walnut, trimmed in satinwood with panels of matched burl walnut. Intended retail price of the De Luxe Super-Six Console, \$285. The six-tube table cabinet is \$210.

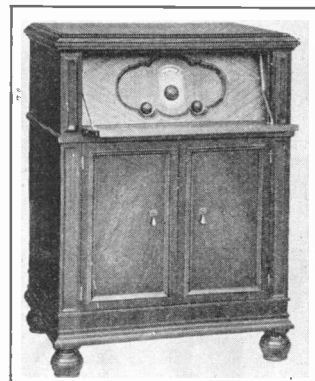

Variable Balancing Condenser with Glass Insulation

Radio Retailing, December, 1926

The B-T "Mikro Mike" condenser, is being manufactured by the Bremer-Tully Manufacturing Company, 532

South Canal Street, Chicago, is for use as a balancing or neutralizing condenser. The dielectric in this capacity unit, variable from 1½ to 25 mfd., is of glass which according to the manufacturer, makes it impossible to short the unit when operated with ordinary voltages. Intended retail price, \$1.

Where to Buy It

News of Latest Products
Gathered by the Editors

All announcements appearing on these pages are published without advertising considerations of any kind whatsoever.

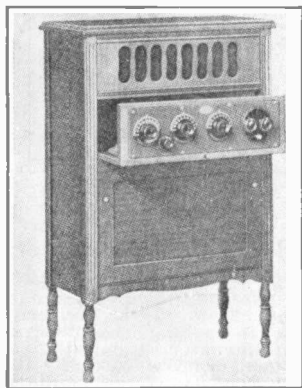

Console With Built-In Horn

Radio Retailing, December, 1926

The Plymouth Furniture Co., Plymouth, Wis., is the manufacturer of the illustrated model 200 console. This has been designed for Atwater Kent Models 20 compact, or 30 and has over-all dimensions of 40 in. high x 25 in. wide x 12 in. deep. It is made of walnut veneer with gum wood trimming. There is ample space in the bottom compartment for either batteries or battery eliminators. The horn is made of wood with metal tone arm and is arranged to take any standard phonograph unit. The sliding drawer where the set chassis goes has screw holes started for panel mounting, so that it takes but a few minutes to install the set. The top is stationary in order that ornaments may be placed there. Intended retail price, \$35.

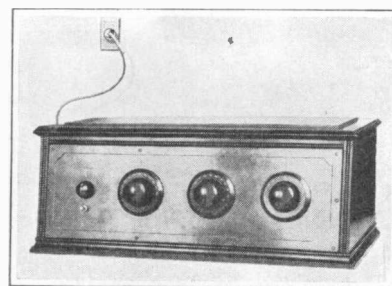

Six-Tube Socket Power Receiver

Radio Retailing, December, 1926

The illustrated receiver to be operated from the electric light line is manufactured by the Terminal Electric Company of New York, and distributed exclusively by the Powerola Radio Corporation, 44 Whitehall Street, New York City. This is Model 150 and is equipped with a mahogany cabinet. It incorporates a tuned radio frequency circuit and is designed for combination with 6 power tubes. It eliminates the A and B batteries. It will tune from 200 to 600 meters and the intended retail price with tubes is \$155. Chassis Model 175 is the same set without the cabinet. It will fit into practically all consoles as over-all dimensions are 7 in. x 18 in. x 11 in. The power device is in a separate metal box for insertion in battery or other space. Intended retail price with tubes \$140.

Reproducer and Receiver with Remote Control

Radio Retailing, December, 1926

Richard T. Davis, 5252 Broadway, Chicago, Ill., is marketing the illustrated "Mastro-Ortholian." This is a power amplifier and receiving set put up in two units. The small unit, which contains the radio frequency and detector tubes weighs approximately 12 lbs. and is portable to any part of the room. The speaker-cabinet contains the audio amplifying tubes, the B-eliminator, trickle charger, double point cone and space for storage battery. This amplifying unit uses 110 volts 60 cycle current and has two tubes, a UX216-B and a UX-310. The dimensions of the first unit are 19 in. wide x 7 in. high x 9 in. deep; the speaker-cabinet is 48 in. high x 14 in. deep x 22 in. wide. The master control is completely shielded and is covered with shark's hide fabrikoid, the ends being finished in a richly designed bronze metal casting. Intended retail price, both units complete except for tubes and storage A battery, \$345.



Battery Tables and Consoles

Radio Retailing, December, 1926

The International Equipment Co., 1324 Chestnut Ave., Kansas City, Mo., is making the illustrated No. 275 battery table. Ample leg room is provided for the operator, and a desk drawer for log books, etc. Also a spacious battery compartment. Can be had in either walnut or mahogany finish. Over-all dimensions are 38½ in. x 18½ in. x 30½ in. Intended retail price \$27.50.

No. 20 battery table has a brown mahogany finish and is designed to accommodate Radiola No. 20, Atwater Kent compact, and all 18-in. panel receiving sets. Over-all dimensions 22 in. x 17 in. x 28 in. Intended retail price, \$20.

No. 475 console is complete with grill, tone chamber, and Utah super-magnetized unit. This is a genuine walnut job and accommodates all 18 in. x 7 in. panel sets. Intended retail price, \$50.

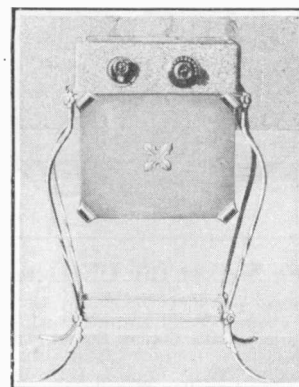

Wrought Iron Radio Stand

Radio Retailing, December, 1926

Designed especially for the Atwater Kent Model 35 radio receiver is the wrought iron radio stand being made by the Progressive Musical Instrument Corporation, 319 Sixth Avenue, New York. It is finished in two-tone brown and gold to match the radio receiver and has a special battery compartment. The intended retail price is \$20.

B Battery Power Unit

Radio Retailing, December, 1926

A B battery power unit is manufactured by the Bremer-Tully Manufacturing Company, 532 South Canal Street, Chicago. Variable voltage regulators have been dispensed with in this unit, which is supplied with fixed resistances

governing the voltages delivered. For use with different tubes, other fixed voltage regulators may be substituted. The eliminator uses a Raytheon tube and may be used on either 110 or 120-volt a.c. lines, delivering current sufficient to operate sets employing up to 7 tubes. Outside dimensions, 4 in. x 7 in. x 10 in. Weight 15 lbs. Intended retail price, with Raytheon tube, \$49.50.

65 Milliampere Rectifier Tube

Radio Retailing, December, 1926

Known as GSX-216-B is the rectifier tube which has been developed by the Gold Seal Electric Company, New York City. It is designed for use with eliminators and power amplifiers. The tube will supply current up to 65 milliamp. and will take an impressed voltage of 550.

What's New in Radio and Where to Buy It—

Filament Type Rectifier Tube

Radio Retailing, December, 1926

The Glenn L. Martin Company, Cleveland, is the manufacturer of the "Aero" rectifier tube. This is a gas-filled tube, having a 5-volt filament and known as Type 505. It is a half-wave rectifier with a maximum a.c. input rating of 440-volts. It will deliver a maximum d.c. load current of 65 milliamp., while the filament draws 2 amp. The intended retail price is \$6.

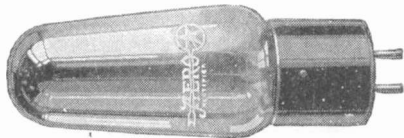

Illuminated Vernier Dial

Radio Retailing, December, 1926

A back panel mounting illuminated vernier dial known as "Glo-Dial" is being made by the Wireless Radio Corp., Varick Ave. and Harrison Place, Brooklyn, N. Y. The dial is translucent with a small light operating from the A battery behind it. A switch at the top controls this light and also forms one of the supports by which the dial frame is fastened to the panel. The other support is found at the bottom where the actuating knob is located. No gears or cogs are used, and a smooth positive friction drive makes possible very fine tuning. Intended retail price, \$1.75.

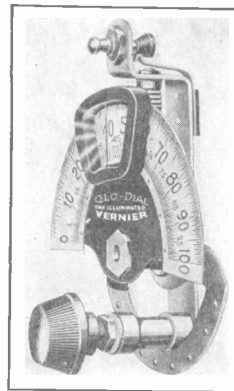

Vernier Dial With Metallic Shield

Radio Retailing, December, 1926

The H. H. Eby Manufacturing Company, 4710 Stenton Avenue, Philadelphia, Pa., is making a shielded dial. It turns either clockwise or counterclockwise and is graduated from 0 to 100 and from 100 to 0. It is made of molded Bakelite, has no back lash and uses no gears. Mounting is accomplished by means of drilling one hole. The intended retail price is \$2.50.

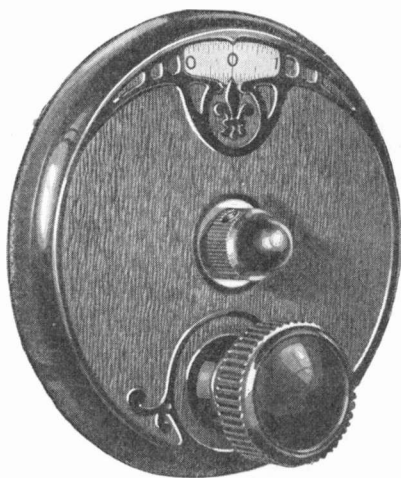

B Battery Eliminator

Radio Retailing, December, 1926

The Greene-Brown Manufacturing Company, 2600 North Western Ave., Chicago, is making the illustrated B battery eliminator, designed to operate on 110-volt, 60 cycle current. It has a current capacity of 60 milliamp., is equipped with an on and off switch, and the detector and intermediate voltages are variable. A new filamentless, full-wave rectifier tube is used and the case which measures 9 in. x 4 in. x 9 1/2 in. is finished in a brown and green crystal lacquer. Intended retail price, complete with tube, \$39.50.



B and C Battery Eliminators

Radio Retailing, December, 1926

The Acme Apparatus Company, 37 Osborne St., Cambridge 39, Mass., is making the illustrated B battery eliminator, known as Type E-3. This is designed for sets using 1 to 6 tubes and for operation on 110-volt, 60-cycle current. Up to 180 volts is furnished. Intended retail price, including the Raytheon tube, \$39.50.

Type E-1 eliminator, for sets using from 1 to 12 tubes, and for operation on 110-volt, 60-cycle current, has an intended retail price of \$50, complete with tube.

Type E-2 eliminator, for sets using from 1 to 12 tubes and for use on 110-volt, 220-volt d.c. current. Intended retail price \$25.

The C battery eliminator, known as C-1, is for operation on 110-volt, 60-cycle current, and has two variable voltages

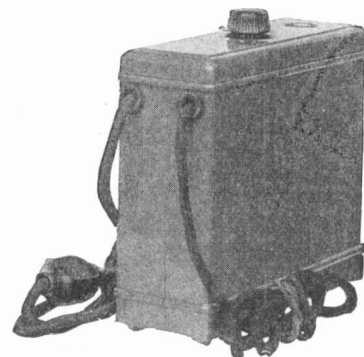

up to 50 volts. The rectifier tube is a UX-199 with a.c. on the filament. Intended retail price, \$16.

Spring Socket for UX Detectors

Radio Retailing, December, 1926

The Bremer-Tully Manufacturing Company, 532 South Canal Street, Chicago, manufactures a new type of spring socket for use with UX type detector tubes. The long "mufflers" press the glass of the tube, preventing microphonic vibration, according to the manufacturer. Flexible leads from socket prongs to the connecting terminals insure proper insulation from vibration. Intended retail price, \$1.

Lamp Socket Antenna Attachment of Bakelite

Radio Retailing, December, 1926

The new lamp socket antenna attachment manufactured by Electrad, Inc., 428 Broadway, New York City, is made entirely of Bakelite. Tested at 2500 volts a.c. by the Board of Fire Underwriters, the unit is said to serve as an efficient antenna when inserted in lighting sockets with an appreciable reduction in extraneous noises.

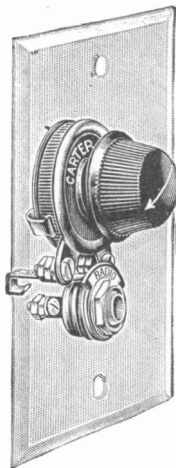

Receptacle Jack With Volume Control

Radio Retailing, December, 1926

The Carter Radio Co., 300 South Racine Ave., Chicago, is making a radio receptacle jack equipped with a volume control. It enables the user to regulate the volume of the speaker without changing the volume output in the balance of the circuit. It is designed for use in hospitals, apartment houses, hotels, etc., where more than one loud speaker or head set are used in the same circuit. Complete with satin finish brass escutcheon plate and screws for mounting in standard outlet box, on wall or baseboard. Intended retail price, \$2.75.

News of Latest Products Gathered by the Editors

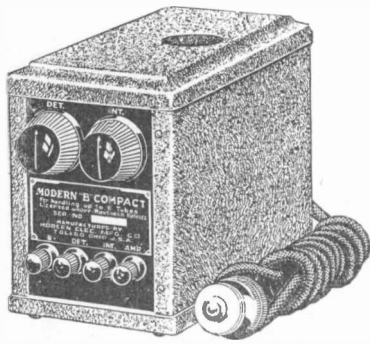

B Battery Eliminator

Radio Retailing, December, 1926

The latest battery eliminator to be manufactured by the Modern Electric Manufacturing Company, 312 Mulberry Street, Toledo, O., is known as the "B Compact." This has been designed to handle up to 6 tubes including 1 power tube. It contains Tobe Deutschmann condensers and there are three positive B taps provided and two variable controls. The finish is olive green crystal lacquer. All antenna and ground effects caused by the lighting circuit are said to be absent in this eliminator. Overall dimensions are $8\frac{1}{2}$ in. x $4\frac{1}{2}$ in. x $5\frac{1}{2}$ in. Total weight is 9 pounds. Intended retail price, complete with Raytheon tube, \$30.

Molded Bakelite Triple Hydrometer

Radio Retailing, December, 1926

The illustrated three-in-one hydrometer is being made by N & N Manufacturing Company, Chicago, and merchandised by The Zinke Company, 1323 South Michigan Avenue, Chicago. It is equipped with three tubes and floats showing in turn whether the battery is empty, half or full. The floats can-

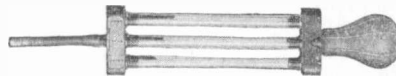

not stick, since they are suspended in the solution not above it. The specific gravities of the floats are, long, 1.280; medium, 1.215; short, 1.150. For testing B batteries a small rubber tube adapter is furnished with each instrument. Intended retail price, \$1.



Power Tubes for Last Audio Stage

Radio Retailing, December, 1926

The Gold Seal Electric Co., New York City, are making a power tube known as GSX-171, designed for use in the last audio stage only. This uses plate voltages of from 90 to 180 with a negative bias of from 16 to 40 volts. For sets not wired for this purpose, the tube may be used by means of a special adapter.

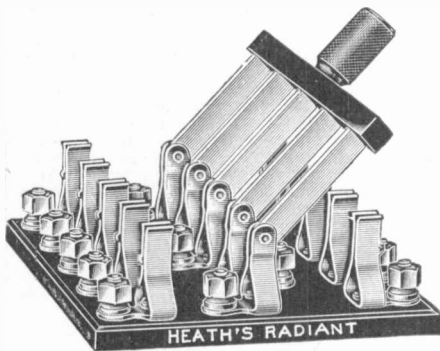

Knife Switch with Bakelite Base

Radio Retailing, December, 1926

Permanent alignment of receptive jaws is the claim made for the knife switch, made by the Heath Radio & Electric Manufacturing Company, 207 First Street, Newark, N. J. The switch, as illustrated, is made with a Bakelite base and is available in all styles from single pole, single throw to five-pole double-throw.

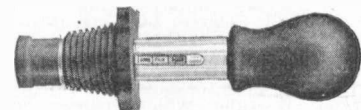

Hydrometer Fixed in Vent Plug

Radio Retailing, December, 1926

A battery tester has been introduced by the Scranton Glass Instrument Company, Scranton, Pa. It is called the Scranton Battery-Cap-Tester, and replaces the regular vent plugs remaining a permanent part of the battery. It is sold in sets of three, one for each cell. Once in place the testers are left there and are not removed except for adding water when they can be unscrewed as easily as the regular plugs. Thus they are always in position for immediate testing, and results are shown instantly without danger of spilling any of the solution or breaking the instruments. Intended retail price, \$2 for set of three.

Free-Edge Cone Reproducer

Radio Retailing, December, 1926

The Pontico Corporation, Telegraph Road, Pontiac, Mich., is now in production on a cone reproducer known as the "Pontico." It is 18 in. in diameter and the finish includes embossing in gold, and gold design on the cone itself. It can be used as a table speaker or hung on the wall by a tasseled cord. According to the manufacturer, features of the speaker to be noted are its lightness and the freedom with which it vibrates to its actuating mechanism. The intended retail price is \$12.50.

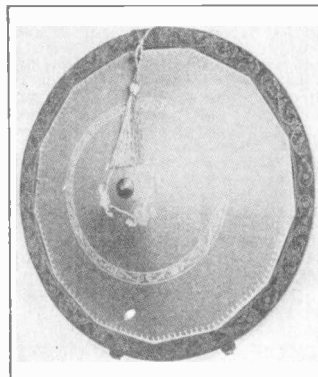

Extension Cord, Plug and Connector

Radio Retailing, December, 1926

The Morse Eureka extension cord, designed so that the output of a radio receiver may be used to operate a loudspeaker at a distance, is equipped with a plug which will fit any standard receiver jack, a duplex cable which may be obtained in lengths from 20 to 50 ft. and a Morse Eureka extension plug which permits any number of cords to be connected in series. Manufactured by the Frank W. Morse Company, Boston, Mass., the complete accessory has an intended retail price of \$1.25 with a 20 ft., cable and \$2 with a 50 ft. length.

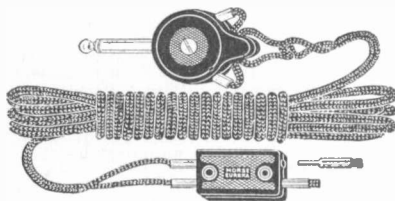

Five-Tube Receivers

Radio Retailing, December, 1926

The Sleeper Radio & Mfg. Corporation of Long Island City, N. Y., offers two new receivers at list prices of \$100 and \$125. One model is called the "Serenader" and the other the "Scout." Both use the same chassis but the Serenader has a built-in tone chamber with a 40 in. air column using the Amplion adjustable unit. Two control tuning is secured by use of a dual condenser for tuning both radio stages. Gold pointers operate by reduction gears over scales calibrated in wave lengths. B battery compartments are provided on the sides of the cabinet and a C battery compartment is in the rear. A cushioned detector socket provided with reversible grid leak connections permits use of either the 201-A or 200-A type tubes. A five-tube tuned radio frequency circuit is employed. A special output transformer is used permitting up to 200 volts for power tubes.

What's New in Radio and Where to Buy It—

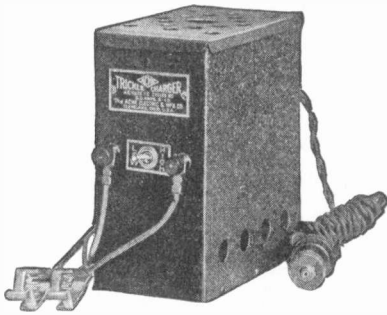

Two-Rate Trickle Charger

Radio Retailing, December, 1926

The Acme Electric and Manufacturing Company, Cleveland, has developed a two-rate trickle charger. It is of a transformer type, has two independent windings, and uses a Tungar bulb for the rectification of the alternating current. A charging current of $\frac{1}{2}$ and $1\frac{1}{2}$ amp. is delivered. Either of the above rates may be obtained by simply throwing a toggle switch, which is mounted on the outside of charger case. The case is made of sheet steel finished with crystalline lacquer, and is mounted on rubber feet.

New Raytheon Tube

Radio Retailing, December, 1926

The Raytheon Manufacturing Company, Kendall Square Building, Cambridge, Mass., is now making type BH tube, designed to stand any load up to 200 volts at 85 millamp. output. This tube has not been designed to replace the type B tube which passes 60 millamp., but rather to be used in circuits requiring more power.

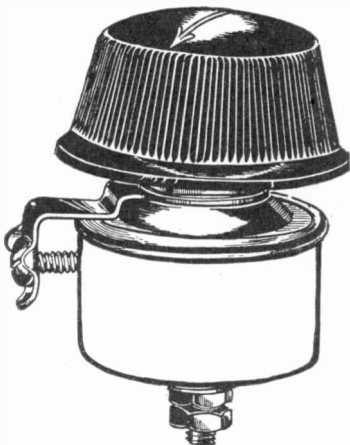

Universal Range Variable Resistor

Radio Retailing, December, 1926

The American Mechanical Laboratories, Inc., 285 North Sixth Street, Brooklyn, N. Y., have placed on the market a universal range "Clarostat." This can be used practically anywhere in a receiving set or B Battery eliminator circuit where a variable resistance is required. It is encased in brass and has a polished bakelite knob which turns a micrometer-threaded steel shaft. A single hole is required for mounting. A resistance variation of from 0 to 5 megohms can be had and up to 20 watts of energy can be handled.

Dial Illuminated from Back of Panel

Radio Retailing, December, 1926

The Martin-Copeland Company, Providence, R. I., is making the illustrated dial, the scale of which is illuminated from the back of the panel. The dial is held to the panel by the switch shown at the top and the knob at the bottom. The frame of the dial is so arranged that any condenser may be mounted directly to this, the shaft of which does not enter into the panel at all. To make mounting easy a template is furnished shown at the right in the illustration, by means of which all holes and especially the window for the bezel may be drilled. Scale readings run either 0 to 100 or 100 to 0. The pilot lamp runs from the 6-volt A battery using $1/10$ amp. Its socket is entirely insulated from the frame of the dial. There is no back lash in the friction drive used. Intended retail price, complete, \$3.50.

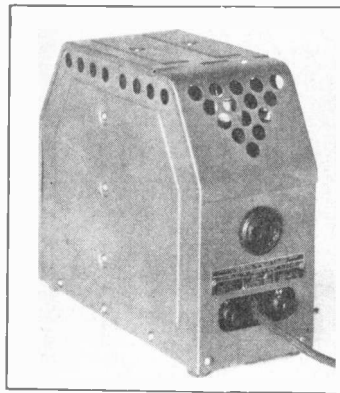
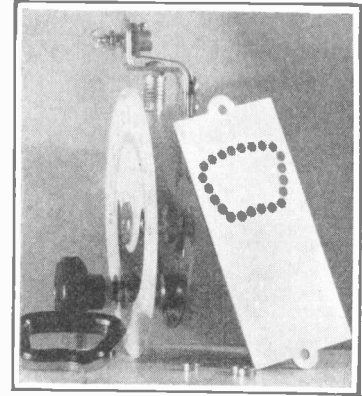

Power Unit for A Battery Supply

Radio Retailing, December, 1926

The Crosley Radio Corporation, Cincinnati, has placed a new A battery eliminator on the market which is said not to contain a trickle-charger or use storage batteries. It operates only when the receiver is in use, being controlled by the filament switch on the set. Regardless of line variations, the voltage output is constant, and the unit will supply power up to 2 amp. A plug in the rear of the unit permits the attachment of a B eliminator, making both the A and B units automatically controlled by the filament switch.

Loop Antenna

Radio Retailing, December, 1926

The Console Fiat Type C Loop is being made by the Radio Appliance Corporation, 4884 N. Clark St., Chicago. It is rectangular in shape with less than a 7 in. turning radius, making it convenient for standing close to walls or furniture. The frame is solid American walnut, with a hand-rubbed lacquer finish and the metal parts and name plate are rose gold. The end pieces through which the brown silk cord is wound are of polished Bakelite. It is easily assembled or taken down and has a bank winding. The base is equipped with a felt bottom and the wire consists of 65 strands of No. 38 copper brown silk covered. Erected, it measures $13\frac{1}{2}$ in. wide by 30 in. high. Natural wave length is 138 meters. Intended retail price, \$12.50.

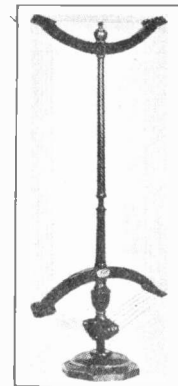

Kit for Six-Tube Receiver

Radio Retailing, December, 1926

The "Alden-Somerbridge" kit, manufactured by the Alden Electric Company, 524 Westminster Street, Providence, R. I., uses a new system of radio frequency amplification and stabilization. The radio frequency amplifier is said to pass on to the detector no noise of its own making. The detector receives an undistorted output from the radio frequency amplifier. The kit consists of: 3 Alden-Somerbridge R. F. transformers, 3 Alden-Somerbridge balancers, 1 By-pass condenser, 2 Working drawings for either two or three dial assembly. The intended retail price is \$18.

News of Latest Products Gathered by the Editors

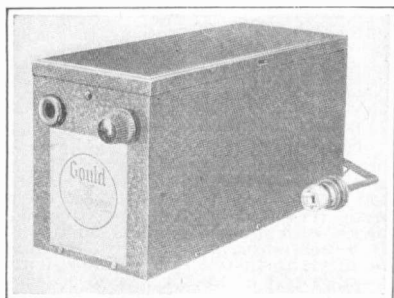

B Battery Eliminator

Radio Retailing, December, 1926

"Unipower B" is the latest battery eliminating device to be made by the Gould Storage Battery Company, Inc., 250 Park Avenue, New York. This device uses a tube for rectifying and delivers 40 milliamp. at 135 volts. The tube itself is rated at 60 milliamp. Over-all dimensions are 5½ in. x 7 in. x 11 in. There are no exposed terminals outside the unit, and a safety switch automatically turns off all power when the cover is lifted. The detector voltage is variable from 0 to 60. The intended retail price for use with 110 v. 60 cycle current, \$55. This unit may also be had for use with 25 cycle current at a slightly higher price.

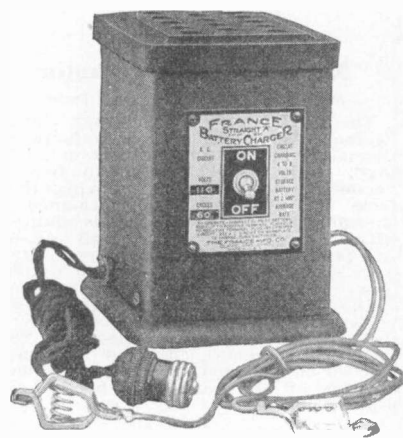

Trickle Charger With Harmless Electrolyte

Radio Retailing, December, 1926

The France Manufacturing Co., 10321 Berea Rd., Cleveland, O., has brought out a trickle charger employing a non-acid electrolyte that will not injure skin or fabric, or fade colors. The charging rate is .5 to .75 amp., and it is said to use very little current. A large transformer makes temperature rise negligible. The finish is baked on, and construction sturdy. Unconditionally guaranteed for a year in ordinary service. Intended retail price, \$10.

Automatic Power Control

Radio Retailing, December, 1926

For sets using a trickle charger and B eliminator or either, the Yaxley Manufacturing Co., 9 South Clinton Street, Chicago, Ill., has made the illustrated automatic power control. This is actuated by the switch on the radio set controlling the filament circuit, and turns the charger or other devices mentioned off or on as the case may be, when the set is turned on and reverses the action when the set is turned off. Made in two types—known as No. 444 and 445—having intended retail prices of \$5 and \$6.



A Battery Power Supply Unit

Radio Retailing, December, 1926

Known as the A-1 is the power supply unit being manufactured by the Acme Apparatus Company, 37 Osborne St., Cambridge 39, Mass. This unit operates the filaments of the tubes directly from the lamp socket and is not a trickle charger. A small battery is contained in the outfit which acts as a condenser and not as a battery. This unit will supply receiving sets using from 1 to 8 tubes, is designed for use on 110-volt, 60-cycle current, and has an intended retail price of \$42, without the tubes.

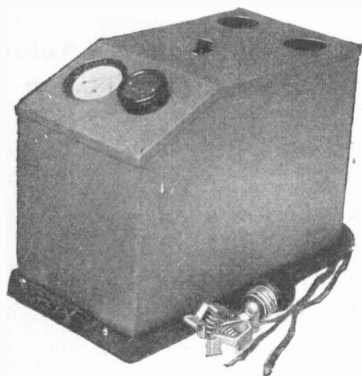

Battery Tester

Radio Retailing, December, 1926

The General Instrument Corporation, 477 Broadway, New York City, is making the illustrated battery "Ga-Jit," which takes the place of a hydrometer. It resembles a tire gage and measures 2½ in. high by ¾ in. in diameter. Upon applying it to the terminals of the storage battery, it indicates whether the battery is low, medium, or full. It is incased in a nickel polished case and has a cord long enough to reach the diagonal length of a battery. The intended retail price is \$1.25.

Hook-Up Wire

Radio Retailing, December, 1926

"Corwico" Flexibus manufactured by Cornish Wire Co., 30 Church St., New York, is a flexible insulated multi-strand copper hook-up wire. It is covered with a varnished cambric flame-proof insulation finished in the following colors: red, green, yellow, brown and black. For circuit distinction three colors totaling twelve feet are supplied in a carton at 50c per carton.



Midget Power Rheostat

Radio Retailing, December, 1926

Amsco Products, Inc., 416 Broome Street, New York, has developed the "Tom Thumb" rheostat. This rheostat measures only 1½ in. in its greatest diameter, mounts with a single hole, and extends less than ¾ in. behind the panel. Its compactness is achieved by mounting the air-cooled resistor element on the periphery of the mounting. Made in resistances from 10 to 50 ohms, at 75c. Potentiometer type at a slightly higher price.

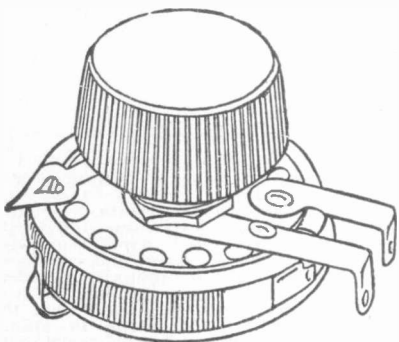

Reproducer Units

Radio Retailing, December, 1926

The Holiday Radio Company, Incorporated, Dooly Building, Salt Lake City, Utah, manufactures two different radio reproducer units, one known as the Holiday Baby Grand and the other as the Standard. The former has an intended retail price of \$6.50 and the latter \$5.50 each, f.o.b. Salt Lake City. These were designed to meet the demand for a good unit at a reasonable price. The units produce large volume and have a very pleasing tone.

What's New in Radio and Where to Buy It—

Multi-Tube Rejuvenator

Radio Retailing, December, 1926

The "Jefferson Tube Charger," made by the Jefferson Electric Manufacturing Company, 501 South Green Street, Chicago, will rejuvenate a number of vacuum tubes without removing them from the receiver. It is designed to operate from the light socket, is equipped with 7 ft. of flexible cord and connection plug and may be used in connection with either dry cell or storage battery tubes. Two small buttons on the panel of the device permit a temporary "flash" voltage to be applied, followed by a short reduced voltage application. The case is of metal, finished in green mottled enamel and an instruction plate is part of the unit. Intended retail price, \$3.50.

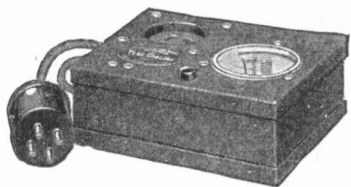

Chemical Type B Battery Eliminator

Radio Retailing, December, 1926

The Willard Storage Battery Company, Cleveland, is now marketing a B Battery eliminator. The rectifier utilizes a chemical solution which, according to the company, will not harm fabrics. Three voltages are furnished, one for detector, and a low and high amplifier voltage with a maximum of 150 volts. It will deliver a maximum of 60 millamp. Overall dimensions are 9 3/4 in. x 4 7/8 in. x 9 3/4 in. Total weight is 22 lb. and the case is finished in a brown crystallized lacquer.

Audio Transformer with Metal Shield

Radio Retailing, December, 1926

The latest addition to the Dongan Electric Manufacturing Company's line of audio transformers for set manufacturers is its type 117. The Detroit company has designed this transformer with a metal half-shielded which not only protects the coils of the unit but adds to its appearance. The transformer is semi-mounted and is available to manufacturers of receiving sets in ratios of 2 to 1, 3 1/2 to 1 and 5 to 1.



Heavy Duty Fixed Resistance

Radio Retailing, December, 1926

Accuracy within 5 per cent of the rated resistance is the claim made for the "Metaloid," heavy duty resistor, manufactured by Amsco Products, Inc., 416 Broome Street, New York City. The resistance may be mounted in ordinary grid-leak clips, being only slightly larger than the standard grid leak in circumference. The resistance element itself is a thin metal coating on a glass tube, and is said to dissipate currents up to 1 watt without change of value. Available in all standard sizes for use in resistance coupled audio amplifiers and as voltage regulators in battery elimination devices.

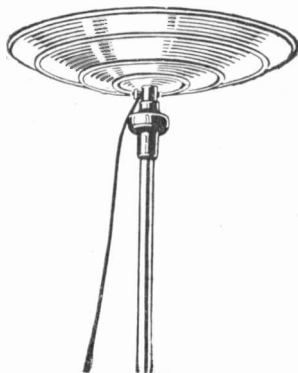

Disk Antenna

Radio Retailing, December, 1926

The illustrated Disk antenna, according to its manufacturer, the Haworth Manufacturing Company, 5119 Plankinton Building, Milwaukee, Wis., clarifies radio reception, at the same time doing away with unsightly wires on the roof. It is necessary, according to the manufacturer, to install this antenna with at least 60 feet of No. 14 wire as a lead-in, though the disk itself must not necessarily be installed on the roof. It may be mounted on a standard of light pipe and installed in any position. Intended retail price, \$15.

Compact Paper Condenser with Mounting Lugs

Radio Retailing, December, 1926

Type 907 paper dielectric condenser, illustrated, is made by the Dubilier Condenser and Radio Corporation, 4377 Bronx Boulevard, New York City, for use as a by-pass condenser. It is equipped with mounting lugs, permitting it to be placed on small space and has a rated d.c. working voltage of 160 volts. It is manufactured in the following capacities and intended retail prices

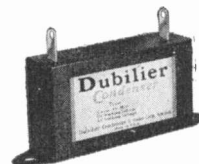

are: .1 mfd., 60c.; .25 mfd., 70c.; .5 mfd., 75c.; 1 mfd., 90c.; 2 mfd., \$1.75. Soldering terminals facilitate wiring.

Filament Switch and Volume Control Combination

Radio Retailing, December, 1926

The "Hi-Ohm" volume control and filament switch, manufactured by the Carter Radio Company, Chicago, Ill., consists of a high resistance, wire-wound and variable in conjunction with a switch. By turning the knob of the instrument to the right the filament circuit is completed and then as it is turned farther the volume increased by cutting resistance out of the plate circuit of a radio frequency amplifier. Resistances may be obtained in maximum values of 10,000, 50,000 or 100,000 ohms and may be used across an audio transformer secondary. The instrument eliminates a control from the radio receiver panel. Intended retail price, with dial and indicator, \$2.50.



Inside Aerial and Loop Wire

Radio Retailing, December, 1926

To meet the demand for inside aerial and loop wire, the Belden Manufacturing Company, 2300 South Western Ave., Chicago, has designed a flexible wire which is especially treated to prevent stretching. Belden inside aerial and loop wire consists of a number of fine copper wires stranded with a few phosphor bronze wires which have been hardened to prevent stretching. The over-all covering is "Rayon." This wire is provided on 125-ft. spools at an intended retail price of \$1.75. It is also available in the same length with cotton covering for \$1.



Filament Voltmeter Equipped with Tip Plugs

Radio Retailing, December, 1926

Type 17B-D.C. voltmeter, manufactured by the Hoyt Electrical Company, Penacook, N. H., is equipped with cord tip plugs and may be inserted directly in jacks provided for this purpose in the filament circuit of many super-heterodyne and other receivers. The meter is mounted in a brown enameled case and may be turned at either horizontal or vertical angles permitting it to be easily read. The range of the instrument is from 0-6 volts. Intended retail price, \$7.50.

All Metal Rheostat

Radio Retailing, December, 1926

The "Dejur" rheostat, manufactured by the Dejur Products Company, Lafayette and Broome Streets, New York City, has an all-metal frame and is air cooled. The resistance itself is exposed to the air on all sides and all loose screws and nuts are eliminated. Soldering lugs are a part of the device. Equipped for single hole mounting, the resistance unit is available in values from 6 to 30 ohms. Special resistances may be obtained on order.

News of Latest Products Gathered by the Editors

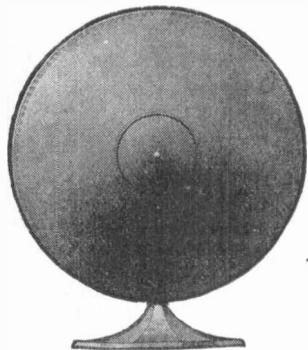

Cone Reproducer Operating on Low Voltage

Radio Retailing, December, 1926
The Trimm Radio Manufacturing Company, 24 South Clinton St., Chicago, Ill., has made a slight change in the design of models No. 7 and 11 cone reproducers. The former is a fourteen-inch cone with an intended retail price of \$12, and the latter is a seventeen-inch cone with an intended retail price of \$16. The driving mechanism has been lightened considerably and a metal ring has been put around the outer edge for protection. The reason for the lightening of the mechanism is that the ordinary cone reproducer has to be operated on at least 135 volts to give expected reproduction. These new models will operate on 90 volts B battery with the same efficiency that was formerly obtained on a higher voltage.

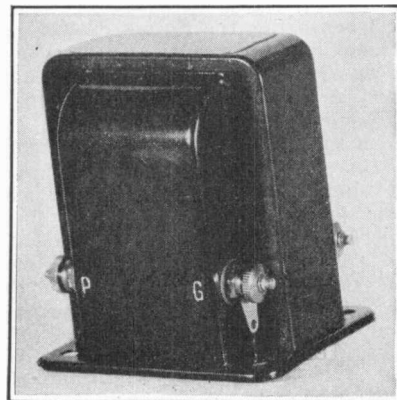

Audio Frequency Transformer

Radio Retailing, December, 1926
The All-American Radio Corporation, 4201 Belmont Ave., Chicago, has developed two new transformers for audio frequency amplification. The binding posts are located conveniently for straight or subpanel wiring, as shown in the illustration. The coil is vacuum impregnated and after assembly the shell is filled with a special compound, and the complete unit hermetically sealed. Two types are made, the first being R-14 which has a ratio of 3:1, and the second R-15 which has a ratio of 5:1. Both have an intended retail price of \$4.50.

Electric Pick-Up for Phonograph Reproduction

Radio Retailing, December, 1926
The Hanscom Radio Devices, Woonsocket, R. I., is making the illustrated "Superunit" phonograph reproducer, which utilizes the audio frequency system and loud speaker of the radio receiving set for the reproduction of phonograph records. According to the manufacturer the reproducing unit is hung in such a manner that only a small portion of the weight is supported



by the needle. Furnished complete with volume control, mounting screws, attachment cord and instructions. The intended retail price is \$16.50.

Six-Volt Soldering Iron

Radio Retailing, December, 1926
The Moto-Ray Manufacturing Company, Inc., 169 Massachusetts Ave., Boston, Mass., is making the illustrated device so that soldering may be accomplished by use of a six-volt storage battery. It consists of a carbon electrode fixed in a suitable handle and two lengths of flexible, rubber covered cord, for making the necessary connections. Upon application an electric arc is at once struck up with intense heat. By using a lower voltage the heat can be cut down. This tool is recommended for service men to carry in their kits, as it greatly facilitates repairing broken connections, etc. Intended retail price complete with two points, \$2.75. Extra points may be bought 3 for 50c.

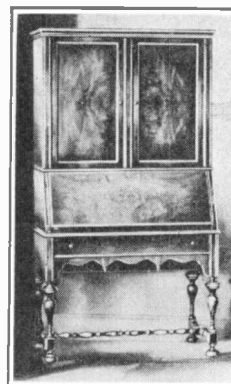
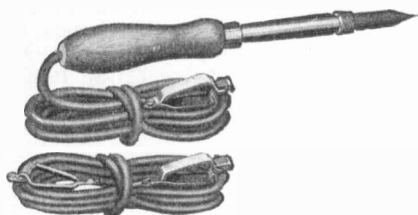

Radiola Furniture

Radio Retailing, December, 1926
Illustrated is a closed secretary model, for use with a Radiola 28, which is finished in two-tone walnut. This and other models were designed and placed on the market through the co-operative efforts of eleven Metropolitan RCA distributors, and may be obtained through any RCA distributor. Intended retail price of this model is \$495. The console is another model housing the Radiola 20. Loud speaker model 100 is built-in and hidden behind grill work. All batteries and other mechanism are fully concealed. Intended retail price \$265. The Secretary model may also be had with hand-painted decorations on it for \$575.
Another console model houses Radiola 20 and has the loudspeaker model 100 built-in and hidden behind grill work. This also conceals all batteries and other mechanism and has an intended retail price of \$285. The spinet model houses Radiola 20, and has an intended retail price of \$175. The stand model is made to match the Radiola 20, which rests on top of it, and has a compartment for concealing all batteries and mechanical equipment. Intended retail price \$140.

Double Range Portable Voltmeter

Radio Retailing, December, 1926
The illustrated PX-2 type double reading voltmeter is being made by the Westinghouse Electric & Manufacturing Company, East Pittsburgh, Pa. Its two ranges of 7½ and 150 volts will embrace all the d.c. voltages ordinarily found with a radio set. It is equipped with three-foot leads and pin-jack terminals. This is a specially high resistance instrument and has an intended retail price of \$10.

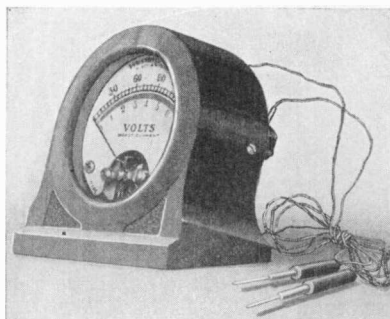

B Battery Eliminator

Radio Retailing, December, 1926
The American Electric Company of Chicago offers the "Burns" B eliminator. It uses a Raytheon tube and is provided with both variable detector and amplifier voltages. It works satisfactorily with sets using from one to eight tubes. The necessary taps have been made for the various voltages for radio and audio amplification, as well as for the higher voltage necessary for power tubes. Once properly connected it requires no further attention or adjustment.

B and C Battery Eliminator

Radio Retailing, December, 1926
B battery voltages up to 180 volts at 85 millamp, and C battery potentials from 0-45 volts are obtainable in the new "Little Giant" BC power unit manufactured by the Webster Company, 3504 West Lake Street, Chicago, Ill. The unit employs a Raytheon rectifier and is equipped with variable voltage controls. It is encased in an iron case finished in bronze and black, and comes complete with a cable and switch. Designed to operate on 110-120 volt 60-cycle current. Intended retail price, complete with tube, \$50.

What the Trade is Talking About

St. Louis Association Runs Its Own Radio Show

In sponsoring the Second Southwest National Radio Exposition in St. Louis, late in October, the St. Louis Radio Trade Association dispensed with a professional show manager and put over a creditable job without outside assistance. The show was placed under the supervision of William P. Mackle, executive secretary, who worked in cooperation with Robert W. Bennett, show committee chairman and Harold J. Wrape, president. As a result the usual 50-50 profit split with a professional manager was eliminated and \$13,545 is available for the association's work of bettering trade conditions for its members.

Visiting dealers met in convention during the show week and were addressed on subjects of general trade interest by L. A. Nixon, National Publicity Council, Carl Boyd, R.M.A. vice-president, Paul B. Klugh, National Association of Broadcasters, George Lewis, Ken-rad Corporation, Ray V. Sutcliffe, Western Editor, *Radio Retailing*, Merle Dustin, Director, Federated Radio Trade School and Harold J. Wrape, President of the Federated Radio Trade Association.

Civil Service Examinations

The United States Civil Service Commission has announced its need for radio engineers and assistants to serve

in the signal corps service at McCook Field, Dayton, O., and at Fort Monmouth, New Jersey. The entrance salaries, \$3,000 per year for Associate Radio Engineers and \$2,400 for Assistant Radio Engineers, are offered to those applicants qualifying in an examination to be filed at the commission's Washington, D. C., office not later than December 30. Applications may be obtained at that office or from secretary of the board of U. S. civil-service examiners at the post office or customhouse of any city. Competitors will be rated on their education, experience, publications, reports or thesis to be filed with the application and will not be required to report for examination at any specific place.

Columbus Trade Association Elects Officers

The Columbus Radio Trades Association, Columbus, Ohio, is again headed by F. W. Dickinson of the Dickinson Hardware Company. Following a successful radio show and electrical exposition sponsored by the association Mr. Dickinson was re-elected association president for the coming year. Henry A. Reinhard was named vice-president, R. M. Saunders, secretary, and James M. Gooley, treasurer.

The association is already formulating plans for a larger exposition next year. Business has shown a very satisfactory increase following its recent venture.

Twenty-Three Stations Join in N. B. C. Inaugural Program

At 8 o'clock Monday evening, November 15, Merlin H. Aylesworth, president of the National Broadcasting Company, Inc., opened the company's inaugural program direct from the Waldorf-Astoria Hotel, New York City. Twenty-three stations, blanketing the country from the east coast to Davenport, Ia., and from Portland, Me., to St. Louis, broadcast programs by world renowned artists.

Mary Garden, Titta Ruffo, and a company of operatic stars under the direction of Cesare Sodero appeared before the microphone early in the evening, followed by Harold Bauer, Will Rogers, Weber and Fields, The New York Oratorio Society and the Edwin Franko Goldman Band. Selections rendered by the New York Symphony Orchestra under the direction of Walter Damrosch were liberally sprinkled throughout the entire program. The debut program of the new company continued into the wee small hours with dance numbers by Vincent Lopez, George Olsen, Ben Bernie and B. A. Rolfe and their orchestras.

Paragon Re-enters the Field

The old Adams, Morgan Company, Inc., Upper Montclair, N. J., manufacturer which went into the hands of a receiver on January 21 last, has been purchased outright by C. S. Phillips, local financier and has re-entered the

Net Profits of Association-Managed St. Louis Show \$13,545

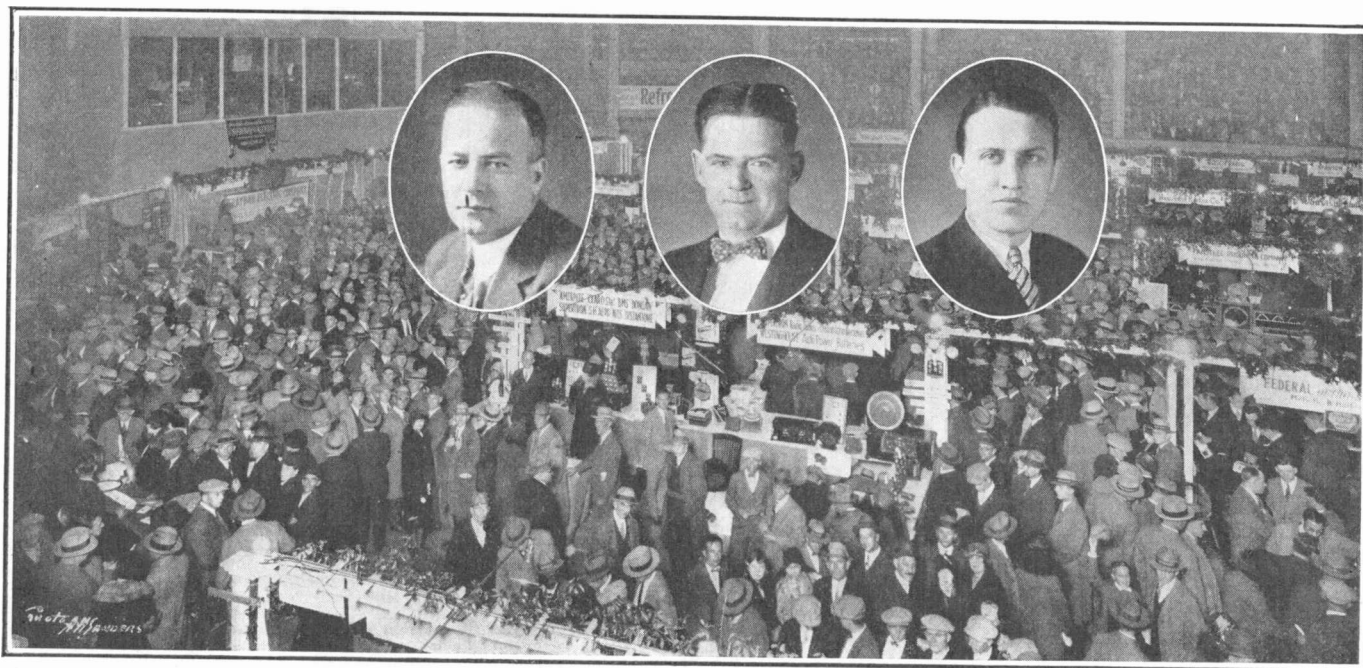

These crowds assembled in the Coliseum during the Second Annual Southwest National Radio Show, held in St. Louis during the week of October 18-23 give some idea of the interest that was created by the efforts of its sponsor, the St. Louis Radio Trade Association. After all bills have been paid and all exhibitor fees collected the net profit of the association, to be employed in the furtherance of association projects, is \$13,545. This achievement is little short of

phenomenal in view of the fact that the entire exhibition was planned and executed entirely by Association officials. The services of a professional manager were entirely dispensed with.

The gentlemen in the inserts, from left to right, Robert W. Bennett, vice-president of the association, Harold J. Wrape, president, and W. P. Mackle, executive secretary, were directly responsible for the success of the venture.

radio manufacturing field. The new concern, known as the Paragon Electric Corporation, is under the direction of Peter A. Petroff, former factory manager of the old company. It is engaged in the production of a six-tube, shielded receiver operating entirely from the light lines, as well as transformers, coils, impedance units, relay controls, battery eliminators and other radio accessories. The company also maintains a Duco finish department.

Federal-Brandes Merger Completed

Two of the oldest concerns in the radio business in this country, the Federal Telegraph Company of California and the Brandes Products Corporation have after lengthy negotiations formed a merger. The new company, with manufacturing plants in Newark, N. J., Palo Alto, Cal., Toronto, Canada, and Slough, England, will maintain executive offices in the Woolworth Building, New York City, and in the Hobarth Building, San Francisco.

Ellery W. Stone, noted engineer and a director of the United Bank and Trust Company, has been elected president of the corporation which is capitalized at \$10,000,000. Rudolph Spreckels, prominent west coast financier, is chairman of the board of directors. Frederick A. Kolster, designer of the radio compass, the decimeter for measuring the width of transmitted radio waves and other similar devices, is chief research engineer.

The Federal Telegraph Company of California, which introduced continuous wave transmitters in this country some years ago, and controls the sale of Poulsen Arc transmitters, is subsidiary to the new corporation. The corporation has also formed the Federal Telegraph Company of Delaware for the conduct of business in China. The Radio Corporation of America controls 70 per cent of the stock of this latter concern while the newly formed corporation, Federal-Brandes, Inc., controls the remaining 30 per cent.

Pacific Dealers Conclude Program Campaign

At the annual meeting of the Pacific Radio Trade Association in San Francisco retiring president Arthur Halloran announced the successful conclusion of the association's campaign to raise \$25,000 among broadcast listeners for the sponsoring of a series of radio concerts by the San Francisco Symphony Orchestra.

The orchestra, composed of nearly 100 pieces, is scheduled to broadcast 21 complete concerts, one each week, from stations KPO, KGO and KFI. Leo J. Meyberg was in charge of the association's soliciting of funds to improve the character of winter programs.

Ernest Ingold, president of Ernest Ingold, Inc., was elected president of the association for the coming year, and is to be aided by the new vice-president-elect Mark E. Smith and by W. J. Aschenbrenner, secretary-treasurer. The association's new board of directors includes: E. J. Koepke, J. A. Ramsey,

N.R.T.A. Dons Napkin at Chicago Show

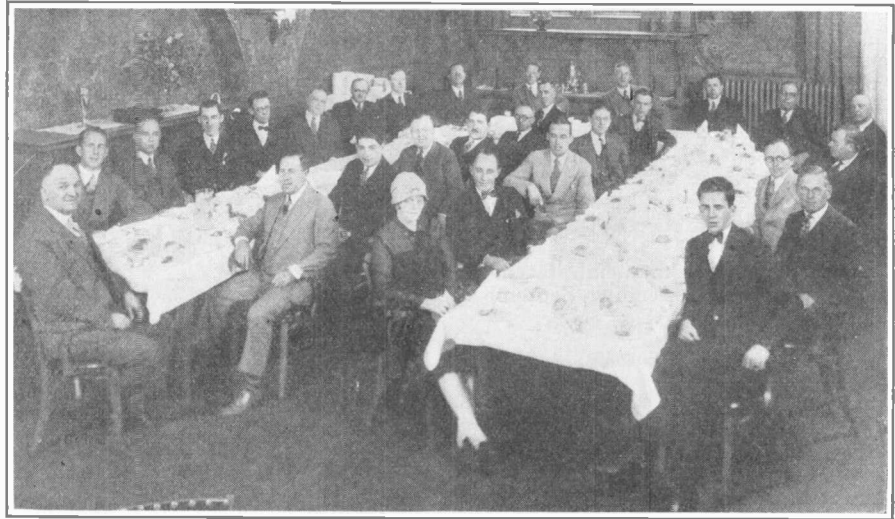

Whether in Minneapolis or Chicago the boys must eat. Radio shows come and go, but nature will be served. Members of the Northwest Radio Trade Association pause for a couple of hours while visiting the Chicago Radio Show to stage a luncheon at the Chicago Electric Club. From left to right in the outer circle: A. J. Carter, Chicago; Powell Crosley, Jr., Cincinnati; W. B. Rogers, Jr., New York; Walter Schilling, New York; H. H. Cory, executive secretary of the N.R.T.A., Minneapolis; Harry T. Smith, president of the N.R.T.A., Minneapolis; Prof. C. M. Jansky, Jr.,

station WCCO, Minneapolis; Arthur T. Haugh, president of the R.M.A.; Tom Findley, Minneapolis; Maurice Clements, business manager of *Radio Retailing*, New York; G. C. Kowfeldt, Minneapolis; B. W. Ruark, executive vice-president of the R.M.A.; John M. Redell, Chicago; F. J. Walpole, Mankato, Minn.; Larry Nixon, New York; Thomas A. Boright, Minneapolis; George Riebeth, Minneapolis; and Russ Wilder, one of the "Ray-O-Vac" twins. Space limitations prevent us from listing the names of the inner circle. We trust that their position of honor will make up for the omission.

W. Jackson, Major N. Levinson, E. A. Portal, R. Eastman and H. W. Dickow. Retiring vice-president, Charles Musladin, reported that the association closed its year with no outstanding bills and a cash balance of \$20,000.

The Four of Them



When Fansteel Products decided to treat radio listeners to a series of concerts by the New York Symphony Orchestra, J. N. Troxel, president of the company, was so "het up" about it that he had to come right down to Carnegie Hall and make sure that Walter Damrosch and W.E.A.F. made a good job of the first performance. They did. Left to right, Merlin H. Aylesworth, president of the National Broadcasting Company, Inc., Walter Damrosch and the "mike," and J. N. Troxel.

Ross Kenyon has been elected treasurer of the Sleeper Radio and Manufacturing Corporation, Long Island City, N. Y. Mr. Kenyon was formerly treasurer of the Northam Warren Corporation. The officers of the company are: Gordon C. Sleeper, president, Herbert C. Doyle, vice-president, Ross Kenyon, treasurer and George O. Castelle, secretary. Theo. Sturchler, of William Schall and Company, 160 Broadway, New York City, has been added to the board of directors.

The Algonquin Electric Company, Inc., Poughkeepsie, N. Y., has resumed the manufacture of Thermodyne radio receivers with a new model, the "Treasure Chest," a seven-tube, master-control receiver in an all-metal cabinet. Leo Potter, former president of the Thermodyne Radio Corporation, has acquired the old trade name and control of the company. W. E. Steinback, former president of the Eisemann Magneto Company and several former Thermodyne officials are associated with Mr. Potter. Offices are maintained at 120 Broadway, New York City. The company will produce about 5,000 receivers for sale to large department stores and does not contemplate wholesale distribution this season. National distribution will probably be resumed in the fall of next year.

The Acme Electric and Manufacturing Company will continue to maintain its production schedule on Universal B Power Supply Units and Control Switches despite a fire on October 28 which partially destroyed its plant No. 1. Shipment of apparatus will be made temporarily from the company's plant No. 2, Cleveland.

R.C.A. Issues Quarterly Statement

At a meeting of the board of directors of the Radio Corporation of America held in New York City, November 5, a dividend of one and three-quarters per cent for the fourth quarter of 1926 was declared on all outstanding preferred stock of the company. The dividend is payable on January 1, 1927, to stockholders on record December 1, 1926.

The corporation's financial statement for the quarter year ending September 30, 1926 is as follows:

Gross income from sales, communications and other income.....	\$14,734,110.07
Deduct:	
General operating and administrative expenses, depreciation, cost of sales, patent amortization, estimated federal income tax and accrued reserve for year end adjustments.....	12,618,019.78
Surplus profits for quarter ended Sept. 30, 1926.....	2,116,090.29
Surplus profits for nine months ended Sept. 30, 1926.....	\$3,986,621.39

Tube Lists Reduced

The Radio Corporation announced a general reduction in the list prices of tubes and several other accessories in a telegraphed release to its dealers November 1st. Prices effective immediately are: UX-200, \$1.75; UX-200-A, \$4; UX-171, \$4.50; UX-112, \$4.50; Duo-Rectron B eliminator, type AP-937 reduced to \$37.50. The Duo-Rectron, selling at its new reduced list, will be known as the Duo-Rectron B Battery Eliminator in order to avoid trade name confusion. The Radiola "20" receiver is now available at R.C.A.'s class double-A discount. Merchandise credits have been issued to retailers and jobbers.



So This Is Wireless!

There is no danger of W. Roy McCanne, president of the Stromberg-Carlson Telephone Manufacturing Company, in the foreground, catching a finger. The queer looking device is not a mouse trap. Ray H. Manson, chief engineer of the company, is not peering intently at a model of a guillotine. Joseph Henry, the famous scientist, demonstrated with this model what is said to be the first remote control device in the country in the Stromberg plant back in 1830. When the current is closed by pressing the "key," the electromagnet draws a bar over against the small bell.

The E-Z-Toon Radio Company, 3234 West Washington Street, Indianapolis, Ind., has re-entered the radio manufacturing field under the direction of Charles Sparks, formerly with the Kellogg Switchboard and Supply Company. The concern, original manufacturer of the E-Z-Toon vernier dial now being manufactured by the Kurz-Kasch Company of Dayton, O., will produce a complete line of radio accessories and electrical parts.

Canadian Radio Interest Running High

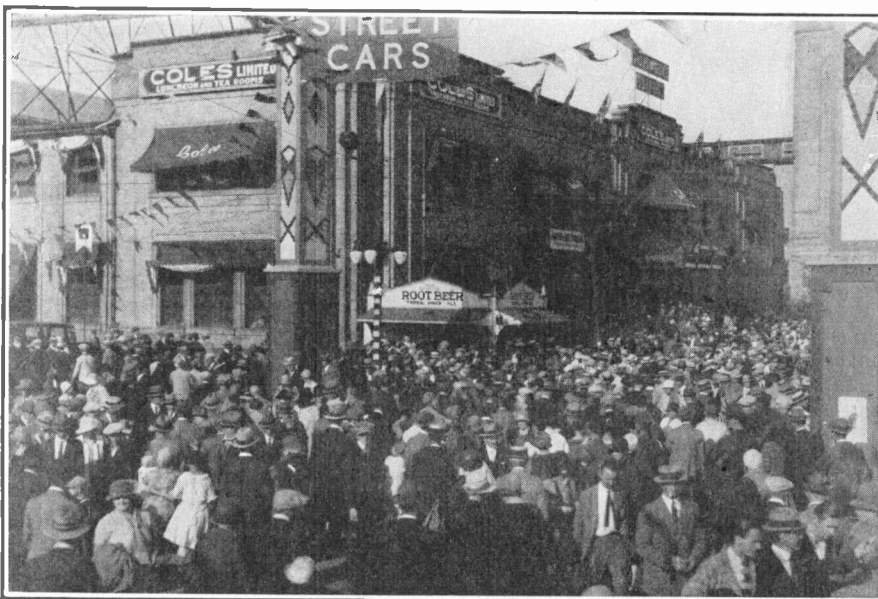

Jobber-exhibitors at the Third Annual Toronto Radio Show, to which thousands of provincial radio fans flocked, displayed the latest American as well as Canadian receiving equipment. This snapshot of the crowd

gathered before the Toronto Coliseum just before the show opened speaks well for the advertising and managerial prowess of the Canadian Radio Trade Association. The Coliseum was jammed during the entire week.

Peruvian Market Now Open to U. S. Radio Exporters

The recent liquidation of the Peruvian Broadcasting Company, which has held all rights to import radio apparatus into Peru for several years, opens this market to its fullest extent to American exporters. The concern held all import rights under a concession which required a certain percentage to be of British manufacture. British material did not sell readily and American merchandise was more popular, thus creating a very unsatisfactory situation. The broadcasting activities have now reverted to the Marconi Company, on behalf of the government, and all radio materials may be sold on a strictly competitive basis.

The stock of apparatus on hand will be sold at reduced prices during the next two months to expedite the liquidation.

New Type Rectifier for A Battery Supply

The application of dry crystals to the rectification of currents as high as from one to two amperes is the distinct departure employed in a new rectifier being made by the Blair Radio Laboratories, 368 Sixth Avenue, New York City. This rectifier is claimed to be 90 per cent efficient and supplies six volts at approximately 2 amperes. The crystals are assembled in tubular form under the pressure of heavy springs located in the center of the tubes, which tubes are about six inches long. Both sides of the cycle are rectified and the filter system consists of a series of chokes and resistances.

This new A battery eliminator in conjunction with the standard Raytheon B and C eliminator is assembled on a steel chassis and covered with a metal shield. It is this unit which is used in the socket power receiving sets made by this company.

The Spartan Electric Corporation, manufacturer of Spartan radio speakers, with general offices at 350 West 34th Street, New York City, has tripled its factory space. The company now occupies the greater portion of the building at 11 Johnson Street, Newark, N. J.

The Crosley Radio Corporation broadcasting station, WLW, Cincinnati, is installing short-wave apparatus and intends to radiate its programs somewhere in the vicinity of 60 meters as well as on the regular 422.3 wavelength it now employs.

The Strouss-Hirshberg Company, Youngstown, Ohio, opened its retail radio store in a new building in that city November 2. The company stocks a complete line of radio apparatus.

E. E. Winsor has acquired the interests of H. C. Whitford in the firm of Winsor and Whitford, Wolcott, N. Y. The concern will henceforth be known as the Winsor Electric Company.

Two's Company—



Miss Norma Smallwood, selected as "Miss America" for the year, graced the King-Buffalo booth at the Radio World's Fair during her recent visit to New York City. She is shown clinging to the arm of Arthur T. Haugh, president of the company, and R. M. A. head, Mr. Haugh is the obviously pleased gentleman at the left. Unfortunately we don't know who the third party is. The photo was mailed to us by Mr. Haugh's publicity director who neglected to mention his name.

Stewart-Warner Reduces Three-Dial Set Prices

List prices of popular Stewart-Warner three-dial set models and horn type speakers have been reduced to increase Christmas sales. Model 305 receiver now lists at \$75, model 300 at \$50 and model 315 at \$200. The 410 console table retails at \$35 and type 400 speaker has been reduced to \$17.50. Model 405 speaker lists at \$12.50.

Fada Now in Australia

Fada Australia, Ltd., has been organized, with headquarters at South Adelaide, South Australia, as the sole distributor of the products of F. A. D. Andrea, Inc., New York City manufacturer of radio receivers and accessories.

The directorate of the new concern, which has placed an initial order for 1,000 radio receivers embracing the entire Fada line, includes E. M. Gillies, manager of broadcast station 2MK, Bathurst, New South Wales, W. C. Smallcombe, managing director of 5CL, the Central Broadcasting Company of Adelaide, and several other well known figures in the Australian broadcast world.

The new concern is another link in the chain of Fada merchandising. Fada

Radio, Inc., of Canada and London were established a short time ago. The receivers shipped were of the 170-AL type, which are designed to cover the American wavelengths and also to include stations operating above this band. 2FC at Sydney, Australia and 6FW at Perth, W. Australia, both stations using more than 5,000 watts input, are factors in the radio industry in the new territory. Both operate above 1,000 meters.

New Insulating Material

A composition of ground mica and load borate known as "mycalex," which uses up mica particles that heretofore went to waste, has recently been developed by the General Electric Company, Schenectady, New York.

The substance, light gray in color and with a metallic ring, is being used in the manufacture of bases for radio transmitter tubes, for antenna insulators in high frequency work and similar uses. It is said to have better insulating properties than porcelain.

It is made plastic by heating to a dull redness in which condition it can be formed into any desired shape by compression in steel molds closed under hydraulic pressure. It is mechanically stronger than porcelain except under pressure, but it is not so heat-resistant as either porcelain or mica.

Metal parts can also be combined with this material during the molding process, making a tighter and stronger combination. Although it can be drilled, filed, sawed, polished and similarly treated by usual machining methods, it is necessary in some instances to use special tools since the wear on the tools when working with mycalex is greater than when cutting metal. The new compound has been recommended for use where the requirements demand an insulating material of high mechanical strength, high dielectric strength and insulating resistance, low losses under high frequencies, heat resistance beyond the ordinary range of molded or sheet materials, and compact construction with metal inserts securely molded in place.

Charles Eisler, president and treasurer of the Eisler Engineering Company, Newark, N. J., manufacturer of radio and incandescent lamp-making machinery, is investigating Russian lamp production methods with a view to increasing the output of factories in that country which have requested his advice. Mr. Eisler sailed for Russia late in October. After completing his business there he will visit several other European countries on a similar mission.

The Callanan Manufacturing Company, Toledo, Ohio, has been chartered to manufacture and deal in radio tubes, parts, accessories and receivers. The incorporators of the new company are LeRoy E. Eastman, George F. Smith, Wayne E. Stichter, Melvin R. Bergman and Stella M. Hughes.

Chas. A. Branston, Inc., has moved its factory, office and showrooms to larger quarters at 297-301 Washington Street, Buffalo, N. Y.

Daven Now Building Sets

The Daven Radio Corporation, 158 Summit Street, Newark, N. J., has purchased a controlling interest in the Port Manufacturing Company of that city. The latter company has been engaged for some time in the production of "Bass Note" receivers under license from the first mentioned company. The new move of Daven, definitely places it in the set manufacturing field. The Port Manufacturing Company will continue production under the supervision of its controlling company. Merchandising policies remain unchanged and Bass Note sets will be sold direct.

In a recently released announcement the Daven Radio Corporation announced a reduction of the list price of its MU-6 power tube to \$4.50.

The American Electric Company, 64th and State Streets, Chicago, has incorporated under the name American Electric Company, Inc., and has combined with the Monarch Telephone and Manufacturing Company of that city. The facilities of the concern for the manufacture of Burns Loudspeakers are thus increased.

The Martin - Copeland Company, Providence, R. I., is the first licensee under patent No. 1,595,863, issued to R. Dorsey, covering types of vernier dials which have recently become popular. Other large manufacturers are expected to follow suit.

The McCarty Seed Company, Fifth and Vine Streets, Evansville, Ind., has installed a radio department and carries a complete line of A-C Dayton radio receivers and other radio products manufactured by the Advance Electrical Company of Terre Haute.

Welcome to Our City



Harold J. Wrape, president of the Federated Radio Trade Association, etcetera, greets Graham McNamee, author and traveller, and Allen McQuhae, noted tenor, upon their arrival at St. Louis station to view the Southwest Radio Show. McNamee is he of the broad smile on the rear platform of the "rattler," Mr. McQuhae is the dashing gentleman in blue, and Harold Wrape the remaining member of the trio.

News of Jobbers and Distributors

Doubleday-Hill Broadcasts Special Trade Features

KQV, the broadcasting station of the Doubleday-Hill Electric Company, 719 Liberty Avenue, Pittsburgh, Pa., is believed to be the only station in the country broadcasting special programs in the interest of electrical and radio retailers.

For some time the company's station has aided retailers by filling in "broadcast gaps" when requested. Dealers who wished to demonstrate radio receivers and were confronted by a silent hour had but to telephone the station manager and a special program was immediately broadcast for their benefit.

This unique service is to be supplemented by the broadcasting of regular talks on the servicing of radio receivers and electrical apparatus. The initial talk described the method of servicing a Crosley 5-50 radio receiver. Dealers were requested to have a set chassis handy so that the instructions of the announcer could be easily followed. Talks are to be so arranged that they are interesting to radio listeners as well as to dealers.

The Commercial Electric Supply Company, 138 East Congress Street, Detroit, commemorates its thirtieth anniversary in the November issue of its house organ, "The Jobber's Salesman." The booklet contains photos of the managerial and sales staffs and a résumé of the company's history. The stockrooms and sales facilities of the company have been well photographed and are much in evidence in this issue.

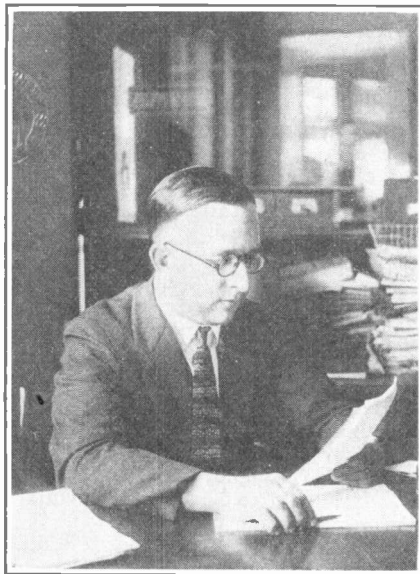

Before we cropped this photo, a neat bronze sign just to the right established the identity of the gentleman as R. J. Myers, manager of W. M. Dutton & Sons, Hastings, Neb., jobber. As chairman of the radio committee of the Hastings Department of Commerce, Mr. Myers engineered the erection of a crystal studio in the Municipal Auditorium from which KFKX's 15 hour 3rd anniversary program was broadcast on October 22.

Ralph Bretzner has been appointed eastern representative for Richard T. Davis, Inc., with headquarters at 160 West 45th Street, New York City. He will handle the company's complete line of Vogue speakers and the Mastro-Ortholian receiver.

Kolster Jobbers Look for Big Season

N. L. Cohn of the Triangle Electric Company, Chicago; B. K. Sweeney of the B. K. Sweeney Electric Company, Denver, and Frank Proudfit of the R. S. Proudfit Company, Lincoln, Neb., met recently in the New York office of Kolster-Brandes, Inc., and predicted that the radio business in their respective territories will exceed last year's figure by a comfortable margin. Business started early for these Kolster-Brandes jobbers and is expected to continue well into the summer months.

Representatives Should Show Credentials

Strangers claiming to be representatives of well known manufacturing concerns should always be requested to show their credentials. An incident that illustrates the necessity of such precaution has been related to us by the Cooley Hardware Company, Canandaigua, N. Y.

A well-dressed man, about 5 ft. 9 in. tall, and weighing about 180 pounds, entered the store some time ago, and announced he was a service man of the Radio Corporation of America. After asking a number of questions which impressed the store manager that he knew the radio business, he asked for a blank letterhead so that he might write his company for advertising material. Several days later the Cooley Company received an invoice from a local jobber, Weed & Company, Rochester, for 300 pounds of solder. The so-called "service man" had placed this order on the Cooley Company's stationery, had taken \$115 worth of solder in his car and disappeared. He introduced himself by the name of Davis and signed the delivery ticket H. Palmer.

W. C. Braun Company, 40 South Clinton Street, Chicago, is the latest wholesaler to join the ranks of the manufacturers. The company has announced the manufacture of a new line of "Monroe" receivers to supplement its parts and accessory sales. Wholesale business will continue as usual.

I. J. Haug & Sons, Ltd., Regina, Saskatchewan, Canada, has been selected as a distributor for Orthosonic radio receivers, manufactured by the Federal Radio Corporation. The company will have exclusive wholesale distribution rights in the province of Saskatchewan.

The American Auto Supply Company, Inc., Scranton, Pa., jobber, has added the following lines to the products which it distributes throughout North-eastern Pennsylvania: Radiotron tubes, Sandar speakers, Utah and Thorola speakers, Tab B batteries, DeForest tubes, Reliable automatic control switches and Keystone lightning arrestors.

Another Portable Show-Room



Here is another one of those traveling radio shows owned and operated by an enterprising jobber to bring his merchandise to the very door of the dealer. The jobber in this instance is the Willis Company of Canton, O. The "rolling stock" is a Reo Speed Wagon

with plenty of room for merchandise. Its inside dimensions are 10 ft. x 5 ft. x 5 ft. 10 in. high. The consoles are securely bolted to the floor by means of removable bars and wing nuts. How'd you like to tote a couple of these samples around in a brief case?

Protecting the Legitimate Retailer

A short questionnaire, mailed to every applicant for a trade discount, by the Van-Ashe Radio Company, St. Louis jobber, has done much to reduce competition between "spare time" radio dealers and retailers who maintain stores and devote their entire time and energy to the business.

The questionnaire, illustrated below, protects the legitimate dealer from the unfair competition of others operating temporarily with insignificant overhead expenses. Through it, the retailer who is actually supporting the industry is protected, the jobber receives full credit information, some idea as to the volume of the applicant's business and a clear picture of its nature. In short it solves the jobber's individual problem of "What is a Radio Dealer?"

Mid-West Radio Dealers Give Their Opinions

What are radio dealers thinking about? A large radio wholesale house in Kansas City, Mo., wanted to obtain an unbiased answer to this question, so it requested its advertising agency to prepare a "Trade Survey" questionnaire. This form was recently mailed to a list of 700 dealers located in the states of Kansas, Missouri, and Northern Oklahoma. The names of these dealers were selected from six different sources and represent therefore a true cross section of dealer opinion in this part of the country. Only the agency's name appeared on the question blank.

Two hundred and ninety-five dealers replied. Here are some of the questions and answers:

Are you satisfied with your present

What Is a Dealer?

WALSH'S RADIO CO.
2075 & FINE ST.
ST. LOUIS, MO. DATE Dec. 2-4

RADIO DEALER QUESTIONNAIRE

Name John R. Smith
Address 1400 Base St.

Do you operate a store? Yes - Smith Do you operate in building sets for resale? N.
If so, under what name? Radio Shop.

Do you operate a Radio Service Dept.? N. Do you operate from your residence or have you a regular place of business? Store

Name the names of jobbers from whom you buy at wholesale prices.
Black Dist. Co. St. Louis
Radio Supply Corp. St. Louis

I understand that the object of this questionnaire is to protect the Radio Dealer against the allowing of amounts or wholesale prices to persons not engaged in the Radio business.

Signed John R. Smith

Discrimination in the granting of trade discounts, as outlined in the illustrated questionnaire sent to every applicant by the Van-Ashe Radio Company, St. Louis, protects legitimate retailers and improves trade conditions.

line of sets? Yes—89 per cent; No—11 per cent.

Would you consider a new line? Yes—60 per cent; No—40 per cent.

What factor in a radio set does your customer consider most important? Tone—40 per cent; selectivity—25 per cent; volume—12 per cent; distance—10 per cent; ease of control—8 per cent; eye value—5 per cent.

Do you prefer built-in, cone or horn type of loud speaker? Cones—52 per cent; built-in—20 per cent; horns—17 per cent; no choice—11 per cent.

Is demand for consoles increasing or decreasing? Increasing—62 per cent; decreasing—26 per cent; no change—12 per cent.

Do you carry parts? The answers were evenly divided on this question.

Is demand for dry cells increasing or decreasing? Decreasing—62 per cent; increasing—27 per cent; no change—11 per cent.

From whom do you prefer to buy your radio sets? Jobbers—61 per cent; manufacturers—35 per cent; no choice—4 per cent.

Do you see any reason for dealing with a wholesale radio jobber who handles radio exclusively rather than with a jobber who handles radio as a side line? Yes—64 per cent; No—22 per cent; Non-committal—14 per cent.

Do you favor restricted territory with exclusive selling rights? Yes—79 per cent; No—7 per cent; Non-committal—14 per cent.

If you were a radio manufacturer what would you do to help the industry?

The dealers indicated their deep interest in the following constructive answers:

1. Eliminate the "gyp" or cut-price dealer and jobber.
2. Give more servicing instructions to dealers.
3. Develop summer radio business.
4. Supply plenty of advertising.
5. Manufacture better and finer instruments.
6. Manufacture fool-proof sets.
7. Control production, so that dumping is eliminated.
8. Adjust the radiocasting situation; so that the better stations can be heard.
9. Help clear the air of man-made electrical disturbances.
10. Advocate fewer stations but more of super-power capacity.

Over 90 per cent of the dealers were enthusiastic over the prospects for radio business for the winter season and felt that the industry was becoming stabilized and worth while.

The Acme Electric and Manufacturing Company, 1444 Hamilton Avenue, Cleveland, has appointed Aaron Goodman, with offices at 250 West 57th Street, New York City, its representative. Mr. Goodman also distributes the products of the Electric Machine Corporation of Indianapolis.

The W. E. Pruden Hardware Company, hardware jobbers, 258 West 52nd Street, New York City, has organized a radio department which will be under the direction of Henry T. Lees.

The Tampa Hardware Company, Tampa, Fla., has been appointed a distributor by the Crosley Radio Corporation, Cincinnati.

A Jobber's Dealer Help

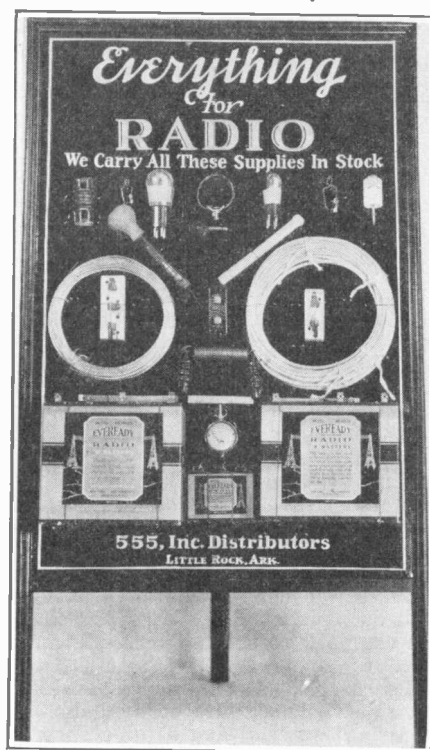

Here's a good parts and accessories display idea for both the retailer and jobber. The illustrated sample board, on which a complete line of accessories is mounted, is supplied to customers of 555, Inc., Little Rock, Arkansas, distributor. A similar display could be easily constructed using dark felt as a background.

The Aitken Radio Company's fifth annual catalog is off the presses and may be obtained by writing the company at Superior and Jackson Streets, Toledo, Ohio. The catalog contains a full list of the products which the company will distribute this year, with photographs and retail prices.

The Detroit Electric Company, Detroit, Mich., is now located in its new building at 101 East Jefferson Avenue. The company's new quarters, with 30,000 sq.ft. of floor space, will permit it to better its service to Michigan retailers.

The Wilmington Electrical Specialty Company, Inc., 405 Delaware Avenue, Wilmington, Del., has added 500 square feet to its floor space to take care of increased business. Major Harry Van Sciver has joined the company's sales staff and will cover New Jersey and Pennsylvania.

The Burmac Company, Inc., Quincy, Illinois, jobber of radio and sporting goods, has merged with the Best & McCarl Sporting Goods Company of that city, and will continue to distribute its regular radio lines.

Perry Saftler is now affiliated with P. W. Mack, Inc., metropolitan representative of the Acme Apparatus Company of Cambridge, Mass., with offices at 231 West 29th Street, New York City. Mr. Saftler was formerly radio sales manager of Pyramid Motor Equipment Company.

New Dealer Help Material

Aids to greater profits provided by radio manufacturers for their dealers

Bosworth Co-operative Bulletin

The Bosworth Electric Manufacturing Company, Cincinnati, distributed the first issue of a co-operative sales and service bulletin "The Bosworth Merchant and Salesman" to its jobbers, dealers and sales representatives November 1.

This little multigraphed leaflet will be forwarded each month to Bosworth representatives in an effort to bring the entire "sales family" into closer contact. It is to contain sales and service ideas employed by Bosworth men as well as news of the latest additions to the company's line of advertising material.

The first issue contained several useful sales ideas, a list of available advertising material and a table showing the milliampere current consumption of various set models. This latter table is designed to aid Bosworth owners in the selection of suitable B battery eliminators.

The Buckwalter Radio Corporation, 2632 Prairie Avenue, Chicago, is distributing four 3 x 6 inch sales pamphlets to retailers. Each booklet bears a forceful message on its cover designed to attract the attention of prospects to the features of the Supertone receiver. One, for instance, bears the caption "Testimony on the Straight

Eight of Radio." Its message of commendation from old customers is put over forcibly by a novel illustration, a courtroom scene playing up the "testimony" idea. Another is entitled "The Radio of Today and Tomorrow." Its accompanying illustration is a photograph of a Chicago monument, the "Fountain of Time," thus featuring permanency. Each booklet is illustrated in three colors and contains photographs of Supertone receiver models with prices and technical descriptions.

E. T. Cunningham, Inc., New York, in its latest catalog of available dealer help materials, lists several counter and window display cards and eight one-inch electros for use in newspaper advertising. Mats may be obtained for any type Cunningham tube without cost to authorized dealers.

The Freed-Eisemann Radio Corporation, Brooklyn, N. Y., lists its entire line of dealer-help materials including newspaper ad mats, window displays and cards, illuminated signs, moving picture slides and direct mail literature in a new illustrated catalog. The company also outlines an advertising method by which it mails retail advertising material direct to any dealer's selected list for 10c. per name. A follow-up record card is mailed to the dealer for each name on the prospect list submitted.

Exide Releases Advertising Broadside

Advertising material for the use of authorized Exide dealers has been released by the publicity division of the Electric Storage Battery Company, Philadelphia. The latest broadside consists of a complete window display outfit of four 6x9 in. easel-backed, counter cards printed in orange and black against a dark blue background, a 36x48 in. centerpiece poster and three long streamers for the sides and top of the window. Yellow, orange and blue are the dominating colors in these displays with all illustrations in the original colors of merchandise.

A short news item for submission to the news editor of local papers is included in the broadside which also contains several mailing circulars, a list of lantern slides for moving picture theater advertising, an authorized dealer transfer poster and a booklet listing all available electrotypes and cuts.

The Westinghouse Electric and Manufacturing Company, East Pittsburgh, Pa., has released two folders entitled "Longer Life for Your Tubes" which bring out pertinent facts on the care and operation of radio measuring instruments. F. 4709 is a four-page folder with a blue cover which describes the necessary things to consider when ordering instruments. F. 4695 is a sixteen-page booklet which goes into greater detail telling how instruments may be installed and listing wiring diagrams in which they may be employed. Both booklets are illustrated and printed in color.

The Day-Fan Electric Company, Dayton, Ohio., has built a small quantity of radio test sets with which A and B battery voltages may be checked, open circuits may be located and grid leaks may be tested for proper resistance. This outfit was described some time ago in the company's house-organ, the "Day-Fan Dial" and several dealers have asked the company to construct the instrument. Equipped with a substantial carrying case and a lock, the instrument is available to the service departments of Day-Fan dealers for \$15.

The Gray & Danielson Manufacturing Company, 260 First Street, San Francisco, furnishes as a merchandising aid a small three page folder which illustrates the outstanding points in the design of its new UX type tube socket. A large photographic illustration of the socket is printed in the booklet with its features called to the attention of the reader by means of small arrows printed in red and descriptive captions.

A Distinctive Kellogg Window Display

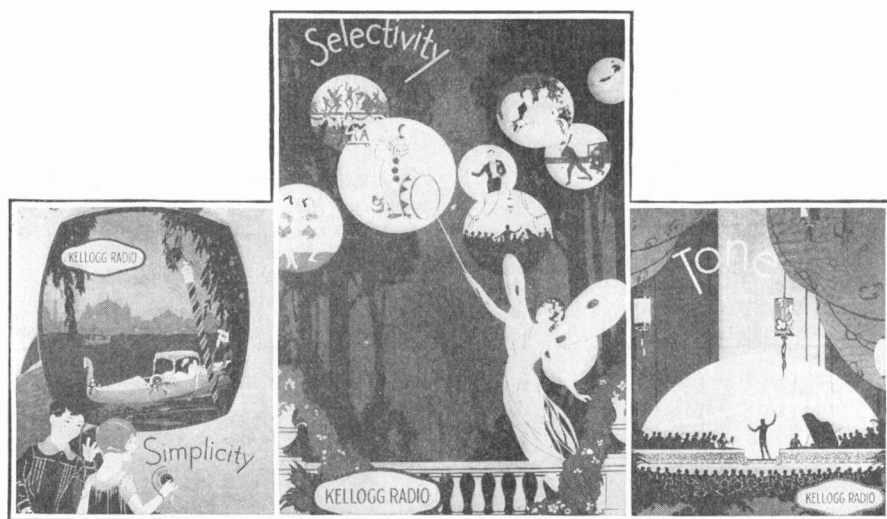

Simplicity, Selectivity and Tone, requisites of a good radio set, are emphasized in these three window display cards furnished by the Kellogg Switchboard and Supply Company, Chicago. A child, turning a single dial in the card at the left graphically illustrates simple tuning. The "magic wand" of the nymph in the centerpiece

points out various broadcast features, while the remaining poster presents a symphony orchestra. The cards are in several colors in an oil process which makes the figures stand out in relief and permits the displays to be washed. The entire set occupies 54 inches of the show window. The centerpiece is 33 inches high.

CROSLLEY RADIO
All prices slightly higher west of Rocky Mts.

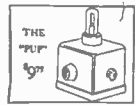

THE PUP
\$27
This little double-circuit 1-tube set has made long distance records.



THE 4-29
\$29
4 tubes. Amazing efficiency, Crescendon equipped.



THE PORTABLE
\$33
The 4-29 in portable form.



THE 5-38
\$38
Five tubes, tuned radio frequency. Two stages non-oscillating radio frequency amplification, Crescendon, two stages audio frequency amplification.



THE 5-50
\$50
5 tubes, 1-dial control acuminators, Crescendon, power tube adaptability.



RFL-75
\$65
5 tubes. True-cascade amplification; non-oscillating and non-radiating.



THE 5-75 CONSOLE
\$75
In a mahogany console. 5-tube 5-50 receiver, Crosley Musicone speaker, ample compartment for batteries.



RFL-90 CONSOLE
\$90
Double drum station selector! Musicone and room for batteries and accessories.



MUS. CONSOLE
\$12.50, \$14.50, \$23.00
12-inch size, \$12.50. Super Musicone, \$14.75. Musicone Deluxe, \$23.50. Also beautiful Musicone console with room for batteries and accessories, as below.



Crosley Features

"CRESCENDON"

When, on ordinary radios, ears must strain to catch station miles away, a turn of the Crescendon on Crosley radios instantly swells reception to room-fil-

ling volume. An exclusive Crosley feature. **ALL-METAL SHIELDED CHASSIS**



This truly great radio achievement, found in several Crosley sets,

furnishes a substantial frame for mounting elements, produces excellent alignment of condensers, shields the units from each other, prevents interstage, prevents the stability of the circuit, increases selectivity and saves costs by standardizing this phase of manufacture.

THE SINGLE-DIAL STATION SELECTOR

Nothing in radio equals the joy or the convenience of single dial control. Crosley single drum control enables you to find the stations sought without log book or "tuning"

"THE ACUMINATORS"

Crosley Acuminators permit tuning in—loud and clear—weak stations passed over and entirely missed by ordinary single dial radios. In tuning high powered and local stations they are not used.

USE OF POWER TUBE

Power tube adaptability marks the Crosley "5-50", "5-75" and "RFL" sets. This feature typifies Crosley provision for best radio reception at moderate cost. This feature is in keeping with all that is most progressive.

HEAD PHONES

\$3.00

QUALITY AND BEAUTY IN CABINETS AND CONSOLES

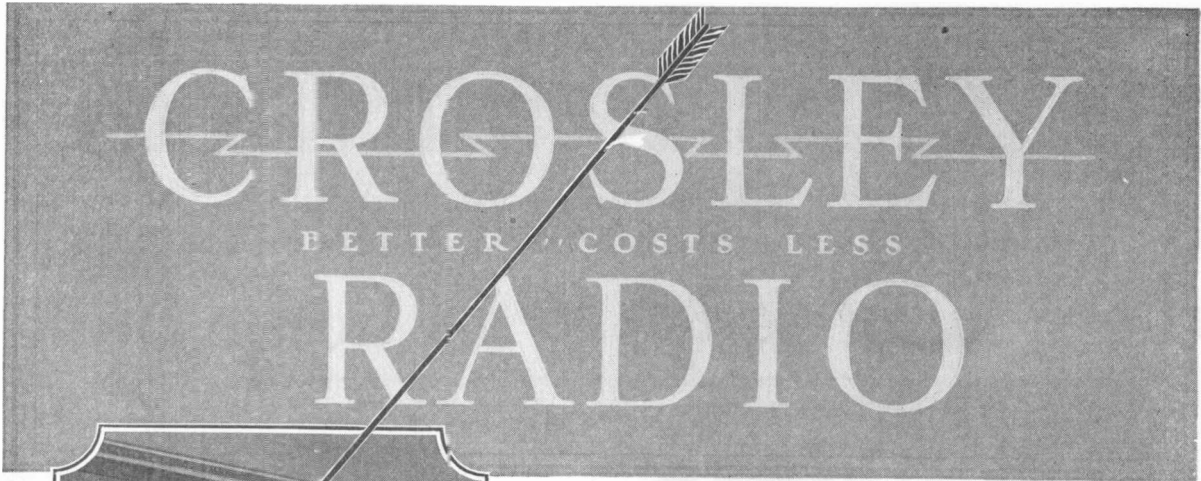

**Single Dial Control
5 TUBES**

POWER TUBE ADAPTABILITY

One hand, one dial, one control—the goal towards which radio manufacturers have been striving—is now perfected in the famous Crosley LOW-PRICED models, 5-50 and 5-75.

Other new features incorporated in these remarkable 5-tube sets—features which make Crosley radios amazing in their performance, regardless of price—are as follows:

The Crescendon—a device that builds up full, satisfactory volume on weak and distant stations.

The Acuminators—these auxiliary tuners enable you to receive with great volume, because of sharp tuning, distant stations passed by and entirely missed on ordinary single dial control sets. With the use of the drum selector alone enough stations will parade by to satisfy everyone—but with the acuminators, even wider and better broadcast is opened to you.

The All-Metal Chassis—a type of construction which shields the various units and prevents interstage as well as external coupling. The result is a great saving in production costs and a greater efficiency in reception.

Rich Mahogany Cabinets—beautifully finished and artistically decorated. The use of such high grade material for cabinet work is possible only because of the tremendous production program for 1927.

The Crosley 5-50 and 5-75 are being welcomed by thousands of persons who have hesitated to replace their out-of-date equipment with sets containing the latest features because the cost was prohibitive.

Now they can have the very latest developments in radio at a price that is easily within their reach—thanks to the genius of Crosley in reducing costs by mass production.

Go to your dealer—and learn what exquisite tone, wonderful selectivity and satisfactory volume are built into these two incomparable radios.

TABLE MODEL 5-tube 5-50 Single dial control with graphic drum station selector. A mahogany cabinet of two-tone finish.

\$ 50

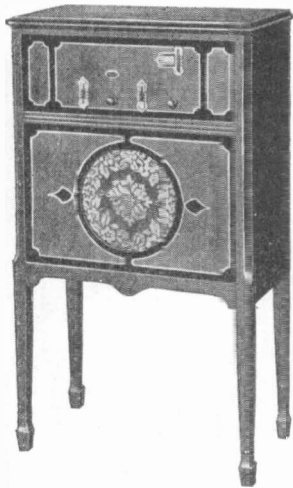

\$ 75

CONSOLE MODEL 5 tube 5-75 Single dial control with graphic drum station selector. A mahogany cabinet, two-tone finish, into which is built the famous Crosley Musicone, cleverly concealed behind a silk screen. Cabinet will hold batteries and accessories. Stands 40 inches high. Rose gold trimmings. Price slightly higher west of Rocky Mountains.

THE CROSLLEY RADIO CORPORATION, CINCINNATI—POWEL CROSLLEY, Jr.,

Crosley manufactures radio receiving sets, which are licensed under Armstrong U. S. Patent No. 1,113,149 or under patent applications of Radio Frequency Laboratories, Inc., and other patents issued and pending. Owning and operating station WLW, first remote control super-power station in America. All prices without accessories.



President
For Catalogue write Dept. 32

Fans want them ~
to add the "professional touch" ~ ~ ~
the note of style ~ ~ ~ to home built sets!

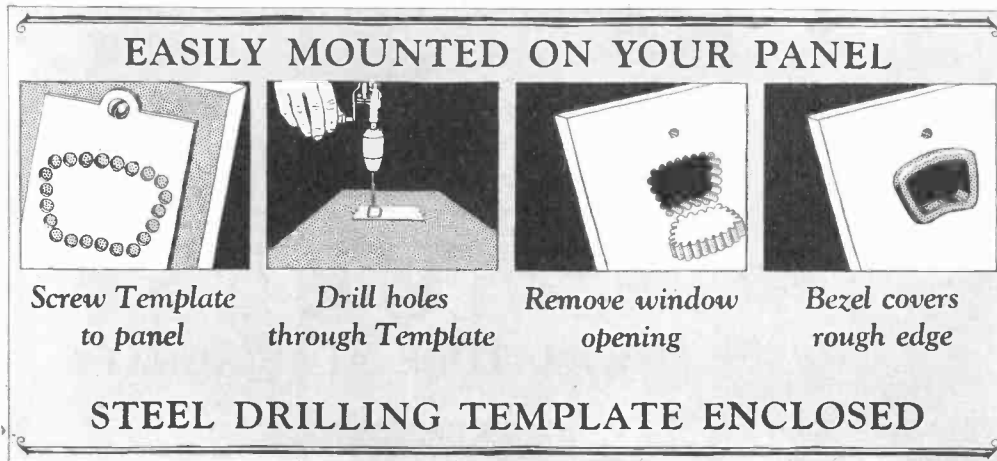

Screw Template
to panel

Drill holes
through Template

Remove window
opening

Bezel covers
rough edge

This new label—printed in striking blue and yellow—now comes pasted on every MAR-CO control carton. It pictures the 4 simple steps in panel drilling, for mounting the control. To show these pictures to a fan . . . is to remove his last resistance to buying the one tuning control that returns you the most profit!

Easy to install ~ ~ ~ and to sell

At the New York, Boston, and Chicago radio shows—the MAR-CO control display was a big center of interest. Qualified observers reported "more interest among set-builders in the MAR-CO control than in any other instrument exhibited".

Its illuminated back-panel scale is the one thing fans everywhere want. It makes a home-built set look "professional".

But, because of this, it also looks difficult to mount—which is NOT the case. For the template supplied makes panel drilling so easy—you simply CAN'T go wrong. And in order to SHOW just how easy the mounting is—MAR-CO is now pasting the label shown above on every carton . . . and reproducing the pictures in color page advertisements in ten radio magazines.

Now, therefore, the wise parts dealer will

feature MAR-CO controls. They give you a bigger profit than any other tuning control. They are specified equipment in a score of this season's most important circuits. And they are continuously featured by the most powerful advertising schedule in the parts field.

The sooner you put a display of MAR-CO controls in your window . . . the sooner your parts profits will grow. MARTIN-COPELAND COMPANY, Providence, R. I. Branch Offices and Representatives in principal cities.

MAR-CO illuminated controls list at \$3.50, including Bezel, Template and MAZDA lamp. Replacement lamps, 20c. Scales read either 0 to 100, or 100 to 0. Lamp runs off "A" battery, draining only .1 ampere. Controls fit all standard condensers, including double and triple models.

MAR·CO
Illuminated Controls

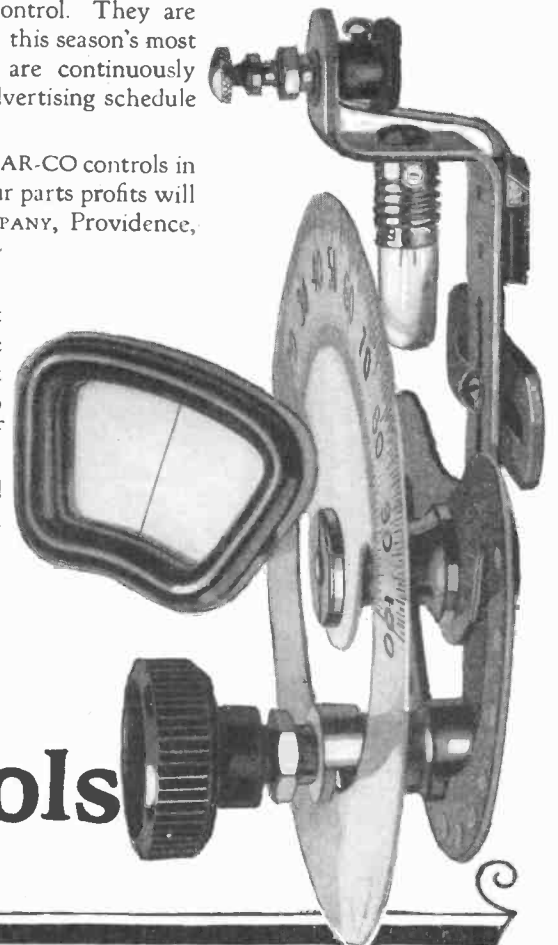

Merchandising Radio Parts

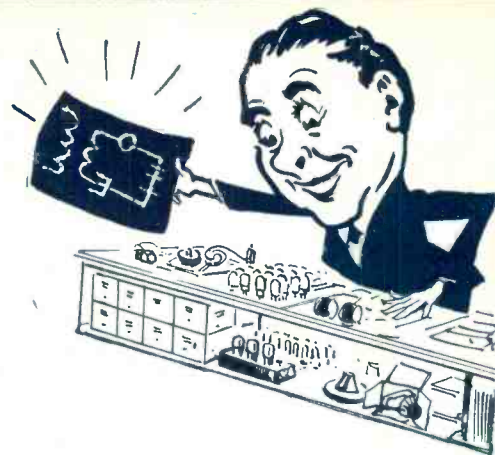

A Section of *Radio Retailing*

December, 1926

What is a Balanced Parts Stock?

An outstanding radio merchant tells us how many of each type of component he carries—dividing his entire stock into its various percentages

IN PRESENTING what we believe to be the first actual parts stock list printed in a radio trade paper, one of the largest parts retailers in New York City has purposely been selected to illustrate proper stock selection.

The Yorkville Radio Company, Inc., 147 East 86th Street, has a parts stock on its shelves valued at \$38,000 retail. Few dealers have invested such an amount purely in radio parts but it is easily seen that the listing of the normal stock of a large dealer is more valuable as a standard of

comparison than that of a small one.

Obviously, though the large dealer's business is tremendous by comparison, his stock must be carefully selected or serious losses result. The inability of a small dealer to dispose of an item ordinarily means the loss of but a few dollars. Furthermore such a small stock may often be disposed of in short order by slightly reducing prices. To concerns such as Yorkville improper or careless purchasing means shelves of dead stock.

A cross-section of the stock of such

a dealer presents a broad view of the business. Severe competition makes it necessary to anticipate the customer's needs. Sales resistance must be reduced to a minimum by stocking merchandise demanded by the consumer. Thus Sid Vorzimer's stock is a reflection of retail demand, not merely a list of merchandise which in his estimation *should* sell.

Mirrored in Yorkville's stock record is an increasing demand for battery eliminator parts, for instance. By-pass condensers, used almost exclusively in eliminator filter systems,



Vorzimer's best selling items are clearly shown in the above illustration to be components which may be used in the majority of standard circuits. They represent 65.1 per cent of his investment.



An Innovation in Packaging EBY Binding Posts

Ever since Binding Posts have been a real factor in the parts business Eby has shown the way to easier, more profitable sales. Here's another Eby idea that saves your clerks' time, keeps down stocks and makes inventories easy.

Now a complete set of the Eby Binding Posts recommended and specified in popular circuits is packaged separately. Each carton contains five complete sets of all the markings necessary. The price of each individual package is clearly marked.

Your jobber has separate packages for the Hammarlund-Roberts, Infradyne, Cockaday, L.C. 27 and Browning-Drake circuits.

EBY Shielded Dial



Completely shielded by an all-metal back, this dial minimizes the effect of body capacity. This is a shielded year and here's a shielded dial that operates any type condenser, clockwise or counter-clockwise. One model—one stock—one price—\$2.50—at your jobber's.

EBY Socket

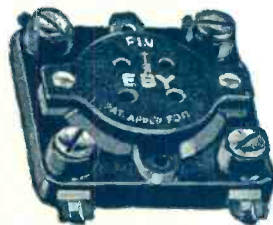

This socket assures a positive three point wiping contact at all times, the most scientifically perfect type of contact known. When the tube moves the contact actually gets tighter and checks the jar. One model—one stock—one price—50 cents—at your jobber's.



THE H. H. EBY MANUFACTURING CO.

4710 Stenton Ave., Philadelphia, Pa.





jump into the foreground, calling for 3.6 per cent of his total parts expenditure. Chokes and impedances, used but little in other than eliminator circuits, account for another 1.3 per cent.

Variable high resistances, used in radio frequency circuits and more recently as voltage controls in eliminators, have become an important item for the same reason. Of his

investment, 4.2 per cent is in such resistances.

With the exception of Vorzimer's complete set kit stock, which apparently reaches 7.8 per cent of the total more because of the high unit cost than the actual quantity ordered, standard parts necessary in the construction of practically every set are stocked heaviest. With less risk of an overnight decline in demand for

such merchandise as sockets, transformers, condensers, rheostats, etc., his stock of these items is high. Thus audio transformers call for a 30 per cent investment, variable condensers 11.3 per cent, vernier dials 3.1 per cent, panel meters 2 per cent, sockets 6.4 per cent, and rheostats 2.3 per cent. Tuned radio frequency kits of three or more coils have become more

Yorkville Radio Company, Inc. 147 East 86th Street, New York City

Total Retail Value of Parts Stock \$38,000

Article	Number in Stock	Retail Value	Per Cent of Total Value, %
Adapters, Tube			
Na-ald, Hoosick, General Radio.....	360	\$250	0.7
Brackets, Sub-Panel			
Benjamin, Silver-Marshall, Radion.....	600	375	1
Condensers, Variable			
Hammarlund, Amsco, Mignon, Remler, SLB, General Radio, Preferred, Silver-Marshall, Ambassador, Cardwell, Duplex, Metralign.....	1,536	4,310	11.3
Condensers, Variable Midget			
Silver-Marshall, Hammarlund, Ambassador, Continental, Chelton, Marco, General Radio, Federal.....	400	400	1.5
Condensers, Fixed			
XL, Sangamo, Dubelier.....	1,800	795	2
Condensers, By-Pass			
Tobe, Dabelier, Sangamo.....	1,625	1,375	3.6
Coils, Tuning			
Ambassador, Aero, Bremer-Tully, Hammarlund-Roberts.....	179	550	1.5
Coil Kits			
Genwin-Lemnis, Daven, Freshman, Erla, Victoreen, Ultradyne.....	250	4,075	10.7
Crystal Detectors			
Brownlie, Steinite, RUF, DX, Rasla, Carborundum.....	150	75	0.2
Diagrams, Circuit			
Silver-Cockaday, Daven Resistor Manual, Hammarlund-Roberts.....	150	37.50	0.1
Dials			
Kurs-Kasch.....	100	75	0.2
Dials, Vernier			
Marco, National, Preferred, Apex, Bremer-Tully, Pilot, Rathbun.....	1,648	1,173	3.1
Grid Leaks			
Eagle, Durham, Bradley, No-Noise, Turn-it, Freshman, Centralab, Marco, Electrad, Daven, Music Master, Pudlin, Tobe.....		500	1.3
Jacks			
Carter, Yaxley, Federal, BMS.....	900	700	1.8
Kits, Resistance Audio			
Sonatron, Daven, Muter, DeJur.....	48	615	1.6
Kits, Complete Set			
Karas Equamatic, Erla, National Browning-Drake, B. T. Counterphase, B. T. Nameless, Victoreen, L. C. 27, Henry Lyford, S-M Shielded 6.....	89	2,943	7.8

Article	Number in Stock	Retail Value	Per Cent of Total Value, %
Meters, Panel Mounting			
Weston.....	150	\$750	2
Panels, Hard Rubber			
	361	210	0.6
Panels, Bakelite			
	159	550	1.4
Rheostats			
Bradleystat, General Radio, Amsco Yaxley, Carter, Centralab, DeJur, Filkostat.....	1,160	875	2.3
Resistances, Variable High			
Federal, Centralab, Electrad, Bradley-ohm, Clarostat, Carter Hi-Ohm.....	1,204	1,605	4.2
Switches, Inductance			
Carter, Yaxley.....	50	50	0.1
Switches, Push-Pull Filament			
Cutler-Hammer, Jones, Marco, Filko, Bradley, Frost, Apco, Yaxley, Carter..	700	350	0.9
Switches, Filament Lock			
Cutler-Hammer.....	100	65	0.2
Switches, Light			
Yaxley, Carter.....	50	75	0.2
Sockets			
Benjamin, General Radio, Silver-Marshall, Amsco, Na-ald, Air-Gap, Frost, Hoosick, Federal.....	6,720	2,455	6.4
Transformers			
Acme, Thordarson, General Radio, Rauland, All-American, Silver-Marshall, Karas, Stromberg-Carlson, Marle, Amertran, Sleeper, Federal, Jefferson, Ambassador, Pacent, Bremer-Tully, Modern, Sampson, RCA, Precise.....	3,196	11,488	30
Transformers, Power			
Acme, Sampson, National, Thordarson, Marle, Amertran.....	60	263.50	0.7
Chokes and Impedances			
Acme, Sampson, Thordarson, Amertran, Marle, National.....	500	500	1.3
Bus Bar			
	10,000	75	0.2
Spaghetti and Covered Wire			
Celatsite.....	100-25 ft. spools	300	0.8
Binding Post Strips			
	200	50	0.1
Binding Posts			
Eby.....	1,200	90	0.2
		\$38,000	100

This table shows the actual percentage of Yorkville's expenditure for each of the various radio parts. Prices are all quoted at retail value and the computed investment percentage is shown in the column at the extreme

right of each listing. Space limitations prevent the listing of each individual trade marked article stock. The total number of each in stock only is shown in the center column.

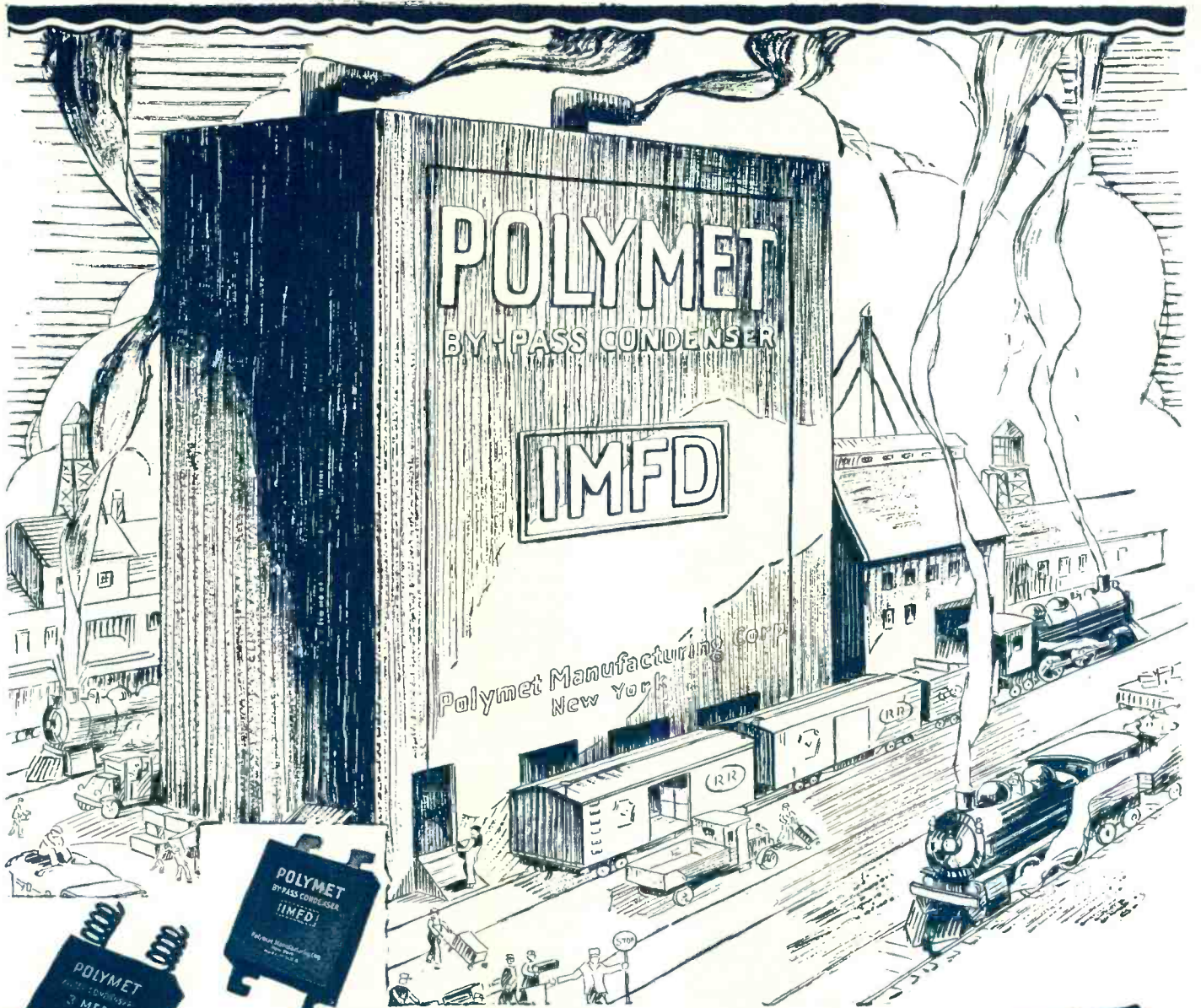

SURE-POLYMET is THE Condenser House!

ON the impersonal, brass-tacks basis of comparative performance rating, Polymet Condensers rank FIRST! 125 manufacturers of high quality receivers and power units specify Polymet as standard equipment — an overwhelming, unprecedented endorsement of the quality ideals built into each Polymet Product.

We will be delighted to send you complete details regarding the various types and capacities of Polymet Condensers; prices, discounts and all other information. Why not write today?

POLYMET MANUFACTURING CORPORATION

599 K Broadway, New York City

"WORLD'S LARGEST MANUFACTURERS OF RADIO ESSENTIALS"

POLYMET PRODUCTS

How Do You Balance Your Parts Stock?

Yorkville's stock selection may be unsuitable for any location other than the busy metropolitan center. The editors invite comment from other retailers.

or less standard equipment, and these items receive 10.7 of the total investment as a normal stock.

Fully 75 per cent of Yorkville Radio's business in parts is "repeat." Located in the heart of a residential section of New York City, Vorzimer has conducted his parts business for a number of years without serious losses due to dead stock.

Few articles are purchased unless customers ask for them. Kits of special design are stocked only when advertising or magazine articles create local interest. The average sale to a parts customer is about \$5.

Review of New Circuits

The January issue of *Popular Radio* will contain a description of Kenneth Harkness' new 6 tube receiver, the K.H.27, written by Mr. Harkness. A wiring diagram, which is reproduced on this page, together with full constructional details and operating instructions is included in the article.

In this new circuit, two novel features have been incorporated. First, its two stages of tuned radio frequency are neutralized by means of small variable balancing condensers used in conjunction with stabilizing coils placed within the tuned transformers in a modified Rice system.

Second, a system of audio amplification recently perfected by E. E. Hiler and employing double-impedances, is used. This amplification system is said to provide truthful reproduction of broadcast signals. A choke-coil and condenser loudspeaker filter is provided.

Two tuning controls only are used, the second radio frequency and detector tuning stages employ-

ing a tandem or gang condenser. Voltages above 135 are recommended on the plate of the last tube to insure good reproduction. Sharp tuning and high sensitivity without the elimination of essential side-band frequencies to attain this end, are the claims made for this receiver due to high interstage voltage increase in the r.f. amplifier.

The component parts of the receiver, keyed with the circuit diagram, are:

- A1, A2 and A3—Harkness radio-frequency transformers.
- B1, B2 and B3—Variable condensers, .00035 mfd. maximum capacity.
- C1 and C2—Variable balancing condensers, .0001 mfd. maximum capacity.
- D1, D2 and D3—Double-impedance audio couplers.
- E—Audio-frequency choke coil, 30 henries.
- F—Fixed condenser, .00025 mfd. with grid leak mounting.
- G—Fixed condenser, .001 mfd.
- H and I—Fixed condensers, .002 mfd.
- J and K—By-pass condensers, 1 mfd.
- L—3 megohm grid-leak.
- M—Fixed resistance, 2 ohms.
- N—Rheostat, 10 ohms.
- O1, O2 and O3—Ballast resistances for $\frac{1}{4}$ amp. tubes.
- O4—Ballast resistance for $\frac{1}{2}$ amp. tube.
- P—Open circuit jack.
- Q—Pilot light bracket and lamp.
- R—Double circuit antenna switch.
- S—Battery switch.
- T1, T2, T3, T4, T5 and T6—Tube sockets.
- Y—Binding posts.
- Two sub-panel brackets.
- 7 inch x 25 inch sub-panel.
- 7 inch x 26 inch panel.
- Two vernier dials.
- Machine screws, soldering lugs, bus-bar, etc.

L-C Junior Power Pack

The January issue of *Popular Radio* will also contain constructional data for a unit designed to eliminate B batteries, designed specifically for the L.C.27 receiver. The power-pack is capable of supplying up to 180 volts plate potential operating from a common 110 volt, 60 cycle light line and also supplies C battery voltages. Full wave rectification is employed, using a full wave rectifying tube of the thermionic or UX-213 type.

About Condensers

The Allen D. Cardwell Manufacturing Corporation, 81 Prospect Street, Brooklyn, provides an interesting booklet for the parts dealer in its latest catalog of radio products. The booklet contains reprints of a series of articles, written by Mr. Cardwell for *Radio Broadcast*, on the theory of variable condensers and design requirements of the low-loss types now in general use. The booklet lists the company's entire line of receiving and transmitting condensers with prices as well as other products of interest to the home builder and experimenter. It is photographically illustrated throughout and also contains a gold mine of odd information such as formulas for finding the inductance of coils, the capacities of condensers, resistance and impedance with tables of wire sizes, etc. It is written in a plain, direct manner with few technical terms and should be easily understood by the "fan" or radio retailer. The booklet is available without charge.

The Carborundum Company, Niagara Falls, N. Y., includes a circuit diagram section in its new catalog which is of interest to parts dealers for distribution to "fans." The dealer help, called the "Hook-up Book," contains a history of the development of carborundum as a radio detector and stabilizer, and also constructional data for a number of popular receivers.

The Kenneth Harkness K.H. 27 Receiver

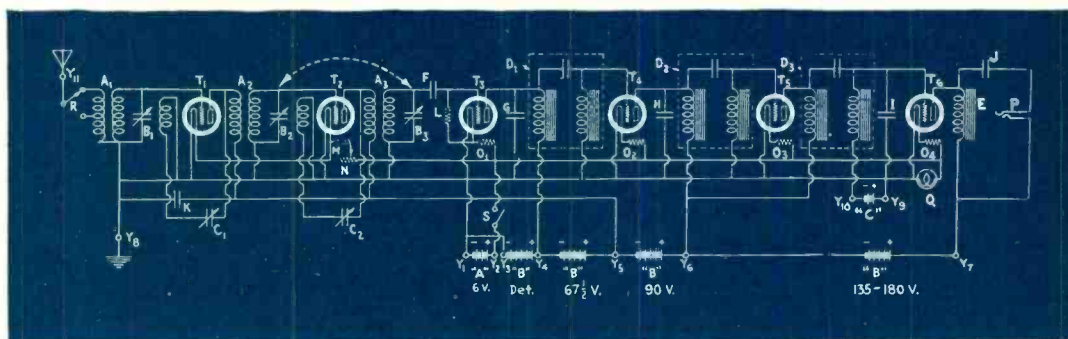

The new K.H. 27 receiver, illustrated above, is to be featured in the January issue of "Popular Radio." A list of its component parts appears on this page where an index to the key numbers in the schematic diagram will also be found

What

FERRANTI

*is doing
for you.*

What Really Comes Through Your Transformer?

We know what you want to get out of your set. Everyone wants it. It is clear, pure-toned reception—and you don't want to miss a note from the muffled base of the kettle drum or the profound booming of the base viol to the shrill "sky-high" tones of the life and piccolo.

So much depends on your circuit, so much on your speaker—but even more on your transformer. To render sweet music and to get the full range of orchestral or instrumental performance, the transformer must faithfully reproduce all frequencies.

The FERRANTI TRANSFORMER Meets Every Condition of Good Audio Reception

It takes two and a half miles of wire for the coils of the A. F. 3 and one and a half for the A. F. 4 plus the many refinements which the genius of Dr. Ferranti has made possible, to create transformers whose amplification curve is almost perfect—almost a straight line. By installing Ferranti you can modernize your old set or perfect your new one. Ferranti will give you an unobscured message from the sending station.

If you want to make the best of the power tube feeding the loud speaker, use Ferranti.

Ask your dealer for a Ferranti. Don't be satisfied until you have installed one. If he does not carry Ferranti Transformers, write us and we shall tell you where you can get one. No better transformer is available at any price.

FERRANTI, INCORPORATED
130 West 42nd Street
New York, N. Y.

For the best available transformer results—Ferranti Audio Frequency Transformer A. F. 3—ratio 3½ to 1—\$12.

For a transformer far superior to the average, use Ferranti A. F. 4—ratio 3½ to 1—\$8.50.

THE NEARLY PERFECT TRANSFORMER

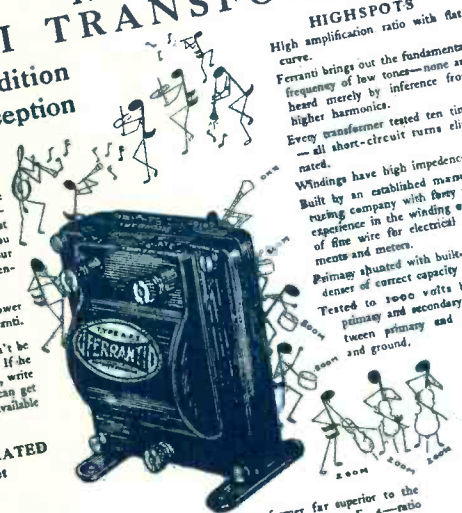

HIGHSPOTS
High amplification ratio with flat curve.

Ferranti brings out the fundamental frequency of low tones—none are heard merely by inference from higher harmonics.

Every transformer tested ten times—all short-circuit turns eliminated.

Windings have high impedance.

Built by an established manufacturing company with twenty years' experience in the winding of coils of fine wire for electrical instruments and meters.

Primary shunted with built-in condenser of correct capacity. Tested to 2000 volts between primary and secondary and between primary and secondary and ground.

IN foremost fan publications—in local newspapers throughout the country—this is the type of advertising that is spreading the truth about radio, about radio reception, about Ferranti Trans-

formers. It is making money for Ferranti distributors and dealers. It is building up a big business, a lasting business because the product is good and stays good.

FERRANTI, Inc.

130 West 42nd St.,
New York, N. Y.



Knockdown Set Specifications

Kits listed on this page include only complete sets of parts.
Basic units and kits of coils alone are not included

Name and Address of Manufacturer	Trade Name and Model Number	List Price	Type of Circuit	No. of Tubes	Stages Audio Amp.	Panel	Type of Instructions Furnished	Weight in Lbs.	Is Kit Complete Except for *Accessories	Other Equipment Furnished
Acme Apparatus Co. Cambridge, Mass.	Model A	\$50.00	Reflex	4	3	7x21 Drilled	Complete	22	Yes	Loop
	Model S-2	75.00	Reflex	5	2	7x24 Drilled	Complete	28	Yes	Loop
Baldwin Pacific & Co. 640 Natoma St. San Francisco, Cal.	Popular "E"	70.00	Super Het.	8	2	6x20	Schematic and Graphic	18	Yes	(Note)
	Improved "A"	75.00	Super Het.	8	2	7x20 Drilled		18	Yes	
	Standard "B"	80.00	Super Het.	8	2	6x26 Drilled		18	Yes	
	Compact "D"	80.00	Super Het.	8	2	8x20		18	Yes	
	Favorite "C"	85.00	Super Het.	8	2	8x20 Drilled		20	Yes	
(Note) And 8x19 1/2 subbase, 2 1/2 x 19 1/2 in. socket strip.										
Gearhart-Schlueter Radio Corp., Fresno, Cal.	Quadraformer V Complete	55.00	TRF	5	2	7x21 Celoron Drilled and Engraved	Complete step by step	17	Yes	2 in. Dial
	Quadraformer VI Complete	70.15	TRF	6	3	7x21 Celoron Drilled and Engraved	Full size charts	20	Yes	
Golden-Leutz, Inc. 6th & Washington Aves. Long Island City, N. Y.	Universal Plio-6	104.00	TRF	6	3	Brass Drilled and Etched	Blue Prints and Book	30	Yes	
	Transoceanic Phantom	220.00	TRF	9	4	Aluminum, Drilled	Blue Prints	45	Yes	
	Transoceanic Silver Ghost	660.00	TRF	9	4	Aluminum, Drilled	Blue Prints	120	Yes	
Hammarlund-Roberts 1182 Broadway New York City	Hi-Q	63.05	Two-stage radio frequency, auto-couple principle	5	2	7x21 Micarta Drilled and Engraved	Book with Photographs and Diagrams		Yes	
Hanscom Radio Devices Woonsocket, R. I.	Superunit-6	85.00	TRF	6	3	8x12 1/2 Formica Drilled	Booklet	15	Yes	Walnut Cabinet
Karas Electric Co. 19 South La Salle St. Chicago, Ill.	Equamate	89.24	TRF	5	2	Front 7x28, Sub. 6x27 Formica drilled and engraved	16 page manual		Yes	
Norbert Radio Service Bureau, 152 W. 42 St. New York City	Diamadyne No. 80	80.00	TRF	6	3	Bakelite Bakelite Inlaid Panel Bakelite 18k Inlaid Panel Bakelite 18k Inlaid Panel Bakelite one knob, electrically lighted revolving dial, visible in dark.			Yes	Console Console (a) Console (b) Console Console
	Melodee No. 90	90.00	TRF	6	3				Yes	
	Metrodyne No. 105 Super	105.00	TRF	7	3				Yes	
		75.00	TRF	7	3				Yes	
	Norbert Console-Art No. 145	145.00	TRF	7	3				Yes	
	(a) Single control, worm drive									
(b) Same as above with special 27x8x8 cabinet										
Norden-Hauck, Inc. Marine Bldg. Philadelphia, Pa.	Norden-Hauck "Super-10"	240.00	TRF Neutralized	10	4	36x9x1 1/2 Drilled, Grained and Engraved	(Note)	40	Yes	
	(Note) Complete, full size constructional blue print.									
Radio Receptor Co., Inc. New York City	Receptrad Multiflex M 4-12	50.00	TRF Reflexed	4	3	7x24	Complete	10	Yes	
Radio Specialty Co., Inc. 98 Park Place New York City	9184	8.85	Reflexed	1	1	Bakelite Drilled 7x10	Blue Print	2	Yes	
	9216	17.95	TRF Biased	5	2	Bakelite Drilled 7x24	Wiring Hints	5	Yes	
Silver-Marshall, Inc. 846 W. Jackson Blvd. Chicago, Ill.	Type 630	56.25	Silver-Cockaday TRF, regen. det.	4	2	Panel & chassis of Bakelite processed & drilled. Brass, panel pierced. Chassis steel, drilled.	Illustrated Pamphlet		Yes	
	Type 630	95.00	TRF	6	2		Illustrated Pamphlet		Yes	

* Tubes, Batteries and Phones.

Variable Condenser Specifications

(Concluded from page 53)

Name and Address of Manufacturer	Trade Name and Model Number	List Price	Capacity in Microfarads		No. of Plates per Unit	Type	Is Vernier Built-in	Method of Mounting	Diam. of Shaft (in Inches)	Overall Dimensions at Min. Cap. (in Inches)	Material of Plates	No. of Units on Shaft
			Max.	Min.								
Samson Elec. Co. Canton, Mass.	Samson Uniform Frequency Condenser Model No. 67	7.00	.000075	.00001	8	SLF		1 or 3 hole	1/4	3 1/2 x 3 x 2 1/2	Brass, copper plated	1
		7.00	.000125	.00001	13	SLF	1 or 3 hole	1				
		7.00	.00025	.000012	25	SLF	1 or 3 hole	1				
		7.25	.00035	.000015	35	SLF	1 or 3 hole	1				
		7.50	.0005	.00002	49	SLF	1 or 3 hole	1				
Silver-Marshall, Inc. Chicago, Ill.	340 317 316B 316A 316	1.50	.000025	.000003	11	SLC	No	1 or 2 hole	1/4	1 1/2 x 1 1/2 x 1 1/2	Brass	1
		4.50	.00914	.000006	11	Mod. SLF	No	1 or 2 hole				1
		4.50	.00035	.000007	27	Mod. SLF	No	1 or 2 hole				1
		4.50	.00035	.000007	27	Mod. SLF	No	1 or 2 hole				1
		4.50	.00035	.000007	27	Mod. SLF	No	1 or 2 hole				1
Warren Radio Corp. New York City	SLF-117 SLF-123	2.75	.00035		17	SLF	No		1/4	4 1/2	Brass	1
		3.15	.0005		23	SLF	No					1
Wireless Radio Corp. Brooklyn, N. Y.	"WRC" Straight Line Separation	1.50	.00025	.00012	13	SLS	No	1 hole	1/4	3 1/2 x 3 1/2 x 2 1/2	Brass or Aluminum	1
		1.60	.00035	.00014	17	SLS	No	1 hole				2
		1.70	.0005	.00018	23	SLS	No	1 hole				3

*SLF = Straight Line Frequency. SLC = Straight Line Capacity.
SLW = Straight Line Wave. Mod. = Modified.

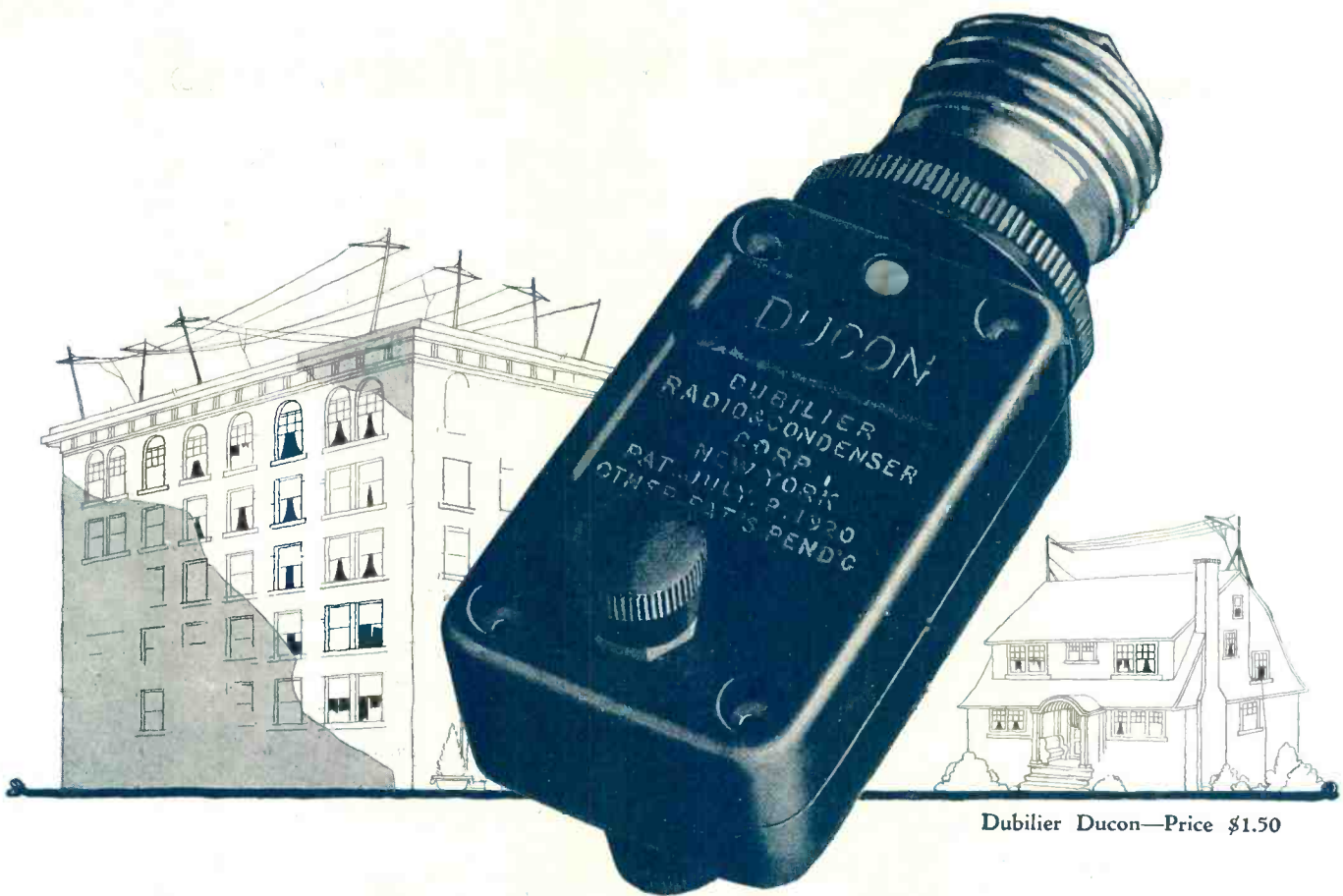

Dubilier Ducon—Price \$1.50

Sell them a Ducon—too

Every owner of an antenna operated set is a prospect for a Dubilier Ducon. When they buy aerial supplies, sell them a Ducon too. Most people prefer the Ducon to any aerial once they have tried it, but every set owner should have one on hand to use when something goes wrong with the aerial.

A Ducon screwed into any lamp socket turns all the house wiring into an antenna without risk either to the wiring system or the set. It consumes no current—there is no noise—no hum—no more roof climbing expeditions. The Ducon gives greater selectivity to sets in crowded neighborhoods. It reduces "static" in the summertime.

Dealers have found that the demand for Dubilier Ducons remains steady throughout the year. Why not sell every set owner a Dubilier Ducon too?

Our new thirty-two page booklet, "Seventeen Ways to Improve Your Set," is just off the press. It is filled with the kind of information every radio fan has long needed on the use of fixed condensers in radio. It will help you to sell more of every kind of radio apparatus you have in stock. Write direct for prices and terms.

Dubilier

CONDENSER AND RADIO CORPORATION

4377 Bronx Blvd., New York, N. Y.

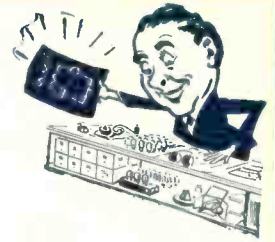

Rectifying Tubes

for Use with B Battery Eliminators

Manufacturer's Name and Address	Trade Name and Type	List Price	Full or Half Wave Rectifier	Type of Base	Maximum A. C. Input Voltage (See Note)	Maximum D. C. Output Current (Millamp.)	Filament Terminal Voltages	Filament Current Amperes	Maximum Overall Length in Inches
Allan Mfg. Co. Arlington, N. J.	Vogue Nonpareil	\$4.00	Half	UX	500	60	5	1.25	
Apco Mfg. Co. Providence, R. I.	Apco Rectifying	2.00	Half	UX	180		6	.5	4½
Cable Supply Co., Inc. 31 Union Square, New York	Speed	6.00	Full	Standard or UX	250 per anode		None	None	4½ UX 4½ UV
Camden Glass Wks. 105 Arch St., Camden, N. J.		3.00	Half	Standard	350	40	5-6	.5 also .75	
C. E. Mfg. Co. Eddy St., Providence, R. I.	DFW DHW	7.00 7.50	Full Half	Standard Standard	220 550	65 65	5 7.5	2 1.25	5½ 5½
Connoway Electric Labs. Magnatron Building Hoboken, N. J.	Magnatron Rex Magnatron Super Rex The Super Rex has a coated platinum filament Magnatron DC-216B Any of the above may be had in the double wave form if desired.	2.00 4.00 7.50	Half Half Half	Standard Standard Standard	330 330 660	40 60 65	5 5 7.5	1.0 .5 1.25	4½ 4½ 5½
Cunningham, E. T. 370-7 Ave., New York City	CX 313 CX 316B	6.00 7.50	Full Full	Large CX Large CX	220 per anode 550	65 65	5.0 7.5	2 1.25	5½ 5½
DeForest Radio Co. Jersey City, N. J.	Dr The above rectifier is for use with the DeForest Type DL9 Power Amplifier.	8.50	Half	UX	550	60	7.5	2	5½
Epom Corp. 114 E. 47th St., New York	Epom D-12	4.50	Full	UV	330	60	None	None	5
Forest Electric Co. 172 New St., Newark, N. J.	Unitron Electrolytic No-Bee Unitron 2 Amp. Electrolytic	6.50 4.50	Half Half	X Screw	250 28	40 2½ amp. also ½ amp.	None None	None None	5½ 5½
Gold Seal Electrical Co., Inc. 250 Park Ave., New York	GSX 216-B	7.50	Half	UX	550	65	7.5	1.25	5½
Ken-Rad Corp. Owensboro, Ky.	216 B	7.50	Half	UX	550	65	7.5	1.25	Standard
Musselman, A. J. Chicago, Ill.	5 R (X213) 7½ R (X216)	6.00 7.50	Full Half	Standard Standard		65 65	5 7.5	2 1.5	
Perryman Electric Co. 33 W. 60th St. New York	PR-213 PR-216A PR-216B	6.00 6.00 7.50	Full Half Half	UX UX UX	220 per anode 350 550	65 35 65	5 5 7.5	2 1 1.25	5½ 4½ 5½
Phila. Radio Mfg. Co. 3040 Stiles St. Philadelphia "C", Pa.	Extra UV201X Extra UV213R Extra UV216R Extra UV216B Philotron UX213 Philotron UX216B	2.00 3.00 2.50 7.50 7.00 7.50	Half Full Half Half Full Half	UV UV UV UV UX UX	200 200 per anode 200 450 220 per anode 550	20 30 30 60 65 65	5 5 5 5 5 7.5	0.25 1.25 1.25 1.25 2 1.25	4½ 4½ 4½ 4½ 5½ 5½
Radio Corp. of America 233 Broadway, New York	Rectron UX213 Rectron UX216B	6.00 7.50	Full Half	Large UX Large UX	220 per anode 550	65 65	5 7.5	2 1.25	5½ 5½
Raytheon Mfg. Co. Cambridge, Mass.	Raytheon Type B Raytheon Type BH	6.00 6.00	Full Full	Standard Standard	325 375	60 85	None None	None None	4½ 4½
Sonatron Tube Co. Chicago, Ill.	Sonatron 213 Sonatron 216B	6.00 7.50	Full Half	UX UX	220 550	65 65	5 6-8	2 2	2½ 2½
Sylvania Products Co. Emporium, Pa.	Sylvania	3.50	Half	Large UX	350	35	5	1	4½
Van Horne Co. Franklin, O.	5R 7½R		Full Half	UX UX	220 550	65 65	5 7.5	2 1.25	5½ 5½

Note:—"Root Mean Square" Voltage Values as Indicated on an A. C. Voltmeter.

The Alden Electric Company, 524 Westminster Street, Providence, R. I., is a new concern manufacturing the Alden-Somerbridge kit of receiver parts. H. A. McAvoy is president and H. M. Sherwood secretary of this corporation which intends to manufacture a full line of electrical and radio apparatus in the near future.

The Thordarson Electric Manufacturing Company, 500 West Huron Street, Chicago, has prepared a small leaflet for the use of dealers in the sale of apparatus which it manufactures for the construction of a power amplifier operating entirely from a.c. light lines. The leaflet contains useful constructional "tips" and also photographic illustrations of available apparatus for this purpose, with prices. A wiring

diagram in pictorial form is also included. The leaflet is known as SD 48 and is obtainable without charge.

The Jefferson Electric Manufacturing Company, 501-511 South Green Street, Chicago, furnishes a folder containing constructional data and circuit blueprints in connection with a Browning-Drake receiver employing Jefferson Concertone audio transformers.

The Samson Electric Company, Canton, Mass., publishes a 40 page booklet covering the subject of audio amplification. The book may be obtained for 25c. a copy in any quantity and has been compiled in response to numerous requests from jobbers and dealers who realize that tone quality will be one of the important factors in parts and kit

sales this year. Transformer coupling and the impedance or choke coil and condenser method of obtaining good reproduction are fully explained and each page contains a circuit or explanatory blueprint diagram. Thorough knowledge of the basic principles outlined in the booklet will undoubtedly enable the home constructor to improve the tone quality of his receiver.

The Kurz-Kasch Company, Dayton, Ohio, furnishes a 48 page log-book, printed on high grade paper and containing a list of all American broadcast stations and those of importance in foreign countries, to each purchaser of three or more Aristocrat tuning dials. Stations are listed alphabetically by call letters and are also cross-indexed according to location.

Reliable Switches Give Dealers an Advantage

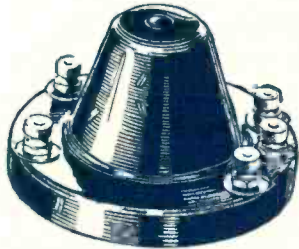

Utility Models

Model 13—For use with receiving sets using 5 volt tubes. Rated capacity .75 to 2 amperes, i. e.—from 3 to 8 type 201-A tubes or their equivalent in amperage drain. List price \$2.00.

Model 14—For use with receiving sets using 3 volt tubes. Rated capacity .3 to .6 amperes, i. e.—from 5 to 10 type 199 tubes or their equivalent in amperage drain. List price \$2.50.

Models 13 and 14 are identical electrically with Models 23 and 24 but are not equipped with plug and cord or receptacles. Connections are easily made to binding posts.



Convenience Types

Model 23—For use with receiving sets using 5 volt tubes. Rated capacity .75 to 2 amperes, i. e.—from 3 to 8 type 201-A tubes or their equivalent in amperage drain. List price \$3.50.

Model 24—For use with receiving sets using 3 volt tubes. Rated capacity .3 to .6 amperes, i. e.—from 5 to 10 type 199 tubes or their equivalent in amperage drain. List price \$3.75.

Models 23 and 24 are complete with plug and cord and receptacles for B Eliminator and Trickle Charger connections.

THE low price of Reliable Automatic Power Control Switches, ranging from \$2.00 to \$3.75, gives dealers a decided price advantage in competitive figuring on set installation. That is why so many dealers are selling Reliable Automatic Power Control Switches. Every dealer recognizes that a Reliable Switch installation will materially reduce his service calls. A Reliable Switch automatically keeps the Trickle Charger working every minute the set is not in use, preventing depleted filament supply. A Reliable Switch also protects B Eliminators by preventing overload on condensers while output of the eliminator is not in use.

Your customers will appreciate having you tell them about these positive-acting devices which make the A Battery Switch on a receiving set automatically turn on or off, either or both the Trickle Charger and B Eliminator as required. Sold under a money back guarantee.

Your jobber is ready to supply you. Sell one with every Trickle Charger and B Eliminator. Use the Coupon below to get full details.

The RELIABLE PARTS MFG. CO.

2821 Prospect Avenue :: :: Cleveland, Ohio

Reliable Automatic Power Control Switch

The Reliable Parts Manufacturing Company
2821 Prospect Ave., Cleveland, O.

Please send me more complete information, dealers' prices, etc., on your Reliable Automatic Control Switches.

My jobber is _____
Name _____ Address _____

AMSCO METALOID

GRID GATES & RESISTORS

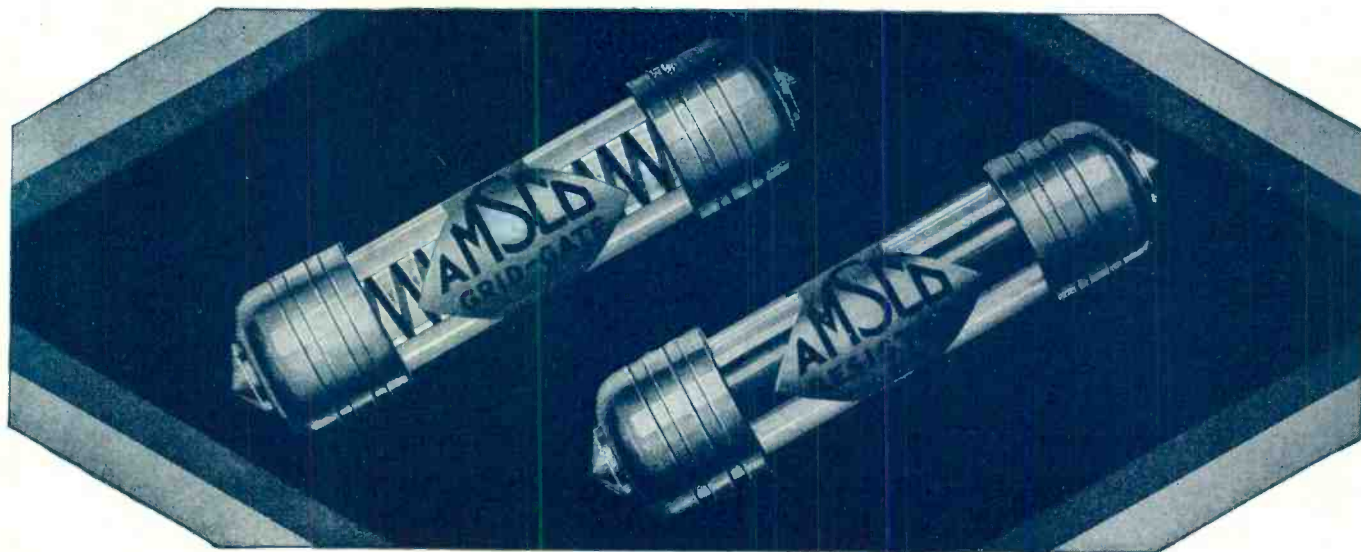

SILENT ACCURATE PERMANENT

THE secret of AMSCO excellence is in the changeless AMSCO METALOID resistance element. It is COLLOIDAL—smooth, stable, never varying with age, moisture or usage—superceding crystalline forms, with their jagged, noisy pathway to the current.

The element is fused into glass, and contact made by a welded joint, spun to the exterior cap. The large element, many times the size of inferior metallic resistors, will dissipate two watts of power with a 500 per cent margin of safe overload.

AMSCO Metaloid Grid Gates and Resistors are standard specification for fine Radio Receivers, and Battery Eliminators requiring high watt dissipation.

AMSCO Accuracy is guaranteed within five per cent of rated value—Silent operation guaranteed without qualification. Insist upon AMSCO.



Microphotogram of Colloidal AMSCO metaloid element. "Smooth, unbroken and silent."

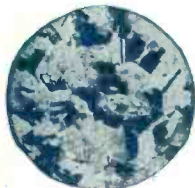

Microphotogram of typical crystalline metallic element. "Jagged and noisy."

Write for Zeh Bouck's monograph on R. C. Amplification. Also leaflets describing AMSCO Allocating Condensers, single, siamese, and three-gang—allocating by frequencies, wavelengths or capacity variations.



AMSCO PRODUCTS, INC.
Broome and Lafayette Streets New York City



ELECTRAD

Electrad Certified Jacks Are The Kind You Like to Sell.

Electrad Certified Jacks are the best for you to sell because they are the best for your customers to buy. Note these points: Positive acting spring of phosphor bronze. Sterling silver contact points. Insulation of hard rubber. Tinned soldering lugs, so placed that good joints can be made easily. Requires less than 1" behind panel. Certified and guaranteed electrically and mechanically. List, open 25c., closed 35c. In Canada, open 35c., closed 50c.

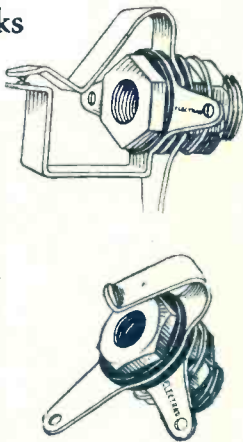

Electrad Certified Switches

Always Satisfy

Examine the way they're made and you'll understand why. Solid brass construction. Tinned soldering lugs placed to make connections easy. Neat design, genuine Bakelite knob. Requires less than 1" behind panel. Favorites with fans and listeners. List 40c.—in Canada 60c.

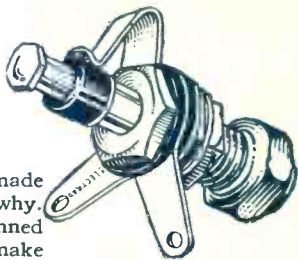

Electrad Certified Lead-In

A sure-fire seller and trade builder. Triple-ply insulation full 10 inches long, covered with waterproof webbing. One-piece copperstrip, heavily tinned to prevent corrosion. Fahnestock clips, all connections riveted and soldered. Fits under locked doors and windows—bends to any shape. List 40c.—in Canada, 60c. Write for details on our square dealer proposition, that helps you sell and protects your profits.

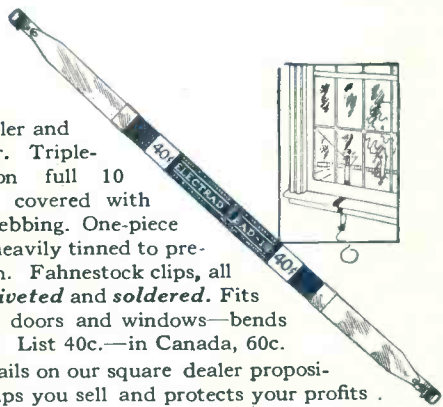

Write for information on the Electrad 500,000 ohm compensator for perfect control of tone and volume. 423 Broadway, New York City.



ELECTRAD

Silent Salesmen!

Use a **BEEDE METER** to test this battery!

WHEN A 45 VOLT BATTERY TESTS ONLY 34 VOLTS AND A 22 1/2 VOLT BATTERY 17 VOLTS IT IS TIME TO CONSIDER REPLACING THEM

WEAK BATTERIES GIVE POOR RECEPTION

YOUR BATTERY DEALER WILL SUPPLY YOU WITH A BEEDE METER.

Get Your FREE Supply of These Sales Making Labels

When you sell a "B" battery, any make, stick one of these labels on it. These labels will help you sell Beede Meters and more "B" batteries. We supply them to our dealers FREE. Beede Meters are low in price but in all other respects they equal the highest priced lines on the market. Your customers will appreciate it if you persuade them to buy a Beede Storage Battery Tester, list \$1.50; a Beede Voltmeter for testing "B" batteries, list price \$1.50; Other Beede Meters include the Midget Pin Jack Voltmeter for Radiolas and Brunswick superhets, list \$2.50. Amperemeters—Volt amperemeters and various panel mount meters for set builder's use.

There is a Beede Meter for every battery need.

Order from your jobber—Liberal discounts—Ask for catalog

BEEDE ELECTRICAL INSTRUMENT CO.

Factory: Penacook, N. H.

New York Sales Office: 136 Liberty St. John L. Madsen, Manager

BEEDE METERS

ACME CELATSITE BATTERY CABLE

—a silk-covered cable of vari-colored Flexible Celatsite wires, for connecting batteries to set. Prevents "blowing" of tubes; gives your set an orderly appearance.



Stranded Enameled Antenna

Best outdoor antenna you can buy. 7 strands of enameled copper wire; maximum surface for reception. Prevents corrosion and consequent weak signals.



The Original Celatsite

—a tinned, copper bus bar wire with non-inflammable "spaghetti" covering, for hook-ups. 5 colors; 30-inch lengths.

We also offer the highest grade of "spaghetti" tubing for Nos. 10 to 18 wires. 5 colors; 30-inch lengths.



Flexible Celatsite

Flexible, stranded wire for point-to-point and sub-panel wiring. Non-inflammable "spaghetti" covering. In black, yellow, green, red and brown; a color for each circuit. Put up in 25-foot coils.



Dealers Write for Acme Wire Products Folder E

THE ACME WIRE CO. - New Haven, Conn.

ACME WIRE

MAKES BETTER RADIO



SEND FOR THIS RADIO FOLDER

Contains seven hookups for B-Eliminators published in a prominent radio magazine.



These Prominent B-Eliminators are equipped with Allen-Bradley Bradleyohm-E as Standard Equipment

- | | |
|-----------------------------------|----------------------|
| Acme | Philadelphia Storage |
| All-American | Battery (Philco) |
| American Bosch | Precision |
| Brown & Green | Radio Receptor |
| DeWitt-LaFrance | Rothermel-London |
| Farrand | Spartana |
| Forest Unitron | Valley |
| Grisby-Grunow-Hinds
(Majestic) | Willard |
| Kellogg | Wilson |

The Demand for Allen-Bradley Resistors is Creating Sales and Profits for You!



Bradleyohm-E

For B-eliminator service requiring wide voltage control, Bradleyohm-E is essential. It is an oversize Bradleyohm with sufficient capacity to handle all normal B-eliminator requirements. Be sure to sell Bradleyohm-E in the checkered carton.



Bradleyunit-A

This solid, molded, fixed resistor has no glass or hermetic sealing in its construction. It is a solid unit with silver-plated end caps and is not affected by temperature, moisture and age. By all means, sell Bradleyunit-A when you sell a fixed resistor.

BRADLEYOHM-E is used as standard equipment for B-Eliminators built by the largest B-Eliminator manufacturers in the country. It stands pre-eminent as the most widely used variable resistor in B-Eliminator work. In fact, it is almost as universally used as the Raytheon tube.

The leading radio engineers who prepare construction articles for radio magazines and newspapers are practically unanimous in their choice of Bradleyohm-E and Bradleyunit-A for their B-Eliminator Hookups.

Radio fans are building thousands of these B-Eliminators, using standard kits. You can capitalize on the growing demand for Allen-Bradley parts by ordering Bradleyohm-E and Bradleyunit-A today. Now is the time to make radio profits.

Allen-Bradley Co.

Electric Controlling Apparatus

489 Clinton Street



Milwaukee, Wisc.

Sell Allen-Bradley Perfect Radio Devices

Your Coil Problem Solved!

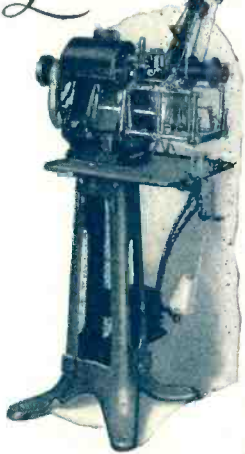

Install a group of
"Universal"
Coil Winding
Machines

and insure
uniform production
of dependable coils
at surprisingly
low cost

or



Purchase these same
coils from us, carefully
wound to your
specifications and
ready for application
to your product

UNIVERSAL WINDING COMPANY

Lesona
BOSTON

TOBE

RADIO
INTERFERENCE
FILTER
No. 1



for
Domestic
Oil Burner
and
Refrigerator
Motors

With this New TOBE Filter your customers troubled with interference from household devices (up to ¼ hp.) may get better Radio Reception. Attacks the trouble at its source, being attached to the offending appliance,—not to the set. We have a limited number now available for Jobbers and Dealers. You may secure yours by writing promptly.

TOBE DEUTSCHMANN CO.
Engineers, Manufacturers and Importers of
Technical Apparatus
Cambridge, Mass.

CORWICO

Radio's Best Wire
"FROM THE GROUND UP"
A Daily Profit Maker

Thousands of miles of Corwico radio wire are sold to radio fans every year. No radio dealer's stock is complete without it. Corwico radio wire is a consistent seller—a daily profit maker for Corwico dealers.

With the Corwico line you can meet the demands of your trade for any type or size radio wire—for from the ground to the aerial, there is a Corwico wire that gives the longest and most efficient service for the particular purpose designed.

TO DEALERS

Corwico is the branded and advertised line of radio wire that outsells the unknown lines. Order Corwico through your jobber.

TO JOBBERS

Write us for full particulars regarding the Corwico proposition.

TO MANUFACTURERS

Let us quote on your wire requirements.

CORNISH WIRE COMPANY
30 CHURCH STREET, NEW YORK CITY

BOSTON 80 Federal St. CHICAGO 337 W. Madison St. KANSAS CITY 268 Baltimore Bldg.
SAN FRANCISCO 585 Mission Street

Efficient Service on Molded Parts

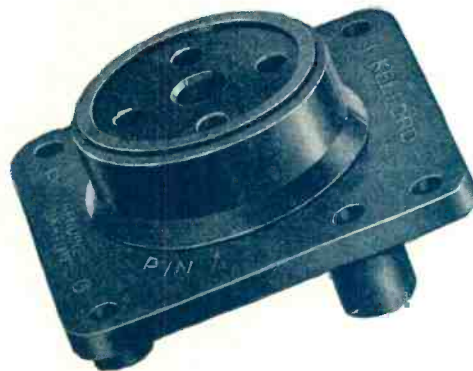

BAKELITE AND MOLDED MATERIAL
MADE TO YOUR SPECIFICATIONS

American Insulator Corp.
52 Vanderbilt Avenue, New York City

SM

The WHY of S-M Audios



Why should you buy S-M audio transformers—why should your customers demand them? Why should every leading publication and circuit specify them?

Here's why:—

Every S-M audio or output transformer is sold with a guarantee—if it doesn't please you or your customer—if it isn't better than anything you've ever tried, you can have your money back.

S-M audios and outputs are guaranteed to be the finest money can buy—better than resistance or impedance coupling. The unofficial reports of large telephone and electrical laboratories have not only verified S-M claims, but gone them one better.

Do you know that custom set manufacturers, builders of theatre reproducing equipment, broadcasting stations, a manufacturer of electrically recorded Phonograph records—all have verified S-M claims—have selected S-M transformers as the best.

In less than six months many thousands of consumers have read the S-M guarantee—bought transformers—tried them—and less than one tenth of one per cent have come back to the factory for refund.

Where, in the history of audio equipment, has such a record ever been equalled? What does it mean? Just satisfaction—satisfaction that you will have—can sell your customers—by simply giving them S-M audios on a satisfaction guarantee.

Read on this page the list of receivers sponsored by every important magazine. They are receiver designs for which S-M audios have been selected—simply because they had sold themselves on performance—the acid test of quality.

New Circuits That Will Sell S-M Audios For You

Radio News, Batteryless Receiver, February 1927 issue
Radio News, Power Amplifier, January 1927 issue
Sleeper's A, B and C Eliminator for 201-A tubes
Radio Mechanics January 1927 issue
Lincoln Super, Radio World December 1926 issue
Radio Broadcast Super, January 1927 issue
Radio Age Super, January 1927 issue
Infradyne, Radio, December 1926 issue
Callies Super, Radio News
Citizens Radio Call Book Monotone, December 1926 issue
Radio Engineering Short Wave Set, December 1926 issue

S-M audios are specified parts of the Shielded Six. Best's A-C operated Browning Drake, Radio Broadcast Local, Volney Hurd's Six tube Browning Drake, Popular Mechanics Super, and many other circuits. Each recommendation is just one more acknowledgment that they are right.

Prices 10% higher west of the Rockies

SILVER-MARSHALL, Inc.
870 West Jackson Boulevard
CHICAGO, U. S. A.

Do you know that you can make a friend of the dissatisfied customer with last year's set by putting in a pair of S-M audios for him? Or simpler yet—when you find a man with a cheap set—get him to invest \$6.00 in an S-M 221 output. When he connects it between his set and speaker, he'll find out what real quality sounds like. Then give him a copy of "The Secret of Quality"—it's free—and he'll come back for the audios after reading it.

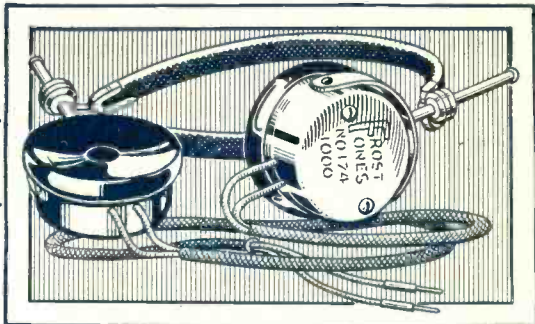

FROST-FONES Need No Introduction

FROST-FONES have long been known to fans and set builders as the one dependable head-set for quality and distance in radio reception. Their high quality is the result of 30 years' experience in the manufacture of telephone apparatus. Their low list prices have made them the largest selling head-sets on the market. List prices, \$3.00 to \$6.00.

FROST-RADIO Super-Variable Resistances

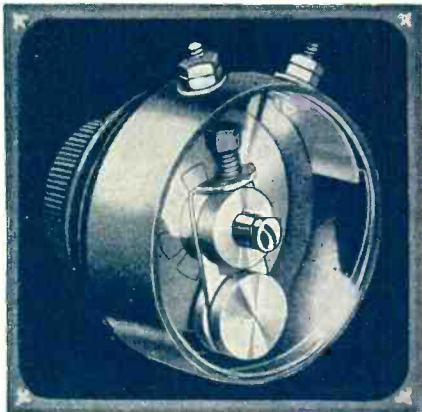

Type 880
and
890 Series

Nearly all of the new radio circuits call for one or more of these new non-inductive high resistance units. They are smooth and noiseless in operation and give any degree of resistance from zero to maximum without steps or jumps. Type 880 (2 terminals) is supplied in resistances of 50,000, 100,000, 200,000 and 500,000 ohms; type 890 (3 terminals) in 400, 2,000, 50,000, 100,000, 200,000 and 500,000 ohms. Both types, list \$1.25 each.

FROST-RADIO RHEOSTATS



Type 800
FROST-RADIO
Bakelite Frame
Rheostat



Type 700
FROST-RADIO
Metal Frame
Rheostat

Built on an air-cooling cast frame of genuine Bakelite. Current carrying capacity is extra large and it cannot overheat. Operates with easy, silent, non-wearing action. It is the ideal control unit for both new and old type tubes. Supplied in resistances of 2½ to 75 ohms. List price, 75c.

Type 700 is a small, ruggedly built rheostat with a sturdy one-piece metal frame. Has the same electrical and mechanical qualities of our Type 800 Bakelite Rheostat. Cannot warp or bend and the shaft alignment is permanent. Supplied in resistances of 2½ to 75 ohms. List price, 50c.



Gem Jac

The Gem-Jac is small and compact—a wonderful space saver. Projects only one inch behind panel. Springs have self-cleaning sterling silver contacts and the frame is nickel plated brass. A fast-selling little item. Prices 40c to 50c, list



Pan-Tab

The Pan-Tab is without a doubt the DeLux radio jack. It has heavier springs, more positive contacts and a finer finish than you will find in other jacks of lesser quality. Arranged for panel or table mounting. List prices, 65c to 90c



HERBERT H. FROST, Inc.

160 North La Salle Street

New York

CHICAGO

Los Angeles

MILLIONS
of sets now in use
NEED THIS PLUG!

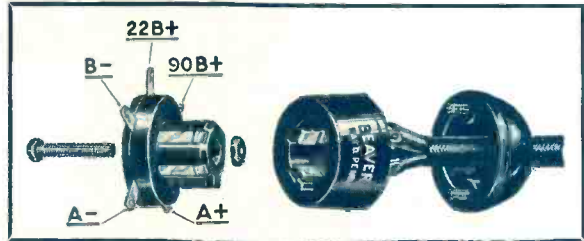

BEAVER Radio Connector Plug

Set mfrs. make the Beaver Plug the standard equipment on your next season's models.

\$1.50



Yes, millions of sets now in use have a tangled confusing mass of separate wires going from the receiver down to the batteries.

Sell this plug along with a standard radio battery cable to eliminate the confusion and mess now existing.

One fool-proof connector plug for all the battery leads!

Get a display carton from your jobber and place it on your counter—If your jobber has none in stock write us. We will send a sample for 80c. to any radio merchant.

Patents pdg.—List price \$1.50.

Some territories still open for mfrs. representatives.

Beaver Machine & Tool Co., Inc.

Newark, N. J.

The EASYMOUNT dial

PATENTED AUG. 10, 1926.

The easiest dial to mount on your set. Unitary construction, no tools needed, can be installed by a child in one minute. Smooth, slow, searching motion to give that hair splitting control needed to find all stations.

List Price \$1.00

De Luxe Model, \$2.50 List

Liberal jobbers' and dealers' discounts

ARTHUR DORSEY

Room 417

25 West 43rd Street, New York, N. Y.

Owner of Letters Patent No. 1,595,863 on indicating devices for radio receiving apparatus and licensee under said patent.

Watch for the
Parts Section
in the
January Issue

GENERAL RADIO

Parts and Accessories
Bring profit to the dealer
and
Satisfaction to the Consumer

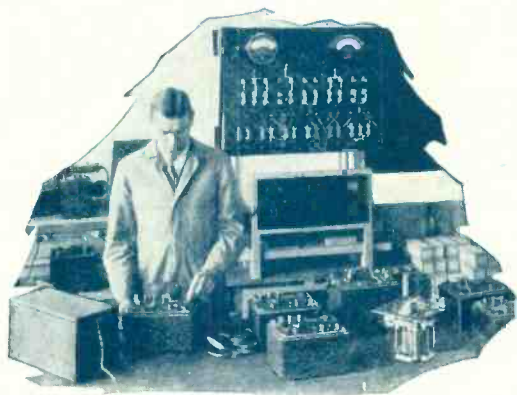
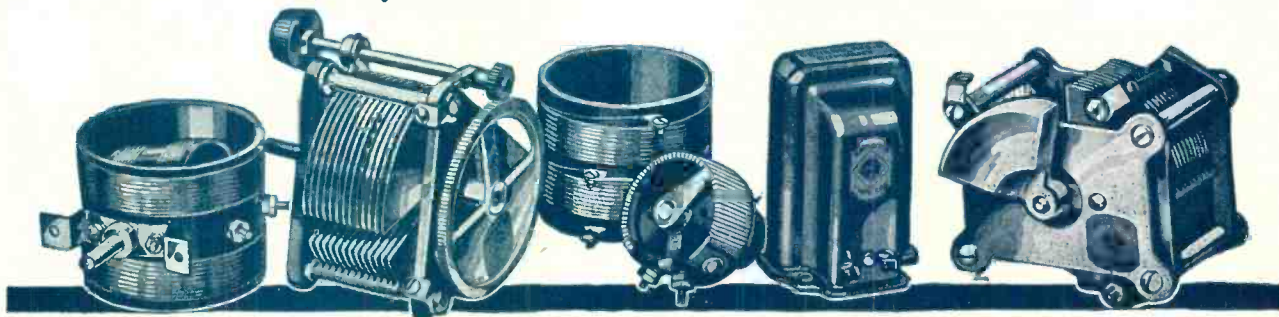

For more than a decade, the General Radio Company has been manufacturing radio laboratory instruments and parts—the outstanding feature of which is PRECISION. These instruments have been supplied in ever-increasing quantities to many well-known radio laboratories of the country, including the General Electric Company, Westinghouse Electric Manufacturing Company, Bell Telephone Laboratories, Bureau of Standards, U. S. Navy, U. S. Signal Corps as well as the leading engineering colleges.

Today General Radio precision instruments are standard equipment in nearly all the radio laboratories throughout this and many foreign countries.

Through the merits of design, performance, and price, General Radio instruments for the scientist or set-builder are universally recognized as the Standards of Quality.

SINCE the early days of radio, amateur operators and set builders have looked upon the General Radio Company as a time-tried producer of dependable apparatus.

The conservative buyer of radio parts considers first the reputation of the manufacturer. He knows from his own experiences and those of others whether this reputation warrants his confidence. It is this self-same confidence upon which the popular preference for General Radio parts and accessories is based.

Radio builders today recognize in building a receiver that its performance depends primarily upon two things; an efficient circuit and the use of good parts. Wherever you find a popular circuit, you will invariably find General Radio parts.

Why not concentrate upon a complete line of quality parts which will give you profit and your set-building customer satisfaction?

Ask your jobber or write for
our latest parts Bulletin No. 926.

GENERAL RADIO CO., Cambridge, Mass.

GENERAL RADIO
PARTS
Behind the Panels of Better Built Sets

Beware of Imitation MICADONS

It has recently come to the attention of this company that imitations of DUBILIER MICADONS are being manufactured abroad and imported.

These imitations on first inspection very closely resemble genuine DUBILIER MICADONS. However, the name DUBILIER is sometimes misspelled "DUBILAER" and the word MICADON is stamped "MIOADON."

The Radio Industry, and jobbers and dealers particularly, are hereby warned against the purchase and use of these imitations which not only are inferior to the DUBILIER MICADON, but also violate the laws of the United States as well as infringe the patents of this company.

Dubilier

CONDENSER AND RADIO CORPORATION

4377 Bronx Blvd., New York, N. Y.



The St. James Transformer

The highly efficient vacuum-treated, dehydrated air core transformer which has been so successfully used in the well-known St. James Super-Het.

A mighty good article with good profits for parts dealers. Very complete and simple working plans available.

Send for our Folder

St. James Laboratories, Inc.
845 Washington Blvd., Chicago, Ill.

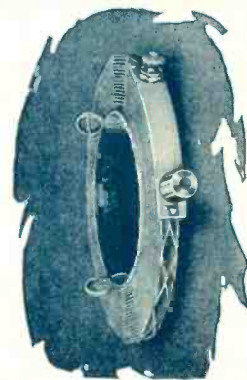

Set Manufacturers!

Standards of radio reception are becoming higher with each new year. 1927 models must be an improvement over those of 1926, and they will be.

Correct coils are vital to good reception. We specialize in such coils. We are producing regularly the most advanced types, built with the famous "Diamond-weave" construction.

Write us concerning your own requirements. We are prepared to furnish better coils for the new sets.

THE F. W. SICKLES COMPANY
140 Union St., Springfield, Mass.

**SICKLES DIAMOND-WEAVE
COILS**

FARADON "UNIVERSAL" CAPACITOR BLOCK



Designed especially for operation in connection with the most generally used Battery Eliminator circuits. Total capacitance 14.2 Mfds., connected to fixed terminals in convenient units permitting ready wiring in desired combinations of capacity. Exceptionally high factor of safety to withstand possible high voltage potential surges. Also By-Pass and Filter Units in individual containers.

TO DEALERS:—If not now supplied, place order at once with your Jobber to secure early shipments.

WIRELESS SPECIALTY APPARATUS COMPANY
JAMAICA PLAIN, Est. 1907 BOSTON, MASS., U. S. A.



DUDLO

DUDLO WIRE AND WINDINGS

Are Used in All Kinds of Electrical Apparatus

In the ever-growing field of electrical apparatus requiring Magnet Wire and Windings, "DUDLO" is the word that first flashes across the mind of the engineer or manufacturer.

The DUDLO Trade Mark recalls to their minds that DUDLO produces the greatest volume, commands the greatest skill, offers the greatest engineering and experimental cooperation and gives the utmost in intelligent and prompt service—all at a lower price than lesser resources would permit.

DUDLO MANUFACTURING CORPORATION, FORT WAYNE, INDIANA

412 Chamber of Commerce Bldg., Newark, N. J.
274 Brannan St., San Francisco, Calif.

160 North La Salle St., Chicago, Ill.
4153 Bingham Ave., St. Louis, Mo.

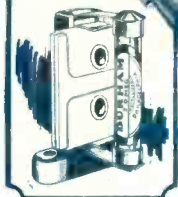
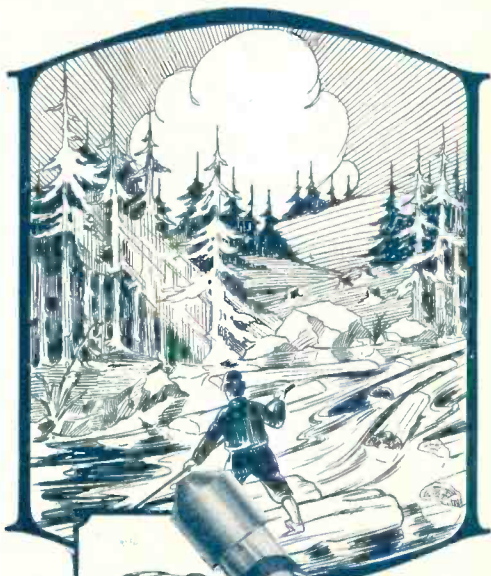

Resistor Mounting
Single mounting 50c.
For condenser . . . 65c.



Ruggedness!

DURHAM Metallized RESISTORS

YOUR customer is interested not only in the immediate performance of a radio part or set but also in how long such part or set will maintain its initial standard.

Sturdy as the evergreens of the mountain slopes, the Durham *Metallized* Resistor is built to endure the stress of changing temperatures and moisture. Noiseless, rugged—and fixed in resistance value.

500 ohms to 10,000 ohms	\$1.00
Above 10,000 ohms to 24 meg.	.75
25 meg. to 10 meg.	.50
Packed 10 to a box, 100 to the carton.	

DURHAM METALLIZED RESISTORS

International Resistance Co.

Dept. J, Perry Building, Philadelphia, Pa.

Selected as standard by the Hammarlund-Roberts Board of Engineers.

Goodrich Silvertown

The Radio Panel Supreme!

- 1 Easier to drill and machine.
- 2 Better color, lasting lustre.
- 3 Lower free sulphur — no discoloration.
- 4 Higher softening point—no warping.

Goodrich V.T. Sockets Spaghetti Tubing
Radiophone Ear Cushions
Battery Mats
Hard Rubber Tubes for Coils

The B. F. Goodrich Rubber Company
Established 1870 Akron, Ohio

Manufacturers and Retailers—

The Double Impedance Unit is to take the place of transformers. It unquestionably is the coming thing. It quadruples the signal, yet with a clarity and tone true to the artist. It is notably free from foreign sounds or noises.

It is no overloading of tubes; no corroding effect on the coils as is experienced with transformers.

PARAGON

in 1916 effected the first transcontinental reception.

In 1917-18 Paragon receivers proved superior in intercepting enemy signals by the Army and Navy.

In 1921 Paragon effected the first transatlantic amateur reception.

In 1923 Paragon products were a sound investment in a hectic market.

In 1924-1925 the Paragon led in one dial control arrangement.

In 1926—Paragon invites you to test the Double Impedance Unit and share with us in this great advance.

The new PARAGON Double Impedance Unit



Write for information, hook-ups and prices

PARAGON ELECTRIC CORP.
Original licensees under basic Hyler patents
Upper Montclair, N. J.

**Windsor Wall or Table
Type Cone Speaker
Amazes Radio World**

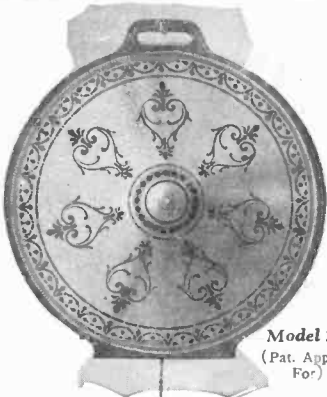

Model 210
(Pat. Applied For)

The latest model Windsor Cone Loudspeaker has astonished the world of radio. In convenience, quality of reception, and extremely low price, it far surpasses anything yet offered. The cone is 22 inches in diameter and is mounted on a sounding board which, in turn, is supported by an easel back. It can be hung up on the wall, as in the picture above, or stood upon any flat surface as shown in the picture below. It contains the famous Windsor loudspeaker unit noted for the extreme clarity and fidelity of reproduction.



Model 210
22-inch Cone Loudspeaker with sounding board and easel back.

\$15.00

(West of Rockies \$18)
(Pat. Applied For)

Model 302 (Shown below)
With Moulded Composition Horn Loudspeaker and 18-inch Cone Loudspeaker.



(Pat. Applied For)

In this Windsor Console is combined both the Windsor Moulded Composition Horn Loudspeaker and the 18-in. Windsor Cone Loudspeaker. The top is 30 in. x 17 in. and stands 29 in. high. Plenty of battery and equipment space is provided by large shelf in rear. Price, finished in Mahogany or Walnut **\$48.00**
(West of Rockies, \$55)

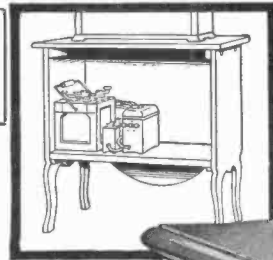

Rear view at left shows large compartment with ample space for batteries, battery charger, or battery eliminator, which are entirely concealed from view. Back is open for ventilation of batteries.

At right is shown the Cone Loudspeaker, with its sounding board, which is quickly and easily removable, allowing instant access to all batteries, battery charger, battery eliminator or other equipment and wiring.

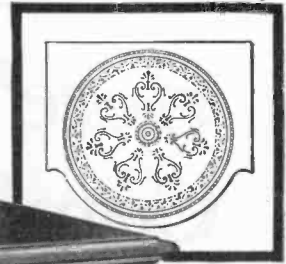

(Pat. Applied For)

Model 200—with 22-inch Cone Loudspeaker

This Windsor Cone Loudspeaker Console is equipped with a 22-inch Windsor Cone Loudspeaker. Its top is 30" x 17" and is 29" high. The battery shelf provides ample space for batteries, charger, battery eliminator and other equipment. Beautifully finished in either Mahogany or Walnut.

Model 200

\$29

Console with Cone Loudspeaker Ready for Set and Batteries
(West of Rockies, \$35)

This is the Fastest Selling Line of Loudspeakers and Loudspeaker Consoles in the Radio World Today



Model 100
with Moulded Composition Horn Loudspeaker or 16-inch Cone Loudspeaker
(Pat. Nov. 18, 1924)

Above is shown a beautiful Windsor Loudspeaker Console, finished in either Walnut or Mahogany, which provides ample space on top for any radio set. The battery shelf beneath will accommodate all necessary equipment. Equipped with either Moulded Composition Horn or 16-inch Cone Loudspeaker. Size: 38 in. x 18 in., and 29 in. high. Price **\$40.00**
(West of Rockies, \$42.50)

To the right is shown the newest Windsor Loudspeaker Console. It is equipped with a 22-inch Cone Loudspeaker and cabinet suitable for 7-inch radio panels up to 26 inches in length. Battery shelf provides ample space for all equipment. Price (without receiving set) **\$44.00**
(West of Rockies, \$52.00)

The quality of radio reception made possible by Windsor Cone and Horn Loudspeakers and Loudspeaker Consoles so far surpasses anything heard heretofore that it amazes and delights every radio enthusiast. The Windsor Line is so complete that everyone can find in it a loudspeaker, loudspeaker table, or loudspeaker console exactly to fit their particular needs.

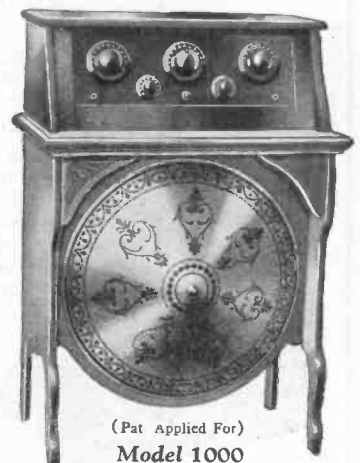

(Pat. Applied For)

Model 1000
with 22-inch Cone Loudspeaker

Note to Dealers: Write or wire today for details of the highly profitable Windsor line.

Electrical Department

WINDSOR FURNITURE COMPANY

1436 Carroll Avenue • CHICAGO, ILLINOIS
Los Angeles Branch—917 Maple Avenue

Here's a Combination That Converts Prospects Into Customers!



"STERLING" TRICKLE CHARGER



This new "Sterling" continuous charger operating from lighting circuit offers owners of six volt and four volt "A" batteries the utmost in convenience, safety and efficiency. Both charging and receiving are controlled from a combination switch in the unit. Equipped with "Sterling" Meter to show that charger is working efficiently. Noiseless in operation; compact enough to fit any compartment that will accommodate three No. 6 dry cells.

R-101 List price with bulb \$14.00.

R-102—Trickle Charger. combines the automatic control unit, which controls A Battery charging and radio broadcasting as well as controlling the B Eliminator—all from the single filament switch on the receiver.

List price with bulb, \$17.50.

"STERLING" AUTOMATIC CONTROL SWITCH

By the use of this simple little device one can forget to turn off the eliminator and no harm to tubes or condenser will result for the Sterling R-105 gives fully automatic control.

In operation, turning on the receiver switch for reception automatically cuts off the trickle charger and turns on the A battery, B eliminator or B battery. When through using the set, turning off the switch cuts off all power from the set and automatically resumes trickle charging of the A battery.

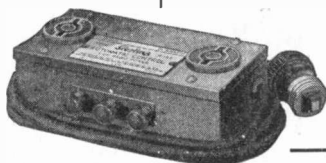

R-105 Automatic Radio Power Control Switch.

List price \$5.25.

Your radio buying public is made up of so many types of people that you must have a line that will not disappoint a single prospect.

The Sterling line of Battery Chargers and Battery Eliminators is the result of an intensive study of your merchandising problems, and is designed to simplify your selling as well as to cover a wide range of price demands and set conditions.

That's what you want, isn't it?

STERLING "B" & "C" POWER

Compare the Sterling "B" Power with any eliminator for output, flexibility, convenience and construction—it can't be equalled.

Sterling No. 97 delivers up to 180 volts at 50 milliamperes; is especially recommended for sets using the new No. 171 or 210 power tubes; has two power-ranges with cut-off switch; uses the improved type Raytheon Tube.

No. R-97 "B" and "C" Power complete with tube, price \$55.00.

No. R-99 "B" Power complete with tube, price \$45.00. Other types, the RT11 and RT40 for up to 5 tubes and Radiolas especially. Prices \$26.00 and \$28.00 with tube.



Sterling

RADIO EQUIPMENT

THE STERLING MFG. CO.,



CLEVELAND, OHIO

Your customers are ASKING THESE QUESTIONS when they buy an eliminator

"Must I purchase a separate C battery and how will I know that a leaky cell is not spoiling my reception?"

In the Freed-Eisemann you do not need a separate C battery. Both C and B are supplied because a leaky cell in a C battery cannot always be detected, and yet can spoil reception. The Freed-Eisemann power unit gives perfect C power.

"Must I operate rheostat controls in addition to the controls on my set, and how will I know that I am furnishing the proper B voltage when I adjust the controls on the Eliminator?"

Freed-Eisemann is automatic. No controls.

"Is there a safety door which will automatically cut off the line current while I'm connecting wires to my set?"

In the Freed-Eisemann the safety door cuts off the line current while you make connections. When closed, all terminals are covered.

"Is there a voltage regulator tube in addition to the rectifier tube so that I will automatically get a steady and not a jumpy current and so obviate the necessity of separate controls on the Eliminator?"

The voltage regulator tube in the Freed-Eisemann B & C Eliminator automatically gives your set just the current it needs in changing from high to low volume stations. No controls

on the Freed-Eisemann. A good Eliminator must have both a voltage regulator tube and a rectifier tube. Two tubes are necessary!

"Has it up to 27 volts of 'C' in addition to full voltage of B supply so I can get the most out of the power tube in the 2nd audio stage?"

"C" governs tone in your set. The Freed-Eisemann Eliminator supplies as high as 27 volts of "C" in addition to 135 volts of steady hum-free "B" current at the same time.

"Can my set be ruined by a sudden over-supply of B voltage and will the Eliminator beyond any chance deliver the exact current and no more?"

If more than 135 volts of "B" are used with your radio, you may burn out the loud speaker windings or the transformers in your set.

In eliminators having knob controls, you never know how much voltage is being delivered. The voltage regulator tube positively will not pass more than the exact current needed.

"When the lights are turned off or on, in houses in my neighborhood, does the Eliminator maintain an even current?"

The Freed-Eisemann transforms the current by the rectifier tube and then maintains an automatically controlled, even supply by the voltage regulator tube.

The ONLY Eliminator that answers ALL these vital questions with "Yes!" is the new

FREED-EISEMANN B & C POWER UNIT



Type GSX-171
High power tubes for use in last stage of audio amplification give increased volume.
Price \$4.50
Look for the red box



Type GSX 216B
For use in battery eliminators to rectify alternating current—advantageous in supplying the higher current required by power tube equipped sets.
List price \$7.50



Type GSX-112
High power tubes for use in last stage of audio amplification give increased volume.
Price \$4.50. Look for the red box



Type GXS-200A
For use as detector only, giving superior strength on weak signals—especially desirable for distance.
Price \$4.00



Type GSX-20Hy-Mu
For use only in the popular resistance coupled amplification, highly efficient in this system.
Price \$4 00

All Standard Types

Everybody recognizes the Venus de Milo as the supreme achievement of the sculptor's art.

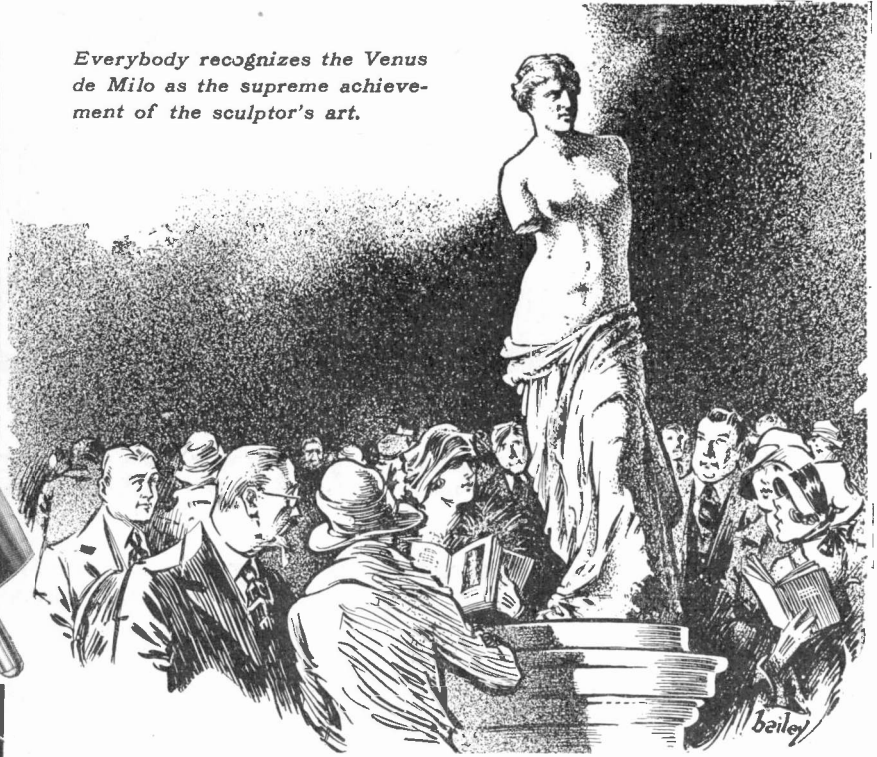

Profits Follow the Crowd

People soon recognize superiority, whether in radio tubes or any other combination of art and skill.

Gold Seal Tubes have won public favor—sales increasing by leaps and bounds. Are you riding on this profit-wave of popularity?

Made right, sold right, and *guaranteed* right — by a company whose record is your best assurance of permanence and a square deal to both jobber and dealer.

Yes, quality counts. It is making money for hundreds of Gold Seal dealers right now. You should be sharing in this success.

Insist on genuine GOLD SEAL Radio Tubes—

All Standard Types

Type GSX201A \$2.00	Type GSX120 . \$2.50	Type GSX216B . . \$7.50
" GSX199 . 2.25	" GSX200A 4.00	" GSX112 4.50
" GS199 . . 2.25	" GSX171 . 4.50	" GSX20-Hy-Mu 4.00

If not obtainable from your jobber, write us for particulars of our attractive dealer proposition.

Have you seen the new Gold Seal window and counter displays? Ask your jobber or write us today.

Gold Seal Radio Tubes

**Jobbers! Some desirable territories still open.
Full Protection. Write for particulars.**

GOLD SEAL ELECTRICAL CO.
INCORPORATED
250 PARK AVE., NEW YORK

A NEW Deal For Dealers!

There are certain factors which control the extent of every dealer's success. If every one of these factors are carried to the highest possible point your complete success is assured.

We are offering you A New Deal which does that very thing. It is of most importance to you—to every dealer of today.

You are in business to make money, build up a strong prestige, sell a product that not only satisfies but delights your customers—in fact, be the “hi-light” of dealers in your community.

Then you are interested in this New Deal, which also eradicates service worries and excess handling.

Find out all about this wonderful proposition, “A New Deal For Dealers.” Do not wait until someone else beats you to it. Fill in the coupon and mail in today—NOW.

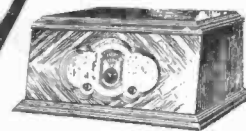
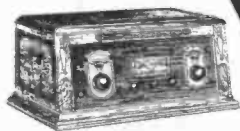

ELECTRICAL RESEARCH LABORATORIES
 2500 Cottage Grove Avenue, Dept. D50 Chicago, Illinois

Please send me complete data regarding your “New Deal For Radio Dealers.” I understand that this inquiry opens up a new avenue of profits and does not obligate me in any way.

Name _____
 Firm Name _____
 Address _____

Eagle "MASTER"

List Price
\$25 (With Bulb)

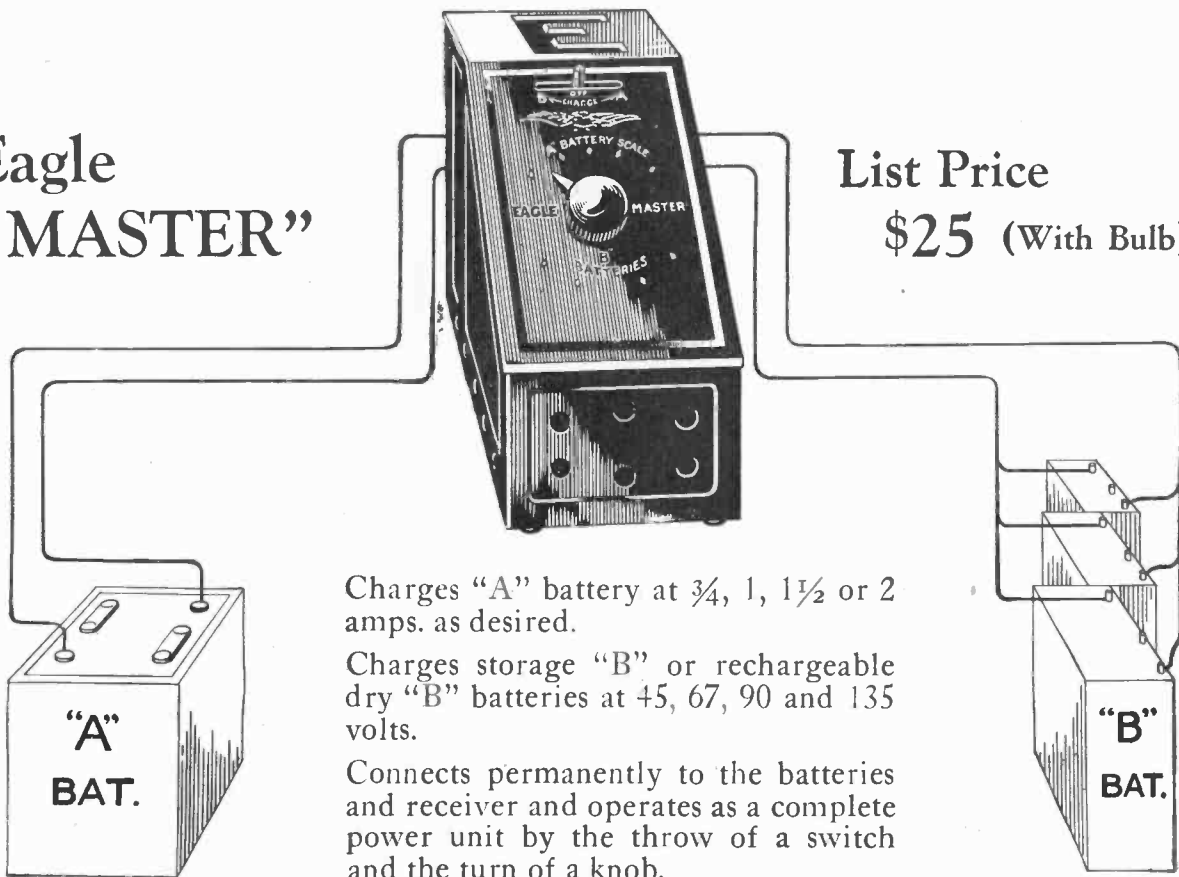

Eagle "TRICKLER"

List Price
\$10.00
Complete

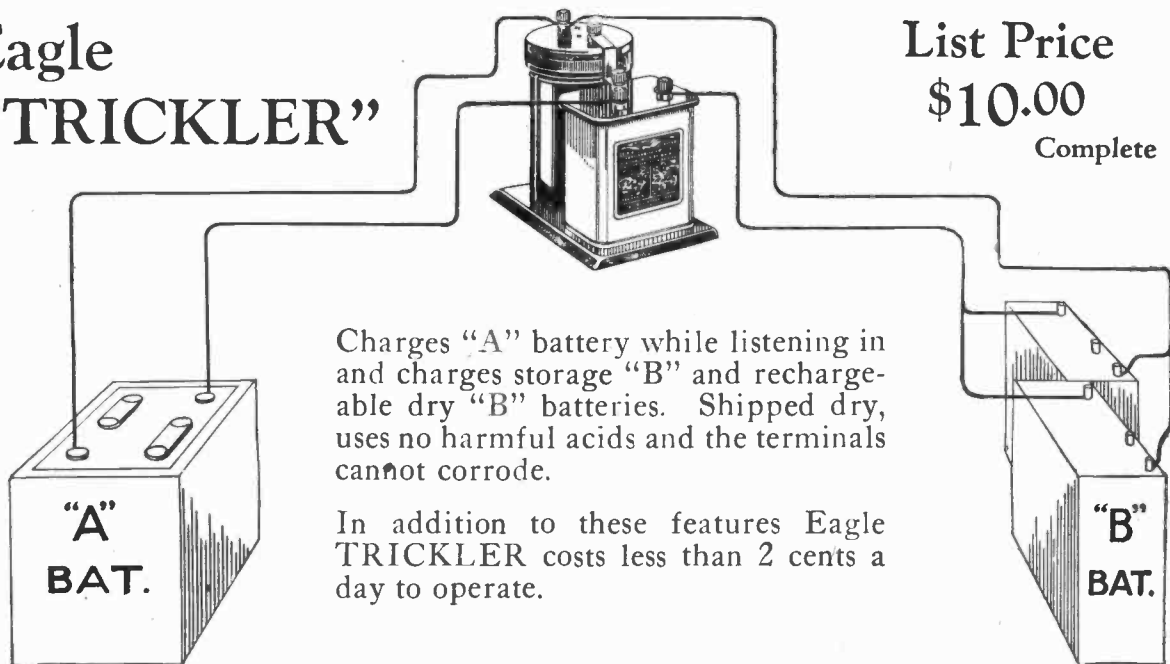

If your jobber can't supply you, write direct to us
for complete information on Eagle Chargers

EAGLE CHARGER CORP., 121 N. Eighth St., Philadelphia, Pa.

EAGLE CHARGERS

There is no Substitute for a Good "B" Battery in Radio

45 VOLTS
30 CELLS
\$4.50

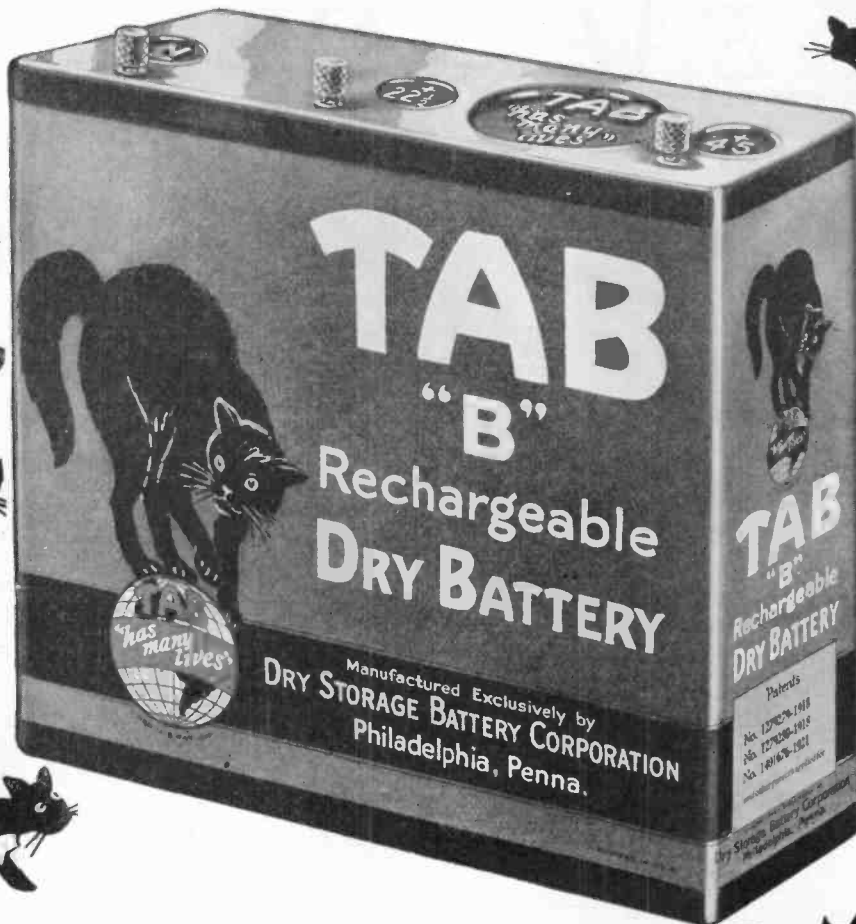

TAB Batteries can be recharged to full voltage six to eight times—at home, with any standard "B" battery charger—or chemical rectifier. In addition, TAB will give longer initial service and has greater shelf life than any other dry "B" battery.

TAB gives 45 volts of steady, dependable "B" battery service at about ONE-SIXTH the operating cost of other dry "B" batteries. A saving of 83 1/3 cents on the battery dollar.

Again—TAB Writes Radio History

ONLY a few months ago we announced TAB batteries—and the radio public was treated to a sensation. At last a dry "B" battery that could actually be recharged, was perfected.

Since that time TAB has been making radio history in another way. It has hung up an unprecedented record.

We know there would be a demand for TAB Batteries, the only "B" battery in its class—the only Dry "B" battery that is rechargeable—the "B" battery absolutely without competition. But even we underestimated the demand.

We are further enlarging our manufacturing facilities to care for an ever increasing demand on the part of the trade and the public. Write for literature and discounts.

Patented and manufactured exclusively by

DRY STORAGE BATTERY CORPORATION
213 South Broad St., Philadelphia, Pa.

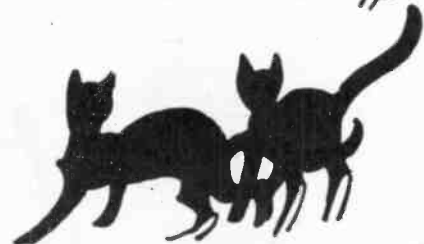

TAB—the Rechargeable Dry "B" Battery

THE YEAR SAYS BUY!

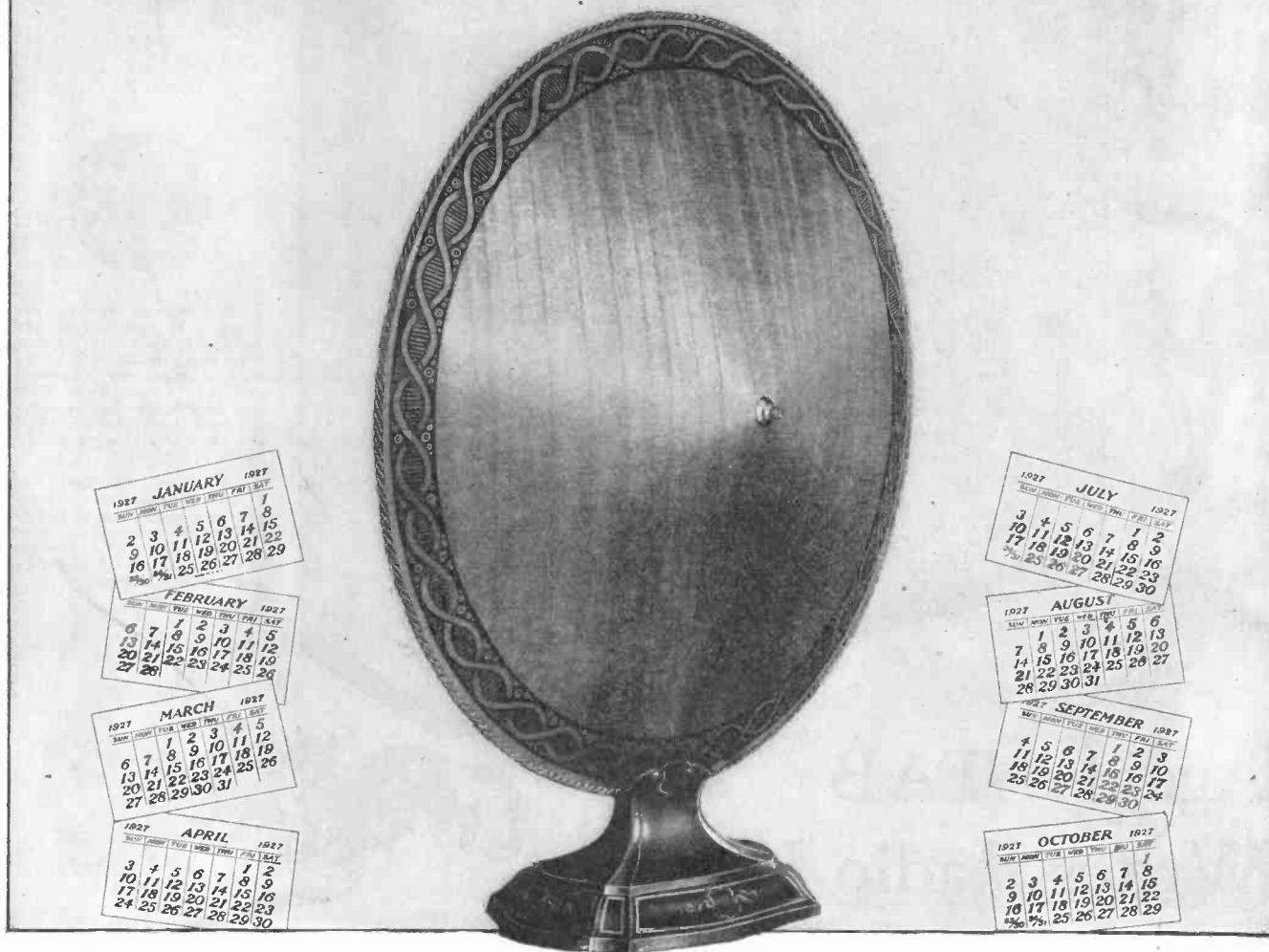

1927 JANUARY 1927

SUN	MON	TUE	WED	THU	FRI	SAT
						1
2	3	4	5	6	7	8
9	10	11	12	13	14	15
16	17	18	19	20	21	22
23	24	25	26	27	28	29

1927 FEBRUARY 1927

SUN	MON	TUE	WED	THU	FRI	SAT
1	2	3	4	5	6	7
8	9	10	11	12	13	14
15	16	17	18	19	20	21
22	23	24	25	26	27	28

1927 MARCH 1927

SUN	MON	TUE	WED	THU	FRI	SAT
1	2	3	4	5	6	7
8	9	10	11	12	13	14
15	16	17	18	19	20	21
22	23	24	25	26	27	28
29	30	31				

1927 APRIL 1927

SUN	MON	TUE	WED	THU	FRI	SAT
1	2	3	4	5	6	7
8	9	10	11	12	13	14
15	16	17	18	19	20	21
22	23	24	25	26	27	28
29	30					

1927 JULY 1927

SUN	MON	TUE	WED	THU	FRI	SAT
1	2	3	4	5	6	7
8	9	10	11	12	13	14
15	16	17	18	19	20	21
22	23	24	25	26	27	28
29	30					

1927 AUGUST 1927

SUN	MON	TUE	WED	THU	FRI	SAT
1	2	3	4	5	6	7
8	9	10	11	12	13	14
15	16	17	18	19	20	21
22	23	24	25	26	27	28
29	30	31				

1927 SEPTEMBER 1927

SUN	MON	TUE	WED	THU	FRI	SAT
1	2	3	4	5	6	7
8	9	10	11	12	13	14
15	16	17	18	19	20	21
22	23	24	25	26	27	28
29	30					

1927 OCTOBER 1927

SUN	MON	TUE	WED	THU	FRI	SAT
1	2	3	4	5	6	7
8	9	10	11	12	13	14
15	16	17	18	19	20	21
22	23	24	25	26	27	28
29	30					

More than a quarter of a million Farrand Speakers sold in twelve months! . . . If you are not already a Farrand Dealer, you should be!



1927 MAY 1927

SUN	MON	TUE	WED	THU	FRI	SAT
1	2	3	4	5	6	7
8	9	10	11	12	13	14
15	16	17	18	19	20	21
22	23	24	25	26	27	28
29	30	31				

1927 JUNE 1927

SUN	MON	TUE	WED	THU	FRI	SAT
1	2	3	4	5	6	7
8	9	10	11	12	13	14
15	16	17	18	19	20	21
22	23	24	25	26	27	28
29	30					

1927 NOVEMBER 1927

SUN	MON	TUE	WED	THU	FRI	SAT
1	2	3	4	5	6	7
8	9	10	11	12	13	14
15	16	17	18	19	20	21
22	23	24	25	26	27	28
29	30					

1927 DECEMBER 1927

SUN	MON	TUE	WED	THU	FRI	SAT
1	2	3	4	5	6	7
8	9	10	11	12	13	14
15	16	17	18	19	20	21
22	23	24	25	26	27	28
29	30	31				

Profit by the value of this well-known name

When your customer sees the name Exide on a radio battery, the sale is half made

MOST people will readily make a purchase on the strength of a well-known name. They may never have bought that particular product before, but they have used other products made by the same company, and these have always lived up to the claims made for them.

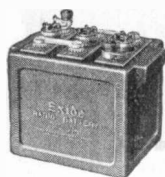

STANDARD EXIDE "A" BATTERY

Rugged, built in one piece. Two-sizes—for 4-volt and 6-volt tubes. Prices, \$6.35 up, and \$12.70 up.

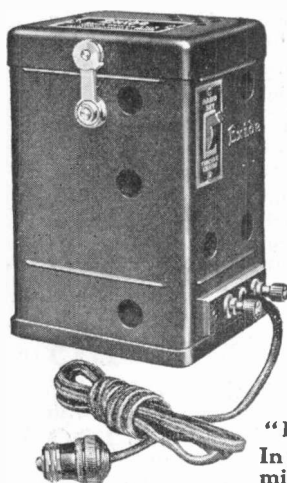

24-VOLT "B" BATTERY
In glass cells. 6000 milliamperes hour capacity. Also made in 48-volt size. Prices, \$10.15 and \$17.45.

RADIO POWER UNIT WITH BUILT-IN SWITCH

Consists of "A" battery, special charger and control switch assembled in handsome mahogany case. In 4-volt and 6-volt sizes. Prices, \$27 and \$36.

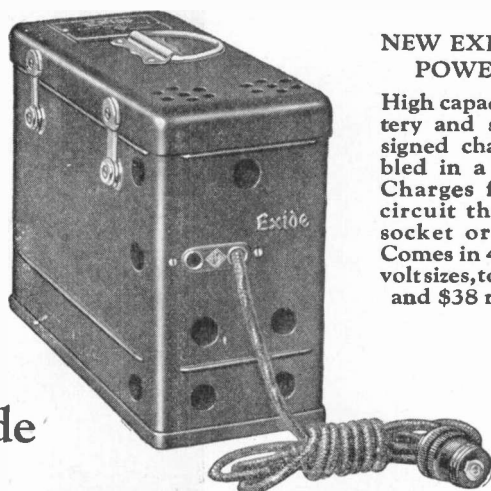

NEW EXIDE RADIO POWER UNIT

High capacity "A" battery and specially designed charger assembled in a single case. Charges from house circuit through light socket or base plug. Comes in 4-volt and 6-volt sizes, to retail at \$28 and \$38 respectively.

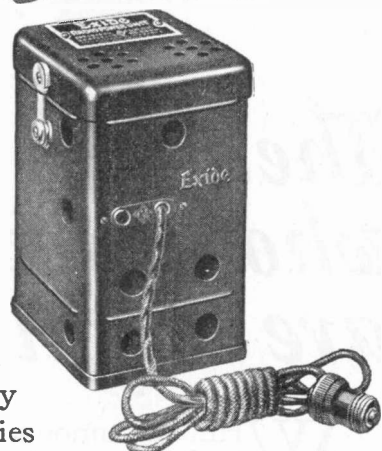

EXIDE MASTER CONTROL SWITCH

To be used with new power unit. Enables you to control both "A" and "B" power supply at set, placing unit anywhere you wish. Retail at \$4.50.

This is why radio dealers find the Exide line of radio batteries so profitable. Most of their customers know the name Exide either from actual experience with Exide Batteries or by reputation. They know that Exide Batteries give steady, dependable service. So, even if they have never used Exide Radio Batteries before—even if they know very little about the principles of radio—the sale is half made when they see the name Exide.

It will be easy for you to cash in on the value of the Exide name. And many casual purchasers will become steady customers when they see the reliable service these batteries give.

There is an Exide Radio Battery to fit the needs of every customer, no matter what kind of set he owns. They are all listed on this page.

Be sure to send in your order promptly if you have any shortages in your stock.

Exide

RADIO BATTERIES

THE ELECTRIC STORAGE BATTERY COMPANY, Philadelphia

Exide Batteries of Canada, Limited, 153 Dufferin Street, Toronto



Pontiac
\$140 List

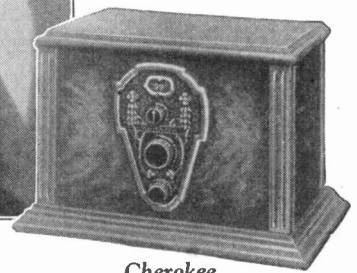

Cherokee
\$65 List

They who believed are Profiting -

WHEN we announced the Mohawk One Dial Radio line for 1926-27, we offered to dealers an opportunity to sell looks, value, performance, and the fruits of a leadership gained through years of one-dial pioneering. Of these the latter is perhaps most important, but to see why requires foresight and keen merchandising sense . . . Hundreds of dealers had that foresight and merchandising sense and believed, as we did, that the pioneer in any field is best equipped in experience and prestige, and so is surest of leadership. They believed and they are profiting now with Mohawk One Dial Radio . . . Now that we have proof to add to promises, we urge again that you write or wire at once for the complete story of Mohawk One Dial Radio.

Mohawk Corporation of Illinois
Established 1920
Independently Organized in 1924
2220 Diversey, at Logan Boulevard, Chicago

- SENECA—Mohawk One Dial, six-tube shielded radio set in walnut drawer. List price . . . **\$57⁵⁰**
- CHEROKEE—Shielded. Rich walnut hand-rubbed piano finish. Full piano-hinged. 10¾ ins. high, 13¼ ins. deep, 15½ ins. long. List price . . . **\$65**
- WINONA—Shielded. Rich walnut. 24 ins. long. List price . . . **\$80**
- CHIPPEWA—Shielded. Rich walnut, two-toned. Built-in loud speaker. List price . . . **\$110**
- PONTIAC—(In large illustration). Shielded. Burl walnut, drop front. Built-in loud speaker. 46 inches high. List price . . . **\$140**
- GENEVA—Shielded. Front full burl walnut, inlaid. Loud speaker built into dome, 44 ins. high. List price . . . **\$185**
- POCAHONTAS—Shielded. Burl walnut inlaid. Built-in loud speaker with 7-foot horn. 45½ inches high. List price . . . **\$300**

Prices west of the Rockies slightly higher.
Canadian prices 40% higher.

Mohawk One Dial Radio

Mohawk Corporation of Illinois Established 1920
Independently Organized in 1924

*This Line
Leads to
Greater
PROFITS*

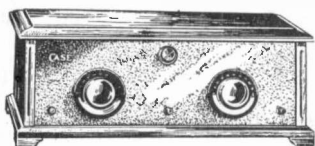

MODEL 60A
6 Tubes, 2 Controls only **\$75.99**
34-in. Solid Mahogany Cabinet
WITHOUT ACCESSORIES

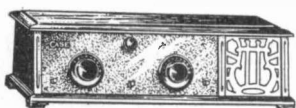

No. 60B, \$100



No. 60C, \$125



No. 60D, \$170

*Selling Better
All the Time~*

STEADILY
FOR **5** YEARS

CASE

RADIO PRODUCTS

*Easier and Quicker
Sales—Larger and
Surer Profits for you!*

Profitable selling does not just happen. It is the result of carefully planned and carefully carried out manufacturing and selling plans.

CASE Radio Receivers assure the radio dealer easier and quicker sales with larger and surer profits for these three reasons:

1. Six-tube tuned radio frequency sets of unusual performance ability.
2. Attractive low prices—liberal dealer profits.
3. National advertising and dealer helps.

CASE advertising reaches over 8,100,000 families—many of them in your community. The CASE merchandising plan helps you get the greatest benefit and profit from that advertising.

A Reputable Product—A National Institution with over 500 Jobbers

CASE Radio Receivers have five years of successful performance to their credit. They are made in a complete range of table and console types to fit every purse. CASE sales have grown steadily every year—CASE dealers have made more money each year.

CASE Sets are manufactured by a well-established, well-financed organization that does business on a sound, conservative basis, assuring greatest satisfaction and profits for all concerned.

The coupon below will bring you the complete CASE merchandising plan—and the details of our liberal dealer franchise. Use it!

Indiana Mfg. & Electric Co.
Marion, Indiana

Send complete information in regard to CASE Radio Receiving Sets.

Name.....

Address.....

.....

.....

PERRYMAN RADIO TUBES

"Distance without Distortion"

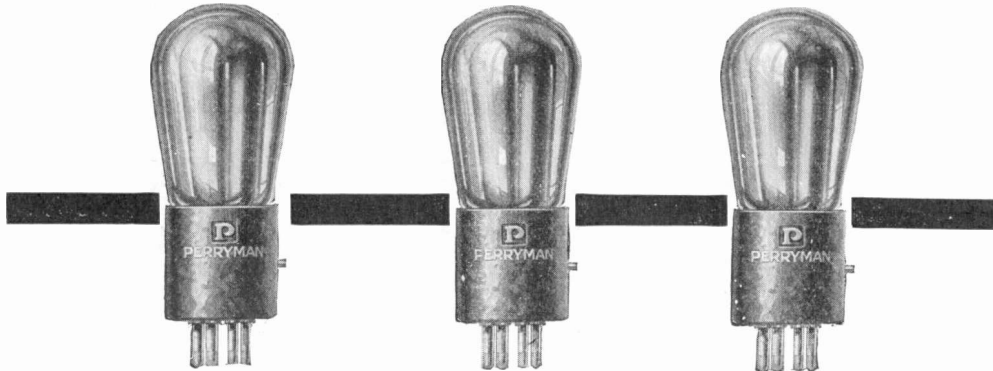

Type R.H. 201-A
Amplifier-Detector
New Standard base
with long pins

Type P. D. 200-A
Super-Sensitive Detector
New Standard base
with long pins

Type P. A. 171
Power Amplifier
New Standard base
with long pins

Teamwork!

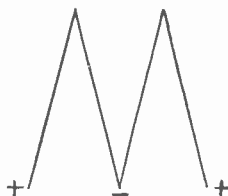

The filaments of Perryman Radio Tubes with the patented Perryman bridge are doubled to form a letter M. This twin construction not only exposes a greater area of filament surface, but it doubles the area of electron emission and increases the capacity of the tube. The real result is a tube that does its appointed work more easily, giving greater volume without distortion. Its longer life is a distinct economy.

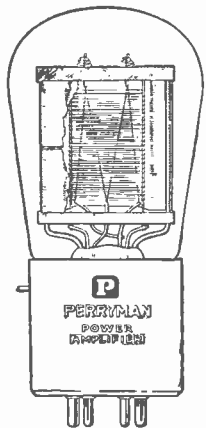

Patented June 22, 1926

The clear glass demonstrating tube shows the patented Perryman Bridge which holds the elements in place at the distance of greatest efficiency. Ordinary jars or jolts do not affect Perryman Tubes.

Preach the gospel of tube teamwork and make five or six sales instead of one. Many of your customers are buying new super-sensitive detectors and using out-of-date amplifying tubes. Others are putting good power tubes on the end of a line of antiquated detector-amplifiers that gum up the works. . . . Every set needs a super-sensitive detector, modern amplifying and an efficient power tube to function properly. Tube teamwork—that's what does the trick. And the best team always wins—Perryman Radio Tubes.

Perryman Distributors are equipped and ready to supply you with tubes, advertising literature and helpful cooperation.



Everywhere the demand is increasing!
FADA HARMONATED RECEPTION
 has made Radio history

FOR years Fada Radio Engineers worked on this problem of improved radio reception and reproduction. They had a definite aim. To satisfy the demands of the more exacting radio public. They christened their achievement "Fada Harmonated Reception."

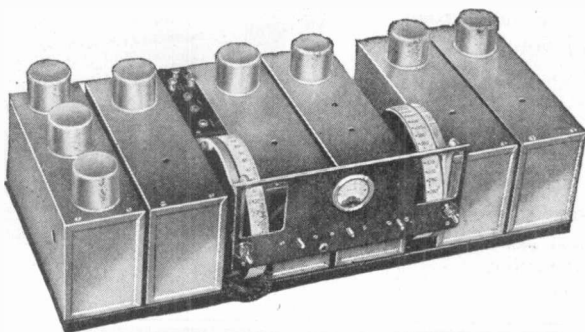

The steel covering of the chassis completely and individually protects each and every "stage". It eliminates interference. The weak signal is brought up to sturdiness at the cone speaker.

THE Fada Cone Speaker has made possible absolute co-ordination between receiver and speaker. Every sound is reproduced with a clearness and accuracy hitherto undreamed of.

Fada Harmonated Reception is beyond a doubt the supreme radio achievement of the year. The immediate nation-wide response proves the fact.

To Dealers: If you are looking beyond the immediate — to an established position in the Radio field — if you are anxious to capitalize on the permanent public demand for Fada Harmonated Reception, write or wire us at once.

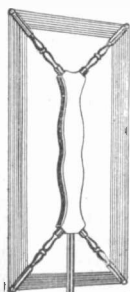

F. A. D. ANDREA, INC.
 1581 Jerome Avenue New York

Manufacturers of TUNED RADIO FREQUENCY RECEIVERS using the highly efficient NEUTRODYNE principle.

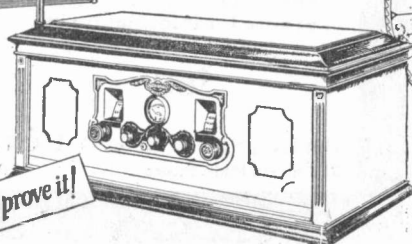
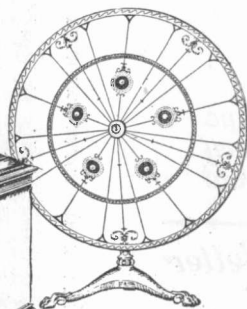

Well prove it!

Fada 8, Table Type—loop operated—loop nests in cabinet cover. Total individual shielding. Four stages of radio frequency—\$300. Fada Cone Speaker, Table Type—\$35.

Fada Neutrodyne Receivers—table and furniture models—5, 6 and 8 tubes—ranging from \$85 to \$400. Fada Cone Speaker—Table Type \$35—Pedestal Floor Type—\$50.



King Cole SIX

THE LAST WORD IN TONE
QUALITY, EASE OF TUNING
AND SELECTIVITY

With its beautiful exterior of matched Burl Walnut of selected quality and its wonderful tone quality, ease of tuning and selectivity, King Cole Radio has made a pronounced hit.

Dust-proof, shielded, two vernier "port type" dials. Battery switch has soft and loud position. Volume control gives any degree of volume smoothly. Plenty of surplus power to bring in distant stations. Superb tone quality is maintained when full volume is being used.

\$100.00

East of Rockies; \$107.50 West of Rockies

ANYLITE ELECTRIC COMPANY
Fort Wayne, Indiana

*Reliable, well-financed distributors and dealers
will find our proposition attractive.*

The Wonder Set !
of the Season ♦

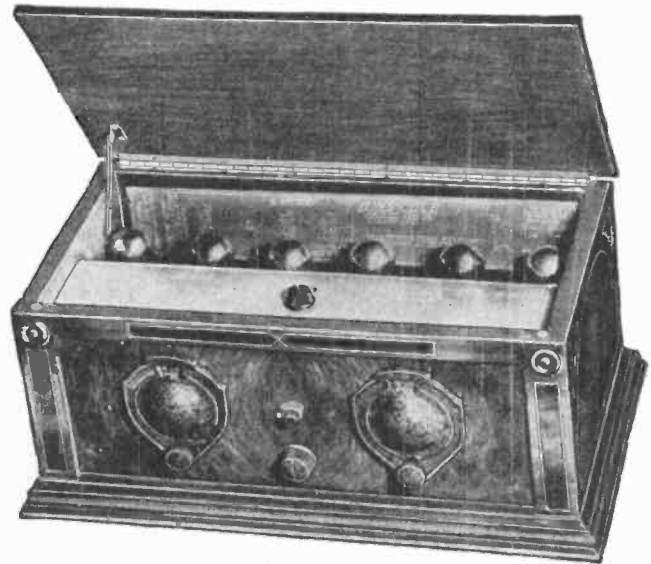

Sell Tubes that
Make Good!

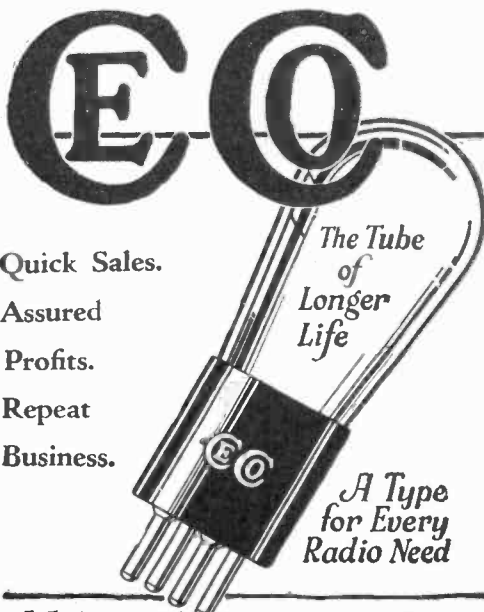

Quick Sales.
Assured
Profits.
Repeat
Business.

*The Tube
of
Longer
Life*

*A Type
for Every
Radio Need*

Makes a Good Receiver Better
Write for Complete Data Sheet
C. E. MFG. CO. Inc. . . . PROVIDENCE . R. I.

PRECISION
ARBORPHONE
PRODUCTS

ARBORPHONE

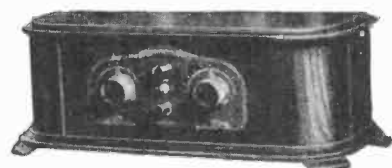

A HAPPY blending of Radio's latest advancements with ultra-precision construction methods makes Arborphone the outstanding receiver of the year.

THE strikingly beautiful Arborphone cabinet assures an ever-active market to the franchised Arborphone dealer. Write or wire for information in your territory.

\$60



\$105
Includes Receiver,
Table and Built-
In Loud Speaker

PRECISION PRODUCTS COMPANY
317 South Main Street Ann Arbor, Michigan

National Factory & Distributors
SANFORD BROS.
1016-1018
1016-1018



The New Balkite Charger

MODEL J. Has a low trickle charge rate and a high rate for rapid charging and heavy duty use. Can thus be used either as a trickle or as a high rate charger and combines their advantages. Noiseless. Large water capacity. Visible electrolyte level. Rates: with 6-volt battery, 2.5 and .5 amperes; with 4-volt battery, .8 and .2 amperes. Special model for 25-40 cycles with 1.5 amperes high rate. Price \$19.50. West of Rockies \$20. (In Canada \$27.50.)

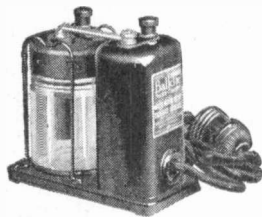

Balkite Trickle Charger

MODEL K. With 6-volt "A" batteries can be left on continuous or trickle charge thus automatically keeping the battery at full power. Converts the "A" battery into a light socket "A" power supply. With 4-volt batteries can be used as an intermittent charger. Or as a trickle charger if a resistance is added. Charging rate about .5 ampere. Over 200,000 in use. Price \$10. West of Rockies \$10.50. (In Canada \$15.)



A New Balkite "B" at \$27.50

Balkite "B" eliminates "B" batteries and supplies "B" current from the light socket. Noiseless. Permanent. Employs no tubes and requires no replacements. Three new models. The new popular priced Balkite "B"-W at \$27.50 for sets of 5 tubes or less requiring 67 to 90 volts. Balkite "B"-X, for sets of 8 tubes or less; capacity 30 milliamperes at 135 volts—\$42. Balkite "B"-Y, for any radio set; capacity 40 milliamperes at 150 volts—\$69. (In Canada "B"-W \$39; "B"-X \$59.50; "B"-Y \$96.)



Balkite Combination

Supplies automatic power to both "A" and "B" circuits. Controlled by the filament switch on the set. Entirely automatic in operation. Can be put either near the set or in a remote location. Will serve any set now using either 4 or 6-volt "A" batteries and requiring not more than 30 milliamperes at 135 volts of "B" current—practically all sets of up to 8 tubes. Price \$59.50. (In Canada \$83.)

All Balkite Radio Power Units operate from 110-120 volt AC current with models for both 60 and 50 cycles. The new Balkite Charger is also made in a special model for 25-40 cycles.

Permanent pieces of equipment— *in this Balkite feature* lies your profit

To tell the difference between Balkite and any other device does not take very thorough examination. You can tell the difference the minute you look at a Balkite Unit. The difference is even more obvious when you pick up the unit and feel it. *Balkite Radio Power Units are permanent pieces of equipment, made to last.*

The evident scrupulous care that goes into the manufacture of every Balkite Unit is not altruism on our part. It is based on the conviction that to be permanently successful the products of any manufacturer must represent honest manufacturing value. In the long run the public will not accept less.

This scrupulous care is also part of our belief that for a manufacturer to be permanently successful everyone connected with the sale of his product must make a legitimate profit out of it. And by legitimate profit we mean more than the temporary profit made out of each sale. We mean that the manufacturer must take every precaution that the profit of the trade is not eaten up by service cost.

Not only does Balkite give you the greatest volume, but the profit you make on your sales is clean. Once sold, Balkite Radio Power Units stay sold. They don't come back. Get behind the line now, and make the maximum profit out of the demand for light socket radio power.

FANSTEEL PRODUCTS COMPANY, Inc.
North Chicago, Illinois

FANSTEEL
Balkite
Radio Power Units



The men behind Neutrodyne

Engineers, physicists, mathematicians, who have placed Neutrodyne in its present position of leadership — and who will keep it there

IN SPITE of the fact that the Neutrodyne receiver of today represents the highest attainments in radio development, no expense is being spared, in the continuance of a policy of constant improvement.

At considerable expense the Hazeltine Corporation and the fourteen companies licensed to manufacture Neutrodyne apparatus maintain a large staff of technical men who devote their entire time to research and experiment in radio. These men, whose names are listed below, are the men who have brought Neutrodyne to the position of leadership it enjoys today. And these are the men whose ideas, designs and inventions will keep Neutrodyne in the forefront of radio in the years to come.

These men are determined that Neutrodyne receivers will always combine the best in sensitivity, selectivity, ease and economy of operation, volume and perfection of tone reproduction.

PROFESSOR L. A. HAZELTINE: M.E. Fellow A.I.E.E. Fellow I.R.E. Fellow American Physical Society. Formerly professor in charge of the Electrical Engineering Department of Stevens Institute of Technology. Inventor of the Neutrodyne Radio Receiver.

R. W. ACKERMAN: C.E. Schools of Mines, Engineering and Chemistry, Columbia University. Active service U. S. Army Engineers, 82nd Division.

LEWIS M. CLEMENT: B.S. in E.E. F.I.R.E. Assistant Chief Engineer of high-power Marconi stations in Honolulu and San Francisco during construction and early operation. Nine years with Bell Telephone Laboratories in charge of radio receiver and special developments, including government transmitter, receivers, secret systems, etc.

J. W. FINK: M.E. Specialist in audio frequency and loud speaker development.

DONALD O. FRIEND: Massachusetts Institute of Technology. S. W. GILFILLAN: Stanford University.

VIRGIL M. GRAHAM: I.R.E. A.I.E.E. University of Rochester.

LELAND H. HANSEN: I.R.E. Designer of radio apparatus since 1916. Formerly with American Marconi Company, 1911-1925. Active service U. S. Signal Corps in France.

FRANK A. HINNERS: F.I.R.E. Pratt Institute. Associated with radio development in all its phases since 1909. Among earliest workers on quenched spark telegraphy in this country. In charge transmitter design supplied U. S. Government during war. Chief Engineer extensive overland radio telegraph system.

F. E. JOHNSTON: A.I.E.E. Long Beach, Cal., Polytechnic and Sorbonne and Ecole Superieur de Electricite, Paris; First Lieut. Radio Intelligence Section U. S. Signal Corps. Croix de Guerre and U. S. Citation. Assistant Engineer in charge construction of high-power station at Warsaw, Poland. Engineer in charge of Riverhead, L. I., Transatlantic Radio Station.

C. T. JOHNSTON: E.E. University of Iowa.

THOMAS S. LEOSER: I.R.E. Lehigh University.

W. W. LINDSAY, JR.: I.R.E. Technical School, Hanover, Germany. Post-graduate work, Columbia University.

R. E. MacDOWELL: B.S. in M.E. and E.E.E. Electrical experimental work, Radio Telephone Officers' School, U. S. Government.

R. MacGREGOR: E.E. Provinside Academy of Electricians, Glasgow, Scotland. Experimental work in British Navy, two years.

W. A. MacDONALD: I.R.E. University of Paris. Lieut. Sig. Corps U. S. Army in France. Engineer in charge development of airplane radio transmitter equipment Signal Corps U. S. Army (four years). Consulting Engineering Dept., Radio Corporation of America.

RAY H. MANSON: E.E. I.R.E. A.I.E.E. Member S.A.E. University of Maine. Chairman Technical Committee, Radio Sect., N.E.M.A. Committee on Communication. Chairman

Electro-Acoustical Sub-Committee of I.R.E. Standardization Com. Member Bur. of Standards, Radio Advisory Committee. Member of Component Part Committee of Tech. Sub-Committee, A.E.S.C. Sect., Committee on Radio.

BENJAMIN F. MIESSNER: I.R.E. Member Soc. to Advance Science. Purdue University. Authority on electrical acoustics. Engaged in radio research since 1908.

JOHN W. MILLION, JR.: A.B. University of Michigan. Instructor, Mathematics and Physics, Des Moines University. Graduate in research, Washington University, St. Louis, Mo. Graduate work, Columbia University. Development work in vacuum tubes and radio reception in Bell Telephone Laboratories, July, 1923, to Jan. 1, 1925.

WILLIAM J. MURDOCK: Designer and manufacturer of radio apparatus since 1904.

J. N. NICHOLS: B.S. in E.E. First Imperial Light Science School, Petrograd, Russia. Engineer Instructor, Russian Imperial Army, and later French Air Service.

J. A. NEILSON: Copenhagen Technical School, Denmark. Research work in Danish Naval Radio Service.

BENJAMIN OLNEY: Electro-Acoustical Engineer. Specially engaged in regard to radio frequency amplification and speech reproduction.

LAWRENCE S. PHILBRICK: Phillips Andover Academy, Massachusetts Institute of Technology.

F. F. PRELAG: B.S. Vienna, Austria. Engaged in experimental research work in radio in Europe and this country.

R. X. RETTENMEYER: M.S. B.S. in E.E. Formerly in the Bell Telephone Laboratories in charge of work on high quality carrier broadcast systems.

A. W. SAUNDERS: E.E. Formerly in Bell Telephone Laboratories in radio receiver development design, including receivers used by U. S. Coast Guard.

ROGER W. SEMONS: R.E. Assistant Instructor, Harvard Radio School, 1917-22. Design Eng. of broadcast stations.

F. J. STRASSNER: B.S. in E.E. and E.E. Formerly with Bell Telephone Laboratories. Engaged in transmission maintenance matters. District plant engineer for New York Telephone Company for eight years.

HOWARD J. TYZZER: I.R.E. Designer of radio receiving apparatus since 1916.

LINCOLN G. WALSH: M.E. A.S.M.E. A.I.E.E. Stevens Institute of Technology. Research work in Bell Telephone Laboratories. Chairman, Metropolitan Section, Intercollegiate Convention, A.S.M.E.

HAROLD A. WHEELER: B.S. in Physics, George Washington University. Graduate work in Physics, Johns Hopkins University. Engaged in special research work with Neutrodyne apparatus since 1922.

S. TRUBEE WOODHULL: B.E.E. University of Michigan. Formerly with the American Marconi Company. Designed transmitting apparatus for United States Navy and special apparatus for operation in the trenches during the war.

Look for this trade-mark

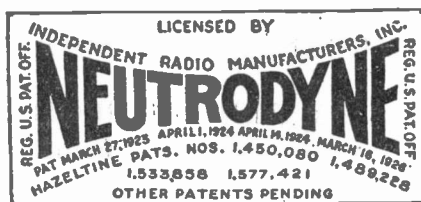

It is your protection against patent infringement liability

The following fourteen manufacturers are the only ones licensed to make Neutrodyne receivers and the protection of distributors and dealers against patent infringement liability, maintained by the Hazeltine Corporation and Independent Radio Manufacturers, Incorporated, applies to none other than Neutrodyne receivers.

THE AMRAD CORPORATION, Medford Hillside, Mass.
F. A. D. ANDREA, Inc., New York City
CARLOYD ELECTRIC & RADIO COMPANY, Newark, N. J.
EAGLE RADIO COMPANY, Newark, N. J.
FREED-EISEMANN RADIO CORPORATION, Brooklyn, N.Y.
GAROD CORPORATION, Belleville, N. J.
GILFILLAN RADIO CORPORATION, Los Angeles, Cal.

HOWARD RADIO COMPANY, Inc., Chicago, Ill.
KING-HINNERS RADIO COMPANY, Inc., Buffalo, N. Y.
WM. J. MURDOCK CO., Chelsea, Mass.
STROMBERG-CARLSON TELEPHONE MANUFACTURING COMPANY, Rochester, N. Y.
R. E. THOMPSON MANUFACTURING CO., Jersey City, N.J.
WARE RADIO CORPORATION, New York City
THE WORK-RITE MANUFACTURING CO., Cleveland, Ohio

HAZELTINE CORPORATION
(Sole owner of "Neutrodyne" patents and trade-marks)

INDEPENDENT RADIO MANUFACTURERS, Incorporated
(Exclusive licensee of Hazeltine Corporation)



This is S-H AERO gold label aerial kit which retails profitably at \$5.00

Whether Your Customers Build or Buy They are prospects for S-H Aerial Kits

At the first sign or sound of imperfect reception, the radio public is beginning to look to the aerial.

Be prepared to sell them S-H "AERO" Complete Aerial Kits which eliminate time and labor and show you a worthwhile profit.

There is an S-H Aerial Kit for every purse or preference, retailing from \$2.50 to \$5.00 and we are prepared to make up special kits to meet your requirements.

If your jobber can't supply you, write to us.

SWAN-HAVERSTICK, INC., TRENTON, NEW JERSEY



Look for our next advertisement in the Saturday Evening Post Issue December 4.

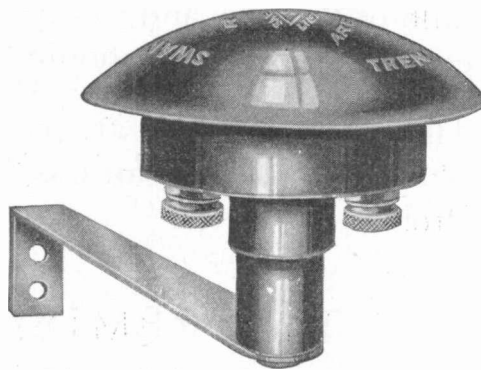

S-H SAFE-GUARD LIGHTNING ARRESTER

A lightning arrester of improved design made of Bakelite with a Bakelite protective petticoat. Approved by the Underwriters. Sells profitably at \$1.00.

Stop that Howl!!

with

The PREMIER Adjustable Tube Ballast

Every dealer is looking for a remedy for stopping the howling and humming caused by microphonic tubes—and here it is,—The Premier *Adjustable* Tube Ballast.

When used in connection with the detector tube this Tube Ballast will eliminate any howling or humming due to microphonic vibrations.

The decided superiority of this Tube Ballast over any other device intended for eliminating microphonic howls is due to the fact that it is adjustable. Tubes have different characteristics and while a fixed device might stop the howling of one tube, it may fail to do so with another tube.

The Premier Adjustable Tube Ballast works freely up and down the bulb of the tube and can be easily and quickly adjusted to the proper location to stop microphonic howls or hums.

These Tube Ballasts are packed 24 to a carton. Dealer's discount 40%. No orders accepted for less than one carton. Send us your order today. Prompt deliveries.

The PREMIER
RADIO CORPORATION

Defiance, Ohio



List
Price
75
Cents
each

PATENT PENDING

The Premier Radio Corporation,
Defiance, Ohio

Please enter order for one carton (if more than one carton is wanted, kindly specify) containing 24 Premier Tube Ballasts and make shipment by Parcel Post or Express.

Name

Address

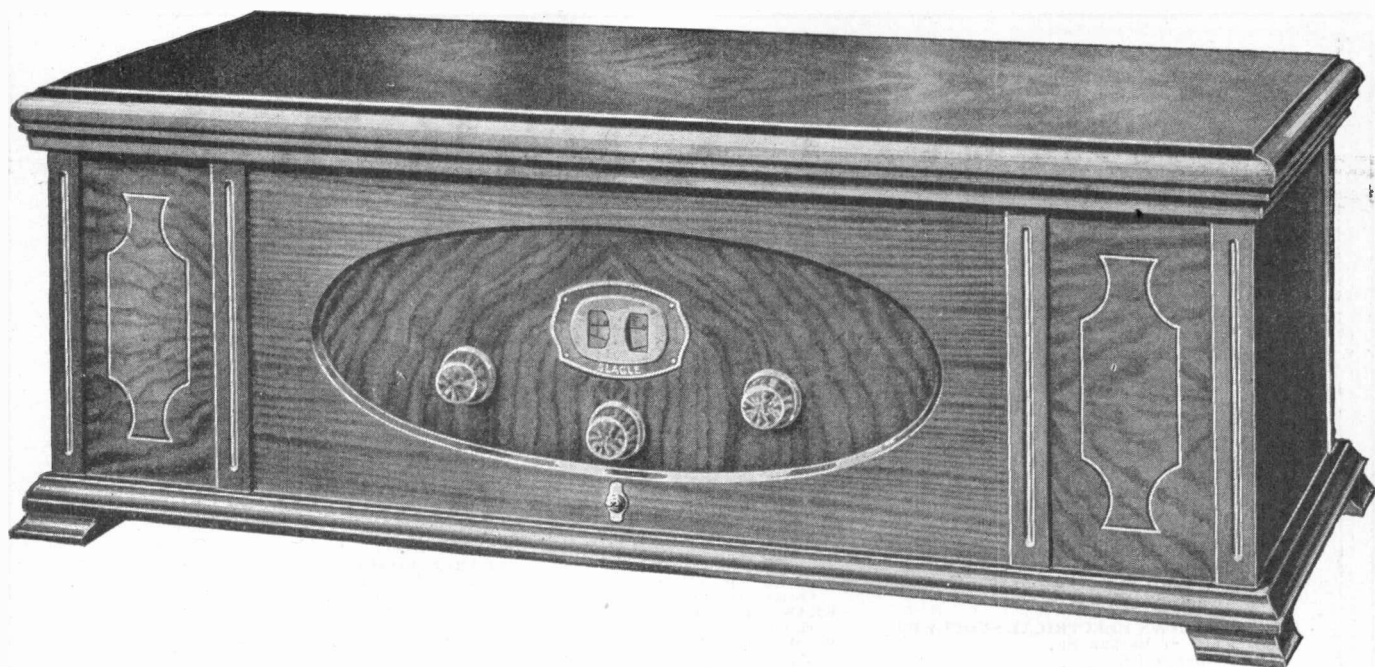

Making Radio History

THE Slagle 2-dial control line of receivers is an outstanding success. All working units are completely protected from each other and the outside by cast-aluminum shielding.

The finest achievement of over 15 years of building high quality radio sets, you will find them a genuine pleasure to sell. The value is there—prices low for the quality. The performance is as nearly perfect as a set has given to date. The owner gets an ever increasing amount of pleasure and satisfaction from his purchase.

That's a combination that builds profitable business for you and for us through you. Let us tell you more about it.

SLAGLE RADIO COMPANY

Fort Wayne, Indiana

Slagle  Radio

Look to These Jobbers

for the Able Cooperation that will
make Your Radio Business a SUCCESS

A-C DAYTON RADIO

ADVANCE ELECTRIC CO.,

Terre Haute, Ind.
ALBANY HDWE. & IRON CO.,
Albany, N. Y.

ALTOONA ELECTRIC SUPPLY CO.,
1120 Twelfth Ave.,
Altoona, Pa.

AMERICAN ELECTRICAL SUPPLY CO.,
117 S. Morgan St.,
Chicago, Ill.

AUTO SUPPLY CO.,
201 E. 5th St.,
Austin, Texas.

BARBER & ROSS, Inc.,
11th & G Sts.,
Washington, D. C.

BLISH, MIZE & SILLIMAN HDWE. CO.,
Atchison, Kansas.

BOGGIS-JOHNSON ELECTRIC CO.,
346 E. Water St.,
Milwaukee, Wis.

BRANDON STOVE CO.,
Little Rock, Ark.

BURLINGTON ELEC'L SUPPLY CO.,
508 Jefferson St.,
Burlington, Iowa.

C-L RADIO CO.,
8 S. Jefferson St.,
Dayton, Ohio.

CITY ELECTRIC CO.,
522 S. Clinton St.,
Syracuse, N. Y.

L. W. CLEVELAND CO.,
Portland, Maine.

COMMERCIAL ELEC'L SUPPLY CO.,
320 S. Broadway,
St. Louis, Mo.

CONTINENTAL ELECTRIC CO.,
1705 Baltimore Ave.,
Kansas City, Mo.

CROWN LIGHT & RADIO CO.,
110 Crown St.,
New Haven, Conn.

W. S. DONNAN HDWE. CO.,
Richmond, Va.

R. B. DUNNING & CO.,
Bangor, Maine.

ELECTRIC BATTERY SER. CO.,
5940 Second Blvd.,
Detroit, Mich.

GRAY BROS. CO.,
1453 Court Place,
Denver, Colo.

GREAT WEST ELECTRIC CO.,
1149 Santee St.,
Los Angeles, Calif.

HABIG MFG. CO.,
1035 N. Meridian St.,
Indianapolis, Ind.

HAGARE HDWE. & PAINT CO.,
164 St. Paul St.,
Burlington, Vt.

W. E. & W. H. JACKSON,
865 Mission St.,
San Francisco, Calif.

JUSTUS & PARKER CO.,
39 E. Chestnut St.,
Columbus, Ohio.

KRAKAUER-ZORK CO.,
El Paso, Texas.

W. W. LEACH CO.,
222 Bedford St.,
Fall River, Mass.

LINCOLN MOTOR SALES, INC.,
1130 Cathedral St.,
Baltimore, Md.

THEO. M. GREEN & CO.,
Third & Harvey Sts.,
Oklahoma City, Okla.

M. & M. COMPANY,
500 Prospect Ave.,
Cleveland, Ohio.

M. & M. COMPANY,
131 E. Market St.,
Akron, Ohio.

M. & M. COMPANY,
22 Front St.,
Youngstown, Ohio.

MARSHALL-WELLS CO.,
Duluth, Minn.

MARSHALL-WELLS CO.,
Billings, Mont.

MARSHALL-WELLS CO.,
Great Falls, Montana.

MARSHALL-WELLS CO.,
2824 10th Ave. S.,
Minneapolis, Minn.

MARSHALL-WELLS CO.,
Spokane, Wash.

MOTOR SUPPLY CO.,
Boston, Mass.

MOTOR TIRE SERVICE,
42 Day St.,
Fitchburg, Mass.

MOTOR TIRE SERVICE,
Worcester, Mass.

PARNES ELECTRIC CO.,
208 Stanwix St.,
Pittsburgh, Pa.

B. V. REDMOND & SON,
108 N. Peters St.,
New Orleans, La.

EARLE ROGERS CO.,
Main & 12th Sts.,
Wheeling, W. Va.

SCHOELLKOPF CO.,
Dallas, Texas.

SCHWABACHER HDWE. CO.,
First Ave. S. & Jackson St.,
Seattle, Wash.

SCHWABACHER HDWE. CO.,
Portland, Oregon.

P. A. & S. SMALL CO.,
York, Pa.

SOUTHERN DRUG CO.,
Houston, Texas.

SOUTHERN OHIO SUPPLY CO.,
310 W. 7th St.,
Cincinnati, Ohio.

SOUTHLAND ELECTRICAL SUPPLY CO.,
512 W. Main St.,
Louisville, Ky.

SPARTAN ELECTRIC CORP.,
350 W. 34th St.,
New York City.

STANDARD MOTOR PARTS CO.,
1310 Grand Ave.,
Des Moines, Iowa.

STERCHI BROS.,
Knoxville, Tenn.

STERCHI FURNITURE & CARPET CO.,
Atlanta, Ga.

STERCHI BROS., INC.,
Asheville, N. C.

STERCHI BROS. FURNITURE CO., INC.,
Nashville, Tenn.

STERCHI BROS. & FOWLER, INC.,
Chattanooga, Tenn.

J. G. STERCHI FURNITURE CO.,
Johnson City, Tenn.

STERCHI BROS. CO.,
Jacksonville, Fla.

SUPPLE-BIDDLE HDWE. CO.,
507 Commerce St.,
Philadelphia, Pa.

SWORDS ELECTRIC CO.,
625 Seventh St.,
Rockford, Ill.

TREMAN, KING & CO.,
Ithaca, N. Y.

THOMAS-OGILVIE HDWE. CO.,
Market & Crockett Sts.,
Shreveport, La.

ISAAC WALKER HDWE. CO.,
Oak & Washington Sts.,
Peoria, Ill.

WAYNE HDWE. CO.,
Ft. Wayne, Ind.

L. A. WOOLLEY, INC.,
75 Ellicott St.,
Buffalo, N. Y.

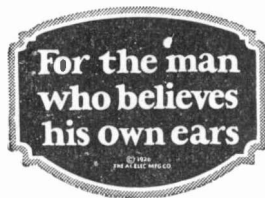

THE A-C ELECTRICAL MFG. COMPANY

Dayton, Ohio

Makers of Electrical Devices for More Than 20 Years

A-C DAYTON

RADIO

Christmas profits for you— sell TUNGARS

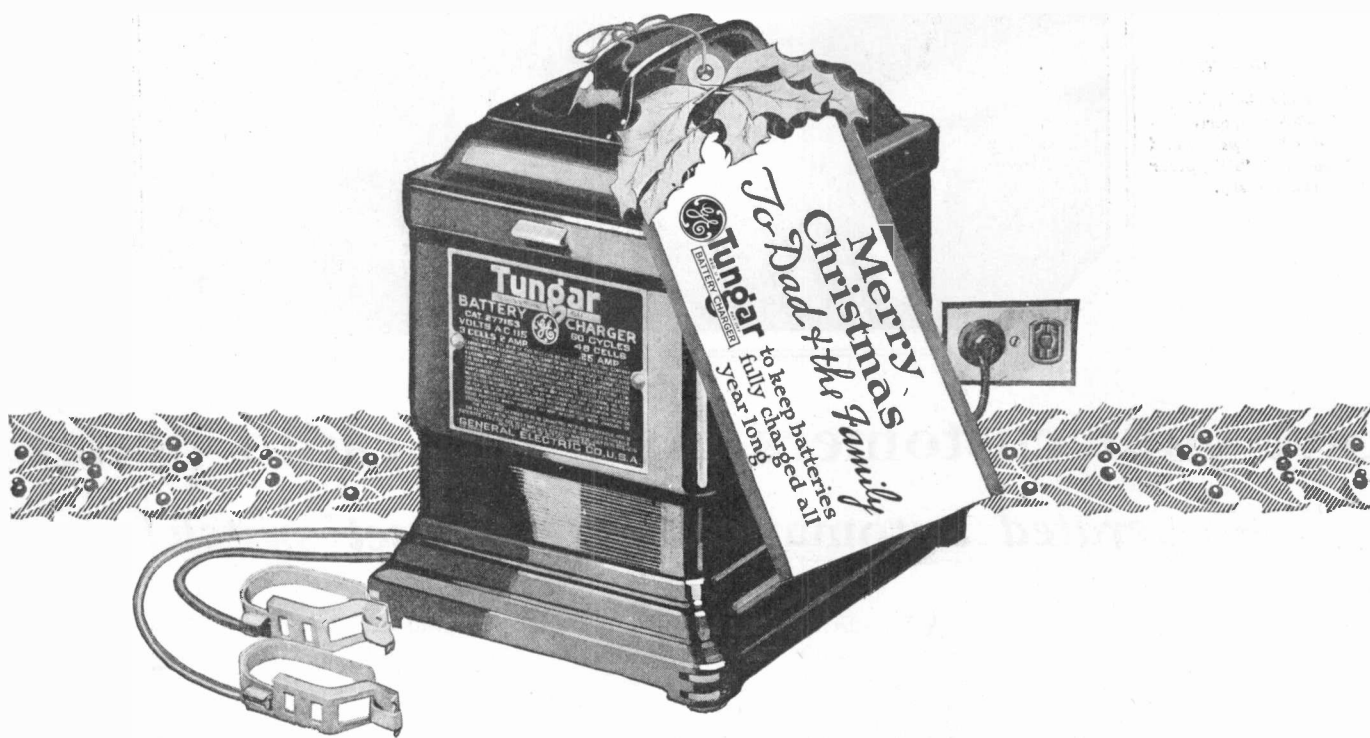

The increase in sales of Tungar Battery Chargers at Christmas time for the past few years proves conclusively that they are ideal gifts.

They are welcomed because they bring with them assurance of full power for radio sets—for years to come. And they also promise the motorist no run-down starting battery. So Tungar is a two-fold gift—and therefore twice as easy to sell.

List Prices

East of the Rockies
 2 ampere Tungar \$18
 5 ampere Tungar \$28
 Trickle Charger \$12
 (60 cycles—110 volts)

Tie in with our Christmas national advertising. Dress your window and showcase by displaying Tungars and using the specially designed Christmas tag.

 **Tungar**
 REG. U.S. PAT. OFF.
BATTERY CHARGER

Tungar—a registered trademark—is found only on the genuine. Look for it on the name plate.

GENERAL ELECTRIC

GENERAL ELECTRIC COMPANY

MERCHANDISE DEPARTMENT

BRIDGEPORT, CONNECTICUT

Automatic!

At one click of the set switch, Unipower supplies "A" power and controls "B" power automatically.

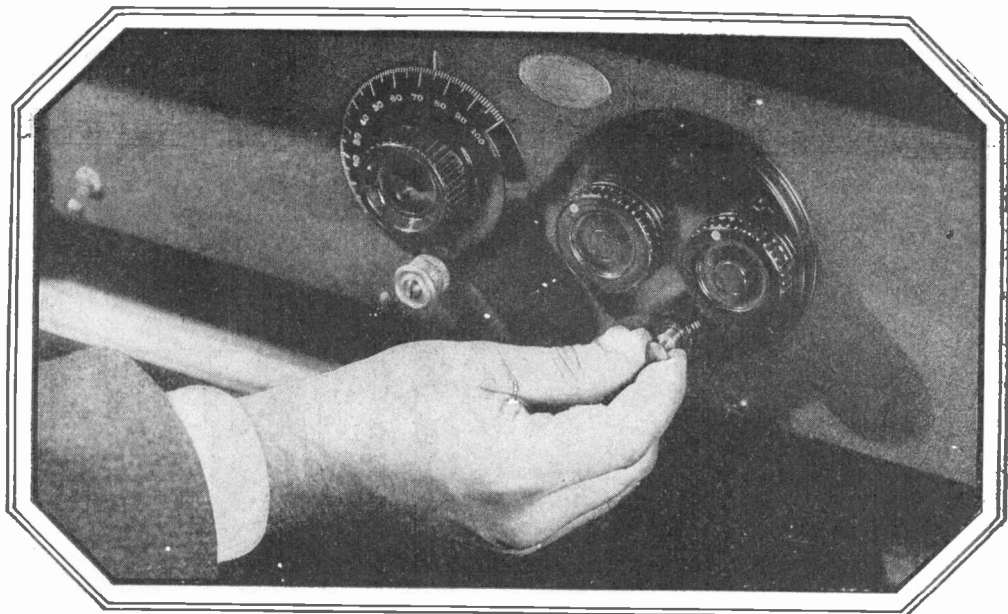

Give your customers unfailing radio power —operated automatically by the set switch!

AT a click of the set switch, Unipower enables *automatic* radio operation . . . *never-failing* "A" power . . . *undisturbed* reception! That's why every customer needs it and will thank you for selling it to him.

With the addition of its remarkable new automatic switching feature, Unipower is again making radio history. It makes possible a power-operated set under one control,—the set switch,—without change in "B" power supply or set wiring. Complicated wiring is entirely eliminated—installation is as simple as that of a storage battery.

Other new refinements to a proven principle—the principle of trickle charge plus the indispensable rapid charge found only in Unipower—are present in the new 6-volt Unipower. Four trickle rates, operated by a simple dial, enable the user of heavily-worked multi-tube sets to adjust the power to the exact rate necessary to his individual set and hours of use.

Experts designed Unipower—time and performance have proven it totally fool-proof. There are no parts that need adjustment or that will need replacement during the normal life of the product. It is so constructed that it *cannot fail*.

Take advantage of the big Unipower months just beginning. Write now for the complete story of automatic "A" power. The Gould Storage Battery Co., Inc., 250 Park Avenue, New York.

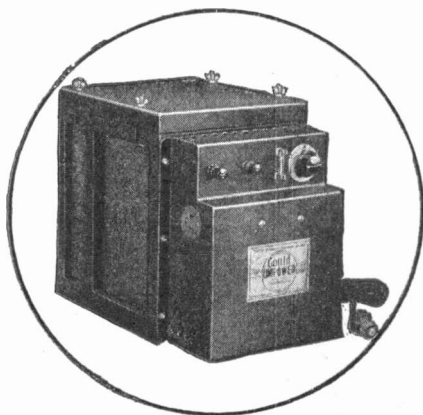

For 201-A tubes or equivalent
AC-6HA. \$42.50.

Unipower contains a Balkite charging unit of Gould design. It operates from alternating current 110-125 volt—60 cycle. Special models, 25-50 cycle, at slightly higher prices.

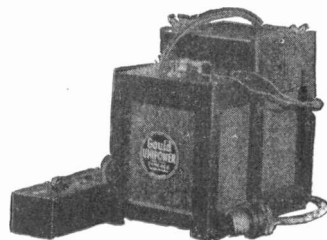

For 199 tubes or equivalent
AC-4. \$33.00.

Proven quality!

Unipower is manufactured by the makers of the famous Gould Batteries for automobiles, submarines, railways, farm-lighting, vehicle and fire-alarm service.

Unipower

A GOULD PRODUCT

AUTOMATIC "A" POWER THAT CANNOT FAIL

A Merry Christmas



SANTA CLAUS SAYS:

“Brach Has a Great Line of **RADIO GIFTS** Which Every Dealer Should Sell”

(1) New! Brach Controlit.

Here is the gift of gifts to owners of radio sets. Controlit makes any radio set a light power-operated set, eliminating all switches from “B” Battery substitute and Trickle Charger and placing complete automatic control in the set switch.

Retails for \$6 in U.S.A.

(2) Brach Lightning Arrester

Brach Arresters dominate the field making it unnecessary to urge dealers to carry the Brach line complete. All Brach Arresters are backed by a \$100 Insurance Guaranty. **Prices \$1 to \$2.50.**

(3) Brach Extension Cord Connector

This simple device—in one piece; made of pure Bakelite—readily connects speaker or head set cord with extension cord.

It will be welcomed in the Christmas “Stocking.”

A 50c Article

(4) Brach Shock-Proof Radio Plug

Should be on the radio gift list—a Shock-Proof Plug that gives perfect electrical contact, withstands high voltages and is easily connected or released. **Retails for 50c.**

(5) Brach Master Aerial Outfit

Here is one of radio’s big sellers—a complete antenna—every needed part—in one package—including a Brach Lightning Arrester. A corking gift for present or prospective radioists. **Price \$3.50; others up to \$5.50**

(6) NEW! Brach Totem-Pole Antenna

Something that meets a demand long unfulfilled—you’ll sell lots of them.

An indestructible, weather-proof antenna—like a flag-pole, with 100 ft. of wound wire. Can be placed on flat or gable roofs, the side of the house, the window ledge; on a boat deck or tent pole. Does away with unsightly make-shifts. Insures fine tone and clarity. A great Christmas gift, especially for those living in apartment houses, hotels, etc.

Price \$10

(7) NEW! Brach Drip-proof Hydrometer

Another trade winner for radio dealers! Better order generously.

To the Brach Hydrometer, with the famous Chaslyn Balls, is combined the drip-proof feature, eliminating the danger of battery acid ruining rugs, floors and clothing.

It will make a strong appeal to your customers. Be ready for them.

Retails at only \$1

Brach

Radio Products

L. S. BRACH MFG. CO., Newark, N. J., U. S. A. L. S. BRACH OF CANADA, Ltd., Toronto, Can.

MAKERS OF THE FAMOUS BRACH LIGHTNING ARRESTERS

SHOWERS

Tone
Volume
Distance
Selective
Foley
Horn
Utah
Unit
Consoles
Only
Battery
Room
Quality
Work
Satisfaction
Guaranteed



Model 448. Top 17" x 32"
Height 40".
WALNUT ONLY

Deliver one or
Carload—at
once

Exclusive
Sales
Franchise

Wide Margin
of Profit

Prices
Amazingly
Low

Showers
Sells and
Stays Sold

Servicing Cut
to Minimum

Backed by
World's Largest
Furniture
Factories

Over \$9,000,000
Manufacturing
Assets Behind
Showers Sets

You Can Make
More on Showers
Console Radio
Now!



This Year' Style in Radio!
All Metal Shielded Construction.
6 Tubes.
1 Dial Control.

Write or Wire Chicago Office Today!

SHOWERS BROTHERS RADIO DIVISION

ESTABLISHED 1868

914 SOUTH MICHIGAN AVE.

CHICAGO, ILLINOIS

B O S C H

REPRODUCER

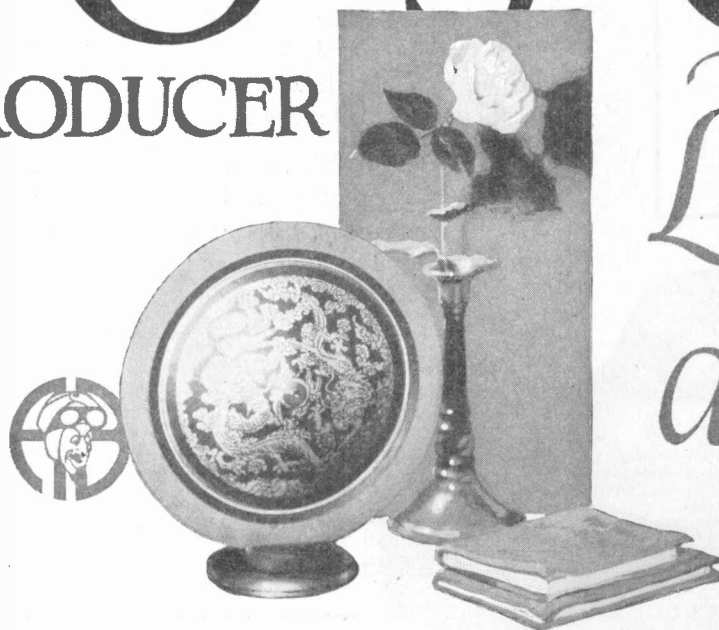

*New
Library
Model
Ambotone*

\$12.50

The newest Bosch Radio achievement—a quality reproducer at \$12.50, mellow and free from metallic sound, a reproducer that will sell easily and in great volume.

The new Bosch Library model reproducer is distinctive. Its entire cone disk is gold ornamented with a wide plain gold circular frame.

Tastefully decorated in the oriental motif and so pleasing is the black and gold combination that it becomes a note of furnishing in any home. It is the ideal guest room or “extra” radio reproducer.

The Library Ambotone may be had at the same price in either the table model or the medallion which with its gold color silken cord hangs upon the wall.

The Bosch Library model reproducer is ready for immediate deliveries.

The Library Ambotone—Table Type or Medallion—\$12.50

NOBATTERY

“B” POWER UNIT

The famous Bosch NoBattery “B” Power Unit answers every demand for a dependable, long lived, lighting socket power attachment that will give silent and unvarying “B” power. NoBattery is entirely automatic, mistake proof, it cannot burn out the tubes of the radio receiver. It pleases customers because it requires no adjust-



ment, is without hum, nothing to fill or spill. Designed for personal and mechanical safety and adequate for any set up to 10 tubes including power tube. Its voltage ranges from 90 to 135. You can feature the Bosch NoBattery with perfect safety. Ed 3 for Alternating Current \$48.00 —Direct Current \$42.00.

All prices slightly higher Colorado and West and in Canada

AMERICAN BOSCH MAGNETO CORPORATION
 Main Office and Works: SPRINGFIELD, MASS. Branches: New York Chicago Detroit San Francisco

Localized Tuning

A new compact set (Model B) featuring the same outstanding tonal qualities and selectivity recognized in all LONE WOLF receivers will be available immediately.

Tuning controls have been localized, assuring ease of operation without sacrificing selectivity.

WRITE FOR DETAILS

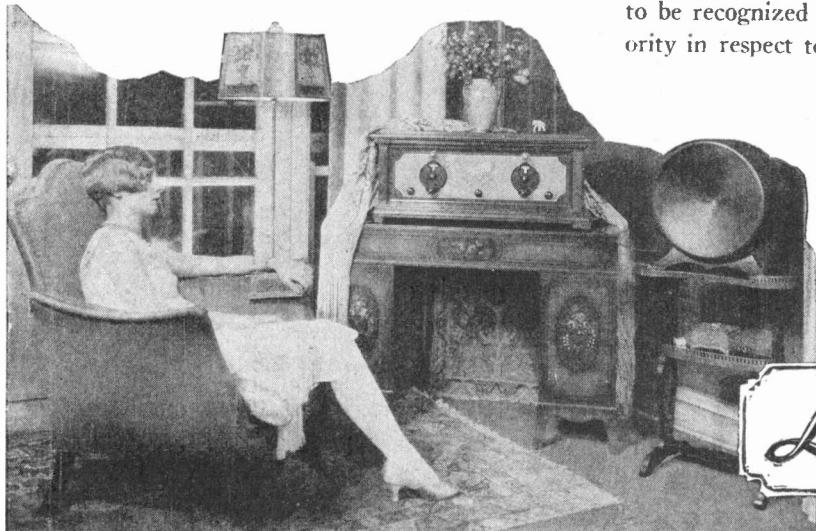

Royal Blue!

A distinctive feature of the LONE WOLF Model A, constructed on a quality basis, is the metal shielding panel finished in royal blue. This panel which is made of bronze with gold plated tuning controls has become a trade-mark for better reproduction, selectivity in congested areas and surprisingly good DX reception. Base note tone quality is an outstanding feature.

The "Lone Wolf" receiver is as distinctive and as much in a class of its own among other receivers as the lone wolf of the timberland. It was so named before its origination because it was made to be recognized at a glance and to be remembered for its superiority in respect to highest quality.

List \$150.00

Performance

Model B is a compact six tube r. f. set made from scientifically selected parts. Shielded coils assure maximum selectivity. Condensers have two bearings instead of the single mounting found in most localized tuning units and further can be adjusted in emergencies.

List \$75.00



4725 Clifton Avenue, Chicago, Illinois

Customers Will Ask You for the
New

MU-RAD

SUPER-SIX RECEIVER

*Will You Fill Their
Order or Lose a Sale?*

Six years of continuous publicity, sane merchandising and positive value have made for Mu-Rad a name that is respected by dealers and public alike. This new Mu-Rad Receiver is all that earlier sets have been, and more.

Your customers have read Mu-Rad's announcement of the new Super-Six Receiver. You will be asked for Mu-Rad demonstrations, will you be ready? Mu-Rad's dealer policy is generous, fair and square and as old as radio. Write today for franchise in your district.



*For Territorial
Rights Address*

MU-RAD
RADIO CORPORATION
Dept. R, ASBURY PARK, N. J.

Get The Lowest Price-First!
on thousands of
NATIONALLY ADVERTISED ITEMS
FROM THIS BOOK *Write for it!*

Paramount
ELECTRICAL SUPPLY COMPANY
160 W. LAKE STREET ~ CHICAGO

Gilfillan

RADIO

Sweetest Tone
Highest Selectivity
Simplest Operation

GILFILLAN BROS., INC.
1815 Venice Blvd., Los Angeles, Cal.

25 Wilbur Avenue
Long Island City, N. Y.

2525 West Penn Way
Kansas City, Mo.

Cooper **A** Eliminator

The "A" Battery is gone - - -
- - - forever!

*N*OW you can enjoy radio without having to put up with the inconveniences caused by the storage "A" battery, for the "A" battery has been totally eliminated as a radio necessity.

The Cooper "A" Eliminator actually eliminates the "A" battery with all its messy watering and charging. Just plug the Cooper "A" Eliminator into the light socket and turn on the set . . . a simple throw of a switch and the current is on . . . tumble back the switch and the

current is off . . . supplies up to 2½ amperes of current, enough to operate any make of receiver using up to ten six-volt tubes.

The Cooper "A" Eliminator is not a power unit. It employs no trickle charger. It needs no attention of any kind . . . no batteries to water . . . no acids or liquids to replace . . . operates purely on a rectification and filtration principle . . . creates noiseless, distortionless filament current direct from the house lighting system.



Good radio dealers in most cities have the Cooper "A" Eliminator on display, \$87.50 (tubes extra); slightly higher West of the Rockies.

This Free Booklet Tells the Story

We have prepared a very complete folder describing the Cooper "A" Eliminator and the principle upon which it is built. May we send it to you?

DEALERS—JOBBER

The Cooper "A" Eliminator is the only device of its kind on the market. It is new in principle—has no competition. Limited distribution and full protection to trade outlets insure legitimate profit. Write for full particulars of our exclusive proposition.

THE COOPER CORPORATION

Radio Division—Dep't R

CINCINNATI, OHIO

Founded 1904—Factories, Cincinnati and Findlay, O.

WESTON

Convertible
"Pin-Jack"
Voltmeter

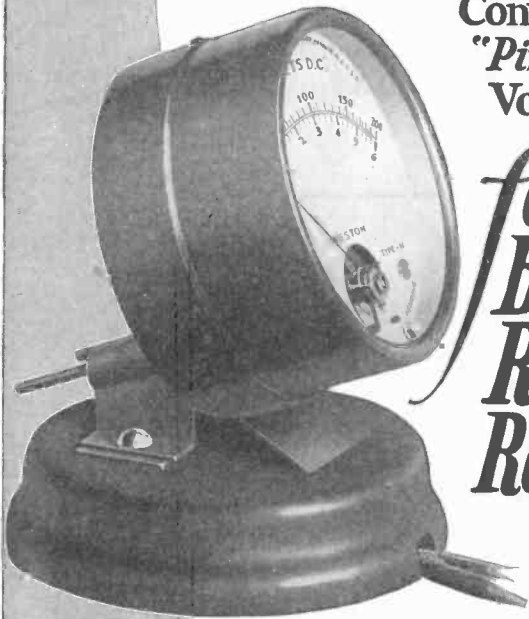

for
Better
Radio
Results

YOU, as a successful dealer who has profited by the sale of Weston instruments, know the benefit of stocking quality products. This new instrument, the Weston Convertible "Pin-Jack" Voltmeter, is the most practical double-purpose radio voltmeter ever offered the radio public. It is a combination of two instruments—a "Pin-Jack" Voltmeter for measuring filament voltage and a High Range Stand for use with the voltmeter for battery testing. Used as a "Pin-Jack" Voltmeter it plugs directly into the filament jacks provided for it on Radiola, Victor, Brunswick and Bosch radio sets. When the instrument is removed and plugged into the High Range Stand you have another instrument that will measure battery voltages and locate circuit troubles, using the 30-inch permanently attached flexible cables. The Weston advertising in the SATURDAY EVENING POST and in newspapers is breaking down your customers' sales resistance—there is no sales resistance among dealers—actually they are eager to place this new instrument in their customers' hands because they know it means permanent radio satisfaction. This Weston Model 506 Convertible "Pin-Jack" Voltmeter keeps customers and sets sold. Write us for full dealer information.

WESTON ELECTRICAL
INSTRUMENT
CORPORATION
25 Weston Ave., Newark, N. J.



STANDARD THE WORLD OVER
WESTON
Pioneers since 1888



ANY HYDROMETER CAN TEST YOUR BATTERY BUT ONLY
THE "BreakNot"
TESTS IT RIGHT!
THAT'S WHY YOUR TRADE BUYS IT

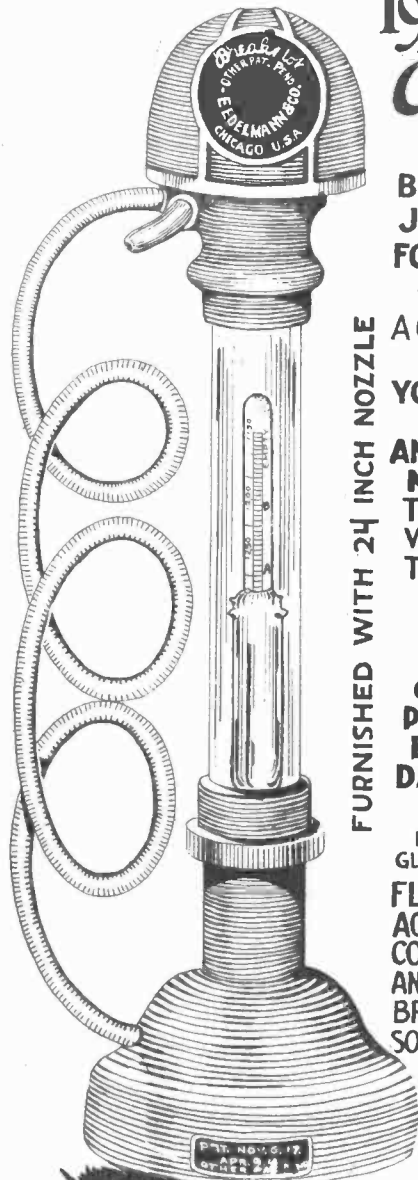

1927 Model
"BreakNot"
RADIO

BATTERY TESTER
JUST THE THING
FOR RADIO A OR B
BATTERIES.

A Child Can Operate It!
USE IT ONCE
YOU'LL USE NO OTHER
SET IT DOWN
ANYWHERE WHILE
MAKING A TEST.
TEST EVERY CELL
WITHOUT MOVING
THE INSTRUMENT.
**WILL NOT
TIP OVER**
PATENTED
CONSTRUCTION
PROTECTS AGAINST
BREAKAGE AND
DANGER OF ACID
SPILLING.

FURNISHED WITH 24 INCH NOZZLE

HAS ONLY HALF AS MUCH
GLASS HAS OTHER HYDROMETERS
FLOAT: GUARANTEED
ACCURATE-PRINTED IN
COLORS EASY TO READ
AND PROTECTED AGAINST
BREAKAGE BY PATENTED
SOFT RUBBER HOUSING
**THE BIGGEST
VALUE \$1.00
EVER BOUGHT**

PRICE \$1.00
EAST OF THE ROCKIES
AND WORTH IT

**Dealers: IF YOU HAVEN'T
THE "BreakNot" IN STOCK
YOUR LOSING MONEY.
EASY TO SELL
PACKED 10 BreakNot's IN COUNTER
DISPLAY-ORDER
FROM YOUR JOBBER TODAY.
OR WRITE US TO TELL YOU MORE ABOUT THIS RAPID SELLER.**

MADE BY
E. EDELMANN & CO.
2332 LOGAN BLVD. CHICAGO ILLINOIS



HOMEPower SALES are Breaking all Records

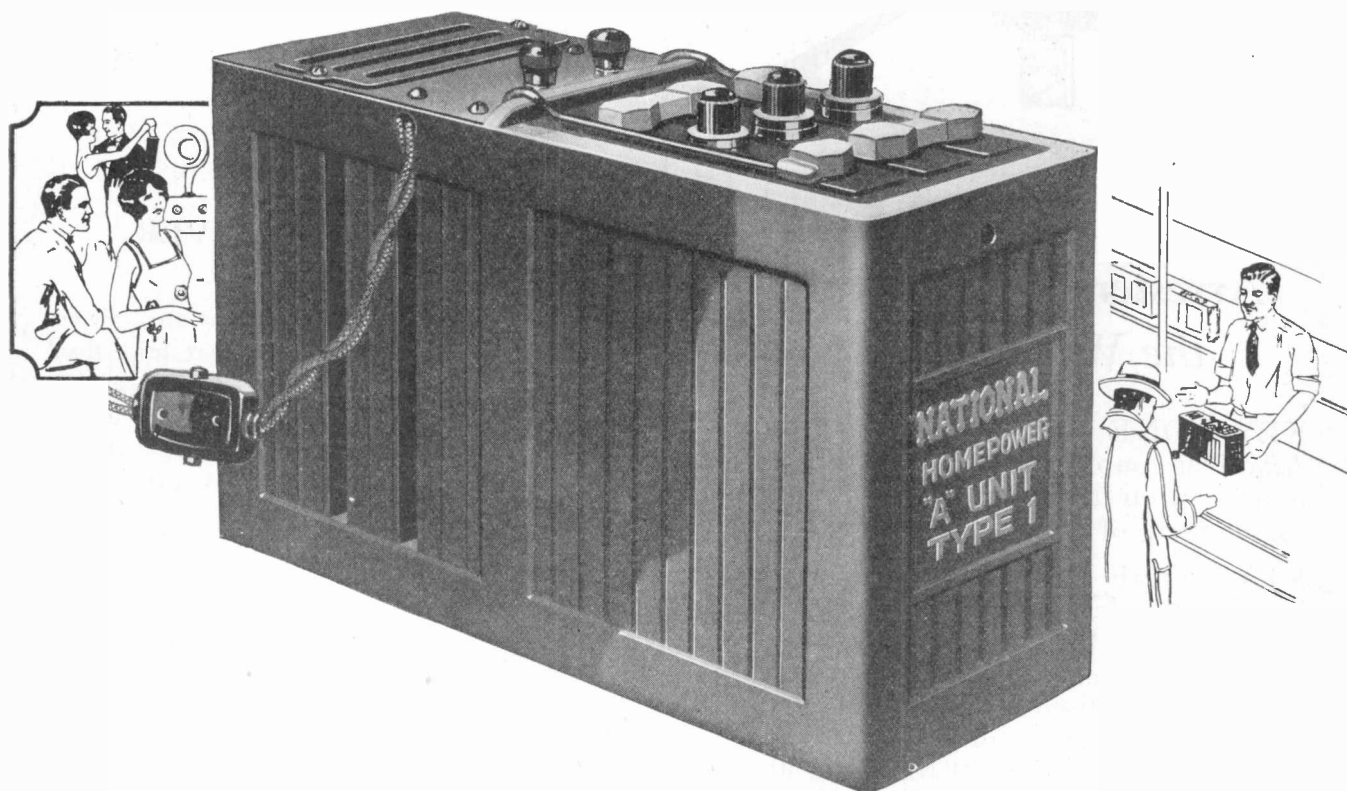

Are you getting your share of this business?

Every radio owner wants a National Homepower, the one "A" power unit that is compact enough to fit into practically all cabinets, is trouble-proof, durable and sells at a fair price.

Sales are proving that Homepower is right in every way. And a strong, consistent National advertising campaign is increas-

ing Homepower buyers by the thousands. Line up with the National *NOW*. Get your share of the easy sales and profits that go with handling this improved unit. See your jobber or write us today.

NATIONAL LEAD BATTERY CO.
General Offices, St. Paul, Minn.
Factories, St. Paul, Chicago, Kansas City, Los Angeles
Branches, New York City, Dallas, Oakland, Atlanta,
Portland (Ore.), Baltimore

NATIONAL



HOMEPower RADIO "A" UNITS

For Sale By Reputable Dealers And Jobbers Everywhere

NATIONAL LEADS THE WORLD IN BATTERY VALUE

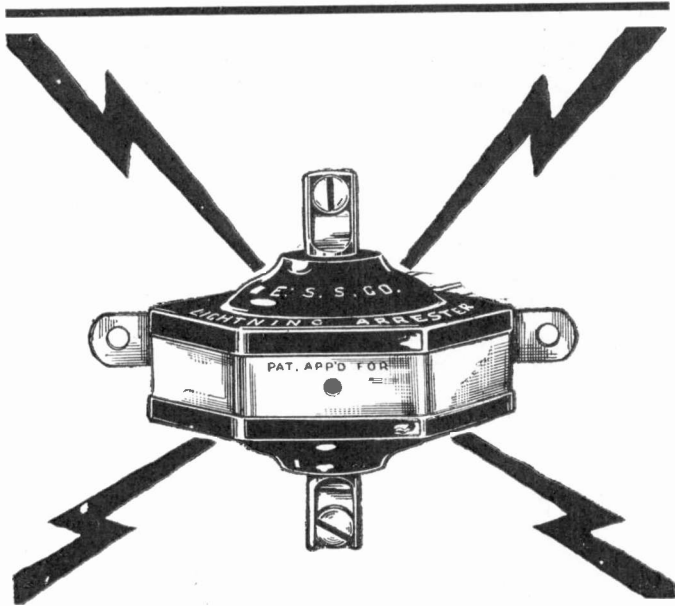

KEYSTONE Lightning Arresters Are Known the World Over

KEYSTONE is the one name the American public has learned to rely upon to protect their radio sets against the dangers of lightning.

KEYSTONE Lightning Arresters are ingeniously designed out of genuine Bakelite and Brass parts to afford absolute protection. They have been consistently advertised to your customers and are made by a company that has produced over 2,000,000 lightning arresters for radio and industrial use.

ELECTRIC SERVICE SUPPLIES CO.

PHILADELPHIA 17th & Cambria Sts.	NEW YORK 50 Church St.	PITTSBURGH Bessemer Bldg.
CHICAGO Illinois Merchants Bank Bldg.	BOSTON 88 Broad St.	DETROIT General Motors Bldg.



KEYSTONE RADIO LIGHTNING ARRESTERS

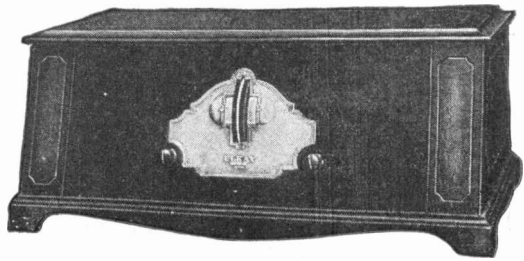

Licensed Under Patents Granted and Pending

Ask Your Jobber for the New "Truphonic"



SIX TUBE RECEIVER

Christmas orders for the new Elkay are arriving in every mail. The call is far more brisk than it was at this time last year. But, we are in good production and you should be able to get the Elkay from your jobber promptly. If you cannot, we will see that you are taken care of.

The points which are making the new Elkay extremely popular are:

1. Truphonic Audio Amplification. A pure note entering the Elkay comes out a pure note.
2. Elkay Synauto R. F. Amplification, which smooths out the tuning, over the entire dial, from 200 to 580 meters.
3. Complete shielding; no interstage coupling; no annoyance from "strays."
4. Uni-control; the flexibility of three dials, all under your thumb.
5. "Floating" sockets on Bakelite sub-panel; all important insulated and wearing parts genuine Bakelite.
6. Beautiful, sloping-front cabinet of brown, natural-grain mahogany, Duco finished.

The Elkay is the product of radio engineers. It is technically right. It will do what a high-grade instrument should do, and you can safely put your reputation and selling energy behind it. Price, \$125 list.

THE LANGBEIN-KAUFMAN RADIO CO.
Dept. M, 62 Franklin St., New Haven, Conn.

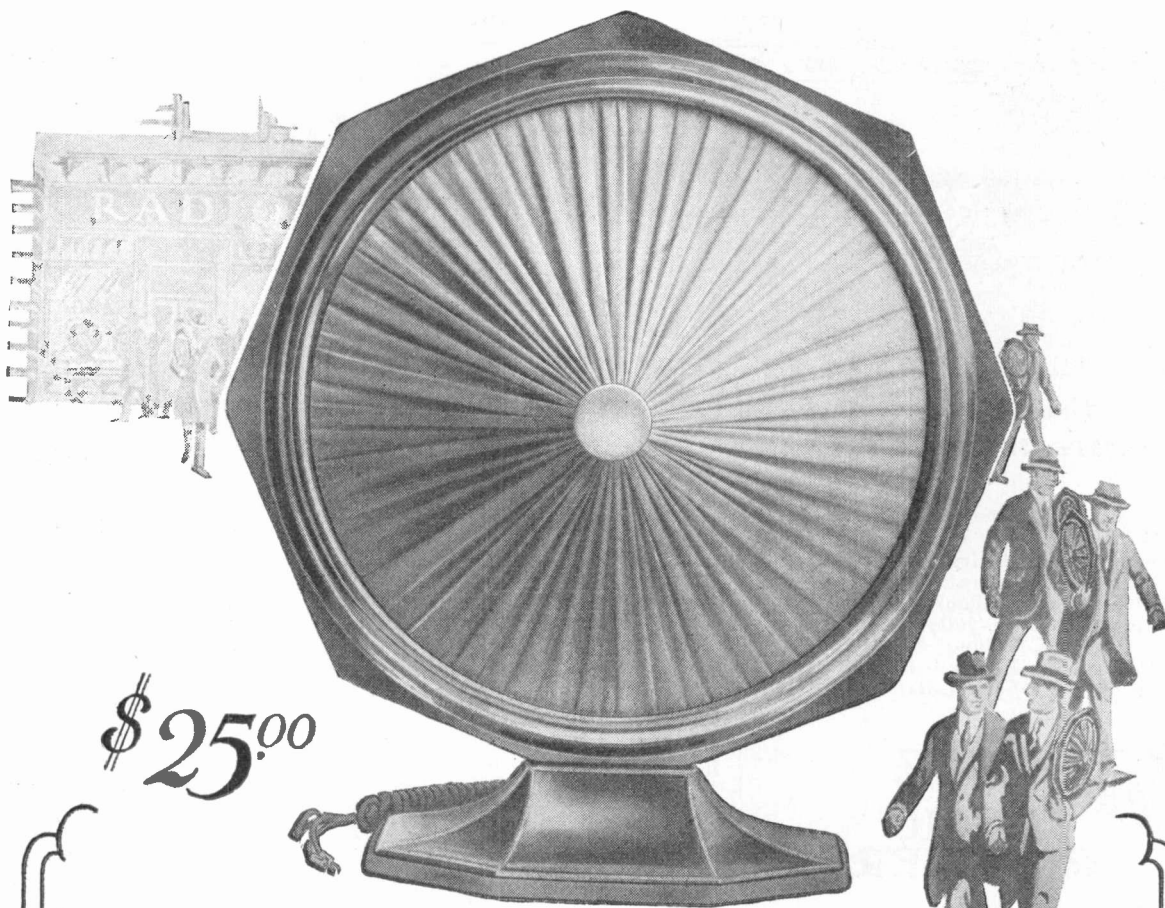

\$25.00

Nine out of Ten Select
The
SONOCHORDE
 CONE

SONOCHORDE sells best by Demonstration. Let your customers see this incomparable Speaker! Then let them hear it—preferably in competition with other speakers!

Only a product of outstanding quality can withstand the acid test of comparison, but statistics show that after actual Demonstration nine out of ten select Sonochorde. There must be a reason!

• Write for the Sonochorde Facts.

BOUDETTE MFG. CO., Chelsea, Mass.
 Factory Sales Agents: Hastings Elec. Sales Co., 42 Binford St., Boston

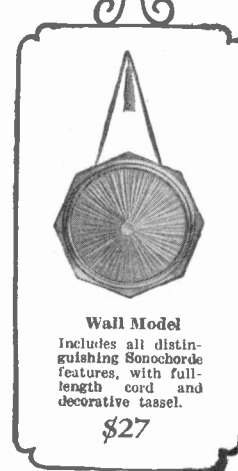
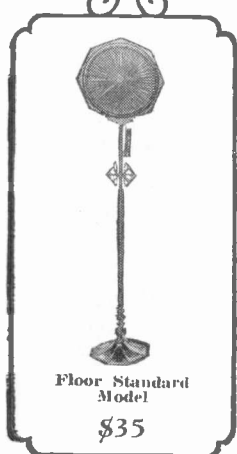



The "Mayfair"
No. 78 Price \$270.00

What a wonderful Christmas gift! The Oriole Console has beauty of outward appearance, richness, dignity! And it brings true entertainment. Full rounded tones—two loud speakers give maximum tonal range, fully 6 1-2 octaves. Distance, Volume, Selectivity, Naturalness, Beauty,—everything you could ask from Radio!

For Christmas ~~~~ lasting joy!

DEALERS who are wise reap Christmas profits from the better merchandise. With dependable Oriole Radio Receivers you have a line of business stimulators that will speed up turn over and enrich your profit while giving lasting joy and satisfaction to both the giver and the recipient. Oriole Receivers with the Trinum Circuit are positively amazing in performance---and they stay sold!

Sales Department
THE ZINKE CO.
1323 S. Michigan Ave.
Chicago, Ill.

Manufactured by
W.K. ELECTRIC CO.
Kenosha, Wis.



The "Canterbury"
No. 75 Price \$150.00
A pleasing console—ample room for batteries.

ORIOLE RADIO RECEIVERS

The "Warwick"
No. 71 \$125.00
A supremely fine instrument.

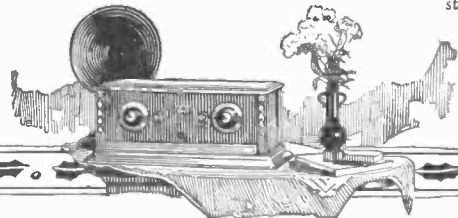

The line for Christmas selling is here...!

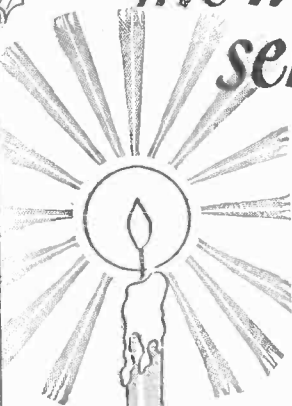

BEAUTY, unique design, satisfying performance, price range---what more can you ask of a line for brisk Holiday merchandising? Certainly turnover will be rapid and profit satisfying to all Velvet Dealers. If you are interested in the Velvet franchise, wire us quickly.

The Jewel Case No. 21

As an example, take the "Jewel Case". Certainly no other speaker ever had such rare beauty and charm of outward appearance! And the volume of rich, clear, delightful tone is just as surprising. The ideal Radio Christmas gift! See that your stock is ample.

Sales Department
Jobbing Division
THE ZINKE CO.
1323 S. Michigan Ave.,
Chicago, Ill.

Manufactured by
The BORKMAN RADIO CORP.
Salt Lake City, Utah
Kalamazoo, Mich.

No. 12, \$16.00
12 1-2 in. Bell

No. 15, \$23.50
14 1-2 in. Bell
Borkman Velvet
Speakers bring beauty
of tone and surprising
range to radio.



No. 18, \$27.50
"The Chinese Cone-flex"
All the low tones of the cone
with all the higher notes of
the horn. Beauty, symmetry!

No. 9, \$12.50
"The Lantern"

Unique in conception—
beautiful finish, pleasing
harmonious lines. Real
power and tonal beauty too

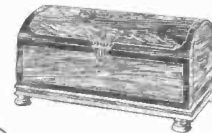

No. 21, \$45.00
"The Jewel
Case"
The most un-
usual speak-
er ever marketed

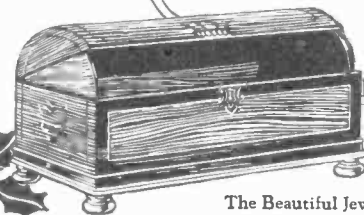

The Beautiful Jewel Case!

Once a customer hears what a Timmons Power Amplifier will do— he will be dissatisfied with his own set until he buys one



Timmons Combination Amplifier and B Supply.
Lists at \$70.00 without tubes.

The only selling that Timmons Power Amplifiers require is demonstrating—your customer's ear does the rest. Just let a radio set owner hear any set in your store *with* and *without* a power amplifier. He might go out of your store without buying the amplifier then—*but*—he will come back for one, and ten chances to one he will tell you how terrible his own set sounds since he has heard the Timmons Power Amplifier.

The Timmons Power Amplifier—for the fine profit it gives you—should be the hardest pushed radio product in your store.

It requires no servicing. There are no installation costs. Anybody can attach it—placed between the radio set and loud speaker.

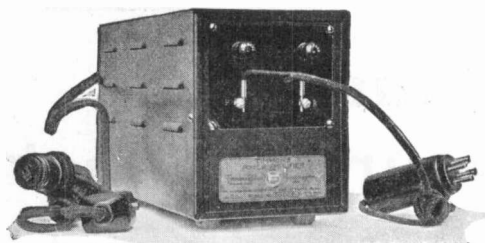

Timmons Amplifier without B Supply
Lists at \$45.00 without tubes.

In addition to your profit on the Amplifiers, you sell a couple of power tubes with each one. Actually you make more profit on one Timmons Combination Amplifier and B supply than on fifty tubes or a dozen B batteriers.

Further than this, when you have one on demonstration, it helps you to sell sets and loud speakers—especially to those customers who have said that they thought they "would wait until radio was developed further." They will be satisfied *that the time has come to buy.*

We have literature for your customers and your jobber will quote discounts.



Timmons Raytheon B-Lim.
Lists at \$47.50 with B H Raytheon tube.

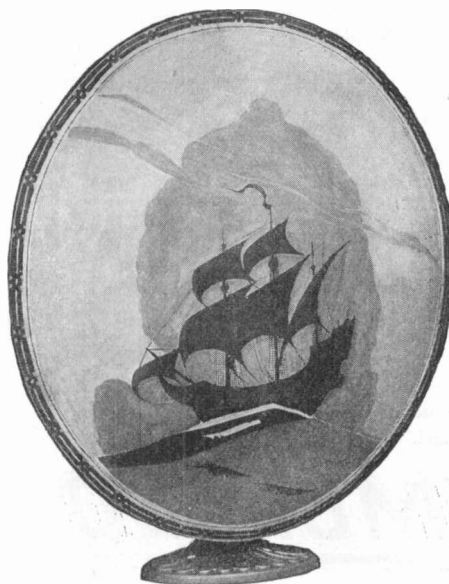

Timmons new Concert Grand Cone. Lists at \$56.00.
The greatest loud speaker that Timmons has ever produced.

TIMMONS RADIO PRODUCTS CORP.
Germantown, Philadelphia

Aerial Kits

LEAD-INS and
GROUND CLAMPS



Style "A" \$3.50

Attractively packed in a display box, these kits contain:

- 1 Nifty Lead-in. 1 Nifty Ground Clamp.
- 1 Approved Lightning Arrester.
- 100 feet No. 7-22 Tinned Copper Antenna Wire.
- 50 feet (white covered) Lead-in Wire.
- 25 feet Hook-up Wire.
- ★2 Housex Crystal Glass Insulators.
- 3 Nail-it Knobs. 2 Screw Eyes.
- 12 Insulated Staples.



Nifty Ground Clamp (shown at left) requires no tools and is easily adjusted to commonly used pipe. Made of tinned copper and brass. No soldering necessary.

Nifty Lead-in (shown below) completely weatherproof, pliable, and insulated. No holes to bore. Fits easily under window or door tightly closed.



Everything that is necessary for the installation of an efficient aerial and ground system. Easy to install. Easy to buy. Easy to sell.

AMOROSO

MANUFACTURING COMPANY
60 India Street,
Boston, Mass.

*ASK US FOR PRICES ON GLASS INSULATORS

Bristophon



Display it in Your Window

The Bristophon, as an outstanding invention of the year, is getting the center of dealers' windows everywhere . . . and is paying its way handsomely. One dealer recently landed 100 live prospects in this way.

The Bristophon is an Electric Phonograph-Amplifier. It gives the old-type phonograph all the tone range, volume and sweetness of the new "phonic" instruments. It works on any phonograph having an even-running turn-table; and in three ways:

1. With radio Power Amplifier and radio speaker;
2. With radio Power Speaker;
3. And with radio speaker alone.

The price of \$45 makes sales easy . . . at a profit eminently satisfactory to you. Write for full details.

The Bristol Company, Waterbury, Conn.

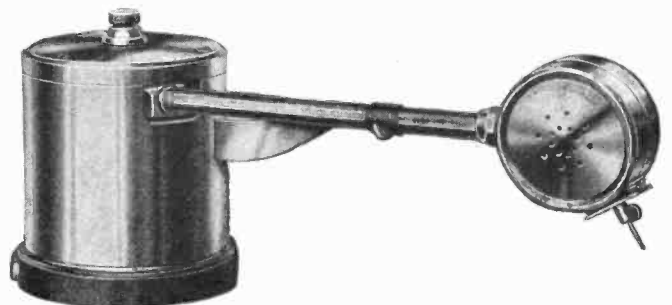

It's here-



\$29⁵⁰

the automatic "A" Power Unit that has everything

You don't need to ask yourself whether you can sell this new Prest-O-Lite Trikl-Automatic "A" Power Unit.

It will sell itself—because it has everything that radio users could possibly wish for in an electric light socket "A" power supply. It's the radio accessory they have all been waiting for.

Just consider what it gives them.

Full "A" power all the time.

Automatic operation of the trickle charger. The charger starts working the instant the radio set is switched off. No other switches to operate, which means that the unit can be controlled any distance from set.

Beauty of design and finish. Small, compact size.

Real economy of operation from ordinary light socket.

Sturdy construction throughout.

And while the price of this unit is low enough to be attractive to every radio enthusiast, there is a fine profit for you.

Don't forget that the Prest-O-Lite name is back of it, which means highest quality, national advertising and a real sales-building merchandising plan for you. Write us today for full details, discounts, etc.

THE PREST-O-LITE CO., INC., INDIANAPOLIS, IND.
New York San Francisco



The new Prest-O-Lite "A" Power Unit is entirely automatic in operation. Only one switch to operate—the one on the radio set.

The battery is a high-quality, special Prest-O-Lite Radio "A" Battery of ample capacity; made especially for radio use.

The charger is built on an entirely new principle. Highest efficiency and absolutely silent. Adjustable to individual needs. Economical. Nothing to get out of order or replace. No moving parts, bulbs, liquid or electrodes.

Write today for full details



Prest-O-Lite

TRIKL-AUTOMATIC "A" POWER UNIT

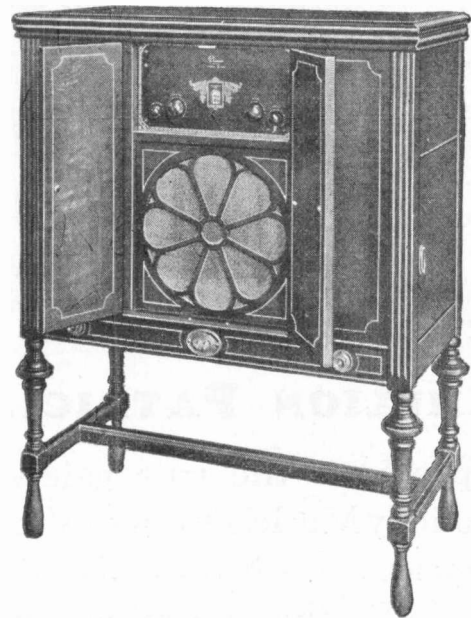

Priess Straight Nine

List Price with-
out accessories \$335.00

Write for name of our distributor in your territory [*We have a most unusual opportunity for the right man*]

SOME very desirable territory is still open. We give exclusive representation and a dealer franchise.

Our line includes a sufficiently wide price range to meet all requirements of a high-class dealer.

Priess Straight Nine. List Price, in handsome figure mahogany cabinet, without accessories \$335

Priess Straight Eight, especially adapted for rural localities. List Price, without accessories \$175

Priess

TRADE MARK
STRAIGHT 9 NINE

Priess Radios are nationally advertised
Write for full information.

PRIESS RADIO CORPORATION
693 BROADWAY NEW YORK

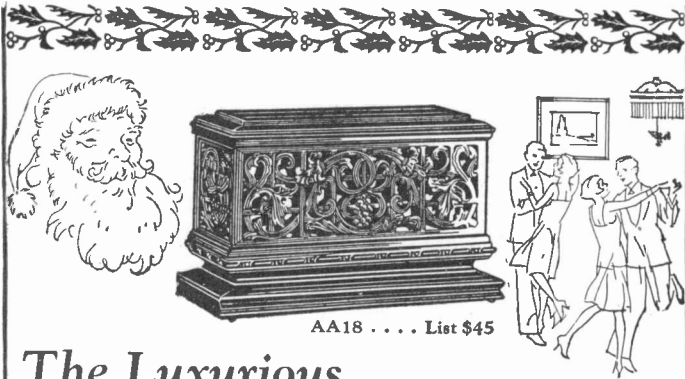

AA18 List \$45

The Luxurious

AMPLION PATRICIAN

reproduces the true gaiety of Holiday Music! Distinguished in appearance—Nationally Advertised—For the discriminating Radio Public, *the ideal Yuletide gift!*

The trade emphatically endorses new Amplion developments

AMPLION CONE-AMPLION PATRICIAN

—our plants at New York and Muskegon are running to full capacity—working overtime! For timely deliveries may we advise ORDERING IMMEDIATELY? Do not miss any Christmas Sales on these profitable new Amplion numbers.

*Write for name of Jobber
in your territory*

THE AMPLION CORPORATION OF AMERICA
Suite E, 280 Madison Ave., New York City
The Amplion Corporation of Canada Ltd.
Toronto, Canada

AC12 AMPLION CONE. List \$30.00

DRAGON MODELS

- AR19 Amplion Dragon List \$42.50
- AR114 Amplion Junior de Luxe List \$27.50
- AR111 Amplion Junior List \$24.00
- AR102 Amplion Dragonfly List \$12.00

PHONOGRAPH ATTACHMENTS

- AR35 Amplion Concert Grand. List \$20.00
- AR67 Amplion Standard Unit List \$12.00



**Models E and G
Superadio B Eliminators**

*Using our
own*
**EDLO
TUBE**

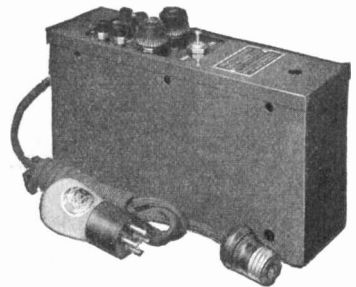

Output low tap. 35 MH. @ 90 v.
Output high tap. 45 MH. @ 135 v.
TAPS—Model E. Variable Detector, Variable Intermediate and Amplifier.
TAPS—Model G. Variable Detector, two Variable Intermediates and Amplifier.

Overall Size 10 1/2-in. x 7-in. x 2 7/8-in.
Price Model E. \$35.00
Model G with G-B Tube 39.50
Model G with H-B Tube 40.00
All models for 110 v., 60 cycle supply.

OUR Rectifier tubes are gas-filled tubes and **GUARANTEED** to be equal to the best and are for sale to Manufacturers, Jobbers and Dealers.

Let us send you samples for test.

Price—G-B Tubes \$5.00
H-B Tubes 5.50

DEWITT-LAFRANCE CO.
Cambridge, Mass.



Radio Dealers—

The busiest part of the radio season is at hand. Be sure that your stock is complete. Jewell radio instruments are popular and profits are good.

Write for our prices and discounts.

Jewell Electrical Inst. Co.
1650 Walnut St., Chicago
"26 years Making Good Instruments."

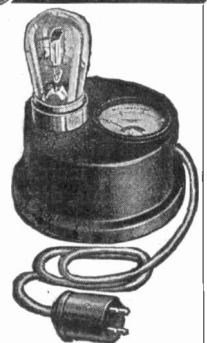

Pattern No. 107
Home Tube Checker

**More Radio
Cabinet Sales**

This Standard No. 401 Radio Cabinet was designed to be highly attractive and to be most practical. Users find that it fully meets their needs.

A number of features including wood horn, make this a cabinet you should consider at once.

Made in Antique Brown Mahogany or Antique Burl Walnut finish. Write for dealers' transportation allowance and discount list.

**STANDARD PIANO
BENCH MFG. CO.**
1221-1227 W. Lake St.
Chicago, Ill.

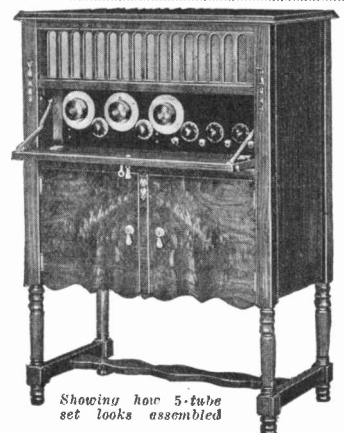

Showing how 5-tube set looks assembled



Console Model
List Price \$72.00



Table Model
List Price \$59.00

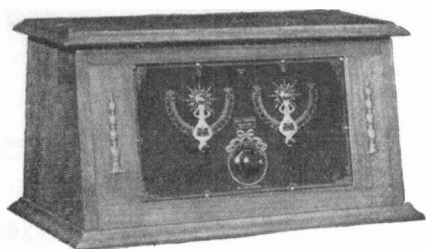

Table Model
Without Speaker
List Price \$36.50

The Radio-Wise and Otherwise

A few years ago the mysteries of radio were known only to the few. The public purchased instruments good, bad and indifferent—dealers had little difficulty disposing of their radio stock regardless of the quality.

Not so today! Today the public is radio-wise! And dealers who are after big profits must reckon with this educated market.

Blue Ribbon Receivers offer a value which both the radio-wise and otherwise instantly appreciate.

Here are the facts—A five tube set equal in performance to any six tube instrument, a point which can be demonstrated; an entirely different, special Blue Ribbon circuit, operating efficiently on dry cell batteries, but *universal* in using storage battery tubes, if preferred; the superior Blue Ribbon tone quality, the result of a new type of speaker unit, always a strong selling point; unusual selectivity; superb summer reception. *And prices astonishingly low for value received.*

One more point, significant for both dealer and customer—Blue Ribbon Receivers are backed by a concern whose reputation for responsibility and high grade products is nationally endorsed.

Some territories still open for live, aggressive representation. Send today for full description of models and attractive selling proposition.

RADIO DIVISION

Chicago Nipple Mfg. Co.
1966 Southport Avenue, Chicago, Illinois

Blue Ribbon Receiver

Fleron

AERIAL EQUIPMENT

New!

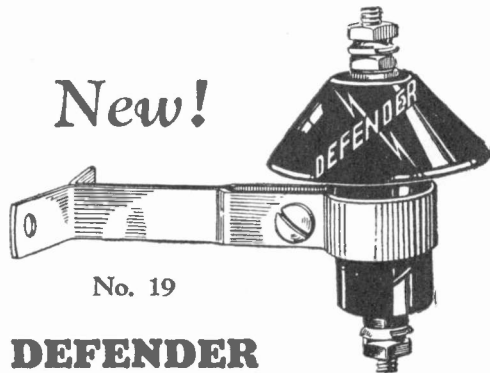

No. 19

DEFENDER LIGHTNING ARRESTER

A new type of Mineral Gap Lightning Arrester for which the demand is steadily increasing. Made of Special Black High Tension Porcelain. Conforms to the latest requirements of the Underwriters' Laboratories. All metal parts of heavy brass. List Price \$1.50.

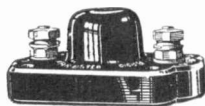

Sentinel Arrester

Pushing this item will bring you large profits with volume. Approved by Underwriters. List price \$1.00.

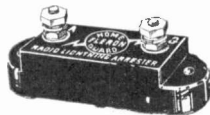

Home Guard Arrester

Large sales volume easily built with this fine piece of merchandise. Approved by Underwriters. List price \$1.50.



COMPLETE AERIAL OUTFITS

Everything necessary for the erection of an aerial of high efficiency packed in a sturdy 3-piece slide container. Four styles and prices. Each Kit is a package of exceptional value.

- | | |
|-------------------------|-------------------------|
| No. 300.....List \$3.00 | No. 400.....List \$4.00 |
| No. 350.....List \$3.50 | No. 500.....List \$5.00 |

OTHER FLERON SPECIALTIES



Glass Insulators

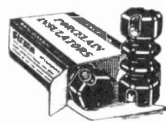

Porcelain Insulators

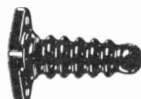

Stand-off Insulators



Lead-in Bushing



Screw Eye Insulators

The Fleron Line of Radio Aerial Equipment is sold by all leading jobbers. Write for folder.

M. M. FLERON & SON, Inc.
TRENTON, NEW JERSEY

THE HYATT 6-TUBE PORTABLE RADIO RECEIVER



A portable radio receiver of highest quality and substantial construction for the home, hotel, club, hospital.

Selective, Long Range, Tone Quality and Volume.

Employing 6-C 299 or UV 199 Tubes, 3 Standard Dry Cells, 2 Burgess No. 5308 "B" Batteries and 1 No. 5360 Burgess "C" Battery.

Equipment includes Loop, Aerial, Inbuilt Speaker with Unit, Single Dial Control.

Enclosed in Black Leatherette Covered and Well Built Cabinet 15-in. wide, 11 1/2-in. high and 9 1/2-in. deep. Wt. 14 lbs. less tubes and batteries, 28 lbs. fully equipped.

LIST PRICE
Less Accessories
\$75.00

F.O.B. CHICAGO, ILL.

LIST PRICE WITH FULL EQUIPMENT \$95.00

Jobbers and Distributors Join us in the distribution of this Wonderful Receiver. Write for our Plan and Discounts

Dealers If your Jobber can not serve you, write us for our Circular and Discounts.

THE ELECTROPHONE CORPORATION
109 NO. WABASH AVE., CHICAGO, ILL.

ELECTRICAL SUPPLIES — RADIO

Don't place your Christmas Holiday order until you have seen the latest issue of Harry Alter's "POCKETBOOK," a 240 page catalog showing a complete line of Electrical and Radio goods, with a special section for Holiday Goods.

Your best source of supply.

Dealers, write for it today.

The Harry Alter Co.
ELECTRICAL AND RADIO SUPPLIES
Ogden at Carroll Ave. CHICAGO ILL.

Sell Udell Radio Cabinets

A good example of our stock line of Radio Cabinets and Tables is No. 746 illustrated at left.

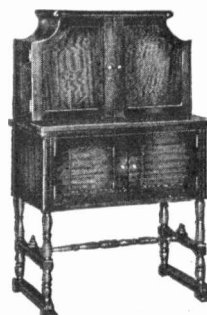

UDELL covers a complete range in design, finish and price. See our permanent displays — spaces 1029-31 American Furniture Mart, Chicago; space 314, New York Furniture Exchange, 206 Lexington Ave. Write for complete catalog R-86 and dealer's discounts.

We also build special Radio Cabinets under contract.

Write your requirements.

THE UDELL WORKS, INC.
28th Street at Barnes Ave.,
INDIANAPOLIS, IND.

Hoyt CELLCHEK

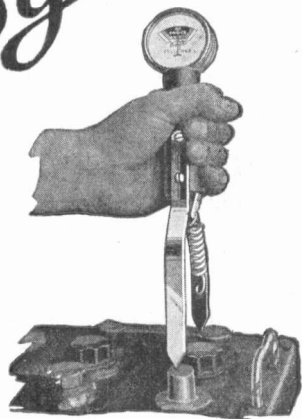

You can help your customer in the selection of acceptable, useful Christmas presents, by suggesting the HOYT CELLCHEK, a new and more accurate instrument for testing Radio storage batteries. The electric meter indicates instantly whether the battery needs re-charging, is low or in good condition. The CELLCHEK operates without the withdrawal of a drop of acid, keeps hands clean and protects rugs and furniture.

Price \$2.50

BURTON-ROGERS CO.

BOSTON, MASS.

Sales Dept. for HOYT Electrical Instruments Co.

The Thoroughness of English Craftsmanship

is splendidly exemplified in the unusual quality of musical reproduction offered by



LOUD SPEAKERS

Built by one of the world's foremost producers of radio equipment. They make distinctly unusual appeal to the buyer with whom tonal value is the paramount consideration.

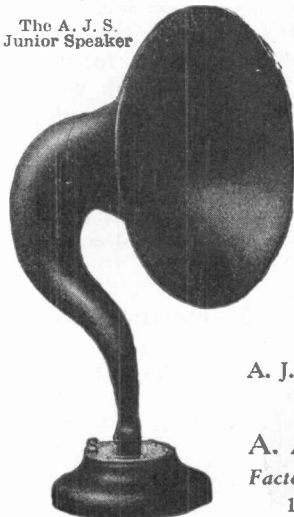

The A. J. S. line is supplied in pedestal, cabinet and large and small horn types, meeting the requirements of a varied trade.

Write for descriptive literature and prices.

Manufactured in England by

A. J. STEVENS & CO. (1914) Ltd.,
Wolverhampton

A. ALEXANDER SINGER
Factory Representative for U. S. A.
15 Moore Street, New York

A Real Sales Maker

Made of selected genuine Mahy. or Amer. Walnut Ply-wood. Finished two tone Antique Brown Mahy. or American Walnut. Battery Compartment. High grade Loud Speaker Wood Horn and UTAH LOUD SPEAKER UNIT COMBINED. 30-in. High, 32-in. Wide, 15-in. Deep. Average shipping weight 62 lbs. Price Antique Brown Mahy. \$36.00. Price, Antique Amer. Walnut \$36.75. Write for liberal jobber and dealers discounts.



Radio Console No. 505

Exclusive United States Sales Representatives
SANFORD BROS.

CHICAGO, ILL.
39 W. Walton Place

CHATTANOOGA, TENN.
815 Broad St.

SEATTLE, WASH.
Amer. Bank Bldg.

SAN FRANCISCO, CAL.
311 Minna St.

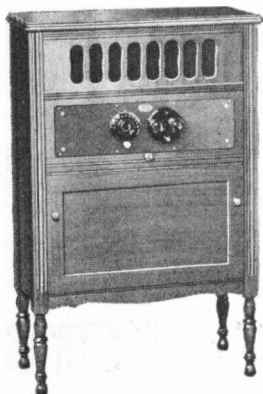

PLYMOUTH Radio Furniture Sells Readily and Makes You a Profit

because it is REAL FURNITURE properly designed and finished and stays sold.

Prices moderate. Liberal dealer discounts. The model 200 illustrated is designed to house either the Atwater Kent 20 or 30. Other consoles for other models and different makes of receivers.

Prompt Delivery.

Plymouth Furniture Co.
25 Juneau Ave.,
Milwaukee, Wis.

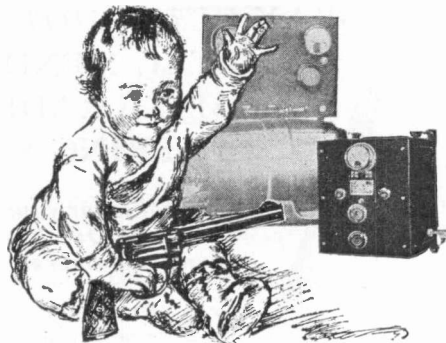

WOULD YOU GIVE A BABY A LOADED PISTOL FOR A PLAYTHING?

INEXPERIENCED employees can operate the Heyer "Twin Six" 12-hour Charger without danger or damage. Chargers that must have a special power line installed and that require expert knowledge to keep from ruining batteries by forcing them at high charging rates are in a class with the LOADED PISTOL.

Some batteries can be charged in 6 to 8 hours but may break down under the 50 to 75 ampere current that rushes through them. So much damage has been done by forcing that Battery Companies have sent special warnings to service stations specifically stating that initial charging must be done with a series system (low current) and not with a C.P. charger (high current).

The "Twin Six" 12-hour series system charges batteries new, old, sulphated, every size and kind—and the investment is only \$144 . . . not \$400.

TWIN SIX 12 HOUR CHARGER

Authorized and Licensed Under HEYER System of Battery Charging and Testing.

CONSOLIDATED EQUIPMENT CORPORATION
160 Grand Street, New York, N. Y.

HARTUNG CLIPS

Continuous Circuit
-Bulldog Grip

A Silent Salesman for Your Counter

This radio clip display carton will make sales for you day in and day out. It's always on the job. You make a bigger profit on its sales, too, for its contents are priced to you just as though you were buying each size clip in quantity.



Order from your jobber today, or let us send you a trial carton direct.

C. F. Hartung Co.
728 East 61st St.
Los Angeles, Calif.

\$10 Loud Speaker

You can sell, at \$10, the most satisfactory loud speaker that money can buy—the new, improved Dulce-Tone, the perfected radio-talking-machine-speaker.

Set the talking machine needle in the Dulce-Tone reed, plug in, and you have the full volume, the beautiful clear tone that only Dulce-Tone and a talking machine can give.

THE GENERAL INDUSTRIES COMPANY
Dulce-Tone Division
Formerly named THE GENERAL PHONOGRAPH MFG. CO.
310 Taylor St., Elyria, Ohio

Fully guaranteed to you and your customers. Nationally advertised in the Saturday Evening Post, Literary Digest and Liberty.

Write for sample and dealer's prices.



MOTO-RAY QUICK HOT METAL MENDERS MAKE RADIO SOLDERING EASY

Valuable for your service men. Quick sales to your customers.

QUICK HOT operates from any low voltage wet battery circuit, heating instantly when circuit is closed. High resistance in carbon point prevents current waste.

Retail Price complete (with 2 points) \$2.75

Packed securely in wood container

No chance for heat or current to flow into your set.

Ask for literature.

Moto-Ray Mfg. Co., Inc.
169 Massachusetts Ave., Boston, Mass.

The Electric Welding Principle Applied to Soldering

We made it for you!



EVERY one of your radio customers will be pleased to have one of these "I Want to Know" booklets—chock full of the latest, up-to-the-minute radio information.

Write Today—the supply is limited

WHOLESALE EXCLUSIVELY
LUDWIG HOMMEL & CO
929 PENN AVENUE PITTSBURGH, PA.

For really dependable "A" battery current

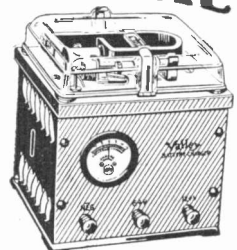

Valley Chargers

VALLEY ELECTRIC COMPANY, ST. LOUIS, MO.

New Harkness Counterflex Models

Better than ever for 1927

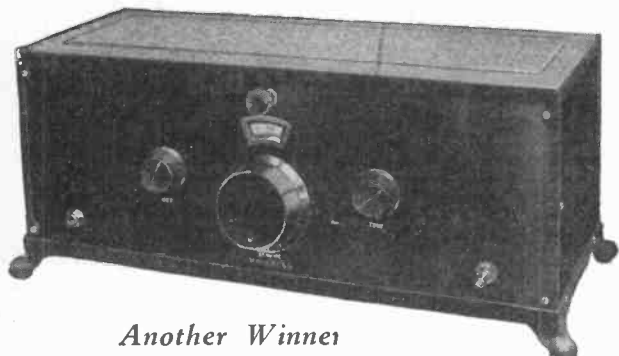

Another Winner

The Improved 5 Tube

Single dial tuning

A truly remarkable set, which will do everything the most critical fan could demand. Simplicity itself in operation, the last word in tone quality, volume and selectivity.

Kit, \$47.50 Complete parts and simplified instructions.	Chassis \$55.00 for use in special cabinet	Set \$62.50 7x18-in. cabinet, as shown.
--	--	---

These prices are list. Jobbers and Dealers—write for attractive discounts.

FREE—A special 16-page Harkness Book with complete illustrations, diagrams, etc., will be mailed on request.

The Radio Guild, Inc.

241-243 Market St.

Newark, N. J.

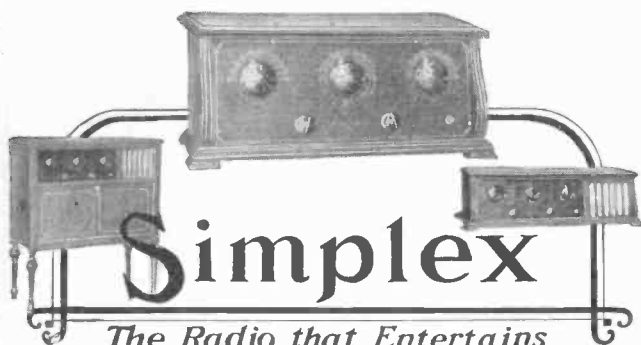

Simplex

The Radio that Entertains

Talk Price and Sell Quality

A good receiver at a fair price—that's Simplex all over. Built to suit Avenue tastes and Main Street pocketbooks. Result: volume sales.

The Simplex 5-tube tuned radio frequency circuit housed in a Walnut finish cabinet is performance in its party clothes.

Simplex SR 9.....	\$ 65
Simplex Console.....	95
Simplex Console.....	125
Simplex Console Grande.....	185

Write Today for Liberal Dealer Proposition

Simplex Radio Company

Main and Rector Streets
Philadelphia, Pa.

35 years' experience behind these sets.

The
FINE-ARTS
FULL SIZE
CONE SPEAKER
Retail \$15.00

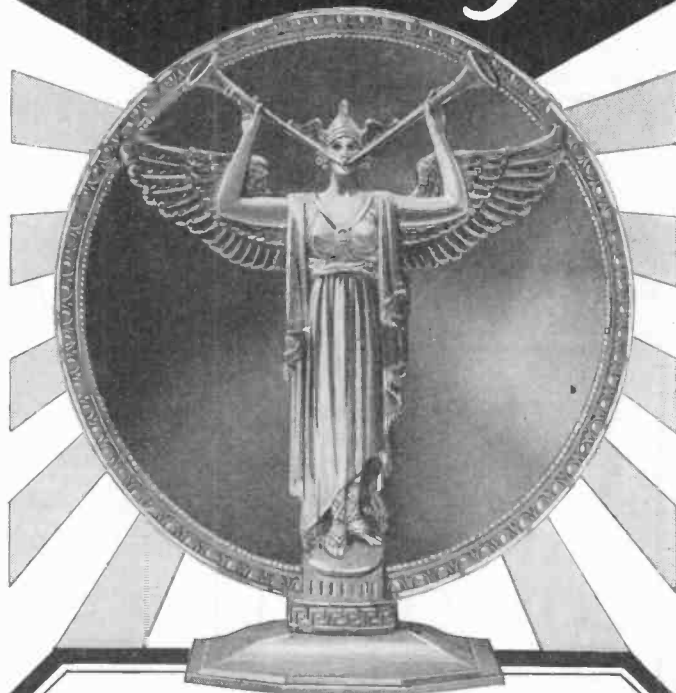

**Designed right—Built right
Priced right—Guaranteed**

Beautiful in appearance—amazing in its tonal qualities. Designed by Frank D. Lewis, pioneer Cone Speaker scientist—and built by the Plaza Music Company, with twenty years of experience in manufacturing and merchandising musical products.

The specially designed powerful unit will take any voltage you can give it. The one-piece seamless diaphragm is made of a specially treated fabric which is absolutely immune to all atmospheric changes. The frame is a fine aluminum and is finished in a rich antique bronze and russet.

It gives full \$35 value for \$15.

Size: Height 15½ inches
Diameter 17½ inches

JOBBERS: Write for our proposition

PLAZA MUSIC CO.
10 WEST 20th ST. NEW YORK

SEARCHLIGHT SECTION

SURPLUS STOCKS—BUSINESS OPPORTUNITIES

UNDISPLAYED—RATE PER WORD:
 Positions Wanted, 6 cents a word, minimum \$1.25 an insertion, payable in advance.
 Positions Vacant and all other classifications, 10 cents a word, minimum charge \$2.00.
 Proposals, 40 cents a line an insertion.

INFORMATION:
 Box Numbers in care of any of our offices count 10 words additional in undisplayed ads.
 Discount of 10% if one payment is made in advance for four consecutive insertions of undisplayed ads (not including proposals).

DISPLAYED—RATE PER INCH:
 1 to 3 inches.....\$6.65 an inch
 4 to 7 inches..... 8.40 an inch
 8 to 14 inches..... 6.20 an inch
 Rates for larger spaces, or yearly rates, on request.
 An advertising inch is measured vertically on one column, 3 columns—30 inches—to a page.

Radio Retailing

SPECIALTIES

Dealers

Don't turn away customers who want transmitting and short wave supplies. Write for our "Ham-List" and discounts. We job a complete line. Curtis Sales Company, 1109 Eighth Avenue, Fort Worth, Texas.

FOR SALE

One Western Electric Power Amplifier with 3-216 A tubes, model 518 W. Speaker in good condition, \$50. PS-24, Radio Retailing, 7 So. Dearborn St., Chicago, Ill.

Surplus Radio Wanted CABINETS CONSOLES SETS, Etc.

Submit samples, etc.
 Oldest and largest surplus buyers in America.

Established 1921

RESIDENT RADIO BUYERS

82-84 W. Broadway, N. Y.

Phone Walker 1778

Also Electrical and Hardware

SPOT CASH FOR ANY QUANTITY

Surplus Stock of Radio Sets and Accessories

RADIO PRODUCTS MFG. CO.
 1020 Washington St., Boston, Mass.

W E P A Y	<i>Liquidate Your Surplus</i>	C A S H
	RADIO STOCK	
	Highest prices paid for surplus radio cabinets, sets and parts. Any quantity.	
	What have you to sell?	
	GENERAL RADIO SET CO. 74 Cortlandt St., N. Y. C.	

Your Overstock is a Dead Investment

Move it at a Profit!!

The Searchlight Section of RADIO RETAILING recognizes the need and convenience of a National "center" where dealers everywhere can bring their overstocks to the attention of others—or can ask for what they wish to buy.

"Searchlight" advertising will help you as a dealer to sell *at a profit* merchandise that otherwise would be a dead loss. And it will help the far-away customer *get something he wants*. Thus both dealer and customer benefit.

This ad.

ONE Western Electric Power Amplifier for sale with three 216 A tubes and Model 518 W speaker, in good condition, \$50.00. Owen Bros. Hardware Co., Shelbyville, Ky.

—brought

this letter from the advertiser:

"We have today received P. O. Money Order for Amplifier from Radio Co. of Little Rock, Ark., as result of our ad in RADIO RETAILING. *Good work!*"

Get your overstocks into the Searchlight Section of the next issue of RADIO RETAILING. The cost will be small.

ALPHABETICAL INDEX TO ADVERTISEMENTS

	Page		Page		Page
A-C Electrical Mfg. Co.	120	Electrad Inc.	92	Paragon Electric Co.	100
Acme Wire Co.	92	Electrophone Corp.	138	Perryman Elec. Co.	112
Algonquin Electric Co., Inc.	71	Fansteel Products Co., Inc.	115	Plaza Music Co.	141
Allen-Bradley Co.	93	Farrand Mfg. Co., Inc.	108	Plymouth Furniture Co.	139
Alter, Harry Co.	138	Federal-Brandes Corp.	12-13	Polymet Mfg. Corp.	84
American Bosch Magneto Corp.	125	Federal Radio Corp.	10	Positions Wanted	142
American Insulator Corp.	94	Ferranti, Inc.	86	Precision Prod. Co.	114
Amoroso Mfg. Co.	134	Fleron & Son, M. M.	138	Premier Radio Corp., The	118
Amplion Corp. of America	136	France Mfg. Co.	6	Prest-O-Lite Co., Inc.	145
Amrad Corp.	19	Freed-Blisemann Radio Corp.	103	Priess Radio Corp.	145
Amsco Prod., Inc.	91	Freshman Co., Inc., Chas.	20	Radio Corp. of America	62-63-Back Cover
Andrea, F. A. D.	113	Prost, Herbert H., Inc.	96	Radio Guild, Inc.	141
Anylite Elec. Co.	114	General Electric Co.	121	Radio Master Corp.	14-15
Apeo Mfg. Co.	Inside Back Cover	General Industries Co.	140	Reliable Parts Mfg. Co., The	90
Atwater Kent Mfg. Co.	30	General Radio Co.	97	Rockford Sales Corp.	8, 9
Bakelite Corp.	24-25	Gillfillan Bros., Inc.	126	Sandar Corp.	23
Beaver Machine & Tool Co.	96	Gold Seal Electrical Co.	104	Sanford Bros.	139
Beede Electrical Inst. Co.	92	Goodrich Tire & Rubber Co.	100	Searchlight Section	142
Benjamin Electric Mfg. Co.	144	Gould Storage Battery Co., Inc.	122	Shamrock Mfg. Co.	27
Borkman Radio Corp.	132	Grebe, A. H. & Co., Inc.	3	Showers Bros. Co.	124
Boudette Mfg. Co.	131	Guerrier Radio Corp.	137	Sickles Co., F. W.	98
Brach Mfg. Co., L. S.	123	Hanscom Radio Devices	143	Silver Marshall	95
Briggs & Stratton Corp.	Inside Front Cover	Hammarlund-Roberts, Inc.	18	Simplex Radio Co. (Philadelphia, Pa.)	141
Bristol Co., The	134	Hartman Electrical Mfg. Co.	28	Slagle Radio Co.	119
Burton-Rogers Co.	139	Hartung Co., C. F.	140	Standard Plano Bench Mfg. Co.	136
C. E. Mfg. Co.	114	Hazeltine Corp.	116	St. James Lab. Inc.	98
Chicago Nipple Mfg. Co.	137	Hommel & Co., Ludwig	140	Sterling Mfg. Co.	102
Clearstone Radio Co.	21	Indiana Mfg. & Electric Co.	111	Stevens & Co., A. J.	139
Consolidated Equipment Corp.	139	International Resistance Co.	100	Stromberg-Carlson Tel. Mfg. Co.	2
Cooper Corp.	127	Jewell Elec. Instrument Co.	136	Swan-Haverstick, Inc.	117
Cornish Wire Co.	94	Ken-Rad Corp., Inc.	7	Sylvania Prod. Co.	16
Crosley Radio Corp.	79	Langbein-Kaufman Radio Co., The	130	Timmons Radio Products Corp.	133
Cunningham, Inc., E. T.	Front Cover	Lone Wolf Radio Corp.	126	Tower Mfg. Corp.	5
Deutschmann Co., Tobe	94	Martin Co., Glenn L.	26	Udell Works, Inc.	138
DeWitt-La France Co.	136	Martin Copeland Co.	80	United Radio & Electric Corp.	17
Arthur Dorsey	96	Mohawk Corp. of Ill.	110	Universal Winding Co.	94
Dry Storage Battery Corp.	107	Moto-Ray Mfg. Co.	140	Utah Radio Products Co.	1
Dubilier Condenser and Radio Corp.	88-98	Mu-Rad Radio Corp.	126	Valley Electric Co.	140
Dudlo Mfg. Corp.	99	Music Master Corp.	4	Vesta Battery Corp.	29
Eagle Charger Corp.	106	National Carbon Co., Inc.	22	W-K Electric Co.	132
Eby Mfg. Co., H. H.	82	National Lead Battery Co.	129	Weston Elec'l Inst. Corp.	128
Edelmann & Co., E.	128			Windsor Furniture Co.	101
Electric Service Supplies Co.	130			Wireless Specialty Apparatus Co.	98
Electric Storage Battery Co.	109				
Electrical Research Laboratories	105				

Used and Surplus Equipment

INDIVIDUAL items of used equipment, or surplus new equipment, or complete plants, are disposed of (and found) through advertising in the *Searchlight* Section of this paper.

This is the section which so effectively aided the Government in selling the many millions of dollars worth of surplus material and equipment accumulated during the war without disturbing the market.

"SEARCHLIGHT"

Good bye Batteries!

The
**SUPERUNIT
SIX**
(Electric)

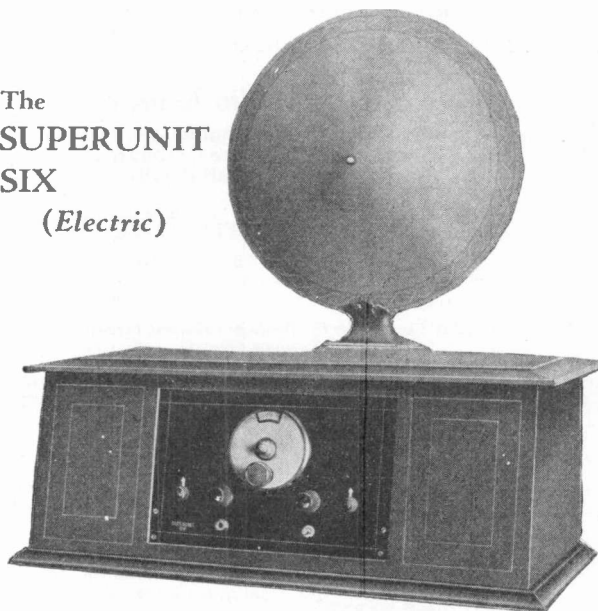

A set using five UX199 tubes and one UX171 which operates on a standard Raytheon Eliminator!

NO BATTERIES—A, B or C

Ample power from your lamp socket, a power tube for quality and no worry!

DEALERS—This set lists at \$95.00. Add a Raytheon eliminator, tubes and a speaker and your installation is complete. Has your competitor anything as good to offer at the price? *Circular on Request.*

HANSCOM RADIO DEVICES
Dept. R., Woonsocket, R. I., U. S. A.

Leadership

in Retailing with Benjamin Radio Products



All Benjamin Radio Products are of the same high standard as the far-famed Cle-Ra-Tone Sockets

Half of the success in retailing depends upon quality and value of the merchandise sold. The other 50% rests upon the business sagacity of the retailer himself.

But for thousands of dealers Benjamin Radio Products have done more than furnish their half in stimulating success and making profits. Honestly better products, made to work efficiently and manufactured with high scientific accuracy, have won public acceptance for the dealer and Benjamin through a comparison of results obtained.

So Benjamin retailers have found it easy to build up and keep a leadership in quality, sales and profits.

Rewards for Radio Reasoners

Awards for novel and original hook-ups, modifications of existing circuits; trade names; slogans. Write our nearest office for full details.

Benjamin Electric Mfg. Co.

120-128 S. Sangamon St. Chicago
 New York 247 W. 17th Street
 San Francisco 448 Bryant Street

Manufactured in Canada by the Benjamin Electric Mfg. Co. of Canada, Ltd., Toronto, Ontario

Improved Tuned Radio Frequency Transformers



Proved through exhaustive and comparative tests to be the most efficient coil for modern radio sets. Better in all important features and characteristics. Space wound. Basket weave. Cylindrical. Highest practical air dielectric. Gives wonderful sharpness in tuning, better volume and purer tone.

2 1/4-inch Diameter Transformer

Compact. Especially desirable for crowded assembly. Eliminates interfering "pick-up."

3-inch Diameter Transformer

Capacity coupling reduced to lowest degree. For use with .00035 Mfd. Condensers.

"Lekeless" Transformers

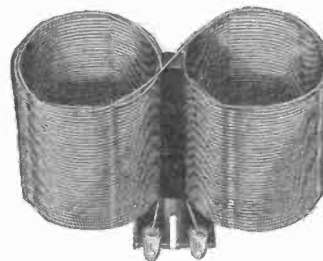

Uniform high inductance, low distributed capacity and low resistance. The external field is so slight that it permits placing coils close together without appreciable interaction. Improvement in tone, volume and selectivity.

Cle-Ra-Tone Spring Supported, Shock-Absorbing Sockets

Stops Tube Noises—Anti-Microphonic. The greatest aid to non-noisy operation. One-piece suspension spring and contact member. Positive tube to terminal connection.

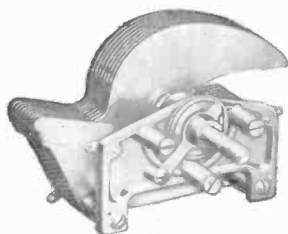
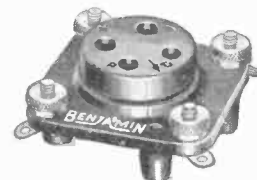

Straight Line Frequency Condensers

No crowding of stations. The broadcast range is spread evenly over the dial. Adjustable turning tension. Beautiful in appearance—a credit to the looks and efficiency of any set. Finished in dull silver. Made in three sizes: .00025 Mfd.; .00035 Mfd.; .0005 Mfd.



Brackets

An aid to simplification in set construction. Supports sub-panel, with room underneath for accessories and wiring. Plain and adjustable.

Battery Switch

Quick, positive, clean-cut make and break. When it's "in" it's "off," eliminating danger and wasteful use of battery.



The *WORLD'S MOST* **POWERFUL** *Battery Charger*



\$12.50

For rapid charging—for better operating performance—for the greatest "A" Battery Charger value ever offered—see the new APCO. At the high charging rate of $7\frac{1}{2}$ amperes per hour (the most powerful known), it packs a wealth of strength into the "A" battery—quickly and without noise.

There are no bulbs to burn out, no jars to fill, nothing to get out of order. Just attach

to lamp socket and "A" battery and the APCO will *quickly* do the rest.

The APCO direct-to-dealer plan protects the dealer and assures bigger profits. APCO products are sold only through APCO Franchise Dealers.

Your territory may be open. Write today for our attractive dealer proposition.

APCO MANUFACTURING COMPANY
 PROVIDENCE, R. I.



NEW YORK

PHILADELPHIA

DETROIT

CHICAGO





Every Christmas Shopper

is a prospect for Radiotron sales

1. for the set he has
2. for the set he buys
3. for gift-giving

RCA Radiotrons are the year-round bread-and-butter business of the reliable radio dealer. And practically every Radiotron in the list is a big Christmas seller.

Every Christmas shopper knows Radiotron quality and reads Radiotron ads he can't miss them



RADIO CORPORATION OF AMERICA
New York Chicago San Francisco

RCA Radiotron

MADE BY THE MAKERS OF THE RADIOLA