

SPECIAL SERVICE FEATURE ISSUE

Formerly

**RADIO &
TELEVISION
NEWS**

**APRIL
1957
35 CENTS**

RADIO & TV NEWS

World's Leading Electronics Magazine

**1957 AUTO RADIOS—
CHEVROLET**

WHY LOUDNESS CONTROL?

FUNCTIONAL WORK BENCH

**BOTTLENECKS
IN TV SERVICE**

**QUESTIONS AND ANSWERS
ON OSCILLOSCOPES**

CONELRAD THE EASY WAY

**PHOTOFLASH
SYNCHRONIZER CHECKER**

**TEST EQUIPMENT ►
FOR THE COLOR SHOP**
(See Page 45)

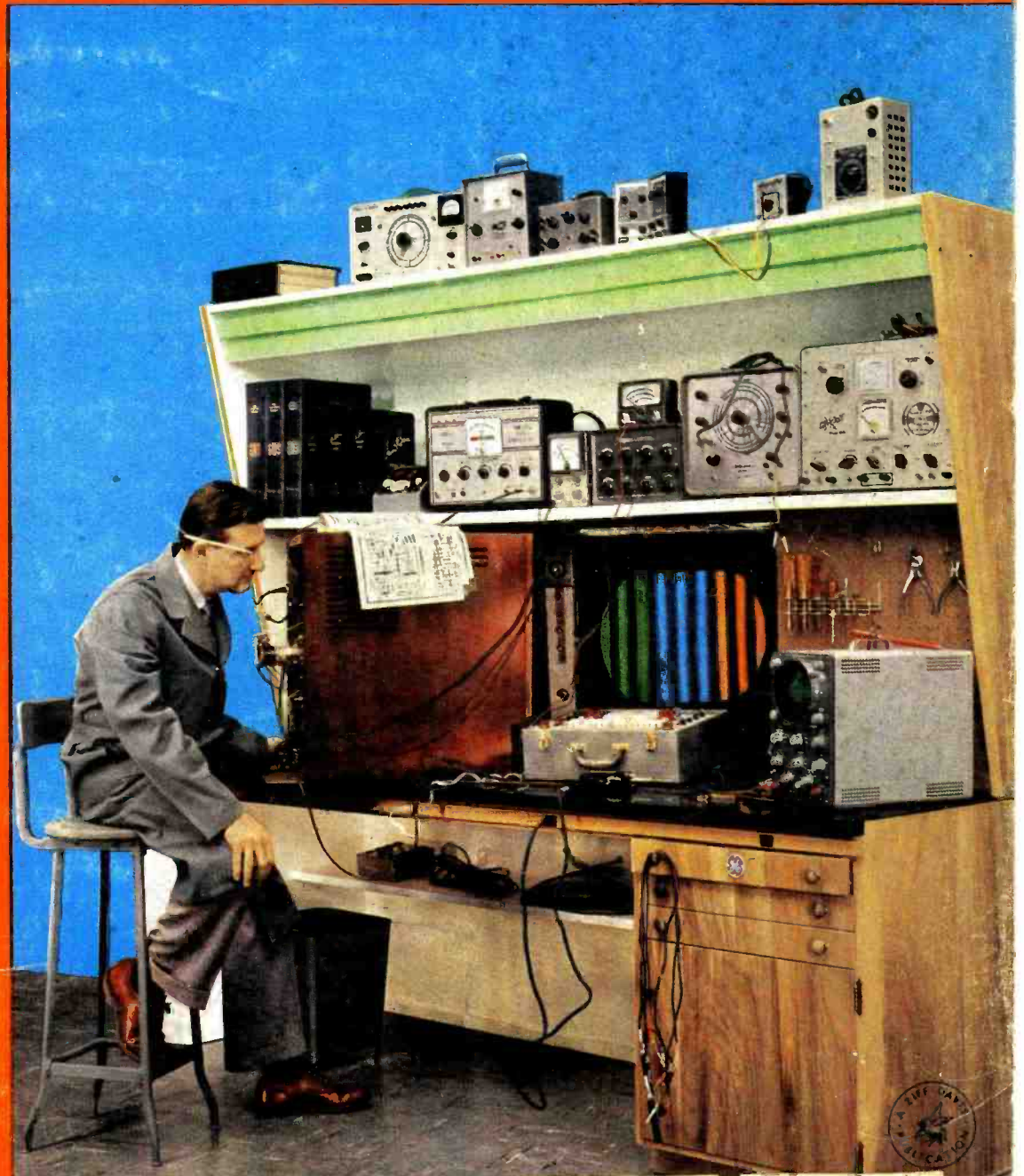

RECEIVED
APR 11 1957
Hudson Radio Svc
913 Emma St
Trenton MO
44-35-102118-78



Independent Service Dealers:

TV-RADIO SERVICE IS YOUR BUSINESS

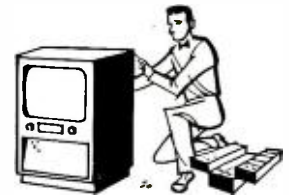

SERVING YOU IS OUR BUSINESS

That's why we say, use Raytheon TV and Radio Tubes for your replacement work. We have no "captive service" organizations to compete with you for TV and Radio service business — we leave the service business to *you*. Serving *you* is our only interest.

First, we serve you with the finest TV and Radio Tubes — Raytheon Tubes — designed to meet the varying needs of the many set manufacturers and

perform perfectly in all makes and models of sets.

Second, we serve you Raytheon Tubes promptly and efficiently through a network of *independent* Raytheon Tube Distributors with trained personnel eager to help *independent* dealers in every way.

Third, we serve you with the exclusive Raytheon Bonded Electronic Technician Program. If you can qualify, you become

part of a nationally recognized and advertised organization, *yet you retain your own independence*. As a Raytheon Bonded Electronic Technician, you're identified as a dependable businessman capable of fast, efficient TV and Radio service on all makes and models of sets. You will have the exclusive Western Union "Operator 25" tie-in bringing business to you, along with many other important advantages.

Ask your Raytheon Sponsoring Bonded Tube Distributor to give you the Raytheon Bonded story.



RAYTHEON MANUFACTURING COMPANY
 Receiving and Cathode Ray Tube Operations
 Newton, Mass. • Chicago, Ill. • Atlanta, Ga. • Los Angeles, Calif.

Raytheon makes all these { Receiving and Picture Tubes, Reliable Subminiature and Miniature Tubes, Semiconductor Diodes and Transistors, Nucleonic Tubes, Microwave Tubes.

Excellence in Electronics

You Practice **SERVICING** with Kits I Send You



Nothing takes the place of PRACTICAL EXPERIENCE. That's why NRI training is based on LEARNING BY DOING. You use parts I send to build many circuits common to Radio and Television. With my Servicing Course you build the modern Radio shown at left. You build a Multitester and use it to help make \$10. \$15 a week fixing sets in spare time while training. All equipment is yours to keep. Coupon below will bring book of important facts. It shows other equipment you build.

You Practice **BROADCASTING** with Kits I Send You



As part of my Communications Course I send you parts to build low-power Broadcasting Transmitter at left. Use it to get practical experience. You put this station "on the air" . . . perform procedures demanded of broadcasting station operators. An FCC Commercial Operator's License can be your ticket to a bright future. My Communications Course trains you to get your license. Mail coupon. Book shows other equipment you build for practical experience.

I Will Train You at Home in Spare Time to be a **RADIO-TELEVISION** Technician



TELEVISION

Making Jobs, Prosperity

25 million homes have Television sets now. Thousands more sold every week. Trained men needed to make, install, service TV sets. About 200 television stations on the air. Hundreds more being built. Good job opportunities here for qualified technicians, operators, etc.



America's Fast Growing Industry Offers You Good Pay, Success

Training PLUS opportunity is the PERFECT COMBINATION for job security, advancement. When times are good, the trained man makes the BETTER PAY, gets PROMOTED. When jobs are scarce, the trained man enjoys GREATER SECURITY. NRI training can help assure you and your family more of the better things of life. Radio is bigger than ever with over 3,000 broadcasting stations and more than 115 MILLION sets in use, and Television is moving ahead fast.

J. E. SMITH, President
National Radio Institute
Washington, D. C.

Our 40th Year

N.R.I. Training Leads to Good Jobs Like These

I TRAINED THESE MEN



"I have progressed very rapidly. My present position is Studio Supervisor with KEDD Television, Wichita."—Elmer Frewaldt, 3026 Stadium, Wichita, Kans.

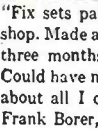

"Fix sets part time in my shop. Made about \$500 first three months of the year. Could have more but this is about all I can handle."—Frank Borer, Lorain, Ohio.



"I've come a long way in Radio and Television since graduating. Have my own business on Main Street."—Joe Travers, Asbury Park, New Jersey.



"I didn't know a thing about Radio. Now have a good job as Studio Engineer at KMMJ."—Bill Delzell, Central City, Nebraska.



BROADCASTING: Chief Technician, Chief Operator, Power Monitor, Recording Operator, Remote Control Operator. **SERVICING:** Home and Auto Radios, Television Receivers, FM Radios, P.A. Systems. **IN RADIO PLANTS:** Design Assistant, Technician, Tester, Serviceman, Service Manager. **SHIP AND HARBOR RADIO:** Chief Operator, Radio-Telephone Operator. **GOVERNMENT RADIO:** Operator in Army, Navy, Marine Corps, Forestry Service Dispatcher, Airways Radio Operator. **AVIATION RADIO:** Transmitter Technician, Receiver Technician, Airport Transmitter Operator. **TELEVISION:** Pick-up Operator, Television Technician, Remote Control Operator.

Start Soon to Make \$10, \$15 a Week Extra Fixing Sets

My training is practical, complete; is backed by 40 years of success training men at home. My well-illustrated lessons give you basic principles you need and my skillfully developed kits of parts "bring to life" things you learn from the lessons. I start sending you special booklets the day you enroll, that show you how to fix sets. Multitester you build with my parts helps you discover and correct set troubles, helps you make money fixing neighbors' sets in spare time while training. Many make \$10, \$15 a week extra this way.

Mail Coupon — Find Out What Radio-Television Offer You

Act now to get more of the good things of life. I send actual lesson to prove NRI home training is practical, thorough. My 64-page book "How to be a Success in Radio-Television" shows what my graduates are doing and earning. It gives important facts about your opportunities in Radio-

AVAILABLE to all qualified VETERANS UNDER G. I. BILLS

Television. Take NRI training for as little as \$5 a month. Many graduates make more than the total cost of my training in two weeks. Mail coupon now to: J. E. SMITH, President, Dept. 7DD4, National Radio Institute, Washington 9, D. C. Our 40th year.

Good for Both - FREE

MR. J. E. SMITH, President, Dept. 7DD4
National Radio Institute, Washington 9, D. C.
Mail me Sample Lesson and 64-page Book, FREE.
(No salesman will call. Please write plainly.)

Name..... Age.....
Address.....
City..... Zone..... State.....

VETS write in date of discharge



Mail Today - Tested Way to Better Pay

RADIO & TV NEWS is published monthly by Ziff-Davis Publishing Company, William B. Ziff, Chairman of the Board (1946-1953), at 64 E. Lake St., Chicago 1, Ill. Entered as second-class matter July 21, 1948, at the Post Office, Chicago, Ill., under the act of March 3, 1879. Authorized by Post Office Department, Ottawa, Canada, as second-class matter. **SUBSCRIPTION RATES:** one year U. S. and possessions, and Canada \$4.00; Pan American Union Countries \$4.50; all other foreign countries \$5.00.

Publisher
OLIVER READ, D.Sc., WIETI
Editor
WM. A. STOCKLIN, B. S.
Technical Editor
MILTON S. SNITZER
Service Editor
SIDNEY C. SILVER
Associate Editor
P. B. HOEFER
Assistant Editor
J. JUSTER
Television Consultant
WALTER H. BUCHSBAUM
Art Editor
HERBERT ASCHER
Art and Drafting Dept.
J. A. GOLANEK
W. K. VAHLING
JAMES A. ROTH
Advertising Director
L. L. OSTEN
Advertising Manager
MURRAY GOLDMAN
Midwest Adv. Manager
JOHN A. RONAN, JR.
Western Adv. Manager
JOHN E. PAYNE



COVER PHOTO: A "service engineered" test bench, designed by General Electric, speeds servicing by improving efficiency of shop. See plans for building bench on page 51 and suggestions on selecting test equipment, page 45. (Ektachrome by Burns Photography Inc.)

ZIFF-DAVIS PUBLISHING COMPANY

President
B. G. DAVIS
Vice-President
H. J. MORGANROTH
Vice-President
M. H. FROELICH
Vice-President & Circulation Dir.
M. MICHAELSON
Secretary-Treasurer
G. E. CARNEY
Art Director
AL GRUEN

BRANCH OFFICES

CHICAGO (11)
 64 E. Lake St., AN 3-5200
 LOS ANGELES (14)
 215 W. 7th St. (Room 412) Triality 8043

*First in radio-
 television-audio-electronics*

Average Net Paid Circulation 258,790



Reg. U. S. Pat. Off.
 Radio & Television News • Radio News • Television News Trademarks Reg. U. S. Pat. Off.

CONTENTS

APRIL, 1957

EDITORIAL-INDUSTRY NEWS

For the Record.....	O. Read	8
Spot Radio News.....	Washington Correspondent	12
New TV Grants Since Freeze Lift.....		12
Earth Satellite's "Innards" Described.....		76
New Home Warning Device Tested.....		80
TV Cameras for Surgical Colorcasts.....		121
Calendar of Events.....		127

HIGH FIDELITY AND AUDIO

Why Loudness Control?.....	Norman H. Crowhurst	42
A New Hi-Fi Speaker System.....		54
Certified Record Revue.....	Bert Whyte	60
The HF-60—A New Power Amplifier.....		64
Additional Notes on "Professional Tape Recording Amplifier".....	Maurice P. Johnson	103
Ionic Cloud High-Frequency Speaker.....		105
Wireless FM Microphone.....		106
New Hi-Fi—Audio Equipment.....		128

SERVICING

Television-Radio

1957 Auto Radios: Chevrolet.....		37
Bottlenecks in TV Service.....	John B. Ledbetter	40
The Functional Work Bench.....	S. E. McCallum	51
Do-It-Yourself Service Center.....	William Leonard	52
G-E's Large-Screen Color Sets.....	Robert Gary	53
Upgrading and Accrediting Technicians.....	Paul B. Zbar	56
Up-to-Date Tube Inventory for Service Shops.....	Murray Barlowe	67
Facing the Phase Detector.....	Bob Eldridge	70
Mac's Service Shop.....	John T. Frye	72
Antenna News.....		118
Service Technician Prestige Sells Sets.....		144
Service Industry News.....		154

Test Equipment

Test Equipment for Color TV Shops.....	Walter H. Buchsbaum	45
The Case for the CRT Tester-Reactivator.....	Art Margolis	48
Questions and Answers on Oscilloscopes.....	Robert G. Middleton	58
New Tube-Tester Data.....		74

AMATEUR AND COMMUNICATIONS

A Two-Terminal Test Oscillator.....	Bob Leonard	61
Adjustable Half-Wave Filter.....	Harry D. Hoofon, W6TYH	62
Conelrad the Easy Way.....	John T. Frye, W9EGV	66
Mary Burke, W3CUL, Wins 1956 Edison Award.....		78
Ninth National ARRL Convention.....		100

ELECTRONIC CONSTRUCTION

Photoflash Synchronizer Checker.....	W. F. Gephart	68
--------------------------------------	---------------	----

DEPARTMENTS

Within the Industry.....	28	Sales Aids.....	138
Technical Books.....	114	What's New in Radio.....	148
		Manufacturers' Literature.....	163



ZIFF-DAVIS PUBLISHING COMPANY
 WILLIAM B. ZIFF (1898-1953) FOUNDER
 Executive Office: 366 Madison Ave.
 New York 17, N. Y. MU 7-8080
 Editorial Office: 1 Park Ave.
 New York 16, N. Y. MU 5-6367
 VOLUME 57 • NUMBER 4



Member
 Audit Bureau of
 Circulations

Copyright © 1957 by Ziff-Davis Publishing Company. All rights reserved.

SUBSCRIPTION SERVICE. All communications concerning subscriptions should be addressed to Circulation Dept., 64 E. Lake St., Chicago 1, Ill. Subscribers should allow at least four weeks for change of address. Include your old address as well as new—enclosing, if possible, an address label from a recent issue of this magazine.

CONTRIBUTIONS: Contributors are advised to retain a copy of their manuscripts and illustrations. Contributions should be mailed to the New York Editorial Office and must be accompanied by return postage. Contributions will be handled with reasonable care, but this magazine assumes no responsibility for their safety. Any copy accepted is subject to whatever adaptations and revisions are necessary to meet the requirements of this publication. Payment covers all author's, contributor's, and contestant's rights, title, and interest in and to the material accepted and will be made at our current rates upon acceptance. All photos and drawings will be considered as part of the material purchased.

**DEVRY TECH CAN PREPARE YOU
IN SPARE TIME AT HOME AS AN**

ELECTRONICS TECHNICIAN!



No Previous Technical Experience or Advanced Education Needed!

Laborers and bookkeepers, store clerks, farmers, salesmen — men of nearly every calling — have taken the DeVry program and today have good jobs or service shops of their own in Electronics.

Here's proof positive that it can be done — done by men like yourself — men who had no previous technical experience, no advanced education.

If you are 17 to 55, we will tell you free how you may prepare for exciting, interesting jobs in Automation Electronics, Radar, Guided Missiles, Communications, Industrial Electronics and many others shown at right. Here is a chance of a lifetime to prepare to cash in on one of today's fastest growing fields. Mail the coupon for details.

DeVry Tech's amazingly practical home method enables you to spend minimum time to get maximum knowledge. In fact, you get exactly the same type of basic training equipment used in our Chicago and Toronto training laboratories — among the finest!

Send coupon for free facts NOW!

Live-Wire Employment Service

DeVry Tech's Placement Department is in contact with some of the best-known employers in the Electronics field. The service is free to all graduates—and DeVry Tech's record in helping to place men has been outstanding.



Draft Age?

We have valuable information for every man of draft age; so if you are subject to military service, be sure to check the coupon.

What a DeVry Tech Diploma Meant to These Men!



G. F. Beane, W. Virginia, was a truck driver. He took the DeVry Tech Training Program, and is now a technical electronics sales representative.



Edward Hahn, Illinois. Was a laborer, now an electronics project engineer with Televiso, Inc. DeVry Tech training helped him prepare for his present position.



Nick Barton, Illinois, came directly from high school to DeVry Tech. Now has his own service shop and tells us he is "literally snowed with work."



George D. Crouch, California, was a retail store clerk. He took the DeVry Program, and today is in the servicing field for himself.

"One of North America's Foremost Electronics Training Centers"



Accredited Member of
National Home Study Council

DEVRY TECHNICAL INSTITUTE

CHICAGO 41, ILLINOIS

FORMERLY

DEFOREST'S TRAINING, INC.



AN INDEX

to a
**BETTER JOB,
A BRIGHTER
FUTURE**

COMMUNICATIONS

RADAR

GUIDED
MISSILES

TELEVISION

MICRO-WAVES

RADIO

INDUSTRIAL
ELECTRONICS

COMPUTERS

AUTOMATION
ELECTRONICS

Sample Lesson **FREE!**

See for yourself how DeVry Tech trains you for real opportunities in Electronics. We'll also give you a free copy of an interesting booklet, "Electronics and YOU."



Mail Coupon Today!

DeVry Technical Institute
4141 Belmont Ave., Chicago 41, Ill., Dept. RN-4-M
Please give me FREE Sample Lesson and your booklet, "Electronics and YOU," and tell me how I may prepare to enter one or more branches of Electronics as listed above.

Name _____ Age _____

Street _____ Please Print Apt. _____

City _____ Zone _____ State _____

Check here if subject to military training.

DeVry Tech's Canadian Training Center is located
at 626 Roselawn Avenue, Toronto 12, Ontario
2004

RCA Custom Convertible SPEAKER SYSTEMS

hi-quality... hi-fidelity... anywhere and any way you like it!

Soft and sweet or loud and lively... in your den or in your living room, RCA CUSTOM CONVERTIBLE SPEAKER SYSTEMS offer *the finest in sound satisfaction.*

Buy with confidence! RCA CUSTOM CONVERTIBLE SPEAKER SYSTEMS through exclusive RCA bottom-porting,

are readily convertible for use as INFINITE Baffle... Bass Reflex... Corner Driver... to suit your room acoustics, and your personal taste. Custom-built appearance is readily obtainable... panels and grill cloths can be removed and interchanged easily for matching or contrasting effects.

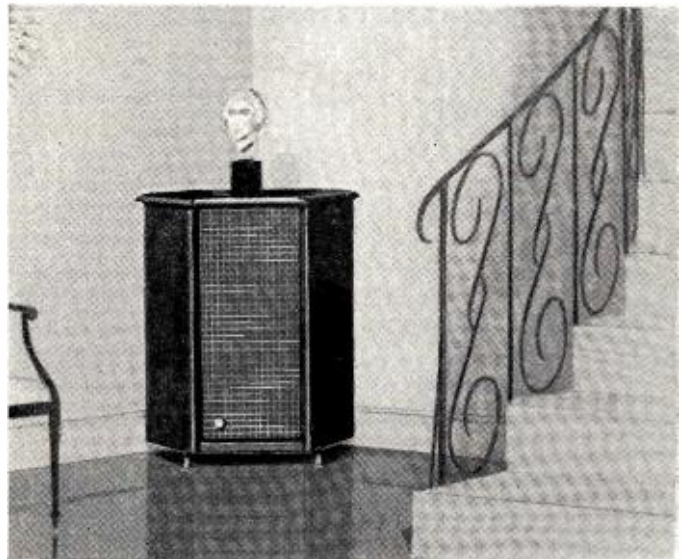
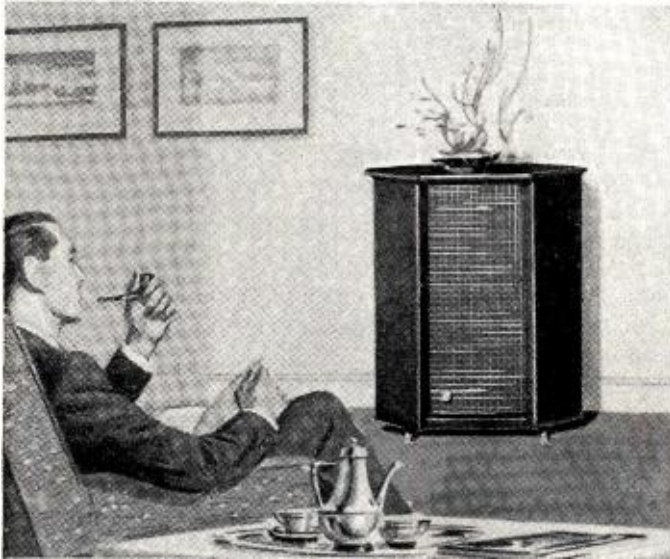

RCA 50151 Bixial Speaker—compares with models two or three times the price! Features 14.5 ounce Alnico-V magnet and 8-ohm voice coil. Its 12-inch woofer employs



Olson-developed foam damping ring; 3-inch tweeter is mounted off-axis to minimize crossover interference; high frequency response extends beyond 18,000 cps.

Suggested User Price (optional) \$33.50

RCA 50251 Direct Radiator Speaker—outstandingly smooth, unsurpassed in its frequency range to 16,000 cps. Features same construction as 50151 and incorporates



medium-weight curved cone for smoothness, range, damping, and sensitivity to equal sound pressure of higher power speakers using double the power input.

Suggested User Price (optional) \$25.25

RCA Enclosures—Beauty in cherry or blonde cabinetry, the solid Honduras Mahogany will enhance room decor with the expensive look and feel of fine woods. Built for a lifetime of use, RCA enclosures feature mortise-and-tenon joints, glue-block

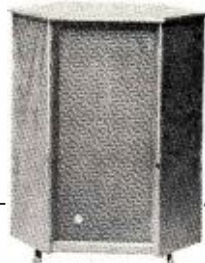

reinforcements and wood-screw clamping. For 12-inch speakers.

Suggested User 300W1 Cherry \$69.95
Price (optional) 301W1 Blonde \$74.50

301X1 Adapter Panel—converts 12-inch enclosures for use with 8-inch speakers.
Suggested User Price (optional) \$2.45



RADIO CORPORATION of AMERICA

COMPONENTS DIVISION

CAMDEN, N. J.

RCA SPEAKERS FOR TV • RADIO • PHONOGRAPH • HIGH FIDELITY • PUBLIC ADDRESS • AT RCA DISTRIBUTORS EVERYWHERE!

Here's a NEW Way to Reach the Top in TV SERVICING

**ALL PRACTICE METHOD—
PROFESSIONAL TECHNIQUES**

Includes 17" picture tube, all other tubes, components for TV receiver. Also 5 inch professional type Scope and highly accurate Signal Generator. Training low in cost; monthly terms.



IF YOU HAVE some Radio or Television experience, or if you know basic Radio-Television principles but lack experience—NRI's Professional Television Servicing course can equip you to go places in TV servicing. This advertisement is your personal invitation to get a free copy of our booklet which describes this training in detail.

Graduate C. Dority of Silver Spring, Md. says: "Your course is so thorough that anyone interested in the challenge of servicing shouldn't miss this opportunity. I can find my way around a TV Chassis as easy as I can my own home as a result of your course."
James D. McIngvale of Lake Cormorant, Miss. says: "I have serviced about 95% of common TV complaints. A year ago I would not have known where to start. I can now fix a Television receiver defect in minutes when it used to take hours."

You Get COLOR TV Textbooks Early

The day you enroll, N.R.I. sends you special Color-TV books to speed your knowledge and understanding of this vast, growing phase of Television. Many full color pictures and diagrams help you recognize defects and help you learn how to correct them quickly and properly. To cash in on the coming color TV boom you'll need the kind of knowledge and experience this N.R.I. training gives.

YOU LEARN-BY-DOING "ALL THE WAY"

This is 100% learn-by-doing, practical training. We supply all the components, all tubes, including a 17" picture tube, and comprehensive manuals covering a thoroughly planned program of practice. You learn how experts diagnose TV receiver defects quickly. You see how various defects affect the performance of a TV receiver—picture, sound and color: learn to know the causes of defects, accurately, easily, and how to fix them.

You do more than just build circuits. You get practice recognizing, isolating and fixing innumerable TV receiver troubles. You get actual experience aligning TV receivers, eliminating interference, using germanium crystals to rectify the TV picture signal, obtaining maximum brightness and definition by properly adjusting the ion trap and centering magnets, etc. There isn't room to list all the servicing experience you get.

Get Details Free—Mail Coupon

Once again—if you want to go places in TV servicing, we invite you to find out what you get, what you practice, what you learn from NRI's course in Professional Television Servicing. See pictures of equipment supplied, read what you practice. Judge for yourself whether this training will further your ambition to reach the top in TV servicing. We believe it will. We believe many of tomorrow's top TV servicemen . . . for black and white, UHF and Color TV . . . will be graduates of this N.R.I. training. Mail the coupon now. There is no obligation. National Radio Institute, Dept. 7DET, Washington 9, D. C.

Oldest and Largest Home Study Radio-Television School



**National Radio Institute,
Dept. 7DET, N.W., Washington 9, D.C.**

Please send my FREE copy of "How to Reach the Top in TV Servicing." I understand no salesman will call.

Name Age

Address

City Zone State

Accredited Member National Home Study Council

KLEIN

THE THRILL THAT
ONLY GOOD TOOLS
CAN GIVE



The radio ham, serviceman or designer knows that the most important tools in his kit are Klein Pliers—long nose, oblique cutters, side cutters.

The quality of the work you do depends in no small measure on the quality of the tools you use. Your reputation as a craftsman is protected when your pliers carry the Klein trademark.



100 years of service to linemen, electricians and industry is back of this new Pocket Tool Guide No. 100. A copy will be sent to you upon request, without obligation.

Mathias **KLEIN** & Sons
Established 1857
7200 McCORMICK ROAD • CHICAGO 45, ILLINOIS

For the RECORD.

SERVICE INDUSTRY: YEAR OF CHANGE

WITH this fourth annual issue in which we take special note of the interests of radio, TV, and electronic service technicians in our contents, it is surely appropriate to assess the status of the industry in some sort of perspective. As in other years, technicians have devoted a great deal of time to the pros and cons of licensing, business ethics, and factory service. Such perennial issues aside, it is hard to recall a year during which there has been greater change in the character of the service industry.

One important turning point was passed without much fanfare: The service industry, now doing business in the billions, took in more consumer dollars over the past year than were put into the purchase of new receivers. Accelerated interest in color and other changes may alter this picture, of course, but the fact remains that the service technician, as a principal purchaser of replacement components, must be courted more earnestly than ever by the manufacturers of components, including those who, in past years, have ignored the technician while going after the more lucrative original-component market.

This change, bound to occur, was just one facet of the increasing recognition being accorded to the technician and the increasing honor being paid him. He continues to be saluted with a "week" or a "month" in his honor, under the sponsorship of *ECA*, *G-E*, and other manufacturers. This year, manufacturers have been joined by government: Arizona TV Serviceman's Week, proclaimed by Governor McFarland, was celebrated the week of March 4th.

Recognition in a more realistic direction has also been evident. Incensed by a program of factory service they considered to be unfairly competitive, service technicians throughout the country raised a strong voice of protest. The manufacturer involved, *G-E*, heard the voice. Anxious to maintain the good-will of the independents, *G-E* called a conference in New York for the express purpose of giving assurance of its good intentions and promising to implement this assurance with an improved parts supply situation, sponsorship of increased educational programs for independent service, and an emphatic halt to the type of advertising that technicians had considered derogatory to them.

If this is the year in which the technician seems to have come of age in so many ways, one would expect that

it was a year of great stability, and that the industry had at last begun to settle into a clearly defined pattern. Nothing could be further from the truth. In fact, it is difficult to recall many years in which there have been more changes.

Increasingly aware that it cannot live by TV alone, the industry has been striking about for new fields. Diversification has become a byword; the technician has learned that his field is electronics, not television. The range of new avenues being explored includes industrial systems, medical electronics, small-appliance service, closed-circuit TV, and marine electronics.

In exploring these new fields, the technician is up against equipment that is often maintained on a contract basis by the manufacturer of that equipment himself. In some cases, this blocks the independent; in others, the manufacturer, unwillingly in the service business to provide needed support for his product, encourages the entry of competition. Even more important a roadblock is the size of the service business seeking new fields. Can a *small* independent compete in a large-scale sphere? He can if he merges with other small shops to form a single larger establishment. There is evidence of a trend in this direction.

Also instrumental in the trend toward merger is the difficulty in procuring and holding skilled technicians. The rate of flow from the small shop to the large plant or factory is alarming—at least to the independent who is interested in growth. The heavy percentage of graduates from technical training institutes who go immediately into industry confirms this trend. The owner of the independent shop is caught between the salary he must pay a good man to keep him and the schedule of charges for services beyond which the customer will rebel.

Partly as an outgrowth of the labor shortage, independent service is re-appraising its stand, in many quarters, on the do-it-yourself-trend. Advising the amateur fixer and selling him parts can be done with less personnel, prevents the service bill from going too high, and keeps the customer from running to the distributor or the drug store. Besides, say supporters of this new view, you can't buck a trend. "If you can't beat 'em, join 'em!"

Whatever else may be said of the service industry, it is certainly not standing still—nor will it stand still. Rapid change—the sign of vigor—is still the keynote.....O.R.

ALLIED'S 1957

value-packed 356-page

CATALOG

free!

the only **COMPLETE** catalog
for everything in electronics

World's Most Complete Stocks

- Latest Hi-Fi Systems and Components
 - Super-Value KNIGHT-KITS
- P.A. Systems & Accessories • Recorders & Supplies • TV Tubes, Antennas, Accessories
 - Amateur Receivers, Transmitters, Station Gear • Test and Lab Instruments
 - Specialized Industrial Electronic Equipment • Huge Listings of Parts, Tubes, Transistors, Tools and Books . . .

Get ALLIED's 1957 Catalog—it's *complete*, up-to-date—356 pages packed with the world's largest selection of quality electronic equipment at lowest, money-saving prices. Get *every* buying advantage at ALLIED: fastest shipment, expert personal help, lowest prices and guaranteed satisfaction . . .

send for the leading electronic supply guide



Our 35th year

ALLIED RADIO

World's Largest Electronic Supply House

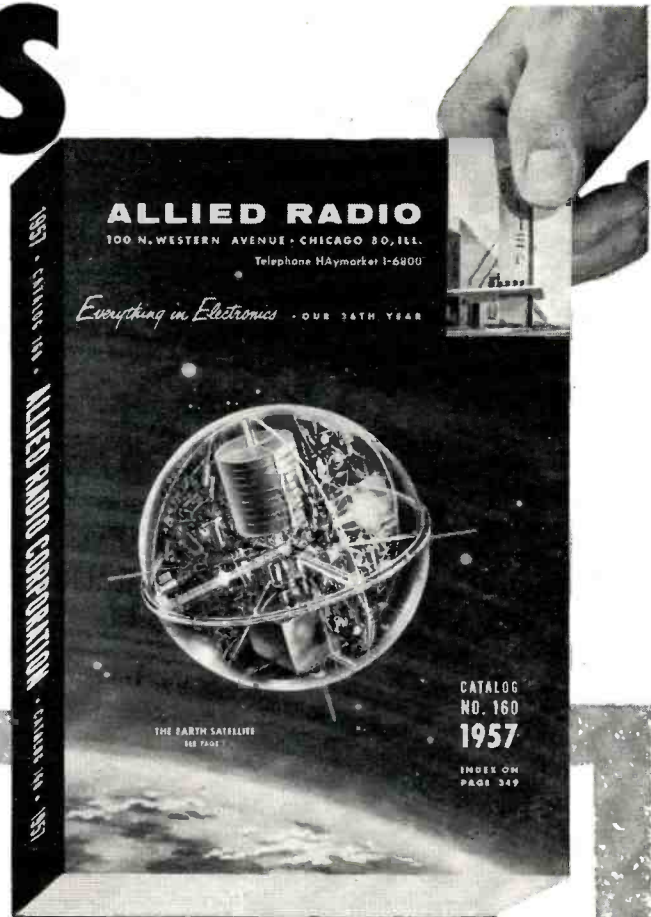

FEATURING

SUPER-VALUE knight-kits

The very finest electronic equipment in money-saving kit form—Test Instruments, Hi-Fi Kits, Ham Kits, Hobbyist Kits. Easiest to build and you SAVE MORE!

EVERYTHING IN HI-FI:

World's largest selection of quality Hi-Fi components and complete music systems. MORE PEOPLE BUY THEIR HI-FI FROM ALLIED THAN ANYWHERE ELSE IN THE WORLD!

EASY-PAY TERMS:

Only 10% down, up to 18 months to pay. Available on orders over \$45. Fast handling—no red tape.



ALLIED RADIO CORP., Dept. 1-B-7
100 N. Western Ave., Chicago 80, Ill.

Send FREE 356-Page 1957 ALLIED Catalog

Name.....

Address.....

City..... Zone..... State.....

Fluxvalve

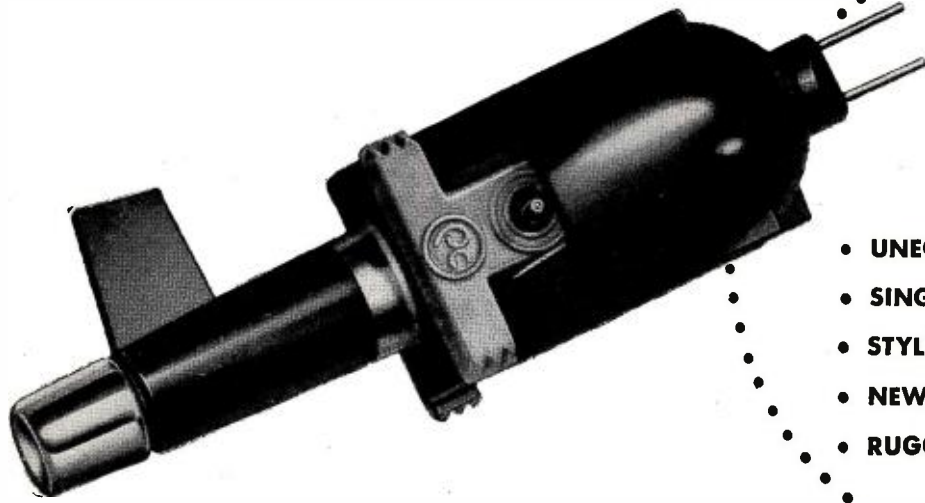

*the
pickup
with*

- UNEQUALLED FLEXIBILITY
- SINGLE OR DOUBLE PLAY
- STYLI EASILY REPLACED
- NEW ANTI-HUM DESIGN
- RUGGED CONSTRUCTION

The only pickup...

**you can custom tailor to fulfill
all requirements for optimum,
unequalled play-back performance
of every record in your collection**

**ONLY THE FLUXVALVE OFFERS ALL
THESE SIGNIFICANT FEATURES:**

High compliance with low vibrating mass . . . unexcelled transient response . . . flat frequency response well beyond both ends of audible frequency . . . unequalled definition and clarity, each instrument or voice is individually distinguishable . . . complete absence of resonances in the audio frequency . . . low overall distortion . . . anti-hum design . . . stylus changing is easy; no tools . . . hermetically sealed cartridge body.

**EXAMINE THESE
EXCLUSIVE FEATURES:**

half mil single play
half mil-1 mil double play
half mil-2½ mil double play
plus: { 1 mil-2½ mil double play
1 mil single play
2½ mil single play

*Enjoy a new listening pleasure and experience . . . ask your dealer to demonstrate
the Fluxvalve . . . words cannot describe the difference . . . but you will hear it!*



PICKERING & CO., INC. OCEANSIDE, N. Y.

Professional Audio Components

"For those who can hear the difference"

Demonstrated and sold by Leading Radio Parts Distributors everywhere. For the one nearest you and for detailed literature: write Dept.

EXPORT: AD. AURIEMA, INC., 89 BROAD ST., NEW YORK / CANADA: CHARLES W. POINTON LTD., 6 ALCINA AVE., TORONTO

ELECTRO-VOICE
Low-Frequency
Drivers



Model 18WK,
Net \$115



Model 18 W,
Net \$115



Model 15WK,
Net \$85



Model 15W,
Net \$85



Model 15BWK,
Net \$43



Model 15BW,
Net \$43



Model 12WK,
Net \$65



Model 12W,
Net \$65



Model 12BW,
Net \$33

ELECTRO-VOICE
TRX Extended-Range
Integrated 3-Way
Loudspeaker Systems



Model 15TRX,
Net \$145



Model 15TRXB,
Net \$79



Model 12TRX,
Net \$120



Model 12TRXB,
Net \$64

ELECTRO-VOICE
Radax Coaxial Integrated
Full-Range
2-Way Loudspeaker
Systems



Model SP15,
Net \$85



Model SP15B,
Net \$43



Model SP12,
Net \$65



Model SP12B,
Net \$33



Model SP8B,
Net \$29.50



Electro-Voice

HIGH-FIDELITY SPEAKERS

Outperform, Outsell Them All!

First in sales of Hi-Fi Equipment, the most complete line of High Fidelity Speakers.

ELECTRO-VOICE manufactures the most complete high-fidelity product family . . . speakers, speaker systems, speaker enclosures, amplifiers, preamps, tuners, phono cartridges, do-it-yourself enclosure kits, and microphones. Available at leading high fidelity distributors.

See, Hear Electro-Voice — Today's Best Selling High Fidelity — At Your E-V Hi-Fi Dealer Today!

Write for Catalog 118-N74.

Electro-Voice®

ELECTRO-VOICE, INC. • BUCHANAN, MICHIGAN

Canada: E-V of Canada, Ltd., 73 Crockford Boulevard, Scarborough, Ontario
Export: 13 East 40th Street, New York 16, U. S. A. Cables: ARLAB

ELECTRO-VOICE
Mid-Bass
Driver-Horn
Assembly



Model 828HF with
A8419, Net \$28

ELECTRO-VOICE
Coaxial Mid-Range
Drivers



Model 848HF,
Net \$52



Model 847HF,
Net \$33

ELECTRO-VOICE
Diffraction Horns



Model 6HD,
Net \$22



Model 8HD,
Net \$18

ELECTRO-VOICE
H-F Drivers



Model T25A,
Net \$58



Model T10A,
Net \$42.50

ELECTRO-VOICE
Super-Sonax
Very-High-Frequency
Drivers



Model T35,
Net \$33



Model T35B,
Net \$21

Free

TRIAD SERVICE AID NO. 1



PTM Service Aid No. 1 is a convenient, easy-to-read wall chart listing the logical steps which the Professional Television Man should use to pinpoint the defective sweep component when faced with a "lost raster." Get your free copy from your distributor, or write to us. Supply is limited.



4055 REDWOOD AVENUE
VENICE, CALIFORNIA

812 EAST STATE STREET
HUNTINGTON, INDIANA

A SUBSIDIARY OF LITTON INDUSTRIES

Spot Radio News

★ Presenting latest information on the Radio Industry.

By RADIO & TELEVISION NEWS
WASHINGTON EDITOR

MICROWAVES, THE NEW WORKHORSE OF RADIO now being sought by an increasing number of radio and TV broadcasters and an unending list of public and private agencies, is now on trial in Washington.

The tremendous demand for these upstairs channels (890 to 13,000 megacycles) has jammed the Commission's hearing schedule and dictated a fact-finding session that will provide a pattern for the future use and requirements of the microwave belt.

A variety of advantages has been responsible for the rising popularity of the microwave signals. They can be directed to any selected spot within view of the transmitter and, by means of successive repeater stations, relayed over added distances. Microwave communications can be in the form of voice and telegraph correspondence, also teletype, facsimile, and TV-relay services. Further, microwave facilities permit push-button observation of industrial and other business operations, and remote control of devices throughout a system. By methods known as multiplexing, many messages or functions may be handled simultaneously over a single microwave channel.

Because of their position in the radio spectrum, microwaves are not affected in the same way by weather and man-made interference as are radio services operating on lower fre-

quencies. In turn, their straight-line directivity permits the same channel to be used by parallel systems transmitting different kinds of information. Microwave systems are usually more economical to install and maintain, as compared to wire lines, where a substantial number of communication channels are required, or a single broad communication channel, such as television, is involved. Also, since the transmitter energy may be concentrated and pointed, microwave requires comparatively little transmitter power.

A major part of the nationwide TV program network operates over microwave systems provided by the telephone companies. In other cases, where such facilities are not available from the telephone companies, individual TV stations have installed their own private microwave relay systems.

Also serving TV are the microwave links which carry programs from the local city studios of a broadcaster to the distant transmitter site of the TV broadcast station. Portable and mobile microwave transmitters make it possible to pick up news, sports, and other events outside of the regular studios and deliver them to the transmitter.

Microwave adjuncts for TV broadcasting, other than intercity circuits operated by common carriers, operate in bands at 2000, 7000, and 13,000 megacycles.

NEW TV GRANTS SINCE FREEZE LIFT

Continuing the listing of construction permits granted by FCC since lifting of freeze. Additional stations will be carried next month.

STATE	CITY	CALL	CHANNEL	FREQUENCY	POWER*
Alabama	Florence	41	632-638	15.8
Utah	Provo	11	198-204	1.38
Wyoming	Casper	6	82-88	12.87

NEW CALL LETTER ASSIGNMENTS

STATE	CITY	CALL	CHANNEL	FREQUENCY
Connecticut	New Britain	WNBC (Formerly WKNB-TV)	30	566-572
Kentucky	Paducah	WPSD-TV (Formerly WPSD)	6	82-88

* ERP = (effective radiated power, kw.)

Money-Making
FCC
 Commercial
 Radio Operator
LICENSE
 Information

FREE

tells
 how

WE GUARANTEE
 TO TRAIN AND COACH YOU AT HOME IN
 SPARE TIME UNTIL YOU GET
YOUR FCC LICENSE

**HERE IS YOUR
 GUARANTEE**

If you fail to pass your Commercial License exam after completing our course, we guarantee to continue your training without additional cost of any kind, until you successfully obtain your Commercial license.

If you have had any practical experience—Amateur, Army, Navy, Radio repair, or experimenting.

**EFFECTIVE
 JOB FINDING
 SERVICE HELPS CIRE
 TRAINEES GET
 BETTER JOBS**

OUR TRAINEES GET JOBS LIKE THESE EVERY MONTH

AIRLINES

In a year and a half, he received his first class FCC license. He isn't through yet. He is continuing his training with Cleveland Institute. His goal is much higher than his present position with Eastern Airlines, so, he is adding technical "know-how" to his practical experience. You can be sure he will go far.
 Bob Thompson, 2935 Ironwood Drive,
 Nashville 14, Tenn.

and install an interoffice phone system. In the space of 14 months, he completed the Master Course and received his first class license. He is now installing and maintaining mobile and microwave equipment.
 James S. Glen, Jr., 2920 Knob Hill Road,
 Tacoma, Wash.

TEST ENGINEER

"I am pleased to inform you that I recently secured a position as Test Engineer with Melpar, Inc. (Subsidiary of Westinghouse). A substantial salary increase was involved. My Cleveland Institute training played a major role in qualifying me for this position."
 Boyd Daugherty, 105 Goodwin Ct.,
 Apt. C, Falls Church, Va.

MOBILE SERVICING

When Jim enrolled, he was a temporary employee of the City of Tacoma, Washington. He was helping wire

**HERE'S PROOF
 FCC LICENSES
 ARE OFTEN SECURED
 IN A FEW HOURS
 WITH OUR
 COACHING**

**HERE'S PROOF FCC LICENSES ARE OFTEN SECURED
 IN A FEW HOURS WITH OUR COACHING**

Name and Address	License	Time
John H. Johnson, Boise City, Oklahoma	1st Class	20 Weeks
Prentice Harrison, Lewes, Delaware	1st Class	27 Weeks
Thomas J. Bingham, Finley, North Dakota	2nd Class	9 Weeks
William F. Masterson, Key West, Florida	2nd Class	24 Weeks
J. A. Niedeck, Bethlehem, Pa.	2nd Class	8 Weeks

**EMPLOYERS
 MAKE JOB OFFERS
 LIKE THESE TO OUR
 GRADUATES EVERY
 MONTH**

**EMPLOYERS MAKE JOB OFFERS LIKE THESE
 TO OUR GRADUATES EVERY MONTH**

BROADCAST STATION IN ILLINOIS: "We are in need of an engineer with a first class phone license, preferably a student of Cleveland Institute of Radio Electronics; 40 hour week plus 8 hours overtime."
WEST COAST MANUFACTURER: "We are currently in need of men with electronics training or experience in radar maintenance. We would appreciate your referral of interested persons to us."

OURS IS THE ONLY HOME STUDY COURSE WHICH SUPPLIES FCC-TYPE EXAMINATIONS WITH ALL LESSONS AND FINAL TESTS.

**Your FCC Ticket
 is recognized by
 employers as proof
 of your
 technical ability**
 Accredited by
 National Home Study Council

MAIL COUPON TODAY

Cleveland Institute of Radio Electronics
 Desk RN-4, 4900 Euclid Bldg., Cleveland 3, Ohio

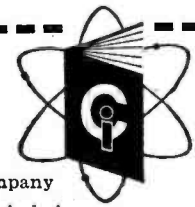

Please send Free Booklets prepared to help me get ahead in Electronics.
 I have had training or experience in Electronics as indicated below:

<input type="checkbox"/> Military	<input type="checkbox"/> Amateur Radio	<input type="checkbox"/> Telephone Company
<input type="checkbox"/> Radio-Tv Servicing	<input type="checkbox"/> Broadcasting	<input type="checkbox"/> Other
<input type="checkbox"/> Manufacturing	<input type="checkbox"/> Home Experimenting	

In what kind of work are you now engaged?.....
 In what branch of Electronics are you interested?.....
 Name..... Age..... Address.....
 City..... Zone..... State.....
 Special Tuition Rates to Members of Armed Forces



Cleveland Institute of
 Radio Electronics
 Desk RN-4, 4900 Euclid Bldg.
 Cleveland 3, Ohio



UNI-DIRECTIONAL

"MONOPLEX"

MODEL 737A



SEMI-DIRECTIONAL

"SONODYNE"

MODEL 51



BI-DIRECTIONAL

"GRADIENT"

MODEL 315

You have your choice of three

SHURE

moderately priced general-purpose microphones

Where quality is essential, yet cost is a factor—you can rely on these SHURE Microphones

FOR PUBLIC ADDRESS • HOME RECORDING • COMMUNICATIONS • PAGING AND INTERCOM SYSTEMS

MODEL 737A "MONOPLEX": Uni-directional, moisture-proofed crystal microphone—reduces feedback by 67%! Can be used under adverse conditions of background noise where conventional microphones would be practically useless. "Humi-seal" Crystal for trouble-free operation even in humid climates. High impedance unit with excellent response to 10,000 cps. Output -54.0 db.

LIST PRICE \$46.00

MODEL 51 "SONODYNE": Semi-directional, dynamic microphone. Switch for low, medium, or high impedance makes it three microphones in one! Ideal for recording and "close-talking" applications. Frequency response is 60-10,000 cps, Output -52.5 db. Unusually rugged microphone; can be used in any climate, indoors or outdoors.

LIST PRICE \$49.50

MODEL 315 "GRADIENT": Bi-directional high fidelity microphone with multi-impedance switch. Picks up sound equally from front and rear; is "dead" at sides. Ideal for interview broadcasting or group recording. Frequency response 50-12,000 cps. Provides exceptional voice and music reproduction. Particularly useful in installations where feedback is a problem. Output -57 db.

LIST PRICE \$85.00

All three units have rugged, die-cast metal cases and are finished in a rich satin chrome.

SHURE BROTHERS, INC.

Microphones — Electronic Components

210 HARTREY AVENUE • EVANSTON, ILLINOIS

"In Electronics Since 1925"

www.americanradiohistory.com

Common carrier use of microwaves has become commonplace. Microwave links constitute about half of the telephone company's national coaxial cable-microwave network. In addition to relaying TV programs, the telephone company system can carry up to 600 two-way conversations at the same time on a pair of microwave channels.

It is in the non-common-carrier and non-broadcast services that the most varied utilization of microwave facilities is found. That is because practically all forms of communication, which can be converted into electric impulses, can be sent by microwave. Consequently, certain industries and business establishments harness microwaves for many purposes. With it, they can direct various activities at remote points. These field installations can, in turn, automatically report pertinent information back to the control office.

Thus, the central station in a microwave system can start, stop, slow, or speed unattended equipment; open and close valves; record pressure, temperature, engine speed, rate of processing and other data; telemeter voltage, current and power; locate line faults; and perform other supervisory functions.

Many public utilities, such as power systems and oil and gas pipelines, depend upon microwave to control installations along the way. Pipelines constitute about two-thirds of the present route mileage of all private microwave systems, and power utilities about one-fourth. One petroleum chain extends from Texas to New York, a distance of 1700 miles. Some other systems are more than a thousand miles in length.

Railroads also employ microwave for signalling and other traffic controls. Radar operation on land and water also involves some incidental microwave utilization. Some private microwave systems provide more than 100 channels for voice communication.

Private microwave operation, at present, is mostly in the 2000- to 6000-megacycle range.

Federal, state, county, and municipal governments find microwave systems a valuable adjunct in handling police, fire, highway maintenance, special emergency, conservation, civil defense, and general administrative matters. One example of Federal use is the Bonneville Power Administration. Microwave also serves to control traffic and otherwise helps in the operation of state highways; examples are the Pennsylvania, New Jersey, and Ohio turnpikes.

Over-the-horizon or tropospheric scatter techniques have recently demonstrated that microwaves have possibilities for international communication, as well as for the TV-program relay. In this type of transmission, signals do not follow the curvature of the earth, but go instead in a straight line beyond the horizon into the atmosphere, where some are scattered by the tropospheric layer back to earth far from their origin. In the early part (Continued on page 124)

*the world's finest mast
at today's lowest prices!*

... because only Channel Master
manufactures telescoping masts
in its own steel tubing mill.

CHANNEL MASTER[®] **new SUPER-MAST**

Packed with new features that reduce installation
time... cut costs... deliver sturdier antenna support—
with the greatest convenience and safety.

NEW! EXCLUSIVE! DUAL T-NUT CLAMP

— saves time, cuts costs

Dual Clamp has 2 T-Nuts to accommodate stand-out insulator and locking
bolt. Eliminates nuisance and cost of additional nut buckle straps.

NEW! EXCLUSIVE! FREE TURNING GUY RING AND BEARING FOR EACH SECTION

— can never bind or jam

Extra large square guy ring for greater stability.

COMPLETELY INTERLOCKED

Can't pull out! Each mast section has swaged neck, expanded bottom.

Can't slip down! Each mast section rests on a heavy-duty cotter "plat-
form" pin. Bottoms are notched to automatically align locking-bolt holes.

Can't twist or turn! Sections are securely locked in place by a sturdy
L-Bolt with man sized lever that makes it easier to tighten without tools.

EASY TO TAKE DOWN!

Both the Dual T-Nut Clamp and Guy Rings are positioned below each joint.
This allows the mast to be completely collapsed without removing the
clamp or the stand-out insulator, and without jamming.

see your **CHANNEL MASTER** distributor

Now Channel Master offers
you the widest selection in TV wire.

- New UHF Tubular Transmission Wire
- New 4-Conductor Rotor Wire
- New Low Priced Addition to VHF Flat Ribbon Transmission Line
- New Hank Packaging— 50', 75', 100'



HOT-DIPPED GALVANIZED
ZINC-COATED Inside and Out

Available
in 20, 30,
40, and 50
foot models.
All models
are 16 gauge
for top 2
sections.
Also Available
Straight-Away
telescoping mast
for economy
installations.

CHANNEL MASTER EXTENDS MASSIVE NATIONAL ADVERTISING CAMPAIGN

MILLIONS OF AMERICANS WILL CONTINUE TO
READ AND REMEMBER CHANNEL MASTER LARGE
SIZE ADS IN AMERICA'S LEADING PUBLICATIONS.



CHANNEL MASTER CORP. ELLENVILLE, N. Y.
the world's largest manufacturer of television antennas and accessories

www.americanradiohistory.com

copyright 1957 Channel Master Corp.

®-Trade Mark Reg. U.S. Pat. Off.

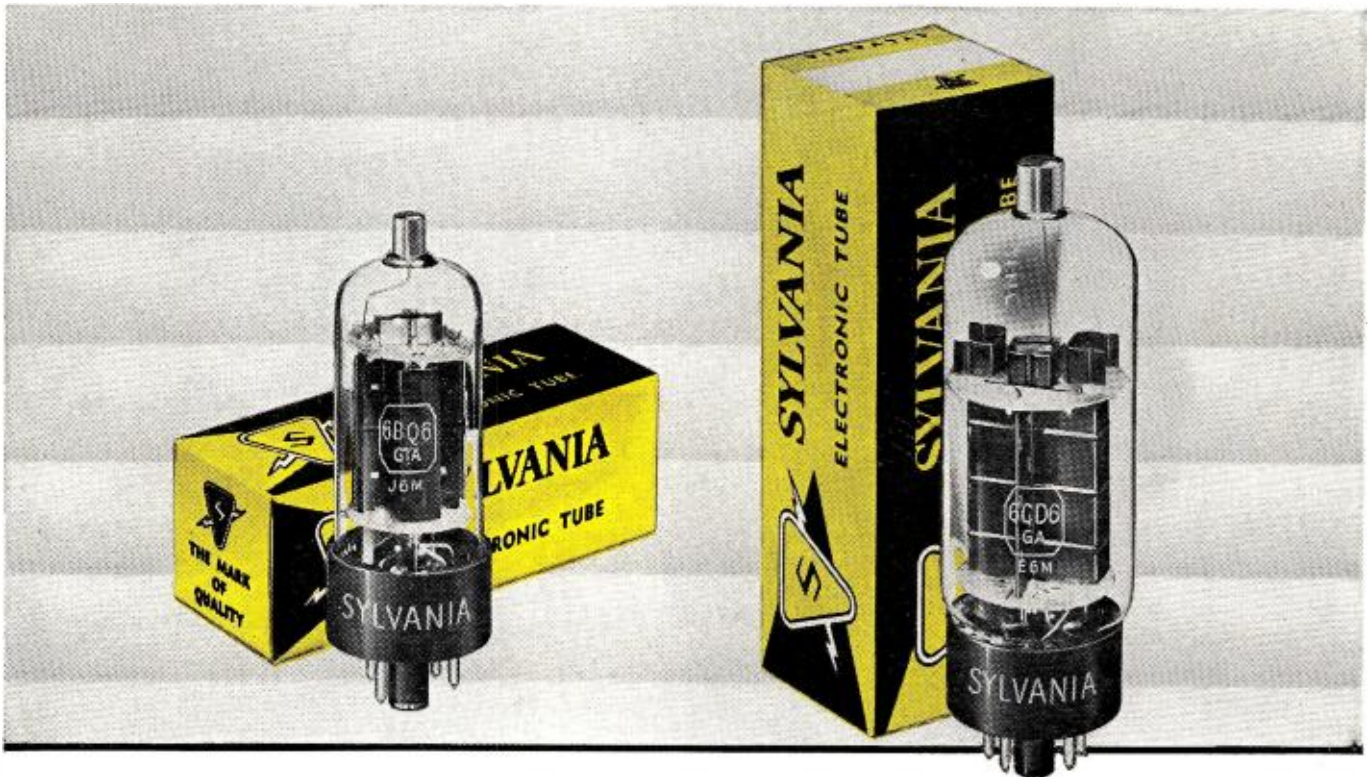

**Here's your first line of defense
against one of TV's biggest service problems**

Sylvania Deflection Tubes

**—upgraded and triple-tested for dependable
performance in TV's hardest working
deflection systems**



Notice how much more rugged the Sylvania wafer stem mount looks (left). That's because the wafer stem results in shorter construction with more points of support and heavier, sturdier leads.

If you haven't yet tried these new Sylvania deflection tubes—you're in for a pleasant and profitable surprise.

They've been carefully redesigned and thoroughly tested to meet the challenge of hard-working deflection systems, tightly engineered circuits and the "runaway" conditions which often result when components age and change in value.

Sylvania's wafer stem construction minimizes the effects of electrolysis resulting from gases driven off by high tube operating conditions. The wafer stem provides wider

spacing between leads and permits the use of heavier lead wires.

The wafer stem adds mechanical ruggedness to these tubes by providing three-point support and reduces internal arcing by increasing the spacing between the plate pigtail lead and the tube mount.

These improvements were made as the result of thorough testing and experimentation to determine points of breakdown in earlier types. Now, these tests serve as important quality control measures for the production of these new deflection types.



SYLVANIA

SYLVANIA ELECTRIC PRODUCTS INC.
1740 Broadway, New York 19, N. Y.
In Canada: Sylvania Electric (Canada) Ltd.
Shell Tower Building, Montreal

LIGHTING • RADIO • ELECTRONICS • TELEVISION • ATOMIC ENERGY



Test No. 1—Static Life Test

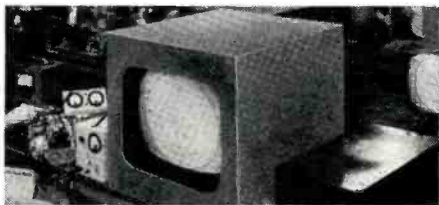

The static life test operates the tube under dc circuit conditions near maximum plate and screen dissipations and dc cathode current. Characteristics are con-

trolled for maximum and minimum values and is considered at the end of its life when characteristics drop below or rise above specified limits.

Test No. 2—TV Life Test

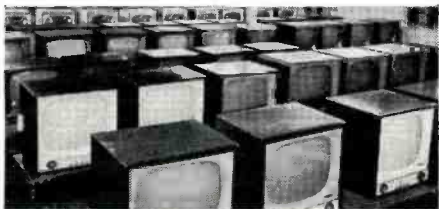

Sylvania deflection tubes are testing in stock models of representative TV manufacturers. Tests are conducted at accelerated line voltages so that tubes are operated at a considerably high level. These

accelerated conditions of 130-volt line increase failure rate 2.37 times to provide important design and production information which results in better quality and dependability for you.

Test No. 3—Dynamic Life Test



These dynamic life test racks enable Sylvania to approximate TV set operating conditions which can be controlled. Thus, an operating standard is established

against which all deflection tubes can be tested.

Look for and specify Sylvania's new deflection tubes in the new carton.

**Learn how you can earn
this famous course
in
COLOR TV SERVICING**

Sylvania has just taken another step in its continuing effort to help the independent radio and TV service dealer. Your Sylvania Distributor can tell you how you can earn the popular Radio-Television Training Association's Color TV Technician course. RTTA is one of the most respected names in home study training methods—has trained thousands in the fundamentals of black-and-white TV and is now doing the same in color servicing.

A Sylvania Exclusive!

When you earn RTTA's color course offered by Sylvania you get a special supplementary lesson in full color. It's a Sylvania extra which serves as a capsule survey of color television which will help you with lesson details.

See your Sylvania Distributor or mail the coupon below and find out how you can start learning color TV right away.



Sylvania Electric Products Inc.
Dept. D34N
1740 Broadway, New York 19, N. Y.

Please send me full details on how I can earn the RTTA home-study course in color TV

Name _____

Service Co. _____

Address _____

City _____

State _____



This General Electric Germanium TV Rectifier is the **QUICK** way to the long-time answer to low voltage problems

Snaps in for easiest installation! Holds full voltage output, without aging! Carries full year's written warranty...and is *competitively priced!*

You can depend on General Electric GERMANIUM rectifiers...because they have a record of over six years of *successful* service in the field. They are presently being used as original equipment by two leading TV Manufacturers, and in other TV sets their performance has been tested and checked by the Howard W. Sams & Company, Inc.

The high efficiency of the germanium junction in these rectifiers provides increased sensitivity and brighter pictures, particularly in low line voltage areas. Unprofitable rectifier callbacks are virtually eliminated by this reliable rectifier, backed by a full year's written warranty.

Installation time is cut to a minimum by its

snap-in-design. The spring clip mounting locks the General Electric rectifier into the hole made for the mounting stud of the original rectifier. You can actually install this new unit in less time than it takes you to remove the old one!

And, on top of everything else, you can sell them at a competitive price. See them today at your General Electric Tube Distributor.

* * *

FREE...REPLACEMENT GUIDE

The General Electric Germanium TV Rectifier REPLACEMENT GUIDE tells you exactly which model fits your customer's set, and is the result of an analysis of all leading sets built since 1953. Only proved replacements are recommended. Get your copy, *free...* at your G-E tube distributor now. Or, write today to *General Electric Company, Semiconductor Products, Section S5847, Syracuse, New York.*



Progress Is Our Most Important Product

GENERAL  **ELECTRIC**

GET IN ON THE TV

BOOM!



L. C. Lane, B.S., M.A.
President, Radio-Television Training Association. Executive Director, Pierce School of Radio & Television.

TRAIN FOR A TOP-PAY JOB AS A TELEVISION TECHNICIAN

NO PREVIOUS EXPERIENCE NEEDED — study AT HOME in your SPARE TIME

Next to the atom and hydrogen bombs, the biggest noise being made today is by the booming radio-television-electronics industry.

Now, while the boom is on in full force, is the time for you to think about how you can share in the high pay and good job security that this ever-expanding field offers to trained technicians.

Just figure it out for yourself. There are more than 490 television broadcasting stations operating right now

and hundreds more to be built; more than 40 million sets in the country and sales increasing daily. Soon moderately priced color television sets will be on the market and the color stampede will be on.

All these facts mean that good jobs will be looking for good men. You can be one of those men if you take advantage of my training now — the same training that has already prepared hundreds of men for successful careers in the radio-television-electronics field.



YOU GET ALL THESE IN THE BASIC COURSE

No experience necessary! You learn by practicing with professional equipment I send you. Many of my graduates who now hold down good paying technician jobs started with only grammar school training.

If you have previous Armed Forces or civilian radio experience you can finish your training several months earlier by taking my FM-TV Technician Course. Train at home with kits of parts, plus equipment to build YOUR OWN TV RECEIVER. ALL FURNISHED AT NO EXTRA COST!

After you finish your home study training in the Radio-FM-TV Technician Course or the FM-TV Technician Course you get two weeks, 50 hours, of intensive Laboratory work on modern electronic equipment at our associate school in New York City, Pierce School of Radio & Television. NO EXTRA COST.

With our TV Studio Technician Course (Advanced training for men with previous radio or TV training or experience) I train you at home for an exciting top-pay job as the man behind the TV camera. Work in the TV studios or "on location" at remote pick-ups! Optional N.Y.C. additional training.

RADIO-FM-TV TECHNICIAN TRAINING

FM-TV TECHNICIAN TRAINING

EXTRA LABORATORY TRAINING IN NEW YORK CITY AT NO EXTRA COST!

TV STUDIO TECHNICIAN TRAINING

LEARN BY DOING—As part of your training I give you the equipment you need to set up your own home service shop and prepare for a BETTER-PAY JOB. You build and keep a Television Receiver designed to take any size picture tube up to 21-inch, (10-inch tube furnished. Slight extra cost for larger sizes.) . . . also a Super-Het Radio Receiver, AF-RF Signal Generator, Combination Voltmeter-Ammeter-Ohmmeter, C-W Telephone Transmitter, Public Address System, AC-DC Power Supply. Everything supplied, including all tubes.

EARN WHILE YOU LEARN—Almost from the very start you can earn extra money while learning by repairing radio-TV sets for friends and neighbors. Many of my students earn enough from spare time earnings to pay for their entire training . . . start their own profitable service business.

FCC COACHING COURSE—Qualifies you for Higher Pay! Given to all my students AT NO EXTRA COST. Helps you qualify for the TOP JOBS in Radio-TV that demand an FCC license! Full training and preparation at home for your FCC license.

VETERANS!

My School fully approved to train Veterans under new Korean G.I. Bill. Don't lose your school benefits by waiting too long. Write discharge date on Postage-Free card below.

CUT OUT AND MAIL TODAY! POSTAGE FREE!

SEE OTHER SIDE

Yours FREE

NO STAMP NEEDED!
WE PAY POSTAGE!

Dear Mr. Lane: Send me your NEW FREE BOOK and FREE SAMPLE LESSON that will show me how I can make TOP MONEY in TELEVISION. I understand I am under no obligation.

(PLEASE PRINT PLAINLY)

Name _____ Age _____

Address _____

City _____ Zone _____ State _____

I AM INTERESTED IN:

- Radio-FM-TV Technician Course
- FM-TV Technician Course
- TV Studio Technician Course
- Color-TV Course

VETERANS!

Write discharge date

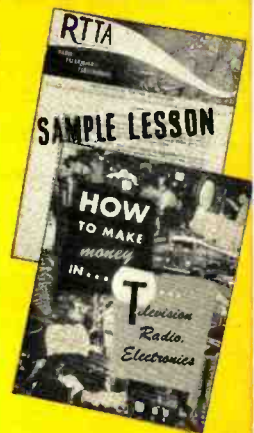

Radio-Television Training Association

52 EAST 19th STREET • NEW YORK 3, N. Y.

Approved by the State of New York • Approved for Veteran Training (Certificate of Eligibility only)

There's a "POT of GOLD" waiting for YOU — at the end of this COLOR-TV servicing rainbow!

Introducing RTTA's COLOR-TV TECHNICIAN COURSE

(advanced training for men who have had radio and TV experience)



Color television receivers will demand installation, set-up, adjustment and servicing by highly trained specialists—training and skill which you can acquire in your spare time, at home through RTTA's up-to-the-minute COLOR TELEVISION TECHNICIAN COURSE. All of the latest information and methods for the servicing and maintenance of all color TV receivers and equipment. Trains you thoroughly, accurately and reliably. You will be on a par with the best, anywhere! **To qualify for this specialized training it is necessary to have had previous radio, television training or experience.**

The step-by-step approach found so successful in teaching our Radio-FM-TV Course, FM-TV Technician Course and TV Studio Technician Course is used in this new, up-to-the-minute COLOR TELEVISION TECHNICIAN COURSE. With the RTTA way, you set your own pace for learning—as rapidly or as moderately as suits your own personal convenience. Lessons are written in easy-to-understand language that everyone can follow. They

are illustrated throughout enabling you to grasp the full meaning of concepts immediately.

The course begins with an introduction to the Laws of Color and defines the differences between the transmission and reception of black-and-white and of color television. Starting at the transmitter you are guided through the development of, and transmission of, the composite Color TV signal. With an over-all view of how the receiver functions each circuit is then analyzed. A knowledge of how Color TV circuits work, both as individual and as cooperative units in the receiver, prepares you for all future developments in the field of Color TV. You also receive thorough instruction on test instruments, alignment, as well as servicing. The RTTA Color TV Course features all of the latest information.

For a complete description of the course, send today for your FREE copy of the RTTA COLOR TV Course Brochure.

SYLVANIA SELECTS RTTA's COLOR TELEVISION COURSE FOR ITS EDUCATIONAL PROGRAM



Service dealers throughout the U.S. will soon be able to learn Color Television from the best available information.

The selection of RTTA's COLOR TELEVISION COURSE by Sylvania Tube Division, one of the nation's top manufacturers of receiving tubes and picture tubes is an added assurance to you of the tremendous value of this course. We are proud of this endorsement by Sylvania. It indicates the outstanding merit of the RTTA course. We know that a company such as Sylvania which has earned its fine reputation over the

years through the high standard of its products and through leadership, would extend such recognition only after careful cooperation and examination by its staff of experts and engineers. They concluded that the RTTA course offers the best opportunity of studying Color Television on a practical basis—to learn the subject thoroughly.

The Color Television Technician Course is being made available to authorized Sylvania Dealers throughout the 48 states who are interested in expanding their knowledge and experience in Color TV servicing.

SEE OTHER SIDE

CUT OUT AND MAIL TODAY!—POSTAGE FREE!

FIRST CLASS
Permit No. 62058
(Sec. 34.9, P. L. & R.)
New York, N. Y.

BUSINESS REPLY CARD

No Postage Stamp Necessary if Mailed in the United States

POSTAGE WILL BE PAID BY

RADIO-TELEVISION TRAINING ASSOCIATION

52 EAST 19th STREET, Dept. AB-4

NEW YORK 3, N. Y.

14 THOROUGH LESSONS

- 1 AN INTRODUCTION TO COLOR
- 2 FORMATION OF THE COLOR SIGNALS
- 3 THE CHROMA SIGNALS
- 4 GENERAL OPERATION OF THE COLOR TELEVISION RECEIVER
- 5 PICTURE TUBES FOR COLOR TELEVISION RECEIVERS — PART I
- 6 PICTURE TUBES FOR COLOR TELEVISION RECEIVERS — PART II
- 7 DETAILED OPERATION OF THE COLOR TELEVISION RECEIVER
- 8 THE CHROMINANCE CHANNEL
- 9 COLOR TELEVISION CIRCUITS — PART I
- 10 COLOR TELEVISION CIRCUITS — PART II
- 11 ADJUSTING THE COLOR TV RECEIVER
- 12 COLOR TV TEST EQUIPMENT
- 13 TROUBLESHOOTING THE COLOR TV RECEIVER
- 14 SERVICING PROCEDURE

SEND FOR YOUR ENROLLMENT APPLICATION TODAY!

Have you seen your Independent Service advertising campaign?



**PICTURE TUBES DO
GET DIRTY! SO CALL YOUR
INDEPENDENT SERVICE-
DEALER AND...**

**Have your
Picture Tube
cleaned today!**



Just like windows and mirrors, the inside of the glass front on your TV set gets dirty. And the face of your picture tube — the TV screen — gets even more fogged up with dust and dirt, smoke and fumes. See for yourself. Have your picture tube cleaned today. You can't imagine how much clearer . . . brighter . . . and more enjoyable your TV picture will be!

**CALL YOUR INDEPENDENT SERVICE-DEALER
FOR HIS SPECIAL "PICTURE TUBE CLEAN-UP."**

He is *your* neighbor. He pays taxes in *your* community. His children go to the same schools and churches as *yours*. And he knows his standing and reputation depend upon the care and thoroughness with which he services *your* community's radio and television sets. What is more, he is trained to service any make of set. So patronize your neighborhood independent radio and television service-dealer.

© CBS-HYTRON, Danvers, Mass.
A Division of Columbia Broadcasting System, Inc.



Ask him for CBS tubes. There are no better tubes made . . . and CBS tubes have this seal.



This emblem is one way to identify your independent radio and television service-dealer. Look for it.

Advertisements like this are appearing every month in all local editions of *TV Guide* . . . telling millions of TV set owners why they should call their neighborhood independent service-dealers.

Ask your CBS Tube distributor how you can have *your* name, address and telephone number listed on adjacent pages in your local edition.

Join with other independent service-dealers . . . independent parts distributors . . . and CBS Tubes. Working together, let's build a strong independent service industry.

Identify yourself as an *Independent Service-Dealer*. Arrange for your *TV Guide* listing. Get the tie-in material *and use it*: Independent Service-Dealer decalcomania . . . window display . . . newspaper mats . . . postal cards . . . door knob hanger . . . and consumer booklet.

Tie In Today! Ask your distributor for your *TV Guide* listing . . . your display . . . and other supporting material. And for free, 4-page PA-131 flyer giving complete details on how you can profit by your independent service program.

Remember: Your continuous purchases of CBS tubes make this independent service-dealer campaign possible. So help keep it going. Say, "I want CBS tubes!"



CBS-HYTRON, Danvers, Massachusetts
A Division of
Columbia Broadcasting System, Inc.



SKITCH... on his Presto Turntable

"MY CUSTOM HI-FI OUTFIT is as important to me as my Mercedes-Benz sports car," says *Skitch Henderson*, pianist, TV musical director and audiophile. "That's why I chose a PRESTO turntable to spin my records. In my many years working with radio and recording studios I've never seen engineers play back records on anything but a *turntable*—and it's usually a PRESTO turntable.

"My own experience backs up the conclusion of the engineers: for absolutely constant turntable speed with no annoying 'Wow' and 'Flutter,' especially at critical 33½ and 45 rpm speeds, for complete elimination of motor noise and 'rumble,' I've found nothing equals a PRESTO turntable. It's heavy... it's brilliantly machined... it's the only instrument on which the genuine audiophile should ever allow his records to be played."

Visit the *Hi-Fi Sound Salon* nearest you to verify Mr. Henderson's comments. Whether you currently own a conventional "one-piece" phonograph—or custom components—we think you'll be gratified with the difference you'll hear when you play your records through custom hi-fi components teamed with a PRESTO turntable. Write for free brochure, "*Skitch, on Pitch.*" to Dept. MP Presto Recording Corporation, P.O. Box 500, Paramus, N. J.



MODEL T-2 12" "Promenade" turntable (33½ and 45) four pole motor, \$49.50

MODEL T-18 12" "Pirouette" turntable (33½, 45 and 78) four pole motor, \$75.00; with Hysteresis motor (Model T-18H), \$131.00

MODEL T-68 16" "Pirouette" turntable (33½, 45 and 78) four pole motor, \$99.00; with Hysteresis motor (Model T-68H), \$170.00

WALNUT "PANDORA" Turntable Cabinet by Robert W. Fuldner, \$42.50

Hear the difference when you play your records on

PRESTO TURNTABLES

A UNITRONICS CORPORATION AFFILIATE

www.americanradiohistory.com

NEW...

General Electric Double-diode

*Vac-U-Sel** Rectifier

Cuts Costs as Much as 35%

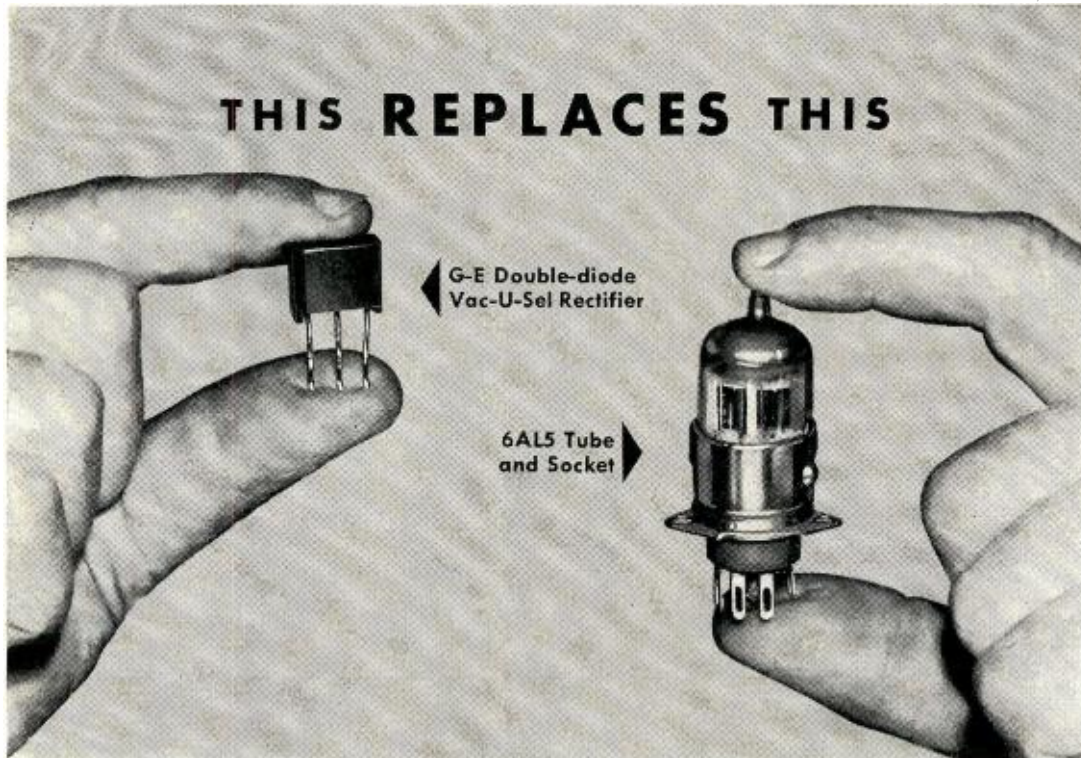

With a few minor modifications in most basic circuits General Electric's new double-diode Vac-U-Sel rectifier can replace the heavier, larger, 6AL5 tube and socket. Cost of the new Vac-U-Sel rectifier to you may be only about 65% that of a tube and socket.

Although designed for a wide range of uses, the new General Electric Vac-U-Sel double-diode rectifier is ideally suited for use as a TV horizontal-phase-detector diode. Other outstanding features include:

- longer life
- breakage-resistant
- low cell capacitance
- no filament power required

Sealed firmly in a durable, moisture-resistant housing the new General Electric Vac-U-Sel selenium rectifier is designed to be automatically assembled by machine. Longer leads are available for hand assembly in conventional chassis. Units consist of two single cells which may be either common cathode or plate-to-cathode connected.

SEE THIS GENERAL ELECTRIC VAC-U-SEL DOUBLE-DIODE RECTIFIER . . . INSTALL IT . . . OBSERVE FIRST HAND ITS HIGH PERFORMANCE . . . WRITE TODAY FOR A FREE PRODUCT SAMPLE.

*Reg. trade-mark of the General Electric Co.

Progress Is Our Most Important Product

GENERAL ELECTRIC

FREE RECTIFIER

for trial installation

To:
General Electric Company
Section C461-45
Schenectady 5, N. Y.

Gentlemen:
Please send me free of charge one new General Electric Vac-U-Sel double-diode rectifier.

NAME _____

COMPANY _____

ADDRESS _____

CITY _____ STATE _____

MR. SERVICE-DEALER:

YOU CAN MAKE \$6⁴⁰ EXTRA on 7 OUT of 10 TV SERVICE CALLS in INDOOR ANTENNA AREAS

Here's How:

with the



Magic Genie®

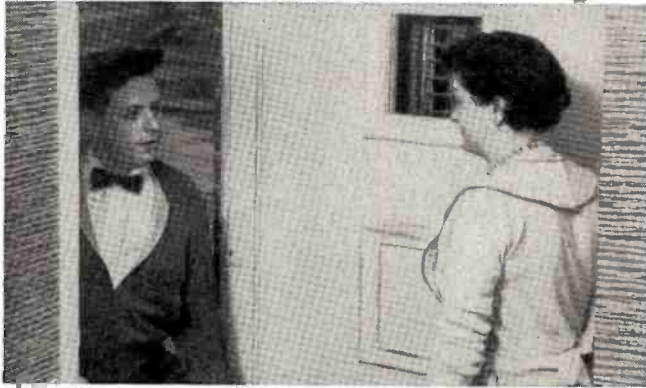

1 TAKE the JFD Magic Genie with you in your tube caddy on your next service call. It's conveniently small and compact.



2 USE the Magic Genie to check the picture after you have serviced the set. Your customer is sure to ask you about it.

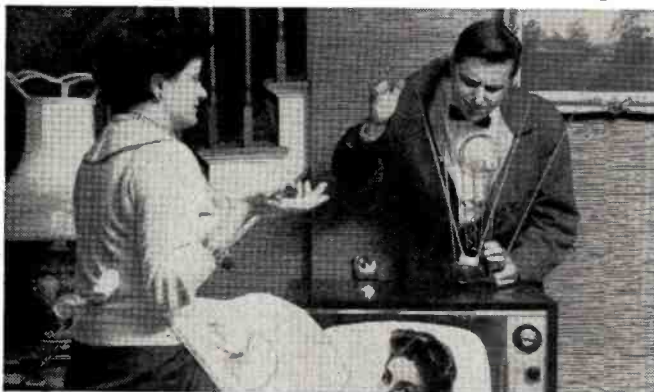

3 SHOW your customer how much more beautiful the Magic Genie looks than the old ugly indoor antenna sitting on top of her TV set.

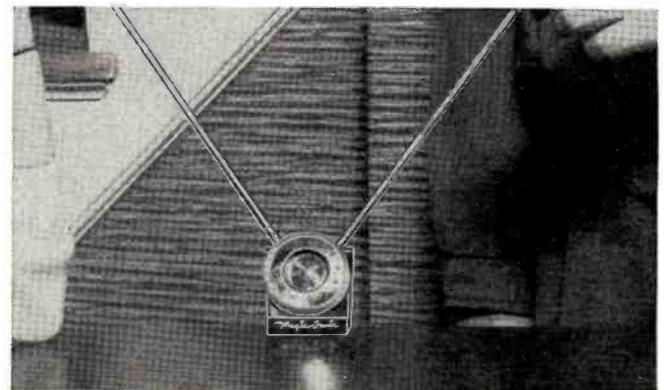

4 DEMONSTRATE the way dipoles rotate and adjust in any direction for powerful black and white and color reception.



5 CLINCH the sale by pointing out the Magic Genie unconditional money-back guarantee backed by JFD's 28 years of electronic know-how.

SEND COUPON FOR FREE MAGIC GENIE MONEY-MAKING SALES KIT AND NAME OF YOUR NEAREST JFD DISTRIBUTOR!

JFD ELECTRONICS, INC.
6102 - 16th Avenue
Brooklyn 4, New York

OKAY!

I want to see how the Magic Genie can make money for me.

Send me your kit and the name of my distributor.

Name _____

Address _____

City _____ Zone _____ State _____



ELECTRONICS, INC.

PIONEERS IN ELECTRONICS SINCE 1929

Call your JFD distributor for your Magic Genies and start earning that extra money now. It's so easy.

NATIONALLY ADVERTISED AT \$17.95 promotionally priced at \$14.95

IT TAKES TWO RCA and YOU

to make the sale



RCA Silverama

with advanced-technique super-aluminizing is the replacement Picture Tube that your customers know, want, and will gladly pay for. IT TAKES RCA'S ENGINEERING LEADERSHIP TO PRODUCE THIS QUALITY PICTURE TUBE. And it takes RCA's dramatic advertising in Life, Saturday Evening Post, TV Guide, and on NBC-TV spectaculars and radio shows, to *help* you make the sale.

BUT IT TAKES YOU TO MAKE THE SALE. It takes your good business sense, your understanding of the customers' needs, and your appreciation of a product that reflects your good reputation.

YOU and RCA...a winning team! See your RCA Tube Distributor immediately for top-quality, customer-accepted RCA Silverama Picture Tubes. You and your customers will be glad you did.



PICTURE TUBES

RADIO CORPORATION OF AMERICA
Tube Division Harrison, N. J.

Mr. Service Dealer 

Nationwide campaign breaks to bring you tremendous sales and profits on

PHILCO Star-Bright ²⁰/₂₀

ALUMINIZED
PICTURE TUBES



Clearlest, Most lifelike picture for any TV. And only Philco gives you this double edged selling tool

Philco Star-Bright 20/20 is the only picture tube that's BONDED to have all new picture making parts... plus full year replacement warranty. This offers double protection to your customers.

Millions of TV set owners will be told to phone service dealers immediately for a picture tube replacement

For 8 consecutive weeks the Philco Star-Bright 20/20 Aluminized Picture Tube story will be told in TV Guide... reaching millions of TV set owners each week. This means big replacement business for *you*. Have stock on hand and prepare to cash in.

Philco Corporation Accessory Division
"A" Street & Allegheny Ave.
Philadelphia 34, Pa.

Please send information on Philco Star-Bright 20/20 Aluminized Picture Tubes.

NAME _____
ADDRESS _____
CITY _____ ZONE _____ STATE _____

RT-457

Be ready when your phone starts ringing! See your Philco Distributor or mail this coupon at once!

PHILCO CORPORATION
ACCESSORY DIVISION PHILA. 34, PA.

Mr. Service Dealer

Here's a complete merchandising program to start your spring portable battery season with a bang!

It's the **Power Packed Payoff** on **PHILCO** Portable Batteries

Order your portable battery requirements from your Philco Distributor on his special plan. Sell the batteries at regular profits . . . and in addition, get any of these extras at no extra cost to you.



1 FREE

10% EXTRA in Philco Portable Batteries

Order any combination of Philco portable batteries and get an extra 10% of the amount in Philco portable batteries of your choice.

2 FREE

with purchase of \$125.00 in Philco portable batteries
\$25.00 Silverplate Service for 6 in anti-tarnish chest



3 FREE

with purchase of \$250.00 in Philco portable batteries.

\$49.50 Bulova Watch

Choice of the shock resistant "President" for men or lovely "Anita" with expansion bracelet for ladies.



PLUS

New Philco Battery Display for Your Counter

Yours free with your Philco portable battery order.



See your Philco Distributor or mail coupon now!

PHILCO CORPORATION
ACCESSORY DIVISION PHILA. 34, PA.

Philco Corporation Accessory Division
"A" Street & Allegheny Ave.
Philadelphia 34, Pa.

Please send information on the Power Packed Payoff on Philco portable batteries.

NAME _____

ADDRESS _____

CITY _____ ZONE _____ STATE _____

RT-457

BUILD THE BEST—

BUILD ALLIED'S OWN

knight-kits

LOWEST COST because our giant buying power passes biggest savings on to you... you do the easy assembly, get professional results and **SAVE!**

knight-kits

EASIEST TO BUILD because KNIGHT-KIT "Step-and-Check" instruction manuals are marvels of clarity—it's just like having a good instructor at your side.

knight-kits

MONEY-BACK GUARANTEE: When properly assembled, KNIGHT-KITS fully meet published specifications, or we refund your money.

EASY TERMS AVAILABLE

knight-kit INSTRUMENT VALUE



EXCLUSIVE "IN-CIRCUIT" CAPACITOR CHECKER KIT

- ★ "In-Circuit" Checker
- ★ "Magic-Eye" Indicator
- ★ Save Almost 60%!

Model Y-119

\$12.50

A tremendous aid to speedier, more profitable servicing—and you save almost 60% over comparable factory-wired units. Permits testing of capacitors while they are wired in the circuits! Simply press a button and the "magic eye" shows opens and shorts (not leakage). Checks by-pass, blocking, coupling and filter capacitors. Tests for opens and shorts on any capacitor of 20 mmf or greater capacity, even if it is in parallel with a resistance as low as 50 ohms. Tests for shorts can be made on any capacitor up to 2000 mfd, even when shunted by as low as 20 ohms. 7 3/4 x 5 1/4 x 5". With tubes, wire, solder. Shpg. wt., 5 lbs.

Model Y-119. Net, F.O.B. Chicago **\$12.50**

See our Supplement No. 165 for 21 other knight kit instrument values

free SUPPLEMENT

featuring knight-kits

Send for our FREE Supplement No. 165 featuring 45 great Knight-Kits, including Test Instruments, Hi-Fi, Hobbyist and Amateur kits. Write for your copy today.



ORDER FROM

ALLIED RADIO

Dept. 01-D7, 100 N. Western Ave., Chicago 80, Ill.

Within the Industry

MERLE W. KREMER has been appointed general manager of the parts division of *Sylvania Electric Products Inc.*



Mr. Kremer joined the company in 1955 as special assistant to Marion E. Pettegrew, vice-president in charge of the radio and television parts, and tungsten and chemical divisions. Prior to that, he was assistant to the president of *Allied Products Corp.* for three years. For ten years, from 1942 to 1952, Mr. Kremer served in various executive and staff positions with *General Electric Company's* lamp department.

His office will be at division head-tric *Company's* lamp department in Cleveland, Ohio.

INSTITUTE OF RADIO ENGINEERS' board of directors recently adopted a plan which will permit qualified non-IRE members to become affiliated with certain of the IRE Professional Groups without first having to join the organization itself.

Adoption of the Affiliate Plan is regarded as one of the most important changes that has been made in the organization structure in its 45-year history. In effect, the IRE is extending the specialized services of its twenty-four Professional Groups to every field of engineering and science, in order to provide more effectively for the rapidly spreading influence of electronics in every walk of scientific and technological life.

It is anticipated that the Affiliate Plan will be particularly beneficial in the field of medical electronics by permitting medical doctors and biologists, who would not be interested in joining the organization, to participate in the activities of the IRE Professional Group on Medical Electronics.

KELVIN ELECTRIC COMPANY recently began operations at 5907 Noble Avenue, Van Nuys, Calif. Products of the newly organized company are precision wire-wound resistors for use in industrial and military electronic equipment, and resistive networks for use as attenuators and precision voltage dividers... The formation of a jointly owned corporation, **GULTON-SPEIDEL, INC.**, was announced by the industrial division of the **SPEIDEL CORP.** and **GULTON INDUSTRIES, INC.**... **GEORGE W. BORG CORPORATION's** equipment division has purchased the **AEROVOX "Hi-Trim Potentiometer"** product. The tangible and intangible assets of this division have been acquired and are

being moved to the equipment division plant at Janesville, Wisc. . . . The operations of **MINNEAPOLIS-HONEYWELL's** Doelcam and Transistor Divisions have been consolidated into a single unit to be known as the Boston Division . . . Formation of the electronic tube division of the **SPERRY GYROSCOPE COMPANY** has been announced. The company is a division of **SPERRY RAND CORPORATION.**

AMPHENOL ELECTRONICS CORPORATION is celebrating its 25th anniversary this year.

Founded in 1932 by Arthur J. Schmitt, the company began its operations, with one other employee, in a loft of a Chicago loop building. The sole product was a radio tube socket made by a revolutionary method of plastics molding. Today, the company manufactures an estimated 25,000 separate parts in seven modern plants in Chicago and Cicero, Illinois. There are now almost 2000 employees.

Arthur J. Schmitt, still president and chairman of the board, is assisted by William H. Rous, vice-president, sales; Dr. R. M. Soria, vice-president, engineering; and John L. Woods, vice-president and controller.

ROBERT SACKMAN has been elected general manager of the *Ampex Corporation* in Redwood City, California.



Mr. Sackman, already a vice-president of the firm, comes to his new position from the post of manager of the instrumentation division.

He joined the company in 1953 to establish and manage the Washington district office. Previously, he headed a Department of Defense research and development branch devoted to recorders and data-processing systems. He attended George Washington University.

UNITED CATALOG PUBLISHERS, INC. has moved to a new building at 60 Madison Ave., Hempstead, N. Y. . . . **UNIVERSAL GENERAL CORPORATION** has announced the change of its name to **UNIVERSAL RELAY CORPORATION** and the removal of its office and warehouses to 42 White St., New York, N. Y. . . . A new division of **GULTON INDUSTRIES** has been established in Albuquerque, New Mexico. The work of this new division will encompass research development and production in the fields of high-frequency telemetering systems and related communica-

**GREATEST
ADVANCE IN
SHOP-METHOD
HOME TRAINING**

EARN MORE MONEY...GET INTO TELEVISION ELECTRONICS-RADIO

Learn ALL 8 PHASES in ONE MODERN HOME-STUDY COURSE
At Home - In Spare Time

YOU GET ALL THIS NEWEST PRACTICAL EQUIPMENT

- Parts to build a modern TV set, including all tubes plus a large screen Picture Tube
- Parts to build a powerful Superhet Receiver, standard broadcast and short wave
- Parts to conduct many experiments and build Continuity Checker, RF Oscillator, TV Circuits, Audio Oscillator, TRF Receiver, Signal Generator
- A Valuable Professional Multitester

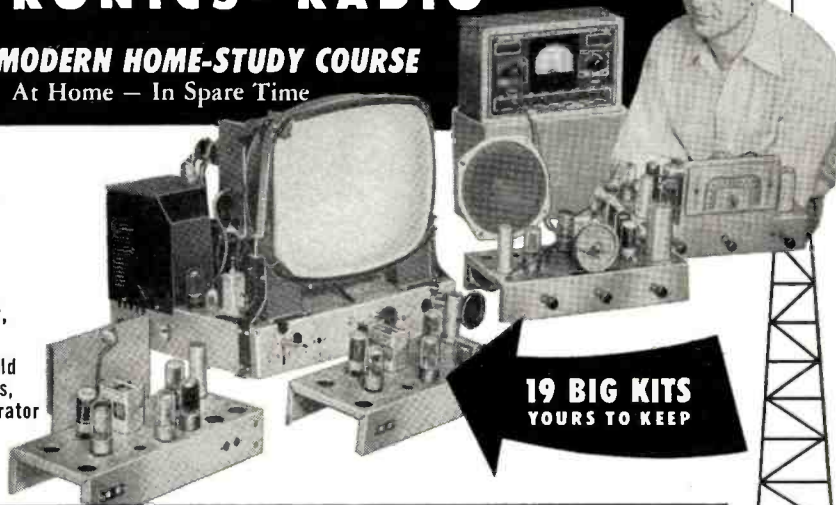

**19 BIG KITS
YOURS TO KEEP**

YOUR NATIONAL SCHOOLS TELERAMA COURSE COVERS ALL 8 PHASES

- | | |
|------------------------------------|--------------------------------|
| 1. TELEVISION, INCLUDING COLOR TV | 5. PREPARATION FOR FCC LICENSE |
| 2. RADIO, FM AND AM | 6. AUTOMATION |
| 3. INDUSTRIAL ELECTRONICS | 7. RADAR AND MICRO WAVES |
| 4. SOUND RECORDING AND HI FIDELITY | 8. COMMUNICATIONS |

YOU ARE NEEDED IN THE TELEVISION-ELECTRONICS-RADIO INDUSTRY!
You can build a secure future for yourself if you get into Electronics NOW! Today's shortage of trained technicians creates tremendous opportunities. National Schools Shop-Method trained technicians are in constant and growing demand for high-pay jobs in Broadcasting and Communications, Electronic Research, Servicing and Repair, and many other branches.

Let National Schools, a Resident Technical School for over 50 years train you for today's unlimited opportunities in electronics! Our Shop Method trains you to be a MASTER-TECHNICIAN. Completely up to date, developed by experienced instructors and engineers, your Telerama Course will teach you all phases of the industry quickly, clearly and correctly. You can master the most modern projects, such as Color TV, printed circuits - even prepare for FCC License without taking a special

course. You can handle sales, servicing, manufacturing, or make good money in your own business. SEND FOR FACTS TODAY!

EARN AS YOU LEARN. Many of our students earn their entire tuition and more in Spare Time jobs we show them how to do while learning.

YOU GET EVERYTHING YOU NEED - Clear, profusely illustrated lessons, shop-tested manuals, modern circuit diagrams, practical job projects - all the valuable equipment shown above

- many other materials and services
- consultation privilege with our qualified staff, and Graduate Employment Service. **EVERYTHING YOU NEED** for outstanding success in Electronics.

RESIDENT TRAINING AT LOS ANGELES

If you wish to take your training in our Resident School at Los Angeles, the world's TV capital, start NOW in our big, modern Shops, Labs and Radio-TV Studios. Here you work with latest Electronic equipment - professionally installed - finest, most complete facilities offered by any school. Expert, friendly instructors. Personal attention. Graduate Employment Service. Help in finding home near school - and part time job while you learn. Check box in coupon for full information.



FREE!

Fully illustrated "Career" Book in TV-Radio-Electronics. PLUS actual sample lesson - yours at no cost, no obligation. CLIP COUPON NOW... MAIL IT TODAY!



MEMBER



APPROVED FOR G.I. TRAINING NATIONAL SCHOOLS

4000 S. FIGUEROA ST., LOS ANGELES 37, CALIF.
187 N. LA SALLE ST., CHICAGO 1, ILL.

NATIONAL SCHOOLS

TECHNICAL TRADE TRAINING SINCE 1905
LOS ANGELES 37, CALIFORNIA

GET FAST SERVICE - MAIL NOW TO OFFICE NEAREST YOU!

NATIONAL SCHOOLS, DEPT. RH-37
4000 S. FIGUEROA ST. OR 187 N. LA SALLE ST.
LOS ANGELES 37, CALIF. CHICAGO 1, ILL.
Rush free TV-Radio "Opportunity" Book and sample lesson. No salesman will call.

NAME _____ AGE _____
ADDRESS _____
CITY _____ ZONE _____ STATE _____

Check if interested ONLY in Resident School training at Los Angeles.
VETERANS. Give date of Discharge _____

The Altec 3000A loudspeaker

the ONLY 22,000 cycle tweeter

The Altec 3000A high frequency speaker is the only tweeter or so-called "super-tweeter" made which has a guaranteed range extending to 22,000 cycles. Many people question the necessity of a high frequency speaker with a range extending half an octave beyond that of the human ear. The extra range has been provided to assure smooth reproduction throughout the entire audible range. In frequency response the 3000A is down approximately seven decibels at 22,000 cycles but is essentially flat from 3000 cycles to the upper limit of human hearing.

Another popular tweeter with an advertised range to 16,000 cycles, the upper limit of human hearing, is down five decibels at 16,000 cycles and this roll-off or loss of high frequency reproduction actually starts at 11,000 cycles. In comparison it can be seen that the extension of the Altec 3000A to 22,000 cycles results in a better response throughout the top 5,000 cycles of the audible range.

Heart of the 3000A speaker, its driving element, is the L1 Pressure Unit. This compression driver without its exponential horn has a useful frequency response to 60,000 cycles and is down only 25 decibels at 100,000 cycles.* This range above 22,000 cycles, which is of no use in high fidelity reproduction, has been reduced in the 3000A in order to achieve the smoothest possible distribution and high efficiency.

The Altec 3000A high frequency speaker is exceptional in its smooth frequency response from 3,000 to 22,000 cycles, and in its even distribution pattern, high efficiency and freedom from tonal coloration. It is ideal for extending the high frequency range of existing speaker systems or as the high frequency component of new low and medium power two-way speaker systems.



L1 Pressure Unit

* For those interested in the detailed performance above 22,000 cycles, we will be glad to provide references to the acoustical textbooks which contain charts and data on the L1 Pressure Unit.

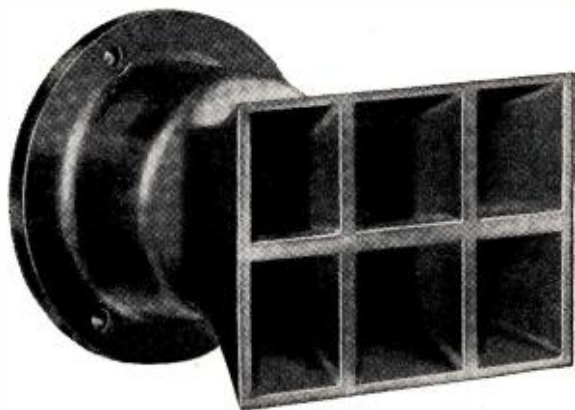

Price \$36.00
N-3000A Network \$18.00

ALTEC FIDELITY IS HIGHEST FIDELITY



ALTEC
LANSING CORPORATION

Dept. 4TM
1515 So. Manchester Avenue, Anaheim, Calif.
161 Sixth Avenue, New York 13, N.Y.

tions devices, ultrasonic dryers, solar furnaces, and geophysical equipment . . . **MOTOROLA INC.** has moved its West Coast headquarters from San Mateo, California, to Burlingame, Calif. The building is located at 1616 Rollins Road . . . **SYLVANIA ELECTRIC PRODUCTS INC.** has formed a semiconductor division. Concurrently, growing volume in special-purpose electron tubes has brought about the establishment of special tube operations. Headquarters of both of these divisions are at Woburn, Mass. . . . **GENERAL ELECTRIC COMPANY** has transferred its facilities for the manufacture of quartz crystals from the company's semiconductor products department to the firm's newly organized communication products department . . . A factory branch to distribute **SYLVANIA** television sets, radios, and high-fidelity phonographs in the Chicago market is now located in the company's regional sales office and warehouse in Melrose Park, a suburb of Chicago . . . Construction has begun on a new one-story, 16,200 square-foot building for **HETHERINGTON, INC.** . . . A new San Francisco Bay area office has been established by the **WESTERN ELECTRONIC SHOW AND CONVENTION**. Location is 60 West 41st Ave., San Mateo, Calif. . . . **GENERAL ELECTRIC COMPANY** has consolidated manufacturing research personnel and facilities into an equipment development operation with headquarters at Schenectady. This is expected to meet the growing demand for receiving tubes . . . The parts division of **SYLVANIA ELECTRIC PRODUCTS INC.** has opened a sales office at 7800 Intervale Ave., Detroit, Mich. . . . The new plant being built by **SIMPSON ELECTRIC COMPANY** at Mercer, Wisconsin is now nearing completion . . . **DAYSTROM, INC.** moved its executive offices from Elizabeth, N.J. to Murray Hill, N.J. The 17,000 square-foot, one-story building is located on a 20-acre plot purchased by the company last year . . . **MOTOROLA INC.**'s eastern communications & electronics headquarters has moved from Fort Lee to Ridgefield, N.J.

KENNETH R. JOHNSON has been appointed vice-president in charge of the home products division of *Packard-Bell Electronics Corp.* . . . The appointment of **E. P. ATCHERLEY** to the newly created post of assistant to the sales manager for distributor sales, electronics products, has been announced by *Sylvania Electric Products Inc.* . . . **GEORGE C. SZIKLAI** has been appointed technical assistant to the vice-president and general manager of *Westinghouse Electric Corporation's* electronic tube division, Elmira, N. Y. . . . *Cook Research Laboratories*, a division of *Cook Electric Company*, has announced the promotion of **ELMER A. BECK, JR.** to the position of executive engineer. . . . *Permo, Incorporated* has announced the promotions of **WILLIAM R. ANTON** and **GEORGE AVALON** to the positions of vice-president in charge of sales, and vice-president in charge of manufacturing respectively . . . **J. RICHARD**
(Continued on page 85)

RADIO & TV NEWS

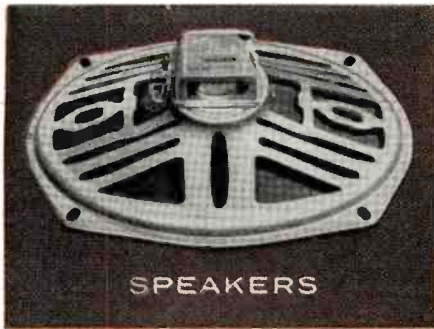

SPEAKERS

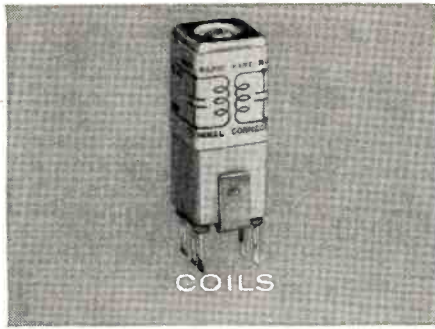

COILS

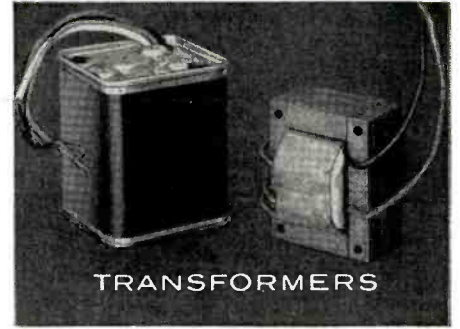

TRANSFORMERS

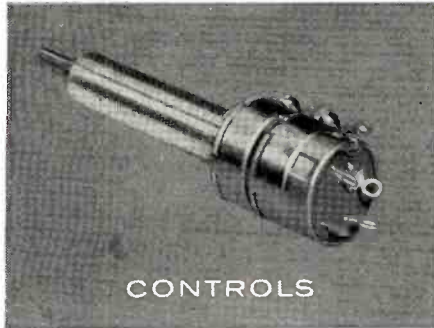

CONTROLS



TRANSISTORS

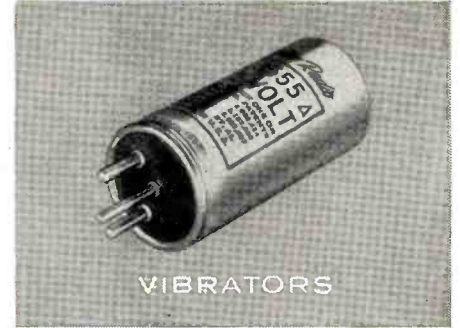

VIBRATORS



TUBES

*From
DELCO
RADIO:*



IRON CORES

a complete line of replacement parts



CAPACITORS



RESISTORS

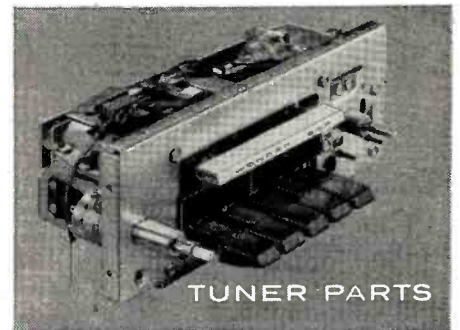

TUNER PARTS

for your Delco Radio service work!

It's one-stop service from the world leader in auto radio! Your Delco Electronic Parts Distributor gives you fast delivery on all items, *plus* a truly profitable Delco Radio independent dealer program that includes:

1. A technical training program conducted by factory engineers.
2. An attractive warranty policy.
3. Plenty of attractive dealer identification.

Delco Radio also offers a wide selection of Special Application Parts for your convenience and profit. Get the facts today.

April, 1957

DELCO



RADIO

DIVISION OF GENERAL MOTORS, KOKOMO, INDIANA



A GENERAL MOTORS PRODUCT — A UNITED MOTORS LINE
Distributed by Electronics Distributors Everywhere



the balance is in your favor

The design of each Newcomb audio product is balanced with the use to which it will be put . . . and to the kind of performance desired.

Equal care and attention is given to all circuit elements so that an internal balance of quality is achieved.

Within the Newcomb Company itself, a balance between Engineering, Production, Testing, and Sales Departments is maintained.

There is even a superior balance to the tone you hear from a Newcomb amplifier. This balance can only be attributed to experience . . . experience gained by twenty years of specialization in the field of sound amplification and reproduction.

If we were asked to give a one word description of any Newcomb product, that word would unquestionably be . . . "balance"! Balance has been the watchword at Newcomb since the company's beginning. Balance in sound, balance in quality, balance within the company itself. The user gets a product in which a fine balance has been struck between operating features, performance, dependability, beauty, and cost.

We have learned through the years that measured specifications may make stimulating reading, but they are not necessarily indicative of the sound that may result. There are no meters which can tell anyone exactly how a

particular amplifier will sound—to the purchaser—under conditions of usage. Until such an instrument is invented, successful sound amplification will owe as much to art and experience as to science and measurement.

It is our belief the product which will be enjoyed the longest is the one that is soundly engineered all the way through—the well balanced design that can only result from experience. Living and working in this belief has brought us to the position we find ourselves in today. Newcomb Audio Products Company is probably the largest independent manufacturer of sound amplification products in the nation.

We make some products which are inexpensive, but they are not "cheap". We make others which cost several times as much, but they are never overpriced. The overall quality and value of any Newcomb product equated against its price finds the balance tilted sharply in favor of the buyer.

It is a real pleasure to work with Newcomb equipment. In twenty years of successful specialization Newcomb has proven its ability to make products that are dependable, flexible, easy to operate, easy to service; and their excellent performance gives enduring satisfaction to the user.

NEWCOMB AUDIO PRODUCTS COMPANY
DEPARTMENT F-4
6821 LEXINGTON AVE., HOLLYWOOD 38, CALIFORNIA

Write for catalog
of Newcomb products
in which you
are interested.



HIGH FIDELITY
AMPLIFIERS AND RADIO TUNERS



PUBLIC ADDRESS SYSTEMS



RECORD AND
TRANSCRIPTION PLAYERS

RADIO & TV NEWS

Join the **NEL-KAYE RECORD CLUB**
SAVE \$1.50 or more
 on ALL L.P. RECORDS



... Any Label
 ... No Exception



plus **FREE** with your membership: **ANY** 10" or 12" Record of your choice.

If you are a true record collector, be it classical, pop, or jazz... this club was designed for you. As a member you can get ANY L.P. ever recorded at actual **DEALERS COST**, that's a saving of **38%** off the current list price. If you purchase as few as one record a week you will save over **\$75** a year.

The Nel-Kaye Record Club has been established for many years. Each year thousands of members take advantage of its unprecedented 38% saving. The membership fee is only **\$10** for 2 years (less than 2c a day) and entitles you to the following:

- 1** One 10" or 12" LP record absolutely **FREE**, **ANY** record — **ANY** label—the choice is entirely up to you. (the value of this **FREE** record alone is actually worth the greater part of your \$10. membership fee.
- 2** During the 24 month period of your membership, you may purchase as many or as few records as you wish.
- 3** There are no restrictions of any kind. You may order any LP record—any label, major or minor — RCA, Decca, Columbia, Capital, Mercury, London, Westminster, Urania, Vox,

Hayden Society, etc., any LP listed in any record Catalog. No exceptions—in short, any LP ever recorded.

4 Monthly Catalogs worth 75c sent **FREE** of charge upon request. (Kindly enclose 25c to cover mailing and handling costs.)

5 All records are guaranteed factory-new and in perfect condition assuring the highest standards of Hi Fidelity recording. Exchanges on any defective records are made immediately without charge.

We do **NOT** manufacture records.
 You are not limited as to selection.

★ Foreign Memberships accepted. ★

JOIN TODAY
 and save many,
 many dollars
 throughout
 the year.

Note: There is a small postage and handling charge on all orders.

Special Offers at Dealer's Cost
 will be made from time to time to club members on all accessories such as diamond needles, tapes, record racks, Hi-Fi phonographs etc.

MONEY BACK GUARANTEE

Full membership fee (less cost of Free membership record) refunded within 60 days if not completely satisfied.

Make checks payable to Dept. R-4
NEL-KAYE RECORDS, Inc. 1604 York Ave., New York 28, N. Y.

I am enclosing \$10 check or money order covering two year membership in the "Nel-Kaye Record Club of the Year." This does not obligate me in any way. I may order as many or as few records of my choice as I wish.

My Free L.P. record choice is.....

NAME.....
 ADDRESS.....
 CITY.....ZONE.....STATE.....

IN GLAMOROUS NEW YORK CITY—ALL EXPENSES PAID PLUS \$100 CASH

WIN A WEEKEND AT THE WALDORF FOR 2

IN THE PYRAMID TWIST-MOUNT CAPACITOR CONTEST

TOTAL—147 WONDERFUL PRIZES—PLUS A PRIZE TO EVERY ENTRANT . . . SERVICEMEN, ENTER NOW! YOU CAN'T LOSE!

IT'S EASY TO WIN ANY ONE OF THESE WONDERFUL PRIZES:

GRAND PRIZE: Weekend at New York's fabulous Waldorf Astoria Hotel for 2, guest of Pyramid. Air transportation from your home to New York and return. Weekend of entertainment including a visit to the famous Gaslight Club, dinner at the Waldorf's Starlight Roof, and breakfast at the Waldorf. Air transportation by CAPITAL Airlines Viscount.

1st PRIZE: One 4-drawer steel file cabinet plus your choice of 50 sets of PHOTOFACT folders. Value: \$120.45.

FIVE 2nd PRIZES: 5 CR-30 PRECISION Cathode Ray Tube Testers. dlr. net \$109 ea.

TEN 3rd PRIZES: 10 CRA-2 PYRAMID Capacitor-Resistor Analyzers. dlr. net \$92.50 ea.

TWO 4th PRIZES: 2 SW-54 NATIONAL Short Wave Receivers. dlr. net \$59.95 ea.

TEN 5th PRIZES: 10 JENSEN professional speaker units consisting of a D-30 lifetime driver unit and RT-20 rectangular horn. dlr. net \$44.40 per set.

FIFTEEN 6th PRIZES: 15 TW CHANNEL MASTER 7 element "traveling wave" TV antennas, Model 350. dlr. net \$33 ea.

EIGHTEEN 7th PRIZES: 18 PYRAMID Pyra-Pak kits consisting of \$69.95 in Pyramid capacitors, metal tool box and tool kit. dlr. net \$29.95.

THIRTY-FIVE 8th PRIZES: 35 PYRAMID gift certificates entitling you to \$10. (dlr. net) of Pyramid capacitors at your distributor.

9th PRIZE: WALCO twin-point diamond phono needle. dlr. net \$30. For G.E. Var. Rel. Cartridge.

FIFTY 10th PRIZES: 50 WALCO needles for G.E. twin-point sapphires. \$3.50 dlr. net.

AND to all entrants a kit of 5 bypass and coupling capacitors featuring the Pyramid type IMP.

It's easy to win any one of 147 big prizes—just follow these simple rules: Identify the unnamed Pyramid T-M capacitor in the TV set schematic appearing on this page. Give the Pyramid stock number, name and model number of TV set. Then mail your entry to Pyramid. Use coupon on this page or obtain additional blanks from your distributor. A different schematic will appear in these servicemen's magazines for 4 months. Prizes will be awarded on a points-earned basis as follows: 5 points for Contest No. 1; 10 points for Contest No. 2; 15 points for Contest No. 3; 20 points for Contest No. 4; and 10 points each contest for neatness. Possible perfect score: 90 points. However it is not necessary to achieve a perfect score to be declared a prize winner.

So act quickly...send in your entries early each month...you can't lose.

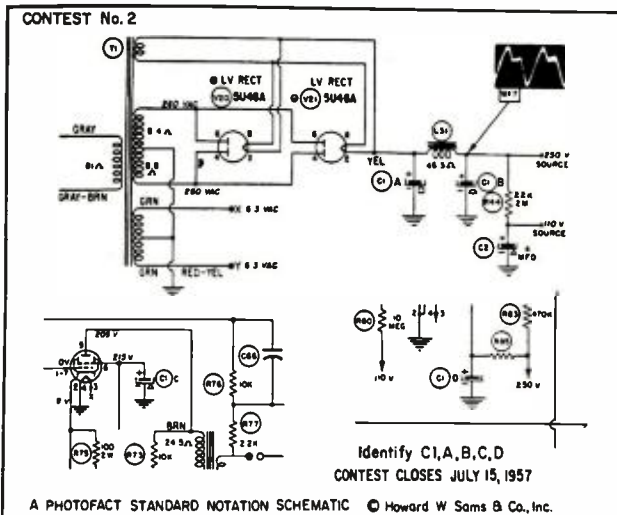

JUDGES: M. Harvey Gernsbeck, editorial director, Radio-Electronics
Oliver Read, D.Sc., publisher, Radio & Television News
Howard W. Sams, chmn. board, Howard W. Sams & Co., Inc.



HELPFUL HINTS

The unidentified capacitor in each entry will be a Pyramid Twist-Mount. All schematics are of TV sets made in the U.S. by a known manufacturer within the past 2 years.

Schematics for reference may be those published by the TV set manufacturers, Howard-Sam's Photofacts, or by any other accepted publisher. You may enter as often as you like but be sure to include a box top (showing stock number) of any Pyramid Twist-Mount Capacitor, with your letterhead or business card with each entry.

WHO MAY ENTER

Any Radio-TV serviceman or employee of a Radio-TV service company may enter. Officers, employees, (members of their families) of Pyramid Electric Co. or its advertising agency are not eligible to enter the contest. All entries are limited to residents of the continental U.S. over 21 years of age.

All entries become the property of Pyramid Electric Co., none will be returned and the decisions of the judges are final. In case of ties, duplicate prizes will be awarded. This contest is subject to all federal, state and local laws and regulations.

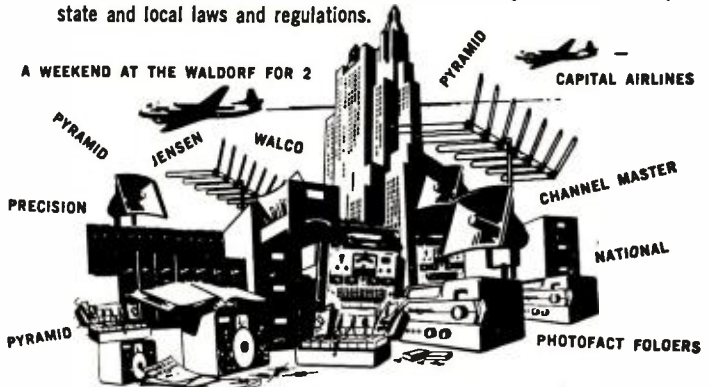

MAIL THIS ENTRY BLANK NOW!

Pyramid Twist-Mount Contest, Dept J
Pyramid Electric Co.
P.O. Box 655, Tyler Park Station, North Bergen, New Jersey

Entry No. (1) (2) (3) (4)—(check one)—is: Pyramid stock No. _____

Twist-Mount values _____

Set manufacturer's name _____ TV set model No. _____

I enclose a box top (indicating stock number) of any Pyramid Twist-Mount Capacitor together with my business card or letterhead or my employer's.

Contestant's name _____ Position _____

Contestant's address _____

City _____ Zone _____ State _____

Employer's Firm name _____

Employer's address _____

City _____ Zone _____ State _____

My jobber's name and address _____

ENTER AS OFTEN AS YOU LIKE—FOR ADDITIONAL ENTRY BLANKS
SEE YOUR JOBBER.

Capacitors, Selenium Rectifiers—for original equipment, for replacement
PYRAMID ELECTRIC COMPANY North Bergen, New Jersey

NEW! 12-WATT Williamson-type HIGH FIDELITY INTEGRATED AMPLIFIER HF12 with Pre-amplifier, Equalizer & Control Section



KIT \$34⁹⁵ WIRED \$57⁹⁵

Compact, beautifully packaged & styled. Provides complete "front-end" facilities and true high fidelity performance. Direct tape head & magnetic phono inputs with NARTB (tape) & RIAA (phono) feedback equalizations. 6-tube circuit, dual triode for variable turnover bass & treble feedback-type tone controls. **Output Power:** 12 w cont., 25 w pk. **IM Dist.** (60 & 6000 cps @ 4:1): 1.5% @ 12 w; 0.55% @ 6 w; 0.3% @ 4 w. **Freq. Resp.:** 1 w: ±0.5 db 12 cps - 50 kc; 12 w: ±0.5 db 25 cps - 20 kc. **Harmonic Dist:** 20 cps: 2% @ 4.2 w; 1/2% @ 2.5 w; 30 cps: 2% @ 11 w; 1/2% @ 6.3 w; 40 cps: 1% @ 12 w; 1/2% @ 9.3 w; 2000 cps: 1/2% @ 12 w; 10 kc: 1% @ 10 w; 1/2% @ 6 w. **Transient Resp:** excellent square wave reproduction (4 usec rise-time); negligible ringing, rapid settling on 10 kc square wave. **Inverse Feedback:** 20 db. **Stability Margin:** 12 db. **Damping Factor:** above 8, 20 cps - 15 kc. **Speaker Connections:** 4, 8, 16 ohms. **Tone Control Range:** @ 10 kc, ±13 db; @ 50 cps, ±16 db. **Tubes:** 2-ECC83/12AX7, 1-ECC82/12AU7, 2-EL84, 1-EZ81. **Size:** HWD: 3 3/4" x 12" x 8 3/4". 13 lbs. **COMING SOON**

NEW! 50-WATT Ultra-Linear HIGH FIDELITY POWER AMPLIFIER

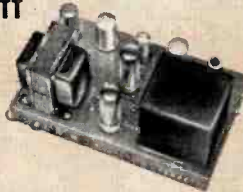

HF50 KIT \$57⁹⁵ WIRED \$87⁹⁵

Like the HF60 shown below, the HF50 features virtually absolute stability, flawless transient response under either resistive or reactive (speaker) load, & no bounce or flutter under pulsed conditions. **Extremely high quality output transformer** with extensively interleaved windings, 4, 8, & 16 ohm speaker connections, grain-oriented steel, & fully potted in seamless steel case. Otherwise identical to HF60. **Output Power:** 50 w cont., 100 w pk. **IM Distortion** (60 & 6000 cps @ 4:1): below 1% at 50 w; 0.5% @ 45 w. **Harmonic Dist.:** below 0.5% between 20 cps & 20 kc within 1 db of rated power. **Freq. Resp.:** at 1 w: ±0.5 db 6 cps - 60 kc; ±0.1 db 15 cps - 30 kc at any level from 1 mw to rated power; no peaking or raggedness outside audio range. All other specs identical to HF60 below. Matching Cover E-2 \$4.50.

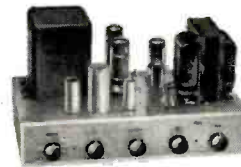

NEW! 50-WATT Ultra-Linear HIGH-FIDELITY INTEGRATED POWER AMPLIFIER HF52 with Pre-amplifier, Equalizer & Control Section

KIT \$69⁹⁵ WIRED \$109⁹⁵

Combines a power amplifier section essentially identical to the HF50 power amplifier with a preamp-equalizer control section similar to HF20 below. Provision for use with electronic crossover network & additional amplifier(s). See HF50 for response & distortion specs; HF60 for square wave response, rise-time, inverse feedback, stability margin, damping factor, speaker connections; HF20 for preamplifier, equalizer & control section description. **Hum & noise** 60 db below rated output on magnetic phono input (8 mv input for rated output), & 75 db below rated output on high level inputs (0.6 v input for rated output). Matching Cover E-1 \$4.50.

The specs are the proof...
7 NEW BEST BUYS by



NEW

HIGH FIDELITY PREAMPLIFIER

#HF61A KIT \$24⁹⁵, WIRED \$37⁹⁵

With Power Supply: #HF61 KIT \$29⁹⁵, WIRED \$44⁹⁵

Will not add distortion or detract from the wide-band or transient response of the finest power amplifiers at any control settings. High quality feedback circuitry throughout plus the most complete control & switching facilities. Heavy-gauge solid brushed brass panel, concentric controls, one-piece brown enamel steel cabinet for lasting attractive appearance. Feedback-type, sharp cut-off (12 db/octave) scratch & rumble filters. Low-distortion feedback equalization; 5 most common recording curves for LPs & 78s including RIAA. Low-distortion feedback tone controls; provide large boost or cut in bass or treble with mid-freqs & volume unaffected. Centralab printed-circuit Senior "Comcontrol" loudness control with concentric level control. 4 hi-level switched inputs (tuner, tv, tape, aux.) & 3 low-level inputs (separate front panel low-level input selector permits concurrent use of changer & turntable). Proper pick-up loading & attenuation provided for all quality cartridges. Hum bal. control. DC superimposed on filament supply. 4 convenience outlets. **Extremely flat wideband freq. resp.:** ±1 db 8-100,000 cps; ±0.3 db 12-50,000 cps. **Extremely sensitive.** Negligible hum, noise, harmonic or IM distortion. **Size:** 4-7/8" x 12-5/16" x 4-7/8". 8 lbs.



NEW

60-WATT Ultra-Linear

HIGH FIDELITY POWER AMPLIFIER #HF60 with ACRO TO-330 OUTPUT TRANSFORMER

KIT \$72⁹⁵ WIRED \$99⁹⁵

Superlative performance, obtained through finest components & circuitry. EF86 low-noise voltage amplifier direct-coupled to 6SN7GTB cathode coupled phase inverter driving a pair of Ultra-Linear connected push-pull EL34 output tubes operated with fixed bias. **Rated power output:** 60 w (130 w peak). **IM Distortion** (60 & 6000 cps @ 4:1): less than 1% at 60 w; less than 0.5% at 50 w. **Harmonic Distortion:** less than 0.5% at any freq. between 20 cps & 20 kc within 1 db of 60 w. **Sinusoidal Freq. Resp.:** at 1 w: ±0.5 db 5 cps - 100 kc; ±0.1 db 15 cps to 35 kc at any level from 1 mw to rated power; no peaking or raggedness outside audio range. **Square Wave Resp.:** excellent from 20 cps to 25 kc, 3 usec rise-time. **Sensitivity:** 0.55 v for 60 w. **Damping Factor:** 17. **Inverse Feedback:** 21 db. **Stability Margin:** 16 db. **Hum** 90 db below rated output. **ACRO TO-330 Output Transformer** (fully potted). **Speaker Taps:** 4, 8, 16 ohms. **GZ34 extra-rugged rectifier** (indirectly-heated cathode eliminates high starting voltage on electrolytics & delays B+ until amplifier tubes warm up). **Input level control.** Panel mount fuse holder. Both bias and DC - balance adjustments. Std octal socket provided for pre-amplifier power take-off. **Size:** 7" x 14" x 8". 30 lbs. Matching cover Model E-2 \$4.50.

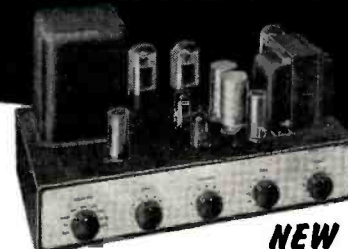

NEW

COMPLETE with Pre-amplifier, Equalizer & Control Section

20-WATT Ultra-Linear Williamson-Type HIGH FIDELITY AMPLIFIER #HF-20

KIT \$49⁹⁵ WIRED \$79⁹⁵

A low-cost, complete-facility amplifier of the highest quality that sets a new standard of performance at the price, kit or wired. **Rated Power Output:** 20 w (34 w peak). **IM Distortion** (60 & 6000 cps/4:1) at rated power: 1.3%. **Max. Harmonic Distortion** between 20 & 20,000 cps at 1 db under rated power: approx. 1%. **Mid-band Harmonic Distortion** at rated power: 0.3%. **Power Response** (20 w): ±0.5 db 20-20,000 cps; ±1.5 db 10-40,000 cps. **Freq. Resp.** (1/4 w): ±0.5 db 13-35,000 cps; ±1.5 db 7-50,000 cps. 5 feedback equalizations for LPs & 78s. Low-distortion feedback tone controls; large boosts or cuts in bass or treble with mid-freqs. & volume unaffected. Loudness control & separate level set control on front panel. Low Z output to tape recorder. 4 hi-level switched inputs: tuner, tv, tape, aux.; 2 low-level inputs for proper loading with all cartridges. **Hum bal. control.** DC superimposed on filament supply. **Extremely fine output transformer:** interleaved windings, tight coupling, careful balancing, grain-oriented steel. 8 1/2" x 15" x 10". 24 lbs. Matching cover Model E-1, \$4.50.

NEW

COMPLETE with FACTORY-BUILT CABINET - 2-WAY HI-FI SPEAKER SYSTEM #HFS1 \$39⁹⁵

See the "BEST BUYS" NOW IN STOCK at your nearest distributor. Fill out coupon on other side for FREE CATALOG.

Prices 5% higher on West Coast.



84 Withers Street, Brooklyn 11, N. Y.



Turn page for other EICO ad.

**the specs are
the test that tells
who's best!**

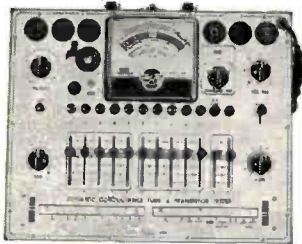

for COLOR & Monochrome
TV servicing
**NEW! DYNAMIC
CONDUCTANCE TUBE &
TRANSISTOR TESTER #666**
KIT \$69.95 WIRED \$109.95

Unexcelled testing thoroughness & accuracy. Checks transistor collector current & Beta using internal dc power supply. Tests all receiving tubes including subminiatures (& Color & Monochrome tv pic tubes with accessory adapter). Composite indication of mutual conductance, plate conductance, & peak emission. Simultaneous sel. of any 1 of 4 combinations of 3 plate, 3 screen, & 3 ranges of control grid voltage. Grid voltage variable over 3 ranges with 5% accurate pot. New series-string voltages for 600, 450 & 300 ma types. 5 ranges meter sens. with 1% precision shunts & 5% accurate pot. 10 SIX-position lever switches for free-point connection of every tube pin or cap. 10 pushbuttons for rapid insert of any tube element in leakage circuit & speedy sel. of individual tube sections. Direct reading of inter-element leakage in ohms. New gear-driven rollchart. Steel case with cover & handle. Sensitive 200 ua meter.



NEW

for COLOR & Monochrome
TV servicing
**TV-FM SWEEP GENERATOR
& MARKER #368**
KIT \$69.95 WIRED \$119.95

The FINEST service instrument of this type ever offered in either kit or wired form at ANY price! Outstanding ease & accuracy in FM & TV (including Color) alignment. Entirely electronic sweep circuit with accurately biased Incredutor: superb linearity on both sides of selected center freq. Newly-designed AGC circuit automatically adjusts osc. for max. output on each band with min. amplitude variations. Sweep gen. range 3-216 mc in 5 OVERLAPPING FUND. BANDS. Sweep width continuously variable from 0.3 mc lowest max. deviation to 0.30 mc highest max. deviation. Variable marker gen. range from 2-75 mc in 3 FUND. BANDS plus a calibrated harmonic band (60-225 mc). Variable marker calibrated with internal marker gen. 4.5 mc xtal included Ext. marker provision. Double pi line filter. Edge-lit hairlines eliminate parallax.

Turn page for other EICO ad



**FREE 1957
EICO CATALOG!**
Tells you how to SAVE 50% on
your test equipment costs!

**TUBE TESTER
#625**
KIT \$34.95
Wired \$49.95
• tests 600
mil series
string type
tubes
• illuminated
roll-chart
Pix Tube Test Adapter\$4.50

**VACUUM TUBE
VOLTMETER #221**
KIT \$25.95
Wired \$39.95
**DELUXE VTVM
214 (7 1/2" METER)**
KIT \$34.95
Wired \$54.95

**#944 FLYBACK
TRANSFORMER &
YOKE TESTER**
KIT \$23.95
Wired \$34.95
• fast check all
flybacks & yokes
in or out of set.
• spots even 1
shorted turn!

Sep. volt-
meter &
ammeter
KIT
\$29.95
Wired
\$38.95
**6V & 12V BATTERY ELIMINATOR &
CHARGER #1050**

**PEAK-to-PEAK VTVM
#232 & UNI-PROBE**
(pat. pend.)
KIT \$29.95
WIRED \$49.95

**NEW COLOR &
Monochrome DC—
5 MC LAB & TV
5" OSCILLOSCOPE
#460**
KIT \$79.95
WIRED \$129.50

**RF SIGNAL
GENERATOR
#320**
KIT \$19.95
Wired \$29.95
150 kc-34 mc,
calibrated har-
monics to 102
mc. Pure or
mod. RF, &
Colpitts osc.
400 cps sine
outputs.

**RF SIGNAL
GENERATOR
#324**
KIT \$26.95
WIRED \$39.95
150 kc-435 mc
with ONE generator!

Sep. hi-gain RF
& lo-gain audio
inputs.
Special noise
locator. Calibra-
ted wattmeter.
KIT \$24.95
Wired \$39.95
DELUXE MULTI-SIGNAL TRACER #147

20,000 Ohms/Volt
MULTIMETER #565
KIT \$24.95
Wired \$29.95
1000 Ohms/Volt
MULTIMETER
536
KIT \$12.90
Wired \$14.90

**5" PUSH-PULL
OSCILLOSCOPE
#425**
KIT \$44.95
Wired \$79.95
**7" PUSH-PULL
OSCILLOSCOPE
#470**
KIT \$79.95
Wired \$129.50

**NEW!
REDI-TESTER
#540**
KIT \$12.95
Wired \$15.95
Multi-range ac/dc
voltmeter, amme-
ter, ohmmeter,
wattmeter, leak-
age checker for
home & auto re-
pairs.

1% accuracy on
all 7 ranges.
Range 75 kc-
150 mc.
Volt reg.
KIT \$39.95
Wired \$59.95
DELUXE RF SIGNAL GENERATOR #315

Reads 0.5 ohms
-500 megohms, 10
mmfd-5000 mfd
power factor.
KIT
\$19.95
Wired
\$29.95
**R-C BRIDGE & R-C-L COMPARATOR
#9508**

VTVM PROBES KIT Wired
Peak-to-Peak\$4.95 \$6.95
RF\$3.75 \$4.95
High Voltage Probe-1\$6.95
High Voltage Probe-2\$4.95
SCOPE PROBES
Demodulator\$3.75 \$5.75
Direct\$2.75 \$3.95
Low Capacity\$3.75 \$5.75

For FREE 1957 catalog, mail coupon NOW!



84 Withers St. • Brooklyn 11, N. Y.

Prices 5% higher on West coast
and subject to change without notice.

EICO, 84 Withers Street
Brooklyn 11, New York

R-4

Send FREE 1957 Catalog and name of neighborhood
EICO jobber.

Name.....

Home Address.....

City.....Zone.....State.....

Occupation.....

Over a Decade of Know-How & Value Leadership in Kits & Instruments — Over 1 Million Sold to Date!

1957 Auto Radios: CHEVROLET



Fig. 1. The "Custom Deluxe Wonder-Bar," Model 987577, directly above, features push-button and search tuning, push-pull output, printed wiring, and a separate subchassis for power supply and audio output. Model 987575 (upper right) uses low-plate-potential tubes and transistor output. Model 987573 (lower right) is a standard tube-vibrator unit.

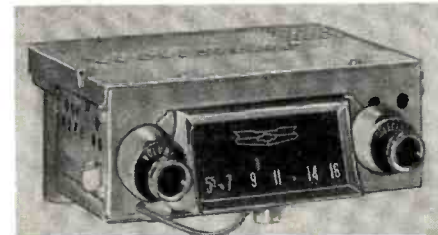
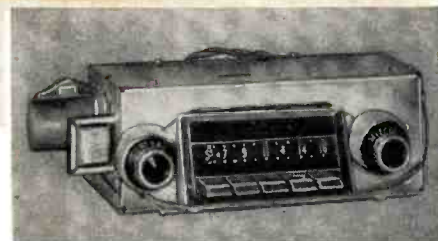

Transistors and printed wiring spark new design trends as streamlined tuning gains favor. With the right data, sets are accessible for service.

WHILE Detroit trumpets the design innovations in the line of chromium cruisers it is turning out this year to fill the nation's highways, often overlooked is the quiet revolution going on in the design of the radios on the sleek car dashboards.

Trends are in evidence on at least four different fronts. Some attempts at finding new ways to put together an automotive receiver are in conflict with each other. Whichever way these conflicts are resolved, their very existence underscores the fact of change. The changes themselves, in any case, are of great interest both to the car owner and the technician who must keep these receivers in repair.

The increased use of printed circuits, strongly evident, is not exclusive to auto receivers. The growing popularity of simplified station-selection devices, an occasional feature of household radios some years ago, is becoming the exclusive domain of the auto-radio designer—the man or woman behind the wheel can't always spare the hand needed for conventional manual tuning. Importance of the transistor—a "natural" in the auto radio, where the expense of its use can be balanced out against other savings it makes possible—has been responsible for at least two departures with

conventional design philosophy, both aiming to accomplish the same thing.

Choice of Receiver Types

Of particular interest is the fact that no line can be drawn between one manufacturer and another in the matter of auto-radio design, at least in one important sense: we do not find that one manufacturer favors one type of approach, with a second manufacturer championing another radio design. Each maker has put the decision in the hands of the public by offering a wide choice of radios. For example, the *Delco Radio Division* of *General Motors Corporation* reflects in its 1957 line of radios the full gamut of innovation mentioned earlier. In fact, all the trends already noted plus at least one other, are evident in the choice of models available for *Chevrolet* cars alone.

All of the *Chevrolet* receivers fall into the printed-wiring class. On some models, printed wiring is used throughout. On others, it is used throughout except for the power supply and audio-output portions, which appear on a separate subchassis, conventionally wired. One of the models with the separate subchassis is the "Custom Deluxe Wonder-Bar" set, Model 987577, shown in Fig. 1.

Of special interest because it is the top model offered for the regular line of *Chevrolet* automobiles, Model 987577 sheds some interesting light on the present unsettled situation in design. With transistors making so much of the news, this top-line receiver incorporating all the deluxe features being offered this year is a conventional tube radio, as shown in Fig. 2. Until some trend definitely manifests itself as far as transistors are concerned, there appears to be a tendency to hedge with conventional receivers.

Schematically, Model 987577 begins with the familiar lineup of r.f. amplifier, converter, i.f. amplifier, and detector-1st audio stages, all powered by a 12-volt vibrator supply, with gas-filled rectifier. Of special interest is the audio-output stage, in line with a generally increased awareness concerning audio fidelity. A push-pull output stage delivers up to 7.5 watts, which is quite a bit of power within the relatively small enclosed space of an automobile interior. The 6" by 9" oval speaker uses a high-energy magnet. While current audio practice generally makes use of a tube for a phase-inverter to feed a push-pull stage, note the transformer that fulfills this function in Fig. 2.

The trigger circuit, in the lower left-hand corner of the schematic, operates a signal-seeking tuner mech-

anism, which it controls through a pair of solenoids (parts 106 and 107) and a relay (part 103). One of the solenoids returns the tuning cores to the low end of the band; the other is used to re-cock the power spring. Accuracy of the automatic tuning provided with this mechanism is reported as better than ± 1 kc. Although the signal-seeking arrangement is electronically similar to that used in earlier versions, mechanical improvement has been achieved. Also, this tuner operates in conjunction with a mechanical push-button station selector, to provide the user with an unusual degree of flexibility in choosing his program material, whether he has a specific station in mind or wants to shop around the dial at random.

Hybrid Design

The "Custom Deluxe" receiver, Model 987575, provides push-button and manual tuning in a hybrid receiver that uses a single-unit chassis, featuring printed wiring. This increasingly familiar type of circuit, consisting of five tubes using low plate voltages and a single transistor, operates directly from the 12-volt auto battery without need of a vibrator or separate power supply. A prototype of this family of hybrid sets was described in an earlier issue of this magazine (see "No Vibrator in New Auto Sets," September, 1956, page 61, and "Low Plate-Potential Tubes," January, 1957, page 46).

Generally speaking, Model 987575 follows the earlier hybrid prototype, with one change in tube type and another in the transistor type, although there are no changes in function. The r.f. and i.f. amplifiers are 12AF6's in this version, instead of 12AC6 as used in the other receiver. The converter is a 12AD6, and the detector-1st audio is a 12F8. To this point, the tube line-up differs from that in a conventional receiver only in that plate and screen voltages for these tubes are in the range of 10-12 volts. Following the 1st audio amplifier is a specially designed 12K5 audio driver. This serves to build up signal to provide sufficient drive for the input to the transistor. The output transistor is a 2N278 power unit. The 2N278, which is rated as a 14-watt dissipation unit at the usual 10 per-cent distortion figure, easily delivers the 6 watts of power output demanded of this stage. To maintain temperature control, the transistor is mounted directly to a cooling fin. This output stage is the only one which doesn't use printed wiring.

Although the most elaborate receiver for the regular Chevrolet line is of conventional circuit design, the situation has been reversed with respect to the set used in the Chevrolet "Corvette." Here the same deluxe facilities—combined manual, signal-seeking, and push-button tuning, plus push-pull audio output—as provided

in the "Custom Deluxe Wonder-Bar" radio have been included, but the design involves five completely conventional tube types, one rectifier (but no vibrator), and four transistors in an unusual configuration that parts company with the hybrid set using 12-volt tubes. Two of the four transistors in this receiver Model 3725156 comprise the push-pull audio output stage. There is no startling departure, in audio output, from what may be found in any number of 7-transistor portables now on the market, except for the above-average power output obtained. The two remaining transistors, however, are used as the heart of an unusual power supply.

Oscillator as Power Source

The transistor power supply, which eliminates the need for the vibrator, is shown in Fig. 3. Input to this pair of 2N174 or 2N290 power transistors is the 12 volts supplied by the car battery. The transistors are in push-pull to form a blocking oscillator. In addition to the two windings, conventional blocking-oscillator circuits, there is a step-up winding that feeds increased-voltage oscillator output to the plates of a full-wave rectifier. The filtered output makes available approximately 200 volts of "B+" for plates and screens of the conventional tubes. Readers may be reminded of the somewhat related r.f. high-voltage power supplies in some early TV receivers.

Fig. 2. Delco's "Custom Deluxe Wonder-Bar," Model 987577, is the top receiver for regular 1957 Chevrolets. Although it provides push-pull audio output, search tuning, and push-button selection, it uses a conventional tube-vibrator circuit.

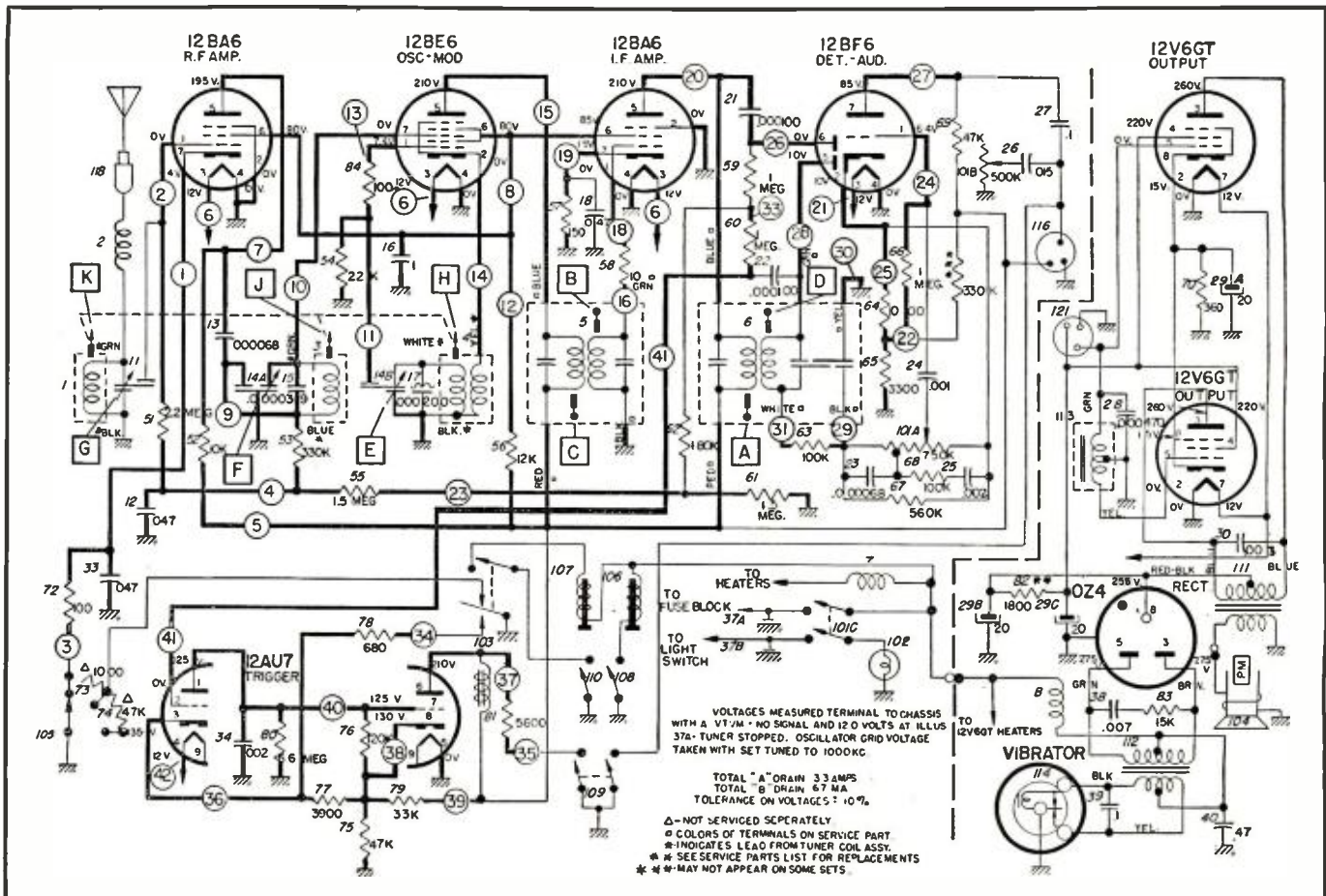

The push-pull audio-output transistors are the same type used in the Model 987575 receiver for the regular Chevrolet cars. In their class AB push-pull arrangement they provide approximately 11 watts of power output. The chassis consists of two sections: the r.f. portion uses printed wiring; the audio-power chassis section contains the four transistors and the 12X4 rectifier. The latter chassis section is made of heavy aluminum, and has the transistors mounted to it on mica insulators. In this way, heat generated by the transistors is conducted to the chassis through the mica to keep the transistors from exceeding their maximum junction temperature.

Rounding out the Chevrolet line are two more conventionally designed units consisting of vibrator, rectifier, and five tubes (Model 987573) or six tubes (Model 987693). The five-tube set, known as the "Standard," is of straightforward design with conventional manual tuning. The second set, the "Custom Deluxe," adds an extra tube for push-pull audio output and provides for push-button station selection. Also, like the 987577, it uses two separately mounted subchassis—a printed-wiring r.f. unit and a conventionally wired section for the audio-output and power-supply stages.

Servicing Roadblocks

Car owners prone to reminiscence have been known to recall, with some amusement, the era when the still-novel auto radio was an intruder to the inside of the automobile, and looked it. The main portion of the radio would mount under the dashboard somewhere, in a separate, easily seen (and easily reached) container. The tuning head, often at the end of a separate extension cable, might be found on the steering wheel, roughly in the position that was occupied years later by the hand shift. While such arrangements scarcely made for streamlined appearance, they did provide the advantage of good access. In a matter of minutes, the entire radio could be taken out of the car and moved to a more convenient place for repair. In those days, the service charge for repairing a defective auto radio was no greater than that for performing similar labor on a house receiver.

Nowadays, radios must be built-in, giving the appearance of being part of the car. Accordingly, getting them out for service amounts to dismantling part of the car. On Chevrolet automobiles, as on many others, the best way to get to the radio is by way of the glove compartment. Removing this compartment provides clear access for one hand to one portion of the receiver, considerably simplifying the matter.

For special considerations pertaining only to the regular line of Chevrolet cars, Fig. 4 will be found most useful. Its exploded views, called-out details, and pinpointing of differences can save much time. Once the receiver

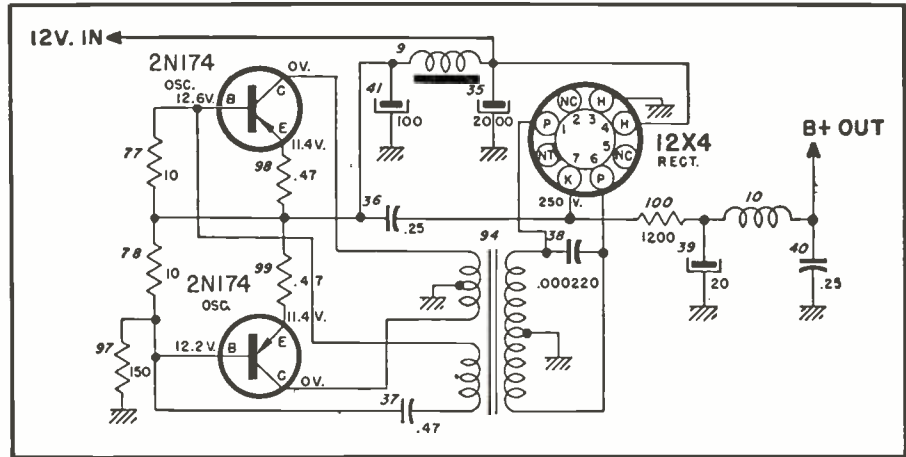

Fig. 3. Two power transistors are operated as a blocking oscillator. Their output is stepped up through the transformer and rectified to provide "B+."

ers are out of the car, troubleshooting routine becomes familiar.

The speaker may be removed by loosening four nuts, not shown, located at each corner under the speaker grille. This permits the grille to be lifted off which, in turn, reveals the heads of four other screws, available from the top of the dashboard, that

hold the speaker directly in place.

Service technicians report that, difficult though the removal procedure would appear to be, trouble ends with the first effort. After one receiver has been removed from a given automobile, subsequent removals from the same make and year of auto present surprisingly few problems.

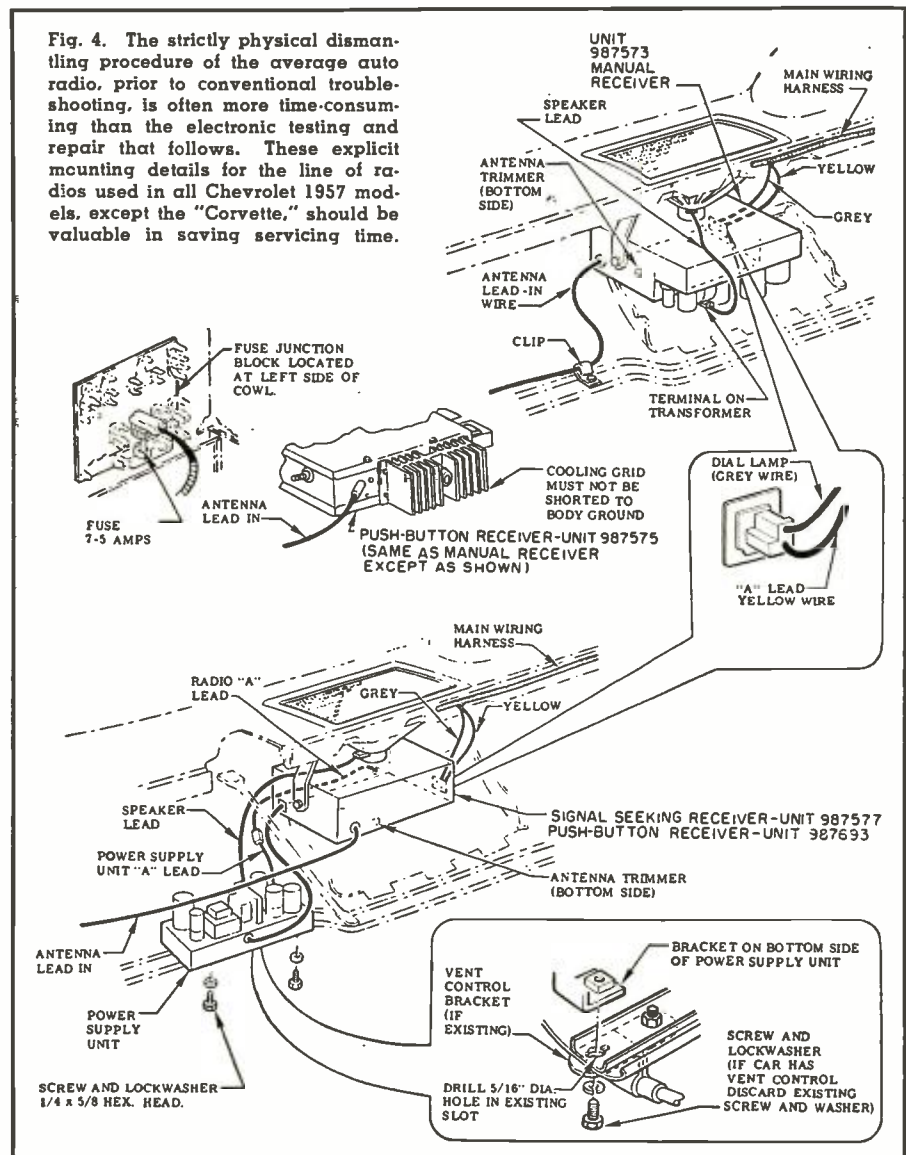

Bottlenecks in TV Service



Once on the bench, as shown here, most receivers present no great problem.

By JOHN B. LEDBETTER

What should be simple service procedure is often complicated by mechanical chassis layout problems. Here are typical cases and remedial suggestions.

IN ANY profession, it is always easier to be an arm-chair general and say, "I would have done it *this way*" or "why didn't they do this or that?" Generally, this type of comment offers few or no constructive ideas and so bears no weight.

In TV servicing, the situation is altogether different. When a new circuit or design is released, technicians in the field are aware that the design engineers have done their best from one particular angle. However, when thousands of field and bench technicians have been called upon to service that same receiver, clean the picture tube, replace hidden parts, struggle with removing and replacing the chassis, etc., problems which understandably may have escaped the designer may become rudely apparent—not only in little irritations but often in valuable service time lost, not only in *repairing* defective circuits but in solving the problem of *getting* to them.

There is no way of knowing how much irritation can be caused or how much time can be lost unless one has worked with these sets day in and day out. Actually, the writer has personal knowledge of one top-rated TV store which recently discontinued two popular makes—simply because the construction in general and difficulty of removing the chassis in particular in most of their 1956 models made servicing a headache.

Confronted as he is by such problems, the practical TV technician often is able to see a solution to problems which might never be realized by engineers or designers outside the

servicing field. In such a position, the technician is no longer an "armchair specialist" but a practical adviser. Where the TV receiver is concerned, he might also be called, seriously or not, a consultant on "internal affairs."

The following actual cases are taken from the direct experience of the writer and others. Remedies are suggested for the benefit of all concerned, including the manufacturers. In the light of the frequently levelled charge that manufacturers introduce these design inconveniences to cut costs, one interesting factor emerges: most of the complaints noted here could be corrected with little or no production difficulties. The result would be worthwhile both for the busy service technician and the harried customer. It would also do no harm to the manufacturer's reputation for putting out a reliable set that can be serviced sensibly.

Case No. 1—Inaccessibility of tubes: In one set, a *Standard Coil* tuner is mounted on its side, with the tubes facing inward. To check the 6J6, the chassis must be removed from the cabinet. The picture tube is mounted so close to the chassis, however, that the 6J6 *still* cannot be reached unless the picture tube is removed or a long jig or screwdriver is used to pry the tube out. To replace the 6J6 (without removing the picture tube), it is necessary to tape the 6J6 to a long screwdriver, socket wrench, or other such device, and fish it into place from the opposite side of the chassis. This is a tedious job which should not be necessary.

Remedy: Either allow sufficient

space between the picture tube and chassis for the technician's hand to pass through, or mount the tuner with the tubes facing *outward* so they are accessible.

Case No. 2—Inaccessibility of tubes: The receiver in question is generally well designed. The tuner, however, is mounted beneath the chassis in a side-mounted position (see Fig. 1) with the 6X8 and 6BQ7 protruding horizontally. For a simple check on either of these tubes, it is necessary to remove the entire chassis. In addition, removal is complicated by burrs in the bottom of the metal cabinet (around the mounting-screw holes) which prevent movement of the chassis without lifting, and by the absence of large, sturdy parts which might afford a hand-hold. (A filter capacitor at the right rear of the chassis *looks* handy, and you may grab it without thinking. This capacitor, however, is mounted on a thin fiber mount which snaps off at the slightest pressure.)

If care is used, the chassis *can* be raised just high enough for delicate hands to slide under the bottom to reach the tuner tubes. Here removal is difficult because of the flat shield plate which extends over both tubes. If the chassis is to be removed completely, a very short a.c. cord (going to a clock on the front of the set) must be disconnected, and the speaker must be removed before the chassis can be taken out of the cabinet. Disconnecting the clock cord can be a job in itself, especially when large-size hands can barely reach the cord connector.

Remedy: A simple solution in this case would be the provision of an access plate in the cabinet bottom (just beneath the tuner) large enough to allow approach to these tubes. (This remedy would also apply to those receivers which conceal the 1B3GT un-

der the chassis, with no way of reaching it except by removing the entire chassis and then removing the cover from the h.v. shield can.) The flat shield plate on the tuner shown in Fig. 1 could be bent downward enough to clear the tubes and still provide adequate shielding. As for the extremely short cord to the clock, either make the connector (located halfway up the cord on present models) easier to reach, or mount a regular plug-in connector on the chassis. Removal of all burrs and rough joints from the metal chassis, which now tend to hamper removal, would also be a boon in servicing these sets.

Case No. 3—Difficulty in removing chassis: Case No. 2 was one example of this type of trouble. Another is a popular 1956 model (24-inch screen) in which the chassis is mounted on a wood shelf which is supposed to slide straight into the cabinet, as shown in Fig. 2. However, the top rear edge of the cabinet is not quite high enough to clear the top of the picture tube. Thus, to return the set to the cabinet, the technician must tilt the front of the chassis sharply until the picture tube has cleared the cabinet top, and then must guide the chassis in place with a cloth strap hanging from the top of the picture tube for this purpose. However, the cabinet itself is light enough to move around on its own during this procedure, and usually does. The safety glass may crash forward—ours did! (The safety glass is held in place only at the top with a thin strip of masking tape, and the tape can slide off rather easily.) Recently, one of these sets in a local shop was so difficult to replace, what with the cabinet and shelf binding, that it required three successive tries by two technicians to get it into the cabinet.

Remedy: Obviously, either provide just enough clearance above the picture tube for the chassis to slide straight into the cabinet, or drop the supporting shelf of the cabinet slightly to eliminate binding or jamming at any point.

Case No. 4—Safety glass not removable: All picture tubes and safety glass have to be cleaned sooner or later. In some parts of the country, this is necessary every six months or more often. In many sets, the entire chassis, picture tube, speaker, remote-tuning assembly, etc., must be removed to provide access to the safety glass and face of the picture tube. Little wonder that most technicians, rather than tackle a dirty glass in the home, leave this time-consuming and money-losing job until the customer complains or the set comes into the shop for other troubles.

Remedy: All safety glass should be removable from the front. This entails no particular design problem, and allows the technician to do a thorough cleaning job in five minutes instead of an hour or more in some cases. If properly designed, the safety glass can still be removed only by a qualified

technician. Some of the new sets have false panels, louvres, or other embellishments which conceal any evidence of screws or like mountings, and hence do not tempt the customer to tamper with or attempt removal of the glass.

Case No. 5—Inaccessibility of tubes and parts in portable TV sets: Most of the new TV portables are rather difficult to disassemble even for simple tube checks or replacement of minor items. With the low-cost service policy (\$12.50 per year) available on these receivers, the technician will not break even if he must spend 10 to 15 minutes extra in getting to the chassis and another 10 minutes or so in re-assembly.

Remedy: Serious thought should be given toward making these sets easier to get into, especially since they require a great deal more servicing in a year's time than their larger kin. It should be possible to design a cabinet half-shell or similar arrangement which would allow access to tubes and parts without too much trouble and without removal of half the cabinet screws. Some of these cabinets are not too difficult in themselves to remove, but initial removal of speaker or speaker leads, antenna connector bracket, interlock bracket, and other odds and ends takes up too much bench time.

Case No. 6—Inaccessibility of components: In many new receivers, as well as some several years old, parts and tube-socket pins are difficult to reach for testing or replacement. In some models, for example, an oblong shield plate covers the entire bottom of the video i.f. strip (see Fig. 3A), including all the video i.f. components

and the video diode detector. This is good from a shielding viewpoint, but the plate often has to be unsoldered at one end and several screws have to be removed to gain access to the detector or video i.f. sockets. In many of these sets, socket voltages can still be checked by using test sockets equipped with external pin connections. Some of these receivers, however, use the permanently attached tube shields (see Fig. 3B) which leave no room for even these test sockets.

Remedy: In the most difficult cases, several test points brought out to easily accessible locations would help. In others, a slight modification of the shield plate would allow easier removal of the plate, possibly by means of a snap-in mounting, or else, a means of reaching the pins without removal of the plate might be worked out.

Case No. 7—Coding and marking of components: The average technician has no trouble in reading resistor values and tolerances, but quite a few have difficulty with the various types of capacitors. Servicing time could be reduced (especially in cases where a burned or scorched unit is found) by stamping the component directly with values rather than identifying it by color. Actually many ceramic, button, and similar capacitors are stamped simply and legibly with the value, tolerance, and voltage rating. In a similar vein, it would help immeasurably if primary and secondary readings of horizontal flyback transformers, d.c. resistance of chokes, yokes, etc., could be similarly marked, possibly on the frame or support of the unit.

Case No. 8—High percentage of
(Continued on page 142)

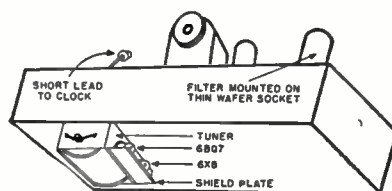

Fig. 1. (Above). Chassis must be removed for simple tests on the tubes in the inaccessible front end of this receiver.

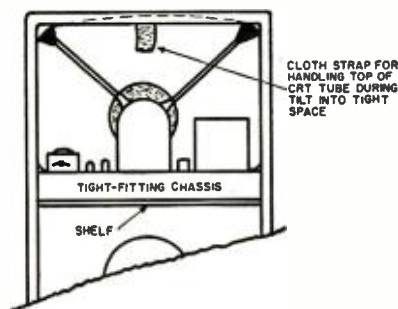

Fig. 2. (Upper right). The tight fit of this chassis in its cabinet space calls for several tries to get it in place, raises danger of safety-glass breakage.

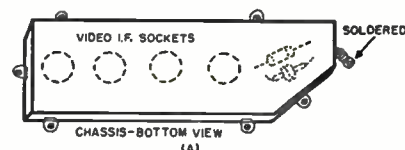
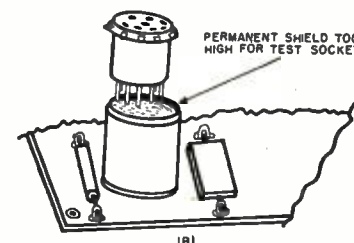

Fig. 3. (Lower right). A shield plate over the video strip (A) must be dismantled in this receiver to gain access to the tubes. Permanently attached tube shields (B) are another service obstacle.



Why Loudness Control?



By
NORMAN H. CROWHURST

A fresh approach to the need for a true loudness control and information on its proper adjustment.

ANY subject that depends upon appreciation by the human senses is bound to be one that comes up for perennial discussion. This is one of them. There are two extreme schools of thought: one of these suggests that correct reproduction requires an accurate re-creation of the original sound wave pattern; this means that all of the components in the original program must be reproduced in exact proportion and *at the same level*; this philosophy does not allow of anything so intangible as a loudness control.

At the other extreme we have the people who believe that human hearing has been "scientifically" established by such data as the Fletcher-Munson curves; therefore, to give a true subjective impression of any reproduced program material, a loudness control *must* be incorporated that introduces compensation according to the accepted and proven data published first by Fletcher and Munson.

In between these two admittedly extremist views a number of subsidiary questions arise and confuse the novice still further. Hence the perennial topic. Let's start out from the classic point of argument that faithful reproduction should be an exact re-creating of the original sound wave pattern.

Pursuing this ideal to its logical conclusion one would assume the loudspeaker should generate a sound intensity in the listening room identical to that received by the microphone

in the recording studio. This leads us to question number one.

When most people say this, they subconsciously think of listening to an orchestral performance in a typical auditorium, from a typical auditor's seat. But, if a microphone were placed in the position of the typical auditor's seat and a recording made, no one with any musical appreciation would want the disc. The reproduced sound would be quite unlike the impression conveyed when sitting in that seat personally. Why should this be?

Whether we use a stereophonic system for reproducing our sound or not, *our hearing is always binaural*, whereas the microphone is not, placed in the position of the typical auditor's seat or wherever you will.

Some readers of this magazine have the misfortune to be deaf in one ear. To them, the remarks which follow will seem incomprehensible, except as pure theory. A few years ago the author was deaf in one ear for a period, an experience which enabled him to appreciate how different everything sounds this way. This experience also confirmed the following explanation.

When we take up our seat in the auditorium and listen to the program, we are primarily conscious of the orchestra; secondarily we hear the reverberation coming from other parts of the building, as a kind of echo, although the time interval is usually too small for it to be noticeable as

a separate entity. But our binaural capacity for differentiating directions enables us clearly to separate, in our subconscious perception, the original sound from the orchestra and that due to the same program reverberated around the auditorium.

The difference in intensity between these two components of sound may not be more than 10 or 20 db but, because of our subconscious interest in the program itself, attention is focused on the orchestra and the reverberant sound is heard merely as a background that lends character. Because of this, our subconscious subjectively increases the *apparent* difference in level to much more than the actual 10 or 20 db.

The microphone, however, being a much more non-subjective device than a pair of human ears, would pick up the whole sound received as a conglomerate, with only the actual 10 to 20 db differential between the direct sound from the orchestra and the reverberant sound from various parts of the auditorium. When this sound is reproduced over any system whatever, even in a thoroughly acoustically damped room, it will sound extremely reverberant and "echo-y." This is because now the direct and reverberant sound both come from the same source, and our binaural faculty of hearing no longer can go to work on it in the same way and direct attention to the orchestra exclusively.

Recording studio personnel, of course, are thoroughly conversant with this fact. They don't advertise it, because listeners naturally prefer to think the recording transports them

to a position in a typical listener's seat in some auditorium. But, to get an effect that puts the direct sound and the reverberant sound more in the correct proportion, as the listener *thinks* he would hear it, the microphone must be placed very much nearer to the orchestra, or, what means practically the same thing (for this purpose), a highly directional microphone must be used to favor sound from the orchestra more than the reverberation.

Modern practice usually places the microphone quite close to the orchestra, or uses an array of microphones distributed among the orchestra so as first to get a pickup that represents the original program material, exactly as played by the orchestra, practically without any reverberation at all. Then, if some reverberation effect is required, the studio uses an echo chamber to add this artificially. This procedure enables the effect to be easily controlled so the resulting sound will have just the right amount of reverberation to give the desired effect.

Certainly this technique produces very fine sounding records, judging by recent releases from most of the record companies. Even the sticklers for accurate reproduction of the original sound will have to admit this although, if they knew it was made this way, they would call it "phony." But let's ask them, which original sound do they really want reproduced accurately, the sound of the orchestra, as heard by, say the conductor, or one of the microphones scattered throughout the orchestra, or the sound as it might be heard in the echo chamber, somewhere between the loudspeaker that produces the sound and the microphone used to pick up the "echo"?

It is quite obvious that neither of these sounds will be the same as that we hope to hear in our living room.

When you sit in the average seat in an auditorium and listen to an orchestral concert, the sound you hear is quite different from that heard by the conductor, or by any of the instrumentalists in the orchestra. All of these performers work to give the best impression to you, the paying audience. The same is true making recordings, only here we have a few more "performers", like the engineers who operate the various controls associated with the microphone levels, echo chamber, etc.

The important thing is that the intended impression is put across, whether by the individual performers working collectively in the orchestra in an actual auditorium, or whether by all those who work together to make a satisfactory record.

Picking up the program at close quarters like this gives another advantage to the record maker. It assists in getting a better dynamic range onto the recording. As well as giving the direct sound from the instruments a bigger advantage over reverberant

sound reflected around the studio, it also gives the program material a better advantage over various other stray sounds, noises that can creep into the studio by devious means.

A good studio is built with all kinds of sound insulation to keep out extraneous and undesired noises. But all such devices only *attenuate* the undesired sounds, they don't completely eliminate them. Consequently, it is still advantageous to have a fairly high level of sound at the microphone, so as to give the biggest possible margin over unwanted background sounds.

This also makes it easier on the recording system, because it gets the program material that much farther above background noise from the microphone itself and the amplifier system.

But picking up sound for the record at this high level and recording it through a system with standard equalization characteristics, means that the original sound pattern can only hope to be truly re-created when played back through the correct compensating playback equalizer characteristic and reproduced over a loudspeaker system *at the original sound intensity*. This will be too loud for comfort—much louder than one would receive sound in the average seat of an auditorium. The intensity of sound in the living room, reproduced this way, would be comparable to the level of sound in the area occupied by the orchestra itself.

To get the true perspective of the music, one needs to be a little farther away or to hear the sound at somewhat lower level. Consequently it is usually desirable to reproduce the sound at a somewhat lower intensity than it is picked up at the microphone for recording.

Let us now consider another angle. Live musicians can, and do, provide

program music for any of the purposes for which we use reproduced music. As well as playing to an audience in an auditorium, musicians, upon occasion, play to entertain people in a living room, or to provide background music in a restaurant or club, while the occupants talk. A group of musicians playing under any of these conditions will naturally adjust their performance to suit the purpose in hand. They will play louder in an auditorium and much quieter in a restaurant or club. How do musicians themselves make this loudness adjustment?

This does not mean that each instrumentalist will reduce his volume by a precise number of decibels. Rather, each reduces his own loudness so that the same sense of balance is achieved at the lower loudness level. This, naturally enough, is done according to the judgment of the musicians' ears.

While musicians' hearing certainly is differently *conditioned* from that of most of us (which is what we infer by crediting a person with a "musical ear"), there is no *intrinsic* difference between the ears of musicians and those of the rest of the population. The famous Fletcher-Munson loudness contours were based on the hearing of musicians as well as of other groups of people. So one would expect an average musician to have a sense of comparative loudness similar to an average person of any other group.

As this is the case, each instrumentalist will automatically adjust the loudness of his playing so as to obtain a perspective of over-all balance that agrees with the general pattern of human loudness sensation.

If we base this on the experience represented in the Fletcher-Munson contours, shown in Fig. 1, and assume that the difference in loudness from the concert hall level to the background music level is from the 70

Fig. 1. The Fletcher-Munson curves of equal loudness at various listening levels.

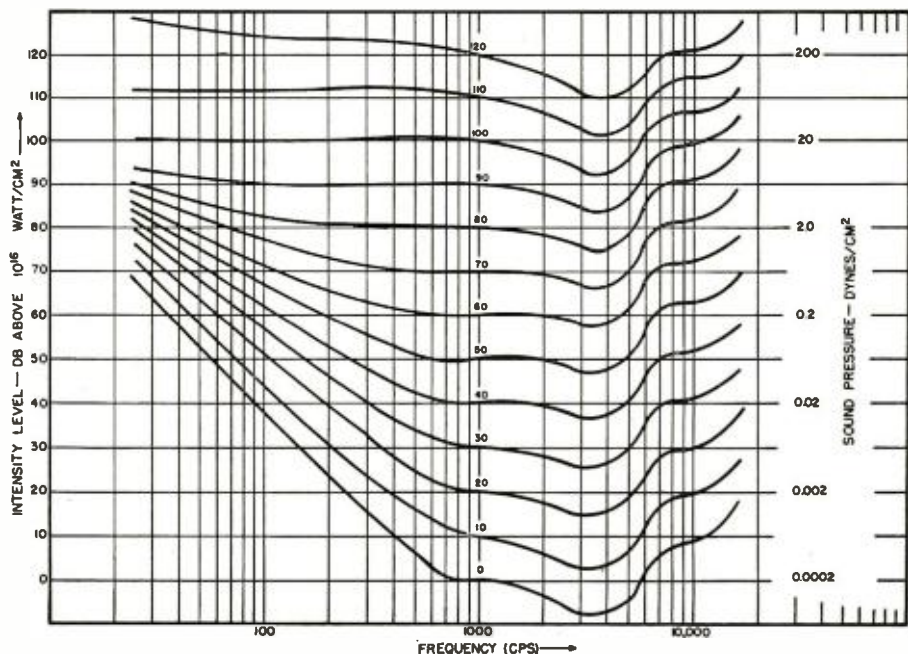

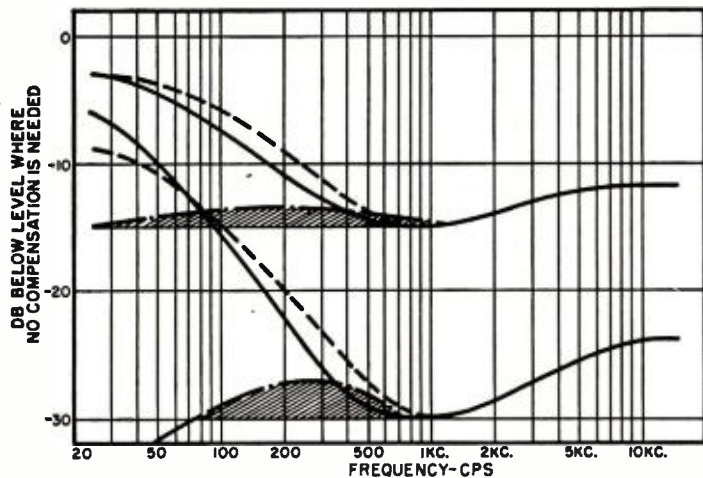

★
 Fig. 2. Comparison between range of control afforded by the average tone control and the kind of change in response required for satisfactory loudness control.
 ★

curve to the 40 curve, this will be a difference of 30 decibels at 1000 cycles and also at most frequencies above this. So musicians playing instruments with frequencies from 1000 cycles and up—or even 500 cycles and up, will reduce the intensity of tone from their instruments by about 30 decibels, or a power ratio of 1000 to 1. But, going down to instruments like the string bass, which may be playing tones in the region from 40 to 80 cycles (taking 60 cycles as an average), the difference between the curve marked 70 and the curve marked 40 is only about 12 decibels.

While the bass player will undoubtedly reduce the *apparent* loudness of his instrument by the same amount as other players in the orchestra, the *actual* intensity difference is much less. The higher instruments reduce by 30 decibels, while the bass player only reduces by 12.

As we have seen in the preceding discussion, music is never recorded at such a low level. If you want to use recorded music for this purpose, you will have to turn the gain or volume control down by 30 decibels or so, and if you want to play at a level suitable for the average living room you will still need to turn it down, by possibly 12 or 15 decibels, from the intensity at which the music was originally recorded.

But to retain the balance at which the group of musicians would naturally play, the bass frequencies must be turned down to a lesser extent than the middle and higher frequencies. This is *our* argument for using a loudness control. If an ordinary volume control is used (which should more accurately be termed a gain control), to produce this effect, the balance is disturbed.

Fig. 3. Tapped pot used as loudness control.

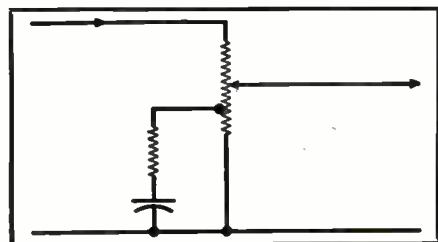

The effect produced is not that of the orchestra playing more quietly but of its being farther away.

This is because all frequencies are attenuated in *proportion*, which is exactly what happens when you listen to a musical program from a distance, unless of course there is exceptional transmission through floors and ceiling, such as may occur if the "distance" is from one floor to another of an apartment house!

This has about sated the esthetic factors that form the basis for discussion as to whether the loudness control is needed at all and, if so, what kind of control should be provided. Having settled that we do need control facilities to make this adjustment, the next point is if a special loudness control is needed, or whether an ordinary volume (or gain) control can be used satisfactorily in conjunction with the regular tone controls?

The alternatives in this stage of the argument are: whether we have a loudness control that automatically increases the relative amount of bass, measured by intensity, as the volume goes down, or whether we use a "straight" gain or volume control and then use the bass knob of the tone controls to get more bass when working at a lower loudness level, if necessary also giving a little boost to the treble end for the same reason. Don't both of these methods really achieve the same thing? And, using just a gain control with tone controls, surely, is simpler than having to "bother with" an additional loudness control?

Time was when it was argued that equalization facilities were not required for all of the different recording characteristics—the tone control would serve for this purpose as well. Going back still further, there was a time when tone control consisted of just a variable resistance in series with a capacitor, conveniently placed somewhere in the circuit, which produced only a variable treble cut. There was no true bass control. All too often, this control was operated with the treble fully cut, because this removed a maximum of unwanted background noise, scratches, and plops, either due to scratch on the record or due to static coming in on the

radio. The average listener of those times couldn't tell the difference between the maximum and minimum position of the control, *as far as the quality of the program itself was concerned*. The only effect noticed was the apparent reduction of background noise.

But, since then, listeners have become educated to *high fidelity*. And the fidelity, both of equipment and of recordings, has improved tremendously. Nowadays, the comparative novice in high fidelity can tell the difference between bass boost and treble cut, or *vice versa*. It requires a little more education to discern the difference between records played with the correct equalization characteristic and with the wrong one, but it certainly is possible to tell the difference.

But, a decade or so ago, strong arguments were put forward that the tone control should serve this function in addition to any other tone compensation that may be desired. Nowadays, any self-respecting preamplifier provides equalization characteristics for RIAA, and usually one or two other recording characteristics that may be encountered; and the average high-fidelity listener appreciates this position and reserves the use of tone controls for their proper function—adjusting for differences in balance that may become apparent, due to differences in the acoustic characteristics of the studio and the listening room, or due to any other variations in the balance of musical composition of the program.

Now the extremist comes along with the loudness control and says this also is a must, in addition to tone controls and equalization. Are we going to accept this further stage as a necessity, along with equalization, or is this really a luxury that is completely unnecessary?

This would seem to depend upon the accuracy of your perceptive powers. This can be illustrated at Fig. 2, which shows a comparison between the range of control given by the average tone control and the kind of change in response needed in a loudness control, to follow the variation predicted by the Fletcher-Munson curves. For the tone control to get enough boost in level at the low-frequency end, gives too much boost at frequencies higher up. The boost has to start in the region of 500 cycles, whereas the loudness contour shows not very much difference at 500 cycles based on true loudness contours.

As the region in question is from 100 to 500 cycles, which corresponds to the middle register of music, use of the low-frequency boost in conjunction with the volume control will over-emphasize the middle register, which is not at all what is required for true loudness impression. So the average tone control puts the low-frequency accentuation in the wrong place, and by the wrong degree.

If you can hear this difference,
 (Continued on page 111)



Fig. 1. RCA Model WR-61B color-bar generator provides a standard pattern.

Test Equipment for Color TV Shops

By **WALTER H. BUCHSBAUM**

Television Consultant
RADIO & TV NEWS

What instruments are needed on a bench to insure handling of all current sets, including color TV?

WE are accustomed to hearing that there are many ways to skin a cat. There are many more ways to equip a fully up-to-date test bench in a modern service shop where it is hoped that all type of complaints to which radio and TV receivers are subject—including those designed for color—can be handled. This is not to say that we would find it impossible to set standards for the type and quality of equipment needed. It merely points up the fact that, once criteria have been established, there are many ways in which they can be met. For this reason, we cannot call the array shown on this month's cover and also in Fig. 3 the only solution in attempting the ideal set-up.

It could better be called one typical set-up, but even here some objection can be anticipated: the orderly arrangement of instruments and working space is a far cry from the hectic disarray characteristic of so many benches during a busy work day. Nevertheless, the efficiency permitted by the carefully organized bench—with a place for everything and everything in its place—is even more important to work toward in the busier shops.

One of the factors that makes possible an intelligently organized layout is the design of the bench itself. The physical plan, in the bench shown, paves the way to the orderly division of work space. This has not happened by accident; designed under the aegis of the *General Electric Company*, the bench is intended to facilitate systematic bench work. The mirror against the back portion, for example, gives the bench man a picture of what is happening on the face of the CRT no matter what position he puts the chassis in for most convenient service. (That picture, of course, is always reversed, and accounts for the reverse order of the color bars on the pattern shown on the cover.) For the other conveniences this bench provides and for details on its construction, see the separate article on the "Functional

Work Bench" elsewhere in this issue.

Aside from the relatively neat layout, the most obvious way in which another equally acceptable array of equipment might differ is that any of the pieces of equipment shown can be interchanged for those of some other manufacturer. For example, although an oscilloscope and a voltmeter would be considered necessary for nearly any shop, there are many types that would answer the purpose. The choice of a particular unit for illustration here does not carry the implication that it is the only one to meet requirements, or that it is the best of those that do.

Furthermore, in order to provide every one of the tests, functions, and other facilities provided by the instruments on this bench, we would not necessarily have to duplicate each individual item of equipment. Various operating facilities are combined in different ways in individual instruments and most shop owners, as they fill out the complement of equipment gradually, will find their decisions for new purchases influenced by what is already on hand. A simple illustration might be that of the owner of an oscilloscope that boasts a sweep phasing control. In choosing a sweep generator, he would not have to insist on such a control.

This sort of flexibility would even account for the elimination of entire pieces of equipment in some cases. For example, if the technician can go beyond the substantial outlay required for a generator of color bars only to

the extent of purchasing one that also provides dots and a crosshatch pattern, he eliminates the later expense of buying a separate generator for convergence and linearity adjustments. On the other hand, a linearity generator compatible with the requirements of color convergence may have been about the shop some time before its use for color was dreamed of, and color-bar output only may then be sought.

The matter of outlay, just mentioned, points up another factor in building up a service establishment sufficient unto today's needs. This point is equally important to the service technician and to his customer, although often overlooked by the latter. Just as the basic crystal-earphone receiver of three decades ago has given way to the complex monochrome and color TV receivers, home audio systems, and other home electronic devices, so the era of servicing by intuition or with the aid of no more than a single fundamental test instrument has yielded to time.

Shown on the bench is at least \$1500 worth of test equipment and service manuals. Not included in this modest estimate is the cost of labor needed to assemble those instruments that were originally procured in kit form. In considering this sum, we should keep in mind two important factors: first, since an attempt has been made to plan the array of equipment shown with economy in mind, the amount is not high. Much more could be spent in similarly equipping



Fig. 2. Winston's Model 150 (upper left) is a rainbow-pattern generator. The Hycon Model 616 (lower left) and Philco Model 7100 (above) give color-bar output.

another bench, especially where it is considered impractical—or even uneconomical—to invest the labor cost required in putting together kit instruments. Second, remember that the outlay involved here represents just one of the many expenditures in order for even a small shop to render proper service. These points are worth consideration by the customer when he is faced with a repair bill of \$20, \$35, or more. They are also worth consideration by the service dealer when he hesitates to make a justifiably high charge for his work because he fears the customer may complain.

Color Equipment

In the light of the high cost of equipping a service bench for today's needs, how much of this heavy outlay can be ascribed to the purchase of units that were not needed until color came along? Surprisingly enough, if the bench has been kept up to date with the growing needs of TV and related electronic servicing up until the advent of color, no more than 20 percent of the investment accounts for additions made specifically for color TV work. On the bench shown, this would account for two units, the *Triplet* color-bar generator, Model 3439, and the *Simpson* white-dot generator, Model 434. In some cases, only one unit would be added for color: either the dot generator would be combined with the color-bar generator, or the dot generator would have been available earlier for use in making linearity checks on monochrome receivers. This estimate is based on the premise that all other equipment that will also be common

to monochrome service work is of sufficiently good quality to satisfy the special demands of color. These requirements will be discussed subsequently, but it may be pointed out now that there is a good argument here for always procuring instruments of best quality rather than getting by with the minimum.

The *Triplet* color-bar generator, Model 3439, shown on the front cover, is one of many special color generators now available. *RCA*, long the leading proponent and pioneer in color TV, offers the color-bar generator Model WR-61B, shown in Fig. 1. This unit supplies optional output as a direct video signal, without carrier, in either negative or positive polarity for direct application to the video amplifier or color circuits where desired. Alternately, an r.f. carrier modulated with this signal is available for convenient connection to the antenna input, where this mode of operation is desired.

All color-bar generators provide an r.f. output, usually on channel 3, and most have a separate video output. Many models also have provision for dot and crosshatch patterns as well as color bars. Typical of this combination is the *Hycon* Model 616, as shown in Fig. 2. To aid the service technician in recognizing color defects, the correct color patterns for NTSC, color-difference and quadrature-type signals are displayed on the front panel of this generator. The horizontal or vertical bar patterns, crosshatch, and white-dot signals available on this generator are also useful in adjusting sweep linearity in monochrome receivers. While the output

level of the r.f. signal in the *Hycon* generator is fixed, the *Philco* Model 7100 shown in Fig 2, has provision for varying the r.f. from 100 to 10,000 microvolts. This is particularly useful in checking color sync and color-killer operation on weak signals, and can be used to check a.g.c. action on monochrome sets as well.

The *G-E* Type ST-16A color alignment generator differs from most other units in that it has a wide range of different color signals, but only in sets of three bars each. Depending on the setting of the selector switch, the three bars can be the *I*, *Q*, and cyan or some similar combination, with almost half of the screen black. The black portion is intended to serve as reference and facilitates many oscilloscope measurements.

A completely different type of color generator is *Winston's* "Wintronix" rainbow generator in Fig. 2. This unit is quite compact, inexpensive, and has only two adjustments. One tunes the r.f. oscillator which operates between channels 2 and 6 and can be set for any of these channels. The other control is adjusted to lock the sync circuit to the proper phase to produce stable color bars. Actually the color pattern obtained from the rainbow generator is completely different from previously described units in that the colors are dependent on the r.f. tuning of both generator and receiver. There is no provision for dual-polarity video signals, nor is there a prescribed color pattern available. Output is fixed in amplitude. The small size and simplicity of operation recommend this unit for house calls where rapid color checks are desired. For detailed alignment and bench troubleshooting procedures the more versatile and elaborate types are probably more popular.

Another type of rainbow color-bar generator is the *Hickok* Model 660, which is also intended for rapid servicing, mostly in the home. Here the color pattern takes the form of a fixed color sequence, starting with yellow at the left, passing through the red, magenta, gray, blue, and green shades. Although this generator provides channel switching from channel 2 to 6, the color signal is crystal controlled and will not change. In addition to color bars, this generator also provides dots or a crosshatch pattern which can be used either at the same time as the color bars or separately. The *Hickok* Model 656XC is a much more elaborate generator which provides clearly defined color bars according to the standards established by the NTSC.

Other generators available are the *Jackson* Model 712 and the *Precision* Model E-440. The *Jackson* generator provides output as either negative or positive video signal or as modulated r.f. The *Precision* unit also provides signal either at the video or r.f. level to produce 10 color bars. One feature provided by this unit is a jack for an external meter to permit direct mon-

itoring of the amplitude of subcarrier and sync signals at the source.

One of the confusing things about the various color-bar generators available is their different patterns. There are at least three or four completely different color-bar patterns in use, with no apparent advantages of one over the other. It is true that for some color receivers the *I, Q* type signal is more suitable than the *R-Y, B-Y, and G-Y*, but this should have no bearing on the number or color of the bars, their width, sequence, and spacing. Once, however, the technician buys a particular color-bar generator he will quickly become familiar with its patterns. Confusion only sets in when he starts working with a different model generator which produces a different pattern.

Most generators furnish both a positive- and negative-polarity video signal, a feature which is of great importance when servicing the video section. Just as in monochrome TV, each video amplifier stage will invert the video signal. At the picture tube the signals must have such a polarity that those applied to a grid go negative for minimum brightness while those applied at the cathode must have the black level going in a positive direction. Failure to inject the correct polarity color-bar signal into the color set will result in wrong colors on the screen.

Another feature to consider is the availability of a sound carrier. This is important when the customer complaint is interference with the color reception. Misadjustment of the sound

i.f. traps or the 4.5-mc. traps in the video section could result in 900-kc. interference which is the approximate beat frequency of the 4.5-mc. inter-carrier sound and the 3.58-mc. color subcarrier. This interference appears as fine lines, weaving over the picture at a relatively slow rate. Most of the more elaborate color-bar generators provide a crystal-controlled sound carrier which can be shut off to verify any sound interference. Needless to say, this carrier also helps in aligning a color set.

Other Equipment

After color equipment is out of the way, most of the other instruments and accessories are familiar carry-overs from the days of monochrome
(Continued on page 159)

Fig. 3. One version of the fully equipped service bench. Many different combinations of instruments can fulfill the same requirements.

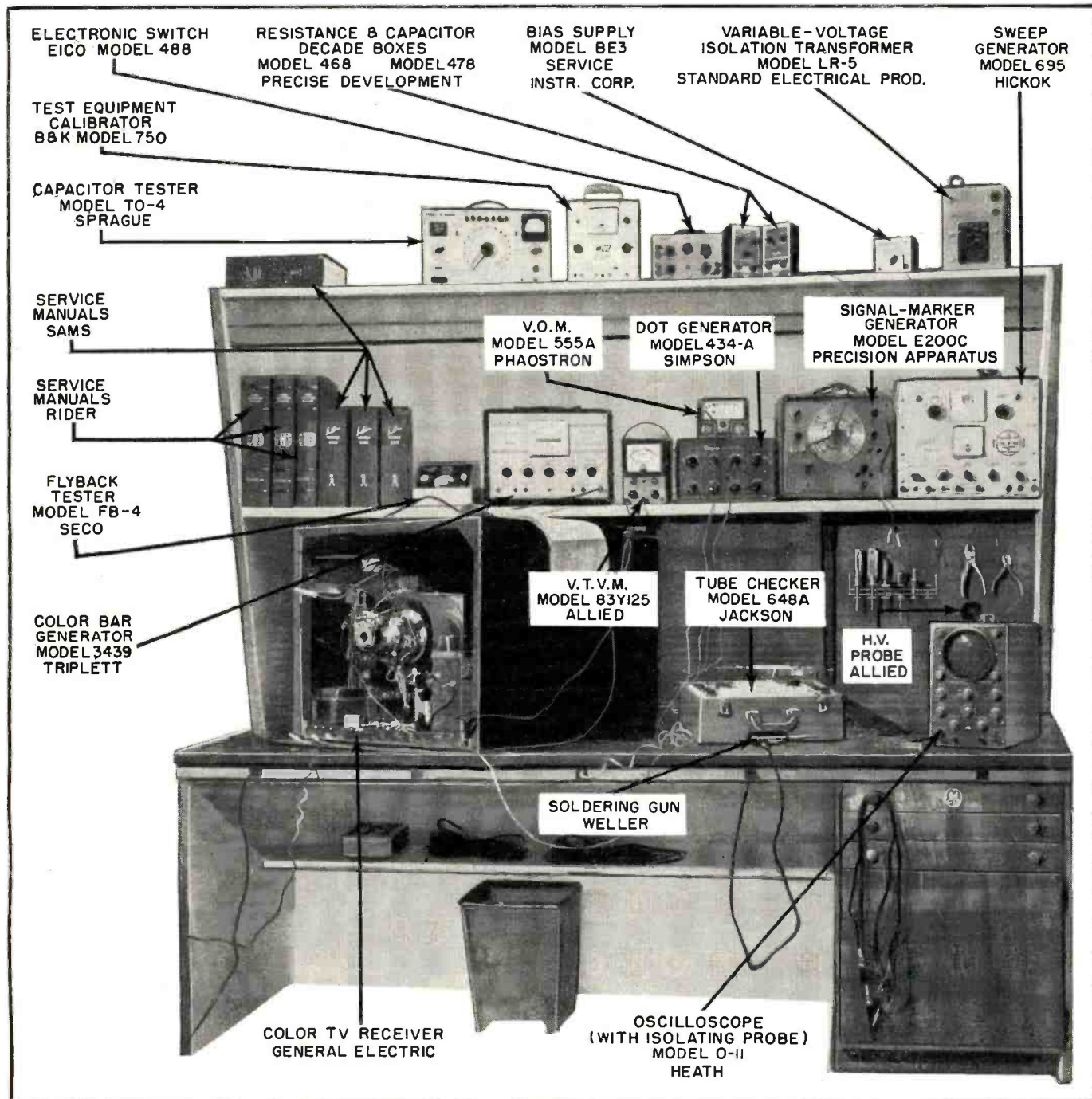

The Case for the CRT Tester-Reactivator

The tester shines in out-of-shop work. →

By ART MARGOLIS

What are the advantages of using this type of instrument? This shop uses it to save time, eliminate doubts, and convince its customers.

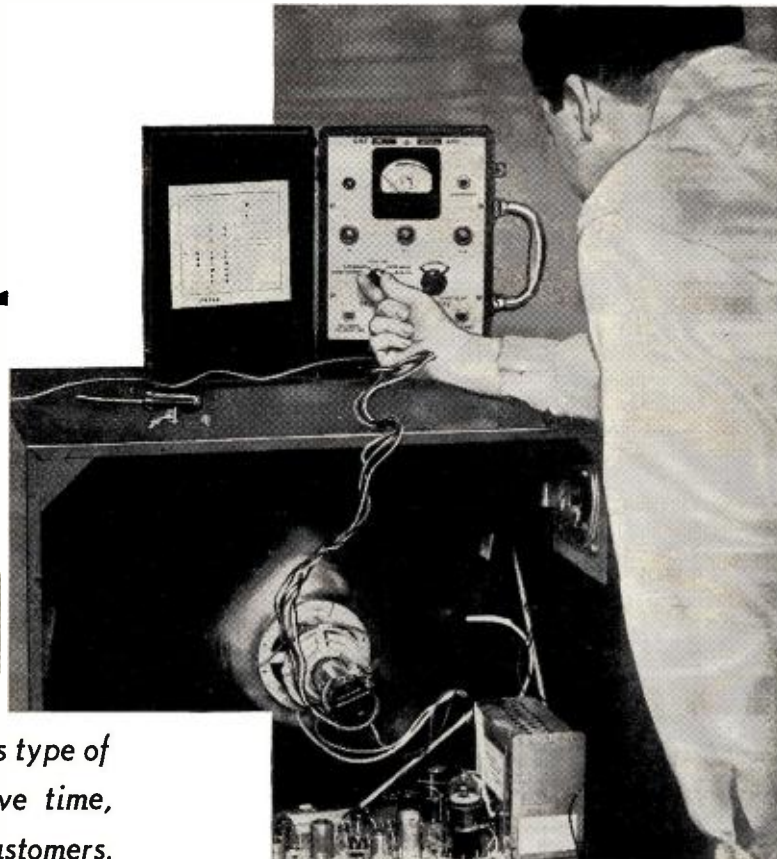

HAVE YOU ever had this experience? You pull a chassis for high-voltage trouble and leave the picture tube still mounted in the cabinet. When the repair is completed, you check out operation using a CRT available in the shop, then you deliver the set. After installation you turn on the receiver and work on adjusting the ion trap—but it just won't be set! The sinking feeling and the realization that the big tube is defective reach you at about the same time. What do you do then?

This entire set of unfortunate circumstances can be ducked by testing the quality of the picture tube on a good checker, as a matter of routine procedure, before leaving that tube behind in the customer's home. Every outside technician in the writer's shop carries his own CRT tester.

Not all of them are of the same make: many models now available will do a good job. The one the writer happens to use himself is a B & K Model 350. With an ammeter and neon lights as the indicating devices, it indicates the quality of the picture tube under test by recording cathode emission and also by indicating continuity or open conditions with respect to the various electrodes. It also indicates and localizes shorts.

Since this unit is one of those that also functions as a reactivator and restorer, it provides some added attractions. It gives a prediction of the probable useful life of the picture tube, for example. Furthermore, it incorporates circuitry that, by the application of various voltages to the tube's electrodes, can correct certain

defects. Some of the duties that can be performed by a combined tester-reactivator include: relief of shorts or leakage between electrodes, welding together of open connections, and the rejuvenation of cathodes that have lost emission. In the eyes of the customer (and to his pocketbook), performance along the lines just mentioned is sheer magic.

When the CRT Is Bad

While many picture-tube defects are easy to analyze, a great number of the others are tricky. That's where the tester steps in to eliminate all doubt. Take the case of a 16-inch RCA set, encountered six months ago, that wasn't too obvious. The symptoms were weak video and a partial loss of vertical sync stability. The brightness control varied the brilliance somewhat, but could not altogether extinguish illumination. In

fact, even at its minimum-adjustment position, brightness remained at a fairly high level.

This symptom will generally result from either of two causes. First, a shorted coupling capacitor from the video amplifier to the picture tube (the .015- μ fd. unit at the grid in Fig. 1) permits the grid to become very positive and results in excessive brightness. The other possible cause is a high-resistance short between the control and screen grids of the picture tube, which would have the same effect. In either case, sync instability can result if the take-off point for sync pulses is in the video-amplifier stage, which is involved in the fault described.

Use of the CRT checker on this call removed any doubt: it clearly indicated a short inside the tube between the control and screen grids. Nor was that the end of its usefulness. One adjustment was used to increase the filament voltage supplied by the reactivator to the picture tube beyond normal value for a short period. This short-term application of increased filament voltage heats up the entire gun structure. Then a button that applied 1000 volts d.c. to the control grid was depressed. Momentary sparking occurred in the neck of the tube, then stopped. The 1000 volts had burned out the short between the two grids. In this case, the short had evidently not been due to direct contact between the two grids, but due to the lodging of a particle between them. Now, six months after the treatment, the picture tube is still in good working condition.

Fig. 1. Similar symptoms can result from leakage in the capacitor shown or from an internal short as indicated. The tester tells which is the case.

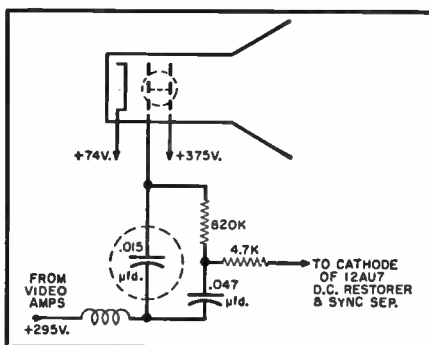

On another receiver, there was no video but good sound and raster. A check through the video i.f. and amplifier stages showed no discontinuity. Some of the miniature tubes were hard to re-insert during this check, requiring more time than usual. The impatient woman of the house didn't seem too pleased with this apparent fumbling.

As a final check before chassis removal, the CRT tester was connected to the neck of the picture tube. It indicated an open control grid. When the set owner was informed of this misfortune, she snapped, "I thought if the big tube goes there isn't any light on the screen." She continued to look cross after receiving a patient explanation of how the picture tube may die in one of several different ways. As a last resort, she was given a brief explanation of how the tester works and asked to operate it herself. The story told by the neon indicators was worth a thousand words. Her attitude changed and a picture-tube sale was consummated.

Another customer had a 14-inch Emerson that had been retired to the bedroom to give service as a second set. As the check on this receiver began, he mentioned, "If the repair is going to run to very much, I guess I'll junk the set." The intermittent symptom occurred every two or three minutes and lasted for only a few seconds. The video would slowly wash away as retrace lines appeared. During the attack, the brightness control would work except that the raster would bloom a bit. Then all returned to normal.

Since the condition happened too fast to permit voltage checks and a picture-tube defect was one of the possibilities, the tester was connected and the waiting began. Sure enough, at the prescribed breakdown time the neon lights winked out a filament-to-cathode short. (See Fig. 2) Evidently insulation between these two electrodes would break down as the filament heat increased. Then, as the cathode drew off some of the filament heat, the condition remedied itself until filament heat rose again a few minutes later. With this elusive intermittent exposed by the tester, the rest was easy: an isolation transformer was installed on the filament. The set has been playing happily ever since.

When the CRT Is Good

Occasionally a technician will come across a TV trouble that looks suspiciously like a bad CRT. Here's where the tester really shines. While invaluable in designating the picture tube as defective it is equally valuable in saying, "The CRT is good," despite apparent evidence to the contrary. For example, a do-it-yourself fan brought in his 21-inch Motorola and began by asking the price of a replacement picture tube. Asked if he were sure his CRT was really bad, he said, "Turn on the set and you'll see."

He seemed right from a quick glance at the symptoms. The filaments were lit. There was plenty of high voltage but no brightness. Adjustments of the ion trap had no effect at all. As a double check, the CRT tester was hooked up. It gave its opinion quite clearly: "This picture tube is good." The reaction of the set owner to this conclusion was, "The machine must be wrong itself."

The chassis was turned on its side and checks were begun in the cathode and grid circuits. The portion of the set involved is shown in Fig. 3. The grid was found to be 80 volts negative with respect to the cathode, and varying the brightness control had no effect on this value at all. Power was then turned off and some resistance readings were made. Mounted directly across the brightness control, with one end to ground, was a .005 μ fd. button capacitor that had turned into a 30,000-ohm resistor. With a new capacitor installed, the picture lit up and performed every bit as well as the tester had said it should.

Once a worried customer came puffing into the shop carrying a 16-inch table-model G-E. "Do you think it's the big tube?" he was anxious to know. The tester quickly said it wasn't. This customer was able to leave the store feeling much better, while his set was being checked to determine what the trouble actually was.

With the set on and the brightness control all the way up, the raster was barely distinguishable even when the shop lights were extinguished. Adjustment of the ion trap brought no improvement. Voltages at the picture-tube grid and cathode were right on the button. Since everything seemed to point to the tube itself as being defective, the checker was applied once more. Again it voiced its approval of the condition of the CRT. Faith in the reliability of the checker was being shaken; it began to look as though it had made a mistake. The picture tube was pulled out and another was substituted. There was no improvement, so apparently the tester had known its business after all.

It took some digging into circuits apparently unrelated to the picture tube to turn up the fault. The plate of the vertical oscillator turned out to

Fig. 2. Intermittent wash-out of the picture, of very short duration, could not be traced in ordinary way. A tester showed it to be due to periodic arc-over from overheating of filament insulation.

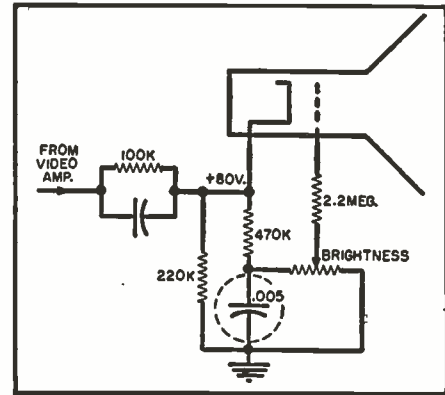
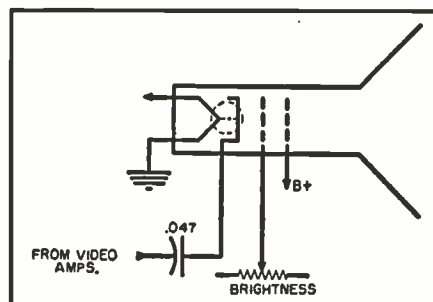

Fig. 3. The CRT itself seemed to be at fault in this case. However, after the tester exonerated it, further probing unearthed the defective capacitor.

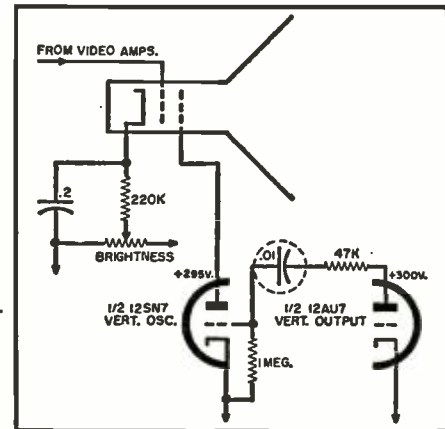

Fig. 4. In this case, a dark raster was the result of a fault in the apparently unrelated vertical circuit. Use of the CRT tester prevented troubleshooting in the wrong direction.

have 110 volts "B+" instead of the 295 called for in the service notes, yet vertical sync and vertical sweep were fine. Nevertheless, the cause for this discrepancy was followed up, and it was found that the drop was due to overconduction which, in turn, was due to a heavily positive voltage on the oscillator grid (see Fig. 4). The .01- μ fd. capacitor between that grid and the vertical output plate had shorted straight across, putting the high positive voltage on the oscillator grid, limited only by the 47,000-ohm resistor. When this capacitor was replaced, the brightness came on full!

After some head-scratching and careful tracing out of the schematic, it was discovered, as can be seen without much trouble from the simplified sketch of Fig. 4, that the second grid of the CRT takes its "B+" from the vertical-oscillator plate. This grid was therefore also down to about 110 volts, keeping the electron beam in the picture tube very weak and drastically reducing illumination. In the face of evidence to the contrary, the tester had been correct.

The Tough Situations

If the service technician handles any appreciable volume of business, he
(Continued on page 122)

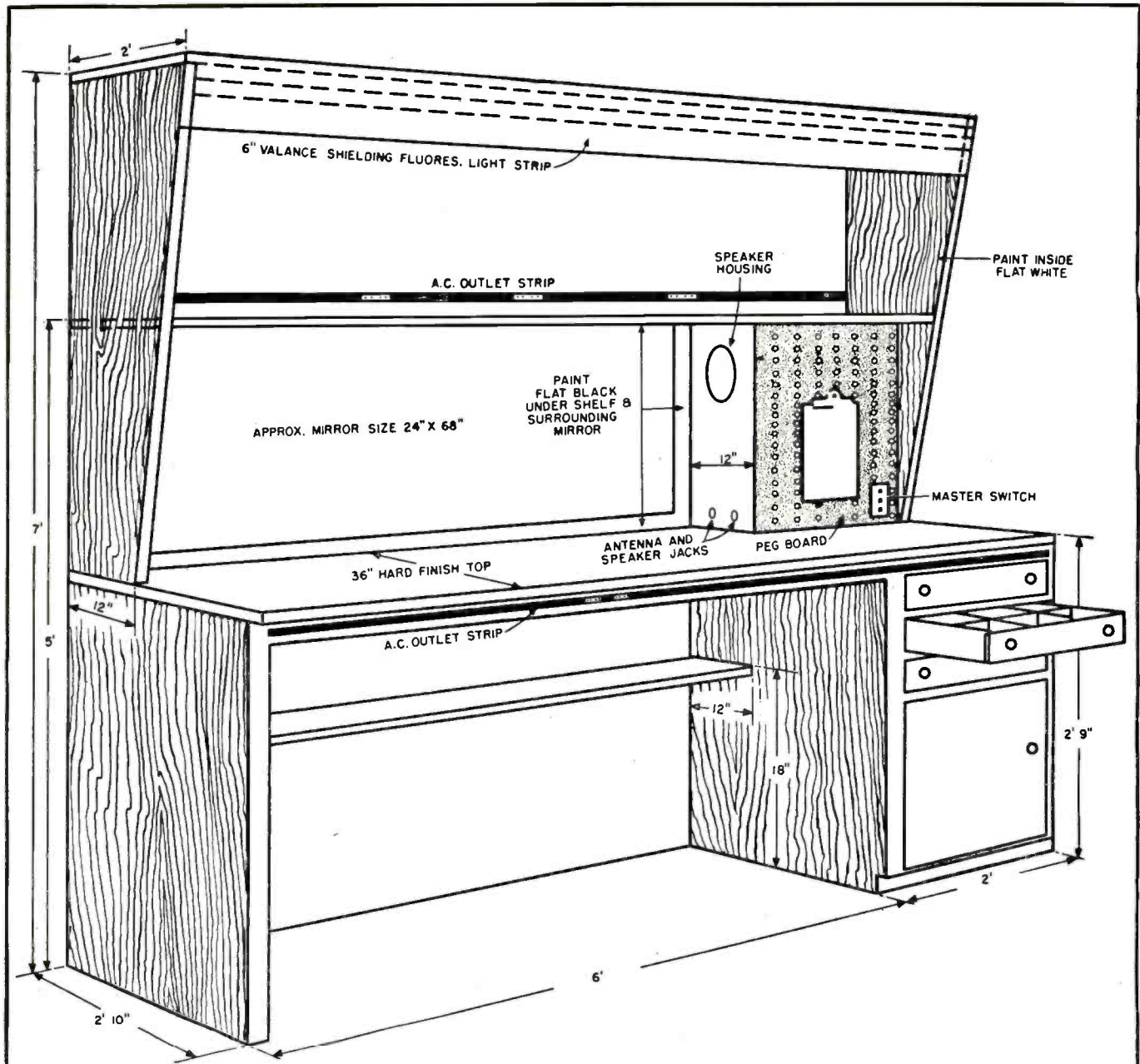

- * CAN BE VARIED IF DESIRED (SEE TEXT) (A) END PIECES
 (B) FOR UPPER SHELF AND HALF OF CANOPY TOP PIECE
 (C) (D) USE FOR SPEAKER ENCLOSURE, SIDE PIECE OF TOOL COMPARTMENT ETC.
 (E) BASE FOR BENCH TOP (F) HALF OF CANOPY TOP PIECE (G) SHELF UNDER BENCH (H) REPLACEABLE
 HARDBOARD COVERING FOR BENCH TOP (I) VALANCE (X) CUT-OUT TO FIT AROUND SPEAKER ENCLOSURE

CUT 2 SHEETS OF 3/4" PLYWOOD LIKE THIS

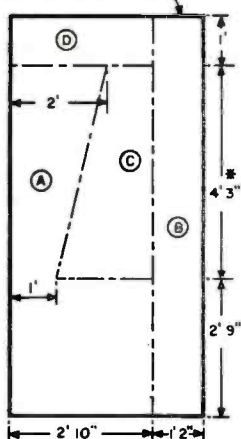

CUT 1 SHEET OF 3/4" PLYWOOD LIKE THIS

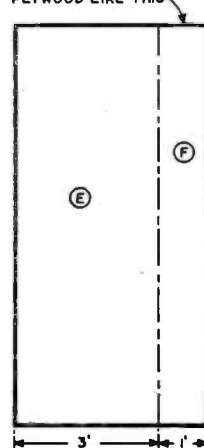

1" X 12" X 6" #2 PINE



CUT 1 SHEET OF 1/8" HARDBOARD LIKE THIS

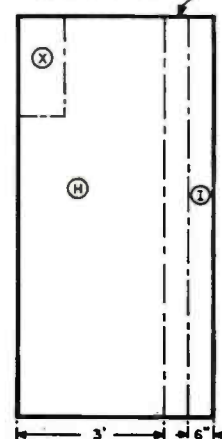

Fig. 1. (Above) Completed version of the model bench, still bare of the mass of equipment it will hold in actual use, but with its many conveniences and special operational features indicated. In larger shops, two such benches can be built side-by-side, with one the mirror image of the other. Benches can be moved to fit in with flexible planning. (Below) The list of materials required. (Left) How the lumber used to build the bench can be kept to a minimum by careful planning, so that the measuring and cutting allows minimum waste.

- 3—4 ft. x 8 ft. pcs. 3/4" plywood (good one side, to be cut as shown)
- 2—4 ft. x 8 ft. pcs. 1/4" plywood (for back of bench)
- 1—4 ft. x 8 ft. pc. 1/8" hardboard (for bench top and valance)
- 60 ft.—2" x 2" stock (for framing)
- 2—A.C. outlet strips
- 1—6 ft. fluorescent fixture (single)
- 1—"Peg-board" panel for front of speaker enclosure
- 1—1 ft. x 6 ft. pc. pine board (for shelf under bench)



By **S. E. McCALLUM**
General Electric Company

A carefully planned layout, worked out by experts, makes the best use possible of available space, promotes efficiency, helps save time and money.

A SERVICE technician's efficiency can depend, to a great extent, upon the design of his work bench. While a few planks nailed together will provide working space as such, the complex nature of modern servicing demands a streamlined work bench with a wide variety of conveniences. For only with built-in convenience can a technician operate with the smooth efficiency that has become necessary in this competitive field.

Unfortunately, the work bench of the average electronics technician has "just growned," like the proverbial Topsy. In many instances the technician started with a simple flat working space and then improvised shelves, drawers, and tool racks as best he could. The result is a hodge-podge to which he has become accustomed—but which basically is a far cry from efficiency. However, valuable time and space can be saved with the construction of a functional work bench designed specifically for servicing television receivers and other electronic equipment.

The bench described here is a practical version of the functional design illustrated in color on the front cover of this issue of *RADIO & TV NEWS*, and again in Fig. 1. The dressy model on the cover was built for use in trade shows and displays—affairs at which a practical bench might appear in the same category as a service technician attending a wedding in his working clothes. Actually, the design of this bench has much to offer the service technician who is either just setting up his shop or who must modernize to handle a greater volume of business. The design is adapted from a shop plans book made available by the *General Electric Company*. Here are some of the features of this design, and some practical hints on building such a bench.

As the average man has an arm-

spread of approximately six feet, it is practical to plan the work unit to a maximum length of eight feet—thus allowing a one-foot margin at each end for "semi-active" working space. The "console" type construction (as opposed to a "built-in" bench) permits moving or re-arranging work facilities if the shop must expand or reorganize its layout in the future.

Television service demands a mirror to enable the bench technician to watch the screen while making chassis adjustments at the rear of the set. Actually a small mirror of any kind can do this job. However, a long built-in mirror along the rear wall just above the bench top is well worth the slight extra cost. It permits the technician to place a TV chassis in practically any position on the bench and still see the picture tube in the mirror from any convenient working stance. This double convenience saves the precious minutes often spent in adjusting a small mirror and moving the chassis to the correct viewing position. Also, the ease of watching the tube face in a long mirror can lead to the bonus benefit of chancing to notice a change in the condition of the picture *when no change was expected*.

The bench design features two a.c. outlet strips. One is along the outer edge of the bench top for plugging in the equipment being repaired and portable testing equipment which it may not be practical to "tie down." The other outlet strip is above and along the back of the upper shelf for powering meters, generators, and other test equipment—items which are to stay put. These separate strips

eliminate the annoyance and danger of criss-crossing a.c. leads which so often get tangled up with tools and parts, cause soldering-iron burns, and lead to accidental dropping and damaging of parts and test equipment.

The slanting canopy design of the side sections provides more than modern styling. It permits the built-in overhead fluorescent fixture to be hung directly out over the working space. This allows a maximum of general lighting which then can be supplemented with a spotlight on an adjustable gooseneck arm affixed to the center of the upper shelf.

The fluorescent fixture, incidentally, should be equipped with an inductance or capacitance filter to prevent radio-frequency radiation that can be caused by the firing of the mercury vapor in the lamp tube. Often this r.f. energy is radiated by power lines; thus the filter should be as close to the lamp ballast as possible.

In the right-hand corner of the bench is a speaker enclosure which serves several purposes. As shown, the front is made of "peg-board" to provide handy racking space. Two switches are built into this box to control lights and the a.c. outlet strips. Antenna connectors are paneled here also. The loudspeaker is a necessity, of course, and features a neatly paneled terminal. The wiring on all these conveniences—antennas, a.c. lines, lights, and speaker—can be worked out to accommodate the needs of the individual technician. In the model illustrated, one a.c. switch turns on the overhead light and the other puts

(Continued on page 158)

Do-It-Yourself Service Center



By WILLIAM LEONARD

*Is the nature of the service business changing?
Shortage of personnel may accelerate a trend.*

WILL the critical shortage of service technicians bring about some drastic changes in the TV service industry?

Several months ago a TV set manufacturer lined up a number of non-servicing dealers to sell his receivers in a large eastern city. Since this manufacturer did not have a consumer service organization of his own, he contacted more than a dozen of the leading independent service dealers in the city with an offer to appoint them to handle warranty service on his sets. All of these service dealers turned down the proposition because they did not have enough technicians to handle their then current volume of service work! Every service dealer contacted claimed he was having to turn business away because he could not get enough qualified men to handle it.

This incident points up a serious situation in the consumer service industry. Manufacturers have been absorbing the graduates of electronic trade schools before the ink is dry on their diplomas. Recently they have stepped up their efforts to draw the best technicians from the service industry with salary and fringe-benefit offers far more attractive than the consumer service industry can afford to pay. Many small, successful service dealers have sold or closed up their businesses to take jobs in defense industries at salaries far above the incomes they could

make for themselves as operators of independent businesses.

Despite the severe shortage of technicians and an abundance of service work available, bait advertising holds a low ceiling over consumer service charges. This ceiling is below what the average businessman needs to meet his steadily increasing overhead and to pay competitive wages to his technicians. Service dealers are caught in the squeeze between rising costs of doing business and inadequate pay for the time and labor involved in both home and shop service. This has led to a growing interest among dealers in some form of licensing as a means of eliminating the bait advertisers and the incompetents who, it is felt, keep service charges down.

Theoretically, the licensing plans now being pushed by many service associations would seem to provide the solution to some of the problems that beset the operators of competent, ethical TV service businesses. The activities of licensed dealers who advertise service at charges below the known cost of doing business would be under critical observation at all times. Service bills padded to make up the difference in service charges plus, as is usually the case, some substantial over-charges would eventually provide the evidence needed to have the offenders' licenses permanently cancelled.

Most service-industry proposals fail to take into account the two most important factors involved in their businesses. The first of these factors is the general public and the constantly changing national pattern of living. The second is the rapid economic change that is taking place in the electronics industry.

The total bill paid annually by the public for servicing electronic products is tremendous. It was estimated recently that the total income from electronic service in 1956 was more than one and one-half billion dollars! This is approximately fifty per-cent of the total volume of business handled by all of the retail hardware dealers in 1956. It is truly a tremendous business.

The heart of the income from electronic service is the vacuum tube. Surveys still show that better than 80 per-cent of the TV service jobs are completed in the home by the replacement of one or more burned out or weak tubes. Many service dealers have found that, with a little coaching, trainees can handle the service on the majority of home service calls simply by checking and replacing defective tubes.

Television was a great mystery to most people during the first few years they had sets in their homes. However, through the payment of service bills and observing technicians check sets, the average set owner has acquired some knowledge of tube types and functions and has lost the fear of touching the innards of a complicated device. In the steady development of the "do it yourself" trend, householders have found they can do many jobs they formerly hired trained people to do. There is every reason to believe there will be a steady increase in the number of people who will take TV tubes to a convenient self-service tester in an effort to service their own TV sets.

Most service technicians raise their hands in holy horror whenever a suggestion is made that an untrained set owner might be able to repair his own TV set by replacing one or more burned out or inoperative tubes. However, the national do-it-yourself trend is encouraging householders to tackle all kinds of maintenance and service jobs around the home. Many amateur carpenters have lost fingers learning to manipulate power saws without bringing on laws to restrict their sale. In this age of electrical living, it is will-o-the-wisp thinking to depend on fear of electrical shock or possible picture-tube implosion to deter set owners from trying to service their own TV sets.

Businessmen in electronic service are taking a realistic view of the steadily changing industry patterns and public buying habits. They are changing their businesses in accordance with these trends to take advantage of them. One development in this direction is the "do-it-yourself service

(Continued on page 134)

G-E's Large-Screen Color Sets

(Top) The 21C700 color TV console uses a front-facing 8-inch speaker, comes in mahogany finish. (Center) Lowest-priced G-E color set is the 21T500, which carries a suggested list price of \$499. (Bottom) Model 21C701, in walnut grain, has an 8-inch speaker on a mounting board that is tilted upward. All sets use the same chassis.

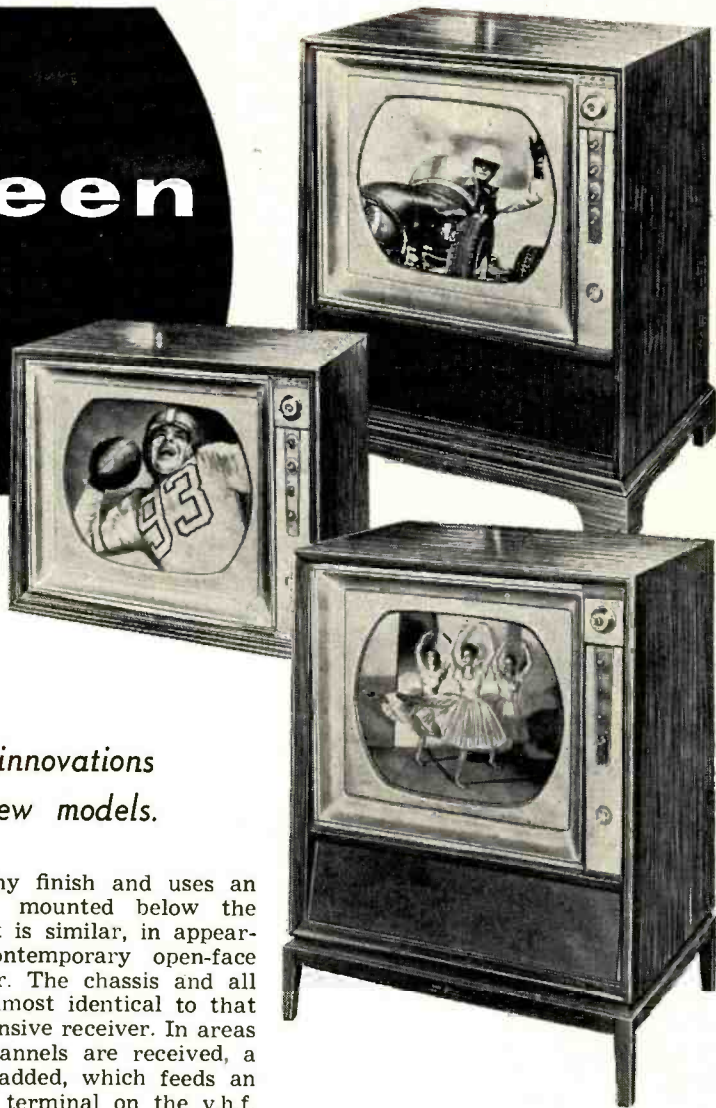

By **ROBERT GARY**

A compact chassis that includes many innovations in circuit design is used in three new models.

IN THE widening ranks of the major manufacturers who have entered the large-screen color TV market is the *General Electric Company*. Like the majority of set manufacturers, *G-E* uses the 21AXP22 round 21-inch color picture tube. However, in many other technical aspects, these receivers are quite new: they incorporate many circuit innovations. On the mechanical side, though, they are very much like their monochrome counterparts. They are as compact, use printed circuitry, and have the three-gun color picture tube mounted directly on the chassis.

Three different models are being offered by *G-E*, with each available in one finish only. The lowest priced, model 21T500, is a mahogany table receiver, made to retail at a suggested list price of \$499. As it appears above, it bears a strong resemblance to a monochrome set. A 5-inch speaker is mounted at the side of the cabinet, and a total of five dual-function controls are available at the front panel. Only the hue and color gain control are concerned with the color operation of the set. The channel-tuning, brightness, contrast, volume, and vertical-hold controls are all common to black-and-white receivers.

The secondary controls, intended for use of the service technician, are accessible from the rear of the receiver. In addition, there is a bank of fuses mounted in fuse holders on top of the chassis. These can also be replaced easily by the technician.

Model 21C700 is also shown above, and ranges in suggested retail price from \$625 to \$675, depending on the location of the distributor. This unit

has a mahogany finish and uses an 8-inch speaker mounted below the picture tube. It is similar, in appearance, to a contemporary open-face console receiver. The chassis and all circuitry are almost identical to that of the less expensive receiver. In areas where u.h.f. channels are received, a u.h.f. tuner is added, which feeds an i.f. signal to a terminal on the v.h.f. tuner. The v.h.f. tuner serves then as an additional i.f. amplifier. The price of any of the *G-E* models increases by \$30 when a u.h.f. tuner is added.

The third model in the new *G-E* color line is the 21C701 pictured here. This one varies in price from \$650 to \$700. The cabinet comes in walnut grain, and features short legs and a speaker board tilted upwards. An 8-inch speaker is used. This model is identical in circuitry to its less expensive brothers. Cabinet styling and workmanship account for the price difference.

G-E does not fix the prices on these color sets, but rather gives its distributors a "suggested retail price," leaving the exact figure up to the individual distributor.

A total of 29 tubes, two crystal diodes, and a special selenium dual diode are used in the receivers. Of the 29 tubes, three are 5U4 power rectifiers, two are h.v. rectifiers and one is the corona discharge h.v. regulator. Circuit features include keyed a.g.c., sync noise cancellation, horizontal and vertical retrace blanking, a special circuit for d.c. restoration, a novel dual-diode color-demodulator system, and a crystal ringing circuit in place of the 3.58-mc. color-subcarrier oscillator found in most other color sets. The

use of this last feature eliminates the requirement for a color-killer circuit. The receiver will automatically produce only black-and-white pictures on monochrome telecasts and color pictures when the color information is present.

Printed circuits are combined with an L-shaped chassis to provide maximum compactness, as well as convenient service and adjustment procedures.

Warranty and Service

All *G-E* color sets carry the standard one-year factory guarantee on the color picture tube. The rest of the receiver has a 90-day factory guarantee on parts, as is customary in the TV industry.

The policy of *G-E* with respect to installation and service of color receivers is to place these procedures under the control of its distributors. All installation and warranty contracts on *G-E* color sets will be sold by distributors, their dealers, or the service organizations of these. The manufacturer provides distributors with a suggested form for the service contract, as well as with detailed technical data, but does not attempt to regulate rates or operation. -30-

A New Hi-Fi Speaker System



OF INTEREST to all high-fidelity enthusiasts is the recent announcement by *Heath Company* of a new high-quality speaker system which is being made available in kit form. Until the advent of this unit, most people associated "kit" equipment with drastically lowered price tags (when compared to assembled units of the same type), simple circuitry to facilitate assembly by the home builder, and sometimes fewer performance features than those offered in commercial units.

This conception will have to be altered in the case of the "Legato." Here is a kit that is among the top units performance-wise, is not designed

"down" to a price, and although not the simplest to construct, anyone experienced in woodworking can assemble it and obtain the high-quality performance of which the system is capable.

A joint project of *Altec-Lansing* and *Heath Company* engineers, this new speaker system is capable of dynamic realism in the reproduction of high-quality sound.

Two 15-inch theater-type speakers,

used as woofers, and a high-frequency driver with sectoral horn are combined to cover the frequency range from 25 to 20,000 cps. All the speakers have been especially designed for this unit and are being supplied by *Altec-Lansing*. The crossover frequency of the dividing network is 500 cps with an input impedance of 16 ohms. Inherent in the design of this new system is correct sound level balance and accurate phasing.

The cabinet is of the modified infinite-baffle type in which a narrow slot about $\frac{5}{8}$ -inch wide and running the entire width of the high-frequency horn is used. The over-all power handling capabilities are 50 watts of program material. Since there is a slot, construction of this enclosure is simplified since it need not be built airtight as many of the infinite-baffle type units must be.

The unit of contemporary design, known as the HH-1-C, is shown in the photograph above. It features straightforward design with slim, tapered vertical struts across the grille cloth to provide an attractive shadow line. The over-all cabinet size is 41 inches long, 22 $\frac{1}{2}$ inches deep, and 34 inches high.

One of the features of the "Legato" is the excellent balance of sound that is attained. This effect is accomplished by proper phasing of the high- and low-frequency drivers and the use of a carefully computed crossover network. By phasing is meant that the acoustic output from the speaker system is such that the sound waves from both the low- and high-frequency units arrive at the listening point as a continuous wave, similar to that derived from a single source. The proper phas-

The combined engineering talents of Altec-Lansing and Heath have produced this new unit—the "Legato".

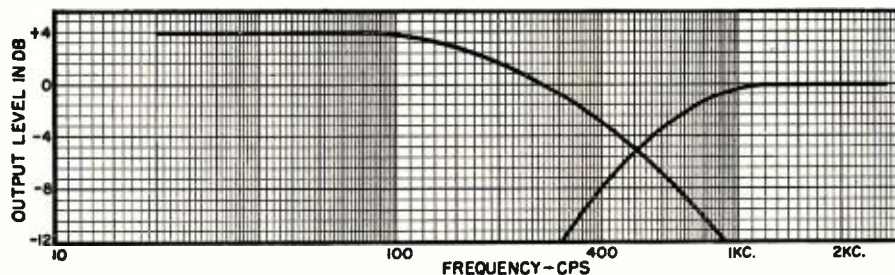

Schematic diagram and performance characteristic of the crossover network. It is a parallel M-derived type with a crossover frequency of 500 cycles-per-second. This dividing network has an additional input—one with a 16-ohm resistor in series. The function of this input is described in detail in the text.

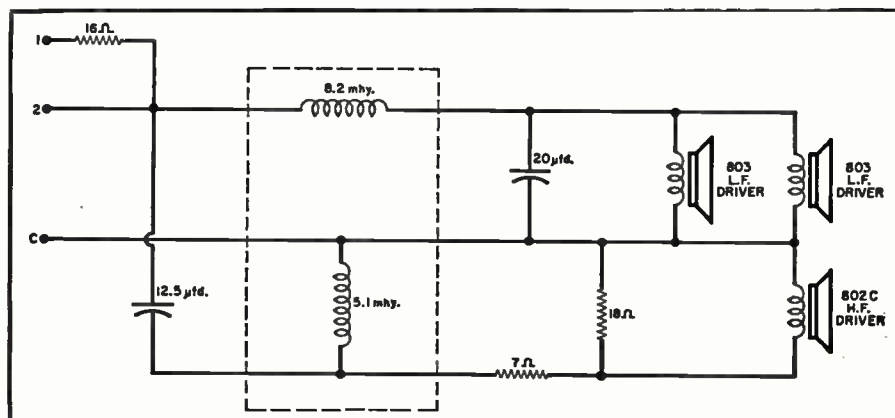

ing is determined by three things: the physical relationship of the two units, polarity, and phase shift of the crossover network. Proper physical relationship is accomplished by having the path lengths virtually the same for all units. This means that the individual waves from each of the speakers travel exactly the same distance between their respective diaphragms and the listening point. By proper polarity, it is meant that the diaphragms of the high-frequency driver and the low-frequency units work in unison. With improper polarity, a dip in the acoustic output will result because of cancellation of waves from the speakers involved. This usually makes the sound appear "thin" because of the lack of energy at the crossover frequency. There will also appear to be two sources of sound. At a position ten feet or more from the speaker enclosure, the sound will be continuous and appear to come from a single source when proper polarity is attained.

As in most speaker systems, it is a difficult task to place the speakers in position within the cabinet to obtain this exact physical relationship. To achieve best results, therefore, it is necessary to use a crossover network that is carefully computed so that any differences in physical relationship between the high- and low-frequency units can be corrected by means of "phase shift". This means that the sound for either the low- or high-frequency units is delayed the required amount of time so that all individual waves of all units reach the listening point at the same time.

It is a combination of proper phase shift in the crossover network and relative position of all speakers that provides the balance achieved in the "Legato". Obviously, this dividing network should not be used for any other speaker system nor, by the same token, should the builder attempt to use another network with this unit. It is of interest to note, referring to the performance characteristics of the dividing network, that the efficiency of the woofers and high-frequency driver units differ. In this particular case, the low-frequency woofers are less efficient than the high-frequency driver. The dividing network takes all this into consideration and provides a balance without external control. In addition, this dividing network provides a rapid cut-off on both sides of the crossover so that interference due to radiation from both low- and high-frequency units is restricted to a very narrow band.

The network has an M equal to .6 and a phase shift of 221 degrees at the crossover frequency. Iron core coils are used to achieve high "Q" and low insertion loss. The distortion of these coils is less than 1% at 80 watts for all frequencies between 20 and 20,000 cps.

There are two inputs to the crossover. The normal inputs, terminals "C" and 2 shown on the diagram, are to be used with a power amplifier that

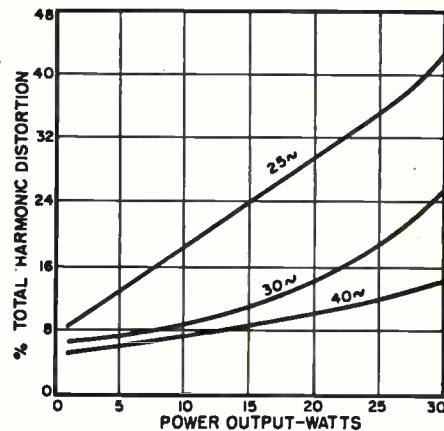
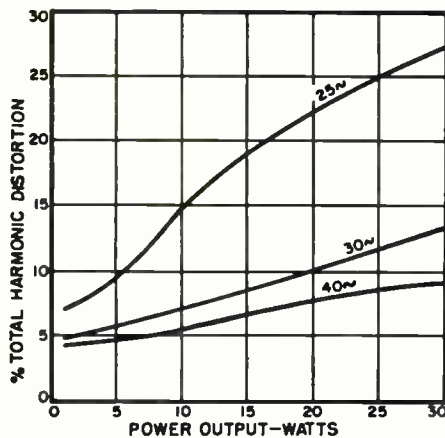

Curves show the total harmonic distortion of the entire speaker system under two conditions. The performance is the average obtained from three different units, using an amplifier with high damping factor. The curve on the left shows the results obtained without the 16-ohm series resistor in the circuit while the curve on the right is with the 16 ohms in series with the amplifier. It is interesting to note the reduction in harmonic distortion in the latter case.

has a variable damping control or any power amplifier that has a damping factor of 1. The inputs, "C" and 1, which put the 16-ohm resistor in series with the power amplifier, are to be used with any amplifier having a damping factor of ten or more. Actually, the objective is to obtain the damping that is provided by an amplifier having a damping factor of 1. This is not a new principle. It has not, however, been covered in too great detail in recent times. Actually, the 16-ohm resistor acts as a de-regulating device which results in less acoustical distortion of the speaker system and gives a boost at both the low- and high-frequency ends of the spectrum.

Basically, the 16-ohm resistor and the speaker units form a series network. At mid-frequencies, when the impedance of the speaker system is 16 ohms, the power is distributed equally between the two. At the low and high frequencies, the speaker impedance is no longer 16 ohms. It rises considerably, particularly at resonant

points. Under these conditions, the distributed energy between the loudspeakers and the series resistance no longer divides equally. Greater energy is then delivered to the speaker units, resulting in increased acoustical output at the low- and high-frequency ends. Although we have not changed the damping factor of the amplifier itself, we have obtained an effect similar to that found with an amplifier having a damping factor of 1.

The addition of this series resistance is a novel idea and one which can be tried with many systems that are in use today. It is particularly advantageous when an infinite-type cabinet is used. For bass-reflex type cabinets, and particularly the *Karlson*, since the bass end is already on the heavy side, the additional boost obtained by a series resistance may unbalance the acoustical output. It is certainly worth trying since it is simple to do and the results are quite interesting. An additional advantage is

(Continued on page 82)



Phantom view of the "Legato" assembly. All of the speakers are Altec-Lansing units. The low-frequency drivers are 15 inches in diameter and cover the frequency range from 25 to 500 cps. The high-frequency driver is an especially designed sectoral exponential horn covering the frequencies 500 to 20,000 cps.

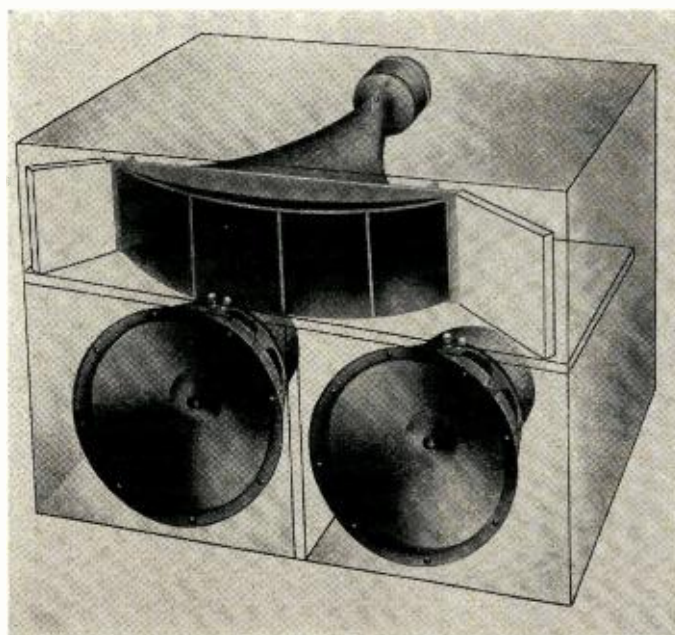

Upgrading and Accrediting Technicians

By

PAUL B. ZBAR

Director, RETMA Technical Training Program



RETMA instructors Zbar (right) and Schildkraut show procedure for measuring u.h.f. field strength.

approved course in advanced television servicing techniques offered by the industry-approved school, of course, to earn his accreditation. However, if he feels he qualifies without undergoing the course of study, he may ask to take a prescribed practical and technical examination in advanced techniques. If he feels that his skills are already equal to or better than the industry's minimum standards, he is given the chance to demonstrate his proficiency in the examination given by the industry-approved school.

Role of the RETMA Course

Some history concerning the development of the course under discussion is appropriate at this point. In 1952 RETMA commissioned the New York Trade School, a privately endowed non-profit institution, to develop and pilot a particular type of course in TV servicing. Specifically, this course was to be geared toward the already practicing TV technician, rather than to the raw beginner.

Under the guidance of an RETMA advisory committee, the Advanced Television Servicing Techniques Course was prepared. The TV service laboratory set up at the New York Trade School was reputed to be the most completely equipped of its kind in the nation. After the course had been successfully tested on two pilot classes, the Director of the Training Program and his associate, Sid Schildkraut, also of the RETMA instructional staff, prepared the Advanced Television Servicing Techniques text, laboratory manual, and instructor's guide. A revision of these books, written to include the latest developments, is in use by some one hundred schools throughout the country now. RETMA has consistently tried to encourage technical, trade, and vocational schools to offer this course in their communities.

Aimed at the already experienced practical technician, the course emphasizes the best use of the latest test equipment, logical servicing procedure, new servicing techniques, proper methods of alignment, and new circuits. It lays the groundwork for successful training in color TV service. Perhaps

Local industry groups sponsor a certification plan based on a recognized technical training program.

IN THE face of rapid technological progress and resultant extensive changes in the service field, television technicians are becoming increasingly concerned about their ability to compete successfully and grow with the industry. The individual technician is faced with such questions as these: How can he keep up with new developments in the field? How can he learn the new service techniques that will reduce his service time? How can he gain public acceptance of his product, which is service? How can he improve his financial position?

The industry as a whole has attempted to offer answers to some of these questions by providing the educational material for upgrading the technician's skills, and also by enlisting the support of existing technical schools to provide the technician with the facilities for learning. Some elements of the industry, starting out with this program, are trying to build further on it to provide a still broader answer to the technician's problems. These elements are promoting an accreditation program.

Accreditation Criteria

What is the nature of this accreditation program and what is an accredited technician? An accredited technician, according to supporters of the program, is one who has demonstrated a certain required level of

technical proficiency. This level will be based on suggested standards of training and skill proposed by the Radio-Electronics-Television Manufacturers Association (RETMA). Once a technician has become accredited, he has a means of identifying himself to the public, if he is self-employed, or to prospective employers, as being "competent" as adjudged by industry-wide standards.

EDITOR'S NOTE: At this point, one may begin to speculate concerning the differences between accreditation and licensing. The latter is conducted by government, whereas the former originates with the industry itself, and is administered by the industry. Licensing, which is a local matter, can develop an uneven national pattern, with contradictory and often conflicting standards in different localities, and with varying degrees of enforcement. Accreditation is more likely to develop a universally accepted standard for evaluating a technician's ability. As the pattern is now developing, however, accreditation will actually be in the hands of local industry groups. A school approved by a Local Industry Advisory Committee, meeting RETMA suggested standards of training and facilities, may issue certificates of accreditation, locally endorsed, to qualified technicians.

The technician may qualify for his certificate of accreditation in either of two ways. He may pass the industry-

the most convincing kind of endorsement the course could have is the comment of technicians who have taken it: they claim that the newly acquired techniques enable them to do a better job—and that, to do it, they are taking an average of 20 per-cent less time at their benches than heretofore!

If this is an advanced course, how is eligibility determined? First of all, the entering student must be working as a TV technician at the time he enters the course. If he has had at least three years' experience as a TV technician, he need not have additional qualifications. If he falls short of this experience requirement, he may still be admitted with at least one year of experience, but he must also show evidence of having successfully completed an approved course in TV.

Accreditation at Work

While RETMA has not itself inaugurated an accreditation program, those within the industry who are building the program are using the course in advanced techniques as the focal point. A better idea of how the program gets under way may be gleaned by examining an actual case. In the New York City area, the Greater New York Electronic Industry Advisory Committee for Education was formed. It has a dual goal. First, it is attempting to promote the RETMA advanced course locally; that is, throughout the city as well as in the neighboring counties of Westchester, Nassau, and Suffolk. Second, it is setting up the machinery for accrediting technicians who successfully complete the course and others who are qualified.

Who are the people in the industry engaged in this effort? On the committee are representatives of several of the country's leading manufacturers of receivers. Leading distributors in the area, evidently convinced that the qualified and accredited technician is a good investment for them, are also serving on the committee. Several local TV dealer and technician organ-

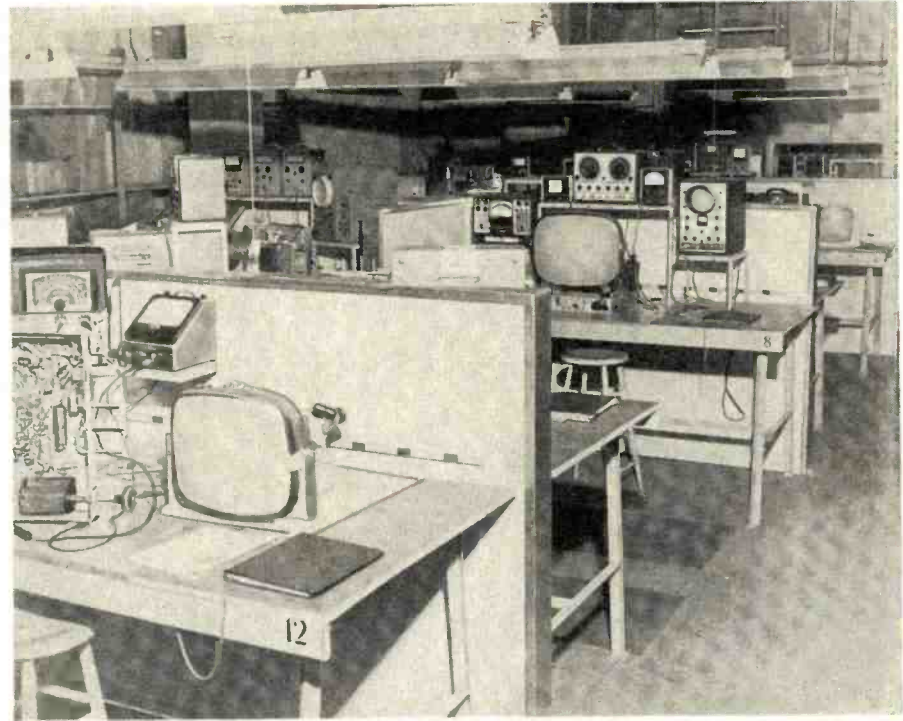

Individual, fully equipped service benches are part of the facilities provided at the New York Trade School for the RETMA technical training program.

izations are included. The list represents a wide sampling of the industry, rather than a limited-interest group. In addition, a representative of the New York City Board of Education serves on the committee.

As to the accomplishments so far, the committee has been instrumental in setting up one school in the New York area to give the RETMA course in addition to the New York Trade School, where the course was born, and is in the process of lining up other institutions. The committee has approved both the Trade School and the newly added institution, the East Meadow High School, on Long Island, to accredit technicians.

As to the formation of the committees, since they are autonomous local units, there is no fixed pattern by which they must develop. Where a

school giving the approved course is already in a community, the opportunity exists for any far-sighted members of any phase of the industry to start the ball rolling by contacting other elements in the industry.

For the name of an approved school in your own community, or for further information about the course in general, address Mr. Don Stover, Service Coordinator, Radio-Electronics-Television Manufacturers Association, 1721 De Sales St., N. W., Washington, D. C. For those living in the New York area, inquiries should be addressed to Advanced Television Servicing Techniques Course at whichever of the two addresses given here is nearest: New York Trade School, 310 East 67th Street, New York, N. Y., or East Meadow High School, East Meadow, Long Island, N. Y. -50-

Lectures, like this one on sweep alignment, are also used.

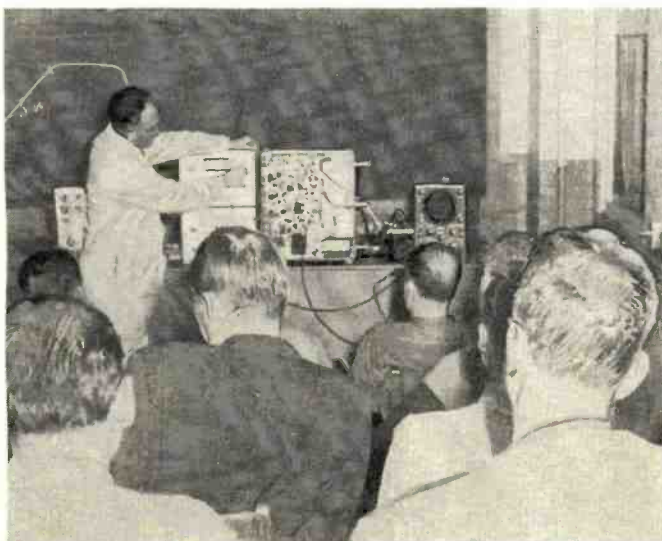

Students, working in pairs for best results, service a set.

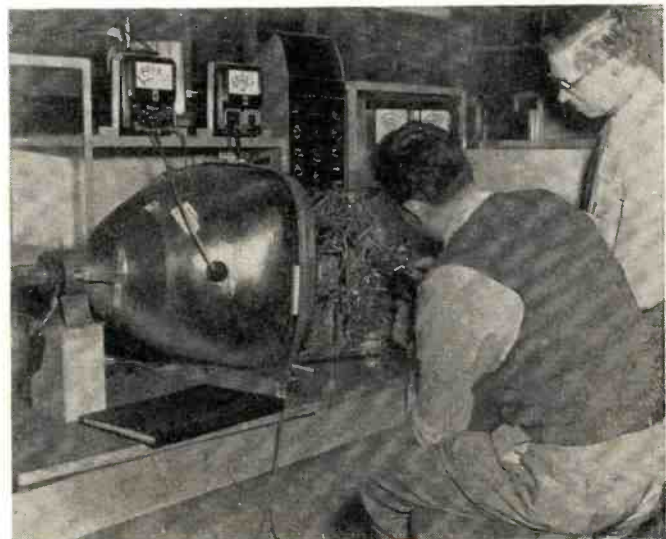

Questions and Answers

on Oscilloscopes

By **ROBERT G. MIDDLETON**
Chief Field Engineer, Simpson Electric Company

Replies to the queries the manufacturer most often gets from technicians on this important instrument.

OF THE many questions manufacturers of oscilloscopes are asked, the most common is, "Which is the right pattern? I can get nearly any pattern I want on the scope screen." The question is too complex to be answered simply. What is involved here is a basic understanding of the operation and application of the instrument. The "right" pattern, of course, is obtained only when operation and application are correct. Still, the high degree of frequency with which the question is asked, even in this era, justifies a fundamental review of the instrument and the nature of the phenomena which it is used to examine.

Basic Scope Display

The display of a 60-cycle sine-wave signal is very basic, and an instructive point from which to start. Turn on the scope and adjust the intensity and focus controls to obtain a bright and well-focused horizontal trace (see Fig. 1). The vertical and horizontal centering controls are adjusted, as required, to center the trace on the scope screen.

If the vertical-gain controls of the scope are advanced to maximum, a pattern is obtained on the scope screen *even though there is no signal input to the scope.* This is a very puzzling point to the beginner, and is explained as follows: the scope input system has a very high impedance. For this rea-

son, the exposed input terminals pick up stray 60-cycle fields about the bench, producing substantial vertical deflection. Note that, when a 1-megohm resistor is shunted across the scope input terminals, the pick-up is eliminated. This is the reason that stray fields do not enter the scope in normal circuit testing—the circuit impedance shunts the scope input, so that any stray pick-up is not observable.

To display the 60-cycle pattern in proper form, the coarse frequency control is set to a position which includes 60 cycles. For the scope illustrated in Fig. 1, the control would be set to the 14- to 250-cycle position. The fine-frequency control is then adjusted to obtain one, two, or more cycles, as desired, of pattern.

To lock the pattern on the screen, so that it does not "run" horizontally, the function switch should be set to a suitable sync position, such as line-sync in the case of this 60-cycle wave, and the sync-amplitude control is advanced just sufficiently to lock the pattern tightly. This 60-cycle sine-wave pattern may appear very elementary, but it has some important properties which are worthy of note.

Fig. 2 shows such a sine-wave pattern, with the important values depicted. The average value of the symmetrical sine wave is zero, and falls along the zero-volt axis, or resting position of the trace when no input

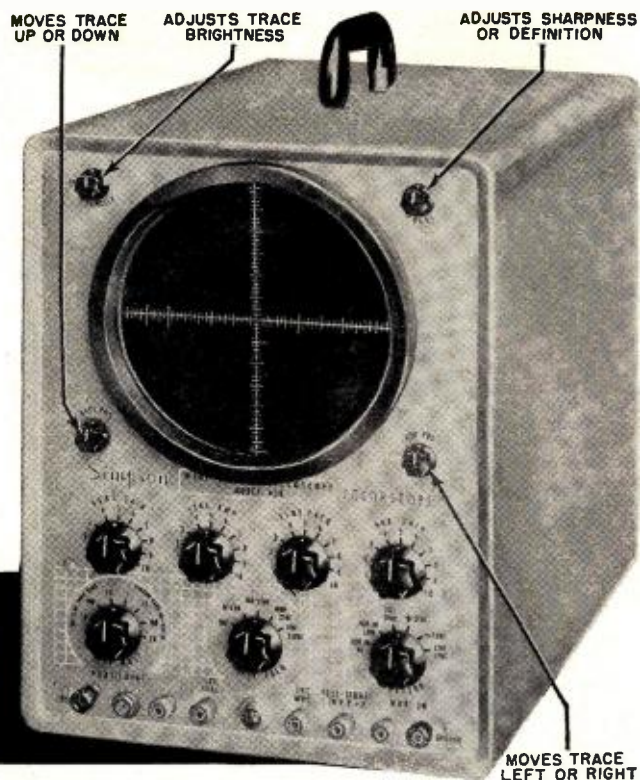

Fig. 1. A wide-band service oscilloscope, suitable for monochrome and color, with some control functions marked.

signal is present. The total excursion of the waveform is a measure of its peak-to-peak voltage. The peak-to-peak voltage is made up of a positive-peak voltage and a negative-peak voltage, as shown in Fig. 2. The r.m.s. voltage is equal to 0.707 of the peak value; this r.m.s. voltage is the value which is indicated by an a.c. service voltmeter.

Why these three values? The first a.c. voltage value which was recognized was the r.m.s. value. This has its origin in power work, and is still used in the measurement of line voltage, transformer voltages, and heater voltages. Power work started out with d.c. power sources (even in some areas today, power lines still supply d.c. voltage). When a.c. power became common, it was desired to measure a.c. voltage in units such that the amount of light, or heat, or power obtained from a 117-volt a.c. line would be the same as that obtained from a 117-volt d.c. line. Thus if a 117-volt (r.m.s.) a.c. line is connected to a soldering iron, just as much heat will be obtained as if a 117-volt d.c. line is connected to that iron.

However, the advent of TV brought in a new requirement: vacuum tubes in most cases respond upon the basis of the applied peak-to-peak signal voltage. In some cases, the tube responds to the positive-peak or to the negative-peak voltage which is applied—this depends upon operating bias. In any case, these newer units of voltage are of chief significance in servicing electronic circuits. The peak voltage of a sine wave is equal to 1.414 times its r.m.s. value, and the peak-to-peak

voltage of a sine wave is equal to 2.83 times its r.m.s. value. It is evident that the peak-to-peak voltage of a sine wave is double the value of either the positive-peak or of the negative-peak voltage. This is so only because a sine wave is symmetrical.

Pulse Voltages

Most television waveforms are not symmetrical. A simple pulse waveform like the one shown in Fig. 3 has a positive-peak voltage which is unequal to its negative-peak voltage as shown in Fig. 4. The peak-to-peak voltage of the pulse is equal to the sum of its positive-peak voltage plus its negative-peak voltage.

It should be noted that the *average* value of a pulse waveform—as of all complex waveforms—is zero. This average level falls along the zero-volt level on the screen; that is, it falls along the resting position of the beam when no input signal is applied to the scope. It is this basic property which is utilized in measuring the positive- and negative-peak voltages of the waveform. Note that, in any pulse or complex waveform, the area of the pattern above the zero-volt axis is exactly equal to the area of the pattern below the zero-volt axis. This is a necessary consequence of the fact that the average value of the waveform is zero.

When a pulse waveform is applied to the input of a d.c. voltmeter, the pointer indicates zero volts. Again, this observation is the result of the fact the average value of the waveform is zero. However, when the pulse voltage is applied to the input of an a.c. voltmeter, the indication obtained depends upon several factors. In general, the indication will be largely meaningless. The pulse waveform does have an r.m.s. value, but this is somewhat difficult to determine, and is of little interest to the service technician. The indication obtained will depend upon the frequency characteristics of the test instrument, which way the test leads are applied to the pulse source, and other factors. Of course, some voltmeters have a peak-indication function, or a peak-to-peak indication function. In such case, a useful measurement can be obtained unless the pulse repetition rate is low and the pulse is narrow. Because of these various considerations and reservations, the use of the techniques that do not involve the scope for waveform examination can be seen to have serious shortcomings.

Voltage Measurements

If the oscilloscope is to be the instrument for reliably measuring waveforms, as well as observing them for appearance, how can dependable measurements be made on an instrument with which, by adjustment, we "can get any pattern we want?" Indeed, these questions pertaining to measurement, and especially to the measurement of peak-to-peak value, fall into the most-frequently-asked category.

Most scopes nowadays provide a

source of calibrating voltage for reference. The scope shown in Fig. 1, for example, makes an 18-volt peak-to-peak sine-wave voltage available through a binding post on the front panel. (Where a calibrating standard of this kind is not built in, a sine wave of known amplitude may be introduced externally with no change in the remainder of the measurement procedure.) When a lead is connected from this binding post, or other source, to the vertical-input terminal of the scope, a known voltage of 18 peak-to-peak volts develops a sine-wave pattern on the screen.

If the vertical-gain controls are adjusted to make the sine wave occupy a total height of 18 squares on the calibrated grid or screen, each square will evidently measure one peak-to-peak volt. Now the calibrating lead can be disconnected and, *provided that the vertical-gain controls are left untouched*, another signal voltage can be measured. After this unknown signal is applied, a count is made of the squares of vertical deflection it achieves. This is its peak-to-peak voltage.

Of course, signal voltages subject to measurement vary widely in amplitude. Some may be so large that they will drive the beam off-screen when applied to the scope with the same vertical-input settings used for the reference voltage; on the other hand, some of these voltages may be so small as to fail to produce measurable deflection. To meet this situation, a step attenuator, or coarse vertical-gain control is provided. Generally this step attenuator is arranged in decimal steps, which are most convenient.

The continuous, fine vertical-gain control, or the vertical vernier, is still left untouched, but the coarse control is turned in either direction the number of steps required to obtain a satisfactory deflection on the screen for the voltage being measured. If the coarse attenuator has been turned up one step to increase the sensitivity of the scope by ten times as compared to its former position, then each vertical square will represent .1 peak-to-peak volt, instead of 1 volt. On the other hand, if the attenuator has been turned down one step, to reduce an oversize waveform, each square will now represent 10 peak-to-peak volts. If the attenuator has been turned down two steps, each square will represent 100 peak-to-peak volts.

Thus the utility of a decimal step attenuator lies in the fact that the basic calibration of the scope is unchanged—only a decimal point is shifted. Some scopes may have a step

Fig. 2. A sine wave is used to illustrate various ways to measure voltage.

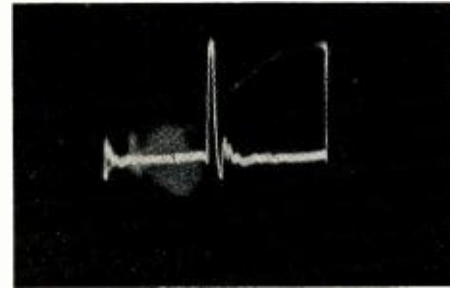
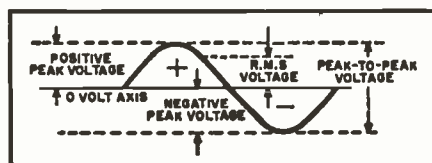

Fig. 3. This asymmetrical pulse waveform is more typical of those encountered in TV than the sine wave. Note the unequal positive and negative peaks.

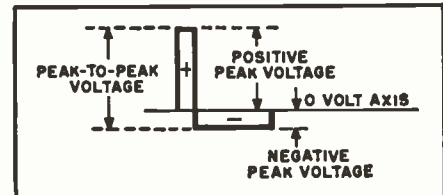

Fig. 4. Positive and negative peak amplitudes are unequal for the pulse, but areas enclosed by each peak are equal.

attenuator that changes sensitivity by some factor other than 10. These can be just as accurate, but they are not quite as convenient, as they may involve a small amount of arithmetic.

While a relatively simple pulsed waveform has been chosen to illustrate the technique of measurement involved, the procedure is used unchanged with the most complex wave-shapes. In fact, most technicians prefer, while taking peak-to-peak measurements, to reduce the horizontal gain or width control to zero. This reduces all waveforms, no matter how different or confusing in shape, to a common denominator—a single vertical line. Since the length of that line is the true peak-to-peak value, irrespective of shape, measurement procedure is simplified.

Avoid Overload

Another question which is often asked concerns distortion of the displayed waveform which results from application of excessive signal voltage to the scope input. It must be recognized that it is quite possible to overdrive a scope amplifier, just as may be done with any other amplifier. When overload occurs, the waveform is clipped on the top, or bottom, or both. The resulting distorted pattern can be very misleading.

To avoid scope overload, a simple operating rule should be followed at all times: Adjust the vertical-input controls so that the *continuous* attenuator is operating on the *upper* portion of its range. If necessary, the coarse attenuator can always be advanced a step or two, to permit this condition. The reason for this precaution is that the output from the coarse attenuator is generally applied to the grid of the scope input stage, while the continuous attenuator works in the cathode circuit. It is grid overdrive which provides overload and clipping.

Certified RECORD REVUE

By BERT WHYTE

THE passing of Maestro Toscanini at the age of 89 was a sad day for music lovers everywhere. I felt very keenly the loss of this towering interpretive genius. As long-time readers of this column know, I was never one of that band of sycophants, to whom the Maestro could do no wrong. I feel that much of this adulation was insincere and I am sure that no one was more aware of this than Toscanini himself. On the other hand, I had unbounded respect and admiration for his uncompromising honesty in all that he undertook to conduct, even though the result may not have always been to my taste. His greatness is incontrovertible, and he has left us the legacy of his recordings to remind us of his accomplishments. Who can forget the blazing excitement and musical magnificence of his readings of the Beethoven "9th", and the "Eroica", the Verdi "Requiem", Debussy's "La Mer", and many, many others.

These recordings will be treasured by any music lover worthy of the name, but in all honesty it must be pointed out, that for many the greatness of the interpretation will be marred, in many cases, by the far from satisfactory sound. The unhappy truth is that in many of the Maestro's recordings he was not afforded the benefits of good sound. Some of this naturally stems from the fact that Toscanini's recording career goes back a long way in time, and recording techniques were quite primitive. In later years, he had the acoustic problems of the infamous "Studio 8H", and it was really just at the end of his conducting days that modern wide-range recording techniques were utilized. I'm not sure, but I don't believe the Maestro and his magnificent orchestra were ever recorded stereophonically. What a pity, if true! With his inordinate ability for orchestral clarity and definition, stereo would have revealed more of the score than ever before and this surely would have pleased the heart of Toscanini. For above all, Toscanini's burning desire was for people to know and understand his beloved music.

The passing of the Maestro serves to emphasize other grievous losses the cause of music has sustained in recent time. Toscanini's brilliant protegee, Guido Cantelli, preceded the Maestro by several months, victim of a plane crash near Paris. The incomparable Walter Gieseking will play for us no longer. The deaths of the great Wilhelm Furtwangler and Erich Kleiber in relatively quick succession, were blows to the music world and especially to *London Records'* ambitious recording plans for these two artists. Truly, the aspiring young conductors and performing artists of today have some very large shoes to fill.

Well, enough of this somber subject and on to more pleasant news.

Devotees of stereophonic music reproduction have long bemoaned the fact that there

is a dearth of high quality recorded stereo tapes, especially in the classical repertoire. Among the major companies, only *RCA Victor* has issued classical stereo tapes and these in relatively modest quantity. Recently *Sonotape*, *Westminster Records'* tape subsidiary, has entered the stereophonic tape field. While not a major label, its initial stereo release has been warmly welcomed, and by the time you read this *Sonotape* will have issued a substantial number of classical stereo tapes. However much this helps, the general feeling is that recorded stereo tape must be available in quantity from the major record companies before stereophonic music reproduction becomes really popular. It is also felt that if just *one* more major company issues stereophonic tapes, this will furnish the impetus needed to stampede the rest of the major labels into action and the stereo bandwagon will be rolling!

This may be wishful thinking on the part of many enthusiasts. Even if it is, we won't have long to wait for the answer, since the idea will soon be put to the test by *Mercury Records'* contemplated entry into the commercial recorded tape field! Nossir, I ain't pullin' yore laig! This is for real, Suh! It is anticipated that they will have a very broad coverage of the tape field, and it is expected that they will have a substantial stereophonic classical release in time to cause a furor at the New York High Fidelity Show in September. And furor is the proper word, because their recordings are absolutely sensational! I know, because I have heard a substantial number of test stereo tapes and in fact I have a test tape at home that I managed to swindle. After repeated listening to this stereo tape, I am still amazed. Why? Because this is the first two-channel stereo I have heard that *consistently* avoids the "hole-in-the-middle-effect". What the *Mercury* engineers have done to achieve this I don't know and understandably, they were quite secretive about the process. I did manage to elicit that in some manner, *three channels* are utilized in the orchestral pickup and the resultant two-channel tape has the third or middle channel somehow discernible as so many decibels of "ghost" sound, even though there is no physical separation of the tape into three distinct channels! Whew!

In any case, what I have heard so far is magnificent. There is the usual airy spacious sound so typical of stereo, the effect considerably heightened here. But beyond this there is something new and this is that the orchestral texture now also has power and extraordinary projection. A startling thing to hear and these tapes richly deserve the *Mercury* slogan, "living presence". The first re-

The opinions expressed in this column are those of the reviewer and do not necessarily reflect the views or opinions of the editors or the publishers of this magazine.

lease should have something of interest for every taste, judging from the repertoire that *Mercury* has available in two-channel stereo. Under consideration are such choice items as Johann Strauss "Waltzes" with Sir John Barbirolli and the Halle Orchestra, Fred Fenell conducting the Eastman Rochester Pops in a LeRoy Anderson program, the Grieg and Liszt piano concertos # 1, with Richard Farrell soloist with the Halle Orchestra, George Weldon conducting. Paul Paray conducting the Detroit Symphony in his own "Joan of Arc Mass", Dorati and the Minneapolis Symphony with "Der Rosenkavalier Suite" and "Till Eulenspiegel"; Barbirolli and the Halle Orchestra in Vaughn Williams "8th Symphony", Fred Fenell again with "Sousa Marches" and "Ruffles and Flourishes", Dorati conducting the London Symphony Orchestra in Rimsky-Korsakov's "Polovtsian Dances" and "Le Coq D'or Suite", Sir John again with Elgar's "Enigma Variations" and finally a wildly exciting recording of Khachaturian's popular "Gayne Ballet," to mention just a few of the goodies.

To anticipate your questions. . . No, *Mercury* has not shelved its three-channel stereo program. Tapes are still and will continue to be recorded in this medium. This is still the ultimate sound, although this new two-channel method comes gratifyingly close. But there are still problems to be solved and quite rightly, *Mercury* must look at the practical aspects and economics of today's tape market. Two-channel stereo machines are available and are being sold in respectable quantities, thus it is only logical that they exploit this market first. For all you advanced super-perfectionists, be heartened by the fact that many forces are at work on the three-channel problems. Something will surely break by the end of this year. One fascinating possibility . . . a "do-it-yourself" three-channel head!

A WAGNER RECITAL

Kirsten Flagstad, soprano with Vienna Philharmonic Orchestra conducted by Hans Knappertsbusch. London LL1533. RIAA curve. Price \$3.98.

Kirsten Flagstad! Who would have thought that they would once again see this magic name on a recording? There has been many a music lover who lamented her "retirement" a few years ago, especially since most of her recordings were made before the era of wide-range, high-fidelity quality. *London Records'* astute scouts heard the great singer at festivals in Norway and, convinced that the beautiful voice was relatively unscathed by the ravages of time, prevailed upon her to resume her recording career. This is one of the first results of Madam Flagstad's emergence from retirement and an unqualified triumph. In the beautiful "Wesendonck Lieder" and in excerpts from "Lohengrin", "Parsifal", and "Die Walkure" for which she is justly famous, Flagstad is heard and can be appreciated as never before on records.

Here the noble beauty of her voice is unfettered at last from the limitations of restrictive recording techniques and the result is breath-taking in its rounded loveliness and purity of tone. The strength and confidence of the voice is all the more amazing when one considers that here is a woman past 60. It would be foolish to say that the voice has not changed since her golden days at the Metropolitan. There is some straining and a bit of unsteadiness on the higher notes, there is an excess of tremolo now and then. But these are minor quibbles indeed. There is still the floating ease of vocal projection, the broad, expansive warmth of her middle register and the organ-like richness when she plumbs the depths of her voice. Younger readers, to whom Flagstad has been little more than a legend, will now have the oppor-

(Continued on page 107)

A Two-Terminal Test Oscillator

By BOB LEONARD

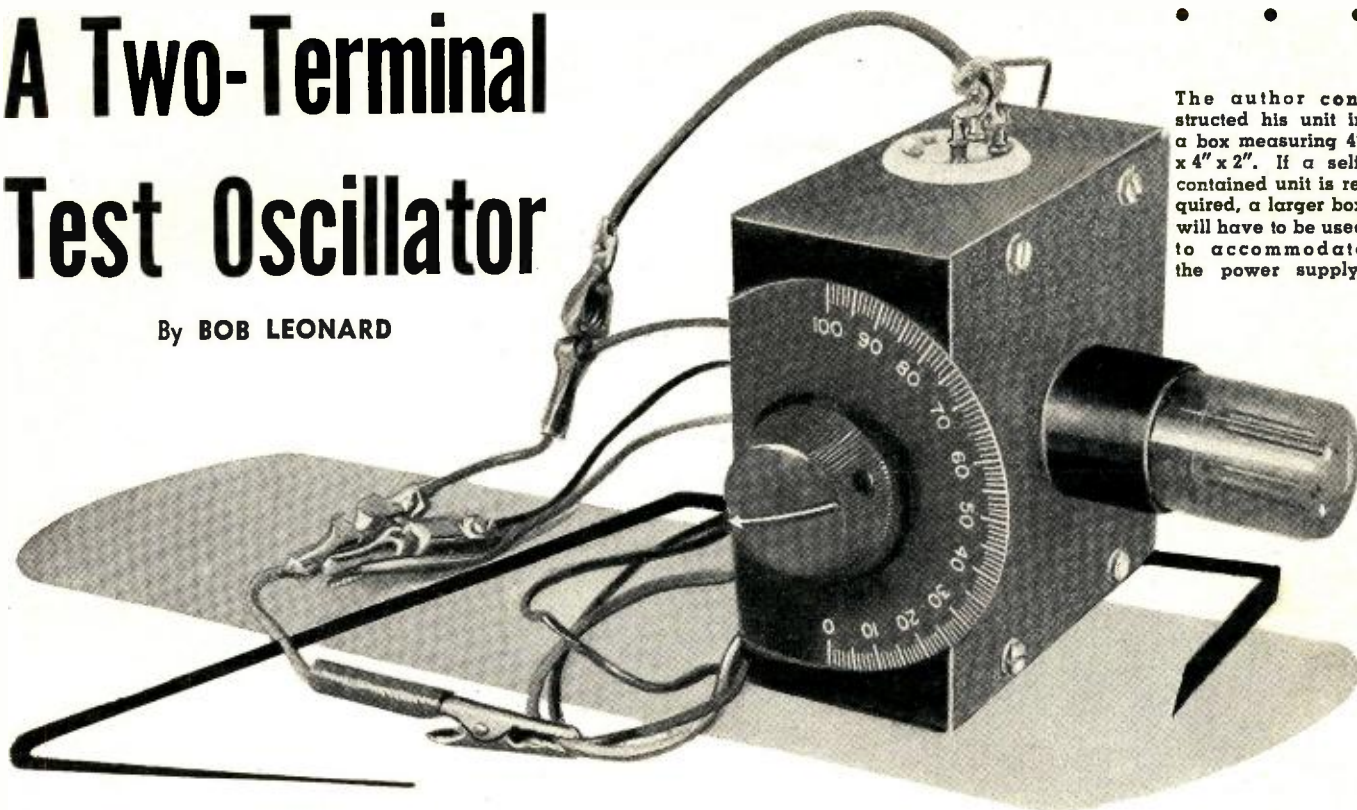

The author constructed his unit in a box measuring 4" x 4" x 2". If a self-contained unit is required, a larger box will have to be used to accommodate the power supply.

BURIED in the pages of radio handbooks are many useful circuits that are neglected by the amateur and experimenter. One of these circuits is that of the *two-terminal* oscillator, a simple device with wide applications.

There are several types of two-terminal oscillators that require, as the name indicates, just *two* connections to an external oscillatory circuit. The old standbys—Hartley, Colpitts, TNT, etc.—require at least three connections. Both the Hartley and Colpitts, for example, have taps of some nature. The Colpitts has a split capacitor arrangement across the tank coil to provide the tap while the Hartley tank has a direct connection made somewhere near the center of the coil to provide the necessary three terminals required by the vacuum-tube power source. The two-terminal oscillator, shown in Fig. 1, has just two connections that must be made to the vacuum-tube power source to obtain oscillations. This simplifies the tank circuit arrangement. Any *LC* combination may be connected across these two terminals and the circuit will oscillate. One of the terminals is a ground connection so the frame of a tuning capacitor may be mounted directly on the chassis. Switching is easily accomplished because one coil terminal is grounded leaving only the other terminal to be handled by the switching system.

The author's version of the two-terminal oscillator was built to provide a device that would determine the tuning ranges of r.f. circuits and act as an audio-r.f. signal source. The unit is built in a 4 by 4 by 2 inch utility box with the 6SN7 socket mounted

Construction details on a simple unit for the hamshack. It can be used as a signal generator or as a grid-dip oscillator and as a v.f.o.

on the top panel, and a 5-prong ceramic socket mounted on one side to accommodate clip leads that connect the external tuned circuit. These leads consist of a ground lead which has an alligator clip on one end and an old pin taken from a 5-prong tube base on the other end and a *hot* lead that is the same length but slightly different in construction. The *hot* lead has an alligator clip on one end but the "socket" end of the lead is soldered to two pins, one or both of which may be inserted in the 5-prong socket. One pin on the *hot* lead is the grid connection, which is always used. The other pin, when inserted in the correct socket hole "picks up" a 75 μ fd. capacitor which is mounted on the side of the box. This capacitor may be used when the external circuit is a coil alone and it is desired to learn the tuning range of the coil. The capacitor is a small surplus unit of the APC type and the dial arrangement

gives a relative indication of the amount of capacity in the circuit. Zero is minimum capacity; 100 is maximum.

Power is taken from a friendly nearby power source (a receiver, etc.) by clip leads. The current drain is small—6.3 volts at 300-450 ma. and 50 to 350 volts at 10 ma. A slightly larger chassis would have permitted the inclusion of a small transformer-selenium rectifier type of power supply to make the unit independent.

Output from the oscillator may be taken from the tuned circuit where it approximates a sine wave, or the cathode circuit will supply a signal that is rich in harmonics. The cathode circuit has a potentiometer connected across the regular cathode resistor to vary the amount of signal that is fed to the tip jack used for the output connection.

The device is simple to use. To check the range of an r.f. tuned circuit just
(Continued on page 137)

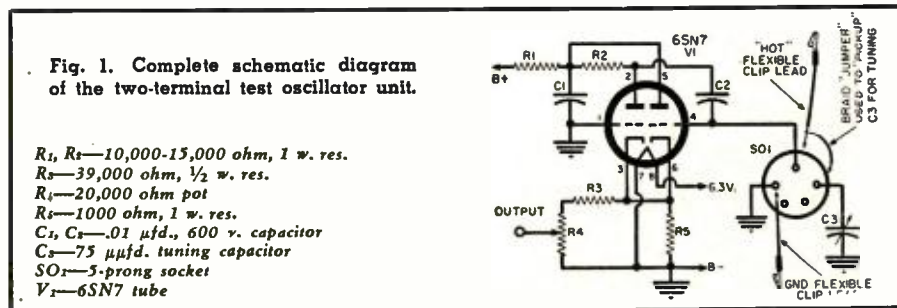

Adjustable

Half-Wave Filter

By HARRY D. HOOTON,
W6TYH

Internal view of harmonic filter. In normal operation unit is completely enclosed.

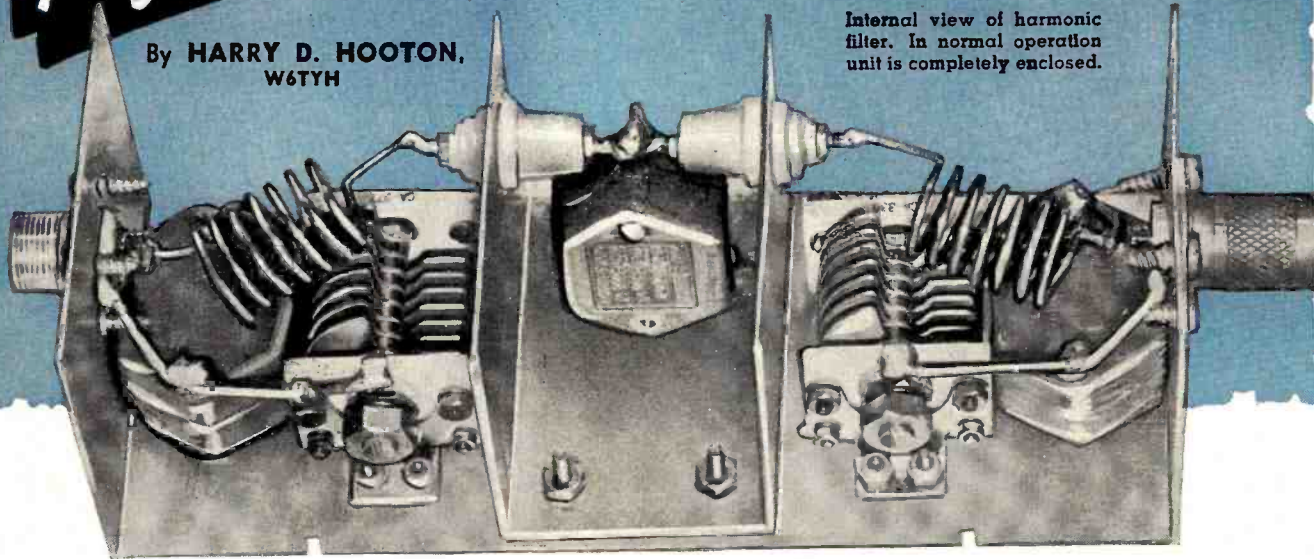

Effective filter for reducing harmonic radiation from ham transmitters. Major bands are covered.

DESPITE the fact that the half-wave harmonic filter has been described in the literature several times during the past three or four years, the average amateur is only vaguely aware of its purpose and possibilities. The filter, as originally described, has been used primarily as a harmonic suppression device for elimination of TVI radiation from the antenna system of an amateur transmitter. The filter also has a number of other important uses which will be discussed in this article.

The photographs and Fig. 1 show an adjustable half-wave filter which was designed to eliminate harmonic-type TVI from the author's 750-watt, 20-meter amateur transmitter. Since many amateurs will be interested in the device as a harmonic filter, this application, as well as the construction and adjustment of this particular filter, will be discussed first.

The term "half-wave" refers to the electrical characteristics of the circuit at the fundamental or operating frequency. As the schematic, Fig. 1, shows, the filter consists of two non-inductively coupled resonant circuits, L_1-C_1 and L_2-C_2 , which are tuned to the frequency of operation. In a filter designed for insertion in series with a 53- or 75-ohm coaxial transmission line, the "Q" of the two resonant circuits will be very low and, as a result, the adjustment of either L or C is not at all critical. The two resonant circuits are mutually coupled by means of capacitor C_3 .

At the frequency to which L_1-C_1 and

L_2-C_2 are resonant, the circuit will exhibit exactly the same electrical characteristics as that of a half wavelength of transmission line. In other words, if we design a filter of this type for a surge impedance of 53 ohms and insert it in series with a 53-ohm transmission line, such as RG/8-U, for example, at the resonant frequency of the two tuned circuits, the electrical effect is exactly the same as that of inserting an additional electrical half-wavelength of 53-ohm line. At frequencies to which L_1-C_1 and L_2-C_2 are not resonant, however, the impedance from the "hot" side of the circuit to ground will be very low. This statement is true for frequencies which lie either below or above the filter frequency passband. This characteristic has the disadvantage that a separate filter must be used for each amateur band as compared with the standard low-pass filter which passes all frequencies below the cut-off frequency. If a half-wave filter designed for 10 meters is inserted in the transmission line from a transmitter operating on 80 meters, or vice versa, the r.f. output would be virtually shorted to ground. Needless to say, the fixed capacitors in the filter probably would overheat. In a properly designed and well-constructed unit, the attenuation of harmonic frequencies will be on the order of 30 db per octave, the attenuation being more apparent on harmonics higher than the third. The half wavelength of coaxial line, which was used for comparison, has no inherent harmonic attenuation.

At the fundamental frequency, both the half-wave line and the half-wave filter will reflect exactly the same value of impedance at the output terminals as that presented at the input. This is true no matter whether the line is "flat" or has standing waves present. Therefore, the half-wave filter, when inserted in series with the transmission line, will have no effect on the loading of the r.f. power amplifier; in fact, the author's transmitter final r.f. amplifier loads to 330 ma. of d.c. plate current from one end of the 20-meter phone band to the other, either with the filter inserted or removed from the coaxial transmission line. This must not be interpreted to mean that the half-wave filter is an impedance-matching device when used in this manner; if standing waves are present on the line, they will also be present across the filter when it is installed.

The presence of standing waves on the line will not cause the filter to change the transmitter loading, as would be the case with a standard low-pass filter, unless the filter components heat up and change value. The harmonic attenuation characteristics remain the same whether or not standing waves are present. However, when the s.w.r. is high, the losses in both the transmission line and the filter will be high. If the s.w.r. is excessively high, particularly with high power, the heavy r.f. current drawn through the fixed capacitors may cause them to overheat and short circuit or even explode. If the s.w.r. is reasonably low (not more than 2:1 ratio) and the filter is built according to specifications, there should be no trouble with heating or component breakdown even at the legal maximum of 1000 watts

input to the final amplifier. The insertion loss of the filter, when properly designed and constructed, operating in a coaxial transmission line with an s.w.r. of 1:1 ratio will be on the order of 0.5 db or less.

The actual construction of the filter shown in the photographs is very simple. The components are assembled in a two-section aluminum box, the dimensions of which are 8 inches long, 3 inches wide, and 2 3/4 inches high. The two ends of the box are fitted with standard chassis-type coaxial fittings. Both tuned circuits are identical. The coils, L_1 and L_2 , consist of 7 turns of #12 bare copper wire, 3/8 inches in diameter, and 7/8 inches in length. The fixed capacitors are standard transmitting micas of 1250 volt rating; the variable capacitors are 50 $\mu\text{fd.}$, double-spaced receiving-type units. The 200 $\mu\text{fd.}$ fixed capacitors (C_1 and C_2) are two 100 $\mu\text{fd.}$ units connected in parallel since this combination appears to give a better current-handling capacity than that of a single 200 $\mu\text{fd.}$ unit. This precaution, however, is not necessary unless the filter must pass r.f. power loads in excess of 600 watts. For low power operation, single units of the proper value will be satisfactory; in fact, for powers of 150 watts or less, the small "postage stamp" receiving-type mica capacitors may be used with safety.

A 7 x 2 3/4-in. sheet of copper has been bent in the form of a U-shaped shield, as shown in Fig. 2 and the photograph. This shield divides the 8-inch aluminum box into three compartments, the two end compartments being 3 inches long and that at the center, formed by the shield, 2 inches long. The purpose of the shielding is to obtain the best possible isolation between the two tuned circuits. The coils, L_1 and L_2 , should be mounted in such a manner that their axes are at 90 degrees with respect to each other. The coils are self-supporting, one end being soldered to the inner conductor terminal of the coaxial fitting and the other to the feedthrough insulator in the copper shield. The two feedthrough insulator terminals inside the copper shield compartment are soldered together and the 440 $\mu\text{fd.}$ mica capacitor, C_3 , is connected from this point to ground. The two parallel 100 $\mu\text{fd.}$ mica capacitors, which comprise C_1 and C_2 , are mounted in the end compartments, as close as possible to the input and output coaxial terminals. The variable capacitors are mounted inside the end compartments, near the copper shield partitions and as close as possible to the paralleled micas. The leads from the coils to the capacitors must be heavy, short, and direct. In the unit shown, the connecting leads are #8 bare copper wire; heavy 1/4- to 1/2-inch copper strap would be better. The object is to reduce the lead inductance and, therefore, the impedance to harmonic frequencies between the "hot" side of the line and ground to the greatest possible degree. It is especially important that short, heavy leads are used from the junction

BAND

1.8 mc.
3.5 mc.
7.0 mc.
14.0 mc.
21.0 mc.
28.0 mc.

COILS L_1, L_2

4.2 $\mu\text{hy.}$, 22 t. No. 16 en., 1" dia., 2" long
2.1 $\mu\text{hy.}$, 13 t. No. 12, 1" dia., 8 t. per inch
1.1 $\mu\text{hy.}$, 8 t. No. 12, 1" dia., 1" long
.55 $\mu\text{hy.}$, 7 t. No. 12, .75" dia., 7/8" long
.42 $\mu\text{hy.}$, 8 t. No. 12, .5" dia., 7/8" long
.3 $\mu\text{hy.}$, 6 t. No. 12, .5" dia., 3/4" long

CAPACITORS

C_1, C_2
1700 $\mu\text{fd.}$ each
850 $\mu\text{fd.}$ each
440 $\mu\text{fd.}$ each
220 $\mu\text{fd.}$ each
165 $\mu\text{fd.}$ each
110 $\mu\text{fd.}$ each

Note: The capacitor values are total capacitance. When using variable trimmers, subtract one-half the maximum capacity of the variable unit from the above values. The center capacitor, C_3 , will be two times the value of either C_1 or C_2 , as given above.

Table 1. Coil and capacitor values required for the most commonly used ham bands.

of the feedthrough insulators to C_3 and from the opposite terminal of C_3 to ground.

When the filter has been constructed, as outlined, it may be inserted in series with the transmission line and the r.f. power from the transmitter applied. It makes no difference which end of the filter is used as input or output; both ends are identical. Before the filter is connected, however, the amplifier should be properly tuned and, if an s.w.r. bridge is available, the s.w.r. should be checked and noted. The filter is now inserted and the two variable capacitors are adjusted for minimum s.w.r. reading on the bridge. If the lowest s.w.r. reading which can be obtained by adjustment of the variable capacitors is higher than the value which was noted in the measurement with the transmission line alone, the inductance of the coils should be varied by spreading or compressing turns, at the same time adjusting the capacitors, until the s.w.r. is the same as the original reading without the filter. The cover should now be placed on the filter box and the harmonic attenuation checked, preferably by tuning a TV set to the channels where harmonic interference has previously occurred.

If an s.w.r. bridge is not available, temporarily short C_3 to ground with a heavy conductor. Adjust a grid-dip meter to the center of the 20-meter band and couple it to L_1 . Adjust the variable capacitor connected to L_1 , for resonance, as indicated by the meter. With L_1 and L_2 as specified, and standard tolerance micas, approximately 20 to 25 $\mu\text{fd.}$ of variable capacitance will be required for resonance at the center of the band. If resonance cannot be obtained by adjustment of the variable capacitors, the coils should be adjusted by spreading or squeezing the turns until each tuned circuit resonates at the band center.

As mentioned, the two circuits will tune very broadly when the filter is connected in series with the coaxial line. The two coils will radiate harmonic energy if the shield cover is removed from the box during operation. Adjustment of the variable capacitors for minimum harmonic interference may be made while watching the TV screen. In order to check the effectiveness of such adjustments, always replace the shield cover after each adjustment. If desired, small holes may be drilled in the shield cover so that adjustments may be carried out with the shield in place.

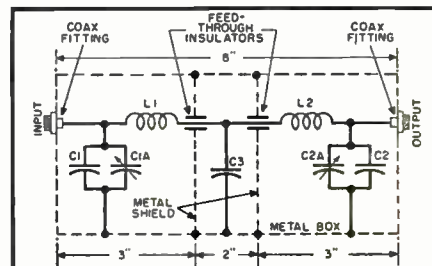

Fig. 1. Diagram of half-wave filter.

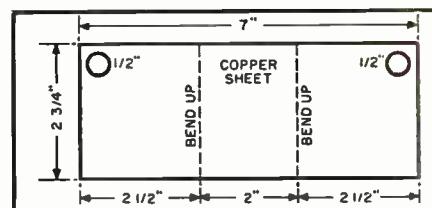

Fig. 2. Plans of copper shield partition.

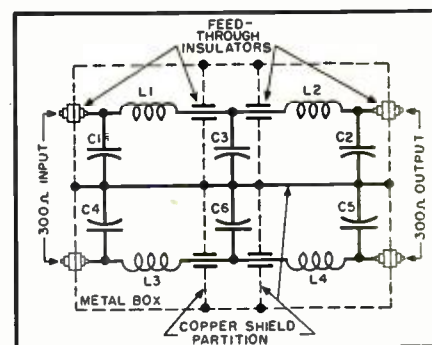
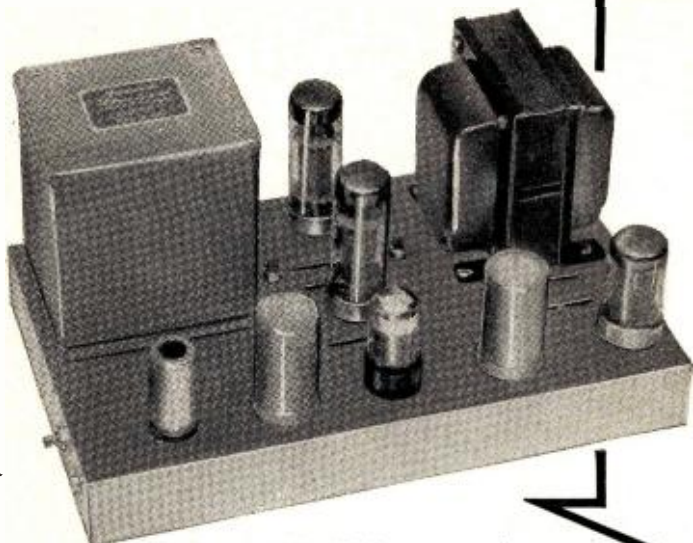

Fig. 3. Balanced filter for open line.

The filter unit just described is designed for use on the 20-meter amateur band only. It will operate satisfactorily with transmission lines from 50 to 100 ohms impedance. If it is desired to use a half-wave filter in connection with an open-wire or standard 300-ohm ribbon line, two filter units, constructed as described will be required. For use on balanced transmission lines, the coaxial fittings would be replaced by feedthrough insulators. Fig. 3 is the schematic diagram of the filter for balanced lines.

Table 1 lists the inductance and capacitance values required to construct half-wave filters for other popular amateur bands. The capacitors used in filters for the 40- and 80-meter bands may be fixed values since the resonant circuits tune so broadly that variable units will be of very little use in making adjustments. On the 20-, 15- and

(Continued on page 84)



Over-all view of the HF-60 power amplifier. It has bottom plate but no top cover.

The HF-60 -A New Power Amplifier

Designed around the British Mullard circuit, it provides "Ultra-Linear" operation and unusually good performance.

A BASIC power amplifier providing 60 watts of audio energy has just been put on the market in both kit and pre-wired form by *Electronic Instrument Co., Inc. (EICO)*. It provides high-fidelity reproduction of the entire dynamic and frequency range covered by present-day microgroove records and tape recorders. According to the manufacturer, it has excellent transient response, good stability, and overall clarity of the reproduced sound without false emphasis anywhere in the audio spectrum. The circuit itself is a variation of the British *Mullard* design which was originally covered in an article in the April, 1956 issue of this magazine. Actually, the published article described a 36-watt power amplifier but with circuit modifications, including fixed bias, this new design is capable of producing 60 watts with IM distortion of below 1% with an input signal of .52 volt.

The output stage is a straightforward, push-pull design using EL34/

6CA7's in an "Ultra-Linear" fixed bias operation. The output transformer is a fully potted *Acrosound* TO-330 unit. The input stage is an EF86 low-noise voltage amplifier which is direct-coupled to a 6SN7GTB cathode-coupled ("long-tailed") phase inverter. This "long-tailed" phase inverter is not necessarily a new design but only recently has it begun to achieve its present popularity. It provides almost perfect balance over the entire frequency and dynamic range, and sufficient drive for the output stage at equal and comparatively low impedances. A complete technical analysis of this circuit is planned for the May issue of *RADIO & TV NEWS*.

The rectifier tube is a GZ34 type with indirectly heated cathode to eliminate high starting voltage on the electrolytic filter capacitors.

The HF-60 incorporates an input jack, input level control, a panel-mounted fuse, switched and unswitched a.c. convenience outlets, a standard octal socket providing preamplifier power take-off, and remote "on-off" switching.

The octal socket provides all of the necessary filament and "B+" voltages for operating a preamp-control unit. The 6.3 volt a.c. filament voltage at 1 amp. may be obtained from pins 1 and 2; pin 4 supplies 350 volts d.c. at a maximum current of 10 ma.; and pin 3 is connected to ground. Control of the 117 volt a.c. line power to the amplifier as well as power for a preamp is made available through the connections to pins 6 and 7.

In addition to these features, the amplifier includes two variable potentiometers: one to adjust balance between the two output tubes and the other to adjust bias voltage.

The original specifications as published by the manufacturer seemed exceptionally good. We thought it wise, therefore, to check out one of the units. The construction itself proved to be relatively simple. The instruction sheets provided with the kit were complete and no difficulty was encountered. The performance characteristics that were obtained followed closely those of the published figures. It is of considerable interest to note how closely they came to the factory specs. The percentage intermodulation distortion, as shown on the graph, was approximately .55 per-cent at full 60-watt output. This compares with the

Performance characteristics of the new 60-watt power amplifier as published by the manufacturer. Unit measures 7" high, 14" wide, and 8" deep over-all.

Rated Output Power	60 watts continuous; 130 watts peak
IM Distortion (60 & 6000 cps @ 4:1)	Below 1% @ 60 watts; below .5% @ 50 watts
Total Harmonic Distortion	Below .5% at any frequency from 20 to 20,000 cps \pm 1 db of 60 watts
Undistorted Sinusoidal Frequency Response	\pm .5 db, 5 cps to 100,000 cps @ 1 watt level; \pm .1 db, 15 cps to 35,000 cps at any level from 1 mw. to 60 watts; no peaking or raggedness outside audio range
Square-Wave Response	20 to 25,000 cps essentially undistorted; 3 μ sec. rise time; no overshoot at any frequency or power level nor visible rounding below 15,000 cps
Inverse Feedback	21 db
Stability Margin	16 db
Damping Factor	Above 12, 20 to 20,000 cps; 17 at 1000 cps
Sensitivity	.52 volt for 60 watts output
Hum	90 db below rated output
Speaker Connections	4, 8, and 16 ohms
Tubes	2-EL34/6CA7, 1-EF86/Z729, 1-6SN7GTB, 1-GZ34
Power Sources	110-120 volts, 60 cps; 150 va. @ no signal; 200 va. @ signal developing rated power; 250 va. @ signal developing peak power (overload), 3 amp fuse
Size	7" high, 14" wide, 8" deep
Weight	30 lbs.

manufacturer's published figure of below 1 per-cent at full output. The harmonic distortion was approximately .17 per-cent at 47 watts, which is within 1 db of full output. This also compares favorably with the published figure of .5 per-cent. Our test, of course, was made at only one frequency, 1000 cps. The total harmonic distortion at frequencies other than this 1000 cps were not taken; therefore, no comparison can be made. The noise level was checked and found to be 92 db down from full output. The damping factor was 15.

It is rather unusual to publish an article on a power amplifier without showing a frequency response curve; however, in this instance, it would have been ridiculous. The over-all response from 20 to 20,000 cps (within the limits of the audio oscillator) showed that the amplifier was absolutely flat within these limits.

One word of caution. Like any other high power amplifier, the output terminals to the speaker should not be shorted or opened when the amplifier is in operation. It is always wise not to change tubes while the power is on. A momentary short or open certainly is not serious but if operation is continued for any length of time, the output tubes can be seriously damaged.

Included in the construction instructions submitted with the kit of parts was a note suggesting the use of a .025 μ fd. capacitor from the center tap ("B+") lead of the output transformer to ground. Apparently in some of the kits this particular capacitor was necessary. However, in the unit that was checked, it was found that this capacitor caused instability. It was determined that eliminating this capacitor was absolutely necessary in order to overcome instability in the amplifier. With the exception of the 6SN7, the tubes used in this amplifier are of foreign manufacture and although they do not have exact American equivalents, these specific tubes are readily available at parts distributors throughout the country.

The damping factor of a power amplifier is becoming a more and more important characteristic in the design of such units. Amplifiers with a damping factor of 10 to 16 can be used with most speakers on the market today. There are some speakers, such as the heavily damped *Acoustic Research* models AR1 and AR2 and several *Altec-Lansing* models that are designed to be used with power amplifiers having a damping factor of approximately one, especially when such speakers are installed in infinite baffles or similar enclosures that do not enhance bass response.

If the HF-60 were used with such speakers, it would provide too much damping and therefore the ultimate response would be less than ideal, especially in the bass region. In such cases it would be necessary to use a series resistor (4, 8, or 16 ohms, depending on the speaker impedance) in series between the amplifier and

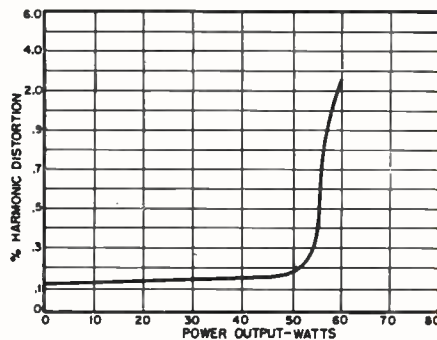
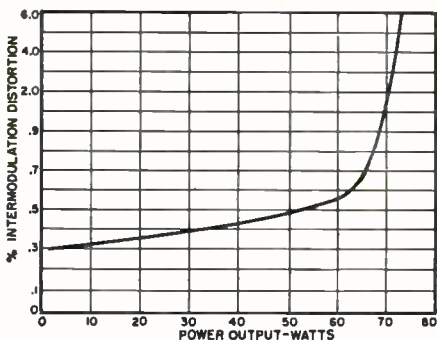

Curves showing the percentage of intermodulation and harmonic distortion. Both of these tests, made independently of the manufacturer, conform quite closely with the published figures. The harmonic distortion characteristic was taken at 1000 cycles and would not necessarily indicate performance at 20 cps and 20 kc. as published by the manufacturer. Equivalent sine-wave power was used in plotting the intermodulation distortion characteristics represented by this performance graph.

speaker system. This would reduce the effective damping factor as required. Obviously this resistor will consume as much power as the speaker system itself, but this would only be true in the mid-frequencies where the speaker impedance is the same as its nominal impedance. At the bass resonant frequency, the speaker impedance rises sharply so that most of the output voltage is developed across the speaker and very little is lost in the series resistor.

The amplifier is designed so that it can be used in a built-in installation (provided there is adequate ventilation) or left free-standing on a table or bookcase.

If a console housing the amplifier is to be used to enclose other audio

gear, at least two inch clearance should be allowed between the top of the amplifier chassis and any shelf mounted above it. If the amplifier and speaker are mounted in the same cabinet, not recommended but sometimes necessary because of a lack of space, sufficient separation must be provided to minimize mechanical speaker vibration reaching the amplifier. The minimum separation recommended by the manufacturer to prevent acoustic feedback is one foot.

All in all, the HF-60 power amplifier performed as expected and conformed to all published specifications. It is available in either kit form at \$72.95 or, if preferred, it is available completely wired by the factory for \$99.95.

-30-

Complete schematic diagram of the HF-60 power amplifier. As was pointed out in the text, the .025 μ fd. capacitor from the "B+" center tap of the output transformer was eliminated in the unit tested. It may or may not be necessary in other models. With variations in circuit design from the original Mullard circuit, and with the inclusion of fixed bias, maximum undistorted output is specified at 60 watts continuous, 130 watts peak. It is a relatively high-gain circuit, requiring only .52 volt to drive it to full output. For other features of this unit, refer to text.

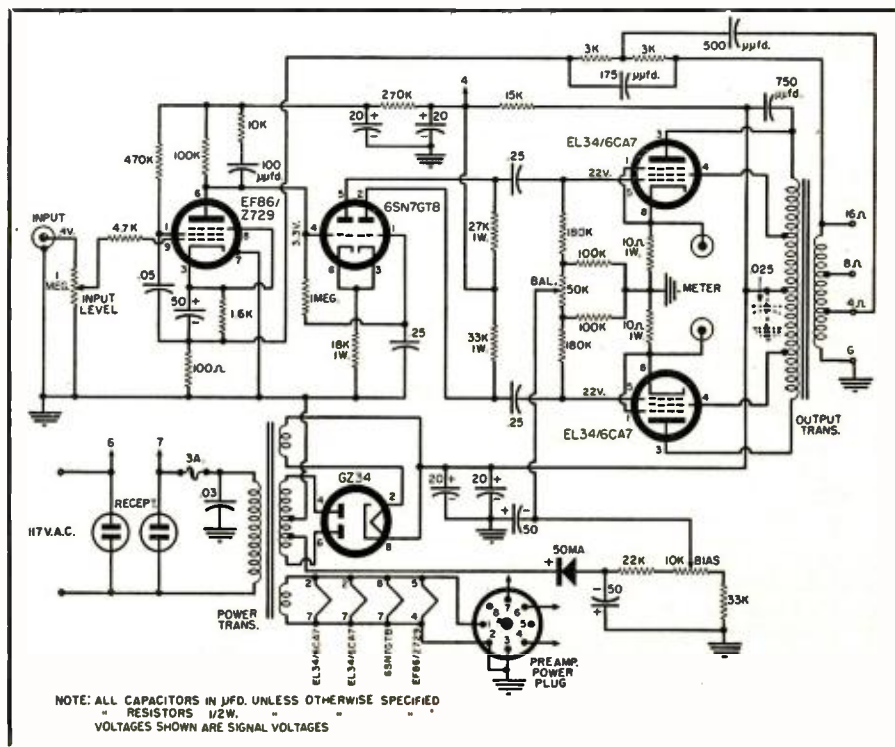

Conelrad

the Easy Way

By

JOHN T. FRYE, W9EGV

A simple circuit, requiring only three components, that can be added to any amateur or broadcast type receiver.

THE writer, along with many other hams, has been patiently waiting for a simple, inexpensive, and good Conelrad device. From experience, he knew that the first ideas presented would probably be elaborate, complicated, and expensive; but he believed that sooner or later someone would come up with an idea for doing it the easy way.

Someone has. Various versions—some pretty badly garbled—of the basic idea shown in Fig. 1 are being heard on the ham bands. The beautiful simplicity of the idea appeals to the service technician in the writer; and, after giving it a thorough trial, he is convinced it is the answer to the Conelrad needs of most hams.

Only three parts, those shown in the dotted rectangle of Fig. 1, need to be added to any standard broadcast receiver to convert it into a Conelrad monitor. Here is how it works:

When the d.p.s.t. switch, S_1 , is in the open position, the receiver acts perfectly normally. When this switch is closed and a strong station is tuned in, the maximum a.v.c. voltage developed across the a.v.c. load resistor, R_1 , to the grid of the first audio tube and biases it to cut-off. Under

these conditions, no sound at all issues from the speaker.

However, when the station to which the receiver is tuned disappears from the air, as it would during an alert, the a.v.c. voltage is no longer developed and the cut-off bias on the first audio tube is removed, restoring the audio amplifier to wide-open operation.

A feedback circuit from the plate of the output tube through the capacitor, C_1 , and the resistor, R_2 , to the grid of the first audio tube converts this am-

Fig. 1. Boxed components are added to receiver to provide Conelrad monitoring.

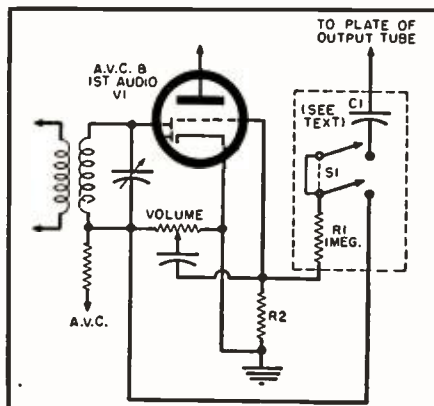

plifier into an audio oscillator; and a loud howl issues from the speaker. The howl continues until the station returns to the air, the receiver is retuned to another station developing sufficient a.v.c. to cut off the first amplifier tube, or switch, S_1 , is opened.

That is all there is to it. S_1 can be mounted in any convenient place at the rear of the set. When applying the system to a.c.-d.c. sets with "hot" chassis, common-sense precautions against shock possibilities should be taken. Some experimenting may be necessary to find the proper value for C_1 to produce the loudest and most piercing tone. In two cases tried by the writer, a mica capacitor of .002 μ fd. worked fine; but since the value of R_2 may vary widely in different receivers and since this resistor as well as the resistance of the volume control determines, to some degree, the optimum value for C_1 , it may be necessary to try a few different capacitors. Leave the volume control nearly wide open when trying different values. Too large a capacitor will result in low frequency popping or motor-boating; too small a capacitor will not produce any sound at all. It will be found that the setting of the volume control will have some effect on the tone, but the capacitor selected should be one that gives the desired tone with the control set near maximum.

To check the operation, leave the switch open and tune in a reasonably strong station. Now close the switch. The station should disappear at once. Next tune off the station. As soon as the receiver is detuned, the audio howl should start. Turning back to the station should stop it.

At the writer's location, stations from better than a hundred miles away easily develop enough a.v.c. voltage to keep the receiver silenced. Any one of several stations may be used for monitoring. This is an advantage with a superheterodyne receiver, for when the transmitter is on certain frequencies an image may fall on a particular broadcast station and render it useless for alerting purposes. Being able to switch to another station when operating that particular frequency is desirable.

In conclusion, let it be pointed out this Conelrad device has the following substantial advantages: it is easy to install; it requires only three inexpensive parts; it does not alter the normal operation or appearance of the receiver to which it is applied in the slightest; it is entirely electronic in operation, requiring no delicate and expensive mechanical relays; it is quite sensitive and will operate on any station delivering a reasonably strong signal; the "alarm" is one that requires no attention and that cannot be ignored; the operation can be checked at any time simply by tuning off the station.

In fact, it is so simple that many broadcast listeners may wish to install it on their receivers, just in case! —30—

WITH the continuing stream of new tube types—this year's list is about 20 per-cent longer than the same list a year ago—keeping a working inventory on hand becomes increasingly difficult. In our shop, we found it necessary to set up a perpetual check system, in which this "minimum-quantity" list is compared to actual stock every morning. As soon as a type falls below its minimum-quantity figure, it is re-ordered. The quantity figure is, of course, relative, depending on the volume of business, but it should hold up proportionately.

The list shown here is for a typical independent shop in a suburb of New York City. It should be a good guide in most other metropolitan areas where v.h.f. reception predominates. In u.h.f. areas, it will be necessary to make minor additions of the 6AF4, 6AN4, and their series-string counterparts.

On the other hand, tube types used in industrial electronic and color-TV service have been included and marked respectively with one and two asterisks. In areas where these are not used, they may be deleted. Our system is far from foolproof—we still find ourselves short occasionally—but this happens far less often than in the past.

-30-



Up-To-Date Tube Inventory for Service Shops

By **MURRAY BARLOWE**
Barlowe Television

*Here's an active inventory of tubes
stripped of dust-gathering deadwood.*

Type	Quantity	Type	Quantity	Type	Quantity	Type	Quantity	Type	Quantity	Type	Quantity
*0A2	2	5AT8	2	6AW8	2	6F5	1	7AU7	3	12BY7	3
*0B2	2	5AV8	2	6AX4	3	6F6	2	7B4	1	12BZ7	2
0Z4	5	5BK7A	3	6AX5	2	6H6	1	7B5	1	12L6	2
1A7GT	1	5J6	3	6BA6	4	6J5	3	7B6	1	12SA7	2
*1AX2	3	*5R4GY	5	**6BD4A	1	6J6	6	7B7	1	12SG7	1
1B3	5	5T8	2	6BC5	10	6K6GT	6	7C5	2	12SH7	1
1H5GT	1	5U4GB	10	6BC7	2	6L6	1	7E5	1	12SJ7	1
1N5GT	1	5U8	2	6BD6	3	6N7	1	7F7	1	12SK7	3
1R5	2	5V4G	3	6BE6	5	6S4	4	7F8	2	12SL7	1
1S4	2	5X8	2	6BF5	2	6S8GT	1	7G7	1	12SN7	4
1S5	2	5Y3GT	4	6BF6	2	6SA7	3	7H7	1	12SQ7	3
1T4	2	6AB4	4	6BG6	6	6SBY7	1	7N7	2	12V6GT	3
1U4	2	6AC7	4	6BH6	1	6SC7	1	7Q7	1	12X4	2
1U5	2	6AG5	5	6BJ6	1	6SF5	1	7X7	1	19BG6	2
1V2	2	6AG7	3	6BK5	1	6SG7	1	7Y4	1	19T8	1
1X2B	5	6AH4	2	6BK7A	3	6SH7	2	12AL5	1	25BQ6	4
*2D21	2	6AH6	3	6BL7	3	6SJ7	2	12AQ5	1	25L6	4
3AU6	4	6AK5	2	6BN6	3	6SK7	3	12AT6	3	25W4	3
**3A3	1	6AK6	1	6BQ6	10	6SL7	3	12AT7	6	25Z5	1
3BC5	4	6AL5	5	6BQ7A	6	6SN7	10	12AU6	2	25Z6	2
3BE6	2	6AL7GT	2	6BX7	2	6SQ7	3	12AU7	10	35A5	2
3BN6	2	6AM8	2	6BY5	2	6SR7	1	12AV6	3	35B5	3
3BY6	2	6AN8	4	6BZ6	2	6T8	3	12AV7	5	35C5	3
3BZ6	2	6AQ5	4	6BZ7	6	6U8	4	12AX4	3	35L6	4
3CB6	4	6AQ6	2	6C4	2	6V3	2	12AX7	3	35W4	5
3CF6	2	6AQ7GT	2	**6CB5	1	6V6GT	6	*12AY7	2	35Y4	1
3CS6	2	6AR5	1	6CB6	10	6W4	10	12AZ7	1	35Z5	4
3Q4	1	6AS5	3	6CD6	4	6W6GT	4	12B4	3	50A5	1
3Q5GT	1	6AS6	2	6CF6	2	6X4	4	12BA6	3	50B5	2
3S4	2	6ASG7	1	6CG7	2	6X5	2	12BA7	1	50C5	2
3V4	2	6AT6	5	6CL6	3	6X8	3	12BD6	2	50L6	5
4BQ7A	4	6AU4	2	6CM6	1	6Y6	1	12BE6	4	5642	2
4BZ7	2	6AU5	3	6CN7	1	7A7	1	12BF6	3	80	1
5AM8	2	6AU6	10	6CR6	1	7AF7	1	12BH7	5	117Z3	2
5AN8	4	6AV5	3	6CS6	2	7AG7	1	12BK5	2	117Z6	1
5AQ5	2	6AV6	4	6E5	1	7AH7	1	12BN6	1		

*Industrial Electronic **Color

Photoflash Synchronizer Checker

By
W. F. GEPHART

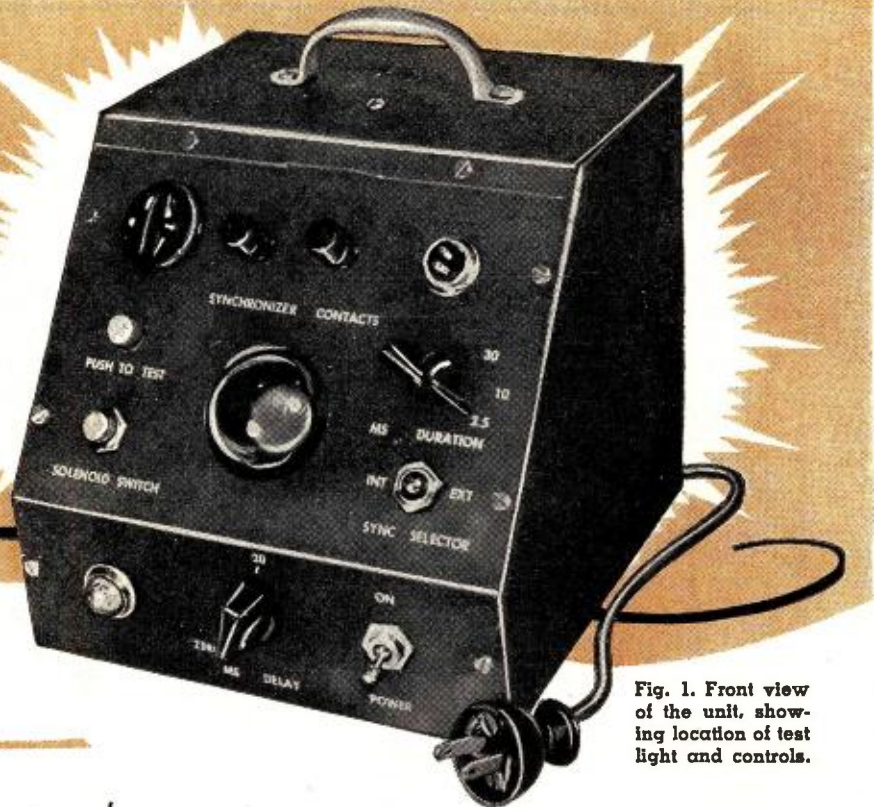

Fig. 1. Front view of the unit, showing location of test light and controls.

A simple, easy-to-operate, and extremely accurate device for checking camera photoflash synchronizer.

WHILE it's bad enough when an amateur misses some pictures because his flash synchronizer is out of adjustment, it is a costly and tragic thing for the professional or news photographer. Any synchronizer should be checked regularly and adjusted to keep on "peak."

The checker to be described is a simple, easy-to-operate, and extremely accurate unit, and costs less than a fourth of the cost of commercially built units. The unit can be built at a low enough price to attract many professional photographers, newspapers, and camera stores, the latter using it as a service feature for their customers.

In checking a synchronizer, the device used must operate independent of the length of time that the synchronizer contacts are closed, as tests of various built-in synchronizers show that the time that the contacts are closed varies from about 2 milliseconds to the length of time that the shutter release is held down.

The device should also provide a "delay" between the time that the contacts close, and the time that the test bulb goes on, to allow for adjustment for flashbulbs which reach their peak light output about 20 milliseconds after ignition. Furthermore, the duration of the test light flash should be variable, to accommodate the varying length of peak output of flashbulbs (from 10 to 30 milliseconds, depending upon type), and the extremely short duration of electronic flash (from .2 to 2 milliseconds).

Finally, the device should be able to test both built-in synchronizers and solenoid-operated external types, since professionals and news photographers prefer the latter type.

The unit described meets these requirements and can be built for around \$25, the exact cost depending on how much surplus gear is available.

Circuit Description

Two 0A4G tubes are connected in a "cathode follower" circuit. The first tube (V_1) acts as a "switch," starting the action when the synchronizer contacts close, and "fires" the tube, causing it to conduct, by momentarily placing 90 volts on the control grid. The tube will continue to conduct (as long as anode voltage is applied through S_2) however, even after the synchronizer contacts open.

Voltage developed across cathode resistor R_2 of V_1 furnishes the triggering potential for the grid of the second 0A4G (V_2), which then conducts. In this stage, anode voltage is secured from a previously charged capacitor (C_3 , C_4 , or C_5), and as soon as the grid of V_2 becomes positive, the tube conducts, and the capacitor discharges through the tube and through the neon bulb (PL_1). This produces an instantaneous flash in the neon bulb, which (when polarity is proper) appears across the top disc of the bulb's plates. The time required for this discharge (and therefore the time that the bulb is lit) depends on the size of the capacitor. While both tubes will continue to conduct, until anode voltage

is removed by releasing S_3 , the neon bulb will be lighted only for the time needed for the capacitor to discharge. When S_3 is released, the high voltage is removed from the plate of V_1 , which stops conducting and is connected to the capacitor, re-charging it for the next cycle.

An RC network between the two stages provides an optional delay between the firing of the first tube and the second tube (and neon bulb) when required. This net can be bypassed by S_4 to give zero delay when testing with electronic flash.

A built-in battery and push-button permit testing solenoid-operated synchronizers, when the selector switch (S_1) is set to "External." The push-button, which should be a snap-action type to insure both contacts closing simultaneously, connects the triggering voltage to the grid of V_1 , and supplies battery voltage through the synchronizer contacts to operate the solenoid.

The use of several different size capacitors (C_3 , C_4 , and C_5), selected through S_5 , permits varying duration of light from the test bulb. Since the d.c. resistance of the neon bulb is approximately 5000 ohms at the indicated voltage, the capacitances shown will provide light durations of 2.5, 10, and 30 milliseconds.

The unit is powered by a selenium rectifier voltage doubler. It is most important, particularly when using a metal cabinet, to be sure that none of the wiring is grounded to the chassis. Many built-in synchronizers have one side grounded to the camera frame, and holding the camera while pressing the "Press-to-Test" button might result in a shock if any part of the

wiring is connected to the chassis or case.

The unit is mounted in a small, sloping front cabinet, and no particular care is required in wiring. It is important that the "Press-to-Test" and "Solenoid Release" buttons be placed close together so they can both be pressed with one hand while the other hand holds the camera or shutter.

The synchronizer sockets used should be selected for the type of synchronizer cords expected to be encountered. In the unit shown, SO_2 is a microphone cable socket modified to accept *Graphflex* cords. Two headless 6-32 machine screws were filed down (around the threads) slightly on one end until they fitted snugly into the socket holes. The other ends were then filed down to fit the synchronizer cord socket.

The switch for "Zero" delay is attached to the potentiometer (R_1), and is a single-pole, double-throw switch, connected so that the circuit is closed when the potentiometer is in the extreme counterclockwise, or "off" position.

The flash discharge capacitors, C_3 , C_4 , and C_5 , should be high-quality units with low leakage. Electrolytics should be avoided because of instability. Working voltage can be as low as 200 volts, and often excellent units can be found in surplus stocks.

Calibration and Operation

The only calibration required is that of the "Delay" control, R_1 . This needs only to be calibrated at the 20 millisecond point, but is made variable, so that when a synchronizer is out of adjustment, the actual delay being experienced can be determined to permit adjustment to increase or decrease the delay.

Calibration can be accomplished either of two ways. If a synchronizer that is known to be adjusted to 20 millisecond delay is available, set the shutter to 1/400 or 1/500 second (or highest speed available), set the "Duration" control to 2.5 milliseconds, and connect the synchronizer to the unit by connecting the cord which normally goes to the flashgun to the proper synchronizer socket on the unit. Release the shutter, watching the neon bulb through the lens, and adjust R_1 until the orange disc of the neon bulb is seen completely as the shutter opens. Mark the setting of R_1 as the 20 millisecond point.

The other means of calibration is by calculation. Measure the actual capacity of C_3 , and set R_1 to the proper resistance value to give a time delay of 20 milliseconds based on the formula $t = R \times C$ (in megohms and microfarads) and mark the scale.

To use the unit, connect the synchronizer (or solenoid) to the synchronizer terminals on the unit, and set the "Selector" switch as applicable ("Internal" for built-in synchronizers and "External" for solenoid units). Set "Delay" as required, and "Duration"

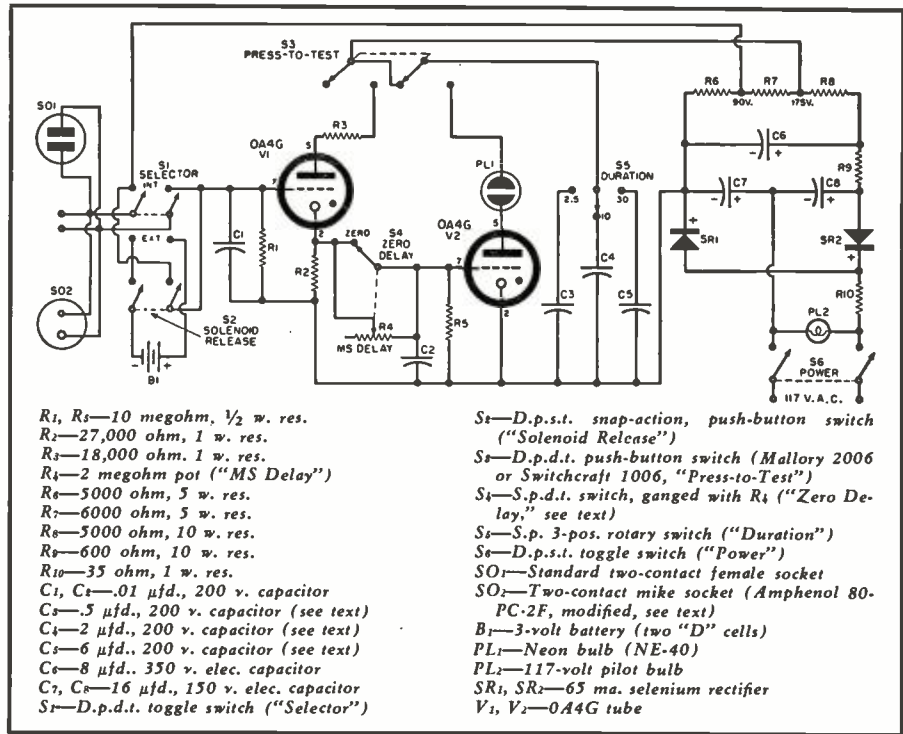

Fig. 2. Complete schematic diagram and parts list for photoflash sync checker.

to 30 milliseconds, and turn the unit on. Open the camera lens wide and set shutter speed to 1/50 second. Hold the "Press-to-Test" button down, release the shutter (either with the shutter release or with the "Solenoid Release" if an external synchronizer is being checked), and watch the neon bulb through the lens opening. If a complete disc of light is seen, continue the tests, increasing the shutter speeds and decreasing the "Duration" time. If at any time during the tests (within the limits set in the following paragraph), part of the disc of light is cut off by the shutter leaves or curtain, adjustment is required.

For flashbulb use, with the unit set at 20 millisecond delay, tests need not be made at less than 10 milliseconds "Duration" for regular shutters, or 30 milliseconds "Duration" for focal-plane

shutters (using long-peak bulbs), since the duration of peak light is 10 and 30 milliseconds for regular and focal-plane (FP) bulbs respectively. When checking for synchronization with electronic flash, tests should be made with "Zero" delay in all cases and down to 2.5 millisecond "Duration."

No voltage regulation is required, even though the operating point of the tubes is somewhat critical. "Firing" voltage must be at least 80 to 83 volts, with anode voltage about twice that. Variations in line voltage will have no effect on the accuracy of the unit, as long as sufficient "firing" voltage is available. With values shown, the unit will operate down to about 100 volts line voltage, and give equally precise results at any voltage above that, within the limits of the voltage rating of the charging capacitors. —50—

Fig. 3. Unit removed from cabinet, showing mounted battery and connecting cord.



Facing the Phase Detector



← Figure 1.

Figure 2. →



By
BOB ELDRIDGE

The circuit is familiar, but much goes on beneath the surface. Know it better, save service time.

LOCATED between the sync separator and the grid of the horizontal oscillator in a very large number of TV receivers is that most popular of all means of controlling horizontal-oscillator frequency, the twin-diode phase detector. Relatively speaking, this stage is quite trouble-free. This is a fortunate circumstance since, to many service technicians who are well versed in the peculiarities of other more complex sections of the set, certain points concerning the phase detector are not too well understood.

There are no insurmountable theoretical difficulties: the tale of how out-of-phase but otherwise identical sync pulses are fed from an inverter to the two sections of the detector, and how a comparison pulse is fed back from the flyback transformer or elsewhere in the output stage, has been told before. Yet how many of those who could explain this over-all process quite confidently can also describe the function of the .05- μ fd. capacitor shown in Fig. 3 between the oscillator grid and ground?

At first glance, this item appears to be merely a means of grounding out noise pulses or other undesired a.c. voltages that may reach this point, so

the natural tendency is to regard it as merely another bypass, to be replaced when defective by a new part "at least as large as the one shown in the schematic." It would seem obvious that, if we thus prevent random pulses from disturbing the steady d.c. bias set up by a.f.c. action, everything should be fine.

Nothing could be farther from the truth, as a simple experiment we can set up will show. With a set that is in normal operating condition, clip this capacitor out of the circuit and observe the effect on the picture. The most noticeable difference is that the picture now jags or tears at random points as pulses of noise momentarily upset the oscillator's stability. This much, which we would expect, is shown in Figs. 1 and 2. Although the defect—the open bypass—is the same in both photos, Fig. 2 depicts the condition when a stronger signal is present with generally less noise. In this still picture, the instability can only be noted as a slight irregularity of vertical lines. The symptom is more evident in practice as a result of the weaving motion.

Now, instead of removing the capacitor altogether, let us go to the other

Fig. 1. This picture is tearing horizontally at random points because the bypass capacitor at the grid of the horizontal oscillator stage is open.

Fig. 2. The horizontal tearing in this picture is much less severe than in the one of Fig. 1, because signal is stronger and there is less noise present. However, the same defect is involved.

extreme and increase its value by substituting, say, .1 μ fd. in place of the original .05 μ fd. On most sets, the result will be loss of horizontal sync! Obviously, this capacitor is not just another bypass. It is part of the combination of values on this grid line, which together have a time constant designed, not only to filter out random noise, but also to form an anti-hunting network for the horizontal oscillator frequency. The real danger here is that if a capacitor of intermediate value has been wired in the circuit (that is, one between the correct value and that value which causes complete loss of sync), the deterioration in performance may not be noticed! We all know that some sets have inherently weaker lock-in than others, and a minimum standard of performance in this respect is a very difficult thing to establish.

As a practical example of the trouble an oversight like this can cause, the writer cites an experience on a chassis which came to the bench with a report of weak horizontal hold. This model was known to have particularly good lock, and the outside technician had noticed that, in this instance, the set would only hold over about half the range of the hold control. In the course of a preliminary inspection of the set, the .05- μ fd. capacitor, which is the subject of our present discussion, was replaced because it was leaky.

After further work on the job, one

of the .001- μ fd. capacitors feeding sync to the phase detector was found to be open but, after its replacement, sync was still not up to the standard expected from this set. After much hair ruffling and fruitless endeavor on a set which checked perfectly normal except for the end result on the picture, it was found that the replacement unit, thought to be .05 μ fd., was actually .09 μ fd. A second new capacitor measured at a little over .05 μ fd. brought performance completely up to scratch.

Incidentally, this experience underlines one golden rule for benchmen. If a definite fault has been found after much digging, but the set still does not operate properly, check over your own previous work before going farther. Apart from anything else, it is so easy to disconnect a component for checking, and forget to put it back in the circuit after the real culprit has been found and replaced.

It is extremely helpful to know what the d.c. voltage being applied from the output of the phase detector to the grid of the oscillator is under a variety of conditions, and also to know how it may be varied. Also of help is some familiarity with abnormal voltage readings and what they are likely to indicate symptomatically.

What should the value of this voltage be, for example, when the set is correctly in hold? What should this reading change to when the receiver is tuned to a vacant channel and the oscillator is running free? How will changes in the setting of the hold control affect the reading at this point?

No single answer will cover the phase-detector circuits used in all receivers, but it is nevertheless advisable for the technician to familiarize himself with the approximate standing voltage at this point in the set. It is just as important to become familiar with the pattern of change that develops with changing conditions.

This cause can best be served if the voltages from a normal set at this point in the circuit, taken under signal and no-signal conditions as well as at various adjustments of the hold control, are recorded on the shop schematic. Of course, it may not be practical to do this with every model of television receiver using this circuit that comes into the shop, but it is generally true that certain sets are more popular in one area than others. Where the technician knows he is likely to encounter a considerable number of brand X receivers, which use the phase detector, he will certainly benefit from making a record of voltage readings.

The writer has himself spent time at the bench, during slack periods, doing nothing but taking readings at various key points of normal sets and transferring this information to the corresponding schematics. Readings taken during defective operation were also recorded. There has been no cause to regret this practice.

A recent case of jumping horizontal frequency pinpoints the wisdom of this

practice. A set came into the shop with a report that it would suddenly jump out of horizontal sync, necessitating adjustment of the ringing coil. A few days later it would revert to the original state. Hold was reported to be good in either setting.

The following course of action was decided upon: the first step was to take a series of voltage readings around the oscillator and phase-detector stages, then to wait for the set to change frequency, and finally to compare the set of new readings then taken with the old ones. As soon as the first set of readings was taken, it became apparent that the controlled grid of the 6SN7 was unusually negative. Reference to the schematic notes made long, long ago gave such a complete picture that it was hardly necessary to check the suspected capacitor before replacing it. The note said, "Normal vacant-channel reading, plus .4 volt; reading with C_1 (Fig. 3) open, minus 2.2 volts; reading with C_2 open, plus 2.5 volts."

The actual reading on the defective set had been minus 2 volts, so the capacitor identified here as C_1 was replaced. The voltage then reverted to exactly .4 positive, and receiver operation returned to normal. The defective capacitor was found to have a resin joint between one plate and its end wire. Note particularly that, because of a pencilled note on a schematic, this set was serviced for an *intermittent* without the need of having to wait for the actual intermittent change in frequency to occur on the bench. Who can say how many days that saved?

If this capacitor had gone *permanently* open, it is interesting to note, the set may never have been brought into the shop at all, because, with the capacitor open, lock was quite good on the two local stations available at the viewer's location. How did this come about? A few minutes spent in "education" on the set after the repair had been made showed that there was enough incidental capacitance across the "open" capacitor to feed some pulse through to the phase detector. The writer well remembers a tip from a visiting field service engineer a few years ago: "If everything seems to check OK, but hold isn't quite right, replace both .001- μ fd. capacitors to the phase detector."

Another capacitor that does not have quite the expected action is the .01- μ fd. unit shown at pin 7 of the 6AL5 in Fig. 3. It is part of the wave-shaping network that inserts the saw-tooth sampling or comparison pulse from the flyback or horizontal-output circuit back into the phase detector. Its value will of course have some effect on the amplitude of the pulse injected into the 6AL5 circuit.

If this capacitor is shorted—one extreme—the result will be a total loss of horizontal sync, as no feedback waveform at all will then be fed to the phase detector. A short in this capacitor, or a short in the 6AL5 tube itself, is indicated when the horizontal pulse can be

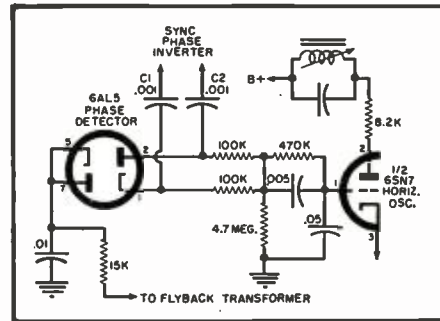

Fig. 3. Although variations in components and values occur, this specific phase-detector circuit is very typical.

found at that end of the allied 15,000-ohm resistor that feeds to the output or flyback system, but cannot be found at the tube or capacitor end.

If the capacitor goes open or decreases drastically in capacitance value—the other extreme—the stage may be driven into such heavy conduction, due to the resultant over-sized pulse, that the d.c. control voltage output is high enough to disable the oscillator completely. Once this occurs, the cause is easy enough to track down, but what happens when the capacitor suffers only a partial loss of value? The d.c. control voltage on the grid of the oscillator may become heavily positive, but not quite so much so that the oscillation is stopped. The plate resistor will probably overheat, causing frequency drift. The resultant incorrect settings of the ringing coil and hold control, made necessary to compensate for the wrong bias voltage, can result in instability and hooking or twisting of vertical lines in the picture. This is another case where it would be useful to know standing bias at the oscillator grid.

The .005- μ fd. capacitor in the filter network off pin 1 of the triode shown in Fig. 3 can be open completely in some sets without causing enough visible defect in the picture to raise a complaint from the set owner. More often, the effect of the failure of this unit is a weave, sometimes of several cycles, in the vertical lines of the picture, as shown in Fig. 4.

Even this relatively straightforward circuit, as we have seen, has its strange and unexpected aspects. —30—

Fig. 4. An open .005- μ fd. capacitor in the filter network at the grid of the oscillator may cause this weave. Under some conditions, the number of cycles of weave will be considerably greater.





By JOHN T. FRYE

SERVICING "TOO-NEW" SETS

SPRING was in the air! Buds were swelling to the bursting point on every branch; robins left off their chirping only long enough to yank elastic worms from the warm earth; cotton candy clouds sailed serenely in the bright April sky; the breeze wafting up from the south was warm and caressing. A young man like Barney, the Number Two service technician at Mac's Service Shop, should certainly have been floating around in a rosy glow.

But when Mac, the owner of the shop, looked down the service bench at his youthful helper, it did not seem that young man's fancy was lightly turning to anything gay and romantic—not from the thoughtful scowl on his face as he stared down at the transistor portable radio on the bench in front of him.

"What's the matter, Wonder Boy; something got you stumped?" Mac asked.

"In a manner of speaking, yes," Barney admitted with dignity. "This transistor job has an intermittent condition—with complications! It will play along for a while and then suddenly go as dead as a hammer. At other times it does not quit entirely but simply drops away down in volume. Shaking or jarring it will usually bring it back to normal operation for a short time. The heck of it is that we have no service data on it. It's too new."

"Are you sure?" Mac asked. "We've got a standing order for service literature to be delivered to us as soon as the distributor gets it, and the publisher of the service data gets out the dope on the new receivers mighty fast."

"I'm sure, all right. I was looking in that new index that came yesterday, and this set is not listed. And I don't mind admitting I need voltage and resistance values and—above all else—a diagram. I'm still not familiar enough with transistor circuits to sail through them without some sort of guide, the way I can with a.c.-d.c. sets. I need a diagram."

"I can understand that, for I need one, too," Mac said. "But let's see what can be done. In a case like this, I've found that many times a manufacturer will use practically the same circuit in two or three different models arranged to fit different cases. Have you checked that possibility?"

"Nope; never thought of it. This is a Model 849. See anything like that in the index?"

"Here is a Model 842 listed," Mac said as he got out the service sheet on that set. "Hm-m-m, it uses six transistors and a crystal diode. The battery is nine volts. How does that check with your patient?"

"Checks fine!" Barney said. "This one has three i.f. transformers. How many does the 842 have?"

"Same number. This set must be pretty close circuit-wise to the one you're working on. This one was in a much larger cabinet. Try checking your set against this diagram."

Barney made a few checks with the v.t.v.m. and then announced, "I think I've spotted some of the trouble. There's supposed to be eight volts on the collector of this converter transistor, but no voltage is present. The voltage goes into the i.f. can, but it doesn't come out. Apparently something is wrong with the primary winding of the first i.f. transformer."

As he talked, he was carefully moving the terminals protruding from the bottom of the i.f. transformer. Suddenly the set began to play. He found that he could make it start or stop simply by moving one terminal this way or that.

"The connection on the outside is all right," Barney said; "the trouble must be up inside on the other end of this terminal. But, man oh man, what a job it is going to be to remove that i.f. transformer. Look at it! It's not as big as the end of your finger; a zillion wires go to those terminals; and the case is soldered to the chassis!"

"Maybe you won't have to remove it," Mac said hopefully. "Use the solder pencil to heat that terminal up so the

solder on it inside the can will be melted as well as the solder outside. That may do the trick."

Barney followed these instructions; and as the solder on the terminal softened, the radio began to play. He did not remove the iron for a few seconds longer. After the solder had cooled, no amount of twisting and pulling on the terminal would make the set cut out.

Barney started to snap the back of the plastic case in position, and as he did so the volume of the set dropped away down. It did not take him long to discover that the ferrite-core antenna was being pressed so firmly against some of the turns of the coil that it was shorting them out when the back was in position, for then this back forced the ferrite-core antenna over against the pinched wire. A bit of thin plastic tape cleared the trouble.

"I'm going to remember that trick of looking up a model similar to the one that puzzles me," Barney promised.

"It won't always work that well," Mac warned; "but even if we had not found a similar model in the service literature we should not have been whipped. We still could have gone to the magazine stacks. Service magazines are continually publishing diagrams of interesting new sets, and I remember seeing several articles recently on new transistor receivers. I should not be a bit surprised if we could find this very set, together with a discussion of the various circuits in it, described in a recent issue of RADIO & TV NEWS. We need all of these tricks because we get quite a few of these brand-new sets that are still in warranty from that department store across the street."

"How come we get that business?" Barney asked curiously. "Why don't they return those sets to the distributor to be repaired. After all, they are still in guarantee."

"The manager explained that when the trouble is minor he'd rather have us take care of it quickly than deprive the customer of the set while it is packed up, shipped back to the distributor, repaired, and returned. He says that with postage, insurance, and paying help to pack and unpack the set, he often comes out ahead to let us do it. If we run across an expensive defect, we charge him an estimate and suggest that he return the set; but when it is a simple matter, we just go ahead and repair it. He takes our advice about what to do."

"Record players can be another headache," Barney commented. "Quite often the changer is made by a different manufacturer than the one whose name is on the player or combination; and in this case the changer manufacturer frequently leaves the make and model number off the base plate. That leaves you in a pickle when you need service data on the changer."

"But I've pretty well licked that
(Continued on page 122)

RCA offers you the
 finest training
 at home in
Radio-TV
 electronics,
TV servicing,
Color TV

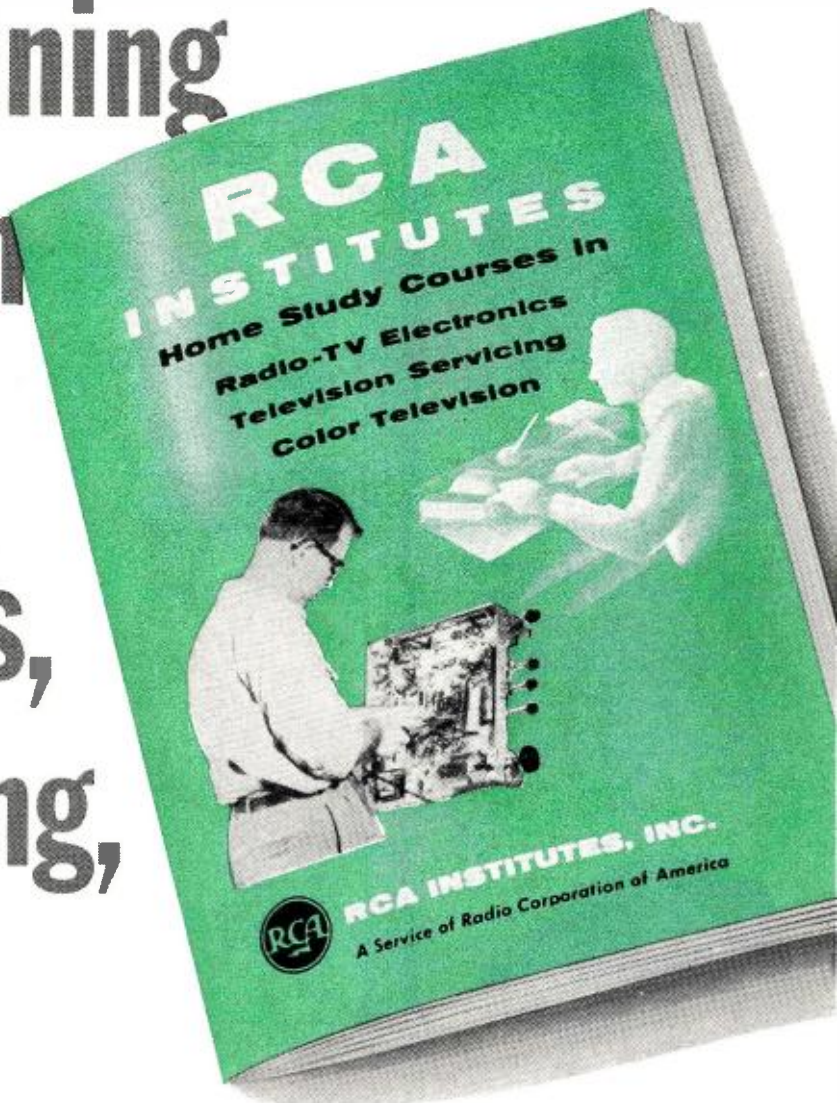

**SEND FOR THIS FREE
 BOOK NOW!**

The instruction you receive and equipment you get (and keep) will start you on your way. Pay-as-you-learn. You pay for only one study group at a time. This 52 page book contains complete information on Home Study Courses for the beginner and the advanced student.



RCA INSTITUTES, INC.
 A SERVICE OF RADIO CORPORATION OF AMERICA
 350 WEST FOURTH STREET, NEW YORK 14, N.Y.
 In Canada—RCA Victor Company, Ltd.,
 5001 Cote de Liesse Rd., Montreal 9, Que.

RCA Institutes, Inc., Home Study N-47.
 350 West Fourth Street New York 14, N. Y.
 Without obligation, send me FREE CATALOG
 on Home Study Courses in Radio, Television
 and Color TV. No salesman will call.

Name
 Please Print

Address

City.....Zone.....State.....

VETERANS
KOREAN G.I.
 P.L. 550
CHECK HERE
 ()

HARVEY's famous hi-fi consultants RECOMMEND



...the DYNAKIT MARK II 50-Watt Power Amplifier Kit

Because of the enormous demand for DYNAKITS (everybody who has heard one seems to want one), they have been in short supply this past summer. Now HARVEY has enough of them in stock to end the drought. Any random sample of the DYNAKIT will deliver a minimum of 50 watts with astonishingly low distortion — and that means not just harmonic and intermodulation distortion but phase shift, square-wave ripple, and low-frequency bounce and flutter as well. Construction time? Three or four hours—with no special skill. Listening quality? "The Greatest!" say the audiophiles. The price? Still only—\$69.75

**NOW BACK
IN STOCK!**



...and the GARRARD 301 3-speed Transcription Turntable

'The Professional'

Among the many top-quality wow-and-rumble-free turntables available today, the GARRARD 301 seems to be the first choice of a large number of hi-fi authorities. The famous Mr. G. A. Briggs, for example, has been using it exclusively in all of his celebrated concert-hall demonstrations throughout the world. The variable + or - fine-speed control, operative on all 3 speeds, may have something to do with the 301's exceptional success — and the Swiss-watch-like precision construction, combined with components of the very highest quality, is quite irresistible. So is the price—only—\$89.00

**MAIL ORDERS SHIPPED
SAME DAY AS RECEIVED**

Include with your payment a generous allowance for shipping charges — the excess will be promptly refunded.

HARVEY Estab. 1927
**RADIO
CO., INC.**

1123 Avenue of the Americas JU 2-1500
16th Ave. at 43rd St. N.Y. 36, N.Y.

New Tube Tester Data

Bring your Jackson and EMC tube checkers up to date with these settings for recent tube types.

JACKSON MODEL 648

Tube Type	Filament	D	Circuit	E	Plate Test	Tube Type	Filament	D	Circuit	E	Plate Test
4AU6	4.2	2347	AC156	40WZ		17BQ6	17.	1237	AB569	18W	
4BA6	4.2	A2347	AC156	55WZ		17CA5	17.	C123	467	20V	
4BE6	4.2	AC1237 A2347	AC456 AC16	35WY 35V		17L6	17.	123	456	35VW	
5BS8	5.6	A123 A127	A45 A89	20XZ 20XZ		DAF91	1.4	14	C356 2	32XZ 100X	
5CM6	5.0	129	B346	35W		DF91	1.4	14	AB267	35XZ	
6BN8	6.3	A126 125 123	AC79 4 8	28XZ 60X 60X		DF904	1.4	14	AB267	35XZ	
6CQ8	6.3	A129 A127	AB358 A46	48V 80Z		DF92	1.4	14	AB267	40YZ	
8BN8	8.4	A126 125 123	AC79 4 8	28XZ 60X 60X		DF96	1.4	14	AB267	24XZ	
9AU7	9.4	123 127	A45 A89	40WZ 40WZ		DK91	1.4	B134 14	AB267 A23	35XZ 23XZ	
9CL8	9.4	A127 A123	AC689 AC45	82Z 65Z		DK92	1.4	14 14	AB2567 A23	39XZ 33YZ	
9X8	9.4	A1249 A128	678* A35	35XZ 20XZ		DK96	1.4	14 14	AB2567 A23	39XZ 33YZ	
12AD7	12.6	A123 A127	A45 A89	65XZ 65XZ		DL92	2.5	14	B236	35V	
12AJ6	12.6	237	AC14 5 6	95X 80X 80X		DL94	2.5	14	AB267	70Z	
12AL8	12.6	A129 A126	AB358 A47	35Y 95X		DL96	3.0	14	AB267	18YZ	
12BL6	12.6	A2347	AC156	75X		DY80	1.4	12	9	38VX	
12CT8	12.6	A127 A123	AC689* A45	50WZ 58V		ECC81	12.6	A123 A127	A45 A89	65WZ 65WZ	
12J8	12.6	A125 129	AB348 6 7	52X 60X 60X		ECC82	12.6	123 127	A45 A89	40WZ 40WZ	
12R5	12.6	C123	467	22V		ECC83	12.6	A123 A127	A45 A89	35W X 35W X	
17AX4	17.	234	6	13W		EF86	6.3	A1237	AB468	28XZ	
						EL34	6.3	1237	456	23W	
						EL84	6.3	123	B569	15WZ	
						EZ81	6.3	123	4 9	15W 15W	
						GZ34	5.0	13	5 8	14W 14W	

*When testing this section for shorts, the K (Cathode) and G1 (Grid No. 1) positions of the shorts test switch will be reversed.

ELECTRONIC MEASUREMENTS CORP. MODELS 204-205-207-209

Tube Type	Hi-Lo	Fil.	F	P	Shunt	Notations
3A3	LO	4	2	10	40	Cold K. Glows at 3, 7, 8 OK over Diode line
3DT6	LO	4	3	1-5-6	38	
6BK4	HI	4	2	5-10	100	Cold K
6CB5	HI	4	2	1-4-5-8-10	18	Glows at 1, 3, 4, 5, 6, 7, 8
6CE5	HI	4	3	1-5-6	16	
6CG8	HI	4	4	1-2	17	
6CG8	HI	4	4	6-7-9	16	
6CM7	HI	4	4	6-7	22	
6CM7	HI	4	4	1-8	17	
6DT6	HI	4	3	1-5-6	17	
10C8	LO	6	4	1-2	38	
10C8	LO	6	4	6-7-8	34	
12AB5	LO	6	4	1-3-6-8-9	52	Glows at 1, 3, 5, 6, 8
12AD6	LO	6	3	1-6-7	33	
12AE6	LO	6	3	1-5-6-7	65	
12AF6	LO	6	3	1-2-5-6	33	
12AJ6	LO	6	3	1-5-6-7	40	
12BL6	LO	6	3	1-2-5-6	37	
12C5	LO	6	3	2-5-6-7	60	Glows at 2, 4, 5
12CR6	LO	6	3	2-5-6-7	55	
12CT8	LO	6	4	1-2	45	
12CU5	LO	6	3	2-5-6-7	55	Glows at 2, 4, 5
12K5	LO	6	3	2-5-6-7	42	Glows at 4, 5, 6
17H3	HI	6	4	3-8	30	Glows at 3, 5, 8-Diode
18A5	HI	6	2	1-5	20	
6386	HI	4	9	3-4	18	
6386	HI	4	9	6-7	18	

SHOW ANY PICTURE or PATTERN

at any time — ON ANY TV SET

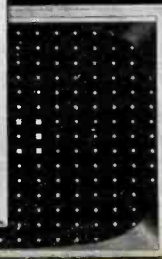
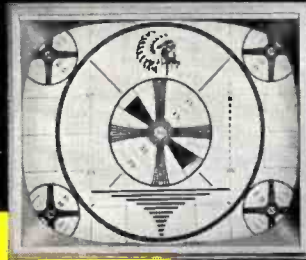

For Both Black & White and Color TV

Provides standard Indian Head Test Pattern for proper TV set alignment, and stable White Dot and White Line Patterns for color convergence adjustments.

For Merchandising & Industrial Uses

Provides closed circuit TV system. Transmits pictures or messages for advertising, educational and commercial visual communication.

MODEL 1000

B&K DYNA-SCAN

PICTURE AND PATTERN VIDEO GENERATOR

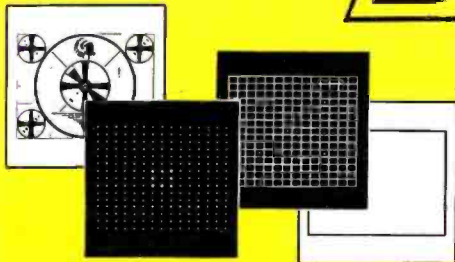

3 TEST PATTERN TRANSPARENCIES AND ONE CLEAR ACETATE SUPPLIED

- 1 Indian Head Test Pattern
- 2 White Dot Pattern
- 3 White Line Crosshatch Pattern

These are broadcast-quality transparencies, and assure accurate, high-definition TV images. You can also transmit your own transparencies of any subject you wish. The clear acetate can be used for special messages. Extra transparencies and acetate available.

Make the most of this *Complete Flying Spot Scanner*. It produces a composite video and sync signal that operates any standard black & white or color TV receiver. Can be used with one or more TV sets or fed into a master antenna system or community antenna system. Maximum resolution capability is well in excess of 450 lines; band width in excess of 5 mc. Projects and reproduces pattern or picture with high definition from any slide transparency. Transmits messages typed or written on clear acetate. Makes convenient stand-by and break-in for community distribution operation. Rugged, compact, portable, and ready to operate.

NET \$199.95

See your B&K Distributor, or Write for Bulletin No. 1000-N

AVAILABLE ON EASY TIME PAYMENT PLAN

B & K MANUFACTURING CO.

3726 N. SOUTHPORT AVENUE · CHICAGO 13, ILL.



Model 950 Dyna-Scan Pickup and RF Generator only. Enables you to make your own picture and pattern video generator at a saving. Supplied with three test pattern transparencies and one clear acetate. Net, \$69.95

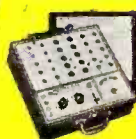

Model 500 DYNA-QUIK Dynamic mutual conductance tube tester. Accurately tests tubes faster. Net, \$109.95



Model 400 CRT Cathode Rejuvenator Tester. Tests and repairs TV picture tubes. Net, \$54.95



Model 750 CALIBRATOR Designed to check and adjust test instruments with laboratory accuracy. Net, \$54.95

BUY THE WORLD'S MOST COMPLETE HI-FI GUIDE!

164
PAGES!



Compiled by the Editors of Popular Electronics

NINE BIG CHAPTERS ON!

- Why and How Hi-Fi
- Tuners
- Tapes
- Record Players and Changers
- Tone Arms, Cartridges and Needles
- Preamplifiers and Amplifiers
- Loudspeakers
- Speaker Enclosures
- Saving Money in Hi-Fi

Also included in this new Hi-Fi volume is a helpful YEARBOOK SECTION covering all the latest trends in high fidelity. This "book within a book" lists the nation's outstanding Hi-Fi records and artists, all FM stations, and contains a complete calendar of 1957 Hi-Fi Shows, plus a directory of Hi-Fi literature available free!



BE SURE TO BUY YOUR COPY!

NOW ON SALE AT ALL NEWSSTANDS AND RADIO PARTS DEALERS!
Price: 75¢

Earth Satellite's "Innards" Described

Instruments that may be shot into space in the "Vanguard Satellite" are described here.

SOME of the instruments that may be shot into space in the "Vanguard Satellite" were described recently at a satellite symposium during the Winter General Meeting of the American Institute of Electrical Engineers in New York. The instruments, it was emphasized by Herman Friedman of the U. S. Naval Research Laboratory, must be limited to two to three pounds to be acceptable for flight.

Mr. Friedman also detailed the type of information it is hoped will be obtained by use of satellites, including observation of solar flares, cosmic rays, measurement of the earth's magnetic field, and important meteorological data.

"The experiments which will be accepted for flight must meet the specifications for the 'Vanguard Satellite' in which two to three pounds are available for the experiment, including detectors and their circuitry, telemetering modulator to feed 'Minitrack' and power supply for these items," he said.

While solar flare information has been gained by rockets, the sum total of this information, obtained above the obscuring layers of the earth's atmosphere, adds up to less than an hour of useful observations. Since flares occur infrequently and at random, and since the phenomenon lasts only for a matter of five or ten minutes, it is a tremendously difficult task to catch the spectrum of such flares with conventional rocketry. A satellite offers the nearest approach to a continuous observing station above the atmosphere. During the period of maximum solar activity in 1957 and 1958, the chances of observing a flare will be quite good. Since sudden ionospheric disturbances are directly associated with solar flares, observations of the far ultraviolet solar spectrum is expected to play a key role in such effects as radio fadeout.

As regards meteorology, a satellite station far above the earth may ultimately provide detailed pictures of complete tropospheric weather systems covering areas as large as the entire United States. At the present state of the art, however, the best that can be done is to devise photoelectric instruments to measure cloud cover distribution.

EDITOR'S NOTE: For a more complete and detailed story about the background of the earth satellite program, "Project Vanguard," and interesting information about the satellite itself, how it will be launched, and what it will carry, readers are referred to a feature article in our next month's issue.

-50-

how long would it take you to solve this service problem?

PHOTOFACT

helps you lick problems
like this in just minutes
for only *2½¢ per model!

SYMPTOM:
Raster, No Sound,
No Picture,
and No Snow...

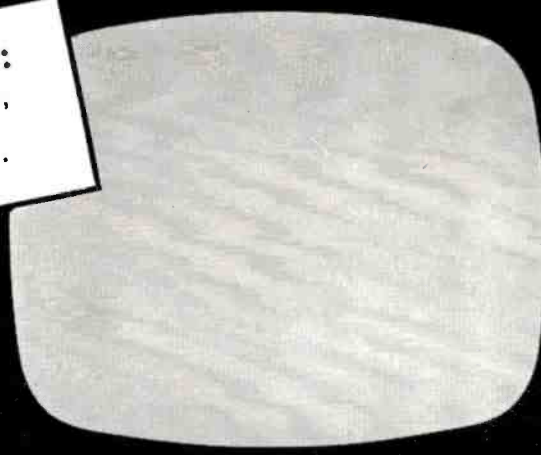

Let's take a look at this problem: A condition such as this can exist only when there is no signal reaching the picture tube or the audio output stage. Using the Tuner Service data (found in every PHOTOFACT TV Folder), first isolate the trouble by connecting an amplitude-modulated signal to the mixer-grid test point "D." The appearance of one or more black bars on the face of the tube would indicate that the trouble is probably in the tuner. So look for the following possible causes:

1. Defective oscillator-mixer tube
2. Defective RF amplifier tube
3. Open plate-load resistor in the oscillator stage
4. Failure of the feedback capacitor in the oscillator stage
5. Open decoupling resistor
6. Dirty or faulty contacts
7. Cold solder joint

Using the applicable PHOTOFACT Folder you can troubleshoot and solve this problem in minutes. Here's how:

Check the oscillator-mixer and RF amplifier tubes. Tubes okay?—then: Check voltages on the tube pins (they're right on the schematic) for open oscillator plate-load

resistor, open RF decoupling resistor, faulty feedback capacitor, dirty switch contacts or cold solder joints.

Every PHOTOFACT Television Folder contains complete detailed information on Tuners, including separate Schematics, separate Keyed Chassis Photographs, Parts Lists, Alignment Points, Test Points, and Field Service Adjustments that will help you quickly locate the proper parts to replace and tell you how to do a touchup or thorough alignment job after making the necessary repairs. These features are a *plus* exclusive in PHOTOFACT.

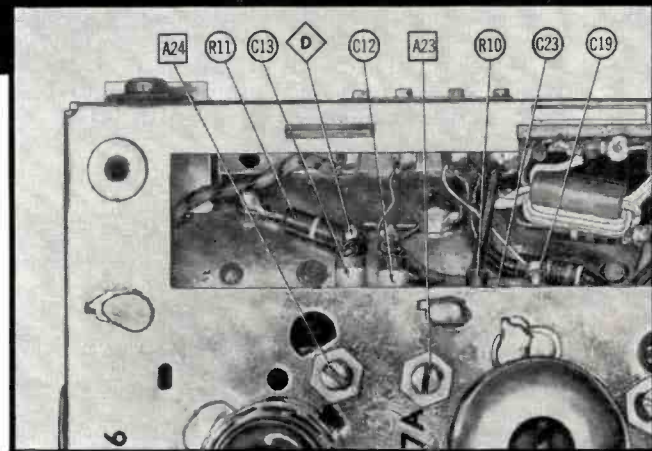

(Based on an actual case history taken from the Howard W. Sams book "TV Servicing Guide")

Whatever your problem or favorite servicing procedure may be—you will always find all of the information you need at your fingertips in PHOTOFACT. For only *2½¢ per model, PHOTOFACT helps you solve your service problems in just minutes—helps you service more sets and earn more daily!

*Based on the average number of models covered in a single set of PHOTOFACT Folders.



MONEY BACK GUARANTEE!

Got a tough repair? Try this—at Howard W. Sams' own risk: see your Parts Distributor and buy the proper PHOTOFACT Folder Set covering the receiver. Then use it on the actual repair. If PHOTOFACT doesn't save you time, doesn't make the job easier and more profitable for you, Howard W. Sams wants you to return the complete Folder Set direct to him and he'll refund your purchase price promptly. **GET THE PROOF FOR YOURSELF—TRY PHOTOFACT NOW!**

FREE



FOR SERVICE TECHNICIANS ONLY

Fill out and mail coupon today for Free subscription to the Sams Photofact Index —your up-to-date guide to virtually any receiver model ever to come into your shop. Send coupon now.

HOWARD W. SAMS & CO., INC.

Howard W. Sams & Co., Inc.
2203 E. 46th St. Indianapolis 5, Ind.

Put me on your mailing list to receive the Sams Photofact Index and Supplements. My (letterhead) (business card) is attached.

I'm a Service Technician: full time; part time

My Distributor is: _____

Shop Name _____

Attn: _____

Address: _____

City _____ Zone _____ State _____

QUARTZ CRYSTALS

Fast Service—Unconditional Guarantee!

Crystals ground and etched to your specified frequency at the lowest cost in the industry—supplied in popular FT-243 holders, 1/2" pin spacing, .093" pin diameter—also in DC-34 holders, 3/4" pin spacing, pin diameter .156 or FT-171 holders, pin spacing 3/4" with banana plug pins (fits 5-prong tube socket).



In FT-243 holders from 1005KC to 9000KC. In DC-34 or FT-171 holders from 1100KC to 8000KC (specify holder wanted).

Tolerance:

.05% \$1.35
 .01% 1.50
 .005% 2.50

With thousands of frequencies in stock for immediate delivery, we list a few of the more popular frequencies. Write for complete listing. Crystals listed are in FT-243 holders but can be supplied in FT-171 holders at 79 cents. (Add 5¢ per crystal for postage and handling.)

YOUR CHOICE	2910	6150	7206	8106
	2945	6300	7225	8125
	3000	6400	7240	8140
	3190	6500	7250	8150
	3195	6575	7273	8175
	3245	6625	7275	8200
	3525	6700	7300	8240
	3885	6706	7306	8250
	3955	6750	7325	8300
	3995	6775	7340	8350
	4110	6800	7350	8375
	4190	6850	7373	8400
	4845	6900	7375	8425
	5030	6950	7400	8450
	5300	7000	7406	8475
	5305	7006	7500	8500
	5700	7025	7606	8525
	5800	7050	8000	8550
	6000	7075	8006	8575
	6025	7100	8025	8600
	6040	7106	8040	8625
	6050	7125	8050	8650
	6075	7140	8073	
	6100	7150	8075	
	6125	7200	8100	

Jobbers write for quantity prices & catalog.

Novice Crystals 80 meter band within 1KC of specified frequency from 3701KC to 3749KC in 40 meter band from 7152KC to 7198KC within 1KC of specified frequencies 79¢; in DC-34, FT-171 or FT-243 holders (specify holder wanted) 79¢. (Add 5¢ per crystal for postage and handling.)

Stock crystals in FT-243 holders from 5675KC to 8650KC in 25KC steps 50¢.

FT-241 lattice crystals in all frequencies from 370KC to 540KC 50¢.

100KC Frequency Standard Crystals	4.50
200KC Crystals	2.00
455KC Crystals	1.00
500KC Crystals	1.00
1000KC Frequency Standard Crystals	3.50
Dual socket for FT-243 crystals	.15

Low frequency FT-241 crystals from 880.20KC to 1040.62KC in steps of 1040 cycles 75¢

(Write for complete listing.)

Texas Crystals

The Biggest Buy in the U.S.

8538 W. GRAND AVENUE · RIVER GROVE, ILL.
 ALL PHONES—GLADSTONE 3-3555

Terms: All items subject to prior sale and change of price without notice. All crystal orders MUST be accompanied by check, cash or M.O. WITH PAYMENT IN FULL. NO C.O.D.s. Postpaid shipments made in U.S. and possessions only. Add 5¢ per crystal for postage and handling charge.

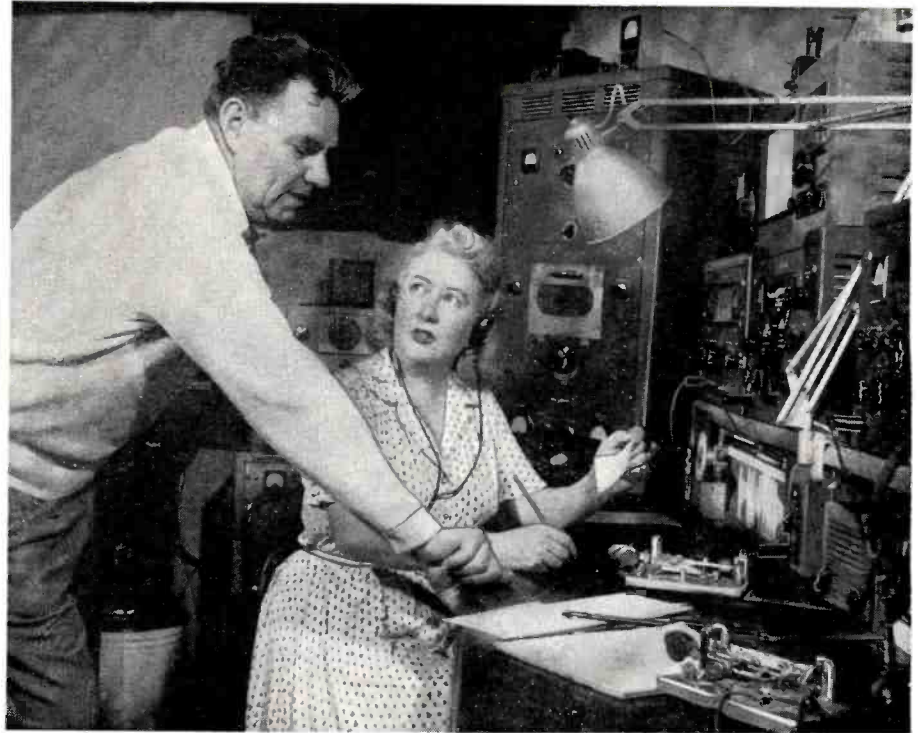

"Mae" Burke, winner of 1956 Edison Award, confers with husband Al, himself a ham.

Mary Burke, W3CUL Wins 1956 Edison Award

Top honors go to ham who handles from 3000 to 10,000 messages a month for GI's and home folks.

FOR the first time in the five-year history of the Edison Radio Amateur Award, top honors have gone to a woman operator—Mary ("Mae") Burke, W3CUL, a 45-year-old housewife of Morton, Pa.

Operating eight hours a day in six different radio message nets, Mae handles an average of 3000 messages per month, principally for service personnel overseas. As one of the nation's top "traffic" operators, she uses Morse almost exclusively. According to Mrs. Burke, she "stays at about 30 words a minute to maintain accuracy."

Mae gives a lot of credit to her husband Alfred, W3VR, who takes the responsibility for maintaining their \$5000 worth of gear, in addition to cooking breakfast and dinner so that she can keep her early morning and late afternoon schedules.

She received the Edison Award Cup and \$500 check at the annual awards banquet held in Washington, Feb. 28th.

Mrs. Burke has handled a total of 312,000 messages since 1949—sometimes reaching a total of 10,000 messages a month. Her longest stretch of operating without missing a schedule was 1825 days—five years without taking a vacation or even a single day off.

The committee felt that such devotion to duty, voluntary though it is, deserved recognition on a national scale.

In addition to the major award, citation plaques were presented to James P. Born, Jr., W4ZD of Atlanta, Ga.; Julius M. J. Madey, K2KGJ of Clark, N. J.; Harry L. Fendt, W2PFL of Great Kills, N. Y.; George W. Bailey, W2KH of New York, N. Y.; Sam E. Baker, W3FIQ of West Springfield, Pa.; C. Newton Kraus, W1BCR, Warren, R. I.; Martha Shirley, W0ZWL, Black Hawk, S. D.; and the "Operation Deepfreeze" committee of the Radio Amateurs of Greater Syracuse.

The 1956 Edison Award judges were: Herbert Hoover, Jr., under secretary of state; Commissioner Rosel H. Hyde of the FCC; Chairman E. Roland Harriman of the American Red Cross; and G. L. Dosland, president of the American Radio Relay League.

Fifty candidates representing twenty-one different states were nominated by friends and associates for efforts in emergencies, educational work, Civil Defense organization, and handling messages to overseas servicemen.

The Edison Award is sponsored annually by the General Electric Company.

WE TRADE HIGHER!



GOING MOBILE? - SEE WALTER ASHE FIRST!

**NOVICES AND
TECHNICIANS**

FOR YOU



GONSET COMMUNICATOR.
Complete station (transmitter-receiver) for home or mobile use. Available for either 2 or 6 meters. NET.....\$229.50

CONVERTERS



GONSET SUPER SIX. Net \$52.50



MORROW 5BR-2. Net.....\$74.95

MORROW



MORROW MOBILE RECEIVER
MODEL MBR-5. 80 thru 10 meters. Dual conversion. 13 tubes. Less power supply and speaker. Net..\$ 224.50



MORROW MOBILE TRANSMITTER
MODEL MB-560. 80 thru 10 meters. VFO or xtal. 90W CW, 60W phone. Less power supply. Net.....\$214.50

GONSET



GONSET MOBILE RECEIVER
MODEL G-66. 80 thru 10 meters plus BC band. Dual conversion. 9 tubes. Less P.S. and speaker. Net...\$189.50
UNIVERSAL POWER SUPPLY. 6-12 VDC, 110 VAC. With spkr. Net \$44.50



GONSET MOBILE TRANSMITTER
MODEL G-77. 80 thru 10 meters. VFO or xtal. 50-60 watts input, pi-network. With power supply. Net.....\$279.50

ELMAC

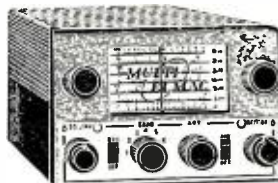

ELMAC MOBILE RECEIVER
MODEL PMR-7. 160 thru 10 meters, plus BC band. Dual conversion. 10 tubes. Less P.S. & spkr. Net \$159.00
PSR-612 POWER SUPPLY. 6-12 VDC Net.....\$ 34.00

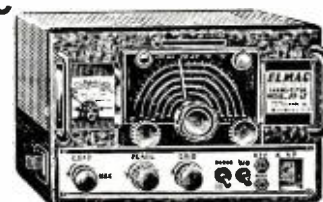

ELMAC MOBILE TRANSMITTER
MODEL AF-67. 160 thru 10 meters. VFO or xtal. 60 watts phone, CW, or NBFM. Less P.S. Net.....\$ 177.00

WRITE FOR FULL DETAILS ABOUT OUR TIME PAYMENT PLAN

All prices f. o. b. St. Louis • Phone Chestnut 1-1125

Walter Ashe
RADIO CO.
1125 PINE ST. • ST. LOUIS 1, MO.

WALTER ASHE RADIO COMPANY
1125 Pine Street, St. Louis, Mo.

OUR 35TH YEAR

Rush "Surprise" Trade-In Offer on my.....
for.....
(show make and model of new equipment desired) RN-4-57
 Send NEW 1957 Walter Ashe catalog.
Name.....
Address.....
City..... Zone..... State.....

Still a big
HIT!

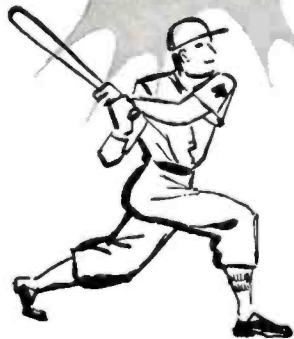

the ALL NEW
BASEBall
auto antenna

Yes, it's a HIT! A NEW and IMPROVED automobile antenna with more on the ball than anything you've ever handled. Positive grounding action! . . . no wet-weather shorts! . . . finest triple-chrome plating! . . . designed by the same team that produces original equipment antennas for Bendix, Emerson, DuMont, G. E., Lear, Motorola, RCA, Westinghouse and Zenith.



FREE!

Eye-Catching
Point-of-Sale Display.
Yours at No Extra Cost.

CONTRACT MANUFACTURERS
FOR 1001 APPLICATIONS

the
antenna
specialists co.

12435 EUCLID AVE. • CLEVELAND, OHIO
Dept. RT-4

America's only complete line of
vehicular communication antennas.
Write For Complete Data and Prices.

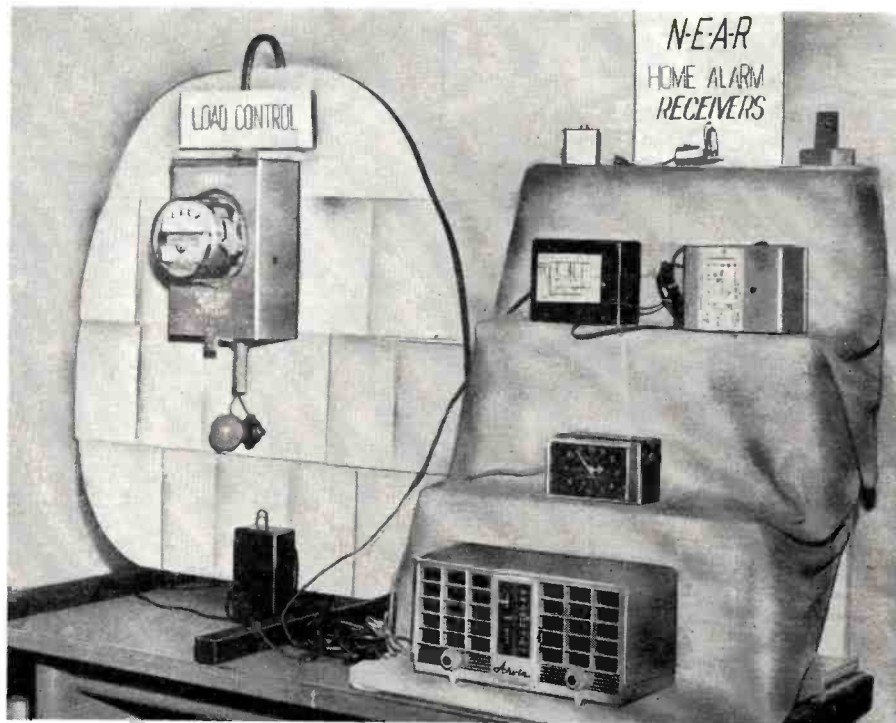

Display of the home alarm during a recent test demonstration. Small plug-in units at top or larger units shown below are connected to the electric clock and radio shown at bottom. The units set off the alarm in the clock and turned on the radio.

New Home Warning Device Tested

Civil Defense Administration announces system triggered through electric power lines. May supplement Conelrad.

THE Federal Civil Defense Administration announced recently that a new internal warning system that could alert Americans at home and at work in the event of an enemy attack has been demonstrated and approved generally by six midwestern electric power companies at Kansas City, Mo. This system, including the receiving device which is called the National Emergency Alarm Repeater (NEAR), has been developed by Midwest Research Institute of Kansas City under a contract from F.C.D.A. If and when it is perfected, NEAR could be used to alert large segments of the population, especially those beyond the range of sirens, to an impending attack.

The alarm receiving device is a small plastic-covered unit which can be plugged into any 117-volt outlet. Once installed, it would give out no sound until civil defense or other authorities gave the order to warn of approaching attack. Then brief, controlled 120-cps signals, sent over the regular electric power network, would trigger the alarm receiver. It would then buzz loudly or ring an alarm to warn the listener to turn on his radio to receive official civil defense instructions. The device can be connected to a radio or electric clock. It can also contain a light which goes on when

the signal is sounded, thus permitting a deaf person to be warned.

The system has been tested satisfactorily on power lines serving Midwest Research Institute without in any way disturbing the normal power transmission. When attached to a radio, the signal affects the speaker and the alarm is sounded even if the set is turned off. The warning device continues with loud volume until it is turned off by a button on the rear of the radio.

Results of the research indicate it is feasible to use the device in a national internal warning system. From a central location, it is conceivable that civil defense officials could alert a state, a group of states, or the entire nation simply by pushing a button.

It is not intended that NEAR will replace existing public warning systems, such as Conelrad Emergency radio broadcasts, sirens, horns, or whistles. It will supplement these and extend the coverage of a national civil defense warning. The next steps in developing NEAR will be to conduct further laboratory tests and to draw up arrangements to manufacture the warning device. Then it is planned to test the system in a medium-sized city in order to determine its effectiveness.

ROHN

Give what the buyer
WANTS

**HOT
DIPPED
GALVANIZED**

**LIFETIME
OF
DEPENDABLE
PERFORMANCE**

**UNEQUALLED
DESIGN!**

These 3 BIG sales features are ROHN Exclusives... features that have been proved positively. Sell—recommend—install ROHN... the world's largest manufacturer of this type of tower... you have the BEST by far!

ROHN Manufacturing Co.

116 Limestone, Bellevue Peoria, Illinois Ph: 4-9156

MAIL THIS COUPON FOR FREE LITERATURE

Rohn Manufacturing Company
116 Limestone, Bellevue
Peoria, Illinois

Gentlemen: Please rush me complete details on the full line of Rohn Towers and Accessories.

Firm _____

Name _____ Title _____

Address _____

City _____ State _____

towers

the
"Magic
Triangle" *
* pat. pending

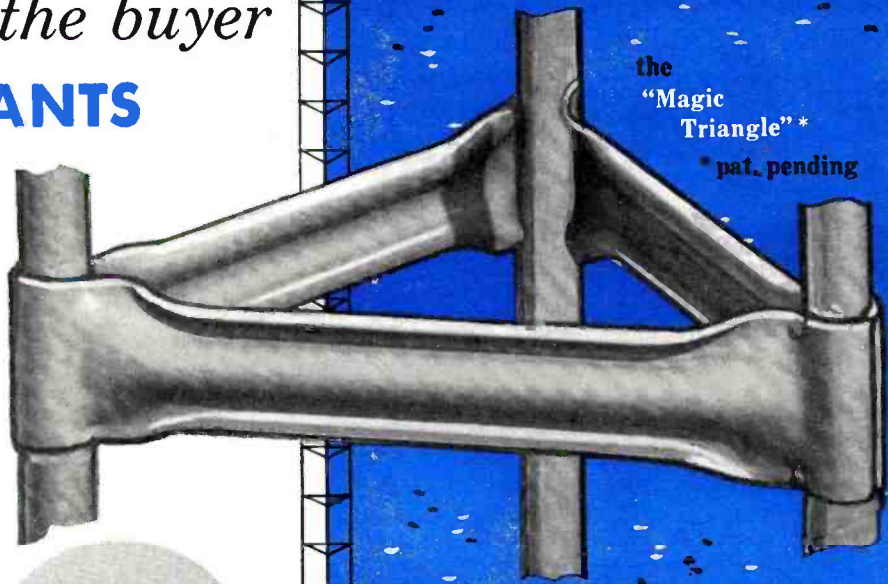

The popular ROHN No. 6 Tower (and ROHN Package Towers) feature the exclusive "Magic Triangle"... the machine produced triangular tower bracing that adds ruggedness, sturdiness and dependability far above any other similar tower!

And, speaking of "similar" towers, there are NONE in existence. ROHN "Superior Design" Towers are far ahead with more exclusive features... with more research... with greater acceptance than any other tower!

See a ROHN Representative or Authorized Distributor for the FULL Rohn Story... it's one you should know!

All models of Rohn Towers are suitable for home TV installations... makes possible elimination of "guy wires" to give a self-supporting installation of gleaming galvanized steel!

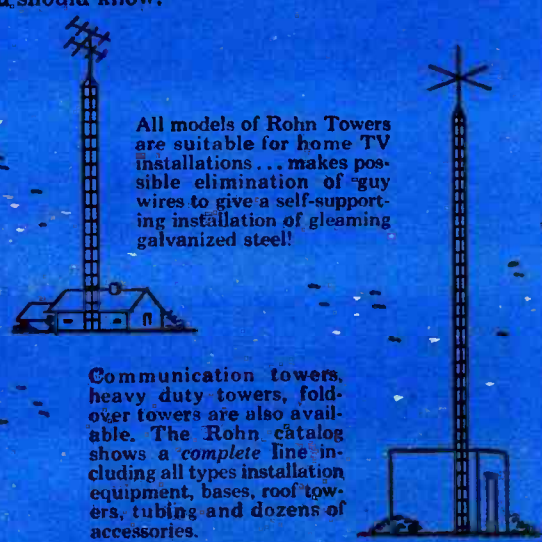

Communication towers, heavy duty towers, fold-over towers are also available. The Rohn catalog shows a complete line including all types installation equipment, bases, roof towers, tubing and dozens of accessories.

PROUDLY DISPLAY THE NEW DECAL

Colorful, new Rohn window decals are available to authorized Rohn Distributors, Dealers and Servicemen. Get yours today and display it proudly.

Your **ERIE** Distributor Has
"PAC" Replacement Modules

for Servicing 1957 Auto Radios

PAC is a group of interconnected capacitors and resistors, combined in a single-insertion unit. Several popular 1957 model automobile and truck radios employ this new concept in component packaging. When servicing these auto radios, a complete PAC (Pre Assembled Circuit) module can be quickly and easily replaced.

Your ERIE Distributor has PAC Replacement Modules in stock. See him for complete information and prices.

ERIE ERIE ELECTRONICS DISTRIBUTOR DIVISION
 ERIE RESISTOR CORPORATION
 Main Offices: ERIE, PA.
 Factories: ERIE, PA. • LONDON, ENGLAND • TRENTON, ONTARIO

LEARN
Television
 RADIO-COLOR-TV
Electricity
 ELECTRONICS
 IN THE GREAT SHOPS OF **COYNE**

TRAIN QUICKLY! OLDEST, BEST EQUIPPED SCHOOL OF ITS KIND in U.S.

Veterans and Non-Veterans—Get practical training in top opportunity fields. Prepare now for a better job and a real future. Advanced education or previous experience not needed. Employment service to graduates.

Enroll NOW—Pay Later

Finance Plan and Easy Payment Plan. Also Part Time Employment help for students. Training in Refrigeration and Electric Appliances can be included.

FREE BOOK Clip coupon for Big Free Illustrated Book. No obligation and No Salesman Will Call. Act NOW.

B. W. Cooke, President

COYNE A TECHNICAL TRADE INSTITUTE OPERATED NOT FOR PROFIT
 Established 1899
 500 S. Paulina, Chicago

B. W. COOKE, Pres.
 COYNE Electrical School
 500 S. Paulina St., Chicago 12, Ill. Dept. 47-85H

Send FREE BOOK and full details on:
 TELEVISION-RADIO
 ELECTRICITY-ELECTRONICS

NAME
 ADDRESS
 CITY STATE

RAD-TEL

ALWAYS BRAND NEW TUBES
 OFFERS THESE PARTS

No. 14 PHONO AMPLIFIER

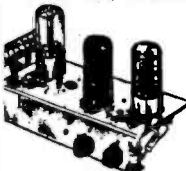

3-Tube—completely wired ready to separate. 2 separate controls. Volume and power, tone control switch comes less output transformer and speaker and tubes individually boxed with schematic. Uses 12AT/AV6, 50B/C5, 35W4 only.

\$349

No. 290 POWER TRANSFORMER



Use in test equip., receivers, amplifiers; also transmitters because of hi current capability. 117V, 60 cycle—540V CT at 228 ma—5V, 3-A, 6-3V, 8.5A.

Lots of 3 **\$350** ea. \$3.95 ea.

No. 123 Philco TV BOOSTER

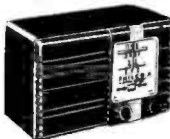

Completely self-contained, incl. 2-6J6 tubes—1 for high channels, 1 for low channels and selenium rectifier. Plastic cabinet. Single \$10.95

Lots of 3 **\$995** ea.

RABBIT EAR ANTENNA

JFD #TAI41. Same as famous JFD. List price \$7.95. Rad-Tel's Low, Low Special Price

\$245 ea.

EXPORT INQUIRIES INVITED—

TERMS: 25% deposit must accompany all orders—balance C.O.D. All shipments F.O.B. Irvington warehouse.

ORDERS UNDER \$5.00 —50c HANDLING CHARGE

PLEASE: send full remittance. Allow for postage and save C.O.D. charges. Unused money refunded. Subject to prior sale.



115 COIT ST., IRVINGTON II, N. J.

Hi-Fi Speaker System

(Continued from page 55)

the fact that less harmonic distortion is obtained, as can be seen in the curves accompanying this article.

Obviously, one objectionable point that should be brought up is that there is a power loss due to this resistance. At a mid-frequency point, it would require an amplifier providing twice as much power to achieve the same effect if the resistor is used. This is, again, another good argument for higher power amplifiers.

According to *Heath*, this new speaker system can be used with any amplifier rated from 7 watts up. However, the amplifier must have good transient stability and low distortion to be completely compatible with this unit.

Your editors actually built and "ear-tested" one of these units. While it would have been nice to be able to take actual acoustical measurements, including distortion, in a live living room, this was not possible. This would have taken some eight mikes (or more) at various positions within the room and then averaging out the results. This is one very satisfactory way of obtaining response characteristics outside of an anechoic chamber.

The measurements actually shown on page 55 were those supplied by the manufacturer of the kit. They represent the total harmonic distortion at various output powers as measured at three specific low frequencies. The curves represent averages obtained from three different loudspeaker systems. Measurements were made by using an amplifier with a high damping factor both with and without the 16-ohm series resistor.

One factor that was particularly noticeable was that the acoustical response certainly provided us with a condition that could be described as "presence". It eliminated the hole-in-the-wall effect and seemed to bring the orchestra right into the living room. Obviously, the large cabinet and multiple speaker system added realism to the acoustical response. If size were no deterrent, one could obtain exceptional results with more speakers and a larger cabinet.

We do not wish to imply that the construction of this unit was simple but if the builder follows the step-by-step instructions no difficulties should be encountered. Since the kit is marketed unfinished, the builder will have to be capable of finishing the unit himself or have it done commercially. Your editors were quite pleased with the mechanical design of the kit and the way in which all joints fitted together. It was also found helpful to use large clamps during glueing.

While originally the manufacturer announced that the "Legato" speaker system would be available in two different cabinet styles, the firm is actually marketing only the "contemporary" version which sells for \$325 in either mahogany or birch.

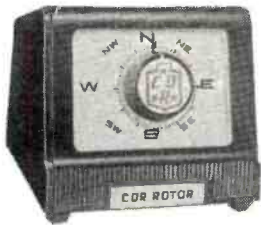

AR-22

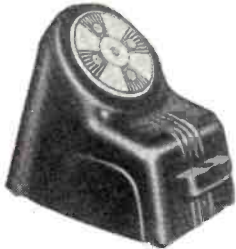

TR-2

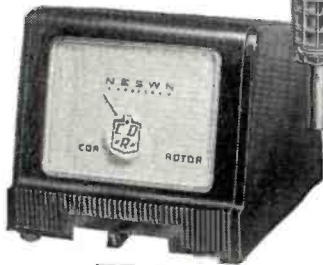

TR-4

5-star feature...



the best color TV picture

the growth of color TV means an even greater demand for CDR Rotors for pin-point accuracy of antenna direction.



a better picture on more stations

CDR Rotors add to the pleasure of TV viewing because they line up the antenna perfectly with the transmitted TV signal giving a BETTER picture . . . and making it possible to bring in MORE stations.

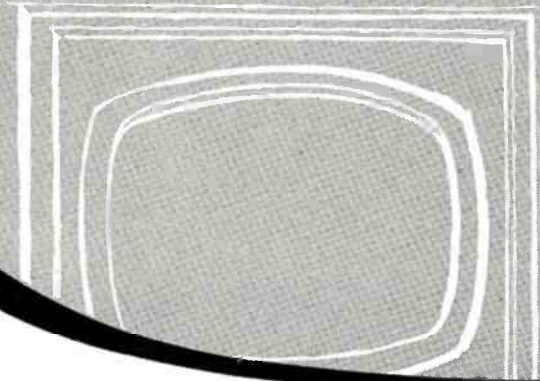

CDR ROTORS

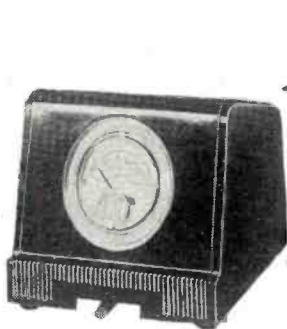

TR 11 and 12

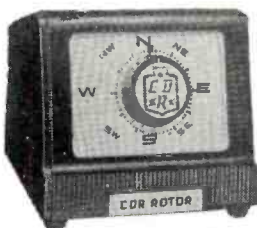

AR 1 and 2



tested and proven dependable

thousands and thousands of CDR Rotors have proven their dependability over years of unflinching performance in installations everywhere in the nation. Quality and engineering you know you can count on.



pre-sold to your customers

the greatest coverage and concentration of full minute spot announcements on leading TV stations is working for YOU . . . pre-selling your customers.



the complete line

a model for every need . . . for every application. CDR Rotors make it possible for you to give your customer exactly what is needed . . . the right CDR Rotor for the right job.

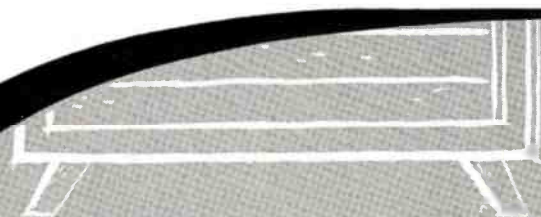

CORNELL-DUBILIER
SOUTH PLAINFIELD, N. J.



THE RADIART CORP.
CLEVELAND 13, OHIO

Introducing...

the NEW **PRECISION**
CATHODE CONDUCTANCE TUBE TESTER

The Finest Instrument of its Type — and only \$79⁵⁰

MODEL
640

THE ALL-NEW MODEL 640 gives you the ultimate degree of value in a tube-checking instrument designed according to time-proven emission-testing principles, as have been recommended by tube manufacturers and RETMA.

THE ALL-NEW MODEL 640 gives you the highest degree of insurance against obsolescence PLUS the utmost simplicity and speed of operation.

THE ALL-NEW MODEL 640 gives you all this, at such low price, without the slightest sacrifice in the long established **PRECISION** standards of workmanship, quality and reliability.

- Free-point 10-lever element selector system for merit, leakage and short tests.
- Tests all modern TV, FM and AM tube types, including series-string types, tuning eyes, gas rectifiers, etc.
- Filament voltages from 3/4 to 117 volts on 24-position rotary selector switch.
- Dual short-check sensitivity.
- Individual tests for each section of multi-section tubes and ballast tubes.
- Built-in pin straighteners for 7 & 9-pin tubes.
- Extra-large, 5 1/4", rugged PACE meter, ±2% accuracy.
- High-speed, 3-window roll chart with time-saving **PRECISION** "Tube Finder" feature."

Model 640: with etched, satin-brushed aluminum panel. Leatherette-covered, solidly constructed carrying case with tool compartment and hinged, removable cover. Case dimensions: 18 x 10 1/2 x 6 1/4 inches. Shipping Wt. 16 lbs. Code: Baker.....Net Price \$79.50

ALSO AVAILABLE—Model PTA Picture Tube Adapter Cable.....Net Price \$7.75



and...

the NEW **PRECISION**
TUBE AND TRANSISTOR TESTER

with Picture Tube Beam Current Test

MODEL
660

- The only moderately priced instrument which gives you comprehensive Icbo, gain, leakage, etc. tests of all RF, audio, power and tetrode transistors.
- Also incorporates all tube testing features of the new Model 640 described above, plus special circuitry for beam-current testing all popular picture tubes. (Requires accessory PTA picture tube cable adapter).

MODEL 660: same styling, case dimensions and weight as Model 640 described above. Code: Baron.....Net Price \$99.50

See these new instruments at all leading electronic parts distributors.



PACE
THE METER OF PRECISION

...Our 25th year of progress in Radio, Television and Industrial Electronics
PRECISION Apparatus Company, Inc.

70-31 84th Street, Glendale 27, L. I., N. Y.

EXPORT: 458 BROADWAY, NEW YORK 13, NEW YORK • CANADA: ATLAS RADIO CORP., LTD., 50 WINGOLO AVENUE, TORONTO, ONTARIO

Adjustable Filter
(Continued from page 63)

10-meter bands, however, the variable trimmers will aid materially in making close adjustments.

As mentioned, the half-wave filter has been used primarily as a means of suppressing harmonic radiation which would interfere with television reception. However, since the unit, at the fundamental frequency, is a lumped-constant half-wave transmission line, it may be used in any application where a standard half-wave transmission line may be required.

Fig. 4 shows the half-wave filter being used to match an unbalanced coaxial transmission line to a balanced load such as a folded dipole antenna. The impedance transformation is approximately 4:1 ratio, the same value as obtained with a standard half-wave "balun" in the same electrical position. This particular application is not so important on the higher frequency bands but on the low-frequency bands, 80 meters for example, the lumped-constant line would be much less expensive and less cumbersome than a half-wave line made from coaxial cable or open wire.

Although the author has never used the circuit in this application, the "filter" should offer some intriguing possibilities as a phasing line between two antennas or between elements in an antenna array. The half-wave line currents at the two terminals of the line, at any given instant, are at 180 degree phase relationship with each other. When the two variable capacitors are adjusted above or below resonance the electrical length of the line is effectively lengthened or shortened. The phase relationship of the currents at each end of the line will vary with respect to each other, leading or lagging, as the case may be, depending upon the resonant frequency of the tuned circuits. It might be possible to use two variable capacitors in each tuned circuit so that one could be adjusted to resonance below the operating frequency and the other adjusted to resonance above the operating frequency with selection of either capacitor by means of a relay controlled from the operating position. A beam of this type could be made bi-directional or uni-directional at will by merely depressing a push-button or throwing a switch. The gain and front-to-back ratio could be adjusted by means of a screwdriver.

Fig. 4. Lumped constant half-wave line as unbalanced-to-balanced matching device.

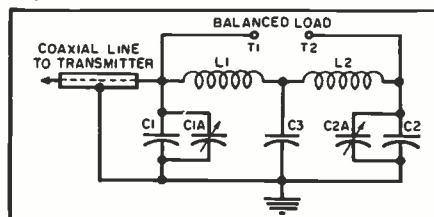

Within the Industry
(Continued from page 30)

KRAPPEL has been appointed product sales manager of electronic components of *Sylvania Electric Products Inc.* . . . **WILLIAM H. GRAHAM** has been elected vice-president of the *Magnavox Company of Tennessee*, and the *Jefferson City Cabinet Corporation*. Both of these companies are wholly owned subsidiaries of *Magnavox* . . . **EDWARD A. ALTSHULER** has been appointed manager of merchandising and market research for *American Electronics, Inc.* . . . **MAURICE R. EASTIN** has been appointed general sales manager of *Brush Electronics Co.*, a division of *Clevite Corporation* . . . **CYRUS WOOD** has been elected assistant treasurer of *Raytheon Manufacturing Company*, and **JOSEPH P. ROVETO** has been appointed manager of semiconductor diode sales for the firm's receiving and cathode-ray tube operations . . . *Pentron Corporation* has appointed **PAUL LEOPOLD** assistant sales manager . . . **WALTER GOODMAN**, manager of *Jerrold-New York, Inc.*, a sales and engineering subsidiary of the *Jerrold Electronics Corporation*, has been appointed sales manager of the company's products line division . . . **MICHAEL F. TUPICA** has been promoted to manager of the Wirecom Division of *Cook Electric Company* . . . **G. A. GODWIN**, and **EDWARD L. NUNG** were elected vice-presidents of *P. R. Mallory & Co., Inc.* . . . **DR. JOHN K. HILLIARD** has been appointed director of advanced engineering of *Altec Lansing Corp.* . . . *The Hallicrafters Company* has announced the appointments of **EDWARD BISHOP** as controller, and **JOHN R. HALLIGAN** as assistant treasurer . . . **JOHN JIPP** of *Ampex Corporation* has been appointed manager of the firm's instrumentation division . . . **HOFFMAN S. BEAGLE** has been elected president of *Electrical Testing Laboratories, Inc.* . . . *Raytheon Manufacturing Company* has named **JULIUS DORFMAN** manager of special tube sales for the receiving and cathode-ray tube operations . . . **JOHN E. NOSKEY** has been elected vice-president in charge of manufacturing of *Utah Radio Products Corp.* . . . The appointment of **EDWIN P. BERLIN** as advertising and sales promotion manager has been announced by *General Transistor Corp.* . . . **ALFRED H. GREBE** has been appointed chief research and development engineer for *Filtors, Inc.*

ROLF GRUENSTEIN has joined the audio and Recordata divisions of *American Electronics, Inc.*, as production manager.

Formerly chief manufacturing engineer for *Ampex Corporation*, Mr. Gruenstein will now be responsible for the production of all tape recorders and Recordata equipment, the introduction of new processes and techniques to in-



crease manufacturing efficiency, and for the development of new material and equipment for use in the production of "Concertone" and "American" tape recorders.

The company also manufactures the "Berlant" tape recorder.

BRENTON T. MORSE has been elected vice-president and treasurer of *Krylon, Inc.*

Mr. Morse was formerly controller and assistant treasurer of *Botany Mills*, and *Gera Mills*. He was also connected with *Haskins & Sells*, nationally known certified public accountants, for many years. He is a certified public accountant, and a member of the American Institute of Accountants.



The company manufactures spray enamels and clear acrylic plastic spray in aerosol containers.

NATIONAL ELECTRONICS CONFERENCE has established a \$2500 fellowship for graduate study in electronics.

The fellowship provides for one year's work at the master of science or doctor of philosophy level at any of eight colleges and universities participating in the conference.

These include Illinois Institute of Technology, Northwestern University, and University of Illinois as sponsors, and Michigan State, Purdue, Michigan, Notre Dame, and Wisconsin as cooperating institutions.

The sponsoring group also includes the AIEE, and IRE, with the RETMA, and SMPTE as participating members of the program.

JOHN K. McDONOUGH has been promoted to vice-president and general sales manager of *General Instrument Corporation*.

Mr. McDonough, who will be in overall charge of sales and marketing for the company's products in the United States and Canada, had been in charge of eastern sales.

Prior to joining the organization in 1955, he was general manager of *Sylvania Electric Products'* radio and television division. His experience of more than 15 years in the radio and television industry has encompassed all phases of manufacturing, engineering, and purchasing, as well as sales.



ORLANDO HAMFEST

THE Orlando Amateur Radio Club's annual hamfest will be held April 28th at Rock Springs, near Orlando, Fla. Registration fee, including dinner and prizes is \$2.00 in advance, with children under 12 admitted for \$1.00. Closing date for advance registrations is April 15th.

Send reservations to the club at P.O. Box 2067, Orlando, Florida.

BUILD THE BEST—
BUILD ALLIED'S OWN
knight-kits

LOWEST COST because our giant buying power passes biggest savings on to you... you do the easy assembly, get professional results and SAVE!

knight-kits

EASIEST TO BUILD because KNIGHT-KIT "Step-and-Check" instruction manuals are marvels of clarity—it's just like having a good instructor at your side.

knight-kits

MONEY-BACK GUARANTEE: When properly assembled, KNIGHT-KITS fully meet published specifications, or we refund your money.

EASY TERMS AVAILABLE

knight-kit HI-FI VALUE
SENSATIONAL HI-FI FM TUNER KIT



Model Y-751 ★ Deluxe custom hi-fi styling
★ AFC and Flywheel tuning
\$37.75 ★ Printed circuit—easy wiring

The best-looking, best-performing tuner kit your money can buy. Covers 88 to 108 mc; features AFC (with special disabling circuit); pre-adjusted RF coils; pre-aligned IF's; cascode broad-band RF amplifier; drift-compensated oscillator; illuminated lucite pointer. Sensitivity is 10 microvolts for 20 db of quieting across entire band. Ideal for use with Knight-Kit 20-Watt Amplifier or any amplifier with phono-tuner switch. 13 x 8 x 4". Complete, ready for easy assembly. Shpg. wt., 12 lbs. Model Y-751. Net, F.O.B. Chicago **\$37.75**

See our Supplement No. 165 for additional knight-kit Hi-Fi values

free SUPPLEMENT



featuring **knight-kits**
Send for our FREE Supplement No. 165 featuring 45 great Knight-Kits, including Test Instruments, Hi-Fi, Hobbyist and Amateur kits. Write for your copy today.

ORDER FROM
ALLIED RADIO

Dept. 01-D7, 100 N. Western Ave., Chicago 80, Ill.

New



MODEL O-11
Shpg. Wt.
21 Lbs.

\$69⁵⁰

- * An improved model of what was already an outstanding instrument.
- * Performance is unmatched in this price range.
- * Incorporates the extra features required for color TV servicing.

Extra!

A FULL YEAR TO PAY

SEND FOR DETAILS OF HEATH
TIME-PAYMENT PLAN.

**5
BIG
REASONS
WHY**



**HEATH
COMPANY**

A SUBSIDIARY OF DAYSTROM, INC.

BENTON HARBOR 15, MICH

HEATHKIT ETCHED CIRCUIT, PUSH-PULL

5" Oscilloscope Kit

COLOR TV

The previous Heathkit oscilloscope (Model O-10) which was already a most remarkable instrument, has been improved even further with the release of the Heathkit Model O-11. It incorporates all the outstanding features of the preceding model, *plus* improved vertical linearity, better sync stability, especially at low frequencies, and much-improved over-all stability of operation, including less vertical bounce with changes in level. These improvements in the Model O-11 circuit make it even more ideally suited for color TV servicing, and for critical observations in the electronic laboratory. Vertical response extends from 2 CPS to 5 MC without extra switching. Response only down 2.2' DB at 3.58 MC. The 11-tube circuit features a 5UP1 cathode-ray tube. Sync circuit functions effectively from 20 CPS to better than 500 kc in five steps. Modern etched circuit boards employed in the oscilloscope circuit cut assembly time almost in half, permit a level of circuit stability never before achieved in an oscilloscope of this type, and insure against errors in assembly. Both vertical and horizontal output amplifiers are push-pull. Built-in peak-to-peak calibrating source — step-attenuated input — plastic molded capacitors and top-quality parts throughout — pre-formed and cabled wiring harness — and numerous other "extra" features. A professional instrument for the serveshop or laboratory. Compare its specifications with those of scopes selling in much higher price brackets. You can't beat it!

1 FEWER DOLLARS BRING MORE REAL QUALITY.

- Factory-to-you sales eliminate extra profit margin.
- "Build-it-yourself" eliminates labor charge.
- Heath purchasing power cuts component costs.

2 PERSONAL SERVICE ASSURES CUSTOMER SATISFACTION.

- You deal directly with the manufacturer.
- We are interested in you before and after sale.

Heathkits®

ARE YOUR BEST BUY...

3 PROVEN DESIGNS MEAN RELIABLE PERFORMANCE.

- Research and development efforts concentrated on kits only.
- All kits guaranteed to meet advertised specifications.

4 EVERY KIT BACKED BY WORLD-WIDE REPUTATION.

- The world's largest manufacturer of electronic equipment in kit form.
- Producer of more than a million electronic kits for the home workshop and industry.

5 EASY TIME-PAYMENT PLAN TO FIT YOUR BUDGET.

GREATEST SELECTION . . .

Whether your particular special interest is in servicing, ham-radio, high-fidelity, or just experimenting—there are Heathkits to fill your needs. You can equip an entire service shop or lab, buy a complete ham station or high-fidelity system, or set up a really deluxe home workshop, by choosing from the more than 70 different "do-it-yourself" electronic kits by Heath. Just glance through the kits displayed in this ad, and you will get some idea of the tremendous array of low-priced, high-quality electronic equipment available.

New HEATHKIT ETCHED CIRCUIT 5" Oscilloscope Kit

- * Brand new model with improved performance specifications.
- * Full 5" scope for service work at a remarkably low price.
- * Attractively styled front panel in charcoal gray with sharp white lettering.
- * Easy to build from step-by-step instructions and large pictorials. Not necessary to read schematic.

This new and improved oscilloscope retains all the outstanding features of the preceding model, but provides wider vertical frequency response, extended sweep-generator coverage, and increased stability. A new tube complement and improvements in the circuit make these new features possible. Vertical frequency response is essentially flat to over 1 mc, and down only 1½ DB at 500 kc. The sweep generator multivibrator functions reliably from 30 to 200,000 CPS, almost twice the coverage provided by the previous model. Deflection amplifiers are push-pull, and modern etched circuits are employed in critical parts of the design. A 5BP1 cathode-ray tube is used. The scope features external or internal sweep and sync, one volt peak-to-peak reference voltage, 3-position step-attenuated input, adjustable spot-shape control, and many other "extras" not expected at this price level. A calibrated grid screen is also provided for the face of the CRT, allowing more precise observation of wave shapes displayed. The new Model OM-2 is designed for general application wherever a reliable instrument with good response characteristics may be required. Complete step-by-step instructions and large pictorial diagrams assure easy assembly.



MODEL OM-2
\$42.50

Shpg. Wt.
21 Lbs.

HEATHKIT LOW CAPACITY PROBE KIT

Oscilloscope investigation of high frequency, high impedance, or broad bandwidth circuits encountered in television requires the use of a low-capacity probe to prevent loss of gain, circuit loading, or waveform distortion. The Heathkit low-capacity probe may be used with your oscilloscope to eliminate these effects. It features a variable capacitor, to provide correct instrument impedance match. Also, the ratio of attenuation can be varied.

No. 342
\$3.50
Shpg. Wt. 1 Lb.

HEATHKIT ELECTRONIC SWITCH KIT

This handy device allows simultaneous oscilloscope observation of two signals by producing both signals, alternately, at its output. It features an all-electronic switching circuit, with no moving parts. Four switching rates are selected by a panel switch. Provides actual gain for input signals, and has a frequency response of ± 1 DB from 0 to 100 kc. Sync output provided to control and stabilize scope sweep. Will function at signal levels as low as 0.1 volt. This modern device finds many applications in the laboratory and service shop. It employs an entirely new circuit, and yet is priced lower than its predecessor.

MODEL S-3
\$21.95
Shpg. Wt. 8 Lbs.

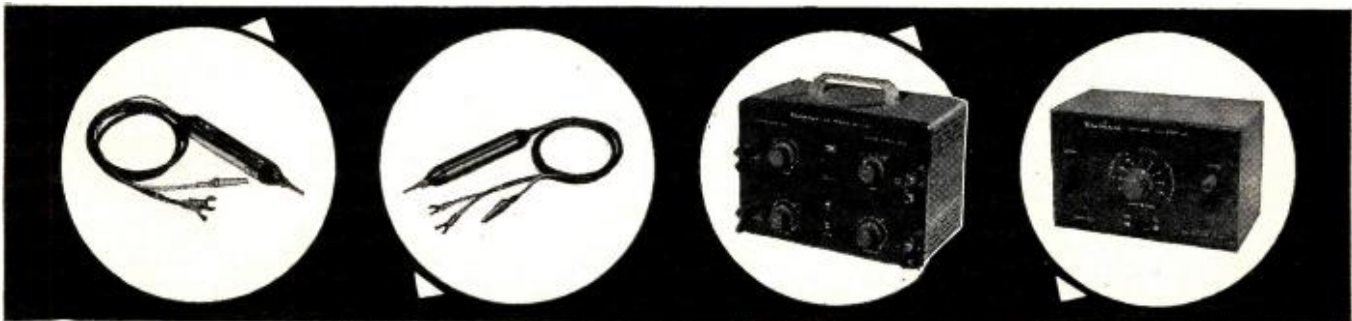

HEATHKIT SCOPE DEMODULATOR PROBE KIT

Extend the usefulness of your oscilloscope by employing this probe. Makes it possible to observe modulation of RF or IF carriers found in TV and radio receivers. Functions much like an AM detector to pass only modulation of signal, and not the signal itself. Among other uses, it will be helpful in alignment work, as a signal tracer, and for determining relative gain. Applied voltage limits are 30 volts (RMS) and 500 volts DC. It uses an etched circuit board to simplify assembly.

NO. 337-C
\$3.50
Shpg. Wt. 1 Lb.

HEATHKIT VOLTAGE CALIBRATOR KIT

This entirely new voltage calibrator produces near-perfect square wave signals of known amplitude. Precision 1% attenuator resistors assure accurate output amplitude, and multivibrator circuit guarantees good, sharp square waves, as distinguished from clipped sine waves. Output frequency is approximately 1000 CPS. Fixed outputs selected by panel switch are; .03, 0.1, 0.3, 1.0, 3.0, 10, 30, and 100 volts peak-to-peak. Allows measurement of unknown signal amplitudes by comparing to known peak-to-peak output of VC-3 on an oscilloscope. Will also double as a square wave generator at 1000 cycles for determining gain, frequency response, or phase-shift characteristics of audio amplifiers. Equally valuable in the laboratory or in radio and TV service shops.

MODEL VC-3
\$12.50
Shpg. Wt. 4 Lbs.

HEATHKIT ETCHED CIRCUIT VACUUM TUBE



MODEL
V-7A

\$24⁵⁰

Shpg. Wt.
7 Lbs.

- * Easy to build — a pleasure to use.
- * 1% precision resistors employed for high accuracy.
- * Etched circuit board cuts assembly time in half.

Voltmeter Kit

The fact that this instrument is the world's largest-selling VTVM says a great deal about its accuracy, reliability, and overall quality. The V-7A is equally popular in the laboratory or service shop, and represents an unbelievable test equipment bargain, without a corresponding sacrifice in quality. Its appearance reflects the performance of which it is capable. A large 4½" panel meter is used for indication, with clear, sharp calibrations for all ranges. Front panel controls consist of a rotary function switch and a rotary range selector switch, zero-adjust, and ohms-adjust controls. Precision 1% resistors are used in the voltage divider circuits and etched circuits are employed for most of the circuitry. This makes the kit much easier to build, eliminates the possibility of wiring errors, and assures duplication of laboratory instrument performance. This multi-function VTVM will measure AC voltage (rms), AC voltage (peak-to-peak), DC voltage, and resistance. There are 7 AC (rms) and DC voltage ranges of 0-1.5, 5, 15, 50, 150, 500, and 1500. In addition, there are 7 peak-to-peak AC ranges of 0-4, 14, 40, 140, 400, 1400, and 4000. 7 ohmmeter ranges provide multiplying factors of X1, X10, X100, X1000, X10K, X100K, and X1 megohm. Center-scale resistance readings are 10, 100, 1000, 10K, 100K ohms, 1 megohm, and 10 megohms. A DB scale is also provided. The precision and quality of the components used in this VTVM cannot be duplicated at this price through any other source. Model V-7A is the kind of instrument you will be proud to own and use.

HEATHKIT Etched Circuit RF PROBE KIT

This RF probe extends the frequency response of any 11-megohm VTVM so that it will measure RF up to 250 megacycles within ± 10%. Employs printed circuits for increased stability and ease of assembly. Ideal for extending service and laboratory applications of your Heathkit VTVM. Shpg. Wt. 1 lb.

No. 309-C
\$3⁵⁰

HEATHKIT 20,000 OHMS/VOLT VOM KIT

Sensitivity of this instrument is 20,000 ohms-per-volt DC and 5,000 ohms-per-volt AC. Measuring ranges are 0-1.5, 5, 50, 150, 500, 1500, and 5000 volts for both AC and DC. Also measures current in the ranges of 0-150 microamperes, 15 ma, 150 ma, 500 ma, and 15 a. Resistance ranges provide multipliers of X1, X100, and X10,000, resulting in center scale readings of 15, 15,000, and 150,000 ohms. DB ranges cover from -10 db to +65 db. Housed in attractive black bakelite case with plastic carrying handle, this fine instrument provides a total of 25 meter ranges on its two-color scale. It employs a sensitive 50 microampere, 4½" meter and features all 1% precision multiplier resistors. Requires no external power, and is, therefore, valuable in portable applications where no AC power is available.

MODEL MM-1
\$29⁵⁰

Shpg. Wt. 6 Lbs.

ETCHED CIRCUIT PEAK-TO-PEAK PROBE KIT

Use this peak-to-peak probe with your 11-megohm VTVM to measure peak-to-peak voltages directly on the DC scales of the instrument. Will measure p-to-p voltages in the frequency range of 5 kc to 5 mc. Employs etched circuit boards for increased circuit stability and simplified construction. Extend the usefulness of your VTVM. NOTE: NO. 338-C Not required for the Heathkit V-7A VTVM. Shpg. Wt. 2 Lbs.

\$5⁵⁰



HEATHKIT 30,000 VOLT DC HIGH VOLTAGE PROBE KIT

This probe provides a multiplication factor of 100 on the DC ranges of the Heathkit 11-megohm VTVM. Precision multiplier resistor mounted inside the two-color plastic probe body. Plenty of insulation for completely safe operation, even at highest TV potentials. Designed especially for TV service work.

No. 336
\$4⁵⁰

Shpg. Wt. 2 Lbs.

HEATHKIT HANDITESTER KIT

The Model M-1 measures AC or DC voltage at 0-10, 30, 300, 1000, and 5000 volts. Direct current ranges are 0-10 ma, and 0-100 ma. Ohmmeter ranges are 0-3000 (30 ohm center scale) and 0-300,000 ohms (3,000 ohms center scale). Uses a 400 microampere meter for sensitivity of 1000 ohms-per-volt. A very popular test device for the home experimenter, electricians, and appliance repairmen, and for use as an "extra" instrument in the service shop. Its small size and rugged construction make it perfect for any portable application. Easily slips into your tool box, glove compartment, coat pocket, or desk drawer. Top quality, precision components employed throughout.

MODEL M-1
\$14⁵⁰

Shpg. Wt. 3 Lbs.



HEATH COMPANY
A Subsidiary of Daystrom, Inc.
BENTON HARBOR 15, MICH.

CONTROLLED QUALITY . . .

Incoming parts inspection, and inspection of material coming off of our own production line assures you of the finest "build-it-yourself" kit that money can buy. Each kit contains all the components you need for assembly—and you can have confidence in the quality of the parts themselves. In addition to this inspection procedure, an extensive proof-building program for each new kit guarantees easy-to-follow instructions and reliable performance.

HEATHKIT NEW AUDIO VACUUM TUBE

Voltmeter Kit

- * Brand new circuit for extended frequency response and added stability.
- * Ten accurate ranges from 0-.01 to 0-300 volts.
- * Modern, functional panel styling. "On-off" switch at both extreme ends of range switch.



MODEL AV-3

\$29⁹⁵

Shpg. Wt.
5 lbs.

This brand new AC vacuum tube voltmeter emphasizes stability, broad frequency response, and sensitivity. It is designed especially for audio measurements, and low-level AC measurements in power supply filters, etc. Employs a cascode amplifier circuit with cathode-follower isolation between the input and the amplifier, and between the output stage and the preceding stages. An extremely stable circuit with high input impedance (1 megohm at 1000 CPS). Response of the AV-3 is essentially flat from 10 CPS to 200 kc, and is usable for tests even beyond these frequency limits. Increased damping in the meter circuit stabilizes the meter for low frequency tests. Nylon insulating bushings at the input terminals reduce leakage, and permit the use of the 5-way Heath binding post.

The extremely wide voltage range covered by the AV-3 makes it especially valuable not only in high-fidelity and service work, but also in experimental laboratories. AC (RMS) voltage ranges are 0-.01, .03, .1, .3, 1, 3, 10, 30, 100, and 300 V. Decibel ranges cover -52 DB to +52 DB. An entirely new circuit as compared to the previous model. Employs 1% precision multiplier resistors for maximum accuracy. Handles AC measurements from a low value of one millivolt to a maximum of 300 volts.

HEATHKIT AUDIO WATTMETER KIT

This instrument measures audio power directly at 4, 8, 16, or 600 ohms. Load resistors are built in. Covers 0-5 MW, 50 MW, 500 MW, 5 W, and 50 W full scale. Provides 5 switch-selected DB ranges covering from -10 DB to +30 DB. Large 4½" 200 microampere meter and precision multiplier resistors insure accuracy. Frequency response is ± 1 DB from 10 CPS to 250 kc. Functions from AC power line. Use in the audio laboratory or in home workshop.

MODEL AW-1

\$29⁵⁰

Shpg. Wt. 6 lbs.

HEATHKIT AUDIO ANALYZER KIT

This multi-function instrument combines an AC VTVM, an audio wattmeter, and an intermodulation analyzer into one case, with combined input and output terminals and built-in high and low frequency oscillators. The VTVM ranges are .01, .03, .1, .3, 1, 3, 10, 30, 100, and 300 volts (RMS). Wattmeter ranges are .15 MW, 1.5 MW, 15 MW, 150 MW, 1.5 W, 15 W, 150 W. IM scales are 1%, 3%, 10%, 30%, and 100%. Provides internal load resistors of 4, 8, 16, or 600 ohms. A valuable instrument for the engineer or serious audiophile.

MODEL AA-1

\$49⁹⁵

Shpg. Wt. 13 lbs.

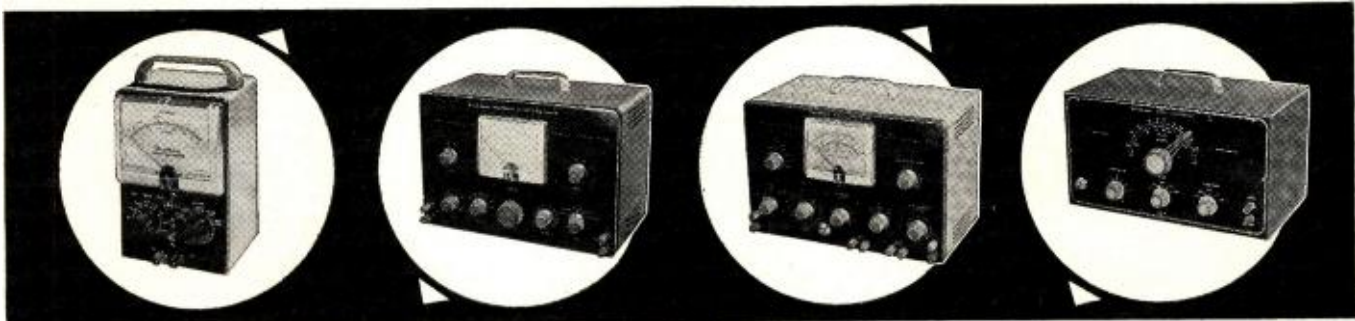

HEATHKIT HARMONIC DISTORTION METER KIT

The HD-1 is equally valuable for the audio engineer or the serious audiophile. Used with a low-distortion audio signal generator, this instrument will measure the harmonic content of various amplifiers under a variety of conditions. Functions between 20 and 20,000 CPS, and reads distortion directly on the panel meter in ranges of 0-1, 3, 10, 30, and 100 percent full scale. Built-in VTVM for initial reference settings and final distortion readings has voltage ranges of 0-1, 3, 10, and 30 volts. 1% precision resistors employed for maximum accuracy. Features voltage regulation and other "extras". Meter calibrated in volts (RMS), percent distortion, and DB.

MODEL HD-1

\$49⁵⁰

Shpg. Wt. 13 lbs.

HEATHKIT AUDIO OSCILLATOR KIT

Producing both sine waves and square waves, the Model AO-1 covers a frequency range of 20 to 20,000 CPS in three ranges. An extra feature is thermistor regulation of output for flat response through the entire frequency range. AF output is provided at low impedance, and with low distortion. Produces good sine waves, and good, clean square waves with a rise time of only two micro-seconds for checking square wave response of audio amplifiers, etc. Designed especially for the serviceman and high-fidelity enthusiast. A real dollar value in test equipment.

MODEL AO-1

\$24⁵⁰

Shpg. Wt. 10 lbs.

HEATHKIT



MODEL
AG-9

\$34⁵⁰

Shpg. Wt.
8 Lbs.

- * Less than 0.1% distortion — ideal for hi fi work.
- * Large 4½" meter indicates output.
- * Step-type tuning for maximum convenience.

Audio Generator Kit

This particular audio generator is "made to order" for high fidelity applications. It provides quick and accurate selection of low-distortion signals throughout the audio range. Three rotary selector switches on the front panel allow selection of two significant figures and a multiplier for determining audio frequency. In addition, it incorporates a step-type output attenuator and a continuously variable attenuator. Output is indicated on a large 4½" panel meter calibrated in volts and in db. Attenuator system operates in steps of 10 db, corresponding with the meter calibration. Output ranges are 0-.003, .01, .03, .1, .3, 1, 3, and 10 volts rms. A "load" switch provides for the use of a built-in 600 ohm load or an external load of higher impedance when required. Output and frequency indicators accurate to within ± 5%. Distortion is less than .1 of 1% between 20 cps and 20,000 cps. Total range is 10 cps to 100 kc. New engineering details combine to provide the user with an unusually high degree of operating efficiency. Oscillator frequency selected entirely by the switch method means that accurate resetability is provided. Comparable to units costing many dollars more, and ideal for use in critical high fidelity applications. Shop and compare, and you will appreciate the genuine value of this professional instrument.

HEATHKIT RESISTANCE SUBSTITUTION BOX KIT

The RS-1 contains 36 10% 1-watt resistors ranging from 15 ohms to 10 megohms in standard RETMA values. All values are switch-selected for use in determining desirable resistance values in experimental circuits. Many applications in radio and TV service work.

MODEL RS-1
\$5⁵⁰
Shpg. Wt. 2 Lbs.

HEATHKIT CONDENSER SUBSTITUTION BOX KIT

This kit contains 18 RETMA standard condenser values that can be selected by a rotary switch. Values range from 0.00001 mfd to 0.22 mfd. All capacitors rated at 400 volts or higher. Capacitors are either silver-mica, or plastic molded.

MODEL CS-1
\$5⁵⁰
Shpg. Wt. 2 Lbs.

HEATHKIT AUDIO GENERATOR KIT

The Model AG-8 is a low cost, high performance unit for use in service shop, or home workshop. It covers the frequency range of 20 cps to 1 mc in five ranges. Output is 600 ohms, and overall distortion will be less than .4 of 1% from 100 cps through the audible range. Output is available up to 10 volts, under no load conditions, and output remains constant within ±1 db from 20 cps to 400 kc. A five-step attenuator provides control of the output. Precision resistors are employed in the frequency determining network.

MODEL AG-8
\$29⁵⁰
Shpg. Wt. 11 Lbs.

HEATHKIT DECADE CONDENSER KIT

Precision, 1% silver-mica capacitors are employed in the Model DC-1 in such a way that a selection of precision capacitor values is provided ranging from 100 mmf (.0001 mfd) to 0.11 mfd (110,000 mmf) in 100 mmf steps. Extremely valuable in all types of design and development work. Switches are ceramic wafer types.

MODEL DC-1
\$16⁵⁰
Shpg. Wt. 3 Lbs.



HEATHKIT DECADE RESISTANCE KIT

The Model DR-1 incorporates twenty 1% precision resistors arranged around five rugged switches so that various combinations of switch positions will provide a total range of 1 ohm to 99,999 ohms in 1-ohm steps. Switches are labeled "units," "tens," "hundreds," "thousands," and "ten thousands." Use it for ohm-meter calibration in bridge circuits as test values in multiplier circuits, etc.

MODEL DR-1
\$19⁵⁰
Shpg. Wt. 4 Lbs.

HEATHKIT VARIABLE VOLTAGE REGULATED POWER SUPPLY KIT

This power supply is regulated for stability, and the amount of DC output available from the power supply can be controlled manually from zero to 500 volts. Will provide regulated output at 450 volts up to 10 ma, or up to 130 ma at 200 volts output. In addition to furnishing B-plus, the power supply provides 6 volts AC at 4 amperes for filaments. Both the B-plus output and the filament output are isolated from ground. Ideal power supply for use in experimental work in the laboratory, the home workshop, or the ham shack. Large 4½" panel meter indicates output voltage or current.

MODEL PS-3
\$35⁵⁰
Shpg. Wt. 17 Lbs.



HEATH COMPANY
A Subsidiary of Daystrom, Inc.
BENTON HARBOR 15, MICH.

BONUS PERFORMANCE . . .
 If a single word had to be selected to describe Heath Company advertising policy, it would be "conservative." By this we mean that the performance specifications and features are not exaggerated, and that the descriptions are accurate. We specify performance on the conservative side so you can be sure of equaling or exceeding our specifications. In almost every instance our kits will do more than we claim. Extra care in construction, and calibration against an accurate standard can extend performance well beyond advertised levels.

HEATHKIT

Signal Generator Kit

- * No calibration required with pre-aligned coils.
- * Modulated or unmodulated RF output.
- * 110 mc to 220 mc frequency coverage.

Here is an RF signal generator for alignment applications in the service shop or the home workshop. Thousands of these units are in use in service shops all over the country. Produces RF signals from 160 kc to 110 mc on fundamentals on five bands. Also covers from 110 mc to 220 mc on calibrated harmonics. RF output is in excess of 100,000 microvolts at low impedance. Output is controllable with a step-type and a continuously variable attenuator. Front panel controls provide selection of either unmodulated RF output or RF modulated at 400 cps. In addition, two to three volts of audio at approximately 400 cps are available at the output terminals for testing AF circuits. Employs a 12AU7 and a 6C4 tube. Built-in power supply uses a selenium rectifier.

One of the most outstanding features about the Model SG-8 is the fact that it can be built in just a few hours, even by one not thoroughly experienced in electronics work. Complete step-by-step instructions combined with large pictorial diagrams assure successful assembly. Pre-aligned coils make calibration from an external source unnecessary.



MODEL SG-8

\$19⁵⁰ Shpg. Wt. 8 Lbs.

HEATHKIT LABORATORY GENERATOR KIT

This laboratory RF signal generator covers from 100 kc to 30 mc on fundamentals in five bands. The output signal may be pure RF, or may be modulated at 400 cycles from 0 to 50%. Provision for external modulation has been made. RF output available up to 100,000 microvolts. Output controlled by a fixed step and a variable attenuator. Output impedance is 50 ohms. Panel meter reads RF output or percentage of modulation. Incorporates voltage regulated B+ supply, double shielding of oscillator circuits, copper plated chassis, and other "extras."

MODEL LG-1

\$48⁹⁵

Shpg. Wt. 16 Lbs.

HEATHKIT TV ALIGNMENT GENERATOR KIT

This improved sweep generator model provides essential stability and flexibility for work on FM, monochrome TV, or color TV sets. Covers 3.6 mc to 220 mc in four bands. Provides usable output even on harmonics. Sweep deviation from 0-42 mc, depending on base frequency. All-electronic sweep circuit eliminates unwieldy mechanical arrangements. Includes built-in crystal marker generator providing output at 4.5 mc and multiples thereof, and variable marker covering 19 to 60 mc on fundamentals and from 57 to 180 mc on harmonics. Effective two-way blanking.

MODEL TS-4A

\$49⁵⁰

Shpg. Wt. 16 Lbs.

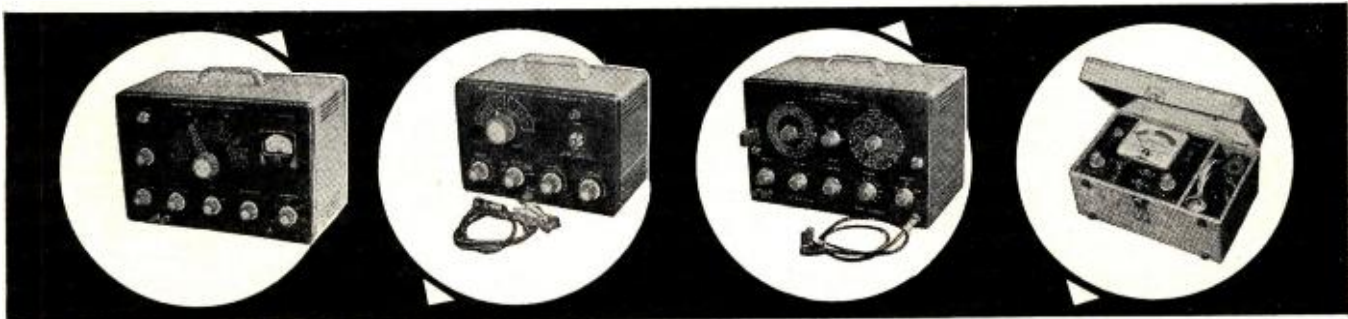

HEATHKIT LINEARITY PATTERN GENERATOR KIT

This instrument supplies information for white dots, cross-hatch pattern, horizontal bar pattern, or vertical bar pattern. It feeds video and sync signals to the set under test, with completely controlled gain, and unusual stability. Covering channels 2 to 13, the LP-2 will produce 5 to 6 vertical bars and 4 to 5 horizontal bars. The dot pattern presentation is a *must* for the setting of color convergence controls in the color TV set. Panel provision made for external sync if desired. Use for adjustment of vertical and horizontal linearity, picture size, aspect ratio, and focus. Power supply is regulated for added stability. Essential in the up-to-date TV service shop.

MODEL LP-2

\$22⁵⁰

Shpg. Wt. 7 Lbs.

HEATHKIT CATHODE RAY TUBE CHECKER KIT

This instrument checks cathode emission, beam current, shorted elements, and leakage between elements in electro-magnetic picture tube types. It eliminates all doubt for the TV serviceman, and even more important, for the customer. Features its own self-contained power supply, transformer operated to furnish normal test voltages for the CRT. Employs spring-loaded switches for maximum operator protection. Large 4 1/2" meter indicates CRT condition on "good-bad" scale. Luggage-type portable case ideal for home service calls. Special "shadowgraph" test permits projection of light spot on screen. Also gives relative check of picture tube screen coating.

MODEL CC-1

\$22⁵⁰

Shpg. Wt. 10 Lbs.

HEATHKIT



MODEL
TC-2

\$29⁵⁰

Shpg. Wt.
12 Lbs.

- * Attractive counter-style cabinet.
- * Wiring-harness simplifies assembly.
- * Large 4½" meter with two-color "good-bad" scale.
- * Separate tube element switches prevent obsolescence.

Tube Checker Kit

This fine piece of test gear checks tubes for quality, emission, shorted elements, open elements, and filament continuity. Will test all tube types normally encountered in radio and TV service work. Sockets provided for 4, 5, 6, and 7-pin large, rectangular, and miniature types, octal and loctal types, the Hytron 9-pin miniatures, and pilot lamps. Condition of tubes indicated on a large 4½" meter with multi-color "good-bad" scale. An illuminated roll chart is built right in, providing test data for various tube types. This tester provides switch selection of 14 different filament voltage values from 0.75 volts to 117 volts. Individual switches control each tube element. Close tolerance resistors employed in critical test circuits for maximum accuracy. A professional instrument both in appearance and performance.

The Model TC-2 is very simple to build, even for a beginner. It employs a color-coded cable harness for neat, professional under-chassis wiring. Comes with attractive counter style cabinet, and portable cabinet is available separately. At this price, even the part-time serviceman can afford his own tube checker for maximum efficiency in service work.

HEATHKIT TV PICTURE TUBE TEST ADAPTER



MODEL 355

\$4⁵⁰

Shpg. Wt.
1 Lb.

Designed especially for use with the Model TC-2 tube checker. Use it to test TV picture tubes for emission, shorts, etc. Consists of 12-pin TV tube socket, 4 ft. cable, octal connector, and necessary technical data. Not a kit.

HEATHKIT PORTABLE TUBE CHECKER KIT

This portable tube checker is identical, electrically, with the Model TC-2. However, it is housed in an attractive and practical carrying case, finished in proxylin impregnated material. The cover is detachable, and the hardware is brass plated. This rugged unit is ideal for home service calls or any portable application.



MODEL
TC-2P

\$34⁵⁰ Shpg. Wt.
15 Lbs.

HEATHKIT VISUAL-AURAL SIGNAL TRACER KIT

Although designed primarily for radio receiver work, this valuable instrument finds extensive application in FM and TV servicing as well. Features a high-gain channel with demodulator probe, and a low-gain channel with audio probe. Will trace signals in all sections of a radio receiver and in many sections of a FM set or TV receiver. Uses built-in speaker and electron beam eye tube for indication. Also features built-in wattmeter and a noise locator circuit. Provision for patching speaker and/or output transformer into external set.

MODEL T-3

\$23⁵⁰

Shpg. Wt. 9 Lbs.

HEATHKIT DIRECT READING CAPACITY METER KIT

Operation of this instrument is simplicity itself. One has only to connect a capacitor to the terminals, select the proper range, and read the capacity value directly on the large 4½" meter calibrated in mmf and mfd.

Ranges are 0 to 100 mmf, 1,000 mmf, 0.01 mfd, and 0.1 mfd full scale. Precision calibrating capacitors supplied. Not susceptible to hand capacity effects. Residual capacity less than 1 mmf. Especially valuable in production line checking, or in quality control.



MODEL CM-1

\$29⁵⁰

Shpg. Wt.
7 Lbs.



HEATHKIT CONDENSER CHECKER KIT

The Model C-3 consists of an AC powered bridge for both capacitive and resistive measurements. Bridge balance is indicated on electron beam eye tube, and capacity or resistance value is indicated on front panel calibrations. Measures capacity in four ranges from .00001 mfd to .005 mfd, .001 mfd to .5 mfd, .1 mfd to 50 mfd, and 20 mfd to 1000 mfd. Measures resistance in two ranges, from 100 ohms to 50,000 ohms, and from 10,000 ohms to 5 megohms. Selection of five different polarizing voltages for checking capacitors, from 25 volts DC to 450 volts DC. Checks paper, mica, ceramic, and electrolytic capacitors. Indicates power factor of electrolytic condensers.

MODEL C-3

\$19⁵⁰

Shpg. Wt. 7 Lbs.



HEATH COMPANY

A Subsidiary of Daystrom, Inc.

BENTON HARBOR 15, MICH.

PIONEER DESIGN . . .
 New and unique approaches to instrument and equipment designs are a Heath Company tradition. We concentrate all our development efforts on kit projects, since this is our prime activity—and not just a sideline. This logically results in more efficient, more reliable circuit designs—and you benefit from this constant engineering progress. Buying from the undisputed leader in the electronic kit field assures you of completely modern equipment, with outstanding advanced design features.

HEATHKIT

Impedance Bridge Kit

- * ½% precision resistors and silver-mica capacitors.
- * Battery-type tubes, no warm-up required.
- * Built-in phase shift generator and amplifier.

The Model IB-2 is a completely self-contained unit. It has a built-in power supply, a built-in 1000 cycle generator, and a built-in vacuum tube detector. Provision has been made on the panel for connection to an external detector, an external signal generator, or an external power supply. A 100-0-100 micro-ampere meter on the front panel provides for null indications. Measures resistance from 0.1 ohm to 10 megohms, capacitance from 10 mmf to 100 mfd, inductance from 10 mh to 100 h, dissipation factor (D) from 0.002 to 1, and storage factor (Q) from 0.1 to 1000. ½ of 1% decade resistors employed for maximum accuracy. Typical accuracy figures are: resistance, ±3T; capacitance ±3%; inductance, ±10%; dissipation factor, ±20%; storage factor, ±20%. Employs a Wheatstone bridge, a Capacity Comparison bridge, a Maxwell bridge, and a Hay bridge. Special two-section CRL dial provides maximum convenience in operation. Use the Model IB-2 for determining values of unmarked components, checking production or design samples, etc. A real professional instrument.



MODEL IB-2
\$59⁵⁰ Shpg. Wt. 12 lbs.

HEATHKIT "Q" METER KIT

The Q Meter permits measurement of inductance from 1 microhenry to 10 millihenries, "Q" on a scale calibrated up to 250 full scale, with multiplying factors of 1 or 2, and capacitance from 40 mmf to 450 mmf, ±3 mmf. Built-in variable oscillator permits testing components from 150 kc to 18 mc. Large 4½" panel-mounted meter is features. Very handy for checking peaking coils, chokes, etc. Use to determine values of unknown condensers, both variable and fixed. Compile data for coil winding purposes, or measure RF resistance. Distributed capacity, and Q of coils.

MODEL QM-1
\$44⁵⁰
 Shpg. Wt. 14 lbs.

HEATHKIT ISOLATION TRANSFORMER KIT

This device isolates equipment under test from the power line. It is rated at 100 volt-amperes continuously, or 200 volt-amperes intermittently. AC-DC sets may be plugged directly into the IT-1 without the chassis becoming "hot." Additionally, since the IT-1 is fused, it is ideal for use as a buffer between the power line and a questionable receiver, or a new piece of equipment. Protects main fuses. Features voltage control, allowing control of the output from 90 volts to 130 volts. Panel meter monitors output voltage. A very handy device at an extremely low price.

MODEL IT-1
\$16⁵⁰
 Shpg. Wt. 9 lbs.

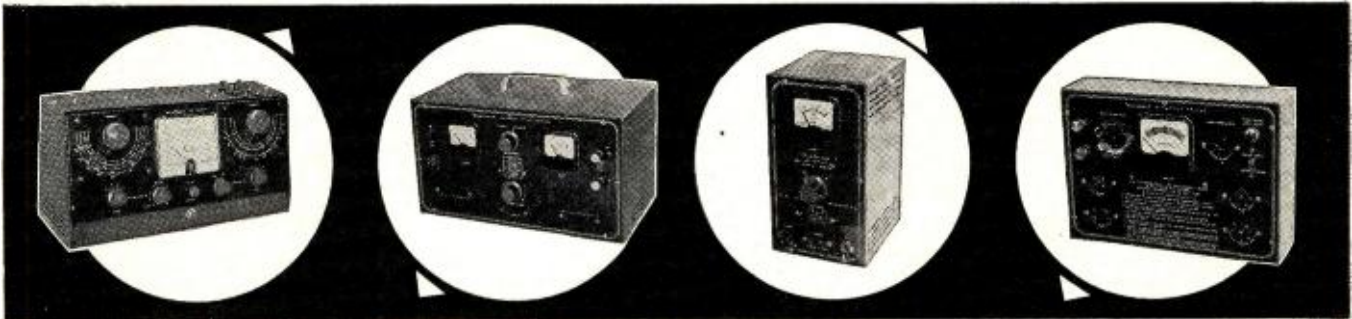

HEATHKIT 6-12 VOLT BATTERY ELIMINATOR KIT

This completely modern battery eliminator will supply DC output in two ranges for both 6-volt and 12-volt automobile radios. The output is variable for each range, so that operating voltage can be raised or lowered to determine how the receiver functions under adverse conditions. Range is 0-8 volts DC or 0-16 volts DC. Will supply up to 15 amperes on the 6-volt range, or up to 7 amperes on the 12-volt range. Two 10,000 microfarad output filter capacitors insure smooth DC output. Two separate panel meters indicate output voltage or output current. Makes it possible to test automobile radios inside at the workbench. Will also double as a battery charger.

MODEL BE-4
\$31⁵⁰
 Shpg. Wt. 17 lbs.

HEATHKIT 6-VOLT VIBRATOR TESTER KIT

This instrument functions very much like a tube checker, to test auto radio vibrators. Vibrator condition is indicated on a simple "good-bad" scale. Tests for proper starting and overall quality of operation, of both interrupter and self-rectifier types of 6-volt vibrators. The model VT-1 is designed to operate from any battery eliminator capable of delivering continuously variable output from 4 to 6 volts DC at 4 amperes or more. It is an ideal companion unit for the Heathkit Model BE-4 battery eliminator. The construction book for the VT-1 contains vibrator test chart for popular 6-volt vibrator types. A real time saver!

MODEL VT-1
\$14⁵⁰
 Shpg. Wt. 6 lbs.

HEATHKIT DX-100 PHONE AND CW



**MODEL
DX-100**
Shpg. Wt.
107 lbs.

\$189⁵⁰

Shipped motor freight unless otherwise specified.
\$50.00 deposit required on c.o.d. orders.

- * Phone or CW on 160, 80, 40, 20, 15, 11 and 10 meters.
- * Built-in VFO, modulator, and power supplies.
- * High quality components used throughout for reliable performance.
- * Features 5-point TVI suppression.

HEATHKIT COMMUNICATIONS TYPE ALL BAND RECEIVER KIT

This receiver covers 550 kc to 30 mc in four bands, and is ideal for the short-wave listener or beginning amateur. It provides good sensitivity and selectivity, combined with good image rejection. Amateur bands clearly marked on illuminated dial scale. Employs transformer type power supply—electrical bandspread—antenna trimmer—separate RF and AF gain controls—noise limiter—headphone jack—and automatic gain control. Has built-in BFO for CW reception.

CABINET: Fabric covered cabinet with aluminum panel as shown. Part 91-15A. Shipping weight 5 lbs. \$4.95

MODEL AR-3
\$29⁹⁵

INCLUDING NEW
EXCISE TAX
(Less Cabinet)
Shpg. Wt. 12 lbs.



EASY ON THE BUDGET!

You can buy Heathkits on an easy time-payment plan that provides a full year to pay. Write for complete details and special order blank.



HEATH COMPANY

A Subsidiary of Daystrom, Inc.
BENTON HARBOR 15, MICH.

Transmitter Kit

The Heathkit DX-100 transmitter is in a class by itself in that it offers features far beyond those normally received at this price level. It takes very little listening on the bands to discover how many of these transmitters are in operation today. A truly amazing piece of amateur gear. The DX-100 features a built-in VFO and a built-in modulator. It is TVI suppressed, and uses pi network interstage coupling and output coupling. Will match antenna impedances from approximately 50 to 600 ohms. Extensive shielding is employed, and all incoming and outgoing circuits are filtered. The cabinet features interlocking seams for simplified assembly and minimum RF radiation outside of the cabinet. Provides a clean strong signal on either phone or CW, with RF output in excess of 100 watts on phone, and 120 watts on CW. Completely bandswitching from 160 through 10 meters. A pair of 1625 tubes are used in push-pull for the modulator, and the final consists of a pair of 6146 tubes in parallel. The VFO dial and meter face are illuminated, and all front panel controls are located for maximum convenience. Panel meter reads driver plate I, final grid I, final plate I, final plate voltage, and modulator current. The chassis is constructed of heavy #16 gauge copper-plated steel. Other high-quality components include potted transformers, ceramic switch and variable capacitor insulation, silver-plated or solid-silver switch terminals, etc. All coils are pre-wound, and the main wiring cable is pre-harnessed. The kit can be built by a beginner from the comprehensive step-by-step instructions supplied. It is a proven, trouble-free rig, that will insure many hours of "on-the-air" enjoyment in your ham shack.

HEATHKIT VFO KIT

You can go VFO for less than you might expect. Here is a variable frequency oscillator that covers 160, 80, 40, 20, 15, 11, and 10 meters with three basic oscillator frequencies, that sells for less than \$20. Provides better than 10 volt average RF output on fundamentals. Plenty of drive for most modern transmitters. Requires a power source of only 250 VDC at 15 to 20 ma. and 6.3 VAC at 0.45A. Incorporates a regulator tube for stability. Illuminated frequency dial reads frequency directly on the band being employed. Temperature-compensated capacitors offset coil heating.

MODEL VF-1

\$19⁵⁰

Shpg. Wt. 7 lbs.



NEW HEATHKIT CW TRANSMITTER KIT

The brand new Heathkit Model DX-20 Transmitter is one of the most efficient little rigs available today. Featuring an entirely new circuit, it is ideal for the novice, and even for the advanced-class CW operator. A 6DQ6A final amplifier provides plate power input of 50 watts. A 6CL6 oscillator is employed, and a 5U4GB rectifier. The transmitter features one-knob bandswitching to cover 80, 40, 20, 15, 11 and 10 meters. It is designed for crystal excitation, but may be excited by an external VFO. A pi network output circuit matches antenna impedances between 50 and 1000 ohms. Front panel controls are functionally located for your convenience. If you appreciate a good signal on the CW bands, this is the transmitter for you!

MODEL DX-20

\$35⁹⁵

Shpg. Wt. 18 lbs.

DOLLAR-SAVING ECONOMY . . .
 There would be no particular achievement in selling inexpensive merchandise at a low price—although it is being done every day. However, there is something to crow about when, through tremendous purchasing power and factory-to-you distribution, Heath Company can offer top-quality equipment, using name-brand components, at such low prices. This is real economy, as opposed to the so-called "bargains". Needless to say, there is a big difference.

**HEATHKIT PHONE AND CW
 Transmitter Kit**

- * 6146 final amplifier for full 65-watt plate power input.
- * Phone and CW operation on 80, 40, 20, 15, 11, and 10 meters. Pi network output coupling.
- * Switch selection of three crystals — provision for external VFO excitation.

The DX-35 features a 6146 final amplifier to provide 65 watts plate power input on CW, with controlled carrier modulation peaks up to 50 watts on phone. In addition, it is a most attractive transmitter. Modulator and power supplies are built-in, and the rig covers 80, 40, 20, 15, 11, and 10 meters with a single band-change switch. Pi network output coupling provided for matching various antenna impedances. A 12BY7 buffer stage provided ahead of the final amplifier for plenty of drive on all bands. 12BY7 oscillator and 12AU7 modulator. Provision for switch selection of three different crystals. Crystals reached through access door at rear. Front panel controls marked "off-CW-stand-by-phone", "final tuning", "antenna coupling", "drive level control", and "band change switch". Panel meter indicates final grid current or final plate current. A perfect low-power transmitter both for the novice, and for the more experienced operator. A remarkable power package for the price. Incidentally, the price includes tubes, and all other components necessary for assembly. As with all Heathkits, comprehensive instruction manual assures successful assembly.



MODEL DX-35
\$56.⁹⁵ Shpg. Wt. 24 Lbs.

HEATHKIT ANTENNA IMPEDANCE METER KIT

This instrument employs a 100 microampere panel meter and covers the impedance range of 0-600 ohms for RF tests. Functions up to 150 mc. Used in conjunction with signal source, such as the Heathkit Model GD-1B grid dip meter, the Model AM-1 will determine antenna resistance and resonance, match transmission lines for minimum standing wave ratio, determine receiver input impedance, etc. Will also double as a phone monitor. A very valuable device for many uses in the ham shack.

MODEL AM-1
\$14.⁵⁰
 Shpg. Wt. 2 Lbs.

HEATHKIT "Q" MULTIPLIER KIT

The QF-1 functions with any receiver with an IF frequency between 450 and 460 kc that is not AC-DC type. Operates from the receiver power supply, requiring only 6.3 VAC at 300 ma. and 150 to 250 VDC at 2 ma. Simple to connect with cable and plugs supplied. Provides additional selectivity for separating two signals, or will reject one signal and eliminate heterodyne. A big help on crowded bands. Provides an effective Q of approximately 4,000 for sharp "peak" or "null". Tunes to any signal within the IF bandpass of the receiver, without changing main receiver tuning dial.

MODEL QF-1
\$9.⁹⁵
 Shpg. Wt. 3 Lbs.

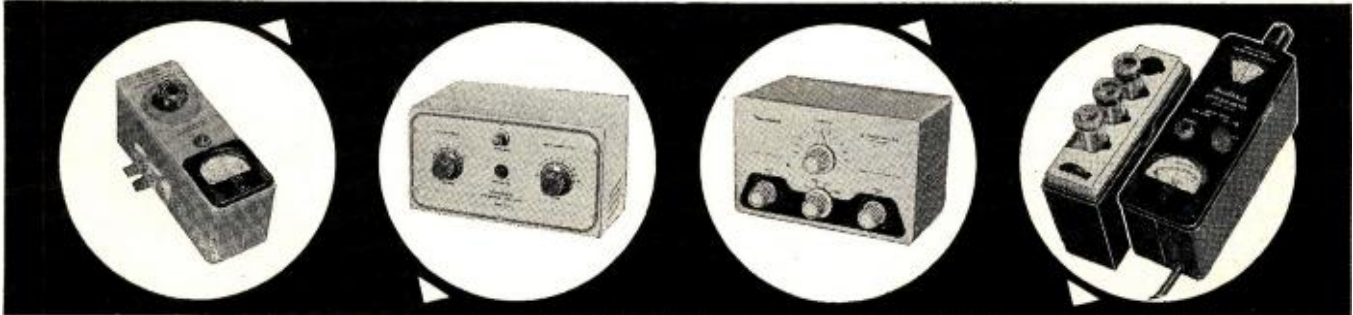

HEATHKIT ANTENNA COUPLER KIT

This device is designed to match the Model AT-1 transmitter to a long-wire antenna. In addition to impedance matching, this unit incorporates an L-type filter which attenuates signals above 36 megacycles, thereby reducing TVI. Designed for 52 ohm coaxial input. Handles power up to 75 watts, 10 through 80 meters. Uses a tapped inductor and variable capacitor. Neon RF indicator on front panel. Copper-plated chassis—high quality components throughout—simple to build. Eliminates waste of valuable communications power due to improper matching. A "natural" for all AT-1 transmitter owners.

MODEL AC-1
\$14.⁵⁰
 Shpg. Wt. 4 Lbs.

HEATHKIT GRID DIP METER KIT

The grid dip meter was originally designed for the ham shack. However, its use has been extended into the service shop and laboratory. Continuous frequency coverage from 2 mc to 250 mc with pre-wound coils. 500 microampere panel meter employed for indication. Use for locating parasitics, neutralizing, determining RF circuit resonant frequencies, etc. Coils are included with kit, as is a coil rack. Front panel controls include sensitivity control for meter, and phone jack for listening to zero-beat. Will also double as an absorption-type wavemeter.

MODEL GD-1B
\$19.⁹⁵
 Shpg. Wt. 4 Lbs.

HEATHKIT BROADCAST BAND



MODEL BR-2
(Less Cabinet)
Shpg. Wt. 10 Lbs.

\$18⁹⁵

INCLUDING NEW
EXCISE TAX*

ATTENTION BEGINNERS . . .

This kit is an ideal "first project" if you have never built a Heathkit before. A good chance to "learn by doing."

- * Miniature tubes and high-gain IF transformer.
- * 5½-inch PM speaker.
- * Rod-type built-in antenna. Good sensitivity and selectivity.
- * Provision for phono jack.
- * Transformer - operated power supply.

Receiver Kit

You need no previous experience in electronics to build this table-model radio. The Model BR-2 receiver covers 550 kc to 1620 kc and features good sensitivity and selectivity over the entire band. A 5½" PM speaker is employed, along with high gain miniature tubes and a new rod-type built-in antenna. Provision has been made in the design of this receiver for its use as a phonograph amplifier. The phono jack is located on the back chassis apron. A transformer operated power supply is featured for safety of operation, as opposed to the usual AC-DC supply commonly found in "economy radio kits." Don't let the low Heathkit price deceive you. This is the kind of set you will want to show off to your family and friends after you have finished building it.

Construction of this radio kit is very simple. Giant size pictorial diagrams and detailed step-by-step instructions assure your success. The construction manual also includes an explanation of basic receiver circuit theory so you can "learn by doing" as the receiver is built. The manual even provides information on resistor and capacitor color codes, soldering techniques, use of tools, etc. If you have ever had the urge to build your own radio receiver, the outstanding features of this popular Heathkit deserve your attention.

CABINET: Proxilyn impregnated fabric covered plywood cabinet available for the BR-2 receiver as shown. Complete with aluminum panel, reinforced speaker grill, and protective rubber feet. Shipping weight 5 lbs., part No. 91-9A. \$4.95*

HEATHKIT PROFESSIONAL RADIATION COUNTER KIT

This sensitive and reliable instrument has already found extensive application in prospecting, and also in medical and industrial laboratories. It offers outstanding performance at a reasonable price. Front-panel meter indicates radiation level, and oral indication produced by panel-mounted speaker. Meter ranges are 0-100, 600, 6,000 and 60,000 counts per minute, and 0-.02, .1, 1 and 10 milliroentgens per hour. The probe, with expansion cord, employs type 6306 bismuth counter tube, sensitive to both beta and gamma radiation. It is simple to build, even for a beginner.

MODEL RC-1

\$79⁹⁵

Shpg. Wt. 8 Lbs.



- * Amazing new circuit for high efficiency.
- * Compact, portable and rugged.
- * Stable circuit requires only one 67½ volt "B" battery and two 1½ volt "A" batteries.

HEATHKIT CRYSTAL RECEIVER KIT

The crystal radio of Dad's day is back again, but with big improvements! The Model CR-1 employs a sealed germanium diode, eliminating the critical "cat's whisker" adjustment. It is housed in a compact plastic box, and features two Hi-Q tank circuits, employing ferrite core coils and variable air tuning capacitors. The CR-1 covers the standard broadcast band from 540 kc to 1600 kc, and no external power is required for operation. Could prove valuable for emergency signal reception. This easy-to-build kit is a real "learn by doing" experience for the beginner, and makes an interesting project for all ages.

MODEL CR-1

\$7⁹⁵

INCLUDING NEW
EXCISE TAX*
Shpg. Wt. 3 Lbs.



HEATHKIT ENLARGER TIMER KIT

The Model ET-1 is an easy-to-build device for use by amateur or professional photographers in controlling the timing cycle of an enlarger. It covers the range of 0 to 1 minute with a continuously variable, clearly calibrated scale. The timing period is pre-set, and the timing cycle is initiated by depressing the spring-return switch to the "print" position. Front panel provision is made for plugging in the enlarger and a safelight. The safelight is automatically turned "on" when the enlarger is "off". Handles up to 350 watts. The timing cycle is controlled electronically for maximum accuracy and reliability. Very simple to build in only one evening, even by a beginner.

MODEL ET-1

\$11⁵⁰

Shpg. Wt. 3 Lbs.



HEATH COMPANY
A Subsidiary of Daystrom, Inc.
BENTON HARBOR 15, MICH.

COMPREHENSIVE INSTRUCTIONS . . .
 The step-by-step assembly instructions provided with each Heathkit are the finest available anywhere. Each manual begins at the beginning, and assumes no previous training or experience on the part of the kit builder. This means that our kits can be built successfully by anyone who can follow instructions. As a matter of fact, new manuals are tested by having the kit built by someone in our office who has had no previous experience in electronics. This is your guarantee of complete and thorough instruction material.

HEATHKIT HIGH FIDELITY

Preamplifier Kit

- * 5 switch-selected inputs, each with its own level control.
- * Equalization for LP, RIAA, AES, and Early 78's.
- * Separate bass and treble tone controls, and special hum control.
- * Clean, modern lines and satin-gold enamel finish.

Literally thousands of these preamplifiers are in use today, because the kit meets or exceeds specifications for the most rigorous high-fidelity applications, and will do justice to the finest available program sources. Provides a total of 5 inputs, each with individual level controls (three high-level and two low-level). Frequency response is within 1 DB from 25 CPS to 30,000 CPS, or within 1½ DB from 15 CPS to 35,000 CPS. Hum and noise are extremely low, with special balance control for absolute minimum hum level. Tone control provides 18 DB boost and 12 DB cut at 50 CPS, and 15 DB boost and 20 DB cut at 15,000 CPS. Cabinet measures only 12-9/16" W. x 3¾" H. x 4¾" D, and it is finished in beautiful satin-gold enamel. 4-position turnover and 4 position roll-off controls provide "LP," "RIAA," "AES," and "early 78" equalization, and 8, 12, 16, and 1 flat position for roll-off. Derives operating power from the main amplifier, requiring only 6.3 VAC at 1 ampere and 300 VDC at 10 MA. Easy to construct from step-by-step instructions and pictorial diagrams provided.

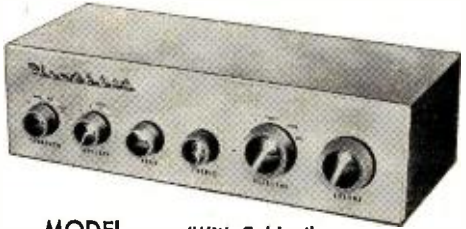

MODEL WA-P2 (With Cabinet)
 Shpg. Wt. 7 Lbs.

\$19⁷⁵



HEATHKIT HIGH FIDELITY FM TUNER KIT

- * Illuminated slide-rule dial covers 88 to 108 MC.
- * Modern circuit emphasizes sensitivity and stability.
- * Housed in attractive satin-gold cabinet to match WA-P2 and BC-1.

This amazing new FM tuner can provide you with real high-fidelity performance at an unbelievably low price level. Covering 88 to 108 MC, the modern circuit features a stabilized, temperature-compensated, oscillator, A.G.C., broadbanded

IF circuits, and better than 10 UV sensitivity for 20 DB of quieting. A high gain, cascaded, RF amplifier is used ahead of the mixer to increase overall gain and reduce oscillator leakage. It employs a ratio detector for high efficiency without sacrifice in high-fidelity performance. IF and ratio transformers are pre-aligned, as is the front end tuning unit. This means the kit can be constructed by a beginner, without elaborate test and alignment equipment. The FM-3A is designed to match the WA-P2 preamplifier and the BC-1 AM **MODEL FM-3A** tuner. An illuminated slide-rule dial is employed for frequency indication. Step-by-step instructions and large pictorial diagrams assure success.

\$25⁹⁵
 INCLUDING NEW EXCISE TAX
 (With Cabinet)
 Shpg. Wt. 7 Lbs.



HEATHKIT BROADBAND AM TUNER KIT

This AM tuner has been designed especially for high-fidelity applications. It incorporates a low-distortion detector, a broadband IF, and other features essential to usefulness in high-fidelity. Special voltage-doubler detector employs crystal diodes for low distortion. Sensitivity and selectivity are excellent. Audio response is ± 1 DB from 20 CPS to 2 kc, with 5 DB of pre-emphasis at 10 kc to compensate for station roll-off. Covers the standard broadcast band from 550 to 1600 kc. Incorporates a 10 kc whistle-filter and provides a 6 DB signal-to-noise ratio at 2.5 UV. RF and IF coils are pre-aligned, and power supply is built-in. Incorporates AVC, two outputs, and two antenna inputs.

MODEL BC-1
\$25⁹⁵
 INCLUDING NEW EXCISE TAX
 (With Cabinet)
 Shpg. Wt. 8 Lbs.

HEATHKIT ELECTRONIC CROSS-OVER KIT

This unusual device functions to separate low frequencies and high frequencies so that they may be fed to separate amplifiers and to separate speakers. This eliminates the need for conventional cross-over circuits, since the Model XO-1 does the complete job electronically. Cross-over frequencies of 100, 200, 400, 700, 1,200, 2,000 and 3,500 CPS are selectable with front panel controls on the XO-1, and a separate level control is provided for each channel. Minimizes inter-modulation distortion problems. Handles unlimited power, since frequency division is accomplished ahead of the power stage. Attenuation is 12 DB per octave, with sharp "knee" at cut-off frequency.

MODEL XO-1
\$18⁹⁵
 Shpg. Wt. 6 Lbs.

HEATHKIT ADVANCED-DESIGN



MODEL W-5M

Shpg. Wt. 31 Lbs.
Express Only

\$59⁷⁵

MODEL W-5

Consists of Model W-5M plus Model WA-P2 pre-amplifier.

Shpg. Wt. 38 Lbs.
Express only... \$79.50

- * Full 25 watt output with KT-66 output tubes.
- * All connectors brought out to front chassis apron.
- * Protective cover over all above-chassis components.

HEATHKIT DUAL-CHASSIS—WILLIAMSON TYPE HIGH FIDELITY AMPLIFIER KIT

This 20-watt high-fidelity amplifier employs the famous Acrosound Model TO-300 "ultra-linear" output transformer and uses 5881 output tubes. The power supply is built on a separate chassis, and the two chassis are inter-connected with a power cable. This provides additional flexibility in mounting. Frequency response is ± 1 DB from 6 CPS to 150 kc at 1 watt. Harmonic distortion is only 1% at 21 watts, and IM distortion is only 1.3% at 20 watts. (60 and 3,000 CPS). Output impedance is 4, 8, or 16 ohms. Hum and noise are 88 DB below 20 watts. A very popular high-fidelity unit employing top-quality components throughout.

MODEL W-3M: Shpg. Wt. 29 Lbs. Express only... \$49.75

MODEL W-3: Consists of Model W-3M plus Model WA-P2 pre-amplifier. Shpg. Wt. 37 Lbs. Express only... \$69.50

HEATHKIT 7-WATT AMPLIFIER KIT

This amplifier is more limited in power than other Heathkit models, but it still qualifies as a high-fidelity unit, and its performance definitely exceeds that of many so-called "high-fidelity" phonograph amplifiers. Using a tapped-screen output transformer of new design, the Model A-7D provides a frequency response of $\pm 1\frac{1}{2}$ DB from 20 to 20,000 CPS. Total distortion is held to a surprisingly low level. Output stage is push pull, and separate bass and treble tone controls are provided. Shpg. Wt. 10 lbs.

MODEL A-7E: Similar to the A-7D, except that a 12SL7 tube has been added for pre-amplification. Two inputs, RIAA compensation, and extra gain.

MODEL A-7D

\$17⁹⁵

INCLUDING NEW EXCISE TAX

\$19.95⁺

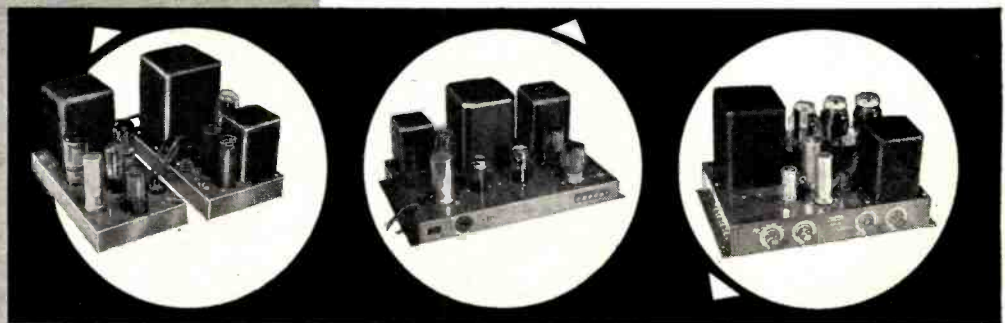

HEATHKIT SINGLE CHASSIS—WILLIAMSON TYPE HIGH FIDELITY AMPLIFIER KIT

The 20-watt Model W-4AM Williamson type amplifier is a tremendous high-fidelity bargain. Combining the power supply and main amplifier on one chassis, and using a special-design output transformer by Chicago Standard brings you savings without a sacrifice in quality. Employing 5881 output tubes, the frequency response of the W-4AM is ± 1 DB from 10 CPS to 100 kc at 1 watt. Harmonic distortion is only 1.5% at 20 watts. Output impedance is 4, 8, or 16 ohms. Hum and noise are 95 DB below 20 watts.

MODEL W-4AM: Shpg. Wt. 28 Lbs. Express only... \$39.75

MODEL W-4A: Consists of Model W-4AM plus Model WA-P2 pre-amplifier. Shpg. Wt. 35 Lbs. Express only... \$59.50

HEATHKIT 20-WATT HIGH FIDELITY AMPLIFIER KIT

This high-fidelity amplifier features full 20-watt output using push pull 6L6 tubes. Built-in preamplifier provides 4 separate inputs, selected by a panel-mounted switch. It has separate bass and treble tone controls, each offering 15 DB boost and cut. Output transformer is tapped at 4, 8, 16, and 500 ohms. Designed primarily for home installations, but also used extensively for public address applications. True high-fidelity performance with frequency response of ± 1 DB from 20 CPS to 20,000 CPS. Total harmonic distortion only 1% (at 3 DB below rated output).

MODEL A-9B

\$35⁵⁰

Shpg. Wt. 23 lbs.



HEATH COMPANY

A Subsidiary of Daystrom, Inc.

BENTON HARBOR 15, MICH.

All prices marked with a † include a new federal excise tax that now applies to receivers, tuners and some amplifiers, even though they may be in kit form. Since the tax is in effect as of July 5, 1956, we have no choice but to reflect it in our kit prices. This note is just to let you know we are not increasing our prices on some kits, but merely including this new tax in them.

Thank you,
HEATH COMPANY

HEATHKIT HIGH FIDELITY

Range Extending
SPEAKER SYSTEM KIT

- * High quality speakers of special design — 15" woofer and compression-type super-tweeter.
- * Easy-to-assemble cabinet of furniture-grade plywood.
- * Attractively styled to fit into any living room. Matches Model SS-1.



MODEL
SS-1B

\$99⁹⁵

Shpg. Wt. 80 lbs.

This range extending unit is designed especially for use with the Model SS-1 speaker system. It consists of a 15" woofer, providing output between 35 and 600 CPS, and a compression-type super-tweeter that provides output between 4,000 and 16,000 CPS. Cross-over frequencies are 600, 1,600, and 4,000 CPS. The SS-1 provides the mid-range, and the SS-1B extends the coverage at both ends of the spectrum. Together, the two speaker systems provide output from 35 to 16,000 CPS within ± 5 DB. This easy-to-assemble speaker enclosure kit is made of top-quality furniture-grade plywood. All parts are pre-cut and pre-drilled, ready for assembly and the finish of your choice. Complete step-by-step instructions are provided for quick assembly by one not necessarily experienced in woodworking. Coils and capacitors for proper cross-over network are included, as is a balance control for super-tweeter output level. The SS-1 and SS-1B can provide you with unbelievably rich audio reproduction, and yet these units are priced reasonably. The SS-1B measures 29" H. x 23" W. x 17½" D. The speakers are both special-design Jensens, and the power rating is 35 watts. Impedance is 16 ohms.

HEATHKIT HIGH FIDELITY SPEAKER SYSTEM KIT



MODEL
SS-1

\$39⁹⁵

Shpg. Wt. 30 lbs.

This speaker system is a fine reproducer in its own right, covering 50 to 12,000 CPS within ± 5 DB. However, the story does not end there. Should you desire to expand the system later, the SS-1 is designed to work with the SS-1B range extending unit — providing additional frequency coverage at both ends of the spectrum. It can fulfill your present needs, and still provide for the future. The SS-1 uses two Jensen speakers; an 8" midrange-woofer, and a compression-type tweeter. Cross-over frequency is 1,600 CPS, and the system is rated at 25 watts. Nominal impedance is 16 ohms. The cabinet is a ducted-port bass-reflex type. Attractively styled, the Model SS-1 features a broad "picture-frame" molding that will blend with any room decorating scheme. Pre-cut and pre-drilled wood parts are of furniture grade plywood. The kit is easy-to-build, and all component parts are included, along with complete step-by-step instructions for assembly. Can be built in just one evening, and will provide you with many years of listening enjoyment thereafter.

- * Special design ducted-port, bass-reflex enclosure.
- * Two separate speakers for high and low frequencies.
- * Kit includes all parts and complete instructions for assembly.

HEATH COMPANY A Subsidiary of Daystrom, Inc. BENTON HARBOR 15, MICH.

ORDER
BLANK

NOTE: All prices subject to change without notice.

Enclosed find () check () money order for _____ Please ship C.O.D. () postage enclosed for _____ pounds.

On Express orders do not include transportation charges — they will be collected by the express agency at time of delivery.

ON PARCEL POST ORDERS include postage for weight shown. ORDERS FROM CANADA and APO'S must include full remittance.

Name _____

Address _____

City & Zone _____ State _____

(PLEASE PRINT)

SHIP VIA

- Parcel Post
- Express
- Freight
- Best Way

QUANTITY	ITEM	MODEL NO.	PRICE

HOBBYISTS...EXPERIMENTERS!

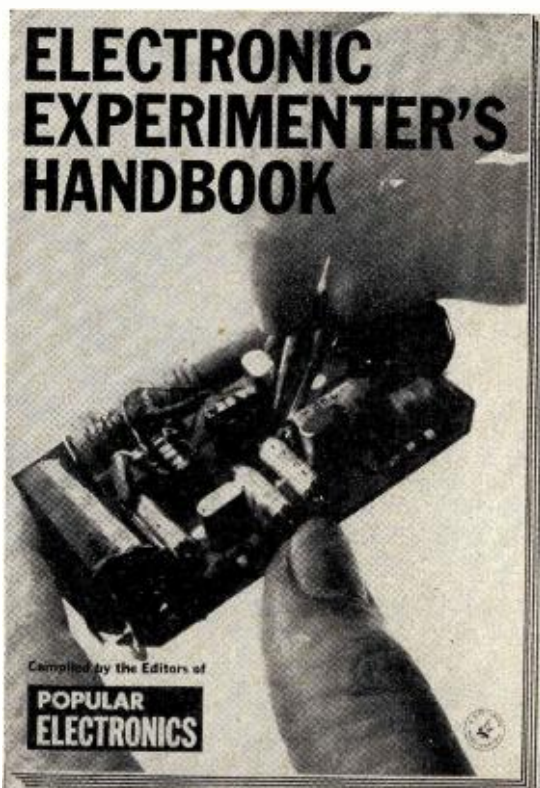

Compiled by the Editors of POPULAR ELECTRONICS

LEARN HOW TO BUILD:

- Your Own AM Hi-Fi Tuner
- Thermistor Fire Alarm
- Electronic Gardening Gadgets
- A Device That Kills TV Commercials
- Electronic Toys
- Geiger Counter
- Transistorized Light Meter
- Your Own Lie Detector
- PLUS DOZENS OF OTHER HANDY, EXCITING ELECTRONIC DEVICES

**BUY YOUR COPY OF THE
ELECTRONIC EXPERIMENTER'S HANDBOOK**

**ON SALE SOON
AT YOUR FAVORITE NEWSSTAND!**

Price: \$1.00

Ziff-Davis Publishing Company
366 Madison Avenue
New York 17, New York



Ninth National ARRL Convention

*International YLRL meet to
be held concurrently at the
Palmer House in Chicago.*

The Ninth National ARRL Amateur Radio Convention, sponsored by the Chicago Area Radio Council, Inc. will be held over the Labor Day weekend (August 30, 31, and September 1) at Chicago's Palmer House. The Second Annual International Convention of the Young Ladies Radio League will be held at the same time in the same place.

It has been nineteen years since Chicago has played host to a national ham radio convention and the CARC has made elaborate and extensive plans for the entertainment of its guests.

The committee has arranged for special rates at the hotel, which has turned three floors over to the meet and the exhibits and activities which will be scheduled. Emphasis has been placed on making the convention a "family affair" with many special activities planned for XYL's and junior ops.

A day nursery will be organized and staffed by qualified personnel so that junior-junior ops can be accommodated.

Registration for the convention is \$10.50 when made by mail in advance and \$12.50 if made on the day of arrival. The fee includes admittance to all activities of the convention, the Saturday night show, and Sunday night banquet. Registration for those not attending the banquet is \$5.50 (in advance) and \$6.50. Registration application and payment should be sent to the Treasurer, Chicago Area Radio Council, Inc., P.O. Box 6797, Chicago, Ill. Requests for hotel reservations are to be made direct with the Palmer House, Chicago, Ill. In order to qualify for the special rates, all such reservations should be addressed ARRL National Convention in care of the hotel.

General manager of the Convention Committee is Jordan Kaplan, W9QKE. The treasurer is Bill Traxler, W9FUJ. The committees are chaired by the following: Exhibits, Fritz Franke; Hotel, Bud Balaste, W9QCR; Program, Phil Haller, W9HPC; YLRL, Cris Bowlin, W9LOY; Food, Ed McMullin, K9AXK; Legal, Bill Peterson, W9VTV; Doc Kryszinski, W9SQE; Novice License Exams, Bill Harper, W9BWM; Registration, George Nesbed, W9LQF; Contests, Lee Weaver, W9KCE; and Publicity, Spencer Allen, W9JGL.

The program planned for convention goers will include tours of electronic industries, exhibits, a "kaffee klatch," floor shows, dinners, and a "Wouf Hong" initiation. Everything except the tours will be all under one roof—for convenience and maximum participation by the conventioners.

Just Printed! Send for this

FREE

booklet today!

see
what the
rapidly
expanding
field of
ELECTRONICS
offers
you

- BETTER JOB
- BETTER PAY
- PROMOTION
- GREATER SECURITY
- GREATER CONFIDENCE
- BETTER LIVING FOR YOU AND YOUR FAMILY

All these benefits can be yours if you act now! Take that first big step this minute—No obligation whatsoever!

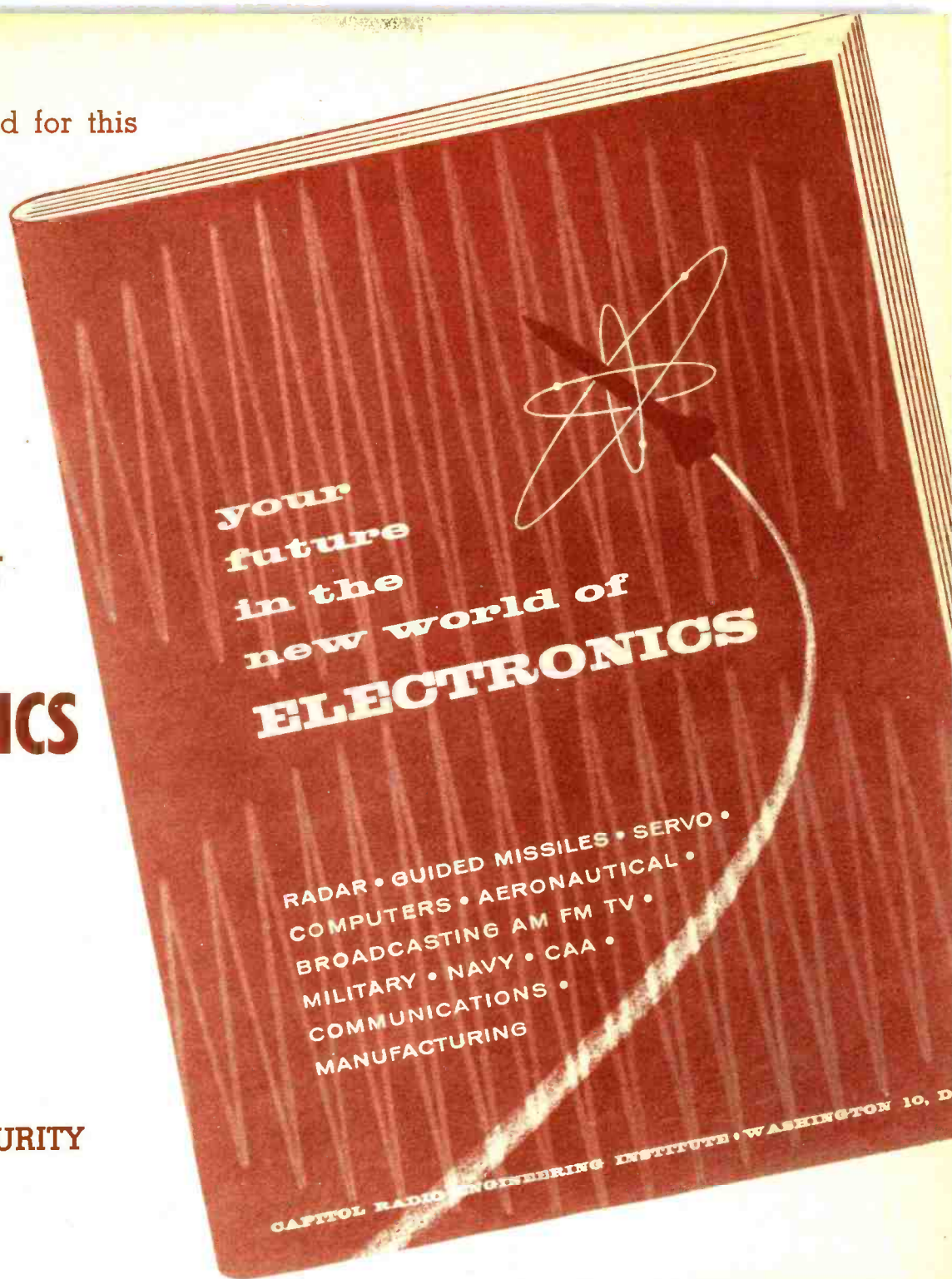

MAIL THIS POSTAGE-FREE POSTCARD TODAY

CAPITOL RADIO ENGINEERING INSTITUTE

ECPD Accredited Technical Institute Curricula

3224 16th St., N. W., Washington 10, D. C.

(R.N. Apr. '57)

HB

Please send me your course outline and FREE Illustrated Booklet "Your Future in the New World of Electronics"... describing opportunities and CREI home study courses in Practical Electronic Engineering.

- CHECK FIELD OF GREATEST INTEREST
- Practical Radio Electronics Engineering
 - Broadcast Radio Engineering (AM, FM, TV)
 - Practical Television Engineering
 - Practical Aeronautical Electronics Engineering

Name..... Age.....

Street.....

City..... Zone..... State.....

Check: Home Study Residence School Korean Veteran

To help us answer your request intelligently, please give the following information:

EMPLOYED BY.....

TYPE OF PRESENT WORK.....

SCHOOL BACKGROUND.....

ELECTRONICS EXPERIENCE.....

IN WHAT BRANCH OF ELECTRONICS ARE YOU MOST INTERESTED?.....



The data that Launched Thousands of Careers is yours **FREE**

Tells how you can be successful in **RADIO-TV-ELECTRONICS**

Send for Your Free Copy Today!

You can plod along for years, getting paltry increases, enjoying little security, finding your work dull and drab.

Then something happens. Things look up. Your earnings rise.

"Luck," some may say. "Contacts," others may suggest.

But in your heart, you will know the answer: "Training." And it all may have started the moment you sent for a free booklet, "Your Future in the New World of Electronics." This booklet tells you where you stand in Electronics.

Tremendous expansion leaves this gigantic industry pleading for trained men. Top manufacturers sold billions of dollars worth of electronic merchandise in 1956. By 1960, the radio-electronics industry should do no less than 15 billion dollars per year, not counting military orders.

Today, there are over 132,000,000 radios in use. There are 38,000,000 TV sets and 477 TV stations in operation. Color TV is coming into high gear. Countless positions must be filled—in development, research, design, production, testing and inspection, manufacture, broadcasting, telecasting and servicing. What do these statistics mean to you? To fill these posts, trained men are needed—men who somewhere along the line take time to improve their knowledge, their skills. Men who, today, perhaps, take two minutes to send for a booklet.

"Your Future in the New World of Electronics" shows how CREI Home Study leads the way to greater earnings through the inviting opportunities described above.

However, CREI does not promise you a "snap." With an accredited technical course such as this, you must *study* to convert your ambition into technical knowledge you can sell in the fabulous Electronics employment market.

Since 1927, CREI has provided thousands of professional electronics men with technical educations. During World War II CREI trained thousands for the Armed Services. Leading firms choose CREI courses for group training in electronics, among them United Air Lines, Canadian Broadcasting Corp., Trans-Canada Airlines, Douglas Aircraft Co., Glenn L. Martin Co., Columbia Broadcasting System, All-American Cables and Radio, Inc., Gates Radio Co., Canadair Ltd., Federal Electric Corp. and U. S. Information Agency (Voice of America).

CREI courses are prepared by recognized experts, in a practical, easily understood manner. You get the benefit of time-tested study assignments, of personal supervision of a CREI Staff Instructor who *knows* and *teaches* you what industry wants. You learn on your own time, during hours selected by you. This complete training is the reason graduates find CREI diplomas keys-to-success in Radio, TV and Electronics. CREI alumni hold top positions in America's leading firms. CREI's Placement Bureau finds better positions for advanced students and graduates. Although CREI does not guarantee jobs, requests for personnel far exceed current supply.

Now is the time of decision. Luck will not propel you forward unless it finds you trained. Contacts won't budge you an inch unless you have the skill to back

them up. The answer is: Technical Training . . . and willingness to learn. Together they will bring you increased earnings in this new Age of Electronics. Fill out the postage-free reply card and mail it now. We'll promptly send you your free copy of "Your Future in the New World of Electronics." The rest—your future—is up to you.

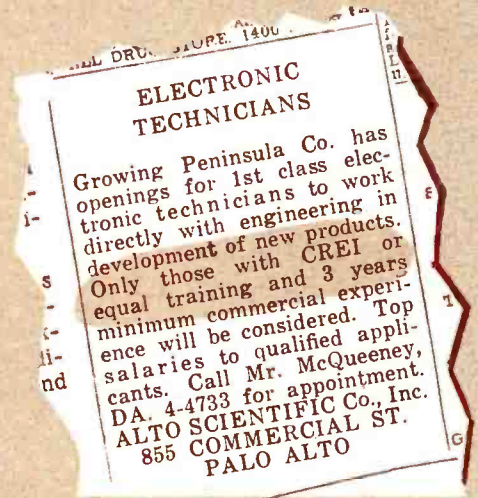

Industry Calls For CREI Training By Name

SO SHOULD YOU!

Here you see an actual help-wanted ad, one of many which specify "CREI or equal" training. This proves that industry approves CREI training, even insists on it!

CREI ALSO OFFERS RESIDENCE TRAINING
CREI Residence School in Washington, D.C. offers training at same high technical level. Classes start at regular intervals. Qualified residence school graduates earn degree: "Associate in Applied Science." Check coupon if you prefer residence study.

KOREAN WAR VETERANS
If you are eligible for training under the new G.I. Bill of Rights, check the coupon for full information.

1st Class

Permit No. 288-R

Sec. 34.9 P.L.R.

Washington, D. C.

BUSINESS REPLY CARD

No Postage Stamp Necessary If Mailed in United States

3c Postage Will Be Paid By

CAPITOL RADIO ENGINEERING INSTITUTE

3224 16th Street, N.W.

Washington 10, D. C.

Additional Notes on "Professional Tape Recording Amplifier"

By MAURICE P. JOHNSON

Parts location, component substitution, and improved equalization for circuit in December, 1956 issue.

A GREAT deal of correspondence from readers since the author's article on "A Professional Tape Recording Amplifier for Home Hi-Fi Systems" appeared in the December, 1956 issue of this magazine indicates that there is much interest in such a home-constructed amplifier. The following material is supplied to assist those who have written and others intending to duplicate the unit.

The exact tube and component placement on the chassis is not entirely obvious from the photographs, and reference to the figure will clarify this. Although a standard 7" x 11" x 2" chassis was used, there apparently has been difficulty in obtaining a cabinet for the 7" x 13" panel. The developmental model utilized a cabinet salvaged from an old *Heathkit* audio generator, model AG-8. This cabinet was available as a replacement part from the *Heath Company*. An easy solution to the problem is to use a 7" x 12" panel in combination with the easily obtained cabinets in this size. The *Bud C-994* is typical.

The enclosed power transformer and choke can be approximated in the *UTC* hermetic sealed "H" series. The H-81 transformer and the H-71 choke will be suitable. Where economy is desired, at the expense of some shielding, the *Merit P-3150* transformer and C-2976 choke will suffice.

Some readers apparently have experienced difficulty in locating the *Pentron* tape deck and oscillator coil. The tape deck has recently been replaced by the redesigned *Pentron TM-56*, which is similar except for the single lever shift control. This current production model is available at parts suppliers, and may be used instead of the 9T-3M. The oscillator coil is available from *Pentron Corporation*, 777 S. Tripp Ave., Chicago 24, Ill., as part No. 311-A-13. The coil is sometimes supplied unshielded, but this is of no great concern.

The *J. W. Miller Company*, Los Angeles 3, Calif., makes an excellent oscillator coil for 60 kc. operation, which is catalogued as the No. 1887-A.

An alternate deck and oscillator coil can be obtained from *Viking of Minneapolis*. Both have been described in detail in the February, March, April, and May, 1956 issues of this magazine. The splendid "Dynamu" heads are

used. The FF-75R deck and D-501 oscillator coil can be substituted for the *Pentron* items, with somewhat extended frequency response. Replacement "Dynamu" heads can be fitted to *Pentron* decks, for those interested.

The foregoing information should help those with procurement problems. Some additional consideration will now be directed toward the equalization problems. The articles on "Tape Recording-Equalization" by Herman Burstein in the January and February, 1956 issues have covered the factors to be considered when equalizing for tape. The NARTB standards apply to 15 ips tape speeds, but the recent trend has been to adopt the same turnovers and curve directly for 7.5 ips as well. This evidently is a satisfactory interim curve for the home

(A) Component layout in top-chassis view. (B) Improved playback equalization and (C) improved recording equalization circuits.

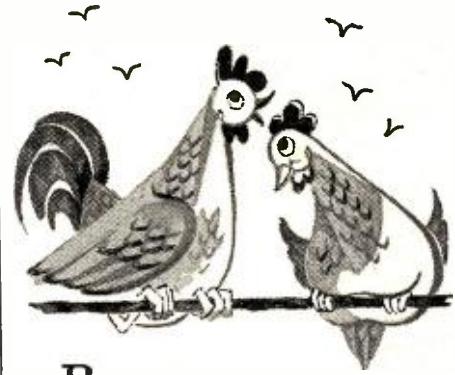
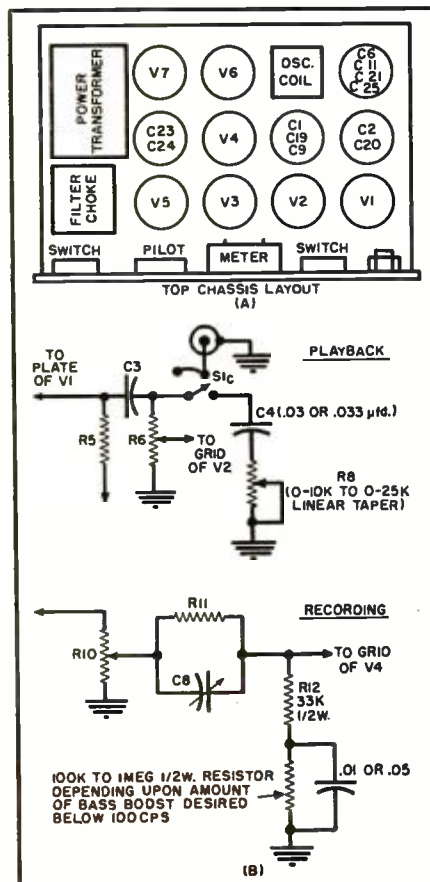

Birds of a feather
flock together,
And so will pigs
and swine;



Rats and mice
will have their choice,
And so will I
have mine.

My choice is Norelco,
Speakers, of course,
The reason I'm honored
to tell;
Few other speakers are
quite as true,
Or will please you
half as well.

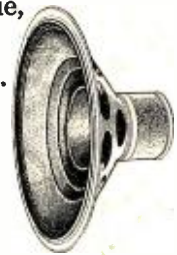

Norelco *FLR* Speakers are available in 5", 8" or 12" sizes in standard impedances. Priced from \$6.75 to \$59.98. Blueprints are available for the do-it-yourself enclosure builder. *Norelco Enclosures* are available in three sizes, priced from \$33.75 to \$119.95.

ADD TO... and improve any sound system with *Norelco*®
*FULL RESPONSE SPEAKERS

Write today to Dept. G4 for brochures and prices of these unique speakers.



NORTH AMERICAN PHILIPS CO., INC.
100 E. 42nd St., New York 17, N.Y.

Building Blocks by **BOZAK** *The Very Best in Sound...*

With these three simple elements you can build your speaker system, step-by-step if you wish, into the crowning achievement in the re-creation of sound — a Bozak B-310 or B-400. Infinite baffling means unlimited flexibility — and at each stage of growth the sound is unchallenged in its class.



**B-207A
COAXIAL
SPEAKER**

A complete wide-range two-way speaker system: 40 to 16,000 cycles, 8 Ohms, 15 Watts or more. Use in multiples to extend bass range and increase power-handling capacity.

**B-209
MID-RANGE
SPEAKER**



The only speaker made specifically for the middle frequencies. For maximum precision in the middles, add it to one or more B-207A's.



**N-10102
CROSSOVER
NETWORK**

Adaptable to one-woofer and two-woofer three-way systems by a simple change in connections; for four woofers add the N-25 Condenser Bank.

Complete systems are available factory-assembled in infinite-baffle enclosures, or you can build your own from plans on request. The 5-cu-ft E-300 cabinet comes as a complete kit for only \$42.50

Quality Loudspeakers

BOZAK

THE R. T. BOZAK SALES COMPANY
Box 966 • Darien • Connecticut

EXPORTS: Electronics Manufacturers'
Export Company • Plainview • New York

system, particularly until definite industry standards are established. This technique is adopted by *Viking* in its designs.

The frequency response of the original design with *Pentron* heads and the original equalization will be within ± 2 db from 50 to 10,000 cps, and may be acceptable for many uses. However, in the light of recent trends, the equalization may be made to conform more closely to the NARTB standards by a few minor changes. It is suggested that Mr. Burstein's articles be studied to familiarize the reader with the reasons for the curve adopted in the standards with regard to distortion, optimum induction, and the like.

Irrespective of the equalization used, it should be pointed out that resistor R_{12} is in error, and should be a 33,000 ohm, $\frac{1}{2}$ watt unit to provide proper treble boost above 1 kc. This correction should be made by any builder of the amplifier.

Some boost in the extremely low bass is added below 100 cycles during recording in the NARTB technique. This can be accomplished by adding an RC boost circuit between the low end of R_{12} and ground. This is shown as the .01 μ fd. capacitor and shunting resistor in the schematic diagram.

To correct the playback curve to conform to the NARTB standard, the value of C_4 should be fixed at .03 or .033 μ fd. and resistor R_8 replaced with a variable control, with linear taper, range of 0-10,000 or 0-25,000 ohms. This control may be located on the panel as the extreme left control marked, in the original front panel photo, "Playback Roll-off." This will replace the original roll-off control which was not found necessary, as explained in the article.

This playback equalization circuit will provide better adjustment of the curve slope from 100 to 10,000 cycles and, in particular, permits adjusting the high end to closer conformity with the NARTB curve. The NARTB standard shows the boost at 50 cycles to be about 23 db above the level at 1 kc., and 10 kc. to be about 10 db down referred to 1 kc. This is a total slope change of about 33 db over this range. With R_8 made variable, the over-all slope varies from about 24 to 35 db change over this region.

The cathode boost and adjustable C_6 - R_{11} network will permit adequate adjustments to the high-frequency recording curve to match the new standard.

Mr. Burstein has suggested that those experiencing difficulty with the *Pentron* erase oscillator may try reducing the value of the grid resistors. However, the author has been securing better than 40 db erasure with the circuit as described and this value seems typical with single gap low power erase heads. Bulk erasers are useful for even better erasure.

It is hoped that this additional information will assist those persons constructing this amplifier.

POWERING 4 OUT OF 5 of the world's greatest amplifiers



the

Amperex® 6CA7/EL34

HIGH-POWER OUTPUT PENTODE

High-fidelity authorities are not in agreement as to which is "best" among the handful of genuinely great power amplifier designs available today. But one thing they know for sure—at least 4 out of 5 of the contenders have 6CA7/EL34's in the output stage. No other comparable tube combines to the same degree the 6CA7's exceptional linearity, high power dissipation and low drive-voltage requirements. It is a true pentode design, with a separate suppressor grid that controls the space charge, resulting in greater linearity on reactive speaker loads than is possible with competitive beam-power tetrodes. A single pair of 6CA7's in push-pull has been successfully used in power amplifiers delivering up to 100 watts undistorted output.

OTHER **Amperex TUBES** FOR
HIGH-FIDELITY AUDIO APPLICATIONS:

- EL84/6BQ5 9-pin power pentode; 17 W PP
- EF86/6Z67 Low-noise high- μ pentode
- ECC81/12AT7 Low-noise medium- μ dual triode
- ECC82/12AU7 low-noise low- μ dual triode
- ECC83/12AX7 Low-noise high- μ dual triode
- GZ34 Cathode-type rectifier; 250 ma.
- EZ80/6V4 9-pin rectifier; cathode; 90 ma.
- EZ81/6CA4 9-pin rectifier; cathode; 150 ma.

At All Leading Electronic
Parts Distributors

**Amperex
ELECTRONIC CORP.**

230 Duffy Ave., Hicksville, Long Island, N.Y.

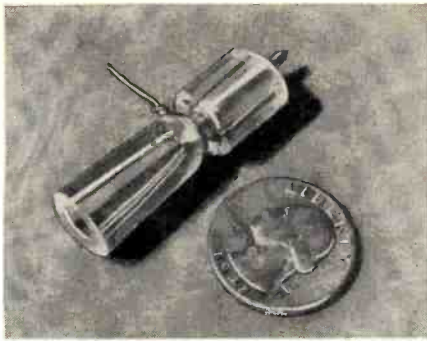

Small quartz cell, not much bigger than a quarter, is heart of new ionic loudspeaker which uses ionized air instead of diaphragm to produce high frequency sound.

Ionic Cloud High-Frequency Speaker

*Ionized air replaces cone
in treble, ultrasonic unit.*

ALTHOUGH the ionic loudspeaker is not new, this type of unit, which uses ionized air in place of the usual diaphragm, has not been widely produced in this country. Recently, however, the *DuKane Corp.* of St. Charles, Illinois, began the manufacture of its version of the ionic loudspeaker, called the "Ionovac."

While the product is being offered initially to the high-fidelity market as a loudspeaker for the more expensive record players and radios, its applications as a generator of ultrasonic waves for use by a wide variety of industries is considered of even greater importance.

Heart of the new device is a small open-ended quartz cell the size of a peanut shell. Air is cupped in a chamber which narrows down to an aperture about the size of an automatic pencil lead. Within this small space, air molecules are bombarded with a high-frequency, high-voltage signal which ionizes the air. The resulting ionized cloud, which glows with a violet hue, takes the place of the usual diaphragm and generates sound directly in much the same way as the old "singing arc." Since the only thing in motion is the air itself, problems resulting from cone resonance or other vibration characteristics are eliminated.

Primarily, the "Ionovac" was developed as a variable generator of both audible and ultrasonic waves—from 1000 cps to 1 mc. With the recently increasing applications of ultrasonics to a good many industries, the manufacturer of the new transducer expects to find many uses for the ultrasonic-producing ability of the "Ionovac." —30—

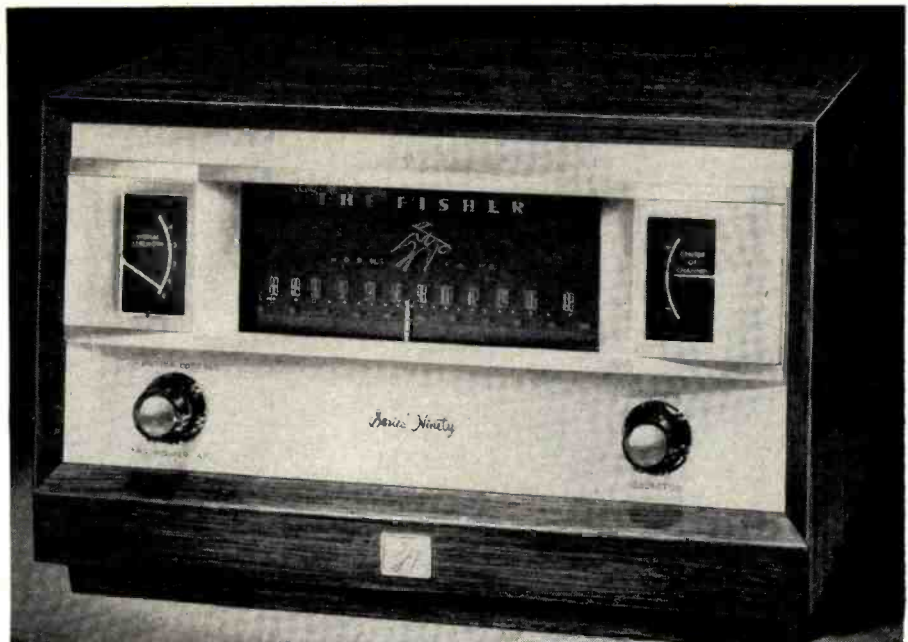

AMERICA'S LEADING FM TUNER • IN SENSITIVITY, APPEARANCE AND WORKMANSHIP

THE ABSOLUTE SENSATION
OF THE
LOS ANGELES and SAN FRANCISCO
HIGH FIDELITY SHOWS!

THE FISHER Gold Cascode FM Tuner FM-90X

THE EXCITING RECEPTION bestowed upon the new FISHER FM-90X on the occasion of its recent introduction, was unanimously supported by the ovation accorded it at the Los Angeles and San Francisco high fidelity shows! The revolutionary GOLD CASCODE RF amplifier, and exclusive FISHER circuitry, has brought the FM-90X to the theoretical limits of sensitivity — an achievement never before possible. This tube is the costliest of its type in the world — and it carries a two-year warranty. *Only THE FISHER has it!* The standard FM-90, with its silver-plated RF shield, already surpasses ALL other FM tuners — excepting the superb, new FISHER GOLD CASCODE 90X.

Basic Features of the Series FM-90

- TWO meters, for micro-accurate tuning. • Revolutionary, dual dynamic limiters, assure noise-free reception where all others fail. • Full wide-band detector for maximum capture ratio. • *Exclusive*, variable inter-station noise eliminator. • Full limiting on signals as low as 1 microvolt. • Dual triode, cascode-tuned RF stage, four IF stages. • Uniform response, 20 to 20,000 cycles. • Three outputs (Main, Recorder and Multiplex). • Dual antenna inputs (72 ohms or 300 ohms balanced). • Four controls. • 10 tubes plus four matched germanium crystal diodes. • Special circuits for meter operation. • Chassis completely shielded and shock-mounted. • Beautiful, die-cast, brushed brass escutcheon and control panel. • Dipole antenna supplied.

• SIZE: 13 7/16" w. x 6 1/4" high x 8 3/4" deep (plus 1" for knobs). • wct: 15 lbs.

FM-90X • Gold Cascode FM Tuner • \$169.50
FM-90 • Professional FM Tuner • \$149.50

MAHOGANY OR BLONDE CABINET: \$17.95

Prices Slightly Higher in the Far West

WRITE TODAY FOR COMPLETE SPECIFICATIONS

FISHER RADIO CORP., 21-23 44th DRIVE • L. I. CITY 1 • N. Y.

Europe's
largest selling
electronic tubes
... and at standard prices!

TELEFUNKEN

electronic pioneer
since 1903



**NOT A REPLACEMENT
BUT AN IMPROVEMENT!**

**NO
RETURNS
NO
MICROPHONICS
NO
DISTORTION
NO
COMPROMISE
WITH
QUALITY**

Write for your Telefunken Tube Manual and
for the name of your nearest jobber.

Exclusively imported by

AMERICAN ELITE, INC.

Dept. X, 7 Park Avenue, New York 16, N. Y.

Exclusive importers also of Hi-Fi Home Systems,
Microphones and Hi-Fi FM Car Radios.



Wireless FM Microphone

*Provides high quality sound
pickup for stage, radio, and
TV via special receiver.*

Bert Berlant, president of Stephens Tru-Sonic Inc., demonstrates his company's new FM wireless microphone transmitter.

A MAJOR production run on a new wireless microphone system has recently been completed by *Stephens Tru-Sonic Inc.*, Culver City, California. The system comprises a miniature FM transmitter, which is highly portable, along with a special FM receiver, power packs, and monitoring amplifier. The unit is designed for high-fidelity sound pickup on the stage, in night clubs, radio and television, motion picture, industrial, and law enforcement applications.

The transmitter is slightly smaller than a package of cigarettes, weighs about 4 ounces, and is easily concealed either on one's person or in a room or stage setting. Designed to be used independently, through a public address system, or for recording, the unique system has numerous uses where a good quality sound pickup is required.

The transmitter radiates about 20 mw. of FM signal on an assigned frequency of 42.98 mc. A small pressure-sensitive capacitor microphone built into the transmitter forms part of the Hartley oscillator (see schematic below). Variations in sound pressure thus produce changes in oscillator frequency at a rate equal to that of the frequency of the sound source. This oscillator is capacitively coupled to a doubler which operates at the second harmonic of the oscillator frequency. Deviation produced in the oscillator is thus multiplied by a factor of 2. A quarter-wave antenna (a fine flesh-colored wire permanently connected to the transmitter) is conductively coupled at the proper point on the tank circuit of the doubler, while the transmitter battery cable and battery act as the ground plane for the antenna system.

The separate receiver uses its own antenna which may be connected to its grounded-grid input stage via a 50-foot coax cable. The receiver is a complete superhet lacking only the audio power output stage. A conventional Armstrong discriminator is used along with two limiters. An a.f.c. circuit is

included to prevent loss of tuning along with an audio squelch circuit to eliminate objectionable noise when the transmitter carrier is not on. Metering facilities are provided to measure incoming carrier strength and proper tuning. The output of the discriminator is fed to a cathode-follower stage, whose output is transformer coupled. The transformer provides a completely isolated output and its leads may be strapped for any conventional transmission line impedance.

The transmitter power supply is a battery pack for portability. The receiver, however, is powered by an a.c. power unit that not only supplies operating voltages but also provides audio amplification for a built-in monitor loudspeaker.

Two models of the complete system are available. One has a range of about 1500 feet, with a useful transmitter battery life of 2 hours continuous (employing the 10 ounce personal battery pack). A larger battery supply is available whose life is 20 hours continuous. The second system has a 500-foot range and a battery life of 6 hours with the small pack. This latter system uses two CK-5672's in the transmitter. The price of the longer range unit is \$1060 complete, while the other unit sells for \$980. —30—

Diagram of transmitter portion of the new Stephens wireless microphone system.

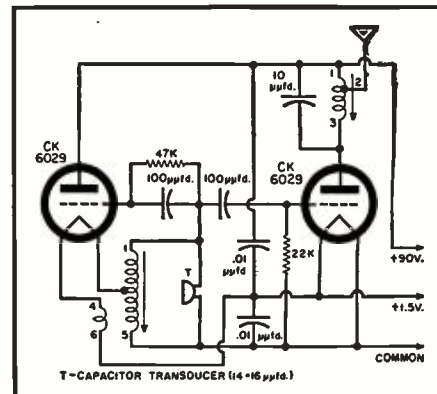

Certified Record Revue
(Continued from page 60)

tunity of hearing what a really great Wagnerian soprano sounds like. With the loving and harmonious support of Knappertsbusch and the Vienna Philharmonic, Flagstad gives what is certainly the performance of choice of the "Wesendonck Lieder". Superbly clean recording with the slight reservation that I would have preferred somewhat closer microphoning of her voice and an acoustic perspective a shade less expansive. If you love singing, don't miss this disc!

BEETHOVEN

SYMPHONY #9
Elizabeth Schwarzkopf, Hans Hopf, Elizabeth Hongen, Otte Edelman, soloists with Beyreuth Festival Chorus and Orchestra conducted by Wilhelm Furtwangler. RCA Victor LM6043. RIAA curve. Price \$7.96. Two discs.

This is certainly one of the most unusual performances of the "9th" on records. Purists will not like it, nor those who want the excitement and drive of Toscanini. The late great Furtwangler was much given to mannerisms and this performance is full of them and other conductorial eccentricities. It is slow paced in some sections, overly fast in others, he uses odd *ritards* and *diminuendos*. Yet for all this, this remains a unique experience and any dedicated admirer of this work would be wise to listen to it. The soloists are better here than in almost any other recording, the chorus well-trained and full bodied. The performance is certainly not dull and, in fact, Furtwangler's conception of the final "Ode to Joy" has an electric excitement of its own. The sound is a bit restricted in frequency and dynamics as might be expected from the 1951 conditions under which it was recorded. For sound fanciers, this is not the "9th" for them . . . for connoisseurs of the "9th", worth looking into for the unusual approach.

SHOSTAKOVICH

SYMPHONY #1

PROKOFIEV

SCYTHIAN SUITE

Orchestre National de la Radiodiffusion Francaise conducted by Igor Markevitch. Angel 35361. RIAA curve. Price \$3.48 (standard package).

Here is a tasty coupling of works by Russia's two best known symphonists. The Shostakovich "1st" is the sixth edition of the work to appear in the LP catalogue and by all odds the best. Its only real competition is the Mitchell reading on *Westminster*, although from a strictly performance point of view, the old Rodzinski had much to recommend. Markevitch has a flair for Russian repertoire and he gives a taut, exciting reading with plenty of drive. Always a careful orchestral craftsman, his propulsive pace is leavened with regard for detail and dynamics, and he brings to the score a refreshing clarity of tone, almost wholly missing in the other versions. In the "Scythian Suite", a wild Prokofievan genuflection to the Stravinsky of "Le Sacre", he manages to make this rather self-conscious score an orchestral *tour de force*.

Hi-fi fans will delight in either work, as they are liberally sprinkled with percussion and plenty of brilliant brass. The sound is some of the finest we have had from Angel. Sharp, clean, and concise, with the strings having a fine rich bite to them, brass well modeled and cleanly defined, percussion in wide variety . . . bass drum, tympani, snares, triangles . . . extensive use of cymbal, all are crisply accurate. A splendid recording, al-



Beautifully **NEW**
in Sight and Sound

THE "Californian" SPEAKER ENCLOSURES
NOW IN KITS

The best engineered speaker cabinet we've ever built. Combines the new Jensen Bass Ultraflex* principle for improved tone plus long wearing St. Regis Panelite top for lasting beauty.

Jensen's new Ultraflex principle provides the newest assistance for low notes giving unbelievable richness of tone without booming and without damping the highs. Space for tweeter, if desired.

The wood appearance of the St. Regis Panelite top has the grain and color sealed in. It resists scratches, scuffing, cigarette burns, fruit acids, alcohol.

The "Californian" enclosures are available two ways—as regular factory built cabinets, or in easy-to-assemble pre-finished kits. Top and bottom of kits are all finished—no painting, varnishing, sanding or covering required.

AVAILABLE TWO WAYS	FACTORY BUILT	PRE-FINISHED KITS
The Californian . . . 24x29x15 inches deep For 12" or 15" speaker AUDIOPHILE NET	DSE-1 \$52.50	DSE-1K \$37.50
The Californian Jr. . . . 19½x23½x13½ in. deep For 8" or 12" speaker AUDIOPHILE NET	DSE-2 \$42.00	DSE-2K \$30.00
BLOND OR MAHOGANY FINISH, SAME PRICE.		
*TM of and Lic. by Jensen Mfg. Co.		

Argos
PRODUCTS COMPANY

310 MAIN STREET, GENOA, ILLINOIS

Craftsmanship in Cabinets

Ask Your Parts Distributor or write Dept. R for FREE Catalog

your present
speaker
in a

KARLSON TRANSDUCER

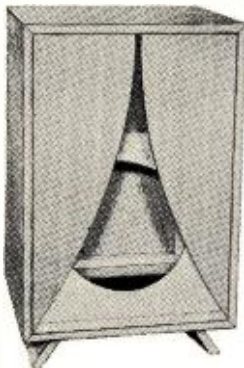

**CAN GIVE YOU
10x THE EFFICIENCY**

2x the dispersion!

2 more octaves bass!

Flatter response — Less distortion!

Unexcelled transient response!



IN EASY-TO-ASSEMBLE

KITS

Hardwood exteriors - capable
of fine furniture finish -
from \$18.60 to \$57 net.

Also assembled models from \$26.70 to \$174.

See Your Dealer or Write:

KARLSON ASSOCIATES INC.

Dept. RTN

1610 Neck Rd. Bklyn. 29, N. Y.



though I should mention that in my review copy, the beginning of part 4, "The Glorious Departure," etc., has some of the oddest background noise I have ever encountered. A sort of sputtery, popping sound of considerable amplitude, which doesn't affect the music at all, but which is most distracting nonetheless. Probably not in all copies, but defectives do occasionally slip by all companies' inspection departments, even the usually careful *Angel*.

WAGNER

DAWN AND SIEGFRIED'S RHINE
JOURNEY
SIEGFRIED IDYLL
PRELUDE TO PARSIFAL
TRISTAN AND ISOLDE (PRELUDE
TO ACT 3)

Detroit Symphony Orchestra conducted
by Paul Paray. Mercury MG50107.
RIAA curve. Price \$3.98.

Once again Frenchman Paul Paray exhibits his unexpected and extraordinary talent for the Wagnerian repertoire. Considered from all aspects, including sound, these are about the most satisfactory readings of these works on records. Paray has the happy knack of being able to extract the essential lyricism and drama of Wagner without over-romanticizing or wallowing in sentiment as do too many of his contemporaries. It is interesting to note how fine an orchestra the Detroit Symphony has become under Paray. The string work is really exemplary, woodwinds are excellent, brass more than equal to the severe demands of these works, percussion has long been outstanding for accuracy in this group. Typical fine-grained *Mercury* sound here, strings are quite lush, orchestral balance superb, dynamic and frequency range very wide, transients cleanly delineated. Acoustics properly spacious for the music involved. If you like Wagner, this is your dish of tea!

SHOSTAKOVICH

SYMPHONY #10 IN E MINOR
Czech Philharmonic Orchestra conducted
by Karel Ancerl. Decca DL9822. RIAA
curve. Price \$4.98.

Somehow I got my wires crossed with the *Decca Company* and I have not been able to report on their many fine recordings for some time. Happily all is straightened out now and *Decca* has been kind enough to supply me not only with their newer releases but with many older releases. So you will see *Decca* in these pages from now on, and bit by bit, we will review many of the older issues that I feel will be of interest to you, as well as the latest output.

One of the older and outstanding recordings is this reading by Karel Ancerl and the Czech Philharmonic of Shostakovich's latest symphony, his "10th in E Minor". This record gives us a fascinating glimpse of the Czech Philharmonic as recorded by *Deutsche Grammophon*. It is audibly obvious that this is a first class ensemble, ranking with the best in Europe. The precision and lushness of the string choirs is something to marvel at, the woodwinds are strong in depth, especially the fine oboe heard in the introduction to the fourth movement, brass is brilliant and weighty, with beautiful horns, percussion is alert and accurate.

Ancerl is a conductor of considerable attainments and he shows that he knows the Shostakovich idiom and its proper exposition. His reading is slower paced than his only real competition, the *Mitropoulos/Columbia* effort, and if his perusal of the score loses some of its excitement because of this, it has the advantage of making the work more cohesive. Actually, the scoring of this symphony calls for slow tempi in all but the brief scherzo and the last movement. Herein lies the danger, where dawdling could divest the work of its interest. Ancerl surmounts this success-

fully and this is, in general, a reading with more feeling than the *Mitropoulos* version. Soundwise this is very well balanced, and has a fine acoustic perspective, but I would have preferred more instrumental definition and a bit more punch and pungency. Well you can't have everything, and all things considered, a worthwhile recording.

HINDEMITH

SYMPHONIC METAMORPHOSIS ON
THEMES OF CARL MARIA VON
WEBER

THEME AND FOUR VARIATIONS
Berlin Philharmonic Orchestra con-
ducted by Paul Hindemith. Decca
DL9827. RIAA curve. Price \$4.98.

Another *Decca* record and a stunning disc. Hindemith is one of the few composers who can successfully conduct his own works. Here he lends his authority to the occasion and there is no question that these are the finest performances of these works. The "Theme and Variations" is not as well known as the "Metamorphosis", but I think most will find it an absorbing piece. The work of Hans Otte on the piano solo work in the "Theme" is outstanding for its rounded, robust tone and the engineers have cooperated with a piano/orchestral recording that is unusually "live" sounding. The "Metamorphosis" under Hindemith's direction is more deliberate than the competing readings . . . he gives some unity to the work with logical tempo transitions between the various sections, and gradually builds to the stirring power of the "March" finale. Big hall sound here, its sonic contours softer than the other versions, but imposing in its over-all grandeur.

DVORAK

CONCERTO FOR VIOLIN AND OR-
CHESTRA

Johanna Martzy, violinist with RIAS
Symphony Orchestra conducted by
Ferenc Friesay. Decca DL9858. RIAA
curve. Price \$4.98.

An entrancing concerto and one is hard put to understand why it is so neglected in the concert hall. It has lovely melody, shapely rhythms, interesting orchestration, and the soloist must cope with some difficult passages, which allows plenty of opportunity for a display of virtuosity. Martzy here shows surprising strength and fiber in her playing and is evidently thoroughly at home with the demands of the work. She has a rich tone, not too lean nor too fat and it is quite enjoyable. I find her approach as logical as Oistrakh's and her execution equally polished. Fricsay and the late, lamented RIAS orchestra furnish knowing and sympathetic accompaniment. With the wide range, cleanly delineated sound Martzy is afforded and the excellence of interpretation, this is the recording of choice.

BEETHOVEN

SYMPHONY #7
Philharmonia Orchestra conducted by
Otto Klemperer. Angel 35330. RIAA
curve. \$3.48 (standard package).

This reading of the Beethoven "7th" is sure to cause controversy. One cannot deny the excellence of the Philharmonia playing, nor the authority of Klemperer as a Beethoven interpreter, nor the splendor of the sound. These factors all weigh heavily in the evaluation of this recording and I personally like the weight and solidity of this reading. But I can hear plenty of howls about Klemperer's tempi. There is no doubt that this is quite the slowest-paced "7th" on records. I think his slow build-up has merit and when we get to the finale the pace he arrives at has more sense and dignity than in some other versions where the finale is whipped to a froth. For the sound enthusiast, this will please for its

RADIO & TV NEWS

massive impact, for others it will be a matter of taste. If you like the old Toscanini version this is not for you. Frequency and dynamic range here is wide, little if any, transient distortion. Huge sound, "big hall" acoustics, all however with no sacrifice of orchestral clarity.

CHARPENTIER
IMPRESSIONS D'ITALIE
 L'Orchestre de la Societe des Concerts du Conservatoire de Paris conducted by Albert Wolff. London LL1511. RIAA curve. Price \$3.98.

The second recording of this rarely heard work and the best. The *Angel* disc with Fouresterie was a pleasing performance, but here we have the irrepressible Albert Wolff, who takes this innocuous score and makes it an exciting and somehow different work. His tempi are faster than Fouresterie, but the music can stand it and is a much more winning piece conducted in this fashion. In four sections, hi-fi fans will particularly enjoy the pungent percussive scoring of the last movement with its wild "Tarantella". As is usual, a good deal of the success of any Albert Wolff recording is the superb sound he is afforded by the *London* engineers, and this is no exception. All is very wide in range, clean of line, and spacious in acoustics. An enjoyable "off-beat" disc in a light and charming vein.

BRUCKNER
SYMPHONY #5 IN B FLAT MAJOR
WAGNER
DAWN AND SIEGFRIED'S RHINE JOURNEY
SIEGFRIED'S FUNERAL MUSIC
 Vienna Philharmonic Orchestra conducted by Hans Knappertsbusch. London LL1527/8. RIAA curve. Price \$7.96. Two discs.

London continues its plan to record all of Bruckner's symphonies with this beautifully conceived "5th Symphony". Knappertsbusch is one of the major Bruckner interpreters and in this second version to appear on LP, he has the field clearly to himself. His tempi are judiciously chosen, his dynamics appropriate to the score, and he elicits playing of superb precision and beauty from the Vienna Philharmonic. This is one of Bruckner's more easily assimilated works, although still massive in concept. There are some fine Brucknerian melodies, a rather bumptious good-humored scherzo, and an overwhelming finale which is a masterpiece of contrapuntal writing. Knappertsbusch also has a knowing way with Wagner and his "Rhine Journey" is excellent and the "Funeral" music quite the most hugely proportioned on record, with sound to match. Sound in the Bruckner is imposing and weighty, but nonetheless wide range and clean in all aspects. Highly recommended.

THE PERCUSSIVE PHIL KRAUS
 Golden Crest Records CR3004. RIAA curve. Price \$3.98.

I LOVE ACCORDIONS
 Golden Crest Records CR3001. RIAA curve. Price \$3.98.

These are examples of the work of a new label whose studio is practically in my backyard in Huntington Station, L.I. This enterprising organization evidently does a great deal of custom and private tape-to-LP-transfer, which is what prompted them to issue a special recording on how to use a tape recorder. (This will be reviewed next month.) These recordings are their entry into the commercial field and I must say that they are putting their best foot forward.

The "Percussive" recording is doubly valuable... it's entertaining as light musical fare and it's a terrific demonstration record. In

April, 1957

Specifications

Description: The 121-C is a self-powered equalizer and preamplifier, complete with the dynamic noise suppressor.
Input Facilities: 2 magnetic inputs, switched on front panel; crystal or ceramic input; five high-level channels including provision for tuner, tape and TV sound. **Tape Recording and Monitoring:** Two special tape recorder output connections, plus monitor channel with monitor-playback switch. **Tape Playback:** Separate channel, with NARTB tape equalization, for playback of tape direct from tape heads. **Frequency Response:** Flat from 19 cps to 35 kc. **Total hum and noise:** On high level inputs 85 db below full output; on low level inputs, 3.2 microvolts equivalent noise input. **Dimensions in mahogany case:** 13½" x 5" x 2½" \$159.95 — Mahogany Case \$19.95.



**THE 121-C
 Dynaural Equalizer Preamplifier**

The most versatile control and compensation unit ever offered. It includes continually variable record equalizers and Scott's patented Dynamic Noise Suppressor.

**H. H. Scott presents
 Components for the Perfectionist**



H. H. Scott, Inc., 385 Putnam Ave
 Cambridge, Mass.

- The Most Versatile Control and Compensation Unit Ever Offered — The 121-C Dynaural Preamplifier.
- The Cleanest Sounding Power Amplifier Ever Developed — The "280" 80 Watt Power Amplifier.

**The "280" 80 Watt
 Laboratory Power Amplifier**

The 80-watt output of this superb amplifier provides ample power reserve for the most demanding applications. Its exclusive Dynamic Power Monitor affords full output on music, yet automatically protects expensive speakers against burnout.



Specifications

Power ratings: 80 watts on music wave-forms (short-time maximum r.m.s.); long-time continuous output 65 watts r.m.s. instantaneous peak output 160 watts. **Frequency response:** Flat from 12 cps to 80 kc. **Dynamic Power Monitor:** Reduces possibility of speaker burnout on overload by limiting maximum continuous output to any value desired between full power and 10 watts. **Speaker Damping control:** Permits continuous adjustment of output impedance to any value between 3% and 200% of load impedance. **Total Hum and Noise:** 90 db below full output. **Harmonic Distortion:** Less than 0.5%. **First-order difference tone IM distortion:** Less than 0.1%. **Outputs:** 3 to 24 ohms and 70 volt tap. \$199.95.
 Also from H. H. Scott: The "240" 40 Watt Laboratory Power Amplifier incorporating many of the features of the "280" ... only \$99.95

Complete H. H. Scott Amplifiers Start at \$99.95!

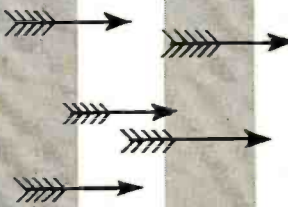

WRITE FOR YOUR FREE COPY OF H. H. SCOTT'S NEW CATALOG
 H. H. Scott, Inc., 385 Putnam Avenue, Cambridge, Mass.

Rush me your new catalog R-4 showing complete high fidelity systems for my home.

Name _____
 Address _____
 City _____ Zone _____ State _____

Export Dept: Telesco International Corp.
 36 W. 40th St., New York City

ARKAY Kits . . . lead the field



ARKAY MAKES TRANSISTOR HISTORY!

Specifications:
 Freq Range—540-1600 kc.
 Inter Freq—455 kc.
 Speaker—3 1/2" Alnico V
 Battery—13 1/2 volt
 Bat. Drain—5.5 Ma.
 Bat. Life—150 hrs.
 Power Output—75 millwatts. (max)
 Earphone Jack for pvt. listening
 Cabinet—High-impact styrene
 Dimensions—5 1/2" x 3 1/2" x 1 1/2"
 Antenna—Large Ferrite Rod
 I.F. Coils (3)—Slug tuned
 Osc. Coil—Slug tuned
 X1—Transistor—Converter
 X2—Transistor—1st I.F.
 X3—Transistor—2nd I.F.
 D1—Diode Detector
 X4—Transistor Audio Driver
 X5—Transistor Power Output



\$31.45

Fed. Ex. Tax Incl.
 Sportsman Carrying Case \$1.75

5 TRANSISTOR PRINTED CIRCUIT SUPERHET PORTABLE

The revolutionary TR-5 is an advanced engineered kit using 5 transistors & crystal diode. A full Superhet printed circuit board cuts wiring time to a minimum. Consists of a converter, 2 stages of I.F. amplification, diode detector, audio driver and class A power amp output stage. Subminiature components used throughout.



ARKAY Model 2X4 2 Band Portable

Top performing 2 Band AM. Shortwave. Dial shows countries transmitting. Kit utilizes 4 low drain-hi gain miniature tubes plus selenium rectifier for electric power. Tuning range 550-1600kc. 6-18mc. Size: 10 1/2"x7"x5 1/2" attractive leatherette cover. Complete with tubes, nuts, etc. except wire & solder & batteries. Easy-to-follow instructions. Uses 1 each Burgess 2x45, C5. For 110-120 volt 50-60 cycle AC-DC or batteries. . . . **\$26.75**
 Batteries for above \$3.16
 Fed. Ex. Tax incl.

ANOTHER ARKAY FIRST!!

SPECIFICATIONS:
 ELECTRICAL RATING—9-volt transistor energizer.

OPERATING FREQUENCIES: Tuning range—540 to 1620 KC. I.F. amplifier—455 KC.

POWER OUTPUT—275 + milliwatts.
SPEAKER—large alnico V permanent magnet.

TRANSISTOR COMPLEMENT: X1 oscillator-converter; X2 1st I.F. amplifier; X3 2nd I.F. amplifier; D1 diode detector-AGC take-off; X4 class B driver; X5 class B output; X6 class B output.
 Federal Excise Tax Included. **\$37.50**



TRANSISTORIZED PORTABLE SUPERHET RECEIVER
 The Model TR-6 is a newly designed all transistor portable superhet receiver push-pull Class B output providing clear crisp output better than 275 milli-watts. Construction is extremely simple because of the advanced engineering techniques employed in its design.



ARKAY Model HFT-7 Hi-Fi AM-FM Tuner

4 UV sensitivity for 20 db quieting. Automatic frequency control with provisions for AFC erase. Allows pinpoint, high selectivity tuning. Foster-Seeley discriminator, high efficiency AM loop stick antenna and temperature compensated oscillator circuit.
 New! Wired & Tested \$49.95
 Kit Less Cover. . . . \$32.00
 Cover for Above. . . . \$ 8.95
 FM Only. \$25.75
 Fed. Ex. Tax Incl.



NEW!
ARKAY MODEL FL-30 Hi-Fi AMP-PRE-AMP

SPECIFICATIONS:
 POWER—30 watts @ 1% IM.
 FREQ. RESPONSE ±1/2 db.—10-40,000 cps.
 HUM—120 db. below rated output.
CONTROLS—(6) Func. selector, loudness, bass, treble, level set, 5-position level compensation control.

Featuring a transistorized front end for use with a reluctance pick-up, this engineering masterpiece assures the finest in HI-FI reproduction. Record equalization for more than 30 labels (LP, RIAA, & EUR). Complete with rose gold panel and black cabinet. **KIT \$49.95**
WIRED & TESTED. \$74.95

FREE! Get the new, big catalogue & specifications of the remarkable ARKAY line—Now at your local dealer!
 Prices 5% higher West of the Mississippi

ARKAY · 120 Cedar Street · N.Y.

fact it is far different than the usual percussion mish-mash . . . this one concerns itself almost exclusively with the high percussives, i.e., the gamelon, tambourine, vibraphone, xylophone, celeste, marimba, finger cymbals, etc. As a test tool for the mid- and high-frequency speakers in a loudspeaker system, this is high perfect, because you have material with the extreme high end of frequency response and hard transients in that range. The recording itself is pristine in its sonic contours; everything is sharp and clean as a hound's tooth. It is hard to record high percussives without excessive overload blur and it is to this company's credit that this was noticeably absent in this recording.

Another unique recording is the accordion disc. Accordion sound is another fine demonstration tool with sharp wavefronts to test the mettle of your system. Can you imagine 21 accordions all going full tilt? That's what is on this record and a mighty sound they make. The music and the arrangement are excellent too, and all in all it is a great record for parties or like frolics. If you can't find this label in your local record shop, drop a card and I'll pass it on to the *Golden Crest* people.

Next month I'll have a batch of new stereophonic releases so watch for the reviews!

—50—

NEW RECORDED TAPES

THE Pentron Corporation, 777 S. Tripp Ave., Chicago 24, Ill., has announced the addition of five new recorded tapes to its "Pentape" library of jazz, pops, and religious music.

The Duke Ellington Tape (RT-800) features the Duke and his orchestra playing Ellington originals. The RT-600 release has Muggsy Spanier and his orchestra playing Chicago-style Dixieland. The tunes are standards which have become associated with Spanier.

Clark Terry and his orchestra are featured on RT-900 while RT-500 carries Larry Paige and his orchestra in a selection of Latin American music.

Tape RT-700 has Shay Torrent playing six old favorite hymns on the Hammond organ.

All of the tapes are recorded at 7 1/2 ips, dual-track, monaural. Their distribution is being handled by regular Pentron dealers.

—50—

UNIQUE "TAPEBOOK"

THE dissemination of information by means of a tape recording is the idea behind a unique "Tapebook" just released by Tape Recording Magazine of Severna Park, Maryland.

The subject of the tape-recorded book is, appropriately, tape recording. The "book" demonstrates recording flaws and terms by sound rather than word descriptions. In addition, it covers recording techniques, recorder care, operation, etc.

The title of this release is "All About Tape—On Tape." The author is Jack Bayha, a well-known audio engineer. The "Tapebook" is narrated by Ed Condit, a radio and TV announcer, and duplication is by Livingston Electronics.

Running time of the book is one hour and each reel of tape is accompanied by a 24-page booklet of illustrations and captions to supplement the spoken word and recorded instructions.

It is available in two forms: a five-inch reel at 3 3/4 ips, dual track; and a seven-inch reel at 7 1/2 ips, dual track. Write the company direct for complete details.

—50—

Why not Own the Best?

Shoot your own 16mm Television Sound-On-Film Talking-Pictures with the "Auricon Pro-600" Camera. \$1497.00 & up. Money-back guarantee. Write for free catalog.



BERNDT-BACH, INC.
 6928 ROMAINE ST., HOLLYWOOD 38, CALIF.
 16MM SOUND-ON-FILM SINCE 1931



50 Free

Get free Duotone DFF Test Card and test needle right in cartridge. Can save whole record collection from damage of worn needle. Takes just 50 seconds to test. Advertised in Life. Ask dealer or write:

*Duotone Fidelity Focus
DUOTONE COMPANY, INC.
 KEYPORT, NEW JERSEY

Why Loudness Control?
(Continued from page 44)

which an educated high-fidelity listener certainly can, then a loudness control is definitely an advantage, in comparison with the use of a volume control with separate tone controls.

The next question is, what arrangement of loudness control and gain or volume control should be used? Do we need both controls, or is one control that can serve both purposes enough?

Some preamplifiers have appeared with a single control, and a loudness/volume switch, which alters the function of the control from one to the other. A little thought will show that this achieves practically no advantage over an amplifier provided with only one or the other.

To be effective, a loudness control must produce the right contour appropriate to the level at which the program is played. As different programs are often recorded at quite widely differing levels (as regards the input delivered to the preamplifier), there is no guarantee that setting the volume/loudness dial to a specific position (say 5) will always reproduce a program at the same loudness, regardless of what disc is being played. But this is how a loudness control should operate, otherwise the loudness contours will not come in the right place.

What we need then is two separate controls: a gain or volume control, to adjust the input received from the recording, so that setting the loudness control to a particular position will give the right loudness in the room for that setting. For example, if you normally listen at a level corresponding to 50 in the loudness contour family, the loudness control should be set to a position which makes this correction from the average recording level of 70. Then the gain control should be adjusted on each particular recording, so the loudness in the room corresponds with the average to which you have become accustomed.

Then, once you have set the gain control for this particular degree of loudness, you can alter the loudness control to play the music softer or louder. Of course, you do not always have to go through this routine just to get it right for a particular recording. It is much simpler to set the loudness control for the desired loudness. This you will become used to with a little practice. Then adjust the gain control so the actual loudness corresponds with the setting on the loudness control.

Some loudness controls, instead of providing a continuously adjustable range, use a multi-position switch, that may have three positions for example, marked low, normal and high, referring to the degree of loudness. This control can then be set according to how you want the music to play

NEW

and magnificent!

- ▶ ESL-BJ Super 90 all-new tangential phono arm
- ▶ Complete line of ESL moving coil microphones, microphone transformers, and transistor transformers
- ▶ ESL transistor amplifier

Write for free details



FOR LISTENING AT ITS BEST

Electro-Sonic Laboratories, Inc.

Dept. R • 35-54 Thirty-sixth Street • Long Island City 6, N.Y.

Famous for the ESL electrodynamic cartridge, the world's most advanced phono pickup • From \$14.95

NEW! UNIVERSITY PORTABLE SOUNDCASTING

POWRPAGE

PROJECTS VOICE BETTER BOOSTS SALES HIGHER

The University Powrpage is ideal for sporting events, coaching, boating, picnics, civil defense, auctions...literally anything requiring portable soundcasting. The voice is projected clearly, distinctly...with a lightweight, self-contained University POWRPAGE. Goodbye to shouting...just press button and talk! No tubes...no waiting for warm-up. Exclusive built-in POWRSAVER circuit. Two different design types for almost every need.

PORTABLE POWRPAGE MODEL PP-1 Only 7½ lbs. Uses seven standard flashlight cells. Unit stands free or hangs from any convenient structure. Press-to-talk switch on microphone and long 11 ft. cable give you complete freedom of movement. Completely weather-proof. *Greatest power and voice clarity in portable soundcasting!*

PISTOLGRIP POWRPAGE MODEL PP-2 Where maximum compactness and freedom of action are desired. Entire unit weighs only 4¼ lbs. Uses six ordinary "pencil" batteries that fit inside the slim, easy-grip handle, or may be powered directly from the 6 or 12 volt D.C. of car or boat ignition system. Completely weatherproof.

See your distributor. For literature and further information write Desk S22, University Loudspeakers, Inc., 80 So. Kensico Ave., White Plains, N. Y.



MODEL PP-1
\$69.75 User Net
(less batteries)



MODEL PP-2 \$65.00 User Net
(less batteries)

LISTEN

University sounds better



Introducing



**DUOTONE
FIDELITY
FOCUS
Loudspeakers**

New Engineering Technique Assures You—Bell-Clear Highs; Vibrant-Undistorted Lows.

DUOTONE—For a quarter of a century, leader in the high fidelity industry, presents for the first time, DFE, DUOTONE FIDELITY FOCUS LOUDSPEAKERS. A new high in manufacturing standards and procedures assures you of a superb quality seldom found in most other loudspeakers. Rigid specifications adhered to and exacting field trials were made before this fine line was presented to the public. It was only the results of these exhaustive tests that assured us of a product worthy of the HI-FI enthusiasts interests. Whether you choose a coaxial speaker such as the Royal or Medallion, or a woofer-tweeter combination like the Supreme and the Duchess, you will be more than satisfied with the excellent response these speakers afford. Stop into your HI-FI dealer's showroom and ask to hear them. Your reward will be the self-satisfaction of hearing excellent high fidelity sound reproduction. There's a DUOTONE FIDELITY FOCUS LOUDSPEAKER to match your system and they are priced to \$53.97.

Write today for our FREE new booklet, "An Objective Study of Loudspeakers". It's designed to help you choose and install your speaker system.

12 in. Coaxial
Cat. No. 12CX-62
35 to 18,000
cps. Power:
25 watts Imp:
8 Ω



The ROYAL

12 in. Coaxial
Cat. No. 12CX-60
35 to 18,000
cps. Power:
15 watts Imp:
8 Ω



The MEDALLION

8 in. Coaxial
Cat. No. 8CX-50
50 to 20,000
cps. Power:
10 watts Imp:
8 Ω



The MARQUIS

8 in. Coaxial
Cat. No. 8CX-70
75 to 19,000
cps. Power:
6 watts Imp:
8 Ω



The VISCOUNT

4 in. Tweeter
Cat. No. 4-TX
1000 cycles to
beyond aud.
Power: 5 watts
Imp: 8 Ω



The DUKE

7 in. Tweeter
Cat. No. 7-TX
350 cycles to
beyond aud.
Power: 10 watts
Imp: 8 Ω



The DUCHESS



in the room and the normal volume control can then be used to get the loudness right. This will generally give a pretty close approximation to the right loudness contour and from this point the tone control can be used to adjust for slight deviations in balance, if it does not sound to the best advantage.

The switched arrangement has the advantage that the correct contour can be tailored into the circuit. Some loudness controls use just a simple tapped potentiometer, the schematic of which is shown in Fig. 3. This does not give sufficient steepness to the loudness compensation, particularly for playing at low levels. In fact, it is little better than the use of the tone control. Maybe, if you have a separate tone control and a loudness control of this type, the two can be used together to get results that come nearer to being right than just the tone control by itself.

But the best arrangement, if you have a loudness control that is continuously variable (like most volume controls), is to use one which comes as a ganged potentiometer, two or more decks with associated components wired on to the potentiometers to produce the required variation of loudness contour as the control is turned.

But discussion of the precise way of getting the right characteristics into a loudness control is another article altogether. It must be said that, after becoming accustomed to the correct use of a good loudness control, going back to a system that only has the regular volume and tone controls seems to lack the degree of smoothness in reproduction obtainable with the loudness control. Especially is it difficult to get satisfaction for low level listening, which is where the good loudness control really does its job well.

This can easily be demonstrated on a preamplifier that has both forms of control, playing a good wide-range program that has plenty of bass and treble. Turn down, first of all, the loudness control and the effect is that the orchestra or program is being played *more quietly*, but still *in the room with you*. Now restore the loudness control to the maximum comfortable level and turn down the volume control. This time the effect is not of the program being played more quietly in the same room, but it seems to go farther away as if it is no longer in the room with you but playing from somewhere down the street.

Sometimes it is nice to have both of these facilities available, but if you principally want to present music that sounds good, you certainly want to have it sound as if it is in the room with you and not being played from a distance away. So it looks as if we really need loudness controls.

Just a final word, however. This decision is not going overboard on the second extreme mentioned at the beginning of this article. The Fletcher-

**NEW—TRANSISTORIZED
RADIO KIT**



Model TK-104, a professionally engineered, completely transistorized superhet receiver kit.

- Printed Circuit Chassis 4 transistors
- Self Contained Speaker—18 mw. Output
- External Phone Jack
- High Gain Ferrite Loopstick Antenna
- Texon Leather Case
- Completely Sub-miniature
- Measures Only 6 x 4 x 2"
- Complete Easy To Follow Instructions

Model TK-201, a two transistor preamplifier kit on a printed circuit board. Complete with all parts and simple easy to follow instructions. The wide frequency range of this preamplifier will please even the most discriminate audiophile.

Order from your dealer or jobber or for more information write today to:

TRAN-KIT ELECTRONICS

467 SOUTH 5th AVE., DEPT. RT-2 MT. VERNON, N. Y.

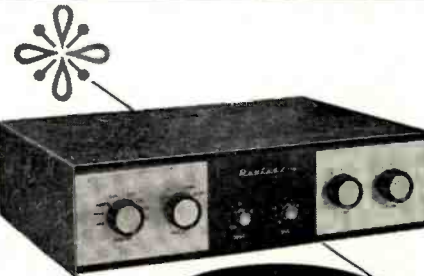

'Golden Series' HI-FI



The "GOLDEN CREST" 20-Watt Amplifier...with continuously variable contour control for Fletcher-Munson correction...

one of a complete line of advanced design high fidelity tuners, amplifiers and components...

hear these quality RAULAND units at your Hi-Fi dealer or write for details...

RAULAND-BORG CORPORATION

3515 W. Addison St., Dept. T, Chicago 18, Ill.

Munson curves may be (and are) scientific, but they do not represent the exact loudness contours of *your* ears. In their investigation, it appeared that individual hearing is so divergent that it is extremely unlikely that anyone has *average* hearing. But use of these average curves assures a control that should satisfy.

Although each of us has hearing that diverges one way or another from these curves, they represent the *shape* of almost everyone's hearing characteristic. This means that our individual loudness *difference* contours will be very close, although the actual contours deviate widely. So a well-designed loudness control, based on loudness *differences*, will sound right to almost anyone. —30—

SHIELDS FOR MINIATURE COILS

By LEON A. WORTMAN, W2LJU

QUITE inexpensive and extremely effective is this little construction "kink." Small aluminum cans, some very neatly painted in bright colors, are usually supplied as containers for 35mm film cassettes. Many photo-supply stores have them on hand, too, and offer them for a few pennies apiece. A few minutes' time, one can hardly call working with thin aluminum "effort" or "labor," and they are transformed into sure-fit shield cans for small coil forms, such as the Amphenol Type 24, and for miniature 7- and 9-pin tubes.

For use as a tube shield or plug-in coil shield, drill a socket hole in the can cover. The cover is considered to be the shallower segment of the film can and should always be the piece mounted to the chassis. Then secure the can cover to the chassis, utilizing the same hardware for the purpose that holds the tube or coil socket in place. A $\frac{5}{16}$ " hole drilled in the bottom of the can, as shown in the photograph, allows the tube tip to protrude and provides ventilation.

When used as a shield for the prongless coil forms, simply drill a center hole in the can cover. Use a single nut and bolt to secure the coil form and can cover to the chassis. Drill small holes all the way through chassis, shield cover, and coil form for the coil lead-wires.

The can very neatly threads together and remains securely, both mechanically and electrically, in position. —30—

Film cans make good equipment shields.

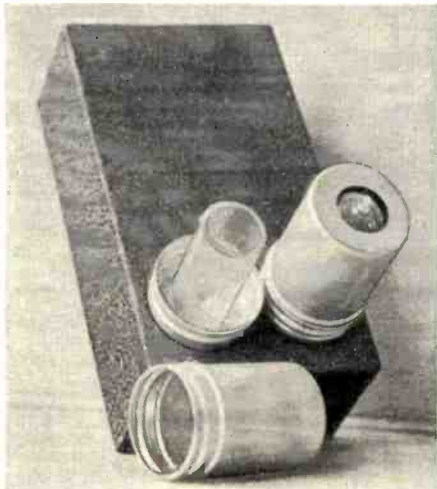

April, 1957

Send for MusiCraft's **FREE** high fidelity catalog



Just off the press!

Jam-packed
with latest
hi-fi values!

Here's a *special* high fidelity catalog that you'll find particularly useful, because we have included *only* equipment which we at MusiCraft consider the *best*—from the standpoint of *compatibility* and stable operating efficiency—in every price range.

Page after page pictures the newest high fidelity equipment with detailed information about characteristics and specifications.

Whatever you want—whatever you need—speakers, tuners, amplifiers, turntables, "do-it-yourself" kits, etc.—MusiCraft's new catalog features all the top quality components from leading manufacturers.

Send now for your free copy of the new **MUSICRAFT HIGH FIDELITY CATALOG**:

MusiCraft

48-A East Oak Street
Chicago 11, Illinois

Delaware 7-4150

name _____

address _____

city _____ zone _____ state _____

BARGAIN HUNTING? **TV SERVICEMEN!**
Write for **SENSATIONAL CATALOG**
HENSHAW RADIO SUPPLY
3619 TROOST KANSAS CITY, MO.

LAM FLUX

ALUMINUM SOLDERING FLUX
With this flux you solder Aluminum the same as other metals. You may use regular lead-tin solder. For 1 oz. send \$2.00 Cash, Check, or M.O.—No C.O.D. Postpaid in U.S.A. Quantity prices on request. Also Tin-Lead, Aluminum, and Glass Solders.
E. Lampe, P. O. Box 371, Lindenhurst, L. I., N. Y.

LEARN TV

'At the most practical school in the west'

Work on late model sets—using modern equipment and service techniques: under qualified technician instructors. Short resident and correspondence courses—no unnecessary math or theory—also UHF and Color TV. APPROVED FOR VETERANS . . . day and nite classes.

Write for free literature, Dept. IA for residence—Dept. IAC for correspondence.

V.S.I. TELEVISION SCHOOL 4570 Firestone Blvd., Box 359
South Gate, California

COMPLETE TRAINING FOR BETTER RADIO-TV SERVICE JOBS



Let these two great new Ghirardi training books teach you to handle all types of AM, FM and TV service jobs by approved professional methods—and watch your efficiency and earnings soar!

Completely modern, profusely illustrated and written so you can easily understand every word, these books pave the way to fast, accurate service on any type of home radio-TV electronic equipment ever made. Each book is brand new. Each contains the latest data on the latest methods and equipment—NOT a re-hash of old, out-of-date material. Each is co-authored by A. A. Ghirardi whose famous RADIO PHYSICS COURSE and MODERN RADIO SERVICING were, for 20 years, more widely used for military, school and home study training than any other books of their type!

THE NEW Ghirardi RADIO-TV SERVICE LIBRARY

Almost 1500 pages and over 800 clear illustrations show step-by-step how to handle every phase of modern troubleshooting and servicing.

1—Radio and Television Receiver TROUBLESHOOTING AND REPAIR

A complete guide to profitable professional methods. For the beginner, it is a comprehensive training course. For the experienced serviceman, it is a quick way to "brush up" on specific jobs, to develop improved techniques or to find fast answers to puzzling service problems. Includes invaluable "step-by-step" service charts. 820 pages, 417 illus., price \$7.50 separately. (Outside U.S.A. \$8.00.)

2—Radio and Television Receiver CIRCUITRY AND OPERATION

This 669-page volume is the ideal guide for servicemen who realize it pays to know what really makes modern radio-TV receivers "tick" and why. Gives a complete understanding of basic circuits and circuit variations; how to recognize them at a glance; how to eliminate guesswork and useless testing in servicing them. 417 illus. Price separately \$6.75 (outside U.S.A. \$7.25).

New low price...you save \$1.25!

If broken into lesson form and sent to you as a "course," you'd regard these two great books as a bargain at \$50 or more! Together, they form a complete modern servicing library to help you work faster, more efficiently and more profitably. Completely indexed so you can look up needed facts in a jiffy.

Under this new offer, you save \$1.25 on the price of the two books—and have the privilege of paying in easy installments while you use them! No lessons to wait for. You learn fast—and you learn right!

STUDY 10 DAYS FREE!

Dept. RN-47, RINEHART & CO., Inc.
232 Madison Ave., New York 16, N. Y.

Send book(s) below for 10-day FREE EXAMINATION. In 10 days, I will either remit price indicated (plus postage) or return books postpaid and owe you nothing.

Radio & TV Receiver TROUBLESHOOTING & REPAIR (Price \$7.50 separately)

Radio & TV Receiver CIRCUITRY & OPERATION (Price \$6.75 separately)

Check here for MONEY-SAVING COMBINATION OFFER... Save \$1.25. Send both of above big books at special price of only \$13.00 for the two (Regular price \$14.25)... you save \$1.25. Payable at rate of \$4 (plus postage) after 10 days if you decide to keep books and \$3 a month thereafter until \$13 has been paid.

Name

Address

City, Zone, State

Outside U.S.A.—\$8 for TROUBLESHOOTING & REPAIR; \$7.25 for CIRCUITRY & OPERATION; \$14 for both. Cash with order only, but same 10 day return privilege.



"APPLIED ANALYSIS" by Cornelius Lanczos. Published by Prentice Hall, Inc., Englewood Cliffs, N. J. 539 pages. Price \$9.00.

An advanced exposition by the Senior Professor at the School of Theoretical Physics, Dublin Institute for Advanced Studies, of the branch of mathematical analysis pertaining to finite algorithms rather than infinite processes. Such subjects as algebraic equations, matrices and eigenvalue problems, large-scale linear systems, harmonic analysis, data analysis, quadrature methods, and power expansions are covered for the physicist or engineer with a strong mathematical background.

"TELEVISION ENGINEERING HANDBOOK" edited by Donald G. Fink. Published by McGraw-Hill Book Company, Inc., New York. 1496 pages. Price \$18.00.

This encyclopedic work represents the contributions of some thirty-three specialists in the television engineering field as compiled and edited by Donald G. Fink, director of research for Philco Corporation.

There are twenty sections in this book covering standards, color, amplification, synchronization, transmitters, receivers, cables, etc., including all of

the quantitative data required to design and operate television equipment anywhere in the world.

The book provides a detailed and comprehensive analysis of both monochrome and color television systems as well as pertinent and needed data on systems and standards in use in Great Britain, France, and throughout the Continent. Detailed design data on all portions of color and black-and-white television receivers is also included.

This volume represents a staggering array of pertinent information and the authors, editor, and publishers are to be congratulated for performing this service to the industry.

"TRAINING MANUAL ON ANTENNAS" edited by the TechRep Div. of Philco. Published by Philco Corporation, Philadelphia. 217 pages. Price \$1.93. Paper bound. Vol. 1.

This is a practical instruction manual which covers the propagation of radio waves, antenna fundamentals, transmission-line theory, methods of feed at the antenna, coupling circuits, types of antennas, and construction and measurement information.

Although primarily designed for use in classrooms and in connection with service training courses, the material included could easily be assimilated by the individual technician working alone. Among the antennas covered are half-waves; parasitic arrays; driven arrays; long single-wire antennas; "V" and rhombics; low-, medium-, and high-frequency antennas; v.h.f. and u.h.f. antennas; and antennas for special applications. Examination sheets are included in the manual.

CODE PRACTICE OSCILLATOR WITH SPEAKER

SCOUT troops, ham clubs, and others concerned with the training of would-be radio amateurs will no doubt be interested in the inexpensive transistorized code practice oscillator circuit shown below. This circuit will drive a small speaker which makes the unit suitable for group instruction as well as for use by individuals learning code on their own.

The circuit uses one 2N107 transistor and is powered by a 22½ volt battery. The pitch of the signal emanating from the small speaker can be varied to suit

the user. The entire circuit may be built into a compact cabinet with the key being plugged in by means of a cable. All of the parts required in the construction are standard and readily available from most parts jobbers with the possible exception of the transformer which is an Argonne AR-96 unit designed especially for transistor circuitry.

The transformer or the entire circuit in the form of a special kit (KT-118) are available from Lafayette Radio. The kit is \$8.95 with the companion key priced at \$1.25 extra.

Schematic diagram and over-all view of the transistorized code practice oscillator.

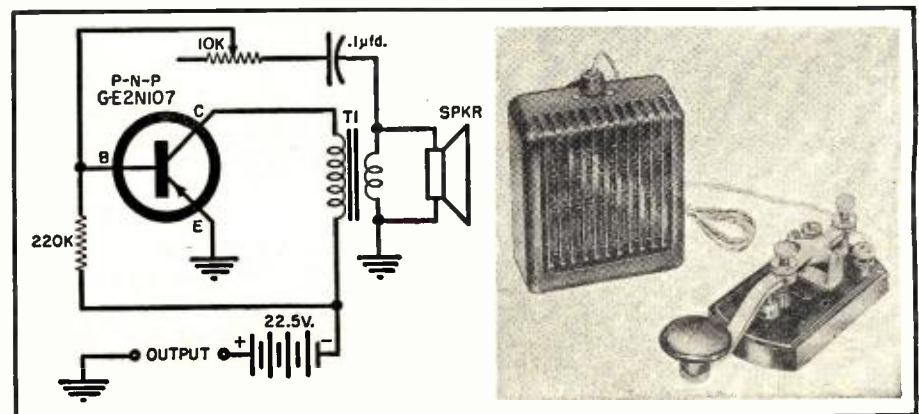

Copies of the book are being distributed by the company, 18th and Courtland Streets, Philadelphia 40, Pa.

"ELECTRONIC METAL LOCATORS" by Harold S. Renne. Published by *Howard W. Sams & Co., Inc.*, Indianapolis. 117 pages. Price \$2.50. Paper bound.

This book was prepared as the direct result of a heavy "consumer demand" for details on building and using units for locating buried metals or "treasures" of various types.

As the author points out, there are many commercial applications for such devices. Manufacturers of a wide variety of consumer items use metal locators to insure that foreign particles are not introduced during processing to the detriment of the user or the maker's reputation.

The book is divided into six chapters dealing with the basic theory behind the design of metal detectors, commercial units, home-built devices, industrial applications, prospecting, and mine detectors. Two appendices are also included and list a comprehensive bibliography for further study, and the names and addresses of companies making commercial versions of these instruments.

Plumbers, electricians, utility workers, householders, hobbyists, prospectors, and experimenters will find this book fascinating reading. As the author points out in his Preface, even if you never find so much as a lead nickel—the fresh air and sunshine will do you a lot of good.

The text is written in an easy-to-read and entirely understandable style. The book fills a real need for a practical manual on an interesting type of electronic gear.

"HOW TO INSTALL & SERVICE INTERCOMMUNICATION SYSTEMS" by Jack Darr. Published by *John F. Rider Publisher, Inc.*, New York. 146 pages. Price \$3.00. Paper bound.

If the number of inquiries received by this magazine is any criterion, there is a wide interest, both professional and lay, in the subject of intercoms.

This book should answer most of the questions that arise in the minds of would-be builders of such gear. Both commercial and home-built units are described and, in addition, a directory of manufacturers has been appended for reference purposes.

"FREQUENCY MODULATION" by L. B. Arguimbau & R. D. Stuart. Published by *John Wiley & Sons, Inc.*, New York. 94 pages. Price \$2.00.

This short volume is based on experience gained by the authors when they were both connected with the Research Laboratory of Electronics at M. I. T. The text material is divided into six chapters dealing with an introduction to FM, the nature of frequency modulation, transmitters, receivers, interference, and the application of FM to television.

As easy to use as a pencil

WALL
INDUSTRIAL
SOLDERING IRONS
give you

More
BTU's...
Faster
HEAT...
Higher HEAT
CONTINUITY

than **ANY OTHER**
soldering irons of equal tip size

Proved 4 times faster on the production lines of America's leading electronics firms. Complete range of sizes... scientifically designed... individually tested... for easier, surer precision work or heavy duty soldering. Operate on 110-120 volts, AC or DC! Model 18T illustrated, \$6.25 list.

Write for FREE Catalog

Exclusive
THERMOSTATIC ACTION...

Guaranteed for the life of the iron!
Prevents excessive tip burning!



WALL MANUFACTURING CO.
Grove City, Pennsylvania
OVER 20,000,000 SOLDERING PRODUCTS SINCE 1864

SENCORE
Another Sencore Time-Saver
Handy "36"
R-C
Substitution Unit

"36"
Most Often Needed Components At YOUR Fingertips!

3 pole, 12 position switch individually selects one of the "36" components for direct substitution.

Contains:

- ★ 12—1 watt 10% resistor from 10 ohms to 5000 ohms
- ★ 12—½ watt 10% resistors from 10K ohms to 3.6 megohms
- ★ 10—600 volt capacitors Completely isolated from 100—mmfd. to .5mfd.
- ★ 1—10mfd., 450V Electrolytic
- ★ 1—40mfd., 450V Electrolytic

★ For Shop, Lab, or outside service

AVAILABLE AT ALL PARTS DISTRIBUTORS!

ONLY \$12.75
DEALER NET

POPULAR SENCORE PRODUCTS

- Transistor Tester
- Leakage Checker
- Filament Tester
- Voltage Regulator
- Bias Supply

SENCORE SERVICE
INSTRUMENTS CORP.
171 OFFICIAL RD., ADDISON, ILL.

Cut out this ad now for further information.

You can forget about chassis "BITES"

\$29.50
From stock or your jobber

Adjust-A-Volt LR-5
VARIABLE TRANSFORMER

No wonder thousands of service men rely on the LR-5! Combines features of both variable and isolation transformer. Drop line voltage to check faulty oscillator. Cook set to breakdown intermittent parts. All without chassis touching jitters! No service bench complete without this unit. Write for descriptive catalog.

STANDARD
ELECTRICAL PRODUCTS CO.
2240 E. THIRD ST., DAYTON, OHIO



How far can you go in Electronics without a Degree?



Bernie Roth examines ribbon from printer during Field Engineering Laboratory period.

Without a formal degree, 24-year-old Bernie Roth is already established as a Computer Units Field Engineer—handling a key responsibility with IBM. At the McGuire Air Force Base, a directional control site for Project SAGE, Bernie is part of a team maintaining an entire electronic digital computer system. In this assignment, he must stay abreast of all the most advanced electronic concepts—developing his professional know-how every day. “That’s what’s different about IBM,” Bernie says. “The graduate engineer has an advantage anywhere—but here at IBM the technician also can grow into managerial positions. IBM is one of the few organizations I know of that is willing to invest time and money in training the technical man—and then gauges his future ability strictly on performance.”

IBM instituted its program for specialized technical training many years ago. The theory behind this built-in educational system asked the question: Why should the capable man be denied the opportunity simply because he lacks a formal degree? The wisdom and foresight of IBM’s decision are reflected in the story of Bernie Roth—in the misgivings of his past—in the certainty of his future.

The Navy steers Bernie on the right course

When Bernie graduated from Croton, N. J. High School in 1950, he received a general diploma—mathematics and science made up a small part of his curriculum. Enlisting in the Navy in 1951, Bernie proved his aptitude for technical work and was assigned to the electronics preparatory school in Jacksonville, Fla. Later, he attended the Class A Aviation Electronics School in Memphis, Tenn. . . . probably the most important phase of his naval training because it was in



Here, he scans the schematic of computer circuits.

Memphis that he became convinced that a technical career was "Right up my alley." But an event that occurred during a furlough in the spring of 1955 put a brand-new light on Bernie's future.

Reports for training

Bernie smiled when he mentioned that his mother had a tendency to clip want ads. "It was just pot-luck that one of the ads she spotted was for IBM Kingston and Project SAGE." Soon afterwards, Bernie hopped a bus to Newark for an interview with the IBM representative. He took the required number of tests—talked over his hopes and ambitions, and "That's about all there was to it." In July, Bernie notified IBM that he was definitely available, and supplied the necessary references. Meanwhile, he made a study of IBM's history, its policies, its growth, and its future—all of which impressed him favorably. One day in September, Bernie received instructions to report to Kingston to begin training in the applications of electronic computers.

The material he studied at Kingston

"The Kingston program is a real experience, and quite an eye-opener in

April, 1957

electronic techniques. First of all, I studied basic circuitry. Then, I actually learned a new way to think—the ability to comprehend the whole from the assorted parts. The student must know how to form logic blocks, and in time, he should be able to design his own circuits. All of this proved especially helpful once I got out into the field. Later on, I studied the various input-output devices which are used as auxiliary units to the central computer. Finally, I analyzed the methods that supply the power for this electronic giant. Millions of



Bernie checks a unit in one of the operating consoles.

watts are needed—a phenomenal amount. In general, I'd say that you couldn't find a better training ground for understanding the uses of electronic as well as electro-mechanical equipment."

How does Bernie feel about his current assignment?

"I'm responsible for the performance of the input-output devices—the auxiliaries that supply information to the central computer. The many Project SAGE outposts—picket ships, reconnaissance planes, Texas towers—flash their signals to the input devices which, in turn, correlate and compile the data. You might say the input devices prepare the food for digestion by the main electronic computer. This, incidentally, is one of the world's largest computers, which is built and tested at Kingston, then disassembled and shipped to a directional control site such as McGuire. Sometimes, I have the chance to assist in systems and displays. Now displays really fascinate me. There's a kind of television screen on which you can detect a plane, determine whether it's friendly or hostile, and where it's headed. My work is always different, never routine, and that's very important to me."

How does the future look to Bernie?

A happy and prosperous future is in the offing for Bernie Roth. And, based on the records of his older associates, he's confident that in five years' time he will qualify as a Systems Engineer, at the very least. The next steps going up the ladder are Group Supervisor and then Group Manager. "The real satisfaction in working with IBM is the opportunity to understand more and more about electronic techniques. And IBM is quick to recognize and reward improved ability through greater knowledge."



An outdoor man, Bernie takes full advantage of the New Jersey game preserve.

What about you?

Since Bernie Roth joined IBM Military Products and the Project SAGE program, opportunities are more promising than ever. This long-range program is destined for increasing national importance, and IBM will invest thousands of dollars in the right men to insure its success.

If you have 2 years' technical schooling—or equivalent experience—IBM will train you for 6 months as a *Computer Units Field Engineer*.

If IBM considers your experience equivalent to an E.E., M.E., or Physics degree, you'll receive 8 months' training as a *Computer Systems Engineer*.

After training, you will be assigned to an area of your choice. You receive *salary*, not wages, plus overtime pay. In addition, every channel of advancement in the entire company is open, and IBM is a leader in a field that is sky-rocketing in growth. And, of course, you receive the famous IBM company-paid benefits that set standards for industry today.

WHY NOT WRITE—today—to Nelson O. Heyer, Room 4304, IBM Corp., Kingston, N. Y. You'll receive a prompt reply.

CUSTOMER ENGINEERS: Opportunities are also available, locally, for servicing IBM machines, after training with pay.

IBM	MILITARY PRODUCTS
DATA PROCESSING • ELECTRIC TYPEWRITERS	TIME EQUIPMENT • MILITARY PRODUCTS

'SCOPES ARE "GOLD MINES"

... When you learn to use them RIGHT... on all kinds of service jobs!



**THIS GREAT BOOK
TELLS ALL YOU NEED TO
KNOW ABOUT THEM!**

Big 2nd Edition

Contains Latest
Data and More
Than 30 Extra
Pictures.

Includes use of
'scopes in color
TV... black and
white TV... Radio
... Industrial Elec-
tronics... Teach-
ing... even in
atomic energy work!

Here's the "secret" of servicing any radio or Television set ever built... easier, better and faster!

In plain language, MODERN OSCILLOSCOPES AND THEIR USES brings you the data on 'scopes that you really need. It teaches you when, where and exactly how to use oscilloscopes on all types of jobs.

You learn how to handle tough jobs easier and faster than you may have thought possible. Every detail is clearly explained—from making connections to adjusting components and setting the controls.

WORK EASIER—BETTER—FASTER

Equally important, you learn how to analyze oscilloscope patterns accurately and in less time. Almost 400 illustrations including dozens of pattern photos make every step perfectly clear.

This famous book—now in its revised 2nd Edition—is more widely used than any other of its type. That's because it gets right down to "brass tacks" in a way you can hardly fail to understand. No complicated mathematics. No involved theoretical discussions. You learn exactly how to use your oscilloscope on all types of AM, FM and television service (including color TV). You learn each step of the work fully—from locating troubles fast to handling tough realignment jobs.

PRACTICE 10 DAYS FREE!

Dept. RN-47, RINEHART & CO., INC.
232 Madison Ave., New York 16, N. Y.

Send 2nd Edition of MODERN OSCILLOSCOPES for 10-day FREE EXAMINATION. I will then remit \$6.50 (plus postage) promptly in full payment or return book and owe you nothing. (SAVE! Send \$6.50 with order and we pay postage. Same 10-day return privilege with money refunded.)

Name

Address

City, Zone, State.....

OUTSIDE U.S.A.—Price \$7.00, cash with order. Money back if you return book in 10 days.



MOTORIZED HAM ANTENNA

E. F. Johnson Company, 2902 Second Ave., S. W., Waseca, Minnesota, unveils a fully automatic multi-band vertical antenna in the Viking "Match-Stick." It is a pre-tuned system remotely driven by a motor that is automatically controlled from the transmitter location. It provides switching through 80, 40, 20, 15, 11, and 10 meters without the need for adjustment. The standing-wave ratio is better than 2:1 on all bands. Impedance is 52 ohms, and the vertical radiation angle is low for DX.

The tuning network is in a weather-proof cabinet at the base of the antenna, with effective length and network selected by weatherproof relays mounted right on the mast. The 35' vertical mast is made of 2" aluminum tubing. The six nylon guy ropes that are furnished will not affect the radiation pattern.

ADDED WAREHOUSE

Snyder Manufacturing Company, of Philadelphia, Penna., has opened its sixth warehouse. The newest one will help provide rapid service for the manufacturer's customers in northwestern U. S. It is located at 1612 Broadway, Seattle, Washington.

3-BAND AMATEUR ANTENNA

Telrex Laboratories, Asbury Park, New Jersey, features performance on three bands, the 10-, 15-, and 20-meter bands, with a single transmission line in "Tri-Band" model TB-57-2E. Fully calibrated so that it may be assembled without adjustment or tuning, the antenna provides optimum spacing of elements on each of the three bands without interlacing. In addition to the

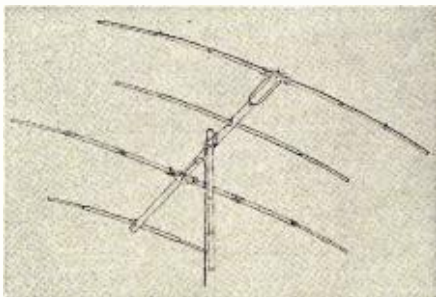

driven element, there is a separate director for 10 meters, a separate reflector for 15 meters, and a separate reflector for 20 meters.

Gain is said to be 5.6 db or better on each band, with front-to-back ratio 18 db or better on each band. Horizontal beamwidth is 65 degrees or better, and the maximum voltage standing-wave ratio is 1.3:1. Adjusted for feeding with a single 52-ohm coaxial cable,

the "Tri-Band" will handle up to 1.5 kw.

Longest element is under 33'; weight is 36 lbs.; all-aluminum construction is designed to withstand 80 m.p.h. winds. The antenna can be handled by a heavy-duty TV rotator.

VERSATILE INDOOR ANTENNA

Radion Corporation, 1130 W. Wisconsin Ave., Chicago, Ill., is distributing its Model 185 Indoor TV Antenna, the "V-8 Universal." The flexible design permits either top-of-the-set mounting or built-on back mounting, as illustrated in the accompanying photos. The 3-section nickel-plated steel dipole is fixed to a high-impact polystyrene mahogany case. The base is protected by a felt pad to protect the cabinet finish. All mounting hardware is included. Usable for both v.h.f. and u.h.f.,

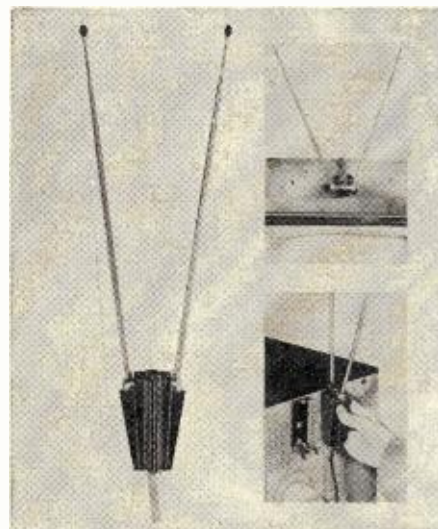

back-of-the-set mounting can be accomplished in minutes with two screws provided. The dealer can cut inventory requirements in that he can stock this single antenna to provide a choice of mounting on a wide variety of new and old TV receivers.

COMMUNITY FIGURE

Channel Master Corporation of Ellenville, N. Y., has reason to be proud of its president, Harry Resnick, as does the entire town. The closing of the Home National Bank of Ellenville, headlined across the country some months ago, left the community without sorely needed banking facilities to continue its economic life. The closing occurred as a result of a shortage of \$1,300,000 left by the former bank president.

Mr. Resnick, as head of a reorganization committee, led the drive that more than covered the shortage from 465 stockholders who formed the new Ellenville National Bank. This new institution is believed to have the broadest ownership base in the Ulster County Catskill resort area. For his efforts, Mr. Resnick was featured as the New York Times' "Man in the News." Explaining his efforts, he said, "This is my town. I owe a lot to Ellenville and its people."

HOW MANY CAN YOU ANSWER "YES?"

1. Do you wish to extend your experience in electronics systems?
2. Would you like to instruct others in advanced fire control systems and laboratory techniques?
3. Would you like to handle a responsible position representing a leading electronics organization?
4. Do you believe that you can accurately relate your findings and studies in technical language?
5. Are you interested in such devices as analog computers, digital computers, power supplies, transmitters, receivers, and microwave antennas?
6. Do you enjoy working with people?

If you can answer "yes" to four of the above questions and have an Electrical Engineering or Physics degree, chances are that you can qualify for one of the several engineering positions in the Hughes Field Engineering department.

In addition to giving you well-rounded experience in electronic systems and controls, Hughes offers you training at full salary, moving and travel allowances, per diem expenses, and many other benefits. For further information write Mr. W. A. Barnes at the address below.

HUGHES

RESEARCH AND DEVELOPMENT LABORATORIES
SCIENTIFIC STAFF RELATIONS
Hughes Aircraft Company, Culver City, Calif.

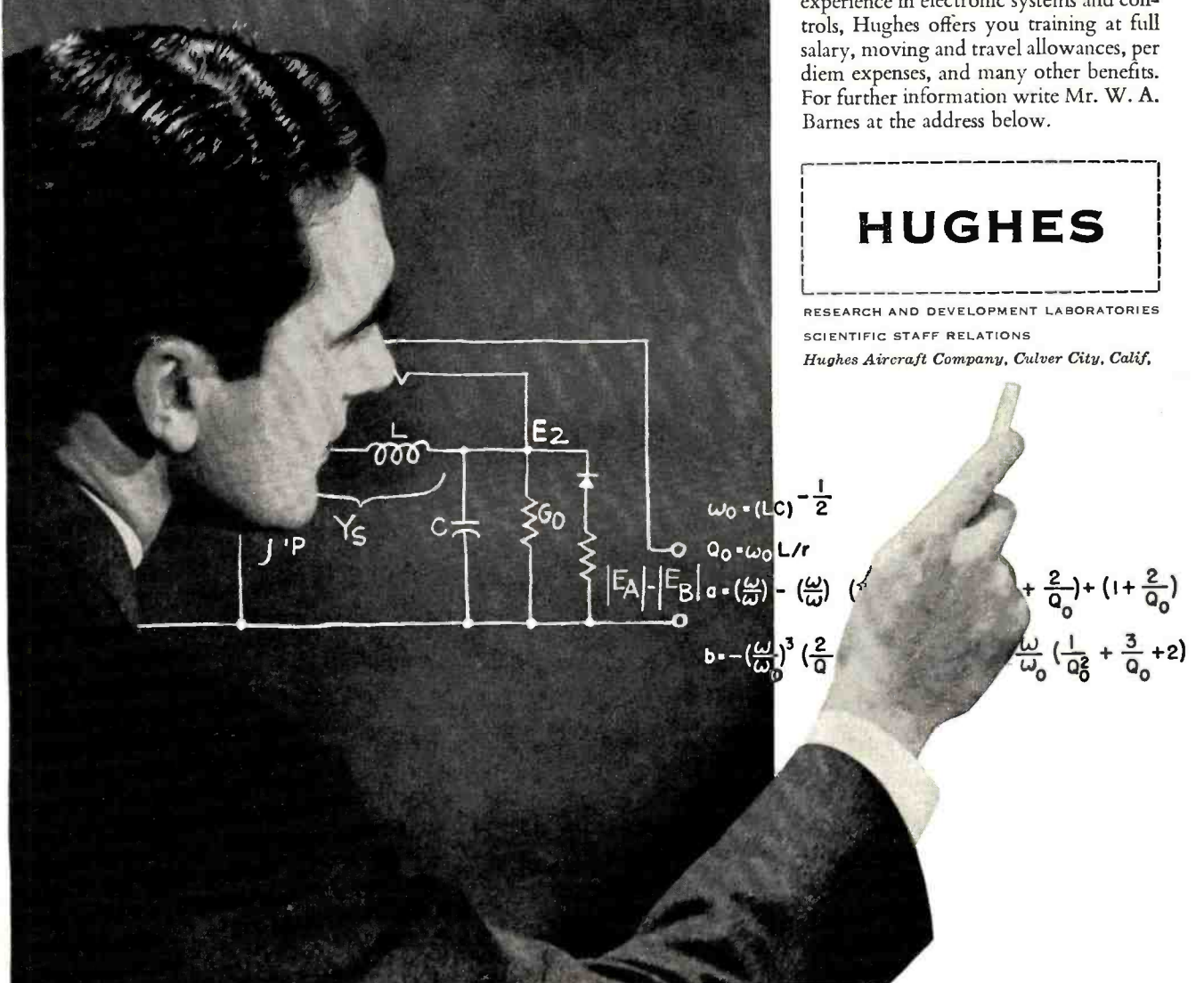

The books...

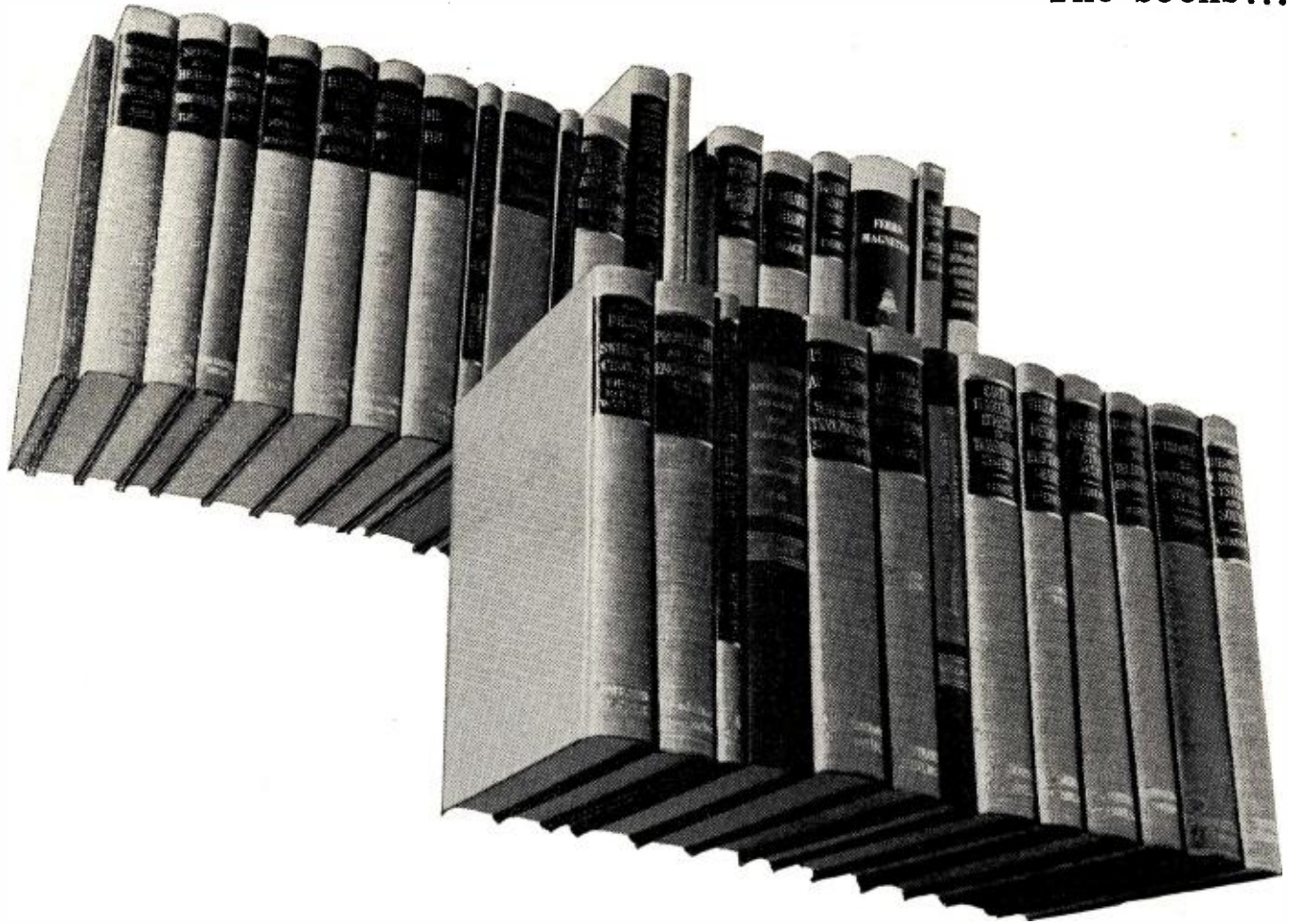

How the scientific world shares in fruits of the telephone art

In their work to improve telephony the scientists and engineers of Bell Telephone Laboratories make important findings in many sciences. They thoroughly report these findings in professional journals and magazines. But sometimes, as knowledge accumulates in a vital field, a "treatment in depth" is prepared in book form.

Bell Laboratories authors have written 36 books to date and others are in preparation. Many have become classics in the Laboratories' primary field of communications. Many have become standard works of wide application because they provide a fundamental guide for technologies in other fields. For example, the design of automatic switching systems is of primary importance in computers; statistical quality control provides the indispensable basis for economical manufacture. Through their books these scientists and engineers and the Laboratories attempt to repay

benefits they receive from the published works of others.

The pictures on the opposite page show some Bell Laboratories authors of technical books. A complete listing of titles may be obtained by sending in this coupon.

Publication Department, Dept. 33

BELL TELEPHONE LABORATORIES

463 West Street, New York 14, N. Y.

Gentlemen:

Please send me a listing of titles, authors and publishers of books written by Bell Telephone Laboratories authors.

Name.....

Street.....

City.....State.....



BELL TELEPHONE LABORATORIES

World center of communications research and development

...the authors

Most of the books written by Laboratories authors are published by D. Van Nostrand Company. Other publishers include John Wiley & Sons and McGraw-Hill. Subjects include speech and hearing, mathematics, transmission and switching circuits, networks and wave filters, quality control, transducers, servomechanisms, quartz crystals, capacitors, visible speech, earth conduction, radar, electron beams, microwaves, waveguides, antennas, traveling-wave tubes, semiconductors, ferromagnetism.



Harold S. Black, B.S. in E.E., Worcester Polytechnic Inst., author of "Modulation Theory."



John R. Pierce, Ph.D., California Inst. of Tech., author of "Traveling-Wave Tubes."



Richard M. Bozorth, Ph.D., California Inst. of Tech., author of "Ferromagnetism."



W. Thornton Read, M.S., Brown University, author of "Dislocations in Crystals."



Hendrik W. Bode, Ph.D., Columbia University, author of "Network Analysis and Feedback Amplifier Design."



Walter A. Shewhart, Ph.D., University of California, author of "Economic Control of Quality of Manufactured Product."

TV Cameras for Surgical Colorcasts

Production begun on first color TV camera system designed for medical use.

THE Radio Corporation of America has started commercial production of the first compatible color television camera system specifically designed for medical use.

Engineered for completely remote operation and maximum operating economy, the medical TV camera is expected to be widely used in hospitals and medical centers, colleges and universities, and research institutions for origination of live closed-circuit or on-air colorcasts of surgical, medical, and educational instruction and demonstrations. First units have been shipped to Walter Reed Army Medical Center, Smith, Kline and French Laboratories, and the University of Michigan Medical School.

The medical camera is designed around three vidicon camera tubes and special circuitry which make possible televising surgical procedures in full-color detail under normal operating-room lighting. The unit is designed to permit long periods of exposure to a single scene without danger of image burn-in, and to eliminate halo or overloading effects caused by reflections from polished instruments or wet tissue.

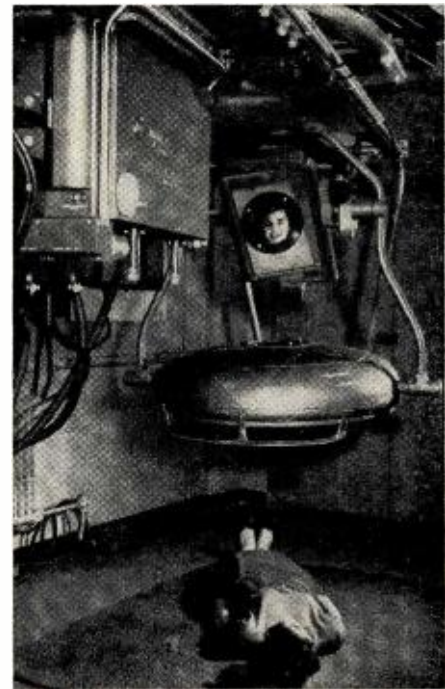

To eliminate interference with surgery or demonstrations, medical TV camera is designed for horizontal installation in overhead fixture which supports both camera, peering into mirror, and surgical lamp.

The camera's "overhead" design keeps it out of interference range of the surgeon or instructor, yet permits unrestricted viewing freedom. Horizontally mounted, the camera looks into a mirror which reflects the optical path downward through an opening in the surgical lamp. Remotely controlled, the mirror can be panned and tilted to change the viewing field without moving camera or lamp. If the lamp is moved, the camera's optical path automatically moves to coincide with the change in lighting path.

The camera's complete remote-control design permits one-man operation of the entire system, including camera focusing and lens selections, as well as operation of the camera mirror. In cases of surgery confined to a tiny area, such as the eye, optical magnification of the televised area can be obtained by selection of lenses with long optical focus. The camera can also be used with a microscope system. —50—

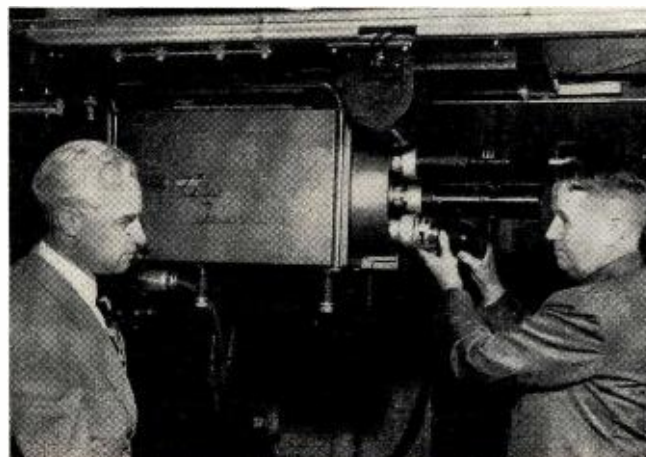

★
First color television camera system specifically designed for medical use. E. C. Tracy (left), Manager of Broadcast and TV Equipment Dept., discusses operation of camera's four-lens turret with J. H. Roe, Manager of TV Camera Engineering.
★

**BUILD THE BEST—
BUILD ALLIED'S OWN**

knight-kits

Here is a typical Knight-Kit value—available only from ALLIED—one of 45 great Knight-Kits you'll find in our special Supplement No. 165. Write for your FREE copy today.

knight-kit HOBBYIST VALUE
PHOTO-ELECTRONIC RELAY KIT



Model Y-702 \$13.50

Build your own modern, dependable photo-electric system at low cost! System consists of relay kit and light source. Ideal as counter, announcer, burglar alarm (can be set to ring bell continuously when beam is broken) and for hundreds of other uses. An ultra-sensitive system, easy to assemble and capable of professional results.

Relay Kit Only. SPST contacts, rated 1 amp. Supplies 6.3 v. at 0.6 amps for alarm, counter, etc. Max. counting rate: 600 per minute. Uses sensitive cadmium selenide photocell. Usable distance from light source below: White, 250 ft.; deep-red filter, 125 ft. With 5696 thyratron tube. Size, 5 x 3 x 5". Shpg. wt., 2½ lbs.

Model Y-702. Net, F.O.B. Chicago... \$13.50

Light Source Kit Only. Sealed-beam bulb; capped filament; removable dark red filter. 6 x 6 x 4". Shpg. wt., 3½ lbs.

Model Y-703. Net, F.O.B. Chicago... \$6.75

OTHER knight-kit HOBBYIST VALUES



WIRELESS BROADCASTER KIT
Y-705 \$9.50



50 W/SEC. ELECTRONIC PHOTOFLASH KIT
Y-244 \$28.50



PHONO AMPLIFIER KIT
Y-790 \$8.95



PHONO OSCILLATOR KIT
Y-760 \$5.85

See our Supplement No. 165 for 12 other knight-kit hobbyist values

free SUPPLEMENT
featuring knight-kits



Send for our FREE Supplement No. 165 featuring 45 great Knight-Kits, including Test Instruments, Hi-Fi, Hobbyist and Amateur Kits. Write for your copy today.

ORDER FROM ALLIED RADIO

Dept. 01-D7, 100 N. Western Ave., Chicago 80, Ill.

The CRT Tester-Reactivator
(Continued from page 49)

cannot avoid occasional situations that involve discomfort and embarrassment, especially when the expensive picture tube is involved. At one time there was no way out with many situations that can now be handled much more readily.

The first time the tester extricated the author from such a spot involved a call-back on a set in a large lake-front home. The owner, a retired manufacturer, was having trouble with a familiar-looking 17-inch *Westinghouse*. This set had been serviced less than two weeks earlier when the secondary of the flyback transformer had shorted to ground. In addition to the transformer itself, it was necessary to replace the high-voltage filter capacitor, the 1B3 rectifier, the 6AX4 damper, and the two 5U4 low-voltage rectifiers. Needless to say, the bill had been a healthy one. However, the symptoms appeared to be genuinely different this time. Brightness was fixed at a high level and there was no video. Sound was good. When the owner asked, "What's wrong?" he had to be told that it looked as though the picture tube had given up. "Picture tube!" he exclaimed, and then let loose with a vigorous tirade.

What can be done in a loaded situation like this? He finally calmed a bit when he was informed of some possibility that the tube could be repaired. He shrugged and sat down. With the tester connected, it was found that the cathode connection had gone open—but if that were the case, why the bright raster? A filament isolation transformer was connected to the tube now, and this caused the raster to disappear altogether. So far so good.

This is what happens in such cases: The heater and cathode of the picture tube are always touching physically, but a thin insulating coating of aluminum oxide on the heater prevents electrical contact. When this insulation deteriorates, there is a heater-cathode short. The combination of filament heat and the mixing of different voltages at this point can cause enough stress to break the cathode structure, resulting in an open cathode. That is apparently what had happened in this case.

Emission from the cathode (and a consequent raster) persisted because the cathode circuit was completed to ground by way of the short to the heater. The isolation transformer for the heater removed this accidental path that was completing the circuit and thus emission stopped. The heater-cathode short that had been causing the stress had been relieved by the transformer. All that remained to be done was to reach into the vacuum of the picture tube to weld the cathode structure back together and the CRT could be made to operate again!

The tester-reactivator was re-installed in an attempt to repair the break. The tester was set to apply heavy filament voltage to the tube. The 1000 volts available from the tester was then applied to the CRT. Nothing happened. With the plastic handle of a screwdriver, the neck of the picture tube was tapped continually, in the hope that the elements inside the picture tube around the open condition could be vibrated close enough together so that the heavy voltage could weld them. Thirty seconds ticked by, with the incredulous set owner watching, before a vibration was felt, quickly followed by a spark in the neck of the tube. The tester was turned off, the isolation transformer was re-installed, and the receiver was turned on. A clear picture came into view on the screen.

The customer could hardly contain himself. It was explained carefully to him that there was some possibility of the repair not lasting, but he was satisfied that at least an honest attempt had been made and that the situation was now hopeful. He paid his fee without complaint and let a relieved technician escape. —30—

Mac's Service Shop
(Continued from page 72)

problem since you bought that complete set of record-changer manuals. I simply leaf through them, looking at the pictures of the changers, until I find one exactly like the one giving me a hard time. Lots of times, of course, I have a pretty good idea whose baby it is just from looking at it; but those manuals are worth their weight in gold when it comes to identifying an unfamiliar changer. And believe you me: most of those Rube Goldberg contraptions are hard enough to work on when you have exploded diagrams, descriptions of the change cycles, and possible trouble charts to help you. Without these things, you are darned near helpless."

As he finished this lecture, Barney walked over to see what Mac was doing to the TV set on the bench. He had removed a couple of stacks of selenium rectifiers from it and was bringing the leads that had gone to the rectifiers underneath the chassis up to what looked like a double fuse-clip mounted top-side.

"What do you think you're doing?" Barney demanded.

"I'm changing over to the new silicon rectifiers recently brought out by *Sarkes Tarzian*," Mac explained.

"Where are they?"

Mac brushed aside an empty 12BE6 tube carton and revealed a couple of little units about the size of cold capsules.

"You mean *them* are going to take the place of *them*?" Barney demanded as he jabbed his forefinger first at the tiny silicon rectifiers and then at the discarded selenium units.

"Ignoring the bad grammar, yes," Mac replied. "Those little Type M500 silicon diodes are rated at 500 milliamperes at 130 volts; and from what I've been reading, they can really take it."

"Looks as though they'd melt right down," Barney muttered. "They don't have the heat-radiating surface selenium rectifiers do."

"Neither do they generate as much heat," Mac replied. "They have a very low reverse current leakage, and the forward voltage drop across them is extremely low. Since the heat generated in the rectifier is directly connected with the forward resistance of that rectifier, when this resistance is lowered, the rectifier heating goes down with it."

"If they have a low voltage drop, I'd think they'd put out more voltage than do the selenium jobs," Barney observed.

"You think right. Actual tests made on TV sets using half-wave voltage doubler circuits showed that when selenium rectifiers were replaced with silicon units, the full-load output voltage was upped from 15 to 30 volts."

"Wouldn't that tend to upset things, maybe pop filter and bypass capacitors, and so on?" Barney asked.

"I was wondering about that, too. However, I doubt you'd have trouble in most cases. The parts you mention ordinarily have more than enough safety margin to take care of the extra voltage. We have found out that most sets work better with the voltage a little high than they do when it is a little low. But there are bound to be some cases, where say the line voltage is above normal to start with, when replacing selenium rectifiers with silicon units may cause a marginal capacitor to give up. But it would probably have gone before long anyway."

"Do you think they will last longer than the selenium units?"

"I'm not going to stick my neck out on that one. I still remember that when selenium rectifiers came on the market I took the word of the 'experts' and passed along to my customers the information that a selenium rectifier would never need to be replaced, that it would last the life of the set. Remembering, with a red face, how wrong I was about that, this time I'm going to wait and see. However, I'll say this: all tests seem to indicate silicon rectifiers may deliver what selenium rectifiers promised. The silicon units seem to suffer no loss in output voltage after many hours of hard usage, and they can operate in higher ambient temperatures than can selenium rectifiers.

"Still, I'm not going to say they will not need replacing. I'll just say this: if they *do* have to be replaced, slipping the old ones out of these little clips and slipping a pair of new ones in place is going to be a whale of a lot easier than replacing those soldered-in, under-the-chassis seleniums!" —30—

BEWARE OF SUBSTITUTES

You know from long experience
the trouble-free operation
selenium rectifiers give!

Replace only with

RADIO RECEPTOR

SAFE CENTER

SELENIUM RECTIFIERS

No other type of metallic rectifier has come close to their record of billions of top performing rectifier hours. Demand RRco. selenium rectifiers that have been proved in the field for so many years — as long lasting original equipment and as replacements.

There's an attractively priced Radio Receptor rectifier immediately available from your distributors stock to fit every radio and TV requirement.

- **No adjustments!**
- **No mounting problems!**
- **No call backs!**
- **No chance of overloading other components!**



Semiconductor Division
Radio Receptor Company, Inc.
Radio and Electronic Products Since 1922
240 Wythe Ave., Brooklyn 11, N. Y. EVergreen 8-6000

Spot Radio News
(Continued from page 14)

build
your own
amateur
transmitter

from these
3 easy-to-assemble
kits!

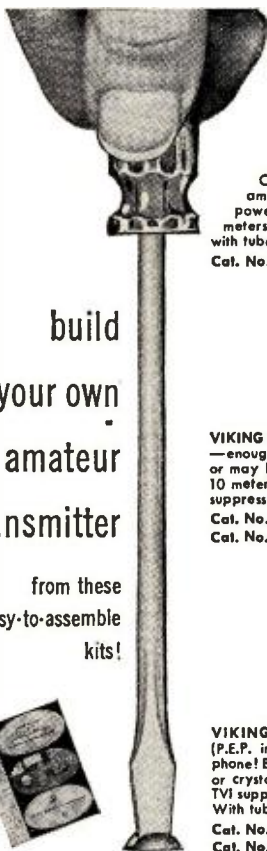

VIKING "ADVENTURER"—An ideal 50 watt CW transmitter for the novice or experienced amateur. Effectively TVI suppressed . . . built-in power supply . . . bandswitching 80 through 10 meters Easy to build and safe to operate. Complete with tubes, less crystal and key.
Cat. No. 240-181 Kit Amateur Net \$54.95



VIKING "RANGER"—Tops for operating convenience—enough power for world-wide contacts! Built-in VFO or may be crystal controlled. Bandswitching 160 thru 10 meters. 75 watts CW input—65 watts phone. TVI suppressed—with tubes, less crystals, key, microphone.
Cat. No. 240-161-1 Kit Amateur Net \$214.50
Cat. No. 240-161-2 Wired . Amateur Net \$293.00



VIKING "VALIANT"—275 watts CW and SSB (P.E.P. input with auxiliary SSB exciter) 200 watts phone! Bandswitching 160 thru 10 meters. Built-in VFO or crystal control. Wide range pin-network output—TVI suppressed—high gain push-to-talk audio system. With tubes, less crystals, key and microphone.
Cat. No. 240-104-1 Kit Amateur Net \$349.50
Cat. No. 240-104-2 Wired . Amateur Net \$439.50

FREE CATALOG!
Write today for
your copy!



E. F. Johnson Company
3107 SECOND AVE. S.W. • WASECA, MINN.

The **NEW** **YEATS "Shorty"**
STATION WAGON & PANEL PICK-UP
appliance dolly



YEATS Model No. 5
Aluminum alloy
Height 47"
Weight 32 lbs.

Only 47" tall, this new YEATS dolly is designed for TV and appliance men who make deliveries by station wagon or panel truck. No need to detach appliance for loading into the "wagon" or pick-up . . . the YEATS "Shorty" will slide into your vehicle with ease. Has aluminum alloy frame with padded felt front, quick fastening (30 second) strap ratchet, and endless, rubber belt step glide. New YEATS folding platform attachment, at left, saves back-breaking work handling TV chassis or table models. Call your YEATS dealer today!



Folding platform is 13 1/2" x 24 1/2" —attaches instantly. (Platform only) \$9.95.



"Everlast" COVERS & PADS

YEATS semi-fitted covers are made of tough water repellant fabric with adjustable web straps and soft, scratchless white flannel liners. All shapes and sizes—Write.



Furniture Pad



TV Cover

SEND postcard for full information on our complete line TODAY!

YEATS appliance dolly

sales co.
Milwaukee, Wis.

2101 N. 12th St.

124

of last year, the FCC made its first regular grant of such a service; for telephone, from Florida to Cuba.

In the present stage of development, all of the private microwave systems, except those of TV broadcasters, are licensed on an experimental or developmental basis. Now that equipment and methods have been improved, and practical operation has been demonstrated, the Commission is considering the possibility of placing many of the non-common carrier microwave services on a regular basis.

However, various considerations are involved, such as the present and future needs for microwave communication; the availability of channels to meet these needs, and, if insufficient, who shall have prior rights in congested areas; and how to deal with interference which may be created by many microwave systems operating in, or converging on, a single large metropolitan area. Also, the question as to whether, and under what conditions, private microwave systems shall be permitted to duplicate or parallel those of common carriers needs to be settled in a way which will best serve the public interest.

THE USE OF PREFERRED CIRCUITS as a practical solution to frequently recurring circuit-design problems, suggested early last year, has now been firmly adopted and become a part of the electronic-development programs of many segments of the armed forces.

Under the guidance of the Bureau of Standards, and in one instance, in cooperation with the Navy Bureau of Aeronautics, it has been found feasible to standardize many of the well-known electronic circuits common to a variety of aeronautical equipment. Various versions of the same kind of circuit found in different devices differ only in minor details. This has been observed to be true in the case of rectifiers, regulators, amplifiers, detectors, pulse generators, and so on. By standardizing many of these basic electronic building blocks, worthwhile advantages to the military user and industrial producer can result through greater operating reliability, fewer spare parts for maintenance, and economies in design and production engineering. One of the building blocks recently investigated is an automatic frequency control that illustrates the type of circuit where the standardization approach is possible.

In a typical radar system, the a.f.c. circuit maintains a constant frequency difference between the transmitter and local oscillator signals by feeding a portion of the transmitter signal along with the local oscillator signal to the a.f.c. mixer. The difference frequency produced by the mixer develops an error signal, whose magnitude and sense are proportional to the amount and the direction by which the difference frequency departs from the desired intermediate frequency. The error signal is amplified and then corrects the frequency of the local oscillator. An additional requirement found to be necessary in most microwave systems is that the local oscillator search for the correct difference frequency when the equipment is turned on, when the transmitter signal is interrupted or when the transmitter signal shifts beyond the a.f.c. hold-in range.

The portion of the a.f.c. system between the mixer and the local oscillator is usually a self-contained subassembly and thus is a logical choice for a preferred circuit. A preliminary study of a number of existing circuits revealed that they are composed of a few basic types. The mixer is followed by i.f. amplifiers which are usually synchronously tuned; the number of stages varies with the bandwidth requirements. In the majority of cases, Weiss-type discriminators are used to develop the error signal in preference to the Foster-Seeley circuit. The video amplifiers, used as error amplifiers, vary from single triodes and pentodes to pentode-triode and pentode-cathode-follower combinations. The control circuits, which also function as sweep generators, are either of the thyatron or phantastron types, with the trend toward the latter.

The performance requirements of these circuits fall within fairly narrow limits. The bandwidth of the i.f. amplifier

and the peak separation of the discriminator are determined by the pulse width of the transmitted signal. Since many radar systems employ both short and long pulses, it was found essential to accommodate the range of pulse widths without adjustment. Two i.f. amplifier stages were required to obtain the necessary gain and bandwidth. While the input signal is constant for a particular system, it varies from 50 to 500 millivolts among the systems studied, and it is necessary to adjust the gain to suit the input level because of the possibility of responding to crystal harmonics. The gain is adjusted by varying the plate-load resistors in the i.f. and video amplifiers. This has been found to be permissible in the former case because the bandwidth requirements are not rigidly fixed.

Because of its better performance, a diode-phantastron circuit was selected instead of the thyratron as a preferred circuit. The sweep rate can be adjusted by selection of two feedback capacitors, the sweep amplitude by a divider on the output of the phantastron, and the sweep centering by a range-set divider.

The choice of input circuit is properly a part of the mixer design. The i.f. amplifier and discriminator are designed for the shortest pulse, and no adjusting controls are provided, or required, for bandwidth. The preferred a.f.c. circuit will operate at pulse widths between .5 and 5 microseconds and duty factors between .001 and .0001. It can be adjusted for input signal levels between 50 and 500 millivolts. The sweep output is a saw-tooth which can be adjusted for rates between .1 and 10 cps, amplitudes between 40 and 150 volts, and average d.c. levels between zero and -200 volts. Values for the eight components necessary to make these adjustments are specified in terms of performance requirements. The result, Bureau of Standards experts say, is a circuit which is usable, without sacrifice in performance, in most a.f.c. systems operating in pulse systems with 30-megacycle i.f.'s.

IN RESPONSE TO THE ARMED SERVICE'S urgent and continually increasing need for accurately calibrated electronic equipment to be used in radar, aircraft control and missile guidance, a \$2-million electronic calibration center will soon be set up at the Boulder (Colorado) Labs of the Bureau of Standards. Scheduled for completion this year, the new center will provide 16 lab rooms with facilities for electrical and electronic calibration services at all frequencies now in general use.

About half of the cost of a modern fighter plane now goes into electronic devices for navigation, fire control, and other purposes. For this equipment to work together as a unit, each of the separate components must be specified, constructed, and evaluated according to accurately calibrated reference standards.

For example, in air-to-air refueling

NEW

at Ward...

REAR FIN ANTENNA

Newest, smartest, pace-setting rear fin on the market. Heavy chrome plated—3 sections extend to 27". 15-ft. lead with built-in signal booster.



MODEL NO. TFL-1

Also available as dummy mount.—Model TFD-1

... AND HERE'S MORE!

NEW FENDER PADS

... for 1957 Fords

Fender Pads—

For mounting 8-Ball mount antennas on front fenders of 1957 Ford. C-61



Fender Pads—

For mounting Tear Drop mounts on front fenders of 1957 Ford. C-62

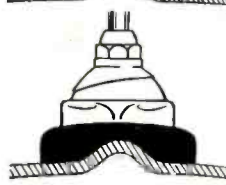

Fast-Selling

Ward

TEAR DROP MOUNT

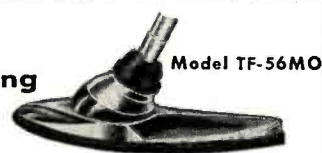

Model TF-56MO

The fastest selling style leader of them all ... the replacement antenna with original equipment styling. Mounts completely outside the car ... easily ... quickly. Heavy chrome plate ... 3 sections extend from 22" to 56".

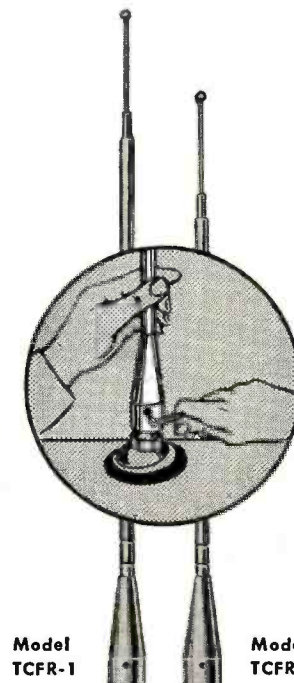

Model TCFR-1

Model TCFR-2

Smart NEW Replacement Masts

No need to disturb the mast. Just slip on and tighten. Easiest, quickest replacement ever developed. Bell-shaped collar on mast fastens to stub of original antenna mast with set screws.

These are just a few of Ward's new quality leaders that have joined the famous Ward family which includes the 8-Ball, Majorette, Silveramic® and many others. Order **TODAY**. For complete information, write: Dept. RTN-4.

Ward PRODUCTS CORPORATION

DIVISION OF THE GABRIEL COMPANY

1148 EUCLID AVE. • CLEVELAND 15, OHIO

IN CANADA, ATLAS RADIO CORPORATION • 50 WINGOLD AVE. • TORONTO, ONTARIO

1957 PHOTOGRAPHY DIRECTORY

& BUYING GUIDE

Most Complete Handbook of Photographic products

See the exciting
new products
from all over
the world

**ON SALE SOON
AT NEWSSTANDS AND
PHOTO STORES ONLY!**



\$1.00

ILLUSTRATED LISTINGS
LATEST MODELS
LATEST PRICES

Cameras . . . Lenses . . . Flashes & Speedlights
Movie Equipment . . . Enlargers . . . Projectors
Exposure Meters . . . Lighting Equipment
Films & Papers . . . Stereo Equipment . . . Filters
Tape Recorders . . . etc. . . etc.

Compiled by the editors of **POPULAR PHOTOGRAPHY**

NEW THIS YEAR in the 1957 PHOTOGRAPHY DIRECTORY & Buying Guide

Special 16-page section on HOW TO SELL YOUR PICTURES FOR CASH!

You'll profit from this money-making guide to the photo market—included as an extra bonus in this year's PHOTOGRAPHY DIRECTORY. This special section lists the name of newspapers, calendar & greeting card firms, trade journals and magazines interested in buying your photographs.

It's typical of the extra features that make the 1957 PHOTOGRAPHY DIRECTORY & Buying Guide bigger, better, more complete than ever.

BUY YOUR COPY TODAY—ONLY \$1.00

On sale soon at your favorite newsstand or photo dealer

of Air Force planes, radar-navigation equipment is used to rendezvous the tanker with the aircraft to be refueled. To assure contact between the two aircraft, their navigation equipment must be precisely calibrated in terms of a single frequency standard. This requires a total of 29 test instruments, each accurate to .1 per-cent. To calibrate the test instruments to this accuracy, 25 measurement standards, accurate to .01 per-cent, must be used. Such uniformity requires inspection and calibration of all secondary standards by a single agency in terms of a master set of standards.

The primary mission of the new calibration center will be to provide this specialized service. They will calibrate interlaboratory secondary standards for such quantities as voltage, power, and impedance against master standards to be maintained at the center. These interlab standards, in turn, will be used to assure the accuracy of working standards in labs, on the production line and in overhaul stations. This service is expected to be of great value not only to the armed services, but also to the electronics and communications industries.

TV-STATION GRANT ACTIVITY hit a new low during the early months of the new year. Only three stations were authorized, as the table listing on page 12 indicates.

THE ULTRA-SENSITIVE MINITRACK RADIOS, designed originally by the Naval Research Laboratory to track earth satellites, are now on the production line and will soon be ready for "Project Vanguard," the first satellite launching that will take place sometime during the International Geophysical Year: July 31, 1957 to December 31, 1958.

These minitrack radios will be sensitive enough to receive signals from a 13-ounce transmitter on the satellite, that will deliver 10- to 50-milliwatt signals at the upper end of the FM band. Tracking will be accomplished by a chain of a dozen receivers, each capable of determining a position in the few seconds the satellite will be within radio range. The sites will be interconnected to obtain a continuous fix on the satellite.

Because of the mounting interest in the satellite program, your editors are planning a number of articles for this summer which will keep you in touch with developments. Watch each issue for such stories.

Once more, radio-electronic engineers have displayed an uncanny skill in developing so remarkable a device that will provide scientists with information on the outer limits of the atmosphere, the characteristics of interplanetary space, solar radiation and its effects on weather and communications, cosmic rays, the density of dust and micrometeorites in outer space, and precise data never before available on the size and shape of the earth. L. W.

Sun	Mon	Tue	Wed	Thu	Fri	Sat
				3	4	5
						12
						19
						26

CALENDAR of EVENTS

APRIL 4, 5, 6

Rocket and Satellite Exposition. Sponsored by American Rocket Society, Inc. Sheraton-Park Hotel, Washington, D. C. Information available from the society at 500 Fifth Ave., New York 36, N. Y.

APRIL 8-10

Spring Meeting. Sponsored by the American Society of Mechanical Engineers. Dinkler-Tutwiler Hotel, Birmingham, Ala. Contact L. S. Dennegar of society at 29 W. 39th St., New York 18, N. Y., for more details.

APRIL 9, 10

First Annual Conference on Electronics in Industry. Sponsored by IRE Professional Group on Industrial Electronics and Armour Research Foundation. Campus of the Illinois Institute of Technology, Chicago, Illinois. Inquiries should be addressed to Conference Secretary, D. H. Thormahlen, Armour Research Foundation, 10 W. 35th St., Chicago 16, Ill.

APRIL 11, 12, 13

1957 Southwestern IRE Conference and Electronics Show. Sponsored by the Houston Section of the IRE. Shamrock Hotel, Houston, Texas. Further information from the Conference at P.O. Box 1234, Houston 1, Texas.

APRIL 14, 15, 16

National Symposium on Telemetering. Sponsored by the Professional Group on Telemetry and Remote Control of the IRE. Sheraton Hotel, Philadelphia, Pa. Additional program information from A. S. Westneat, Jr., Applied Science Corp. of Princeton, Box 44, Princeton, N. J.

APRIL 24, 25, 26

Seventh Region IRE Conference. Sponsored by the IRE. Conference and Federal Buildings in Balboa Park, San Diego, California. Mailing address, 7th Regional IRE Conference, U.S. Grant Hotel, San Diego.

APRIL 26, 27

Eleventh Annual Spring Technical Conference on Television. Sponsored by the Cincinnati Section of the IRE. Engineering Society of Cincinnati Building, 1349 E. McMillan St., Cincinnati, Ohio. Information on accommodations available from Charles B. Shaw Jr., Hangar 3, Lunken Airport, Cincinnati 26, Ohio.

MAY 13, 14, 15

National Conference on Aeronautical Electronics. Sponsored by Dayton Chapter of IRE. Contact John E. Wilkinson in care of IRE, Dayton, Ohio, for further information.

SEPTEMBER 15-19

1957 Distributor Conference. Sponsored by The Heart of America Chapter of The Representatives, Excelsior Springs, Mo. W. E. Fry, 4550 Main St., Kansas City, Mo., is publicity chairman of event.

ADDS INCOME 2 WAYS

1. Tests and Repairs Picture Tubes
2. Makes New Tube Sales Easier



Quickly Spots and Corrects TV Picture Tube Troubles Without Removing Tube From the Set

TESTS the picture tube for all the important factors which determine the quality of the tube.

RESTORES emission and brightness.

REPAIRS inter-element shorts and open circuits. Checks leakage.

LIFE TEST checks gas content and predicts remaining useful life of the picture tube.

GRID CUT-OFF reading indicates the picture quality customer can expect.

QUALITY DESIGN makes it easy to use. Provides quick reading at a glance.

CRT 400 PROVES REAL MONEY-MAKER

Here's what Joe Driscoll of TV Trouble Shooters, St. Paul, Minnesota says: "It has made more money for us than any other instruments, with the possible exception of tube checkers. We make an additional charge each time we use the instrument in the home to check or correct picture tube conditions. We have been able to convince customers much easier that their old tubes need replacing and have enjoyed a nice profitable business from the sale of new picture tubes without leaving any doubt whatever in the customer's mind that he needed a new tube."

This is typical of the experience of thousands of servicemen using the CRT 400. It cuts service-operating costs... brings new profits... builds customer good-will... quickly pays for itself. Also saves money on TV set trade-in reconditioning. Has 4½-inch plastic meter. Easily portable. **NET \$54.95**

See Your Distributor today or Write for Bulletin No. 400-N

Makers of CRT, DYNA-QUIK, DYNA-SCAN and CALIBRATOR

B & K MANUFACTURING CO.

3726 N. Southport Ave. • Chicago 13, Illinois



BEWARE OF IMITATIONS

There Is Only One Original Dependable NO-NOISE

Volume Control and Contact Restorer with Perma-Film



Cleans, lubricates, protects... not a carbon-tet solution. Still available in the new 6 oz. spray can. Net to servicemen—\$2.25

"NO NOISE"

2 oz. bottle. Net to servicemen. **1.00**

Also available in 8 oz. bottles and quart cans. At your nearest distributor.

TUNER-TONIC with PERMA-FILM

Cleans, lubricates, restores all tuners including wafers type. Won't change or affect capacities, inductance or resistance. Won't harm insulations or precious metals, nor attack plastics. For television, radio and FM. Eliminates all noise, oxidation and dirt indefinitely.

Non-toxic, non-inflammable, insures trouble-free performance. **\$3.25** Net to servicemen. Extra economical because a small amount does the job!



ELECTRONIC CHEMICAL CORP.

813 Communipaw Avenue

Jersey City 4, N. J.

**BUILD THE BEST—
BUILD ALLIED'S OWN**

knight-kits

Here is a typical Knight-Kit value—available only from ALLIED—one of 45 great Knight-Kits you'll find in our special Supplement No. 165. Write for your FREE copy today.

knight-kit HOBBYIST VALUE
2-TRANSISTOR POCKET RADIO



NEW!

Model
Y-262
\$14⁶⁵

It's fun to build this efficient pocket-size broadcast band radio. Entirely self-contained, complete with built-in antenna (no external antenna required), battery and earphone. Features reflex-type 2-transistor circuit. Printed circuit panel simplifies assembly. Has high-gain ferrite-core antenna; super-sensitive miniature dynamic earphone for excellent tone quality; variable capacitor for accurate tuning; months of dependable operation from single long-life alkaline cell battery supplied. Two simple controls—On-Off-Volume and Tuning. Handsomely styled leatherette carrying case. Fits coat pocket or may be worn from belt; only 4 x 3¼ x 1¼". Complete, with step-by-step instructions. Shpg. wt., 1½ lbs. Model Y-262. Net, F.O.B. Chicago. **\$14⁶⁵**

OTHER knight-kit HOBBYIST VALUES



"10-IN-1" LAB KIT
Y-265 **\$12⁶⁵**



"6-IN-1" LAB KIT
Y-770 **\$7⁹⁵**



3-WAY PORTABLE
RADIO KIT
Y-730 **\$19⁹⁵**



"OCEAN HOPPER"
SW RECEIVER KIT
Y-740 **\$17⁵**

See our Supplement No. 165 for 12 other knight-kit hobbyist values

free SUPPLEMENT
featuring knight-kits



Send for our FREE Supplement No. 165 featuring 45 great Knight-Kits, including Test Instruments, Hi-Fi, Hobbyist and Amateur Kits. Write for your copy today.

**ORDER FROM
ALLIED RADIO**

Dept. 01-D7, 100 N. Western Ave., Chicago 80, Ill.



New Hi-Fi-Audio

Equipment

NEW AM-FM TUNER

Unique styling characterizes the new AM-FM tuner recently introduced by Sargent-Rayment Company of 4926 E. 12th St., Oakland 1, Cal.

The Model SR-100 incorporates two positions for broad or sharp AM

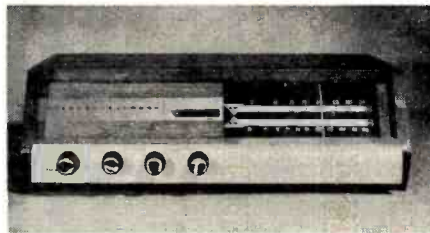

tuning, a two-tube low distortion AM detector, a bridged-"T" 10 kc. filter, a sensitive ferrite core antenna, two-position FM with a.f.c. either on or off, and cathode-follower output.

The tuner is housed in a cabinet which measures 4½" high, 15" wide, 11½" deep and is available in either walnut or blonde finishes.

MOVING COIL CARTRIDGE

Fairchild Recording Equipment Co., 10-40 45th Ave., Long Island City 1, N.Y., is now offering its Model XP-2 hand-constructed cartridge of the moving coil type.

Featuring a bonded diamond stylus



assembly and an unusual damping system, the new unit is said to provide exceptional clarity and definition, particularly at high frequencies.

The new unit is available in limited quantities through regular audio and sound equipment dealers.

THE KAY "AUDIOLATOR"

Kay Electric Company, 14 Maple Ave., Pine Brook, N. J., has come out with an all-transistor beat frequency audio oscillator which it is marketing as the "Audiolator."

Designed for field service, military,

commercial and domestic hi-fi, and industrial applications, the circuit provides constant output over a frequency range of from 50 to 15,000 cps. The output voltage is 1 volt at an impedance of 600 ohms. The output is flat ± 1 db over the entire range.

This compact test unit measures only 6" x 2" x 3¾". Its mercury or penlite cells are said to last approximately 400 hours. A data sheet is available on this new item and may be obtained direct from the manufacturer.

SABLE RECORD BRUSH

The Duotone Co., Inc., Keyport, N. J., is now merchandising a new static-resistant record brush made of



sable hair as an "impulse" item for added sales.

The new brush fastens on the arm of any type machine. It cleans the dust from the record grooves in advance of the needle and thus not only keeps the dust from being ground into the record grooves as the needle passes over it, but also saves wear on the needle itself.

These sable brushes are available on a display card housing thirteen of the items, each packed in a dustproof bag. Write the company for full details.

TRANSISTOR FOR AUDIO

The Semiconductor Division of Radio Corporation of America, Somerville, N. J., has developed a new alloy-junction transistor which is designed especially for use in large-signal audio-frequency applications, such as single-ended or double-ended power output stages and high-gain class A driver stages of radio receivers and a.f. amplifiers.

The RCA-2N270 is of the germanium p-n-p type and has flexible leads. It is hermetically sealed in an insulated metal case measuring .375" long and .360" in diameter. In class A amplifier service, a single unit can deliver a maximum signal power output of approximately 60 mw. with a power gain of 34 db. In class B push-pull arrange-

ment, two of the transistors can deliver a maximum-signal power output of approximately 500 mw. with a power gain of 32 db.

Audio amplifiers utilizing the 2N270 may be designed to provide the indicated power gains at low distortion with high efficiency. These performance characteristics make this transistor particularly useful in many types of battery operated equipment such as home radios, communications receivers, and phonographs.

A technical bulletin on the 2N270 is available on request.

GRANCO AM-FM TUNER

Granco Products, Inc., 36-07 20th Ave., Long Island City 5, N. Y., has added a new AM-FM tuner to its line of audio gear.

The Model T-270 is designed for use with phonographs, tape recorders, TV

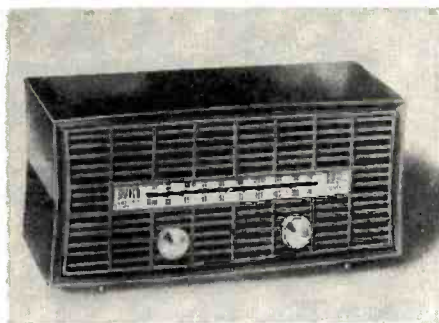

receivers, and hi-fi systems. It may be easily connected to any such instruments thereby making it possible to receive all FM and AM broadcasts.

The company's exclusive coaxial tuning unit assures drift-free reception. Built-in antennas are used for both AM and FM reception. The six tubes plus selenium rectifier provide a circuit which has a frequency response of 20 to 15,000 cps. The polystyrene cabinet is styled to blend with any room decor.

SONOTONE SPEAKERS

Sonotone Corporation, Elmsford, N. Y., has recently introduced two new loudspeakers to the audio trade.

The CA-12 is a 12" coaxial unit which includes many of the features found in the company's "Linear Standard" speaker line.



It provides a flux density of 12,000 gauss (woofer) and 8500 gauss (tweeter), low resonant frequency, wide frequency range (40-14,000 cps) and an exclusive elliptical cone tweeter for wide dispersion. The unit uses an Alnico V magnet and comes complete with an LC dividing network.

The second unit is the W-12, a 12" woofer. This speaker is the same unit as used in the CA-12 coaxial. Because of its modest price, this speaker is ideal for use in multiple speaker sys-

4 IDEAS

for getting even more use from your
Weller SOLDERING GUN

Your Weller Soldering Gun is the most useful tool in your shop. Service technicians find new, practical uses for it every day. Here are some time-saving applications:

1 CIRCUIT AND COMPONENT DEFECT ANALYSIS. Energized tip of Weller Gun is substituted for signal generator to find defective components in both audio amplifier section and picture circuit. Quickly uncovers thermal intermittance trouble.

2 REACHES COMPONENTS THROUGH CHASSIS CUT-OUTS. Weller Guns, with their long, thin electrodes, reach recessed tube sockets and connections through small chassis cut-outs. Pre-focused twin spotlights light up this hard-to-get-at work.

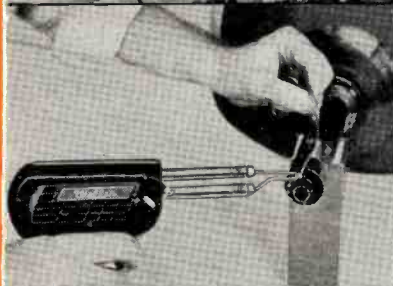
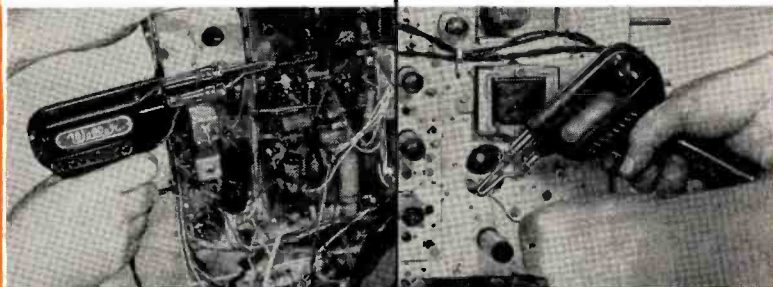

3 NEW SOLDER FOR CATHODE TUBE BASE PIN. Defectively soldered (or loose) base pin is re-sweated to remove imperfections. New solder is then applied to establish uninterrupted contact. Weller Gun is ideal for this type of repair.

4 SOLDERING BROKEN TERMINAL LEADS. Weller Soldering Gun permits controlled application of heat. Solder is maintained at correct viscosity. This enables serviceman to produce rounded joints and prevent corona discharge in high-voltage compartment.

Weller SOLDERING KIT 8100K IDEAL FOR

ALL SERVICE WORK



Complete kit for the price of the gun alone! Latest type Weller Gun — Model 8100, over 100 watts, with triggermatic heat control. 2 pre-focused spotlights. Reaches through small openings into dark places. Kit includes Wire Soldering Brush, wire-twisting Soldering Aid, Kester Solder. Top value at \$7.95 list.

SEE THE FULL LINE OF PROFESSIONAL MODEL WELLER GUNS AT YOUR ELECTRONIC PARTS DISTRIBUTOR

Weller ELECTRIC CORP. • EASTON, PA.
601 Stone's Crossing Road

Your choice of school is highly important to your career in



INDUSTRIAL ELECTRONICS



RADIO-TELEVISION



ELECTRONICS COMMUNICATIONS

Become an ELECTRICAL ENGINEER or an ENGINEERING TECHNICIAN at

MSOE in Milwaukee

Choose from courses in:

ELECTRICAL ENGINEERING
Bachelor of Science degree in 36 months. Communications or electrical Power options.

ENGINEERING TECHNICIAN
Assoc. in Applied Science degree in 18 months.
Electronics Communications
Electrical Power.

MSOE — located in Milwaukee, one of America's largest industrial centers — is a national leader in electronics instruction — with complete facilities, including the latest laboratory equipment, visual aid theater, amateur radio transmitter — offers 93 subjects in electrical engineering, electronics, radio, television, electrical power, and electricity.

Advisory committee of leading industrialists. Courses approved for veterans. Over 50,000 former students. Excellent placement record.



QUARTERS BEGIN OCTOBER, JANUARY, APRIL, JULY

Choose wisely — your future depends on it. Write for more information today!

MILWAUKEE
SCHOOL OF ENGINEERING
Dept. RN-457, 1025 N. Milwaukee Street
Milwaukee 1, Wisconsin
Send FREE career booklet.

I am interested in _____ (Name of course)
Name _____ Age _____
Address _____
City _____ Zone _____ State _____
If veteran, give discharge date _____

tems using several woofers or for stereo systems.

Write the company direct for further details on either or both units.

BELL 20-WATT AMPLIFIER

Bell Sound Systems, Inc., 555 Marion Road, Columbus, Ohio, is now marketing its "2300" 20-watt amplifier which incorporates several new circuit and design features.

The new unit includes a built-in preamp which provides inputs and equalization for playback directly from a tape head or ceramic cartridge, in addition to standard high and low level magnetic cartridges. Harmonic distortion is less than .3% and peak power output is 40 watts. Seven inputs provide for two low magnetic cartridges or tape heads, ceramic or crystal cartridges, high magnetic cartridges, radio, TV, or auxiliary equipment. Eight outputs are provided for 4, 8, and 16 ohms, high-impedance recording, two separate outputs for speakers to be switched, and two a.c. outlets.



The circuit is housed in a streamlined, modern cabinet which measures 4" high. The perforated front panel and slots on top of the cabinet are designed to dissipate heat. The company will forward a data sheet on this new amplifier to those writing the firm direct.

"KNIGHT" FM TUNER KIT

Allied Radio Corporation, 100 N. Western Ave., Chicago 80, Ill., is now offering a new FM tuner in its "Knight" kit line.

Combining contemporary cabinet styling with printed circuitry, flywheel tuning, a.f.c., etc., the circuit features two control knobs (on-off-a.c.-non-a.f.c. and tuning). The tuner can be used with any amplifier that has volume and tone controls. The a.f.c.

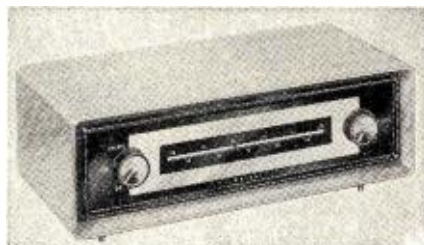

makes tuning simple and eliminates drift by locking in the station tuned. A disabling switch cuts out a.f.c. for easier tuning of weak or distant stations. The flywheel dial mechanism operates smoothly and an illuminated lucite indicator assists the tuning operation.

Printed circuit wiring speeds and simplifies assembly of the kit. All leads of critical length or position are

WESTON TEST EQUIPMENT

MODEL 665—SELECTIVE ANALYZER and VOLT-OHM-MILLIAMMETER... **\$12.95**
MODEL 664 — CAPACITY CHECKER and AC VOLTMETER... **\$10.95**
BOTH ABOVE WITH OAK CARRYING CASE... **\$21.95**

DM-35D DYNAMOTOR

12 Volts 10.5 Amps Input—625 V. **\$13.50** ea.
225 Ma Output. Guaranteed

IMPULSE COUNTER TO 99,999... **\$2.95**
115V. 60 cy. operation

.001 15,000 VDC Ceramic Condenser Low-loss 2 for **99c**

WESTERN ELECTRIC Stepping relay 44 steps, 6-12 Volt coil... **\$4.95**

115 V AC RELAY 115 V 60 Cyc Coil DPDT, 10 Amp Contact... **\$1.89** ea. 3 for **\$4.95**

VEEDER ROOT COUNTER 5 Digit ratchet counter. Resettable. **\$2.95**

EIMAC VACUUM CONDENSER 32,000 VDC 12 MMF... **\$4.95**
25 MMF... **5.95**
50 MMF... **7.95**

G. E. RELAY CONTROL

(Ideal for Model Controls, Etc.)
Contains a sigma midget 5,000 ohm, relay (trips at less than 2 MA), high impedance choke, bimetal strip, neon pilot and many useful parts. The sensitive relay alone is worth much more than the total low price of... **\$1.10** Each 10 for **\$9.25**
FREE Model Control Book with Purchase of 10.

SENSITIVE PLUG-IN RELAY 4 pole ST 14,000 OHM COIL Plugs into Octal Socket. each **\$1.69**

WESTON 0-1 MILL METER 270° SCALE 2" CASE MODEL #1329 ea. **\$4.95**

12-14 VOLT DYNAMOTOR 375 Volt at 150 Ma. with Filter... **\$4.95**

ANTENNA RELAY 12 Volt DC, DPDT plus extra SPST 10 amp contact. Low loss ins. ea. **\$1.39**

PANEL METERS

2" METERS		3" METERS	
0-1 Ma	\$2.95	0-150 Ma	\$3.95
0-1 Amp	2.95	0-500 V. DC	3.95
0-5 Amp RF	3.95	0-2 Amps DC	3.95
150-0-150	4.95	0-1.5 Amps DC	2.95
Microamp	4.95	0-5 Amps RF	4.95
DC 0 to -15	2.95	0-2 Amps RF	4.95

OIL CONDENSER BARGAINS

1 mfd 600 VDC	\$.25	8 mfd 1000 vdc.	\$1.35
2 mfd 600 VDC	.45	12 mfd 1000 vdc.	1.59
4 mfd 600 vdc.	.75	6 mfd 1500 vdc.	1.95
8 mfd 600 vdc.	.95	2 mfd 2000 vdc.	1.50
10 mfd 600 vdc.	.99	3 mfd 2000 vdc.	2.25
1 mfd 1000 vdc.	.60	4 mfd 2000 vdc.	2.95
2 mfd 1000 vdc.	.75	4 mfd 5000 vdc.	14.75
4 mfd 1000 vdc.	1.25	1 mfd 3000 vdc.	1.95
		2 mfd 10KV DC.	27.50

BIG BARGAINS IN LITTLE TYPE

Kit of 25 WIRE WOUND RES. 5 to 50 watt. **\$1.95**
Kit of 10 TRANSMITTING MICAS... 1.00
500 MMF CERAMIC CONDENSERS... 10 for .50
15 MEG 1% METER MULTIPLIER... 10 for 1.49
1 MFD 400VDC OIL COND. 10 for .95

Min. Order \$3.00—25% with order F.O.B. New York 10 DAY GUAR. PRICE OF MDSE. ONLY

ADVANCE
ELECTRONICS COMPANY
6 WEST BROADWAY, NEW YORK 7, N. Y.
Phone REctor 2-0270

New Motorola Auto Radios 1950 - 1954

Ford, Chevrolet, Plymouth, Dodge Manual \$27.50—Pushbutton \$34.95
Complete radio
Custom control heads to fit in dash of above cars.

1957 Dodge—1956-7 Ford—1955-6 Plymouth—1955-6 Chevrolet
Manual \$29.95
Custom radio complete to fit in dash of above cars. Fast, C.O.D. Shipment

LIBERTY AUTO RADIO
191 E. 161 St. New York 51, N. Y.
LUdlow 8-9411

pre-wired on the printed circuit board. The r.f. coils are pre-adjusted and require no further alignment after the kit is assembled. Sensitivity is 10 μ v. for 20 db quieting at any point on the FM band.

Information on the Number 83 Y 751 is available from the company. Fully illustrated instructions accompany each kit.

"XOPHONIC SOUND"

Radio Craftsmen, a division of Precision Radiation Instruments, Inc., 4223 W. Jefferson Blvd., Los Angeles 16, Calif., is now offering a newly devel-

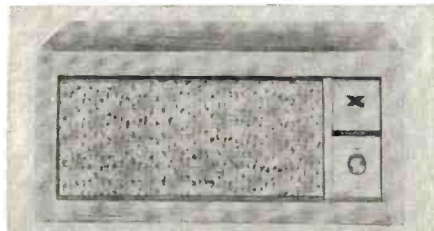

oped sound delay system, speaker enclosure, and amplifier combination which has been tradenamed the "Xophonic."

The unit consists of a second sound source which is added to the present system (radio, phono, tape, or hi-fi) to provide a split second delay and lend "presence" to the reproduced material. An important feature of the "Xophonic" is that no special source material is needed. It functions with any ordinary AM or FM broadcast, with ordinary records or tapes, and even with a TV set.

The entire system is housed in a hardwood cabinet. For full information write the manufacturer direct.

THE FISHER "500"

Fisher Radio Corporation, 21-21 44th Drive, Long Island City 1, N. Y., has recently introduced a complete receiver which will be marketed as the "500."

The new unit includes an FM-AM tuner, audio control center, and 30-watt amplifier all on a single compact chassis. A record changer and loud-speaker unit are all that is required to complete a high-fidelity sound system.



The "500" has a meter for micro-accurate tuning, wide-band FM detector, and frequency response from 16 to 32,000 cps from the amplifier. This component can handle up to 60-watt peaks.

There are four inputs, including a separate tape playback preamp-equalizer. The 4, 8, and 16 ohm outputs match all existing speaker systems. In

April, 1957

APRIL SPECIALS NO FOOLING!

Save 75% on Standard TV Components!

KAY MODEL MEGA-PIX

Output signal frequencies: TV HF picture and sound frequencies. Maximum picture and sound carrier output: 250 MV across 72 ohms. All 12 VHF channels. \$495.00 value.
Special price.....ea. **\$125.00**

TV CHASSIS

Mfg. by American Television, 21" series string chassis, completely wired, less tubes and yoke. Buy them for replacement parts: flyback, tuner, 2-seleniums, condensers, resistors, controls, etc. All brand new, ideal for experimenting on latest type circuits.
Special price **\$15.95** ea.

17" VERTICAL CHASSIS

Manufactured by American Television AC-DC Series String Chassis. Includes—2 Selenium, flyback, Vert. output coils, condensers, controls, resistors, etc. Right off factory production line but not in working condition.
\$4.95 While they last

Same as above, with tuner—\$9.95 While they last
Schematics are not available for these chassis, however, with some knowledge of TV these can be put in operation. These require tubes, yoke and alignment.

HICKOK Mod. 610A Signal Generator used in good condition only 4 available 15 $\frac{3}{4}$ x14x7".....Special **\$95.00**

R.C.A. Model 195A V.O.M. Used in good condition. While they last.....\$22.95

POWER TRANSFORMER SPECIALS

No. 2289, 150 Ma. 750 VCT. 5V C5A. 6.3V C5A. Upright Mt. 4-5/16x3 $\frac{3}{8}$ x4 $\frac{1}{8}$ ".....Special **\$3.95**
No. 10024 200 Ma. 800 VCT. 5V C5A. 6.3 C5A. Half shell Mt. 3 $\frac{3}{4}$ x4 $\frac{1}{4}$ x3 $\frac{3}{8}$ ".....Special **\$4.95**

No. 9113119 Pri 117V. 60 CY. Sec. 800 VCT 300 Ma. Fil. 6.3V C5A.—5VC 3.5A. 5VC 2.5V.—24V C1A.—5VC 2.5A Upright Mt. 5 $\frac{1}{4}$ x4 $\frac{1}{2}$ x3 $\frac{3}{4}$ ".....Special **\$5.95**

POWER TRANSFORMER

TPA-10026 Half Shell Type, 117 V 60 cy. pri.; 355-ohm—355V Sec.; 5V C 5A; 6.3VC 9A. **\$4.95**

ELECTROLYTIC BARGAINS

Cardboard Insulated, with wire leads.	Mfd.	Volts	ea.	per 10
	50-30	150	\$5.59	\$4.95
	50	450	.39	2.95
	50	5	.39	2.95
	12	475	.39	2.95
	50	250	.39	2.95
	50	350	.49	3.95
	20-100	450-25	.59	4.95
	4	400	.29	1.95
	4	200	.19	1.45

COLOR TV CHASSIS

Here's a tremendous deal for you experimenters! Color TV chassis mfg. by Scott, using many genuine RCA parts. These are brand new and about 75% complete. Worth at least \$150.00 in replacement parts alone! While they last you get can type condensers, H.V. condensers, H.V. transf., yoke, power transf., output transf., controls, I.F.'s, coils, resistors, condensers, etc. (no tubes).....All for **\$39.50**

RAYTHEON #25AX4 H.V. CHASSIS

Costs less than flyback alone! Complete with flyback, HV Socket, HV leads, cage, condensers, resistors, etc.Only **\$3.95**
Same as above with 3 tubes.....\$7.95

RAYTHEON A-294902 FRONT END

Complete front end section for 21" Raytheon. Includes tuner, I.F.'s resistors, condensers, etc.Only **\$3.95**

4.5 MC GENERATOR

Used to align sound I.F.'s. These are used but in wonderful condition. Bought at auction from Capehart. Worth much more than our low price complete with schematic.Only **\$39.50**

SPECIAL SMALL PARTS BAG

Over 500 usable radio and TV parts. This is not a surprise package; no junk included. Many parts have been removed from new chassis and sub-assemblies, many are brand new. Contains condensers, resistors, knobs, sockets, switches, etc.**\$3.95** per asst.
A terrific value for only.....\$3.95 per asst.

TWIST LOCK CONDENSER SPECIALS

40-20-20 MFD@150V.....49c ea. 10 for **\$3.95**
60 MFD@450V, 40-20 MFD@350V.....59c ea. 10 for **\$4.95**

MIDGET IF

455 KC Broadcast band IF. 3/4" sq. x 2" high. Used for input or output.....79c per pair 10 for **\$2.95**

ASSORTMENTS

CERAMICS. 100 asst. tubular and disc type ceramic cond., all std. values. Stk. #101.....**\$2.95** per asst.

BY-PASS. 50 asst. paper tubular by-pass condensers. Wide range of std. values! Guaranteed fresh. Stk. #102.....**\$2.95** per asst.

MICAS. 50 asst. std. value mica condensers. Wide range of sizes. Stk. #103.....**\$2.95** per asst.

RESISTORS. 100 asst. carbon 1/2, 1, 2 watt imported resistors. Stk. #104.....**\$1.00** per asst.

RESISTORS. 100 asst. carbon 1/2, 1, 2 watt std. American mfg. AB, Stackpole, IRC, etc. Stk. #105.....**\$2.95** per asst.

WIRE-WOUND RESISTORS. 50 asst. 5, 10, 20, 25, 50W in wide range of values. Stk. #106.....**\$4.95** per asst.

TERMINAL STRIPS. 100 asst. Wide range of sizes and shapes from 1 lug to 8 lug. Stk. #107.....**\$1.95** per asst.

BATHTUB CONDENSERS. 25 asst. Great for building hi-fi amps. & ham equip. Stk. #108.....**\$2.95** per asst.

CONNECTORS. 100 asst. battery plugs and small connectors. Stk. #110.....**\$2.95** per asst.

TUBE SOCKETS. 50 asst. 7 pin, 9 pin, octal, etc. Stk. #115.....**\$1.95** per asst.

TWIST LOCK COND. 10 asst. Twist locks. Sell one and get your investment back! Stk. #114.....**\$2.95** per asst.

TOGGLE SWITCHES. 10 asst. Another great money saver for the builder. Stk. #113.....**\$2.95** per asst.

KNOBBS. 50 asst. radio & TV knobs. Stk. #111.....**\$1.95** per asst.

B&J ELECTRONICS INCORPORATED

5335 1/2 W. DIVERSEY CHICAGO, ILL. Phone BE 7-1660

Terms: F.O.B. Chicago, Ill. Cash with order or 25% deposit on C.O.D. orders. All merchandise subject to prior sale. Prices subject to change without notice.

\$500 per month?

mobile radio is bursting at the seams

That's a conservative income from mobile-radio maintenance!

equipment needs regular, careful maintenance

105-B MICROMETER FREQUENCY METER

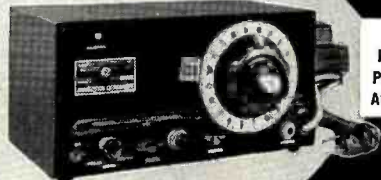

Heterodyne type, measures crystal-controlled transmitters on the bench
0.1 to 500 mc. Price **\$220.00 net.**

205-A FM MODULATION METER



Measures peak deviation ± 25 kc. Tunable 25-500 mc. in one band. Small, rugged. Price **\$240.00 net.**

LAMPKIN

test equipment is preferred by most mobile engineers!

Send for free booklet telling how you can earn money in mobile-radio maintenance.

LAMPKIN LABORATORIES, INC. MFM Division BRADENTON, FLORIDA

LAMPKIN LABORATORIES, INC. MFM Division, Bradenton, Florida
At no obligation to me, please send
 Free booklet Data on Lampkin meters.
Name.....
Address.....
City..... State.....

**MORE INCOME
IN 1957
FOR INDEPENDENT
TV TECHNICIANS!**



Receiver ...
precision-engineered
"for those who want the
finest" ... is a non-
competitive line.

**GENEROUS COMMISSIONS
THRU EXCLUSIVE
PROFITABLE TV
TECHNICIAN FRANCHISES
NOW AVAILABLE**

You can recommend ATR with the pride and assurance of your own know-how and the reputation and craftsmanship of AMERICAN TELEVISION & RADIO

- ✓ ... as original sets
- ✓ ... as replacement sets
- ✓ ... as the No. 1 set in two-set homes
- ✓ ... and for special chassis installations (without cabinet)



**UNEQUALLED
IN
PERFORMANCE**

**UNMATCHED
IN QUALITY
CONSTRUCTION**

**UNSURPASSED
IN
BEAUTY**



**FOR FULL INFORMATION —
WRITE TODAY FOR COLORFUL
BROCHURE SHOWING THE
NEW LINE OF ATR TV SETS**

ALSO MANUFACTURERS OF DC-AC INVERTERS,
"A" BATTERY ELIMINATORS, AUTO RADIO VIBRATORS



addition, there is a recorder output. The unit is equipped with seven controls, including a nine-position channel selector, a four-position loudness contour control, volume, bass, treble, a.c. power, and station selector controls.

The chassis measures 13 $\frac{1}{16}$ " wide, 12 $\frac{1}{2}$ " deep, and 6 $\frac{1}{2}$ " high. Blonde or mahogany cabinets are available optionally at extra cost.

AUDIO CATALOGUES

"HOW GOOD IS YOUR ARM?"

Fairchild Recording Equipment Company, 10-40 45th Ave., Long Island City, N. Y., is now offering copies of a new 16-page booklet entitled "How Good Is Your Arm?" to those interested in high-fidelity disc reproduction.

The clearly written and informative booklet explains the basic problems involved in the design of a good tone arm. It covers such important aspects of arm design as resonance, tracking, tracking error, torsional resonance, pivot design, etc.

The company will supply copies of the brochure without charge.

CONSUMER HI-FI GUIDE

A 64-page illustrated guide to high fidelity is being offered by RCA Victor dealers as a service to consumers. Prepared by the company's Radio and "Victrola" Division, the new publication provides a simple, non-technical explanation of hi-fi, what it is, how it works, and how to best enjoy it in the home.

The book, with a four-color cover, includes chapters on the history of recorded sound, how records are made, what constitutes a hi-fi set, where to place a set, tape recording, stereo sound, suggested musical libraries, and an explanation of technical terms.

Supplies of the new book may be obtained through the company's local distributors.

POCKET TAPE RECORDER

Complete details on its pocket-sized, battery-operated tape recorder are given in a six-page leaflet now available from Mohawk Business Machines Corp., 944 Halsey St., Brooklyn, N. Y.

The brochure includes complete technical specifications on the "Midgetape," details on physical size and applications, and a listing of the various custom and standard accessories that are available for use with the recorder.

"SEVEN VILLAINS"

ORRadio Industries, Inc., Shamrock Circle, Opelika, Ala., has issued a small rib-tickling brochure entitled "The 7 Old-Fashioned Villains of Tape Recording."

This vest-pocket-sized 32-page booklet tells, in humorous vein, how the "seven old-fashioned villains were wreaking endless woe" on tape recorder users and how they were "foiled" by the "Irish Tape's" little leprechaun, "F. R. O'Sheen."

An added feature of the booklet is a playing time chart carried on the back

pfK
pre-finished
Kits

PFK-120/150 PFK-500 PFK-300

designed by
Paul Klipsch

Now you need only a screwdriver to put together a furniture-finished Klipsch speaker enclosure, indistinguishable from factory-assembled Rebel 3, 4 or 5. Also available as conventional, unfinished kits.

cabinart

Write for Complete Catalog!
36 pages . . . 16 other hi-fi kits . . . 29
equipment cabinets . . . 4 matched speaker
systems . . . 20 hi-fi accessories.

'57

Cabinart 99 North 11th Street
Brooklyn 11, N. Y.

largest manufacturer of cabinets and kits for hi-fi
a division of G & H Wood Products Co., Inc.

found in
37
national
brands

It's the wise serviceman who recognizes the huge cartridge replacement market. He stocks Ronette; national manufacturers of 37 brands of phonographs specify Ronette as their original equipment cartridge.

Ronette

ACOUSTICAL CORPORATION
190 Earle Avenue, Lynbrook, New York

cover, along with details on the various tapes available in the company's line.

Write for copies of the booklet to: "F. R. O'Sheen" in care of the company. -30-

BLUE RIDGE HAMFEST

THE Blue Ridge Amateur Radio Society Inc. is holding its third annual hamfest on Sunday, May 19th, at Lakeside Amusement Park, Salem, Virginia.

Registration starts at 7 p.m. on Saturday at the club station with refreshments and activities for YL's and XYL's. Registration will continue Sunday at 9 a.m. The program will start at 11 a.m. with several outstanding speakers scheduled to address the crowd.

The dinner, \$1.50 for adults and \$1.25 for children, is scheduled for 1 p.m. Checks for dinner reservations should be made out to the club and mailed to W4FNT, Box 2002, Roanoke, Va. -30-

"OLD TIMERS' NITE"

THE Twelfth Annual Old Timers' Nite Round-Up and Banquet, sponsored by the Delaware Valley Radio Association, has been scheduled for Saturday, April 20th in the Grand Ballroom of the Stacy-Trent Hotel, West State Street at Willow in downtown Trenton, N. J.

As in the past, the party will be strictly stag and will honor the early living pioneers of wireless. A turkey dinner will be served promptly at 6:30 p.m. and the program will include personalities prominent in early radio and wireless history. Prizes will be awarded for the earliest ham and commercial tickets and a special "Grand OM" award will be bestowed on the attendee whose operating experiences date back to the early days of wireless. W2ZI's collection of old time wireless gear will again be on display, by popular request.

Reservations must be made before April 15th. A check for \$6.00 and a self-addressed envelope should accompany requests for reservations. Write the club at its Trenton, N. J., address. -30-

VERMONT QSO PARTY

THE Tri-County Amateur Radio Club of Brattleboro, Vt., is again inviting all radio amateurs to participate in its "Vermont QSO Party." This annual event, now in its sixth year, covers a 24-hour weekend period from 6 p.m. (EST), Saturday, April 6th, to 6 p.m. (EST), Sunday, April 7th.

There are no time limits nor power restrictions. Any band may be worked. Outside stations are advised to use "CQ Vermont" when calling while Vermont stations will use "CQ (call) de VT" on c.w. and "CQ (call) in Vermont" on phone.

A certificate will be awarded to the highest scoring station in each state, U.S. possession, Canadian province, or country and to the highest scoring station in each Vermont county. A certificate will be awarded to any station working 13 of the 14 Vermont counties.

Logs and scores must be postmarked not later than June 1st. They should be sent to Ray N. Flood, W1FPS, 2 Marlboro Ave., Brattleboro, Vt.

Mark your calendars and get in on the fun! -30-

April, 1957

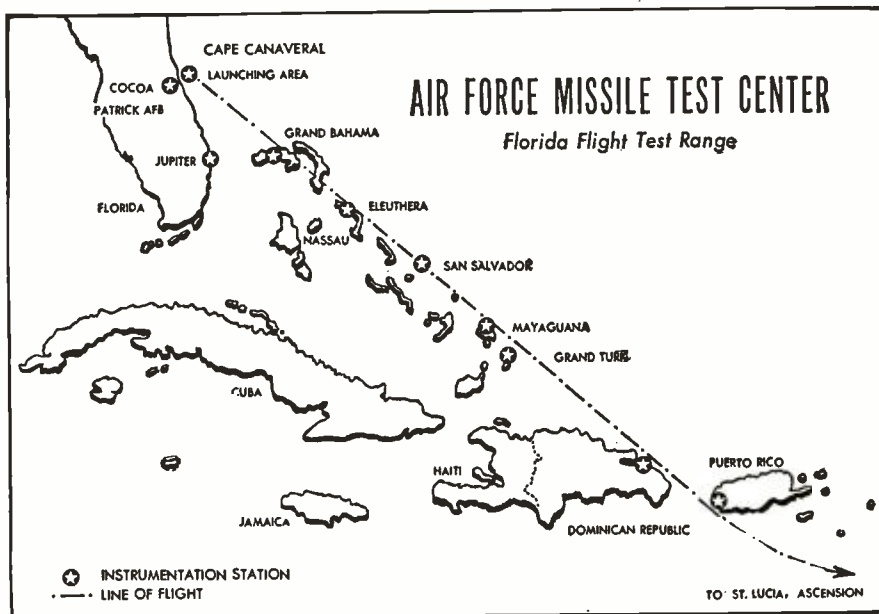

RCA

ANNOUNCES OPPORTUNITIES

In Guided Missile Test Instrumentation For Electronic Technicians

At the following locations

PATRICK AIR FORCE BASE, FLORIDA

Engineering development technicians
Radar
Communications
Test Equipment

CAPE CANAVERAL

Radar
Radio
Telemetry
Timing
Telephone
Optics

Enjoy pleasant Florida living and working at these locations.
Liberal company benefits. Relocation assistance.

INTERESTING DOWN-RANGE ASSIGNMENTS

Radar	Telemetry	Telephone
Radio	Timing	Optics

These positions are located on the Islands shown on the map above. Salary, 30% differential, meals and lodging furnished. Return to U.S. every 3 months.



For information and arrangements for personal interview, send complete resume to:

Mr. H. C. Laur
Technical Employment, Dept. N-16-D
Missile Test Project
RCA Service Co., Inc.
P.O. Box 1226, Melbourne, Florida



RADIO CORPORATION of AMERICA

FIELD ENGINEERS:

HERE'S THE GOOD WORD—



Bendix Radio

IS CONTINUING ITS RAPID EXPANSION AND NEEDS YOU!
Bendix Radio, the leader in its field, has numerous excellent opportunities for Field Engineering Personnel for both U.S. and overseas assignments. You will be responsible for the installation, overhaul and maintenance of long-range Bendix radar equipment.

ACT NOW! YOU'LL OBTAIN THESE IMPORTANT ADVANTAGES:

- ★ The prestige of representing the leader in its field.
 - ★ Opportunity for professional development & advancement.
 - ★ Excellent salary.
 - ★ Overseas allowance.
 - ★ Many other company benefits
 - ★ Field allowance.
 - ★ Relocation expenses.
- It is preferable that you have had a minimum of two years college, plus at least four years engineering experience in radar or communications systems.

Send resume to: MR. O. A. BOWMAN
Field Engineering
Dept. R

Bendix Radio

DIVISION OF BENDIX AVIATION CORP.
BALTIMORE 4, MARYLAND



UP A TREE?

Don't be a crazy cat—come down and get a Merit exact replacement. Our engineering and production keep your parts jobber supplied with parts, superior to the original, that drop into place without mechanical or electrical change in set chassis.



MERIT

MERIT COIL AND TRANSFORMER CORP.
4427 N. CLARK ST., CHICAGO 40, ILLINOIS

PROVEN!



LIST
9⁹⁵ COMPLETE

WUERTH TUBE-SAVER

TRIPLES LIFE OF ALL TUBES

Proven in military use, the patented Tube-Saver reduces destructive inrush currents . . . lets tubes warm up slowly.

Guaranteed to TRIPLE the life of all HiFi and TV TUBES, including costly picture tubes. Cuts call-backs . . . Just plug in . . .

SELLS ITSELF

Available now in:

NEW YORK—Emerson, New York, Inc.
CHICAGO—Allied Radio Corp.
PHILADELPHIA—Radio Electric Service Co.
DETROIT—Radio Specialties Co.
CLEVELAND—Emerson Radio of Ohio
WASHINGTON—Sylberne Radio & Electronics Co.
BALTIMORE—American Distributing Co.
LOS ANGELES—Newark Electric Co.
FT. WORTH—Audio Associates

Wuerth Tube-Saver Corp.

9125 Livernois Ave., Detroit 4, Mich.

Do-It-Yourself Service

(Continued from page 52)

centers" that many dealers have set up in their shops.

When self-service tube testers started to show up in drug stores, these service dealers took a close look at this new type of competition. They realized that, irrespective of complaints from the service fraternity, thousands of people will try to save service charges by testing their own tubes. Since the drug stores sold tubes at manufacturers' list prices, they considered this cleaner competition than the over-the-counter sales of tubes at dealer net prices to the general public by many parts jobbing houses.

As a result of these analyses, many service dealers bought self-service testers and set up do-it-yourself centers in their shops. They promote these centers, and encourage set owners to bring their TV tubes to an *electronic service* shop, where they can get the advice of experts about servicing their own sets. All of these self-service centers that have been widely advertised have been highly successful.

In one city where a self-service center was set up, it is located within a couple of blocks of a super drug store where a self-service tester had been installed. Within a month after this service dealer started to publicize his do-it-yourself center, he was able to get most of the set owners who normally would have been taking their TV tubes to the drug store to test them. He gained a remarkable increase in tube sales and a substantial increase in his over-all service business.

Because of the critical shortage of service technicians, some dealers look upon the do-it-yourself development as a way for them to "hire" set owners to work for them at no cost. They reason that the costly part of home service work is the cost of labor and transportation. By letting the set owners provide the labor and transportation at their own expense, the dealer profits from the sale of tubes.

About 50 per-cent of the sets self-serviced by the owners are restored to satisfactory operation by the replacement of defective tubes. Owners of the others are perfectly willing to pay adequate charges for a technician to call at the home and make the other repairs necessary to get the sets operating properly.

Many of these dealers have added other widely used parts and tools for home maintenance work which they display in the do-it-yourself corner of their shops. As one dealer put it, "There is a lot of truth in the saying that 'If you can't whip 'em, join 'em.' I realized I could not stop people from doing things for themselves. So I decided to make it easier for them to repair their own TV sets by patronizing my shop. It is paying off."

—50—

Superior's New Model 770-A

The FIRST VOLT-OHM MILLIAMMETER



USING THE NEW "FULL-VIEW" METER
71% MORE SCALE AREA!

Yes, although our new FULL-VIEW D'Arsonval type meter occupies exactly the same space used by the older standard 2 1/2" Meters, it provides 71% more scale area. As a result, all calibrations are printed in large easy-to-read type and for the first time it is now possible to obtain measurements instead of approximations on a popular priced pocket-sized V.O.M.

- Compact — measures 3 1/8" x 5 7/8" x 2 1/4".
- Uses "Full View" 2% accurate, 850 Microampere D'Arsonval type meter.
- Housed in round-cornered, molded case.
- Beautiful black etched panel. Depressed letters filled with permanent white, insures long-life even with constant use.

Specifications — • 6 A.C. VOLTAGE RANGES: 0-15 30/150/300/1500/3000 Volts. 6 D.C. VOLTAGE RANGES: 0-7.5/15/75/150/750/1500 Volts. 2 RESISTANCE RANGES: 0-10,000 Ohms, 0-1 Megohm. 3 D.C. CURRENT RANGES: 0-15/150 Ma., 0-1.5 Amps. 3 DECIBEL RANGES: -6 db to +18 db, +14 db to +38 db, +34 db to +58 db.

The Model 770-A comes complete with self-contained batteries, test leads and all operating instructions.

\$15.85 NET

Superior's New Model TW-11 STANDARD PROFESSIONAL TUBE TESTER



- Tests all tubes, including 4, 5, 6, 7, Octal, Lock-in, Hearing Aid, Thyatron, Miniatures, Sub-miniatures, Novals, Sub-minars, Proximity fuse types, etc.
- Uses the new self-cleaning Lever Action Switches for individual element testing. Because all elements are numbered according to pin-number in the RMA base numbering system, the user can instantly identify which element is under test. Tubes having tapped filaments and tubes with filaments terminating in more than one pin are truly tested with the Model TW-11 as any of the pins may be placed in the neutral position when necessary.
- The Model TW-11 does not use any combination type sockets. Instead individual sockets are used for each type of tube. Thus it is impossible to damage a tube by inserting it in the wrong socket.
- Free-moving built-in roll chart provides complete data for all tubes. All tube listings printed in large easy-to-read type.

NOISE TEST: Phono-jack on front panel for plugging in either phones or external amplifier will detect microphonic tubes or noise due to faulty elements and loose internal connections.

SEPARATE SCALE FOR LOW-CURRENT TUBES—Previously, on emission type tube testers, it has been standard practice to use one scale for all tubes. As a result, the calibration for low-current types has been restricted to a small portion of the standard scale. The extra scale used here greatly simplifies testing of low-current types.

The Model TW-11 operates on 105-130 Volt 60 Cycles A.C. Comes housed in a beautiful hand-rubbed oak cabinet complete with portable cover.

\$47.50 NET

Superior's New Model TV-60

20,000 OHMS PER VOLT

ALLMETER



SPECIFICATIONS

- 8 D.C. VOLTAGE RANGES (At a sensitivity of 20,000 Ohms per Volt) 0 to 15/75/150/300/750/1500/7500/30,000 Volts.
- 7 A.C. VOLTAGE RANGES: (At a sensitivity of 5,000 Ohms per Volt) 0 to 15/75/150/300/750/1500/7500 Volts.
- 3 RESISTANCE RANGES: 0 to 2,000/200,000 Ohms, 0-20 Megohms.
- 2 CAPACITY RANGES: .00025 Mfd. to 30 Mfd.
- 5 D.C. CURRENT RANGES: 0-75 Microamperes, 0 to 7.5/75/750 Milliampers, 0 to 15 Amperes.
- 3 DECIBEL RANGES: -6 db to +58 db.

AUDIO SIGNAL TRACER SERVICE: Functions in the same manner as the R.F. Signal Tracing service specified at right except that it is used for the location of cause of trouble in all audio and amplifier systems.

R.F. SIGNAL TRACER SERVICE: Enables following the R.F. signal from the antenna to speaker of any radio or TV receiver and using that signal as a basis of measurement to first isolate the faulty stage and finally the component or circuit condition causing the trouble.

FEATURES

Giant recessed 6 1/2 inch 40 Microampere meter with mirrored scale. Built-in Isolation Transformer. Use of the latest type printed circuit and 1% multipliers assure unchanging accurate readings.

Model TV-60 comes complete with book of instructions; pair of standard test leads; high-voltage probe; detachable line cord; R.F. Signal Tracer Probe and Audio Signal Tracer Probe. Pliofilm bag for all above accessories is also included. Price complete. Nothing else to buy. ONLY

\$52.50 NET

Superior's New Model TV-12 TRANS-CONDUCTANCE TUBE TESTER



TESTING TUBES

- Employs improved TRANS-CONDUCTANCE circuit. An in-phase signal is impressed on the input section of a tube and the resultant plate current change is measured. This provides the most suitable method of simulating the manner in which tubes actually operate in Radio & TV receivers, amplifiers and other circuits. Amplification factor, plate resistance and cathode emission are all correlated in one meter reading.

ALSO TESTS TRANSISTORS!

- NEW LINE VOLTAGE ADJUSTING SYSTEM. A tapped transformer makes it possible to compensate for line voltage variations to a tolerance of better than 2%.
- SAFETY BUTTON—protects both the tube under test and the instrument meter against damage due to overload or other form of improper switching.
- NEWLY DESIGNED FIVE POSITION LEVER SWITCH ASSEMBLY. Permits application of separate voltages as required for both plate and grid of tube under test, resulting in improved Trans-Conductance circuit.

TESTING TRANSISTORS

A transistor can be safely and adequately tested only under dynamic conditions. The Model TV-12 will test all transistors in that approved manner, and quality is read directly on a special "transistor only" meter scale. The Model TV-12 will accommodate all transistors including NPN's, PNP's, Photo and Tetrols, whether made of Germanium or Silicon, either point contact or junction contact types.

Model TV-12 housed in handsome rugged portable cabinet sells for only

\$72.50 NET

SHIPPED ON APPROVAL NO MONEY WITH ORDER — NO C.O.D.

We invite you to try before you buy any of the models described on this and the following page. If after a 10 day trial you are completely satisfied and decide to keep the Tester, you need send us only the down payment and agree to pay the balance due at the monthly indicated rate. (See other side for time-payment schedule details.)

**NO INTEREST
OR FINANCE**

CHARGES ADDED!

If not completely satisfied, you are privileged to return the Tester to us, cancelling any further obligation.

SEE OTHER SIDE!

Cut out and mail TODAY! ▶

All prices net, F.O.B., N.Y.C.

FIRST CLASS

Permit No. 61430

New York, N. Y.

BUSINESS REPLY CARD

No Postage Stamp Necessary if Mailed in the U. S.

VIA AIR MAIL

POSTAGE WILL BE PAID BY —

MOSS ELECTRONIC DIST. CO., INC.

3849 TENTH AVENUE

NEW YORK 34, N. Y.

Superior's
New
Model

76

For the first time ever: ONE TESTER PROVIDES ALL THE SERVICES LISTED BELOW!



IT'S A CONDENSER BRIDGE

with a range of .00001 Microfarad to 1000 Microfarads (Measures power factor and leakage too.)

IT'S A SIGNAL TRACER

which will enable you to trace the signal from antenna to speaker of all receivers and to finally pinpoint the exact cause of trouble whether it be a part or circuit defect.

IT'S A RESISTANCE BRIDGE

with a range of 100 ohms to 5 megohms

IT'S A TV ANTENNA TESTER

The TV Antenna Tester section is used first to determine if a "break" exists in the TV antenna and if a break does exist the specific point (in feet from set) where it is.

SPECIFICATIONS

RESISTANCE BRIDGE SECTION

2 Ranges: 100 ohms to 50,000 ohms; 10,000 ohms to 5 megohms. Resistance can be measured without disconnecting capacitor connected across it. (Except, of course, when the R C combination is part of an R C bank.)

As Design Engineers, we the undersigned would like to say that the Model 76 is in our opinion the best combination unit of its kind we have been privileged to design. Although it is comparatively a low-priced tester, it will, after you become acquainted with its multiple services, be your most frequently used instrument.

S. LITT
L. MELENKEVITZ

CAPACITY BRIDGE SECTION

4 Ranges: .00001 Microfarad to .005 Microfarad; .001 Microfarad to .5 Microfarad; .1 Microfarad to 50 Microfarads; 20 Microfarads to 1000 Microfarads. This section will also locate shorts, and leakages up to 20 megohms. And finally, this section will measure the power factor of all condensers from .1 to 1000 Microfarads. (Power factor is the ability of a condenser to retain a charge and thereby filter efficiently.)

SIGNAL TRACER SECTION

A built-in high gain pentode voltage amplifier, plus a diode rectifier, plus a direct coupled triode amplifier are combined to provide this highly sensitive signal tracing service. With the use of the R.F. and A.F. Probes included with the Model 76, you can make stage gain measurements, locate signal loss in R.F. and Audio stages, localize faulty stages, locate distortion and hum, etc. Provision has been made for use of phones and meter if desired.

TV ANTENNA TESTER SECTION

Loss of sync., snow and instability are only a few of the faults which may be due to a break in the antenna, so why not check the TV antenna first? The Model 76 will enable you to locate a break in any TV antenna and if a break does exist, the Model 76 will measure the location of the break in feet from the set terminals. 2 Ranges: 2' to 200' for 72 ohm coax and 2' to 250' for 300 ohm ribbon.

Model 76 comes complete with all accessories including R.F. and A.F. Probes; Test Leads and operating instructions. Nothing else to buy Only

\$26⁹⁵
NET



Superior's New Model TV-50

GENOMETER

A versatile all-inclusive GENERATOR which provides ALL the outputs for servicing:
A. M. Radio • F. M. Radio • Amplifiers • Black and White TV • Color TV

7 Signal Generators in One!

- ✓ R.F. Signal Generator for A.M.
- ✓ R.F. Signal Generator for F.M.
- ✓ Audio Frequency Generator

- ✓ Bar Generator
- ✓ Cross Hatch Generator
- ✓ Color Dot Pattern Generator
- ✓ Marker Generator

R. F. SIGNAL GENERATOR: Provides complete coverage for A.M. and F.M. alignment. Generates Radio Frequencies from 100 Kilocycles to 60 Megacycles on fundamentals and from 60 Megacycles to 180 Megacycles on powerful harmonics.

VARIABLE AUDIO FREQUENCY GENERATOR: In addition to a fixed 400 cycle sine-wave audio, the Genometer provides a variable 300 cycle to 20,000 cycle peaked wave audio signal.

BAR GENERATOR: Projects an actual Bar Pattern on any TV Receiver Screen. Pattern will consist of 4 to 16 horizontal bars or 7 to 20 vertical bars.

MARKER GENERATOR: The following markers are provided: 189 Kc., 262.5 Kc., 456 Kc., 600 Kc., 1000 Kc., 1400 Kc., 1600 Kc., 2000 Kc., 2500 Kc., 3579 Kc., 4.5 Mc., 5 Mc., 10.7 Mc., (3579 Kc. is the color burst frequency.)

CROSS HATCH GENERATOR: Genometer will project a cross-hatch pattern on any TV picture tube. The pattern will consist of non-shifting horizontal and vertical lines interlaced to provide a stable cross-hatch effect.

DOT PATTERN GENERATOR (FOR COLOR TV): The Dot Pattern projected on any color TV Receiver tube by the Model TV-50 will enable you to adjust for proper color convergence.

MODEL TV-50 comes absolutely complete with shielded leads and operating instructions. Only

\$47⁵⁰
NET

SHIPPED ON APPROVAL NO MONEY WITH ORDER — NO C. O. D.

MOSS ELECTRONIC DISTRIBUTING CO., INC.
Dept. D-329 3849 Tenth Ave., New York 34, N. Y.

Please send me the units checked. I agree to pay down payment within 10 days and to pay the monthly balance as shown. It is understood there will be no finance or interest charges added. It is further understood that should I fail to make payment when due, the full unpaid balance shall become immediately due and payable.

- | | |
|---|--|
| <input type="checkbox"/> Model 770-A Total Price \$15.85
\$3.85 within 10 days. Balance \$4.00
monthly for 3 months. | <input type="checkbox"/> Model TV-12 Total Price \$72.50
\$22.50 within 10 days. Balance \$10.00
monthly for 5 months. |
| <input type="checkbox"/> Model TV-60 Total Price \$52.50
\$12.50 within 10 days. Balance \$8.00
monthly for 5 months. | <input type="checkbox"/> Model 76 Total Price \$26.95
\$6.95 within 10 days. Balance \$5.00
monthly for 4 months. |
| <input type="checkbox"/> Model TW-11 Total Price \$47.50
\$11.50 within 10 days. Balance \$6.00
monthly for 6 months. | <input type="checkbox"/> Model TV-50 Total Price \$47.50
\$11.50 within 10 days. Balance \$6.00
monthly for 6 months. |

Name _____
Address _____
City _____ Zone _____ State _____

All prices net, F.O.B., N.Y.C.

We invite you to try before you buy any of the models described on this and the preceding page. If after a 10 day trial you are completely satisfied and decide to keep the Tester, you need send us only the down payment and agree to pay the balance due at the monthly indicated rate.

NO INTEREST OR FINANCE CHARGES ADDED!

If not completely satisfied, you are privileged to return the Tester to us, cancelling any further obligation.

SEE OTHER SIDE!

◀ Cut out and mail TODAY!

Two-Terminal Oscillator

(Continued from page 61)

clip the power leads on the nearest power source, clip the test leads across the tuned circuit being investigated, set your receiver to the frequency you want to hit, turn on the b.f.o. in the receiver, and rotate the capacitor on the external tuned circuit. If the r.f. circuit tunes to the desired frequency you will hear the oscillator "swish by" in the receiver. If the tuned r.f. circuit is one that employs a split-stator capacitor be sure to connect the leads from the two-terminal oscillator *across the coil*, not just across one capacitor section! The grid of the 6SN7 must have a complete d.c. path to ground if the circuit is to oscillate. Clipping across one section in a split-stator tank will *not* complete the circuit and there will be no oscillation.

To check the tuning range of a coil alone, "pick up" the 75 μfd . capacitor by inserting the extra pin on the *hot* lead into the proper hole on the 5-prong socket, put the alligator clips on the two coil leads and listen to your receiver. The inductance of a coil may be calculated roughly by connecting a capacitor of known value across the coil, locating the frequency of the oscillator by tuning the receiver, and substituting the results in the well-known resonance formula.

A set of coils from a *McMurdo Silver Model 903* wavemeter is used when it is necessary to employ the oscillator as a signal generator. These coils plug into the 5-prong socket and "pick up" the 75 μfd . capacitor for tuning. The long leads in this particular unit limit the top frequency to 70 mc., but this circuit with shorter leads will perform at higher frequencies; the writer had a 6J6 that worked satisfactorily as a local oscillator in a 144 mc. converter using this circuit.

The device may be used as a grid-dip oscillator. The *McMurdo Silver* coils are used and a v.t.v.m., set on a low d.c. range, is connected to the cathode pin tip connector and ground. Resonance of a coupled circuit is indicated by a *rise* in cathode voltage. The isolating resistor between the potentiometer and the cathode of the tube keeps the r.f. voltage to a small value which is harmless to the v.t.v.m.

For audio signal output, clip the test leads on a choke and capacitor combination. Take the output from the tuned circuit or from the cathode connector. Remember that the grid of the 6SN7 must have a complete return path to ground for d.c.!

This circuit offers interesting possibilities for use as a v.f.o. It is quite stable even when built in the fashion described in this article, so with shorter leads and a good coil and capacitor combination, it could very well be used as a master oscillator for the ham rig.

-30-

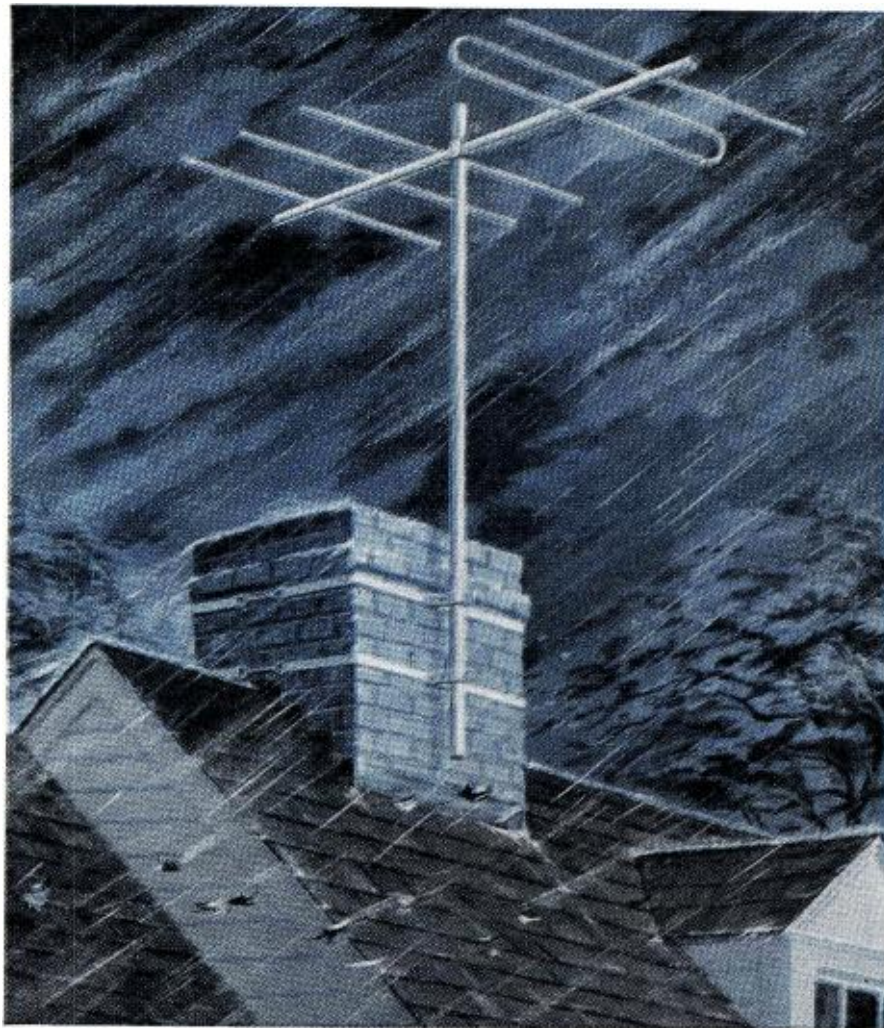

sturdy, steel PERMA-TUBE TV masting is corrosion proof

Perma-Tube, most famous name in TV masting, stays strong because it is corrosion proof. Perma-Tube is treated with vinsynite—then coated with a metallic vinyl resin base both *inside* and *outside*.

Perma-Tube is guaranteed to be free from rust in a salt spray test of 500-hours minimum to ASTM Specification 13 117-49T. Longer mast life is assured.

Resistance to bending in Perma-Tube is greater than in galvanized masting. Machine-fitted joints speed field assembly, insure close

tolerance for strength and rigidity. *Joints are stronger than the tubing itself.*

Five diameters of fitted joint Perma-Tube are available, ranging from 2½" OD to 1¼" OD. Telescoping masts can also be erected up to 50 feet high, using 10 foot lengths of high strength J&L 16-gauge Perma-Tube.

Get complete details on popular Perma-Tube TV masting. Write to the Jones & Laughlin Steel Corporation, Dept. 495, 3 Gateway Center, Pittsburgh 30, Pa.



Jones & Laughlin

STEEL ... a great name in steel!

**BUILD THE BEST—
BUILD ALLIED'S OWN
knight-
kits**

Here is a typical Knight-Kit value—available only from ALLIED—one of 45 great Knight-Kits you'll find in our special Supplement No. 165. Write for your FREE copy today.

**knight-kit INSTRUMENT VALUE
PRINTED CIRCUIT VTVM KIT**



Model
Y-125
\$24⁹⁵

Tops for stability, accuracy and value. Greatly simplified wiring—entire chassis is a printed circuit board. Uses low-leakage switches; 1% film-type precision resistors. Balanced-bridge, push-pull circuit permits switching to any range without adjusting zero set. SPECIFICATIONS: Easy-to-read 4 1/2" meter with sensitive 200 microamp movement. Zero-center scale and direct-reading db scale. Polarity reversing switch. Response, 30 cycles to 3 mc. Input resistance, 11 megs. Ranges: AC peak-to-peak volts, 0-4-14-40-140-400-1400-4000; AC rms v. and DC v., 0-1.5-5-15-50-150-500-1500; ohms, 0-1000-10K-100K; 1-10-100-1000 megs; db scale, -10 to +5. Complete, including battery and test leads. Size, 7 3/4 x 5 1/4 x 4 1/4". Shpg. wt., 7 lbs.

Model Y-125. Net, F.O.B. Chicago. . . . \$24⁹⁵

OTHER knight-kit INSTRUMENT VALUES



20,000 OHMS/VOLT
VOM KIT
Y-140 \$29⁵⁰



1000 OHMS/VOLT
VOM KIT
Y-128 \$16⁹⁵



TUBE CHECKER KIT
Y-143 \$29⁷⁵



RF SIGNAL
GENERATOR KIT
Y-145 \$19⁷⁵

See our Supplement No. 165 for 18 other knight-kit instrument values

**free SUPPLEMENT
featuring knight-kits**



Send for our FREE Supplement No. 165 featuring 45 great Knight-Kits, including Test Instruments, Hi-Fi, Hobbyist and Amateur Kits. Write for your copy today.

**ORDER FROM
ALLIED RADIO**

Dept. 01-D7, 100 N. Western Ave., Chicago 80, Ill.

**SALES
AIDS**

CAPACITOR PACKAGES

Pyramid Electric Company of North Bergen, New Jersey, is now packaging its line of capacitors in handsome and distinctive new boxes. This organization is one of the nation's leading producers of capacitors, rectifiers, and capacitor-resistor analyzers. As can be seen, the new boxes are most attractive, and should stimulate sale of the item.



THEFT-PROOF STAND

A new display stand for RCA Victor pocket-size transistor radios—with an effective guard against pilferage—is announced by the company.

The two-level metal stand can safely "lock" the radios in place by brass wicket and clip, thereby making theft nearly impossible. In addition, it gets the radios out on the counter where prospects can hear them, touch them, and examine them closely.

The coral and gray stand, which will display the company's three pocket-size transistor radios, takes up counter space of only sixteen inches in width, and nine inches in depth.

This display is available through RCA Victor distributors throughout the country.

"PROFIT PACKAGE"

Electro Mechanical Instrument Co., manufacturers of a low price line of precision instruments, are offering a



special "profit package" for the jobber, complete as illustrated.

This is designed with the dealer's problems in mind, and the package contains one of each of the company's major instruments best suited to jobber operation, including a.c. and d.c. ammeters, milliammeters and voltme-

**XCELITE Hand Tools
PREFERRED BY THE EXPERTS**



**NEW
99-X10
SHAFT
makes your
99-PR
and 99-JR
sets more
useful
than ever!**

**No. 99-JR set
SNAP IN
THIS EXTRA
8"
REACH!**

One end snaps firmly into your 99-PR or 99-JR handle—nut driver or single end screwdriver in 99 sets

Fits all nut driver and single end screwdrivers in 99 sets

XCELITE, INCORPORATED

Dept. E, Orchard Park, N. Y.

In Canada—Charles W. Pointon Ltd., 6 Alcina Ave., Toronto, Ontario.



**GET INTO
ELECTRONICS**



Valparaiso Tech trains for top flight positions. Tech. rep., field engineers, sales and specialists in communications, missiles, computers, radar, automation, color television. Basic and advanced theory and laboratory. Major companies visit school for our graduates. 21 months' course. High school grad. or equivalent. Dormitories—campus. Start April, July, Sept., Jan. G. I. approved. Write for catalog.

**VALPARAISO TECHNICAL INSTITUTE
Dept. RD Valparaiso, Indiana**

ters, voltage testers, relay and flag indicator, with the combined inducements of small investment, low inventory, economy of space, and point-of-sale material and literature.

Convenient inventory sheets are attached to the reverse side of the stand-up carton display to enable easy checking and re-ordering.

RADIO DISPLAY BOARD

Arvin Industries, Inc., is supplying display boards to its distributors and to retail stores handling the line. This board will attractively exhibit four radios, including three all-transistor sets.

Accompanying the display are special "gift season" window trims for spring selling events, such as Mother's Day, Father's Day, anniversaries, graduations, and weddings.

Made of "Peg-Board," the display rack has metal brackets which hold the radios. Prominently displayed are



the new "Arvinyl"-aluminum-cased transistor radio and the transistor pocket portable. The latter locks to the board so that it can't be shoplifted.

The board is twenty-four inches in height, and about eight inches deep. It measures twenty-four inches wide.

FLASHING SCREEN DISPLAY

The RCA Victor TV division has introduced a new flashing display that demonstrates the "like two sets in one" story of color television.

This inexpensive display for dealers is considered one of the most effective advertising pieces yet developed to demonstrate the compatibility of the company's color TV receivers in obtaining both color and black-and-white programming.

The display, which completes a demonstration in 10 seconds, features a full-size replica of a table model color TV set. The picture on the screen shows a black-and-white reproduction of a typical scene from a TV "Spectacular" for 5 seconds. Then the same picture automatically changes to color for another five seconds.

Construction is of heavy-gauge cardboard, and the over-all dimensions are 40 inches high, 44 inches wide, and 12 inches deep—small enough to set on a counter or on a small table in a window or showroom.



For Electronic Knowledge and Skill Quickly, Easily... at Low Cost READ RIDER BOOKS

Latest in the Famous Rider Basic Series

□ BASIC POWER ELECTRICITY

by Anthony J. Pansini

The important subject of electricity as used in the industrial and power utilities field is made crystal clear in this "picture-text" course. The pictorial approach for the utmost in visualization is combined with clear, concise text to give a down-to-earth explanation of this subject that is rigorously correct technically.

□ PICTORIAL MICROWAVE DICTIONARY

by Victor J. Young & Mercedith W. Jones

This pictorial dictionary, written by two acknowledged experts in the microwave field, presents with rigorous accuracy the microwave language.

Derivation, explanation, definition, and illustration are combined in such fashion as to give the reader complete coverage of the microwave activity. Organization of the dictionary makes it easy to use... and very understandable.

Soft Cover, 5 1/2 x 8 1/2", illus.

#188.....Only \$2.95

□ BASICS OF PHOTOTUBES & PHOTOCELLS

by David Mark

This book is devoted to the explanation of the principles and practices surrounding phototubes and photocells, with the utmost in visual presentation to make the subject most understandable. It is tantamount to a "picture course"... yet it is authoritative and modern.

Soft Cover, 136 pp., 5 1/2 x 8 1/2", illus.

#181.....Only \$2.90

□ REPAIRING TELEVISION RECEIVERS

by Cyrus Glickstein

The most modern completely practical book, written by an expert with long experience in television receiver repair. Devoted to troubleshooting and repair techniques which are modern, yet down-to-earth. Covers the use of simple as well as elaborate test equipment of all kinds. Profusely illustrated.

Soft Cover, 212 pp., 5 1/2 x 8 1/2", illus.

#191.....Only \$4.40

□ HOW TO INSTALL & SERVICE INTER-COMMUNICATION SYSTEMS

by Jack Darr

The growth of the intercom as a modern tool of business presents an important service and installation opportunity. This book covers completely installation and maintenance of commercial intercommunication equipment.

Soft Cover, 152 pp., 5 1/2 x 8 1/2", illus.

#189.....Only \$3.00

□ TV TUBE LOCATION & TROUBLE GUIDE

(RCA) by Rider Lab. Staff

This book shows the tube locations for all RCA TV receivers produced between 1947 and 1956. It lists the tube complement, key voltages, and common troubles correlated with the tubes that may be responsible for them. Complete chassis and model index.

Soft Cover, 56 pp., 5 1/2 x 8 1/2" illus.

#194.....Only \$1.25

□ INTRODUCTION TO PRINTED CIRCUITS

by Robert L. Swiggett

Gives complete coverage to the various manufacturing processes, practical applications and the servicing techniques peculiar to printed circuits.

Soft Cover, 112 pages, 5 1/2 x 8 1/2", illus.

#185.....Only \$2.70

BASIC SERIES by

Van Valkenburgh, Nooger & Neville, Inc.

The fabulous picture-text books that teach faster and easier! The theory, principles, and practice of electricity, electronics, and synchros and servos are here presented in a manner that permits a rapid grasp of the fundamentals of these vitally important subjects. Over 2,000 specially prepared illustrations present, explain, and make every topic discussed picture-clear.

□ Basic Electricity

#169, soft cover, 5 vols., 624 pp.,

#169II, cloth bound in single binding...\$11.50

□ Basic Electronics

#170, soft cover, 5 vols., 550 pp.,

#170II, cloth bound in single binding...\$11.50

□ Basic Synchros and Servomechanisms

#180, soft cover, 2 vols., 270 pp.,

#180II, cloth bound in single binding...\$6.95

□ Hi-Fi Loudspeakers & Enclosures

by Abraham D. Cohen,

#176, MARCO cover, 360 pp.....\$1.60

#176II, cloth bound.....\$5.50

□ How to Service Tape Recorders

by C. A. Tuthill,

#167, soft cover, 160 pp.....\$2.90

□ How to Troubleshoot a TV Receiver

by J. Richard Johnson

#152, soft cover, 128 pp.....\$1.80

□ Basic Vacuum Tubes & Their Uses

by Rider & Jacobowitz,

#171, soft cover, 208 pp.....\$3.00

#171II, cloth bound.....\$4.50

□ How to Use Meters

John F. Rider;

#144, soft cover, 144 pp.....\$2.40

□ Fundamentals of Transistors

by Leonard Krugman,

#160, soft cover, 144 pp.....\$2.70

□ Introduction to Color TV (2nd Edition)

by Kaufman & Thomas,

#156 soft cover, 160 pp.....\$2.70

□ How to Select and Use Your Tape Recorder

by David Mark,

#179, soft cover, 148 pp.....\$2.95

□ Obtaining & Interpreting Test Scope Traces

by John F. Rider,

#146, soft cover, 190 pp.....\$2.40

□ Television — How it Works (2nd Edition)

by J. Richard Johnson,

#101, leather finish MARCO, 352 pp.....\$4.60

#101-II, cloth bound.....\$5.50

IF YOU WANT THE BEST IN TV SERVICE INFORMATION

ON

RCA EMERSON
PHILCO MOTOROLA
ADMIRAL CROSLEY
GE ZENITH
SYLVANIA WESTINGHOUSE
HOFFMAN PACKARD-BELL

RIDER'S NEW S D O

("single diagram only")

SERVICE

ONLY 50¢ PER CHASSIS
AT YOUR LOCAL JOBBER

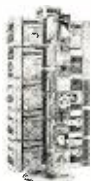

Buy these and many other RIDER BOOKS at your electronics parts jobber, book store or department store book department. Look for the Rider Bookseller.

Write for FREE 1957 Spring-Summer catalog RN-4. If your jobber, book store, or department store does not sell the Rider books you want, order direct by checking book desired in this ad. Add state and city tax where applicable. Canadian prices approximately 5% higher.



JOHN F. RIDER PUBLISHER, INC. 116 West 14th Street, New York 11, N. Y.

LAFAYETTE SENSATIONAL VALUES!

IN COMPLETELY WIRED TEST EQUIPMENT

at LESS than the PRICE of KITS!

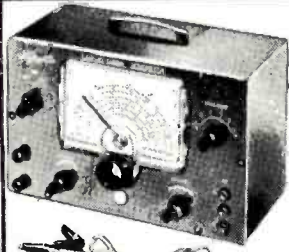

LAFAYETTE SIGNAL GENERATOR

NEVER BEFORE HAS A COMPLETELY WIRED AND TESTED INSTRUMENT OF SUCH ACCURACY AND QUALITY BEEN OFFERED AT SUCH A PRICE!

- FREQUENCY 120 KC TO 260 MC
- 120 KC TO 130 MC ON FUNDAMENTALS
- LABORATORY ACCURACY AND QUALITY

A completely wired and tested instrument not to be confused with units sold in kit form at almost the same price, but with a quality and accuracy of instruments 3 to 4 times its price. Six overlapping ranges generate signals of 120KC-320KC, 320KC-1000KC, 1MC-3.2MC-11MC, 11MC-38MC and 37MC-130MC all on fundamentals with calibrated harmonics from 120MC to 260MC. Selector switch gives instant choice of ranges. Switch gives choice of internal modulation of 400 CPS or use of any external source at other frequencies. For audio testing the 400 cycle signal can be used separately. RF output is in excess of 100,000 microvolts and jacks are provided for choice of either high or low RF output. Stability is insured by special circuit design. Has a fine adjustment RF control. AF output is 2-3 volts. AF input is 4 volts across 1 megohm. Large clear 5 inch etched dial plate and pointer are protected by transparent plastic bezel. Common AF terminals for EXT-MOD input and INT-AF for audio tests eliminate need for special AF output connectors. Machine engraved panel lettering. Handsome gray metal case with carrying handle. Measures 6 1/2" x 10" x 4 1/2". Comes complete with pair of leads. AC line cord and plug. Operates on 105-125V 50-60 cycle AC. Shpg. wt., 8 lbs.

22.50

Outputs are unmodulated RF, modulated RF and 400 CPS audio. RF output is in excess of 100,000 microvolts and jacks are provided for choice of either high or low RF output. Stability is insured by special circuit design. Has a fine adjustment RF control. AF output is 2-3 volts. AF input is 4 volts across 1 megohm. Large clear 5 inch etched dial plate and pointer are protected by transparent plastic bezel. Common AF terminals for EXT-MOD input and INT-AF for audio tests eliminate need for special AF output connectors. Machine engraved panel lettering. Handsome gray metal case with carrying handle. Measures 6 1/2" x 10" x 4 1/2". Comes complete with pair of leads. AC line cord and plug. Operates on 105-125V 50-60 cycle AC. Shpg. wt., 8 lbs.

LAFAYETTE LSG-10 SIGNAL GENERATOR **22.50**

NEW POCKET AC-DC VOM MULTITESTER

2,000 ohm per volt Sensitivity on both DC and AC

160 ua 3" METER
1% PRECISION RESISTORS
SILVER CONTACT SELECTOR SWITCH

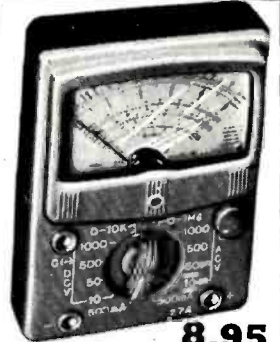

FULL SCALE RANGES

DC Volts: 0-10; 0-50; 0-500; 0-1000 Volts - AC Volts: 0-10; 0-50; 0-500; 0-1000 Volts - DC Current: 500 ua and 500 ma - Resistance: 0-10K; 0-1 Meg - Decibels: -20 to +22; -20 to 36 db (0 db - 0.775 V) - Capacity: 250 mmd to 2 mfd - .005 mfd to 1 mfd - Output Ranges: 0-10; 0-50; 0-500; 0-1000 volts

8.95

Best Buy in America! A very accurate and sensitive VOM. This Multitester is a complete instrument (not a kit) with high quality and sensitive 160 microamp meter; 2000 ohm precision resistors, AC and DC. Single selector switch, 1% accuracy and ruggedness. In attractive plastic front panel, with metal bottom for ruggedness and shielding. First capacity range requires 50 volt AC source. Second capacity range requires 10 volt AC source. Size 4 1/4" x 3 1/2" x 1 1/4". Complete with test leads and batteries. Shipping weight 4 lbs. **Complete 8.95**
RW-27A

NEW!

LAFAYETTE CAPACITANCE-RESISTANCE TESTER WITH "IN-SET QUICK CHECK"

COMPLETELY WIRED AND TESTED



- TWO INSTRUMENTS IN ONE
- CHECKS ELECTROLYTIC, PAPER, MICA AND CERAMIC CONDENSERS
- 4 DIRECT READING CAPACITY SCALES FROM .00001 MFD TO 1000 MFD
- CHECK FOR OPEN SHORTS, LEAKAGE AND INTERMITTENTS
- 2 RESISTANCE RANGES FROM 100 TO 5 MEGOHM

Here is a "must" for servicemen and lab technicians. A completely self-contained AC operated capacitance and resistance bridge, plus a quick check for in the set testing. Large 5 direct reading scale has 4 ranges of .00001 to .005 MFD, .001-.5 MFD, .1-50 MFD and 20-1000 MFD. Resistance ranges are 100-50,000 OHMS and 10-1000 Resistance ranges are 100-5 MEGOHM. Quick check feature enables you to check capacitors for shorts, open or intermittent while in circuit—no need to remove them from the set till you're sure they need replacement. Leakage test switch gives you choice of 25, 150, 250, 350 or 450 volts for checking leakage under correct potential. Separate power factor control with continuous settings from 0 to 50%. Operation is simple and accurate, using a magic-eye tube as the null detector. Attractively finished steel case with etched panel and rounded corners, measures 14 1/2" L x 8 3/4" H x 5" D. Shpg wt. 19 lbs.

34.50

you choice of 25, 150, 250, 350 or 450 volts for checking leakage under correct potential. Separate power factor control with continuous settings from 0 to 50%. Operation is simple and accurate, using a magic-eye tube as the null detector. Attractively finished steel case with etched panel and rounded corners, measures 14 1/2" L x 8 3/4" H x 5" D. Shpg wt. 19 lbs.

MODEL LC-4

NET 34.50

HIGH SENSITIVITY 20,000 OHM PER VOLT DC 10,000 OHM PER VOLT AC MULTITESTER



LOOK AT THESE!

FULL SCALE RANGES:
D.C. Volts: 0-6; 0-30; 0-120; 0-600; 0-1200; 0-6000 Volts - A.C. VOLTS: 0-6; 0-30; 0-120; 0-600; 0-1200 Volts - RESISTANCE: 0-10K; 0-100K; 0-1 Meg; 0-10 Megohms - D.C. CURRENT: 0-60 Microamp; 0-6; 0-60; 0-600 Milliamps - DECIBEL: -20 to +17 db (0 db - 0.774V) - CAPACITY: .0001-.01; .005-.15 mfd - INDUCTANCE: 20-2000 millihenry - OUTPUT RANGES: 0-6; 0-30; 0-120; 0-600; 0-1200 Volts



19.95

The new Lafayette high sensitivity Multitester is a complete instrument (not a kit). In addition to its unusual sensitivity of 20,000 OHMS PER VOLT ON D.C. AND 10,000 OHMS PER VOLT ON A.C., and the extraordinary number and scope of its ranges, it is packed with features that would make it cost at least twice as much if made in this country. Uses 1% precision resistors, silver contacts on selector switch, 35 ua 3" meter. Dependable, rugged and accurate. Even the test leads are heavy duty with high voltage insulation. Voltage source required for low capacity range is 120V A.C., for high range capacity and inductance scales is 6V A.C. Attractive plastic front with metal bottom. Size 6 1/4" x 4 1/4" x 2 1/2". Complete with batteries and leads. Shipping weight 4 1/2 lbs. **Single, Each 19.95**
RW-30A

In lots of 3, Each 19.25

NEW!

LAFAYETTE CAPACITOR-RESISTANCE TESTER

COMPLETELY WIRED AND TESTED

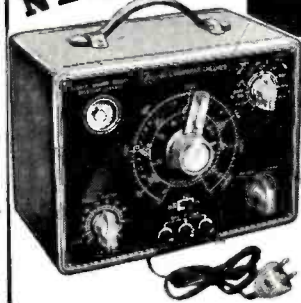

21.50

- COMPLETELY WIRED AND TESTED
- CHECKS ALL TYPES OF CONDENSERS FOR CAPACITY, LEAKAGE, OPEN SHORTS OR INTERMITTENT CONDITION
- DIRECT READING SCALES FROM .00001 TO 1000 MFD AND 100 TO 5 MEGOHMS

A stable and accurate bridge type circuit measures capacitance in 4 ranges of .00001-.005 MFD, .001 to .5 MFD, .1 to 50 MFD and 20 to 1000 MFD. Two resistance ranges of 100-50,000 and 10-1000 to 5 megohms. Check leakage under actual load with choice of 25, 150, 250, 350 or 450 volts available by selector switch. Power factor control from 0 to 50%. Checks for leakage, open, short, or intermittent operation. All readings taken directly off scales after setting magic eye to maximum. Completely self-contained power supply. Attractively finished steel case with rounded corners and etched panel. Operates from 110V AC. Size 9 3/8" L x 7 1/2" H x 5 1/2" D. Shpg. wt. 10 lbs.

MODEL LC-15

NET 21.50

BUILD A 6 TRANSISTOR SUPERHET RECEIVER

FOR GROUP AND PRIVATE LISTENING

- 100% SUBMINIATURE PARTS—NO COMPROMISES!
- LABORATORY DESIGNED—SENSITIVE, SELECTIVE, STABLE!
- CLASS B PUSH-PULL AMPLIFICATION—PLENTY OF POWER!

Superb Performance! Incomparable Value!

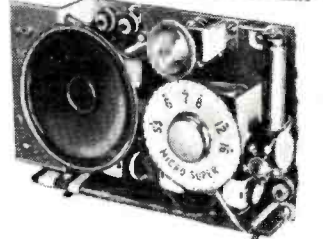
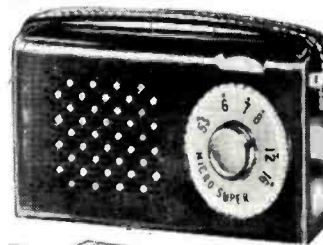

33.50

Transistor-wise Lafayette is proud to present its 6 Transistor Superhet Receiver Kit KT-119. An outstanding achievement of constant research and design, this kit represents the optimum in sensitivity, selectivity and stability. You'll be amazed at its superior commercial quality! You'll be elated with its surprising performance! The circuit, using 3 high frequency RF Transistors, 3 dependable audio Transistors and Crystal Diode, features a specially matched set of 3 I.F.'s, Oscillator, High-Q Loop, Class B Push-Pull Audio Amplification, and Transformer Coupling in audio and output stages. Special care has been taken in the design for exact impedance matching throughout to effect maximum transfer of power. Has efficient 2 3/4" speaker for exemplary reproduction, and earphone jack for private listening. Complete with all parts, transistors, pre-punched chassis, battery and easy-to-follow step-by-step instructions. 6" x 3 1/2" x 1 1/2". Shpg. wt., 3 lbs.

KT-119—Complete Kit—Less Case.....Net **33.50**

MS-339—Sturdy, attractive brown leather case with carrying strap for KT-119. 6" x 3 1/2" x 1 1/2". Shpg. wt., 1 lb.....Net **2.95**

MS-279—Sensitive matching earphone.....Net **2.39**

LAFAYETTE RADIO

DEPT. RD1

JAMAICA 33; N. Y. 165-08 Liberty Ave. Write for FREE Bargain Packed Catalog!

100 SIXTH AVE., NEW YORK, N. Y.
BOSTON, MASS., 110 Federal St.
PLAINFIELD, N. J., 139 West 2nd St.
NEWARK, N. J., 24 Central Ave.
BRONX, N. Y., 542 E. Fordham Rd.

FREE!
LAFAYETTE
CATALOG



**ELECTRONIC CATALOG
PACKED WITH MONEY SAVERS**

Packed with the largest selection of Electronic, Radio and T.V. Parts, and equipment, PA, Hi-Fi systems, tubes, antennas, Transistor Kits, parts and components, Test Equipment, new build your own kits, tools, books, Microscope, drafting equipment, Binoculars, Telescopes, All Radio, TV and Ham supplies — ALL AT GREAT SAVINGS — For the economy minded servicemen, dealer, engineer and technician. **CHUCK FULL OF BUYS! SEND FOR YOUR FREE COPY TO-DAY.**

PROFESSIONAL TRANSCRIPTION TURNTABLE AND VISCOUS-DAMPED TONE ARM
THE FINEST TRANSCRIPTION TURNTABLE AND TONE ARM FOR THE PROFESSIONAL USER AND THE AUDIOPHILE



PK-100A TRANSCRIPTION TURNTABLE
New 3-speed instrument with built-in stroboscope and viewer for exact speed determination, and magnetic brake for instantaneous speed variation. Precision engineered to meet professional standards for wow, rumble and flutter content. Heavy 12" cast aluminum rim-driven turntable. Variable speed control permits adjustment of each speed within $\pm 7\%$ using efficient frictionless magnetic brake. Heavy-duty constant speed 4-pole induction motor freely suspended, and isolated by shock-mountings to eliminate vibration transfer. R-C filter network suppresses "pop" in speaker. Truly a delight for the connoisseur. Size: 13 1/2" x 14" and requires 2 3/4" clearance above and 3 3/4" below motorboard. For 110-130V and 60/50 cycle AC. Power consumption 12 watts. Handsome hammertone gray finish. Shpg. wt., 20 lbs.
PK-100-A.....Net **49.50**

PK-90 VISCOUS-DAMPED TONE ARM
This transcription arm assures dependable and stable operation, utilizing the "floating action" principle of "viscous-damping." The arm is supported at a single point by a pivot and jewel bearing having negligible friction. Damping is accomplished by a silicone fluid occupying the gap between a ball and socket. This damping control permits high compliance and negligible tracking error, and prevents damage to either record or stylus should the tone arm be accidentally dropped. Low frequency resonance, skidding and groove-jumping are likewise minimized. The tone arm accepts all records up to 16" and accommodates virtually all hi-fi cartridges by means of precisely engineered adapters which simplify installation and provide proper tracking.
This tone arm is a quality companion to the PK-100 with matching finish. Shpg. wt., 2 1/2 lbs.
PK-90.....Net **15.95**

LAFAYETTE'S FM-AM TUNER KIT

- SIMPLIFIED DETAILED INSTRUCTION MANUAL
- MEETS FCC REQUIREMENTS FOR RADIATION
- GROUNDED GRID TRIODE AMPLIFIER
- ARMSTRONG FM CIRCUIT WITH FOSTER-SEELEY DISCRIMINATOR
- AFC DEFEAT CIRCUIT WITH FRONT PANEL CONTROL



The excellence of its design and the quality of its components combine to provide this compact high-fidelity FM-AM tuner with superb characteristics normally found in units costing several times as much, and with performance unbelievable at this low price. Features Armstrong FM circuit with limiter and Foster-Seeley discriminator. Simplified tuning with slide-rule dial and flywheel counterweighted mechanism. AFC defeat circuit combined with tuning control. Attractive etched copper-plated and lacquered finish.

SPECIFICATIONS

FREQUENCY RANGE: FM, 88-108 MC; AM, 530-1650 KC. **ANTENNA INPUT:** FM, 300 ohms; AM, Ferrite loopstick and high impedance external antenna. **CONTROLS:** 2—a function control for AM, FM, PHONO, TV and a tuning/AFC defeat control. **DISTORTION:** Less than 1% rated output; **FREQUENCY RESPONSE:** FM, ± 5 db 20 to 20,000 cps; AM, ± 3 db 20 to 5000 cps. **SENSITIVITY:** FM, 5 μ V for 30 db quieting; AM, loop sensitivity 80 μ V/meter. **SELECTIVITY:** FM, 200 KC bandwidth, 6 db down — 375 KC FM discriminator peak to peak separation; AM, 8 KC bandwidth, 6 db down. **IMAGE REJECTION:** 30 db minimum. **HUM LEVEL:** 60 db below 100% modulation. **TUBE COMPLEMENT:** 2-12AT7, 1-6BA6, 1-6BE6, 2-6AU6, 1-6AL5 plus 1-6X4 rectifier. **SIZE:** 5 1/2" high x 9 3/4" wide x 9 1/2" deep (excluding knobs). **CONSUMPTION:** 30 watts. For 110-120V, 60 cycles AC. Less metal case. Shpg. wt., 9 lbs.
KT-100 kit, less cage.....Net **34.95**
ML-100—Metal cage for above, shpg. wt., 3 lbs.....Net **5.00**

3 WAY HI-FI SPEAKER SYSTEM



- 15" Woofer with 31.5 oz Magnet
- 8" Mid-range speaker
- Acoustical Lens Tweeter
- 3-Way Crossover Network

A complete 3-way system capable of performance heretofore found only in systems at many times this price. The components were specially selected by Lafayette sound engineers to offer the maximum in audio fidelity at the lowest price possible. Includes continuously variable presence and brilliance controls. Offers superb reproduction across the entire audio spectrum. Shpg. wt., 25 lbs.
SY93.....Net **55.50**

HW-7 Hi-Fi Tweeter w/Acoustical Lens..... **14.95**
LN-3 3-way Crossover Network with Controls..... **14.95**
LN-2 2-Way Crossover Network with Control..... **8.75**

LAFAYETTE MATCHED HIGH FIDELITY PHONO SYSTEM



Reg. Value
~~158.55~~
SALE!
119.50

Nothing Finer At This Price
NEVER—in the annals of HIGH-FIDELITY has a phono system of this quality—at this price—been offered. A Lafayette "best buy" system designed around the new Lafayette LA-59 amplifier. The performance of this Phono system surpasses the most critical requirements of music lovers. Twenty-four combinations of record equalization provide an almost endless variety of tone compensation to match varying recording characteristics. This system includes the famous Garrard RC-121 "Renown" 4 speed automatic and manual record changer, LAFAYETTE LA-59 18 watt amplifier with features found only in the most expensive amplifiers. G.E. triple-play—turnover cartridges with genuine G.E. DIAMOND SAPPHIRE STYLI, AND LAFAYETTE SK-58 12" coaxial HI-FI speaker. All units are supplied with plugs, jacks and prepared color-coded interconnecting cables for quick easy installation. For 110-125 volt, 60 cycle AC. Shpg. wt. 50 lbs.
HF-154—Complete Phono System.....Net **119.50**

Lafayette Radio 165-08 LIBERTY AVE.
DEPT RD2 JAMAICA 33, N. Y.

NAME _____
ADDRESS _____
CITY _____
ZONE _____
STATE _____

SEND FREE LAFAYETTE CATALOG

CUT OUT AND MAIL TODAY!

FREE 3-in-1 PRECISION SCREWDRIVER SET WITH EVERY ORDER

regardless of size!

ALL TUBES UNCONDITIONALLY GUARANTEED FOR 1 YEAR

Take your pick any assortment

100 receiving tubes \$38

On orders of less than 100 tubes — 41c each

BRAND NEW TV PICTURE TUBES

RCA and DUMONT Licensed Partial Listing No dud required

Type	T.M. Price
10BP4	\$10.95
12LP4	12.95
12QP4	10.00
14CP4	15.25
15DP4	16.95
16BP4	18.50
16GP4	19.25
16KP4	17.00
16RP4	\$17.00
17BP4	19.00
17GP4	21.00
17LP4	18.00
19AP4	23.00
20CP4	24.00
21ALP4A	24.00
21EP4	24.00

Picture tubes F.O.B. PASSAIC, N. J. via Railway Express

PRETESTED TUBES—INDIVIDUALLY BOXED

024	6AU6	65H7	12BA8
1B3GT	6AU5GT	65J7GT	12BE6
1H5GT	6AV5	65K7GT	12BZ7
11C5	6AV6	65L7GT	12BH7
11N5	6AX4GT	65N7GT	12BY7
1N5GT	6AT6	65Q7	12SA7
1Q5GT	6AH4GT	65R7	12S7
1R5	6BA6	61B	12S7GT
1S4	6C5	6U8	12SK7
1S5	6BE6	6V3	12SL7GT
1T4	6BG6G	6V6GT	12SN7GT
1T5GT	6BJ6	6W4GT	12SQ7
1U4	6BK5	6W6GT	12SR7
1U5	6BN7	6X4	19T8
1X2	6BL7GT	6X5GT	19B6G
3Q4	6D6GT	6Y6G	25BQ6GT
3S4	6E07	7C5	25L6GT
3V4	6BY5G	7C6	25Z5
5U4G	6BZ7	7E7	25Z6GT
5V4G	6C4	7F7	35B5
5Y3	6C8E	7F8	35C5
6AB4	6CD6G	7N7	35L6GT
6AC7	6F5	12AL5	35W4
6AG5	6H6GT	12A77	35Y4
6AG7	6J5GT	12AUG	35Z5GT
6AF4	6J6	12A7U	50A5
6AK5	6K6GT	12AV6	50B5
6AL5	6L6	12AV7	50C5
6AQ7	654	12AX7	50L6GT
6AS5	658GT	12AX4GT	117Z3
6AT6	65A7	12B77	

Free Postage on all prepaid continental U.S.A. orders, 50c handling charge on all orders under \$5.00, 25% deposit on all C.O.D. Subject to prior sale.

TUBE MART

DISCOUNT HOUSE

PRescott 3-0330

The Lokpot Bldg. Passaic, N. J.

Bottlenecks in Service

(Continued from page 41)

tube and component failures: This complaint is increasing, seemingly out of proportion, as more and more new sets arrive in an inoperable condition or fail very early in the customer's home. To the writer's personal knowledge, one large TV store discontinued handling two popular makes of receivers because of repeated servicing difficulties and poor reliability of components. The same store recently uncrated a new expensive console which would not operate properly until 6 tubes and a diode were replaced. This was not an isolated case. It occurs with alarming frequency, although usually in lesser degree, with other new sets.

Additional new-set troubles which seem to be occurring at an increasing rate include: (1) faulty tuners (defective or inoperative on one or all channels), (2) inoperative or intermittent printed circuits (poor solder joints, etc.), (3) leaky or shorted tubes, and (4) defective components, especially flyback transformers.

Remedy: Increased pressure on manufacturers of parts and tubes should be exercised by manufacturers of sets to comply with industry standards and to maintain a more realistic program of inspection and quality control. Also a closer check on inspection and final assembly in the individual manufacturers' own plants is probably in order.

In conclusion, no attempt has been made to catalogue all the troubles that come up in the field. Those that are brought up here do give a general picture of what can go wrong. Also, it would not be entirely correct to place the blame for some of the short-cuts directly on the manufacturer of the set. As long as a lower price remains a deciding factor in switching a purchaser from one TV receiver to another, otherwise ill-advised measures will continue to be used to cut costs. Perhaps one of the things that is needed is better consumer education with respect to his TV set. If the owner can be made to understand, in practical dollar-and-cents terms, that a receiver for which he pays less initially can cost him more in service bills in the long run, a useful purpose can be served all around.

Also, in the many cases where a design element that obviously does not save money obstructs servicing, the need for education of the manufacturer and his engineers is evident. This job is the responsibility of the technician and the service dealer, who should be more vocal in letting the set maker know of such service hurdles.

Increasing reliability of set performance and reducing servicing time can only work to the mutual benefit of all three principals involved—owner, manufacturer, and service technician.



UNIVERSAL TV TUBE BRITENER

Does Everything



At All Distributors

manufactured by

Perma-Power COMPANY

4727 N. DAMEN AVE., CHICAGO 25, ILL.
Phone LOngbeach 1-0070

manufacturers of electronic equipment since 1928

TERADO

Trav-Electric CONVERTERS

MOBILE POWER

Give You **110 A.C. HOUSE CURRENT ANYWHERE**
You Drive or Cruise



LIST \$11.95 UP

For 6 and 12 Volt Car Batteries—Capacities: 10 to 125 Watts

NO INSTALLATION
Just plug into cigar lighter on dash of car, truck, or boat—and away we go

- OPERATE PORTABLE TV
- SMALL DO-IT-YOURSELF
- TOOLS WHEREVER NEEDED

One of the great conveniences of our electronic age

101 USES



PORTABLE TV



DO-IT-YOURSELF HOBBY TOOLS

ALL ELECTRIC SHAVERS

SEE YOUR ELECTRONIC PARTS DEALER OR JOBBER

TERADO COMPANY

DESIGNERS & MFRS. OF ELECTRONIC EQUIPMENT SINCE 1927

1058 RAYMOND AVE., ST. PAUL 14, MINNESOTA

Loran APN / 4 Oscilloscope

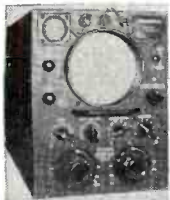

Easily converted for use on radio-TV Service Bench!

BRAND NEW
Completely Assembled
Supplied with 5" Scope
type 5CP1
and RCA
100 Kc.
Crystal
Unit

\$14.95

1-95-M FIELD STRENGTH METER

Tunes 100 to 155 Mc. Made for Signal Corps. Like New **\$34.50**

MN26Y BENDIX DIRECTION FINDER
150-325 Kc; 325-695 Kc; 3.4-7 Mc. Complete with tubes, motor. **\$26.95**

BRAND NEW
USED, like new, incl. tubes and dynamotor. **\$18.95**

BENDIX DIRECTION FINDER

12-tube remote control Navigation Direction Finder and communications receiver. 150 to 1500 Kc in 3 bands, 28 V. DC input. Ideal for commercial navigation on boats and planes. Complete installation comprises:
MN-26-C Receiver, used, with 12 tubes **\$16.50**
MN-26-C With 12 Tubes, BRAND NEW **\$24.95**
MN-20-E Rotatable Loop. **4.25**
MN-52 Azimuth Control Box. **2.95**
All necessary accessories for above in stock.

TS-16/APN TEST SET. BRAND NEW, complete with all cables. \$12.95

JUST ARRIVED!

MODEL OAC-2 NAVAL RADIO TEST EQUIPMENT FREQUENCY METER, 110 V 60 cycles AC, 105 to 127 Mc. Mfd by LIEBEL-FLAR-SHEIM CO. BRAND NEW, Export Packed \$44.50

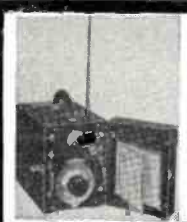

BC-906 FREQ. METER—SPECIAL!
Cavity type, 145 to 235 Mc. BRAND NEW in original factory packing, complete with antenna. Manual included. **OUR LOW PRICE \$8.88**

BC-221 FREQ. METER. \$129.50

BC-221 FREQ. METER CASE

Aluminum Case for BC-221 or TS-164 Freq. Meters. Shock Mounted. BRAND NEW. **\$3.99**
Add 50c for packing.
Original 1000 Kc Crystal for BC-221. BRAND NEW **\$8.45**

TG-5-B TELEGRAPH SET

Made for USA Army Signal Corps. A dandy little field set for 2-way communication. Sturdy metal container, 6 3/4" x 4 1/2" x 3 1/2", with hinged covers, complete with telegraph key and headset. BRAND NEW, in carrying case, with shoulder strap. **\$9.95**
Used, exc. Cond. **\$7.95**
TG-10 KEYS. Complete with all Tubes. **\$21.95**

BRAND NEW SELSYNS

Operates from 57 1/2 volts, 400 cycles. New tested. Conversion diagram for 110 volts AC included.
2J1G1 Selsyn Control Transformer. **\$2.95**
2J1H1 Selsyn Differential Generator. Each. **\$2.95**
Caps for Above. 50c

DYNAMOTOR VALUES!

Type	Input	Output	Used	BRAND NEW
DA-19-A	28V 11A	400V 400A	\$4.99	\$6.95
DM-28	28V	224V .07A	2.95	4.95
DM-32A	28V 1.1A	250V .05A	2.95	5.95
DM-33A	28V 5A	575V .16A	1.95	3.95
	28V 7A	540V .25A		
DM-34D	12V 2A	220V .080A	4.25	5.50
DM-37	25.5V 9.2A	625V .225A	5.95	8.95
DM-40	14V 3.4A	172V .138A	1.75	3.45
DM-53A	28V 1.4A	220V .080A	3.95	5.95
DM-64A	12V 5.1A	275V .150A		7.95
PE-73C	28V 20A	1000V .350A	8.50	11.50
PE-86	28V 1.25A	250V .050A	2.95	5.24
PE-103	6/12V Input, 500V @ 160 Ma output	With cables and plugs, excellent, like new.		\$24.50



2 VOLT BATTERY "PACKAGE"
1—2V. 20 Amp. Hr. Willard Storage Battery **\$2.45**
1—2V. 7 prong Synchronous Plug-in Vibrator **1.49**
1—Quart Bottle Electrolyte (for 2 cells) **1.45**
ALL BRAND NEW!
Combination Price. **\$4.99**

Willard 6-Volt Midget Storage Battery
3 Amp. Hour. BRAND NEW. 3 3/8" x 1-13/16" x 2 3/8". Uses Standard Electrolyte. Only **\$2.22**

ASB-5 RECEIVER FOR 420 Mc BAND!

As featured in "CQ" for October 1956. Easily converted, makes a marvelous receiver for 420 Mc band, with RF amplifier! Supplied complete with all tubes.
OUR LOW PRICE. \$1.29
Tuning Knob for ASB-5 Receiver. **\$1.29**
ASB-5 INDICATOR. **\$16.95**

Ham Special! Famous BC-645 XMITTER-RECEIVER



With MANUAL for Easy Conversion to CITIZENS' BAND!

Makes wonderful mobile rig for 420-500 Mc. Easy to convert for phone or CW 2-way communication. This small rig originally cost over \$1000—yours for practically a song! You get it all, in original factory carton, BRAND NEW, complete with 17 tubes, less power supply. Conversion Instructions Included. **\$29.50**
Shpg. wt. 25 lbs.

PE-101C DYNAMOTOR for BC-645, has 12-24V input (easy to convert for 6V Battery operation) **\$7.95**
UHF ANTENNA ASSEMBLY, for BC-645. **\$2.45**
Complete set of 10 Plugs for BC-645. **\$5.50**
CONTROL BOX for above. **\$2.25**
SHOCK MOUNT for above. **1.25**
CONVERSION BOOKLET. Instructions for most useful surplus rigs. **\$2.50**

SCR-522 2-METER RIG!

Terrific buy! VHF Transmitter-receiver, complete with all components, 100-156 Mc. 4 channels. Xtal-controlled, Amplitude modulated voice. They're going fast! Excellent condition.
SCR-522 Transmitter-Receiver, complete with all 18 tubes. \$33.33
COMBINATION. Special

Receiver Only, with all tubes. **\$19.50**
Transmitter Only, with all tubes. **\$22.25**

ARC-5/T-23 TRANSMITTER

100-156 Mc Includes 2-832A, 2-1625 Tubes. **\$19.95**
BRAND NEW

SPECIAL Limited quantity ARC-5/T23 xmitters. BRAND NEW, less tubes. **\$7.95**
OFFER! Excellent Used, less tubes. **\$5.95**

ARC-5 MARINE RECEIVER-TRANSMITTER

Navy Type Comm. Receiver 1.5 to 3 Mc
BRAND NEW with 6 tubes. **\$16.95**

Navy Type Comm. Transmitter 2.1-3 Mc
BRAND NEW with 4 tubes and Xtal. **\$12.45**

AN/ARR-2 RECEIVER

BRAND NEW—A Terrific Value! Tuning Range 234 to 238 Mc. Tubes: 7-9001, 3-6AK5, 1-12A6. Only a few at this low price! Complete. **\$8.88**
With 28 V 1.6A Dynamotor, complete. **\$12.98**

110 VOLT AC POWER SUPPLY KIT for above. **\$7.95**

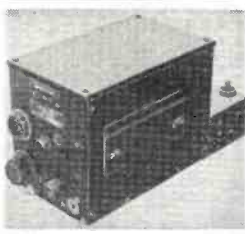

NAVY RECEIVER TYPE ARB

Four Band. 195 to 9050 kc. Low Freq., Ship, Broadcast—40 to 80 meters. Includes tubes and dynamotor, for 24 volt operation. Easily converted for 110 V., 12 V, or 6 V. Schematic Included. Excellent Condition. Overall: 8 1/4" x 7 1/4" x 15 1/4". Wt. 30 lbs.
COMPLETE WITH ALL TUBES. \$21.50
Special.



LORAN APN-4

FINE QUALITY NAVIGATIONAL EQUIPMENT

Determine exact geographic position of your boat or plane! Complete, BRAND NEW installation consists of: ID-6B/APN-4 Indicator; R-9B/APN-4 Receiver; PE-206 Inverter; Set of Plugs; Visor for Indicator; Operation manual; Brand New, Export **\$129.50** packed. COMPLETE.

APN-9A LORAN Receiver Indicator, less tubes, NEW (demilitarized) **\$29.50**

WRITE FOR FREE CATALOG!

Please include 25% Deposit with order—Balance C.O.D. MINIMUM ORDER \$3.00. All shipments F.O.B. Our Warehouse N.Y.C.

G & G Radio Supply Co.
Telephone: CO 7-605
51 Vesey St., New York 7, N. Y.,

R24-ARG/5 NAVY TYPE

(Similar to BC-946) BROADCAST RECEIVER

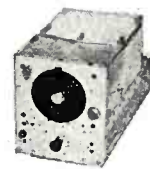

520 to 1500 Kc. 6 tubes: 3-12SK7, 12SR7, 12A6, 12K8. For dynamotor operation. Easily converted to 110 or 32 Volt. 2-IF stages, 3-gang tuning cond. Complete with all tubes, in original scaled carton. BRAND NEW. **\$19.95**

BC-457 TRANSMITTER—4-5.3 Mc. complete with all tubes and crystal. BRAND NEW. **\$7.88**
BC-458 TRANSMITTER—5.3 to 7 Mc. Complete with all tubes and crystal. BRAND NEW. **\$7.88**
BC-459 TRANSMITTER—7-9.1 Mc. complete with all tubes and crystal. BRAND NEW. **\$11.95**
ARC-5/T-15 TRANSMITTER—3 to 4 Mc. BRAND NEW complete with all tubes & crystal. **\$8.88**

110 VOLT AC POWER SUPPLY KIT

For All 274-N and ARC-5 Receivers
Can be assembled quickly and easily, on pre-drilled chassis. Plugs into the rear of any model 274-N receiver and delivers 24 volts as well as "B" voltage. Complete kit of parts with metal case, instructions. **\$7.95**

SPLINED TUNING KNOB for 274-N and ARC-5 RECEIVERS. Fits BC-453, BC-454 and others. Only **49c**

SCR-274 COMMAND EQUIPMENT

ALL COMPLETE WITH TUBES Excellent Brand Type Description Used Used NEW

BC-453 Receiver	190-550 KC.	\$9.95	\$11.95	\$14.95
BC-454 Receiver	3-6 Mc.	7.19	8.29	11.95
BC-455 Receiver	6-9 Mc.	5.25	7.95	9.95
BC-456 Modulator		2.24	2.75	4.24
BC-450 3-Receiver Control Box		1.49	1.95	
BC-451 Transmitter Control Box		1.25	1.49	
BC-696 Xmtr	3-4-Mc (like new)	6.95	8.88	

BC1206-C BEACON RECEIVER

195 to 420 Kc. made by Satchel-Carlson. Works on 24-28 volts DC. 135 Kc. 1F. Complete with 5 tubes. Size 4" x 4" x 6". Wt. 4 lbs. BRAND NEW **\$8.88**
Brand New, less tubes. **\$5.95**
USED, with tubes. **\$5.95**
USED, less tubes. **2.95**



BRAND NEW SPECIAL PURPOSE TUBES

in Original Individual Packing
JAN CRP-730A MAGNETRON, Raytheon. **\$3.45**

Type	Each	Lots of 12	Lots of 100
6J6W	5.45	\$5.15	\$41.00
1625	.26	2.75	13.50
1626	.19	1.75	13.50
1628	.27	3.05	33.95
826	.44	4.95	39.50
21724B	.35	3.95	29.50
VR10	.79	8.88	70.00
VR150	.79	8.88	70.00
8002R	.59		
RK65	.725		

NEW! Cathode Ray Tubes NEW!

3CP1 **\$1.18** | 5BP4 **\$2.22**
3F7 **1.18** | 5CP1 **2.45**
5BP1 **2.22** | 5LP7 **1.88**

BUBBLE SEXTANT

Made for U. S. Armed Forces by AGFA ANSCO. Actually worth \$150 or more! Has illuminated averaging disc for nighttime use. Complete with carrying case. Only **\$9.95**



DYNAMIC HANDMIKE, with "Press-to-talk" Switch, cord and plug—BRAND NEW, only **\$2.95**

DYNAMIC HEADPHONES, 600-ohm impedance, with large earphone cushions, cord and phone plug. BRAND NEW, special. **\$2.95**

DYNAMIC Headphone with Dynamic Mike. BRAND NEW. \$3.95

Hi-Fi DYNAMIC HEADSET with Cushions
Freq. Range: 40-14000 CPS. No Distortion. BRAND NEW. **\$5.95**

MICROPHONES

Model	Description	Used	BRAND NEW
T-17	Carbon Hand Mike	\$5.45	\$7.95
T-30	Carbon Throat Mike	.33	.69
T-45	Navy Lip Mike		.99
RS-38	Navy Type	2.45	4.95
T-24	Carbon Mike		3.95
TS-9	Handset		4.95

HEADPHONES

Model	Description	Used	BRAND NEW
HS-23	High Impedance	\$2.25	\$4.35
HS-33	Low Impedance	1.99	4.65
HS-30	Low Imp. (featherwt.)	1.49	2.25
H-16/U	High Imp. (2 units)	2.75	7.95
CD-307A	Cords, with PL55 plug and R36 Jack.		.99

BC-442 ANTENNA RELAY

Wonderful Value! Consists of 3/4 amp 2" R.C. Ammeter (antenna current indicator, 0-10 scale, Transmitter-Receiver Switching relay, in aluminum case with associated components. BRAND NEW. **\$2.24**



Buy The World's First Color Television Annual!

136 pages covering every phase of Color TV

- FUNDAMENTALS OF COLOR TV (A Complete Course)
- COLOR SETS ON THE MARKET
- PICTURE TUBES AND COMPONENTS
- TECHNICAL ANALYSIS OF SETS
- SERVICING AND INSTALLING
- TEST INSTRUMENTS FOR COLOR TV
- CONVERTERS, COLOR WHEELS, VITASCAN



NOW ON SALE AT ALL
NEWSSTANDS
ONLY \$1.00

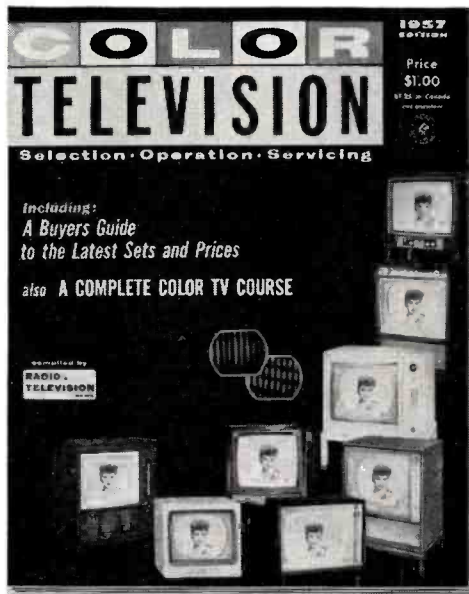

MORSE CODE

Learn Morse Code
... FAST ...
by SOUND with
UNCLE SAM'S RECORDINGS

Code signals are transmitted at SLOW speed to allow you time to DUPLICATE them in DIDAH language or with whatever instrument you have to work with ... also at FAST speed so that you will be FAMILIAR with how they SOUND when you hear them on the air.

Send ONLY \$1.25 for your
7 inch 45 RPM Record

Dealer and Jobber Inquiries
Invited

UNCLE SAM RECORDINGS, Dept. C-4
59 E. Van Buren St. Chicago 5, Illinois

ALWAYS
READY

TO HELP YOU
TO TEST YOU
TO TEACH YOU

GIVES YOU
MESSAGES TO
DECODE

We will pay you \$\$\$\$.
for an AN/ARN-6
or any of its components
AS-313 LOOP, etc.

**Phone us collect on
ABOVE ITEMS
Stanley 7-0406**

SIMILAR FABULOUS PRICES FOR:
APR-9 . . . ARC-1 . . . ARN-7 . . . ART-13 PARTS
. . . BC-788-C . . . I-152-C . . . LP-21-AM, -LM,
or MO-18A or MC-507 from these loops . . . R-65/
APN-9 . . . TEST SETS I-100, TS-117, -125, -147,
-148, -488. What other electronics have you?

ARROW SALES, INC.
Dept. R.N.
7460 Varna Ave. No. Hollywood, Calif.

TELEVISION

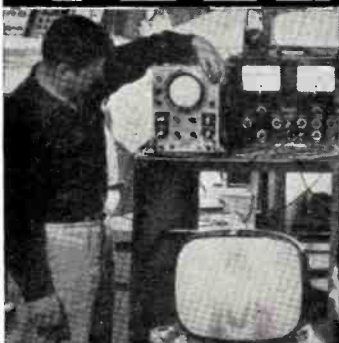

AT HEADLS YOU LEARN
BY DOING IN MODERN
ELECTRONICS LABORATORIES

HEALD
ENGINEERING COLLEGE

Van Ness at Post, RTN
San Francisco, Calif.

Industry needs Electronic Trained Men
Now! Qualify for **BIG PAY JOB**, 9 short
months. No other type of training can
compare with actual shop practice you
get at Healds under expert instructors.

Bachelor of Science Degree, 27 Months

- Electronics Engineering (B.S. Degree)
- Electrical Engineering (B.S. Degree)
- Television Technician (9 Months) Color TV
- Electronics Technician (12 Months)

Heald College ranks **FIRST** West of the
Mississippi in "Who's Who in America"

Approved for Veterans
DAY AND EVENING CLASSES
Register Now. Write for Catalog.
(No Obligation.)

Your Name

Address

City

State

Service Technician Prestige Sells Sets

*One manufacturer banks
on public's confidence
in independent service.*

IT IS not unusual for manufacturers to hand out periodic pats on the back to the independent service profession but, however sincere they may be, it is unusual for one of them to support this confidence by predicating his sales program on this faith in the service technician.

Nevertheless, *American Television & Radio Co.*, of St. Paul, Minn., is doing exactly that. This organization, producer of battery eliminators, auto radio vibrators, and d.c.-a.c. inverters, has also been producing a TV receiver aimed at the market for deluxe and custom-built sets. Available either in fine cabinetry or as a separate chassis for custom installation, the set offers such features as hi-fi push-pull audio output, full 4-mc. video response, a 4-stage video i.f. strip, a 2-stage audio i.f. strip, and such other characteristics as are usually associated with quality design.

In choosing an outlet for these receivers, *ATR* has paid the independent service technician a considerable compliment. The manufacturer feels that the same technician who, in discussing set sales, has said, "Service is my business; I can't compete with the discount houses," is the very man it wants to put its sets across.

To attract independent service technicians, *ATR* is offering exclusive franchise certificates. Included in the sales plan are safeguards for dealers such as exclusive distribution through certified independents with no sales through discount operations.

The manufacturer is banking on the confidence it feels that service technicians have earned from their customers. *ATR* feels that people who are interested in high-quality performance rather than lowest price will rely on their service technicians for recommendations as to what receiver to purchase. In turn, the set maker backs up receivers with a strong guarantee.

As a further good-will gesture in the direction of the service fraternity, the manufacturer is seeing to it that complete service and other technical data is available on its chasses at all times, directly through its own facilities or through other agencies. In fact, the *ATR* organization will make full data available, on request, so that prospective technician-dealers may examine the circuit and thus have a basis for making recommendations to customers concerning the capabilities of the set.

STANDARD LINE

MANUFACTURERS
ORDERS INVITED
EXPORT ORDERS
INVITED

Below is A Partial List—Send For FREE Complete List and Order Form

QZ4	.42	5AT8	.79	6BK7	.75	7A4	.46	12J5	.39
1A7GT	.42	5J6	.79	6BL7GT	.74	7A5	.52	12L6	.59
1B3GT	.66	5T8	.79	6BN6	.57	7A6	.44	12SA7	.47
1C5GT	.40	5U4G	.48	6BQ6GT	.79	7A7	.44	12SG7	.54
1C6	.25	5V4G	.57	6BQ7	.75	7A8	.44	12SJ7	.44
1C7G	.25	5V6GT	.49	6BY5G	.57	7AU7	.69	12SK7	.47
1D5GP	.42	5X8	.79	6BZ7	.75	7B4	.43	12SL7GT	.59
1H4G	.45	5Y3	.38	6C4	.36	7B5	.40	12SN7GT	.56
1J6GT	.46	5Y4G	.42	6CB6	.50	7B6	.41	12SQ7	.39
1L4	.45	5Z3	.44	6CD6G	1.17	7B7	.42	12TV6GT	.44
1L6	.54	6A7	.56	6CU6	.79	7B8	.46	12W6	.59
1LA4	.55	6A8	.46	6D6	.47	7C4	.41	12X4	.36
1LA6	.46	6AB4	.44	6E5	.43	7C5	.41	14A7	.44
1LB4	.58	6AC7	.66	6F5	.36	7C6	.42	14B6	.44
1LC5	.48	6AF4	.75	6F6	.37	7C7	.44	14Q7	.44
1LC6	.46	6AG5	.49	6H6	.37	7E5	.44	19T8	.69
1LD5	.56	6AG7	.68	6J4	1.59	7E6	.44	19B6GG	.17
1LE3	.56	6AH4G2	.69	6J5	.38	7E7	.48	25BQ6GT	.84
1LH4	.63	6AH6	.70	6J6	.48	7F7	.58	25CA5	.79
1LN5	.46	6AK5	.53	6K6GT	.38	7F8	.55	25CD6	1.29
1NS5GT	.49	6AL5	.41	6K7	.67	7N7	.57	25CU6	.99
1R5	.50	6AM8	.79	6L6	.59	7Q7	.58	25L6GT	.46
1S5	.45	6AN8	.45	6N7	.59	7X7	.64	25W4GT	.42
1T4	.50	6AQ5	.45	6Q7	.39	7Y4	.34	25Z6	.36
1U4	.46	6AS5	.47	6S4	.39	7Z4	.39	27	.24
1U5	.45	6AS7G	2.25	658GT	.70	12A4	.59	35B5	.47
1V2	.70	6AT6	.38	65A7	.47	12A6	.40	35C5	.46
1X2	.66	6AT8	.79	65B7Y	.47	12AB5	.59	35L6GT	.47
2A3	.49	6AU4GT	.64	65C7	.40	12A05	.49	35W4	.38
2A7	.54	6AU5GT	.60	65G7	.42	12AT6	.40	35Y4	.40
2D21	.95	6AU6	.42	65H7	.42	12AT7	.65	35Z3	.38
3A4	.50	6AU8	.79	65J7	.42	12AU6	.42	35Z5GT	.40
3A5	.50	6AV5GT	.64	65K7	.49	12AU7	.58	39/44	.25
3AL5	.52	6AV6	.38	65L7GT	.56	12AV6	.66	50A5	.47
3AU6	.52	6AV8	.89	65N7GT	.56	12AV7	.66	50B5	.47
3BZ6	.57	6AX4GT	.65	65Q7	.40	12AX4GT	.64	50C5	.44
3BC5	.57	6AX5GT	.56	65S7	.40	12AX7	.62	50L6GT	.45
3BN6	.57	6BA6	.46	6T4	.85	12AZ7	.62	84/62A	1.25
3CB6	.55	6BC5	.49	6T8	.67	12BA6	.45	117L7GT	1.25
3Q4	.46	6BC8	.89	6U5	.54	12BA7	.59	117N7GT	1.25
3Q5GT	.56	6BD5GT	.52	6U8	.79	12B6	.45	117P7GT	1.25
3S4	.46	6BE6	.45	6V3	.79	12BH7	.59	117Z3	.36
3V4	.55	6BF5	.39	6V6GT	.45	12BY7	.63	117Z6GT	.61
4BQ7	.75	6BG6G	1.17	6W4GT	.39	12CA5	.59		
4BZ7	.75	6BH6	.50	6W6GT	.52	12CU6	.79		
5AM8	.79	6BJ6	.46	6X4	.38	12DQ6	.79		
5AN8	.79	6BK5	.67	6X5	.38				
5A95	.49			6X8	.74				

FEATURING
FAMOUS FACTORY

TUBES

- INDIVIDUALLY BOXED!
- GUARANTEED ONE YEAR!
- FACTORY BOXED • FACTORY IRREGULARS
- NEW JAN SURPLUS • EQUIPMENT TUBES

ALWAYS 1000 TYPES IN STOCK

FREE POSTAGE! On All Orders
Shipped In U.S.A., Territories and
A.P.O.'s. Send 25c for handling on or
ders under \$5.00. Please send approx.
postage on Canadian and foreign
orders. Excess will be refunded.

Receiving Tubes Sent Parcel Post

Thousands of TRADE-IN TVs

Reconditioned By Factory Trained Technicians! Guaranteed To
Be In Working Condition When You Receive Them!

10"	\$25.00	19"	\$56.00
12"	\$30.00	20"	\$63.00
14"	\$35.00	21"	\$70.00
16"	\$42.00	24"	\$95.00 (when available)
17"	\$49.00	27"	\$129.00 (when available)

Get yourself a second set or buy some for re-sale!
FREE BONUS . . . two set coupler given with each set.
All TVs sent motor freight or Railway Express F.O.B. our warehouse.
Sorry, no A.P.O. shipments.

Please Specify Console
or Table Model
When Ordering

Standard Line
PICTURE TUBES
Guaranteed One Year

Any 10" Tube	\$10.75
Any 12" Tube	\$12.75
Any 14" Tube	\$14.75
Any 16" Tube	\$16.75
Any 17" Tube	\$17.75
Any 19" Tube	\$20.75
Any 20" Tube	\$20.75
Any 21" Tube	\$22.75

All Picture Tubes sent Railway Express F.O.B. our
warehouse. Sorry, no A.P.O. shipments.

**FREE
12" TV SET**
with every receiving
tube order of \$100.00
or more!

**FREE
16" TV SET**
with every receiving
tube order of \$200.00
or more!

**FREE
25**
ASSORTED RESISTORS
with every tube
order of \$6.00 or
more!

Bonus TV sets
are shipped
complete with
cabinet and pic-
ture tube F.O.B.
our warehouse.
With slight adjust-
ments and mini-
mum labor they
can be restored
like new.

REMEMBER—
You Buy Quality
When You
Buy Stand-
ard. Quali-
ty Never
Shouts—It
A l w a y s
Whispers.

We Are Not Selling
Price—We Sell
Only Quality

STANDARD LINE

ELECTRIC COMPANY

432 HARRISON AVENUE, HARRISON, N. J. • Phone: HUmboldt 4-4997

AMERICA'S FINEST VALUES IN "LOW COST" HIGH FIDELITY

ECONOMY 20-WATT AMPLIFIER \$24.95



Model HF-21

\$24.95

Push-Pull 6L6 Output Tubes
Response 30-15,000 cps
Bass and Treble Tone Controls
Input for Xtal or Dynamic Mike
Input for Xtal or V. R. Phono

A tremendous High Fidelity amplifier value. Response 30 to 15,000 cps. Electronic bass and treble boost by separate tone controls. Use this amplifier with any record changer having crystal or variable reluctance cartridge, radio tuner or high impedance crystal or dynamic microphone. 20-watts power output. Use with any 8-ohm speaker. Chassis size 7 3/4" x 10 1/2" x 7 1/2" high. Complete with tubes: 2-6L6, 2-6CA, 12AX7 and 5U4G. This is a terrific value. A ready to use High Fidelity amplifier at less than the cost of a kit. Ship. wt. 19 lbs. Model HF-21, 20-watt Hi-Fi amplifier. Sale price \$24.95.

NEW IMPORTED MONARCH HIGH FIDELITY AUTOMATIC CHANGER

With RONETTE #222 Hi-Fi turn-over crystal cartridge with separate sapphire needles. **SALE PRICE \$27.95**

Monarch Model UAB new imported high fidelity 4-speed automatic record changer, size 10 7/8" x 12 3/4". Plays 7", 10" and 12" records automatically. Rotational speeds of the same speed in any order. Features a 4-pole high fidelity motor eliminating rumble and wow. 9 turntable with high fidelity rubber molded cushion dynamically balanced. Counter balance tone arm with adjustable weight to any desired cartridge—adaptable with G.E. cartridge. Ship. wt. 15 lbs. Model UAB Monarch automatic record changer with Ronette No. 222 crystal cartridge—Sale Price \$27.95. With Goldring No. 500 Var. Rel. Cartridge—Sale Price \$29.95. 45 rpm spindle, \$1.88 extra.



12" COAXIAL PM SPEAKER RESPONSE 25-17,000 CPS

\$9.95

Model 12X3Y, new 1957 12" Coaxial PM Speaker, has high efficiency 12" woofer with Alnico V magnet and acoustically suspended 3 1/2" Alnico V tweeter. Built-in crossover with variable brilliance control on an 18" lead for remote control of the tweeter volume. 10-watts response 25 to 17,000 cps. Ship. wt. 7 lbs. Stock No. 12X3Y, 12" coaxial PM Speaker. Sale Price \$9.95.

SPECIAL MONEY SAVING COMBINATION PACKAGE DEAL

Model HF-21, 20-watt Hi-Fi Amplifier
Model UAB, MONARCH Hi-Fi Automatic Changer, and Model 12X3Y, 12" Coaxial PM Speaker as described above:

With RONETTE #222 Cartridge \$59.95
Stock No. HF21U8-R

With GOLDRING #500 Cartridge \$61.95
Stock No. HF21U8-G

(45 rpm spindle, \$1.88 extra.) Ship. wt. 46 lbs.

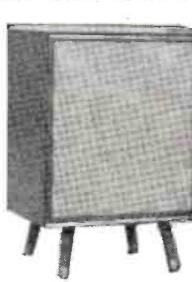

3-1957 MODEL HI-FI SPEAKERS

● COMPLETE SYSTEMS WITH 4 SPEAKERS
● ACOUSTICALLY LINED ENCLOSURES

The new 1957 Hollywood, 4 speaker high fidelity speaker systems are expressly designed to give realistic reproduction from your Hi-Fi amplifier or FM-AM radio. Juke box bass response with brilliant, middle and high range response. All 3 models have genuine L-C crossover networks and variable brilliance controls. Only 2 wires to connect to the 4 or 8 ohm tap on your Hi-Fi amplifier. A fine speaker system to use with our Imperial 20, 30 and 34 high fidelity amplifiers, and all FM-AM chassis in our Radio & TV News offerings. Adjusting the twin tone controls on our Imperial amplifiers along with the brilliance control on the Hollywood speaker systems you can have fidelity of your own personal taste.

3 Hollywood models are housed in the same fine cabinet. Choice of either Mahogany, Walnut or Maple finish enclosures are fully enclosed and acoustically lined. Small enough in size for the average room, yet large enough for proper baffling. 35" high, 19" front to back, 25" wide. Specify cabinet finish when ordering, otherwise we will ship mahogany finish. Take \$3.00 discount when you order with any of the Imperial amplifiers or Espey FM-AM chassis offered in this 3 page ad.

Model H-4H, Hollywood 4 speaker high fidelity speaker system, 20 watts, response 20 to 17,500 cps. Choice of Mahogany, Walnut or Maple finish enclosure. Features a 12" General Electric 6-8 oz. Alnico V magnet, aluminum voice coil woofer, plus 6" mid-range and 2-5/8" tweeters. Built-in variable brilliance L-C crossover network. Model H-4H, Ship. wt. 55 lbs. Price \$39.95.

Model Y-4Y, Hollywood 4 speaker, high fidelity speaker system, 25 watts, response from 20 to 17,500 cps. Choice of Mahogany, Walnut or Maple finish enclosure. Features 12" General Electric 14 oz. Alnico V magnet, aluminum voice coil woofer, plus 6" mid-range and 2-5/8" tweeters. Built-in variable brilliance L-C crossover network. Model Y-4Y, Ship. wt. 55 lbs. Sale price, \$44.95.

Model Z-4Z, Hollywood 4 speaker, high fidelity speaker system, 25 watts, response from 18 to 17,500 cps. Choice of Mahogany, Walnut or Maple finish enclosure. Features a 15" 21 1/2 oz. Alnico V magnet, heavy duty woofer, plus 6" mid-range and 2-5/8" tweeters. Built-in variable brilliance L-C crossover network. Model Z-4Z, Ship. wt. 57 lbs. Sale price, \$49.95.

NEW IMPERIAL SPEAKER SYSTEMS

Imperial IV with 8" G.E. High Fidelity Speaker **\$19.95**



3-Way Imperial VI with 12" G.E. Speaker **\$29.95**

New 1957 Model IMPERIAL IV, High fidelity speaker system with General Electric 8" speaker. Housed in a high quality leatherette covered plywood cabinet 10" x 10" x 24" long. Fully enclosed; covered on all sides except back. Use as an auxiliary speaker or with any high fidelity radio, amplifier or home music system. The IMPERIAL IV contains a General Electric Model 850 or 870 Nordic extended range high fidelity 8" PM speaker with 6.8 oz. Alnico V magnet and curvilinear cone with 8 ohm voice coil and a 5" tweeter. Response 50 to 15,000 cps. Ship. wt. 14 lbs. Model IV Imperial \$19.95.

1957 Model Imperial VI, 3-way speaker system. Baffle is of heavy wood, leatherette covered. Similar in appearance to the Imperial IV pictured above, except 4" taller and 1" deeper. Equipped with 3 matched speakers. A 12" G.E. Model 1203 with 9 oz. Alnico V magnet, plus 5 1/2" PM for middle range and 3" tweeter. Simple to connect to any high fidelity amplifier. (8 ohms impedance). Ship. wt. 25 lbs. Stock No. IMP-VI, Sale price, \$29.95. Ideal for use with HF-20 and IMP-30 amplifiers described above.

GENERAL PURPOSE AUTO-RADIO



Over \$49.95 List Value Radio, Nash model NH3C for Nash Rambler, manufactured by Motorola. Works on 6-volt stage battery, custom built Superheterodyne receiver, rating 4.3 Amp., 6.3 volts D.C. broadcast amplifier, 1600KC, five tubes: 1 each 6BE6 Conv., 6BA6 Det. AVC-AF amplifier, 6AS5 audio output and 6X4 rectifier with a 4x6 PM 3-ohm speaker. With some ingenuity, this set can be adapted to many other types of installation where a 6.3 VDC is available. Overall size: 10 1/2" long, 5 1/4" high, 4 1/2" deep (\$7 with knobs). Knobs: 8 1/2". Ship. wt. 10 lbs. Stock No. NH3C, Sale price, \$17.95 each or two for \$34.00.

SALE PRICE \$17.95

IMPERIAL 30-WATT AMPLIFIER \$29.95

NEW 1957 MODEL Push-Pull 6L6 Output Tubes Response 15-20,000 CPS

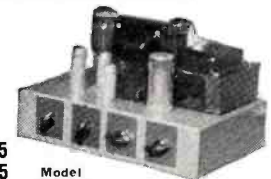

Model IMP-30

Bass and Treble Tone Controls
Compensated Gain for G.E. Carl. Input for Xtal or Dynamic Mike
With GU-14Y, 12" Coax Speaker . \$39.95
With P15-GR, 15" Coax Speaker. \$49.95
With Imperial IV Speaker System \$46.95
With Imperial VI. \$55.95 With HF-33GE \$76.95

New 1957 model 7 tube Imperial 30 watt High Fidelity audio amplifier. A \$100.00 list value for only \$29.95. Features a heavy 4 lb., specially wound high fidelity output transformer with 150% inverse feed-back; push-pull 6L6 output tubes and frequency response from 15 to 20,000 cps. Matches 8 or 16 ohm speakers. You can center your entire custom music system around this low cost 30 watt amplifier. This Imperial 30, 30 watt amplifier may be used with any radio tuner or record player. It will drive any speaker system that you may have. Use from one to ten 8" speakers or any 12" or 15" coaxial speaker or any 3-way speaker system. Tone compensated input for either a crystal phono pickup or a General Electric variable reluctance pickup. Also, has input for crystal or high impedance dynamic microphones. 4 controls are mike gain, phono gain, treble tone and bass boost tone control. This amplifier weighs 21 lbs. net. Full size transformer components would cost you up to \$15.00 if purchased separately. 4 controls are microphone gain, phono gain and separate variable dynamic microphones. Complete with tubes: 6AT6, 12AU7, 6CA, 12AU7, 2-6L6GA, plus 5U4G rectifier. Stock No. IMP-30, 30 watt Imperial High-Fidelity amplifier complete with tubes and diagram. Ship. wt. 23 lbs., Sale price only \$29.95.

NEW IMPERIAL 24 WATT AMPLIFIER \$39.95

PUSH-PULL EL-34 ENGLISH MADE MULLARD OUTPUT TUBES WILLIAMSON TYPE CIRCUIT RESPONSE 15-20,000 CPS

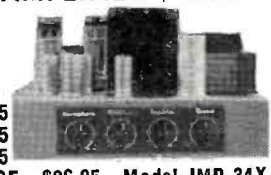

With GU-14Y, 12" Coax Speaker. \$49.95
With P15-GR, 15" Coax Speaker. \$59.95
With Imperial IV Speaker System \$56.95

With SP12125CR. \$65.95. With HF-33GE. \$86.95. Model IMP-34X

New, 1957 model, 24 watt high fidelity amplifier for the audio enthusiast who wants McGee's finest amplifier. This amplifier features push-pull Telefunken or EL-34 English made Mullard output tubes in a Williamson circuit. Heavy duty 6 lb. specially wound Williamson type ultra-linear output transformer in potter case has a response from 15 to 20,000 cps. Matches 8 or 16 ohm speakers. Amplifier has input for crystal pickup and built-in pre-amplifier for the popular General Electric and Goldring variable reluctance cartridges; as well as input for crystal or high impedance dynamic microphones. 4 controls are microphone gain, phono gain and separate variable treble and bass boost tone control with off-on switch. Chassis size: 12 1/4" x 7 3/4" x 7 1/4" high. Complete with 7 tubes and diagram. Model IMP-34X, 24 watt high fidelity amplifier, ideal for use with any of our high fidelity coaxial or multiple speaker systems. Ship. wt. 26 lbs. Sale price, \$39.95.

McGEE'S NEW 1957 MODEL 25 WATT 12" COAXIAL SPEAKER

- ★ 14 1/2 oz. G.E. 12" WOOFER—
- ★ 3 1/2" COAXIALLY SUSPENDED TWEETER—
- ★ BUILT-IN CROSSOVER—
- ★ ALUMINUM VOICE COIL WOOFER—

\$18.95

McGee's new 1957 model, GE-120XT, 12" 25 watt high fidelity coaxial PM speaker. No frills, or dummy pot cover, it's all speaker value. Features a General Electric 12", 14 1/2 oz. Alnico V woofer with aluminum voice coil and exponential, molded steam-response 3 1/2" Alnico V tweeter. Response 15 to 17,500 cps. McGee extends the high frequency response to 17,500 cps. It is electrically connected to accept only the upper register of audio. Only two wires connect this complete high fidelity speaker to any 8 ohm amplifier. Ship. wt. 8 lbs. Stock No. GE-120XT. McGee's new 1957 model, 20 watt deluxe 12" coaxial PM speaker. Only 2 wires to connect to any 8 ohm Hi-Fi radio or amplifier. Features an aluminum voice coil General Electric 12" PM speaker with 10 oz. Alnico V magnet, plus a coaxially suspended tweeter. Crossover network built-in. Responds up to 17,500 cps. Stock No. GE-100XT, 12" coaxial PM speaker. Ship. wt. 8 lbs. Sale price, \$14.95.

TREMENDOUS McGEE VALUE NEW 1957 HI-FI SPEAKER SYSTEMS ON BAFFLE BOARDS

Model B-125-X, high fidelity 20-watt, 5-way speaker system, mounted on an 18" square baffle board. Has 12" Jensen woofer, 2-4x6" mid-range speakers, plus a 4" high-range and 3" tweeter; all with Alnico V magnets. Built-in LC crossover network with variable brilliance control. Ship. wt. 11 lbs. Stock No. B-125-X, 5-way, 20-watt Hi-Fi speaker system. AUDIOPHILE VALUE \$30.00. SALE PRICE \$18.95.



Model B-236, high fidelity 24-watt, 4-way speaker system, mounted on a 24" square baffle board. Has 12" 9-oz. woofer, a new high fidelity extended range 6x9" speaker, plus 2-5" tweeters; all with Alnico V magnets. Built-in LC crossover network with variable brilliance and presence controls. Ship. wt. 16 lbs. Stock No. B-236, 4-way, 24-watt Hi-Fi Speaker system. AUDIOPHILE VALUE \$49.95. SALE PRICE \$27.95.



Model B-347, high fidelity 30-watt, 5-way speaker system, mounted on an 30" x 24" baffle board. Has 15" UTAH 21 1/2-oz. woofer, 2-new high fidelity extended range 6 x 9" speakers, plus 2-5" tweeters; all with Alnico V magnets. Built-in LC crossover network with variable brilliance and presence controls. Ship. wt. 22 lbs. Stock No. B-347, 5-way, 30-watt Hi-Fi speaker system. AUDIOPHILE VALUE \$59.95. SALE PRICE \$39.95.

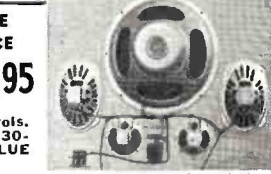

Mount these Hi-Fi speaker systems in your own cabinet or use for custom installation. Ideal for use with any radio or amplifier. Completely wired with only 2-wires to connect to any 8-ohm output (Take 10% discount if ordered with any radio or amplifier listed hereon.) Grill cloth, 75¢ extra.

22 TUBE ESPEY FM-AM HI-FI TUNER-AMPLIFIER

SALE PRICE \$119.90

A REGULAR \$199.50 NET VALUE COMBINATION FOR \$119.90

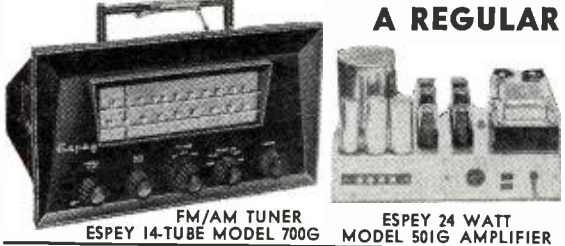

FM/AM TUNER
ESPEY 14-TUBE MODEL 700G

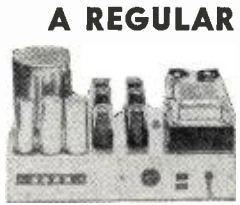

ESPEY 24 WATT
MODEL 501G AMPLIFIER

MODEL 700G
FM-AM TUNER
ONLY—
SALE PRICE \$79.95

MODEL 501G
AMPLIFIER
\$39.95
If Ordered
with Tuner

\$49.95 SEPARATE

McGee offers you both the regular \$119.50, 14 tube Deluxe FM-AM tuner and the \$79.50 value 8 tube audio amplifier for the special sale price of only \$119.90. The Model 700G Espey tuner has its own built in power supply. Performance features are: 20 cps to 20,000 cps, with less than 1/4 percent distortion with one volt audio output. Chassis is 14" long, 8 1/2" high and 10" deep. Features a one-piece molded, gold color plastic front which makes a custom installation both extremely attractive and easy at the same time. Full tuned RF stages-AFC on FM with defeating switch for easy FM tuning. Built-in preamplifier for GE or other popular variable reluctance cartridges. Three position equalizer switch for LP, AES or European records. Separate bass and treble tone controls with 23db boost. Chassis is equipped with AC outlet jacks, auxiliary input jacks for tape recorder, etc. Has built-in ferrite loop antenna for AM broadcast band and 300 ohm input for FM band. This fine quality FM-AM tuner is second to none. It has all of the features that you might expect of a tuner that would cost as much as \$200. All of the controls are on the front panel. This is a most desirable feature when the tuner is used in conjunction with a good audio amplifier, such as the 501G Model 501G, 8 tube ultra linear high fidelity, 24 watt audio amplifier is made to match the 700G tuner. This amplifier is offered separately at the special sale price of \$49.95, but costs you only \$39.95 when purchased with the 700G Espey tuner. This amplifier features less than 1/2 percent distortion with high fidelity response from 10 cps to 20,000 cps. Hum level so low oriented iron core. Output impedance taps of 4, 8 and 16 ohms. This output transformer alone is a \$20.00 value. Buy just the 700G FM-AM tuner at the special sale price of \$79.95, or buy both the 700G tuner and the matching 501G amplifier for \$119.90. Model 501G amplifier sale price, \$49.95 when purchased separately. Tuner, \$79.95. Amplifier, \$39.95. Shipping wt., 22 lbs. See the special deals of the 700G-501G tuner-amplifier combination with record changer and GE cartridges for extra money saving values. Also, special discount on speakers and speaker systems when ordered with your Espey tuner and amplifier.

ESPEY DEAL—1A
Espey 700G-501G tuner with 24 watt amplifier plus new 455 Collaro changer on metal base—1 Mill Diamond Needle \$10.00 extra. Net \$144.95

ESPEY DEAL—2
Espey 700G-501G tuner with 24 watt amplifier plus new 455 Collaro changer equipped with a GE RPX-052A cartridge. Net \$164.95

ESPEY DEAL—3
Espey 700G-501G tuner with 24 watt amplifier plus Garrard RC-98 equipped with a GE RPX-052A cartridge. Net \$194.95

SPE MENDED
Order any of the following speakers with your Espey tuner and amplifier:
12" coaxial PM, CU-14Y—\$10.00 extra
15" coaxial PM, P15-CR—\$20.00 extra
Imperial VI system—\$15.00.
Imperial VI system—\$25.00.
Norelco 9762—12" regularly \$59.50 at \$30.00 extra.
EV84—15W system—\$150.00 extra.

VM HI-FI CHANGER. SALE PRICE \$29.95



LESS BASE \$29.95
LESS CART. \$29.95
WITH GE RPX-052A \$45.90
4 Speed Monarch SALE PRICE \$27.95
with 222 Ronette Ceramic Cart. Diamond 1 Mil Stylus \$10.00 Extra

New offering of VM Hi-Fidelity, 3 speed record changer with or without metal base. A large special purchase makes this low sale price possible. Reg. net on VM-936 less cartridge was \$38.97. Reg. net on VM-936 less cartridge was \$45.47. The VM-936-938 Hi-Fi Series changers are equipped with two plug-in tone arm heads which will hold popular G.E. or Pickering single or dual play cartridges. Both have 4-90 motor for constant speed, hum free operation with a VR cartridge. Plays all 3 speeds and all sizes. Will inter-mix 10" and 12" records of same speed. Shuts off after last record plays. Multiple silence picture during change cycle. Furnished with large 45 RPM spindle. Chassis size 13 1/2" x 13 1/4" x 8 1/2". High, 4 1/2" above plate. Ship. wt. 12 lbs., with base 15 lbs.

VM-936HF, 3 speed changer, less cartridge and base, only \$29.95.
VM-936HF, 3 speed changer, less cartridge and base, only \$29.95.
VM-936HF-GED with G.E. "Golden Treasure" RPX-052A VR cartridge; 1 mil diamond and 3 mil sapphire stylus, only \$45.90.
VM-936HF, 3 speed Hi-Fi changer with metal base, less cartridge, Sale price, \$32.95.
VM-936HF-G with G.E. RPX-050A VR cartridge, \$38.90.
VM-936HF-GED with G.E. RPX-052A "Golden Treasure" cartridge; 1 mil diamond, 3 mil sapphire stylus, only \$48.90.

4-SPEED COLLARO Latest 1957 Model RC-456, Collaro 4 speed record changer. 4-speed and manually. Inter-mixes records of the same speed and shuts off after last record. Fast 8 second change cycle. Automatic disengagement of idler wheels eliminates flat spots that cause wow and flutter. All of the desirable features of the Model RC-532, plus 4 speed operation. Model RC-456 with G.E. variable reluctance cartridge with 3 mil sapphire and 1 mil diamond stylus. Sale price, \$48.95. Large spindle \$3.30 extra.

New Model UAB, Monarch 4 speed imported High Fidelity record changer. Features a high fidelity motor, a turntable with molded rubber pallet. Counter-balanced tone arm will accept any of the popular Hi-Fi cartridges. Plays all 4 speeds and all 3 sizes. Inter-mixes 10" and 12" records of the same speed and shuts off after last record plays. Base size, 10 7/8" x 12 3/4". Ship. wt. 15 lbs. Large spindle for 45 RPM records, \$1.80 extra.

Model UAB-H with 222 Ronette Hi-Fi flipover ceramic cartridge, \$27.95.
Model UAB-HD, same as above but with 1 mil diamond stylus, \$37.95.
Model UAB-G with 500 Goldring variable reluctance cartridge, \$29.95.
Model UAB-UD, same as above but with 1 mil diamond stylus, \$39.95.

GOLDRING V. R. CARTRIDGE
WITH 2 SAPPHIRE STYLII \$5.95
WITH 1 MIL DIAMOND, 3 MIL SAPH. \$13.95

McGee offers the internationally famous Goldring variable reluctance phono cartridge, made in England and sold throughout the world to those who want the finest and most accurate music reproduction from 33 1/3, 45 and 78 RPM high fidelity phono records. Input gain and compensation similar to G.E. v.r. cartridge required. Furnished as standard equipment with 1 and 3 mil stylus. A regular \$9.90 net item on sale at McGee for \$5.95. For \$13.95 with a diamond 1 mil stylus. These are the latest production, individually cartoned turnover cartridge with mounting bracket. Fits tone arms on most changers. Made for and bearing the famous Wilco-Gay Record name. (Wilco-Gay) cartridge with diamond 1 mil stylus, \$13.95. 1 mil diamond stylus for Goldring V.R. cartridge, purchased separately, \$9.95.

8" NORELCO P14 \$7.95
2 for \$15.00

Specialty Priced at \$7.95 for this ad. Norelco imported from Holland 8" Hi-Fi PM Model 970M—fine audio reproduction from 75 cps to 19,000 cps —Imp. 4 ohms. Flux density 11,000 Gauss. Powerful Alnico Magnet. A fine addition to your Hi-Fi speaker collection.

12" NORELCO 9760 HI-FI SPEAKER \$19.95

Model 9760, 12" Norelco 20 watt extended range high fidelity PM speaker. Has a 15.8 ohm Ticonal magnet. Response from 10 to 20,000 cps. Made by North American Phillips Co. of Holland. A single cone coaxial speaker with extra high frequency cone. 8 ohm voice coil. Resonance frequency 45 cps. Total flux density, 8000 gauss. Ideal for use with any Hi-Fi amplifier or FM-AM chassis. Sale price only \$19.95.

Model 9762, 12" Norelco 20 watt extended range high fidelity PM speaker. Better quality than above, in that it has a 38 ohm Ticonal magnet, greater flux density of 11,000 gauss and a metal high frequency mechanism built in the center of the large cone. Model 9762, 12" Norelco Hi-Fi PM speaker, Sale price only \$29.95.

NEW 8 TUBE 6 VOLT PUSH-BUTTON MODEL \$37.95

New model SH-78555-X, 8-tube, 6-volt universal mounting auto radio with push buttons and 6x9 speaker. Made for Hicon cars but their compact construction lends them to underdash installation. Has push-pull 6A6Q powered audio. Stock No. SH78-555-X with 8x9 speaker—\$37.95. With 2—5x7 speakers—\$39.95; with 1—5x7 speaker \$37.95. Specify speaker size wanted. Three-section top cow mounting antenna—\$2.29 extra.

McGee's Famous 12 AND 15 INCH COAXIAL P.M. HIGH FIDELITY SPEAKERS
\$12.95 \$23.95

12-Inch Model CU-14Y
15-Inch Model P15-CR

Model CU-14Y, 12" high fidelity coaxial PM speaker. Response from 30 to 17,500 cps. Full 6.8 ohm Alnico V magnet in the 12" woofer. Special coaxially suspended high frequency tweeter. Built-in crossover network. Only two wires to connect to your radio or amplifier. Matches 3-2 to 8 ohm output. Don't confuse this speaker with many cheap speakers that are offered. This is a fine quality speaker. Stock No. CU-14Y. Sale price \$12.95 each, two for \$25.00.

Model P15-CR, 15" high fidelity coaxial PM speaker. Response down to 20 cps, and up to 17,500 cps. Full 2 1/2 oz. Alnico V magnet in the 15" woofer. Specially made, coaxially suspended 5" high frequency tweeter. Built-in crossover network. Only two wires to connect. Matches 3-2 to 8 ohm output transformer. A regular \$62.50 list speaker. Model P15-CR. McGee's Sale Price, \$23.95.

McGee's new 15" Junior coaxial PM speaker, 15" woofer has 6.8 ohm Alnico V magnet. Specially suspended tweeter with crossover. Only two wires to connect to any 8 ohm radio or amplifier. Frequency response from 40 to 15,000 cps. Model No. M15-CR, 15" Junior coax PM speaker, Sale price, \$16.95.

FAMOUS STANDARD COIL CASCADE TUNERS
TV-2000 series Standard Coil cascade tuners complete with 6B6 and 6BK7 or 6BQ7 tubes. Thousands of TV sets use this famous tuner. Tunes 12 channels (2 thru 13). For 21 mc I.F. circuit. This tuner will give 2 to 1 better reception than the old pentode type servicemen replace all older tuners with this cascade model. Available with either 2 7/8" or 4 1/4" shaft length. A tremendous purchase makes our low \$12.95 price possible. Specify shaft length desired. Stock No. TV-2000-3. Sale price 2 FOR \$25.00.

Matching knobs for Standard Coil tuners. Set No. SKC-2 for fine tuning and channel selector. Set VCK-2, matching volume and contrast knobs. Either set only \$9c a pair.

STANDARD COIL PENTODE TUNERS \$7.95

SC-94B, Standard Coil, 21 mc Pentode tuner with 6BC5 or 6AQ5 and 6J6 tubes. Popular 12 channel, 2 thru 13, used in millions of TV sets. Why spend time repairing an old tuner when it may be easier to just replace it. Shaft can be cut to desired length. Available with 2 7/8", 3", 4 1/4" or 4 1/2" shaft. Specify length of shaft. Sale price, \$7.95 ea., 2 for \$15.00. Matched knob set \$9c extra.

TWO-TUBE SARKES-TARZIAN TV TUNER WITH TUBES \$7.95

No. TT-3A, 2 tube Sarkes-Tarzian 12 channel tuner for 21mc. Used in CBS, Arvin, Crosley, etc. Ideal or general replacement. 3 1/2" shaft. With tubes, \$7.95 each, 2 for \$15.00.

No. TT-2C, 2 tube Sarkes-Tarzian 41 mc Cascade tuner with tubes, 4 1/4" shaft. Smallest cascade tuner made. Popular in many sets. \$7.95 each, 2 for \$15.00. Either of the above tuners with 9" shaft, \$1.00 extra.

Type 3, 3 tube 21 mc Sarkes Tarzian tuner with tubes. Rotary switch type complete with 6C4, 6BH6 and 6AQ5 tubes. Regular cost is several times our new low price of only \$4.95. Wired, ready to hook-up to video and sound I.F. strip. Use with either separate sound or inter-carrier. Built-in fine tuning. 2 7/8" shaft. Net, \$4.95.

RCA KRK-12 TV TUNER Brand New—with Tubes
SALE PRICE \$6.95
2 for \$13.00

RCA Model KRK-12, UHF-VHF TV tuner with tubes: 2-6BQ7A, 6AF4 and 854. A complete tuner with all 12 VHF strips, but with blank strips in the UHF positions. This tuner fits many RCA sets using 40 megacycle I.F.'s. 27D382 also KCS-66, etc. Original tuner list was about \$50.00. We introduced this tuner new at about the value of the tubes. Ship. wt. 10 lbs. McGee's sale price, \$6.95 each, 2 for \$13.00.

MINIATURE BROADCASTING STATION FOR MICROPHONE AND PHONO WITH CRYSTAL MICROPHONE SALE PRICE \$9.95

Sensational new model MCL-E3 miniature broadcasting station for microphone and phonograph. Can be received on any broadcast radio in the home. No wires to connect, tunes in just like a radio station. Has input jacks for crystal mike or record player. Complete with 12KB and 70L7 tubes and instructions. Operates on 110 volts AC. Simple to operate; one control fades from microphone to record. Frequency can be adjusted so as not to interfere with local radio stations. Miniature broadcasting station, complete with crystal hand mike and instructions. Ship. wt. 4 lbs. Net price \$9.95.

McGEE RADIO COMPANY PRICES F.O.B. KANSAS CITY. SEND 25¢ OR FULL REMITTANCE WITH ORDER. BAL. SENT C.O.D. TELEPHONE VICTOR 2-5092 1903 McGEE ST., KANSAS CITY, MISSOURI

BUILD THE BEST— BUILD ALLIED'S OWN knight-kits

Here is a typical Knight-Kit value—available only from ALLIED—one of 45 great Knight-Kits you'll find in our special Supplement No. 165. Write for your FREE copy today.

knight-kit INSTRUMENT VALUE 5" GENERAL-PURPOSE SCOPE KIT



Model
Y-146
\$49.50

Feature for feature, the world's best scope kit value. Equal in performance to wired units several times its price. Ideal for radio and TV servicing, audio work and hundreds of other applications. Phantastron sweep circuit provides extreme sweep linearity; retrace blanking on all ranges eliminates retrace lines; vertical sensitivity is three times that of comparably priced scope kits. Printed circuit and laced wiring harness speed assembly. SPECIFICATIONS: *Vertical Response*— ± 3 db, 3 cps to 1.5 mc.; ± 6 db to 2.5 mc. *Vertical Sensitivity*—.025 rms v/inch. *Sweep*—15 to 150,000 cps in 4 ranges. *Horizontal Sensitivity*—.07 rms v/inch. *Vertical Input Imp.*—3.3 meg shunted by 45 mmfd. *Calibrating Voltage*: 1 volt peak-to-peak, applied by push-button switch. Complete with 5" CRT, wire, solder, etc. $9\frac{1}{4} \times 13\frac{3}{4} \times 17\frac{3}{4}$ ". Shpg. wt. 28 lbs. Model Y-146, Net, F.O.B. Chicago. . . . \$49.50

OTHER knight-kit INSTRUMENT VALUES



5" WIDE-BAND SCOPE KIT
Y-144 \$69.00



VOLTAGE CALIBRATOR KIT
Y-136 \$127.50



HIGH-GAIN SIGNAL
TRACER KIT
Y-135 \$26.50



TV-FM LINEAR
SWEEP GENERATOR
Y-123 \$447.50

See our Supplement No. 165 for 18 other knight-kit instrument values

free SUPPLEMENT featuring knight-kits



Send for our FREE Supplement No. 165 featuring 45 great Knight-Kits, including Test Instruments, Hi-Fi, Hobbyist and Amateur Kits. Write for your copy today.

ORDER FROM ALLIED RADIO

Dept. 01-D7, 100 N. Western Ave., Chicago 80, Ill.



What's New in Radio

FLAT TRANSISTOR "LOOPSTICKS"
Superev Electronics Corp., 4-6 Radford Place, Yonkers, N. Y., is now offering eleven different transistor-matched "Loopsticks" designed espe-

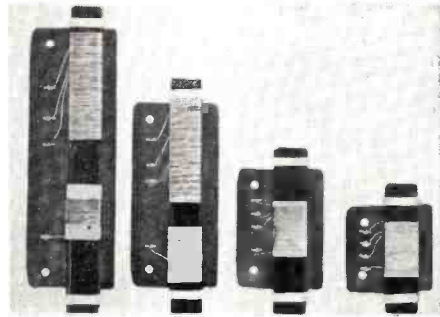

cially for miniature equipment construction.

Features of these new transistor components include complete electrical adjustability, compactness, maximum signal transfer, and increased sensitivity. Each "Loopstick" is packed with full installation instructions including nine suggested circuits and a summary of transistor receiver design.

A descriptive catalogue on these new antennas is available on request.

RC RECEIVER

Gyro Electronics Company, 325 Canal St., New York 13, N. Y., is now offering a new miniature radio control receiver which operates on a single 22½-volt hearing-aid "B" battery and one 1½-volt "A" battery.

Weighing only 2 ounces complete with relay and housed in a strong plastic case, the Model 22X measures only $1\frac{1}{4} \times 2\frac{1}{4} \times 1\frac{1}{4}$ ". The circuit uses two standard long-life, low-cost tubes in a supersensitive and stable circuit. Total idling current is approximately .5 ma. rising to 3 ma. on signal. Greater current change can be obtained by using a single 30-volt "B" battery if desired.

The receiver comes complete with an installation kit. Write the firm for full details and prices.

NEW METER MOVEMENT

Phaostron Instrument and Electronic Company, 151 Pasadena Ave., South Pasadena, Calif., is now in production on a new core magnet meter movement which is designed to provide good linearity for 100 degrees of scale arc.

Sensitivities as low as 20 microamperes are accomplished with a coil resistance of 3000 ohms and better-than-average spring torque provides ample stability.

The simplified, improved, and refined mechanical design and assembly

BUILD 16 RADIO CIRCUITS AT HOME \$22.95 with the New DELUXE 1957 Progressive Radio "Edu-Kit" only

A PRACTICAL HOME RADIO COURSE

NOW ALSO INCLUDES:

- TRANSMITTER
- SIGNAL TRACER
- SIGNAL INJECTOR
- CODE OSCILLATOR



- No Knowledge of Radio Necessary
- No Additional Parts or Tools Needed
- Excellent Background for TV

FREE Set of Tools, Pliers-Cutters, Tester, Soldering Iron, Alignment Tool.

WHAT THE "EDU-KIT" OFFERS YOU

The 1957 "Edu-Kit" offers you an outstanding PRACTICAL HOME RADIO COURSE at a rock-bottom price. You will learn radio theory, construction and servicing. You will learn how to build radios, using regular schematics; how to solder and wire in a professional manner; how to service and trouble-shoot radios. You will learn how to work with punched metal chassis as well as the new Printed Circuit chassis. You will learn the principles of RF and AF amplifiers and oscillators, detectors, rectifiers, test equipment. You will learn and practice code, using the Progressive Code Oscillator. You will build 16 Receiver, Transmitter, Code Oscillator, Signal Tracer and Signal Injector circuits, and learn how to operate them. You will receive an excellent background for TV. In brief, you will receive a basic education in Electronics and Radio, worth many times the small price you pay, only \$22.95 complete.

PROGRESSIVE TEACHING METHOD

The Progressive Radio "Edu-Kit" is the foremost educational radio kit in the world, and is universally accepted as the standard in the field of electronic training. The "Edu-Kit" uses the modern educational principle of "Learn by Doing." You begin by building a simple radio. Gradually, in a progressive manner, and at your own rate, you construct more advanced multi-tube radio circuits, learn more advanced theory and techniques, and do work like a professional radio technician.

THE KIT FOR EVERYONE

You do not need the slightest background in radio or science. The "Edu-Kit" is used by young and old, schools and clubs, by Armed Forces Personnel and Veterans Administration for training and rehabilitation. One of the most important aspects of the "Edu-Kit" is the Consultation Service which we provide. We welcome students to send us their problems, whether related to any of the material covered in the "Edu-Kit" course, or encountered in other experiences in the field of electronics.

THE "EDU-KIT" IS COMPLETE

You will receive all parts and instructions necessary to build 16 different radio and electronic circuits, each guaranteed to operate. Our kits contain tubes, tube sockets, variable, electrolytic and paper dielectric condensers, resistors, tie strips, coils, hardware, tubing, punched metal chassis, instruction Manuals, etc. In addition, you receive Printed Circuit materials including Printed Circuit Chassis, special tube sockets, hardware and instructions. You also receive a useful set of tools, pliers-cutters, an alignment tool, professional electric soldering iron, and a self-powered, dynamic Radio and Electronics Tester. The "Edu-Kit" also includes Code instructions and the Progressive Code Oscillator. You will also receive lessons for servicing with the Progressive Signal Tracer and the Progressive Signal Injector, a High Fidelity Guide, FCC Amateur License Training Book, and a Quiz Book.

All parts, components, etc., of the "Edu-Kit" are 100% unconditionally guaranteed, brand new, carefully selected, tested and matched. Everything is yours to keep. The complete price of this practical home Radio and Electronics course is only \$22.95.

TROUBLE-SHOOTING LESSONS

You will learn to trouble-shoot and service radios, using the professional Signal Tracer, the unique Signal Injector, and the dynamic Radio and Electronics Tester. Our Consultation Service will help you with any technical problems.

J. Stasaitis, of 25 Poplar Pl., Waterbury, Conn., writes: "I have repaired several sets for my friends, and made money. The "Edu-Kit" paid for itself. I was ready to spend \$240 for a course, but I found your ad and sent for your kit."

FREE EXTRAS

- Set of Tools • Radio Book • Radio and Electronics Tester • Electric Soldering Iron • Pliers-Cutters • Alignment Tool • Tester Instruction Book • Hi-Fi Book • TV Book • Quiz Book • Membership in Radio-TV Club • Consultation Service • FCC Amateur License Training • Printed Circuitry

90-DAY UNCONDITIONAL MONEY-BACK GUARANTEE

ORDER FROM AD—RECEIVE FREE BONUS RESISTOR & CONDENSER KITS WORTH \$7

- "Edu-Kit" Postpaid. Enclose full payment of \$22.95.
 - "Edu-Kit" C.O.D. I will pay \$22.95 plus postage.
 - Send me FREE additional information describing "Edu-Kit." Include FREE valuable Radio & TV Servicing Manuals. No obligation.
- (Outside U.S.—No C.O.D.'s "Edu-Kit" for 105-125 V. AC/DC \$23.95; 210-250 V. AC/DC \$26.45)

Name _____
Address _____

PROGRESSIVE "EDU-KITS" INC.

497 Union Ave., Dept. 64E, Brooklyn 11, N. Y.

ORDER FROM OLSON - YOU'LL SAVE!



TAPE RECORDER

- Dual Speakers
- Dual Speed
- Dual Track
- Neon Indicator
- Fast Forward & Rewind

\$79.53



A truly amazing tape recorder with ALL the extras at NO extra cost. Records 3 1/2 IPS and 7 1/2 IPS. Has dual track for recording both edges of the tape. Records up to 3 hours on a 7" reel of our longer play tape. Dual speakers for full tone. Rewinds forward or back at high speed (52 seconds). Equipped with torque brake for positive stopping action. Frequency response 100-9500 cps. Automatic ultra-sonic type eraser built-in. Other features are: full volume and tone control, input jack for mike, radio and phono, monitoring jack. Speed control accuracy is 2%. Complete with ceramic mike. Case size: 8 1/2" x 14" x 11 3/4". Operates on 115 volts, 60 cycles AC. UL approved.

This recorder is precision built and unconditionally guaranteed by a famous Chicago manufacturer. Also guaranteed unconditionally by Olson.

Foot Control for Above

Stock No. **\$12.88**
AM-46

Permits fast stop and start with minimum time lag. Grey hammerhead finish, rubber foot pad. With full instructions and 6 ft. cable assembly.



Columbia PHONOGRAPH

PLAYS 33 1/3, 45 AND 78 RPM

LOOK AT THIS TERRIFIC DEAL

Columbia Model 412 Phonograph... \$29.95
Set of 5 Columbia 45 Extended Play Records... 7.50
Regular Price \$37.45

Beautifully finished two-tone portable carrying case. Tone arm is Columbia with turn-over Ronette cartridge with dual sapphire needles. Automatic pop-up adapter for 45 RPM discs. Plays all 7, 10, and 12" records at 33 1/3, 45 and 78 RPM.

Powerful Amico 5 speaker. High power amplifier with volume and tone controls. Case size 12 x 10 x 5 1/2". 115 Volt AC 60 cycle. Brand new. Factory sealed cartons. The 5 Columbia extended play records feature such artists and orchestras as: Xavier Cugat, Eddie Condon, Rampart Street Banders, Libera, Art Van Damme, Jimmy Boyd, Jean "Toots" Thielmans.

Selections, 20 in all, range from popular to classical.



Stock No. AS-243

\$21.88
3 for only \$63.00

Approx. Shpg. wt. 11 lbs.

Combination 6-12 Volt BATTERY CHARGER KIT

Stock No. **\$5.95**
KB-39 Each

Will charge 6 or 12 volt battery overnight. Heavy duty selenium rectifier, oversize power transformer, and 2 1/2" dia. charge indicating meter. Complete with all parts, wire, solder & illustrated instructions. SHPG. wt. 7 lbs.



Powerfone WALL TELEPHONE

Stock No. **\$3.93** Pair
PH-3
3 pair for \$11.00

Two station telephone set. Works up to one mile. Guaranteed as good tonal quality as your telephone. Each phone has built-in push button buzzer & push-to-talk button. Sensitive enough to hear a whisper. With 2 flashlight batteries, 2 wall hangers, and 50 ft. of wire.

Extra 2-conductor cable for above Stock No. W103 100 ft. \$1.19
Stock No. W104 250 ft. \$2.50



45 RPM RECORD PLAYER

Ready To Plug-in

\$16.38

Stock No. RP-36



Attractively styled, compact, fully automatic changer is only 10" x 7" x 7" in size. Will play up to 12—7" records with one loading. Equipped with low pressure tone arm mounted in smooth working bearings and famous 1.5 volt Ronette cartridge with sapphire stylus. Has record reject button. Works with any radio, amplifier or TV. Complete with base, line and phono cords. Operates on 110-120 volts, 60 cycle AC.

PHONO MOTOR & ARM

Stock No. **\$5.78**
AS-205



Monarch (Famous Made-in-England Brand) 3 speed motor and turntable plus a genuine Webster tone arm with turn-over cartridge and dual precious tipped needles. Brand new 100% guaranteed. Reg. \$13.00 Value.

TELEPHONE PICKUP

STOCK NO. M-80

\$2.95
EACH

3 for \$8.00 10 for \$25.00



Records both sides of telephone conversation. Use disc, wire, tape recorder or amplifier. Simply lay pickup under any cradle type telephone and connect lead to recorder or amplifier. Operates by induction. Regular \$5.95 value.

ATTENTION MANUFACTURERS

If you have large quantities of surplus electronic parts you wish to sell, call or write OLSON at once. We pay top prices!



SEND FOR **FREE** CATALOG

HOW TO ORDER

Mail your order to 281 E. Market St., Akron 8, Ohio. Send remittance with order (add for postage 5c for each dollar's worth ordered—10c for each dollar's worth if you are more than 1000 miles away). OLSON REFUNDS EVERY CENT NOT USED. Or—send no money—we'll ship C.O.D. and you pay mail or expressman for merchandise and postage. ALL MERCHANDISE 100% GUARANTEED. PLEASE—MINIMUM ORDER \$5.00.

Continuous Play TAPE MAGAZINE

Repeats Recorded Messages Endlessly

Reg. Price \$12.50

\$1.89

Stock No. X-643

3 for \$5.00



Makes and plays recorded messages endlessly. Can be erased and re-recorded as many times as desired. Brand new. Offered at this low, low price because we can't supply mounting hardware. Can easily be mounted on recorder with homemade bracket. Repeat messages in stores, carnivals, rehearsals, etc. Each magazine is loaded with 100 ft. of finest double coated tape. Will record and play both sides consecutively. 10 minutes at 3 1/2 IPS or 5 minutes at 7 1/2 IPS.

RCA VICTOR Combination Portable RADIO—"45" PHONOGRAPH

Model 6BY4—

"Golden Throat"

\$29.88

Battery Operated

Reg. Price \$59.95

Stock No. RA-263

3 for \$88

Only Olson dares to cut the price so low. Cash in during our sale. This famous RCA Victor Portable Radio-Phonograph is completely battery powered and works anywhere.

LOOK AT THESE FEATURES

Plays all 45 RPM discs. Constant speed motor runs on 4 flashlight batteries. Radio is super-hot, iron-core IF with automatic volume control, powered by one A-B pack, oversize "RCA Victor Golden Throat" Speaker system. Built-in Ferrite antenna pulls in distant stations full range 540-1600 KC. Lightweight RCA tone arm with Sonotone cartridge and precious tip needle. Record storage compartment under lid. Size 5 1/2" h; 11" w, 12" d. Carrying handle folds into grille.



A-B Battery Pack—RCA VSO-64 or Burgess 4TZ60. Stock No. BA-38. Ea. \$3.85

FLASHLIGHT CELLS, 4 required RCA VSO-36 or Burgess No. 2. Stock No. BA-23. Ea. \$1.00

OLSON RADIO WAREHOUSE

281 E. MARKET ST., AKRON 8, OHIO

OLSON BARGAIN STORES IN:
CHICAGO—623 W. Randolph St.
CHICAGO—123 N. Western Ave.
CLEVELAND—2020 Euclid Ave.
PITTSBURGH—5918 Penn Ave.
MILWAUKEE—423 W. Michigan
BUFFALO—711 Main Street

the Quality is high
NAME BRAND TUBES

Unconditionally Guaranteed for one year.



Prices are low!

FREE! 4-Piece SCREWDRIVER SET with every order
BRAND NEW PRETESTED TUBES—INDIVIDUALLY BOXED

024	.43	8A87	.80	6BQ7A	.80	6SR7	.42	12SK7	.48
1AX2	.59	8AC3QT	.80	8V55G	.58	6T7G	.41	12SK7GT	.50
1B3QT	.68	8AC7	.87	6BZ7	.38	6T7G	.63	12SL7GT	.80
1R4	.68	8AF4	.78	6C4	.37	6T8	.88	12SN7GT	.57
1R5	.85	8A5	.80	6C5GT	.38	6U5	.60	12SQ7GT	.40
1S4	.85	8A7	.80	6C7F	.80	6V4GT	.46	12T7	.44
1S6	.81	8AH4	.80	6C6	.47	6W4GT	.40	19B6G	1.18
1T4	.51	8AHS	.70	6C8E	.51	6W6GT	.53	19T8	.70
1T5QT	.58	8A5S	.44	6C16	.71	6Y9G	.80	19X66GT	.47
1U4	.47	8ALS	.42	6C06G	1.18	6X8GT	.39	25L8GT	.47
1U5	.80	8AL7GT	.70	6C6E	.51	6X8	.78	25L6GT	.37
1U6	.80	8AOS	.46	6D6	.48	6Y9G	.80	35A5	.48
1X2A	.68	8AQ6	.42	6E3	.44	7A4-XKL	.48	35A5	.48
2A3	.50	8AQ7GT	.70	6F5GT	.37	7N7	.50	35CS	.48
3A4	.57	8A8S	.80	6H9GT	.38	7Q7	.59	35L9GT	.47
3AL5	.57	8A8S	.80	6J5	.39	7Y4	.39	35W4	.39
3AUB	.57	8AS3	.48	6J6	.49	7Z4	.40	35Y4	.40
3AV6	.57	8AT6	.39	6J7	.43	12AT8	.41	35Z3	.41
3BA6	.57	8AU6	.65	6J7GT	.45	12AT7	.45	35Z6GT	.39
3E6A	.K0	8AUSGT	.60	6J8G	.80	12AU6	.43	16T5GT	.40
3Q5GT	.87	8AU6	.43	6K5GT	.47	12AU7	.59	80A3	.48
3V4	.47	8AV6	.39	6G6GT	.39	12AV6	.42	80B8	.48
3V4	.88	8AK6	.67	6K7	.39	12AV7	.67	80C5	.48
5AQ5	.60	6AX5GT	.57	6K7GT	.39	12AX7	.83	80L9GT	.45
6A7B	.80	6BA8	.47	6K80	.68	12AY7	.60	70L9GT	.45
6I6	.80	6BA7	.49	6K8GT	.69	12BA8	.46	12L7GT	.46
6T6	.69	6BC5	.50	6L9G	.68	12BA7	.90	11Z3	.37
6T6	.80	6B05GT	.53	6M4	.4J	12B4	.68		
5U4G	.88	6B2G	.48	6M7	.48	12B6	.60		
5V4G	.88	6B5	.40	6M7GT	.48	12B7	.60		
5X4G	.46	6B6G	1.18	6S07GT	.57	12B7T	.64		
5Y3G	.39	6B8G	.51	6M7	.41	12J3GT	.40		
5Y3GT	.46	6B8GT	.47	6M7GT	.57	12K8	.60		
5Y4G	.43	6BK5	.68	6M7	.43	12S7GT	.48		
6Z3	.48	6BK7A	.76	6M7	.50	12S7GT	.48		
6Z4	.80	6BL7GT	.75	6M7GT	.57	12S7GT	.47		
6Z7	.87	6BN6	.58	6M7GT	.57	12S7T	.47		
6AB4	.48	6BQ6GT	.80	6BQ7	.41	12S7GT	.47		

BRAND NEW TV PICTURE TUBES

RCA and DUMONT Licensed

No dud required

10" Tube	\$10.95
12" Tube	\$12.95
14" Tube	\$14.95
16" Tube	\$16.95
17" Tube	\$17.95
19" Tube	\$20.95
20" Tube	\$20.95
21" Tube	\$22.95



Add \$4.00 to above prices for aluminized tubes

send all your old, broken tubes to
Metallic Enterprises, Inc., 113 Mill St., Paterson, N. J. and receive credit dollars for them. we will allow you a 5¢ credit toward each tube you buy.

TERMS: FREE POSTAGE on all prepaid continental U.S.A. orders on receiving tubes only. 50¢ handling charge on all orders under \$5. 25¢ deposit on all COD's. Picture tubes F.O.B. Passaic, N. J. via Railway Express.

STANLEY 935 MAIN AVE.
PASSAIC, N. J.
Gregory 1-2498

- Westinghouse
- Sylvania
- National Union
- GE

COYNE
TRAINS YOU
IN SPARE TIME
AT HOME

COYNE QUALITY TRAINING AT LOWEST COST

TELEVISION
RADIO-COLOR TV

Only from famous COYNE do you get this modern up-to-the minute TV Home Training. Easy to follow instructions—fully illustrated with 2150 photos and diagrams. Not an old Radio Course with Television tacked on. Includes **UHF** and **COLOR TV**. Personal guidance by Coyne Staff. *Practical Job Guides* to help you **EARN MONEY QUICKLY** IN A TV-RADIO SALES AND SERVICE BUSINESS—part time or full time. **COSTS MUCH LESS**—pay only for training—no costly "put together kits."

SEND COUPON FOR FREE BOOK
SEND COUPON BELOW for Free Book and full details including EASY PAYMENT PLAN. NO COST OR OBLIGATION—NO SALESMAN WILL CALL.

B. W. COOKE, JR. **COYNE** FOUNDED 1899
PRES. **ELECTRICAL SCHOOL**

A TECHNICAL TRADE INSTITUTE OPERATED NOT FOR PROFIT
500 S. Paulina Dept. 47-HT5 Chicago 12, Illinois

COYNE ELECTRICAL SCHOOL
Television Home Training Div.
500 S. Paulina St., Chicago 12, Ill., Dept. 47-HT5

Send FREE BOOK and details of your Television Home Training offer.

Name _____
Address _____
City _____ State _____

A.... Always
B.... Buy
C.... Columbia

TBS TREASURE HOUSE!
Consists of transmitter-receiver, motor generator, power supply, remote control, magnetic controller, 230 VDC, 60-80 Mc. Excellent condition. Complete ALL FOR **\$49.95** ONLY

METERS! ALL EXCELLENT!
0-1 ml. 3-inch, round, W.E. Only..... \$2.99
0-150 V.A.C. 2-inch, round, G.E..... 2.99
0-2 ml. 2-inch, round, General Electric... 2.49
0-15 V.A.C. 2-inch, round, Westinghouse... 2.49
0-5 amps, R.P. 2-inch, round, Westinghouse

CONDENSERS—OIL FILLED
10 mfd. @ 1500 V..... \$2.95
10 mfd. @ 600 V. GE..... 1.25
10 mfd. @ 600 V..... .89

PANEL RACK! SAVE \$100.00!
This is class! Seven (7) foot high and 19 inches wide. Crackle finish. Brand, spanking new. Original box. ACQ cost **\$49.50**
\$150.00. Yours for

NEW TUBES! LATE DATE!
5Y3 85c
6AU6 85c
6BA6 80c
6BE6 85c

IT'S BRAINARD FOR BEST IN HI-FI!
14 W. HIGH FIDELITY AMPLIFIER: With pre-amp. Experts call it best in U. S. 1 Brand new..... \$51.95
25 W. HIGH FIDELITY AMPLIFIER: with pre-amp. A super buy for the guy with educated ears..... \$61.95
COMPENSATORS: Net price \$15.00. Your price..... \$7.50

ARB RECEIVER
190-9050 Kc. 4-band continuous tuning. Excellent condition..... **\$19.95**

COMMANT GEAR—EXCELLENT COND.
BC-453 RECVR. 19-55 MC Q 5'er..... \$12.95
BC-454 RECVR. 3-6 MC 80 meters. ONLY..... 4.95
BC-455 RECVR. 6-9.3 MC. 40 meters..... 4.95
BC-457 XMTR. 4-5.3 MC. Special..... 2.95
BC-458 XMTR. 5-8.7 MC. It's a steal!..... 2.95
4-5.3 MC. XMTR. Brand new, boxed. Only..... 4.95
5-8.7 MC. XMTR. Spelling new! Boxed..... 4.95
BC-456 MODULATOR. Excellent cond..... 4.95
BC-442 ANTENNA SWITCHING RELAY: with vacuum cleaner. New, low price..... 3.49
TRIPLE RECEIVER RACK. With shock mount..... 2.50
DOUBLE XMTR. RACK With shock mount..... 2.50
ALL PLUGS: For SCR-374N or RC-4. Ea. 1.10

Columbia ELECTRONICS
2251 W. WASHINGTON BLVD.
LOS ANGELES 18, CALIFORNIA

provides many structural advantages including: sintered rings and pole faces and precision die-cast brackets that replace conventional screw machine parts and stamping. Shock-mounted jewel assemblies incorporated in the unit provide ruggedized construction.

The new movement is being produced at present in a 2½" round, clear plastic case but will be made available in any of the company's custom meter styles.

CONTACT CLEANER

Caig Laboratories, 46 Stanwood Road, New Hyde Park, Long Island, N. Y., is currently marketing a new contact cleaner and preservative under the tradename "Cramolin."

According to the company, the new liquid reduces contact resistances to their minimum values, reduces sparking of brushes on commutators, improves performance of contacts and collector rings, and protects against salt air and other corrosive atmospheres.

Applied on moving parts, the liquid will stay on since it contains a chemical compound which is strongly attracted by metal surfaces and cannot be removed completely, even by high pressure friction.

The manufacturer will supply additional details and prices on request.

NEW TRANSISTOR SETS

Arvin Industries, Inc., Columbus, Ind., has recently introduced several



new transistorized radio receivers to the trade.

The top of the line is the new Model 9577P which measures 6¾" x 3¾" x 1½". The unit is housed in an unbreakable plastic cabinet designed with a modern accent to harmonize with today's costume accessories. The set comes with a belt or pocket clip in back which doubles as an easel stand and is equipped with the firm's distance-extending "Magnetenna." The set is being offered in ebony, Siamese pink, or bone white—all with gold trim. An earphone accessory for private listening is also available.

TRANSISTOR TESTER

Baird-Atomic, Inc., 33 University Road, Cambridge 38, Mass., has developed a new portable transistorized in-

25—40 Watt Transmitter FOUNDATION UNIT

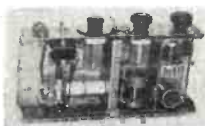

Plug-In Oscillator Unit as used in BC-610 Transmitter. Ideally suited for Trans. Foundation. Contains variable Cond., 1/140 MMFD, 2/100 MMFD, Fixed Cond., Coils, Crystal Holder, Switch, Knob, etc. TU-48 2.5—3.2 MC; TU-49 3.2—4 MC. Circuit Diagram included on Each Unit. Price...**\$2.95**

COMMAND EQUIPMENT

USED: NEW:
550 to 1500 REC. Navy \$14.95 \$19.95
1.5 to 3 MC REC. Navy 7.95
3 to 6 MC REC.—BC-454 7.95
6 to 9 MC REC.—BC-455 7.95
2.1 to 3 MC TRANS., Navy 7.95 9.95
3 to 4 MC TRANS., Navy 5.95
4 to 5.3 MC TRANS.—BC-457 4.95
5.3 to 7 MC TRANS.—BC-458 4.95
7 to 9 MC TRANS.—Navy 7.95
100 to 156 MC TRANS.—T-23 14.95

PE-110 AC POWER SUPPLY

115 Volt 60 cycle Power Supply for BC-669 Rec. Trans. Complete with Tubes, 25 ft. AC Power Cord, Spare Tubes, Vibrator, Capacitor, Fuses. Housed in wood chest. Brand New...**\$59.50**
CD-515 CORD for BC-669 \$2.75
RM-21 CONTROL BOX for BC-669 4.95

SELSYNS—115 V 60 CYCLE

115 Volt 60 cycle Synchronous TRANS. Can be used to turn small Beam Antenna and as Indicator. Size: 5" x 3 1/2" —#C-78414. (Removed from New Equipment.)**\$7.95**



METERS:

DC AMMETER HOYT—

In portable metal case, with Test Leads, 4 1/2", Fan Mirrored Scale 0-15 ADC...**\$3.95**
DB METER—10 to Plus 6, Westinghouse 3", NC-35 Imp. 600 ohms @ 1000 cycle...**\$4.95**
0-3 RF AMMETER IS-128: 2 1/2" Rd. NEW: 2.95
0-8 Amp RF w/Thermocouple IS-89: 2 1/2" Rd. 4.95
0-15 AC DC—2 1/2" Rd.; IS-122 4.95
0-500 MA DC—2 1/2" Rd.; IS-22 4.95

TRANSFORMERS AND CHOKES

115 V. 60 CYCLE PRI. TRANS.:
600 VCT/100 MA—6.3 V/5 A.; 5 V/3 A. \$3.95
240 VCT/35 MA—24 V/9 A.; 6.3 V/6 A.; 6.3 V/3 A. 1.75
1500 VCT/260 MA—6.5 V/3 A.—6.5 V/5 A.—5 V/4.5 A. 9.95
700 VCT/150 MA—5 V/3 A.; 6.3 V/4.5 A. CSD. 3.95
1890 V/12.6 MA—Tapped 2.5 V 2 A. 5.95
1100 V/80 MA—7.5 VCT/3.25 A. 5.95
720 VCT/50 MA—6.3V/2.5 A.—5V/2 A. 2.50
662 VCT/110 MA—6.3V/2 A.—5V/2 A. 3.95
16 Volt 35 Amp. 115/230. ... \$14.95; 24V—1 Amp 1.50
9 Volt CT—35 Amp.—Tapped 4.5 V. 7.95
12 Volt—Two separate windings—4 amp each 5.95
5 V/2 A.; 5 V/2 A.; 5 V/2 A.; 5 V/6 A. 2.95
312 VCT/70 MA.; 6.3 V/2.1 A. & 5 V/3 A. 1.75
600-0-600 VAC—200 MA. 12.5 V. 2 A.; 12.5 V. @ 2 A.; 5 V. @ 3 A.—#H-108—Price... 8.95
250-0-250 VAC—50 MA. 24 V. 1 A.; and 6.3 V. 1 A.—#H-109—Price... 4.95

Choke—12.5 Hy/100 MA. \$1.95
Choke—8 Hy/150 MA—200 Ohm—Open Frame... 1.25
Choke—5 Hy/150 MA—85 Ohm 1.50
Choke—10 Hy/250 MA—2 3/4" x 2" x 3" Potted... 4.95
Choke—5 Hy/400 MA—4 1/2" x 4" x 5 3/4" "A" Choke—.1 Hy @ 1 A .7 ohm. Size: 2 1/4" x 2 1/4" x 2 1/4" Price: 1.95

MICROPHONES & HEADSETS

F-1 BUTTON CARBON MIC.



(Pictured at left) High Gain—Can be used on desk, car, hand, or strapped to chest. Complete with on-off Moun.**\$1.95**
Switch NEW: U: \$2.50
RS-38 CARBON MIC. with PL-68 Plug U: \$2.50
HS-30 HEADSET—Hearing aid type U: \$1.50
HS-18 HEADSET—4000 ohm. U: \$1.95
TS-9 HANDSET—Push to talk Sw. No plugs. U: \$2.95—N: \$4.95
TS-13 HANDSET—Push to talk Sw. w/PL-68 & PL-55. U: \$3.95—N: \$5.95

FAMOUS ARMY SCR-625 MINE DETECTOR

For Prospectors, Miners, Oil Companies, Plumbers, etc. Portable unit for locating all types of buried metal objects up to 24" or more depending on size and ground condition. Detection by means of a tone. Packed in a chest. Operating weight approx. 15 lbs. Shipping wt. approx. 40 lbs. Complete with batteries...**\$39.95**

Address Dept. RN • \$5.00 Order Minimum, & 25% Deposit on C.O.D.'s • Prices are F.O.B. Lima, Ohio

100 WATT TRANSMITTER BC-375

BC-375 100 Watt TRANSMITTER—Voice CW—Freq. 200—500 KC., 1500—12500 KC. by use of Plug in Tuning Units. Uses 1/10y & 4VT-4C Tubes. Size: 23" L. x 21" H. x 8" W. Complete with Tubes, **\$29.95** less Tuning Units. USED:

TUNING UNITS For BC-375 & BC-191:
TU-5: 1.5 to 3 MC. NEW: \$4.95 USED: \$3.95
TU-6: 3 to 4.5 MC. 3.95
TU-7: 4.5 to 6.2 MC. 3.95 2.95
TU-8: 6.2 to 7.7 MC. 3.95 2.95
TU-9: 7.7 to 10 MC. 3.95 2.95
TU-10: 10 to 12.5 MC. 3.95 2.95
TU-26: 200—500 KC. 3.95 2.95
BC-306: Antenna Tuner 3.95 2.95
CABLES: PL-64-61 or 59 Each End. Each: 2.75

ANTENNA MATCHER—

Variable Inductance Tuner, 100 Watt Cap—From BC-375—No Dial. USED: **\$5.95**

TA-12B BENDIX TRANSMITTER

Frequency 300-600 KC and 3000 to 7000 CW & MCW 100 Watt. Four separate oscillators easily converted to cover 20-10-80 Meters by using crystal for 10 Meter Band. Selector channel switch changes ECO, IPA, and Output Tanks at one time. All controls mounted on front panel. Uses 3/807, 4/12SK7; also has output Meter. Size: 15 1/2" x 10 1/4" x 6 3/4". Com- **\$32.95**

For Conversion—See Surplus Manual #2—Price: \$2.50
MP-28-BA MODULATOR & POWER SUPPLY For TA-12. Modulated Max. Signal Carrier output 75 Watts Class B. Uses 2/807, 1/6F6, 1/6N7. Dynamotor input 24 VDC output 540 VDC 450 MA. Prices: New: \$14.95—Used: \$10.95

RA-10 BENDIX RECEIVER

150-1100 KC and 2-10 MC. Excellent for range and marine use. 7 Tubes: 3/6SK7, 1/6K17, 1/6CS, 1/6K6G, 1/6K8. Complete with Dynamotor, MR-9 Control Box, Plugs, Remote Tuning shaft. Size: 10" x 8 1/2" x 17". RA-10 DA—24 Volt 150-1100 KC & 2-10 MC. Used \$34.95
RA-10 CA—12 Volt 150-1100 KC & 2-10 MC. U: \$39.95
RA-10 FA—24 Volt 150-400 KC & 2-10 MC. U: 29.95
Surplus Conversion Manual—#1 or #2. Ea.: 2.50
For List of contents in each Manual, send 3c stamp.

BC-1158 TRANS. & MODULATOR:

Frequency coverage 53.3 to 95 MC. 50 Watt. RF Doubler, Amplifier and Modulator Sections. using 4/815 and 10/12SN7 Tubes. Can be converted to 2-6-10- or 20 Meters. Complete with Tubes, Meter, Blower, NEW: **\$39.95** Used: **\$29.95**

TELEPHONE & CONTROL EQUIPMENT



REMOTE CONTROL RM-52—(Pictured at right) Can be used with RM-53 or used as a separate telephone system. Up to 1/2 mile. Uses 4 flashlight batt. Also can be used as a direct remote control for radio equipment. Provides bias for Mic. & Sidetone to headset. High or Low Imp. Also Mic. & Phone Jacks.

USED: **\$2.95** NEW: **\$4.95**

TS-13 HANDSET for RM-53 or RM-52. Used: \$5.95

EE-8 FIELD TELEPHONE

Ideal for private telephone system for two or more phones, up to 17 miles. Hand ringer, generator with handset, carrying case. Uses 2 flashlight batteries. **\$14.95**
USED—Checked

WIRE—Weatherproof Twisted Pair: 500 ft. \$4.75—135 ft. \$1.00—2500 ft. \$19.95. Per Foot at 1 1/2¢.
COMBAT WIRE—Rubber covered W-130. \$.01 per Ft.

100—156 MC TRANSMITTER & RECEIVER—SCR-522 TRANS. &

RECEIVER: 100—156 MC, 4 Channel, Crystal Control, AM Voice Operation. 18 Tubes—Trans.: 2/832, 3/12A6, 1/6SS7, 1/6G6—Rec.: 1/9002, 1/9003, 3/12A6, 2/12AH7, 1/12C6, 1/12H6, & 3/12SG7. Complete with Tubes, Schematic, and Conversion Info. for amateur use—Good Cond. **\$34.95**
REC.—Chassis Only, w/Tubes \$10.95 without. \$9.95
TRANS.—Chas. Only, w/Tubes \$22.50 without. \$9.95
SCHEMATIC and Conversion Info. Only \$2.50

ANTENNA EQUIPMENT

MAST BASES—INSULATED

MP-22 BASE—Ins. spring action; direction of bracket can be raised or lowered easily. **\$2.95**
Wt. 9 lbs.
MP-22A—Same as above, except takes smaller MS-51 section **\$2.95**
MP-33—Insulated type w/heavy coil spring and 5" dia. Ins. Requires 2" hole for mounting. **\$5.95**
Wt. 8 1/2 lbs.
MP-37—Heavy coil spring with 8" Ins. 2" mounting hole req. Wt. 10 1/2 lbs. **\$5.95**
MP-48—Insulated type with heavy coil spring. Needs 1 3/8" mtg. hole. Wt. 11 1/4 lbs. **\$4.95**

MAST SECTIONS FOR ABOVE BASES:

Tubular steel, copper coated painted, in 3 ft. sections, screw-in type. MS-53 can be used to make any length with MS-52-51-50-49 for taper. Any section. @ 50¢ Each
Larger Diameter Section: MS-54 75¢
WHIP ANTENNAS—5 Ft. w/Rigid Base \$1.50—6 Ft. No Base \$1.50—10 Ft. Throw Out \$1.50—94" Telescoping \$1.00—18 Ft. 3 Sections, Telescoping \$5.95—20" Telescoping (Chrome) 50¢.

DYNAMOTORS & GENERATORS:

INPUT VOLTS	OUTPUT VOLTS	STOCK No.	PRICES: USED: NEW:
12 VDC	220	DM-34	\$2.95 \$ 4.95
12	225	D-402	5.95 8.95
12	625	DM-35	9.95
12	230	PE-133	4.95 6.95
12	540	DA-12	14.95
12	230	DA-14	8.95
14	220	DM-24	4.05 7.95
14	1030		
	515	DM-42	4.05 9.95
14	425	WE-377	5.95
14 VDC	330	BD-87	3.95 5.95
14	250	DM-25	6.85 8.95
14	1000	BD-77	14.95
14	230	DM-21	6.95
24	250	DM-32	2.95 5.95
12	250	60 12V/DM-32	4.95
24	250	PE-86	8.95
28	1000	PE-73	8.95

12 to 24 VDC PM Dynamotor—Supplies 24 VDC 2 A, from 12 VDC. also 500 V 50 MA. @ 6 VDC will supply 12 VDC & 250 V 50 MA. **\$4.95**
#0515 New:

COAXIAL CABLE & CONNECTORS

CD-1071 CORD—With PL-259 Plugs each end. 50 ohm coax 2 Ft. long. Prices: 59¢ Each—Or in Lots of 10 @ 50¢ Ea.
PL-259—Plug. Ea. End & 32"—RG-54/U—58 ohm 50¢
SO-239 Chassis Conn. f/PL-259 (Removed). .3 for \$1.00
UG-21/U—Plug ea. end & 32"—RG-11/U—75 ohm 50¢
UG-22/U—With 4" Coaxial Cable. 50¢

RADAR TRANS.



Transmitter Frequency 143 to 194 MC. using one 3A5 Tube. In plastic case 4 1/2" x 1 1/2" mounted top of 58" Telescoping Antenna with 14" Dipole. Battery Case for holding 2/BA-30 1 1/2 V. & BA-38 103 1/2 Volt "B." Has on & off Sw. Tel. Ant. mounts side of batt. case.

Price: **\$2.95**



POWER SUPPLY

110 V. For Army/Navy COMM. RECEIVERS
Eliminates set conversion. For use w/BC-453-454-455-946 or any sets requiring 24 V. @ 1 A. & 250 V. @ 50 MA. Ready to use: has 4" speaker, volume control, CW and on-off switches. Complete with cord and plug/rec. Price. NEW: **\$18.95**

NOW—OPERATE BEACON RECEIVER FROM 12 VOLT

BC-1206CM BEACON RECEIVER: 200-100 KC. 5 Tubes, 135 KC IF, operates from 24 VDC—**\$9.95**
New \$5.95
Used \$5.95
For 12 Volt operation, use this PM DYNAMOTOR—12 VDC input, output 24 VDC. Size: 2 1/2" x 4" x 4" **\$4.95**
7" Dyn. Only

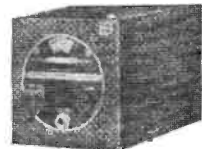

AC POWER SUPPLY—To operate BC-1206 from 110 Volt 60 cycle. Complete with Speaker, etc., in same type cabinet as illustrated at top of this column—Price **\$18.95**

FAIR RADIO SALES

132 SOUTH MAIN ST. LIMA, OHIO

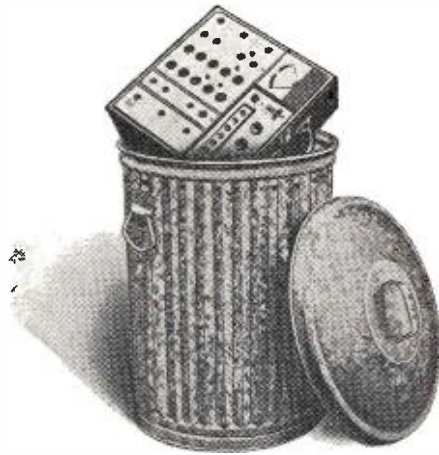

New Automation PUNCH CARD TV Tube Tester CANNOT BECOME OBSOLETE!

Speed-test complete set of tubes in minutes with the new DynaMatic Tube Tester

- Lightest and smallest Gm tester available. Take it on house calls.
- Perforated plastic cards set up socket pin connections and test voltages. Perfo cards are made available as fast as new tubes appear in TV sets.
- Permits full-complement tube testing.
- DynaMatic is a dynamic mutual conductance tester—NOT an emission checker.
- Measures mutual conductance in micromhos on 2 ranges, 0-6000, 0-18000



136-10 31st Road,
Flushing 54, New York



\$139.95

5% higher on West Coast. Subject to change without notice.

WAS \$49⁹⁵ Now only \$29 in Kit form, or \$39.95 completely wired.
DIRECT FROM FACTORY

\$181 in INSTRUMENTATION FUNCTIONS for only **\$29** IN KIT FORM

7 Performs these VITAL FUNCTIONS \$39.95 wired



- COMPLETELY CHECKS:**
- ← Flybacks and Yokes
 - ← Selenium Rectifiers
 - ← Continuity
 - ← Condensers
 - ← Picture Tubes
 - ← Series Filament Tubes — for Newest TV Sets
 - ← Reactivates Pic. Tubes

TV COMPONENT TESTER by TRANSVISION

BUY THIS GREAT 7-in-1 SERVICE INSTRUMENT DIRECT FROM FACTORY and SAVE 40%.

MONEY-BACK GUARANTEE
Try it for 10 days. If you return it, your cost, less 10% re-packaging charge, will be promptly refunded.

TRANSVISION, INC., NEW ROCHELLE, N. Y.

Send _____ TV Component Testers:
— Kit form; — completely wired. Enclosed find \$ _____ deposit; balance C.O.D.

Name _____
Address _____
City _____ State _____

TRANSVISION, INC.
NEW ROCHELLE, N. Y.

IF YOU MUST SPEND YOUR MONEY...
Why not get Something for it?

QUIETROLE

the Choice of Better Servicemen Everywhere

Available in 2 oz., 4 oz., 8 oz.



QUIETROLE

Costs little more than the poorest substitutes. Why take less than the BEST...

No Product can match its merit . . .
None can equal its quality . . .
It's the answer to noisy controls and switches

QUIETROLE is the original product of its kind

MADE BY **QUIETROLE Company**
SPARTANBURG, South Carolina

strument for the measurement of transistor parameters in quality control testing, circuit design, incoming inspection, and general troubleshooting.

The Model ET-1 has been designed specifically for the measurement of β , h_{11} , and I_{co} . The instrument is completely self-contained with its own 1 kc. oscillator and mercury cell power supply. Battery life of the mercury cell is about 1000 hours. Printed circuitry has been used throughout, increasing the portability and ease of maintenance. The instrument measures $5\frac{1}{16}$ " wide, $5\frac{1}{2}$ " deep, and 10" high. Full details are available on request to the manufacturer.

TRIODE-TETRODE FOR TV

The Tube Division of *Radio Corporation of America*, Harrison, N. J., has developed a new 9-pin miniature tube containing a medium- μ triode and a sharp cut-off tetrode designed especially for applications in black-and-white and color TV receivers.

The 6CQ8 is especially useful as a combined oscillator and mixer tube in tuners of TV receivers which utilize an intermediate frequency on the order of 40 mc. The triode unit of the tube is not only useful as a v.h.f. oscillator but also as an r.f. amplifier, phase splitter, sync clipper, and sync separator. The tetrode unit is also useful as a sound or video intermediate frequency amplifier tube.

The tube has a 450 ma. heater with a controlled warm-up time to minimize voltage unbalance during starting in TV receivers utilizing the series heater-string arrangement.

METAL-TO-GLASS TUBE KITS

Colman Tool & Machine Co. of Amarillo, Texas, has added four new kits for the conversion from metal picture tubes to all-glass picture tubes in older models of TV sets to its line.

Kit No. C-6 fits *Wells-Gardner*, *Air-line*, *Truetone*, *Firestone*, *Coronado*,



and *Arlington* sets. The No. C-7 will handle *Arvin* and *Silvertone* models while the No. C-8 is designed to be used with *RCA 27"* receivers. The No. C-9 is designed to be used with *Crosley* models.

FERRITE CORE CHOKES

National Company, 61 Sherman St., Malden 48, Mass., has added a complete set of high "Q" ferrite core choke coils to its "Blue Chip" line of components.

Available in fourteen inductances from 150 μ hy. to 1 mhy., these compact chokes are intended for use in

networks and filters at frequencies from 50-1500 kc. and may also be used as resonant elements in i.f. and r.f. circuits.

Typical "Q" values are 142 at 240 kc. and 182 at 460 kc. for a 1 mhy.

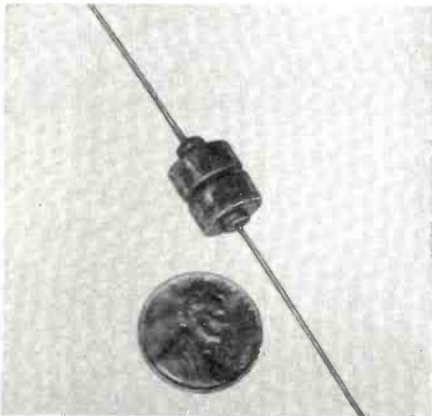

choke. Coil form length is $\frac{5}{8}$ " with $1\frac{1}{2}$ " pigtail leads. The entire unit is impregnated with fungus-proof varnish to provide maximum protection under tropical heat and humidity conditions.

Specifications, prices, and performance data on these units are available from the manufacturer on request.

CODE PRACTICE DISCS

Uncle Sam Recordings, 59 E. Van Buren St., Chicago 5, Ill., is now offering a new Morse Code disc for code practice and training.

Available as either a 7" 45-rpm or

12" 78-rpm disc, the records feature slow signals which are transmitted with time allowance between signals for the student to duplicate them in "Didah" language or whatever instrument is being used in the course. Fast signals are also transmitted to acquaint students with on-the-air sessions.

Code messages are sent at both fast and slow speed for the student to decode. An explanation of the "Didah" language and how to use it is also included on the record in addition to instructions on how to transmit Morse with a flashlight.

TV ALIGNMENT TOOLS

Walsco Electronics Manufacturing Company of Los Angeles, Calif., is currently introducing three new "Tel-A-Turn" tools which have been especially designed to make TV set alignment faster and more accurate.

The tools automatically count and indicate the number of turns made to

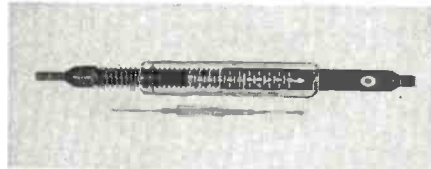

facilitate resetting of slugs, trimmers, screws, etc., to their original position. The tools are made of durable plastic with a clear lucite calibrated sleeve that records each full and quarter ro-

tation in either direction of the tool.

The newly introduced line includes an i.f. aligner, an alignment screwdriver, and a double-ended hex aligner for top and bottom slugs. Parts jobbers are handling the distribution of these new items.

EQUIPMENT SWITCHING

Anchor Products Co., 2712 W. Montrose Ave., Chicago, Ill., is now offering



a 3-way "Selecto-Switch" which has been designed to permit flexibility in the switching of various items of electronic gear.

Suitable for use with TV receivers and an antenna, several antennas and a TV receiver, components of a hi-fi system, u.h.f./v.h.f. receivers, TV or FM gear, or two speakers in a system, the small Model S-203 is housed in a hi-impact plastic case which measures just 3" x 1 $\frac{3}{4}$ " x 1".

A large, easy-to-grasp indicator rotates the positive-acting three-way switch.



NOW! Take The "Headache" Out of TV Trouble Shooting

**Amazing Handbook Helps You Accurately
Pin Point TV TROUBLES
IN 10 MINUTES**

**SAVES TIME . . .
MAKES YOU MORE VALUABLE!**

Now for the first time—a practical procedure for spotting the cause of trouble in any TV set—FAST! Overcomes the most difficult, most time consuming TV trouble shooting problems. There's no guesswork! Quick, simple tests tell you in which of 5 TV set sections to find the cause of the trouble. Fool-proof Check Charts help you locate the exact trouble spot at once, from as many as 700 possibilities. Not a book for the "tinkerer" or home owner who tries to fix his own TV set—IT'S A BOOK WRITTEN FOR TV SERVICEMEN TO SAVE TIME AND MONEY. The hours and aggravation it can save you on a single servicing job more than pays for this amazing handbook. Helps you make more money as an expert speedy TV trouble-shooter!

NEEDED BY EVERY TV SERVICEMAN

"Pinpoint TV Troubles in 10 Minutes" is one of the most valuable "tools" you can carry on a servicing call. Amazingly practical. Over 300 spiral bound fast reference pages with 50 time-saving Check Charts; dozens of important diagrams and tests; explanations of circuits and designs. Fits easily into tool kit for handy on-the-job reference. The only book of its kind available. Prepared and guaranteed by the famous Coyne Electrical School. Costs nothing to examine on Coyne's liberal FREE TRIAL Offer. So get your copy now!

COYNE ELECTRICAL SCHOOL
(Educational Book Publishing Division)
500 S. Paulina St., Dept. 47-RT, Chicago 12, Illinois

BRAND NEW!

**DOES AWAY WITH
GUESSWORK!**

**NOTHING LIKE
IT BEFORE!**

USE IT ON 7 DAYS FREE TRIAL!

You must see this sensational new handbook to believe how much time it can save you—how it makes your days more productive and your work easier. Send no money, just the coupon. We'll rush your copy to you on FREE TRIAL. Try it yourself. Then, after 7 days either send only \$3.95 plus postage, or return the book and owe nothing. Take advantage of this no-risk offer NOW!

MAIL COUPON NOW!

Educational Book Publishing Division

COYNE ELECTRICAL SCHOOL, Dept. 47-RT

500 S. Paulina St., Chicago 12, Ill.

YES! Rush new TV trouble shooting handbook: "Pinpoint TV Troubles in 10 Minutes" for 7 days FREE TRIAL per your offer.

Name Age

Address

City Zone State

Check here if you are enclosing \$3.95. We pay postage. 7-day money back guarantee.

BUILD THE BEST—
BUILD ALLIED'S OWN
knight-kits

Here is a typical Knight-Kit value—available only from ALLIED—one of 45 great Knight-Kits you'll find in our special Supplement No. 165. Write for your FREE copy today.

knight-kit AMATEUR VALUE
50-WATT CW TRANSMITTER KIT



Model
Y-255
\$38⁹⁵

Here's top value for the Amateur—a band-switching transmitter kit for 80, 40, 20, 15 and 10 meters at a new low price. Conservatively rated at 50 watts—actually operates at up to 60 watts input on 80 and 40 meters. Oscillator is highly efficient 6AG7, final is reliable 807 transmitting tube. Pi-output matches 50-1200 ohms impedances—permits use with random length antennas—no need for external antenna tuner or coupler. Controls: Osc. Tuning; Bandswitch; Final Amplifier Tuning; Antenna Loading; Grid-Plate Meter Switch; Off-On Switch. Finest quality components—low-loss ceramic coil forms; RF-type coax connector; copper-finished steel chassis. Effective TVI suppression. Convenient jacks for crystal and external VFO on front panel. With step-by-step instructions. Less crystal and key. Shpg. wt., 19 lbs. Model Y-255. Net. F.O.B. Chicago... **\$38⁹⁵**

OTHER knight-kit AMATEUR VALUES



SELF-POWERED VFO KIT
Y-725 **\$28⁵⁰**



RF Z-BRIDGE KIT
Y-253 **\$5⁸⁵**



100-KC CRYSTAL
CALIBRATOR KIT
Y-256 **\$10⁵⁰**



TRANSISTORIZED CODE
PRACTICE KIT
Y-239 **\$3⁹⁵**

free

SUPPLEMENT
featuring **knight-kits**



Send for our FREE Supplement No. 165 featuring 45 great Knight-Kits, including Test Instruments, Hi-Fi, Hobbyist and Amateur Kits. Write for your copy today.

ORDER FROM
ALLIED RADIO

Dept. 01-D7, 100 N. Western Ave., Chicago 80, Ill.



SELECTING the first Monday night of each month for their regular meetings, a group of service technicians from the counties of St. Francis, Jefferson, Washington, Reynolds, and Iron in Missouri formed the Mineral Area Television Electronic Service Association as an affiliate of the National Alliance of Television & Electronic Service Associations.

This new Missouri NATESA affiliate was organized with five members. They plan to rotate the monthly meetings between the several towns in the east central Missouri area to make it convenient for all electronic service technicians to participate in the association's activities. Officers elected to serve for the first year include Ed Engle of Crystal City, president; Melvin DeClue of Potosi, vice-president; Harold Ransom of Desloge, secretary; and Carl Warren of Flat River, treasurer.

Missouri electronic technicians who are interested in this new association may obtain membership information from Ed Engle, *Engle Radio & TV Service*, 304 Bailey Road, Crystal City, Missouri.

Toledo Dues Increase

At the recent annual election of the Electronic Technicians Association of Toledo, Vern LaPlante was re-elected to the post of chairman of the Executive Committee for the coming year. Other officers and committee members elected include Richard Shirk, vice-chairman; Quentin Hannan, secretary; Lee Kemberling, Lavan Helm, Richard Missler, Gerald Wallach, and Dean Tobin, to complete the eight-man executive board.

The members approved two changes in the ETAT constitution and by-laws. The first of these changes makes provision for two types of membership in the association—active and/or honorary. The second change was a substantial increase in the Association's dues structure to provide the necessary income for a more aggressive program on behalf of the organization members.

The ETAT executive committee chairman, Vern LaPlante, has been one of the service industry's most active proponents of a national service association composed of state-wide organizations. During the past year, he attended all important service-industry clinics and conferences in all parts of the country. His philosophy is that the creation of a strong independent service industry hinges on the development of strong local associations. He feels that seventy-five per-cent of the service problems must be resolved at

the local level, fifteen per-cent at the state level and ten per-cent at the national level.

New Pennsylvania Group

The recently formed Electronic Service Dealers Association of Western Pennsylvania has embarked on a positive program of self-help since its charter was formally granted early this year. Headed by Bert A. Bregenzer, who has long been identified with programs designed to improve the lot of independent service businesses, the new group was recent host to Karl Heinzman, dynamic president of the Television Service Association of Michigan. Mr. Heinzman outlined the extensive program of the Detroit association to drive gyps and incompetents out of the electronic service business in the auto capital.

The ESDAWP arranged for a permanent meeting place in downtown Pittsburgh for its members. It is planned to operate a continuous service clinic in the association's new headquarters. Plans are under way to carry an association listing in the yellow pages of the Pittsburgh phone directory without individual member identification. Service calls that come into the central headquarters will be channeled to the member whose shop is nearest the place where service is needed.

1957 Long Island Officers

Chris Stratigos, who operates *Maple Radio & TV* in Rockville Center, Long Island, was elected president of the Radio Television Guild of Long Island at their recent annual election. He succeeds Murray Barlowe, during whose two-year tenure in the president's spot the Guild accomplished many outstanding achievements.

Officers elected with Mr. Stratigos to guide the Guild in the year ahead include Ralph Milne of *Mid-Island Radio & TV*, Rockville Center, vice-president; Bob Barasch of *Bell Television*, Lindenhurst, recording secretary; Jack Wheaton of *M & W Radio*, East Williston, corresponding secretary; Bob Larsen of *Windsor TV*, Laurelton, treasurer; and Tim Barasch of *Ace TV*, St. Albans, sergeant-at-arms.

Named as trustees for the association were Bob Henderson of *I-R TV*, Baldwin; Henry Warwick of *Henry's Radio TV*, Hicksville; Earl Horton of *Best Electronic & Marine Supply*, Hempstead; Fred Strickland of *Fred Strickland's Radio*, Huntington; Jim Holmes of Hempstead and Mike Toto of Roslyn.

In his first message as the organiza-

\$135 DELCO SELECT-O-MATIC RADIO

• 9 TUBES • 12 VOLT • 6 VOLT CONCORD SPECIAL

General Motors Finest Radio

- Ideal for Cars, Boats, Trucks, Tractors, Farms, Summer Camps • Push-Pull 6V6 Output! • 9 Tube Circuit • Extended Range 6" x 9" PM Speaker • Covers Full B'cast Range • Volume, Tone and Sensitivity Controls • Signal Seeker Tuning and • Manual Tuning TOO!

Stock No. DEL 9-612 RN47.

\$34⁹⁵

For 12 Volt Operation
Use Concord Vol-ta-Drop. Price \$3.95 extra



New 1957 COLLARO RC 456 4 Speed Record Changer

FINEST ENGLISH CHANGER!

Collaro presents the latest design in their quality 4 speed changer. Loaded with fine features the RC 456 will add much to your present or contemplated Hi-Fi system.

- Four speeds, 16 2/3, 33 1/3, 45, 78 RPM.
- Rugged rumble-free 4 pole motor.
- Weighted, balanced turntable.
- Switches off automatically, rejects instantaneously.
- Full Manual or Automatic operation.
- Intermixes all size records.
- Automatic Idler Disengagement.
- Size: 12" x 13 1/2" Requires 5 1/8" above and 2 5/8" clearance below.

Stock No. RC-456-RN4
Accessories for Above.
45 RPM Spindle, \$3.25
Stock No. Col-Spi-RN4
Woodbase cut to fit RC-456 in Mahogany or Blond, \$3.95
Stock No. RC-456-WB (State Color)
Mounting board for RC-456, unpainted, \$1.95
Stock No. RC-456-MB-RN4.



Concord's Price

\$29⁹⁵

less cartridge, with plug in shell
\$31.95 with flip-over cartridge

SONOTONE DUAL-SAPPHIRE TURNOVER CARTRIDGES Ceramic Element

Lots of 3
\$275 ea.

Reg. \$9.50 Each



Humidity-proof ceramic retains shape in all kinds of weather; cuts distortion, adds response range. Now used in VM, Columbia 360, Webcor Crescent changers. Replaces many others. Stock No. AG-2T-RN47. Wt. 8 ozs. Net \$2.95 ea.

NATIONAL "HORIZON" 10 WATT HI-FI AMPLIFIER

CONCORD'S MONEY SAVING PRICE **\$44⁵⁰**

Sold Everywhere for \$79.95

- Built in preamplifier. Five position input selector-reCORD equalizer switch.
- Output better than 10 watts with harmonic distortion less than .5%, peak power 25 w.
- Control function selector, loudness/volume, treble, bass.
- Output impedance: 8 and 16 ohms.
- Hum and noise level: better than 70 DB below full output.
- Unity coupling eliminates distortion found in most amplifiers.
- Push-pull 6V6 output—Tube lineup: 12AX7, 2—6V6's, 5Y3GT.

Stock No. NTL-H—RN 47.

Size: 4" H x 14 1/2" W x 12 1/4" D.

Stock # NTL-H-RN47

DIAMOND NEEDLES

for any GE "Triple Play" cartridges

DIAMOND-SAPPHIRE
Stk. No. GE-13-DSRN47
(Reg. List \$31.00 Net \$18.23) **\$11.65** EACH

DUAL-DIAMOND
Stk. No. GE-13-DORN47
(Reg. List \$50.00 Net \$29.37) **\$19.95** EACH

for any GE "Single Play" cartridges

LP DIAMOND
Stk. No. GE-LP-DRN47
(Reg. List \$27.50 Net \$16.17) **\$10.75** EACH

78 DIAMOND
Stk. No. GE-78-DRN47

for all GE "Clip-in" Type cartridges

LP DIAMOND
Stk. No. GE-A-LP-DRN47
(Reg. Net \$15.68) **\$10.35** EACH

78 DIAMOND
Stk. No. GE-A-78-DRN47

for all "Sonotone" 9980 & 2T cartridges

DIAMOND SAPHIRE
Stk. No. SON-DSRN47
(Reg. List \$30.00 Net \$18.00) **\$12.50** EACH

For use in any "Shure" single or turnover cartridge that uses a small knurled nut to hold the stylus in place.

LP DIAMOND
Stk. No. SH-LP-DRN47
(Reg. List \$25.00 Net \$15.00) **\$9.95** EACH

78 DIAMOND
Stk. No. SH-78-DRN47

For use in all "Ronette and Collaro Studio" cartridges

LP DIAMOND
Stk. No. RON-LP-DRN47
(Reg. List \$25.00 Net \$15.00) **\$9.95** EACH

78 DIAMOND
Stk. No. RON-78-DRN47

CONCORD'S LUCKY BUY SAVES YOU \$\$\$\$

Finest Quality 4-Tube Personal Portable Radio Fully Warranted!!

Imported to save you money, Concord bought a carload and passes savings along to you. Double check the quality features and you'll hurry to buy several.

- Full 4 Tube Super-Het Circuit (1—1R5, 1—1T4, 1—1U5, 1—3S4)
- Full Broadcast Coverage 532 Kc—1640 Kc.
- Quality 2 1/2" PM Speaker.
- "Hi-Impact" Plastic Case for Added Safety.
- Uses Long Life Batteries for Economy in Operation.
- Retracting Handle for Portable Use.
- Your Choice of Colors at No Added Cost—Ebony, Maroon, Ivory.
- One Piece Chassis, Easily Removed.
- Highly Sensitive Bar Type Antenna.
- Personal Size: 6 3/4" x 4" x 1 1/2".
- Weight with Batteries Only 1.7 Lb.



Sold Nationally for \$21.95

CONCORD'S CLOSETOUT PRICE

\$13⁹⁵

less batteries
Batteries for above
Eveready 935 & 415 \$1.84
Stock No. 5 Star-RN-47
Shipping Wt. 2 lbs.

Famous British Imported Hi-Fi Flip Cartridge



Lots of 5

\$175

Regular Price \$8.50
Has dual precious metal stylii—Has 33 1/3—45 rpm needle and 7 rpm needle—Used only in high quality phonographs—Will give response 50 to 12,000 cycles—Complete with 1/2" center mounting bracket and turnover mechanism. We used this item on a check and were so surprised we grabbed all we could lay hands on. A ridiculous low price for these. Single—\$1.98 Stock No. EV-FPC-RN47

Model A7M-5 Sim. to Mod. AX



Exceptionally light-weight two-needle cartridge furnished complete with removable twisting mechanism. Ideal replacement cartridge fits most tone arms of leading manufacturers of record changers and players. Stock No. 99-K-HAS3RN47. Reg. \$8.25

CONCORD CAMERA DIVISION

FAMOUS GERMAN IMPORT

ILOCA II STEREO

F3.5 ctd matched lenses.
FLASH 5NYC. • B&W or COLOR.
Stock No. CAM-115-RN47.

NEW BOLSEY B-2 KIT

F2.8, Case & Flash. Sells Reg. \$66.50.
Stock No. CAM-B2-RN47.

WE BUY, SELL, TRADE CAMERAS • PROJECTORS • ENLARGERS
Write for our prices before you buy or sell

IMPORTED BINOCULARS

All Binoculars Have Deluxe Leather Carrying Case! Prisms Held Rigid with Steel Straps
6x30 FIELD OF VISION—420 FT. at 1000 YARDS—Fig. B. Perfect ALL AROUND binoculars. Feature coated lenses, light weight alloy bodies. Center focus. Shipping Wgt. 3 lbs. **\$17.50**
Stock No. B1-RN-47

6x15 FIELD OF VISION—367 FT. at 1000 YARDS—Fig. D. Here's the right glasses for use at RACE TRACK, for ANTI-SPORT USE, and at the OPERA or THEATRE. Individual Focusing. Shipping Wgt. 2 lbs. Stock No. B2-RN-47. **\$16.69**

7x35 FIELD OF VISION—300 FT. at 1000 YARDS—WIDE ANGLE FIELD OF VISION—495 FT. at 1000 YARDS—Fig. E. Use these binoculars for HUNTING, BIRD STUDY, SPORTS. The wide angle glasses are wonderful for horse racing. Center Focusing. Shipping Wgt. 3 lbs. Specify Type. **\$20.90**
Stock No. B3-RN-47

Wide Angle **\$29.40**
7x50 FIELD OF VISION—372 FT. at 1000 YARDS—Fig. C. The most wanted binocular, will give good service in SPORTS VIEWING, HUNTING, OUTDOOR USE. Shipping Wgt. 3 1/2 lbs. Specify Type. **\$24.90**
Stock No. B4-RN-47

Individual Focus **\$21.45**
8x25 FIELD OF VISION—315 FT. at 1000 YARDS—Fig. B. An ideal glass for GAME SPOTTING, BIRD WATCHING, SPORTS. Shipping Wgt. **\$17.95**
Stock No. B5-RN-47

Individual Focus **\$15.25**
16x50 FIELD OF VISION—183 FT. at 1000 YARDS—Fig. C. A high power binocular for LONG DISTANCE VIEWING as PLANE SPOTTING, MARINE USE, MOUNTAIN VIEWING, CENTER FOCUS. **\$31.30**
Ship. Wgt. 3 1/2 lbs.—Stock No. B6-RN-47

* Add 10% Fed Tax to above prices

40% to 50% OFF REG. PRICES



NEW 1957 15" COAXIAL SPEAKER

- Don't Lose the Beauty of Low Response
- Our Price is Less Than You Would Pay for a Smaller, Inferior Unit
- One Piece Molded Cone
- Built-In Cross Over Network
- Massive Alnico No. 5 Magnet Weighs Almost 1 Lb.
- Modern Design in the 15" Woofer
- 4" Tweeter Delivers Brilliant Highs
- Handles 25 Watts with Ease
- Frequency Response 30 to 16,000 CPS.
- Voice Coil Impedance 8 OHMS

Stock No. CX5-15A-RN47. Shpg. wt. 12 lbs.



Worth \$45.00

New 1957 Model Crosley Transistor BOOK RADIO PRICE SLASHED!

- Genuine Embossed Top-Grain Leather Binding
- Complete with 23 Karat Gold Embossing Kit for Inscribing the Owner's Name on Cover
- Uses 2 transistors with 3 multi-purpose tubes
- Modern printed circuit for top efficiency
- Tunes standard broadcast range
- HERE'S BRILLIANT SOUND, PLUS BEAUTY IN YOUR CROSLEY TRANSISTOR BOOK RADIO!

Stock # BUK-RAD-RN47

CONCORD'S CUT PRICE . . . **\$23.95** (less batt)

Batteries for above
1—45 V. \$1.75; 1—4 V. Mercury \$1.88

YOUR 1957 CATALOG IS READY . . . WRITE FOR FREE COPY

CONCORD RADIO CORP.

RUSH THE FOLLOWING ITEMS:

1— 3—

2— 4—FREE CATALOG

I AM ENCLOSING \$

SEND C.O.D. I ENCLOSE 20% DEPOSIT

NAME

ADDRESS

45 WARREN ST., N. Y. 7
DEPT. RN-47

REDMOND BLOWER

110V. 60 cyc. 3 Amp. 1600 RPM. 3 1/4" Blower wheel—Outlet 2" Diameter. Suitable for cooling Transm. tubes, etc. . . . ea. **\$7.95**
2 for \$15.00

SMALL BLOWER—Operates on 12 V. to 24 V. DC or 24 V. to 36 V. AC. . . . ea. **\$2.95**

SMALL PIONEER DYNAMOTORS
Ideal for Amateur or Commercial Service 5.5 to 6 volt DC input—output 400 volts at 175 MA cont. or 275 MA intermittent duty. Comes complete with A & B filters. RF hash filter & internal cooling fan. . . . each **\$14.95**

DYNAMOTOR STARTING RELAY
12V DC coil. Solenoid type fully enclosed. Will easily handle 50 amps. Contacts and winding isolated from ground. . . . ea. **\$1.75**
2 for \$3.00

MARION 2 1/2" METER
Basic 0-1 mil has dual scale. 0-100 ma and 0-500 VDC. Complete with 500 Volt Meter Multiplier . . . ea. **\$3.95**

REVODEX MICROMETER DIAL
1" Diameter dial. Satin Chrome plated. Grad. 0-100 div. Black face front Grad. 1-10. Actually counts 1000 div. or 10 turns. Contains mounting hardware and full instructions. For rotary inductors, helipot, or any other device with 1/4" shaft. . . . ea. **\$2.95**

G. E. RELAY CONTROL
(Ideal for Model Controls, Etc.)
Contains a sigma midget 8,000 ohm, relay (trips at less than 2 Ma), high impedance choke, bimetal strip, neon pilot and many useful parts. The sensitive relay alone is worth much more than the total cost. . . . ea. **\$1.10** ea. **\$9.25**
low price of . . . for

RELAYS
Sealed Claire SPST. Norm. closed 3000 ohm coil 2 1/2 ma. . . . ea. **95c**
Claire Telephone Type 11,300 ohm coil DPDT cont. 10 amp 125V. Sens. 4MA. ea. **\$3.95**
Cutler Hammer Contactor—110V 60 cy. 4 pole s.t. Norm. open 25 amp contacts. ea. **\$6.95**
Hermetically Sealed Relay Coil 110V AC 60 cy SPDT Contacts 5 Amps. . . . ea. **\$1.85**

12 Volt DPDT DC Relay . . . ea. **\$1.35**
Cramer Time Delay Relay, 220V 60 cy. 45 sec. adj. 2 pole DT. . . . ea. **\$6.95**
G.E. Plug in Relay 5 prong 2000 ohm coil 4 mil. SPDT. . . . ea. **\$1.75**
Telephone type relay 12 V. DC @ 10 ma. triple pole single throw. Normally open. **\$1.25**
SIGMA-SF Relay, 16,000 ohm coil. SPDT adjustable tension and contacts. 500 Microamp sensitivity. . . . ea. **\$3.95**

OIL CONDENSER SPECIALS

BRAND NEW			
2 MFD 800 VDC	.50	1 MFD 3000 VDC	1.85
4 MFD 800 VDC	.75	4 MFD 3000 VDC	5.95
6 MFD 800 VDC	.85	4 MFD 4000VDC	14.95
8 MFD 800 VDC	.95	6 MFD 4000VDC	16.95
10 MFD 800 VDC	1.19	1 MFD 6000 VDC	6.45
12 MFD 800 VDC	1.50	5 MFD 7500 VDC	1.49
2 MFD 1000 VDC	.85	2 MFD 10,000	
4 MFD 1000 VDC	1.35	1 MFD 15,000	VDC 39.95
1 MFD 1200 VDC	.75	2 MFD 1500 VDC	29.50
1 MFD 1500 VDC	.75	1 MFD 25,000	VDC 49.50
2 MFD 1500 VDC	1.10	5 MFD 330 AC	.95
6 MFD 1500 VDC	3.95	(1000 DC)	
10 MFD 1500 VDC	3.50	20 MFD 330 C	2.50
1 MFD 2000 VDC	.85	8 MFD 660 AC	2.35
2 MFD 2000 VDC	1.50	(2000 DC)	
4 MFD 2000 VDC	3.50		
10 MFD 2000 VDC	6.95		
4 MFD 2500 VDC	4.95		

NEW PANEL METERS

G.E., WESTINGHOUSE, W.E., SIMPSON, etc.
1 1/2" 0-50 Mil . . . ea. **2.95**
DC
1 1/2" 0-5 Amps . . . ea. **3.45**
with ext. 1.5 MA (Basic)
Thermocouple 3.95 . . . ea. **3.95**
0-2 Amp DC
0-500 Volts DC 4.50
2" METERS
18-36 Volts DC **\$1.95**
0-5 Amps DC 2.95
0-200 Mill AC . . . ea. **2.95**
0-150 MA RF
Int. Thermo. 3.49
0-9 Amps R.F. 2.95 (dual range) 3.95

EIMAC VACUUM CONDENSERS

50 MMF-32KV **\$9.50**
25 MMF-32KV **8.50**
12 MMF-32KV **7.50**

CHOKES—FULLY CASED

10 HENRY 80 Mil (unshielded) **90c**
8 HENRY @ 200 Ma. **\$1.95**
10 HENRY @ 315 Ma. **3.50**
3 HENRY @ 630 Ma. **3.50**
6 HENRY 450 Mil. **4.95**

Read 'n' Save Bargains

Precision Meter Multiplier—1 Megohm **\$1.49** ea.
1% tolerance
IRC MFA 1 Meg. Resistor 35 Watts **.85c**
HEINEMAN CLRC BREAKER
110 V. 60 cy. 20 amps. Curve 4 **1.25**
.01 MMF 1000 VDC MICAS **5 for .95**
.0004 2500 VDC MICAS **5 for .95**
1 MFD Oil Condenser 400 VDC **20c** ea.
10 for 1.50
Thordarson Filament Transf. pri 115V. 60 cy. Secondary 2 1/2 V. 10 amps. 7500V. 3 amp. 5 V. 3 Amps. **3.25**
Receiving element fits standard W.E. or Conn. telephone handsets **65c**
FIL. TRANSF. Pri. 110V. 60 cy. Sec. 6.3V @ 10 amps **\$1.65**

All merchandise sold on a 10 day money back guarantee basis

Min. Order \$3.00—25% with Order—F.O.B. New York
PEAK
ELECTRONICS COMPANY
66 W. Broadway, New York 7, N. Y., WO-2-5439

tion's president, Mr. Stratigos said: "How many of us can look upon 1956 and say 'This was a good year for me?' To those of us who can reminisce with pleasure, I say hang onto what you have with both hands and take a good-sized bite for added security.

"Those of you who look upon this past year sourly—or not at all—gather round and peer through my gloom-ridden glasses at the possible future. Look closely at the endless ranks of drug-store tube testers calmly eating what might have been your profits. You were asleep in 1956. Wipe the lenses and look once more. See those vast stores of tubes continuously moving through the discount houses with a mere dribble here and there reaching customers through your shop. Have a good sleep last year? Don't put those glasses down! Take another peek. That's it. Now, see all those dots on that map? Each one represents a manufacturer's service center quietly and efficiently set up to service your customers and take care of their every electronic need. Are you ready to come out of hibernation yet?

"You can throw away the glasses you looked through, for they showed the possible future. But, beware—for if you sleep through 1957, this future will be real. As individuals you can do nothing—as a group a great deal."

Chicago Licensing Conflict

The sharp difference of opinion among service dealers on the subject of municipal and state licensing was clearly reflected in a recent clash between two Chicago service associations over the subject. The men involved were Frank Moch, acting in the capacity of chairman of the board of TESA-Chicagoland, and Howard Wolfson, chairman of the executive committee of the Associated Radio & Television Servicemen of Chicago.

Last year, Mr. Wolfson outlined in a letter the reasons for his belief that licensing would hurt, rather than help, small service dealers like him. Mr. Wolfson operates a one-man service business in the Chicago Loop district. As a result of this letter, Frank Moch, representing an organization of larger service shops, questioned Mr. Wolfson's status as a TV service dealer and proposed a debate:

"We believe the best way to resolve this issue would be for you to meet, in debate, a member of this association of professional service people at an open meeting of the service people in this area and the general public. We shall await your response to this challenge."

Mr. Wolfson, promptly accepting the challenge, replied: "Being a member of the Associated Radio & Television Servicemen, it is their desire, I am told, to handle the details under which this debate will be held. Accordingly, a Committee has been appointed which will be in touch with you, to arrange the details.

"Debating is in the finest of American traditions, and whatever arrange-

The ALL NEW "15-POUNDER" MYSTERY PACKAGE

of ELECTRONIC PARTS
Worth \$35.00
OUR PRICE
\$2.95
NOTE: Package to cover Mailing Costs. EXCESS REFUNDED
SATISFACTION GUARANTEED

BUTTERFLY CONDENSERS
YOUR CHOICE
\$4.95

These units make the finest tuners for Ultra-high frequency transmitters, receivers, frequency meters, and oscillators.

TYPE A 4 1/4" Dia. TYPE A-106 330 MC. Airplane Type
TYPE C 2 1/2" Dia. TYPE C-300 1000 MC. Uses 388A tube
TYPE B 4 3/4" Dia. TYPE B-125 683 MC
TYPE D 2 1/2" Dia. TYPE D-300 1000 MC. Cite for Red Dot.

RELAYS
3VDC 11-OHMS D.P.D.T. 3A. CONTACTS \$1.29
6VDC 24-OHMS D.P.S.T. 8A. CONTACTS. \$1.95
110VAC 15A. CONTACTS S.P.S.T. \$1.75
TELEPHONE TYPE 7500-OHMS S.P.D.T. 2A. CONTACTS \$2.49

OIL CONDENSER
\$1.65
2 MFD. 3000 VDC. Pyranol Oil W/Mounting Brackets.
3-2 Mfd. 3000 VDC. New removed from equip. 4 1/2" x 4 1/4" x 2 1/2"

PHOTO ELECTRIC CELL
95c
Cell used in A.M.P.R.O. Sound Vacuum Protector. Also useful for opening garage doors and Alarm Systems.

GE Pyranol Oil CONDENSER
32 MFD. 320 VAC. 60 Cy. Removed from equip. NEW. **95c**

ALL-PURPOSE FIL. TRANSFORMER
PRI. 117 v. 60 cyc. sec.
Sec. W. . . . 12A
" " " " 25A
" " " " 35A
" " " " 50A
" " " " 75A
\$4.95
BRAND NEW

RCA Output Transformer
P.P. 6L8'S 25 WATTS
Pri. 5000 ohms output SEC. 25 500 ohms sidestone 15 to 15,000 cy. flat.
\$1.95

SWING CHOKE **\$5.95**
2H-7H 550 MA. Thordarson T48003.

100 ASSORTED CRYSTALS
FT-243 FT-241A FT-171B Type Holders FREQ. RANGE 2015 KC to 38.1 MC.
\$50.00 Value **\$7.95**
HOTTEST BUY IN THE U.S.A.

AUDIO CHOKE
80H-1MA. 4,500 ohms. 15,000 turns of 44 wire. Size: 1 1/2" x 3/4" x 3/8". Ideal for radio control, planes, boats, etc. **95c**

ALLIGATOR CLIP
Slicing type with 8 Ft. cord and 100 lbs. spare lug. Ideal test clip. TL-137. **2 for 25c**

HERSHEL RADIO CO.
5249 GRAND RIVER Detroit 8, Michigan

110V, AC POWER SUPPLY FOR 274N RECEIVERS

Just plug it into the rear of your 274-N RECEIVER . . . any model. Complete kit and black metal case, with ALL parts and diagrams. Simple and easy to build in a jiffy. Delivers 24 volts plus B voltage. No wiring changes to be made. Designed especially for the 274-N receiver. Only \$8.95.

Filament trans. for 274N receivers. Pri. 110V, 60 cy. AC. Sec. 24V @ .8A. An excellent buy at **\$1.95** ea.

SPLINED TUNING KNOB FOR 274N RECEIVERS

An exclusive O-R item manufactured for us. Fits BC-453, BC-454 and other 274N receivers. This is a really hard-to-obtain item. Only .89c ea.

OFFENBACH-REIMUS
1564 Market Street, San Francisco, Calif.

ments are jointly made will, of course, be agreeable to me."

The ARTS Committee recommended that the debate be held before and judged by a panel of men of knowledge and affairs. Mr. Moch refused to accept this recommendation by stating: "In the first place, the cost of unbiased persons of this caliber would be prohibitive and the money could be spent to far better advantage in this issue. In the second place, we obviously never intended the debate to be simply a test of rhetorical prowess, forensics or jurisprudence."

In reply, the ARTS Committee offered to pay the cost involved in providing a panel of competent judges if TESA-Chicagoland would pay the rent for the hall in which the debate was held. Mr. Moch countered that they should drop the matter, that TESA-Chicagoland would stick to its own meeting on the subject of licensing, and that Mr. Wolfson would be permitted to attend it and express his views if he wished.

Arizona Salutes Service

On March 4, Governor McFarland of Arizona proclaimed Arizona TV Servicemen's Week. For the city of Phoenix, Mayor Williams issued a similar proclamation. To publicize this week, BEST (Better Electronic Service Technicians), with headquarters in Phoenix, arranged for giant window displays at the *Arizona Public Service Co.*, the local light and power utility, and also in the windows of a number of banks.

Seminars held during the week covered such business and other non-technical subjects as financing, shop and job organization, customer relations, salesmanship, and effective lighting and display. Festivities were capped by a televised dinner at which both the governor and mayor spoke.

Columbus Officers

Associated Radio-TV Service Dealers of Columbus, Ohio, is being headed up by Jack Voigt as president for 1957. Other officers for the year include Paul Herman, vice-president; Leo Loudner, treasurer; and Don Sisk, secretary.

In its campaign against manufacturers who are also competitors for service business, ARTSD, aside from attacking the set makers involved, is also trying a somewhat different tack. It is calling attention to manufacturers selling replacement parts in its area who have taken definite stands against factory service.

Chicago Publication

Associated Radio & Television Servicemen of Illinois joins the ranks of service organizations who put out official publications of their own. Vol. 1, No. 1, of "Common Sense," their mimeographed monthly, has been distributed. The first issue deals with the general approach of ARTS and with subjects that are scheduled for discussion in future issues. They include licensing, back-door selling, bait advertising and captive service.

SAMS BOOKS keep you ahead in ELECTRONICS

SAMS books cover every phase of Electronics for the service technician, engineer, student or experimenter. Listed below are a few of the many valuable SAMS books available at electronic parts distributors and leading book stores.

the only book of its kind available!



only \$2.95

"AUTO RADIO REMOVAL"

This time-saving new book gives you step-by-step instructions for the easy removal of radio, power supply and speaker units from all 1955 standard and sports model automobiles. The following information is provided for each car covered: tools required for removal; phantom view of dash panel with radio in place (quickly locates chassis mounting nuts, bolts, cables, antenna and speaker leads); photo showing actual removal of radio. Rear-deck speaker data is given for each model; shows if cutout is provided, speaker size required, and whether speaker control is included or must be added. Includes brief summary of preliminary servicing procedures which should be performed to determine whether radio removal is required to effect repair. An invaluable book. 104 pages; 5 1/2 x 8 1/2"; illustrated. Order today, postpaid only \$2.95

USE THIS ORDER FORM

- | | |
|---|--|
| <input type="checkbox"/> AUTO RADIO REMOVAL \$2.95 | <input type="checkbox"/> Key Checkpoints in TV Receivers. Prepared by the Howard W. Sams engineering staff. Provides many applications for general TV service work, including time-saving information on how to make quick tests at key points to determine where trouble lies, and how to check overall performance of the receiver after repair, to insure against callbacks. 182 pages; 5 1/2 x 8 1/2"; illustrated.....\$2.00 |
| <input type="checkbox"/> Transistor Circuit Handbook. This authoritative book completely covers all phases of transistor circuits, types, construction, characteristics, applications, techniques for wiring and testing. 430 pages, 6 x 9"; illustrated.....\$4.95 | <input type="checkbox"/> Tape Recorders—How They Work. Explains recording theory, tape characteristics, motorboard mechanisms, drive motors, amplifiers, magnetic heads, volume indicators, equalization circuits—covers everything you want to know about recorders. 176 pages; 5 1/2 x 8 1/2". \$2.75 |
| <input type="checkbox"/> Metallic Rectifiers. Covers theory, principles and applications of copper-oxide, magnesium-copper sulfide, selenium and new silicon type rectifiers. Includes interesting circuits, applications, terminology, etc. Authoritative complete. 286 pages; 5 1/2 x 8 1/2"; illustrated.....\$3.00 | <input type="checkbox"/> Servicing AGC Systems. Describes the operation and circuit variations of the various types of AGC systems and explains the servicing techniques that can be applied. Illustrated by actual case histories and photographs of symptoms. 132 pages; 5 1/2 x 8 1/2"; illustrated.....\$1.75 |
| <input type="checkbox"/> Color TV Training Manual. Prepares the Technician for Color TV service work. Covers principles of the Color TV system; Color receiver circuits; installation and servicing sets. Includes color blocks outlining the use of color test equipment. 260 pages; 8 1/2 x 11"; 300 illustrations. \$6.95 | <input type="checkbox"/> Servicing & Calibrating Test Equipment. Shows you how to keep your test instruments in reliable working order, how to determine proper operation and avoid erroneous indications. Explains calibration procedures; gives method for performance record-keeping; shows simple ways to check instrument accuracy; describes proper maintenance and servicing of instruments. 192 pages, 5 1/2 x 8 1/2"... \$2.75 |
| <input type="checkbox"/> Hi-Fi Handbook. Invaluable data on Hi-Fi design, selection and installation, including fidelity, sound theory and distortion; loudspeakers; baffles and enclosures; amplifiers, preamps and controls, program source equipment; systems design, selection and installation. 240 pages; 5 1/2 x 8 1/2"; illustrated.....\$3.00 | <input type="checkbox"/> Send Book List |
| <input type="checkbox"/> Servicing TV Sweep Systems. Describes the operation, circuit function and circuit variations of vertical and horizontal sweep systems common to most TV receivers. Tells how to analyze circuits; troubleshoots for you. 212 pages; 5 1/2 x 8 1/2"; illustrated.....\$2.75 | |
| <input type="checkbox"/> Electronic Metal Locators. Explains operation, describes basic types available, shows how to construct home-built units, describes applications. Covers interesting uses in industry as well as applications in prospecting and mine location. Complete and authoritative. 124 pages; 5 1/2 x 8 1/2"; illustrated.....\$2.50 | |

There is an authoritative Sams book on virtually any Electronic subject in which you're interested. Check below for FREE Book List describing all Sams books.



...HOWARD W. SAMS & CO., INC.....

Order from your Parts Jobber today, or mail to Howard W. Sams & Co., Inc., Dept. 1-D7 2201 East 46th St., Indianapolis 5, Indiana.
Send books checked above. My (check) (money order) for \$..... is enclosed.

Name.....
Address.....
City.....Zone.....State.....
(outside U.S.A. priced slightly higher)

Look for SAMS BOOKS on the "Book Tree" at your Parts Distributor

AIREX

THE HI-FIDELITY SUPERMARKET

WHERE THE PRICE IS ALWAYS RIGHT

RECORD CHANGER BARGAIN

LATEST WEBSTER AUTOMATIC CHANGER: Inter-mixes 10"-12" records. Automatic shut-off. GERPX050A dual sapphire reluctance cart. Heavy duty 4 pole motor. With line cord and plugs. **\$29.95**
Base for above—\$3.95; Automatic 45 spindle \$2.49

NATIONALLY FAMOUS CASER RELUCTANCE CARTRIDGE TYPE RPX OS2A. Triple play .003 mill sapphire & .003 mill diamond. Clip-in stylus. Stylus pressure 6-8 grams. **\$17.95**

NATIONALLY FAMOUS RELUCTANCE CART TYPE OS2A. Triple play sapphire needles for all records. clip-in stylus. stylus pressure 6-8 grams. **\$6.95**

NEW TECH-MASTER 60 WATT AMPLIFIER—PRE-AMPLIFIER KIT

Only unit of its kind on the market. Full 60 watts output. 120 watt peak. Frequency 20-20,000 cycles \pm 1db at 60 watts. Intermodulation distortion less than 1% at 60 watts and less than 1/4% at listening level. Output 4, 8, 16 OHMS. RIAA, AES, NAB, LF & 78 equalization. Input selector for auxiliary, tuner, TV & tape. Tape output from built-in cathode follower jack. Uses direct interstage coupling, special ultra linear output transformer variable cart tone control. Uses 12AX7, 12AU7, 6AN8, 5U4GB, & 2-6550. Bass & treble control. Separate selenium for bias supply. Full case instructions. Size 10 1/2" D x 14" W x 5 1/2" H. **\$79.95**
COVER FOR ABOVE. **\$7.50**



Grommes Hi-Fi Amplifier Kits
10 Watts. 18 watts peak. Resp. 20-20,000 cps \pm 1 db. Preamp. 4 in. Input. 100-80 db. 2% Harm. Dist. at 10 watts. Complete with detailed step by step instruction manual, all resistors, condensers, tubes, wire & solder. Easy to make, 2-12AX7, 2-6V6, & 5Y3. Bass & Treble boost. Limited quantity. **\$24.95**



New 20 watt Grommes amplifier kit, mdl. 61PKK, 30 watts peak. Response 20-20,000 cps \pm 1/2 db. 100-80 db. full equalization & compensation. Complete with case, 7 tubes, detailed instructions, wires and solder. **\$59.50**



FM-AM TUNER KIT
Easy to assemble. Professional quality performance. 3 double tuned IF stages. Foster-Seyley discriminator. Automatic frequency control & defeat. 7 tubes -70DB. Distortion less than 1% at 100 microvolts for 20 DB quieting on FM & 20 microvolts on AM. FM selectivity 200KC band width 8 DB down; AM 8KC band width 5 DB down. 5 1/4" high x 3 1/2" deep. Complete with step-by-step instructions. **\$29.95**
FM TUNER ONLY—\$23.95 • **COVER—\$3.95**
These units are ideal in combination with any of the Hi-Fi Amplifier kits listed above.

MULLARD HI-FIDELITY TUBES

Type	Replaces	Price	Type	Replaces	Price
EL34	6CA7	\$4.35	ECC82	12AU7	\$2.20
EL37	6L6; 5881;	\$3.50	ECC83	12AX7	\$2.50
	KT66	\$3.50	EF86	2729;	\$2.75
EL84	6BQ5	\$2.40		6287	\$2.75
ECC81	12AT7	\$2.50	GZ32	5Y4; 5U4	\$2.95

Nationally Known Utah Speakers

12" coaxial, exclusive built-in crossover network assures a frequency response from 35 to 17,500 cps. 12 watt cap. 8 OHMS impedance. Reg. **\$24.95** **\$12.88**

15" woofer—response 30 to 8,000 cycles. 21.5 oz. magnet. 25 watt capacity. 1 1/2" voice coil. 8 OHMS impedance. Reg. **\$34.95** **\$19.95**

5" super tweeter—response 3000 to 19,500 cps. 25 watt capacity. 3/4" voice coil. 8 OHMS impedance. with built-in crossover network. **\$7.95**

FAMOUS NORELCO SPEAKER

Model 9762M—12" twin cone coaxial type, full resonance speaker. Frequency range 35 to 18,000 without baffle. Flux density 11,000 GAUSS. 30 watt capacity. Impedance 8 OHMS. One of the finest quality speakers on the market today. Reg. list **\$89.50** **\$39.95**

Complete TV Set—Designed & Engineered by Tech-Master with Sylvania Aluminized Tube

• Designed for fringe area operation
• 6 microvolt sensitivity • Automatic gain control • Auto-transformer high voltage system. • 3 stage stagger-tuned IF • Heavy duty power transformer • 2 stage video amplifier sweep circuit • High gain Standard Coil tuner • 17 KV high voltage output • Automatic brightness control • Complete with mounting brackets. Alnico V speaker and knobs. **\$177.95**

Standard Coil Cascade TV Tuner

Replacement for any type TV set. 41 MC. IF. Shaft length 3 1/4". **\$9.95**
Knobs to match—69c. in lots of 3, \$6.95 ea.

Building Your Own Hi-Fi System? SEND US YOUR LIST OF COMPONENTS. We will give you a PACKAGE QUOTATION ON THEM.

All merchandise is brand new, factory fresh & guaranteed. Mail & phone orders filled on receipt of certified check or MO of 20% of items as a deposit. Balance C.O.D., F.O.B. factory N. Y. Prices & specifications subject to change without notice. Hi-Fi Yearbook—\$7.95 (Refundable with purchase from yearbook).

AIREX RADIO CORP.

64 Cortlandt St. N.Y. 7, N.Y. CO 7-2137

The Functional Work Bench

(Continued from page 51)

power on the two outlet strips. This makes it possible to turn off the overhead light when conditions call for it, as when looking for arcing or checking for the presence of a dim raster.

Three shallow drawers provide adequate space for tools and the more commonly-used small parts and hardware items. Under the drawers is a closed storage space, while under the bench is a long shelf of many uses. Additional shelves or storage compartments can be built under here to suit the individual.

Construction

Accompanying sketches (Fig. 1) show how the side pieces, shelves, and bench top can be cut from sheets of plywood.

The bench illustrated in the sketches is 7 feet high—which, in some instances, might not fit in a shop or basement. The 4-foot, 3-inch height of the upper section of the bench can be reduced if desired or necessary. This dimension should be determined before construction begins.

While the hard-rubber top on the colorful display model puts this dressy version in the class of fine furniture, a more practical work surface is one-eighth-inch hardboard. This pressed material wears well, resists soldering iron burns, and is inexpensive. It should be cut out to fit so that it can be replaced at a future date.

The framing of the bench should be solidly put together with wood screws. Liberal use of screws in attaching the sides and back will make for maximum sturdiness. Drawers can be individually made, or can be purchased from lumber supply houses. Another alternative would be to use one of the standard metal parts and tool cabinets here. The test equipment shelf should have a metal angle brace at the center to prevent eventual sagging.

A strip of hardboard or plywood from four to six inches wide can be used as a valance to shade the overhead lighting fixture in lieu of the translucent green Fibreglas illustrated in the color picture. Inexpensive door mirrors can be purchased together with mounting hardware.

The bench can be left natural wood color by applying three coats of clear varnish, lightly sandpapering between the first two coats—or it can be painted any color that fits the surroundings. The inside of the overhead canopy and the space above the upper shelf should be painted white to reflect light. However, the underside of the upper shelf, the speaker enclosure panel, and the woodwork around the mirror should be painted black to absorb light and prevent unwanted reflection on the glass face of the picture tube in the TV set under repair.

NATIONAL COMMUNICATIONS RECEIVER

RBI-5 15-600 KC. 6 Bands. Operates from 115V. 60 Cy. Gov't. Cost \$800. Brand New **\$59.95**

COLLINS TRANSCEIVER MBF

60-80 Mc. Operates from 115V, AC-DC. 27 Tubes. Fair Cond. Use on 6 Meters. **\$19.95**

TEST SET TS-182/UP

This is a Signal Generator with calibrated freq. dial and attenuator using a 2" Cathode Ray tube as indicator. Operates from 115V. 60 Cy. 150-240 Mc. 50 lbs. Fair Cond. **\$24.95**

CAPACITOR ANALYZER & RESISTANCE BRIDGE

10 Mmfd. —100 Mfd. 1 Ohm-10 Megs. Uses eye tube & meter indicator. Operates from 115V. 60 Cy. 12x10x10. 12 lbs. Good Shape **\$22.50**

CATHODE RAY TUBE SUB-ASSEMBLY

Consists of a 2A1A, Shield, Sliding hood and calibrated scale on face of tube. Exc. **\$4.95**

ARC-5 Receiver 3-6 Mc. with autotune **\$6.95**

ARC-5 Xmters 3-4 Mc. Exc. Cond. w/tubes **\$5.95**

ARC-5 Xmters 5.3-7 Mc. Brand New **\$4.89**

1% Mirror Scale Meter 0-1 Mil. 4 1/2" sq. Roller Smith. Brand New. **\$9.95**

807W/5933—Ruggedized Version of 807. Regular Net **\$12.50**

Brand new Ind. Box. **\$1.59** Doz. **\$15.00**
Sylvania **\$1.59**

Fila. Xform. 12V. 3 A. **\$1.49**

Mod. Xform. Collins **\$1.95**

807, 6L6 **\$1.95**

5V. 13 ACT **\$1.95**

Input Xformer — Collins Shielded, ratio 75-125. 000 Ohms CT. **\$1.29** 5 for 5.00

BRAND NEW JAN TUBES

3A53 for 1.00	VR1503 for 2.00
6V62 for 1.00	12SJ72 for 1.00
6X52 for 1.00	12SL72 for 1.00
6BA63 for 2.00	9544 for 1.00
0B23 for 2.00	9554 for 1.00
2C39AEa. 10.95	9564 for 1.00
VR 1053 for 2.00	9573 for 1.00

JUST ARRIVED Subminiature Transistor Transformers Brand new types. Worth over \$3.00 each. Production Quantities. SPECIAL... **3 for \$1.00**

55B XFORMERS (QST article) **3 for \$5.00**

REX RADIO SUPPLY CO.

88 Cortlandt St., New York, N. Y.



FIX OLD RADIOS IN A JIFFY!

Fix 'em good as new... without lost time or needless testing

Often it takes more time than it's worth to fix old radios but NOT when you own this 3 1/2 pound, 744-page Ghirardi RADIO TROUBLESHOOTER'S HANDBOOK! The only service guide of its kind still in print! Gives common trouble symptoms and remedies for over 4,800 old-time receiver models made by 202 manufacturers prior to 1942—also auto radios. Even beginners can use it to repair old sets that might otherwise be thrown away because service data is lacking or because testing takes too long.

CUTS SERVICE TIME IN HALF

This famous Handbook more than pays for itself the first time you use it. Covers 85% of the things that are apt to go wrong. Shows exactly where the trouble is likely to be. Explains step by step how to fix it without lost time or useless testing.

Gives full service details on old sets made by Airline, Apex, Arvin, Atwater Kent, Belmont, Bosch, Brunswick, Clarion, Crosley, Emerson, Fada, G-E, Kolster, Majestic, Motorola, Philco, Pilot, RCA, Silvertone, Spartan, Stromberg and dozens more.

10 DAY FREE EXAMINATION

Dept. RN-47, RINEHART & CO., Inc.
232 Madison Avenue, New York 16, N. Y.

Send RADIO TROUBLESHOOTER'S HANDBOOK for 10-day examination. If I decide to keep book, I will then send \$6.95 plus postage. Otherwise, I will return book promptly and owe you nothing. (SAVE! Send \$6.95 with order and we pay postage. Same 10-day return privilege with money refunded.)

Name

Address

City, Zone, State

OUTSIDE U.S.A.—Price \$7.50 cash with order only. Money back if you return book in 10 days.

Color Test Equipment (Continued from page 47)

TV service or even from radio service. In many cases, however, the advent of color imposes more stringent requirements on these standbys.

The oscilloscope, for example, should have a vertical-amplifier bandwidth of at least 4.2 mc. and a stable horizontal sweep range of better than 30 kc. Most older scopes will lack either the stability or gain or bandwidth to be useful in the more accurate measurements required in color service work; in many cases the failure to come up to present need may be in more than one of these departments. This is worth considering if the owner of an old scope is contemplating the alteration of his instrument to modernize it. Building a separate high-gain, wide-band amplifier for direct connection to the scope deflection plates will effect considerable improvement, for example, but how much good is achieved if the sync-sweep circuits in the instrument do not exhibit stable operation at the frequencies at which it is convenient to view certain phenomena in the color circuits? It is often more economical, in the long run, to replace an obsolete instrument with one to attempt to bring it up to date.

In many ways, the performance of the oscilloscope depends on its auxiliary probes. These have also increased in number and type with the growing complexity of the equipment subject to service. At least one detector probe will be desired for use with the scope, and very likely more than one will be useful. There is a variety of low-impedance, high-impedance, half-wave, and full-wave demodulator probes of varying degrees of insertion loss to match the variety of uses for such probes. Sometimes a demodulator probe is needed to check for the presence of signal in an i.f. or r.f. circuit. A more familiar application would be to observe circuit response on the scope in conjunction with a sweep generator. Still another use for one type of detector probe is to provide low-frequency (video) sweep output for examining response in the low-frequency chroma circuits of a color receiver. This is achieved by beating a fixed frequency from a standard signal or marker generator against one of the standard r.f. or i.f. sweep bands provided by the sweep generator. The probe then detects the heterodyned band, beat down to a lower (video) range of frequencies, for application to the circuit under test.

Also useful with a scope to avoid or minimize detuning of circuits under test, or to avoid other forms of loading, is the low-capacity isolating probe. These are often made with a trimmer capacitor externally available so that the probe may be adjusted to suit the particular input characteristics of a given scope. In

FREE!
ANY
\$1 ITEM
FREE WITH
\$10 ORDER!
THIS OFFER
UNLIMITED

- 20 PRINTED CIRCUITS. Ass'd. top makers, for transistor, radio, hobby circuitry. Reg. 10. **\$1**
- 3 AC-DC CHOKES. 80 ohms. 3H-50ma. For hobby power supplies. Open frame mtg. Wt. 2 lbs. Reg. \$1 each. **\$1**
- 5 ROLLS TAPE, electrical, plastic, friction, rubber. For home, shop or lab. Reg. \$2. **\$1**
- MINI-METER BUY! 134" round, chromed. 0 to 6 amps, AC. For model railroads, power supplies, etc. mobile. Reg. \$3. **\$1**
- 60 XFMRs & COILS. IF coils, choked, 25 types. Wt. 3 lbs. Reg. \$15. **\$1**
- WORLD'S SMALLEST RADIO KIT. 2 1/2 x 1 1/4 x 3/4". Permeability tuner diode, pre-drilled case. All parts, instructions. Reg. \$3.50. **\$1**
- 8 TRANSISTOR SOCKETS, for subminiature tubes, too. Mica filled. Reg. \$3. **\$1**
- 10 FP ELECTROLYTICS. Ass'd. twist-lock units; singles, duals, triodes. Wide variety values. Wt. 2 lbs. Reg. \$12. **\$1**
- 10 TUBULAR ELECTROLYTICS. Variety of pig-tail units. Radio, TV and hobby must! Wt. 1 lb. Reg. \$8. **\$1**
- 30 DISC CAPACITORS. Most-used ceramics; standoffs, too! Ass'd. hobby values to .01 mfd; 5,000 3KV. Wt. 1/2 lb. Reg. \$6. **\$1**
- 2 TRANSISTOR LOOP-UPS. Tapped, hi-Q ferrite rod core. Best selectivity & sensitivity. Wt. 1/2 lb. Reg. \$5. **\$1**
- 2 AC HOBBY MOTORS. Scoop! 115 VAC, 60 cycles, 3,000 rpm for fans, blowers. Priced to sell! Reg. \$10. Wt. 3 lbs. **\$1**
- 2 SUB-MINI Transistor Couplers for coupling transistor circuits. Center-tapped, 100K imp, 5,000 DC ohms. 1/2 x 1/2". Reg. \$10. **\$1**
- SUN BATTERY/PHOTO CELL. 1 1/2" dia. up-mounted. Better than B2M! Reg. \$5. **\$1**
- SUB-MINI CRYSTAL MIKE. Postage stamp size. 3/4" sq. Styrene case. High imp., clear, crisp response. Reg. \$6. **\$1**
- 125 RESISTORS, 1/2 to 24; 40 values; 5 ohms to 10 meg. 5%. too! **\$1** Reg. \$15.
- 3 LBS. HARDWARE. 2000 pcs. ass'd. screws, springs, washers, etc. **\$1** Reg. \$8.
- G-E PREAMP KIT for magnetic cartridges. Chassis, parts, diagram. Less GSC7 (88 extra) Wt. 1 lb. Reg. \$4.50. **\$1**
- 175-FT. HOOKUP WIRE in 25-ft. rolls. Ass'd. colors, stranding, insulation. 2 #18 to 24. Wt. 2 lbs. Reg. \$3.75. **\$1**
- 100 CERAMIC CONDENSERS. Ass'd. types, top makers. 30 values, color-coded. Discs, too. **\$1** Reg. \$15.
- 4 CRYSTAL DIODES, popular types—IN50, IN58, IN69, IN81. **\$1** Reg. \$5.
- 5 SILICON DIODES, IN105, two IN22, IN23. Reg. \$15. **\$1**
- 60 TUBULAR CONDENSERS. 30 types, .0005 to 0.5 mfd to 1500V. Wt. 2 lbs. Reg. \$12. **\$1**
- 70 RESISTORS. Insulated IRC, A-B, etc. 5 ohms to 10 meg; 1% & 2%. 10% & 5%. too. Wt. 1/2 lb. Reg. \$10.85. **\$1**
- 70 TERMINAL STRIPS and boards, 15 types, 1 to 20 screw & solder pts. Wt. 1 lb. Reg. \$5. **\$1**
- 60 STANDARD KNOBS. Ass'd. colors, bakelite & plastic. Wt. 2 lbs. Reg. \$6. **\$1**
- 70 MICA CONDENSERS. 30 values: .0001 to .01 mfd to 1000V. Silver, 1% included. Wt. 1 lb. Reg. \$5. **\$1**
- 100 RADIO PARTS including resistors, condensers, strips, controls, forms. Wt. 2 lbs. Reg. \$1 \$6.
- 40 POPULAR BULBS, 1.1 to 6V, screw & bayonet types, miniature. Wt. 1/2 lb. Reg. \$3.20. **\$1**
- EMERSON TUNER. Hi-Q, permeability tuned ANT & OSC coils, w/paddlers, on 2x4" plate; w/variable tuning mech. 340 to 1000 kc. Reg. \$5. **\$1**

APRIL SHOWER of BUCK BARGAINS!

FAMOUS **KIT KING** DOLLAR BUYS
ONE DOLLAR EACH!

FREE!
NEW SPRING
FLYER!

Hundreds of Bargains!
Subminiature • Audio
Transistor • Solar
Household • Tools
Photo Eqpt. • Motors
Parts • Optics

- 40 MINIATURE CONDENSERS. Ass'd. miniature, subminiature, printed circuit types: Centralab, Sprague. **\$1**
- 40 MINIATURE RESISTORS in poly box, 1/4" long. 20 values: 15 ohms to 10 meg, 1/5w. **\$1** Reg. \$5.
- 40 MOLDED CONDENSERS. 0001 to 0.1 mfd up 1000V. Brown, black, ceramic case. Wt. 1 lb. Reg. \$8. **\$1**
- 30 POWER RESISTORS. WW, candohm, sand-coated vitreous. 15 values, 5 to 500 Ohm to 1000 ohms. Wt. 2 lbs. Reg. \$1 \$8.
- TORS. WW & carbonfilm, 30 PRECISION RESISTORS. 20 values. 56 ohms to 1 meg; 1/2, 1 & 2w. 10% Reg. \$21. **\$1**
- 35 TUBE SOCKETS. 4 14 prong, Transistor, printed circuit, 7 & 9 octals. Ceramic & mica, too. Wt. 1 lb. Reg. \$8. **\$1**
- 15 PRINTED CIRCUIT SOCKETS. Cinch mica-filled. 7-pin mini tubes. Etched circuits, too. Wt. 1/2 lb. Reg. \$10. **\$1**
- 15 TRIMMERS, ass'd. values, mini types included. All ceramic; some w/shafts. Reg. \$10. **\$1** Wt. 1 lb.
- 15 VOLUME CONTROLS. Singles, concentric, TV, some w/switch. Std. shafts. Up to 1 meg. Some \$1 \$2.50 each.
- 15 ROTARY SWITCHES, ceramic & bakelite; 1, 2, 3, 4, 5, 6, 8, 10, 12, 24. Shop must! Wt. 3 lbs. Reg. \$10. **\$1**
- 20 AC/DC LINE CORDS for clocks, motors, etc. 2-cond. w/ molded plugs. Wt. 1 lb. Reg. \$5. **\$1**
- 10 "RUL" BOXES. Ass'd. sizes, clear plastic hinged boxes w/snap locks. Reg. \$2.50. **\$1**
- 8-PC. NUTDRIVER SET. Plastic handle, 3/16, 7/32, 1/4, 5/16, 11/32, 3/8, 7/16" steel socket wrenches in plastic case. Wt. 1 lb. **\$1** \$3 value.
- 15-PC. TWIST DRILL SET, 1/16 thru 1/4" by 64ths. in graduated plastic holders. Reg. \$4. **\$1**
- 15 PANEL SWITCHES. Scoop! Push, toggle, micro, thermal, power. Wt. 2 lbs. Worth \$17. **\$1**
- SUPER SOLAR BATTERY. High output Sun Battery NEVER WEARS OUT! 2 1/2 x 1 3/4 x 1 1/2" molded case w/plastic window, banana plugs. For all sun-powered gadgets. In leather case. Reg. \$10. **\$2.98**
- WORLD'S SMALLEST SPEAKER. For transistor radios. 1 1/2" sq. 1 ohm V.C. magnet. 3.2 or 10 ohm V.C. available. Reg. \$5. **\$1.99**
- SUPER-POWER DYNAMIC PHONE. Hearing-aid type, 8,000 ohms, worth \$10! Sensitive, Hi-Fi Super-powered; makes weak sigs loud. Alnico magnets. **\$3.99**
- D-60 MIN. PHOTO TIMER. "Minute Mixer" by Rhodes. Less dial & hardware. Built-in 15A microswitch, controls appliances, too! Wt. 2 lbs. Reg. \$6. **\$1**
- R/C CONTROL SCOOP! Chassis includes 15 to 63-1.5A fit 3,000 ohm mini control relay, resistors, cond., pot, socket, etc. Wt. 2 lbs. Reg. \$1 \$2.
- 4 HOBBY TIMERS. 3-second limit. Multi-gear, handwood. Wt. 1 lb. Reg. \$12. **\$1**
- 3 P-P OUTPUT XFMRs. Match push-pull 50B5, 50L6, 6X4, 6X5 to 3-4 ohms. Open frame. Wt. 2 lbs. Reg. \$8. **\$1**
- 200 MILA, 60 OHMS, 2H. Open frame. Wt. 3 lbs. **\$1** Reg. \$9.
- 50 PLUGS & RECEPTORS. CLES. Fine ass't. of pop, chassis, panel, speaker, power plugs & receptacles, connectors. Wt. 2 lbs. Reg. \$8. **\$1**
- 15,000-OHM MINI RECEPTOR. DPDT cont. for plate & control circuits. Wt. 1/4 lb. Reg. \$5.50. **\$1**
- 4 PRY CIRCUIT RECEPTORS. 1/2-wave, herm. sealed. 7/8 x 3/4" w/axial leads. For transistor circuitry, too. Reg. \$1 \$5.50. **\$1**
- 2 ASTATIC XFMRs. 600-15 ohm Pri. to hi-imp. grid. Herm. sealed. Wt. 5 lbs. Worth \$1 \$1.
- VEEDER-ROOT COUNTER. 000 to 999, reset type. For all counting jobs. Motor, coils, recorder. Reg. \$6. **\$1**
- 10 PRTD CIRCUIT PARTS. Hobby must! Incl. "dime-size" 10K pot, switch, xfmr, rectifier socket & resistors. Reg. \$1 \$8.
- 2 Transistor "OUNCER" XFMRs. Interstage, 1 x 3/4 x 3/4". Wt. 1 oz. Impedance ratios unknown. 5 color-coded leads. Reg. \$1 \$8.
- 100 COIL FORMS. Wide variety sizes, insulation. Wt. 1 lb. Reg. \$10. **\$1**
- 6 JEWELER'S SCREWDRIVERS. A must for transistor ultra-mini hobby work! Swivel top, chromed brass construction. Reg. \$1 \$3.50. **\$1**



**3-TUBE
POCKET/
PERSONAL
SUPERHET
RADIO**
ONLY \$12.99

- Attractive 5 1/2 x 3 1/2 x 1 1/2" ebony/ivory case. Real big set performance! w/built-in hearing-aid phone and directional antenna. NO EXTERNAL CONNECTIONS. Plays anywhere. Vol. & tuning controls. A sensitive, selective, factory-built unit sold elsewhere from \$20 to \$28.
- Batteries, \$2 extra.



**SOLAR/CELL
TRANSISTOR
RADIO KIT**

- A "Kit King" kit. Dual-powered, pocket size! Sensitive, ample volume. Sun Battery for daytime or electric light; Mercury Cell for night-outlasts regular batteries 3 times! MINUTES TO COMPLETE. ALL PARTS MOUNTED! Pre-drilled styrene cabinet, step-by-step instructions, hi-gain transistor, diode, inter-loopstick permeability tuner, posts, jacks, wire, hardware. Wt. 3 oz. **\$5.88**

**HOW
TO
ORDER**

Check items wanted. Return entire ad w/check or money order, including sufficient postage; excess returned. C.O.D. orders, 25% down. Rated, net 30 days. Print name, address and amount of money enclosed in margin.

LEKTRON SPECIALTIES

131-133 Everett Ave. Chelsea 50, Mass.

SCHEMATICS—CONVERSIONS FOR SURPLUS GEAR

NEW LIST DI MANY ADDITIONS!
Send stamped, self addressed envelope for List D. Add 25¢ for chart explaining AN nomenclature. DO IT TODAY!
**R. E. BOX 1220
GOODHEART BEVERLY HILLS, CAL.**

**SENDING
CODE
RECEIVING
SPEED**

Be a "key" man. Learn how to send and receive messages in International Morse code. Communicate with operators around the globe. Learn at home quickly through famous Candler System. Used by best operators. Qualify for Amateur or Commercial License. Write for FREE BOOK. **CANDLER SYSTEM CO.**
Dept. 2-D, Box 928, Denver 1, Colo., U.S.A.

ENGINEERING

Prepare for **B.S. DEGREE in 27 MONTHS**

unlimited opportunities of the Electronic Age! Earn your B.S. degree in 27 months at Indiana Technical College. Intensive, specialized course. Comprehensive training in electronics, television, advanced radio theory and design, math and electrical engineering. Modern laboratories. Low rate. **B.S. DEGREE IN 27 MONTHS** in Aero., Chem., Civil, Elec., and Mech. Engineering; in 36 MO. in Math., Chem., Physics. Also preparatory courses. G. I. appr. Enter June, Sept., Dec., March. Earn part of your expenses in Ford Wayne while studying. Catalog.

INDIANA TECHNICAL COLLEGE
947 E. Washington Blvd., Fort Wayne 2, Indiana
Please send me free information on B.S. ENGINEERING DEGREE IN 27 MONTHS as checked.
 Electronics Chemical Aeronautical
 Civil Mechanical Electrical
Name _____
Address _____

**BUILD THE BEST—
BUILD ALLIED'S OWN
knight-
kits**

Here is a typical Knight-Kit value—available only from ALLIED—one of 45 great Knight-Kits you'll find in our special Supplement No. 165. Write for your FREE copy today.



knight-kit HI-FI VALUE
25-WATT LINEAR-DELUXE AMPLIFIER KIT

Model Y-755
\$44.50

Luxury quality at modest cost! Williamson-type circuit delivers 25 watts of virtually flawless response. Can be used with any tuner or preamp with a full set of controls (for volume, tone and equalization). Printed circuit wiring board for simplified assembly; balance control for precise matching of output tubes; variable damping control. Response: ± 0.5 db, 10-120,000 cps at 20 watts. Harmonic Distortion: 0.15% at 30 watts. Intermodulation: 0.4% at 20 watts. Output Impedances: 4, 8 and 16 ohms. 6 $\frac{1}{4}$ x 14 x 9" deep. Chrome-plated chassis. With all parts, tubes and easy-to-follow instructions. Shpg. wt., 25 lbs.

Model Y-755. Net, F.O.B. Chicago\$44.50
Y-759. Metal top cover for above.....\$4.25

OTHER knight-kit HI-FI VALUES



FM HI-FI TUNER KIT
Model Y-751
\$37.75



10-WATT HI-FI
AMPLIFIER KIT
Y-753 **\$23.50**



20-WATT HI-FI
AMPLIFIER KIT
Y-750 **\$35.75**

See our Supplement No. 165 for other knight-kit Hi-Fi values

free SUPPLEMENT
featuring knight-kits



Send for our FREE Supplement No. 165 featuring 45 great Knight-Kits, including Test Instruments, Hi-Fi, Hobbyist and Amateur Kits. Write for your copy today.

**ORDER FROM
ALLIED RADIO**

Dept. 01-D7, 100 N. Western Ave., Chicago 80, Ill.

some cases, the probe may be peaked so that its bandpass characteristic complements that of a scope whose response is limited. The improvement that can be obtained in this way, however, is also limited. The isolating probe, which reduces input signal by a factor of 10 or 15, can also be used as an attenuator probe.

The v.t.v.m. that has been used successfully in monochrome service is equally acceptable for color work. The high-voltage probe used in conjunction with it, however, must be capable of measuring the higher order of second-anode voltages found in color receivers. A probe that extends the meter's range to 20 kv., quite adequate for most black-and-white receivers, is out of date for color sets that use 25 kv. or more of ultor voltage.

Other items of test equipment can have their utility extended into color with minor additions. In the case of sweep and marker generators, as essential for color as for black and white, the color subcarrier i.f. must now be shown too. Many late types of crystal-controlled marker units include 3.579-mc. crystals; the addition of this accessory crystal is all that is necessary in the case of most good older generators. The extension of the low-frequency range of the sweep generator by means of the probe and by heterodyning with a fixed-frequency generator has already been noted. This lowered sweep range is useful in checking and aligning bandpass in the chroma stages.

After we have finished with the core of instruments generally conceded to be indispensable, a number of instruments appear in our typical set-up that are likely to evoke some controversy over their value and inclusion. It is equally likely that many a technician will note the absence of a favored, specialized piece of gear in this assembly that he personally considers to be outstandingly useful. The differences in the type of equipment usually serviced or the individual troubleshooting techniques will account for most of this latitude. Other variations will occur because some types of equipment, particularly the more specialized ones, are relatively new and only just beginning to win popularity. In any case, justification for some of the items shown is offered.

Capacitor checkers, especially of the in-circuit variety, are winning increased acceptance because of the time they save. The electronic switch, which can display two traces from different circuits at the same time in conjunction with a conventional oscilloscope, is useful in localizing malfunction to one of the many stages that exist in today's complex equipment. It can do this because it can simultaneously show the input and output signals for a single stage or circuit at the same time. Trouble is often indicated by changes that have occurred in the output.

A conveniently adjustable bias sup-

SAVE 1/2 — PAY PART-BY-PART — HAVE FUN
Assembling the Schober

**ELECTRONIC
ORGAN** in KIT form



**NO SPECIAL
SKILLS
NEEDED**

Now you can afford a real, full concert organ, just like those made by the foremost organ manufacturers. Because over 1/2 the cost is saved when you assemble it yourself. And it's REALLY EASY: only 24 separate units, all with printed circuits, and detailed-to-the-smallest-step instructions. In addition, you purchase each of the 24 kits when you are ready for it — and can afford it.

You'll get a real kick out of putting the "Schober Electronic Organ together — and then sitting down and pulling out the stops for Strings, Trumpets, Clarinets, Diapasons, Flutes, etc.

Compact CONSOLE

One of the many exclusive features of this exceptional offer is the handsome console, made by hand in Old World Craftsman manner. It is equally at home in a traditional or modern setting, and takes little more space than a spinet piano.

Free Literature

Complete descriptive booklet and price list are available on request. And, if you wish to hear the glorious pipe organ tone of the Schober Electronic Organ, a 10" long playing recording by Dr. C. A. J. Parmentier, renowned organist, is available for \$2. This is refundable when you order. Write today and see what a fine instrument you can get at such a great saving.

The SCHOBER ORGAN CORPORATION

2248-N Broadway, New York 24, N. Y.
* Designed by Richard H. Dorf.

ELECTRIC BRAIN KIT

Can you think faster than this machine?



Control Panel of GENIAC set up to do a problem in check valve research.

Be careful before you answer. GENIAC the first electrical brain construction kit is equipped to play tic-tac-toe, cipher and encipher codes, convert from binary to decimal, reason (in syllogisms) as well as add, subtract, multiply and divide. Specific problems in a variety of fields—actuarial, policy claim settlement, physics, etc., can be set up and solved with the components. Connections are solderless and are completely explained with templates in the manual. This covers 33 circuits and shows how new ones can be designed.

You will find building and using GENIACs a wonderful experience: one kit user wrote us: "this kit has opened up a new world of thinking to me." You actually see how computing, problem solving, and game play (Tic-tac-toe, nim, etc.) can be analyzed with Boolean Algebra and the algebraic solutions transformed directly into circuit diagrams. You create from over 400 specially designed and manufactured components a machine that solves problems faster than you can express them.

Schools and colleges, teachers of science or math, engineering, philosophy or psychology will find these excellent demonstrators of circuitry, solutions in symbolic logic, theory of numbers, cybernetics, and automation.

SEND for your GENIAC kit now. Only \$19.95 with over four hundred components and parts. Fully illustrated manual and wiring diagrams. We guarantee that if you do not want to keep GENIAC after one week you can return it for full refund plus shipping costs. Add \$1 west of the Miss. \$21.95 outside U.S.A.

Dept. RT-47, Oliver Gorfield Co.
126 Lexington Ave., N. Y. 16, N. Y.

RADIO & TV NEWS

ply with a good range of voltage becomes increasingly useful, as the service and alignment instructions by most manufacturers of color receivers call for fixed, externally supplied negative voltage of various values to be applied to the bandpass amplifier and other chroma stages during alignment and checking.

A variable-voltage transformer (or some other variable-voltage source) is convenient for checking critical operation of a receiver under low line-voltage conditions, in simulation of a condition in the set owner's home. Somewhat higher-than-normal line voltages may be applied to hasten the breakdown of intermittent components. With the increase in manufacture of receivers that do not use power transformers, and in which parts of the chassis may therefore be at ground potential, an isolation transformer is a wiser precaution than ever. On the bench shown, the isolation transformer and variable-voltage source have been combined in one instrument.

Although there will always be argument as to its merit, the tube tester continues to be a popular item. The individual's approach to service techniques will decide whether a tube tester fits into the picture and, if so, which of the available types is called for.

The presence of a calibration unit on the bench may elicit some question. However, the bench must be assured of some safeguards against errors in frequency settings, voltage readings, and the like, for certain critical circuits and applications, and inclusion of this instrument dramatizes that need. Depending on the other equipment available, the separate calibrator may not be needed. Where crystal-controlled accuracy is obtainable for important frequencies without the calibrator, and where reliable standard voltages and resistances are available for setting and checking other instruments accurately, a separate unit can be eliminated.

The appearance of both the v.t.v.m. and the v.o.m. on a single bench is common enough not to arouse a great deal of conflict these days. The latter will be called upon for its facility for measuring current and general ease of use; the former will permit measurement of low-voltage, high-impedance circuits, such as in a.g.c. lines, with less circuit loading and greater accuracy. Often both will be used at the same time, as when various parts of a set are being monitored simultaneously to track down an intermittent.

Conclusion

The complex nature of color TV requires increasingly elaborate test equipment. However, the higher repair prices this calls for are also warranted by the greater entertainment value and initial cost of these sets. Both customer and dealer must recognize this fact. The prices the latter is now entitled to, as well as greater

SCR-522 VHF Transceiver—100-156 Mc. 4 channels, crystal controlled, complete with tubes New \$39.50 Used \$29.50

AN/APR5A—Airborne superhet radar search rec. Freq. range 1000 to 6100 MC. Rec has a 10 MC IF band width operating from 90/115V AC, single phase 60 to 2600 cps, and one amp. at 26V DC—complete with tubes. \$149.50

COMMAND ARG-5 TRANSMITTER
T-20... 4 to 5.3 MC New
T-21... 5.3 to 7 MC \$595
Used \$3.95
T-23 100-156 MC
New \$13.95
Used 9.95
3 to 4 mc. like new \$5.95

RCA MOBILE RECEIVER
30-41 mc. AM. \$14.95 each.
DYNAMOTOR FOR ABOVE
6V DC Input-250 V DC Output. \$6.95 each.
RCA MOBILE TRANSMITTER
30-41 mc. AM Crystal Controlled. \$14.95 each.
DYNAMOTOR FOR ABOVE
6V DC Input-375 Volts 250 ma Output. \$9.95 each.

FM WOBULATOR CAPACITOR
Frequency modulation unit with a permanent magnetic field and a moving coil mechanism driving a metal diaphragm supported at the rim. This diaphragm sets as a moving plate of the frequency modulator capacitor. W/instructions. Build TV sweep sig. gen. BRAND NEW. \$2.75
2 for only \$4.95

Sweet Oscilloscope Deals
INDICATOR UNIT. For conversion to test scope, panadapter, analyzer, etc. Double deck chassis. 5CP1 mounted in tube shield. Less small tubes and crystal, but complete with 3CP1. 0.95 Exc. Cond. each \$9.95
ASB-7 Radar Indicator Unit: For conversion to test scope or for use as modulation monitor. Has standard test-scope CR tube, H Cent, V Cent, Brill. Foc. Gain, and range selection switch. External power source was used. Tubes: 4-6AC7, 3-6H6, Less 1-5BP1. New \$9.95

BC929 RADAR, \$9.95
BC-929 A Radar Indicator Scope. This unit could be rebuilt into a fine test scope. It is an ideal size, 8x9x14 priced with tubes 2-6SN7, 2-6H6, 6C6, 6X3 and 2X2. This is a red hot buy. Scope Price. New w/schematic and Conversion \$9.95

LORAN APN-4 FINE QUALITY NAVIGATIONAL EQUIPMENT
Determine exact geographic position of your boat or plane! Complete, BRAND NEW installation consists of: 1D-6B/APN-4 Indicator; R-9B/APN-4 Receiver; PE-206 Inverter; Set of Plugs; Visor for Indicator; Operation manual; \$129.50
Brand New, Export packed \$129.50
ID6B INDICATOR, R9B RECEIVER, \$69.50
Excellent. \$69.50

UHF TRANSCEIVER, APG-5
2500 Mc complete with 2C43, 2C40, 3E29, 1B27, VR105, 5Y2, 6AL5, 2 each \$39.50
2X2 and 8 each 6AK5. \$39.50

PE109 INVERTER
12VDC input, 115 VAC, 1 1/2 amp, single phase, 400 cycle output. \$34.50
Brand New \$34.50
Exc. used \$27.50

WRITE FOR NEW BULLETIN ALL ITEMS F.O.B. CHICAGO
25% Deposit required with orders
R W ELECTRONICS
2430 S. Michigan Ave., Chicago 16, Ill.
Dept. N, PHONE: CA lumb 5-1281-2-3

\$45.00 Hi-Fi Headset

Uses annular grooved plastic fibre cones with voice coils as in speakers, and chamois ear pads to obtain spacing for correct acoustical load. GIVES FINEST MUSIC REPRODUCTIONS! Imp.: 300 Ohms per unit or 600 Ohms when wire series.

USED. EXC. COND. \$4.95
WITH BRAND NEW CHAMOIS \$6.19
CUSHIONS

APG 5 or 15 CAVITY
10 Cm. 2C43 osc Xmitter, 2C40 Loc. Osc. Rec. 1B27 TR; tubes 2400 to 3000 MCS, less tubes. Price \$4.95

Radio Receiver 11-tube UHF tunable 234-258 MC receiver with schematic. Complete with tubes. 3 ea. of 6AK5, 7 ea. of 9001, 1 ea. of 12A6, Like new \$6.95
Less Tubes \$2.95

SCOPE TUBES

3BP1
3CP1
3EP1
3HP1
5AP1
5CP1
\$1.95 ea. 4 for \$7.00

DYNAMOTORS

Type	Input	Output	Excellent	New
BD-77	12 VDC	1000 VDC	350 MA	\$14.95
BD-83	12 VDC	375-150 MA		1.95
DM-37	24 VDC	625 VDC	225 MA	2.95
DM-34	12 VDC	220 V	80 MA	2.95 4.95
DM-65	12 VDC	440 VDC	400 MA	14.95 19.95
DA-1A	24 VDC	230 VDC	100 MA	4.95
DM-28	24 VDC	230 VDC	100 MA	4.95
DM-32A2	12 VDC	250 VDC	60 MA	4.95

MOBILE HEAVY DUTY DYNAMOTOR: 14 V. INPUT-output: 1030 VDC 250 MA. Tapped 516 V. 215 MA. use or 6 V DC INPUT-500 V. 175 MA. While they last—DM-42-Excel. Condition. \$6.95
Brand New. \$9.95

MG-149F Inverter. 24 VDC input, 115AC, 400 cycles, 500 VA single phase. \$15.95
Exc. \$15.95
Used \$9.95
RS-38 Navy Carbon Hand Mike. \$2.45 ea.
Exc. \$2.45 ea.
I-96A Signal Generator 100-156 Mc, complete w/cords and cables, like \$69.50
new \$69.50
RAX Navy Aircraft Receiver 200-1500 Kc. Used exc. \$17.95

MN-26-C—Remote Control Navigational Direction finder and communication receiver. Manual DF in any one of three freq. bands, 150 to 1500 KC. 215. Self contained dynamotor supply. Complete installation, including receiver, control box, loop, azimuth control, Left-Right Indicator, plug, loop transmission line and flex. shafts, oper. & main. manual. Ideal for use in boats, etc.
BRAND NEW \$39.50
MN-20-E Loop. 4.95
MN-52-CRANK Drive. New 2.50
MN-28-C New 4.95
MN-26-C Revr., New 19.95
MN-40-E Azimuth Indicator, New 9.95
DYNAMOTORS for above, 12VDC, MN-26 9.95

METER—3"-0.5 Ma. 270° Indication—By Pass Shunt and add scale. Excellent Condition. \$1.25
Five for \$5.00

NAVY RANGE BEAM FILTER
Chop off QRM by turning knob to pass only 1,020 cycles with enough width for code, or speech, rejects all else; with phone plug and jack.
BRAND NEW \$1.69
Used \$1.29

CHAMOIS CUSHIONS
Ear cushions for HS type headphones.
BRAND NEW—PER PAIR \$1.19

TAPE RECORDERS

Tapes—Accessories
Nationally Advertised Brands
UNUSUAL VALUES
Send for Free Catalog
DRESSNER
69-02 RA-174 St.
Flushing 65, N. Y.

MERITAPE
Low Cost, High Quality Recording Tapes—in boxes or cans.

RESISTORS—NON INDUCTIVE AT VHF 50 OHM CARBON
10 WATT 4 for \$1.00 p.p.
5 WATT 10 for \$1.00 p.p.
5 Watt are Ceramic Insulated
Ideal for series-parallel combinations for Dummy Loads, R. F. Watt meters, etc.
Write for quantity prices.
VACRI CO., Connersville, Ind.

Top Pay Jobs in TV-ELECTRONICS-RADIO

High pay, opportunity, prestige, security... all yours, as a qualified Electronics Technician! Get your training NOW in the big, recognized shops, Labs, and TV-Radio Studios at National Schools in Los Angeles, foremost since 1905. Here you work with latest Electronics equipment—professionally installed—finest, most complete facilities offered by any school. Expert, friendly instructors. Personal attention. Graduate Employment Service. Help in finding home near school. Part time job while you learn. Mail coupon NOW, TODAY... for full information.

NATIONAL SCHOOLS
National Schools Dept. RXH-47
4000 So. Figueroa Los Angeles 37, Calif.
Send Free Electronics Opportunity Book Today

Name _____ Age _____
Address _____
City _____ State _____

Low-Cost Power Transistors

FOR EXPERIMENTERS AND RADIO AMATEURS

Now you can build a variety of economical transistorized amplifiers capable of real power output . . . 10 watts in Class B push-pull. The CBS 2N255 and 2N256 feature high power coupled with high current amplification and their construction permits high heat dissipation. These alloy-junction germanium transistors are also designed for six-volt (2N255) and twelve-volt (2N256) battery operation . . . ideal for mobile use.



2N255 . . . \$2.90 net

2N256 . . . \$3.35 net

It's easy to put these transistors to work. CBS Power Transistor Applications, PA-16, gives complete data . . . operating notes . . . and six simplified power transistor circuits. Pick up this free booklet . . . and get your low-cost 2N255 and 2N256 transistors at your CBS Tube distributor's — today.

Reliable products through
Advanced-Engineering



semiconductors

CBS-HYTRON
Semiconductor Operations, Lowell, Mass.
A Division of
Columbia Broadcasting System, Inc.

work efficiency made possible by additional equipment, are factors to be taken seriously.

Consider some possibilities with the array of Fig. 3: One color set can be completely aligned with sweep and marker generators and scope, while another is checked for color convergence and correct adjustment of chroma circuitry, through its display of the output from the color-bar generator. The variable-voltage source can be operating another receiver at high line voltage to expose an intermittent condition, while this other work is being done.

Perhaps the advantages of having proper equipment can best be understood by technicians who have, at one time or another, had to do with make-shifts. The increasing sale of test instruments is proof that most service technicians realize that they are no better than their tools permit. —30—

PICKUP FOR "ELECTRO-TACH"

By HARRY B. CORDES

SOME time after the appearance of "The Electro-Tach" in the November, 1956 issue of this magazine, the author started experimenting with various configurations of pickup devices which would simplify installation and improve performance. As a result, a new pickup which eliminates the necessity for elaborate shielding and sparkplug wires has been developed and, in addition, provides signal level control which can be adjusted for optimum performance. The circuit reduces troubles due to spurious pickup from other plugs (kickups on the meter) and skipping of weak signals (kickdowns on the meter).

Essentially, this pickup is an RC circuit which couples the sparkplug voltage pulse into the thyatron circuit at a greatly attenuated level. The coupling capacitors are 100 $\mu\text{fd.}$, 7500 volt Sprague disc capacitors (#75CA-T1). The signal level control is a 1000 or 2500 ohm pot. The input wire to the RC circuit is sparkplug cable covered with shielding braid to within one or two inches of the sparkplug terminal.

The RC circuit is mounted in a metal can and located under the hood. Care should be taken to mount the capacitors, especially the first two units at the left of the circuit diagram, so that the bare leads and capacitor bodies are at least $\frac{1}{2}$ inch from the nearest grounded metal part. A generous coating of Krylon will be helpful.

The signal level control is adjusted with the engine idling. Gradually increase the resistance of the pot until spurious kickups are noted on the meter. Then decrease the resistance to just below this point.

This pickup modification in no way changes the remainder of the tachometer circuit, as originally described. —30—

Modification of original pickup circuit.

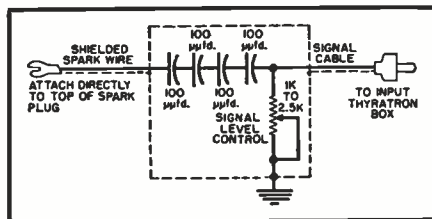

ONE DOLLAR BUYS

As much as \$15 worth—Everything Brand New and sold to you with a money back guarantee.
100 — ASSORTED $\frac{1}{2}$ WATT RESISTORS . . . \$1
70 — ASSORTED 1 WATT RESISTORS . . . \$1
35 — ASSORTED 2 WATT RESISTORS . . . \$1
1 — BEST 4" PM SPK. 1 oz. alnico ± 5 magnet . . . \$1
100' — TWIN LEAD-IN WR. 300 Ω , heavy duty . . . \$1
50 — ASST. TUBULAR CONDENSERS 85 $^\circ$. . . \$1

ONE THOUSAND AMAZING

VALUES—HUNDREDS MORE
"DOLLAR BUYS" IN OUR NEW
COMPLETE CATALOGUE—FREE

CAPITAL ELECTRONICS

218 FULTON ST., N. Y. 7, N. Y. CO-7-7842

More Guaranteed New Unused Surplus

Not specially coded salvage but standard first grade catalog items, Isolantite standoff lugs, inverted mounting hermetically sealed cans also means fully shielded!

Audio input trans, 500 ohm or carbon mike to 10,000 ohm or single grid. Fine for that mobile merit part # A5245 . . . $1\frac{1}{2} \times 1\frac{1}{2} \times 1\frac{1}{4}$. . . 1.40
Modulation trans, 100 watt cc. 21,000 prim. CT to 9,000 ohm sec. 3500 WV ins. 15 lbs. net. Merit part # A5247 . . . $4 \times 4 \frac{1}{2} \times 7$. . . 14.95
Filament trans 5 volt 10 amp. 6300 WV ins $7\frac{1}{2}$ lbs. Merit part # P5291A 4.95
Power Resistors 225 watt. About 12 in long x $1\frac{1}{2}$ diam. 3500, 3600, 10000, 80000, and 150,000 high temp 95
Power Rheostats—750 ohm 0.45 amps Ohmite, new 3.25 Limited Quantities

Check with Order and I Will Pay the Freight in USA!

ELECTRIC CITY RADIO SUPPLY
522 So. Washington Ave. Scranton 5, Pa.

We pay MOST the FASTEST for:

AIRCRAFT ELECTRONICS | **INSTRUMENTS**
Transmitters Receivers Air Speeds
ADF Altimeters Altimeters
Indicators Antennas Compasses
Dynamometers Inverters Gyros
NATCO AVIATION ELECTRONICS
3012-B West Burbank Blvd. Burbank, Calif.

WE DON'T NEED ENGINEERS

. . . but they write to us daily to order our **GENIAC Electric Brain Construction Kits**. So do TEACHERS, SCIENTIFIC AMATEURS INDUSTRIAL FIRMS and schools. (See list below.) THOUSANDS OF SATISFIED CUSTOMERS have bought GENIACS on a 7 DAY REFUND guarantee. We are proud to offer our 1957 Model, with up to the minute improvements for the thousands of new customers who can use them.



WHAT IS A GENIAC?

Here is a picture of the 1957 Model GENIAC in the display rack (\$3.00 separately) which comes with every kit. GENIAC stands for Genius Semi-Automatic Computer. A kit of specially designed switch deck and racks which permit the user to construct more than thirty different machines (following directions and wiring diagrams) and as many more as he is able to design himself. These machines demonstrate the applications of electric circuitry.

APPLICATIONS OF GENIAC

SIMPLE COMPUTER CIRCUITS for binary, decimal adding, subtracting, dividing, multiplying machines. PROBLEMS in symbolic logic, reasoning, comparing. PSYCHOLOGICAL TESTING and EXPERIMENT GAME PLAYING CIRCUITS for tit-tat-toe and nim. ACTUARIAL SYSTEMS.

SOME OF OUR CUSTOMERS

Allis-Chalmers • Remington-Rand International Business Machines • Manuel Missionary College • Barnard College • Westinghouse Electric • Phillips Laboratories • General Insurance Co. of America • Lafayette Radio • Rohr Aircraft Co. • Albert Einstein Medical College • Naval Research Laboratories • Board of Education, Tecumseh, Nebraska • Los Angeles Public Schools • Jefferson Union High School • Oklahoma A & M • Courland Jr. High School • Bell Telephone Laboratories.

WHAT COMES WITH THE KIT?

BOOKS—1. SIMPLE ELECTRIC BRAINS, AND HOW TO MAKE THEM. 64 page experiment manual.—NEW! 2. MINDS AND MACHINES . . . 200 page text on computers, automation and cybernetics.—NEW! 3. WIRING DIAGRAMS for basic GENIAC circuits.—NEW! 4. Beginners Manual for the person who has little or no familiarity with electric circuits.—NEW! 5. GENIAC study guide . . . the equivalent of a full course in computer fundamentals. Lists additional readings. PARTS—PANELS, DISCS, RACK (for easy assembly and display), Hardware, wire, tools, battery, holder etc. for more than thirty machines. SEND FOR YOUR GENIAC now. At only \$19.95, a bargain, comes complete with over 400 parts and components, 5 books and manuals. We guarantee that if you do not want to keep GENIAC after one week you can return it for full refund.

Add 80¢ west of Miss. \$2 outside U. S. Mail Name and Address with check or Money Order to
OLIVER GARFIELD CO. Dept. RT47A
126 LEXINGTON AVE. NEW YORK 16, N. Y.

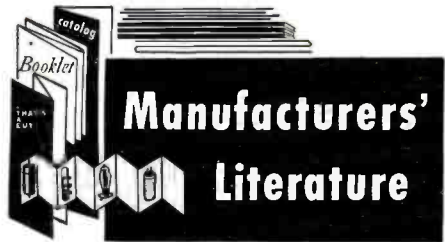

Manufacturers' Literature

B-A 1957 CATALOGUE

Burstein-Applebee Company, 1012-14 McGee St., Kansas City 6, Mo., is now offering copies of its new 1957 catalogue of radio, electronic, and TV equipment.

The 172-page publication lists hundreds of new items for the first time. The catalogue will be forwarded without charge on request.

NEW NAM BOOKLET

The Education Department of the National Association of Manufacturers, 2 E. 48th St., New York 17, N. Y., has issued a new booklet which stresses the key role of the skilled craftsman as the "anchor man" on industry's technological team.

Entitled "Your Opportunities in Industry as a Skilled Craftsman," the pocket-sized 32-page booklet covers the scope, content, and importance of apprentice training and cites the immediate values of vocational-industrial and industrial arts training in helping a youngster get a head start on skill development.

The illustrated booklet covers six vital craft specialties in detail, including that of maintenance electrician. Opportunities open to the skilled craftsman in metal working, electronics, automation, and atomic energy are related. The second book in this series, entitled "Your Opportunities in Industry as a Technician," will be off the press soon.

Both books, which have been published expressly for junior and senior high school students, guidance counselors, and libraries, may be obtained by writing the NAM direct.

BENDIX COMPUTER BULLETIN

A six-page illustrated bulletin describing its Model G-15D general purpose digital computer and its digital differential analyzer accessory is now available from the Bendix Computer Division, 5630 Arbor Vitae St., Los Angeles 45, Cal.

New programming techniques and a complete new line of input and output equipment are also described in this publication. Write the manufacturer for a copy.

"BUILDING BLOCKS"

Servo Corporation of America, New Hyde Park, N. Y., has issued a new 4-page "pop-up" folder showing a complete system-simulating laboratory designed around the company's "Servo-mation Building Blocks." These "building blocks" cut project time and costs, reduce testing and debugging time, and enable engineers to under-

MARINE RADIOMEN

• • • BRAND NEW IMPEDANCE BRIDGE designed not only to measure reactance and resistance of components, but also to measure antenna resistance and reactance at marine frequencies. Range is 25 to 5 mc. Complete with accessory box of plug-in standards and educational instruction book with a special section devoted to marine antenna measurements. No power is required for the bridge. Carry it anywhere you carry your signal generator. This is what you have always needed to load and trim antennas to get all the power of your customers' transmitters into the air. Here is accurate laboratory equipment, made for the U. S. Navy to duplicate a commercial bridge presently being sold for \$590.00! Please order by our Cat. No. 123-611BRIRN. Shpg. wt. 60 lbs. Only **\$125.00**

AHOY, THAR! The following Marine Bargains are described more fully in our new Marine-Radio Bargain Bulletin. Send for it! It's free!

- 1) MARINE RADIOTELEPHONES: Three types starting at \$279.50. Sharpest buys. The hand of the sea!
 - 2) LORAN INSTALLATION: Complete, brand new. 24/32 V. **\$129.00**
 - 3) 12 V. BENDIX REMOTE READING COMPASS: Complete, new, with book and cables. Puts your binnacle on a little corner of the desk in your cabin; with automatic compensation for azimuth and heeling errors! All for only **\$49.50**
 - 4) EXTREMELY CLEVER SCIENTIFIC LIFE BOAT OR LIFE RAFT DEVICE that could save your life! **\$4.95**
 - 5) RADIO DIRECTION FINDER: Without front-or-back ambiguity. Brand new. **\$27.50**
- Many other Receivers and Direction finders at similar fabulously low prices. Example: 6-tube Superhet Receiver. 195 kc-9.05 mc, continuous, excellent condition, with tubes, Only **\$19.95**

AMATEURS!

The absolutely hottest yet ready-to-go, factory wired mobile transmitter receiver!

Ask the southern W6's and K6's about the **BLACK WIDOW!** Now introduced nationally for the first time! Heaters wired for quick changeover 6 or 12 V. Uses your car-radio speaker to reduce size and cost. Requires external power supply 300 V., 200 ma, not included. Only 6" wide, 3" high, 6" deep. Hang it under the dash. Built-in tune-up meter also serves as S-meter. Crystal plugs in to front panel for quick, easy, frequency changes. (VFO plugs in now in the works, will be ready soon.) 8 Watts output! Very sensitive and selective band-spread superhet receiver with vernier tuning and large calibrated dial. **BLACK WIDOW: \$165.00**
2 meter **\$165.00**
6 meter
We have a limited supply of 12 V. dynamotors to supply this unit. Sold only with the **BLACK WIDOW SPECIAL \$6.95**

WHISTLE HIGH OR WHISTLE LOW

and make a motor turn or stop to change your TV channels or open garage door. Or switch to contact A or B to kill commercials, switch your model railroad, or water your lawn! We sell you the polarized, sensitive relay for \$2.95; we supply a brochure with bridge design equations. You furnish the brains and tuned Circuits. **MORE FUN!** Send for our new **RELAY BULLETIN!** You'll learn about the relay without a coil and the tricks it can do!

420 MC SPECIALS

RECEIVER: 46ACJ has double-conversion. Uses 13 tubes. Three 446-A Lighthouse Tubes tune 450-600 mc. and you re-tune only the oscillator. We give schematic and instructions. First IF of 85 mc is amplified in 2 stages. Second IF of 16 mc has 4 stages. Detector is followed by two stages. Brand new. Includes 8-6AC7, 3-446A, 1-6AG7, 1-6HG. **\$9.95**

If you have lots of 6AC7's get it less these only **\$6.95**

TRANSMITTER: 30 Watt TV transmitter. Uses 4-8025, 2 as 250-385 mc P-P osc. driving the other two as PA. The PA is grid modulated by a 3-tube video amp. and plate-mod by a 3-tube svnc amp. New with all tubes, schematic and instructions for easy conversion to 420. Only **\$15.75**
COMB. DEAL: Recvr & Xmitter, new, with tubes, both for only **\$23.50**

MOBILE HASH EATER

L-C Network Line Filter up to 25 amperes, cuts up line-carried ignition and static noises. Hi-Fi Boys, Attention: This unit has two 4 MFD, 50 v. oil bath-tubs & hi-Q choke. Use parts for Freq. Divider network. Shpg. wt. 7 lbs. Cat. 180LF1RN. Only **79c**

THE BEST, HANDIEST CARBON MIKE

RS-38. Used in CAA towers. Fits in the palm of your hand! Has press-to-talk button on cord. A springy curled cord only 1 ft. long which stretches to 4 1/2 ft. With standard PL-68 3-circuit plug at other end. Like new and guaranteed. **\$2.95**
Terrific buy at only **\$2.95**
NEW-With hanger. **\$5.00**

6 VOLT COMMAND POWER

6 v. dynamotor with exact base to snap on to any BC, ARC or ARA Command Receiver. Same efficiency as the 24 V. unit, same output. **\$9.95**
Fully guaranteed. Only **\$9.95**

DON'T STEAL THE HANDESET FROM A PHONE BOOTH!
STEAL IT FROM US FOR ONLY \$1.79!

WESTERN ELECTRIC'S E1 HANDESET, guaranteed condition, with 3-coil cord, P1 button top-quality receiver unit, ready to use for Radiotelephone, Intercom, or to start your own Telephone Company. With instruction sheet telling you how to make a telephone intercom system. Shpg. wt. 2 lbs. **\$1.79**
Cat. 1280TL7RN. Only **\$1.79**
Get six of them cheaper. Ask for **\$8.95**
Cat. 1906TL7X6RN. Six for only **\$8.95**

ARROW SALES, INC.

Western Mailing Address: Box 3007-R, NORTH HOLLYWOOD, CALIF.
Central Mailing Address & Sales-Shawroom: 2441 S. Mich. Av., Dept. R., CHICAGO 16, ILL.
California Distributors' Stores
G. L. Electronics, Inc., 1632 Venice, Los Angeles; P.A.R.T.S., Inc., 8905 San Fernando Rd., Sun Valley

Wide-Pass Test Scope & 455 KC Panadaptor

Both in one compact unit! Brand new with schematic. Also 3-25 and 30 mc. inputs. The only modification required is to replace only one power transformer with 60 cy. units we show you how to find in your hell box and how to connect 1D-60/APA-10. A item that cost govt. \$1,000! Cat. 14061SCRIN. Only **\$39.50**



MATCHED MINIATURE METERS

Gorgeous new line—not surplus! Only 1 3/4" square, 1 1/2" high. Handsome black calibration on white face. 2% accuracy. D'Arsonval movements. Guaranteed! DC Microamperes: 0-50 \$5.95, 0-100 or 100-0-100 \$5.50, 0-200 \$4.95, 0-500 \$4.50. DC Milliamperes: 0-1, 0-100, 0-200, 0-300, 0-500, any one \$3.50. DC amps: 0-10 \$3.95, 0-150, 0-3 \$5.95. AC Volts: 0-15 or 0-150, either one \$3.95

FREQUENCY METER BARGAIN!

BC906 is also a wonderful Grid Dip Meter and Relative Field Strength Meter! Frequency 144-225 mc. covers VHF communications and upper TV channels. You tune a silver-plated cavity to resonance with a large National Velvet Vernier dial. A probe in the cavity feeds the diode plate of a 185 and the rectified negative voltage applied to the grid of the same tube dips the plate current as shown on a 0-500 dc microammeter. The dial is individually calibrated with a curve showing 100 kc per dial division. The entire unit is in a compact carrying case only 1 1/2 x 8 1/4 x 6 1/2" with a leather handle. Schematic is pasted inside. Includes 100 kc per dial division. Specs inside for one ea. 1.5 V and 45 V batteries. This precision laboratory device is in excellent condition **\$7.95**

FREQUENCY METER AND TEST OSCILLATOR! 115 V., 50-800 cy. power supply. In frequency meter section, crystal oscillator, 100 kc/sec. Oscillator section puts out sine or pulse modulated RF. With tubes, headset, cords, adapters, radiators, etc. and INSTRUCTION BOOK **\$19.95**
LU-3, 465-498.5 MC Cat. 2006TY1RN. **\$19.95**
LU-1, 470-493.5 MC Cat. 2806TY2RN. **17.95**

ONE-WAY STREET FOR ELECTRONS! Operate Transistors, DC Relays, Meters, etc. From Your AC Line . . . Or Detect Radio Signals . . . New extra-high peak-inverse JAN Germanium Diode 1N70 stands 100 v. peak and gives you up to 30 ma average current! A terrific buy gives them to you new and guaranteed at the bargain rate of **8 for \$2.98** only

VHF CHECKER WITH SCOPE DISPLAY

150-240 mc
Brand new unit made for Air Forces, so you know that it is made right. Signal generator feeds pulsed RF to your receiver. Output of your receiver is displayed and measured accurately. Built in AC power supply 115 V., any frequency from 50 to 1200 cy. Also use the scope to analyze Hi-Fi amplifiers by pulsing its sweep from your square-wave generator. Each sweep will present one complete pulse from your amplifier's output. Shpg. wt. 50 lbs. **\$42.50**
BRAND NEW, with all tubes and instruction **\$42.50** book, for only **\$42.50**

FREE! Big Bargain Catalog! Send for your copy.

All shpts. FOB whse. Send 25% dep. with all COD orders. Item sub. to prior sale & change of price without notice. Min. order \$2.50.

MUST MOVE OUR WAREHOUSE

Set Builders—Experimenters

GIANT SURPRISE KIT \$4.95

25-30 lbs. of brand new RADIO PARTS . . . no junk . . . Transformers, Filter and Bypass Condensers, Resistors; Wirewound, Carbon, Volume Controls, Sockets, Wire, Variables, Chassis and Gang Switches. Parts that every Service Man, Experimenter or Ham needs. Express or Freight Shipments Only. No C.O.D.

NEWARK SURPLUS MATERIALS CO.
324 PLANE ST., Newark, N. J.



college grads get ahead faster!

. . . have higher incomes . . . advance more rapidly. Grasp your chance for a better life. Share rewards awaiting college-trained men. Important firms visit campus regularly to employ Tri-State College graduates. Start any quarter. Approved for Vets.

Bach. Sc. degree in 27 months

Complete Radio Eng. courses (TV, UHF, FM, Electronics). Also Mech., Civil, Elec., Chem., Aero., Eng. 36-months in Bus. Adm. (Gen. Bus., Acctg., Motor Transport Mgt.). Superior students faster. More professional class hours. Small classes. Enrollment limited to 150. Beautiful campus. Well-equipped labs. Prep courses. Enter June, Sept., Jan., March. Earnest, capable students (whose time and budget require accelerated courses and modest costs) are invited to write Jean McCarthy, Dir. Adm., for Catalog and "Your Career in Engineering and Commerce."



TRI-STATE COLLEGE

1647 College Avenue Angola, Indiana

gear. One page is devoted to a listing and specifications on a variety of small parts.

Copies of this bulletin will be forwarded without charge on request.

RETMA STANDARDS LISTING

The Engineering Office of the Radio-Electronics-Television Manufacturers Association, 11 W. 42nd St., New York 36, N. Y., has issued a 10-page listing of bulletins and publications which are currently available for distribution.

The material included in the listing covers a variety of subjects and some of the standards still available date back as far as 1947. Those whose work involves reference to various industry standards will undoubtedly want a copy of this master list.

FEDERATED PURCHASER CATALOGUE

Federated Purchaser, Inc., of Mountainside, N. J., has issued a 196-page general catalogue, its first in many years.

The publication consists of a concise compilation of pertinent data on thousands of electronic components. Copies of this new catalogue can be obtained from any of the company's branches in New York, N. Y.; Newark, N. J.; Easton and Allentown, Pa.; or Los Angeles, Calif.

SILICON RECTIFIER DATA

Sarkes Tarzian Inc.'s Rectifier Division, 415 N. College Ave., Bloomington, Ind., has available a series of "Design

Notes" covering its silicon rectifiers for various applications.

The types covered and the number of the corresponding data sheet are as follows: Type N1 (#3), Type N2 (#4), Type N3 (#5), Type N4 (#6), Type P1 (#7), Type P2 (#8), Type P3 (#9), Type P4 (#10), Type Q4 (#11), Type M (#12), Type L (#13), and Type LF (#14).

Write the company direct for any of the data sheets required.

HICKOK GENERATOR

The Hickok Electrical Instrument Company, 10524 Dupont Ave., Cleveland 8, Ohio, has issued a data sheet on its Model 660 white-dot-bar-color display generator which lists special design features and specifications.

The unit is small sized and portable. It is designed to be used for on-location color TV checks even in the absence of a station signal. Copies of Form 660 describing this piece of equipment are available from the manufacturer without charge.

ELECTRONIC WIRE

The Wire and Cable Department of General Electric Company, Bridgeport 2, Conn., has just issued a four-page folder on high-temperature electronic wire that meets all the requirements for Specification MIL-W-16878B.

These wires, designed for the internal wiring of electrical and electronic equipment, meters, and panels, are

(Continued on page 166)

TV TELLS HOW TO ANSWER RADIO T.V. QUESTIONS SERVICE LIBRARY



\$8 COMPLETE 2 VOLUMES

Get this Information for Yourself 7 DAY TEST—PAY ONLY \$2 MO.

HERE IS LATE INFORMATION IN A HANDY FORM FOR RADIO AND TELEVISION REPAIRMEN, SERVICEMEN AND STUDENTS

AUDELS T.V. RADIO SERVICE LIBRARY—Over 1500 Pages—1085 Illustrations & Diagrams, 1001 Important Facts & Figures on Modern T.V. Radio, Electronic Devices at your fingers' ends Highly Endorsed.

INCLUDES TRANSISTORS and Transistor Circuits, Rectifiers, Record Changers, P. A. Systems, Tape Recorders, Phonograph Pick-ups, F.M., Auto Radio, Radio Compass, Short Wave, Radar, etc.

ASK TO SEE IT!

IT WILL PAY TO KNOW—The Basic Principles—Construction—Installation—Operation—Repairs—Trouble Shooting. Shows How to get Sharp, Clear, T.V. Pictures. Install Aerials—How to Test. Explains Color Systems, Methods of Conversion, Terms, etc. Includes Ultra High Frequency—Valuable for Quick Ready Reference and Home Study.



MAIL ORDER

AUDEL Publishers, 49 W. 23 St., New York 10, N. Y. Mail AUDELS T. V. RADIO SERVICE LIBRARY (2 Volumes) \$8 on 7 days free trial. If O. K. I will remit \$2 in 7 days and \$2 monthly until \$8, plus shipping charge, is paid. Otherwise I will return them.

Name _____ Address _____ Occupation _____ Employed by _____ SAVE SHIPPING CHARGES! Full Payment With Coupon and We Pay Shipping Charges.

Apology to Readers of Radio & TV News Due to the tremendous response to our wonderful values in tubes, our huge staff at Video Electric Co. was unable to adhere to our 5 day shipment policy. For this reason, some orders were delayed a number of days. We at Video wish to offer our profound apologies for any inconvenience caused our customers. We are attempting to remedy the situation at once.

PROMPT SHIPMENT ON ALL ORDERS

\$3700 DON'T PAY MORE FOR SET TESTED LONG LIFE DEPENDABLE RADIO & TV TUBES • BUY VIDEO INDIVIDUALLY BOXED • ALL GUARANTEED FOR ONE YEAR OR YOUR MONEY BACK

Some Standard Brand—Others With Famous VIDEO Brand

0A2	5U4G	6HG6T	12A7T
0A3	5U8	6J4	12AU6
0A4	5V4G	6J5GT	12A7
0B2	5V6GT	6L6	12AV6
0C3	5Y3	6K6GT	12AV7
0Z4	5Y4G	6L6	12AX4GT
1A7GT	6AB4	6N7GT	12AX7
1B3GT	6AC7	6S4	12AZ7
1C7G	6AG5	6S7G	12B4
1F4	6AF4	6SA7	12BA6
1H4	6AH4GT	6SB7	12BE6
1H5GT	6AK5	6SC7	12BH7
1J6GT	6AL5	6SF5	12BV7
1L4	6AM8	6SF7	12C6
1L6	6AN4	6SG7	12SA7
1LA6	6N8	6SH7	12SG7
1LC5	6AQ5	6SJTGT	12SH7
1LM4	6AQGT	6SK7GT	12SJGT
1LN5	6AS5	6SL7GT	12SK7
1NSGT	6AS7G	6SN7GT	12SN7GT
1S4	6AT6	6SQ7	12SQ7
1S5	6AU4GT	6S57	12V6GT
1T4	6AU5GT	6SV7	12X4
1U4	6AU8	6T8	14A7
1U5	6BU5GT	6U4GT	14B6
1V2	6AV6	6U7G	14Q7
1X2	6AK4GT	6U8	19B6GG
2A7	6AK5GT	6V3	19T8
2D21	6BA6	6W6GT	24A
2K2	6BC5	6W4GT	2AV5GT
3A4	6BC7	6W6GT	25BQ6GT
3A5	6BE6	6X4	25CD6G
3AL5	6BF5	6X5GT	25CU6
3AU6	6BG6G	6X8	25L6GT
3BC5	6BH6	6Y6G	25W4GT
3CB5	6J6	6Z5	25Z6GT
3Q4	6K5	7A7	35L6GT
3Q5GT	6K7	7B5	35W4
3S4	6BL7GT	7B7	35Y4
3V4	6BN5	7C5	50A5
4B27	6BQ6GT	7C6	50B5
4B97	6BQ7	7C7	50C5
5AM8	6BY5G	7F7	50L6GT
5AN8	6BZ7	7F8	80
5AQ5	6C4	7N7	117N7GT
5AT8	6CB6	7Q7	117P7GT
5AW4	6CD6G	7S5	12A7G
5AZ4	6CF6	7Z4	12AT6
5J6	6C56	12A6	
5T4	6CU6GT	12AH7GT	
5T8	6E5	12AT6	

We Have OVER 1000 USED TV SETS

At All Times In Our Huge Warehouse

Buy one or more of these WORKING TV's to sell or use as your own second set! All Sets in GOOD WORKING condition!

Your Choice—Console or Table Model

10"	...\$23.00	19"	...\$58.00
12"	...\$28.00	20"	...\$64.00
14"	...\$33.00	21"	...\$72.00
16"	...\$40.00	24"	...\$99.00
17"	...\$46.00		

When ordering TV's, state whether table model or console is desired. Also preference on make of set. All TV's sent railway express F.O.B. Newark. On any quantity WIRE or CALL today!

FREE BONUS ANTENNA GIVEN WITH ANY TV SET ORDER!!

FREE RCA "CHEATER" CORD GIVEN WITH ANY TUBE ORDER OF \$7.00 OR MORE!!

FREE POSTAGE in U.S.A. and Territories on orders over \$5.00. 25¢ handling charge on orders under \$5.00. 25% deposit required on C.O.D.'s. Please send approximate postage or freight on Canadian and foreign orders. Subject to prior sale.

SEND for our FREE complete TUBE & PARTS LIST and order blank.

40¢

FOR ANY

TUBE

we will not be undersold

VIDEO

ELECTRIC COMPANY

79 CLINTON PL. NEWARK, N. J.

Phone HUmboldt 4-9848

BUILD THE BEST— BUILD ALLIED'S OWN knight-kits

Here is a typical Knight-Kit value—available only from ALLIED—one of 45 great Knight-Kits you'll find in our special Supplement No. 165. Write for your FREE copy today.

knight-kit HOBBYIST VALUE 2-TRANSISTOR POCKET RADIO



Model
Y-262
\$1465

It's fun to build this efficient pocket-size broadcast band radio. Entirely self-contained, complete with built-in antenna (no external antenna required), battery and earphone. Features reflex-type 2-transistor circuit. Printed circuit panel simplifies assembly. Has high-gain ferrite-core antenna; super-sensitive miniature dynamic earphone for excellent tone quality; variable capacitor for accurate tuning; months of dependable operation from single long-life alkaline cell battery supplied. Two simple controls—On-Off-Volume and Tuning. Handsomely styled leatherette carrying case. Fits coat pocket or may be worn from belt; only 4 x 3 3/4 x 1 1/4". Complete, with step-by-step instructions. Shpg. wt., 1 1/2 lbs.
Model Y-262. Net, F.O.B. Chicago. \$1465

OTHER knight-kit HOBBYIST VALUES



"10-IN-1" LAB KIT
Y-265 \$1265



"6-IN-1" LAB KIT
Y-770 \$795



3-WAY PORTABLE
RADIO KIT
Y-730 \$1995



"OCEAN HOPPER"
SW RECEIVER KIT
Y-740 \$175

See our Supplement No. 165 for 12 other knight-kit hobbyist values

free SUPPLEMENT featuring knight-kits



Send for our FREE Supplement No. 165 featuring 45 great Knight-Kits, including Test Instruments, Hi-Fi, Hobbyist and Amateur Kits. Write for your copy today.

ORDER FROM ALLIED RADIO

Dept. 01-D7, 100 N. Western Ave., Chicago 80, Ill.

available with three types of insulation: thermoplastic, nylon, and silicone for various voltages.

Complete specifications and application data are given in the folder which has been designated as Publication No. 19-586.

MICROTRAN CATALOGUE

Microtran Company, Inc., 145 E. Mineola Ave., Valley Stream, N. Y., is now offering free copies of its new 1957 transformer catalogue to those who request it.

This 20-page booklet lists a stock line of miniaturized transistor driver and output transformers designed for typical servo, missile, or airborne applications in MIL-T-27 hermetic, molded, or open constructions.

GENERAL RADIO "VARIACS"

General Radio Company, 275 Massachusetts Ave., Cambridge 39, Mass., has just issued a new 24-page bulletin covering its complete line of "Variac" adjustable autotransformers.

Dimension drawings, in addition to photographs, are included for all models, and complete specifications and prices are tabulated.

The company will supply copies of "Bulletin O" without charge on request.

TRANSISTOR MANUAL

The Semiconductor Products Department of General Electric Co., 1224 W. Genesee St., Syracuse, N. Y., has recently issued a compact 64-page booklet covering transistor applications, circuits, and specifications.

Entitled "Transistor Manual" and priced at 50 cents a copy, the booklet covers basic semiconductor theory, construction techniques, transistor applications, an explanation of parameter symbols, specifications of G-E transistor types, a list of registered RETMA transistor types, circuit diagrams, transistor radio cross reference chart, and a bibliography. The diagrams cover simple and elaborate circuits.

VARIABLE CAPACITOR DATA

Hammarlund Manufacturing Company, Inc., 460 W. 34th St., New York 1, N. Y., is offering a new catalogue covering its line of variable capacitors.

The new publication lists all standard variables the company makes and provides complete electrical and mechanical information on each. —30—

PHOTO CREDITS

Page	Credit
37, 38, 39...	General Motors Corporation
40	Hoffman Television
45, 121...	Radio Corporation of America
46 (top left)	Winston Electronics, Inc.
46 (bottom left)	Hycan Mfg. Co.
46 (right)	Philco Corporation
47	Burns Photography, Inc.
53, 78	General Electric Company
54, 55	Heath Company
58, 59	Simpson Electric Company
64	Electronic Instrument Co.
80	Midwest Research Institute of Kansas City
105	DuKane Corporation
106	Stephens Tru-Sonic, Inc.
114	Lafayette Radio

BE QUALITY WISE... BUY QUAL-KITS!



HI-FI AMP. KIT
Complete 6 tube-10 watt amplifier. Push-pull beam power output, built-in pre-amp. 5 position selector switch, 3 position record equalization, LP, RIAA, Eur. Response 1/2 db. 20-20,000 cps. Output 10 watts at less than 2% 1M. Low noise level and harmonic distortion. **\$28.50**

Every kit complete with 28 page fully illustrated instruction and assembly manual. Cover and legs optional.



HI-FI AM-FM TUNER KIT
Advanced 7 tube circuit plus Rectifier for full sensitivity and selectivity. Distortion less than 1%. Sensitivity is 5 uv for 30 db quieting on FM, 25 uv AM. Armstrong FM Circuit with limiter. Foster-Seeley Discriminator. 20-20,000 cps response. Full AFC control — no drift. Easy assembly. **\$28.95**

Add 10% Fed. Tax Write for FREE catalog and name of nearest dealer carrying these remarkable units.

QUALITY-ELECTRONICS

319 Church St. Dept. T-4 New York 13, N. Y.

EASY TO LEARN CODE

It is easy to learn or increase speed with an Instructograph Code Teacher. Affords the quickest and most practical method yet developed. For beginners or advanced students. Available tapes from beginner's alphabet to typical messages on all subjects. Speed range 5 to 40 WPM. Always ready—no QRM.



ENDORSED BY THOUSANDS!

The Instructograph Code Teacher literally takes the place of an operator-instructor and enables anyone to learn and master code without further assistance. Thousands of successful operators have "acquired the code" with the Instructograph System. Write today for convenient rental and purchase plans.

INSTRUCTOGRAPH COMPANY

4711 SHERIDAN ROAD, CHICAGO 40, ILLINOIS

ELECTRONICS

PREPARE FOR A GOOD JOB!
BROADCAST ENGINEER
RADIO SERVICING AUTOMATION

TELEVISION SERVICING
BLACK & WHITE—COLOR

APPROVED FOR VETERANS AND SURVIVORS
OF VETERANS
BUILDING AIR CONDITIONED
SEND FOR FREE LITERATURE

BALTIMORE TECHNICAL INSTITUTE
1425 EUTAW PLACE, BALTIMORE 17, MD.

ZYTRON "QUALITY BRAND"

RADIO & TV RECEIVING

TUBES

BRAND NEW
INDIVIDUALLY BOXED

Terrifically LOW PRICED!
Send TODAY for Complete Catalog

ZYTRON TUBE COMPANY

220 West 42nd Street - New York 36, N. Y.

TO GET MOST DOUGH— SELL TO HARJO!

WE'RE BUYING: BC-224 & BC-348 RECEIVERS.
ARC-3 ARC-13 BC-788 R5/ARN-7

Cash or trade. Quick action. Top money!

HARJO SALES CO.
503 N. Victory Blvd. Burbank, Calif.

Classified

RATE: 50¢ per word. Minimum 10 words. June issue closes April 10th. Send order and remittance to: RADIO & TELEVISION NEWS, 366 Madison Ave., N. Y. C. 17.

RADIO ENGINEERING

COMPLETE radio, electronics theory & practice; television; broadcasting; servicing; aviation, marine, police radio. 18 or 21 months. Catalog. Valparaiso Technical Institute, Dept. N, Valparaiso, Ind.

DESIGN—Construction Service or Consultation on any type of Electronic Device. Electronic Service Engineers, Poteau, Oklahoma.

FOR SALE

DIAGRAMS—Radios, Amplifiers, Changers, \$1.00 Each. Television Service Data \$2.00. Unknown Models, Give Tube Layout and Part Numbers. Kramer's Radio Service, Dept. 656, 36 Columbus Ave., New York 23, N. Y.

USED Kay Mega Sweep Model 111-A \$300. Used Sylvania 7 Inch Laboratory Oscilloscope Type 404 \$195. New Sylvania 7 Inch Laboratory Oscilloscope Type 403 \$175. Used Community Engineering Corp. Sweep Generator Model 100-S \$100. Used Equipment in Good Condition. Telco Dept. R-1, 16 South Dorcas St., Lewistown, Pa.

BUY Government Surplus—Walkie-Talkie; Radio-TV Electronics; Transceivers; Test Equipment; Oscilloscopes; Radar; Voltmeters—Fraction of Army costs—Buy direct from U. S. Government Depots—List & Procedure \$1.00—Brody, Box 8-RTB, Sunnyside 4, New York.

TELEVISION Antenna Towers. The finest self-supporting Antenna Towers available at reasonable prices. Heights to 200 feet, \$59.95 up. Allied Electronics, 111 North 41st, Omaha, Nebraska.

MONITORADIO, Police-Alarm Receivers Model PR-9 factory guaranteed, sealed cartons, \$15.00 and your used Communications Receiver such as S-38, S-20, S-22, S-53, SW-54; \$5.00 cash and your used Communications Receiver such as S-40, NC-57, RME-84, VHF-152A. If you desire MR-10 or MR-33 instead of PR-9 add \$15.00 to cash payment. Trade-in Receivers must be in good saleable condition. Ship Express properly packed. We will forward your Monitoradio COD if you wish. Offer ends June 1st. Allied Electronics, 111 North 41st, Omaha, Nebraska.

DIAGRAMS for repairing radios \$1.00. Television \$2.00. Give make, model. Diagram Service, Box 672-RN, Hartford 1, Conn.

TUBES—TV, Radio, Transmitting And Industrial Types at Sensibly Low Prices. New, Guaranteed, 1st Quality, Top Name Brands Only. Write For Free Catalog or Call Walker 5-7000, Barry Electronics Corp., 512 Broadway, New York 12N, N. Y.

NEW—Limander model 100, the Consonant Amplifier-Limiter with high speed noise squelch. Electronic Systems Engineering Company, 903 Cravens Building, Oklahoma City, Oklahoma.

COMPLETE Television Sets \$11.95. Jones TV, 1115 Rambler, Pottstown, Pa.

ATTENTION Canadian Hams: New Bendix TA-12 transmitters and RA10-DB receivers with control box at 29.50 each. Those units are hermetically sealed, packed in individual wooden cases. Good serviceable AT1 transmitters at 17.50 each and AR2 receivers at 37.50 each. AT1/AR2 built for 12 volt input. Jas. Slater, Kingston, Nova Scotia.

\$1.00 BUYS 50 resistors 100 ohm to 2.2 megohm. W9VTZ, Haunfelder, 900 West Glendale Avenue, Milwaukee 9, Wisconsin.

WANTED

SELL Your Way To Wealth! Wanted Surplus military and commercial aircraft electronics: ARN-7, ARC-3, 51R-3, APN-9, RC-348, RTA-1B, BC-788, I-152, L-5, MN-53, 18S-4, BC-610, CW-3, test equipment and All Vacuum Tubes. Top prices paid. For fattest checks—sell to Rex! Bob Sanett, W6Rex, 1524 S. E. Drive, Los Angeles 35, California. Phone: REpublic 5-0215.

AN/APR-4, AN/APR-9, other "APR," "ARR," "TS," ARC-1, ARC-3, ART-13, everything surplus; Tubes, Manuals, Laboratory equipment. Describe, price in first letter. Engineering Associates, 434 Patterson Rd., Dayton 9, Ohio.

April, 1957

PLATINUM Electronic Scrap. Highest prices. Estimates by mail. Satisfied customers from coast to coast. Ship with perfect confidence. Cash sent by return mail. Noble Metals Co., Box 1113, Santa Monica, California.

CYLINDER and old disc phonographs. Edison Conqueror, Idelia, and Oratorio models. Berliner Gramophones and Zono-ophones, Columbia cylinder Graphophones, and coin-operated cylinder phonos. Want old catalogues and literature on early phonos prior to 1913. Will pay cash or trade late hi-fi components. Box 50 % RADIO & TELEVISION NEWS.

WANTED: Receiver R5/ARN-7, MN-62A Transceivers, RT18/ARC-1, AN/ARC-3, BC-788C, I-152C, Collins, Bendix equipment, Test Sets, Dynamotors, Inverters. We pay highest prices. Advise quantity, condition, price first letter. Aircraft Radio Industries, Inc., 15 East 40th St., New York City, telephone LEXington 2-6254.

WANTED—Radio Transcriptions-Thesaurus By Rhythmakers, Also Associated, World, Etc. Ken Crawford, 215 Steuben, Crafton, Pa.

CASH Paid! Sell your surplus electronic tubes. Want unused, clean transmitting, special purpose, receiving, TV types, magnetrons, Klystrons, broadcast, etc. Also want military & commercial lab test and communications gear. We swap too, for tubes or choice equipment. Send specific details in first letter. For a fair deal write, wire or telephone: Barry, 512 Broadway, New York 12, N. Y. Walker 5-7000.

OLD band FM receiver, 44-48-MC, state price and condition. A. M. Nohe, 246 W. 6th Ave., Huntington, W. Va.

REPAIRS AND SERVICING

HIGH Fidelity Speakers Repaired. Amprite Speaker Service, 70 Vesey St., N. Y. 7, N. Y. Ba. 7-2580.

ELECTRONIC Kits and components wired and assembled. F. Yarnall, Myerstown, Pa.

TAPE RECORDERS

RECORDERS, Tape, Hi-Fi. Wholesale Prices. Catalogue. Klarston, 215 E. 88th St., N. Y. C. 23.

TAPE Recorders, Tape. Unusual Values. Free catalog. Dressner 69-02 R, 174 St., Flushing 65, N. Y.

RECORDERS Wholesale! Tapes: 1200' \$1.39; 1800' \$1.85. Towers—155, Philadelphia 5.

HIGH FIDELITY

DISGUSTED of "Hi" Hi-Fi Prices? Unusual Discounts on all your High Fidelity requirements. Write now. Key Electronics Co., 120 Liberty St., New York 6, N. Y.

CORRESPONDENCE COURSES

USED Correspondence Courses and Books sold and rented. Money back guarantee. Catalog free. (Courses bought.) Lee Mountain, Pisgah, Ala.

INSTRUCTION

ENGINEERING Degrees earned by home study. (Residential courses also available). Pacific International University, (American College of Engineering), Box 27724-C, Hollywood 27, Calif.

DO you want to be a writer? No engineering background or writing experience required to be a technical writer. Our students earning over \$600.00 per month before completing course. Write Technical Publications Institute, 9022-L, Melrose, Los Angeles 46, California.

MISCELLANEOUS

TRADE-in TV sets. Ship anywhere. 10"-\$8, 12"-\$12, 16"-\$18, 17"-\$20. Packing \$3 extra. Send money order for immediate shipment. Justis Bros. Newport, Del.

DECALS—Trademarks, Service, Sales, etc. Write Allied Decals, Inc., 8378 Hough, Cleveland, Ohio.

BUSINESS cards for TV servicemen. Raised printing. Free cuts. Polart Company, 20115 Goulburn, Detroit 5, Michigan.

HQ for the 5 TOP QUALITY brands of

TUBES

AT SENSIBLE PRICES!

- 90-Day RETMA guarantee • Brand New
 - Individually boxed • First quality only
- WRITE FOR LATEST RECEIVING AND TV TUBE PRICE LIST, FREE!

1825 ... \$3.35	307A ... \$.60	1820 ... \$3.50
1Q27 ... 44.50	355A ... 11.00	162535
CL-2 ... 10.00	357A ... 14.00	2050 ... 1.00
2C35 ... 2.00	371E75	205165
2C39A ... 11.00	403A ... 1.20	5817 ... 1.35
2C45 ... 2.25	403B ... 2.25	5836 ... 2.95
2C53 ... 9.75	404A ... 12.50	5836A ... 2.95
2D2170	416A ... 25.00	5642 ... 1.00
2E24 ... 2.34	416B ... 39.00	5646 ... 4.35
2K25 ... 13.50	417A ... 3.50	5651 ... 1.40
2K45 ... 35.00	417A/ ...	5654 ... 1.40
2K55 ... 15.00	5642 ... 12.00	5656 ... 4.50
3B24 ... 1.50	5647 ... 44.00	5670 ... 1.15
3B24W ... 4.75	KU-610 ... 3.50	5675 ... 8.00
3B29 ... 4.75	WL/695/ ...	567685
3B31 ... 1.85	658 ... 90.00	5678 ... 1.85
3C23 ... 3.95	GL673 ... 12.50	5691 ... 4.75
3C31 ... 1.00	701A ... 1.85	5692 ... 5.00
3C45 ... 7.00	703A ... 1.10	5693 ... 3.75
3J30 ... 25.00	717A ... 7.50	6703WA ... 4.50
3W2000LK	723A/B ... 7.50	5718 ... 2.00
	725A ... 3.00	5719 ... 2.00
*4-65A ... Write	*570TL ... 2.00	5720 ... 2.00
*4-125A ... 30.25	80090	572675
*4-250A ... 35.00	802 ... 2.25	5744 ... 1.25
*4-400A ... 45.00	803 ... 2.00	5749 ... 1.25
B24/EL3C ... 4.50	805 ... 5.00	5763 ... 1.25
4C35 ... 13.50	807 ... 1.10	5812 ... 1.00
4C45 ... 45.00	807W ...	5814 ... 1.00
*4PR60A ... 40.00	8933 ... 1.75	5840 ... 4.50
5C22 ... 27.00	813 ... 8.50	5876 ... 8.00
6AK5W ... 1.40	814 ... 2.80	5881 ... 2.95
6B4 ... 6.00	81520	591045
6C21 ... 13.50	816 ... 1.50	591045
6J4 ... 1.75	836 ... 1.25	6111 ... 4.95
6L6W ... 7.75	837 ... 1.25	6112 ... 4.95
15E ... 1.20	83870	6130/ ...
FG32 ... 4.35	845 ... 3.00	6130/ ...
*345 ... 1.45	865A ... 1.20	3C45 ... 6.00
VCS0/32VK ... 8.00	872A ... 1.00	6181 ... 3.25
HK-60/ ...	917 ... 1.30	6183 ... 450.00
1641 ... 1.25	918 ... 1.10	6201 ... 3.00
RK65/ ...	927 ... 1.00	6350 ... 10.00
SD23 ... 7.50	930 ... 1.50	6539 ... 9.00
HV69 ... 2.25	95440	8006 ... 3.25
RK72 or ...	95540	8020 ... 1.00
73 ...	95635	900175
F123A ... 3.95	95735	900260
VXR-130 ... 1.50	95735	9003 ... 1.35
203A ... 2.50	958A35	900650
21150	99125	900620
250R ... 2.95	CK100535	
HK253 ... 5.00	CK100745	
GL299 ... 2.00	CK1026 ... 2.35	

* (SURPLUS) and many others, over 1000 types in stock! WRITE!

2 COLOR TUBE CARTONS

Keeps your tube stock neat. New safety partition prevents tube breakage. Distinctively lithographed in glossy red and black. The most distinctive tube carton available today. Minimum quantity: 100 of any one size. Write for case lot prices.

FOR TUBE PER 100
 Miniature ... 6AUG, etc. ... \$1.00
 GT ... 6SN7, etc. ... 1.25
 Large GT ... 183, etc. ... 2.00
 Large G ... 5U4G, etc. ... 2.00

WHITE GLOSSY BOXES
 Completely blank. No printing or color. Otherwise same as above. Same high quality, same low prices. Specify "WHITE" when ordering. When color is not stated, 2 color cartons will be shipped.

TUBE STACKERS
 White glossy only. Ministacker holds 10 Mini tube cartons; "GT" stacker holds 10 "GT" cartons.
 SIZE PER EACH
 Ministacker11 1/2
 GT26



INVISIBLE INFRA-RED CL-2 LAMP \$10.00

The device that makes license free transmission a reality! 2 way voice or MCW can be transmitted over concentrated invisible infra-red rays. Information on how to construct a 2 way transmit-receive station available.
 CL-2 LAMP, w/info (worth \$50) ... \$10.00

ELECTRONIC EQUIPMENT SPECIALS

- DUMONT 5" OSCILLOSCOPE, Model 274A, at less than 1/2 reg. price! Exc. cond. ... \$65.00
- RCA 5" OSCILLOSCOPE, Model 403. A real good buy. Clean, v. gd cond. ... \$88.00
- RCA TV SWEEP GENERATOR, Model WR-59A. In exc. cond. A bargain at only ... \$75.00
- WALKIE TALKIE! BC-611. Exc. cond. in pairs only, with batteries. A good buy! ... \$119.00
- DYNAMOTOR, V. compact, 12 VDC in, 420 VDC @ 250 ma. int. out. (150 ma. cont.). ... \$9.95
- Lots of 3, each ... 8.95
- FREQUENCY METER, Lavioie Model 1055M (TS-127/U) 375 to 725 Mcs. Covers citizens band, color TV, etc. BRAND NEW in orig. pkg! ... \$34.50
- TV XTAL 13 CHANNEL MARKER, Kay "Mega-marker" incl. all 13 stns. V. gd. ... \$49.50
- SIGNAL GENERATOR, Measurement Corp., model 78FM. 86-110 Mcs. 30 Kc. deviation. Excellent condition ... \$175.00

EXTRA! JUST ARRIVED!

25 TONS of the most beautiful Ham. Industrial Radio station, and Service tech. transformers in existence. Much too many to list here, and all at the lowest prices you ever saw. Write for special transformer listing. It's FREE!

WRITE FOR "BARRY'S GREEN SHEET." FREE!

TERMS: 25% deposit with order, balance C.O.D. All merchandise guaranteed. F.O.B. N.Y.C.

Subject to Price Variation & Stock Depletion

BARRY ELECTRONICS CORP.

512 Broadway, Dept. RN, N.Y. 12, N.Y.

Call Day or Night—24 Hour Phone Service

Phone: Walker 5-7000

ELECTRONIC FLASH! LUCKY PURCHASE
\$59 SHAWLITE 400II SPECIAL \$20

Assembled & ready to work! Not a kit. Latest features SUPER CIRCUIT
 -Low cost flash less than 3/4c. Inbuilt
 AC & Batteries* all in one case, powerful,
 compact. Guide # Color 60-4,
 B&W 200-4. Rectos 2 sec's. Limited
 Qty. Special \$20.
 *Batteries not included.
 Two (2)/240V.....\$10



"DUMONT" TV-Hi-Fi-LAB
 Hi-Lo-V Power Supply—Base "Solo"
 Constant Voltage Regulated Power
 Transformer: Delivers 20 to 30000
 volts for 30" TV & 30% Regulated
 420VDC @ 350ma Brute force filtered. Filament 6.3V
 @ 6A. Included 3 Sensitive Relays for H, H^o & Vert
 Delay & protect ckt's. Tubes 2/5U4, 2/6SN7, 2/6AL5,
 2/6BG6, 2/1B3, OA3, 6W6, 6SJ7 & Diagram. Wgt.
 65 lbs. SPECIAL \$39, 3 for \$100

NEW 60 Watt Hi-Fi Amp & Pre

U-Build-It Preamp & Amplifier Tech-
 Master Model 19: 20 to 40000 cycles at
 60 watts with minimum distortion. Bass
 & Treble Tone Controls, 5 point Record Selector,
 Phono-Pickup Selector, Signal Selector, Tape Recorder
 input, 10 lb. Hi-Fi Output Transformer feeds 4, 8 or
 16 ohm speakers & electrostatic units also, 2 power
 outlets. The Newest, Latest, Finest design easily
 built. Techmaster Model 19 Kit.....\$79.95
 Cover Grill Cabinet.....\$7.50
 Model 19 Assembled.....\$129.50
 DYNA-KIT 8 to 100,000 cycles/50 watt amplifier kit.
 Simplest, best & finest amplifier kit.....\$69.50
 DYNA-KIT professional wired.....SPECIAL \$79

New T14 "TABPHONIC" 14 watt/Hi-Fi Amplifier (20
 to 25,000 cps) finest components, factory wired, com-
 plete ready to operate. Tubes (5) 12AD7, 12AL7,
 6C4, P.P. 6V6/6CM6 & 6RW4. Contains Phono Equal-
 izer Selector, Volume, Bass, Treble, Humble Filter &
 Contour Loudness Controls. Removable Gold satin finish
 escutcheon. Amp size 8"x12". SPECIAL \$42.95

NEW IMPROVED "TAB" HI-FI SPEAKERS

With Inbuilt Network Ticonal Alnico 5 Plus
 Magnet, 4 to 8 Ohms V.C.
 15" TRIAX, 25 Watt/20-20,000 Cycles.
 MODEL F15H3X.....\$36
 12" TRIAX, 20 Watt/40-20,000 Cycles.
 MODEL F12H3X.....\$27
 12" COAX, 20 Watt/35-18,000 Cycles.
 MODEL F12M2X.....\$22

FAMOUS GE PHONO CARTRIDGES

Original Boxed, Money Back Gtd.
 RPX050A .001 & .003 (SS).....\$6.75
 RPX052A Golden Treasure (DS).....\$19.25
 RPX053A Golden Treasure (DD).....\$28.00
Replacement Needles TETRAD Diamond
 RPF013A—Dual(D&S) 0.003D "Tetrad" @ \$10.98
 RPF014—Dual(D&S) 0.003D "Tetrad" @ \$10.98
 RPF015—Dual(D&S) 0.003D "Tetrad" @ \$10.98
 "Tetrad"
 M.G./LPor 78 Diamond any Phono.....\$8.98
 M.G./LPor 78 Sapphire any Phono.....\$12.49
 M.G./LPor 78 Sapphire Dual.....\$24.49

FINEST HI-FI RECORDING TAPE

1200 Ft.—7" Reel **\$1.45** Lots
 Money Back Gtd.

Highest quality controlled plastic base
 tape made by new Ferro-Sheen process.
 Precision coated & slit. Gtd. Constant
 output. Splice Free. Freq. 7 1/2 IPS
 40-15Kc Oxide Wnd In. 3 For \$1.50
 EACH: SINGLE @ \$1.59 EA. 5 For \$7.49
 New 1st Quality "MYLAR" 2400 ft.—7" Reel Ferro-
 Sheen processed Recording Tape.....@ \$4.49
 "TAB" Special @.....3/512; 12/545

Write For Hi-Fi & Bonus Catalog C "TAB" B4U Buy
 Hi-Fi. We Buy! Sell & Swap as Well.

0A2	.80	9LP7	2.00	6BQ6	1.19	7Q7	.79
0B2	.72	2C22	20/\$1	6BQ7	.99	12AT6	.59
0B3	.82	7193	20/\$1	6C4	.49	12AT7	.79
0C3	.84	434A	1.98	6CB6	.69	12AU7	.69
0D3	.80	1N34A	2/\$1	6C5	1.49	12AV6	.59
0Z4	.50	CK722	.99	6H6	.59	12AX6	.59
1AX2	.98	5U4	.59	6J5	.59	12AX4	.79
1B3	.78	6V4	.59	6K5	.59	12BA7	.69
1L4	.82	5Y3	.59	6G6	.59	12BH7	.89
1R4	.88	6A4	.89	6K7	.79	12BY7	.89
1R5	.78	6AC7	.79	6L6	1.19	12SA7	.69
1S4	.78	6AC7	.97	6S4	.59	12SK7	.69
1S5	.68	6A4	.89	6S7	.79	12SN7	.69
1T4	.69	6AH6	.95	6SH7	.69	12SQ7	.69
1U5	.59	6AK5	.69	6S7	.69	12TA7	.69
1X2	.66	6AL5	.59	6SK7	.69	19BQ6	1.69
2D21	.68	6AQ5	.66	6SL7	.69	25BQ6	1.29
2X2	.48	6A26	.79	6S7	.79		
2V3	.48	6AT6	.49	6SQ7	.59	35C5	.59
3A5	.69	6AU4	.89	6T4	1.19	35L6	.59
954	10/\$1	6AU6	.59	6T8	.98	35W4	.54
955	.33	6AX4	.79	6U8	.98	50A5	.65
957	.30	6BA6	.59	6V6	.59	50A5	.69
1619	4/\$1	6BC5	.59	6W6	.79	50B5	.79
1625	.29	6BE6	.59	6X4	.39	50C5	.69
1626	5/\$1	6BF5	.79	7A8	.79	50L6	.69
1629	4/\$1	6BG6	1.49	7C5	.79	75	1.00
807	1.15	6BK5	.89	7F7	.79	76	5/\$1
808	.89	6BL7	.99	7F8	.79	77	5/\$1
5B1	1.49	6BN6	.89	7N7	.79	117L7	1.75

KITS! KITS! KITS!

All Kits Contain Most Popular Values & Sizes

EXTRA: ONE FREE KIT WITH EACH \$10 KIT ORDER.

25 Precision Resistors	25 Power Resistors
10 Switches	65 Mica Cond's
25 Knobs	5 Crystal Diodes
75 Carbon Resistors*	250 ft. Hookup Wire
36 Panel Lamps	15 Fuses
10 Electrolytic Cond's	35 Ceramic Cond
15 Volume Controls	10 Rotary Switches
25 Tube Sockets	5 Crystals
50 Tubular Cond's	60 Inductors & Coils
500 Lugs & Eyelets*	5 Microswitches
10 Bathtub Oil Cond's	10 Wheat Lamps
5 lbs. Surprise Kit	140 Insulators
10 Xmit Mica Cond's	*In Plastic Box

ONE KIT EACH.....only **99¢**

INFRARED SNOOPSCOPE

See In Dark Tube

Selected, GTD & Tested for resolution.
 1st class image converter viewing tube.
 Hi-sensitivity, simplified design 2" dia.
 Hi-Resolution Tube & Screen.....Special @ \$4.75; 2/\$9

Snoopscope Power Supply

Cabinet.....\$21.95
 Cabinet.....\$13.95

Money Back Gtd (cost \$5) min. order
 shpg charges
 Tubes
 Prices

INDEX OF Advertisers

APRIL 1957

While every precaution is taken to insure accuracy, we cannot guarantee against the possibility of an occasional change or omission in the preparation of this index.

ADVERTISER	PAGE	ADVERTISER	PAGE
Advance Electronics Company.....	130	McGee Radio Company.....	146, 147
Airex Radio Corp.....	158	M. R. Company, The.....	167
Allied Radio Corp.....	9	Mallory & Co., Inc., P. R.....	Fourth Cover
28, 85, 122, 128, 138, 148, 154, 160, 166		Merit Coil & Transformer Corp.....	134
Altec Lansing Corporation.....	107	Milwaukee School of Engineering.....	130
Amperex Electronics Corp.....	104	Moss Electronic Distributing Co.....	135, 136
American Elite, Inc.....	106	Muscraft.....	113
American Television & Radio Co.....	32		
Antenna Specialists, Inc.....	80	Natco Aviation.....	162
Argos Products Company.....	109	National Radio Institute.....	3, 7
Arkay Kits, Inc.....	110	National Schools.....	29, 161
Arrow Sales, Inc.....	163, 79	Nel-Kaye Records, Inc.....	33
Ashe Radio Company, Walter.....	79	Newcomb.....	32
Audel Publishers.....	165	North American Phillips Co., Inc.....	103
B & J Electronics.....	131	Offenbach & Reimus.....	156
B & K Manufacturing Co.....	127, 75	Olson Radio Warehouse.....	149
Baltimore Technical Institute.....	166		
Barry Electronics Corp.....	167	Peak Electronics Company.....	156
Bell Telephone Laboratories.....	120, 121	Perma Power Company.....	142
Bendix Radio.....	134	Philco Techrep Division.....	26, 27
Bernat-Bach, Inc.....	110	Photography Directory & Buying Guide.....	126
Bozak Sales Co., The R. T.....	104	Pickering & Co., Inc.....	10
		Electronic Experimenter's Handbook.....	100
Cabinart.....	132	Precision Apparatus Company, Inc.....	84
Candler System Co.....	159	Presto Recording Corp.....	22
Capital Electronics.....	162	Progressive "Edu-Kits," Inc.....	148
Capitol Radio Engineering Institute.....	101, 102	Pyramid Electric Company.....	34
CBS-Hytron.....	21, 162		
Channel Master Corp.....	15	Quality Electronics.....	166
Cleveland Institute of Radio Electronics.....	13	Quietrol Company, Inc.....	152
Color Television Annual.....	144		
Columbia Electronics.....	150	R.C.A. Institutes, Inc.....	73, 133
Concord Radio Corp.....	155	RW Electronics.....	161
Coyne Electrical School.....	82, 150, 153	Radio Corporation of America.....	6, 25, 133
		Radiart Corp., The.....	83
Delco Radio.....	31	Radio Receptor Co., Inc.....	123
DeVry Technical Institute.....	5	Radio-Television Training Association.....	19, 20
Dressner.....	161	Rad-Tel Tube Co.....	82
Duotone Company, The.....	110, 112	Rauland-Borg.....	112
		Raytheon Manufacturing Company.....	Second Cover
Electric City Radio Supply.....	162	Rex Radio Supply.....	158
Electronic Chemical Corp.....	127	Rider Publisher, Inc., John F.....	139
Electronic Instrument Co., Inc. (EICO).....	35, 36	Rinehart & Co., Inc.....	78, 118, 158
Electro-Sonic Laboratories, Inc.....	111	Rohn Manufacturing Company.....	81
Electro-Voice.....	11	Ronette Acoustical Corp.....	132
Erie Resistor Co.....	82		
		Sams & Co., Inc., Howard W.....	77, 157
Fair Radio Sales.....	151	Schober Organ Corporation, The.....	160
Fisher Radio Corp.....	105	Scott, Inc., H. H.....	30
		Service Instrument Co.....	115
G & G Radio Supply Co.....	143	Shure Brothers, Inc.....	14
Garfield Company, Oliver.....	160, 162	Stan-Burn Radio & Electronics Co.....	164
General Electric.....	18, 23	Standard Electrical Products.....	145
Goodheart, R. E.....	159	Standard Line.....	150
		Stanley Electronics Corp., Inc.....	150
Harjo Sales Co.....	166	Sylvania Electric Products, Inc.....	16, 17
Harvey Radio Co., Inc.....	74		
Head Engineering College.....	144	"TAB".....	168
Heath Company.....	86, 87, 88, 89, 90, 91, 92, 93, 94, 95, 96, 97, 98, 99	Tele-Test Instrument Corporation.....	152
Henshaw Radio Supply.....	113	Terado Company.....	142
Hershel Radio Co.....	156	Texas Crystals.....	114
Hi-Fi Guide and Yearbook.....	76	Tran-Kit Electronics Co.....	112
Hughes Research & Development Laboratories.....	119	Transvision, Inc.....	152
		Triad Transformer.....	8
Indiana Technical College.....	159	Tri-State College.....	163
Instructograph Company.....	166	Tube Mart.....	142
International Business Machines Corp.....	116, 117		
		Uncle Sams Recordings.....	144
JFD Manufacturing Co.....	24	United Radio Corp.....	163
Johnson Company, E. P.....	124	University Loudspeakers.....	111
Jones & Laughlin Steel Corporation.....	137		
		V. S. I. Television School.....	113
Karlson Associates, Inc.....	108	Vacri Co., The.....	161
Klein & Sons, Mathias.....	12	Valparaiso Technical Institute.....	138
		Video Electric Co.....	165
		Viking of Minneapolis.....	Third Cover
		Wall Manufacturing Co.....	115
		Ward Products Corporation.....	125
		Weller Electric Corporation.....	129
		Wuerth Tube-Saver Corp.....	134
		Xcelite, Incorporated.....	138
Lafayette Radio Corp.....	140, 141	Yeats Appliance Dolly Sales Co.....	124
Lampe, E.....	113		
Lampkin Laboratories, Inc.....	131	Zytron Tube Company.....	166
Lektron Specialties.....	159		
Liberty Auto Radio.....	130		

SETTINGS STYLED BY
 MR. and MRS. J. SMITH, U.S.A.
 TAPE COMPONENTS BY
 VIKING OF MINNEAPOLIS

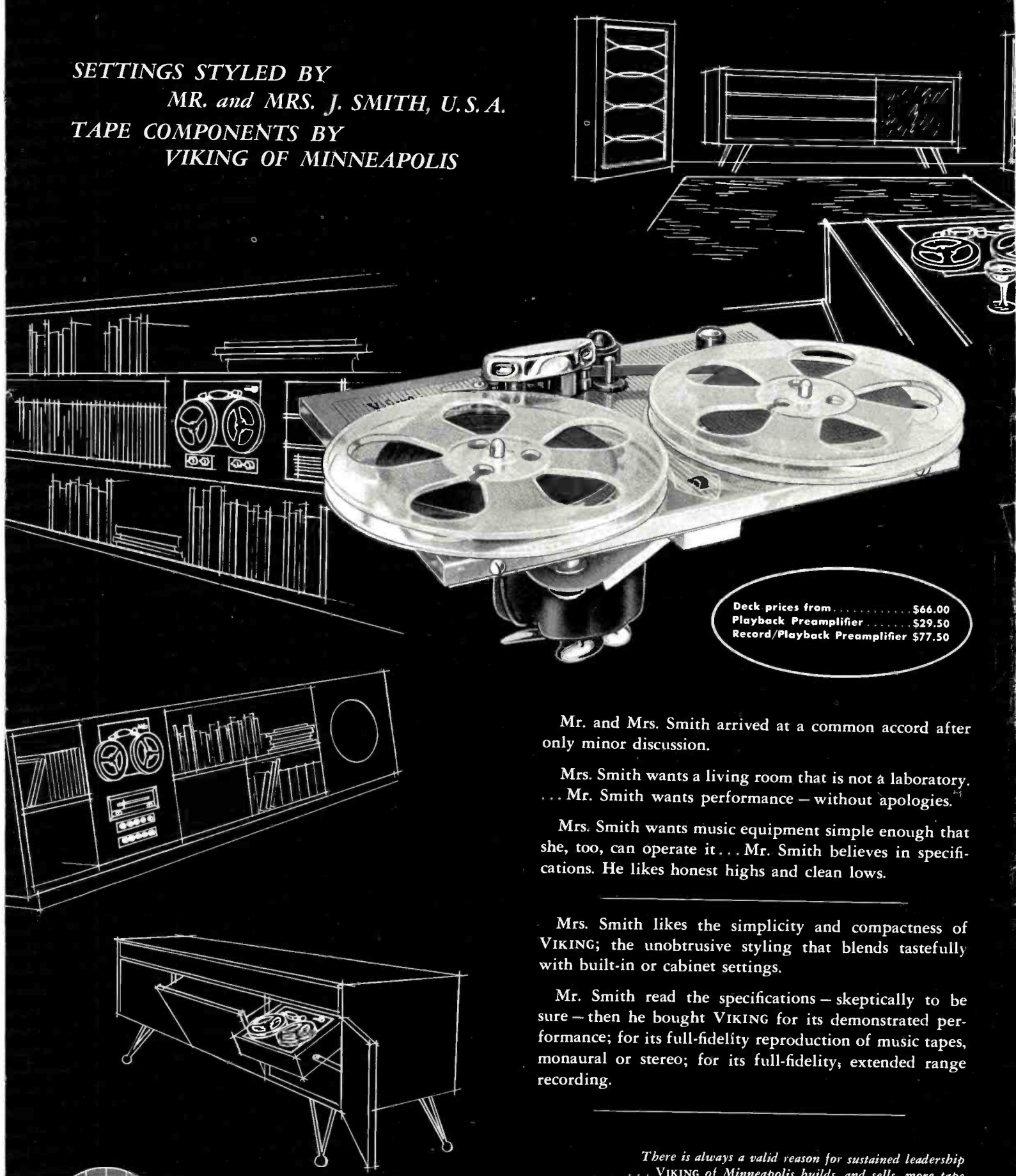

Deck prices from \$66.00
 Playback Preamplifier \$29.50
 Record/Playback Preamplifier \$77.50

Mr. and Mrs. Smith arrived at a common accord after only minor discussion.

Mrs. Smith wants a living room that is not a laboratory. . . Mr. Smith wants performance — without apologies.

Mrs. Smith wants music equipment simple enough that she, too, can operate it . . Mr. Smith believes in specifications. He likes honest highs and clean lows.

Mrs. Smith likes the simplicity and compactness of VIKING; the unobtrusive styling that blends tastefully with built-in or cabinet settings.

Mr. Smith read the specifications — skeptically to be sure — then he bought VIKING for its demonstrated performance; for its full-fidelity reproduction of music tapes, monaural or stereo; for its full-fidelity, extended range recording.

There is always a valid reason for sustained leadership . . . VIKING of Minneapolis builds, and sells, more tape system components (decks and preamplifiers) than any other manufacturer of high fidelity equipment.



VIKING OF MINNEAPOLIS

9600 Aldrich Avenue South, Minneapolis 20, Minnesota

EXPORT DIVISION: 23 Warren Street, New York City 7, New York
 Cable: SIMONTRICE, NEW YORK (All Codes)

P. R. MALLORY & CO. Inc.
MALLORY

...the battery line
designed for you

in *performance*
profit
promotion



This year's news in batteries is the Mallory Battery Program!

It's more than "just another battery line." It's a brand new concept, of battery performance, battery value and battery promotion—all rolled up in a program that produces growing sales for you *all year 'round*.

Get into the fast-growing transistor radio market for mercury batteries—pioneered by Mallory. They end your problems with shelf life . . . give your customers new standards of long life, constant power, economy. And for tube type portables, you can depend on the new full line of Mallory zinc-carbon batteries.

See your Mallory distributor today . . . and get full facts on the Mallory Battery Program!

P. R. MALLORY & CO. Inc.
MALLORY

P. R. MALLORY & CO. Inc., INDIANAPOLIS 6, INDIANA

• Capacitors • Vibrators • Resistors • Power Supplies • Controls

www.americanradiohistory.com