

# RADIO & TELEVISION NEWS

*World's Leading Electronics Magazine*

SEPTEMBER  
1954  
35 CENTS  
In U. S. and Canada



## IN THIS ISSUE

A MODERN METAL LOCATOR

ACOUSTIC MEASUREMENTS  
FOR THE AUDIOPHILE

DOT PATTERN GENERATOR FOR  
COLOR AND MONOCHROME

AN ECONOMY V. F. O.

SERVICING MIDGET RECEIVERS

SIMPLIFIED DESIGN  
OF FEEDBACK EQUALIZERS

TRANSISTORIZED  
MOISTURE DETECTOR

REDUCING TURNTABLE RUMBLE

THE NEW "600"  
(See Page 51)



WILMINGTON N CAR  
WILMINGTON PUBLIC LIBRARY  
AN-84-65618-75

Mr. Service Dealer:

THIS **RAYTHEON** AD IS YOUR AD

**LIFE**

**DOCTOR**  
(of Sound and Sight)

Your RADIO AND TELEVISION SERVICE DEALERS might be called eye and ear specialists, because theirs is the exacting job of curing the ills of the instruments that supply you with looking and listening pleasure. To accomplish the tremendous task of keeping America's millions upon millions of television and radio sets in top condition, requires many trained technicians, expensive up-to-the-minute equipment, and a wealth of experience and know-how.

America is fortunate indeed to have tens-of-thousands of competent TV-Radio technicians from coast to coast, doing the miraculous job of keeping up with this complex and fast growing industry. Raytheon salutes them all and is especially proud of those who are RAYTHEON Bonded ELECTRONIC TECHNICIANS. During the past ten years more than 35,000 Registered Bond Certificates have been issued by Raytheon to qualified service dealers all over the country. In spite of the fact that these dealers have handled many millions of jobs less than fifty complaints have been received.

Facts such as these justify confidence in your TV and Radio Service Dealer. Make doubly sure of satisfaction by taking a moment to look up the Raytheon Bonded Electronic Technician near you. Find him through his shop identification or in the yellow pages of your telephone directory.

**RAYTHEON**  
Bonded  
ELECTRONIC TECHNICIANS

Look for this seal here's what it stands for:  
RAYTHEON Bonded Electronic Technicians:

1. GUARANTEE ALL RADIO AND TELEVISION REPAIR WORK FOR 90 DAYS
2. Use only parts of recognized quality
3. Charge you more than list price for parts installed
4. Test customers' tubes as accurately as possible
5. Keep labor charges at a reasonable level
6. Perform only such work as is necessary
7. Maintain proper equipment for good repair work
8. Maintain the highest quality service.

RAYTHEON MANUFACTURING COMPANY, Receiving and Cathode Ray Tube Operations  
NEWTON, MASS. CHICAGO, ILL. ATLANTA, GA. LOS ANGELES, CALIF.

RECEIVING TELEVISION AND RADIO TUBES, INDUSTRIAL AND POWER TUBES, TELEVISION SETS, ROOM AIR CLEANERS, SEMICONDUCTOR PRODUCTS, DIATHERMY EQUIPMENT, ELECTRONIC COOKERS, ELECTRONIC EQUIPMENT, ELECTRONIC DUPLICATORS, INDUSTRIAL EQUIPMENT, ULTRASONIC MACHINES, TOOLS, AND ELECTRONIC TUBES, SONAR, RADAR AND COMMUNICATIONS EQUIPMENT FOR THE UNITED STATES GOVERNMENT

SEPT. 13, 1954

More than twenty-six million people will read about you and the good work you are doing, in the September 13th issue of LIFE Magazine. We at Raytheon are publishing this advertisement because we believe you deserve a public pat on the back for the successful way you have met every challenge of the Radio and Television Service industry. We

are telling you about it in advance so that you can take full advantage of its appearance to help increase your volume and profit. It's our way of saying thank you for using and recommending Raytheon Quality Radio and Television Tubes.

**RAYTHEON MANUFACTURING COMPANY**

Receiving and Cathode Ray Tube Operations  
Newton, Mass., Chicago, Ill., Atlanta, Ga., Los Angeles, Calif.

RAYTHEON MAKES ALL THESE:

RECEIVING AND PICTURE TUBES • RELIABLE SUBMINIATURE AND MINIATURE TUBES • SEMICONDUCTOR DIODES AND TRANSISTORS • NUCLEONIC TUBES • MICROWAVE TUBES



*Excellence in Electronics*

ST0004A 57

## You Practice SERVING with Kits I Send You



Nothing takes the place of PRACTICAL EXPERIENCE. That's why NRI training is based on LEARNING BY DOING. You use parts I send to build many circuits common to Radio and Television. With my Servicing Course you build the modern Radio shown at left. You build a Multitester and use it to help make \$10, \$15 a week fixing sets in spare time while training. All equipment is yours to keep. Coupon below will bring book of important facts. It shows other equipment you build.

## You Practice BROADCASTING with Kits I Send You



As part of my Communications Course I send you parts to build low-power Broadcasting Transmitter at left. Use it to get practical experience. You put this station "on the air" . . . perform procedures demanded of broadcasting station operators. An FCC Commercial Operator's License can be your ticket to a bright future. My Communications Course trains you to get your license. Mail coupon. Book shows other equipment you build for practical experience.

# I Will Train You at Home in Spare Time to be a RADIO-TELEVISION Technician



## TELEVISION Making Jobs, Prosperity

25 million homes have Television sets now. Thousands more sold every week. Trained men needed to make, install, service TV sets. About 200 television stations on the air. Hundreds more being built. Good job opportunities here for qualified technicians, operators, etc.

## America's Fast Growing Industry Offers You Good Pay, Success



Training PLUS opportunity is the PERFECT COMBINATION for job security, advancement. When times are good, the trained man makes the BETTER PAY, gets PROMOTED. When jobs are scarce, the trained man enjoys GREATER SECURITY. NRI training can help assure you and your family more of the better things of life. Radio is bigger than ever with over 3,000 broadcasting stations and more than 115 MILLION sets in use, and Television is moving ahead fast.

**J. E. SMITH, President**  
National Radio Institute  
Washington, D. C.

**Our 40th Year**

## N.R.I. Training Leads to Good Jobs Like These

### I TRAINED THESE MEN



"Am transmitter-studio operator at KPAT. Most important day of my life was when I enrolled with NRI."—Elmer Frewaldt, Madison, S. Dakota.

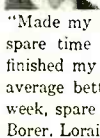

"Made my first \$100 from spare time work before I finished my course. Now I average better than \$10 a week, spare time."—Frank Borer, Lorain, Ohio.



"I've come a long way in Radio and Television since graduating. Have my own business on Main Street."—Joe Travers, Asbury Park, New Jersey.

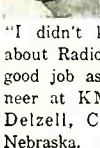

"I didn't know a thing about Radio. Now have a good job as Studio Engineer at KMMJ."—Bill Delzell, Central City, Nebraska.

**BROADCASTING:** Chief Technician, Chief Operator, Power Monitor, Recording Operator, Remote Control Operator. **SERVICING:** Home and Auto Radios, Television Receivers, FM Radios, P. A. Systems. **IN RADIO PLANTS:** Design Assistant, Technician, Tester, Serviceman, Service Manager. **SHIP AND HARBOR RADIO:** Chief Operator, Radio-Telephone Operator. **GOVERNMENT RADIO:** Operator in Army, Navy, Marine Corps, Forestry Service Dispatcher, Airways Radio Operator. **AVIATION RADIO:** Transmitter Technician, Receiver Technician, Airport Transmitter Operator. **TELEVISION:** Pick-up Operator, Television Technician, Remote Control Operator.

## Start Soon to Make \$10, \$15 a Week Extra Fixing Sets

My training is practical, complete; is backed by 40 years of success training men at home. My well-illustrated lessons give you basic principles you need and my skillfully developed kits of parts "bring to life" things you learn from the lessons. I start sending you special booklets that show you how to fix sets the day you enroll. Multitester you build with my parts helps you discover and correct set troubles, helps you make money fixing neighbors' sets in spare time while training. Many make \$10, \$15 a week extra this way.

## Mail Coupon — Find Out What Radio-Television Offer You

Act now to get more of the good things of life. I send actual lesson to prove NRI home training is practical, thorough. My 64-page book "How to be a Success in Radio-Television" shows what my graduates are doing and earning. It gives important facts about your opportunities in Radio-

**AVAILABLE to all qualified VETERANS UNDER G. I. BILLS**

Television. Take NRI training for as little as \$5 a month. Many graduates make more than the total cost of my training in two weeks. Mail coupon now to: J. E. SMITH, President, Dept. 4JE, National Radio Institute, Washington 9, D. C. Our 40th year.

## Good for Both - FREE

MR. J. E. SMITH, President, Dept. 4JE  
National Radio Institute, Washington 9, D. C.  
Mail me Sample Lesson and 64-page Book, FREE.  
(No salesman will call. Please write plainly.)

Name..... Age.....  
Address.....  
City..... Zone..... State.....

**VETS** write in date of discharge

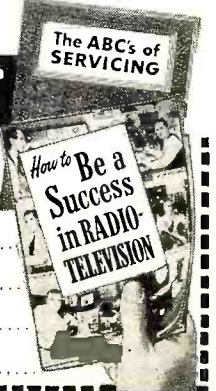

## Mail Today-Tested Way to Better Pay

**RADIO & TELEVISION NEWS** is published monthly by Ziff-Davis Publishing Company, William B. Ziff, Chairman of the Board (1946-1953), at 64 E. Lake St., Chicago 1, Ill. Entered as second-class matter July 21, 1948, at the Post Office, Chicago, Ill., under the act of March 3, 1879. Authorized by Post Office Department, Ottawa, Canada, as second-class matter. **SUBSCRIPTION RATES:** Radio & Television News—one year U. S. and possessions, and Canada \$4.00; Pan-American Union countries \$4.50; all other foreign countries \$5.00. Radio-Electronic Engineering Edition—one year U. S. and possessions, and Canada \$6.00; Pan-American Union countries \$6.50; all other foreign countries \$7.00. Postmaster—Please return undelivered copies under form 3589 to 64 E. Lake St., Chicago 1, Ill.

Editor and Asst. Publisher  
**OLIVER READ, D.Sc., WIETI**

Managing Editor  
**WM. A. STOCKLIN, B.S.**

Technical Editor  
**H. S. RENNE, M.S.**

Service Editor  
**CHARLES TEPPER**

Assistant Editors  
**P. B. HOEFER**  
**M. C. MAGNA**

Television Consultant  
**WALTER H. BUCHSBAUM**

Short-Wave Editor  
**KENNETH R. BOORD**

Art Editor  
**FRANK SAYLES**

Draftsman  
**A. A. GANS, W2TSP**  
**J. A. GOLANEK**

Advertising Manager  
**L. L. OSTEN**

Midwest Adv. Manager  
**JOHN A. RONAN, JR.**

Western Adv. Manager  
**JOHN E. PAYNE**

# RADIO & TELEVISION NEWS

*First in radio-  
television-audio-electronics*

Average Paid Circulation over 230,000

Radio News Trademark Reg. U. S. Pat. Office • Television News Trademark Reg. U. S. Pat. Office.

## CONTENTS

## SEPTEMBER, 1954

A Modern Metal Locator.....	Rufus P. Turner, K6AI	35
Acoustic Measurements for the Audiophile.....	Lawrence Fleming	38
Miniature Preamp.....	Robert Wiener	40
Fundamentals of Color TV—Color Synchronization (Part 7).....	Milton S. Kiver	42
Dot Pattern Generator for Color and Monochrome.....	Walter H. Buchsbaum	45
Servicing Midget Receivers.....	James A. McRoberts	48
1954 TV Receiver Specifications.....		50
The New "600".....		51
Transistorized Moisture Detector.....	Louis E. Garner, Jr.	52
Simplified Design of Feedback Equalizers.....	Arthur J. Rose	54
An Unusual TV Phase Detector.....	John K. Frieborn	51
Certified Record Revue.....	Bert Whyte	61
Two-in-the-Hand (Part 2).....	Rob Wagner, W6WGD	61
"Concert Hall on Wheels".....	Abraham B. Cohen	66
An Economy V.F.O.....	J. T. Goode, W6LVT	68
A Transistor Phase Inverter.....	W. H. Caldwell	71
Reducing Turntable Rumble.....	Roy B. Lang, Jr.	72
Regulating the Speed of Record Players.....	Herman Burstein	74
Mac's Radio Service Shop.....	John T. Frye	76
The C900 FM Tuner.....	L. J. Herman	82
An Outboard Bass-Booster.....	Allan M. Ferres	88
A New Antenna Coupling System.....	Harold Harris	117
New TV Stations on the Air.....		128
New TV Grants Since Freeze Lift.....		128
A New Slant on TVI.....	David T. Geiser, W1ZEO	130
Radio-TV Service Industry News.....		158

## DEPARTMENTS

For the Record.....	The Editor	8	What's New in Radio.....	103
Within the Industry.....		16	Manufacturers' Literature.....	136
Spot Radio News.....		24	New Audio Equipment.....	166
Short-Wave.....	K. R. Boord	90	Technical Books.....	175



COVER PHOTO: "It's like putting an elephant in a birdcage," according to Bob Hope when he first glimpsed the new Ampex 600 portable tape recorder at NBC's Hollywood studios. (Ektachrome by Jerry Holscher)

### ZIFF-DAVIS PUBLISHING COMPANY

President

**B. G. DAVIS**

Vice-Presidents

**H. J. MORGANROTH**

**M. H. FROELICH**

Secretary-Treasurer

**G. E. CARNEY**

Circulation Manager

**M. MICHAELSON**

### BRANCH OFFICES

CHICAGO 111

24 E. Lake St., AN 3-5270

LOS ANGELES 1141

Springer Center, 900 Wilshire Blvd., Mich. 9836



COPYRIGHT 1954

(All Rights Reserved)

**ZIFF-DAVIS PUBLISHING COMPANY**

WILLIAM B. ZIFF (1898-1953) FOUNDER

Editorial and Executive Offices

366 Madison Ave., New York 17, N. Y.

VOLUME 52 • NUMBER 3



Member  
Audit Bureau of  
Circulations

**SUBSCRIPTION SERVICE:** All communications concerning subscriptions should be addressed to Circulation Dept., 64 E. Lake St., Chicago 1, Ill. Subscribers should allow at least four weeks for change of address.

**CONTRIBUTIONS:** Contributors are advised to retain a copy of their manuscripts and illustrations. Contributions should be mailed to the New York Editorial Office and must be accompanied by return postage. Contributions will be handled with reasonable care, but this magazine assumes no responsibility for their safety. Any copy accepted is subject to whatever adaptations and revisions are necessary to meet the requirements of this publication. Payment covers all author's, contributor's, and contestant's rights, title, and interest in and to the material accepted and will be made at our current rates upon acceptance. All photos and drawings will be considered as part of the material purchased.

**RADIO & TELEVISION NEWS**

All Electronic Parts  
YOURS TO KEEP!

Now!  
Work over  
**300**  
practical projects  
WITH THESE  
PARTS...

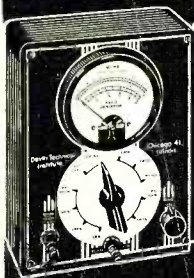

MULTIMETER



**5** INCH  
"SCOPE"

... TO  
HELP YOU LEARN

# TELEVISION

**RADIO-ELECTRONICS** Now ... at home in spare time you can get BOTH the very training and subsequent Employment Service you need to help you start earning real money in America's thrilling, multi-billion dollar opportunity field of Television-Radio-Electronics. Now that Television is coming to almost every community, here is a chance of a lifetime to prepare to cash in on one of Television's great expansions.

D.T.I.'s amazingly practical home method enables you to set up your own HOME LABORATORY. You get many Electronic parts which you mount on individual bases with spring clip connectors. Tops for experimenting! Add or remove parts in a jiffy. No wasted hours of soldering and unsoldering for each project. You spend *minimum* time to get *maximum* knowledge of important circuits that really work. In fact, you get exactly the same type of basic training equipment used in our Chicago training laboratory—one of the nation's finest.

### Build and KEEP This VALUABLE TEST EQUIPMENT

Your home laboratory projects also include building and keeping a versatile 5 inch Oscilloscope and precision Jewel Bearing Multi-Meter. These quality commercial test instruments help you EARN WHILE YOU LEARN and will prove mighty valuable, should you later decide to start your own full time TV-Radio service business. You also build and keep a quality 21 inch TV SET.

### D.T.I. Provides EVERYTHING YOU NEED to master TELEVISION

In addition to your home laboratory and easy-to-read lessons, you even use HOME MOVIES—a wonderfully effective and exclusive D.T.I. training advantage. You watch hidden actions ... see electrons on the march. Important fundamentals ... become "movie clear," helping you learn faster ... easier ... better.

Full time Residential training in D.T.I.'s great Chicago Laboratories also available. MAIL COUPON TODAY for all facts. (If subject to Military Service, you'll especially welcome the information we have for you.)

D.T.I.'s Training is available in Canada



HOME MOVIES

**21** INCH

Build and keep this BIG DTI Engineered TV set—easily converted to U.H.F. (DTI offers another home training, but without the TV set.)

**89 WAYS TO EARN MONEY**

**MAIL COUPON TODAY!**

"ONE OF AMERICA'S FOREMOST TELEVISION TRAINING CENTERS!"



**DEVRY TECHNICAL INSTITUTE**

AFFILIATED WITH  
**DEFOREST'S TRAINING, INC.**  
CHICAGO 41, ILLINOIS

**DEVRY TECHNICAL INSTITUTE**

4141 BELMONT AVE., CHICAGO 41, ILL. DEPT. RN-9-K

I would like your valuable information-packed publication showing how I can get started toward a good job or my own business in Television-Radio-Electronics.

Name \_\_\_\_\_ Age \_\_\_\_\_

Street \_\_\_\_\_ Apt. \_\_\_\_\_

City \_\_\_\_\_ Zone \_\_\_\_\_ State \_\_\_\_\_

It's no secret

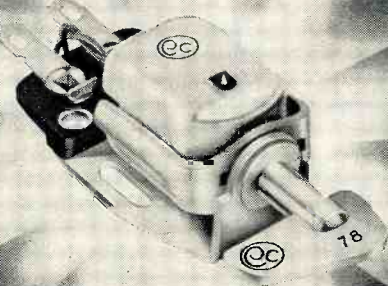

Professionals use Pickering MAGNETIC Cartridges

You're in the best of company if you use a Pickering MAGNETIC Cartridge. You have this in common with:

1. Leading record companies who use Pickering Cartridges for quality control.
2. Leading FM/AM good music stations and network studios.
3. Leading manufacturers of professional equipment for radio stations, recording studios, wired music systems and automatic phonographs, who install Pickering Cartridges for the maximum performance of their equipment.

Why Pickering MAGNETIC Pickups are the Choice of Recording and Broadcast Engineers!

"All modern disc recordings are made with MAGNETIC cutters. Within the geometrical and mechanical limitations of recording and reproducing equipment, a Pickering Pickup will re-generate an exact replica of MAGNETIC cutter response to the original program of music, speech or sound. This is a fundamentally inherent characteristic of the Pickering Pickup, supported by basic electromagnetic theory and countless

precise laboratory measurements. This is why Pickering MAGNETIC Pickups provide the most nearly perfect coupling possible, between reproducing equipment and original program. This is why they sound cleaner ... less distorted.

"Through the medium of the disc material, the reproducing system is effectively driven by the cutter electrical response itself."



**PICKERING** and company incorporated • Oceanside, L. I., New York

PICKERING PROFESSIONAL AUDIO COMPONENTS

*"For those who can hear the difference"*

... Demonstrated and sold by Leading Radio Parts Distributors everywhere. For the one nearest you and for detailed literature write Dept. C-5.

# COLOR-TV IS HERE

... where are you?

## TV Color Course FREE of extra charge with your RCA Tube purchases

The TV technician who is ready—who knows color TV theory, receivers and servicing techniques—will be the one to make the BIG profits. YOU can be one of those technicians—if you start learning now!

### Home Study Course

The RCA Home Study Course in Color TV has been planned and prepared by instructors at the RCA Institutes, with the close cooperation of engineers and training specialists of RCA. By studying at home, under the guidance of these experts, you can learn the facts about Color TV Theory, Receivers, and Servicing—quickly . . . clearly . . . thoroughly! The RCA Institutes' Color TV course is a practical, down-to-earth home-study plan that covers the facts you will need to install and service color sets successfully.

This valuable, important course in Color TV is FREE of extra charge with your purchases of RCA Tubes. See your RCA Tube Distributor for complete details.

### Nine Easy-to-Follow Lessons: COLOR-TV THEORY

1. Introduction to Color TV
2. Principles of two-phase modulation and colorimetry
3. Principles of Color TV receivers

### COLOR-TV RECEIVERS

4. Tricolor Kinescopes
5. The color television system
6. Color TV receiver circuits

### COLOR-TV SERVICING

7. Set-up and adjustment of color
8. Servicing and alignment
9. Test equipment for Color TV servicing

### DO YOU KNOW THESE COLOR-TV TERMS?

- |                       |                         |                           |
|-----------------------|-------------------------|---------------------------|
| ★ dynamic convergence | ★ saturation            | ★ beam-positioning magnet |
| ★ shadow mask         | ★ chroma                | ★ burst                   |
| ★ three-beam gun      | ★ dynamic-phase control | ★ gamma corrector         |
| ★ purity              |                         |                           |
| ★ matrix              |                         |                           |



**RADIO CORPORATION of AMERICA**  
ELECTRON TUBES

HARRISON, N. J.

**SLIM MODERN**

*low cost*  
**CRYSTAL  
MICROPHONE**



Another value-leader in the complete line that gives you better choice than ever in crystal microphones! Combines E-V quality features with handsome new slim design—for attractive and effective use in public address, home tape recording and communications. Frequency response is smooth, peak-free 70-8000 cps. High output level. Omnidirectional polar pattern. Can be used in upright or angle position. Hi-Z. Moisture-sealed crystal. Pressure cast case, finished in rich Satin Chromium.  $\frac{5}{8}$ "-27 thread stand coupler. Size  $1\frac{3}{16}$ " x  $6\frac{3}{4}$ " including swivel mount. 18 ft. cable. Net wt. 11 oz.

**Model 926. List Price \$24.50**

Ask your E-V Distributor or write for Condensed Catalog 119

NO FINER CHOICE THAN

**Electro-Voice**

ELECTRO-VOICE, INC. • BUCHANAN, MICH.  
Export: 13 E. 40th, N.Y. 16, U.S.A.

*For the* **RECORD.**

BY THE EDITOR

POPULAR ELECTRONICS

FROM modest basement shops and experimental attic laboratories have emerged the fundamental ideas that have resulted in the fastest growing industry of our times—electronics. Our vast radio communications systems—spread like a giant web over the entire world—keep us informed of news almost as soon as it happens. The radio “ham,” using simple electronic equipment, communicates with his fellow hobbyists throughout the world as simply as the housewife talks to her neighbor *via* telephone.

A large group of medics watch a delicate operation on a color TV screen. Every detail seen by the operating surgeon and the color camera is observed in isolated rooms. Instructions and comments of the surgeon are heard clearly from the loudspeaker system. An airplane is lost and is forced down at sea. Its call for help is heard by or made known to the FCC monitoring stations. A “fix” is made by electronic direction finders and the position of the lost plane is flashed to nearby vessels which quickly proceed to the rescue. A hostile airplane is spotted on a radar screen. Interceptors are dispatched to engage the enemy. Radio navigational aids protect us as we fly in an airliner and bring us to a safe landing on a fog-bound runway.

These are but a few of the thousands of applications for electronic devices that serve to protect life, limb, and property and that provide means of education and entertainment never dreamed of by our forefathers.

Many electronic devices are born in the great laboratories of the industry—but a greater number of pioneer developments have emerged from the experimenter’s bench and the basement ham shack. So-called tinkerers or gadgeteers have contributed many valuable ideas and important discoveries that have led to valuable patents.

The problem of maintenance of electronic devices, especially home units such as radio, television, and hi-fidelity equipment has been a real bottleneck and will become an even greater problem as we reach sizable production of color television.

A vast field of opportunity in electronics awaits the individual who will learn, by simple experiments, the fundamentals of circuitry, components and equipments. Others will become indoctrinated with electronics at the hobby level. The fascinating hobby of radio control finds thousands of young-

sters and oldsters meeting frequently to fly their airplanes and to sail their boats. And many a garage door is opened and closed by radio impulses from simple devices made in the home shop. One of the greatest hobbies in the world—amateur radio—has been tremendously stimulated by relaxed requirements to qualify for a coveted license and the “novice” class is attracting thousands of newcomers to this world-wide hobby.

Industry has recognized the importance of training new engineers, scientists, and technicians and our trade schools have produced thousands of technicians and other specialists. But many thousands more are needed to meet the ever-increasing demand for new blood in the industry.

Those of us who have grown up with electronics have been forced to keep pace with new developments at an ever-increasing rate. Circuitry has become more complicated through the years. Television and industrial electronics, telemetering and computing, and now color TV have necessitated a higher level of approach for RADIO & TELEVISION NEWS and other technical magazines. This, unfortunately, has deprived thousands of people interested in electronics of a regular source of information written in simple, understandable terms. POPULAR ELECTRONICS, a brand new magazine now on the press, is the answer to the demand for a monthly publication devoted entirely to electronics at a practical and hobby level.

POPULAR ELECTRONICS will be devoted to the science of electronics at a How-It-Works, Why-It-Works, How-To-Do-It, and How-To-Use-It level. Its writers and editors have all grown up with electronics. They have all cut their eyeteeth in radio, TV, and communications as experimenters and hobbyists. They appreciate, from long experience, that “practical know-how” is all-important and essential to success in the fascinating science of electronics. They include experimenters, hams, short-wave experts, radio-control enthusiasts, instructors, technicians, editors, and engineers.

We will appreciate your help in telling your friends about POPULAR ELECTRONICS. It will reach the newsstands later this month. Perhaps they too will be interested in this leading science of our times. And, finally, won’t you please tell us how YOU and your family like POPULAR ELECTRONICS? O. R.

RADIO & TELEVISION NEWS



# free

# 1955 VALUE PACKED ALLIED

## 308-PAGE CATALOG

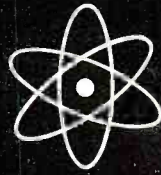

the only COMPLETE  
catalog for Everything  
in TV, Radio and  
Industrial Electronics

### SEND FOR IT TODAY

Get ALLIED's 1955 Catalog—308 pages packed with the world's largest selection of quality electronic equipment at lowest, money-saving prices. Select from the latest in High Fidelity systems and components; custom TV chassis, TV antennas and accessories; AM and FM receiving equipment; P.A. Systems and accessories; recorders and supplies; Amateur receivers, transmitters and station gear; specialized industrial electronic equipment; test instruments; builders' kits; huge listings of parts, tubes, tools, books—the world's *most complete* stocks of quality equipment. ALLIED gives you *every* buying advantage: fastest shipment, expert personal help, lowest prices, assured satisfaction. Get the big 1955 ALLIED Catalog. Keep it handy—save time and money on *everything* in Electronics. Send for your FREE copy today.

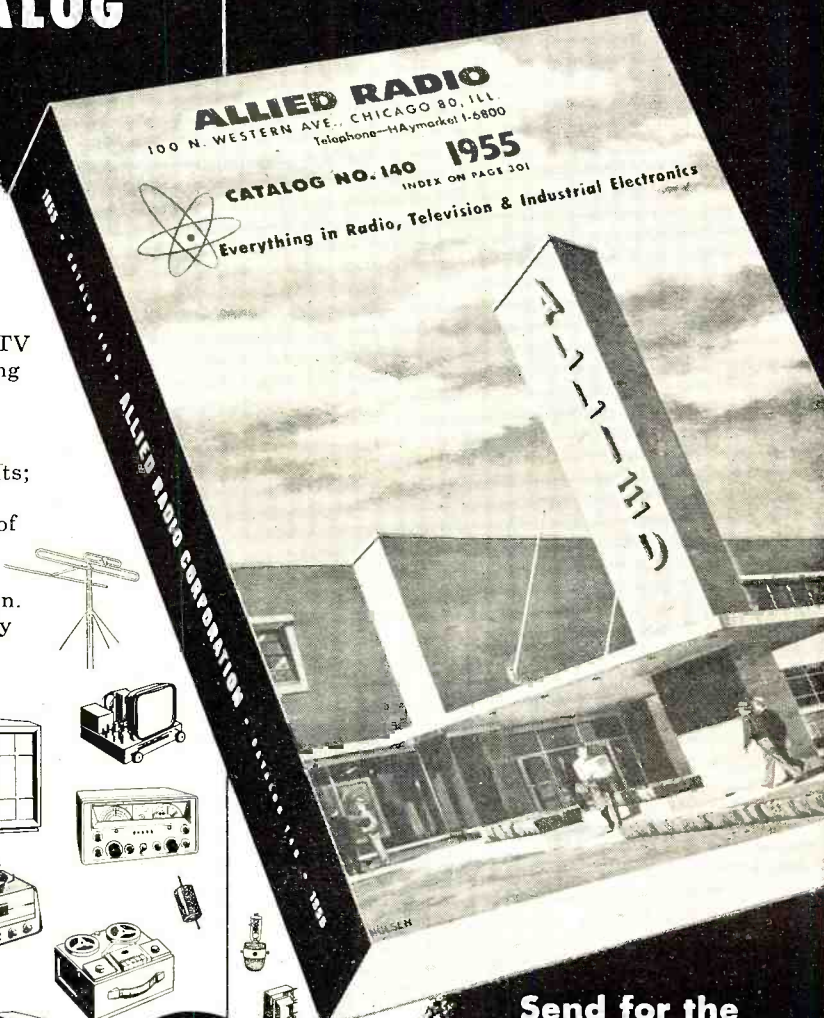

### World's largest Stocks

- All TV and Radio Parts
- All Electron Tube Types
- Test and Lab Instruments
- High Fidelity Equipment
- Custom TV Chassis
- AM, FM Receiving Equipment
- Recorders and Supplies
- P. A. Systems, Accessories
- Amateur Station Gear
- Builders' Kits & Supplies
- Equipment for Industry



## ALLIED RADIO

# free

World's Largest Electronic Supply House

#### EASY-PAY TERMS

Use ALLIED's liberal Easy Payment Plan—only 10% down, 12 months to pay—no carrying charges if you pay in 60 days. Available on Hi-Fi and P. A. units, recorders, TV chassis, test instruments, Amateur gear, etc.

#### HI-FI SPECIALISTS

To keep up with the latest and best in High Fidelity, look to ALLIED. Count on us for *all* the latest releases and largest stocks of Hi-Fi equipment. We specialize, too, in TV supply—and are foremost in the field of Builders' Kits.

Send for the  
leading Electronic  
Supply Guide

ALLIED RADIO CORP., Dept. 1-J-4  
100 N. Western Ave., Chicago 80, Illinois

Send FREE 308-Page 1955 ALLIED Catalog

Name .....

Address .....

City ..... Zone ..... State .....

ultra-modern facilities for the FASTEST SERVICE IN ELECTRONIC SUPPLY



*Sensationally  
New!*

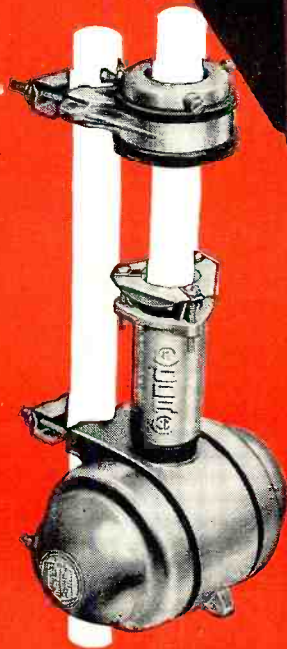
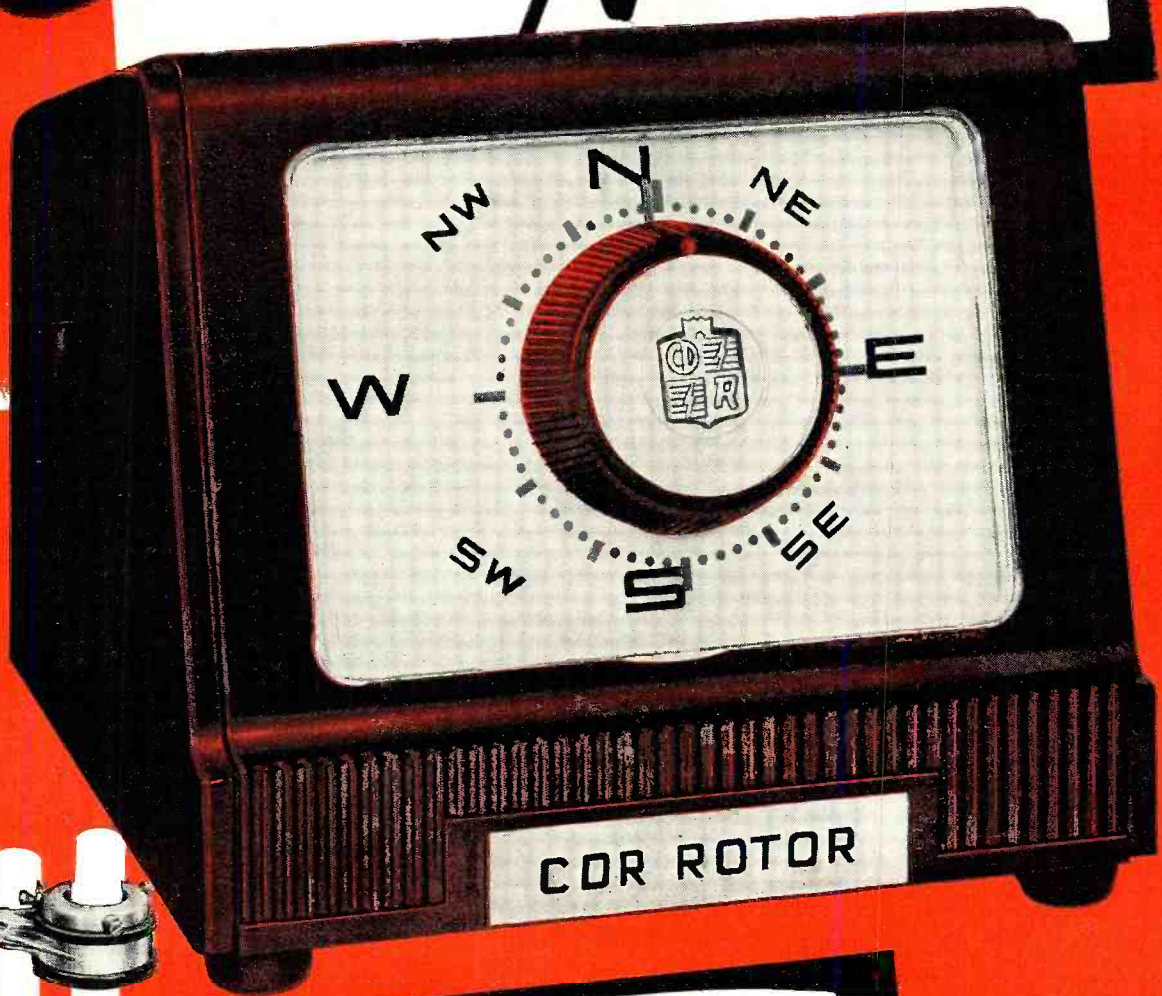

*Pre-Sold* to consumers in every leading TV market area with saturation TV spot announcements as well as newspaper advertisements. These further helps — animated point-of-sale display... newspaper mats ... envelope enclosures... window streamers.

Models AR-1 and AR-2

# CDR AUTOMATIC ROTOR

*40% sharper tuning*  
than any other  
**AUTOMATIC ROTOR**

They said it couldn't be done – never thought it possible – but HERE IT IS! The AR-1 and AR-2... the sharpest tuning AUTOMATIC ROTORS in the world. Superior construction and quality manufacture are featured in these as in the other CDR ROTORS, plus a handsome NEW MODERN DESIGN CABINET styled along lines for gracious, contemporary living. An added feature is a MECHANICAL BRAKE THAT IS RELEASED MAGNETICALLY! Here, truly, is the ultimate in rotors – handsome design, accurate, pinpoint, automatic performance easier to set and adjust – and CDR dependability!

### Model AR-2

... complete, AUTOMATIC rotor with THRUST BEARING... and handsome modern design plastic cabinet, uses 4 wire cable.

### Model AR-1

... same as AR-2, without thrust bearing.

### Model TR-2

*The heavy-duty rotor with plastic cabinet featuring "Compass Control", illuminated "perfect pattern" dial, uses 8 wire cable.*

### Model TR-4

*The heavy-duty rotor complete with handsome, modern design cabinet with meter control dial, uses 4 wire cable.*

### Model TR-11

*The same as the TR-12 without thrust bearing, complete with meter control dial cabinet, uses 4 wire cable*

### Model TR-12

*A special combination value consisting of complete rotor including thrust bearing. Handsome modern cabinet with meter control dial, uses 4 wire cable*



**CORNELL-DUBILIER**

SOUTH PLAINFIELD, N. J.



THE **RADIART** CORPORATION

CLEVELAND 13, OHIO

# WARD Antenna Rama

... means a complete merchandising and profit building program for TV antenna dealers ... antennas designed to meet any installation requirement ... in every price range ... smartly styled ... precision engineered ... and backed by dynamic advertising and merchandising ... all designed to make **WARD** your most profitable line!

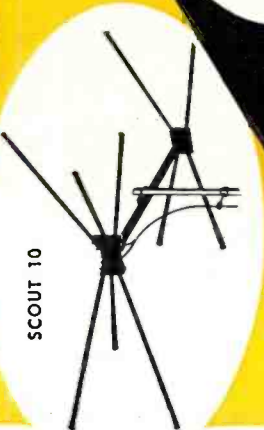

SCOUT 10

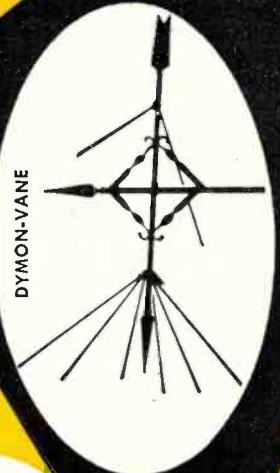

DYMOM-VANE

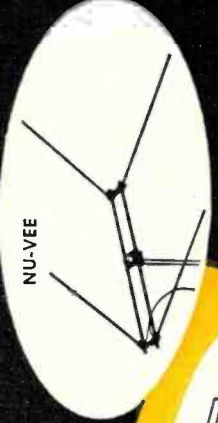

NU-VEE

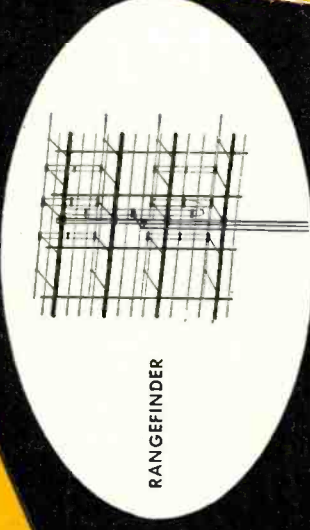

RANGEFINDER



LONGVIEW

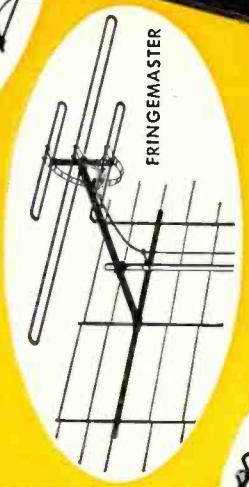

FRINGEMASTER



WARRIOR

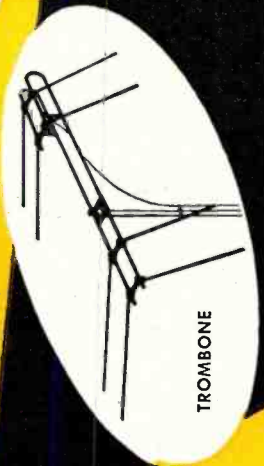

TROMBONE

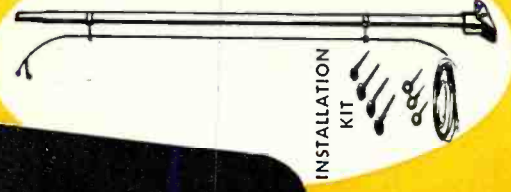

INSTALLATION KIT



*Let SAM work for you...*

**S**ales promotion — Eye catching displays, mailing pieces, catalog sheets.  
**A**dvertising — Effective national advertising plus local tie-in.  
**M**erchandising — Quality products, attractive prices, and actual sales leads for you.

**WARD PRODUCTS CORP.**

1148 EUCLID AVENUE, CLEVELAND 15, OHIO

Canadian Distributor: Atlas Radio Co., Ltd., Toronto, Canada



*The Best Costs Less When You Buy*

# THE FISHER

## Custom Audio Components

■ If you are buying 'for keeps' buy the best *first!* Buy FISHER, *quality* leader for seventeen years. Engineered for the professional, functionally designed for home use. "Of the very best!"—*High Fidelity.*

### FM-AM TUNER, Model 70-RT

Features extreme sensitivity, low distortion and low hum. Armstrong system, *adjustable* FM-AFC and AM selectivity. Preamplifier-equalizer, 2 inputs, 2 cathode follower outputs. Six controls. Self-powered. \$184.50

### FM-AM TUNER, Model 50-R

Same features as 70-RT above, but designed for use with external preamplifier-equalizer such as 50-C. Hum level better than 100 db below 2 volts output. Fully shielded and shock-mounted. Self-powered. \$164.50

### MASTER AUDIO CONTROL, Series 50-C

25 choices of record equalization, plus separate bass and treble tone controls, loudness balance control. Five inputs and input level controls, two cathode follower outputs. Chassis only, \$89.50 • With cabinet, \$97.50

### 25-WATT AMPLIFIER, Model 70-A

50-watts peak! More *clean* watts per dollar. Less than ½% distortion at 25 watts (0.05% at 10 watts.) Response ±0.1 db, 20-20,000 cycles; 1 db, 10 to 50,000 cycles. Hum and noise virtually non-measurable! \$99.50

### 50-WATT AMPLIFIER, Model 50-A

100-watts peak! World's *finest* all-triode amplifier. Uniform within 1 db, 5 to 100,000 cycles. Hum and noise 96 db below full output. 1M distortion below 2% at 50 watts. Highest quality components thruout. \$159.50

### SPEAKER ENCLOSURE, Series 50

NEW! Regardless of the speaker or enclosure you are now using, the "50" Horn will revolutionize its performance. For use with 12" or 15" speaker systems. 50-HM (Mahogany) \$129.50 • 50-HB (Blonde) \$134.50

### PREAMPLIFIER-EQUALIZER, Model 50-PR

*Professional* phono equalization facilities at low cost! Independent switches for LF turn-over and HF roll-off. Output lead up to 50 feet. Can accommodate any low-level, magnetic pickup. Self-powered. \$22.95

### HI-LO FILTER SYSTEM, Model 50-F

Does what ordinary *tone* controls cannot do, for it suppresses all types of noise with an *absolute minimum* loss of tonal range. High impedance input; cathode follower output. Use with any equipment. \$29.95

*Prices slightly higher west of the Rockies*

WRITE TODAY FOR COMPLETE SPECIFICATIONS

FISHER RADIO CORPORATION • 39 EAST 47th STREET • NEW YORK, N. Y.

*It's New! It's Here!*



# SILVER

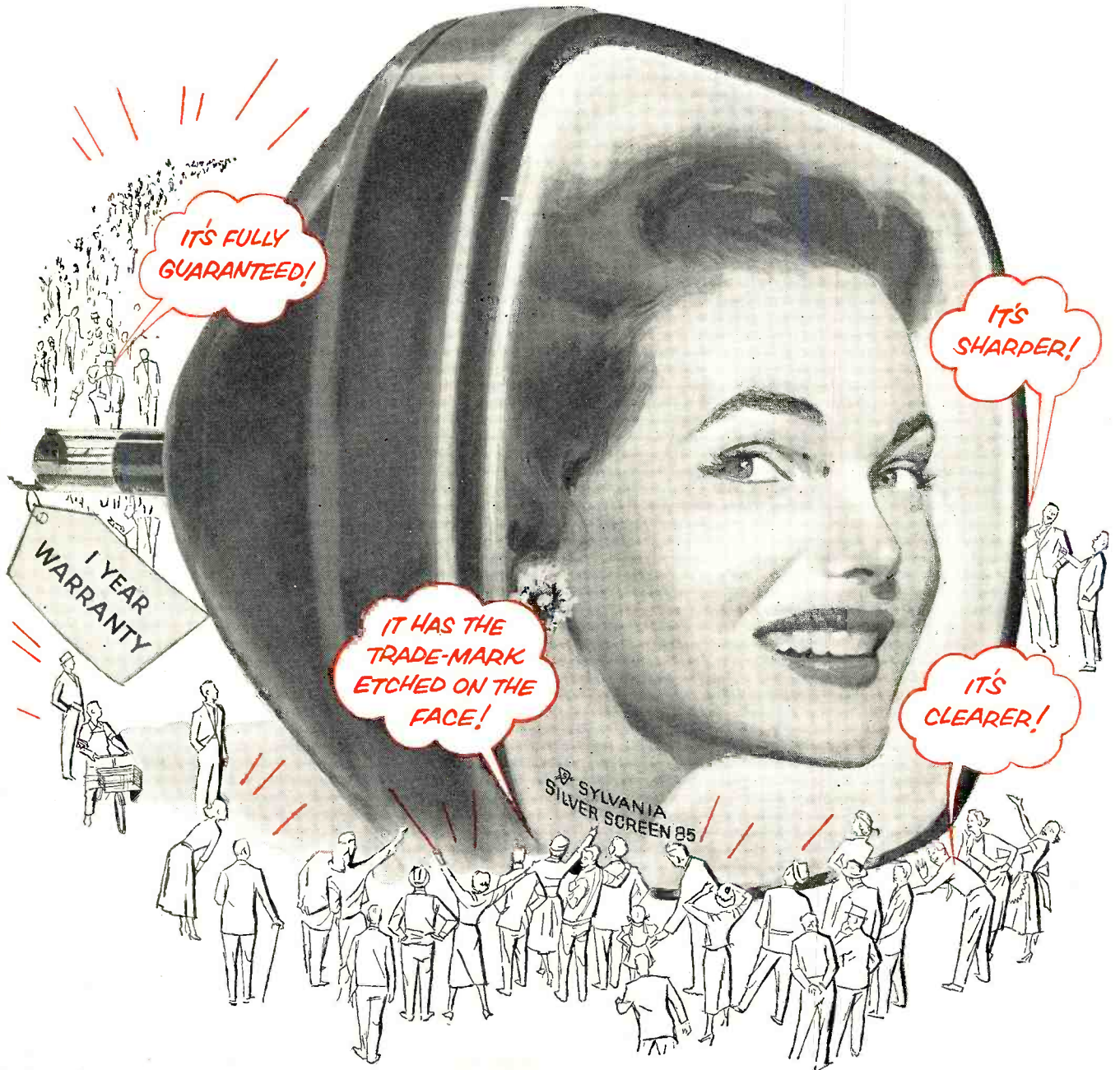

*IT'S FULLY  
GUARANTEED!*

*IT'S  
SHARPER!*

*IT HAS THE  
TRADE-MARK  
ETCHED ON THE  
FACE!*

*IT'S  
CLEARER!*

SYLVANIA  
SILVER SCREEN 85

# IT'S SYLVANIA'S

# SCREEN 85<sup>99</sup>

**The Picture Tube with three amazing design features!**

**SILVER-ACTIVATED SCREEN...SUPER ALUMINIZED REFLECTOR  
PRECISION-FOCUS ELECTRON GUN**

**YOU CAN BE PART OF THE  
BIGGEST PICTURE TUBE  
CAMPAIGN IN THE INDUSTRY!**

All this promotion material  
is yours **FREE**  
—All you have to do is ask for it!

- attractive window streamers . . .
- colorful counter and window displays . . .
- radio and TV commercials for you to use on your local stations . . .
- newspaper mats . . .
- publicity releases . . .
- postcards . . .
- envelope stuffers . . .
- a brand new booklet to describe the revolutionary "Silver Screen 85" to your customers . . .



Here is a truly great achievement in television picture tubes! Sylvania's "SILVER SCREEN 85" is the last word in design and engineering perfection. It's the picture tube with the SILVER-ACTIVATED SCREEN, to produce television's sharpest, clearest pictures; the SUPER ALUMINIZED REFLECTOR to catch and use all available light, giving pictures more depth, more dimension than ever before; the PRECISION-FOCUS ELECTRON GUN that scans every inch of the screen, making images stand out in pinpoint detail.

From foreground to background, pictures are razor-sharp, crystal clear! Blacks are *really* black—whites are *true* white. Only professional movies can duplicate

the "Silver Screen 85" picture. It's a SUPER ALUMINIZED PICTURE TUBE, designed to give top performance, made to the highest quality standards, and backed by the world's most experienced manufacturer of picture tubes!



**YOUR SYLVANIA  
DISTRIBUTOR HAS THE  
"SILVER SCREEN 85" NOW!  
MAKE SURE YOU ARE PART  
OF THIS PROFIT-PACKED  
PROMOTION—CALL HIM,  
WRITE HIM, SEE HIM TODAY!**

**24 MILLION PEOPLE—INCLUDING YOUR CUSTOMERS—WILL HEAR ABOUT THE "SILVER SCREEN 85" EVERY WEEK ON "BEAT THE CLOCK"! 80 STATIONS NOW REACH 93% OF THE TV HOMES IN THE COUNTRY.**

Right in your own town! That's where Sylvania will help you sell the "Silver Screen 85"! Hard-selling commercials will tell millions of people every week that you're the man to see for a new "SILVER SCREEN 85."

# SYLVANIA



Sylvania Electric Products Inc., 1740 Broadway, New York 19, N. Y.

In Canada: Sylvania Electric (Canada) Ltd., University Tower Building, St. Catherine Street, Montreal, P. Q.

**LIGHTING • RADIO • ELECTRONICS • TELEVISION**

Royal Twins



of High Fidelity  
**INTERELECTRONICS**  
Coronation

**30 Watt Amplifier**

Class A-1  
Advanced Supra-Linear  
Williamson Circuitry **\$99.50**



**Preamplifier \$79.50**  
**Equalizer Console**

Exclusive feedback circuitry  
Over 50 db. feedback  
Virtually no distortion

Here are the twins that are providing high fidelity enthusiasts with their greatest thrill. The very finest equipment combining every desirable feature: Startling realism, high power, lowest distortion, polished chromium chassis, attractive low prices. Smart . . . both are ultra compact and precision crafted with highest quality components.

**AMPLIFIER:** KT-66 tubes, 60 watts peak! Multi-section grain-oriented output transformer. 5 to 200,000 cycle response. Less than 0.05% distortion at 15 watts. Hum and noise level virtually non-measurable. Preamp power.

**PREAMPLIFIER:** Z-729 input tube. 5 to 200,000 cycle response. 5 inputs, 16 equalization curves. Unusual bass and treble compensation. Independent recorder output. Variable loudness control. Lifetime sealed precision networks.

Hear the Coronation Twins today!  
Trade inquiries invited.

**INTERELECTRONICS**  
2432 GRAND CONCOURSE  
New York 58, N. Y.

Within the  
**INDUSTRY**

**JERRY KIRSHBAUM** has been re-elected to the post of president of the Eastern Division of the Sales Managers' Club. He is sales manager of *Precision Apparatus Company, Inc.* of Elmhurst, New York.



Robert Fenece of *International Resistance Co.* was re-elected vice-president of the club. Walter Jablon of *Freed-Eisemann Radio Co.* was elected to the board of directors of the Show Corporation for a period of two years.

The Sales Managers' Club is one of the sponsoring organizations for the Radio Parts Show.

\* \* \*

**CORNELL-DUBILIER ELECTRIC CORPORATION** opened its new Sanford, N.C. plant recently with elaborate ceremonies and an open house. The new facility provides 275,000 square feet of operating space including a two-story administration building . . . **COLLINS RADIO COMPANY'S** New York office has been moved to 261 Madison Avenue . . . The Powder Metal Division of **THE BASSICK COMPANY** has announced its third facilities expansion in Bridgeport, Conn. . . The establishment of a new Midwest sales office at 1 South Northwest Highway, Park Ridge, Illinois has been announced by **POLYTECHNIC RESEARCH AND DEVELOPMENT CO., INC.** of Brooklyn. Kenneth W. Meyers is in charge of the new office . . . **TRANSAMERICA ELECTRONICS CORP.** has moved into its own building at 115 Liberty St., New York. The move gives the company 10,000 square feet of warehouse space . . .

**LENNOX ENGINEERING ASSOCIATES** has transferred its high production manufacturing to **PARK PRODUCTS COMPANY** of Cleveland. The transfer includes its dual-ring centering device and ion traps for TV. The **LENNOX** organization will continue its consulting, research, and design activities . . . **GRANCO PRODUCTS, INC.** has opened a new plant annex at 36-17

20th Ave., Long Island City, N.Y. adjacent to its original plant . . . **TRAVLER RADIO CORPORATION** has built a new 80,000 square foot addition to its central plant in Orleans, Indiana, bringing the total footage of the Orleans plant to 250,000 square feet . . . **PENTRON CORPORATION** has acquired a modern plant occupying the entire 700 block of South Tripp Ave. in Chicago. The 3-story building has 75,000 square feet of floor space . . . **SYLVANIA ELECTRIC PRODUCTS INC.** has commenced operations in its new 110,000 square foot warehouse and sales office it has leased in Teterboro, N.J. . . **MAGNECORD, INC.** has purchased a manufacturing and office building at 1101 S. Kilbourn St., Chicago.

\* \* \*

**WILLIAM P. SHORT** is the new general manager of the *Gabriel Electronics Division of The Gabriel Company*. He will also continue his post as assistant to the president of the parent firm.



Prior to his new appointment, Mr. Short headed a number of staff and facilities organization programs in the electronics industry and was formerly vice-president in charge of piezoelectric and acoustic development for the *Clevite Brush Development Company*.

After the war he was assistant technical director in charge of microwave commercialization at *Federal Telecommunication Laboratories*. He also held posts with *Crosley, RCA*, and at the Radiation Laboratory of MIT.

\* \* \*

**STANLEY W. HORROCKS** has been appointed general manager of the Special Products Division of *Aerovox Corporation*. He is responsible for the engineering, manufacturing, and market analysis and development for products of the division . . . **ALLEN J. DUSAULT** is the new sales manager for the transistor division of *CBS-Hytron*. He will be responsible for coordinating all ac-

(Continued on page 18)



**HOWARD E. ANTHONY**—well known for his pioneering in the test instrument field met with tragic death in his private airplane when it crashed recently. The success of the Heath Co. which he founded was due to his foresight and engineering genius. He was very active in civic affairs and a respected leader in his community. His innovations in the kit field have substantially contributed to the widespread acceptance of electronic test instruments. The Heathkit has become world famous and a respected item in laboratories and radio-TV service shops in every nation. Industry has lost a great leader. The service profession has lost a real friend.



**It's New! 3 Years in Development  
-NOW READY FOR YOU!**

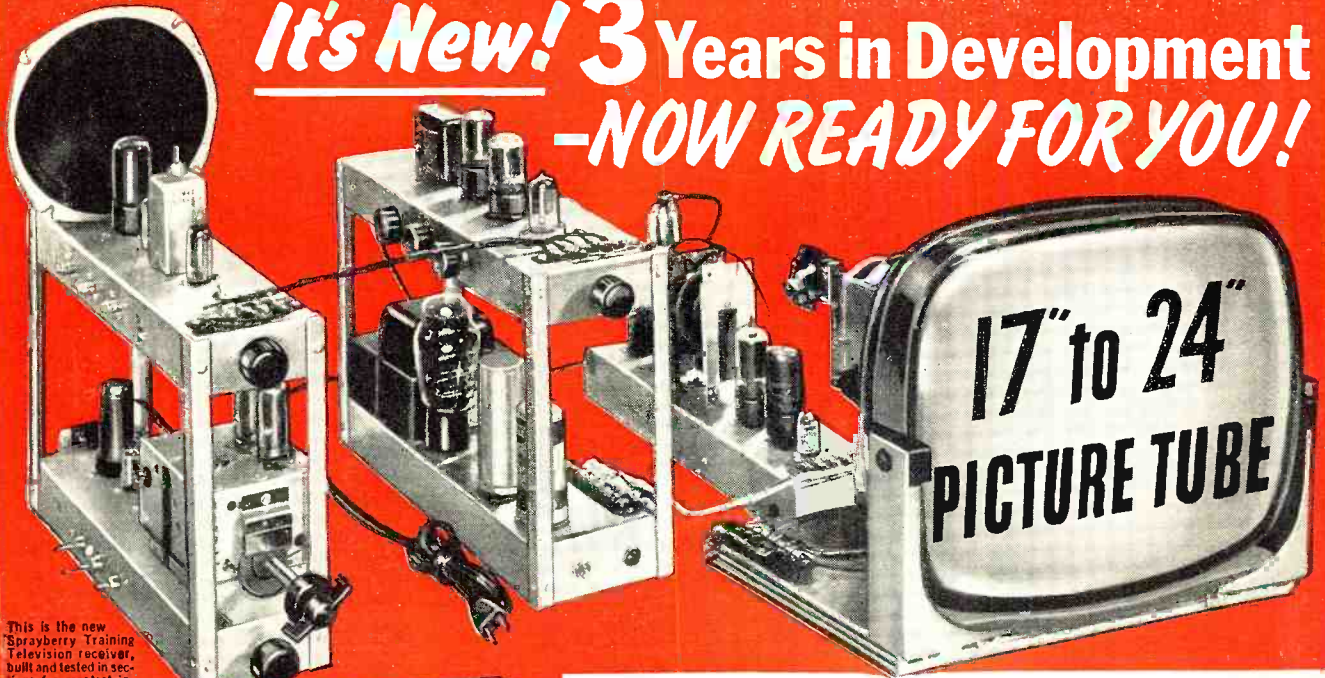

This is the new Sprayberry Training Television Receiver, built and tested in sections for greatest instructional value.

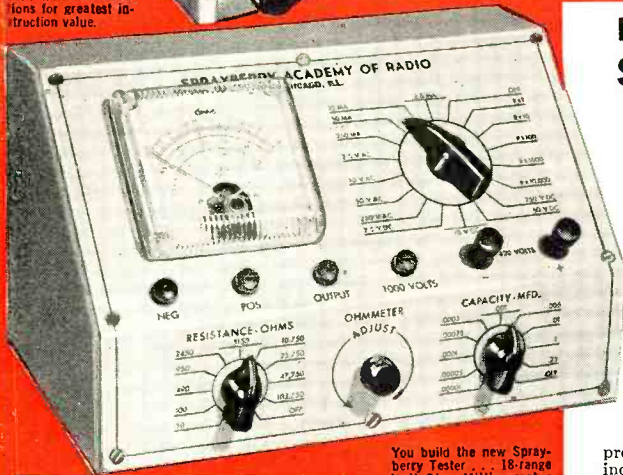

These photos show only a small part of the training equipment I send my students.

You build the new Sprayberry Tester... 18-range Volt-Ohm-Milliammeter readings plus output meter and condenser and resistor substitution selector.

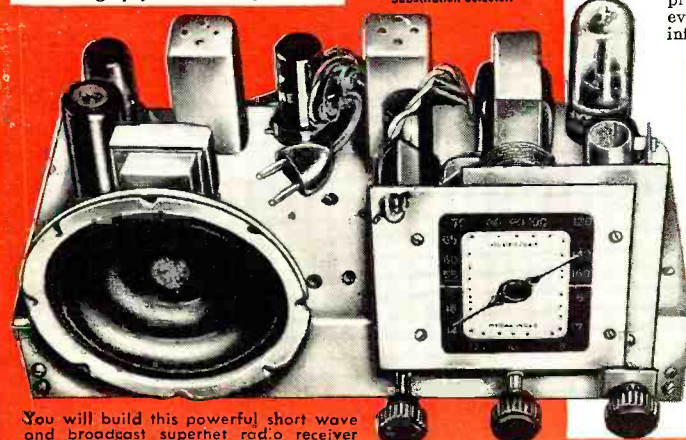

You will build this powerful short wave and broadcast superhet radio receiver for valuable shop instruction practice.

**New Equipment! New Lessons! Enlarged Course!**  
**SPRAYBERRY PRACTICAL TRAINING IN**  
**RADIO-TELEVISION**  
**3 NO OBLIGATION TRAINING PLANS**



Frank L. Sprayberry  
President, Sprayberry  
Academy of Radio

**You have NO MONTHLY PAYMENT CONTRACT to sign  
... pay for this outstanding training as you learn!**

The complete facts are so big and so important to any man seeking training in Radio-Television that I urge you to mail the coupon below at once for my big all-new 56 page FREE CATALOG and FREE Sample Lesson. Get the full story of this remarkable new and up-to-the-second Training Plan. You'll read about my 3 NO OBLIGATION PLANS or "packaged unit" instruction for both beginners and the experienced man. You'll learn how I can now prepare you in as little as 10 MONTHS to take your place in this fast moving big money industry as a Trained Radio-Television Technician. You'll see that you take no risk in enrolling for my Training because you DO NOT SIGN A BINDING TIME PAYMENT CONTRACT. I have been training successful Radio-TV technicians for 22 years... I can prepare you, too, to get into your own profitable Service Shop or a good paying job, even if you have no knowledge of Radio-Television. Mail the coupon... I rush full information FREE and without obligation. (No salesman will call.)

**NEWEST DEVELOPMENTS**

Your training covers U H F, Color Television, FM, Oscilloscope Servicing, High Fidelity Sound and Transistors.

**PRACTICE AND TRAIN AT HOME WITH 25 NEW KITS OF EQUIPMENT**

You get valuable practical experience in construction, testing and shop practice. You build a powerful 2 band superhet radio, the all-new 18 range Sprayberry multitester, the new Sprayberry Training Television receiver, signal generator, signal tracer and many other projects. All equipment is yours to use and keep... and you have practically everything needed to set up a Radio-Television Service Shop.

All your training is IN YOUR HOME in spare hours. Keep on with your present job and income while learning. I help you earn extra spare time money while you learn. If you expect to be in the armed forces later, there is no better preparation than practical Sprayberry Radio-Television training. Rush coupon below for all the facts—FREE!

**SPRAYBERRY ACADEMY OF RADIO**  
**111 NORTH CANAL STREET, DEPT. 25-N, CHICAGO 6, ILLINOIS**

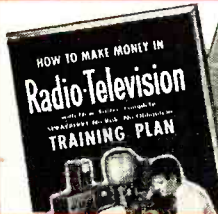

**FREE CATALOG AND SAMPLE LESSON**

Rush coupon for my catalog "How to Make Money in Radio-Television". PLUS an actual sample Sprayberry Lesson without obligation—ALL FREE. Mail coupon NOW!

SPRAYBERRY ACADEMY OF RADIO MAIL THIS COUPON FOR FREE  
 Dept. 25-N, 111 N. Canal St., Chicago 6, Ill. FACTS AND SAMPLE LESSON

Please rush all information on your ALL-NEW Radio-Television Training Plan. I understand this does not obligate me and that no salesman will call upon me. Include New Catalog and Sample Lesson FREE.

Name \_\_\_\_\_ Age \_\_\_\_\_

Address \_\_\_\_\_

City \_\_\_\_\_ Zone \_\_\_\_\_ State \_\_\_\_\_

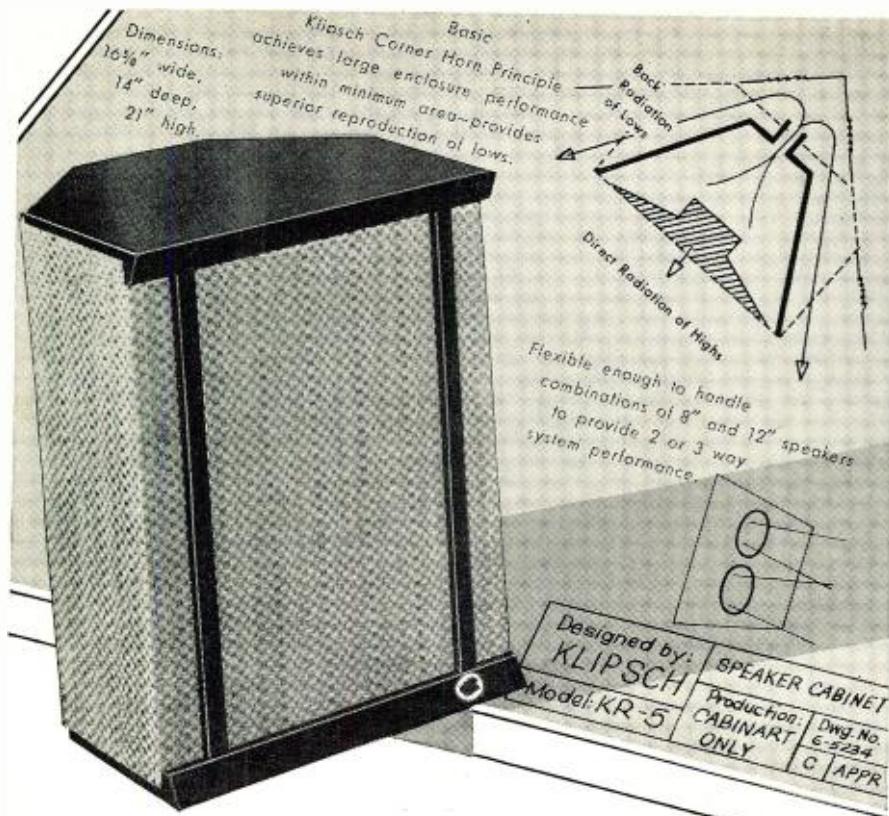

**... and the little monster  
walked right off  
the drawing board!**

Conceived in the fertile imagination of Paul Klipsch, America's leading designer of loudspeaker enclosures, and brought to life by the advanced production facilities of CABINART, the Little Monster astounded everyone who came into contact with it. Startled and awed by its almost-Klipschorn performance on light and middle bass, they were amazed at its complete freedom from boom and distortion.

**You too will be amazed . . . RESPONSE LIKE THIS  
FROM A 20" CORNER HORN SPEAKER ENCLOSURE!**

Paul Klipsch had blueprinted a small corner horn enclosure . . . light enough to move anywhere in the home, compact enough to fit in any space, versatile enough to complement any decor, and with performance enough to please the most critical ear . . . thus the Little Monster was born. Size . . . 20 inches; weight . . . 28 pounds; versatility . . . it can be wall-mounted, corner-hung, placed on a table, a bench, a shelf, anywhere in the home; performance . . . unbelievable!

The Little Monster, fifth in the Rebel series and thus called the KR-5, approaches Klipschorn performance on light middle bass . . . is excellent for its size even on heavy pipe organ bass. The response is smooth and clean . . . completely free from boom and distortion.

The acoustical science as applied to musical instruments has been incorporated within the Klipsch-Rebel series—so that the enclosure itself assumes the characteristics of a musical reproducer.

The KR-5 is thus scientifically engineered to provide the maximum performance possible from a 20" corner horn.

*This latest Klipsch Design by CABINART is available in both finished and Utility (unfinished) models. Also available is a portable model in Leatherette.*

**Finished \$48.00      Utility \$33.00**

*See the KR-5 at your local jobber,  
or write for complete information to Dept. 15-J*



**G & H WOOD PRODUCTS CO.,**  
75 North 11 St., Brooklyn 11, N. Y.

tivities pertaining to the company's sales of semi-conductor products . . . *Sprague Electric Company* has named **JAMES C. P. LONG** manager of its Washington, D.C. office, succeeding **JOHN P. SHERIDAN** who has been promoted to the post of coordinator of government liaison at the company's home office in North Adams, Mass. . . . **LESLIE ROBERTS** was elected president and chief executive officer of *Philharmonic Radio and Television Corp.* at a recent meeting of the board of directors. He replaces **BERNARD H. LIPPIN** who stepped up to board chairmanship . . . **S. JOHN LaPUMA** is the new publicity director for *JFD Manufacturing Company, Inc.* He succeeds **DAVID B. TOLINS, JR.** who is joining the creative staff of *Cowan and Dengler*, New York advertising agency . . . *DeWald Radio Manufacturing Corporation* has named **HERBERT A. FRANK** general sales manager for all operations in both radio and television . . . **JOHN J. HOLLAND**, formerly electronic equipment contracting officer for the U.S. Army Signal Corps at Fort Monmouth, has joined *Stromberg-Carlson Company* as head of quality control and inspection for the company's radio-television division. His duties will cover both commercial and military production . . . **DAVID TURNER**, founder and chairman of the board of *The Turner Company*, died recently in Cedar Rapids, Iowa. He was 72 . . . **S. W. GROSS**, vice-president in charge of sales for *Emerson Radio and Phonograph Corporation*, has been appointed vice-president and assistant to the president of the firm . . . **DWIGHT H. LADD** is the new manager of the Dallas plant of *Federal Electric Products Company* and its subsidiary, *Pacific Electric Manufacturing Corporation*.

**JAMES O. BURKE** has been elected executive vice-president of *Standard Coil Products Co., Inc.*, Chicago manufacturer of television components and aircraft instruments.

The company also announced the appointment of Jere H. Cavanaugh as financial administrator

for the company.

Mr. Burke, who founded *Standard Coil* with Glen E. Swanson in 1935, is also treasurer and a director of the company.

Mr. Cavanaugh, formerly treasurer of *McCord Corporation*, will work directly under Mr. Burke.

**THE 1954 HI-FI SHOW**, which will be held at the Palmer House in Chicago, September 30, October 1 and 2, is sponsoring a unique contest for those attending the Show.

The management has announced that the contest will be built around the theme "What Hi-Fi Means to Me." Persons attending the Show may obtain

*(Continued on page 170)*

# Now, TV set owners can understand benefits of Aluminized Tubes!



These three advertisements will appear in **POST** this fall.

## THESE ADVERTISEMENTS IN **POST** EXPLAIN THAT:

1. **IN MAGAZINES**, the pictures you see (when magnified) are made by a series of tiny dots applied to the paper *mechanically*.

**ON YOUR TV SCREEN**, the pictures are also made by a series of dots (which appear as lines) applied *electronically*. These dots, in both cases, create a variety of tones including black, a range of grays, and ~~white~~. BUT, it is the **LENGTH** of this "Black-to-White Range" (the gray scale) that makes the picture excellent, good, fair, or poor.



ARTHUR GODFREY famous CBS star



TRUE BLACK

SHORT  
"BLACK-TO-WHITE RANGE"

TRUE WHITE



LONG  
"BLACK-TO-WHITE RANGE"

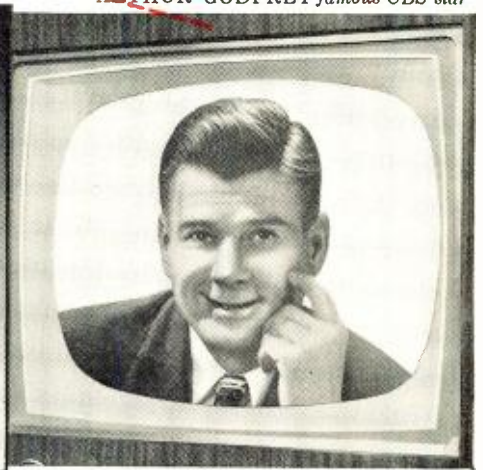

2. **ORDINARY PICTURE TUBES** used in most TV sets made before 1953 produce a *short* "Black-to-White Range." While the picture is good, the picture tube cannot develop enough *light output* for a *long* "Black-to-White Range."

3. **CBS-HYTRON MIRROR-BACK TUBES** produce up to *twice the light output* of ordinary picture tubes. Like the silver backing on a mirror, the *shiny* aluminum backing on a Mirror-Back tube reflects to the viewer *all the light* on the screen. The resulting increased brightness and reduced halation (unwanted spreading of light from one dot to another) is *essential* to give you a *long* "Black-to-White Range." The full range you *must* have for the clearest, sharpest, brightest pictures that are a joy to watch.

TALK LONG "BLACK-TO-WHITE RANGE" PICTURES  
**...SELL BIGGER-PROFIT**

## CBS-HYTRON MIRROR-BACK PICTURE TUBES

Talk . . . demonstrate . . . and sell "Long-Black-to-White-Range" clearer, sharper, brighter pictures. It's easier to sell premium-grade, brand-new CBS-Hytron Mirror-Backs . . . with their controlled quality and dependable full-year guarantee. Profit more. Tie in with POST. Get this Mirror-Back Promotion Kit . . . from your CBS-Hytron distributor, or mail coupon.



CBS-HYTRON Main Office: Danvers, Massachusetts

A Division of Columbia Broadcasting System, Inc.

A member of the CBS family: CBS Radio  
CBS Television • Columbia Records, Inc.

CBS Laboratories • CBS-Columbia • CBS International • and CBS-Hytron



**CBS-HYTRON**, Danvers, Mass.

I want all the material to identify me as a *Certified Quality Service* dealer who sells Mirror-Back tubes. Please rush me CBS-Hytron Mirror-Back Promotion Kit containing:

- 22 x 28-inch Advertised-in-POST window poster.
- 25 consumer self-mailers. "How You Can Have Clearer, Sharper, Brighter TV Pictures."
- Certified Quality Service* decalcomania.

I enclose 25¢ for postage and handling.  
I want . . . more consumer self-mailers at 1¢ each, for which I enclose an additional \$ . . . . .

Name . . . . . (please print)

Street . . . . .

City . . . . . State . . . . .

# See For Yourself

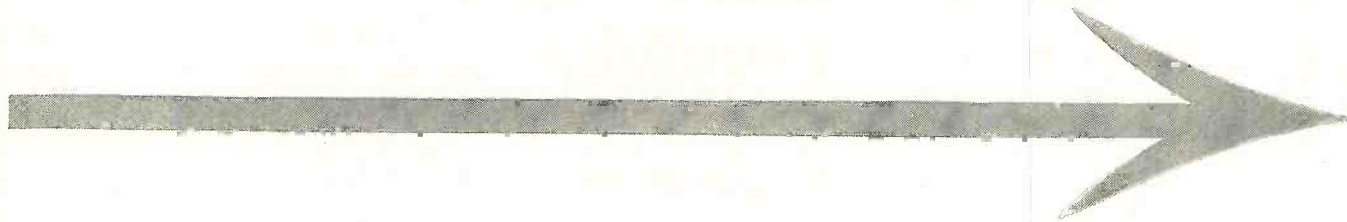

# *New!*

# PHILCO

**SUPER PERFORMANCE**



# ANTENNAS



# GUARANTEED TO OUTPERFORM ANY EQUIVALENT TYPE ANTENNA OR YOUR MONEY and LABOR COSTS BACK

There's been enough words written about TV antenna performance. Now . . . *see the facts for yourself!* Compare any of the new PHILCO Super-Performance TV Antennas with any equivalent type on the market. If the new PHILCO does not give you the finest picture possible, your money back for the antenna *plus* your labor costs up to \$10.00. Ask your PHILCO Distributor for complete details on this amazing offer!

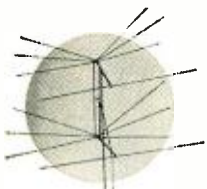

**PHILCO VHF  
SUPER CONICAL**

#### **PHILCO TWO-BAY SUPER CONICAL ALL-CHANNEL ANTENNA**

Strong signal pickup on VHF channels 2 through 13 . . . UHF channels 14 through 83 . . . ideal for fringe area reception . . . all-aluminum construction with dowelled elements: Part No. 45-3096-2. Rugged single bay design: Part No. 45-3096.

#### **PHILCO GOLDEN YAGI UHF ANTENNA**

Designed for 300 ohm operation . . . all metal construction . . . 11 db to 12 db gain on various channels. "Cronak" coated components resist salt air . . . humidity. Six models cover entire UHF spectrum: Basic Part No. 45-1996.



**PHILCO UHF  
GOLDEN YAGI**

#### **PHILCO PARAFLECTOR ALL-CHANNEL UHF ANTENNA**

Pre-assembled, all-aluminum . . . 8 to 10 db gain . . . outstanding fringe area performance . . . immediate mounting on existing masts. Part No. 45-3071. Bow Tie, Part No. 45-3069 and Bow Tie with reflector, Part No. 45-3070 give top quality pictures in many UHF areas.

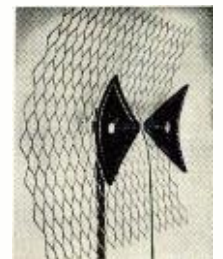

**PHILCO UHF  
PARAFLECTOR**

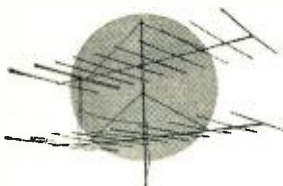

**PHILCO VHF  
LOW BAND YAGI**

#### **PHILCO TWO-BAY VHF LOW BAND YAGI ANTENNA**

10 elements . . . all-aluminum . . . factory pre-assembled. Top performance on channels 2 through 6 . . . 13 db to 15 db gain on various channels. Single bay Part No. 45-3112-2 through 6. Stacked version harness Part No. 45-3267.

**PHILCO CORPORATION ACCESSORY DIVISION**

"A" AND ALLEGHENY AVE. • PHILADELPHIA 34, PA.

The  
pole  
that  
need  
not  
be  
climbed



*Fastening wires with new tool.*

Since telephony began, there has been just one way to install telephone wires on poles: have a trained man climb up and fasten them there. Now Bell Laboratories engineers have developed a special pole line for rural areas. The entire line can be erected without climbing a pole.

The whole job is done from the ground. Light-weight poles are quickly and easily

erected. Newly created tools enable men to fasten wires to crossarms 10 to 25 feet over their heads.

This inexpensive line promises more service in sparsely populated places. From original design to testing, it exemplifies a Bell Telephone Laboratories team operation in widening telephone service and keeping costs down.

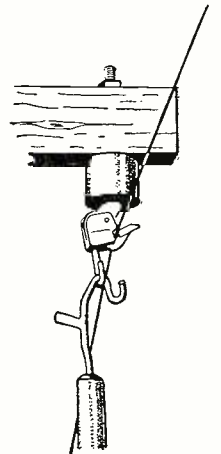

*Key to the new "climbsless" pole is this insulator. Ground crews use long-handled tools to place the wire in position and then lock it fast.*

## Bell Telephone Laboratories



IMPROVING TELEPHONE SERVICE FOR AMERICA PROVIDES CAREERS FOR CREATIVE MEN IN SCIENTIFIC AND TECHNICAL FIELDS

# Write your own ticket



L. C. Lane, B.S., M.A.  
President, Radio-Television Training Association. Executive Director, Pierce School of Radio & Television.

Use your experience in radio to step into a higher paying television job by studying AT HOME in your SPARE TIME.

The fabulous television industry has seen many booms — in building of broadcasting stations, manufacture of black and white VHF sets, and sale of these sets to millions of families — but the biggest booms are yet to come.

From my experience in the radio-television-electronics field and my contacts in high places, I can tell you that past TV booms will look small compared to the booms that will come with construction of new VHF and UHF stations and perfection of low-cost color television sets.

These developments are just around the corner. If YOU want to be in on the ground floor for the jobs that will be created, now is the time to do it. You can keep your present job and study one of my two NEW courses — FM and Television Technician Course — TV Cameraman and Studio Course.

These Courses — especially prepared for home study — will train you for top-paying jobs in the ever-expanding radio-television-electronics industry. You'll be able to write your own ticket to get a better pay job or set up your own business.

## EXPERT FM-TV TECHNICAL TRAINING

My FM-TV Technician Course lets you take full advantage of your previous experience — either civilian or Armed Forces. YOU CAN SAVE MONTHS OF TIME. My FM-TV Technician Course completes your training by providing a thorough background in Frequency Modulation and Television Theory and Practice.

You "Learn by Doing", working with parts and equipment I send you. Six large kits of FM and TV parts are given to you as part of the course. You build and keep a professional GIANT SCREEN TV RECEIVER complete with big picture tube (designed and engineered to take any size up to 21-inch).

Upon completion of your training you may — if you desire — take two weeks of shop training at my associate resident school in New York City AT NO EXTRA COST!



## PRACTICAL TV CAMERAMAN AND STUDIO COURSE



My TV Cameraman and Studio Course is designed to train TV Studio Technicians and TV Cameramen, urgently needed today by Television Broadcasting Stations throughout the nation.

New TV Stations are now mushrooming throughout the country. Men who can work as Audio Technicians, TV Cameramen, Microphone Boom Operators, Monitor Operators, Turntable Operators, Control Room Technicians can write their own tickets.

I will train you for an exciting high pay job as the man behind the TV camera. Work with TV stars in TV studios or "on location" at remote pick-ups.

Available if you want it . . . one week of actual work with studio equipment & TV Cameras at my associate resident school in New York City.

This course is a MUST for those who wish to increase their technical knowledge of television operations.

## TRAINING FOR BEGINNERS

My Radio-FM-Television Technician Course is especially prepared for men with no previous experience or training. I have trained hundreds of men for successful careers in radio-television-electronics. Many of them had only a grammar school education and no previous experience whatsoever in the field.

Two weeks of intensive shop practice at my associate resident school is also included with this Course.

# Radio Television Training Association

52 EAST 19th STREET • NEW YORK 3, N. Y.

Licensed by the State of New York • Approved for Veteran Training

September, 1954

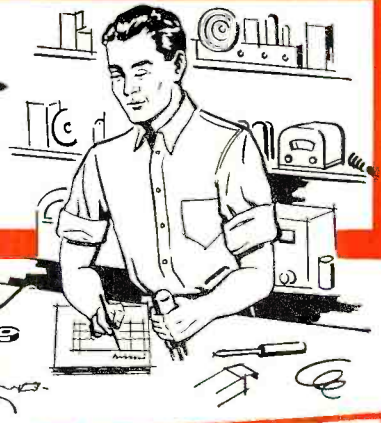

## VETERANS!

My School fully approved to train veterans under new Korean G.I. Bill. Available only to Veterans discharged after June 27, 1950. If eligible, CHECK COUPON.

### FREE FCC COACHING COURSE

Important for BETTER PAY JOBS requiring FCC License. You get this training AT HOME and AT NO EXTRA COST. Top TV jobs go to FCC-licensed technicians.

### EARN while you LEARN

Almost from the very start you can earn extra money while learning, repairing Radio-TV sets for friends and neighbors. Many of my students earn up to \$25 a week . . . pay for their entire training from spare time earnings . . . start their own profitable service business.

YOU GET THESE FOUR  
**Free**

- FREE SAMPLE LESSON
- FREE 48-STATE LIST OF FUTURE TV STATIONS
- FREE TV JOB OPPORTUNITIES LIST
- FREE HOW TO MAKE MONEY IN TV

MAIL THIS COUPON TODAY!  
NO SALESMAN WILL CALL!

Mr. Leonard C. Lane, President  
RADIO-TELEVISION TRAINING ASSOCIATION  
52 East 19th Street, New York 3, N. Y. Dept. T-9

Dear Mr. Lane: Mail me your NEW FREE BOOK, FREE SAMPLE LESSON, and FREE aids that will show me how I can make BIG MONEY IN TELEVISION. I understand I am under no obligation and no salesman will call.

(PLEASE PRINT PLAINLY)

Name \_\_\_\_\_ Age \_\_\_\_\_

Address \_\_\_\_\_

City \_\_\_\_\_ Zone \_\_\_\_\_ State \_\_\_\_\_

I AM INTERESTED IN:

- Radio-FM-TV Technician Course
- FM-TV Technician Course
- TV Cameraman & Studio Technician Course

**VETERANS!**  
Check here  for Training under NEW G.I. Bill.

**NEW!**

NICHOLS  
**NEVER-STAIN**  
TRADE MARK

**Aluminum**  
TV AND RADIO  
**GROUND WIRE**

RUST  
PROOF



- ★ High Electrical Conductivity
- ★ Inconspicuous — Low Reflectivity
- ★ Pliable — Specially Tempered
- ★ Etched finish — clean
- ★ STD. No. 8 B & S Ga. (.128" dia.)

**Aluminum**  
TV ANTENNA  
**GUY CABLE**

RUST  
PROOF



- ★ Seven — 18 Ga. Stranded Wires
- ★ Flexible — Specially Tempered
- ★ High Strength Aluminum Alloy for all Types of Antennas.
- ★ Approx. break strength — 500 lbs.



\*Packed 2-500 ft. continuous coils per carton marked every 100 ft. with bright red tape.



Order from your jobber or write us direct. Address Dept. TVN-3

**NICHOLS**  
WIRE & ALUMINUM CO.  
DAVENPORT, IOWA  
World's Largest Manufacturer of Aluminum Nails

**Spot Radio News**

★ Presenting latest information on the Radio Industry.

By RADIO & TELEVISION NEWS'  
WASHINGTON EDITOR

**THE ULTRA-HIGH PROBLEM**, which has become one of the most entangled issues ever placed before a Congressional committee, has kept the midnight lamps burning not only in the offices of the investigating Senators, but in quarters of the Commission and industry, too. Up for study were a parade of proposals, presented by scores of witnesses, which could start a new freeze, eliminate intermixture of v.h.f. and u.h.f. stations in the same market, remove all TV to u.h.f., institute a new plan for licensing of networks, cut back v.h.f. facilities to single market coverage, or perhaps provide subsidies for panicky ultra-high operators.

One of the boldest recommendations from Madame Commissioner Frieda Hennock, suggested that the committee must move promptly in a number of directions to aid the high bands. She felt that all Fall mergers, including dropouts and dropins must be halted; network programs should become available to the ultra-high stations; cancelled construction permits of u.h.f. permittees who had requested extensions should be re-instated; station coverage should be extended by boosters, and TV should eventually be moved to the upstairs channels. She also recommended legislation which would bar from interstate shipment any chassis that were not equipped to receive channels 2 to 83.

Intermixture was also soundly criticized by Senator Edwin C. Johnson. In a talk presented before the National Television Community Association, he called the decision to mix channels "insane," comparing it to an attempt to mix oil and water. And yet, he said, the . . . "FCC still stubbornly maintains that its original decision is correct."

According to the fiery Senator, the Commission entered . . . "two horses in the race; one a thoroughbred with breeding lines which showed it could run a long race superbly well; the other electronically fit, but hobbled by the big boys with monopoly in their hearts.

"The eggs have been scrambled and the omelette is on the way to being fried," NCTA listeners were told. "Once you start down Niagara Falls you do not retrace your steps," the Senator went on. So, he said, the

Commission . . . "clings to the hope that by some miracle the jockey on the second horse will push him into running a dead heat."

The plea for demixing was also supported by CBS Prexy Frank Stanton, who said that *Columbia* had always opposed intermixture, since it placed too great a burden on the ultra-high stations who had to compete with established low-band stations in the same markets. Commenting on the proposal to move all stations upstairs, he said that such a move would weaken the whole system, deprive some areas of service, and damage the quality of programs. He also criticized the suggestion that antenna heights and power of very-high stations be reduced; this approach, he felt, was equivalent to abandonment of the low-bands, for circulation would be reduced and the usefulness of channels 2 to 13 would be seriously impaired.

The plan to move everything to the ultra channels was censured too by Mayor David L. Lawrence of Pittsburgh, who went to Washington to ask for v.h.f. channels for his city. The ultra-highs, he said, did not and cannot provide sufficient coverage in the nation's steel center, because of the hilly terrain. His testimony revealed that eight applicants for the city's two v.h.f. channels had invested nearly a half-million dollars preparing for a hearing, and another half-million might be spent before decisions were rendered. In addition, he said, about \$14-million was tied up in pledges and subscriptions to those applying for low-band licenses to operate.

In a blistering statement filed with the subcommittee by Dr. Allen B. Du Mont, the '48 freeze was called the core of the present trouble. For, he said . . . "the freeze reserved to two networks the almost exclusive right to broadcast in all but 12 of the 63 markets which had television service." Because of this situation, he added, the . . . "other two networks did not have and have not had . . . more than a ghost of an opportunity to get their programs into the markets so necessary, if high quality programs are to be produced and attract advertisers from whom revenue and profits must come."

(Continued on page 124)



Busy service crew at Jersey Tire Co. speeds repairs with latest G-E methods. That's Al Alfonso at extreme left. John MacDougall next, with shop supervisor, Kurt Schlacht, in foreground.

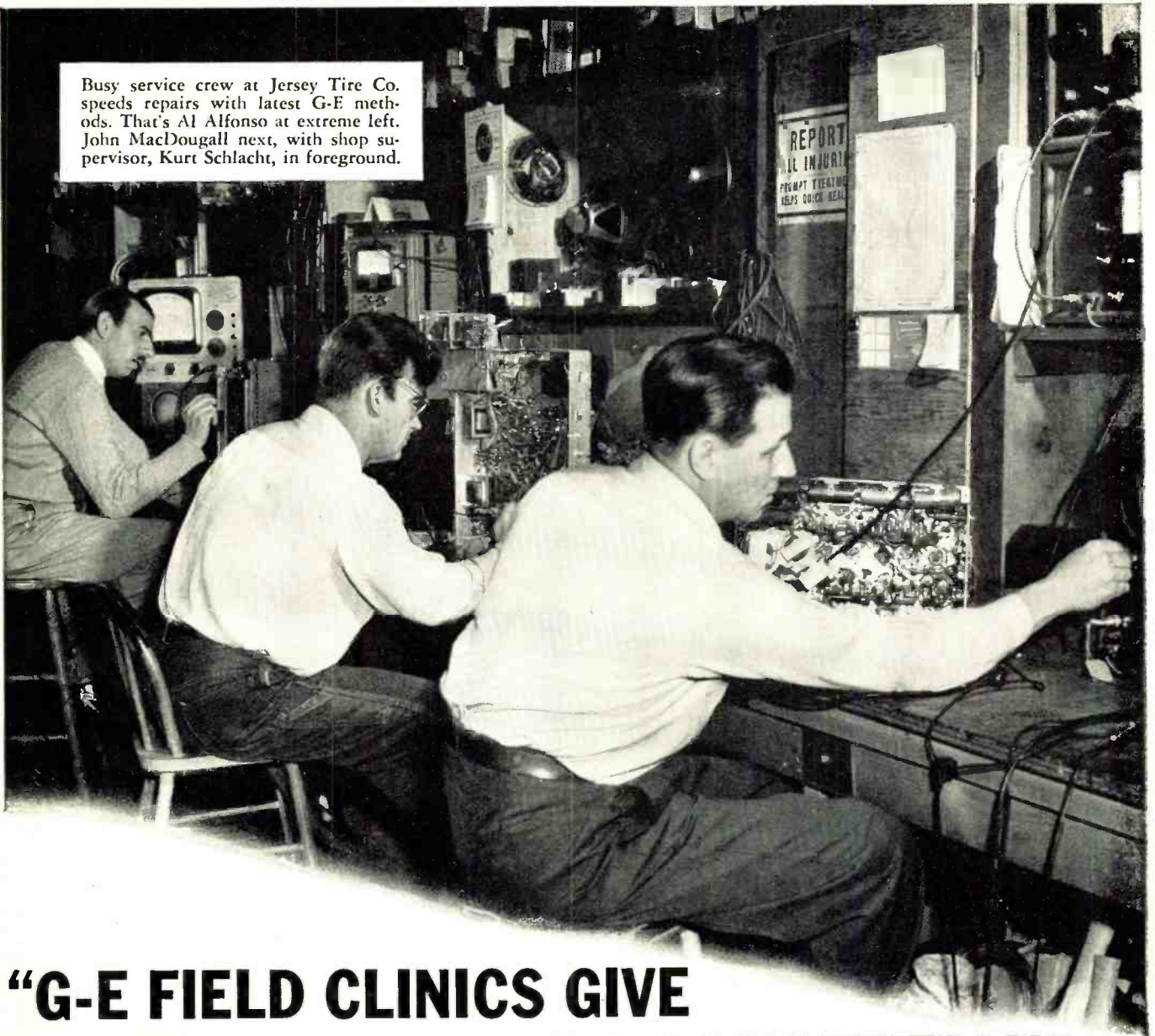

## "G-E FIELD CLINICS GIVE YOU EDGE ON TODAY'S COMPETITION"

WITH competition keener, now more than ever it pays to take advantage of free G-E Field Clinics. They'll show you newest short cuts in diagnosing and correcting TV ailments. You'll give better, faster service—keep customers happier, step up number of calls a day. Call your G-E Distributor today for place and date of next clinic nearest you.

"Yesterday's TV service methods are outdated today. That's why all of us here at Jersey Tire Co.

think the G-E Field Clinics are so great. The Clinics give you the edge on today's competition with the latest TV service methods. Customers tell us our service is far better than our competitors'—and that's the biggest boost a service business can have. We handle more repairs quicker. Just can't beat those G-E Field Clinics."

says *Leo Kaplowitz*

owner of this enterprising Perth Amboy firm.

*Progress Is Our Most Important Product*

**GENERAL  ELECTRIC**

RADIO & TELEVISION DEPARTMENT, SYRACUSE, N. Y.

No more chasing  
all over town to find  
an exact replacement!



No more waiting  
for delivery  
of out-of-stock items!



**Heard about Centralab's new Fastatch\* Custom-Control System?**

**Now 4,000 combinations of resistance and taper**

**are ALWAYS IN STOCK, wherever you see this sign**

**With this new plan, your Centralab distributor always has the dual-concentric replacement you need . . . one that's 100% tested and guaranteed by Centralab**

Again, pioneering by Centralab pays off for you. Again, Centralab saves you time, steps, and money. Here's how:

Centralab introduces a unique system of Fastatch dual-control units that snap together to give you more than 4,000 different combinations of resistance and taper.

So now your Centralab distributor can give you the right replacement for

practically any dual-control custom, current or future (including color TV)!

Moreover, you don't have to do the manufacturer's job—there are no loose parts . . . no lugs to bend . . . no tricky assembling. Fastatch units are completely assembled, tested, and guaranteed by Centralab.

Have your Centralab distributor demonstrate these new Fastatch units. And send coupon for bulletin 42-218.

**Centralab**  
©

## It's a snap

to get the  
right  
custom dual

### Snap front unit...

(with outer shaft  
cut to length)



### To rear unit...

(with blue shaft  
cut to length)



### Snap on switch...

(from Fastatch  
KB series)



### Add the knobs

—and there's your  
custom dual



**Centralab**

SAFEST FOR SERVICING

*Tear out coupon and mail today!*

### **CENTRALAB,**

A Division of Globe-Union Inc.

910-1 E. Keefe Avenue, Milwaukee 1, Wisconsin

Send me free bulletin 42-218.

Name.....

Company.....

Address.....

City.....Zone.....State.....

B-3754

\*Trademark

When the profile of the Cadillac looked like this

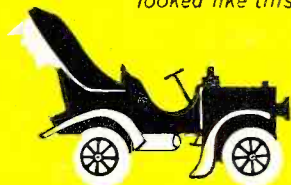

It was understandable that the profile of a V.O.M. might look like this



But this is the profile of today's Cadillac

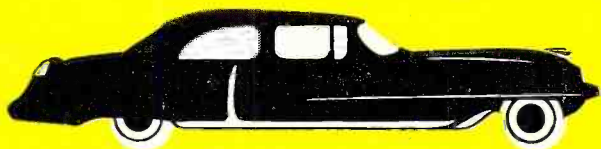

And if you buy a V.O.M. that is truly of today it will have a profile like this



## STREAMLINING signifies the difference!

In cars, streamlining symbolizes the tremendous advances in automotive engineering and performance. In fine test equipment, too, streamlining signifies the difference.

The flush switches, dials and jacks of the Smoothie make it easy to slip in your pocket, carrying case or tool kit, eliminate snag hazards on your bench.

But even more—the streamlining expresses externally the advanced internal design which makes the Triplet Model 630 as superior to the obsolete knobby bumpy-faced testers as the Cadillac of today is to the Cadillac of fifty years ago. These internal design features include such developments as selector switch of molded construction, completely enclosed; elimination of harness wiring, etc. Your most frequently used tester—your V.O.M.—should be the best—the one of which many thousands are in use in laboratories today—the Smoothie, Triplet Model 630 Volt-Ohm-Mil-Ammeter, \$39.50 net. Ask your parts jobber or write Triplet Electrical Instrument Company, Bluffton, Ohio.

# the SMOOTHIE

the only streamlined V.O.M. with a smooth face

TRIPLITT  
**630**

Volt-Ohm-Mil-Ammeter



Burton Browne Advertising

# Home Study Courses in **TELEVISION SERVICING** offered by **RCA INSTITUTES**



Study Television Servicing—from the very source of the latest, up-to-the-minute TV and Color TV developments. Train under the direction of men who are experts in this field. Take advantage of this opportunity to place yourself on the road to success in television. RCA Institutes, Inc. (A Service of Radio Corporation of America), thoroughly trains you in the "why" as well as the "how" of servicing television receivers.

## FIRST HOME STUDY COURSE IN COLOR TV SERVICING

Now you can train yourself to take advantage of the big future in Color TV. RCA Institutes Home Study Course covers all phases of Color TV Servicing. It is a practical down-to-earth course in basic color theory as well as how-to-do-it servicing techniques.

This color television course was planned and developed through the combined efforts of instructors of RCA Institutes, engineers of RCA Laboratories, and training specialists of RCA Service Company. You get the benefit of years of RCA research and development in color television.

Because of its highly specialized nature, this course is offered only to those already experienced in radio-television servicing. Color TV Servicing will open the door to the big opportunity you've always hoped for. Find out how easy it is to cash in on color TV. *Mail coupon today.*

### SEND FOR FREE BOOKLET

Mail coupon in envelope or paste on postal card. Check you are interested in. We will send you a booklet that gives you complete information. No salesman will call.



**RCA INSTITUTE, INC.**  
A SERVICE OF RADIO CORPORATION OF AMERICA  
350 WEST FOURTH STREET, NEW YORK 14, N. Y.

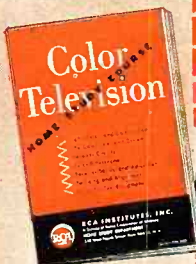

## HOME STUDY COURSE IN BLACK-AND-WHITE TV SERVICING

Thousands of men in the radio-electronics industry have successfully trained themselves as qualified specialists for a good job or a business of their own—servicing television receivers. You can do this too.

This RCA Institutes TV Servicing course gives you up-to-the-minute training and information on the very latest developments in black-and-white television.

As you study at home, in your spare time, you progress rapidly. Hundreds of pictures and diagrams, easy-to-understand lessons help you to quickly become a qualified TV serviceman.

There are ample opportunities in TV, for radio servicemen who have expert training. Mail coupon today. Start on the road to success in TV Servicing.

### MAIL COUPON NOW

RCA INSTITUTES, INC.  
Home Study Dept. RN-954  
350 West Fourth Street, New York 14, N. Y.  
Without obligation on my part, please send me a copy of booklet on:

- Home Study Course in TELEVISION SERVICING.  
 Home Study Course in COLOR TV SERVICING.

Name \_\_\_\_\_ (please print)

Address \_\_\_\_\_

City \_\_\_\_\_ Zone \_\_\_\_\_ State \_\_\_\_\_

RECEIVE EVERY CHANNEL

**NOW** AND IN THE **FUTURE**

TRU-YAGI PERFORMANCE on ALL CHANNELS 2-83 - B & W or COLOR

At last, a high gain, low cost antenna everyone wants that meets every need in all sections of the country.

THE VEE-D-X  
**SUPER CHIEF**  
WITH "DYNA-PHASE" \*

The FIRST all-channel antenna employing Dyna-phase, the sensational development recently released by the VEE-D-X laboratories. This new phasing technique permits extremely high gain over the entire VHF-UHF band with excellent directivity - high front-to-back ratio - all with a single transmission line. Neat in appearance, the SUPER CHIEF is completely pre-assembled. Ruggedized all aluminum construction featuring new VEE-D-X "squeeze lok" tubing on all elements - doubly reinforced at the stress points with a swaged aluminum sleeve and braced to the boom with triad lock hardware for durability plus easy installation.

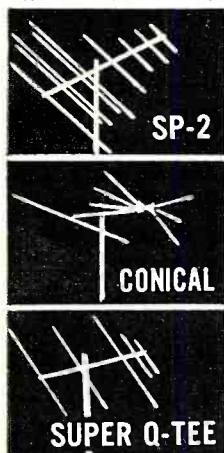
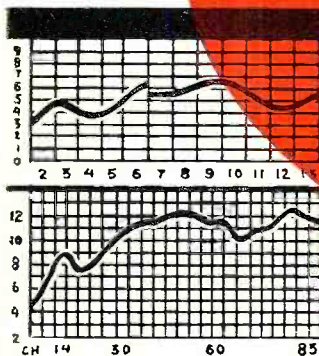
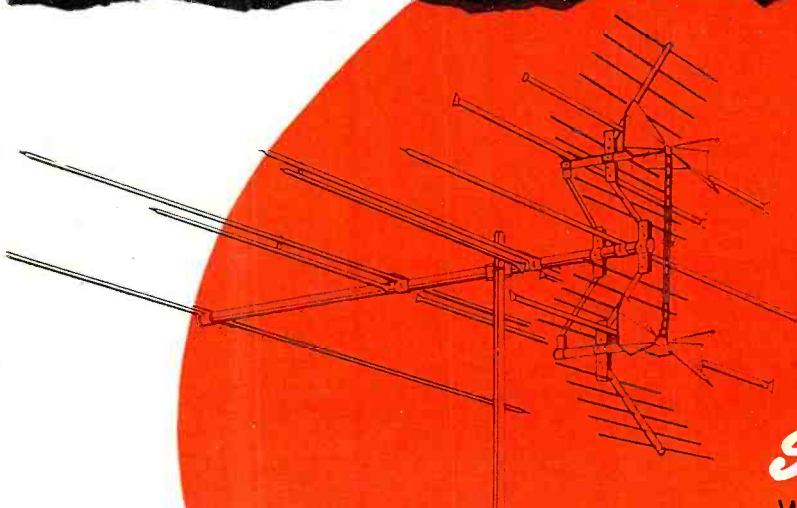

THE VEE-D-X  
**CHIEF**

Small in size but a Goliath in performance, the CHIEF is essentially a high-gain antenna for channels 7-83 that performs satisfactorily on channels 2-6 as well. Same rugged construction as the SUPER CHIEF, this antenna comes pre-assembled for trouble-free installation within minutes.

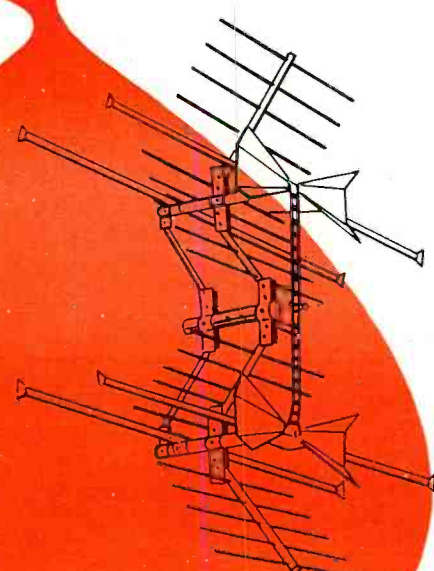

A COMPLETELY NEW LINE

OF **VEE-D-X** ANTENNAS

LaPOINTE ELECTRONICS INC.  
ROCKVILLE, CONN.

\* COPYRIGHT 1954 LAPOINTE ELECTRONICS INC.  
RADIO & TELEVISION NEWS

EVERYTHING IN PERFORMANCE  
 ... AT A PRICE  
 YOUR  
 CUSTOMERS  
 WILL LIKE!

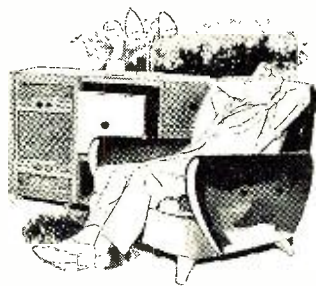

THE INDUSTRY'S MOST  
 COMPATIBLE LINE...  
 BEST ODDS GOING FOR  
 SATISFIED CUSTOMERS!



SIMPLE TO SELL...  
 THEY LISTEN ONCE... LOOK AT  
 THE PRICE TAG  
 ... AND BUY!



**HIGH-FIDELITY,  
 the G-E way,  
 MAKES SENSE!**

THOSE seven simple words tell the complete story. Your customers may spend a lot more money for equipment, but they'll never buy better performance than the General Electric Custom Music Ensemble delivers! Here, in *one integrated sound system*, lies the answer to widest high-fidelity customer interest... your greatest potential for profit and sales.

**To go places** in the high-fidelity business, go all the way with General Electric! Get aboard early... mail the coupon below for complete information today.



**CUSTOM  
 INSTALLATIONS  
 WITH MATCHED EQUIPMENT**

**HAVE  
 BONUS APPEAL!**



UNEQUALLED REPUTATION FOR  
 QUALITY... G-E's FAMOUS  
 VARIABLE RELUCTANCE  
 CARTRIDGE PROVES IT!



General Electric Company, Section R994  
 Electronics Park, Syracuse, New York.  
 Send me information on all units in the G-E high-fidelity equipment line.

NAME.....  
 ADDRESS.....  
 CITY..... STATE.....

**GENERAL  ELECTRIC**



**"HI-FI IS FOR EVERYBODY" . . .**

says *Robert Newcomb*

. . . Regardless of budget, way of life, or space limitations. Ownership of a true high fidelity system no longer requires an extensive technical background. In fact, today it doesn't even require more than a moderate expenditure to enjoy the wonderful realism of high fidelity.

Look over these new Hi-Fi Products and you'll see that Robert Newcomb not only believes that Hi-Fi is for everybody . . . but has a complete line of products to prove it.

Whatever your Hi-Fi plan, whatever your Hi-Fi budget, Newcomb is right there with the right amplifier.

**FOR SUPERIOR RADIO RECEPTION . . .**

*New* CLASSIC 200  
2 KNOB FM-AM TUNER



**\$169.50** AUDIOPHILE NET

Designed for use with any amplifier having its own complete set of controls. It's today's most advanced tuner. Designed and built by Newcomb . . . Completely new, distinctly different, and noticeably better! Fully enclosed and beautifully finished to use "as is." To place in a cabinet, Newcomb's exclusive "Adjusta-Panel" feature makes a simpler, neater job. U/L approved. Output is 10 volts at less than 1/4%. 1 volt at less than 4/100%. Effective to 200 ft. from amplifier.

Many new circuit advances have been made in both FM and AM sections. Results: 30 db of quieting with only 1 1/2 micro-volts input on FM. 1 Microvolt AM sensitivity for 1 volt output. Only 6 3/4" high by 11 1/2" by 11 1/2".

**FOR TRUE STEREPHONIC REPRODUCTION . . .**

*New* MODEL 3D-12, 25 WATT  
2 CHANNEL AMPLIFIER

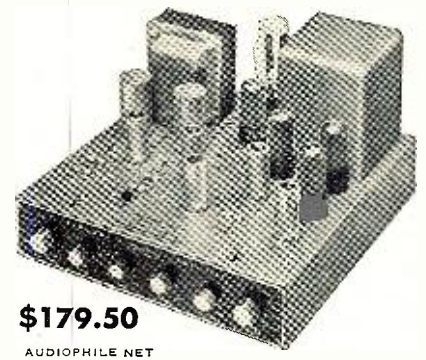

**\$179.50**  
AUDIOPHILE NET

Really two complete matched 12 1/2 watt amplifiers and preamplifiers in one. Common set of control knobs for both amplifiers offers easier operation, perfect results. All normal controls are provided plus new "focus" control. Channel selector switch gives operator choice of stereophonic reproduction, stereophonic reversed, Channel A, Channel B, or enhanced 2 channel monaural for simulated stereophonic reproduction of ordinary records. Dual tape "inputs" and dual "outputs" to tape make the 3D-12 ideal for use with the new "Binaural" tape recorders. Crossover selector provides various recording curves for both channels. Special switch provides correction for Cook Binaural recordings. Distortion below 1% at 25 watts. Response ±1 db 20-20,000 cycles.

**NEWCOMB Classic Series AMPLIFIERS . . .**

**WITH REMOTE CONTROL . . . . . OR . . . . .**

These remote controlled Newcomb Classic Series Amplifiers offer matchless performance and complete sound control . . . music exactly as you want to hear it. Words can't describe these superb products. Both give you: True remote control up to 50 or 100 ft.; Separate crossover and rolloff controls for up to 36 different recording curves; New "Level" control; Advanced design Loudness control; New rumble filter; Seven inputs; Mike input; Tape "Input"; "Output" to tape; No-Glare petite pilot light; and they're

U/L approved. Only your ears can convince you Hi-Fi can be so close to perfection. For utmost pride . . . for classic beauty . . . for luxurious operating ease and utmost listening pleasure . . . for substantial savings in cabinetry and installation expense . . . for lowest distortion *for life* . . . Own a Newcomb Classic Series Remote Controlled Amplifier. Don't fail to see and hear these premier products of Newcomb's 17 years of sound leadership.

*New* CLASSIC 2500-R

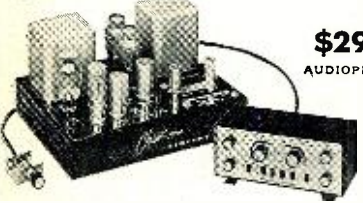

**\$297.50**  
AUDIOPHILE NET

25 watt Ultra Fidelity Remote Controlled Amplifier-Preamplifier • Less than 1/100% distortion up to 10 watts, less than 2/10% at 20 watts • 10 to 100,000 cycle response within 1/10 db from 10 to 30,000 cycles • Program condition compensator • Unequalled dual range tone controls. Bass range -16 db to +23 db, Treble range -25 db to + 23 db • D. C. operated preamplifier.

*New* CLASSIC 1500-R

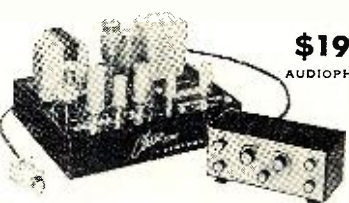

**\$197.50**  
AUDIOPHILE NET

20 watt Ultra-Fidelity Remote Controlled Amplifier-Preamplifier • Less than 5/100% distortion at average listening levels • Less than 1/2% distortion at 15 watts • 10 to 100,000 cycle response within 1 db to 30,000 cycles • Dual range tone controls, Bass range -17 db to +20 db, Treble range -20 db to +18 db • Ultra conservative design for extended tube life.

*New* CLASSIC R-7

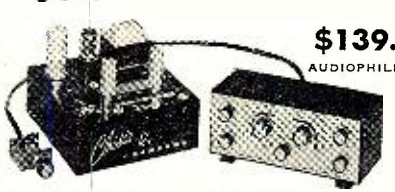

**\$139.50**  
AUDIOPHILE NET

**Remote Controlled Ultra-Fidelity Pre-Amplifier**  
Bring your present amplifier up to date with a new "front end." The New Classic R-7 Remote Master Control Unit and Pre-Amplifier offers guaranteed results, the most modern of circuitry, tremendous range of control . . . plus operating and cabinet saving advantages of real remote control. All inputs connect directly to the power supply chassis only. Beautiful control unit is a decorator's delight.



Newcomb Classic Series Amplifiers with their exclusive "Audi-Balance" (Pat. Pending) distortion control device assures you of absolute minimum distortion for life! No matter how perfect your amplifier when new, its distortion is bound to increase with age. During the useful life of a set of tubes, output tube unbalance is the greatest single cause for amplifier distortion being above the minimum of which the amplifier is capable. Aging can unbalance a set of tubes and replacement pairs are

seldom sufficiently identical twins to balance automatically.

With Newcomb's exclusive "Audi-Balance" feature for lifetime distortion control, you are not left to guess whether your amplifier is continuing to provide the lowest distortion possible. You *know* by just pressing a button! What's more, you can do something about it . . . instantly . . . by just turning a small control and listening to the distortion disappear!



## New NEWCOMB "COMPACTS"...

For Use "As Is"...Need No Cabinetry!

With these "Compacts," Newcomb makes true Hi-Fi via selected components practical for everyone. They're simplest of all to install. Just sit down, plug in and use. They need no cabinetry but include Newcomb's exclusive "Adjusta-Panel" feature to make installation in a cabinet extremely easy if necessary. Both U/L approved. They're absolutely ideal for the apartment dweller because they're so easy to set up or move.

### COMPACT 12

\$99.50 AUDIOPHILE NET



12 Watt High Fidelity Amplifier-Preamplifier-Control Unit. • Less than 1% distortion at 12 watts • Response  $\pm 1$  db 20-20,000 cycles • Separate crossover and rolloff controls give 36 different recording curves • Input selector and rumble filter • Seven inputs • Mike input • Tape input • Output to tape • Wide range separate bass and treble tone controls, Bass range -15 db to +18 db, Treble range -18 db to +16 db • Hum balance control • New "Level" control • Advanced design "loudness" control • Size only 4 1/2" high x 12 1/2" x 9".

### COMPACT 10

\$79.50 AUDIOPHILE NET

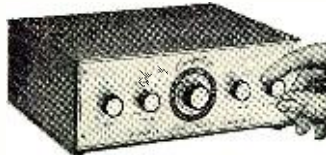

10 Watt High Fidelity Amplifier-Preamplifier-Control Unit. • 10 watts at less than 1% distortion • Response  $\pm 1$  db 20-20,000 cycles • 6 position recording curve selector • Input selector • Built-in rumble filter • Separate bass and treble tone controls in new "Interlocked" tone circuitry for "foolproof" results and less frequent need for tone control adjustments • Hum balance control • 6 inputs • Tape input • Output to tape • Mike input • Loudness control • Size 3 3/4" x 7 3/4" x 9 3/4".

## New NEWCOMB "A" SERIES

For the Budget Minded Perfectionist

MODEL A-127R 12 watt Semi-Remote Controlled High Fidelity Amplifier-Preamplifier.



MODEL A-127R  
\$89.50 AUDIOPHILE NET

12 watts at less than 1% distortion • Control unit on 4 ft. cable solves many installation problems • 20-20,000 cycles  $\pm 1$  db • 6 position recording curve selector • Input and rumble filter selector • Large potted output transformer • Advanced design tone controls, Bass range -15 db to +18 db; Treble range -18 db to +16 db • 6 inputs • Tape input • Output to tape • Mike input • Loudness control • Loudness compensation switch • "Adjusta-Panel" • Removable "gold" anodized dial plate • Hum balance control • "Petite" pilot light • U/L approved.



MODEL A-127  
\$79.50 AUDIOPHILE NET  
Identical to A-127R except all controls are on chassis.

### MODEL A-107

\$59.50 AUDIOPHILE NET



10 Watt High Fidelity Amplifier-Preamplifier. 10 watts at less than 1% distortion • 6 position recording curve selector • Potted output transformer • New electrically isolated input circuitry requires no input switching... Just turn on and use • 6 Inputs • Tape input • Output to tape • Mike input • Separate bass and treble tone controls with new "Interlocked" circuitry for foolproof operation • Adjusta-Panel • Removable "gold" anodized dial panel • Petite pilot light • U/L approved.

FOR PERFECTION IN EVERY DETAIL

... WITHOUT REMOTE CONTROL

Identical to the Classic 2500-R and Classic 1500-R without remote control, the Classic 2500 and Classic 1500 offer full Classic Series perfection in every detail at lowest possible cost. All controls are on chassis. They also feature Newcomb's exclusive "Adjusta-Panel" that lets you instantly extend knob shafts to accommodate cabinet panels up to 3/4" thick. Dial panel is removable, beautifully finished in "gold" anodizing process that never tarnishes. Panels include petite pilot light. Both U/L approved. All ratings identical to the equivalent remote control models.

## New CLASSIC 2500 New CLASSIC 1500



\$219.50  
AUDIOPHILE NET



\$119.50  
AUDIOPHILE NET

LISTEN ... and you'll hear something wonderful!

# NEWCOMB®

Sound Quality Since 1937

### NEW, FASCINATING, INFORMATIVE BOOK ON HI-FI... 25c

This 25¢ book can save Hi-Fi enthusiasts and music lovers hundreds of dollars. Not a catalog, "Hi-Fi Is For Everybody" is packed with money-saving facts, how-to illustrations and suggestions. Written in easy-to-understand language, this new, practical approach to Hi-Fi tells how to get more for each dollar invested in components, how to cut costs without sacrificing quality or looks, how to plan



the simplest system with an eye toward building the most elaborate. Beautifully illustrated. Handy cost-estimating sheet makes it easy to keep track of purchases and budget

### NEWCOMB AUDIO PRODUCTS CO., DEPT. F-9

6824 Lexington Ave., Hollywood 38, California

- I am enclosing \$\_\_\_\_\_. Please send me \_\_\_\_\_ copies of "Hi-Fi Is For Everybody" @ 25¢ each.
- Please send me free catalog MCS54 on Newcomb High Fidelity Components.

NAME \_\_\_\_\_

ADDRESS \_\_\_\_\_

CITY \_\_\_\_\_ ZONE \_\_\_\_\_ STATE \_\_\_\_\_

# NOW... 2 SENSATIONAL EICO SCOPE VALUES!

NEW AMAZING FEATURE PACKED  
7" PUSH-PULL OSCILLOSCOPE

Only EICO Has All These Features

- VERTICAL FREQ. RESPONSE: flat  $\pm$  2 db 10 cps - 1 mc
- VERTICAL SENS.: .01 volts rms/inch
- HOR. FREQ. RESP.: flat  $\pm$  0 db 10 cps - 200 kc, -4 db at 500 kc
- HOR. SENS.: 3 volts rms/inch
- SWEEP RANGE: 15 cps-100 kc
- 3-STEP FREQ.-COMPENSATED ATTENUATOR eliminates freq. distortion, overloading.
- CATHODE FOLLOWER inputs to both amplifiers
- PUSH-PULL outputs in both amplifiers
- RETURN TRACE BLANKING
- INT. VOLTAGE CALIBRATOR
- V & H TRACE EXPANSION & CENTERING: 1.5X full screen without distortion.
- DIRECT CONNECTION to vert. CRT plates.
- PHASING CONTROL of internal 60 cps sine wave sweep.
- AT FRONT PANEL: Intensity mod. input; 60 cps, sawtooth outputs.



MODEL 470K  
KIT \$79.95. WIRED \$129.50.

- 221K VTVM KIT \$25.95. WIRED \$39.95
- AC/DC volts: 0-5, 10, 100, 500, 1000 (30 kv with HVP probe)
- Res.: 0.2 ohms-1000 meg. 5 ranges
- DC input R: 25 meg
- 4 1/2" meter in can't burn out circuit
- 1% mult. resistors
- HIGH VOLTAGE PROBE \$4.95
- Extends range of VTVMs & voltmeters to 30 kv.



360K SWEEP GEN. KIT \$34.95. WIRED \$49.95.

- Continuous coverage of all TV & FM freqs. from 500 kc to 225 mc.
- Sweep width variable 0-30 mc.
- Crystal marker oscillator, variable amplitude.

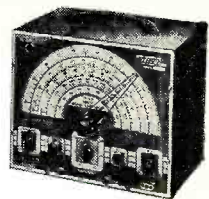

630K CATHODE RAY TUBE CHECKER  
KIT \$17.95 WIRED \$24.95



- Checks all types of TV picture and C.R. tubes in the set or carton. Bridge measurement of peak beam current (proportional to screen brightness).
- Detects shorted & open elements

214K VTVM KIT \$34.95. WIRED \$54.95.



- Large 7 1/2" meter, can't burn-out circuit.
- AC/DC volts: 0-5, 10, 100, 500, 1000 (30 KV with HV Probe).
- 5 ohms ranges from .2 ohm to 1000 meg.
- DC input R: 25 meg.
- 1% mult. resistors.

Large 7 1/2" meter

950B-K R-C BRIDGE & R-C-L COMP. KIT \$19.95. WIRED \$29.95.



- Measures & tests all resistors; .5 ohm to 500 megohms.
- Every type condenser, 10 mmf to 5000 mfd.
- 0-500 DC voltage source for capacitor leakage testing.

ICO EXCLUSIVE! 5" PUSH-PULL SCOPE, 425K, Amazing feature-packed economy-priced  
Wired, \$79.95. KIT, \$44.95.

PUSH-PULL V & H amplifiers. Sens: 0.5-1 rms v/in. Useful to 2.5 mc. SWEEP: 15 cps-76 kc. Z-axis intensity modulation. Dual trace positioning controls.



- SCOPE VOLTAGE CALIBRATOR KIT 495K KIT \$12.95. WIRED \$17.95
- Sq. wave output at power-line freq. with full-scale readings of 1, 1, 10 or 100 V. peak-to-peak
- Accuracy  $\pm$  5% of full-scale on each range.

12V BATTERY ELIMINATOR KIT 350K KIT \$29.95. WIRED \$38.95.

- DC output: 0-8 V or 0-16 V.
- Continuous current rating: 10 A at 6 V, 6 A at 12 V.
- Intermittent current rating: 20 A at 6 V, 12 A at 12 V.
- Separate Voltmeter & Ammeter.



NOW! ONLY EICO KITS & WIRED INSTRUMENTS Gives You LIFETIME SERVICE & CALIBRATION GUARANTEE\* at less than our cost of handling (See EICO Guarantee Card enclosed with each Kit & Instrument).

352K BAR GENERATOR KIT \$14.95 WIRED \$19.95

- Reliable, accurate, portable, easy-to-use.
- Operates on channels 2-6. 16-23 vert. bars to check H linearity. 13-22 hor. bars to check V linearity.
- Shows pic size & V & H sync circuit stability.
- Entirely independent of station-sent signals.



Prices 5% higher on West Coast. Specifications and prices subject to change without notice.

## New! EICO SCOOPS!

232K PEAK-to-PEAK VTVM with DUAL-PURPOSE AC/DC Uni-Probe\*  
KIT \$29.95 WIRED \$49.95



Measures directly p-p voltage of complex and sine waves: 0-4, 14, 42, 140, 420, 1400, 4200 V. DC/RMS sine voltage range: 0-1.5, 5, 15, 50, 150, 500, 1500 v. Ohms: 0-1000 meg. 7 non-slip ranges on every function. Calibration without removing from cabinet. Zero center. Freq. Resp. 30 cps-3mc. 1% precision ceramic multipliers. Exceptional stability and accuracy. Compact, portable (8 1/2 x 5 x 5"), smart, rugged. NEW! UNI-PROBE! Terrific time-saver! Only 1 probe for all functions—a half-turn of probe-tip selects DC or AC (Peak-to-Peak or RMS)/OHMS!

249 K PEAK-to-PEAK VTVM with 7 1/2" METER KIT \$39.95 WIRED \$59.95

944 K FLYBACK TRANSFORMER AND YOKE TESTER  
Kit \$23.95 Wired \$34.95

Tests all flybacks and yokes, in or out of TV set - in just seconds! Detects even 1 shorted turn!

Exclusive separate calibration for air- and iron-core flybacks assures utmost accuracy. Large 4 1/2" meter, 3 colored scales. Compact, portable (8 1/2 x 5 x 5"), smart, rugged.



- 488K ELECTRONIC SWITCH KIT \$23.95. WIRED \$39.95
- 1171K DECADE RESISTANCE BOX KIT \$19.95. WIRED \$24.95
- 1180K DECADE CONDENSER BOX KIT \$14.95. WIRED \$19.95

315K DELUXE SIG. GEN. KIT \$39.95. WIRED \$59.95.

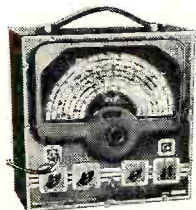

- Covers range of 75 kc to 150 mc.
- 7 calibrated scales: accuracy better than 1%.
- Bandspread vernier tuning.
- 4-step RF shielded output multiplier: constant output Z.

377K SINE & SQUARE WAVE AUDIO GEN. KIT \$31.95. WIRED \$49.95.



- Complete sine wave coverage, 20-200,000 cps in 4 direct-reading ranges.
- Complete square wave coverage, 60-50,000 cps.
- Cathode follower output circuit.

536K MULTIMETER KIT \$12.90. WIRED \$14.90.  
526K MULTIMETER KIT \$13.90. WIRED \$16.90.



- 1000  $\Omega$ /V: 31 ranges
- DC/AC volts: Zero to 1, 5, 10, 50, 100, 500, 5000.
- DC/AC Current: 0-1, 10 ma; 0.1, 1 A.
- Ohms: 0-500, 100 K, 1 meg.

565K MULTIMETER KIT \$24.95 WIRED \$29.95.

555K MULTIMETER KIT \$29.95 WIRED \$34.95. (1% precision resistors)



- 20,000  $\Omega$ /V: 31 ranges.
- DC/AC/Output volts: 0-2.5, 10, 50, 250, 1000, 5000.
- DC Current: 0-100 ua; 10, 100, 500 ma; 10 A.
- Ohms: 0-2K, 200K, 20 meg.

145K SIG. TRACER KIT \$19.95. WIRED \$28.95.



- Audibly signal traces all IF, RF, Video & Audio circuits from ANT to SPKR or CRT in all TV, FM, AM, etc. without switching.
- Germanium crystal diode probe responsive to over 200 mc.
- Integral test speaker.

320K SIG. GEN. KIT \$19.95. WIRED \$29.95.



- Vernier tuning condenser.
- Stable Hartley RF osc., range: 150 kc to 34 mc, calibrated harmonics to 102 mc.
- Pure or modulated RF, & Colpitts oscillator 400 cps sine outputs.

322K SIG. GEN. KIT \$23.95. WIRED \$34.95. (As above, plus individual calibration of its 5 bands.)

Write NOW for FREE latest Catalog R-9

© 1954

Separate Assembly & Operating Manuals supplied with each EICO KIT!

You build EICO Kits in one evening, but... they last a lifetime!

SAVE OVER 50%! See the famous EICO line TODAY, at your local jobber.

# A MODERN METAL LOCATOR

By RUFUS P. TURNER, K6AI

Complete construction details on a modern, streamlined version of old-fashioned "treasure locator" of the '30's.

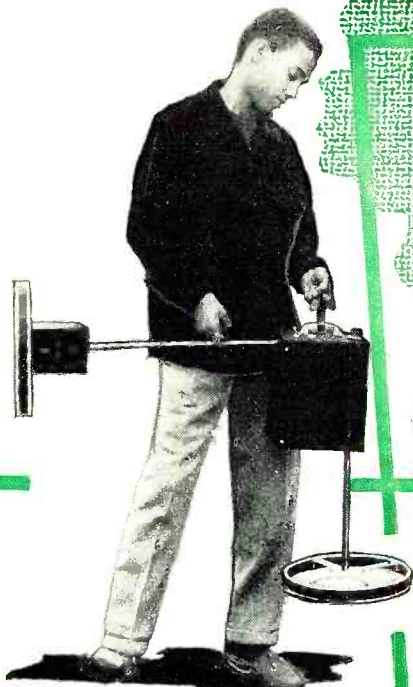

Fig. 1. The streamlined metal locator in operation. Here the operator is observing the deflection of the meter. The unit also includes headphones which can be used in conjunction with the meter or as an independent indication of presence of metal.

**D**URING the thirties, portable electronic treasure locators were built enthusiastically by radio experimenters. It is not known to what extent these pieces of equipment were actually applied to metal prospecting, but response to constructional articles was startling. Today, one sees locators of the same general type in use by utilities workmen to locate underground pipes, and there certainly is no hocus-pocus about these modern metal divining rods.

It has been some time since constructional details on a simple metal locator have appeared in a popular

electronic magazine and the Editor's mail shows a growing demand for information along this line. It is interesting to note that an early 1954 news item mentioned large sales of treasure locators during 1953!

Most underground-metal locators of the electronic type operate on the same basic principle, that is, reflection of radio waves by an underground metallic mass. The equipment consists of a separate low-frequency transmitter and receiver. For maximum portability, each is provided with its own loop antenna. The transmitter loop is oriented to send a good portion of its signal into the earth, and in plain ground this signal for the most part is lost. When the waves strike an underground metallic mass, however, a portion of the energy is reflected and is picked up by the receiving loop. Some indicating means, such as the deflection of a meter or an increase in headphone volume, then informs the operator of the presence of the metal.

Over some soils, the response of the metal locator can be quite sharp, occasional operators having reported the possibility of finding small pipes buried at considerable depth. In general, however, a number of factors in-

fluence success of the method. A few of these are type of soil, terrain, amount of moisture, purity of the metal, size of the mass, depth of location, transmitter power, receiver sensitivity, operating frequency, influence of nearby conducting or non-conducting objects, and presence of underground water. As in playing the Theremin, the operator of a metal locator develops a certain amount of skill and "sense of feel" only after gaining experience with the device, and the metal locator accordingly must be regarded as a tool unable to do any thinking of its own but capable of aiding an operator who is able to appraise all of the conditions under which it is used.

## Instrument Requirements

There are several reasons for choosing a low frequency for a metal locator. First, there must be a maximum of earth penetration with a minimum of reflection from the surface of the ground. High frequencies bounce from the surface. Second, capacitance effects due to nearby objects react less severely with large tuned loops at low frequencies. Third, FCC regulations stipulate that the field strength must not exceed 15 microvolts-per-meter at

Fig. 2. Top chassis view of receiver. The 90-volt "B" battery is shown for comparison. The coaxial cable for connection to the receiving loop leaves the chassis on the left, as shown.

Fig. 3. Under chassis view of the receiver unit. Note the simplicity of the device and the liberal use of miniature components to reduce the over-all size to a mere 5 x 3½ x 2 inches.

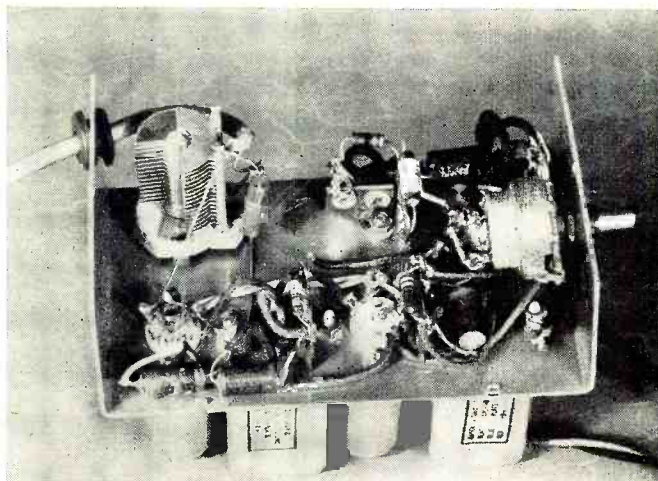
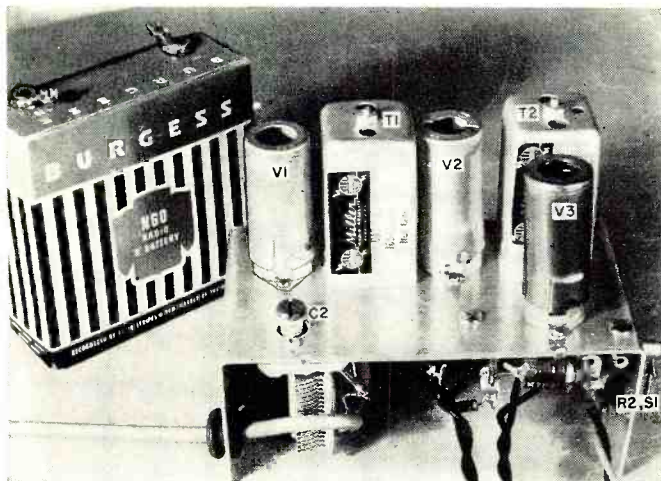

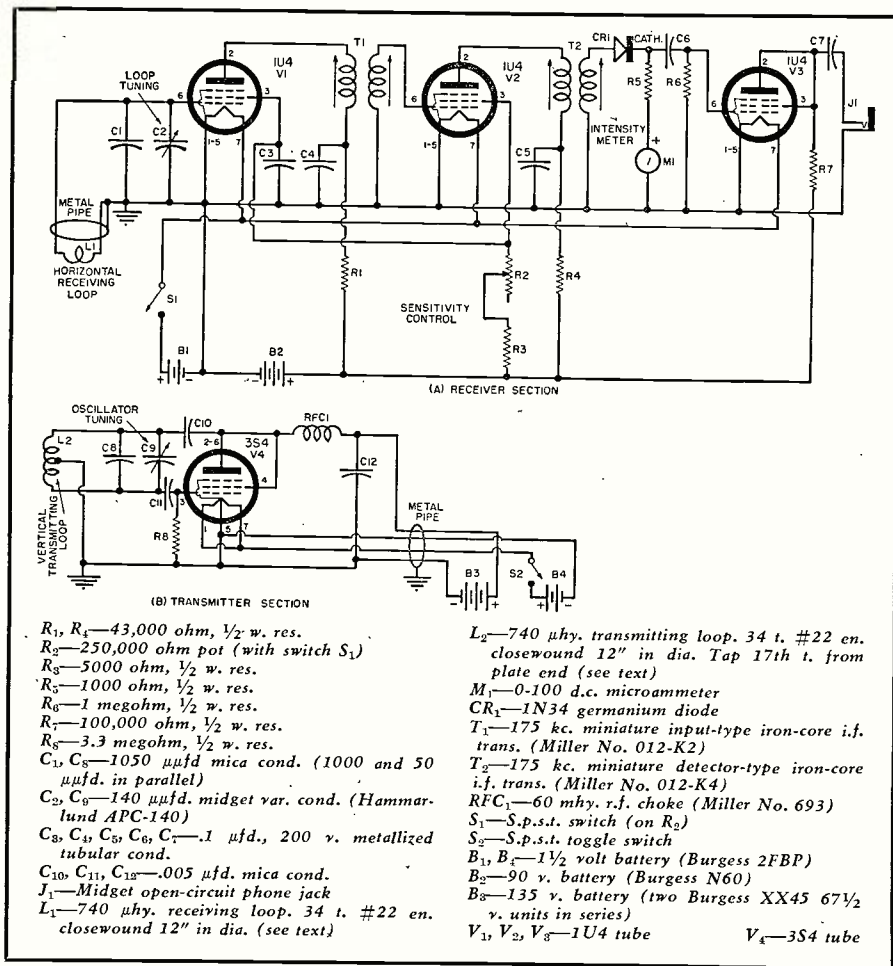

Fig. 4. Complete schematic of metal locator (A) receiver and (B) transmitter.

small batteries, all with the same capabilities as the larger tubes and components formerly used.

Structural features of the instrument are shown in the photographs and drawings. The main box, which holds the receiver chassis and batteries, is a standard 10" x 8" x 7" radio utility box. The carrying handle, intensity meter, sensitivity control, headphone jack, and "on-off" switches are mounted in the top of this box. (See Fig. 8.)

An 18-inch length of 3/8-inch-diameter dural pipe (with 1/16" wall thickness) extends backward from the top rear of the main box and supports the transmitter box. The entire transmitter circuit is contained within the latter, a 5" x 4" x 3" aluminum chassis box. "A" and "B" battery leads are pulled through the 18-inch pipe into the main box. The pipe is strong and gives good support to the transmitter. The transmitter loop is mounted directly to the bottom of the shaft bushing passed through the hole in the hub of the loop wheel.

A 12-inch length of pipe extends downward from the bottom of the main box and holds the receiving loop. A length of RG-29/U coaxial cable brings the loop connections through this pipe into the main box to the receiver. This cable is visible in Figs. 2, 3, and 7.

The two loops are wound on 12-inch-diameter flanged Lucite wheels. These wheels have been designed especially for this metal locator and are obtainable from D. M. Ackley, 131 E. 137th Street, Hawthorne, California.

In use, the metal locator is grasped by the carrying handle. The transmitting loop extends to the rear, and the receiving loop downward. (See Fig. 1). The layout keeps all sections of the instrument in the proper relationship without requiring an awkward superstructure. The transmitter is mounted close to its loop tank, and the all-metal construction provides good electrical shielding. Use of aluminum in all parts, except the main box, which was available only in steel, minimizes weight. When necessary, the pipe assemblies may be dismantled for easy transportation of the instrument.

Fig. 4 is the complete circuit diagram. The receiver (Fig. 4A) is a fixed-tuned t.r.f. unit, consisting of two 1U4 pentode, i.f. transformer-tuned, r.f. amplifier stages (*V*<sub>1</sub> and *V*<sub>2</sub>); a germanium diode detector (1N34); and a triode-connected 1U4 audio amplifier stage (*V*<sub>3</sub>). Both of the transformers are of the miniature iron-core-tuned type. *T*<sub>1</sub> is a Miller No. 012-K2. *T*<sub>2</sub> is a Miller No. 012-K4. Fixed condensers shunting the primary and secondary windings of the transformers are inside the transformers and are not shown in the schematic. The receiving loop, *L*<sub>1</sub>, is the grid coil of the 1st r.f. amplifier, and is tuned by the combination of *C*<sub>1</sub> and *C*<sub>2</sub>.

The rectified d.c. component from

a distance from the transmitter equal to 1/6.28 of the transmitting wavelength. This means that the lower the frequency, the greater will be the operating distance available without violating the law. Practical considerations determine how low the frequency should be. One of the most important of these is the increasingly large size of the transmitting and receiving loops. A good compromise seems to be frequencies in the range 100 to 200 kc.

Another important requirement is transmitter power. For maximum penetration into unfavorable soils, high power would seem desirable. However, the input power is limited by the requirement that the locator be battery-operated, and also by the FCC restriction on field strength. Furthermore, even in the absence of those two considerations, the power could not be extended to the point where severe interference would occur directly between the transmitter and receiver in the locator.

Receiver sensitivity receives its share of consideration. Reduced transmitter power would appear to be compensated by employing a high-sensitivity receiver. But here again, a practical limit appears. If the receiver is too sensitive, the transmitter, although low-powered, will interfere directly with its operation. An extremely sensitive receiver also is

susceptible to interference from radio transmitters, static, and hum fields.

### Streamlined Layout

The old-time treasure locators were extremely bulky. The loop antennas were usually 2 to 4 feet square and were placed on the front and rear ends of a 5-foot-long wooden framework which the operator straddled. These devices were heavy, ungainly, and hard to transport.

In developing the locator described in this article, size reduction was a major consideration. The over-all dimensions of the loop antennas were reduced progressively to determine the smallest size at which satisfactory 175-kc. operation could be obtained with metals at known depths. The final selection was 1-foot-diameter coils, 1 1/4 inch wide. The distance between transmitting and receiving loops was closed down to the smallest separation at which direct interference was negligible. This was done in order to shorten the locator framework. Final separation is approximately 26 inches between the nearest points with the loops at right angles to each other.

The time-honored wood construction was eliminated. All-metal construction gives superior shielding, slenderness proportions, and better durability.

The present model has substituted miniature tubes and components and

the diode is applied to the 0-100 d.c. microammeter,  $M_1$ , through the 1000-ohm resistor,  $R_5$ . The deflection of this meter is proportional to the average value of the received carrier.

The audio component of detector voltage, developed across  $R_5$ , is presented to the grid of the a.f. amplifier,  $V_3$ . High-impedance headphones are capacitance-coupled to the output of  $V_3$  through jack  $J_1$ .

The screen potentiometer,  $R_3$ , serves as an r.f. gain control for adjusting sensitivity of the receiver.

The receiver operates on  $1\frac{1}{2}$  volts for the tube filaments and 90 volts for the plates and screens. A small 90-volt "B" battery (*Burgess N60*),  $B_2$ , and medium  $1\frac{1}{2}$ -volt "A" battery (*Burgess 2FBP*),  $B_1$ , are used. The receiver "on-off" switch,  $S_1$ , is mounted on the sensitivity control,  $R_3$ . This switch interrupts filaments only. Since there is no "B" battery drain unless the filaments are burning, this switch is the only one required in the receiver.

The entire receiver is built on a standard aluminum U-chassis, 5" long,  $3\frac{1}{2}$ " wide, and 2" high. Figs. 2 and 3 show constructional details of the receiver. Mounting of the receiver inside the main box is shown in Fig. 7.

The transmitter (Fig. 4B) is built around a triode-connected 3S4 tube,  $V_1$ . At 135 volts, this tube has the same capabilities as the paralleled pair of 1A5G tubes so often used in the transmitter sections of the old-time treasure locators. A shunt-fed Hartley arrangement is used with the tank-coil tap grounded. The tank coil,  $L_2$ , is the transmitting loop, and is

tuned by  $C_3$  and  $C_5$  in parallel. The air trimmer,  $C_5$ , which is screwdriver-adjusted from the outside of the transmitter box, allows close adjustment of the transmitter to the receiver frequency.

The oscillator circuit employed in the transmitter is self-modulating. An amplitude modulation frequency of approximately 250 cycles is obtained by means of squegging action by the high value of the grid resistor (3.3 megohms)  $R_5$ . This expedient saves the complication of an additional audio modulator stage.

The transmitter is powered by a separate  $1\frac{1}{2}$  volt "A" battery,  $B_1$ , (*Burgess 2FBP*) and 135 volts of "B" battery,  $B_2$ , provided by two  $67\frac{1}{2}$ -volt batteries (*Burgess XX45*) in series. As in the receiver, only a filament switch,  $S_2$ , is provided, since there is no "B" battery drain when the 3S4 filament is extinguished.

### Construction

The photographs show the mechanical details of the instrument.

The 18-inch,  $\frac{3}{8}$ "-diameter dural pipe supporting the transmitter box, and the similar 12" pipe supporting the receiving loop are threaded  $\frac{1}{2}$ -inch on each end for  $\frac{3}{8}$ -24 hexagonal nuts. The pipes are attached to the boxes by means of a pair of nuts on each end of each pipe. Scrape the enamel clean around the pipe holes on the boxes, to insure good grounding.

Mechanical details of the transmitter and receiver units are given in the section "Streamlined Layout." The receiver tubes must be shielded to prevent oscillation.

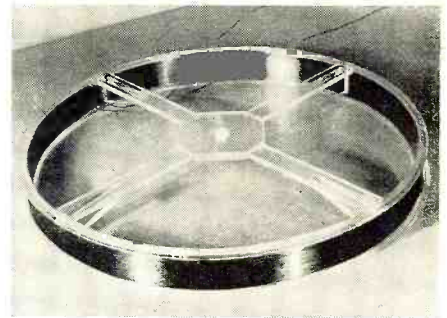

Fig. 5. One of the loop antennas employed in the metal locator. Both loops are wound on 1-foot diameter Lucite wheels. The center hole takes the supporting dural pipe.

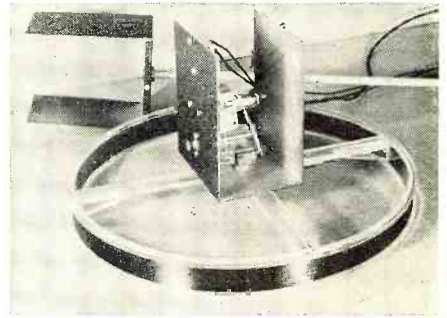

Fig. 6. The transmitter section. The unit is assembled inside the metal box which is attached directly to the transmitting loop which is the transmitter tank coil. The sides of the transmitter box with supporting pipe, through which the leads are pulled into the main box, are shown at rear.

Wiring is not critical in either transmitter or receiver. However, attention must be given the usual rules of good wiring practice, especially  
(Continued on page 119)

Fig. 7. Inside view of main box. Transmitter loop pipe is visible at upper right. The receiving loop pipe has not been attached. Batteries were later secured with a strap and buckle.

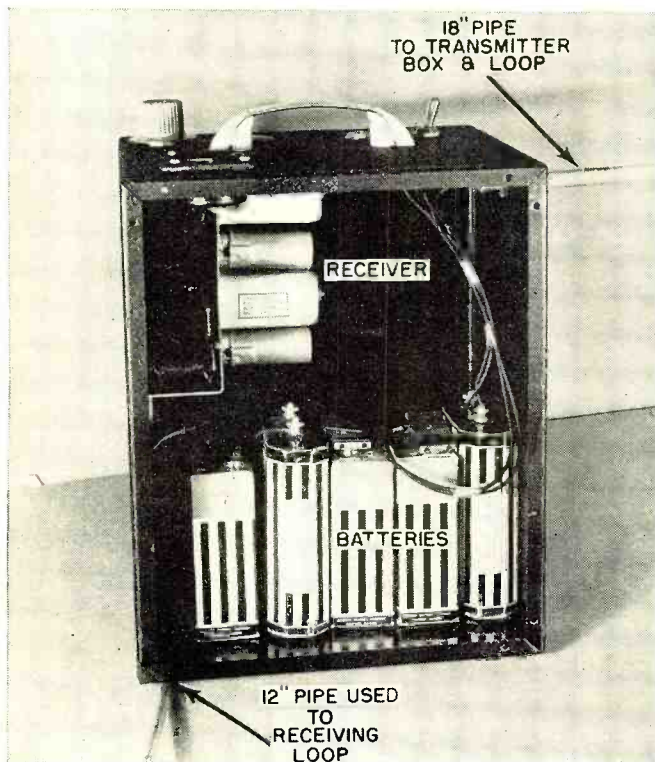
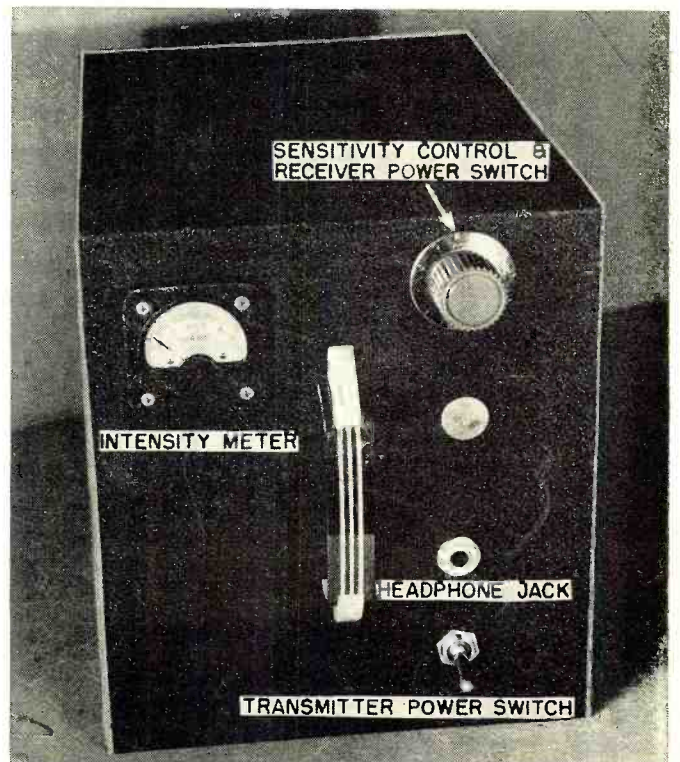
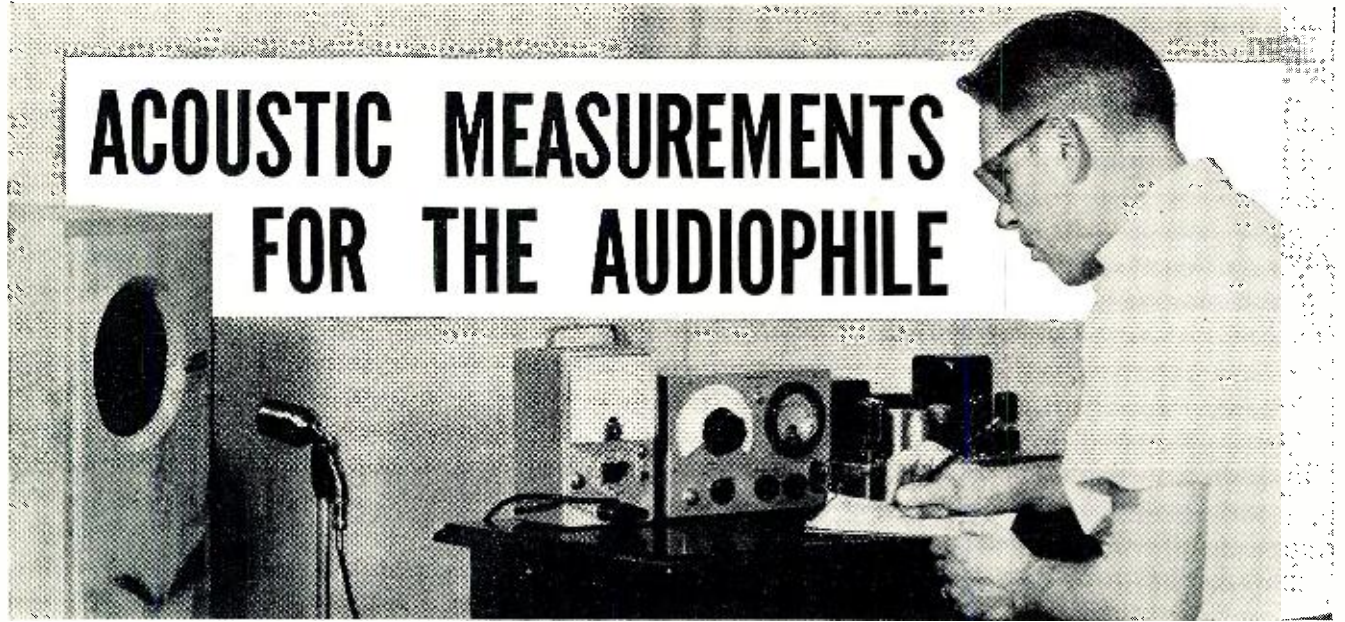

Fig. 8. Top view of the main chassis. The loop antenna pipes have not been attached as yet to the bottom and back of box. "Butch plug," at right of meter, covers hole cut by mistake.



# ACOUSTIC MEASUREMENTS FOR THE AUDIOPHILE



Author's setup for making the acoustic measurements described in text. Room was 15x30 feet.

By LAWRENCE FLEMING

**W**HY can't the frequency response of a loudspeaker be measured with a good microphone and some simple test equipment, as is done every day with amplifiers and tone control circuits? The answer is that it can. Room reflections will put a lot of extra humps and valleys in the response curve, so that it can't be called very accurate or authoritative; but it will show the performance of the speaker in that location, and will give a far better index of the quality of the system than no curve at all.

Besides the speaker itself and an amplifier to drive it, only three pieces of measuring gear are needed: an audio oscillator, a microphone, and an audio voltmeter. In this day of inexpensive kits, a perfectly satisfactory oscillator and audio voltmeter can be bought in kit form for less than sixty dollars. For less than half this cost, microphones are available that are flat  $\pm 2$  db from 60 to 10,000 cycles—so much better than any cone speaker that they can serve as a good practical standard.

The big laboratories such as *Bell Telephone* and Harvard use only one facility, barring such luxuries as automatic curve recorders, that can't be duplicated by an individual. This is the big acoustically-dead room or anechoic chamber. This article is intended to show how one can get useful and interesting results without such a room, but a short look at what the room does will not be amiss. The walls of any ordinary room reflect sound pretty well, and even acoustic tile is a poor absorber at low frequencies. The standing waves which result will fill the measured response curve full of extra peaks and dips which are not the fault of the speaker at all, but of the room. The best way to get rid of these

*Many important and pertinent details about your speaker system can be obtained from the simple tests described.*

room resonances is to build a really dead room, a good-sized anechoic chamber which, incidentally, costs at least as much as a five-room house. The next best solution is to hang the speaker and microphone from the top of a tall pole out-of-doors. Wind and ambient noise are difficulties here. The third best scheme is to point the speaker out of a window, with the microphone supported in front of it on the end of a pole.

To get a reasonably accurate, *authoritative* response curve, which can be used in engineering reports and manufacturers' literature, the tests must be made in an anechoic chamber or at least out-of-doors.

## Indoor Tests

No one listens to a speaker in an anechoic chamber. What we listen to is a speaker-living-room combination. Why not, then, check a sound system in the room in which it is used? True, the results will not be exactly valid for some other room, or even for a different location in the same room. But the maximum frequency range of the system can always be found and the best equalization for that room and speaker system can be determined.

Trials made by the writer, and published data, indicate moreover that room reflections do not mask the important over-all characteristics of a speaker's response curve. The authoritative text by Beranek<sup>1</sup> shows smoothed response curves for the same speaker in five widely different rooms. With

the small kinks smoothed out, all curves agreed within  $\pm 3$  db below 700 cycles and within  $\pm 1$  db above 700 cycles.

Working in an attic room about 15 x 30 feet with ordinary *Celotex* walls, the writer finds that the effects on response of sizeable changes in the size of the port in a bass-reflex enclosure, of changes in enclosure volume, and of the cavity due to the speaker being set back an inch or so from the front face of the cabinet, all stand out clearly in the plotted curves.

## Equipment

Fig. 2 is a block diagram of the test set-up. Any of the audio oscillators on the market, either in kit or assembled form, will do for the signal source. Constant output within 1 db or so from 30 to 15,000 cycles is all that is required. The amplifier should be flat over this range, but need not deliver much power, since only half a watt or less is needed to deliver a good signal to the mike. If the amplifier should be a poor pentode job with little damping, incidentally, a boomy speaker resonance will stand out like a sore thumb when the curve is drawn.

The audio voltmeter used by the writer was a *Heathkit AV-2*. Others may be available; the *Ballantine Model 300* is one of the best but too expensive for the average audiophile, or one can be constructed from available parts<sup>2</sup> if a well-stocked junk box is on hand.

The microphone used by the writer

is an *Electro-Voice* Model 630, an inexpensive dynamic unit which has exceedingly flat response (as supplied by the manufacturer) from 80 to 5000 cycles, and no peaks greater than 1 db from 70 to 10,000. It is down 5 db at 50 and 13,000 cycles. Most microphone manufacturers will supply an individual response curve at small cost. The dynamic was preferred to the crystal because the low (1 megohm) input impedance of the audio voltmeter will droop the bass response of a crystal somewhat, perhaps 3 db at 50 cycles, and this droop will vary in Rochelle salt crystals with temperature. The dynamic is somewhat an individual preference, however, and many microphone manufacturers recommend crystal mikes for this type of service.

If higher cost is no drawback, a top-quality condenser microphone is the best of all, with a high-grade, broadcast-quality dynamic ranking second. Ribbon microphones are probably less desirable because of their lower output and the artificial bass emphasis that results from placing the microphone too close to the sound source.

The important point is that any microphone (except carbon and speech-only types) has vastly smoother response than any cone speaker, and much smoother than most horns. This is because a microphone is much smaller than a speaker. Where the size of any speaker cone leads to complicated multiple resonances from a few hundred cycles on up, the small dimensions of a mike make it inherently smooth up to 10 kc. or so. In the middle audio range where enclosure resonances and cone breakup produce the rough jagged frequency response typical of cones, the mike is flat as a die, relatively, and makes a perfectly practical standard of comparison.

### Taking the Curves

The closer the microphone is to the speaker, the greater will be the ratio of direct-to-reflected sound picked up by the mike. While there are advantages to working several feet away, the best practice in ordinary indoor surroundings is to place the mike a foot or two away. In non-coaxial, two-way systems, the mike should be placed closer to the front of the tweeter, because the bass unit is less directional;

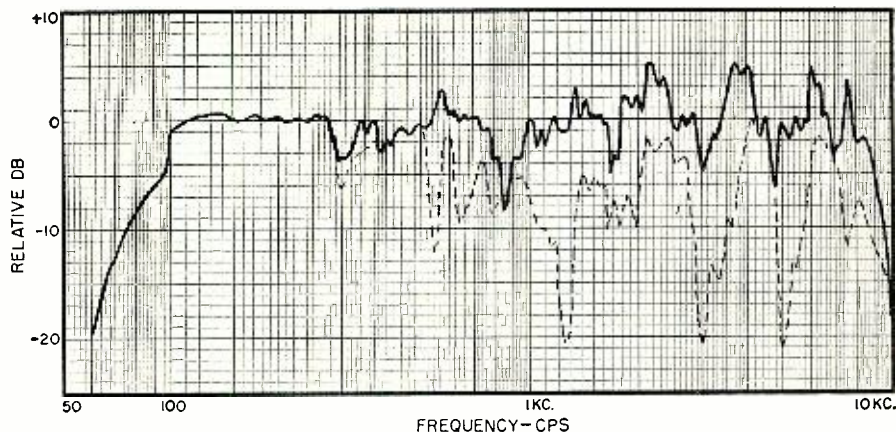

Fig. 1. Response of a good quality, 8-inch speaker as measured in a 2 cubic foot padded enclosed cabinet, and taken in a large room. Dotted curve shows effect of cavity resonances due to the closing of one of double doors on front of cabinet.

but if the curve obtained is jagged at the crossover frequency it may be the fault of the mike location, and some experimenting with its position is indicated.

The audio oscillator and the audio voltmeter must be located alongside each other, because a lot of looking back and forth will be needed.

Set the oscillator at around 200 cycles and set the level to give a convenient reading on the audio voltmeter—high enough so that a 10 db dip is easily readable, and low enough to keep from waking the neighbors. Around 8 millivolts is typical. Now run the oscillator frequency over the audio range to get a general preliminary visual picture of the character of the curve, and reset the level if necessary.

The actual plotting on graph paper cannot be done completely point-by-point, as it is when measuring electrical circuits, because the curve is generally far too complicated. Cones, at any rate, have hundreds of little peaks and dips throughout the range, and much of this fine detail is affected by the presence of nearby objects and even by the position of the operator himself. Even in large laboratories the practice is to discard much of this fine structure before publishing a curve. The procedure required is to plot, as points, only a couple of dozen or so of the crests of the main peaks and troughs of the important valleys. Sketch in the intermediate wiggles to

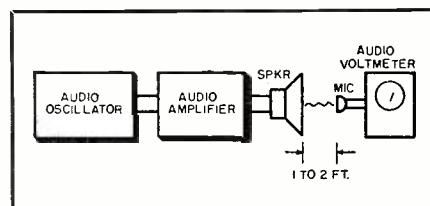

Fig. 2. Setup for measuring speaker response.

taste. One might, for example, mark the top of a 6 db peak at 310 cycles, then the bottom of an 8 db dip at 550 cycles, and fill in the space between freehand, based on the observation that there were four small wiggles alternating between 0 db and +2 db in the interval.

An estimate of the order of magnitude of the room reflections can be gained by placing the microphone facing away from the speaker in various locations near the other walls, and looking for frequencies where an appreciable signal is picked up. Such reflections are generally strongest in the low and middle audio range, less so above 1 or 2 kc.

Practice in taking this kind of data is very helpful. A single curve is not of too much value, but after taking several in different locations, or with different speakers or modified enclosures, the utility of the set-up can be appreciated.

Some curves taken by the writer in  
(Continued on page 112)

Fig. 3. (A) Example of bass changes. (1) 8" plastic-edged cone, triode feedback amplifier, 2 cu. ft. closed box; (2) Same unit driven from high-impedance source; and (3) With back of box removed. (B) Measured response of 4" speaker in table-model receiver.

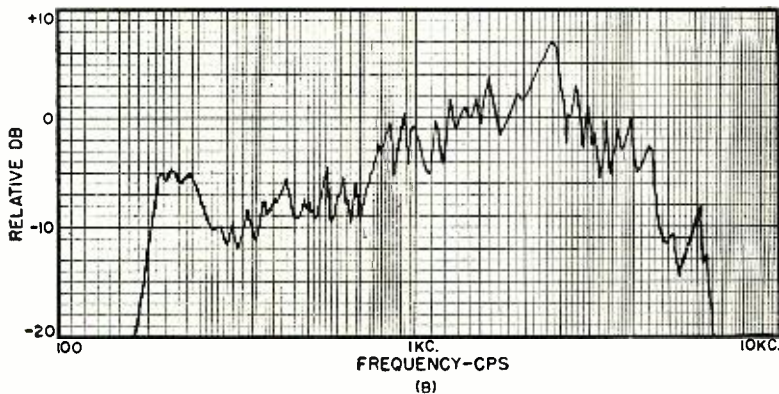
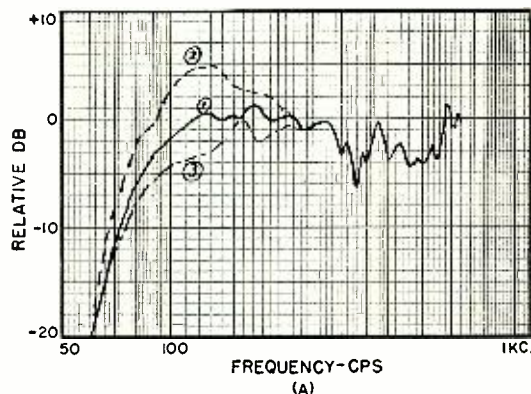
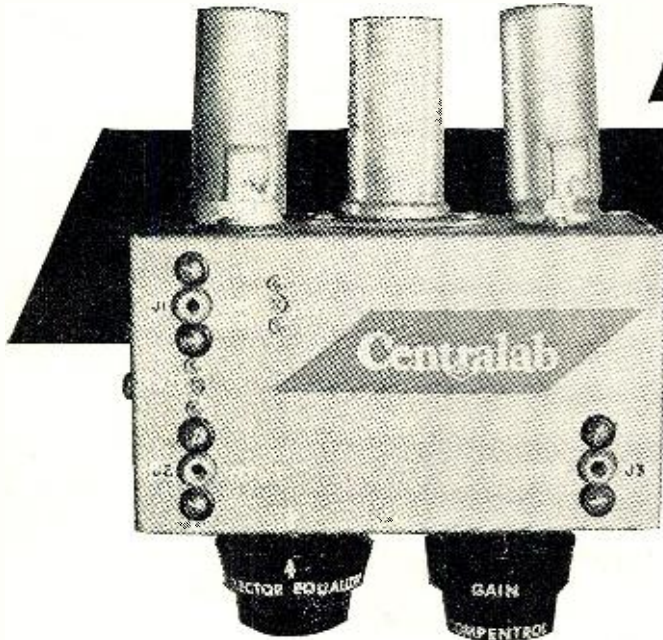

Fig. 1. The Printed Electronic Circuit preamp which measures 5½"x3"x2⅛". With equalizers using standard components, the over-all size of the unit will have to be enlarged.



# MINIATURE PREAMP

By  
**ROBERT WIENER**  
Product Engineer  
Centralab, Div. of Globe-Union, Inc.

*This compact preamplifier was designed to demonstrate how miniaturization can be accomplished through use of printed circuits. Although it cannot be duplicated exactly in the form shown, it can be reproduced to a reasonable degree by substituting standard radio parts for the printed circuits which are not currently available at parts distributors.*

THE miniature preamp to be described was designed, primarily, to demonstrate the practicality of printed circuits in audio gear rather than to present any radically new or startling circuitry.

The fact that the final version of this experimental circuit required only two dual-triodes and a minimum of controls was a pleasant "bonus."

The most important feature of the unit is its small size which has been achieved by using *Centralab* PEC's (Printed Electronic Circuits) wherever possible. With the exception of the five equalizer circuits, all of the listed components are readily available. By making the chassis slightly larger, standard components can be sub-

stituted for the printed equalizer networks.

Simplicity of operation is obtained by using only three controls: a selector-equalizer switch and a dual control consisting of a "Compentrol"<sup>1</sup> (*Centralab's* compensated loudness control) and a gain control. The selector-equalizer switch has six settings, the first five being phono equalizer positions and the sixth bypassing the equalizers for other sources. More inputs may be added but, for the purposes of this article, only one additional position is included. The selection of equalizer positions, as shown in Fig. 4, will provide most settings normally required.

*Centralab* has recently introduced the "Senior Compentrol." This is a dual concentric unit with the compensated loudness control mounted on the rear and operated by the inner shaft (front knob). A level-set unit, the front control, is connected to the "Compentrol" and is operated by the outer shaft (rear knob).

The debate over compensated loudness controls vs tone controls has been, is, and always will be waged. However, based on the author's experience in building various control systems, he has found that usually bass and treble

controls are set for flat response or some degree of boost—seldom for cut. The "Compentrol" offers a combined bass and treble boost in itself and, with the judicious use of the level set, a flexible tonal range is obtained. Despite the controversy, the reader is urged to try the unit himself and make up his own mind.

The schematic of the preamp is given in Fig. 4. There are, as mentioned previously, two dual-triodes—a 12AX7 and a 12AU7. The 12AX7 serves as the equalizer section and the 12AU7 is the preamp.

The two switch decks of the single ganged switch ( $S_1$ ) in the preamp section serve separate functions. The section which switches the inputs is designated as  $S_{1A}$ . The first five positions are shorted together since these positions are the five phonograph equalizer positions controlled by the other deck. The sixth position connects directly to the input  $J_2$  and  $R_s$ . Switch  $S_{1B}$  is used to select any of the five available equalizer circuits and in its sixth position disables this portion of the circuit.

The first input,  $J_1$ , is for phono. The second input,  $J_2$ , is for radio, TV, tape, or any input having the higher voltage output commonly associated with these program sources. This jack is connected to the level set,  $R_s$ . This level set, as well as  $R_i$  for the phono input, is a *Centralab* Model 1 control used in hearing aids and miniature radio receivers. The one used in the construction was specially modified with mounting studs so that the control could be attached directly to the chassis, with the screwdriver shaft available as a semi-permanent adjustment. A standard midget hearing aid control (the *Centralab* B16-118) can be used equally as well.

The switch rotor of  $S_{1A}$  is connected

Fig. 2. Equivalent circuits for the printed circuit equalizers shown dotted in Fig. 4.

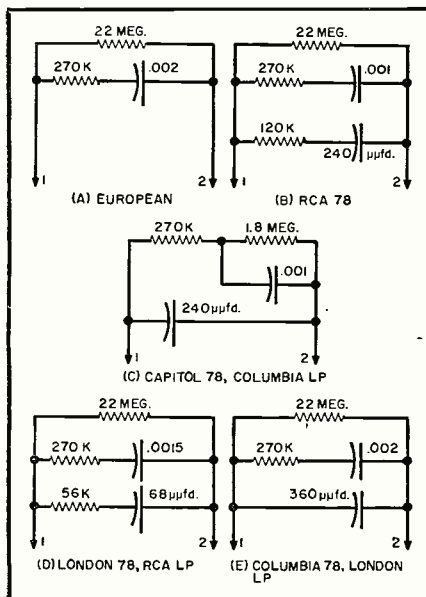
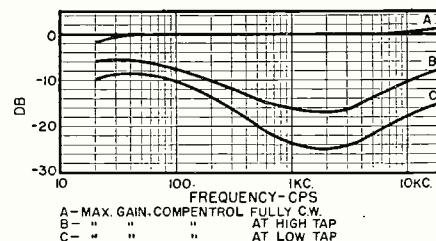

Fig. 3. Gain vs frequency of preamp equalizer. Input is .245 v. at  $J_2$ , 0 db level 24.5 v. at 1 kc. "B+" is 240 volts d.c.





to the low-frequency filter composed of  $C_6$ ,  $C_7$ ,  $C_8$ ,  $R_{12}$ ,  $R_{13}$ , and  $R_{14}$ . Following this is the first section of the 12AU7 feeding the volume control  $R_{16}$ .  $R_{16}$  was inserted in the stage preceding the "Compentrol" to do away with a grid resistor for  $V_{2B}$ , as well as to decrease some noise commonly encountered in high-gain amplifiers. Ordinarily the "Senior Compentrol" is to be used with the level-set control feeding the "Compentrol" directly. This is the manner in which they are supplied, but the user may make this change if he feels that it is desirable.

The center terminal of the level-set control is tied to the grid of the output stage,  $V_{2B}$ , and its plate a.c.-coupled to the right terminal of the "Compentrol." There are several points to be noted about placing the "Compentrol" in the output of the preamp. With this connection, the grid resistor of the following stage, usually the first audio stage of the power amplifier, should be removed. That is, the "Compentrol" should feed directly into the following grid. In addition, the device is one which exhibits decreasing impedance with increasing frequency and thus, aside from exceedingly low frequencies which are filtered out in the low-frequency filter, offers a low-impedance output.

The impedance level may not be comparable to that of a cathode follower when connected with long cables to the power amplifier but with this control in the output, the gain that would have been lost in the cathode follower is retained and some measure of low-impedance output is obtained. A phono jack,  $J_3$ , tied to the center terminal of the "Compentrol," is the output take-off to the power amplifier.

The response of the preamp portion of the circuit is shown in the graph of Fig. 3. The response was obtained with the input at  $J_2$  and the gain maximum, i.e., level set, volume, and "Compentrol" full on. Curve A of Fig. 3 shows the response of these two stages. At 20 cps, the output is down about 2 db while at 20,000 cps it is up about 1½ db. The response is quite good but may be modified if desired. The droop at the low-frequency end of the spectrum is due to the low-frequency filter taking over. Unfortunately, none of the audio generators available to the author furnished a lower frequency than 18 cps so the effect of the filter cannot be demonstrated here.

The high-frequency rise could be decreased by changing the value of  $C_9$ , the cathode bypass condenser for  $V_{2A}$ . This is a .01  $\mu$ fd. ceramic unit and can be increased in value by some 50 percent to drop the response. Other means can be employed but since they are familiar to the hi-fi enthusiast, they will not be discussed here.

Curves B and C (Fig. 3) show the output curve when the "Compentrol" is set at the high (62½ per-cent rotation) and the low tap (37½ per-cent rotation) respectively.

Referring to Fig. 3, the gain figure

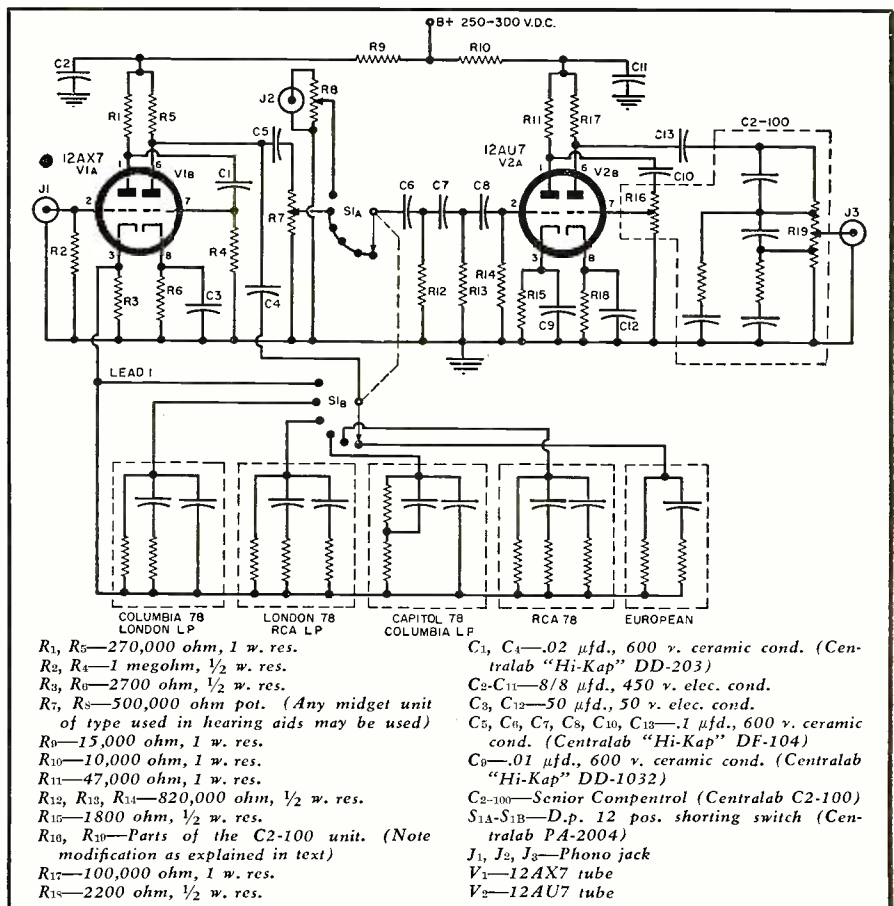
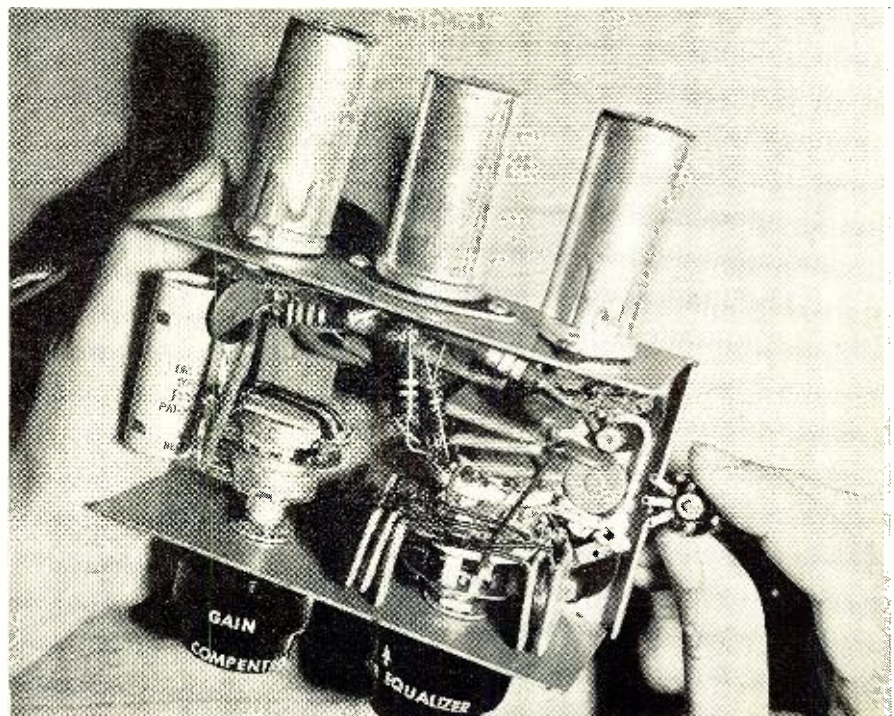

Fig. 4. Complete schematic of the printed circuit preamp. The equalizer networks, shown dotted at lower left, are not commercially available but suitable networks can be substituted by following the diagrams and parts values shown in Fig. 2.

is 100 or 40 db since the input voltage at  $J_2$  was .245 volt (1 kc.) and the output voltage at  $J_3$  was 24.5 volts.

The equalizer circuit is basically the one used in the H. H. Scott 120-A (Continued on page 78)

Fig. 5. Interior view of the preamp showing compact arrangement of components, use of the PEC plates, and the special Model 1 subminiature control (held in hand). The equalizer switch's arrow is pointed to the "European" equalizer.



Shown below is the new Du Mont 19-inch "Chroma-Sync" color TV picture tube which uses three guns and a curved mask.



# FUNDAMENTALS OF

# COLOR TV

## COLOR

## SYNCHRONIZATION

By MILTON S. KIVER

Pres., Television Communications Institute

*Part 7. The color sync section—its job is to make certain that the correct colors are reproduced.*

**T**HE SERVICE technician is by now fully acquainted with the function of the sync circuits in a black-and-white receiver. Briefly stated, they serve to maintain the picture in synchronism with the scene being transmitted by the station. In a color receiver similar circuits are employed for the same purpose. In addition, color receivers must be told what colors to produce at each point in the picture and for this purpose a special color sync signal is sent. This sync signal takes the form of a burst which is placed on the back porch of each horizontal sync pulse and consists of at least 8 cycles of the missing 3.58 mc. color subcarrier.

In the receiver this special color sync burst is separated from the rest of the signal and routed to a color sync section. (Here, again, the similarity to the sync pulses is apparent.) The purpose of the color sync section in a color television receiver is to insure that the color subcarrier which is recombined with the received color signal possesses the correct frequency and the proper phase. Both are important if we are to re-obtain the desired color voltages at the output of the *I* and *Q* demodulators.

It may be well to recall at this point that each color is represented by a different angular position of the resultant *I* and *Q* vectors. See Fig. 1. For example, green is 61° behind the reference burst (in a counterclockwise direction); red is 77° ahead of the burst, etc. To produce a given color requires that the *I* and *Q* vectors combine with each other to produce a resultant whose position occupies the

angular position of that color. There is nothing fundamentally rigid about these different color positions. Actually, all they represent is a system in which various colors are represented by certain angular positions with respect to a given reference. In the present instance, the phase of the color burst is the reference and the correct reproduction of the color scene at the receiver hinges on the fact that the phase of the color burst is fixed by the FCC and that the color subcarrier which is re-inserted in the color signal has its phase established by the color burst.

Should something occur at the transmitter which causes the color burst phase to vary, without a corresponding change in the angular positions of the various colors, then the set viewer will be treated to the spectacle of seeing the various colors in the picture change. By the same token, any in-

stability in the color sync circuits of a receiver will also lead to the development of the wrong colors. In fact, it has been found that a change of only  $\pm 5$  degrees in the phase of the color subcarrier will produce a noticeable change in the color picture. From this it is evident that the tolerances in the color sync section are among the most stringent in the entire color receiver. It is safe to predict that many of the service technician's headaches will originate right here.

There are several approaches to the development of 3.58-mc. signals possessing the proper phase and frequency. One method, illustrated in Figs. 2 and 4, employs an automatic phase control (a.p.c.) system in conjunction with a crystal oscillator. The input to the color sync section is at the burst amplifier. This stage is normally cut off (by a high positive voltage on the cathode) except when the color burst is passing through the receiver. At these instants, a negative pulse of about 37 volts is obtained from a winding on the horizontal output transformer and applied to the cathode of the color burst amplifier. The pulse counteracts the positive cathode voltage and permits the tube to conduct, amplifying and then transferring the color burst to the following phase detector.

The transformer in the plate circuit of the burst amplifier has a high-impedance primary and a bifilar secondary tightly coupled to the primary. The burst signal voltage is on the order of 60 volts peak-to-peak on either side of the secondary center tap.

In the phase detector, two triodes are employed to compare the frequency and phase of the received color burst with the frequency and phase of a locally-generated c.w. signal. The latter voltage is brought into the phase circuit via a color phasing amplifier

**EDITOR'S NOTE:** Part 1 of this series, which appeared in the March, 1954 issue, explained color mixing and its application in color TV. Part 2, appearing in the April issue, described the NTSC color signal. The block diagram of a typical color TV receiver was described in the May issue. The June article in this series described the tuner, sound, and some of the video circuits of a color receiver. Typical chrominance circuits (demodulator, matrix, adders, etc.) were analyzed in the July article. The formation and composition of the color signal were explained in August.

In view of the many requests received, RADIO & TELEVISION NEWS will publish this series in reprint form. The first three parts are in a single unit (50 cents), the balance will be reprinted in individual parts at 20 cents each. For quantities of 50 or more, write for quotations. Address your inquiries to RADIO & TELEVISION NEWS Reprint Editor, 366 Madison Ave., N. Y. 17, N. Y.

and possesses an amplitude of 25 to 35 volts peak-to-peak. If any phase difference exists between the two signals, a correction voltage is developed at point "A" and fed to the grid of a reactance tube. Here it alters the effect of the reactance circuit on the 3.58-mc. crystal oscillator and thereby causes the frequency of the oscillator to change.

For a clearer analysis, the phase detector circuit is shown by itself in Fig. 3. The incoming burst appears across the full secondary of the phase discriminator transformer and since the center-tap of this winding is effectively at ground potential (via  $C_1$ , which has negligible impedance at 3.58-mc.), the signal polarity at one end is  $180^\circ$  out-of-phase with the signal polarity at the other end. We can represent this relationship as shown in Fig. 5A.  $E_{R1}$ , the burst voltage applied to the cathode of one phase detector section is  $180^\circ$  out-of-phase with  $E_{G2}$ , the voltage which the grid of the other phase detector section receives.

At the same time, the cathode of  $V_2$  and the grid of  $V_1$  receive a portion of the generated 3.58-mc. voltage from the color phasing amplifier. This voltage, labeled  $E_0$ , can be represented as shown in Fig. 5B. The resultants of  $E_0$  and  $E_{R1}$  and  $E_0$  with  $E_{G2}$  are also indicated in Fig. 5B and it can be seen that they are equal. That is,  $E_A$  is equal to  $E_B$ . This represents the condition when the generated 3.58-mc. oscillations possess the proper frequency and phase with respect to the incoming color burst. There is no output voltage across  $C_1$  and none to the reactance tube.

On the other hand, when the frequency of the generated 3.58-mc. voltage speeds up or slows down, one section of the phase detector conducts more heavily than the other and the reactance tube receives a correcting negative or positive voltage from the phase detector. Fig. 5C shows the positions of  $E_0$  for these two latter conditions. Notice in each instance that  $E_A$  and  $E_B$  are no longer equal in length; in one case  $E_A$  is greater than  $E_B$  and in the other case it is shorter than  $E_B$ .

The correcting voltage for the reactance tube appears across condenser  $C_1$  and is applied to grid 1 of the reactance tube (point "A"), as explained previously.

The plates of  $V_1$  and  $V_2$  do not enter into the operation of the phase detector circuit. They merely serve as tube shields. In some later phase detector circuits 6AL5 double diodes are used, the plates of the diodes functioning as the grids do in the circuit of Fig. 4. Another possibility is to use triode tubes connected as diodes, with the plate tied directly to the grid.

A color phase control in the output circuit of the color phasing amplifier permits manual adjustment of the phase of the local oscillator voltage applied to the phase detector. The range here is 150 degrees. This control

Fig. 1. Color phase diagram showing the positions of the various key colors and the I and Q vectors. The position of the color burst is shown.

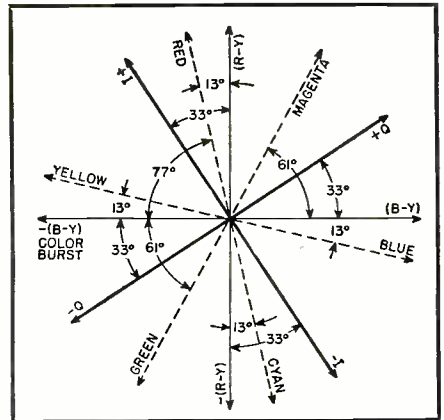

is generally made available at the front panel (exposed or hidden behind a plate) to enable the set viewer to compensate for any color changes (i.e., shifts) in the color sync circuits. It is also possible for the phase of the color burst signal to be altered by passage through the receiver and manual adjustment is necessary for proper color rendition. In viewing a picture, the color phase control is adjusted to achieve the most pleasing flesh tones or color of some familiar object.

One other control in the phase detector circuit is the a.f.c. balance potentiometer. This enables the technician to bring both sections of the phase detector into balance should this adjustment be required.

The crystal oscillator also produces the 3.58-mc. color subcarrier signal voltage needed by the I and Q demodulators. The I demodulator receives its voltage directly from the cathode of the oscillator tube. The 3.58-mc. signal for the Q demodulator is fed first to a quadrature amplifier where the  $90^\circ$  phase shift is introduced. Then it is transferred to grid No. 3 of the Q demodulator. Both 3.58-mc. signals are on the order of 25 to 30 volts peak-to-peak amplitude at the demodulators.

The final item in the color sync section is the color killer stage. The grid of this tube ties into the phase detector at a point ("B" in Fig. 4) where a negative voltage is developed when a color burst (and, hence, a color signal) is being received. The negative

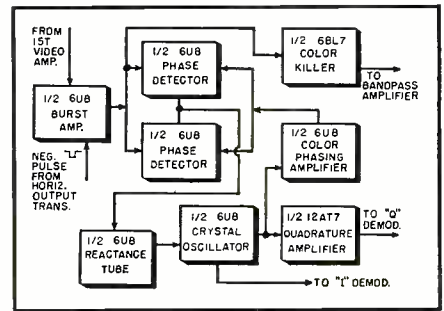

Fig. 2. Block diagram of a color sync section of a color television set.

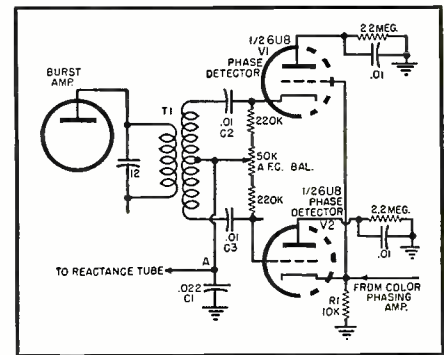

Fig. 3. Phase detector circuit of the color sync section of the set of Fig. 4.

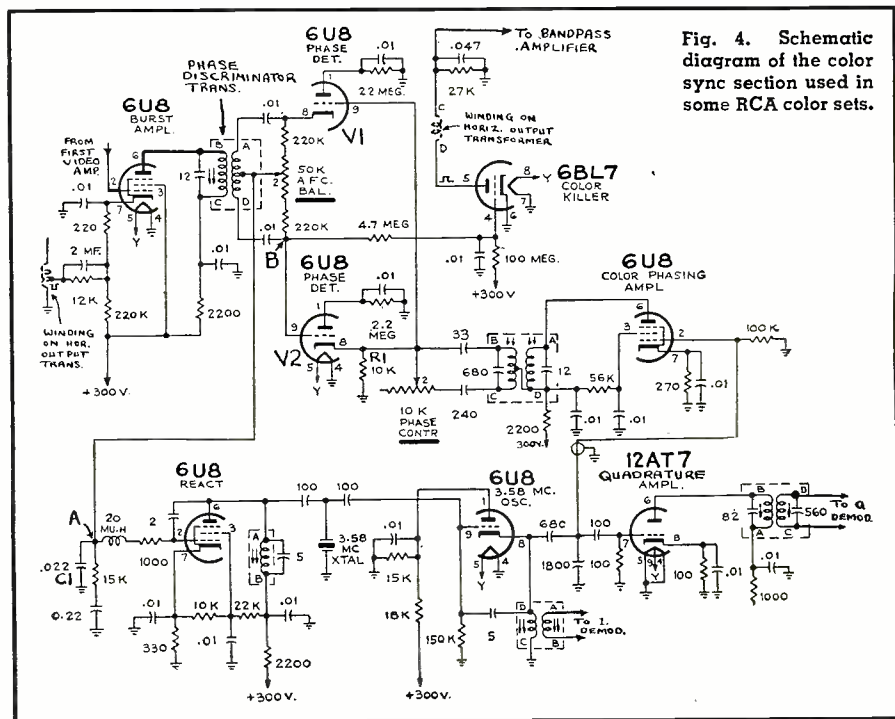

Fig. 4. Schematic diagram of the color sync section used in some RCA color sets.

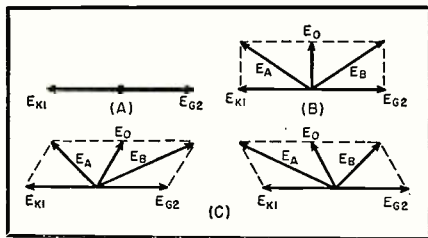

Fig. 5. Various voltage vector relationships in the phase detector circuit. (A) The incoming burst voltage applied to  $V_1$  and  $V_2$ . (B) The combination of the burst voltage and color phasing voltage. (C) When the phasing voltage,  $E_o$ , lags (left) its normal phase, or when it leads it (right), the voltages across the phase detector tubes in Fig. 3 are unequal.

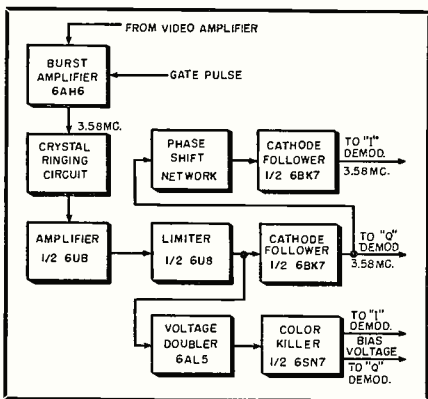

Fig. 6. Block diagram of a color sync section using a crystal ringing circuit.

voltage is strong enough to bias the color killer tube to cut-off, even when its plate receives a positive pulse from the horizontal output transformer. With no current through the tube, no voltage is developed across the plate load resistor of this tube and no bias voltage is produced for the grid of the bandpass amplifier. This enables the bandpass amplifier to conduct, which

is the desired condition when color signals are being received.

Consider, now, what happens when no color signal and hence no color burst is present. The voltage at point "B" becomes slightly positive and the killer tube conducts each time its plate is pulsed positively. The flow of current through the killer tube establishes enough negative voltage across its plate load resistor to bias the band-pass amplifier to cut-off. This prevents extraneous information from reaching the color circuits and producing a random colored background.

A second type of color sync section is shown in Figs. 6 and 7. This is seen, both from its block diagram and actual circuitry, to differ in several important respects from the a.p.c. system. The most important difference lies in the use of a crystal ringing circuit as the generator of the 3.58-mc. color subcarrier signal. This circuit takes the place of the previous crystal oscillator and the phase detector network and is seen to represent a saving in parts and tubes. Its method of operation is as follows.

A quartz crystal is used which, when excited by the color burst at the start of each horizontal line, will continue to "ring" or oscillate at its natural frequency (here 3.58 mc.) for the duration of the line. A color burst from the burst amplifier activates the quartz crystal and because of its extremely high "Q" (hence, low loss) it continues to oscillate with very little decrease in amplitude until the next burst arrives. The trimmer condenser in series with the crystal can change its resonant frequency by several hundred cycles and thus take care of normal crystal tolerances.

The stage following the crystal is an amplifier and the stage beyond that is generally a limiter to smooth out variations in the output of the ringing circuit. Output from the limiter may

be used as one of the 3.58-mc. driving voltages for the  $I$  or  $Q$  demodulators while the same output, passed through a  $90^\circ$  phase shifting network will provide the driving voltage for the other demodulator.

The crystal ringing method is fairly simple and when properly designed will operate satisfactorily. It does not contain any particularly critical components and so will remain stable once it has been adjusted.

A color killer network may be readily tied in with the ringing system. One approach to this is shown in Fig. 7. A portion of the oscillations developed by the crystal ringing circuit is fed to a double-diode rectifier. The circuit is a voltage-doubler and operates as follows. During the positive half of the applied wave, tube  $V_1$  conducts and effectively charges condenser  $C_1$  to the peak value of the wave with a polarity as indicated in Fig. 7. On the negative half cycle, the applied voltage combines with the voltage present across  $C_1$  to yield approximately twice the peak value of the 3.58-mc. wave itself. Since the voltage is now negative,  $V_2$  conducts and charges  $C_2$  to approximately the same value. The voltage across  $C_2$  is negative with respect to ground and is high enough to bias the color killer tube to cut-off. This prevents the flow of current through this tube when the plate is triggered by positive pulses obtained from the horizontal output transformer. As a result, no voltage is developed in the output circuit of the killer tube and so none can be forwarded to the grids of the  $I$  and  $Q$  demodulators. This permits the demodulators to accept color signals which is the desired action under these conditions.

Consider now what happens when no color signal is present. At these times there are no color bursts to excite the ringing crystal and so no 3.58-mc. oscillations are generated. That means that the color killer tube receives no negative voltage from the preceding bias rectifier and therefore the killer tube is able to conduct freely whenever its plate is triggered positively. This conduction leads to the development of a fairly large negative voltage in the plate circuit of the killer tube and this voltage is forwarded to the grids of the  $I$  and  $Q$  demodulators, keeping these latter stages in a cut-off condition.

### Sync Separators and A.G.C.

The sync separator and a.g.c. sections of a color television receiver do not differ either in form or purpose from the same stages of a black-and-white receiver. As proof of this, the sync separator stages of a color television receiver are shown in Fig. 8. The input signal is obtained from the video detector or some point immediately thereafter and fed to the sync separator stages where as much of the video signal as possible is removed. In Fig. 8, the separated pulses then go to a phase splitter or inverter where pos-

(Continued on page 174)

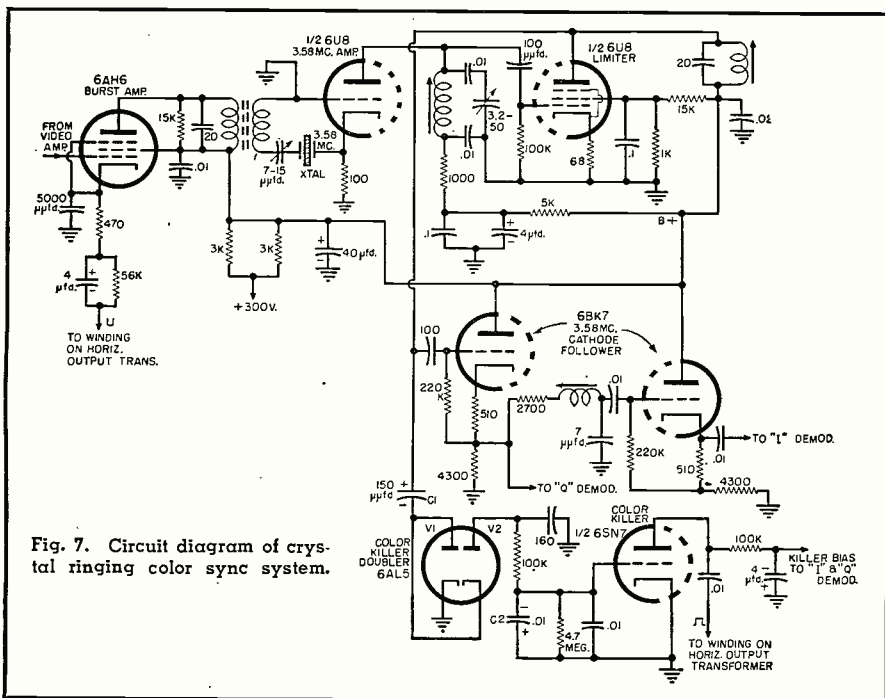
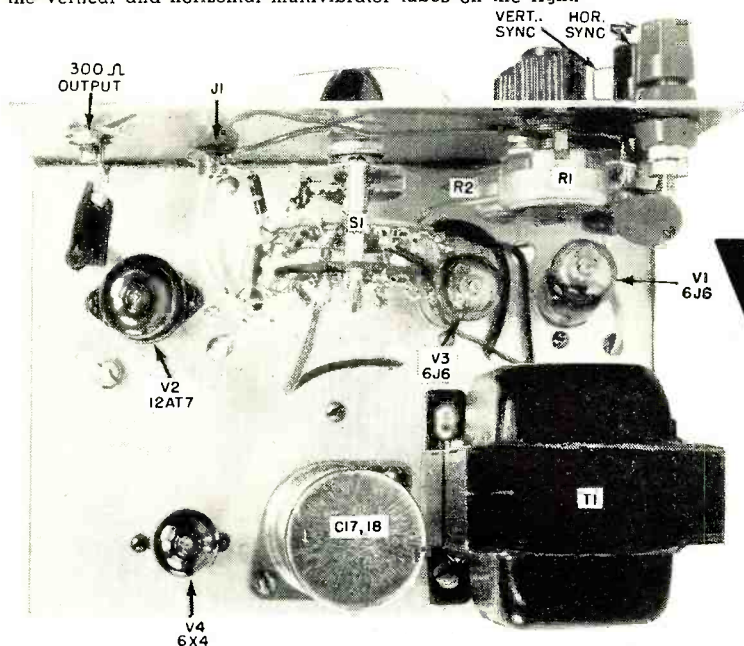

Fig. 7. Circuit diagram of crystal ringing color sync system.

# DOT PATTERN GENERATOR

Fig. 1. Top view of the pattern generator showing the parts layout. Note how the video amplifier-r.f. oscillator tube is located on the left side of the chassis, away from the vertical and horizontal multivibrator tubes on the right.



FOR  
**COLOR**  
 AND  
**MONOCHROME**

By  
**WALTER H. BUCHSBAUM**  
 Television Consultant  
 RADIO & TELEVISION NEWS

**O**F GREAT IMPORTANCE in color TV receivers are the d.c. and dynamic convergence adjustments which determine correct color registry. In addition, the vertical and horizontal linearity controls must also be set much more accurately than in black and white receivers. For this reason service technicians will need a pattern generator which produces horizontal and vertical bars as well as a white dot pattern.

In this article we present a simple pattern generator which can be constructed by anyone familiar with radio and TV. All parts used are standard items and a minimum of alignment is required.

This pattern generator is useful for current black-and-white TV service work since it furnishes modulated r.f. as well as a video signal for four different patterns. A switch selects either the white dot, crosshatch or grid, vertical bar, or horizontal bar pattern. Internal or external vertical and horizontal synchronization is possible.

## Circuit Operation

As can be seen from the block diagram in Fig. 2, the unit consists of four major sections. The horizontal multivibrator, running at a multiple of the horizontal scanning frequency, generates narrow vertical bars on the picture-tube screen. Operating at some multiple of the vertical scanning frequency, the vertical multivibrator produces horizontal bars on the screen. By means of a switching network, the outputs of these two pulse gen-

erators are fed to a gating and video amplifier tube. The output of this stage modulates the r.f. oscillator which covers channels 2 to 6 and has a 300-ohm balanced output. If the video signal itself is desired, it can be taken off through a separate terminal on the front panel and applied directly to the second detector or video amplifier in the TV set. For r.f. operation, a short length of 300-ohm twin-lead is connected from the pattern generator to the antenna terminals of the TV set. Any of the low frequency TV channels can be used.

The detailed circuit diagram and parts list of the pattern generator is shown in Fig. 3.  $V_1$  is a 6J6 used as the horizontal multivibrator and operates usually at about 157 kc. or some other multiple of 15,750 cps. The external synchronizing signal is applied to the multivibrator through  $C_1$  and  $R_1$  which permits adjustment of the sync pulse amplitude. Usually it is only

necessary that a lead be clipped on to the wire going to the horizontal deflection yoke coils of the TV set. The fly-back pulse picked up is sufficient to lock in the multivibrator and produce stable vertical bars on the screen. A simple plate-coupled multivibrator circuit is used which produces rectangular waves of unequal widths.  $R_2$  controls the frequency of the multivibrator and allows setting it for any desired number of vertical bars.

$V_3$  in Fig. 3 is the vertical multivibrator. This stage can be synchronized by means of the vertical pulse of the TV set.  $R_{12}$  allows adjustment of the sync pulse amplitude while  $R_{13}$  determines the frequency and, therefore, the number of horizontal bars on the screen. Again, a simple plate-coupled multivibrator circuit is used, producing a rectangular waveform. The coupling networks which feed the vertical pulse to the switching network introduce some differentiation and help sharpen the narrow pulse. This results in a fairly thin bar on the screen.

The switching network consists of a rotary four-pole, five-position switch. One pole or section is used as the a.c. "off-on" switch and the other three sections provide the four different patterns. Before going into details of the switching system, consider the type of

*Here's an instrument which is invaluable for color TV servicing and is easily built from standard parts.*

Fig. 2. Block diagram of the pattern generator described in this article.

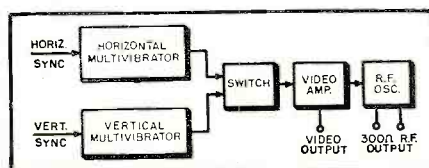

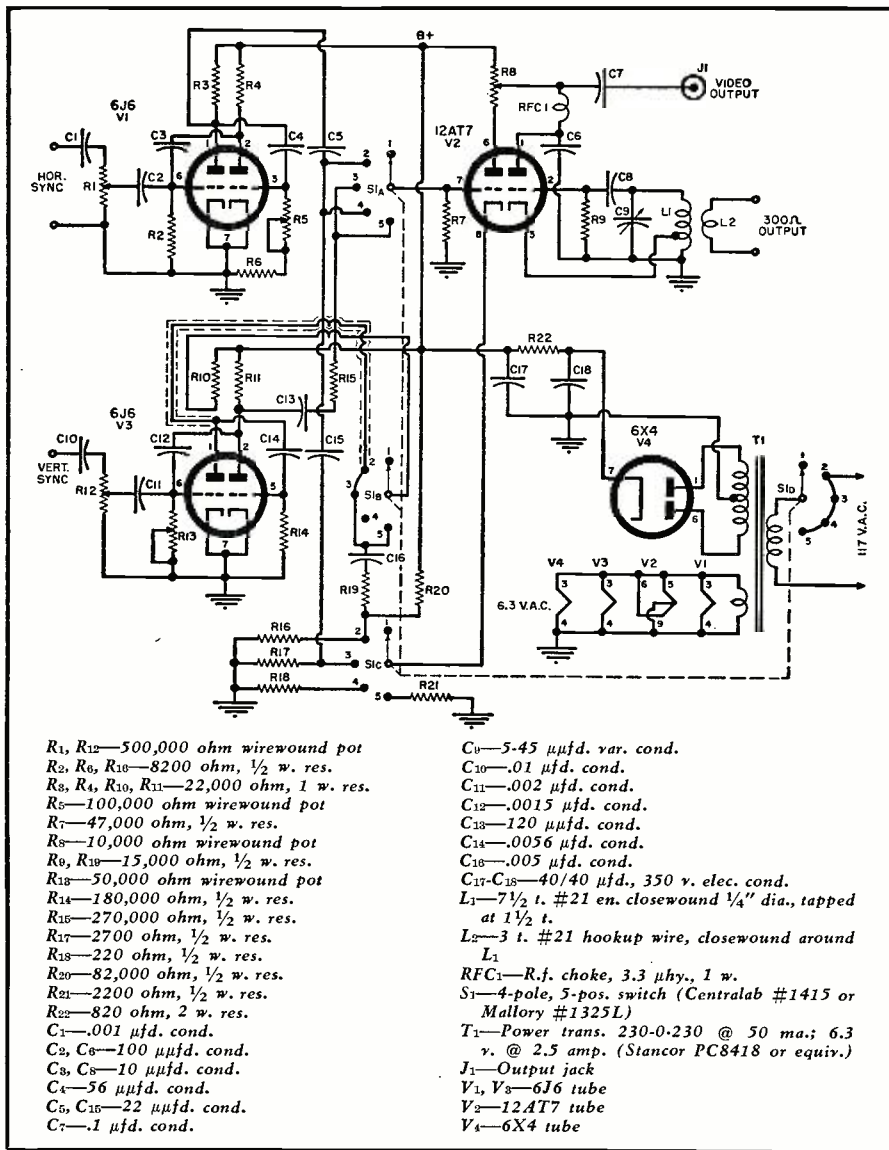

Fig. 3. Complete schematic diagram and parts list for the dot and bar pattern generator. Easily-obtained, standard parts are used throughout this unit.

signals required for each position. Taking the last position first, horizontal bars are generated when only the output of the vertical multivibrator reaches the grid of the video amplifier. Therefore, in position 5, S<sub>1A</sub> receives the differentiated vertical pulse through C<sub>13</sub> and R<sub>15</sub>. The latter resistor is used to avoid overloading the video amplifier grid. In position 5 the cathode of V<sub>2</sub>, the video amplifier, goes to ground through R<sub>21</sub>.

When vertical bars are desired we switch to position 4 and now only the signal from the horizontal multivibrator, V<sub>1</sub>, is required. To avoid stray pickup from the vertical multivibrator, V<sub>5</sub>, this stage is disabled by switch section S<sub>1B</sub> which eliminates plate voltage from one half of the tube in position 4. Since more video gain is required for the weaker horizontal pulses, R<sub>15</sub> is now connected as cathode resistor for V<sub>2</sub>.

So far the switching system is quite simple, but it becomes slightly more complicated when we want to obtain a grid pattern. For this type of signal

the vertical and horizontal signals should be amplified equally, without interference to each other. In switch position 3 the vertical pulse goes to the grid of V<sub>2</sub> through C<sub>13</sub> and R<sub>15</sub> while the horizontal pulse is applied to the cathode of V<sub>2</sub> through C<sub>5</sub> and C<sub>15</sub>. The purpose of this is to further differentiate the horizontal pulse, and is especially effective since it feeds into the cathode resistor R<sub>17</sub>, which is only 2700 ohms. As a result, both the vertical and horizontal bars appear equally wide and equally strong, producing a good grid pattern.

The circuit required for the dot pattern is obtained in switch position 2. In order to produce white dots, the video signal must contain horizontal pulses only during the brief duration of the vertical pulse, and the vertical pulse should only be amplified during the period of the horizontal pulse. In other words, only the intersection of the horizontal and vertical bars should be visible. In conventional dot generators this effect is achieved by using a 6AS6 or similar gating tube and ap-

plying each signal to one of the active grids. Since 6AS6 tubes are fairly expensive and low cost as well as simplicity is desired here, we have arranged the video amplifier so that it doubles as the gating tube. The horizontal pulses are applied through C<sub>5</sub> to the grid of V<sub>2</sub> when the switch is in position 2. Vertical pulses are applied through C<sub>15</sub> and R<sub>15</sub> to the cathode of V<sub>2</sub>. Note that here the vertical pulses are taken from the opposite polarity plate of the multivibrator. The reason for this is that a negative-going pulse is required to gate the video amplifier.

S<sub>1C</sub> in position 2 connects the V<sub>2</sub> cathode to a voltage divider, R<sub>16</sub> and R<sub>20</sub>, which applies a fixed cathode bias of about 12 volts. This cuts off the tube and allows no signal to pass. The gating action occurs when a negative polarity vertical pulse overcomes the fixed bias and permits a short burst of horizontal pulses to pass.

The first position of the selector switch is used to shut off the a.c. power as is evident from the connection of S<sub>1D</sub>. A simple, full-wave power supply is used here. It supplies 125 volts d.c. and has a current drain of about 35 ma.

The second triode section of V<sub>2</sub> is an r.f. oscillator, capacity tuned from 50 to 90 mc. to cover the low-band TV channels. Plate modulation is used here which permits a single amplitude control, R<sub>8</sub>, to vary both the video output signals and the modulation percentage. The drawback of this arrangement is that changing the output control will also vary the oscillator frequency slightly. Actual tests have shown that this variation is less than 1 mc. and the TV receiver bandwidth is usually such that readjustment of the fine tuning control at the TV set compensates sufficiently. The r.f. output is obtained by means of a three-turn coil wound on the same form as the oscillator coil.

### Construction

The chassis layout in Fig. 1 is simple and straightforward. A standard 5" x 7" x 2" aluminum chassis was used. There does not appear to be any critical lead length or location for either the vertical or horizontal multivibrator, but it was found necessary to shield the lead from pin 1 of V<sub>5</sub> to switch section S<sub>1B</sub> to prevent stray pickup in the dot-pattern circuit. It is also advisable to locate the 12AT7 away from the vertical multivibrator for the same reason. In addition, the r.f. oscillator section should be isolated somewhat. In Fig. 1 is shown the r.f. output lead which consists of a piece of 300-ohm twin-lead going from L<sub>2</sub> to the 300-ohm terminals. Some readers may prefer to omit the terminal strip and bring out a long 300-ohm lead for direct connection to the TV set.

All resistors used are 10% values; paper and tubular or flat ceramic condensers are used throughout. No difficulty should be encountered if mica

condensers are used, but it is not advisable to connect condensers having a negative temperature coefficient into the multivibrator circuits.

When the generator is first turned on, set the two frequency control potentiometers  $R_2$  and  $R_{13}$  to an approximate midpoint position and check the output of the video amplifier on an oscilloscope. In switch position 2, dot pattern, only a faint signal may be visible unless a sensitive, wide-band scope is used. The grid pattern, switch position 3, will appear like the scope picture of Fig. 4 when the oscilloscope is set for about 600 cps. In this illustration the large, wide pulse is the vertical multivibrator output while the smear near the base line actually consists of the higher frequency horizontal pulses.

Turning the selector switch to position 4, we obtain the horizontal pulses only. When the scope frequency is adjusted to about 25 kc., the waveform shown in Fig. 5 should be observed. Each sharp spike represents one of the vertical lines on the screen. In order to see the sharp point as clearly as in Fig. 5, the oscilloscope should have a bandwidth of at least 1 mc., otherwise a rounded waveshape similar to a sine wave will appear.

The pattern obtained in switch position 5 is similar to that of position 3, except that no horizontal pulses appear and the baseline will be free from the fuzz shown in Fig. 4. When the output amplitude control is set for maximum, the peak-to-peak voltage at the video terminal will be approximately 20 volts on all switch positions except position #2. For the dot pattern the video amplifier operates with slightly reduced gain and because of the sharp, short burst of horizontal pulses the oscilloscope picture shows a peak-to-peak voltage of about 15 volts.

The final step in adjusting the pattern generator is to check out the r.f. oscillator. To make sure it is oscillating, check the grid bias with a decoupled v.t.v.m. probe. While a 5 to 45  $\mu\text{fd.}$  air-trimmer type condenser is used here, a somewhat larger value may be used and plates removed to make the range.  $L_1$ , the oscillator coil, can be stretched or squeezed together to provide for full coverage from channels 2 to 6.  $L_2$  can be varied by changing its coupling with the tank circuit. The correct coupling is obtained when approximately equal output is achieved on all channels. One way to check this is by means of a 300-ohm crystal detector, with its output connected to the oscilloscope. About 0.5 volt of signal should be obtained on the scope and this should remain substantially constant when the tuning condenser is varied over the band.

#### Using the Pattern Generator

Switch position 5 generates horizontal bars which can be fed directly to the video output amplifier in the TV set, or the r.f. signal can be introduced at the antenna terminals. When the

horizontal-bar pattern is applied at the TV receiver antenna terminals, simply tune the set for any channel between 2 and 6 and tune the pattern generator for a good screen pattern. A typical horizontal-bar pattern is shown in Fig. 6.

In some instances it will be found that the TV set does not readily lock-in with the bar pattern or, when the pattern is applied to the picture-tube grid, no sync action at all takes place. To make the bar stand still, clip a lead from the vertical sync terminal to either the vertical deflection yoke leads, the yoke terminal, or the terminals of the vertical output transformer. This will lock the multivibrator in the generator to the receiver vertical sweep, assuring absolute synchronization. The sync amplitude control,  $R_{12}$  in Fig. 3, helps to adjust the sync signal for best lock-in.

Horizontal bars are usually used to check the vertical linearity, and the method used is the same for monochrome and color receivers. Adjust the height and vertical linearity controls until the picture is slightly smaller than the screen. Count the number of horizontal bars and expand the sweep until the top and bottom bars are just within the picture tube mask. Adjust linearity and height until the spacing between bars is equal and the same number of bars is still visible.

For checking horizontal linearity, the vertical bars shown in Fig. 8 are obtained in switch position 4. In general, the same connection as for the horizontal-bar pattern is used. For good synchronization it is helpful to clip a lead from the horizontal sync terminal to either the high voltage



Fig. 4. Oscilloscope waveform obtained at the video output with the switch in position 3 furnishing the grid pattern.



Fig. 5. With the selector switch in position 4 the output waveform shows a sharp spike for each vertical bar.

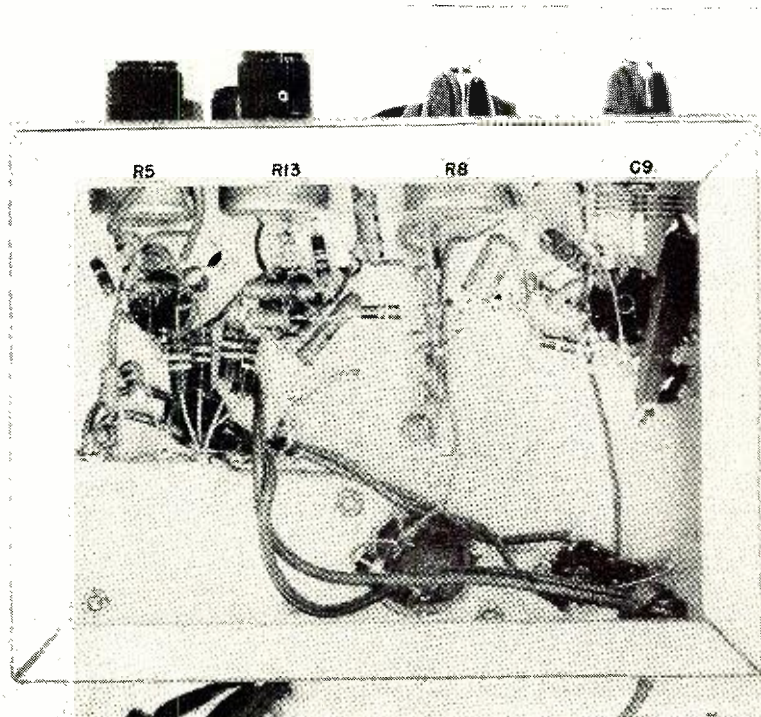

Fig. 6. Horizontal bar pattern obtainable from the generator in position 5.

lead or one of the leads going to the horizontal yoke coils. Usually the capacitive pickup from such an ar-

*(Continued on page 134)*

Fig. 7. Bottom chassis view. Ten per-cent tolerance resistors and paper and tubular or disc ceramic condensers are used throughout, except for the oscillator trimmer and power supply electrolytic filter condensers. See the parts list.



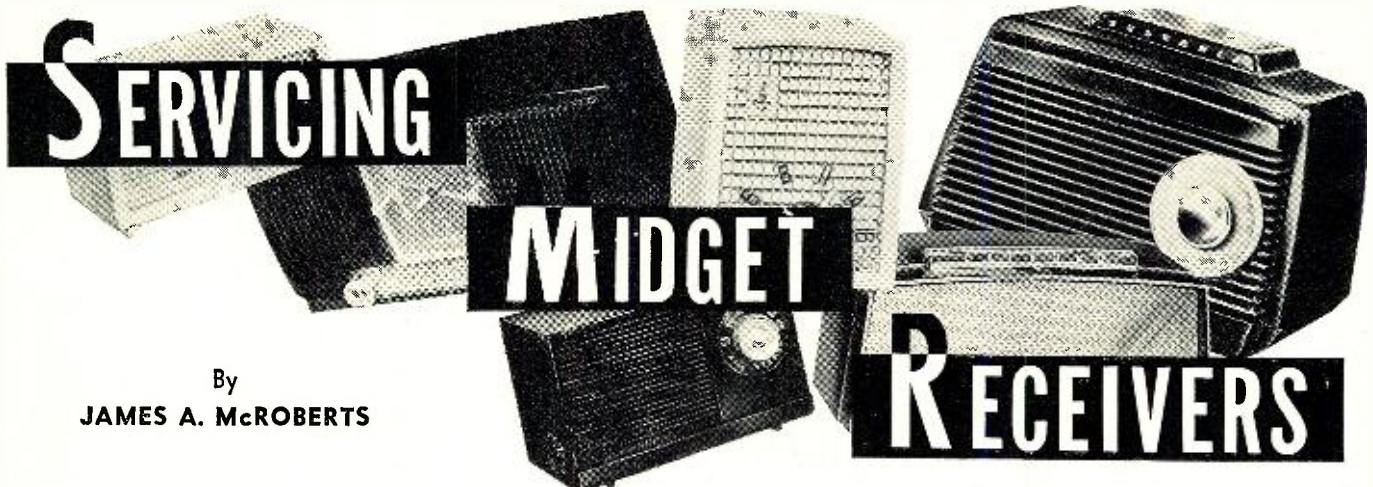

# SERVICING

# MIDGET

# RECEIVERS

By  
**JAMES A. McROBERTS**

**Q**UITE a number of troubles are peculiar to the midget-type radio receiver—battery portables, 3-way portables, and a.c.-d.c. sets. All of these sets are handy to carry to the vacation spot with its usual changes in humidity. Also, the smaller sets lend themselves to mass-production techniques using the printed- and the etched-circuit arrangements. The power supply of the 3-way jobs was discussed in the article "Troubleshooting 3-Way Portables" (July, 1954 *RADIO & TELEVISION NEWS*). Herein, the signal part of midget receivers and peculiarities of etched and printed circuits will be considered.

Unless some specific clue to the trouble is readily apparent, the troubleshooter should handle his testing in the time-ordered and proven method; 1. Get the power supply working. 2. Next, the audio and detector. 3. Follow with the i.f. 4. Finish with the converter and r.f., if any.

Step 1 entails a rapid check of the voltages of the "B+" and "A" supplies in 3-way sets. Visual observance of the rectifier operation is adequate for a.c.-d.c. sets. A quick test for the audio is to touch the hot side of the volume control—a buzz should result. The i.f. may be tested by a signal generator set to the proper frequency and connected to the antenna. Noise should be heard as an additional clue if the i.f. is good. Failure to pass a signal with a good i.f. usually means a bad oscillator. Note that the converter is also an i.f. tube.

The procedure just outlined is presented in the block diagram of Fig. 1 for the convenience of the reader. We now turn to more specific troubles of midget receivers.

## Oscillator Failure

Midget sets almost invariably employ a converter as a combination mixer-oscillator. A very frequent complaint is failure of the oscillator to oscillate. Several reasons exist. The most simple cause is moisture in the oscillator coil. The cure is very simple: dry the coil in the sun, or use a blast of warm air from a fan near a radiator or a hair dryer *on low heat*.

*Small radios that have been working overtime all Summer long may need service now—here is some practical information for clearing up troubles.*

Another frequent source of trouble is the resistor which supplies the oscillator plate (actually one section of the screen grid in most sets) with "B+" from the power supply. This resistor tends to increase in value with age, thereby lowering the oscillator plate supply voltage.

Fig. 2A shows a partial schematic of a typical converter circuit. Note that the oscillator "B+" supply is also the screen supply for the i.f. which may have a separate bypass condenser which might leak. Also, the screen bypass condenser of the converter tube may have lost some of its capacity with time—these sets are carried around in much greater extremes of climate than their home-radio counterparts—and the oscillator r.f. return through this condenser may be so greatly reduced that the tube can not oscillate. Try shunting this condenser early in the troubleshooting.

Some cases of repeated failure to oscillate after using hand-picked 1R5 converters have been cured permanently by using a separate dropping resistor for the screen of the converter with a new bypass condenser for this electrode. The value of the original dropping resistor must be increased since part of the current no longer flows through it, and the volt-

age on the i.f. screen must be prevented from becoming excessive. This change is shown in Fig. 2B.

The reader should note that the filament bypass to "B-" is part of the oscillatory circuit (Figs. 2A and 2B) and can cause loss of oscillation if the capacity decreases too much. Naturally, if the grid leak increases unduly in resistance, the circuit may not oscillate, or may "squeg" at a low frequency, that is, oscillate periodically. The grid leak resistance must be returned to the proper filament terminal in portables and 3-way sets.

## Frequent Tube Failure

Frequently, some particular tube or tubes will go bad far too often in a particular set. The trouble ordinarily springs from overheating of the tube filaments and, generally, develops in sets using series operation of the signal-tube filaments. It rarely occurs in sets in which the tube filaments are in parallel, as on a 1.5-volt "A" battery. Two principal causes exist for this trouble:

1. The schematic diagrams of Figs. 3A and 3B show bypass resistors. These may open or increase greatly in value, thereby not bypassing the plate current of those tubes in the string whose filaments are closer to "A+." This unbypassed current is now added to the tubes nearer to "B-" on the filament string. Figs. 3A and 3B are equal insofar as bypassing action, but the values of the bypassed resistors are different for the two cases. One scheme bypasses each tube filament individually, while the other returns the excess current to "A-" and "B-" from each terminal requiring bypassing.

If the signal tubes are in their sockets, test with the voltmeter for the correct drop across the filaments. *Re-*

**Fig. 1. Block diagram of a typical midget receiver showing the conventional service steps for checking the circuits, as explained in the text.**

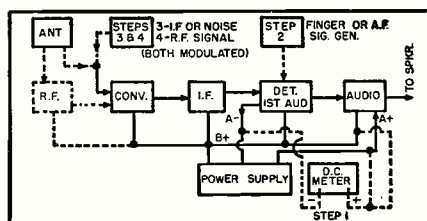



move the signal tubes to test with the ohmmeter.

2. The filament string may be bypassed to "A—" by bypass condensers which can leak or short-circuit. Fig. 3C shows such a case for a leaky condenser around the r.f. and detector tubes. These two tubes will have less than normal filament voltage across their terminals while the remainder of the filament string will have more than normal voltage across their terminals, resulting in premature failure of the latter tubes.

Disconnect the suspected condenser and check the filament voltage; don't pay any attention to oscillation which may develop while this condenser is disconnected for testing. Do not test with an ohmmeter unless you are sure that you cannot damage the filaments. Check the filter condenser from "A+" to "A—". This may leak excessively and overheat the dropping resistor for the filament string. Suspect such a case if this resistor gets too hot and the "A" voltage is low.

### Printed Circuits

Many of the modern portables and midget a.c.-d.c. sets utilize a printed circuit (*Couplate*) in the audio section. Some sets, such as some *Motorolas*, use the same *Couplate* as part of the r.f. filter network into the grid of the 1st audio. Fig. 5 shows the printed circuit *Couplate* PC-91 as employed in *Zenith's* 3-way portable receiver, chassis 5L42.

These printed circuit assemblies are very brittle and must not be subjected to mechanical shock. Neither should the leads be cut too short in replacing such a unit since some allowance should be made for thermal expansion and contraction; if this allowance is not made, the result might be a broken printed circuit unit such as shown in Fig. 4. Allow at least  $\frac{3}{8}$  inch beyond the soldered joint for expansion and contraction. The wire leads should be bent at an angle prior to clipping so that the unit may be soldered into position more readily. Such is an objection to the vertical position of the unit illustrated in Fig. 4, installation would be easier if the unit were at a 45° angle to the vertical.

If a unit becomes defective, the best repair is the replacement of the entire unit. Shunting the coupling condenser between terminals 5 and 6 of the PC-91 of Fig. 5 would be good if one could be sure that the condenser in the PC-91 would remain open circuited—there is no guarantee that it will remain open however. The same logic applies to the screen and the plate resistors of this component (the 4.7 megohm and 1 megohm resistors) inasmuch as a resistor which has changed its value might change again. When such a change occurs, it may cause an intermittent, and intermittent troubleshooting jobs are unwelcome visitors to the shop.

An entirely different state of affairs is the case of a part which has a separate terminal such as the 2.2

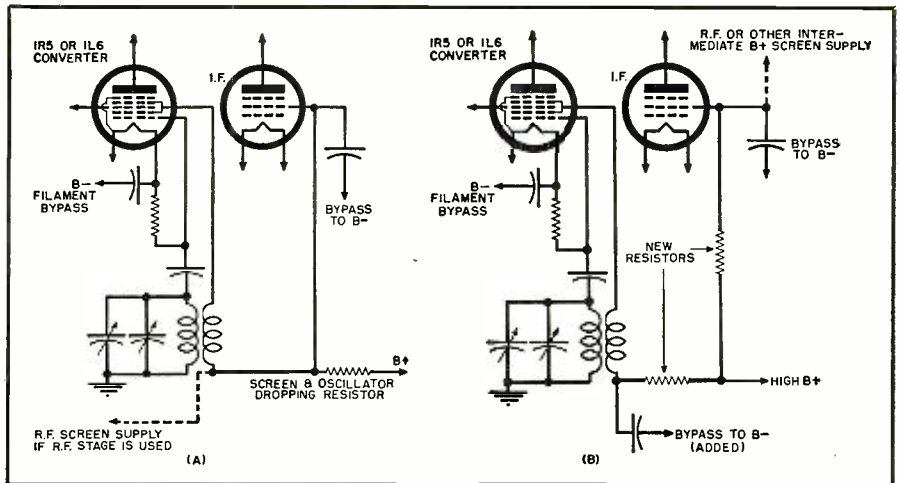
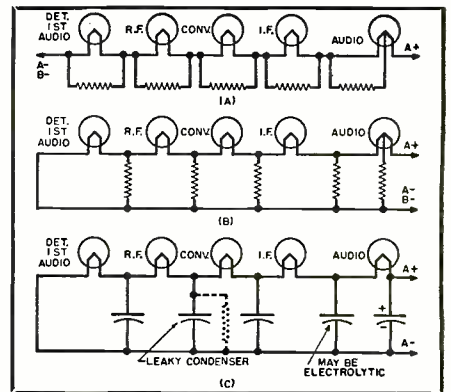

Fig. 2. (A) One type of oscillator circuit for 3-way portable radios. (B) Modification of the circuit in (A) resulting in a higher voltage on the converter screen grid (which also serves as the plate for the oscillator section of tube).

Fig. 3. Various methods of bypassing the plate current around the filaments of a portable radio are shown here. (A) Bypass resistors across each filament. (B) resistors from each filament to "B—," (C) bypass condensers. One condenser in (C) is leaky and its effective leakage resistance is shown.



megohm grid resistor of the PC-91 of Fig. 5. An external resistor is entirely feasible in such an instance from terminal 6 (the grid of the output) to the plus terminal of the detector filament, with terminal 2 of the printed circuit left unconnected. Note that the grid bias of the output tube is obtained from the filament IR drop of 4.5 volts from the most negative terminal of the output tube filament to the plus filament lead of the detector. Care must be exercised in grid return connections in these sets.

Fig. 4 is also representative of the etched circuits often employed in mid-gset sets. These etched circuits and other conventional types are frequently sprayed with a waterproofing compound and testing should be performed with needle probes.

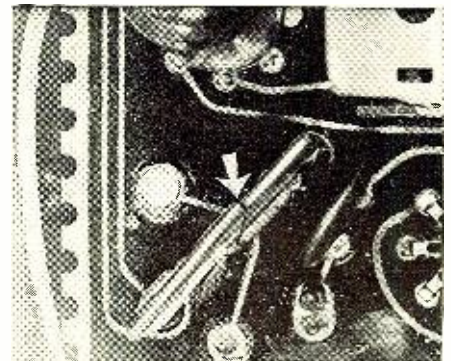
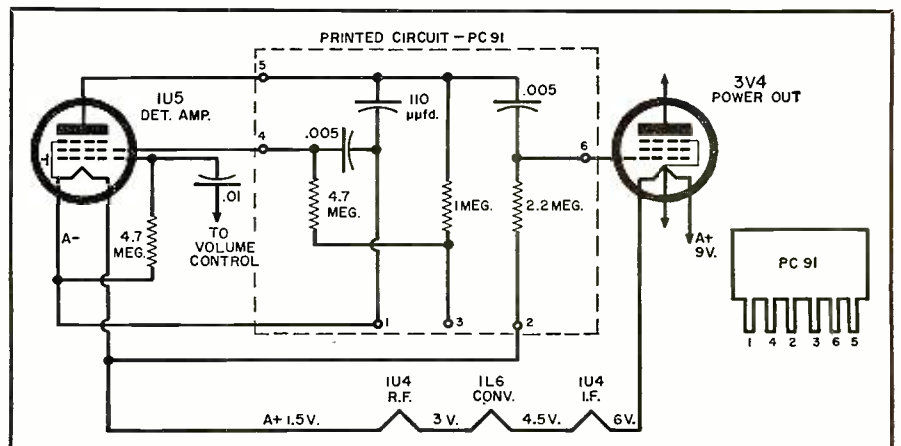

Fig. 4. Part of an etched radio circuit containing a cracked "Couplate."

Fig. 5. Partial schematic diagram of the Zenith 3-way portable 5L42 chassis showing the printed circuit "Couplate" hookup and filament wiring for the complete set.



# 1954 TV RECEIVER SPECIFICATIONS

Continuation of the list of mechanical and electrical specifications on current model TV sets for service technicians. See next issue for additional listings.

MFR.	CHASSIS	TUBES							VIDEO I.F. FREQ: (MC.)	H.V. <sup>4</sup> (KV.)	U.H.F. PROVISION	POWER (WATTS)	SPECIAL FEATURES	
		TUNER	I.F. <sup>1</sup>	VIDEO <sup>2</sup>	AUDIO	SWEEP <sup>3</sup>	P.S.	CRT						
SPARTON (Cont'd)	27D214	6BQ7 6J6	6BA6	6AH6 6AL5	6AL5 6AT6	6AL5, 6BQ6GT 6BQ6GT, 6S4	1B3GT 5U4G	21EP4A	26.25	14.5	Strips	260		
	29U214	6CB6 6CB6	6AU6	6AU6 6AU6 6V6GT	6SN7GT, 6SN7GT 6W4GT, 6W4GT 12AU7	5U4G			26.25	14.5	11	275		
STEWART-WARNER	9300	6BQ7	6CB6	1N64	6AQ5	6AH4GT, 6AX4GT	1B3GT	21MP4	26	14.4	Strips	200	5, 10	
	9325	or 6BZ7 6J6	6CB6 6CB6	6AU6 6T8* 12BY7	6AU6 6T8*	6BE6, 6BQ6GT 6SN7GT, 12AU7	5U4G		41.25	14.4	11			
	9310	6BQ7 or 6BZ7	6CB6 6CB6	1N64 6AU6 6T8*	6AQ5 6AU6 6T8*	6AU5GT, 6AX4GT 6BE6, 6CD6G 6SN7GT, 12AU7	1B3GT 5U4G	27EP4 27NP4 27RP4	26	17.5	Strips	275	5, 10	
	9370	6J6	6CB6	12BY7				24CP4	26	17.5	Strips	275	5, 10	
	9340	6BQ7 or 6BZ7 6U8	6CB6 6CB6 6CB6	1N64 6AU6 6T8* 12BY7	6AQ5 6AU6 6T8*	6AH4GT, 6AX4GT 6BE6, 6BQ6GT 6SN7GT, 12AU7	1B3GT 5U4G	21MP4	41.25	14.4	11	200	5, 10	
	9350	6BQ7 or 6BZ7	6CB6 6CB6 6CB6	1N64 6AU6 6T8*	6AQ5 6AU6 6T8*	6AU5GT, 6AX4GT 6BE6, 6CD6G 6SN7GT, 12AU7	1B3GT 5U4G	27EP4 27NP4 27RP4	41.25	17.5	11	275	5, 10	
	9360	6U8	6CB6	12BY7				27CP4	41.25	17.5	11	275	5, 10	
	9380	6BC5 6J6	6AU6 6AU6 6AU6	1N64 6AU6	6AQ5 6AU6 6T8	6AH4GT, 6BQ6GT 6C4, 6SN7GT 6W4GT, 12AU7	1B3GT 5U4G	17HP4 17RP4	26	16	Strips	200	5, 10	
	STROMBERG-CARLSON	621	6BQ7 or 6BZ7 6J6	6BA6 6BA6 6CB6 6CB6	6U8* 6W6	6AU6 6T8 6U8* 6V6GT	6AL5, 6AU6 6AX4GT, 6BQ6GT 6C4, 6S4 6SN7GT, 6SN7GT 12AU7	1B3GT 5U4G 5U4G	21FP4A	26.4	16	Strips	265	5, Noise Control
		621A	6BQ7 or 6BZ7 6J6	6CB6 6CB6 6CB6	6U8* 6W6	6AU6 6T8 6U8* 6V6GT	6AL5, 6AU6 6AX4GT, 6BQ6GT 6C4, 6S4 6SN7GT, 6U8* 12AU7	1B3GT 5U4G 5U4G	21FP4A	45.75	16	Strips	265	5, Noise Control
622		6AF4 6BZ7 6X8	6CB6 6CB6 6CB6	6U8* 6W6	6AU6 6T8 6U8* 6V6GT	6AL5, 6AU6 6AX4GT, 6BQ6GT 6C4, 6S4 6SN7GT, 6U8* 12AU7	1B3GT 5U4G 5U4G	21FP4A	45.75	16	11	265	5, Noise Control	

1. Video i.f. tubes only. 2. Includes detector and a.g.c. 3. Includes sync section and a.f.c. 4. CRT 2nd anode voltage. 5. Removable safety glass. 6. Local-fringe a.g.c. adjustment. 7. High-fidelity sound. 8. Aluminized picture tube. 9. TV-radio-phonograph combination. 10. Built-in antenna. 11. 82-channel tuner. 12. Adjustable dial light. \*Part of tube is used in another section.

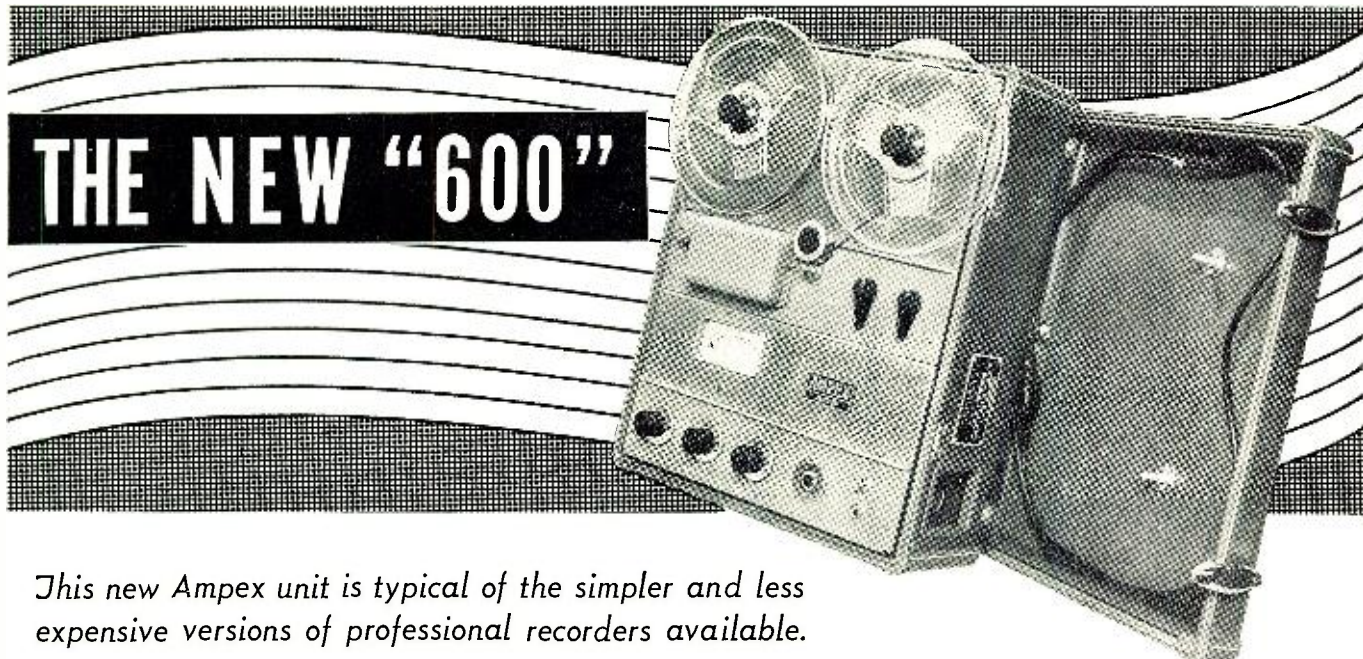

*This new Ampex unit is typical of the simpler and less expensive versions of professional recorders available.*

**N**OW that high-fidelity tape recordings are commercially available in reasonable quantities, manufacturers of professional recording equipment are wooing the golden-eared home users with machines capable of reproducing all of the quality which is available on these professionally-recorded magnetic tapes.

Taking advantage of their experience in building quality equipment, manufacturers of such gear are now offering smaller, less expensive units for this new market. They feel that home users, for instance, will not need the heavy-duty editing facilities required by broadcasting and recording studios. Hence, machines of this class feature a  $7\frac{1}{2}$  ips single speed which gives full fidelity, rather than two speeds found in commercial equipment. This enables manufacturers to use a lighter, less expensive motor and eliminates the necessity for providing facilities for changing equalization to meet different tape speeds.

One example of the "new look" in professional recorders suitable for the home hi-fi market is the *Ampex "600"* shown on this month's cover and on this page.

It is a 28-pound portable unit which is housed in a regular *Samsonite* overnight case. The removal of eight screws allows it to be taken from its portable case for custom installation in the home. It may be operated in either a vertical or horizontal position.

The Model 600 has a frequency response of  $\pm 2$  db from 50 to 10,000 cps, with the curve falling off no more than 4 db at 40 cycles and at 15,000 cycles. It has a better than 55 db signal-to-noise ratio, measured at the level of 3% total r.m.s. harmonic distortion of a 400-cycle tone and flutter and wow below .25%.

Since the capstan is constantly rotating whenever the power switch is on, tape starting time is practically instantaneous, reaching full, stable play-

ing speed in less than .1 second. The seven-inch reel capacity provides slightly more than a half-hour's continuous playing or recording time—equal to the reel size on which the pre-recorded tapes are being marketed.

Operating modes are controlled by two switches. One has positions for "play" and "record." It cannot be switched to "record" unless a separate safety button is depressed, thus preventing accidental erasure of recorded tapes. The other switch has positions for "fast forward" and "rewind." These two switches are interlocked so that tapes cannot be torn by switching between high and low speeds while the tape is engaged with the capstan.

Two inputs are provided for recording: a "line" input and a "microphone" input. Each is controlled by its own level control so that both inputs can be used simultaneously providing, in essence, a built-in mixing arrangement. The microphone input is for high impedance mike, but can be easily converted to low impedance by installing an accessory transformer. The line input can be fed from a tuner, record player, or another magnetic tape recorder unit.

The recording level is metered on a professional vu meter, which, unlike a flashing neon light, gives a quantitative picture of the recording action. Thus, the user can utilize the complete dynamic range of the machine by recording at as high a level as possible without introducing distortion due to tape saturation effects.

Since this particular unit employs three heads—separate heads being used for recording and playback—tapes can be monitored as they are recorded. A monitor selector switch connects the phone jack, the meter, and the output connector to either the incoming signal or to the signal as it is being recorded.

Like all professional-type recorders the "600" does not incorporate a

speaker or audio amplifier. A separate amplifier-speaker unit, the Model 620, in a matching portable case, is available for those who want a single-package unit. This auxiliary unit contains a 10-watt amplifier and a specially-designed 8" speaker—all in a coordinated acoustic enclosure.

In order to obtain maximum compactness at minimum cost, the "600" utilizes a single synchronous motor to provide constant speed for both recording and playing back and to provide high speed for fast forward and rewind. In "record" or "play" positions the motor drives the capstan through a non-slip nylon belt. A separate belt from the capstan flywheel drives the take-up reel. Hold-back tension on the supply reel is provided through a shock-relief clutch and disc brakes. The brakes are specially designed so that wear over a period of years will be negligible and tape tension will be maintained at 8 ounces—sufficient for tape head contact and low enough to prevent tape stretch.

In the high-speed rewind and fast forward modes, the motor pulley directly engages either the take-up reel clutch or the rewind reel clutch. The shock-relief brakes are disengaged so that hold-back tension is provided only by the special hold-back brakes. This tension is only 1 ounce—low enough so that the problem of head wear during high tape speeds is circumvented without lifting the tape from the recording and playback heads.

Units such as the "600" described here are rapidly narrowing the gap between the so-called "home" and "professional" recorders, thus speeding the day when the inherent advantages of tape recordings will be within the financial range of most families who enjoy good music.

When that day dawns, tape recorders will be as much "standard" equipment in the American household as refrigerators or TV sets are now. —30—

# TRANSISTORIZED MOISTURE DETECTOR

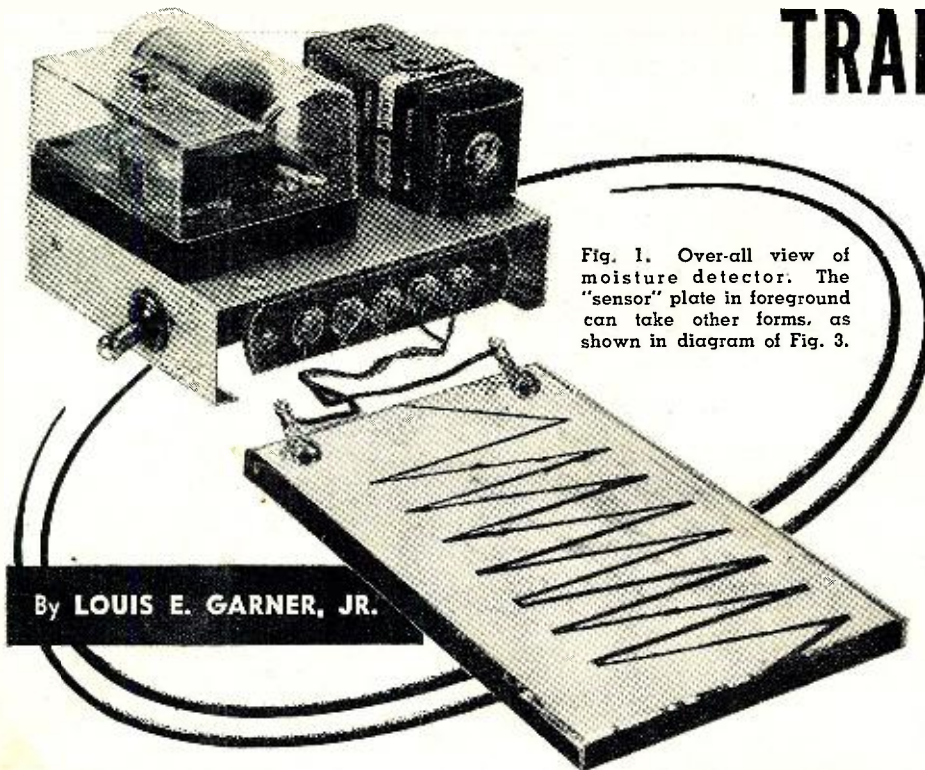

Fig. 1. Over-all view of moisture detector. The "sensor" plate in foreground can take other forms, as shown in diagram of Fig. 3.

By LOUIS E. GARNER, JR.

*Construction details on a compact unit which can be used to warn the householder of unusual or dangerous leakage.*

**E**LECTRONIC experimenters and technicians occasionally find it necessary to devise and build some type of simple moisture or rain detector. The unit may be destined for their own use, or may be built at the request of a friend, relative, or neighbor.

There is no doubt that the applications of a reliable moisture detector are quite varied . . . from closing a window with the first few drops of rain to protecting the family washing (by sounding an alarm so clothes may be removed from the line), or from detecting leaks and excessive condensation to giving a signal when "bed-wetting" occurs.

Unfortunately, many of the "rain detector" designs suggested and used in the past required vacuum tubes or thyratrons for their operation . . . making line voltage operation almost mandatory, and battery operation, at the best, expensive and cumbersome. Line voltage operation restricts the possible applications of a moisture detector considerably—outdoor use is limited, and applications involving possible body contact may be dangerous.

By *transistorizing* a moisture detector, however, low voltage battery operation becomes economically feasible, and such an instrument has virtually unlimited application. A typical transistorized moisture detector, suitable for construction by the home builder, is illustrated in Fig. 1, with the complete schematic diagram given in Fig. 2.

Since only a few components are required, the cost of the completed device is reasonable and compares favor-

ably with vacuum-tube operated units. Wiring and assembly is straightforward and simple, and the average technician should have little or no difficulty in assembling a similar unit in an evening's time.

## Circuit Description

As can be seen by reference to Fig. 2, the basic device consists of a moisture sensing element ("sensor"), a *p-n-p* junction transistor connected as a "grounded-emitter" direct-coupled amplifier, and a relay, used for controlling an external circuit.

The "sensor" consists of two pieces of aluminum foil cemented to a piece of plastic, with a very narrow separation between the conductors (from 1/16" to 1/8").

In operation, the base-emitter circuit of the transistor is normally open, and little or no collector current can flow through the relay. The relay thus remains open.

Should a drop of moisture fall on the "sensor" plate so as to contact both pieces of foil simultaneously, the base-emitter circuit is closed, and base current may flow. The electron path in the base circuit is from the negative terminal of the battery, through the power switch, *S*<sub>1</sub>, through resistor *R*<sub>1</sub>, through the drop of moisture on the "sensor" plate, and through the base-emitter of the transistor back to the positive terminal of the battery.

This base current flow permits a corresponding collector current flow to take place, though of much larger amplitude due to the current amplification of the transistor stage. The col-

lector current flow closes the relay which may be used to switch on some external circuit.

A single battery, *B*<sub>1</sub>, supplies both base and collector current. A power switch, *S*<sub>1</sub>, is provided to turn the unit "off" when operation is not desired.

Series resistor *R*<sub>1</sub> serves to limit base current to a safe value, even if the "sensor" elements are accidentally short-circuited. The high d.c. resistance of the relay coil satisfactorily limits collector current well within the maximum ratings of the transistor.

## Construction Hints

The author's model of the moisture detector has been assembled on a small standard aluminum chassis. Parts layout and wiring are clearly visible in the over-all (Fig. 1) and under-chassis (Fig. 4) views. However, this type of assembly need not be followed by another builder since the circuit is completely non-critical—leads may be made as short or as long as may be desired.

However, if the builder decides to solder the transistor directly into the circuit, as in the author's model, he should exercise care to avoid overheating the transistor leads. The transistor is quite susceptible to heat damage. Allow the transistor leads to remain reasonably long, covering them with insulating tubing, and complete the soldering as quickly as possible, using a hot, clean, well-tinned iron.

As an alternative, a socket may be provided for the transistor. Use a standard five-pin subminiature tube socket. Only three of the socket terminals are needed.

The moisture detector might easily be assembled in a standard metal utility box or *Bud* "Minibox" to provide a completely enclosed unit.

**Parts Substitutions:** Although comparatively few parts are required for the construction of this device, it is still possible to make a number of parts substitutions to utilize components that may already be available in the builder's "junk box."

A slide, rotary, lever, or even key-operated switch may be substituted for the toggle switch (*S*<sub>1</sub>) used in the model. A key-operated switch is an especially good selection as it permits one or two persons to exercise complete control over the operation of the unit.

A type CK721 junction transistor may be directly substituted for the type CK722 shown in the schematic diagram, and will provide somewhat greater sensitivity. No other component changes are necessary.

Another relay may be substituted for the unit specified in the parts list. Choose a relay which will not require more than about 2 milliamperes coil current for operation, and with a moderately high d.c. resistance. In a few instances it may be necessary to use a higher voltage battery should a different relay be employed.

Since very little current is drawn from the battery until the moisture detector actually operates (relay closes), battery life is quite long. In some instances the battery life in the detector may approach the normal "shelf life."

Because of this, the builder may exercise wide latitude in his choice of a battery. A conventional zinc-carbon dry battery, a "wet-cell" storage battery, or a mercury battery may be used as the power supply for the unit.

#### Assembling "Sensor" Plate

The "sensor" plate consists, basically, of two conducting elements separated by a narrow strip of insulating material. It may be made up in any one of several ways, depending on the inclinations of the individual builder and the facilities available to him. The "sensor" plate used in the author's model is clearly visible in the foreground of Fig. 1, and has been made up using heavy-duty aluminum foil, a piece of Bakelite (lucite, polystyrene, or similar plastic will do as well), and cement.

A piece of aluminum foil was first cemented firmly to the flat Bakelite plate. A narrow strip (about  $\frac{1}{8}$ " wide) of the aluminum was then cut out in a saw-tooth pattern, leaving two insulated conductors. Contact to the foil was made by means of soldering lugs held in place by small machine screws.

A variety of patterns may be used in place of the "saw-tooth" employed by the author, provided the foil is clearly divided into two separate conducting elements. A few possible patterns are illustrated in Fig. 3.

A "sensor" plate may also be made up by using a "sandwich" consisting of two pieces of copper or brass screening separated by a piece of plastic screening. Over-all dimensions may be as large or as small as is desired.

However, irrespective of the method chosen for assembling the "sensor" plate, care should be taken that the two conducting elements are not so close together that accidental short-circuits may easily occur (resulting in "false alarms"), nor so far apart that a single drop of moisture cannot make contact with both conductors.

Once the wiring is completed, the moisture detector may be easily checked for operation by closing the power switch ( $S_1$ ), wetting the finger, and touching the "sensor" plate in the gap between the two conducting ele-

ments (there is no danger of shock). The relay should close. Remove the finger and allow the damp spot to dry, the relay should then open.

If satisfactory operation is not obtained, carefully check all connections. Look out especially for "cold-soldered" joints and errors in wiring. Make sure that the battery has been connected with the correct polarity.

If a different relay has been used in place of the unit specified in the parts list, it may be that insufficient current flows to operate the relay. This may call for a larger battery.

When using a larger battery, take care that the maximum ratings of the transistor are not exceeded. The collector voltage should not exceed 20 volts and collector current should not exceed 5 ma. In addition, a new value should be chosen for  $R_1$ . Using Ohm's law, calculate a resistance value which will not allow more than 5 ma. base current flow, even if the "sensor" elements are shorted together.

Once the moisture detector is operating properly, it may be set up to perform the desired function. Let us discuss a few typical applications:

**Rain Alarm:** To use the moisture detector as a rain alarm, connect the relay contacts to operate an alarm bell, buzzer, or signal light. Place the "sensor" plate on a window sill or in a similar exposed location.

For maximum response two or more "sensor" plates should be provided, simply connect the additional plates in parallel. A separate "sensor" plate may be placed on each window sill if desired.

If the builder prefers, the relay may be used to actuate a small electric motor (set up to close the open window) instead of sounding an alarm signal. Should this arrangement be employed, a small "limit switch" should be placed on the window frame to shut off the motor after the window is closed.

Such a "limit switch" may be installed quite easily by using either a *Micro-switch* or small push-button switch in series with the motor leads, arranged to open the motor circuit when the window is fully closed.

*Condensation or Leakage Detector:*

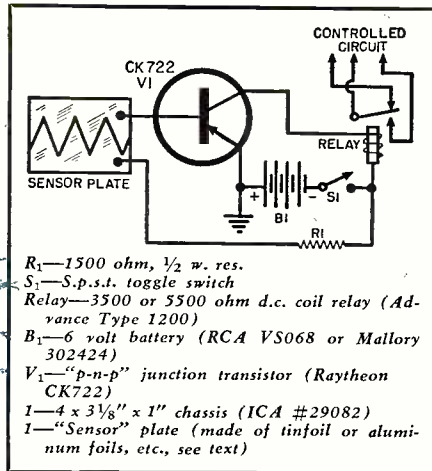

Fig. 2. Complete schematic of moisture detector. Parts variations are possible.

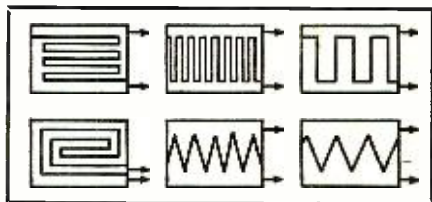

Fig. 3. Possible arrangements of "sensor."

Where condensation or water leakage is a problem, the "sensor" plate may be placed under the suspected pipes so that the first drop of water to fall will sound an alarm. Locate the "sensor" at the lowest point under the suspected pipe.

**"Bed-Wetting" Alarm:** To use the moisture detector in this application, a flexible "sensor" plate should be made up that can be easily slipped under bed-sheets. Such a flexible "sensor" may be obtained either by using the screen "sandwich" previously mentioned or by cementing aluminum foil to thin plastic sheeting material.

The relay may be connected to turn on a soft light or to sound a gentle bell or chime—harsh, loud, and sudden noises should be avoided.

**Controlling Water Level in a Tank:** The moisture detector may be easily used to maintain a constant water

(Continued on page 98)

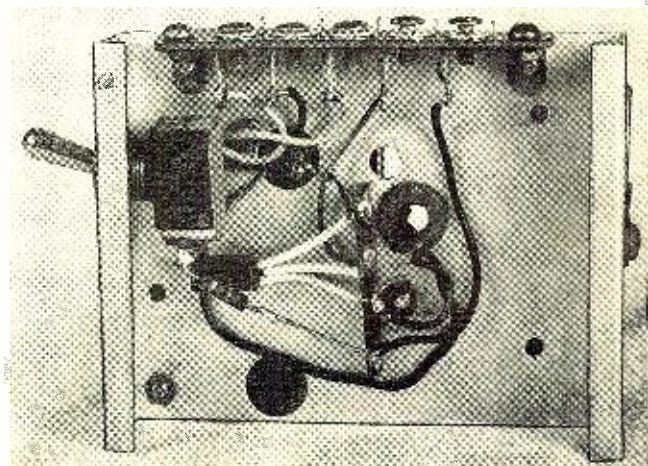

Fig. 4. Underchassis view of detector. Any parts arrangement is suitable as circuit operation is far from critical. See article



# SIMPLIFIED DESIGN OF FEEDBACK

## EQUALIZERS

By ARTHUR J. ROSE

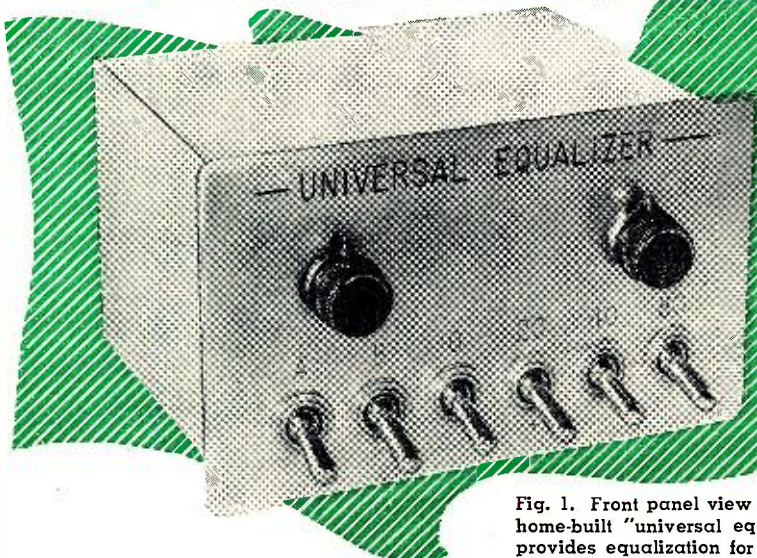

Fig. 1. Front panel view of the author's home-built "universal equalizer" which provides equalization for all type discs.

*Design charts for an infinite variety of playback curves, an analysis of equalizer problems, and a suitable circuit.*

EVERYONE has his own ideas about recording equalization. From the recording company brain trusts to the designer responsible for undoing the record cutter's handiwork, opinion is varied and outspoken. Consequently, high-fidelity enthusiasts are faced with a bewildering array of factual as well as fictional recording characteristics. This problem, in part, stems from the big question mark that accom-

panies many curves published by other than official sources. Fortunately, this confusion is gradually disappearing and perhaps within a few years all will be an open book. This revelation is coming about as manufacturers realize the maturity of the present not-so-average record buyer and because of some persuasive arm twisting by audio equipment designers.

Of course there will be those who insist on being arty. Once the record owner is addicted to providing the "recommended" curve for some particular label, he will doubtless find that some super equalization has been applied to give a thrilling "high fidelity" effect. The orchestra sounds as if it were right inside your ear, for example.

While it is true that by merely applying the mirror of the recording response as generated by the pickup one is able to obtain the coveted "flat" response, one is limited by choice rather than by technology. Almost any curve can be effected. The problem lies in the question: "What curves shall I include?" Attempts to design universal switching arrangements are complicated by sheer numbers.

One solution that comes to mind is to use two switches. One sets the low-frequency response, while the other sets the high-frequency characteristic. With, for example, six position switches, thirty-six different combinations are possible! Somewhere within this number should be the correct response for the record in question. Imagination will supply variations of the number of switches and number of posi-

tions. Thus unlimited possibilities present themselves.

It is not entirely the purpose of this article to give a horse laugh to the equalization snafu. Most people are serious as to why "such and such" a curve is ideal. Well meaning groups have met the problem with sensible middle-of-the-road solutions. It is not funny to the guy trying to get his sound system to come up to expectations—and he never will unless he properly equalizes his records.

Rather than stress the difficulties of equalizer design, straightforward design procedures will be given. Then after the reader understands the easily-made graphical and arithmetic solutions that have been worked out, he can return to the more perplexing aspects. Suggestions for designing workable equalizers will precede the description of a "universal equalizer."

### Circuit

Throughout the ensuing discussion it will be assumed that the feedback is great enough at all frequencies concerned so that the equalizer gain is dependent only upon the degree of feedback. Aside from simplifying the analysis, three important results stem from this assumption:

a. Wide variations of tube characteristics and supply voltages can be tolerated.

b. Distortion is reduced by an appreciable amount, even at the lowest frequencies.

c. Maximum possible bass boost is realizable.

In practice, this is accomplished by using a good deal more feedback than is apparently required. With a 500 cps turnover frequency, assuming 6 db-per-octave rise, the resultant boost at 50 cps is 20 db. In a linear system this is easily done. However, it has been shown elsewhere<sup>1</sup> that feedback systems with less than infinite ratios of open loop gain to effective midband gain flatten out at the lower frequencies. For close to ideal results, a ratio of 80 is satisfactory.

Although subject to controversy, ratios of 20 to 1 have been used<sup>2</sup>. This

Fig. 2. A feedback equalizer and its equivalent passive network. Either type may be designed using the procedure given in text.

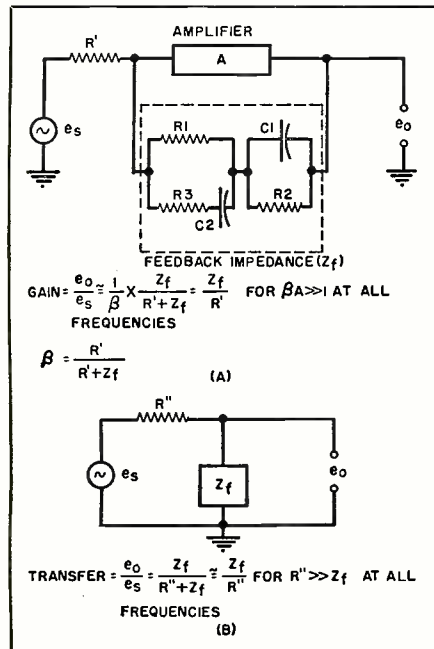

ratio is the basis for many passive equalizer circuits that give bass rise curves asymptotic to 26 db, reaching a maximum boost of 26 db at zero cps. In an ideal system where both recording and playback units are compensated by such a network, nothing is lost. In actual use, there is a definite loss of lower bass frequencies.

Fig. 2A shows a feedback equalizer. At midband, only  $R_1$  of the complex feedback impedance,  $Z_f$ , is effective. Therefore, the midband gain is  $R_1/R'$ . For satisfactory operation, the ratio of open loop gain,  $A$ , to midband gain should be 80 or greater.

An equivalent passive equalizer, shown in Fig. 2B, should have  $R''/R_1$  equal to 80 or more.

In either circuit, bass boost is produced by  $R_1$  and  $C_1$  and bass leveling by  $R_2$ . High-frequency de-emphasis is produced by  $R_1$  and  $C_2$ . Introduction of  $R_3$  lowers the slope of the de-emphasis curve and causes two other effects that will be discussed shortly.

A simplification of the feedback impedance,  $Z_f$ , in Fig. 3B shows effective networks throughout the spectrum. Equations relate circuit constants to applicable frequencies.

### Ideal Equalization Curve

The exaggerated response curve of Fig. 3A shows the scope of the analysis. Were it not for  $f_c$  and  $f_r$ , the matter would reduce to the familiar simple case where  $R_2$  and  $R_3$  are not included. This gives a straight bass rise below the turnover frequency,  $f_t$ , and a straight treble de-emphasis above the starting frequency,  $f_s$ . Both approach 6 db-per-octave in rate. Introduction of bass de-emphasis below  $f_c$  and treble de-emphasis with less than a 6 db-per-octave rate demands consideration of the entire feedback impedance. The RCA "New Orthophonic" and London ffr 78 curves are of the latter type, whereas the NARTB and AES are of the simpler type.

Constants for the feedback impedance for any desired curve shape are derived from the vector gain equations of the circuit in Fig. 2. These equations will be given as a matter of record. However, their solutions have been greatly simplified by plotting various parameters. As a result, circuit constants can be rapidly and easily found even by persons with a limited mathematical background. Sample problems following the derivation of the design charts will serve to illustrate this.

### Impedance Equations

By virtue of the previously made assumption, the gain at any frequency is dependent only upon the feedback and therefore upon  $Z_f$  of Fig. 3B. Relative response then is merely the ratio of the  $Z_f$ 's at different frequencies. For convenience, all gain is referred to the gain where  $Z_f$  equals  $R_1$ .

A further simplification is made by splitting  $Z_f$  into a low-frequency equivalent ( $Z_f$  greater than  $R_1$ ), and a high-

frequency equivalent ( $Z_f$  less than  $R_1$ ). Interaction, although slight, will have to be considered in some cases.

Gain at low frequencies can be expressed by

$$db = 10 \log \left[ 1 + \frac{r^2 + 2r}{r^2 \left( \frac{f}{f_t} \right)^2 + 1} \right] \dots \dots (1)$$

where:  $r = \frac{f_t}{f_c} = \frac{R_2}{R_1}$

if  $R_3 = 0$ , then:

$$db = 10 \log \left[ 1 + \left( \frac{f_t}{f} \right)^2 \right] \dots \dots \dots (2)$$

Plotting equation (1) for various values of the parameter  $r$  (see Fig. 4) shows responses to be expected for changing values of  $R_2$ . It can be seen that the effect of this resistance is to decrease the initial slope of the curve and then level it off below  $f_c$ . It has no effect on the turnover frequency.

In order to retain some perspective of the curves in familiar form,  $f_t$  is shown as if it were 500 cps—the most prevalent turnover frequency. For other turnovers, the boost values hold equally well, but the curves have to be relocated by shifting the frequency axis. This will give the more commonly experienced picture.

There is no particular problem associated with the bass region. Usually the turnover frequency and the frequency where leveling occurs are given. Circuit constants to give these frequencies are obtained by their defining equations.

However, when a particular response is desired and  $f_c$  is not known, then the curves are most useful. Here, one must match the desired curve with one in Fig. 4 and extract a value of  $r$ .

Quite different is the situation encountered in the high-frequency region. Here, the addition of the series resistor,  $R_3$ , has the effect of lowering the frequency at which de-emphasis starts as well as altering the curve shape. Since the exact starting frequency is more-or-less obscure, the frequency that yields a response 3 db down is used for the reference frequency,  $f_s$ . This applies, to some extent, in the bass region as the turnover frequency occurs with the response up 3 db.

Gain at higher frequencies can be expressed by  $-db =$

$$10 \log \left[ 1 + \left( \frac{f}{f_s} \right)^2 \right] - 10 \log \left[ 1 + \left( \frac{f}{f_r} \right)^2 \right] \dots (3)$$

Here there is a subtraction of two curves. One is the de-emphasis produced by  $10 \log [1 + (f/f_s)^2]$  and the other is a rise produced by  $10 \log [1 + (f/f_r)^2]$ . When  $R_3=0$ , the second curve disappears and a simple de-emphasis curve results. (See Fig. 6).

In terms of time constants, the high-frequency response is:

$$-db = 10 \log [1 + \omega^2 t_1^2] - 10 \log [1 + \omega^2 t_2^2] \dots (4)$$

where:

$$t_1 = R_1 C_2 \dots \dots \dots (5A)$$

$$t_2 = R_3 C_2 \dots \dots \dots (5B)$$

$$t = t_1 + t_2 \dots \dots \dots (5C)$$

$$f_s = \frac{.159}{t} \dots \dots \dots (5D)$$

These equations show how  $f_s$  is low-

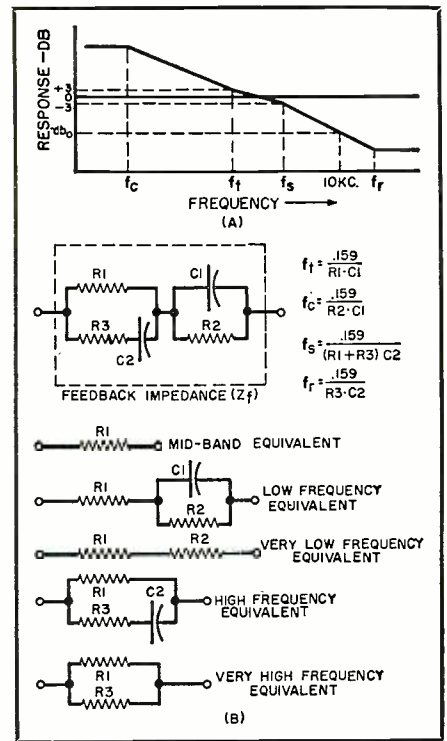

Fig. 3. (A) Idealized equalizer response curve with significant frequencies and response points shown. (B) Feedback impedance network. Equations relate components to the frequencies given in (A) of diagram.

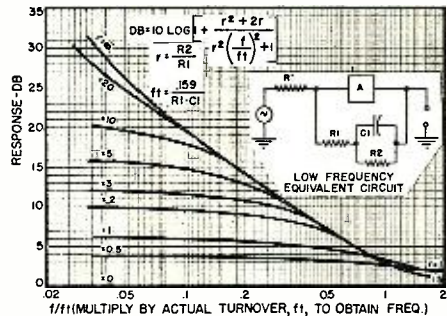

Fig. 4. Bass response curves for values of parameter  $r$ . Text describes how resistor  $R_2$  is used to flatten the response curves.

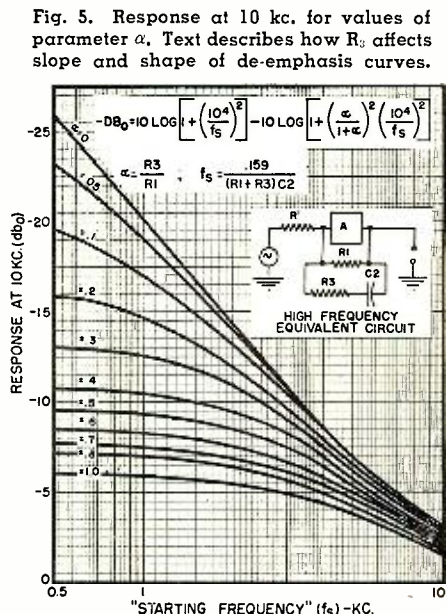

Fig. 5. Response at 10 kc. for values of parameter  $\alpha$ . Text describes how  $R_3$  affects slope and shape of de-emphasis curves.

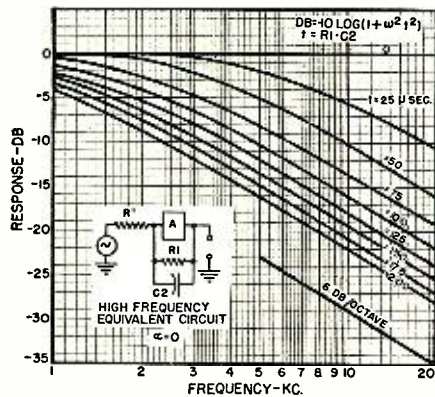

Fig. 6. De-emphasis curves when  $\alpha = 0$ .

ered as  $R_3$  increases. If  $R_3 = 0$ ,  $t = t_2$ . As  $R_3$  is increased,  $t$  becomes greater by the increasing  $t_2$ . Hence  $f_s$  becomes smaller.

If a factor  $\alpha$  is introduced such that  $\alpha = R_3/R_1$  it is evident that  $t_1 = t_2/\alpha$ , and  $t = \alpha t_2/(1 + \alpha)$ . Substituting in equations 3, 4, and 5 and combining,

$$-db = 10 \log \frac{1 + \left(\frac{f}{f_s}\right)^2}{1 + \left(\frac{\alpha}{1 + \alpha}\right)^2 \left(\frac{f}{f_s}\right)^2} \quad (6)$$

As customary in treating de-emphasis curves, the response at 10 kc. is specified. If this response,  $db_0$ , is plotted versus  $f_s$  for significant values of the parameter  $\alpha$ , one obtains a useful, general guide to de-emphasis curves. This is done in Fig. 5. Constants for a particular curve are easily obtained once  $\alpha$  is known.

### Design Procedure

1. Write down all available information about curve.
2. Draw curve on semi-log graph paper.
3. Determine value of  $R_1$  from gain considerations given earlier. 100,000 ohms is a good, all-around value (for passive network, use 10,000 ohms).
4. Find  $C_1$ . Since the bass turnover frequency,  $f_t$ , is always known:

$$C_1 = \frac{.159}{f_t R_1} \quad (7)$$

where:  $f_t$  is in cps,  $R_1$  in megohms, and  $C_1$  in microfarads.

5. Determine  $R_2$  by one of the following methods:

(a) If bass curve is straight and approaches 6 db-per-octave, then  $R_2 = \infty$

(b) If frequency where bass de-emphasis begins,  $f_c$ , is known, then

$$R_2 = \frac{.159}{f_c C_1} \quad (8)$$

or:

$$R_2 = \left(\frac{f_t}{f_c}\right) R_1 \quad (9)$$

where:  $f_c$  is in cps,  $R_1$  and  $R_2$  in megohms;  $C_1$  in microfarads.

(c) If  $f_c$  is not known, match desired curve to one in Fig. 4. Interpolate if necessary. Fill in frequency scale according to turnover frequency (e.g., if  $f_t$  is 800 cps, then  $0.1 f_t = 80$  cps,  $0.2 f_t = 160$  cps, etc.) Determine  $r$  from chosen curve. Then

$$R_2 = r R_1 \quad (10)$$

$$f_c = \frac{f_t}{r} \quad (11)$$

6. Determine  $R_3$  and  $C_2$  by one of the following methods:

Case I. Curve approaches 6 db-per-octave droop.  $R_3 = 0$

(a) If de-emphasis time constant,  $t$ , is known (e.g., 100 microseconds), then:

$$C_2 = \frac{t}{R_1} \quad (12)$$

where:  $t$  is in microseconds,  $R_1$  in megohms,  $C_2$  in micromicrofarads.

(b) If starting frequency,  $f_s$ , is known, then

$$C_2 = \frac{.159}{f_s R_1} \quad (13)$$

where:  $f_s$  is in cps,  $R_1$  in megohms,  $C_2$  in microfarads.

(c) If response at 10 kc.,  $db_0$ , is known, see Fig. 5. Find  $f_s$  for given  $db_0$  on  $\alpha = 0$  curve. Proceed as in (b).

Case II. Curve is less than 6 db-per-octave.  $R_3$  is finite.

From starting frequency,  $f_s$ , and response at 10 kc.,  $db_0$ , determine suitable  $\alpha$  from Fig. 5. Then,

$$R_3 = \alpha R_1 \quad (14)$$

and:

$$C_2 = \frac{.159}{f_s (R_1 + R_3)} \quad (15)$$

where:  $f_s$  is in cps,  $R_1$  and  $R_3$  in megohms,  $C_2$  in microfarads.

### Typical Curve Problems

#### I. AES (Fig. 7A)

This curve will be defined as having a straight 400 cps bass turnover frequency and treble de-emphasis of sim-

ply -12 db at 10 kc.  $f_t = 400$  cps,  $db_0 = -12$ .  $R_1$  is chosen as 0.1 megohm. Using Procedures 4, 5a, and 6 (Case 1c).

$$R_2 = \infty, R_3 = 0$$

$$C_1 = \frac{.159}{400 \times 0.1} = .004 \mu\text{fd.}$$

From Fig. 5,  $\alpha = 0$ ,  $f_s = 2650$

$$C_2 = \frac{.159}{2650 \times 0.1} = .0006 \mu\text{fd.}$$

#### II. RCA "New Orthophonic" (Fig. 7B)

Here there is a bass turnover frequency of 500 cps with de-emphasis starting at 50 cps. Treble de-emphasis is simply 75 microseconds.  $R_1$  is chosen as 0.1 megohm. Procedures 4, 5b, and 6 (Case 1a) are used.

$$R_3 = 0$$

$$C_1 = \frac{.159}{500 \times 0.1} = .0032 \mu\text{fd.}$$

$$R_2 = \frac{.159}{50 \times .0032} = 1 \text{ megohm or}$$

$$R_2 = \frac{500}{50} \times 0.1 = 1 \text{ megohm}$$

$$C_2 = \frac{75}{0.1} = 750 \mu\mu\text{fd.}$$

#### III. Columbia LP (Fig. 7C)

For purposes of instruction, the bass section of this curve will be defined as "looking like the  $r = 5$  curve of Fig. 4." The turnover frequency is 500 cps. Treble de-emphasis is 3 db down at 1590 cps and falls at a rate approaching 6 db-per-octave.  $f_t = 500$ ,  $r = 5$ ,  $f_s = 1590$  cps.

Again choose  $R_1$  as 0.1 megohm. Procedures 4, 5c, and 6 (Case 1b) are used.

$$R_3 = 0$$

$$C_1 = \frac{.159}{500 \times 0.1} = .0032 \mu\text{fd.}$$

$$R_2 = 5 \times 0.1 = 0.5 \text{ megohm}$$

$$f_c = \frac{500}{5} = 100 \text{ cps}$$

$$C_2 = \frac{.159}{1590 \times 0.1} = .001 \mu\text{fd.}$$

#### IV. London frr 78 (Fig. 7D)

The bass curve is simply a straight 400 cps turnover and can be derived as outlined previously. However, the treble section is an example of Procedure 6 Case II.

De-emphasis emerges at 3 kc. and is down 5 db at 10 kc. Inspection of Fig. 7, curve D, shows 6 kc. as the 3 db down frequency. Using  $f_s = 6$  kc. and  $db_0 = -5$ , Fig. 5 gives  $\alpha$  as 0.4.

$$R_3 = 0.4 \times 0.1 = 0.04 \text{ megohm}$$

$$C_2 = \frac{.159}{6000 \times 0.14} = .00019 \mu\text{fd.}$$

### Other Aids To Design

Although much time has been spent in preparing a comprehensive analysis of equalizer circuits, only the general results can be shown here due to space limitations. However, the designer can make full use of them by spending

Fig. 7. Playback curves. (A) AES, (B) Columbia LP, (C) RCA "New Orthophonic," and (D) London frr 78 rpm discs. See author's discussion in text for full details.

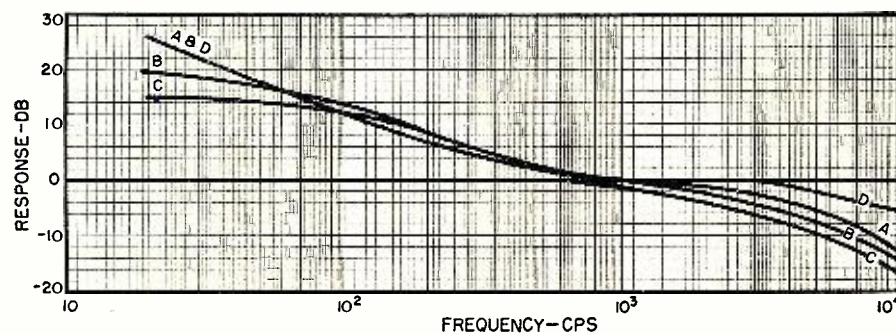



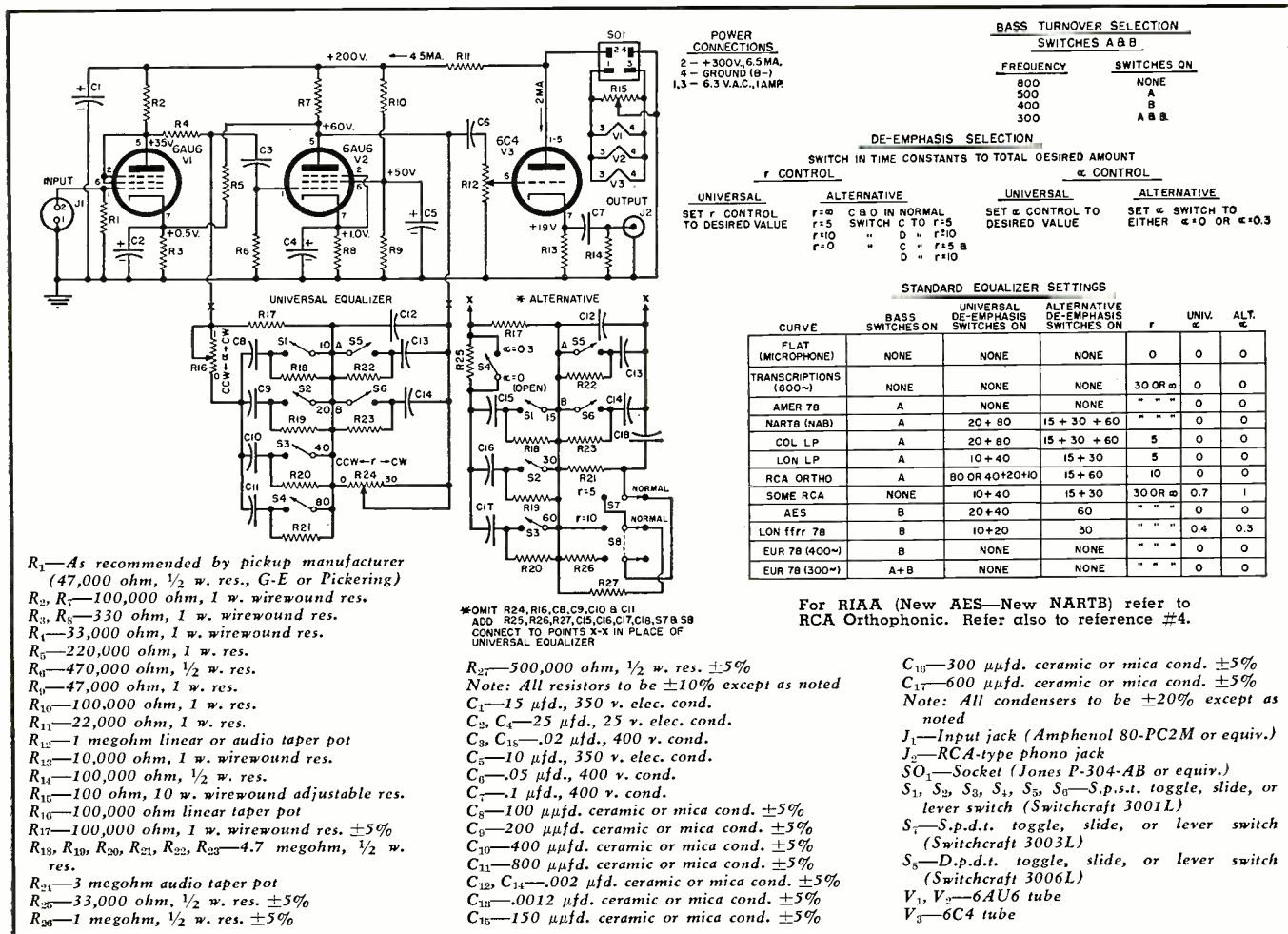

Fig. 8. Complete schematic for a "universal equalizer" and an alternative switching arrangement. Charts show the switching operations and suitable settings for the standard playback curves.

enough time to fully understand the general equations and the significance of various interrelationships. For example, the relationship

$$\frac{\alpha}{1 + \alpha} = \frac{f_s}{f_r} \dots \dots \dots (16)$$

is useful in making a quick diagnosis of a complex de-emphasis curve. By examining the curve, the 3 db down frequency,  $f_s$ , and the leveling frequency,  $f_r$ , can be determined. Using equation (16),  $\alpha$  is obtained. Then  $R_{23}$  and  $C_2$  are found by solving equations (14) and (15).

In a great many cases simple de-emphasis, where  $\alpha = 0$ , is required. Fig. 6 shows actual response curves for this condition.  $C_2$  for a particular response is found by solving equation (12).

It is to be pointed out that although there are but a few standard curves in which  $\alpha$  is other than zero, the use of variable or switched resistors for  $R_{10}$  is most useful in producing modifications of de-emphasis slope often required to exactly equalize some recordings. This is equally true in the bass region where adjustment of  $R_{24}$  accomplishes equalization correction. See Fig. 8.

### Practical Equalizers

Returning to the problem that was

presented earlier, it can be readily seen that the greatest difficulty now facing the designer concerns the choice of curves he is to use and the means he should use to switch them. Before he can begin, however, he must obtain accurate definitions of these curves in terms of the factors that determine their circuit constants. This task is made difficult because of conflicting information from different sources. The equalizer recommendations given in Fig. 8 are based on the most reliable information available to the writer. However, this does not preclude conflict between these sources or between those recommended in Fig. 8 and sources available to the reader.

Once a satisfactory agreement has been reached as to the nature of the curves, the designer can turn to the problem of switching. Most widely used methods fall into two groups:

- a. Single switching of complete playback curve
  - b. Dual switching—one switch selects the bass while the other selects the treble
- A more recent innovation falls into a third category:
- c. Sets of push-buttons or two position switches that individually select a complete curve and in combination give additive curves.
- Following naturally from this is a

scheme that the writer feels to be most flexible and one that is slated for increased popularity:

- d. Dual sets of push-buttons or two position switches that give desired curves by adding separate bass and treble curves.

The distinction between methods (c) and (d) may not be too clear. Method (c), for example, uses a number of two-position slide switches. Each switch selects a particular complete curve such as the AES or London. Using more than one switch at a time adds together whatever curves are chosen and a new curve results. This method has an advantage of simplicity—2<sup>n</sup> curves can be formed with n switches—but curves formed by addition of standard curves may be useless and there are bound to be duplications and wide gaps in the range of curves.

Method (d) can handle as many curves as (c), but each curve represents a small incremental change from the preceding one. Thus the entire range of standard curves can be included as part of a system that offers extreme flexibility. To accomplish this, several switches are assigned to the bass section only and several more to the treble. This method is the basis of a universal equalizer.

(Continued on page 156)

# AN UNUSUAL TV PHASE DETECTOR

By  
JOHN K. FRIEBORN

*Analysis of a phase detector, used in some recent TV sets, which takes control voltage from the grid of a triode tube.*

**D**URING the past few years we have become familiar with cathode-follower and grounded-grid connections of triodes in addition to the conventional grid-input, plate-output connection. No possible connection of a triode can surprise us much any more, unless, of course, someone should devise a circuit with the input applied to the plate and the output taken from the grid. Someone has!

At least four different manufacturers have used or are using a horizontal phase detector circuit in which one input signal is applied to the plate of a triode, one input signal is applied to the cathode, and the output is taken from the grid. Apparently, this all started three or four years ago, with the *Hoffman* 170 series chassis. The circuit of the horizontal phase detector and horizontal oscillator on this chassis is shown in Fig. 1.

The general function of any horizontal phase detector in a television receiver is to compare a signal from the receiver's deflection circuit with a signal corresponding to the transmitted sync pulses and to produce a d.c. voltage output whose amplitude and polarity depend upon the phase relation between the two signals. The resultant voltage controls the frequency of the horizontal oscillator.

In the circuit of Fig. 1, a saw-tooth

derived from the receiver's horizontal output is applied to the plate of  $V_{112A}$  and a negative sync pulse is applied to the cathode.

The electron flow from cathode to grid determines the d.c. voltage output from the circuit. Electrons will flow even though the grid is slightly negative with respect to the cathode, because the initial velocity of the electrons leaving the cathode will overcome a slight amount of repulsion from the grid. This phenomenon produces the so-called "contact potential," which makes the grid slightly negative (and charges  $C_{150}$  slightly negative) even with no signal applied.

If the sync pulses are applied to the cathode, but no other signals are applied to the tube, the resulting negative potential of the cathode with respect to the grid will cause additional electron flow, charging  $C_{150}$  more negative with respect to ground. The time constant of the discharge circuit,  $C_{150}-R_{150}-R_{151}$ , is long in proportion to the interval between horizontal sync pulses; the charge on  $C_{150}$  therefore will be almost constant and nearly equal to the peak amplitude of the sync pulses.

When a signal is applied between plate and ground, some of the signal will be dropped across the tube, from plate to cathode, and some will appear across  $R_{150}$ , between cathode and

ground. If the sync pulse is applied to the cathode and the saw-tooth is applied to the plate, we now have two signals appearing between cathode and ground; the amount of electron flow from cathode to grid will depend upon the combined effects of the two signals. If, at the time the negative sync pulse is applied, the instantaneous value of the saw-tooth signal is positive, the electron flow to charge  $C_{150}$  will decrease. The normal operating condition is that the sync pulse occurs approximately midway in the retrace part of the saw-tooth. The resulting charge on  $C_{150}$  and bias on the grid of  $V_{112A}$  is approximately  $-0.42$  volt. The component values in the horizontal oscillator circuit are such that this bias sets the frequency of the oscillator to approximately 15,750 cps.

If the frequency of the oscillator is slightly too low, the saw-tooth cycle will be too long in proportion to the sync pulse cycle; the next sync pulse will occur at a more negative point on the saw-tooth retrace. The increased negative bias on the coupling tube of the multivibrator ( $V_{112A}$ ) will have the same effect as would a decreased bias on the discharge tube ( $V_{112B}$ ): it will cause the frequency to increase. Conversely, if the frequency originally is too high, the change in charge on  $C_{150}$  will decrease the frequency. The over-all effect of the automatic frequency control system is to adjust the frequency of the horizontal oscillator so that each succeeding sync pulse will occur at the same point in the saw-tooth retrace.

If operation of the circuit should happen to begin with the sync pulse occurring during the trace rather than the retrace part of the saw-tooth, the phase correction at first would be in the wrong direction, but the final effect would be the same. If the first sync pulse occurred slightly after the receiver's retrace and the second still later, the control circuit would not reduce the phase difference but increase it; that is, each succeeding sync pulse would be later and later with respect to the retrace. Eventually (probably within a few cycles), however, the sync pulse would occur during some portion of the following retrace. In other words, if the receiver frequency was originally slightly too high, it would be made still higher until the receiver had gained whatever part of

Fig. 1. Horizontal phase detector and oscillator circuit of some Hoffman chassis.

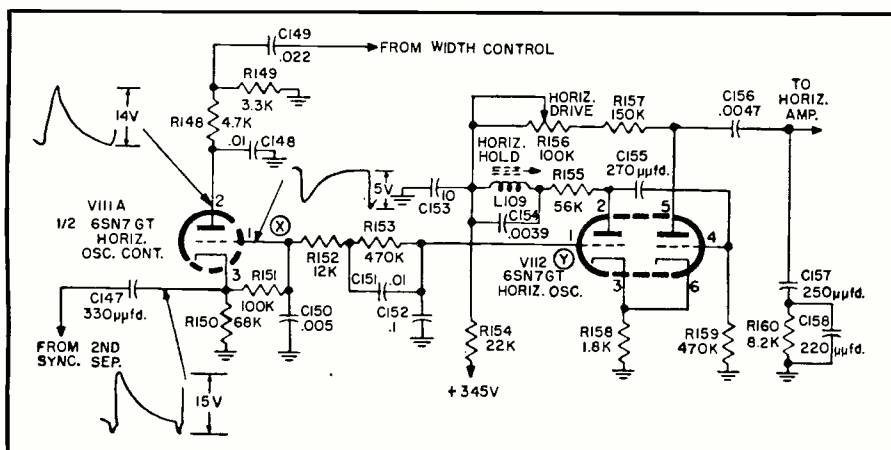

a cycle was required to make some part of the retrace coincide with the sync pulse. Then normal control action would begin.

In Fig. 1,  $R_{152}$ ,  $R_{153}$ ,  $C_{151}$ , and  $C_{152}$  form a filter to reduce the effect of noise on synchronizing, while at the same time allowing the circuit to respond as rapidly as necessary to changes in frequency.

A horizontal phase detector circuit identical to that in Fig. 1 was used in Hoffman 180 series chassis, but not in later series.

Similar circuits have been used in other receivers. Fig. 2 shows a partial schematic of some Westinghouse chassis (V-2175, V-2178, V-2192, V-2194, and V-2200 series among others). Fig. 3 shows the circuit used by Meck in chassis 9026, 9032, and 9033 (late 1952 or early 1953). A circuit used in Trav-ler chassis 36A2 and 36B2 (late 1952 or early 1953) is shown in Fig. 4. These circuits differ from that of Fig. 1 only in details. All of them have different output filters, representing their respective designers' solutions of obtaining maximum noise immunity and speed of response at minimum cost. Two of the circuits, the Westinghouse and the Meck, have slight positive voltages applied to the plate of the triode. In spite of the differences, functioning of all of these circuits is substantially as described for the circuit of Fig. 1.

### Troubleshooting

Troubles in receivers using this circuit can be localized by simple checks. The following procedures should help conserve servicing time to a considerable degree.

First, manipulate the horizontal hold control. Careful adjustment should result in an upright picture, at least momentarily, without going to either limit of the control's range. If not, the trouble—at least one trouble—is in the horizontal oscillator circuit. The faulty component usually can be found by: (1) replacing the tube, (2) measuring voltages and resistances and comparing them with the receiver service data, and (3) bridging coupling and bypass condensers to check for opens. (Improper voltage at the grid of the oscillator tube input section sometimes may be caused by a short in the phase detector tube).

If the picture can be brought into synchronization momentarily, but drifts out, probably the oscillator circuit is all right, but its bias is not being corrected by the phase detector. Vary the hold control and measure the d.c. voltage between ground and the oscillator tube grid (point "Y" on the circuit diagrams). If the voltage does not vary, replace the phase detector tube and recheck.

If replacing the tube does not restore the bias variation, measure voltages between ground and each point along the line between the oscillator and phase detector grids. If the voltage varies at any of these points but not at the oscillator grid, a series com-

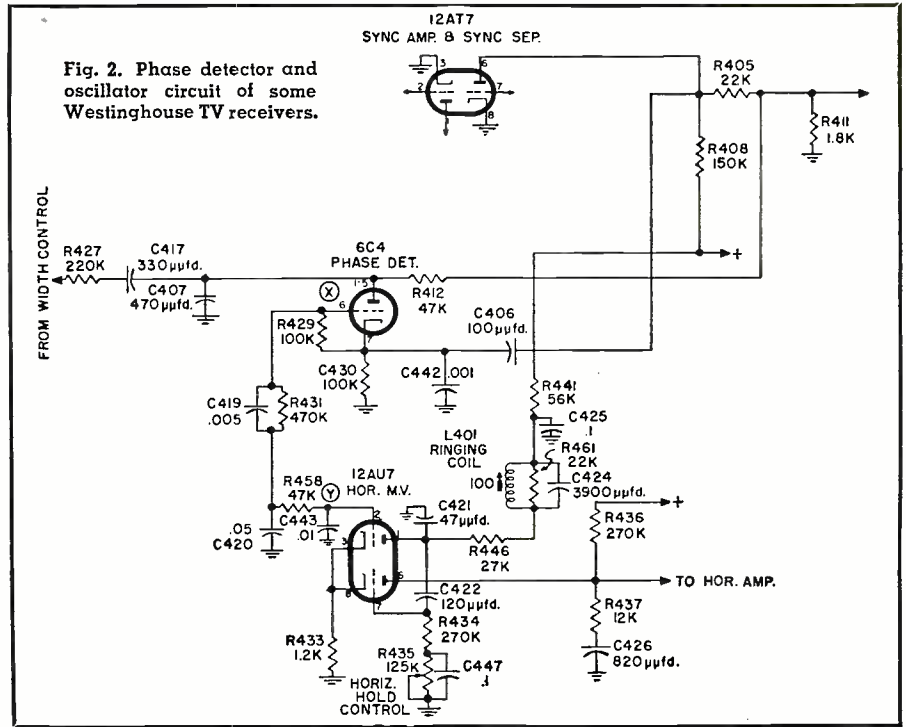

ponent in the filter is open or a shunt component is shorted.

If the voltage does not vary, even at the phase detector grid (point "X") the trouble is in the phase detector circuit or in the circuit feeding the sync pulse or saw-tooth signal to the phase detector. Replace any sync channel tubes which have not been replaced already.

With an oscilloscope, check the sync signal input at the phase detector cathode. (Remove the horizontal oscillator tube or otherwise disable the oscillator circuit so that the sync pulse can be observed separate from the saw-tooth.) If no sync pulse is found at the phase detector cathode, trace the sync signal channel with the scope.

Check waveforms at the phase detector plate and along the line between phase detector and horizontal output circuit.

Finally, check resistances and bridge condensers in the phase detector circuit.

Although rare now, triode grid output circuits are gaining popularity.

-50-

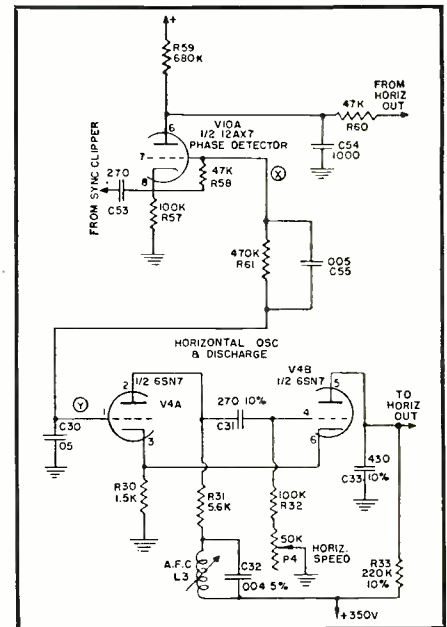

Fig. 3. Horizontal phase detector and oscillator circuit used in Meck TV sets. Note that in this circuit a positive voltage is fed to the detector's plate.

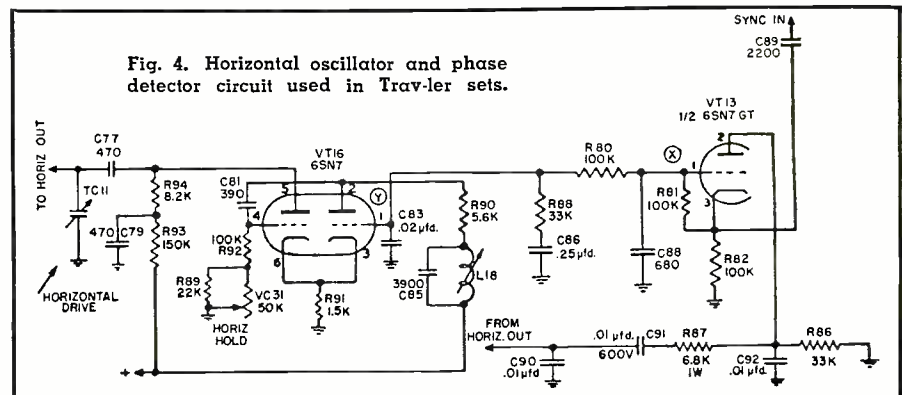

Fig. 4. Horizontal oscillator and phase detector circuit used in Trav-ler sets.

# Certified RECORD REVUE

By **BERT WHYTE**

**W**ITH this issue, the Certified Record Revue celebrates its first anniversary. It seems incredible that a year could pass so swiftly. Nevertheless it has, and it's time to pause a moment and indulge in a little "stock-taking." It seems to be a congenital disease of authors, to give forth with much flowery oratory when giving credit to those who are responsible for their success. In a way I suppose it's almost unavoidable. I heartily dislike "corn," especially insincere "corn." But how can I do otherwise than convey to you my heartfelt gratitude for your loyal and generous support which has made this anniversary possible. Believe me, even if it sounds trite, one of the biggest thrills in my life was to receive your kind letters after the appearance of my first column. It gives a fellow a nice warm feeling to know he has so many friends who like to read his stuff and who find the time to sit down and write letters about the column. Again, thank you for your kindness and support, and an especial vote of thanks to Mr. Oliver Read. A record review column in a magazine like **RADIO & TELEVISION NEWS** was a somewhat daring innovation, and Mr. Read's faith in the project and his encouragement has been greatly appreciated.

In a year's time, we have reviewed a great many recordings. Out of all this welter of good, bad, and indifferent recordings, one fact is significant. The general level of LP quality is far above that which prevailed last year. Wider frequency response, more dynamic range, better surfaces, all these have become things which are looked for as the accepted norm, rather than as an exceptional quality to be found only in the most rare of recordings. Certainly, there are many gradations of quality, even among discs which qualify as high fidelity recordings. The differentiation of these qualities is, however, more a matter of equipment, acoustical environment, and subjective listening. By and large, the average LP which is purchased today, has more high quality sound than the average music-lover's equipment is capable of reproducing. New and greater sound quality will be available in the records of the not-too-distant future. *Mono-*

*groove* stereophonic discs have been successfully demonstrated and could well be introduced as early as the spring of 1955. As these developments occur, I'll do my best to keep you informed.

As you may remember, during this past year I have campaigned for the commercial release of pre-recorded tapes, both monaural and binaural. As I pointed out, there was a certain amount of tape material on the market. Most of these tapes were, however, of such dubious quality and trivial repertoire, they found little acceptance. If you don't already know, I'm sure you will be happy to learn that pre-recorded tape is finally available from a major record company! Yessir, with the release of monaural and binaural tapes by *RCA Victor*, a new era in recorded music has begun! The initial release contains such diverse items as the Dvorak "5th" with Toscanini, Tchaikovsky's "5th" with Stokowski, Brahms' "2nd Piano Concerto" with Rubenstein, and other symphonic works. Strauss' "Also Sprach Zarathustra," with Reiner and the Chicago Symphony is the first work available in *Victor's* binaural editions. I think you will agree that this is a tremendous step forward in recorded music. *RCA Victor* certainly deserves credit for taking the long overdue plunge into this field. You can be sure that the other major record companies will follow suit; in fact I can practically guarantee, two other well-known companies will be in the pre-recorded tape business early in 1955! It goes without saying, I welcome this new musical medium and beginning with the next issue, pre-recorded tapes will be reviewed as well as disc recordings. In accordance with my established policy of naming the equipment used in reviewing recordings, I will apply this practice to the new pre-recorded tapes. I hope this will prove helpful and find favor with you.

By the time you read this month's column, most of you will have had your vacations and with the fall and winter before you, take a renewed interest in your hi-fi rig and the state of

The opinions expressed in this column are those of the reviewer and do not necessarily reflect the views or opinions of the editors or the publisher of this magazine.

your record library. While you were busy enjoying the sunshine and the outdoor life, the record companies have not been idle. A lot of fine records were issued this spring and summer. Before the annual fall deluge of new recordings, you might like to know about some of this warm-weather output. Therefore, you will find more records reviewed than usual this month, but of necessity, the reviews must be shorter.

Equipment used this month: New *Weathers* A-510 FM pickup and arm, *Weathers* P-661 preamp, *Rek-O-Kut* T12H turntable, *McIntosh* 30-watt amplifier, *Jensen* "Triaxial" speaker in *Karlson* exponential slot enclosure.

## DELIUS

### A MASS OF LIFE

**Royal Philharmonic Orchestra conducted by Sir Thomas Beecham. Robina Raisbeck, soprano; Monica Sinclair, contralto; Charles Craig, tenor; Bruce Boyce, baritone; the London Philharmonic Choir. Columbia SL-197. NARTB curve. Price \$11.90.**

Those of you who are familiar with the Delius of "Song of Summer" and "Over the Hills and Far Away," will find a Delius made of sterner stuff in this first-time-on-LP recording. Taken from the text of Nietzsche's "Thus Spake Zarathustra," this is an emotionally supercharged work, quite unlike anything of the usual Delius serenity and pastorate-like qualities found in most of his music. This is passionate music, of great intensity, an extremely beautiful work which once heard, leaves an indelible impression. Structurally very complex, it is nonetheless a most assimilable work, easy to listen to. Sir Thomas, as the principal champion of Delius' music, lavishes affection on the score and the performance is formidable in its power. Monica Sinclair, the contralto in this recording, is easily the standout vocalist, although the others are more than competent! The London Philharmonic Choir does nobly with its difficult task, and the Royal Philharmonic is, as usual, big-toned, super-precise. Sound is quite variable, not too wide range, thick textured at times, with very heavy bass line requiring a few db cut on the NARTB curve. Strings generally smooth and occasionally some spectacular percussion effect coupled with weighty brass. If you've never cared much for Delius, give this a try for a different appraisal of the work of this tragic Briton. Good surfaces.

## KATCHATURIAN

### MASQUERADE SUITE

**L'Orchestre de la Societe des Concerts du Conservatoire de Paris conducted by Richard Blareau. London LD9100. RIAA curve. Price \$2.95.**

Another "light" item for your listening while the hot weather is still with us. One of the new *London* low-price ten-inch series, it offers the best performance available on records of this rather obvious music. Blareau exercises a properly light touch which relieves the music of some of its preten-

(Continued on page 139)

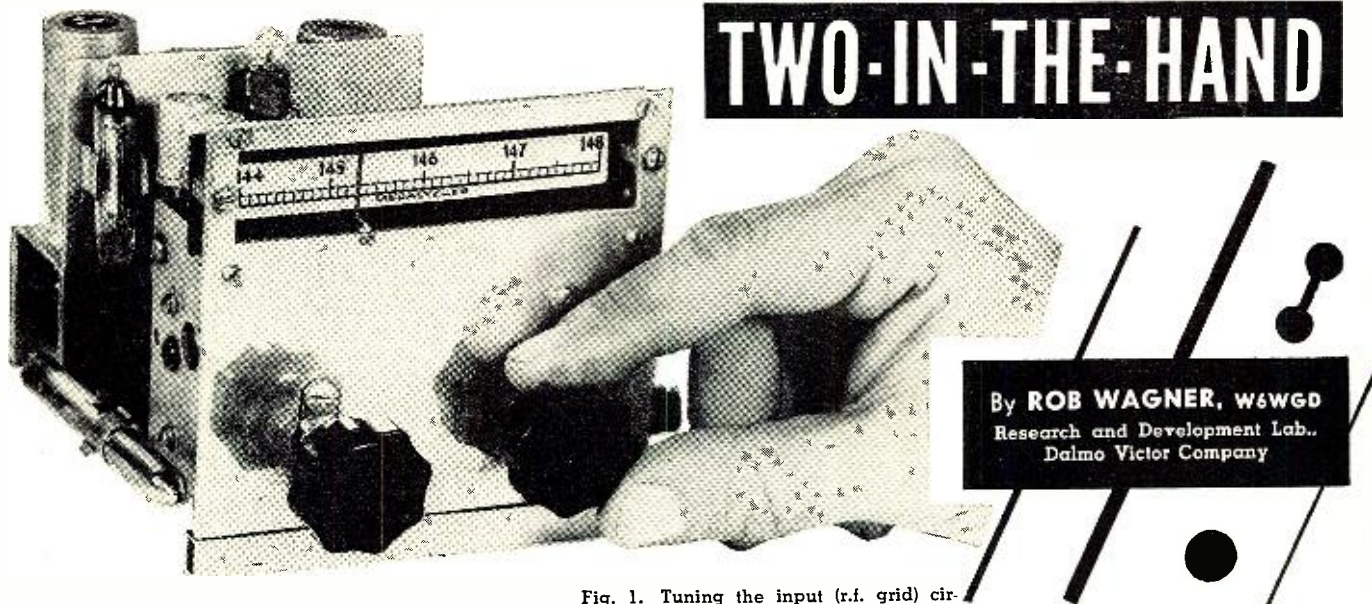

Fig. 1. Tuning the input (r.f. grid) circuit for optimum signal-to-noise ratio.

**L**AST month's midget transmitter article endeavored to show that v.h.f. mobile equipment needn't crowd the car's spare tire out of the trunk, yet can have enough power output to compare favorably with equipment requiring several times more space.

This mobile (or home-station) converter fits the same miniature category as the transmitter and incorporates a unique design feature which gives stability exceeded only by crystal control, allowing maximum performance to be built into minimum space.

The circuit consists of a low-noise, push-pull r.f. amplifier, balanced push-pull mixer, an extremely stable permeability-tuned v.h.f. oscillator, i.f. amplifier, and a crystal-controlled second mixer, giving output at 1600 kc. for third conversion within the auto radio of a standard automobile.

Before describing this equipment, I wish to thank W6YEB (Les Sebald of *United Air Lines*) for use of his basic idea (the slug-tuned 2-meter oscillator) around which a year's development work resulted in the following design.

#### General Description

Fig. 2, the schematic diagram, tells the story. The GL-5670 (2C51) twin-triode r.f. amplifier was tested for noise figure, and shows a satisfactory edge over the currently popular 6J6.

Various schools of thought exist as to the merits of different r.f. amplifiers; I'm not arguing with any of 'em! Neutralized push-pull, cascode, grounded-grid, and other types of low-noise amplifiers apparently perform equally well if properly built and adjusted, using the tubes best suited for each circuit. What's one man's meat is another man's amplifier, so I prefer the balanced r.f. stage, which shows a pretty fair noise figure and very good input sensitivity.

Next, the 5670 balanced mixer. The

*Part 2. Concluding article covers a midget double-conversion front end which features a unique permeability-tuned oscillator, balanced mixer, and the low signal-to-noise ratio necessary for copying those weak 2-meter DX stations. A 2C51 tube is used.*

circuit has been used extensively in radar receivers for quieter conversion of weaker impulses, so its choice in the design of this circuit was a natural. The circuit employs a push-pull triode, the local oscillator signal being applied to each triode grid in-phase. Inasmuch as the output of the push-pull stage is out-of-phase with the oscillator voltage applied to the grids, oscillator tube noise cancellation theoretically occurs, resulting in a nice quiet first conversion. This theory was proved by trial of the mixer with other types; at least I haven't discovered a better one yet.

Now let's look at the "heart" of the converter, the 9002 slug-tuned oscillator. This one has proved to be the neatest thing I've ever tried insofar as stability is concerned. Mechanically, it's a bit rougher to construct than a condenser-tuned oscillator, but the work involved is really worth it. Once adjusted, the converter can be tuned to a weak signal, then dropped on the table or car floor, banged around in general, and when the tubes stop ringing—lo and behold! Don't touch that dial! The signal is still there!

Of course, there are those who prefer crystal-controlled oscillators, and I'm not arguing with them either. However, for those who like a tunable oscillator, this one eliminates the disadvantages of broadband amplifiers and such and, if properly constructed, has the closest approximation of crystal stability.

The 6BA6 i.f. amplifier is standard, except that regular i.f. transformers were discarded in favor of "home-brewed" jobs, which not only con-

served space but provided a slightly higher "Q" than did some commercially-available cans.

The 6BE6 second conversion stage is unique in that no tuned circuits are used. Inasmuch as gain and selectivity are not required at this stage of the converter (adequate gain before, and much selectivity after), the minimum space taken by the tube, crystal, and a few resistors and condensers helps along toward miniaturization. Fig. 5 indicates "before-and-after" size of the converter. Before (for home-station operation) chassis length was four inches. (See Fig. 9). Addition of the inch-wide i.f. amplifier and second conversion stages for mobile use still left room in the car for one wife, one and 8/9ths children, a mother-in-law, a week's groceries, tools, fishing tackle, and a carton of 4-X-150-A's.

The net result of all this is a strong, healthy 1600 kc. signal at the output plug. Further selectivity due to the car radio's low-i.f. third conversion results in a receiving system capable of separating all but zero-beat signals.

Now for a few disadvantages. In double conversion systems, it's hard to eliminate "birdies" resulting from an unpleasant admixture of beating local oscillator signals. A third oscillator (triple conversion)—though properly isolated—can cause further trouble. Only by careful experimentation can these annoying invisible "beats" be attenuated, and frankly, I haven't had the time to iron 'em out completely. Choice of the 9 mc. rock at the second mixer was made arbitrarily because it happened to be handy, and results in several inaudible birdies within the

directly to the stator plates of their respective tuning condenser,  $C_2$  and  $C_1$ , with short connections to the grid and plate pins of the tube socket.  $C_2$  may be adjusted from the front panel, so that best signal-to-noise ratio may be obtained for any given signal. The plate circuits are electrically crossed over, as shown in Fig. 2, allowing neutralizing condensers  $C_{N1}$  and  $C_{N2}$  to mount directly from grid to opposite plate circuits across the bottom of the tube socket.

Rather than fool about with such devices as pieces of snipped twin-lead in an attempt to neutralize the front end, construct your own version of neutralizing condensers. Take a couple of plastic spacers from your ladder line and file a flat lengthwise along the top of each; their lengths should be about  $\frac{3}{8}$ ". Using #2-56 machine screws and thin, springy brass shim stock, make a compression padder similar to broadcast-radio trimmers. A clearance hole through the upper plate allows passage of a #4-40 binder head machine screw, which threads into the plastic and allows adjustment of the neutralizing capacity. The capacity will not exceed a few micro-microfarads and, considering lumped circuit inductance and capacity, should be adequate to balance out the grid-plate capacity of each half of the tube.

$C_3$ , the cathode bypass condenser, is a surplus button feedthrough silvermica condenser, the outer shell of which solders directly to the tube socket's center pin, the common ground return for the entire r.f. stage. The center conductors of  $C_2$  solder directly to either cathode pin, and  $R_1$  mounts from one cathode to ground at the socket.  $L_1$ 's center tap grounds to  $C_3$  visible in Figs. 5 and 6.

Rotors of  $C_2$  and  $C_4$  are not grounded; these points "float" in order to allow the inductances to seek their own electrical grounds. With rotors grounded, electrical circuit balance becomes hard to obtain, resulting in neutralization difficulties.

Adjustment of the r.f. amplifier and other stages is treated following the circuit descriptions; now let's look at the mixer.

### The Balanced Mixer

As mentioned previously, the choice of the 5670 as a balanced mixer was natural as five and two. Figs 5 and 6 illustrate the loose mutual coupling between mixer input coil  $L_1$  and r.f. plate coil  $L_2$ , necessary to maintenance of the "Q" and selectivity of each tuned circuit.

Speaking of "Q," observe that I've used butterfly tuning condensers and unloaded inductance. Heretofore, the trend in v.h.f. front ends appears to have been toward use of silver-ceramic trimmers, and tuned circuits loaded down with a half-meg or so to "broaden" the bandpass. Nix! The tuned circuits employed herein have a relatively higher "Q" and a response curve over the 4 mc. passband which

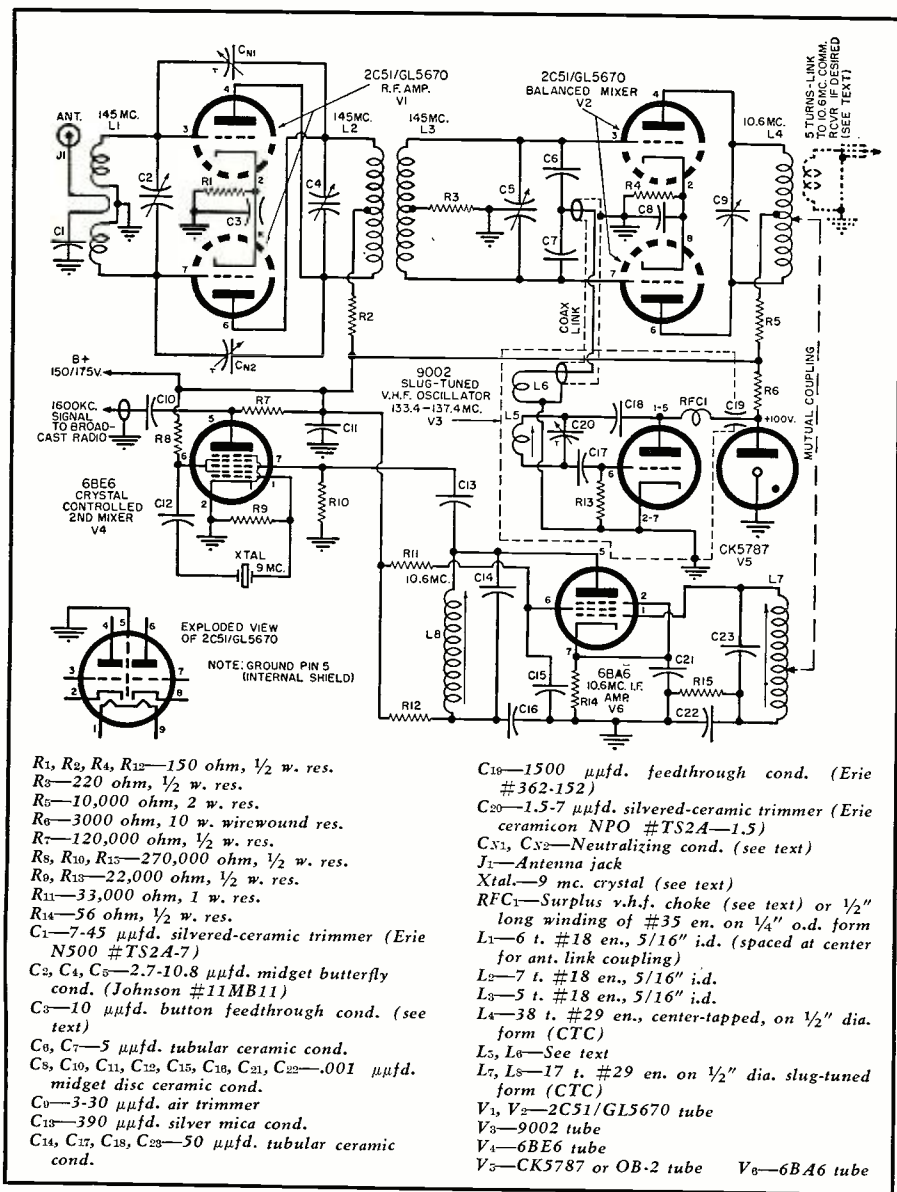

Fig. 2. Complete schematic, parts list, and coil data covering the 2-meter front end.

two-meter band. However, they're "not there" when the high-powered locals are watching television, and I've had some pretty good DX contacts in spite of 'em, even when the power boys were clobbering the local ether. The birdies have been attenuated, however, and are not troublesome enough to warrant immediate extinction.

With any essentially broadband front end, cross-modulation is a problem, too, although it occurs only when very strong local signals are on the band. I can live with it, because apparently only a very high-"Q," extremely selective front end will ease the problem. For mobile work, construction of a tuned or coaxial r.f. stage is almost out of the question. So let's take the bad with the good, the latter having the edge, and proceed with a description of each individual circuit.

### The R.F. Amplifier

The 5670 is a nine-pin miniature,

ideally suited to this application. Its construction (Fig. 2) allows the mechanical layout to correspond to that of the schematic diagram.

Figs. 5 and 6 illustrate how neatly this tube can be incorporated. The use of home-made neutralizing condensers  $C_{N1}, C_{N2}$  facilitates construction and adjustment.

The single-turn antenna link mounts on the reactance "tuner-outer"  $C_1$  and the center conductor of the coaxial input receptacle,  $J_1$ , Coax feed for mobile operation was installed after having used a balanced line to the input for home-station operation; both systems proved satisfactory. Should there be standing waves on the coaxial feed line,  $C_1$  should tune out the link's reactance and allow optimum coupling to the input circuit.

Grid coil  $L_1$ , 6 turns of #18 tinned solid hookup wire, was wound on the shank of a 5/16" dia. drill, leaving a space between the two 3-turn sections for insertion of the antenna link. Both  $L_1$  and its 7-turn counterpart,  $L_2$ , solder

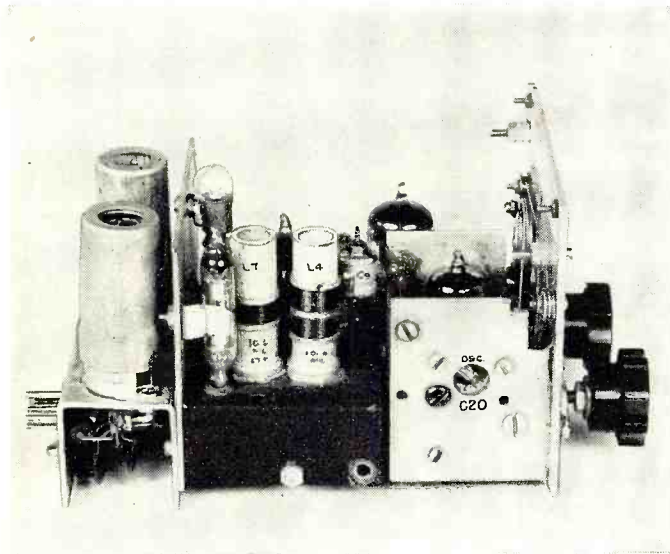

Fig. 3. Side view, with oscillator shield removed, showing oscillator bandset condenser,  $C_{20}$ , and mutual coupling between  $L_4$  and  $L_7$ . Note size of CK5787 tube and its fuse clip mounting.

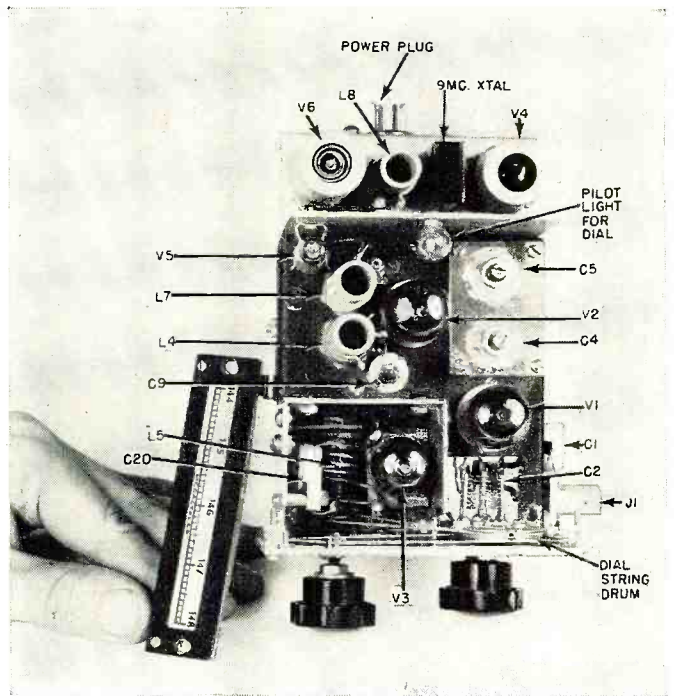

Fig. 4. Top view with the slide-rule dial removed to show details of the dial stringing and location of various parts.

leaves plenty of gain at the band edges without sacrificing what little selectivity there is in this type of miniature tuned circuit.

The rotor of  $C_5$  returns to ground, and  $L_3$  requires less inductance than the r.f. coils, resulting in a slightly more selective tuned circuit.  $R_3$  provides the grid-circuit ground return, while  $C_6$  and  $C_7$  solder directly to the grid pins, their center junction terminating the coaxial link from the oscillator stage.

$R_1$  and  $C_8$  provide cathode bias and bypassing; correct operating point for the mixer stage is determined by varying plate voltage rather than cathode potential.

The 10.6 mc. mixer plate circuit,  $L_1$ - $C_9$ , is plainly visible in Fig. 3. Wound on a CTC (Cambridge Thermionic Co.) ceramic slug-tuned form (with slug

removed), the plate coil resonates with  $C_9$  a Philips 3-30  $\mu\text{fd.}$  air trimmer. Should this type be unavailable, substitution of the same capacity in a silvered-ceramic unit is OK, although not so easily adjusted.

Now let's consider  $R_5$ .  $R_5$  is quite important to correct mixer operation, as it determines the tube's plate voltage, placing the operating point of the 5670 at its optimum location on the characteristic curve. After considerable experimenting with different mixer plate voltages, a noise-generator check showed the mixer to be operating at approximately a 3 db better signal-to-noise ratio using a plate supply of between 35-55 volts as compared to the signal-to-noise ratio resulting from application of higher plate voltages. The 3, db noise figure can mean a lot when the guy in East

Decalomania is running an even race with the noise level!

The operating point of the tube could probably have been moved in similar fashion by varying the tube's cathode bias. However, I've built a miniature electronically-regulated variable voltage power source, and couldn't resist the chance to play with it, and the value of  $R_5$  is the result.

So that the mixer will *mix*, we must get something besides amplified r.f. into the tube, so let's proceed with the local oscillator.

#### Slug-Tuned V.H.F. Oscillator

The "ultraudion" v.h.f. oscillator seems to be one of the most popular circuits for 2-meter converter application. With the 9002's cathode grounded, feedback occurs through  $L_5$  between grid and plate, each of

Fig. 5. Bottom view of the converter with the oscillator shield removed to clarify oscillator assembly and wiring. The cigarette shown at left gives idea of oscillator's miniaturization.

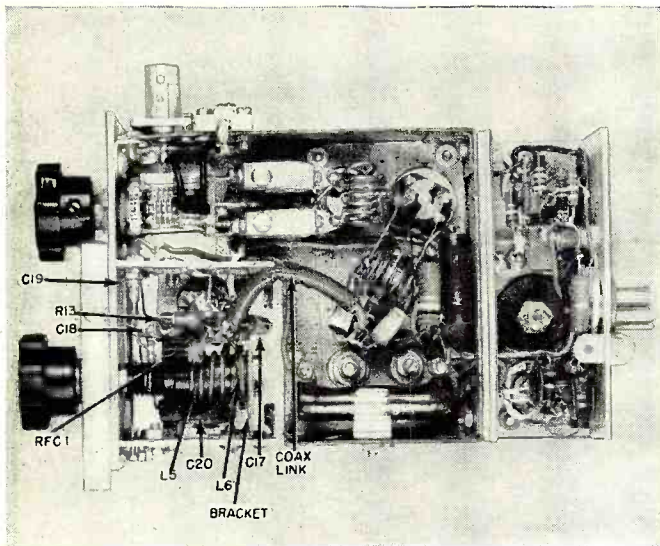
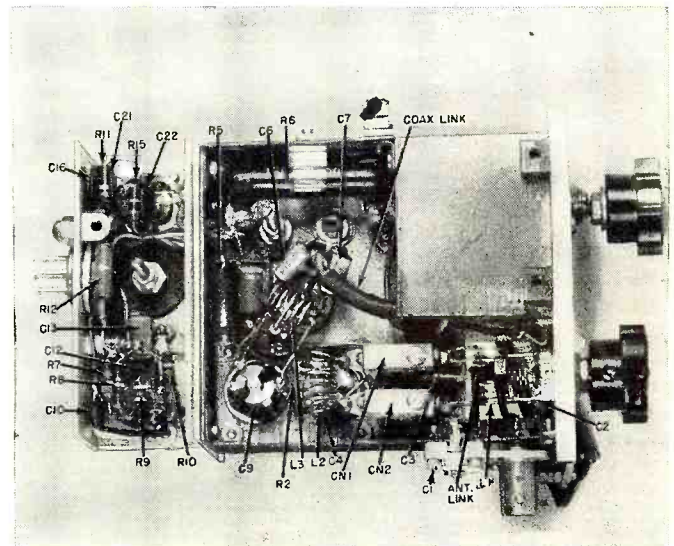

Fig. 6. Bottom view with shield in place. The home-made neutralizing condensers lie across r.f. stage. For convenience, the r.f. stage layout follows the schematic, Fig. 2, exactly.



which are blocked from d.c. by condensers  $C_{18}$  and  $C_{17}$ .  $R_{13}$  provides grid bias, and  $C_{20}$  acts as the "band setter." The two-turn link,  $L_6$ , carries oscillator voltage to the mixer grids through a short piece of low-loss coaxial cable.

The r.f. choke,  $RFC_1$ , a surplus item lifted from a piece of v.h.f. gear, prevents r.f. voltage from sneaking back into the "B+" line. Due to the converter's small size, use a Raytheon CK5787 voltage regulator tube to stabilize the oscillator plate voltage. This pencil-sized bottle regulates between approximately 90 and 108 volts at a total current rating of 30 ma. (For devotees of rack-and-panel receiver construction, a VR-90 works equally as well!)

Now for the tuning method, the best I've ever used for v.h.f. Exceeded in stability only by a crystal oscillator, this system allows you to drop the converter on the table or car floor and not lose the signal to which you are listening! (I've got lots of witnesses to the "drop test" who'll back up that statement!) Unlike a condenser-tuned oscillator, there's no "pinging" when the device is jarred or shaken, because none of the components vibrate, other than the tube's elements. Try the following constructional kinks which have evolved from a year's tinkering with this oscillator and discover its advantages for yourself.

Fig. 8 shows a sectional view of the assembled parts, and Fig. 7, an exploded perspective, illustrates the individual components in order of assembly. No dimensions are given, as each potential constructor will have his own ideas as to the size of his tuner, thus only the basic idea is presented here.

Coil form (5) in Fig. 7 is made from a surplus "522" slug-tuned coil by sawing off the ridged end containing the old winding. Presto! There's your slug-tuned form, with the 8-32 threaded bearing intact within, ready to wind and mount.

The tuning slug (6) requires that a clearance hole for the 8-32 machine screw be drilled through the slug's centerline with a hand-operated drill. You can lose a few slugs during the drilling process, but a bit of practice is all it takes.

An ordinary #8-32 machine screw of sufficient length to fit your application completes the main portion of the tuning assembly. Dime-store cement (the type used to mend dishes, etc.) secures the slug to the threaded screw, and lock-nut (11) cinches against one end of the slug as shown. Dial cable pulley (7) is threaded and cemented onto the screw against the slug's other end. More about this later, but first let's see what we now have: With the 522 form offering a threaded bearing surface for one end of the screw, and the front bearing assembly (10) providing a second threaded bearing upon the panel, we have a completely vibration-proof permeability tuner which turns silently in and out of  $L_6$ , varying its frequency smoothly and effectively. The main requirements for crystal-like stability are: (a) positive grounding of both ends of the tuning screw, (b) stabilized plate voltage for the oscillator tube, and (c) dogged sturdy mechanical construction of the over-all oscillator assembly. You can go one better and insulate both ends of the tuning screw, and eliminate one possible cause of instability.

Back to item (7), the dial cable pulley. Before you make this, better determine the over-all length of your slide-rule dial. Mine happens to be  $3\frac{3}{8}$ ", thus I wanted a given number of dial rotations to cover the band and move the dial pointer a lateral distance of  $3\frac{3}{8}$ ".

In this case, one dial turn-per-megacycle was desired to result in a 4-turn vernier coverage of the two-meter band. How do you figure the relationship between your tuning knob and dial pointer? Let's go back to high school:

Circumference is equal to pi times diameter. Let dial length be represented by circumference ( $C$ ) and pulley groove diameter by  $D$ . Thus, if  $3\frac{3}{8}$ " equals pi  $D$ , then  $D$  equals  $C/\pi$  or  $3\frac{3}{8}$ " divided by 3.1416. This is approximately 1.2 inches. Any length of looped string wound around this diameter of 1.2 inches will move a dial pointer  $3\frac{3}{8}$ " for one rotation of that diameter. Inasmuch as we want 4 dial rotations to equal  $3\frac{3}{8}$ ", we divide 1.2 by 4, which comes out to about 0.3 inch, or a bit over  $\frac{1}{4}$ ", which is close enough. Assuming that you may

not wish to build a converter of such abbreviated dimensions as mine, just substitute your dial length in the equation  $D = C/\pi$ , divide the result by the number of turns you wish to take in covering the band, and you're in business.

Pulley (7) is made from a piece of phenolic rod, the composition of which helps to make the dial cord relatively slip-free over long periods of time. Five grooves were cut by hand, using a small 3-cornered file, which was spiralled around the rod until a "thread" took shape to the proper depth. After grooving the pulley, an 8-32 tap is run through its center, so that it can be screwed tightly onto the tuning screw, first using dime-store cement on the threads to secure the assembly.

After assembly, chuck up the tuner in your drill motor and taper the slug as illustrated by holding a file against its "inner" end at about a 15° angle. The tapered slug tends to make the bandspread coverage more linear, but to attain linearity, you'll find that patient experimentation is the only answer.

The hole in the front panel through which the tuning screw passes should be made larger than the slug's outer diameter; this facilitates quick removal of the entire slug assembly through the front panel, after removal of bearing (10). You'll find this feature helpful when experimenting with slug taper.

Bracket (2) should be very securely mounted to one wall of the oscillator shield can, for obvious reasons.

The  $\frac{1}{4}$ " o.d. tuning knob shaft has an 8-32 threaded center, which allows it to be screwed on and locked to the tuning screw by lock nut (13). Mine came from the shack's "hell-box" of unsorted hardware.

Oscillator coil  $L_6$  should be wound with no smaller than #12 solid copper wire. Its 4 turns are cemented firmly upon coil form (5) leaving sufficient lead length to bend back and over the assembly to reach bandset condenser  $C_{20}$ . Oscillator component assembly is best described by reference to the illustrations.

Notice the cigarette alongside the bottom view of the oscillator in Fig. 5? It was placed in the photo to illus-

Fig. 7. "Exploded" diagram of the slug-tuned oscillator coil.

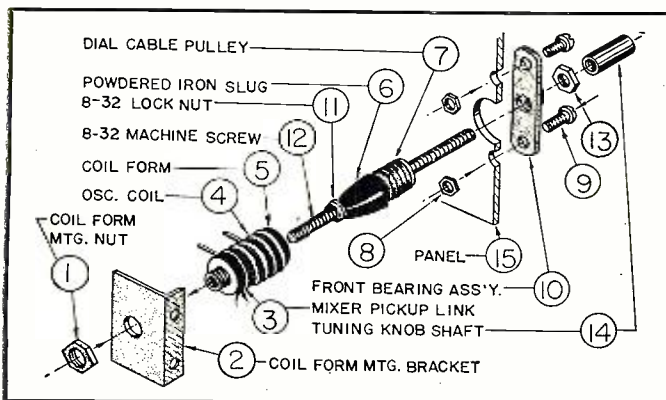
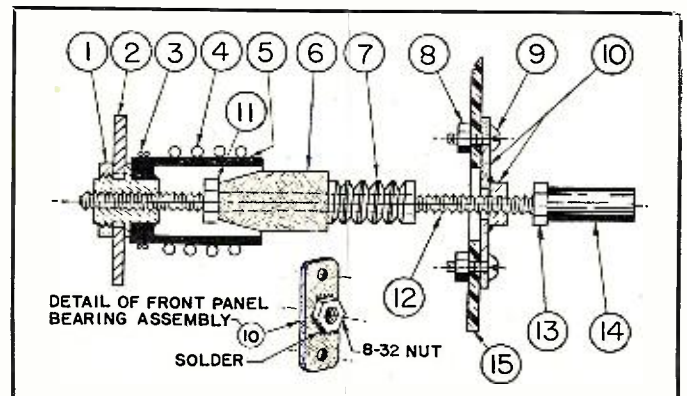

Fig. 8. Section through center line of assembly. Refer to Fig. 7.





trate the miniscule dimensions of the assembly, which is not a gag, but an attempt to keep connections as short (and consequently as vibration-proof) as possible.

The dial cord should be of the type having a nylon center and silk outer sheath. Don't try to use the flexible metal kind; in this type of rig it doesn't work out too well.

Fig. 4 shows the clearest illustration of dial cord assembly. Two small pulleys fasten securely beneath the panel's dial slot just past each end. The pulleys are made of brass, and may be purchased at your local radio supply store in a two-bit package assortment. The pulleys do not rotate, but offer a smooth, fixed guide path over which the dial cord passes, just beneath the indicator "window." The pointer, a piece of hookup wire doused with the XYL's red nail polish, clips around the dial cord which carries it across the aperture.

To eliminate slippage and loss of calibration with constant use, I've employed the a.c.-d.c. receiver trick of using a take-up reel, seen mounted above the input tuning condenser. The reel serves one main purpose: to afford a place upon which to pull tight and fasten both ends of the dial cord. It rotates on a midget roller-bearing in my converter, but assuming you haven't access to this sort of fanciness, rest assured that a #6-32 screw makes a fair center bearing. Your reel can be made from a 1/8" thick piece of aluminum, phenolic, or Bakelite, although the metal is recommended. Cut out a circle of the required diameter (the circumference of which can be no less than the length of your dial scale), tighten a machine screw through its center, and chuck it into your drill motor. The motor held in the bench vise makes an improvised lathe, and a flat file held against the rotating edge of the metal forms the disc. A smaller file cuts a flat groove around the circumference, leaving a thin rim on each side to act as cord retaining walls. Refer to the interior of the XYL's table-model radio for further instructions!

The cable makes two complete loops around the dial drive pulley, as seen in Figs. 4 and 5, making it essentially slip-free during rotation. A bit of experimenting shows the easiest way to assemble the arrangement, the main requirement being to pull the entire system taut, using the reel as an anchor for each end of the dial cord. The #2-56 machine screws cinch down the cord's ends against the reel's rear surface.

The slide-rule dial was hand-drawn and lettered on a translucent piece of paper held between the front aluminum escutcheon and a piece of steel-wool roughened plastic. The pilot light (Fig. 4) illuminates the dial evenly from behind, presenting a nice "commercial" effect. Details in Fig. 5 should help in clarifying the assembly.

Tricks involved in getting the oscil-

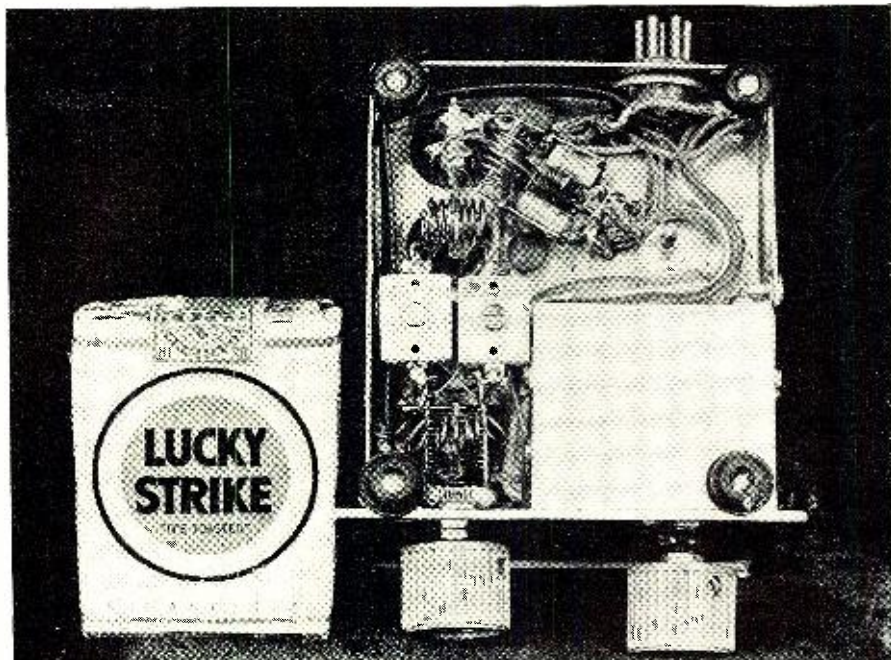

Fig. 9. Original size of converter as used in home-station operation. A 300 ohm balanced input and cut-down broadcast trimmers were used in this model.

lator to tune the band will be discussed in the following section; now let's peek at the last two stages. If you're interested in using some of the preceding ideas for a home-station converter to work into your communications receiver, stop here. Run a link from  $L_1$  to that BC-348 or HRO; it works like a bomb! I used just this much (Fig. 9) for several months into an HRO with excellent results. For those interested in mobile applications, the following circuits may be of some interest.

#### The I.F. Amplifier

The 6BA6 constitutes a conventional amplifier stage, except that I wound my own i.f. "transformers." This was necessitated by space requirements, in addition to the fact that most of the smaller commercially-available i.f. cans appeared to have less "Q" than the amount desired for this design.

The coil dimensions given in the parts list of Fig. 2 result from experiments conducted with a "Q"-meter, and show a better figure of merit than was obtainable with some manufactured units of comparable size. Little need be said about this stage other than if it is constructed with the values and voltages shown, its operation should be satisfactory.

#### Second Conversion Stage

Let's say we've got the 10.6 mc. equivalent of a 144 mc. signal coming from the i.f. amplifier through  $C_{13}$  to the control grid of the 6BE6 converter tube. The 9 mc. crystal replaces a resonant tank circuit between oscillator grid (1) and injection grid (6), which once again comprises an ultraudion circuit. Now we have two different signal frequencies boiling around inside the tube: 10.6 and 9.0

megacycles. Mix 'em up, and take your pick of their sum or difference frequencies appearing at the 6BE6 plate. In this case, it's the difference frequency of 1.6 mc. (1600 kc.) for presentation to the car's BC set.

Now if we wanted gain out of this stage (which we don't need), or selectivity (we get plenty of that within the car radio's third conversion), we could put a tuned circuit in the plate of the 6BE6. Don't bother! All we want is the difference frequency of 1600 kc. appearing at pin #5 on the tube socket.

The aforementioned birdies have been attenuated by limiting the injection grid's potential to about 7 volts with  $R_8$ . It would seem that a 9 mc. crystal oscillator running with 7 volts on the plate will have pretty limited harmonic output; this is true, but even though infinitesimally small, the harmonics are still there, mixing with those of the 9002 oscillator.

If we must live with 'em, at least let's keep them quiet as possible, so that even though inaudible, a strong local signal will modulate 'em as little as possible. The direct 16th crystal harmonic, however, falls right on 144 mc., which provides a handy band-edge marker for constant checking of dial calibration.

The output side of  $C_{10}$  is taken through the power input plug into a coaxial cable and to the car radio's antenna terminal.

Further isolation of those pesky harmonics could possibly be obtained by using a selective tuned circuit in the control grid circuit of the 6BE6; this step is recommended for those builders whose size limitations place fewer restrictions on the number of components utilized.

(Continued on page 171)

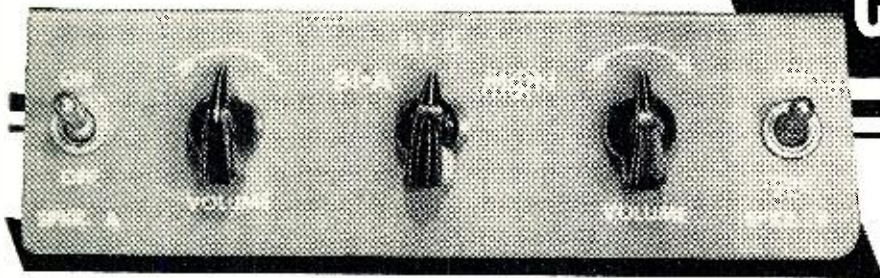

Fig. 1. Front view of the stereo selector panel which permits three separate setups with the two speakers used in the system.

## Improve auto radio reception by installing a synthetic "stereo" system. Two quality loudspeakers are required.

THE family automobile of today is a vital factor in our way of life. We live in it summer and winter. It has most of the conveniences of one's living room: comfortable settees, cigarette lighters at one's fingertips, ashtrays at one's elbow, a day bed if you so desire it, heating systems for the winter, air conditioning systems for the summer, unit refrigeration for picnicking convenience, telephone service if needed, and, of course, radio for entertainment purposes.

This latter item, the auto radio (system) is of great concern to the music lover and the high fidelity enthusiast, for compared with the performance of the elaborate home systems with which these people are familiar, the usual auto radio is more than somewhat deficient. Why? The more obvious answers stem from the following conditions. Space limitations militate against an audio output section on the auto radio comparable to those usually found in the home high-fidelity apparatus. Available loud-speaker area on the dashboard severely restricts the size of the reproducer that may be designed into the auto radio system. Baffle enclosure space on the dashboard is also at a premium. These apparently restrictive conditions, however, need not cause us to despair. These millstones around the neck of improved audio reproduction may perhaps be converted to keystones . . . keystones to a different approach to the attainment of high fidelity in the automobile.

Let us then explore a method of bringing to the wayfaring traveler a unique system of *mobile* high fidelity, comprised of a multiple speaker system integrated with a special control and distribution unit (Fig. 1), which will, in a great measure, convert the comparatively small "living room" of an automobile into a miniature "Concert Hall on Wheels."

High fidelity in sound reproduction may mean many things to many people, but the cornerstone of all high-fidelity systems is faithfulness of re-

production of the original sound. This reproduction must add nothing to, nor take anything away from the original sound; the reproduction must be clean, it must be realistic—it must have "presence." These attributes are met in widely varying degrees by many speakers now on the market. It is not our present intention to analyze what makes a good high-fidelity speaker. This subject was treated in detail in a previous article.<sup>1</sup> It goes without saying that the better the loudspeaker, the better will be the sound system.

Our present purpose is, however (assuming that true high-fidelity speakers are to be used in the system), to discuss another criterion of high fidelity that transcends the capabilities of a *single* speaker. Specifically, we refer to an attribute applicable to speaker systems only, and that is "acoustic perspective"—or to use a term suddenly come into prominence, "3-D" sound. Now "3-D" sound, or more accurately, stereophonic sound, is not new. Walt Disney's "Fantasia" was one of the early popular demonstrations of stereo sound.

There are at present many systems of stereo sound. An analysis of these systems will make it evident that although they may all differ in detail, they have one element in common. This unifying factor is the *spatial separation of two or more speakers*, within the auditory environment, where the *individual* speakers of the system carry only specially channelized portions of a "total" sound picture. Such channelized transmissions for the home are, at present, available through "binaural" radio broadcasts, tape recordings, and discs. But where we are limited to single channel reception, as is presently the case for automobile radios, what are the prospects of stereo expansion of this single-channel sound?

A *limited* measure of stereo enlarge-

1. Cohen, Abraham B.: "Hi-Fi Loud-speaker Design," RADIO & TELEVISION NEWS, Dec. 1952.

ment of single channel sound may be obtained in one's living room, for instance, by the simple expedient of spatially separating two speakers, each speaker carrying the same identical program content. Now, although this arrangement is feasible in one's home, some practical reconsideration must be given to the problem of its application to the comparatively small "living room" space of an automobile. Fortunately, we will find that this re-examination will lead us into a different and more effective solution of stereo sound for the automobile for *single-channel transmission* than is possible simply by spatially separating two loudspeakers.

We will start with the basic assumption that we are going to use high-fidelity speakers, and that we are going to use them in some stereophonic manner, a manner to be determined by the particular conditions prescribed by the internal geometry of the car. Now the maximum spatial separation of two speakers within a car would obtain between the front and rear of the car, naturally. This places the occupants of the car squarely *between* the two speakers. This condition immediately puts a very special prerequisite on the two-speaker system arranged for acoustic spatial spread within the car. The sound output level of the two speakers becomes *individually* very critical.

Let us assume that the two speakers, front and rear, are both radiating *equal* sound energy. The front seat occupants, situated approximately five times closer to the dashboard than to the rear of the car, would effectively hear only the dashboard speaker. And conversely, the rear seat occupants, being so much closer to the rear, would effectively hear their rear speaker only. In both instances, therefore, the acoustic spread would be entirely lost. We might then suggest some form of volume balancing device between the two speakers. Although the final form of the present system being discussed has such a device, it alone is not enough to provide the proper acoustic perception of their spatial separation.

What other characteristic does sound have, in addition to volume level, upon which we may operate? There is, of course, the *frequency* of the sound. Now whereas the two speakers may not be individually separable when they both play the same note, an entirely different condition would prevail if one speaker were to reproduce, say, a tone of 100 cps, and

# ON WHEELS

By  
**ABRAHAM B. COHEN**  
University Loudspeakers, Inc.

the other speaker were to reproduce a tone of perhaps 5000 cps. These two notes, respectively a typical bass fiddle note and a piccolo note, are so distinctively separated in their frequency and tonal characteristics, that they would be instantly spotted as originating at the two different places when the separate speakers were located forward and rear. This spatial localization of the two separate sound sources on this frequency basis becomes especially effective where the listener is located *between* the speakers as is the case in a two-speaker system in an automobile.

Now the writer realizes full well that true stereo sound is an entirely different matter than just separation of various bands of frequencies, and that such a procedure is only an expediency by which it is attempted to pull single-channel transmission up by its own bootstraps into the level of multi-channel transmission necessary for true stereo sound. However, it might be suggested that this expedient not be dismissed too lightly. If we get down to basic concert-hall techniques relative to the actual physical grouping of the musical performers, be they instrumentalists or vocalists, we will learn that the many "standard" seating arrangements for these groups are in themselves *geometric segregations on a frequency-band basis*.

Consider the piano keyboard. The bass notes are on the left, the treble notes are on the right. Now examine a typical symphony orchestra set-up (Fig. 2A). On the left are the violins, first and second, but both limited to the same frequency range encompassing the treble and upper middle tones of the musical spectrum. As we scan toward the right we find the flutes, clarinets, and to the rear of these, the trumpets, and the french horns. These are all mostly in the middle frequency section of the musical spectrum. Then further to the right we find the bassoons, violas, and to their rear the trombones. These instruments in general encompass the middle frequency regions with extension into the upper bass notes. As we finish our panoramic inspection to the right we will find the percussion instruments, (drums, tympani), then the cellos, and to their rear are the bass viols, all instruments limited to the lower bass portion of the musical spectrum. This panoramic inspection shows us that the symphony orchestra is practically a giant keyboard, like that of a piano, but with the "treble" frequencies on the left hand in this case, and the "bass" fre-

quencies on the right hand. The reason for this development may no doubt be found in the musical histories, and we may even guess at the reasons, but these reasons are not our present concern. We are concerned with the fact that these arrangements *do* exist and we are desirous of reproducing these "geometric-frequency" arrangements in our own acoustic environment, the automobile interior. We will leave to the next (and last) portion of this article the actual construction and installation of the system for this special case, and we will assume for the moment that the system is already in place and differentiating the program content properly, and in such a manner, that the treble tones come to us from the forward speaker, and the bass tones arrive from the rear shelf speaker.

To be perfectly factual in this matter, we must point out, however, that there will be no sharp line of demarcation in the musical spectrum where the one speaker abruptly stops "making music," and the other speaker starts. Fortunately, there is an area in this middle section where, due to the design of the control system involved, the output of the bass speaker tapers off at the same time that the treble speaker output begins to build up. Therefore when the musical program content consists of these middle tones, both front and rear speakers will produce *approximately* the same volume output and the same frequency output.

Now what may we expect from such a system? The first immediate effect upon the car occupant is that he suddenly becomes the "center of musical gravity," if you please, of the music around him. Since he is physically "captured" in the car *between* his speakers as illustrated in Fig. 2B, he finds himself musically in the same position as does the conductor of a

(Continued on page 163)

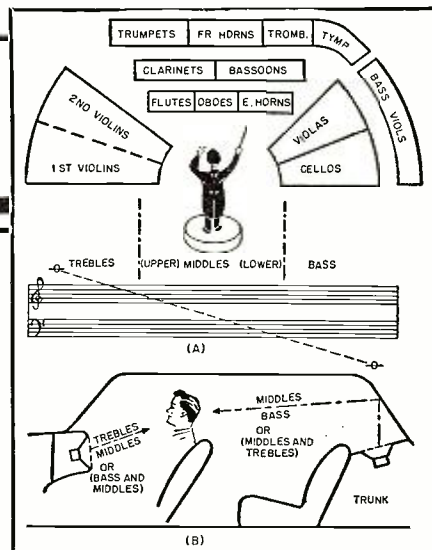

Fig. 2. (A) Seating arrangement of a symphony orchestra where instruments are geometrically segregated on a frequency-band basis. (B) The "Concert Hall on Wheels" system puts the car's occupant in the musical center of gravity, corresponding to conductor's position in front of an orchestra.

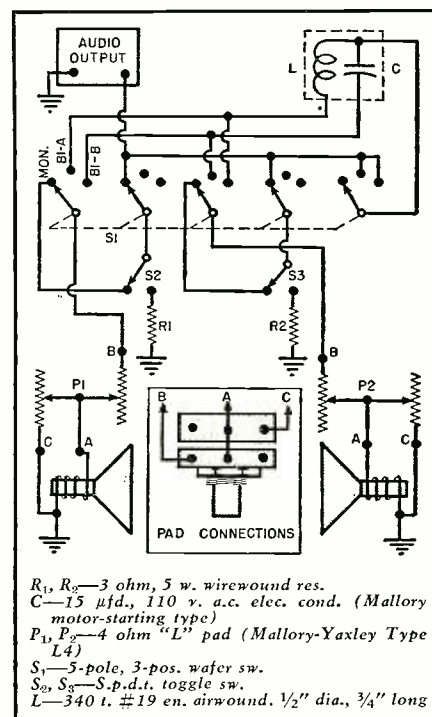
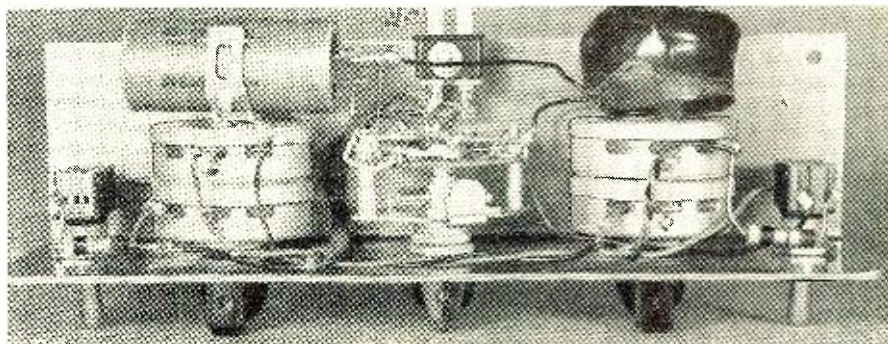
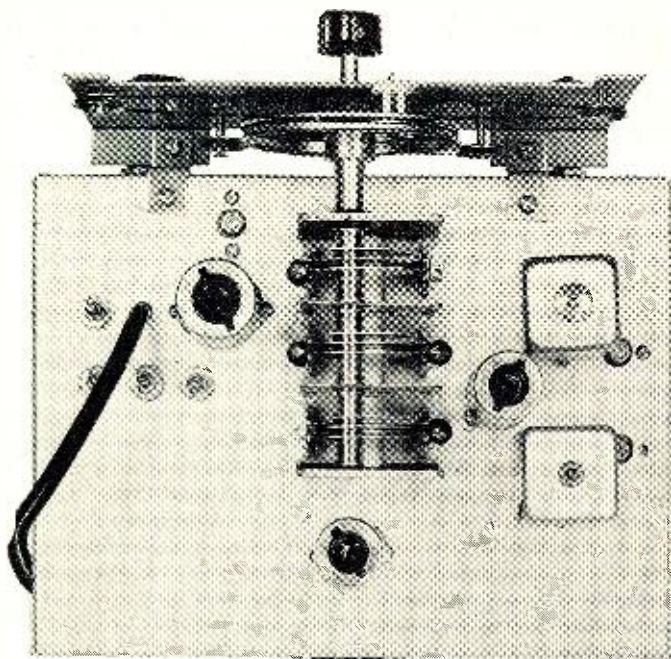

Fig. 3. Schematic of the stereo control.

Fig. 4. Rear view of the control showing the most advantageous placement of parts.





Top view of the author's home-built v.f.o. It is built on a chassis measuring 6" x 8" x 2". All parts are standard.

AN ECONOMY

V.F.O.

By J. T. GOODE, W6LYT

*Construction details on a stable unit covering 80, 40, 20, 15, 10, and 2 meters with enough output to drive a final amplifier except on 2 meters. Standard parts are used.*

**T**HERE is nothing new in the design of variable frequency oscillators. The desire to have a v.f.o. is quite understandable, and they are available on the market. It would then seem that anyone interested could purchase what he wanted and the subject would be closed.

Your author was presented with this problem and came up with the following answers.

Number one, they are not cheap and number two, they did not cover all bands. Also they would not drive a final amplifier. These limitations constituted a challenge to correct this situation.

If a v.f.o. could be designed that was stable, covered multiband operation (80-40-20-15-10-2 meters), and had sufficient output to drive a final amplifier with the exception of 2 meters, there would be something new in v.f.o. design.

With these specifications in mind and a pair of 6146's in parallel running at 150 watts' input becoming the final amplifier, the v.f.o. to be described was designed. The 2-meter transmitter required 8 megacycle drive to replace the crystal but plugged directly into the crystal socket.

In creating a v.f.o. to meet the specifications another very desirable feature was worked out. All parts and coils are commercially available,

at a total cost of approximately \$20.00. Two v.f.o. units were constructed in eight hours and this included punching the chassis, mounting all parts, and wiring. In construction, TVI was taken into consideration.

In designing a v.f.o. several factors must be considered. The lower the frequency of the base frequency oscillator the greater the stability, on the other hand this requires frequency multiplication which will complicate the design.

By selecting a base frequency of 1750 to 2060 kc. the 80, 40, 20, 15, 10, and 2 meter bands could be covered. At this base frequency stability could be obtained easily with negative coefficient capacity correction and a standard broadcast oscillator coil.

The amount of drift was so low that checking it with a BC-221-AH frequency meter was inaccurate due to calibration points at one kc. intervals and the drift of the BC-221-AH. After this error was established a *Hewlett-Packard* frequency counter was used to check the frequency drift. The drift was as follows.

The v.f.o. turned on cold, frequency 3500.6 kc.; after ten minutes operation—3499.1 kc.; after thirty-eight minutes—3499.8 kc.; after one hour—3499.8 kc.; and after one hour and forty-five minutes—3501.4 kc.

The maximum drift took place in

the first ten minutes of operation and this drift was not severe. After this time the drift was very slow which indicated that negative compensation was taking effect causing the drift to reverse. In actual use the v.f.o. is not operated constantly resulting in a reduction of drift. To date in all-band operation no station contacted has mentioned a noticeable drift.

In view of the fact that the frequency measured was twice the oscillator frequency, the drift is actually in cycles.

Another design factor in a v.f.o. is the detuning effect of the amplifier being driven by the v.f.o. This detuning effect results from the necessary coupling between the two units and can cause calibration error depending on the tuning of the final amplifier. While this error may be small, it is undesirable.

In the v.f.o. described this detuning effect is negligible. This was accomplished by operating the base oscillator 1750 to 2060 kc. and doubling in the plate circuit. This circuit, in turn, drives another stage which operates as an amplifier or multiplier stage. All tuned circuits are ganged, resulting in the same tuning at all times.

No switching is used in the oscillator circuit which improves stability when the switch contact problem is considered. All band changing takes place in the plate circuit of the amplifier multiplier.

Voltage regulation is used on the oscillator screen and plate only. The amplifier multiplier stage does not require voltage regulation and the plate voltage can be increased or decreased to give desired output. The oscillator

plate and screen voltages are regulated at 150 volts. This low voltage reduces current drain which, in turn, reduces coil heating which is a drift factor.

While it is common to rate power output in watts, another type of measurement was made which will make it easier for the reader to judge whether this v.f.o. has sufficient output for his particular application. The measurement is in grid current through a 10,000 ohm resistor. For each grid ma. ten volts of bias is developed across the resistor. For example, 10 grid ma. result in 100 volts of bias. Seven grid ma. give 70 volts of bias.

The output of the v.f.o. was fed directly into the grid of a 6V6GT tube. Connected to the grid was an r.f. choke, 10,000 ohm resistor, and milliammeter. Output measurements are given in Table 2.

The v.f.o. furnished sufficient output to drive a pair of 6146's on 80, 40, and 20. 15-meter operation requires tripling in the final from 40 meters. 10-meter operation requires doubling from 20 meters.

The output at 8 mc. is ample to drive the grid circuit in place of an 8 mc. crystal. This same output can replace 24 mc. crystals. Tuning of the v.f.o. and 2-meter transmitter remain the same. The crystal oscillator stage simply becomes a tripler stage when the v.f.o. output is plugged into the crystal socket.

In some crystal oscillator circuits the crystal is operated above ground for regeneration purposes. In this case it may become necessary to modify the circuit for proper connection to the v.f.o.

There is a d.c. blocking condenser in the v.f.o. so no d.c. appears in the output cable. It will always be necessary to have a grid resistor in the stage being driven. Most crystal oscillator circuits have such a resistor and will require no modification for connection to the v.f.o. In no case is a grid blocking condenser needed. On the other hand if one is in the circuit it need not be removed. The only effect, if any, would be a slight reduction in grid drive.

By screwing a metal cover to the bottom of the chassis, the unit is completely shielded with the exception of the variable condenser. The tubes should have shields. No TVI was experienced when the v.f.o. was operated ten feet from a TV receiver and both units connected to the same wall plug.

All parts are commercially available but it was necessary to modify two of the coils. This modification takes about two minutes per coil. Simply unwind 30 turns from one coil and 33 turns from another coil. (See parts list accompanying diagram). If a grid dip oscillator is available, coils  $L_3$ ,  $L_4$ ,  $L_5$ , and  $L_6$  can be wound on coil forms to tune to frequencies specified in the parts list.

Coils  $L_1$  and  $L_2$  should be those specified since the negative correction

80 METERS	40 METERS	20 METERS	15 METERS	10 METERS	2 METERS
3.500	7.000	14.000	21.000	28.000	144
3.550	7.100	14.100	21.250	28.400	145
3.600	7.200	14.200	21.300	28.500	146
3.650	7.300	14.300	21.450	28.800	147
3.700		14.350	21.600	29.200	148
3.750		14.400		29.600	
3.800				29.700	
3.850					
3.900					
3.950					
4.000					
		PHONE BANDS			
3.800-4	7.2-7.3	14.2-14.3	21.25-21.45	28.5-29.7	144-148

Table 1. Dial calibration points for the 80, 40, 20, 15, 10 and 2-meter bands.

takes care of drift. Another type of oscillator coil was tried resulting in a drift of 1 kc. per minute for twenty minutes and was still drifting when unit was turned off, despite the same amount of negative correction. This undoubtedly was due to coil heating.

The circuit is straightforward and uses a minimum of parts. The oscillator is a 6AQ5 with the grid circuit tuned to the 160-meter band using the screen grid as a plate. The plate circuit is tuned to cover the 80-meter band. These two circuits are gang tuned and tracked, resulting in constant grid drive to the 5763 amplifier multiplier stage, over a frequency range of 3495 to 4120 kc. With this tuning range and frequency multiplying 40, 20, 15, 10, and 2 meters can be covered without switching the oscillator frequency. For 80-meter operation the plate circuit of the 5763 is ganged and tracked with the oscillator frequency.

On bands other than 80 meters the plate circuit of the 5763 is fixed tuned

for the center frequency of each range covered.

$C_1$ - $C_5$ - $C_{12}$  is a three-gang FM variable condenser.  $C_2$ ,  $C_6$ , and  $C_{13}$  are 75  $\mu$ fd. air trimmers.  $C_4$  is the oscillator grid condenser and  $R_1$  the grid leak.  $L_1$  is a broadcast-type tapped oscillator coil, with an adjustable iron core.  $L_2$  is a receiver short-wave antenna coil with an adjustable iron core. This coil has an antenna winding which is not used and is not shown on the circuit diagram. This holds true for coils  $L_3$ ,  $L_4$ ,  $L_5$ , and  $L_6$ .

The tap between  $R_2$  and  $R_3$  is a test point used during alignment adjustments.

$R_4$  is the screen dropping resistor for the 5763.  $C_7$ ,  $C_9$ , and  $C_{10}$  are r.f. bypass condensers.  $C_8$  is the grid coupling condenser and  $C_{11}$  is the plate blocking condenser which removes d.c. from the output cable.

$L_6$  is the 80-meter coil and is tracked from 3500 to 4000 kc.  $L_5$  is the 40-meter coil and is tuned to 7150 kc. This same coil is used for 15-meter

Complete schematic of v.f.o. As shown, circuit is designed for high-impedance output. For use with low impedance outputs, see text for the required variations.

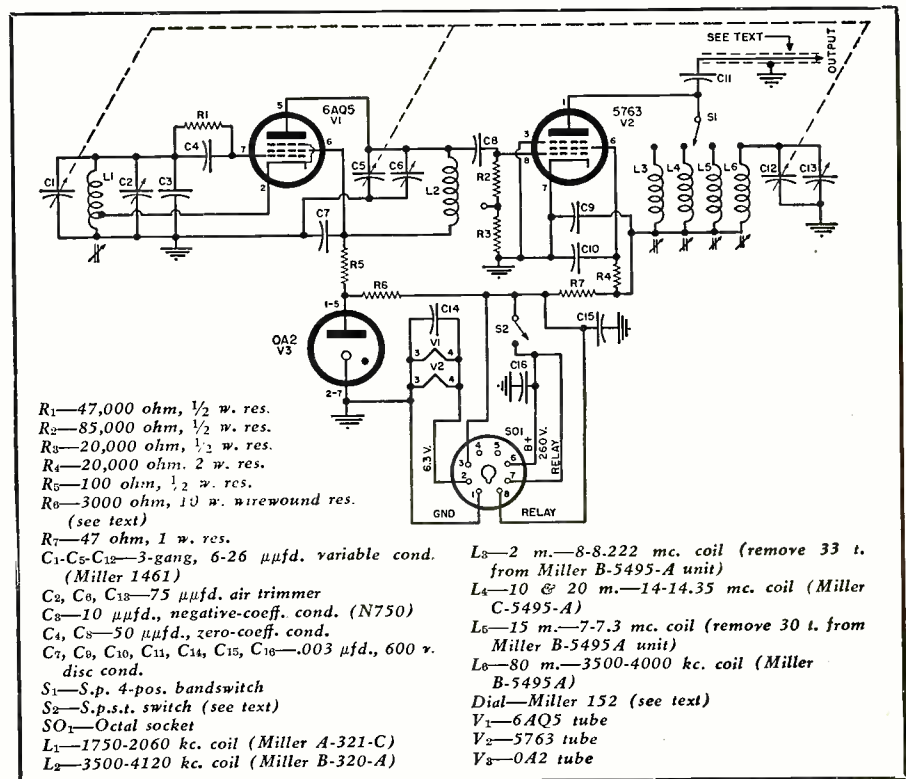

operation.  $L_4$  is the 20-meter coil and is tuned to 14,175 kc. This coil is also used for 10-meter operation.  $L_3$  is the 2-meter coil and is tuned to 8111 kc.

$R_5$  and  $R_7$  are decoupling resistors in the "B plus" leads.  $C_{14}$ ,  $C_{15}$ , and  $C_{16}$  bypass condensers reduce r.f. leakage of the power leads connected to the v.f.o. These condensers are necessary only if TVI is a problem.

The output cable is 72-ohm coaxial line. Its length is 16 inches. Since the capacity of the line is part of the plate circuit, this length is important. The length is maximum to obtain tracking with coil  $L_6$ . The length could be shortened and the difference in capacity corrected by trimmer  $C_{13}$ . The iron cores in  $L_3$ ,  $L_4$ , and  $L_5$  will compensate for some variation in cable length.

Switch  $S_1$  is a single-pole, four-position bandswitch. Switch  $S_2$  can be a single-pole, single-throw toggle switch or a multiple-contact bandswitch. The latter type switch makes possible additional switching such as "standby," "transmit," "tuning," and "relay."

$V_3$  is a 0A2 voltage regulator tube.  $R_6$  is the dropping resistor. The actual value of this 10-watt resistor will depend on the "B plus" voltage applied to the v.f.o. If conserving current drain is desirable this resistor should be adjusted to cause a current drain of approximately 12 ma. through the VR tube. With a supply voltage of 300 volts, a 3000-ohm resistor will cause a current drain of approximately 30 ma. which is the maximum rating of the 0A2. As the supply voltage is reduced the current drain will drop.

The power socket,  $SO_1$ , is an octal tube socket. Connections to this socket are shown on the circuit diagram for relay operation. The connection to pin number three is a matter of convenience with this pin being used as a tie point.

There are several things to consider when selecting a dial. If the v.f.o. is

to be used by zero beating other stations, the slide-rule dial shown on the v.f.o. is satisfactory and is commercially available. The cost of such a dial is considerably less than a mechanically driven dial.

Those desiring considerable bandspread for each band calibration should use mechanical bandspread dials.

The location of parts on the chassis can be determined by checking the circuit diagram and the photographs. The chassis is a standard size 6" x 8" x 2". Bottom covers are available.

Test equipment necessary for alignment is as follows: frequency meter, d.c. voltmeter, and grid-dip meter. An all-band receiver with "R" meter could be used if a grid-dip meter is not available.

Set trimmers  $C_2$  and  $C_6$  at half capacity and  $C_{13}$  at minimum capacity. Place the bandswitch in the 80-meter position. Connect the output cable to the grid circuit of the stage to be driven by v.f.o. A milliammeter should be placed in this circuit. A test circuit can be temporarily wired as described earlier. Connect a 0-50 d.c. voltmeter from the junction of  $R_2$ - $R_3$  to ground, positive ground.

Set the frequency meter on 3495 kc. Close the variable condenser and adjust the iron core of  $L_1$  to zero beat. Adjust the iron core of  $L_2$  for maximum reading on the voltmeter. If a 20,000 ohm-per-volt meter is used the voltage reading should be approximately 20 volts. A 1000 ohm-per-volt meter will give a lower reading. Maximum reading is all that is required.

Open the variable condenser and set the frequency meter to 4120 kc. Adjust  $C_2$  for zero beat. Adjust  $C_6$  for maximum reading on the voltmeter. It will be necessary to repeat this adjustment several times since one adjustment affects the other. Always adjust the iron cores on the low-frequency end of the dial and trimmer condensers on the high-frequency end of the dial.

When the desired frequency range is set the voltmeter should indicate maximum over the entire tuning range. Some minor adjustments of the iron core of  $L_2$  and trimmer  $C_6$  may be required to accomplish this.

Next close the condenser and adjust the iron core of  $L_6$  to give maximum output reading on the grid meter of the driven stage. Open the variable condenser and adjust trimmer  $C_{13}$  for maximum reading. Repeat this adjustment several times until the output reading is constant over the entire band. Due to the capacity of the output cable, trimmer  $C_{13}$  will tune at approximately minimum capacity.

At this stage of adjustment the oscillator is now set for all bands and the amplifier multiplier stage is set for 80 meters.

Next set switch  $S_1$  for 40-meter operation. Adjust the frequency meter to 7150 kc. Tune the variable condenser to zero beat. Adjust the iron core of  $L_5$  for maximum reading on the grid meter of the driven stage. 40 meters is now set. Check with grid dip oscillator to see that  $L_5$  is not adjusted to some harmonic other than 7150 kc.

Set switch  $S_1$  for 20-meter operation. Adjust frequency meter to 14,200 kc. Tune variable condenser to zero beat. Adjust iron core of  $L_1$  for maximum reading on grid meter of the driven stage. The tuning range of this coil is great enough to tune to the third, fourth, and fifth harmonic of 3500 kc. The 20-meter band uses the fourth harmonic. Use the grid dip oscillator and adjust this coil to approximately 14,200 kc. and then use the grid meter indicator for final adjustment.

Set switch  $S_1$  for 2-meter operation. Adjust frequency meter to 8111 kc., tune variable condenser for zero beat. Adjust iron core of  $L_3$  for maximum reading on grid meter of driven stage. Again use grid dip oscillator to in-

*(Continued on page 120)*

Underchassis view of v.f.o. The band coils can be seen near center at right and connected to band-change switch at top.

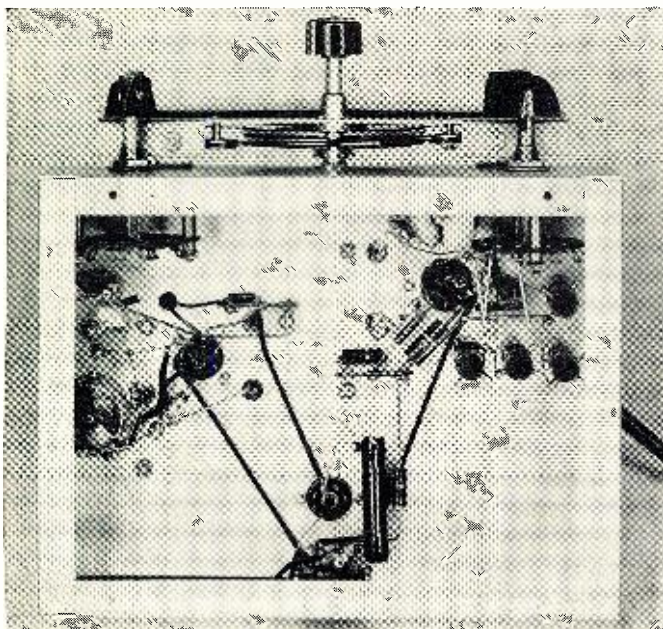

Table 2. Output measurements of v.f.o. The measurements were made using 260 volts on the plate of the amplifier-multiplier stage. The plate voltage was increased to 280 volts causing the output at 14.2 mc. to increase from 7 to 8 ma. This stage can be operated at 300 volts, resulting in a still greater increase. The plate current drain of the v.f.o. running 260 volts is approximately 50 ma., not including the voltage regulator tube. This tube should be adjusted to pull approximately 15 ma.

80 METERS		20 METERS	
3500 kc.	11 ma.	(Double freq. for 10 m.)	
3750 kc.	12 ma.	14.0 mc.	6 ma.
4000 kc.	12 ma.	14.1 mc.	6.5 ma.
		14.2 mc.	7 ma.
		14.35 mc.	6 ma.
40 METERS		8 MC. OUTPUT	
(Triple freq. for 15 m.)		(for 2 m. xmtrs. using 8 mc. crystals)	
7000 kc.	10 ma.	144 mc.	8.5 ma.
7100 kc.	11.5 ma.	145 mc.	10 ma.
7200 kc.	11.5 ma.	146 mc.	10.5 ma.
7300 kc.	10.5 ma.	147 mc.	10 ma.
		148 mc.	9.5 ma.

# A TRANSISTOR PHASE INVERTER

A PHASE inverter is a circuit which provides coupling between the output of a single-ended stage and the input to a push-pull stage. A phase inverter provides two outputs which are 180 degrees out-of-phase, so that when one grid of the push-pull stage is driven positive, the other is driven negative.

Phase inverter coupling can be provided by a transformer, a vacuum-tube stage, or by a transistor stage.

The transformer stage is the simplest to use. It requires no power for operation, and provides a voltage gain. There are several disadvantages to the transformer, however. It has a limited frequency response, and is sensitive to hum pickup from the magnetic fields of power transformers. In some applications the weight of a transformer is a serious disadvantage.

These difficulties led to the development of the vacuum-tube phase-inverter circuit. The vacuum-tube stage is insensitive to power transformer hum fields, has an excellent frequency response, and is lighter in weight than most transformers. Its disadvantage lies in its requirement of heater and plate power, and, in some designs, in hum pickup from the heater of the tube.

These drawbacks led to the transistor phase-inverter development. The transistor stage has the same advantages as the tube stage, with respect to frequency response and insensitivity to power fields, with the further advantage of lighter weight. In addition, the transistor stage needs no heater power, so there is no hum pickup from this source.

The transistor circuit uses a base input, with an emitter-follower output to provide isolation, and a collector output for phase reversal. The equivalent circuit is given in Fig. 1A.

The two loop equations are:

$$R_c(I_b - I_c) = E \dots \dots \dots (1)$$

and:

$$I_c(R_c + R_L) = E - R_m I_b \dots \dots \dots (2)$$

Solving equation (1) for  $I_b$  gives:

$$I_b = \frac{E}{R_c} + I_c \dots \dots \dots (3)$$

and substituting in (2):

$$(R_c + R_L) I_c = E - \frac{R_m}{R_c} E - R_m I_c \dots \dots (4)$$

$$\frac{I_c R_L}{E} = \frac{R_L(R_c - R_m)}{R_c(R_c + R_L + R_m)} = -1 \dots \dots (5)$$

Equation (5) must equal minus one to give phase inversion at unity gain in the collector branch of the circuit. Therefore:

$$R_L(R_m - R_c) = R_c(R_c + R_L + R_m) \dots (6)$$

Choosing  $R_c = 27,000$  ohms from d.c. considerations, and using a CK722 transistor with collector resistance,  $R_c = 500,000$  ohms, and mutual resistance,  $R_m = 200,000$  ohms; then, substitution in equation (6) gives the load resistance,  $R_L = 120,000$  ohms.

By W. H. CALDWELL

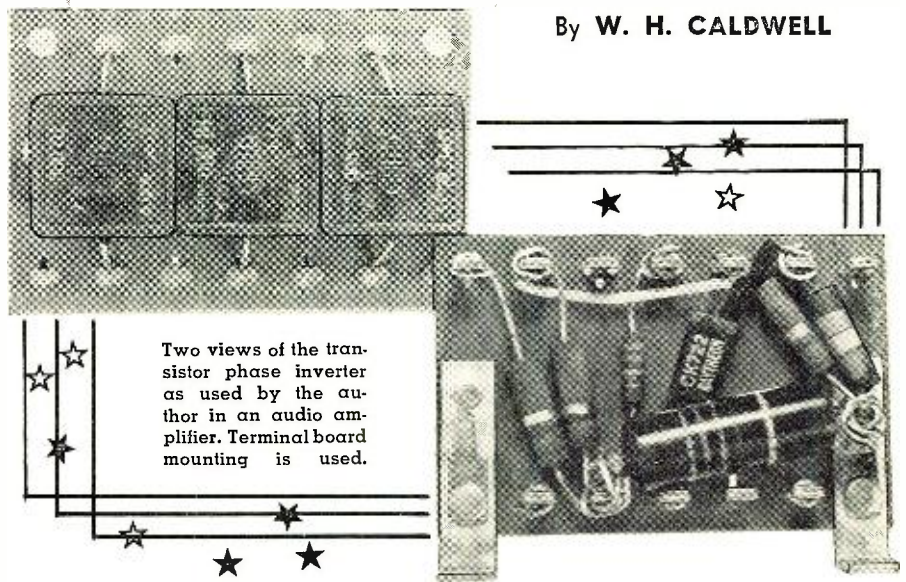

Two views of the transistor phase inverter as used by the author in an audio amplifier. Terminal-board mounting is used.

*Details on a novel application of transistors of interest to experimenters. It may be used in audio amplifier circuits.*

Add a dropping resistor for operating from 250 volts, add coupling and bias resistors, coupling and bypass condensers, and the circuit of Fig. 1B is derived.

The photographs show a compact terminal-board mounting of the circuit. The phase inverter serves to drive push-pull 6V6 tubes in an audio amplifier. The unit serves as a good project to introduce the experimenter to transistor techniques. The design was discussed in some detail to show how it can be adapted to other transistors.

The variations in the gain of the circuit, especially in the collector branch, with different CK722 transistors depends on how close tolerances the manufacturer holds on the characteristics of the transistor. There are,

however, two aspects of this circuit which favor uniformity of performance. One is the use of the transistor to provide unity gain, so that there is no multiplication of variations. The other factor is the large amount of degeneration introduced in the emitter branch of the circuit. Of five CK722 transistors used in the circuit, the maximum variation was found to be less than ten per-cent.

The gain in the emitter branch is constant to within two per-cent for various CK722 transistors. The balance between collector and emitter is quite good, and can be made as close to unity as desired by adjusting the collector load resistor, although this is not necessary for most applications.

The maximum signal level that the

*(Continued on page 129)*

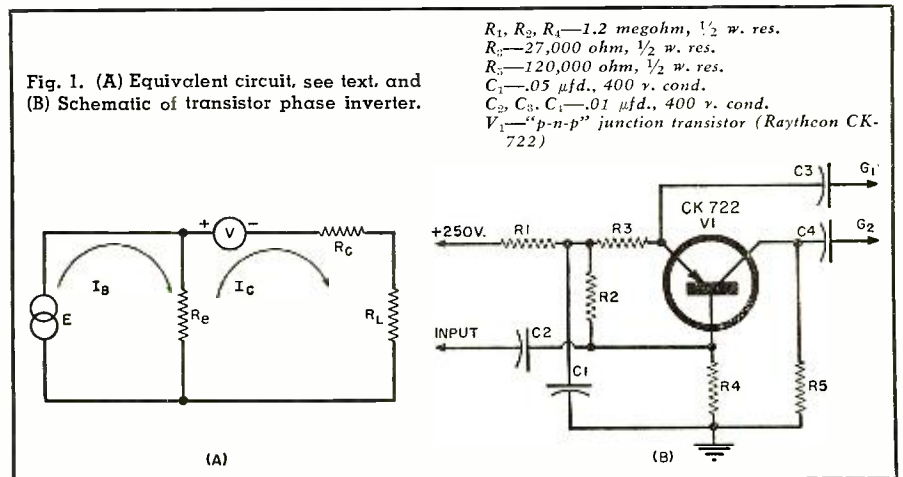

Fig. 1. (A) Equivalent circuit, see text, and (B) Schematic of transistor phase inverter.

- $R_1, R_2, R_4$ —1.2 megohm,  $\frac{1}{2}$  w. res.
- $R_3$ —27,000 ohm,  $\frac{1}{2}$  w. res.
- $R_5$ —120,000 ohm,  $\frac{1}{2}$  w. res.
- $C_1$ —.05  $\mu$ f., 400 v. cond.
- $C_2, C_3, C_4$ —.01  $\mu$ f., 400 v. cond.
- $V_1$ —"p-n-p" junction transistor (Raytheon CK-722)

# REDUCING TURNTABLE RUMBLE

By ROY B. LANG, JR.

*Cut out rumble, flutter, and other low-frequency noise in hi-fi audio systems with this high-pass filter.*

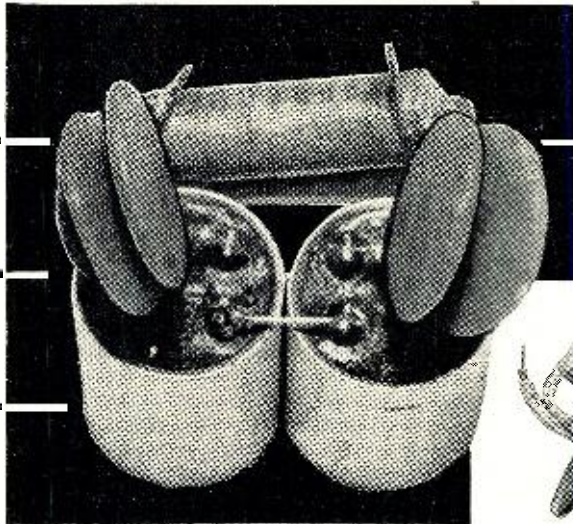

Fig. 1. High-pass rumble filter with a sharp cut-off characteristic at 30 cps.

Fig. 2. Rumble filter enclosed in shield can, constructed from condensed milk or similar container, provides hum reduction.



**A**DVANCES in the design of speakers, output transformers, record pickups, and the circuitry around them have made audio systems quite efficient at frequencies extending as low as 20 cycles per second. Record manufacturers have kept abreast of these new developments and many recordings made today will cover the full range of the audio spectrum. This gives recorded music a realism which it never had in the past—but not without presenting a serious problem. For example, any system which will take a 30- to 40-cycle note from a recording and faithfully reproduce it is just as effective in converting any low-frequency

mechanical disturbances into sound. For this reason, when the designer is ready to choose a turntable to be used in his high-fidelity system, he must face the question of convenience and particularly cost *vs* performance.

A commercial transcription table will provide superior performance with a minimum of rumble of the type caused by mechanical vibrations in the motor and drive assembly. The average person, however, will probably compromise with the more economical and convenient three-speed changer. Although these changers are usually well designed and constructed from quality materials, their selling price places a practical limit upon the accuracy of armature balance and bearing tolerances in the drive motor assembly. This results in a certain amount of mechanical vibration which, in turn, is converted into rumble and speaker cone flutter at the listening end of the system.

Occasionally, a system may suffer a continual fluttering of the speaker cone at some frequency between 20 and 30 cycles-per-second. Besides being on the threshold of audibility, flutter interferes with the normal cone action for frequencies above 30 cycles.

Fortunately, flutter frequency is consistent, and at the extreme low end of the musical scale, therefore, the problem is well suited to the application of a high-pass filter. In order to minimize attenuation of the hard-won bass response of the system, it is desirable to determine the frequency of the cone flutter accurately and then design a filter which will sharply attenuate the flutter signal as well as other spurious signals below flutter frequency. Fig. 4 shows the form taken by the response curve of an amplifier incorporating an ideal high-pass filter. Of course, such a perfect filter is out of the question, but an approximation of the curve shown in Fig. 4 would reduce the disturbance to something less than an objectionable level.

An accurate measurement of flutter frequency may be made with a calibrated "strobelight" and a "modulationless groove" record. The latter is a record made on a standard recording blank with no signal applied to the head during cutting. This special record is played with the gain of the system set high enough so that the speaker cone flutter is very noticeable. While the cone is oscillating, the "strobelight" is focused on the cone and the flashing frequency adjusted until some convenient reference point (the voice-coil leads, for example) on the cone seems to stand still. It is then a simple matter to determine the flutter frequency. Besides this method of checking flutter, there are test records available which will determine flutter, although not as accurately as the "strobelight" will.

If a calibrated "strobelight" is unavailable, the filter should be designed to give maximum attenuation at 24 cycles because the motor characteristics from one changer to another are similar enough so that the flutter fre-

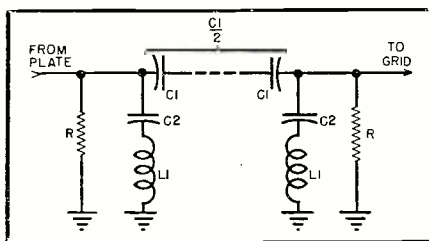
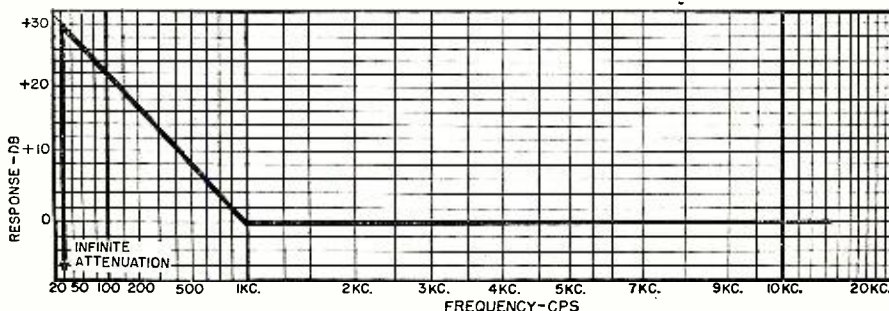

Fig. 3. Generalized circuit for the high-pass rumble filter. The values of the various components depend on the cut-off frequency desired and can be determined from equations in the text.

Fig. 4. An ideal high-pass filter would give this type of amplifier response.





quency varies no more than a few cycles.

The filter described in this article and shown in Figs. 1 and 2 was designed for a system using a well-known European three-speed changer, but was found to work equally well with a system using a very popular American-made changer. The type of filter chosen to do the job was a pi-section filter composed of two series  $m$ -derived half-sections put together. The schematic is shown in Fig. 3, and the values of the various components may be determined by the following equations:

$$f_c = \frac{f_f}{\sqrt{1-m^2}} = 1.25f_f = 30 \text{ cps}$$

where  $f_c$  is the cut-off frequency of the filter,  $f_f$  is the frequency of maximum attenuation or flutter as determined by the "strobelight" (24 cps), and  $m$  is 0.6. (The latter value has been empirically determined and gives an attenuation characteristic that most nearly approximates the ideal shown in Fig. 4.)

$\frac{C_1}{2} = \frac{1}{2m(2\pi f_c)R} = \frac{4420}{R} \mu\text{fd. (approx.)}$   
where  $R$  is the characteristic impedance of the filter network.

$C_2 = \left(\frac{m}{1-m^2}\right) \frac{1}{2\pi f_c R} = \frac{4976}{R} \mu\text{fd. (approx.)}$   
and

$$L_1 = \frac{R}{2\pi f_c m} = 0.00884R \text{ hy. (approx.)}$$

The resistance  $R$ , which appears in Fig. 3 and the preceding equations, is the characteristic impedance of the filter, and may be determined only when the value of the inductors at cut-off frequency is known. The filter must be terminated with this resistance in order to prevent wave reflections back through the network.

Because the rumble filter described in this article was highly successful with two different makes of three-speed changers, the author recommends the filter circuit shown in Fig. 6. The response curve for the recommended filter is shown in Fig. 5. The cut-off frequency for the filter is 30 cps with maximum attenuation occurring at 24 cps.

The inductors used in the circuit of Fig. 6 were UTC type O-13. There may be some difficulty in getting the same type of inductances and, if a substitution must be made, it would be wise to test the new inductors in a series-resonant circuit for the values of "Q" and  $L$  at the cut-off frequency,  $f_c$ . Such a test circuit is shown in Fig. 7. A trial and error method of determining the value of capacitance needed may be used in place of a decade condenser box.

For determining the inductance by means of this test setup, change the capacitance in the circuit until a maximum voltage drop is obtained across the resistor, indicating resonance in the circuit. The inductance  $L_x$  is then equal to  $1/(4\pi^2 f_c^2 C)$ . The "Q" of the

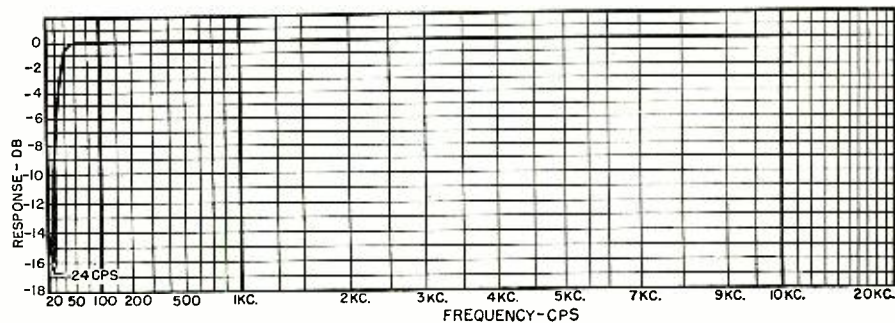

Fig. 5. Bandpass characteristic of the rumble filter shown in Fig. 6.

coil can then be obtained from the equation " $Q$ " =  $2\pi f_c L/R$ , where  $L$  is the value of the inductance just measured,  $R$  is the d.c. resistance of the coil, and  $f_c$  is the cut-off frequency.

If it is convenient, the inductances used in the filter should have equal values of "Q"—the higher the better. It may be most convenient to get the inductors first and then calculate their "Q" and  $L$  at the desired cut-off frequency. The values of the other components are easily calculated after this. Although the use of a specific inductor is cited here because it is ideally suited to this application, it is entirely possible that other inductors may be used with equal efficiency.

Originally, the rumble filter was intended to be placed in the output circuit of the second stage in the pre-amplifier. However, the hum pickup here was very noticeable without magnetic shielding. A small condensed milk can which had been emptied and then opened by melting the solder over a stove was just large enough to hold the filter and provided an excellent magnetic shield. (See Fig. 2.) This reduced hum to a very low level. Later, the filter was transferred to the input stage of the main amplifier where it worked just as effectively and with no hum whatsoever. Fig. 8 shows the schematic of that part of the main amplifier circuit containing the rumble filter.

The addition of the filter changed the over-all frequency response curve of the amplifier, as shown in Fig. 9. The dotted line shows the original response characteristic. This response is in some respects far removed from the ideal—but flutter was reduced to a negligible amount over normal operating volume levels with no noticeable difference in the audible bass response of the system. —50—

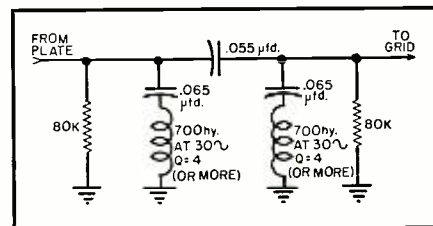

Fig. 6. Schematic diagram of the high-pass rumble filter. Other values for the components may be used but they must be determined from the equations in the text.

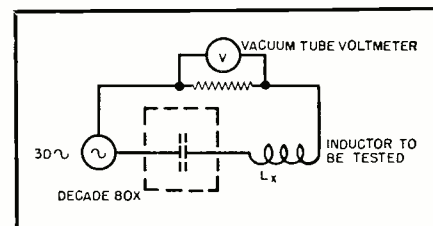

Fig. 7. Test setup for determining the "Q" and inductance of an inductor for use in the filter at the cut-off frequency.

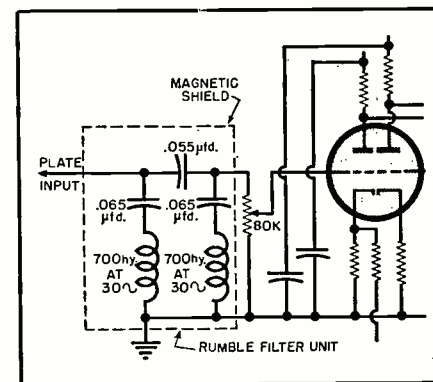
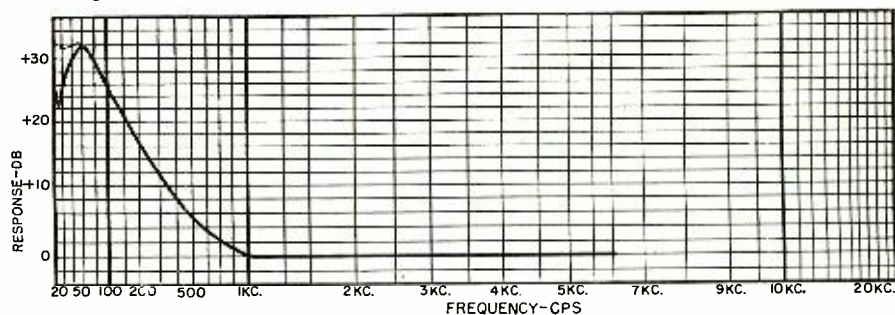

Fig. 8. Schematic of filter as installed in an amplifier input circuit. This rumble filter is also effective when put in the phono preamplifier circuit.

Fig. 9. Actual amplifier frequency response curve with the rumble filter added.



# REGULATING THE SPEED OF RECORD PLAYERS

By HERMAN BURSTEIN

*The simple devices described here may be incorporated in many of the popular three-speed record changers.*

**D**UE to the latitude of practical manufacturing tolerances and often because of voltage variations, three-speed changers are sometimes inaccurate at one or more speeds. Whereas professional standards call for a maximum deviation of .3 per-cent from required speed, errors as high as 5 per-cent and more are sometimes found in commercial changers. Trained ears, and often untrained ones, are offended by the resulting departure from correct pitch in reproduced music.

It has been found that the speed of a *Webster* three-speed changer can be corrected by varying the tension on the spring between the mainplate of the changer and the link bearing the idler wheel which moves the turntable. When the turntable and idler wheel are removed, this spring is exposed to view. Increasing the spring tension (shortening the spring) serves to decrease speed and *vice versa*.

While changing the length of the idler link spring will achieve reasonable accuracy for one given speed, say 33½ rpm, this may not achieve the same degree of improvement for the other two speeds. In fact, the other speeds may become less accurate. Therefore the writer has installed in his *Webster* changer a simple device for varying, at will, the tension of a spring connected to the idler link. With a few modifications, this device may be used with almost all three-speed changers.

First the idler link spring was removed. Then a short piece of strong

nylon fishline was tied to the idler link hole where the spring was previously attached, see Fig. 1. The line was passed through the hole in the mainplate where the other end of the spring was formerly hooked, underneath the mainplate, and tied to a small swivel of the type used for fishing lures. The swivel in turn was connected to one end of a fairly stiff spring and the other end of the spring was inserted in a hole drilled through the end of a thumbscrew mounted at the rear of the changer, see Fig. 2.

A hole for the thumbscrew was drilled through the rear rim of the mainplate so that the screw lies on a horizontal plane, with its threaded end pointing to the front of the changer. The screw passes through the hole and threads onto a nut, on the other side of the rim (the inside). This nut is kept in place and prevented from turning by the pressure of a small piece of metal bolted to a closely adjoining hole.

Turning the thumbscrew in one direction or another increases or decreases the tension on the spring attached to it, correspondingly changing the degree of pull on the idler link exerted through the swivel and fishline, and altering the speed of the changer within a small but sufficient range. (It was found that the original idler link spring was not rigid enough to provide the desired degree of speed variation in a few turns of the thumbscrew, so a spring of greater rigidity was substituted.)

In order to facilitate frequent speed

checks, an NE-45 neon lamp was installed on the changer. A candelabra base for the lamp was affixed to the rear of the mainplate by means of the *Phillips* screw which secures one of the changer's mounting springs. Current for the lamp is taken from the a.c. leads between the phonograph "on-off" switch and the motor (see Fig. 2) so that the NE-45 is lighted whenever the phonograph is on. Thus, the lamp not only provides proper light for observing a strobe card but also serves as a safeguard against failure to shut off the phonograph. Current consumption is negligible, for the NE-45 uses only about ¼ watt. A 6 or 7 watt bulb may be used if it is found that the NE-45 does not provide enough light.

As previously stated, professional standards call for a maximum frequency deviation of .3 per-cent. When using a strobe card this means that not more than 21 bars (or dots) per minute should appear to pass a given point. This is true for all speeds. The following explanation of the strobe card principle will help the reader understand how the standard of 21 bars is calculated. A speed of 33½ rpm is assumed for purposes of explanation.

A neon lamp on 60-cycle current flashes 120 times per second—60 times positive and 60 times negative—or 7200 times per minute. If the phonograph turntable revolves exactly 33½ times per minute, the lamp flashes 216 times per revolution (7200 divided by 33½). Conversely, each flash corresponds to 1/216 revolution of the turntable. Inasmuch as the 33½ section of a strobe card has 216 bars (or dots), each flash illuminates a bar that has arrived in exactly the same position that was occupied in the preceding flash by the bar ahead of it. This, aided by persistence of vision, produces the illusion of the bars remaining stationary. However, if the turntable is fast, each bar moves more than one bar distance during the interval between flashes, so that the bars appear to be moving clockwise. Similarly, a slow turntable causes the strobe card bars to seem to move counterclockwise.

Returning to the fact that the neon lamp flashes 7200 times per minute and illuminates 7200 bars during this period (33½ revolutions x 216 bars in the case of a 33½ strobe card), a .3 per-cent error in turntable speed is .003 x 7200 bars, or 21.6 bars.

It will be noted that the 78 rpm section of the strobe card does not contain the same number of bars as the 33½ section. For testing 78 rpm, the strobe card uses 92 bars. When the neon lamp flashes 7200 times per minute, it still illuminates 7200 bars on 78 rpm because 92 x 78 equals approximately 7200. As before, a .3 per-cent error in turntable speed at 78 rpm would cause approximately 21 bars to appear to pass a given point.

In much the same manner, a strobe card may be used for checking 45 rpm turntable speed. For this use, the strobe card contains 160 bars (or dots) in a circle.

Fig. 1. Top view of the modified record changer showing a fishline substituted for spring in hole of the idler pivot.

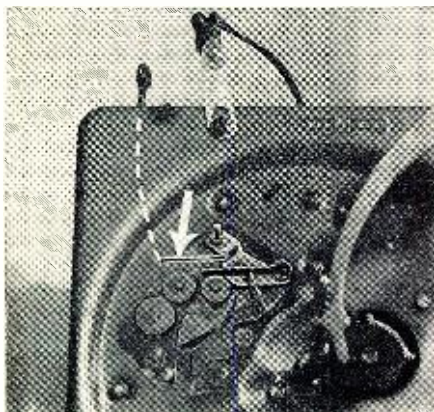
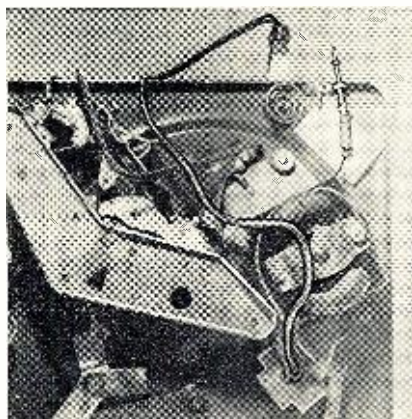

Fig. 2. Bottom view of changer showing thumbscrew assembly and neon lamp connection to "on-off" switch near motor.



# YOU be the Judge!

Let the Kay-Townes SUPER-KATY  
prove its superiority over  
**ALL** other TV antennas  
on the market today!



Here's why the famous  
**KAY-TOWNES**

*Super* **KATY**

wins in every case!

- FAR REACHING Reception!
- New MOLDED, RIBBED INSULATOR for low water absorption!
- New RIGID Construction to withstand gale-force winds!
- EASY Installation!
- LESS DEPTH on mast!
- Best by Color-Test!  
Super Katy has been proved the best antenna for fine color reception by actual field tests.

Every Super Katy installed  
will bring **NEW SALES!**

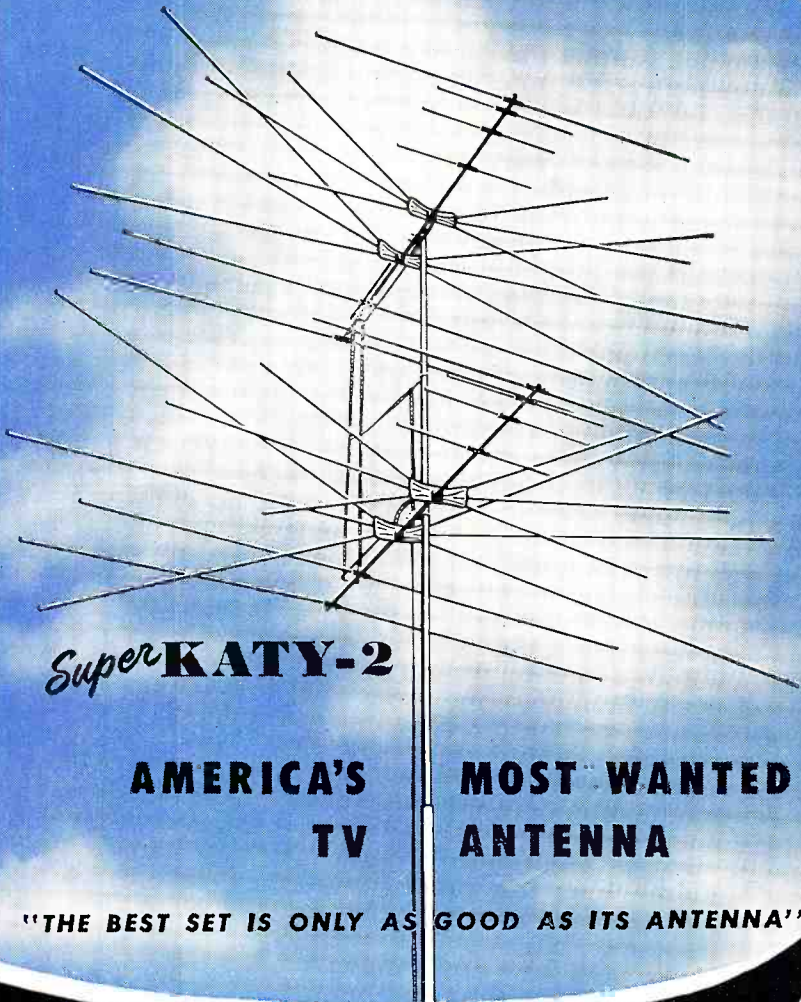

*Super* **KATY-2**

**AMERICA'S MOST WANTED  
TV ANTENNA**

"THE BEST SET IS ONLY AS GOOD AS ITS ANTENNA!"

### The long reach, long profit antenna

"Fringe area" dealer-servicemen in every part of the country are reporting outstanding sales and service stories... and, mounting TV consumer demand! The new, revolutionary Super "KATYS" have now convincingly proved every quality and performance claim attributed to them.

Kay-Townes' original SUPER KATY design... now amazingly improved... will out-perform any other competitive antenna on the market today, regardless of type or design principle!

Manufactured and Distributed in CANADA: By  
DELHI METAL PRODUCTS, LTD., DELHI, ONTARIO

**KAY-TOWNES  
ANTENNA CO.**  
ROME • GEORGIA

*Originators of*  
the **BIG-JACK**  
*the world's most Copied TV Antenna*

# Mac's RADIO SERVICE SHOP

By JOHN T. FRYE

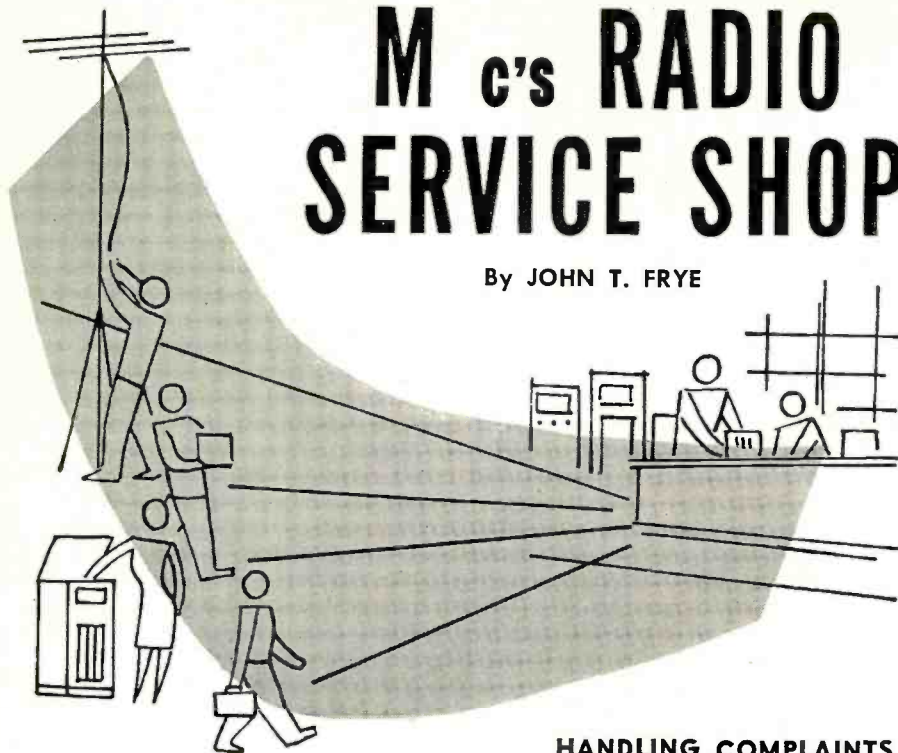

## HANDLING COMPLAINTS

ON THE way back from his lunch hour, Mac took a short cut and quietly ducked in the back door of his service shop. As he stepped inside, he could hear his assistant, Barney, talking with a customer out front. Mac's forehead creased in a frown as he listened.

"Now I hope you're satisfied, Mr. Carney," the youth was saying. "You've got a tube for nothing, just as you wanted, even though you didn't have it coming."

"I got it because you weren't able to wiggle out of giving it to me," the customer said angrily as he slammed out the door.

"Man, those characters kill me!" Barney complained bitterly as he came back into the service department. "A week ago we put a new 50C5 in that joker's set, and today a 35W4 went out. In his book, that's our fault; so we owe him a new tube for free. Finally I got so fed up with his belly-aching I gave him the tube to shut him up. Was that OK?"

Without answering Mac seated himself on the service bench stool and waved Barney to his favorite perch on the end of the bench. "I think it is high time we had a little heart-to-heart on the general subject of handling complaints," the older man said. "I was listening to that little skirmish you had with Mr. Carney, and I think the technique you displayed leaves a little something to be desired."

"Guess you're right," Barney readily admitted. "I was too soft. I should have tossed him out of the store."

"Overlooking the fact that Brother Carney outweighs you by at least sixty pounds and could play you like an accordion, that's not exactly what I had in mind," Mac answered; "but let's

examine the whole thing from the beginning:

"In the first place, we may as well face the fact that every service shop is bound to have some complaints. This would be true even though Marconi himself did the service work and the angel Gabriel sat in the front office to handle public relations. In fact, we may go a step further and admit that some of these complaints will be justified—at least from the point of view of the average customer who knows from nothing about electronics."

"Let's not admit any more than we have to," Barney cautioned.

Mac grinned and went on: "You know as well as I that sets have a fiendish ability to perform perfectly on the test bench and then to misbehave most shamefully as soon as they are in the customer's house. Quite often there are natural explanations for this perverse behavior. In many cases a difference in the line voltage present at the shop and at the customer's home is at fault. For example, the oscillator of a three-way portable will often quit dead when the line voltage falls below a certain critical value but will run merrily all day long on a line voltage that is only two or three volts higher. There are other cases in which an output tube that is being worked right up to the limit of its voltage ratings will start secondary emission from the screen if the line voltage rises five volts, and you know how much trouble that can cause. Finally, we are both familiar with the host of changes that can take place in a TV set when the line voltage hops up or down a few volts. Yet most customers think the line voltage is identical in all parts of a city.

"Still worse, though, is the fact that

the voltage can be all right and yet individual house wiring can have a pronounced effect on reception in a set, especially if that set uses a built-in loop antenna. I have seen many cases where switching on a certain house circuit will produce very noticeable changes in the strength of a received signal. Part of this may be due to a condition wherein adding or subtracting one circuit from the house wiring can throw the whole wiring system in and out of resonance with a broadcast signal or change the position of standing waves on that system. In other cases the various wires and grounded conduit in the ceiling and walls may exert a shielding effect on the loop antenna such as is produced by the girders of a steel bridge on a car antenna. At any rate, I know of two houses in which a loop antenna receiver will not work satisfactorily. If the set is put on an extension cord and taken outside, the signal comes up the instant you step across the threshold; but inside the house, reception is very weak. The only solution is to install an outside antenna.

"And finally there is the plain cussedness of inanimate objects—and every true technician believes devoutly in this—that causes a receiver to fail between the time the service technician switches it off and the time the set owner turns it on. The technician who has not had this embarrassing, hard-to-explain experience happen to him has not been in the game very long."

"On the other hand," Mac continued, "there are many complaints that are not justified at all."

"Go on!" Barney urged eagerly. "This is the part I like."

"Well, all of us have customers who seem to think that once we have worked on a set and collected a service charge we are obligated to keep it running from that day forth without any further compensation."

"Yeah," Barney agreed. "Those guys remind me of something I was just reading. It seems that if you save a man's life in China his life then becomes your sole responsibility, and you are supposed to feed and care for him the rest of his days—or yours. Those customers you are talking about try to apply the same line of reasoning to their sets."

"The thing to do with these people is to impress on their minds the real facts of your service guarantee. Make it clear you only stand behind your own work, and even here your guarantee is for a reasonable length of time and not for life. Point out that when the radio was bought brand-new, it was very likely guaranteed for only ninety days. Compare that with the full one-year warranty most service shops put on any parts they install. Above all, however, make it crystal clear that your guarantee applies only to the parts you replace and not to the whole set."

"A big trouble there is that widely  
(Continued on page 92)

The easy way  
is the right way . . .

when you use *Mallory Midgetrols*®

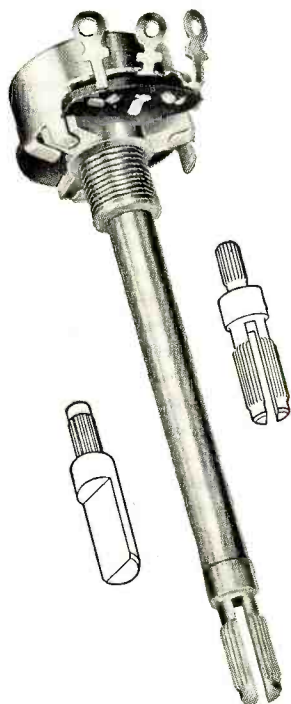

*Easy*

because the round, tubular shaft of the Mallory Midgetrol can be cut accurately and quickly. Easily adapted to split-knurl, flatted, or set screw type knobs. And you save additional time because AC switches can be attached instantly without control disassembly.

*Right*

because Mallory Midgetrols are engineered to match the electrical characteristics of original equipment of any radio or TV set . . . give equal, often better, performance than the original control.

*For Jobs*

done right the easy way, always use Mallory Midgetrols. You'll save time and trouble. And, equally important, you can depend on Mallory Midgetrols for performance that makes satisfied customers.

*To make your auto radio repair work easier . . .*



The new Mallory Auto Radio Control Guide speeds selection of the proper control for every job that comes your way. Ask your Mallory Distributor for a copy . . . or write to P. O. Box 1558, Indianapolis, Ind.

P. R. MALLORY & CO. Inc.  
**MALLORY**

CAPACITORS • CONTROLS • VIBRATORS • SWITCHES • RESISTORS  
RECTIFIERS • POWER SUPPLIES • CONVERTERS • MERCURY BATTERIES  
**APPROVED PRECISION PRODUCTS**

**P. R. MALLORY & CO. Inc., INDIANAPOLIS 6, INDIANA**

**Miniature Preamp**  
(Continued from page 41)

equalizer. The deviation is the output of the second stage  $V_{1B}$ . In the original the outputs are separated into positions for the standard (78 rpm) records and for the LP's (both 33 and 45 rpm). The output for the 78's is divided down for the lower output voltage while that for LP is not. Component-wise the circuit follows the Scott circuit but the feedback networks are made in the style of the Centralab "Couplate." These five "Couplates" are special units and are not currently available. They are shown in connection with this piece of equipment merely to demonstrate the adaptability of printed circuits to the audio field. There are five of these circuits. The components which these replace are shown within the dotted lines at the lower left-hand corner of Fig. 4. Fig. 2 is the schematic for these five plates with the component values indicated. From this diagram the reader can see just how many connections and components are saved by using printed circuitry.

Response curves for the complete unit are shown in Fig. 6. The input was fed into  $J_1$  at 1 mv. and the output was read at  $J_3$ . Gain was maximum throughout. These curves include the total response for the unit

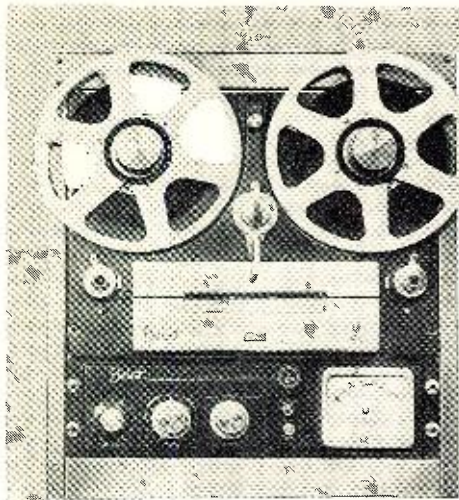

*New*  
**BERLANT BROADCAST RECORDER \$545<sup>00</sup>**

**ANSWERS THE NEED**

In a nation-wide questionnaire the chief engineers of radio stations and recording studios were asked to set the specifications for the ideal professional tape recorder. They did... THIS IS IT!

**PERFORMANCE**

Every requirement of frequency response, freedom from distortion, stability of motion, dynamic range, timing accuracy and tape handling ability, is met and exceeded by this recorder at both tape speeds.

**DEPENDABILITY**

Designed and built for continuous operation under the most rigorous conditions, this recorder combines rugged components and advanced engineering to guarantee maximum dependability with minimum maintenance.

**SIMPLICITY**

New concepts in design, construction and operation result in a functional simplicity that is reflected in the recorder's performance, dependability and last, but not least—economy.

**TO THE ENGINEER**

Compare this machine, point by point, with any other recorder on the market, regardless of price. You will find it the ideal recorder for your needs.

WRITE FOR BROCHURE NUMBER 55

**BERLANT ASSOCIATES** 4917 W. JEFFERSON BLVD. LOS ANGELES 16, CALIF.

*Bert Berlant*

MANUFACTURERS OF *Concertone* WORLD'S FOREMOST HIGH FIDELITY TAPE RECORDERS AND ACCESSORIES

**AUDELS TV-RADIO SERVICE LIBRARY**

HERE IS LATE INFORMATION IN A HANDY FORM FOR RADIO AND TELEVISION REPAIRMEN, SERVICEMEN AND STUDENTS



2 VOLS. \$6 COMPLETE \$1 A MONTH PAY ONLY

AUDELS T.V.-RADIO SERVICE LIBRARY—Highly Endorsed—1001 Facts—Over 1552 Pages—625 Illustrations, Diagrams of Parts. Presents Important Subjects of Modern Radio, Television, Industrial Electronics, F.M., Public Address Systems, Auto, Marine & Aircraft Radio, Phonograph Pick-Ups, etc.

**IT PAYS TO KNOW!**

The Basic Principles—Construction—Installation—Operation—Repairs—Trouble Shooting. Shows How to get Sharp, Clear T.V. Pictures. Install Aerials—How to Test, Explains Color Systems, Methods of Conversion, Terms, etc. Includes Ultra High Frequency (U.H.F.)—Valuable for Quick Ready Reference & Home Study. Tells How to Solve T.V. & Radio Troubles—Answers Your Questions.

Get this Information for Yourself. 7 DAY TEST—ASK TO SEE IT!

**MAIL ORDER**

AUDELS, Publishers, 49 W. 23 St., N.Y. 10, N.Y. Mail AUDELS T.V. RADIO SERVICE LIBRARY 2 Vols. \$6 on 7 days free trial. If O. K. I will remit \$1 in 7 days and \$1 monthly until \$6 is paid. Otherwise I will return them.

Name \_\_\_\_\_  
Address \_\_\_\_\_  
Occupation \_\_\_\_\_  
Employed by \_\_\_\_\_ RN

**STAY ON THE AIR WHEN POWER FAILS...with an ONAN Electric Plant**



**AUTOMATIC START & STOP**

Model 10EL, 10KW A.C.

When storms, floods, or fires interrupt electricity and force you off the air, you lose listeners and income. Guard against loss, assure vital public service during emergencies by installing an Onan Electric Plant. Onan Standby Electric plants serve many network and private stations. Gasoline driven automatic models to 50,000 watts.

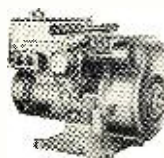

PORTABLE ELECTRIC PLANTS FOR MOBILE RADIO USES

Supply A.C. power for broadcasting at scene of events. Light in weight. Can be carried by hand or in trunk of car. A.C. models: 400 to 3,500 watts.

Write for **FREE Folder**

**D. W. ONAN & SONS INC.**  
7904 University Avenue  
Minneapolis 14, Minnesota

Fig. 6. Gain vs frequency of the equalizer with input at  $J_1$  equal to 1 mv. See text.

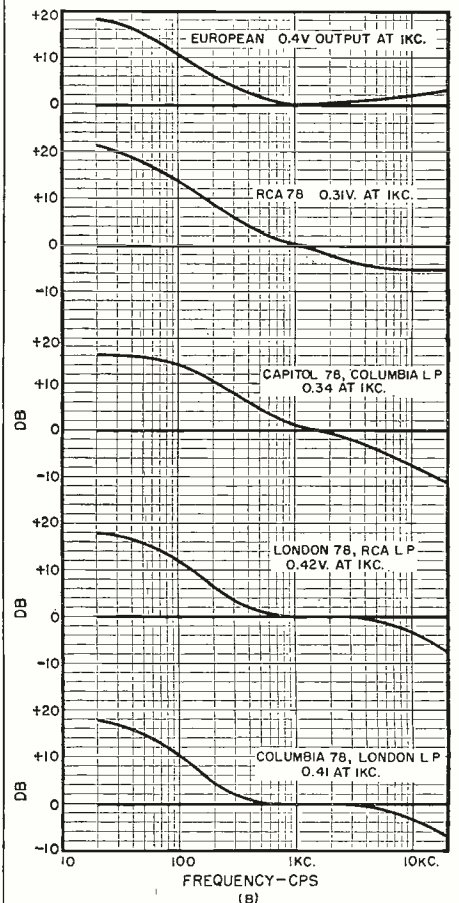

# OUR 34th YEAR AS RADIO PARTS DISTRIBUTORS

**DON'T READ THIS AD—**  
If you are looking for cheap tubes,  
but if you want **GOOD TUBES** at reasonable prices this is for YOU

**PREMIER Unconditionally Guarantees All Tubes For One Full Year**  
VERY BEST BRANDS AVAILABLE FOR IMMEDIATE DELIVERY. INDIVIDUALLY BOXED.

0A4G...1.19	6AC5GT...89	6F5GT...59c	6X8...1.29	12BH7...89	35Y4...95c
024...59c	6AC7...1.49	6F6GT...59c	6Y6...69c	12BY7...89	35Z3...69
0240...79	6AF4...1.76	6F7...1.59	74A...95	12BZ7...1.19	35Z4...59
1A5GT...79	6AG5...99	6F8...1.59	74A...95	12F5GT...89	35Z5...59
1A7GT...79	6AG7...1.49	6G6...95	7A5...89	12H6...35	5L...99
1B3GT...95	6AJ5...2.95	6H6GT...69c	7A7...79c	12K7GT...69c	36...95c
1H4...29c	6AK5...89	6J5GT...59	7A8...89	12K8...89	37...95c
1H5GT...59	6AK6...1.19	6J6...79	7B4...89	12Q7GT...89	38...88c
1J6GT...59c	6AL5...69c	6J7...69	7B5...89	12S6...89	41...69c
1L4...1.19	6A05...69c	6K5GT...69	7B6...89	12S7GT...95	42...89
1L6...1.29	6AR5...79	6K6GT...59	7B8...89c	12SFSGT...69	45...69
1L8...1.19	6AS...89	6K7GT...59	7C4...1.29	12SF7...69	45Z5...69
1LA6...1.19	6AS5...59	6K8GT...1.19	7C5...89	12SG7...89	46...89c
1LC5...69	6AS5...59	6L5...95	7C6...95	12SH7GT...89	47...89c
1LC6...1.19	6AU5GT...1.29	6L6...1.39	7C7...79c	12S7GT...69	50A5...95
1LD5...1.19	6AU6...89	6L7...1.19	7E6...79c	12SL7GT...69	50B5...69c
1LE3...1.19	6AV...59	6N6G...1.29	7E7...79c	12SN7GT...95	50C3...1.29
1LH4...1.19	6AV5GT...89	6N7GT...1.19	7F7...89	12S07GT...69c	50C6...79
1LN5...1.19	6AV6...59	6P5GT...69	7F8...1.49	12S7GT...69c	50X6...69
1N5GT...79c	6AX5...79	6P7GT...69	7G7...1.19	12S8GT...95	50Y6...95
1P5GT...79c	6AX6...69	6Q7GT...69	7G8...1.19	12Z3...95	57...79c
1Q5GT...79c	6AX7...69	6R7GT...69	7H7...1.19	14A7...95c	58...79c
1R5...1.19	6AY5GT...89	6S4...59	7I7...1.19	14A7...95c	70L...1.49
1S4...95	6B4G...1.29	6S5GT...59	7K7...1.19	14A7...95c	70L7GT...1.49
1S5...95	6B4G...1.29	6S6GT...59	7L7...79	14A7...95c	71A...79c
1T4...69c	6BA5...59	6S7GT...59	7M7...79	14B6...89c	77...69
1T4...69c	6BA7...89	6S8GT...59	7N7...79	14B8...89c	78/606...99
1U5...59	6BC5...69	6S9GT...59	7O7...79	14C5...1.19	80...89
1V2A...89c	6BD5GT...89	6T7GT...59	7P7...1.19	14D7...1.29	83...1.49
2A6...89c	6BF5...59	6U5GT...59	7Q7...1.19	14E7...1.29	84/624...69
2A7...89c	6BF6...69c	6V5GT...59	7R7...1.19	14F8...1.29	85...79
2B3...89	6BG6...1.89	6W5GT...59	7X6...95	14G7...95	VR90...1.19
2B7...89	6BG6G...1.89	6X5GT...59	7X7...79c	14H7...1.19	VR105...1.49
2E5...89	6BH6...69c	6Y5GT...59	7Z4...79	14X7...1.19	VR150...1.49
2X2/879...89	6BJ6...69c	6Z5GT...59	7Z5...79	14Y7...1.19	V751...29c
2A6...89c	6BK6...1.19	6Z6GT...59	7Z6...79	14Z7...1.19	V752...29c
2A7...89c	6BL7...79	6Z7GT...59	7Z7...79	12A7...1.49	117L7...1.49
304...69	6BL7...79	6Z8GT...59	7Z8...79	12A8...69	117N7...1.89
305GT...89	6BN6...1.19	6Z9GT...59	7Z9...79	12A9...69	117P7...1.89
354...69	6BQ6G...1.19	6Z0GT...59	6S0GT...59	12A5...59	117Q7...1.89
354...69	6BQ6GT...1.19	6S1GT...59	6S2GT...59	12A6...59	117R7...1.89
5T4...1.29	6B07...1.19	6S3GT...59	6S4GT...59	12A7...59	117S7...1.19
5U4G...69	6B7...1.29	6S5GT...59	6S6GT...59	12A8...59	117T7...1.49
5V4G...89	6C4...59	6S7GT...59	6S8GT...59	12A9...59	117U7...1.89
5W4...59c	6C5GT...69c	6S9GT...59	6S0GT...59	12A5...59	117V7...1.89
5W4GT...59c	6C6...69c	6T0GT...59	6T1GT...59	12A6...59	117W7...1.89
5Y3GT...49	6C7...69c	6U0GT...59	6U1GT...59	12A7...59	117X7...1.89
5Y4G...59	6C8...69c	6V0GT...59	6V1GT...59	12A8...59	117Y7...1.89
5Y4G...59	6C9...69c	6W0GT...59	6W1GT...59	12A9...59	117Z7...1.89
5Y4G...59	6D0...69c	6X0GT...59	6X1GT...59	12A5...59	118A7...1.89
5Y4G...59	6D1...69c	6Y0GT...59	6Y1GT...59	12A6...59	118B7...1.89
5Y4G...59	6D2...69c	6Z0GT...59	6Z1GT...59	12A7...59	118C7...1.89
5Y4G...59	6D3...69c	6Z2GT...59	6Z3GT...59	12A8...59	118D7...1.89
5Y4G...59	6D4...69c	6Z4GT...59	6Z5GT...59	12A9...59	118E7...1.89
5Y4G...59	6D5...69c	6Z6GT...59	6Z7GT...59	12A5...59	118F7...1.89
5Y4G...59	6D6...69c	6Z8GT...59	6Z9GT...59	12A6...59	118G7...1.89
5Y4G...59	6D7...69c	6Z9GT...59	6Z0GT...59	12A7...59	118H7...1.89
5Y4G...59	6D8...69c	6Z0GT...59	6Z1GT...59	12A8...59	118I7...1.89
5Y4G...59	6D9...69c	6Z1GT...59	6Z2GT...59	12A9...59	118J7...1.89
5Y4G...59	6E0...69c	6Z2GT...59	6Z3GT...59	12A5...59	118K7...1.89
5Y4G...59	6E1...69c	6Z3GT...59	6Z4GT...59	12A6...59	118L7...1.89
5Y4G...59	6E2...69c	6Z4GT...59	6Z5GT...59	12A7...59	118M7...1.89
5Y4G...59	6E3...69c	6Z5GT...59	6Z6GT...59	12A8...59	118N7...1.89
5Y4G...59	6E4...69c	6Z6GT...59	6Z7GT...59	12A9...59	118O7...1.89
5Y4G...59	6E5...69c	6Z7GT...59	6Z8GT...59	12A5...59	118P7...1.89
5Y4G...59	6E6...69c	6Z8GT...59	6Z9GT...59	12A6...59	118Q7...1.89
5Y4G...59	6E7...69c	6Z9GT...59	6Z0GT...59	12A7...59	118R7...1.89
5Y4G...59	6E8...69c	6Z0GT...59	6Z1GT...59	12A8...59	118S7...1.89
5Y4G...59	6E9...69c	6Z1GT...59	6Z2GT...59	12A9...59	118T7...1.89
5Y4G...59	6F0...69c	6Z2GT...59	6Z3GT...59	12A5...59	118U7...1.89
5Y4G...59	6F1...69c	6Z3GT...59	6Z4GT...59	12A6...59	118V7...1.89
5Y4G...59	6F2...69c	6Z4GT...59	6Z5GT...59	12A7...59	118W7...1.89
5Y4G...59	6F3...69c	6Z5GT...59	6Z6GT...59	12A8...59	118X7...1.89
5Y4G...59	6F4...69c	6Z6GT...59	6Z7GT...59	12A9...59	118Y7...1.89
5Y4G...59	6F5...69c	6Z7GT...59	6Z8GT...59	12A5...59	118Z7...1.89
5Y4G...59	6F6...69c	6Z8GT...59	6Z9GT...59	12A6...59	119A7...1.89
5Y4G...59	6F7...69c	6Z9GT...59	6Z0GT...59	12A7...59	119B7...1.89
5Y4G...59	6F8...69c	6Z0GT...59	6Z1GT...59	12A8...59	119C7...1.89
5Y4G...59	6F9...69c	6Z1GT...59	6Z2GT...59	12A9...59	119D7...1.89
5Y4G...59	6G0...69c	6Z2GT...59	6Z3GT...59	12A5...59	119E7...1.89

10% DISCOUNT ON ORDERS OF 100 TUBES OR MORE—  
5% DISCOUNT ON 50 TUBE ORDERS

**Write for our FREE BARGAIN CATALOG**

### HI-FI at LO cost

#### COAXIAL SPEAKERS

12" COAXIAL PM SPEAKERS. High Fidelity with Crossover filter attached; 20 watts; 40-19,000 cps. response; 8 ohm Voice coil. ea. \$12.95

10" coaxial speaker. Take advantage of your TV set's FM sound. This speaker matches and replaces 80% of all TV speakers. ea. \$10.95

15" COAXIAL SPEAKER. 20 WATTS. 17,500 cps. 25 watts. ea. \$9.95

12" COAXIAL SPEAKERS. High Fidelity with Crossover filter attached; 20 watts; 40-19,000 cps. response; 8 ohm Voice coil. ea. \$12.95

10" coaxial speaker. Take advantage of your TV set's FM sound. This speaker matches and replaces 80% of all TV speakers. ea. \$10.95

15" COAXIAL SPEAKER. 20 WATTS. 17,500 cps. 25 watts. ea. \$9.95

### P M SPEAKERS

Very best quality — NATIONAL BRANDS. Individually Packed.

3" ..... ea. \$1.39  
4" ..... ea. 1.58  
5" ..... ea. 1.59  
6" Special Price. ea. 1.79  
8" ..... ea. 3.13  
10" ..... ea. 5.11  
12" ..... ea. 5.91

5 x 7, 6 volt field auto radio speaker. \$1.89

### ELECTO VOICE SPI2-B

Rated BEST BUY In Saturday Review and Consumers Reports. The nation's most popular deluxe HI-FI speaker.

29.10

### AUDIOTAPE

For Your Tape Recorder IT SPEAKS FOR ITSELF

1200 ft. plastic base type 1251 —list \$5.50. Dealer net... 3.67

600 ft. plastic base type 651 —list \$3.50. Dealer net... 2.39

### New WEN "Quick HOT" Soldering Gun

Extra long narrow tips to reach tight spots. Practically indestructible.

Featherweight 5.95 but 135 watts!

### REAR SEAT SPEAKER KIT

Complete with heavy magnet 6 x 9" PM speaker, 70 ohm, grille, screen, switch kit, switch plate and brackets, all wiring harness and complete instructions.

All for only 6.57

### REGENCY RC-50

All channel UHF Converter. Much more gain than strips, and fits any set. Only... \$14.99

### UHF BOW TIE ANTENNA

Factory assembled, single-bay, ea. \$2.39

Two-bay array with matching device... \$4.51

Two-bay array with matching device, 3 mast sections, and UHF-VHF coupler... \$7.51

## TUBE KITS

## BEST BRANDS AT BEST PRICES

3V4, 1T4, 1R5, 1S5. List Value \$8.00. Tube Kit only \$1.98	SELENIUM RECTIFIERS
354, 1T4, 1S5, 1R5. List Value \$7.80. 4-Tube Kit \$1.98	75 mill. \$ .69
1U4, 354, 1S5, 1R5. List Value \$7.80. All Four Tubes for \$1.98	65 mill. \$ .79
11723, 1U5, 354, 1R5, 1T4, AC-DC Portable Kit. All for \$2.49	100 mill. \$ .89
12AT6 12BA6, 12BE6, 35W4, 50B5. 5 Tubes for \$2.59	150 mill. \$ 1.29
50LGGT, 35Z5GT, 12S07GT, 12S47GT, 12SK7GT. 5 Tubes for \$3.49	250 mill. \$ 1.65
	300 mill. \$ 1.75
	350 mill. \$ 1.95
	400 mill. \$ 2.45
	450 mill. \$ 2.49
	500 mill. \$ 2.55

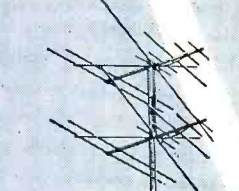

### DOUBLE CONYAGI

The equivalent of 40 dipoles. Newest development for long distance TV reception. MONEY BACK GUARANTEE. This is a BIG ANTENNA. Reflectors 9 feet long. Conical elements over 10 feet long. Solid rugged wind proof construction. List Price \$49.95

DEALER NET. Complete with lead, mast, mount and everything you need for professional installation \$22.94

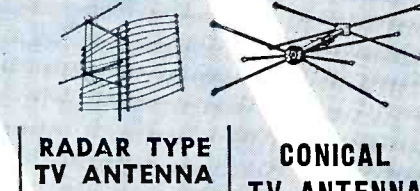

### RADAR TYPE TV ANTENNA

For UHF and VHF RECEIVES ALL CHANNELS

212 miles reception recorded. 125 miles common. This unbeatable antenna has been reinforced to withstand 150 mile winds.

Satisfaction guaranteed or your money back. Less Mast, List Price \$49.95. Your Cost. \$19.95

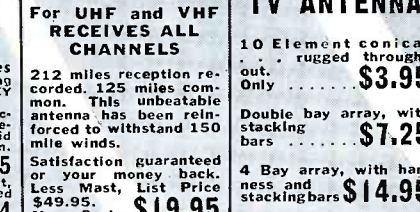

### CONICAL TV ANTENNA

10 Element conical rugged throughout. \$3.95

Double bay array, with stacking bars \$7.25

4 Bay array, with harness and stacking bars \$14.95

### 300 OHM TWIN LEAD

55 Mil. 100 ft. \$1.59  
985

1000 ft. \$1.89

20 Ga., 80 Mil. 100 ft. \$1.95

1,000 ft. \$16.95

UHF TUBULAR 300 OHM LINE

1,000 ft. \$29.50

100 ft. \$3.95

All Channel Foam Line, 100 ft. for \$6.95, 50 ft. for \$3.95

### TV MASTS AND HARDWARE

Bargain Chimney Mount \$1.89

Stainless Steel Chimney Mount. Net. \$2.50

Twelve lead ins. each 3c

Mortar nail insulator each 8c

Mast Ins. each 15c

Ten foot mast. Seamless, expanded end, sturdy enough for the largest arrays. \$2.39

Only. \$2.39

5 ft. DURABLE MAST, heavy gauge 1/4" diam, with interlocking end. Slip two sections together for a ten-foot. 5 sections = 25 ft. Each section. \$1.25

FILTER CONDENSERS		MOLDED TUBULAR BY-PASS CONDENSERS		MISCELLANEOUS BUY
FP Type or Tubular with Fresh Stocks Always				6-foot LINE CORD UL 10 for \$1.00
8 mfd. 450V. .35	80-40 450V. 1.29	600 VOLT .001		TV INTERLOCK CORDS ea. 4 I. F. TRANSFORMER-456 \$3.31
8-8 450V. .45	10 mfd. 50V. .19	600 VOLT .002		
10-10 450V. .39	20- 50V. .19	600 VOLT .005	9c	PILOT LIGHTS. Type No. 41 10 for 39c. 100 for \$2.19
20- 450V. .45	50- 50V. .25	600 VOLT .01	12c	VOLUME CONTROLS WITH SWITCH. 2" shaft, 1 meg. 1/2 meg. 1/4 meg. .3
20-20 450V. .49	100- 50V. .29	600 VOLT .05	12c	SINGLE ION TRAPS... 1
30-30 450V. .45	20 mfd. 150V. .35	600 VOLT .1	19c	DOUBLE ION TRAPS... ea. 2
30-30 450V. .59	20-20 150V. .45	400 VOLT .25	19c	OUTPUT TRANSFORMER- for 50L6, 29c; for 6V6, 3
40-40 450V. .69	30-30 150V. .49			
60 450V. .89	40-20 150V. .49			
60-40 450V. .89	40-40 150V. .49			
80 450V. .89	50-30 150V. .49			

### 21" TV CONVERSION KIT COMPLETE WITH CABINET AND NEW TUBE

15 Month Guarantee

Now you can make that conversion. This table model cabinet eliminates your bottle neck. Supplied complete with 21" picture tube, 70 degree yoke, gold mast and safety plate, fly back transformer and width coil, very easy to install and all \$50.00

### TV CONVERSION KITS ALL NEW TUBES 15 Month Guarantee

Easily installed consisting of rectangular picture tube, A newly designed combination of horizontal output flyback transformer and wide angle deflection yoke for 90° applications. Flyback transformer develops 18.5 k.v. with 280 volts of B supply. Only a single 6CG6 driver and a GAX4 damper need be used to fully deflect the 90° sweep. AGC-FC winding is incorporated. Yoke is housed in a non-rigid shell so that expansion and contraction will not injure the windings. Complete with matching network and wire leads. Complete kit, including 6CG6, GAX4GT schematics and instructions for conversion procedure, \$38.45 value, only \$17.95 net.

Kit, as above, complete	Price
20" Kit, as above, complete	\$25.95
21" Kit, as above, complete	\$34.95
24" Kit Rectangular	39.95
24" Kit, Round	79.95
27" Kit, as above, complete	99.95
24" & 27" Rectangular Kits Contain 90° yoke.	

### RESISTOR KITS

Insulated 1/2, 1 & 2 watt assortment of most used values I. R. C. Ohmit Stackpole, Speer.

100 for... \$2.99

### TV Filament Resistor Kit

Replace GLO BAR resistors in ALL GLO television. Also used in Motorola, Hoffm, Sears, Pathe, Te tone, etc. Kit will place any temp. sensitive resistor. Net... \$1.49

### BIG SCREEN TV 90° matched unit deflection kit for 24 and 27 inch rectangular picture tubes. A newly designed combination of horizontal output flyback transformer and wide angle deflection yoke for 90° applications. Flyback transformer develops 18.5 k.v. with 280 volts of B supply. Only a single 6CG6 driver and a GAX4 damper need be used to fully deflect the 90° sweep. AGC-FC winding is incorporated. Yoke is housed in a non-rigid shell so that expansion and contraction will not injure the windings. Complete with matching network and wire leads. Complete kit, including 6CG6, GAX4GT schematics and instructions for conversion procedure, \$38.45 value, only \$17.95 net.

SIZE	PRICE	SIZE	PRICE
7JP4	17.95	16P4A 16"	21.95
8BP4	18.95	16LPA4 16"	24.20
10BP4 10"	14.95	16RPA 16"	21.95
12JP4 12"	17.95	16TP4 16"	21.95
12LP4B 12"	19.40	16WPA4 16"	22.20
12LP4A 12"	19.40	16YPA4 17"	22.95
14CP4 14"			

# Handle Tough Service Jobs

AS "SLICK" AS YOU DO THE EASY ONES!



## FIX ANY RADIO OR TV SET EVER MADE...

Easier . . . Better . . . Faster

How to troubleshoot the professional way

AM, FM and TV realignment made easy

Testing tips and ideas

A complete guide to TV service

Component problems and how to solve them

Special problems in battery sets, communications receivers, recorders, etc.

Servicing tuning and switching mechanisms

... and dozens of other subjects

Owning this big, up-to-the-minute book is like having two of the world's greatest electronic experts standing by your side on every job . . . telling you just what to do, exactly how to do it!

Written by Ghirardi and Johnson, Radio & Television TROUBLESHOOTING AND REPAIR is a complete guide to modern professional methods . . . the kind that really pay off big. Step by step, it takes you through service procedures . . . from locating troubles fast and with less testing to making repairs accurately and promptly.

For beginners, this giant book is a complete service training course . . . at only a fraction of the price you might expect. For experienced servicemen, it is the ideal way to "brush up" on specific jobs; to develop better methods and shortcuts; and to find quick answers to problems that will enable you to handle tough jobs as fast and accurately as you now handle the easy ones.

Contains 820 big pages. Over 400 clear pictures, diagrams and charts make things doubly clear.

Remember! More men now in good servicing jobs got their training from Ghirardi books than any others of their type . . . and this new book is the latest and greatest of them all! Practice from it for 10 full days AT OUR RISK!

### EXAMINE IT FREE!

Dept. RN-94, RINEHART & CO., INC.  
232 Madison Ave., New York 16, N. Y.

Send Ghirardi's new Radio & TV TROUBLESHOOTING AND REPAIR book for 10-day FREE EXAMINATION. If I decide to keep book, I will then promptly remit \$6.75 (plus a few cents postage) in full payment. If not, I will return book postpaid and owe you nothing.

Name .....

Address .....

City, Zone, State.....  
OUTSIDE U.S.A.—Price \$7.25 cash with order.  
Money back if book is returned within 10 days.

and should not be compared precisely to the curves published by manufacturers. The output voltages at 1 kc. are listed on the curves and thus are the levels taken for 0 db. Generally they run at .40 volt out and thus show that the over-all gain at 1 kc. is .40/.001 or 400. This is 52 db. At the low-frequency point (20 cps) the boost amounts to 20 db in most curves and the total is then about 70 db. These figures are representative of the requirements for most power amplifiers. Since the output of most magnetic cartridges is actually on the order of 10 mv. or more at the maximum gain setting, the curves would result in about 4 volts output—far more than required for living room listening unless the neighbor's living room is included in your audio system.

The photograph, refer to Fig. 5, illustrates wires that are used to connect the unit to the required external power source; "B+", heater, and ground. The jack,  $J_1$ , is shown with  $J_2$  directly below it. The screwdriver adjustments for the level sets are to the right and above the respective inputs. The output jack,  $J_3$ , can be seen at the extreme lower right of the photo. The dual knobs, labeled "gain" and "Compentrol" control those functions while the dummy dual knob labeled "selector-equalizer" controls that switching function. The arrow in Fig. 5 points to the "European" record setting and is switched clockwise through all the

remaining functions of the selector.

The five equalizer plates are visible in Fig. 5 at the sides of the equalizer switch.

The plates at the rear of the switch are the .1  $\mu$ fd. ceramic condensers,  $C_5$ ,  $C_6$ ,  $C_7$ ,  $C_8$ ,  $C_{10}$ , and  $C_{11}$ . Note that the switch is actually a 2 to 12 position one and since, in this case, only six positions were used the remaining terminal points were put into service as tie points for "B+", filter resistors, and other components that would have otherwise required extra terminal points.

The reader will note that the chassis is not crowded so there is no need to "cheat" on the assembly. Those who want to duplicate this construction using components for the not-available equalizer plates will have to use a slightly larger chassis since obviously something will have to give.

It is hoped that the prospective builder will be pleased by the quality of reproduction as well as by the ease of operation. It is left for him to incorporate whatever additional inputs, a.c. switching, etc. he desires. It is left for the manufacturer of equipment to determine whether his customers want gadgets and controls or simplicity along with their listening pleasure.

### REFERENCE

1. Wiener, R. & Nelson, N.: "The Compentrol—A Compact Loudness Attenuator." RADIO & TELEVISION NEWS, November 1953.

-50-

## EXTENDING COIL CALCULATOR RANGE

By ELBERT ROBBERSON

ONE of the handiest aids the experimenter or engineer can have around the lab is the Allied "Coil Winding Calculator." This device has one disadvantage and that is in not continuing its scale to include windings of spacings greater than 1/10th inch.

This factor prevents calculations being made for coils of wire any heavier than about #10 and completely rules out one of the most popular ham coil conductors, copper tubing. By means of a simple modification, however, the range may be increased to include coils of winding pitches as low as 3 turns-per-inch.

The scales are logarithmic, so intervals of a given length are halved in value, going to the left on the scale. This means that calibrations may be transferred to the unmarked portion of the rule from the part already marked, as long as this relation is kept in mind.

First mark a card opposite the graduations for 15, 20, 25, 30, 35, 40, 45, and 50 turns-per-inch. Then move the card to the left so the 50 turn mark is opposite 10 turns on the calculator scale. Transferring graduations from the card to calculator body will now give points

for spacings of from 3 up to 10 turns-per-inch.

Now, remove the slide, insert a strip of sheet metal in its place for backing and, with a razor blade, extend the window to the new 3 turn mark. Reassemble, and the calculator may now be used for figuring any sized coil.

-50-

The calculator window, backed by a steel strip, may be extended by using razor blade.

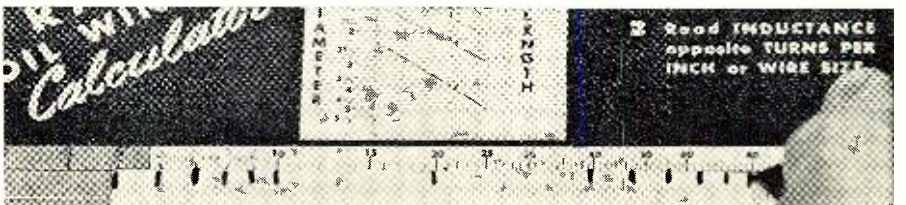



JFD ADVANCED ENGINEERING CREATES A RADICALLY NEW ANTENNA!

**INCREDIBLE**  
is the only way to describe the new JFD



**JET-HELIX**  
a radical new flat plane helical concept for VHF-UHF

**INCREDIBLE FEATURES!**

- delivers highest gain!
- outstanding front to back ratio!
- sharpest picture clarity!
- greatest fidelity color reception!
- finest snow-free, trouble-free performance!

**INCREDIBLE FACTS!**

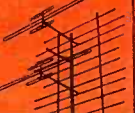
IT ALL ADDS UP TO A NEW HIGH IN S/N RATING

S/N FIGURE OF MERIT *		
JFD JET-HELIX — 57.85%		
ANTENNA A 	ANTENNA B 	ANTENNA C 
43.15%	31.85%	38.5%

\*The S/N Figure of Merit sums up the major individual characteristics of an antenna in one concise value. Write for S/N Figure of Merit engineering folder No. 299 for complete details.

THE JET-HELIX IS BETTER BY AN AVERAGE OF 44.5%

- The Microwave Helix design delivers record-shattering power and performance—highest signal magnitude on all channels with the least possible amplified noise!
- Only the Jet-Helix has been exhaustively pre-tested in the field by JFD engineers!
- Only the JFD Jet-Helix comes to you backed by the greatest consumer advertising support in antenna history—literally pre-selling the Jet-Helix for you!
- Yes, compare its Alcoa Aluminum construction, compare its pre-assembled convenience—compare the JFD Jet-Helix by any standards known—and you must agree—here is the New Star of Antennas—the JFD Jet-Helix!

THE JET-HELIX IS THE ONE ANTENNA THAT OUTPERFORMS ALL OTHERS IN FRINGE AREAS ON BOTH VHF-UHF

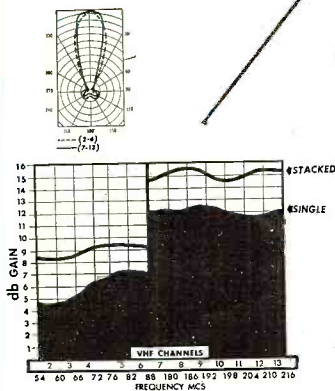
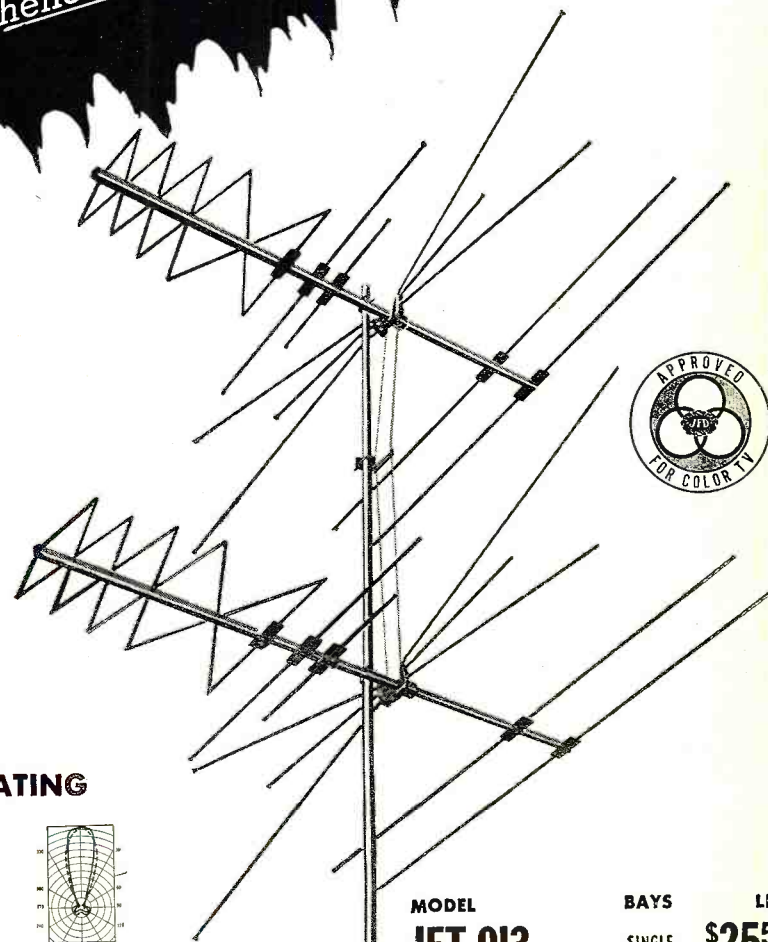

MODEL	BAYS	LI
JET 913	SINGLE	\$255
JET 913 S	STACKED	\$525
JET 913 S-5	HALF WAVE STACKED	\$550

DO NOT CONFUSE WITH OTHER SIMILAR ARRAYS! THIS ANTENNA IS RADICALLY NEW!



JFD MFG. CO., INC.  
BROOKLYN 4, NEW YORK

INTERNATIONAL DIVISION  
15 MOORE STREET NEW YORK C



### Sensational Value! 80-Meter Receiver

RCA Model AVR-20-A LIMITED QUANTITY! Originally designed for Aircraft and boats. Tunes 2300 to 6500 Kc. Perfect for 80 meter Ham work. Crystal controlled. Phone and CW. Provision for low and high impedance phones. Tubes used: 6B8, 6F7, 6S7, 6K8. 3-gang tuning cond. Vernier tuning. Designed for 6 volt operation. Easily converted to 110 volts AC. Less power supply. SENSATIONAL GIVE-AWAY. PRICE, WITH TUBES \$9.95 AS IS

### Terrific Transmitter-Receiver Buy! FAMOUS BC-645 450 Mc.—15 Tubes



BRAND NEW, in original carton! Easy to convert for phone or CW 2-way communication, covering these bands: 420-450 Mc Ham Band, 450-460 Mc fixed or Mobile 460-470 Citizens Band, 470-500 Mc TV experimental. Contains 15 tubes: 4-7F7, 4-7H7, 2-7E6, 2-6F6, 2-955, 1-9E23, 1-6A, 512 101x131/2x43/4". Wt. 25 lbs.

BRAND NEW \$29.50 each

CONVERSION DIAGRAM INCLUDED!

PE-101C DYNAMOTOR for BC-645, has 12-24V input (easy to convert for 6V Battery operation.).....only \$4.45

UHF ANTENNA ASSEMBLY, for BC-645.....\$2.45

### HEADSETS

	Excellent USED	BRAND NEW
HS-23 high impedance.....	\$2.25	\$4.45
HS-33 low impedance.....	1.79	5.45
HS-30 low imp (feather).....	1.49	2.22
H-16/U high imp (2 units).....		7.95
CD-307A cords, with PLSS plug and JK26 jack, 8' long.....		.99

### MICROPHONE BARGAINS

Western Elec, Breast Mike.....	Brand New	\$1.75
T-45 Navy Lip Mike.....	Brand New	\$1.25
T-17 Carbon Hand Mike.....	Brand New	\$6.95
T-30 Carbon Throat Mike.....	Brand New	\$ .69
T-24 Single Button Carbon Mike.....	Brand New	\$3.95

ARC-5 MARINE RECEIVER-TRANSMITTER Revr 1.5 to 3 Mc. BRAND NEW.....\$22.50 Xmitter 2.1 to 3 Mc BRAND NEW.....\$22.50 Comb. Xmtr and Revr with Tubes, NEW.....\$45.00

### BEACON RCVR BC-1206-C

Complete with 5 tubes. Tunes 195 KC to 420 KC. IF Frequency—135 KC. Receiver Sensitivity—3 Microvolts for 10 Milliwatts output. Output Impedance—300 Ohms and 4000 Ohms. Volume Control—RF Gain Control, Power Supply—24-28 Volts Aeroplane Battery. Current—75 Amperes. \$12.95 BRAND NEW.....\$21.95

### SCR-274N COMMAND and ARC-5 EQUIPMENT

All Complete With Tubes—Prices Slashed!

Type	USED	Excellent	BRAND NEW
BC-453 Revr. 190-550 Kc.....	\$18.50	\$24.50	\$44.50
BC-454 Revr. 3-6 Mc.....	9.25	11.25	21.95
BC-455 Revr. 6-9 Mc.....	8.95	10.95	16.50
BC-456 Modulator.....		2.75	4.75
BC-457 Xmtr. 4-5.3 Mc.....	12.50	16.50	24.50
BC-458 Xmtr. 5.3-7 Mc.....	7.95	9.75	23.50
BC-459 Xmtr. 7-11 Mc.....	12.95	14.25	22.50
BC-696 Xmtr. 3-4 Mc.....	18.95	29.95	
BC-450 3-Revtr. Control Box.....		1.49	1.95
BC-451 Xmtr. Control Box.....		1.25	1.49
3-Receiver Rack.....		1.79	2.95
2-Transmitter Rack.....		1.59	3.25
Single Transmitter Rack.....			3.25

ARC-5/T-23 Transmtr. with crystals, tubes, circuit diagram. Brand New \$39.50

MODULATED BC-221-AK FREQ. METER 125 to 20,000 Kc. with xtal check points in all ranges. Complete with tubes, xtal, calibration charts. Limited quantity, each BRAND NEW.....\$210.00

### GOULD 6-VOLT STORAGE BATTERY

Navy Standard, Black Rubber Case. BRAND NEW. 15 Amp. Hour Rating.....\$6.95



### GOULD 4-VOLT LEAD STORAGE BATTERY

(2 Cell) 16 Amp. Hrs. Portable Metal Case, Brand New \$3.95

WILLARD 6-VOLT MIDGET STORAGE BATTERY 3-amp hr. BRAND NEW. 3 5/8" x 1-13/16" x 2 3/8". Uses standard electrolyte.....\$1.95

WILLARD 2-VOLT STORAGE BATTERY. 20 AMP. HR. BRAND NEW.....\$2.69 1-Qt. Electrolyte, enough for two cells.....\$1.45

### DYNAMOTORS

Type	Input	Output	Exc. Used	Brand New
DM-32A	28V 1.1A.	250V .05A.	\$4.90	\$7.50
DM-33A	28V 5 A.	575V .16A.	1.95	3.49
	28V 7 A.	540V .25A.		
DM-28	28V	224V .07A.	2.25	4.95
PE-73	28V 20A.	1000V .350A.	9.50	12.50

Please include 25% Deposit with order—Balance C.O.D. MINIMUM ORDER \$3.00. All Shipments F.O.B. Our Warehouse N.Y.C.

**G & G Radio Supply Co.**  
Dept. N-9  
51 Vesey St., New York 7, N. Y., CO 7-4605  
Branch: 16 W. Kinzie St., Chicago, Ill.

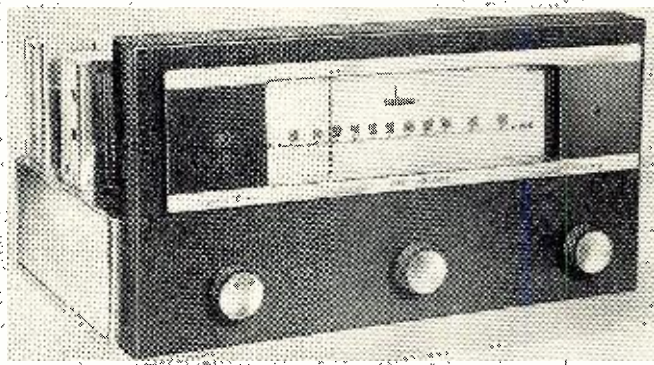

Front panel view of the Craftsman C900 FM tuner. The chassis measures 13 1/2" x 7 1/8" x 8 3/4". The knobs and control shafts extend 1 1/2" from the front of chassis.

# THE C900 FM TUNER

By L. J. HERMANN

Applications Engr., Radio Craftsmen, Inc.

Engineering details on a new Craftsman tuner that uses photo-etched coils in a unique circuit design.

ONE of the interesting and unique features of the new Craftsman C900 FM tuner which recently appeared on the market is the use of photo-etched coils for the i.f. and discriminator circuitry.

This feature, combined with a cascode r.f. circuit, amplified a.f.c., and a new intermediate frequency, is responsible for the unusual sensitivity of the tuner. The C900 has a sensitivity of 1  $\mu$ v. for 20 db quieting and 2  $\mu$ v. for 30 db quieting. Frequency response is  $\pm .5$  db from 20 to 20,000 cycles with .1 per-cent intermodulation distortion at 75 kc. peak station modulation.

Each of the i.f. coils and the discriminator is photo-etched on glass-filled melamine, a material that is extremely stable under wide ranges of temperature and humidity. The accuracy of the photo-etching process allows complete control of transformer coupling and eliminates annoying phase shift. In addition, the high capacity of the photo-etched coils minimizes tube variation and eliminates the need to realign the tuner when an i.f. tube is changed.

Initial step in preparing the photo-etched i.f. coils used in the FM tuner described.



The r.f. stage uses a double-triode cascode circuit designed around the 6BK7A. The antenna input circuit has been optimized for use with standard 300-ohm twin-lead but 72-ohm shielded lead can be used without circuit modification, if desired.

A new i.f. of 20.6 mc. has been selected to remove oscillator radiation from the FM band, thus allowing any number of the units to be attached to the same antenna without interaction. Only one spurious image is present within the entire FM band with the i.f. chosen and that is 80 db below the desired station level.

Another feature is a newly-designed a.f.c. circuit utilizing a d.c. amplifier. This circuit provides a correction factor of 30 db and assures accurate tuning to the center of the FM carrier. In addition, the a.f.c. has sharp cut-off skirts so that it does not extend over too great a tuning range, an important feature of any FM tuner.

The three front-panel controls are a.f.c., on-off-volume, and tuning. Ten tubes, including a rectifier, are used in the circuit. Two 1N64's serve as the FM detector.

The individual photo-etched i.f. coil completely wired and ready to be slipped in can.

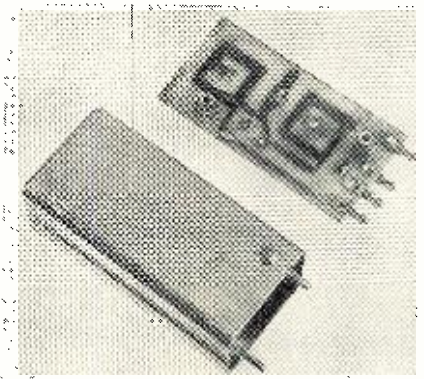

# The BUY of a Lifetime!

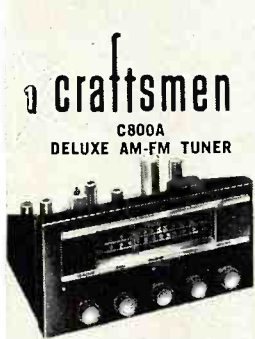

**1 craftsman**  
C800A  
DELUXE AM-FM TUNER  
Latest production with higher sensitivity and improved tone balance. Incorporates Craftsman's famous AFC, Phono Pre-Amp and Record Compensator. Net \$159.50



**2 craftsman**  
C500A  
ULTRA FIDELITY AMPLIFIER  
Featuring the famous Williamson Circuit with superior KT66 Output Tubes. Full 15 watts 20 to 20,000 cps within 1/10 of 1 db. Distortion so low it can hardly be measured. Net \$99.50



**3 GARRARD**  
"TRIUMPH" RC80 AUTOMATIC  
3-SPEED RECORD CHANGER  
The standard of excellence the world over. Plays all records, 33 1/2, 45, 78 rpm records in 7", 10" and 12" sizes. Quiet, smooth-running 4-pole motor, weighted turntable. Automatic shut-off after last record. Muting switch cuts out sound during change cycle. Net \$49.50  
**SPECIAL '45' SPINDLE for Garrard "Triumph" Changer** Net \$3.50



**4 Electro-Voice**  
12 TRXB TRIAXIAL SPEAKER  
Advance design full range easy to mount 12" TRIAXIAL 3-WAY SPEAKER SYSTEM. Electro-Voice laboratory research has combined Woofer, Middler and Tweeter into a near-perfect instrument for sound reproduction. Clearly and realistically reproduces all tones and overtones with unexcelled balance. Net \$59.70



**5**   
GENERAL ELECTRIC  
RPX-050 TRIPLE-PLAY  
VARIABLE RELUCTANCE  
MAGNETIC PICKUP  
For finest phono reproduction of all types of records. Considered by many engineers and music lovers the finest pickup at any price! Furnished mounted in changer ready for use. Supplied with genuine General Electric Double Sapphire Needle. Net \$8.20

## TERMINAL'S Sensational "5-STAR" Hi-Fi BUY!

### Complete, Matched PHONO-RADIO SYSTEM

ALL BRAND NEW famous name components • ALL current models and production • ALL Fully Guaranteed • Supplied with ALL TUBES • Warranty Cards • Instructions • Indoor Antenna • GE Dual Sapphire Needle • ALL Cables and Plugs • Your '5-STAR' System consisting of ALL ITEMS ILLUSTRATED and DESCRIBED ABOVE... comes ready to plug together and play!

OUR BIG BUY YOUR BIG SAVING!

This Complete System for

Only \$259. f.o.b. our store

Total Regular Net \$379.90

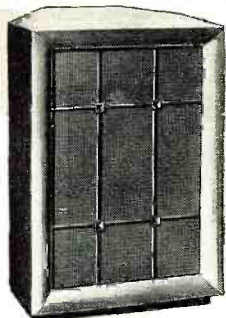

**ELECTRO-VOICE ARISTOCRAT SPEAKER CABINET WITH KLIPSCH LICENSED FOLDED HORN**  
Companion Speaker Cabinet for the PEERAGE Equipment Console. Corner enclosure designed to match the characteristics of the Electro-Voice 12TRXB Speaker. The patented KLIPSCH principle provides a full octave of added bass without boominess and greater speaker power handling capacity. 29 1/2" high, 19" wide, 16 1/2" deep.  
In MAHOGANY Net \$66.00 • In BLONDE Net \$72.00

**Electro-Voice**  
KLIPSCH  
MATCHED  
COMPANION CABINETS  
for '5-STAR' SYSTEM

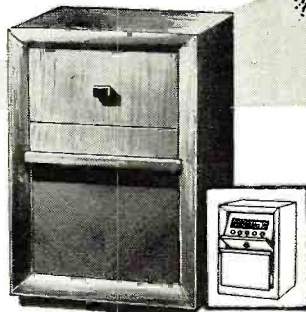

**ELECTRO-VOICE PEERAGE EQUIPMENT CONSOLE**  
Fashioned by furniture craftsmen. In Beautiful Blonde Korina or Tropical Mahogany Veneer, hand-rubbed finish. Supplied all cut out to house C800A Tuner, C500A Amplifier and RC-80 Changer. Tilting tuner compartment opens to easy-to-operate angle. Record changer mounts in drawer directly below tuner panel on roller slides for smooth operation. 29 3/4" high, 20 1/2" wide, 18 3/4" deep.  
In MAHOGANY Net \$96.00 • In BLONDE Net \$102.00

"5-STAR" Hi-Fi SYSTEM  
Complete with Both PEERAGE and ARISTOCRAT Matched Cabinets  
(As Shown Here)

In MAHOGANY... Only \$379.50  
Total Regular Net \$541.90  
In BLONDE... Only \$389.50  
Total Regular Net \$553.90

**MAIL ORDERS FILLED WITHIN 48 HOURS**

If you cannot come to our store for this sensational value, order by mail. Send full remittance or \$25.00 on account. Balance C. O. D. Every item FULLY GUARANTEED.  
**DON'T DELAY - ORDER TODAY!**  
WE RESERVE THE RIGHT TO LIMIT QUANTITIES



**Terminal Radio** CORP.

85 CORTLANDT STREET, NEW YORK 7, N. Y. • WOrth 4-3311

© COPYRIGHT 1954 TERMINAL RADIO CORP.

# NOW! 2 WAYS TO GET

## CHANNEL MASTER'S

# ROTO-KING

the new  
rotator  
with  
these  
10  
superior  
features



model no. 9521

model no. 9520  
without directional indicator.

### 10. Midget Control Cabinet

— a beauty!

Beautifully styled. Smallest cabinet on the market, only 2 3/4" x 4". Blends harmoniously with any type of home decor. Fingertip control bar. An eye-appealing sales clincher!

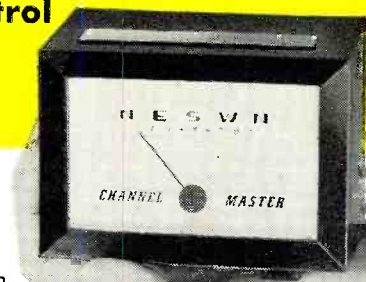

Write for complete technical literature.

#### 1 Flexible Worm Gear

Actually comes in contact with more gear teeth than *straight-bar* worm gear. This means no-slip gear control, no back-lash, no binding; longer life.

#### 2 Motor Easily Removed

Motor instantly removed from housing — faster, easier to replace than cartridge types. Lowest servicing cost, because motor is separate from gear train.

#### 3 Electrical and Mechanical Stops

Hair-line accuracy. No over-shooting. No drifting or coasting. Perfect tuning

#### 4. Lightweight — Strong

All-aluminum die castings, steel reinforced. Built-in guy wire anchors.

#### 5 Straight-Thru Mast Mounting

Both rotating and stationary masts go completely through rotor. Grips 12" section of rotating mast, for greatest resistance to horizontal thrust.

#### 6 Weatherproof

Straight-Thru design permits water to drain freely. Weather cannot interfere with performance of rotator.

#### 7. Extremely High Torque

Will turn any 4-bay antenna in wind with ease.

#### 8 Built-in Chimney Mount

And — rotor takes up to 1 5/8" mast.

#### 9. Built-in Thrust Bearing

3-race ball bearing. Takes heaviest loads without strain.

# RECEPTION FROM ALL DIRECTIONS!

*CHANNEL MASTER'S all-new*

## **SELECTENNA**

**coupling system**

**A truly revolutionary  
Channel Master development  
that permits  
unlimited antenna combinations  
with only one transmission line!**

**No moving parts — No motors**

**No switches — Fully automatic!**

- For the first time, you can tie together any combination of antennas, including separate antennas operating on the SAME BAND.
- Ideal for areas currently using rotators, manually-operated selector switches, and "omni-directional" antennas.
- System is installed quickly, economically — one filter needed for each channel. UHF easily added.

**TYPICAL COMBINATIONS — never before possible!**  
*Only one down-lead to the set.*

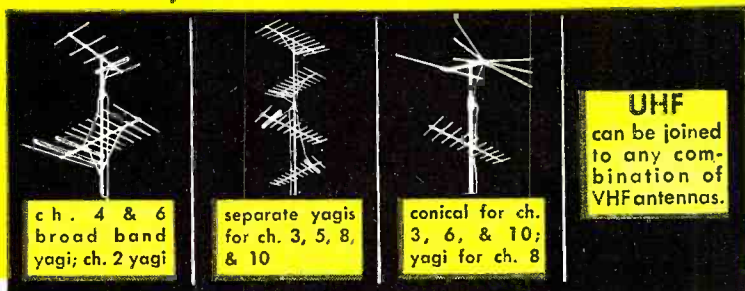

**DOES NOT OBSOLETE THE ROTATOR —**

but gives the installation man a new approach to an old problem. Choose the system that provides the better answer to each individual installation.

Couplers snap together. This interlocked stack, consisting of four Antenna Couplers and one Hi-Lo Coupler, would join the 4 antennas in combination on the left.



**CHANNEL MASTER CORP.** ELLENVILLE, N. Y.

World's Largest Manufacturer of TV Antennas



Out of the roar of big guns . . .

a new **HORIZON** in high fidelity



The jarring shocks of gunfire . . . the insidious dampness of salt spray . . . globe-girdling distances and static! National radio receivers have taken punishment like this 24 hours a day, month-after-month on board 9 out of 10 Navy ships.

National radio equipment has also served the Army, the Civil Aeronautics Administration, industry, the Kon-Tiki Expedition and radio amateurs throughout the world.

Only a background like this — unmatched by any other high-fidelity manufacturer — could produce the magnificent new HORIZON Criterion AM-FM tuner and inter-matched amplifiers.

*tuned to tomorrow* 

**National** 

**FOR COMPLETE SPECIFICATIONS WRITE DEPT. R-94**

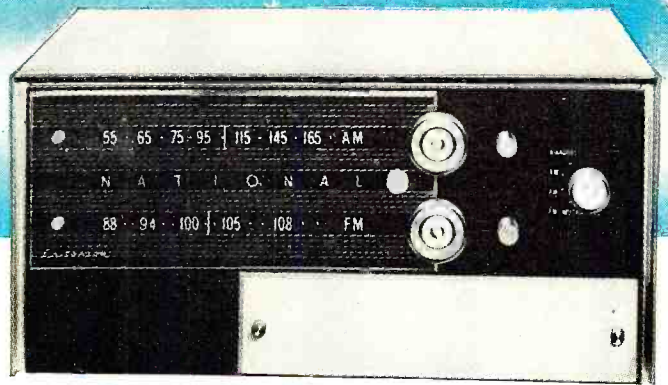

## HORIZON *Criterion*

AM-FM TUNER \$169.95 (SIZE: 16½" x 7¾")

Never before a tuner so versatile!

You can enjoy full-band AM!

You can listen to matchless, drift-free FM!

You can hear both at the same time, using dual sound systems!

You can receive revolutionary new binaural broadcasts as they are made available in your area! Two gain controls and separate tuning condensers are provided — one for AM, one for FM!

Exclusive Mutamatic FM Tuning eliminates all hiss and noise between stations, so annoying when tuning conventional tuners! Stations leap out of velvety silence — stay locked in automatically! Superior design eliminates drift.

An exceptional capture ratio rejects all unwanted signals up to 80% of the strength of the desired signal. The FM sensitivity proves the name — "the Criterion" — by which all other tuners are judged.



## HORIZON *20*

20-WATT AMPLIFIER \$84.95 (SIZE: 14½" x 4")

To surpass the present high level of amplifier design, National proudly introduces new power amplifiers with a revolutionary new output circuit employing unity coupling.

With unity coupling, the output transformer is no longer required to supply the coupling between output tubes for distortion cancellation as in normal push-pull circuits. Instead, the transformer supplies only the impedance matching between the tubes and the speaker system, thus eliminating impulse distortion created by transformers. Music is reproduced with an unclouded transparency — at all listening levels — never before achieved!

The HORIZON 20 is a 20-watt amplifier with a total harmonic distortion of less than .3% and total intermodulation distortion of less than 1% at full rated output. Frequency response is  $\pm 1$  db 20 cps to 20 kcs.;  $\pm 1$  db 10 cps to 100 kcs. Power response at rated output is  $\pm .15$  db, 20 cps to 20 kcs. Hum and noise is 80 db below rated output.



## HORIZON *5*

PREAMPLIFIER-CONTROL UNIT \$49.95

The HORIZON 5 achieves a new high in frequency response ( $\pm 1$  db, 20 cps to 100 kcs) and voltage output (up to 10 volts) — a new low in distortion (less than .2% harmonic, .3% intermodulation)!

Four inputs, 7 record equalization curves, a loudness-volume control and bass and treble controls are provided.

Entire unit slips quickly, easily into either the tuner or 20-watt amplifier.



## HORIZON *10*

10-WATT AMPLIFIER \$79.95 (SIZE: 14½" x 4")

Incorporating the revolutionary new unity-coupled circuit in a 10-watt amplifier design, the HORIZON 10 offers performance never before achieved at such a moderate price!

The built-in preamp-control unit offers a choice of 3 inputs, 3 record equalization curves, a loudness control and separate bass and treble controls.

Harmonic distortion is less than .5%; intermodulation distortion, less than 2% at rated output. Frequency response is  $\pm 1$  db, 20 cps to 20 kcs.; power response,  $\pm 2$  db, 20 cps to 20 kcs. Hum and noise are better than 70 db below rated output on high-level input, better than 50 db on low level input.

**NOW!**



# COLOR TV COVERAGE IN PHOTOFACT!

**FIRST COLOR TV FOLDER**

the **RCA Model CT-100**

**OVER 40 FACT-PACKED PAGES**

It's a terrific **FIRST**—complete data based on actual analysis of the production model...full schematics, block diagrams, parts lists, tube placement, alignment, wave forms, set-up adjustments—*everything* you want to know about this actual color set—information you want and need to get out in front on Color TV!

## here's how to get it!

- 1 Included with Photofact Folder Set No. 252—out Sept. 1st. You get it in addition to over 100 pages of regular Photofact TV-Radio coverage. Get the Color TV Folder at the regular price of the complete Set...Only \$1.75!
- 2 You can buy the Color TV Folder separately if you wish. Available from your distributor for only \$1.00!

**GET IT EITHER WAY FROM  
YOUR PARTS DISTRIBUTOR**

**HOWARD W. SAMS & CO., INC.**  
2203 East 46th Street  
Indianapolis 5, Ind.

# AN OUTBOARD BASS-BOOSTER

By **ALLAN M. FERRES**

Add a bass boost circuit to your equipment without changing existing wiring. Power for booster comes from the amplifier.

“**EVERYTHING** sounds fine, but I'd like just a little more bass.”

Sometimes this comment is heard after a custom installation is completed, and if you hesitate to dig into factory-made equipment to correct the trouble, this booster will produce the required additional bass with a minimum of effort on your part. It is simple to demonstrate and often can be sold to old customers after other repairs or adjustments have been made on their sets.

The circuit is simple and the few parts required can be mounted in an aluminum can 2 x 2 x 4 inches, small enough to fit into a corner of the amplifier or tuner compartment of almost any set. The booster uses a 6C4 triode as a resistance-coupled amplifier with an RC frequency-response-correcting network in the grid circuit. The tube furnishes just enough gain to compensate for the loss in the network so that the mid- and high-frequency amplification is zero. The booster can be connected to the input of the power amplifier so as to increase the bass response for all the signal inputs or connected to the output of the record player, AM-FM tuner, or TV set, if only one of these requires the additional bass. In order to reduce the number of parts, no controls are included.

Power to operate the booster is obtained from the power amplifier of the installation, either by means of an adapter plug, placed under a 6V6, 6L6, 6K6GT, or similar tube, or by running flexible leads to the underside of a socket. The plate voltage is taken from the screen pin of the tube. The ground connection is obtained from the shield of the output lead, so no other lead need be run to the chassis. If motorboating is experienced due to poor voltage regulation of the output tube's screen supply, then the plate voltage for the booster can be picked off some other well-filtered high-voltage point in the circuit.

$C_X$  is mounted to a dual tie point, one lug connected to  $R_2$  and  $R_3$  and the other lug grounded. After the booster is installed, various values of  $C_X$  should be tried until the desired bass response is obtained. Fig. 1 shows the response that is obtained with values from .01 to .05  $\mu\text{fd}$ . If less boost is required after the proper value of  $C_X$  is selected,  $C_X$  can be shunted with a resistor, the value being determined by test. 100,000 to 470,000 ohms are typical values.

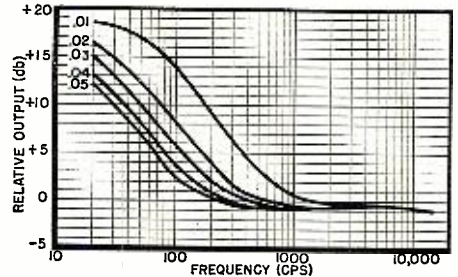

Fig. 1. Response of booster with different condenser values from .01 to .05  $\mu\text{fd}$ . The zero level is .775 volt in this instance.

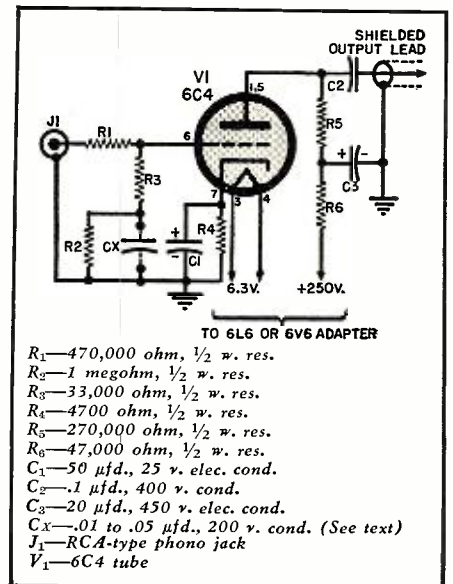

Fig. 2. Complete schematic of the outboard booster. It may be mounted in a 2"x2"x4" can, fitting into the equipment cabinet.

The booster should be mounted so that only a foot or two of output cable is required in order to prevent a loss of high-frequency response. Only .15 amp. at 6.3 volts and 1 ma. at 250 volts are required to operate the unit, which will not overload the power amplifier power supply.





A new  
dimension  
in price and  
performance

WALSCO

Scotty

377

LIST

GUARANTEED FOR 1 YEAR

**Greatest Antenna  
Value in America**

The new "Scotty" has every quality feature necessary for crystal-clear reception in metropolitan and suburban areas. Good gain and directivity on all VHF channels. Used effectively for UHF, or as a combination antenna. Tested and approved for color reception.

**COMPARE**

WALSCO "Scotty"	3.77
Antenna B	7.50
Antenna C	4.86
Antenna D	5.40
Antenna E	4.60

Place your order today

Easily  
stacked for  
semi-fringe  
reception

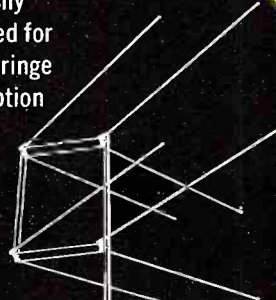

3602 Crenshaw Boulevard, Los Angeles 36, California

Export Distributor:  
AD AURIEMA, Inc., 89 Broad St., New York 4, N.Y.



# International SHORT-WAVE



Compiled by **KENNETH R. BOORD**

**S**HORT-WAVE reception continues good and dial twirlers will find many rewarding contacts these days.

**Albania**—ZAA, 7.852A, Tirana, noted with *English* 1700-1730A; in French 1645. (Cox, Dela.) Has *English* also 1400-1430. (Pearce, England)

**Algeria**—Radio Algeria, 6.160, heard through heavy QRM 1638 with Arabic. Fair level in Dela. (Cox)

**Anglo-Egyptian Sudan**—Radio Omdurman varies around 4.992 now in parallel with 6.437, heard 1350 in Arabic. (Fairs, England, via URDXC)

**Angola**—CR6RA, 11.862, Luanda, noted at good level 1620. (Cox, Dela.)

**Argentina**—Radio Splendid, 9.320AV, Buenos Aires, noted with news in Spanish 1900. (Niblack, Ind.)

**Australia**—VIM4, 4.920, Brisbane, Queensland, closes 0830 with "God Save the Queen." (*Malmo DX-aren*, Sweden) VLX9, 9.660, noted 0400 at weak level in Md. (Zahner) The DX session beamed to British Isles, Europe on Sun. is now 0200 over VLA9, 9.58. (Balbi, Calif., others)

**Azores**—Ponta Delgada is still noted on 11.925 at 1400-1500 in Portuguese; heard on 4.845 with news in Portuguese 1630. (Pearce, England)

**Belgium**—Brussels, 15.335, noted closing in French 1244, good level in N. C. (Ferguson) Is strong in *English* to North America, 11.85, at 2000-2200 closedown. (Crowell, Pa., Stanley, Conn., others) Noted closing 2200 on

This young ham-SWL is Bob Weggel, W9ZZJ, of Rhinelander, Wisconsin. Bob uses a WRL "Globe Scout" transmitter which runs 40 watts on phone and 50 watts on c.w. His receiver is a Hallcrafters S-19 and his antenna is a half-wave zepp 25 feet above ground, fed with 72-ohm twin-lead. Bob has worked 22 states on the 75-meter band alone, the most distant being Georgia, Kansas, Texas, Wyoming, New Hampshire, Massachusetts, Rhode Island, and New York. Bob is a 16-year-old high school junior.



9.144 at strong level, then with transmission for Africa. (Grennell, Ohio) On Mondays, when HCJB, Quito, Ecuador, is *silent*, Brussels can be heard on 9.745A closing 1845 in Portuguese. (Niblack, Ind.)

**Bolivia**—CP38, 9.444A, La Paz, noted at fair level with religious session in Spanish 2115-2130 closedown. (Cox, Dela.; Ferguson, N. C.) CP5, 5.970, opens 0600 with the slogan, "La Voz de Bolivia, La Paz." (*N.Z. DX Times via Winch, Calif.*)

**Brazil**—ZYY9, 4.973, Sao Luiz, excellent 2200; "Emissora Continental," 3.295, excellent 2130. (Cox, Dela.) *Radio Gazeta*, Sao Paulo, has been heard in Sweden on 6.135A. (Radio Sweden)

**British Guiana**—ZPY, 3.255A, noted 2015 with BBC relay. (Cox, Dela.)

**British New Guinea**—VLT6, 6.130, Pt. Moresby, noted relaying ABC news 0430, R6. (Zahner, Md.)

**Bulgaria**—Radio Sofia, 7.671, good level in *English* 1620. (Cox, Dela.) Excellent on 9.700 to North America 2300. (Braunstein, Conn.) Excellent on this channel 2000-2030 in *English*. (Ellentuch, N. Y., others)

**Canada**—CHOL, 11.72, CKLO, 9.63, are good level 2130 with news. (Hatter, N.Y.)

**Canary Islands**—EA8AB, 7.505A, Tenerife, noted 1550 with music; announcements in Spanish; poor level, CWQRM. (Cox, Dela.)

**Cape Verde Islands**—CR4AA, 7.398V, Praia, good level with native songs 1610 tune-in. (Cox, Dela.)

**Ceylon**—Radio Ceylon, 11.770, noted 2030-2330, good level; 7.190 parallels. (Hardwick, N. Z.) Is heard on 17.810 at 0415-0615 in *English*. (Radio Australia) Noted over 6.006 at 0745 with news, music. (Sanderson, Australia) Latest schedule for VOA relays over *Radio Ceylon* is 0830-1230 to India-Pakistan, 7.235, 11.875.

**Chile**—CE1174, 11.74, Santiago, noted 2250 at good level with popular American recordings with *English* lyrics. (Niblack, Ind.)

**China**—Radio Peking, 15.053A, noted in Chinese 2038 and still coming through well at 2117 tune-out but was

somewhat weaker then. (Ferguson, N.C.) Noted in Sweden on 9.040 in Chinese 1740. (*Nattugglan*, Sweden)

**Colombia**—HJFQ, 5.018, Manizales, is heard as early as 1700 at fair level; HJAB, 4.788, Barranquilla, is excellent around 2125; HJDW, 5.055, Medellin, fair with music 1720; HJGB, 4.815, Bucaramanga, fair 2130; HJFH, 4.875, Armenia, fair 2150; HJAP, 4.931, Cartagena, fair 2155; HJCW, 4.945, Bogota, excellent 2200. (Cox, Dela.) HJCF, 5.965, Bogota, strong 0600. (Cushen, N.Z.)

**HJKH**, 5.070A, Sutatenza, has resumed *English* on alternate Sats. for listeners in Australia, New Zealand at 0530-0545. (Cushen, N.Z.; Radio Australia, others)

**Costa Rica**—Due to an electricity shortage, the schedule of TIFC, 9.647A, San Jose, continues to be Mon-Sat. 0600-1300, 1700-2300; Sun. 0700-1300, 1700-2300, according to the station. (Bellington, N.Y.) Often noted with organ melodies around 2200. (Calos, Calif.)

**Czechoslovakia**—Prague uses 11.76 now parallel 9.55 with *English* to North America 1930-2000, 2300-2330. (Ferguson, N.C.; Niblack, Ind.; Roese, Ill.; Parsons, Pa., Foster, Ill., others)

**Denmark**—OZF5, 9.52, Copenhagen, has improved signal opening first daily transmission to North America 2030. (Ellentuch, N.Y.; Foster, Ill.; Stanley, Conn., others) Good 2200-2300 in second beam to North America. (Gilcher, Ohio, others)

**Dominican Republic**—HI2A, 6.048AV, Santiago, is currently being logged as early as 1830 through heavy QRM. (Niblack, Ind.) HI2G, 9.590, noted with weak signal in Spanish 1000-1030. (Stanley, Conn.) HI2T, 9.735, noted opening 0700 with strong signal in Spanish. (Foster, Ill.)

**Egypt**—Radio Cairo noted on 12.030A at 1600 in Arabic. (Parsons, Pa.) Heard 1730 in parallel with 7.049A. (Saylor, Va.) Cairo now uses 17.725 instead of 15.315 at 0700-1000 to Far East in Arabic, *English*, Urdu, Indonesian. (WRH; Pearce, England)

**El Salvador**—YSAXA, 11.950A, San Salvador, logged 1855-1900 on a Friday with "*English by Radio*" (Spanish-*English* lesson). (Niblack, Ind.) Good around 1745. (Foster, Ill.)

**Ethiopia**—Radio Addis Ababa, ETAA, 15.054A, is heard from as early as 1240 to 1430 closedown. Frequency varies (Continued on page 149)

(Note: Unless otherwise indicated, all time is expressed in American EST; add 5 hours for GCT. "News" refers to newscasts in the English language. In order to avoid confusion, the 24 hour clock, has been used in designating the times of broadcasts. The hours from midnight until noon are shown as 0000 to 1200 while from 1 p.m. to midnight are shown as 1300 to 2400.) The symbol "V" following a listed frequency indicates "varying." The station may operate either above or below the frequency given. "A" means frequency is approximate.

NEW 1955

# Heathkit

## Engineering Features

### New PRINTED CIRCUITS

One of the many tremendous improvements in the new 1955 Heathkits is the use of an etched metal process printed circuit board. Printed circuits will be used in Heathkits whenever they will affect construction simplification, performance stabilization, and lend themselves to instrument design. Now for the first time a kit instrument company offers the advantages of modern printed circuit instrument construction technique. For the first time consideration has been given toward reducing the kit assembly time. Also this is the first time that printed circuit boards have been hand soldered on a volume basis. Offered only by Heathkit, the pioneer and leader in kit instrument design.

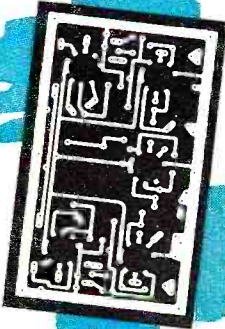

### New PEAK-TO-PEAK VTVM CIRCUIT

New 6AL5 full wave rectifier in AC input circuit permits full scale peak-to-peak measurements. Seven ranges — upper limits 4000 volts peak-to-peak. Just the thing you TV servicemen have needed in making TV circuit voltage checks. Precision resistor voltage divider limits AC RMS level to 150 volts. Prevents overloading the rectifier — extends upper limit AC RMS ranges to 1500 volts — further protects meter and circuitry against AC flash-over or arcing. Another definite example of continuing Heathkit design leadership in the kit instrument field.

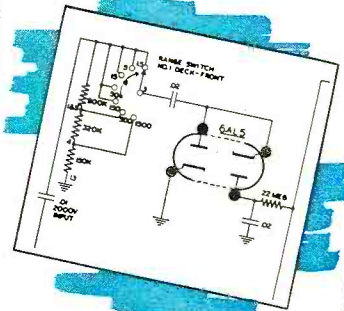

### New HIGH READABILITY PANELS

New 1955 Heathkits feature complete panel redesign. Sharp white lettering applied to the beautiful charcoal gray panels, provide a new high in readability. Lettering is easy-to-read open style and panel calibrations are vividly clear against the pleasing soft gray background. New knobs of exclusive Heathkit design.



### New 3" UTILITY SCOPE

The new 3" Scope is a "natural" for the well rounded line of Heathkit instruments. Small in size, 11 3/4" deep, 6 1/2" wide, 9 1/2" high, yet big in performance. Just think of the value an Oscilloscope for \$29.50. Brilliant intensity, sharp focusing, wide positioning range. An ideal portable Scope for the TV serviceman — a second shop scope — modulation monitor for you hams (deflection plate terminals in rear of cabinet). Performance to spare for all general scope applications. See specifications on following page.



### New STYLING New COLOR

New styling and coloring is responsible for tremendous improvement in Heathkit appearance. The new instrument panel color combination is high definition white lettering in a soft charcoal gray panel. Cabinet color is a lighter leather gray. The satin gold baked enamel cabinet for the WA-P2 Pre-amplifier is further indicative of the modern pacesetter trend in Heathkit styling.



### New SCOPE SWEEP CIRCUIT 10 CYCLES — 500 KC

New 1955 Heathkit Model 0-10 Scope features a new wide frequency range sweep generator covering 10 cycles to 500,000 cycles. This to 500,000 cycles in coverage is available in five virtually decade range sweep frequency range usually available. Excellent retrace time characteristics, actually less than 20% at 500 KC. Use of the free running Heath circuit provides a larger margin of stability and a new high in Heathkit Scope performance.

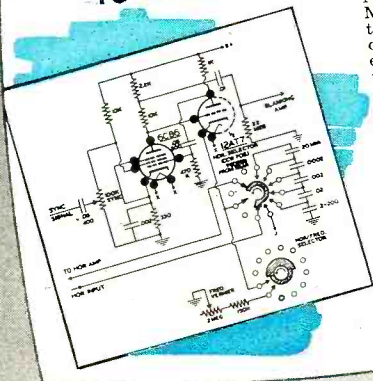

### Continuing PROGRESS FUTURE LINE EXPANSION

The outstanding improvements featured in the 1955 Heathkit line are representative of the progress characterized by the Heath Company operation. Long range planning will provide a continuing succession of new kit releases to further expand the Heathkit line which already represents the world's greatest selection of electronic kits. The innovations in the 1955 line, are representative of additional new models scheduled for release for the coming years.



SEE THE INSTRUMENTS ON THE FOLLOWING PAGES

**HEATH COMPANY • Benton Harbor 15, Mich.**

# Heathkit ELECTRONIC SWITCH KIT

The basic function of the Heathkit Electronic Switch Kit is to permit simultaneous oscilloscope observation of two separate traces which can be either separated or superimposed for individual study. This is accomplished through the use of two individually controlled inputs working through amplifier, multi-vibrator, and blocking stages. The output of the Electronic Switch is connected directly to the vertical input of the Oscilloscope. A typical example of usefulness would be simultaneous observation of a signal or waveform as it appears at both the input and output stages of an amplifier.

### APPLICATIONS

An Electronic Switch has many applications to increase the over-all operating versatility of your oscilloscope. It can be used to check amplifier distortion—audio crossover networks—phase inverter circuits—to measure phase shift—special waveform study, etc. The instrument can also be conveniently used as a square wave generator over the range of switching frequencies, often providing the necessary wave form response information without incurring the expense of an additional instrument. Ownership of this instrument will reveal many entirely new fields of oscilloscope application and will quickly justify the modest cost of the Electronic Switch Kit.

Tube complement:  
2—6SJ7, 3—6SN7,  
1—6X5.

Continuously variable  
switching rates in three  
ranges from less than 10  
CPS to over 2000 CPS.

Individual input  
gain controls, po-  
sition control,  
coarse frequency  
control, and fine  
frequency control.

Transformer operated for  
safety when used in con-  
junction with other equip-  
ment.



MODEL S-2

**\$23.50**

Shpg. Wt.  
8 lbs.

# Heathkit VOLTAGE CALIBRATOR KIT



MODEL VC-2

**\$11.50**

Shpg. Wt. 4 lbs.

Another useful oscilloscope accessory particularly in circuit development work and in TV and radio service work. The Voltage Calibrator provides a convenient method for making peak-to-peak voltage measurements with an oscilloscope, by establishing a relationship on a comparison basis between the amplitude of an unknown wave shape and a known output of the voltage calibrator. Peak-to-peak voltage values are read directly from a calibrated panel scale without recourse to involved calculations.

### FEATURES:

To off-set line voltage supply irregularities, the instrument features a voltage regulator tube. A convenient "signal" position on the panel switch by-passes the calibrator completely and the signal is applied through the oscilloscope vertical input, thereby eliminating the necessity for constantly transferring test leads.

### RANGES:

With the Heathkit Voltage Calibrator it is possible to measure all types of complex waveforms within a voltage range of .01 to 100 volts peak-to-peak. Build this instrument in a few hours and enjoy the added benefits offered only through combination use of test equipment.

# Heathkit LOW CAPACITY PROBE KIT



No. 342

**\$3.50**

Shpg. Wt. 1 lb.

An oscilloscope accessory, the 342 Low Capacity Probe permits observation of complex TV waveforms without distortion. An adjustable trimmer provides proper matching to any conventional scope input circuit. Excellent for high frequency, high impedance, or broad bandwidth circuits. The attenuation ratio can be varied to meet individual requirements.

# Heathkit SCOPE DEMODULATOR PROBE KIT



No. 337-C

**\$3.50**

Shpg. Wt. 1 lb.

Extend the usefulness of your oscilloscope by observing modulation envelopes of RF or IF carriers found in TV and radio receivers. The Heathkit Demodulator Probe will be helpful in alignment work, as a gain analyzer and a signal tracer. Easy construction with the new modern printed circuit board. Voltage limits are 30 volts RMS and 500 volts D.C.

# HEATH company

BENTON HARBOR 15,  
MICHIGAN

different causes can produce the same symptom in a receiver," Barney suggested. "An open voice coil, a shorted condenser, an open resistor, or a defective tube could all result in a receiver that would seem exactly the same to the customer. It's not like a car. There any fool can plainly see that engine trouble, transmission trouble, or differential trouble are entirely separate things."

"That's a good point," Mac applauded, "and it should always be kept in mind. On the other hand, we get some complaints in which there is obviously no connection between the original trouble and the new complaint. For example we repair a set that is completely dead because of an open voice coil and two or three weeks later the customer returns with the set that is now humming badly because of a filter condenser that has suddenly opened up. He argues that since he had the set repaired only a short time ago, you should take care of this new difficulty at no charge. Often he will try to justify this attitude that he secretly realizes is unreasonable by saying the set never acted right since it was repaired but that he simply has not had time to bring it back or call you on the telephone.

"In a few cases a customer will have the gall to return a set that he says significantly is 'dead again' when that set shows definite evidence of misuse. I mean things like two or three tubes that are rattling around loose out of their sockets and a cabinet that is badly cracked from the set's being dropped, or a speaker cone that someone's little darling has punched so full of holes that it looks like a colander."

"What can you do with people like that?"

"The best insurance against complaints, justified or otherwise, is to keep a complete record of every set that passes through the shop. When a set comes in, write down exactly all the troubles the customer mentions. Record what measures you took to correct them. If new parts were put in, describe them by make, part number, and use. List your charges. If your customer forgets every other detail of the transaction, he will remember this! Possibly you recommended that a slightly noisy control be replaced or that a low hum be reduced with new filter condensers, but the customer did not want to go to this expense. Be sure and note that the recommendations were made. Put down the date when the work was done. It will amaze you the way time shrinks in some customers' minds. A repair job done over a year ago will be described as work you did 'a month or so ago.'

"Then when a customer comes in with a complaint, pull out this card immediately and compare the facts on it with what he tells you. If the new

# NEW *Heathkit* 5" PUSH-PULL OSCILLOSCOPE KIT PRINTED CIRCUIT

The new 1955 Heathkit Model O-10 is the first truly color television kit oscilloscope with necessary high sensitivity and bandwidth. Outstanding instrument appearance is the result of new modern styling and color harmony. The first kit constructed oscilloscope to offer a labor-saving printed circuit board. New sweep generator with frequency range five times greater than previous models. Additional major improvements are a new high voltage power supply, improved vertical and horizontal electronic positioning control action, extreme horizontal amplifier sensitivity for trace magnification over three times CRT face width.

**NEW SWEEP GENERATOR:** The first sweep generator outside of expensive Laboratory units to go above 100 KC. Yet this new Heathkit has five times the frequency range with stable, locked-in traces. Complete range 10 cycles to 500,000 cycles. The generator has such excellent synchronization characteristics, that the results closely approximate a triggered sweep and under most conditions, the trace is locked to a multiple of sync frequency throughout the entire control range. Sweep multi-vibrator is direct coupled pentrode-triode and frequency determining capacitors are not part of multivibrator circuit.

Simplified, standardized construction technique of vertical and horizontal amplifier construction made possible through the use of a single printed circuit board.

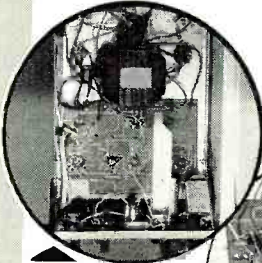

Clean, open, under chassis construction and wiring. Possible only through use of pre-cabled wiring harness, and simplified printed circuit boards.

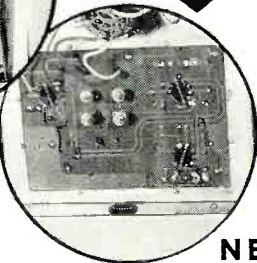

First color television service Oscilloscope with necessary high sensitivity and full 5 megacycle bandwidth.

New printed circuit construction, all components mounted on high insulation surface resulting in uniformly low circuit capacities.

New type wide frequency range Heath sweep generator, 10 cycles to 500,000 cycles.



New 5UP1 CR tube

New cabinet styling and color harmony—charcoal gray panel with high readability white lettering.

New electronic positioning controls for instantaneous, definite positioning without bounce or overshoot.

MODEL O-10

**\$69<sup>50</sup>**

Shpg. Wt. 27 lbs.

**SENSITIVITY AND BANDWIDTH:** Operating characteristics of the newly designed vertical amplifier provide a high degree of sensitivity (25 millivolts per inch) and excellent bandwidth characteristics 5 cycles to 5 MC (down only 3 db). Only the new Heathkit Oscilloscope has the necessary sensitivity for full 5 megacycle bandwidth for color servicing. Uniformly high level operation with a high degree of stability is assured through the use of new printed circuit board construction. Printed circuits reduce the assembly time, error possibility, and provide rigid mounting for all components.

New horizontal amplifier provides trace width three times the diameter of the CR tube. This new amplifier together with DC positioning, allows greater magnification of trace for observation of small transients and step portions of TV sync pulses.

**OTHER OUTSTANDING FEATURES:** Retrace amplifier—Z axis modulation—peak-to-peak voltage calibrating source with calibrated grid—all plastic molded condensers for long trouble-free life and drift elimination—voltage regulated power supply—new wiring harness for neat professional appearance—new cabinet styling and color harmony. Combinations of design and performance features available only in the new Heathkit O-10 Oscilloscope.

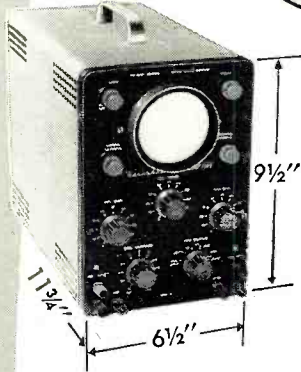

NEW

*Heathkit*

3" PRINTED CIRCUIT

## OSCILLOSCOPE KIT

MODEL OL-1

**\$29<sup>50</sup>** Shpg. Wt. 15 lbs.

New easy-to-build printed circuit board with high insulation factor.

New Heathkit instrument styling—charcoal gray panel with high readability white lettering.

New Heath twin triode sweep generator 15-100,000 cycle sweep.

New compact utility Scope—light-weight—portable for service work.

Deflection plate terminals—ideal for ham transmitter modulation monitoring.

Here is the newest addition to the line of Heathkit Oscilloscopes. Just the instrument you servicemen, hams, students, and experimenters have been asking for. A general purpose low priced utility scope to be used in everyday work. Through the use of a 3" 3GP1 CRT it has been possible to reduce the cabinet size and weight so that the instrument is a compact portable unit especially useful for TV servicemen to carry on home service calls and as an extra shop utility scope. At this low price every ham can afford an oscilloscope for transmitter modulation monitoring. Convenient slide switch controlled terminals at rear of scope cabinet.

**PRINTED CIRCUIT:** This new Heathkit uses a prefabricated printed circuit board to standardize amplifier and sweep generator assembly. Cuts building time in half, eliminates major portion of wiring, and insures exact duplication of engineering pilot model. Condensers, resistors, and tube sockets are mounted directly on the board and soldered in place.

**DESIGN FEATURES:** Cathode follower input circuits in both vertical and horizontal amplifier—electronic positioning control for wide range of vertical or horizontal spot deflection—Heath twin triode sweep generator—provisions for external and internal sync—external and internal sweep—60 cycle line sweep—Chicago power transformer—4 section electrolytic filter condenser—plastic molded bypass and coupling condensers. Tube lineup 4-12AU7 horizontal and vertical amplifiers, 12AX7 sweep generator, 6X4 low voltage rectifier, 1V2 high voltage rectifier, 3GP1 CRT. Cabinet size 11 3/4" deep x 6 1/2" wide x 9 1/2" high. A terrific instrument value at \$29.50.

NEW

*Heathkit*

5" PRINTED CIRCUIT

## OSCILLOSCOPE KIT

MODEL OM-1

**\$39<sup>50</sup>** Shpg. Wt. 24 lbs.

Printed circuit board construction for accurate trouble-free assembly.

Twin triode Heath sweep generator 15-100,000 cycle range.

By popular request we are again offering a 5" full sized general purpose Oscilloscope using a 5BP1 CRT. All of the necessary design features for servicemen, students, experimenters, hams, etc. This fine oscilloscope value features printed circuit board construction for easy assembly and reduced wiring time. Also features the new Heathkit styling and color harmony with the charcoal gray panel and white lettering for high readability.

**SWEEP GENERATOR:** Sweep generator range using Heath twin triode circuit 15-100,000 cycles in four positions. Provisions for external as well as internal sweep and external or internal sync in addition to 60 cycle line sweep. Easy positive synchronization.

Heavy duty power supply using TV type 1V2 high voltage rectifier assures adequate accelerating potential for good trace definition. Deflection plate direct terminal connections available on rear of cabinet. Useful in transmitter modulation checking.

Good performance, simplified operation, and easy assembly are all characteristics of this new model Heathkit Oscilloscope.



**HEATH** company

BENTON HARBOR 15,  
MICHIGAN

# Heathkit MULTIMETER KIT

The new Heathkit Multimeter is a "must" to complete the instrument lineup of any well equipped service shop. Here is an instrument packed with every desirable service feature, many of which are not found in other Multimeters. All of the measurement ranges you need or want. High sensitivity 20,000 ohms per volt DC; 5,000 ohms per volt AC.

## ★ ADVANTAGES

Complete portability through freedom from AC line power operation—provides service ranges of direct current measurements from 150 microamps up to 15 amperes—can be safely operated in RF fields without impairing accuracy of measurement.

## ★ RANGES

Full scale AC and DC voltage ranges are 0-1.5, 5, 50, 150, 500, 1500 and 5,000 volts. Direct current ranges are 150 microamps, 15, 150 and 500 milliamperes and 15 amperes. Resistances are measured from .2 ohms to 20 megohms in 3 ranges and db range from -10 to +65 db.

## ★ CONSTRUCTION

The Heathkit MM-1 features a unique resistor ring switch mounting assembly procedure. With this method of assembly the precision resistors are wired to the rings and range switch before actual mounting of the switch to the instrument panel. This procedure affords the advantage of simpler construction yet complete accessibility of precision resistors in event replacement is ever required. Ohmmeter batteries were selected for convenience of replacement and only standard commercially available types are used. Batteries consist of 1 type C flashlight cell and 4 Penlite cells. All batteries and necessary test leads are furnished with the kit.

All 1% precision multiplier resistors—sensitive 50 microamp  $4\frac{1}{2}$ " Simpson meter.

Total of 35 meter ranges on two color scale.

New modern cabinet styling—attractive appearance.



20,000 ohms per volt sensitivity DC; 5,000 ohms per volt AC.

Polarity reversal switch eliminates transferring of test leads.

MODEL MM-1

**\$26.50**

Shpg. Wt. 6 lbs.

## Heathkit HANDITESTER KIT



MODEL M-1  
**\$14.50**

Shpg. Wt. 3 lbs.

The Heathkit Model M-1 Handitester readily fulfills major requirements for

a compact, portable volt-ohm milliammeter. The small size of the smooth gleaming molded bakelite case permits the instrument to be tucked into your coat pocket, toolbox or glove compartment of your car. Always the "Handitester" for those simple repair jobs.

## RANGES:

Despite its compact size, the Handitester is packed with every desirable feature required in an instrument of this type. AC or DC voltage ranges, full scale, 10, 30, 300, 1,000 and 5,000 volts. 2 convenient ohmmeter ranges 0-3,000 ohms and 0-300,000 ohms. 2 DC milliammeter ranges 0-10 milliamperes and 0-100 milliamperes.

## CONSTRUCTION

The instrument uses a 400 microampere meter movement which is shunted with resistors to provide a uniform 1 milliampere load in both AC and DC ranges. This design allows the use of but 1 set of 1% precision divider resistors on both AC and DC and provides a simplicity of switching. A small hearing aid type ohms adjust control provides the necessary zero adjust function on the ohmmeter range. The AC rectifier circuit uses a high quality Bradley rectifier and a dual half wave hookup. Necessary test leads and battery are included in the price of this popular kit.

## Heathkit RESISTANCE SUBSTITUTION BOX KIT

MODEL RS-1

**\$5.50**



Shpg. Wt. 2 lbs.

36 standard RTMA 1 watt resistor values between 15 ohms and 10 megohms with an accuracy of 10% are at your fingertips in the Model RS-1 Resistance Substitution Box kit. This sturdy and attractive accessory will easily prove its worth many times over as a time saving device. Order several today.

## Heathkit CONDENSER SUBSTITUTION BOX KIT

MODEL CS-1

**\$5.50**



Shpg. Wt. 2 lbs.

18 standard RTMA values are available from .0001 mfd to .22 mfd. An 18 position switch set in the panel of an attractive bakelite case allows quick changes without touching the test leads. Invest a few minutes of your time now and save hours of work later on.

# HEATH company

BENTON HARBOR 15,  
MICHIGAN

complaint bears no relation to the old, point that out as tactfully as you can. If the parts you put in before can be checked easily, such as tubes, identify them in your record and in the set and test them *first* while the customer is looking on. If they are bad, replace them promptly and cheerfully. If they are good, the customer can see for himself that the parts you put in are not responsible for his present trouble.

"More important than what you do, however, is the way you do it. To get into the proper frame of mind, try to imagine just how the customer is feeling. In the first place, he is unhappy because the device he had repaired is on the blink again. Quite likely he is secretly ashamed of having to tell you he thinks you did not do a good job. Probably his wife has nagged him into bringing the set back. Remember, though, that when a man has to do something of which he is not proud, he bolsters his resolution with anger and stubbornness. At such a time he is doubly quick to resent the slightest reflection on his motives or behavior. A man with a service complaint is a man with a chip on his shoulder.

"That is why it's especially important that you do or say nothing to give the impression you consider the complaint unjustified—at least not until you have had a chance to check the facts. Receive the complaint as cheerfully as you did the original service job. Thank the customer for bringing the set back to you. If he makes any small apology, quickly assure him you *want* any sets that are not completely satisfactory returned. Then, if at all possible, make an immediate check to see what the trouble is. Always give a returned set precedence over any other receivers you may have in the shop.

"To sum it all up, the first thing to do with a complaint is to determine with all possible speed if it is justified or not. If it is, correct the trouble at once with no charge to the customer. If it is not, try to demonstrate to the customer through your records and checks made in his presence that there is no connection between the work you did and his present trouble. Try to maneuver him into a position where he will say that they are entirely separate things. It is much better for him to say this than for you to do so. If he will not listen to reason, you are forced to decide whether you want to placate him by yielding to his unfair demands or to stand fast. Personally, I prefer to stand fast. While I know that it is supposed to be a good business practice to assume 'the customer is always right,' I simply can't force myself to become a party to a fraud through weakness. If I do give in after I have explained that the fault is not mine, the customer has every right to doubt my sincerity."

Mac paused briefly and then concluded, "There are two points that should be kept constantly in mind in dealing with complaints. First, there are these wise words of Voltaire:

# NEW Heathkit

## VACUUM TUBE

# VOLTMETER KIT

### PRINTED CIRCUIT DESIGN

Another outstanding example of continuing Heath Company pioneering and leadership in the kit instrument field. A new **printed circuit** VTVM. New peak-to-peak circuit—new styling and new panel design. A prewired, prefabricated printed circuit board eliminates chassis wiring, cuts assembly time in half, assures duplication of Engineering pilot model specifications, and virtually eliminates possibility of construction error.

#### CIRCUIT:

A 6AL5 tube operated as a full wave AC input rectifier permits seven peak-to-peak voltage ranges with upper limits of 4000 volts P—P. Just the ticket for you TV servicemen. Voltage divider in the 6AL5 input circuit limits applied AC input to a safe level. This circuitry and the isolation of the meter in the cathode of the 12AU7 bridge circuit affords a high degree of protection to the sensitive 200 microampere meter.

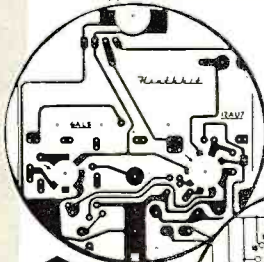

The first kit instrument to offer a labor-saving, error-free **printed circuit board**. Your instrument an exact wiring replica of Engineering development model.

Full wave rectifier in AC input circuit. Read peak-to-peak and RMS volts with upper limit of 4000 P—P and 1500 volts RMS. Voltage divider input circuit.

#### RANGES:

Seven voltage ranges. 1.5, 5, 15, 50, 150, 500 and 1,500 volts DC and AC RMS. Peak-to-peak ranges 4, 14, 40, 140, 400, 1400, 4000. Ohmmeter ranges X1, X10, X100, X1000, X10K, X100K, X1 meg. Additional features are a db scale, a center scale zero position, and a polarity reversal switch.

#### IMPORTANT FEATURES:

High impedance 11 megohm input—transformer operated—1% precision resistors, 6AL5 and 12AU7 tube—selenium power rectifier—individual AC and DC calibrations—smoother improved zero adjust control action—new panel styling and color—new placement of pilot light—new positive contact battery mounting—new knobs—test leads included.

The new V-7 also sets the pace as a kit instrument style leader. Smart, good-looking charcoal gray panel and soft leather gray cabinet. High readability panel with sharply contrasting white calibrations. The pleasing, eye catching, modern styling is in harmonious balance with the outstanding circuit design improvements. Easily the best buy in kit instruments.

*New* charcoal gray baked enamel panel with high readability, white lettering, soft leather gray cabinet, subdued pilot light indicator.

*New* printed circuit board for faster, easier construction—exact duplication of Lab development model.

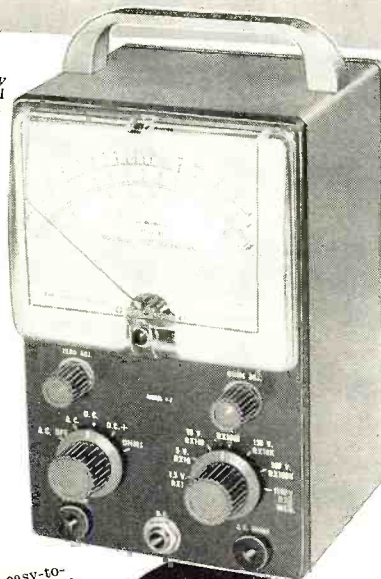

*New* easy-to-read open panel layout. Off-on switch now incorporated in the selector switch.

MODEL V-7

**\$24.50**

Shpg. Wt. 7 lbs.

*New* peak-to-peak meter scale—new color harmony—new knobs.

### Heathkit AC VACUUM TUBE

## VOLTMETER KIT

MODEL AV-2

**\$29.50**

Shpg. Wt. 5 lbs.

Extreme sensitivity has been emphasized in the design of the Heathkit AC VTVM. Ten full scale RMS ranges are .01, .03, .1, .3, 1, 3, 10, 30, 100, and 300 volts. Frequency response is substantially flat from 10 cycles per second to 50 KC with input impedance of 1 megohm at 1 KC. Will accurately measure as low as 1 millivolt at high impedance. Total db range is -52 db to +52 db. An excellent kit for measuring

the output of phono cartridges and the gain of amplifier stages. Use it also to check power supply ripple, as a sensitive null detector, and for compiling frequency response data. Features one knob operation, 200 microampere Simpson meter and precision resistors.

### Heathkit

## AUDIO WATTMETER KIT

Read audio power output directly without using external load resistors with the new Heathkit Audio Wattmeter. Built-in non-inductive load resistors provide impedances of 4, 8, 16, and 600 ohms. Flat response from 10 CPS to 250 KC. Full scale power ranges are 0-5 MW, 0-50 MW, 0-500 MW, 0-5 W and 0-50 W. Model AW-1 will operate continuously at 25 watts and has a duty cycle of 3 minutes at 50 watts. Total db range in five positions is -50 db to +48 db, using the standard 1 milliwatt 600 ohms.

MODEL AW-1

**\$29.50**

Shpg. Wt. 6 lbs.



### Heathkit 30,000 VOLTS DC

## PROBE KIT

Measure up to 30,000 volts DC with the Heathkit VTVM and the 336 high voltage Probe. Precision resistor provides multiplication factor of 100. Can be used with any 11 megohm input VTVM. Housed in a Polystyrene two color sleek plastic probe body for safety of operation.

No. 336

**\$4.50**

Shpg. Wt. 1 lb.



### Heathkit PEAK-TO-PEAK

## PROBE KIT



No. 338-C

**\$5.50**

Shpg. Wt. 2 lbs.

Peak-to-peak values not exceeding 80 volts at a DC level of not more than 600 volts, can now be read directly by using 338-C Probe with previous model Heathkit VTVM's or any VTVM with 11 megohm input resistance. Probe construction features a modern printed circuit board for easy assembly. Frequency range 5 KC to 5 MC.

### Heathkit RF PROBE KIT

The Heathkit RF Probe will permit the measurement of RF voltages up to 250 MC with an accuracy of ±10%. The limits are 30 volts AC and a DC level of 500 volts. Designed for any 11 megohm input VTVM. Modern styling, Polystyrene aluminum housing, Polystyrene insulation, and printed circuit board for easy assembly.



No. 309-C

**\$3.50**

Shpg. Wt. 1 lb.

**HEATH company**  
BENTON HARBOR 15,  
MICHIGAN

# Heathkit 6-12 VOLT BATTERY ELIMINATOR KIT

Here is the new 12 volt Heathkit Battery Eliminator so necessary for modern up-to-date operation of your Service Shop. Furnishes either 6 or 12 volt output which can be selected at the flick of a panel switch. Use the BE-4 to service all of the new 12 volt car radios in addition to the conventional 6 volt models.

### RANGES:

This new Battery Eliminator provides two continuously variable output voltage ranges. 0-6 volts D.C. at 10 amperes continuously or 15 amperes maximum intermittent and 0-12 volts D.C. at 5 amperes continuously or 7.5 amperes maximum intermittent. The output voltage is clean and well filtered, as the circuit uses two 10,000 mfd condensers.

The continuously variable output feature is of definite aid in determining the starting point of vibrators, the voltage operating range of oscillator circuits, etc.

### OTHER USES:

The controllable low voltage DC supply has many other applications besides primary use in car radio service work. Can be nicely used as a battery charger, or low voltage DC supply for electric trains. Has applications in high gain audio work requiring clean DC filament supply. Can be used for low power electro-plating or as a power supply for battery powered intercommunication systems.

Automatic overload relay—self resetting—fuse protected.

New 18 plate split type, heavy duty rectifier unit.

Continuously variable output voltage, either 6 or 12 volt operation.

Constant ammeter and voltmeter monitoring.

MODEL BE-4

**\$31.50**

Shpg. Wt. 17 lbs.



# Heathkit VIBRATOR TESTER KIT

MODEL VT-1

**\$14.50**

Shpg. Wt. 6 lbs.

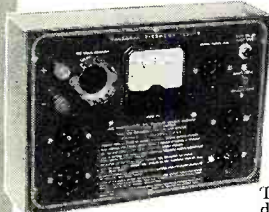

This time-saving device will quickly pay for itself in your auto radio service shop. 6 volt vibrators can be checked instantly on the Good-Bad type meter scale. Operation requires only a variable DC voltage from 4 to 6 volts at 4 amperes. Model BE-4 Battery Eliminator is recommended for this application.

Five test sockets provide for the testing of hundreds of interrupter and self-rectifier types. Proper starting voltage is determined easily and accurately. Over-all quality is then unmistakably indicated on the panel mounted meter.

# Heathkit IMPEDANCE BRIDGE KIT

MODEL IB-2

**\$59.50** Shpg. Wt. 12 lbs.

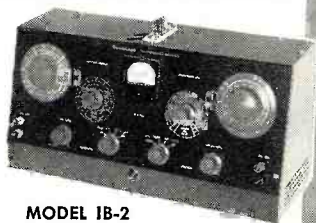

The new Heathkit Impedance Bridge features built-in adjustable phase shift oscillator and amplifier. This instrument actually represents four instruments in one compact unit. The Wheatstone bridge for resistance measurements, the Capacity Comparison bridge for capacity measurements, Maxwell bridge for low Q, and Hay bridge for high Q measurements.

### DESIGN:

Panel provisions for external generator use. A new two section CRL dial, provides ten separate "units." Ten separate units switch settings and fractions of units are read on a continuously variable calibrated control. A special minimum capacity shielded and balanced impedance matching transformer between the generator and bridge circuit is automatically switched to provide correct load operation of the generator circuit. The instrument uses 1/2% precision resistors and condensers in all measurements circuits.

# Heathkit VARIABLE VOLTAGE ISOLATION TRANSFORMER KIT

MODEL IT-1

**\$16.50**

Shpg. Wt. 10 lbs.

Variable output voltage between 90 and 130 volts AC. Rated at 100 volt-amperes continuously and 200 volt-amperes intermittently. The principle function of the Heathkit Isolation Transformer is to isolate the circuit being tested from line interference being caused by motors, appliances, etc. It works backward too by isolating such devices from the line. Many other uses, especially with AC-DC type circuits. Do not confuse the Heathkit Isolation Transformer with the hazardous auto transformer type line voltage boosters.



**HEATH company**  
BENTON HARBOR 15,  
MICHIGAN

'We cannot always oblige, but we can always speak obligingly.'

"Second, there is this: if you are going to accede to the complaining customer's wishes, you should do it promptly, cheerfully, and in all good humor. If matters deteriorate to the point where he feels he has forced you to make an adjustment, any good will that could have resulted from your act has gone glimmering."

-30-

## N. Y. SERVICING CLASSES

FREE courses in radio and television servicing will be conducted by Milton Wendroff and Robert Schwartz at the Queens Evening Trade School, 47th Avenue and 37th Street, Long Island City 1, N. Y. Anyone over 17 years of age who wishes to upgrade himself (beginners and advanced), and is presently employed in some phase of radio or TV, is eligible. Classes meet two nights a week from seven to nine p.m.

Registration is September 13th and 14th, from seven to nine p.m. in the school auditorium.

-30-

## LICENSE EXAMS

THE FCC wishes to call attention to the new radio amateur rules recently put into effect concerning the opportunity presented to amateur clubs and associations to assist new amateurs and the Commission by establishing examining committees within their membership to undertake these examinations as an adjunct to their amateur activities.

All Novice and Technician class operator examinations must be given and Conditional examinations will continue to be given by volunteer examiners. These examiners must be 21 years of age to give the amateur theory test and to give the code test must (a) hold Extra, Advanced, or General amateur privileges or (b) have, within five years, held a commercial radiotelegraph ticket or (c) must, within five years, have been employed in U. S. service as an operator of a manually-operated station.

FCC field engineers will help clubs in setting up examining committees for such license testing.

-30-

## S-40A TIP

By B. W. WELZ

CONVERTERS, preselectors, etc. that require external power can be used effectively with the Hallicrafters S-40A ham receiver without tearing into the receiver to get at the power supply.

These receivers are equipped with an "S-meter" socket on the rear of the chassis. The socket has terminal points for 260 volts d.c., 110 volts d.c., and 6.3 volts a.c. The socket connections are shown in Fig. 1.

In order to utilize any of these voltages merely use a five-prong tube socket wired as desired.

-30-

Fig. 1. How "S-meter" socket on S-40A receiver can be used for external power.

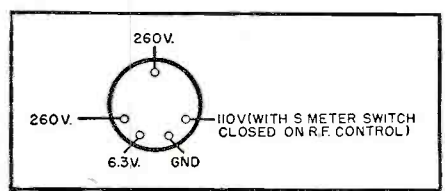



# NEW *Heathkit* TV ALIGNMENT GENERATOR KIT

Here is the most radically improved Sweep Generator in the history of the TV service industry. The basic design follows the latest high frequency techniques which result in a combination of performance features not found in any other sweep generator.

#### SWEEP:

Sweep action is obtained electronically through the use of a newly developed controllable inductor, thereby eliminating all moving parts with their resultant hum, vibration, fatigue, etc. Frequency coverage entirely on fundamentals, is continuous from 4 MC to 220 MC at an output level well over a measurable .1 volt.

Triple marker system. 4.5 MC crystal controlled marker—continuously variable marker—provisions for external marker.

#### MARKER:

The same instrument incorporates a triple marker system with a crystal controlled reference. A variable marker provides accurate coverage from 19 to 60 MC on fundamentals, and 57 to 180 MC on calibrated harmonics. A separate fixed crystal controlled 4.5 MC marker can be used for checking IF, band-pass, calibration, reference, etc. Provisions are also made for external marker use. A 4.5 MC crystal is supplied with the kit.

#### POWER SUPPLY:

The transformer operated Power Supply features voltage regulation for stable oscillator operation. Three sets of shielded cables are furnished with the kit. Sweep range is completely and smoothly controllable from zero up to a maximum of 50 MC, depending upon base frequency.

Here is a TV Sweep Generator that truly no serviceman can afford to be without for rapid, accurate, TV alignment work.

Controllable inductor sweep oscillator with output entirely on fundamentals.

Triple marker system 4.5 MC crystal controlled—3 sets of low loss, low capacity shielded cables included.

Electronically operated, smooth continuously variable sweep circuit—no vibration, hum or noise.

Frequency coverage: 4 MC—220 MC continuous including FM spectrum. RF output well over .1 volt.



MODEL TS-3

**\$44.50**

Shpg. Wt. 18 lbs.

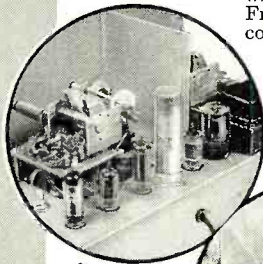

Automatic amplitude control circuit—constant output voltage regulated power supply.

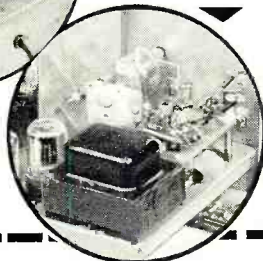

# NEW *Heathkit* SIGNAL GENERATOR KIT

MODEL SG-8

**\$19.50** Shpg. Wt. 8 lbs.

The new Heathkit service type Signal Generator, Model SG-8 incorporates many design features not usually found in this instrument price range. Frequency coverage

is from 160 KC to 110 MC in five ranges, all on fundamentals, with useful calibrated harmonics up to 220 MC. The RF output level is well in excess of 100,000 microvolts throughout the frequency range. The oscillator circuit consists of a twin triode tube, one-half used as a Colpitts oscillator, and the other half as a cathode follower output which acts as a buffer between the oscillator and external load, thereby eliminating oscillator frequency shift usually caused by external loading.

All coils are factory wound and adjusted, thereby completely eliminating the need for individual calibration and the use of additional calibrating equipment. The stable, low impedance output, features step and variable attenuation for complete control of RF level. A separate 6C4 triode acts as a 400 cycle sine wave oscillator, and a panel mounted switching system permits choice of either external or internal modulation.

# *Heathkit* LABORATORY GENERATOR KIT

The new Heathkit Laboratory type Signal Generator definitely establishes a new performance standard for a kit instrument. An outstanding feature involves the use of a panel mounted 200 microampere meter calibrated both in microvolts and percent modulation, thereby providing a definite reference level for using the Signal Generator in design work, gain measurements, selectivity, frequency response checks.

#### DESIGN:

Additional design features are copper plated shield enclosure for oscillator and buffer stages resulting in effective double shielding. Fibre panel control shaft extensions in RF carrying circuits, thorough AC line filtering, careful shielding of the attenuator network, voltage regulated B plus supply, selenium rectifier, etc.

#### RANGES:

Frequency coverage from 150 KC to 30 MC all on fundamentals in five separate ranges. Output voltage .1 volt with provisions for metered external or internal modulation. Output impedance termination 50 ohms. Transformer operated power supply.

Investigate the many dollar stretching features offered by the LG-1 before investing in any generator for Laboratory or Service work.



MODEL LG-1

**\$39.50**

Shpg. Wt. 16 lbs.

# NEW *Heathkit* BAR GENERATOR KIT



MODEL  
BG-1

**\$14.50** Shpg. Wt. 4 lbs.

The Heathkit BG-1 produces a series of horizontal or vertical bars on a TV screen. Since these bars are equally spaced, they will quickly indicate picture linearity of the receiver under test without waiting for transmitted test patterns. Panel switch provides "standby—horizontal and vertical position." The oscillator unit uses a 12AT7 twin triode for the RF oscillator and video carrier frequencies. A neon relaxation oscillator provides low frequency for vertical linearity tests. The instrument will also provide an indication of horizontal and vertical sync circuit stability as well as overall picture size. Operation is simple and merely requires connection to the TV receiver antenna terminal. Transformer operated for safety.

**HEATH company**  
BENTON HARBOR 15,  
MICHIGAN

**Moisture Detector**  
(Continued from page 53)

level in a tank. The "sensor" plate is not used in this application. Instead, a special "sensor" unit is made up by mounting two metal rods or tubes a short distance apart ( $\frac{1}{4}$ " to  $\frac{1}{2}$ ") in an insulating block.

The "sensor" is then mounted on the side of the tank so that the rods project downward to the desired level. The insulating block, to which terminal connections are made, should be so located as not to be dampened by the inlet pipe.

A solenoid-operated valve is placed in the inlet pipe, with the solenoid connected in series with the "normally-closed" terminals of the moisture detector relay.

As long as the water level stays below the two rods, the relay is open and the solenoid valve is actuated, permitting water to flow through the inlet pipe and into the tank. As soon as the water level reaches the predetermined point and makes contact with the "sensor" rods, the relay is pulled closed, opening the solenoid circuit and permitting the inlet valve to close.

When the water level drops below the two rods, as when water is drawn from the tank, the moisture detector relay again drops out, permitting the valve to operate.

Note that this application differs from those previously discussed in that the relay is normally held closed. This places a small, but constant, current drain on the battery.

Because of this, and in any application where a current drain may exist for comparatively long periods of time, a periodic "battery inspection and test" schedule should be set up and followed.

**Sump Pump Control:** In this application the rod type "sensor" element is also employed. Mount the rods in the sump at the desired level (slightly above the intake of the pump).

Connect the moisture detector relay contacts to operate the sump pump motor when the relay is closed.

There is very little current drain from the battery unless water collects in the sump to a sufficiently high level to make contact with the "sensor" rods. When this happens, the moisture detector relay closes, turning on the sump pump motor. The relay will stay closed, and the motor will continue to operate, until the water level drops below that of the "sensor" rods.

**General Suggestions:** Whenever the moisture detector is used to control a motor, solenoid, or other circuit, make sure that the relay contact ratings are not exceeded. If the current requirements are greater than can normally be handled by the relay employed, use the moisture detector relay to control another, heavy-duty, power relay.

If desired, a 100,000 ohm rheostat may be connected in series with  $R_1$ . This rheostat may be used as a sensitivity control and will permit some degree of operational adjustment. —30—

*Heathkit*  
**VISUAL-AURAL**  
**SIGNAL-TRACER**  
**KIT**

The new Heathkit Visual-Aural Signal Tracer features a special high gain RF input channel used in conjunction with a newly designed wide frequency range demodulator probe. High RF sensitivity permits signal tracing from the receiver antenna input. Separate low gain channel and probe available for audio circuit exploration. Both input channels are constantly monitored by an electron ray beam indicator so that visual as well as aural indications may be obtained.

**NOISE LOCATOR:**

A decidedly unusual feature is a noise locator circuit used in conjunction with the audio probe. With this system, a DC potential is applied to a suspected circuit component and the action of the voltage in the component can be seen as well as heard. Invaluable for ferreting out noisy or intermittent condensers, noisy resistors, controls, IF and power transformers, etc.

**WATTMETER:**

Built-in calibrated wattmeter circuit will prove useful for quick preliminary check of total wattage consumption of equipment under test. Separate panel terminals provide external use of the speaker or output transformer for substitution purposes. Saves valuable service time by eliminating the necessity for speaker removal on every service job. The same panel terminals also provide easy access to a well filtered B plus supply for external use. Don't overlook the many interesting service possibilities provided through the use of this instrument, and let the Signal Tracer work for you by saving time and money.



Substitution test speaker—utility amplifier.

Noise locator circuit—calibrated wattmeter.

RF and audio probes supplied along with necessary test leads.

Visual and aural signal tracing.

**MODEL T-3**  
**\$23.50**

Shpg. Wt. 9 lbs.

*Heathkit* **CONDENSER CHECKER KIT**



**MODEL C-3**

**\$19.50** Shpg. Wt. 7 lbs.

Here is a handy test instrument for any Service Shop. Unknown values of capacity and resistance are quickly determined on the direct reading condenser checker dial. Capacity is measured in four ranges from .001 mfd to 1000 mfd. Resistance in the range from 100 ohms to 5 megohms.

DC polarizing voltages of 25, 150, 250, 350, and 450 volts are available for leakage tests on all types of condensers. For electrolytics, a power factor control is provided to balance out inherent leakage and to indicate directly the power factor of a condenser under test. Proper balancing of the AC bridge is reflected in the degree of closure of an electron beam indicator tube.

Model C-3 uses a transformer operated power supply, spring return leakage test switch, and a convenient combination of panel scales for all readings. Test leads are furnished in addition to precision components for calibrating purposes. Quick and easy to operate, the Heathkit Condenser Checker will save valuable time and increase your Shop efficiency.

*Heathkit* **"Q" METER KIT**



**MODEL QM-1**

**\$44.50**  
Shpg. Wt. 14 lbs.

The Heathkit QM-1 represents the first practical popular priced Q meter available within the price range of schools, laboratories, TV service men, and experimenters. This instrument will enable the operator to simulate conditions encountered in practical circuits and to measure the performance of coils or condensers at the operating frequencies actually encountered. All indications of value are read directly on the  $\frac{1}{2}$ " 50 microampere Simpson calibrated meter scale. Measures Q of condensers, RF resistance, and the distributed capacity of coils. Oscillator section supplies RF frequencies 150 KC to 18 MC in four ranges. Calibrate capacity with range of 40 MMF to 450 MMF with vernier of  $\pm 3$  MMF. Investigate the many services this instrument can perform for you.

*Heathkit* **AUDIO OSCILLATOR KIT**



**MODEL AO-1**

**\$24.50**  
Shpg. Wt. 10 lbs.

The Heathkit Audio Oscillator will produce both sine and square waves within the frequency range from 20 CPS to 20 KC in three ranges. Thermistor controlled linearity results in a variation of no more than  $\pm 1$  db in a 10 volt (no load) variable output level. There will be less than .6% distortion from 100 CPS throughout the audible range. Low impedance 600 ohm output. Precision 1% resistors, used in the range multiplier circuits to provide accurate calibration.

**HEATH company**

BENTON HARBOR 15,  
MICHIGAN

# Heathkit TUBE CHECKER KIT

The Heathkit TC-2 Tube Checker was primarily designed for the convenience of radio and TV servicemen and will check the operating quality of tubes commonly encountered in this type of work. Test set-up procedure is simplified, rapid, and flexible. Panel sockets accommodate 4, 5, 6, and 7 pin tubes, octal and loctal, 7 and 9 pin miniatures, 5 pin Hytron, and a blank socket for new tubes. Built-in neon short indicator, individual 3-position lever switch for each tube element, spring return test switch, 14 filament voltage ranges, and line-set control to compensate for supply voltage variations, all represent features of the TC-2.

Illuminated for easy reading and quick identification of chart reference.

Simplified construction—new harness type wiring—closer tolerance resistors.

Improved smooth running roll chart mechanical action.

Smart, professional appearance—available in counter or portable models.

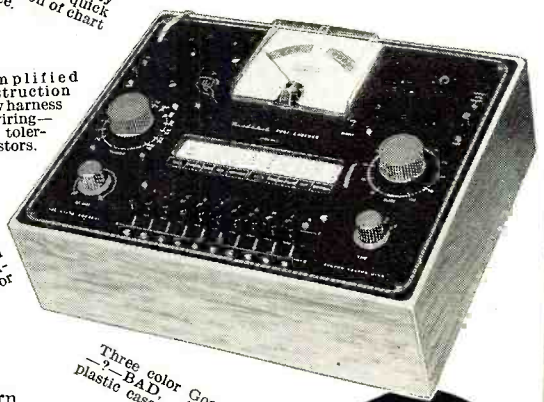

Three color Good—2-BAD, 4 1/2" plastic cased meter.

MODEL TC-2  
**\$29.50**  
Shpg. Wt. 12 lbs.

Results of tube tests are read directly from the large 4 1/2" Simpson 3-color meter. Checks emission, shorted elements, open elements, and continuity. Wiring procedure has been simplified through the use of multi-wired color coded cable providing a harness type installation between tube sockets and lever switches. This procedure insures standard assembly and imparts a "factory built" appearance to the instrument. New Construction Manual furnishes detailed information regarding tube set-up procedure for testing of new or unlisted tube types. No delay necessary for release of factory data.

## Heathkit PORTABLE TUBE CHECKER KIT

The portable model is supplied with a strikingly attractive two-tone cabinet finished in rich maroon proxylin impregnated fabric covering with a contrasting gray on the inside of the detachable cover.

MODEL TC-2P  
**\$34.50**  
Shpg. Wt. 15 lbs.



## Heathkit REGULATED POWER SUPPLY KIT



MODEL PS-2  
**\$33.50** Shpg. Wt. 15 lbs.

Here is a source of regulated D.C. voltage for circuit development work. Power supply voltage and current drain to the circuit under test are constantly monitored by the 4 1/2" panel mounted meter. Separate 6.3 volt at 4 ampere A.C. filament source available. The regulated and variable output voltage will be constant over wide load variations, and hum ripple will not exceed .012% at 250 volts under a 50 MA load. Completely isolated circuit, standby switch, and other desirable features, make the Model PS-2 extremely useful in a wide variety of applications.

## Heathkit TV PICTURE TUBE TEST ADAPTER

The Heathkit TV Picture Tube Test Adapter used with the Heathkit Tube Checker Kit, will quickly check picture tubes for emission, shorts, etc. and determine tube quality. Consists of standard 12-pin TV tube socket, four feet of cable, octal socket connector, and data sheet.



No. 355  
**\$4.50** Shpg. Wt. 1 lb.

## Heathkit DECADE RESISTANCE KIT



MODEL DR-1  
**\$19.50**  
Shpg. Wt. 4 lbs.

Twenty 1% resistors are decaded in 1 ohm steps to provide any value between 1 ohm and 99,999 ohms. Sturdy ceramic switches with silver plated contacts insure reliable service. Use the Decade Resistance in bridge circuits, meter multipliers, calibrations, or any application requiring a wide range of precision resistance values.

## Heathkit AUDIO GENERATOR KIT

Here is an Audio Generator with features generally found only in the most expensive instruments. Sine wave coverage from 20 cycles to 1 Megacycle—response flat  $\pm 1$  db from 20 cycles to 400 Kc—continuously variable and step attenuated output. Because the output voltage is relatively constant over wide frequency ranges, the AG-8 is ideal for running frequency response curves in audio circuits. Once set by means of the attenuator, this voltage may be relied upon for accuracy within  $\pm 1$  db. Instrument features low impedance 600 ohm output circuit and distortion less than .4 of 1% from 100 CPS through audible range.



MODEL AG-8  
**\$29.50**  
Shpg. Wt. 11 lbs.

## Heathkit DECADE CONDENSER KIT

The Heathkit Decade Condenser provides a ready source of capacity values from 100 mmf to .111 mfd inclusive in capacity steps of 100 mmf. Silver plated contacts on husky ceramic switches, assure positive contact for each switch position. Precision silver mica condensers  $\pm 1\%$  accuracy for close tolerance accurate work.

MODEL DC-1  
**\$16.50**  
Shpg. Wt. 3 lbs.



**HEATH** company  
BENTON HARBOR 15,  
MICHIGAN

# NEW *Heathkit* HIGH FIDELITY PREAMPLIFIER KIT

Here is the exciting new Heathkit Preamplifier with all of the features you Audiophiles have asked for and at a down-to-earth price level. Beautiful satin gold baked enamel finish, striking control knobs and arrangement, attractive custom appearance and entirely functional design.

#### DESIGN:

Uses three twin triode tubes in a shock mounted chassis, 2-12AX7 and 1-12AU7. Features tube shielding, plastic sealed color coded capacitors, smooth acting controls, good filtering, excellent decoupling, low hum and noise level, and all aluminum cabinet. Special balancing control for absolute minimum hum level. Cathode follower, low impedance output circuit for complete installation flexibility.

#### SPECIFICATIONS:

Provides five switch selected inputs, 3 high level, and two low level, each with individual level controls—4 position LP, RIAA, AES, and early 78 equalization switch—4 position roll-off switch, 8, 12, 16 with one flat position. Separate tone controls, bass 18 db boost and 12 db cut at 50 CPS, treble 15 db boost, and 20 db cut at 15,000 CPS. Power re-

Equalization for LP, RIAA, AES, and early 78.

Separate bass and treble tone controls—special hum control.



Cathode follower low impedance output circuit.

Beautiful, modern appearance blends with any interior color scheme.

Five switch selected inputs with individual level controls.

requirements from Heathkit Williamson Type Amplifier power supply 6.3 volts AC at 1 ampere, and 300 volts DC at 10 MA. Over-all dimensions 12 $\frac{1}{8}$ " wide x 5 $\frac{3}{8}$ " deep x 3 $\frac{3}{8}$ " high.

#### APPLICATION:

The new Heathkit WA-P2 Preamplifier has been designed to operate with any of the Heathkit Williamson Type Amplifiers and is directly interchangeable with the previous Model WA-P1 Preamplifier unit. Order your kit today and enjoy completely smooth control over the operation of your Hi-Fi system. Obtain the exact tonal balance of bass and treble with the precise degree of equalization you want. Note that the design of the WA-P2 accommodates the newly established RIAA curve.

MODEL WA-P2

**\$19<sup>75</sup>**

Shpg. Wt. 7 lbs.

## HAM EQUIPMENT

Single knob band switching—pre-wound coils.



Crystal or VFO excitation—metered operation.

52 Ohm coaxial output—built-in power supply.

MODEL AT-1

**\$29<sup>50</sup>**

Shpg. Wt. 16 lbs.

filter, good shielding and a 52 ohm coaxial output. The 425 volt, 100 milliampere power supply and 5U4 rectifier are more than adequate for the 6AG7 oscillator multiplier and 6L6 amplifier doubler.

### *Heathkit* AMATEUR TRANSMITTER KIT

The Heathkit AT-1 Transmitter has established a high reputation and has been enthusiastically accepted by hundreds of experienced operators as well as beginners. Power input up to 35 watts for the novice and suitable as a standby exciter for your higher powered rig later on.

Model AT-1 can be crystal or VFO excited and operates on 80, 40, 20, 15, 11 and 10 meters. The pre-wound coils with the oscillator and amplifier are switched simultaneously by the rugged band switch. Meter switch allows a reading of the final grid and plate current on the panel mounted meter. Modulator input and VFO power sockets are provided as well as a key jack for CW operation. Other features include a crystal socket, standby switch, key click filter, AC line filter, good shielding and a 52 ohm coaxial output. The 425 volt, 100 milliampere power supply and 5U4 rectifier are more than adequate for the 6AG7 oscillator multiplier and 6L6 amplifier doubler.

Brand  
NEW

Smooth acting illuminated and precalibrated dial.

### HEATHKIT VFO KIT

The new Heathkit VFO is the perfect companion to the Heathkit Model AT-1 Transmitter and it has sufficient output to drive any multi-stage transmitter of modern design. Good mechanical and electrical design insures operating stability. Coils are wound on stable, heavy duty, ceramic forms using Litz or double cellulose wire coated with Polystyrene cement and baked for humidity protection. Variable capacitor of differential type construction, especially designed for maximum bandspeed. Kit is furnished with a carefully precalibrated scale which provides well over two feet of scale length. Smooth acting vernier reduction drive and illuminated dial provides easy tuning and zero beating.

Power requirements 6.3 volts AC at .45 amperes, and 250 volts DC at 15 mls. Just plug it into the power receptacle provided on the rear of the AT-1 Transmitter. Seven band coverage 160 through 10 meters with 10 volt average RF output. Uses 6AU6 electron coupled Clapp oscillator and OA2 voltage regulator.

Copper plated chassis—aluminum cabinet—easy to build.



Seven band coverage 160 through 10 meters at 10 volt RF output.

6AU6 electron coupled Clapp oscillator and OA2 voltage regulator.

MODEL VF-1

**\$19<sup>50</sup>**

Shpg. Wt. 7 lbs.

*Heathkit*

### GRID DIP METER KIT

The invaluable instrument for Hams, servicemen and experimenters. Useful in TV service work, for alignment of traps, filters, IF stages, peaking compensation networks, etc. Locates spurious oscillation, provides a relative indication of power in transmitter stages. Use it for neutralization, locating parasitics, correcting TVI, measuring CL and Q of components, and determining RF circuit resonant frequencies. The variable meter sensitivity control, headphone jack, 500 microampere Simpson meter, continuous frequency coverage from 2 MC to 250 MC. Pre-wound coil kit and rack included.

#### LOW FREQUENCY COILS:

Low frequency range extended to 355 KC by the use of two additional coils. Complete with dial correlation curves. Set 341-A for GD-1B and set 341 for GD-1A. Shpg. wt. 1 lb. Price \$3.00



MODEL GD-1B

**\$19<sup>50</sup>** Shpg. Wt. 4 lbs.

*Heathkit* ANTENNA

### IMPEDANCE METER KIT

MODEL AM-1 Determine antenna resonance and resistance, transmission line surge impedance, and receiver input impedance. Works with one-half and one-quarter wave lines, half wave and folded dipoles, harmonic mobile and beam antennas. Resistance type SWR bridge—100 microampere meter—frequency range 0-150 MC—impedance range 0-600 ohms.



**\$14<sup>50</sup>**

Shpg. Wt. 2 lbs.



MODEL AC-1

**\$14<sup>50</sup>**

Shpg. Wt. 4 lbs.

### *Heathkit* ANTENNA COUPLER KIT

For the Heathkit AT-1 Transmitter or any comparable Amateur Transmitter. Will handle power up to 75 watts at its 52 ohm coaxial input. Matches a wide range of antenna impedances with its L type tuning network and neon indicator. A tapped inductance provides coarse adjustment and a transmitting type variable condenser sets it "right on the nose." Will operate on the 10 through 80 meter bands.

**HEATH** company  
BENTON HARBOR 15,  
MICHIGAN

# New LOW PRICED HEATHKIT SINGLE UNIT Williamson Type High Fidelity AMPLIFIER KIT

Here is the newest Heathkit Hi-Fi Amplifier at the lowest price ever quoted for a complete Williamson Type Amplifier circuit. The W-4 Model has been designed for single chassis construction, and only for the new Chicago Transformer Company Model BO-13 "super range" high fidelity output transformer. This transformer, a new development in the Hi-Fi field, is being offered at substantial saving over transformers of comparable quality. It is outstanding in performance and on the basis of our tests, we find it equal in every respect to transformers used in the W-2 and W-3 Heathkit series.

## LOW PRICES:

Through utilization of a single chassis with resultant economy obtained through elimination of duplicate sheet metal fabrication, connecting cables, plugs, sockets, and a new Chicago "super range" output transformer, a 20% price reduction has been made possible without sacrificing kit quality.

## COMPONENTS:

The new Heathkit W-4 uses the same heavy duty power transformer and choke. It has all of the features of previous models including individual jacks and a wire wound control to balance the output tubes—plastic high quality capacitors and the exact circuitry previously utilized in Williamson Type Amplifiers. Intermodulation distortion and harmonic distortion are both at the same low level as in the W-2 and W-3 models.

## CONSTRUCTION:

Here is the opportunity for even the economy minded Hi-Fi enthusiast to enjoy all of the advantages offered through Hi-Fi reproduction of fine recorded music. Simplified step-by-step Construction Manual completely eliminates necessity of electronic knowledge or special equipment. Assemble this Amplifier in a few pleasant hours.

Rugged, heavy duty,  
single chassis con-  
struction.

Output impedances  
4, 8, and 16 ohms.



Standard brand components used, no sacrifice of quality.

Lowest price high quality  
Williamson Type Amplifier ever offered.

Send for free booklet  
High Fidelity  
Especially  
For You."

## COMBINATIONS AVAILABLE

W-4M with Chicago "super-range" transformer only. Single chassis main amplifier and power supply. Shipping **\$39.75** weight 28 lbs. Express only **\$39.75**

COMBINATION W-4 with Chicago "super-range" transformer only includes single chassis main amplifier and power supply with WA-P2 preamplifier **\$59.50** kit. Shpg. wt. 35 lbs. Express only

## NEW Heathkit 20 WATT High Fidelity AMPLIFIER KIT

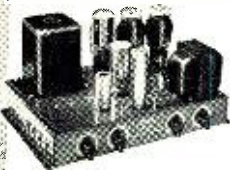

MODEL A-9B

**\$35<sup>50</sup>**

Shpg. Wt. 24 lbs.

In keeping with the progressive policy of the Heath Company, further improvement has been made in the already famous Heathkit High Fidelity 20 Watt Amplifier. Additional reserve power has been obtained by using a heavier power transformer. A new output transformer designed and manufactured especially for the Heath Company, now provides output impedances of 4, 8, 16 and 500 ohms. The harmonic distortion level will not exceed 1% at the rated output.

## FEATURES:

Outstanding features of the Heathkit 20 watt Amplifier include frequency response of  $\pm 1$  db from 20 CPS to 20 KC. Separate (boost and cut) bass and treble tone controls. Four switch selected input jacks and a special hum balancing control. Flexibility is emphasized in the in-

put circuits and proper equalization for all input devices is incorporated.

## TUBE LINEUP:

12AX7 magnetic preamplifier and first audio amplifier. 12AU7 two stage amplifier with tone controls. 12AU7 voltage amplifier and phase splitter. Two 6L6 push-pull beam power output and 5U4G rectifier. The Heathkit Model A-9B is excellent for custom installation and is designed for outstanding service at a very reasonable cost.

## Heathkit SIX WATT AMPLIFIER KIT



MODEL A-7B

**\$15<sup>50</sup>**

Shpg. Wt. 10 lbs.

An outstanding value, this economically priced 5 watt Amplifier is capable of performance expected only in much more expensive units. Only 2 or 3 watts output will ever be used in normal home applications and Model A-7B will be more than adequate for this purpose.

## SPECIFICATIONS:

Two switch selected inputs are available for crystal and ceramic phono pickups, tuner, TV audio, tape recorder, and carbon type microphone. Model A-7B features separate bass and treble tone controls, push-pull balanced output stages, output impedances of 4, 8, and 15 ohms, and extremely wide frequency range  $\pm 1\frac{1}{2}$  db from 20 CPS to 20 KC. Not just a souped up AC-DC job. Full wave rectification, transformer operated power supply and good filtering, result in exceptionally low hum level.

## MODEL A-7C

Provides a preamplifier stage and proper compensation for the variable reluctance cartridge and low level microphone. **\$17.50**

## Heathkit WILLIAMSON TYPE AMPLIFIER KIT

Here is the famous kit form Williamson Type high fidelity Amplifier that has deservedly earned highest praise from every strata of Hi-Fi music lovers. Virtually distortionless, clean musical reproduction, full range frequency response, and more than adequate power reserve.

## OUTPUT TRANSFORMERS:

This outstanding Williamson Type Hi-Fidelity Amplifier is supplied with the famous Acrosound TO-300 output transformer. This quality transformer features the popular "ultra-linear" output circuit for clean maximum power level. Separate chassis for amplifier and power supply.

## SPECIFICATIONS:

Frequency response within 1 db from 10 cycles to 100,000 cycles. Harmonic distortion at 5 watt output less than .5% between 20 cycles and 20,000 cycles. IM distortion at 5 watts equivalent output .5% using 60 and 3,000 cycles. Output impedances of 4, 8, or 16 ohms. Overall dimensions for each unit 7" high x 5 $\frac{1}{2}$ " wide x 11 $\frac{1}{2}$ " long.

## CONSTRUCTION MANUAL:

This fine kit is supplied with a completely detailed step-by-step Construction Manual and the only effort required is the assembly and wiring of the pre-engineered kit. Even the complete novice can successfully construct this Amplifier and have fun building it.

## COMBINATIONS AVAILABLE:

W-3 Amplifier Kit (Includes Main Amplifier with Acrosound Output Transformer, Power Supply and WA-P2 Preamplifier.) Shipping weight 37 lbs. Shipped express only. **\$69.50**

W-3M Amplifier Kit (Includes Main Amplifier with Acrosound Output Transformer and Power Supply.) Shipping **\$49.75** weight 29 lbs. Express only



**HEATH company**  
BENTON HARBOR 15,  
MICHIGAN



## WHAT'S

# New in Radio

The products described in this column are for your convenience in keeping up-to-date on the new equipment being offered by manufacturers. For more complete information on any of these products, write direct to the company involved.

### COLOR DOT GENERATOR

*Sylvania Electric Products Inc.* has announced a new TV service instrument for color TV convergence adjustments.

The new instrument, the Model 506 color television dot generator, is designed for use in adjusting static and

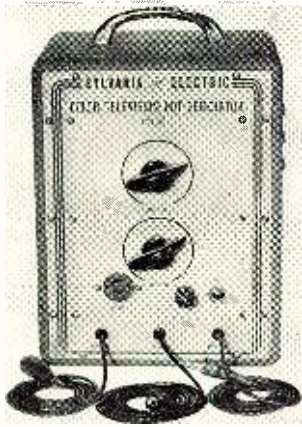

dynamic convergence of 3-gun color tubes. The instrument produces a pattern of small rectangular white dots on the tube screen, each dot being about  $\frac{1}{4}$ " long and 2 or 3 vertical scan lines high. Nominally, the pattern of dots is 16 horizontally by 12 vertically, although the exact number can be changed somewhat by the synchronizing controls.

For full details on this new piece of test gear write the company's Electronic Equipment Sales Dept., 1221 W. Third St., Williamsport, Pa.

### TRANSISTORS FOR A.G.C.

Tetrode grown-junction transistors suitable for use in audio amplifier a.g.c. circuits have been announced by *Texas Instruments Incorporated*, 6000 Lemmon Ave., Dallas 9, Texas.

These germanium, hermetically-sealed units have two base layer connections allowing introduction of feedback. The amplification factor of the tetrode through the amplifier section is guaranteed to be .95 or better. Output signal attenuation of over 20 db can be secured with less than 100  $\mu$ a. applied to the second base lead.

Detailed information on the new Type 700 units is available in bulletin form from the company.

### TINY ELECTROLYTICS

*Illinois Condenser Company*, 1616 N. Throop St., Chicago 22, Illinois has added a new line of miniature and subminiature electrolytic condensers to its line.

Designated as the Types MT and

SMT, these low cost, low current drain units are especially designed for use with transistors, printed circuits, hobby models, etc. where small size and lightweight components are required.

They are manufactured in a capacity range of  $\frac{1}{2}$  to 100  $\mu$ fd. and from 3 to 75 volts. They are available in case styles of  $\frac{1}{8}$ ",  $\frac{3}{16}$ ",  $\frac{1}{4}$ ", and  $\frac{3}{8}$ " diameters. Lengths range from  $\frac{1}{2}$ " to  $1\frac{1}{4}$ ".

### "SCOTCH" ELECTRICAL TAPE

*Minnesota Mining and Manufacturing Co.*, St. Paul 6, Minn. has recently introduced its "Scotch" plastic electrical tape in a convenient new roll size for use in radio, TV, appliance, and instrument manufacturing and repair fields.

The new tape is  $\frac{3}{8}$ " wide and combines convenient size with good insulation and holding properties. Because of its thin, 7-mil backing and its new narrow width the tape provides a higher degree of conformability, making a tight, neat-appearing splice wrap.

### COLOR SIGNAL GENERATORS

*Kay Electric Company*, Pine Brook, N. J. is now offering two signal generators for the presentation of full-fidelity NTSC standard colors.

Known as the "Multi-Chrome Chromabar" and "Uni-Chrome Chromabar,"

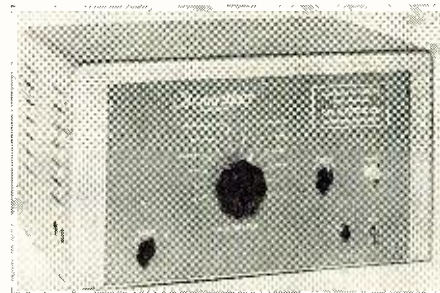

the former is for multiple presentation simultaneously while the latter is for single color presentation. Both generate green, yellow, red, magenta, blue, cyan, white, and black. Other colors, gray shades or "T" and "Q" may be had at additional cost.

### MINIATURE TRANSFORMERS

*Audio Development Company*, 2833 13th Ave. South, Minneapolis, Minn. is in production on a new line of miniature hermetically-sealed transformers and chokes.

Suitable for use in circuitry such as geophysical and transistor applications, these compact transformers and chokes measure only  $\frac{3}{4}$ "x $1\frac{1}{16}$ "x $1\frac{7}{8}$ ".

## Quality Features OF TUNG-SOL PICTURE TUBES

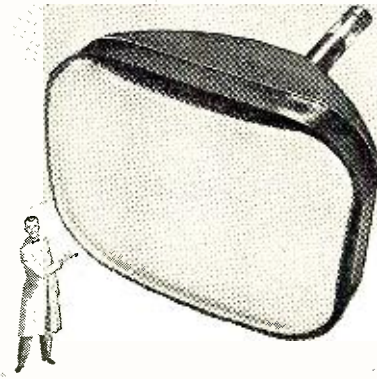

Gun made of best grade non-magnetic steel.

Glass bead type assembly is stronger both mechanically and electrically—gives greater protection against electrical leakage.

Rolled edges in gun minimize corona.

Custom built stem with greater spacing between leads assures minimum leakage.

Low resistance of outside conductive coating minimizes radiation of horizontal oscillator sweep frequency.

Double cathode tab provides double protection against cathode circuit failure.

Selected screen composition resists burning (X pattern).

Rigid control of internal conductive coating provides utmost service reliability.

Designed for use with single or double field ion trap designs.

One-piece construction of parts assures better alignment.

Maximum dispersion of screen coating assures uniform screen distribution.

Tung-Sol makes All-Glass Sealed Beam Lamps, Miniature Lamps, Signal Flashers, Picture Tubes, Radio, TV and Special Purpose Electron Tubes and Semiconductor Products.

TUNG-SOL ELECTRIC INC., Newark 4, N. J. Sales Offices: Atlanta, Chicago, Columbus, Culver City (Los Angeles), Dallas, Denver, Detroit, Newark, Seattle.

## TUNG-SOL®

RADIO AND TV TUBES



You Can Build A Reputation On Tung-Sol Quality

TUBES		60% TO 90% OFF LIST!		TUBES	
OC3/	VR105 . . .80	6J6 . . . . .55	471A . . .1.19	532A . . .1.19	
OD3/	VR150 . . .85	6L6GA . . .1.05	717A . . . . .79	722A . . . . .99	
1B22 . . . . .69	6N7 . . . . .70	6L6M . . .1.20	801A . . . . .19	826 . . . . .39	
1A7 . . . . .69	6SA7 . . . . .49	6SN7 . . . . .55	832A . . .6.95	836 . . . . .5.50	
1L4 . . . . .49	6SJ7 . . . . .54	6SK7 . . . . .54	837 . . . . .1.35	841 . . . . .29	
2B22 . . . . .69	6SK7 . . . . .54	6SL7 . . . . .55	843 . . . . .17	864 . . . . .19	
2C26 . . . . .09	6SN7 . . . . .55	6SS7 . . . . .75	931A . . .4.75	1026 . . . . .19	
2C26A . . . . .09	6SS7 . . . . .75	6SU7 . . .2.49	1026 . . . . .19	1026 . . . . .19	
2D21 . . . . .1.15	6SU7 . . . . .75	6Y6 . . . . .70	1026 . . . . .19	1026 . . . . .19	
2X2 . . . . .39	6Y6 . . . . .70	7C4 . . . . .39	1026 . . . . .19	1026 . . . . .19	
3B22 . . . . .1.19	7C4 . . . . .39	12A6G . . .1.15	1026 . . . . .19	1026 . . . . .19	
3B6 . . . . .39	12A6G . . .1.15	12AH7 . . .1.20	1026 . . . . .19	1026 . . . . .19	
5R4G . . . . .1.15	12AT7 . . .85	12C8 . . . . .59	1026 . . . . .19	1026 . . . . .19	
5T4 . . . . .70	12C8 . . . . .59	12H6 . . . . .55	1026 . . . . .19	1026 . . . . .19	
6AG5 . . . . .70	12H6 . . . . .55	12L8 . . . . .29	1026 . . . . .19	1026 . . . . .19	
6AJ5 . . . . .1.25	12L8 . . . . .29	12SG7 . . .75	1026 . . . . .19	1026 . . . . .19	
6AK5 . . . . .75	12SG7 . . .75	12SH7 . . .59	1026 . . . . .19	1026 . . . . .19	
6AK5W . . .1.45	12SH7 . . .59	12SJ7 . . .54	1026 . . . . .19	1026 . . . . .19	
6AL5 . . . . .49	12SJ7 . . .54	15R . . . . .39	1026 . . . . .19	1026 . . . . .19	
6AL5W . . .75	15R . . . . .39	2050W/CT .1.75	1026 . . . . .19	1026 . . . . .19	
6AQ5 . . . . .52	2050W/CT .1.75	28D7 . . . . .1.50	1026 . . . . .19	1026 . . . . .19	
6AS6 . . . . .1.90	28D7 . . . . .1.50	39/44 . . . . .29	1026 . . . . .19	1026 . . . . .19	
6RA6 . . . . .54	39/44 . . . . .29	114B . . . . .29	1026 . . . . .19	1026 . . . . .19	
6BE6 . . . . .54	114B . . . . .29	215A . . . . .09	1026 . . . . .19	1026 . . . . .19	
6BE6 . . . . .54	215A . . . . .09	221A . . . . .29	1026 . . . . .19	1026 . . . . .19	
6BQ6 . . . . .1.15	221A . . . . .29	316A . . . . .29	1026 . . . . .19	1026 . . . . .19	
6C4 . . . . .65	316A . . . . .29	388A . . . . .59	1026 . . . . .19	1026 . . . . .19	
6D4 . . . . .2.50	388A . . . . .59	VT127 . . . . .15	1026 . . . . .19	1026 . . . . .19	
6H6 . . . . .50			1026 . . . . .19	1026 . . . . .19	
6J4 . . . . .4.25			1026 . . . . .19	1026 . . . . .19	

**SAVE! SCR-522 RECEIVERS**

less oscillator assembly, frequency shifter and tubes. Contains all Coils, Transformers, Resistors, Condensers and other valuable parts. **\$5.95** SPECIAL 2 for \$10.00 each



**Field Telephones**  
Army surplus plus completely reconditioned and electrically tested, using 2 flashlight cells and a pair of interconnecting wires. GUARANTEED.  
Like new

**TELEGRAPH KEYS**



- J37 . . . . . \$1.50
- J38 . . . . . 1.50
- J41 . . . . . .98
- J45 . . . . . 3.95

**SCR-274N COMMAND AND ARC-5 EQUIPMENT**

RECEIVERS	USED	EXCELLENT	NEW
BC-453-190 to 550 KC.		\$24.95	\$49.95
BC-453-3 to 6 MC.		12.95	29.95
BC-455-6 to 9 MC.		12.95	29.95
1.5 to 3.			

TRANSMITTERS	USED	EXCELLENT	NEW
A-958-2.1 to 3 MC.			24.95
BC-457-4 to 5.3 MC.		12.95	
BC-458-5.3 to 7 MC.	\$8.95	12.95	
BC-459-7 to 9.1 MC.			24.95
T-15 ARC 5-500 to 800 KC.			24.95

**ADDITIONAL EQUIPMENT**

BC-456 Modulator		1.95	6.25
BC-450 Control Box (3 Receiver)		1.79	2.98
BC-451 Control Box (Transmitter)			2.49
BC-442 Relay Unit (ANT)	1.29		5.49
Flexible Shafting with gear to fit receivers			1.95
3 Receiver Rack	1.79	2.29	2.98
Shock Mount for Receiver Rack		1.25	
7 Transmitter Rack		2.39	3.95
Single Transmitter Rack			3.49
DM-33 Dynamotor for Command Set			3.95

**HEADSETS**

HS-23 high impedance. BRAND NEW with ear pads.	\$4.65
HS-33 low impedance. BRAND NEW with ear pads, cord and PL54 PLUG.	5.65
HS-33, used.	1.89
CD-307A Cords, 6 ft. NEW.	.49
HS-16 high impedance-used.	.88

**MICROPHONE SUPER-SALE**

T-44 MIKE-magnetic type consisting of Mike Unit MC-253, Cord CO-287, Plug PL-179 and Jack JK-26.	\$1.29
T-45 MIKE-Carbon Lip Mike.	1.95
T-17 MIKE-Carbon-BRAND NEW.	9.75
TS-13 HANDSET-BRAND NEW.	7.95
T-12 Western Electric Carbon Hand Mike with Cord & PL-68 Plug. BRAND NEW.	3.95

**BC-221 Frequency Meter**

Real Value! QUANTITY IS LIMITED—so first come, first served. They are just like new, with original calibration charts. Range 125-20,000 KC with crystal check points in all ranges. Complete with crystal and tubes. **\$139.50**  
Standard with AC power supply.  
MODULATED TYPE . . . \$159.50  
MODULATED TYPE with AC Power Supply . . . \$199.50  
Limited quantity of BRAND NEW MODULATED FREQ. METERS . . . \$210.00  
These Frequency Meters are factory tested, checked for frequency alignment and GUARANTEED.



**MINIMUM ORDER \$2.00**

Immediate delivery—send 25% deposit on C.O.D. orders. If sending full remittance, allow for postage and tax C.O.D. charges. All shipments F.O.B., N.Y.C. warehouse. (N.Y.C. residents add sales tax.)

**PLATT ELECTRONICS CORP.**

Dept. A, 489 Broome St., N. Y. 13, N. Y.  
PHONES: WO 4-0827 and WO 4-0828

Available drawn in both standard steel and Mumetal, they are obtainable in a practical range of specifications.

Write the company's Industrial Sales Division for full details on this line.

**FLYBACK TESTER**

TeleTest Instrument Corp., 30-01 Linden Place, Flushing, Long Island, N. Y. has introduced a new flyback tester, which tells exactly what condition any flyback is in, according to the

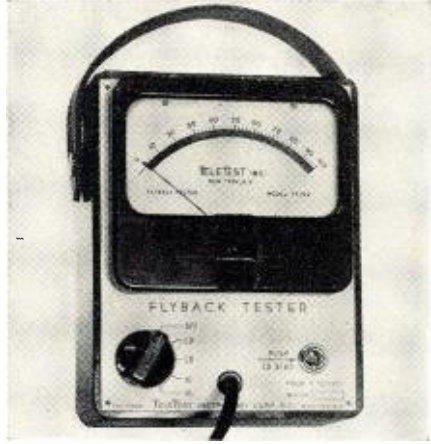

company. This unit will test good as well as faulty units.

The instrument checks not only continuity but also yokes, width coils, and linearity coils for shorted turns. Flybacks are checked under full operating voltage conditions.

The unit is portable and compact and comes equipped with a leather carrying strap. The dial is clear and easy to read while the control panel is simply and efficiently designed.

**SIMPSON TUBE CHART**

Simpson Electric Co., 5200 W. Kinzie St., Chicago 44, Illinois has announced the availability of a new tube chart for its Model 1000 plate conductance tube tester. The chart is available from the factory for \$2.00.

The new chart shows all of the new tubes produced since the last chart was introduced in May of last year. On November 1, 1954, the company will issue its free supplement showing all the tubes added since this new chart was issued.

**PROBE-INSPECTION LIGHT**

Moore Manufacturing Company, Swedesboro, New Jersey is marketing



a new tool which combines a probe and inspection light in a single unit.

With the mirror and plastic probe removed the handle of the instrument

provides a powerful insulated-top flashlight. When the probe is inserted the light is beamed to the probe tip which offers a flood of light at the tip end. When the mirror is slipped on the probe, the illuminated reflector permits ready inspection of tight wiring.

**NEW TUBES FOR TV**

CBS-Hytron of Danvers, Massachusetts has announced the availability of three new tubes designed for use as horizontal deflection amplifiers in television receivers.

These tubes, which are interchangeable with 6BQ6GT, 12BQ6GT, and 25BQ6GT, are the 6CU6, 12CU6, and 25CU6 respectively. The 12CU6 and the 25CU6 are now available for series-string operation and are particularly useful for low-cost, transformerless television sets which employ several tube heaters in series across the 117 volt a.c. line to eliminate the need for a filament transformer.

The 6CU6 features heavier-gauge plates with large radiating fins, vents in beam plates, plate aligned for maximum radiation of heat from the grids, etc.

Data sheets on these new tubes are available from the manufacturer.

**TV BAR GENERATOR**

Electronic Instrument Co., Inc., 84 Withers Street, Brooklyn 11, N. Y. has just introduced a bar generator for TV servicing which is currently available in both kit and factory-wired form.

The new Eico Model 352 is portable,

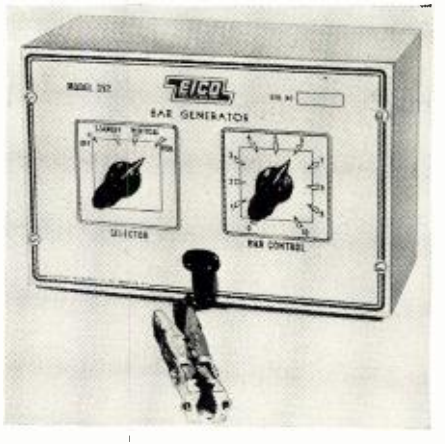

lightweight, and simple to operate. It provides a series of vertical or horizontal bars on the TV screen when connected to the antenna terminals of any TV set. Since these bars will be equally spaced on a correctly adjusted set, a quick indication is obtained of the picture linearity in the set under test. The instrument also indicates over-all picture size and vertical and horizontal sync circuit stability.

The instrument operates on channels 3, 4, or 5 and provides 16 vertical bars and 12 horizontal bars.

**REPLACEMENT FLYBACKS**

The Stancor Division of Chicago Standard Transformer Corporation, Addison and Elston, Chicago 18, Illinois has added exact replacement fly-



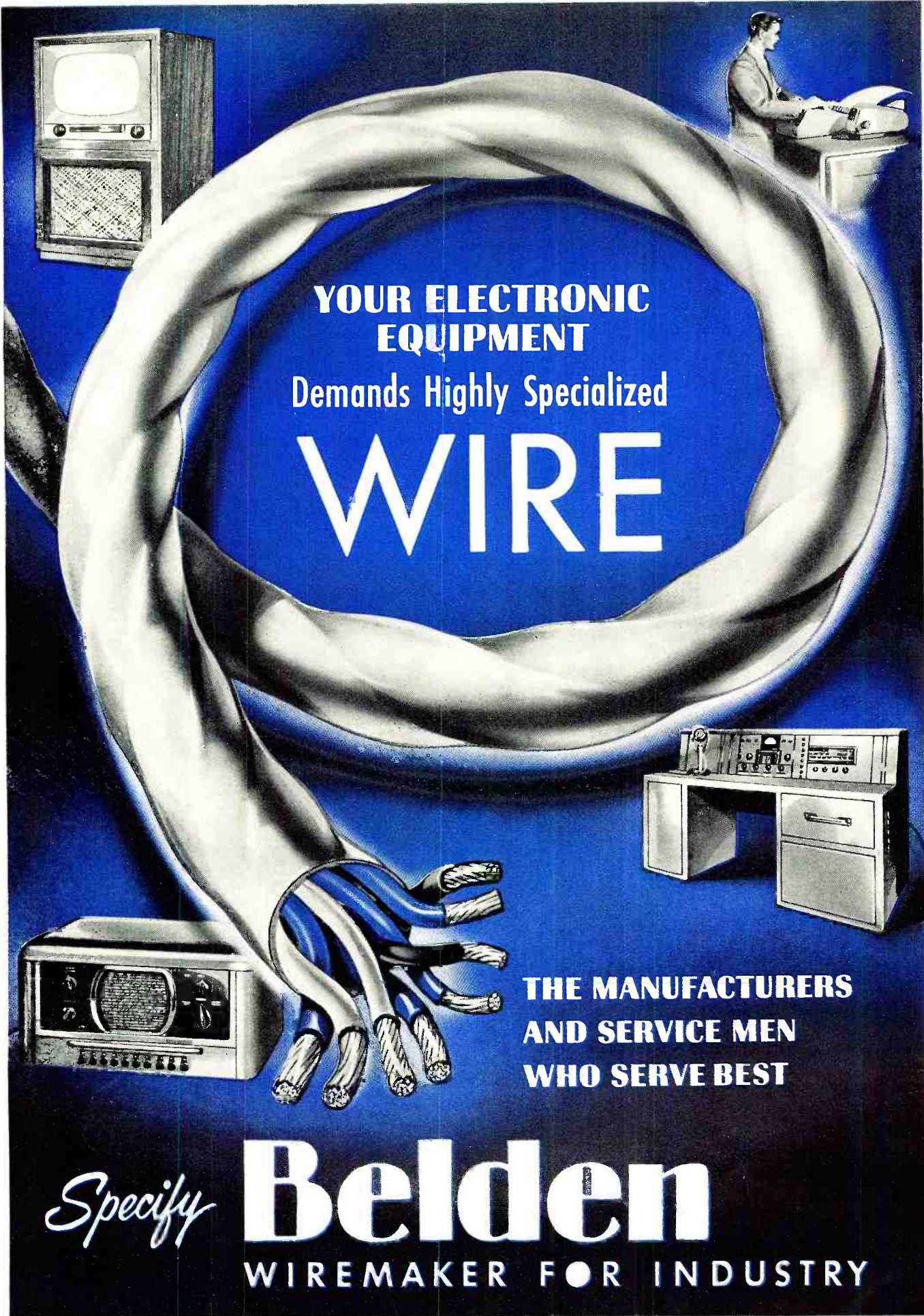

**YOUR ELECTRONIC  
EQUIPMENT**  
Demands Highly Specialized  
**WIRE**

**THE MANUFACTURERS  
AND SERVICE MEN  
WHO SERVE BEST**

*Specify*

**Belden**

**WIREMAKER FOR INDUSTRY**

# the 630

IS STILL THE FINEST  
TV CHASSIS EVER DESIGNED

...and there is no finer  
630 chassis than the  
**GOLD MEDAL**

## by TECH-MASTER

featuring a new and improved system of  
Picture-Sound synchronization which affords  
simple pin-point tuning with highest picture  
resolution and drift-free undistorted sound  
under all signal conditions... UHF or VHF.

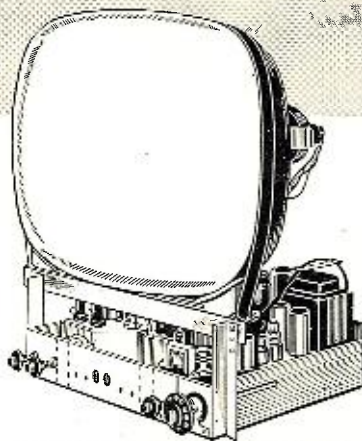

- MODEL 2430:** For picture tubes up to 24"  
Audio connection for optional use of external  
amplifier.  
Net Price..... (Less Kine) .....\$189.50
- MODEL 2431:** Same as 2430, but with true  
fidelity Push-Pull audio amplifier.  
Net Price..... (Less Kine) .....\$199.50
- MODEL 2439:** For new 90° kinescopes. (24"  
rectangular, 27" and 30")  
Net Price..... (Less Kine) .....\$262.50

Also Available VHF/UHF



**TECH-MASTER CORPORATION**  
TELEVISION and RADIO  
75 FRONT STREET, BROOKLYN 1, NEW YORK

TECH-MASTER TV Chassis

TECH-MASTER TV Kits

TECH-MASTER Audio Equipment

backs for *Motorola* and *Muntz* sets to  
its line.

The model A-8239 is a replacement  
for *Motorola* Nos. 24K792753 and 24K-  
701099 and can be used in over 100  
*Motorola* chassis and models.

The A-8240 replaces *Muntz* part  
#TO-0036.

Bulletin 491, covering these units, is  
available without charge from the  
company.

### CR TUBE TESTER

*Authorized Manufacturers Service  
Co.*, 919 Wyckoff Ave., Brooklyn 27,  
New York has introduced a light-  
weight, portable cathode-ray tube  
tester for service applications.

Known as the Model 101, the unit is

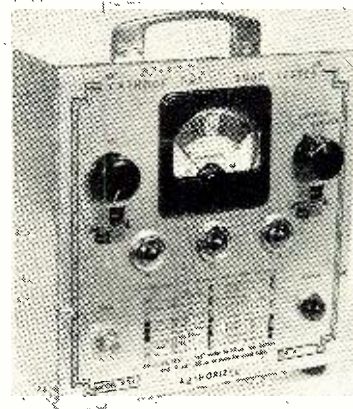

so designed as to provide positive test  
indication for continuity and emission  
within 90 seconds. All phases of poten-  
tial trouble and breakdown are out-  
lined on the front panel. No additional  
computations are required. Complete  
facilities are available for testing  
opens, shorted elements, leakage, cath-  
ode emission, and gaseous tubes. Tests  
can be made with the CRT in carton,  
TV set, cabinet, or on the bench.

### COMPACT TUBE TESTER

*Seco Manufacturing Company* of  
5015 Penn Avenue South, Minneapolis,  
Minn. has developed a portable model  
grid circuit tube tester which can be  
housed in the technician's tube caddy  
for service work in the customer's  
home.

The device isolates a.g.c. tube mal-  
functions and employs an electric eye  
to reveal faults such as control grid  
emission, grid-to-cathode or cathode-  
to-heater shorts and gaseous conditions  
in tubes.

Additional information on the Model  
GCT-3 is available from the company.

### SUBMINIATURE RELAY

*American Telasco Ltd.* of Hunting-  
ton, N. Y. is marketing a new sub-  
miniature relay which is designed espe-  
cially for applications requiring small  
size, light weight, high sensitivity,  
thermal and shock stability, and fast  
reaction time.

The new P-100 relay weighs only 1  
ounce, has over-all dimensions of 1 3/16"  
x 7/8" x 1 1/16", 3500 ohms resistance, and  
sensitivity of less than 20 mw.

RADIO & TELEVISION NEWS

## PUT THE HIGH IN HIGH FIDELITY!



High  
Fidelity Techniques  
by John H. Newitt

The book that  
says goodbye to  
guesswork in  
choosing, build-  
ing and servicing  
hi-fi equipment.  
512 pages  
203 pictures  
Price \$7.50

Whether you specialize  
in high fidelity service,  
custom building or simply  
want to build a top-notch  
outfit for yourself, this big  
512-page book will guide  
you every step of the way.  
Helps you get better re-  
sults at less cost. Shows  
what to do... what mis-  
takes to avoid. Gives you  
a full understanding of the  
many different methods,  
circuits, designs, equip-  
ment, components and  
other subjects that are de-  
bated whenever hi-fi fans  
get together.

### A COMPLETE GUIDE

Written by one of the  
nation's leading experts,  
High Fidelity Techniques  
is complete, authentic and  
easy to understand. From  
beginning to end, it is  
chock full of how-to-do-it  
tips, service hints, custom-  
building ideas and data,  
charts and diagrams of the  
most helpful sort.

## 10-DAY FREE EXAMINATION!

Dept. RN-94, RINEHART & CO., INC.  
232 Madison Ave., New York 16, N. Y.

Send HIGH FIDELITY TECHNIQUES for 10-day  
FREE EXAMINATION. If I like book, I will  
then promptly send \$7.50 (plus a few cents post-  
age) in full payment. Otherwise, I will return  
book postpaid and owe you nothing!

Name .....

Address .....

City, Zone, State .....

OUTSIDE U.S.A.—Price \$8.00 cash with order only.  
Money back if book is returned in 10 days.

## !!A WHALE OF A BUY!! PORTABLE EMERGENCY MARINE TRANSMITTER

(Mackay Type 168-B) . . . . . **READY TO OPERATE!!**  
Complete self-contained battery-operated unit in port-  
able case (21" x 18" x 10") Type A2 emission,  
1000CPS tone at 300 KC. 3 Watt output.  
Operates either FULLY AUTOMATIC or MANUALLY with  
built-in key. MAJOR COMPONENTS INCLUDE: 6V.  
Vibrapak (100ma) 6V. Keying Motor (with gear &  
cam assy); Antenna Tuning Variometer; Set of  
Tubes; Telegraph Key; Antenna Assembly. Used-ex-  
cellent condition. PARTS ALIGNED. \$149.50  
OVER \$75.00! . . . . . Less battery. Ship-  
ping wt. 45 lbs. THEY'LL GO FAST AT



**!!ALNICO MAGNETS!!**  
Just a few of the many types  
in stock . . . . .  
POLISHED BAR—3/16"x7/32"  
x3/32—12/1.00; 100 7.50  
"U" Type—3/4"x3/8"x1/2"  
ea. 49c. 12/5.00  
RING Type—1/16"O.D., 3/8"  
I.D., 5/16" deep . . . . .  
ea. 79c. 5/3.50  
"HEELING MAGNETS"—Set of  
2 round 3/4" dia. Bars, 1/4"  
& 1 3/8" Wood Cased—Set  
1.98  
ALNICO MAGNET KIT—Power-  
ful Bar, Block, "U" Rod,  
etc. Kit of 10 asstd. . . . . 1.98

(WRITE FOR LATEST ALNICO SUPPLEMENT)

7-44A MICROPHONE . . . . . Brand New, orig. carton .98  
DYNAMIC HEADSET & HAND MIK (press-to-talk) . . . . . 3.75  
Brand new, orig. carton (Mk II, #19) . . . . . 3.09  
1/2" SPONGE RUBBER . . . . . any size up to 36"x48"  
ft. . . . . 1.49  
"FIBREGLASS" ACOUSTICAL CABINET LINING  
1" thick, 36" wide . . . . . per running foot. . . . . 1.15  
2" PANEL METERS . . . . . 0-5ma. DC. calib. for  
recording level. 1/4" flange, 1" deep. . . . . 2.49

## KITS!! KITS!! KITS!!

**WHOPPING VALUES FOR EVERYONE!!**  
"JUMBO RADIO-TV-ELECTRONICS PARTS KIT"  
OVER 10,000 ALREADY SOLD! . . . . . A "Grab-Bag" of  
new & surplus inventory oddies ends for every Serv-  
icer, Ham, Student, 17 FULL lbs. of: Controls,  
Switches, Sockets, Wire, Resistors, Con-  
densers, TV Diagrams & Parts, Photofacts.  
ETC. ETC. (Ship. wt. 20 lbs.) ALL FOR  
REPAIR YOUR OWN SPEAKERS!! . . . . . SPEAKER  
CONE KIT . . . . . Assortment of popular sizes 4" to  
12", incl. oval. Less voice coils. Kit of 12 as-  
sorted . . . . . 1.98  
SPEAKER REPAIR KIT . . . . . Professional assortment  
of Voice Coil Forms, Rings, Felt, Charcoal, Lbr.,  
Spiders, Shim Kit, Cement & Instructions. . . . . 2.49  
!!SPECIAL!! . . . . . BOTH CONE & REPAIR KITS FOR  
ONLY . . . . . 3.95  
"DIRECT FACTORY SPEAKER REPAIRS SINCE 1927"  
Min. Order \$3.00. 20% deposit req. on all C.O.D.'s.  
Full remittance with foreign orders

**EOTONE RADIO CORP.**  
67 Day Street  
New York 7, N. Y.

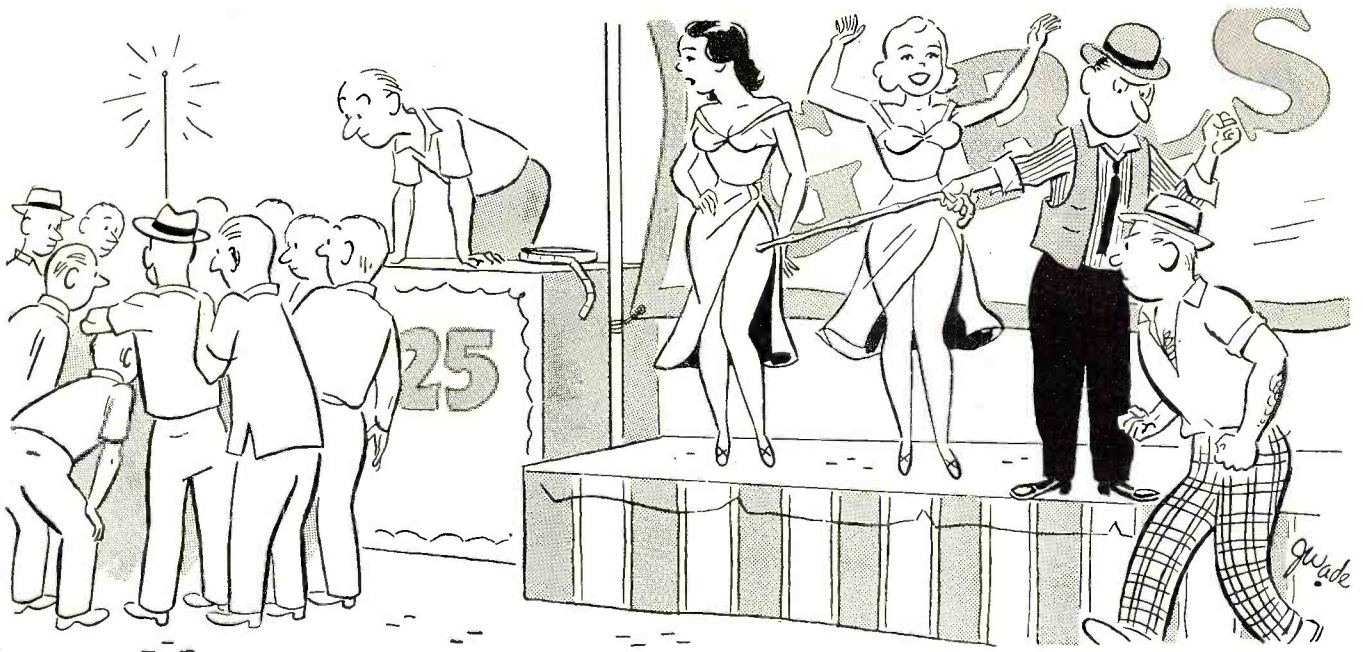

**"Get that guy with his WALTER ASHE "Surprise" Trade-in out of here!"**



JOHNSON VIKING II TRANSMITTER KIT.  
Net \$279.50. Wired and tested. Net \$337.00



JOHNSON VIKING RANGER TRANSMITTER-EXCITER KIT. Less tubes. Net \$179.50.  
Wired and Tested. Net \$258.00.  
Set of tubes for Ranger \$23.92



BARKER & WILLIAMSON TRANSMITTER.  
Net \$442.50

Always the center of attraction for the economy minded, "Surprise" allowances continue to pile up evidence that you just can't beat Walter's trade-in deal on used test and communication equipment. Get your trade-in working today. Wire, write, phone or use the handy coupon below.

## HELP, FELLAS!

I bought too many new Hallicrafters SX-71 receivers, and now the boss says I've got to sell 'em or else!

All fresh stock, brand new, and in factory-sealed cartons.

### WE CAN HELP EACH OTHER

Just drop me a line at once, here at Walter Ashe, and I'll give you the longest trade in the country on one of these SX-71's. I guarantee you'll be pleasantly surprised. So what say?

Sincerely yours,  
JOHNNY SHONTZ

### CENTRAL ELECTRONICS SINGLE SIDEBAND EXCITERS

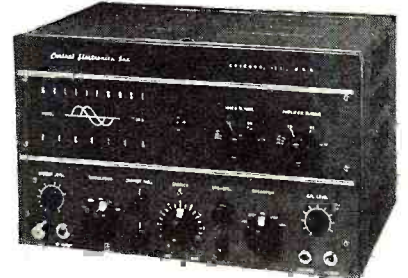

MODEL 10B MULTIPHASE EXCITER KIT.  
10 watts peak output. Net \$129.50.  
Wired and tested. Net \$179.50



MODEL 20A MULTIPHASE EXCITER KIT.  
20 watts peak output. Net \$199.50.  
Wired and tested. Net \$249.50

All prices f. o. b. St. Louis • Phone Chestnut 1-1125

**Walter Ashe**  
**RADIO CO.**  
1125 PINE ST. • ST. LOUIS 1, MO.

### FREE CATALOG!

WALTER ASHE RADIO COMPANY  
1125 Pine Street, St. Louis 1, Missouri

R-9-54

Rush "Surprise" Trade-In Offer on my \_\_\_\_\_

for \_\_\_\_\_  
(show make and model number of new equipment desired)

Send New Free 1955 Catalog.

Name \_\_\_\_\_

Address \_\_\_\_\_

City \_\_\_\_\_ Zone \_\_\_\_\_ State \_\_\_\_\_

Send  
for  
your  
copy  
today

## COMMAND EQUIPMENT (274N-ARC5, ATA)

	As Is	Exg. Used
190-550 KC .....	\$7.95	\$14.95
1-5-3 mc .....		14.95
3-6 mc .....	5.95	9.95
6-9 mc .....	5.95	9.95
3-Rec. Rack .....		1.50
3-Control Head .....	1.00	2.50
BC 458 Transmitter .....	4.95	6.95
459 Transmitter .....	7.95	12.95
456 Modulator .....	1.95	3.95

BC-929—Contains power supply 110 V. 400 cycles, has 7 tubes such as 3CP1, brand new, complete with tubes. Each. **\$9.95**

### ARC-5/R-28 2 MTR RCVR

2 meter superhet, absolutely one of the BEST available today! Tunes from 100 to 150 mcs. in four crystal channels. (Easily converted to continuous tuning.) Complete with 10 tubes. Excellent. **\$1795**

T-23/ARC-5 Transmitter. 100-156 MC. complete with tubes. Used exc. **\$29.95**

### WOBULATOR BUILD

### TV-FM-AM SWEEP GENERATOR

You can build "Versatile Sweep Frequency Generator" with APN-1 magnetic units. **\$5.95**

5BP1, 5FP7, 4AP10, **\$2.95**

BC-375—TRANSMITTER with TU5 Tuning Unit—exc. **\$49.95**

AN/APR5—A Airborne superhet radar search rec. Freq. range 1000 to 3000 MC. Rec. has a 10 MC 1F band width operating from 80/115 VAC, single phase 60 to 2600 cps. and one amp. at 26 VDC.

Complete with tubes. **\$250.00**

AN/APT5 TRANSMITTER—operates over a freq. of 300 to 1400 MC; output 30 Watts. The carrier freq. is noise-modulated with effective random noise freq. up to 2 MC. Complete with tubes. **\$99.50**

I-122 SIGNAL GENERATOR RF signal 15 to 25 MC and 90 to 125 MC; modulated at 400 cps. or 625 cps. Power supply 100 to 135 VAC, 25 to 60 cps.

NEW **\$49.50**  
Spare parts kit for above, new. **\$9.95**

MOBILE HEAVY DUTY DYNAMOTOR: 14 V. INPUT—output: 1030 VDC 260 MA. Tapped 515 V. 215 MA. use @ 6 V DC INPUT—500 V. 175 MA. While they last—DM-42—Excel. Cond. **\$9.95**

New: **\$14.95**

AN/APN 9 Loran long range navigation system as used in ships and aircraft. Brand new—original cartons. ea. **\$295.00**  
Write for full particulars

BC 1267 Transmitter & Receiver 154-186 mcs. 1 kw pulse oscillator superhet circuit. Can be easily converted to 2 meter converter and outboard amplifier. Used, exc. cond. ea. **\$14.95**

RA 105 **110 VAC**  
Power Supply for above. **\$14.95**  
Brand new. each

### DYNAMOTORS

	Input	Output	Price
D-1	5.6V	425 @ 75 MA.	\$14.95
D-2	14V	575 @ 150 MA.	7.95
DM-32A	28V @ 1.1	250 @ 40 MA. used	7.95
		new	7.50
D-101	27V @ 1.75	285VC—.075 amps. 3 for	1.95 5.00

Carlson Stromberg Chest Mike—New. ea. **\$ 1.29**

TG 34 Keyer—good condition—as is. ea. **9.95**

CRYSTALS—DC34 & DC35 (200), 1680—4440 Kc. set of 200 **39.50**

MK 11 Receiver Transmitter. New @ **49.50**

BC620—20-27 Mc—FM Transceiver—Like New **39.50**

PE 117—6-12 V DC Power Supply—Like New. ea. **12.95**

TS Handset W.E. F I—used, exc. ea. **2.45**

Low Freq. Crystals—FT 241 A for SSB, lattice filter, 1/2" spe. 54th harm channels listed by fund. Fractions omitted. See previous Radio-TV news issues for frequencies 49c each. 10 for **\$3.00**

WRITE FOR NEW BULLETIN AND PRICES.

Shipments F.O.B. Chicago.

20% Deposit on Orders.

## R W ELECTRONICS

Dept. N, 2430 S. Michigan Ave.

Chicago 16, Ill.

PHONE: Calumet 5-1281-2-3

The relay is housed in a protective plastic case which helps to provide high thermal and shock resistance. It is equipped with a six-pin plug which fits a molded or laminated socket supplied with the relay. Polarity may be reversed by reversing the relay in its socket.

### U.H.F. TEST UNIT

Granco Products Inc., 36-17 20th Ave., Long Island City 5, New York is currently marketing a u.h.f. signal-gain generator which has been de-



signed for engineers, research workers, and service technicians doing u.h.f. work.

The Model SU-200 is compact, lightweight, and is equipped with a carrying case for portability. The generator features coaxial tuning elements, continuous and precise tuning over the entire u.h.f. band, calibration in both frequency and channel designations, balanced detector meter circuit and gain control, and simplified operation. The frequency range is 440 to 910 mc. with an accuracy of  $\pm 2\%$ .

### PORTABLE TUBE TESTER

Radio City Products Co., Inc., Easton, Pa. is now in production on a new, compact portable tube tester, the Model 327P.

Although the tester contains a 4 1/2" rectangular meter with an easy-reading scale, it is ultra-compact in size and light in weight so that it can be carried out on the job or used on the bench. It will test all radio and television receiving tubes. All CR picture tubes, including color tubes, can be tested by means of adapter cables which are available separately.

The oak case measures 9 1/2" x 11" x 5 1/2".

### V.T.V.M.

Chicago Industrial Instrument Co., 536 West Elm Street, Chicago 10, Ill. recently introduced a new "Unidial" v.t.v.m., the Model 541.

A single control is used to select both range and function. A special circuit feature permits the use of regular test leads from 50 cycles to 100 mc. An isolation cartridge snaps on the regular probe when necessary.

The instrument has a 4 1/2" fan meter for long scale length in a small space. The company will supply full specifications on request.

### VOLTAGE BOOSTER

The Regency Division of I.D.E.A., 7900 Pendleton Pike, Indianapolis 26, Ind. is marketing a new voltage booster that can maintain a 117 volt power supply to any TV set irrespective of line voltage variations from 90 to 130 volts.

The VB-1 is an autotransformer with tapped primary so it can be used in high voltage areas to decrease the line voltage or in low voltage areas to increase the line voltage. Indicator lights on the switch side of the booster reveal the proper operating position of the voltage switch.

### TUBE TESTER

Vidaire Electronics Mfg. Company, 576 W. Merrick Road, Lynbrook, N. Y. has added a new technician's tube tester to its line of TV accessories.

Known as the "Adapt-Test," the new unit has dual sockets with 20 inches of lead extensions that bring all socket voltages out into the open. Used with any voltmeter, the technician can reach remote and inaccessible tube sockets on any chassis. Test points are clearly numbered for easy identification.

Currently the unit is available in three models—the AT-1 for all octal tubes, the AT-2 for 7-pin miniatures, and the AT-3 for 9-pin miniatures.

### MINIATURE TRANSFORMERS

The development of a new line of miniature transformers has been an-

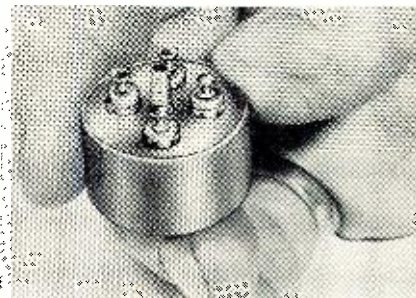

nounced by Torwico Electronics, Inc., 961 Frelinghuysen Ave., Newark 5, N. J.

Currently available with outputs of 3 va. and 6 va., one typical unit in the line measures 1" o.d. x 3/4" high. It weighs about 1 1/2 ounces. Electrical ratings are an input of 115 volts, 400 cycles; power output of 6 va.; regulation of 10 per-cent; and heat rise of 40 degrees C, class A.

Miniature transformers with special ratings are also available from this same manufacturer.

### TV ACCESSORIES

American Electronics Co., 1203-05 Bryant Ave., New York 59, N. Y. is in production on a line of television accessories for the service technician.

(Continued on page 146)

# king size savings

by the leader...

## TRANSAMERICA ELECTRONICS CORP.



**EVERY TUBE  
GUARANTEED  
6 MONTHS**

**Branded — Bulk Packed in Original Mfr's. Nested Cartons or Individually Boxed  
EVERY TUBE METER AND CHASSIS TESTED FOR TOP QUALITY**

0A2 .....\$ .87	1T4 ..... .46	6AS5 ..... .62
0A3/VR75 .97	1U4 ..... .46	6AT6 .... .36
0A4G .... .60		6AU6 .... .40
0B2 ..... .74	1U5 ..... .40	6AV5GT . .79
0B3/VR90 .90	1X2 ..... .55	6AV6 .... .36
	2A3 ..... .90	
0C3/VR105 .95	2A5 ..... .49	6AX4GT . .57
0D3/VR150 .85	2A6 ..... .49	6B7 ..... .93
0Z4 ..... .53	2A7 ..... .60	6B8G .... .29
1A4P .... .35		6BA6 .... .38
1A5GT ... .40	2B7 ..... .62	6BA7 .... .55
	2X2 ..... .39	
1A7GT ... .45	2X2A .... 1.14	6BC5 .... .49
1AB5 .... .38	3A4 ..... .44	6BE6 .... .37
1B3GT ... .67	3A5 ..... .90	6BF5 .... .69
1C5GT ... .40		6BG6G .. 1.15
	3A8GT ... .59	6BH6 .... .45
1C7G .... .37	3B7 ..... .39	
1D7GT ... .75	3D6 ..... .38	6BJ6 .... .41
1E7GT ... .35	3LF4 .... .71	6BK7 ... .89
1F4 ..... .40	3Q4 ..... .48	6BL7GT . .65
1F5G .... .44		6BN6 .... .79
	3Q5GT ... .48	6BQ6GT . .75
1H4G .... .40	3S4 ..... .46	
1H5GT ... .38	3V4 ..... .50	6BQ7 .... .88
1J6G .... .59	5T4 ..... 1.25	6C4 ..... .35
1L4 ..... .45	5U4G ... .49	6C5 ..... .39
1L6 ..... .61		6C6 ..... .54
	5V4G .... .76	6C8G .... .85
1LA4 .... .59	5Y3G ... .38	
1LA6 .... .75	5Z3 ..... .33	6CB6 .... .42
1LB4 .... .77	6A6 ..... .45	6CD6G .. 1.05
1LC5 .... .59	6A7 ..... .80	6D6 ..... .67
1LC6 .... .75		6D8G .... .95
	6A8 ..... .65	6E5 ..... .76
1LD5 .... .49	6AB4 .... .42	
1LE3 .... .75	6AB7 .... .71	6F6 ..... .45
1LG5 .... .75	6AC5GT . .95	6F7 ..... .90
1LH4 .... .75	6AC7 ... .68	6F8G .... .69
1LN5 .... .55		6G6G .... .63
	6AF4 .... .89	6H6 ..... .49
1N5GT ... .61	6AF6G ... .75	
1P5GT ... .56	6AG5 .... .47	6J5 ..... .38
1Q5GT ... .55	6AG7 .... .90	6J6 ..... .50
1R4 ..... .81	6AH6 ... .88	6J7 ..... .49
1R5 ..... .47		6J8G .... .90
	6AK5 .... .59	6K6GT ... .39
1S4 ..... .55	6AL5 ... .35	
1S5 ..... .40	6AQ5 ... .39	6K7G ... .38
1SA6 .... .48	6AQ6 ... .36	6K8G ... .64
	6AQ7GT . .68	6L6G ... .39

**Our Tubes are of Excellent Quality Because:**

1. We've specialized in selling vacuum tubes exclusively for many years.
2. Our tubes are obtained from Receiver Manufacturers' surplus inventories as well as from Government sources.
3. Our modern, completely equipped laboratories check every tube received, and you are invited to see this special test equipment in operation.

Even though our inventories contain almost every Tube type made over the past 20 years—in quantities of more than a million assorted types—it is impossible to list every type. You are therefore urged to include in your order any additional types required.

6L6GA ... .99	7A4 ..... .45	12A6 .... .49	12SF7GT . .68	35Z5GT .. .45
6N7 ..... .95	7A5 ..... .55	12A7 .... .98	12SG7 ... .70	36 ..... .35
			12SH7 ... .70	
6Q7 ..... .49	7A6 ..... .65	12AH7GT. .85	12SJ7 ... .55	37 ..... .35
6R7 ..... .49	7A7 ..... .65	12AL5 ... .40	12SK7GT. .49	39-44 ... .35
6S4 ..... .39	7AD7 ... .90	12AT6 ... .35		42 ..... .40
6S7G ... .55	7AG7 ... .55	12AT7 ... .62	12SL7GT . .49	43 ..... .53
6SA7 ... .40	7AH7 ... .55	12AU6 ... .36	12SN7GT . .50	45Z3 ... .40
			12SQ7GT . .53	
6SC7 ... .75	7B4 ..... .44	12AU7 ... .59	12SR7 ... .49	46 ..... .45
6SD7GT . .38	7B5 ..... .55	12AV6 ... .44	12Z3 ... .39	47 ..... .85
6SF5GT . .45	7B6 ..... .55	12AV7 ... .64	14A4 ... .65	49 ..... .38
6SF7 ... .58	7C4 ..... .55	12AX4GT . .55	14A5 ... .57	50L6GT .. .61
6SG7 ... .40	7C7 ..... .65	12AX7 ... .55	14A7 ... .53	50X6 ... .62
			14AF7 ... .59	
6SH7 ... .60	7E5 ..... .59	12AY7 ... .72	14B6 ... .45	50Y6GT .. .57
6SH7GT . .50	7E6 ..... .40	12BA6 ... .47	14B8 ... .63	56 ..... .47
6SJ7 ... .54	7F7 ..... .64	12BA7 ... .59	14C5 ... .80	57 ..... .53
6SK7 ... .39	7F8 ..... .90	12BD6 ... .46	14C7 ... .65	58 ..... .56
6SL7GT . .49	7G7 ..... .80	12BE6 ... .45	14E6 ... .65	70L7GT .. 1.00
			14E7 ... .80	
6SN7GT . .48	7H7 ..... .56	12BH7 ... .60	14F7 ... .65	71A ..... .52
6SQ7 ... .37	7J7 ..... .75	12C8 ... .34	14F8 ... .90	76 ..... .42
6SR7 ... .45	7K7 ..... .80	12F5GT .. .35	14H7 ... .57	77 ..... .53
6SR7 ... .45	7L7 ..... .77	12H6 ... .45	14N7 ... .67	78 ..... .43
6ST7 ... .48	7N7 ..... .57	12J5GT .. .39	14Y4 ... .67	81 ..... 1.10
6T8 ..... .57			19 ..... .45	82 ..... .67
6U7G ... .45	7Q7 ..... .57	12J7GT .. .57	19BG6G . 1.15	83 ..... .77
6U8 ... .59	7R7 ..... .59	12K7 ... .53	19T8 ... .75	84 ..... .52
6V6 ... .38	7S7 ..... .83	12K8 ... .55	22 ..... .40	85 ..... .57
6V4GT ... .41	7V7 ..... .87	12Q7G ... .57	25AV4GT . .80	89Y ..... .29
6V6GT .. .41	7W7 ..... .85	12S8GT .. .60	117L7GT . 1.17	
			117Z3 ... .38	
6X4 ... .35	7X6 ... .57	12SA7GT . .62	25BQ6GT . .75	117Z4GT . .73
6X5 ... .35	7Y4 ... .40	12SC7 ... .68	25L6GT .. .40	117Z6GT . .70
6X8 ... .70	7Z4 ... .45	12SF5 ... .48	25W4GT . .45	2051 ... .93
			25Z5 ... .60	
			25Z6GT .. .40	9001 ... 1.47
			26 ..... .42	9002 ... .98
			27 ..... .37	9003 ... 1.30
			32L7GT .. .95	9006 ... .67
			35C5 ... .37	803 ... 2.95
			35L6GT .. .45	
			35W4 ... .43	807 ... 1.25
			35Y4 ... .44	814 ... 3.50
			35Z3 ... .40	836 ... 7.95
				866A ... 1.45

Minimum Order: \$10.00. Terms: 25% with order, balance C.O.D.; please include postage. All prices subject to change without notice. F.O.B. New York City. Mail Order Division.

# TRANSAMERICA ELECTRONICS CORP.

## 15 Liberty Street New York 6, N. Y.



Superior's New Model 770-A

The FIRST Pocket-Sized

# VOLT-OHM MILLIAMMETER

## USING THE NEW "FULL VIEW" METER

**71% MORE SCALE AREA!!**

Yes, although our new FULL-VIEW D'Arsonval type meter occupies exactly the same space used by the older standard 2 1/2" Meters, it provides 71% more scale area. As a result, all calibrations are printed in large easy-to-read type and for the first time it is now possible to obtain *measurements instead of approximations* on a popular priced pocket-sized V.O.M.

**THE MODEL 770-A COMES COMPLETE WITH SELF-CONTAINED BATTERIES, TEST LEADS AND ALL OPERATING INSTRUCTIONS.**

### Features

- ★ Compact—measures 3 1/8" x 5 7/8" x 2 1/4"
- ★ Uses "Full View" 2% accurate, 850 Microampere D'Arsonval type meter
- ★ Housed in round-cornered, molded case
- ★ Beautiful black etched panel. Depressed letters filled with permanent white, insures long-life even with constant use.

### Specifications

6 A.C. VOLTAGE RANGES: 0-15/30/-150/300/1500/3000 Volts. 6 D.C. VOLTAGE RANGES: 0-7.5/15/75/150/750/1500 Volts. 2 RESISTANCE RANGES: 0-10,000 Ohms, 0-1 Megohm. 3 D.C. CURRENT RANGES: 0-15/150 Ma., 0-1.5 Amps. 3 DECIBEL RANGES: -6 db to +18 db, +14 db to +38 db, +34 db to +58 db.

**\$15.85**  
ONLY NET

Superior's  
New

# TELEVISION BAR GENERATOR

THROWS AN ACTUAL BAR PATTERN ON ANY TV RECEIVER SCREEN



### Two Simple Steps

1. Connect Bar Generator to Antenna Post of any TV Receiver.
2. Plug Line Cord into AC Outlet and Throw Switch.

**Result:** A stable never-shifting vertical or horizontal pattern projected on the screen of the TV receiver under test.

### SPECIFICATIONS:

Power Supply: 105-125 Volt 60 Cycles  
Power Consumption: 20 Watts  
Channels: 2-5 on panel, 7-13 by harmonics  
Horizontal lines: 4 to 12 (Variable)  
Vertical lines: 12 (Fixed)  
Vertical sweep output: 60 Cycles  
Horizontal sweep output: 15,750 Cycles

### FEATURES:

Provides linear pattern to adjust VERTICAL linearity, height, centering • Provides linear pattern to adjust HORIZONTAL drive, width, peaking, linearity, centering • Provides vertical sweep signal for adjusting and synchronizing vertical oscillator discharge and output tubes • Provides vertical signal to replace vertical oscillator to check vertical amplifier operation • Provides horizontal sweep signal for adjusting an synchronizing horizontal oscillator A.F.C. and output tubes • Provides horizontal sweep signal to check H.V. section of fly-back and pulse operating power supplies • Provides signal for testing video amplifiers • Can be used when no stations are on the air.

TV BAR GENERATOR COMES COMPLETE WITH SHIELDED LEADS AND DETAILED OPERATING INSTRUCTIONS.

**\$39.95**  
ONLY NET

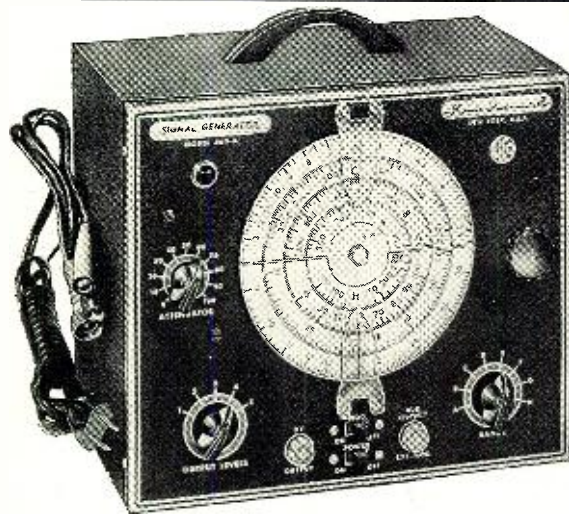

Superior's New Model 660-A AN AC OPERATED

# SIGNAL GENERATOR

PROVIDES COMPLETE COVERAGE for AM-FM & TV Alignment

### SPECIFICATIONS:

• Generates Radio Frequencies from 100 Kilocycles to 60 Megacycles on fundamentals and from 60 Megacycles to 220 Megacycles on powerful harmonics. • Accuracy and Stability are assured by the use of permeability trimmed Hi-Q coils. • R.F. available separately or modulated by the internal audio oscillator. — Built in 400 cycle sine wave audio oscillator used to modulate the R.F. signal also available separately for audio testing of receivers, amplifiers, hard of hearing aids, etc. • R.F. Oscillator Circuit: A high transconductance

heptode is used as an R.F. oscillator, mixer and amplifier. Modulation is effected by electron coupling in the mixer section thus isolating the oscillator from load changes and affording high stability. • A.F. Oscillator Circuit: A high transconductance heptode connected as a high- $\mu$  triode is used as an audio oscillator in a High-C Colpits circuit. The output (over 1 Volt) is nearly pure sine wave. • Attenuator: A 5 step ladder type of attenuator is used.

### TUBES USED:

- 6BE6 as R.F. Oscillator, mixer and amplifier.
- 6BE6 as Audio Oscillator.
- 6H6 as Power Rectifier.

The Model 660-A comes complete with coaxial cable test lead and instructions.

**\$42.95**  
NET

# SHIPPED ON APPROVAL

## NO MONEY WITH ORDER — NO C.O.D.

Try any of the above instruments for 10 days before you buy. If completely satisfied then send down payment and pay balance as indicated on coupon. **No Interest or Carrying Charges Added!** If not completely satisfied return unit to us, no explanation necessary.

MOSS ELECTRONIC DISTRIBUTING CO., INC.  
Dept. D-61, 3849 Tenth Ave., New York 34, N. Y.

Please send me the units checked. I agree to pay down payment within 10 days and to pay the monthly balance as shown. It is understood there will be no carrying, interest, or any other charges, provided I send my monthly payments when due. It is further understood that should I fail to make payment when due, the full unpaid balance shall become immediately due and payable.

Model 660-A ..... Total Price \$42.95  
\$12.95 within 10 days. Balance \$5.00  
monthly for 6 months.

Model 770-A ..... Total Price \$15.85  
\$3.85 within 10 days. Balance \$4.00  
monthly for 3 months.

Name .....

Address .....

City .....

Zone..... State.....

Television Bar Generator Total Price \$39.95  
\$9.95 within 10 days. Balance \$5.00  
monthly for 6 months.



Superior's new  
Model 670-A

# SUPER METER

A COMBINATION VOLT-OHM MILLIAMMETER PLUS  
CAPACITY REACTANCE INDUCTANCE AND DECIBEL MEASUREMENTS

**SPECIFICATIONS:**

D.C. VOLTS: 0 to 7.5/15/75/150/750/1,500/7,500 Volts  
 A.C. VOLTS: 0 to 15/30/150/300/1,500/3,000 Volts  
 OUTPUT VOLTS: 0 to 15/30/150/300/1,500/3,000 Volts  
 D.C. CURRENT: 0 to 1.5/15/150 Ma. 0 to 1.5/15 Amperes  
 RESISTANCE: 0 to 1,000/100,000 Ohms 0 to 10 Megohms  
 CAPACITY: .001 to 1 Mfd. 1 to 50 Mfd. (Quality test for electrolytics)  
 REACTANCE: 50 to 2,500 Ohms, 2,500 Ohms to 2.5 Megohms  
 INDUCTANCE: .15 to 7 Henries 7 to 7,000 Henries  
 DECIBELS: -6 to +18 +14 to +38 +34 to +58

**ADDED FEATURE:**

The Model 670-A includes a special **GOOD-BAD** scale for checking the quality of electrolytic condensers at a test potential of 150 Volts.

The Model 670-A comes housed in a rugged, crackle-finished steel cabinet complete with test leads and operating instructions.

**\$28<sup>40</sup>**  
NET

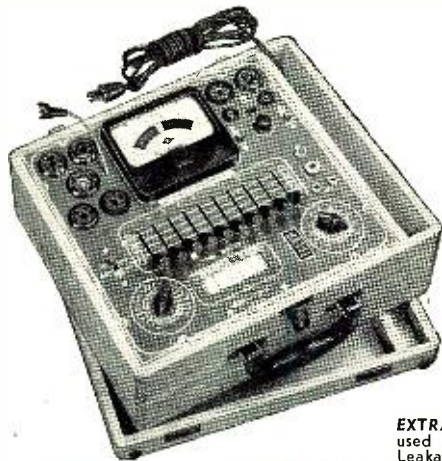

Superior's new  
Model TV-11

# TUBE TESTER

**SPECIFICATIONS:**

- ★ Tests all tubes including 4, 5, 6, 7, Octal, Lock-in, Peanut, Bantam, Hearing Aid, Thyatron, Miniatures, Sub-Miniatures, Novals, Sub-minars, Proximity fuse types, etc.
- ★ Uses the new self-cleaning Lever Action Switches for individual element testing. Because all elements are numbered according to pin-number in the RMA base numbering system, the user can instantly identify which element is under test. Tubes having tapped filaments and tubes with filaments terminating in more than one pin are truly tested with the Model TV-11 as any of the pins may be placed in the neutral position when necessary.
- ★ The Model TV-11 does not use any combination type sockets. Instead individual sockets are used for each type of tube. Thus it is impossible

to damage a tube by inserting it in the wrong socket.

- ★ Free-moving built-in roll chart provides complete data for all tubes.
- ★ Newly designed Line Voltage Control compensates for variation of any Line Voltage between 105 Volts and 130 Volts.
- ★ NOISE TEST: Phono-jack on front panel for plugging in either phones or external amplifier will detect microphonic tubes or noise due to faulty elements and loose internal connections.

The model TV-11 operates on 105-130 Volt 60 Cycles A.C. Comes housed in a beautiful hand-rubbed oak cabinet complete with portable cover.

**\$47<sup>50</sup>**  
NET

**EXTRA SERVICE**—The Model TV-11 may be used as an extremely sensitive Condenser Leakage Checker. A relaxation type oscil-

lator incorporated in this model will detect leakages even when the frequency is one per minute.

**SUPERIOR'S NEW MODEL TV-40**

# C.R.T. TUBE TESTER



★ A complete picture tube tester for little more than the price of a "make-shift" adapter!!

The Model TV-40 is absolutely complete! Self-contained, including built-in power supply, it tests picture tubes in the only practical way to efficiently test such tubes: that is by the use of a separate instrument which is designed exclusively to test the ever increasing number of picture tubes!

**EASY TO USE:**

Simply insert line cord into any 110 volt A.C. outlet, then attach tester socket to tube base (ion trap need not be on tube). Throw switch up for quality test . . . read direct on Good-Bad scale. Throw switch down for all leakage tests.

★ Tests all magnetically deflected tubes . . . in the set . . . out of the set . . . in the carton!!

**SPECIFICATIONS:**

- Tests all magnetically deflected picture tubes from 7 inch to 30 inch types.
- Tests for quality by the well established emission method. All readings on "Good-Bad" scale.
- Tests for inter-element shorts and leakages up to 5 megohms.
- Tests for open elements.

Model TV-40 C.R.T. Tube Tester comes absolutely complete—nothing else to buy. Housed in round cornered, molded bakelite case. Only . . . . .

**\$15<sup>85</sup>**  
NET

**SHIPPED ON APPROVAL  
NO MONEY WITH ORDER — NO C.O.D.**

Try any of the above instruments for 10 days before you buy. If completely satisfied then send down payment and pay balance as indicated on coupon. **No Interest or Carrying Charges Added!** If not completely satisfied return unit to us, no explanation necessary.

**MOSS ELECTRONIC DISTRIBUTING CO., INC.**  
Dept. D-61 3849 Tenth Ave., New York 34, N. Y.

Please send me the units checked. I agree to pay down payment within 10 days and to pay the monthly balance as shown. It is understood there will be no carrying, interest or any other charges, provided I send my monthly payments when due. It is further understood that should I fail to make payment when due, the full unpaid balance shall become immediately due and payable.

Model 670-A . . . . . Total Price **\$28.40**  
\$7.40 within 10 days. Balance \$3.50  
monthly for 6 months.

Model TV-11 . . . . . Total Price **\$47.50**  
\$11.50 within 10 days. Balance \$6.00  
monthly for 6 months.

Model TV-40 . . . . . Total Price **\$15.85**  
\$3.35 within 10 days. Balance \$4.00  
monthly for 3 months.

Name.....  
Address.....  
City..... Zone..... State.....

# Supreme in the FRINGE

## NEW ROCKET ULTRA-POWERED Fringe-King

- Super Broad-band Reception
- Synchronized for Color or Black and White
- Super Front-to-Back Ratio
- Gain: 8 db Low-Band 11 db hi-band
- Minimum co-channel interference

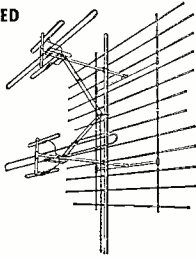

The Rocket Fringe King provides a new improved super broad-band reception in fringe and deep fringe areas that measurably increases reception pleasure. New design greatly increases uniform antenna response, with very good UHF primary and sub-primary receptivity. Front-to-back ratio higher than multi-channel yags. When installed, we guarantee you can "see" the difference.

Model FK-232

**\$2395 ea.**

With stacking harness



## NEW LOW PRICE! RADIART TELEROTOR

Radiart's famous TR-2 at new money-saving price. Powerful, rugged, weather-proof—handles installations up to 150 lbs. Control box light indicates orientation of antenna. Factory lubricated for life. Truly a good buy at our new price. Uses 8-cond. wire.

**\$2697**  
MODEL TR-2

## FAMOUS ROCKET ZOOM-UP TOWERS

• Sturdy • Reliable • Easiest Installation  
Economize with Rocket Zoom-up Towers. Offers quickest, easiest way to make an installation up to 50'. Each section telescopes inside the other—to erect, simply slide out each section in its turn—insert bolt thru section below—tighten to keep mast from turning. Each tower complete with guy rings, bolts, and mounting base suitable for peak or flat roof. Handsome and sturdy. Rocket Zoom-ups offer you economy and long life. Order by size.

20' ..... \$ 9.95 30' ..... \$15.95  
40' ..... 19.95 50' ..... 29.95  
(Deduct 10% discount in lots of 3)

# SUPER RECEPTION IN FRINGE AREAS AT BARGAIN PRICES!

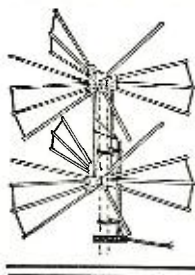

360° Super Directronic  
Electrically Rotates  
in All Directions  
VHF-UHF CHANNELS  
2-83

Exclusive Engineering and design cuts costs to \$2350  
Powerful, 24 element 2 bay Directronic antenna is electronically beamed to any transmitter in fringe area by 6-position selector switch. No motors or electricity. Extremely high gain. COMPLETE WITH 6-POSITION DIRECTRONIC BEAM SELECTOR, 75' TUBULAR TRI-X CABLE, UNIVERSAL U-CLAMPS. Order model AX-524.

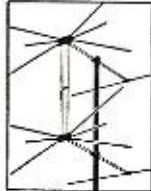

## 2 BAY 16 ELEMENT CONICAL ARRAY

**\$4.99 EACH IN LOTS OF 3 \$5.30 Each**

Hi-gain 16-element conical with sturdy 3/8" hi-tensile aluminum elements. For fringe use. Complete coverage of Ch 2 thru 13. Packed in cartons of three 16-element arrays, per carton, with tie rods, at \$14.95 per carton. Single 16-element array, \$ 5.30  
1 carton 6 arrays—no tie rods ..... 13.50  
4 bay stacking assembly—No. 4B ..... 1.95  
Low-loss Tubular twin lead—100' coil ..... 4.95  
Ll. arrestor-tubular or flat lead ..... .65  
7' UHF Mast standoffs ..... .12  
7" UHF Screw standoffs ..... .06



## UHF CORNER REFLECTOR

**ONLY \$299 EACH IN LOTS OF 6**

**SINGLE LOTS \$3.50 EACH**

This hi-gain UHF Corner Reflector can only be offered you at this low price for a short time. 8 to 11 db gain across UHF band. Order Model F-6.

ALL PRICES F.O.B. CLEVELAND, OHIO  
Do not remit more than complete purchase price. Pay shipping charges on receipt of goods. 25% deposit on all C.O.D. orders, please. Money-back guarantee. Prices Subject to Change Without Notice

**National Electronics**  
OF CLEVELAND  
**THE HOUSE OF TV VALUES**  
109 Delco Building Cleveland 3, Ohio

# Acoustic Measurements

(Continued from page 39)

the 15-by-30 foot attic room mentioned previously, are shown to illustrate the sort of results to be expected.

Figs. 1 and 3A were taken off an 8-inch cone of the high-fidelity type having a curved cone and a soft plastic edge suspension. The 2 cubic-foot enclosure was an old cabinet made of 1" thick wood throughout, padded inside and totally enclosed. The microphone was located 1 foot away, on axis. The solid curve shows response flat within  $\pm 5$  db from 95 to 9500 cycles, which is pretty good for this combination. There is a certain appearance of regularity about the major peaks at 1300, 2300, 4000, and 6000 cycles that point toward a possible cavity resonance in the enclosure or nearby; perhaps the padding is not good enough.

The enclosure had double doors on the front. Closing one of the doors produced the curve shown in dotted lines in Fig. 1. The general level has dropped above 500 cycles and the response is very much rougher, with three 20 db dips at 1250, 3000, and 5000 cycles.

While the effect of closing one door had an obvious effect on the musical quality—it sounded "thinner," it was not hard to become accustomed to. Identification of what was wrong was difficult from a listening point of view because there was little change in the over-all balance between highs and lows, no boomy bass or distortion which are the landmarks we look for in judging sound quality. On a dark night in some places, a rough response like this might be passed off as high-fidelity sound; it would be fatiguing, but the frequencies seem to be there. Yet measurements show clearly what is wrong.

Resonant cavities always produce such a series of dips. Too-heavy grille cloth reflects sound enough to produce these cavity effects. This effect, indeed, is worse than the absorption of highs by the cloth. An unpadded enclosure, of course, introduces a terrific series of lumps in the response.

Fig. 3A shows curves taken from the same speaker, where changes were made that affect the bass response. Only the bass portion is drawn. The solid curve (1) is the normal speaker as in Fig. 1. There is a small difference in the 60-130 cycle region due to moving the cabinet out of the corner into the middle of the room, and the smaller detail in the curves between 130 and 600 cycles is different, but not more than 1 or 2 db.

The upper dotted curve (2) is the same set-up driven by a high-impedance source to remove the effect of damping of the triode amplifier. The source was simulated by connecting a 100-ohm resistor in series with the voice coil and resetting the amplifier level. The bass peak at 120-130 cycles is now 5 db higher. If the speaker

# NEW EICO PROBES\*

## SCOPE PROBES



SCOPE DEMODULATOR PROBE

KIT \$3.75 WIRED \$5.75

LOW CAPACITY PROBE

KIT \$3.75 WIRED \$5.75

DIRECT PROBE

KIT \$2.75 WIRED \$3.95

**SPECIAL . . . All 3 Scope Probes**  
**KIT \$9.95 WIRED \$14.95**

## VTVM PROBES

VTVM RF PROBES

KIT \$3.75 WIRED \$4.95

PEAK-TO-PEAK PROBES

KIT \$4.95 WIRED \$6.95

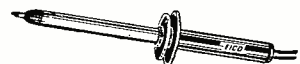

Sensational High Voltage Probe

Model HVP-2 . . . ONLY \$4.95

© 54 Extends range of VTVMs & VOMs to 30kv



Write for FREE Catalog RP-9

ELECTRONIC INSTRUMENT CO., INC.  
84 Withers Street • Brooklyn 11, N. Y.

# STAN-BURN E-DARKS

## \*CATHODE RAY TUBE SPECIALS\*

One Year Guarantee

G. E.	STAN-BURN
*10BP4A . . . . . \$14.95	*10BP4A . . . . . \$10.20
*10P4A . . . . . 24.45	*12LP4A . . . . . 13.95
*12LP4A . . . . . 18.75	*12QP4 . . . . . 11.90
*12QP4A/B1014 . . . . . 21.00	*12JP4 . . . . . 11.90
Dumont . . . . . 28.75	*12UP4A . . . . . 14.50
*12UP4B . . . . . 24.50	*14CP4 . . . . . 15.60
*15DP4/B1014 . . . . . 23.75	*15DP4 . . . . . 17.50
Dumont . . . . . 30.95	*16KP4 . . . . . 17.50
*16AP4A (N.U.) . . . . . 25.25	*16PP4 or A . . . . . 17.50
*16P4A (N.U.) . . . . . 31.25	*16JP4 or A . . . . . 17.50
*16GP4 or B . . . . . 24.20	*16CP4 or A . . . . . 17.50
*16KP4/16RP4 . . . . . 28.35	*16FP4 . . . . . 17.50
(Aluminum) . . . . . 26.25	*16WP4 . . . . . 17.50
*16JP4A (N.U.) . . . . . 25.50	*16AP4 . . . . . 17.50
*16P4A . . . . . 26.50	*16GP4A . . . . . 23.00
*16WPA . . . . . 31.25	*16EP4 . . . . . 19.00
*16GP4B . . . . . 31.25	*16EP4A . . . . . 23.50
*17BP4A . . . . . 24.25	*16GP4 or A . . . . . 21.00
*17P4B . . . . . 20.30	*17BP4 . . . . . 18.50
*17CP4 . . . . . 23.90	*17CP4A . . . . . 21.60
*17CP4B . . . . . 29.00	*17GP4B . . . . . 22.60
(Aluminum) . . . . . 41.50	*19FP4 . . . . . 23.00
*19AP4A . . . . . 30.00	*19AP4 . . . . . 23.90
*20CP4 . . . . . 37.50	*19A4 . . . . . 24.90
*21AP4 . . . . . 42.00	*20CP4 . . . . . 25.50
*21EP4 . . . . . 31.80	*21EP4 . . . . . 25.50
*21EP4A . . . . . 78.50	*21AP4 . . . . . 26.50
*24AP4 . . . . . 78.50	*24AP4 . . . . . 43.00

## QUANTITY CRT USERS

We will give you DUD allowances if you ship them to us Prepaid. 10 CRT's minimum shipment. WRITE FOR DETAILS.

**AUTHORIZED DISTRIBUTORS** for General Electric, Kenrad, Tung-Sol, National Union, De Wald, Regal, Automatic and General Motors.

Automatic Custom-Built Radios for Plymouth, Ford, Chevrolet and many others, always in stock.

We carry a Complete line of HI-FIDELITY and sound equipment. Send us your requests.

We also carry a complete line of popular makes of Radio Tubes at 50/10 discount. Also many other special purpose and transmitting types, and all electronic parts and equipment at lowest prices. Send us a list of your requirements for prompt quotations.

Terms: 20% with order. Balance C.O.D. All prices F.O.B. NEW YORK Warehouse. Minimum order \$5.00. Write for our latest price list and Hi-Fi catalog to Dept. RN-3.

**STAN-BURN** RADIO and ELECTRONICS CO.  
1697 BROADWAY • NEW YORK 19, N. Y.



# SYLVANIA TEST EQUIPMENT

**OFFERS LABORATORY PRECISION,  
COMPLETE DEPENDABILITY AND  
NEW TIME-SAVING FEATURES**

**ENGINEERED BY SYLVANIA • STYLED BY SUNDBERG & FERAR**  
... world famous in electronics ... leaders in industrial design

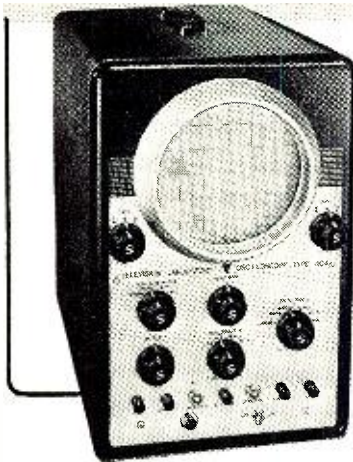

## SYLVANIA TELEVISION LABORATORY OSCILLOSCOPE TYPE 404

An extremely sensitive, wide band, all-purpose oscilloscope created especially for designing and servicing television receivers.

### FEATURING

- Flat response from 10 cycles to 2 mc.
- Sensitivity—0.01 volts. (10 millivolts per inch)
- Input impedance—5 megohms and 26mmf.
- Unusual sync stability.
- Frequency-compensated attenuator.
- Vertical and horizontal polarity reversing switches.
- High voltage and demodulator probes included with instrument.
- 7-inch cathode-ray tube.

## TWO NEW SYLVANIA POLYMETERS

**QUICK, ACCURATE MEASUREMENT  
OF COMPLEX WAVEFORMS**



### COMPOSITE VIDEO SIGNAL

Plate of video amplifier  
(75 volts peak to peak)



### COMPLEX WAVE FOR TRIGGERING

Grid of vertical oscillator  
(180 volts peak to peak)



### COMPLEX WAVE FOR DEFLECTION

Plate of vertical output tube  
(1700 volts peak to peak)



DELUXE  
POLYMER  
TYPE 302



SERVICE POLYMER  
TYPE 301

## REDUCE SERVICE TIME Read Direct Peak to Peak Voltages

The new ac input circuit provides for full wave rectification to give you direct peak to peak readings of symmetrical and asymmetrical waveforms. This feature has been included in the new Polymeters to aid in measuring signals of a complex nature. A point to point search quickly localizes circuit failures and minimizes service time.

Available through your Sylvania Radio Tube Distributor

# SYLVANIA

**TEST EQUIPMENT**

Sylvania Electric Products Inc., 1221 W. Third St., Williamsport, Pa.

In Canada: Sylvania Electric (Canada) Ltd., University Tower Bldg., St. Catharine St., Montreal, P. Q.

**RADIO • TELEVISION • LIGHTING • ELECTRONICS**

# NEW Reproducer

sounds like  
\$200 -  
COSTS  
LESS  
THAN  
\$60†

Now you can  
enjoy high fidelity  
without  
high prices



**What Is It?** A new Argos sound enclosure—handsomely styled—built with “Craftsmanship in Cabinets”—plus a Jensen speaker and tweeter.

**How Does It Work?** It uses the Jensen Duette\* principle—which in effect gets double the use out of the internal air mass. It gives big-speaker fidelity in half the space.

**How Can I Hear It for Myself?** Ask your Argos—or Jensen—Parts Distributor. Your ears cannot be deceived. It *does* sound like \$200.

†Argos AD-1 Cabinet.....\$21.50

Jensen KDU-10 speaker and tweeter components kit.....

Total.....Under \$60.00

Prices may vary West and South.

\*TM of and Licensed by Jensen Mfg Co.

Also see new matching cabinets for Record Player and Tuner or Amplifier.



were a cheap job with a stiff-edge cone, instead of one with a soft plastic suspension, the bass peak would be 15 or 20 db.

The lower dotted curve (3) was taken with the back of the cabinet removed, other conditions being as in curve (1).

Below the cone break-up frequency, curves are much smoother and easier to plot, so that experimentation with enclosures for best bass is relatively easy.

Obviously, this speaker system does not have good bass. It was used for illustrative purposes only. Critics may say, and correctly, that the curves of Fig. 3A really show that you can't get blood from a turnip. While this particular 2-cubic-foot box is not alleged to be anything but a box, no ordinary bass-reflex or closed baffle this size is much better. To get low frequencies you have to use a speaker system designed for it.<sup>3</sup>

Fig. 3B is presented for comparison. It is an ordinary table-model radio with a 4-inch speaker and plastic cabinet, the speaker being fed from the same triode amplifier as was used in the previous curves. Microphone distance and amplifier level were the same as for the other curves, so that an estimate is gained of the relative efficiency of the 4-inch cone and the higher-quality 8-inch unit. The final drop-off here is at about 160 and 6500 cycles. Average output between 200 and 1000 cycles is around 8 db lower than that of the large speaker. Level is up to the 8-inch only between 1200 and 3000 cycles. Fed from the pentode in the radio, this speaker undoubtedly would have shown much more output in the 200-cycle range. Below 300 cycles the speaker output was, incidentally, quite distorted, the harmonic content running around 50 to 100 percent even at ordinary listening level. This is about typical of table-model radios.

## Accessories

Oscilloscope observation of the microphone signal is a very useful adjunct to the measurement of the overall response. The creation of phony bass by harmonic distortion in both speakers and amplifiers is an old procedure, but not dead. Careful listening to sine-wave signals from a speak-

Fig. 4. Modification of audio voltmeter kit to accommodate a scope jack. Add the jack and 5100-ohm isolating resistor as shown.

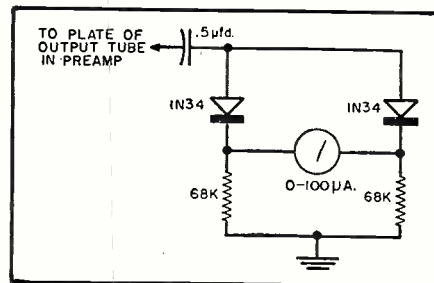
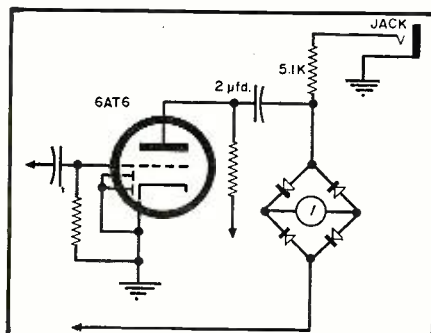

Fig. 5. Rectifier-voltmeter circuit to be added to a flat preamp for measuring mike output. Sensitivity is 5 v. full-scale.

er will show, with practice, whether the output is mainly the fundamental frequency or not. However the scope will give a surer picture. It will also show up clearly the maximum sound level the speaker system will deliver at low frequencies without waveform distortion.

Since the mike output is too low for most oscilloscopes, it is convenient to make the audio voltmeter do double duty as a preamplifier. In a *Heathkit* AV-2 meter, the modification diagrammed in Fig. 4 will work. Merely install a phone jack in the front panel, and connect the center spring of the jack to the output circuit through a 5100-ohm isolating resistor. When the meter reads full-scale the output at the jack will be about 1 volt. Phones or other low-impedance loads cannot be used out of this jack without causing errors in the meter reading, but an oscilloscope input has no effect. There is some waveform distortion at the zero-axis (not on the peaks) due to the full-wave rectifier circuit in the meter, but this has negligible effect for general scope monitoring.

If an audio voltmeter is not available but some other gear is, it is possible to make a meter suitable for rough measurements out of a flat preamplifier having a gain of about 1000. Merely connect to the output the rectifier-meter circuit shown in Fig. 5, making sure that the over-all response is flat and that the amplifier does not overload before the meter gets to full scale.

## REFERENCES

1. Beranek, Leo: "Acoustic Measurements," John Wiley and Sons, page 679.
2. Fleming, Lawrence: "An Electronic A.C. Voltmeter," RADIO & TELEVISION NEWS, February 1951.
3. Olson, Harry F.: "Cabinets for High-Quality Direct Radiator Loudspeakers," RADIO & TELEVISION NEWS, May 1951. -30-

## ELEMENT PROTECTION

By E. H. MARRINER

**M**ANY amateurs have overlooked the possibility of using "Scotch" #33 electrical tape to protect 10- and 2-meter beams from corrosion.

Along the seacoast, plastic coatings, varnishes, and other substances just don't do the job. The telescoping elements form an oxide hindering the performance of the beam. Sometimes the elements just fall off.

I have found that by wrapping the elements with "Scotch" electrical tape, they will last for years. This keeps the aluminum as clean as the day it was wrapped. -30-

RADIO & TELEVISION NEWS

# FREE

TELLS HOW—  
**WE GUARANTEE**  
 TO TRAIN YOU AND COACH YOU  
 AT HOME UNTIL YOU GET  
**YOUR FCC LICENSE**

if you have had any practical radio experience—  
 amateur, Army, Navy, radio repair, or experimenting

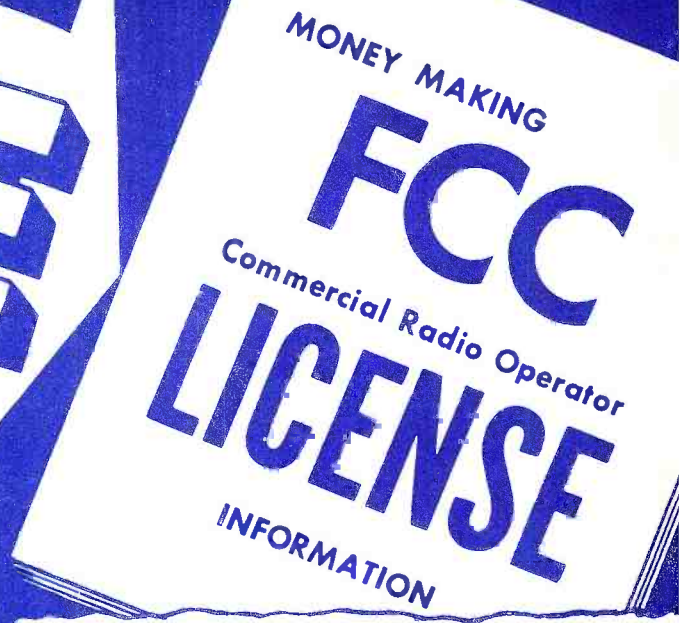

**TELEVISION ENGINEERING** Included in our Training and Coaching

Your FCC Ticket is recognized by employers in the electronic field as proof of your technical ability.

**ACT NOW!**

TELLS HOW— **Our Amazingly Effective JOB-FINDING Service Helps CIRE Students GET BETTER JOBS**

**GETS AIRLINES JOB**

"Due to your Job-Finding Service I have been getting many offers from all over the country, and have taken a job with Capital Airlines in Chicago, as Radio Mechanic."

Harry Clare, 4537 S. Drexel Blvd., Chicago, Ill.

**GETS CIVIL SERVICE JOB**

"I have obtained a position at Wright-Patterson Air Force Base, Dayton, Ohio, as Junior Electronic Equipment Repairman. The Employment Application you prepared for me had a lot to do with my landing this desirable position."

CHARLES E. LOOMIS, 4516 Genessee Ave., Dayton 6, Ohio.

**GETS FIVE JOB-OFFERS FROM BROADCAST STATIONS**

"Your 'Chief Engineer's Bulletin' is a grand way of obtaining employment for your graduates who have obtained their 1st class license. Since my name has been on the list I have received calls or letters from five stations, in the southern states, and am now employed as Transmitting Engineer on WMMT."

ELMER POWELL, Box 274, Sparta, Tenn.

**GETS PUBLIC UTILITIES JOB**

"I have secured the position of Radio Technician with the Toledo Edison Company. I want to thank you once more. The help you gave me was much more than would ordinarily be expected—both in obtaining my license and in finding employment."

Norman W. Stokes, Jr., Rt. 11, Box 612, Toledo 7, O.

TELLS HOW— **Employers Make JOB OFFERS Like These To Our Graduates Every Month**

Letter from nationally-known airplane manufacturer: "We need men with electronic training or experience in radar maintenance to perform operational check-out of radar and other electronic systems . . . starting salary . . . amounting to \$329.33 per month."

Letter from nationally-known Airlines: "We would also appreciate if you would place the following additional advertisement in your bulletin—Wanted—Superintendent of Communications . . . Salary \$866.66 per month."

These are just a few examples of the job offers that come to our office periodically. Some licensed rationians filled each of these jobs; it might have been you!

**HERE'S PROOF FCC LICENSES ARE OFTEN SECURED IN A FEW HOURS OF STUDY WITH OUR COACHING AT HOME IN SPARE TIME**

Name and Address	License	Lessons
Lee Worthy, 2210 1/2 Wilshire St., Bakersfield, Cal.	2nd Phone	16
Clifford E. Vogt, Box 1016, Dania, Fla.	1st Phone	20
Francis X. Foerch, 38 Beucler Pl., Bergenfield, N. J.	1st Phone	38
S/Sgt. Ben H. Davis, 317 N. Roosevelt, Lebanon, Ill.	1st Phone	28
Francis X. Foerch, 38 Beucler Pl., Bergenfield, N. J.	1st Phone	38

CARL E. SMITH, E.E., Consulting Engineer, President

Ours is the only home study course which supplies FCC-type examinations with all lessons and final tests.

**Mail This Card Now**  
 NO POSTAGE REQUIRED  
 Get All 3 FREE

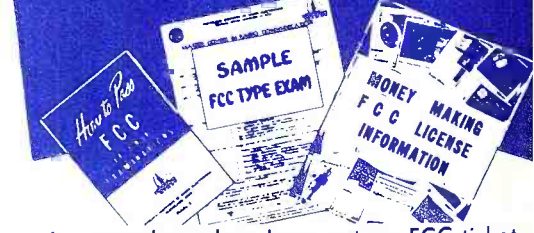

I want to know how I can get my FCC ticket in a minimum of time. Send me your FREE booklet, "How to Pass FCC License Examinations" (does not cover exams for Amateur License), as well as a sample FCC-type exam and the amazing new booklet, "Money-Making FCC License Information".

Also send me your FREE Booklet "There's Money for You in 2 Way Mobile Radio Servicing."

NAME \_\_\_\_\_  
 ADDRESS \_\_\_\_\_  
 CITY \_\_\_\_\_  
 ZONE \_\_\_\_\_ STATE \_\_\_\_\_

Special tuition rates to members of the U.S. Armed Forces

**CLEVELAND INSTITUTE OF RADIO ELECTRONICS**  
 Desk RN-68 4900 Euclid Building, Cleveland 3, Ohio  
 (Address to desk to avoid delay)

**SEE OUR AD ON NEXT PAGE**

# Want To Double Your Pay?

I can train you to pass your FCC License Exams in a minimum of time if you've had any practical radio experience—amateur, Army, Navy, radio servicing, or other. My time-

proven plan can help put you, too, on the road to success. Just fill out the coupon and mail it. I will send you free of charge, a copy of "How To Pass FCC License

Exams," plus a sample FCC-type Exam, and the amazing new booklet, "Money Making FCC License Information."  
**CARL E. SMITH, President**



## How To Pass FCC COMMERCIAL RADIO OPERATOR LICENSE EXAMINATIONS



### HERE IS YOUR GUARANTEE

Should you fail the FCC commercial license examinations after completing your course, we guarantee to continue your training, without additional cost of any kind, until you successfully obtain your commercial license, provided you first take your examinations within 90 days after completing the course.

### IMPORTANT

SEE OTHER SIDE FOR MORE INFORMATION

Brand New- Just Off The Press!

**FREE**

TO ANY RADIO-TV SERVICEMAN WHO WANTS **A BIGGER INCOME!**

- Learn how servicing of mobile equipment has become a million dollar business.
- Learn how smart radio servicemen are cashing in.
- Learn how you can get in on the ground floor, what the profits are, every step you take in this expanding market. This is opportunity knocking at your door. Don't miss out.
- Learn what the latest authentic FCC statistics about growing mobile service needs in this country mean to your future in radio servicing.



## SERVICING 2-WAY Mobile Radio Systems PAYS BIG MONEY

Mail the Card At Once. Get This Free Booklet too.

### If You're in the Armed Forces PLAN NOW for PRESENT and FUTURE SECURITY IN CIVILIAN LIFE

- 1 Use your spare time, NOW, while you are in the armed forces, to prepare for the FCC license examinations, and get your FCC Commercial License.
- 2 Shortly before discharge, use our **AMAZINGLY EFFECTIVE JOB-FINDING SERVICE** to get your choice of good-pay jobs.

Special tuition rates to members of the U.S. Armed Forces.

#### Ex-Navy Man Gets RCA Job

"Since my discharge from the Navy I have been employed by RCA Service Company. Believe it or not, I owe all of my good fortune to your course of instruction, and I can truthfully recommend it to anyone."

**CLARENCE JOHNSON, 730 Barron, Redwood City, Calif.**



**Stromberg-Carlson employs Ex-Army Man**

"I am now working as a lab technician in the engineering department of Stromberg-Carlson Company. My CIRE course and 2nd 'phone helped a great deal in obtaining this position."

**JOHN P. DALEY, P.O. Box 327, Lima, New York**

**CARL E. SMITH, E.E., Consulting Engineer, President**  
**CLEVELAND INSTITUTE OF RADIO ELECTRONICS**  
 4900 EUCLID BUILDING • CLEVELAND 3, OHIO  
 Desk RN-68 (Address to desk No. to avoid delay)

TEAR OUT AND MAIL THIS CARD NOW!



**BUSINESS REPLY CARD**  
 FIRST CLASS PERMIT No. 8685, Sec. 34.9, P.L.&R. Cleveland, Ohio

Cleveland Institute of Radio Electronics

4900 EUCLID AVENUE

CLEVELAND 3, OHIO

Desk RN-68

# A NEW ANTENNA COUPLING SYSTEM

By **HAROLD HARRIS**

Vice-President, Engr., Channel Master Corp.

*Here's a promising new method for obtaining good TV on alternate channels from different directions.*

FROM the earliest days of TV, the range of transmission has exceeded theoretical predictions and, as a result, practically every community which can receive TV can receive it from more than one channel and from more than one direction. Until now, the problem of receiving TV from a number of different directions has been met by three general methods:

1. The use of a rotator in conjunction with a broadband antenna. This, by far, is the most common approach to the problem.

2. The use of two or more yagis, independently oriented in conjunction with a manually operated antenna selector switch located at the set.

3. The use of so-called omni-directional antennas, consisting of a series of straight or conical dipoles which can be connected in different combinations by a manually operated antenna selector switch at the set.

The purpose of this article is to describe a new method of solving this problem. This method, developed by engineers at *Channel Master Corporation*, and called the "Selectenna Coupling System," permits up to seven separate v.h.f. yagi antennas to be coupled on the mast to a single transmission line, provided there is at least one channel separation between them (or the guard band between channels 4 and 5). This method eliminates the use of compromise antenna types, extra tuning equipment, and the extra manual operation at the set when switching channels.

The system consists of a series of very narrow bandpass filters, having a 300-ohm impedance at resonance and an impedance of several thousand ohms off resonance. The number of filters used bears a general relationship to the number of channels to be received.

Let us illustrate the most simple installation problem of this type. Assume that channels 2 and 4 lie in different directions and that reception is desired from each of them. The ideal solution would be to couple the channel 2 and channel 4 yagi antennas together and run one lead down to the set. However, very serious difficulties arise when we attempt to do this.

When the channel 2 and channel 4

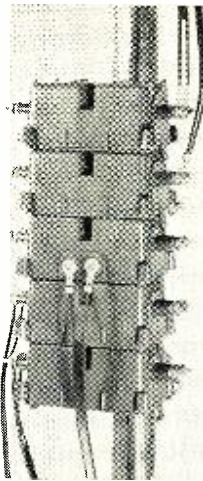

Fig. 1. "Selectenna" coupler system in use and some views of individual couplers. The couplers snaplock together when mounted onto the mast. Only one downlead goes to the TV set. The coupler (bottom left), with its bottom removed, is for the high band channels, the other (bottom right) is for the lows.

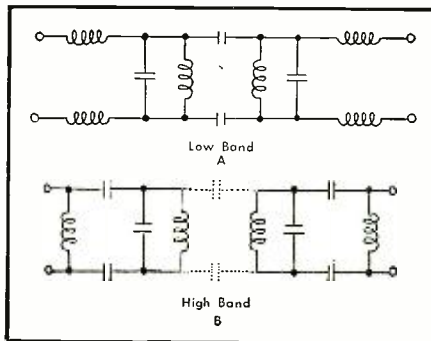
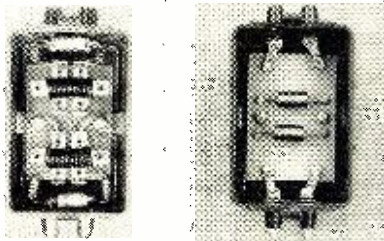
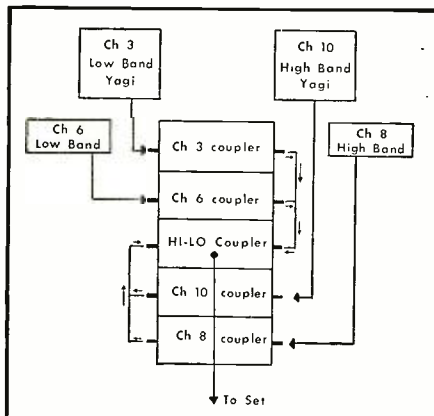

Fig. 2. Schematic diagrams of the couplers for high- and low-band frequencies.

Fig. 3. Block diagram of a typical antenna setup using couplers. The actual coupler arrangement is shown in Fig. 1.



**ATTENTION!!**  
Executives and Salesmen!

Shave in the  
Comfort of  
Your Own Car,  
Boat or Plane!

WITH **ATR**

## SHAV-PAK

Specially Designed for  
Operating Standard A.C.  
Electric Shavers in  
Automobiles, Buses,  
Trucks, Boats, and  
Planes.

Keep in  
Glove  
Compartment!

PLUGS INTO  
CIGARETTE LIGHTER  
RECEPTACLE  
ON DASH

**\$12.95**  
LIST PRICE

TYPE	INPUT D.C. VOLTS	A.C. OUTPUT 60 CYCLES	OUTPUT WATTAGE	LIST PRICE
6-SPB	6	115 volts	15	12.95
12-SPB	12	115	15	12.95

**DICTATE REPORTS  
ACCURATELY-PROMPTLY!**

make your car, boat or plane  
a "rolling office"

WITH **ATR**

## INVERTERS

for changing your  
storage battery  
current to A. C.

Household  
ELECTRICITY  
Anywhere  
in your own car!

Plugs into  
Cigarette Lighter  
Receptacle on Dash

**\$2250**  
AND UP  
LIST PRICE

**ATR INVERTERS . . .**  
especially designed for operating  
standard 110 volt A. C. . . .

- TAPE RECORDER
- WIRE RECORDERS
- DICTATING MACHINES
- ELECTRIC RAZORS

See your jobber or write factory today  
for complete information

**ATR** **AMERICAN TELEVISION & RADIO CO.**  
Quality Products Since 1931  
SAINT PAUL 1, MINNESOTA—U. S. A.

# a new concept of audio control

with Hinged Tone Controls

## THE NEW **craftsmen**

### C350 EQUALIZER-PREAMPLIFIER

**NOW** . . . Craftsmen offers the high fidelity enthusiast the finest, most advanced pre-amplifier ever built — featuring **hinged tone controls** — a Craftsmen exclusive that produces clean, smooth changes in bass and treble with unbelievable clarity. The sharp shelving contours and resulting transient distortion prevalent in conventional pre-amplifiers are completely eliminated. For the first time, a tone control system is offered that allows really accurate balancing of highs and lows, doing away with the "not just right" feeling that so often occurs with even the finest high fidelity systems. The C350 is designed and engineered to provide every essential feature of an audio control center. Complete flexibility, extreme accuracy, and negligible distortion are the qualities which make the C350 outstanding.

C350.....Net price **\$129.50**

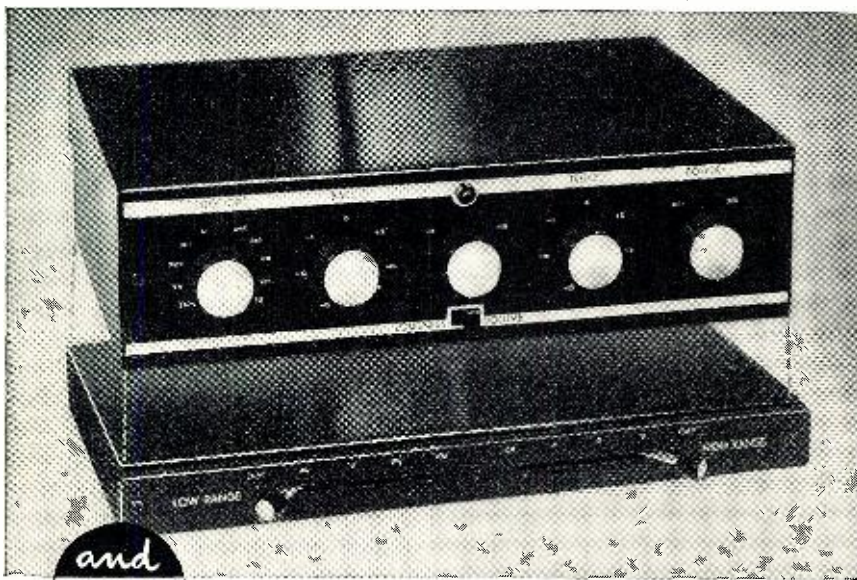

### C375 FILTER SYSTEM

A new sharp cut-off filter system featuring ten positions of cut-off action. The C375 effectively reduces hum, turntable rumble, hiss, record scratch and sub-sonic surges which are often present in broadcasts and recordings.

**The C350, together with the Craftsman C375 filter system, affords every conceivable type of audio control.**

The C375 will be available at your high fidelity dealer about November 15.

You can hear the difference at your radio parts distributor.  
For complete information send for bulletin 502.

**The Radio Craftsmen, Inc. Dept. R-9**

4403 N. Ravenswood Ave. Chicago 40, Ill.

antennas are tied together through a length of transmission line, serious losses occur because one antenna shunts the other. In addition, spurious channel 2 pickup from the channel 4 antenna is introduced, and this further degenerates the performance of the channel 2 antenna. The same thing is true if we consider the effect of a channel 2 antenna on channel 4 reception.

The ideal solution would be to put a bandpass filter, one channel wide, in series with each antenna. This filter would have a 300-ohm impedance at resonance and an impedance of several thousand ohms on either side of its selected channel. This system would then permit the channel being received to go through its respective filter unimpeded. The other filter isolates the inoperative antenna and keeps it from interfering with the one in operation. The outputs of the bandpass filter for each channel would be tied in parallel and one line could be brought down to the set.

Fig. 2A shows the bandpass filter circuit for the low band; Fig. 2B shows the circuit for the high band. In operation, these two circuits are virtually the same. Capacitive isolation is used instead of inductive isolation in the high band because it was found that the required value of inductance resonated with the distributed capacity of the coils at high-band frequencies. An inductance was also put across the high-band terminals to compensate for stray capacitances resulting from the size of components, hardware, and placement of parts. This inductance corrects the skirt impedance off resonance, and prevents it from being low in magnitude and from appearing capacitive.

The physical layout was extremely critical, and in order to get condensers of the proper "Q" metal stampings were used on the high-band couplers as condenser plates. Fig. 1 shows the physical placement of components for the high- and low-band couplers.

The circuits are completely symmetrical, therefore, it makes no difference which end is used for the input and which is used for the output.

Since it is not possible to maintain the high impedance of the high-band couplers on low-band frequencies, it is necessary to use a high-low coupler of special design when coupling high- and low-band antennas through this system.

Fig. 3 shows the case where four separate yagis are used—two for the high band and two for the low band. The combined outputs of the low band and the combined outputs of the high band are fed into a high-low coupler and combined. The single coupler transmission line carrying all four channels runs from the high-low coupler to the set.

It should be noted that the channels of higher frequency on both the high band and low band should be the ones closest to the line—or high-low coupler—running directly to the set.

## Metal Locator

(Continued from page 37)

with respect to keeping grid and plate leads well separated to prevent feedback.

### Initial Adjustment

After the instrument is completed and switched on, the receiver may be aligned with a test oscillator or signal generator set to 175 kc. The high side of the generator output should be connected to the grid of  $V_1$  through a series resistor of at least 1000 ohms. For this adjustment, make sure that the transmitter is switched off. Set the sensitivity control,  $R_2$ , at about half-range. Use meter  $M_1$  as the alignment indicator, as the i.f. transformer trimmers and condenser  $C_2$  are adjusted for peak response.

If a test oscillator is not available, switch the transmitter on, and run a length of insulated wire temporarily between the transmitting and receiving loops. Pass the wire around the circumference of each loop to obtain good coupling. Set trimmer condenser  $C_6$  in the transmitter to about one-half maximum capacitance. Then align the receiver section, in the conventional manner, using the transmitter in this fashion as the test oscillator.

Whichever method is employed to align the receiver, the transmitter must be set exactly to the receiver frequency. This is done in the manner just described with a length of insulated wire temporarily coupling the two loops, and tuning  $C_6$  for maximum swing of meter  $M_1$ , or for loudest headphone signal. When the coupling lead is removed, the meter should not show a deflection greater than about 1/5 full-scale due to direct transmission between the loops, unless a mass of metal is in their immediate vicinity.

### Operation and Use

After the instrument is aligned, it is ready for use. Hold the locator so that the receiver loop is not too close to the operator's body. Stand with the locator over a fairly large metallic area, such as a flat sheet or large pan. The meter should increase deflection and the headphone signal should rise. Adjust  $C_6$  for peak meter swing and loudest headphone signal.

Walk over an area known to have no buried metallic objects, noting the "deadness" of the instrument. Now, try it over a known buried pipe or other metallic mass, noting the change in meter and headphone indications. It has been observed that the meter occasionally will show a sharp downward, instead of upward, deflection over some types of buried metal.

Generally, the meter will be the more sensitive indicator. However, it is a good idea to have both meter and headphones in the circuit, since

# Performance never before possible

## THE new craftsmen C1000

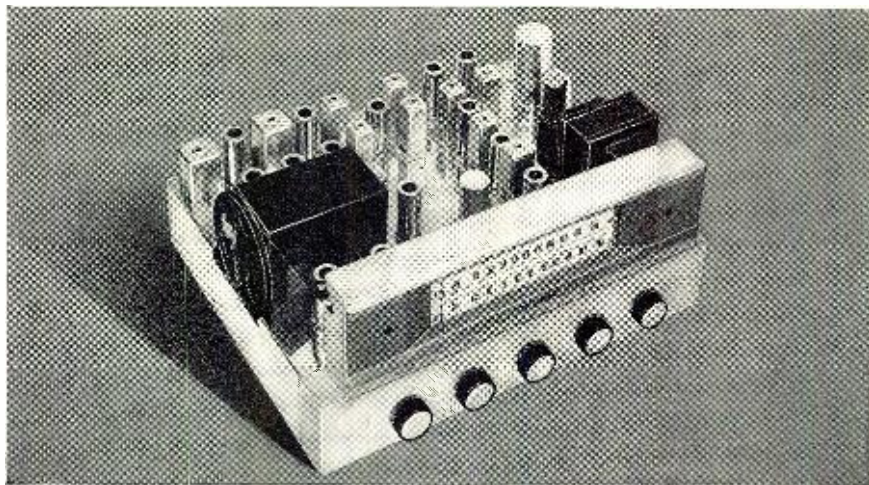

Here is the finest FM-AM Tuner ever made. . . . The new Craftsman C1000 is the entire control center for the finest high fidelity system, combining in one chassis a superlative FM-AM Tuner and equalizer-preamplifier. The C1000 affords greater sensitivity, more features and flexibility and the highest standard performance ever attained!

**FM sensitivity** of 1 mv. for 20 db quieting but with wide band pass characteristics and excellent discriminator linearity for undistorted performance. **AFC** for simplified tuning and freedom from drift may be switched out if desired.

**Two AM band width positions:** "Sharp" for noisy areas and DX-ing and "Broad" for high fidelity local reception. **Bandwidth:** FM-200 KC; AM-13KC and 5KC.

Tuned RF stages and separate triode converters assure low noise level. A 10 kc whistle filter eliminates adjacent channel interference.

The audio circuit affords input for magnetic or variable reluctance cartridges, **four positions of record equalization**, separate bass and treble tone controls each giving 15 db boost and attenuation and input positions for tape recorder and TV. **Frequency response:** FM-20 to 20,000 cps 1/2 db. AM-20 to 5,000 cps 1/2 db. **Distortion:** 0.05% IM at 1 1/2 volts; Harmonic content negligible. New beauty of design adds refreshing smartness to room interiors, even when used without cabinet installation. **The C1000** (16 tubes, including rectifier) . . . . . \$179.50 net.

The C1000 is indeed a true audio control center.



### new C550 30 watt amplifier

A basic high fidelity audio amplifier, without controls. For use with high fidelity tuners or preamplifiers such as the C1000 or C350.

**30 full watts** of audio with only 1/10 of 1% harmonic and 1/2 of 1% IM distortion. **Exclusive thermal time delay** provides complete protection of power supply; the same type of time delay used in broadcast transmitters. **New circuit design and core materials** provide exceptional stability margins and extended range. Power response: 10 to 50,000 cps 0.1 db at 30 watts. FR 0.1 db 20 to 20,000 cps at 1 mw. Damping factor 32:1. 16 tubes including KT66 output tubes, rectifier and thermal time delay! **C550** . . . . . \$109.50 net

See and hear these outstanding new Craftsman developments at your Radio Parts Distributor.

For complete information on C1000 request Bulletin 503; on C550 ask for Bulletin 504.



**The Radio Craftmen, Inc. Dept. R-9**

4403 N. Ravenswood Ave. Chicago 40, Ill.

# KESTER



Since the most important single step in Radio-Television Servicing is soldering . . . it's just plain good sense to use the best — KESTER SOLDER . . . Key Name in Solder for More Than 50 Years.



**KESTER SOLDER COMPANY**  
4235 Wrightwood Avenue • Chicago 39, Illinois  
Newark 5, New Jersey • Brantford, Canada

# SOLDER



**DON'T THROW OLD RADIOS AWAY!**

Here's the data you need to fix them FAST and r-i-g-h-t!

There's a "secret" to repairing old radios fast and profitably . . . and this big RADIO TROUBLESHOOTER'S HANDBOOK is it!

Just look up the old make and model you want to fix. This manual-size, 3 1/2 pound, 744-page Ghirardi handbook tells what the trouble is likely to be . . . and shows you exactly how to fix it. No useless testing! No wasted time! Even beginners can handle jobs "slick as a whistle."

**THE ONLY GUIDE OF ITS KIND!**

**Cuts service time in half!**

Included are common trouble symptoms and their remedies for over 4,800 models of home and auto radios and record changers. Actual case histories cover practically every model made by 202 manufacturers between 1925 and 1942—Airline, Apex, Arvin, Atwater Kent, Belmont, Bosch, Brunswick, Clarion, Crosley, Emerson, Fada, G-E, Kolster, Majestic, Motorola, Philco, Pilot, RCA, Silvertone, Sparson, Stromberg and dozens more. Gives how-to-do-it data on SPECIFIC jobs—NOT general theory. Includes hundreds of pages of invaluable tube and component data, service short cuts, etc.

**\*\*\*TRY IT 10 DAYS . . . at our risk!\*\*\***

Dept. RN-94, RINEHART & CO., Inc.  
232 Madison Ave., New York 16, N. Y.  
Send Ghirardi's RADIO TROUBLESHOOTER'S HANDBOOK for 10-day free examination. If I decide to keep book, I will then remit the full price of only \$6.50 plus a few cents postage. Otherwise, I will return book postpaid and owe you nothing.

NAME.....  
ADDRESS.....  
CITY, ZONE, STATE.....

New **TUBES** Standard  
Guaranteed Brands

**PRICES SLASHED FAR BELOW WHOLESALE!**

Standard brands only! One of largest stocks in U.S. We sell—buy—trade. WRITE FOR FREE CATALOG JUST OFF PRESSES.

1A3	.70	6K7	.75	50L6GT	.69
1A7	.85	6L6	1.40	83	.99
1C5	.80	6L7	.85	0A2	.95
1C7	1.00	6N7	.85	0B2	3.99
1C21	1.00	6S4	.60	1021	3.50
1LA4	.90	6SA7	.80	2021	3.95
1LC6	.90	6SC7	.95	2021	1.15
1LN5	.90	6SF5	.90	2X2	.69
1NS6T	.65	6SF7	1.00	3FP7	1.95
1R4	.90	6SG7	.75	36P1	1.95
1R5	.75	6SH7	.75	3HP7	2.95
1X2A	.90	6SJ7	.60	5AP1	2.95
3D6	.49	6SK7	.60	58P4	2.95
3Q4	.60	6SL7GT	.75	5FP7	1.95
3AS6T	.80	6SN7GT	.85	12AY7	.95
3S4	.65	6SQ7	.55	114B	.49
5T4	1.40	6SR7	.70	304TL	6.95
5V4	1.00	6SS7	.90	707A	2.95
5X4	.65	6ST7	.65	807	1.50
5V3GT	.65	6T8	.75	809	2.90
5V4G	.65	6U8	1.00	811A	3.49
6A7	1.00	6V6GT	.70	813	7.95
6AC5	.75	6W4GT	.60	829	6.50
6AC7	.90	6X4	.60	830B	1.95
6AG7	1.10	6Y6G	.85	832A	6.50
6AK5	.75	7A7	.85	865	1.00
6AL5	.95	7C4	.90	866A	1.30
6AQ5	.65	7J7	.90	872A	1.95
6AQ6	.75	7N7	.90	922	1.30
6AT6	.45	12A6	.75	923	1.30
6AU6	.70	12A77	.95	931A	4.50
6AV5GT	1.10	12AU7	.95	954	.33
6B6	1.00	12AX4GT	.80	955	.49
6BG6G	1.60	12C8	.80	956	.49
6BH6	.70	12H6	.62	957	.49
6B16	.70	12L6	.60	958A	6.99
6C4	.60	12K7	.80	959	1.50
6CD6	1.50	12K8	.59	1619	.30
6J4	4.50	12SC7	.89	1625	.35
6J6	.70	12SF7	.99	2050	1.30
6C6	.95	12SH7	.70	2051	.95
6D6	.85	12SL7GT	.92	9001	1.10
6F6	1.10	12SV7GT	.80	9003	1.25
6F7	1.00	12SQ7	.65	9002	.85
6F8G	1.00	12SR7	.49	9003	1.15
6G5G	.85	25L6GT	.69	9003	1.15
6H6	.60	45Z5	.69	5004	.49

Thousands of other types of Transmitting and Receiving Tubes. Prices subject to change without notice. Californians add sales tax. Add postage to order. Minimum order \$5.00.

**SPECIAL! VACUUM CAPACITORS!**

6 mfd. 30KV	10.00	50 mfd. 40KV	14.50
50 mfd. 20KV	10.00	100 mfd. 10KV	12.00
50 mfd. 32KV	12.50	100 mfd. 20KV	14.00

**Jsh**  
SALES CO.

**ELECTRONICS**  
Dept. R-H  
7552 Melrose Ave.  
Los Angeles 46,  
California

the phones free the operator's eyes for watching traffic and other items.

### Possible Improvements

Since the present instrument was completed, two possible improvements have been suggested. One is the addition of a 3S4 audio output stage after V<sub>3</sub> to boost headphone volume, if the additional battery drain seems justifiable to an individual builder. The second is provision for grounded electrostatic shields for the two loops. Capacitance effects gave this author no trouble. However, the loops might be shielded by wrapping them first with insulating tape, and on top of this winding tightly a layer of metal foil. The foil winding must not be completed—a gap of about 1/8 inch can be left between the beginning and ending of the winding—to prevent "shorted-turn" effects. -30-

### An Economy V.F.O.

(Continued from page 70)

sure coil is tuned to correct harmonic.

The next step is to calibrate the dial. See Table 1. Since the base oscillator frequency remains the same on all bands, the calibration is greatly simplified. Draw five straight lines across calibration card, spacing these lines approximately 1/4-inch apart. Each line can be calibrated for a separate band. The 2-meter calibration will be located on the opposite end of the dial from the other bands so one line can be used for 2 meters as well as one of the other bands.

The first step in calibrating the dial is to close the variable condenser and mark the pointer position. Whenever the dial is removed and then replaced, close the condenser and set pointer at this mark.

Set the frequency meter to 3500 kc. Zero beat the v.f.o. You now have a calibration point at 3500 kc. on 80, 7000 kc. on 40, 14,000 kc. on 20, 21,000 kc. on 15, and 28,000 kc. on 10 meters. Next set frequency meter on 3550 kc. and zero beat the v.f.o. Check points as follows: 3550 kc. on 80, 7100 kc. on 40, 14,200 kc. on 20, 21,300 kc. on 15, and 28,400 kc. on 10 meters.

Two-meter calibration starts at 4000 kc. Set frequency meter to 4000 kc. Zero beat the v.f.o. This gives a calibration point of 4000 kc. for the 80-meter band and 144 megacycles for the 2-meter band.

Repeat this operation until all bands are calibrated as desired.

The v.f.o. is designed for high-impedance output. Low-impedance output can be made with the following modification.

Three-turn pickup coils are wound around the "B plus" ends of coils L<sub>3</sub>, L<sub>4</sub>, L<sub>5</sub>, and L<sub>6</sub> using number 18 wire. The windings require insulation between coils. A layer of Scotch tape between the windings will be satisfactory.

One end of each pickup coil is con-



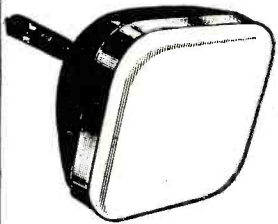

PICTURE TUBES

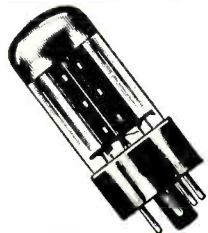

RECEIVING TUBES

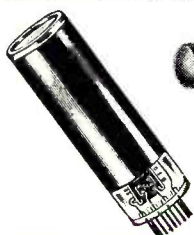

SPECIAL PURPOSE TUBES

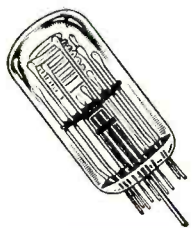

INDITRONS



MAGNETIC PICKUP TUBES



TRANSISTORS

BETTER  
**ELECTRONIC**  
PRODUCTS

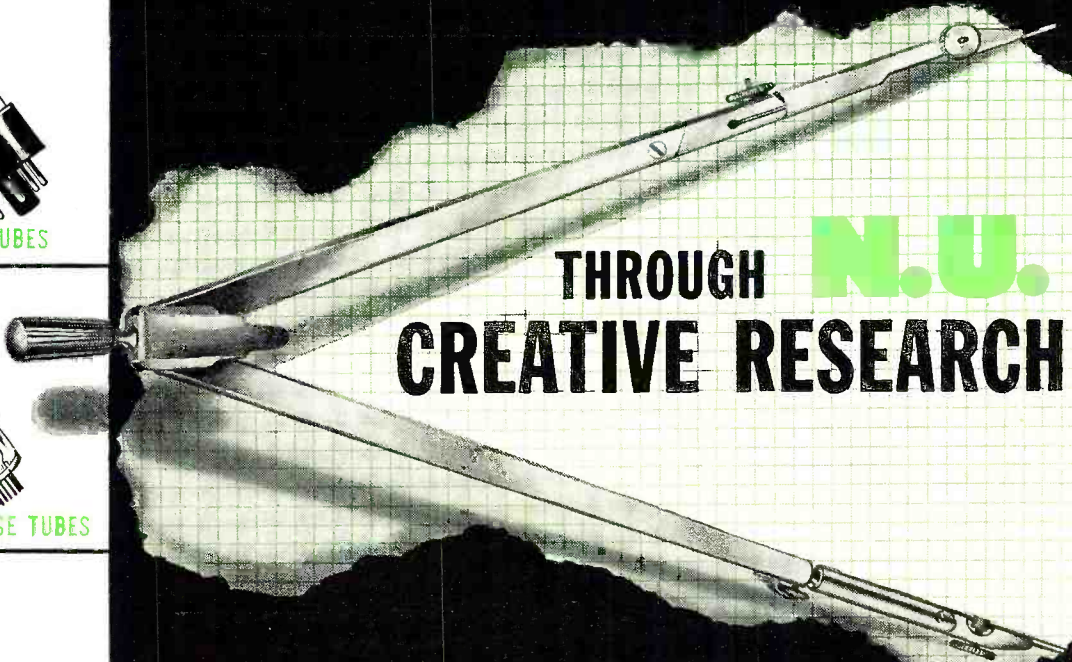

THROUGH **N.U.**  
CREATIVE RESEARCH

YOU CAN  
USE WITH  
CONFIDENCE

**NATIONAL UNION  
ELECTRIC CORP.**

HATBORO • PENNSYLVANIA

# HARVEY'S COMPLETE STOCK INSURES PROMPT DELIVERIES

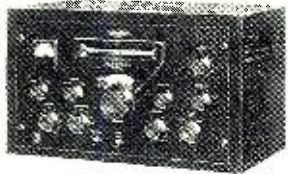

## COLLINS 75A-3 AMATEUR RECEIVER with MECHANICAL FILTER

The famous, superbly-built Model 75A-2, re-designed and modified to use the new Collins mechanical filters. Supplied with one 3 KC filter and provision for one additional filter, with front panel switch for filter selection. Double-conversion superheterodyne circuit for top performance on the 160, 80, 40, 20, 15, 11, and 10 meter bands. Only the band in use is shown on the slide rule dial. Vernier zero set control on front panel.

Dimensions: 21-18" wide, 12 1/2" high, 13-1/16" deep.

Complete with tubes.....\$5300  
Speaker.....20.00



## COLLINS 32V-3 AMATEUR TRANSMITTER

A receiver-sized, high-performance rig built to Collins standards in every detail. Rated at 150 watts input CW, 120 watts phone, gang-tuned, with bandswitching to cover 80, 40, 20, 15, 11 and 10 meter bands. Excellent audio gives extraordinarily good readability. Stable VFO, completely enclosed R-F section and thorough filtering and shielding provide the maximum protection against TVI.

Write to Harvey for full details \$77500  
Complete with tubes.....

## The NEW ORLOKATOR Junior

Reliable Low Cost  
Geiger Counter



Extremely simple to operate, the Orlokator Junior detects ores with as little as .1% Uranium. This sensitivity is greater than is available with any instrument in this price range.

Visual and audible indicators are provided: flashing neon and headphone. Geiger tube is built-in. Employs standard type, long-life batteries. Operates with single switch and detects beta and gamma rays, X-rays and cosmic rays. Weighs only 3 3/4 lbs.

Complete with headphone, batteries and instructions.....\$49.95

Generous Trade-In Allowances  
On Your Present Equipment

NOTE: Prices Net, F.O.B., N.Y.C.  
Subject to change without notice.



# Harvey

RADIO COMPANY, INC.

103 W. 43rd St., N.Y. 36, N.Y. • JU 2-1500

nected to ground. Switch  $S_1$  is changed to a two-pole, four-position band-switch. The other end of the pickup coil windings connects to contacts on the added section of switch  $S_1$ . The output cable now connects to the pole contact on switch  $S_1$ . The output cable is no longer connected to the plate circuit of the 5763 and condenser  $C_{11}$  is eliminated. Trimmer  $C_{13}$  should be connected to the plate of the 5763 and disconnected from  $L_6$ .

The alignment procedure would remain the same.

Those not interested in 2-meter operation can increase the bandspread on all bands by adjusting the frequency range from 3495 to 4005 kc. This requires no change in parts other than eliminating coil  $L_3$ .

Since receiver coils are used throughout, the color code on coil  $L_2$  is not standard. The green lead should connect to the plate of the 6AQ5 and

the black lead goes to "B plus." The red and blue leads are not used and should be cut off. The color code for coil  $L_1$  is correct. Coils  $L_3$ ,  $L_4$ ,  $L_5$ , and  $L_6$  are supplied with lugs only. The pickup winding on these coils is not used but need not be removed.

The drift compensating condenser,  $C_3$ , is a 10  $\mu$ fd. unit. Due to tolerances it is possible the drift characteristic will vary between units. If this difficulty develops the value of this condenser can be changed.

Frequency drift can be corrected in two ways. Change the value of  $C_3$  slightly, using the same negative coefficient or use the same value and change the negative coefficient. The one thing to remember is the capacity value of  $C_3$  should be a small amount of the total capacity across  $L_1$ . Any change in this condenser will require recalibration. Check drift before calibrating the dial.

-30-

## HALLOCK REPORTS

By C. HOWARD BOWERS

ONE of the busiest individuals we have contacted in this series of career sketches is Mr. J. H. Hallock, engineer-in-charge of the Federal Communications Commission office in Portland, Oregon—and a real old time wireless operator.

We have found in most wireless men an inherent dislike for much hustle and bustle, but this man Hallock is all over the shop with the many duties and obligations of his territory. He did stand still long enough, however, to tell us that he first started with wireless experimenting back in 1906 at Portland, Oregon and that his first transmitter was a "rhum-korf coil" with a "wehmult interrupter" and for a more perfect description we quote Mr. Hallock, "The resultant spark tone was a cross between a sore-throated frog and a Jersey bull with the heaves!" After some months of no contacts he progressed to a 2 kw. closed-core transformer, plate glass condensers, and an open spark gap. The noise of this contraption was more startling than its signal strength, however he was in business and eventually contacted two or three of his, not-too-far, pals. The project eventually wound up in a "blaze of glory" when a large portion of the roof burned off, for which he naturally disclaimed all knowledge!

Mr. Hallock, known to his many friends as "Joe," broke into "big time" wireless in 1909 at the old United Wireless Company station "DZ" Portland, Oregon and, although this job carried no pay, it was very attractive because of the fact that the first trick operator was a stately blond in her twenties—and who t'heck wanted pay anyway? This company, blond and all, was taken over by Marconi Wireless Company about 1911, but by then Joe was day operator for the old Continental Wireless Company, also at Portland, and was busy putting ten on a line until they too folded.

Our "try anything once" friend, along with his pal Cliff Watson (see Feb. 1954 issue, page 186), soon made their way to San Francisco and the possibility of a sea-going wireless job. Cliff Watson was no more affluent than our Joe and for some three weeks they enjoyed the free-lunch in Gene Casserley's Bar on lower Market Street, augmented by an occa-

sional short beer to maintain prestige! Came the day however, when two schooners needed operators and Marconi's marine superintendent, L. Malarin (30, these many years) wanting to be fair about the choice of jobs, said, "Boys, let's flip for it. Heads, Hallock gets his choice and tails, Watson gets his choice!" Some choice! So started Joe's experience on ships from 1911 to 1915; "SS J. B. Stetson," "SS Chehalis," "SS Rosecrans," "SS J. B. Chanslor," "SS Humbolt," "SS Santa Rita," "SS Admiral Schley," "SS Nevadan," and then to the old shore station "PC" at Astoria, Oregon.

After some special assignments with the old Radio Division of the Department of Commerce, Washington, D. C. (1916-1918) Joe was called by the Navy as a Chief Special Mechanic, Radio, and made assistant chief engineer in building a 1000 kw. arc station near Bordeaux, France—largest arc transmitter ever built. In 1922, after World War I, Mr. Hallock and his former associate formed the Hallock & Watson Radio Service, for sales, engineering, and broadcast manufacturing and, according to the former, they had the first broadcast license in Portland, Oregon.

After this venture, our subject old timer handled announcing activities for station KGW/KEX Portland, Oregon where he did sports and special events for the Red and Blue nets of NBC. In 1935 he returned to the Federal Radio Commission at Washington, D. C., later known as the Federal Communications Commission, where in 1942-1944 he was identified as Chief of the Security Section, in charge of physical surveys of communication facilities with recommendations for anti-sabotage protection. That was his most important assignment, and he has been with the Commission ever since.

Mr. Hallock aptly expresses himself by saying, "Since 1919 I have been married to the same wife. (She's very patient.) Also, have a son who is quite normal; that is, he has no interest in radio!"

We hail Mr. Hallock as a scholar, a gentleman, and a judge of good communication. We wish him continued success.

-30-

RADIO & TELEVISION NEWS

# ADVANCE! Raise your earning power—learn RADIO-TELEVISION-ELECTRONICS by SHOP-METHOD HOME TRAINING

## GOOD JOBS AWAIT THE TRAINED RADIO-TV TECHNICIAN

There is a place for *you* in the great Radio-Television-Electronics industry when you are trained as National Schools will train you at home!

Trained technicians are in growing demand at good pay—in manufacturing, broadcasting, television, communications, radar, research laboratories, home Radio-TV service, and other branches of the field. National Schools Master Shop-Method Home Training, with newly added lessons and equipment, trains you in your spare time, right in your own home, for these fascinating opportunities. **OUR METHOD IS PROVED BY THE SUCCESS OF NATIONAL SCHOOLS TRAINED MEN, ALL OVER THE WORLD, SINCE 1905.**

## EARN WHILE YOU LEARN

Many National students pay for all or part of their training with spare time earnings. We'll show you how you can do the same! Early in your training, you receive "Spare-time Work" Lessons which will enable you to earn extra money servicing neighbors' and friends' Radio and Television receivers, appliances, etc.

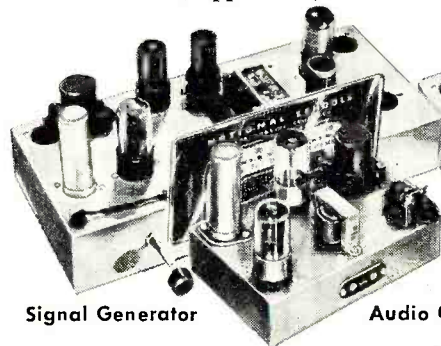

Signal Generator



Audio Oscillator

T. R. F. Receiver

**MASTER ALL PHASES!**  
Get Master Shop-Method Home Training from an Established Practical Resident School with its own Training Shops, Laboratories, Studios — almost 50 Years of Successful Experience in Training Ambitious Men.  
**We Bring National Schools To You!**



Shops, Laboratories, Studios — almost 50 Years of Successful Experience in Training Ambitious Men.



You also receive this Multitester

Superheterodyne Receiver

## LEARN BY DOING

You receive and keep all the modern equipment shown above, including tubes and valuable, professional quality Multitester. *No extra charges.*

## FREE! RADIO-TV BOOK AND SAMPLE LESSON!

Send today for National Schools' new, illustrated Book of Opportunity in Radio-Television-

Electronics, and an actual

Sample Lesson. No cost—

no obligation. Use the

coupon now—we'll

answer by return

airmail.

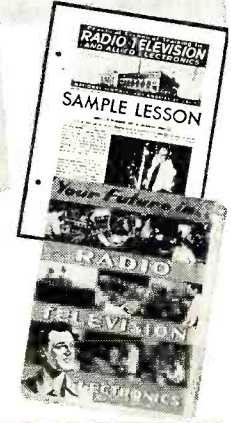

## National Schools Training is All-Embracing

National Schools prepares you for your choice of many job opportunities. Thousands of home, portable, and auto radios are being sold daily—more than ever before. Television is sweeping the country, too. Co-axial cables are now bringing Television to more cities, towns, and farms every day! National Schools' *complete* training program qualifies you in all fields. Read this partial list of opportunities for trained technicians:

- Business of Your Own • Broadcasting
- Radio Manufacturing, Sales, Service • Telecasting
- Television Manufacturing, Sales, Service
- Laboratories: Installation, Maintenance of Electronic Equipment
- Electrolysis, Call Systems
- Garages: Auto Radio Sales, Service
- Sound Systems and Telephone Companies, Engineering Firms
- Theatre Sound Systems, Police Radio
- And scores of other good jobs in many related fields.

**APPROVED FOR  
VETERANS  
AND  
NON-VETERANS**  
Check coupon below

Both  
Resident and  
Home Study  
Courses Offered!

## NATIONAL SCHOOLS

LOS ANGELES 37, CALIFORNIA • ESTABLISHED 1905  
IN CANADA: 811 W. HASTINGS STREET, VANCOUVER, B.C.

## GET FACTS FASTEST! MAIL TO OFFICE NEAREST YOU!

(mail in envelope or paste on postal card)  
**NATIONAL SCHOOLS, Dept. RH-94**

**4000 S. Figueroa Street** or **323 West Polk Street**  
**Los Angeles 37, Calif.** or **Chicago 7, Ill.**

Send **FREE** Radio-TV Electronics book and **FREE** sample lesson. No obligation, no salesman will call.

NAME \_\_\_\_\_ BIRTHDAY \_\_\_\_\_ 19 \_\_\_\_\_  
ADDRESS \_\_\_\_\_  
CITY \_\_\_\_\_ ZONE \_\_\_\_\_ STATE \_\_\_\_\_  
 Check here if interested in Resident School Training at Los Angeles.  
VETERANS: Give Date of Discharge \_\_\_\_\_

## TELEVISION TRAINING

You get a complete series of up-to-the-minute lessons covering all phases of repairing, servicing and construction. The same lesson texts used by resident students in our modern and complete Television broadcast studios, laboratories and classrooms!



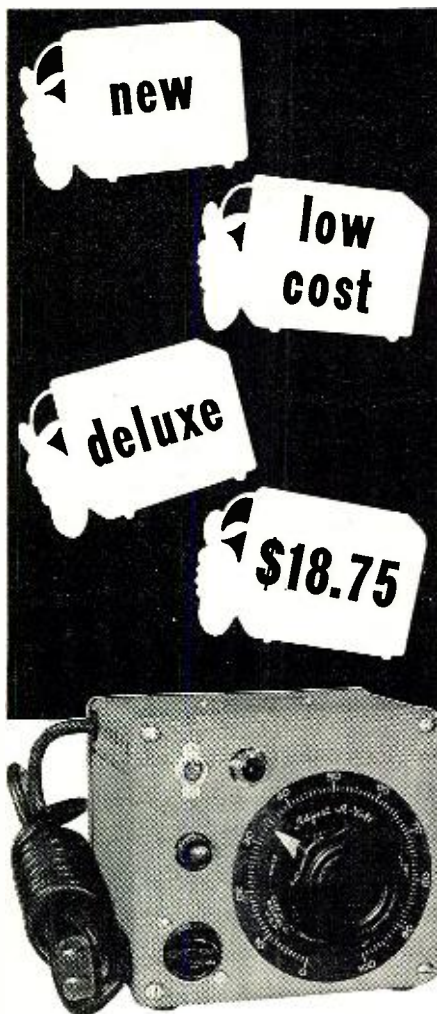

## Adjust-A-Volt PA-3

### VARIABLE TRANSFORMER

For smooth continuous line voltage control for power supplies and instruments, control of heat, motor speeds, light, etc. The highly efficient new Adjust-A-Volt PA-3 is a modern, deluxe variable autotransformer designed for servicemen, laboratories, model shops and other applications where a source of variable a-c voltage is required. Max. load rating 0.4 KVA. Max. output current 3.0 A.

PA-3 features the new LoRes brush track plating which assures longer life and a special brush assembly that maintains constant pressure during entire brush life. Small and compact (6½" x 6½" x 6½"), the PA-3 is equipped with on-off switch, convenient fuse, cord and plug, receptacle and pilot light. Attractive grey hammerloid finish.

Delivery from stock of your favorite jobber.

**STANDARD  
ELECTRICAL PRODUCTS CO.**  
2238 E. THIRD ST. • DAYTON, OHIO, U.S.A.

### Spot Radio News (Continued from page 24)

If prompt action had been taken to establish a new allocation table and the u.h.f. channels opened when there were less than a million TV sets operating, Dr. Du Mont declared, there . . . "would not have been the suppression of the 'courage and daring' of the two smaller networks."

Reviewing the properties of the higher bands, Dr. Du Mont pointed out that the optimistic side of the u.h.f. picture has not been properly presented. During the approximately nine years of commercial TV, he said, available transmitter power for the lower band stations has increased from a fraction of a kilowatt in '38 to 50 kilowatts this year. But, during the two years of high-band TV, power from a transmitter has increased only from 1 to 12 kilowatts, permitting an effective radiated power of about 250 kilowatts; but one-quarter of the output permitted under the present rules. However, it was pointed out, given the proper incentive, manufacturers will shortly achieve the maximum power allowed under the law; it has already been announced that a high-gain antenna, which would be available soon, would almost double the power output now available.

Analyzing receiver characteristics, the CRT pioneer said that early v.h.f. chassis had noise figures of about 20 db, and as late as three years ago the industry average was approximately 14 db; this year the figure has been improved and now is between 5 and 10 db. Last year, noise figures for u.h.f. sets averaged about 20 to 24 db; this year it's about 14 to 18 db. However, it was noted, it has been found possible to build a receiver with a noise figure of less than 7.5 db; but such a set would cost from \$175 to \$200 more than current models. We all know, said Dr. Du Mont, that with the proper incentive, most in industry could produce u.h.f. chassis with noise figures as low as the v.h.f. models, and mass production would lead to smaller costs and lower prices for the finished product.

The receiving antenna was also carefully surveyed in the Du Mont report. To illustrate the effectiveness of antennas on the low and high bands, two conditions for channels 4 (approx. 70 mc.) and 52 (approximately 700 mc.) were posed. Using simple dipoles in equal strength fields from stations on such channels, it was explained, the u.h.f. antenna would pick up only 1/100 the power that the very-high antenna would pick up; however, the high-band antenna would only be 1/10 as long as the v.h.f. antenna, Dr. Du Mont explained. Because of this small size, he added, it is a relatively simple matter to increase the capture ability of the antenna. For example, a commercially available u.h.f. antenna, such as the double di-fan with reflectors, has

a power gain greater than 10. Using this antenna, in equal fields, the ultra-high model will therefore receive 1/10 the power of the v.h.f. antenna. The FCC has recognized this differential, Dr. Du Mont added, and has therefore compensated for it by permitting 10 times the power on channel 52 as on channel 4.

The remaining factor in the system is the propagation path, the Senate committee was told. This, it was said, is a complex factor, with many variables to worry about. For instance, between the transmitting and receiving antennas, the signal may be refracted in the earth's atmosphere and ionosphere; it may be reflected from natural and man-made irregularities in the terrain, and it may be diffracted or bent over and around obstacles on the earth's surface. Furthermore, the signal at the receiving site is generally a resultant of many signals which have arrived over many different paths. Because of these peculiarities, most of the propagation information has been obtained by experiment. According to diffraction theory, the report said, it was predicted that as the frequency is increased the tendency for waves to bend over and around obstacles is decreased; measurements proved this to be so. Accordingly, u.h.f. coverage in rough terrain will be found to be more spotty than v.h.f. coverage. But, it is not true that the v.h.f. signals fill in valleys and u.h.f. signals do not; both signals, it was revealed, are attenuated when they are required to bend over hills and the difference in the amount of bending has frequently been exaggerated.

Dr. Du Mont's brief also stated that, according to theory, the u.h.f. signal should suffer less from man-made interference than the v.h.f. signal. This also has been proven in practice; commutator interference from rotating machinery, diathermy, electric razors and other similar items, all cause considerable interference on low-band v.h.f. and virtually none on u.h.f.

The absence of multipath effects on the high bands was described as possibly the most significant difference between high- and low-band reception. This, it was said, did not jibe with theory and came as a complete surprise to several investigators. Almost, without exception, declared Du Mont, engineers and the public alike have expressed amazement at the clarity and sharpness of u.h.f. pictures.

Reviewing the influence of multipath effects on black-and-white, and color, Dr. Du Mont said that such effects are viewed as smear and ghosts on black-and-white pictures, and on color, contamination of the color is added. During recent experimental color tests on the low- and high-bands, it was found that transmissions on the u.h.f. bands were substantially superior to those delivered by a low-band transmitter.

THE GENERAL ECONOMIC PLIGHT  
of telecasters in the early days of TV,

RADIO & TELEVISION NEWS

revealed in a few briefs during the first few days of the hearings, were re-emphasized by many v.h.f. broadcasters, in answer to dollar complaints made by u.h.f. operators.

One broadcaster said that many v.h.f. stations have been struggling for years. In his case, almost four years passed before any profits appeared. Currently, he added, there are stations in New York and Los Angeles where red ink still flows.

Describing the experiences of *Westinghouse*, a spokesman said that . . . "along with other pioneers in the early days of radio and again in the early days of TV . . ." the company faced . . . "exactly the same problems being presented to the Senate Subcommittee by u.h.f. protagonists. The problem then and now is an adequate number of sets in the hands of the public and attractive programming which the advertising industry is willing to support."

INDEPENDENCE DAY was celebrated in an unusual way at the Limestone Air Force Base, Limestone, Maine, when the nation's tiniest TV station, with an eight-watt output, capable of providing reception to 15,000 living within a three-mile radius, was officially dedicated.

Conceived by General Curtis E. LeMay, Commander, Strategic Air Command, as an entertainment medium for personnel at isolated bases, the unique operation is geared to provide live telecasts and film recordings of major network programs.

Studios and transmitter facilities are housed in a television shack, ten by thirteen feet, constructed atop a four-story base hospital. Presently ten hours of network programs are provided every day. In addition, those on the base hear three live newscasts daily and twice-daily weatherman reports. Regularly-scheduled flying safety programs are also carried, as well as religious telecasts produced by Air Force chaplains and their staffs. It has been estimated that there are about 1000 TV sets on the base.

Describing Air Force policy on the operation of these morale TV stations, Colonel Bertram C. Harrison, Commander, 42nd Bombardment Wing, said: "We will operate television stations only in areas where it is not possible to receive TV programs from commercial outlets. We do not intend to compete with private industry. Our sole purpose is to provide television entertainment to our people when it is not available from privately-owned stations."

The first program from this station was actually presented last Christmas. The Limestone base was selected as the initial site because of its isolated position, a few miles from the Canadian border.

Participating in the official previewing ceremonies were Colonel Jackson W. Lewis, Commander of the base; Colonel William B. Campbell, Deputy Commander, 42d Bombardment Wing;

**OUTSTANDING for HIGH FIDELITY!**

**BUY DIRECT AND SAVE**

**AND SAVE**

**'PRE-FAB'**

**COLLINS TUNERS and RECEIVERS**

**AUDIO PRODUCTS CO.**

**NOW!... with AFC**

Collins Audio Products Co. is the way affiliated with Collins Radio Co.

Each Collins Tuner Kit is complete with punched chassis, tubes, power transformer, power supply components, hardware, dial assembly, tuning eye, knobs, wire, etc., as well as the completed sub-assemblies: FM tuning units, AM tuning units, IF amplifiers, etc., where applicable. All sub-assemblies wired, tested and aligned at the factory make Collins Pre-Fab Kits easy to assemble even without technical knowledge. The end result is a fine, high quality, high fidelity instrument at often less than half the cost—because you helped make it and bought it direct from the factory.

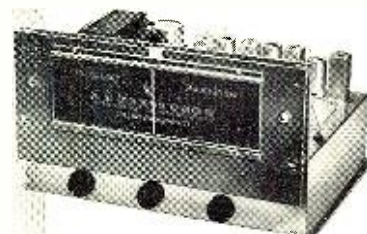

FM Tuner Kit

**\$55**

with AFC \$58.50

The FM-11 tuner is available in kit form with the IF Amplifier mounted in the chassis, wired and tested by us. You mount the completed RF Tuning Unit and power supply, then after some simple wiring, it's all set to operate. 11 tubes: 6J6 RF amp, 6AG5 converter, 6C4 oscillator, 6BA6 1st IF, (2) 6AU6 2nd and 3rd IF, (2) 6AU6 limiters, 6AL5 discriminator, 6AL7-GT double tuning eye, 5Y3-GT rectifier. Sensitivity 6 to 10 microvolts, less than 1/2 of 1% distortion, 20 to 20,000 cycle response with 2DB variation. Chassis dimensions: 12 1/2" wide, 8" deep, 7" high. Illustrated manual supplied. Shipping weight 14 lbs.

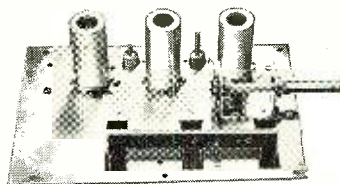

FMF-3 Tuning Unit

**\$1525**

with AFC \$18.75

The best for FM. The most sensitive and most selective type of "front end" on the market. 6 to 10 microvolts sensitivity. Image ratio 500 to 1. 6J6 tuned RF stage, 6AG5 converter, 6C4 oscillator. Permeability tuned, stable and drift-free. Chassis plate measures 6 1/2" x 4 1/2". In combination with the IF-6 amplifier, the highest order of sensitivity on FM can be attained. Tubes included as well as schematic and instructions. Draws 30 ma. Shipping weight FMF-3: 2 1/2 lbs. Dial available @ \$3.85.

IF-6 Amplifier

6 Tubes. Shipping Wgt. 3 lbs.

**\$1975**

**FOR USERS OF COLLINS TUNERS**

Receive \$5.00 credit toward the new FMF-3A front end! Mail us your old front end with \$13.75 and we will send you the new, improved FMF-3A with A.F.C., or, remit the full amount of \$18.75 and when we receive your old unit in return a check will be mailed you for \$5.00.



AM-4 Tuning Unit

**\$2450**

Tops in AM superhet performance! A 3-gang tuning condenser gives 3 tuned stages with high sensitivity and selectivity. Assembly is completely wired, tested and aligned ready for immediate use. Frequency coverage 540 KC to 1650 KC at a sensitivity of 5 microvolts. Tubes 6BA6 RF amplifier; 6BE6 converter; 6BA6 IF amplifier and 6AT6 detector. Draws 30 ma @ 220 volts. Mounts on a chassis plate measuring 4" x 7 3/8". Shipping weight 2 1/2 lbs. Dial available at \$3.85.

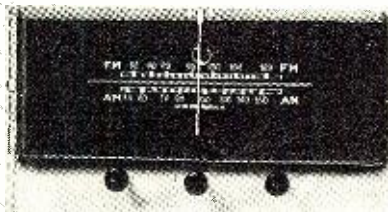

FM/AM Tuner Kit

**\$7750**

with AFC \$81.00

The original 15 tube deluxe FM/AM pre-fab kit redesigned on a smaller chassis. The tuner now measures 14" wide by 12" deep by 7 1/2" high. This attractive new front and dial assembly opens up new applications where space is at a premium. Kit includes everything necessary to put it into operation—punched chassis, tubes, wired and aligned components, power supply, hardware, etc. Kit comprises FMF-3 tuning unit, IF-6 amplifier, AM-4 AM tuning unit, magic eye assembly and complete instructions. All tubes included. Shipping weight 19 lbs.

**MAIL COUPON TODAY**

To: Collins Audio Products Co. Inc. RN-9  
P.O. Box 368, Westfield, N. J.  
Tel. Westfield 2-4390

- FM Tuner Kit  FM/AM Tuner Kit  FMF-3 Tuning Unit
- with AFC  with AFC  with AFC
- IF-6 Amplifier  AM-4 Tuning Unit

NAME.....

ADDRESS.....

CITY.....STATE.....

Amount for Kit \$..... See weights, add shipping cost \$.....

Total amount enclosed \$..... Check  Money Order

**WHEN YOU THINK OF TUNERS, THINK OF COLLINS AUDIO PRODUCTS**

# NOW MEASURE MOBILE-RADIO RIGS UP TO 500 MC!

Make frequency and FM deviation checks on unlimited numbers of channels with just these 2 meters!

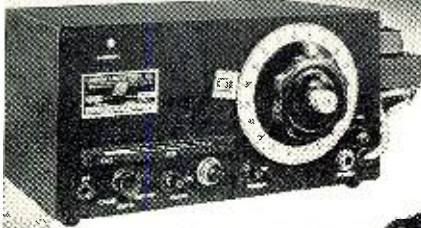

### LAMPKIN 105-B MICROMETER FREQUENCY METER

Uses one crystal to measure all transmitters from 0.1 to 175 mc., and crystal-controlled transmitters to 500 mc. Gives readings of percent error from assigned frequencies. Acts as precision CW signal generator for receiver final alignment. \$220.00.

PORTABLE—Width less than 13"... weight less than 14 lbs., each.  
MEET FCC REQUIREMENTS — for mobile-service checks.

For technical data, mail coupon today!



### LAMPKIN 205-A FM MODULATION METER

Direct indication of peak voice deviation, 0-25 kc positive or negative. Tunable 25-500 mc. in one band. Doubles as relative field-strength meter. Built-in speaker. Jack for oscilloscope. \$240.00.

LAMPKIN LABORATORIES, INC.  
MFM DIVISION  
BRADENTON, FLORIDA

Without obligation, please send me data on Lampkin meters.

Name \_\_\_\_\_  
Street \_\_\_\_\_  
City \_\_\_\_\_ State \_\_\_\_\_

LAMPKIN LABORATORIES, INC.  
Bradenton, Florida

## First Quality, Famous Make SOUND TAPE 1200 ft. ON PLASTIC REEL

Brand new, high quality, plastic base tape. Full range. Stock up at this low price. Order type AT120.

Type PT120 Super sensitive, professional tape for high-fidelity use. \$2.89 per reel. 6 reels or more—\$2.49 per reel.

\$1.95

\$1.79 each  
6 or more.

## All Directional TV AERIAL 360° DIRECTRONIC SYSTEM

Exclusive Snyder Engineering and designs cut cost to

\$18.95

COMPLETE with three 3 1/2 ft. masts, 75 ft. 3 cond. cable, Beam selector sw., guy rings and mtg. base. Electronically beams complete 360° rotation to give clear pic on all channels. You choose direction with directronic selector sw. mounted on or near TV set. Complete double stacked array with 18 hi-tensil double alloy aluminum elements. AX-599 same as TX-599 less masts, guy ring & mtg. base . . . . . \$16.95

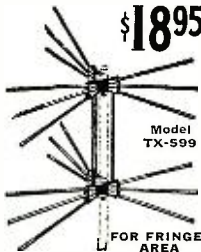

## SNYDER BROAD BAND YAGIS

- Higher Gain Than Conventional Yagis
- For Fringe and Ultra Fringe

High signal level for sharp, bright pictures. Hi-tensil 3/8" aluminum elements: 7 on low band; 9 on high band. Complete with universal U clamps.

RB2-6 for Ch. 2 thru 6 \$9.95  
RB7-13 for Ch. 7 thru 13 \$4.95

Write for FREE "FYI" Bulletin No. 137

WHOLESALE  
RADIO PARTS CO., Inc.  
311 W. Baltimore St.  
BALTIMORE 1, MD.

when there's a soldering job to be done...



Ungar does a better job!

On industrial assembly lines... in home workshops... in electronic labs... for production, repair, maintenance... the world's most versatile family of pencil soldering irons is on the job, doing a better job! No wonder they're called "Ungar's Little Angels"!

• Interchangeable tips for every soldering need from repair to high-speed production soldering.

• Feather-light, designed for hard-to-reach jobs.



Write for Catalog U-18

UNGAR ELECTRIC TOOLS, INC.  
P.O. Box 312, Venice, California

Major Peter O. E. Bekker, Information Services Officer at the base, and Second Lieutenant Charles Hughes, technical director of the station, and formerly a staff member of a Washington TV station.

A METHOD OF CONVERTING solar light into electrical energy has been developed by the Wright Air Development Center, near Dayton, Ohio. The conversion powers of the ARDC generator were described as so great that a wafer-thin slab of crystal, four feet by fifteen feet, either resting on or built into the roof of the house, could supply enough current to operate all of its lights, stove, refrigerator, and other appliances, 24 hours a day.

The secret, spokesmen said, was in the use of cadmium sulfide, a yellow powder used as a pigment in paint, which when processed into crystal form permits a direct conversion of light into electrical impulses.

Attached to opposite sides of the crystal are electrodes or terminals; one, made of silver, is the positive, and the other made of indium, a soft metal normally used as an alloy in some bearings, is the negative.

In use, light striking the crystal-electrode interface induces a direct current electrical potential, which is carried out by means of the electrodes. If the electrodes are connected to a motor or some other electrical device, the current will flow as though it were produced by a generator; Actually, this is an electrical generator driven by the sunlight; it is technically known as a barrier-layer cell.

The amount of current is determined by the area of the electrode attached to the crystal. In the pilot model, a one-eighth square inch area produced one-third volt. The barrier-layer cell, as developed by the ARDC scientists, is said to differ from the thermocouple method of inducing electrical energy, in that the latter requires a hot and cold junction and utilizes heat rather than light.

HARASSED by the Senatorial investigation, which has stymied filings and procedures, the hearing division of the Commission has released few grants. As this column was being prepared, channels listed on page 128 were authorized for, in the main, v.h.f.; only one u.h.f. grant had been approved.

A HIGH-SPEED DIGITAL COMPUTER, designed to serve as an experimental nucleus for a complex data-processing network, which can solve problems involved in automation or control of air traffic, has been completed by the Bureau of Standards. Known as the *Dyseac*, and utilizing dynamic electronic circuitry techniques which involve the performance of all logical operations by diode gating, electrical delay lines are used for all incidental pulse storage and transformer-coupled pulse amplifiers use only one tube type for all amplification.

Circuitry has been reduced to standard  
RADIO & TELEVISION NEWS



The data that Launched  
Thousands of Careers  
is yours FREE to show

**HOW YOU CAN BE SUCCESSFUL  
IN RADIO-TV-ELECTRONICS**

Send for Your Booklet Today!

**Y**OU CAN plod along for years, getting a paltry increase now and then, enjoying little security, finding your work dull and drab.

Then something happens. Things look up. You become more confident. Your earnings rise. You feel more important.

"Luck," some may say.

"Contacts," others may suggest.

But in your heart, you will know the answer: "Training." And it all may have started the moment you filled out a coupon requesting a copy of a free booklet named "Your Future in the New World of Electronics." From this data you get knowledge of where you stand in Electronics. Tremendous expansion leaves this gigantic industry pleading for trained men. Top manufacturers sold billions of dollars worth of electronic merchandise in 1953. By 1960, the radio-electronics industry should do no less than 10 billion dollars per year, not counting military orders.

Today there are over 97,000 radio-equipped police cars; an even larger number of taxis are radio equipped (at least 87,000); 32,000 civilian planes have radio; 35,000 American ships have radio.

Today there are over 120,000,000 radios in use. There are 28,000,000 TV sets and 381 TV stations in operation. Color TV is coming into its own. Countless positions must be filled—in development, research, design, production, testing and inspection, manufacture, broadcasting, telecasting and servicing. To fill these posts, trained men are needed—men who somewhere along the line take time to improve their knowledge, their skills. Men who, today, perhaps, take two minutes to send for a booklet.

"Your Future in the New World of Electronics" shows you how CREI Home Study leads the way to greater earnings through the inviting opportunities described above.

However, CREI does not promise you a "snap." With an accredited technical school such as this, you must study to convert your ambition into technical knowledge you can sell in the fabulous Electronics market.

Since its founding in 1927, CREI has provided thousands of professional radio men with technical educations. During World War II CREI trained thousands for the Armed Services. Leading firms choose CREI courses for group training in electronics, at company expense, among them United Air Lines, Canadian

Broadcasting Corporation, Trans-Canada Airlines, Sears, Roebuck and Co., Bendix Products Division, All-American Cables and Radio, Inc., and RCA Victor Division.

CREI courses are prepared by recognized experts, in a practical, easily understood manner. You get the benefit of time-tested materials, under the personal supervision of a CREI Staff Instructor, who *knows* and *teaches* you what industry wants. This is accomplished on your own time, during hours selected by you, and controlled by your own will power. This complete training is the reason that graduates find their CREI diplomas keys-to-success in Radio, TV and Electronics. CREI alumni hold top positions in America's leading firms. At your service is the CREI Placement Bureau, which finds positions for advanced students and graduates.

Although CREI does not guarantee jobs, requests for personnel far exceed current supply.

Now is the time of decision for you. Luck will not propel you forward unless it finds you trained. Contacts won't budge you an inch unless you have the skill to back them up. The answer is: Technical Training . . . and willingness to learn.

Together they will bring you increased earnings in this new Age of Electronics. Fill out the coupon shown below and mail it now. We'll promptly send you your free copy of "Your Future in the New World of Electronics." The rest—your future—is up to you.

CREI resident instruction (day or night) is offered in Washington, D. C. New classes start once a month.

**VETERANS:** If you were discharged after June 27, 1950—let the new G.I. Bill of Rights help you obtain CREI resident instruction. Check the coupon for full information.

**MAIL COUPON FOR FREE BOOKLET**

**CAPITOL RADIO ENGINEERING INSTITUTE**

Dept. 119A, 3224 16th St., N.W., Washington 10, D. C.

Send booklet "Your Future in the New World of Electronics" and course outline.

CHECK  Practical Radio Engineering  Aeronautical Radio Engineering  
FIELD OF  Broadcast Radio Engineering (AM, FM, TV)  
GREATEST  Practical Television Engineering  
INTEREST  TV, FM & Advanced AM Servicing

Name .....

Street .....

City..... Zone..... State.....

Check  Residence School  Veterans

# YOU CAN WIN A NEW FORD!



Nothing to buy! Nothing to sell!

Just Illustrate and Explain a New Application for International Rectifier Corporation Selenium Diodes

**50 PRIZES**

**Grand Prize**

New Ford V-8 Mainliner Tudor Sedan and 49 other valuable prizes

**INTERNATIONAL RECTIFIER CORPORATION'S Selenium Diode Application Contest is open to everyone!** Here's all you have to do — pick up an official entry blank from your favorite parts distributor. Illustrate and explain a new practical application for International Rectifier Selenium Diodes. Have the entry blank countersigned by your distributor's salesman and then forward it to us before January 1, 1955. Rules and regulations for this contest are included in the entry blank along with helpful hints on selenium diode applications.

**JUDGES—Dr. Lee de Forest—United Engineering Labs., Los Angeles, California. J. T. Cataldo, F. W. Parrish—International Rectifier Corp.**

**SAMPLE ENTRY** ↓

—APPLICATION—

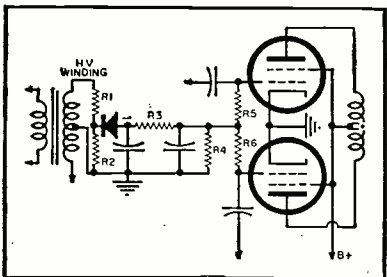

—EXPLANATION—

Typical application for providing fixed bias for push-pull stage of an audio system using International Rectifier Corp. Selenium Diode in conjunction with a voltage divider and filter network...etc.,...etc.

**DON'T DELAY! ENTRY BLANKS ARE AVAILABLE FROM YOUR PARTS DISTRIBUTOR**

CONTEST ENDS JANUARY 1ST, 1955

**INTERNATIONAL RECTIFIER CORP. EL SEGUNDO, CALIFORNIA**

ardized packages; only two types of etched-circuit plug-in packages are required as basic building blocks, thus simplifying design practice, construction, and maintenance.

Single basic circuit serves as a low-impedance pulse driver, a flip-flop, and for a number of gating functions. Each tube package consists of an amplifier, pulse transformer, and a number of diodes.

**THIS CENTURY** should be known as the *Century of Electronics* rather than the *Era of Atomic Energy*. So said radio's grand old man, Dr. Lee de Forest, recently during an AIEE luncheon meeting in Los Angeles.

Reviewing the import of the electron tube, he said that electronics is now a billion-dollar per year industry, which is continuously increasing in scope and utility. Today, the engineering audience was told, electronics is

used to sound ocean depths, locate schools of fish, and in diathermy and encephalography, it is an indispensable tool of the medical staff. The electron, he added, completely controls aviation.

When, last year, a representative of a tube company presented him with its billionth tube, he was flabbergasted, for he said, little did he realize in 1906 that the world's supply of two triodes in his possession would eventually grow to such proportions. Frankly, he declared, he wasn't aware of the "... dynamite he had in his pocket."

In his opinion, the *Century of Electronics* is a more apt description of the present age, because without complex electronic devices, nuclear developments would be impossible. The fast expanding future of electronics, Dr. de Forest added, is "... unlimited and unpredictable in every human field." . . . . . L.W.

## NEW TV STATIONS ON THE AIR

(As of August 25, 1954)

The following new stations bring the lists published in previous issues up to date.

STATE, CITY	STATION	CHANNEL	FREQUENCY RANGE (IN MC.)	VIDEO WAVELENGTH (IN FT.)	VIDEO POWER (IN KW.)
Florida					
West Palm Beach	WJNO-TV	5	76-82	12.74	100
Missouri					
Sedalia	KDRO-TV	6	82-88	11.8	16.2
St. Louis	KWK-TV	4	66-72	14.61	100
New York					
Buffalo	WGR-TV	2	54-60	17.8	100
North Carolina					
Asheville	WLOS-TV	13	210-216	4.65	170
Pennsylvania					
Harrisburg	WCMB-TV	27	548-554	1.79	77.6
Tennessee					
Old Hickory (Nashville)	WLAC-TV	5	76-82	12.74	100
Utah					
Salt Lake City	KUTV	2	54-60	17.8	27.5
West Virginia					
Charleston	WCHS-TV	8	180-186	5.43	316
Wisconsin					
Marinette	WMBV-TV	11	198-204	4.93	115

KBID-TV, channel 53, Fresno, California; KDZA-TV, channel 3, Pueblo, Colorado; KFXD-TV, channel 6, Nampa, Idaho; WRAY-TV, channel 52, Princeton, Indiana; KFAZ, channel 43, Monroe, Louisiana; WBKZ-TV, channel 64, Battle Creek, Michigan; WFTV, channel 38, Duluth, Minnesota; KMBC-TV, channel 9, Kansas City, Missouri; WBES-TV, channel 59, Buffalo, New York; KNUZ-TV, channel 39, Houston, Texas; and WTOV-TV, channel 27, Norfolk, Virginia, have gone off the air. WKJF-TV, channel 53, Pittsburgh, Pennsylvania, has been temporarily suspended.

KDYL-TV, channel 4, Salt Lake City, Utah has changed its call letters to KTVT (TV). The frequency of the video carrier = 1.25 + channel lower freq. limit. Total number of TV stations now on the air in U.S.: 390 (126 of which are u. h. f.)

## NEW TV GRANTS SINCE FREEZE LIFT

Continuing the listing of construction permits granted by FCC since lifting of freeze. Additional stations will be carried next month.

STATE	CITY	CALL	CHANNEL	FREQUENCY (mc.)	POWER* (Video)
Arizona	Phoenix	.....	3	60-66	100
Minnesota	Minneapolis	.....	9	188-192	316
Missouri	Jefferson City	KRCG	13	210-216	86.3
Ohio	Mansfield	.....	36	602-608	17
Wisconsin	Milwaukee	WTWV	12	204-210	251

### NEW CALL LETTER ASSIGNMENTS

Alabama	Munford	WEDM	9	186-192
Arkansas	Ft. Smith	KNAC-TV	5	76-82
California	Stockton	KOVR	13	210-216
Michigan	Flint	WJRT	12	204-210
North Carolina	Durham	WDTV	11	198-204
Ohio	Youngstown	WFMJ-TV	21	512-518
Utah	Salt Lake City	KTVT	4	66-72
Washington	Seattle	KCTL	20	506-512
West Virginia	Oak Hill (Beckley)	WDAY-TV	4	66-72

\*ERP=(effective radiated power, kw.) . . . =Call letters to be announced



## Transistor Phase Inverter

(Continued from page 71)

phase inverter will handle is ten volts peak, which is sufficient for push-pull 6V6 tubes in class A operation. The minimum signal level is determined by the noise factor of the transistor. The transistor phase inverter may be excessively noisy, if used directly from a low-output microphone; a minimum signal level of -40 db should be obtained, by a vacuum-tube stage, if necessary, for good performance.

For good frequency response the phase inverter should be used with high-impedance input and output circuits, and the shunt capacity should be kept low. Short, direct wiring to other stages should be used. If the phase inverter must be used with an input circuit or output circuit of low impedance, the input or output coupling condensers may be increased, if it is desired to improve the low-frequency response.

A voltmeter of 20,000 ohms-per-volt or better, or a v.t.v.m. should be used in measuring the voltages. The base

voltage, measured at the junction of  $R_2$  and  $R_3$ , is +70 volts above ground. Emitter voltage, at the junction of  $R_3$  and  $C_3$ , is +72 volts. Collector voltage, at the junction of  $R_4$  and  $C_4$ , is +18 volts.

$R_4C_4$  form a decoupling and voltage-dropping network to supply +90 volts at the junction of  $R_4$  and  $C_4$ . The input signal is fed through  $C_2$  to the transistor base at the junction of bias resistors  $R_2$  and  $R_3$ . The emitter current flowing through load resistor  $R_3$  develops the in-phase output voltage, which is coupled through the blocking-condenser  $C_3$  to one grid  $G_1$ . Collector current flowing through  $R_4$  gives the phase-reversed output, which is coupled through blocking condenser  $C_4$  to the other grid,  $G_2$ , of the push-pull stage.

It would appear that the transistor will find increasing use as a phase inverter in audio amplifiers of the push-pull class, provided that transistors are available at a price competitive with the triode.

When this happy day dawns, we can expect to see not only smaller and more compact amplifiers but units of unparalleled reliability. —30—

## TV INTEGRATOR ACTION

By ED NOLL

**A** KNOWLEDGE of the functions of the integrator circuit in TV can be best understood by seeing it in action. The vertical synchronizing interval is a small time portion of the total vertical field period, however, if the oscilloscope is set on the 600 cycle range the vertical interval is discernible and can be spread out over a substantial portion of the screen. A heavy bright base line will be present because the beam will sweep back and forth along this line nine times for each field. Only on every tenth sweep does the vertical sync interval arrive and deflect the pattern vertically, see Fig. 1C.

The set of integrator waveform photographs shown in Fig. 1 demonstrates the functions of the triple-section type. As the scope is moved progressively along the integrator notice how the vertical is emphasized more and more above the horizontal sync components. This action shows the reduction of the horizontal so it can not interact with the precise firing of the vertical and impair interlace. Likewise, any noise impulses are attenuated progressively by each section of the integrator, improving the noise immunity of the vertical deflection system.

Fig. 1A demonstrates much about the operation of the vertical synchronization system. It shows clearly the charge and discharge activity during the vertical sync interval. Along the base line we can observe the charge and discharge of the integrator during the horizontal sync intervals showing a constant level. Right at the very center of the horizontal group you can see the charge and discharge periods of the leading set of equalizing pulses.

Finally the first long duration vertical sync pulse arrives and the voltage rises sharply on the integrator. It continues to rise for the six vertical sync pulses because of their long duration and short spacing. Notice that this voltage has an

over-all exponential rise just as with any condenser charge. At the end of the vertical interval notice how quickly the equalizing pulse interval with short duration and wide spacing quickly discharges the integrator exponentially. Horizontal intervals carry the charge back to the base line eventually. It is important to note that the trailing set of equalizing pulses do the bulk of the discharge work. —30—

Fig. 1. Waveforms obtained at successive stages of a 3-stage TV vertical integrator. (A) Input section of the integrator, (B) second section, and (C) output section. Notice how the horizontal sync components are decreased.

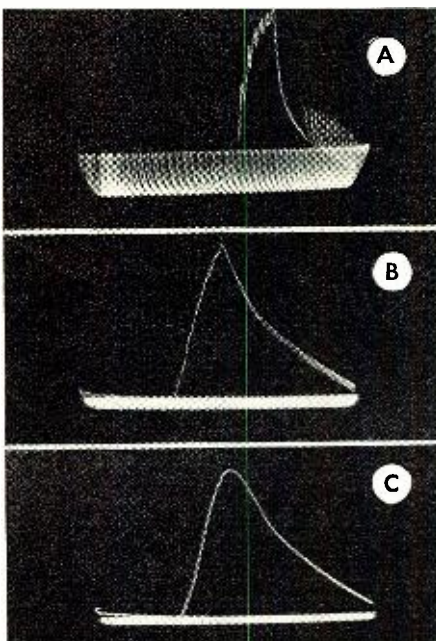

# AT LAST LORAN

FINE QUALITY  
NAVIGATIONAL  
EQUIPMENT

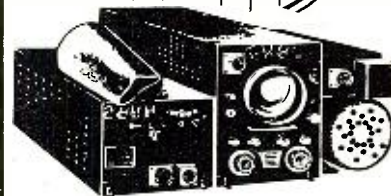

Marine or Airborne Long Range Navigational equipment! Determine the exact geographic position of your boat or airplane!

The LORAN system enables a navigator to determine the exact position of his craft accurately and quickly. The accuracy of the system and the speed at which readings may be taken and interpreted make the system particularly useful in any trans-oceanic boat or airplane. The complete LORAN system is made up of internationally located ground stations which provide a special radio signal pattern solely for LORAN usage. The AN/APN-4 system receives these signals and translates them into information useful to the navigator. Accurate geographic positions may be located up to 1200 miles from any LORAN transmitting facility. Complete installation weighs less than 100 pounds. Accurate and dependable navigation available 24 hours per day!

For the FIRST TIME...  
LATEST "B" MODEL  
complete BRAND NEW  
installations.

Consisting of:

- ID-6B/APN-4 Indicator
- R-9B/APN-4 Receiver
- PE-206 Inverter
- Set of PLUGS
- VISOR for Indicator
- Reproduction of original Technical Manual outlining operation, installation, and servicing.

**\$129.50**  
Complete as  
Described

EXPORTERS AND FLEET OPERATORS: We solicit your inquiries for this and like equipments.

ID-6A/APN-4 Loran Indicator. Uses 5CP1 Cathode Ray Tube. Easily converted to test oscilloscope, panadapter, analyzer, visual counter, etc. Contains extremely accurate 100 KC crystal to time sweeps and marker pips at 2, 20, and 100 KC or 50, 500, and 2500 microseconds. Two parallel sweeps, time differences between signals, between half power points on pass-band curves, and numerous other scope uses. Use the counter circuits for FM demodulation, or to time camera shutters, etc. Double deck chassis, 5CP1 mounted in full tube shield, lots of octal sockets (used 25 tubes). Plenty of room to build on any scope circuits you can dream up. Contains 22 pots, loads of switches, condensers, transformers, small parts. Less small tubes, COMPLETE with 5CP1, Crystal, and schematic in cabinet 19 1/2" x 9" x 11 1/4" BRAND NEW! While they last. **29.50**

R-9A/APN-4. 160-meter Loran Receiver, plus high voltage for scope and low voltage power supply. Three channels tunable from 1.6 to 3.3 MC, one channel tunable 7.58 to 11.75 MC. The power supply delivers 240-275 volts continuously variable at 150 ma electronically regulated to  $\pm .01\%$ , 1450 vdc above ground at 1.2 ma, 1250 vdc at 1.2 ma below ground. With schematic and instructions for 60 cycle operation. BRAND NEW, **14.50**  
less tubes.....

3-6B4-G and 1-6H6 FREE with first 500 Receivers purchased.

● R-65/APN-9 LORAN Receiver and Indicator. COMPLETE light weight unit LATEST MODEL NEW only... **\$ 295**

**R.W.**  
ELECTRONICS

2430 S. Michigan Ave.  
CHICAGO 16, ILLINOIS  
CALumet 5-1281

Become an  
**ELECTRICAL ENGINEER**



**Major in Electronics or Power  
BS Degree in 36 months**

Prepare now for a career as an electrical engineer or engineering technician — and take advantage of the many opportunities in these expanding fields.

You can save a year by optional year 'round study. Previous military, academic, or practical training may be evaluated for advanced credit.

**Enter Radio and Television  
— courses 12 to 18 months**

You can be a radio technician in 12 months. In an additional 6-months you can become a radio-television technician with Associate in Applied Science degree. Color television instruction is included in this program.

These technician courses may form the first third of the program leading to a degree in Electrical Engineering. Twenty-one subjects in electronics, electronic engineering and electronic design are included in these courses.

Courses also offered: radio-television service (12 mos.); electrical service (6 mos.); general preparatory (3 mos.).

Terms — September, January, April, July

Faculty of specialists. 50,000 former students—annual enrolment from 48 states, 23 foreign countries. Non-profit institution. 51st year. Courses approved for veterans. Residence courses only.

MS-6A



**MILWAUKEE  
SCHOOL OF ENGINEERING**

MILWAUKEE SCHOOL OF ENGINEERING  
Dept. RT-954, 1025 N. Milwaukee Street  
Milwaukee 1, Wisconsin  
Send FREE illustrated booklets  
 Career in Electrical Engineering.  
 Career in Radio-Television.

I am interested in.....  
(name of course)

Name..... Age.....

Address.....

City.....Zone.....State.....

If veteran, indicate date of discharge.....

# A NEW SLANT ON TVI

By **DAVID T. GEISER, W1ZEO**

*Describes a set of antenna and line filters which, with careful screening, cut down annoying TV set radiation.*

**T**HERE is a word, "bilateral," which describes components that have identical characteristics in each direction of current flow. This word also applies to TVI. Amateurs can interfere with television receivers; television receivers can (and do) interfere with amateurs.

The writer has not been troubled with his transmitter causing TVI; it was debugged long ago. Recently, however, he purchased a television set. Having heard what a broadcast set sounded like close to a television receiver, he was somewhat prepared for what he heard on 75 meters. Every 15,750 cycles there was a rough "S9+" harmonic on the HQ-129X. Between these harmonics was a fire-siren whine of the video, averaging between "S6" and "S7." There could be little amateur operation, except with local stations, until this condition was cleared.

The local dealer from whom the set had been conditionally purchased was given the bad news. The writer was referred to W1JXY, who is the local authority on 17-inch "transmitters." He suggested making sure that the antennas of the HQ-129X and the TV set were as well isolated and selective as practicable (they were), and recommended removal of the television lead-in at the TV set to check the path as to radiation or power-line conduction. Disconnecting this lead reduced the interference of the HQ-129X to "S2." Naturally, the next thing to do was to install a high-pass filter where the TV antenna leads entered the cabinet. Unfortunately, the cabinet was not at the same r.f. potential as the chassis, so grounding the filter to the metal cabinet (with a fiber back) made the interference peg the meter on the ham receiver. The high-pass filter was necessary in spite of this discouraging step. All that had happened was that the antenna and the cabinet were at the same (under 30 mc.) potential, so they were both radiating. The power line acted as the ground.

A trip was made to the local hardware store for copper screening and, in the best transmitter style, a shielded back was made for the TV receiver. (If the cabinet is wood or plastic, it will probably be necessary to shield the top, bottom, and sides also.) Installation of the shield reduced the interference to

about "S9," although little hope had been held for even this much improvement. Constructed by a pessimist, the shielded back (see Fig. 1B) also had mounting provisions for line filters, so line filters were installed.

Now the transmitter (beg pardon, TV receiver) was moderately shielded, and all leads were filtered. Absolutely no interference could be picked up on the station receiver between 550 kc. and 30 mc. This looked so good that the home broadcast sets were brought close, plugged into the same power outlet as the TV set, and turned on. With the cabinets a foot or more apart, no noise could be picked up from the TV set. With one set resting on the TV receiver, noise could be picked up, but this was not perceptible on local stations.

Checking, each of these features were found necessary: the back had to be shielded, a high-pass antenna filter was needed, and the power line required low-pass filters. The work was not elaborate or complete; paint was not scraped from the back edge of the metal cabinet, so only point-bonding of the shielding was obtained. The results, however, were adequate and the work stopped when satisfaction was reached. What r.f. leakage remained was coming out of the front of the cabinet but, as described, was negligible.

Although inexpensive commercial filters were used by the author, filters designed for home construction are

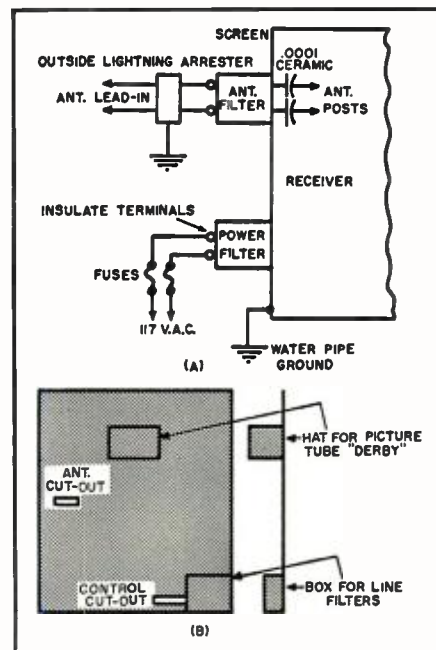

Fig. 1. (A) Filter setup used to cut down on TV set interference radiation. (B) Layout for the copper screen used for shielding the back of the TV set.

# BUILD 15 RADIOS AT HOME ONLY \$19.95

With the New Improved 1955

Progressive Radio "EDU-KIT"

NOW INCLUDES

High Fidelity,  
Signal Tracer,  
Code Oscillator



- ATTRACTIVELY GIFT PACKED
- FREE SOLDERING IRON
- NO ADDITIONAL PARTS NEEDED
- EXCELLENT BACKGROUND FOR TV
- 10 DAY MONEY-BACK GUARANTEE
- SCHOOL INQUIRIES INVITED
- ABSOLUTELY NO KNOWLEDGE OF RADIO NECESSARY

## WHAT THE PROGRESSIVE RADIO "EDU-KIT" OFFERS YOU

The Progressive Radio "Edu-Kit" offers you a home study course at a rock bottom price. Our Kit is designed to train Radio Technicians, with the basic facts of Radio Theory and Construction Practice expressed simply and clearly. You will gain a knowledge of basic Radio Principles involved in Radio Reception, Radio Transmission and Audio Amplification. You will learn how to identify Radio Symbols and Diagrams; how to build radios, using radio circuit schematics; how to mount various radio parts; how to wire and solder in a professional manner. You will learn how to operate Receivers, Transmitters, and Audio Amplifiers. You will learn how to service and trouble-shoot radios. You will learn code. You will receive training for F.C.C. license.

In brief, you will receive a basic education in Radio, worth many times the small price you pay.

## THE KIT FOR EVERYONE

The Progressive Radio "Edu-Kit" was specifically prepared for any person who has a desire to learn Radio. The Kit has been used successfully by young and old in all parts of the world. It is not necessary that you have even the slightest background in science or radio.

The Progressive Radio "Edu-Kit" is used by many Radio Schools and Clubs in this country and abroad. It is used for training and rehabilitation of Armed Forces Personnel and Veterans throughout the world.

The Progressive Radio "Edu-Kit" requires no instructor. All instructions are included. All parts are individually boxed, and identified by name, photograph and diagram. Every step involved in building these sets is carefully explained. You cannot make a mistake.

## PROGRESSIVE TEACHING METHOD

The Progressive Radio "Edu-Kit" comes complete with instructions. These instructions are arranged in a clear, simple and progressive manner. The theory of Radio Transmission, Radio Reception, Audio Amplification and Servicing by Signal Tracing is clearly explained. Every part is identified by photograph and diagram. You will learn the function and theory of every part used.

The Progressive Radio "Edu-Kit" uses the principle of "Learn by Doing". Therefore you will build radios, perform jobs, and conduct experiments to illustrate the principles which you learn. These radios are designed in a modern manner, according to the best principles of present-day educational practice. You begin by building a simple radio. The next set that you build is slightly more advanced. Gradually, in a progressive manner, you will find yourself constructing still more advanced multi-tube radio sets, and doing work like a professional Radio Technician. Altogether you will build fifteen radios, including Receivers, Transmitters, Amplifiers, Code Oscillator and Signal Tracer. These sets operate on 105-125 V. AC/DC. An adaptor for 210-250 V. AC/DC is available.

## THE PROGRESSIVE RADIO "EDU-KIT" IS COMPLETE

You will receive every part necessary to build 15 different radio sets. Our kits contain tubes, tube sockets, chassis, variable condensers, electrolytic condensers, mica condensers, paper condensers, resistors, line cords, selenium rectifiers, tie strips, coils, hardware, tubing, etc.

Every part that you need is included. These parts are individually packaged, so that you can easily identify every item. A soldering iron is included, as well as an Electrical and Radio Tester. Complete, easy-to-follow instructions are provided.

In addition, the "Edu-Kit" now contains lessons for servicing with the Progressive Signal Tracer, F.C.C. instructions, quizzes and fidelity instructions. The "Edu-Kit" is a complete radio course down to the smallest detail.

## TROUBLE-SHOOTING LESSONS

Trouble-shooting and servicing are included. You will be taught to recognize and repair troubles. You will build and learn to operate a professional Signal Tracer. You receive an Electrical and Radio Tester, and learn to use it for radio repairs. While you are learning in this practical way, you will be able to do many a repair job for your neighbors and friends, and charge fees which will far exceed the cost of the "Edu-Kit". Here is your opportunity to learn radio quickly and easily, and have others pay for it. Our Consultation Service will help you with any technical problems which you may have.

## FREE EXTRAS

- ELECTRICAL & RADIO TESTER • ELECTRIC SOLDERING IRON • TV BOOK • RADIO TROUBLE-SHOOTING GUIDE • CONSULTATION SERVICE • QUIZZES • F.C.C. TRAINING

Progressive "Edu-Kits" Inc., 497 Union Ave., Dept. RN-33, Brooklyn 11, N.Y.

MAIL TODAY—Order Shipped Same Day Received.

10 Day Money-Back Guarantee. Include ALL FREE EXTRAS.

- Send "Edu-Kit" Postpaid. I enclose full payment of \$19.95 (U.S.A. only).
- Send "Edu-Kit" Postpaid. I enclose full payment of \$20.95 (Outside U.S.A.).
- 210-250 V. Adaptor for "Edu-Kit," \$2.50.
- Send "Edu-Kit" C.O.D. I will pay \$19.95 plus postage (U.S.A. only).
- I wish additional information describing "Edu-Kit." No obligation.
- Send me FREE Radio-TV Servicing Literature. No obligation.

Name .....  
Address .....

PROGRESSIVE "EDU-KITS" INC.

497 Union Ave. Dept. RN-33 Brooklyn 11, N. Y.

At Last!

a complete

# TUBE TESTER

\$24.90  
for only



New EMC Model 208\*

\*Pat. Pending tests all tube types quickly... easily... accurately... in the field or shop.

The sensational new EMC Model 208\* gives you for the first time a complete precision tube tester for less than \$25.00.

With it you can quickly and accurately test all tube types for quality as well as shorts, leakages, filament continuity and opens.

CHECK THIS EXCLUSIVE COMBINATION OF FEATURES:

1. Lowest market price
2. Completely portable
3. Checks all octal, octal, miniature and noval base tubes
4. Flexible switching system assures complete testing of all present and future tube types
5. Elements numbered according to RTMA base system
6. Individual sockets for each tube type
7. Checks completely for quality as well as shorts, leakages, filament continuity or opens between any two tube elements
8. Visual line voltage check with adjustable control assures accurate quality testing
9. Matches and checks Hi-Fi tubes such as 1614, KT 66, and 5881
10. Space saving, high impact case, 5 1/4 x 6 3/4 x 2 7/8"
11. Comes complete with detailed instruction book and tube listings

An invaluable tool for: Servicemen, radio hams, HI-FI fans, students, hobbyists.

MODEL 208 TUBE TESTER (COMPLETELY WIRED AND TESTED) Only \$24.90

MODEL CRA (PICTURE TUBE ADAPTOR OF MODEL 208) \$4.50

Write to Dept. RN-9 today for complete catalog of precision test equipment.

EXPORT DEPT.—136 LIBERTY ST. N. Y. 6, N. Y.

# EMC

ELECTRONIC MEASUREMENT CORPORATION  
280 LAFAYETTE STREET  
NEW YORK 12, N. Y.

# New TUBE TESTER

Exclusive

# HICKOK

Dynamic  
Mutual Conductance



Model 533AP

Larger, easy-to-read meter scale and a calibrated GM circuit provide increased accuracy in testing today's newer tubes.

This handy new HICKOK portable is a sound investment in highest quality electronic test equipment—whether for the radio-TV service bench, the inspection line or the laboratory.

## FEATURES . . .

- Exclusive HICKOK Tube Gas Test, Tube Noise Test and Future Tube Life Test provide for accurate electronic circuit balancing.
- New calibrated GM circuit.
- Separate Grid Signal: 2.5 volts AC.
- HICKOK Dynamic Mutual Conductance circuits with most accurate tube evaluation directly in micromhos.
- Bias Fuse prevents accidental damage to bias potentiometer.

Write today for full information on the HICKOK complete line of Dynamic Mutual Conductance Tube Testers.

**THE HICKOK ELECTRICAL INSTRUMENT CO.**  
10524 Dupont Avenue Cleveland 8, Ohio

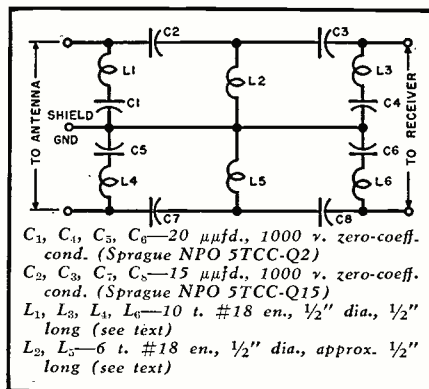

- $C_1, C_3, C_5, C_6$ —20  $\mu\text{fd.}$ , 1000 v. zero-coeff. cond. (Sprague NPO 5TCC-Q2)  
 $C_2, C_3, C_4, C_5, C_6$ —15  $\mu\text{fd.}$ , 1000 v. zero-coeff. cond. (Sprague NPO 5TCC-Q15)  
 $L_1, L_3, L_4, L_6$ —10 t. #18 en.,  $\frac{1}{2}$ " dia.,  $\frac{1}{2}$ " long (see text)  
 $L_2, L_5$ —6 t. #18 en.,  $\frac{1}{2}$ " dia., approx.  $\frac{1}{2}$ " long (see text)

Fig. 2. Schematic diagram and parts list for the antenna high-pass filter.

shown in Figs. 2 and 3. The high-pass antenna filter shown in Fig. 2 contains series  $m$ -derived sections rather than shunt sections and thus, does not require the power-frequency blocking condensers recommended in Fig. 1A. Attenuation with shielded construction is good. Zero coefficient condensers, of the type specified in the parts list of Fig. 2, insure low insertion loss, good balance, easy adjustment, and a degree of stability not usually found in commercial television antenna high-pass filters. The lengths of  $L_1, L_3, L_4,$  and  $L_6$  should be adjusted to grid dip with  $C_1, C_3, C_5,$  and  $C_6$  respectively at 41 mc. Similarly, the length of  $L_2$  and  $L_5$  should be adjusted to grid dip with  $C_2, C_3$  and  $C_4, C_5$  respectively at 93.4 mc.

Figure 3A shows the line filter. The constants given for the home-made filter give adequate attenuation for the degree of shielding used on the television receiver. Figure 3B shows constructional details necessary for maxi-

Fig. 3. Schematic diagram, physical layout, and parts list for line filter.

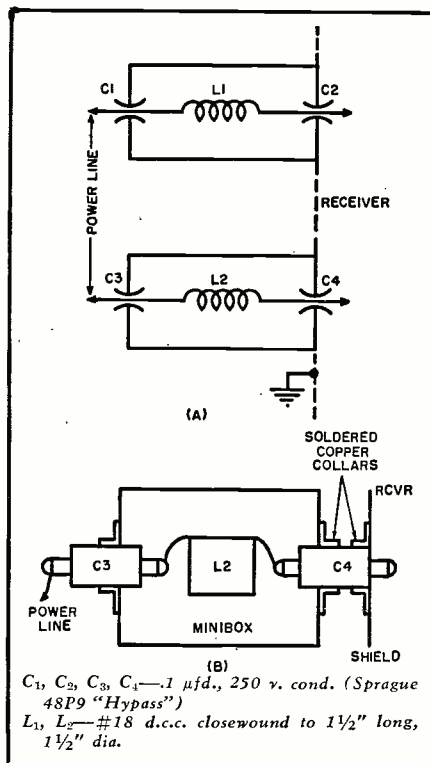

- $C_1, C_2, C_3, C_4$ —1  $\mu\text{fd.}$ , 250 v. cond. (Sprague 48P9 "Hypass")  
 $L_1, L_2$ —#18 d.c.c. closewound to  $1\frac{1}{2}$ " long,  $1\frac{1}{2}$ " dia.

mum filter effect, although in most cases this degree of care will not be required.

Figure 1A outlines certain installation precautions. If the power wiring of the set is not fully understood, it is best to include the ceramic blocking condensers to prevent power shorts via the antenna filter if a commercial unit rather than the home constructed one is used. Other factors of safety should not be overlooked, particularly the installation of grounds, fusing, insulation, and the lightning arrester.

The wife and children can now watch TV without interference from my transmitter; I can ham without the TV set interfering with the station receiver. It's bilateral.

## FISH "SCANNERS"

By SYDNEY H. COOKE

TO INCREASE the size of their catches, Pacific Coast fishermen and operators have adopted electronic instruments almost as fast as they have come from the laboratory. Today we find direction finders, automatic pilots, radiotelephones, and echo sounders as standard equipment aboard West Coast high-line fishing vessels.

The new Minneapolis-Honeywell "Sea Scanar" was recently installed on the salmon-herring seiner "Pacific Sunrise"—one of the 114-unit fleet of The Canadian Fishing Co. Ltd.

Test fishery is now underway with this sweeping sounder which gives the distance, angle, and depth of the school of fish—thus locating the school and the extent of its density. The range of the instrument is down, ahead, and 180 degrees to the port and starboard. The standard echo sounder normally indicates only those objects which the ship is passing over not objects ahead of the ship or to the left and right of its path.

The "Sea Scanar" works like a searchlight, sweeping to port and starboard for whale while the echo sounder functions similarly to locate "bottom." The whale, of course, would give an indication of a "bottom."

Different problems arise in scanning for whales than those encountered when locating schools of fish. The limited range imposes some difficulties in whaling. For example, at the range of 1600 feet the indication of the whale gets fuzzy on the tracer. Scanning is better at 800 or 400 feet—a range which is considered too close for whaling operations. Whalers would like to see the range increased to 1600 feet which is the normal distance for whaling operations. They would also like a gyro-compensator under the instrument to take care of the roll of the vessel in the trough of the sea out in the open Pacific. A whale coming bow on is clearly indicated, but coming broadside, the beam jumps every wave and shows a blurb in the tracer or nothing at all.

Last season, during the whaling operations of the British Columbia Packers Ltd., which operate a fleet of 78 fishing vessels and packers, a similar unit was installed on the whaler "Nahmint" with Capt. Harry Simpson in command and Victor Gagen as mate and harpoon gunner.

Out of a catch of some 539 whales during the season, the harpoon gunner estimates that three of this catch would not have been found without the scanner unit.

# NEW PATENTED RADAR ANTENNA

OPENS NEW HORIZONS TO TV VIEWERS

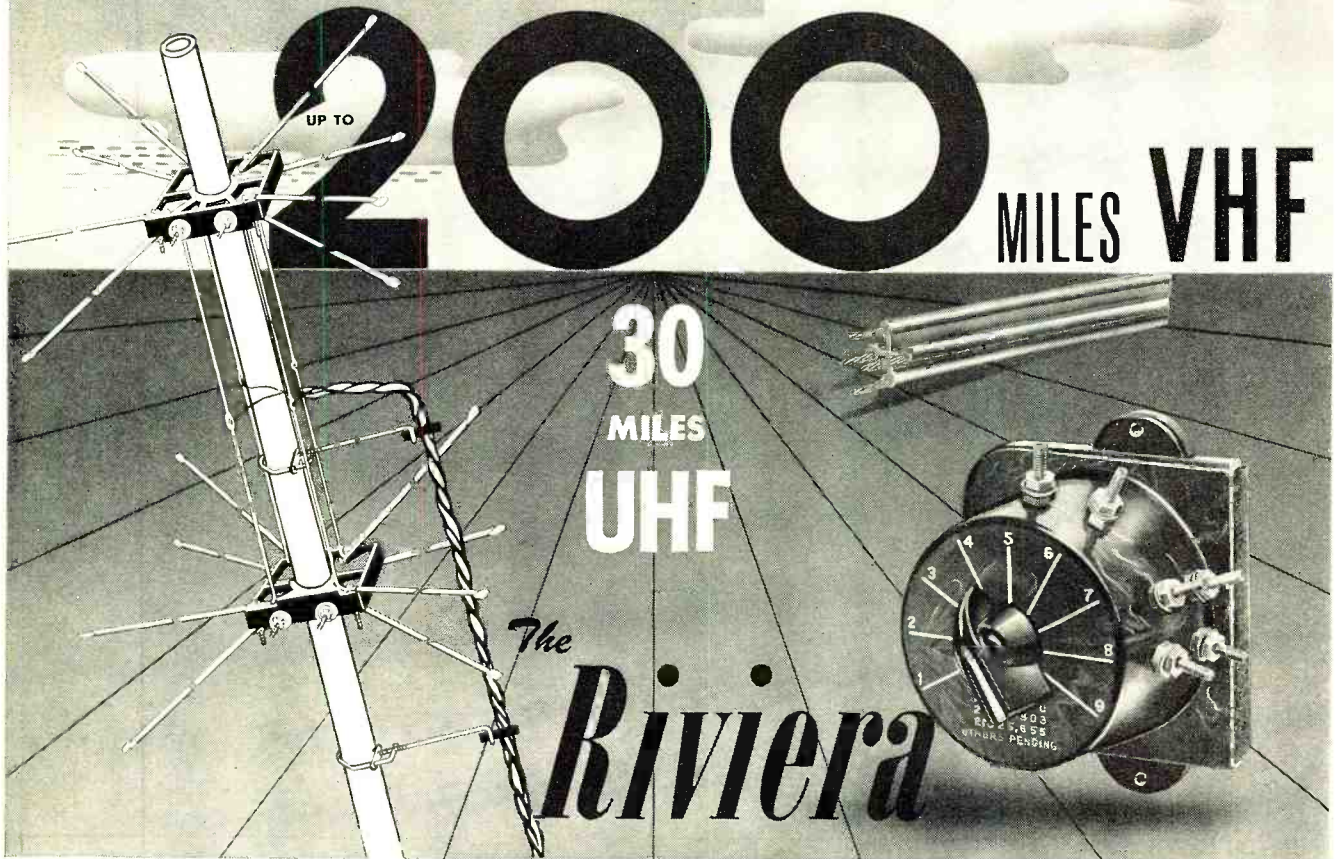

**ALL DIRECTIONS • ALL CHANNELS • 2-83**

**COLOR AND BLACK-WHITE without ANY ROTORMOTOR**

*These are the reasons why the "Riviera" is by far the most powerful VHF antenna on the market today!*

1. Utilizes 16 elements 60" long, 1/2" diameter.
2. Utilizes a specially designed, extra low loss four conductor air-dielectric POLYMICALENE transmission line which has up to 50% less loss when wet than the finest conventional transmission lines.
3. The "Riviera" encompasses an electro-magnetic capture volume of well over 650 cubic feet, many times more than conventional antennas.
4. The antenna works on the revolutionary principle that the approaching wave front is elliptically rather than horizontally polarized.
5. The new specially designed 9 position electronic orientation switch, aside from changing directivity, maintains a consistently better impedance match over the entire UHF-VHF spectrum.
6. The above features combine to give the "Riviera" antenna greater usable gain at the TV set antenna terminals than the best of any competitive antennas using rotor motors.

This new wonder antenna, called the "Riviera", is already making history. Beyond any question of a doubt, and on an unconditional money back guarantee, it will positively outperform in the field under actual installation conditions, any and all competitive antennas on the VHF channels, with or without rotor motors.

## POLAR PATTERNS

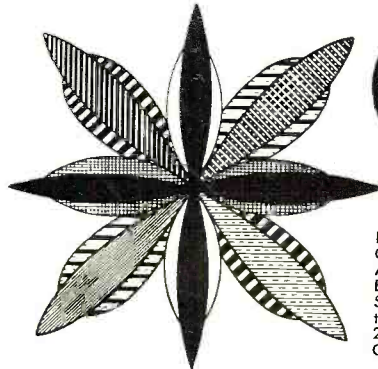

only  
**\$49<sup>50</sup>**  
LIST PRICE

Price includes:  
Complete Stacked  
Array • Stacking  
Bars • 9 Position  
Switch • Switch-  
to-set Coupler •  
2 Stand-offs, 7 1/2" •  
Complete instructions

The polar directivity response patterns show the major lobes of the "Riviera" antenna on VHF. It shows the fullness of coverage in all directions of this remarkable, patented antenna as it is turned through each of the nine switch positions. Each degree of shading constitutes a different switch position. This excellent directivity response, which can be switched at will, plus the extremely high gains, clearly indicate why the Riviera is such a superior performer.

IN UHF-VHF DISTRICTS . . . USE

The **NEW Super 60**

100 MILES VHF • 60 MILES UHF

**ALL CHANNEL ANTENNA CORP.**

47-39 49th STREET, WOODSIDE 77, N. Y.

EXETER 2-1336

# FO8AJ

## Dot Pattern Generator (Continued from page 47)

rangement is sufficient for stable sync. The sync control,  $R_1$  in Fig. 3, regulates the sync pulse amplitude. It is important to set the horizontal frequency control to get a stable, fixed number of vertical bars as shown in Fig. 8. The procedure for adjusting horizontal linearity is similar to that outlined for the vertical sweep section. Pincushioning or other yoke distortion will appear as bent, bulging, or wavy vertical bars.

For a rapid check of both vertical and horizontal linearity the grid or crosshatch pattern can be used. As Fig. 9 shows, this type of pattern tends to accentuate any non-linearity and therefore allows more accurate ad-

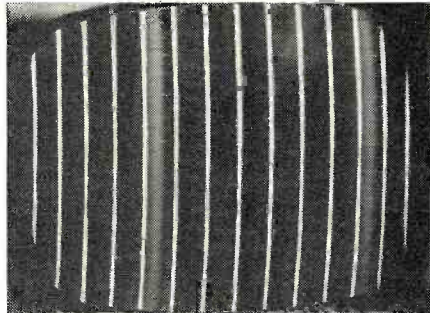

Fig. 8. Vertical bar pattern with the generator selector switch in position 4.

justment. Just compare the squares in the center of the screen with the squares at the sides or corners. In Fig. 9, it is apparent that the horizontal sweep is compressed at both sides while the vertical sweep is expanded at the bottom and compressed at the top.

The great utility of the pattern generator described here lies in the fact that it produces white dots as shown in Fig. 10. This white-dot pattern is of great help in adjusting convergence on shadow-mask type color picture tubes such as the 15GP22 and its larger cousins, as described in the July 1954 issue of RADIO & TELEVISION NEWS. The dot pattern will produce white dots only when proper convergence is achieved. When convergence is off, two or three colored dots will appear.

The dot signal can be introduced

Fig. 9. Grid or crosshatch pattern used for linearity adjustments, position 3.

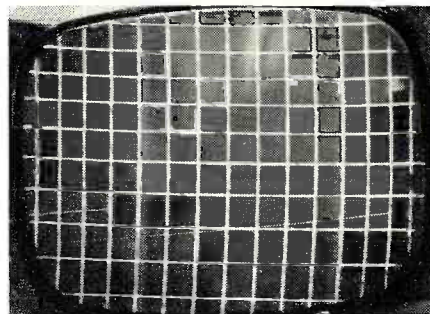

## SPECIAL OF THE MONTH

30 MFD 2500 V. DC OIL CONDENSER. CERAMIC INSULATORS  
BRAND NEW GOV'T SURPLUS **\$12.95** ea.

**NATIONAL "S" METER**  
2" Sq., Illuminated Scale, calibrated in DB, 0-1 Ma movement. **\$2.95** EA.  
2 for \$5.50

**MINIATURE METER**  
0-500 Microamps, 1 3/8" scale, Bakelite case. An accurate tiny meter ideal for GD meters, SWR Bridges, etc. **\$3.95** EA.  
BRAND NEW. 3 for \$9.95

**R.F. AMMETER**  
2 1/2" General Electric 0-4 amps RF, Internal Thermo. **\$3.75** EA.  
2 for \$6.95

**MOBILE DYNAMOTORS**  
Made by Pioneer. Input 6 VDC. Output 400 V. @ 175 Ma. Mounting bracket attached. Removed from equipment. All checked and guaranteed. This is your chance to get a small rugged Dynamotor at only **\$12.95** EA.

**WESTON METERS**

0-150 VAC Rectifier type. . . . .	Model 301	\$7.95
0-100 V.D.C. (1000 ohms/v) . . . . .	"	5.95
0-10 Ma (KV Scale) . . . . .	"	5.95
0-50 Ma Dc . . . . .	"	5.95
0-150 Ma Dc . . . . .	"	5.95
0-1.5 Mills DC . . . . .	"	5.95
0-200 Microamps (Spec. Scale) . . . . .	Model 731	7.95
0-1 Ma (0-100 Scale) . . . . .	"	6.95

**PANEL METERS**  
GOV'T SURPLUS, G.E., WESTINGHOUSE, WESTERN ELECTRIC, SIMPSON, ETC.

<b>2" METERS</b>		<b>3" METERS</b>	
0-80 ma DC. . . . .	\$3.49	0-500 Microamps . . . . .	\$5.95
0-15 ma DC. . . . .	3.49	0-50 Mill. . . . .	4.50
<b>3" METERS</b>		0-200 Microamps . . . . .	4.50
0-400 Microamps . . . . .	\$6.95	0-150 Volts AC. . . . .	6.95
0-500 Microamps . . . . .	5.95	0-3 Amp RF. . . . .	5.95
0-200 Milliamp . . . . .	4.50	0-20 Amp RF. . . . .	6.95
0-250 Milliamp . . . . .	4.50	0-750 Volts DC. . . . .	5.95
0-3 Milliamp . . . . .	3.95	0-15 Volts DC. . . . .	4.95

MANY OTHER METERS IN STOCK. PLEASE WRITE YOUR REQUIREMENTS.

**WESTON FREQUENCY METER**  
Model 814. 350 to 450 cycles, 100 to 125 Volts. Regular Price \$100.00.  
Our Price, **\$29.95** EA.  
Brand New . . . . .

**OIL CONDENSERS**

4 MFD-600VDC . . . . .	\$ .95	10 MFD-2000VDC . . . . .	\$6.95
10 MFD-600VDC . . . . .	1.50	12 MFD-2000VDC . . . . .	7.95
2 MFD-1000VDC . . . . .	.95	4 MFD-2500VDC . . . . .	3.95
3 MFD-1000VDC . . . . .	1.25	4 MFD-2500VDC . . . . .	5.95
12 MFD-1000VDC . . . . .	2.95	2 MFD-3000VDC . . . . .	4.95
15 MFD-1000VDC . . . . .	3.50	4 MFD-3000VDC . . . . .	5.95
3 MFD-1500VDC . . . . .	2.65	5 MFD-4000VDC . . . . .	1.50
5 MFD-1500VDC . . . . .	2.85	1 MFD-4000VDC . . . . .	2.75
6 MFD-1500VDC . . . . .	2.95	4 MFD-4000VDC . . . . .	12.95
10 MFD-1500VDC . . . . .	3.75	15 MFD-5000VDC . . . . .	49.95
15 MFD-1500VDC . . . . .	5.50	1 MFD-7500VDC . . . . .	1.75
2 MFD-2000VDC . . . . .	2.25	3 MFD-8000VDC . . . . .	24.95
3 MFD-2000VDC . . . . .	2.95	1 MFD-20KV . . . . .	49.95
4 MFD-2000VDC . . . . .	3.95	.00025 MFD-25KV . . . . .	5.50
6 MFD-2000VDC . . . . .	4.95	24 MFD-240VAC . . . . .	4.95
		5 MFD-600VAC . . . . .	2.95

**G. E. RELAY CONTROL**  
(Ideal for Model Controls, Etc.)  
Contains a sigma midget 8,000 ohm, relay (trips at less than 2 MA), high impedance choke, bi-metal strip, neon pilot and many useful parts. The sensitive relay alone is worth much more than the total **\$1.25** Each 10 for **\$9.90**  
low price of . . . . .

**WIRE WOUND RESISTOR KITS**

25 Assorted 10 Watt. . . . .	\$1.95
25 Assorted 20 Watt. . . . .	2.50
50 Assorted 5, 10, 20 and 50 Watt. . . . .	4.95

<b>EIMAC VACUUM CONDENSERS</b>	<b>SOLA CONSTANT VOLT TRANSFORMERS</b>
12 MMF 32KVDC. \$10.95	Input 95-135 Volts
50 MMF 32KVDC. 12.95	Output 115V Regulated
	250 VA . . . . . \$33.65

**READ 'N' SAVE BARGAINS**

Non-Ind resistors, 250, 100 watt. . . . .	\$0.55
5 Henry 10 ma chokes. . . . .	.95
Heinemann ckt brkr, 5.5 amp, 110 V. . . . .	.95
Var. ceramic trimmer 7 to 45 mm. . . . .	1.50
Erie 500 mmv ceramic. . . . .	10 for .50
15V AC relay SPST 15 Amp contacts. . . . .	1.75
220V AC relay SPST 15 Amp contacts. . . . .	1.75
.01 mmf. 1000 VDC Micas. . . . .	5 for .95
.0004 2500 VDC Micas. . . . .	5 for .95
.04 600 V Micas. . . . .	5 for .95
100,000 ohm, 100 Watt resist. . . . .	.45
Fil. Transf. 115V, 60 cy Sec. 10V @ 1.75 Amp 1.25	
Fil. Trans 115V, 60 cy Sec. 6.3V @ 7A. . . . .	1.95

Min. Order \$3.00—25% with Order—F.O.B. New York.

**PEAK ELECTRONICS CO.**  
66 West Broadway, New York 7, N. Y.  
Phone WOrth 2-5439

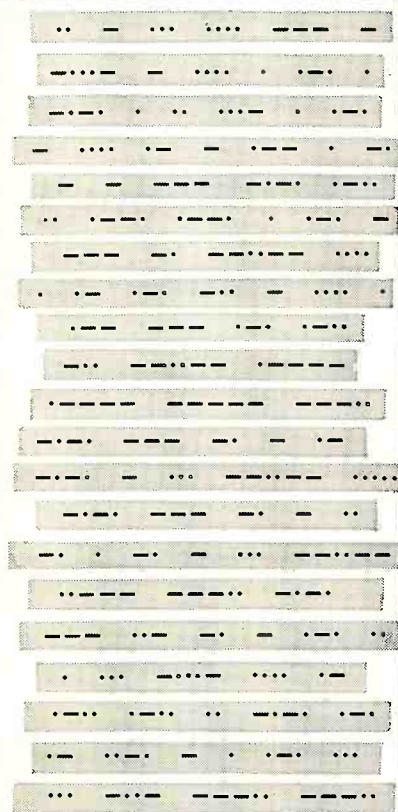

# hallicrafters

CHICAGO 24, ILLINOIS



**MAIL THIS COUPON**  
FREE—Send me World-wide Time Conversion Dial Calculator and all band frequency allocation chart plus a fund of other handy data.

Name \_\_\_\_\_  
Address \_\_\_\_\_  
City \_\_\_\_\_ State \_\_\_\_\_  
 Ham (call letters \_\_\_\_\_)  Listener  
Occupation \_\_\_\_\_  
Hallicrafter equipment I would like to know about: \_\_\_\_\_

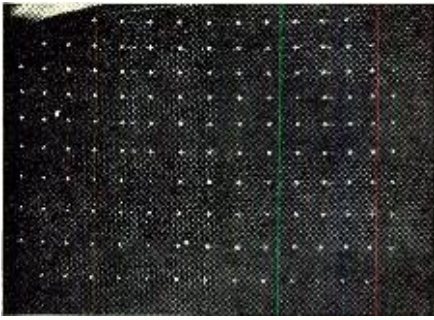

Fig. 10. White dot pattern for color TV convergence adjustments. switch set at 2.

either through the antenna or through the video stages, as with the other patterns. To obtain only the desired dots, set the video gain controls for maximum and adjust the brightness control until the screen is completely black, except for the white dots.

Because it is possible to synchronize the pattern generator to the receiver sweep circuits, rather than the other way around, the video signal can be applied anywhere in the video circuit without loss of sync. This permits signal tracing the video section of receivers and also allows using the generator instead of a station signal for channels 2 through 6. When an intermittent defect appears and some doubt exists as to whether it is in the antenna or in the receiver, use the r.f. signal from the generator to see whether the intermittent is really in the set or not.

To use the signal-tracing method of troubleshooting in the r.f. or i.f. section, just connect the pattern generator, set for horizontal bars, and use a crystal detector with earphones to trace the loud buzz through the various stages. Since the video signal for horizontal bars is about 600 cps, it provides a low-frequency buzzing which can be easily identified through earphones or any signal tracing equipment. The amplitude of the video signal can be controlled by the output control,  $R_5$  in Fig. 3, but the r.f. amplitude has to be adjusted either by the receiver gain control or else by the amount of detuning or the method of coupling. In many instances the author found that it is merely sufficient to bring a clip lead from the generator r.f. terminals near the TV receiver to obtain strong, stable patterns. -30-

### ST. LOUIS "HAMBOREE"

THE annual Egyptian-St. Louis area "Hamboree" and picnic will be held, rain or shine, on Sunday, September 19, at the Egyptian-St. Louis Radio Club Grounds, 1 mile east of the Mississippi River on the south side of U.S. highway 66.

An interesting and varied program has been planned by the committee. Food and drinks will be available on the grounds. Admission will be free to out-of-town hams.

For further information contact either W9AIU, the club station at Granite City, Ill., or W0WPS, the committee chairman. -30-

September, 1954

# WHOA, Mr. Serviceman!

DON'T JUST REPLACE-

# MODERNIZE

with wide-range, high-compliance

# SONOTONE

TITONE

## CERAMIC CARTRIDGES



Always install a Sonotone, the original ceramic cartridge—your customers will love you for it. It will start them on the road to high-fidelity—and additional new business for you!

Write for free Sonotone manual today!

New Sonotone Phonograph Modernization Manual includes an up-to-date cross reference and phonograph model index, fully explains how to use Sonotone Ceramic Cartridges. Send coupon below for your free copy, now!



ELECTRONIC APPLICATIONS DIVISION

## SONOTONE CORPORATION

Elmsford, New York

SONOTONE CORPORATION  
Elmsford, N.Y.

Dept. ( N )

Please send me a free copy of the Sonotone Phonograph Modernization Manual

Name \_\_\_\_\_

Address \_\_\_\_\_

City \_\_\_\_\_ State \_\_\_\_\_

IT'S A  
**CRIME**  
TO OWN A  
**hallicrafters**



A crime punishable by death behind the Iron Curtain yet there are **HALLICRAFTERS** owners there using receivers left by the Allied armies—who risk everything to maintain contact with freedom and truth.

Hidden in cellars, **HALLICRAFTERS** receivers dependably perform their part against the complete blotting out of information and truth.

*Used by 33 governments,  
sold in 89 countries.*

**hallicrafters**

CHICAGO 24, ILLINOIS

# MANUFACTURERS' LITERATURE

The various listings presented in this section are for your convenience. The bulletins, unless otherwise indicated, are available to all our readers. For prompt attention write directly to the manufacturer for this literature.

## RMS CATALOGUES

*Radio Merchandise Sales, Inc.*, 2016 Bronxdale Ave., New York 62, N. Y. is making available two new, up-to-date catalogues.

Catalogue 55-S, which is a supplementary issue of the company's regular annual catalogue, describes and illustrates all of the firm's latest antennas and accessories. The second publication, 55-H, details the company's complete line of hardware.

Both catalogues are conveniently punched for insertion in catalogue stands. Either or both may be obtained by writing Clifford Shearer, the firm's director of advertising.

## CENTRALAB DATA

*Centralab*, 900 E. Keefe Street, Milwaukee 1, Wis. has issued two new data sheets, one covering feedthrough bushings and the other JAN ceramic standoffs.

The information is provided in abbreviated, tabular form for quick reference. Details of the mechanical construction are also included. Either or both of these publications is available on request.

## HIGH-VOLTAGE RESISTORS

*International Resistance Company*, 401 N. Broad St., Philadelphia 8, Pa. is now offering copies of its Bulletin G-1.

The new publication provides comprehensive data on 45 different types of high-voltage resistors, including characteristics, construction, individual specifications, applications, installation information, etc.

This 8-page publication on the Type MV resistors is available on request.

## AUTO ANTENNAS

*Snyder Manufacturing Company*, Philadelphia 40, Pa. has just published a redesigned catalogue illustrating its new line of auto radio antennas.

The new publication is printed in full color and includes descriptive information on the company's series of cowl and fender mount auto radio antennas plus rear and deck mount antennas. Featured is the new "Snyder-Matic" auto antenna which raises or lowers three sections by means of finger-tip dash control.

Requests for copies of this new catalogue should be addressed to Dick Morris, sales manager of the firm.

## NEDA BATTERY INDEX

The 1954 edition of the "NEDA Battery Index," published by National Electronic Distributors Association, is

being offered by the association to all distributors, service technicians, dealers, etc.

Single copies of the publication are free and larger quantities are available at \$5.75 per hundred by writing the Association at 228 N. LaSalle St., Chicago 1, Illinois.

## SOUND EQUIPMENT

*The David Bogen Co., Inc.*, 29 Ninth Ave., New York 14, N. Y. is now distributing a new catalogue covering p.a. amplifiers, sound systems, and sound accessories.

A section entitled "Hints for Selecting the Proper Sound System" has been included for the benefit of the layman. The new catalogue, PA554, gives complete specifications on the *Bogen* line.

The catalogue is currently available from the company's distributors or from the company direct.

## CONDENSER SPECIFICATIONS

*Astron Corporation*, 255 Grand Avenue, East Newark, N. J. has prepared a new folder which gives technical information on its "Blue Point" line of molded plastic paper condensers.

The folder, AB-20B, outlines operating characteristics, voltage ratings and deratings, capacitance stability as well as the test conditions required of the units. Tolerances, wire lead sizes, and other pertinent data are also included.

Copies are available without charge from the company.

## WARD ANTENNAS

*Ward Products Corporation*, 1148 Euclid Avenue, Cleveland, Ohio is currently offering copies of its new illustrated brochure to distributors and dealers.

The new publication features individual flexible catalogue sheets. Instead of the traditional type of booklet, the sheets are housed in a multi-colored folio type cover. By using the individual sheets the catalogues can be kept up-to-date when new models are made available.

Full details on each of the antennas in the company's line are provided.

## CABINART CATALOGUE

*G & H Wood Products Company*, 75 North 11th Street, Brooklyn 11, New York has issued a new catalogue covering the *Cabinart* line of hi-fi equipment cabinets, speaker enclosures, and kits.

The pocket-size catalogue illustrates all of the company's models and includes individual specifications and spot illustrations which highlight each



# RAD-TEL Full Year Guaranteed TUBES

70 TO 90% OFF... RAD-TEL TUBES FOR QUALITY, PERFORMANCE, AND DEPENDABILITY

## COMPARE! Save More At RAD-TEL On All Parts!

### VARIABLE CONDENSERS

Manufactured by Philco, Radio Condenser, etc. 2 Gang AM and FM, No. 9 Each 89c. Lots of 3 79c.

Contains 2 separate sections for AM and 2 for FM with padder condensers. With attached slug tuned high frequency coil whose plunger is geared to condenser shaft. Pulley type drive wheel.  
 2 Gang AM, 3 Gang FM No. 10, equipped with drum pulley and padders. Each 89c. Lots of 3 79c.  
 3 Gang AM Superhet No. 12, complete with padder and pulley type drive wheel. Each 89c. Lots of 3 79c.



### No. 132 CATHODE RAY TUBE REJUVENATOR



Fits all makes of picture tubes. Completely automatic. Easy to install, no tools needed. For A.C. parallel circuits. Your Old Picture Tubes are Still Useful. List price...\$5.95

Lots of 10 \$1.09 Each \$1.29

### No. 75—ARMY-NAVY HEADSETS

Individually boxed. Very sensitive. Meets both Army and Navy specifications. List price \$16.00.  
 Each 2.95 Lots of 3 2.83 per set Each...



### WAFER ROTARY SWITCH KITS

A choice combination of single, double, etc. from 2 to 8 positions. Special Kit of 10... 1.39  
 Lots of 3 Kits... 1.29

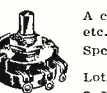

### No. 107—DOUBLE FLYBACK

Up to 125KV output. RCA Type Horizontal deflection transformer. With two filament windings for voltage doubler operation. First time at this low price... 1.89 ea. Lots of 3 1.79  
 RCA Type Flyback Transformer \$1.45 Lots of 3 \$1.35



### No. 125—PHILCO TV BOOSTER

Completely self-contained, including 2 6J6 tubes... 1 for high channels and 1 for low channels and selenium rectifier. Plastic cabinet. In factory-sealed cartons, complete with instructions. Model TB-3 \$9.95



### No. 46—HI-VOLTAGE R. F. COIL

4500 VOLTS RF TRANSFORMER  
 Ideal for TV and Oscilloscope power supplies, using 5" to 7" tubes. This buy is too BIG to be beaten!  
 List price \$7.50  
 Each 79¢ Lots of 3 each 69¢



### No. 97—WEN SOLDERING GUN

3 seconds on 120 Volt A.C. readies it for any soldering requirement. 250 Watt size. Also cuts plaster tile (with special tip). Multi-useful! UL approved. Built in spot light.  
 Each 9.71  
 List price—\$12.95  
 Lots of 3, \$8.64 each  
 TIPS  
 Fralloy Long Life... 35c each  
 Standard Tip... 11c each



### No. 100—WEN POLISHER

\$9.00 each Lots of 3 \$8.75 ea.

## All New Parts At Old Fashioned SAVINGS!

### SPEAKERS

All Standard Brands Dynamic + PM  

Size	Ohms	Price	Lots of 5
5" x 7"	1000	\$0.99	\$0.89
5" x 7"	1800	.99	.89
5" x 7"	2750	.99	.89
5" x 7"	400	1.49	1.29
(with GK6 output transformer)			
8"	680	1.95	1.70
(with 6V6 push-pull transformer)			
1.5"	38	.49	.29
1.5"	1.47 oz.	1.95	1.70
(with 50L6 output transformer)			
1"	.68 oz.	1.89	1.64
(with 50L6 output transformer)			
8"	2.15 oz.	2.95	2.65
10"	2.15 oz.	3.95	3.60



### No. 3—VERTICAL OUTPUT TRANSFORMER

Very popular, used in most TV sets. Well-known manufacturer. Matches vertical output tube to the deflection yoke, 10 to 1 ratio. A terrific buy on a top performer.  
 List Price—\$4.50  
 95c each  
 Lots of 5 90¢ each



### No. 133 Electrolytic Condensers

Assorted condensers, consists of single, double, triple and quadruple. All popular voltages and capacities. All standard popular brands  
 Kit of 10 \$2.39



### No. 81—ANODE CAPS

Fits all TV sets. Phosphor bronze metal plug with rubber insulator and high voltage lead. Seize this buy NOW! List price 75c.  
 each 19¢ Lots of 10 18¢ each



### No. 53 BIAS CONDENSERS

500 MFD 12 V.—Mfgd. by Sangamo, Aerovox & Cornell-Dubilier  
 List price—\$2.00  
 Maximum value in minimum space. A buy you've been looking for!  
 35c each; Kit of 10, \$2.95



### No. 15—RESISTORS

(ASSORTMENT OF 200)  
 Standard RTMA Coded or Value Printed. Uninsulated, 1/2 Watt, 1 Watt, 2 Watt, and some 10 Watt. List price—\$10.00.  
 \$1.39  
 Lots of 10 Kits 99c each



### No. 106—DOUBLE SHELL TYPE POWER TRANSFORMER

No. J184 PRI. 117V. Sec. 266V. 300 ma; 5v, 6 AMP; 6.3V, 1.5 AMPS; 6.4V, 1.4 AMPS; 6.4V, 4.4 AMPS.  
 \$3.50 each



### JAN TUBES

No. 1619, 1626, 1629, 615, 7193, 954 and 45 special.  
 Asst. Pkg. of 10 \$2.70  
 Some tubes easily worth \$2 each

### Additional Tube Values!

1E7	.29	12B4	.60
1LB4	.69	12C8M	.34
1P5GT	.57	12SCTM	.63
2V3	.38	35	.58
3B7	.27	36	.39
3D6	.27	46	.69
6AS6	1.49	55	.49
6AU4GT	.68	58	.60
6U5	.57	1274	.30

Type	Price	Type	Price	Type	Price	Type	Price
OA2	.74	6AU6	.46	6Y6G	.48	12V6GT	.46
OA4	.68	6AV5GT	.83	7A4	.47	12X4	.38
OB2	.81	6AV6	.40	7A5	.59	14A4	.69
OC3	.72	6AX4GT	.65	7A6	.69	14A5	.59
OD3	.70	6B4	.54	7A7	.69	14A7	.63
OZ4M	.65	6BA6	.49	7A8	.68	14AF7	.59
1A5	.49	6BA7	.57	7AD7	.79	14B6	.63
1A7GT	.47	6BC5	.54	7AF7	.53	14B8	.63
1AX2	.62	6BD5	.59	7AC7	.69	14C5	.79
1B3CT	.73	6BD6	.45	7AH7	.79	14C7	.79
1C5	.43	6BE6	.51	7B4	.44	14E6	.75
1C6	.24	6BF5	.41	7B5	.45	14E7	.88
1H4	.30	6BF6	.37	7B6	.69	14F7	.65
1H5GT	.49	6BC6G	1.25	7B7	.49	14F8	.69
1L4	.46	6BH6	.53	7C4	.59	14H7	.59
1LA4	.59	6BJ6	.49	7C5	.69	14J7	.30
1LA6	.69	6BK5	.80	7C6	.59	14N7	.84
1LC5	.59	6BK7	.80	7E5	.59	14N7	.79
1LC6	.79	6BL7GT	.83	7E6	.30	14S7	.89
1LD5	.59	6BN6	.59	7E7	.59	14W7	.30
1LE3	.59	6BQ6GT	.98	7F7	.79	14X7	.69
1L5	.69	6BQ7	.90	7F8	.79	14Y7	.62
1LH4	.69	6BZ7	.90	7G7	.89	19B6C	1.39
1LN5	.59	6C4	.40	7H7	.59	19T8	.69
1NSGT	.67	6C5	.39	7J7	.79	19V8	.79
1Q5GT	.58	6C6	.58	7K7	.69	24A	.39
1R5	.62	6CB6	.54	7L7	.59	25AV5GT	.83
1S4	.59	6CD6	1.11	7N7	.69	25BQ6GT	.98
1S5	.51	6CF6	.64	7Q7	.66	25L6GT	.51
1T4	.58	6CS6	.51	7R7	.89	25W4GT	.59
1T5	.59	6D6	.59	7S7	.79	25Z5	.66
1U4	.57	6E5	.48	7V7	.89	25Z6	.49
1U5	.50	6F5GT	.39	7X6	.54	26	.45
1V	.43	6F6	.59	7X7	.70	27	.39
1X2A	.63	6G6	.42	7Y4	.69	32L7	.89
2A3	.30	6H6GT	.41	7Z4	.59	35A5	.58
2X2	.49	6J5GT	.43	12A6	.54	35B5	.52
3A4	.45	6J6	.52	12A8GT	.61	35C5	.51
3E5	.46	6J7	.43	12AL5	.37	35L6GT	.51
3LF4	.69	6K5	.47	12AQ5	.52	35W4	.47
3Q4	.48	6K6GT	.45	12AT6	.41	35Y4	.54
3Q5GT	.69	6K7	.44	12AT7	.72	35Z3	.59
3S4	.58	6L6	.64	12AU6	.46	35Z4	.47
3V4	.58	6L7M	.68	12AU7	.60	35Z5GT	.47
5A24	.59	6N7M	.63	12AV6	.39	45	.55
5T4	.79	6Q7	.45	12AV7	.73	45Z5	.49
5U4G	.55	6R7	.69	12AX4	.67	50A5	.55
5W4CT	.50	6S4	.48	12AX7	.63	50B5	.52
5Y3CT	.37	6S7M	.79	12AY7	.69	50C5	.51
5Y4	.51	6S78	1.69	12AZ7	.59	50L6GT	.61
5Z3	.45	6S8GT	.53	12BA6	.49	50X6	.49
6A6	.51	6SA7GT	.55	12BA7	.60	50Y6	.49
6A7	.69	6SD7GT	.41	12BD6	.45	50Y7	.50
6AB4	.44	6SF5GT	.46	12BE6	.51	56	.49
6AC5	.69	6SG7GT	.41	12BF6	.39	57	.58
6AC7M	.86	6SH7GT	.49	12BH7	.63	70L7	.97
6AF4	.90	6SJ7GT	.41	12BY7	.65	75	.49
6AG5	.56	6SK7GT	.53	12BZ7	.65	76	.44
6AG7M	.99	6SL7GT	.48	12H6	.56	77	.57
6AH4	.57	6SN7GT	.59	12J5	.42	78	.47
6AH6	.73	6SQ7GT	.46	12J7	.49	80	.43
6AJ5	.65	6SR7GT	.45	12K8	.59	83V	.68
6AK5	.55	6SS7GT	.42	12Q7	.59	84/6Z4	.46
6AK6	.59	6T4	.99	12S8GT	.62	85	.59
6AL5	.42	6T8	.80	12SA7GT	.65	117L7	.99
6AM8	.78	6U6	.59	12SF5	.50	117P7	.99
6AQ5	.50	6U8	.78	12SC7	.51	117Z3	.37
6AQ6	.37	6V6GT	.50	12SJ7M	.67	117Z6	.69
6AQ7	.70	6W4CT	.47	12SK7GT	.63	807	.99
6AR5	.45	6W6GT	.57	12SL7GT	.57	866A	1.39
6AS5	.50	6X4	.37	12SN7GT	.52	Hi-PO#567	1.39
6AT6	.41	6X5GT	.37	12SQ7GT	.56		
6AU5GT	.82	6X8	.75	12SR7M	.49		

# RAD-TEL TUBECO. Dept. RN9 115 Coit St., Irvington 11, N. J. "Integrity Is Our Chief Asset"

**TERMS:** A 25% deposit must accompany all orders—balance C.O.D. All shipments F.O.B. Irvington warehouse. **ORDERS UNDER \$10—\$1.00 HANDLING CHARGE.** Subject to prior sale.  
**PLEASE:** Send full remittance... allow for postage and save C.O.D. charges! We refund all unused money!  
 Phone: Essex 5-2947  
 Tubes in Bold Type Cover 90% of Demand

**"LIKE MOST HAMS  
I STARTED WITH  
HALLICRAFTERS"**



says  
W9JZN, Hibbard E. Bannard, Trustee of  
North Suburban Radio Club—W9AP

"I started on the air with a Hallicrafters Sky Buddy. I still have it and it functions well. Later I got a Hallicrafters S-40 and it really performed for me.

I don't think you can beat any Hallicrafters equipment at the price. I'm certainly impressed with the many features of the SX-88, such as the main tuning and band spread locking device and the built in crystal calibrator."

*Used by 33 governments,  
sold in 89 countries.*

**hallicrafters**

CHICAGO 24, ILLINOIS

**MAIL THIS COLUMN**  
FREE—Send me, with your Time Conservation Deal Card, later mail all recent frequency allocation charts plus a card of other handy data.

Name: \_\_\_\_\_  
Address: \_\_\_\_\_  
City: \_\_\_\_\_ State: \_\_\_\_\_  
 Home local letters  Listener  
Occupation: \_\_\_\_\_  
Hallicrafters equipment I would like to know about: \_\_\_\_\_

cabinet's layout and equipment requirements.

Copies are available from local parts distributors or from the company direct.

**EICO BROCHURE**

*Electronic Instrument Co., Inc.* of 84 Withers Street, Brooklyn 11, N. Y. has published a new brochure to aid distributors in doing a better selling job at low cost.

Printed in two colors and comprising 6 pages, this new publication describes the highlight specifications of the complete *Eico* line of 38 kits and 42 factory-wired instruments. The brochure folds to 6¼" x 4" for mailing. Space is provided for jobber imprint and addressing. The brochure can be self-mailed for 2 cents postage or enclosed in a business envelope.

**JAVEX CATALOGUE**

*Javex*, P.O. Box 646, Redlands, California is now offering copies of its new catalogue No. 254.

The publication covers television installation practices, types of accessories available for a multiplicity of installations, etc. The catalogue gives sizes, prices, colors, and ratings and also lists advertising and promotional materials currently available.

Those interested in v.h.f.-u.h.f. television, experimental p.a. work, amateur radio, and audio fields are invited to write for a copy of this catalogue.

**TV ALIGNMENT TOOLS**

*General Cement Mfg. Co.*, 919 Taylor Ave., Rockford, Illinois, is currently offering a new illustrated brochure which features 36 television tools plus five tool kits containing matched sets of alignment tools.

Known as No. 3545, the new publication carries brief descriptive paragraphs and illustrations of the equipment. A copy of this brochure and additional information on the company's line of alignment tools is available on request.

**SIMPLIFIED HI-FI DATA**

*Newcomb Audio Products Company*, 6824 Lexington Ave., Hollywood 38, Cal., is now offering copies of a new booklet entitled "Hi-Fi is for Everybody!"

Designed to offer a new understanding and simplified approach to high fidelity, this 32-page publication is packed with valuable suggestions for potential hi-fi equipment customers.

The booklet sells for 25 cents a copy and is available from the company direct.

**PLANNING FOR COLOR**

The Television Transmitter Division of *Allen B. Du Mont Laboratories, Inc.*, 1500 Main Ave., Clifton, N. J., has issued an elaborate booklet "Station Planning for Color Television" which is designed to assist management in setting up its color facilities.

TV Station owners and operators may obtain a copy of this publication by writing the company direct. —30—

**HERE'S Fast, Easy  
Picture Tube  
and Receiver  
Testing**

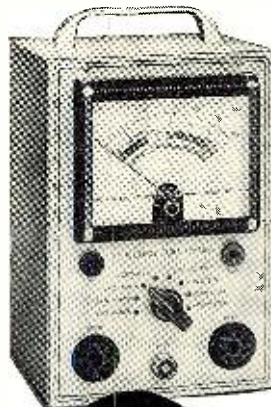

**FOR ALL  
MAGNETIC  
BLACK-  
AND-WHITE  
OR  
COLOR SETS**



Take the guesswork out of C-R tube testing and TV troubleshooting! New Boland & Boyce C-R Tube Tester tests all magnetic picture tubes *dynamically*—under the receiver's own power. Tells instantly whether tube or set is at fault. 600 V. d-c range extends to 30 or 60 KV by HV Probe.

**BOLAND  
& BOYCE  
DYNAMIC  
C.R.T. TESTER  
Model 701**

Tests tubes in set under receiver's own power or out of set with handy plug-in power supply.

Locates picture tube or receiver faults instantly

Builds customer satisfaction . . . Shows quality of each element directly on GOOD-?BAD scale

Factory wired or easy-to-build kit form

Send today for brochure describing complete line of B&B products.

B&B #703 Power Supply—Plugs into #701 C-R Tube Tester. Provides continuously variable d-c voltages to simulate receiver operation for out-of-set tests. Operates from 115 volt a-c source. KIT—\$9.95. FACTORY WIRE & TESTED—\$12.95.

B&B #702 Universal HV Probe—Extends range of any VTVM, multimeter, or voltmeter having sensitivity of 10,000 ohms-per-volt or more. Supplied with complete set of plug-in precision resistors and instructions to accurately match any meter . . . any range—30KV, 60KV, and many others. Save money. Use this one probe with several instruments. Ideal for B&B #701 C-R Tester.



**BOLAND & BOYCE, Inc.**  
Dept. RN-94, 236 Washington Avenue  
Belleville 9, N. J.  
RADIO & TELEVISION NEWS

**Certified Record Revue**

*(Continued from page 60)*

tiousness. The engineering on this disc is in keeping with the standard *London* has set for this series, which is to say the sound is indistinguishable from the best found in their regular output. Nice, live sound here, exceptionally well balanced. Quiet surfaces.

**BEETHOVEN**

**SONATA #5 IN F MAJOR FOR VIOLIN AND PIANO**

**BRAHMS**

**SONATA #3 IN D MINOR FOR VIOLIN AND PIANO**

Christian Ferras, violinist, and Pierre Barbizet, pianist. Telefunken LGX66014. RIAA curve. Price \$5.95.

More of the music in the first *Telefunken* release, this time two charming sonatas by two of the "three B's." It has often been argued that you can't bring a symphony orchestra into a living room. But every living room can have a piano and violin within its confines. This recording is a literal recreation of a violin and piano sonata as it might sound in *your* parlor. Not too much reverb has been used—you don't have to stretch your imagination or your room to make it fit. Yet the essential "liveness" is present. The violin is smooth and edgeless, the piano clean and liquid-toned, with none of the harsh, too bright-too close "mike sound" which is the bane of so much piano recording. The Brahms gets an altogether exemplary performance from the participants, the Beethoven is less successful. The Beethoven is at fault principally from lack of warmth, from playing too precise, too disciplined. Ferras has a big rich tone, and when he relaxes (as in the Brahms) his fluency of expression is splendidly evident. Ferras is to visit this country in the fall and this recording augurs for a successful debut. Barbizet, while the subsidiary talent, is a convincing and capable pianist, and the whole of the recording is in superb balance. The RIAA curve was adequate without recourse to bass and treble controls.

**POULENC**

**SEXTETTE FOR WIND INSTRUMENTS AND PIANO**

**HINDEMITH**

**QUINTET FOR WIND INSTRUMENTS**

The Fine Arts Wind Players with Leona Lurie, pianist. Capitol FDS, P8258. RIAA curve. Price \$5.95.

Chamber works for woodwinds are usually associated more with the 18th century composers than with our contemporaries, yet many a work in this form has been composed by some of our most celebrated moderns. The Hindemith Quintet is an early masterpiece, composed in 1922, and as such predates most of the Hindemith output with which we are familiar. The work seems simple, and yet it is full of invention, and displays the composer's incomparable skill in contrapuntal

**LONG-PLAYING 33 1/3 R.P.M. HIGH-FIDELITY**

**8 MASTERPIECES**

**NO STRINGS ATTACHED!**

**\$1.00**

*Without obligating yourself to buy another record, you can enjoy all advantages of trial membership.*

**Long  
Playing**

**N**OW YOU can get a real start on a complete record collection. You get ALL EIGHT masterpieces—complete to the last note—for only \$1.00. NOT \$1 each, but \$1 for ALL EIGHT!

Of course, this price bears no relation to the value of the recordings. Even for TWENTY times that amount, you could not buy these masterpieces in recordings of equal quality.

**Why We Make This Amazing Offer**

We were FORCED to make this "give-away" offer . . . for only by putting our recordings in your hands can we convince you how extraordinary their tonal quality is. Performed by internationally-renowned orchestras, conductors, and soloists. Custom-pressed on the purest vinyl plastic. Reproduced with a fidelity of tone which encompasses the entire range of human hearing . . . 50 to 15,000 cycles!

**HOW CLUB OPERATES:** As a trial member, you are not obligated to ever buy another record from us. You do, however, have the right to try—free of charge—any of the Society's monthly selections which interest you. You receive prior notice of these. You pay nothing in advance. And you are not obligated to keep those you try . . . even after you have played them and read the interesting music notes which accompany each selection. You pay only for those which—after having tried them—you decide you really want to own. And for these, you pay only the low member's price of \$1.50 per long-playing disc, embodying on the average about 40 minutes of music by the great masters. *A saving of about 2/3 off the usual retail price!*

Think how much beauty and serenity these recordings will add to your life—at a trifling cost. Think what a cultural advantage your children will gain by having great music as an everyday inspiration.

**Mail Coupon Now**

We obviously cannot keep "handing out" such magnificent long-playing recordings indefinitely. Production capacity limits the membership rolls; once filled the offer has to be withdrawn. So avoid disappointment. Rush coupon with a dollar today. *The Musical Masterpiece Society, Inc., Dept. 479, 43 West 61st Street, New York 23, N. Y.*

**Not \$1 each, but \$1 for all 8!**

**SCHUBERT**

Symphony No. 8  
(The "Unfinished"),  
Zurich Tonhalle Orch.  
Otto Ackermann, Conducting

**BEETHOVEN**

The Ruins of Athens  
(March and Choir),  
Netherlands Philharmonic  
Choir and Orch.  
Walter Goehr, Conducting

**BRAHMS**

Academic Festival Overture,  
Utrecht Symphony  
Paul Hupperts, Conducting

**MOZART**

Piano Concerto in E Flat, K 107  
Artur Balsam, piano,  
Winterythur Symphony Orch.,  
Otto Ackermann, Conducting

**BACH**

Tocatta and Fugue in D Minor,  
A. Schreiner; Organ of the  
Tabernacle, Salt Lake City

**WAGNER**

Die Meistersinger, Prelude, Act 1,  
Zurich Tonhalle Orch.,  
Otto Ackermann, Conducting

**DUKAS**

Sorcerer's Apprentice,  
Utrecht Symphony,  
Paul Hupperts, Conducting

**MOUSSORGSKY**

Night on Bald Mountain,  
Netherlands Philharmonic  
Walter Goehr, Conducting

**FREE** "Music in Your Home" by Olin Downes

Mail coupon at once to receive, FREE, fascinating brochure by dean of American music critics. A guide to the valuable program notes and musical annotations which come free with every selection.



The Musical Masterpiece Society, Inc. Dept. 479  
43 West 61st Street, New York 23, N. Y.

**ALL 8 MASTERPIECES—\$1.00**

Here is my dollar in complete payment; please send me ALL 8 of the masterpieces listed above and enroll me as a trial member. Send me notice of future selections which I may try for 5 days without cost or obligation. For those future 1p. discs I decide to keep after I have tried them, I will pay only the special member's price of \$1.50 each, plus few cents shipping. I may cancel my trial membership at any time.

Name.....  
Address.....  
City..... State.....  
In Canada address: 686 Bathurst St., Toronto 4, Ont.

# Inventory

## OF EQUIPMENT AT

Western Union Telegraph Co.  
Development & Research Dept.  
Electronics Research Div.  
Water Mill, N. Y.

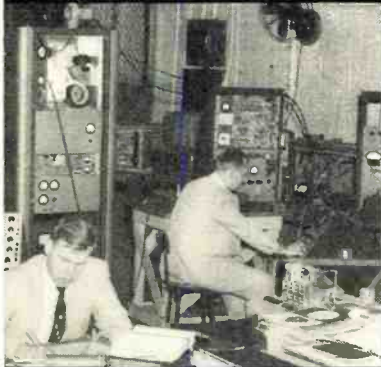

INCLUDES

# 13

## hallicrafters RECEIVERS



### **HALLICRAFTERS SX88**

Wherever world wide, all band radio reception is important and reliability of receiver performance paramount, there is bound to be **HALLICRAFTERS!** The radio man's radio.

*Used by 33 governments,  
sold in 89 countries.*

# hallicrafters

CHICAGO 24, ILLINOIS

scoring. Easy to listen to, but very difficult to perform, this recording is a prime example of virtuoso wind playing. The Fine Arts Wind Players are splendid artists, thoroughly "at home" with the demands of these complex scores. The Poulenc work is the sort of thing we have come to expect from this composer. Sassy, jazzy, it bubbles with light-heartedness and good humor. It's a Parisian boulevardier feeling his oats. The sound of the woodwinds (and the piano in the Poulenc) is outstanding. Sibilant, snarly, guttural, sensuous, whatever the score calls for is delivered with fine, strong intonation, very wide range, with good transients and not a trace of wow or flutter in the longer decay periods. No adjustment was necessary with the RIAA curve. A disc like this is a "must" for wind students.

### **MACDOWELL SECOND INDIAN SUITE**

Eastman-Rochester Symphony Orchestra, conducted by Howard Hanson. Mercury MG40009. RIAA curve. Price \$5.95.

To those of you to whom the name MacDowell conjures up the salon-sweetness of his "To a Wild Rose," this work will come as quite a surprise. Yes, MacDowell has had to bear his musical cross, but this recording should do much to lighten his burden and dispel the notion that he was a composer of naught but trivia. This "Indian Suite" is a full blown symphonic work, and is not in the slightest tainted by the saccharine scoring so typical of "movie-type" tributes to the noble redskin. The five movements of the suite are based on actual thematic fragments of music from such tribes as the Iroquois, Chippewa, the Iowas, and Kiowa. MacDowell has used his material very cleverly and the result is a moving, evocative picture of a dying race. The scoring is brilliant throughout the work, from the powerful expression of the "Legend," the beauty and tenderness of "Love Song," the haunting despair of the "Dirge," to the chilling ululations of "In War-Time" and frenzied gaiety of "Village Festival." Dr. Hanson conducts with a knowing and devoted hand, and his ever-improving orchestra responds with superb playing. Sound is typical Mercury, sharp biting brasses, clean silken strings, with some extra sonorous contrabass, and super-accurate percussion of great impact. Wide dynamics and just enough reverb for proper acoustic perspective completes the sonic picture. RIAA curve was adequate and surfaces were quiet.

### **STRAUSS, RICHARD AUS ITALIEN**

Vienna Philharmonic Orchestra, conducted by Clemens Krauss. London LL969. RIAA curve. Price \$5.95.

The recent death of Clemens Krauss will certainly leave an aching void in the ranks of the few conductors who really know how to interpret the difficult music of Richard Strauss. Krauss' mastery of this composer's works is

never more evident than in this recording of the early tone poem, "Aus Italien." Written by Strauss on the inspiration of a trip to Italy, it is clearly an immature work, but not without very definite promise of the Strauss that was to come. The most famous part of this work is in the last movement wherein Strauss utilizes the theme material of "Funiculi, funicula." In Krauss' competent hands this is riotous good fun and is a fitting finale to Strauss' pastorale wanderings in the first three movements. The conducting of Krauss is a miracle of precision, coupled with warmth and feeling. His tempi never vary, his obvious good humor is tempered with respect. The Vienna Philharmonic is wonderful and always sounds better in Krauss' loving care. Soundwise, this is an imposing disc. The sonorities generated are truly huge. Clean strings, very weighty brass, fluent woodwinds, and authoritative percussion with some excitingly "live" cymbal clashes in the last movement. Superb balance is a notable feature of this disc. The third version of "Aus Italien" to appear on LP, it is much superior to the other recordings, from both the sonic and conductorial viewpoints. A few db of bass boost helped the RIAA curve in my acoustic setup. Quiet surfaces.

### **FRANCK SYMPHONY IN D MINOR**

Vienna Philharmonic Orchestra, conducted by Wilhelm Furtwangler. London LL967. RIAA curve. Price \$5.95.

A popular sport among music critics for some time has been deriding the conductorial idiosyncrasies of Wilhelm Furtwangler. While it is undoubtedly true that Furtwangler is a man with some ideas peculiarly his own and has more than his share of artistic temperament, he is nevertheless a conductor of great talent. Some of his early performances of Wagnerian music, especially "Tristan und Isolde," were fabulous and have yet to be improved upon by anyone. In this umpteenth version of the Franck warhorse, Furtwangler has chosen the straight and narrow path in matters of tempo and expression and has come up with one of the best performances on records. Throughout the work, Furtwangler accents the lyrical qualities, while exercising restraint in the opening movement, and avoids the temptation of bombast. His is the gradual build-up and the finale usually fraught with redundancy, is a clean-lined and powerful evocation. The Paul Paray-Detroit Symphony version on Mercury is amazingly close to this performance, in nearly all respects. The choice here is strictly a matter of taste, or perhaps will be dictated by the sound qualities. Both the Mercury and the London discs represent all that is the best in modern recorded sound, but from differing viewpoints. The London sound is "big-hall," hugely proportioned, with the "over-all bloom" typical of the best European recordings. The Mercury sound is super-precise with all elements sharply delineated and extra-

**if you like**

**p c u e s**

**..don't miss**

An exciting collection of the  
world's greatest  
pictures, expertly selected  
by the editors of  
PHOTOGRAPHY magazine.

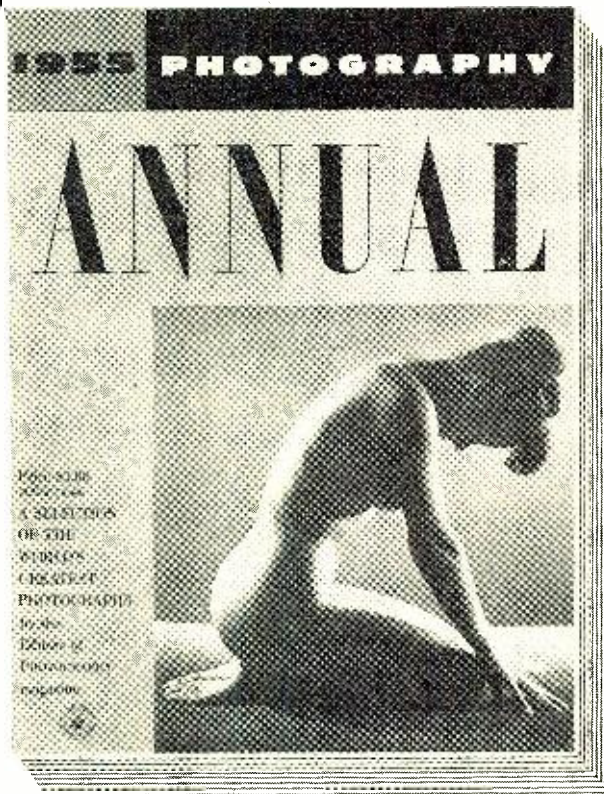

**24 pages of brilliant color.**

**More than 250 top-notch photographs.**

**3 big sections—packed with inspiring pictures,  
new ideas, practical information.**

- MAKING PICTURES
- COLOR PHOTOGRAPHY TODAY
- SEEING PICTURES

**PHOTOGRAPHY ANNUAL**—a must for everyone who enjoys good pictures . . . an important addition to every photographic library . . . an ideal gift!

**WATCH FOR IT!**

**now on sale at newsstands and camera stores**



ZIFF-DAVIS Publishing Company, publishers of PHOTOGRAPHY Magazine, PHOTOGRAPHY Annual, PHOTOGRAPHY Directory, MODERN BRIDE, RADIO & TELEVISION NEWS, RADIO-ELECTRONIC ENGINEERING, FLYING, G.I. JOE, AMAZING STORIES, FANTASTIC, LONDON MYSTERY MAGAZINE.

# TRANSVISION

## F E D STRENGTH MET · R

*Finest  
at  
Any Price*



For 110V AC,  
and BATTERY  
OPERATION

**SAVES 50% OF  
INSTALLATION COST**

Works from antenna  
(no TV set needed)

**FINEST** because: Each Meter is individually calibrated in microvolts on every channel. Widest range—10-50,000 microvolts. 12 channel selector, Multiplier switch for weak signal areas.

**Pays for itself on 3 or 4 jobs.** Measures relative picture signal strengths directly from antenna. Determines best antenna system and orientation. Checks receiver re-radiation (local oscillator). Identifies signals—TV, FM, TVI. Easy to operate, light, rugged. Many other exclusive features.

\*Model FSM-5, for 110V AC only. Complete with tubes. Wt. 13 lbs. net \$79.

Model FSM-5B, for Battery Operation and 110V AC. Wt. 13 lbs. net \$89.

TRANSVISION, INC.  
NEW ROCHELLE, N. Y.

**\$79**  
NET\*

A MUST IN  
FRINGE AREAS

**UHF  
OR  
VHF**

**10 DAY TRIAL:**  
Try these fine instruments for 10 DAYS. Then, if you return them, your cost less 10% (our cost of re-packaging) will be refunded.

## COMMUNITY and MASTER TV ANTENNA SYSTEMS

Transvision offers the Finest System at Lowest Cost of Installation and Maintenance . . . proven in thousands of difficult installations.

A few of the many  
**ADVANTAGES:**

Highest power output allows longest cable runs  
Central system with only 1 point of service . . . Operates up to 500 TV sets from 1 amplifier . . . Lowest cost per outlet . . . Maximum signal to each set with minimum interference.

**FREE:** Engineering advice. Send us your problem for quick solution.

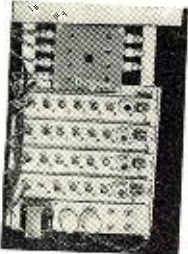

Transvision, Inc., New Rochelle, N. Y., Dept. N9

- Send me \_\_\_\_\_  
 Enclosed find \$\_\_\_\_\_ deposit. Balance C.O.D.  
 My JOBBER is \_\_\_\_\_  
I accept your 10 Day Trial terms.

Name \_\_\_\_\_  
Address \_\_\_\_\_  
City \_\_\_\_\_ State \_\_\_\_\_

**JOBBER INQUIRIES INVITED**

inary dynamics. I think anyone contemplating the purchase of the Franck symphony would be wise to concentrate on these two versions. The final choice, if a matter of sound, might be no more than a question of your particular equipment and acoustic surroundings, so listen to both these recordings. The RIAA curve did not need adjustment.

### TCHAIKOVSKY

**SYMPHONY #2 IN C MINOR**  
Royal Philharmonic Orchestra, conducted by Sir Thomas Beecham. Columbia ML 4872. NARTB curve. Price \$5.95.

Columbia is to be commended for upgrading their catalogue with this recording. The only other LP version was their earlier recording by Mitropoulos and the Minneapolis Symphony which was a 78 rpm transfer. This new disc is superior in every way, performance- and sound-wise. If you are not familiar with this early Tchaikovsky symphony I strongly urge you to listen to this recording. You will find all the elements that have endeared the later symphonies to so many hi-fi fans. Plenty of excitement is generated in this work along with some beautifully lyric sections, as in the second movement. While this work holds none of the power of the 4th, 5th, or 6th symphonies, it is still an interesting and entertaining work, never trite, and really a pleasant change after the countless performances of the last three symphonies. Sir Thomas has always been a master of Tchaikovsky's symphonies and this is not the first time he has recalled the earlier symphonies, (especially this 2nd and the 3rd) from relative obscurity. He knows his material and delivers a nicely paced, well organized reading. The Royal Philharmonic is obviously enjoying itself and plays with verve and vigor. Splendid sound, fine strings, especially in the pizzicato sections, bright brass and heavy, accurate percussion in bass drum and tympani. NARTB curve was better with a couple of db bass boost. Moderately quiet surfaces. A good, but not outstanding, performance of the "Waltz of the Flowers" is included for good measure on the second side.

### KETELBEY

**IN A MONASTERY GARDEN  
IN A PERSIAN MARKET  
IN A CHINESE TEMPLE-GARDEN  
THE CLOCK AND THE DRESDEN  
FIGURES**

Rochester Pops, conducted by Morton Gould. Columbia AL47. NARTB curve. Price \$2.85.

One of the best sounding discs to come from Columbia in a long time. In fact, the sound is so good as to lead one to suspect Columbia has made some new improvements in mike pick-up or cutterhead or somewhere along the line. The music is frankly, if not brutally programmatic, but has found considerable favor with a large segment of the public. It would be unkind to call it corny. It is perhaps best described as "dated." This kind of stuff lends itself very well to up-to-date hi-fi

treatment, however, and the result is a low-cost feast of gorgeous hi-fi effects. Rip-snortin' percussion effects here, with Chinese gongs boinging all over the place, clean strings and brilliant brasses. Morton Gould is the right man for this sort of thing and he makes the most of it. The Rochester Pops is composed mainly of personnel from the Eastman-Rochester and Rochester Philharmonic symphonies and is a first class group. NARTB curve was just right. Ticky surfaces in my copy.

### FAURE

**REQUIEM**  
Orchestre des Concerts Lamoureux, conducted by Jean Fournet with Pierrette Alarie, soprano; C. Maurane, baritone; Choerur E. Brasseur; M. Durafle, organist. Epic LC3044. NARTB curve. Price \$5.95.

The fifth version of this lovely work to appear on LP and in many ways, the best. Fauré was a gentle soul and he was not given to bombast in his music. His "Requiem" reflects his nature perfectly, being a deeply moving, quietly somber and low-key version of the Mass for the Dead. The absence of violins in the scoring is in keeping with the general tenor of the work and Fauré depends on the darker-toned violas and celli, along with contrabass and organ. Pierrette Alarie has a splendid voice and uses it reverently and compellingly. The baritone was too nasal for my taste, but knew his role well enough. The choir is a tightly organized group, with excellent articulation. The Angel version of this work has excellent soloists too, but they are not shown off to such good advantage as in this disc because of the sonic deficiencies. This recording has fairly wide range and good dynamics and, above all, good acoustic perspective, so important in choral works. There is a minimum of fusion and "blast" effects between the vocal and orchestral elements. Fournet shows a healthy regard for tempi and expression, but manages to conduct at a pace which sustains interest and does not impose hardships on his forces. The NARTB curve was improved by a little treble cut and bass boost. Moderately quiet surfaces.

### SIBELIUS

**THE LEGENDS OF LEMMINKAINEN**  
Symphony Orchestra of Radio Stockholm, conducted by Sixten Ehrling. Capitol P8226. RIAA curve. Price \$5.95.

A few years ago this work was relatively unknown in the LP catalogue, except for a couple of recordings of one of the legends, the famous "Swan of Tuonela." Now here we are faced with the third edition of recent months! The Jensen reading on London seemed to be near-definitive. This disc offers it considerable competition. Ehrling is one of Scandinavia's better conductors and his familiarity with this music is evident. There is little to choose between them in matter of performance. Ehrling's pace is slower and more deliberate and he emphasizes the

dramatic elements of the work. Jensen essays the more lyric touch and, in general, keeps the work from becoming too heavy-handed. Both readings are uncommonly good and the matter of choice is made still more difficult by the similarity in sound quality. In this version are to be found fine, clean strings, some splendid brass sonorities, very "live" woodwinds and notable percussion. The *London* version is somewhat wider range in frequency and dynamics, and has a definite edge in the matter of acoustic balance. You won't go wrong with either disc. The RIAA curve was better with some bass boost. Good surfaces in my copy.

**FALLA**

- RITUAL FIRE DANCE
- ANDALUZA
- DANCE OF THE MILLER'S WIFE
- GRANADOS
- THE MAIDEN AND THE NIGHTINGALE
- PLAYERA
- ALBENIZ
- SEGUIDILLA
- SEVILLA
- TANGO IN D MAJOR
- INFANTE
- EL VITO

Leonard Pennario, pianist. Capitol P8190. RIAA curve. Price \$5.95.

Some familiar and not-so-familiar music for piano in the Spanish idiom. The pianist is young Leonard Pennario, who is endowed with a dazzling technique and uncommonly fine musicianship. This type of repertoire is right up his alley and the keyboard fairly sizzles with his virtuosity. The most famous work in this collection, "The Ritual Fire Dance," is given an unusual and different performance by Pennario. He goes to considerable pains with pedal technique to sharply accentuate the rhythmic elements. His is the most "Spanish" reading of this piece I have ever heard. The other works are brilliantly played and the little-known "El Vito" is an astonishing tour-de-force for Pennario. Exceptional piano sound in this disc. Piano is properly miked "close-to," with the percussive effect needed for this type of repertoire, perfectly reproduced. Nice wide range and good dynamics and nary a trace of wow or flutter add to an attractive recording. The RIAA curve needed no compensation. Very quiet surfaces.

**MASCAGNI**

CAVALLERIA RUSTICANA  
Milano Symphony Orchestra and Chorus, conducted by Franco Ghione, with Mario del Monaco, Elena Nicolai, Aldo Protti, Laura Didier, Anna Maria Anelli. London LL990/991. RIAA curve. Price \$11.90.

Who would ever have thought that a music lover would have *nine* versions of "Cavalleria Rusticana" on discs to choose from! Yet this present recording is indeed the 9th edition in what looks like a never ending stream. You might think that choice here would be really difficult. Not so. The only other album worthy of consideration with this edition is the recent release

Why you need a  
**TRANSCRIPTION ARM**  
for your home music system

Today there is much discussion of amplifiers, loudspeakers and proper enclosures... all necessary for top hi-fi performance in your home music system. Yet one of the most important parts of your music system has long been neglected... the arm that guides the cartridge across the record. The arm acts as a housing for the cartridge and plays a similarly important part to that of the speaker enclosure. An arm should not change the characteristic performance of a good cartridge by introducing resonances or distortion of any sort.



Fairchild, with extensive experience in the development of professional recording equipment, now offers you a studio-quality transcription arm for home music systems. This arm allows the cartridge alone to lift all the tone color from your recordings—completely eliminates the undesirable effects of arm resonance. Continuous perfect mid-groove tracking is assured by precision-engineered offset and dual pivoting. There is no side thrust, skidding or groove jumping.

And the Fairchild Transcription Arm is so easy to use! The arm rest is built-in and automatic. Any standard cartridge, reluctance or dynamic, plugs easily into proper position.

Professionalize your home music system today with the Fairchild Model 280 Transcription Arm.

An extraordinary value at **\$29.50**

For finest listening with any arm be sure to use Fairchild's high compliance diamond cartridge! This professional cartridge completely eliminates listening fatigue caused by tracking distortion—reduces record and stylus wear.

**ONLY \$37.50**

Available at better Audio dealers. Write for free folder.  
**FAIRCHILD RECORDING EQUIPMENT**  
154th Street and Seventh Avenue, Whitestone 57, New York  
Manufacturers of the World's Finest Professional Sound Equipment

**MORE JOBS than graduates**  
Demand for our engineering graduates exceeds supply. Effective placement. Study in this world-famed college established 1884. Quarters start Sept., Jan., March, June. Approved for Korean Vets.

**Electronic Engineers**  
Excellent opportunity for professional growth and advancement in the electronics industry.

**Bach. Sci. degree in 27 months**  
Complete Radio Eng. courses . . . TV, UHF and FM. Also Mech., Civil, Elec., Chem., Aero. and Adm. Eng.; Bus. Adm., Acct. Small classes. Well-equipped labs. Modest costs. Prep. courses. Write Jean McCarthy, Director of Admissions for Catalog and Campus View Book.

**TRI-STATE COLLEGE**  
1694 College Avenue, Angola, Indiana

Hey!  
SEE THE NEW  
PRINTED  
CIRCUIT  
Heathkit  
VTVM  
with P-P Scales

PAGE **95**

# N.J.R.T. TUBES 70% to 90% OFF LIST

## GUARANTEE

ALL NJRT TUBES ARE BRAND NEW AND FULLY GUARANTEED FOR ONE YEAR

Type	Price	Type	Price	Type	Price	Type	Price	Type	Price
1A7GT	.45	6AL5	.39	6BZ7	.55	6W4GT	.45	12V6GT	.50
1B3GT	.67	6AQ5	.39	6C4	.39	6W6GT	.45	12X4	.35
1H5GT	.38	6AQ6	.36	6CB6	.45	6X4	.39	19B6G6	1.15
1L4	.50	6AQ7	.68	6CD6G	1.15	6X5GT	.35	19T8	.75
1NSGT	.62	6AR5	.45	6F6	.45	7E6	.40	25B06GT	.75
1R5	.48	6AS5	.50	6H6	.53	7X6	.58	25L6GT	.45
1S5	.40	6AT6	.39	6J5	.40	7L7	.77	25W4GT	.45
1T4	.48	6AU4GT	.70	6J6	.50	12AL5	.40	35A5	.49
1U4	.48	6AU5	.82	6K6GT	.39	12AT6	.35	35B5	.38
1U5	.40	6AU6	.45	6L6	.62	12AT7	.65	35C5	.38
1X2	.65	6AV6	.39	6R7	.49	12AU6	.38	35L6GT	.45
3A4	.45	6AX4GT	.59	6S4	.39	12AU7	.55	35W4	.45
3Q4	.48	6BA6	.40	6S8GT	.51	12AV6	.50	35Z5GT	.45
3Q5GT	.48	6BA7	.57	6SA7GT	.41	12AV7	.60	45	.53
3S4	.48	6BC5	.49	6SB7Y	.76	12AX4GT	.55	50B5	.41
3V4	.50	6BD6	.45	6SC7	.59	12AX7	.55	50C5	.41
5U4G	.55	6BE6	.39	6SD7GT	.39	12BA6	.40	50L6GT	.59
5Y3GT	.39	6BF5	.55	6SK7GT	.39	12BA7	.57	70L7GT	1.07
5Y4G	.39	6BG6G	1.20	6SL7GT	.49	12BE6	.41	76	.42
6AB4	.42	6BH6	.45	6SN7GT	.55	12BH7	.65	81	1.25
6AF4	.92	6BJ6	.41	6SQ7GT	.37	12BY7	.65	117L7GT	1.19
6AF6	.75	6BK7	.89	6T8	.75	12BZ7	.65	117P7GT	1.39
6AG5	.49	6BL7GT	.65	6U7	.56	12SL7GT	.49	117Z3	.39
6AH4	.67	6BQ6GT	.77	6U8	.59	12SN7GT	.50	807	1.25
6AK5	.59	6BR7A	.92	6V6GT	.45	12SR7met	.55		

T.V. PIX TUBE BRIGHTENER **\$1.39**

PEE-WEE "HIDE-A-WAY" ANTENNA **79¢**  
no bigger than a half dollar.

**HI-PO TV RECTIFIER TUBES LAST LONGER**  
Makes Picture brighter, larger  
HI-PO 567 TO REPLACE 5U4G **\$1.39**  
HI-PO 6578 TO REPLACE 6SN7GT **\$1.95**

**FREE FIVE 1L4 TUBES INDIVIDUALLY CARTONED LIST \$11.25 WITH EVERY ORDER OF \$25.00 OR MORE.**  
Many 7 volt types not listed. All tubes individually boxed. For orders under \$10 add \$1 handling charge. Tubes offered subject to prior sale. Prices subject to change. All orders shipped F.O.B. 25% deposit on c.o.d. shipments.  
SEND FOR FREE TUBE LISTING.



## NEW JERSEY TELEVISION SUPPLY CO.

Sole Distributor of NJRT Tubes

906B WESTFIELD AVE., ELIZABETH, N. J. EL. 5-3900

**NEW! SWING BINS**  
WONDERFUL FOR SMALL PARTS STORAGE!  
**\$2.92**

Unique new storage unit creates extra space for dozens of small items. Easy to attach to any wall, shelf or table top. Clear plastic "see-thru" drawers swing out for easy access. Movable dividers make 1 to 4 compartments in each. Holds everything from nuts and bolts to small tools, bottles, etc. Indispensable for work shop, garage or even the kitchen. Drawer size: 2 1/2" W. x 1 1/8" D. x 9 1/2" L. Screw holes provided in steel bracket for mounting unit in desired position.  
No. 36A198. **\$2.92**  
6 Drawer. NET EACH.....  
No. 36A199. 12 Drawer. NET EACH..... \$6.81

### BURSTEIN-APPLEBEE CO.

1012-14 McGee St., Kansas City 6, Mo.

Send me 36A198.5 enclosed  
 Send me 36A199.5 enclosed

Name.....

Address.....

City..... State.....

Include postage for parcel post shipments.

### 2-METER CONVERTER

Now you can receive 2-meters on a conventional Short Wave Receiver. Especially designed Push-Pull 6J6 R. F. Amplifier into 6J6 Oscillator-Mixer. Balanced line input, coaxial output. All slug-tuned adjustments, high quality components. Output frequency is 21 to 25 MC. Highly stable oscillator.

SMALL SIZE 5" long, 3 1/4" wide, 3 1/2" deep. . . . AN EXCELLENT BUY OF COMPONENT PARTS ENABLES US TO SELL AT THESE LOW PRICES. . . . WE GUARANTEE SATISFACTORY RESULTS. . . .

FOR ADDITIONAL DETAILS REFER TO CQ MAGAZINE: PAGE 32, DEC., 1953

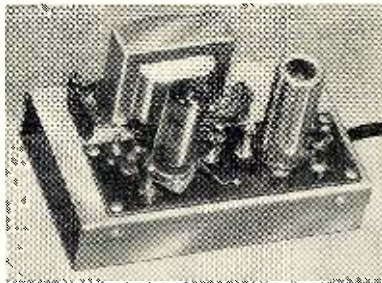

MODEL 2A (Illustrated) with A.C. Power Supply COMPLETELY WIRED, TESTED, ALIGNED UNITS  
MODEL 1A—Without Power Supply— **\$16.95**  
With Tubes .....  
MODEL 2A—With A.C. Power Supply— **\$21.95**  
With Tubes .....  
IN KIT FORM, LESS TUBES, WITH COMPLETE SIMPLIFIED INSTRUCTIONS. PRE-WIRED Excepting Tuned Circuits and Power Supply. Anyone with even the slightest experience can complete in a comparatively short time.

MODEL 1—Without A.C. Power Supply ..... **\$9.95**  
MODEL 2—With A.C. Power Supply ..... **\$14.45**

SEE YOUR LOCAL JOBBER or WRITE US

### K & L RADIO PARTS CO.

1406 VENICE BLVD. LOS ANGELES 6, CALIF.

\*COMING SOON; VFO FOR 2 METERS, HIGHLY STABLE, REASONABLY PRICED.

of *Angel*. This situation is largely due to two outstanding artists, Mario del Monaco, the "Turiddu" of this set, and Maria Callas, the "Santuzza" of the *Angel* set. What a pity these superb artists are not together in the same recording. That would be a truly definitive "Cavalleria." Instead we have Elena Nicolai (not to be confused with Greek mezzo, Elena Nicolaidi) as "Santuzza" in this album, and di Stefano as "Turiddu" in the *Angel* set. Mess, isn't it! Well, if we can't have them together, which of these "Cavallerias" do we want? I made my decision this way; di Stefano in the *Angel* disc is barely adequate in his performance. Elena Nicolai, while no match for the illustrious Callas, gives a quite satisfactory performance; at least she is convincing! The roles of "Alfo," "Lola," and "Lucia" are sung equally well in both the *London* and the *Angel* sets. Tempo, expression, choral balance, all these factors are equal. Thus we come to the question of sound. The *Angel* is productive of good clean sound, but this *London* is quite a few notches above being merely good. Acoustics and vocal/orchestral balance are the best I've heard in an opera recording for some time. The orchestra has a cleaner, more luminous sound than the *Angel*; where percussion tends to "muddy-up" in the *Angel*, it's sharp and accurate in the *London*. There you have it. Better sound plus the better balance of vocal talent, give the *London* set an edge over the *Angel* in my opinion. The *Angel* does have the advantage of being a couple of dollars cheaper, by virtue of the fact they leave the fourth side blank (just the same as in the old acoustic recording days!) and you pay only for "Cavalleria Rusticana." The fourth side in the *London* has an operatic recital by Mario del Monaco. In some familiar arias and a few off the beaten track, he gives further evidence of his tremendous talent. RIAA curve was adequate. Moderately quiet surfaces. —50—

### WAVY LEFT SIDE OF RASTER

By JAMES A. McROBERTS

A WEAVING left-hand side of the raster was experienced on an Admiral model 17DX10 and some others. The right-hand side of the raster was perfectly normal, so the trouble evidently was caused by something upsetting the start of the horizontal sweep. The effect could be caused by vibration of the set cabinet or chassis, or the sound from the loudspeaker.

The defect was localized to the yoke in this instance by tapping various parts with a small rubber mallet of the type used for tapping tubes while testing them. The maximum wave or weave of the left-hand side of the raster (also picture when present) was experienced when the yoke was jarred. The trouble was apparently the upper half winding on the yoke which was varying its capacity to the yoke frame.

The yoke was sprayed with a plastic insulating compound, given an hour to dry, and then tested. The trouble was cured. —50—





# BOOKS

RADIO • T.V. • AUDIO • ELECTRONICS

## Servicemen for Amateurs Experimenters

*New!*

**200. HOW TO USE SIGNAL AND SWEEP GENERATORS.** By J. Richard Johnson. A practical handbook for the service technician, the radio amateur and the experimenter. \$2.00

**228. TELEVISION SERVICING.** By Walter H. Buchsbaum. This gives clear simple instructions on the installation and maintenance of every type of TV receiver . . . shows you how to locate and repair every conceivable trouble a TV set can have . . . offers the latest information on the design and construction of TV receivers. It also devotes an entire, new chapter to color television, showing exactly how color TV receivers differ from black-and-white receivers. \$5.95

**230. THE RADIO MANUAL, Fourth Edition.** By George E. Sterling and Robert B. Monroe. No other single volume now available covers the entire field of radio so thoroughly—from elementary electrical and radio theory to the most advanced applications in AM, FM, and Television Broadcasting, Marine Radio, and Marine Navigational Aids, Emergency Services, State, Federal and International Laws. 820 pages. \$12.00

**232. RADIO TROUBLE SHOOTING GUIDEBOOK, vol. 1.** By John F. Rider and J. R. Johnson. A troubleshooting guidebook that covers AM, FM, troubleshooting, undesired signals, weak signals, distortion, noise, dead receivers. 140 pages. 5 1/2 x 8 1/2. Paper bound. \$2.30

**205. HOW TO TROUBLESHOOT A TV RECEIVER.** By J. Richard Johnson. A step by step guide for newcomers. \$1.80



**206. UHF TELEVISION ANTENNAS AND CONVERTERS.** By A. Lytel. Latest information on all types, covers latest UHF installation techniques. \$1.80

**233. TV TROUBLESHOOTING AND REPAIR GUIDEBOOK, vol. 2.** By Robert G. Middleton. A gold mine of valuable TV service information. Troubleshooting front ends; Servicing the Video I-F strips; Faults in video amplifiers; Trouble analysis in sound I-F and detector systems; Practical pointers in audio amplifier servicing; Trouble in horizontal circuits. 160 pages. 8 1/2 x 11. Paper covered. Price \$3.30

**234. THE RADIO AMATEUR'S HANDBOOK.** Compiled by the American Radio Relay League staff. 800 pages, including catalog section. Price \$3.00

**236. HEARING AIDS, THEIR USE, CARE, AND REPAIR.** By M. Mandl. Provides information needed by users, prospective purchasers, dealers and servicemen. 90 illus. 158 pages. \$3.50

**208. MODERN OSCILLOSCOPES AND THEIR USES.** By Jacob H. Ruiter, Jr., 360 pages, 370 illus. \$6.00

**224. RADIO DATA CHARTS.** By R. T. Beatty. Charts required in the design of radio receivers cover such items as frequency, wavelength, inductance, capacity, frequency, self-inductance, r.f. coil windings, reactance of coils or condensers, transformer design, choke and transformer design. The only equipment necessary to utilize any of the nomograms is a straightedge. \$2.00

**225. TELEVISION SIMPLIFIED.** By Milton S. Kiver. The most up-to-date, complete, and practical television handbook now available for repair men, radio workers and all who are interested in the practical opportunities a working knowledge affords. \$6.75

**226. TELEVISION AND FM RECEIVER SERVICING.** By Milton S. Kiver. New, third edition of this famous definitive text. \$4.20

**227. TELEVISION REPAIR MAN'S TUBE LOCATION GUIDE.** By William Prior, Jr. Almost every known make of set including over 4000 models are covered with tube location diagrams. Put it in your service kit, in your shop, in the home. Only \$1.00

**221. HIGH FIDELITY SIMPLIFIED, 4th Ed.** By Harold D. Weiler. A non-technical explanation of hi-fi techniques and the necessary components which constitute a hi-fi system. Covers the latest tape recorders and the newest types of enclosures and speaker systems. 208 plates. \$2.50

**222. HOME MUSIC SYSTEMS.** By Edward T. Canby. How to assemble parts at greatest savings. \$4.00

**223. HIGH FIDELITY HANDBOOK.** By Greene, Radcliffe and Scharff. A virtual encyclopedia of step by step instructions, hundreds of diagrams that make it easy, inexpensive to select, install, assemble, and enjoy your own HI-FI system for records, tape, FM, AM, TV. Expert guidance in layman's language. \$4.50

**216. A GUIDE TO AUDIO REPRODUCTION.** By David Fidelman. An A to Z explanation of the reproduction of sound. Discusses all phases of systems and requirements plus design, construction, assembly, and testing of systems and components. Explains in detail the circuitry of preamplifiers and amplifiers; complete discussion of phono cartridges, tuners, microphones, loudspeakers and enclosures. For the radio and TV service technician, engineer and experimenter. Companion volume to Weiler's High Fidelity Simplified. 250 pages. \$3.50



**217. HIGH FIDELITY TECHNIQUES.** By John H. Newitt. For the engineer, home builder of audio gear, service technician, studio personnel and professionals in the audio field. 12 chaps. in easy to read language. \$7.50

**218. RECORDING AND REPRODUCTION OF SOUND, 2nd Ed.** By Oliver Read. A complete presentation of the entire subject of sound. Discusses modern theory and methods used in the recording and reproduction of sound, based upon years of experience and research. Includes charts and Appendix. 810 pages. \$7.95

**237. INTRODUCTION TO COLOR TELEVISION.** By M. Kautman and H. Thomas. Discusses color wavelengths and frequencies; primary colors and circuits used in a color TV receiver and gives complete explanations as to their operation—setting up and adjustment procedure. \$2.10

**238. HOW TO INSTALL AND SERVICE AUTO RADIOS.** By Jack Darr. This book for service technicians discusses installation problems and special servicing requirements of the automobile radio. It gives information on antenna installations for the car, vibrator testing, noise suppression, and it furnishes a complete list of tools, spare parts, and other equipment needed to do auto radio repairing and servicing. \$1.90

**239. HOW TO LOCATE AND ELIMINATE RADIO AND TV INTERFERENCE.** By Fred D. Rowe. Both radio and television interference are discussed; why they occur and their solutions. \$1.80

**240. ELEMENTS OF RADIO.** By Abraham Marcus & William Marcus. New revised edition. \$6.00

**241. TRANSISTORS, THEORY, AND PRACTICE.** By Rufus P. Turner. This handbook of current transistor practice will be welcomed by experimenters since it covers, in non-mathematical terms, practical circuitry using transistors. \$2.00

**242. SOUND REPRODUCTION.** By G. A. Briggs. \$3.50

**243. LOUSPEAKERS — The Why and How of Good Reproduction** by G. A. Briggs. \$1.60

**245. AUTOMATIC RECORD CHANGER SERVICE MANUAL.** By Sams Staff. \$3.00

**246. THE AMATEUR'S GUIDE TO TV, RECORD PLAYER, HI-FI, AND RADIO REPAIRS.** By the editors of Popular Science. This special "how-to" book instructs and guides in locating and repairing most of the annoying troubles found in TV, radio, and other home sound units. \$2.95

**247. HOW TO SERVICE TAPE RECORDERS.** By C. A. Tuthill. Operation of recording heads and drive mechanisms used are explained and illustrated. All varieties of electronic circuits used in tape recorders are diagrammed and explained. Trouble shooting techniques. \$2.90

**248. OBTAINING AND INTERPRETING TEST SCOPE TRACES.** By John F. Rider. A book that explains scope traces in clear, non-mathematical terms! \$2.40

**FOR THE YOUNG READER**

**231. ALL ABOUT RADIO AND TELEVISION.** By Jack Gould, Radio and Television Editor, The New York Times. The how and why of radio and television are explained clearly and directly in simple language and with over 100 illustrations and diagrams. It shows how a picture is changed into electricity, how to build a foxhole radio, why we have networks, how to communicate with the moon by radar. 160 pages. 6 3/4 x 9 1/8. \$1.95

## When You Want a Book



Your Radio & TV News Book Service will attempt to procure any book in this field for you. Just send title, author and price.

**MAIL THIS COUPON NOW**

**RADIO & TELEVISION NEWS BOOK SERVICE, Dept. R-9**  
201 East 57th Street, New York 22, N. Y.

I enclose \$..... for which please ship postpaid books circled or indicated below. If not satisfied I can return them within 5 days for refund.

200 205 206 208 216 217 218 221 222 223 224 225 226 227 228 230  
231 232 233 234 236 237 238 239 240 241 242 243 245 246 247 248

Any book not listed..... \$.....

Name.....

Address.....

City..... Zone..... State.....

**ALL ORDERS SHIPPED POSTPAID.** Sorry, no COD's. Add 3% sales tax with orders for N. Y. C. delivery; add 25¢ per title for delivery outside U.S.A., except for APO's.



**SH!**  
**LIKE**  
**NEW!**



**QUIETROLE**  
Reg. U. S. Pat. Off.  
**The ORIGINAL**  
**NON-INFLAMMABLE**  
**NON-CONDUCTIVE**  
**LUBRICANT CLEANER**

CONTROLS & SWITCHES like new by the BASKETFUL for only a few PENNIES . . . that's what QUIETROLE can do for you, and only QUIETROLE will give that long lasting smooth, quiet operation . . . even



new controls last longer and operate quieter when treated with QUIETROLE . . . the original and most reliable product of its kind.

**THE CHOICE OF**  
**BETTER SERVICEMEN**  
**"EVERYWHERE"**

Supplied in 2; 4; and 8 oz. sizes. Ask for it at your distributor.



manufactured by  
**QUIETROLE**  
**COMPANY**  
Spartanburg, South Carolina

**What's New in Radio**  
(Continued from page 108)

Now available are a "Thru-Window Coupler," two-set couplers, and u.h.f.-v.h.f. antenna crossover networks. The couplers are available as the Model C-2 and C-2B, an economy and bifilar-coil unit, respectively. The crossover networks are designated as the UV-2 for installations with one u.h.f. and one v.h.f. antenna while the UV-3 is for one u.h.f. and two v.h.f. antennas.

Data sheets on all five of these products are available from the manufacturer.

**SYLVANIA SCOPE**

Sylvania Electric Products Inc.'s Radio and Television Division, 1221 W. Third Street, Williamsport, Pa. is now offering a sensitive, wide-band, all-

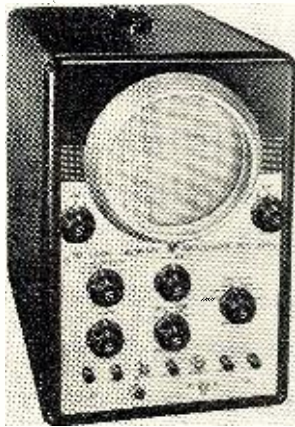

purpose oscilloscope which was created especially for designing and servicing television receivers.

The Type 404 uses a 7" cathode-ray tube for extra-large patterns. Vertical sensitivity is 10 millivolts-per-inch while horizontal sensitivity is 150 millivolts-per-inch. The sweep rate is from 25 cycles to 50 kc.

A data sheet giving complete specifications is available from the company on request.

**SQUARE-WAVE GENERATOR**

New London Instrument Company, P. O. Box 189, New London, Conn. has recently added a square-wave gener-

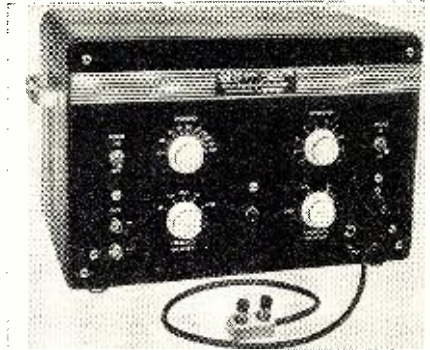

ator to its line of electronic measuring equipment.

The Model 183 provides square waves suitable for testing the transient and

**SAVE! CLOSEOUT SAVE!**  
**COMMAND SETS**  
**NEVER BEFORE! . . . NEVER AGAIN!**

**"Q" 5's** 190-550KC **\$10<sup>95</sup>**  
**LIKE NEW! XLNT COND.**



**274N and ARC 5**  
**EQUIPMENT**

Type BC-455 Revr. 6-9 Mc. Used, with tubes—Like New . . . . .	<b>\$3.95</b>
BC-456 Modulator. Used with tubes . . . . .	3.95
Sold as is, Less tubes . . . . .	2.95
BC-696 Xmtr. As is, Less tubes . . . . .	9.95
BC-457 Xmtr. 4-5.3 Mc. Used, with tubes . . . . .	6.95
Sold as is, Less tubes . . . . .	3.95
BC-458 Xmtr. 5.3-7 Mc. Used, with tubes . . . . .	6.95
Sold as is, Less tubes . . . . .	3.95
BC-459 Xmtr. 7-9.1 Mc. Used, with tubes . . . . .	9.95
Sold as is, Less tubes . . . . .	5.95
BC-450 3 Revr. Control Box. Used . . . . .	1.49
BC-451 Xmtr. Control Box. Used . . . . .	1.49
3 Receiver Rack. Used . . . . .	1.49
2 Xmtr. Rack. Used . . . . .	1.49

**METERS—**

**WESTON • SANGAMO**

All New. All D.C. 2" Square.	
0-5 Ma	
0-15 Ma	
0-50 Ma	<b>\$3.29 each</b>
0-100 Ma	or
0-200 Ma	<b>3 for \$9.00</b>
0-300 Ma	
0-500 Ma	



0-2 Ma . . . . .	\$1.95
Voltmeter. 2" Sq. 0-20 Volts . . . . .	3.29
DC Voltmeter. 2" Sq.—0-300 Volts W/Ext. resistance. Complete . . . . .	\$3.95; 3 for 9.95
RF Ampmeter. 2" Sq.—0 to .5 Amp . . . . .	2.95
Ampmeter 2" rd.—0 to 50 Amp . . . . .	2.29
Ampmeter 2" Sq.—0 to 50 Amp . . . . .	\$3.29; 3 for 9.00
3" Rd. Meters. DC. All New. 0-15, 0-30 . . . . .	
0-100 Mills . . . . .	\$3.95; 3 for 9.00
2 1/2" Rd. 0-30 Mills. Ea. . . . .	3.95
2" Rd. 0-50 Ma. 0 to 5 Ma. Movement . . . . .	\$2.95; 3 for 8.00
Thermocouple. 2" rd. 350 Mill. H.F. . . . .	3.29
Amp. Meter. No. 60-0-60 . . . . .	.97
"S" Meter . . . . .	Used 2.49

GP-7 NAVY XMITTER. 100 watt master os. can use on any freq. from 350-9050 kc. by using proper plug-in. With 1 tuning unit . . . . . \$13.95

Novice Band Crystals . . . . . **99c**

CASH WITH ORDER. Include 4% sales tax with California orders—plus approximate postage. Excess will be refunded. Approximate shipping weight per unit: 15 lbs.

**SAM'S SURPLUS**

1306 BOND STREET LOS ANGELES 15, CALIF.

*New* **HEATHKIT**

**VFO**  
AND  
**HAM**  
**GEAR**



ON PAGE  
**100**

**LEARN TV SERVICING**

Send for free 24-page illustrated booklet which tells you how to become a successful TV technician. America's leading TV servicing school offers you a specialized training program that omits non-essential math & design theory. You concentrate on radio & TV servicing only. You get professional training & experience right in our fully-equipped shops & laboratories. Write Dept. R-94.

Approved for Veterans  
**WESTERN TELEVISION INSTITUTE**  
341 W. 18th St. Los Angeles 15, Calif.

# coming in September...

...THE FIRST AND ONLY MAGAZINE ON  
PRACTICAL ELECTRONICS FOR THE  
HOBBYIST, THE EXPERIMENTER AND  
THE NOVICE.

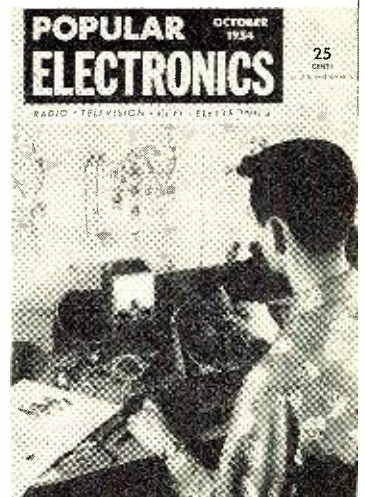

POPULAR ELECTRONICS will provide all the essential information on electronic components, construction, instruments and systems. Yet, it will be written simply enough so that even those with a beginner's knowledge of electronics can readily understand its how-to-build-it, how-to-use-it, how-it-works articles.

**POPULAR ELECTRONICS WILL MAKE THE IDEAL SUPPLEMENT TO YOUR READING OF RADIO & TELEVISION NEWS . . . POPULAR ELECTRONICS WILL MAKE THE PERFECT GIFT FOR THE ELECTRONICS BEGINNERS AMONG YOUR FRIENDS.**

*Every issue will be filled with easy-to-understand articles like these . . .*

- OPPORTUNITIES IN ELECTRONICS
- INTRODUCTION TO HIGH FIDELITY
- PICTURES ON MAGNETIC TAPE
- HOW TO BUILD A BIKE RADIO
- HOW TO LAY OUT A CHASSIS
- HOW RADAR WORKS
- MEET THE TRANSISTOR
- HOW TO SOLDER
- VOICE-OPERATED MODEL TRAIN CONTROL
- BUILDING THE HOME BROADCASTER

(Fill out this form and mail it today.)

THE FIRST ISSUE IS CERTAIN TO BE A SELLOUT AT NEWSSTANDS . . . AND A COLLECTOR'S ITEM IN YEARS TO COME! MAKE SURE YOU AND YOUR FRIENDS RECEIVE YOUR COPIES!

**ORDER YOUR OWN AND GIFT CHARTER SUBSCRIPTIONS NOW AT THE SPECIAL INTRODUCTORY RATE OF ONLY \$1.00 FOR 5 ISSUES (NEWSSTAND PRICE 25c)**

**Please enter my CHARTER SUBSCRIPTION to  
POPULAR ELECTRONICS**

**INTRODUCTORY RATE: 5 ISSUES—\$1.00**

My Name \_\_\_\_\_

Address \_\_\_\_\_

City \_\_\_\_\_ Zone \_\_\_\_\_ State \_\_\_\_\_

Please enter my Charter Subscription to  
POPULAR ELECTRONICS.

Please enter a Charter Subscription to  
POPULAR ELECTRONICS as my gift to:

Name \_\_\_\_\_

Address \_\_\_\_\_

City \_\_\_\_\_ Zone \_\_\_\_\_ State \_\_\_\_\_

Donor's Name \_\_\_\_\_

(to appear on gift card)

I enclose \$ \_\_\_\_\_ for \_\_\_\_\_ Charter Subscriptions at  
\$1.00 each.

Mail today to

POPULAR ELECTRONICS

366 Madison Ave.

New York 17, N. Y.

R 9-4

**JUST A FEW SAMPLES  
FROM OUR NEW  
FALL CATALOG!!**

**AUTOMATIC SYNCHRONOUS  
DUAL TIME DELAY  
Cramer Relay  
Model 1-C2H**

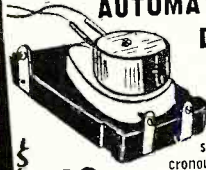
 Dual continuously interrupting switch timer. 60 cycle AC synchronous motor revolves at 1/2 RPH operating 2 single pole single throw 15 ampere switches. One switch is cammed so that it is open for one hour and then closed for one hour. The other is cammed to open for one 5 minute period every two hours. The two cams are so arranged that the two switches are in the open position simultaneously for 5 minutes out of each 2 hour period. Guaranteed Brand New. Overall size — 4 x 3 x 2 3/4". Shpg. wt. 1 1/2 lbs. Stock No. 99-0-1C2H...Worth \$12.50

**Fantastic Value!!**

**HAYDON  
3.6 Watt — 1 RPM  
TIMING MOTORS  
110 V — 60 Cy.**



**\$1.39**

Reg. \$7.50 Value **Quantity Limited**

**FM Dipole 98¢  
VEE-DX MODEL DRFM**



**Safety Before Sorrow!!**

**Miniature 20 amp  
Circuit Breakers**

**Single Pole — 98¢ ea.  
Non-Trip Free**

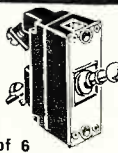

94¢ ea Lots of 6  
Good for 20 Amps 115 Volts AC/DC

**DOOR INTERLOCK SAFETY SWITCHES**

**TYPE A** GE Pressure Type  
10 Amp- 125 Volts



**TYPE B** BRYANT AC Receptacle  
Type 10 Amp- 125 Volts



Your Choice  
Type A or B  
**79¢**  
Lots of 10 73¢



**HEADSET "POT-LUCK"**

High Impedance  
U.S. Govt. **98¢**  
Headsets ea.

CONCORD RADIO 53 Vesey St., N. Y. 7,  
Dept. N9

20% deposit with C.O.D. **MINIMUM ORDER \$5.00**  
 Send new CONCORD CATALOG!

NAME \_\_\_\_\_  
ADDRESS \_\_\_\_\_  
CITY \_\_\_\_\_ ZONE \_\_\_\_\_ STATE \_\_\_\_\_

Dlgbv 9-1132

**Concord Radio • 53 VESEY ST. NEW YORK 7, N. Y. •**

frequency response of wide-band amplifiers and accurately measures their amplitude. The frequency range is from 10 cps to 1 mc. continuously variable over decade steps. It has a low impedance output which provides 10 volts plate-to-plate. A high impedance 100 volts plate-to-plate is available. A 60 db step attenuator and a 20 db continuous attenuator provide means of using the generator as a voltage calibrator.

**FIELD STRENGTH METER**

Industrial Television, Inc., 369 Lexington Avenue, Clifton, N. J. is in production on a new version of its field strength meter.

The new model IT-136R features continuous u.h.f. tuning, a Standard



Coil v.h.f. tuner, preselection stage for maximum selectivity, and freedom from spurious response.

It is lightweight for portability, a.c. operated for economy, and battery operable for maximum versatility.

**CRYSTAL PHOTOCELLS**

Standard Piezo Company of Carlisle, Pa. is now offering low cost and extremely small cadmium sulfide crystal photocells which are capable of operating inexpensive sensitive relays directly without an amplifier.

Standard types as small as 1/4" diameter by 1/4" deep, exclusive of leads, deliver from 2 to 5 ma. when exposed to light of from 50 to 100 footcandles intensity with approximately 100 volts applied across cell and load. Thus, where a light source of good intensity is available, no amplifier is needed.

Bulletin PC-10, giving complete details, is available upon letterhead request.

**SERVICE INSTRUMENT**

Superior Instruments Co., 2435 White Plains Road, New York 67, N. Y. has announced an improved version of the "Super Meter," the Model 670-A. The new model now includes a built-in isolation transformer which reduces the possibility of meter damage by 50 per-cent.

In addition to its function as a v.o.m., this unit also measures capacity, reactance, inductance, and decibels. It also includes a "good-bad" scale for checking the quality of electrolytics at a test potential of 150 volts.

The Model 670-A is housed in a crackle-finished steel cabinet which measures 6 1/4" x 9 1/2" x 4 1/2". It comes complete with test leads and operating instructions.

-50-

SEE ALL *Three*  
BRAND NEW  
HEATHKIT  
SCOPES  
ON PAGE  
**93**



**BUY DIRECT  
MANUFACTURER TO DEALER**  
ANTENNAS-INSTALLATION  
HARDWARE AND ACCESSORIES  
WRITE FOR CATALOG

*Skysweeper inc.*  
P. O. BOX 68A  
McHENRY, ILL.

**Faster, Easier, more PROFITABLE Operation**

Get into the **MASTER habit!**

Brings you the product data of the industry in one handy book — all products vital to your daily sales and service operations. In the customer's home, across the counter or on the bench, you'll value the MASTER'S thoroughly complete descriptions, specs, illustrations and prices . . . all systematically organized in 18 big sections. Over 1300 pages of unabridged catalog data direct from the manufacturers. Keeps you abreast of all latest Electronic products. Increase your sales and speed-up your buying — the MASTER way.

As **\$1.95** at your parts distributor. Publisher's price **\$6.50.**

Get Your MASTER now from leading parts distributors or write to:  
United Catalog Publishers, Inc., 110 Lafayette St., N. Y. 13

Eliminates Small Catalogs and Loose Literature

OFFICIAL BUYING GUIDE OF ELECTRONICS-TV-RADIO INDUSTRY

- 1370 pages
- 8" x 11" — 5 lbs.
- Over 8,000 illus.

Just a few of the more than 85,000 items included:

Tubes — Transmitters  
Test Equip. — Receivers  
Transformers  
Capacitors — Antennas  
Resistors — Wire & Cable  
Coils & Relays  
Recording & PA  
Hardware & Tools

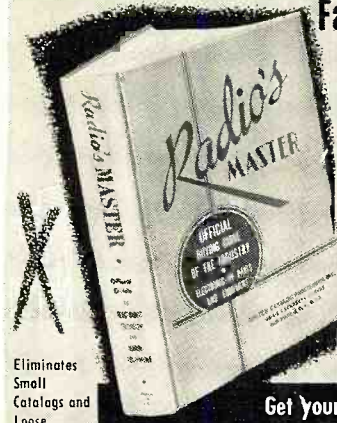

## International Short-Wave

(Continued from page 90)

at times. (Cox, Dela.; Machajewski, N.Y., others)

**Falkland Islands**—A new and more powerful transmitter is being erected at Port Stanley; listed schedule on 6.125, 1500 kc., and 600 kc. as 1815-2000. (Radio Sweden)

**Fiji Islands**—*Radio Suva*, 3.980, noted with BBC news relay 0400, bad QRM; listed schedule of 0030-0530, 1400-1600, 1900-2100, 500 watts. (Zahner, Md.)

**France**—Paris, 11.845, noted around 1400 to Middle East in French. (Zahner, Md.) Heard with *English* for the United Kingdom 1500-1600 on 11.700. (Morgan, Calif., others) Uses 6.045 in parallel now. (Pearce, England)

**French Equatorial Africa**—*Radio Brazzaville*, 11.970, is strong around 1700. (Sicks, Ore.)

**French Guiana**—*Radio Cayenne*, 6.232A, noted in French 1742 but at weak level. (Hardwick, N. Z.)

**French West Africa**—*Radio Dakar*, 9.560A, heard 0247 with man in French, fair level in Calif. (Morgan)

**Germany**—*Radio Liberation*, Munich, now operates over 3.990, 6.055, 6.175, 6.185, 7.130, 7.225, 7.275, 9.585, 9.680, 9.765, 11.720, 11.765, 11.780; 3.990 and 6.175 are 20 kw., others are 10 kw. (WRH) *Deutsche Welle*, 11.795, Cologne, noted closing 1035. (Morgan, Calif.) Heard on this frequency 2000 with news in Spanish to Latin America. (Ferguson, N.C.) Noted to North America 2030-2330 over 7.290, 6.075. (Alley, Mass., others)

**Gold Coast**—Gold Coast news is radiated from Accra, 6.049, at 0745; on 4.915 at 1245. (NNRC)

**Greece**—Chania, 6.678, noted in Greek 1300, weak and with CWQRM. (Hardwick, N.Z.) Overseas sources say *Radio Athens*, 11.718, now has *English* 1200-1300, 1330-1430. (Radio Australia, others) Larissa, 9.745, noted 1450 with operatic selections; with music also around 0115. (Pearce, England)

**Guatemala**—TGNB, 9.668, noted at good level 2230 in *English*. (Brooks, Kans.; Braunstein, Conn.) TGCQ, 9.700A, *Radio Central*, heard around 1800-1900 in Spanish. (Saylor, Va.) TGWB, 6.180, good level around 2000. (Morgan, N.Y.)

**Haiti**—On a recent Wed., *Radio Commerce*, 6.088A, was noted with French-*English* lesson 1745. (Bellington, N.Y.) Heard on 9.485 at strong level 1730 in French. (Grennell, Ohio) 4VEH was recently measured on 9.656 at 0930, good level in N.C. (Ferguson)

**Holland**—Hilversum, 1173, good with *English* 1645-1725A. (Brooks, Kans., others)

**Hong-Kong**—ZBW3, 9.525, noted 0515 at good level with music. (Sanderson, Australia)

**Hungary**—*Radio Budapest* noted 2300-2300 to North America on 9.833. (Rugel, Kans.) Is again noted using 11.910 at 1700 for *English* session.



**WHEN CORROSION TRIES TO SMEAR PERMA-TUBE STAYS CLEAN**

... and so does your reputation!

**Here's why PERMA-TUBE backs up quality service:**

- 1. PERMA-TUBE IS CORROSION-PROOF . . .** it's treated with vinsynite—then coated *inside and outside* with a metallic vinyl resin base. It's guaranteed to be free from rust in a salt spray test of 500 hours minimum to an American Society of Testing Materials Specification B117-49T. This assures long life.
- 2. PERMA-TUBE IS STURDY . . .** it's made of special, high-strength J&L Steel.
- 3. PERMA-TUBE IS EASILY INSTALLED . . .** it's the only mast with *both ends* of the joint machine fitted.

**Here's proof of how PERMA-TUBE resists corrosion.**

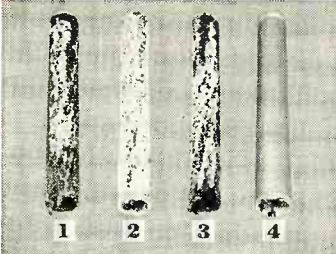

- 1 . . . Mechanical tubing (note white corrosion and pitting)
- 2 . . . Mechanical tubing (note white corrosion and pitting)
- 3 . . . Galvanized mechanical tubing (note zinc is completely gone and steel severely pitted)
- 4 . . . PERMA-TUBE (note there is literally no creepage of corrosion from the cut edge and coating is intact down to base steel)

Test samples after 40-day corrosion test. Immersed in 3.3 per cent salt solution in jars.

**What is your reputation worth?**

This book is like an insurance policy for quality service. Write for your copy today! It's free.



**J&L  
STEEL**

Jones & Laughlin Steel Corporation  
Dept. 495, 3 Gateway Center, Pittsburgh 30, Pa.  
Please forward a copy of your "PERMA-TUBE" booklet.

Name \_\_\_\_\_  
Company \_\_\_\_\_  
Address \_\_\_\_\_

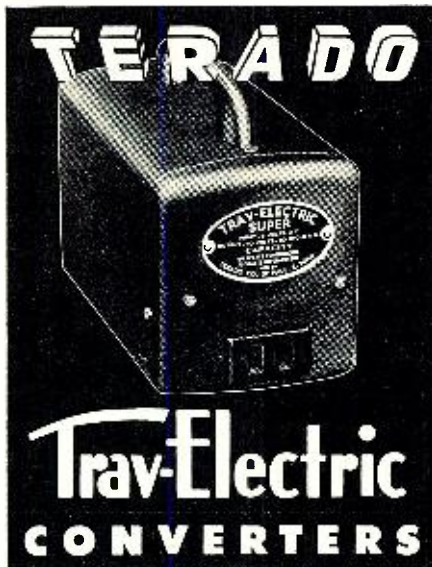

Provide  
**House Current  
Anywhere**

—from battery in car, truck, boat. At the beach—picnic grounds—at cabin—on trips—anywhere!

Easy! No installation! Just plug Trav-Electric into cigar lighter on dash.

**Trav-Electric Operates:**

- Tape Recorders
- Electric Shavers
- Radios
- Soldering Irons
- Dictating Machines
- Small Electric Drills
- Portable Phonographs
- Etc., etc., etc.

**6 Models—10 to 100 Watts**  
—a size for every need

**"MIDGET"**

Model 6-11160  
10-15 Watts  
About as small as a pack of cigarettes  
**\$11.95 LIST**



**"JUNIOR"**

Model 6-110  
115 Cycle—30-40 Watts  
**\$12.95 LIST**

**"SENIOR"**

Models 6-1160  
Size 2 1/2" x 2 1/2" x 4 1/2"  
35-40 Watts  
**\$15.95 LIST**

**"MASTER"**

Model 6-51160  
40-50 Watts  
Size 4" x 5" x 6"  
**\$27.50 LIST**

**"SUPER"**

Model 6-71160  
(Shown at top of ad)  
60-75 Watts  
Size 4" x 5" x 6"  
**\$37.95 LIST**

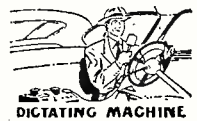

**—and now, the "CHIEF"**

New—just out—Model 6-81160—75-100  
Watts—automatic on-off switch—  
**\$49.95 LIST**

See your Electronic, Hardware,  
or Automotive Jobber or Dealer

**Terado Company**

Designers and Mfrs. of Electronic Equipment  
**1058 Raymond Ave., St. Paul 14, Minn.**

In Canada Write: Atlas Radio Corp., Ltd.  
560 King St. West, Toronto 28, Ont.  
Export Sales Division: Scheel International, Inc.  
4237 N. Lincoln Ave., Chicago 18, Ill., U.S.A.  
Cable Address—Harsheel

*Iceland*—TFJ, 12.174, Reykjavik, is still coming through in its *Sunday only* session 1115-1130. (Cox, Dela.) Has poor modulation. Sent new QSL card which shows view of transmitter. (Pearce, England)

*India*—AIR broadcasts in *English* to Europe daily 0230, news 0235, over 15.380, 17.740. (Radio Sweden) Glendemann, Calif., reports AIR on 9.685A around 0735-0915.

*Indo-China*—"Voice of Vietnam," Saigon, has news now 0900 on 9.625 *only*, and is then parallel with *Radio France-Asie*, 11.83; the 7.27 outlet has news in French 0815 and is not in parallel with 9.625 at that time. (Balbi, Calif.) *Radio France-Asie*, 9.755, still has *English* for Europe 1100. (Pearce, England, others) Heard on 15.420 at 0345 with *French-English* lesson and music. *Radio Hirondelle*, 7.405, Hanoi, noted 0500 with news in French. (Sanderson, Australia) *Radio-diffusion Nationale Khmère*, Cambodia, now radiates on this schedule—Phnom-Penh, 6.090, 1 kw.; *testing new* 10 kw. transmitter also; Battambang (*new*), 6.035, 50 watts; Siemreap (*new*), 4.970, 200 watts, in French and Cambodian 2300-0100, 0500-0815, 1800-1900. (Scheiner, N.J.)

*Iran*—*Radio Teheran*, EPB, 15.100, can be heard some days as early as 1330. (Ferguson, N.C.) Has news 1515, closes 1530. (Crowell, Pa., others)

*Iraq*—*Radio Baghdad*, HNQ, 11.702A, noted *after* 2344 when Stockholm closes on 11.705; has Arabic vocal music; when Stockholm puts carrier back on the air for Western North America 2351A, Baghdad is blocked out. (Morgan, Calif.) Has brought into use *new* channel of 3.295A for broadcast in *English* for Europe 1415-1500 close-down; news 1430. (Cushen, N.Z., others)

*Israel*—Tel Aviv now is using the *new* 50 kw. transmitter for French ("*Voice of Zion*") session 1515-1600, and for *English* 1600-1645 close-down; by now may have inaugurated special beams for America, Europe, Africa; lists current frequency as 9.008. (Levy, N.Y.; Silverman, N.Y., others)

*Italy*—Rome, 9.57, excellent in *English* 2130-2150. (Kirby, Mo.) And parallel on 9.780. (Ballou, Calif.) Noted with Italian session (starting with news) from 2000 to North America on 9.78. (Ferguson, N.C.) With *English* 1915 on 11.905A parallel 9.57. (Parsons, Pa., others) Heard opening to Britain with news 1330 on 7.290, 11.810, 15.400. (Pearce, England)

*Japan*—During recent *tests*, the *new* commercial outlet, JJ2KY (now JOZ), 3.925, was heard at fair level 0600. (Balbi, Calif.) QRA for this one is Nippon Short Wave Broadcasting Co., 13 Akasaka-shinsaka, Tokyo, Japan. (ISWC, London) Should be operating now regularly around 1700-0900 as JOZ, 3.925, and JOZ2, 6.095. (N. Z. *DX Times*)

*Kenya Colony*—Nairobi has moved from 4.855 to 4.885 to avoid interference to another station which had prior claim to 4.855; transmissions are

ELECTRICAL  
ENGINEERS  
or  
PHYSICS  
GRADUATES

with experience in  
RADAR  
or  
ELECTRONICS  
or those desiring to enter  
these areas...

The time was never  
more opportune than  
now for becoming  
associated with the field  
of advanced electronics.  
Because of military  
emphasis this is the most  
rapidly growing and  
promising sphere  
of endeavor for the  
young electrical  
engineer or physicist.

Since 1948 Hughes Research and Development Laboratories have been engaged in an expanding program for design, development and manufacture of highly complex radar fire control systems for fighter and interceptor aircraft. This requires Hughes technical advisors in the field to serve companies and military agencies employing the equipment.

As one of these field engineers you will become familiar with the entire systems involved, including the most advanced electronic computers. With this advantage you will be ideally situated to broaden your experience and learning more quickly for future application to advanced electronics activity.

Positions are available in the continental United States for married and single men under 35 years of age. Overseas assignments are open to single men only.

Scientific and Engineering Staff



RESEARCH AND  
DEVELOPMENT  
LABORATORIES

Culver City,  
Los Angeles County,  
California

Assurance is required that  
relocation of the applicant  
will not cause disruption of  
an urgent military project.

primarily intended for listeners in Kenya and antennas are designed accordingly, station officials point out. (Radio Sweden, others)

**Kuwait**—Radio Kuwait, 5000, is heard in N.Z. in Arabic 1500, signs off 1600; good level. (Hardwick)

**Malaya**—BFEB, Singapore, noted 0815 on 11.955. (Cox, Dela.) Heard on 11.820 at 0800-0815. (Rugel, Kans.) Noted on 9.690 at 0430 with news. (Sanderson, Australia)

**Radio Malaya**, 7.200, Singapore, has news 0900. (Paris, Australia via Malmö DX-aren, Sweden)

**Mexico**—XEXE, 11.900, Mexico City, is good level around 1930 in Spanish. (Roeseher, Ill.)

**Mozambique**—Lourenco Marques, 7.240A, is heard in Japan in English 0955, and with "Lucky Disc" program. (Japanese Short Wave Club)

**New Caledonia**—Radio Noumea, 3.375, noted at weak level 0253 with music, French announcements, news in French 0300 by man; also heard 0300 on 6.035A, weak but clear. (Cox, Dela.) Strong in Calif. on 6.035A at 0310. (Morgan) Cushen, N. Z., says the 3.375 outlet has been noted with a new transmission from 1400 for "early morning listeners" in New Caledonia.

**New Zealand**—ZL2, 9.540, noted 0200-0300; ZL3, 11.780, heard closing 2300. (Milnes, Ore.)

**Nigeria**—Lagos, 4.800, logged 1700 with news, closed 1710. (Cox, Dela.) Kaduna, North Regional Station, 3.327, is noted at fair strength in England around 1445 with African music. (Fairs, via URDXC)

**Norway**—Radio Norway, 7.210, Oslo, good level to North America 2000-2100 (Sun. to 2020 when has closing feature "Norway This Week" in English). (Braunstein, Conn., others)

**Pakistan**—Radio Pakistan noted on 11.885 parallel 15.225A in Southeast Asia beam now 1945-2030A, news 2000; best on 11.885. (Bellington, N.Y.) Heard on 15.255 in English 0745-0830; in English 1500-1545 on 7.010, 9.545. (Crowell, Pa., others) Has news 0945 on 9.484 now. (Pearce, England) Heard on 11.914 at 1915 with news. (Sanderson, Australia)

**Panama**—HP5J, 9607, Panama City, fair 2135 with classical music. (Cox, Dela.) HORT, Radio Balboa, 6.065, has been heard in N. Z. before 0630.

**Paraguay**—ZPA1, 5.955A, Asuncion closes down 2200. (N. Z. DX Times) ZPA4, 9.735, Radio Stentor, noted in Spanish 2100, fair level in N. Z. (Hardwick)

**Peru**—OAX4T, 9.562, and OAX4Z, 5.955, Lima, are both used for English 2300. (Radio Australia, others)

**Philippines**—DZH9, 11.855, Manila, is strong 0900 when has world news. (Grimm, Texas) Heard over DZH7, 9.730, at 0500-1130 with news, native music. (Milnes, Ore.) Good on this frequency 1000 with religious session. (Brown, Wyo.)

**Poland**—Radio Warsaw noted on 9:615 with interval signal 1700, then with French session. (Bellington, N. Y.)

# NEW SURPLUS AT NEW LOW PRICES

### FLUORESCENT FLOODLIGHT



This unit uses 6 15 Watt fluorescent bulbs in parallel on 115 V., 60 CY. AC. Unit measures 21" x 21" x 4" and weighs approx. 30 lbs. Will make an ideal Bench Light, Garage Light, or use 2 or more for photographic Floodlights. These units are all NEW. This is a \$75.00 Value, priced specially low less tubes with starters and ballasts. \$14.95 Ea.

### RADIOSONE UNITS

Type AN/AMQ-1. Used by weather stations. Unit is sent into air on balloon to transmit information on temperature, moisture, and barometric pressure to the ground. All New. \$4.94 Ea.

### 304 TL TUBES

High Power Triode. Bulk Packed. All Checked. Special \$2.95 Ea.

### RADIO DIRECTION FINDER



BC-1003 Receiver. Frequency Range 100 KC-1000 KC in 3 bands. Has Loops mounted on top with Sense and Balance Circuits. Less power supply. In Exc. Cond. with Tubes. \$49.95 Ea. 12 V. Input Dyn. for above Receiver \$6.95 Ea.

### SPECIAL A.C. MOTORS

1/40 Horse Power. Bodine Sync. Motor, 1800 R.P.M. Operates on 110, 115, 60 Cy. Has 2 shafts and fan type fan mount. Uses 5 Mfd. capacitor for starting. Used for Fan, or small Grinder, Buffer or Hobby work. All in excellent condition. \$7.95 Ea. Capacitor \$1.00

### MIDGET SELSYNS

AV6 type operates from 6-12 Volts 60 Cycle. Use as both transmitter and receiver. These compact little units draw almost no current and work fine for all remote position indicating applications. OD 2 1/4" x 1 1/4" x 2". Has screw return shaft. All New (Appr. wt. 1 lb.) \$1.95 Ea.

### SELSYN MOTORS



Type 5F Synchro Motors, used in pairs for remote tuning or remote position indicators. 115 V., 60 Cy. operation. Size 3 1/4" Dia. \$35.00 Pair long. Like New.

### BC 375 TUNING UNITS

TU-3 (200-500 KC), TU-7 (4500-6200 KC), TU-8 (6200-7700 KC), TU-9 (7700-10000 KC), All with Vernier Dials. And Many useful parts. All used. Low Price \$1.50 Ea.

### POLE CLIMBERS AND BELTS

Telephone Type Climbers with Leather Leg Straps. Used. Excellent Cond. \$2.95 Ea. Safety Tool Belts. Leather, to use with pole climbers. Used. Excellent Cond. \$3.50 Ea.

### BC-659 TRANSCEIVER



Ideal Mobile Equipment Operating from 6, 12, or 24 Volts DC Power Supply. Frequency Range 27 MC to 38 MC F.V. Unit is crystal controlled. With Vibrator Power Supply and Tubes less crystals. All New \$35.00 Set

### MICA CAPACITORS FIG. A UPRIGHT MOUNTINGS

MFD	1000 V. Ea.	MFD	2500 V. Ea.	MFD	Ea.
.01	\$1.00	.025	2.25	.00006	.95
.07	.95	.0075	1.50	.00005	.95
.062	.90	.005	1.50	.004	3.50
.05	.85	.00025	1.25	.002	3.25
<b>1500 V.</b>					
.075	1.25	.006	1.50	.0015	3.25
.05	1.10	.005	1.50	.00075	2.75
.039	1.10	.003	1.50	.00045	2.25
.03	1.00	.002	1.50	.0004	2.25
<b>2000 V.</b>					
.03	2.25	.00025	1.35	.00009	1.50
.01	2.00	.00015	1.25	<b>7500 V.</b>	
.006	1.50	.0005	1.25	.0005	3.95
.005	1.50	.00025	1.25	<b>8000 V.</b>	
.003	1.25	.00015	1.25	.01	5.95
.00275	1.25	.0001	1.15	.0006	4.50
.0025	1.25	.00009	1.10	.0005	4.50
.00125	1.00	.00008	1.00	.00025	3.95
.00003	1.00	.000075	1.00		

### FIG. B SCREW TERMINAL CAPACITORS

MFD	500 V. Ea.	MFD	1200 V. Ea.	MFD	2500 V. Ea.
.05	1.00	.022	.85	.015	1.60
.04	.95	.02	.85	.01	1.50
.02	.75	.01	.75	.0035	1.25
<b>600 V.</b>					
.01	.65	.001	.65	.003	1.25
.007	.65	.005	.50	.002	1.00
<b>1250 V.</b>					
.0375	.75	.025	.95	.0018	1.00
.02	.75	.03	.95	.00063	.90
.0005	.45	.01	.80	.0005	.90
.00015	.35	.006	.80	.0004	.85
.00005	.35	.004	.60	.00025	.85
<b>1000 V.</b>					
.01	.75	.004	.75	.00015	.85
.00005	.50	.00007	.75	.00005	.75

### CAPACITORS WITH FIXED OIL FILLED SOLEIL, PYRANOL, C.D. ETC. ALL D.C. VOLTAGE RATINGS

MFD	400 V. \$0.79	MFD	1000 V. \$1.00
2	400 V. \$0.79	2	1000 V. \$1.25
333	400 V. 2.95	3	1000 V. 3.95
10	400 V. 1.75	10	1000 V. 4.95
1	600 V. 1.95	1	1500 V. 1.50
4	600 V. 1.95	4	1500 V. 2.25
6	600 V. 1.95	1	2000 V. 1.95
8	600 V. 1.95	2	2000 V. 1.95
8x8	600 V. 2.25	3	2000 V. 3.50
10	600 V. 2.95	1	3000 V. 3.95
15	600 V. 2.95	1	3000 V. 3.95
20	600 V. 2.95	1	3000 V. 3.95

All Mail Orders Promptly Filled, F.O.B., San Francisco. All California Orders—Add 3% Sales Tax. Do not send postage stamps. 20% Dep. on all C.O.D. orders. All items subject to prior sale and prices subject to change without notice. On purchases under \$5.00 send full amount.

### Thousands! CRYSTALS Thousands!

FT-241 54th Harmonic Type. Fundamental Frequencies Listed below in KC.

370	390	410	430	449	469	486	508
372	392	412	432	451	471	488	510
374	394	414	434	453	471	490	512
376	396	416	436	454	473	492	514
378	398	418	438	456	475	494	516
380	399	420	440	458	477	496	518
382	400	422	442	460	479	498	520
384	402	424	444	462	481	502	
386	404	426	446	464	482	504	
388	406	428	447	466	484	506	

Each Frequency \$1.60  
500 KC. \$1.25

### CRYSTALS DC-34 and DC-35, 3/4" Spacing

1690	2090	2360	2710	3000	3390	3700	3890	4065	4280
1705	2105	2375	2711	3010	3395	3702.5	3895	4080	4305
1720	2106	2390	2732	3027.5	3412	3705	3905	4085	4310
1770	2155	2395	2745	3077.5	3440	3710	3920	4080	4325
1790	2175	2415	2764	3095	3462.5	3730	3925	4095	4335
1810	2185	2422	2775	3117	3480	3745	3935	4115	4345
1830	2202	2435	2776	3149	3485	3750	3940	4130	4350
1850	2215	2446	2807	3155	3500	3765	3950	4135	4370
1870	2220	2466	2816	3161	3520	3770	3960	4150	4380
1890	2235	2478	2831	3190	3540	3775	3965	4155	4397.5
1910	2240	2491	2851	3201	3550	3790	3985	4175	4405
1930	2255	2514	2863	3270	3575	3795	3990	4175	4415
1950	2258	2540	2894	3279	3580	3807.5	4012.5	4192.5	4435
1970	2275	2586	2899	3280	3610	3825	4015	4210	4440
1990	2300	2587	2925	3311	3630	3830	4020	4215	
2010	2315	2605	2926	3317.5	3650	3850	4030	4235	
2030	2326	2625	2960	3345	3655	3855	4035	4240	
2050	2335	2643	2971	3365	3660	3870	4050	4255	
2075	2365	2685	2980	3385	3680	3885	4055	4275	

PRICE 50c Ea. \$6 for \$4.50  
SHIP FREQUENCIES 2142, 2174, 2615, 2670 \$2.00 Ea.

### 12 VOLT DYNAMOTOR



PE-55 Power Pack. Complete New Unit with DM-19 Dynamotor, Filter and Relay Base. Continuous Ratings, 500 V. @ 200 MA output or intermittent 500 V. @ 400 MA. These are all NEW in original cases. \$17.95 Ea. Output Cable for above dynamotor. \$2.95 Ea.

### RM-29 FIELD PHONES

Remote control unit for Transmitter or Receiver which can be used in pairs over wire with internal 4 1/2 V. battery as field telephones. Enclosed in a metal case and with canvas carrying bag. Ideal for House, Garage or Intercom. All NEW less handsets @ \$8.95 Ea. \$16.95/Pk.

### PE 104 VIBRATOR POWER SUPPLY

Part of BC-654 Transformer, Input, 60 R 12V.D.C. Output, 6, 14 and 84 U.D.C. Pos. 1.4, 6, 12 and 31 V. D.C. Neg. In excellent condition. \$8.95 Ea.

### SIGNAL LIGHTS



Type K3, 12 volt Signal Lamps. Portable bakelite enclosed 12 Volt Sealed Beam Light. Use as Flashing Signal or Steady Signal. Comes with mounting bracket for permanent mount with carrying case, and 20 feet rubber covered Heavy Duty Extension Cord. All New. \$4.95 Ea.

### 12 or 24 VOLT VIBRATOR INVERTER

Use for Mobile Radio, Trucks, Boats, etc. where 110 Volt, 60 Cycle is desired. Can be used with 12 or 24 Volts D.C. input, 110 V., 60 cycle, 240 watt maximum output. Uses separate vibrator for each input voltage. In enclosed case. Ideal for motor use. excellent condition. \$27.50  
12 Volt 68 Amp. Hour Battery—New \$14.95

### TUBE SPECIALS

2K54 \$24.95 Ea.  
5J33 9.95 Ea.  
All New—Original Carton.

### PARTS BOXES



Durable, Strong Wood Boxes with 2 drawers. Corners are 1 1/2" thick. Will make an ideal box for storing small resistors, condensers, fuses, or any small parts on tools. Dimensions 10 1/2" W. x 17 1/2" L. x 7" H. Drawer dimensions are 9 1/2" W. x 16 1/4" L. x 2 3/4" H. Hinged cover and carrying handle. All New. \$2.95 Ea.

### LOW VOLTAGE CIRCUIT TESTERS

These Testers made for checking complete ignition system in 6 or 12 Volt cars or trucks. Generator, Regulator, Battery, Etc. Can be checked individually or together while engine is running or still. These units are all in excellent condition. Low Priced. \$17.95 Ea.

### SOUND POWER HANDSETS



Use these phones without any external or internal voltage supply. Two or more can be used with only 2 wires interconnecting them. Use for TV installation, house to house or house to garage. All new. Per Pair \$18.95

### FIELD TELEPHONES

EE-8 Type, Uses 2 1 1/2 Flashlight Batteries for Power. Transmits over wire up to 10 miles, with Magneto Ringer. In Leather Case. In excellent Condition. \$32.50 Per Pair

### HEAD SETS

High Impedance R-14 Phones 8000 Ohm. For all standard Radio Output Circuits. All New. \$2.50 Ea.

### ARMY AMMUNITION CANS



Type M-3 50 Cal. Cans 12" Long x 6" Wide x 7 1/2" Deep.  
Type M-1 Cans 18 1/2" Long x 3 1/2" Wide x 6 1/2" Deep.  
All aluminum with Leather Handle and Hinged Top with Latch. Use for 3 your small parts or tools. O.D. Color, clean them and buff or paint. Each \$1.50

## STANDARD SURPLUS 1230 Market St., San Francisco 3, Cal. Telephone HEmlock 1-3106

# STOP VOLUME CONTROL NOISE!

★ CLEANS  
★ LUBRICATES  
★ PROTECTS

Perfect Contact Restorer—cleans and restores volume controls, band switches, push button assemblies, electrical contacts. NO NOISE is not a carbon tet. solution.



## "NO NOISE"

**\$1** 2 oz. bottle.  
Net to Servicemen

## CONTAINS AMAZING NEW PERMA-FILM

Out go dirt and oxidation immediately on contact! Scratch, hum and noise are eliminated with one drop and you're assured of top performance from then on!



New 6-oz. Spray Can  
**\$2.25** Net to Servicemen

Available in 8 oz. bottles and quart cans.  
Call nearest distributor or write:

**ELECTRONIC CHEMICAL CORP.**  
813 Communipaw Ave., Jersey City 4, N. J.

**Portugal**—Lisbon's 9.746A outlet is good level in Portuguese to North America 1900-2100. (Parsons, Pa., others) Noted using 15.030 again 0600-0800; heard closing 1530 on 11.996; noted 1535 on 4.000, and near 11.910 at 1650. (Pearce, England)

**Roumania**—Bucharest, 9.57, good in English 2200-2230A in North American beam, closes English with interval signal, then goes into Roumanian transmission. (Hyson, Md.; Kirby, Mo., others) Heard as early as 1800 relaying Radio Moscow. (Balbi, Calif., others) Noted on this channel for further English to North America 2330-2400. (Rugel, Kans., others) Heard parallel over 6.144A. (Machajewski, N. Y.) Noted with English session 1430 on 12.032, 9.570, 6.210, 9.254. (Pearce, England)

**South Korea**—A new station on 6.895 is the American Forces Korean Network, calling "This is Vagabond," noted around 0600 or earlier to after 0730; at 0700 relays AFRS news from the Far East Network, Tokyo, Japan. (Morgan, Calif.) Has bad CWQRM, announces is on 1150 kc., 1 kw., and 6.895, 400 watts, 24 hours daily. QRA is announced as Vagabond, c/o Postmaster, Box 72, San Francisco, Calif., USA. (Radio Australia)

HLKB, 7.935, Seoul, noted 0505 with Western music and news in Korean. (Sanderson, Australia) Under good conditions, HLKA, 2.510, Seoul, can be heard in Japan 0430 with time signal, 0500-0515 in English; announces as

"The Voice of Free Korea." (Japanese Short Wave Club)

**Spain**—Madrid, 9.363A, noted at excellent strength ending English to North America 2350. (Kroll, N. Y.) Measured recently on 9.348. (Ferguson, N. C.) Valladolid, 7.006A, noted 1535 with popular songs; Radio Mediterraneo, 6.995A, Valencia, tuned 1625 with music. (Pearce, England)

**Spanish Morocco**—Radio Dersa. Tetuan, now uses 6.067, 0.25 kw., 0700-1900. (WRH)

**Sweden**—Radio Sweden, 15.155, is good 0600 with news to South America. (Levy, N. Y.) Fine level 0000 on 11.705 to Western North America in English. (Grimm, Texas; Brown, Wyo.) Strong on this channel 2300. (Winch, Calif.)

**Switzerland**—Berne, 11.715, noted closing 1730. (Niblack, Ind.) Berne's 9.535 outlet is good level to North America 2030-2300. (Braunstein, Conn.) Excellent in parallel over 7.210. (Stanley, Conn.) Noted on 11.865 at 1350 with news. (Crowell, Pa.)

**Syria**—Damascus is now heard on 9.555 with its English session 1630-1730 closedown. (Levy, N. Y., others) Heard on 11.913A to Latin America 1900-2100. (Malmo DX-aren, Sweden) And parallel on 9.555. (Niblack, Ind., Saylor, Va.)

**Tahiti**—Radio Tahiti, 6.135A, Paapeete, noted 2325 with music, announcements in French; closed 0008, weak to fair level in Dela. (Cox) Heard on 7.120 closing 0218 with "La

# Windsor RADIO & TV RECEIVING TUBES GUARANTEED ONE FULL YEAR ... FOR PEAK PERFORMANCE!

Type	Each	Type	Each
0A2	\$.90	1N64	.75
0B2	.88	1R4	.85
0C3	.95	1R5	.62
1A7GT	.67	1S4	.67
1AE4	.90	1S5	.52
1B3GT	.69	1T4	.52
1H5GT	.51	1U4	.51
1J6	.93	1U5	.51
1L4	.63	1V2	.45
1L6	.66	1X2A	.74
1LA4	.82	2X2	1.43
1LA6	.80	3A5	.90
1LB4	.82	3LF4	.76
1LC5	.80	3Q4	.66
1LC6	.80	3Q5GT	.72
1LD5	.80	3S4	.61
1LE3	.80	3V4	.62
1LG5	.80	5R4GY	1.00
1LH4	.80	5U4G	.49
1LN5	.80	5V4G	.83
1N34	.90	5Y3G	.37
1N5GT	.63	5Y3GT	.42
1N48	.50	5Y4G	.43

Thousands of Service Organizations and Dealers send us REPEAT orders month after month—they KNOW you can depend on the WINDSOR promise of PEAK PERFORMANCE! Every tube we ship is first carefully tested in our labs, right in a radio or TV set, under actual operating conditions. Each WINDSOR tube is attractively packaged in the famous WINDSOR carton that has gained consumer acceptance throughout America.

BUY—and SELL—WINDSOR TUBES, with CONFIDENCE!

Type	Each	Type	Each	Type	Each	Type	Each	Type	Each
6AG7	.68	6BE6	.51	6Q7GT	.55	7A5	.70		
6AB4	.51	6BF5	.56	6R7	.75	7A6	.57		
6AC5GT	.82	6BF6	.43	6S4	.51	7A7	.58		
6AC7	.90	6BG6G	1.47	6S8GT	.75	7A8	.56		
6AF4	1.10	6BH6	.53	6SK7GT	1.05	7AD7	.65		
6AG5	.58	6BJ6	.53	6SC7	.63	7AE7	.63		
6AH4	.58	6BK5	.76	6SD7	.55	7AG7	.65		
6AH6	.89	6BK7	.97	6SF5GT	.66	7AH7	.65		
6AK5	1.05	6BL7GT	.94	6SG7	.55	7AJ7	.70		
6AL5	.44	6BN6	.98	6SH7GT	.52	7B4	.54		
6AN8	.95	6BQ6GT	.38	6SJTGT	.52	7B5	.51		
6AQ5	.31	6BQ7	.92	6SK7GT	.55	7B6	.52		
6AR6	.78	6BY5G	.85	6SL7GT	.58	7C7	.58		
6AR5	.42	6BZ7	1.09	6SN7GT	.69	7C4	1.05		
6AS5	.55	6C4	.41	6SQ7GT	.46	7C5	.56		
6AS7G	4.50	6C5GT	.60	6T8	.85	7C6	.50		
6AT6	.42	6CB6	.58	6U4GT	.60	7C7	.58		
6AUSGT	.85	6CD6G	1.57	6U5	.72	7E5	.85		
6AV5	.47	6CS6	.56	6U6	.86	7E6	.65		
6AV6	.41	6D6	.63	6V3	1.09	7E7	.85		
6AX4	.72	6E5	.72	6V6GT	.51	7F7	.69		
6B8G	.93	6F5GT	.54	6V8	.85	7F8	.97		
6BA6	.50	6H6GT	.55	6W4GT	.50	7G7	.85		
6BA7	.66	6J5GT	.44	6W6GT	.63	7H7	.61		
6BC7	.78	6J6	.68	6J7	.37	7J7	.85		
6BD5GT	.98	6K6GT	.45	6X5GT	.70	7K7	.77		
6BD6	.54	6K7	.70	6Y8	.82	7L7	.85		
		6L6G	.88	6Y6	.64	7N7	.62		
		6L6GA	.88	6ZV5	.60	7Q7	.62		
				7A4/XXL	.57	7R7	.70		



Type	Each	Type	Each
12S7GT	.55	25W4GT	.53
12S7GT	.57	25Z6GT	.46
12S7GT	.59	35A5	.55
12S7GT	.46	35B5	.53
12V6	.51	35C5	.53
14A7	.58	35D6GT	.43
14B7	.58	35E4	.48
14C5	.50	35F4	.48
14C5	.85	35G5	.48
14C7	.70	35H5	.48
14E6	.70	35I5	.48
14E7	.85	35J5	.48
14F7	.69	35K5	.48
14F8	.97	35L5	.48
14J7	.85	35M5	.48
14K7	.75	35N5	.48
14Q7	.62	35O5	.48
14R7	.85	35P5	.48
14S7	.80	35Q5	.48
19B6G	1.53	35R5	.48
19T8	.97	35S5	.48
21V5	.85	35T5	.48
25B6GT	.98	11Z3	.43
25L6GT	.53	11Z6GT	.75

## WINDSOR "WONDER-BEAM" 3-WAY TV ANTENNA

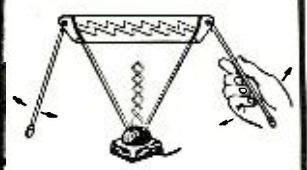

For Average Areas, Fringe Areas, and UHF. Adjustable arms, and new electronic wonder-switch for optimum performance with any TV set!

**SPECIAL PRICE, \$5.69** Each  
Lots of Six ..... \$5.95 Each  
Singly ..... \$5.95 Each

## FREE! WINDSOR TUBE CADDY

Most practical service-aid ever designed for Radio & TV repairmen! Now offered FREE with every purchase of \$150.00 or accumulated purchases totaling \$150.00 within 90 days. (You get Caddy credit memo with each purchase.)

- Carries approximately 125 tubes including meters and tools.
- 16 3/4" Long, 8 1/4" Wide, 13 3/4" High. Weighs only 9 lbs.
- Ruggedly constructed with heavy leatherette covering, strong plastic handle, nickel plated hardware, and reinforced with metal clamps.

WINDSOR TUBE CADDY MAY ALSO BE PURCHASED **\$14.95** OUTRIGHT FOR



Note to our Latin-American Friends: "Se Habla Espanol."

## WINDSOR "BROW-LITE"



Leave Both Hands Free To Work!

World's most useful flash-light! Ideal for Radio & TV Repairmen. Uses standard penlite batteries and bulb. Won't interfere with glasses. Rides above them over the brow. Complete with Batteries ..... **\$4.95**

25% Deposit with Order. All merchandise F.O.B. N.Y.C. For orders less than \$10, add \$1 handling cost. Deduct 2% if full remittance accompanies order. All merchandise subject to prior sale and price changes without notice.

**Windsor ELECTRONIC TUBE CO.**  
2612-N NOSTRAND AVENUE, BROOKLYN 10, N. Y.

Write for Additional Tube Types and Prices. We also stock Special Purpose and Transmitting Tubes at Similar Savings! Dept. N-9.



Marseillaise," poor quality due to noise and CWQRM.

*Taiwan (Formosa)*—BED4, 11.92, Taipei, is heard weak to fair in the North American transmission 2200-0100 sign-off. (Balbi, Morgan, Calif.) Has strong signal on *new* beam to the Near East opening 0230 with anthem, then with news on 11.735 parallel 11.920. (Morgan, Calif.; Sanderson, Australia) BED36, 7.300, noted 0600 with news in Chinese, then Western music, good level. (Sanderson, Australia)

*Tangier—Pan-American Radio* uses 1178 kc. and 7.290 around 0400-1145, 1300-2000, in *English*, French, Spanish, Italian, Arabic, Hindi. (*Malmo DX-aven*, Sweden) Lists relay of news from VOA, New York, for 1400. (Pearce, England)

*Turkey—Radio Ankara* now uses TAU, 15.16A, parallel TAP, 9.465, with *English* for Western Europe 1600-1645. (Morgan, Calif., others) TAT, 9.515, has good signal in Kans. during the daily *English* beam to North America, at 1815-1900. (Rugel) TAV noted on 17.825 opening 0830 with news to Southeast Asia. *Technical University of Istanbul*, 7.030A, noted 1440 with music, closed with orchestral music 1500; does *not* seem to be in use Sundays.

*Uganda*—The Uganda Broadcasting Service now radiates on 971 kc., 1 kw., and 5.026, 7.5 kw. in Luganda dialect 0945-1115; in *English* 1115-1215 (news 1115). (Radio Sweden)

*USI (Indonesia)*—Paris, Australia, notes Medan's YDP, 4.930, at 0930 with clock chimes. Surakarta's YDG3, 7.250A, with native session 0830. (*Malmo DX-aven*, Sweden) Djakarta, 9.710, heard 0622-0700 with news, music. (Rugel, Kans.) Heard with *English* for Europe 1400-1500 over YDF8, 9.865. (Pearce, England) The *Indonesian Air Force Station*, 11.940, operates daily 0430-0730 with 7.5 kw. (*WRH*) YDO, 3.250, Bandjermasin, opens 0430 with *English* recordings. (Collett, N. Z.)

*USSR—Baku, Azerbaidjan*, 4.358, noted announcing "Govori Moskva" at 1430, indicating a relay of *Radio Moscow* then. (Fairs, England, *via* URDXC)

(Continued on page 154)

## NEW SUPER POST TOWERS FOR TELEVISION ANTE NAS IN FRINGE AREAS

### TOWERS OF STRENGTH

#### TO LAST A LIFETIME

Self-supporting tower built up of galvanized steel sections. No guy wires necessary. Easy to erect. Safe and resistant to high wind. Available in heights 33 ft., 47 ft., 60 ft., 73 ft., 87 ft., and 100 ft., with bases in proportion.

### FRINGE AREA TV BUYERS MUST HAVE SPECIALLY BUILT TOWERS FOR CLEAR RECEPTION

Tower and the TV set go hand in hand as a package sale to rural TV buyers. Provides an extra sale and profit to dealers. An excellent fast selling accessory for jobbers and dealers.

### TERRITORIES OPEN FOR JOBBER DEALER FRANCHISE

Write for complete structural details, packing, prices, discounts, and territorial assignment.

Available in Heights from 33 ft. to 100 ft.

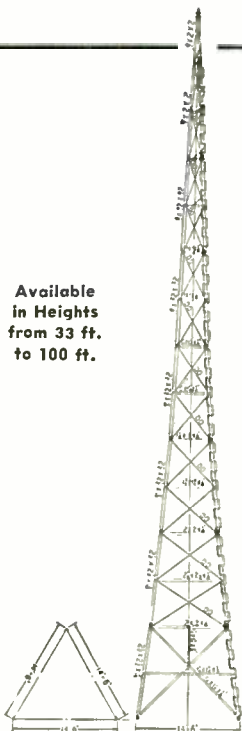

MANUFACTURED BY

## AERMOTOR CO.

Dept. 6109, 2500 Roosevelt Road, Chicago 8, Illinois  
BUILDERS OF STEEL TOWERS SINCE 1888

COYNE offers  
LOW COST

**TELEVISION  
RADIO - ELECTRONICS**  
Training in  
Spare Time AT HOME

The future is YOURS in TV-RADIO!

A fabulous field—good pay—fascinating work—a prosperous future! Good jobs galore, or independence in your own business!

Coyne brings you the first *truly lower cost*, MODERN—QUALITY Television Home Training; training designed to meet Coyne standards. Not an old Radio Course with Television "tacked on". Here is MODERN TELEVISION TRAINING including working knowledge of Radio. Includes UHF and Color TV. No Radio background or previous experience needed. Personal guidance by Coyne Staff. **Practical Job Guides** to show you how to do actual servicing jobs—*make money early in course*.

Don't pay for a lot of costly extras—*pay only for what you learn!* The extras "thrown in" may look impressive, by and large they add little to what you actually **LEARN**—but how they do add to the price! With Coyne Television Home Training you pay only for your training, *no costly extras*.

B. W. COOKE, President

**COYNE** FOUNDED 1899  
ELECTRICAL SCHOOL

A TECHNICAL TRADE INSTITUTE CHARTERED  
NOT FOR PROFIT

500 S. Paulina Street, Chicago 12, Dept. 64-HT5

ELECTRICITY ★ RADIO ★ TELEVISION ★ REFRIGERATION ★ ELECTRONICS

September, 1954

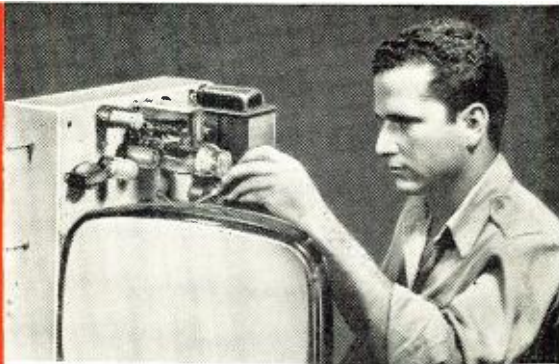

### SEND COUPON FOR FREE PICTURE FOLDER

and full details, including easy Payment Plan. No obligation, no salesman will call.



### COYNE ELECTRICAL SCHOOL

Television Home Training Div.  
500 S. Paulina St., Chicago 12, Ill.,  
Dept. 64-HT5

Send Free Picture Folder and details on Television Home Training. This does not obligate me and no salesman will call.

Name \_\_\_\_\_

Address \_\_\_\_\_

City \_\_\_\_\_ State \_\_\_\_\_

more  
Cannon lines  
now available  
at jobbers'  
shelves!

get the full story...

Write for ICC  
and RJC catalogs TODAY!



Twenty pages of information on 14 different lines of Cannon connectors, including list prices on more than 850 individual items. 130 illustrations.

Audio, military, general industrial. Get your copies... NOW!

When you write for our catalogs... Please refer to this magazine or Dept. 145

## CANNON PLUGS



CANNON ELECTRIC COMPANY  
3209 Humboldt St., Los Angeles 31, California  
Factories in Los Angeles; East Haven; Toronto, Canada; London, England. Representatives and distributors in all principal cities.



AN3108B Plug AN3102A receptacle

### "AN" (Air Force-Navy) Series Connectors

Proved in military service. World-wide standard. Lightweight. Uniform in quality. Interchangeable inserts. Threaded coupling nut. Rapid and easy disconnect. Cable clamps and other accessories.

typical lines newly offered...



K-21C Plug K-32S receptacle

### Cannon "K" Series

All-purpose... Adapted to a variety of general electrical and electronic applications. Special Acme thread. Rugged. 220 contact layouts available.

Venezuela — YVKM, 5.030, *Radio Continente*, heard in Spanish 2200 to sign-off which varies 2255-2257.

### Press Time Flashes

Sunspot predictions as broadcast by Berne, Switzerland, include Sept.—3; Oct.—3; Nov.—3. (Ferguson, N. C.) According to ISWC, London, *Radio St. Vincent*, VP2SA, 3.336, operates *Sundays* 1600-1700 with 400 watts. (Morgan, Calif.) *Radio Peking* has replaced 11.96 with 15.385 for *English* 2200. (*N. Z. DX Times*) A Communist Chinese outlet is noted on 6.78 at 0815 with news in Chinese parallel several *Radio Peking* outlets. (Balbi, Morgan, Calif.)

According to press dispatches, *Deutsche Welle*, Cologne, German Overseas Service, this year will begin construction of the most powerful short-wave transmitters ever used for German overseas broadcasting—200 kw. compared with the two 20 kw. transmitters now in use (at Hamburg with relay from Cologne studios). When the new stations are completed, broadcasts, in addition to German, will include *English*, French, Spanish, Portuguese. (McPhadden, Calif.) *Radio Pakistan's* regional services are scheduled for Lahore, 1 kw., 2045-2300 Arabic, 3.915, 0200-0400 *English* (except Fri.), 6.075; 0700-1230 (Urdu-Punjab, 3.335, Dacca, 7.5 kw., 2000-2200 Arabic, 4.807; 0100-0230 Bengali (except Fri.), 7.150; 0600-0645, Urdu, 4.807; 0700-1130 *English* (except Fri.), 3.325. (WRH)

BED7, 7.130, Taipei, Taiwan (Formosa) closes 0815 in Chinese, and apparently then moves to BED4, 11.920, where has been noted 1015 in Chinese parallel with BED6, 11.735. (Morgan, Calif.) This year's annual gathering of members of the Newark News Radio Club was held Aug. 21 at Green Lane, Pa. A new club is Heureka DX-Club, c/o Harald Torgard, Nilserukleiva 15, U. M., Oslo, Norway. "On the Air" reports a new club, the New England Listeners Club, c/o Norm Rivers, 18 Saari Parkway, Fitchburg, Mass.

Leon Levy, N. Y., reports a broadcast on 9.833 (channel of Budapest, Hungary), called "*Ce Soir en France*" ("*This Evening in France*") is heard in French 0300-0330; seems to be a session for or by French Communists; asks for reports to Radio Liberte, 6 Boulevard Poissonier, Paris 9, France.

A newcomer is *Radio Sarawak*, Kuching, 4.870 and 850 kc., British Borneo, heard with *English* 0530-0630, Iban (native dialect) 0630-0700, Chinese to 0745, Malay 0745-0830, and then *English* 0830-0845 closed down; is low-powered. (Radio Australia, others) Heard identifying 0830, then with news relay from BBC; closed 0841 with "God Save the Queen." (Balbi, Calif.) During the recent trouble in Guatemala, TGNA, Guatemala City, was damaged severely by machine-gun fire, according to press dispatches. (Morgan, Calif.) WRH and other overseas sources say *Radio Addis Ababa*,

# CLOSE OUT!

WORLD-FAMOUS  
HI-FI 3-SPEED  
AUTOMATIC PHONO  
3 SPEAKERS

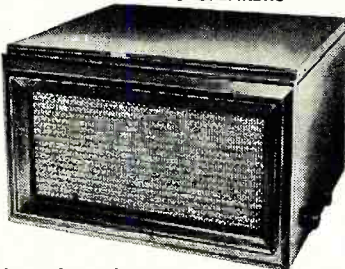

Deluxe 3-speed automatic record player with speaker cross over network for true high-fidelity. 4 tube amplifier scientifically designed to reproduce from 20 to 20,000 cycles. Automatic shut-off for amplifier when last record has played. Beautiful mahogany cabinet with luxurious woven grill. Dimensions: 17 7/8" x 15 7/8" x 11". Weight 30 lbs.

Nationally  
Advertised  
for \$139.95

CLOSE OUT  
PRICE!

**\$72.50**

Write Dept. RN-9 for FREE catalog.

**STEVE-EL Electronics Corp.**

61 Reade St. New York 7, N. Y.

**CODE SENDING  
RECEIVING SPEED**

Be a "key" man. Learn how to send and receive messages in code by telegraph and radio. Commerce needs thousands of men for jobs. Good pay, adventure, interesting work. Learn at home quickly through famous Candler System. Quality for Amateur or Commercial License. Write for FREE BOOK. CANDLER SYSTEM CO. Dept. 2 K, Box 928, Denver 1, Colo., U.S.A.

**"SNOOPER" GEIGER COUNTER**

Super-sensitive! Only 1 1/4 lbs! Fits pocket—uses flashlight battery. Find a fortune in uranium. Order Now! Send \$5.00, balance C.O.D. MONEY BACK GUARANTEE. FREE CATALOG—scintillator and larger uranium and metal detectors. DEALERS WANTED.

**29.95 COMPLETE**

PRECISION RADIATION INSTRUMENTS  
2235 RT S. La Brea, Los Angeles 16, Calif.

## GET INTO ELECTRONICS

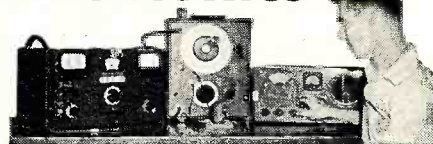

You can enter this uncrowded, interesting field. Defense expansion, new developments demand trained specialists. Study all phases radio & electronics theory and practice: TV; FM; broadcasting; servicing; aviation, marine, police radio. 18-month course. Graduates in demand by major companies. H.S. or equivalent required. Begin Jan., March, June, Sept. Campus life. Write for catalog.

**VALPARAISO TECHNICAL INSTITUTE**  
Dept. RD Valparaiso, Indiana

Ethiopia, has moved from 15.054A to 15.345 (same channel as used by VOA, Tangier). *Not confirmed.* ISWC, London, says that by now the *English* sessions of *Radio Luxembourg* should be relayed via short-wave on 6.090.

AFN, Frankfurt, Germany, now uses 3.188 (new) at 0000 (Sun. from 0100) to 1900; 10 kw.; replaces 5.470. (WRH, others) Noted with call, news, weather 0100. (Pearce, England) According to station announcements, the *English* session from *Radio Pakistan* to Indonesia 0745-0830 now is on 15.360. (WRH) The Southeast Asia beam from AIR, Delhi, 0830-0945 (news 0835) is now on 11.710, 15.325. (WRH)

According to the *N. Z. DX Times*, the *Voice of America* will move from New York to Washington as of Nov. 1, with new QRA of 330 Independence Ave., S.W., Washington, D. C.

The Far East Network, Tokyo, Japan, noted testing on 6.160, very strong level, parallel with JKL, 4.86, latter only fair signal, at 0815. (Balbi, Calif.)

The clandestine anti-Communist "underground" station, "*Radio Free Russia*," has been logged on 6.530V at 1315 to close at 1335 when signed off with march; identifies as "*Govori Radyo Stanzia Svobodnaya Rossiya*." (Fairs, England, via URDXC)

**Acknowledgment**

Thanks for the fine reports. Keep them coming during the autumn DX season ahead—to Kenneth R. Boord, 948 Stewartstown Road, Morgantown, West Virginia, USA. Good listening, fellows! . . . . . K. R. B.

The names of the seven radio pioneers who were the first to achieve trans-Atlantic communications on short waves have been engraved on the monument marking the historic site of Station IBCG in Greenwich, Conn. The monument, unveiled by the Radio Club of America over three years ago, was altered to include the names of the participants in memory of Major Edwin H. Armstrong. The pioneers whose names now appear on the monument are: Ernest V. Amy, Edwin H. Armstrong, George E. Burghard, Milton Cronkhite, Paul F. Godley, John F. Grinan, and Walker Inman.



September, 1954

**NEW!**  
**"Realist"**

**HIGH-FIDELITY  
RADIO TUNERS**

**Designed by Radio Shack  
to meet the demand for  
substantial quality  
at a direct-to-you  
sensible price!**

*Guarantee: 5 microvolt sensitivity for 30 db quieting on FM tuner. 5 microvolt sensitivity on AM tuner. Standard RETMA 90-day guarantee.*

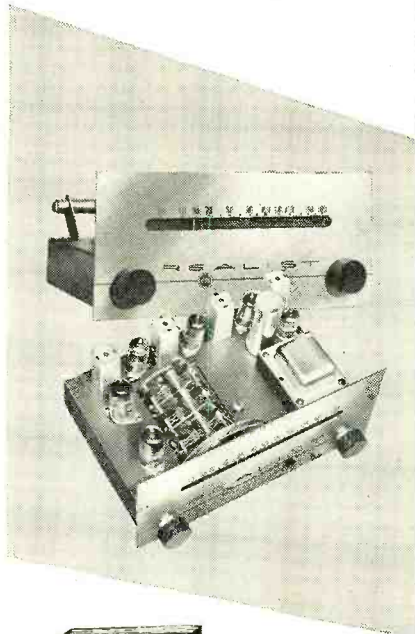

**Free!**

**New 224-Page  
1955 Catalog,  
Write Today!**

- FM TUNER..... \$39.95
- AM TUNER..... \$29.95
- MAG. TAPE ..... \$1.85
- CATALOG..... FREE

NAME \_\_\_\_\_  
STREET \_\_\_\_\_  
TOWN \_\_\_\_\_

**FM**  
**\$39<sup>95</sup>**

**ARMSTRONG! AFC! TUNED RF STAGE!**

**AM**  
**\$29<sup>95</sup>**

**TUNED RF STAGE! AC! LOOPSTICK!**

**FM . . .**

5 uv sensitivity; tuned RF stage; Armstrong circuit with double-tuned limiter, low-noise triode mixer; balanced AFC; 20-20000 cps ±0.5 db; 180 kc bandwidth, 6 tubes (2 dual) plus rect.; AC power supply. Only 4 1/4 H x 9 1/2 W x 6 3/8 D; ship. wt. 6 1/4

**AM . . .**

5 uv sensitivity; tuned RF stage; 8 kc bandwidth; superhet; 20-5000 cps ±3 db. 5 tubes (1 dual); AC power supply. Same size as FM tuner.

**PLUS VALUES:** ultra-compact to fit anywhere; built-in tape output, phono/function switch, solid 1-piece full-panel front. For binocular — purchase of both tuners saves you at least \$100. Use with any amplifier, radio, TV, sound system. Both tuners EXACT match! Exclusive at Radio Shack!

**NEW!**

**"ARCHER"** Magnetic recording tape, 7" reel, plastic base 1200 ft. x 1/4", at the lowest price in the country! Exclusive at Radio Shack. Guaranteed 1st quality.



**\$1<sup>85</sup>**  
Order No. R-8101

**RADIO SHACK**  
CORPORATION

167 Washington St., Boston 8, Mass.

# A REED IS A RE D IS A REED...

*if it's recorded  
on Soundcraft  
Magnetic  
Recording  
Tape*



A reed is never a flute . . . or a flue pipe. So, to be sure of capturing all the haunting brilliance of reed instruments — and the full range of sounds of a whole orchestra — always use Soundcraft Tapes! Why?

Because *all* Soundcraft Tapes, and *only* Soundcraft Tapes, combine:

- Constant depth oxide for uniform middle- and low-frequency response
- Micro-Polished® coating, a Patented Soundcraft Process that eliminates unnecessary head wear and gives uniform high-frequency response right from the start
- Pre-coated adhesive applied to base firmly anchors oxide to base
- Surface-lubrication on *both* sides! No friction, no chatter, no squeal
- Chemical balance throughout to prevent cupping, curling, peeling, chipping
- Uniform output of  $\pm 1/4$  db. within a reel,  $\pm 1/2$  db. reel-to-reel

**THE WORLD'S FINEST TAPES . . . YET THEY COST NO MORE**

**Editors and Engineers**  
PUBLICATIONS

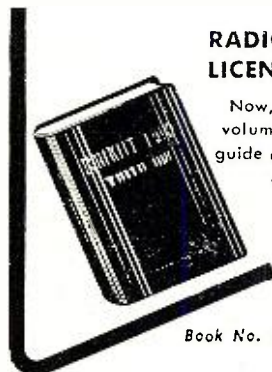

## RADIOTELEPHONE LICENSE MANUAL

Now, in one convenient volume, complete study-guide questions with clear, concise answers for preparation for all U.S.A. commercial radio-telephone operator's license examinations

Book No. E&E-RL7

**\$3.75\***

**WORLD'S EQUIVALENT TUBES** (Equivalents Vade Mecum) **NEW 10TH EDITION** A guide for substitutions of radio tubes, indicating direct or near equivalents.

Book No. E&E-VM10 . . . . . \$5.00\*

**WORLD'S RADIO TUBES** (Brans' Vade Mecum) **9TH EDITION**. Lists over 15,000 tubes from every tube making country. Printed in 16 languages.

Book No. E&E-VM9 . . . . . \$5.00\*

**ANTENNA MANUAL**. A practical, comprehensive book on antennas, for everyone interested in transmission and reception. Over 300 pages.

Book No. E&E-AM1 . . . . . \$3.50\*

**SURPLUS RADIO CONVERSION MANUAL, VOL. 1**. Practical conversions. Write for list of contents. Book No. E&E-SM1 . . . . . \$2.50\*

**SURPLUS RADIO CONVERSION MANUAL, VOL. 2**. Companion to Volume 1. Book No. E&E-SM2 . . . . . \$2.50\*

\*Plus any tax.

**BUY FROM YOUR DISTRIBUTOR**

ADD 10% ON DIRECT MAIL ORDERS TO  
EDITORS and ENGINEERS, Ltd.  
BOX 689A, SANTA BARBARA, CALIF.  
Reckitters under firm BAKER & TAYLOR, Hillside, N. J.

## SOUNDCRAFT TAPES FOR EVERY PURPOSE

**Soundcraft Tape** for all high-fidelity recording.

**Soundcraft Professional Tape** for radio, TV and recording studios. Splice-free up to 2400 feet. Standard or Professional hubs.

**Soundcraft LIFETIME® Tape** for priceless recordings. For rigorous use. For perfect program timing. A third as strong as steel. Store it anywhere. Guaranteed for a lifetime.

Get the Soundcraft Recording Tape *you* need today. Your dealer has it.

REEVES

# SOUNDCRAFT

CORP.

Dept. U9,

10 E. 52nd St., N. Y. 22, N. Y.

**FOR EVERY SOUND REASON**



## SAVE HOURS OF WORK

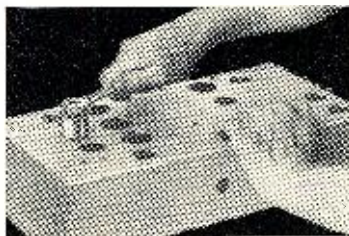

**quickly make round, square, key and "D" openings with Greenlee Radio Chassis Punches**

In  $1\frac{1}{2}$  minutes or less you can make a smooth, accurate hole in metal, bakelite or hard rubber with a GREENLEE Punch. Easy to operate . . . simply turn with an ordinary wrench. Wide range of sizes. Write for details. Greenlee Tool Co., 1889 Columbia Ave., Rockford, Ill.



## Feedback Equalizers (Continued from page 57)

### Universal Equalizer

In the interest of greatest flexibility, a means for an ordered control of the various factors that contribute to a playback curve has been devised. Such an arrangement can be termed a "universal equalizer." With this device, one is able to effect any desired playback characteristic and an infinite number of variations about that characteristic.

Although originally meant as a means for confirming the preceding design data, the "universal equalizer" has proven invaluable in the investigation of the effects of factors such as acoustics at the recording location and losses in the recording process. These factors are instrumental in changing the effective recording characteristic.<sup>3</sup> It has been found that many different recordings made by the same manufacturer require different compensation to sound right. Often the required compensation is a slight deviation from the generally accepted one. Sometimes it varies greatly. This type of correction cannot be accomplished by the usual preamplifier tone controls.

After careful consideration of the many factors that enter into high-gain preamplifier design, the configuration shown in Fig. 8 has been chosen. 6AU6's are exceptionally quiet and dependable tubes. The equalizer stage has a gain of 240, reduced to 3 at mid-band by feedback. Preceding this stage, a triode connected 6AU6 with a gain of 30 brings the over-all mid-band gain to 90. Thus the unit can directly drive a final power amplifier if need be. Normally, a switching and tone compensating amplifier is used between the two.

Other combinations of triodes and pentodes can be successfully used, but most combinations will not give as high a gain.<sup>1</sup>

Equalizer switching is negotiated by either the "universal" or "alternative" methods of Fig. 8. Both schemes use the same bass turnover selector switches. The first method gives de-emphasis from 0 to 150 microseconds in 10 microsecond steps, whereas the alternative goes from 0 to 105 microseconds in steps of 15 microseconds.

Selection of  $\alpha$  and  $r$  differs in that the "universal equalizer" offers continuously variable control of these factors over the entire wide range while the alternative gives the extreme ends and popular middle settings. The "universal"  $\alpha$  and  $r$  dials can be panel calibrated, if desired, with an ohmmeter. In both cases, the calibration marking represents the fraction or multiple that is placed into the circuit by  $R_{23}$  and  $R_{26}$ . Some constructors may wish to calibrate their dials in terms of  $\frac{1}{r}$  and  $\frac{1+\alpha}{\alpha}$  in order to more

**RADIO & TELEVISION NEWS**

readily aid mental calculation of  $f_c$  and  $f_r$ .

$$f_c = \frac{1}{r} f_t$$

$$f_r = \frac{1 + \alpha}{\alpha} f_s$$

Potentiometers for these controls should be wired so that a clockwise rotation gives maximum response.

Operation of either equalizer is conducive to rapid and easy selection of any desired curve. Bass turnover frequencies are selected by switches A and B. Treble de-emphasis is selected by throwing the switches marked directly in microseconds. The total de-emphasis is the sum of the individually chosen ones.  $\alpha$  and  $r$  are directly selected.

It may occur to the reader that these schemes rely upon the user's detailed knowledge of playback curves. For this reason, these means of selection are unsuitable for the uninitiated. Charts such as the one that accompanies the schematic can be prepared for their use until the user becomes familiar with the scheme of things.

Component tolerances must be carefully watched if results are to be as expected. Commercially available condensers will deviate as much as 100% from their marked value and should be bridged beforehand. Resistors should also be bridged for very best results.

Soldering of these components must be done with care lest they change value with excessive heat. Do not overlook either of these suggestions as most complaints of poor operation can be traced directly to carelessness on these counts.

Since the output impedance of the equalizer stage is fairly low at the higher frequencies, the cathode follower output is not necessary where short output cable lengths will be used or where the unit forms part of a complete equalizer-preamplifier. However, for general use, the cathode follower is desirable.

Liberal use has been made of high resistance "click suppressors" across all switching points.  $R_s$  forms part of a rumble filter.<sup>1</sup> It is recommended that the reference 1 be consulted by those wishing to construct the "universal equalizer." Suggestions for building the equalizer-preamplifier described there are applicable here as well. Some may prefer to use the equalizer schemes of this article in place of the one in reference 1.

#### REFERENCES

1. Rose, Arthur J.: "Equalizer-Preamp", RADIO & TELEVISION NEWS, June 1953
2. Langford-Smith, F., ed.: "Radiotron Designer's Handbook", Fourth Edition, pages 7.3-3.3
3. Wortman, Leon A.: "Audio Equalization", RADIO & TELEVISION NEWS, May 1953
4. "The Curve that Conforms," RADIO & TELEVISION NEWS, July 1954.

-30-

IT'S NEW                      IT'S COMING  
**IT'S TERRIFIC!**  
**POPULAR ELECTRONICS**

September, 1954

*A Star Is Born...*

**Only EICO #232 Peak-to-Peak VTVM has all these Advanced Features ★**

★ **FOR THE FIRST TIME ALL CALIBRATION IS DONE WITH INSTRUMENT IN CABINET.**

★ **7 non-skip ranges on every function — DC/RMS sine volts: 0-1.5, 5, 15, 50, 150, 500, 1500. (To 30 kv with HVP probe.) Res.: 0.2 ohms to 1000 megs.—Uniform 3 to 1 scale ratio assures extreme wide-range accuracy.**

★ **Flat freq. response 30 cps to 3 mc.**

★ **Measures directly peak-to-peak voltage of complex & sine waves: 0-4, 14, 42, 140, 420, 1400, 4200. Vital for TV servicing. Saves the cost of separate Peak-to-Peak Probe.**

★ **Modern styling, etched panel; compact, easily portable. Size: 8½" x 5" x 5".**

**NEW  
PEAK-TO-PEAK  
VTVM  
AT LOWEST COST**  
With Exclusive  
**Uni-Probe**

★ **Terrific time and trouble-saver! One probe for all functions—in a "twist of the wrist" it selects DC or AC (Peak-to-Peak & RMS)/OHMS!**

★ **No annoying lead tangle, no back-and-forth prod changing. Positive-action, super-rugged!**

**KIT \$29.95**  
**Factory Wired \$49.95**

Complete with UNI-PROBE at no extra cost

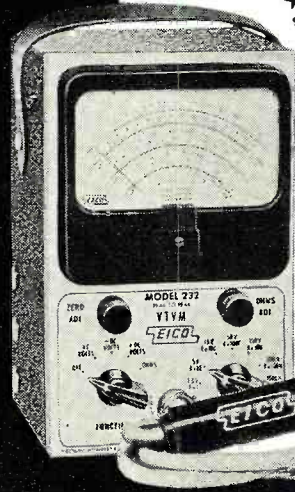

**Excellent for your bench**

Model 249 Peak-to-Peak VTVM with Giant 7½" Meter

**KIT \$39.95**

**Wired \$59.95**

Complete with UNI-PROBE

See this amazing engineering achievement at your jobber today. Write now for FREE latest catalog **RV-9**

**EICO**

ELECTRONIC INSTRUMENT CO. INC.

84 Withers Street

Brooklyn 11, N. Y.

Prices 5% higher on West Coast. © 54

#### RECEIVING

**TUBES**

**THREE TOP BRANDS ONLY!  
AT TREMENDOUS SAVINGS OVER  
REGULAR WHOLESALE**

**OTHER TUBES AVAILABLE AT SAME LOW, LOW PRICES**

Latest Code	Dates	Boxed	Fully RTMA Guaranteed
0Z4	.62	6AK5 1.30	6BQ7 1.42
1B3	.95	6AL5 .63	6BZ7 1.52
1X2	1.06	6AQ5 .76	6CB6 .76
5U4	.63	6AU6 .67	6J6 .92
5Y3	.48	6AV6 .60	6K6 .65
6AB4	.80	6BA6 .71	6SN7 .85
6AC7	1.25	6BG6 1.98	6V6GT .75
6AG5	.83	6BK7 1.28	6W4 .70
6AH6	1.40	6BQ6 1.42	12AT7 1.05
			35Z5 .51
			50L6 .75

Send for FREE catalog of additional tubes and parts

Check These **BIG BARGAIN** Prices

Brand New Pix Tubes Full One Year Guarantee

**SEPTEMBER SPECIAL!  
21EP4—17.95 & DUD**

	With Old Tube	With Old Tube
10BP4	10.45	9.95
12LP4	12.95	11.95
12LP4A	14.50	11.95
12QP4	12.95	11.95
14CP4	13.95	12.95
15AP4	15.95	14.95
16AP4	18.45	16.95
16CP4A	19.45	15.95
16DP4A	16.45	14.95
16EP4A	20.45	16.95
16FP4	16.45	14.95
16GP4	20.45	16.95
16HP4	16.45	14.95
16JP4	20.45	16.95
16KP4	16.45	14.95
16LP4	20.45	16.95
16MP4	16.45	14.95
16NP4	20.45	16.95
16OP4	16.45	14.95
16PP4	20.45	16.95
16QP4	16.45	14.95
16RP4	20.45	16.95
16SP4	16.45	14.95
16TP4	20.45	16.95
16UP4	16.45	14.95
16VP4	20.45	16.95
16WP4	16.45	14.95
16XP4	20.45	16.95
16YP4	16.45	14.95
16ZP4	20.45	16.95

**STUART ELECTRONICS DISTRIBUTORS**

Dept. R-8

Minimum Order \$10.00

TERMS: 25% Check or Money Order, Balance C.O.D., F.O.B. New York. Satisfaction Guaranteed or money back in 10 days.

149-09 Union Turnpike

Flushing 67, N. Y.

OLympia 8-3553, 4352

# 7 RIDER BOOKS JUST PUBLISHED!

**ADVANCED TELEVISION SERVICING TECHNIQUES** by RETMA Teaching Staff! Tells step-by-step how to service every section of a TV receiver . . . how to use all kinds of test equipment in servicing (sweep generators, signal generators, vacuum tube voltmeters, scopes, ohmmeters).

176 (8½ x 11") pages, soft cover. Only \$3.60  
**LABORATORY WORKBOOK** for use with main book. 32 (8½ x 11") pp. . . . . \$0.95

**SPECIALIZED AUTO RADIO MANUALS**

VOL. 1-A: covers Ford, Lincoln, Mercury.  
 VOL. 2-A: covers Buick, Cadillac, Oldsmobile.  
 VOL. 3-A: covers Chevrolet, Pontiac, GMC and Chevrolet Trucks.

VOL. 4-A: covers Chrysler, DeSoto, Dodge, Dodge Trucks, Plymouth.

VOL. 5-A: **INDEPENDENT CAR MANUFACTURERS**—Henry-J, Hudson, Kaiser-Frazer, Nash, Studebaker, Willys.

Complete installation, removal and servicing information on factory-installed car radios (1950-1954) . . . parts lists, schematics, tube layouts, dial stringing.

Each 8½ x 11", soft cover. Vol. 3-A \$1.80; all others . . . . . \$3.00

**COLOR TV DICTIONARY** More than a dictionary! Complete explanation of new color TV terms and definitions—over 50 illustrations. Vital for everyone interested in color TV.

72 (5½ x 8½") pages, soft cover. Only \$1.25

**R-C and R-L TIME CONSTANT** First in a new review series on difficult technical subjects. Covers practical applications of Time Constant and how it affects circuit operation.

48 (5½ x 8½") pages, soft cover. Only \$0.90

**TV FIELD SERVICE MANUAL—Vol. 2**

Most marvelous guide to in-the-home servicing—spiral bound, lies flat for easy reference! Troubleshooting, tube layouts, picture adjustment, dial stringing. VOL. 2 covers Bendix, Capehart, CBS Columbia, Crosley, DuMont. VOL. 1 covers Admiral, Affiliated Retailers (Artone), Aimcee (AMC) Air King, Air Marshall, Allied Purchasing, Andrea, Arvin and Automatic.

VOL. 2—160 (5½ x 8½") pages, soft cover. Only \$2.40

VOL. 1—128 (5½ x 8½") pages, soft cover. Only \$2.10

**OBTAINING AND INTERPRETING TEST SCOPE TRACES** Key to successful use of oscilloscope. Covers radio, audio, TV, transmitters.

More than 500 waveforms. Over 140 (5½ x 8½") pages, soft cover. Only \$2.40

**HOW TO SERVICE TAPE RECORDERS**

How to troubleshoot and service all kinds of tape recorders. Explains drive mechanisms, recording heads, electronic circuits. Also tells how to set up a tape recorder repair shop.

5½ x 8½". Soft cover. Only \$2.90

In Canada, all prices approximately 10% higher.

**SEND FOR COMPLETE NEW RIDER CATALOG**

Buy these books now from your jobber, bookstore—if not available from these sources, write to:

<b>JOHN F. RIDER</b>		<b>PUBLISHER, INC.</b>	
In Canada:		480 Canal Street, New York 13, N. Y.	
Charles W. Poinon		Export Agent:	
6 A'ging Ave., Dept. 7,		Roburn Agencies, Inc.	
Toronto, Ontario		39 Warren Street	
		New York 7, New York	
West Coast Office:		Cable Address:	
4216-20 W. Jefferson Blvd.		Boburnage N. Y.	
Los Angeles, California			

# RADIO-TV Service Industry News

**AS REPORTED BY THE  
TELEVISION TECHNICIANS LECTURE BUREAU**

**A** GOOD indication of the growing use of electronic assemblies in a wide variety of new applications is the requests to the Bureau from equipment manufacturers for the names of competent, independent service companies in areas where their products have been sold.

The Bureau has been making this service available to electronic manufacturers. The "National Electronic Service Directory" forms are filed by states and cities. When a manufacturer needs the help of an independent service company in any section where he has sold equipment, the Bureau provides a list of the service companies in that section that have indicated they have the personnel and facilities to handle the type of equipment involved in the installation.

There are hundreds of small manufacturers who have been making specialized electronic equipment for the defense program, that have developed equipment for commercial use to be marketed when their defense commitments taper off. The availability of competent independent service facilities on a national scale is a boon to these small companies and they, in turn, will create installation and maintenance business that will add to the stable, bread-and-butter volume of the service companies that have the personnel, equipment, and management "know how" to handle it.

**A Job or a Business**

The rapidly expanding opportunities that are opening up for independent electronic service businesses bring into sharp focus the differences between service companies that are operated as *businesses* and those that merely provide a *job* for the owner.

The volume of business that was once available from television servicing led many men into the business on their own on the false premise that this type of service work would, in itself, provide enough business to give the operator a better-than-average income. In this, the reference is to new businesses that entered the field just to handle television service and not to those businesses that, as successful

radio service businesses, were able to expand their facilities to handle television service work.

There are highly versatile men who possess the rare combination of a flare for business management and exceptional personal electronic skill. They are tireless workers who have a good natural sense about handling customers, so they build a following of service customers; they maintain liaison with non-servicing dealers from whom they get service referrals; and they are able to handle a large volume of service work by themselves. This sort of a service business provides the owner with a good income as long as he is in good health and can stand the pace of the work. But when he stops the business stops.

The more versatile service companies that have grown up with TV servicing as their base, are flexible as to personnel and capable of expanding in any direction in which profitable service business may be added. Some of these businesses have expanded outside of the electronics field to add service volume that can be handled by their regular personnel. A major field opening up for television service companies is that of installing and servicing room air conditioner units. This field has a short season but it falls during the period that television service is at a low ebb. It is of no interest to the refrigerator service companies since their businesses have to handle peak work loads during the same period that room air conditioners are in greatest demand.

A serious problem that faces the individual technician when he starts a service shop and depends on C.O.D. business developed through advertising to sustain him, is that of getting an adequate, consistent volume of business. Usually, the cream of the service customers are held by the dealers who sold the sets or by the companies that handled initial maintenance and service. A natural tendency is to advertise TV service for less money than established service businesses charge for it. The error in this reasoning is that price shoppers for service are largely fringe customers—usually the most

troublesome type to handle. Many of them are drops, for various reasons, from the mailing lists of the companies that originally handled their service. They are a headache to any technician who solicits their work.

### Neglected Service Business

The mirage of profitable business in servicing TV sets has blinded most small service shop operators to the income-opportunities that are available in servicing other types of home electronic devices. Radio service, for example, has been badly neglected. Yet it is a business that the small shop operator could have for the asking since it has been of little interest to the larger service companies.

A little ingenious merchandising would bring in service volume in radio sets when the business is needed. A 2-week "community special" offer to repair any 5-tube model radio for \$2.50 plus the cost of parts would pull a lot of inoperative radios into a shop. This could be promoted inexpensively in a striking handbill delivered door-to-door.

Record-changer maintenance is another type of service that has been completely overlooked by most small service shops. Since there are at least two radio sets and one record player of some kind in practically every home, the service shop that goes after this type of business is working in a one hundred per-cent market for its services.

Properly promoted, record-changer service will bring added income in the sale of replacement needles, cartridges and, in many homes where a substantial investment in records has been made, sales of albums, needle pressure gauges, record cleaners, etc.

### Recorders

The bars are down on the use of magnetic tape recorders in practically every home now that popular recordings are being sold on one-hour spools. The lack of dependable service—or any kind of service in some localities—for wire and tape recorders has been a sore spot with many users of these devices. With the widening interest in and utility of tape recorders to provide packaged entertainment in the home, the small shop operator, and particularly those located in community or residential areas, can put a sounder base under their businesses by offering home recorder service.

### Color Television

It is doubtful whether color television receiver servicing, in volume, will ever fall into the hands of the small shops. The deterring factor will be the cost of the test equipment necessary to do the service economically and efficiently.

The failure of the average service shop operator to take into account all of his costs of operation in establishing his service labor rates, precludes his keeping abreast of the times with the new instruments.

September, 1954

## Pay Only 10% Cash Down

### 18 Months to Pay on Major Equipment



Now it is easier than ever to buy from WRL. Pay as little as 10% down and the balance in 18 months. No red tape — we handle our own financing. We will give you a generous trade-in allowance on your present equipment. We have over 600 recon-ditioned used items — with new factory guarantee. Send for free list. You will profit most when you deal with WRL — THE WORLD'S MOST PERSONALIZED RADIO SUPPLY HOUSE and THE WORLD'S LARGEST DISTRIBUTOR OF AMATEUR RADIO TRANSMITTING EQUIPMENT.

**LEO I. MEYERSON**  
W8GFQ

**HALLICRAFTERS S-40B \$119.95 | HALLICRAFTERS SX-71 \$249.95**

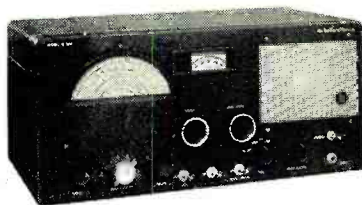

**\$9.54 Per Month**  
(12 months)

**\$12.00 CASH DOWN**

Communication receiver with built in speaker covering 540-Kc to 44 Mc in four bands. One RF stage, 2 IF stages.

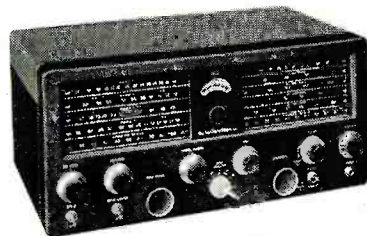

**\$13.63 PER MONTH** **Cash Down \$25.**  
(18 Months)

Double Conversion sharp selectivity, plus built-in NBFM at moderate cost. 11 tubes plus voltage regulator and rectifier. Low down payment.

#### HALLICRAFTERS RECEIVERS AVAILABLE

MODEL NUMBER	12 MONTHLY PAYMENTS	DOWN PAYMENT	CASH PRICE
S-38C	\$3.97	\$ 5.00	\$ 49.95
S-53A	\$7.95	\$10.00	\$ 99.95
S-72 Port	\$8.74	\$11.00	\$109.95
S-77A	\$9.54	\$12.00	\$119.95

MODEL NUMBER	18 MONTHLY PAYMENTS	DOWN PAYMENT	CASH PRICE
S-76	\$10.90	\$20.00	\$199.95
SX-62	\$19.07	\$35.00	\$349.95
SX-71	\$13.62	\$25.00	\$249.95
HT-20XMTR	\$24.50	\$44.95	\$449.50

**JUST OFF THE PRESS!**  
**FREE NEW 1955 CATALOG**

**SEND TODAY**



WRITE FOR DETAILED EQUIPMENT SPECIFICATION SHEETS



WRITE - WIRE - PHONE 2-0277 COUNCIL BLUFFS, IOWA

WORLD RADIO LABORATORIES  
3415-27 W. Broadway  
Council Bluffs, Iowa R-9

Please send me:

- 3' x 4' U.S. Radio Map 25c  
 New Catalog  
 Used Equipment List
- WRL XMTR Info  
 SX-71 Info  
 S-40B Info  
 NEW LOG BOOK 25c

Name .....  
Address .....  
City ..... State .....

## New TV DYNATRACER

THE 3-IN-1 TEST TOOL:

**Signal Tracer • Voltage Tracer • Component Checker**  
Presents a Different, Simplified Method of Troubleshooting  
**REQUIRES NO ADDITIONAL EQUIPMENT**

The self-powered DYNATRACER isolates trouble to a stage or component . . . tracing signals through any Video, Sound, Sync, AFC, Horizontal or Vertical Sweep Circuit. What's more, the remarkable DYNATRACER traces voltages (50/500v AC/DC) & instantly locates open, shorted, intermittent or leaky (up to 20 MEGOHMS) condensers, resistors, coils, transformers, etc.

Save time, labor & money with the DYNATRACER  
...the most indispensable TV repair tool ever made.

Complete troubleshooting manual enclosed.

**Century ELECTRONICS CO.**

211-04 99th Ave. Dept. 217 Queens Village, N. Y.

ONLY  
**\$4.95**  
Post Paid  
U.S.A. Only



For a limited time only . . .

FREE TRIAL OFFER

SEND NO MONEY WITH ORDER — NO C.O.D.

If the marvelous DYNATRACER isn't all we say, send it back within 10 days without cost or obligation. But we know you'll agree that the DYNATRACER is the best friend you ever had on your work bench. So order your DYNATRACER now!

## AIREX'S NEW HI-FIDELITY 1955 CHANNELOC 630FA3

Full Tone Control • 10 WATT HI-FI Sound System  
HI Gain Cascade Tuner • 4 Microvolt Sensitivity  
The Perfect Chassis for Fringe Areas  
New Exclusive Advancements

- 10 Watt Push Pull Audio Output • Front Focus Control • Channeloc-Looks picture & sound together
- Drift free operation • Automatic Freq. Control
- Gated A.G.C. • Fringe Area Control • Full 4 MC Picture Bandwidth • Phono connection & Switch
- Efficient Retrace Blanking • Automatic Brightness Control • Full Focus Cosine Yoke • Color Connection on Chassis • Extra Heavy Duty Focus Coil • Fused HV Power Supply • All Molded Plastic Condensers
- 6CB6 Tubes in Video I.F. • Handles up to 24" Rnd
- Improved Sync System • R.C.A. Direct Drive Fly-back • Improved Video amplification • Heavy Duty Power Transformer
- Improved Horizontal Sweep • Full range 12" Loudspeaker • 4 Micro-volt Sensitivity • Ready for UHF Stations • Size 22" x 16" x 10".

**\$164<sup>95</sup>**

Less CR Tube & Brackets  
12" Hi-Fi Speaker  
With UHF 83 Channel  
Convtr.—\$211.90

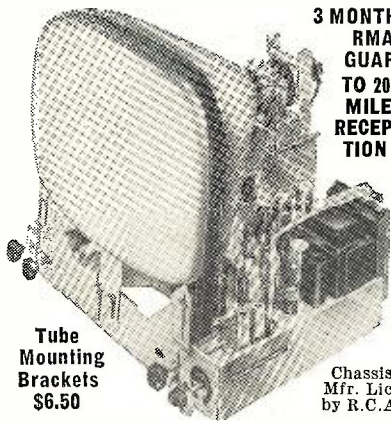

3 MONTHS  
RMA  
GUAR.  
TO 200  
MILE  
RECEP-  
TION

Tube  
Mounting  
Brackets  
\$6.50

Chassis  
Mfr. Lic.  
by R.C.A.

### MAGNAVOX HI-FI 3 Speed Record Changer

Dual stylus cart, heavy  
duty 4" pote motor. Inter-  
mixes 10-12".  
Each ..... \$28.70  
Regularly \$54.50

### TV GOLD PLASTIC MASKS

16" and 17" ..... \$ 4.95  
20" and 21" ..... \$ 7.95  
24" ..... \$14.95  
27" ..... \$17.95

### BARGAIN CABINET BUY

Mahogany console cabinet  
cut for 630 FA-3  
Chassis. With mast, glass  
& tube mount-  
ing brackets. . . . \$49.95  
In Blond . . . \$59.95  
FREE cabinet brochure

### AIR KING

6 Tube Radio Chassis  
Superhet. 1 stage R.F., 2  
stages I.F., 2 gang con-  
denser. Complete—6 tubes,  
speaker & built-in anten-  
na. Removed from origi-  
nal equip- . . . . \$10.95

### TV PICTURE TUBE SALE

Standard Brands. Factory  
New. Guar. 1 year.

- 17" Tube ..... \$24.95
- 20" Tube ..... \$32.95
- 21" Tube ..... \$34.95
- 24" Tube Rect. \$59.95
- 27" Tube Rect. \$74.95

### FM-AM RECEIVER

Regal. 10 Tubes. Covers  
full FM-AM band. 10 Watt  
Push-pull audio output.  
Separate bass & treble  
controls. Built in FM-AM  
antenna. With 12" Hi-Fi  
speaker  
\$5 additional . . . \$49.95  
Complete line of Tuners,  
Amplifiers, Speakers, Pho-  
no Pick-Ups, Cartridges, In-  
terchangers  
(Free Catalog Available)

## AIREX'S NEW SENSATIONAL 630-9 TV CHASSIS FOR 27" PICTURE TUBE OPERATION

- Channeloc-Picture & sound locked together. No drift
- Reception up to 200 miles
- 22 KV high voltage power supply
- High gain super cascade tuner
- Phono connection & switch on chassis
- Full 4 MC band width
- 90 degree deflection
- For 24" & 27" rect. tubes
- Adaptable for color
- 6L6 Vertical amplifier
- RMA guarantee

**\$179<sup>95</sup>**

With  
12" Hi-Fi  
RCA Speaker  
Tube Mtg Brackets. . . . \$6.50  
27" Aluminized rect tube (guar-  
anteed 1 year)..... \$74.95

All merchandise brand new, factory fresh, guaranteed. Mail & phone orders filled upon receipt of certified check or money order for \$25 as deposit on TV chassis. 20% on other items. Balance C.O.D., F.O.B. factory N. Y. Prices & specifications subject to change without notice.

**AIREX RADIO CORP.**

171 WASHINGTON ST., N. Y. 7, N. Y.  
CORTLANDT 7-5218

In home radio service, an experienced technician could get by with inexpensive test equipment if he wasn't concerned with the quality of the sound that came from the set and if he was content to charge off the extra time he had to give to the tough ones he serviced by hit or miss methods.

A certain amount of servicing of monochrome TV sets can be done by simple tube substitutions, although it is a bad practice since a tube failure is often an indication of impending circuit failure. However, only an inept technician attempts even minor service on a TV set without having some test instruments within reach. So the test instrument investment for monochrome receiver servicing has been considerably higher than was necessary for radio servicing.

Color television will require a substantial investment in test instruments even for use in the simplest replacements and adjustments that can be made in the home. Sound business reasoning will lead to the conclusion that this equipment should be amortized in service charges as rapidly as is legally possible. It is questionable whether one man working alone, with all of the other responsibilities of running a business, could handle a large enough work load to amortize his equipment, pay his business expenses, and provide him with an income commensurate with his training and experience.

### Bad Advertising

Recently an advertising man, commenting on the various things that small business operators do that are negative promotions, pointed out the TV service signs on old battered cars and trucks as an example of inept advertising.

People like to deal with prosperous-looking, successful businesses, he said, and the appearance of a service car or truck with a company or an individual's name on it tells its own story to the prospective purchaser of service. If the service car or truck looks good it lends prestige and dignity to the service company that has its name on it. If it is dog-eared, battered up, it carries a connotation that the service company is on the fringe of failure.

Where old, battered automotive equipment is used on service calls, he said, it is far better to leave all advertising off it.

This also applies to the appearance of the service shop. The caliber of people who are willing to pay for first-class service won't deal with businesses that have dirty, unkempt store fronts and show windows. A set owner in Grand Rapids, Michigan recently told your editor that he and several friends there had called a service company to service their TV sets because they had been impressed with the appearance of the building and show windows when they drove by the shop. "An orderly, neat appearing business like that," they reasoned, "must know how to give good service."

The appearance, deportment, and  
**RADIO & TELEVISION NEWS**

## GET INTO ONE OF THESE GREATER OPPORTUNITY FIELDS

# Electricity or Radio- Television

## TRAIN IN THE GREAT SHOPS OF COYNE

Prepare for your future NOW. Get practical training in TELEVISION—RADIO—ELECTRICITY—ELECTRONICS—all vital in industry. Prepare now for a better job that also offers a real future in the years ahead. Learn on real equipment at Coyne—no advanced education or previous experience needed.

Approved for Veterans—finance plan—enroll now, pay most of tuition later. Part time employment service while training if needed.

FREE BOOK Clip coupon for Big Free Illustrated Book. No salesman will call. Act NOW.

B. W. COOKE, President  
**COYNE** FOUNDED 1899  
**ELECTRICAL SCHOOL**  
A TECHNICAL TRADE INSTITUTE CHARTERED  
NOT FOR PROFIT  
500 S. Paulina St., Chicago, Dept. 64-85H  
ELECTRICITY • TELEVISION • RADIO • REFRIGERATION • ELECTRONICS

B. W. COOKE, Pres.  
COYNE ELECTRICAL School  
500 S. Paulina St., Chicago 12, Ill. Dept. 64-85H  
Send FREE BOOK and details on:  
 RADIO-TELEVISION  ELECTRICITY

NAME.....  
ADDRESS.....  
CITY.....STATE.....

## CRYSTALS!

**ALL HAM FREQUENCIES**  
Individually, Ea. .... \$0.79  
In lots of 5. Ea. .... .69  
In lots of 10. Ea. .... .59  
SINGLE SIDE BAND CRYSTALS..... .69

**COMPLETE SET—80 CRYSTALS**  
Ranging from 370-516 Kc., 54th Harmonic. INCLUD-  
ING 500 Kc. & 455 Kc. crystals. . . . \$6.95  
Only ..... Per set

**COMPLETE SET—120 CRYSTALS**  
Ranging from 370-540 Kc., 72nd Harmonic. INCLUD-  
ING 500 Kc. & 455 Kc. crystals. . . . \$9.95  
Only ..... Per set

200 KC. CRYSTAL ..... Ea. \$1.49  
500 KC. CRYSTAL ..... Ea. .75

**CRYSTAL GRINDING KITS**  
With Instructions  
80 METER KIT. .... \$6.49  
40 METER KIT. .... 5.49  
2 METER KIT. .... 5.49

**\$600 VALUE! SPECIAL! HOT!!**  
A TRANSCEIVER WITH A RAFT OF USES! Makes  
an ideal 2-Meter transmitter. Only a few of its  
many parts include: miniature blower, gear reduc-  
tion motor easily converted to 110 VAC, over 40  
miniature tube sockets, 7 Panel coaxial fittings,  
microswitches, & MUCH MORE! Excellent condi-  
tion. Original cost over \$600!  
IT'S ALL YOURS FOR ONLY..... \$9.95

**MS-53 INTERCHANGEABLE ANTENNA MAST**  
New. Per 3 ft. section. .... Ea. 97c

**0-1 THREE-INCH MILLIAMPER METER**  
270° indication. You just by-pass shunt and \$1.95  
add scale. ONLY..... 2.49  
WITH Shunt By-passed.....

**ARB NAVY RECEIVER.** Excel. cond. .... \$27.50  
**SCR-518 UHF ELECTRONIC ABSOLUTE**  
**ALTIMETER.** New. Less tubes. .... 19.95  
**TELEPHONE DIAL.** Used, excel. cond. .... 1.75  
**LATEST TYPE FIELD PHONES.** Excellent  
condition. PER PAIR. .... 19.50

400 MICA CAPACITORS. Assorted. Mounted  
10 to a strip. All 400..... \$ 1.95  
ARW-2 REMOTE CONTROL RECEIVER. NEW.. 27.50

Send for FREE Catalogue!

All merchandise sold as is. Items subject to prior sale.

**J. J. GLASS ELECTRONICS CO.**  
1615 S. MAIN ST., LOS ANGELES 15, CALIF.



**MODEL 27-Z  
TESTER**  
(Made in Japan)

**\$10.95**

(Plus 25c shipping)

RANGES: AC and DC volts 0-5/25/250 (500), DC MA 0-1/10/100/250, Ohms 0-10K, 100K, Black bakelite panel, metal case. Manufacturer claims extreme accuracy and our spot checks show them to be within 1%!



**HEAVY DUTY ALNICO-5 MAGNETRON MAGNET.** 7 1/2 lb. EA. Will lift 50 lbs. From 4430... **\$7.49**  
**BABY WINCH.** Reversible. 24 V. AC or DC. Bike sprocket or cable drum take-off. For beam, garage door opener, Bar-B-Que, boat rudder control, etc. NEW WITH INSTRUCTIONS... **\$4.95**

**RADIO CONTROL**

Build receiver from schematic we furnish with our 5 high-peaked, extremely selective AF band-pass filters. Kill interference from other transmissions. Get 5 operations at one R.F. From Air Forces radio-controlled target plane receiver. Passes... **\$2.95**  
All five with schematic. Only...

**CAN CONTAINING 4 CLARE TYPE K MINIATURE RELAYS.** **\$2.95**

**GENERATOR-ALTERNATOR SPECIAL  
120V AC PLUS 12VDC**

Two units in one package, each complete in itself: the removable centrifugal slip clutch and the generator-alternator. Clutch maintains armature speed of 2400 rpm for drive speeds varying between 2400 and 4200 rpm. Outputs 120v. 800 cy. 1 ph. 1080 VA plus 12 v. 40 A DC. Drive it from engine or electric motor. With diagram and instructions. **\$19.95**

New condition... **GENERATOR-ALTERNATOR** same as above except that DC output is 28.5 V. @ 25 amp. Excl. **\$9.95**

**GENERATOR-ALTERNATOR** similar to above except that DC output is 200 amps. Ask for 2CM81B1 **\$12.95**

**115 V. 60 CYC. BRASS-BOUND HEAVY-DUTY SEL-SYNS.** 1/4 in. diam. shaft. **\$12.95**  
PER PAIR, Only...  
Each additional Unit... **\$5.95**

**CRYSTAL DIODE.** 1N60. New. J.A.N. approved. 6 E. 40 ma. EACH... **69c**  
5 FOR... **\$2.95**

**ANTENNA MAST SECTIONS**

Each 1 meter long. Screw together. MS-49, 50, 51, 52. New. Each... **\$2.95**  
MS-53. This is the bottom section that fits into itself. Use one or more for extra height. Each... **98c**

**DC VOLTAGE CHANGER:** Changes 12 VDC to 24 VDC so you can operate 24 v. receiver with no modifications and also take advantage of its 24 v. remote control features. Ea... **\$5.95**

**\$45.00 HI-FI HEADSET AT \$7.95**

Uses annular grooved plastic fibre cones with voice coils as in speakers, and padded chamois ear muffs to obtain spacing for correct acoustical load. Gives finest music reproduction... **\$7.95**

**24-HOUR TIME CLOCK SWITCH  
90% DISCOUNT!**

**HEAVY DUTY SANGAMO MECHANISM:** 115 or 230 V. 60 cycles. Up to 3 "ON"s and "OFF"s. Skip "OFF" any one or two days with 30A DPST Switch. Controls lawn sprinklers, neon signs, hen-house lights, etc. With instructions. Guaranteed... **\$4.95**  
(dealers: Write for quantity discounts.)

**HALF-INCH PIPE SIZE SOLENOID VALVE.** 18 to 24 VDC. 1.5A. Controls lawn sprinkler with above mechanism... **\$2.95**  
**TRANSFORMER.** 115 V., 60 cycles to 24 V., 6A., for above solenoid & many other uses... **98c**  
**SELENIUM RECTIFIER.** 30 VAC max. 1-2 A full wave. For above transformer & solenoid... **\$1.50**

**12 V. RECEIVER DYNAMOTOR**

Same as the 24V dynamotor on the back end of your 274-N or ARC-5 command receivers, except that these are made for 9 to 14 volts. Same base plate and plug connections. Output 230V, 60 ma. DY-1/ARR-2X, like new, checked out... **\$4.95**

**5B1 CR TUBES.** New. Boxed. Ea. \$1.29; 3 for \$3.49 (Shipped RailX only).  
**OMNITE DUMMY LOAD** 100 W., 73 ohm, non-inductive. Usual net price is \$6.98. BRAND NEW. **98c**

Special. **IMPROVED 2 V. WILLARD WET CELL BATTERY.** Same size as old 20-2 but 27 a.h. instead of 20. Ea... **\$2.95**

**12 V. UNIVERSAL MOBILE DYNAMOTOR  
(D. W. Thomas Engineering Inc.)**



Your choice of EITHER 400 V. @ 350 MA OR 600 V. @ 200 MA. Change by simple link switch on model with relay and filter base or by choice of relay on the model less base. 10" long, 5" wide. Grey hammerhead. Easily mounted. BRAND NEW with hook-up instructions and circuit permanently affixed on base. A sensational value!  
Less base **\$10.95** With base **\$17.95**

**G. L. ELECTRONICS, INC.**

905 S. Vermont Ave., Los Angeles 6, Calif.  
Minimum Order \$5.00 Total. 25% Deposit Required  
All Prices F.O.B. Los Angeles, Calif. Buyers Add Sales Tax  
GET ON OUR MAILING LIST

**SCHEMATICS—CONVERSIONS  
FOR SURPLUS GEAR**

**NEW LIST! MANY ADDITIONS!**

Send stamped, self addressed envelope for List C. Add 25c for chart explaining AN nomenclature.

R. E. BOX 1220  
GOODHEART BEVERLY HILLS, CAL.

working habits of the man who calls to service the set in the home provide either good or bad advertising for the business. Recently a set owner, pointing to the illustration of a v.t.v.m. on your editor's desk, said "The man who takes care of our TV set always uses a complicated gadget like that. Once we called another man who advertised cheaper service. He came out and just changed two tubes and didn't check anything. Two weeks later we had trouble again. So we called this reliable service company. He used this kind of a set to test our TV and found that one of the parts had shorted out. That's what caused the tubes to burn out. Believe me, we'll never call a service man again because he advertises cheap service charges."

This clearly demonstrates how the set owning public pays for its own education about service. When a set owner buys service on price and gets stung—as they usually do—they never try to buy service again on the basis of price.

**Building a Business**

Servicing electronic equipment will continue to open up new business opportunities for men who crave the freedom of individual initiative through operating their own businesses. Very few industries provide this kind of an opportunity. Complex mechanisms make it necessary to use expensive equipment to service them. Service organizations are necessary to support these substantial investments in servicing and maintenance equipment so the amortization load can be carried by a group of men.

This will also happen in some phases of electronic service. Television, for instance, will gradually shift to color sets and the more complex servicing problems color reception will present. And remember, too, that television will find a place in many important applications in the home in other than broadcast TV. For instance, the same method that would make subscription TV possible could also be used for visual as well as aural communications between set owners provided TV cameras were installed at both points. Although this would be impractical at this time because of the cost of the cameras, the industry that spanned the gap from radio to television in less than twenty-five years will someday produce television cameras within the price range of the average home owner.

Because of the many complex factors involved, the shift of television from monochrome to color will probably bring about a decided shift of television maintenance and servicing into the hands of well-managed service organizations that are able to carry the substantial stock and equipment that will be required. This service industry will employ many thousands of technicians, supervisors, and managers of service; some estimates forecast a total service force of more than 300,000 people engaged in the business of installing and servicing TV by 1960. But television is just one facet of the

**Here's how to  
GET MORE WORK  
OUT OF YOUR  
Oscilloscope!**

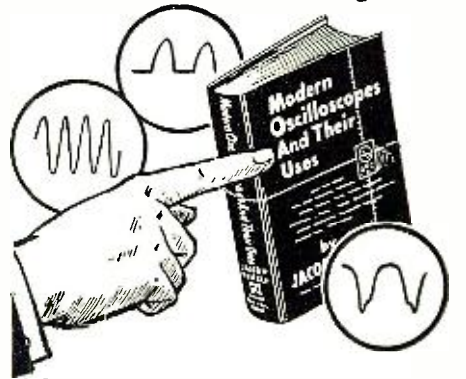

**A complete, easily understood guide to using the handiest, most profitable service instrument of all**

**MODERN OSCILLOSCOPES AND THEIR USES**

By Jacob H. Ruiter, Jr.

of Allen B. Du Mont Laboratories, Inc.  
326 pages, 370 illustrations. Price \$6.



**'SCOPE EXPERTS  
get better jobs  
... bigger pay!**

Oscilloscopes are gold mines for servicemen who learn to use them fast, fully and accurately on all types of work—AND HERE AT LAST IS A BOOK THAT REALLY SHOWS YOU HOW.

In clear, easily understood terms, it teaches you when, where and exactly how to use the oscilloscope... how to interpret patterns... how to use your 'scope to handle tough jobs easier, faster, and better.

It contains no involved mathematics — no complicated discussions. Instead, it gets right down to "brass tacks" in explaining how oscilloscopes operate. Then you learn exactly how to use them in lab work and on all types of AM, FM and television service—from locating troubles to handling tough realignment jobs.

**WORK EASIER—BETTER—FASTER!**

Each operation is clearly explained step by step. You learn to determine just where and how to use the 'scope on a specific job; how to make connections and adjust the circuit components; how to set the controls; and HOW TO ANALYZE OSCILLOSCOPE PATTERNS fast and accurately. 370 illustrations including dozens of pattern photos make things doubly clear.

No other type of specific service training can mean so much to you in boosting your efficiency and earning power! Send coupon NOW for 10-day FREE examination!



Dept. RN-94, RINEHART & Company, Inc.  
232 Madison Ave., New York 16, N. Y.

Send MODERN OSCILLOSCOPES AND THEIR USES for 10-day FREE EXAMINATION. If book is sent to factory, I will then send you \$6.00 promptly in full payment. If not, I will return book postpaid in good condition and owe you nothing.

NAME .....

ADDRESS .....

CITY, ZONE, STATE .....

OUTSIDE U.S.A. \$6.50, cash only. Money back if you return book within 10 days.

Prices are Low at

# Harjo

First Time Offered — Maybe the last Value-of-the-Year!

## MINIATURE LINE MATCHING TRANSFORMERS

Orig. Gov't Cost Approx. \$14 — Will Duplicate Functions of \$55 Parts!

Complete With Schematic (add 25c for postage)

### WHILE THEY LAST

- For blocking oscillators on TV Camera input circuits
- For blocking oscillators on TV Receivers
- Tone Oscillator transformer for electric organ
- For digital computer systems, blocking and count down
- For phone patches
- For transistor 0-circuits
- 100's other uses!

Tiny transformer weighs only 4-oz., 1 3/16" x 1 3/16" x 2" high. Mfg'd under JAN specs & test standards. It's hermetically sealed. Four windings—2 input of 150 ohms impedance each—and 2 output of 1 of 100 ohms and one of 600 ohms impedance. Rated 6 WATT, 200-4000 cy., 500 V., RMS test. Hurry, they won't last long at this price!

CERAMIC CONDENSERS, kit of 100 assid. brand new standard brands.

\$10 value ..... Postpaid **\$1**

COAXIAL CABLE SPECIAL. **\$4.95**

FT & T COAXIAL CABLE, RG-8/U, 110 ft. roll complete with PL-259 connectors at each end. Individually boxed and actually branded **\$5.95**

FT & T. While they last.

**APS 13 Complete 420 MC RADIOPHONE**

\$14.95 Value!

Price Slashed!

**\$3.95**



Easy to convert with our schematic and simple instructions. Range in most cases equal to 2 meters. FB for communication, ranches, farms, etc. Complete with RF sections conversion booklet and 30 MC I.F. strip, less tubes, dynamotor.

Look! 701A XMTR. TUBES **\$2.95** 2 for \$5

DuMont 3GP1 Cathode Ray Tubes **\$1.79** 3 for \$5

While they last at this reduced price! New, orig. boxes. FILAMENT TRANSFORMERS for these, only **\$2.95**

Same as used in Dumont 224A oscilloscope. New orig. boxes.

SOUND POWERED HEAD & CHEST SET. Navy type, no batteries needed. Ideal for TV antenna installations, etc. 20' cord. **\$7.95**

TELESCOPIC ANTENNA. 7' long, 3 sections for portable or mobile. **95c**

NEW POWER TRANSFORMER. 110 V., 60 cy primary, 150 V. 30 MA secondary, 6-3-1 amp. l. FB for grid dip kits, test equip and Bias supplies. **79c ea.—4 for \$3**

TS45/APM X-Band Signal Generator

For small labs, schools and service shops. Hurry—while they last! **\$125**

Western Electric HANDSET complete with cord. Xmt. cond. FB for mobile and home telephone systems. **\$2.95**

TV TUNERS. Standard coil. Cascode with 6BQ7, 6J6. New. **\$13.95**

METER SPECIAL! 0-4 amps. rf. GE 3-inch round enclosed in aluminum case. A must for accurate XMTR. output readings. **\$3.95**

500 OHM BRIDGE T PAD. **79c or 2 for \$1.50**

**RCA SURPLUS TV CAMERA**

New Low Price! **\$225**

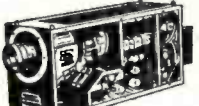

With 1848 iconoscope and 6-stage video amplifier and clipper.

For movie pickup chains and training and experimental work. Complete info on request—but hurry as they won't be around long at this new low price!

Just Released! New SIGNAL CORPS TELEPHONES

New Pair **\$19.50**

Long range, waterproof lite aluminum case complete with batteries. Bell or noon indicator for all signal. Uses a handset with F-1 button. Makes a terrific fone patch.

ARC-4 VHF TRANSCEIVER

Complete with Schematic **\$24.50**

For novice, 2-meter CB or CAP. All tubes included, less dynamotor and xtals.

SAVE ON COMMAND EQUIPMENT

T-21/ARC-5 5.3-7 MC Xmt. **\$6.95**

R-27/ARC-5 6.9-11 MC Revr. **6.95**

24V Filament Transformer for above. **.98**

Command Set Tuning Knobs for above. **.59**

HIGH-VOLTAGE FAN BELT GENERATOR for mobile rigs. 1000V @ 50 MA. from fan belt—for 200 to 300 Watt outputs. Complete with pulley, voltage regulator, hookup diagram, xmt. tube and circuit comb.—ready to install! **\$24.95**

12V or 24V GENERATOR, brand new, your choice **\$8.95**

WE PAY MORE FOR RADIO PARTS, EQUIPMENT! CASH IN SURPLUS—OR TRADE! Write now!

WRITE FOR FREE CATALOG! 1000's of items not listed here—All shipments F.O.B. Warehouse!

# Harjo Sales Co.

Dept. RH 4109 Burbank Blvd., Burbank, Calif.  
P.O. Box 1187 Magnolia Park Station  
CABLE: Harjo Phone: Victoria 9-2411

giant industry electronics is destined to be. We previously mentioned the vast service market in radios and record changers that has been almost completely neglected by the independent service industry for the past several years. Another electronic device that has been rapidly coming to the fore is the radio-controlled mechanism for remote operation of garage doors. Many small radio shops hit a business bonanza when they started promoting these units in their communities.

In the field of mobile two-way communications, the Citizens band will eventually bring into existence a variety of instruments which will operate on this assigned band of frequencies. Many model airplane and model boat enthusiasts control their powered craft by radio using miniature transmitters and receivers sold by hobby shops.

Despite its amazing potential, the electronics industry will always keep the door of opportunity open for the technician who wants to engage in business of his own. But to make a success of his business, the ambitious technician-businessman must understand his industry well enough so that he can make a place for himself by selling service on the type of equipment he can handle profitably in the area where he operates.

## "CBS-COLORTRON 205"

CBS-Hytron has demonstrated its "CBS-Colortron 205" large-screen, direct-viewing, all-glass, tri-color television picture tube to the press. It employs a curved shadow mask and tri-color screen in combination with the three-beam electronic gun. The tube provides a choice of full color or black-and-white pictures on a screen having an area of 205 square inches. In the matter of size it most closely approximates the standard 21 inch black-and-white tube.

The increased screen area has been obtained by printing the screen directly on the inside of the face and by constructing its curved shadow mask so as to achieve maximum utilization of the area on the face. This additional screen area has been gained by positioning the three supports for the shadow mask above and below the desired screen area to obtain the desired 4 x 3 aspect ratio. The sides of the mask and screen are thus left free of interference.

Development of a photographic technique, similar to photoengraving, makes it possible to deposit the screen (composed of approximately 300,000 triangularly arranged groups of phosphor dots) directly on the inside of the tube's curved face—the same location used in black and white picture tubes. A light, easily assembled curved shadow mask is uniquely positioned behind this screen. This mask is perforated with approximately 300,000 tiny matching holes through which the electron beams from the three guns are aimed at their related phosphor dots on the screen. Because each shadow mask is used as a negative to print its individual screen, the screen and mask are brought into perfect registry.

As we go to press RCA has just announced a 21" color tube, which gives a 250-square-inch picture.

## "CAVEAT EMPTOR"

tube  
(Let the buyer beware)

Good advice for the modern serviceman! Today more and more used tubes are being sold in the guise of new tubes. They look good and most operate good... at first. But too many break-down too soon...

Too often cheap prices and extravagant claims have fooled the buyer into purchasing these imitations, instead of the genuine article.

Barry Electronics sells First Quality. Fully Guaranteed, individually boxed, Standard-Brand tubes. Our tubes do not have to be "set or meter checked." They are from original, sealed cartons from the five leading tube manufacturers.

Cheap imitations such as seconds, reworked bargains, and off-brands result in unnecessary call-backs, expenses, and loss of customer goodwill...

You can place your confidence in our New, First Quality, fully-guaranteed STANDARD-BRAND tubes.

WRITE TODAY FOR THE BARRY HANDY-ORDER FORM. A COMPLETE LISTING OF STANDARD BRAND RADIO & TV TUBES AT OVER 60% DISCOUNT.

AUTHORIZED DISTRIBUTORS  
CBS-HYTRON EIMAC WESTINGHOUSE

SPECIAL-PURPOSE? WE STOCK OVER 2000 TYPES!

TWO-COLORED TUBE CARTONS, with new Safety Partitions. Prevents Tube Breakage. This Super-Gloss Red and Black Carton is the Most Distinctive Box Available Today! Minimum: 100 any one size. Quantity prices on request.

SIZE	FOR TYPES SUCH AS	EACH
Miniature	(6AU6, 6AL5, etc.)	\$.01
GT.	(6SN7, 6W4, etc.)	.0125
LARGE GT.	(1B3, 6BQ6GT, etc.)	.015
LARGE G.	(5U4G, 6BG6G, etc.)	.02

TERMS: 25% with order, balance C.O.D.  
All merchandise guaranteed. F.O.B., N.Y.C.  
PHONE: Rector 2-562

# BARRY ELECTRONICS CORP.

136-F LIBERTY ST. N. Y. 6, N. Y.

## RECORDING TAPE (PLASTIC BASE)

40% OFF (NEW)

- 1200 ft. plastic tape with plastic reel included.
- Each reel individually boxed.
- Choice of nationally famous top quality brands such as: Webcor (2806) 3.20; Reeves (SPN-12) 3.20; Audio (1251) 3.25; Scotch (111-A) 3.25; Panacoustic (71-A) 3.25; Irish. Professional grade (211 RPA) 3.30.
- FREE! A 7.95 tape carrying case included with purchase of 12 new tapes!

USED RECORDING TAPE (PLASTIC BASE)

1200 Feet Wound on Plastic Reels

\$1.99 (1-23) reels	\$1.75 (48-95) reels
\$1.79 (24-47) reels	\$1.71 (95-143) reels
\$1.68 (gross or more)	

\*\*Standard hub plastic reel supplied with above. For tape wound on professional 2 1/4" hub, add 9c extra per reel.  
\*\*Empty 7" box (2 cover) for above reels 5c each (not sold at this price separately).

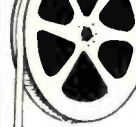

New empty plastic reels in boxes for easy labeling. 3" 10c; 4" 22c; 5" 24c; 7" 29c; 7" Professional reel (2 1/4" hub) 39c ea. EMPTY BOXES: 3" 3c; 4" 5c; 5" 5c; 7" 10c ea.

We carry all brands of new tape, recording blanks, tape recorders, etc., at low prices. PLEASE INCLUDE SUFFICIENT POSTAGE.

COMMISSIONED ELECTRONICS CO.  
2503 Champlain St. N.W., Washington 9, D. C.

## TV TRADE-IN SETS BOUGHT — SOLD

- Philco • Emerson • GE • Admiral
  - Motorola • Tele-King • Others
- 10"—\$17; 12" to 17"—\$20 up

Send check or money order now!  
List available—Add \$5 each for packing  
WASHTEK SERVICE CO.  
1501 Boston Road, Bronx, N. Y. DA 3-9281

## "Concert Hall on Wheels"

(Continued from page 67)

flesh and blood orchestra, as the composite Fig. 2 illustrates. While the trebles are on one side of him and the basses on the other, the middles coming from both sides become directionally diffused and serve to form a physical (or acoustical) bridge between the treble and the bass ends of the car.

Now to get down to brass tacks. How is all this effect achieved? How shall we take the single channel (monaural) program that we receive on the car radio and convert it into a *synthetic* stereo system? Having already justified this conversion on the basis of "geometric-frequency" band separation, let us examine what this entails from a technical angle.

Such frequency-band separation of the ordinary type is, by itself, not new nor difficult to obtain. It is accomplished by means of a "crossover" network, of which the general form is illustrated in the dotted section of the accompanying schematic diagram, Fig. 3. It will be noted from this schematic, however, that this crossover network is only one small part of the present system, and although we shall presently see that in this application the crossover network is somewhat unconventional, it will nonetheless be advantageous to briefly point out the major advantages that accrue to the usual multi-speaker system employing crossover networks. First, by the use of such frequency-band discriminating networks intermodulation distortion is greatly reduced by the separation of the signal energy into a low-frequency band and into a high-frequency band, and subsequent channeling of the electrically separated bands of energy into physically independent reproducers. This permits the low-frequency and high-frequency reproducers to function independently, each with maximum efficiency.

What differentiates the present system from a simple dual-channel speaker system? We are not dealing here with a simple woofer and tweeter, but with two speakers "A" and "B," which today may be called upon to perform as woofer (A) and tweeter (B) or tomorrow as woofer (B) and tweeter (A). The "A-B" or "B-A" arrangement will be dependent upon factors such as who is sitting in what section of the car, the musical preference of the car occupants, the musical content of the program, and the noise conditions encountered on the road. This necessary alternate woofer-tweeter or tweeter-woofer arrangement places a very special prerequisite upon the system. In contrast to the usual *frequency-band specialized* woofer and tweeter, both speakers in this system must be of equal *wide range and high fidelity* capabilities.

The crossover frequency for this ap-

## Busiest tool on the job



For on-the-job servicing, you'll find the new Weller Soldering Gun the handiest soldering tool you've used. Just pull the trigger and it heats instantly... release trigger and it cools instantly. No waiting. No chance of damaging rugs or endangering children. Besides the speed and safety, the Weller Soldering Gun—

Goes anywhere inside tight circuit-loaded chassis—without damage to parts or wires. Slim streamlining and longer reach makes tight spots easy. Dual spotlights illuminate work—no shadows.

Gets hot fast *when* you want it. Makes soldering joints that are sound and does it efficiently with full, constant heat.

Gives you power plenty—from 100 to 150 watts with a click of the trigger; or on heavy duty model—from 200 to 275 watts, instantly!

Ask your distributor for a demonstration, or write direct for bulletin.

# Weller

## Better from Grip to Tip! SOLDERING GUN S

810 Packer Street, Easton, Pa.

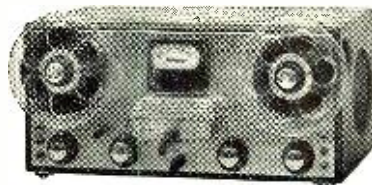

**Now for the first time—true broadcasting quality priced low enough for all to enjoy. Six years development has resulted in the only recorder of its price meeting NARTB broadcasting standards.**

3 speeds—15", 7½", 3¾"  
± 2 db 30-11000 cps at 7½"/sec.  
3 motor mechanism, 2 inputs  
less than .25% flutter and wow  
20 watt hi-fi amp. built in  
8" 10 watt speaker built in

Write today for free brochure to Dept. R9  
Dealer Inquiries Invited

INTERNATIONAL RADIO & ELECTRONICS CORP. • ELKHART, INDIANA

*Builders of Broadcast Equipment Since 1938*

Watch for new Crown ad in October issue

**irish**  
DR. AND  
**GREEN BAND**  
 Professional



**The FINEST TAPE**

**Your Recorder Can Use....**

Frequency Range: 20-20,000 cps  
 Lowest noise level • Uniform sensitivity  
 Minimum amplitude variation • Less distortion

600 feet on plastic reel.....net \$2.10  
 1200 feet on plastic reel.....net 3.30  
 2400 feet on metal reel.....net 7.71  
 SPLICE-FREE



**THE TAPE THAT MIRRORS**

**THE ORIGINAL SOUND**



Available at Most Sound Dealers

**ORRADIO Industries, Inc.**  
 OPELIKA, ALABAMA

Export Division: Morhan Exporting Corp., New York, N. Y.  
 In Canada: Atlas Radio Corp., Ltd., Toronto

**QUARTZ CRYSTALS**

FT-243-.093" PIN DIA.—.486" PIN SPC

FOR HAM AND GENERAL USE • GUARANTEED

4035 5500 5925 6425 7450 7673 7900	1015 6175 7000 7425 8425
4080 5675 5940 6673 7473 7675 7906	2125 6200 7025 7425 8450
4110 5700 5950 6675 7475 7700 7925	3500 6440 7050 8025 8475
4165 5706 5973 6700 7500 7706 7940	3735 6450 7075 8050 8500
4190 5725 6240 6706 7506 7720 7950	3800 6473 7100 8075 8525
4280 5740 6250 6725 7525 7725 7973	3885 6475 7125 8100 8550
4300 5750 6273 6750 7540 7740 7975	3940 6500 7150 8125 8575
4397 5773 6275 6775 7550 7750 8225	3990 6506 7175 8150 8600
4490 5806 6300 6800 7573 7773 8250	6000 6550 7250 8173 8625
4495 5840 6325 6825 7575 7775 8273	6025 6573 7300 8175 8650
4930 5850 6340 6850 7600 7800 8275	6050 6575 7306 8200 8700
5030 5852 6350 6875 7606 7825 8300	6075 6600 7325 8340 8733
5205 5873 6373 6900 7625 7840 8325	6100 6606 7340 8350
5300 5875 6375 6925 7640 7850 8630	6125 6625 7350 8375
5385 5880 6400 6950 7641 7873	6140 6640 7375 8380
5485 5906 6406 6975 7650 7875	6150 6650 7400 8400

49c each—10 for \$4.00      99c ea. 10 for \$8.00

Low Frequency—FT-241A for SSB, Lattice Filter etc., .093" Pins, .486" SPC, marked in Channel Nos. 0 to 79, 54th Harmonic and 270 to 389, 72nd Harmonic. Listed below by Fundamental Frequencies, fractions omitted.

370 393 414 437 501 522 400 461	5910
372 394 415 438 502 523 440 462	6370
374 395 416 481 503 525 441 463	6450
375 396 418 483 504 526 442 464	6470
376 397 419 484 505 527 443 465	6497
377 398 420 485 506 529 445 466	6522
379 401 422 486 507 530 446 468	6547
380 402 423 487 508 531 447 469	6610
381 403 424 488 509 533 448 470	7350
383 404 425 490 511 534 450 472	7380
384 405 426 491 512 536 451 473	7390
385 406 427 492 513 537 452 474	7480
386 407 429 493 514 538 453 475	7580
387 408 430 494 515	7810
388 409 431 495 516	7930
390 411 433 496 518	457 479
391 412 435 497 519	458 480
392 413 436 498 520	459

CR-1A

SCR

1/4" P

1/2" S

FT171B BC-610  
 2 Banana Plugs  
 3/4" SPC

2030 2220 2360 3202 3570
522
2045 2258 2390 3215 3945
2065 2260 2415 3237 3955
2082 2282 2435 3250 3995
2105 2290 2442 3322
2125 2300 2532 3510
2145 2305 2545 3520
2155 2320 2557 3550

BC746 TUNING UNITS, CHANNELS 10 AND 12—foundation coils and condenser for 80 meter VFO or exciter—less xtals  
 PBC  
 SEE ARTICLE BY W3PPG IN MARCH '54 CQ.

add 20c postage for every 10 crystals (or less)

49c each—10 for \$4.00      99c each — 10 for \$8.00

Spec.—200 KC without holder—59c, 3 for \$1.50

Spec.—200KC or 500KC in FT241A Holder, \$1.79 ea.

**SUN**  
 PARTS DISTRIBUTORS, LTD.

520 TENTH ST. N. W.—WASH. D. C., DEPT. N

**KEEP YOUR RECORDS YOUNG!**

USE THE

**MERCURY**  
 Disc-Charger



This tiny plastic device contains a radioactive material which constantly ionizes the air in its vicinity, drawing off the static electricity generated by your records.

Since static electricity causes records to attract and hold dust, use of the Disc-Charger\* eliminates the static electricity and allows the stylus to pick up the dust and clean the record in a few plays. As records now no longer attract dust, records stay clean and noise free.

1/2 gram—clips to any pickup arm see your local distributor, \$4.50 or shipped postpaid, only...

**MERCURY SCIENTIFIC PRODUCTS CORP.**

1725 W. 7th St.  
 LOS ANGELES 17, CALIF.

\*Pat. App. For

plication was selected on the basis of dividing the ten octaves of the usable musical spectrum from 16,351 cps to 16,744 cps into two equal parts of five octaves each. This places the actual crossover frequency at 493.88 cps (approximately 500 cps). By this choice the lower five octaves become the "bass and lower middle choirs" of the orchestra, and the upper five octaves become the "upper middles and treble choirs" of the orchestra.

To permit selecting the manner in which this binaural or stereo system will operate, that is, whether it will be "woofer-tweeter" or "tweeter-woofer," a simple selector system is provided as shown in Fig. 1, and as indicated in the schematic diagram. In the one position, "Bi-A," the lows are channeled to the forward speaker, while the highs are sent to the rear. In the alternate position, "Bi-B," this channeling is reversed. Thus there is afforded a choice of orchestral set-up best suited to the operator's musical tastes. You may have the bass in front of you and the treble in back, or you may chase the bass into the rear of the car and bring the violins forward at the turn of the switch from "Bi-A" to "Bi-B."

The third position of this switch, "Mon.," eliminates the frequency separation function completely, thus making the two speakers perform exactly the same over the full fidelity range. With the master selector switch in this "monaural" position, there are provided auxiliary "on and off" toggle switches which permit the use of one or both speakers, either front or rear. Dummy loads are provided in these auxiliary circuits so that switching these speakers on or off will not upset the level of either speaker individually.

Individual volume controls for each speaker are also provided so that the proper volume balance between the speakers may be obtained for any one of the three alternate switch positions, and to compensate the individual output levels for the unequal distances of the two speakers from either the front or rear seat (whichever one happens to be the favored one). Since most of the volume manipulation will be performed at this control panel, it may prove desirable, but by no means necessary, to remove or jump the built-in volume control of the receiver itself. If this is done, then a fixed volume control should be inserted in the receiver, and this volume control should be set at the point where the audio output stage will not be pushed into areas of distortion.

The constants shown on the schematic (Fig. 3) for the 500 cps crossover section are selected for a 3.2 ohm output circuit which is the normal output impedance of an automobile radio. For economy sake, the 15  $\mu$ f. condenser may be a low voltage back-to-back type of electrolytic. This is small in size and may be mounted by means of a fuse clip soldered to the rear of one of the "L" pads as shown in the rear view of the device (Fig. 4).

The second "L" pad may serve as a support for the choke by soldering to its back a brass screw which will, in turn, support the lightweight air core choke. The winding data for this choke, L, is given in the schematic diagram.

There is no hard and fast rule as to how to operate this binaural system, therefore the alternate switch position is made available. In cases where the existing speaker is located down low and perhaps pointed downward as in some not-too-old installations, it will be found advantageous to operate the system with this downward-beamed speaker reproducing the lows. The rear speaker which will, in this case, reproduce the highs, may then be mounted in a separate enclosure placed on the rear shelf of the car in such a manner that it will beam the high frequencies forward.

However, if the existing speaker is well up on the dashboard and directed fairly well at the listener, as in the more modern car installations, then the installation may be modified in the following manner. Admirable low-frequency results may be obtained if a good high-fidelity speaker is mounted flush on the rear shelf so that the back of the speaker looks into the trunk of the car. This trunk volume will provide adequate rear baffling of the speaker which is so essential for the reproduction of good low-frequency sound. As far as the treble tones from this speaker are concerned, the rear window, usually at an inclination of close to 45° will, by reflection, throw the treble tones forward into the passenger area of the car, when this speaker is called upon to carry the treble.

However, it will be found in practice that the operation of this installation will afford the most pleasure when the forward speaker becomes the treble reproducer and the rear speaker performs the bass function. The trebles coming toward the face of the listener will add greatly to the acoustic "presence." Since most of the intelligibility of sound is in the treble region, the listener will get a better perspective acoustic picture if the highs "face" him, and the lows float around to him from some other direction. The user will of course have to follow his own preferences in this matter and these performances will, to a considerable degree, be affected by the car's interior acoustic properties, by the quality of the speakers used, by the program material being received, and by the favored listening position within the car.

The placement of this stereo control panel is determined by the car in which it is installed. It may be mounted in the glove compartment to keep it out of prying hands. However, if you like to exhibit your accessories, some convenient spot may usually be found below the dashboard panel. Or it may even be built into some blank section of the dashboard such as the glove compartment door.

-30-

September, 1954

# ROHN *the Foremost Name* in TV Towers...

2 PRESENTS  
**new additions**

## the "PACKAGE" TOWER

The "Superiority" secret is in the "magic" triangle!

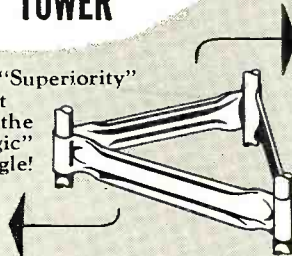

The answer to your storage space dreams — reduced freight rates give you the edge on competition!

PAT. PENDING

Both towers are self-supporting and have all the Rohn "Superior Design" features that make the Rohn line truly proved in performance and nationally accepted!

## the NO. 6 TOWER

Built to fill 75% of your requirements — structurally as sound as the Rohn Standard No. 10 Tower — yet costs less!

These new Rohn Towers continue to feature the famous triangular design, the self-supporting features and the simplicity of design which gives extraordinary ruggedness and durability! New, advanced Rohn designing utilizes mass production machinery to greatly lower cost — yet actually produce a tower structurally sturdier than before! Get full facts today on Rohn Towers that are loaded with "Sales Appeal" . . . so far advanced in design and engineering to be truly years ahead!

See your authorized Rohn Representative or Distributor for catalog sheets and complete details. Or . . . write, phone or wire . . .



**MANUFACTURING CO.**  
DEPT. RTN 116 LIMESTONE BELLEVUE  
PEORIA, ILL.

"Pioneer designers and manufacturers of towers of all kinds sold with assurance and satisfaction coast-to-coast!"

## Audiorama 1954

Presented by THE AUDIO FAIR

More than 125 manufacturers, from all over the world, will exhibit and demonstrate their products — the finest components, equipment and accessories. Their representatives will answer your questions and help you with your audio problems. AUDIORAMA 1954 is for broadcast engineers, sound-on-film men, governmental, military and municipal agencies, business and industrial purchasing agents — for everybody interested in quality sound reproduction.

AUDIORAMA 1954 is presented by THE AUDIO FAIR  
Harry N. Reizes, Managing Director, 67 W. 44th St., N. Y.  
An AUDIO FAIR-VIDEO FAIR, INC. Project

**NO  
ADMISSION  
CHARGE  
YOU ARE  
INVITED**

**FOUR DAYS**  
Oct. 14, 15, 16, 17  
**FOUR FLOORS**  
5th, 6th, 7th, 8th

**Hotel New Yorker**  
New York City

1 to 10 P.M. Daily  
Sun. 12 Noon to 6 P.M.

SPONSORED BY



Buy PEERLESS  
and you buy  
the BEST!

Insist on Peerless 20-20  
And 20-20 Plus transformers.

Consistent quality.  
Uniform response.

Smooth roll-off.  
High efficiency.

Low distortion.  
No dips, no peaks.

When your amplifier is equipped with a Peerless 20-20 Transformer (20-20,000 cycles) you can be confident of high quality performance. Rigid adherence to stringent specifications and tight quality control are reflected in the outstanding performance of Peerless 20-20 transformers—surpassed only by the 20-20 PLUS line.

When superlative performance is desired, the Peerless 20-20 PLUS is the answer. The 20-20 PLUS has all the famous features of the 20-20 line PLUS wider frequency range, PLUS improved efficiency, PLUS smaller size, PLUS increased power rating, PLUS greater value. You can depend on Peerless for the best.

Write today for the Peerless Catalog

 **PEERLESS**  
Electrical Products

A DIVISION OF



9356 Santa Monica Blvd., Beverly Hills, Calif.  
161 Sixth Avenue, New York 13, New York

# NEW EQUIPMENT FOR THE AUDIO TECHNICIAN

## TAPE REPEATER REEL

*Industrial Electronics, Inc.*, 127 Light Street, Baltimore 2, Md. is now offering a tape repeater reel which may be placed on the take-up spindle of any tape recorder.

The reel is designed to be loaded with up to 20 minutes of tape. The tape can be wound in either direction. The reel itself is ruggedly constructed of heavy plastic with precision ball-bearing tape rollers. The removable retainer band is chrome-plated spring brass. The over-all diameter is 6.75 inches and the  $\frac{3}{16}$ " center hole fits standard tape recorder spindles, thus converting any tape recorder into a message repeater.

## NATIONAL AM-FM TUNER

*National Company* of Malden, Mass. has introduced a line of audio components which has been styled for contemporary living and provides good performance and appearance.

One of the new units in the company's "Horizon" line is the "Criterion" AM-FM-binaural tuner which incorporates several interesting features.



Among the new features are the company's "Mutamatic" tuning for rejection of inter-station noise, printed circuitry, and 8 to 10 capture ratio, plus good stability, selectivity, and sensitivity plus freedom from drift.

The new tuner permits simultaneous AM and FM reception with separate volume and tuning controls to permit simultaneous outputs. Provision is also made for receiving FM multiplex broadcast as soon as the system is authorized by the FCC.

## UTC AMPLIFIER KIT

*United Transformer Company*, 150 Varick Street, New York 13, N. Y. is now offering an amplifier kit which employs new engineering principles to provide an instrument with 36 db of feedback on a multiple loop basis.

The amplifier has a rated power output of 20 watts with .07 per-cent intermodulation distortion at 1 watt and 1 per-cent at 20 watts. Frequency response is controlled for 1 db from 20 to 20,000 cps.

Because of its printed circuit construction, completion of the kit involves only the additional connection of 17 leads to screw terminals. For full details on the MLF amplifier kit, write the manufacturer direct.

## CABINART ENCLOSURE

*G & H Wood Products Company*, 75 North 11th Street, Brooklyn 11, N. Y. has introduced a new equipment cabi-

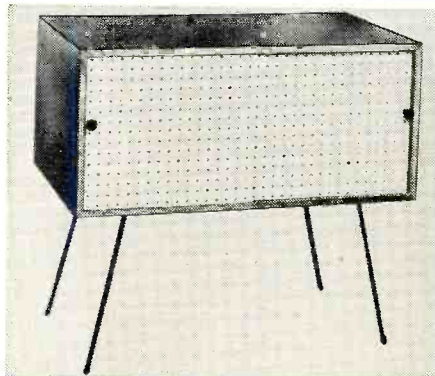

net, the Model 50, which has been especially designed for the modern interior.

The new "Cabinart" unit houses high-fidelity equipment in a contemporary setting. Sliding front panels of perforated white Masonite keynote its functional design. The cabinet may be used on wrought iron legs, wall mounted, or atop a bench. It measures 35½" wide, 16" high, and 16" deep. The wrought iron legs are 16" long.

## RCA SPEAKERS

Two new loudspeakers have been added to the replacement line offered by the Tube Division of *Radio Corporation of America*, Harrison, N. J.

The speakers are a 6½" PM type (RCA-220S1) for replacement service in table model radio and TV receivers and in centralized sound systems; and a 6 by 9 inch PM type (RCA-218S1) for use in auto radios and in home music systems. Both speakers utilize standard RETMA mounting dimensions. The Type 220S1 incorporates a 2.15 ounce *Alnico V* magnet, a 3.2 ohm voice coil, and a special "universal" flange for mounting a wide range of transformer sizes. The Type 218S1 has a 3.2 ohm voice coil, an *Alnico V* magnet weighing only 2.9 ounces yet having the performance capabilities of a speaker designed with a 3.16 ounce magnet.

## THE "COBRA-JECTOR"

*Atlas Sound Corp.*, 1449 39th Street, Brooklyn 18, N. Y. has added a new wide-angle, all purpose projector to its line of horns.

The "Cobra-Jector" is designed to

RADIO & TELEVISION NEWS

provide penetrating coverage of wide areas and under adverse sound conditions. The new Model CJ-30 features an indestructible polyester fiber-glass

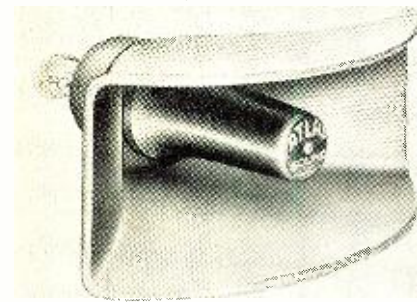

projector, an Alnico V Plus magnetic assembly, 100 per-cent phenolic diaphragm and voice-coil assembly, all-weather double-sealed non-resonant construction, all-weather tropicalized and polarized finish on all metal parts, and universal mounting bracket.

Input power is 15 watts, input impedance is 8 ohms. Response is 250 to 9000 cps. The front opening measures 14" x 6". The over-all length with bracket is 14".

### RECORD PLAYER

Olympic Radio & Television Inc., 34-01 38th Ave., Long Island City, N. Y. is now marketing a portable record player, the "Contata."

The instrument features a Garrard professional-type record player, a G-E reluctance pickup, a preamplifier, and an a.c. circuit with power transformer. The frequency range of the unit is 30 to 15,000 cps. Separate bass and treble controls are provided.

### TAPE RECORDER INVERTERS

American Television & Radio Co., 300 E. 4th Street, St. Paul, Minn. is now offering an inverter which permits the operation of any standard tape recorder in an automobile.

The recorder inverter operates from the 6- or 12-volt d.c. automotive stor-



age battery system and provides 110 volts a.c. to the recorder. It is available with mounting brackets for under-the-dashboard or trunk mounting. A remote control unit is available for use with the inverter when it is mounted in the trunk compartment.

Complete literature on these units is available from the company on request.

### PACKAGED PHONO-RADIO

Terminal Radio Corporation's Sound Studios at 85 Cortlandt St., New York 7, N. Y. is now offering a complete

# CRYSTALS



## FT-243 CRYSTALS

Lots of 10 or more. Each . . . .69c  
Lots of 5 or more. Each . . . .79c  
Individually. Each . . . . .99c

1110	2450	2715	3015	3410	6362	7500	8000
1129	2455	2720	3020	3420	6373	7510	8006
1159	2460	2725	3025	3435	6375	7520	8008.3
1195	2465	2730	3030	3465	6405	7530	8010
1525	2470	2740	3035	3500	6406	7540	8016.7
1900	2475	2745	3040	3540	6425	7550	8020
1915	2480	2750	3045	3540	6425	7550	8025
1930	2485	2755	3050	3560	6425	7550	8030
1940	2490	2760	3055	3600	6425	7550	8033.3
1950	2495	2765	3060	3600	6425	7550	8040
1965	2500	2770	3065	3600	6425	7550	8041.7
1977	2510	2775	3070	3600	6425	7550	8050
1980	2515	2780	3075	3625	6425	7550	8066.7
1985	2520	2785	3080	3625	6425	7550	8070
2010	2525	2790	3085	3640	6425	7550	8073.3
2015	2530	2795	3090	3650	6425	7550	8075
2017	2535	2800	3095	3650	6425	7550	8078.3
2020	2540	2805	3100	3650	6425	7550	8080
2025	2545	2810	3105	3650	6425	7550	8083.3
2035	2550	2815	3110	3650	6425	7550	8090
2040	2555	2820	3115	3650	6425	7550	8091.7
2040	2560	2825	3120	3650	6425	7550	8100
2055	2565	2830	3125	3650	6425	7550	8106.6
2065	2570	2835	3130	3650	6425	7550	8108.3
2090	2580	2840	3135	3650	6425	7550	8111.0
2105	2585	2845	3140	3650	6425	7550	8116.7
2125	2590	2850	3145	3650	6425	7550	8125
2130	2595	2855	3150	3650	6425	7550	8130
2145	2600	2860	3155	3650	6425	7550	8133.3
2155	2605	2865	3160	3650	6425	7550	8140.3
2165	2610	2870	3165	3650	6425	7550	8141.7
2175	2615	2875	3170	3650	6425	7550	8150
2180	2620	2880	3175	3650	6425	7550	8158.3
2185	2625	2885	3180	3650	6425	7550	8160
2195	2630	2890	3185	3650	6425	7550	8163.4
2300	2635	2895	3190	3650	6425	7550	8170
2305	2640	2900	3195	3650	6425	7550	8173.3
2320	2645	2905	3200	3650	6425	7550	8180
2350	2650	2910	3205	3650	6425	7550	8183.3
2355	2655	2915	3210	3650	6425	7550	8188.3
2360	2660	2920	3215	3650	6425	7550	8190
2365	2665	2925	3220	3650	6425	7550	8191.7
2370	2670	2930	3225	3650	6425	7550	8197.0
2375	2675	2935	3230	3650	6425	7550	8206.3
2390	2680	2940	3235	3650	6425	7550	8210
2415	2685	2945	3240	3650	6425	7550	8216.7
2430	2690	2950	3245	3650	6425	7550	8220
2435	2695	2955	3250	3650	6425	7550	8225
2440	2700	2960	3255	3650	6425	7550	
2442	2710	2965	3260	3650	6425	7550	

### MISCELLANEOUS & SHIP BAND FREQUENCIES

81.95	KC.	Octal tube type (Used in SCR-584)	\$3.99
200	KC.	In FT-241 holder	1.99
200	KC.	Type DC-15 in octal tube base type holder	1.99
327.8	KC.	No. D-68342. (Used in TS-102/AF)	9.95
500	KC.	FT-241	1.99
1000	KC.	FT-241	2.49
1000	KC.	Type DC-6 in octal tube base type holder	3.45
2000	KC.	FT-243	1.99
2342	KC.	DC-34	2.99
2174	KC.	DC-34	2.99
2182	KC.	FT-243	2.99
2500	KC.	FT-243	2.99
2632	KC.	FT-243	2.99
2637	KC.	FT-243	2.99
2638	KC.	DC-34	2.99
2643	KC.	FT-243	2.99
2670	KC.	FT-243	2.99
2647	KC.	FT-443	2.99
2670	KC.	DC-34	2.99
2738	KC.	Type 1-C	2.99
2738	KC.	FT-243	2.99
2738	KC.	MC-7	2.99
3008	KC.	FT-243	1.99
3088	KC.	FT-243	2.99
3093	KC.	FT-243	2.99
3098	KC.	FT-243	2.99
3103	KC.	FT-243	2.99
3188	KC.	FT-243	2.99
3193	KC.	FT-243	2.99
3198	KC.	FT-243	2.99
3203	KC.	FT-243	2.99
5000	KC.	FT-243	1.99
10,000	KC.	Type SR-5 Biley in CR-1 holder	1.99

### RADIO AND TELEVISION ELECTRONICS



in all Technical Phases  
New Classes (Day and Evening) Start 1st of Dec., Mar., June, Sept.

Free Placement Service for Graduates  
For Free Catalog write Dept. RN54

RCA INSTITUTES, INC.

A Service of Radio Corporation of America  
350 WEST 4TH ST., NEW YORK 14, N. Y.

## FACTORY REPAIRS

ON ALL MAKES AND TYPES OF  
TEST EQUIPMENT

Send units via parcel post—  
will quote after inspection.

Write for NEW FREE Catalogue

GENERAL ELECTRONIC DIST. CO.

100 PARK PLACE, NEW YORK 7, N. Y.

## GENERAL EQUIPMENT

Away it goes—at new tremendous reductions!

COMBINATION POWER SUPPLY  
NEW! COMPLETELY SHIELDED! HERMETICALLY SEALED!

Schematic diagram affixed to each unit.  
1 POWER TRANSFORMER: Input 117 VAC. 60 cycles. Output 600 VCT @ 8.5 MA; 5 V @ 2 amps; 6.3 V @ 7.5 amps; 6.5 V @ 0.3 amps.  
1 DUAL FILTER CHOKE: to match above transformer. 9.5 Henry @ 8.5 MA.  
BOTH UNITS . . . . . ONLY **\$2.95**

### COMMAND RECEIVERS

Drastic Reductions!  
THE FAMOUS "Q-5e"! 190-550 Kc. With tubes. Used, good condition. **\$10.95**  
NEW LOW PRICE . . . . .  
3-6 MC. With tubes. LESS DIAL ASSEMBLY. Used, good cond. . . . . \$4.95  
3-6 MC. With tubes. Used, good cond. . . . . 7.95  
6-9 MC. With tubes. Used, good cond. . . . . 4.95  
BC-456 MODULATOR. With tubes, good cond. 2.45

### MOTORS! BEST BUY EVER!

NEW LELAND ELECTRIC MOTOR: With reduction gear box which reduces to 60 r.p.m. Motor rating 1/4 h.p., 110/120 VAC, 60 cycles, 1725 r.p.m. A great buy at only **\$49.95**  
NEW UNIVERSAL ELECTRIC MOTOR: Series wound, 1/40th h.p., 28 VDC, 1.2 amp., 6,000 r.p.m. Shaft diameter 1/4 inch protrudes 1/2 inch. Operates on AC or DC! Only **\$1.49**

REVERSIBLE MOTOR: 1/40th h.p. with reduction gear box. Series wound, 28 VDC. Will also operate on AC. Terrific value for gadgeteer! Used, good condition. Only **\$1.95**

SCOPE 5 CP1 . . . . . \$4.95  
TUBES 7 BP7 . . . . . 3.95  
HEADBAND: Fits standard dual headset units. **39c**  
New . . . . .

### 77 TONS OF ACCESSORIES!

Thousands of tubes, crystals, motors, blowers, transmitters, receivers, cables, gadgets and ???? COME ON IN AND JOIN THE HUNT! See how we feel it, twist it, shake it! Bid what you like! No reasonable offer refused!

### TEST EQUIPMENT

78-B MEASUREMENTS CORP. TEST SET. Modulation 400 and 8200 cycles. Two bands: 15-25 MC and 190-230 MC. Operates on 110 VAC 60 cycles. New condition . . . . . **\$49.95**  
Used . . . . . \$39.95  
WRITE FOR PRICES ON THE FOLLOWING. Drastically reduced!  
TE-19A TS-7/ASQ TS-35A/AP  
O-73/URT TS-14/AP TS-102A/AP

### TG-10 CODE PRACTICE SET

3 BRAND NEW REELS OF TAPE! **\$19.95**  
Numbers 10, 13 and 14.  
Practice set complete with tubes, good cond. ready to operate! Shm, wt. 80 lbs.

BRAND NEW CODE PRACTICE TAPE: Reels 99c  
+10, 13 and 14. Each . . . . .  
REELS #1 thru #9, #11, #12, #15. Ea. \$1.25

### 75 MC CRYSTAL CONTROLLED RECEIVER

28 VDC input.  
Clean cond. with dynamotor, less tubes.  
Sensitive relays alone are worth the price! **\$3.95**

### APG-17 LOW FREQUENCY ALTIMETER

Range: 50 to 400 ft. 28VDC input. COMPLETE!  
BRAND NEW IN ORIGINAL CARTON! Includes all plugs and cables, control boxes, antennas, rack etc. READY FOR INSTALLATION. **\$99.50**

CRYSTAL BUYERS: It is important to indicate second choice frequencies wherever substitutions may be made!

MINIMUM ORDER: \$2.50. Calif. buyers add 3% sales tax. Send 25% deposit with order, balance C.O.D. All items F.O.B. Los Angeles, Cal., subject to prior sale and change of price without notice.

### SEE OUR ADS!

➔ Aug./54 RADIO & TV NEWS  
➔ Aug./54 C.O.  
For COMPLETE LIST of types of crystals, frequencies and prices.  
➔ WRITE FOR NEW, FREE CRYSTAL CATALOGUE!

## U. S. CRYSTALS, INC.

805 S. Union Ave. Los Angeles 17, Cal.

## CORONA RADIO KITS

EASY TO BUILD • EDUCATIONAL  
EXCELLENT RECEPTION

Broadcast  
Superhet  
Kit

**\$14.75**

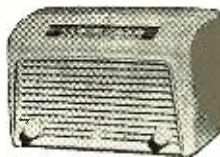

ROCKET 115K—Latest Single Band superhet circuit for ultimate in sensitive reception and tonal quality. Kit includes all necessary parts, punched chassis, attractive bakelite mahogany cabinet, built-in loop antenna, iron core IFs, big Alnico V speaker tubes: 12SK7, 12SA7, 12AU6, 3Z5. Automatic vol. control, beam power output. Tunes 540 to 1700 Kc. Simple step-by-step instructions included.  
Plaza 812K 2-Band AC-DC Super Kit. . . . . \$20.75  
Globemaster 814K 3-Band Super Kit. . . . . \$24.75  
All kits supplied less wire and solder. Please include 25% deposit with C.O.D. orders. Dept. N-9.

CORONA RADIO & TV CO.  
370 Broadway New York 13, N.Y.

NEW STOCK OF FIRST QUALITY

# TE TRON TUBES

**Guaranteed! Lowest Prices Ever!**

All tubes individually boxed . . . unconditionally guaranteed for one year.

**GIFT OFFER!**  
One 6BG6G tube will be shipped FREE with any order accompanying this ad.

TYPE	PRICE	TYPE	PRICE	TYPE	PRICE	TYPE	PRICE
024	.45	6AC7	.65	6BN6	.90	6V3	.80
I A7GT	.53	6AG5	.52	6BQ6GT	.83	6V6GT	.48
IB3GT	.52	6AH4GT	.65	6BQ7	.85	6W4GT	.43
IH5GT	.51	6AJ5	.96	6BY5G	.60	6W6GT	.53
IL4	.51	6AK3	.96	6BZ7	.95	6X4	.37
IL6	.51	6AL5	.43	6C4	.41	6X5GT	.38
IL6H	.49	6AQ3	.48	6CB6	.51	6X8	.80
IN5GT	.51	6AR3	.48	6CD6G	1.63	7F8	.49
IS5	.43	6AU5GT	.60	6CU6	.95	7N7	.49
IT4	.51	6AV5GT	.60	6F6	.42	12AL5	.43
IU4	.51	6AW5GT	.43	6F5GT	.44	12AT6	.37
IU5	.43	6AX	.37	6H6	.50	12AT7	.71
2A3	.35	6AX4GT	.60	6J6	.61	12AU6	.43
2A7	.35	6AX5GT	.60	6J5GT	.49	12AU7	.58
3Q4	.53	6BA6	.56	6K6GT	.39	12AV6	.42
3Q5GT	.61	6BA7	.58	6L6	.78	12AV7	.73
3S4	.48	6BE6	.46	6S4	.41	12AX7GT	.60
3V	.48	6BF5	.48	6S8GT	.65	12AX7	.61
5U4G	.43	6BF6	.48	6SA7GT	.45	12AZ7	.65
5V4G	.41	6BG6G	1.18	6SK7GT	.45	12B4	.72
5Y3GT	.31	6BH5	.51	6SL7GT	.60	12BA6	.46
5Y4G	.41	6BJ5	.51	6SN7	.60	12BA7	.58
H4.5	.40	6BK7	.78	6S7GT	.38	12BE6	.46
HK7	.40	6BL7GT	.78	6T8	.71	12BY7	.65
HQ7	.40			6U8	.76	12BZ7	.63

**FREE** \$7.20 list value Bonus Box of three 6SN7 tubes and 25 assorted resistors with each order of \$25 or more.

**SAME DAY SERVICE**

48 Hour Postal Delivery To West Coast

TERMS: Save all freight and postage charges. All orders accompanied by full remittance will be shipped POST-AGE PAID anywhere in the continental U.S.A. 25% deposit required on C.O.D.'s. Minimum order \$10.00. Open accounts to rated firms only.

Send for Free complete tube listing and monthly specials! Get on our mailing list.

**SPECIAL! . . . till Oct. 1st**

TYPE	PRICE	TYPE	PRICE
IR5	.44	6SA7	.41
IX2	.57	6SK7	.41
5Z3	.37	6SQ7	.35
6AB4	.35	12BH7	.55
6AF4	.89	12SN7GT	.18
6AT6	.34	19BG6G	1.09
6BC5	.41	35L6GT	.37

Watch for our monthly specials of key radio and TV types. Each month new key types will appear. Take advantage and order your requirements now.

## TELTRON ELECTRIC COMPANY

428 HARRISON AVE. DEPT. RN9 HARRISON, N. J.  
Phone HUmboldt 4-9848

### "TIP WRENCH" ADJUSTABLE SOCKET POCKET WRENCH GETS NUTS, BOLTS and SCREWS into "Hard-To-Get-At" Places

HOLDS THEM FIRMLY WHILE TIGHTENING "TIP WRENCH" IS BUILT TO WORK IN DEEP. Holds nuts, bolts and screws where fingers can't hold them. It eliminates fumbling—SAVES VALUABLE MINUTES IN REPAIR or LINE PRODUCTION WORK. "TIP WRENCH" SPEEDS THE JOB—SAVES ITS COST MANY TIMES OVER. RUST PROOF. SHOCKPROOF—has tough Vinylite insulated shank. NO SLIPPAGE WHEN "TIP WRENCH" GRIPS.



ORDER A SET TODAY



**NEEDED IN EVERY TOOL BOX & KIT**  
3 RIGHT SIZES

- No. 1 For No. 2 to No. 8 Nut or Screw. 8 1/2" long.
- No. 2 For No. 6 to No. 12 Nut or Screw. 8 3/4" long.
- No. 3. For No. 6 to No. 12 Nut or Screw. 4 1/2" long. EACH . . . . . **\$1.35**

**Sold on a Money-Back Guarantee**

ORDER THROUGH YOUR SUPPLIER  
If he cannot furnish immediately, ORDER DIRECT and Give Supplier's Name. . . . Or WRITE FOR DESCRIPTIVE LITERATURE.

### TIPCO COMPANY

5865 Wilmington Ave., Los Angeles 1, Calif.

### CORY INTERLOCKS

Type B986. Safety Type, with Lock and Key (as shown) Contacts rated 20 Amp. Dspt. Play Safe at the Low Price of . . . . . **\$2.85**

Type "C"—Same as Above, but with Double Lock and 2 Keys. Both Locks Must be Operated Before Switch Operates. . . . . **\$3.95**

### THIS MONTH'S SPECIALS

**SPEAKER-TWEETER** Used on Beachmaster Amplifier. Has 2" Voice Coil and Diaphragm. Response to 20,000 Cycles. Will Handle up to 50 Watts. Complete with Spare Cone. 8 Ohms. . . . . **\$9.95**

**VIBROPACK, PE-204:** Input 12VDC/0.58 Amp. Out: 2X4.3V/50MA, 2X45VDC/0.5MA. 2X85VDC/5MA. New. Complete with Spare Vibrator. Well-Shielded and Portable. . . . . **\$4.75**

**PRESSURE SWITCH,** For Art-13, CR2927-B-100. SPST. N. O. 10 AMP AT 24 VDC up to 40,000 ft. Trips at 9.72" mercury; resets at 12.10" Merc. Collins 260N457. . . . . **\$6.49**

### MOBILES! C. D. MEN! CAP! I

IDEAL DYNAMOTOR — CONVERTS EASILY TO SUPPLY UNIT DELIVERING

12 VOLT INPUT	6V INPUT
810V at 150 MA	300V at 90 MA
225V at 125 MA	160 at 110 MA

BRAND NEW WITH CONVERSION DATA \$3.75

### DYNAMOTORS

TYPE	INPUT VOLTS	OUTPUT AMPS	PRICE
35X-059	19	3.8	.095
POSX-15	14	2.8	.220
DA-7A	28	27	1100
DM33A	28	7	540
BD AR 93	28	3.75	375
23350	27	1.75	285
B-19 Pack	12	9.4	275
			500
			300
			150
			14.5
			5.
PE 73 CM	28	19	1000
BD 69:	14	2.8	220
DAG-33A	18	3.2	450
DM 25:	12	2.3	250

† Less Filter \*Replacement for PE 94.  
‡ Used, Excellent.  
PE 94-C, Brand New . . . . . **6.95**

Send M.O. or Check. Shipping Chgs. C.O.D.  
**COMMUNICATIONS EQUIPMENT CO.**  
131 Liberty St., Dept. N-9 New York City 7, N. Y.

packaged radio-phon system consisting of a *Craftsmen* C800A AM-FM tuner, a *Craftsmen* C500A amplifier, a *Garrard* RC-80 changer, an *Electro-Voice* 12 TRXB triaxial speaker, and a *G-E* RPX-050 triple-play variable reluctance magnetic cartridge.

The company is also offering two cabinets to house this "5-Star System," an *Electro-Voice* "Peerage" unit to house the equipment and the "Aristocrat" with folded horn for the speaker.

### "LARGO" SPEAKER SYSTEM

*Permoflux Corporation*, 4900 W. Grand Ave., Chicago 39, Ill. is merchandising a new wide-range speaker system, the "Largo."

The system utilizes the new *Permoflux* Model 8V81 "Super Royal" speaker and the 32KTR "Super Tweeter" model in an acoustically correct en-

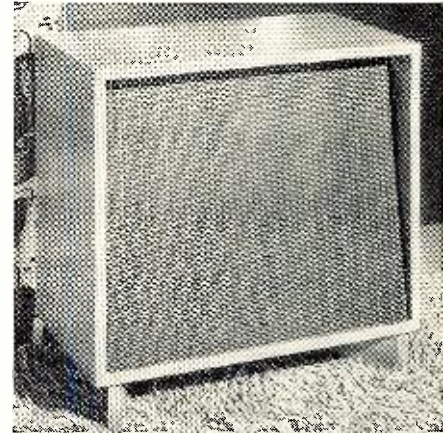

closure designed to match the speaker characteristics. The enclosure is a unique horn-loaded, non-resonant baffle with the horn loading of the speaker back wave taking place in the cabinet base. This principle results in an extremely compact unit with every inch of the cabinet serving a useful acoustic purpose.

Frequency response is 35 to 16,000 cps. It will handle 15 watts, has an impedance of 8 ohms, and measures 24" wide, 14" deep, and 21" high.

### FREED-EISEMANN TUNER

The Model 750 AM-FM tuner has been added to the *Freed-Eisemann* line of audio components.

AM and FM circuits are designed for maximum gain at minimum noise, with a.f.c.-controlled FM terminating in a Foster-Seely limiter-discriminator. The new tuner is self-contained with all controls within a fully-enclosed front panel assembly. The unit is housed in a baked ebony finish on the front panel with bronze escutcheon and two-tone knobs. The chassis and other metal parts are copper plated.

### STEPHENS ENCLOSURES

*Stephens Manufacturing Corporation* of Culver City, California has introduced a "patio-garden" speaker enclosure, the Model 602.

Designed for installation under the eaves, the new enclosure is 29 1/2" wide, 20 1/2" high, and 17 1/2" deep at the top and 6 1/2" at the bottom. The unit is



# NEWARK ELECTRIC COMPANY

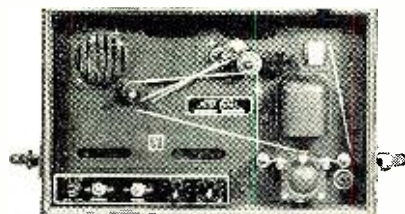

## New! TG-34A KEYER

115 or 230 V. @ 50 to 60 cycle—KEYER TG-34A is an automatic unit for reproducing audible code practice signals previously recorded in ink on paper tape. By use of the self contained speaker, the unit will provide code practice signals to one or more persons or provide a keying oscillator for use with a hand key. The unit is compact, in portable carrying case, complete with tubes, photo cell, and operating manual. Size: 10 $\frac{1}{2}$  x 10 $\frac{1}{2}$  x 15 $\frac{1}{16}$ ". Shipping Weight: 45 lbs. **A550. Prices—While They Last.....22.95**

**J38 U.S. Army Type Transmitting Key A613 .....each 89c**

**T-26 Handset.** Telephone chest unit with F-1 Western Electric transmitter. **A551 .....New. Each 2.25**

**T-21 Handset.** Manufactured by Western Electric. Standard F-1 Carbon transmitter. **A552 .....Like New Condition. Each 3.95**

**Filter Choke.** 15 Hy., 150 MA., 200 ohm D.C. Resistance. Metal Cased. Flexible Lead Terminals. Size: 3 $\frac{1}{4}$  x 3 $\frac{1}{2}$  x 3 $\frac{1}{8}$ ". Mounting Centers: 2 $\frac{1}{2}$  x 2 $\frac{1}{2}$ ". **A310 .....Net 2.45**

**Filter Choke.** 10 Hy., 150 MA., Resistance 18 ohms. Size: 3 x 2 $\frac{3}{4}$  x 3 $\frac{3}{8}$ ". Sealed case. Ceramic terminals. Made to Government specifications. **A311 .....Net 1.95**

**Filter Choke.** 10 Hy., 100 MA., Resistance 18 ohms. Ceramic Terminals. Size: 2 $\frac{1}{2}$  x 2 x 3 $\frac{1}{4}$ ". Four  $\frac{3}{32}$ " Mounting screws. Mounting centers 1 $\frac{7}{8}$  x 1 $\frac{5}{8}$ ". **A312 .....Net 1.49**

## Brush Model BA-116 Crystal Mike

At lowest price ever! While limited quantities last! Rugged microphone. Ideal for tape recording, PA, or Amature use. Response, 50 to 6,000 cycles. Output level, -53 db. High impedance. Standard  $\frac{3}{16}$ "-27 thread, for mike stand connection if desired. Ideal for desk use, without additional stand. Brown finish. Wt., 1 $\frac{1}{2}$  lbs. **A501 .....Net 5.95**



Sensational Buy!

Type M "Imperial" Bass Reflex Cabinet

Originally \$107.31

Now Only 36.95

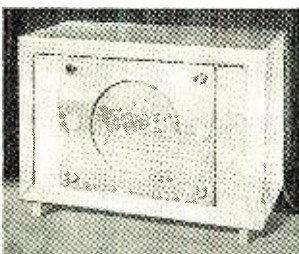

Modern speaker enclosures especially designed to house any good 15" reproducer to provide magnificent "concert hall" reproduction. May be placed upright with wedge foot rails supplied or placed horizontally for "low boy" effect. Concealed cutouts, covered by removable matching wood discs, are provided in the panel for range and level controls. Cabinets are of selected mahogany veneers finished in blonde or cordovan mahogany. Baffle space 9 cubic ft. Dimensions: 36x24x18". Shpg. Wt., 80 lbs. **87F301. Cordovan mahogany. SPECIAL PRICE .....NET EACH 36.95**

FOB Chicago, Include Shipping Charges and Insurance

Department R-9

# NEWARK ELECTRIC COMPANY

223 W. Madison St. Chicago 6, Ill. State 2-2950

September, 1954

also adaptable for indoor use in those areas where outdoor listening is seasonal.

The Model 602 is a rear horn-loaded enclosure for use with the "Tru-Sonic"

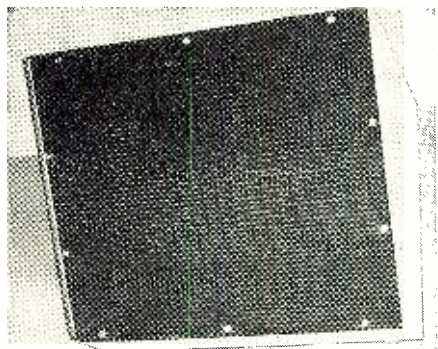

122AX coaxial or 112FR 12" speakers. Two other models, the 600 and 603, are also available in this same line. Write the company for complete specifications.

## RECORDER-RADIO

Two new tape recorder-radio combinations have been announced by *Ampro Corporation*, 2835 N. Western Ave., Chicago, Illinois.

In both models the built-in radio utilizes the tape recorder's amplification system consisting of a six-tube, four-rectifier circuit playing through a 6 by 9 inch *Alnico* PM speaker. The "Hi-Fi" (Model 756-T) at 7 $\frac{1}{2}$  ips, has a frequency response of 40 to 12,500 cps while the "Celebrity" (Model 755-T) at 3 $\frac{3}{4}$  ips has a frequency response of 40 to 8000 cps.

Both instruments feature an electromagnetic piano-key control system. Solenoids operate all functions, eliminating breakdowns and wear often found in mechanical linkage systems, and provide fast, simplified recording and playback.

## BOGEN AMPLIFIER

*David Bogen Co., Inc.*, 29 Ninth Ave., New York 14, N. Y. is in production on the DB15G amplifier which uses the partial cathode-loading techniques and features a built-in record equalizer having separate controls for low-frequency turnover and high-frequency equalization.

The new amplifier, which is designed as a companion unit to the company's R640G AM-FM tuner, is compact and sturdy. It incorporates the company's

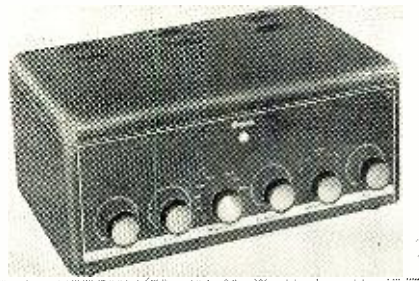

"loudness contour selector" which permits the selection of five distinct frequency response characteristics.

Information on both the amplifier

## LEARN COLOR TV THIS EASY WAY!

Just off the Press!

## ABC of COLOR TV



H. G. Cisin's remarkable book takes the mystery out of Color TV. The only book which explains this fascinating new TV development in a simple down-to-earth manner. It actually translates the highly technical descriptions of research scientists into plain everyday language.

Covers basic color principles, compatible color TV system, the color signal, color TV reception, plus practical pointers on color pix tubes, tests, servicing, antennas etc. Just the info TV servicemen must have to cash in on this rapidly expanding new field. Profusely illustrated. **Only \$1**

## NEW! 1955 TV DOCTOR

ATTENTION: NOVICE SERVICEMEN!



The new TV DOCTOR was written expressly for you by H. G. Cisin, noted TV educator and author. Mr. Cisin has trained thousands of TV technicians, many of them now holding important positions in television. His years of experience are embodied in this valuable book! TV DOCTOR contains just the info you need to start in TV servicing. No theory, math or formulas, but full of practical information. Copyrighted Trouble Shooting Guide pin points hundreds of TV troubles, enabling you to diagnose faults without previous experience. Method applies to all TV sets, old and new. Special chapter on COLOR TV. Useful data about TV sets, tuners, antennas, lead-ins, interference, safety suggestions. Many clear illustrations. **Only \$1**

## FAMOUS "TV CONSULTANT"

TV Serviceman's Silent Partner



New, easy-to-use way to solve toughest TV troubles. UHF sect. includes conversions, installations and servicing. Modern alignment methods shown by pictures, diagrams and simple directions. Tell exactly what to do and how to do it. Practical pointers on use of all TV Test Instruments. Over 300 pix, raster and sound symptoms. Detailed directions tell where and how to find faulty parts. Over 135 RAPID CHECKS, many using pix tube as trouble locator. 125 illustr. of scope wave forms, diagrams, station patterns, show you defects take mystery out of TV servicing. NO THEORY—NO MATH—NO FORMULAS—just practical service info. covering all types of TV sets. **Only \$2**

## NEW! 1954 TV TUBE LOCATOR

TROUBLE INDICATING TUBE LOCATION GUIDES for over 3000 most popular models from Admiral to Zenith plus PIX TUBES used in each model! 1947 to 1953 models. A storehouse of valuable TV servicing info. priced very low for large volume sales. **Only \$1**

## NEW! Trouble Shooting PIX GUIDE incl. TV TERMS Explained

Sec. 1 is a fully illustrated GUIDE to off-recurring pix faults. Causes and cures explained. Copyrighted Trouble Indicating illustrated chart tells where troubles start in typical TV set—illustrations show resulting faulty TV pictures. Sec. 2 explains hundreds of TV terms in non-technical language. **Only \$1**

## NEW! TV TROUBLE TRACER

Each vol. contains different copyrighted "Trouble Indicating TUBE LOCATION GUIDES" of over 500 most popular TV models. Vol. 1 has older sets, vol. 3 newest 1954 models. 40 common picture troubles illustrated, traced to source and cured. **Vols. 1, 2 & 3 .....Only 50c ea.**

## H. G. CISIN, PUBLISHER

Order from your Jobber today, or if not stocked, write to

HARRY G. CISIN, Dept. R4  
Amagansett, New York

Enclosed find \$..... Send

- |  |  |
|--|--|
| <input type="checkbox"/> Color TV        | <input type="checkbox"/> TV Pix Guide      |
| <input type="checkbox"/> TV Doctor       | <input type="checkbox"/> TV Tracer, Vol. 1 |
| <input type="checkbox"/> TV Consultant   | <input type="checkbox"/> TV Tracer, Vol. 2 |
| <input type="checkbox"/> TV Tube Locator | <input type="checkbox"/> TV Tracer, Vol. 3 |

Name .....

Address .....

City..... Zone... State.....



SHE WANTS  
FINE FURNITURE



HE WANTS  
TECHNICAL EXCELLENCE

YOU SATISFY BOTH WITH

# Manfredi

HI-FI SPEAKER ENCLOSURES

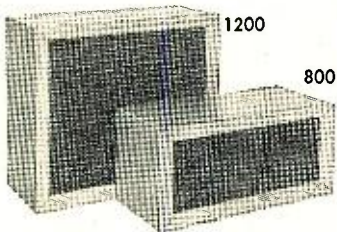

**HUMMINGBIRD** — Model 800 for 8" speaker; 1200 for 12" speaker. Compact without loss of performance... excellent tonal fidelity.

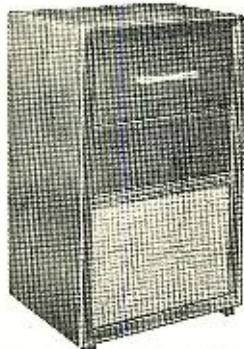

**FLAMINGO** — Model 2000 — Universal cabinet and speaker enclosure... maintains high acoustical integrity. Houses complete hi-fi system... finest woods and veneers. 36 1/8" x 22 1/4" x 18 1/2" deep.

You protect your own reputation when you sell a Manfredi cabinet or enclosure—the woods stand up...performance stands out! This excellence has been the mark of Manfredi craftsmen for over a quarter-century. Write for illustrated brochure.

## Manfredi

WOOD PRODUCTS CORP.

226 New York Ave., Huntington, L. I., N. Y.

and tuner will be supplied by the manufacturer on request.

### COMBINATION STYLUS

Pickering & Company, Inc., Ocean-side, Long Island, N. Y. is now offering the Model 260 turnover pickup cartridge with a diamond stylus for long-playing recordings and a sapphire stylus for standard 78 recordings. The diamond stylus is of .001" radius for LP's while the sapphire unit has a radius of .0027" for standard grooves.

Except for the sapphire stylus, this new unit is identical in all respects to the company's Model 260 double-diamond turnover pickup. —50—

### Within the Industry

(Continued from page 18)

entry blanks on any of the exhibit floors and there is no limitation to the number of entries that may be submitted by any person.

Personnel affiliated with distributors, dealers, and manufacturers may compete, along with the general public. Prizes will consist of merchandise certificates for sound equipment of the winner's selection.

\* \* \*

**HARRY L. CHANEY** has been appointed chief engineer for *Kay-Townes Antenna Company*, of Rome, Georgia. He was formerly an electronics engineer at the Signal Corps Engineering Lab. at Belmar, N.J. where he developed and designed a receiving tube characteristics



test set which has been adopted as a standard at the Lab.

Since the war he has been a field engineer with *Tele-King* and chief engineer for *Electronic Devices Company* of New York.

In his new post he will be in charge of all engineering and development programs at the antenna firm's electronic laboratory.

\* \* \*

**G. LEONARD WERNER** has been named general sales manager of *The Astatic Corporation* of Conneaut, Ohio.



Mr. Werner resigned as sales manager of *Mark Simpson Manufacturing Co., Inc.* to accept his new position. He also served as chief engineer and director of sales engineering with the *Masco* organization.

He entered the radio business in 1930 and for a number of years manufactured sound and intercom equipment and other electronic devices. He has been a ham since the mid-20's. He is associated with the IRE, SME, Sales Manager's Club, and the SE-8 technical group of RETMA. —50—

## TRANSISTOR SPECIAL!

### BRAND NEW!

NAME BRAND JUNCTION TRANSISTOR, top quality, guaranteed! Not a closeout but standard production! Low price made possible by our huge quantity order.

WE FURNISH COMPLETE SPEC SHEET AND SCHEMATIC for Microphone and Phono Preamplifiers, AF Amplifiers, AF Power Output Circuit, AF Oscillator and Phono Broadcast Oscillator!

Guaranteed minimum alpha is 0.90 which provides a voltage gain of approximately 100; power gain approximately 30. Power output will fill any normal room with music from a 5" speaker!

Please allow up to 40 days for delivery, sooner if military orders do not intervene. All this for only... **\$3.95**

Add 10c for postage and handling.

**R. E. GOODHEART**

P.O. Box 1220-B Beverly Hills, Cal.  
"In Electronics Since 1945"

## Gov's Surplus PANEL METERS

0-200 Milliamp., G.E. Model DO-58, 4" square. Each... **\$3.95**

0-15 D.C. Milliamp., G.E. Model DO-58, 4" square... Each **\$3.95**  
0-750 D.C. Milliamp., G.E. Model DD-6, 6" square... Each **\$10.95**

110 Volt, A.C. Relays, 2 N.O., 2 N.C. Contacts... Each **\$3.95**  
28 Volt, D.C. Relays, 2 N.O. Contacts... Each **97c**

Full Remittance Must Accompany Order  
Postage Prepaid in U.S.A.

**ZIDELL**  
MACHINERY & SUPPLY CO. (Elec. Div.)  
3121 S. W. Moody St. • Portland 1, Ore.

## TELEVISION

**PREPARE FOR A GOOD JOB!**  
BROADCAST ENGINEER  
COMMERCIAL OPERATOR (CODE)  
RADIO SERVICING

Television Servicing

(Approved for Veterans)  
SEND FOR FREE LITERATURE  
**BALTIMORE TECHNICAL INSTITUTE**  
1425 EUTAW PLACE, BALT. 17, MD.

**IT'S NEW!**

**IT'S COMING!**

**IT'S TERRIFIC!**

# POPULAR ELECTRONICS

**ENJOY 3 COLOR TELEVISION  
FILTER SCREEN NOW**

Changes dull eye-straining black and white pictures into beautiful color tones. Seconds to attach. No tools used. Helps eliminate glare. Order direct. Send \$1 for screen size up to 16", \$1.25 size 17", \$1.50 size 20", \$2 size 21", \$2.50 size 24", \$3 size 27". (Also available are single solid color screens in blue, green, or amber.) Prices on solid color screens are 10% less. We pay postage except on C.O.D. orders. Satisfaction guaranteed. Inquiries from dealers also welcomed.

Zingo Products, Johnstown 19, New York

**Two-in-the-Hand**  
(Continued from page 65)

As it stands right now, I can still live with the birdies, and have been copying pretty good DX in the car without too much trouble due to other strong local stations.

**Tuning and Adjustment**

Assuming that you've built up the preceding stages, have an adequate plate supply, and are hearing something besides 60-cycle hum in the speaker, initial adjustments of each stage are in order.

**The R.F. Amplifier:** You'll be glad you built those neutralizing condensers, as there's a lot of doodling required to arrive at a well-adjusted and properly neutralized push-pull amplifier. I like to neutralize the stage with antenna and power connected; after all, that's the condition under which it must operate. Try this:

After resonating  $L_1$ ,  $L_2$ , and  $L_3$  with a grid dipper, screw both neutralizing trimmers in to maximum capacity and rotate  $C_2$  over its range. Chances are you'll hear the gosh-awfullest noises as the stage "takes off" at resonance! Back off the adjustment of each neutralizing condenser *very slightly* and rotate  $C_2$  again. More racket!

Continuing the process—a tiny adjustment at a time—you should eventually find settings of  $C_{N1}$  and  $C_{N2}$  where the stage approaches neutralization, and the background noise "peaks" at resonance. After each adjustment of the neutralizing condensers,  $C_1$  should be retuned with  $C_2$  to keep input and output tanks resonated together, as changing neutralizing capacity slightly detunes each tank circuit.

When you find the point where the background noise peaks, the stage is not necessarily neutralized; it may be regenerative, although not oscillatory. Here's where more fine adjustment enters. There will be a neutralizing condenser setting where noise peaks the *least amount*, which should represent the approximate center of the "neutralizing plateau." At that point, the amplifier should show the best signal-to-noise ratio, but not its maximum gain. If the stage is regenerative, its gain will be somewhat higher, but so will its ability to amplify noise! Remember, signal-to-noise ratio is determined by the r.f. stage, and you can crank in plenty of gain later in the i.f. stages, where the lower frequency noise figure is of less importance.

Fig. 1 shows manual adjustment of  $C_2$  to obtain best relative signal-to-noise ratio at a given signal frequency. Because the resonance peak is usually not the place where best signal-to-noise ratio occurs, I've brought the input control out where it may be manipulated and, if necessary, slightly detuned from the signal frequency. You'd

**NEW ITEMS:**

**NOTE:** The following items are NEW additions to our stock. Each month other new items will be added! If there are any items that do not appear in this ad but have been advertised previously, send us your order today!

TS-291/U VOLTOHMETER—Meter 3" square. 1000 ohms per volt. D'Arsonval Movement—0/300/600 VDC scale and 0-1 Meg. Case size: 3 1/2" x 5 3/4" x 2 1/4". W/Test Leads P/O 1-56 Test Set—**NEW \$7.95**

H-55/U HEADSET & BOOM MICROPHONE—Low impedance Headset and Boom Carbon Mic. Lightweight, Used—Tested. **\$4.95**

TS-9 HANDSET w/Butterfly Sw. Used, Tested. \$3.95

TS-13 HANDSET w/Sw. PL-68 & PL-55, Used, Tested. 6.95

TS-10 HANDSET—Sound Powered—Used, Tested. 6.95

WE-1A HANDSET—Chrome Plated Brass, Used, Tested. 3.95

T-17 CARBON MIC.—w/PL-68—Used, Tested... 6.95

T-30 THROAT MICS.—Used, "As is"—5 for... 1.00

BC-669—CONTROL BOX RM-21—With CD-513 Cord, Handset Holder, Volume Control, Sw., etc. New \$4.95 Handset Plug for Control Box: 75c. CD-513 Cord for use from BC-669 to PE-110: \$2.95.

POWER SUPPLY 24 VDC—3 Amp output; 115 Volt 60 cycle input. Completely filtered with 0-75 VDC Output meter & two Tungsten Bulbs—Used, Tested. \$12.95

GEARED HEAD MOTOR—110 Volt 60 cycle, 24 RPM, 1/100 HP. Right Angle Drive—Size: 7 1/2" x 4" x 4". Shaft size: 3/16" x 3/4". NEW. \$9.95

GEARED HEAD MOTOR—110 Volt 60 cycle—1.9 RPM. Size: 2 1/2" x 2 1/2" x 2 1/2". Torque: 75 oz. in. NEW. \$9.95  
BD-77C DYN. ARMATURE Only, NEW. 7.95

**ANTENNA EQUIPMENT**



**MAST BASES—INSULATED:**

MP-22 BASE—(Illustrated) Ins. spring action; direction of bracket can be raised or lowered easily. \$2.95

MP-132 BASE—1" heavy coil spring; 2" Ins. Overall length: 1 1/2". Weight: 2 3/4 lbs. \$5.95

MP-S-33 BASE—Insulated type with heavy coil spring and 5" dia. Ins. Requires 2" hole for mounting. Weight: 9 lbs. \$5.95

MP-48 BASE—Insulated type base with heavy coil spring. Requires 1 3/8" mounting hole. Weight: 11 lbs. \$6.95

MP-37 BASE—Insulated type with heavy coil spring. 7" dia. insulator; requires 1 3/8" hole for mounting. Weight: approx. 10 lbs. \$8.95

**MAST SECTIONS FOR ABOVE BASES:**

Tubular steel, copper coated, painted in 3 ft. sections, screw-in type. MS-53 can be used to make any length with MS-52-51-50-49 for taper. Any section. @ 50¢ Each  
Larger Diameter Section: MS-54. 75¢

**COAXIAL CABLE & CONNECTORS**

CD-1071 CORD—With PL-259 Plugs each end. Removable Vinylite covering over Plugs, 50 ohm coax 2 Ft. long. Prices: 50¢ Each—Or in Lots of 10 @ 50¢ Each.

PL-259—Plug ea. end & 32"—RG-54/U—58 ohm. 50¢

UG-21/U—Plug ea. end & 32"—RG-11/U—75 ohm. 50¢

UG-22/U—With 4" Coaxial Cable. 50¢

RG-8/U (SPECIAL) 51.5 ohm. Same size as RG-8/U. Prices: 1 to 100 ft. @ 3¢ per ft.—100 to 500 ft. @ 1 1/2¢ per ft.—500 to 1000 ft. @ 7¢ per ft.—1000 ft. Rolls (or more) @ 6 1/2¢ per ft.

RG-34/U—71 ohm, 145 ft. length. \$15.00

Address Dept. RN • Minimum Order \$5.00  
Prices F.O.B., Lima, Ohio • 25% Deposit on C.O.D. Orders

**TG-34A KEYS**

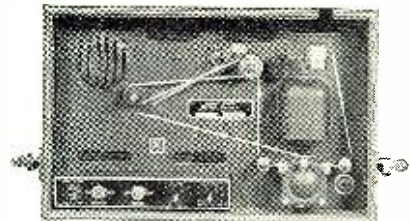

115 or 230 V. @ 50 to 60 cycle—KEYER TG-34A is an automatic unit for reproducing audible code practice signals previously recorded in ink on paper tape. By use of the self-contained speaker, the unit will provide code practice signals to one or more persons or provide a keying oscillator for use with a hand key. The unit is compact, in portable carrying case, complete with tubes, photo cell, and operating manual. Size 10 9/16" x 10 1/2" x 15 13/16". Shipping weight: 45 lbs. Prices—While they last!

**BRAND NEW: \$24.95 • USED: \$14.95**

**TG-10 KEYS:** Same function as TG-34A. only larger, using 2/6N7—2/6L6—2/6SJ7—1/5U4G Tubes and 1/923 Photo Cell. Housed in standard Metal Cabinet, and can be removed for 19" rack mtg. Size: 11" H x 24" W x 18 1/2" D.—Used—Tested: \$19.95.

**RECORDER FOR CODE TAPES:**

BC-791—Recorder and Amplifier of Code Signals directly from a Radio Receiver or local sending on 3/8" Paper Tape with ink writing stylus. Tape can be played back on any TG-10 or TG-34 Keyer. Uses 1/117N7GT and 2/117P7GT Tubes. 115 Volt 60 cycle operation. No Tubes, Tape, or Tape Puller included. Tape Puller from TG-10 or TG-34 can be used.

**PRICES—NEW: \$7.95 — USED: \$4.95**

**PRACTICE CODE TAPES:**

Code Training and Practice Inked Paper Tapes on 16 MM 400 ft. Reels for telegraph and radio operation. 15 Reels to a Set, in wood case—for use with TG-34A and TG-10 Keyers. Complete SET—Price. **\$12.95**

SEPARATE TAPES for following lessons:  
Tape #11—Traffic      Tape #8—Code Groups  
Tape #12—Traffic      Tape #2—Receiving  
Each on 16 MM Reel, in metal container: \$1.25 Ea.

**BLOWERS—115 VAC 60 CYCLE**

**SINGLE TYPE:** (Illustrated at left) 100 CFM. 2 1/4" intake; 2" outlet. Complete size: 5" x 6". Order No. 1C939. \$8.95

**DUAL TYPE:** 100 CFM. 4" intake; 2" Dis. Each Side. Complete Size: 8" x 6". Order No. 1C880. \$13.95

**COMPACT TYPE:** 108 CFM. Motor built inside squirrel cage, 4 1/2" intake; 3 3/8" x 3" Dis. Complete size: 4 1/4" W x 8 3/8" H x 8 1/8" D. Order No. 2C067. \$14.50

**FLANGE TYPE:** 140 CFM. 3 1/2" intake; 2 1/2" Dis. Complete size: 7 1/2" W x 7 1/4" H x 6 3/4" D. Order No. 1C807. \$13.95

**FLANGE TWIN:** 275 CFM. 4 1/2" intake; 3 1/4" x 3" Dis. Complete size: 11 3/4" W x 8 3/8" H x 8-1/16" D. Order No. 2C069. \$21.95

**PE-101 DYNAMOTOR—**

6 or 12 Volt. (Reprints of original CQ conversion articles Oct. and Dec. '52 issue—furnished.) This is the Dynamotor the Hams have been talking about! Easily adapted to supply 625 V. @ 150 MA. and 325 V. 125 MA. @ 12 Volts—or 300 V. 90 MA. and 160 V. 110 MA. @ 6 Volts. NEW: **\$4.95**

**FAIR RADIO SALES** 132 SOUTH MAIN ST. LIMA, OHIO

**RADIO ENGINEERING DEGREE IN 27 MONTHS**

Radio engineering is a big field. There's room for you in it—if you're good. Get first-class training at Indiana Tech. Intensive, specialized course, including strong basis in mathematics and electrical engineering, advanced radio theory and design, television, electronics, Modern laboratories. Low rate. Also B.S. DEGREE IN 27 MONTHS in Aeronautical, Chemical, Civil, Electrical and Mechanical Engineering. G.I. Government approved. Enter September, December, March, June. You can earn part of your expenses right here in Fort Wayne while you are studying.

**INDIANA TECHNICAL COLLEGE**

994 E. Washington Blvd., Fort Wayne 2, Indiana  
Please send me free information on B.S. Engineering Degree in 27 months as checked.

Radio-Television       Aeronautical  
 Civil       Mechanical       Electrical

Name \_\_\_\_\_  
Address \_\_\_\_\_

*New*  
**PRINTED CIRCUIT BOARDS**  
NOW USED IN **HEATHKITS**  
SEE PAGE **95**

# ANGLE GENESEE goes to Junior Hi Fi Cabinets

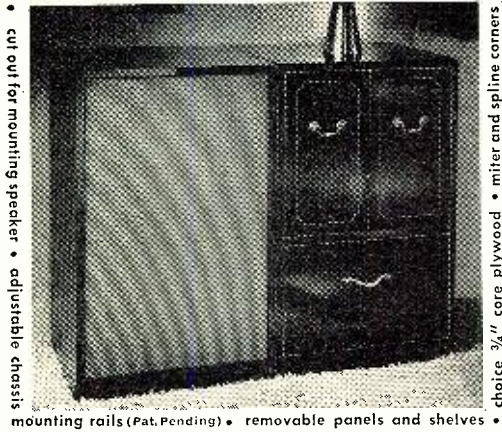

cut out for mounting speaker • adjustable chassis

choice 3/4" core plywood • miter and spline corners

mounting rails (Pat. Pending) • removable panels and shelves

Truly a chip off the old A-G block, the "Genesee Junior" features quality advantages of the famous regular Angle Genesee customized line. Designed for the space and budget-conscious audiophile with taste, these junior equipment and speaker cabinets come finished, unfinished or in "Do-it-yourself" kits. Contemporary natural birch or traditional mahogany. Other popular finishes at modest additional cost.

Speaker cabinets as low as \$59.50 completely finished.

With 15" speaker mounting cut out. 12-J adaptor available for 12" speakers. 21 1/2" wide, 18 1/2" deep, 34" high.

Equipment cabinets as low as \$79.50 completely finished.

Chassis compartment 15 1/8" deep, 17 3/4" high. Record Player shelf 19 3/4" wide, 17" deep.

Send for full details today.



GENESEE CORPORATION  
114 Norris Drive  
Rochester, N. Y.

Note. A few dealer franchises still available.

- Please send me free complete information on the new "Genesee Junior"
- Please send name of dealer nearest me
- I am a hi fi dealer. Please contact me about a "Genesee Junior" franchise.

Name .....

Address .....

City..... Zone..... State.....

## EASY TO LEARN CODE

It is easy to learn or increase speed with an Instructograph Code Teacher. Affords the quickest and most practical method yet developed. For beginners or advanced students. Available tapes from beginner's alphabet to typical messages on all subjects. Speed range 5 to 40 WPM. Always ready—no QRM.



ENDORSED BY THOUSANDS!

The Instructograph Code Teacher literally takes the place of an operator-instructor and enables anyone to learn and master code without further assistance. Thousands of successful operators have "acquired the code" with the Instructograph System. Write today for convenient rental and purchase plans.

## INSTRUCTOGRAPH COMPANY

4711 SHERIDAN ROAD, CHICAGO 40, ILLINOIS

Check THE NEW  
**HEATHKIT SCOPE**  
FOR  
\$29.50  
ON PAGE  
**93**

be surprised to note the difference made with control over this function. In many cases, adjusting the input has made the difference between copying a bit of plain noise level or bringing an "S" one-half signal into QSA range.

**The Oscillator:** With the converter operating, turn on your transmitter crystal oscillator or choose a time when you know signals are on the band. Using an insulated tuning tool, slowly rotate  $C_{20}$  until a rush of noise can be heard; at that point, you're nearing the correct oscillator frequency setting. Careful adjustment of  $C_{20}$  should bring in a harmonic of your crystal oscillator and other local signals.

Start this procedure with a trial setting of the slug about half-way into  $L_5$ . Find a signal near the low end of the band, then screw the tuning knob out until you locate another signal near the top end of the band. Count the number of turns required between band edges; if bandspread is too limited, then start over, but with the slug starting a half-turn farther out, etc. A little practice allows fine adjustment of the slug position to the point where the band is just tuned by a given number of dial rotations. This takes some patient work, but is really worth it when the last adjustment has been made.

It's difficult to obtain absolute dial-scale linearity; the band has a tendency to crowd when the slug is closest to the coil. Proper tapering of the slug will help the situation, and requires time and patience.

After you're satisfied with bandspread tuning and linearity, tune to several known signal frequencies, marking each lightly on a blank dial. After adjusting the mixer grid circuit (see next section) the dial may be inked permanently. After once setting up the system, a properly-constructed slug-tuned device of this nature will hold calibration until two meters freezes over, and you'll probably be glad you took the trouble.

If you'd rather not fool with a slide-rule indicator, a bit of gear-ratio figuring can result in a neat pulley-and-vernier dial arrangement, wherein a commercially available unit such as the *National* MCN dial string-gearred to the slug pulley, accomplishes the same purpose. It's much easier, and not quite so pretty, but perhaps you'd prefer to be more of an operator and less of an artiste!

**The Mixer:** Use the grid-dipper to ascertain that  $L_5$  resonates to 145 mc., and  $L_1$  to about 10.6 mc. Temporarily wind a few turns of link around  $L_4$  and couple it to your communications receiver, tuned to 10.6 mc. With the r.f. and oscillator stages operating, peak both coils on background noise.

Now here's where some tricky business enters.  $L_6$ , coupling r.f. voltage from oscillator to mixer, is shown to be two complete turns of linkage. That much coupling was found to be necessary for a satisfactory amount of

## Lafayette's Exclusive Sale!

3 TUBE  
CIRCUIT

alliance

**CASCAMATIC**  
the NEW automatic  
**TV BOOSTER**

SMASH  
PRICE! 29.95

6.25 ea. IN  
LOTS OF 3  
singly, ea. 6.50

The Alliance Cascamatic TV booster is the latest accessory which combines all the advantages of television boosters in a single unit! Fully automatic — requires no further tuning — no manual control. Automatically turns on and off with set. Completely hidden from view — mounted in back of the set. Instantly installed — requires no further attention. Improves quality of both picture and sound signals. Eliminates noise — improves signal-to-noise ratio. Features famous "California" circuit with three tubes. Works on all VHF channels. Uses two 6B6 tubes and one 6BK7. Attractive metal cabinet 4" x 6 1/4" x 4 1/4". 110-125 volts, 60 cycles AC. Complete with tubes and instructions. Shpg. wt. 2 1/2 lbs.

**CASCAMATIC TV BOOSTER.**  
In lots of 3, 6.25 ea (single ea., 6.50)  
List \$29.95

STOP-GO SESSIONS TIMER

The timer that's almost human. Just set this marvelous Sessions electric timer mechanism to switch on or off your radio, television, or electrical appliance automatically. Will turn on your radio at any desired time. Has miracle "Sleep Switch" so that you can play your radio when you go to bed and it turns off automatically at a pre-set time, allowing up to 90 minutes to elapse. With mounting bracket. For 117 volts 50/60 cycles AC.

No. MS-67  
4.75

Greatest Tape Buy Ever!

1200 FT. REEL  
Genuine Plastic Base  
RECORDING TAPE

LAFAYETTE made a terrific deal with one of the leading manufacturers of recording tape to supply us with their regular tape which sells for almost twice our price. WE GUARANTEE ABSOLUTE SATISFACTION OR YOUR MONEY BACK. The finest, professional-quality recording tape obtainable. Highest performance for thousands of playings. Red Oxide Base in a smooth, uniform coating; greater signal strength; with maximum fidelity; uniform frequency response from 40-15,000 cps.

\$1.89 per roll plus postage  
C.O.D. accepted

Write for free catalog.

NEW YORK, N.Y.	100 Sixth Ave.
BRONX, N.Y.	542 E. Fordham Rd
NEWARK, N.J.	24 Central Ave.
PLAINFIELD, N.J.	139 West 2nd St.
BOSTON, MASS.	110 Federal St.

injection voltage to be delivered to the mixer grids. Injection voltage is extremely important with respect to optimum conversion efficiency, signal-to-noise ratio, and good over-all noise figure. Axiom: 'Tis better to over-inject than under-inject.

Because of the amount of coupling, the oscillator is heavily loaded, thus tuning the mixer grid circuit changes the oscillator frequency. So OK, it pulls—it's a fixed-tuned stage, isn't it? When you resonate the mixer grid, you'll alter the dial calibration a bit, thus final calibration should not be made until the mixer is tuned to its proper frequency.

Using your communications receiver as a temporary i.f. strip, go back to the r.f. stage and start all over again until you're satisfied the three stages are beginning to operate properly. By the time you're ready to try the converter in your car, the remaining circuits present practically no problem.

**The I.F. Amplifier and Second Converter:** Sticking closely to the values given for these two stages should result in immediate operation. The 6BA6 stage will amplify to beat the band when  $L_r$  and  $L_s$  are peaked at the intermediate frequency; using background noise as a source reference, resonate both coils, lock their slugs in place, and forget 'em.

If wired according to the diagram, the 6BE6 mixer should also function right away. With the converter connected to the car radio's antenna input, you'll hear satisfactory amounts of background hiss if all's well, and very little otherwise. There being no tuned stages in the second mixer, ascertain that the 9 mc. crystal is oscillating. This is determined by listening for its 16th harmonic at 144 mc., weak but distinguishable. With the harmonic tuned in, place a finger against the crystal holder, which should shift the frequency very slightly, thereby identifying the harmonic as such.

Potential at pin #6 of the 6BE6 socket should be approximately 7 volts when the over-all plate supply delivers about 150 volts. Over-all current drain of the 5 tubes should not exceed 30 ma.—22 ma. for the tubes, and 8 ma. necessary to "fire" the voltage regulator tube. Power supply may be made from the car radio's vibrator pack, providing it's not one designed to go dead with an extra milliamperes drain. Most modern car radios should be capable of fulfilling the function with little trouble.

#### A Final Word

The converter was designed not as a general mobile front end, but rather as an extremely selective receiving system to be used in the pursuit of DX from a fixed-mobile location. Standing still, in other words. The tuning is quite sharp, and was meant to be that way; this is a DX amateur's receiver.

At this writing, some DX has been heard (and worked) from the car,

September, 1954

After They  
Tried Them All  
**THIS IS THE ONLY  
FLYBACK TESTER USED  
BY SERVICE MEN AT:**

**JOHN WANAMAKER  
SUNSET APPLIANCES  
WINSTON APPLIANCES  
AND MANY OTHERS**

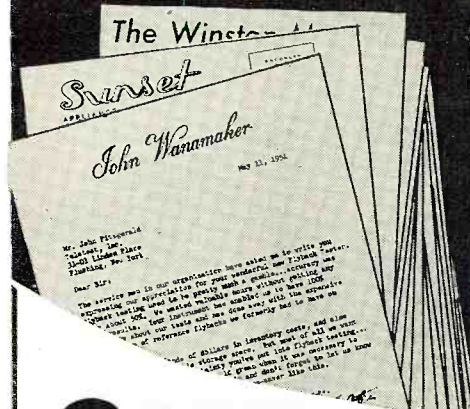

With other  
flyback testers  
you can be sure  
only 50% of the time

**AMAZING NEW**

**TELETEST**  
INSTRUMENT CORP.

**FLYBACK TESTER  
IS 100% ACCURATE**

A great new step  
forward in elec-  
tronic testing!  
Now for the first  
time, a flyback  
tester that tests  
GOOD flybacks  
as well as bad!

## 6 BIG REASONS WHY TELETEST IS BEST

1. Its reliable... previous testers often gave bad readings on a good flyback transformer. Now Teletest indicates a transformer's exact condition: good or bad.
2. Checks continuity AND tests yokes, width coils, and linearity coils for *shorted turns*, including a *single shorted turn*.
3. Checks flyback under full operating voltage without danger of shock. On previous testers, shorts at operating voltage might not show at 100 V.
4. Needs no reference flyback... other testers need a known good reference flyback of the exact type as the one being tested.
5. Tests color flybacks without a reference unit... other testers need an expensive color flyback as a reference.
6. No calibration adjustment required.

**\$44.95**

**TELETEST**  
INSTRUMENT CORP.

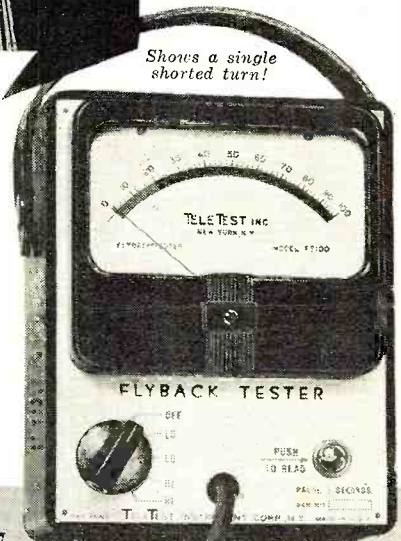

**31-01 Linden Place  
Flushing, New York**

Write today for detailed information.

**Only \$36.78**  
Per Mo.  
(18 months)

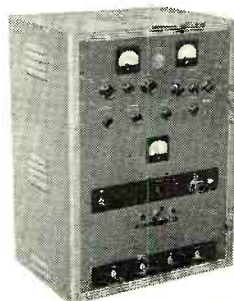

**\$6750**  
Cash  
Down

**\$67500**  
Wired-  
Tested

MODEL 500

### Making Ham History!

COMPLETE BAND SWITCHING 500 WATT

## GLOBE KING TRANSMITTER

In keeping with WRL's policy of always giving you MORE WATTS PER DOLLAR, we now offer you a complete 500 watt bandswitching 160 through 10 meter transmitter using the popular husky 4-250 A tube in final. Complete TVI shielding and by-passing of RF section and meters. Includes co-ax antenna change-over relay and push-to-talk features. Pi-network final tuning will match any antenna system from 52 to 600 ohms with output impedance selector switch on front panel. This arrangement serves as an ideal antenna tuner. Several safety features included for protection of final tube which is forced air cooled. Has provision for VFO. High level 100% plate modulation. XMTR designed for future use with single sideband exciter. Hammertone finished cabinet approximately 31" H x 21 3/4" W x 15" D.

Write for Free GLOBE KING Folder No. 2

**WORLD RADIO LABORATORIES**

Box 811 Council Bluffs, Ia. Phone 2-0277

**XCELITE Hand Tools**  
PREFERRED BY THE EXPERTS

YES—THERE IS SUCH A  
THING AS TOP VALUE!

It's yours in XCELITE PLIERS

By "value", we mean high grade tool steel drop forged electronic pliers. We mean induction hardened, hand-honed blades that cut clean and stay sharp. We mean the same accurate workmanship you find in XCELITE screwdrivers and nut drivers. And by VALUE we mean list prices of only \$2.90 for our No. 59 Needle Nose Assembly Plier—\$3.10 for 6" diagonal—\$2.70 for 6" side cutter—many others. Ask your supplier for bargains like this!

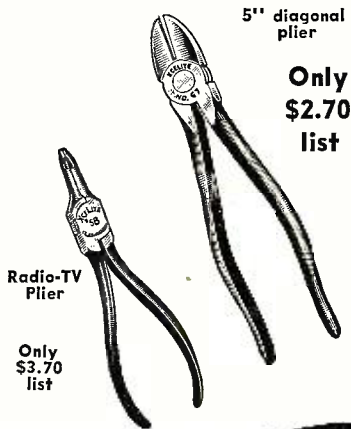

Radio-TV Plier

Only \$3.70 list

5" diagonal plier  
Only \$2.70 list

**XCELITE, INCORPORATED**  
(Formerly Park Metalware Co., Inc.)  
Dept. E. Orchard Park, N. Y.

For Originality  
LOOK TO XCELITE

**NOW Start fixing TV and Radio sets right away!**



Even if you never fixed a lamp or door bell before . . .

It's easy with these plain, simple directions written for the man with no technical training. You deal only with the things that go wrong in sets—the parts—start doing actual repair work even before you finish the book. Just think—No Math! No Theory! No Lab work!

Just Published!

**Television and Radio Repairing**  
by John Markus • 556 pp., 225 illus., \$7.95

For every television and radio part, no matter what make the set is, Markus shows you how to recognize symptoms of trouble . . . how to test to make sure . . . how to order the new part . . . and how to install it. Here's your chance to share the big money in servicing today—without investing a good deal of cash—and by starting right in your own home or working for a service outfit. First repair job pays for the book.

Shows you how to:  
—Test tubes without a tester  
—Eliminate noise in receiver . . . improve dim TV picture . . . how to order the new part . . . and how to install it.  
—Repair, replace, adjust all parts  
—Solder connections  
—Install antennas  
—Run your own service shop profitably  
—and many others.

SEE THIS BOOK 10 DAYS FREE  
McGraw-Hill Book Co., Inc., Dept. RTN-9  
327 W. 41 St., NYC 36

Send me Markus' Television and Radio Repairing for 10 days' examination on approval. In 10 days I will remit \$7.95, plus few cents for delivery, or return book postpaid. (We pay for delivery, if you remit with this coupon; same return privilege.)

PRINT

Name .....

Address .....

City..... Zone... State.....

Company .....

Position .....

This offer applies in U.S. only. RTN-9

**COLUMBIA SEZ:**

"If cutting prices is a crime—we plead guilty!" WE WILL MEET OR BEAT ANY COMPETITIVE PRICE! TRY US!!

SCR-183 12 V. Receiver & Transmitter  
Covers Marine, Aircraft and Ham bands with proper coil. WITH 2 coils, 2 control boxes, tuning head, flex cable 12 V dynamotor. Approx. 25 W. out. Plus schematic. Only \$12.95

Assorted Resistors—New!  
Long pig-tails. American made—not Japanese  
Kit of 1,000 ..... \$7.50  
Kit of 500 ..... 4.25  
Kit of 100 ..... 3.8  
Kit of 50 ..... .65

Oil-Filled Condensers  
All Brand New!  
8 MFD @ 600 VDC. \$ .89  
2 for ..... 1.75  
8 MFD @ 1,000 VDC. 1.89  
2 for ..... 3.50  
10 MFD @ 600 VDC. 1.19  
2 for ..... 2.29  
8 x 8 MFD @ 600 VDC. .95

\*\*\*  
New Signal Relays  
DPDT. Hermetically sealed metal base. No better values!  
15,000 OHM. Each. \$2.99  
2 for only ..... 5.00  
5,000 OHM  
Polarized. Ea. 1.99  
3 for ..... 5.00

BC-611 Handie-Talkie  
Finest communication. Compact. Excellent cond. With batteries \$65.00  
Ready to go! ea. \$122.50  
Per Pair .....

Sound Powered Field Phones  
Brand new, same as EE-8. Audio and vis. signals. ea. \$29.95  
Per Pair ..... \$55.00

Rear Seat Speaker Kits! New! Wired!  
Complete with hardware.  
5" x 7" ..... \$7.49  
6" x 9" ..... \$8.95

Ask for FREE BEST BUY BULLETIN!  
**COLUMBIA ELECTRONICS**  
2251 W. Washington Blvd. Los Angeles 18, Cal.  
All orders P.O. Los Angeles • 25% deposit required  
• DEALER INQUIRIES INVITED • Min. order \$3.00

Receivers  
BC-455 40-meter. \$3.95  
BC-454 75-meter. 7.95  
Transmitter  
BC-375 100 W. Covers 200-12500 Kc. with proper tuner. Good condition \$29.50

All Radio & TV Tubes New! Guaranteed! 60% off! Write today!

Western Electric Handset  
With F-1 button. Like new. Special this month only. Each \$2.95

LM Freq. Meter  
Crystal calib. 125-20,000 Kc. Modulated. Excel. cond. Complete with uncalibrated book. A great value. Only \$24.50

New 7-ft. Collapsible Antenna with base \$1.29

T-17 MIKES—good physical cond. \$2.95 Each

\*\*\*  
ARB Receiver  
Freq. 195-9050 Kc. Covers Beacon, Marine, Broadcast, 80, 75, and 40 Meters. Loop input or single wire. Motor driven band switching. Can be used to complete remote control. Excellent condition \$24.50

2 Meter or 220 Band Variable Transmitter  
Freq. 95-215 MC. 30 W. Output P.E. contains 2-832, 2-5R4, 2-6C4, 1-6X5, 1-6V6, 3-6AC7, 1-931 photoelectric cell, 2-24 V. motor blowers, etc. Summer giveaway. Like new \$15.95

Free Crystal Catalogue Sheet  
A raft of frequencies and holders for ham, novice and commercial use. SEND FOR IT!

using just the 19" quarter-wave whisker, which DX apparently was inaccessible to a few home-station installations having the advantage of high-gain beam antennas. Just to prove the point, said DX was first contacted with a mobile 4-element 7.6 db beam from a high, clear hilltop location, then the same stations were re-worked from the driveway of the house in a flat residential section, using only the quarter-wave whisker.

The main reason for writing this article (other than for money!) was to present the advantages of the slug-tuned oscillator. Hoping you'll give it a try, and sure that you'll enjoy using it as much as we have, here's 73 and good luck from W6WGD. -30-

**Basic Color TV**  
(Continued from page 44)

itive pulses are made available to a vertical blocking oscillator. At the same time, both positive and negative pulses are made available to the phase detector in the horizontal sweep system. Appropriate filters are inserted between the pulse take-off points and their respective sweep systems to remove the undesired pulses and permit only the desired pulses to get through.

The a.g.c. stage used in nearly all color television receivers is of the keyed or triggered variety, that is, positive pulses reach the plate of the tube at the same instant that positive horizontal sync pulses in the video signal arrive at the control grid of the a.g.c. tube. The tube current that flows when these two pulses are active establishes the negative bias voltage that is fed back to the control grids of several video i.f. stages and the grid of the r.f. amplifier.

Many of the a.g.c. systems now employed in monochrome sets may be used in color sets with similar results. The introduction of the color signal has not basically altered the need for or purpose of automatic gain control.

The deflection systems of most present-day color TV receivers, like the a.g.c. systems, strongly resemble their monochrome counterparts. These, together with the high-voltage and convergence circuits, will be discussed next month.

(To be continued)

Fig. 8. Sync separator section of a color TV set. Note similarity to the circuits used for this function in monochrome sets.

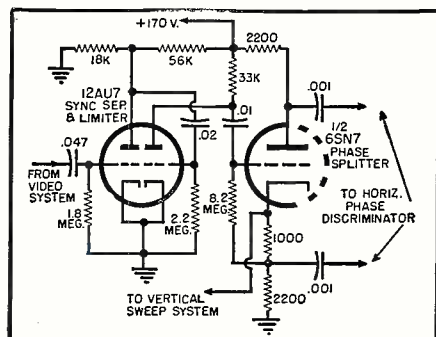

## INDICATOR SCOPE

ID6/APN4



Made to operate in conjunction with Radio Receiver R9/APN-4. Unit includes one 5" scope tube, crystal controlled standard oscillator, sweep circuits, marker pulses. Excellent cond. Less tubes but with 5" scope tube.

Weight 40 lbs. **\$19.95**  
WITH TUBES & CRYSTAL.....\$39.50

**DYNAMOTOR SPECIAL:** 9 V. input. Output 450 V. 75 mils. With extended shaft and drive gear on one end. New **\$7.95**

## ARB NAVY RECEIVER

105 to 9050 KC. Four Bands, Calibrated Dial. LF-Ship-BC-80 & 40 Meter—Complete with Tubes and Dynamotor. For 24 Volt operation; easily converted to 110 V—12 or 6 Volt. Size: 8 1/4" x 7 1/4" x 15 1/4". Excellent cond. **\$19.95**

With schematic. Weight 30 lbs. ....

**D.U.I. DIRECTION FINDER LOOP AMPLIFIER** for ARB receiver. With tubes and loop. Excellent condition. With schematic **\$19.95**



**C.A.P. SPECIAL BC-625 VHF TRANSMITTER**

Freq. range 100-150 MC. With

modulation section and speech amplifier. Less tubes & crystals, with conversion dope. **\$9.95**  
Used, good condition. (See Nov/53 CQ.)

## TG-10 CODE KEYS

Self-Contained Automatic unit for code practice signals from an inked type recording. Complete with 7 tubes and electric eye; Audio freq. output of 800 CPS. Size: 11 x 24 x 18 1/2"—110-220 VAC 60 cy.—78 RPM motor can be used for a turntable—Power unit can be used for a P.A. system—wt. **\$19.95**  
65 lbs. Excellent Condition. ....

## UHF TRANSMITTER-RECEIVER

APS-13

**\$495**



Freq. range 415-420 MC. 5 stages of 30 MC. 1F amplifier. Complete with R.F. and I.F. sections. Less dynamotor, tubes, and tube shields, with schematic. Excl. cond. Weight 13 lbs.

## UHF FM TRANSCEIVER APG-17

2 watt FM transmitter-receiver radar set, frequency range 1475-1525 MC. The antenna system consists of 2 double-bay cylindrical parabolas to operate in the above frequency. Electronic computer unit has air cooled power supply for the transceiver. Complete installation. Brand new. P.U.R. ....



**UHF TRANSMITTER**

15 watt UHF tunable transmitter, frequency range 475-585 MC. Two 8012 RF tubes as push-pull oscillators. Wide band video amplifier 100-3500 KC. Blower

motor cools RF section. Weight 45 lbs. **\$9.95**  
(Less Tubes). Excellent condition .....

## BEST HEADSET & MIKE BUYS

H-16U HEADSET.	8,000 ohms. ....	<b>\$3.95</b>
HS-18 HEADSET.	New. ....	<b>2.45</b>
HS-23 HEADSET.	High imp. New. ....	<b>4.95</b>
HS-30 HEADSET.	Featherweight type. Low imp. NEW. ....	<b>1.49</b>
HS-33 HEADSET.	Low imp. New. ....	<b>5.50</b>
HS-38 HEADSET.	USED, excel. cond. ....	<b>1.49</b>
NEW	.....	<b>3.50</b>
RS-38 MIKE.	NEW. \$4.95	Excl. .... <b>2.75</b>

**T9—MODULATION TRANSFORMER.** For BC-610 Transmitter. Pri. 16,000 ohms CT; sec. 8,330 ohms @ 250 ma. Fully shielded steel case. New. **\$34.50**



**TS-10 Sound Powered Handset**

Uses no batteries or external power source. Ideal for TV installation work, for construction projects, connecting outbuildings, extensions, etc., includes 5 ft. cord.

NEW. Each **\$ 9.95**  
NEW. Per Pr. **18.50**

**NEW HAM CIRCULAR!**  
Ask for your FREE copy!

Drastic reductions on selected hot items!

All shpts. F.O.B. whse. Calif. residents add sales tax, 25% deposit required. Specify shipping instructions and ADD SHIPPING COSTS TO EACH ORDER. All items subject to prior sale and change of price without notice.

## ARROW SALES INC.

Mailing Address: Box 3878-R, North Hollywood, Cal.  
Office-Warehouse: 7460 Varna Ave., N. Hollywood, Cal.

## Technical BOOKS

"HOW TO INSTALL & SERVICE AUTO RADIOS" by Jack Darr. Published by John F. Rider Publisher, Inc., New York. 111 pages. Price \$1.80. Paper bound.

A practical, no-nonsense approach characterizes this volume by one of the "old timers" in the auto radio servicing field.

From his wealth of experience the author has provided specific "how-to-do-it" instructions for the technician who wishes to take advantage of the lush market for installing and service these "mobile music boxes."

The author has limited his discussion to the circuitry and techniques that are unique with auto radios so the user of this text must have a thorough working knowledge of AM receiver circuitry.

The text is divided into three main sections covering installation, servicing, and the service shop. The section on the service shop is especially valuable since the business end of servicing is often neglected because of the emphasis on the servicing angles. Coming from a practicing and successful shop owner, this material is a veritable gold mine for the newcomer in the field as well as the experienced hand.

\* \* \*

"LOUDSPEAKERS" by G. A. Briggs. Published by Wharfedale Wireless Works, England. Available from British Industries Corporation, 164 Duane St., New York 13, N.Y. 86 pages. Price \$1.60. Third Edition.

This handy, pocket-sized manual has been written for the layman and the audiophile lacking formal training in audio engineering.

Since the author is one of those all-too-rare individuals who can make complex subject matter intelligible to the tyro, we believe that most readers will find this book enlightening and informative.

Almost all of the material presented in this slim volume is basic and thus immune to obsolescence. The chapters cover the development of speakers, magnets, chassis or cone housing, cones, centering devices, impedance, phons and decibels, frequency response, response curves, volume and watts, resonance and vibration, cabinets and baffles, extension speakers and volume controls, room acoustics, transients, crossover networks, negative feedback, transformers and matching, comparing performance, speaker life, Doppler effect, and speaker efficiency.

\* \* \*

"SPECIALIZED AUTO RADIO MANUAL" by Rider Staff. Published by John F. Rider Publisher, Inc., New York. 123 pages. Price \$1.80. Paper bound. Volume 3-A.

This is the third volume in this new series from Rider and covers receivers

## THE American IDEA

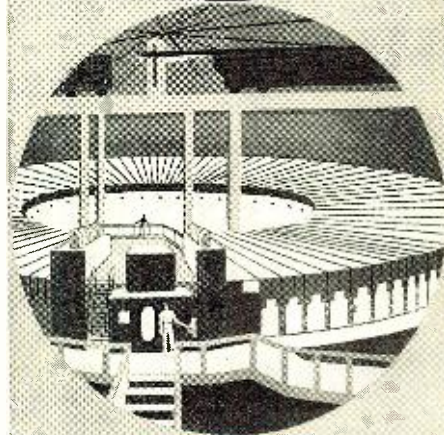

"To find and follow the better way"... Gigantic offspring of the cyclotron, the Bevatron—world's greatest magnet—can send masses of protons hurtling around its 135'-diameter race track at almost the speed of light. "Idea", to penetrate deep into the atomic nucleus, where lie secrets of matter and energy.

With us, the "American Idea" is, by directed effort and applied know-how, to continue to lead in bringing you electronic products of the highest quality.



Replacement Phonograph Cartridges

Complete line of "Full Vision" Microphones  
D33 Broadcast  
D-22 Public Address

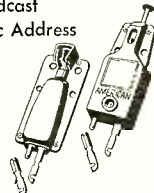

INSIST ON AMERICAN FOR QUALITY  
Send for FREE Catalog 47



American microphone co.

370 South Fair Oaks Ave. • Pasadena, 1, Calif.

## 100 WATT-SECOND PHOTO FLASH OUTFIT

For use on 6/12 or 12/24 VDC with a built in vibrator supply or easily used on 110 V.A.C. (Write for details.) Size: 1 1/2 x 1 1/4 x 4 1/4. Wt. 50 lbs. Consists of:

**SYLVANIA 200 WATT SECOND BULB**—similar to Syl. Type R-4330. Enclosed in heavy duty Pyrex for rugged service.

**2-G.E. PYRANOL 23 MFD @ 2000 VDC INT. CONDS.**

Ignition coil, trigger housing, lamp ass'y which is adaptable with any type reflector with 20 ft. 4 cond. #16 Cord.

**PLUS-2000 V xfmr.**—relays—tubes—fuses—power cord, switches, vibrator & misc. parts. Provisions for remote control triggering for a camera. This outfit Originally Cost \$472.50. **\$2995**  
BRAND-NEW with manual—COMPLETE & READY TO OPERATE.

## MISC. PHOTO-FLASH PARTS

**200 WATT-SECOND SYL. FLASH BULB**.....\$7.95  
**23 MFD @ 2000 VDC INT. PYRL. CONDENSER** 7.95  
**LAMP ASSY w/ign. coil & trigger**.....5.95  
**6/12 or 12/24 V. Vibrator**.....3.95

**TG-34-A CODE KEYS**—15/230 V 50/60 cycle—Automatic unit reproduces code practice signals recorded on paper tape. This unit will provide code signals to one or more persons by use of self contained speaker. Keying oscillator for use with a hand key. Compact in portable carrying case. Complete with tubes, photo-cell manual. Size: 10 9/16 x 10 1/2 x 15 13/16. Sh. Wt. 45 lbs. BRAND-NEW in original carton \$24.95. USED.....**\$14.95**

**TG-10 CODE KEYS**—Similar in operation to TG-34 but more audio output. Housed in a standard metal cabinet. Size: 11 x 24 x 18 1/2. Sh. Wt. 65 lbs. with tubes and photo cell. USED BUT EXCELLENT.....**\$19.95**

**MCELROY INKED DOUBLE TRACK TAPE SET**—15 reels in metal carrying case w/handle—used with any code unit using inked tape. NEW.....**\$16.95**

**INDIVIDUAL TAPES** for the following lessons—#1, #2, #6, #8, #11. NEW in metal containers.....ea. **\$1.25**

**VIBRATOR POWER SUPPLY PE-157**—Operates from 2 V wet cell. Output: 1.4 V at 500 ma and 125 V @ 50 ma or 1.4 V @ 350 ma and 60 V @ 15 ma. Case 5 1/2 x 6 x 11 1/2. Contains 4" speaker, vibrator, xfmrs, diagram, etc. Like NEW w/cable & plug. Batt. not incl. USED BUT EXCELLENT.....**\$14.95**

**SUPREME METER #5918**—Sealed for Volt-Ohm-Output. 40 u movement. 2 1/2" round body. 4 x 4 1/4" square face. Out of Model 592 Test Set. 2.03 lbs. NEW. Boxed.....**\$6.95**

**0-200 DC UA METER**—Accuracy 2%. Sensitivity 960 ohm per .1 V. D'Arsonval movement. 40 scale div. 2 1/2" round body. 4 x 4 1/2 x 19/32 rect. Flange. NEW.....**\$6.95**

**WESTINGHOUSE PX-14 AMMETER**—1% accuracy—1-1.10 DC AMPS—Open face portable—P.M. moving coil—005 ohms—3/4" meter face. 4 1/2 x 5 1/2 x 1 1/2—with test leads and leather carrying case—BRAND-NEW in original box.....**\$9.95**

**TRIUMPH SWITCH ASSY**—Model G-30-27. 5 pole 8 pos.—compl. wired w/all volt multipliers & current shunt resistors—w/copper oxide rect. knob, mfg. hdw. NEW.....**\$2.95**

**TECH. MANUAL** for BC-221 Freq. Meter. New.....**\$1.25**

**115 VAC 60 cycle BLOWER**—1525 rpm. Type L. Model 3571—approx. 100 cu. ft. dis. 3/4" intake—2 1/2" outlet. Motor size 3 1/2 x 3". Has mounting bracket with detachable heating element.....**\$9.95**  
Less heating element.....**\$8.95**

**PHONETTE SPEAKER BOX**—contains 5" dyn. spk. 25 V Haydon timer motor. (See Feb. ad for picture & compl. description.) **\$1.95 ea.** 2 for.....**\$3.50**

**PROP PITCH MOTOR**—24-33 VAC or DC. Reversible. 3 wires required. 7000 to 1 gear reduction—appr. 3/4 RPM. Rugged gear train and sturdy thrust bearing. Wt. 65 lbs. ....**\$15.50**  
25% WITH ORDER—BAL. INCL. POSTAGE C.O.D. MICHIGAN RESIDENTS ADD 3% SALES TAX.

## AARON ELECTRONIC SALES

3830 Chene Street Detroit 7, Michigan

SAVE \$\$\$

THOUSANDS OF BARGAINS

Send Stamp for our

GIANT CATALOG

UNITED RADIO CO.

58A MARKET ST. NEWARK, N. J.



Free!

Get More Service Calls with

EICO DECALS

For Store Windows & Cars.

Write EICO

Brooklyn 11, N.Y. Dept. RD-9

installed in Chevrolets, Pontiacs, GMC trucks, and Chevrolet trucks during the years 1950-1954.

Like the previous volumes in the series each receiver is pictured, diagrammed, and completely described. A schematic and parts list is included for each receiver along with the necessary alignment data and hints covering any tricky features or special "bugs."

The service organization or technician who specializes in auto radio service work can step up servicing volume with factory-authorized information of this type.

"TECHNICIAN'S GUIDE TO TV PICTURE TUBES" by Ira Remer. Published by John F. Rider Publisher, Inc., New York. 152 pages. Price \$2.40. Paper bound.

This is a specialized work covering the fundamentals of television only as they apply to the operation, maintenance, and repair of the picture tube and its accessory parts.

The bulk of the book is devoted to direct-view picture tubes as befits their pre-eminent position in present-day television but projection tubes and the new color picture tubes are also covered but in a less thorough manner.

The author covers the basic parts of the picture tube, picture tube accessories and adjustments, physical and electrical characteristics, repair and replacement, as well as including a table of picture tube specifications.

The text material is well illustrated, clearly and simply written, and is prepared in such a way that the maximum amount of information has been disseminated in the fewest possible pages.

## PHOTO CREDITS

Page Credit  
40, 41.....Centralab,  
Division of Globe-Union, Inc.  
42.....  
Allen B. Du Mont Laboratories, Inc.  
48 (left).....Arvin Industries  
48 (second left).....  
.....General Electric Company  
48 (third from left).....  
.....Radio Corporation of America  
48 (center right).....  
Emerson Radio & Phonograph Corp.  
48 (second from right).....  
.....Motorola, Inc.  
48 (right).....  
.....Sylvania Electric Products Inc.  
51.....Ampex  
61, 63, 65....Dalmo Victor Company  
66, 67. University Loudspeakers, Inc.  
82.....Radio Craftsmen, Inc.  
117.....Channel Master Corp.  
155.....Radio Club of America

## ERRATUM & ADDENDUM

A typographical error was responsible for the mis-print in connection with the offer of the "Rectifier Handbook" (page 126, July issue) by Sarkes Tarzian, Inc. The company is located in Bloomington, Indiana not Bloomington, Illinois as indicated in the item.

Many of our readers have inquired about the availability of binders for their back issues of RADIO & TELEVISION NEWS. We have recently heard of a source for such binders and are passing the information along to our readers. Goldsmith Brothers, 77 Nassau Street, New York 8, N. Y. are in a position to supply such binders. Write direct to the firm for prices.

Terrific Hi-Fi VALUES  
HEATHKIT AMPLIFIERS and PREAMP  
PAGE 101

FIRST QUALITY NEW TUBES TOP BRANDS NAME OF MFG. ON EACH TUBE  
GUARANTEED ONE YEAR

1B3 .96	6AT6 .59	6CB6 .76	12AT7 1.05
5U4 .59	6BA6 .71	6CD6 1.89	12AU7 .87
5V4 .99	6AX4 .92	6J5 .65	12BA6 .71
5Y3 .49	6BE6 .73	6J6 .90	12BE6 .73
6AC7 1.21	6BG6 1.89	6K6 .65	12SN7 .83
6AG5 .81	6BK7 1.19	6SA .69	25BQ6 1.41
6AL5 .63	6BQ6 1.38	6SN7 .85	35W4 .49
6AQ5 .76	6BQ7 1.39	6T8 1.05	35Z5 .51
6AU5 1.19	6B27 1.39	6V6 .72	50B5 .76
6AU6 .67	6C4 .59	6W4 .69	50L6 .78

ROOT ELECTRONICS IN-9-1959  
1600 Nostrand Avenue Bklyn. 26, N. Y.  
Terms: 25% check or money order Bal. C.O.D. F.O.B.

GET YOUR F.C.C. LICENSE QUICKLY!  
Correspondence or residence preparation for F.C.C. examinations. Results guaranteed.  
An FCC commercial operator license means greater opportunities and higher pay. We are specialists in preparing you in a MINIMUM OF TIME, to pass FCC examinations for all classes of licenses. Beginners get 2nd class license in 5 weeks and 1st class in 3 additional weeks. Write for free booklet.  
GRANTHAM SCHOOL OF ELECTRONICS  
Dept. 103-B, 6064 Hollywood Blvd., Hollywood 28, Calif.

URGENT! URGENT!  
ELECTRONIC TUBES  
We Pay Spot Cash for:  
RADIO, TV -all types  
State types, condition of merchandise, quantities and price.  
COLUMBIA ELECTRONICS CORP.  
115 Liberty Street, N. Y. C.

IT'S NEW IT'S COMING  
IT'S TERRIFIC  
POPULAR ELECTRONICS

\$2.95 EACH OR 2 FOR \$5.00!  
Genuine Telephone Company Upright Telephone complete with cords, in tested and guaranteed condition with 50 ft. of wire, roll of tape, inter-communication instructions. Tape and wire offer for this month only. Complete line of telephones, dial, magneto, inter-communication, etc. Write for free list. All shipments F.O.B.  
TELEPHONE ENGINEERING CO.  
Dept. 9-C4 Simpson, Pa.

MEN! THIS IS IT!  
Nothing like these Adult Cartoon Booklets, ever!  
REAL COLLECTORS ITEMS.  
1. Maggie and Digs  
2. Toots and Jasper  
3. Tiffie the Sailor  
4. Lord Pushbottom & Emma  
5. Villain & Little Nell and others. WITH ORDER  
FREE CATALOG OF TITILLATING NOVELTIES.  
FITS WEST POCKET - 10 for \$1 22 for \$2!  
Box 8516, Dept. 926 Hollywood 46, Calif.  
G. T. SALES



# Classified

Rate 50c per word. Minimum 10 words

## RADIO ENGINEERING

COMPLETE radio, electronics theory & practice; television; broadcasting; servicing; aviation, marine, police radio. 12 or 18 months. Catalog. Valparaiso Technical Institute, Dept. N, Valparaiso, Ind.

### FOR SALE

ISOLATION transformers. 35 watt #55R 117v to 117v or 135v plus 6.3v .45a tap 2% x 2% x 3 1/2 x 1 1/2. 10 watt #372 117v to 117v plus 6.3v .6a 2 x 1 1/2 x 1 1/2. Use with Selenium rectifier for 25ma dc. \$1.35 Empire Electronics Co. 409a Ave. L, Brooklyn 30, N. Y.

TELEVISIONS, Working. \$25 up. WJAP 1420 South Randolph, Arlington 4, Virginia.

DIAGRAMS—Radio \$1.00; record changers, recorders \$1.25. Television with service data \$2.00. Where model unknown, give part numbers. Kramer's Radio Service, Dept. S53, 36 Columbus Ave., New York 23, N. Y.

TAPE Recorders, Tapes, Accessories. Unusual Values. Dressner, Box 66R, Peter Stuyvesant Station, N. Y. 9.

FREE: Get our monthly electronic lists. Dick Rose, Everett, Wash.

TUBES and equipment bought, sold, and exchanged. For action and a fair deal, write B. N. Gensler, W2LN1, 136F Liberty, N. Y. 6, N. Y.

AN/APR-1, other "APR," "ARR," "TS," "IE," ARC-1, ARC-3, ART-13, everything surplus: Tubes, Manuals, Laboratory equipment. Describe, price in first letter. Engineering Associates, 434 Patterson Rd., Dayton 9, Ohio.

ALUMINUM TUBING, Angle and Channel Plain and Perforated Sheet. Willard Radefield, Postoria, Ohio.

SALE! New \$21.95 Videon Junior TV Booster \$9.95 each, New \$19.95 VDX antenna rotor \$19.95 each Cash only. Hargis, Box 716, Austin, Texas.

SMALL HIGH VOLTAGE POWER SUPPLY. Ideal for Geiger or Scintillation counters. 3 to 6 VDC Input. Adjustable, Regulated Output 700 to 1000 VDC @ 2 ma. Money Back Guarantee. \$21.95. Free Literature. Radionics Laboratory: Havre De Grace, Md.

USED sound equipment. Woodburn, 915 Washington, Iowa City, Iowa.

HI FI & P.A. Amplifier owners. Four tube AM plug in tuners complete with fittings and installation instructions \$28.75. Can be installed in twenty minutes on any amplifier. F. M. Units available. Kuhn Electronics, 17 Glenwood, Cincinnati 17, Ohio.

HI FI Records at savings. Example: \$12.90 Mercury Olympian Nutcracker Suite, just released \$9.00. Reviewed July Radio News. Free catalog: High Fidelity Records, Box 701, Kansas City, Mo.

CODE—practice oscillator kit, complete with transistor and battery \$14.95 postpaid. Caldwell, Box 685X, 1421 Arch St., Phila. 2, Pa.

BLOUNDER-TONGUE channel 3 CS-1 strips. Slightly used. 1 for \$40.00. J. K. Colchour, 274 Chestnut St., Pensacola, Fla.

G.E. Cartridges—\$3.95, VM Triomatic—\$23.50, Collaro 3/532 Intermix-spindle-xtal—\$34.50. Tuners, Amplifiers, Low Prices. Fidelity Unlimited, 63-05 39th Ave., Woodside, N. Y.

TV-1M antennas. All types including UHF. Mounts, Accessories. Lowest prices. Wholesale Supply Co., Dept. H, Lunenburg, Mass.

DIAGRAMS for repairing radios \$1.00. Record-changers \$1.50. Television \$2.00. Give Make, Model. Diagram Service, 672-RN, Hartford 1, Connecticut.

### WANTED

"TELETYPEWRITERS, tape send-receive or receive only. Model 14, any quantity or condition. Box 540, Radio & Television News."

WILL buy all ART-13/type T-47A \$200.00; ART-13/type T-17 \$150.00; BC-348 unmodified \$65.00; BC-348 modified \$50.00; APN-9 \$200.00; ARC1 Radio \$200.00; BC-312 Receiver \$60.00; BC-312 Receiver \$60.00; R3/ARN7 \$135.00. Ship via Express C.O.D., subject to inspection to: H. Finnegan, 49 Washington Ave., Little Ferry, N. J.

ANTIQUE Radio Sets or Parts W6MEA 2341 Ivyland, Arcadia, Calif.

### SITUATIONS WANTED

14 YEARS Aviation Experience. 6 yrs. coll., age 34, administrative, communications. Prefer Govt liaison or sales work. LCDR Dave Bowman, N.A.S. Minneapolis, Minn.

(More classified ads on page 178)

September, 1954

# TOP QUALITY TUBES ONE YEAR GUARANTEE BELOW MFRS' PRICES!

Type	Price	Type	Price	Type	Price	Type	Price
OA2	.89	6A3	.89	6X4	.89	6X4GT	.89
OA3	.98	6A7	.82	6X5	.89	6X5GT	.89
OA4G	.65	6A7	.82	6X6	.89	6X6GT	.89
OB2	.74	6A8	.46	6X7	.89	6X7GT	.89
OB3	.74	6A8	.46	6X8	.89	6X8GT	.89
OC3	.98	6AB7	.75	6X9	.89	6X9GT	.89
OD3	.98	6AC7	.75	6X10	.89	6X10GT	.89
OZ4	.54	6AG5	.45	6X11	.89	6X11GT	.89
1A4	.37	6AG7	.45	6X12	.89	6X12GT	.89
1A6	.37	6AG7	.45	6X13	.89	6X13GT	.89
1A7	.49	6AG7	.45	6X14	.89	6X14GT	.89
1A85	.59	6AG7	.45	6X15	.89	6X15GT	.89
1AX2	.63	6AG7	.45	6X16	.89	6X16GT	.89
1B3	.59	6AG7	.45	6X17	.89	6X17GT	.89
1D8GT	.77	6AG7	.45	6X18	.89	6X18GT	.89
1G4	.49	6AG7	.45	6X19	.89	6X19GT	.89
1G6GT	.54	6AG7	.45	6X20	.89	6X20GT	.89
1H4	.39	6AG7	.45	6X21	.89	6X21GT	.89
1I6G	.59	6AG7	.45	6X22	.89	6X22GT	.89
1L4	.45	6AG7	.45	6X23	.89	6X23GT	.89
1L4A	.45	6AG7	.45	6X24	.89	6X24GT	.89
1LA6	.79	6AG7	.45	6X25	.89	6X25GT	.89
1L84	.79	6AG7	.45	6X26	.89	6X26GT	.89
1LC5	.79	6AG7	.45	6X27	.89	6X27GT	.89
1LD5	.52	6AG7	.45	6X28	.89	6X28GT	.89
1LE3	.78	6AG7	.45	6X29	.89	6X29GT	.89
1LH4	.78	6AG7	.45	6X30	.89	6X30GT	.89
1LN5	.57	6AG7	.45	6X31	.89	6X31GT	.89
1NS	.63	6AG7	.45	6X32	.89	6X32GT	.89
1PSGT	.56	6AG7	.45	6X33	.89	6X33GT	.89
1Q5GT	.57	6AG7	.45	6X34	.89	6X34GT	.89
1R5	.45	6AG7	.45	6X35	.89	6X35GT	.89
1S4	.58	6AG7	.45	6X36	.89	6X36GT	.89
1S5	.43	6AG7	.45	6X37	.89	6X37GT	.89
1SA6	.48	6AG7	.45	6X38	.89	6X38GT	.89
1T4	.45	6AG7	.45	6X39	.89	6X39GT	.89
1T5	.79	6AG7	.45	6X40	.89	6X40GT	.89
1U4	.49	6AG7	.45	6X41	.89	6X41GT	.89
IU5	.39	6AG7	.45	6X42	.89	6X42GT	.89
IV	.59	6AG7	.45	6X43	.89	6X43GT	.89
IX2A	.55	6AG7	.45	6X44	.89	6X44GT	.89
2A3	.95	6AG7	.45	6X45	.89	6X45GT	.89
2A4G	.95	6AG7	.45	6X46	.89	6X46GT	.89
2A6	.49	6AG7	.45	6X47	.89	6X47GT	.89
2A7	.64	6AG7	.45	6X48	.89	6X48GT	.89
2B7	.62	6AG7	.45	6X49	.89	6X49GT	.89
2X2	.39	6AG7	.45	6X50	.89	6X50GT	.89
2X2A	1.15	6AG7	.45	6X51	.89	6X51GT	.89
3A4	.44	6AG7	.45	6X52	.89	6X52GT	.89
3A5	.93	6AG7	.45	6X53	.89	6X53GT	.89
3A8	.60	6AG7	.45	6X54	.89	6X54GT	.89
3B7	.39	6AG7	.45	6X55	.89	6X55GT	.89
3D6	.39	6AG7	.45	6X56	.89	6X56GT	.89
3L4	.79	6AG7	.45	6X57	.89	6X57GT	.89
3Q4	.52	6AG7	.45	6X58	.89	6X58GT	.89
3Q5GT	.55	6AG7	.45	6X59	.89	6X59GT	.89
3S4	.50	6AG7	.45	6X60	.89	6X60GT	.89
3V4	.44	6AG7	.45	6X61	.89	6X61GT	.89
5T4	1.28	6AG7	.45	6X62	.89	6X62GT	.89
5U4G	.53	6AG7	.45	6X63	.89	6X63GT	.89
5V4	.82	6AG7	.45	6X64	.89	6X64GT	.89
5Y3GT	.38	6AG7	.45	6X65	.89	6X65GT	.89
5Z3	.44	6AG7	.45	6X66	.89	6X66GT	.89

WE SPECIALIZE IN TUBES—Receiving, Transmitting and Special Purpose, etc.—serving the industry for years. More than 3000 different types in stock for IMMEDIATE DELIVERY! Because of the extreme care and precision used in testing our tubes in our fully equipped labs, and retesting at time of shipment—we readily guarantee every tube—not for 3 or 6 months—but for ONE FULL YEAR! All tubes individually boxed in handsome 3-color cartons.

### Buy ELECTRON Tubes... to RESELL at a PROFIT!

Type	Price	Type	Price	Type	Price	Type	Price
6SD7GT	.38	7A7	.69	12A7	.89	14A4	.69
6SF5	.45	7AD7	.95	12AL5	.42	14A5	.59
6SF7	.59	7AG7	.55	12AT6	.39	14AF7	.59
6SG7GT	.40	7AH7	.56	12AT7	.68	14B8	.65
6SH7	.60	7BA	.44	12AV6	.39	14C7	.69
6SH7GT	.50	7B5	.59	12AV7	.58	14D7	.67
6SJ7	.50	7B6	.42	12AV7	.58	14F7	.95
6SK7	.34	7C4	.58	12AX4GT	.59	14H7	.69
6SL7GT	.52	7C5	.59	12AX7	.59	14Y4	.69
6SN7GT	.52	7C7	.59	12AY7	.79	19	.19
6SQ7	.41	7E5	.59	12B6	.59	19B6G	1.29
6SR7	.45	7F7	.59	12BA7	.59	19T8	.79
6ST7	.49	7H7	.59	12BD6	.44	22	.44
6T7	.79	7J7	.59	12BE6	.59	25A5C	.64
6T7A	.95	7L7	.59	12B7	.65	25B6GT	.79
6T7G	.79	7N7	.62	12B7	.65	25L6GT	.41
6T8	.59	7O7	.61	12BY7	.59	25V5	.59

## THIS MONTH'S SPECIALS

Our new policy brings you Greater tube savings than you thought possible! As a GOODWILL offering, we are giving, each month, a number of popular tube types (listed in extra hand) AT PRICES BELOW OUR OWN COST! Look for these terrific offers of different types each month, in industry-wide publications.

Type	Price	Type	Price	Type	Price	Type	Price
6U7G	.45	7R7	.65	12BZ7	.63	4523	.42
6V8	.59	7S7	.85	12C8	.34	46	.49
6V6GT	.37	7T7	.91	12F5GT	.35	316A	.39
6W4GT	.45	7W7	.85	12J5GT	.39	49	.44
6W6	.48	7X7	.49	12K7	.58	50A5	.55
6X4	.36	7Z4	.44	12J7GT	.58	50B5	.44
6X5GT	.29	7Z7	.65	12K8	.58	50L6GT	.62
6X8	.74	10Y	.69	12Q7GT	.59	50M6GT	.59
7A5	.59	12A6	.99	12S7GT	.64	56	.49
7A6	.59	12A7	.99	12S7GT	.64	58	.58
						58	.58
						70L7GT	1.00
						71A	.75
						75	.49
						76	.43
						77	.55
						78	.55
						81	1.11
						82	.69
						83	.79
						84	.54
						85	.59
						89 Y	.29
						1177GT	.98
						117Z3	.38
						12Z4GT	.75
						807	1.39
						2051	1.95
						9000	.68
						9006	.68
						9008	.68
						9009	.68
						9010	.68
						9011	.68
						9012	.68
						9013	.68
						9014	.68
						9015	.68
						9016	.68
						9017	.68
						9018	.68
						9019	.68
						9020	.68

### EXPORT:

We are World Suppliers for Receiving & Special Purpose tubes of all types. Our prices are the most competitive on the Export Market—WE INVITE COMPARISON! Our skilled export personnel assures fast efficient handling of your orders.

Minimum order \$10. Please include 25% deposit with order. Prices subject to change without notice. All prices F.O.B. our warehouse, N.Y.C.

WRITE FOR TYPES NOT LISTED.

## ELECTRON TUBE WHOLESALE, INC.

140 DUANE STREET • NEW YORK 13, N. Y. • Phone: BArdway 7-7616

NEW LISTING!  
Just out—all popular tube types at lowest wholesale prices! Send today for your FREE COPY!

## ARKAY KITS

WORLD'S FINEST

RADIO PHONOGRAPHS TV TEST EQUIPMENT HI-FI  
Write for FREE Brochure

WORLD'S LARGEST MANUFACTURER  
OF CUSTOM BUILT TELEVISION

# MATTISON

## SILVER ROCKET 630 CHASSIS Featuring Syncromatic Tuning NO DRIFT UHF-VHF-DX

ONLY THE MATTISON 630 ELIMINATES DRIFTING APART OF PICTURE AND SOUND ON UHF, VHF and DX RECEPTION. SELECT YOUR CHANNEL SOUND IS AUTOMATIC. (Syncromatic tuning is an exclusive Mattison 630 Circuit)

Tube Complement:  
29 tubes  
3 rectifiers  
1 CRT

**SILVER ROCKET**  
630 Chassis with  
built in UHF Tuner

33



### All Channel UHF Tuner

• UHF Cascode I.F. amplifier adds additional I.F. stage. Very important because UHF transmitters operate with moderate power and RECEIVER must be sensitive to give top notch UHF performance.

## SILVER ROCKET 630 CHASSIS • with TUNEABLE • BUILT-IN BOOSTER for Better DX Reception

Tube Complement:  
28 tubes  
3 rectifiers  
1 CRT

Select Your Channel  
SOUND IS  
AUTOMATIC!

32

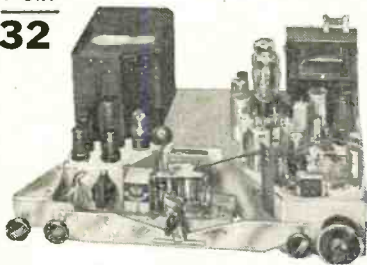

### Tuneable Booster

• Broad band single knob control pre-amplifier built in to eliminate long leads which may cause regeneration and attenuation of signal.

• ONLY THE MATTISON 630 CHASSIS HAS AN ALL CHANNEL TUNEABLE BUILT-IN BOOSTER THAT INCREASES SIGNAL STRENGTH UP TO 10 TIMES.

ALL CABINETS MADE IN MATTISON'S OWN CABINET FACTORY. AVAILABLE IN EVERY FINISH AND STYLE. WRITE FOR COMPLETE CATALOG.

**DEALERS! SERVICE MEN!** Here is your opportunity to become the "important" TV Dealer in your area for THE FINEST CUSTOM-BUILT LINE OF TV RECEIVERS. FREE!! Write for Mattison's merchandising portfolio explaining the "UNASSEMBLED PLAN" and "\$1,000,000 FLOOR PLAN."



Manufactured with integrity

When you buy from Mattison you need only one source of supply! You can buy a Mattison Chassis, a Mattison Cabinet or a complete Mattison TV Set!

**Mattison Television & Radio Corp.**  
10 West 181st St., Dept. RN, N. Y. 53, N. Y.

## Classified Continued from Page 177

### RECORDS

25-50% DISCOUNT on guaranteed factory fresh LP records, and pre-recorded tape. Send 20c for complete LP catalogue. Record Sales, 4710 Caroline, Houston 4, Texas.

### CORRESPONDENCE COURSES

USED correspondence Courses and Books sold and rented. Money back guarantee. Catalog free (Courses bought.) Lee Mountain, Pisgah, Ala.

### MISCELLANEOUS

BUILD your own electronic organ, or miniature electronic brain. Jim Kirk, W6DEG, 1552 Church St., San Francisco 14, Calif.

ALL makes speakers repaired. Amprite Speaker Service, 70 Vesey St., New York City 7.

TEST Equipment repaired and calibrated by Factory staff. All makes. Superior, Simpson, Triplett, Eico. Prompt service. Free estimate. Douglas Instrument Laboratory, 176 Norfolk Avenue, Boston 19, Mass.

TEST equipment repair, and kit construction. Write for information. Bigelow Electronics, Beulah, Michigan.

# INDEX OF Advertisers

SEPTEMBER  
1954

ADVERTISER	PAGE	ADVERTISER	PAGE
Aaron Electronic Sales	176	McGraw-Hill Book Co., Inc.	174
Aermotor Co.	153	Mercury Scientific Products Corp.	164
Airex Radio Corp.	160	Milwaukee School of Engineering	130
All Channel Antenna Corp.	133	Moss Electronic Distributing Co., Inc.	110, 111
Allied Radio Corp.	9	Musical Masterpiece Society, Inc., The	139
Altec Lansing Corporation	166	National Company	86, 87
American Microphone Co.	175	National Electronics of Cleveland	112
American Television & Radio Co.	117	National Radio Institute	3, 179
Angle Genesee Corporation	172	National Schools	123
Argos Products Company	114	National Union Electric Corp.	121
Arkay Radio Kits, Inc.	177	Newark Electric Company	169
Arrow Sales, Inc.	175	Newcomb Audio Products Co.	32, 33
Ashe Radio Co., Walter	107	New Jersey Television Supply Co.	144
Audel Publishers	78	Nichols Wire & Aluminum Co.	24
Audio Fair Corporation	165	Onan & Sons, Inc., D. W.	78
Baltimore Technical Institute	170	Orradio Corporation	164
Barry Electronics Corp.	162	P.A.R.T.S., Inc.	177
Belden Mfg. Co.	105	Palley Supply Co.	177
Bell Telephone Laboratories	22	Peak Electronics Co.	134
Berlant Associates	78	Philco Corporation	20, 21
Boiland & Boyce	138	Photography Annual	141
Burstein-Applebee Co.	144	Pickering & Company, Incorporated	6
CBS-Hytron	3rd Cover, 19	Platt Electronics Corp.	104
Candler System Co.	154	Popular Electronics	147
Cannon Electric Company	154	Precision Radiation Instruments	154
Capitol Radio Engineering Institute	127	Premier Radio-TV Supply	79
Centralab	26, 27	Progressive "Edu-Kits," Inc.	131
Century Electronics Co.	159	Q.T. Sales	176
Channel Master Corp.	84, 85	Quietrol Company	146
Cisin, H. G., Publisher	169	R.C.A. Institutes, Inc.	29, 167
Cleveland Institute of Radio Electronics	115, 116	RW Electronics	108
Collins Audio Products Co., Inc.	125	Radiart Corporation, The	10, 11
Columbia Electronics	174	Radio Corporation of America	7
Columbia Electronics Corp.	176	Radio Craftmen, Inc.	118, 119
Commissioned Electronics Co.	162	Radio Shack Corporation	155
Communications Equipment Co.	168	Radio & Television News Book Service	145
Concord Radio	148	Radio-Television Training Association	23
Corona Radio & T.V. Co.	167	Rad-Tel Tube Co.	137
Coyne Electrical School	153, 160	Raytheon Manufacturing Company	2nd Cover
DeVry Technical Institute	5	Reeves Soundcraft Corp.	156
Editors & Engineers, Ltd.	156	Rider Publishers, Inc., John F.	158
Electronic Chemical Corp.	152	Rinehart & Co., Inc.	80, 106, 120, 161
Electronic Instrument Co., Inc. (EICO)	34, 112, 157, 176	Rohn Manufacturing Co.	165
Electronic Measurements Corporation	131	Root Electronics	176
Electron Tube Wholesalers, Inc.	177	Sams & Co., Inc., Howard W.	88
Electro-Voice	8	Sam's Surplus	146
Fairchild Recording Equipment Corp.	143	Skysweeper	148
Fair Radio Sales	171	Sonotone Corporation	135
Fisher Radio Corporation	13	Sprayberry Academy of Radio	17
G & G Radio Supply Co.	82	Stan Burn Radio & Electronics Co.	112
G & H Wood Products Company	18	Standard Electrical Products Co.	124
G. L. Electronics, Inc.	161	Standard Surplus	151
General Electric Co.	25, 31	Steve-EI Electronics Corp.	154
General Electronic Dist. Co.	167	Stuart Electronic Distributors	157
Goodheart, R. E.	161, 170	Sun Parts Distributors, Ltd.	164
Grantham School of Electronics	176	Sylvania Electric Products	14, 15, 113
Greenlee Tool Co.	156	"TAB"	180
Hallcrafters	134, 136, 138, 140	Tech-Master Products Co.	106
Harjo Sales Co.	162	Telephone Engineering Co.	176
Harvey Radio Company, Inc.	122	Tele Test Instrument Corp.	173
Heath Company, 91, 92, 93, 94, 95, 96, 97, 98, 99, 100, 101, 102, 143, 146, 148, 171, 172, 176	132	Teltron Electric Company	168
Hickok Electrical Instrument Co.	132	Terado Company	150
Hughes Research and Development Laboratories	150	Terminal Radio Corp.	83
Indiana Technical College	171	Tipeco Company	168
Instructograph Company	172	Transamerica Electronics Corp.	109
Interelectronics Corp.	16	Transvision, Inc.	142
International Radio & Electronics Corp.	163	Triplett	28
International Rectifier Corp.	128	Tri-State College	143
JFD Manufacturing Co.	81	Tung-Sol Electric, Inc.	103
J. J. Glass Electronics Co.	160	U. S. Crystals, Inc.	167
JSH Sales Co.	120	Unger Electric Tools, Inc.	126
Jones & Laughlin Steel Corporation	149	United Catalogue Publishers Inc.	148
K & L Radio Parts Co.	144	United Radio Co.	176
Kay-Townes Antenna Company	75	Valparaiso Technical Institute	154
Kester Solder Company	120	Walco Electronics Corporation	89
Lafayette Radio	172	Ward Products Corp., The	12
Lampkin Laboratories, Inc.	126	Washtek Service Co.	162
La Pointe Electric	30	Weller Electric Corp.	163
Leotone Radio Corp.	106	Western Television Institute	146
Mallory & Co., Inc., P. R.	4th Cover, 77	Wholesale Radio Parts Co., Inc.	126
Manfredi Wood Products Corp.	170	Windsor Electronic Tube Co.	152
Mattison Television & Radio Corp.	178	World Radio Laboratories	159, 173
		Xcelite, Incorporated	174
		Zidell Machinery & Supply Co.	170
		Zingo Products	170

# Here's a NEW Way to Reach the Top in TV SERVICING

**All-practice method—  
professional techniques,  
skills, knowledge of  
circuits, etc.**



**Includes 17" picture tube, all other  
tubes, components for a TV Receiver,  
Scope, Signal Generator, HF Probe.  
Low Introductory price under \$200,  
on easy terms. Mail Coupon today.**

**I**F YOU HAVE some Radio or Television experience, or if you know basic Radio-Television principles but lack experience—NRI's new Professional Television Servicing course can train you to go places in TV servicing. This advertisement is your personal invitation to get a free copy of our booklet which describes this training in detail.

### **LEARN-BY-DOING "ALL THE WAY"**

This is 100% learn-by-doing, practical training. We supply *all* the components, *all* tubes, including a 17-inch picture tube, and comprehensive manuals covering a thoroughly planned program of practice. You learn how experts diagnose TV receiver defects quickly. You see how various defects affect the performance of a TV receiver—picture and sound; learn to know the causes of defects, accurately, easily, and how to fix them. You do more than just build circuits. You get practice recognizing, isolating, and fixing innumerable TV receiver troubles.

You get actual experience aligning TV receivers, diagnosing the causes of complaints from scope patterns, eliminating interference, using germanium crystals to rectify the TV picture signal, obtaining maximum brightness and definition by properly adjusting the ion trap and centering magnets, etc. There isn't room on this or even several pages of this magazine to list all the servicing experience you get.

### **UHF AND COLOR TV MAKING NEW BOOM**

Installing front-end channel selector strips in modern UHF-VIIF Television receivers and learning UHF servicing problems and their solution is part of the practice you get if you live in a UHF area. To cash in on the coming color TV boom you'll need the kind of knowledge and experience which this training gives.

### **GET DETAILS OF NEW COURSE FREE**

Once again—if you want to go places in TV servicing, we invite you to find out what you get, what you practice, what you learn from NRI's new course in Professional Television Servicing. See pictures of equipment supplied, read what you practice. Judge for yourself whether this training will further your ambition to reach the top in TV servicing. We believe it will. We believe many of tomorrow's top TV servicemen will be graduates of this training. Mailing the coupon involves no obligation.

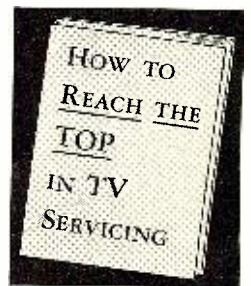

**National Radio Institute, Dept. 4JET  
16th and U Sts., N.W., Washington 9, D. C.**

Please send my FREE copy of "How to Reach the Top in TV Servicing." I understand no salesman will call.

Name \_\_\_\_\_ Age \_\_\_\_\_

Address \_\_\_\_\_

City \_\_\_\_\_ Zone \_\_\_\_\_ State \_\_\_\_\_

### 866A KIT and XFORMER

(2) 866A Tubes & Sockets. Transformer 141H. Pri 1.5V 60 cye Sec. 2.5VCT/10 Amp Hi-Volt Insulation ..... \$4.98

### CIRCUIT BREAKERS

Heinmann Magn Bkrs. Amps: 220, 3, 7, 9, 12, 20, 30, 35, 40, 80, 120  
 Ea. \$1.98; 12 for \$20.50 for \$75.00  
 SQ. D. & CH Toggle SW Bkrs. Amps: 5, 10, 15, 20, 25, 30, 35, 40, 50, 60, 75, 90, 100, 125, 150, 175, 200, 225, 250, 275, 300, 325, 350, 375, 400, 450, 500, 550, 600, 650, 700, 750, 800, 850, 900, 950, 1000, 1100, 1200, 1300, 1400, 1500, 1600, 1700, 1800, 1900, 2000, 2200, 2400, 2600, 2800, 3000, 3200, 3400, 3600, 3800, 4000, 4500, 5000, 5500, 6000, 6500, 7000, 7500, 8000, 8500, 9000, 9500, 10000, 11000, 12000, 13000, 14000, 15000, 16000, 17000, 18000, 19000, 20000, 22000, 24000, 26000, 28000, 30000, 32000, 34000, 36000, 38000, 40000, 45000, 50000, 55000, 60000, 65000, 70000, 75000, 80000, 85000, 90000, 95000, 100000, 110000, 120000, 130000, 140000, 150000, 160000, 170000, 180000, 190000, 200000, 220000, 240000, 260000, 280000, 300000, 320000, 340000, 360000, 380000, 400000, 450000, 500000, 550000, 600000, 650000, 700000, 750000, 800000, 850000, 900000, 950000, 1000000, 1100000, 1200000, 1300000, 1400000, 1500000, 1600000, 1700000, 1800000, 1900000, 2000000, 2200000, 2400000, 2600000, 2800000, 3000000, 3200000, 3400000, 3600000, 3800000, 4000000, 4500000, 5000000, 5500000, 6000000, 6500000, 7000000, 7500000, 8000000, 8500000, 9000000, 9500000, 10000000, 11000000, 12000000, 13000000, 14000000, 15000000, 16000000, 17000000, 18000000, 19000000, 20000000, 22000000, 24000000, 26000000, 28000000, 30000000, 32000000, 34000000, 36000000, 38000000, 40000000, 45000000, 50000000, 55000000, 60000000, 65000000, 70000000, 75000000, 80000000, 85000000, 90000000, 95000000, 100000000, 110000000, 120000000, 130000000, 140000000, 150000000, 160000000, 170000000, 180000000, 190000000, 200000000, 220000000, 240000000, 260000000, 280000000, 300000000, 320000000, 340000000, 360000000, 380000000, 400000000, 450000000, 500000000, 550000000, 600000000, 650000000, 700000000, 750000000, 800000000, 850000000, 900000000, 950000000, 1000000000, 1100000000, 1200000000, 1300000000, 1400000000, 1500000000, 1600000000, 1700000000, 1800000000, 1900000000, 2000000000, 2200000000, 2400000000, 2600000000, 2800000000, 3000000000, 3200000000, 3400000000, 3600000000, 3800000000, 4000000000, 4500000000, 5000000000, 5500000000, 6000000000, 6500000000, 7000000000, 7500000000, 8000000000, 8500000000, 9000000000, 9500000000, 10000000000, 11000000000, 12000000000, 13000000000, 14000000000, 15000000000, 16000000000, 17000000000, 18000000000, 19000000000, 20000000000, 22000000000, 24000000000, 26000000000, 28000000000, 30000000000, 32000000000, 34000000000, 36000000000, 38000000000, 40000000000, 45000000000, 50000000000, 55000000000, 60000000000, 65000000000, 70000000000, 75000000000, 80000000000, 85000000000, 90000000000, 95000000000, 100000000000, 110000000000, 120000000000, 130000000000, 140000000000, 150000000000, 160000000000, 170000000000, 180000000000, 190000000000, 200000000000, 220000000000, 240000000000, 260000000000, 280000000000, 300000000000, 320000000000, 340000000000, 360000000000, 380000000000, 400000000000, 450000000000, 500000000000, 550000000000, 600000000000, 650000000000, 700000000000, 750000000000, 800000000000, 850000000000, 900000000000, 950000000000, 1000000000000, 1100000000000, 1200000000000, 1300000000000, 1400000000000, 1500000000000, 1600000000000, 1700000000000, 1800000000000, 1900000000000, 2000000000000, 2200000000000, 2400000000000, 2600000000000, 2800000000000, 3000000000000, 3200000000000, 3400000000000, 3600000000000, 3800000000000, 4000000000000, 4500000000000, 5000000000000, 5500000000000, 6000000000000, 6500000000000, 7000000000000, 7500000000000, 8000000000000, 8500000000000, 9000000000000, 9500000000000, 10000000000000, 11000000000000, 12000000000000, 13000000000000, 14000000000000, 15000000000000, 16000000000000, 17000000000000, 18000000000000, 19000000000000, 20000000000000, 22000000000000, 24000000000000, 26000000000000, 28000000000000, 30000000000000, 32000000000000, 34000000000000, 36000000000000, 38000000000000, 40000000000000, 45000000000000, 50000000000000, 55000000000000, 60000000000000, 65000000000000, 70000000000000, 75000000000000, 80000000000000, 85000000000000, 90000000000000, 95000000000000, 100000000000000, 110000000000000, 120000000000000, 130000000000000, 140000000000000, 150000000000000, 160000000000000, 170000000000000, 180000000000000, 190000000000000, 200000000000000, 220000000000000, 240000000000000, 260000000000000, 280000000000000, 300000000000000, 320000000000000, 340000000000000, 360000000000000, 380000000000000, 400000000000000, 450000000000000, 500000000000000, 550000000000000, 600000000000000, 650000000000000, 700000000000000, 750000000000000, 800000000000000, 850000000000000, 900000000000000, 950000000000000, 1000000000000000, 1100000000000000, 1200000000000000, 1300000000000000, 1400000000000000, 1500000000000000, 1600000000000000, 1700000000000000, 1800000000000000, 1900000000000000, 2000000000000000, 2200000000000000, 2400000000000000, 2600000000000000, 2800000000000000, 3000000000000000, 3200000000000000, 3400000000000000, 3600000000000000, 3800000000000000, 4000000000000000, 4500000000000000, 5000000000000000, 5500000000000000, 6000000000000000, 6500000000000000, 7000000000000000, 7500000000000000, 8000000000000000, 8500000000000000, 9000000000000000, 9500000000000000, 10000000000000000, 11000000000000000, 12000000000000000, 13000000000000000, 14000000000000000, 15000000000000000, 16000000000000000, 17000000000000000, 18000000000000000, 19000000000000000, 20000000000000000, 22000000000000000, 24000000000000000, 26000000000000000, 28000000000000000, 30000000000000000, 32000000000000000, 34000000000000000, 36000000000000000, 38000000000000000, 40000000000000000, 45000000000000000, 50000000000000000, 55000000000000000, 60000000000000000, 65000000000000000, 70000000000000000, 75000000000000000, 80000000000000000, 85000000000000000, 90000000000000000, 95000000000000000, 100000000000000000, 110000000000000000, 120000000000000000, 130000000000000000, 140000000000000000, 150000000000000000, 160000000000000000, 170000000000000000, 180000000000000000, 190000000000000000, 200000000000000000, 220000000000000000, 240000000000000000, 260000000000000000, 280000000000000000, 300000000000000000, 320000000000000000, 340000000000000000, 360000000000000000, 380000000000000000, 400000000000000000, 450000000000000000, 500000000000000000, 550000000000000000, 600000000000000000, 650000000000000000, 700000000000000000, 750000000000000000, 800000000000000000, 850000000000000000, 900000000000000000, 950000000000000000, 1000000000000000000, 1100000000000000000, 1200000000000000000, 1300000000000000000, 1400000000000000000, 1500000000000000000, 1600000000000000000, 1700000000000000000, 1800000000000000000, 1900000000000000000, 2000000000000000000, 2200000000000000000, 2400000000000000000, 2600000000000000000, 2800000000000000000, 3000000000000000000, 3200000000000000000, 3400000000000000000, 3600000000000000000, 3800000000000000000, 4000000000000000000, 4500000000000000000, 5000000000000000000, 5500000000000000000, 6000000000000000000, 6500000000000000000, 7000000000000000000, 7500000000000000000, 8000000000000000000, 8500000000000000000, 9000000000000000000, 9500000000000000000, 10000000000000000000, 11000000000000000000, 12000000000000000000, 13000000000000000000, 14000000000000000000, 15000000000000000000, 16000000000000000000, 17000000000000000000, 18000000000000000000, 19000000000000000000, 20000000000000000000, 22000000000000000000, 24000000000000000000, 26000000000000000000, 28000000000000000000, 30000000000000000000, 32000000000000000000, 34000000000000000000, 36000000000000000000, 38000000000000000000, 40000000000000000000, 45000000000000000000, 50000000000000000000, 55000000000000000000, 60000000000000000000, 65000000000000000000, 70000000000000000000, 75000000000000000000, 80000000000000000000, 85000000000000000000, 90000000000000000000, 95000000000000000000, 100000000000000000000, 110000000000000000000, 120000000000000000000, 130000000000000000000, 140000000000000000000, 150000000000000000000, 160000000000000000000, 170000000000000000000, 180000000000000000000, 190000000000000000000, 200000000000000000000, 220000000000000000000, 240000000000000000000, 260000000000000000000, 280000000000000000000, 300000000000000000000, 320000000000000000000, 340000000000000000000, 360000000000000000000, 380000000000000000000, 400000000000000000000, 450000000000000000000, 500000000000000000000, 550000000000000000000, 600000000000000000000, 650000000000000000000, 700000000000000000000, 750000000000000000000, 800000000000000000000, 850000000000000000000, 900000000000000000000, 950000000000000000000, 1000000000000000000000, 1100000000000000000000, 1200000000000000000000, 1300000000000000000000, 1400000000000000000000, 1500000000000000000000, 1600000000000000000000, 1700000000000000000000, 1800000000000000000000, 1900000000000000000000, 2000000000000000000000, 2200000000000000000000, 2400000000000000000000, 2600000000000000000000, 2800000000000000000000, 3000000000000000000000, 3200000000000000000000, 3400000000000000000000, 3600000000000000000000, 3800000000000000000000, 4000000000000000000000, 4500000000000000000000, 5000000000000000000000, 5500000000000000000000, 6000000000000000000000, 6500000000000000000000, 7000000000000000000000, 7500000000000000000000, 8000000000000000000000, 8500000000000000000000, 9000000000000000000000, 9500000000000000000000, 10000000000000000000000, 11000000000000000000000, 12000000000000000000000, 13000000000000000000000, 14000000000000000000000, 15000000000000000000000, 16000000000000000000000, 17000000000000000000000, 18000000000000000000000, 19000000000000000000000, 20000000000000000000000, 22000000000000000000000, 24000000000000000000000, 26000000000000000000000, 28000000000000000000000, 30000000000000000000000, 32000000000000000000000, 34000000000000000000000, 36000000000000000000000, 38000000000000000000000, 40000000000000000000000, 45000000000000000000000, 50000000000000000000000, 55000000000000000000000, 60000000000000000000000, 65000000000000000000000, 70000000000000000000000, 75000000000000000000000, 80000000000000000000000, 85000000000000000000000, 90000000000000000000000, 95000000000000000000000, 100000000000000000000000, 110000000000000000000000, 120000000000000000000000, 130000000000000000000000, 140000000000000000000000, 150000000000000000000000, 160000000000000000000000, 170000000000000000000000, 180000000000000000000000, 190000000000000000000000, 200000000000000000000000, 220000000000000000000000, 240000000000000000000000, 260000000000000000000000, 280000000000000000000000, 300000000000000000000000, 320000000000000000000000, 340000000000000000000000, 360000000000000000000000, 380000000000000000000000, 400000000000000000000000, 450000000000000000000000, 500000000000000000000000, 550000000000000000000000, 600000000000000000000000, 650000000000000000000000, 700000000000000000000000, 750000000000000000000000, 800000000000000000000000, 850000000000000000000000, 900000000000000000000000, 950000000000000000000000, 1000000000000000000000000, 1100000000000000000000000, 1200000000000000000000000, 1300000000000000000000000, 1400000000000000000000000, 1500000000000000000000000, 1600000000000000000000000, 1700000000000000000000000, 1800000000000000000000000, 1900000000000000000000000, 2000000000000000000000000, 2200000000000000000000000, 2400000000000000000000000, 2600000000000000000000000, 2800000000000000000000000, 3000000000000000000000000, 3200000000000000000000000, 3400000000000000000000000, 3600000000000000000000000, 3800000000000000000000000, 4000000000000000000000000, 4500000000000000000000000, 5000000000000000000000000, 5500000000000000000000000, 6000000000000000000000000, 6500000000000000000000000, 7000000000000000000000000, 7500000000000000000000000, 8000000000000000000000000, 8500000000000000000000000, 9000000000000000000000000, 9500000000000000000000000, 10000000000000000000000000, 11000000000000000000000000, 12000000000000000000000000, 13000000000000000000000000, 14000000000000000000000000, 15000000000000000000000000, 16000000000000000000000000, 17000000000000000000000000, 18000000000000000000000000, 19000000000000000000000000, 20000000000000000000000000, 22000000000000000000000000, 2400000

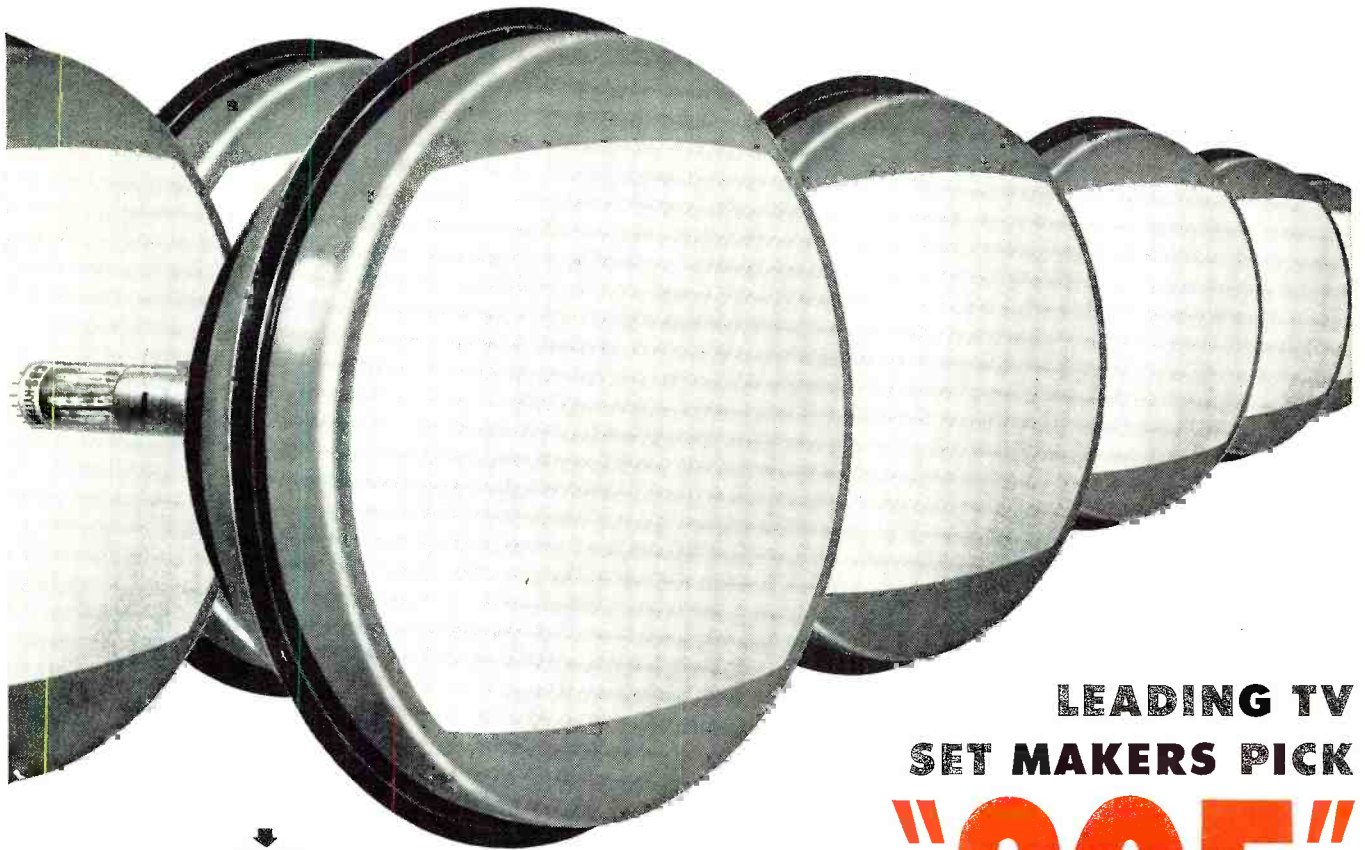

**LEADING TV  
SET MAKERS PICK**

**"205"**

**CBS-COLORTRON**

**LEADING BIG-SCREEN COLOR TUBE**

- ... for **Biggest Picture**
- ... for **Superior Performance**
- ... for **Delivery NOW!**

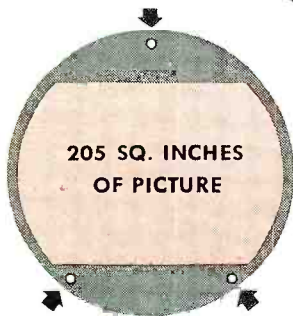

**HOW "205" ACHIEVES BIGGEST PICTURE**

As its name implies, picture area of "205" is a big 205 square inches. The "205" achieves this maximum utilization of screen area: 1. By photographic printing of tricolor screen directly on inside of curved face. 2. By using a simple, light-weight shadow mask. 3. By positioning the three mask supports above and below the desired screen area . . . where the screen is masked off anyway by the set maker to obtain the desired 4 x 3 aspect ratio. This permits full lateral use of screen.



**IT'S CBS-HYTRON FOR NEW  
COLOR RECEIVING TUBES TOO**

TYPE	DESCRIPTION
CBS-Hytron 3A3	Half-wave, high-voltage rectifier
CBS-Hytron 6AM8	Diode, sharp-cutoff pentode
CBS-Hytron 6AN8	Medium- $\mu$ triode, sharp-cutoff pentode
CBS-Hytron 6BD4A	Sharp-cutoff beam triode, high-voltage regulator
CBS-Hytron 6BD6	Sharp-cutoff r-f pentode color demodulator
CBS-Hytron 6BJ7	Triple-diode d-c restorer

The CBS-Colortron "205" is *today* traveling in freight cars and trucks to the nation's leading TV set manufacturers. It was chosen by them, because of: The "205's" larger 205-square-inch screen. The "205's" over-all superior performance. The "205's" easier circuit adjustments. The "205's" absence of "pincushioning" and other distortion. And the "205's" availability in production quantities now!

**BIG-SCREEN COLOR TV IS HERE . . . today . . . at CBS-Hytron.** Original . . . simple . . . functional . . . advanced design of the "205" made this possible: 1. With its curved screen-mask construction. 2. With its maximum use of the screen area. 3. With its electromagnetically converged three-beam electron-gun assembly. And CBS-Hytron's huge, new Kalamazoo plant stands ready to step up the "205's" availability when needed. Yes, you can look to CBS-Hytron as the leader . . . and major producer of big-screen color picture tubes.

**NEW . . . FREE "205" DATA**

Keep abreast of big-screen color TV. Four-page sheet on CBS-Colortron "205," RETMA type 19VP22, contains complete data on: Construction . . . operation . . . application . . . installation . . . adjustment . . . electrical and mechanical characteristics. Write for Bulletin E-227 today!

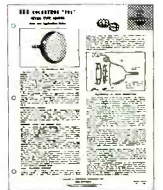

**CBS-HYTRON** Main Office: Danvers, Massachusetts

A Division of Columbia Broadcasting System, Inc.

A member of the CBS family: CBS Radio • CBS Television • Columbia Records, Inc. • CBS Laboratories  
CBS-Columbia • CBS International • CBS-Hytron

RECEIVING • TRANSMITTING • SPECIAL-PURPOSE • TV PICTURE TUBES • CRYSTAL DIODES AND TRANSISTORS

# Boost your converter sales



The Mallory Concealed Converter—first on the market

## Give Your Customers their choice

### ...with two Mallory converter styles

Mallory . . . and only Mallory . . . offers you both types of ALL-CHANNEL UHF CONVERTERS—one designed to fit inside any TV set and the other to be used on or beside any set.

The New Mallory '188' Concealed Converter is mounted inside the TV set . . . out of sight! All that shows is a clear plastic selector dial and switch. Installation is easy. A bracket and four screws are supplied to mount the unit on either side or at the top in wood cabinets. For plastic or metal cabinets, the converter may be mounted on the fiber-board rear enclosure.

Both the Mallory '188' and the Mallory '88' Cabinet Model give the same trouble-free performance, that has made Mallory the leading converter in every area since the start of UHF telecasting.



The Mallory Cabinet Converter—first on the market

**No radiation problem!** Mallory Converters contain specially designed components to prevent troublesome interference from radiation—a problem common to low quality converters which can ruin TV reception over a wide area.

**Give yourself greater Converter Sales . . . By giving your Customers Their Choice of Mallory Converters.**

P. R. MALLORY & CO. Inc.  
**MALLORY**

CAPACITORS • CONTROLS • VIBRATORS • SWITCHES • RESISTORS  
RECTIFIERS • POWER SUPPLIES • CONVERTERS • MERCURY BATTERIES

**APPROVED PRECISION PRODUCTS**

**P. R. MALLORY & CO. Inc., INDIANAPOLIS 6, INDIANA**