

# RADIO NEWS

JUNE  
1948  
35¢

FUNDAMENTALS OF  
INDUSTRIAL ELECTRONICS

PAGE 56

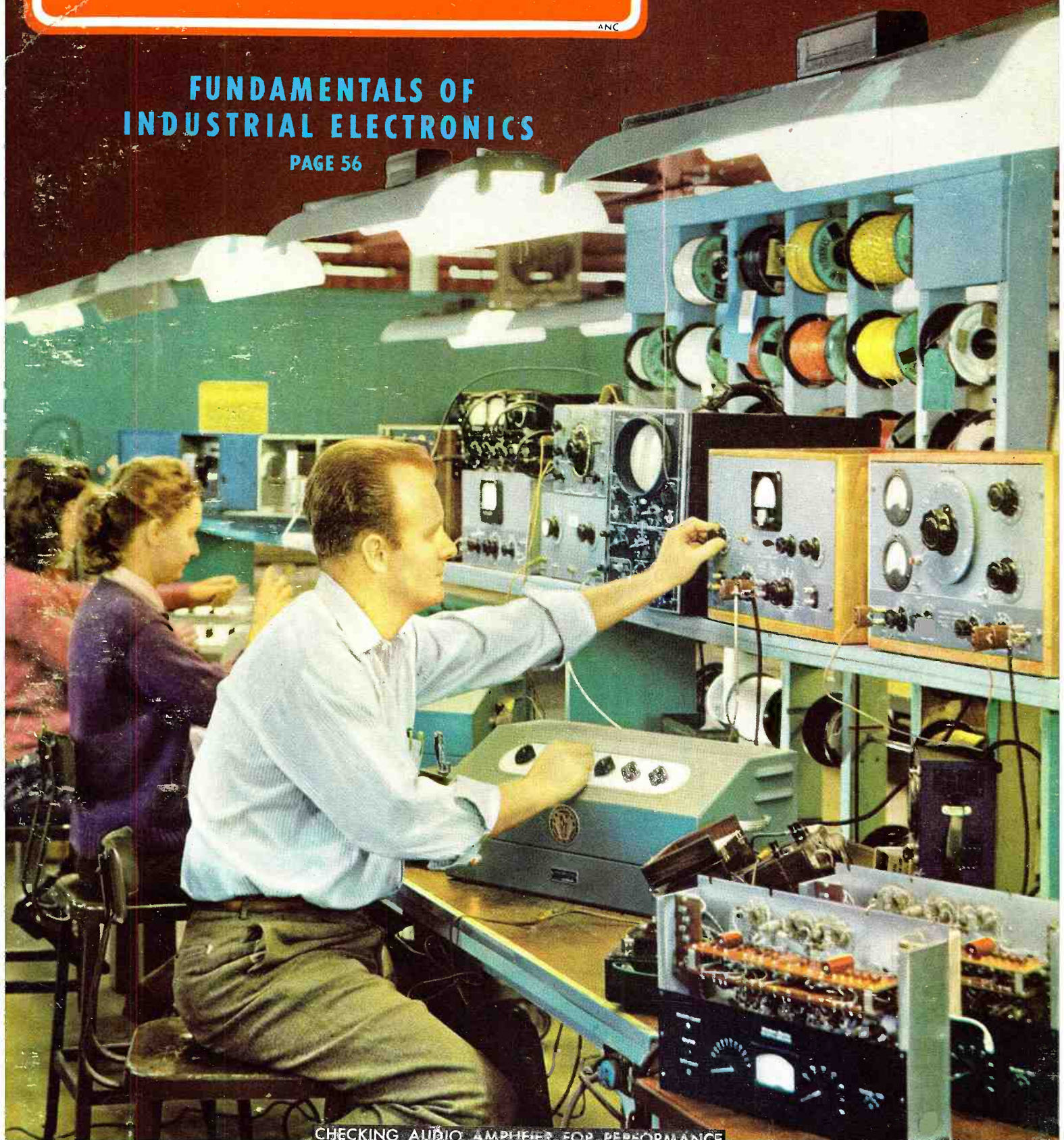

CHECKING AUDIO AMPLIFIER FOR PERFORMANCE

**FOR THE  
NEWEST IN  
TV AERIALS**

**Watch  
WARD**

**GREATER TV  
EFFICIENCY WITH  
NEW "HIGH-LOW"  
ARRAY BY WARD**

All major parts pre-assembled.  
Saves costly installation time.

Here's another "first" by Ward in the rapidly expanding field of television reception. Advanced Ward design and engineering makes receivers work to their highest degree of efficiency.

That's the opinion of satisfied set owners, service installers, and major set manufacturers, who are all directly interested in the improved performance of television.

As a result of months of exhaustive scientific research and field testing, Ward now makes available a high band TV array which can be stacked above the standard television elements, and independently oriented! Also new is a kit for stacking two of Wards finest television assemblies into a two-bay array for a greater gain than ever before.

Sure, there have been other multiple antennas, but none with the scientifically measured spacing and complete adaptability of the new Ward models. You can see the difference yourself on the television screen when a "Magic Wand" aerial is connected to the set.

Send in coupon today for free copy of new Ward catalog.

**ORIENTING AND GAIN.** Each bay tilts in any plane, can be oriented in any direction to give sharpest focus possible. Eliminates awkward or tricky installations. Permits hairline adjustments for utmost gain on both the high and low band stations.

**ADAPTABILITY.** Ease of combination of assemblies in basic kits makes "Magic Wand" Aerials more adaptable than ever to the varying requirements of each installation. This superior flexibility means a highly specialized Ward TV aerial for each purpose, with fewer models in stock, no obsolescence, and greater profits! Write today for free catalog!

Please send me free copy of your new catalog showing latest developments in television aerials.  
NAME \_\_\_\_\_  
ADDRESS \_\_\_\_\_  
STATE \_\_\_\_\_ CITY \_\_\_\_\_  
IF JOBBER OR DEALER  
COMPANY NAME \_\_\_\_\_

**THE WARD PRODUCTS CORPORATION  
DIVISION OF THE GABRIEL COMPANY  
1524 E. 45th STREET, CLEVELAND 3, OHIO  
IN CANADA: ATLAS RADIO CORP. LTD., TORONTO, CANADA**

**WORLD'S LARGEST PRODUCER OF AERIALS FOR CAR AND HOME**

**WARD  
Magic Wand<sup>\*</sup>  
AERIALS**

**YOU BUILD THIS** Radio Circuit early in Course with Soldering Equipment and Radio Parts I send; practice mounting, connecting, soldering Radio parts.

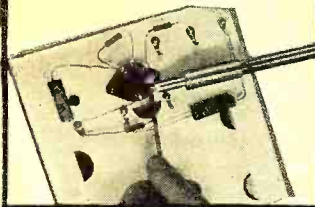

**YOU PRACTICE** Radio Servicing with this Tester built from parts I send. Also use it to help earn **EXTRA MONEY** fixing neighbors' Radios.

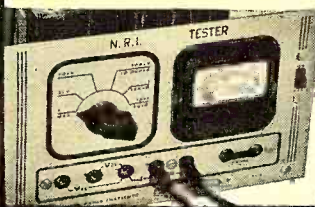

**YOU PRACTICE** "FM" Servicing on this Frequency Modulation (FM) Signal Generator, built with parts I supply; learn by repairing circuit defects.

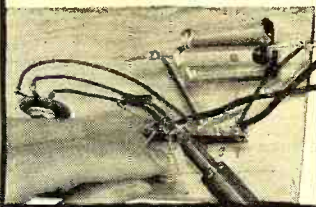

**YOU BUILD THIS** Vacuum Tube Power Pack, make changes which give you experience, learn how to locate and correct power pack troubles.

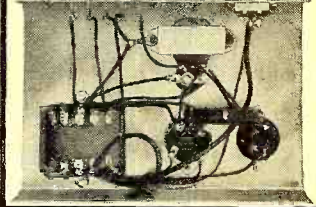

**YOU BUILD THIS** A. M. Signal Generator which provides amplitude-modulated signals for many tests and experiments, gives you practical experience.

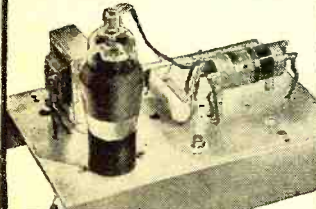

**YOU PRACTICE** signal tracing on this complete Superheterodyne Circuit you build with parts I send you, use it to conduct many tests and experiments.

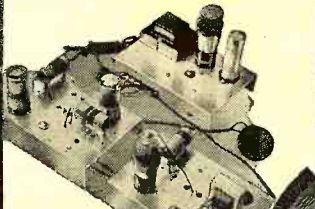

## You Get **PRACTICAL EXPERIENCE** With This Superheterodyne Receiver

**YOU BUILD THIS** complete, powerful Radio Receiver that brings in local and distant stations. N. R. I. gives you **ALL** the Radio parts . . . speaker, tubes, chassis, transformer, sockets, loop antenna, etc.

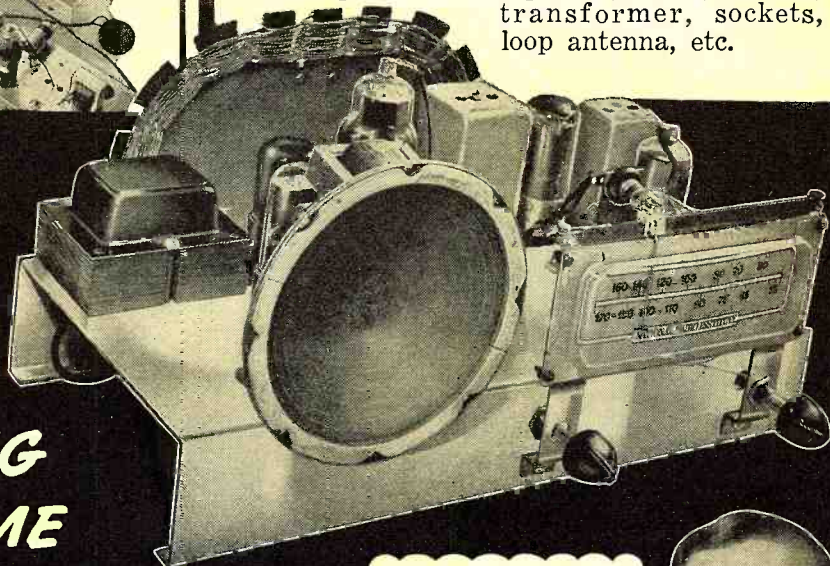

# LEARN RADIO

**BY PRACTICING IN SPARE TIME**

**WITH BIG KITS OF PARTS I SEND YOU**

Do you want a good-pay job in the fast-growing Radio Industry—or your own Radio Shop? Mail the Coupon for a Sample Lesson and my 64-page book, "How to Be a Success in Radio-Television-Electronics," both **FREE**. See how I will train you at home—how you get practical Radio experience building, testing Radio circuits with **BIG KITS OF PARTS I SEND!**

**Many Beginners Soon Make EXTRA Money in Spare Time While Learning**

The day you enroll I start sending **EXTRA MONEY** manuals that show how to make **EXTRA** money fixing neighbors' Radios in spare time while still learning! It's probably easier to get started now than ever before because the Radio Repair

Business is booming. Trained Radio Technicians also find profitable opportunities in Police, Aviation, Marine Radio, Broadcasting, Radio Manufacturing, Public Address work. Think of even *greater* opportunities as public demand for Television, FM and Electronic devices continues to grow! Send for **FREE** books now!

**Find Out What NRI Can Do For You**  
Mail Coupon for Sample Lesson and my **FREE** 64-page book. Read the details about my Course, letters from men I trained; see how quickly, easily you can get started. No obligation! Just **MAIL COUPON NOW** in envelope or paste on a penny postal. J. E. SMITH, President, Dept. 8FR, National Radio Institute, Pioneer Home Study Radio School, Washington 9, D. C.

**I WILL TRAIN YOU AT HOME**  
**MY COURSE INCLUDES FREQUENCY MODULATION, TELEVISION, ELECTRONICS**



## TRAINED THESE MEN

**Has Own Radio Service**

"I have my own Radio and Television sales and servicing business. I get enough repair jobs to keep me going right along."—ALEXANDER KISH, 34 Pershing Avenue, Carteret, New Jersey.

**Good Spare Time Business**

"I have been getting receivers to repair right along, and with N. R. I. methods I don't have to spend much time on them."—S. N. STRICKLAND, 191 Dale Homes, Portsmouth, Virginia.

**GET BOTH 64 PAGE BOOK SAMPLE LESSON FREE**

**MR. J. E. SMITH, Pres., Dept. 8FR, National Radio Institute, Washington 9, D. C.**

Mail me **FREE** Sample Lesson and 64-page book about how to win success in Radio and Television—Electronics. (No salesman will call. Please write plainly.)

Name \_\_\_\_\_ Age \_\_\_\_\_  
Address \_\_\_\_\_  
City \_\_\_\_\_ Zone \_\_\_\_\_ State \_\_\_\_\_

Check if Veteran

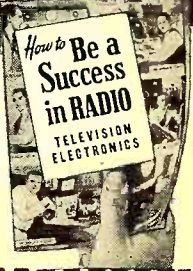

# VETERANS

You get this training in your own home under G. I. Bill. Mail Coupon.

**APPROVED FOR TRAINING UNDER GI BILL**

Editor  
**OLIVER READ, W9ETI**  
 Managing Editor  
**WM. A. STOCKLIN**  
 Technical Editor  
**H. S. RENNE, EX-W8PTS**  
 Associate Editors  
**RAY FRANK, W9JU**  
**P. B. HOEFER**  
**E. HITZEL**  
**S. KRUMBACH**  
 Staff Photographer  
**ARTHUR E. HAUG**  
 Staff Artist  
**R. S. KUPJACK**  
 Advertising Manager  
**L. L. OSTEN**  
 Midwestern Advertising Manager  
**JOHN A. RONAN, JR.**  
 Art Director  
**HERMAN R. BOLLIN**

# RADIO NEWS

Trade Mark Registered U.S. Patent Office No. 378427

*First in radio-electronics*

Average Paid Circulation over 148,000

## CONTENTS

JUNE, 1948

Exploring the Infinitesimal.....	Tom Gootee	39
An Open Letter to the Radio Manufacturer.....	A. C. W. Saunders	43
The AFCA and National Defense.....	Brig. Gen. S. H. Sherrill	44
New Trends in Receiver Design.....	W. William Hensler	46
A New Approach to Gang Tuning.....	Newton G. Noell, W9BMS	48
Conversion of SCR-274N Receivers.....	C. W. Roeschke, W5MLX	49
Measuring Modulation Percentage of AM Signals.....	Rufus P. Turner, WIAY	52
A Versatile Substitution Tester.....	Sidney S. Fleishman	53
Adding Single-Sideband Selectivity to the Communications Receiver.....	McMurdo Silver	54
Fundamentals of Industrial Electronics.....	Robert Endall	56
A Vacuum Tube Voltmeter.....	R. H. Krueger	60
Wide Range Phonograph System.....	Glen Southworth	62
Mac's Radio Service Shop.....	John T. Frye	64
The Recording and Reproduction of Sound (Part 16).....	Oliver Read	65
Regulated D.C. Supply Improvements.....	W. L. Kinsell	68
Modern Television Receivers (Part 3).....	Milton S. Kiver	71
Another Method of Power Supply Control.....	Jack D. Gallagher, W5HZR	88
Photo-Sensitive Devices And The Radioman.....	John P. Gschwind	130

## DEPARTMENTS

For the Record.....	The Editor	8	What's New in Radio.....	82
Spot Radio News.....	Fred Hamlin	18	Technical Books.....	96
Within the Industry.....		28	New Receivers.....	144
Short-Wave.....	K. R. Boord	70	Manufacturers' Literature.....	180



COPYRIGHT 1948  
 ZIFF-DAVIS PUBLISHING COMPANY  
 185 North Wabash Ave., Chicago 1, Ill.  
 VOLUME 39 • NUMBER 6



Member  
 Audit Bureau of  
 Circulations

RADIO NEWS is published monthly by the Ziff-Davis Publishing Company, 185 N. Wabash Ave., Chicago 1, Ill. Subscription Rates: in U. S. and Canada \$4.00 (12 issues), single copies 35 cents; in Mexico, South and Central America, and U.S. Possessions, \$4.00 (12 issues); in British Empire, \$5.00 (12 issues)—all other foreign countries \$5.00 (12 issues). Subscribers should allow at least 2 weeks for change of address. All communications about subscriptions should be addressed to: Director of Circulation, 185 N. Wabash Ave., Chicago 1, Ill. Entered as second class matter March 9, 1938, at the Post Office, Chicago, Illinois, under the Act of March 3, 1879. Entered as second class matter at the Post Office Dept., Ottawa, Canada. Contributors should retain a copy of contributions and include return postage. Contributions will be handled with reasonable care but this magazine assumes no responsibility for their safety. Accepted material is subject to whatever revisions and by-line changes that are necessary. Payment made at our current rates, covers all authors', contributors', or contestants' rights, title, and interest in and to accepted material, including photographs and drawings.

RADIO NEWS

hallicrafters  
*famous*

**MODEL SX-42**

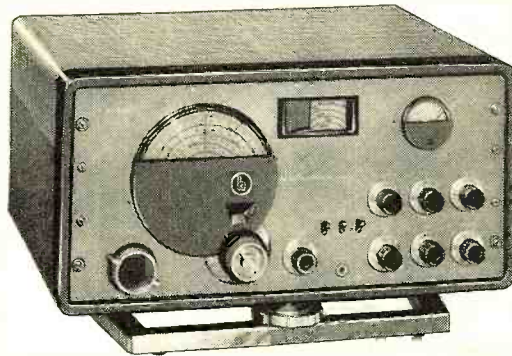

**Continuous frequency coverage from 540 kc to 110 Mc in 6 bands: AM—FM—CW**

Greatest continuous frequency coverage of any communications receiver—from 540 kc to 110 Mc in six bands AM, FM, CW—with exceptionally fine performance on CW. Offers in one superbly engineered, precision instrument a top flight standard and VHF communications receiver; standard, short wave and FM broadcast receiver. Freedom from drift and maximum stability are provided by temperature compensation and the use of a type VR-150 voltage regulator tube. The tremendous frequency range is made possible by the development of a new “split-stator” tuning system and the use of dual intermediate frequency transformers. **\$275<sup>00</sup>**



**All the essential amateur frequencies from 540 kc to 108 Mc**

**MODEL SX-43**

The SX-43 provides custom quality, precision engineering, excellent performance and wide frequency range at a medium price. The SX-43 offers continuous coverage from 540 kc to 55 Mc and has an additional band from 88 to 108 Mc. AM reception all bands. CW on four lower bands and FM on frequencies above 44 Mc. In the band 44 to 55 Mc, wide band FM or narrow band AM, just right for narrow band FM reception, is provided. **\$169<sup>50</sup>**

Copyright 1948, The Hallicrafters Co.

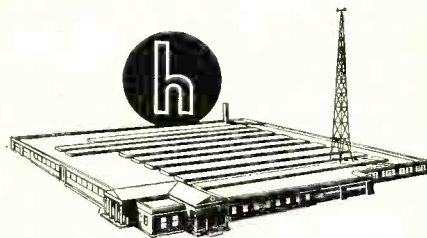

**hallicrafters  
RADIO**

THE HALLICRAFTERS CO.  
4401 W. Fifth Ave., Chicago 24, Illinois  
MANUFACTURERS OF RADIO AND ELECTRONIC EQUIPMENT

LISTEN FOR THE *Gatti* - hallicrafters *expedition*

Hallicrafters mobile, radio-equipped expedition now operating via short wave from the Mountains of the Moon, Africa. Listen for these call letters:

**VQ5-GHE**

**VQ3-HGE**

**VQ4-EHG**

**VQ5-HEG**

Visit your distributor for maps, itinerary, schedules, other details.

# THE OSCILLOSCOPE THAT IS

# *Sensitive!*

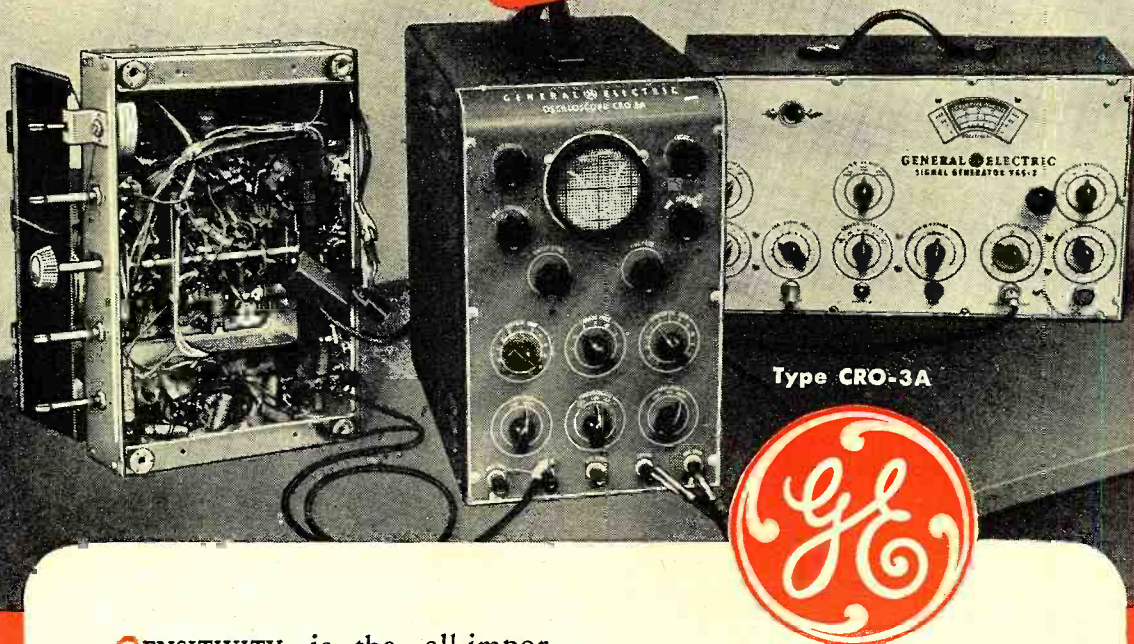

Type CRO-3A

**S**ENSITIVITY is the all-important feature in your oscilloscope if it is to do the service job you require. The CRO-3A can provide a larger image than many bigger oscilloscopes which have less amplification. It has exceptional stability, which means a trace without "jumping" or "jittering."

The CRO-3A is the oscilloscope you will want for AM-FM servicing—because it is most flexible in use—can do more jobs on the bench—gives real performance.

Take a minute to review these additional features which mean oscilloscope satisfaction:

- Exceptionally sharp trace—pinpoint focus.
- Length of trace can be expanded to several times the tube diameter, giving same advantage as larger tubes.

- Heavy case is an inherently good shield from magnetic fields, provides rugged protection of instrument.
- Normal deflection polarity: vertical is positive up and horizontal is positive to the right.
- The CRO-3A is well laid out and cleanly wired with a simple, yet effective circuit.
- Removable calibrated screen for measure of wave amplitude and symmetry of form.
- Removable light shield.
- Binding posts will take ordinary leads or banana plugs.
- The CRO-3A is well-styled—compact—requires minimum space—and is light enough to be portable.
- Due to its sensitivity it can be used with the YGS-3 Signal Generator for single stage alignment.
- Highly recommended for visual alignment of AM-FM receivers.
- And the price—extremely modest.

Check these features again—then order the CRO-3A.

For further information on this oscilloscope write: *General Electric Company, Electronics Park, Syracuse, New York.*

# GENERAL ELECTRIC

184-G3

HOW TO MAKE MONEY  
in RADIO  
ELECTRONICS  
TELEVISION

HOW TO READ  
RADIO DIAGRAMS  
AND SYMBOLS

SPRAYBERRY  
ACADEMY  
OF RADIO

GET THESE 2 BIG BOOKS

**FREE**

IF YOU  
WANT TO LEARN

**RADIO!**

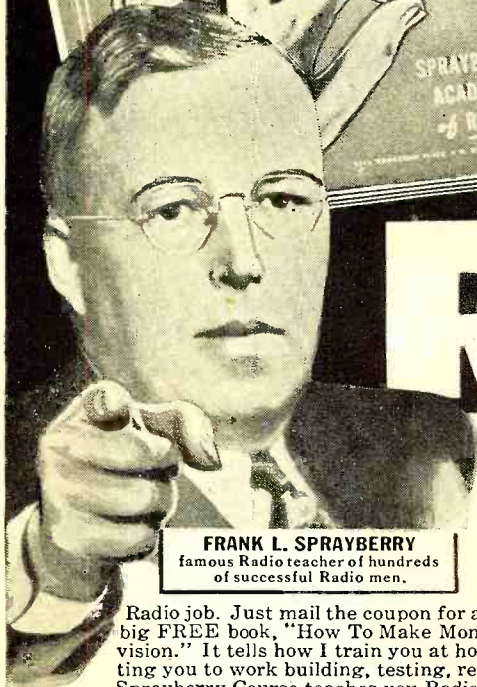

**FRANK L. SPRAYBERRY**  
famous Radio teacher of hundreds  
of successful Radio men.

I TRAIN YOU RIGHT BY SENDING YOU 8 BIG KITS OF  
RADIO EQUIPMENT INCLUDING A POWERFUL 6 TUBE  
SUPERHET RECEIVER AND 16 RANGE TEST METER!

Find out NOW how Sprayberry Training prepares you for a Radio Service Business of your own — or a good pay into Radio. The Radio Repair Business is booming! Good Radio Service and Repair Shops are needed everywhere as millions of new sets are in use. Trained men are wanted for opportunities in Police, Aviation and Marine Radio, F. M. and Standard Broadcasting and Television. Manufacturers are looking for men who know Radio as production reaches new peaks. GET THE FACTS ABOUT YOUR FUTURE IN RADIO. MAIL the COUPON TODAY for my FREE BOOKS!

Soon after you start I send you my famous BUSINESS BUILDERS that help you earn EXTRA CASH getting and doing neighborhood Radio Service jobs while learning. You couldn't pick a better time to get into Radio. The Radio Repair Business is booming! Good Radio Service and Repair Shops are needed everywhere as millions of new sets are in use. Trained men are wanted for opportunities in Police, Aviation and Marine Radio, F. M. and Standard Broadcasting and Television. Manufacturers are looking for men who know Radio as production reaches new peaks. GET THE FACTS ABOUT YOUR FUTURE IN RADIO. MAIL the COUPON TODAY for my FREE BOOKS!

Radio job. Just mail the coupon for a FREE Sample Lesson and my big FREE book, "How To Make Money In Radio, Electronics, Television." It tells how I train you at home during spare hours by putting you to work building, testing, repairing Radio equipment. The Sprayberry Course teaches you Radio by working with 8 big kits of Radio parts I supply. You build a powerful 6 tube superhet Radio, a 16-range test meter, perform over 175 interesting, PRACTICAL experiments. My lessons are easy and interesting — you need no previous experience in Radio. I start you at the beginning... and give you valuable "bench" experience that sticks with you.

LEARN HOW TO BUILD-TEST-REPAIR RADIOS By Working with YOUR HANDS!

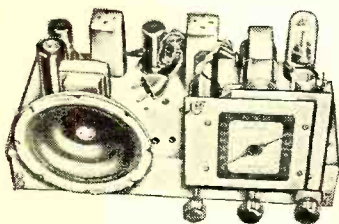

You really learn Radio the PRACTICAL way... when you build this big, powerful 6-tube Superhet Radio from parts I send you.

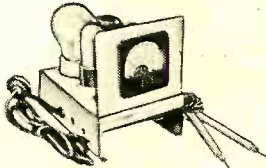

I give you a fine, moving coil type Meter — with parts for a complete analyzer and Circuit Continuity Tester. "Trouble-shoot" with professional accuracy.

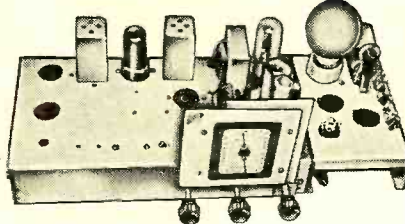

You don't have to buy expensive ready-made equipment. You get valuable experience building this Signal Generator and Multi-purpose Tester.

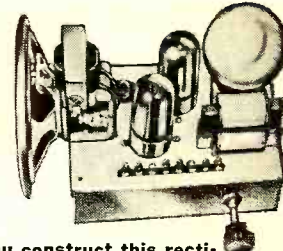

You construct this rectifier and filter, resistor and condenser tester, and really get on the Practical end of Radio.



Trained Radio men can step into their own profitable Radio Service Shop — or —



New developments are constantly opening new big pay job opportunities in Radio.

**LOW COST RADIO TRAINING STUDY AT HOME IN SPARE HOURS**

Sprayberry Training costs surprisingly little! Easy monthly payments, if desired. Everything you need is furnished — nothing else to buy. With Sprayberry Training to back you up, you will be able to step into your own profitable Radio Service Business or go on to a big opportunity in Radio, Electronics or Television. The equipment I send you is yours "for keeps" — to use in your business or job. I have trained hundreds of successful Radio men — and I can help you too. Get the facts about Sprayberry Training — it's your first step to success, security and a bigger income in a field where you'll really enjoy your work. Fill out and mail coupon TODAY. I'll rush my two FREE books to you by return mail.

**VETERANS:** Approved for G. I. Training under Public Laws 16 and 346.

**Sprayberry Academy of Radio**

F. L. SPRAYBERRY, President

Room 2568, Sprayberry Bldg., Pueblo, Colorado

**RUSH COUPON Today!**

**SPRAYBERRY ACADEMY OF RADIO**

F. L. SPRAYBERRY, President  
Room 2568, Sprayberry Bldg., Pueblo, Colorado

Please rush my FREE copies of "How To Make Money In Radio, Electronics and Television" and "How To Read Radio Diagrams and Symbols." No salesman will call.

Name..... Age.....

Address.....

City and Zone..... State.....

CHECK HERE IF A VETERAN

(Mail in an Envelope or Paste on Penny Postcard)

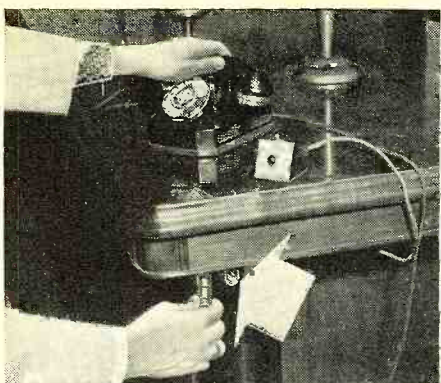

# For the RECORD

BY THE EDITOR

## "X" MARKS THE SPOT

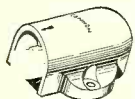

... where the X-3-42 Receptacle (shown just above) unobtrusively reposes underneath the table top so that the intercommunication phone may be moved around the executive conference table. The Type "X" Series is particularly adapted to plug-in intercom systems such as shown above, and is also widely used in sound service, instruments, radio and public

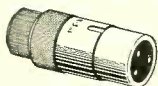

X-3-11 Plug  
\$1.75 List

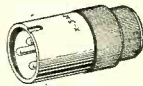

X-3-12 Plug  
\$1.25 List

address systems. Two plug and 3 receptacle types are available with 3 different insert arrangements (interchangeable): one 15-amp.; three 15-amp.; and three 10-amp. and one 15-amp. contacts. Shells are diecast zinc



X-3-13 Receptacle  
\$1.75 List



X-3-14 Receptacle  
\$1.25 List

with bright nickel finish, and have accommodation for 3/16" to 9/32" cable. Friction engagement. Available direct from more than 225 distributors over the U.S.A. or from factory.

Listed and priced in the RJC-2 and C-47 Condensed Catalogs. Engineering drawings of the "X" in P&O Bulletin. Specify bulletin desired. Address Dept. P-228.

SINCE 1915

# CANNON ELECTRIC

Development Company

3209 HUMBOLDT ST., LOS ANGELES 31, CALIF.

IN CANADA & BRITISH EMPIRE:  
CANNON ELECTRIC CO., LTD., TORONTO 13, ONT.

WORLD EXPORT (Excepting British Empire):  
FRAZAR & HANSEN, 301 CLAY ST., SAN FRANCISCO

OUR daily mail is seldom opened without revealing some very worthwhile and constructive comments from radio servicemen. Each letter is read with care and quite often, one will contain comments of particular interest in pointing out some "sore spot" that the radio serviceman feels can be healed with proper treatment.

The majority of letters are from servicemen that operate their own shops. Many have been in the radio repair business for years and have sold and repaired radios of many makes and models.

These men are proud of the reputation they have enjoyed in their community in spite of the bad publicity leveled at their profession. When mechanical or electrical improvements can be made in the sets they sell, they then expect the manufacturer to at least listen to their reasoning and constructive criticism of his product.

We know that many servicemen would welcome an opportunity to be members of an Advisory Board to make recommendations to the set manufacturers, from a practical viewpoint, based on actual "case histories." These men could show, for example, that their selling profit on new sets is often cut simply because Mrs. Jones finds her brand new radio giving trouble and a service call is required.

Radio servicemen are looking for trouble in old sets—that's their bread and butter—but not in brand new ones that eat up their profit.

In analyzing the above mentioned letters it becomes apparent that the greatest criticism is made about methods and assembly techniques, rather than about the component parts in the sets. Loops

wound in cabinets, trick pilot lamps, miscellaneous connections to tuning gangs, plugless speaker cables and plastic covered wiring, these all interfere and take time to disconnect when seeking for trouble in Mrs. Jones' new receiver.

We'll bet that any group of radio service dealers, if given the opportunity, would insist that the sets they sell to their customers be engineered from a practical standpoint—not just on paper. It would be a step in the right direction.

DURING the war many radiomen were forced to adopt substitute methods of servicing, due to the lack of proper test equipment, which was either too costly or not available.

In the past two years there have been many new developments in new test equipment. Vacuum tube voltmeters have left the laboratory stage and now rank with the standard volt-ohm-milliammeter in reliability. Signal tracers have been greatly simplified by the elimination of tuned circuits, and have greater versatility.

New signal generators make it possible to do an accurate job of aligning FM and TV receivers. In conjunction with an oscilloscope, the procedure may be made visual, with the result that a far better job may be done.

An audio oscillator in conjunction with an output meter or oscilloscope will enable the serviceman to make a check of audio systems, with resultant better over-all performance. The expenditure for proper test equipment will pay for itself in a short time—in time saved. Equip your shop with the best equipment and give your customers improved service at lower cost. . . . . O.R.



Get Your **ALLIED** Catalog Now  
 Get More for Your Money in Every Way  
 Get Everything New in Your Radio...

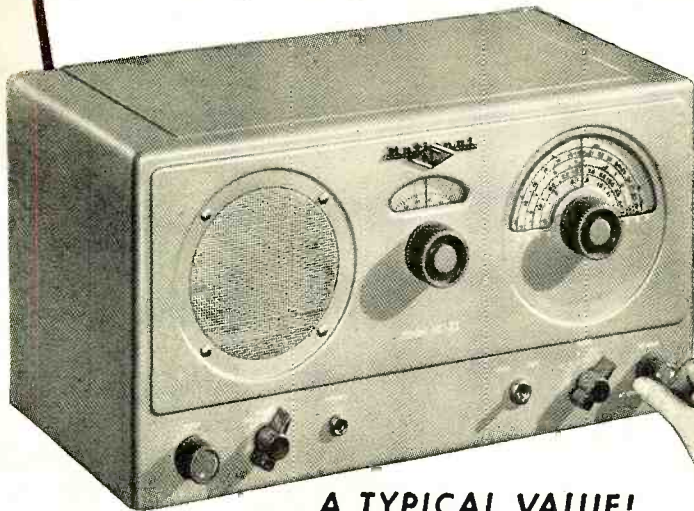

A TYPICAL VALUE!

**The New NATIONAL NC-33 Receiver**  
 Packed with Professional Features—A Great Buy!

NOW—enjoy the thrill of owning the National NC-33, the sensation-ally brilliant new communications receiver. It's built to highest engineering standards—easy to operate—delivers top-notch reception on broadcast and short-wave bands. Perfect for SWL's and beginning Amateurs. Covers 500 kc to 35 mc continuously in 4 bands. Main tuning dial is calibrated for easy location of all important amateur, police and foreign bands. Band-spread dial operates over entire frequency range. Has automatic noise limiter; adjustable pitch BFO, universal antenna input; built-in 5" PM speaker; headphone jack; comfortable, glareless tuning dials. Self-contained in attractive modern cabinet, finished in smooth gray. For real enjoyment and dependable all-around performance at nominal cost, the NC-33 takes top honors. Comes complete with tubes. Operates on 105-125 volt, 40-60 cycle AC, or DC. Stock No. 97-596.

NET, FOB Chicago **\$65<sup>95</sup>**

Terms: \$13.19 down, \$5.08 monthly for 11 months.

**IMMEDIATE DELIVERY ON THESE FAMOUS NATIONAL RECEIVERS**

National HRO-7.....	\$299.36	National NC-2-40D.....	\$225.00
National NC-57.....	89.50	National NC-46.....	107.40
National NC-173.....	189.50	NEW! National HFS	
National NC-183.....	269.00	Receiver-Converter.....	125.00

Net FOB Chicago. Prices subject to change without notice.  
 Attractive Time Payment Terms. Trade-ins Accepted.



**FREE**

Send for

**Radio's Leading Buying Guide**  
**172 Pages Packed with Value**

Here's how to get the most for your Radio dollar! Use ALLIED'S great 1948 Catalog, the Buying Guide that brings you everything in radio and electronics at lowest, money-saving prices. ALLIED has everything for Servicemen, Soundmen, Engineers, Amateurs and Builders. Complete selections of latest home radio and Television receivers, test equipment, P. A. Systems and amplifiers, Amateur gear, thousands of parts, tubes, kits, tools, books—ready for fast shipment. Get the advantages of the most famous service in radio—expert handling, helpful personal attention, money-saving values! Send today for your copy of the ALLIED 172-page Catalog—the most complete in Radio.



Everything in Radio  
 for Everyone in Radio

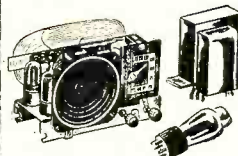

Send for Radio's  
 Leading Buying Guide

**FREE**



**THE WORLD'S  
 LARGEST  
 RADIO  
 SUPPLY  
 HOUSE . . .**

**★ ALLIED RADIO**  
*Everything in Radio  
 and Electronics*

ALLIED RADIO CORP.  
 833 W. Jackson Blvd., Dept. 1-F-8  
 Chicago 7, Illinois

- Send FREE 172-Page ALLIED Catalog.
- Enter order for National Model.....
- Enclosed \$.....  Full Payment
- Part Payment (Balance C.O.D.)
- Send ALLIED Easy Payment Plan details and order blank.

Name \_\_\_\_\_  
 Address \_\_\_\_\_  
 City \_\_\_\_\_ Zone \_\_\_\_\_ State \_\_\_\_\_

**HERE IT IS**

**NEW!  
DIFFERENT!  
BETTER!**

**The ONLY RADIO BATTERY  
That Has The**



**Interlocked Flat Cell**

**PLAYING HEART**

**Enlarged Cutaway Section Shows . . .  
EACH CELL INTERLOCKS WITH ITS NEIGHBOR—  
FORMS THE PLAYING-HEART OF YOUR RADIO**

**LOOK!**

• Each Cell Holds More Power-Producing Chemicals.

• No Waste Space.

• Lasts Hours Longer.

• Costs No More.

• Already Standard Equipment with 12 Radio Manufacturers.

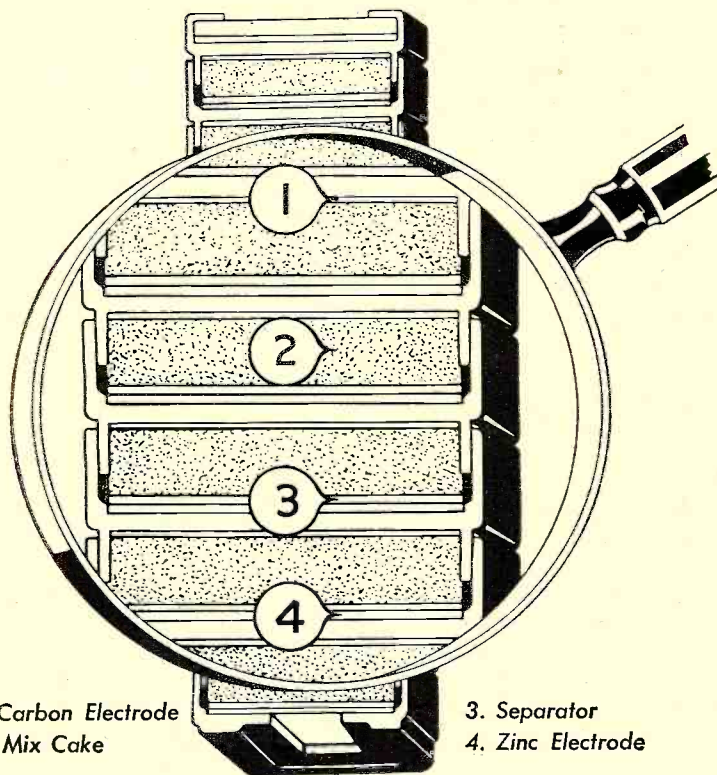

1. Carbon Electrode  
2. Mix Cake

3. Separator  
4. Zinc Electrode

**EXCLUSIVE!**

• Result of 5 years' Scientific Electronic Research.

• Patented U. S. Pat. No. 2416576.

• Triple-Sealed Against Power Leakage.

• No Binding Tapes.

• No Sealing Wax.

• Greatly reduces Battery Failure . . . 91% Less Soldered Connections.

# Increase Your Radio Battery Sales This Summer

with the *Sensational*

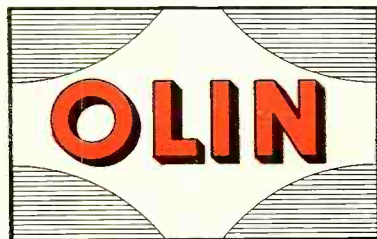

## Interlocked Flat Cell Battery

The demand for portable radio batteries this summer promises to be the greatest in radio history . . . estimated to be \$52,000,000.

All over America, portable radio owners will

be customers for this startling new electronic development that gives more hours of listening pleasure . . . yet costs no more.



AVAILABLE IN  
POPULAR SIZES  
FOR PERSONAL  
AND PORTABLE  
RADIOS

### Available in 2 Brands

**WINCHESTER**  
TRADE-MARK



Make your store headquarters for the Olin Interlocked Flat Cell Radio Battery.

Fill in coupon below, for descriptive Catalog and get the complete Product and Sales story.

**Don't Disappoint Your Customers  
They'll Want . . .**

**THE ONLY RADIO BATTERY**

That has the  Interlocked  
Flat Cell **PLAYING-HEART**

Olin Industries, Inc.  
Electrical Division  
New Haven, Conn.  
Dept. A—

Mail me at once Descriptive Catalog  Bond-Olin or  
 Winchester-Olin. (Check brand desired.)

NAME.....

ADDRESS.....

CITY.....STATE.....

**ANOTHER  
RIDER  
"FIRST"**

**OPENING UP PROFITS FROM THE  
TELEVISION SERVICING MARKET...**



**VOLUME 1 RIDER  
Television  
MANUAL**

**Approximately 1350 Pages — PLUS  
Two Separate Books, "How It Works"  
and Index . . . . Complete \$15.00**

**OUT IN JUNE**

- Circuit Descriptions—Schematics—Patterns — Alignment — Voltage and Resistance Tables — Chassis Views—Parts Lists.
- Separate "HOW IT WORKS" BOOK (about 200 pages). Explanation of the underlying theories of Antennas — Channel Frequencies — R-F Sections—Sound and Video Channels—Sync and Sweep Circuits—Waveforms in Circuits—Power Supplies—Alignment and Servicing.
- Complete, Accurate, Separate INDEX.

Again Rider's out front! This time with the first industry-wide compilation of television circuit data.

Here is an important companion volume to the other famous Rider Manuals. Here is everything that must be known about the 1946-47 television receivers (both complete and kit) produced by the industry's leading manufacturers. No expense has been spared in publishing this material. The same rugged type of loose-leaf binder is used as on all Rider Manuals.

Diagrams have been reproduced in good size; in many cases requiring the use of Double Spreads and GIANT PAGES which unfold to the equivalent of six ordinary pages. Here is complete information. Authentic factory information. Here is a volume you will want right now. Order it from your Jobber today!

The Television "HOW IT WORKS" BOOK available Separately at \$2.70

**"CERTAINLY WE HAVE ALL 17 RIDER MANUALS,  
and have ordered the Television Manual"**

"Certainly we have all 17 Rider Manuals and have ordered the Television Manual. I can't imagine any high class, efficient radio service laboratory operating satisfactorily without them. I'll have Volume 18 on the shelf, too, as soon as it's published,"

*Says* **R. B. GRAF**  
SERVICE MGR.

Ward Radio & Appliances, Silver Spring, Md.

**JOHN F. RIDER, PUBLISHER, Inc., 404 Fourth Avenue, N. Y. 16**  
Export Agent: Rocke International Corp., 13 E. 40th St., N.Y.C. Cable ARLAB

A conspicuous characteristic of Rider Manual owners is their unswerving loyalty to "The World's Greatest Compilation of Radio Servicing Data." This is a steady patronage born of the benefits provided by Rider Manuals during eighteen years of continuing service to the servicing industry. Copies of Vol. 1, published 18 years ago, are still paying profits to their owners. Give your shop the sign of Successful Servicing—a complete set of Rider Manuals.



**You NEED ALL 17**

Volume XVII.....	\$15.00
Volume XVI.....	8.40
Volume XV.....	18.00
Volumes XIV to VII (ea. vol.).....	15.00
Volume VI.....	11.00
Abridged Manuals I to V (one vol.).....	17.50
Record Changers and Recorders.....	9.00
Master Index, covering Manuals, Vols. I to XV.....	1.50

**RIDER MANUALS Mean SUCCESSFUL SERVICING**

NOTE: The Mallory Radio Service Encyclopedia, 6th Edition, makes reference to only one source of Radio Receiver Schematics—Rider Manuals.

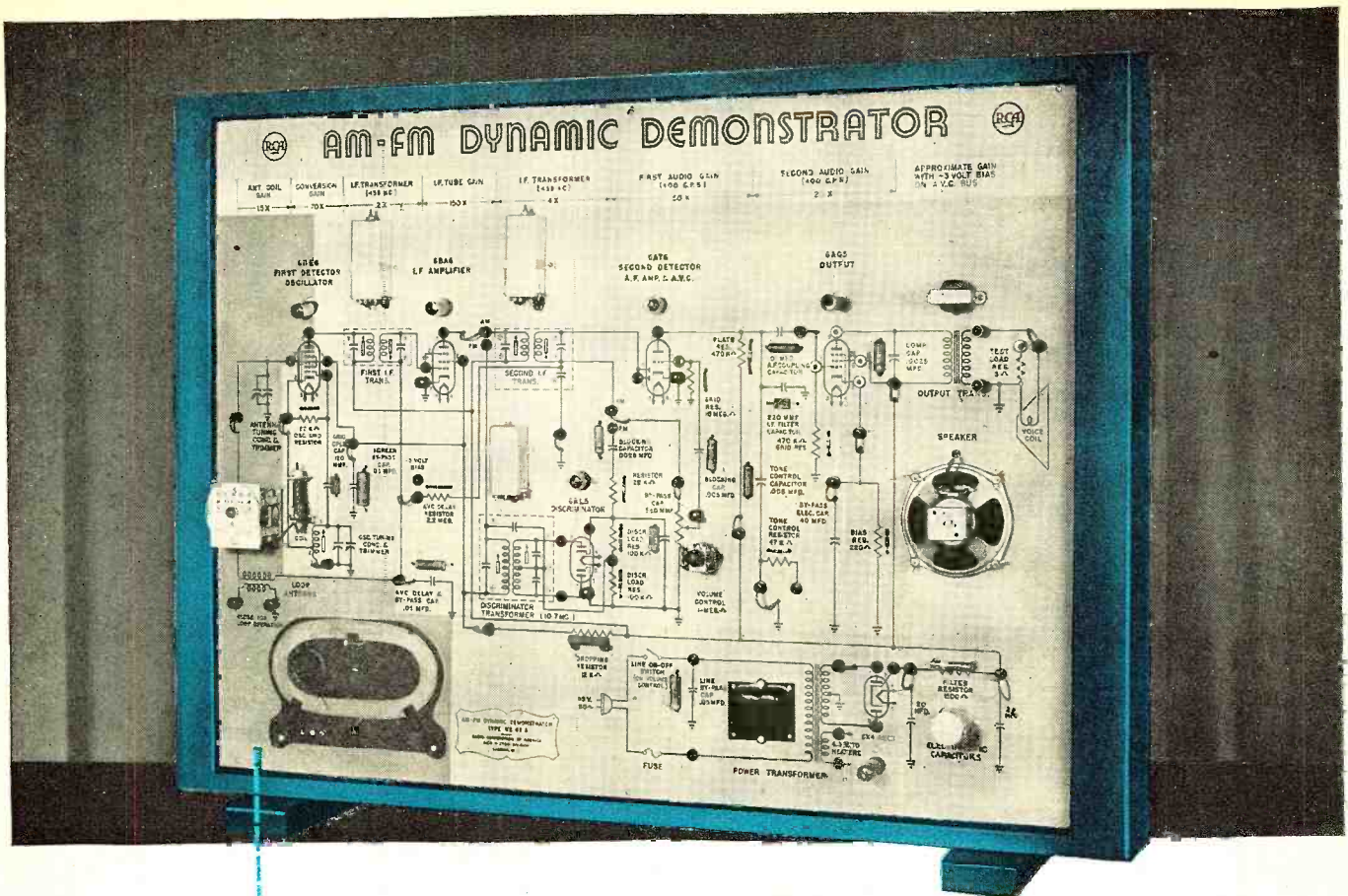

# it's a schematic... it teaches radio...it has FM!

**Quickly demonstrates radio theory, servicing, and the use of test equipment**

It's a schematic of a modern six-tube superheterodyne receiver with the working parts mounted beside the correct symbols. All parts are actually connected and operate!

**Circuits separated by different colors**—Large color blocks mark each circuit section... it's easy to follow the function of each stage in reproducing the signal. Approximate gain data is printed at the top of the panel.

**Simulates circuit and part failures**—At all important measuring points, pin jacks permit complete signal tracing, from antenna to speaker. By means of switches on the back, you can simulate hard-to-analyze circuit and part failures. Jumpers are provided at various points to demonstrate automatic volume control, the effects of resonance adjustments, etc.

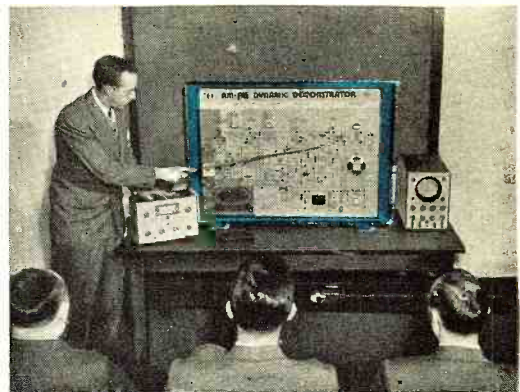

RCA's Dynamic Demonstrator has helped thousands to learn radio theory. See your RCA Test Equipment Distributor for complete information on this new AM-FM model.



**RADIO CORPORATION of AMERICA**  
**TEST AND MEASURING EQUIPMENT**  
**HARRISON, N. J.**

June, 1948

13

# Wells Summer Specials!

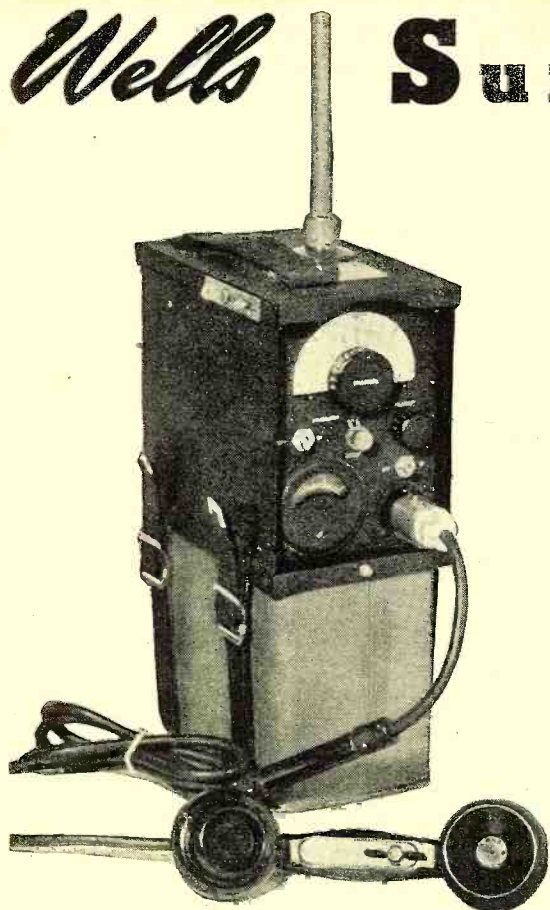

BC 222 WALKIE TALKIE

## PORTABLE AND MOBILE EQUIPMENT

The easiest way to "go mobile" is to take along a BC 222 Walkie Talkie. The BC 222 operates anywhere. It is a complete, battery powered transmitter—receiver that performs surprisingly well on 10 and 6 meters. You can make good phone contacts over considerable distances. Incidentally, Walkie Talkies are perfect for 2 way communication when tuning a beam. Every radio club should own a pair. Our BC 222 Walkie Talkies are rebuilt and guaranteed. They are shipped ready to operate, complete with batteries, telescopic whip antenna, push-to-talk handset, coils for 2 bands and crystal calibrator. Continuous frequency range from 28 to 52 MC. Price only \$45.00 each. Extra A and B Battery Pack (80 hours continuous service) only \$4.75 each.

### Roleon Audio Tone Generators for MCW! Manufactured Exclusively for Wells

A quick, low cost way of getting a beautiful MCW note on 11 meters and other authorized bands is to set up a Roleon in front of your phone rig microphone. The Roleon is a precision high frequency buzzer with adjustments for getting just the tone you like best. A resonator boosts the sound output so you can be sure of 100% modulation. A pair of No. 6 dry cells will operate a Roleon for a long time but any convenient source of 3 to 4½ volts D.C. is satisfactory. A Roleon, a key and a battery also make an ideal inexpensive code practice set. Roleon High Frequency Buzzer—Only \$1.30 each. Please add 10c for packing and mailing in U.S.



### 10 METER MOBILE WHIP ANTENNA

This 8 foot, 3 section mobile antenna is an outstanding value. The elements are made of strong, copper plated steel tubing. The big 4" ceramic insulator reduces wet weather losses to a minimum. A rubber molded spring mounting is also provided. The antenna is terminated at the base with a coaxial fitting for connecting a 72 ohm cable—no moisture problem. Mobile Whip Antenna, complete — only \$5.75 each.

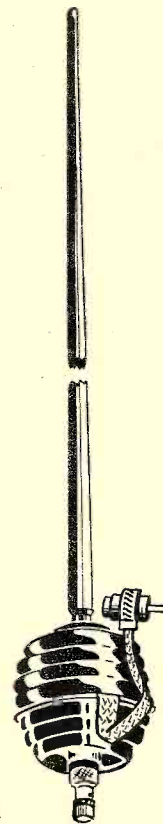

ORDER DIRECT FROM WELLS OR THROUGH YOUR LOCAL PARTS JOBBER

**WELLS**  
SALES, INC.

Be Sure to Write for the Brand New WELLS  
Amateur Catalog H 400 . . . It's Free!

320 N. LA SALLE ST. DEPT. R-6, CHICAGO 10, ILL.

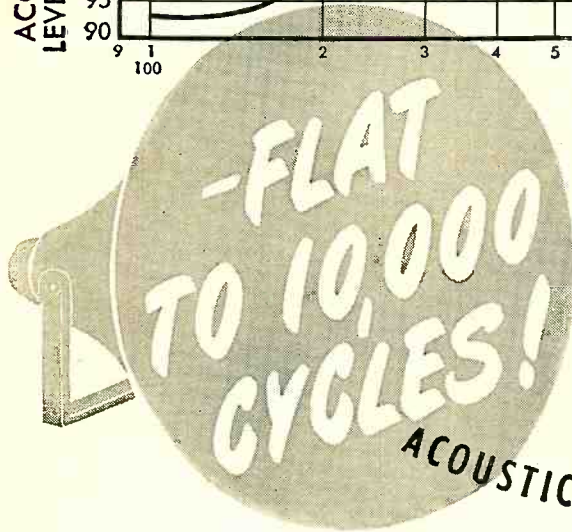
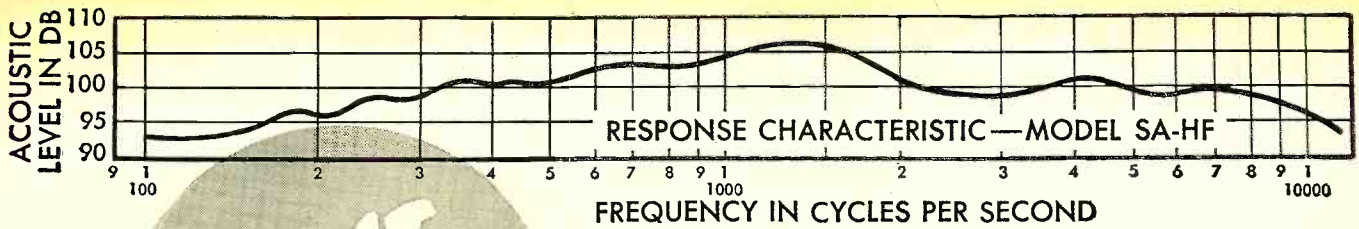

**UNIVERSITY LEADERSHIP**—Electrically and mechanically right to the last detail, every UNIVERSITY Loudspeaker reflects the fact that UNIVERSITY has been chiefly responsible for every worthwhile development in reflex loudspeakers. Among these pioneering developments of UNIVERSITY are the first high efficiency Alnico PM driver unit; first 25 watt break-down-proof unit with bakelite diaphragm and dural voice coil suspension; first unit to incorporate battleship ruggedness and efficiency due to exclusive "rim-centering"; first hermetically sealed waterproof driver unit; first driver unit covered by a one year unconditional replacement guarantee.

## MODEL SA-HF

The Model SA-HF is the product of exhaustive research aimed at developing a driver unit capable of meeting present day high fidelity standards. How well UNIVERSITY engineers succeeded in this undertaking is best indicated by the characteristics of the Model SA-HF. Acoustic response is essentially flat through the entire range of audible frequencies to 10,000 cycles. Conservative continuous power rating is 25 watts. Completely weatherproof and ruggedly constructed for heavy duty, the SA-HF is a high-efficiency unit for every sound requirement.

**\$37.00**



## MODEL MA-25

Like all UNIVERSITY Driver Units, the MA-25 is designed to withstand continuous outdoor exposure to wind, rain, sleet and snow. The dual features of rim-centering construction and powerful Alnico permanent magnet provide exceptional efficiency and permanent alignment. Conservatively rated for continuous duty at 25 watts, the MA-25 covers the standard frequency range to 6,000 cycles. It is recommended for all applications requiring flawless reproduction within this frequency range.

**\$25.00**



WRITE FOR CATALOG!

ACOUSTIC REPRODUCERS OF QUALITY AND EFFICIENCY FOR EVERY NEED \*  
ACOUSTIC REPRODUCERS OF QUALITY AND EFFICIENCY FOR EVERY NEED \*  
ACOUSTIC REPRODUCERS OF QUALITY AND EFFICIENCY FOR EVERY NEED

**DRIVER UNITS**—UNIVERSITY offers a complete line of high-efficiency driver units with power rating up to 25 watts and frequency response to 15,000 cycles. All are unconditionally guaranteed for one year.

**REFLEX TRUMPETS**—Construction is all-weather type, exceptionally rugged. Rubber rim damping eliminates acoustic resonance and vibration. Reflex construction provides maximum air-column length in minimum space.

**University Loudspeakers, Inc**



80 SO. KENSICO AVENUE • WHITE PLAINS • NEW YORK

# An Antenna is not *JUST A PIECE OF WIRE*

Not any longer, it isn't. Those days  
are gone forever.

That's why you need the new

## antenna *manual*

- It's a cheap and easy way to become an antenna expert. Your favorite dealer will have copies in June, and will gladly part with one for \$3.50.
- It's the most comprehensive antenna book yet published, with all the old tried-and-true standards, plus some brand new ones.
- Equally necessary for the professional radioman and for the amateur.

Three hundred pages full of down-to-earth practical information which will help you with the many problems which arise in the ever-expanding radio field.

Thorough treatment is given to Antenna techniques and propagation data for all frequencies from 16 kc. to 1000 Mc., regardless of application.

Gets down to basic facts, yet is written so that you can understand it without brushing up on your math.

An absolute necessity for every engineer, amateur, station technician, and serviceman. Presents in a single volume a comprehensive compilation of antenna, transmission line, and propagation data of vital interest to all those associated with the more practical aspects of radio transmission and communication, including television and navigation aids.

Among the new, "hot" amateur antennas described are:

- The VERTICAL TRIAD, a compact dx-dandy for 40 meters. High gain over 360 degrees.
- The OCTAPUSH, a single array for 40, 20, and 10!

- The X-CURTAIN, an improved "Lazy-H." Hotter than a firecracker on 10.

- The ELECTROTATOR, an electrically rotated broadside curtain. The beam turns while the antenna stands still!

Written by WOODROW SMITH, W6BCX, Editor of the prewar "Radio" and "Radio Handbook." Many of you know him as the developer or popularizer of the Lazy-H array, the Plumber's Delight 3-element rotary, the Bi-Square array, the link-coupled universal antenna coupler, and other little gems which after many years help hams snag dx, save money, and avoid pink tickets for harmonics.

The ANTENNA MANUAL has the same happy combination of practical how-to-build-it data and simple underlying explanations that make the "Radio Handbook" one of the largest-selling radio texts in existence. "Sugar-coated" radiation, propagation, antenna, and transmission line theory help you understand what's going on.

Comprehensive, practical, how-to-build-it data on all the more popular antennas — and some brand-new ones which have never before appeared in print.

If he cannot supply you, you may order direct from us; Please add 10¢ for mailing; foreign, 25¢

**GET IT FROM YOUR  
FAVORITE DEALER for**

**\$3.50**  
in U.S.A.  
Clothbound

### RADIO HANDBOOK

One of the world's most popular how-to-build-it texts; a general book for everyone in radio transmitting from beginning amateur to practical, experienced engineer. 512 large pages (same size as this magazine). Clothbound, gold-stamped. \$3.00 per copy at your dealer's. By mail from us, \$3.25 postpaid; foreign \$3.50.

### RADIO AMATEUR NEWCOMER

The only comprehensive book for the beginner. You need no other to get your license, and get on the air. • How-to-build simple equipment for a complete station on all newcomer bands. • Operating instructions • Complete section of study questions for the license exams. • Amateur regulations. Only \$1.00 at your dealer. By mail from us, \$1.10 postpaid.

### WORLD'S RADIO TUBES

("Radio Tube Vade Mecum"). Characteristics of over 10,000 radio tube types, including U. S., British, French, Czech, Swiss, German, Australian, Italian, Russian, Japanese, Scandinavian etc. So extensive is the coverage of this book that it is available in 12 languages! \$3.00 per copy at your dealer; by mail from us, \$3.10 postpaid; foreign, \$3.25.

*Editors and Engineers*  
LIMITED

1302 KENWOOD ROAD Santa Barbara CALIFORNIA



**NOW...** WESTINGHOUSE GIVES YOU THE FIRST  
GENUINE CABINET DEVELOPMENT  
IN 25 YEARS

**THE DUO** cased in **MICARTA**  
...The **MIRACLE MATERIAL**

Tough enough for gears, bearings, and bushings . . . beautiful enough for fine furniture—that's Westinghouse Micarta, the miracle material that won't burn, stain, crack, warp, dent, chip, or splinter!

Demonstrate this indestructible cabinet to your customers! Snuff out cigarettes on it. Prove to them that alcohol won't stain

it. Let them lift out the carry-about radio. Have them listen to the full, rich tone of the radio . . . the true-to-life reproduction of the automatic record player.

Then clinch your sales with the welcome news that Micarta's ease of fabrication makes possible a significant price reduction you can pass on to them.

*Stock up on the MICARTA DUO today! Watch this feature-packed combination pile up sales for you!*

HOME RADIO DIVISION • WESTINGHOUSE ELECTRIC CORP • SUNBURY, PA.

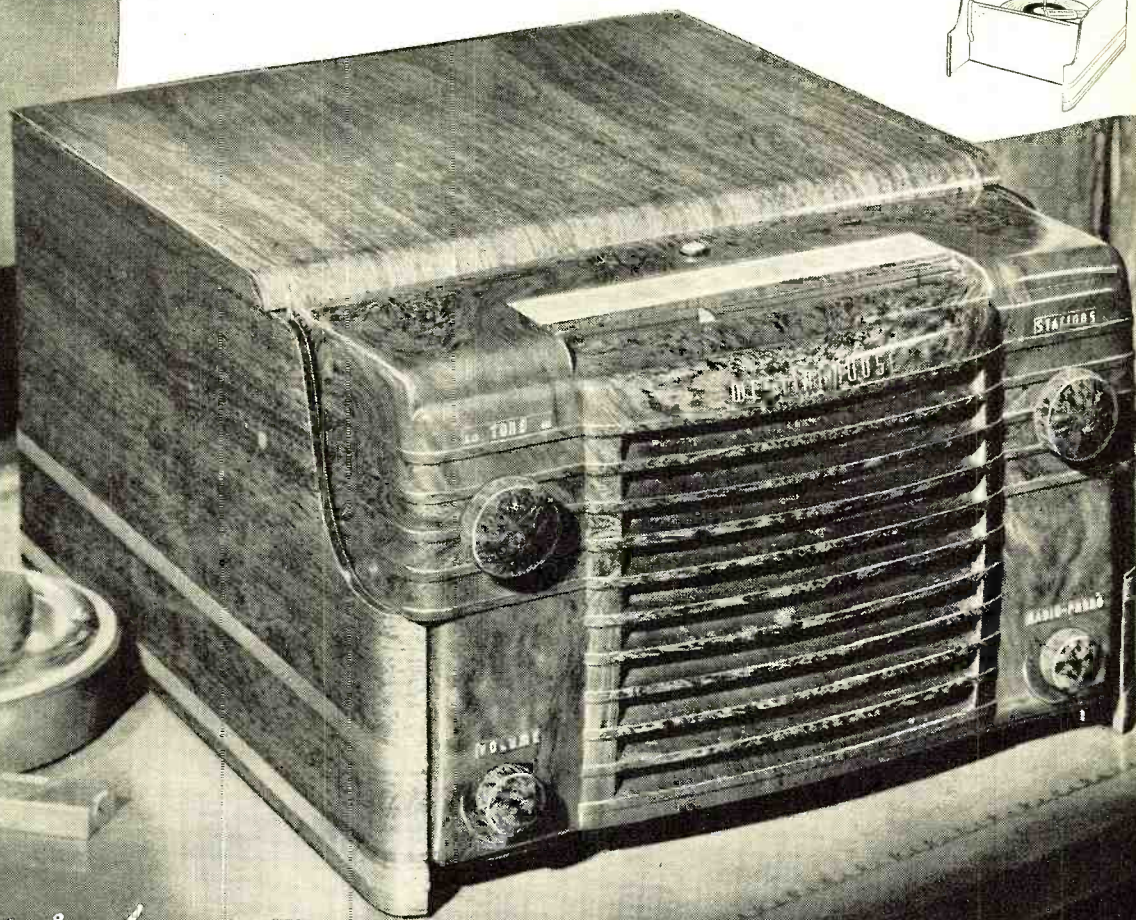
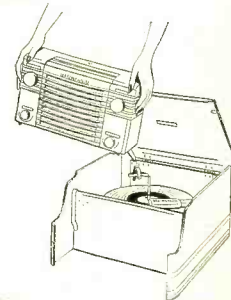

*Radio's first name is*

**Westinghouse**  
PLANTS IN 25 CITIES OFFICES EVERYWHERE

**RADIO TROUBLESHOOTER'S HANDBOOK**

Eliminates  
useless testing  
on 4 jobs out of 5



**...YOUR COMPLETE PRACTICAL RADIO SERVICE LIBRARY**

**...in two giant books**



**MODERN RADIO SERVICING**

A complete guide to troubleshooting, instruments, circuit analysis, repair.

**LEARN TO WORK BY MODERN, PROFESSIONAL METHODS**

**1 Train for the big pay jobs!**

Ghirardi's MODERN RADIO SERVICING is a complete, 1 vol. course in all phases of professional radio-electronic repair. Tells how to make preliminary trouble checks on difficult jobs; how to analyze any circuit and its components; how, when and where to use all types of test instruments and interpret their readings to track down the trouble—even how to start a service business of your own. Everything is explained simply and thoroughly. 706 clear illustrations and 723 self-test review questions make study easy. Complete 1300-page book only \$5—see special combination price offer below.

**CUT TIME IN HALF ON COMMON SERVICE JOBS**

**2 Work faster—make more money**

Almost 4 out of 5 radio repair jobs can be handled as easily as falling off a log! Just look up the model of the set to be fixed. Chances are Ghirardi's RADIO TROUBLESHOOTER'S HANDBOOK tells exactly what the trouble is, exactly how to fix it. Gives common troubles, their symptoms and remedies for over 4800 radios by 202 manufacturers. Hundreds of additional pages contain tube data; transformer trouble listings, alignment charts any dozens of diagrams, etc., for faster, better service on any radio ever made. Only \$5—see special combination offer.

**MONEY-SAVING OFFER!**

Let Ghirardi's RADIO TROUBLESHOOTER'S HANDBOOK save time, help you make more money on common service jobs. Let MODERN RADIO SERVICING train you in truly scientific servicing that can pave your way to the big money jobs. Get BOTH big books at the special price of only \$9.50 for the two (\$10.50 foreign). Use coupon today—at our risk!

**Read these GIANT books for 5 DAYS ... at our risk!**

Dept. RN-68, Murray Hill Books, Inc.,  
332 Madison Ave., New York 16, N. Y.

- Enclosed find \$..... for books checked; or
- send C.O.D. (no C.O.D.'s. outside U.S.A.) and I will pay postman this amount plus a few cents postage. In either event, I may return books within 5 days for complete refund of my remittance.
- MODERN RADIO SERVICING \$5 (\$5.50 outside U.S.A.)
- RADIO TROUBLESHOOTER'S HANDBOOK \$5 (\$5.50 outside U.S.A.)
- SPECIAL MONEY-SAVING OFFER Both of above big books only \$9.50 (\$10.50 outside U.S.A.)

Name.....  
Address.....  
City & Zone..... State.....

**Spot Radio News**

**\* Presenting latest information on the Radio Industry.**

By **FRED HAMLIN**

Washington Editor, RADIO NEWS

**BEFORE THE SNOW FLIES**, from the looks of things here in Washington, facsimile broadcasting to the general public on a commercial or semi-commercial basis will probably be under way. Fax enthusiasts, of course, want it. Some, indeed, go so far as to say that if commercial development is not rapid, "you will have no facsimile service." The quote is from John V. L. Hogan, one of the enthusiasts. Fax, he and others have made quite clear to the Federal Communications Commission, must pay its way soon like any other radio service or be relegated to the ashcan of inventions that failed to find a public. Mr. Hogan, *Radio Inventions*, and *Faximile, Inc.*, would perish that last thought, and there is every indication that FCC is also in favor of giving facsimile its try at the commercial market. A decision to that effect may be forthcoming between the time this is written and the day you read it.

**INTRIGUING HIGHLIGHTS** of the FCC hearings on fax late this spring was the testimony which brought out that perhaps the best way to get fax on the airwaves would be to have it share time with FM within the same band. Most of those who testified felt that interruption of FM sound programs for facsimile broadcasts, far from harming FM, might enhance its attraction. Don't run to your FM set and expect to get a copy of the latest flash news, served up by facsimile, as a result of reading this. Mass use of the media is still a long way off, even its best friends admit. But there is every indication that facsimile is about to come out of the baby stage. Could be, given as many years as it took to develop other radio devices, it will be as lusty a feature on the airways as straight sound radio and television. Stronger, say its backers. And sooner than you think.

**TELEVISION**, regardless of the angle from which you look at it, still crowds the news spectrum and from the looks of things will continue to do so for the rest of the year. Straw-in-the-wind items keep cropping up, such as the fact that television set ownership in the New York City area increased 100 per-cent

from January to March. This statement is the result of a personal-interview survey of 3500 families in ten counties in New York and New Jersey. Another straw-in-the-wind which continues to surprise the industry and hints of a much larger mass market than was at times anticipated, is that the survey indicates more than 40 per-cent of the video sets are owned by middle and lower-middle income groups. Poorer homes, many without telephones, have a television antenna on the roof.

**RADIO LEADERS** are hailing the progress with enthusiasm. "Television is advancing like wildfire this year," said Dr. Ray H. Manson, president of *Stromberg-Carlson*, recently, "and is destined to be the leading—if not the most important—broadcast entertainment medium of the year." He adds: "From the standpoint of the manufacturer, television production offers an important plus in this year's operations. Radio broadcasting will continue for many years as the only means of mass entertainment outside of metropolitan areas. However, the large radio-phonograph-television unit is the best buy for most families, and the all-purpose instrument will eventually be considered standard equipment in every living room, for it is an instrument that offers complete home entertainment."

**BOND GEDDES** echoes these thoughts, and adds some facts and figures, as executive vice-president of the Radio Manufacturers Association, which give you an idea of how video has come up in the world. "In 1947," he points out, "approximately 178,500 TV receivers were produced, according to reports of RMA manufacturers. Industry estimates of 1948 production total 600,000 sets." The production figure this year is already pushing toward the 200,000 mark. The race to reach the receivers with stations is also going strong, Mr. Geddes reports. While there are only some 20-odd commercial TV stations on the air, the Federal Communications Commission has granted construction permits for 86 additional transmitters and is considering applications for 181 more, he says. Sev-

**RADIO NEWS**

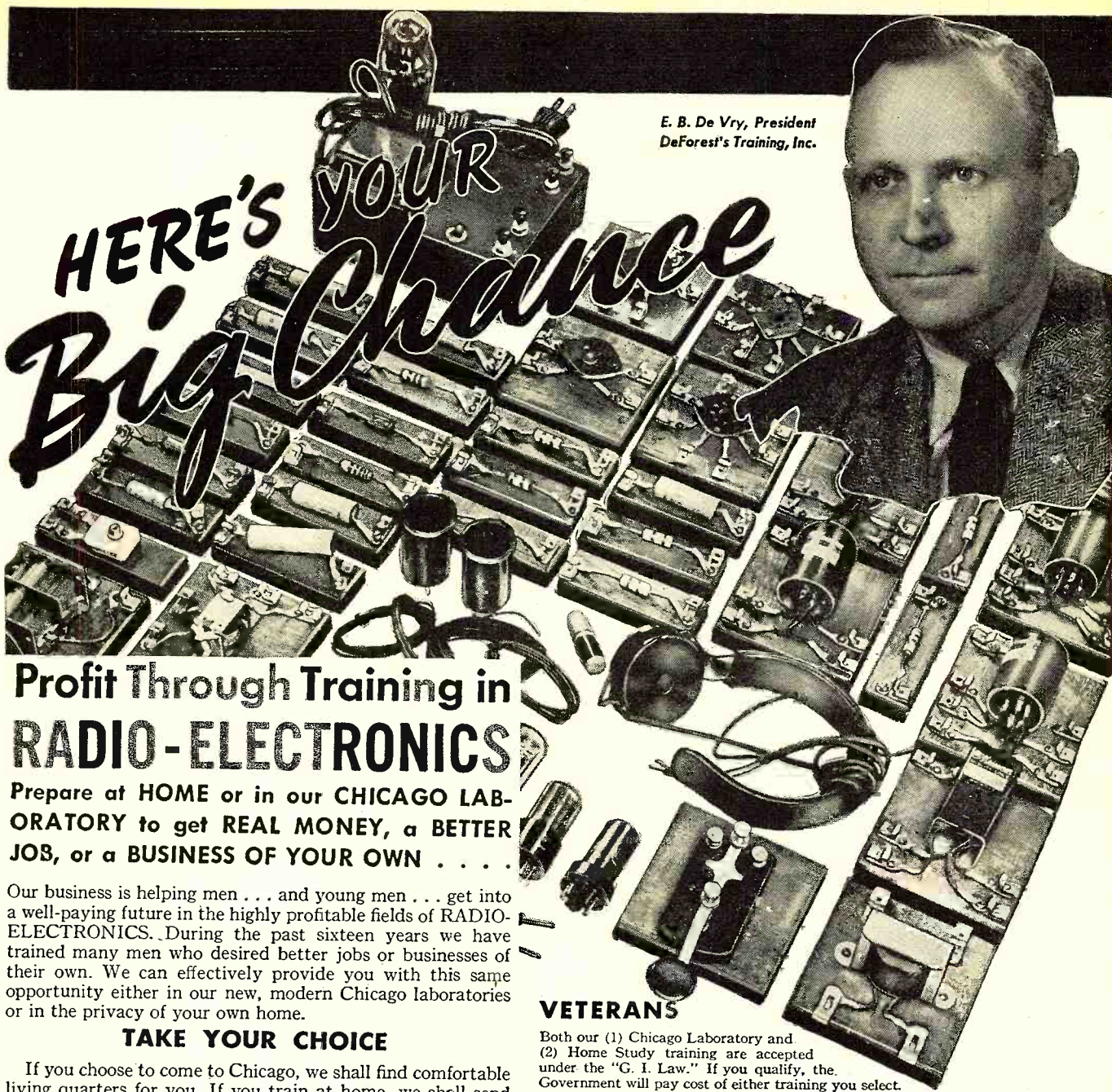

E. B. De Vry, President  
DeForest's Training, Inc.

# HERE'S YOUR Big Chance

## Profit Through Training in RADIO-ELECTRONICS

Prepare at HOME or in our CHICAGO LABORATORY to get REAL MONEY, a BETTER JOB, or a BUSINESS OF YOUR OWN . . . .

Our business is helping men . . . and young men . . . get into a well-paying future in the highly profitable fields of RADIO-ELECTRONICS. During the past sixteen years we have trained many men who desired better jobs or businesses of their own. We can effectively provide you with this same opportunity either in our new, modern Chicago laboratories or in the privacy of your own home.

### TAKE YOUR CHOICE

If you choose to come to Chicago, we shall find comfortable living quarters for you. If you train at home, we shall send you modern, practical equipment. In either of these two methods, you will have the supervision of some of the finest instructors in the country. Fill in coupon below and we shall send you, absolutely FREE, full information about our program of building men for better opportunities in RADIO-ELECTRONICS. DeForest's Training, Inc. also includes instruction in FM Radio, Television and Industrial Electronics.

If you prefer to remain at home, you receive eight (8) big kits of radio parts and assemblies from which you can work out dozens of fascinating radio circuits to gain practical experience in your own home. In addition, you receive a 16 mm. motion picture projector and 12 information-packed reels of film which help you learn faster . . . easier. You also get modern looseleaf lessons with handy fold-out diagrams.

### EMPLOYMENT SERVICE

When you complete your training our effective Employment Service helps you get started toward a real future. Mail coupon below today . . . do not delay.

### VETERANS

Both our (1) Chicago Laboratory and (2) Home Study training are accepted under the "G. I. Law." If you qualify, the Government will pay cost of either training you select.

## MAIL THIS OPPORTUNITY COUPON NOW!

Mr. E. B. De Vry, President  
DeForest's Training, Inc.  
2533 N. Ashland Ave., Dept. RN-6  
Chicago 14, Illinois

Please show me how I may get started toward a good job or a business of my own in Radio-Electronics.

Name . . . . . Age . . . . .

Address . . . . . Apt. . . . .

City . . . . . Zone . . . . . State . . . . .

If under 16, check here for special information.

If a discharged Veteran of World War II check here.

# DeForest's Training, Inc.

CHICAGO,  
ILLINOIS

Associated with the DeVRY Corporation  
Builders of Movie & Electronic Equipment

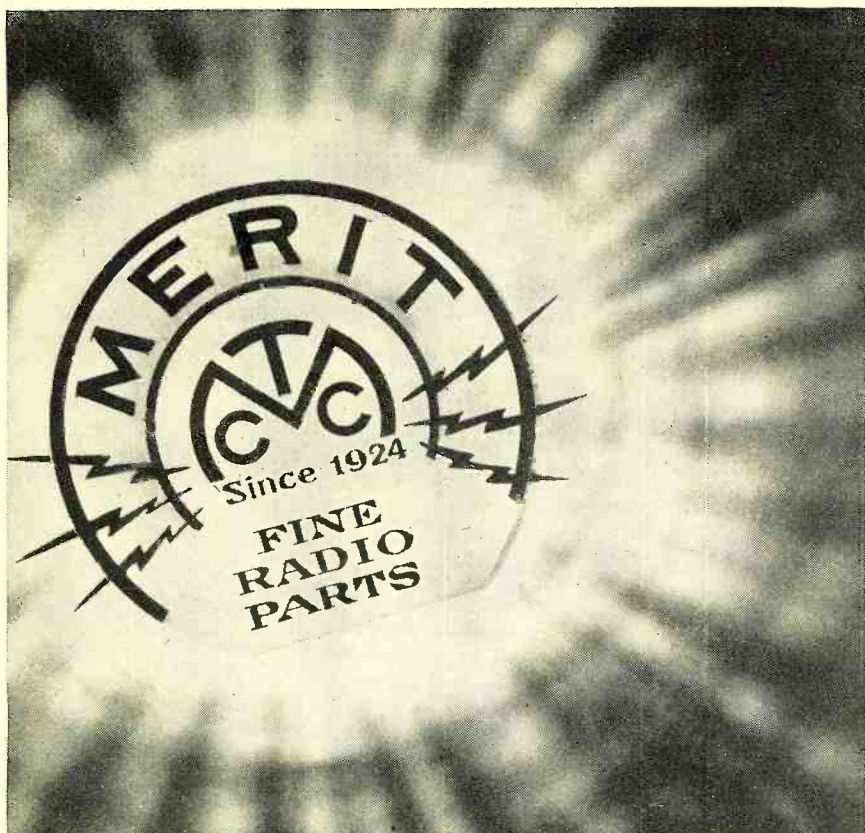

## FOR SERVICE THAT *Satisfies!*

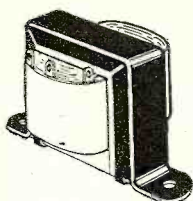

MERIT Model "F"

This MERIT Series provides 8 types of wide range, but is especially designed to meet the demand for replacements for the new personal radios. Here is MERIT Quality—with an attractive price factor.

### Example:

### UNIVERSAL OUTPUT TRANSFORMERS

To Provide Correct Coupling Between a Variety of Output Tubes and Any Speaker Voice Coil.

Type No.	List Price	Tube	Ohms Impedance Pri.
A-2902	\$2.20	Single	1500-2000-4000-5000-7000-10000
A-2998	1.80	Single	3500-5000-7000-10000
A-2999	1.80	Single	12000-15000-18000-25000

Type No.	Sec.	Pri. M.A.	Max. Watts	Mtg. Ctrs.	Dimen.			Mtg.
					H	W	D	
A-2902	.1 to 40	55	10	2 3/4	1 1/2	2 13/16	1 1/2	A-2902 F
A-2998	3.2	35	3	1 3/4	1 1/8	2 1/8	1 3/8	A-2998 F
A-2999	3.2	10	3	1 3/4	1 1/8	2 1/8	1 3/8	A-2999 F



## MERIT COIL & TRANSFORMER CORP.

TELEPHONE

4427 North Clark St.

Long Beach 6311

CHICAGO 40 ILL.

eral recent developments, such as plans for extending coaxial cable circuits, assure the extension of television networks and improvement in progress.

**REGULAR RADIO** is still very much in the running, however, Mr. Geddes hastens to point out, and he agrees with Dr. Manson that it will be the leading media for some years. "The glamour of television should not mislead anyone," he says, "into believing that radio is on the way out and that he should refrain from buying a needed replacement for his prewar set. Some radio listeners today are buying additional sets so that there will be a radio for every one in the family or a set for every room in their homes." This RMA-inspired campaign, mentioned at other times in this column, is coming along fine. You may recall that a test sales program was set up this spring in Hartford, Connecticut. Radio, newspaper, and direct sales methods were used, and with startling results. RMA reports that for the duration of the campaign, sales in Hartford were two and a half times greater than those in Providence, R. I., chosen because it parallels Hartford in population, market area, and other factors. Now the campaign is being pushed nationwide, and if it proves nothing else, it underlines the findings of the industry's leaders—radio is going to be around a long time, and is still as popular as it ever was, television's dramatic spurt regardless.

**WE HAVEN'T SAID MUCH** for some time about the international situation so far as radio is concerned, so we checked up on it the other day with Wayne Coy, the FCC chairman, and discovered that there's been a lot going on in the field. We learned that this year there will be a total of 15 international radio conferences, all the way from The Hague to Montreal, and that the spirit of friendly international cooperation that pervaded the meetings at the Atlantic City conference (even the Russians played ball, for once) is still in the air in the international field. The conferences this year will work out the details of the broad principles laid down at Atlantic City. But it's a long, hard job, in case you haven't already guessed. Take the Provisional Frequency Board meeting in Geneva. It started in January and probably will be in session for two years. Its job is to produce a draft of the first edition of the new international frequency list as agreed upon at Atlantic City. That list will show the specific assignment of frequencies to specific stations. Drawing it up is a tough job, full of endless detail. The date on which the Atlantic City Radio Regulations will finally become completely effective is September 1, 1949—with luck. But that

(Continued on page 186)

# Specify the 1201

## DELUXE ALNICO 5 LOUDSPEAKER

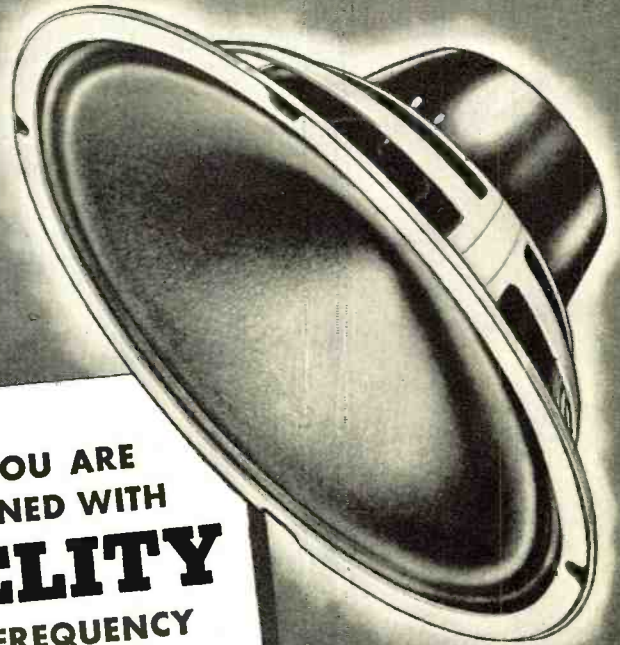

WHEN YOUR  
JOB DEMANDS  
**POWER**  
25 WATTS  
POWER HANDLING  
CAPACITY

WHEN YOU ARE  
CONCERNED WITH  
**FIDELITY**  
BROAD FREQUENCY  
CHARACTERISTIC  
50—13,000 CYCLES

EQUIPPED WITH  
THE FAMOUS  
**GENERAL ELECTRIC**  
**ALUMINUM FOIL BASE**  
**VOICE COIL**

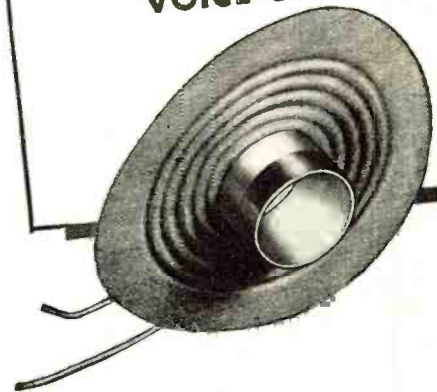

**P**OWER, fidelity and a price that will amaze you for a speaker of this exceptionally high quality—it's the G-E 1201.

It's a wide range speaker with the frequency response stretched out at both ends of the curve to give intense realism, smooth, full lows and "high fidelity." A curvilinear cone is employed to provide this extended frequency response. Alnico 5, 14½ ounces of it, gives high sensitivity and smooth response.

The moving parts in the speaker assembly are ruggedly designed to take high power without damage to the speaker in any way.

Note: Frequency response 50—13,000 cycles.

For complete information on this outstanding speaker write: *General Electric Company, Electronics Park, Syracuse, New York.*

# GENERAL ELECTRIC

# The Answers TO EASY FM & TV SERVICING



The big profits in service lie in repairing FM and TV receivers — of which thousands are already in use. Fast, efficient service demands *visual alignment* of sound and video i.f. amplifiers. McMurdo Silver, world-famous builder of Laboratory Caliber Electronic Test Instruments, gives you the quick, accurate answers. Use 909 or 911 with any good 'scope, follow the simple, clear pictorial instructions and you'll master FM and TV alignment in "no time flat."

## 911 FM/TV SWEEP SIGNAL GENERATOR WITH CRYSTAL MARKER OSCILLATORS.

Covers 2 thru 226 megacycles in three bands upon accurately calibrated 3-range dial without band-switching! Output variable from zero to 1/2 volt. One graduated knob sets linear electronic FM sweep to anything between 40 Kc. and 10 megacycles—low enough for sharp communication FM to high enough for the biggest TV sets. Provides saw-tooth horizontal synchronizing voltage to 'scope at 2x power line frequency giving steady, stable mirror-image trace on your 'scope of i.f. — and r.f. — amplifier selectivity curves. Two panel knobs control amplitude of marker-frequency "pips" produced by two built-in low-drift 1 and 5 mc. crystal oscillators. These marker "pips" let you determine precisely correct pass-band in TV i.f. alignment . . . also serve as standard-frequency signals for checking calibration of all types of receivers, signal generators, etc.



\$78.50\*

## 909 FM/TV SWEEP SIGNAL GENERATOR.

Already America's most popular sweep signal generator. Model 909 is identical to Model 911 above except that it does not include crystal marker oscillators — uses your present AM signal generator to provide variable-frequency marker "pips" when desired. Using any good 'scope and following the clear, concise pictorial instructions, Model 909 makes you master of FM and TV visual alignment . . . the only method guaranteeing fast and perfect i.f. alignment. Thousands already in use by smart service technicians and in the laboratories and factories of FM and TV set manufacturers prove it to be exactly the instrument you have demanded. Convenient portable size matches all Silver LCETI — turns your shop into a modern service laboratory.

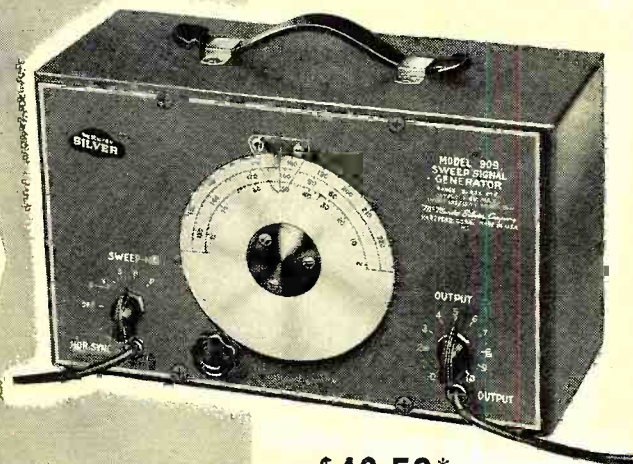

\$48.50\*

\*Prices slightly higher West of Rockies.

Send for 1948-1949 Catalog of NEW LCETI Test Instruments

OVER 37 YEARS OF RADIO ENGINEERING ACHIEVEMENT

*McMurdo Silver Co., Inc.*

EXECUTIVE OFFICES: 1240 MAIN ST., HARTFORD 3, CONN.  
FACTORY OFFICE: 1249 MAIN ST., HARTFORD 3, CONN.

LABORATORY  
CALIBER  
ELECTRONIC  
TEST  
INSTRUMENTS

Make More Money in

# Radio TELEVISION & ELECTRONICS

**NOW!**

Get these 2 BIG BOOKS  
**FREE!**



**LEARN  
BY DOING**

Work with Real Experimental Equipment  
Furnished without  
Extra Cost as Part of  
your National Schools  
Training

Experience is the best teacher. You learn by experience with the exclusive National Shop-Method of Home Training. With the apparatus sent you, you actually build various types of standard equipment—a powerful super-heterodyne receiver, a signal generator, an audio oscillator, low power Radio transmitter and other units. You make tests and conduct experiments that show you the why and how of Radio. You understand what makes the various elements of Electronics operate because you actually see them work for you. Not only do you gain splendid experience by this method of learning, but you receive valuable equipment you will use on the job in the practice of your profession as a Radio Technician. Mail the coupon and learn what this means to you.

Send Coupon  
and prove to  
yourself what  
YOU can do  
in RADIO and  
TELEVISION!

**FREE LESSON INCLUDED**

Examine the exclusive National Shop Method of Home Training. See for yourself how sound and practical it is. Be convinced that you can learn Radio, Electronics, Television—quickly and easily in your spare time. This trial is ABSOLUTELY FREE.

Mail the coupon here for the books that tell you the complete story of National Schools Master Shop Method of Home Training in Radio, Electronics and Television.

This is the MODERN SYSTEM OF TRAINING, it matches the rapid progress constantly being made in Radio, Television and Electronics. It is TIME TESTED, too. National Schools has been training men for more than a third of a century. It is the very same training that has helped thousands to more pay and greater opportunity. You owe it to yourself—your future—to read the book "Your Future in Radio, Electronics and Television"—FREE to you when you send in the coupon.



You build this fine modern Superheterodyne Receiver and other units, with the complete standard parts we send you. This valuable equipment becomes yours to use and keep.

You learn by building  
equipment with standard  
radio parts we send you

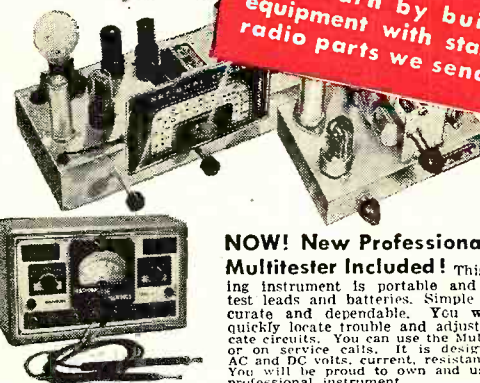

**NOW! New Professional  
Multitester Included!**

This versatile testing instrument is portable and complete with test leads and batteries. Simple to operate, accurate and dependable. You will be able to quickly locate trouble and adjust the most delicate circuits. You can use the Multitester at home or on service calls. It is designed to measure AC and DC volts, current, resistance and decibels. You will be proud to own and use this valuable professional instrument.

## SHOP METHOD HOME TRAINING FROM A TECHNICAL TRADE RESIDENT SCHOOL

National Schools brings its exclusive Shop Method of training right into your own home. You can learn the most up-to-date approved practical training projects, systems and modern circuits from the very beginning in your spare time. Here is sound and practical home training—the development of experienced instructors working with students right in the shops, NEW Television and Broadcast Studios and Experimental Laboratories of NATIONAL SCHOOLS—one of the most advanced technical trade education centers in the world.

Take Advantage Now of these Outstanding Features of National Schools 1948 Training Program

1. National Schools' 1948 Course is planned to prepare you for real success in Radio, Television and Electronics.
2. Experimental equipment supplied with the Course has been completely revised to give you the most up-to-date practical experience with new circuits, new units, etc., right in your own home.
3. New Television Lessons have been expanded to give you training in the latest developments in this important field.
4. The 1948 Course includes a Professional Multitester (shown above) for your use in spare or full-time Radio work.
5. National Schools gives you advanced training—the key to the better positions in Radio, Television, Electronics.
6. You are sent standard Experimental Equipment, including tubes and accessories, for building a modern Short Wave and Standard Broadcast Superheterodyne Receiver. All equipment becomes your personal property.
7. National Schools' 43 years of experience in Technical Trade Training, our modern shops and laboratories, highly trained instructors are back of your time-tested Training Plans for a brighter future.

Both Home Study and  
Resident Training Offered

**Approved  
for  
Veterans**

Check Coupon

G. I. APPROVED

## NATIONAL SCHOOLS

LOS ANGELES 37, CALIFORNIA EST. 1905



**MAIL OPPORTUNITY COUPON FOR QUICK ACTION**

MEMBER: NATIONAL COUNCIL OF  
TECHNICAL SCHOOLS

NATIONAL SCHOOLS, Dept. RN-6  
4000 South Figueroa Street, Los Angeles 37, California

MEMBER: NATIONAL HOME  
STUDY COUNCIL

(Mail in envelope or  
paste on penny post card)

Mail me FREE the two books mentioned in your ad, including a sample lesson of your course. I understand no salesman will call on me.

NAME ..... AGE .....

ADDRESS .....

CITY ..... ZONE ..... STATE .....

.... Check here if Veteran of World War II

**RM-251** is a distinguished addition to the Jensen reproducer family. This "decorator-designed" Bass Reflex cabinet utilizes any fifteen inch Jensen loud speaker including the coaxial. Of sufficient size, it makes an ideal base for almost any television or receiver equipment.



**Jensen**

**CUSTOMODE REPRODUCER**  
Chicago



# New! STANCOR'S

## ST-203-A

# Mobile Transmitter Kit



IN YOUR CAR



IN YOUR SHACK



AT YOUR SUMMER HOME



THE STANCOR'S ST-203-A is a compact, versatile transmitter designed primarily for mobile operation, but also useful for fixed station service. You can operate the ST-203-A in your car, then quickly transfer it for use in your shack, summer home or other fixed location. Special mounting fasteners make the ST-203-A quickly transferable from car to fixed station.

Power is obtained from a dynamotor or vibrator supply for mobile work or from an AC supply at a fixed location. Performs efficiently with the surplus PE-103-A dynamotor and a T-17B carbon microphone.

Briefly, the circuit lineup consists of a 6V6 harmonic oscillator working from 7 mc. crystals, a 2E26 Class C amplifier, a 6J5 grounded-grid speech amplifier, and a push-pull 6V6 Class A-1 modulator.

Attractively styled in silver-gray hammertone finish with gray plastic control knobs and brushed metal carrying handle. Size only 8 5/8" x 7 3/8" x 6 3/4". Weight with tubes and crystals, 9 1/4 pounds.

Kit includes prefabricated chassis, mounting plate, dust cover, prepared lead wires, all constructional components, and detailed, illustrated instruction manual. **AMATEUR NET PRICE, less accessories... \$44<sup>70</sup>**

### NOTE THESE FEATURES:

- 27.5 Watt Amplifier Plate Power Input
- Radiotelephony-Amplitude Modulation
- Two Crystal-Controlled Frequencies
- Covers Popular 10 and 11 Meter Bands
- Press-to-Talk Operation
- Both Mobile and Fixed Station Use
- Accessories Available at Low Cost
- Compact — Lightweight
- Moderately Priced

*See the ST-203-A Kit at Your Stancor Dealer Today or Write Direct for Descriptive Bulletin*

standardize on **STANCOR**  **TRANSFORMERS**

STANDARD TRANSFORMER CORPORATION • 3580 ELSTON AVENUE • CHICAGO 18, ILLINOIS  
June, 1948

# PHOTOFACT Publications Help You to Success!

Have more practical, useful, complete data than you can get anywhere else...

**READY NOW!**

## PHOTOFACT VOLUME 4

Includes First Three TV Course Installments!

Latest companion to popular Volumes 1, 2 and 3 — brings your file of post-war receiver service data right up to July 1948! Most accurate and complete radio data ever compiled... an absolute **MUST** for all Servicemen. Everything you need to know for faster, more profitable servicing, in handy, unified form. Includes: Exclusive Standard Notation schematics; photo views keyed to parts lists and alignment data; complete parts listings and proper replacements; alignment, stage gain, circuit voltage and resistance analysis; coil resistances; dial cord stringing; disassembly instructions; record changer repair instructions. Order Volume 4 today — it's the *only* service data that meets your *actual* needs!

- Vol. 4. Models from Jan. 1, 1948 to July 1, 1948
- Vol. 3. Models from July 1, 1947 to Jan. 1, 1948
- Vol. 2. Models from Jan. 1, 1947 to July 1, 1947
- Vol. 1. All post-war models up to Jan. 1, 1947

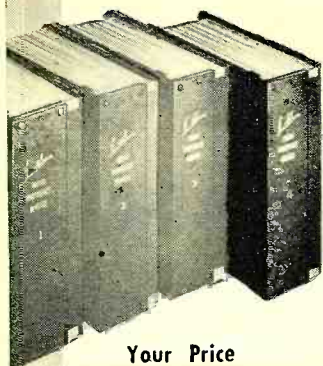

Your Price  
Each Volume,  
in DeLuxe Binder  
**\$18<sup>39</sup>**

## 1947 Automatic Record Changer Manual

Nothing like it! Covers more than 40 different post-war models. Absolutely accurate, complete, authoritative — based on actual analysis of the equipment. Shows exclusive "exploded" views, photos from all angles. Gives full change cycle data, adjustment data, service hints and kinks, complete parts lists. Shows you how to overcome any kind of changer trouble. **PLUS** — for the first time — complete, accurate data on leading Wire, Ribbon, Tape, and Paper Disc Recorders. 400 pages; 8 1/2" x 11"; hard cover; opens flat. Don't be without this manual. **ONLY \$4.95**



## Radio Receiver Tube Placement Guide

The book that shows you exactly where to replace each tube in 5500 radio receiver models. Covers receivers from 1938 to 1947. Each tube layout is illustrated by a clear, accurate diagram. Saves time — eliminates risky hit-and-miss methods, especially when the customer has removed tubes from the set. A handy pocket-sized 192-page book, indexed for quick reference. You'll use it profitably every single day. Order several copies for your bench and outside calls! **ONLY \$1.25**



**FAMOUS \$500<sup>00</sup>  
TELEVISION COURSE  
At No Extra Cost to You!**



## NOW RUNNING IN CURRENT PHOTOFACT FOLDER SETS

Here's the first practical, successfully proved Television instruction for the Service Technician! Now — at no extra cost to you — you can prepare for profitable Television servicing without taking time off from your business. If you can service a Superheterodyne, the PHOTOFACT Course will teach you clearly and simply how to service a Television Receiver. Telegrams, letters and 'phone calls by the hundred acclaim the first installment of the \$500 Television Course which appeared in PHOTOFACT Folder Set No. 38. If you haven't started the Course (which is running in current PHOTOFACT Folder issues) — be sure to get PHOTOFACT Sets No. 38, 39 and 40 today! Stay ahead of the game with PHOTOFACT!

**Don't Miss a Single Installment!**

## Dial Cord Stringing Guide

The book that shows you the one *right* way to string a dial cord. Here, for the first time, in one handy pocket-sized book, are all available dial cord diagrams covering over 2300 receivers, 1938 through 1946. Makes dial cord restringing quick and simple. Pays for itself in time saved on a single dial cord repair job. A "must" for every service bench and tool kit. Order today! **ONLY \$1.00**



## BOOST YOUR EARNING POWER!

Mail This Order Form  
to HOWARD W. SAMS & CO., INC.  
2924 E. Washington St., Indianapolis 7, Indiana

My (check) (money order) for \$.....enclosed.

- Send Photofact Sets — 38, — 39, — 40. \_\_\_\_\_ (\$1.50 per Set).
- Send Photofact Volume 4 (including Sets Nos. 31 through 40) in DeLuxe Binder, 18.39.
- Vol. 3.  Vol. 2.  Vol. 1 (\$18.39 each).
- Automatic Record Changer Manual, \$4.95.
- Tube Placement Guide, \$1.25.
- Dial Cord Stringing Guide, \$1.00.
- Send FREE Photofact Cumulative Index.

Name \_\_\_\_\_

Address \_\_\_\_\_

City \_\_\_\_\_ State \_\_\_\_\_

**HOWARD W. SAMS & CO., INC.**  
INDIANAPOLIS 7, INDIANA

Export—Ad. Auriema—89 Broad St., New York 4, N. Y.—U. S. of America  
Canada—A. C. Simmonds & Sons, 301 King St., East—Toronto, Ontario

**PHOTOFACT SERVICE**

"The Service that pays for itself over and over again"

*Delco  
now offers*

# "PACKAGED PROFITS"

**Most popular models in Delco Home Radio now grouped for best display, quickest turnover!**

Here's a great opportunity to pep up your radio sales and step up your radio profits! You can now purchase Delco Home Radios in carefully selected "profit packages"—each with a brilliant new display stand which holds six models.

**Pick your package**

**Take your profit**

Each Delco is a quality product, backed by three great names: General Motors, Delco and United Motors. And the complete Delco line is so diversified that it attracts a wide range of prospects. Talk to your United Motors' distributor (or write to United Motors Service, General Motors Building, Detroit 26, Michigan) . . . select one or more of these new "profit packages" . . . you'll find you're in business to make money!

## DELCO RADIO

**A GENERAL MOTORS PRODUCT**

*Delco radios are distributed nationally by United Motors Service. See your United Motors distributor about the Delco Radio line.*



### DELCO PACKAGE NO. 1502

Twenty-four assorted Delco table model radios, including one combination radio and record player and one display stand.

DEALER'S PROFIT.....\$249.67

### DELCO PACKAGE NO. 1504

Fifteen assorted Delco console and table model radios and radio-record player combinations and one display stand.

DEALER'S PROFIT.....\$298.12

Ask about other "Profit Packages" not listed here

# HARVEY

has **BEST BUYS**

## FM TRANSLATOR General Electric Model XFM-1



Post-war version of the old G.E. J.F.M-90 Translator which was used and enjoyed by tens of thousands of discriminating radio listeners.

Covers 88-108 mc range, dial 12 inches long, uses guillotine tuning for highest efficiency, high stability. Designed for export, has power inputs for 110 to 250 volts, 50/60 cy. Used in conjunction with good audio section or separate amplifier will provide best FM listening you ever heard. In attractive natural walnut cabinet — 10 3/4" high x 15 3/4" wide x 11 3/8" deep, complete with 8 tubes. Tropic-proof construction. Quantity limited, no more available. Get your order in while they last!

Available only from HARVEY

Special price .....\$49.50  
For use with the FM tuner we recommend any of the following:

Altec-Lansing A-323 B Amplifier.....	\$125.00
Altec-Lansing 600 Speaker.....	45.00
Altec-Lansing 603 Speaker.....	63.00
Altec-Lansing 604 Speaker.....	157.50
Crossover for 604.....	30.00
Stevens Tru-Sonic P52A Speaker with crossover.....	123.00
Stevens Tru-Sonic P52FR Co-Spiral Speaker.....	48.00

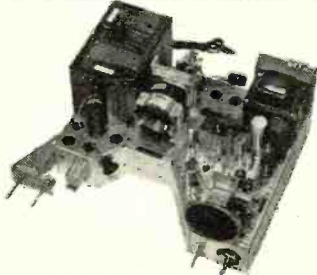

### RCA 630TS TV Chassis

Complete kit of parts, including all hardware, pre-wired and aligned RCA front end, condensers, resistors, punched chassis, all tubes including kine, complete manual with service notes, all RCA.....\$198.50

NOTE: All prices are Net, F.O.B. N.Y.C. and are subject to change without notice.

Telephone: **7-1900** LO. 3-1800

**HARVEY**  
**RADIO COMPANY INC.**

103 West 43rd St., New York 18, N. Y.

# Within the INDUSTRY

W. W. JABLON has been elected a Vice-President of the *Esbey Manufacturing Company, Inc.* of New York. He will head the jobbing and special products division of the company. The jobber division markets a line of replacement chassis and tuners through distributors and mail order houses while the special products division manufactures various kinds of electronic equipment on subcontract for other companies.



Mr. Jablon, who was previously connected with *The Hammarlund Mfg. Co., Inc.* is a Director of Radio Parts and Electronic Equipment Shows, Inc.

**BENDIX RADIO DIVISION** of *Bendix Aviation Corporation*, has announced the recent appointment of Vincent C. Judd, to the new position of manager of automobile radio sales. Mr. Judd will have offices at *Bendix Aviation Corporation's* Research Laboratory, 4855 Fourth, Detroit, Michigan.

Mr. Judd, formerly a major in the Signal Corps, was stationed in Detroit during the war as liaison officer with automotive manufacturers. His work was with automobile manufacturers for radio installation provisions and electrical noise suppression on tanks, jeeps, staff cars, and other types of mobile radio applications. After leaving the Armed Forces, Mr. Judd joined the sales engineering staff of *Bendix Radio Division*. Before joining the Army, he was a member of the company's engineering department.

**JOHN F. McALLISTER** was recently appointed Designing Engineer of the Specialty Division of *General Electric Company* at Electronics Park. In this capacity he will be responsible for the design of the division's products for radio servicemen, precision testing units, and other electronic application developments.



Mr. McAllister is a graduate of the University of Pennsylvania and holds a degree in physics and engineering. He joined *General Electric* in 1939 and was assigned to the Test Department. Mr.

McAllister spent four years studying and teaching in the company's Advanced Engineering Courses dealing with radio wave propagation, circuits, radar techniques, and new electronic engineering activities.

During that time he was assigned to research work on a number of government equipment projects, including work with the V-2 rocket. In 1947 he returned to Syracuse and was appointed section leader of service test and precision test equipment, a post he relinquished to take his present position.

**LEWIS GORDON** has been appointed Director of the International Sales Division of *Sylvania Electric Products Inc.* Previously Mr. Gordon was assistant to the Vice President of Sales. He has been a sales executive with *Sylvania Electric* since he joined the company in 1931 as Manager of New York district sales when he opened the first New York City office. He has been manager of national domestic accounts in lighting sales for many years.



A Harvard graduate, Mr. Gordon will make his new headquarters at *Sylvania Electric's* International Sales Division office, 50 Broadway, New York City.

**SUPREME, INCORPORATED**, has acquired the manufacturing rights, facilities, and assets of the *Supreme Instruments Corporation*. The new corporation is composed of executives, representatives, and key employees of the old company.

The transfer of property and rights includes all patents, engineering developments and trade-marks. *Supreme, Incorporated*, will continue to sell test equipment and meters under the name "*Supreme*." All guarantees of equipment previously sold by *Supreme Instruments Corporation* will be fulfilled by the new company.

Until completion of their new air conditioned plant they will continue to occupy the quarters of the old company.

**WHIPPLE JACOBS**, president of the *Belden Manufacturing Company*, has been named chairman of the Electrical Engineering and Physics division of the Development Program campaign of Illinois Institute of Technology.

When constructed, the \$800,000 Elec-

No More  
Guesswork

with

**OHMITE**

*Little Devil*

**COMPOSITION RESISTORS**



You never have to guess about the resistance and wattage of any Little Devil resistor. Every unit is not only color-coded, but individually marked for quick, positive identification.

Ohmite Little Devils are rugged and dependable. Millions of these tiny, molded composition resistors have been used in critical war equipment and in leading laboratories. They meet Joint Army-Navy Specification JAN-R-11, including salt water immersion cycling and high humidity tests. Little Devils can be used to their full wattage ratings of 70° C (158° F) ambient temperature. They dissipate heat rapidly, have a low noise level, and low voltage coefficient.

Ratings for maximum continuous RMS voltage drop are high . . . 350 volts for the 1/2-watt unit, 500 volts for the 1-watt unit, and 1000 volts for the 2-watt unit. Ohmite Little Devils are light, compact, easy to install. They're available from stock in Standard RMA values from 10 ohms to 22 megohms, in 1/2, 1, and 2-watt sizes. Values as low as 2.7 ohms in the 1-watt size only. Tol.  $\pm 10\%$ . Also  $\pm 5\%$  in 1/2 and 1-watt sizes.

**Ask for them BY NAME  
from your Distributor**

**OHMITE MANUFACTURING CO.**  
4885 FLOURNOY STREET, CHICAGO 44, ILL.



**SEND FOR BULLETIN 135**  
Gives complete data and list of RMA values. Includes dimensional drawings and handy color code. Write for it, today.

Be Right with **OHMITE**

RHEOSTATS • RESISTORS • TAP SWITCHES • CHOKES • ATTENUATORS

The Sweetest Music  
this Side of Heaven...

from this NEW, IMPROVED

# LEAR MAGNETIC PHONO PICK-UP

HIGH FIDELITY



## \$ Profit and Exquisite Record Reproduction...

**JOBBERs ... SERVICEMEN ...** turn service calls into profitable sales with ease. This new LEAR Reluctance Pick-Up transforms "flat" old-fashioned sound into full-toned modern reproduction!

This new, improved High-Fidelity Reluctance Pick-Up is LEAR engineered to excel in quality of performance ... and priced for your profit. Replaces millions of old style crystal pick-ups now in use! Jewel stylus eliminates needle changing — holds surface noise to a bare minimum. It performs a miracle of modernization — assures full tonal beauty of sound wherever installed.

List this "hot" seller in your catalog! Service men who feature the new LEAR Magnetic Pick-up will pick up extra profits every day! Cash-in now—write for complete discount price list today!

### To complete your LEAR Sound Service:

New, Improved LEAR PRE-AMPLIFIER, List Price—\$9.90

To provide additional amplification with use of MP-103 LEAR Magnetic Pick-up. Can be connected directly to old crystal cartridge input. High voltage and filament wires provided for connection into existing equipment. Two-position switch permits high-fidelity response to finest quality recordings.

No. PA-103 (not shown here)—LEAR Tone Arm Assembly with MP-103 Magnetic Variable Reluctance Pick-Up Cartridge, List Price \$15.50.

Designed for high-fidelity reproduction of 10" and 12" recordings Spring counter-balance provides "feather touch" operation—only 17 grams stylus pressure on record. This reduces record wear to a minimum. Handsomely finished in brown metallic.

**Factory Representatives—Distributors:** A few choice territories are still available for these and other fine LEAR Electronic Products. Write today giving full details.

110 Ionia Ave. N. W. Grand Rapids 2, Mich.

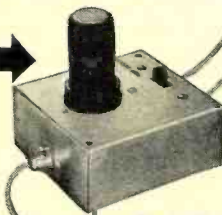

No. A-172

LEAR

trical Engineering and Physics building, will stand on the site of the present Main building built in 1891. It will contain specialized laboratories for basic electrical circuits and electrical machinery, nuclear physics, radio and television, a physics demonstration museum, and an integrated physics library.

Mr. Jacobs, a trustee of Illinois Tech since 1943, is also a director of the Chicago Association of Commerce and Industry, and a vice-president of the National Electrical Manufacturers Association.

\* \* \*

GEORGE COHEN was recently appointed General Manager of the parts sales and service departments for Emerson Radio and Phonograph Corporation. His departments service all Emerson products and control the sale of parts, tubes, and accessories for all of the company's radios, phono-radios, and television sets.



Prior to his promotion Mr. Cohen served as Emerson Radio's General Manager in the War Assets Administration Division handling the disposal of surplus electronic properties. During the war he served as Manager of the company's equipment engineering department.

\* \* \*

J. M. BAXTER has been named sales representative for the Jensen Manufacturing Company's line of acoustic equipment in the states of Indiana and Kentucky.

Mr. Baxter has been in radio since 1929 when he joined the original Capehart organization as an engineer on p.a. and sound equipment. He served as chief engineer for the Capehart Corporation until 1939 at which time he was placed in charge of record changer development by Farnsworth Television & Radio Corporation.

He recently resigned his position with Farnsworth to organize his own sales representative firm.

\* \* \*

NATIONAL BUREAU OF STANDARDS has announced three new appointments. William B. Haliday has joined the staff of the Electron Tube Laboratory and will be engineer in charge of model tube construction. During the war and until his recent appointment he was a radio engineer with the Naval Research Laboratory.

Also joining the Electron Tube Laboratory will be Russell E. Dorrell, an electronics engineer. Mr. Dorrell will aid in the development and standardization of test methods and equipment for evaluating tube performance.

The third appointment was that of Paul V. Horton, to the Engineering Elec-

(Continued on page 128)

RADIO NEWS

# TELEVISION ASSEMBLY CO.

INTRODUCES THE

*Champion Models*  
with

**DUMONT INPUTUNER**

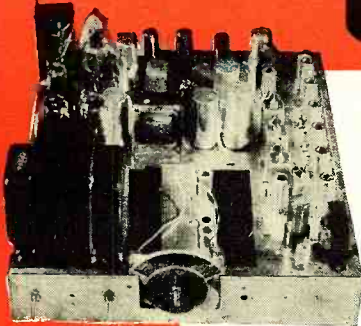

The Dumont Inputuner tunes continuously from 44 to 216 megacycles without a break, covers all 13 channels as well as FM, amateur, and aviation channels. For ease and convenience of operation no band switching of any kind is required when tuning from channel to channel with the inputuner system. Just one simple operation to reach any desired station.

Assemble the Champion model of your choice, 10" flat surface screen picture, 51 sq. in. picture, 12" screen picture with 75 sq. in. picture or the 15" screen picture with 120 sq. in. picture.

All Champion Models are complete with all tubes and components including the CR Tube.

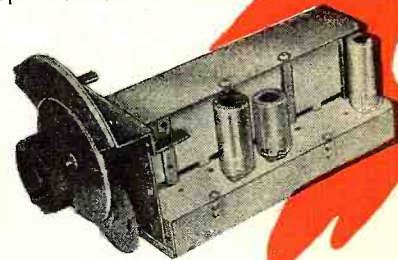

10" FLAT SURFACE

**\$ 273.10**

DEALERS NET

12" SCREEN PICTURE

**\$ 303.10**

DEALERS NET

15" SCREEN PICTURE

**\$ 393.10**

DEALERS NET

## *Standard Models*

NOW AVAILABLE WITH  
THE STANDARD MODELS—  
FM RADIO AT A SLIGHT  
ADDITIONAL COST OF  
\$7.95.

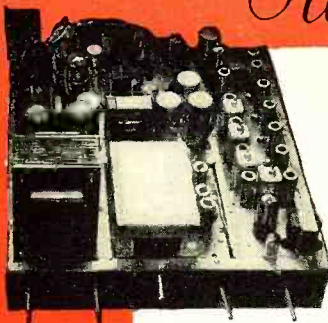

All Television Assemblies are complete and include: 29 RCA Tubes plus CR Tube—Heavy duty RCA 6.8 oz. slug PM speaker—Specially designed dipole antenna, with 60 ft. lead in—complete pictorial charts for placement of components and schematic diagrams for wiring supplied with assembly.

Superior performance is obtained with a new IF Video & Sound IF Strip (Pat. Pend.) aligned, wired, pretuned, tubed and tested. All circuits are contained on one chassis ready to use with the front end unit supplied. This front end will handle 13 channels and is aligned and tested, mounted on a separate chassis. Merely connect B plus filament and output IF leads to the television chassis. It is not necessary to make any RF alignments. These units utilize a clipper circuit which filters out ignition noises.

10" FLAT SURFACE

**\$ 229.50**

DEALERS NET

12" SCREEN PICTURE

**\$ 259.50**

DEALERS NET

15" SCREEN PICTURE

**\$ 349.50**

DEALERS NET

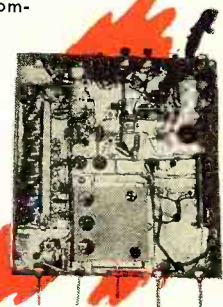

**Guaranteed**

All Television Assemblies are guaranteed to operate to your satisfaction when simple directions are followed.

TERMS: 10%  
DEPOSIT WITH  
ORDER. BALANCE  
EXPRESS COLLECT.

TELEVISION  
ASSEMBLY CO.

540 BUSHWICK AVE.  
BROOKLYN 6, N. Y.



# Precision . . . .

The ease and grace of a figure skater is a manifestation of infinite skill and precision. The delicate mechanisms that make the RADIART VIBRATOR outstanding represent precision manufacture at its best. The skillful engineering . . . the finest quality materials would be of little value without the precision manufacture that makes a working body of material and design. This is the RADIART VIBRATOR . . . another of the reasons for its superiority. This is why Radiart is preferred everywhere by servicemen who know vibrators.

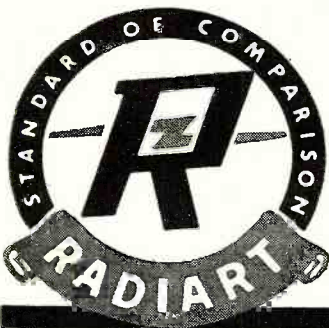

## The Radiart Corp.

CLEVELAND 2, OHIO

EXPORT: SCHEEL INTERNATIONAL, INC.





An entire season of baseball action—from Opening Day to World Series—is yours with RCA Victor television.

## ***You're right in the game—with Television***

● Comes the shout "Play Ball!" and there you are . . . right on top of every play.

Through television developments in RCA Laboratories, all the action is yours—the crack of bat against ball—fast infield plays—even side-lights in bull pen, dugout, grandstand and bleachers.

At the ball park, RCA Image Orthicon television cameras—rivalling the

human eye in sensitivity—get all the action in day or night games. Shifts from over-all views of the field, to "close-ups," of individual players are swift and revealing . . .

And at the *receiving end*—your RCA Victor "Eye Witness" home television set gives you brighter, clearer pictures. You can see the ball that the batter misses, or you can watch his home run smash sail over the distant fence.

Today, because of the original and continuing work of RCA scientists, millions can enjoy sports, entertainment, educational and news events, on television. Research at RCA Laboratories—always a "step ahead"—enters every instrument marked RCA or RCA Victor.

When in Radio City, New York, be sure to see the radio, television and electronic wonders at RCA Exhibition Hall, 36 West 49th St. Free admission. Radio Corporation of America, RCA Building, Radio City, New York 20, N. Y.



**RADIO CORPORATION of AMERICA**

# RADIO SERVICEMEN!

## 9 PRIZES FOR 18 IDEAS

### HERE'S HOW EASY IT IS TO WIN

Right now, you may have a winning idea at work in your shop. An idea for a simple service tool which makes your work easier, faster, more profitable. Hytron wants to help make such needed tools available to all servicemen — at cost. You can cash in on your idea easily — and also help the other fellow.

Simply obtain an official entry blank from your Hytron jobber — or write us. Answer a few simple questions on the blank. Then include a sketch with constructional details — or a photograph — or a model of your proposed tool. Mail

to Hytron Contest Editor. The tool should be simple, practicable, durable, compact, easy and economical to manufacture. Examples: Hytron Tube Tapper and Miniature Pin Straightener.

That's all there is to it. Nothing to buy. Nothing difficult. No fancy writing. And could you use one of those beautiful deluxe test equipments — or one of those crisp new Savings Bonds! Check the easy rules. Get an official entry blank today for full details on how to win. Send in as many entries as you wish — in any or all six contests. Everyone wins a Tube Tapper. Your idea may hit the jackpot. Let's go!

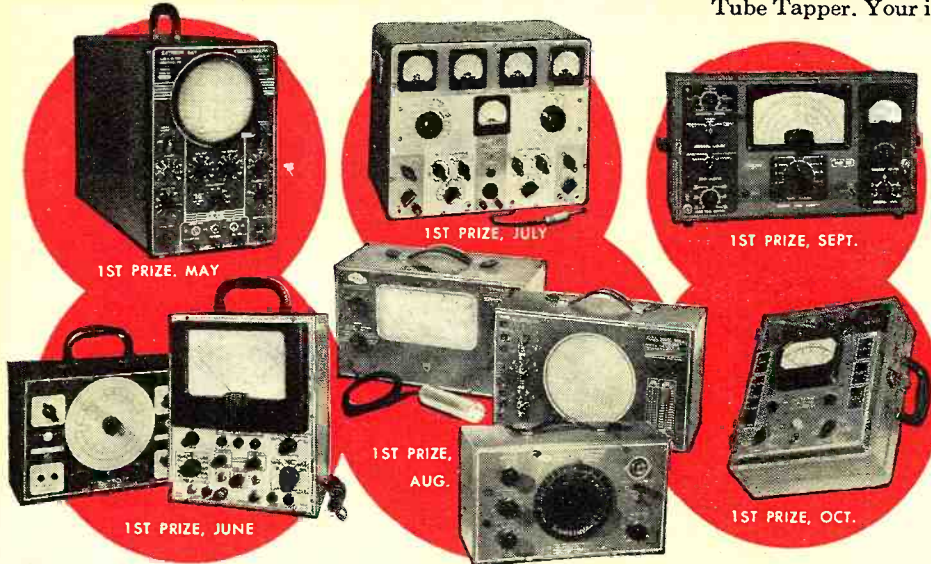

### HERE ARE THE EASY RULES

**WHO** . . . Any bona fide radio serviceman who repairs radios for the general public and who lives in continental United States is eligible for these contests, except employees of Hytron, their advertising agencies, and their families.

**HOW** . . . Get official entry blank from your Hytron jobber, or write us. Describe on blank your idea for a shop tool for radio servicemen. Include sketch and constructional details — a photo — or model. Make your proposed tool simple, practicable, durable, compact, easy and economical to manufacture (preferably to sell without profit at 50¢ or less) — like the Tube Tapper or Miniature Pin Straightener.

**WHERE** . . . Mail to CONTEST EDITOR, HYTRON RADIO & ELECTRONICS CORP., SALEM, MASS.

**WHEN** . . . There are six monthly contests. Opening and closing dates for each contest are the first and last days of each of the months from May through October, 1948, inclusive. The postmark date determines month of entry. Entries for final month's contest must be postmarked before midnight, October 31, 1948, and received by November 15th. At judges' discretion, unsuccessful entries in any month's contest may be re-considered among following months' entries. You may submit as many different ideas as you wish in any or all six monthly contests. Use separate blank for each entry.

**PRIZES** . . . See special listing of prizes.

**JUDGES** . . . Entries will be judged on originality, simplicity, practicability, durability, compactness, and ease and economy of manufacture. Judges will be: Sanford Cowan, Editor & Publisher of *Radio Service Dealer*; W. W. MacDonald, Managing Editor of *Electronics*; Oliver Read, Chief Editor of *Radio News*; Joseph Roche, Editor of *Radio Maintenance*; J. L. Stoutenburgh, Executive Editor of *Radio & Television Retailing*; Lewis Winner, Chief Editor of *Service*.

Judges' decisions final. Duplicate prizes in case of ties. No entries returned. Entries become property of Hytron, who may, at its option and by special arrangement with the entrant, pay the cost of a patent application (if the tool is patentable) with the understanding that Hytron is to have a non-exclusive license to manufacture, distribute, and sell the tool without royalties. Contests subject to all Federal and State regulations. Winners will be notified by mail. Grand prize winner will be announced in radio service trade papers shortly after close of final contest. Prize winner list available approximately one month after close of last contest.

### HERE ARE SOME EXAMPLES



Hytron's Tube Tapper and Miniature Pin Straighteners show you the kind of tool wanted. Check off the qualities. Simple? Yes. Practicable? Usable time-savers. Durable? Built to last. Compact? Carry them in your pocket. Easy and economical to manufacture? Adapted to mass production. Tube Tapper a nickel; Pin Straightener 49¢ — both under 50¢. Tools associated with tubes preferred, but other original service tools also acceptable.

### HERE ARE THE PRIZES

#### First Prizes

- MAY DuMont Type 274 Five-Inch Oscillograph.
- JUNE Radio City Products Model 665-A, the "Billionaire", V-T Volt-Ohm-Capacity Meter, Insulation Tester; and Model 705-A Signal Generator.
- JULY Hickok Model 156A Indicating Traceometer.
- AUG. McMurdo Silver Model 900A "Vomax" Electronic Volt-Ohm-Milliammeter; Model 904 Condenser/Resistor Tester; and Model 905A "Sparx" Dynamic Signal Tracer/Test Speaker.
- SEPT. Jackson Model 641 Universal Signal Generator.
- OCT. Weston Model 769 High Frequency Electronic Analyzer.

- Second Prize — Each Month \$50 U. S. Savings Bond
- Third Prize — Each Month \$25 U. S. Savings Bond

#### Grand Prize

\$200 U. S. Savings Bond — to contestant whose idea is judged to be best of the 6 winning monthly first prizes.

SPECIALISTS IN RADIO RECEIVING TUBES SINCE 1921

# HYTRON

RADIO AND ELECTRONICS CORP.

MAIN OFFICE: SALEM, MASSACHUSETTS





These "sound jurors" record their preferences as they listen over test circuits.

# Trial by "Sound Jury"



The engineer in the foreground talks over the test circuits which the other engineer sets up on a "circuit simulator."

**A**FTER Bell Laboratories engineers have designed a new talking circuit, they measure its characteristics by oscilloscopes and meters.

But a talker and a listener are part of every telephone call, and to satisfy them is the primary Bell System aim.

So, before the circuit is put into

operation, a "sound jury" listens in. An actual performance test is set up with the trained ears of the jurors to supplement the meters.

As syllables, words, and sentences come in over the telephones, pencils are busy over score sheets, recording the judgment of the listeners on

behalf of you and millions of other telephone users.

Targets of the transmission engineer are: your easy understanding of the talker, the naturalness of his voice, and your all-around satisfaction. To score high is one of the feats of Bell System engineering.

## BELL TELEPHONE LABORATORIES

Exploring and inventing, devising and perfecting for continued improvements and economies in telephone service



# Centralab Announces an

See how **EASILY** and **QUICKLY** "Adashaft"\* Radiohms can be assembled!

No WIGGLE, no wobble, no slip when you use Centralab's "Adashaft" Radiohm. Just insert shaft pilot in hole provided in control stub shaft, and slip "C" washer into place. Quick as a wink, control and shaft become an integral unit, ready for smooth, trouble-free operation. Notice the wide selection of shaft types which Centralab offers you — for every kind of set from large radio-phonograph combinations to small automobile receivers. Shafts are rugged—built to withstand hard usage, yet easy to cut to lengths required.

*\*Trademark registered*

**BEFORE ASSEMBLY**

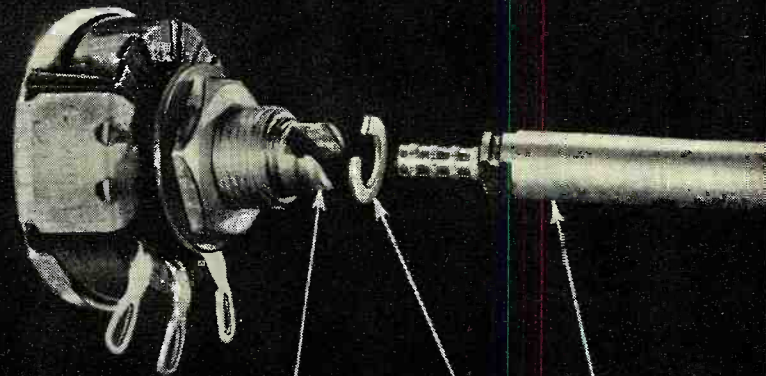

Slotted Stub Shaft "C" Washer "Adashaft"

**AFTER ASSEMBLY**

**Where line switches are required, use CRL attachable Switch Covers!**

Available in five types for "R" Radiohms, 4 types for "M" Radiohms, 1 type for "E" Radiohms. Minimum life of 50,000 mechanical and electrical operations. Underwriters approved. Contact carrier is propelled by full-floating, compression type spring, provides easy, positive action. Rated at 3 amp., 125 volts; 1 amp., 250 volts.

# Improved "Adashaft" \* Radiohm

SIX TYPES OF SHAFTS GIVE YOU WIDE VARIETY!



K-185 3" Fluted "Adashaft" (supplied standard)



K-176 1 3/8" Split "Adashaft"



K-177 3 7/8" Split Knurl "Adashaft"



K-166 3" Auto Type "Adashaft"



Long Guide Funnel



Short Guide Funnel



K-167 6" Auto Type "Adashaft"



Long Guide Funnel



K-165 10" "Adashaft" 1/32" flat



K-184 Slotted Insulating Coupler



K-161 Coupler Shaft

## See how "Adashaft" Radiohms cut down overhead on service and repairs!

**N**OW, YOU CAN HAVE a small stock of controls on hand, yet be prepared to handle almost any kind of control replacement problem for your customers! Yes, that's what Centralab "Adashaft" Radiohms give you, and that's why more and more radio service dealers are using them to speed up service and cut down inventory.

ble in all sizes for all Model "M" volume control applications. See for yourself how they can streamline your service operations. Ask your jobber about them, or write direct for further information.

# Centralab

Division of GLOBE-UNION INC., Milwaukee

Centralab "Adashaft" Radiohms are available  
June, 1948

*Six Months from Today*

# Which will YOU hold?

REGRET TO ADVISE  
YOU FAILED YOUR  
FCC EXAMINATIONS -

← THIS  
OR THIS →

1<sup>ST</sup> CLASS  
RADIO TELEPHONE  
OPERATOR'S LICENSE

## WANT YOUR FCC COMMERCIAL LICENSE IN A HURRY?

Use CIRE Training and Coaching Service—and Get Your "Ticket" in a Few Short Weeks!

Thousands of new jobs are opening up—FM, Television, Mobile Communication Systems—These are only a few of the radio fields which require *licensed* radio technicians and operators.

Get your license without delay—Let Cleveland Institute prepare you to pass FCC license examinations, and *hold the jobs which a license entitles you to*, with CIRE streamlined, *post-war* methods of coaching and training.

**Your FCC Ticket Is Recognized in ALL Radio Fields as Proof of Your Technical Ability.**

More than ever before an FCC Commercial Operator License is a sure passport to many of the better paying jobs in this New World of Electronics.

Employers frequently give preference to the license holder, even though a license is not required for the job. Hold an FCC "ticket" and the job is yours!

### HUNDREDS OF SATISFIED, SUCCESSFUL STUDENTS

"I have taken the first class phone license examination and received my first class ticket last Saturday May 31. In closing I must say yours is an excellent radio course, and I really appreciate your help and the fine service you have rendered me." Student #2876N12

"I passed the FCC examination in radiotelephone 2nd class, at Detroit June 3rd, and I want to thank you for your ready assistance as my instructor on Section I of Nilson's Master Course." Student #2779N12

"I have had my 1st class radiotelephone license since March of this year, and plan to continue with your course since I find it a great help in studying transmitters." Student #2779N12

"After sending in Lesson E I took the commercial operator's license examination for 2nd class radiotelephone, and passed O.K. I received the license last week." Student #2772N1



If you've had any practical radio experience—amateur, Army, Navy, radio servicing or other, my time proven plan can help you, too, on the road to success. Fill out the coupon below and mail it. I'll send you, FREE, the entire story. Edw. H. Guilford Vice President

*I can show YOU*  
**HOW TO PASS**  
**FCC COMMERCIAL RADIO OPERATOR'S EXAMS**

CIRE training and coaching makes it **EASY** to get your FCC ticket

**EVEN WITH THE NEW EXAM**

## BULLETIN

FCC adds FM and television to the First Class License Exam. Effective July 1, 1948, to get a First Class ticket, you will be examined in Frequency Modulation and Television, too.

**Get ALL THREE FREE**

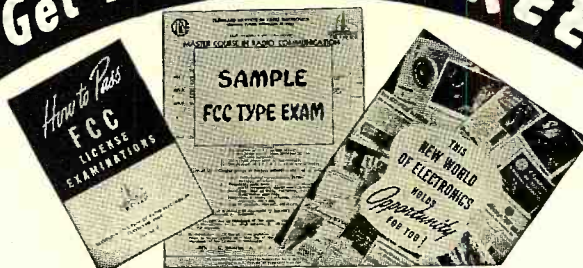

CLEVELAND INSTITUTE OF RADIO ELECTRONICS  
RN-6 Terminal Tower, Cleveland 13, Ohio

I want to know how I can get my FCC ticket in a few short weeks. Send me your FREE booklet, "How to Pass FCC license Examinations" (does not cover exams for Amateur License) as well as a sample FCC-type exam and Catalog A, describing opportunities in Radio-Electronics.

NAME \_\_\_\_\_  
ADDRESS \_\_\_\_\_  
CITY \_\_\_\_\_ ZONE \_\_\_\_\_ STATE \_\_\_\_\_  
 Veterans check for enrollment under G.I. Bill  
NO OBLIGATION — NO SALESMEN

# Exploring the Infinitesimal

By  
**TOM GOOTÉE**

***A practical explanation of the Electron Microscope, and the use of electrons to obtain magnification.***

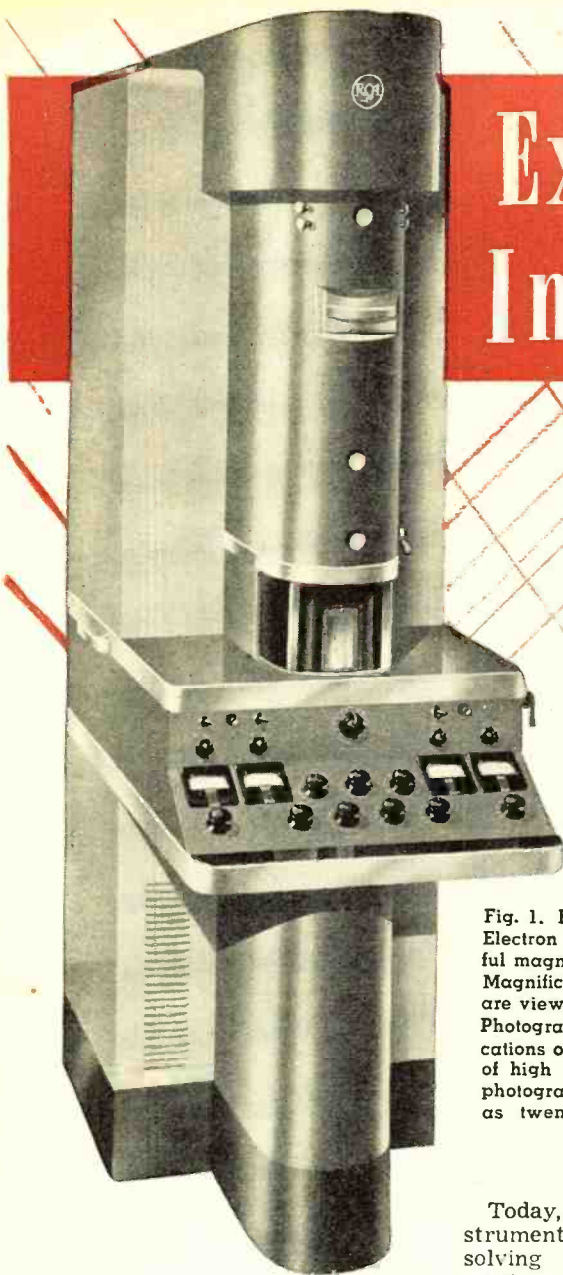

Fig. 1. Latest model of the RCA-developed Electron Microscope provides greater useful magnification than ever before possible. Magnifications from 100 to 20,000 diameters are viewed directly on a fluorescent screen. Photographs are usually made at magnifications of 5000 to 10,000 diameters. Because of high resolution (clarity of detail), these photographs may be enlarged as much as twenty times without loss of detail.

Today, this improved electronic instrument provides much higher resolving power (better clarity) and much greater useful magnifications than have heretofore been possible. Any degree of magnification, from less than 100 times to more than 20,000 times, can be obtained directly and viewed on a small fluorescent screen.

Magnified images can also be recorded on a photographic plate. These photographs, known as *electron micrographs*, are usually made at magnifications of 500 to 10,000 diameters. Then, because of their high degree of resolution (or clarity), these photographs can be enlarged as much as 20 times, thus providing, when necessary, *total useful magnifications as great as 100,000 diameters!*

## **Basic Principle**

Although a massive and seemingly complex instrument (Fig. 1), the principle of the Electron Microscope is relatively simple and in many ways similar to the ordinary optical or light microscope. This similarity is shown (Fig. 3) by a comparison of the basic

components of the two types of magnifying systems.

Essentially, the light microscope consists of a source of illumination, a condenser lens to concentrate the light in a beam on the object or specimen being examined, an objective lens controlling the focus and quality of a magnified image, and a projector lens for further magnification to produce a final image.

In the Electron Microscope, these optical elements are replaced by electronic elements. (See Fig. 3.) A high-speed electron beam is used instead of a light beam, and the electrons are controlled and focused by means of magnetic coils or magnetic-field lenses—replacing the solid, glass, optical lenses.

The source of illumination is an electron gun, consisting of a filament and cathode, and a specially shaped anode or plate. Electrons emitted by the heated filament are attracted at a furious rate toward the anode, due to the high positive potential of the anode, 50,000 volts, with respect to the cathode. There is a small hole in the center of the anode, however, and most of the electrons shoot through this opening at a tremendous velocity.

Almost immediately, the electrons are concentrated in a beam by the magnetic-field action of the condenser lens. This doughnut-shaped coil bends the paths of the electrons, and directs the resultant high-intensity beam on the object to be examined.

The usual microscope slide is much too thick to be penetrated by the electron beam. For this reason, the

**N**AN has always searched for knowledge of the infinitely small. Until a few years ago, however, he was unable to penetrate deeply into the unknown and unexplored universe that he knew existed but could not see.

Optical or light microscopes—in use since the Seventeenth Century—provide only a partial solution. They have their rightful place in science, but their power is limited, because their operation depends on light waves. They cannot see particles much smaller than the wavelength of light, thus, their greatest magnification—about 2000 diameters, or 2000 times—is only a teasing, long-distance glimpse of the infinitesimal.

It remained for scientists and engineers, working in the field of *electron optics*, to develop a new and revolutionary magnifying device—the *Electron Microscope*—the most powerful microscope in existence.

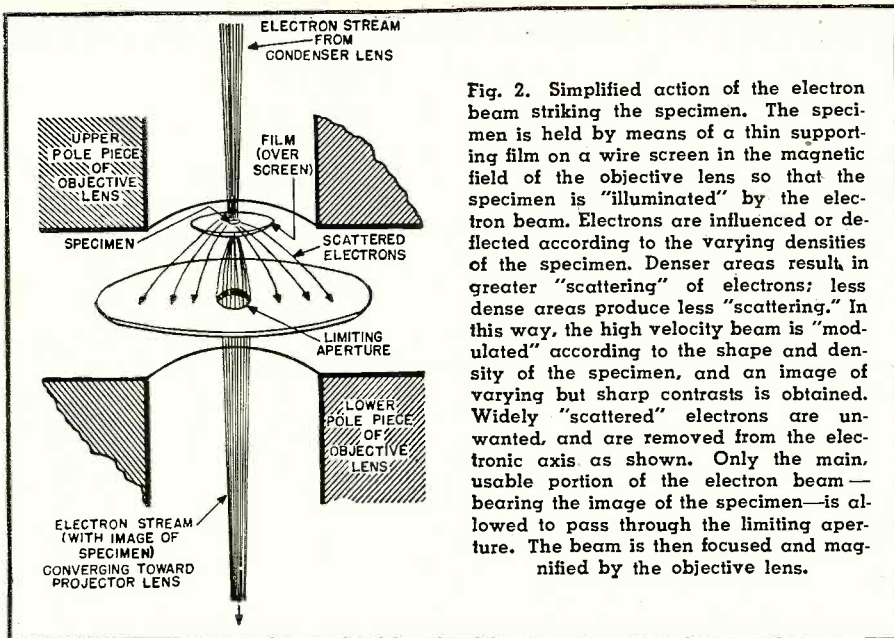

Fig. 2. Simplified action of the electron beam striking the specimen. The specimen is held by means of a thin supporting film on a wire screen in the magnetic field of the objective lens so that the specimen is "illuminated" by the electron beam. Electrons are influenced or deflected according to the varying densities of the specimen. Denser areas result in greater "scattering" of electrons; less dense areas produce less "scattering." In this way, the high velocity beam is "modulated" according to the shape and density of the specimen, and an image of varying but sharp contrasts is obtained. Widely "scattered" electrons are unwanted, and are removed from the electronic axis as shown. Only the main, usable portion of the electron beam—bearing the image of the specimen—is allowed to pass through the limiting aperture. The beam is then focused and magnified by the objective lens.

object or specimen is placed on a very thin supporting film or membrane, which is only a few millionths of an inch in thickness and is effectively transparent to the electron beam. The film is made of collodion and is strong enough to support most types of specimens, but for greater rigidity the film is placed over a 200-mesh screen about  $\frac{1}{8}$ -inch in diameter.

When the specimen is bombarded by the high-velocity beam, the path

of each electron is affected in varying degree (Fig. 2) according to the density or composition of the specimen at the point of contact. Portions of a specimen having great density, such as metallic oxides, cause wide "scattering" or abrupt dispersal of all electrons striking such areas. Portions of less density cause less "scattering" of electrons, in proportion to the density of the area where electrons strike. In this way, a specimen is "illu-

Fig. 3. Electron Microscope is similar in basic principle to the ordinary optical or light microscope. Essentially, the light microscope (left) consists of a source of illumination, a condenser lens concentrating the light in a beam on the specimen or subject under observation, an objective lens controlling the focus of the image, a projector lens for further magnification for microphotography, and an observation screen. In the Electron Microscope (right), optical elements are replaced by electronic elements; the beam of light is replaced by a beam of high speed electrons, and the solid optical lenses are replaced by magnetic field lenses created by energizing magnetic coils. Electronic action takes place in a vacuum within a high, cylindrical metal column. Current for controlling each lens and the electron accelerating voltage is obtained from separate, regulated power supplies.

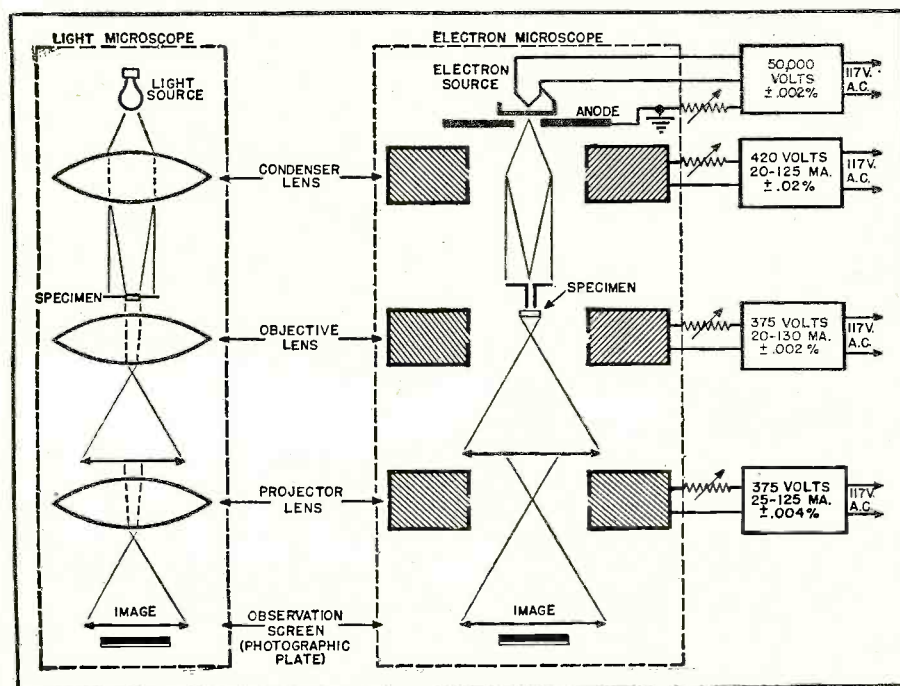

minated" by the electron beam. Electrons which are widely "scattered" are of no importance, and are eliminated by means of a limiting aperture. The electrons which pass through the aperture, however, bear an image corresponding to the varying density of the specimen under observation.

The small unit (film on screen) containing the specimen is held in proper place by means of a T-shaped specimen holder (Fig. 6) resembling a small, brass cartridge. The specimen holder is mounted in the magnetic field of the objective lens. The electron beam is brought to a focus by the magnetic-field action of this coil, to form an enlarged image.

A part of the area of this magnified image is selected for further, final magnification. Electrons forming this part of the image are allowed to enter the magnetic field of a third coil, known as the projector lens. The electrons are brought to a focus, producing a greatly magnified final image.

Since the electron beam is invisible to the human eye, a fluorescent observation screen is placed in such a way that the beam falling upon it produces a visible image. The screen is enclosed by the viewing chamber of the microscope, but three glass windows in the chamber permit simultaneous observation of the final image by several persons. The front window of the viewing chamber is also equipped with a 2-power glass-lens magnifier to aid the operator in focusing images.

Photographs of the final image can be made by allowing the electron beam to fall directly upon a conventional photographic plate.

### Control of Operation

Efficiency of this electronic action depends to a great extent on precision control of all factors which influence, or which might influence, the electron beam. This is accomplished in a number of ways.

The physical appearance of the essential electronic components (Fig. 6) illustrates their relative size and (simplified) arrangement inside the main column of the microscope.

The electron gun has an adjustment for raising or lowering the filament heater with respect to the cathode, controlling, to a certain extent, the intensity of the electron beam. Two thumb screws near the base provide angular or "tilt" adjustment of the assembly and two other screws move the gun laterally at right angles to the axis of the column, thus directing the electron beam so that it coincides exactly with the tiny aperture of the condenser lens (Fig. 6).

The magnetic field of the condenser lens regulates the intensity of the beam striking the specimen, and this action is controlled by the amount of current flowing through the coil.

Focusing of the electron beam is accomplished by the magnetic field of the objective lens, producing an en-



larged image. This focusing action is controlled by the amount of current flowing through the coil with no physical change of lens or coil position necessary.

Similarly, no change of lens or coil is required for final magnification, because the electron beam is focused by the magnetic field of the projector lens and, again, this action is controlled by the amount of current flowing through the coil.

Each of the three magnetic lenses contains a pole piece designed for the particular electronic function. Pole pieces for the condenser and objective lenses are fixed. In the case of the projector lens, however, four distinct adjustments of the pole piece provide four broad ranges of magnification. A gap of  $\frac{3}{16}$ -inch between the two parts of the pole piece offers a magnification range from 7500 to about 22,000 diameters as the projector lens current is raised from minimum to maximum. When the gap is  $\frac{1}{16}$ -inch, the magnification range is from 4000 to 11,000 diameters. If only the top half of the pole piece is used, the range is from 700 to 4000 diameters. If no pole piece is used with the projector lens, the magnification range is from about 75 to 750 diameters, with distortion usually apparent in the lower part of this range. Within any of these four broad ranges of magnification, there are ten distinct values or steps of magnification, according to the amount of current applied to the coil of the projector lens. Any specified amount or degree of final magnification is obtained by selecting a suitable, fixed, and stable value of energizing current for the magnetic coil.

Only the essential components (Fig. 6) can be allowed to influence the high-velocity electrons passing from the electron gun to the photographic plate. Stray magnetic fields, vibration noises, and all disturbing factors and extraneous effects must be eliminated. For this reason, all of the essential components associated with electronic magnification are enclosed in a single, rigid, well-shielded, cylindrical column (Fig. 4) rising above the control panel.

Since electrons are influenced and scattered by air, the path of the electron beam must be essentially void of air. For this reason, the large, cylindrical, metal column is evacuated by means of suitable pumping apparatus. The state of the vacuum within the column is controlled by a single hand crank, which actuates certain valves operating an oil-diffusion pump (Fig. 4) and a mechanical force-pump. A high vacuum is obtained in a relatively short time. After insertion of a specimen, within 60 seconds the column can be evacuated sufficiently for normal use of the microscope. An interlock prevents application of the filament voltage before the required vacuum is obtained.

In operation, the ability of the magnetic lens system to produce an enlarged image depends upon two important factors; the *value of current* energizing each of the three coils, and the *velocity* of the electron beam. To obtain clear and detailed photographs of highly magnified images, these two factors must be constant during the time of exposure. For this reason, separate power supplies are used to provide extremely well-regulated current for each of the three coils. These power supplies are located in the middle and lower cubicles of the cabinet behind the microscope column and operating panel.

Since the velocity of the electron stream is determined by the potential difference between cathode and anode of the electron gun, this important accelerating potential (50,000 volts) must be maintained with an exceptionally high degree of constancy. This is accomplished by a novel high-voltage power supply (Fig. 5) contained on a single, separate chassis located in the upper cubicle of the power cabinet. Input r.f. oscillations, stabilized at 75 kc., are rectified by three type 8013-A diodes arranged in parallel, providing a stabilized and filtered output. So well-regulated is the output, 50,000 volts up to 1 milliamper, that it is constant to within less than one volt. Styrene con-

Fig. 5. Power supply furnishing an extremely stable, well-regulated accelerating voltage for the electron beam of the microscope. Output of 50,000 volts, up to 1 milliamper, is constant to within less than one volt. Styrene condensers play an important role in this unit. All connecting elements, shields, and tube sockets are of metal and are gold plated.

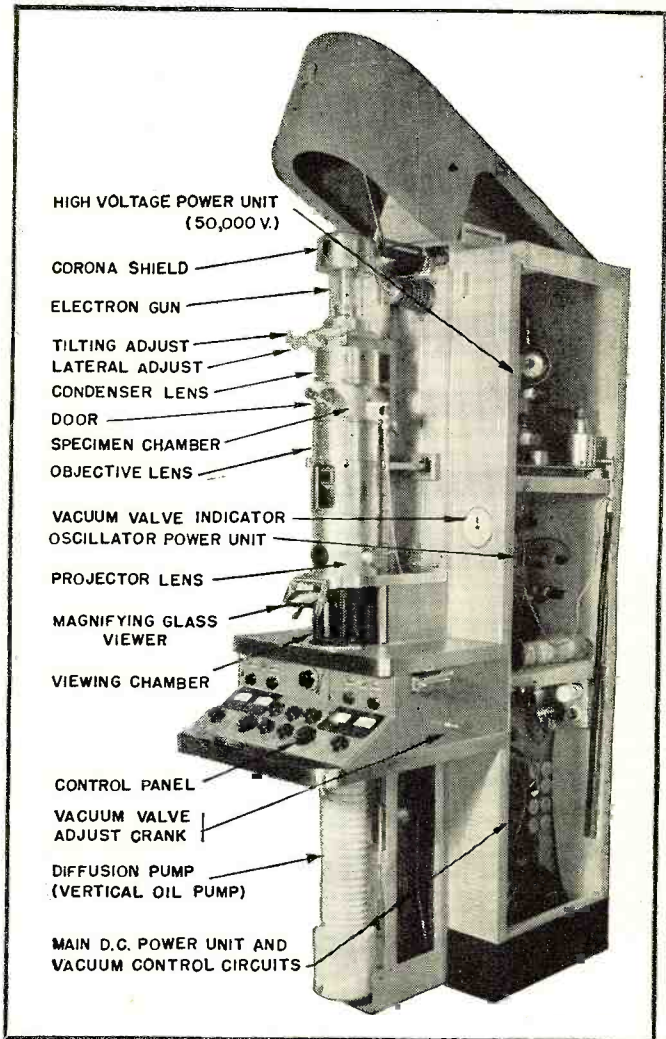
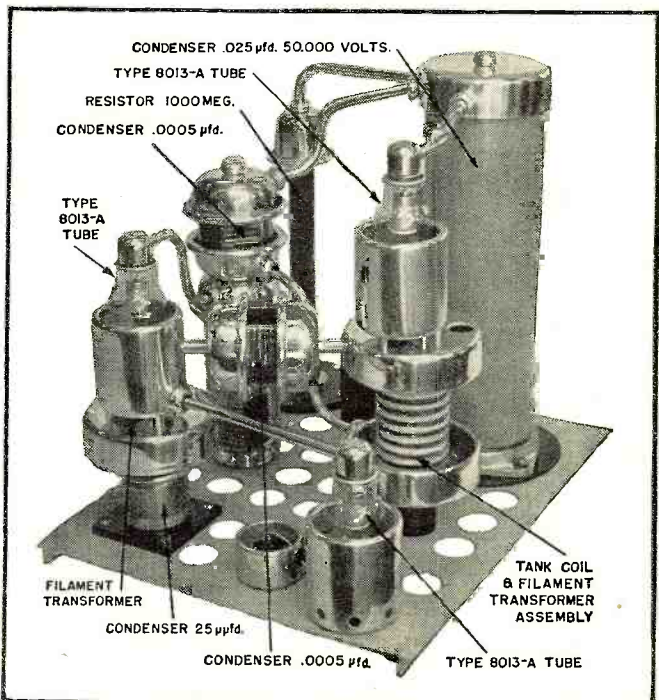
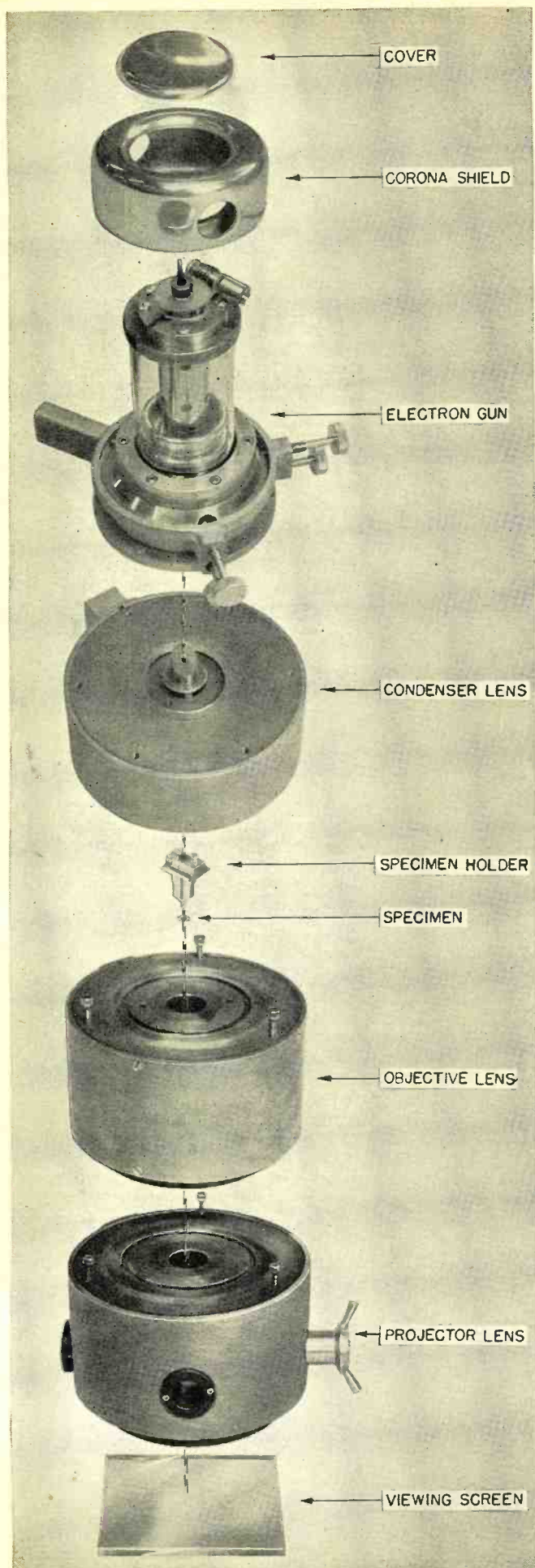

Fig. 4. Complete Electron Microscope, with metal covers removed to show location of all important electronic elements, power supplies, vacuum equipment, control panel, and other major components. Compare this with the simplified arrangement of essential electronic elements as shown in the diagram, Fig. 6.





densers are used; and connecting elements, shields, and tube sockets are metal, and gold plated!

A total of 25 vacuum tubes, power oscillators, rectifiers, and regulators, are used in the three power units contained in the cabinet of the microscope.

### Resolution

The complete Electron Microscope (Fig. 4) is considerably more complicated than the ordinary light microscope. Yet in some ways the operation of the Electron Microscope is much simpler and far more convenient. Both types of magnifying devices have certain limitations with respect to one another, but the chief difference between the two types is the higher resolving power and much greater useful magnification of the Electron Microscope.

Ordinary optical or light microscopes are quite adequate for taking photographs at magnifications of 1000 or 2000 diameters. However, an attempt at further enlargement by photography would reveal no new information; the resultant pictures would merely be larger and considerably less clear. This condition exists because the original photographs do not have sufficient resolution (clarity of detail) to permit magnification greater than 1000 to 2000 diameters. In other words, the resolving power of a light microscope is limited.

In the visible range, light waves have lengths between .0004 and .0008 of a millimeter. These wavelengths are relatively long when compared with the size of the particle or object to be viewed; and it is impossible to detect objects or details very much smaller than the wavelengths of the type of "illumination" used. For this reason, the resolving power of a light microscope is limited by the wavelength of its source of illumination, i.e., light.

High-velocity electrons used in the Electron Microscope, however, have a wavelength about 1/100,000 that of visible light. Thus, image resolution with the Electron Microscope is far greater than that obtainable with the light microscope.

Resolution is defined as the ability to distinguish between separate parts or sections of an image.

As a practical example, the average human eye cannot resolve two dots on a piece of paper unless they are at least .2 millimeter apart. One millimeter equals 1000 microns; but even the micron is too big to measure the infinitesimal field of vision of the Electron Microscope. The Angstrom unit is used; and 1 micron is equal to 10,000 Angstrom units.

Stated another way, the average human eye cannot resolve or distinguish detail that is smaller than about 2,000,000 Angstrom units. The Electron Microscope, however, has a maximum resolution of better than 100 Angstrom units!

In everyday terms, this means that particles smaller than a millionth of an inch can be seen clearly and distinctly by the Electron Microscope.

(Continued on page 102)

←  
 Fig. 6. Essential components of the Electron Microscope, which originate and control the high-speed stream of electrons. The electron gun consists of a heated cathode and "open" plate, and is the source of the electron beam. Velocity of electrons is maintained constant by the potential difference (50,000 v.) between cathode and anode. Downward direction of electron emission is controlled by tilting and lateral adjustments of the electron gun assembly. Density of the electron beam, just prior to its application to the specimen under observation, is controlled by the magnetic field of the condenser lens. Passing through the specimen holder, the electron beam "illuminates" the prepared specimen. Electrons are affected or influenced according to the varying density of the specimen area being illuminated. Some electrons are scattered out of the field completely; those that continue their journey bear an image of varying density. Focusing of the electron beam is accomplished by adjusting the amount of current flowing in the coil composing the objective lens, with all distances between electronic elements remaining fixed. The amount of final magnification of the image is determined by the amount of current flowing in the coil of the projector lens; and again no physical movement or change of lenses is necessary to vary the amount of magnification. Final image is obtained when the electron beam strikes an observation screen or photographic plate.

# An Open Letter to the RADIO MANUFACTURER

By A. C. W. SAUNDERS  
Saunders Radio & Elec. School

**Servicemen make excellent goodwill ambassadors--  
you can help them by heeding these suggestions.**

**T**HE engineer designs a radio receiving circuit employing mathematics and techniques of radio physics.

The radio service technician approaches the maintenance of a radio receiver with a knowledge of test instruments, technical skill, and patience.

In design, the circuit is engineered to give the utmost in performance. This is considered in the blueprint and mathematical stage. For "eye appeal", to aid sales promotion, the receiver is dressed up with a handsome dial and cabinet as befits the American home.

In making the prototype of a receiver the mechanical design of the chassis and the parts layout is tailored to fit a production schedule and minimum manufacturing cost considerations. The latter, of course, is economically sound. However, in the arrangement of component parts very little consideration, if any, is given to future repair problems.

We can support this statement with an example from a recent servicing report which showed where a manufacturer located an i.f. transformer too near the rectifier tube. This caused frequency drift. The hours spent in tracking down the source of the trouble were most discouraging. Space does not permit listing the many errors, from the service standpoint, in design and layout of component parts. To mention a few examples will serve to illustrate the point of this article.

The object of this "open letter" is to point out that suggestions from experienced radio servicemen can be of great value to the industry as a whole and will result in giving the general public better and quicker service.

The most profitable service is quick service. For the radio repairman time consumed in getting to the root of a trouble is wasted time. An example of this is in the case of the i.f. transformer versus the rectifying tube. The record shows four hours of troubleshooting. It took only 2 minutes to place a piece of asbestos as a heat shield around the i.f. can.

*The Radio Service Industry* now has 27 years of knowledge and experience. The time has come when the repairman in the field should be given a chance to offer constructive suggestions on receiver layout which, if adopted, would enable him to give better service and face less criticism. It is only natural to feel that such an exchange of views between them would be of mutual benefit to both manufacturers and servicemen.

I venture, on behalf of the radio service fraternity, to make the following simple suggestions for consideration.

The tube socket pin connections are important test points in diagnosis. In most cases these contact points are obscured and difficult to reach. They are invariably hidden by a conglomeration of component parts and wiring networks. It becomes a practical impossibility to apply a signal tracing probe, or for that matter, a voltmeter test prod without first removing a number of component parts. When this has been done,



THE AUTHOR

frequently the test is of no value. For example, the output transformer in a popular model receiver completely covered three tube sockets and the connecting wires of the transformer were inaccessible for tracing or test. Cases of this kind are numerous.

The reproduction of the above mentioned receiver was unexcelled, but disturbed by intermittent operation. The cause was eventually found to be a tone control condenser buried under an array of component parts. These parts had to be removed before the condenser was accessible for test and observation. The record shows: time consumed in removing parts—30 minutes; diagnosis—5 minutes; replacing parts removed—30 minutes. This amounted to one hour wasted due to inaccessibility of the defective unit at the plate of the output tube. It is suggested that the tube socket terminal connections be at all times accessible for making tests.

A competent radio repair technician (most of us are that) is one who spares the soldering iron and systematically performs a test in tracking down trouble. If given the opportunity he is able to diagnose an electrical defect in a ten tube receiver in ten minutes while his soldering iron is still cold. His system is as follows:

1. He first inspects the underneath wiring of the chassis for obvious defects such as poor connections and loose parts. This is a *must* for every receiver. He does this first before applying power.
2. He then checks tubes. Sometimes he has to rig up a derrick to get the tubes out of tough locations.
3. He then tests "A", "B", and "C" voltages, and signal traces, if necessary.
4. Then he aligns the set, if necessary.

(Continued on page 141)

# The AFCA and NATIONAL DEFENSE

*Hams and former military communications personnel can render a real service to the country by signing up with AFCA.*



Communications are vital in all phases of national defense. Large scale operations in the air, on the land, or on the sea would be impossible without overall communications.

By  
**BRIG. GEN. S. H. SHERRILL**  
Executive Secretary  
Armed Forces Communications Assn.

I SHOULD like, at the beginning of this article, to examine in rather general terms the military situation of the United States from the point of view of Industry's part in it. This can be done by quoting General Eisenhower and General Collins in their most recent utterances. They are, therefore, the thoughts of military leaders to whom all information on these matters is available.

You know, after the first World War, the public settled back and said: "Well, we have won this one. Thank God, we will never have another one of these. We are through with this business of war. We don't want to hear any more about it. That is the job of the Army and the Navy. That is what we pay them for. Let them worry about it." So everyone settled back and the Army and Navy attempted to do what they could with no support or interest from most Americans and their representatives.

Washington feels very keenly that we must not let that condition develop again because the problems of national security are far too profound, and their ramifications are too great, frankly, to

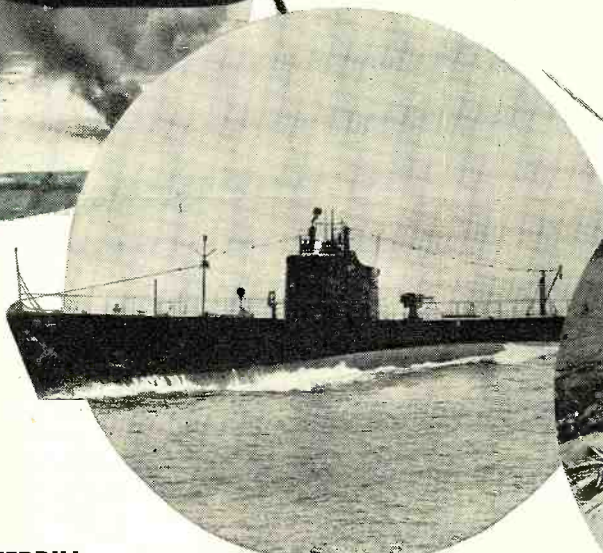

trust them to the military services alone. We are confident that any war of the future—as never before—will be total and will touch whole populations to a degree hard for us in the United States even to imagine. Certainly, we know from the last two world wars that they were not fought solely by people in uniform. And even the greatest proportion of people who fought it in uniform, were civilians a few short months or years before the pay-off.

We have finally learned that national defense is not the exclusive property and concern of men in uniform, but is the responsibility as well of labor, management, agriculture, industry, and every group that goes to make up the national life. We also have gained a clearer appreciation than ever before of the value of the time factor in the security problem. The layman, equally with the professional, has correctly interpreted the events and developments of our century to mean that no matter how vast may be a nation's latent or potential power, it will be helpless to defend itself if, unprepared, it is suddenly subjected to attack by a modern military machine.



Many did believe that, in 1948, major security projects have slight chance of passage because this is an election year. But now—since March—the people and their representatives in Congress are at last awake to the danger of apathy in military preparedness.

Our unique industrial economy—universally accepted as a major factor in the Allied victory—is stronger than ever before. Foremost among many technical advances, we have achieved atomic fission. Alone among the industrial powers, our production plant suffered no physical damage during World War II; in fact, we amplified our productivity and developed new techniques that vastly increase our economic efficiency. Consequently, our productive capacity now exceeds, by a greater margin than ever before, our essential domestic consumption, and this differential is a highly indicative yardstick of a nation's defensive potential.

Generally speaking, another war would be fought with weapons devel-

oped before its onset. Except in rare instances, weapons whose development is initiated after outbreak of war have little effect on its outcome because of the time lag between birth of the idea and the attainment of volume production. We must do everything possible now to assure ourselves that we will fight another war with weapons more advanced than those of an enemy. In particular, we must concentrate on designing ground army equipment that will be air-transportable; airborne troops must be given relatively the same supporting fire power that was available to infantry divisions in the last war. And aircraft of maximum speed and fire-power must be developed—with the latest in communication and photographic equipment.

Planning for American security, however, is based ultimately on our industrial economy. This is the primary field of the Munitions Board and the National Security Resources Board—agencies established in recognition of the fact that, if numbers were the sole yardstick of military capacity, we could not expect victory over a more numerous foe. General Marshall observed at the end of World War II that we were able to mount successful offensive operations all over the world despite a strategic inferiority in numbers of troops, because the United States industrial establishment vastly exceeded that of the combined enemy. Superiority in the air and on the sea, in ground mobility and fire power, based on industrial output, gave our combat forces superiority at the points chosen for attack. In the future, military readiness must include industrial readiness; and industrial mobilization must be an integral part of de-

fense mobilization. Effective organization, and the enabling legislation required, merit a priority in our security planning.

Joint effort by government agencies, the Armed Forces, industry, and labor can assure us the quick conversion of the nation's industrial establishment to war effort should an emergency demand it. For this, as for political and military planning, we have the lessons of two world wars to guide us.

The major defects of past industrial mobilization have been; inexperience of civilian plant operators in producing purely military items, inefficient allocation of material due to competition between the services and between them and private enterprise, and delays caused by retooling, and by shortage of skilled manpower in some areas while a surplus existed in others. The fundamental defect, however, was the lack, during peacetime years, of coordinated preparation by the industrial and military establishments for the future effort that would be demanded of them jointly.

All of the foregoing indicates that there is a greater need now than ever before for closer cooperation between the military and civilians. Ordnance saw a need for a link between them back in 1919, 29 years ago, and Army Ordnance Association was formed. Over the intervening years that Association has grown in size and ability to assist the Armed Forces; so much so that the Chief of Army Ordnance recently stated: "Since World War II, the Association has carried on a splendid fight for national awareness of the dangers of apathy in armament matters. Perhaps no other group within or without the Govern-

ment strove so consistently and for so many years for the right to give industry educational orders. Certainly no other civilian group has done so much in promoting what I call the Science-Industry-Ordnance Fraternity.

"In conference with the Army Ordnance Association, it has been decided that, henceforth, the Ordnance Department will keep industry informed through the Association. The Association will thus be the liaison to tell manufacturers our plans for production, the problems we have for them to solve, ways in which cooperation and coordination may be made more effectual. Five active committees of the Association—on artillery, fire control, gauges, small-arms ammunition, and small arms—have already sat in conference with us a number of times, and put much effort into solving of our mutual problems. Members of these committees are key industrialists, and when they speak for the companies of which they are executives, their attack on problems is direct and followed by action."

Industrial engineering of the sort these men carry on is vital. Recognition of this fact is seen in the present aim of the Army-Navy Munitions Board to develop an industrial mobilization plan that is larger, more all-embracing than any attempted before in peacetime. Some phases of the plan have already been activated, while top military and industrial experts are working out others.

And that brings me to Armed Forces Communications Association, the reasons for its formation and what it has done and hopes to accomplish. Just recently, the Munitions Board in a directive outlining to the military planners the procedure to follow in the alloca-

(Continued on Page 188)

Naval radiomen, such as these shown operating a "walkie-talkie", can again fill a vital role in national preparedness.



# New Trends in RECEIVER DESIGN

By

**W. WILLIAM HENSLER**

Staff Eng., Howard W. Sams & Co., Inc.

**A**T THE late war's end, there was a shortage of all consumer items. Included in this shortage were home radio receivers. This condition resulted from radio receiver manufacturers engaging in other work, thus causing a stoppage of new receiver production as well as contributing to a shortage of replacement and repair parts. After replacement parts and tubes became available many receivers could not be put in operation economically, and there was an obvious need for radio receiver manufacturers to produce new equipment quickly. The O. P. A. regulations constantly hampered the radio industry, necessitating many compromises in components and parts. The radio industry was one of the first to convert to peacetime activities, and incidentally, has been one of the first to fill the needs of the market. As proof of this prompt action, it has been estimated that 15 million receivers were manufactured in 1946 and about 18 million in 1947. One of the reasons for this quick recovery to near-peak production was the fact that many of the first postwar models were identical chassis to the last prewar models. This made it possible to use the same production tools, design engineering, alignment and test procedures, and thus quickly produce a product.

In a few cases some manufacturers were able to design and perfect new equipment superior to their prewar product. The apparent successes in this field are the new FM receivers, which are designed to cover both the old and new frequency bands. Prewar, of course, the FM frequency assignment was 42-50 megacycles and some manufacturers had produced receivers operating in this band. By the end of the war, the FCC had allocated a new band of frequencies, ranging from 88 to 108 megacycles, for

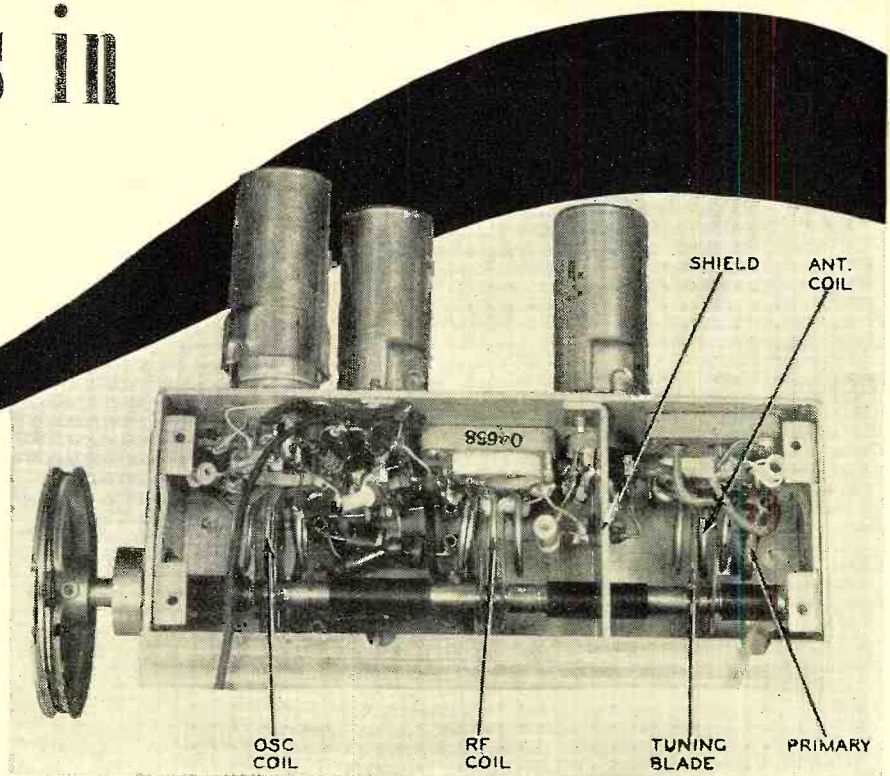

Fig. 1. Side view of Meissner Model 2961 FM tuner with shield removed.

**Part 1. The first of a series of articles covering special design features encountered in new postwar receivers. This article deals with the construction and operation of several types of FM-AM tuner units.**

FM broadcasting. Although many new techniques had been developed during the war for operation at these frequencies, there are several different tuning systems being used at the present time. This article will consider these FM input and tuning systems.

There are, at present, six distinct types of FM tuning systems being employed by radio receiver manufacturers. While some of them are more or less conventional types, it is well to point out that the requirements for an FM tuning system are somewhat different from the requirements for a standard AM tuner. First, the system must be mechanically rugged. Any tendency of the system to "give" will cause poor

calibration, misalignment, and tuning backlash—all faults which are amplified many times over the same difficulties in AM systems in the broadcast band. If the design engineer has solved the problem of producing a mechanically stable tuning system, he must then solve the problem of the most satisfactory method for injecting the FM signal from the antenna into the tuning system itself.

### Capacity Tuned

This tuning system does not vary too greatly from the conventional design that has been used in AM receivers, the main difference being in the size of the tuning condenser and the coil. The tuning condenser usually has three plates and the coil consists of from three to six turns of wire which is usually silver-plated to give a higher "Q." Some of these coils have adjustable powdered iron slugs which may be adjusted for proper tracking.

There are two methods of coupling the antenna to the antenna coil. One is the conventional circuit using an antenna coil having a primary and secondary. The other provides for connection of the antenna to a tap on the antenna coil at the proper impedance point. The tapped coil method is especially effective where an unbalanced in-

Fig. 2. Schematic of the input circuit of the G.E. "guillotine" FM tuner.

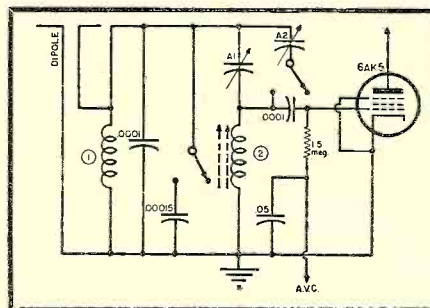

put system is used. The low side of the antenna coil is already grounded so that the shield of the unbalanced line may be grounded to the chassis. The ungrounded side of the line is connected to the tap on the antenna coil. Thus, with only one tap, the antenna impedance has been matched and a gain is realized due to the autotransformer action in the antenna coil. The other system, however, is more often used due to the more popular use of the balanced "300 ohm" line. The primary usually consists of two turns of wire, either wound inside the antenna coil or interwound at the low end of the antenna coil. The center of the primary is connected to the chassis, or more frequently is bypassed to chassis to give antenna isolation.

Most of these input systems couple to the grid of the first tube. There is another type of coupling being used. This method uses a grounded grid amplifier. *Arvin* and *Westinghouse* have introduced models using this type of amplifier. The FM signal is coupled to a coil or choke which is in the cathode circuit of the tube. The grid is grounded, or, in this case, is bypassed to ground so that a.v.c. voltage may be applied to the tube. A schematic of this circuit is shown in Fig. 3. The tube current, which flows through the cathode coil (7), reduces the effective "Q" of the coil and broadens the passband of the circuit. The grounded grid acts as a shield between the input and the output circuits. This type system requires no tuning condenser for the input circuit. The output is coupled from the plate to the grid of the next stage which is connected as a cathode follower.

Because the input capacity of a cathode follower is very low, the input resistance of the tube is correspondingly high. Note that the cathode connection

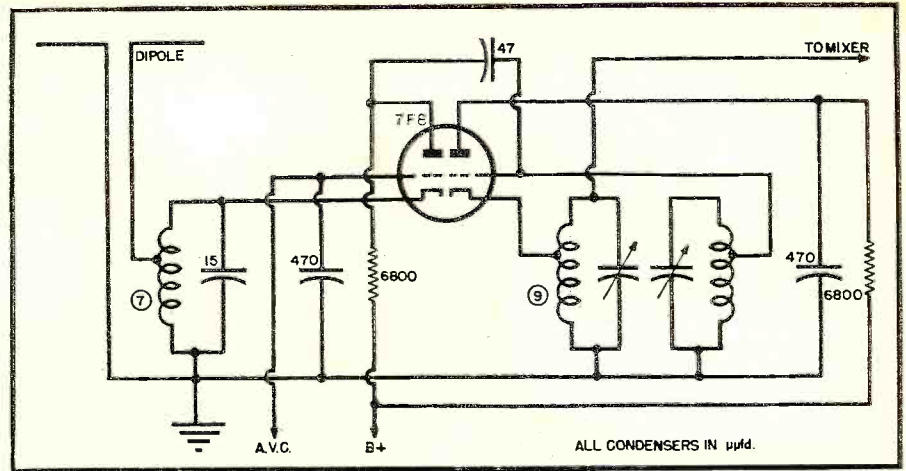

Fig. 3. Schematic diagram of the input circuit of Arvin and Westinghouse FM receivers which use the grounded-grid radio-frequency amplifier.

is tapped down on the cathode coil (9) so that some gain may be realized from the stage.

The FM and AM sections of the tuning condenser are usually combined into a single unit. This eliminates the need for coupling the two units together for tuning. To prevent excessive r.f. currents in the chassis, some manufacturers isolate the frame of the tuning condenser from the chassis and then ground each section with a large braided strap. This strap is returned to the chassis near the associated tuned circuit, thus reducing chassis paths in series with the tuned circuit.

The most popular type oscillator used in the condenser-tuned circuits is the "hot cathode" type. This is probably due to the ease with which the coil can be tapped. Since the oscillator coil is connected to the chassis, the heater terminal of the oscillator tube to be grounded may be connected to the cathode. A heater choke is connected in series with the other heater lead. This places the heater above r.f. ground and reduces the

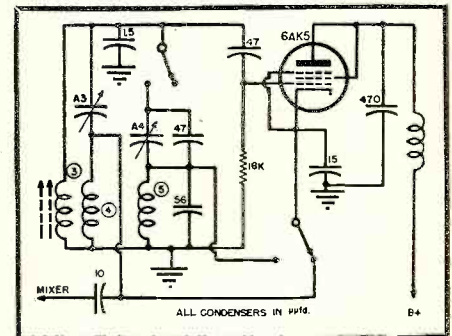

Fig. 4. Circuit of the oscillator portion of the G.E. "guillotine" FM-AM tuner showing the bandswitching arrangement used.

shunting effect of the heater-to-cathode capacity.

Those sets not using separate oscillators usually use the 6SB7-Y or 6BE6 as mixers. The use of a dual-triode is becoming more popular. *Motorola*, *Westinghouse*, *Crosley*, and *Philco* are a few of the companies who are using this type of converter almost exclusively. In this

(Continued on page 170)

Fig. 5. Top view of the G.E. "guillotine" tuner.

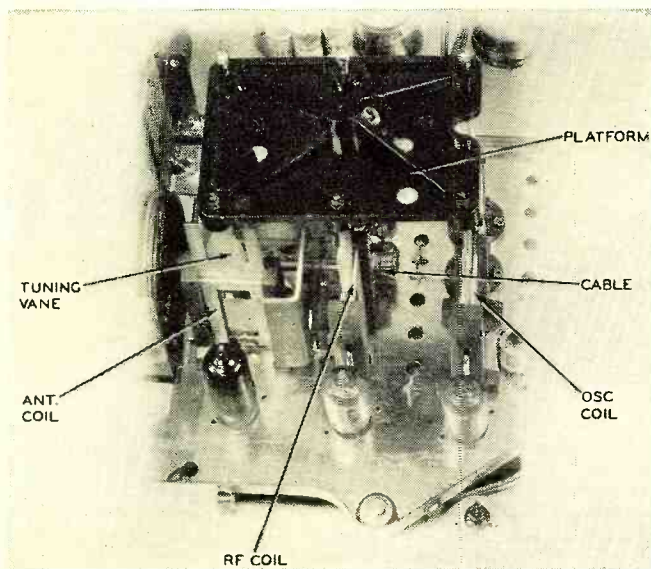
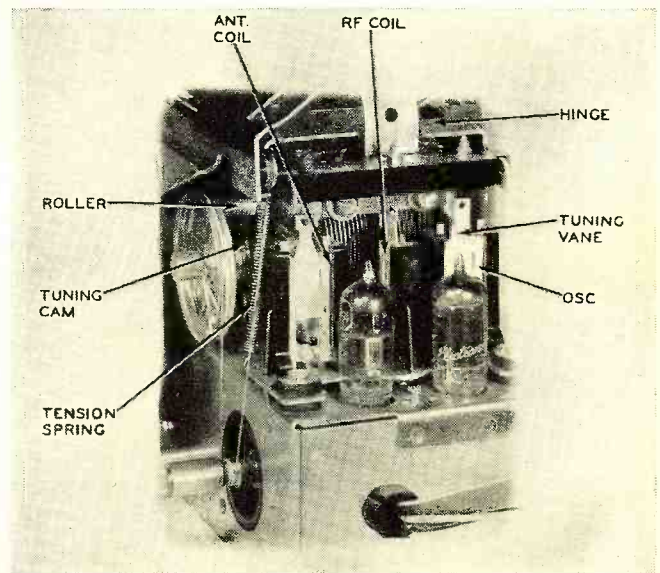
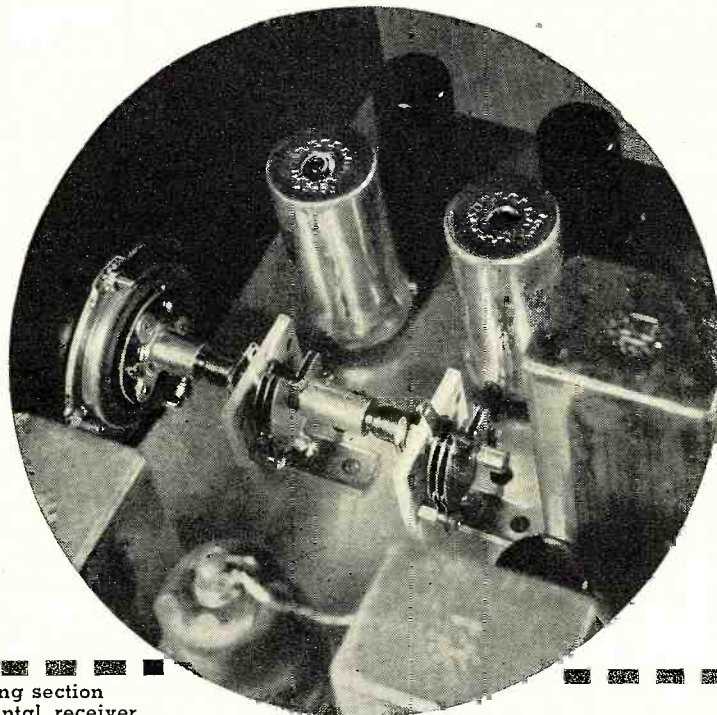

Fig. 6. Another version of the "guillotine" tuner.



# A New Approach To GANG TUNING

By NEWTON G. NOELL, W9BMS



Top view of tuning section of the experimental receiver. Access holes in coil shields are for adjusting the padder condensers.

## Simple method for designing ganged tuned circuit for home-built sets, using permeability tuned coils.

Fig. 1. Typical application of slug-tuned coils in a superheterodyne receiver.

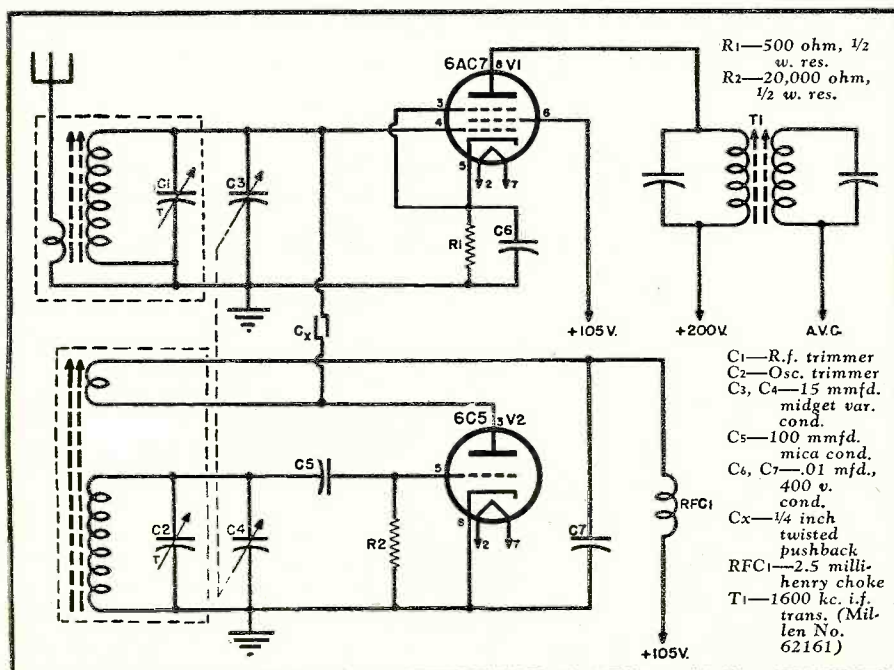

IT is a well-known fact that few amateurs attempt building the receivers they use, a possible exception to this being the simple regenerative jobs most of us used to learn the code and get started on the air. Reasons for this are many and varied, but the most important is undoubtedly the difficulty in using ganged tuning while retaining good tracking characteristics. It is the author's conviction, however, that the introduction of shielded, permeability tuned, plug-in coil forms should be a definite incentive to build our own receivers. They are tailormade for the job!

Little design information has been published on the use of permeability tuned coils. Therefore, it is the purpose of this article to set forth a relatively simple method of designing ganged tuning circuits using Millen 74001 coil forms, and to describe briefly a receiver that was built experimentally in the development and proof of the author's ideas.

Correct tracking in a superhet receiver is accomplished by designing the local oscillator and r.f. tank circuits so that the local oscillator always tunes to a frequency equal to the signal frequency plus or minus the intermediate frequency. This may be done easily by using a high ratio of fixed to variable capacity across the tuned circuits, providing the frequency band to be covered is relatively narrow. The one drawback, that of pruning the inductance to the exact value, can be eliminated by using permeability tuned coils. If the fixed capacity across each tuned circuit, in the form of small zero or negative drift ceramic types, is mounted inside the coil shields, the advantages to the amateur designer are easily seen.

Determination of the values of  $L$  and  $C$  to use is accomplished through the use of  $LC$  constants and a little simple mathematics.

The  $LC$  constant for any one given frequency is  $K = 25330/f^2$ , where  $f$  is in megacycles,  $C$  in micromicrofarads, and  $L$  in microhenrys. Thus, to cover a given band of frequencies:

$$K_1/L - K_2/L = C_{\text{variable}}$$

Solving for  $L$ :

$$L = (K_1 - K_2) / C_{\text{variable}}$$

Knowing  $L$ , the padder value is:

$$C_{\text{pad}} = K_2/L - C_{\text{input}} - C_{\text{min.}} - C_{\text{stray}}$$

Where:

$K_1$  is the  $LC$  constant for the low end of the band

$K_2$  is the  $LC$  constant for the high end of the band

$L$  is the desired inductance

$C_{\text{variable}}$  is  $(C_{\text{max.}} - C_{\text{min.}})$  of the tuning condenser

$C_{\text{input}}$  is the r.f. input capacity of the mixer tube or the oscillator tube, as the case may be

$C_{\text{stray}}$  is the distributed capacity of

(Continued on page 172)



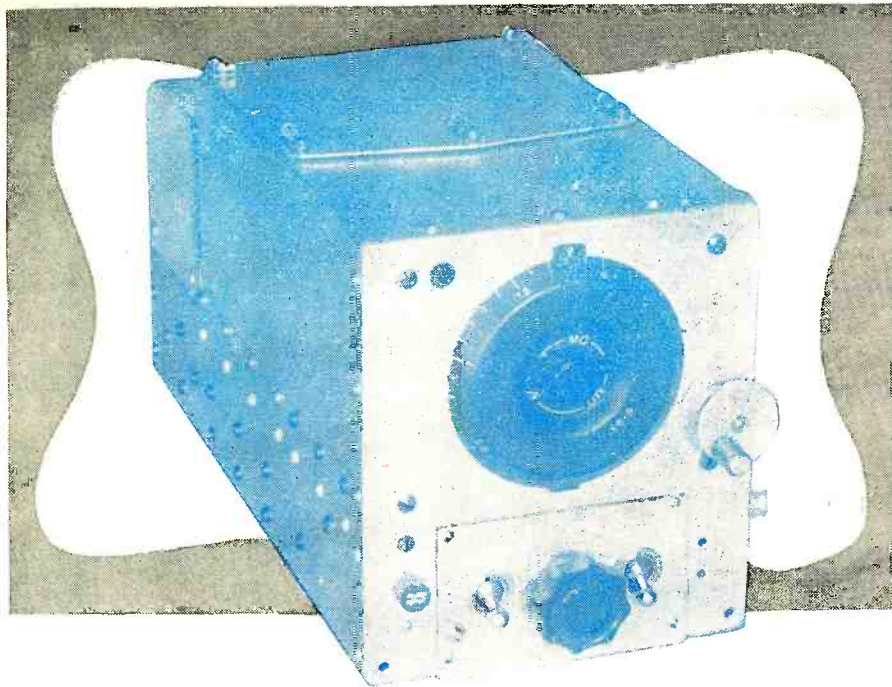

Fig. 1. A converted unit with a built-in speaker located at the rear of chassis.

# Conversion of SCR-274N RECEIVERS

By C. W. ROESCHKE, W5MLX

**Simple methods for converting receivers of the 274 series and extending their ranges.**

THE receivers of the SCR-274 series including the ARC-5 Navy version, offer the advantage of excellent construction combined with good performance. Little conversion is required to adapt these receivers to either a.c. or mobile operation, and inasmuch as the per unit cost is low, several may be purchased and used as auxiliary or standby units.

These receivers are supplied in four frequency ranges which may be readily identified by the model number. The BC-453 covers the range of 190 to 550 kc., the BC-946 covers 520 to 1500 kc., while the BC-454 covers from 3.0 to 6.0 mc. The range from 6.0 to 9.1 mc. is covered by the BC-455. These receivers all have the same general appearance and construction, and the only essential difference lies in the i.f. frequencies and frequency ranges. The circuit shown in Fig. 4 is typical of all the receivers in this series. Minor differences are in the tuning capacities and the values of a few parts.

There are several methods of conversion that may be used, depending on the

results desired. As the receivers are supplied for 28 volt d.c. operation, if batteries or a power supply are available to furnish this voltage and the receiver is equipped with the original dynamotor, no changes at all are necessary. However, it is doubtful if many users will care to operate the receivers under this condition.

The tube lineup of the receivers consists of a 12SK7 r.f. stage, a 12K8 oscillator-mixer, two 12SK7's as i.f. amplifiers, a 12SR7 as a combined second detector and b.f.o., and a 12A6 output stage. The heaters of the tubes are wired in series in pairs, permitting use on a 24 to 28 volt heater supply.

If a 24 to 28 volt transformer, capable of furnishing one-half ampere is available, the filament circuit need not be rewired. Recently there have been several transformers of this type advertised. There are also combination transformers available which are capable of furnishing the necessary plate voltage.

In the event that it is desired to use a transformer of the standard type, it will be necessary to rewire the heaters so that the heaters are all in parallel.

The first step in this conversion is the removal of the bottom plate, easily accomplished by the removal of the screws holding it in place. The tubular condensers and other components mounted along the sides of the chassis should also be removed and allowed to hang over the sides of the chassis. The leads to these components should not be removed, as they will be replaced when the conversion is complete. The heater wiring may be easily traced by following the diagrams in Figs. 3 and 4. One terminal of each heater should be grounded, and a common lead run to the other heater terminals.

When the heater rewiring has been completed, the next step is the inclusion of a gain control. This is best installed in the small adapter socket panel, held in place by four screws. This panel should be removed and disassembled, retaining only the panel portion. The hole presently occupied by the knob should be enlarged to  $\frac{3}{8}$  inch diameter to take a standard gain control. Two  $\frac{1}{2}$  inch holes are drilled on either side to accommodate the b.f.o. and standby

Fig. 2. Bottom view of a converted receiver with the ten meter converter added. The 6J6 converter tube may be seen mounted between the coil box and front panel.

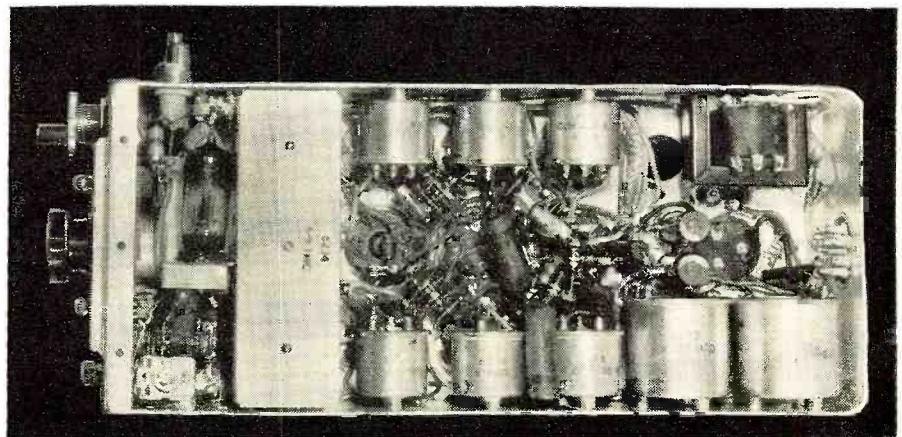

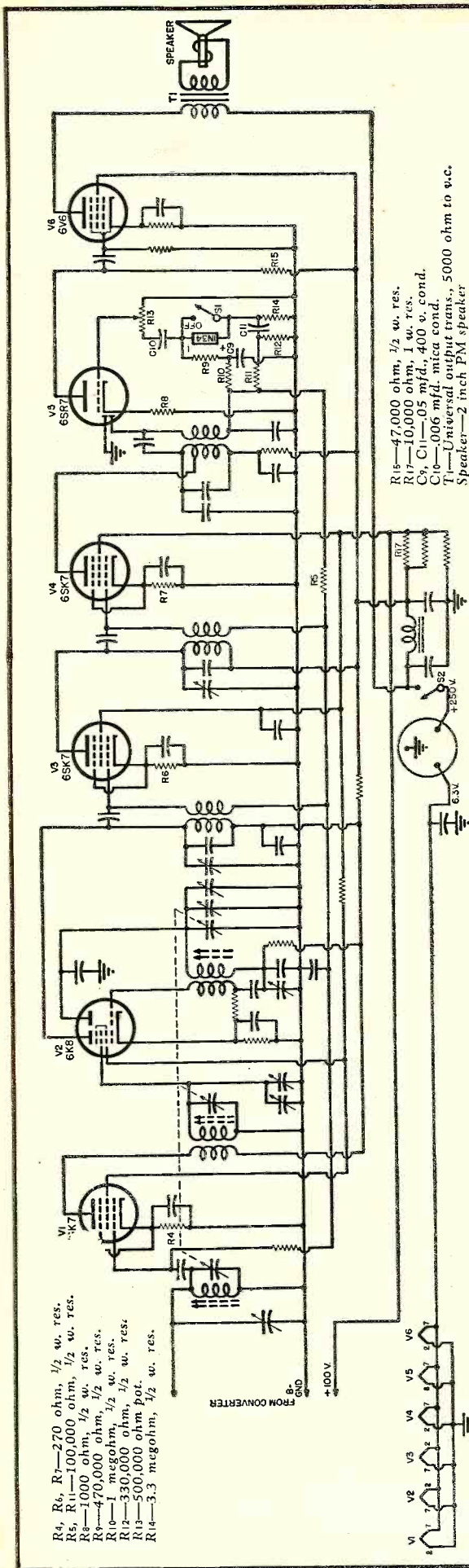

Fig. 3. Converted receiver with audio stage, noise limiter, a.v.c. and audio gain control added. Only parts which differ from the original are numbered.

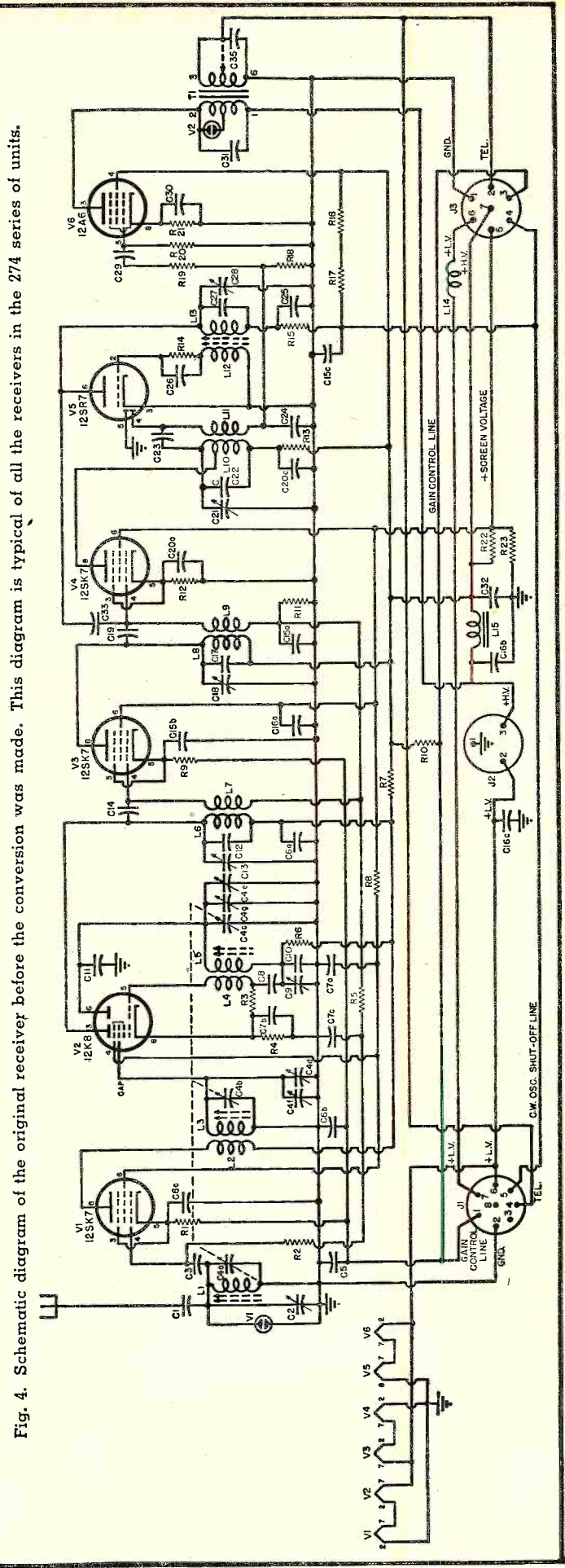

Fig. 4. Schematic diagram of the original receiver before the conversion was made. This diagram is typical of all the receivers in the 274 series of units.

switches. The gain control is connected between terminals 1 and 2 on the receptacle located just behind the control panel.

A 50,000 ohm wirewound control is the value found most satisfactory in this position. The control selected should have a taper designed for control of cathode bias. The b.f.o. on-off switch is connected between terminals 5 and 2 on the control plug. The standby switch is connected from terminal 7 and terminal 2, and serves to ground the center terminal of the power transformer secondary shown in Fig. 7.

The audio output of the receivers is rather low, but is sufficient to drive a small speaker or a pair of headphones. A phone jack may be mounted on the side of the chassis, and connected to terminal 4 of the control plug. The frame of the jack should be grounded to the chassis.

Normally the receivers are supplied with the output transformer connected for high impedance (8000 ohm) output. A tap on the output transformer permits the matching of 600 ohm loads. With the majority of headphones in use, the high impedance tap is the proper one, and the connections of the output transformer should be examined to see which connections are used.

Parts list for diagram, Fig. 4.

- R1, R4, R5—620 ohm res.
  - R2, R20—2 megohm res.
  - R3—51,000 ohm res.
  - R5—150,000 ohm res.
  - R6\*—150,000 ohm res.
  - R7, R8, R13—200 ohm res.
  - R15—360,000 ohm res.
  - R11, R19—100,000 ohm res.
  - R12—510 ohm res.
  - R14\*—100,000 ohm res.
  - R15\*—5100 ohm res.
  - R16\*, R17\*—51,000 ohm res.
  - R18—510,000 ohm res.
  - R21—1500 ohm res.
  - R22, R23—7000 ohm res.
  - C1—8.5 mmfd. cond.
  - C2—15 mmfd. cond.
  - C3—100 mmfd. cond.
  - C4—62 mmfd. per sec. (in BC-455)
  - C4—147 mmfd. per sec. (in BC-454)
  - C5—3 mfd. cond.
  - C6—.05/.05/.05 mfd. cond.
  - C7—.05/.05/.05 mfd. cond.
  - C8, C24—200 mmfd. cond.
  - C9—40 mmfd. cond.
  - C10\*—240 mmfd. cond.
  - C11—3 mmfd. cond.
  - C12, C14, C17, C19, C22, C23—180 mmfd. cond.
  - C13, C18, C21—17 mmfd. cond.
  - C15—.05/.05/.05 mfd. cond.
  - C16—.22/.22/.22 mfd. cond.
  - C20—.05/.01/.05 mfd. cond.
  - C25, C31—.001 mfd. cond.
  - C26\*—100 mmfd. cond.
  - C27\*—185 mmfd. cond.
  - C28—34 mmfd. cond.
  - C29—.006 mfd. cond.
  - C30—15 mfd. cond.
  - C35—750 mmfd. cond.
  - L1—Ant. input
  - L2, L3—R.f. amp.
  - L4, L5—R.f. osc.
  - L6, L7—In first i.f.
  - L8, L9—In second i.f.
  - L10, L11—In third i.f.
  - L12, L13—C.w. osc.
  - L14—112 microhenry r.f. choke
  - L15—3 henry a.f. choke
  - T1—Output trans.
  - V1, V2—Neon tubes
- \*Indicates values that vary with the receiver. Those shown apply to receiver B-455-B (6.9.1 mc.) only. Additional circuit elements which may be required in other radio receivers are not shown in this schematic.

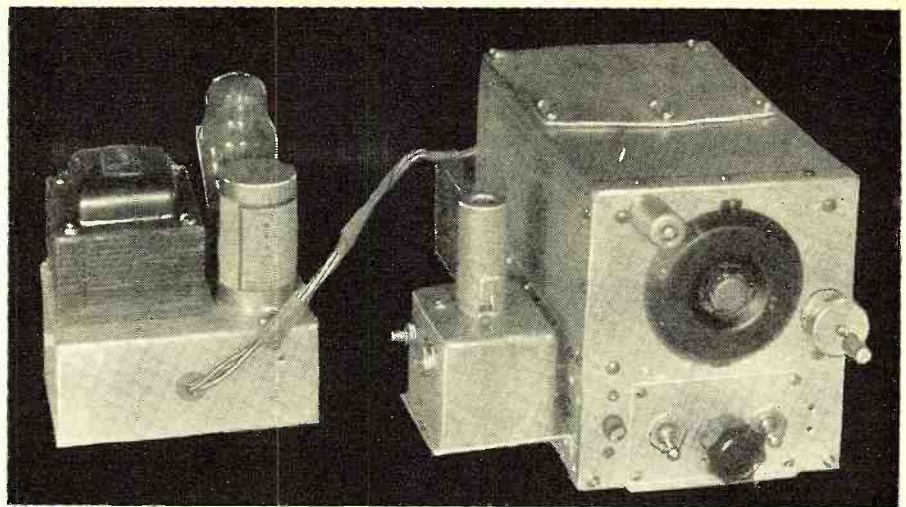
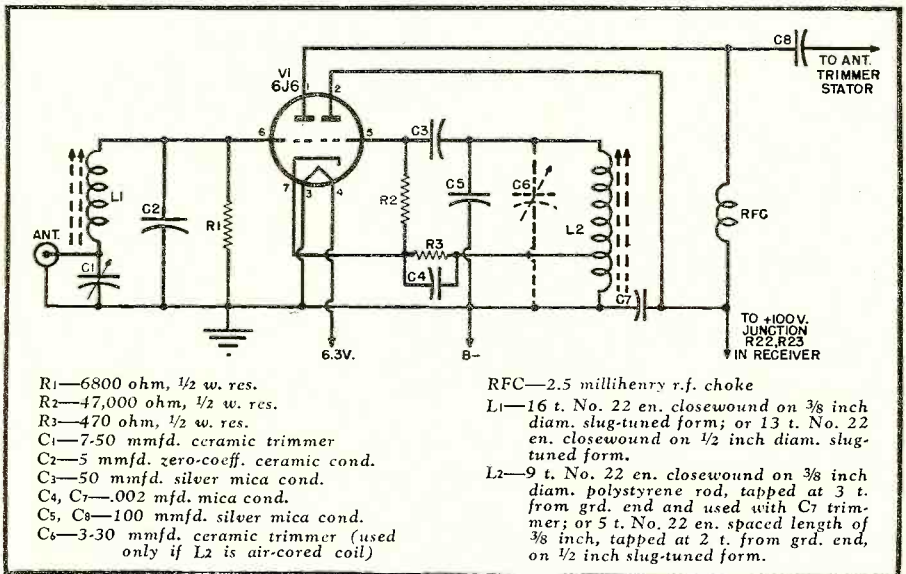

Fig. 5. A converted receiver with a.c. power supply and "outboard" converter.

With the alterations listed to this point, the receiver is ready for service, with the proper source of power. A satisfactory a.c. supply is shown in Fig. 7. The use of the resistor R1 in place of the normal filter choke serves a dual purpose. It serves to drop the output voltage to the proper value of 250 volts

and, in addition, contributes materially to the filtering action. The 5.0 and 6.3 volt windings of the power transformer are connected in series, to give a total voltage of approximately 12 volts under the load of the receiver. Care should be taken to see that the voltages in the

(Continued on page 162)



- R1—6800 ohm, 1/2 w. res.
- R2—47,000 ohm, 1/2 w. res.
- R3—470 ohm, 1/2 w. res.
- C1—7-50 mmfd. ceramic trimmer
- C2—5 mmfd. zero-coeff. ceramic cond.
- C3—50 mmfd. silver mica cond.
- C4—3002 mfd. mica cond.
- C5, C8—100 mmfd. silver mica cond.
- C6—3-30 mmfd. ceramic trimmer (used only if L2 is air-cored coil)
- RFC—2.5 millihenry r.f. choke
- L1—16 t. No. 22 en. closewound on 3/8 inch diam. slug-tuned form; or 13 t. No. 22 en. closewound on 1/2 inch diam. slug-tuned form.
- L2—9 t. No. 22 en. closewound on 3/8 inch diam. polystyrene rod, tapped at 3 t. from grd. end and used with C7 trimmer; or 5 t. No. 22 en. spaced length of 3/8 inch, tapped at 2 t. from grd. end on 1/2 inch slug-tuned form.

Fig. 6. Schematic of the converter section used with the 274 series receivers.

Fig. 7. An a.c. power supply suitable for powering any of the 274-N receivers.

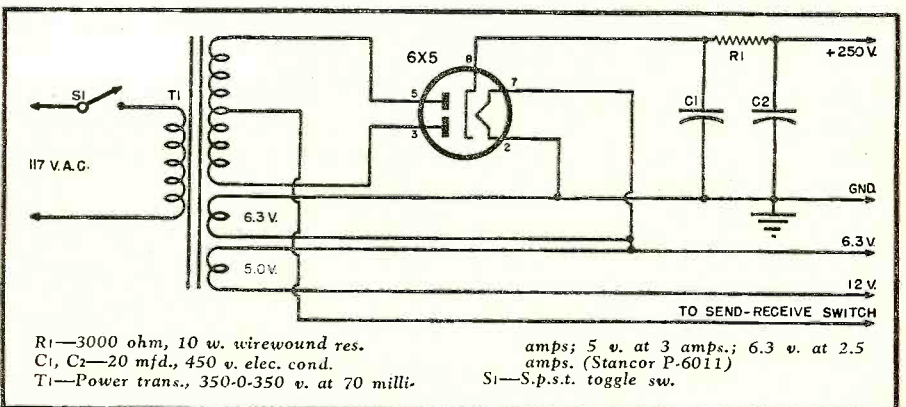

- R1—3000 ohm, 10 w. wirewound res.
- C1, C2—20 mfd., 450 v. elec. cond.
- T1—Power trans., 350-0-350 v. at 70 milliamps; 5 v. at 3 amps.; 6.3 v. at 2.5 amps. (Stancor P-6011)
- S1—S.p.s.t. toggle sw.

# Measuring Modulation Percentage of AM SIGNALS

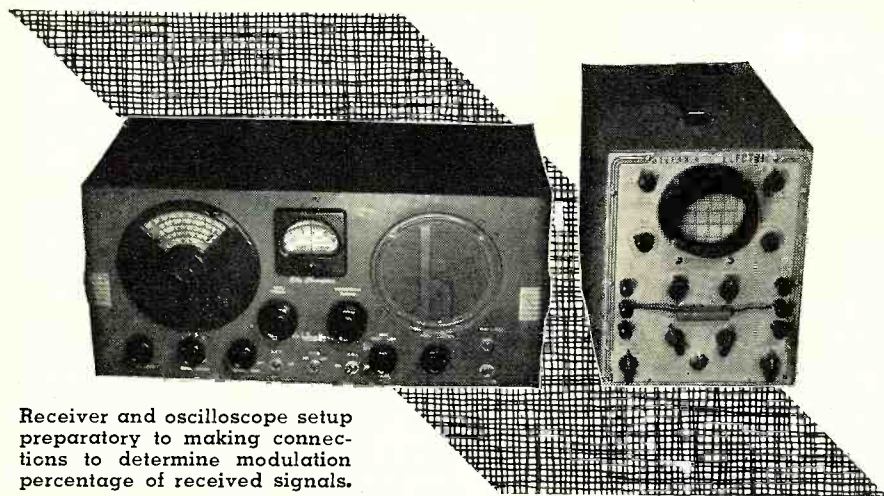

Receiver and oscilloscope setup preparatory to making connections to determine modulation percentage of received signals.

By RUFUS P. TURNER, W1AY

**Properly connected to a receiver, a scope will give modulation patterns for received signals.**

IT IS well-known that per-cent modulation reports given by most hams for received signals usually are worthless. To be sure, extremes such as overmodulation and undermodulation may be detected, but the ear is not a dependable instrument and should not be the basis of numerical reports. No serious operator is overly disturbed by an ear report rating his modulation as

such-and-such definite percentage. Indeed, it is amazing to note the various degrees of overmodulation which commonly are recognized by top amateur phone operators as flat 100 per-cent.

From time to time, readers have shown interest in securing a quantitative scheme for more accurately reporting the modulation percentage of received signals. The viewpoint has been that a simple modulation indicator would rank with the S-meter in furnishing useful information regarding received signals.

### Oscilloscopic Method

The operator who is seriously interested in measuring the modulation percentage of received signals has at his disposal an interesting oscilloscopic method. A number of amateurs already use the oscilloscope to check transmitter modulation and can shift the instru-

ment easily to the receiver. Information concerning this method has not appeared in the radio magazines for several years and undoubtedly some amateurs will learn about it for the first time from this article.

Fig. 1 shows the basic connections employed. The amplitude-modulated r.f. signal is applied to the horizontal and vertical deflecting plates of the cathode-ray tube through a phasing network comprised of condenser C and resistor R. The horizontal and vertical amplifiers of the oscilloscope are not used. The "DIRECT" inputs are employed in this application.

Action of the RC combination produces a circular or elliptical pattern on the oscilloscope screen. If the reactance of the condenser is equal to resistance R, the pattern is a circle (See Fig. 3A). For all other ratios of reactance to resistance, an ellipse appears. (See Fig. 3).

When the carrier is unmodulated, the ellipse or circle is formed by a reasonably thin line. A pattern of this type is shown in Fig. 4A. When modulation is applied to the carrier, however, this line swells outwardly and inwardly to produce a "doughnut", as in Fig. 4B, or a disc as in Figs. 4C and D. When modulation is removed, the pattern flips back to a thin-lined ellipse or circle.

Fig. 4B shows how modulation percentages up to 100 may be determined from measurements made from the center of the pattern (point A) along any radius through the pattern. These dimensions may be measured with a scale or ruler, dividers, or by means of the oscilloscope screen graduations. Anything less than 100 per-cent modulation will produce a doughnut, such as shown in Figure 4B—that is, there will be a central dark or open area. At 100 per-cent modulation, this center hole will just close completely. This unmistakable pattern is shown in Figure 4C. When the signal is overmodulated, the pattern will close up, but a bright button also will appear at its center, as shown in Figure 4D. The diameter and brilliance of this button is somewhat proportional to the amount of overmodulation, however there is no simple way of determining how much higher than 100 the percentage is. It is both interesting and useful to watch these patterns form as the received signal "talks up."

Fig. 2 shows how the oscilloscope must be connected to the receiver to

(Continued on page 181)

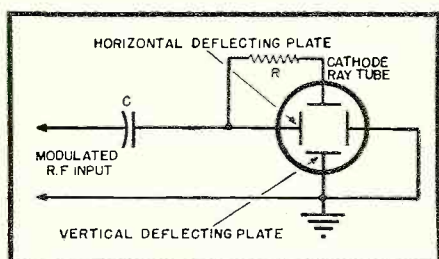
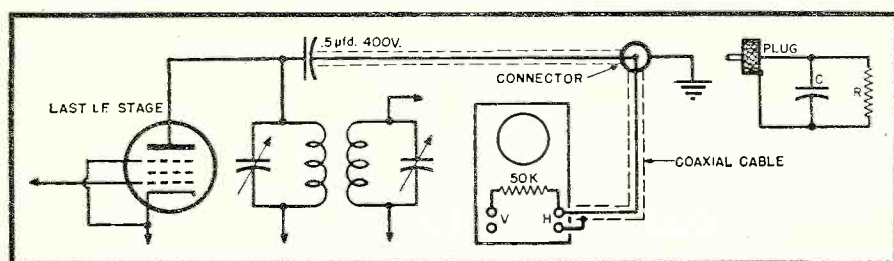
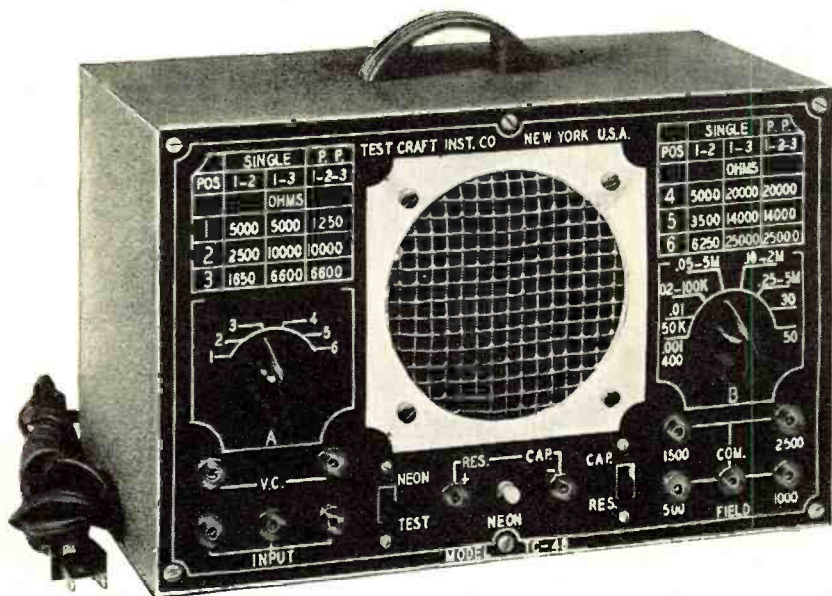

Fig. 1. Connections for producing "circular" modulation patterns on the screen.

Fig. 2. Complete connections between oscilloscope and receiver. At right is a "constant alignment" replacement plug to be inserted when the cable and oscilloscope are disconnected from the receiver.



# A Versatile SUBSTITUTION TESTER



Front panel view of a commercially-built radio servicing and test unit.

By **SIDNEY S. FLEISHMAN**  
Test-Craft Instrument Co.

## Operation and construction data on a commercial test unit designed to facilitate radio servicing.

**T**HE radio serviceman, a skilled diagnostician, like the doctor, must have the proper equipment to fulfill his obligations to his trade or profession. Efficient diagnosis of "ailing" radio receivers requires good diagnostic equipment. With the proper equipment, the serviceman eliminates all guesswork, thus tending to reduce loss of time and labor.

The increased complexity of the radio servicing profession because of recent developments in new circuits and other electronic equipment has established the fact that no radio engineer, serviceman, or hobbyist can be without the proper laboratory or service equipment.

An efficient aid to the radio serviceman is the novel instrument briefly outlined here. Basically a universal type of test speaker, this instrument also incorporates a resistance-capacity decade, leakage tester, continuity tester, output meter, voice coil, and field substitution. Because of its versatility, this instrument establishes the use of the fundamental test of substitution, the pros and cons of which have long since been thoroughly discussed. Receiver components, when under instrument tests, often appear to be in perfect condition, how-

ever, when substitution is made, they prove to be otherwise. Primarily designed as an auxiliary instrument, this unit used in conjunction with other instruments facilitates service work.

This instrument, designed around a specially engineered universal transformer, affords proper matching of load impedances up to 25,000 ohms. Both dynamic and permanent magnet types of speakers can be tested equally well. It affords replacement or substitution of any type of speaker, thereby eliminating the need for removing a speaker from the customer's home. Various load

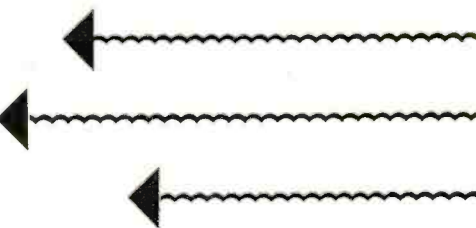

impedances are listed on a chart which is a permanent part of the front panel.

Upon suspecting an open field, the serviceman need only open the field circuit and by means of the tip jacks (marked "Field" on the front panel of the instrument) can easily and rapidly select any substitute field impedance from 500 to 2500 ohms. See Fig. 1A.

If an output transformer is suspected of being defective, it is only necessary to open the primary of the defective transformer and connect the leads from the jacks marked "Input" across the plate and the "B+" of the output tube at points X. Fig. 1B. The proper selection of the input, by means of the three input jacks 1, 2, or 3, is entirely dependent upon the load and the resistance in question. The selection of the substitute output transformer impedance and the input jacks is made by means of the front panel chart.

If the voice coil is suspected of being defective, substitution can be made easily and readily. The leads of the voice coil are first opened and connection is made at points Y by means of the test leads connected to the tip jacks marked "V.C." across the secondary of the output transformer of the receiver being tested. Fig. 1B.

The resistance substitution decade of this instrument incorporates six standard resistors. These resistors are those

(Continued on page 183)

Fig. 1. (A) Method for checking open field coil in a speaker. (B) Means for testing an output transformer (instrument inserted at points X) and method for testing a defective voice coil with tester being inserted at points Y on the diagram.

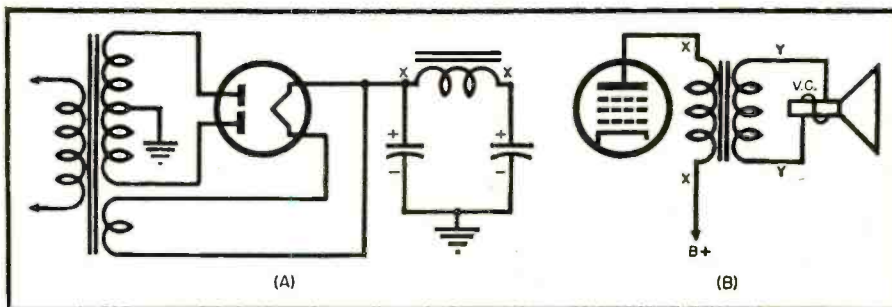
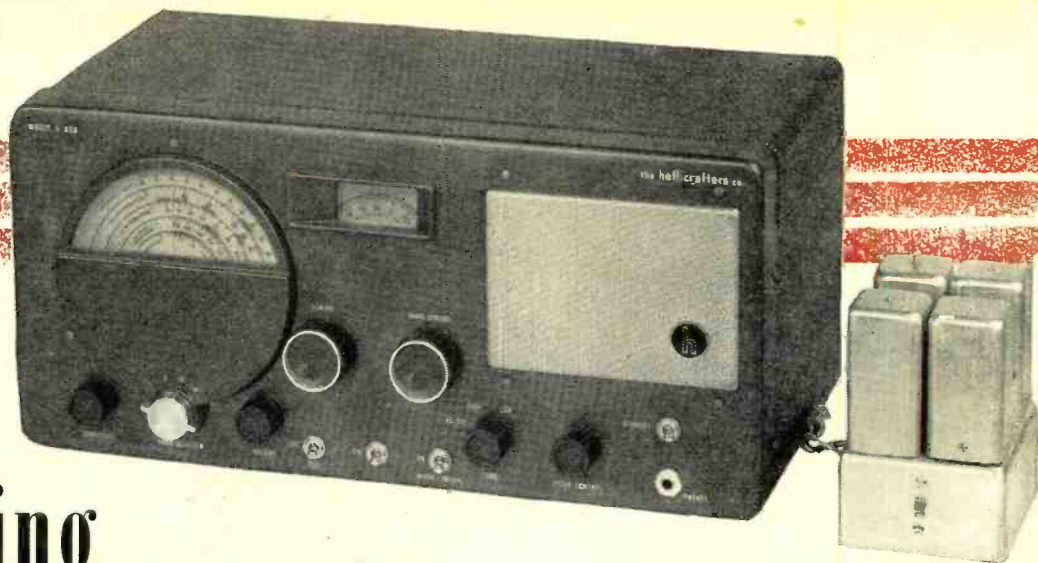

Fig. 1. The "805" shown used with a Hallicrafters S-40.



# Adding Single-Sideband Selectivity to the Communications Receiver

By **McMURDO SILVER**  
McMurdo Silver Co., Inc.

## **A description of a new, super-selective i.f. channel for use with your present receiver.**

**F**OR the amateur or the short-wave listener who has never been troubled by noise, heterodyne interference, or the inability to bring in every station clearly, this article will have no interest. Since it is doubtful that such a person exists, it is probable that the unit described will be of some interest to most readers.

The 100 kc., super-selective i.f. amplifier to be described may be connected to any broadcast or communications-type receiver which employs any intermediate frequency between 450 and 500 kc. Since 455 kc. has been adopted almost universally as the standard for receivers manufactured in recent years this i.f. amplifier may be added to practically any receiver.

When added, it will yield a small increase in sensitivity. Most important however, it will give the receiver a gain in selectivity, and a reduction in noise and interference of approximately four times.

Sharpness of tuning in any superheterodyne receiver is a function of the number, quality, and degree of primary-to-secondary coupling of the tuned circuits in the i.f. amplifier and of the in-

termediate frequency employed. Most receivers incorporate one or two i.f. stages having from four to six i.f. tuned circuits operating at 455 kc. The most expensive receivers may use three i.f. stages having a total of eight tuned i.f. circuits. For a given coil "Q," selectivity may be increased by a factor of approximately 4.55 times if the i.f. were lowered to 100 kc.

An alternative for improving receiver selectivity is by means of the widely-used i.f. crystal filter. For 100 cycle selectivity desired in c.w. telegraph reception this is satisfactory—except for the complexity of operation of the crystal filter. This is usually so great that many amateurs, even though they could use such selectivity, actually operate their receivers with the crystal filter switched out as it is too bothersome to operate.

For speech and broadcast reception the crystal filter has never proved satisfactory. Any attempt to "broaden" its selectivity curve usually results in a still sharply peaked nose to the selectivity curve coupled with curve skirts widening too fast for good selectivity but not fast enough to avoid serious distortion of signal quality. To make the general

situation just a bit worse, amateurs who have written of their experiences along this line have commented that the mania for "high fidelity" reception has caused receiver manufacturers to lessen rather than increase the selectivity of their newer receivers.

Ever since there has been an interference problem in radio reception engineers have recognized that the ideal selectivity curve would be drawn in the shape of a perfect rectangle—just wide enough to give passband width adequate for desired quality of reception yet high enough to insure rejection of nearby stations.

Articles appearing in the October and December, 1947, and the January, 1948, issues of "QST" have proposed methods of increasing receiver selectivity toward this ideal. The principle involved was to heterodyne, by a local oscillator, the usual 455 kc. receiver i.f. to a lower frequency at which greater selectivity could be obtained. This may be accomplished by a simple "outboard" i.f. amplifier added to an existing receiver.

The lower the new "outboard" intermediate frequency chosen, the greater the selectivity obtainable. Also the lower the "outboard" i.f. chosen, the greater the probability of image interference due to a signal at twice this new i.f. getting through the basic receiver i.f. amplifier. For reasons of cost, bulk, complexity and such possible new i.f. image interference vs. desired selectivity, 100 kc. appears to be a logical choice. By methods possible today really excellent "Q's"

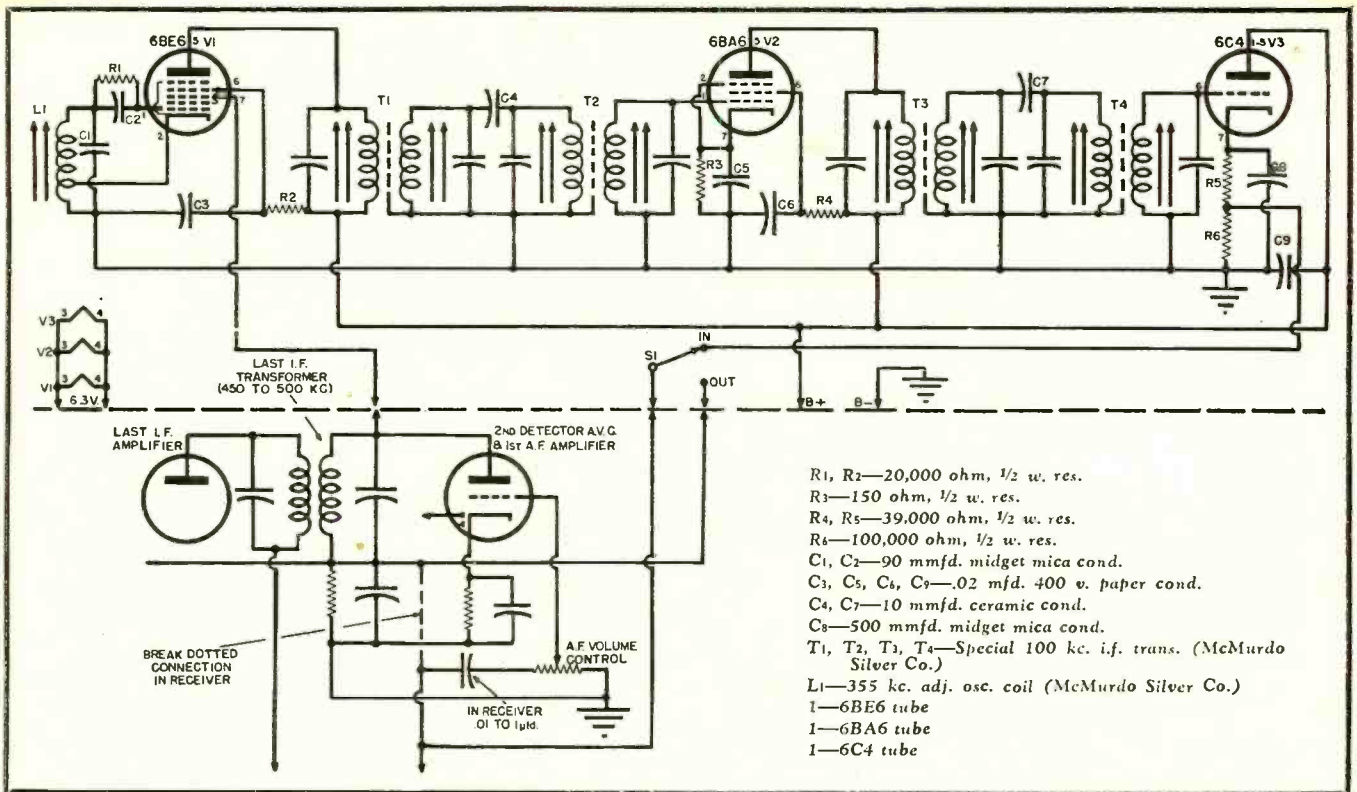

Fig. 2. Schematic diagram of the "805" converter and i.f. channel. The unit is used in place of the regular receiver i.f. channel to provide increased selectivity. The "805" is shown at top while a typical receiver i.f. is shown below.

may be obtained at 100 kc.—so much so as to yield the close-to-ideal selectivity curve of Fig. 4 for four specially designed 100 kc. i.f. transformers.

At first glance it might seem that any receiver exhibiting the sharpness of tuning of Fig. 4 would cut sidebands to a point where speech would be rendered almost unintelligible. It is only 2.4 kc. wide at its "2 times down" point, falling off with close to theoretically perfect steepness to a width of only 7.2 kc. at 10,000 times down. Fortunately, a long recognized but seldom used fact sets such thinking to naught. In any amplitude modulated broadcast or amateur phone transmission there exists the carrier frequency plus two sidebands carrying the modulating intelligence. One sideband lies below the carrier frequency and one above it. Both contain the identical audio modulation. To any engineer it is obvious that we need receive but one of these two sidebands for good signal intelligibility.

If we now look at Fig. 4 in terms of using its super-selectivity to accept but one of the two transmitted sidebands, we see that the audio frequency range is not one-half of 2.4 kc. but instead is 0 to 2400 cycles. Such a frequency range is probably as good, maybe even a bit better, from a fidelity standpoint than that provided by many of the broadcast receivers in use today.

We may, at will, tune in either sideband of a desired station. By so doing we will eliminate entirely the noise, heterodyne squeals, and station inter-

ference affecting the other sideband. Thus, we have a two-to-one improvement in selectivity. However, our conventional double sideband receiver will probably have a selectivity curve nose 8 to 12 kc. broad, with skirts falling so slowly as to be unable to reject interference lying 10 to 20 kc. away on either side of the desired signal in the event of reasonably strong interference.

If we credit the average receiver with much more selectivity than will ever ordinarily be found, that is, with a curve nose which is only 10 kc. wide at "2 times down," then it is self-evident that

selectivity, such as is shown in Fig. 4, will give a four-times improvement. In actual practice the increase in effective selectivity is much greater due to the new ability to reject all interference on one side of the signal or the other.

Figs. 1 and 3 show how we may go about getting this "new look" in truly steep-sided curve skirts. We may get it "in a box" as seen in these photographs or it may be built into an new or existing receiver in accordance with the circuit of Fig. 2. The important thing is that the circuit may be added to almost  
(Continued on page 137)

Fig. 3. Top and under-chassis views show simplicity of the unit's construction.

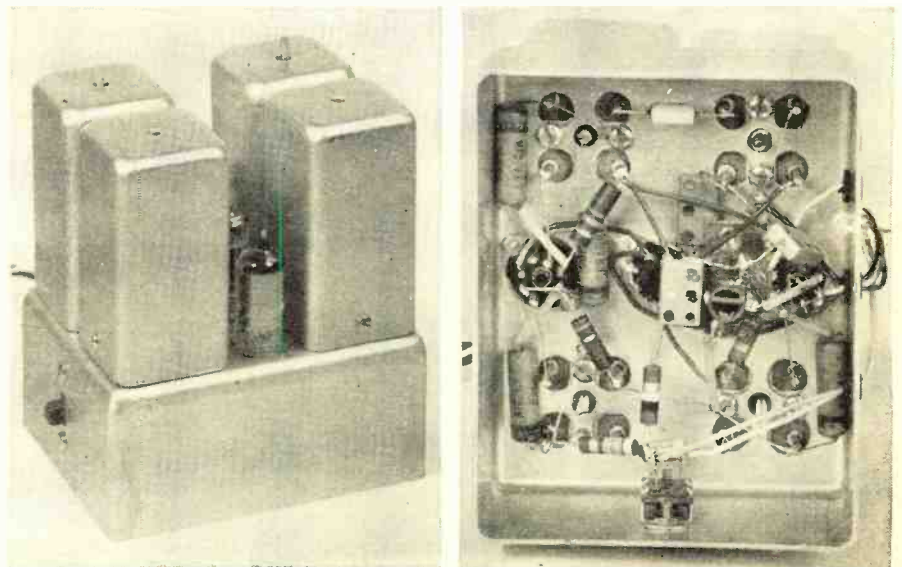

# Fundamentals of Industrial ELECTRONICS



The 750 watt TOCCOTRON, a bench type induction heating machine designed primarily for silver brazing and soldering, but adaptable to other uses.

By ROBERT ENDALL

## Servicemen—here is a source of income which has been largely overlooked but can prove lucrative.

AT THE present time it is difficult for the independent radio service dealer to predict the future progress of the radio service industry. Competition is increasing in the home radio-phonograph service field, while the need for service is decreasing with the appearance of new sets on the market. Some television receiver manufacturers are now offering installation and factory service, for an additional fee, as part of the purchase of their television receivers. Another possibility which may develop is that FM receivers, black-and-white, and color television receivers—which are much more complex and critical than AM receivers and require the use of advanced testing equipment and technical knowledge—may be serviced mainly through large centralized service organizations, if not by one manufacturer. Any of these eventualities would leave the independent radio service dealer out of the picture to some extent.

It is impossible at present to forecast whether any of the above possibilities will materialize, and what will be their effect upon the industry if they do. To a

large extent this will depend upon the quality and adequacy of the services supplied by the independent radio dealer. For his own best interests, therefore, as well as for the interests of the entire in-

Fig. 1. An electronic motor speed control system consisting of a d.c. motor driven by a motor-generator set whose field is energized by the electronic regulator.

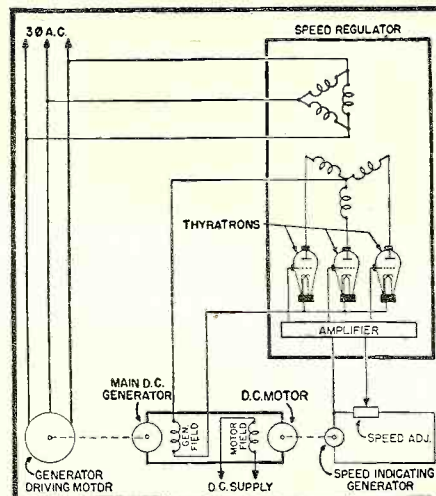

dustry it is imperative that he keep his technical progress and equipment abreast of the latest developments in electronic design and manufacture. Instead of allowing himself to be restricted to the relatively narrow prewar fields of home and automobile radio sales and service, he should attempt instead to expand the field of application of the services which he can supply.

One phase of the electronic industry which can potentially become a major phase of the radio service industry in the reasonably near future is the installation, maintenance, and repair of industrial electronic equipment. The fields of application of electronic controls in industry are increasing at a tremendously rapid pace, now that their value has been demonstrated by their many wartime applications. Proof of the importance and potentialities of industrial electronics is given in the recent statement of the Federal Communications Commission that *the dollar volume of r.f. heating equipment alone at the present time is equal to the total value of production of all communications equipment.*

A number of considerations arise in the service of industrial electronic equipment which make it quite different in certain respects from servicing other radio and electronic devices, and which make the services of the independent radio repairman particularly valuable.



When a failure is encountered in an electronic control device installed in a factory production setup, immediate location and repair of the defective item is of the utmost importance, since many thousands of dollars worth of time, labor, and materials may be lost by unnecessarily prolonged delays in the resumption of production. In addition, preventive maintenance and periodic inspection of equipment perform the extremely valuable function of detecting potential breakdowns of equipment and correcting the defects before they can interrupt production. These factors may open the field of industrial electronic servicing to the local independent radio repairman, since the owner of a manufacturing plant can always count on having preventive maintenance and emergency repair service available on immediate notice, and is at the same time spared the expense of employing his own maintenance department for electronic control equipment.

In many communities, the radio service dealer who has established his competence often tends to take on the position of a sort of independent radio and electronic consultant, to design and build numerous electronic devices which his customers may desire for various purposes. In the past, such equipment has consisted mainly of custom-built radio receivers and phonographs, and gadgets such as automatic garage door openers, burglar alarms and photoelectric exposure timers. In some cases, however, they have been of a much more complex nature such as custom-built test equipment for industrial concerns. There is every possibility that this tendency may extend to the field of industrial electronic controls, particularly in their installation and maintenance. With an intelligent and conscientious approach on the part of independent repairmen, this should become a major field for the future utilization of their services. However, the great responsibility involved in such service cannot be too strongly emphasized, and the service dealer who plans to engage in industrial service work must be prepared to accept fully this responsibility.

This article is written to present an introduction and brief review of the basic principles of industrial electronics, for the benefit of the radio repairman who would like to prepare himself for future work on industrial electronic control equipment.

#### Major Applications

In many applications the introduction of electronic principles has made it a relatively simple matter to perform functions which would otherwise be impossible, while many other industrial problems have been solved better and more cheaply by mechanical or other electrical means. Electron tube devices

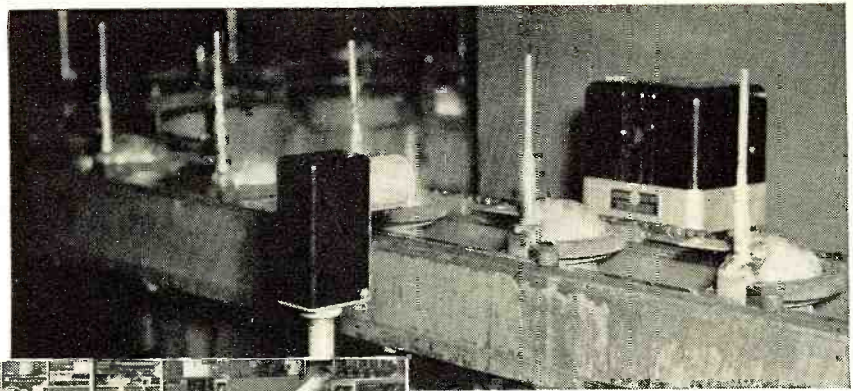

↑ An example of a photoelectric relay setup to count objects passing on a conveyor. The objects interrupt a beam of light thus actuating the relay unit.

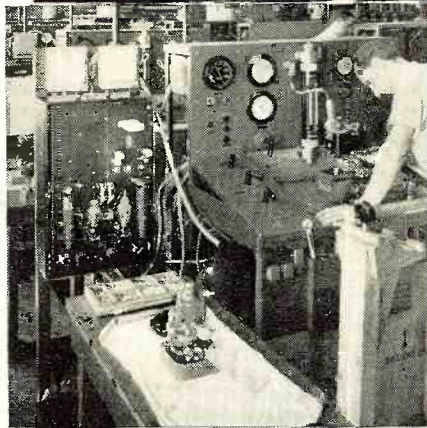

← Electronic motor drive used in testing airplane propeller governors. Continuous and accurate control of speed is possible with this electronic control.

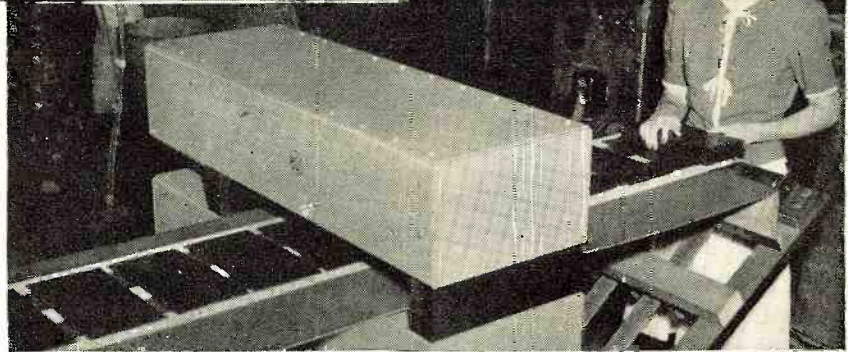

↑ Electronic metal detector inspecting plastic blanks to eliminate any piece containing metal particles before the material is subjected to processing.

→ Photoelectric color register control for multicolor gravure press.

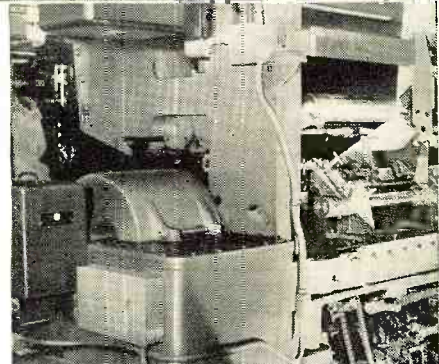

↓ Photoelectric scanning head with gas-cutting control mounted on gas-cutting machine. The photoelectric scanning head follows the pattern.

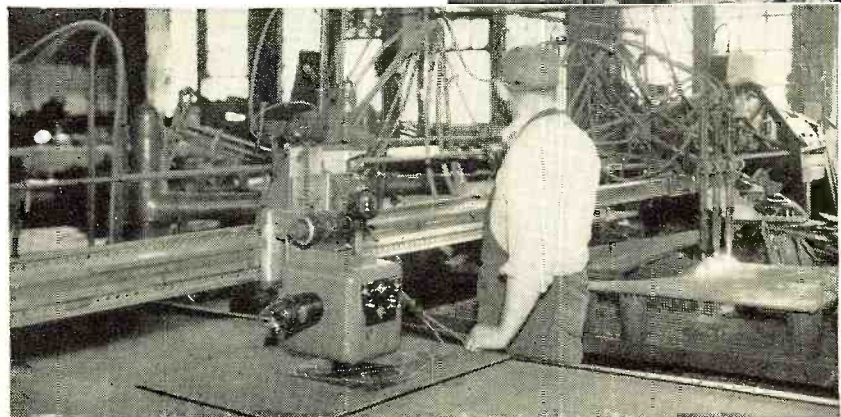

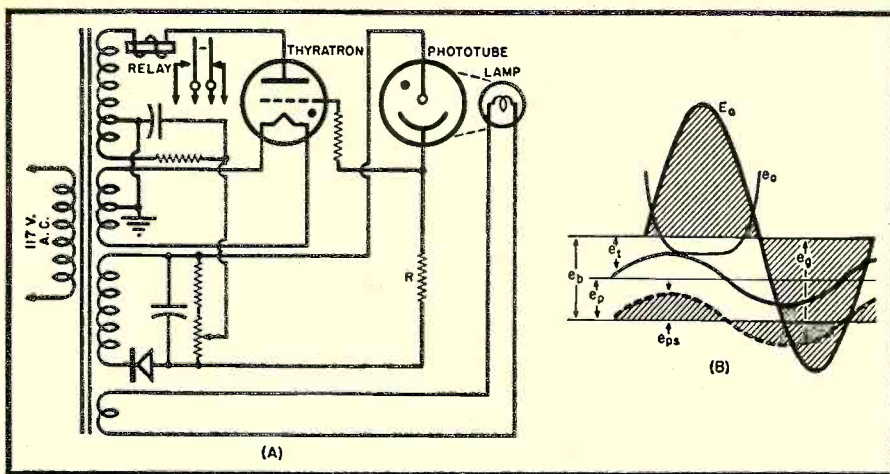

Fig. 2. (A) Basic circuit for an a.c. operated photoelectric relay. (B) Voltage relations of the basic circuit shown in (A).

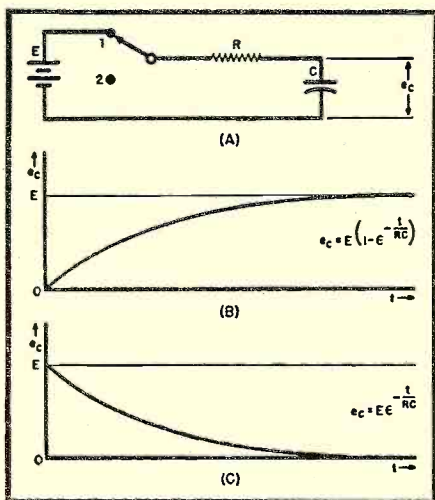

Fig. 3. (A) Circuit for determining voltage across a condenser in a single series RC circuit. (B) Voltage across condenser charging and. (C) discharging.

have proved of value to industry in such applications as process control, as safeguard and alarm devices, and for electrical, mechanical and optical measurements. A few of the many important

types of electronic controls, and some of their major applications, will be described briefly to give an indication of their great present and potential value to industry:

(1) Photoelectric controls, which were the earliest application of electronics in industrial control, are still among the most widely used and among the most important applications of electronics in industry. They are useful for actuating systems in response to a change of color, shade, density, shape, or position of any component of the system, without mechanically touching the controlling object. There are several types of applications:

- (a) Where only a simple on-and-off relay effect is desired, for instance as limit switches to control manufacturing operations, or for the stoppage of machinery when a light beam is affected, as by a break in a printing press paper roll.
- (b) Where a varying light intensity produces a variable regulating effect, as in process regulating equipment.

Fig. 4. Schematic diagram of a lock-in type of photoelectric relay.

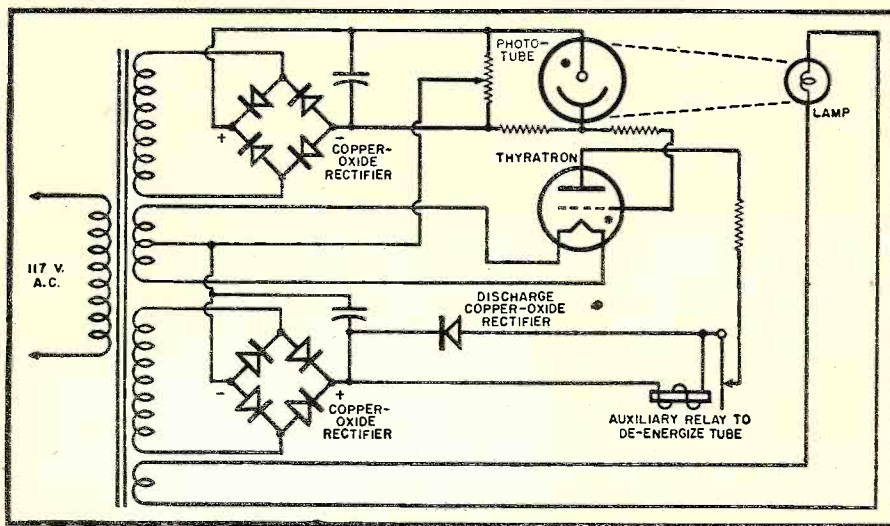

(c) Where a selective effect is desired, as in sorting or grading of objects according to some characteristic such as color or size.

By careful design of the optical system so that the variation in light depends only upon the particular characteristic which it is desired to detect, the phototube can serve as a practical substitute for the human eye in many industrial applications.

The simplest and earliest type of industrial photoelectric device is the photoelectric relay, which responds to the presence or interruption of the light beam with an on-off action. It has many applications in making automatic such functions as production counting, conveyor control, door control, lighting control, and many others known only to the individual users. It is possible also to make use of the simple photoelectric relay in connection with optical and mechanical systems of special design to perform many other functions such as automatic weighing control, printing controls, pin-hole detection, grading and sorting, improved safety controls for many types of dangerous machinery, and many other similar applications.

In addition to the on-off photoelectric relay, the continuously variable response of the phototube to a variable light input may be used as the basis for regulating many types of industrial processes where continuously variable control is required. Photoelectric equipment has been applied to perform a variable regulating function in a large number of industrial operations because the phototube satisfies two great needs characteristic of most regulated processes: (a) a means for quick analysis, and (b) a means for quick response control. Many of the more important industrial photoelectric applications fall under this classification of process regulators. Equipment for this type of application includes; chemical process regulators, loop regulators on paper coating or steel strip mills, register regulation for printing machines and for packaging operations, temperature regulation, and controls for other industrial processes.

(2) In many industrial applications, the timing or duration of different processes is of great importance in determining the quality of the final product. Electronic timing circuits may be used to control manufacturing operations which are performed in a definite time sequence in which all the time intervals may be of fairly long duration, as well as processes in which one of the time intervals is so short that it cannot possibly be controlled with any degree of success by any other method. Some of the applications of automatic timing and sequencing devices in the first category include injection molding processes, heat treating cycles, honing machine

operations, photographic printing, intermittent testing, and sequencing of a large variety of industrial operations. Applications in the second category include the precise measurement of time intervals, and the extremely important field of resistance welding control.

(3) The growing industrial need for simple and accurate control of adjustable-speed motors operated on alternating current has largely been solved by the application of electronic techniques. The use of the electronic circuit for motor control has made it possible to obtain the adjustable-speed characteristics of the shunt-wound d.c. motor while taking advantage of the almost universal availability of a.c. power, and at the same time attain a much greater stability and accuracy of control than when the same motor is operated in a d.c. system. The electronic method of motor control has innumerable industrial applications in the operation of all types of machine tools, and wherever else smooth stepless adjustment is required over a wide range of motor speeds.

(4) Accurate measurement and control of temperature is another of the major needs of industry where the application of electronic principles has been of great help. At some stage in their preparation, almost all products pass through one or more processes in which temperature is an important factor. Very often the choice of method and instruments to keep the temperature within set limits may have a considerable bearing on product cost and quality, on continuity of production, and on the life of plant equipment.

The electronic temperature control circuit converts the output of the temperature-measuring element into energy which regulates the action of the furnace or refrigerator, or whatever other type of temperature controlling mechanism is used. The characteristics of electronic circuits are so well suited to the field of temperature control that they have already become the standard method of control in a constantly increasing number of processes. In metallurgical processes and research, where the accurate control and regulation of temperature are especially important and the range to be covered is very wide, a large variety of electronic instruments have been developed to maintain constant temperatures or to vary temperature automatically according to a predetermined time schedule. Controls for high temperatures have been widely used in the production of steel and various iron and steel products, for control of cement kilns, and in the control of furnaces for the manufacture of many other types of products. Electronic controls have also been used in many systems where control of room temperature and refrigerating systems is re-

June, 1948

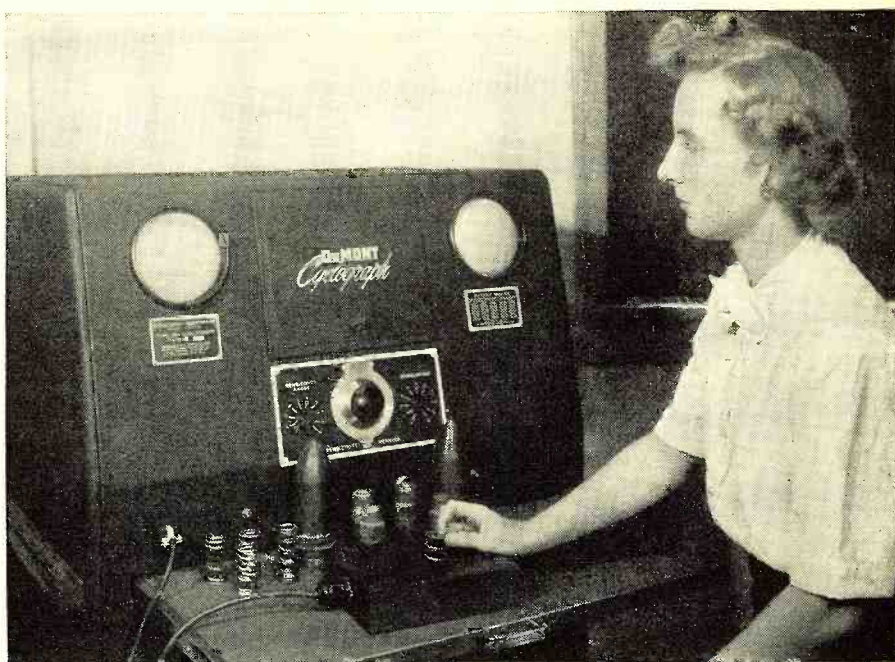

The DuMont Cyclograph for testing materials by means of magnetic induction.

quired. Refrigeration applications are numerous in oil refining processes, in metal tempering and surface hardening, in rubber processing, and in many other well-known industrial processes. Control of room temperature is one of the requirements of air-conditioning in the paper, textile, and food industries.

(5) The use of electronic circuits to generate power has demonstrated its value in the field of high-frequency heating. Heating of non-conducting objects by dielectric losses, and of conducting objects by induction, from a high-power radio-frequency oscillator have so completely been shown to be superior to other methods in a wide variety of applications that they have become an accepted industrial technique. This method has been especially useful in such fields as vacuum tube production, in the molding and heat-treating of all types of small metal parts, and have enabled such processing to be done much more quickly and conveniently than by older methods.

(6) In industrial operations it is ex-

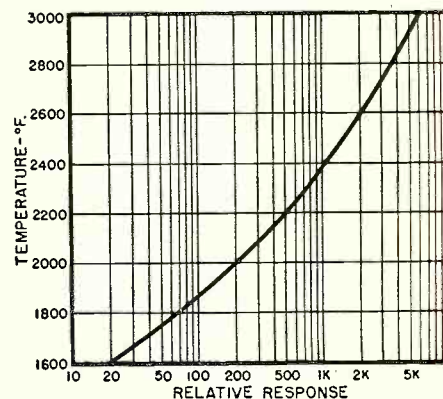
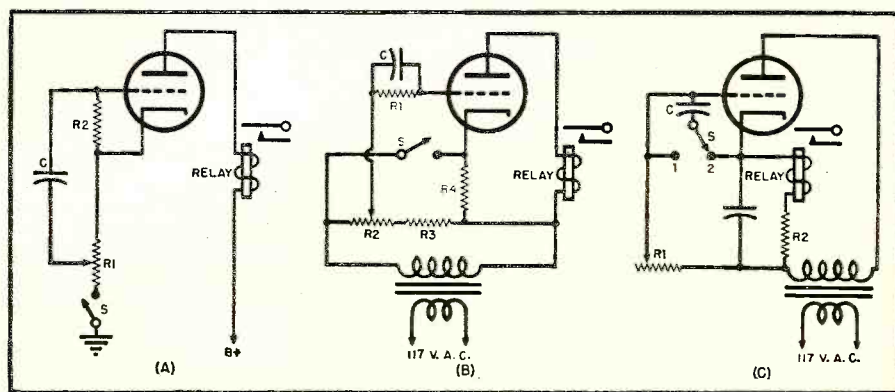

Fig. 5. Typical curve showing phototube response to a black-body radiation.

tremely desirable to be able to stop or position valves, transmission, hydraulic equipment, fire doors, etc., from a conveniently located remote point. One of the important characteristics of electronic equipment in this connection is the ease and simplicity with which signal levels and amplitude of response are

(Continued on page 109)

Fig. 6. Schematic diagrams showing three basic electronic timing relays.



# A VACUUM TUBE VOLTMETER

By  
R. H. KRUEGER

**This general-purpose v.t.v.m. is compact in size and versatile in operation. It has a high input impedance, is battery-operated, provides for a.c.-d.c. measurements, and incorporates a polarity-reversing switch.**

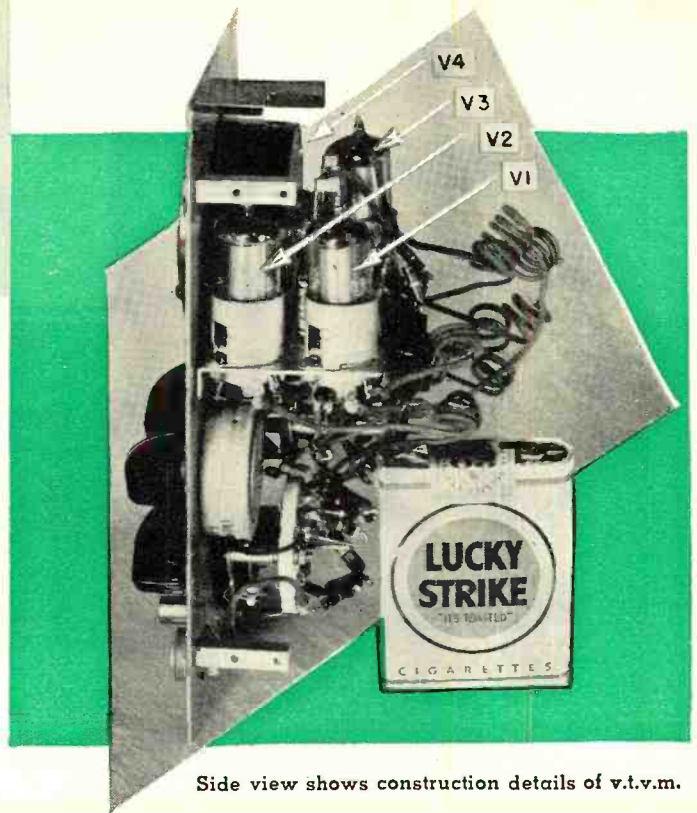

Side view shows construction details of v.t.v.m.

THE vacuum tube voltmeter described in this article features small size, reasonably long battery life, and a voltage scale which is linear on all ranges. This instrument has proved handy when working on battery radios out in the field where no a.c. mains are available. Due to its small size and portability it has also been found useful around the service shop.

The meter used is a 0-150 microampere, 2½ inch, round unit, although any other meter with a microamp range of 0-100 or 0-200 may be used. If other than a 0-150 microammeter is used, resistors  $R_{12}$  and  $R_{15}$  (Fig. 2) will have to be changed. If the microammeter is a 0-200 type, it is recommended that resistors  $R_{12}$  and  $R_{15}$  be of the order of 35,000 ohms. This, in turn, will increase the "B" battery drain a little but not enough to shorten the battery life appreciably.

The instrument is entirely self-contained and uses standard sized No. 950 Eveready flashlight batteries and a small "portable" size 45-volt "B" battery, such as the Burgess XX30. Voltage ranges of 0-1.5, 0-15, 0-150, and 0-1500 are covered by the unit. The accuracy of the instrument is very nearly that of the meter and is entirely dependent upon the accuracy of the input resistors,  $R_1$ ,  $R_2$ ,  $R_3$ , and  $R_4$ .  $R_5$  is an isolating resistor located in the probe and need not be very accurate. A 3 megohm resistor,  $R_6$ , was inserted between the grid of the input tube and the range selector switch to help stabilize the circuit. The grid of this tube was bypassed to ground through a 500  $\mu$ fd. condenser.

The circuit is a cathode follower balanced bridge and uses four 3S4 tubes connected as triodes. Each tube has

its own filament battery and as none of the filaments is common a separate filament switch was used for each tube. Two wafers of a four-wafer switch were used for the "A" battery switch which consists of 2-pole, 4-position switches mounted on each wafer. These are located at the front part of the switch. The third wafer is the "B" battery switch and breaks the positive lead. These switches are wired so that they are "on" in all positions except the "off" position. Wafer number four is located at the rear of the switch and serves to reverse the polarity of the meter, which in turn reverses the polarity of the test leads. This makes a total of four positions for the switch, namely, "off," "negative," "positive," and "a.c." If the meter should indicate "positive" when the selector switch is in the "negative" position, the leads at the microammeter should be reversed to correct the reading.

There are nine fixed resistors and

Fig. 1. Alternative input circuit that may be used should dial scale be calibrated in divisions of 1, 10, 100 or 1000, full-scale.

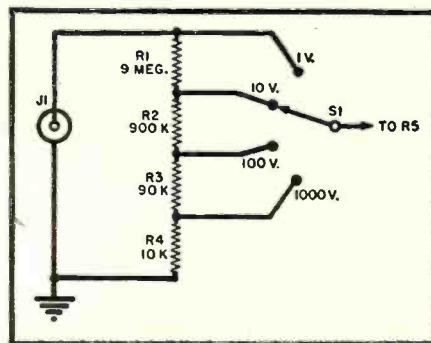

one potentiometer in the bridge circuit proper. None of these resistors is critical in value as long as they are matched in pairs. Resistors to be matched are:  $R_3$  and  $R_{11}$ ,  $R_2$  and  $R_{10}$ ,  $R_6$  and  $R_7$ , and  $R_{12}$  and  $R_{15}$ . About two per-cent accuracy in matching the pairs is close enough for proper balance of the bridge circuit. No trouble was encountered in matching tubes for the bridge balance, nor was any trouble encountered in selecting tube  $V_1$  (Fig. 2) to give no grid current and consequently no deflection of the meter when the test leads were shorted. When the range switch is moved through the different ranges no resetting of the zero adjustment will be required. Reversing the position of the tubes may be necessary in order to obtain bridge balance, but a little experimenting with different tubes in different positions should bring about a balance when the "zero-adjust" potentiometer is set at approximately center position.

Although the input circuit uses a probe with a 1 megohm resistor, this has little detuning effect on the circuit under measurement. The probe was constructed using a standard test prod, a 1 megohm resistor, a piece of shielded, single-wire microphone cable, and a connector. The resistor was placed as close to the tip of the test prod as possible and the shielding run close to the resistor. This type of construction produces no meter deflection when the probe is handled.

The input voltage divider, or range switch, was chosen to give voltage readings of 1.5, 15, 150, and 1500 volts.

(Continued on page 98)

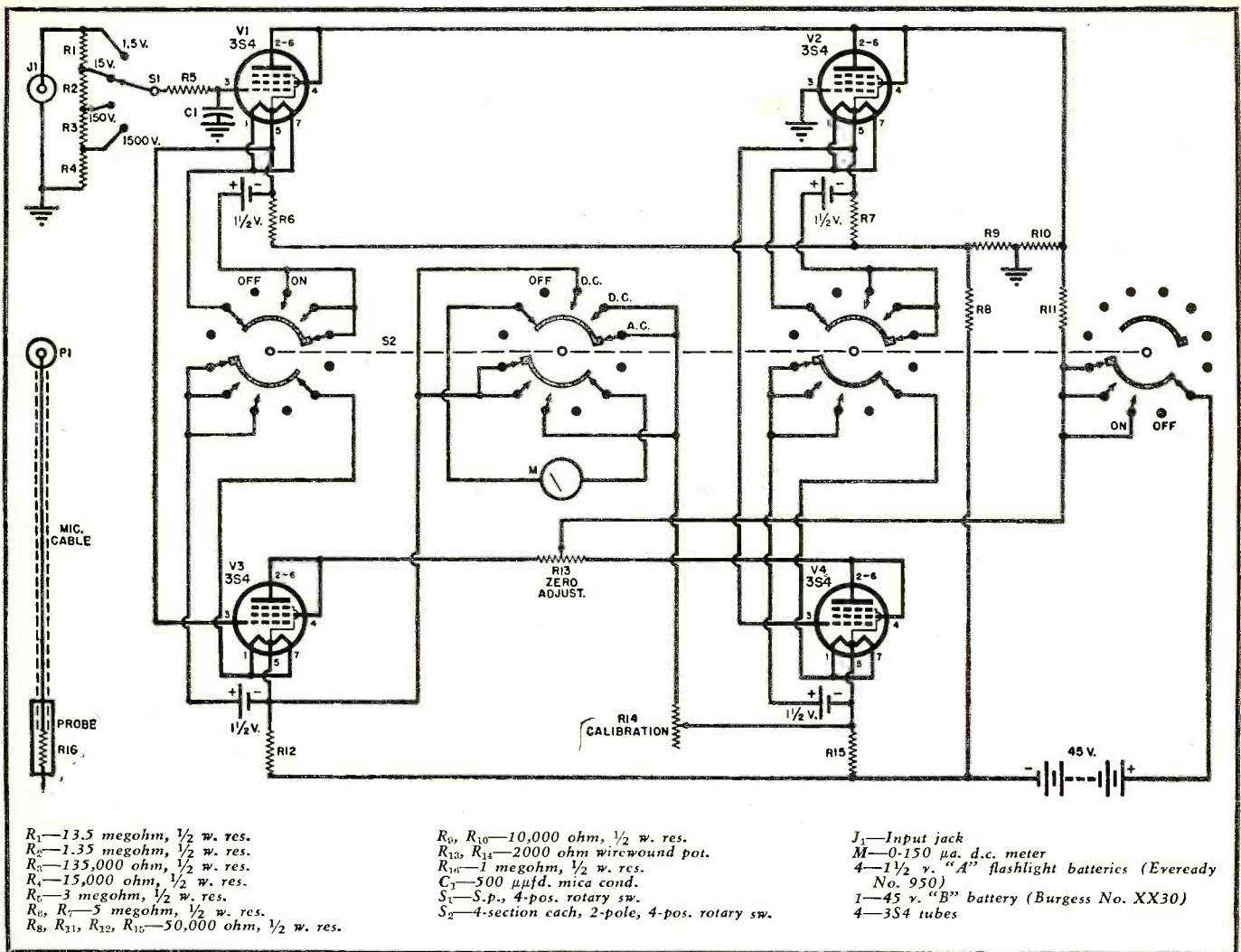
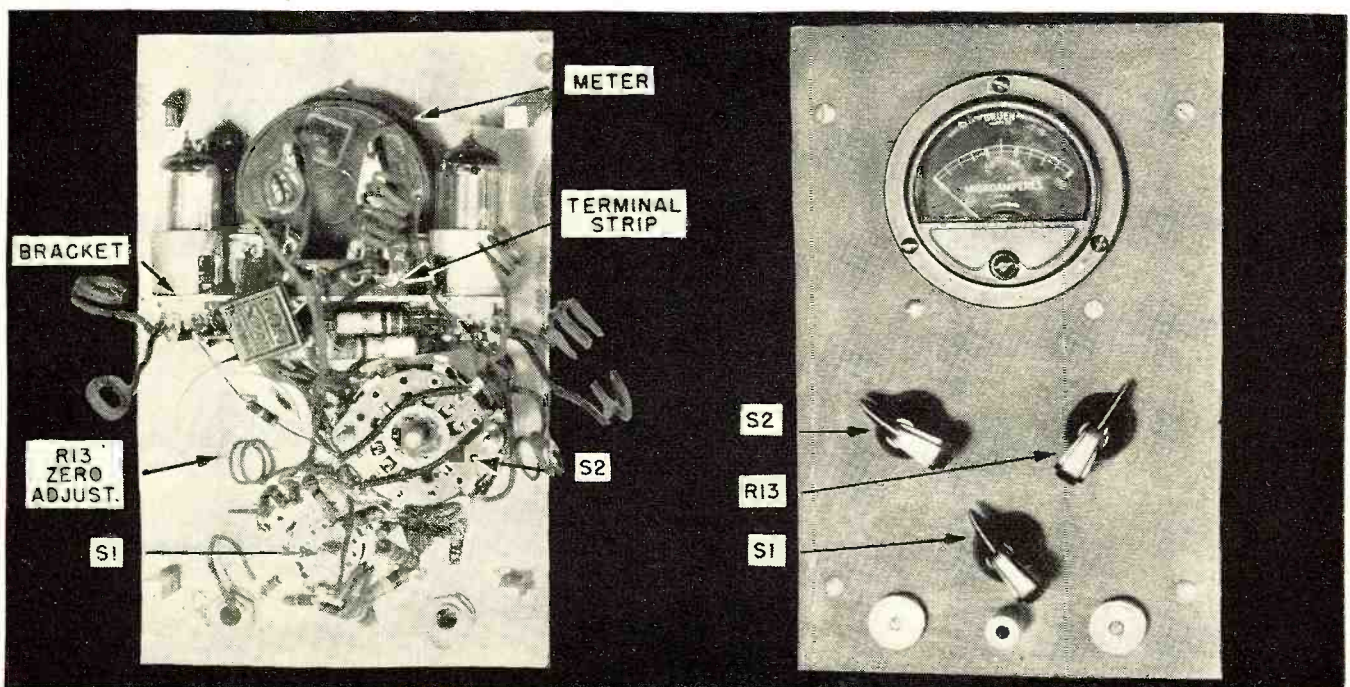

Fig. 2. Wiring diagram for self-contained v.t.v.m. Circuit is basically a balanced-bridge type cathode follower.

★ ★ ★  
 Front and rear views of the home-built v.t.v.m. One of the input jacks, shown at the bottom of the front panel, is not connected in the circuit. It is simply used to balance the appearance of the panel.



# Vide Range Phonograph System

(Left) Chassis with power supply and high and low frequency amplifiers. (Right) Ten cu. foot speaker enclosure with 3 inch PM speaker mounted coaxially inside of a 12 inch permanent magnet speaker unit.

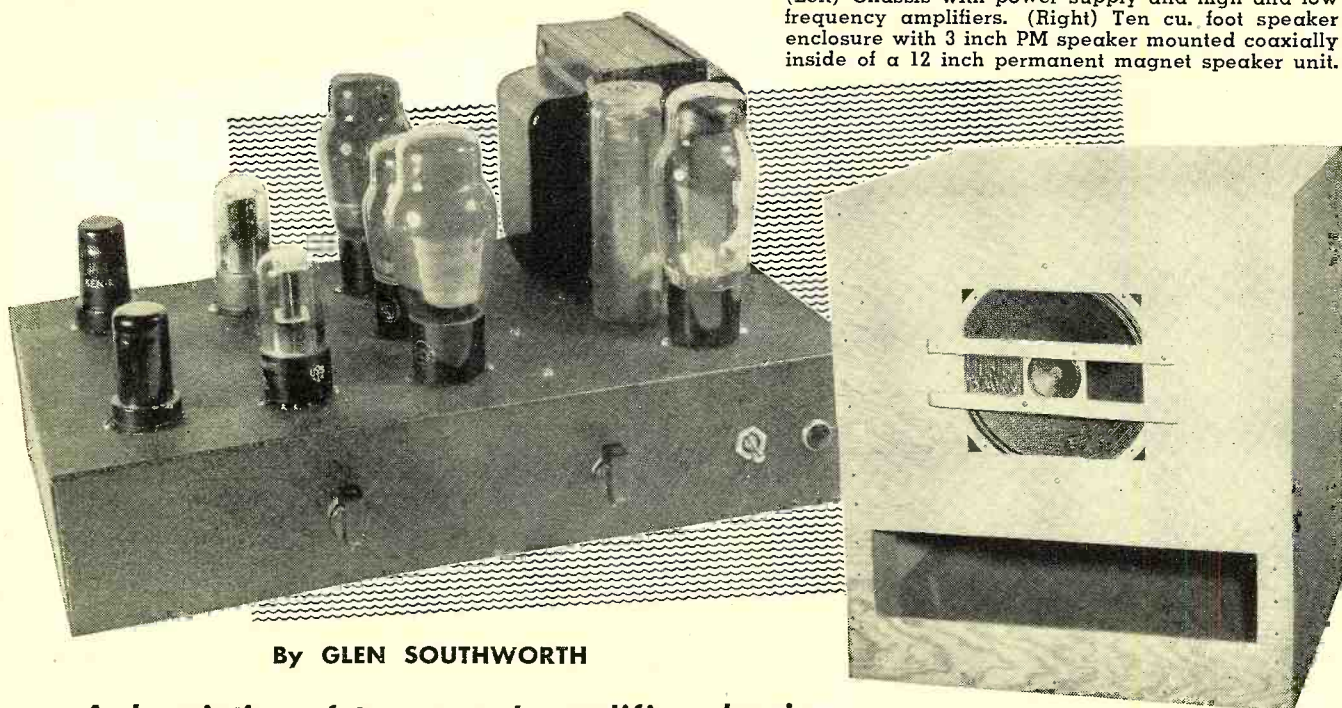

By GLEN SOUTHWORTH

**A description of two novel amplifiers having separate low and high frequency sound channels.**

INTEREST in high fidelity radios and phonographs has grown markedly since the end of the war, and today an increasing number of sets with high

power amplifiers and coaxial speakers are being placed on the market, while for those who wish to assemble their own system several lines of high quality

amplifiers, speakers, and associated equipment are currently available. Unfortunately, ready made equipment is priced considerably higher than the average music lover can afford. By using circuits designed to compensate for the deficiencies in commercial grade components, wide range reproduction may be enjoyed at a reasonable cost.

The system described in this article employs two separate amplifiers, one for the range between twenty and one thousand cycles, and the other for the range between one thousand and twenty thousand cycles. The advantages of this arrangement are numerous.

Absolutely linear response does not mean maximum listening enjoyment in most cases, as the hearing characteristics of different individuals vary widely, high frequency cut-off being from six to twenty thousand c.p.s. Generally, as people grow older their sensitivity to high frequencies decreases and they may derive greater enjoyment from a well accentuated treble. On the other hand, many people enjoy accentuated bass response, and with the use of two separate amplifiers and their associated tone networks, a very wide range of frequency response may be obtained.

Intermodulation distortion is probably one of the chief reasons that many people do not like highs in reproduced music. As a reproducing system is nearly always reproducing complex waves, har-

Fig. 1. Schematic of simplified amplifier with a maximum power output of 6 watts for the low frequency stage and 4 watts for the high frequency stage.

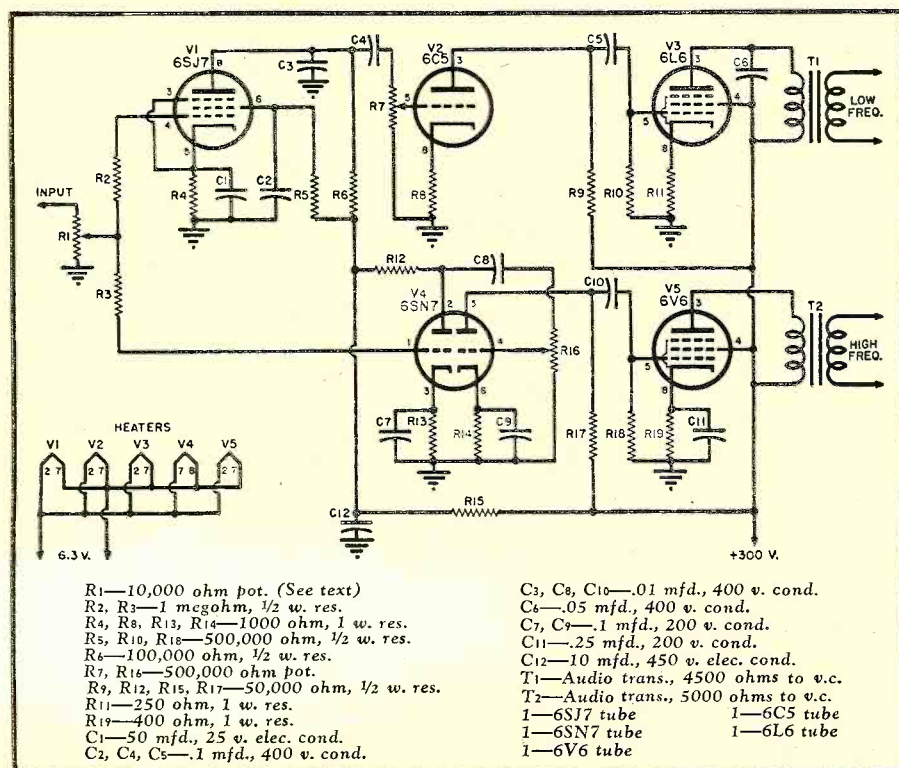

monic distortion may not be particularly objectionable as it merely alters the relationship of the fundamental and harmonics somewhat, giving a somewhat different timbre to the music and sometimes is deliberately introduced to give the listener a sense of "liveness." Intermodulation distortion is noise generated by the modulation of one audio frequency by another to produce spurious "sidebands" which are of an unmusical character and which may make high notes sound screechy or sound like speaker rattle. In conventional amplifiers, intermodulation distortion is related to harmonic distortion as they are both produced by nonlinearities. When large amplitude bass frequencies are passed through the same amplifier with relatively small amplitude high frequencies, severe intermodulation distortion may result from the tubes being driven onto a nonlinear portion of the plate curve, which gives, according to one researcher, approximately four per-cent intermodulation distortion for every one per-cent of harmonic distortion.

The use of two separate amplifiers means that intermodulation distortion can be effectively reduced by separating the large amplitude bass impulses from the lower amplitude high frequencies at the input, thus preventing their interaction.

Conventional coaxial and multiple speaker systems are of two main kinds, those with a mechanical crossover systems such as found in "dia-cone" type coaxial speakers, and those with an electrical crossover system of the LC type usually fed from a five hundred ohm line. A dual amplifier system does away with the need for either of these. The high frequency unit drives a high frequency radiator which may be a conventional three or four inch PM speaker, while the low frequency unit drives a twelve or fifteen inch speaker. It should be noted that two twelve inch speakers will approximately equal the radiating area of a seventeen inch speaker and four, a twenty-four inch speaker, though may be inferior from the standpoint of resonant frequency and transient response.

Selecting a speaker with a low resonant frequency is desirable to prevent boom in reproduction, and it is best to pick a fairly heavy diaphragm to keep the speaker from cracking up at high volume levels.

Frequency runs made on small three, four, and five inch PM speakers showed that acoustic output could be obtained to above sixteen thousand c.p.s., and that the speakers were capable of radiating considerable amounts of power above one thousand c.p.s., though the power handling capabilities are limited and care must be taken to attenuate

(Continued on page 149)

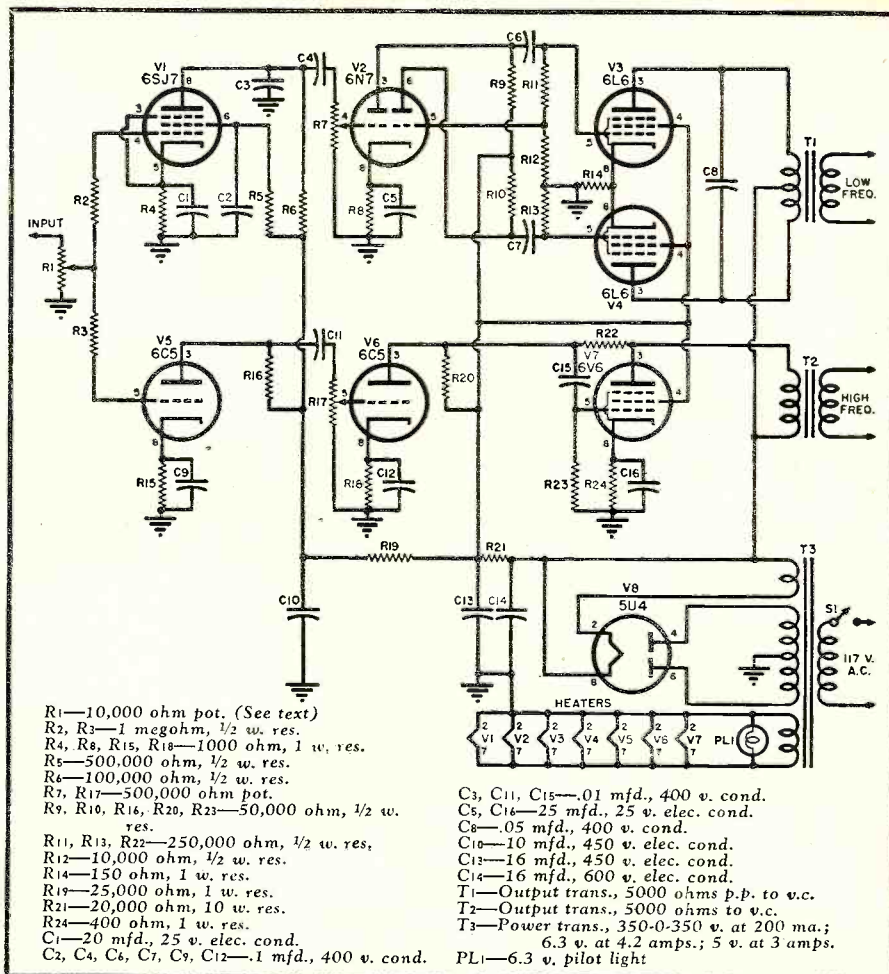
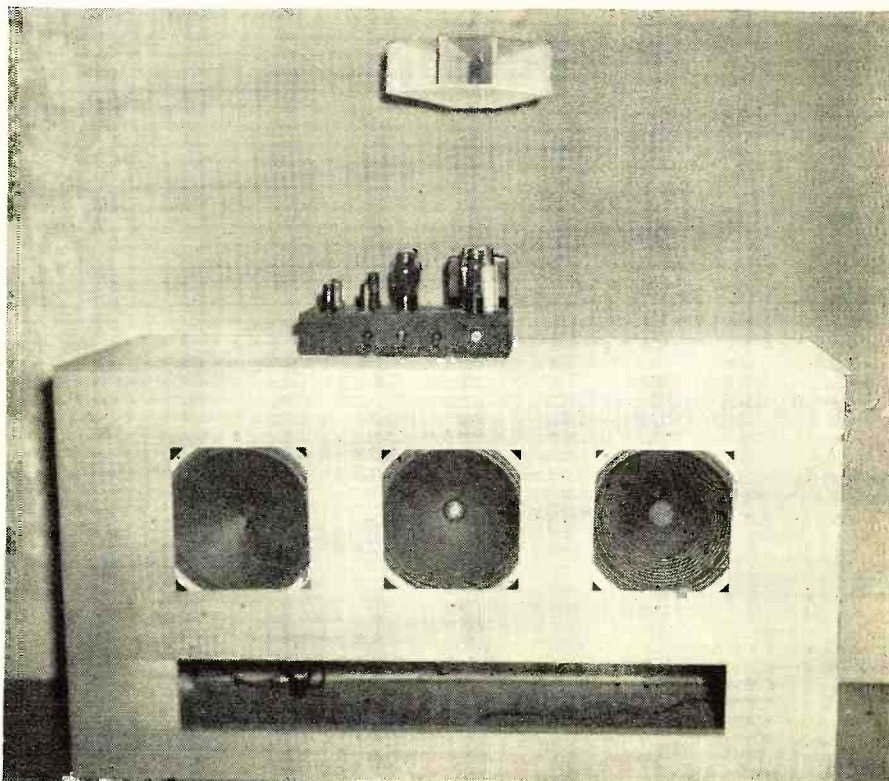

Fig. 2. Schematic of amplifier using push-pull 6L6's for the low frequency power amplifier, and a single 6V6 for the high frequency power amplifier. Values given are for a crossover frequency of approximately 1000 cycles per second.

A more elaborate 25 cu. foot enclosure housing three 12 inch speakers. The tweeter is coupled to small plywood horn mounted above low frequency enclosure.



# Mac's RADIO SERVICE SHOP

By JOHN T. FRYE

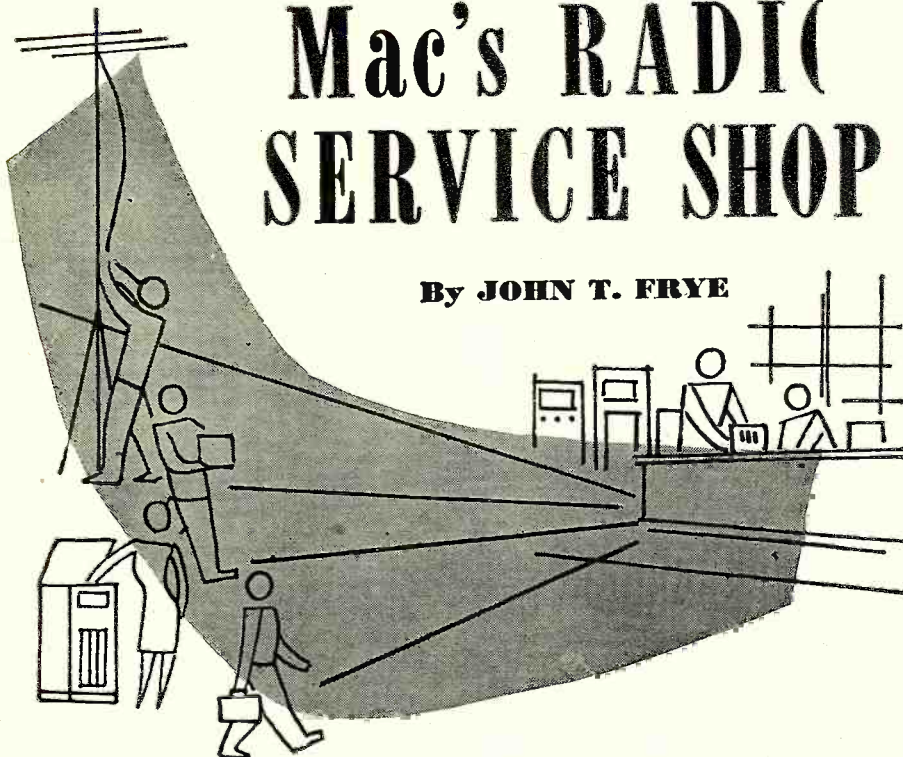

MISS PERKINS, precisely at two minutes to nine, stepped inside Mac's Radio Service Shop ready to start another day as its very efficient office force. Before the door could close behind her she was pounced upon by a red-headed demon and swung dizzily about the office while the demon sang very lustily and slightly off-key, "Oh, waltz me around again, Matilda!"

"Barney Jameson, you let me go!" she gasped. "Let me down this instant!"

After one last wild swing, Barney obediently deposited her on her desk, her hat tilted rakishly over one eye, and her horn-rimmed spectacles far down on her sharp little nose.

"What on earth is the matter with you?" she demanded, her hands fluttering about trying to repair the damage.

"It's my *birthday*, Matilda—I mean, Miss Perkins," Barney explained with such a dazzling smile that she could not resist smiling back just a little.

"And that, when you remember that our assistant is a wild young Irishman, should explain everything," Mac said with a chuckle from where he had been watching in the open door of the service department. "Well, my young bucko, you come on back here. I have a birthday present for you."

Winking and leering wickedly over his shoulder at Miss Perkins, Barney made a dash and slid through the door into the service department.

"Where it is? Where's the present?" he demanded.

"Right there," Mac replied, waving at the service bench. "Starting today,

you are going to do some troubleshooting."

"Honest, Boss?" Barney asked happily. "You mean you are really going to let me show you how much I have learned out of those books I've been beating my brains out on?"

"How much or how little," Mac said dryly. "First, though, I want to brief you a little on procedure. To begin with, there is the matter of testing tubes. The roller chart on the checker shows you how to set each control for a particular tube. Always set up the controls and then double-check the settings *before* you stick a tube in the tester."

"That's to keep from burning out a filament, I presume," Barney said airily.

"You presume right, and another thing toward the same end is to arrange the tubes to be checked in this tray so that those with the lowest filament voltages are on the left and the filament voltages are progressively higher as you go toward the right. For instance, you might have a couple of 6SS7's, a 12SA7, a 12SQ7, a 35Z5 and a 50L6 laid out in that order. If you checked from left to right, you would run no danger of putting a tube in the tester with too high a filament-voltage setting, for every change necessary in this control is toward a higher setting."

"Check and double-check," Barney said, making a circle out of his thumb and forefinger.

"Don't forget to adjust the line voltage on the checker, either," Mac admonished. "Do it with a tube plugged in."

"Do I have to check the line-voltage for each tube?"

"Ordinarily, no. Adjust it with the first tube in the checker and let it alone for the rest; however, when testing a tube with a heavy filament current, such as an 83, you may have to boost it up a little."

"I've got it," Barney stated. "If the hand goes into the green, I stick the tube back in the set; if it stays in the red, I throw the tube away; and if it stops in that little orange space, I toss a coin to see whether I throw the tube away or use it."

"It's not quite that simple," Mac said with a grin. "In the first place, you check all the elements for shorts by throwing these switches and watching the neon lamp. While making this test, you keep tapping the tube with this little rubber hammer; and don't let me catch you hitting it as though you were trying to drive a tent-stake," he warned, trying to scowl fiercely.

"Okay, Boss, okay!" Barney replied, holding his arms up as though warding off an expected blow. "I'll see you don't catch me."

"Don't just strike the tubes on top. Tap them first on one side and then on the other," Mac went on. "Don't neglect to check each section of multi-purpose tubes separately."

"What *do* I do with those that read 'doubtful'?" Barney asked.

"I usually leave that up to the customer. Of course, if a new tube makes a noticeable difference, I replace the old one; but often this is not the case. Usually, though, the customer will tell you to discard the doubtful ones."

"And now let's talk about the service bench," Mac went on. "For the present, you will not use the scope, the signal tracer, or the vacuum-tube voltmeter. Those belong in the high school of radio servicing, and you are still in the grades. The signal generator and the multimeter there are your troubleshooting weapons, and they are capable of telling you a lot more about what is wrong with a radio than you will be able to understand."

"Such cruel, cutting words—and on my birthday, too!" Barney muttered darkly.

"You will hear a lot worse words if you damage that meter," Mac warned. "Take a good long look at it. Notice how straight that pointer is. See how snugly it hugs zero. Watch how smoothly it swings. Mind that it stays that way."

"Do you have any helpful suggestions—as though I didn't know," Barney said sweetly.

"Plenty of 'em. For one thing, while checking receiver voltages in general, stay on the five-hundred-volt range. With that big scale, you can easily read it down to five volts. Most receiver voltages will not go much beyond half-scale, and if you happen to get the polarity reversed—and this should not happen often if you watch what you are doing—you are not likely to bend the pointer."

(Continued on page 126)

RADIO NEWS



# The RECORDING and REPRODUCTION of SOUND

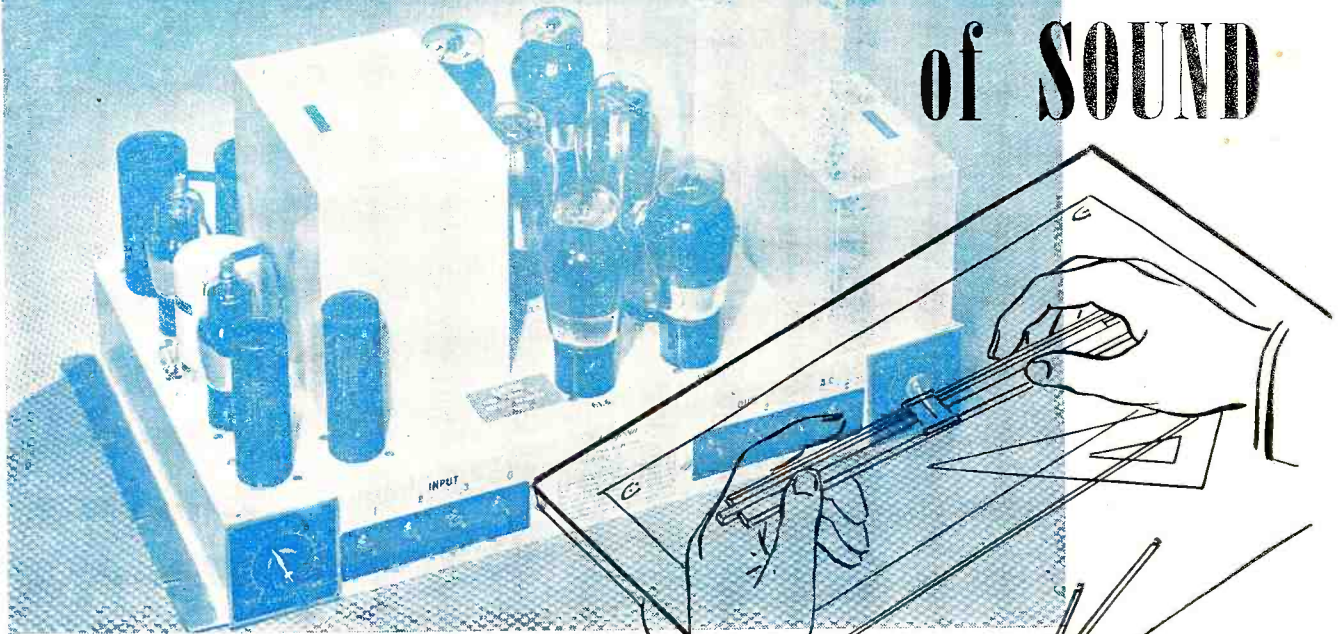

The Langevin Model 101A amplifier.

By **OLIVER READ**  
Editor, RADIO NEWS

## Part 16. Performance testing of voltage and power amplifiers used in recording units.

**A**MPLIFIERS may be divided into two classifications, i.e., *voltage* amplifiers and *power* amplifiers. A voltage amplifier is an amplifier which is intended to deliver a large alternating voltage into a high resistance load. The

complete cycle; in a class AB amplifier this is the case for more than 180 degrees but less than 360 degrees; in a class B amplifier for only 180 degrees and in a class C amplifier for less than 180 degrees.

the condition worse unless the amplifier is to be used for only one input device of very low output. In general, it is best to put the volume control in the earliest possible stage and to place tubes with low bias and high gain first.

A tube used as a voltage amplifier delivers maximum amplification (equal to  $\mu$ ) if the a.c. load is infinite and the actual plate voltage remains at the rated value. The gain drops with the plate load and with the plate voltage,

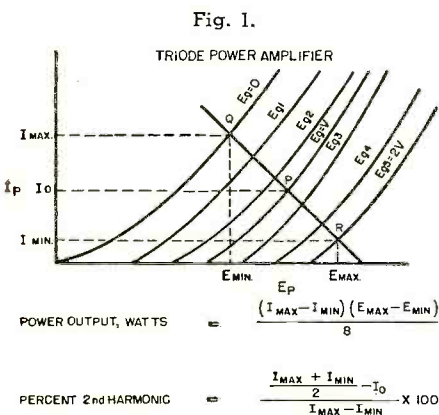

power amplifier is designed to deliver appreciable power and may or may not require power to drive the grid circuit.

Amplifiers are also divided according to their method of operation into class A, class AB, class B, and class C amplifiers. In a class A amplifier the plate current is a faithful reproduction of the waveform of the applied grid voltage over a

Multi-stage amplifiers generally consist of several stages of voltage amplification followed by one or more stages of power amplification. The total amplification is limited by miscellaneous noises such as thermal agitation and shot effect which occur in the first stage and are amplified along with the signal. When the amplification becomes so great that these noises become a large part of the output, the amplifier becomes useless. Therefore, it is necessary to keep the noise down, especially in the first stage. Operating the units at lower voltages and using special tubes are some of the remedies employed.

In multi-stage design it is important to proportion the stages so that none of the early stages can become overloaded before maximum output is obtained in later stages. Such a condition may occur if the volume control is placed in the second stage and the input device delivers more voltage than the bias of the first stage. Placing the volume control in a later stage will make

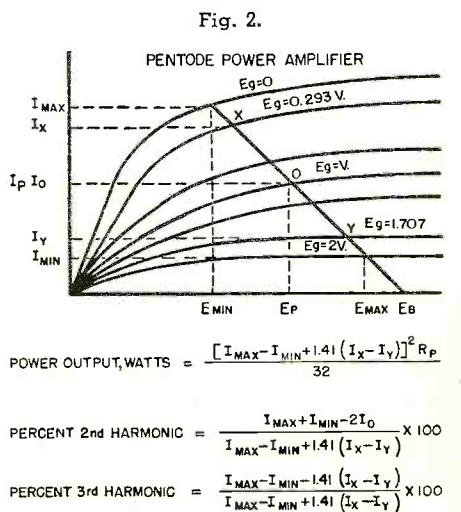

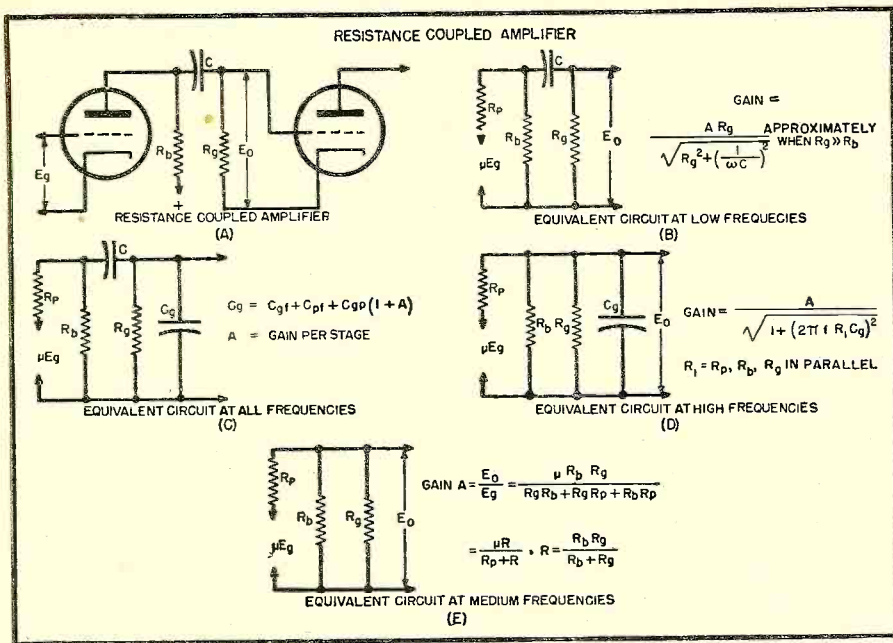

Fig. 3.

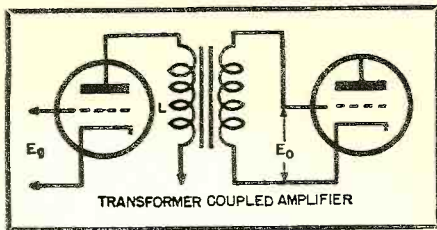

Fig. 4.

so that the best compromise of plate load and plate voltage must be determined. Other problems, such as parallel capacitance, must be taken into consideration.

The obtainable gain and the maximum output as well as the distortion of any tube can be determined for any load and power supply by a geometrical construction on the plate family of curves (*E<sub>p</sub>-I<sub>p</sub>* curves).

When the load has the same a.c. and d.c. resistance, the load line is drawn from the plate supply point on the X axis at a slope equal to 1/R or I/E, taking into consideration the scale of units employed along the coordinate axes. An operating point is then selected, representing the fixed grid bias; variations in plate current and plate voltage for any grid voltage can then be read. The load should be so selected that the intersections of grid voltage lines are regularly spaced.

When the a.c. load is different from the d.c. load, a load line should first be drawn corresponding in slope to the d.c. load and starting from the plate voltage point on the X axis. At the chosen operating point the real load line should be

Fig. 5.

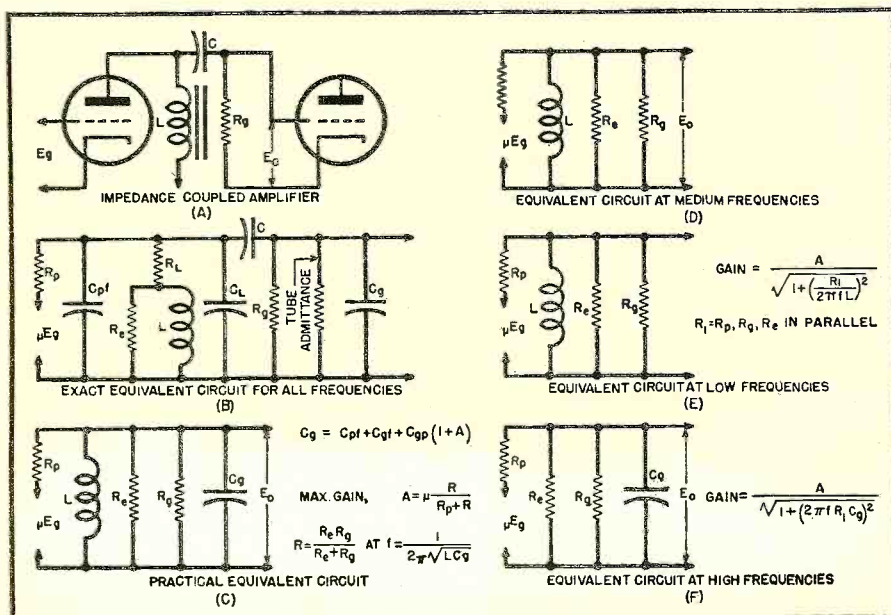

constructed at a slope corresponding to the a.c. load resistance. Maximum output and gain are immediately apparent from the curves.

**Power Amplifiers**

Maximum undistorted output is obtained from triodes when the load equals  $2R_p$ , for pentodes when the load is approximately 1/5th  $R_p$ . The performance as a single-ended class A amplifier can be predicted from the *E<sub>p</sub>-I<sub>p</sub>* curves as shown in the example in Fig. 1. Draw the load line through the chosen operating point at the slope corresponding to the a.c. load (the d.c. resistance is usually negligible). For minimum distortion, the segments of the load line, PQ and PR should be equal. When the ratio of their respective lengths is 9:11, the harmonic distortion is five per cent.

In Fig. 1 maximum power output and harmonic distortion is given in the equations. Fig. 2 gives the same data for pentodes. The gain of amplifiers is often given in decibels. The decibel is a logarithmic unit, expressing the ratio between two magnitudes of power. Mathematically:

$$\text{db.} = 10 \log (P_1/P_2)$$

where  $P_1$  and  $P_2$  are the output and input power (in watts) respectively of the amplifier.

When the impedance at input and output are equal, the decibel may also be expressed in terms of voltages or currents:

$$\text{db.} = 20 \log (E_1/E_2)$$

$$\text{db.} = 20 \log (I_1/I_2)$$

The decibel is used, in addition, as a unit of loss and gain in networks. Although the decibel is not an absolute unit of power level, it can be used to indicate the power level in decibels above or below an arbitrary "zero level." One of the most frequently employed zero levels is 6 milliwatts. In acoustical measurements a zero level of  $10^{-16}$  watts per square cm. has been accepted.

**Audio Amplifiers**

Audio-frequency amplifiers may be divided according to their type of coupling into resistance-coupled amplifiers, transformer-coupled amplifiers, impedance-coupled amplifiers, and direct-coupled amplifiers.

The charts of Figs. 3, 4, 5, and 6 show the fundamental circuits. Complete information on the constants for resistance-coupled amplifiers and their performance will be found in tube manuals.

Resistance-coupled amplifiers have the advantage of economy while the frequency response can be made nearly flat. The phase distortion is less than that of other types of coupling except direct coupling. Disadvantages include lower gain than impedance or transformer coupling with the same tubes and power supply and the tendency to "motorboating."

Impedance-coupled amplifiers have a lower voltage drop across the load, thus making the plate voltage higher. The frequency response falls off at the low end as well as at very high frequencies, above the point where parallel resonance occurs. The drop at the low end can be minimized by placing a resistor across the plate choke. If the value of the resistance is 1/3 of the choke reactance at the lowest frequency, or less, the impedance of the combination will not vary more than a few per-cent over the audio range.

At present, transformer-coupled triode amplifiers can be designed to have a frequency characteristic as good as that of a resistance-coupled amplifier. The gain of such amplifiers is not as high as that of the resistance-coupled amplifiers using pentode tubes, and the cost of the transformers is high. When sensitive amplifiers are used and a transformer is at the input, the hum problem is much greater than with RC amplifiers. Well shielded transformers are required and even then critical placing is necessary.

Direct coupling is really a special case of resistance coupling. In such circuits the plate of the first stage is directly connected to the grid of the next, a condition which requires some juggling with power supplies. Since the load between stages is a resistance and the coupling elements per stage are reduced, this type of amplifier can be made to have a better response than most other types. Response at low frequencies is better and delay distortion is less. The main difficulties are the tendency to drift due to temperature changes and the difficulty in designing amplifiers of many stages. It is possible, however, to make an amplifier employing a drift-corrector which makes the system practical for amplification of a.c. signals but not for d.c. Practical circuits for a single-ended amplifier and a push-pull amplifier are shown in Fig. 6.

#### Feedback

When a portion,  $B$ , of the output of an amplifier having a voltage amplification  $A$ , is fed back to the input, the gain becomes:  $A/(1-AB)$ . In this case  $B$  is positive for regeneration and negative for degeneration. Non-linear distortion, noise, and hum will be multiplied by the factor:  $1/(1-AB)$ .

These equations hold when the feedback voltage is in series with the input signal and there are no additional phase shifts due to reactances.

Fig. 7 shows several ways of arranging the feedback circuit in transformer-coupled and resistance-coupled circuits. There is a phase shift of 180 degrees in each stage which should be taken into consideration; in addition, there is a phase shift in each stage which varies with frequency but is never more than 90 degrees. This fact limits the number

of stages to be bridged by the feedback circuit. When the sum of the shifts amounts to 180 degrees, oscillation starts unless the gain at that point is less than one. For this reason, degeneration is limited, as a rule, to three stages and to about 30 db.

#### Measuring Distortion in A.F. Amplifiers

The simplest qualitative test for distortion in a class A audio-frequency amplifier stage may be made, as shown in Fig. 8, by applying a signal voltage of proper level to the input and inspecting the circuit for one or all of the following abnormal conditions:

- (a) Presence of d.c. grid current.
- (b) Fluctuation of the d.c. plate current.
- (c) Fluctuation of the d.c. cathode

voltage, if the circuit employs cathode resistor bias.

Each of these indications generally occurs in a positive direction, and each will disappear upon removal of the signal. It must be borne in mind, however, that this method is purely rudimentary in nature and serves only to detect the presence of distortion. One or two of the indications may be absent, depending upon the main cause of the trouble.

The three simple indications are well known and frequently used by servicemen and p. a. testers who have no equipment suitable for making quantitative distortion measurements, but must, in the course of routine testing, localize distortion without reference to the actual per-cent harmonic energy present. (Continued on page 165)

Fig. 6.

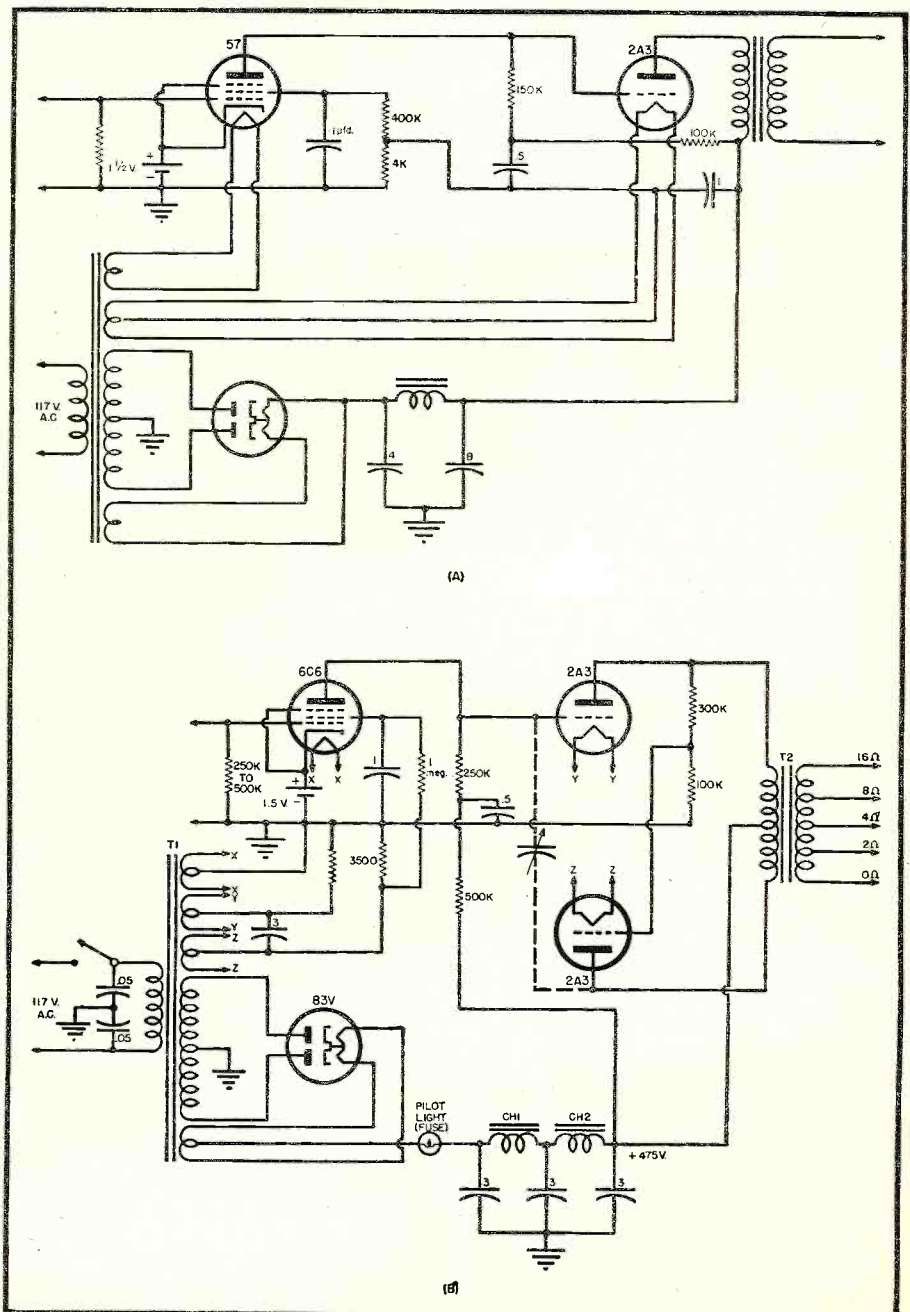

# REGULATED D.C. SUPPLY Improvements

By  
**W. L. KINSELL**

Senior Project Engineer  
Farnsworth Television & Radio Corp.

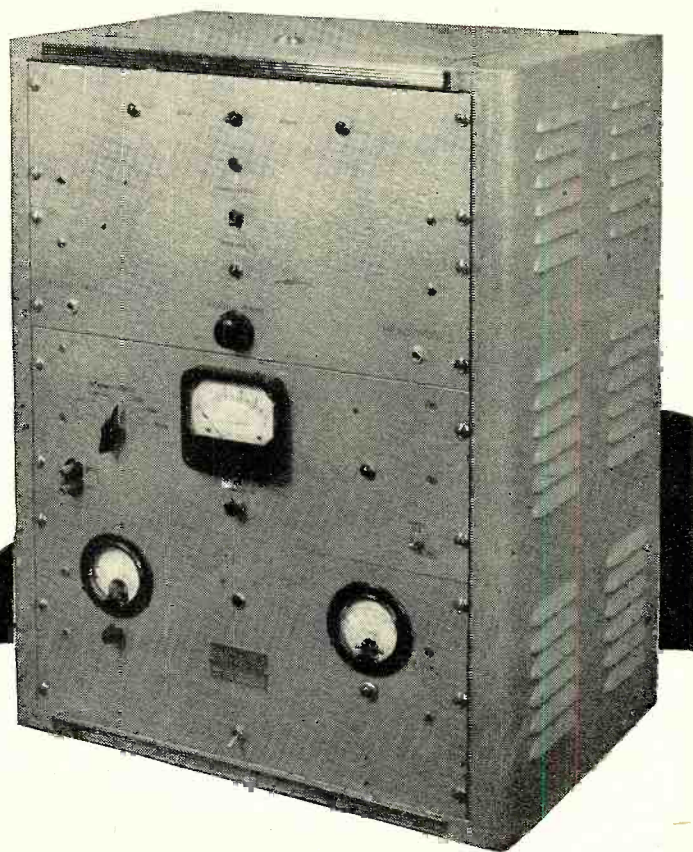

Fig. 1. Special test equipment incorporating the regulated power supply in the bottom panel of the unit.

## Theory and construction of a d.c. power supply with improved voltage regulation.

THE MOST common and simplest application of electronic tubes is in the conventional a.c. operated d.c. power supply. It is involved in nearly all electronic apparatus and the information needed for its design is well covered by all general radio engineering texts and handbooks in considerable detail.

When the functioning of equipment requires a stabilized low impedance

source of d.c. power, it is necessary to resort to the use of one of the varieties of electronically regulated d.c. power supply systems that have become so well-known and widely used within the past ten years. Much has been written on the principles involved and detailed instructions on the design of a system to supply any given voltage and current have been outlined. Since this is a subject that is at once relatively simple,

yet not entirely familiar to all individuals who may find themselves interested in or required to use regulated supplies in applications demanding their advantages, a bibliography is presented as an appendix to this paper that will provide the reader with both general and detailed coverage of the subject. RADIO NEWS readers will find M. S. Kay's article in the November 1944 issue to be very informative. Therefore, no space will be used here to cover the theory or describe the several varieties of regulated power supplies in use.

Fig. 2. (A) Conventional regulator, and (B) with screen resistor  $R_s$  added.

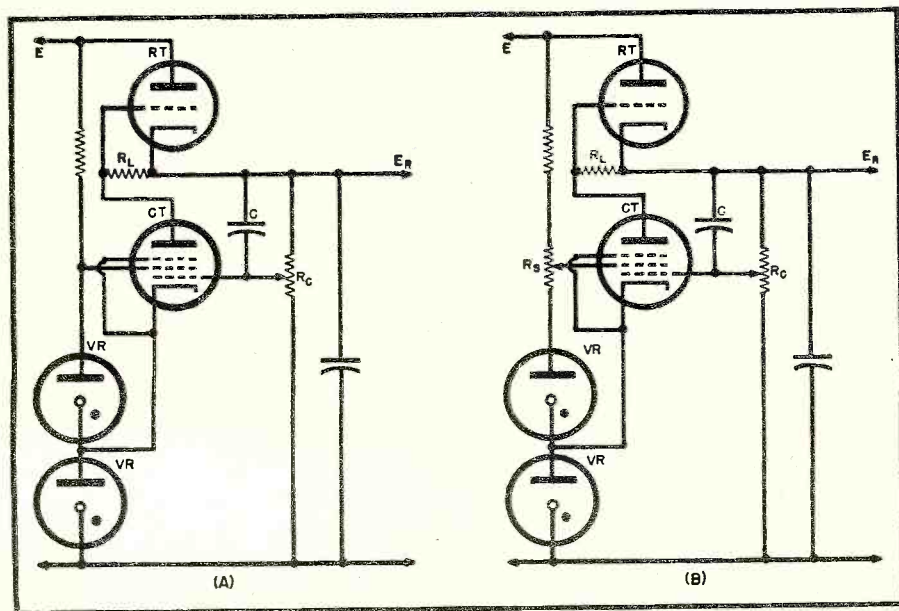

### Present Deficiencies

For all applications where today's regulated power supplies fill the bill, no improvements would be necessary. However, as fine as these supplies are, there are already demands for supplies of improved characteristics.

For example, suppose the output voltage of such a system varies one-half of one per-cent as the line voltage fluctuates over short or long periods of time. This degree of stabilization is roughly representative of what may be expected of an average regulated supply. At 300 volts, the variation may approximate one or two volts. As with any performance, though this regulation may be entirely satisfactory for most applications, there is some equipment whose performance is limited solely by the stability of its power supply and there are new designs

of complex electronic apparatus that might be made successful if power supply stability could be improved. Therefore, we must not assume that the conventional regulated power supply, because it is such an improvement over the unregulated type, is all that it need be. This article will point out a method for bringing about this improvement that does not appear to have been developed previously.

In passing it should be pointed out that the aspect of voltage stabilization that is most annoying may be termed, for lack of a more standard term, "jitter". While it is important for a voltage stabilizer to iron out supply or line voltage drift, it may in some cases be even more important to reduce jitter caused by the line voltage transients that are so bad in some locations. It is quite common to observe the output voltage of a regulated supply jumping erratically twenty-five or fifty millivolts, oftentimes very sharply due to line voltage transients. While this is relatively good stabilization, such an effect can be very undesirable in some cases. The change to be described by this article will effectively reduce this phenomenon to a few per-cent of the usual value.

One of the other power supply characteristics for which this article will indicate improvement is that which is correctly known as "regulation". As the load on a power supply varies, its output voltage will also vary. As in the case of stabilizing the effects of line voltage fluctuations, the variations due to "regulation" when the load changes may run about one-half per-cent over the useful range, or one or two volts when delivering 300 volts. True, this is very small, but some of the complex applications we see in electronic equipment may be more successful and more may be possible if this also can be improved. This article will show the manner in which this may be done.

A slightly different expression for this latter characteristic is "internal impedance". If the output voltage of a supply did not vary as the load changes, it would be equivalent to a battery with zero resistance and we would say that it has zero internal impedance. Consequently the improvement to be described in regulation will reduce the internal impedance of the supply. An average value for a conventional supply may be five or ten ohms, without this further improvement.

One additional characteristic which may be improved by the method given by this article is hum voltage. While the hum on the output of a conventional regulated supply may measure five to ten millivolts and may be insignificant for many applications, it too is capable of improvement by the means to be described. Many occasions arise where ad-

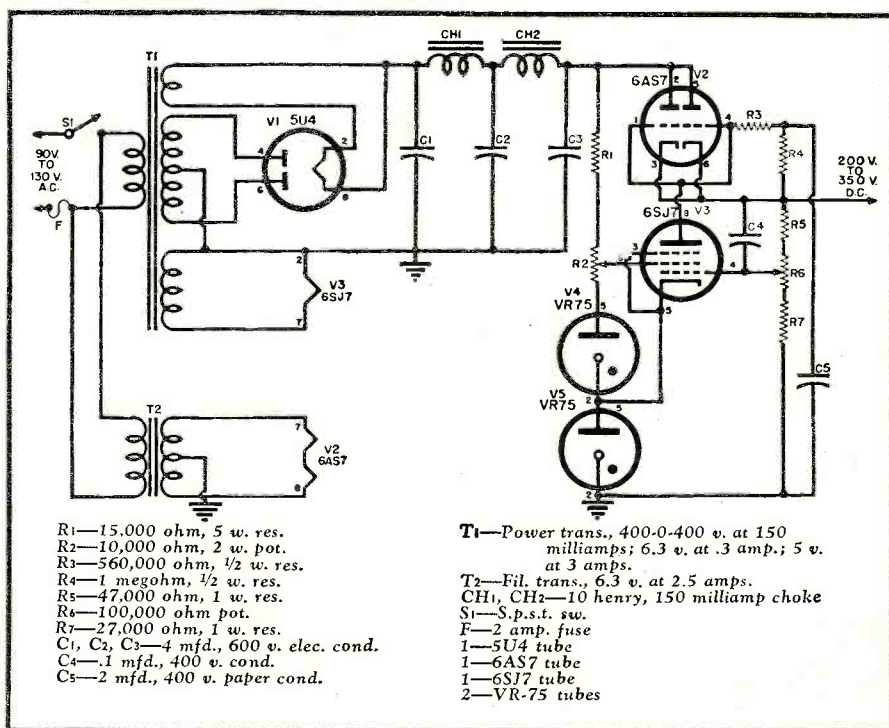

Fig. 3. Circuit diagram of a 100 milliamper regulated power supply.

STABILIZATION					
POT SETTING	0	1/4	1/2	3/4	Max.
Output Voltage Change	-1.1v	- .6v	0	+ .5v	+ 1v
(See Text)	-2.5v	-1.8v	-1.3v	- .7v	-.2v
REGULATION					
POT SETTING	0	1/4	1/2	3/4	Max.
Output Voltage Change	-1.v	- .75v	- .35v	0	+ .3v
(See Text)	-1.5v	-1.3 v	-1.1 v	-1. v	-.8v
INTERNAL IMPEDANCE					
POT SETTING	0	1/4	1/2	3/4	Max.
Internal Impedance ohms	40	30	14	0	-12

Table 1. Performance data on the improved d.c. voltage regulator.

ditional filtering is necessary to reduce hum in circuits carrying low signal levels. The reduction of this hum by the means to be described is just as effective and probably cheaper.

(Continued on page 174)

Fig. 4. Rear view of the power supply chassis of unit shown in Fig. 1.





# International SHORT-WAVE

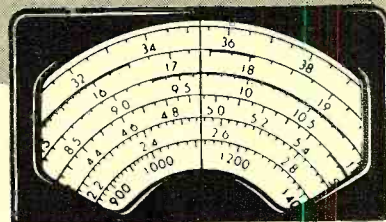

Compiled by **KENNETH R. BOORD**

**T**HIS is the *Saigon Story*, as related by Monsieur Jean Pipon, head of the English Department of *Radio Saigon*, French Indo-China, on the March 16, 1947, special broadcast dedicated to readers of this department of RADIO NEWS:

"On a day in the summer of 1928, the Director of the French Radio-Electric Society, in his office in the Boulevard Haussman, Paris, sent for his commercial agent. A customer had just arrived from Saigon, who wanted to buy a 12-kw. short-wave broadcasting station. At that time, only the most important countries had such luxuries. The man must be mad—or, at best, a very poor joker! When inquiries were made, however, it was found that the man, Monsieur Joseph de la Pommeraye, was a 'serious' prospective customer, who, with a group of friends, wished to 'endow' French Indo-China with a powerful radio station. The commercial agent hastened to invite the gentleman to luncheon, and on this occasion learned of the forthcoming creation of the Franco-Indochinese Radio Company.

"Twelve months later, this company purchased a plot of ground at Chi-Hoa, on the outskirts of Saigon, and had buildings constructed there. Two engineers came from France, and also a fine orchestra—certainly the best that Indo-China had ever known, for of the seven musicians engaged, five were first-prize winners from the Paris Conservatory.

"On July 18, 1930, the first *Radio Saigon* broadcast took place, in the presence of the Governor-General, Monsieur Pasquier. From the very beginning, results were excellent (except within a radius of about 150 miles and in Cambodia). Considerable improvement was achieved by the addition of new aerials.

"Letters came in from the four corners of the globe, so to speak. Listeners everywhere showed their enthusiastic admiration for France's fine effort. In Indo-China, however, the population was not well-equipped to hear the new station's broadcasts. In 1930, there were only 108 radio sets in the entire country, and these were of the loudspeaker type.

"It was suggested that the Administration should have at least one radio

receiver installed in the public hall of every village. But, alas, nothing came of this idea, and what was worse, owing to the heavy expenses incurred, *Radio Saigon* was obliged to cease its transmissions on April 30, 1932. Letters of disappointment and protest poured in from all over the world. Yet in spite of various press campaigns, 'The Voice of France in the Far East,' the name under which *Radio Saigon* was known to many hundreds of listeners, remained silent.

"In 1938, the matter was taken up in Paris and Indo-China, and these negotiations resulted in the formation of the Indochinese Broadcasting Com-



**Pierre Crenesse**, internationally famous war correspondent and France's most popular radio commentator, has arrived in New York to take up his new duties as director of the French Broadcasting System in the United States. Among his duties, Mr. Crenesse will have charge of exchange programs between France and the United States. The New York office is already servicing over 200 radio stations.

pany. In January 1939, the transmitting apparatus was taken from Chi-Hoa and was installed in Phu-Tho. The studios were set up temporarily at the Radio-Electric Centre in Saigon itself. In March 1939, French radio specialists arrived on the Air-France plane. Thanks to their valuable help, the first broadcast from the new studio was given at 0700 hours on April 1.

"We carried on under considerable difficulties. There were frequent breakdowns in the technical equipment, which we were still waiting patiently to have renewed, and we were particularly short of gramophone records. Gradually then,

both equipment and recordings began to arrive. Broadcasters became more varied and daily transmissions were given in French, Cochinchinese, Tonkinese, *English*, Dutch, Cambodian, Chinese, and Siamese. A tremendous mail arrived with every boat; in fact, about 60 per cent of the letters received bore foreign stamps.

"Then in September of 1939, war broke out in Europe. *Radio Saigon* found itself unable to continue as a private enterprise. Government aid was given and the 'Voice of France in the Far East' continued to be heard. Then came June 1940—and the Armistice! All telephonic and telegraphic communications with France were broken, and so Indo-China was unable to receive any first-hand news from France. However, listeners continued to hear three daily news bulletins. But they hardly realized the tremendous amount of work that was involved for the staff of the station and for the Radio Control Service. For a month, the head of this Service could not have had more than two or three hours sleep each night. Surrounded by contradictory reports and telegrams, he was continually listening-in—hoping to find out what was really happening in France. Meanwhile, more technical equipment had arrived and *Radio Saigon* could now be heard throughout the French Empire.

"When the Japanese first arrived in Indo-China, they were, of course, much concerned with the radio and tried their best to turn the station into a pro-Japanese affair. They somehow managed to 'drag' from a timorous Government rights of control over the station's broadcasts.

"But they met with stubborn Underground opposition—at least from some members of the staff. I could make a long story of my Homeric struggle with their censors and the system of code signals established with other Allied stations—but time does not permit. Everything went along more or less smoothly until March 9, 1945. That was the date of the Japanese 'cou de force' which resulted in their overthrowing the French colonial government and taking full power.

(Continued on page 152)

**RADIO NEWS**

# MODERN

## Television

# RECEIVERS

The front-end section of  
Motorola Model VT101 set.

**Part 3. A discussion of the mixer  
and oscillator stages in TV sets.  
R.f. alignment data is also given.**

By  
**MILTON S. KIVER**

**W**E HAVE been forced, by space limitations, to consider the r.f. section of the receiver in three separate articles. From the servicing viewpoint, in which we are primarily interested, the r.f. amplifier, oscillator, and mixer should be lumped together in one package and looked upon as a single operating unit. As we progress through the television receiver, we will find other stages which can be combined into distinct units until, at the conclusion, we will have converted the complex television receiver structure into seven distinct packages. Troubleshooting will then devolve into a system whereby we localize each defect to a certain unit and thereafter center our complete attention on this unit until the defect has been found. In this article we conclude the r.f. package with an analysis of mixers and the alignment methods applicable to these stages.

Within the mixer of the television receiver, the received signal and the oscillator voltage both modulate the electron stream to form the desired audio and video i.f. voltages. Most radiomen have long been accustomed to pentagrid converters in this section of an AM receiver. Television sets, however, almost never use these tubes because of the proportionately large amount of noise voltage they generate plus the instability in oscillator frequency. Oscillator operation becomes increasingly critical with frequency and it is best to provide separate tubes for the oscillator and mixer.

Miniature high-frequency triodes and pentodes appear to find equal application as mixers in current television re-

ceivers. Incoming signals, at this point in the receiver, are extremely weak and all extraneous noise must be prevented from approaching signal strength. Triodes are superior to pentodes and the latter are superior to pentagrid converters because each element within a tube develops a certain amount of noise. In this respect, diodes would be the best tube of all to use, except that it is felt the amplification provided by triodes and pentodes outweigh whatever reduction in noise would result from the use of a diode.

The signal from the r.f. amplifier is transformer or impedance coupled to the mixer in nearly all circuits. The major exception to this occurs in the *RCA* quarter-wave transmission-line tuner. Here, a combination of link and capacitive coupling carries the signal over to the mixer tuning line. The oscillator voltage, in all sets, is transferred either by capacitive or inductive coupling. *Andrea, DuMont, Industrial Television, Motorola, Belmont, Farnsworth, and United States Television* employ capacitive coupling. Representative of this group is the circuit shown in Fig. 1. In all instances, the oscillator voltage is applied to the control grid of the mixer through a small 1-5 mmfd. condenser.

Inductive coupling is employed by *RCA, Admiral, Philco, and General Electric*. In the *RCA* tuner (which is also employed by *Admiral*), a single turn of link coupling is placed between the oscillator and mixer lines. See Part 2. In addition, the physical location of the two units is such as to also provide direct coupling.

The *RCA* tuning line differs considerably from the conventional circuit and hence merits additional attention. The grids of the twin triode mixer are fed in push-pull by both the signal and the oscillator and the i.f. voltages produced (by the heterodyne action) are in phase on the mixer plates, permitting the two plates to be connected in parallel. Unwanted signals of i.f. frequency that arrive at the converter grid in a push-pull manner are out of phase at the mixer plates. Since the plates are tied together, these signals are cancelled out.

A series-resonant circuit placed between the end of the mixer tuning line and ground prevents i.f. feedback in the mixer by grounding the grids for the i.f. frequency. They also function as a trap to reject all short-wave signals of i.f. frequency which arrive at the mixer grids in a push-push manner. Iron-core screws permit variation of the induc-



tance of selected coils in the quarter-wave line for circuit alignment. A 10,000-ohm resistor is effective on Channels 1 through 8 to broaden the response to the required 6.0 mc. On Channels 9 through 13, the resistor is unnecessary

because 6.0 mc. represents a smaller percentage of the total frequency and hence is easier to achieve with coils of the same *Q* or less.

In *General Electric* television receivers, coupling between oscillator, r.f. ampli-

fier, and mixer is accomplished inductively by placing all coils on the same form and in close proximity to each other. See Fig. 2. The plate coil of the r.f. amplifier is adjacent to the grid coil of the mixer. The oscillator coil is placed

on the opposite side of the mixer grid coil. The oscillator and r.f. amplifier coils are located as far as possible in order to minimize radiation of the oscillator signal through the antenna system. A signal so radiated can have an injurious effect on any nearby television receiver, as indicated by the interference pattern obtained from the screen of a nearby set. See Fig. 4.

In the particular arrangement employed in Fig. 2, adjustment of the bandwidth response is made by moving the plate coil closer to or farther away from the grid coil. Spreading or squeezing of the plate or grid coil turns, raises or lowers the resonant frequency.

*Philco* receivers employ a turret tuner in which the r.f. amplifier input and antenna coils are wound on the same snap-in form. The output of the r.f. amplifier is impedance coupled to the mixer. The mixer and oscillator coils are wound on a second snap-in form. On Channels 1 through 6, the coupling between oscillator and mixer is inductive; for Channels 7 to 13, capacitive coupling is added in order to obtain a greater transfer of oscillator voltage. The r.f. section of the *Philco* receiver has been previously shown.

We have now a fairly comprehensive analysis of the front-end or r.f. section of current television receivers. Servicing techniques applicable to these stages have been covered in the first two articles of this series and little new need be added for the mixer stage. The three stages function as a group and what is true of one will generally apply to all. Of remaining interest is the alignment of these stages.

#### R.F. Circuit Alignment

Television circuits, in the front-end of the receiver, must be capable of passing a 6.0 mc. range of frequencies. In order to achieve this, overcoupling in the tuned circuits is resorted to and the usual r.f. response curve, then, has the appearance shown in Fig. 3. The over-coupling produces the dip in the center with a peak on either side. The dip should be no greater than 30 per

**Table 1. A comparison of present-day television receivers. The chart below includes only those models which are on the market and which have been discussed in the articles thus far. As new models become available, they will be added to chart and adequate explanation of their operation given.**

Manufacturer	Model No.	Picture Type		Tube Size Diam.	Screen Size	Model Type		Tuning Method		R.F. Amp.	R.F. Osc.	Mixer
		Direct	Proj.			Table	Console	Continuous	Selector Switch			
Admiral	30A14	X		10	6 x 8		X		X	6J6 <sup>6</sup>	6J6 <sup>6</sup>	6J6 <sup>6</sup>
	30A15	X		10	6 x 8		X		X	Same as Model 30A14		
	30A16	X		10	6 x 8		X		X	Same as Model 30A14		
Andrea	T-VJ12	X		12	7½x10	X			X <sup>1</sup>	6J6	6J6	6AG5
	C-VJ12	X		12	7½x10		X		X <sup>1</sup>	Same as Model T-VJ12		
	CO-VJ12	X		12	7½x10		X		X <sup>1</sup>	Same as Model T-VJ12		
Belmont	21A21	X		7	5½x 4¼	X			X	6AK5	6C4	6AK5
Du Mont	RA-101	X		See Note 4			X	X		6J6	6J6	6AK5
	RA-102	X		12	7½x10		X	X		6J6	6J6	6AK5
	RA-103	X		12	7½x10	Note 5		X		6J6	6J6	6AK5
Farnsworth	GV-260	X		10	6 x 8	X			X	6BA6	½-6J6	6AG5
General Electric	801	X		10	6 x 8		X		X	6AU6	½-7F8	½-7F8
	802	X		10	6 x 8		X		X	Same as Model 801		
Industrial Television Inc.	IT3R	X		See Note 3					X <sup>7</sup>	6J6	6J6	6AK5
Motorola	VT71	X		7	4½x 6	X			X	½-7F8	½-7F8	½-7F8
	VT101	X		10	6½x 8½		X		X	6AG5	½-6J6	½-6J6
Philco	48-1000	X		10	6 x 8	X			X	6AG5	6J6	6AG5
	48-1050	X		10	6 x 8		X		X	Same as Model 48-1000		
	48-2500		X	5	15 x20		X		X	6AG5	6J6	6AG5
RCA	621TS	X		7	4½x 5½	X			X	6J6	6J6	6J6
	630TS	X		10	6½x 8½	X			X	6J6	6J6	6J6
	721TS	X		10	6½x 8½	X			X	6J6	6J6	6J6
	630TCS	X		10	6½x 8½		X	X		Same as Model 630TS		
	721TCS	X		10	6½x 8½		X	X		Same as Model 721TS		
	730TV1	X		10	6½x 8½		X	X		Same as Model 721TS		
	730TV2	X		10	6½x 8½		X	X		Same as Model 721TS		
	641TV	X		10	6½x 8½		X	X		6J6	6J6	6J6
	8TS30	X		10	6½x 8½	X			X	Same as Model 630TS		
648PTK		X	5	15 x20		X		X	6J6	6J6	6J6	
United States Television	T-502	X		10	6 x 8		X		X	6AG5	6AK5	6AK5
	T-507		X	5	21 x16		X		X <sup>2</sup>	6AG5	6AK5	6AK5
	T-525	X		5	25 x19		X		X <sup>2</sup>	Same as Model T-507		
	T-530	X		5	30 x22½		X		X <sup>2</sup>	Same as Model T-507		
	T-621	X		5	22¼x16¼		X		X <sup>2</sup>	Same as Model T-507		

<sup>1</sup>The Andrea receivers employ a tuner "turret" which is somewhat similar to the Philco tuner except that all 13 channels are wired into position. The r.f., mixer, and oscillator tubes, with their circuit components, are also contained within the copperplated steel case. This reduces reradiation and protects the circuits from external fields.

<sup>2</sup>The r.f. tuning circuits of U.S.T. receivers closely resemble those employed in G.E. receivers. See explanation in Part 1 of this series.

<sup>3</sup>Industrial Television receivers are designed solely for commercial use. The picture tube is housed separately and controlled by a control unit located some distance away. Picture sizes can range from 6x8 inches for a 10-inch diameter tube to 12¼x17¼ inches for a 20-inch diameter tube.

<sup>4</sup>The set appears in six different style cabinets: Hampshire, Sherwood, Westminster, Revere, Plymouth, and Devonshire. Differences between models are in the size of the cathode-ray tube. The Hampshire and Westminster use a 20-inch tube; the other four models use a 15-inch diameter tube.

<sup>5</sup>This model receiver is available in three types of cabinets, two of which are table models and one is a console.

<sup>6</sup>Models 30A14, 30A15, and 30A16 employ an r.f. end section which is very similar to the RCA front end system.

<sup>7</sup>Industrial Television employs the "Inductuner" in an arrangement similar to that found in DuMont receivers.



cent of the maximum amplitude of the curve. If the dip exceeds 30 per-cent, the coupling is too tight and should be loosened somewhat. The audio and video carriers are placed within 90 per-cent of the maximum amplitude.

The equipment needed to properly align the r.f. stages include:

1. A sweep signal generator with a center-frequency range from 44 to 216 mc. and a maximum sweep of 10 mc.
2. An AM signal generator capable of providing frequencies from 44 to 216 mc.
3. An oscilloscope.
4. A vacuum-tube voltmeter.

In the order of receiver alignment, the r.f. stages are the last ones adjusted. However, we are concerned only with these stages at the moment and we will assume that the video i.f. and audio i.f. circuits have already been adjusted. When the analysis reaches these particular sections of the receiver, a full discussion of their alignment procedure will then be given.

The order of receiver alignment within the r.f. section varies with the manufacturer. Some start with the oscillator and then align the r.f. tuning circuits. Others suggest that the process commence at the r.f. circuits, leaving the oscillator for last. In most cases it makes little difference which is taken first, so let us begin with the oscillator.

In every set, the oscillator must be precisely set to each of thirteen frequencies, one for each channel.\* There are three possible ways to accomplish this adjustment.

1. Apply a signal at the r.f. sound carrier frequency and note the indication at the FM detector output.
2. Check the oscillator frequency directly against the known frequency of a separate signal generator, noting the indication on an oscilloscope.
3. Using a sweep generator, a marker signal, and an oscilloscope.

#### Method No. 1

The application of Method No. 1 will depend upon whether the set is using a Foster-Seeley discriminator, a balanced ratio detector, or an unbalanced ratio detector.

a. *Foster-Seeley Discriminator.* In this type of detector, the output is zero when the signal reaching it is exactly at the i.f. value. Connect an AM signal generator to the antenna terminals of the receiver and set it to the sound carrier frequency of some channel, say 13. This is 215.75 mc. Connect a vacuum-tube voltmeter across the full discriminator output, as shown in Fig 5A. Set the receiver selector switch to channel 13. Now vary the oscillator tuning adjustment for this channel until the meter reads zero. The voltage polarity will be positive on one side of this zero point

June, 1948

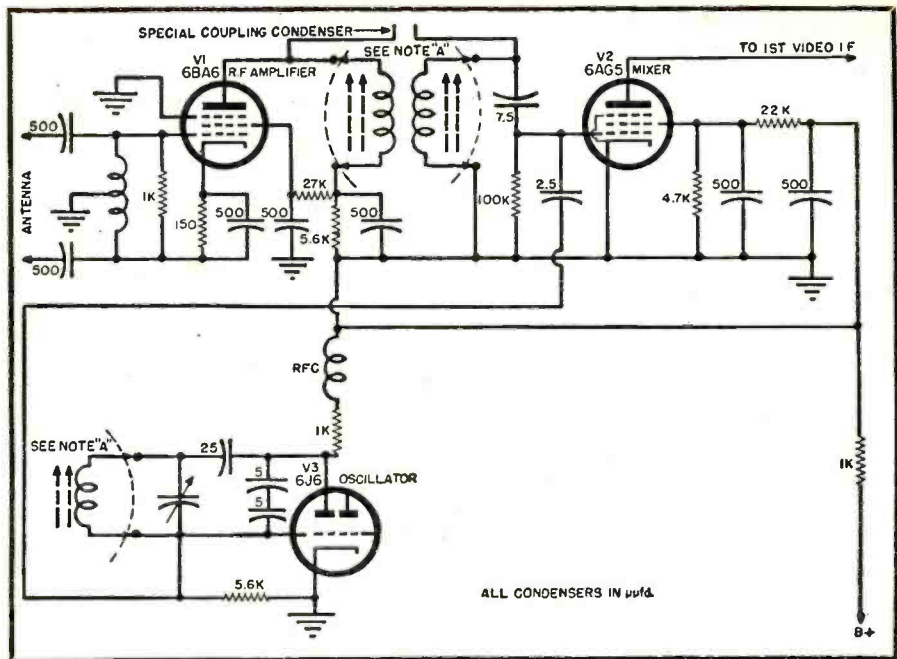

Fig. 1. The r.f. section of the Farnsworth Model GV-260 television receiver. The special coupling condenser consists of two short sections of wire over which has been placed a length of spaghetti. Adjustment is made by varying the distance between the ends of the wires. Note "A". An eight position rotary switch that switches in different coils for each of the available television channels.

and negative on the other. Each channel is adjusted, in turn. Whether we start with Channel 1 or Channel 13 will depend upon the design of the receiver. In RCA sets, for example, we must start with Channel 13 because each lower channel is dependent upon the setting of each higher channel. When the coils are independent of each other (as in most circuits), then the starting channel is immaterial.

b. *Balanced Ratio Detector.* A balanced ratio detector is shown in Fig 5B. Connect the vacuum-tube voltmeter between point A and ground. Connect the AM signal generator to the antenna terminals of the set and set it for the sound r.f. carrier of the desired channel, again say 13. Place the receiver on the same channel. Now adjust the oscillator coil for this channel until the meter reads zero. The same procedure is followed for all channels. Always be certain that the receiver selector switch is set to the channel being adjusted.

c. *Unbalanced Ratio Detector.* An unbalanced ratio detector is shown in Fig 5C. Connect a vacuum-tube voltmeter between point B and ground. The AM signal generator is connected to the receiver input terminals, using the same frequencies noted previously. The oscillator tuning adjustments are now set for maximum voltage on the vacuum-tube voltmeter. A similar procedure is followed for each of the thirteen channels.

In each instance, the incoming signal

\*In any one community, the maximum number of assigned channels is seven. However, in order to make the above procedure universally applicable, all channels will be considered.

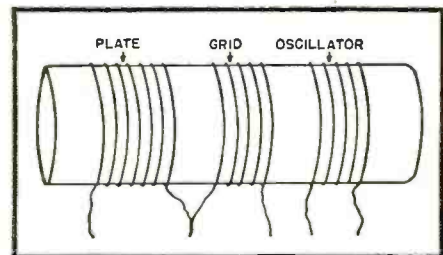

Fig. 2. The plate, oscillator, and mixer grid coils are all placed on a common form in General Electric video receivers.

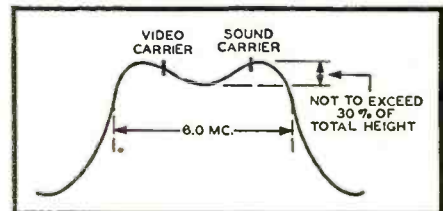
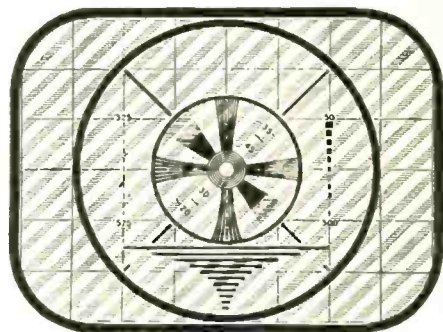

Fig. 3. This is the form of the r.f. response curve for most television receivers. Serviceman should recognize it.

Fig 4. The interference pattern produced on a video screen by other r.f. signals.



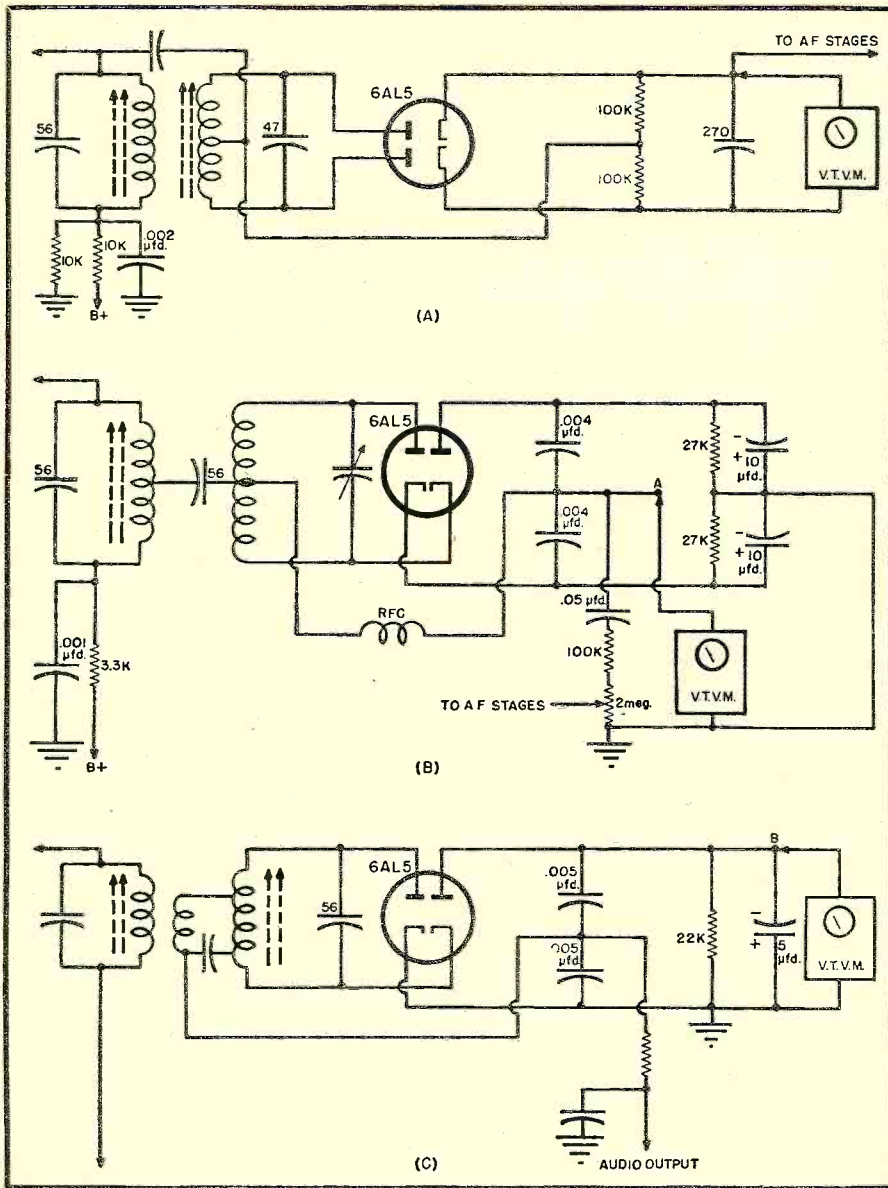

Fig. 5. (A) A Foster-Seeley discriminator as used in RCA television receivers. (B) A balanced ratio detector employed in Philco television receivers. (C) An unbalanced ratio detector similar to those found in Belmont and Motorola Model VT-71 sets.

mixes with the oscillator voltage, producing a difference or i.f. frequency. When the i.f. is at the proper frequency, the indications noted above will be obtained.

**Method No. 2**

For the second method of checking the oscillator frequency, we connect the apparatus as shown in Fig. 6. The oscillator and signal generator voltages beat

Fig. 6. Connecting the test apparatus for Method No. 2 as described in text.

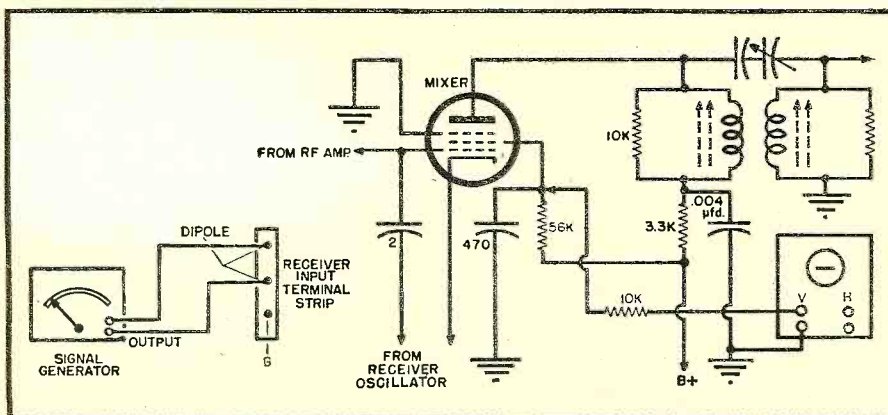

against each other and the beat signal is visible on the oscilloscope screen. The oscillator is adjusted until its frequency is equal to that of the signal generator. When this occurs, the difference beat frequency is zero and only a straight horizontal line is visible on the screen. Note that now the signal generator must be set to the oscillator frequency and not to the sound r.f. carrier frequency, as in Method No. 1. To compute this value, add the sound r.f. carrier frequency plus the sound i.f. Thus, for Channel A, a sound r.f. carrier frequency of 65.75 mc. and a sound i.f. of 21.25 mc. will result in an oscillator frequency of 87 mc. Hence, the calibrating AM generator should be set to 87.00 mc. for this channel. For other channels the value would naturally be different.

The vertical input terminals of the oscilloscope are shown attached to the junction of the screen bypass condenser and screen dropping resistor. When the mixer is a triode, the oscilloscope should be connected to the junction of the plate dropping resistor and the plate bypass condenser.

**Method No. 3**

In this third method, we require a sweep signal generator, an AM signal generator and an oscilloscope. Connect the oscilloscope to the grid of the first audio amplifier. (The volume control should be turned completely clockwise, for maximum output.) Connect the sweep and AM signal generators to the input terminals of the receiver. (50-mmfd. isolating condensers in the leads of both signal generators.) Set the receiver controls for the desired channel and adjust the sweep generator so that it sweeps across this channel. The AM signal generator is set at the frequency of the sound r.f. carrier for this channel. The response pattern obtained on the screen will appear as shown in Fig. 7. Somewhere along this curve will be a pip, produced by the AM signal generator. The receiver oscillator coil is now adjusted until the pip falls exactly in the center of the linear section of the FM detector curve.

This latter method of alignment is applicable to all television receivers since all FM detectors possess essentially the same S-shaped response curve.

When a "Fine-Tuning" control is available, it is placed at mid-position and kept there throughout the alignment of the r.f. amplifier, mixer, and oscillator stages.

**Input and R.F. Circuit Alignment**

For the r.f. and mixer tuning circuits, we require a response curve on all channels similar to the one shown in Fig 3. At the higher channels, Nos. 7 through

# AS NEW AS THE FUTURE!

... the only transformer  
line of its kind

*Advanced, practical  
engineering  
gives you*

## THESE OUTSTANDING FEATURES

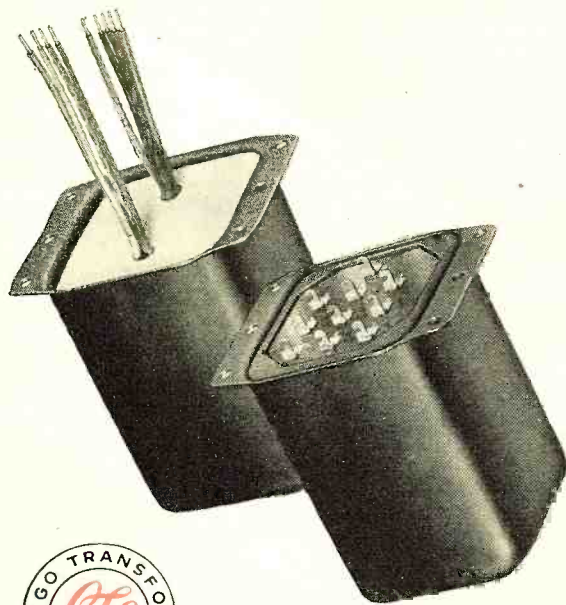

# CHICAGO TRANSFORMERS

*Sealed in Steel*

Have Complete Details On Hand For Your New Equipment Planning

**WRITE TODAY FOR CATALOG**

**CHICAGO TRANSFORMER** Division, Essex Wire Corporation

3501 ADDISON STREET, CHICAGO 18, ILLINOIS

### 1 SEALED IN STEEL CONSTRUCTION

Chicago Transformer's drawn steel cases provide convenient, compact mountings; seamless steel-wall protection against atmospheric moisture and corrosion; unsurpassed strength and rigidity to withstand shock and vibration; clean, streamlined appearance that adds eye-appeal to any equipment.

### 2 CHOICE OF CONNECTORS

Solder lugs or wire leads. Most units are available with identical ratings in two base styles to fit your price and/or wiring preference.

### 3 CHARACTERISTICS KEYED TO MODERN TUBES

Voltage, current, and output ratings have been designed for one purpose only—to fill the requirements of the receiving, transmitting, and industrial electronic tubes currently most in demand. No listings wasted on obsolete circuit needs. Result—a condensed, yet comprehensive, line that's right in step with today's new circuit designs.

### 4 EXACT MATCHING OF REACTORS

with power transformers. Current ratings of plate and filament supply transformers and of the high voltage plate transformers are matched by choke capacities specially designed for the purpose. Mountings match, as well, for uniform, "tailored" good looks.

### 5 TRUE HIGH FIDELITY THROUGHOUT 3 RANGES

Frequency response within  $\pm 1/2$  db; distortion exceedingly low, even at low frequencies. These are the characteristics of the input and output transformers. Driver and modulation transformers provide response within  $\pm 1$  db. All audio units are designed for frequency ranges that fit three classes of up-to-date audio application. Full Frequency Range: 30-15,000 cycles (good up to 20,000 cycles, where required). Public Address Range: 50-10,000 cycles. Communications Range (voice): 200-3,500 cycles.

# SUPER VALUES from MID-AMERICA!

## Stromberg-Carlson DYNATENNA

This famous-make FM antenna has been advertised and sold for many times the low price MID-AMERICA asks! Covers both FM bands. Delivers FM reception at its best. Complete with 60 ft. of 300-ohm twin lead-in. Line is standard approved flat-type, solid dielectric with weather-resisting insulation. Mounts anywhere easily . . . vertically or horizontally to match polarization of trans-

mitting station. Illustrated instructions and all necessary hardware. A screwdriver is only tool needed for assembly. Dynatenna is seamless, heat-treated, all aluminum . . . will withstand severest weather.

**\$4.95**

each  
\$4.45 each  
in lots of 3



## PERMEABILITY TUNER

Build a really HOT 5 or 6-tube AC-DC superhet receiver! Takes place of old-style gang condenser, of and antenna coils; regular 455 KC intermediate frequency. **MA-2167** Complete with permeability tuned oscillator coil, 4" x 2 1/4" x 2 1/4"; 2 1/4" diameter dial drum. Complete with diagrams for building 5 and 6 tube sets. Order **MA-2169** Loop Antenna . . . 15¢  
Order **MA-2914** Drilled, Punched Chassis . . . 39¢

**\$1.24**



## BANTAM 1-WATTER

BCR-746-A tuning unit used as foundation for Bantam 1-Watter described in Jan. 1948 QST. Makes tiny crystal-controlled CW xmitter. Measures only 3 1/2" long, 2 1/4" high, 1 1/2" wide. Requires only 1 1/2 volts "A", 30 to 90 volts "B". Draws 8 to 15 ma under load. Supplied less crystal, 154 tube and plug-in coil **MA-907**. . . . . **24¢**

## SPECIAL AUDIO TRANSFORMERS

Exceptionally high-quality universal output transformer for up to 12" speakers. Rated at 12 watts. Matches any single, push-pull or parallel tubes to 6-8 ohm voice coil. 12" color-coded leads. 2" high with 2 1/4" mounting centers for installation on chassis or speaker. Complete with instructions for matching tube impedances. **MA-1205** **\$1.19**

Hermetically sealed 200 ohm CT to 50,000 ohm grid. Use as microphone transformer, line-to-grid, etc. 2 1/4" x 1 1/4". **MA-1262** **69¢**  
Single 3000-ohm to 4-ohm voice coil output for 50L6, 35L6, etc. 1 1/2" high on 2 1/4" mounting centers. **MA-1255** . . . . . **49¢**

## Heavy Duty Noise Filters

Rated on 10 amps, 115-volt AC. Measures only 1" x 1 1/4" square. Install right in amplifiers, receivers and other equipment where line noises must be kept at a minimum. Nationally-known manufacturer. **MA-2164** . . . . . **79¢**

Filter for mobile power supplies. Rated 10 amps, 6-30 VDC. Has additional 2 mfd, 100 VDC condenser. 2" high, 2" square. **MA-2165** . . . . . **59¢**

## SPEAKER SPECIALS

All with Heavy ALNICO 5 Slugs

3 1/2" PM MA-2062 . . \$1.39    4x6 Oval PM MA-2187 \$1.39  
5" PM MA-2071 . . \$1.39    6" PM MA-2189 . . \$1.95

## ORDER FROM THIS AD!

Quantities are limited, so get your order in now! Minimum order shipped, \$2.50. Send 25% deposit, balance C. O. D. Get on MID-AMERICA's mailing list to receive BIG BARGAIN BULLETINS that list latest, greatest buys in radio parts, electronic equipment. Send orders to Desk E-68.

**MID-AMERICA CO. Inc.**  
2412 S. Michigan Avenue  
Chicago 16, Ill.

Manufacturer	Model No.	Oscillator		R.F. Amplifier & Mixer		Matching Network	Order of Channel Alignment R.F., Osc. and Mixer		
		Mfg. Recommended Methods	Other Methods Applicable	Mfg. Recommended Methods	Other Methods Applicable				
Admiral	30A14	1a or 2	3	A	B	Yes	Channel 13		
	30A15	Same as Model 30A14							
	30A16								
Andrea	T-VJ12	1b	2 and 3	A	B	Yes	Immaterial		
	C-VJ12	Same as Model T-VJ12							
	CO-VJ12								
Belmont	21A21	3	1c and 2	B	A	Yes	Note 1		
Du Mont	RA-101	R.f. section of these receivers is not to be aligned by men in the field. In case of difficulty, the Inductuner assembly is to be removed from set and returned to manufacturer.							
	RA-102								
	RA-103								
Farnsworth	GV-260	1a	2 and 3	A	B	None Required	Immaterial		
General Electric	801	1a	2 and 3	A	B	None Required	Immaterial		
	802	Same as Model 801							
Industrial Television, Inc.	IT3R	R.f. section of these receivers is not to be aligned by men in the field. In case of difficulty, the Inductuner assembly is to be removed from set and returned to manufacturer.							
Motorola	VT71	2	1c and 3	A	B	Yes	Channel 1		
	VT101	1a	2 and 3	B	A	Yes	Immaterial		
Philco	48-1000	1b	2 and 3	B	A	None Required	Note 2		
	48-1050	Same as Model 48-1000							
	48-2500								
RCA	621TS	1a or 2	3	A	B	Yes	Channel 13		
	630TS	All R C A Television receivers use same r.f. tuner and all are aligned in the same manner.							
	721TS								
	630TCS								
	721TCS								
	730TV1								
	730TV2								
	641TV								
8TS30									
648PTK									
United States Television	T-502	3	1a and 2	B	A	Yes	Immaterial		
	T-507	All the models listed use essentially the same type of r.f. tuner and all are aligned in the same manner.							
	T-525								
	T-530								
	T-621								
T-621									

### NOTES

1. The Belmont receiver employs continuous tuning and therefore the r.f., oscillator, and mixer tuning circuit adjustments are similar to those made on low-frequency AM sets where continuous tuning is likewise employed. The six lower television channels are tuned by one set of coils and the upper seven channels by another. For each set, the turn spacing of a coil is adjusted at the low end of that band and a trimmer condenser adjusted at the high end to insure tracking over the entire band.
2. The R.F. and mixer circuits of Philco receivers require alignment only on channel 10. Once the two trimmer condenser adjustments have been accurately set, all other channels will automatically fall into proper position.

Table 2. Table shows manufacturers' preferred method of aligning TV receivers.

13, the 6.0 mc. bandpass is easier to achieve and the overcoupling between coils is not so marked. In the Farnsworth Model GV-260 receiver, the recommended response characteristic for Channels 7 through 13 is shown in Fig. 8A. For G.E. receivers, the recommended response curve is shown in Fig. 8B. These are variations that will be encountered among the various receivers on the market. During alignment, compare the response curves obtained with those recommended by the manufacturer in his service bulletin. If no curves are given in the bulletin, adjust the circuit until those shown in Fig. 3 are obtained. After the alignment is completed, examine the test pattern received from a local station. All vertical wedges should be visi-

ble up to at least 250 or 300 lines. Detail should stand out clearly. If the picture is fuzzy, readjust the input and r.f. coils, watching the test pattern until it is as clear and sharp as possible. An "air-check" should be run on every receiver before it leaves the shop.

In the response curve of Fig. 8B, the high-frequency end is peaked more than the low-frequency end. This is done purposely in this receiver to offset losses suffered by the high-frequency signals when passing through the set.

Alignment of the input and r.f. stages can be achieved by either of two methods, and each is applicable to all television receivers. In Table 2, the manufacturer's preference is indicated together with all applicable methods.

# HOT RADIO VALUES at SUN RADIO!

## CRYSTALS!

In the greatest purchase of radio transmitting crystals ever made by one wholesaler in the history of the Radio Parts Industry, Sun Radio acquired title to over a half million dollars (500,000.00) of Army Surplus, precision built, exactly tooled crystals in moisture proof holders which are shock mounted. Please note that crystal shipments of 6 or less are packed in cloth containers to expedite handling. No worry because all crystals are shock mounted and guaranteed delivered perfect. All crystals have Army MC harmonic rating but Sun encloses directions for deriving the correct fundamental frequency in kilocycles.

### CRYSTALS WITH A MILLION USES

Fractions Omitted

412	420	429	437	445	470	479	490	497	506	516	
413	422	430	438	446	459	472	481	491	498	507	518
414	423	431	440	447	462	473	483	492	501	508	519
415	424	433	441	448	466	474	484	493	502	509	522
416	425	434	442	451	468	475	485	494	503	511	523
418	426	435	443	453	477	487	495	504	512		
419	427	436	444			488	496	505	515		

**49c**  
each

I.F. Frequency Standards	Crystal Frequency Standards	For Crystal Controlled Signal Generators
450	454.166	526.388
451.388	455.556	527.777
452.777	459.259	529.166
		531.944
		533.333
		537.500
		538.888
		530.555

99c each

\$3.89 ea.

99c each

### ASSORTED MISCELLANEOUS CRYSTALS

372kc	376kc	381kc	384kc	387kc
374	377	383	386	388
375	379			

39c each

### FOR HAM AND GENERAL USE

Fractions Omitted				
390kc	395kc	402kc	405kc	408kc
391	396	403	406	409
392	398	404	407	411
393	401			
394				

79c each

priced at a fraction of the cost of their holders alone.  
• Payments must accompany order. Enclose 20c for postage and handling. Minimum order—\$2.00 plus postage.  
• Crystals are shipped packed in cloth bags inasmuch as they are shock mounted. All shipments guaranteed.

### CRYSTALS

FOR SCR 522

5910kc	7350
6370	7480
6450	7580
6610	7810
	7930

\$1.29 each

### Crystals from BC 610

3/4" Spacing — 2 Banana Plugs

2045	2258	2360	2532	3250
2105	2260	2390	2545	3322
2125	2282	2415	2557	3510
2145	2300	2430	3202	3520
2155	2305	2435	3215	3550
2220	2320	2442	3237	3570
				3580
				3945
				3955
				3995

\$1.29 each

## PANEL METERS

ALL BRAND NEW AND GUARANTEED

GE	2" Round	0-500 D.C.-M.A.	\$2.97
Simpson	2" Round	0-15 D.C.-V.	2.97
Triplett	2" Square	0-40 D.C.-V.	2.97
Sun	2" Round	0-300 D.C.-V.	2.97
GE	3" Square	0-150 A.C.-V.	3.49

### G I RECORD CHANGER

Plays twelve 10" or ten 12" records automatically. Standard changer used in Westinghouse, General Electric, Emerson, etc. at a new low price.

\$15.95

### MAGNETIC HEADPHONES

2000 ohms, 8' Cords with Army plug. All unused; show slight handling.

\$1.98

### 100 WATT BENDIX TRANSMITTER

4 Separate E. C. O.

\$49.95

These can be easily converted to 20—40—80 meters. Crystal required for 10 meters. Each electronic coupled oscillator dial has 3000 divisions enabling quick precision shifting. This transmitter was constructed of the highest quality of precision parts, with laboratory precision. Four separate output tanks; one 4-position selector channel switch having seven sections which changes the ECO, IPA and output tanks simultaneously. — BRAND NEW, complete with tubes. **\$49.95**

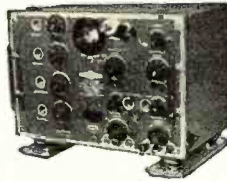

### SCR-522VHF TRANSCEIVER

Tunes 100—156 MC. Don't confuse these with other incomplete and abused 522s. Sun Radio offers electronically perfect and guaranteed 522s...AND COMPLETE with tubes, remote control box, 28 volt dynamotor (can be converted to 110 V operation), 4 crystals and ALL CABLE CONNECTORS but less cable. **\$24.95**



## WALKIE TALKIE

SET \$129.90

SCR195 Walkie Talkies, brand new, weight 27 1/2 pounds including knapsack. Range up to 25 miles in open country. Frequency 52.8 to 65.8 MC. Transmitter and receiver with regular hand set. Complete ready to operate with spare parts. Each **\$69.95**



### ANTENNAS

(A) Small four-section telescopic aerial ideal for portable receivers, transceivers or test equipment.

99c

(B) 22" tapered high frequency aerial covering 150 to 200 MC. Ideal for mobile or fixed station use.

\$2.69



### FM TRANSMITTER

BC-684 These units are BRAND NEW, providing 35-watt output, 10 channel push button crystal control employing NON-LINEAR MODULATING COIL. This unit tunes from 27 to 38.9 mc. These units come complete with tubes less power supply, covers, and crystals. Excellent 10 meter FM transmitter for "Ham" or Police use. **\$24.95**



### RADAR RECEIVER

BC-1068A Guaranteed excellent condition. It is a "Hot" receiver for the "Ham" and short wave experimenter covering the 174 to 210 MC television band. Has individually slug tuned antenna R.F., Detector and oscillator circuits resulting in maximum sensitivity; contains 2 R.F. and 5 I.F. stages detector and video amplifier. Complete with 110 volt AC power supply and 14 tubes. **\$39.95**



### Wavemeter BC-1073A

These units are only slightly used and are guaranteed in good condition. They contain a high quality resonant cavity wavemeter, oscillator heterodyne amplifier, electric tuning eye, complete with nineteen tubes (8-65N7-GT, 1-6S17, 1-6SA7, 2-6V6GT, 2-6H6, 1-5Y3GT, 1-9002, 1-9006, 16U5, 1-6SF5) 110-Volt A.C. Power supply. 27" x 20" x 6 1/4". Net weight 95 lbs. These units tune from 150 to 210 megacycles. Original cost \$550.00, your cost. **\$24.95**

### V. H. F. TRANSMITTER

Here is one of the greatest offerings in war surplus! Hundreds sold at \$20 and now closed out at an amazingly low price. Brand new. Battery operated (67 1/2 v B and 1 1/2 v A). Frequency 80 to 105 mc. Complete with 2-1G4 tubes and full instruction manual. Ready to go on the air. Less batteries **\$6.95**



### PORTABLE AMPLIFYING MEGAPHONE

U. S. Army Signal Corps Surplus! Complete in portable carrying case with electric megaphone and microphone, pistol grip and trigger switch. Additional hand microphone and switch. Portable tripod stand. Combination amplifier and battery case. Projects voice up to 1/4 mile. Used but guar. perfect. Complete with batteries. **\$59.95**



### SPERRY AMPLIFIER

Manufactured by Sperry Gyroscope Co. These amplifiers contain 2 beam power output tubes (1632) similar to 25L6, 2 twin triodes (1633 & 1634) similar to 6SC7, 2 mica condensers, dozens of color coded half watt resistors, 3 bathtub condensers, 2 dual bathtub condensers, 1 bathtub condenser with 4 sections, 3 hermetically sealed transformers, 2 wafer shielded rotary switches with resistor assembly, 1 volume control, 4 octal sockets, measurements 9 1/2" x 5 1/2" x 3 1/2". Brand new. Easily converted to excellent audio amplifier. **\$3.95**

• TERMS: All items F.O.B., Washington, D. C. All orders \$30.00 or less, cash with order. Above \$30.00, 25 per cent with order, balance C.O.D. Foreign orders cash with orders, plus exchange rate.

## SUN RADIO

OF WASHINGTON, D. C.

938 F STREET, N. W. WASH. 4. D. C.

TS13

HANDSET

Combining a 200 ohm carbon mike and 2500 ohm earphone with butterfly switch for talk-listen. Has 6" flexible rubber cord with 1-PL55 and 1-PL68 plugs attached. BRAND NEW **\$2.95**

**INCREASE PROFITS!  
BUILD GOOD WILL!**

# ...SELL SEEBURG RECORD CHANGERS

## FOR REPLACEMENT

Model DR-1. Two-post construction. High or low output cartridge. Size: 13 1/4 x 13 1/4 inches

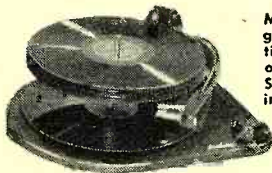

Model DS-1. Single-post construction. High or low output cartridge. Size: 12 x 13 3/8 inches.

## FOR PLAYING THROUGH EXISTING RADIOS

Model DR-101. Same chassis as DR-1 with walnut finish wood base. Size: 13 1/4 x 13 3/4 inches



Model DS-101. Same chassis as DS-1 with walnut finish wood base. Size: 12 1/2 x 14 1/4 inches

● These are the same quality mechanisms—now available for retail sale—that are standard equipment on so many of today's leading radio-phonograph combinations. And there's good reason for this preference. For Seeburg Changers assure simple, dependable operation . . . constant sustained speed . . . quiet performance . . . the last word in listening pleasure.

Plan now to sell and install Seeburg Changers for every purpose. Mail the coupon.

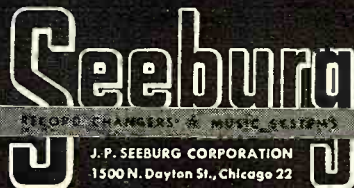

Seeburg Home Record Changers are available through our nation-wide distributing organization—located in all principal cities.

MAIL THE  
COUPON  
FOR FULL  
INFORMATION

J. P. Seeburg Corporation  
1500 N. Dayton St., Chicago 22, Ill.  
Gentlemen: Please send complete information on Seeburg Home Record Changers.  
Name.....  
Company.....  
Address.....  
City..... State..... RN-6

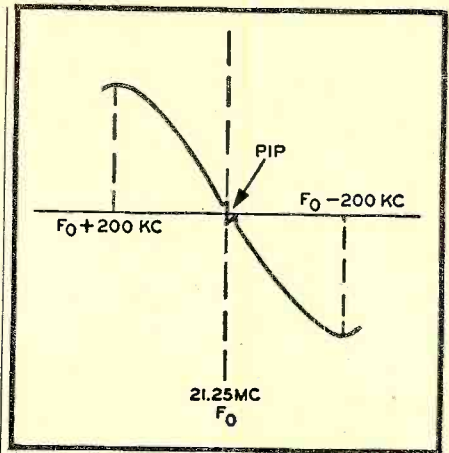

Fig. 7. The S-curve obtained at the output of an FM detector.

One further point before we discuss the two methods. When the sweep generator is connected to the input of the receiver for alignment of the input and r.f. circuits, check with the manufacturer's data to determine whether a resistive matching network should be inserted between the generator and the set. In some sets, it makes no visible difference in the response curves whether or not the generator output is matched to the receiver input; in others it does. When information concerning the manufacturers' preferences are not available, it is best to match the signal generator output to the receiver input.

Matching the generator to the receiver input terminals can be accomplished by means of the resistor network shown in Fig. 9. The values for resistors *A*, *B*, and *C* are determined as follows:

1. Resistor *A* is made equal to the stated output impedance of the generator.
2.  $A+B+C$  should equal the stated receiver input as closely as possible.
3. *B* and *C* should be equal to each other.

To illustrate the use of these rules, let us suppose that the stated output for a sweep generator is 30-ohms. Resistor *A*, then, would be 30-ohms. The receiver input is 300-ohms, requiring that resistors *B* and *C* each be 135 ohms. (300 minus 30 equals 270 and 270 divided by 2 equals 135 ohms.) Values as close as possible to these computed should be used.

(Continued on page 158)

Fig. 8. The r.f. response curves for channels 7 through 13 for (A) Farnsworth and (B) General Electric television receivers.

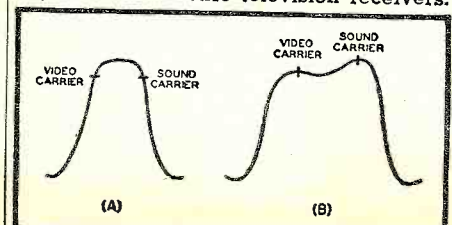

## HOW TO GET THE MOST from only BASIC TEST EQUIPMENT

Servicing by Signal Substitution  
The Simple, Modern, Dynamic Speed approach to receiver alignment and adjustment problems, FM-AM-TV.

- Nothing complex to learn
- No extra equipment to purchase
- Universal — non-obsolete
- Employs only Basic Test Equipment

S-S-S tells HOW — in simple, direct language.

New 9th edition now off the press. 100 pages of valuable information.

Available from all leading radio parts and equipment distributors or directly from factory at only 40c per copy.

PRECISION APPARATUS COMPANY, Inc. • 92-27 Horace Harding Blvd., Elmhurst 9, N. Y.

# 250,000 CARTONED RADIO TUBES ASSORTED FOR \$3500

INDIVIDUALLY CARTONED — FULL REPLACEMENT — BRANDED HYVAC — YOU PICK THE TYPES FROM LIST BELOW

117P7GT 32L7GT 12A8GT 12K7GT 25Z6GT 6A7 47	12F5GT 6S8GT 6P5GT 3V4 6C5 12SA7GT 12SK7GT	12SQ7GT 35L6GT 35Z5GT 50L6GT 6K7GT 6A8GT 5Y3GT	6K6GT 4Q7GT 6V6GT 6X5GT 6SA7GT 6SD7GT 6SK7GT	6SN7GT 6SQ7GT 25L6GT 70I7GT 117L7GT 117Z3 12AT6	12BA6 12BE6 35W4 35B5 3Q4 5085 1T4 1L4	1J4 1R5 1S5 3Q4 354 1B4 1K8	12A6 12SF7 6F5 6J5 6SJ7 12SJ7 6AJ5	6SF5 6BA6 6BE6 6AT6 6X4 6BJ6 6AK5	6BH6 6C5 117P7 32L7 12A8
--	--	--	--	---	---	---	--	---	--------------------------------------



**COAXIAL 12" PM SPEAKER**  
**\$27.50 VALUE**  
**NET \$12.95**

Designed by one of America's finest speaker builders, for FM high fidelity radios; selling in the \$500.00 bracket. Has 12" Alnico V PM with 4" built-in tweeter. The hi-pass filter is built-in. Just hook on to any 8 ohm output transformer. Will take approximately 18 watts. This speaker should sell for \$35.00. Why buy a regular speaker, when we are offering a co-axial speaker at only \$12.95. Stock No. 4-12X. Weight 8 lbs. Only a few hundred available.

### 15" ALNICO P.M. SPEAKER \$19.95

JUKE BOX TYPE, JUMBO 15" PM speaker, with 1 1/2" 8 ohm voice coil. Has 21.5 oz. of Alnico V magnet. (Equal to 110 oz. of ordinary magnet material). This speaker is so finely tuned, it should sell for \$100.00. Designed for full base response, such as required of juke boxes, etc. Will take 20 watts average, 30 watts peak audio power. Made by a nationally known speaker builder. Latest 1948 production, individually cartoned. Weight . . . lbs. Stock No. M2. Net \$19.95, 2 for \$38.00.

### 12" ALNICO V 12 OZ. MAG. P.M. \$9.95

Heavy duty 12" PM speaker, with 12.1 oz. of Alnico V magnet. (Equal to 60 oz. of ordinary magnet material). Has 8 ohm voice coil. Will take 15 watts average or 22 watts peak audio power. Made by a nationally known speaker manufacturer. This is a fine speaker for all type of public address and radio set use. Good base and treble response. Latest 1948 production, individually cartoned. Weight . . . lbs. Retail price \$25.00, Net \$9.95 each. Stock #2K1.

### 15" 1000 OHM FIELD \$13.95

Nationally known make—15" 1000 ohm speaker, 1 1/2" 16 ohm voice coil. Will take 25 watts. Factory cartoned, fully guaranteed. Stock No. 15U2. NET \$13.95, Two for . . . \$26.50

### Popular P.M. Speakers

AT LESS THAN HALF PRICE  
EVERY SPEAKER GUARANTEED

4 in. P.M. 1 oz. Alnico V. mag.	\$.099
5 in. P.M. 1 oz. Alnico V. mag.	\$.099
5 in. P.M. 1.47 oz. Alnico V. mag.	\$1.19
5 in. P.M. 2.15 oz. Alnico V. mag.	1.49
6 in. P.M. 1.47 oz. Alnico V. mag.	1.49
6 in. P.M. 2.15 oz. Alnico V. mag.	1.98
6 in. P.M. 3.16 oz. Alnico V. mag.	2.95
8 in. P.M. 2.15 oz. Alnico V. mag.	2.95
8 in. P.M. 3.16 oz. Alnico V. mag.	3.45
10 in. P.M. 2.0 oz. Alnico 3. mag.	4.45
12 in. P.M. 7 oz. Alnico V. mag.	4.95
12 in. P.M. 46 oz. Alnico 3. mag.	9.95

### SAVE ON FIELD SPEAKERS

4 in. Dynamic, 450 ohm field.	\$1.89
5 in. Dynamic, 450 ohm field.	1.89
5 in. Dynamic, 1000 ohm field.	1.89
8 in. 2 ohm field for heavy duty auto radio use.	2.95
8 in. Dynamic, 1000 ohm field.	2.95
12 in. Dynamic, 1000 ohm field.	4.95
12 in. RCA 450 Reg. 10.00 net 1 1/4" Voice Coil	4.95

### SPEAKERS WITH OUTPUT ATTACHED

5 in. P.M. 1.47 oz. Alnico V. mag. with 50L6 output.	Special \$1.49
5 in. P.M. 1.47 oz. Alnico V. mag. with Push-Pull output trans.	Scope \$1.69
5 1/2 in. G.E. P.M. Square with 50L6 output trans.	Special \$2.25
6 in. P.M. 1.47 Alnico V. magnet with 7000 ohm primary output trans.	Special \$2.25
Heavy Duty 8" 450 Ohm Speaker with 6V6 output.	\$2.95

### POPULAR OVAL SPEAKERS

4x6 in. P.M. 1.47 oz. Alnico V. mag.	\$1.49
5x7 in. P.M. 2.15 oz. Alnico V. mag.	1.95
4x6 Dynamic, 450 ohm field	1.95

### VIBRATOR SCOOP \$1.99



Heavy Duty Vibrator—Made for 6-110 volt amplifiers. Freq. 60 CPS. Scoop price . . . \$1.99  
135 ma 6-110 volt conventional power transformer, with all windings; will run phono motor. \$5.95 (Use with above vibrator)

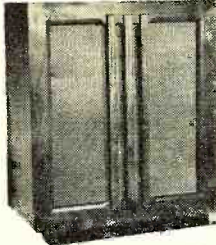

### WALNUT SPEAKER BAFFLE \$16.95

Walnut floor type speaker baffle. Size 12x22x26 inches. Will accommodate either 12 or 15 inch speakers. Air relief outlets in corner of grill. Weight 30 lbs. A \$25.00 value for only \$16.95. Stock #L-25. Net \$16.95. Why not order one of these with any of the speakers listed in adjacent copy?

### BIG SALE OF GENERAL ELECTRIC AUTO AERIALS

Genuine General Electric Auto Aerials. Individually factory cartoned. All are made by Ward. This is a real scoop on autoaerials. Order a good supply now, and save from 50 to 75 cents, on these top quality aerials. G.E. Model UZA-006, same as Ward SC-6. Side cowl 3 section 66", 36" shielded lead List \$4.95. Sale Price . . . \$2.49  
G.E. Model UZA-007, same as Ward SC-8. Side cowl 4 section 100", 36" shielded lead List \$6.95. Sale Price . . . \$3.49  
G.E. Model UZA-011, same as Ward TCF-3. Universal top-cowl mounting, 3 section 56". With 36" shielded lead. List \$5.35. Sale Price . . . \$2.65  
G.E. Model UZA-012, same as Ward DCF-3. 3 Section 56" fits all fenders, regardless of contour. With 36" shielded lead. List \$6.25. Sale Price . . . \$3.10



### PORTABLE P.A. \$39.95

18 watt complete portable public address system. Has inputs for a crystal or dynamic mike and phono pick-up. Has push-pull TC85 tubes in output. Attractive leatherette covered split type case. Priced complete with two 10" PM speakers. This is a complete public address system wired ready to play. Stock No. RC-18. Net \$39.95. Priced complete with crystal mike and desk stand.

### \$59.50 VALUE MUSICAL AMPLIFIER WHILE THEY LAST \$19.95



8 watt musical amplifier, 4 tube AC type. Inputs for crystal or dynamic mike and phono or instrument pickup. 2 gain controls and tone control. Has heavy duty built-in 8" speaker. Attractive leatherette covered case. Made by a large manufacture to sell at \$59.95. Brand new, fully guaranteed. For 110 volt AC operation. Our scoop price, \$19.95. Stock No. C-LX. Contact instrument pick-up, \$6.95 extra. Deluxe instrument pick-up, with volume control, \$8.95 extra. Crystal mike and desk stand \$4.95. Shipping weight, 20 lbs.

### 14-WATT AMP. \$29.95



**THIS AMP. SHOULD SELL FOR \$50.00**

Here is a high fidelity amplifier scoop we may never be able to offer again. Licensed under Western Electric patents. Brand new factory cartoned, 14 watt average output; 25 watt peak output. Matches 4-8-16 or 500 ohm line. Complete with tubes 6SL7, 6SN7, 2-12SL7, 2-6V6gt and 5Y3. Designed for 110 volt AC, 60 cycle operation. Frequency response 50 to 12,000 CPS. Hum level down 69 DB. Gain for two mikes and one phono pick-up. Eastern amplifier. Model E14A. . . . . Net \$29.95 Model E25A. Same as model E14A, except it has 2-6L6 output tubes, giving 30 watts output. . . . . Net \$44.95

### TUBULAR ELECTROLYTICS

In paper tubes with pig tail leads  
8 Mfd. 450 Volt Tubular. . . . . 39c each; 100 for \$32.50  
16 Mfd. 450 Volt Tubular. . . . . 59c each; 10 for \$ 5.25  
8x8 Mfd. 450 Volt Tubular. . . . . 49c each; 10 for \$ 4.50  
20x20 Mfd. 150 Volt Tubular. . . . . 39c each; 10 for \$ 3.50  
50x30 Mfd. 150 Volt Tubular. . . . . 49c each; 10 for \$ 4.25

### 75% OF ALL THE TUBES YOU USE 49c EACH

Guaranteed Standard Brands  
Cartoned and Uncartoned

12AH7 27 26 78 76 384 5U4G 5Y3G 6AC7 6C5 6H6 6J5	6K7 9001 9002 9003 1625 6S47 6S7 6S87 6S17 6SK7	6SL7 6SN7 6SQ7 6SR7 6V6 GT 6X5 GT 6AB7 12AT6 12BA6 12BE6 12H6 12J5 GT	12SQ7 12SH7 12SL7 12SA7 12SL7 12SC7 1T4 1R5 1S5 6R7 6L7 7Z4	12SQ7 12SR7 50L6 12SK7 25L6 GT 35L6 GT 35Z5 GT 1R5 1S5 50B5 6R7 6L7 7Z4
---	--	--	--	---

### SCOOP! ON NEW C.R. TUBES

Brand New Fully Guaranteed

3 API . . . . . \$1.95	5 FP7 . . . . . \$1.95
3 BPI . . . . . 1.95	7 FP7 . . . . . 2.95
	9 LD7 . . . . . \$2.95
5 BP4—Has white screen; ideal for television. . . . \$2.95	

### DETROLA CHANGER \$12.95 2 for \$25.00

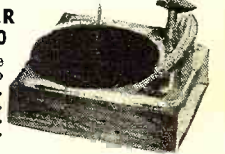

Detrola Changer, Base size 11 1/2 x 12 inches, \$12.95. Two for \$25.00. Aero Changer, Base size 12x13 inches, \$12.95. VM-800 Changer, Base size 13x14 inches, \$14.95.

General Instrument changer, base size 10 1/2 x 12", \$16.95. Seehurg, triple post, World's best, base size 14x14 inches, \$37.95. Made to fit leatherette bases for above changers, \$1.95. Specify type of changer for base.

### REPLACEMENT MOTOR FOR CHANGER . . . \$1.49

SMALL PHONO MOTOR. This 110 volt AC, 60 cycle phono motor is used on 80% of all automatic changers. Order one just to have around for replacement. Scoop price, \$1.49; Two for . . . \$2.79

### WIRELESS RECORD PLAYER In Two Tone Plastic \$10.95



Nationally known wireless type record player, with RCA silent sapphire pick-up. Beautiful two tone plastic case. Self starting phono motor, with two tube tunable broadcast band phono oscillator, which easily fits under plastic base. Automatic switch turns on motor when pick-up arm is raised. Stock #3-RC.

### 1948 MODEL—MIKE-BROADCASTER ONLY \$7.95

Broadcasts 800 to 1500 KC from either a phono pick-up or a crystal or dynamic mike. Makes any radio receiver a P.A. system, record player or recording amplifier. Gives broadcast quality. Has fade control from mike to record, simulating a regular broadcast station. This is a powerful model; using 2 35L6, 12SJ7 and 35Z5 tubes. Priced with tubes and connecting instructions. Works on 110 volts AC-DC. Crystal mike and desk stand \$4.95 extra. Model DE-5 truly a de-luxe mike-phonograph oscillator.

### 3-TUBE PHONO. OSC. ONLY \$3.95

Model DE-4—Phonograph oscillator. Broadcasts from 800 to 1500 KC. Gain for any crystal pick up. A new powerful circuit is used to assure plenty of power. Has variable gain control for proper modulation. Priced Model DE-4 Net. . . . . \$3.95

### SUPERHET BROADCAST TUNER for connection to phono amp. or P.A. system.

Compact chassis 5 3/4 x 3 3/4 inches. May be mounted inside the record player cabinet. Requires only three connections to amplifier. Uses 6SA7 or 12SA7, 6SK7 or 12SK7 and crystal diode. Complete with tubes, loop antenna, dial and instructions for connecting to any amplifier. Net \$7.95. Specify if tuner is to be used with AC or AC-DC type amplifier.

**McGEE RADIO COMPANY**

June, 1948

WRITE FOR CATALOG  
Prices F.O.B. K.C.

SEND 25% DEPOSIT—BALANCE C. O. D.  
1225 McGEE ST., KANSAS CITY, MISSOURI

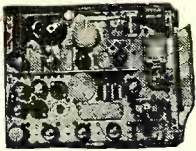

**BRAND NEW  
BC-645**

**9.95 TWO FOR \$19.00**

A small complete Transmitter and superhet receiver, for the 450 megacycle band. Diagrams for building AC power supply and conversion furnished. Ideal for MCW, CW or phone. The tubes (4-7E7, 4-7H7, 2-7E8, 2-6F6, 2-955 and WE-316A) are worth more than our sale price. BC-645 I.F.F. unit \$9.95 each, Two for \$19.00. Extra WE-316A tube 99c. 12 volt DC dynamotor (furnished all power) \$2.95. BC-645 shipping weight 25 lbs.

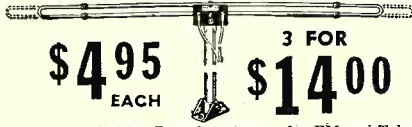

**\$4.95 EACH**

**3 FOR \$14.00**

Super value. Folded Di-pole antenna, for FM and Television. Complete with 60 feet of twin 300 ohm line and 4 low-loss stand-off insulators. This folded di-pole covers frequencies 42 through 108 megacycles. Trombone action makes exact tuning to any one weak station. Furnished with adjustable mounting bracket. Has 5 foot mast. Made for Stromberg-Carlson. Stock No. Mt-300—Net \$4.95. Weight 4 lbs. Individually packed.

**OUR LEADER  
FULL SIZE 3-WAY  
PORTABLE RADIO  
\$22.95**

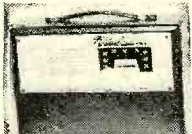

Full size 3 way portable radio. Operates on self contained 300 hour bat. or 110 volt AC—DC. Has tubes plus disc. receiver. A full superhet circuit. Attractive tan leatherette case. Made or sell for \$39.95 our price only \$22.95 weight 10 lb. Made by Nationally known mig. 7 1/2-9. 90 pack bat. \$2.95. KM-11

**"HOTTEST PICK ME UP RADIO IN AMERICA"  
NO TALLER THAN A PEN  
NET EACH \$19.95  
IN LOTS OF 3 \$58.50**



Model 747-3 way personal radio. Receives broadcast 550 to 1650 KC. Small size only 4x5x8 inches. However, uses full size parts with 2-gang condenser and loop. Priced complete with 4 miniature tubes and disc rectifier. These sets are only slightly larger than the smallest personal radio. Volume and tone like a big set. Kit of batteries \$2.05 extra.



**G.E. VARIABLE RELUCTANCE PICK-UP. \$4.65**

Scoop—Pre-amplifier for General Electric Variable Reluctance pick-up. Easily connected to any AC or AC-DC amplifier. Wired and Tested with 6SC7 or (12SC7) tube. Diagram for connections is furnished. Specify whether you want pre-amplifier for AC or AC-DC use. Net price, Pre-amp. with Tube and G.E. Pick-up—\$6.95. G.E. Variable reluctance pick-up cartridge with permanent needle. Net \$4.69.



**KIT MODEL J-41.** Our leader record player kit. Fine tone, low needle scratch; includes two-tone leatherette covered portable case, rim-drive photo motor, high output crystal pick-up and 5" Alnico 5 PM speaker. 70L7 ready wired and tested amplifier. No wiring to do, just mount the parts in the case. Has the tone and volume controls. Kit Model J-41

**\$14.95**

Kit model 61-X. Has a beautifully made leatherette covered portable case; similar in appearance to our model J-41. Has an even speed 78 RPM phono motor, light weight crystal pickup and a powerful, 4 tube transformer type; wired and tested, push-pull 7C5 phono amplifier. Has separate tone and volume controls. Full 6 1/2" heavy duty PM speaker. All you do is mount the amplifier, motor and pick-up. This is the last word in portable record players. Kit 61-X, Net \$22.95. Above kit model 61-X, with single post automatic record changer \$29.95.

**POWERFUL SINGLE RECORD PLAYER KIT Z-26.**

Housed in an attractive leatherette covered cabinet. Latest 78 RPM rim drive motor and light weight pick-up. Ready wired and tested 70L7 type tube amplifier. Tone and volume control. 5" PM speaker (Alnico V). This kit easily slips together. Priced complete with tubes and hook-up instructions. Kit Z-26.....Net \$9.95



**PARTS SALVAGE SCOOPS  
PACKARD BELL PRE-AMP \$1.99**



Housed in a handy aluminum case 5x4x5, priced complete with tubes 6SL7, 7, has many usable parts. Relay and control PL68 plug and patch cord.

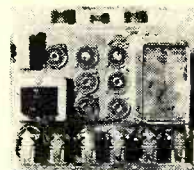

**RELAY SCOOP  
\$2.95**

lbs. Stock No. C-1T. Net

Auto pilot amplifier salvage scoop. Has 6 high resistance relays that operate in tube plate circuits on less than 8 mills. Also 4 controls. Choke cond., etc. Less tubes. Used but in good condition. Weight 12 lbs. Net \$2.95; two for \$5.50.



**AZMITH CONTROL  
99c**

A remote control for azimuth indicators. Has toggle switch, miniature pilot light and socket. B r a n d new. Type MN 32H, weight 2 lbs. Net 99 cents.

**8-WATT AMPLIFIER WITH P.P.  
50 L6 \$7.95**



4 tube, plus rectifier, AC-DC amplifier. Push-pull 50L6 output tubes, with 12S37 (Gain for mike or G.E. variable reluctance pickup), 12SL7 (Gain for conventional crystal pick-up) and phase inverter. This is a nice small audio amplifier, with tone and fader control, plus inverse feedback. Furnished wired and tested, complete with tubes. 8 watts output. Ready to play. Weight 6 lbs. Model TM-4. Net price \$7.95. Crystal mike and desk stand \$4.95 extra. 8" PM speaker \$2.95 extra. G.E. variable reluctance pick-up cartridge \$4.69 extra.

**BINGO AMPLIFIER \$13.95**

Bingo Amplifier. We offer you the above push pull 50L6 amplifier in a small leatherette case with 8-in built-in speaker for only \$13.95. Ideal for paging and announcing. Stock No. BG-4. Weight 14 lbs. Crystal mike and stand, \$4.95.

**SCOOP! 110 M.C. REC. \$7.95**



BC-733 D Localizer Receiver  
Freq. 108-110 Mc; Tube complement; 10 tubes—1—12SQ7, 2—12SR7, 1—12A6, 1—AHTGT, 2—12SG7, 3—717A. Now only.....\$7.95  
NEW CONDITION  
A RED HOT VALUE.

**CARBON HAND MIKE, 99c**



Army carbon hand mike with push-to-talk switch, cord and plug. Brand new and factory cartoned. While they last, 99c each; two for \$1.89; ten for \$6.90.



**R-89 \$6.95**

R-89/ARN-5 Glide Path Receiver 11 tube superhet. Formerly used for blind landing. Adaptable for many uses. Receives 326 to 335 MC. Contains six relays. 11 tubes 7-6A75, 12SR7, 2-12SN7, 25D7. Size 13x5x6. Weight 12 lbs. A beautiful piece of equipment. Has three crystals. Priced complete with xtals and tubes. R-89/ARN-5 Used condition, Net.....\$6.95

**MODULATOR SALVAGE \$2.95**

Another red hot value in salvage. All kinds of good usable parts in this unit. Con. Res. Relays, Modulation trans. and tubes VR150, 1275 and 1625. Originally designed to modulate the BC-457 W.E. Transmitter. You can find many uses for this BC-456 Modulator scoop. 28V Dynamotor.....\$1.95



Net \$2.95; two for \$5.50

**ANT CURRENT METERS \$1.95**

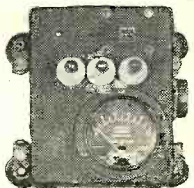

Antenna Current Meter as used with the popular command transmitters. Has 0 to 10 2 inch. Thermo coupled meter. Built in vacuum condenser. A scoop value.

Used \$1.95; two for \$3.69 New \$2.95; two for \$5.50

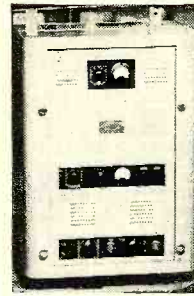

**RCA M 2545**

Ship board master amplifier. 23 tubes including 2 6L6 and other 6 volt type tubes. D B Meter. Built-in tube checker. Designed for 110 volts AC 60 cycle use. Has spare parts kit of trans and chokes. Only those who have worked with this amplifier will know its terrific value. Brand new with tubes, only \$139.50. Cost the gov. up in the thousands.



**POWER PACK SCOOP**

Small power pack for 110 volt 60 cycle use. Produces 1.5 volt DC. A voltage at 200 to 350 mills, plus 100 volt DC. B voltage at 25 mills. Convert 1.5 volt battery radios to 110 volts AC. Stock No. CV-1. Weight 4 lbs. Net \$3.95; two for \$7.50.

**PORTA-POWER**

Electro Porta Power. Converts any 4, 5, or 6 tube 1 1/2 volt, 90 volt portable or farm radio to 110 volt AC operation. Multiple socket arrangement makes easy, quick connection possible. Every shop should have one of these. Regular \$9.95 value. Scoop price.....\$5.95



**VEEDER ROOT METER**



Counts number of feet of trailing wire antennae; number turns when winding on coil; applicable for many uses; beautiful bakelite case, jeweled dial, pilot light enclosed, 3 position switch, counts up to 1000. Each.....95c

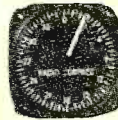

**3" SELSYN INDICATOR**

Works on 16 to 25v. 60 cycle  
**\$2.45 EACH**  
**Two for \$4.45**



**ARC-4 \$14.95**

**IDEAL FOR 2 METERS  
Priced Complete With  
20 Tubes—and 12-28  
Volt Dynamotor**

FOUR CHANNELS CRYSTAL CONTROLLED. ARC-4 for VHF frequencies 140 to 144 megacycles. There are 7 tubes in the transmitter: 832, two 16L4, two 6V6 and two 6L6. The receiver section has 13 tubes: two 6AC7, four 6N7, three 12SQ7, two 12SQ7 and two 12A6. The unit is actually two receivers and one transmitter in one piece. One receiver is for stand-by use. Has built on dynamotor for 12 or 24 volt DC operation. Priced complete with tubes and four crystals and dynamotor. Items convert this for two meter operation. It's a scoop at this price. Used.



**Crystal Calibrator \$2.95**

Crystal Calibrator, gives 50 KC beat note through an Xtal synced, multivibrator. Furnished complete, less 200 KC Crystal. With tubes 12SA7 and 2-12SL7. A handy item to have. Scoop price.....\$2.95



**SCR-518 ALTIMETER \$2950**

Brand New

Famous SCR 518 A Altimeter. Brand new factory cartoned. Worth over \$900.00. Made by RCA. Complete as pictured. Has 29 tubes. Works in the 500 MC region. This is the complete unit. Transmitter, receiver, power supply and 3" scope indicator. Reads altitude up to 30,000 ft. Operates on 23 volts. D.C. Complete with tubes. 68X7, 2 8013, 2 68X7, 6C8, 68N7, 68N7, 23D4, 6V6, 10 6AC7, 2 2X2, 95L, 955, 956, 615 and 3 in. CR tube 180SP. A RED hot scoop at only \$29.95 complete.

**15 TUBE SCOOP \$995**

**BRAND NEW**  
AM 61A Indicator Amplifier. Brand new factory cartoned. Has 28 volt DC Blower motor and fan. 2 2mfd 1000 volt cond. 2 2X .5 mfd, 1000 volt cond. and many other parts. Complete with 15 tubes, 7 68N7, 5 VR 105, 5X3, 3 6SL7, 8016. As a salvage item this is a RED HOT BUY. The tubes are worth more than our price. Weight 30 lbs. Net \$9.95

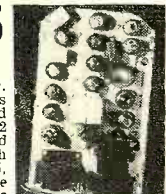

**McGEE RADIO COMPANY**

PRICES  
F O B  
KANSAS CITY

SEND 25% DEPOSIT—BALANCE C.O.D.  
1225 MCGEE ST., KANSAS CITY, MISSOURI

RADIO NEWS



### 8-TUBE RADIO KIT WITH COAXIAL SPEAKER, \$37.95



A COMBINED BROADCAST SUPERHET RADIO CHASSIS AND 15 WATT P. A. SYSTEM  
HEAVY DUTY 12" P.M. SPEAKER  
CROW 8" SLIDE RULE DIAL, 2 GANG COND.  
REC. BROAD, 550 TO 1700 KC AND 19 TO 49 METERS  
PUSH PULL 6V6—TONE CONTROLS  
INPUTS FOR CRYSTAL OR DYN. MIKES AND PHONO-PICKUP. WE FURNISH EVERYTHING TO BUILD THIS DELUXE CHASSIS

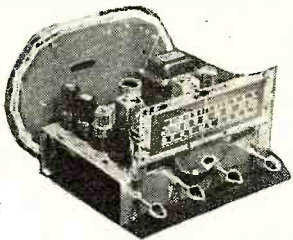

• WHY NOT ORDER THE ARMCHAIR CABINET WITH THIS KIT  
• HAS INPUT GAIN FOR THE G.E. VARIABLE RELUCTANCE PICKUP  
• CHASSIS SIZE 9 1/2"x11 1/2" HIGH

Here is something new in radio. A real 15 watt power amplifier with bass and treble controls. Has extra gain stage for crystal or dynamic mikes. And on the same chassis, a standard superhet radio receiver. We furnish all parts, knobs, escutcheon plate and tubes: 6SA7, 6SK7, 6SR7, 6SN7, 6SJ7, two 6V6 and 5Y3. No cabinet. Extra care in designing the power supply section assures low hum level, making this unit ideal for recording as well as P.A. use. We furnish everything as well as schematic diagram and photos of the completed chassis. Weight 35 lbs.

PRK-24 Radio-Amp. Kit with 12" P.M. speaker With tubes .....Net

\$29.95

CPR-15. Exactly the same kit as the PRK-24 kit; except it is furnished with a 12" Cinacut wide range speaker. (Has built-in high frequency tweeter.) This is our finest kit .....Net

\$37.95

### ARMCHAIR CABINET \$29.95 Will House PRK-24 or CPR-15

Beautifully made walnut armchair cabinet. Outside dimensions 24" high, 16 1/2" deep, and 27" wide. Ample room for radio receiver 14" long, 9" high and 10" deep. Will hold a changer up to 14" square. Will accommodate speaker up to 12". Has record album storage compartment. Hinged lid covers changer compartment. Cabinet Ar-15 Net \$29.95. Detrola automatic changer \$12.95 extra.

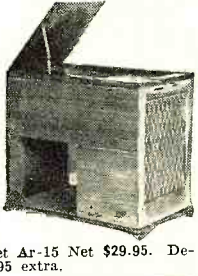

### WIRE RECORDER \$69.95

Portable Wire Recorder Model GN-11

Has ready wired and tested 5 tube AC type amplifier with push-pull 6V6 tubes. Built-in eraser circuit. Input for crystal mike or phono pickup. Diagrams show how you can record from any radio receiver. 3 position switch enables you to quickly change from record to playback or conventional P. A. system. This amp delivers 12 watts of good clean audio. Here is what you get: Webster 79 recording mechanism, with 15 minute spool of wire, attractive leatherette covered case, 8" heavy duty PM speaker and wired and tested 12 watt AC wire recording amplifier. All you do is mount the amp, recording mechanism and speaker. Simple instructions furnished. Portable Recorder Model GN-11 Net \$69.95. Crystal mike \$4.95 extra.



### DELUXE WIRE RECORDER \$79.95

This wire recorder incorporates all necessary circuits for recording and playbacks. Has built-in eraser circuit. The amplifier is of the AC transformer type, with push-pull 6V6 output tubes. Has tone control and fader control. Input stage for wire recording from either crystal mike, radio receiver or phono pickup. Amplifier is wired, tested and ready to operate. This unit is classed as a kit, only because you have to mount the Webster wire recording mechanism, amplifier and speaker. Everything is furnished, including a 15 minute spool of recording wire. Kit includes wired and tested 12 watt amplifier, expressly made for wire recording and public address use. Leatherette split type case and 10" PM speaker, furnished with regular \$52.92 Webster wire recording mechanism. Kit model GN-12. Net \$79.95. Crystal mike and desk stand \$4.95 extra.



### PORTABLE RADIO DISC-RECORDER KIT, \$54.95

\$90.00 value for only \$54.95. We furnish every part to build a powerful radio and dual speed recorder. The attractive leatherette case houses the sensitive superhet broadcast radio and General Industries R90L 33 1/2 and 78 RPM dual speed recorder; play back mechanism. The 6 tube receiver and amplifier is all on one chassis: 12SA7, 12SQ7, 12SK7, 12SL7, mike gain; two 35L6 push-pull output; plus disc rectifier. Has plenty of gain for crystal or dynamic mike. Has 6" heavy duty PM speaker and tone control. Kit C-31, everything complete, with tubes and diagram, \$54.95. Crystal mike and desk stand \$4.95 extra. This is without a doubt one of the best values in kits we have ever offered. Wt. 40 lbs.

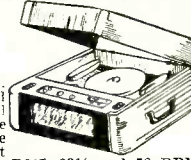

### SUPER MIDGET KIT, \$10.95 OUR SUPER VALUE

Build this new super Midget Broadcast Radio. Has beautifully made walnut cabinet. Size 7 1/2"x4 1/2"x5 1/2". Attractive slide rule dial. Incorporates a standard superhet circuit with 456 KC IFS & AVC. Has 2 gang condenser and loop ant. Every part including Alnico V PM speaker and tubes, 12BD6, 12A7, 50B5 & 35W4. Furnished as well as photo and easy-to-follow diagram. Weight 5 lbs. Model KP-T.



### BUILD A RADIO Like you would buy 5-TUBE KIT ONLY \$9.95



Made from Detrola Components  
Attractive 13" blond cabinet AC-DC radio kit with illuminated slide rule dial. Incorporates a standard 2 gang superhet circuit. Loop antenna, ready-punched chassis. This is another one of our line production radio kits. Every part is furnished. Includes tubes: 12SA7, 12SK7, 14A7, 35Z5 and 50L6. Diagram, photos and instructions are included. Has full 5" Alnico 5 PM speaker. Receives broadcast 550 to 1650 KC. Shipping weight 9 lbs. Model TF-6. Net \$9.95.  
Model TF-6 wired and tested..... \$14.95

### 1949 MODEL AC-DC KIT \$12.95



This is our latest and finest AC-DC radio kit. Receives Broadcast, 540 to 1650 KC. Has full length illuminated slide rule dial. Choice of Ivory or Walnut plastic cabinet. Full high efficiency 2 gang superhet circuit, with loop antenna. Ready punched chassis, full 5" PM speaker. Every part fits. Everything furnished, including tubes, 12SA7, 12SK7, 12SQ7, 35Z5 and 50L6. This kit will go together just like it would on the production line. Diagram, photos and instructions are furnished. Shipping weight 9 lbs. Kit model XA-49. Net \$12.95.

### AMERICAN AND FOREIGN KIT \$14.95

550 to 1600 KC and 6 to 18 MC



This radio kit is housed in an attractive grey opalescent finished metal cabinet. Incorporates a standard 2 gang superhet circuit. Receives Broadcast (550 to 1600 KC) and foreign short wave (6 to 18 Megacycles). This kit is complete, nothing else to buy; just as all our kits. Ready-punched chassis. It will go together just as it would down a production line. Has full 5" PM speaker. Complete with tubes: 12SA7, 12SK7, 12SQ7, 35Z5, 50L6. Diagram, photos and instructions are furnished. Shipping weight 10 lbs. Kit model DT-5. Net \$14.95

### 12 WATT AMPLIFIER KIT, \$14.95



Push Pull 6V6's Gain for Mike

KIT MODEL AC-12. 12 watt amplifier kit. Ideal for high quality record player as well as public address or recording amplifier. Matched component parts, ready punched chassis pan. One control fades from phono to microphone. Gain enough for crystal or dynamic microphone. 100 mil power transformer, for 110 volt AC 60 cycle operation. Priced complete with tubes: 2-6V6, 6SN7, 6SH7 and rectifier. Diagrams and photos furnished. Kit AC-12. Net \$10.95. 12" Alnico 5 PM speaker \$6.95 extra; crystal microphone and desk stand \$4.95 extra.  
The above AC-12 amplifier wired and tested ready to operate net \$14.95 Specify stock No. AC-125. 12 inch Alnico V PM speaker \$5.95 extra. Crystal mike and desk stand \$4.95.

### 20-WATT UTILITY AMP. KIT, \$17.95

Build this 20 watt utility 110 volt AC, 20 Watt power amplifier. Ready punched chassis, size 12 x 6 x 2 1/2 inches. Has two input circuits, one mike and one phono. Mike stage has 135 DB gain, for crystal or dynamic mike. Has bass and treble controls. Designed for use with PM speakers; has 8-16 ohm output transformer. All parts and easy-to-follow diagram furnished, including tubes: 2-6SN7, 6J5, 2-6L6GA, 6Z3. Kit Model 20-LX.....Net \$17.95



### INTER COM KITS \$7.95

Inter-com kit. All parts furnished to build a small two-way call system (Master and one sub-station speaker). Has 3" speaker and tubes 70L7 and 12SL7. Has separate 3" speaker for sub-station. Ready punched chassis. Everything complete, less cabinet. Diagrams and photo furnished. Kit TB-3. Net Price \$7.95.



### 4 TUBE RADIO KIT \$6.95

4 tube AC-DC, TRF radio kit. Ideal for students and beginners. Every part furnished to build this kit, including tubes, diagram and photos. Has Alnico V PM speaker and tubes 12SK7, 12SL7, 50B5 and 35W4. Plastic cabinet with slide rule dial. Receives broadcast 550 to 1600 KC. This is the easiest type of radio to build. Kit Model TF-4 Net \$6.95. Weight 6 lbs.

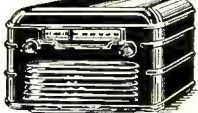

### 3-WAY PORTABLE KIT \$16.95

• 4 Tubes Plus Disc Rectifier  
• 300 Hour Battery Pack Included  
• Beautifully Built Portable Case  
Build this powerful, 4-tube, 3-way portable kit. Operates on 110 volts AC or DC or self contained batteries. Receives broadcast 550 to 1650 KC. Incorporates a standard superhet circuit with AVC and loop Ant. Has Alnico 5 PM Speaker, 2 gang condenser. All parts and batteries are furnished including tubes, Disc Rectifier, 1R5, 1R4, 1R3 and 354. Has attractive leatherette portable cabinet size 7x9x9. Weight 14 lbs. Kit Model 3-7A. Net \$16.95

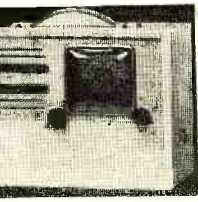

### PORTABLE RADIO KIT MAKES A \$32.50 RADIO

Complete with Batteries \$14.95

*Personal*  
Size: 6 1/2"x3 1/4"x4 1/8"  
Weights Only 3 1/2 Lbs.  
• Two-Tone Ivory, Red Plastic Cab. • Loop Aerial, Built-in Lid  
• 4-Tube Superhet • AVC. • Looks like and is a Commercial Radio Kit  
• Two-Gang Cond., Lucite Dial • Simple Assembly and Wiring Instructions  
This kit is ready for immediate delivery. The same nationally known factory that manufactures tens of thousands of this radio, is line-producing this radio kit for us. Every part, from the cabinet down to the last resistor, is matched. The chassis is ready punched; all you do, is mount the parts and wire. This radio kit will assemble into a beautiful personal radio for you. Just the same as it does for the factory. We furnish you a diagram, photograph of the completed chassis and full assembly instructions so that those with a minimum knowledge of radio may wire this kit. The beautiful case is made of metal with plastic hinged lid and snap on back. The lucite face of the receiver has an inlaid gold design. The circuit is the conventional two gang superhet type, with A.V.C. Receives the broadcast band, 540 to 1650 KC. Uses miniature tubes: 1R5 converter, 1S5 detector A.V.C., 1T4 amplifier and 8S4 power amplifier. Alnico V PM speaker. The loop antenna is built in the lid. Radio comes on automatically when lid opens. Operates on self-contained batteries. Priced complete with tubes and 6 7/8 volt "B" battery and flash cell (Not AC-DC). Nothing else to buy. Model X-45. Price \$14.95. Include Postage for 6 lbs.

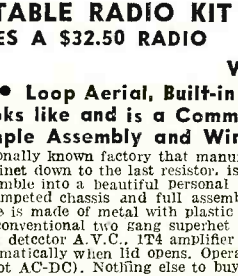
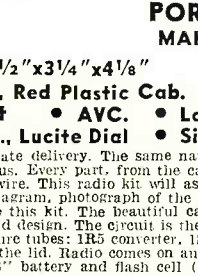

SCOOP MODEL X-45 PERSONAL PORTABLE KIT WIRED AND TESTED WITH BATTERIES. NET \$17.95  
**McGEE RADIO COMPANY** WRITE FOR CATALOG SEND 25% DEPOSIT—BALANCE C.O.D.  
June, 1948 PRICES F.O.B. K. C. 1225 McGEE ST., KANSAS CITY, MISSOURI

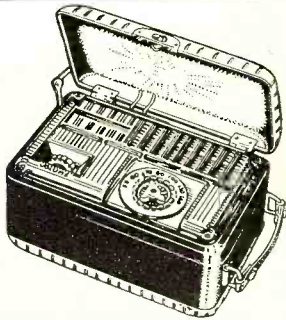

# What's New in Radio

## NEW CARDIOID MIKE

The Turner Company of Cedar Rapids, Iowa has developed a new cardioid microphone for use in commercial broadcast, recording studios, and high quality p.a. systems.

Known as the Model 77, this new unit has been designed to effectively control feedback and features a wide-range



pickup at the front and a sharply attenuated output at the rear.

Discrimination between front and rear is approximately 15 db. at all frequencies. Response is within plus or minus 5 db. from 70 to 10,000 c.p.s. Level is 62 db. below 1 volt/dyne/sq. cm. at high impedance. The unit is equipped with a 4-position output switch giving 50, 200, 500 ohms or high impedance output and features a tilting head and quick disconnect cable.

Additional details on the Model 77 may be secured by writing *The Turner Company*, Cedar Rapids, Iowa.

## HEAVY DUTY TEST LEADS

A new set of high voltage, heavy duty test leads, the Model 910, is being manufactured by *Reiner Electronics Company* of New York to meet the requirements of television measurements.

These leads are tested at 20,000 volts and are rated at 15,000 volts. The tips are of case hardened steel, so that the points cannot become blunt or dulled despite hard use. A special construction permanently anchors the insulated conductor to prod handles which are made of a high quality material having zero moisture absorption, extremely low power factor and surface leakage, and extremely high resistance.

A combination thumb rest and shield, designed to prevent leakage and creep-

age is provided for maximum protection and ease of handling. The set consists of one black and one red lead, each 54 inches long.

*Reiner Electronics Company*, 152 West 25th Street, New York 1, New York will supply additional details and prices on request.

## CONDUIT FITTINGS

*Cannon Electric Development Company* of Los Angeles has added three new conduit fittings to its line of AN connectors and accessory fittings.

The AN3060 Conduit Coupling is used for connecting either flexible or rigid aluminum, brass or other conduit; the AN3064 Box Connector is used with the AN3066 Conduit Coupling locknut to form a termination inside conduit boxes or panel, and the AN3068 Conduit Coupling Adapter is used to make a coupling between any two male-threaded conduit fittings.

Standard finish on all these items is tin plate or natural. Melted petrolatum, conforming to specification AN-VV-0-236, is used as an over-all coating. Material is diecast aluminum or bar stock.

Copies of bulletin sheets covering the above fittings may be secured by writing the Catalogue Department, *Cannon Electric Development Company*, 3209 Humboldt Street, Los Angeles 31, California.

## TELEVISION KIT

*Transvision, Inc.* has announced the availability of a television kit which features a new-type cabinet with built-in lens.

In addition to magnifying and clarifying the picture, the new lens is said to

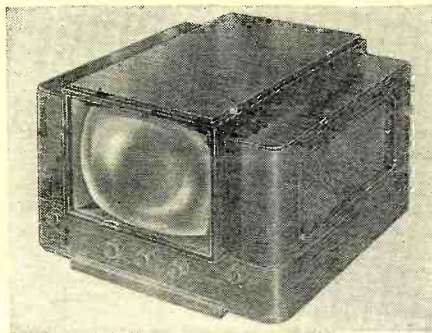

create the effect of apparent rotation of the picture so that when the observer moves, the picture still seems to be in focus and clearly visible from any angle.

The kit, which is being marketed as the Model 10BL, comes complete with a 10" tube and cabinet with built-in lens.

The unit uses the electromagnetic direct-view picture tube, has complete FM radio, receives all channels in any area, and comes completely supplied with antenna and lead-in wire. The cabinet is available in mahogany, walnut, or blonde finishes.

*Transvision, Inc.*, 385 North Avenue, New Rochelle, New York will supply additional data and prices on request.

## COAXIAL SWITCH

*The Workshop Associates Incorporated* has developed a new coaxial switch designed to be used with RG-59/U coaxial cable. The new unit is used to switch

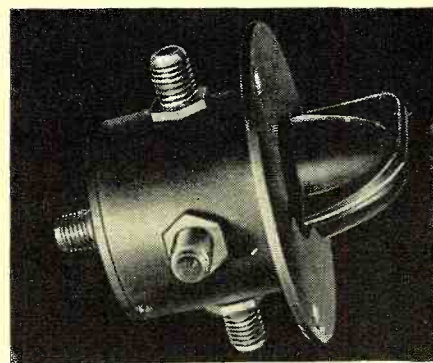

from one television channel to another utilizing the company's new television receiving system.

The unit provides for switching any one of four antennas to a receiver. The switch may also be used to meet the television sales demonstration problem. By using additional switches, any number of television sets can be demonstrated from one location. The switch maintains a low standing wave ratio.

A complete line of solderless, silver-plated coaxial connectors for RG-59/U is available as extra accessories.

*The Workshop Associates Incorporated*, 66 Needham Street, Newton Highlands 61, Massachusetts has additional details available on request.

## POWER CONVERSION UNIT

Radio amateurs will be especially interested in the new power conversion unit being offered by *Radio Products Sales Company* of Los Angeles.

By means of the new unit, d.c.-operated war surplus dynamotors, receivers, transmitters, relays, and motors may be operated from a.c. power mains without rewiring the equipment.

Units are available for any voltage or amperage rating. Standard units are available covering these popular model dynamotors: DMDX, 12 volts, 2 amps.;

**RADIO NEWS**



TILLMAN F. BABB, Wilshire Radio Shop, 6114 Mockingbird Lane, Dallas, Texas. Tillman knows his tubes, and like thousands of outstanding servicemen, he prefers Ken-Rad tubes. They're quality, through and through.



# "KEN-RAD TUBES PAY OFF!"

"Ken-Rad tubes? I'll say I use them!

"Ken-Rad tubes have been doing a job for me for 13 years. And I'll say this—there's not a better tube made. They perform well and stand up.

"You can depend on them to make customers happy. Happy customers build business.

"And I'm not letting customers down. I'm selling *quality*. It pays off!

"That's why I'm for Ken-Rad tubes!"

## "Ken-Rad tubes are MADE TO PAY OFF"

"We make Ken-Rad tubes to stand up—satisfy users—and build business for servicemen.

"Before a Ken-Rad tube is sent to you it must pass a series of tests for noise, microphonics, static, life, short, appearance, gas, air and hum.

"That's why Ken-Rad tubes meet your most exacting demands—for quality, stamina, endurance.

"That's why they'll bring customers back satisfied."



ROBERT HAGAN, Shop Foreman, Quality Laboratory, is in charge of the strict Life Test, above. It's typical of the numerous tests that Ken-Rad tubes must pass before leaving the plant.

*The Serviceman's Tube*

178-GA7-8850

**KEN-RAD** *Radio Tubes*  
 PRODUCT OF GENERAL ELECTRIC COMPANY  
 Schenectady 5, New York



# ANNOUNCING The RAYTHEON BANTAL A new and better tube

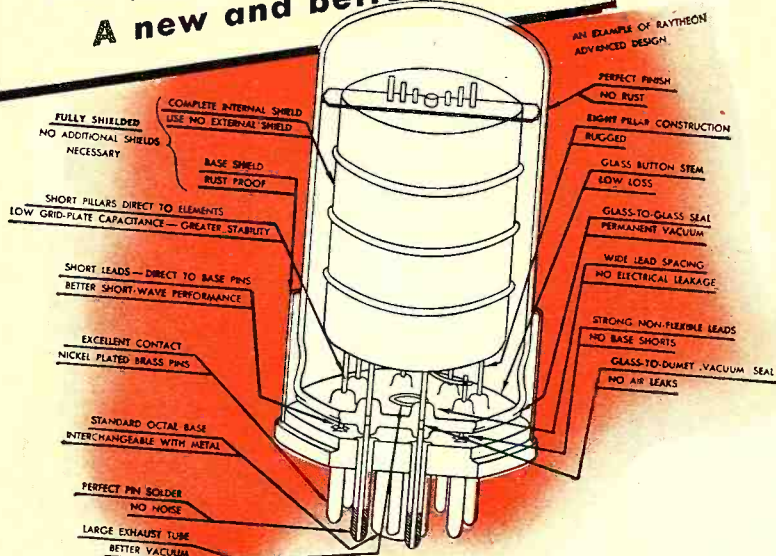

Just think! All the above design improvements and construction advantages in one tube—the RAYTHEON BANTAL tube.

- **Rugged Eight Pillar Construction**
- **Completely Shielded Internally** — No external shielding hardware or installation labor! Increases your service profit!
- **Made In Eight Popular Types** 6SA7GT-6SJ7GT-6SK7GT-6SQ7GT-12SA7GT-12SJ7GT-12SK7GT-12SQ7GT
- **Superior Performance Assures Customer Satisfaction And Repeat Business**
- **All At No Extra Cost!**

Your Raytheon Distributor — sponsor of the famous Bonded Dealer-Service Program — is now delivering Bantal Tubes.

Look for this distinctive marking on the Raytheon Bantal Tube. The 12SK7GT Tube illustrated replaces ordinary "GT" and Metal 12SK7 Tubes. Only the Bantal Tube is needed in stock!



## RAYTHEON MANUFACTURING COMPANY

RADIO RECEIVING TUBE DIVISION

NEWTON, MASSACHUSETTS • CHICAGO, ILLINOIS • LOS ANGELES, CALIFORNIA

RADIO RECEIVING TUBES • SPECIAL PURPOSE TUBES  
TRANSMITTING TUBES • HEARING AID TUBES

PE-77, 12 volts, 39 amps.; DM-310A, 24 volts, 1.1 amps.; 5DY83AB1, 28 volts, 5 amps.; PE-103, 12 volts, 10 amps.; DM-28, 24 volts, .7 amp.; PE-73C, 24 volts, 19 amps.; and the 12 volts, 4.5 amps. unit is also considered standard.

All complete installation diagram and price data are free upon request. Address all correspondence to Seymour Friedman, Department C-35, Radio Products Sales Company, 1501 South Hill Street, Los Angeles 15, California.

### VIBRATOR DEAL

Radio servicemen are now being offered a new sturdy and practical metal stock cabinet in combination with a group of fast-moving vibrators and buffer capacitors by P. R. Mallory & Co., Inc. of Indianapolis, Indiana.

Known as the "2448 Vibrator Deal", this offering includes six vibrators which



are said to cover 75% of normal replacement requirements. The metal cabinet is designed for simplified stocking of these parts and also to facilitate inventory checking. The new unit is a companion piece to the volume control cabinet which the company made available last year.

Further information may be obtained from Mallory distributors or from P. R. Mallory & Co., Inc., Indianapolis, Indiana.

### SHURE NEEDLES

Shure Brothers, Inc. has announced that its new "Muted Stylus" needles are available in osmium or sapphire.

These replacement needles are the only units that can be used in the company's "Muted Stylus" crystal cartridges. These new units feature silent tracking and simple fingertip replacement.

The Model A62A (osmium) and the Model A61A (sapphire) are packaged in a unique point-of-sale card.

Further information on these replacement needles may be secured by writing Shure Brothers, Inc., 225 W. Huron Street, Chicago 10, Illinois.

### NEW HAM RECEIVER

National Company, Inc. is in production on the new NC-33 receiver which is be-  
(Continued on page 160)

RADIO NEWS

**IRVING JOSEPH**  
 WHERE PRICE IS AN OBJECT AND  
 QUALITY IS UNDERSTOOD - EVERY ITEM  
 WE SHIP IS BACKED UP BY AN UNCON-  
 DITIONAL GUARANTEE.

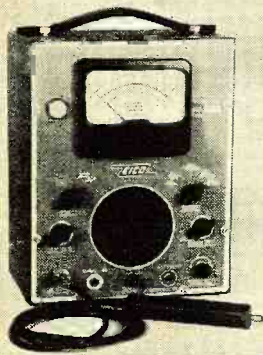

**EICO MODEL 113-A  
 SIGNAL TRACER WITH  
 VACUUM TUBE PROBE**

Permits rapid tracing or following a signal audibly through the receiver from antenna to speaker, locating the faulty section quickly. Isolates the precise cause of trouble with the VTVM section by making point to point checks giving both audible and visual indications. Perfect for checking distortion or fading. Signal may be traced through entire receiver without interfering with normal operation.

**MULTI-ANALYST**

- Wide frequency response from 30 cycles to 300 mc.
- High input impedance of 26 megohms on DC.
- All electronic AC and DC voltmeter and ohmmeter.
- DC and AC ranges 0-5, 10, 100, 500, 1000 volts.
- Ohmmeter reads from .1 ohm to 100 megohms in six ranges.
- Built-in speaker for monitoring either IF, RF or AF channel.
- VTVM cannot be damaged by overloading.
- Tests-phono pick-ups — microphones, etc. for distortion or voltage output.
- Will substitute for any defective stages in radio receiver or amplifier.

Yours Net **\$89.50**

Write for further information on Eico Signal Generator and Eico VTVM.



88 to 108 Mc.

Edwards F-M FIDELOTUNER in Cabinet as shown, ready for your listening pleasure.

Size 11" long, 6" wide, 6 3/4" high. Shipping Wt. 7 1/2 lbs.

**FIDELOTUNER  
 FOR YOUR F-M LISTENING PLEASURE  
 SOME OUTSTANDING FEATURES:**

1. Real Discriminator Circuit for Maximum realization of F-M possibilities.
2. Three IF stages including Limiter stage.
3. Connects to any radio or amplifying system (old or new).
4. Permeability tuned IF and Disc "K-Trans."
5. Slide Rule Dial.
6. Easy finger-tip tuning.
7. Full F-M coverage 88 to 108 Mc.
8. Five Tubes Plus Selenium Rectifier.
9. VHF Insulation Throughout.
10. Local Reception Antenna Included.
11. 105-130 volt 60 cycle AC operated.

Each **\$31.50** Lots of 3 **\$28.50**

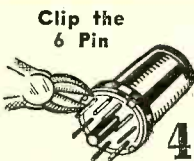

**024 (CK-1005)**

Full wave gas rectifier—octal base. Makes a perfect replacement for 024

44¢ ea. 10 for **\$4<sup>10</sup>** 100 for **\$37<sup>00</sup>**

**NEW  
 3-WAY PERSONAL  
 GLOBE  
 PORTABLE  
 RADIO**

that tops them all for VALUE!

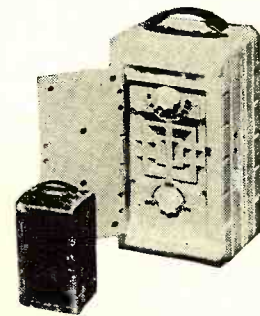

- 4 Tube super circuit, plus life-time selenium rectifier.
  - Battery operation for outdoors
  - —110 volt AC or DC indoors.
  - Alnico 5" PM Speaker.
  - Weighs only 4 1/2 lbs. with batteries.
  - Beautiful plastic case measures 8 1/2 x 4 1/2 x 4 inches.
  - Four beautiful gleaming colors: Maroon—Ivory—Tan—Black.
  - Performance equal to regular \$39.95 models.
- 4 ATTRACTIVE COLORS  
 • MAROON • IVORY • TAN  
 • BLACK

This is the set they rave about. Small, compact and beautifully designed in colorful plastic. Use it outdoors on battery operation—indoors on any 110 volt AC or DC current. You'll marvel at its fine operation—its wonderful tone—its great sensitivity.

Each **\$29.95** Lots of 3 **\$27.50** Lots of 6 or more **\$24.50**



**A FULL POWERED  
 SUPERHETERODYNE RADIO**

Styled for tomorrow. Powered for sharp, clear reception. A wonderfully toned superhet circuit. In practically unbreakable plastic cabinet. An amazing value.

Tele-Tone Model 165 . . . **\$9.95**



**MODEL 159  
 5 TUBE  
 AC-DC  
 TABLE MODEL**

Walnut . . . . . **\$19.95**

**MODEL 166  
 5 TUBE  
 SUPER-  
 HETERODYNE  
 with handle**



Ivory only . . . . . **\$16.95**

**MODEL 183—3 Tube Record Player  
 With Automatic Record Changer.**



Push-Pull Output.  
 Cabinet Dimensions —  
 13 1-16" Width — 7"  
 High—12 3/4" Deep.

**\$34.95**

**MODEL 182—  
 2 TUBE RECORD  
 PLAYER**

High Power Output.  
 Cabinet Dimensions —



12 1/2" Wide — 5 3/8"  
 High—10 3/4" Deep.

**\$19.95**

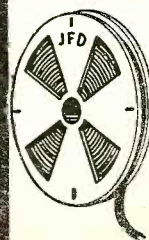

**JFD TWIN LEAD 300 ohm WIRE**

Extruded parallel ribbon-type lead-in wire. Insulated with polyethylene—300 ohm impedance. Excellent for FM and TV receivers. Made to withstand weather and use.  
 No. TW300—100' Reel  
 List price . . . . . **\$2.91**

Also available in 500' and 1000' spools.

**TERMS**

Minimum order \$2.00. All orders shipped f.o.b. Chicago, 25% deposit on all c.o.d. shipments.

**IRVING JOSEPH**

220 S. Halsted St., Chicago 6, Ill.

# HEATHKIT SERVICE INSTRUMENTS

BUILD . . . LEARN . . . SAVE

Ideal for Schools, Training Courses, Laboratories—Service Shops, Hobbyists.

## HEATHKIT SIGNAL GENERATOR KIT

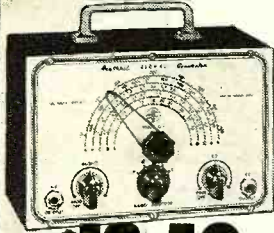

**\$19.50**

NOTHING ELSE TO BUY

Every shop needs a good signal generator. The Heathkit fulfills every servicing need, fundamentals from 150 Kc. to 30 megacycles with strong harmonics over 100 megacycles covering the new television and FM bands. 110 V 60 cycle transformer operated power supply.

400 cycle audio available for 30% modulation or audio testing. Uses 6SN7 as RF oscillator and audio amplifier. Complete kit has every part necessary and detailed blueprints and instructions enable the builder to assemble it in a few hours. Large easy to read calibration. Convenient size 9" x 6" x 4 3/4". Weight 4 1/2 pounds.

## HEATHKIT SINE AND SQUARE WAVE AUDIO GENERATOR KIT

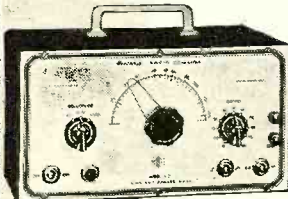

**\$34.50**

NOTHING ELSE TO BUY

The ideal instrument for checking audio amplifiers, television response, distortion, etc. Supplies excellent sine wave 20 cycles to 20,000 cycles and in addition supplies square wave over same range. Extremely low distortion, less than 1%, large calibrated dial, beautiful 2 color panel, 1% precision calibrating resistors, 110 V 60 cycle power transformer, 5 tubes, detailed blueprints and instructions. R.C. type circuit with excellent stability. Shipping weight 15 pounds.

## HEATHKIT SIGNAL TRACER KIT

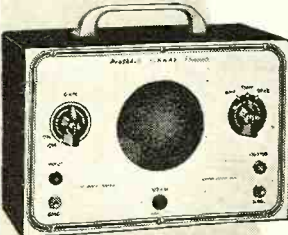

**\$19.50**

NOTHING ELSE TO BUY

Reduces service time and greatly increases profits of any service shop. Uses crystal diode to follow signal from antenna to speaker. Locates faults immediately. Internal amplifier available for speaker testing and internal speaker available for amplifier testing. Connection for VTVM on panel allows visual tracing and gain measurements. Also tests phonograph pickups, microphones, PA systems, etc. Frequency range to 200 Mc. Complete ready to assemble. 110 V 60 cycle transformer operated. Supplied with 3 tubes, diode probe, 2 color panel, all other parts. Easy to assemble, detailed blueprints and instructions.

Small portable 9" x 6" x 4 3/4". Wt. 6 pounds. Ideal for taking on service calls. Complete your service shop with this instrument.

## HEATHKIT HIGH FIDELITY AMPLIFIER KIT

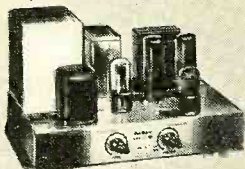

**\$14.95**

NOTHING ELSE TO BUY

Build this high fidelity amplifier and save two-thirds of the cost. Push pull output using 1619 tubes (military type 6L6's), two amplifier stages using a dual triode (6SN7), and a phase inverter give this amplifier a linear reproduction equal to amplifiers selling for ten times this price. Every part supplied; punched and formed chassis, transformers (including quality output to 3-8-15 ohm voice coil), tubes, controls, and complete instructions. Add postage for 20 lbs. 12" PM speakers for above. \$6.95

## NEW 1948 HEATHKIT 5 INCH OSCILLOSCOPE KIT

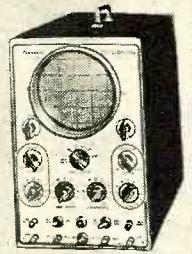

**\$39.50**

NOTHING ELSE TO BUY

A necessity for the newer servicing technique in FM and television at a price you can afford. The Heathkit is complete, beautiful two color panel, all metal parts punched, formed, and plated and every part supplied. A pleasant evening's work and you have the most interesting piece of laboratory equipment available.

Check the features—large 5" 5BP1 tube, compensated vertical and horizontal amplifiers using 6SJ7's, 15 volts to 30 M cycle sweep generator using 884 gas triode, 110 V 60 cycle power transformer gives 1100 volts negative and 350 volts positive.

Convenient size 8 1/2" x 13" high 17" deep, weight only 26 pounds.

All controls on front panel with test voltage and ext. syn post. Complete with all tubes and detailed instructions. Shipping weight 35 lbs.

Order today while surplus tubes make the price possible.

## The NEW HEATHKIT VACUUM TUBE VOLTMETER KIT

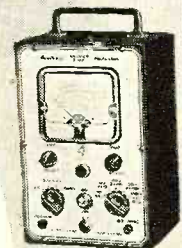

**\$24.50**

NOTHING ELSE TO BUY

The most essential tool a radio man can have, now within the reach of his pocketbook. The Heathkit VTVM is equal in quality to instruments selling for \$75.00 or more. Features 500 microamp meter, transformer power supply, 1% glass enclosed divider resistors, ceramic selector switches, 11 megohms input resistance, linear AC and DC scale, electronic AC reading RMS. Circuit uses 6SN7 in balanced bridge circuit, a 6H6 as AC rectifier and 6X5 as transformer power supply rectifier. Included is means of calibrating without standards. Average assembly time less than four pleasant hours, and you have the most useful test instrument you will ever own. Ranges 0-3, 30, 100, 300, 1000 volts AC or DC. Ohmmeter has ranges of scale times 1, 100, 1000, 10M and 1 megohm, giving range .1 ohm to 1000 megohms. Complete with detailed instructions. Add postage for 8 lbs.

## HEATHKIT CONDENSER CHECKER KIT

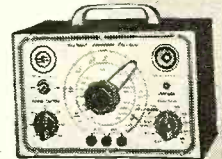

**\$19.50**

NOTHING ELSE TO BUY

A condenser checker anyone can afford to own. Measures capacity and leakage from .0001 to 100 MFD on calibrated scales with test voltage up to 500 volts. No need for tables or multipliers. Reads resistance 500 ohms to 2 megohms. 110V 60 cycle transformer operated complete with rectifier and magic eye indicator tubes.

Easy quick assembly with clear detailed blueprints and instructions. Small convenient size 9" x 6" x 4 3/4". Weight 4 pounds. This is one of the handiest instruments in any service shop.

### A WORD ABOUT HEATHKIT INSTRUMENTS

All Heathkit service instruments are supplied complete in every way—grey crackle cabinets, 2 color calibrated panels, all tubes, test leads (where required) etc. All are 110 V transformer operated. Calibrations are complete and exact, 1% precision resistors are supplied where needed.

Heath engineers are ready to assist and advise. Heathkits are sold direct to customer, order from this ad. All are guaranteed.



The **HEATH COMPANY**

BENTON HARBOR, MICHIGAN

# COMMAND SET ACCESSORIES

# BEST of SURPLUS

## TRANSMITTER POWER SUPPLY KIT

For BC645, 223, 522, 274N's, etc. Ideal for powering military transmitters. Supplies 500 to 600 volts at 150 to 200 MA plate, 6.3 at 3.6A, also 9V and 12V A.C. Kit supplied complete with husky cased Acme 110V 60 cycle power transformer, 5U4 rectifier. Sprague oil filled condenser, cased choke, punched chassis, and all other parts, including detailed instructions.  
Complete — nothing else to buy

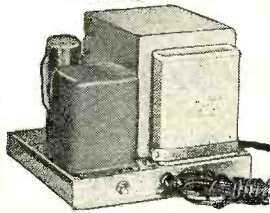

**\$11.95**

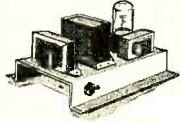

### 110V RECEIVER POWER SUPPLY KIT

With 24 volt filament, no wiring changes inside set, punched chassis and volume control

**\$5.95**

### 5" PM SPEAKER

With output transformer, matching headphone output

**\$2.80**

Dual receiver rack FT277A with connecting plugs

**\$1.00**

Single transmitter rack FT234A

**\$1.00**

### MILITARY CONVERSION POWER TRANSFORMERS

Convert your military receivers without rewiring the filament. "A" type supplies 500 VCT at 50 MA, 5V at 2A and 24V at 1/2A. "B" type supplies 500 VCT at 50 MA, 5V at 2A and 12V at 1 amp. State whether A or B type desired.

**\$2.95**

## POWER TRANSFORMER *Specials*

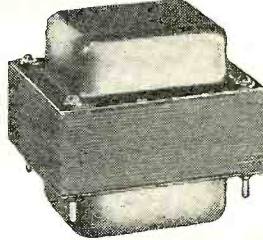

A wonderful buy in a new production heavy duty power transformer. Primary 117V 60 cycle. Secondaries supply 746 V.CT at 220 MA, 6.3V. at 4.5 A., and 5V at 4 A. An ideal transformer for high quality amplifier modulator, small transmitter or quality radio. Will handle 13 tube radio receivers. Supply is limited, order early.

**\$3.95 ... FOR \$9.95**

### INPUT AND OUTPUT TRANSFORMER

Two units in one case carbon microphone input and output from 155 to 150 ohm load used in Handie Talkie No. 744 special

**\$1.00**

Filter Choke 15 henries at 60 MA cased type hermetically sealed No. 643, each

**\$1.00**



### OUTPUT TRANSFORMER

Push pull 6V6's to 6-8 ohm voice coil excellent characteristics No. 800. 3 for...

**\$1.95**



### OUTPUT TRANSFORMER

Couples, 6C4, 6J5, etc. to 500 or 5,000 ohm line No. 716. 2 for

**\$1.00**

### MIDGET

### AMATEUR TRANSMITTER KIT

Complete kit to assemble a 1 Watt battery operated amateur 80 meter transmitter, including tube and crystal. Range up to 500 miles. Only accessories needed are sending key and batteries. Complete instructions supplied. Add postage for 2 lbs.

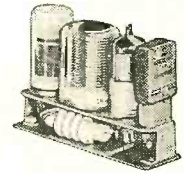

**\$3.95**

### ACCESSORIES

Key (add postage for 2 lbs.) ..... **\$1.00**  
Kit of batteries (add postage for 4 lbs.) ..... **3.25**

### AN/APN1 RADIO ALTIMETERS

Brand new, complete with tubes, dynamotor, antennae, indicator, switch, plugs and instruction manual. Consists of 420 MC transmitter and receiver. Converts into excellent boat radar indicating in feet, or amateur 420 MC rig. In original crate.



**\$34.95**



### T32 TABLE MICROPHONE

One of the Army's best. Built by Kellogg, ideal for factory call system, public address, amateur use. Brand new in original cartons, add postage for 5 lbs.

**\$2.95**

### DYNAMOTORS

Consists of electric motor operating generator on same shaft. Many applications—operating radios from storage battery—using as motor.

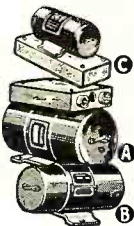

Dynamotor C—Input 28 volts, output 220 volts at 60 MA. Shipping Weight 6 pounds.

**\$1.50**

Dynamotor A—Input 12 volts, output 1000 volts at 350 MA. Shipping Weight 72 pounds.

**\$5.95**

Dynamotor B—Input 6 or 12 volts, output 500 volts, 160 MA. Shipping Weight 30 pounds.

**\$5.95**



### SOCKET SPECIALS

Single hole mounting octal, brown, low loss, bakelite, less locking rings,

25 FOR **\$1.00**  
2 hole flange mounting octal bakelite 1-5/16" mounting centers.

20 FOR **\$1.00**  
Ceramic 2 hole flange mounting octals, 1 1/2" mounting

10 FOR **\$1.00**  
Ceramic acorn sockets

5 FOR **\$1.00**

### SOCKET KIT

20 beautiful octal, octal and miniature sockets. **20 FOR \$1**

### HEARING AID HEADPHONES

The Army's best—eliminate flat ears and outside noise. Complete with transformer for conversion from low to high impedance. With cord and plug complete. Add postage for 1 lb.

**\$1.00**



### HEATHKIT 3-TUBE ALL-WAVE RADIO

110-volt AC operation

An ideal way to learn radio. This kit is complete ready to assemble, with tubes and all other parts. Operates from AC. Simple, clear detailed instructions make this a good radio training course. Covers regular broadcasts and short wave bands. Plug-in coils. Regenerative circuit. Operates loud speaker. Battery model for use where no AC house current is available. Add postage for 3 lbs.

**\$8.75**

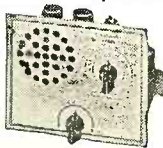

Heathkit Beginners' Radio 110-volt type ..... **\$8.75**

Heathkit Beginners' Radio, battery type (2 tubes, no rectifiers) ..... **\$8.75**

Headphones for either type HS 30 per set ..... **\$1.00**

2 1/2" permanent magnet loudspeaker for either type ..... **\$1.95**

Batteries, complete kit for battery type set..... **\$3.25**

### INTERPHONE 2-WAY CALL SYSTEM KIT

Ideal call and communication system for homes, offices, factories, stores, etc. Makes excellent electronic baby watcher, easy to assemble with every part supplied including simple instructions. Distance up to 1/5 mile. Operates from 110 V.A.C. 3 tubes, one master and one remote speaker. Shipping Weight 5 pounds.

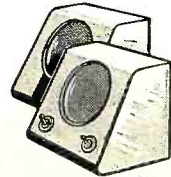

**\$14.50**

### G. E. MODEL BC-375 TUNING UNITS

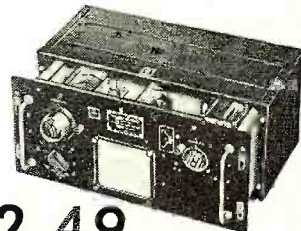

**\$2.49**

These General Electric 150 Watt transmitter tuning units are the greatest surplus buy. Over \$30.00 worth of new condensers, coils, switches. National Velvet vernier dial, etc. Supplied complete with cabinet and two reprints of conversion articles for transmitter and receiver reprinted from RADIO NEWS. Specify TU5B, TU10B or TU26B. Add postage for 20 lbs.



**The HEATH COMPANY**

**BENTON HARBOR, MICHIGAN**

**free**  
radio  
book

RADIOS  
HAM  
P. A.

Mail coupon for buying  
guide to the best values in Radio,  
Ham and P. A. Equipment. Send too for the  
newest flyer jam-packed with bargains.

**Spot-lite Values**

performs  
**25 Ceramicon  
Condensers**

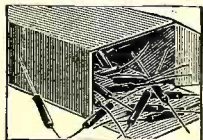

Provide ultimate stability. Temperature coefficient is determined by the ingredients of the ceramic dielectric; controllable to within very fine limiting values. Color coded. Flexible pig-tail leads. Shpg. wt. 1 lb.

AP5511—Your Cost..... **69c**

**Crystal FM Converter**

Change old FM (40-50 Mc) to new FM in a few moments and at lowest cost. Efficient operation; this is a superior device. No loss of signal. Easy to install.

AP5700—Your Cost.

Only **\$6.00**

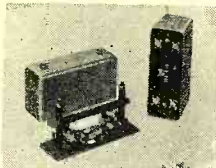

from **Lafayette**

MAIL NOW

New York  
100 SIXTH AVE.  
110 Federal St., Boston 10  
24 Central Ave., Newark 2

**Lafayette Radio**

RADIO WIRE TELEVISION, INC.  
Dept. RF-8, 100 Sixth Avenue, N. Y. 13  
Send #AP5511 @ 69¢ ea..... quantity   
#AP5700 @ \$6.00 ea..... quantity   
Enclosed: check  money order   
Send catalog  New Flyer C42

Name.....  
Address.....  
City..... Zone..... State.....

# Another Method of POWER SUPPLY CONTROL

By JACK D. GALLAGHER, W5HZB

*Plate power on last—filament power off last—in spite of switching order — a foolproof system.*

**M**ANY articles have been written about power supply construction and protective devices therein to prevent turning on plate voltages first, but a great majority of the methods employed were based on the operation of a relay. Also various switching arrangements were devised so that no line voltage would be present if the switch controlling the high voltage plate transformer was turned on first. Then, if the operator saw that no filament voltage was applied when he flipped one switch, he turned that switch off and turned on a second switch, which turned on the filaments. However, if the operator forgot to turn off the first switch he threw, both filament and plate voltages would be applied simultaneously when he flipped the remaining switch.

In order to eliminate the possibility of turning on plate voltage first in high voltage power supplies, the following features are found desirable and should be incorporated in the power supply switching system:

1. Irrespective of the switch thrown first, all filament voltages should be applied first.
2. In spite of the switch thrown last, all filament voltages should be turned off last.
3. No one switch, or combination of switches, when turned on in succession should turn on both filament and plate voltages simultaneously.

Although not an essential ingredient in cooking up a foolproof switching

arrangement for a power supply, a method of controlling the transmitter from the operating table should be considered. Also, the same three features should be incorporated in the control box as are incorporated in the transmitter itself.

The three d.p.s.t. toggle switches are the main switches which control each of the transformers shown. The filament transformer represents all of the filament transformers in the transmitter. Plate transformer No. 1 represents the oscillator and buffer plate transformers, and plate transformer No. 2 represents the high voltage transformer. Any bias supply may be connected in parallel with the primary of the filament transformer or plate transformer No. 1.  $S_4$  is a s.p.s.t. toggle switch which shorts out the lamp in series with one side of the high voltage plate transformer primary. This is a simple method of obtaining low voltage for tuning-up purposes. The lamp ( $PL_4$ ) may be a 150 or 200 watt bulb, while  $PL_1$ ,  $PL_2$  and  $PL_3$  are standard 115 volt pilot lamps.

It can be seen from Fig. 1A that any d.p.s.t. switch will turn on the filament voltage and  $PL_1$ . However, the discussion to follow will assume that  $S_3$  has been turned on first. In this case, the filament voltage is applied first. Turning on  $S_1$  will not turn on either plate supply. If the remaining switch ( $S_2$ ) is then turned on, both plate supplies will be turned on simultaneously. This, of course, does not present any problem since the filaments are already on.

Fig. 1.

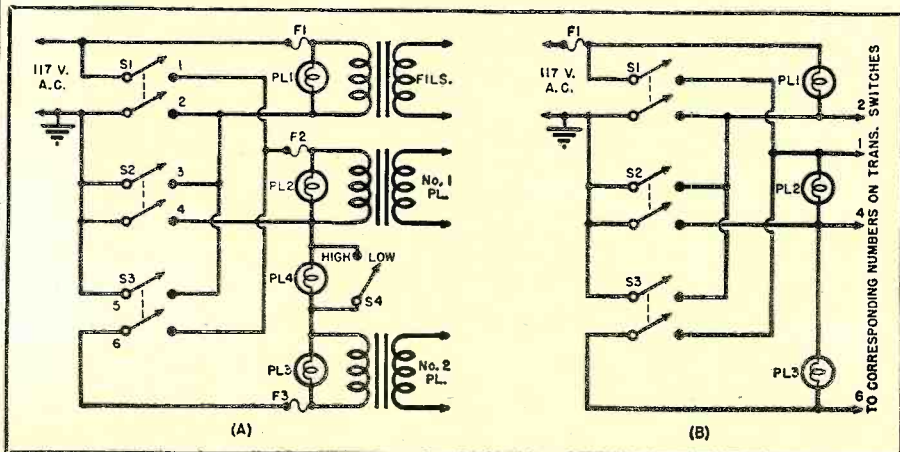



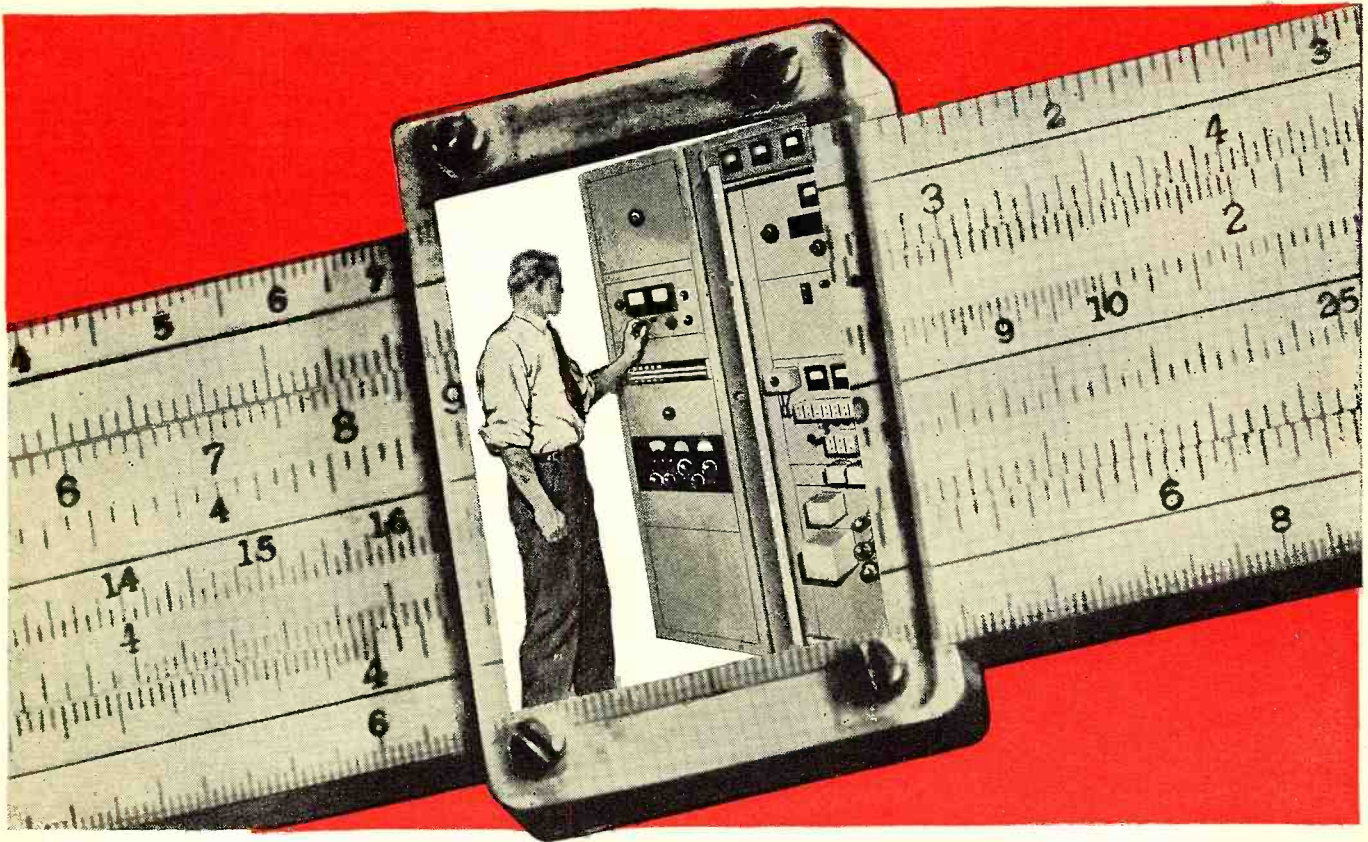

Here's how you can figure on a **BETTER JOB** in  
**RADIO-ELECTRONICS, Broadcasting, Television, Servicing, Manufacturing**

**Add CREI Technical Training to Your Present Radio Experience, Then Get That Better Radio Job—Make More Money—Enjoy Increased Security.**

You can't plan your future on a slide rule. But you can take a measurement of your own capabilities.

Look at the successful radioman. You'll find that he's the fellow who looked and *planned* ahead. Today, you have the same opportunity—at a time when radio's *technical* progress has gone beyond the supply of technical Manpower. Never before have so many men like you had the opportunity to step ahead into better-paying jobs . . . jobs that offer real interest and security in any one of the many expanding fields that urgently need competently trained men.

You can't say, "I don't need more training." Every ambitious radio technician needs more training. No matter what your experi-

If you have had professional or amateur radio experience and want to make more money, let us prove to you we have the training you need to qualify for a better radio job. To help us answer intelligently your inquiry—*please state briefly your background of experience, education and present position.*

**Capitol Radio Engineering Institute**

*An Accredited Technical Institute*

Dept. RN-6, 16th and Park Road, N. W., Washington 10, D. C.

Branch Offices: New York (7) 170 Broadway • San Francisco (2) 760 Market St.  
 June, 1948



ence, you must fortify yourself with up-to-date technical knowledge to qualify for the better jobs and to stave off the new competition that war-time activity has brought into the field.

CREI has a course of training for *you*. You will find our proved type of training practical and thorough. Whether your future lies in broadcasting, television, servicing, manufacturing or any branch of communications, you will find that you can "go all the way with CREI" from introductory, basic principles to advanced training, and on to specialized fields of radio-electronics.

Send for, and read, our interesting 24-page booklet. It explains our self-improvement program, courses and what CREI can do for you. It will give you a good idea how practical and easy-to-understand our training is, and why many thousands have enrolled for CREI courses since 1927.

**VETERANS! CREI TRAINING AVAILABLE UNDER G. I. BILL**

**MAIL COUPON FOR FREE BOOKLET**

**CAPITOL RADIO ENGINEERING INSTITUTE**

16th & Park Road, N. W., Dept. RN-6, Washington 10, D. C.

Gentlemen: Please send your free booklet, "CREI training for your better job in Radio-Electronics," together with full details of your home-study training. I am attaching a brief resume of my experience, education and present position.

Check field of greatest interest:

- PRACTICAL RADIO-ELECTRONICS       PRACTICAL TELEVISION
- BROADCASTING       AERONAUTICAL RADIO ENGINEERING
- RECEIVER SERVICING       INDUSTRIAL ELECTRONICS

NAME \_\_\_\_\_

STREET \_\_\_\_\_

CITY \_\_\_\_\_ ZONE \_\_\_\_\_ STATE \_\_\_\_\_

I AM ENTITLED TO TRAINING UNDER G. I. BILL.

# RESCO

FOR TELEVISION NEEDS!

## "Vision" All Channel Tele-Booster

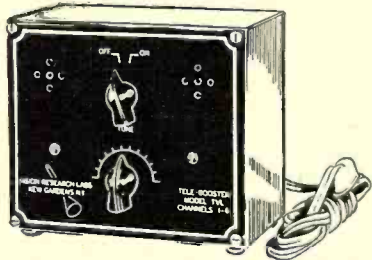

- Uses two type 6AK5's in wide-band amplifier circuit
- Self-contained power supply uses selenium rectifier
- Covers ALL television channels in use
- Eliminates outdoor antennas in many locations
- Improves receiver immunity to off-channel interference
- Simple to install and operate—requires only external connection to receiver

Will Work on ANY Television Receiver

**\$25** NET

A Swell Buy for Those Who Build Their Own Television Receivers!

### PICTURE TUBE

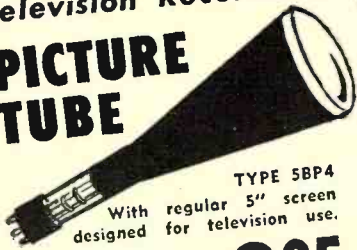

TYPE SBP4  
With regular 5" screen designed for television use.

Brand New and Fully Guaranteed

**2.95** Net

Power Transformer For Above Supplies:  
• 6V at 0.6 amps for filament of SBP4 • 2.5V at 1.75 amps for filament of 2X2A rectifier • 2200 V AC at 2 ma (2500 V DC at filter)

No. T8 **7.95** Net

### Complete Set R.F. and I.F. Coils for any size television receiver

All I.F. transformers are completely shielded and double-tuned. Includes:  
• 1 Antenna Input Transformer • 1 R.F. Coil • 1 Oscillator Coil • 5 Video I.F. Coils • 1 FM Discriminator Trans. • 2 Video Peaking Coils • 1 Instruction Sheet Showing Typical Circuits.

Designed for Standard I.F. Frequencies of 21.5 MC for Sound and 26 MC video. No. 510

**9.95** Net

Include Postage with Cash Orders

**Radio Electric**  
SERVICE CO. OF PENNA., INC.

7TH AND ARCH STREETS, PHILA. 6, PENNA.  
Branches: 5930 Market St. & 3145 N. Broad St., Phila.  
Also in Wilmington, Det., Easton, Pa., Allentown, Pa., Camden, N.J.

$S_1$  is left off (the low position), until all tuning has been accomplished, then it is turned on for full plate voltage to the transmitter final.

Turning off the transmitter may be accomplished by turning off  $S_1$  first, which will turn off the high voltage first. Either  $S_1$  or  $S_2$  will then turn off the remaining plate voltage, and the last switch thrown will turn off the filament voltage. If  $S_1$  (or  $S_2$ ) is turned off first, both plate supplies will be turned off together, and  $S_3$  will turn off the filaments last. Of course there are many different combinations involved when turning the transmitter on and off by all the methods possible with the switches shown, but none of these arrangements will turn on any plate voltage first, or turn on both filament and plate voltages at the same time.

Fig. 1B shows the connections to three d.p.d.t. switches inside a 3" x 4" x 5" metal box which may be mounted on the operating table. Once the transmitter has been tuned up and  $S_1$  (Fig. 1A) left closed, the transmitter may be turned off and operated from the operating table by means of the connections in Fig. 1B. The same switching facilities are incorporated in the control box as are found in the transmitter, with the exception of  $S_1$ .

Only four wires are needed, as shown in Fig. 1B, to connect the

switching arrangement in the control box with that in the transmitter. Of course the line voltage obtained for the control box must be correctly polarized with the line voltage entering the transmitter, otherwise the switching arrangement at the operating position would not work properly. If the line voltage to the control box (as shown in Fig. 1B) is not used, it will be necessary to run six wires from the control box to the transmitter.

The size of the control box will depend on the switches and panel lights selected for the purpose. In any case however, the box should be fastened securely to the operating table. The size of the fuses shown in Figs. 1A and 1B will depend on the current drawn by each supply. Their location does not have to conform to Fig. 1A, but they should be used wherever possible. If it is desired to control the primary of the high voltage plate transformer (No. 2) by a relay, the wires connected to 5 and 6 of  $S_3$  should be disconnected and the primary of the relay connected to these points, then the remaining wires should be connected to the appropriate contacts of the relay.

The three features set forth at the beginning of this article have been fulfilled. However, the connections to the switches were not as easily conceived as the simplicity of the diagrams might indicate.

An entirely new type of metal lens for focussing radio waves in radio relay systems is under development at Bell Telephone Laboratories. Present plans call for the use of the lens, theoretically capable of handling from 50 to 100 television channels or tens of thousands of simultaneous telephone messages, in the proposed radio relay link which the Bell System is planning between New York and Chicago. The new lenses are based on the theories of light transmission through atomic and molecular structures and use metallic spheres, discs, or strips in a scaled-up pattern similar to the arrangement of atoms in a crystalline molecule. Shown with three different small-scale models of the lens is Dr. Winston E. Kock of Bell Telephone Laboratories, who developed the new lens. The model in the rear uses metallic spheres mounted on insulators and that to the right uses metallic discs, also mounted on insulators. The lens in foreground employs thin metallic discs mounted in polystyrene foam. Lens shape is clearly noticeable here.

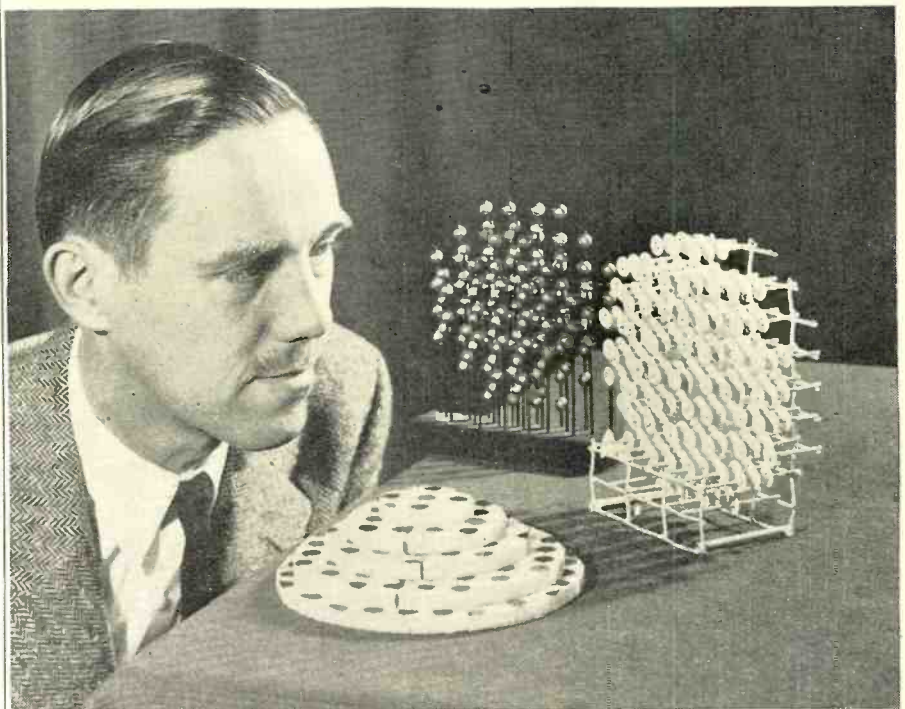



# Get ready for better television for more people

YOU WILL make more money from television, in both installation and service, when thousands instead of hundreds can afford to buy receivers. *Lighter and more compact television receivers are now a reality!*

The answer is simple. Selenium Rectifiers eliminate power transformers, rectifier tubes and filter chokes in the multiple power supply. Weight is cut as much as 90 per cent in the power supply, because a complete Selenium unit weighs less than half a pound. Operation is cooler. There is the electronic advantage of no interference to the cathode ray tube due to stray magnetic fields. This new power supply can be located almost anywhere in the set.

Now is the time to know more about this new development. Federal, *first* manufacturer of Selenium Rectifiers in this country and pioneer of their many developments, is also *first* in Selenium Rectifiers to power television receivers. Equipment and circuits have been tested in our laboratories. Write today for "Selenium Rectifiers for Television Receivers"—a paper that gives you full information. Address Dept. F959.

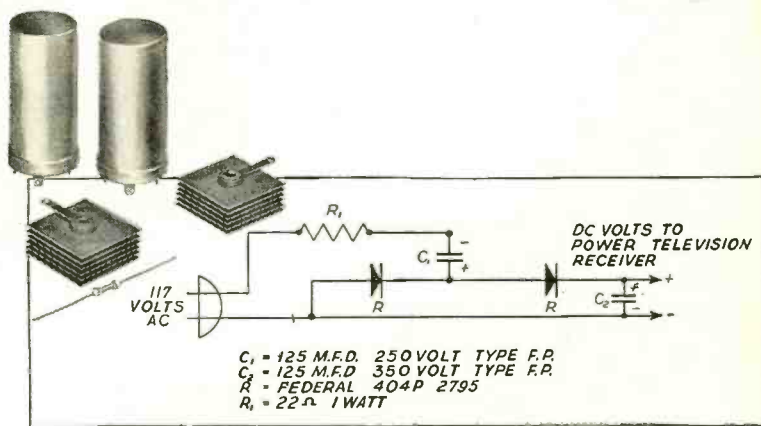

**FTR**  
An IT&T Associate

KEEPING FEDERAL YEARS AHEAD... is IT&T's world-wide research and engineering organization, of which the Federal Telecommunication Laboratories, Nutley, N. J., is a unit.

## Federal Telephone and Radio Corporation

SELENIUM and INTELIN DIVISION, 900 Passaic Ave., East Newark, New Jersey

In Canada:—Federal Electric Manufacturing Company, Ltd., Montreal, P. Q.  
Export Distributors:—International Standard Electric Corp., 67 Broad St., N.Y.

# "ARROW" leads with Better Buys!

## COMMAND SET SCR-274 MEDIUM FREQUENCY

Excellent condition ..... \$24.95  
Complete installation with 2 transmitters, 3 receivers, racks, tubes, crystals control box and plugs.

### BLOWER MOTOR

24V, small portable with fan, ideal for defroster or ventilator unit, 17,000 RPM, BRAND NEW..... \$1.95

### TEST CABLE

Coaxial cable used for connecting signal generator to receiver, complete with PL-55 on one end, 2 spare terminals on other end; shielded, 6 ft. long, NEW ..... 19c

### THE LAZIEST Q-5'er

FL-8-A, used when flying radio range. RANGE-VOICE-BOTH switch selects 1020 pass ONLY, or voice freq. minus 1020 cps, or by-passes filter completely. Put in series with hi-impedance headset when listening to 1 kc MCW..... 95c

**AUTOMATIC FREQUENCY CONTROL UNIT**  
Western Electric type used for controlling frequency for teletype and telephone work, complete with 3-6SJT and 2-6H6 tubes. Complete plate unit, brand new in original box... \$4.95

### BC-604 FM 35 WATT TRANSMITTER

A-1 condition, complete with tubes, 10 channel push buttons, less crystals and power supply, each ..... \$10.95

### BC-788 FOR 420 MC

Complete with tubes. Excellent cond. Complete transmitter-receiver, 14 tubes including 3-6I6; 9-6AG5; 1-6L6; 1-5Y3. Six wide band IF stages. Has 98.356 KC crystal. Details on page 53 of "QST", Nov. 1947. ONLY... \$10.95

### PE-151 INVERTER

12V DC input; 115V AC output; 150 watts; ideal power supply for mobile work and sound systems. BRAND NEW ..... \$12.95

### Wave Meters

Each  
Freq. range: 22 to 30 meg. }  
Freq. range: 37 to 53 meg. } \$7.95  
Freq. range: 155 to 230 meg. }

AC operated, complete with carrying case and magic eye for tuning indicator, vernier tuning dial.

### FILTER CHOKES—All Fully Enclosed

3.7 H. @ 145 MA. DC. 125 ohms DC. Res. 59c  
4 MTG. Studs, each ..... 59c  
100 mi 10H..... 59c

### APN-1 RADIO ALTIMETER

Complete 420 MC transmitter-receiver unit, complete with all plugs, indicators. BRAND NEW ..... \$34.50

AN/PRS-1 MINE DETECTOR—BRAND NEW ..... \$9.50

PE-103 DYNAMOTOR . . . used..... 5.95

### BC-929-A

Contains power supply 110 V. 400 cycles, has 7 tubes such as 3CP1, brand new, complete with tubes. Each \$17.95; Used, ea..... \$14.95

### R-78/APS-15

Has 45 tubes, one 5" scope tube, one 2" scope tube, has 3 meters, 4 power supply units 110V 400 cycles, complete with tubes. \$39.50

Each ..... \$39.50

### BENDIX COMPASS RECEIVER MN-26

Remote control commercial type navigational receiver. Indicates direction of any desired transmitting station. 3 bands—frequency range: 150 Kc to 1500 Kc; has 12—6 V. type tubes. Brand new, original cost \$600. \$24.95

Now ..... \$24.95

Accessories for Above:

Loop MN-20 ..... \$6.95

MN-28 Control Box ..... 5.95

MN-52 Loop Control Unit ..... 1.95

Loop Transmission cable—168" long..... 8.95

### T-17B HAND MIKE

BRAND NEW..... perfect carbon hand mikes, light wt., 200 ohms, single button, press to talk switch, 5 ft. rubber cord, plus, dust cover. 89c ONLY

## COMMAND RECEIVERS and TRANSMITTERS

(274N Series)—Complete with Tubes

NEW  
BC-454A; 3 to 6 MC..... \$5.95  
BC-458; 5.3 to 7 MC..... 5.95  
BC-457; 4 to 5.3 MC..... 5.95  
T-20/ARC-5 same Freq. UB457 5.95  
BC-456 MODULATOR.  
Brand New ..... 2.95

## RECEIVER

Low impedance, magnetic type receiver, ideal unit for pillow receiver or small microphone, NEW ..... 39c

### HEADSET BUY

HS-33 (Red plug), low impedance. Used, almost like new. With rubber cushions..... 95c  
4' Extension Cord for above..... 65c

### ANIS/APT-10

Pre-amplifier Model K-1, designed to raise output level of magnetic type microphone, complete with 2 tubes 6SL7GT and 28D7 and hand switch, brand new in original cartons.

Each \$1.95 3 for \$5.00

## RCA AVT-112A—AIRCRAFT TRANSMITTER

For radio-telephone communication; for 6, 12 or 24 volt source freq. range from 4500 to 6500 KC. Small in size and wt. (wt. 6 lbs.). Complete with 6 tubes, oscillator circuit, power amplifier modulators, dual tuning indicator and amplifier, with instruction manual, less crystal. BRAND NEW in ORIGINAL CARTONS— \$12.95  
ONLY. Each ..... \$12.95

## ALTIMETER TRANSCIEVER RT-7/APN-1

Frequency 418-462 Mc FM, with 14 tubes: 3-12SJ7; 4-12SH7; 2-12H6; 1-VR150; 2-955; 2-9004; 27 V. Dynamotor, used in working condition ..... \$7.95

### RECEIVER-POWER SUPPLY UNIT

For the APN-1 indicator; complete with 16 tubes; 110 V. 400 cycles. BRAND NEW ..... \$10.95

## MONTHLY SPECIALS

### 40-80 METER XMITTER

New equipment: Transmitter-Modulator and coil sets to cover 2.5-7.7 mc; transmitter tubes 2 No. 10 special and 2 No. 45 special, receiver (less the receiver coil sets), receiver tubes 1-37, 1-38, 4-39/44, shock mounts, dynamotor, antenna switching relay, receiver control box, transmitter control box, charts, dials, and instruction book. \$9.95  
What a sweet buy! Only..... \$9.95

### SMALL PORTABLE MOTORS

No. 1—Universal type, 24 volts DC shunt with two leads, 1 1/2" diameter by 2 1/2" long with 1/4" shaft, 3/8" long. New. Ea. .... \$1.49

No. 2—Delco motor, 24 volts DC shunt type, 4 leads, 6000 R.P.M. 1 1/2" diameter by 2 1/2" long, 3/4" shaft one inch long. NEW. Ea. .... \$1.49

No. 3—Pincor motor, 24 volts DC shunt type, 4 leads, 5000 R.P.M. 1 1/2" diameter by 2 1/2" long, 3/4" shaft, 3/8" long. NEW. Ea. .... \$1.49

Above motors are ideal for small hand-driven portable applications. Set of 3 ..... \$3.95

Set of 3 ..... \$3.95

All shipments F.O.B. Chicago—20% Deposit Required on all orders. Minimum order accepted \$5.00.

## REMOTE CONTROL BOX

BC-450—Triple receiver control box, can be modified to a FT-260 local control for command receivers, NEW..... \$1.95

## SETCHELL CARLSON RADIO RECEIVER

Designed to receive A-N beam signals. 24-28 vdc 21.6 watts. Tube complement: 14H7 or 14A7, RF amplifier; 14H7 or 14J7, mixer; 14A7 or 14H7, IF amplifier; 14H7, detector and 1st audio amplifier; 28D7, output amplifier, 195 to 420 kc. 4" high x 4" wide x 6 1/2" long—wt. 3 lbs., 4 oz. BRAND NEW in original carton..... \$5.95

## ANTENNA THERMO-COUPLE METER

BC-442; 0-10 amps, with extra relay and 50 MMFD 5000 Volt condenser . . . used with command transmitters. BRAND NEW..... \$1.95

## ARB AIRCRAFT RADIO RECEIVER

The ARB is a six tube, four band, superheterodyne Aircraft Radio Receiver with built-in dynamotor, designed for the reception of MCW (tone or voice) or CW within the frequency range 195 to 420 kc to 9.05 megacycles. Used..... \$15.95

### R-89/ARN-5A

Glide path receiver. Crystal control of local oscillator, 332-335 mc, complete with relays, 7-6AJ5, 1-12SR7, 2-12SN7, 1-28D7, and 3 crystals; 6497 kc, 6522 kc, 6547 kc, 90-cycle band-pass and 150-cycle band-pass filters, excellent for making an intermodulation checker. Beautiful cabinet and chassis as foundation for many interesting experimental and construction projects. Broad pass band on 20.7 mc IF's ideal for television. Schematic furnished. Used, excellent. Only..... \$6.95

### BC-733-D

Localizer receiver of the blind landing system. Companion to the glide path receiver. Also contains 90 and 150 cycle band-pass filters, 108.3 to 110.3 mc. by relay selection of crystals in the local oscillator. Wide pass-band on 8.9 mc IF's ideal for FM. Has a wonderful AVC system using rectified output of an RF oscillator as power supply for 100 volt DC bias. With relays, crystals, and 10 tubes: 3-717A, 2-12SG7, 1-12SQ7, 1-12A6, 1-12AH7, 2-12SR7. Schematic furnished! \$6.95  
Condition: Used, excellent, only..... \$6.95

### VEEDER-ROOT METER AND CASE

Counts up to 1000. Each ..... 59c

### HAND-TYPE MICROPHONE RS-38

Carbon type, with PL-68 plug, brand new... \$1.95  
Used ..... 1.00

### BC-645 TRANSMITTER-RECEIVER

BRAND NEW..... 15 tubes interrogator-transmitter designed for airborne use, 435 to 500MC frequency range. With some modifications the set can be used for 2-way communication, voice or code, on the following bands: ham band; 420-450mc; fixed and mobile; 450-460mc; citizens radio band; 460-470mc; television experimental; 470-500mc; complete with all tubes, including WB Doorknob tube. Size 10 1/2 x 13 1/4 x 4 1/2". Net wt. only 25 lbs. Your cost..... only \$9.95  
DYNAMOTOR FOR ABOVE Model PE-101-C ..... \$2.95

### RADIO PARTS

100 Resistors 1/2 to 1 watt..... 95c

100 Tubular bypass condensers, assorted, .01 to .05, all 600 Volt..... \$4.69

Electrolytic condensers 50-30, 150 Volt..... 10 for \$2.89

1/2 Meg. Volume Controls 1" shaft with switch. 10 for..... \$3.00

1/2 Meg. Volume Controls 1" shaft without switch. 10 for..... 1.95

Crystal Pick-up, new light wt..... each 1.79

### 400 CYCLE AUTOSYN MOTOR

Ideal for indicating direction of antenna systems—BRAND NEW..... each \$2.95

### HEADPHONES

Signal Corps, 8000 ohms or 200 ohms, each..... used 79c

# ARROW SALES, INC.

MAIN OFFICE

59 WEST HUBBARD ST., CHICAGO 10, ILL.

Telephone SUPERior 5575

NORTH SIDE BRANCH

1802 NORTH HUMBOLDT BLVD.

SOUTH SIDE BRANCH  
8310 SOUTH HALSTED ST.

# "ARROW" leads with Better Buys!



## BIAS METER Brand New

Originally used for measuring voltages and tele-type and telephone equipment. Can be used for measuring DC voltages and bias voltages also checking polarity of DC voltages. Complete with adaptor plug and schematic. Enclosed in metal carrying case. Requires no batteries for operation ..... \$5.95 ea.

### T-26/APT-2

Radar jamming transmitter, 450-710 mc. Heising amp. mod. by noise from 881A photo-tube. Output 3 to 7 watts. All control on front panel. 2-6AC7 and 1-6AG7 video circuit supply random noise, with pass band of 20 kc. to 4 mc. to the 807 mod. 2-368AS tubes in a push-pull 1/4-wave transmission-line osc. circuit supply the RF. Power furnished by 2-5R4GY and 1-2X2 tube. Contains 27vac blower. Input 27vac and 75-35v or 105-125v, 400 to 2800 cy. Brand new in original export case, with all tubes and handbook. Don't let this get away from you—Order today! \$9.95 At only .....

### T-27/APT-3

Another noise-modulated radar jamming transmitter, companion to the APT-2. 85-135 mc. Power output 3 to 7 watts. M.O.P.A. type transmitter. Built with 4 demountable sub-chassis: R.F. Osc.; R.F. Amp.; photoelectric noise source, video amplifier and modulator; power supply. Tubes are: 1-820B RF Amp., 1-832 RF Osc., 1-931A Photo-tube, 2-6AC7 video amp., 1-6AG7 mod., 1-5R4GY rectifier. Brand new, in original export case, with all tubes ..... \$10.95 and handbook .....

### ANTENNA EQUIPMENT BUYS

AN-109-A. 62" long solid whip antenna, very flexible, made of cad. plated silicon vanadium steel, 1/4" dia. at threaded end, tapering to 0.1" at tip end. A dandy antenna, a dandy fishing rod. A dandy price. \$2.69

4 to carton, per carton ..... \$2.69  
Doublet Antenna Kit, used with the famous Hallcrafters BC-610, consisting of 7 steel-alloy mast sections in a handy canvas bag. Each section is 5' 6" long, 1 1/2" OD with the last 6" rolled to a smaller OD to telescope into the end of the preceding section. No taper. Assemble into mast up to 35' high or shorter by any multiple of 5'. Finished in weatherproof olive drab. Ideal for erection of FM and Television Beams! Drop your coaxial cable right through the center! Brand New, export packed. \$8.95  
Kit of 7 and bag .....

### COAXIAL CABLE BUYS

RG-8/U: 52 ohm coax. cable, brand new, cut to length, min. quant. 100 ft. .... \$2.95

### SCR-522 VHF COMMAND UNIT

2-Way Radio; freq. range 100-156 MC.; complete with crystals, tubes, plugs, dynamotor ..... \$24.95 used, in excellent condition.....

### ARC 4 TRANSMITTER AND RECEIVER

For operation VHF frequencies in range of 140-144 mc. Four channel crystal controlled, manufactured by Western Electric—24V operation. Complete with crystal and dynamotor. Used. \$19.95  
Good condition.....

### PE-117 UNIVERSAL POWER SUPPLY

6 or 12 volt input; output 145 volts and 90 volts; less vibrator, voltage regulator and rectifier tube; ideal mobile power supply unit; excellent condition. each ..... \$2.95

### DYNAMOTORS AND INVERTERS

BD-77, Dyn. Unit 14v in, 100v, 350 ma out, with relay fuse box and filters ..... \$5.35  
DM-21 Dynamotor; Part of BC-812 and BC-814, 14v in, 25v, 100 ma out ..... \$2.47  
DM-34 Dyn: 12v in, 220v, 80 ma out ..... \$2.29  
DM-35 Dyn: 12v in, 625v, 225 ma out ..... \$3.25  
PE-101-C Dyn. Unit: 12 or 24v in, outputs 800v, 20 ma, 400v, 135 ma, 9v, 1.1A ..... \$2.75  
PE-55Dym. Unit: 12v or 24v in, either 16 or 25 amp, 500v out, either 200 or 400 ma. .... \$3.75  
PE-206 Inverter Unit; rotary converter, 28v in, 80v at 500 VA, 800 ex. out ..... 3.95  
PE-103 Dynamotor, used ..... \$6.95  
DM132A—each. . . . .95c 3 for ..... \$2.00

### OUTPUT TRANSFORMER

Hi-Fi; used in Scott-made Navy receiver. Fully potted, Pri. 6000 ohms, output secondary 800 ohms CT, inverse feedback secondary ..... \$1.49  
60 ohms CT. ONLY .....

## TUBES

BRAND NEW!	PRICE	BRAND NEW!	PRICE
2J32	\$19.95	832A	\$2.95
869B	19.95	837	1.95
872A	.95	838	2.95
6G6	.79	839	2.95
304TL	1.95	58P4	1.95
2C26A	.69	58P1	1.39
841	.59	5CP1	1.39
6AK5	.69	5FP7	1.39
1N5GT	.69	12BE6	.49
6AT6	.69	12SF7	.49
6H6	.49	864	.49
6J5	.49	954	.49
6J6	.49	RK34	.39
6J7	.59	35W4	.39
6SF7	.39	1625	.39
5R4	.59	1629	.39
36	.39	2051	.39
10Y	.49	9001	.49
12A6	.39	9002	.49
12C8	.49	9003	.49
12H6	.39	9004	.49
12J5	.39	9005	.49
12K8	.69	9006	.49
12SJ7	.59	7193	.39
12SR7	.59	110 VAC Neon	
12AT6	.49	Light	.39
Amperite 10T1			.39

Write for lot prices!

### C-1 AUTO PILOT AMPLIFIER

The complete amplifier includes one rect. 7Y4, 3-7F7's for amplification and control, 3-7N7's for signal discrimination, 1 power transformer, 6 relays, 4 control pots, chokes, condensers, etc. Convert for use on radio controlled models, doors, etc. Operates from 24 V. DC. Size: 9 1/2" x 6 1/2" x 3 1/2". Complete. Used—good condition ..... \$4.95  
ONLY .....

### SELSYN METER TO INDICATE POSITION

#### C-71A/APQ-13

Contains 2" meter, FS-100uA Weston 506, 0-300 V, 0-30 MA, with 6 precision resistors, as external multipliers and shunts; toggle switches, push switches, rotary switch, pots, knobs, etc. \$4.95  
GOOD CONDITION .....

### TORQUE AMPLIFIER

#### AM 19/APA-14

Provides amplification of information from Flux Gate Compass to drive torque unit and differential gear of azimuth differential unit CN-4/APA-14. Input 26 VDC and 115 V; 400 cv. Part of stabilization assembly AN/APA-14. With plugs, 3-6SN7GT, 2-6H6, transformer, oil-filled condensers. EXCELLENT CONDITION ..... \$2.95

### MEGAPHONE—Brand New

Only 40 of these to sell. Amplifier straps on shoulder, then just hold megaphone and speak in mike mounted on rear of projector. Amplifier is conventional type, shipped with tubes. Amplifier-dry battery operated less battery ..... \$29.95  
ONLY .....

### SELSYN INDICATORS

For use with beam rotators for indication of direction of beam. Operate from 15-24V. 60 cycle AC supply. Small model, 3 inch diameter, 2.45  
eter, only .....

Large model, 5 inch diameter, only ..... 2.95

### GE METER

0-10 amps., DC. .... each \$2.29

## PHANTOM ANTENNA Brand New



Used with any 80 meter transmitter as a dummy load for adjusting transmitter for maximum output before going on air. Freq. range: 2MC to 4.5MC, with instruction manual, enclosed in metal case with cover ..... \$1.95 ea.

### SCR-518-A

Radar altimeter 515 mc. Fast screen CR tube, hi-voltage power supply, connectors, cables, 29 tubes: 1-SK7, 2-SQ12, 2-6S7, 1-6C8G, 1-6SN7GT, 1-6FSG, 1-23D4, 1-6Y6G, 1-6V6GT, 10-6AC7, 3-2X2, 1-954, 1-955, 1-956, 1-6J5, 1-1808P1 cathode ray tube. \$24.95  
Brand new .....

### SCR-522 CONTROL UNIT

BC-602-B, brand new, export packed. 1 "off" push-button switch, 4 channel-selecting push-button switches, 5 pilot lamp assemblies with pilot bulbs and film dimmer and lever switch with locking control. With Schematic ..... 98c

### 80 and 40 METERS

7-tube Superhet RA-10, Bendix 1F and communications receiver, 200-1100 kc and 2-10 mc. In excellent condition, inside like brand new. Complete with tubes and dynamotors. Easily converted to 110V. Schematic furnished. \$14.95  
Only .....

### R-5/ARN-7 COMPASS RECEIVER

Very late model ADF receiver. Includes broadcast band. Frequency 100 to 1750 kc, in 4 bands. 5-gang tuning capacitor. With 15 tubes: 4-6K7, 1-6I7, 1-6I5, 2-6B8, 2-6F6, 1-6N7, 1-6SC7, 2-2051, 1-5Z4. SCHEMATIC FURNISHED. Like new, SPECIAL ..... \$19.95

### BC-433-G COMPASS RECEIVER

SCR-269-G ADF receiver, similar to the R-5/ARN-7 described above and uses same tubes. Frequency 200-1750 kc in 3 bands. SCHEMATIC FURNISHED. Like new, SPECIAL ..... \$14.95

### TRANSFORMER AND CHOKE SPECIALS

Output: Hammarlund, Super-Pro 6F6 push-pull class AB self biasing, 10,000 ohm CT primary, two secondaries: Monitoring headset output 8000 ohms and power output 600 ohms ..... \$1.89  
Output: Push-Pull 6L6's, 20 watts to 50 ohm load, Impedance ratio 15,000 to 50. Fully potted. .... 98c  
Output: 10 assorted uncouplers for ..... 1.89  
Driver: For Push-pull output. Used in Bendix radio-compass receiver. Pri. 6000 ohms. Sec. 3000 ohms CT. Turns 15 ohms ..... 79c

### 2-METER TRANSMITTER SCOOP!

The famous AN/ARC-5 VHF Transmitter (T-23/ARC-5), brand new 100-156 mc but less tubes, crystals, and the holders for the 832A tubes. Furnished with complete schematic, 4 Xtal-controlled channels selected by 3 motor-driven turrets. Motor can be spun by hand for manual band switching or driven by low-power rectifier power pack. Tubes required are 2-1625 and 2-832A. Don't pass ..... \$4.95  
this up at ONLY .....

### POWER SUPPLY FOR BC-223

PE-125 VIBRATOR TYPE  
12 or 24 volt input DC; output 475 volts-200 ma. 8 volts DC at 4.5 amps. BRAND NEW ..... \$8.95  
with schematic diagram.....

### SPRAGUE PULSE FORMING NETWORKS

Used in small radar modulators, available in 3 sizes, 67 ohms impedance, 7.5 Kilowatt rating.  
H-603, one micro second, 200 pulses ..... \$1.95  
per second .....  
H-601, 3 micro seconds, 200 pulses ..... 2.95  
per second .....  
H-602, 16 micro seconds, 60 pulses ..... 3.95  
per second .....  
ALL THREE ABOVE FOR ONLY... 4.95

### OIL-FILLED CONDENSERS

.25 MFD at 1500 VDC ..... 59c  
.25 MFD at 15,000 VDC ..... \$4.95  
2 MFD 220 VAC ..... 29c  
.25 MFD at 600V DC ..... \$1.49  
2 MFD at 60V DC ..... 29  
4 MFD at 220V AC ..... 29  
5 MFD at 750V AC ..... 29  
2 X .25 at 2000V DC ..... 29  
3000 MFD at 3V DC ..... 19

## ARROW SALES, INC.

MAIN OFFICE

SOUTH SIDE BRANCH  
8310 SOUTH HALSTED ST.

59 WEST HUBBARD ST., CHICAGO 10, ILL.  
Telephone Superior 5575

NORTH SIDE BRANCH  
1802 NORTH HUMBOLDT BLVD.



Here, and on following pages, are circuit diagrams and parts lists of many new postwar radio receivers. Radio News will bring to you other circuits as quickly as possible after we receive them from manufacturers.

## War Surplus Bargains



**R5/ARN-7  
RECEIVER**

ONLY

**\$19.95**

control heads available  
\$4.50

Three bands 200 to 1750 KC. Complete with 17 tubes required. This set is ideal for conversion to home broadcast Receiver addition to ham shack, etc. Reported sold for many times the price when brand new. A Receiver that would be hard to pick up at this price.  
No cables or plugs

## ARC-4 TRANSMITTER & REC.

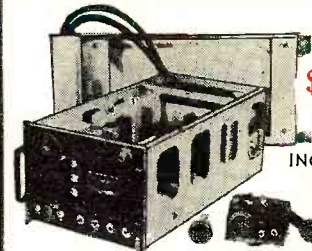

**\$19.95**

INCLUDING  
CASE

Operates on any of its 4 predetermined crystal controlled frequencies in the range of 140 MC. Complete with tubes, remote control, junction box, shock mounting base and connecting plugs. This unit is ideal for amateur UHF or mobile telephone. Operates from self-contained 24 V DC dynamotor. 12 V available upon request.

## BC-221 FREQUENCY METER

Covers 125-20,000 KC Battery operated. A beautiful instrument .....\$49.95

**T-12-B CARBON MICRO-PHONES Handmike** .... \$1.00

**HS-33 HEADPHONES**  
600 ohm (Used) ..... 75c

**HEADPHONE EXTENSION CORD** ..... 50c

**WILLARD LEAD ACID CELLS**  
6 V. (dry-chgd.) ..... \$3.00  
6 V. (in metal carrying case—dry-chgd.) \$4.00  
(Add electrolyte, specific gravity 1.265 drugstore)

**ART/13 CONTROL HEAD WITH CONNECTING PLUG** ..... \$2.50

**DYNAMOTOR MODULATOR UNIT** ..... \$1.95

**ANTENNA RELAY UNIT** ..... \$1.25

**INTERPHONE AMPLIFIER**  
\$1.95

All Prices F.O.B. Indianapolis

TERMS: CASH WITH ORDER

**AMERICAN SURPLUS  
PRODUCTS CO.**

537 N. CAPITOL AVE.  
INDIANAPOLIS, IND.

RADIO NEWS, JUNE, 1948

WARDS MODEL 74BR-2707A

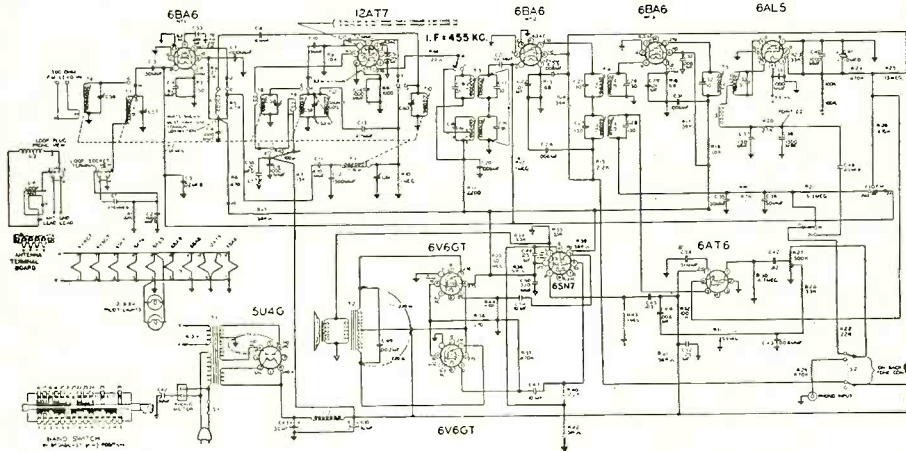

RADIO NEWS, JUNE, 1948

CROSLY MODEL 56TP-L

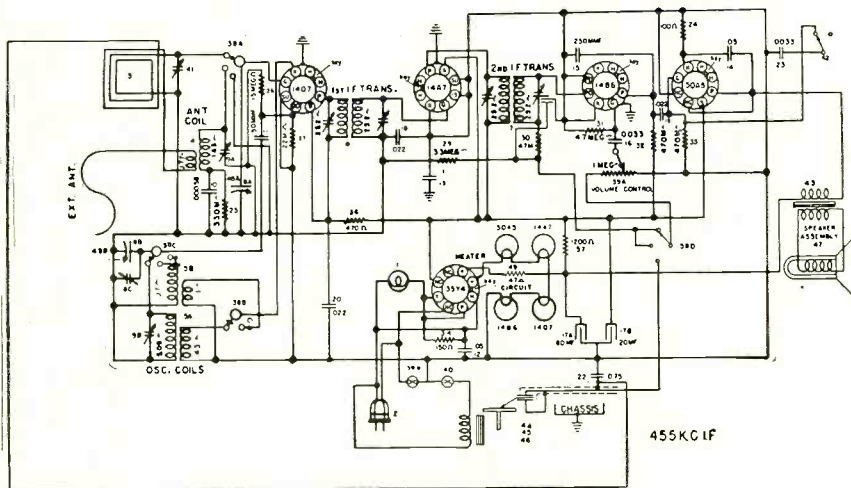

RADIO NEWS, JUNE, 1948

ADMIRAL MODEL 7C60 CHASSIS 6B1

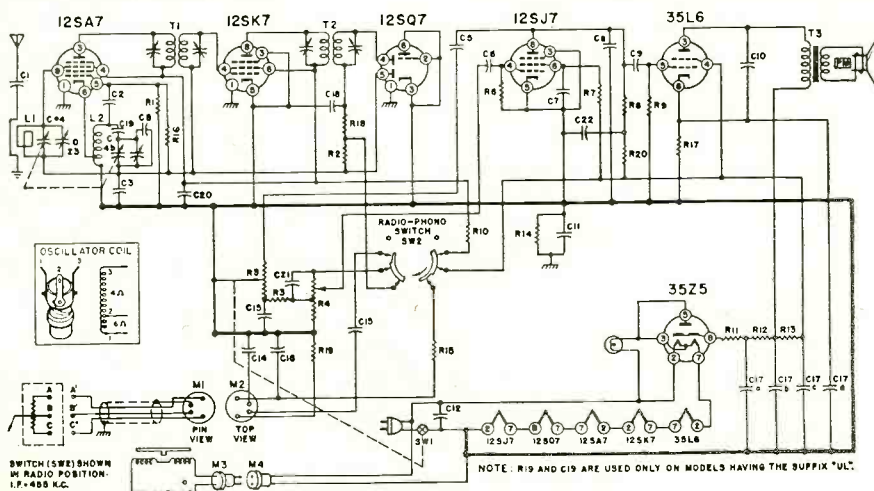

# PEAK SUPER SPECIALS

4 METER BARGAINS FOR THIS MONTH

\$2.95 EACH

10 FOR \$24.75

- 2" GE 0-1 Amp RF (Internal Thermo)
- 2" Weston 150-0 150 Microamps (Sperry Scale)
- 2" GE 0-30 Amps DC (Internal shunt)
- 2" Sun 0.1 MA Basic (Volt Scale)



**SPERTI RF VACUUM SWITCH**  
9200 volts peak 8 amps. Used as antenna switch in Collins RT 13. Brand new \$1.75

## FEDERAL SELENIUM RECTIFIER

Full wave. 36 volts input. 28 volts output at 6.1 amps. Brand new \$7.95



## DAVEN AUDIO FREQUENCY METER—Model 837E

Direct reading from 0-30 KC in 4 separate ranges on Weston Model 271 Fan Meter. Built-in voltage regulated power supply operates from 115 volts 60 cycles, has high input impedance. With pick-up can be used to determine frequency in vibration tester. With suitable mixer can check deviation of R.F. carrier from standard. Mounts on 8 3/4" x 19" rack panel. Complete with tubes. Slightly used but perfect. Only \$59.50

## SCOPE TRANSFORMERS

Hermetically Sealed. 1800 v. 4 ma, 6.3 v. @ .9 amps 2.5 v. @ 1.75 amps \$5.95 ea.

## AMERTRAN TRANSTAT

and Variable Stepdown Transformer  
110/220 volts 60 cycle input. Output variable plus or minus 10% of 115 volts at 3.5 amps. Also can be connected to give different voltage combinations. Brand new only \$12.95



## CHOKO SPECIALS

Western Electric Filter Choke 4.3 henry 620 mills 42 ohms DC resistance. 4 7/8 x 5 9/16 x 3/8 Ceramic Insulators \$4.95 ea.  
NYT Choke—8 Hy 160 ma. 140 ohms DC \$1.29

## METER SPECIALS (Brand New)

1 1/2" 0.1 ma Basic	\$3.95
2" 0.5 ma (amp scale)	1.95
2" 0-1.2 ma (0-100 scale)	2.49
2" 0-120 ma RF	4.95
3" 0-50 amps AC	4.95
3" 0-75 amps AC	3.95
3" 0-20 ma DC	2.95
3" 200-0-200 volts DC	2.95
3" 0-10 ma	3.50
3" 0-2 ma DC	3.95
3" 0-20 ma DC	3.95
3" 0.15 ma DC (square)	3.95
3" 0-150V AC	3.95
3" 0-150 volts AC Rectifier type (Linear)	5.95
3" 0-50 microamps	9.95
3" Running Time Meter	7.95
4" 1-0-1 ma DC (Blank scale)	3.95

## OIL CONDENSERS Nationally Known

2 mfd 600 vdc	\$.39	3 mfd 3000 vdc	\$3.95
4 mfd 600 vdc	.59	1 mfd 5000 vdc	4.50
3/3 mfd 600 vdc	.79	1 mfd 7500 vdc	1.95
14 mfd 600 vdc	1.35	1/1 mfd 7500 vdc	2.45
2 mfd 1000 vdc	.79	.01/.01 12 KV de	5.75
4 mfd 1000 vdc	.95	.65 mfd 12500 vdc	12.95
2 mfd 1500 vdc	1.25	.75/.35 mfd (dual)	
1 mfd 2000 vdc	1.15	8/16 KV de	14.95

## MISCELLANEOUS SPECIALS

2-11 mmf Butterfly with ball bearings	\$.59
G.E. S.P.D.T. Relay 10000 ohm coil	.59
Heineman Circuit Breaker 5 amp. 110V. A.C.	.89
G.E. Solenoid W/Microswitches 24 V.D.C.	.69
Ohmite 25 ohm 25 watt Rheostat	.39
Microswitch 10 amp. (interlock)	.59
C.H. Bat Handle Switch—D.P.S.T. 1/2 H.P.	.95
Veeder Root Counter	.95
Single Plate to P.P. input 3:1 ratio trans.	.49
500 foot Drums R G/8 U Coax	24.50
4 Quadrant Phasing Condenser	1.95
Trim Commercial Phones (High Imp.)	4.50

If not rated, 25% with order, balance C.O.D.—Minimum order \$3.00.

## PEAK ELECTRONICS CO.

188 WASHINGTON ST., DEPT. MR  
NEW YORK 7, N. Y.

# Technical BOOKS

## "SURPLUS RADIO CONVERSION MANUAL"

by R. C. Evenson and O. R. Beach. Published by Techno-Graphic Publications, Los Angeles. 115 pages. Price \$2.50.

This handy little manual should cure a lot of conversion headaches. The authors of this book have covered conversion details and diagrams for the BC-221 frequency meter, the BC-342, BC-312, and the BC-348 receivers, the BC-412 radar oscilloscope, the BC-645 transmitter-receiver, the BC-946B receiver, the SCR-274N receivers, the SCR-274N transmitters, the SCR-522 transmitter and receiver, the TBY transeiver, the PE-103A dynamotor, and the BC-1068A/1161A receiver. In addition, the book includes an "Electronic Surplus Index", a cross index of A/N tubes and their commercial equivalents, an amateur allocation chart, and a commercial television and FM channel listing.

Complete data is given for each conversion along with the necessary circuit diagram and component changes. A copy of this manual should find a place in every ham shack whose operator is using surplus wartime equipment.

\* \* \*

## "TELEVISION ENCYCLOPEDIA" by Stanley Kempner.

Published by Fairchild Publishing Company, New York. 415 pages. Price \$6.50.

The need for a definitive work on the subject of television has been known in the industry for some time but it remained for Mr. Kempner to compile this non-technical reference book covering all of the major aspects of video.

The author has gathered together in one small handbook innumerable facts on the television industry including a historical survey of television in the form of a chronological record of its evolution from the earliest research in electronics to the present day; biographical sketches of pioneers and contemporaries in the fields of science, entertainment, information, and commerce who have helped to bring television to its present state; a glossary of technical and trade terms including semi-technical, easily-understood descriptions of the operation, construction, and programming techniques of television; a section on "The Urban Market for Television"; and an extensive television bibliography designed to facilitate research of a more specialized nature.

The encyclopedia is illustrated with historic as well as contemporary photographs.

RADIO NEWS' readers who have enjoyed his articles on television will find the same clarity of presentation in Mr. Kempner's full length treatise on video.

# CUT HOLES 1/2" to 3 1/2" IN RADIO CHASSIS



WITH A GREENLEE RADIO CHASSIS PUNCH

• Save hours of work... no reaming or tedious filing. Punch cuts through chassis quickly... makes accurate, clean holes for sockets, plugs, and other receptacles. Just turn with an ordinary wrench. There's a GREENLEE Punch in each of these sizes: 1/2", 5/8", 3/4", 7/8", 1", 1 1/8", 1 1/4", 1 1/2", 1 3/4", 1 1/2", 2 1/4". Write for complete facts. Also get information on Knockout Punches and Cutters for conduit and meter holes up to 3 1/2". Greenlee Tool Co., 1886 Columbia Avenue, Rockford, Illinois.

TOOLS FOR CRAFTSMEN

# GREENLEE



## LAKE SPECIALS

Natl. Brand Phono Pickup	Each \$1.95	Per 10 \$17.00
Natl. Brand Phono Motors	3.65	35.00
Gen. Ins. Record Changers		
12"x11"	13.95	130.00
Allig. Port Cab. for any changer		
17 1/2"x17 1/2"x10" Cutout for 6" Spkr.	7.95	75.00

## SPEAKERS

3" 450 Ohm	1.49	14.00
4" 450 Ohm	1.49	14.00
5" 2750 Ohm or 450 Ohm	1.89	18.00
5" PM with 50L6 Transformer	1.39	13.00
6" PM	1.59	15.00
8" PM-1000 or 1800 Ohm field	3.50	32.00
5" Permatic Speaker-Special	.49	4.50
12" PM Heavy Duty Alnico-5	5.95	55.00
12" Dynamic 450 or 1000 Ohm	5.65	53.00

## PARTS

500M Ohm Chgo. Tel. Vol. cont. & switch	.39	3.50
50x30 Mfd. 150 V Natl. Brand Cond.	.42	3.90
40x40 Mfd. 150 V Natl. Brand Cond.	.42	3.90
40x40 Mfd. 150 V 20 Mfd. 25 V-F.P.	.39	3.75
Universal AC DC Line Cords	.50	4.75
All other Sizes from 135-350 Ohms	.45	4.25
100' 7x26 Bare Aerial Wire	.22	1.95
70 Mil. Power Transf. 6 Volt	1.95	17.50
40 Mil. 2 1/2 V. Power Transf.	.85	8.00

## AUTO AERIALS AND SUPPLIES

68" 3 Section Natl. Brand Aerial	1.75	16.50
96" 3 Section Natl. Brand Aerial	2.50	22.50
3 Section Univ. Mount	2.25	20.00
Spark Plug Suppressors	.10	.95
Distributor Suppressors	.10	.95
Generator Condensers 1/2 Mfd.	.20	1.95
7" Auto 6 Volt Speaker	3.65	35.00
7" Auto PM Dyn. Spkr. Heavy Duty	3.65	33.00
4 Prong Std. Oak Vibrator	1.39	13.50

Sale on Tubes—For Limited Time Only—50-10% Discount on List Prices of National Brand Tubes!

Write for our new 1948 illustrated catalog!

# Lake Radio Sales Co.

615 W. Randolph Street  
DEPT. A

Chicago 6, Ill.

RADIO NEWS





# JOHNSON OFFERS

## *A Condenser To Fit Every Need!*



**TYPE C & D** — Sturdily constructed to give trouble-free operation under the most severe service, JOHNSON Type C and D Condensers cost less than any other quality condensers. Features include sturdy construction, heavy aluminum plates .051" thick, Steatite insu-

lation and center rotor contacts on all dual models. Both front and rear shaft extensions permit ganging. Available in 52 different models, single or dual sections, with spacing varying from .175" to .500" and maximum capacities from 50 to 1,000 mmfd.

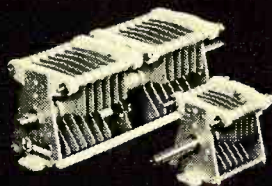

**TYPE E & F** — Rugged and compact, JOHNSON Type E and F Condensers for medium and low power transmitters have more capacity per cubic inch and occupy less panel space for their rating than any other condenser on the market. Features include Steatite insulation, sta-

tor mounted above to reduce capacity to ground, front and rear shaft extensions that permit ganging. Available in 45 different models, single or dual sections, spacing .045" to .125", and maximum capacities from 35 to 500 mmfd.

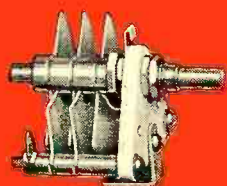

**TYPE G** — The JOHNSON Type G Condenser is widely used as a neutralizing condenser for medium and low power stages. It's equally famous for its outstanding performance in grid and plate tuning at high and ultra high frequencies. Features include front and rear

shaft extensions and universal mounting bracket and locking nut. Available only in single sections with single end plate. Seven models from which to choose. Capacities from 3.5 to 52 mmfd. Plate spacing from .045" to .225".

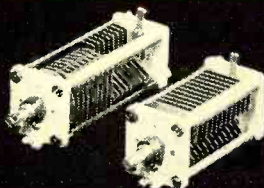

**TYPE H** — Combining minimum weight with small size, JOHNSON Type H Condensers are designed especially to withstand heavy vibration. Steatite end plates prevent any possibility of "short circuit loops" and permit panel mounting

with both rotor and stator insulated from ground. Aluminum plates are .020" thick. End plates are 1 1/8" square. Available in 17 different models, single or dual sections, spacing .030" or .080", and maximum capacities from 25 to 100 mmfd.

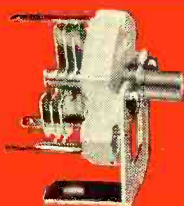

**TYPE J** — A midget condenser with big condenser characteristics, Type J has wider spacing than most small types, yet occupies little more space. It is ideal for oscillator and low power stages. Universal type mounting brackets make possible a variety of mountings in-

cluding chassis, panel or inside tube socket type inductors. Steatite end plate. Available only in single sections with single end plate. Six different models with maximum capacities from 7 to 102 mmfd. Plate spacing is .025".



**MIDGET AIR VARIABLES** — Here are three of the smallest air variables ever produced. **SINGLE TYPE** — Available in four models: 1.55 to 5.14 mmfd, 1.73 to 8.69 mmfd, 2.15 to 14.58 mmfd, and 2.6 to 19.7 mmfd.

**DIFFERENTIAL TYPE** — Available in four models: 1.84 to 5.58 mmfd, 1.98 to 9.30 mmfd, 2.32 to 14.82 mmfd and 2.67 to 19.30 mmfd. **BUTTERFLY TYPE** — Available in four models: 1.72 to 3.30 mmfd, 2.10 to 5.27 mmfd, 2.72 to 8.50 mmfd, and 3.20 to 11.02 mmfd.



Write For New Complete  
**JOHNSON**  
Condenser Catalog

**TYPE N** — When space is limited, yet you need extremely high voltage rating, fine adjustment with uniform voltage breakdown rating throughout the full capacity range, the JOHNSON Type N Neutralizing Condenser is the perfect answer.

Available in three different models. Capacity range in each type is approx. 1.5 mmfd. to 10.5 mmfd., peak RF breakdown ratings at 2 MC ranges from 8,500 with the N125 to 14,500 for the N375.



# JOHNSON ... a famous name in Radio

E. F. JOHNSON CO., WASECA, MINNESOTA

*All Mail Orders Shipped Promptly!*

**SAVE ON THESE MONEY-SAVING VALUES!**

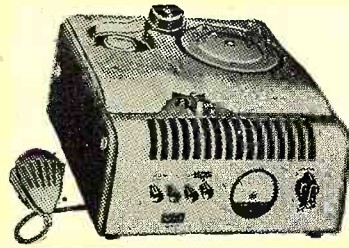

**WEBSTER CHICAGO MODEL 78  
WIRE RECORDER  
NEW SIMPLIFIED ADAPTER MAKES  
IT EASY TO CONVERT ANY RADIO  
INTO A WIRE RECORDER  
COMBINATION**

The Model 78 Wire Recorder is especially adaptable for home use in connection with a radio receiver or with a high fidelity public address type amplifier and speaker. Compact in design with simple push button controls. Model 78 comes complete with necessary cords, plugs, microphone, 15-min. spool of wire, and full instructions for easy connection. Head phones may also be used for quiet, private play back of a recording.  
List price \$153.00  
Net ..... **\$99.96**

**2 TUBE WIRELESS PHONO OSCILLATOR**



This fine piece of equipment is being sold at almost the price of the tubes alone. A real bargain while quantity lasts.  
Each ..... **\$3.25**

**6 TUBE DETROLA PHONO-COMBINATION AC CHASSIS**

Complete with tubes, speaker, and aerial. Completely wired.  
Each ..... **\$14.95**



**6 TUBE DETROLA AC-DC CHASSIS**

Complete with tubes, speaker, and built-in antenna. Completely wired.  
Each ..... **\$9.95**

**G.E. VARIABLE RELUCTANCE CARTRIDGE**

A wonderful new magnetic cartridge that provides excellent high fidelity reproduction. Practically eliminates needle noise. Fits almost any pickup. Requires preamplifier.



Made for Models as shown 1-General Electric 2-Clarkstan 3-Pickering 4-Lear.  
Order by number

Requires preamplifier.  
List Each ..... **\$7.95**  
Each ..... **4.67**

**PREAMPLIFIER FOR G. E. VARIABLE RELUCTANCE CARTRIDGE**

3"x3"x1 1/2". Increases output, and equalizes cartridge for flat response. Attaches easily. Complete with tube and diagram.

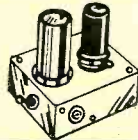

List, each ..... **\$9.00**  
Net, each ..... **4.82**

Write for our new, FREE 1948 Catalog . . . Terms: 25% Deposit with order . . . Balance C.O.D. F.O.B. Chicago.

**Mort's Radio Shack**

630 W. RANDOLPH STREET

CHICAGO 6, ILL.

**BUILD YOUR OWN COIN-OPERATED RADIOS**

These High Quality Kits Make It Possible for You to Enter this Highly Profitable Business with a Small Cash Outlay. Easily Assembled with Ordinary Tools found in any Home Workshop. Chassis are Completely Wired (With Tubes). All Holes are drilled. Step-by-Step Instruction Sheet furnished with each Kit.

**ITEMS COMPOSING KIT SOLD SEPARATELY**

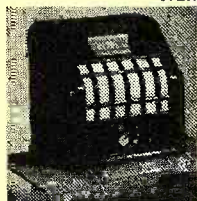

**DELUXE TABLE MODEL-KIT**  
Can Be Screwed Down or Hooked to Table with "C" Clamp.  
COMPLETE KIT...\$31.00

- PLASTIC CABINET AND GRILLE FOR TABLE MODEL \$ 5.75
- Richly grained Brown—Exceptional Acoustics—Only Equaled by this Type Cabinet.
- TIMERS (Quarter—1 or 2 hour).....\$ 4.95
- TIMERS (Nickel—10 Minutes).....\$ 4.95
- METAL HINGED BASE AND BACK with No-Cheat Coin Box and Brackets.....\$ 3.45
- 2 Locks, Wing Nuts, Name Plates, etc.....\$ 1.80
- A.C. RADIO CHASSIS R.C.A.—5-Tube Super-Het Completely Wired.....\$15.35
- PLASTIC BASE to Complete Console Model.....\$ 4.25
- HEADSET for Beauty Parlor, Dryer and Halder (Not Included in Kit).....\$ 1.80

ALL SHIPMENTS F.O.B. LOS ANGELES

**RADIO COIN MATIC**

1110 South Normandie Avenue • Los Angeles 6, California

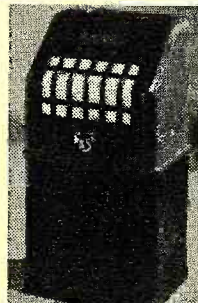

**DELUXE CONSOLE MODEL KIT**  
No Stand Needed—Can Be Fastened to Floor.  
COMPLETE KIT...\$35.00

**Vacuum Tube Voltmeter**

(Continued from page 60)

These ranges were selected so that the original meter scale, which was calibrated 150 microamperes full-scale with markings at 60 and 90, could be used. This obviated drawing a new scale. The builder has the choice of drawing a new scale or using other voltage dividers to give readings which will correspond to the markings on the scale of the meter being used. It is suggested, however, that a 20-division scale be used, in which case a voltage divider providing readings of 1, 10, 100, and 1000 volts full-scale would be employed. No trouble should be encountered in securing a "low volts" reading of 1 volt full-scale. Refer to Fig. 1 for a diagram of this voltage divider.

The input resistance (Fig. 2) totals 15 megohms which is a practical value for all d.c. voltage measurements. Resistors  $R_1$  through  $R_4$  were mounted directly on the 4-position wafer switch which is used as the voltage range selector. The value for  $R_1$  was made up of a 10 megohm and a 3 megohm resistor which read a little on the high side.  $R_2$  comprised a 1 megohm unit and a 350,000 ohm resistor.  $R_3$  is made up of a 100,000 ohm and a 35,000 ohm resistor, while  $R_4$  is a standard 15,000 ohm unit.

The complete circuit diagram is given in Fig. 2. It will be readily recognized as a balanced bridge type cathode follower. The cathodes of  $V_1$  and  $V_2$  are connected directly to the grids of  $V_3$  and  $V_4$  respectively. Note that the input tube is neither in the bridge nor the meter circuit.  $V_1$  and  $V_2$  are supplied by a very low voltage taken from the bleeder circuit,  $R_5$  and  $R_{10}$ . Heavy degeneration is developed through their 5 megohm cathode resistors. Their total plate current is of the order of 4  $\mu$ a. while the plate current of  $V_3$  and  $V_4$  is approximately 1 ma. The bleeder current is approximately 0.375 ma. with 45 volts of "B" battery.

The circuit is self-explanatory. The only thing to remember is that pins 1 and 7 on the tube sockets must be connected together as these become the positive connections to the batteries. Pins 5 on the tube sockets are connected to negative and these connections are used for the cathode leads.

A small bracket which holds the tube sockets, the calibrating potentiometer, and the resistor strip is bolted to the panel. The resistors are mounted either on the tube sockets or to this resistor strip. The "on-off" d.c. positive and d.c. negative switch is located to the left of the panel and the "zero-adjust" potentiometer is to the right. Below this and in the center is located the voltage range switch. The bottom of the panel carries the jacks for the test leads, the center jack being ground. The jacks shown in the photograph are *Amphenol* units.

The panel and bracket are constructed out of 1/16" aluminum. A wrin-

# More for Your Money R & M RADIO

Satisfaction  
Guaranteed or  
your money back

## SPECIAL! EXPERIMENTER'S KIT

Worth \$13.33 at low R & M prices!

**\$7.95**

ALL NEW PARTS AS FOLLOWS:

### 34 Resistors—worth \$2.38

Two each of the following, values 1/8 to 1 watt: 1, 15, 34, 50, 100, 120, 150, 180, 200, 500, 5900 k; 1, 1.5, 2.2, 4.7, 10 meg.

### 8 Condensers—worth \$4.56

One each: .05 mfd, 600v; 10 mfd, 350v; 15 mfd, 150v; 20 mfd, 250v; 40 mfd, 150v; 50 mfd, 150v; 150 mfd, 25v; 200 mfd, 10v.

### 3 Potentiometers—worth \$1.77

1 meg ohm; 500 meg; 20 meg, each with switch

### 12 Tube Sockets—worth \$1.80

4 each: octals, miniatures, 5-pin mediums.

### Wire, Ceramicons, etc.—worth \$2.82

25 ft. #18 hookup wire; 25 ft. #20 hookup wire; 3 Ceramic trimmers, 15-40; 15-40; 15-200 mfd; 2 double-section 15-60 mfd; 12 asstd. ceramicons; 1 SPST switch; 1 SPDT switch, one side monetary.

## TRANSFORMERS

#1 Power XMFR: Pri—115v 60 cycle; sec—500 CT @ .06 amp.; 24v @ 1/2 amp. Your cost only.....\$3.90

#2 Filament: Pri—115v 60 cycle; Sec. 1—14v @ 7 1/2 amp.; sec. 2—14v @ 7 1/2 amp. Series 28v @ 7 1/2v.; parallel 14v @ 15 amp. Your cost only..\$4.50

#3 Filament: Pri—115v 60 cycle; Sec. 24v @ 2 amp. Your cost only..\$2.25

## HEAVY DUTY ANTENNA ROTOR

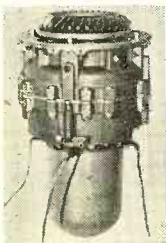

For 6, 10 or 20 meter arrays on one rotor; strength to support and rotate whole mast. Requires 30 volts AC or DC. Fully reversible . . . motor speed 7076 to 1 on the mast. Enough power to turn your house.

Torque developed is terrific!!! .....\$9.50

## T-17 CARBON MICROPHONE

Brand new  
**\$1.85**  
each

Used \$1.00 each



## HEADPHONES 69c

HS-33 with cord and plug, 600 ohms — Used, in A-1 condition.

## CONVERSION BOOK

(with a purchase of \$5 or more, available to you at just \$1.00)

Data on conversion, with schematic diagrams, instructions, and discussion, on the following:

Diag. and Conversions: BC-348, SCR-522, BC-375, SCR-274, SCR-274-10 meter mobile.

Diagrams for: BC-221, ART-13 Collins Xmtr., APN-1, APN-4, SCR-718.

Save \$1 by ordering when you purchase \$5 (or more) worth of equipment.

**\$2**

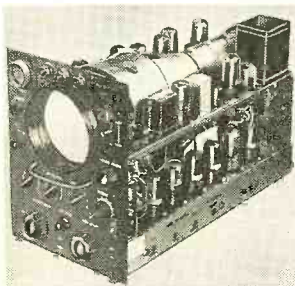

## APN-4 INDICATOR PRECISION OSCILLOSCOPE

Special for amateurs, experimenters and repairmen; can be converted into the following: 5-inch panoramic set with marker pips at 100 kc—20 kc—2 kc to enable you to observe crystal and V.F.O. drift and width of frequency deviation of FM; a precision sweep scope that is accurate with electronic switch for observing two signals simultaneously, and 100 kc lab. type crystal with TPTG oscillator circuit feeding six frequency divider stages. Tube lineup: (1) 5CP1, (3) 6SL7, (14) 6SN7, (6) 6H6 and (1) 6SJ7. Only.....\$19.50

## HEADPHONE EXTENSION CORDS....25c

Approx. 72" long, rubber cov., with JK-26 & PL-55 plugs

## HEADPHONE ADAPTERS MC-385....30c

(4 for \$1)

From high to low impedance, 4000 to 600 ohms; contains matching transformer.

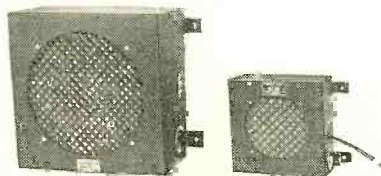

## HIGH FIDELITY SPEAKERS

6-inch, 10-watt PM Speaker, ea. **\$7.95**

12-inch, 15-watt PM Speaker, ea. **\$14.50**

Brand new in Heavy Duty Steel Cabinets with beautiful black wrinkle finish.

Also has T-pad volume control and 600 ohm line to speaker transformer. Wall mounting brackets and slope front.

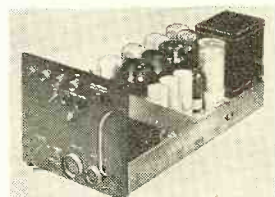

## APN-4 RCVR—SCOPE POWER SUPPLY

4 switch-selected screw-driver tuned RF channels; IF freq. 1050 kc, band-width 45-60 kc; RF freq. 16-2000 kc. Tubes: (2) 2Y2, (3) 6B4, (4) 6SK7, (1) ea. 5U4, 6SU7, 6SA7, 6H6, VR150. Makes fixed tuner for med. freq. police calls or PA system. Has power supply for 5" scope, with 400 cycle trans. Electronic-controlled low v. supply; delivers 260 vdc. 150 mls reg. to .01%. Power supply alone worth more than price.....\$12.50

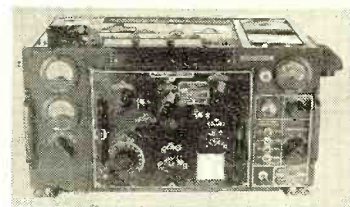

## NAVY TRANSMITTER GP-7

125 watt xmtr., self-contained AC, 400 cycle power supply; suppressor grid modulation for phone, VFO controlled, 803 in final; built of std. parts .....\$17.50

● SAVE C.O.D. CHARGES by remitting in full, or send 25% deposit with orders. Please don't send money for postage; we ship "transportation charges collect".

R & M RADIO COMPANY, Dept. N  
1426 N. Quincy St., Arlington, Va.

- Send Conversion Book.  \$2 inclosed.  
 Send C.O.D. Send FREE catalogue on kits:  
 Xmtr.  Receiver.  Television.  
 Transformer Listing

Name.....

Address.....

City.....

Zone..... State.....

**THE NEW LANGEVIN TYPE 122 EIGHT WATT AMPLIFIER  
WITH THE PLUG-IN ADAPTOR FEATURE**

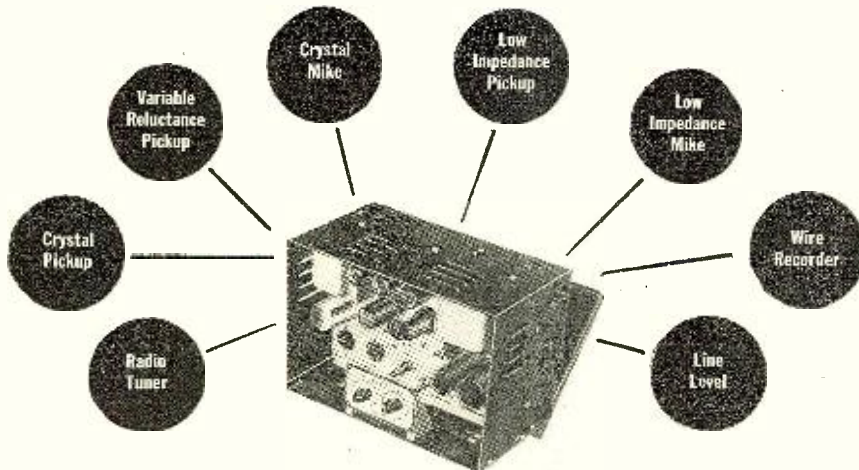

**8 APPLICATIONS... 1 AMPLIFIER**

This ONE Langevin amplifier is easily adaptable for EIGHT types of input . . . just by plugging in the correct channel adaptors.

**UNIQUE MECHANICAL DESIGN...**

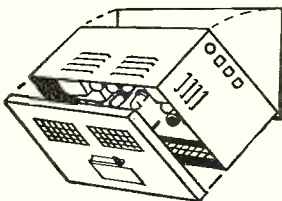

makes the 122 easy to install and service. The case and chassis are combined... entire unit drops forward from hinged back to expose wiring and connections... tubes plug-in horizontally... front cover snaps on... screwdriver type lugs are provided for input connections.

*25th Year of Langevin Quality*  
Write TODAY for Bulletin X1031 for complete specifications.

The new Type 122 provides two independent input channels each with three extra ready-wired sockets for standard Langevin Plug-In equalizers, transformers, voice filters and vacuum tubes to adapt the amplifier to your requirements.

Electrically, the new Langevin 122 is a low noise level, low distortion unit with wide range frequency response:  $\pm 1$  db from 30 to 15,000 cycles; 8 watts with less than 3% Total RMS Harmonic Distortion from 50 to 15,000 cycles.

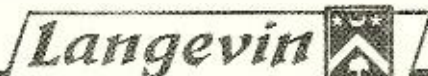

**LANGEVIN MANUFACTURING CORPORATION**  
37 West 65th Street, New York 23, New York

**NEW INDOOR TELEVISION ANTENNA**

**ELIMINATES REFLECTIONS**

**-VISIBEAM-**

For Use With All Television Receivers. Ideal for Hotels and Apartments. Compact—12" Diameter—Table Lamp Size. Made of Polished Lucite. Tunes to all channels.

THERE IS NO LANDLORD OR INSTALLATION PROBLEM WHERE THE VISIBEAM IS USED

RETAILS AT \$16.95  
At Your Dealers

Mfg. by **BURNETT SERVICE CO.**  
178 W. 168 St., New York 52, N. Y.



PAT. APP.

kle varnish was applied to the panel to give the instrument a professional appearance. Small dials were drawn on a piece of bristol board and then attached to the instrument. The bracket which holds the tubes was laid out in such a manner that the tubes would clear the meter when they were inserted in their sockets.

After all wiring is completed and checked against the circuit diagram the batteries should be soldered or connected in the circuit. Before the tubes are put in the sockets a voltage check should be made with a voltmeter. If everything checks OK, the potentiometer,  $R_{11}$ , is set for maximum resistance and the tubes are inserted in the sockets. By adjusting potentiometer  $R_{13}$ , located on the front panel, it should now be possible to zero the meter. No deflection of the meter should be noticed when the test leads are shorted. If a noticeable deflection occurs, a different tube should be tried in  $V_1$ . Several tubes of questionable quality were tried in  $V_1$  and showed up defective in this position.

A cabinet was constructed of  $\frac{1}{4}$ " plywood to house the instrument and its associated batteries. The cabinet measures  $4\frac{1}{4}$ " x 7" x  $3\frac{3}{4}$ ". Brackets were made to hold the batteries in place. These are mounted on the sub-panel in back of the instrument. This sub-panel is mounted to the main panel by means of four  $\frac{1}{4}$ " metal spacers,  $2\frac{3}{8}$ " long.

This v.t.v.m. needs no calibration other than the standard scale divisions. It is advisable to have a scale with at least fifteen divisions so that voltages as small as .1 volt may be read with ease. A new scale may be drawn if the meter being used does not have a suitable one. For extreme accuracy, if a new scale is used, the meter should be calibrated against another meter of known accuracy.

An a.c. probe was constructed for measuring a.c. voltages such as r.f., a.f., and power line. The probe used consisted of a crystal diode, such as the 1N34, and a .02  $\mu$ fd. mica condenser. (Details for constructing this probe were given in the article, "Sensitive Probe Uses Crystal Diode" by Rufus P. Turner in the May, 1947 issue of RADIO NEWS.) The probe used with this instrument was constructed of bakelite tubing  $\frac{7}{8}$ " i.d. and 3" long. A bakelite disc was inserted at the prod end and the tip of a standard test prod was inserted in the disc. A metal disc was inserted at the other end and to this was attached the spring end of an Amphenol connector. This was soldered to the disc with a piece of single conductor, shielded microphone wire and attached to the Amphenol connector. Measurement of voltages over 50 volts a.c. are not recommended with this probe as the heavier voltages may damage the 1N34.

Just a word about the operation of the instrument. It was found that the "A" batteries weakened first so the instrument should be turned on only when it is in use and turned off as soon as the job is finished.

BC191/375 & TU & TUBES used LN\*...\$12.95  
 BC605 TANK Interphone & Tubes & Dyn... 4.95  
 GIBSON GIRL XMTTR ONLY 7.95  
 GG BALLOON 4 ft & Hydrogen gas generator 4.95  
 GG NYLON BOX KITE 2.95  
 RCA ET8026 lifeboat Xmttr LN\* 19.95  
 MACKAY 168 lifeboat Xmttr LN\* 29.95  
 RADIO XMTTR 149A 375 to 500KC&Tubes 29.95  
 RADIO XMTTR 167B/21024mc's/150Watt...149.95  
 VARIAC 200C/860 Watt/0-130V... 16.95  
 APN4 Revr & Indicator... 79.95  
 USN ABF/SCR695 RCVR & DYN LN\*... 9.95  
 BC1066 UHF BATTERY RCVR LN\*... 9.95  
 BC196 SIG GENRRR UHF BAT new... 5.95  
 BC906/polE46 freq mtr & monitor & Range 150 to 225mc's. Bat on new... 29.95  
 DAK RCVR 250-1500kc & 60cy Pwr LN\*... 39.95  
 GO-9 XMTTR 300-600ke/75W LN\*... 98.50  
 BC1073 WVMTTR 150-210mc's used LN\*... 10.95  
 BC433/MN26 Radio Compss RCVR used LN\* 21.95  
 ARN-5 or BC733 RCVR less tubes LN\*... 16.95  
 MP313 RCVR & XMTTR less tubes LN\*... 6.95  
 APN1 ALTIMETER less tubes LN\*... ca. 5.95  
 BC457. 458 Xmttr used LN\*... ca. 5.95  
 BC456 Modulator less tubes & Dyn LN\*... 1.69



**Precision Resistors  
for Meters  
Bridges, Amplifiers  
All Standard Makes**

SEE PREVIOUS RADIO NEWS Ad's or WRITE  
 for PRECISION RESISTOR LIST

PRECISION RESISTOR LIST	PRICE
5&10% 2000 to 95000 ohms.....	Ten for \$1.98
1% From .116 to 95000 ohms.....	Ten for 3.00
1% From 0.1 to 0.95 MEGohms.....	Ten for 5.00
1% From 1 to 20 Megohms.....	Ten for 6.95

**VICTOREAN VACUUM PRECISION**  
 RESTRS 0.83, 1, 1.5, 2, 3, 3.75 MEG  
 ACCY 1/2, 1% HiVols, 2% 1/2 to 1/3 Ten for 7.50

IRC NAVY PRECISION I MEG 1/2 of 1/2... 1.69  
 IRC NAVY WW Caged 2 MEG 1/5 of 1/2... 4.95

**RECTIFIERS BRIDGE TYPE**

INPUT	OUTPUT	CURRENT	PRICE
0-18V	0-14	1.35Amp	2.25
0-18V	0-14	5Amp	4.85
0-36V	0-28	320ma	1.49
0-36V	0-28	1.5Amp	2.39
0-36V	0-28	1.5Amp	2.89
0-64V	0-54	220ma	3.49
0-64V	0-54	5Amp	16.95
0-90V	0-80	150ma	2.85
0-135V	0-116	2.4Amp	12.95
0-126V	0-110	130ma	2.95
0-144V	0-125	150ma	2.95
0-330V	0-300	40ma	.85

**FULL WAVE CENTER TAP**

460VCT	0-110V	1.6Amp	6.95
460VCT	0-110V	220ma	3.49
460VCT	0-110V	3.5Amp	14.95
600VCT	0-256V	2.4Amp	12.95
650VCT	0-272V	150ma	2.95

**HALF WAVE TYPES\***

0-28V	0-12V	150ma	.59
0-72V	0-36V	300ma	.98
0-130V	0-100V	100ma	.98
0-216V	0-144V	75ma	1.75

\* USE WITH CAPACITOR any VDC at 2Xoutnut

**CAPACITORS**

6000mfd/15WV \$2.98	500 mfd/60WV.....\$	.98
2000mfd/50WV \$1.98	500 mfd/200WV.....	1.49
CAPACITORS OIL RATED WVDC		
TAPPED 2.8mfd/200VDC oil.....	15 for	1.50
2mfd/330VAC/1000VDC oil 1/8A CSD.....	5 for	1.98
5mfd/600WV/220VAC & Brkts oil.....	2 for	1.80
7mfd/600V 99c; 10mfd/600V.....	1.39	
3.3mfd/225VAC \$1.25; 4mfd/600V.....	.89	
20mfd/600V \$2.75; 4mfd/330VAC/1000VDC	1.39	
15mfd/330VAC/1000VDC & 2000VDC intrmt	4.50	
3mfd/2000VDC \$4; 4mfd/3000VDC.....	5.95	
2mfd/2000VDC \$2.49; 2mfd/5000VDC.....	10.00	
4mfd/5000VDC \$5; 2mfd/2500VDC.....	28.00	
1mfd/2500VDC \$95; 1mfd/4000VDC.....	3.75	
.00025mfd/25KV.....	4.95	
2mfd/400V 12 for \$1; 3x1mfd/400V.....	10 for 1.00	
1mfd/400V 12 for \$1; 2mfd/400V.....	5 for 1.00	
.5mfd/500V 10 for \$1; 1mfd/500V.....	8 for 1.00	
.05mfd/600V 30 for \$1; 2x.05mfd/600V.....	25 for 1.00	
3x.05mfd/600V 15 for \$1; 3x.22mfd/600V.....	12 for 1.00	
3x.1mfd/600V 8 for \$1; 2x.25mfd/600V.....	6 for 1.00	
3x.25mfd/600V 5 for \$1; .5mfd/600V.....	8 for 1.00	
.1mfd/1000V 4 for \$1; .25mfd/1000V.....	4 for 1.20	
.2mfd/5000V \$2.25; 1mfd/3600V.....	3.25	

**TRANSFORMERS 115V/60cy INPUT**

7500V or 15000V DOUBLER 35ma.....	15.95
10800VCT or 21000V DOUBLER 95ma.....	19.95
1320V & 375VCT/110ma, 5V/3A.....	
2.5V/3.25A & 6.3V/2.75A Cascd HV Instd..	7.95
1350VCT/150ma, 6.3V/5A, 5V/2A.....	6.95
640VCT & 1250V/250ma @\$.45.....	2 for 8.95
500VCT/60ma, 6.3V/4A Hmctly Cascd.....	1.29
1100VCT/212ma \$5.95; 10V/8A/12KV.....	6.95
5V/115Amp \$10.95; 2.5V/10A/10KV.....	3.95
1000VCT/45ma, 795VCT/80ma, 3x5V/3A.....	
& 6.3VCT/1A, 6.3V/3A HV/Hmctly CSD..	4.95
93, 103, 112, 117 or 230V/1.6KW.....	16.95
115 or 230V/8Amp/1.8KW Auto Transf.....	18.95
872A's COMBINATION TRANS sockets.....	12.00
866A COMBINATION Tubes, sockets, Xformer	5.95
570VCT/180ma, 5V/2A, 6V/4A CSD.....	3.95
510VCT/125ma, 5V/2A, 6V/4A CSD.....	3.25
TRIPLETT TUBE CHECKER TRANSF.....	2.95
220 to 440V-or-110 to 220V/250Watt.....	4.95
AUTO TRANSF 6V/2A, 150V/1.6A, 35V/1.2A	3.95
SEL RECT R/115/60c, 42.5V/2A.....	4.25

**CHOKES**

15-29Hy/150ma SWINGING CASCD.....	2.95
12Hy/300ma \$3.95; 3Hy/40ma.....	1.00
15Hy/400ma or 20Hy/300ma/12KVins.....	7.95
3Hy/400ma; 15KV \$2.75; 8Hy/200ma.....	2 for 2.89
8Hy/150ma new UTC cracked bkite T'Pd 2 for	1.78
0.5Hy/100ma 4 for 98c; 50Hy/150ma.....	1.95
8Hy/110ma \$1.29; 12Hy/275ma.....	3.29
TIME DELAY RELAY 115V/10Amp/ACDC.1.49	

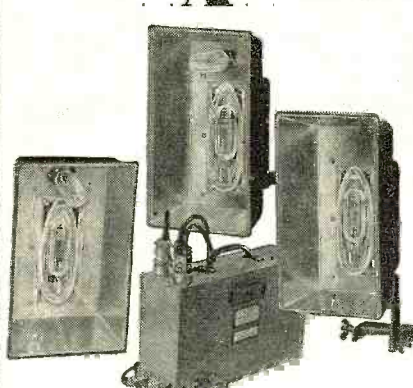

**STROBFLASH KIT #1503 AIRCORPS**  
 COMPLETE POWER SUPPLY, TRANSFORMERS  
 RECTIFIERS, RELAY, 3 STROBOLAMPS  
 12000000 lumens light outpt/15000 flashes,  
 Plastic shade for Color & B.W. film  
 CONDENSERS 50mfd/2000V/110 Watt see &  
 ACCESSORIES, REFLECTORS, Connectors,  
 Connecting Cords, Diagram & Instructions  
 on how to convert unit for 110VAC.  
**BRAND NEW GUARANTEED**

**SPECIAL "TAB" BUY \$68**

**SAME UNIT & STORAGE BATS**  
 PORTABLE OPERATION  
 ADJUSTABLE 54" TELESCOPIC  
 STANDS FOR MTG STROBOLITES  
 "TAB" SPECIAL \$7.95, 3 for 18.00

**STROBFLASH COMPLETE READY**  
 for operation 115VAC 195.00

**COMMERCIAL STROBO COMPLETE**  
 WITH STANDS FOR INDUSTRIAL  
 OPERATION 295.00

**PORTABLE HI POWER STROBO**  
 FLASH Hioutput 149.50

**STROBOLAMPS X400** with built-in  
 ignition Xformer in plastic sealed  
 protected case & reflectors, outpt  
 12,000,000lumens/15000 flashes  
 SPECIAL \$16.95, 2 for 32.00

**STROBO CONDNSRS GE PYRANOL**  
 four 8mfd/660 VAC/2000V-32mfd 11.95

**IN34 X'DIODES @ \$1.08; 2 for \$2.10; 10 for \$9.85**  
 IN21A, 22, 23A, 25 G/insp @ \$1..... 12 for 10.00  
 IN23B, IN26 NEW @ \$2..... 10 for 17.50  
 THERMISTOR BEAD OR BULB..... 3 for 2.50  
 THERMISTOR ID68391 @ \$2..... 3 for 5.00  
 HIPOWER VARIABLE ANTENNA MATCHING

**NETWORK #1001A BRAND NEW** 1000 to 7000  
 KC IKW-RF easily converted to hi freqs. Pi Network  
 adjustable in & outpt. CASED 15"x15"x23" Relay  
 Each net contains heavy edgewise Ribbon coil &  
 250mft/7000V Variable Condnsr Johnson & RF  
 mtr thermocouple 0-8Amp/3" Sq. With TECH  
 manual. Will match & load majority ANTENNAS.  
**STURDY CONSTRUCTION Wgt 45 lbs. Excellent**  
 for Police, Airport, Broadcast & Amateur stations.  
**TAB SPECIAL 115V/60cy INPUT** \$12.95  
 SAME UNIT LESS ANTENNA COIL Includes  
 Housing, VAR CONDNSR Rf meter, insulators,  
 dials TECH manual, NEW. SPECIAL .....\$8.95



**DEFLECTION YOKES** 20000 ohm TELIV... \$5.95  
 DEFLECTION YOKES 4000 ohm TELIV..... 5.95  
 DEF YOKE. Same as RCA201DI TELIV... 7.95  
 NAVY NOISE LINE FILTERS 10 Amps/  
 130V AC filters from .1 to 1000 me's min  
 25 DB & from 1 to 1000 me's/55 DB each \$1.29@  
 2 for 2.20

**NAVY NOISE FILTER** 30 Amp/250V AC &  
 DC filters from .15 to 1000 me's min 44 DB &  
 from .18 to 30 me's/60 DB. Filters line noises  
 for RCVRs, XMTTRS, OIL BURNERS, RE-  
 FRIG, MCH TOOLS, SIGNS, G'Cost \$39@;  
 SPECIAL \$4.50 @, 2 for \$8; 4 for ..... 15.00

"TAB" MONEY BACK GUARANTEED \$5. MIN.  
 ORDER F.B. N.Y.C. AND SHIPPING CHARGES  
 & 25% DEPOSIT, C'TABOGRAM. WORTH 2-7230

TEST LEADS 8' & instld 20 Amp clip....PR 49  
 CODE TAPE BLANK ROLLS..... 4 rolls 1.00  
 STORAGE BATTERY 2V/BB54 ..... 2 for 3.98  
 STORAGE BATTERY 2V/BB206..... 2 for 3.00  
 STORAGE BATTERY 36V/BB52 WILLARD  
 BR18/3-11/16x1-7/16x29/32"/wt. 35 lb. ideal  
 for portable use \$3.95 @ ..... 3 for 10.00  
 BAT 3V/F2BP BURGESS 1047 NEW..... 5 for 1.00  
 FRICTION TAPE 75 ft. USRubCo..... 8 for 1.00  
 RUBBER TAPE 30 ft..... 4 for 1.00  
 USN 10 Station Master Intercom used..... 39.95  
 BUZZER HiFREQ Adjust 6V operation..... .98  
 BELL AC/DC 115V operation..... 1.29

**"TAB" FOR TUBES**

044G	\$.90 W/LS31	\$9.95	2J21	\$12.75
0Z4	1.20 703A	4.95	2J55	18.00
1B3/8016	2.00 717A	.89	2K29	4.95
1E7G	.98 723	2.95	1R4/1294	1.40
1L4	.98 723AB	14.95	HK24/3C24	3.75
1P5G	..73 803	7.95	6S1P/1SN4	.91
2C40	..73 803	7.95	CK1005	.30
2D21	..98 804	8.95	CJ6	4.95
2X2	..49 805	4.95	F127A	12.00
2V3G	..98 807	1.49	T200	12.00
3A4	..75 808	1.95	4J47	35.00
3B7/129	..93 810	5.75	RX215	9.95
3D6/1299	..93 810	8.90	6S67	5.95
5R4G	1.00 813	8.90	6S1P/1SN4	3.95
5T4	1.53 814	2.98	FG104	14.95
5U4G	..69 815	3.95	FG105	16.95
5W4	..98 816	1.15	5D21	19.00
5Y3G	..53 826	1.45	GL434	12.95
5Y4G	1.00 828	10.00	6S67	.84
5Z4	1.00 829B/3E29	2.25	6S67	.95
6A7	..98 836	1.10	6S17	.79
6A7C	..72 837	2.25	6S17	1.00
6A65	..97 845	4.95	6S7	.91
6A7	..98 860	2.49	6S7GT	.69
6A15	..98 861	14.95	6S67	.89
6A15	..91 864	1.00	6S87	.74
6B4G	..129 865	1.00	6S1P/1SN4	.91
6B8G	..98 868	1.00	6V6GT	.98
6C4	..39 872A	2.20	6X5	.37
6C5	..75 884	1.10	6Y6GT	.88
6C6	..73 922	1.49	12A6	.29
6C8G	..98 923	1.39	12A7	.77
6D4	..98 931A	2.98	12SA7	1.00
6E5	..74 954	1.40	12SH7	.88
6E5	..98 922	1.40	954	.49
6F6/1613	..69 9012	3.95	957	.49
6F8	1.20 9013	3.95	958A	.49
6G5/6H5	..98 9020	4.95	1613	.69
6G6	1.08 9001	.49	1614	1.50
6H6G	..48 9002	.59	1616	2.75
6H6M	..68 9003	.49	1619	.39
6J5	..98 9004	.49	822	1.49
6J5	..72 9006	.49	1624	.79
6J6	..81 902A	2.85	1625	.39
6J7	..88 2A1P	1.95	1626	.45
6K5G	1.10 2A1PA	4.95	1629	1.39
6K6GT	..74 3A1P	3.25	1635	1.90
6K7	..78 3B1P	2.75	1641/RK60	.84
6K7	1.20 3P1	2.95	2030	1.18
6L6	1.24 3FP7	2.95	2051	.98
6L7	1.16 3GP1	3.95	7193	.49
6N7	1.23 3JP12	3.95	8005	4.25
6S7	1.20 5A1P	2.75	TUNGAR*	
6SA7G	..98 5B1P	3.75	19969R	2.95
2525	..70 5BP4	3.75	20X672*	2.95
12SK7	..79 5P7	3.75	28981R1*	2.50
35Z5	..61 5FP7	3.95	28981R1*	2.50
35L6	..74 7HP1	3.95	MAZDA PL**	
50L6	..72 7BP7	3.95	44**Box	.40
80	..52 9P1	3.95	47**Box	.50
83V	1.25 9IP12	3.95	49**Box	.60
0C3/VR105	..74 1B24	2.95	S6**Box	1.40
0C3/VR150	..74 1B27	2.95	SOCKETS	
211	..79 1P24	2.95	Accorn .6 for 1.00	
250TH	18.00 2E22	1.50	866	1.24
250HT	18.00 10Y	.59	Maximal	.49
304TH	3.95 15E	1.49	Maximal	.59
304TL	2.49 2C26	.39	2X2HV	.30
393	5.95 2C34/RK34	.49	TUBES OTD	
446A	2.98 3E24	.74	exposed open Fil &	
450TH	25.00 3C23	4.95	450TL	29.95
450TL	29.95 24G/3C24	.67	Breakage	

**FUSES**

**TYPE 3AG-1/32, 1/4, 1/2, 3/4, 1 Amp @ .06¢..20 for \$1.00**  
 3AG-1, 3, 4, 5, 10, 15, 20 Am @ .03¢..40 for 1.00  
 4AG-5, 10, 15 Amp @ .05¢..... 25 for 1.00  
 4AG-SloBlo 1, 3, 5, 10, 15, 20 Amp @ .12¢ ..... 10 for 1.00  
 5AG-SloBlo 1, 3, 5, 6, 35 Amp @ 20¢. 6 for 1.00  
 5AB-800ma, 4, 10 Amp @ .09¢..... 12 for 1.00  
 7AG-200ma, @ 10¢ ..... 12 for 1.00  
 8AG-1/32, 1 Amp @ .09¢..... 12 for 1.00  
 LittleFuse 1000V-3/8, 1/2, 1 Amp @ .30¢. 4 for 1.00  
 BUSS 4000V-1/2 Amp @ 75¢..... 4 for 2.25  
 2"x1/2" Fuse Cartridges 3, 5, 6, 35 Amp @ 12¢ ..... 10 for 1.00  
 2x1/2" Renewable 3, 6, 10, 15, 20 Amp @ 30¢ ..... 4 for 1.00  
 3x1/2" Renewable 3, 6, 10, 60 Amp @ 65¢ for 5.00  
 TELEPHONE Grasshopper Fuse WE 3A @ .09¢ ..... 12 for 1.00  
**FUSE HOLDERS LF #1075 for 3AG @ 25¢ ..... 5 for 1.00**  
**FUSE HOLDERS LF #442001 for 4AG @ 30¢ ..... 4 for 1.00**  
 3AG Clip Mtg 3 for 25¢;  
 Dual Mtg @ 20¢ ..... .6 for 1.00  
**C'TAB for FUSES, CLIPS, HOLDERS**  
 Rite T'day HEINEMAN CIRCUIT BREAKER 3, 5, 10 & 15, 20, 30, 40, 80, 100, 180 @ \$1.95 ..... 10 for 18.00  
 Heineman Dual 10 Amp \$2.95;  
 KLIX 60 Amp ..... .89  
 SQ'D KLIXON & CH 5, 10,

## A WHOLE CARLOAD OF FM RECEIVERS AND TRANSMITTERS

This may be your last chance at these desirable items.

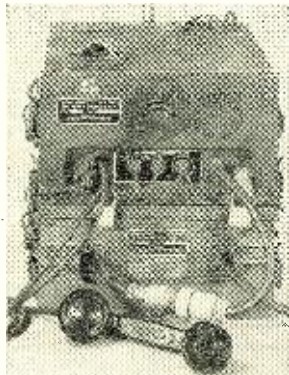

**FAMOUS BC-659 PORTABLE FM TRANSCIEVER**, 27 to 38.9 Mc, xtal controlled; ideal for "hams," police, seismograph crews, park service, etc. Battery operated power supply 6, 12 or 24 volt. As shown, with all tubes, speaker and meter, less handset & xtals.

Like new, with power supply.....\$17.95  
 Like new, less power supply..... 12.95  
 Used, good, with power supply..... 12.95  
 Used, good, less power supply..... 7.95  
 Used, fair, less power supply; some need minor repairs..... 4.95  
 Choice of xtal for any channel, each... 1.00  
 Set of 120 xtals in case..... 35.00  
 Battery BA-41 when purchased with BC-659 .50

**27 to 38 Mc FM RECEIVER BC-683** for police, park service, seismograph, "hams." Superhet, BFO, squelch; 10 pushbuttons & manual tuning; with 10 tubes, speaker, case; 12 or 24 volt dynamotor; diagram.

Used, excellent ....\$23.95  
 Used, good ..... 18.95



### 27 to 38 Mc FM TRANSMITTER

BC-684, 30 watt, 10 channel push-button xtal controlled; with covers, all tubes, meter, diagram, less xtals. Some with dynamotors.

Used, excellent .....\$23.95  
 Used, good ..... 18.95

### COMBINATION OFFER:

BC-683 and BC-684, used, excellent.....\$45.00  
 BC-683 and BC-684, used, good, both for. 35.00  
 Set of 80 xtals in drawer for BC-684 (when purchased with xmtr) ..... 14.95

**20 to 30 Mc FM RECEIVER BC-603** for 10 & 11 meters; looks just like BC-683 above; superhet, BFO, squelch; 10 pushbuttons & manual tuning. Makes fine 10 meter converter or IF strip for 88 to 108 Mc wide-band FM; with 10 tubes, speaker, diagram; 12 or 24 volt.....\$11.95

**FREE CONVERSION INSTRUCTIONS:** simple, easy change to 115 v A.C. Converter diagram furnished. Complete conversion (power supply & converter) costs less than \$7 to build.

**20 to 30 Mc FM TRANSMITTER BC-604** for 10 & 11 meters; looks just like BC-684 above; 10 channel pushbutton xtal controlled; with all tubes, meter, diagram, case & covers, less xtals; 12 or 24 volt. Used, good .....\$11.95

**COMB. OFFER:** BC-603 & BC-604.....\$22.95  
 Set of 80 xtals in drawer for BC-604 (when bought with xmtr).....\$10.95

(BC-603 & BC-604 F.O.B. Tulsa, Okla, or Oakland, Calif)

**27 to 38 Mc FM RECEIVER BC-923;** similar to BC-683 above, but 4-channel band-switch instead of push-button tuning. With all tubes, less xtal. Used, cases fair, OK inside.....\$11.95

**27 to 38 Mc FM TRANSMITTER BC-924,** companion to BC-923. Similar to BC-684; used, with all tubes, cases fair, OK inside.....\$11.95

**COMB. OFFER:** BC-923 & BC-924.....\$22.50

Check with order, or 25% deposit on C.O.D.'s Shipped express collect, unless otherwise requested. **FREE LIST**

## ELECTRONIC SUPPLIES

Stores in Tulsa, Okla. & Oakland, Calif.

1032 12th St.

Oakland, Calif

## Infinitesimal (Continued from page 42)

In practical operation the microscope normally is used at magnifications between 5000 and 10,000 diameters. Obtained at such values is the best combination of image brightness, size of the photographic field, and time of photographic exposure. Any desired additional magnification is obtained by photographic enlargement, making possible a much greater total useful magnification of the specimen.

In general, absorption of electrons (from the beam) does not occur in the very small and extremely thin specimens that are usually placed under observation. Occasionally, however, certain types of specimens absorb electrons from the beam and the released energy appears as heat. The temperature of the specimen, itself, may often be raised (in this manner) to such a high degree that decomposition and structural changes take place. As an additional limitation, the electron beam generates sufficient heat to kill all life cells, and then dehydrate the remaining inert mass.

During periods of observation, molecular or chemical changes in the specimen often take place, due to the artificial conditions existing in the vacuum chamber of the microscope.

Such limitations, however, are but

obstacles eventually to be overcome by the scientist and engineer.

It is important to note that it is not always advantageous to use the Electron Microscope, when similar information supplied by the optical or light microscope is sufficiently accurate and adequate. Contrary to sweeping statements circulated by over-zealous press agents, the Electron Microscope has not replaced the light microscope!

A fair consideration of both types of magnifying instruments reveals that they actually supplement each other. For low-order magnification, the light microscope is more versatile, and entirely adequate for many forms of scientific research. When powerful magnification is required, the Electron Microscope can be depended upon to supply finely focused images of high resolution. The amount of magnification plus resolution required are the determining factors as to which of the two types of microscopes to use. Thus, there is a place in science for both instruments.

The precise ability to probe the sub-microscopic—at high magnifications with high resolution—identifies the scientific importance of the Electron Microscope. It makes visible many objects which have never before been seen, bringing a new depth of vision to science and industry alike, helping to improve the way of life for all mankind. —30—

## NEW YORK TV OWNERSHIP

**T**HE research division of WPIX, New York has just released some interesting figures regarding television receiver ownership in the New York area.

The study reveals that nearly three out of four sets are in the homes of families with modest incomes. Distribution of 31,755 home receivers in the New York viewing area was studied and 53 per-cent of the sets were found to be in New York City with 47 per-cent installed in the suburbs.

When the New York City list was analyzed as to the neighborhoods in which the set owners lived, WPIX discovered that only 26.5 per-cent of the sets were in the higher income localities. The remainder were in homes that made up the middle, lower middle, and poor income neighborhoods.

Brooklyn leads the list with 41.6 per-

cent of the City total yet that borough has not a single high income district, according to the survey. Sets in the middle and lower income groups in this borough outnumbered those in the middle income group by six to one.

By income levels, the survey found that 12.5 per-cent of the sets were in high income districts and 14 per-cent in the upper middle income neighborhoods throughout the city. The great bulk of the sets, 60 per-cent, were found in the middle income level and the two lowest income groups accounted for more home sets than did the highest, according to the survey.

Thus, 26.5 per-cent of the television receivers were installed in upper middle and high income homes while over 73 per-cent were to be found in middle, and poor income districts. —30—

## GOPHER HAMFEST

**T**HE St. Paul and Minneapolis Radio Clubs are sponsoring their first post-war Gopher Hamfest on June 18 and 19 at the Nicollet Hotel in Minneapolis.

A special program has been planned featuring the best in technical talks and prizes. An amateur contest, put on by the Dakota Division Radio Clubs, has been scheduled for the entertainment at the turkey dinner to be held Saturday night.

Advanced registration fee (By June 14th) is \$5.00 with late registrants paying \$5.50 for their admission. Ladies will be admitted for \$3.50. Free rooms at hams' homes for advance registrants will be provided if requested.

For tickets and further information write to Gopher Hamfest, Box 685, Minneapolis, Minnesota.

—30—

# New 1948 and F.M. Manuals

## BIGGEST BARGAIN IN RADIO DIAGRAM

Make these two new mammoth volumes your money-saving source for data on all recently released receivers. Learn about modern circuit developments, be ready to repair any new radio no matter how complex. You pay only \$2 for each of these large manuals. With these two volumes on your workbench there is nothing else to buy, nothing else to pay—a whole year of radio diagrams and service data yours for a couple of dollars total. Again **Supreme Publications** beats all competition and gives radio servicemen greatest bargains in service information. Other volumes for previous years described below. **No-risk** examination granted to servicemen.

## FIND ALL RADIO FAULTS DOUBLE-QUICK

You can speed-up and simplify radio repairs with **SUPREME PUBLICATIONS** Manuals. Service all radios faster, better, easier, save time and money, use these **most-often-needed** diagram manuals to get ahead, earn more per hour. For the remarkable bargain price (only \$2 for most volumes) you are assured of having in your shop and on the job, needed diagrams and other essential repair data on 4 out of 5 sets you will ever service. Every popular radio of all makes from old-timers to new 1948 sets, including F.M. and Television, is covered. Clearly printed circuits, parts lists, alignment data, and helpful service hints are the facts you need to improve

your servicing ability. Save hours each day, every day, begin to earn more by making repairs in minutes instead of hours. Let these manuals furnish you with diagrams for 80% of all sets. There is no need to spend large sums for bulky, space-wasting manuals, or to buy additional drawings every few weeks; be wise, use **SUPREME** Manuals to get the most in diagrams and service data for the smallest cost. Act today and be money ahead with **Supreme Publications**.

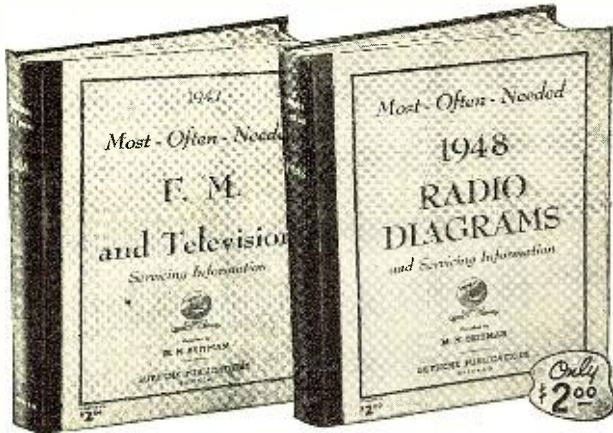

### F.M. and Television

Use this new giant manual of factory instructions for troubleshooting, repairing, and alignment of any 1947-1948 F.M. and Television set. Every popular make, including new F.M. tuners, AM-FM combinations, and all types of television receivers. Detail circuit diagrams, theory of operation, test hints, alignment data, including both meter and oscilloscope methods. This is the material you need to fix any modern F.M. or Television set. Don't turn this profitable work away for lack of knowledge and information. Use this newest **Supreme** manual to save time and money on your very next F.M. job. Data presented on 192 large pages, 8½x11 in. Sturdy, manual-style binding. Just published. Special price.. **\$2.00**

### New 1948 Manual

Be prepared to repair quickly all new 1948 receivers. In this big single volume you have clearly-printed, large schematics, needed alignment data, replacement parts lists, voltage values, and information on stage gain, location of trimmers, and dial stringing, for almost all recently released sets. Makes toughest jobs amazingly easy. Find faults in a jiffy. Speed-up all repairs. The time saved on your next job will pay the \$2 bargain price for the complete manual—after that you use it **FREE**. A worthy companion to the 7 previous volumes used by over 120,000 shrewd radio servicemen. New manual covers models of 42 different manufacturers. Giant size: 8½x11", 192 pages + index. Manual-style binding. Price, only.. **\$2.00**

**Models Made by:**  
R.C.A., Zenith, Philco, Sears, Fada, Emerson, Belmont, Detrola, Crosley, G.E., Westinghouse, Arvin, Majestic, Stewart-Warner, Admiral, Delco, Stromberg-Carlson, Wards, West'n Auto, Sparton, Motorola, and many others.

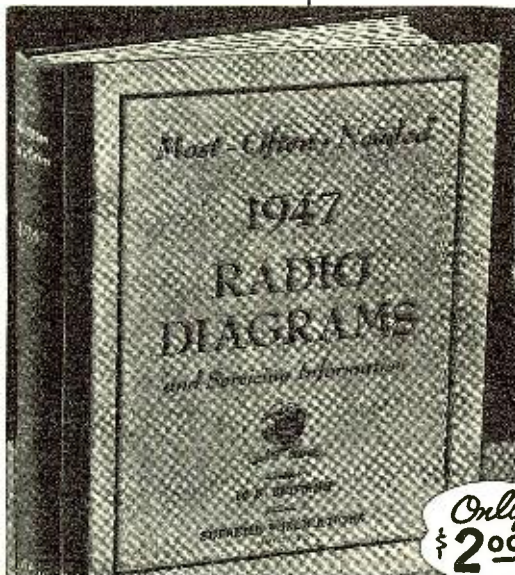

Only \$2.00

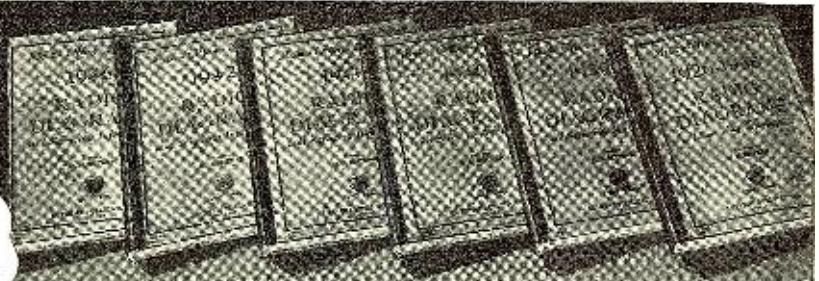

**Use coupon to order manuals for examination**  
Include all popular sets from 1926 to 1948.

Select **Supreme** Diagram Manuals and Record Changer Books you want to examine. Send the convenient no-risk trial coupon. Use the manuals in your own home or shop for 10 days at our risk. Decide for yourself that **Supreme Publications** are the greatest values in service data. You must be completely satisfied, or return manuals and receive your money back.

### Record Changers Manuals

#### Post-War Models

Service expertly all modern (1945-1948) record changers. Just follow simplified factory instructions to make needed adjustments and repairs. Hundreds of photographs and exploded views. Large size: 8½ x 11 inches. 144 fact-filled pages. Price only \$1.50, postpaid.

#### Pre-War Models

Just what you need to repair quickly thousands of pre-war (before 1942) automatic record changers, manual units, pickups, wireless oscillators, recorders, and combinations. Hundreds of mechanical and electrical diagrams. 128 large pages; size 8½ x 11 inches. Price, only \$1.50.

**See Your Radio Jobber or Send Coupon** →

## NO RISK TRIAL ORDER COUPON

**SUPREME PUBLICATIONS, 9 S. Kedzie Ave., Chicago 12, ILL.**

Ship the following manuals on trial under your guarantee of satisfaction or money-back.

- |  |        |                                      |                         |
|--|--------|--------------------------------------|-------------------------|
| <input type="checkbox"/> New F.M. and Television Manual..            | \$2.00 | <input type="checkbox"/> 1948        | PRICED AT ONLY \$2 EACH |
| <input type="checkbox"/> Post-War Record Changers.....               | 1.50   | <input type="checkbox"/> 1947        |                         |
| <input type="checkbox"/> Pre-War Record Players & Recorders          | 1.50   | <input type="checkbox"/> 1946        |                         |
| <input type="checkbox"/> I am enclosing \$....., send postpaid.      |        | <input type="checkbox"/> 1942        |                         |
| <input type="checkbox"/> Send C.O.D. I am enclosing \$..... deposit. |        | <input type="checkbox"/> 1941        |                         |
|  |        | <input type="checkbox"/> 1940        |                         |
|  |        | <input type="checkbox"/> 1939        |                         |
|  |        | <input type="checkbox"/> 1926-1938 — | \$2.50                  |

Name: .....

Address: .....

# Supreme Publications

PUBLISHERS OF RADIO BOOKS, MANUALS, AND DIAGRAMS

9 South Kedzie Ave.  
June, 1948

Chicago 12, Illinois

## Brooks AM-FM Tuner Model ST-14

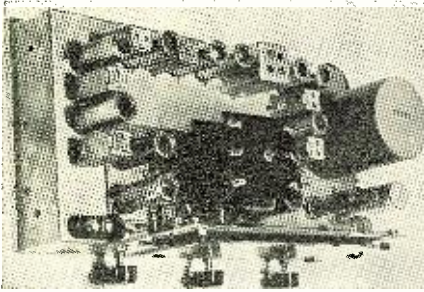

### Engineered For Custom Built Installations

#### Features . . .

Excellent sensitivity on both AM and FM bands. Separate, wide band IF strips terminating in a single output jack. Standard 300 ohm FM antenna serves both AM and FM requirements. Completely compensated for frequency drift. Fourteen high gain miniature tubes allows compact size 7"x13"x6". Inductive tuning maintains selectivity over both entire bands. FM circuit incorporates an RF, converter, 3 IF, cascade limiters and discriminator stages. AM circuit incorporates an RF, converter, IF, and detector stages. 8 inch slide rule dial. Self contained power supply.

**Net Price .....\$125.00**

#### FM Tuners

Model FMT-10 .....**\$69.95**  
Model FMT-7 .....**\$49.95**  
FM Front End—with tubes and  
8 inch slide rule dial .....**\$20.00**

See your jobber or write

**Brooks Electronic Laboratories**

621 Main Street  
Waltham, Massachusetts

# Parts List

FOR CIRCUIT DIAGRAMS APPEARING ON PAGES 94 and 95

### ADMIRAL MODEL 7C60

Part No.	Code and Description
60B8-223	R <sub>1</sub> —22,000 ohm, ½ w. res.
60B8-105	R <sub>2</sub> —1 megohm, ½ w. res.
60B8-273	R <sub>3</sub> —27,000 ohm, ½ w. res.
75B2-6	R <sub>4</sub> —1 megohm vol. control & sw. (tapped at 500,000 ohms)
75B1-12	R <sub>5</sub> , SW.—2 megohm tone con- trol & sw.
60B8-475	R <sub>6</sub> —4.7 megohm, ½ w. res.
60B8-185	R <sub>7</sub> —1.8 megohm, ½ w. res.
60B8-104	R <sub>8</sub> —100,000 ohm, ½ w. res.
60B8-474	R <sub>9</sub> —470,000 ohm, ½ w. res.
60B8-101	R <sub>10</sub> —100 ohm, ½ w. res.
60B28-3	R <sub>11</sub> —33 ohm, 1 w. res.
60B28-7	R <sub>12</sub> —220 ohm, 1 w. res.
60B28-2	R <sub>13</sub> —1000 ohm, 1 w. res.
60B8-154	R <sub>14</sub> —150,000 ohm, ½ w. res.
60B8-223	R <sub>15</sub> —22,000 ohm, ½ w. res.
60B8-106	R <sub>16</sub> —10 megohm, ½ w. res.
60B14-151	R <sub>17</sub> —150 ohm, 1 w. res.
60B8-104	R <sub>18</sub> —100,000 ohm, ½ w. res.
60B8-333	R <sub>19</sub> —33,000 ohm, ½ w. res.
60B8-473	(UL models only)
64B1-12	R <sub>20</sub> —47,000 ohm, ½ w. res.
65B6-4	C <sub>1</sub> —.005 µfd., 600 v. cond. (early models only)
64B1-30	C <sub>2</sub> —50 µfd. ceramic cond.
A1341	C <sub>3</sub> , C <sub>16</sub> , C <sub>27</sub> —1 µfd., 200 v. cond.
64B1-14	C <sub>4</sub> , C <sub>18</sub> —Two-section gang
64B1-25	C <sub>5</sub> , C <sub>12</sub> —0.02 µfd., 600 v. cond.
64B1-22	C <sub>6</sub> , C <sub>9</sub> , C <sub>15</sub> —.01 µfd., 400 v. cond.
65B6-18	C <sub>7</sub> , C <sub>13</sub> , C <sub>14</sub> , C <sub>26</sub> —.05 µfd., 400 v. cond.
64B1-23	C <sub>8</sub> —15 µfd. ceramic cond.
64A-2	C <sub>10</sub> —.03 µfd., 400 v. cond.
64B1-15	C <sub>11</sub> —.18 µfd., 200 v. cond.
67A14-1	C <sub>13</sub> —.001 µfd., 600 v. cond.
65B6-5	C <sub>17</sub> , 30/30/20/20 µfd., 150/150 /150/25 v. elec. cond.
64B1-24	C <sub>19</sub> —250 µfd. ceramic cond.
65B6-6	C <sub>12</sub> —.02 µfd., 400 v. cond. (UL models only)
Part of L <sub>1</sub>	C <sub>21</sub> —50 µfd. ceramic cond.
69B13	C <sub>23</sub> —3.30 µfd. trimmer (late models only)
69A14	L <sub>1</sub> —Loop antenna
72B3	L <sub>2</sub> —Osc. coil
72B4	T <sub>1</sub> —First i.f. trans.
98A33-10	T <sub>2</sub> —Second i.f. trans. T <sub>3</sub> —Output trans.

### MANTOLA MODELS 92503 92504

Part No.	Code and Description
60B8-223	R <sub>1</sub> —22,000 ohm, ½ w. res.
60B8-105	R <sub>2</sub> —1 megohm, ½ w. res.
60B8-475	R <sub>3</sub> —4.7 megohm, ½ w. res.
60B8-224	R <sub>4</sub> —220,000 ohm, ½ w. res.
60B8-474	R <sub>5</sub> —470,000 ohm, ½ w. res.
60B8-151	R <sub>6</sub> —150 ohm, ½ w. res.
60B8-154	R <sub>7</sub> —150,000 ohm, ½ w. res.
75B1-6	R <sub>8</sub> —1 megohm vol. control & sw.
60B28-3	R <sub>9</sub> —33 ohm, 1 w. res.
60B28-2	R <sub>10</sub> —1000 ohm, 1 w. res.
64B1-30	C <sub>1</sub> —.1 µfd., 200 v. cond.
65B7-11	C <sub>2</sub> —50 µfd. mica cond.
64B1-24	C <sub>3</sub> —.02 µfd., 400 v. cond.
64B1-25	C <sub>4</sub> , C <sub>9</sub> —.01 µfd., 400 v. cond.
64B7-22	C <sub>5</sub> —250 µfd. mica cond.
65B7-27	C <sub>7</sub> —500 µfd. mica cond.
64B1-24	C <sub>8</sub> —.02 µfd., 400 v. cond.
67A10	C <sub>9</sub> —50/30 µfd., 150/150 v. elec. cond.
64A2-2	C <sub>10</sub> —18 µfd., 200 v. cond.
64B1-22	C <sub>11</sub> —.05 µfd., 400 v. cond.
64B1-12	C <sub>12</sub> —.005 µfd., 600 v. cond. (early models only)
68A18	C <sub>13</sub> —Two-gang cond.
69C44	L <sub>1</sub> —Loop antenna
69A43	L <sub>2</sub> —Osc. coil
98A4	T <sub>1</sub> —Output trans.
72B50	T <sub>2</sub> —First i.f. trans.
72B51	T <sub>3</sub> —Second i.f. trans.

### BELMONT MODEL A-5D118

Part No.	Code and Description
C-9B1-78	R <sub>1</sub> —22,000 ohm, ½ w. res.
101-272	R <sub>2</sub> , S <sub>1</sub> —500,000 ohm vol. control & sw.
C-9B1-34	R <sub>3</sub> —3.3 megohm, ½ w. res.
C-9B1-35	R <sub>4</sub> —4.7 megohm, ½ w. res.
C-9B1-26	R <sub>5</sub> , R <sub>8</sub> —150,000 ohm, ½ w. res.
C-9B1-27	R <sub>6</sub> —220,000 ohm, ½ w. res.
C-9B1-52	R <sub>7</sub> —150 ohm, ½ w. res.
C-9B2-63	R <sub>9</sub> —1200 ohm, 1 w. res.
C-9B2-4	R <sub>10</sub> —33 ohm, 1 w. res.
C-9B1-43	R <sub>11</sub> —27 ohm, ½ w. res.
115-779	C <sub>1</sub> —Antenna plate
129-114	C <sub>2</sub> —300 µfd. mica cond.
124-137	C <sub>3</sub> , C <sub>6</sub> —Dual trimmer
100-9	C <sub>4</sub> —.05 µfd., 200 v. cond.
129-39	C <sub>5</sub> —50 µfd. mica cond.
100-91	C <sub>7</sub> —.15 µfd., 400 v. cond.
129-12	C <sub>8</sub> —250 µfd. mica cond.
100-25	C <sub>9</sub> —.002 µfd., 600 v. cond.

100-71	C <sub>10</sub> —.004 µfd., 600 v. cond.
129-2	C <sub>11</sub> —500 µfd. mica cond.
100-26	C <sub>12</sub> —.02 µfd., 400 v. cond.
100-13	C <sub>13</sub> —.05 µfd., 400 v. cond.
119-92	C <sub>14</sub> —40/20 µfd., 150/150 v. elec. cond.
136-18	T <sub>1</sub> —Complete permeability tun- ing unit
108-157-H	T <sub>2</sub> —Input i.f. coil with trimmers
108-157-0	T <sub>3</sub> —Output i.f. coil with trim- mers
105-139 or C-12C-11763-3	T <sub>4</sub> —Output trans.
114-268	T <sub>5</sub> —4 in. PM speaker

### WARDS MODEL 74BR-2707A

Part No.	Code and Description
C-9B1-21	R <sub>1</sub> —22,000 ohm, ½ w. res.
C-9B1-31	R <sub>2</sub> , R <sub>10</sub> —1 megohm, ½ w. res.
C-9B1-52	R <sub>3</sub> —150 ohm, ½ w. res.
C-9B2-79	R <sub>4</sub> —27,000 ohm, 1 w. res.
C-9B1-17	R <sub>5</sub> —4700 ohm, ½ w. res.
C-9B1-11	R <sub>6</sub> —470 ohm, ½ w. res.
C-9B4-76	R <sub>7</sub> —15,000 ohm, 2 w. res.
C-9B1-19	R <sub>8</sub> —10,000 ohm, ½ w. res.
C-9B1-62	R <sub>9</sub> —1000 ohm, ½ w. res.
C-9B2-15	R <sub>11</sub> , R <sub>15</sub> —2200 ohm, 1 w. res.
C-9B1-31	R <sub>12</sub> , R <sub>35</sub> , R <sub>43</sub> —1 megohm, ½ w. res.
C-9B1-48	R <sub>13</sub> , R <sub>16</sub> —68 ohm, ½ w. res.
C-9B2-81	R <sub>14</sub> , R <sub>17</sub> —39,000 ohm, 1 w. res.
C-9B1-13	R <sub>18</sub> —1000 ohm, ½ w. res.
C-9B1-23	R <sub>19</sub> —47,000 ohm, ½ w. res.
C-9B1-79	R <sub>20</sub> —27,000 ohm, ½ w. res.
C-9B1-34	R <sub>21</sub> —33 megohm, ½ w. res.
C-9B1-78	R <sub>22</sub> —22,000 ohm, ½ w. res.
C-9B1-80	R <sub>23</sub> , R <sub>28</sub> —33,000 ohm, ½ w. res.
C-9B1-29	R <sub>24</sub> , R <sub>26</sub> , R <sub>37</sub> —470,000 ohm, ½ w. res.
C-9B1-302	R <sub>25</sub> —15 megohm, ½ w. res.
A-10A-13001	R <sub>27</sub> —400,000 ohm vol. control & sw.
C-9B1-94	R <sub>29</sub> , R <sub>44</sub> —470,000 ohm, ½ w. res.
C-9B1-35	R <sub>30</sub> —4.7 megohm, ½ w. res.
A-11A-12988	R <sub>31</sub> —500,000 ohm tone control & radio-phono sw.
C-9B1-86	R <sub>32</sub> —100,000 ohm, ½ w. res.
C-9B1-68	R <sub>33</sub> , R <sub>34</sub> —3300 ohm, ½ w. res.
C-9B1-200	R <sub>36</sub> , R <sub>42</sub> —51,000 ohm, ½ w. res.
C-9B4-55	R <sub>38</sub> —270 ohm, 2 w. res.
C-9B1-83	R <sub>39</sub> , R <sub>41</sub> —56,000 ohm, ½ w. res.
C-9B1-66	R <sub>40</sub> —2200 ohm, ½ w. res.
C-9B1-50	R <sub>45</sub> —100 ohm, ½ w. res.
C-9B1-42	R <sub>46</sub> —22 ohm, ½ w. res.
C-9B1-81	R <sub>47</sub> —5600 ohm, ½ w. res.
C-8G-11732	C <sub>1</sub> , C <sub>11</sub> —470 µfd. cond.
C-8G-13695	C <sub>2</sub> —1000 µfd. cond.
C-8G-11484	C <sub>3</sub> —50 µfd. cond.
C-8G-13018	C <sub>4</sub> —62 µfd. cond.
C-8D-11304	C <sub>5</sub> —.02 µfd., 200 v. cond.
C-8G-13201	C <sub>6</sub> , C <sub>7</sub> , C <sub>8</sub> , C <sub>14</sub> , C <sub>51</sub> , C <sub>53</sub> —1000 µfd. cond.
C-8G-11789	C <sub>8</sub> —10 µfd. cond.
C-8G-13017	C <sub>10</sub> —15 µfd. cond.
C-8G-11731	C <sub>12</sub> —1500 µfd. cond.
A-8G-12495-6	C <sub>13</sub> —4.7 µfd. cond.
A-8G-12495-4	C <sub>15</sub> —2.2 µfd. cond.
C-8G-13026	C <sub>16</sub> —51 µfd. ceramic cond.
C-8G-12159	C <sub>17</sub> , C <sub>25</sub> , C <sub>26</sub> —20 µfd. ceramic cond.
C-8G-12160	C <sub>18</sub> , C <sub>19</sub> —91 µfd. ceramic cond.
C-8D-11734	C <sub>20</sub> , C <sub>23</sub> , C <sub>24</sub> , C <sub>29</sub> , C <sub>31</sub> , C <sub>43</sub> , C <sub>44</sub> — .006 µfd., 600 v. cond.
C-8G-11734	C <sub>21</sub> —100 µfd. ceramic cond.
C-8G-10761	C <sub>22</sub> , C <sub>28</sub> —.01 µfd., 400 v. cond.
C-8G-13025	C <sub>27</sub> , C <sub>28</sub> —150 µfd. ceramic cond.
C-8G-11789	C <sub>32</sub> —10 µfd. ceramic cond.
C-8G-11891	C <sub>33</sub> —51 µfd. ceramic cond.
C-8G-13060	C <sub>34</sub> —51 µfd. ceramic cond.
A-8F-13047	C <sub>35</sub> , C <sub>36</sub> —50 µfd. dual mica cond.
C-8F-229	C <sub>37</sub> —150 µfd. mica cond.
C-8G-13059	C <sub>38</sub> —1500 µfd. ceramic cond.
C-8G-13201	C <sub>39</sub> , C <sub>40</sub> —1000 µfd. ceramic cond.
A-8C-13132	C <sub>41</sub> —10 µfd., 50 v. elec. cond.
C-8D-11304	C <sub>42</sub> —.02 µfd., 200 v. cond.
C-8D-10813	C <sub>45</sub> , C <sub>46</sub> —.05 µfd., 400 v. cond.
C-8D-10760	C <sub>47</sub> , C <sub>52</sub> —.1 µfd., 400 v. cond.
C-8D-10770	C <sub>48</sub> —.05 µfd., 200 v. cond.
C-8D-10789	C <sub>49</sub> —.002 µfd., 600 v. cond.
C-8G-11741	C <sub>50</sub> —330 µfd. ceramic cond.
C-8D-13439	C <sub>52</sub> —.25 µfd., 400 v. cond.
A-8C-12154	C <sub>53</sub> —10 µfd., 450 v. elec. cond.
A-2M-12518	C <sub>56</sub> , C <sub>57</sub> , C <sub>59</sub> , C <sub>60</sub> , C <sub>61</sub> —Plate trimmer cond.
A-8E-13575	C <sub>58</sub> —Trimmer cond.
H-13J1321	C <sub>62</sub> —.02 µfd., 600 v. cond.
B-8C-11629	C <sub>63</sub> —30/30 µfd., 450/450 v. elec. cond.
B-12C-13042	T <sub>1</sub> —Power trans.
C-13A-13009-1	T <sub>2</sub> —Output trans. for speaker
C-13B-13014-1	T <sub>3</sub> —Input i.f. trans.
C-203-11745-1	T <sub>4</sub> —Output i.f. trans.
B-13E-13028	T <sub>5</sub> —Ratio det. coil assembly
	T <sub>6</sub> —FM antenna coil assembly



# SLASHED PRICES DOWN

No. P.S. 406



## A POWER SUPPLY FOR INDUSTRIAL APPLICATIONS

May be used to power an oscilloscope used with the Federal D.A.Q. Direction Finder for powering the scope. Delivers 2500 volts @ 3 ma. 325 v. @ 100 ma. Also contains a regulated sweep amplifier. Wt. approx. 40 lbs. **\$29.95**

**SELSYN MOTORS**  
110 V 60 CYCLE INPUT

No. S for indicating direction of your beam or actually driving it. Made in two popular sizes. Type 11-5 are heavy duty brass motors which will drive. **\$12.95** per pair.

No. S2 Type 1—Light duty for use as indicators **\$9.95** per pair

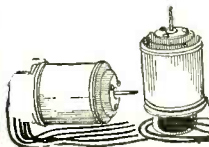

No. T 606  
400 CYC. OSC. COIL PERMEABILITY TUNED  
Here is your chance to add modulation to either your BC-221 Frequency Meter or to any other piece of equipment you are contemplating. **\$2.49**



No. H 466  
THREADWELL TAP AND DIE KIT

Here is a complete Radio Man's tool kit. All popular sizes of taps & dies for Radio Use. Mounted in a metal tool kit.



Includes the tap handle and die handle. No radio man can afford to be without this kit. List Price **\$16.00** Your Cost **\$12.00**

No. BM 601 **BEAM ROTATING MOTOR**



3 R.P.M. with built in reduction gears — weather proof. Reversible—AC or DC. This motor will drive any type of array — small, compact and strong. Requires 30 volts which can be obtained by the simple use of a lamp bulb in series with the line. A wonderful value at **\$12.95**

No. M-462 **3 1/2 INCH "S" METER**

Used in a Bridge Circuit, will give you accurate readings on your surplus receiver or receiver not equipped with meter. Uses light for lighting meter face. **\$4.95**



## DESIGNED FOR THE 522 TRANSMITTER A FOUR BAND SELECTOR UNIT

Which replaces the selector motor allowing you to change frequency from the front panel quickly. Can be installed in 10 minutes **\$3.00** ca.

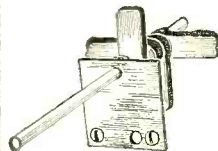

# KITS!

## TUBE KITS

Complete set of tubes for SCR-522.... **\$17.95**  
Complete set of tubes for BC-348..... **\$7.95**  
Complete set of tubes for BC-312..... **\$7.95**  
**Specify Model Numbers**

BC-348 Owners

## CONVERTER FOR BROADCAST BAND

Convert that BC-348 without any alteration in your circuit. Our special converter takes power from receiver. Just tune your set to 450 kc. and forget it. All tuning is done on a converted panel covering 550 to 1600 kc.—double conversion means High Sensitivity. Excellent Fidelity and Higher Selectivity—complete basic kit with schematic and full instructions—less chassis dial and tuning knobs. **\$6.50**  
Terrific Buy at .....

Model 200-EA. 5-ELEMENT 2 METER BEAM KIT. Folded di-pole driven element. All-aluminum construction. Feed with low impedance coaxial cable. Amateur net price **\$8.40**

No. K 600

## SPEED KEYS MADE BY TED McELROY

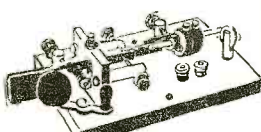

The World's Champion CW man—beautifully made with large contacts. Designed for any keying application. In two models. Black base mounting with all parts heavily plated. **\$6.68**

No. K 600A All plated including base.... **\$9.66**

No. M248

## 2 1/2" 0-1 MIL MOVEMENT

Bakelite cased meter—27 ohms. Basic resistance may be used wherever a small 1 mil movement is needed—for S-Meter in receiver or basic meter in test equipment. A steal at **\$2.95**

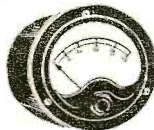

No. C 3002

## BUTTERFLY CONDENSER

This cond. has the tank circuit built in—just plug in a tube. (Designed for W.E. 368AS) Operates from 200 to 1000 mcs. Can be used with any high frequency triode. **\$1.98**

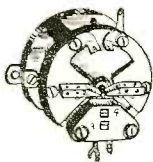

No. R 3001

## OVER CURRENT RELAY

Automatic reset—Overload coil is 3000 ohms—Can be shunted for any current simply—Protect those expensive final amplifier tubes, to reset simply press a button. Reset coil is 110 v. 60 cycles. **\$2.49**



No. S 4704

## MOSSMAN SWITCHES

Always Popular in

Two Models.  
1 Triple Pole Double Throw **\$1.25**  
2 Ten Pole Double Throw **\$2.10**

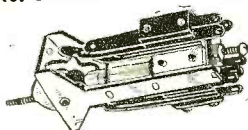

No. R 474

## KEYING RELAY



Here is a keying relay made to mount in a tube socket. Double pole Double Throw relay—sealed in vacuum 300 ohm coil. Will follow 100 words a minute. Stock up now **\$2.00**

No. S-601

## SPERTI VACUUM SWITCH

Used in the famous Collins Art-13 Transmitter for Antenna Switching ... **\$1.95**

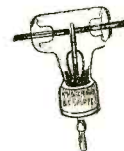

No. C-641

## R.F. UNITS FROM THE BC-312

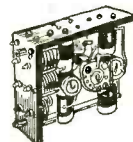

Contains six coils which cover from 1500 KC to 18 Mc. Has a ceramic band switch to change from any coil. Each coil is tuned with an air padder. Build your own receiver or signal generator with this assembly. A marvelous Buy at **\$1.98**

## DYNAMOTOR

Used with the popular BC-312 Radio Receiver. 12 volts input—235 volts @ 90 ma. Output complete with filter mounted in can **\$2.49**



No. D 4064

No. T-4640

## TRANSFORMER



Here is a rugged transformer built to Army specs. Hermetically sealed with Franklin Terminals for easy soldering. Primary 115 v. 60 cys. Sec. No. 1 815 v. ct @ 58 ma. Sec. No. 2 5.4 v. @ 3 a. Sec. No. 3 6.4 v. @ 6 a. Weight 10 lbs. Your cost **\$2.49**

No. T-406

## MODULATION TRANSFORMER

Designed for an 807 final. 6L6 tubes as modulators, a small compact job to handle moderate power **\$3.25**

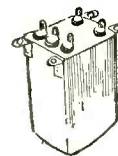

No. T 500

## FILAMENT TRANSFORMER



115 v. primary 60 cy. two secondaries, both 2.5 volts @ 10 amps—each may be used in series to deliver 5 volts @ 10 amps e.t. or as two 866 fil. windings insulated at 10,000 volts. A steal at **\$4.35**

No. A-4060

## 5 WATT AUDIO AMPLIFIER



Complete with tubes and output transformer. Has volume and tone controls—a real quality job. Not to be confused with AC-DC amplifiers of nondescript value—115 v. 60 cye. input **\$11.75**

20% DEPOSIT WITH ORDERS UNLESS RATED

# NIAGARA RADIO SUPPLY CORP.

160 GREENWICH STREET

NEW YORK 6, N. Y.

ALL PRICES F. O. B., N. Y. C.

# No foolin'--SENCO gives REAL VALUE!

WE'RE STARTING JUNE WITH A BANG. ITEM AFTER ITEM ARE YOURS AT SENCO'S NEW LOW PRICES!

## Brand New Willard #27-2 2 Volt Storage Battery and 2 Volt Vibrator



Used in General Electric model #530 charge A PACK portables. Suitable for all farm radio sets. Individually boxed. BOTH FOR \$2.69  
 Battery alone \$1.79  
 Vibrator alone 99c  
**6 Volt Auto Vibrators**  
 4 Prong \$1.09 Each



**Standard Brand IF TRANSFORMERS**  
 Midget Type 456 KC Input-Output.  
 Medium size 456 KC  
 I F Coils—Input and Output. Only 49c Each

### OUTPUT TRANSFORMERS



50L6 .....ea. 39c  
 3Q5 .....ea. 39c  
 6V6 .....ea. 44c  
 All Sturdily Constructed.

### VOLUME CONTROLS

Popular Brand 3/4" shaft tapped with switch.  
 1/4 meg. ohms 1 meg. ohms 39c Each  
 3/4 meg. ohms 2 meg. ohms

### PORTABLE RECORD PLAYER

- \* 3-Tube Amplifier
- \* Tone Control
- \* Volume Control
- \* On & OFF Switch



Plays 10" and 12" records.  
 Has permanent magnetic speaker using new type Alnico V magnet. Comes with leather weight crystal pick-up. Works on AC current with long AC line cord and rubber plug. Handsomely encased in brown alligator leatherette, brown python or red python.  
 12 1/2" x 10 1/2" x 5 1/2".  
 Complete with 3 tubes ready to play..... **\$16.95**

### SENSATIONAL SPEAKER SAVINGS!

3 1/4" Cone 4" Sq. Frame.....	\$1.19 ea.
4" P.M. Speaker.....	1.19
5" P.M. Speaker.....	1.15
5 3/4" Cone 6" sq. Frame.....	1.55
6" P.M. Speaker.....	1.55
8" P.M. Speaker.....	2.75
12" P.M. Speaker.....	4.95



**Nationally Advertised CRYSTAL MIKE** With 7 ft. mike cable and PL 55 plug and stand.  
**ONLY \$4.39 COMPLETE**

**829 PUSH PULL TWIN-UNIT**  
 Beam Power Amplifier  
 Tube ..... \$1.49 Ea.

### Standard Brand AC PHONO MOTOR & PICKUP

60 cycle, 115 volts, with Turntable. Complete. **\$4.35**

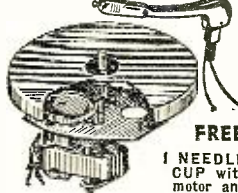

**FREE**  
 I NEEDLE CUP with motor and pickup

### LOOK AT THESE TUBE VALUES!

EVERY TUBE IN CARTON R.M.A. GUARANTEED

Type	Each	Each	Type	Each	Each
02A	69c	59c	6V5G	59c	49c
1A3	45	39	6V8GT/G	45	39
1A5GT/G	59	49	6X5GT/G	49	39
1A7GT/G	55	45	7A4	53	43
1H5GT/G	59	49	7A7	59	49
1L4	49	45	7A8	58	48
1LH4	69	59	7B6	44	35
1LN5	69	59	7F7	49	44
1N3GT/G	59	49	7N7	49	44
1S5	59	55	7X7	49	44
1T4	69	55	(XXFM)	44	35
1U5	36	30	7Y4	44	35
1V	45	39	12A6	35	25
2A5	65	55	12A8GT	39	35
2A6	45	35	12A7E	50	45
2A7	39	29	12B6	50	45
2X2/879	35	29	12BE6	50	45
3A4	49	39	12J5GT	35	27
3S4	55	45	12J7GT	45	39
5U4G	50	40	12K7GT	45	39
5W4GT/G	39	34	12K8Y	49	39
5X4G	39	35	12Q7G	45	39
6A7	42	37	12SA7GT/G	40	32
6V3GT/G	40	35	12S7	45	40
6Y4G	40	37	12S7GT	55	40
6Z4	59	49	12SK7GT/G	45	35
6A7	50	45	12SR7GT/G	40	32
6A8GT	49	39	12S8T	35	32
6AC5	69	59	14A7	65	55
6AC7/1852	65	60	14B6	59	49
6AV6/6AK7	89	79	24A	49	39
6AK5	74	69	25L6GT/G	49	45
6B7	55	49	25Z5	49	45
6C4	29	25	25Z6GT/G	45	39
6C5GT	40	35	26	49	39
6C5MG	89	79	27	49	44
6C6	45	32	32L7GT	52	48
6C8G	39	29	35A1	49	39
6D6	49	45	35L6GT/G	45	39
6F3	55	45	35W4	43	40
6F6GT	45	39	35Y4	43	40
6H6GT/G	45	39	35Z3	44	35
6J5GT/G	45	39	35Z5GT/G	43	39
6J6	59	49	38	49	39
6L7GT	42	38	39/44	35	29
6K6GT/G	45	39	41	49	45
6K7G	50	41	47	49	39
6K7GT/G	49	39	50A5	60	55
6K8G	55	49	50B5	42	32
6L6G	79	69	50L6GT	50	45
6Q7GT	47	39	56	55	45
6R7	55	45	57	45	39
6R7GT	59	49	58	45	39
6SA7	49	39	75	50	39
6SA7GT/G	44	37	76	49	45
6S7	49	45	77	35	27
6S7G	44	39	80	40	38
6S7GT	40	32	83V	79	69
6S7GT/G	44	37	85	49	45
6SL7GT/G	49	39	99V	35	25
6SN7GT	49	47	99X	35	25
6SQ7GT/G	44	37	117Z6GT/G	89	76
6SD7	49	39	182B	99	89
6U6	49	39	1231	39	29
6U7G	35	25	1644	89	29

- B-13E-13031
- B-13D-13027
- B-13D-13030
- B-13C-13029
- B-13C-13032
- B-13D-12974
- A-16A-13033
- A-16A-13243
- B-14MA-11066-5

- T7—AM antenna coil assembly
- T8—FM osc. coil assembly
- T9—AM osc. coil assembly
- T10—FM r.f. coil assembly
- T11—AM r.f. coil assembly
- T12—AM osc. shunt coil ass'bly
- L1—Choke coil assembly
- L3—Loop loading coil
- L4—Broadcast loop antenna

### EMERSON MODEL 508

- Part No. Code and Description
- 320970 R1—100,000 ohm, 1/4 w. res.
  - 321210 R2, R5—1 megohm, 1/4 w. res.
  - 390040 R3—3 megohm vol. control
  - 321450 R4—10 megohm, 1/4 w. res.
  - 321370 R5—4.7 megohm, 1/4 w. res.
  - 321330 R7, R8—3.3 megohm, 1/4 w. res.
  - 310730 R8—10,000 ohm, 1/4 w. res.
  - 340470 R10—820 ohm, 1/2 w. res.
  - 900140 or 900120 C1, C2—Two-gang var. cond.
  - C3, C4—Trimmers (Part of C1,C2)
  - C5, C6—Trimmers (Part of T1)
  - C7—.0001 ufd. (Part of T2)
  - C8, C15, C15—.02 ufd., 100 v. cond.
  - 928010 C9, C12—.0001 ufd. ceramic cond.
  - 920130 C10—.001 ufd., 100 v. cond.
  - 920140 C11, C13—.003 ufd., 150 v. cond.
  - 910110 or 928020 C14—.0002 ufd. cond.
  - 925070 C17—8 ufd., 100 v. elec. cond.
  - 700030 L1—Loop antenna
  - 180002 or 180020 SP—PM speaker
  - 720240 T1—First i.f. trans.
  - 720260 T2—Second i.f. trans.
  - 734090 T3—Output trans. (for speaker 180002)
  - 734204 T3—Output trans. (for speaker 180020)
  - 716040 T4—Osc. coil

### CROSLLEY MODEL 56TP-L

- Part No. Code and Description
- W-48858 1—Type 47, 6.3 v. dial light
  - C-132300-1 2—Cable and plug assembly
  - AC-134605 3—Antenna loop assembly
  - AW-134994 4—Antenna coil assembly
  - 5A, 5B—Two-sect. coil assembly
  - AW-134065 6—First i.f. trans.
  - AW-q34158 7—Second i.f. trans.
  - B-134995 8A, 8B, 8C—Two-section var. cond. with trimmer
  - AB-134982 9A, 9B—Two-sect. trimmer cond.
  - GC-210685-143 10—580 ufd., 300 v. mica cond.
  - B-226638-55 11—50 ufd., 50 v. mica cond.
  - 39001-65 12, 14—.05 ufd., 200 v. cond.
  - 39001-67 13—.1 ufd., 200 v. cond.
  - 39001-73 15—250 ufd., 500 v. mica cond.
  - 39001-10 16, 23—3300 ufd., 600 v. cond.
  - W-134988 17A, 17B—60/20 ufd., 150/100 v. elec. cond.
  - 39001-63 18, 19, 20—.022 ufd., 200 v. cond.
  - 39001-66 22—.075 ufd., 200 v. cond.
  - 39281-7 24—100 ohm, 1/2 w. res.
  - 39281-28 25—330,000 ohm, 1/2 w. res.
  - 39281-38 26—15 megohm, 1/2 w. res.
  - 39281-21 27—22,000 ohm, 1/2 w. res.
  - 39281-34 29—3.3 megohm, 1/2 w. res.
  - 39281-23 30—47,000 ohm, 1/2 w. res.
  - 39281-35 31—4.7 megohm, 1/2 w. res.
  - 39281-29 32, 33—470,000 ohm, 1/2 w. res.
  - 39281-8 34—150 ohm, 1/2 w. res.
  - 39281-11 36—470 ohm, 1/2 w. res.
  - 39015-26 37—1200 ohm, 1 w. res.
  - B-134720 38A, 38B, 38C, 38D—Four-section band change sw.
  - C-46846-6 39A, 39B—1 megohm vol. control & sw.
  - Part of 3 41—Antenna trimmer
  - W-134939 42—Tone control sw.
  - B-134940 43—Output trans.
  - C-134724 44—Phono motor & spindle assembly
  - B-134245 46—Tone arm & cartridge a by
  - B-135023 47—Speaker
  - W-137367 49—47 ohm, 1 w. res.

-30-

25% deposit on all orders, balance C.O.D. F.O.B. New York

# SENCO RADIO, Inc.

71 WEST BROADWAY, N.Y. 7, N.Y.  
 TELEPHONE — BEEKMAN 3-6498

## QUANTITY SURPLUS BUYERS

We Offer Quick Delivery On Your Largest Orders.

Our large inventory of electronic equipment and parts includes many of those hard-to-get items. Much of our stock is stored in Eastern warehouses, affording quick, low-cost delivery of large orders. Send for latest inventory lists (use your business letterhead, please). Phone and telegraph inquiries invited. Liberal quantity discounts allowed.

WE HAVE A LARGE STOCK OF RUBBER COVERED MULTI-CONDUCTOR CABLES - ALL WIRE GAUGES - ANY NUMBER OF CONDUCTORS - SHIELDED, UNSHIELDED

# G. & M. EQUIPMENT CO., Inc.

6505 VAN NUYS BOULEVARD • VAN NUYS, CALIFORNIA • STATE 4-3233



"We call this one our polite model!"

The New Model 777

# TUBE & SET TESTER

## 20,000 OHMS PER VOLT!!

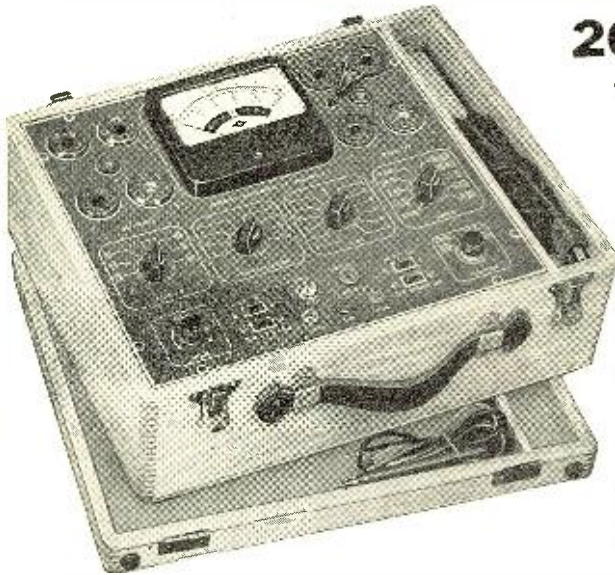

**TUBE TESTER SPECIFICATIONS:**

- Tests all tubes including 4, 5, 6, 7, 7L, Octals, Loctals, Television, Magic Eye, Thyratrons, Single Ended, Floating Filament, Mercury Vapor Rectifiers, New Miniatures, etc. Also Pilot Lights.
- Tests by the well-established emission method for tube quality, directly read on the scale of the meter.
- Tests leakages and shorts of any one element against all elements in all tubes.
- Tests both plates in rectifiers.
- Tests individual sections such as diodes, triodes, pentodes, etc., in multi-purpose tubes.
- New type line voltage adjuster.

**V. O. M. SPECIFICATIONS:**

- DC Volts: (at 20,000 Ohms per Volt) 0 to 7.5/15/75/150/750/1,500 Volts
- AC VOLTS: (At 10,000 Ohms per Volt) 0 to 15/30/150/300/1,500/3,000 Volts
- DC CURRENT: 0 to 1.5/15/150 Ma. 0 to 1.5 Amperes
- RESISTANCE: 0 to 5,000/50,000/500,000 Ohms. 0 to 50 Megohms
- DECIBELS: (Based on zero decibels equals .006 Watts into a 500-Ohm line.) -10 to +18 db., +10 to +38 db., +30 to +58 db.

Model 777 operates on 90-120 Volts 60 cycles AC. Housed in beautiful hand-rubbed cabinet. Complete with test leads, tubes, charts and detailed operating instructions. Size 13" x 12½" x 6".

**\$59<sup>95</sup>**  
NET PRICE

## The New Model 650 SIGNAL GENERATOR

**RANGE**  
100 Kilocycles  
to  
105 Megacycles



R. F. obtainable separately or modulated by the Audio Frequency.

- ★ Audio Modulating Frequency—400 cycles pure sine wave—less than 2% distortion.
- ★ Attenuation—3-step ladder type of attenuator (T pad).

★ Uses a Hartley Exciter Oscillator with a Buffer Amplifier.

★ Tubes: 6J5 as R.F. Oscillator; 6AS7 as modulated buffer and Mixer; 6SL7 as audio oscillator and rectifier.

Complete with coaxial cable, leads and instructions.

REDUCED  
FROM \$48.75  
**\$39<sup>95</sup>**  
TO

## The New Model 670 SUPER METER

**A Combination**  
VOLT-OHM-MILLIAMETER plus  
CAPACITY REACTANCE,  
INDUCTANCE and  
DECIBEL MEASUREMENTS

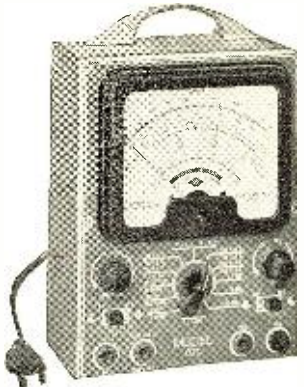

D.C. VOLTS: 0 to 7.5/15/75/150/750/1500/7500. A.C. VOLTS: 0 to 15/30/150/300/1500/3000 Volts. OUTPUT VOLTS: 0 to 15/30/150/300/1500/3000. D.C. CURRENT: 0 to 1.5/15/150 Ma.; 0 to 1.5 Amps. RESISTANCE: 0 to 500/100,000 ohms, 0 to 10 Megohms. CAPACITY: .001 to .2 Mfd., .1 to 4 Mfd. (Quality test for electrolytics). REACTANCE: 700 to 27,000 Ohms; 13,000 Ohms to 3 Megohms.

INDUCTANCE: 1.75 to 70 Henries; 35 to 8,000 Henries. DECIBELS: -10 to +18, +10 to +38, +30 to +58.

THE MODEL 670 COMES HOUSED IN A RUGGED, CRACKLE-FINISHED STEEL CABINET COMPLETE WITH TEST LEADS AND OPERATING INSTRUCTIONS. SIZE 5½" x 7½" x 3".

**\$2840**  
NET

## The New Model 247 TUBE TESTER

**Features:** Incorporates a newly designed element selector switch which reduces the possibility of obsolescence to an absolute minimum. Any pin may be used as a filament pin and the voltage applied between that pin and any other pin, or even the "top-cap."

New free-point system permits the Model 247 to overcome the difficulties encountered with other emission type tube testers when checking Diode, Triode and Pentode sections of multi-purpose tubes, because sections can be tested individually when using the new Model 247. The special isolating circuit allows each section to be tested as if it were in a separate envelope. The Model 247 provides a super sensitive method of checking for shorts and leakages up to 5 Megohms between any and all of the terminals. Continuity between various sections is individually indicated.

One of the most important improvements, we believe, is the fact that the 4 position fast-action snap switches are all numbered in exact accordance with the standard R. M. A. numbering system. Thus, if the element terminating in pin No. 7 of a tube is under test, button No. 7 is used for that test.

Model 247 comes complete with new speed-read chart. Comes housed in handsome, hand-rubbed oak cabinet sloped for bench use. A slip-on portable hinged cover is included for outside use. Size 10¼" x 8¾" x 5¾".

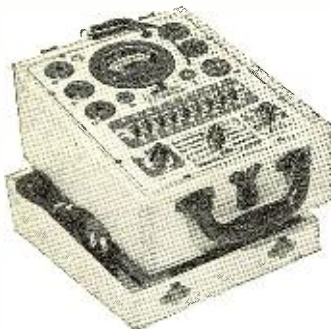

**ONLY**  
**\$29<sup>90</sup>**  
Net

AVAILABLE FOR IMMEDIATE SHIPMENT FROM STOCK—20% DEPOSIT REQUIRED ON ALL C.O.D. ORDERS

**MOSS ELECTRONIC DISTRIBUTING CO.**

DEPT. RN-6 229 FULTON STREET  
NEW YORK 7, N. Y.

# HERE'S MORE FOR YOUR MONEY

When you buy

**TRADE-IN FEATURE OF THE MONTH**  
**HAMMARLUND HQ-129X COMMUNICATION RECEIVER.....**

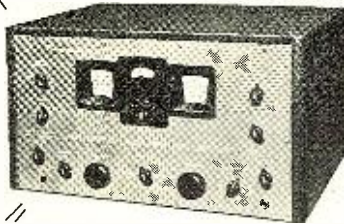

**only \$177.30**

**SPEAKER IN MATCHED CABINET..... ONLY \$11.85**

This deluxe Hammarlund Receiver can now be yours at a substantial saving on a Walter Ashe Trade-In deal.

When you trade

Getting far more for your used Test and Communications equipment means paying much less for the new! That's the important, money-saving advantage in dealing with Walter Ashe. Cash in now on the bigger-than-ever allowances offered by Walter Ashe on your used equipment. Wire, write, phone or use the handy coupon below.

## FILTER CHOKES



4.5 Hy. X 150 Ma., 70 ohms Res. #5269 Shpg. Wt. 6 lbs.

2 for..... **79c ea.**  
 One only.....99c ea.



Dual 12 Hy. X 200 Ma., 150 ohms Res. per section. #2785 Shpg. Wt. 17 lbs.

Only..... **\$4.95**



4 Hy. X 300 Ma., 40 ohms Res. #6317 Shpg. Wt. 13 lbs.

Only..... **\$4.95**



8 Hy. X 500 Ma., 55 ohms Res. #8056 Shpg. Wt. 18 lbs.

Only..... **\$11.85**

## FILTER CONDENSERS

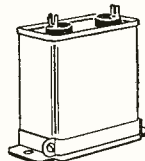

3 Mfd. X 400 VAC. Good for about 1500 VDC. Shpg. Wt. 3 lbs.

Only..... **98c**



2 Mfd. X 2500 VDC. Oil filled, standard brand. Shpg. Wt. 4 lbs.

2 for **\$3.25 ea.**  
 One only. \$3.50 ea.

## SURPLUS TUBES — WHILE THEY LAST NEW — IN CARTONS

3AP1 .....	\$1.96	807 .....	\$1.13
5R4GY .....	.75	809 .....	1.45
5BP1 .....	1.96	811 .....	1.95
5BP4 .....	1.96	813 .....	5.95
6AK5 .....	.90	814 .....	4.50
24G .....	1.10	815 .....	2.25
VT-127A .....	2.95	829B .....	3.00
VR-105 .....	.75	872A .....	3.00
VR-150 .....	.75		

REMEMBER . . . your Trade-In's worth more at the Walter Ashe Store. For real money-saving get Walter Ashe's offer before you make that trade.

## DON'T FORGET!

Walter Ashe is Headquarters for "Good-as-new," reconditioned Test and Communications equipment. Look at the following typical examples of money-saving bargains.

(and there are many more space doesn't permit listing!)

Hallicrafters — S-40.....	only \$ 57.50
Hallicrafters — SX-25.....	only 89.50
National NC-173 and Spkr.....	only 149.00
R M E — VHF-152.....	only 67.50
McMurdo Silver Vomax.....	only 45.00
Solar — CBB-160.....	only 32.50
Clough Brengle CRA Scope.....	only 40.00
Leeds Northrup Wheatstone Bridge Model S-5300.....	only 75.00

(Quantities limited on above items)

SEND FOR COMPLETE LIST

GET YOUR FREE COPY OF OUR LATEST CATALOG

PHONE Chestnut 1125

ALL THE BIG NAME BRANDS of New Test Instruments and Communication Equipment in Stock — ready for immediate delivery.

TIME PAYMENTS AVAILABLE

ALL PRICES F. O. B. ST. LOUIS

**Walter Ashe RADIO CO.**  
 1125 PINE ST. • ST. LOUIS 1, MO.

## CARBON HANDMIKE



Type T-17B handmike. S. B. carbon with push-to-talk switch on handle. Brand new. Shpg. Wt. 3 lbs.

ONLY **69c**

## TRANSMITTING KEY



Type J-37. Large coin silver contacts. Shpg. Wt. 2 lbs.

Only **98c**

## HEADPHONES



Type HS-16A. 2000 ohms impedance. Canvas Web headband, and long standard type cord. Shpg. Wt. 3 lbs.

**\$1.47**



## PE-103A DYNAMOTOR

6 or 12 VDC input, 500 VDC at 160 Ma. output. Brand New. Shpg. Wt. 81 lbs.

ONLY **\$9.95**

WOJWD WOWTM WOPGI  
 W9NRF WOQDF

Use this coupon to get Walter Ashe's "Surprise" Trade-in Allowance on your used factory-built test equipment. RNG

WALTER ASHE RADIO CO.

1125 Pine St., St. Louis 1, Missouri

Am interested in the following slightly used, reconditioned Test Equipment.....

(list preference)

I want to trade.....

(describe used equipment)

for.....  
 (show make, model of new Receiver desired or other equipment)

Rush my FREE COPY of the big, New 1948 Walter Ashe Catalog.

NAME.....

ADDRESS.....

CITY.....ZONE.....STATE.....

## Industrial Electronics

(Continued from page 59)

controlled in an electrical circuit. For example, simple on-off switches and small potentiometers in the grid circuits of tubes can control extremely large amounts of power. The speed and direction of large electronically controlled motors supplying many horsepower may be regulated by a compact control station containing simple push-button switches and small potentiometers, situated at any distance from the motor and the main control circuit. Other types of remote controls, such as servo systems and pulsing drive systems, have been of considerable value in the control of such industrial equipment as conveyors, cranes, drilling and tapping machines, engine lathes, laundry machines, knitting and winding machines, printing presses, and wherever else accurate remote control is needed.

(7) One of the new and increasingly important fields of application of industrial electronics is in the non-destructive testing of materials. The requirements of competition in sales and production, emphasizing the need for reliability and dependability of the product, have demonstrated the importance of rapid and reliable methods of testing important and critical parts, and have been an outstanding incentive to the development of such types of tests. In the past, large quantities of material in many processes could be tested for certain properties only by testing suitably chosen samples of the entire lot, because of the destructive nature of the test itself. The application of electrical and magnetic principles has made it possible in many cases to perform non-destructive total inspection of the entire quantity as a simple routine procedure. Some of these methods have played an important part in the success of certain types of engineering activities. For instance, the reliability of aviation engines and parts is due to a great extent to magnetic test methods which have prevented defective parts from being placed in service, while x-ray radiography may be said to have been the turning point in sound and reliable welding. Electronic methods are also widely employed in the measurement of dimensions, displacement, velocity, acceleration, fluid flow, pressure, temperature, illumination, and other factors. Many manufacturers who originally started using such inspection methods because of government requirements, have learned its value and will continue using it for the information it provides, enabling them to improve quality, reduce costs, and budget labor more adequately.

(8) Another important phase of elec-

# wanted . FACTORY SALESMEN

## FOR THE HIGH-QUALITY PROFESSIONAL TYPE

# Lear WIRE RECORDER

HIGH FIDELITY



### Portable Model in Convenient Carrying Case

Includes AM Radio • Lear High-Fidelity Wire Recorder • Leartronic Scratch Filter • Single Record Phonograph Turntable with Leartron Pickup • Dynamic Speaker • Microphone.

One Full Hour Spool of Wire with Cue Disc • Index Pads • Connection Cable to attach Lear High-Fidelity Wire Recorder to any radio or loud speaker. Radio time clock, headphones, and additional spools available as accessories.

### generous discount arrangements for qualified representatives

#### CHECK THESE IMPORTANT FEATURES

- A precision instrument
- Built by experienced engineers
- Full range of high and low tones
- Easy to operate and use
- Hours of uninterrupted performance
- Automatic timer
- Complete range of models and prices, with and without AM-FM Radio
- Super-fast rewind
- Wire can be used over and over
- Records direct, or from phonograph, radio
- Nationally advertised

*Ideal for Radio Stations • Advertising Agencies  
Auditions • Air Checks • Remote Broadcasts  
Public Events • Schools & Colleges  
Dramatic & Voice Teachers  
Language Schools • Courts & Police, etc.*

**We have begun** a nation-wide campaign of publicity and advertising that will create steady and profitable demand for the LEAR high-fidelity wire recorder. You can share in these sales and profits while calling on your present trade! **If you are an independent** radio supply salesman—or, if you operate a radio supply business with a live-wire sales staff—you can make money selling the LEAR High-Fidelity Wire Recorder. **We have a most attractive deal for you now**—if you are ready to do a REAL SELLING JOB! No middlemen or distributors—this is a direct factory deal where you get the full discounts!

For complete details, send information about yourself, your organization and your territory TODAY—to Dept. A.

# Lear

INCORPORATED

110 Ionia Ave. N. W., Grand Rapids 2, Mich.

# HERBACH & RADEMAN

presents

## OUTSTANDING VALUES FROM THE PAGES OF "THIS MONTH"

Shown here are just a few of the hundreds of values listed every month in our bulletin "THIS MONTH". In "THIS MONTH" we bring you the outstanding "buys" from the surplus market as well as an up-to-the-minute listing of new products, gadgets and devices from scores of nationally known manufacturers. In effect "THIS MONTH" is a perpetual radio and electronic-parts guide.

RADIO NEWS READERS are invited to be put on our mailing list — free — by merely filling out the coupon below.

### ALNICO MAGNETRON MAGNETS



Horseshoe shaped magnet, originally designed for use in microwave radar equipment. Field strength 4800-4900 gauss. Size 5 1/4" W. x 5 1/2" H. x 2" thick. Mts. on base 3" x 2 1/4". Airgap 19/32". Wht.—8 lbs. Lifts more than 5 times its own weight. With Keeper. No. RN-1056. **\$4.95**

### PRECISION APPARATUS 844P VOLT-OHM-MILLIAMMETER

All purpose AC-DC Multimeter in hardwood hinged cover case with a 4 1/2" 1000 ohm per volt meter.

#### RANGES

AC and DC Volts 0/12/60/300/600/1200/6000  
Milliamperes D.C. 0/1.2/12/300/600/1200  
Amperes D.C. 0/12  
Ohms 0/400/100,000/1 meg/10meg  
Decibels 6 Ranges from -12 to 70 D.B.  
Output Volts 0/12/60/300/600/1200/6000  
Case has tool compartment. With test leads less batteries. (Batteries \$1.40 additional)  
Regular Price \$34.20. **\$24.95**  
No. RN-844P

### REVERSIBLE MOTOR



Built like a fine watch. Continuous duty 1/50 H.P. Capacitor start reversible motor for operation on 115V. 60 cycle. Speed 3300 r.p.m. Size 3 1/4" x 3 1/4". Shaft 5/16" diam. x 1-3/16" long. With capacitor. No. RN-1002. **\$7.95**

### ALL METAL SPEAKER BAFFLE

Enclosed all metal, sloping front, black crackle finish wall baffle. Takes a 12" speaker. Front entirely hinged. 14"H.x14"W.x9"D. Wht.—16 lbs. No. RN4TH. **\$2.95**

### NO SUPERLATIVES

No, we're not "the biggest," "the oldest" nor "the greatest" parts house in the world; we do guarantee complete satisfaction on every purchase. We also guarantee speedy delivery on all orders. Order direct from the page and be sure you send us your name for our mailing list. Quantities Limited. Minimum order \$2.00.

Terms 20% deposit, balance C.O.D.  
All prices are quoted F. O. B. warehouse Phila., Pa.

### MANUFACTURING DIVISION

**HERBACH & RADEMAN, Inc.**  
*Electronics Specialists*

522 MARKET ST., PHILADELPHIA 6, PA.

Yes indeed, send me your monthly Bulletins.

Name .....  
Address .....  
City ..... Zone ..... State .....

tronic technique which is of tremendous importance to almost every branch of industry is the use of electronics to improve industrial safety equipment. Electronic circuits are used in safety control devices to indicate when plant equipment is operating under unsafe conditions and to stop or slow down the equipment until safe operating conditions are restored. For example, equipment can be protected against operating speeds which are too great, and furnaces against temperatures which are too high. In the use of safety equipment for protecting workers from being hurt by industrial machinery, one of the most important considerations is whether the machine operator will cooperate in its use. Since photoelectric equipment is simple and rugged, and interrupting a light beam requires little physical effort or even conscious thought, it will remain operative where thoughtless operators might be tempted to bypass devices requiring more strenuous effort. This application of electronics in promoting greater safety for industrial personnel and equipment pays high dividends in preventing costly damage to expensive plant equipment and in the protection of employes from accidents.

It is well known to every radio technician that in addition to their desirable properties, electron tubes have certain undesirable characteristics. These characteristics can be decided drawbacks when tube circuits are used for industrial applications, unless they are carefully taken into account. Experience has shown that as far as their practical effect upon a desired result is concerned, most of these faults may be largely eliminated by careful choice of the circuits in which the tubes are used. The cir-

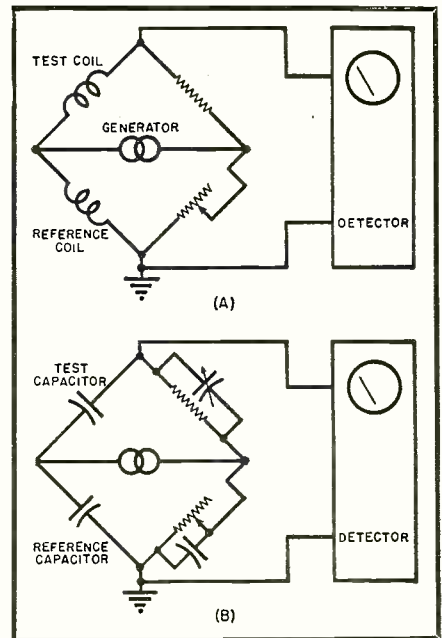
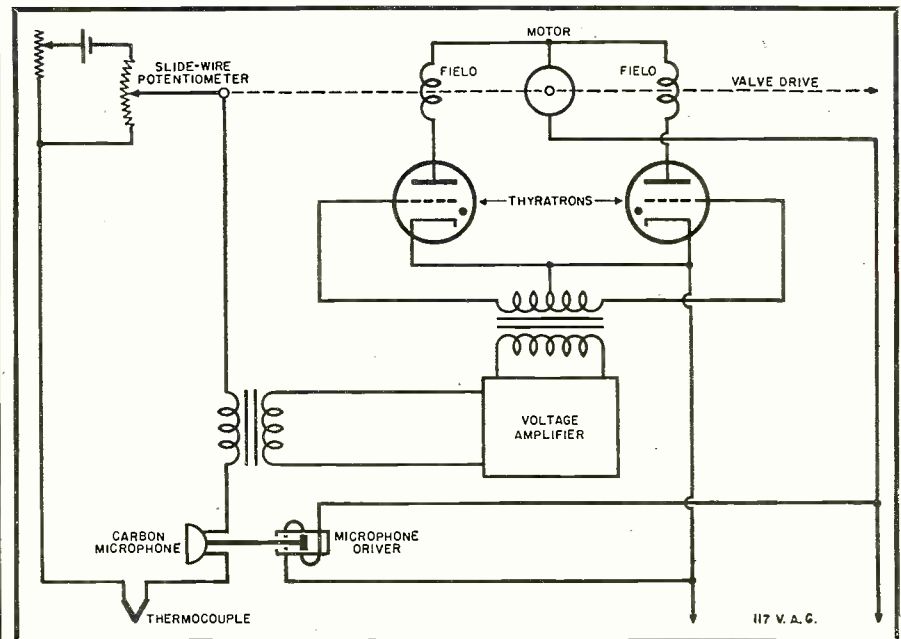

Fig. 7. (A) Basic type of circuit to measure core loss and inductance for the inspection of metal objects inserted in a test coil. (B) Circuit to measure resistivity and power factor for the inspection of dielectric objects inserted in test condenser. (See text for explanation).

cuits must be engineered so that the results are not affected by normal variations in the operating characteristics and possible slow changes in some of the parameters in regular operation. There are a few basic principles which have been found useful in helping to choose circuits in such a manner as to reduce considerably most of the noticeable effects of aging and other normal circuit variations. The fewest possible number of tubes should be used as the controlling elements. A "feedback" circuit in which the result is compared to the

Fig. 8. Temperature control circuit using motor-balanced thermocouple-potentiometer.



# A GREAT **TRANSVISION** FIRST!

**NEW... Sensational TRANSVISION Development now offers  
LARGE-IMAGE DIRECT-VIEW TELEVISION at low cost!**

**BIGGEST VALUE in TELEVISION!**

**Model 10BL TELEVISION KIT with FM Radio  
... Features Beautiful CABINET with BUILT-  
IN LENS ... Gives LARGE 120 Sq. In. Picture**

**Roto-picture effect:** Picture "rotates," giving the appearance of being in focus and clearly visible from every angle! Uses 10" Electromagnetic Direct-view Picture Tube.  
Features new-type cabinet with built-in lens which magnifies, clarifies and heightens contrast of the picture. The lens also creates the effect of apparent rotation of the picture, so that when the observer moves, the picture still seems to be in focus and clearly visible from any angle.

**ECONOMICAL KIT, EASY TO ASSEMBLE.** In point of value, this Television Kit provides the opportunity of acquiring a LARGE-IMAGE direct-view television set at a VERY LOW PRICE; also very economical from a tube replacement angle. This model is available in KIT FORM, for easy assembly; no technical knowledge required. Simple step-by-step instructions are included. Saves as much as 50% over the cost of receivers with similar picture magnitude.

**TECHNICAL DATA:** Model 10BL uses a 10" Electromagnetic Direct-view Picture Tube; has complete F.M. Radio which comes completely factory-wired; receives all channels in any area; supplied complete with antenna and lead-in wire. The LENS is 15" x 11", giving a picture size of approx. 10" x 12" or 120 sq. in.; the highly-styled cabinet measures 26" wide x 17" high x 19" deep, available in Mahogany, Walnut, or Blonde finishes.

**PRICES:** Transvision MODEL 10BL Television Kit, with FM, 10" tube, cabinet with built-in lens, antenna, 60 ft. lead-in wire.....LIST \$359.00  
MODEL 12BL, same as 10BL except that it uses 12" tube, giving picture area of 130 sq. in.....LIST \$389.00

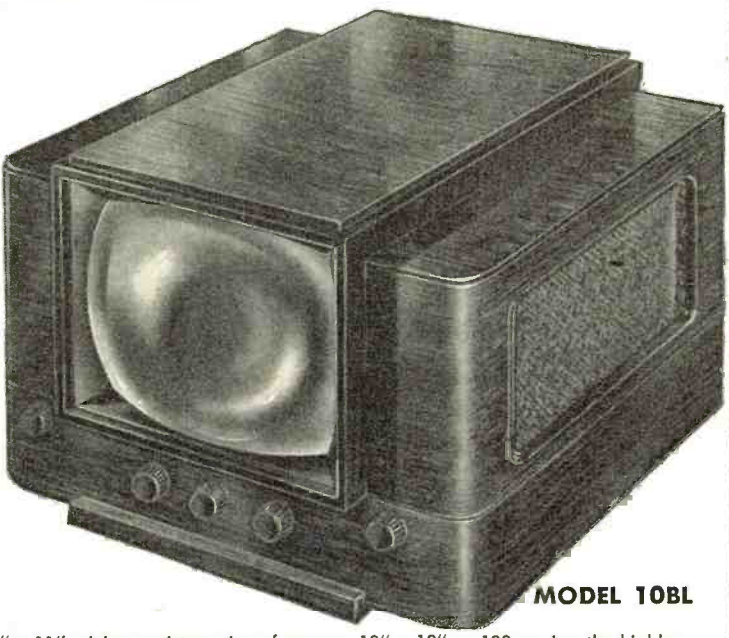

**MODEL 10BL**

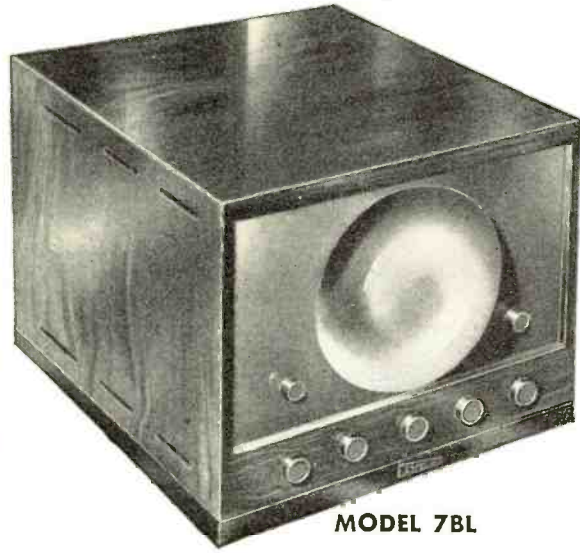

**MODEL 7BL**

**Scoop! New Revolutionary MODEL 7BL  
Television Kit with Specially Designed  
CABINET with BUILT-IN LENS**

- Uses 7" Electrostatic Picture Tube
- Gives 50 square inch picture of superior quality

**FEATURES:** Though it has a 7" tube, the effect is equivalent to a 10" set because the built-in lens magnifies the picture. Also picture performance is superior because the lens clarifies and heightens contrast of the image. Picture "rotates" apparently, as the observer moves, giving the effect of always facing the observer. This is effective to a very wide angle. Pre-tuned for 5 channels.

**PRICE:** Including cabinet with built-in lens, antenna, 60 ft. of lead-in wire. NET \$189.00

**TRANSVISION "SERVICE NOTES"**

**The Key to Successful Television Servicing**

Transvision's "Service Notes" is a compilation of confidential Television Notes and Information, the product of experience with over 20,000 television receivers, now made available to the public.  
The "Service Notes" is a most valuable compilation of instructions and data on Magnetic and Electrostatic Television Receivers. Though compiled in the course of servicing Transvision Kits, the information is applicable to any type of television receiver.  
"Service Notes" is complete with photographs and diagrams. The information is worth a small fortune. The cost is low.  
LIST \$2.95



All prices 5% higher west of Mississippi; all prices fair traded.  
For further information see your distributor, or write to:  
**TRANSVISION, INC. Dept. RN, NEW ROCHELLE, N. Y.**



# NOW! BUILD 15 RADIOS \$14.75

COMPLETE KIT ONLY...

**ABSOLUTELY NO KNOWLEDGE OF RADIO NECESSARY  
YOU NEED NO ADDITIONAL PARTS!**

**THE PROGRESSIVE RADIO KIT IS THE ONLY COMPLETE KIT**

Operates on 110-120 volts AC/DC. Contains everything you need. Instruction Book, Metal Chassis, Tubes, Condensers, Resistors and all other necessary radio parts. The 36-page Instruction Book written by expert radio instructors and engineers teaches you to build radios in a professional manner. The first circuit built is a simple one-tube detector receiver. Each succeeding circuit incorporates new arrangements of detectors, RF and AF amplifiers. This kit is excellent for learning the principles of receiver, transmitter and amplifier design. It is used in many radio schools and colleges. All of the commonly-used detectors are used, including diode, grid leak, plate and infinite-impedance. The transmitters are designed with Hartley and Armstrong oscillators, using screen-grid and control-grid modulation. Both vacuum tube and selenium rectification are employed in these circuits. The circuits are designed to provide excellent performances. Altogether, fifteen circuits are constructed, including 11 receivers, 1 audio amplifier, and 3 transmitters. The sets start with simple circuits of 1 tube plus rectifier, gradually grow more complex, and finish with several examples of radio sets using three tubes plus rectifier.

**PROGRESSIVE RADIO KIT . . . ONLY \$14.75**

### SPECIAL FREE OFFER

Electrical and Radio Tester sent absolutely FREE with each Progressive Radio Kit. PLUS FREE membership in Progressive Radio Club. Entitles you to free expert advice and consultation service with licensed radio technicians. Write for further information or ORDER your KIT NOW!

### PROGRESSIVE SCOOPS!

#### FM COIL & CONDENSER KIT

Designed for operation on 88-108 MC (new band), contains 2 IF transformers, 1 Limiter Transformer, 1 Discriminator Transformer, 1 RF coil, 1 Variable condenser, Schematic and wiring instructions. Excellent for schools, experimenters and Radio Hobbyists.  
Price only **\$4.95**

#### CONDENSER KIT

50 Paper Tubular Condensers. Values from .002 mfd to .1 mfd. 400 V. DC to 600 V. DC.  
Only **\$1.95**

#### RESISTOR KIT

100 Carbon Resistors, 1/2 Watt, RMA color-coded. Values from 120 ohms to 2.2 megohms \$1.50

10-10 MFD. 450 W.V. DC Electrolytic Condensers ..... **65c**

20-20 MFD. 150 W.V. DC Electrolytic Condensers ..... **30c**

40-40 MFD. 150 W.V. DC Electrolytic Condensers ..... **45c**

Antenna and RF Coil Set (Broadcast Band) ..... **59c**

6" Alnico Slug Speaker... **\$1.69**

Selenium Rectifiers ..... **79c**

Midget Soldering Iron 35 Watts 110/120 volts UL approved **69c**

55 Watt Soldering Iron UL approved ..... **\$1.90**

75 Watt Soldering Iron UL approved ..... **\$2.40**

Long Nose Pliers and Cutters ..... **\$1.45**

#### PROGRESSIVE RADIO TOOL KIT

contains 75 Watt 110/120 Volt soldering Iron, long nose pliers & cutters, screwdriver, insulated alignment tool ..... **\$3.25**

#### ESPEY CUSTOM-BUILT

1. AC Superhet AM-FM receiver.
2. Frequency Modulation Circuit.
3. 11 finest quality tubes, including rectifier.
4. 4 dual purpose tubes give 15 tube performance.
5. Automatic volume control.
6. Full-range volume control.

Your Price **\$84.00**

#### PROGRESSIVE AMPLIFIER KIT \$15.75



#### HIGH FIDELITY, HUMLESS, AMPLIFIER. SEVEN TUBE PERFORMANCE

This newest Progressive Kit will enable you to build a newly-designed, high fidelity, humless amplifier. Beautiful aluminum custom-punched chassis, etched tone and volume control plates. Designed by former Western Electric engineer. Ideal amplifier for television kit or set, FM tuner, AM tuner, microphone, phonograph, wire and instantaneous recorders. Electrify your musical instruments by connecting them to the Progressive Amplifier by means of a contact mike. Amplifier can be readily modified to match the GE reluctance pick-up. Separate mike and phono input. Regulated power supply maintains constant voltage supply. DC heater supply, whether amplifier is used on AC or DC provides humless operation by eliminating cathode-heater leakage hum. Contains degenerative feedback for improved frequency response. Balanced phase inversion and push-pull beam power output. Every stage thoroughly decoupled to improve low-frequency response and to prevent motor-boating. Tone and volume controls completely variable. Seven-tube performance. Uses 2 selenium rectifiers, 2 beam power amplifiers, 1 high- $\mu$  pentode mike amplifier, 1 twin-triode phase inverter, and 1 voltage regulator tube.  
Progressive AMPLIFIER KIT (less Tubes and Speaker)..... only **\$15.75**

TUBES for Progressive Amplifier Kit 1-12SL7, 1-12SJ7, 1-VR75, 2-12A6's. Complete Set **Only \$3.00**

#### BUILD A 5 TUBE AMPLIFIER—ONLY \$5.95

Ideal for phonograph, FM tuner or microphone. Has 5 tubes including rectifier. Kit is complete with tubes, chassis, volume control, tone control, radio parts, hook-up wire, solder and instructions. We can provide a 4-inch PM speaker with mounted output transformer to fit on chassis, priced at \$1.95. Or use this kit with your own speaker. It has 5 watts output, more than enough to drive a 12-inch speaker. .... **Only \$5.95**

#### AM-FM HIGH FIDELITY RECEIVERS—Model No. 7-BC

7. High-Fidelity AM-FM reception.
8. Full-range combination bass-treble tone control.
9. 13 watt (maximum) Push-Pull Audio Output.
10. 10 inch PM speaker with Alnico V magnet.
11. Indirectly illuminated "slide-rule" dial.
12. Loop antenna for AM and Folded Dipole antenna for FM reception supplied.
13. Provisions for external antennas.
14. Wired for phonograph operation.
15. Licensed under RCA and Hazeltine patents.
16. RMA listed.

\$25.00 deposit required with C.O.D. orders

WRITE FOR PROGRESSIVE ELECTRONICS CO., Dept. RN-10 We pay Postage on Prepaid Orders. GRESSIVE QUANTITY PRICES 497 UNION AVE. ● BROOKLYN 11, NEW YORK All C.O.D. Orders Shipped Collect.

cause should be used whenever the tube circuit is to regulate power flow to some device. Wherever possible, steps should be taken to insure that grid circuit voltages change at a high rate over wide ranges at the instant that control of the tube is required. Thus, saturating transformers providing peaked voltages, or capacity-coupled circuits or some other expedient, according to the need, should be provided. Since tubes may respond almost instantaneously, the most careful construction and layout of parts to obtain minimum intercircuit coupling, together with careful shielding and filtering is essential in order to avoid difficulty due to stray transient voltages.

The most important principle which applies to the use of electronic controls is that each application must be studied individually and an individual control system designed for each installation. In the setting up and installation of systems, as well as for spares and renewals, the individual components of the system should be checked carefully for each of the following points:

1. Reliability of the manufacturer of the control device, and of the service agreement offered.
  2. Simplicity of the device.
  3. Whether or not the device employs up-to-date tubes.
  4. Operation limits, such as temperature and vibration, of the device. These should be compared with the actual conditions of installation.
  5. Cost of renewal tubes and sources from which they are available.
  6. Whether or not the device serves a function which only electron tubes can perform. Often a simpler, mechanical or non-electronic device is available which requires less maintenance time and expense.
  7. Power handling capacity of the relay, if it is a relay device, should be compared with the actual load to be imposed on it.
  8. Efficiency of the device. Tubes and lamps age gradually before final failures. Lenses and mirrors may not always be as efficient as when new and clean. Atmosphere may be full of fine dust.
  9. Grade of insulation on low-power circuits. Moisture must be considered. For example, a phototube passes only a few microamperes, hence any leakage because of reduced resistance may be serious.
  10. Adequacy and sturdiness of construction.
  11. Ease of removal of parts for maintenance.
  12. Space required for mounting.
  13. Cost and maintenance.
- Every industrial control application must be considered as custom-built, even when standard packaged units are used in the final setup. Otherwise, the

In Indiana  
**IT'S**  
Stanton Radio Supply  
521 State St.  
HAMMOND, INDIANA

**RCA Institutes, Inc.**  
Offer thorough training courses in all technical phases of Radio and Television  
**WEEKLY RATES** **DAYS—EVENINGS**  
**VETERANS:** RCA Institutes is approved under G. I. Bill of Rights  
For Free Catalog write Dept. RN-48  
**RCA INSTITUTES, Inc.**  
A Service of Radio Corporation of America  
350 West 4th St., New York 14, N. Y.

**WRIGHT VERIFIED SPEAKERS**  
**"They Glorify The Tone"**  
**WRIGHT Inc.**  
2232 University Avenue **St. Paul 4, Minnesota**



application of electronics to industrial control will tend to become a gadget business through failure to utilize electronics properly. The possibilities which electronic principles and methods offer, when correctly applied and properly coordinated to electrical and mechanical design, are too great for this to be permitted to occur.

As in the case of all other radio and electronic equipment, one of the most important requirements for intelligent servicing is a thorough understanding of the principles and operation of the equipment. This factor is especially important in industrial equipment because of the large amount of money and responsibility which are involved in keeping a large production process operating continuously.

The basic principles involved in the design of industrial electronic circuits are already known to the radio serviceman. The difference is only in the manner in which these principles are applied. A few of the most basic types of electronic control circuits will be described here to familiarize the serviceman with the type of circuit design and to provide an indication of the basic approach to industrial electronic circuits. These fundamental circuits form the basis of a large proportion of the electronic control equipment which is in use in industry at the present time.

*Photoelectric controls.* The most fundamental photoelectric control device, and the one which has found the widest application up to the present time, is the photoelectric relay. The basic alternating current photoelectric relay consists of a phototube connected to control a thyatron, as shown in Fig. 2A. The phototube may be connected in such a manner that the thyatron will conduct and energize the relay when the illumination is increased, or when it is decreased, depending upon the particular application. In the circuit shown, when no light is applied to the phototube, the thyatron grid is biased to a negative potential with respect to the cathode, and the tube passes no current. The grid and plate voltage relations are shown in Fig. 2B. The grid voltage  $eg$  consists of the direct voltage  $eb$  on which is superimposed the alternating voltage  $eps$  in such phase that the tube will always break down at the beginning of the positive half-cycle of the anode voltage  $Ea$ . The reason for applying a.c. as well as d.c. voltage to the grid is in order to keep the current through the thyatron and the relay essentially constant regardless of the amount of illumination on the phototube. The operation of the circuit is as follows: When the phototube is illuminated, a current flows through it and the grid resistor  $R$ , resulting in the voltage drop  $ep$  across  $R$ . The total grid voltage  $et$  is shown

June, 1948

## Did You Know...



THAT IN 2 MINUTES  
AN AVERAGE RADIO  
SPEAKER EXERTS  
ENOUGH ENERGY TO  
DRIVE A GOLF BALL  
OVER 575 YARDS?

**W**e know it's impossible for a speaker to swing a golf club, but *it is true* that in just 2 minutes time an average loudspeaker does exert enough energy to drive a golf ball over 575 yards! This means that although OPERADIO builds speakers with the skill and care of a watchmaker . . . these speakers are sturdily constructed to stand up under heavy, continuous use. OPERADIO speakers are delicately balanced to authentically reproduce the sweetest high notes of a piccolo, yet, carry the tremendous power of a full orchestra crescendo.

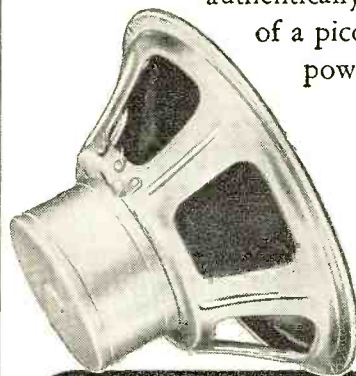

ASK FOR OPERADIO SPEAKERS —  
A FULL LINE OF OUTSTANDING  
SPEAKERS FOR EVERY PURPOSE!

# OPERADIO

## RADIO REPLACEMENT and PUBLIC ADDRESS SPEAKERS

OPERADIO MFG. COMPANY • St. Charles, Illinois

# BIG JUNE CLEARANCE SALE! WALKIE-TALKIE



BC-222 Frequency Range 28 to 52 Mc. Portable Radiotelephone transmits and receives anywhere in the 28 to 52 Mc. Band which includes 6 and 10 Meters. Ready to operate. Complete with Handset, Tubes, Schematic, Antenna, and Batteries. Checked before shipment.  
Reconditioned by Gov't. and Guaranteed..... **\$39.50**  
New—Guaranteed..... **\$49.50**

## INTERPHONE AMPLIFIER BC-347

Army Aircraft Type; uses 6F8 Tube. Contains two (2) Midget High Fidelity UTC output transformers (7/8"x1 1/4"). Input 200 ohm to single or push-pull Grid, Output 200 ohm from single or push-pull plate, plus resistors, cond., etc. Completely enclosed. Size: 2 1/2"x4"x6". Less Tube— **\$0.79**  
only, each ..... **\$2.00**  
or 3 for .....



## BC-1023 MARKER BEACON RECEIVERS

Receives 75 Mc. Modulated Signal, can be varied from 82 to 80 Mc. Operates self-contained sensitive relay that can be used to operate equipment from remote point. Needs only 12 to 14 volts DC for filament and plate voltage. Complete with 4 Tubes, instruction book. Shock mounted. Size: 5 3/8"x5 3/8"x3-7/16". New, in original boxes. Shpg. Weight: 4 lbs. **\$3.50**  
Price—only  
BC-301 Same Freq. as above, only uses one tube  
6P7 Relay operates on 1Ma. Less tube..... **\$1.95**

## COMMAND RECEIVER

BC-454—3 to 6 Mc. Only \$5.95  
BC-456—Modulator, Only \$2.50

## DYNAMOTORS

**MOBILE USE**  
9 Volt input; Output 405 volts 95 MA. Also will operate from 6 Volt input; Output 280 Volts 95 MA. Size: **\$3.95**  
3"x7" DM 635x...

## P.M. FIELD DYNAMOTORS

12 or 24 Volt input; Output 500, 50 Ma. at 6 Volt input; Output 240, 50 Ma. **\$3.50**  
12 or 24 Volt input; Output 275, 110 Ma. at 6 Volt input; Output 120, 110 Ma. **\$1.95**  
PE-101 For BC-645 Transceiver ..... **\$2.95**  
PE-98 For SCR-522 12 Volt ..... **\$12.95**

## ITEMS STILL AVAILABLE

As Described in our March and April Ads  
BC-221 Frequency Meters—Used, only... **\$39.50**  
BC-375 Transmitters—New, only **\$17.50** and **\$29.50**  
BC-375 Tuning Units—New, only **\$2.50** and **\$3.00**  
A-27 Phantom Trans. Load, Anten.—Only **\$1.29**

INVERTERS MG-149 F, 24 volt DC input. Output 26 volts 250 VA, 400 cycle and 115 volt 500 VA 400 cycle. Used, Excellent Condition..... **\$ 9.95**  
PE-206 28 Volt DC input, Output 80 volts 500 VA, 800 cycle ..... **\$10.50**

**ALL EQUIPMENT IS SOLD AS NEW UNLESS OTHERWISE SPECIFIED!**

MINIMUM ORDER—\$2.00  
Prices are F.O.B., Lima, Ohio  
25% DEPOSIT ON C.O.D. ORDERS

**FAIR RADIO SALES**  
223 S. MAIN ST. • LIMA, OHIO

exactly at the point to cause breakdown, since the voltage *et* is shown equal to the critical grid voltage *ec*. When the thyatron fires, the relay is energized and the operation is completed. Interruption of the beam of light reduces *ep* and causes the relay to open.

The alternating-current photoelectric relay requires the light impulse to last an appreciable length of time for proper operation. However, many processes require a control which will respond to a light impulse lasting only a few microseconds. Units for performing this function make use of the lock-in characteristic of the thyatron. A typical circuit is shown in Fig 4. It should be noted that in such circuits provision must always be made to open the plate circuit of the thyatron to de-energize the tube, for instance, by means of an auxiliary control relay as shown in the circuit of Fig. 4. When great sensitivity and speed of response are required, the output of the phototube may be applied to the grid of a high-vacuum amplifier which, in turn, is coupled to the grids of one or more thyratrons.

*Timing controls.* Automatic timing and timing control by means of electronic circuits are generally accomplished by making use of the principle that a certain finite time is required for a condenser to accumulate a given amount of charge when a potential is applied to it through a resistance. The time required for a given amount of charge to accumulate can be varied by changing the resistance or the capacity. The circuit and mathematical relations of this process are quite well known, and are repeated briefly in Fig. 3 for convenient reference. The time required for the voltage across the condenser to reach a definite value may be used either to delay an operation for a given period after the receipt of an impulse, or to perform an operation for a given period after the receipt of an impulse, or in multiple combinations to control more complex timing sequences. Also, by allowing a condenser to charge in series with a known resistance and voltage for a period of time, and then measuring the voltage across the condenser, a measure of the charging time can be obtained.

A few basic types of electronic timing relays are shown in Fig. 6. The operation of the time delay relay shown in (A) may be explained briefly as follows: When *S* is closed, plate voltage is applied to the tube and current starts flowing. As the current increases the voltage drop across potentiometer *R*<sub>1</sub> causes a charging current to flow through resistor *R*<sub>2</sub> to condenser *C*, producing a negative bias at the grid of the tube. Thus the plate current through the tube cannot build up rapidly. After a pre-

**CALLING ALL CARS**

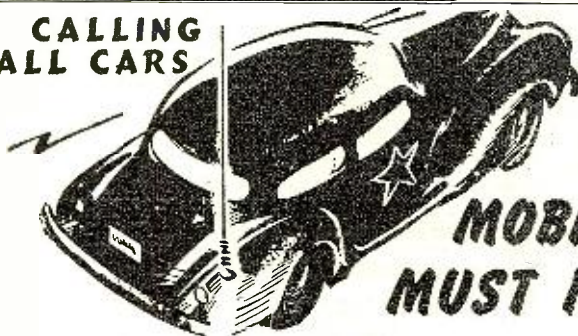

**WHERE MOBILE RADIOS MUST NOT FAIL...**

## JAMES PUSH-PULL VIBRATORS ARE MANDATORY

Over the years the performance of the James Vibrator has justly earned its outstanding reputation for maintained frequency and output. It is for this reason that so many police cars, and taxicabs require James Push-Pull construction.

Note these additional features:

- (1) Uniform accuracy of contact adjustment.
- (2) Angular positioned reed arms (patented)
- (3) Larger magnetic coil—more driving force.

New vibrator replacement guide will bring you up-to-date on vibrator interchangeability.

Ask your Radio Parts Jobber or write

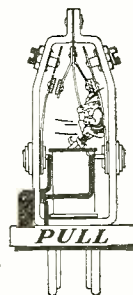
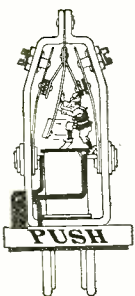

**JAMES VIBRAPOWR CO.**

3224 W. Armitage Ave.

Chicago 47, Illinois

**MONEY BACK GUARANTEE** We believe units offered for sale by mail order should be sold only on a "Money-Back-If-Not-Satisfied" basis. We carefully check the design calibration and value of all items advertised by us and unhesitatingly offer all merchandise subject to a return for credit or refund. You, the customer, are the sole judge as to value of the item or items you have purchased.

## The Model 88-A COMBINATION

# SIGNAL GENERATOR AND SIGNAL TRACER

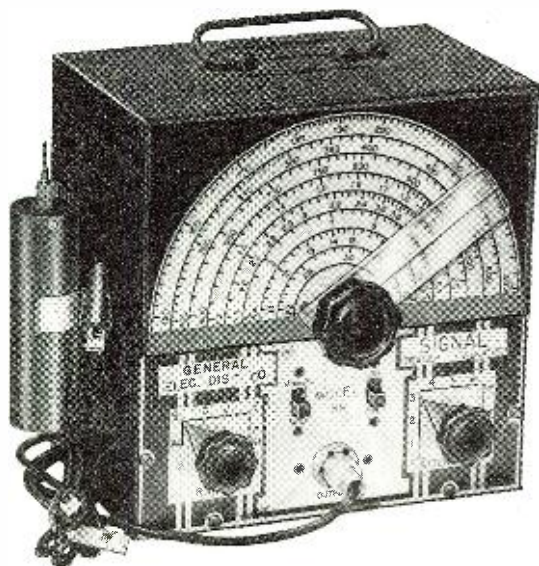

The Model 88 comes complete with all test leads and operating instructions.

Only.....

**\$28<sup>85</sup>**  
NET

The ultimate in signal tracing procedure is achieved by the Model 88, for the use of this model, enables you to use either the broadcast signal itself or the signal injected by the Signal Generator. This is especially useful of course when servicing "dead" or "intermittent" receivers. The Model 88 you will find is the greatest time-saver ever provided for by combining a full range Signal Generator and Signal Tracer into one unit; the set up time for interconnecting, etc., is entirely eliminated.

### Signal Generator Specifications:

- Frequency Range: 150 Kilocycles to 50 Megacycles.
- The R.F. Signal Frequency is kept completely constant at all output levels. This is accomplished by use of a special grid loaded circuit which provides a constant load on the oscillatory circuit. A grounded plate oscillator is used for additional frequency stability.
- Modulation is accomplished by Grid-blocking action which has proven to be equally effective for alignment of amplitude and frequency modulation as well as for television receivers.
- Positive action attenuator provides effective output control at all times.
- R.F. is obtainable separately or modulated by the Audio Frequency.

### Signal Tracer Specifications:

- Uses the new Sylvania IN34 Germanium crystal Diode which combined with a resistance-capacity network provides a frequency range of 300 cycles to 50 Megacycles.
- Simple to operate—Clips directly on to receiver chassis, no tuning controls.
- Provision is made for insertion of phones of any impedance, a standard Volt-Ohm Milliammeter or Oscilloscope.

## The New Model 606 TUBE & SET TESTER

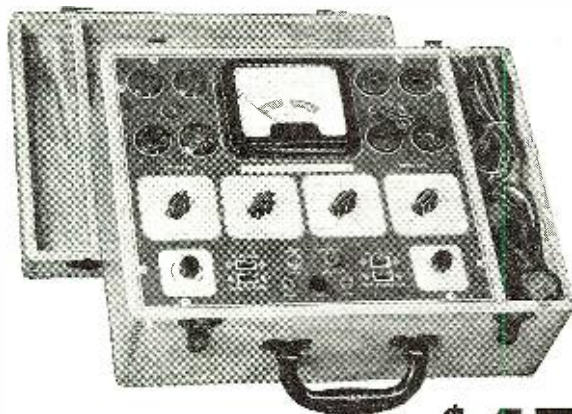

Model 606 comes housed in a beautiful hand rubbed oak cabinet complete with portable cover, test leads, tube charts, and detailed operating instructions

**\$47<sup>85</sup>**  
ONLY NET

20% DEPOSIT REQUIRED ON ALL C.O.D. ORDERS

### A COMPLETE TUBE TESTER

- Tests all tubes including the new post-war miniature octals such as the 12AT6, 12AU6, 35W4, 50B5, 11723, etc.
- Tests by the well-established emission method for tube quality, directly read on the scale of the meter.
- Tests shorts and leakages up to 3 Megohms in all tubes.
- Tests leakages and shorts of any one element against all elements in all tubes.
- Tests both plates in rectifiers.
- Tests individual sections such as diodes, triodes, pentodes, etc., in multi-purpose tubes.

### A COMPLETE MULTI-METER

- 6 D.C. VOLTAGE RANGES:  
0 to 7.5/15/75/150/750/1,500 Volts
- 6 A.C. VOLTAGE RANGES:  
0 to 15/30/150/300/1,500/3,000 Volts
- 4 D.C. CURRENT RANGES:  
0 to 1.5/15/150 Ma. 0 to 1.5 Amps.
- LOW RESISTANCE RANGE:  
0 to 2,000 Ohms (1st division is 1/10th of an ohm.)
- 2 MEDIUM RESISTANCE RANGES:  
0 to 20,000/200,000 Ohms
- HIGH RESISTANCE RANGE:  
0 to 20 Megohms
- 3 DECIBEL RANGES:  
-10 to +38 +10 to +38 +30 to +58 D.B.

**GENERAL ELECTRONIC DISTRIBUTING CO.** DEPT. RN-6 98 PARK PLACE,  
NEW YORK 7, N. Y.

# Books that TELL YOU HOW

These books offer you valuable aid for radio and television work. Use the coupon below to see copies on approval.

## 1. Introduction to Practical Radio

*By Tucker.* All radio fundamentals very thoroughly explained, including all essential mathematics. Many problems show just how to use basic formulas in practical circuit calculations and the construction and repair of radio equipment. \$3

## 2. Principles of Radio for Operators

*By Atherton.* An easy book, with hundreds of illustrations, on the operating principles of each part of radio, including antennas. All basic commercial equipment explained and illustrated. \$4

## 3. Ultra-High-Frequency Radio Engineering

*By Emery.* The fundamentals in clear, simple terms, with worked-out examples to show how theory is specifically applied in the design of circuits and the prediction of circuit performance. \$3.75

## 4. An Introduction to Electronics

*By Hudson.* A masterly explanation in non-mathematical terms of electronic theory, the construction of electronic and phototubes, and their innumerable uses today. \$3.30

## 5. Principles and Practice of Wave Guides

*By Husley.* The theory, construction and operating techniques of key devices, developed during the war, for high-frequency equipment. \$4.75

## 6. Fundamental Electronics and Vacuum Tubes

*By Albert.* A new revised edition of a standard work on the principles of electronic tubes and tube circuits, their analysis and use in both power and communication engineering. \$6

### SEE COPIES ON APPROVAL

The Macmillan Co., 60 Fifth Ave., New York 11

Please send me copies of the books checked by number below, with the privilege of returning them within 10 days without charge.

1. 2. 3. 4. 5. 6.

Signed.....

Address.....

(Please give postal zone no.)

determined time, dependent upon the adjustment of  $R_1$ , the plate current will be sufficient to operate the relay. The maximum delay obtainable is proportional to the product of  $R_2$  and  $C$ , therefore to obtain sufficient sensitivity of adjustment, resistor  $R_2$  should be changed for different time delay ranges. This circuit is capable of providing delay times between 0.05 second and 3 minutes, and once an adjustment of the potentiometer has been made, the delay remains constant within 5 per-cent.

Another type of time delay relay, which is a.c. operated, is shown in Fig. 6B. When the starting switch  $S$  is open, condenser  $C$  charges, through grid rectification, to a voltage determined by the setting of the potentiometer  $R_2$  and the magnitude of  $R_2$  and  $R_3$ . The tube cannot conduct while  $S$  is open. When  $S$  is closed, plate current does not begin to flow until the charge on  $C$  is dissipated through  $R_1$ , thus giving the required delay.

A circuit in which the closing of a switch causes a relay to close for a definite time, and then release, is shown in Fig. 6C.  $R_2$  is large enough so that normally the grid bias of the tube keeps the current below the operating level of the relay. When  $S$  is thrown to position 2, the instantaneous potential of the grid becomes that of the cathode, and the plate current of the tube rises sufficiently to close the relay. As condenser  $C$  charges, the tube current gradually approaches its normal value. When the current has decreased sufficiently, the relay again opens. The length of time the relay stays closed is varied by changing the value of variable resistor  $R_1$ . The back contacts of the switch are connected to discharge  $C$  when  $S$  is opened, so that there will be no initial charge on  $C$  at the beginning of the next operation.

*Motor Controls.* The most widely used method of electronic control for large size motors, such as are used in industrial applications, is by converting the alternating-current supply to direct current to permit the use of shunt-wound d.c. motors. Electronic controls may be used either to supply full d.c. power and control to the motor, or to regulate the speed of a d.c. motor which is driven by a motor-generator set. In applications where speed regulation is desired, but where full electronic control is not necessary, the speed regulator system shown in Fig. 1 may often be used. This arrangement consists of a d.c. motor driven by a motor-generator set whose field is energized by the electronic regulator. The speed of the motor determines the voltage developed by the speed indicating generator, whose output is then applied through an amplifier and regulating circuit to the grids of the thyratrons which supply the generator field.

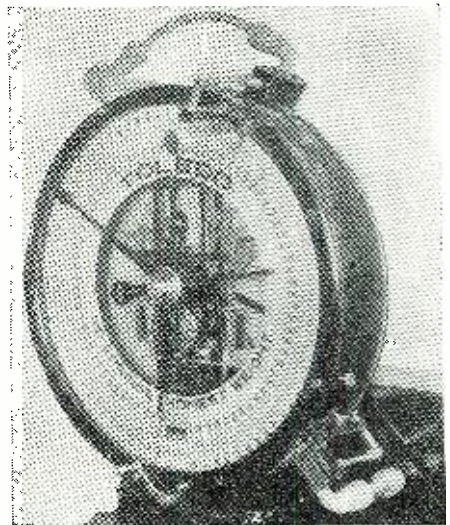

Photoelectric equipment shown mounted on a scale for automatic weighing control.

With this type of regulator the speed may be maintained to an accuracy of approximately one-half per-cent and may be adjusted over a 10:1 speed range.

Adjustable-speed systems having complete electronic control use thyatron rectifiers to supply the field and armature currents of a d.c. motor from the a.c. line. This system is generally used for the control of motors up to about five horsepower in size. A unit of this type permits continuous adjustment of motor speed over a range of at least 20:1 below the base speed of the motor, and an additional range of 4:1 above base speed by field weakening. There are several different types of control circuits for this type of service. The control circuit performs the functions of adjusting the speed of the motor, keeping the speed constant with variations in load, compensating for  $IR$ -drop in the armature, and automatic control of acceleration.

*Temperature control.* There are many methods of controlling and measuring temperatures by electronic methods. The electronic circuit in a temperature control system performs the function of converting the output of the temperature-indicating device (such as thermocouples, resistance thermometers, radiation pyrometers, etc.) into a form in which it regulates the action of the control circuit. A basic type of temperature-control system, making use of a thermocouple indicating element in a motor-balanced potentiometer arrangement for controlling the temperature of the system by means of valves or dampers coupled to the motor, is shown in Fig. 8. Any d.c. unbalance voltage between the thermocouple and the potentiometer is converted to a.c. by means of a carbon microphone driven directly from the 60 cycle line. The converted voltage is then amplified and applied to the grids of the

**STANDARD BRAND**  
**CONDENSER \$2.00**  
1 MFD 600 VOLTS DC  
152 IN BOX  
PER BOX



**HASH FILTER CHOKES**  
**FOR MERCURY VAPOR TUBES**  
CARRIES 500 MA LOAD  
59c pr.—2 pr. \$1.00

**STEP DOWN TRANSFORMER**  
PRIMARY 440/220 VOLTS  
SECONDARY 230/115 VOLTS ... **\$14.95**  
800 KVA

**SELENIUM RECTIFIERS**  
Full Wave Bridge Type

INPUT		OUTPUT		
up to 18v AC	up to 12v DC	1 Amp.	\$1.95	
up to 18v AC	up to 12v DC	5 Amp.	4.45	
up to 18v AC	up to 12v DC	10 Amp.	7.45	
up to 18v AC	up to 12v DC	15 Amp.	9.95	
up to 18v AC	up to 12v DC	30 Amp.	14.95	
up to 36v AC	up to 28v DC	1 Amp.	3.45	
up to 36v AC	up to 28v DC	5 Amp.	7.45	
up to 36v AC	up to 28v DC	10 Amp.	12.45	
up to 36v AC	up to 28v DC	15 Amp.	18.95	
up to 54v AC	up to 36v DC	.25 Amp.	.98	
up to 115v AC	up to 100v DC	.25 Amp.	2.95	
up to 115v AC	up to 100v DC	.5 Amp.	6.95	
up to 115v AC	up to 100v DC	5 Amp.	19.95	

**OIL CONDENSERS**  
NATIONALLY ADVERTISED BRANDS  
All Ratings, D. C.

2x.1mfd. 600v	\$0.35	1mfd. 2000v	\$0.95
.25mfd. 600v	.35	3mfd. 2000v	2.75
.5mfd. 600v	.35	4mfd. 2000v	3.75
1mfd. 600v	.35	15mfd. 2000v	4.95
2mfd. 600v	.35	2mfd. 2500v	2.49
4mfd. 600v	.60	1mfd. 2500v	1.25
8mfd. 600v	1.10	.25mfd. 2500v	1.45
10mfd. 600v	1.15	.5mfd. 2500v	1.75
3x.1mfd. 1000v	.45	.05mfd. 3000v	1.98
.25mfd. 1000v	.45	1mfd. 3000v	2.25
1mfd. 1000v	.60	.25mfd. 3000v	2.65
2mfd. 1000v	.70	.5mfd. 3000v	2.85
4mfd. 1000v	.90	1mfd. 3000v	3.50
8mfd. 1000v	1.95	12mfd. 3000v	6.95
10mfd. 1000v	2.10	2mfd. 4000v	5.95
15mfd. 1000v	2.25	1mfd. 5000v	4.95
20mfd. 1000v	2.95	1mfd. 7000v	2.95
24mfd. 1500v	6.95	3mfd. 4000v	6.95
25mfd. 2000v	1.05	2mfd. 3000v	3.45
.5mfd. 2000v	1.15	2x.1mfd. 7000v	3.25

**HIGH CAPACITY CONDENSERS**

2x3500 mfd.—25WVDC	\$3.45
1000 mfd.—15WVDC	.99
100 mfd.—50WVDC	.49
4x10 mfd.—400VDC	.89

**CODE KEYS TG-10**

This practice Code Keyer contains a 7 tube 110 volt 60 cycle Amplifier plus an electric eye tube. It also contains a 110 volt 60 cycle motor which runs your code tape through at the rate of 5 to 25 words per minute. The amplifier would make an excellent P.A. system and the motor would turn a timetable very nicely.

**NEW—\$24.95**

(Less Tubes)

**R5/ARN-7 RADIO COMPASS RECEIVER**

Three bands 200 to 1750 K.C. Complete with 17 tubes required. This set is ideal for conversion to home broadcast Receiver, addition to ham shack, etc. A Receiver that would be hard to pick up at this price.

Only \$31.95—NEW

USED—\$17.95

**BC 733 RECEIVER**

A Western Electric 10 tube Receiver cover 100-120 Mc. Complete with 10 tubes, crystals, etc.

New ..... \$12.95  
Used ..... \$ 7.95

**PERMALLOY SHIELDS**  
for CATHODE RAY TUBES

3" Shield ..... \$1.49  
5" Shield ..... 1.98

**TUBES (Brand New)**

Standard Brands

1N21 .....	\$0.39	F-127A .....	\$22.50
2AP1 .....	2.25	371B .....	5.95
2C40 .....	1.19	450TH .....	39.95
2D21 .....	.89	703A .....	7.95
2V3G .....	1.25	715B/C .....	12.95
2X2 .....	.84	721A .....	4.35
3AP1 .....	3.00	723A/B .....	23.50
3BP1 .....	2.95	726A/B .....	23.50
3E29 .....	2.95	801 .....	1.49
3GP1 .....	3.95	802 .....	1.98
5BP4 .....	4.94	803 .....	8.95
5CP1 .....	3.95	804 .....	9.95
5JP1 .....	11.95	805 .....	4.95
5LP1 .....	11.95	806 .....	14.95
5R4GY .....	.98	807 .....	1.15
5Y3 .....	.39	808 .....	2.95
6AB7 .....	1.20	809 .....	1.50
6AC7 .....	1.20	810 .....	6.95
6AG5 .....	1.20	811 .....	1.95
6AG7 .....	.99	812 .....	3.15
6AJ5 .....	.99	813 .....	8.95
6AK5 .....	.90	814 .....	4.45
6AL5 .....	.81	815 .....	3.95
6AQ6 .....	.81	829-A-B .....	3.95
6AR6 .....	1.29	832 .....	2.25
6BA6 .....	1.20	833A .....	39.50
6C4 .....	.67	836 .....	1.75
6C5 .....	.67	837 .....	2.50
6D4 .....	.99	838 .....	3.95
6F6 .....	.81	861 .....	69.50
6F6G .....	.67	866 .....	.75
6J4 .....	1.50	872A .....	2.50
6J5 .....	.62	884 .....	.98
6J6 .....	.89	885 .....	.98
6L6G .....	1.20	902P1 .....	8.45
6L7 .....	.98	954 .....	.75
6N7 .....	.99	955 .....	.75
6SH7 .....	.81	956 .....	.75
6SL7 .....	.91	957 .....	.75
6SN7 .....	.91	958 .....	.75
6SR7 .....	.67	959 .....	.75
7A4/XXL .....	.81	1005 .....	.69
7F7 .....	.99	1616 .....	2.95
7L7 .....	.99	1619 .....	.75
10Y .....	.98	1622 .....	1.98
15E .....	1.50	1624 .....	.90
HK24G .....	1.75	1625 .....	.75
25D7 .....	.98	1626 .....	.75
30 .....	.31	8001 .....	6.49
35T/TG .....	3.50	8005 .....	4.95
VR75 .....	.99	8011 .....	3.75
VR90 .....	.75	8016 .....	1.65
VR105 .....	.75	8025A .....	4.95
VR150 .....	.75	1654 .....	1.98
100TH .....	12.95	9001 .....	1.15
100TS .....	3.00	9002 .....	1.15
211 .....	1.25	9003 .....	.98
75T .....	2.95	9004 .....	.98
250TH .....	17.50	9005 .....	.98
257B .....	6.49	9006 .....	.98
304TH .....	9.95	F-128A .....	75.00

**GLIDE PATH RECEIVER R-89/ARN-5**

Glide Path Receiver used in the Instrument Landing System covering the frequency range 332 to 335 mc; complete with the following tubes: 7—6A15, 1—12SR7, 2—12SN7, 1—28D7, including three crystals 6497KC, 6522K, 6547KC.

Brand New ..... \$14.95  
Used ..... \$ 9.95

**TRANSFORMER—115 V 60 Cyc.**  
HI-VOLTAGE INSULATION

3710v @ 10 ma.; 2x2½v @ 3A .....	\$9.95
2500v @ 15 ma. ....	6.50
2500v @ 4 ma.; 2½v @ 2A, 6.3v @ 1 amp .....	7.95
2150v @ 15 ma. ....	5.50
1750v @ 4 ma.; 6.3v @ 3A .....	6.50
1600v @ 4 ma.; 700v CT @ 150 ma.; 6.3v @ 9A .....	7.95
1200v CT @ 400 ma.; 10v CT @ 10A .....	9.95
550-0-550 @ 150 ma.; 5v @ 3A; 2x6.3v @ 5A CT .....	7.95
525-0-525v @ 60 ma.; 925v @ 10 ma.; 2x5v @ 3A; 6.3v @ 3.6A; 6.3v @ 2A; 6.3v @ 1A .....	7.95
520-0-520v @ 120 ma.; 5v @ 2A; 6.3v CT @ 2A .....	1.98
500-0-500v @ 25 ma.; 262-0-262v @ 55 ma.; 6.3v @ 1A; 2x5v @ 2A .....	4.49
500-0-500v @ 100 ma.; 5v CT @ 3A .....	4.95
400-315-0-100-315v @ 200 ma.; 2.5v @ 2A; 5v @ 3A; 6.3v @ 9A .....	6.50
400-0-400v @ 200 ma.; 5v @ 3A .....	4.95
375-0-375v @ 400 ma. ....	4.95
350-0-350v @ 150 ma.; 5v @ 3A; 6.3v @ 6A; 78v @ 1A .....	4.95
350-0-350v @ 45 ma.; 675v @ 5 ma.; 2½v @ 2A; 2x6.3v @ 1A; 6.3v @ 2½A .....	4.95
350-0-350v @ 80ma.; 6.3v @ .6A; 6.3v @ 3.75A; 2x5v @ 3A .....	3.98
385-0-385-550v @ 200ma.; 2½v @ 2A; 5v @ 3A; 3x6.3v @ 6A—PRL 110/220 .....	7.95
350-0-350v @ 150 ma.; 5v @ 3A; 6.3v @ 7.5A; 6.3v @ 3A .....	4.95
350-0-350v @ 35 ma. ....	1.49
340-0-340v @ 300 ma.; 1540v @ 5 ma. ....	5.95
335-0-335v @ 60 ma.; 5v @ 3A; 6.3v @ 2A; 0-13-17-21-23v @ 70 ma.—PRL 110/220 .....	4.95
325-0-325v @ 120 ma.; 10v @ 5A; 5v @ 7A 3.49	
300-0-300v @ 65 ma.; 2x5v @ 2A; 6.3v @ 2½A; 6.3v @ 1A .....	3.49
250-0-250v @ 100 ma.; 2x6.3v @ 4A; 6.3v @ 5A; 6.3v @ 1A .....	4.95
120-0-120v @ 50 ma. ....	.98
80-0-80v @ 225 ma.; 5v @ 2A; 5v @ 4A .....	3.95
24v @ 6A .....	3.50
13.5v CT @ 3.25A .....	2.95
3x10.3v @ 7A; CT .....	9.95
12.6v CT @ 10A; 11v CT @ 6.5A .....	7.95
6.3v @ 10A; 6.3v @ 1A .....	3.50
6.3v @ 1A; 2½v @ 2A .....	3.45
6.3v @ 2½A; 6.3v @ 2A; 2½v @ 2A .....	5.95
6.3v @ 25A; 6.3v @ 3A; 5v @ 12A; 6.3v CT @ 9A .....	4.95
5v—190A .....	17.50
3v—115A .....	14.95
220v to 110v @ .75 kv. ....	2.98
6.3v CT @ 3A; 5v CT @ 4A .....	4.25

**FILTER CHOKES**

HI-VOLTAGE INSULATION

10 hy @ 400ma. ....	\$4.95	325 hy @ 3ma. ....	3.49
8 hy @ 300ma. ....	3.95	1 hy @ 800 ma. ....	14.95
25 hy @ 160ma. ....	3.49	10 hy @ 250ma. ....	2.49
12 hy @ 150 ma. ....	2.25	10 hy @ 200ma. ....	1.98
12 hy @ 100ma. ....	1.39	10/20 @ 85ma. ....	1.59
30 hy @ 70ma. ....	1.39	15 hy @ 125ma. ....	1.49
.05 hy @ 15 amps. ....	7.95	15 hy @ 100ma. ....	1.39
.1 hy @ 5 amps. ....	6.95	3 hy @ 50ma. ....	.29
4 hy @ 600ma. ....	5.95	30 hy Dual @ 20ma 1.49	
200 hy @ 10ma. ....	3.49	8/30 hy @ 250ma. ....	3.50
600 hy @ 3ma. ....	3.49	10 hy @ 100ma. ....	1.29

**ATTENTION!**

**INDUSTRIALS — LABS — SCHOOLS — AMATEURS**

Let us quote on components and equipment that you require. We have too many items to be listed on this page. Place your name on our mailing list now for new catalog.

**RADIO HAM SHACK Inc.**  
63 DEY STREET • NEW YORK 7, N. Y.

# WELLER

## SOLDERING GUN

Time Saving-Money Making Features

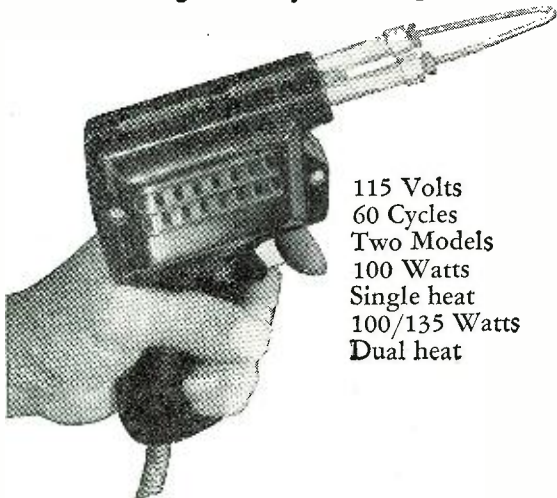

115 Volts  
60 Cycles  
Two Models  
100 Watts  
Single heat  
100/135 Watts  
Dual heat

See your radio parts distributor or electrical wholesaler. Or write direct for bulletin.

**WELLER Mfg. Co.**  
810 Packer St. • Easton, Pa.

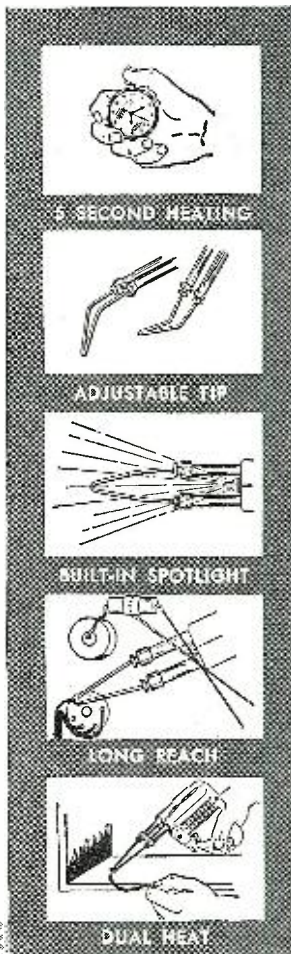

thyratrons and, depending upon the polarity of the d.c. unbalance voltage, one or the other of the tubes will fire and drive the motor in the proper direction to rebalance the circuit. The anode of each thyatron is connected directly in series with one of the field windings of a d.c. series-wound commutator motor, which is coupled to the potentiometer slider and may be directly coupled to a valve or damper that controls the operation of the heating or cooling system. This type of control system may be used for other types of applications by eliminating the balancing motor. Then, instead of the motor windings, two magnetic relays would be connected in the plate circuit of the thyratrons, one to control a heating system and the other a cooling system, or to turn a heater on and off.

For high temperatures, the radiation pyrometer is the most suitable measuring device. The relation between the temperature of an object and its radiation has been thoroughly investigated, and is determined according to definite mathematical formulas. The amount of radiant energy may be determined quantitatively by either a thermocouple or a photocell, which has previously been calibrated in terms of temperature by means of an incandescent filament whose temperature characteristic is known. For most control purposes the photoelectric pyrometer is usually preferable to the thermocouple type, since it is much more rugged, has a very rapid response, and its output may be applied directly to the vacuum tube control circuit. A typical curve of relative phototube response is given in Fig. 5. There is no upper limit to the temperatures which can be measured by pyrometers, while the lower limit may go as low as about 110 degrees C depending upon the particular design of instrument. The photoelectric pyrometer, when used for control purposes, consists essentially of a simple photoelectric relay controlled by the amount of incident illumination—the output of the phototube being amplified by a stable vacuum-tube amplifier whose output drives the control circuit. Photoelectric pyrometers of this type have been used with excellent results in conjunction with a wide variety of control equipment for many types of applications, particularly in controlling the temperatures of furnaces and incandescent materials.

*Electronic testing of materials.* Various types of electronic circuits can be used for testing different characteristics of materials. Two basic circuit arrangements for determining characteristics of materials under test by electronic methods are shown in Fig. 7. The circuit in A makes use of magnetic induction principles applied to the testing of metal

**SCOOP SCHUH DOES IT AGAIN!**

**NARROW BAND F. M. Noise Free Reception!**

Only adapter for BC-348 receiver using 915 KC IF. Also made in 455-465 KC Model 39/4x4 1/8x1 1/2". Completely Chromium Plated. Easily mounted. Uses 6AK5 limiter and 6AL5 discriminator. Instructions supplied. Price (less tubes) **\$10.95**

6AL5 tubes ..... 90c each  
6AK5 tubes ..... 90c each

**Trade in your AM modulator on Sonar NBFM equipment. Liberal Allowance.**  
BC 610 Components ... Modulator Decks Less modulation transformer. Completely wired. **\$14.95**

**RIA20 Powerpack** converts BC312 receiver to AC operation. Fits in dynamotor compartment. A so for external use with BC348, 314, Z24, and used with BC696 and 459 as EGO. Input 110-120 VAC. 60 cycles. Output 250 VDC @ .95 MA, 12V @ .5 A, 12V CT @ 3A. Shipping weight, 12 lbs. **\$7.95**

11Hy. .600 amp. Chokes. **\$7.95**

**1/4" PORTABLE ELECTRIC DRILL**  
Steel tubing, polished chrome plated housing. Black finish, die-cast handle and gear case. Pistol grip with trigger switch. 72 in. rubber cord, plug. Operates on 110-120V AC or DC. 60 cycle for less. No load speed, 1700 R.P.M. Length 11 1/2 in. Each **\$14.50**  
Lots of 3 ..... **13.50**

**DRIVER TRANSFORMERS**  
2A3 to 100 TH Tubes. **\$1.95**

**ELECTRONIC FLASH KIT**  
Portable. Can be used on batteries or AC—complete with wet batteries and built-in charger. Case and sub panel supplied. Ideal for commercial use. 250 flashes from batteries without recharging. Instructions supplied.  
Less Argon Bulb **\$69.00**  
Write for FREE Merit Catalog listing all transformers and chokes

TERMS: 30% with order. Balance C.O.D. Shipt. F.O.B. Chicago

**SCHUH'S RADIO PARTS**  
1253 Loyola Avenue • Chicago 26, Illinois

**WAR SURPLUS BARGAIN KIT**

**4 LAMPS ELECTRONIC PHOTO FLASH EQUIPMENT, THE FAMOUS "MODEL 1503" AIRCRAFT FLASH UNIT.**

This powerful high quality equipment was made for the U.S. Air Corps and will be shipped to you brand new in original boxes.

- **THE POWER SUPPLY** is built into a beautiful gray finished case, with all connectors, relay control, 2 condensers each 2000 Volts, 50 M.F.D. light output 110 Watts seconds, can be used with any 12 Watt battery as a professional studio flash equipment. The power pack alone is worth more than the price we are asking for the complete unit.
- **THE FOUR HIGH SPEED FLASH TUBES** are plastic sealed, unbreakable, 12 million peak lumens light output for more than 15,000 flashes.
- **IN ADDITION TO THIS WE SUPPLY:** aluminum reflectors, transformer, connectors, connecting cords, spare parts, diagram and instructions on how to use it for battery or on how to convert the unit for 110 Volt A.C.
- **IT IS THE BEST VALUE IN WAR SURPLUS MATERIAL. WHILE THEY LAST.**

**\$68.00**  
PRICE complete

**CINEX INC. Dept. N.R.**  
165 West 46th St. New York 19, N. Y.

objects. It consists of a simple a.c. bridge with a voltage detector to indicate the amount of unbalance. Two identical coils form two arms of the bridge; and two resistances, one of which may be variable, form the other two arms. One of the two coils serves as the reference coil, and the other as the test coil into which the metal parts are inserted for testing. Variation in the metallurgical properties of the specimen inserted in the test coil will cause the core loss and inductance to vary, thus unbalancing the bridge. To use this circuit for testing, two standard parts must first be positioned in the coils and the bridge balanced. Then the reference specimen is left in the reference coil, the part to be tested inserted in the test coil, and the amount of unbalance measured by the voltage detector. If the indication is within previously determined acceptance limits the piece is accepted; if the indication is outside these limits it is rejected. This simple magnetic induction principle is the basis also of a number of more complicated commercially developed materials testers.

Measurements of resistivity and power factor have been found of great value in determining properties of dielectric materials and objects. These measurements can conveniently be performed by means of the simple bridge circuit shown in (B) of Fig. 7, and the procedure is similar to that used in magnetic induction testing. In this case the test specimens are made the dielectric material in two identical test condensers, and any difference in resistivity and power factor is measured by the bridge circuit. Resistivity and power factor measurements furnish a convenient practical method for determining the moisture content of a large variety of both solid and liquid non-conducting materials, and a number of electronic moisture indicators have recently been developed which depend essentially upon measurement of the power factor of the material.

#### Servicing

Because of the great cost of production stoppages due to equipment failures, *preventive maintenance* of industrial electronic equipment is of much greater importance and much more desirable than repair after a breakdown which may interrupt production. Electronic control circuits for industrial applications are therefore ruggedly constructed, conservatively rated, and have a minimum of moving parts to break or get out of adjustment. However, they are nevertheless subject to damage in operation due to such factors as vibration which may loosen connections or break wires, tube failures, relay contacts requiring cleaning or getting out of adjustment, and dust and dirt which reduce the effectiveness of the optical systems of photoelectric devices.

June, 1948

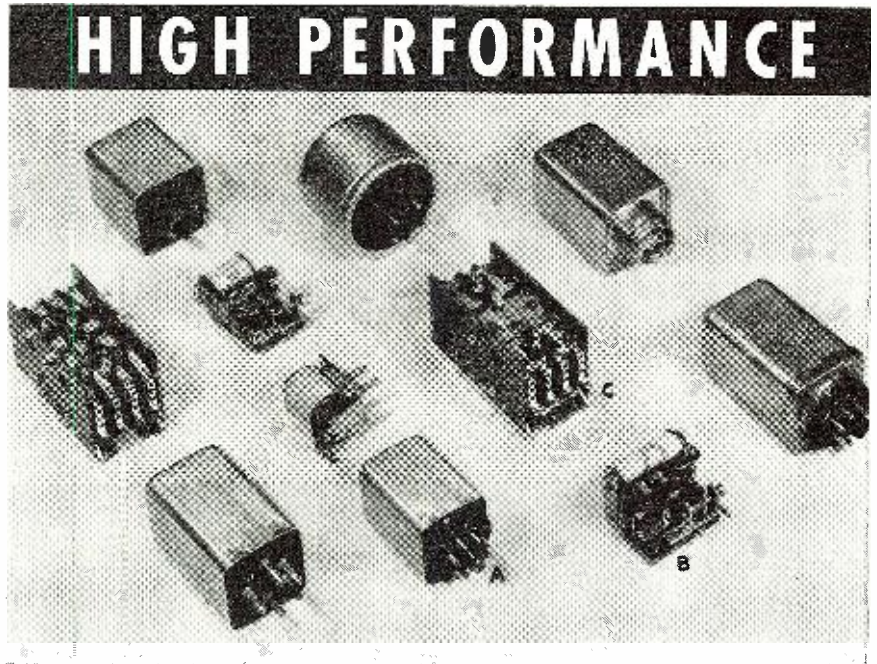

### SPECIAL PURPOSE STANDARD RELAYS

In the preparation of relay specifications for particular functions, cases frequently arise which appear to have wide-spread occurrence.

We have adopted a policy of listing certain of these special purpose relay specifications as standard, especially when the performance results are exceptionally good.

#### FOR HIGH-SPEED KEYING OR DIALLING

on low to medium dc power, 50-250 volts supply:

Type 41RO-72327-X (A in cut) List \$3.80

- SPDT Relay, 2000 ohm dc coil
- Operate, 4 ma. or less; 5-10 ma. normal current
- Contacts: Tungsten (standard) for 0.5 amp or less, moderate to high voltage, long life; fine silver for higher current, lower voltage, moderate life (e.g. 5,000,000).

Typical timing: Milliseconds

Final coil current 7.5 ma *:	source 50V	100V	200V
Open N.C. contact	4 ms.	2.5 ms.	1.5 ms.
Transfer to N.O.	1.5	1.0	.7
Open N.O. contact	1.0	1.0	1.0
Transfer to N.C.			
(Includes Bounce)	3-5	3-5	3-5

\*Sufficient external series resistance employed to limit current to this value.

Write for additional data  
and timing curves

### AC—DC—POLAR TYPES



**Sigma Instruments, Inc.**  
*Sensitive* **RELAYS**

96 CEYLON ST., BOSTON 21, MASS.

- HIGH SPEED
- LONG LIFE
- LOW INPUT
- PRE-ADJUSTED

# 30,000 SUCCESSFUL RADIO SERVICE- TECHNICIANS READ



## EVERY MONTH

RADIO MAINTENANCE today fills a breach that has existed in the radio field for a long time. Already 30,000 technicians read RADIO MAINTENANCE every month because it is devoted entirely to the radio servicemen.

The RADIO MAINTENANCE staff specializes in the preparation of articles on every phase of Radio Maintenance in series form which may be filed and used for reference. The leading articles cover everything for the radio servicemen on Television, FM and AM; Test Equipment; Electronic Appliances; Tools; Antennas; Alignment; Troubleshooting; Repair; Construction; Pick-Ups and Sound Amplification and Reproduction Equipment. Also, in RADIO MAINTENANCE each month there are departments on hints and kinks, the latest news of the trade, review of trade literature, radiomen's opinions, new products and news from the organizations. All articles are presented in a step-by-step precision style, clearly illustrated with schematics, accurate photographs, specially prepared drawings, white on black charts, color diagrams, isometric projection and exploded views.

Binders in beautiful green simulated leather are now available for your RADIO MAINTENANCE magazine. See the current issue for details. RADIO MAINTENANCE is not sold on newsstands.

RADIO MAINTENANCE MAGAZINE RN-6

460 Bloomfield Avenue,  
Montclair, N. J.

Please send me RADIO MAINTENANCE for  
( ) 2 years, \$5 ( ) 1 year, \$3  
( ) Payment enclosed ( ) Bill me later

Name .....  
Address .....  
City—State .....  
Occupation .....  
Title .....  
Employed by .....

\* Independent Serviceman—Dealer Serviceman—Service Manager—Dealer—Distributor—Jobber.

**BOLAND & BOYCE INC., PUBLISHERS**

The basic procedures for maintaining electronic equipment in good working order are essentially the same as the procedures used to keep any piece of mechanical or electrical equipment working. Careful periodic inspections should be made for surface defects, and any which are found should be corrected immediately. Necessary repairs or adjustments should be made, and the equipment cleaned thoroughly and tested under actual operating conditions as a final check. The procedures which should be followed in the maintenance of electronic control circuits are closely analogous to the methods used in the maintenance of commercial broadcast equipment, where loss of air time due to equipment failures may result in considerable expense to the broadcast station.

Although industrial electronic equipment varies in electrical and mechanical design for different applications, a few simple rules are helpful in keeping all types of equipment in proper operation:

- Carefully read and follow instructions issued by the manufacturer.
- Tubes should be carefully checked before being put into regular service. (Receiver type tubes may be checked in any standard commercial tube tester. Phototubes may be checked in a specially constructed test instrument containing a variable light source, a polarizing voltage and a vacuum-tube voltmeter—and should be tested under the most unfavorable light conditions which will be encountered in service. Thyratrons may be checked in an instrument which measures total emission and plate voltage necessary to fire the tube with a given value of grid bias. Other tubes such as cathode-ray tubes, ignitron rectifiers and high-power oscillator tubes must be checked in the circuits in which they are used.) All tubes should be given a final operational check in the equipment in which they are used.
- Inspection and test plate current of tubes at regular intervals, preferably every month or oftener if they have 24-hour duty service.
- Keep a record of the plate current. Be sure the filament or heater voltage is the same each time the tube is tested.
- When the plate current begins to fall off, or there is any other indication that tube performance is falling off, replace the tube before it goes bad.
- Inspect connections and mechanical parts for looseness, and tighten them. Vibration tends to loosen electrical connections as well as mounting bolts which hold such heavy parts as transformers, reactors, and filter condensers in place. If frequent tightening is found necessary, the panel should be shock mounted to reduce the vibration.
- Keep the installation free from dirt and moisture.

# RADIO TUBES

For immediate shipment

R.M.A. Guaranteed

Below Distributor Costs

Individually Sealed Cartons

Type	Price
6K6GT	.40
6K5GT	.46
6V6GT	.46
6SA7GT	.46
6SJ7GT	.46
6SK7GT	.46
6SQ7GT	.46
6X5GT	.40
12SA7GT	.46
12SQ7GT	.46
12SK7GT	.46
12SJ7GT	.46
35L6GT	.40
35Z5GT	.32
50L6GT	.46

25% DEPOSIT REQUIRED ON C.O.D.

10% DISCOUNT ON LOTS OF 50 OR MORE

2% C.O.D.

**RAVAC ELECTRONICS CORP.**

432—4th Avenue  
New York 16, N. Y.

- ARC-5 rcvr 190-550kc w/dyn loop or ant input, good cond. w/tubes.....\$6.95
  - ARC-5 2-sect rcvr or xmitter racks.....\$2.49  
plugs for ARC-5 or SCR-274n..... .45
  - TBY xmitter or rcvr w/tubes 27-80m \$14.95
  - 4-SECT OIL COND. 8-8-8-8 mfd 600v, new, w/clamps. A real buy.....\$1.95
  - RL-42 Ant real excellent beam rotator wks on 8-24vac reversible, new.....\$1.95
  - SUPERIOR MODEL 670 SUPER-METER tests volts, ohm, milliamps, capacity, reactance plus decibel measurements w/leads \$28.40
- 25% deposit FOB LA send full amount, save COD charge. Calif. buyers send tax. All items subject to prior sale. Rush your order.

**V & H**

**RADIO & ELECTRONIC SUPPLY**

2033 WEST VENICE BLVD.

LOS ANGELES, CALIF.

Phone RE 21652

**25,000**

repaired loud speaker paper cones PROVE, CONE PATCH cement saves you TIME and MONEY, CONE PATCH musical cement positively does not warp cones. Reproduces all musical vibrations, is almost invisible and stronger than new. 100% satisfaction guaranteed or money refunded. Postcard brings folio. \$1.00 postpaid. Inquiries invited from salesmen and jobbers.

RADIO RESEARCH PRODUCTS—W. Malloy, Mgr.  
6417 Harper Avenue Chicago 37, Illinois

## NEW WIRE RECORDER HEAD

High quality, plug in armour type.

Record — erase — reproduce

\$2.50 ea.—50c with order—balance C.O.D.

**RECORDING DEVICES COMPANY**

36 N. Elizabeth St. Lombard, Ill.



# HAMS! EXPERIMENTERS! Look at these EXCLUSIVE "G & G" BUYS!



### TERRIFIC VALUE! 24-VOLT STORAGE BATTERY, BRAND NEW! 11-AMP. HRS.

Made by Delco. 12 cells, heavy duty, very rugged. Shipped dry, uses standard sulphuric acid electrolyte.

VERY SPECIAL... **\$14.95**

**SPECIAL! 24 VOLT DELCO 12-CELL STORAGE BATTERY**  
17 ampere-hours. Only a few left at **\$16.95**

**GOULD 6-VOLT STORAGE BATTERY**  
Navy Standard, Black Rubber Case. BRAND NEW. 15 Amp. Hour  
Rating ..... **\$4.95**



**WILLARD 6-VOLT STORAGE BATTERY**  
Similar to above but in transparent plastic case. Real value at..... **\$4.95**

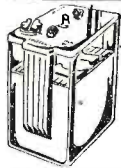

### WILLARD 2-VOLT STORAGE BATTERY 20 Ampere-Hours

Exact replacement for GE portables — brand new. Each ..... **\$1.49**

**WILLARD 6-VOLT STORAGE BATTERY**  
27 amp. hrs.

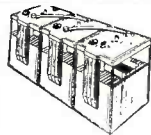

3-cell battery, transparent plastic case, very specially priced. **\$4.50**

**1-QUART BOTTLE BATTERY ELECTROLYTE**  
Made by Willard, for above storage batteries. 1 qt. sufficient for two 2-volt cells. Hermetically sealed. SPECIAL. per qt. bot. **95c**

**7-PRONG 2-VOLT RADIO VIBRATOR** for Portable and Farm Sets Replacement for GE LB 530. .... **\$1.65**

### BC367 Interphone AMPLIFIER

Here's a terrific value for you! Unit comprises a 2-watt audio amplifier with input and output transformers; 600 cycle audio oscillator for signalling. Housed in compact metal case. Originally built for Signal Corps. Complete with two 6V6 tubes. Slightly used, your cost ..... **\$4.95**  
BRAND NEW, in original carton..... **\$6.95**

### HANDMIKE T-17

Shure model T-17 mike 200-ohm carbon single button, with press-to-talk switch, 5-ft. rubber cord and plug. BRAND NEW, individually packed, lots of 3 ea. **99c**



### HANDSET

Cradle-type handset with butterfly switch, unbreakable black plastic, 4-ft. 3 wire cable. BRAND NEW, individually packed, each ... **\$2.75**

**ASTATIC R-3 CRYSTAL HANDMIKE**, with 6-ft. R.C. Mike Cable..... **\$4.50**

### HEADPHONES—All Brand New!

Individually packed, complete with phone plug. HS-33 600 ohms, in lots of 3..... **\$2.45** each  
HS-23 2000 ohms, in lots of 3..... **1.85** each  
HS-30, With earplugs, LOTS OF 12..... **44c** each

**118 MMFD TRANSMITTING CONDENSER** Very Special Ham Value! 31 plates, Airgap .109", overall length 4 1/2", ceramic insulation, normal list price \$11.85..... each **99c**

**BEEDE DC METER**, new, black bakelite case, 3" round 0-1000DC Ma. Special **\$1.95**

**SPECIAL 409.5 KC CRYSTAL** lots of six ..... each **29c**

## BC-645 XMTR RECEIVER 15 TUBES 435 TO 500 MC

BRAND NEW!  
**\$9.75**



The electronic equipment that saved many lives in the war. Set can be modified to use for 2-way communication, voice or code, on following bands: ham band 420-450 mc, citizens radio 460-470 mc, fixed and mobile 450-460 mc, television experimental 470-500 mc. 15 tubes (tubes alone worth more than sale price!): 4-7F7, 4-7H7, 2-7E6, 2-6F6, 2-955 and 1-WE316A. Now covers 460 to 490 mc. Brand new BC-645 with tubes, less power supply in factory carton. Shipping weight 25 lbs.

**2 for \$18.95**

PE-101C DYNAMOTOR for above BC645..... **\$2.95**

### UHF ANTENNA ASSEMBLY

A rare bargain for UHF experimenters! Consists of 7 aluminum rods, in calibrated lengths as follows:

3 rods 12" long for 200-247 Mc  
1 rod 9 1/2" long for 248-313 Mc  
1 rod 7 1/2" long for 312-400 Mc  
1 rod 5 1/2" long for 402-517 Mc  
1 rod 4 1/2" long for 512-667 Mc  
All rods in handy fabric pouch. Two UHF coaxial coupling insulators included.  
\*2 of these rods suitable for BC-645 Transceiver

All BRAND NEW, in original carton, set of 7 rods, only **\$2.45**

### McElroy Automatic KEYS

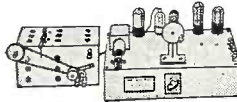

Suitable for keying transmitter, or for code practice. Has photoelectric cell and sensitive relay. Variable speed motor operates on 110 volts 60 cycles AC, or DC, complete with 2-117Z6 and 1-117L7 tubes. **\$14.95** your cost

### Down Come Prices! CATHODE RAY TUBES

All Brand New, in Original Cartons



5BP1 Lots of 4, each ..... **\$1.79**  
5BP4 Lots of 4, each ..... **1.95**  
3FP7 Lots of 4, each ..... **1.49**

304TL Eimac, each ..... **\$2.95**  
GE-211 Each ..... **1.22**

### DC AMMETER 0-15 Amps



Terrific buy at this price! Has 3 1/2" easy-reading scale with 75 divisions. Two binding posts. Black plastic case 1 1/2" x 5 1/4" x 2 1/4". Rubber covered test clip leads included, all in black metal carrying case with hinged cover. BRAND NEW. Wonderful for automotive, battery charging, and general test work. Value \$25.

All yours for only..... **\$3.99**



**RCA AYT-112A AIRCRAFT XMTR**  
2500 to 6500 Kc, 6 tubes, compact, powerful, operates on 12 volt source. Less crystal. Brand New **\$12.95**

### RADIO RECEIVERS

All Brand New in Original Cartons  
BC-454A 3.1 to 6 Mc complete with tubes **\$6.95**  
40-WATT VFO DRIVER  
BC-457A 4 to 5.3 Mc..... **\$5.95**  
BC-458A 5.3 to 7 Mc..... **6.95**

### QUANTITY PRICES

Inquiries welcomed from institutions, wholesalers, dealers, large users ... Phone, write, wire for quantity prices.

Please include 25% Deposit with order — Balance C.O.D. Minimum order \$3.00. All Shipments F.O.B. Our Warehouse N.Y.C.

**G & G** GENUINE MAJESTIC  
**RADIO PARTS SERVICE**  
53 VESEY STREET · NEW YORK 7, N.Y.

## SENSATIONAL Smash Value!

### COMPLETE I.F.F. Equipment RC-188-A

Bargain opportunity of a lifetime! This I.F.F. equipment originally cost about \$20,000... now buy it for a tiny fraction of cost! Easily converted for Television. Complete assembly consists of Control unit with 5" C.R. Tube, transmitter and receiver assembly (157 to 185 Mc). Indicator unit, and Power Supply (450 watts), operating on 110 volts, 60 cycles AC. All assembled, ready to operate. 62 Tubes included: 8-6V6GT, 9-6SL7GT, 14-6SN7GT, 1-5CP1, 2-9006, 1-6Y6G, 2-6E5, 1-100TH, 2-6J5, 2-2C26, 1-3E29, 1-6H6, 1-6AG5, 3-6AK5, 1-6C4, 3-2X2, 1-6X5GT, 3-5U4GT. Overall size 55" high, 28" wide, 20 1/2" deep. Shpg. weight 855 lbs. Your cost, complete, BRAND NEW, in original packing... **\$195.00**

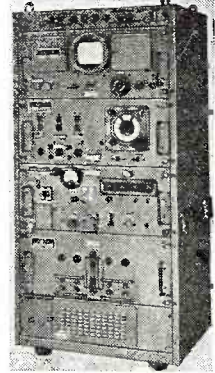

### P-M SPEAKERS

4-inch lots of 4 **\$1.15** each  
5-inch lots of 4 **1.25** each  
6-inch lots of 4 **1.75** each  
8-inch lots of 4 **2.75** each  
10-inch lots of 4 **3.60** each  
12-inch lots of 4 **4.85** each  
all less transformer.



### WALL BAFFLE

for 12" to 15" Speakers

Solidly built walnut wood baffles, specially priced while stocks last. Perfect for theatres, auditoriums and general P.A. work. Lots of 4, each **\$2.75**



### REPLACEMENT RADIO CABINET

Here's an exceptional bargain for you! This attractive, well-built walnut wood cabinet is drilled for 3" airplane dial and standard receiver controls. Takes up a 6" speaker. Overall size 12 1/2" wide, 17 3/4" high, 7 3/4" deep. Actual value \$10.00. It's yours, while stocks last, at only ..... each **\$1.29**



### TU-75-B XMTR TUNING UNIT

Hams! You'll want this! Tuning unit uses 3-815 tubes. Has 5 tuning condensers, coils, all components easily converted to 2-meter rig! BRAND NEW, in original carton, with tubes, all yours for..... **\$14.95**

### Western Electric Field Phone Set EE-8

Leather case, with handset, generator, ringer, etc. Requires 2 flashlight cells. Wonderful value! Good Used ea. ... **\$8.50**

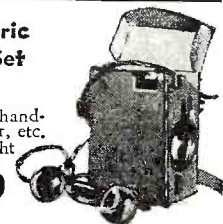

# Chicago

## INSTRUMENTS

### Quality at Low Cost!



#### POCKET VOLT-OHM-MILLIAMMETERS FOR ONLY \$5.25

Anyone can now own a good volt-ohm-milliammeter. There is a Chicago V.O.M.A. priced at only \$5.25. Chicago "Featherweights" that slip easily into the pocket are the original miniature radio test instruments. They are popular throughout the world.

For years, Chicago Instruments have given radio men accurate, dependable service. And because of simplicity of design and freedom from "gadgets" we have been able to hold down prices to a fraction of what you would normally pay for instruments of similar quality.

Chicago Instruments are available in a variety of ranges and sensitivities. You may see them at your Suppliers or get the complete details by writing for Bulletin No. 10.

CHICAGO INDUSTRIAL INSTRUMENT CO., 536 W. ELM ST., CHICAGO 10, ILL.

8. If trouble from burned-out tubes is common, keep a record of filament voltage and of variations in line supply voltage over a 24-hour period. Use a recording voltmeter if one is available.

9. Inspect water-cooling and vacuum-pumping systems periodically.

10. Maintain free circulation of air about the device and particularly about the tubes.

11. As most bulbs become very hot during operation, do not let them come in contact with any metallic object or be subjected to drops or spray of liquid. Cooling air streams should be distributed over the entire tube, not concentrated on one spot.

12. Clean lenses and mirrors of photoelectric equipment regularly, using lens tissue.

13. Avoid extraneous light to phototubes, directly or by reflection.

14. Inspect relays and contactors more frequently than similar devices used with motors. The former operate at higher speed and more often than the latter.

15. Indicating meters should be inspected at periodic intervals and any abnormal readings investigated immediately. Encourage machine operators to report any irregularities in the performance of their machines and associated controls.

Preventive maintenance consists primarily of constant attention to small details which indicate when equipment may break down. If the above steps are taken, the equipment will remain in the best operating condition that can be attained by preventive maintenance, and expensive work stoppages will be kept to a minimum.

However, in spite of all the precautions which can be taken, equipment will inevitably break down. When this happens, swift and accurate trouble shooting together with the necessary adjustment, repair, or replacement must follow as soon as possible. The procedures which must be employed in servicing industrial electronic circuits are essentially the same as those which are followed in servicing any other type of electronic circuit. Power supplies should be checked first to insure that blown fuses or some other defect in the power supply are not preventing power from being applied to the control circuit. If the power supply is functioning properly, the trouble should then be looked for in the control circuit from the symptoms of the equipment failure, or by inspection of the equipment and measurement of the operating voltages and currents. The value of keeping records which show all important voltage, current, resistance, and capacitance values is demonstrated on such occasions.

With the applications of electronic controls constantly increasing in a wide

## NESCO ELECTRONICS Presents

**TU-10B or TU-5**  
Tuning unit for BC-375 - a terrific parts value with a metal case.  
Band New ONLY **\$2.10**

**REMOTE CONTROL UNIT RM-12**  
Has built-in EE-5 with hand set, 3" DB meter and remote control unit. Used, **\$9.95** very good

**BC-306**  
Antenna loading unit for BC-375. Brand New. Another parts value **\$1.50**

**CD-605**  
A two-foot cord with a PL-55 plug; with low to high impedance xformer for your headset **39c**

**AN/CRW-2 V.H.F. RECEIVER**  
6 tubes; 3-6SL7, 1-6SN7, 1-6SG7, 1-6J5. Dynamotor, plug-in coils and sensitive relays. This was one of the Army's "Secret" V.H.F. remote control receivers. A thousand and one uses. Like new in a metal case. Each **\$5.95**

**PLUGS and Connectors**  
Your choice for ONLY **49¢** each

20% deposit required on all C.O.D. orders

**BC-733D**  
A 10-tube superhet receiver for lateral blind landings guidance (CAA type certificate) (TC-1045) Excellent condition 108-110MC. Tube complement: 1-12SQ7; 2-12SR7; 1-12A6; 1-AH7GT; 2-12SG7; 3-717A-tubes alone worth more than this low price of **\$4.95** EACH

**SHOCK MOUNTS**  
4 each of 3 sizes—small, medium and large. New. ALL FOR ONLY **99c**

**RM-29**  
An Ideal portable field telephone. Complete in a rugged steel case for years of wear. Ringer circuit and TS-13 handset. No leather case to deteriorate. Compact 5"x8"x9"—also used as remote control on SCR-284. Lt. wt. 13 lbs. Excellent condition only ea. **\$9.95** 2 for **\$18.95**

**WILLARD**  
2 Volt Storage Battery  
Brand new, spill-proof, use standard electrolyte. Suitable for all farm sets and portables. Built-in hydrometer. SPECIAL **98c** EACH

**1625 TUBE**  
Army-Navy Standard  
This is a 12 V filament 807 tube. A tremendous buy at **29c** Ea. 4 for **\$1.00**

**SOLDER**  
One pound spool, highest grade compound of tin and lead, rosin core, on metal spool. Brand New. **69c**  
A REAL BUY, Ea. **\$3.95** 6 spools

**ANTENNA RELAY UNIT BC-442**  
0-10 Weston Meter and 30MMF 3000 V. vacuum condenser change over unit, with mounting I.T-229. Brand New. **\$1.95** Ea. ONLY

For the SCR-522.....PLQ-167  
PL-172  
PLQ-255  
For the BC-733.....PL-3108-22-4S  
For your 269-F Radio Compass inverter.....PL-147, 148, 151,  
For the SCR-274-N.....152, 154A, 155, 258  
For the RC-375.....PL-59-PL-61-PL-64  
For the ART-13.....U-6U U-8U U-10U  
Coax Fittings.....PL-258 (83-1J)—PL-259A  
(83-1SP)—UG-21U—UG-22U

division of  
**NATIONAL EQUIPMENT & SUPPLY CO., INC.**  
806-8-10 W. Jackson Blvd. Chicago 7, Ill. MONroe 9504

variety of industrial operations in factories and plants of all sizes and types, the radio repairman can find an important place in the installation and maintenance of industrial electronic equipment. There are a great variety of circuits available for performing many different control functions, and an installation in a single plant or factory may contain equipment made by a number of different electronic manufacturers. If the complete plant installation does contain electronic control equipment supplied by different companies, no one manufacturer will supply complete maintenance service. Furthermore, not all of the companies supplying electronic controls are in a position to service their equipment throughout the country, particularly on short notice in emergencies, and the size of the installation may be too small to warrant the fulltime employment of an electronic maintenance department plus all the necessary equipment. Time is a major factor in keeping down the expenses involved in any breakdown of production, and since local radio repairmen are immediately available on the spot at any hour, they are in the most logical position to supply such service. Because of the many benefits both to the users of electronic controls and to the radio repairman, industrial electronics can be expected to become a major field of operations for the radio serviceman. —30—

#### HAMS HELP RESEARCH

**P**ROFESSOR Serge Korff, New York University College of Engineering, reported recently that in planning and carrying out his recent cosmic ray expedition to Puerto Rico he was aided by the radio link established between the University's ham station and another amateur installation on the island.

Through the amateur contacts, intricate details were handled in a few days which normally would have taken weeks via the mails. Professor Korff also advised that other ham stations will cooperate with New York University on cosmic ray research projects to be carried out this summer in the vicinity of Denver.

Amateur radio station W2DSC was established at New York University College of Engineering in September 1946 by the Signal Corps Unit of the Reserve Officers Training Corps. Under the leadership of Major Leonard Drazen and Professor Philip Greenstein, the NYU amateur radio club which operates the station has a membership of seventy-five.

Professor Korff noted that the surprising thing is that this ham station which was initiated for purely instructional purposes has paid off dividends in research fields as an important communication facility. —30—

June, 1948

**AS GOOD  
AS IT LOOKS**



**MODEL S20X**

WITH SLIDE-LOCK SWITCH AS ILLUSTRATED AT SLIGHT EXTRA COST

#### ALL THESE FEATURES AT LOW COST

- ★ Metalseal crystal
- ★ High level: 54db below 1 volt/dyne/sq. c.m.
- ★ Smooth response:  $\pm$  5db from 50-7000 c.p.s.
- ★ Corrosive resistant aluminum diaphragm
- ★ Convenient, light weight
- ★ Modern styling
- ★ Turner quality

*Microphones* **BY TURNER**

It's the new Turner Model S20X Hand Microphone for home recording, public address and amateur work. Beautifully finished in rich baked brown enamel. Light in weight and convenient to use. Fits the hand perfectly, hangs on a hook when not in use.

Its performance is the kind you expect in a microphone costing three times as much. Response to voice and music pickups is smooth and flat over the most desired frequency range. Level is exceptionally high. The entire circuit is shock mounted to withstand rough treatment and is equipped with barometric compensator.

**SEND NOW FOR BULLETIN**

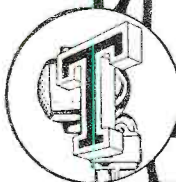

**THE TURNER COMPANY**

900 17th Street N.E. • Cedar Rapids, Iowa

**TURN TO TURNER FOR SOUND PERFORMANCE**

CRYSTALS LICENSED UNDER PATENTS OF THE BRUSH DEVELOPMENT CO



Living Room Concerts

More Economical



Airport & Train Announcements

Cannot Tangle



Broadcast Station Monitoring

Now Available! **8 HOURS OF CONTINUOUS PLAY ON THE MAGNETAPE RECORDER**

Longer Playing Time



30 Second Rewind

Also — on this one amazing instrument, you can record and play back with unmatched fidelity, any sound that can be heard. Enjoy complete operas and symphonies without record-changing pause, or annoying needle talk and needle chatter. Edit and rearrange your recorded material with ease. The ideal recorder-reproducer for home, office, industry and broadcast station.



Industrial Factory Work Music

Quieter Operation



Conference Recording

Also, for the first time, in one compact instrument, you have a choice of three tape speeds for high fidelity, medium fidelity, or 8-hour voice recording. Write today for illustrated technical Magnetape Recorder and accessory catalog. Send 25c for A. C. Shaney's latest booklet, "Elements of Magnetic Tape Recording—and 999 Applications."



Passenger Entertainment

Improved Response Range



Copying Valuable Disc Records

Complete Automatic Erasing



Recorded Lectures

**AMPLIFIER CORP. of AMERICA**

398-2 BROADWAY

NEW YORK 13, N. Y.

**YOU CAN OWN THIS GENUINE LABORATORY-TYPE INSTRUMENT!**

ONLY \$10

**B&W**



**SINE WAVE CLIPPER**

Speeds Accurate Analysis of Audio Circuits! Simplifies Selection of Components! Saves Valuable Time!

Here's an instrument that will do most of the jobs usually assigned to a square wave generator costing about 10 times as much! The B&W Sine Wave Clipper provides a test signal particularly useful in examining the transient and frequency response of audio circuits. Designed to be driven by an audio oscillator, the clipper provides a clipped sine wave—hence the name "Sine Wave Clipper!" Used in engineering work, repair work, or with equipment under development, it will quickly pay for itself many times over.

See it at your favorite parts distributor's, or write for complete information.

**BARKER & WILLIAMSON, Inc.**  
Dept. RN-68—237 Fairfield Ave.,  
Upper Darby, Pa.

**TECHNICAL KO<sub>5</sub>**

OIL FILLED CONDENSERS		TRANSMITTING MICAS	
.05 MFD 1000 V	\$0.35	.000025	2500 V \$0.15
.05	500 V .14	.00005	2500 V .15
.1	2500 V .75	.00005	3000 V .35
.1	7500 V 1.65	.00005	5000 V .85
2x.1	7000 V 4.10	.000067	2500 V .20
.12	15000 V 7.95	.00007	2500 V .20
.25	1000 V .35	.00025	2500 V .25
.25	4000 V 2.15	.00025	5000 V .85
.25	6000 V 3.75	.00072	2500 V .25
10x.25	600 V 1.05	.0008	5000 V .85
.5	600 V .28	.0001	2500 V .25
.5	1000 V .40	.0011	5000 V .85
.5	2000 V .75	.002	1200 V .20
.75	2000 V .60	.005	3000 V .65
1.0	330 VAC .30	.0025	1200 V .15
2.0	1000 V .45	.00275	2000 V .25
2.0	200 V .20	.003	2500 V .30
2.0	600 V .40	.003	3000 V .65
2.0	1000 V .60	.004	2500 V .35
4.0	600 V .50	.005	1000 T.V. .15
4.0	1000 V 1.00	.005	3000 V .65
5.0	220 VAC .55	.008	2000 V .35
6.0	600 V .70	.008	1200 V .15
6.0	1000 V 1.45	.01	1200 T.V. .15
8.0	600 V .85	<b>TUBES-CHOKE</b>	
8.0	1000 V 1.75	6V6 METAL	\$0.89
10.0	600 V 1.00	12K8 METAL	.29
30.0	80 VAC 1.40	1001A-10H,	
30.0	330 VAC 3.75	250 OHM	1.59

POTS: 20K-50K-100K .....\$0.19  
POTS: DUAL-1 MEG, 1/2 MEG, '250K-50K' .. .30  
SHIELDED WIRE #22 .....50 Ft. for .65  
RESISTOR KIT ASSORTED 1/2W .....100 for 1.49  
BATHTUB KIT 3x.1, .5, .05, ETC. ....10 for .58  
CONDENSER KIT .01-.00001 .....100 for 2.99  
MICAS .01, .002, .005, ETC. ALL VALUES .... .08  
.01 150V PAPER (MIDGET) .....60 for 1.00  
0.1 600V PAPER .....8 for 1.00

\$2.00 min. order F.O.B. N.Y.C. Add postage  
50% deposit, balance C.O.D. with all orders.  
Manufacturers' inquiries invited. Send for Flyer.  
Prices are subject to change without notice.

**TECHNICAL RADIO PARTS CO.**  
265 Greenwich St. Dept. RN-1 N. Y. 7, N. Y.

**GROUND SIDE INDICATOR**

By ALFRED H. FORTIER

I AM AT present building a small radio receiver in which I am using the compact selenium rectifier power supply described in the April, 1947 RADIO NEWS ("Versatile Power Supply," page 67).

Since the metal chassis is grounded through the power line, I wanted a simple indicator to enable me to tell when the plug was inserted in the correct position.

The schematic diagram (Fig. 1) illustrates the simple circuit devised for this purpose.

The switch used in this circuit must be of the type with a metal handle (such as a toggle) so that when the hand contacts the handle the former is electrically connected to the chassis through the switch mounting. Under this condition the neon lamp will glow (before the switch is turned "on") if the plug is inserted "backwards," but will not glow if the plug is in the correct position to ground the chassis through the grounded side of the power line.

The current which passes through the body to light the lamp is so very small that it cannot be felt and is entirely safe. The switch must be a double-pole type so that no current will bleed back through the filter circuit to light the lamp falsely. —30—

Fig. 1.

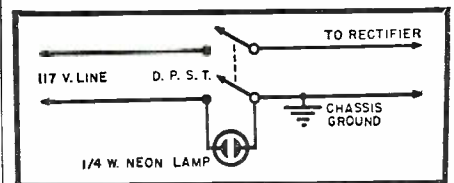

**CABLING MADE EASY**

PLASTIC telephone cord covers, sold everywhere in ten cent and hardware stores to prevent kinking of telephone cords, are ideal to use for holding the separate wires of homemade interconnecting cables neatly, firmly but flexibly together without the tedious work of lacing with cord.

These cord covers are about four feet long, and more than one can be used if a greater length is desired. They are available in various colors so that color coding is possible.



"Johnson fixes all the pilot light assemblies!"

RADIO NEWS



# Essee Specials!

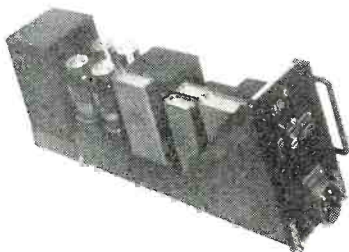

### PP-51/APQ-9 RECTIFIER-POWER UNIT

400 cycle 115 V. Contains 4-5R4GY tubes, 2-4Mfd. 1000 V. DC condensers. 2-1 Mfd. 1500 V. DC condensers. 400-2600 cycle transformers, power resistors, etc. Weight 38 lbs.  
Size 21" L x 5 1/2" W x 7 3/4" H..... **\$4.95**



### PP-2/APQ-5 POWER UNIT

400 cycle, 115 V. Contains 10 tubes as follows: 2-5U4G's, 1-6X5GT, 3-6Y6G's, 1-6SL7GT's, 2-VR150-30 and numerous condensers, transformers and resistors. Weight 17 lbs.  
Size 21" L x 5 1/2" W x 7 3/4" H..... **\$5.75**

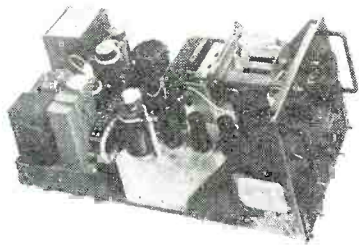

### T-26/APT-2 RADAR TRANSMITTER

Contains tunable VHF circuit using 2-JAN CTL 703A's or 368AS tubes. Other tubes are: 2-5R4GY's, 1-2X2, 1-807, 1-6AG7, 2-6AC7's, and 1-931A. Other parts such as 21 V. DC motor and blower, HV, condensers and transformers, terminal strips and Amphenol connectors, knobs, fuse holders, etc. make this unit invaluable for parts alone. Weight approx. 45 lbs.  
Size 21" L x 10 1/2" W x 7 3/4" H..... **\$9.75**  
in metal case.

### DETROLA AIRCRAFT RECEIVER

5 tube superhet. Covers 200-400 Kc. with some overlap. 28 V. DC at 3/4 ampere power source required. Size about 4 1/4" x 4 1/4" x 5 1/2". Weight 4 lbs.  
With built-in power supply filter..... **\$3.75**

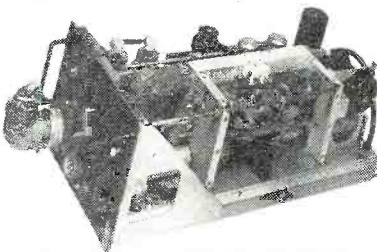

### T-39/APQ-9 RADAR TRANSMITTER

Loaded with VHF parts and tubes such as 2-RCA 8012's, 1-931A, 2-807's, 1-6AG7, 2-6AC7's. The RCA 8012's are rated at 50 W. input to 500 Mc. Contains variable parallel-plate oscillator silver plated, ventilating blower and motor, ceramic tap switch, pots, terminal strips, gears, counters, etc. Weight 36 lbs.  
Size 22" L x 10 1/2" W x 7 3/4" H..... **\$9.75**



### SPERRY A-5 AUTO PILOT AMPLIFIER RACK

Contains 115 V. AC voltmeter and 350-450 cycle Frequency meter. A total of 4 amplifier chassis comp etc with following tubes included in rack: 2-1631's, 6-1632's, 3-1633's, 3-1634's, and 2-1614 tubes. Numerous transformers, resistors and condensers make this unit invaluable for parts. Weight 38 lbs.  
Size 12" L x 14" W x 10 1/4" H..... **\$6.95**

### DYNAMIC HANDMIKE

High impedance type—with press-to-talk switch that shorts microphone when released and operates relay or other circuit when depressed. Designed for close talking PA and mobile communications service. Speech is brisk and clear. Made to stand rough handling. Black wrinkle finished. Has 6 ft. 3 conductor shielded rubber covered cable and standard amphenol plug. Made by Electro-Voice for the Signal Corps. Comparable mikes list at \$28.00.  
Special, each ..... **\$7.95**

### AMATEUR VHF MOBILE XMTR—RCVR

Western Electric No. 233A 12 Volt VHF Xmtr-Rcvr with tubes. Has Ballenlyne dynamotor—6 or 12 V. input, 500 V., .16 amps output—built-in. Four channel crystal controlled. For operation in range of 140-144 Mc. Transmitter has seven tubes: S32, two 1614, two 6V6, and two 6L6. Receiver section has 13 tubes: two 6AC7, four 6N7, three 12SL7, two 12SQ7, and two 12A6. Priced complete with tubes, four crystals and dynamotor. Hams can convert this for 2-meter operation. It is a scoop at this price. Used  
New, with manual ..... **\$29.50**  
but guaranteed in good condition.

### GRAIN OF WHEAT—PILOT LIGHTS

Screw base type with receptacle. 3 V. very tiny size. Used for aircraft instrument illumination. Ideal for model makers, hobbycraft designers, etc. Shipping weight 2 lbs. per box of 25. Brand new.  
Each ..... \$ .10  
Gross ..... **10.00**

### BC-314 RECEIVER

Frequency coverage 150-1500 Kc. in 4 ranges. Two RF stages, 1st detector, two IF stages, second detector, RF oscillator, CW oscillator and audio. Total, 9 tubes. 14 V. DC at 5.3 amps. input to dynamotor. Easily converted for 110 V. AC. Use headphones or speaker or both.  
New, with manual ..... \$89.50  
Used ..... **69.50**

### ANTENNA KNIFE SWITCH

Has 2 1/2" porcelain insulator bakelite base, heavy blades 4" long.  
Single Pole Double Throw ..... \$0.75  
Double Pole Double Throw ..... 1.00  
Triple Pole Double Throw ..... 1.25

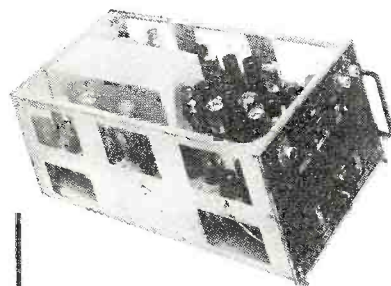

### SN8/APQ-5B

Contains 31 usable tubes consisting of 2-6H6's, 3-6AC7's, 2-2050's, 1-6SATGT, 2-VR105's, 10-6AG7's, 7-6SN7GT's, 1-VR75, 2-6SL7GT's, 1-6N7. Other parts such as 17 Shallicross precision wire-wound resistors of 30,000, 120,000, 150,000, 250,000, 20,000, 20,000, 200,000 and 1000,000 ohms value. Relay DPDT, variable condensers, Amphenol and Cannon connectors, tap switches, networks and transformers make this another invaluable part item at the advertised low price. Weight 28 lbs. Contained in aluminum case. **\$14.95**  
17 1/2" L x 11 1/2" W x 7 3/4" H.....

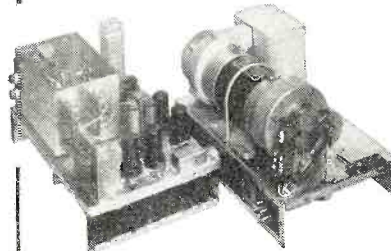

### TYPE CRZ-43AA AIRCRAFT RADIO RECEIVER

Another item for the VHF experimenter. Contains ten tubes: 6-S17's, 2-6H6's and 2-7138's. Relays, condensers, resistors, Amphenol connectors, dynamotor, carbon pile voltage regulator and numerous other parts. Weight approx. 32 lbs.  
Size, 12" W x 11" H x 8" D..... **\$6.95**

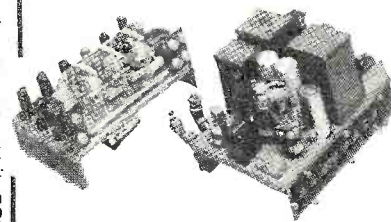

### BC-800A RADAR TRANSMITTER & RECEIVER

Loaded with tubes and components for the VHF experimenter. Contains 19 tubes including 1-955, 3-956's, 1-2C26, 1-5U4G, 1-2X2, 1-6SN7, 7-6AC7's, 2-6SL7GT's, 1-6V6GT, and 1-6H6GTG. Several IIF tuned circuits, 7 amphenol chassis fittings, sockets, 24 V. blower and motor (will operate on 110 V. AC), 2-4Mfd. 600 V. condensers, and many other resistors and parts. Weight approx. 40 lbs. In metal case  
12 1/2" W x 11 1/2" H x 8" D..... **\$14.95**

# Essee Radio Co

130 W. New York St.  
Indianapolis 4, Ind.

Unless Otherwise Stated, All of This Equipment Is Sold As Used  
**CASH REQUIRED WITH ALL ORDERS**  
Orders Shipped F.O.B. Collect

**RADIOMEN!**  
**GET THIS**  
*Brand New!* **Valuable Book**  
**OF "150 NEW**  
**RADIO DIAGRAMS**  
**EXPLAINED"**  
**FREE**

**10 to 1 Satisfaction**  
**GUARANTEE**

"I personally guarantee that at the end of 1 year from date of receipt, my Applied Practical Radio set will have earned for you at least 10 times its cost, or you may return it and I'll return every cent you paid."

B. W. Cooke, Pres.

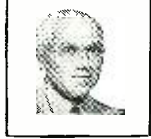

Here's a sensational "get acquainted" offer! This big, new book, "150 New Radio Diagrams Explained" is yours, absolutely FREE! It contains circuits and data on the latest Radio and Television sets. Easy-to-read, 8 1/2 x 11" size, with full instructions on how to read and use diagrams. Belongs in every radioman's kit.

**HOW TO GET YOUR FREE BOOK**

You can get this book Free just for looking over — without cost or obligation — the sensational new 5-volume Coyne set "APPLIED PRACTICAL RADIO." It's just off the press. Here's everything you want to know about radio, from basic principles to up-to-the-minute Television and FM, PA, shortwave, aviation-auto radio, multibands, tele-transmission testing instruments and trouble-shooting short cuts, phototubes, etc., all clearly explained.

Shows how to construct, install, service all types of apparatus. Step-by-step photos break equipment down before your eyes! Newest testing methods. Hundreds of subjects, over 1500 pages, almost 1000 illustrations, diagrams. Written for home training and field reference — so complete, so up-to-date and practical that every man interested in radio should see it.

**SEND NO MONEY** You can see how much this set can mean to your future, without cost or obligation. I'll send "APPLIED PRACTICAL RADIO" postpaid, for you to look over for 7 days FREE—and with it, the Radio and Television Diagrams book as an outright Gift! This book is yours to keep free whether or not you decide to keep the 5-Volume Set! In 7 days, either return the 5-Book Set and owe nothing or pay \$3 then and \$3 a month until \$16.75 is paid. Or you can save \$1.75 by paying \$15.00 cash price.

**Use Coupon Now!**

YOU ARE NOT BUYING THE 5 VOLUME SET WHEN YOU SEND THIS COUPON. You are merely asking to see the books free for 7 days. Free Book Offer is limited — so mail coupon today.



**FREE BOOK COUPON**

B. W. Cooke, Pres., Coyne Electrical & Radio School, 500 S. Paulina St., Dept. A8-T3 Chicago 12, Illinois

Send me the NEW 5-volume Coyne Set, "APPLIED PRACTICAL RADIO" for 7 days FREE examination per your offer. Also send "150 New Radio Diagrams Explained" as a FREE gift.

NAME ..... AGE .....  
 ADDRESS .....  
 TOWN ..... ZONE ..... STATE .....

**Mac's Service Shop**  
 (Continued from page 64)

"Another precaution," Mac continued, "is always to pull the receiver plug before you go probing around with the ohmmeter; and it is also a good idea to check first with the voltmeter before using the ohmmeter if the set has just been turned off. Quite often an open speaker field winding or bleeder resistor will allow the filter condensers to remain fully charged even though the line plug has been pulled for several seconds. To put the ohmmeter across a fully charged filter condenser will damage the instrument as quickly as placing it across the same points with the set turned on."

"Why do you always plug sets you are working on into one of those three outlets marked 'Receiver Test?'" Barney inquired.

"Because those three sockets are fed from the line through an isolation transformer with a tapped secondary. The tap-switch just below that 150 volt a.c. meter allows me to put any voltage from 90 to 130 volts on those outlets. That is a great help in cracking some kinds of intermittents."

"Why do you call that an isolation transformer?"

"Because that is its main job. It isolates the receiver fed by its secondary from the line-voltage circuit that has one side grounded. Lots of a.c.-d.c. sets have one side of the line attached directly to the chassis, and quite often you will find a transformer set in which the bypass condenser from one side of the line to the chassis has been shorted out by lightning. If you had one of these sets plugged directly into

the light circuit, and if the hot side happened to be the one going to the chassis, and if you touched the chassis with one hand and any grounded object with the other—"

Barney rolled his eyes toward the ceiling and pretended to be plucking an imaginary harp to show he understood. For once, though, Mac did not smile at his clowning.

"Barney," he said seriously, "I do not expect you to remember everything I tell you, but here is one thing I want you never to forget: *Never underestimate the danger that lurks in any electrical circuit.* Working with radios every day, as you soon will be, it is all too easy to fall into a 'Who's afraid?' attitude toward the shocks you can get from a receiver. Just try to remember that there are hundreds of people lying out in the cemetery looking at the wrong side of the grass who were put there by the 110-volt a.c. house current. It only takes from seventy to ninety milliamperes of current to cause death. Under the right conditions, sixty volts or less can drive that much current through your body. Many of the sets you will be working on will have upward of seven hundred volts across the power transformer secondary, and any of them can furnish more than a hundred milliamperes of current."

"Yet," Mac continued, "you will hear some chowder-heads in the service game boasting about how often they are 'bitten' with electricity every day. They seem to think it is to their credit. If they had any sense, they would know that the good mechanic is always the careful mechanic."

Barney, too, looked sober as he promised, "I'll remember that, Mac."

Racks of television picture tubes which have just been "aluminized" in the Buffalo, New York tube works of General Electric Company. The aluminum is vaporized on the back of the fluorescent screen inside the tube and acts as a reflector to improve light output image detail and contrast. Thomas O. Moffit, foreman, and James S. Klock inspect the tubes

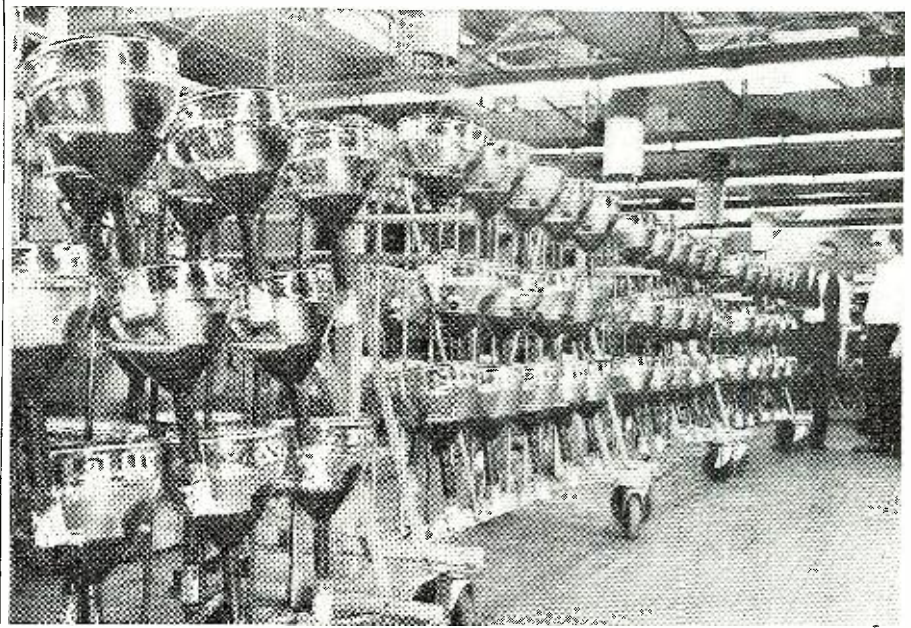

# NEW GUARANTEED SURPLUS!!

## SYNCHROS

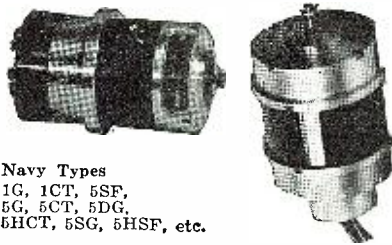

Navy Types  
1G, 1CT, 5SF,  
5G, 5CT, 5DG,  
5HCT, 5SG, 5HSF, etc.

Pioneer Autosyns—AY-1, AY-14, AY-20, AY-30, AY-54, AY101D, 851, etc.

Kollman 775-01. G.E. 2J5HA1, 2J5FB1, 2J6F3, 2JD5HB1, 2J1F1, 2J1G1, 2J1H1, etc.

## DC MOTORS

John Oster. Series wound. 27V 7000 rpm. 1/100 H.P. Stock #SD-30. Price \$2.75 ea.

Westinghouse—1171391. 27V 6.5 amps. series. Fan cooled. 3" diam. 4 1/2" lg., 1/8 H.P. Cont. duty. Stock #SD-156. Price \$6.75 ea.

Delco 5069370. 27.5V Alnico field. 10,000 rpm. Similar to S-65 but has straight shaft extension. Stock #SD-16. Price \$4.75 ea. net.

DC Timing Motor—Haydon 1/2 rpm. 29 volts, 100 mils. Stock #SD-157. Price \$3.75 ea.

Constant Speed DC Motor—G.E. 5BA25MJ24. 24V DC 7100 rpm. RC noise filter. Stock #SD-100. Price \$8.50 ea.

G.E. Reversible—5BC26AC134. 1/20 H.P. 24V @ 3.4 Amps. Shunt wound. Cont. duty 4 1/2" diam. x 6 1/2" lg. 1 1/4" shaft extension. 3/8" diam. 2 1/4" sq. 1" conduit box mounted on motor. Explosion proof. Stock #SD-143. Price \$12.50 ea.

250 RPM. Delco 5067127. 27V P.M. field. 1 1/4" diam. x 3 1/4" lg. 42 tooth 3/8" pitch diam. pinion on 0.250 shaft. Stock #SD-108. Price \$2.95 ea.

110 RPM. G.E. Aircraft Motor. 5BA10AJ18D. 27V @ 0.7 amps. 1 oz./ft. 1 3/8" diam. x 3 1/2" lg. 1/4" shaft extension 0.250 diam. with removable coupling. Stock #SD-98. Price \$2.95 ea.

Radio Compass Loop LP-21-LM. Stock #SD-99. Price \$9.50 ea. net.

Phase Shift Capacitor—4 stator single rotor. 0-360° phase shift. Stock #SD-114. Price \$4.75 ea.

Magnesyne—Pioneer CL-3, 6 power. Transmitter or receiver. Stock #SD-6. Price \$3.75 ea.

## NULL TYPE SYNCHRO INDICATOR



Precision position indicator. Uses Bendix size 5 Selsyn, rectifier tube, transformer, magic eye tube and illuminated 360° dial. Ideal for Hams, labs and experimenters. May be used with SD-43 Synchro transmitter.

Stock #SD-119. Price \$6.95 each.

## SERVO MOTORS

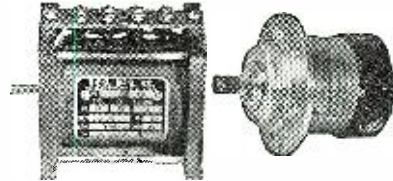

Pioneer CK-2, 10047-2-A for 400 cycles; Diehl FP-25-3, FPE-25-11 (CDA-211052) and ZP-105-8 (CDA-211377) for 60 cycles.

## 400 CYCLE MOTORS

E.A.D. J-33. 115V 3 phase. Synchronous. 8000 rpm. 2" x 3". Stock #SD-59. Price \$6.75 ea.

E.A.D. J-72B. 115V 2 phase induction motor. 4700 rpm. Stock #SD-140. Price \$9.75 ea.

Westinghouse Blower. Type FL. 6700 rpm. Capacitor type motor. 17 C.F.M. blower. Outlet 3/4" x 1 1/4". Includes capacitor. Stock #SD-144. Price \$6.75 ea.

Quantity prices on request.

## DC Motor—Delco 5069466

Alnico field. 27.5V 10,000 rpm. 1" x 1" x 2". Use as motor or as tachometer generator. Stock #SD-65.



Price \$1.95 each  
Add 15c for P.P. & handling

## Microwave Antenna—

AS-217A/APG 15B. 12 Cm dipole and 13 inch parabola housed in weatherproof Radome 16" diam. 24V DC spinner motor for conic scan. Stock #SD-95. Shipping wt. 70 lbs. Price \$9.50 ea.



## Remote Position Indicating System—

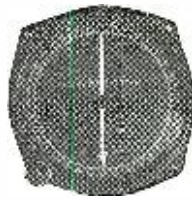

6-12V 60 cycles. 5 inch indicator with 0 to 360° dial. Heavy duty transmitter. Stock #SD-115. Price \$9.95 per system.



## Size 5 Synchro Generator

Similar to Navy Ordnance type 5G with shaft detail per Army Ordnance Dwg. C-78414. 115V 60 cy. Stock #SD-43. Price \$9.50 ea.

## INVERTERS



Pioneer  
12116, 12117,  
12121, 12123, etc.

Holtzer Cabot MG-149F, MG-149H, MG-153F, etc.

General Electric 5D21NJ3A, etc.

Leland 10563, PE-218, etc.

Wincharger PU-7/AP, etc.

## 60 CYCLE AC MOTORS

G. E. Reversible. 1/150 H.P. Shunt wound. 40 volts 5000 rpm. Split field. Stock #SD-18. Price \$4.75 ea. Stock #SD-19. Similar to above but not split field. Price \$2.75 ea.

Barber-Colman. 0.001 H.P. wound shaded pole type. Reversible by relay or s.p.d.t. switch. Stock #SD-27. Price \$3.75 ea.

Timing Motor—Haydon 1 rpm. 115V AC. Stock #SD-133. Price \$2.85 ea.

G. E. Amplidyne—5AM45DB15. MG-16-A. Input 115V 60 cy. Output 250V DC at 0.6 amps. Cont. Duty. Stock #SD-147. Price \$59.50 ea.

DC Selsyn System—24V DC transmitter and indicator. Indicator calibrated for flap position. 360° dial easily added. Stock #SD-129. Price \$9.50 per system.

Pioneer Magnetic Amplifier Assembly. Saturable core type output transformer. 400 cycle. Operates from plates of 6SN7 to supply 1 phase of servo motor. Stock #SD-44. Price \$8.75 ea.

Aircraft Amplidyne—G.E. 5AM31NJ18A. Input 27V DC @ 44 amps. Output 60V DC @ 8.8 amps. 530 watts. 10 min. duty. Air cooled. 1 1/4" x 5 1/2". Stock #SD-111. Price \$14.50 ea.

Linear Actuator—Foote Bros. 10801. 1/6th H.P. reversible DC motor. 24V at 11.5 amps. Linear travel 5 inches. Limit switches for end of travel. Stock #SD-161. Price \$12.50 ea.

Inverter—Wincharger PU-7/AP. Input 28V DC at 160 amps. Output 115V 400 cycles at 21.6 amps. Voltage and frequency regulated. Continuous duty. Net weight 75 lbs. Dimensions 18" x 8" x 10". Stock #SD-164. Price \$79.50 ea.

ALL PRICES F.O.B. CLIFTON, N. J.

# SERVO-TEK PRODUCTS Co.

INCORPORATED  
Surplus Division

ARmory 4-2677

Write or call for  
complete listing.

247 CROOKS AVE.

Open account shipments  
to rated concerns,  
others may order C.O.D.

CLIFTON, N. J.

# "ACORN" SAYS... ALL MERCHANDISE GUARANTEED!

**SENSATIONAL CLOSEOUT!  
10 STATION INTER-COM**  
16 Watts PP Output

\*Standard 3 wire control system.  
\*Operates on 110 volt, 60 cycle AC.  
Price includes all tubes and 3 metal-housed sub-stations as shown. Complete instruction sheet included. Shpg. Wt. 60 lbs.  
**\$79<sup>50</sup>**  
BRAND NEW

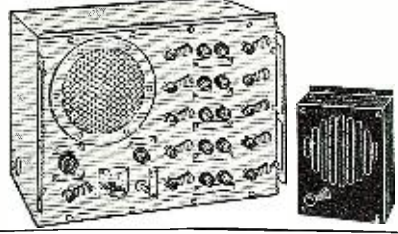

**POWER TRANSFORMER SPECIAL**  
Primary 115 volt, 60 cycle. Secondary 720 volt CT at 150 MA., 6.3 volt CT at 4 Amps., 5 volt at 3 Amps. Dimensions 3 1/2" L. x 3 1/4" W. Mtg. Dimensions 2 1/2" x 3 1/4". Shipping weight 6 lbs.  
**\$4.45 each**  
3 for \$12.50

**PP 6L6 OUTPUT TRANSFORMER**  
Fully shielded, upright mtg., output transformer. Will handle 25 watts from push-pull 6L6's. Mtg. centers 3 3/8". 3" H. x 2 1/4" W. x 3" D. Primary 6600 ohm to 1-3-15 ohm voice coil. Ship. weight 4 lbs.  
**\$2.45 each**  
3 for \$7.00

**BRAND NEW AMERTRON TRANSTATS VOLTAGE REGULATORS**  
130/230 volts. 50/80 cycles. Max. output .65 KVA. Single phase. 0-280V Commutator Range. 2 1/2 Amps. Max. Shipping weight 23 lbs. **\$24.95**  
115 volts, 60 cycle. Max output .25 KVA. Single phase. 103-106 V. Commutator Range. Max. Amps. 2.17. Ship. wt. 15 lbs. **\$12.95**  
115 volts, 400 cycles. Load KVA output .72. Output 75-120 volts. 6 Amps. Max. Shipping weight 14 lbs. **\$6.95**

**SHURE CARBON MIKE**  
T-17-B. Single button carbon with press-to-talk switch. 5 foot rubber cord and PL68 plug. Original packing. Brand new. **79¢ each**  
3 for \$2.25  
JK33A Jack for PL68 plug 15c each.

**1" DIAL LIGHT ASSEMBLY WITH DIMMER**  
An attractive, sturdy metal dial light in Red, Clear, and Amber glass jewels. Screw type socket. Extends 3/8" beyond panel, 2 1/2" in the rear. Remarkable Value!  
**69c**  
3 for \$2.00

**FILTER CHOKE**  
Hermetically sealed 15 henry. 70 Mill Choke. 420 ohm DC resistance. Mfd. to Navy specs. by Stancor. Dimensions 2 1/2" W. x 2 1/2" D. x 4 1/2" H. Mtg. centers 1 7/8" x 2 1/2". Shpg. Wt. 5 lbs. 3 for \$2.25

**RAYTHEON MAGNETRONS 723 A/B \$4.79 ea.**

**ACORN ELECTRONICS CORP.** TERMS: 20% cash with order. Balance C.O.D. All prices F.O.B. our warehouse in New York City. No orders under \$2.50.  
80 Vesey St. New York 7, N. Y.

## Within the Industry (Continued from page 30)

tronics Section. Mr. Horton will be concerned principally with the formulation and utilization of new and improved plastics and other non-metallic materials that may be of use in the work of the section. He was previously associated with the *Plax Corporation* as chief chemist in the organic chemical section.

\* \* \*

**GEORGE F. PLATTS**, was recently appointed executive vice-president of *Clippard Instrument Laboratory, Inc.* of Cincinnati, Ohio. Mr. Platts' new duties will consist of expanding the sales, sales promotion, and advertising activities of the concern, marketing a line of r.f. and television coils, laboratory and service type electronic and electrical test equipment.



Prior to joining the *Clippard* organization, Mr. Platts was general manager, electric products division, of *McQuay-Norris Mfg. Co.* Mr. Platts holds the rank of Commander in the United States Naval Reserve, and during World War II served in connection with the No. 2 Secret Weapon Project, the VT (Proximity Fuse). Later he became a resident inspector of naval material at the *Crosley Division and Sylvania Electric Products Inc.* He is a senior member of the IRE.

\* \* \*

**RAYTHEON MANUFACTURING CO.** has announced the appointment of Norman B. Krim as manager of the Receiving Tube Division.

Mr. Krim succeeds Carl J. Hollatz, vice-president of *Raytheon's* subsidiary, *Belmont Radio Corp.* of Chicago, who now becomes general manager of *Belmont* and will devote his full time to that branch of the company.

\* \* \*

**J. A. MILLING** has been appointed to the newly-created position of Commercial Vice President of the *RCA Service Company*. In his new position Mr. Milling will supervise merchandising, sales, advertising, and promotional activities of the service company, which is the servicing organization of the *RCA Victor Division*.



Mr. Milling received his degree in electrical engineering from *Clemson College*. In 1928 he joined *RCA* and served in the engineering, advertising, and sales divisions of the Tube Department.

RADIO NEWS

## HARD TO GET SURPLUS CIRCUIT DIAGRAMS

A COMPLETE SERIES OF SCR-274-N COMPONENTS **\$1.**

- AS LISTED BELOW
- |             |              |
|-------------|--------------|
| BC-453 REC. | BC-456 MOD.  |
| BC-454 REC. | BC-457 TRAN. |
| BC-455 REC. | BC-458 TRAN. |
| BC-946 REC. | BC-459 TRAN. |
| BC-422 ANT. | BC-696 TRAN. |
- RELAY UNIT & BC-450 RADIO CON. BOX

ALSO DIAGRAMS COVERING . . .

APN-4	ASB-4	BC-412
APN-9	ARB (Navy)	BC-645
ASB-5	BC-211	APS-13
ASB-8	Collins MBF	BC-733
APT-5	SCR-522	

**\$1. Each Any 3 \$2. All 14 \$3.50**  
IF YOU WANT CIRCUITS NOT LISTED WRITE US . . . IF YOU HAVE CIRCUITS NOT LISTED LET US KNOW—WE CAN USE THEM.

### COMING SOON—HOW TO BUILD A TELEVISION REC. FOR ONLY \$75.00!

Complete constructional data, including: Chassis layout, wiring diagrams, parts placement drawings, parts list and ALL the dope you need to build a Complete Television set including picture tube. This is not a surplus, but built from standard materials. **\$3.50**  
Orders will be filled in the order received.

**TEC PUBLICATIONS**  
2221 GRAND AVE., LONG BEACH, CALIF.

## "America's Best Buy" TUBULAR ELECTROLYTICS Fresh Stock. Fully Guaranteed

Capacity	W.V.	Each	per 10	100
25 mfd.	25V	\$0.17	\$1.59	\$14.95
50 mfd.	50V	.21	1.79	16.95
100 mfd.	50V	.24	2.29	19.98
20 mfd.	150V	.21	1.89	17.95
30 mfd.	150V	.22	1.95	18.95
40 mfd.	150V	.23	2.04	19.74
50 mfd.	150V	.24	2.14	20.45
20-20 mfd.	150V	.29	2.49	22.98
30-20 mfd.	150V	.32	2.95	25.98
40-20 mfd.	150V	.36	3.25	29.95
50-30 mfd.	150V	.39	3.49	32.98
8 mfd.	450V	.21	1.99	19.50
8-8 mfd.	450V	.42	3.98	35.76
16 mfd.	450V	.39	3.74	33.78

**BY-PASS CONDENSERS**

Capacity	Voltage	Each	per 10	per 100
.01	600V	\$0.06	\$0.55	\$4.60
.02	600V	.06	.55	4.75
.05	600V	.06	.55	4.85
.1	600V	.07	.65	4.49
.25	600V	.11	.98	8.95
.005	1700V	.14	1.25	9.95
.007	1700V	.14	1.25	9.95
.01	1700V	.15	1.30	10.20
.02	1700V	.16	1.40	10.95

An assortment of 50 of the above By-pass condensers. Fine value for the small shop or experimenter, only \$2.98

**RESISTOR ASSORTMENT**  
100 assorted 1/4-1/2 watt carbon resistors. All RMA color coded. Special **\$1.29.**

**CRYSTALS 98c each**  
Your frequency plus or minus 10 KC

80 Meter	3500-4000KC
40 Meter	7000-7300KC
20 Meter	7300-7425KC
10 Meter	7300-7425KC
6 Meter	6250-6750KC
2 1/2 Meter	8000-8222KC

Postage extra 20% deposit on COD. Write for latest bargain list featuring "America's Best Buys."  
**POTTER RADIO CO.**  
1314 McGee St., Kansas City 6, Mo.



ment until 1935 when he was transferred to the home office at Camden, New Jersey to direct replacement parts and test equipment sales. In 1939, after serving for a year as co-ordinator of the RCA Victor Division's television activities, he was made supervisor of the company's commercial activities in small radio sets. He was transferred to the Manufacturing Department in 1942 and the following year he was appointed manager of the Indiana plant and General Manager of all the company's manufacturing activities in April, 1944. Prior to his new appointment Mr. Milling was General Manager of the newly-formed Parts Division.

\* \* \*

PAUL H. WENDEL has joined the "Photo-fact" staff of Howard W. Sams & Co., Inc. of Indianapolis.

After his discharge from the AAF in 1945, Mr. Wendel joined the staff of RADIO NEWS as an associate editor and later served as business manager of *Radio Maintenance Magazine*.

-30-

### TV NET EXTENSIONS

TO MEET the growing needs of television broadcasters, American Telephone and Telegraph Company has announced extensive plans to provide additional intercity network facilities this year extending from the east coast as far west as the Mississippi River.

Included in the plans are 2000 miles of television network channels in the midwest from Buffalo to St. Louis which will be available in time for the football season this fall. The existing eastern network, which stretches along the coast from Boston to Washington, will also be increased and extended in time for the national political conventions which start in June in Philadelphia. In addition it is expected that the new midwestern network will be connected with the east coast network by the end of the year, linking these two sections of the country by television.

Two television channels, so that one program can be sent in each direction, will be provided in early October to connect Cleveland, Toledo, Chicago, and St. Louis and one channel to carry programs from this network to Buffalo.

Two additional television channels from New York to Washington to serve these cities and Philadelphia and Baltimore will be added to the present eastern network by June, thus doubling the television channels between these cities. During the political conventions, three of these television channels can be set up to carry separate programs from Philadelphia to cities on the network, both north and south. This network will also be extended south by the addition of one channel which will enable programs to be received in Richmond, Virginia.

In December the new midwestern and the eastern networks will be linked by connecting Philadelphia and Cleveland with coaxial cable. It will then be possible for the first time for the same television program to be broadcast simultaneously by stations in cities linked to the network from Boston to St. Louis.

-30-

June, 1948

# TELEVISION INDUSTRIES Co.

PICTURE IF & SOUND IF STRIP and FRONT END. This sensational picture If & Sound If Strip developed by our engineering staff enables you to build a 10"-12"-15"-20" direct view or projection type receiver with FM sound. Supplied with a

13 channel RF front end unit. The front end covers channels from 44 to 88 mc/s and 174 to 216 mc/s (13 channels). Matched antenna input for 300 ohm line. Tubes: 1-6J6 RF amplifier 1-6J6 converter 1-6J6 oscillator.

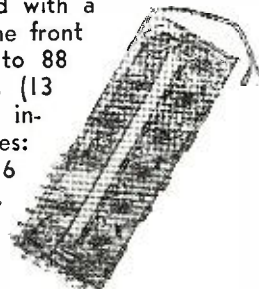

**\$119.50**

DEALERS NET

● PICTURE IF — 5 picture IF stages of amplification and second detector. SOUND IF STAGES 2 IF stages with limiter and discriminator. VIDEO amplifiers — 2 stages video with a frequency response of 4.5 mc/s ONE DC RESTORER. IF FREQUENCY audio 21.25 — picture 25.75.

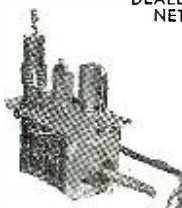

Picture IF band width 4.5 mc/s. All the above circuits and tubes are contained on one chassis. Front end unit on separate chassis. Both picture IF and sound IF delivered completely wired, tested, tubed, and matched ready for use.

## DUMONT INPUTUNER

The Dumont Inputuner tunes continuously from 44 to 216 megacycles without a break—covers all 13 television channels as well as FM, amateur, and aviation channels. For ease and convenience of operation no band switching of any kind is required when tuning from channel to channel with the inputuner system. Just one simple operation to reach any desired station.



**\$97.90**

LIST



Deflection Yoke similar to RCA part # 201D1

**\$13.75**

LIST

## BAUSCH & LOMB TELEVISION PROJECTION LENS



Television Industries Co. is proud to announce that they have been appointed national wholesale distributors for the Bausch & Lomb f: 1.9 Television Projection Lens. Sample orders filled immediately.

**\$125.00**

DEALERS NET

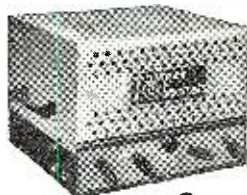

### R. F. POWER SUPPLY

27 — 30 K.V.  
for  
Projection Television

**\$125.00**

DEALERS NET

Contact Us for your Local Distributor

# TELEVISION INDUSTRIES Co.

540 BUSHWICK AVE.  
BROOKLYN 6, N. Y.

# Photo-Sensitive Devices And The Radioman



Fig. 1. Weston Model 594 photoelectric cell.

By JOHN P. GSCHWIND

***Servicing or building photoelectric operated devices is not difficult. Here are a few pointers to remember.***

SOME years ago I had occasion to construct my first "light-controlled" unit—a simple door-opener for a chicken house. A friend of mine wanted a device that would turn his flock out into the chicken yard at full daylight every morning. As the daylight hour varies throughout the year, a time-clock switch would not do the job and a photocell actuated device was indicated. Since then I have made a nice profit constructing and servicing hundreds of varied types of light sensitive installations. But the time spent delving into highly technical treatises on photocells and phototubes in an attempt to solve my problem of the moment has always been excessive. There are many fine books and papers on the subject, but all that I have seen are highly technical, theoretical discussions by the engineer and for the engineer. In this article I will try to avoid unnecessary theory and confine my remarks to the practical aspects of photocells and phototubes, their types and uses and the principal circuits.

It might be well to insert a word here concerning the distinction be-

tween "photocell" and "phototube." The two terms have entirely separate meanings, and cannot be used interchangeably. A photocell is a cell whose electrical properties are affected by illumination, such as photovoltaic or photoconductive cells. A phototube refers specifically to a vacuum or gas-filled tube in which electron emission is produced directly by light falling on an electrode (the cathode). This distinction will be clarified in the following discussion.

As you undoubtedly know, a light-sensitive device is a device (not necessarily a "tube," viz., the Weston cell) that undergoes an electrical change when exposed to light. The various light-sensitive devices can be divided into three basic groups because of the three basic electrical changes resulting from this action of light. First, (and without arranging them in any order of importance) we have the "photovoltaic" cell, which from its name indicates that it actually creates a difference in potential when subjected to light. An early form of the photovoltaic cell was made by immersing a lead anode and a copper oxide

cathode into an electrolyte of lead nitrate solution. Light striking the electrolyte produced an ionization which caused a difference in potential between the copper oxide and the lead. This was literally a voltaic cell battery whose amount of activity was in proportion to the amount of light impinging upon the electrolyte. While it probably was the inspiration for the term "photovoltaic cell," this early unit was so unwieldy as to have few useful applications. The best-known type of photovoltaic cell consists of a metal disc coated with a light-sensitive material such as selenium, which is covered with a transparent conducting surface (such as a diaphanous mirror). Light passes through the transparent conducting surface and strikes the selenium, forcing off some passing electrons to the metal disc thus resulting in a difference of potential between the metal disc and the transparent conducting surface. Naturally, in production models, insulators are interposed between the transparent conducting surface and the selenium covered metal, and collector rings or some such devices are utilized as terminals. The Weston cell shown in Fig. 1 is typical. The current produced may be measured by a microammeter, and such a combination unit constitutes the standard "photoelectric light meter" as used by lighting engineers. The popular "photoelectric exposure meter" for photographic use is the same basic unit combined with a dial that enables the user to interpret the indicated current changes as usable units of photographic exposure. This type of cell has proven to be invaluable for use with portable light-intensity indicating devices because it produces its own current and no external power source is necessary. Further, although its frequency discrimination when subjected to the visual and near-visual bands is slight, by the

Fig. 2. (A) Internal construction of a commercially-built photo-conductive cell. Light falling on the selenium decreases the resistance between connectors "A" and "B". (B) Construction details and circuit hookup for a photo-emissive type of phototube.

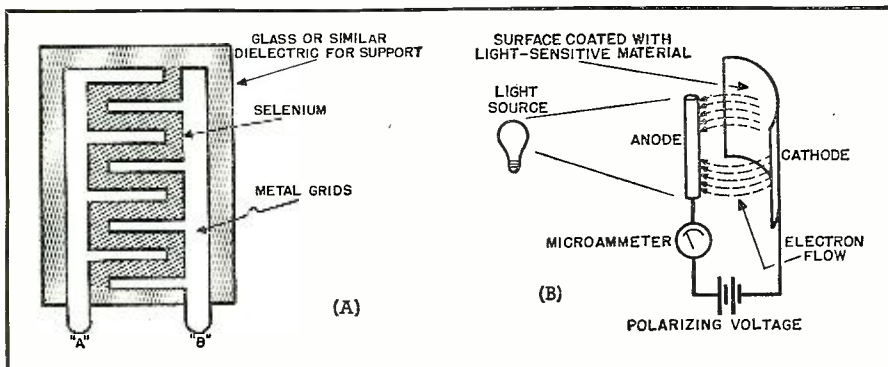

**THE GREATEST VALUES**

**"Communications"**

**AT LOWEST PRICES**

**Microwave Tubes**

Tube	(Magnetrons) Freq. Range	Pk. Pwr. Out.	Price
2J31	2820-2860 mc	285 Kw	\$15.00
2J21-A (725-A)	9345-9405 mc	50 Kw	\$25.00
2J22	3267-3333 mc	265 Kw	\$13.00
2J26	2892-3019 mc	275 Kw	\$15.00
2J27	2865-2992 mc	275 Kw	\$15.00
2J31	2820-2860 mc	285 Kw	\$15.00
2J32	2780-2820 mc	285 Kw	\$15.00
2J33	PKG. 32-9-3263 mc	5 Kw	\$25.00
2J55	PKG. 93-5-9105 mc	50 Kw	\$25.00
3J31	24,000 mc	35 Kw	\$17.50
W.E. 700-A	680-710 mc	100 Kw	\$30.00
W.E. 720-BY	2800	1000 Kw	\$25.00

MAGNETS for 2J21-A (725-A), 2J22, 2J26, 2J27, 2J31, 2J32 and 3J31, each ..... \$8.00

Field Strength (Gauss)	Distance Between Pole Faces	Pole Face Diameter	Price
4850	5/16"	3/4"	\$8.00
1500	1 1/2"	1 1/8"	\$8.00
1000 (Electromagnet)	Adjustable 2 3/4" to 3"	2 1/2"	\$12.00

**CATHODE RAY TUBES**



5BP1'S...\$1.20 3BP1...\$1.25  
3FP7...\$1.20 5FP7...\$1.75

**ANTENNA EQUIPMENT**

**ANTENNA AN/122-A.** Used in Adcock array of 4 elements, these dipoles make efficient, lightweight beams for the 6 or 2 meter band. Each dipole element is 12' long, overall, made of 3/8" dural tubing. One side of dipole is adjustable in length by means of a bevel gear arrangement to facilitate fine tuning. Get four of them for only \$20.00 or \$5.65 each.

**ANTENNA AN/104-A.** The famous Ax-handle antenna, used with the SCR 522. Ideal for that mobile quarter wave up to 2 meters. Streamline construction. Two units can be used as an efficient dipole for 2 meters or FM & TV reception. Each unit consists of a copper sheath 21" long, molded about a sturdy wooden support with an 83-1R connector. \$7.75 ea. or 2 for \$13.50.

**AN-128 A.** 2 meter directive array consisting of 2 vertical dipoles working against a square reflector, approx. 4'x3'. Surge impedance is 50 ohms. New, complete with support assembly ..... \$40.00  
Schematic diagram ARC-5 xmt. and rcvr ..... ea. 50c

**BC 306.** Antenna variometer unit for BC 375 transmitter. New ..... \$4.95

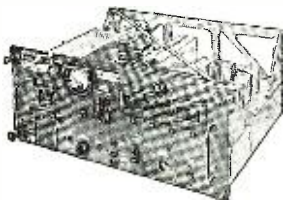

**BC 1267 XMTR-RCVR.**

XMTR consists of tuned line pulse oscillator on 154-186 mc. Can be modified to operate on voice or CW, and put to work on the amateur 2-meter band. It CVL is a superhet with 2 stages of RF and 5 stagger-tuned I.F. stages (11 mc). Plenty of room on chassis for additional components and changes. Fixed, but in excellent condition. .... \$27.50  
Complete with power supply for operation from 117 v. 60 cycles ..... \$42.50

**HEADSETS**

Dynamic mike and headset combination. A high quality, efficient unit, used in B-19 tank Xmt's. Mike and phones complete, new ..... \$2.75  
R-13 headsets: 8000 ohms impedance, rubber cushions. Comes with 8' cord and plug PL 55. New ..... \$1.95  
HS 30 headset. Insert type headset cuts out background noise, and low impedance (500 ohms) assures efficiency and fidelity. A MUST for every ham at this price ..... \$ .85  
Xfmr to match 8000 ohms output ..... \$ .35

**AN/PRS-1 MINE DETECTOR**

Used by the armed forces in campaigns all over the world, for locating intricately hidden mines, the AN/PRS-1 detector can perform an amazingly great number of duties for you. It can locate buried water pockets, water pipes, tree stumps . . . everything; whether metallic or not, as long as it has bulk. Every home owner, camper, and prospector needs one. The detector uses headphones and meter for both aural and visual indication. All units include detector unit and amplifier, all tubes, cables, etc.

New, complete ..... \$12.74  
With Batteries ..... \$21.76



**PE 73 CM (G.E.)** Power supply for BC 375 Input: 28 VDC Output: 1000 VDC @ 350 Ma. New ..... \$4.95  
**BD 77KM** Power Supply for BC 191 with spare fuse links, etc. Input 14 v.d.c. Output 1000 v. @ 350 ma. New ..... \$9.95  
Used excellent condition ..... \$5.95  
**PE 101-C** input 13/26 VDC @ 12.6/6.3 A. Output 400 VDC @ 435 Ma. 800 VDC @ 20 Ma. 9 VAC @ 1.1 A. New ..... \$3.49  
**PE 86 N.** Input: 28 VDC, Output: 250 VDC @ 60 ma. .... \$1.95  
**DA6 33A** Input: 18 VDC @ 3.2 A. Output: 450 VDC @ 60 Ma. .... \$2.45  
**DM 33:** Input 28 VDC @ 7 a. Output: 510 VDC @ 250 Ma. Power supply for SCR 374 modulator. filters, etc. .... \$3.95  
**DM 23350:** Input: 27 VDC @ 1.75 A. Output: 285 VDC @ 75 Ma. .... \$3.50  
**DM 21:** Input: 14 VDC, Output 235 VDC @ 90 Ma. Power supply for BC 312 ..... \$2.49  
**PE 55:** Input: 12 vdc @ 25 amp. Output 500 vdc @ 400 ma. (slightly used) ex. cond. \$4.95  
**MP 10 G** Power supply, using 2 dynamotors. Input: 24-28 vdc. Output: 1000 vdc @ 400 ma. 230 vdc @ 100 ma. New complete with relays, filters, etc. BENDIX ..... \$40.00  
**B-19** power pack (dynamotor). Input: 12 vdc @ 9.4 amp. Output: 275 vdc @ 110 ma. 500 vdc @ 50 ma. New, complete in metal case with 2 plugs, filters, etc. .... \$3.95  
**DM 28-R.** Input: 28 v.d.c. @ 1.25 amp. Output: 270 v.d.c. @ 70 ma. New, with enclosed terminal box. .... \$3.25  
**ZA /USA .0515,** Input: 12/24 v.d.c. 4/2 amp. Output: 500 v.d.c. @ 5t ma. Compact square shape, size 7 1/2"x4 1/2"x3" ..... \$3.95  
**ZA /USA .0516,** Input: 12/24 v.d.c. @ 8/4 amp. Output: 275 v.d.c. @ 110 ma. 12 v.d.c. @ 3 amp. Compact square, size 7 1/2"x4 1/2"x3" ..... \$4.25  
**DM-25:** In 12VDC 2.3A Out 250VDC 50 ma. .... \$2.49  
**DM-42:** In 14VDC. Out 515/1030 VDC 215/200 ma. and 2.8VDC ..... \$3.95  
**BD-AR 93.** Input: 28vdc @ 3.25 amp. Output: 375 vdc @ 150 ma. Pioneer, New ..... \$4.95

**INVERTERS**

**PE 206-A.** Input: 28 v.d.c. @ 38 Amp. Output: 80 volts @ 500 volt-amp, 800 c.v. Leland Electric. New, complete with instruction book, relays, filters, etc. .... \$12.50  
**PE 218—**Input: 25-28 v.d.c. @ 92 amp. Output: 115 volts, 1300 volt-amps, 380/500 cv. Leland Electric. New \$35.00; Used, good condition. .... \$20.00

**RELAYS**

7220-24. Contactor, SPST, 24-28 vdc. contacts 400 amps. .... \$1.20  
1077BP. Antenna changeover, DPDT, 28 vdc. .... \$1.15

**TELEPHONE RELAYS**

**GR 206,** DPST, 500 ohms, 24 vdc (Normally open) ..... \$1.05  
**SC 5853** SPST w/spdt section, 24 vdc, 1000 ohms ..... \$1.10  
Send for complete listing of W.E. telephone relays in stock.

**CROSS POINTER INDICATOR**



Two 0-200 microampere movements, 3" case, many applications ..... \$2.50

**TWEETER SPEAKER**

Made by W.E., this unit was originally used in battle announcing system aboard ships. Response up to 17,000 cps. 1 1/2" radiating surface, perm magnet, dynamic type. Wt. 4 1/2 lbs. New, with spare cone. .... \$9.95

**BUTTERFLY CAPACITOR**

Balanced wobulator capacitor, 50 mmf, 13 plates, ball bearings, 1" extended shaft. 1 1/2"x1 1/2"x1 1/4". .... \$1.05



**INDICATOR BC 704 A**

Indicator Part of Radar Set SCR 521. Makes an excellent foundation unit for a high gain scope. Has following tubes: 4-6AC7, 3-6H6, and 1-6BP1 CR tube. Comes enclosed in metal shield. New, with all tubes, less power supply. With wooden carrying case. .... \$17.50

**CERAMICON CAPACITORS**

(Erie, Centralab) \$7.50 per 100			
3 mmf ..... ±5%	67 mmf ..... ±0%	5 mmf ..... ±5%	100 mmf ..... ±5%
4 mmf ..... ±5%	115 mmf ..... ±2%	8.5 mmf ..... ±5%	120 mmf ..... ±5%
11 mmf ..... ±5%	240 mmf ..... ±3%	15 mmf ..... ±2.5%	250 mmf ..... ±3%
48 mmf ..... ±2%	500 mmf ..... ±15-30%	50 mmf ..... ±2%	1000 mmf ..... ±5%
60 mmf ..... ±3%			

**SILVER-MICA BUTTON CAPACITORS**

(Erie, Centralab) \$9.50 per 100		
185 mmf ..... ±2.5mmf		
175 mmf ..... ±2.5mmf		
500 mmf ..... ±10%		

**Sonar Sound Detection Unit**

Ideal for detecting under water sounds, such as fish swimming in schools, within a 15 mile area. Using a Rochelle salt crystal, which is about 1000 times more sensitive than quartz. It is completely enclosed in a solid rubber sheath. This sound detector was originally used in harbor defense. Coupled to an audio amplifier, this can be found to have many valuable applications, it's the Model JR which contains 7 microphone units ..... \$12.50

**MOTOR DRIVEN SWITCH**

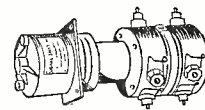

Switch operates at 1800 rpm, using internal 24 VDC motor. Switch is DPDT, and was originally designed for automatic switching of YAGI radar antennae ..... \$2.00

**ARC-5 ACCESSORIES**

**CONVERSION COILS FOR ARC-5**

M.O. Coils	P.A. Coils	Antenna Loading Coils	Freq. Range
\$1.00 each	\$1.00 each	\$ .85 each	
#6029	#7247	#6033	3-4 Mc.
#6030	#9293	#6034	4-5.3 Mc.
#6032		#6035	7-9.1 Mc.

**TRANSMITTERS**

**CONVERSION KIT,** consisting of 1-M-O coil, 1-P.A. coil, 1-ANTENNA COIL, in any one particular frequency range

**ARC No. 6538** variable receiving capacitor, 62 mmf section, 3 sections, .03" spacing, 8 rotors. Worm drive ratio 38:1 ..... \$1.75  
**ARC No. 4990,** variable xmtg capacitor, 22.4—145 mmf, .05" spacing, 11 rotors. Each ..... \$1.00  
**ARC 6632** Var. Xmtg. capacitor, 29.2—117 mmf, .06" spacing, 16 rotors, worm drive; 96:1 ..... \$1.00  
Single rcvr. mtg. racks, \$1.00; dual ..... \$1.50  
Single shock mounts for rack \$5.00, dual ..... \$1.00  
**DUAL CONTROL BOXES FOR RCVRs.** ..... \$1.00

**POWER CHOKES**

6 Hy @ 150 ma. ....	\$1.50
Dual Choke: 2-7 Hy @ 100 Ma. ....	\$ .90
Dual Choke: 7 Hy @ 75 Ma. 11 Hy @ 60 Ma. ....	\$1.30
8.5 h @ 125 ma. ....	\$1.50
25 h @ 65 ma. ....	\$1.10
1 h @ 12A., 46 ohms .....	\$9.95

**BC375 TUNING UNITS**



From BC 191 & BC 375 TU 9B-7700 to 10,000 kc. TU 26B 200-500 kc. TU 22 B 350 to 650 kc. Will supply closest unit to specified frequency at time of shipment. Each ..... \$2.25

All merchandise guaranteed. Mail orders promptly filled. All prices, F.O.B. New York City. Send Money Order or Check. Shipping charges sent C.O.D.

**COMMUNICATIONS EQUIPMENT CO.**

131 "N" Liberty St., New York City 7, N. Y.

Digby 9-4124



# Better Products for the Radio Industry

## NEW G-C STATIC CHASER INJECTOR and POWDER

Tire static powder kits—improve auto radio reception. Eliminates wheel static interference. New powder is blown into all inner tubes—easy to use. For every car owner!  
No. 5604 Injector for G-C Static Powder—List \$1.50



No. 5605—G-C Static Powder Packet for 5 tires—List \$1.00  
No. 5606—Kit—One Powder Packet and Injector—List \$2.50

## NEW G-C MINIATURE TUBE PIN STRAIGHTENER



Every Radio Man needs a tube pin straightener for the new miniature glass tubes. Each man should have 2 for 3—one to carry with him and several fastened to his bench.  
No. 5191 ..... List \$1.00



Have you seen the new G-C "Speedex" Wire Strippers... write for illustrated literature.

RADIO DIVISION, DEPT. H

## NEW G-C TUBE PULLER



Makes it easy to remove or insert miniature tubes—simple to operate. Inserts or extracts tubes where fingers will not reach—into hard-to-reach places. Saves time and money. Ends tube breakage. Prevents burnt fingers.

No. 5093—Miniature Puller ..... List \$1.65  
No. 5093-D—Display of 12 ..... List \$19.80

## NEW G-C FIELD CHASS EZ



Holds almost any radio chassis in position! Has special reversible hooks for flanged type chassis or, to tilt chassis back if necessary. Made with slide adjustment—takes only 5 seconds to install. No parts to lose—will never wear out. A real convenience for the radio serviceman!  
No. 5207—Chassis ..... List \$3.65

G-C Products are available at leading distributors. Write for your copy of our new illustrated catalog.

**GENERAL CEMENT Mfg. Co., Rockford, Ill., U. S. A.**

Manufacturers of over 3,000 products • Sales offices in principal cities

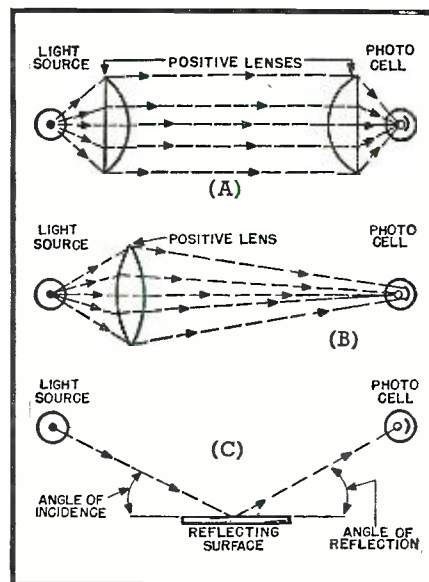

Fig. 3. (A) A small light source can be concentrated and made to operate a photocell at relatively great distances. (B) A single lens is used to concentrate beam of light on photocell. (C) Light beam is reflected before being concentrated on cell.

addition of sharp cut-off filters (layers of glass or other transparent material dyed to permit the passage of just certain desired colors or frequencies of light) between the cell and the light source, it is possible to employ these units to match or sort colors. There are two major disadvantages to the photovoltaic type of cell in general use. First, the amount of current generated by the cell is so small that it will only operate delicate meters or extremely sensitive relays. Where these photovoltaic cells are employed to actuate counting or separating mechanisms it is necessary to have the first sensitive relay actuate a second heavier relay that can handle the additional current necessary. The other major disadvantage lies in the fact that they are somewhat sluggish in their response to rapid changes of light intensity. In my own experience I have found that they are much better for positive use, that is where the action desired is to be as a result of light falling on the unit, rather than for negative use, where the desired action is to be the result of the cessation of light. This is probably because all those I have used seem to have a "fatigue factor" where the amount of current produced decreases when the cell is subjected to a high intensity of light for long periods of time.

The second group-type of light-sensitive device is termed the "photoconductive cell." This group is comprised of photocells that vary their electrical conductivity in proportion to the amount of light.

Most of these depend upon selenium, or a combination of selenium and other elements, as the variable resistance portion of the cell. Some of the commercial models of this type cell utilize two comb-like grids with the teeth placed as shown in Fig. 2A.

## SHOOTS TROUBLE FASTER!

MAKES MORE  
MONEY FOR YOU  
ON JOB OR AT  
SERVICE BENCH!



PRICE  
**\$9.95**  
at distributor  
or postpaid,  
direct. Sorry,  
no COD's.  
Ohioans add  
3% State  
Sales Tax

## Signalite

### MULTI-FREQUENCY GENERATOR

In radio service work, time means money. Locate trouble faster, handle a much greater volume of work with the SIGNALITE. As a trouble shooting tool, SIGNALITE has no equal. Merely plug in any AC or DC line, start at speaker end of circuit and trace back, stage by stage, listening in set's speaker. Generates RF, 1F and AUD10 Frequencies, 2500 cycles to 20 Megacycles. Also used for checks on Sensitivity, Gain, Peaking, Shielding, Tube testing, Wt. 13 oz. Fits pocket or tool kit. See at your dist. or order direct.

**Clippard** Instrument  
Laboratory, Inc.

DEPT. N, 1125 BANK STREET  
CINCINNATI 14, OHIO

QUALIFIED JOBBERS WRITE, WIRE  
FOR DETAILS.

## AMSCO'S JUNE SPECIALS

### BUILD YOUR OWN 6-TUBE SUPERHETERODYNE RECEIVER

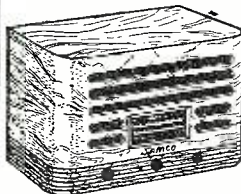

6 tube super-het.  
2 band receiver...  
slug tuning. We  
furnish all parts less  
tubes.

**\$8.95**

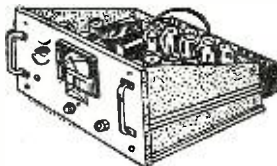

### PHOTO-CELL AMPLIFIER

110V 60 cy.  
Drawer type.  
Has milliammeter  
on front panel. Com-  
plete with  
tubes - 6V6,  
6J7, 45, 60  
and VR105.

**\$9.95**

### MASTER CONTROL FOR RADIO COMPASS

Complete with meter..... **\$1.39**

### SERVICE KIT

Includes assortment of:  
100 Resistors, 1/2 and 1-  
watt.  
50 Condensers, paper,  
mica electrolytic &  
can.  
10 Switches, Toggle,  
Gang & Rotary.  
100 ft. Spaghetti, various  
sizes.  
12 Knobs, round and bar.  
2 lbs. Hookup wire.  
20 Fuses.  
6 Volume Controls.  
10 Type Sockets.  
1 lb. Hardware (screws,  
nuts, lugs, etc.)

### Wire Wound Resistors—

10 & 25 Watt.  
25 Connectors, Plugs,  
Ties.  
10 Jacks (Phone) & Tip.  
12 Padder Condensers.  
12 Terminal Boards.  
25 Ceramic Insulators.  
2 Panel Lights (1  
neon).  
1 Screw Driver.  
1 Tube Puller.  
2 Allen Wrenches.  
2 Panel Fuse Holders.  
4 Binding Post Strips,  
and many other valu-  
able items.

Your Cost **\$9.95** Complete

WRITE FOR OUR 1948 CATALOG

AMERICAN SALES CO.

1811 W. 47th St.

Chicago 9, Ill.

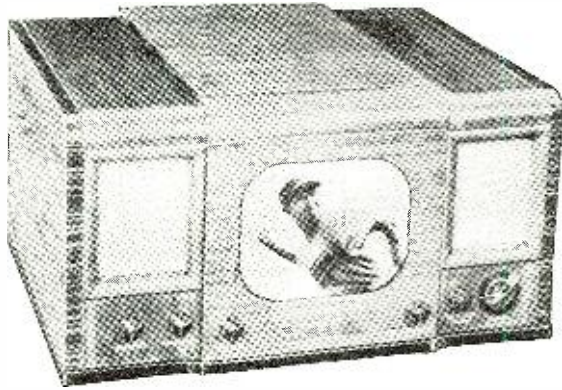

**DeWald BT-100 DIRECT VIEW 10\"/>**

- 52 square inch picture
- 13 channels
- Balanced input circuit
- Safety Kinescope Protector
- Six simple controls
- Safety High Voltage
- New Hi-Q trap circuits
- Automatic Picture Stabilizer

Fine Hardwood Walnut Veneer 25 1/2" x 15" x 19"  
 Net price to dealers only by application on  
 Dealer's Letterhead

LIST  
**\$372.10**

*Before you buy TELEVISION  
 See the DeWald BT-100—  
 By far the finest we've been  
 able to discover ANYWHERE*



**DeWald B-504 "Personal"**

- AC/DC and Battery Operation
- Superheterodyne circuit
- 4 tubes & Selenium rectifier
- Instantaneous operation
- P.M. Alnico 5" speaker
- Size 4" x 8 5/8" x 7 1/4"

LIST \$27.95  
 Also available Battery Operated  
 LIST \$19.95

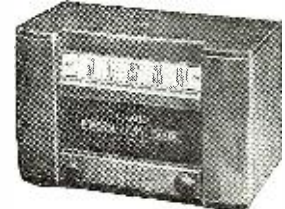

**DeWald B-612 "Wireless  
 F. M. Tuner"**

- Simply plug in and play
- No wiring to radio necessary
- AC/DC operation
- Five tube & rectifier Superhet.
- Balanced F.M. Detector Circuit
- Hand-rubbed walnut cabinet
- Size 11" x 6" x 7 1/2"

LIST \$39.95

**VALUES! VALUES! COME AND GET 'EM!**

**Dealers! Dealers!  
 WRITE FOR DISCOUNT SHEETS**



**Temple MODEL G-410  
 G411  
 NEWEST  
 PERSONAL PORTABLE**

- Four tubes
- Battery Operated
- Uses one flash cell and 67 1/2 V. Battery

LIST **\$14.95**



**No. 521**

- Five tubes, Selenium Rect.
- Broadcast Band and
- Short Wave from 5.5 to 18.5 mc.

LIST **\$64.95** NET **\$43.48**

*New!* **TEMPLE 3 WAY  
 PERSONAL PORTABLE**

AC, DC, Battery  
 Operated



**BIG  
 VALUE!**

LIST LESS BATTERIES

**\$24.95**



8" high-  
 4 7/8" wide-  
 4 1/4" deep

- 4 tubes plus Rectifier
- Full 4" speaker
- Choice of Finishes from \$24.95 to \$29.95 List
- Wt. 5 lbs., incl. batt.
- New Superhet. Circuit



**Temple AC, DC, Battery  
 G612**

- Completely self-contained
- Six tubes—Auto. Vol. Control
- Full vision Slide Rule Dial
- Uses longer life batteries

LIST **\$49.95** NET **\$21.95**



**Minerva No. 410A**

- Walnut Bakelite Cabinet
- Alnico V 5" PM Speaker
- 2 Hi-gain Air Core IF
- High Signal to noise ratio
- 4 tubes, selenium rect.
- 12" x 7 3/4" x 6 1/8"

LIST **\$15.95**



*Press-To-Magic*  
**TOASTER**

**Don't Pass Up  
 THIS VALUE**

Has every feature incorporated in most expensive toasters, PLUS new modern streamline design. Rich Chrome finish. Extra wide slots. Thermostatic control.

Only  
**\$19.95**  
 LIST

AVAILABLE FOR DELIVERY IN ANY QUANTITY

**WARREN DISTRIBUTORS**

**3145 WASHINGTON STREET  
 JAMAICA PLAIN 30, MASS.**

# Look!

## Send for FREE BULLETIN

Sent you every month. It's crammed full of real buys. A post card with your name and address brings it to you. You can't afford to miss its bargains. Mail your card today.



### VALUE and PRICE LEADERS THAT CANNOT BE MATCHED

#### VOLUME CONTROLS

Our own private brand—made by a nationally known manufacturer. • The same kind that net for \$1.09. • Noise-free carbon construction, standard shaft and bushing. • Individually boxed in our colorful carton carrying the RSE quality seal of approval. • Complete with switch, full range of sizes.

10 M ohms	100 M ohms	each per 10 asstd. <b>\$5.50</b>
15 M ohms	250 M ohms	
25 M ohms	500 M ohms	
50 M ohms	1 Meg ohms	
2 Meg ohms	500 M Knurled Shaft	

500 M ohms less switch, 39c each, 100 for \$35.00

#### SELENIUM RECTIFIERS

these prices speak for themselves!

100 mil. size	<b>59c</b>
Regular List \$1.60	
200 mil. size	<b>79c</b>
Regular List \$2.25	

#### SAVE \$ ON FUSES

3AG and SFE Types. 52 to 93% Discount! Limited Supply—Check Your Costs and Buy Now! Box of 100

Type and Rating	3AG5 (Slo-Blow)	<b>\$1.19</b>
3AG 1/2 Amp	3AG10	<b>\$2.40</b>
3AG2		
SFE 4 Amp	SFE6	<b>\$1.92</b>
SFE 9 Amp	3AG10	<b>\$1.68</b>
SFE 14	3AG15	
SFE 20 Amp		

Quantity Prices Not Assorted

#### OZ4's at 73% OFF!

Until sold out—RSE offers 15000 new guaranteed OZ4 tubes. You know who made them—You can't go wrong at **59c**



DEMAND THIS SEAL OF QUALITY

#### ORDER INSTRUCTIONS.

Minimum order—\$2.00. 25% deposit with order required for all C.O.D. shipments. Be sure to include sufficient postage—excess will be refunded. Orders received without postage will be shipped express collect. All prices F.O.B. Detroit.

# RADIO SUPPLY & ENGINEERING CO., Inc.

129 SELDON AVE. DETROIT 1, MICH.

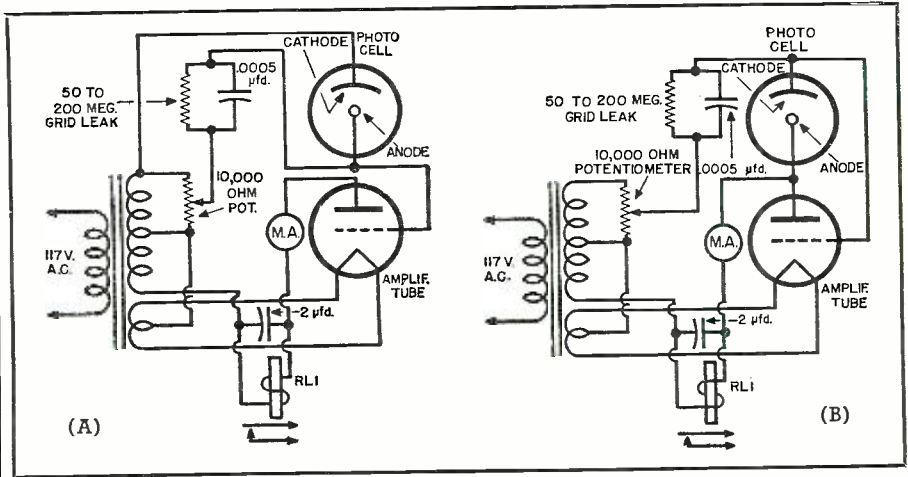

Fig. 4. Basic amplifier circuits that may be used with photo-emissive type photocells. (A) Plate current increases with increase in light. (B) plate current decreases with increase in light.

These grids are made of a conductive metal and are mounted on glass or other dielectric. Selenium or a similar material is then placed in a layer either under or over and in contact with the grids. When light strikes the selenium its electrical resistance decreases. According to some technical references, this increase of conductivity of the selenium is caused by the fact that the light impact "loosens" electrons from the selenium atoms and thereby permits freer movement. As this article is designed to be practical rather than technical and although physicists may disagree as to the causes, I do know that some cells I have used have "dark to light" resistance variations as much as ten or twenty times. For example, a cell with a normal "dark" resistance of five megohms may have its resistance lowered to less than one-half megohm when subjected to a powerful light. These "photoconductive cells" may be used in a simple series circuit (with battery or other external power source) to control the operation of a light relay or, because of the high resistance of the cell, may also be used in a vacuum tube circuit, in series with the grid, to cause a resultant variation of the grid bias. The primary disadvantage of this type has been its extreme sluggishness, the ordinary cell requiring a lapse of several seconds from the time of full illumination until reaching point of lowest resistance, and a similar lapse for recovery of resistance after the light has been removed. However I have used some commercial cells of this type that are fast enough to be entirely suitable for "audio-modulated" light, so their time-lag must be as little as one ten-thousandth of a second!

The third group type may be called the "photoemissive type" of phototube. As may be surmised from the name, the operation of these tubes depends upon the principle that certain metals (such as sodium, potassium, and lithium) have the property of emitting electrons when subjected to light. (In actual practice the oxides or hydrides of these metals are com-

monly used as they are more sensitive than the pure metals.) This property of "electron emission" permits the construction of a vacuum tube in which the cathode does not have to be heated. The cathode is a metal plate surfaced with one of the previously mentioned sensitive materials and the anode is a rod or bar of conductive material as shown in Fig. 2B. When light strikes the light sensitive material electrons are thus released and consequently a current flow from this light-sensitive cathode to the anode or plate is permitted. Some manufacturers insert small amounts of certain rare gases (such as argon, krypton, neon) into their vacuum tubes, just as is done with the "gaseous" type of radio tubes because ionization of these gases, as a result of bombardment by the electrons emitted by the light sensitive material, will produce a greater total number of electrons flowing between the cathode and plate and so increase the flow of current. The current flow through this type of tube is very low so some form of amplification is generally necessary. However, this offers no great handicap because if we take a simple vacuum tube amplifier and connect the cathode of the phototube (the light-sensitive surface) to the grid of the vacuum tube and add a grid resistor, and connect the anode of the phototube to the plate of the amplifier tube we then have a phototube amplifier. Additional stages of amplification may be added if necessary, and either direct, resistance, or transformer coupling may be used. Fig. 4 illustrates two basic amplifier circuits utilized with this type of tube. In circuit "A" the plate current is increased with an increase of light while in circuit "B" the plate current is decreased with an increase of light. Thus, by choice of the proper circuit to fit the job, the necessary plate current can be kept low except at the times that the unit causes the desired action. Most of the modern commercial phototubes in this group are very stable, suffering from practically no "light-fatigue" effect. They are, in general, comparatively free

# 12 BOOKS IN 1

IN THE

## RADIO DATA BOOK

THE ONLY RADIO HANDBOOK OF ITS KIND! . . . 1148 PAGES, 12 SECTIONS, EACH A COMPLETE COVERAGE OF ONE RADIO SUBJECT.

TOGETHER THE 12 SECTIONS FORM THE MOST COMPLETE RADIO HANDBOOK YOU CAN BUY! EASY TO READ . . . A QUICK REFERENCE!

Plan every operation in radio and electronics with the Radio Data Book. This new radio bible will be your lifelong tool . . . you will use it every day, on the board, at the bench, in the field! Use it for engineering, construction, trouble-shooting and testing. The RADIO DATA BOOK will be your invaluable aid in design, experiment and in layout. It will help make your production better, faster and easier. In any and every operation in radio and electronics, you will use the RADIO DATA BOOK!

The RADIO DATA BOOK is a work of complete authority, prepared by engineers with many years of practical experience. They have been assisted by the Boland & Boyce staff of editors skilled in preparing electronics manuals for the U. S. Signal Corps for many years. These men have worked for several years gathering material for this book . . . all the knowledge of radio principles and operation . . . all the statistics . . . all the newest developments in electronics . . . every possible angle and detail. Eighteen months were spent digesting this material into the most concise, the clearest, and the most readable form. The result is this invaluable manual . . . The RADIO DATA BOOK. Whether you use this book for general reference, for scientific instruction, or for education, one thing is certain—the practical help, the daily usefulness you will derive from it will prove to be worth many, many times its astonishingly low price!

Here's a description of just ONE section—Section 5, Sound Systems:

This section covers the planning, selection of components, and assembly of complete P. A. installations. Every type of unit and material used in a sound system is described and analyzed. Components are classed as to size and type of P. A. installations in which they should be used. Tables and charts are given from which to determine power and ratings. Microphone and speaker construction are described and illustrated in detail . . . placement in auditoriums, etc., for proper acoustical results is explained and illustrated. Patterns of the different types of microphones are illustrated as are the proper methods of wiring up the various units, etc.

The above is just one of the twelve big sections in the RADIO DATA BOOK. We wish we had room here to describe all twelve in detail, but just look over the list of sections, and you will see why this is the best radio handbook money can buy. Send in your order for the RADIO DATA BOOK today!

**Coming Soon!**

### THE VIDEO HANDBOOK

Everything in Television in one Complete Textbook.

OVER 500 PAGES COMPLETELY ILLUSTRATED

This new handbook will be invaluable to everyone concerned with the technical aspect of Television. Everything from the basic theory of television through the design and characteristics of receivers to final installation, operation, and maintenance is covered. This is a completely new book that includes all of the latest developments in the field—the components discussed are of the newest design—the practical maintenance described is a result of intensive study of the equipment placed in operation during the past few months.

There are five completely illustrated sections in the VIDEO HANDBOOK, each over a hundred pages long. Each section completely covers.

The VIDEO HANDBOOK will be out October 15th, but we have received a flood of orders already. To insure your getting a copy in the first printing—mail your order now.

The VIDEO HANDBOOK is \$5.00 alone, or you can order it with the RADIO DATA BOOK and get both books at the special price of \$9.00. Send in the coupon today.

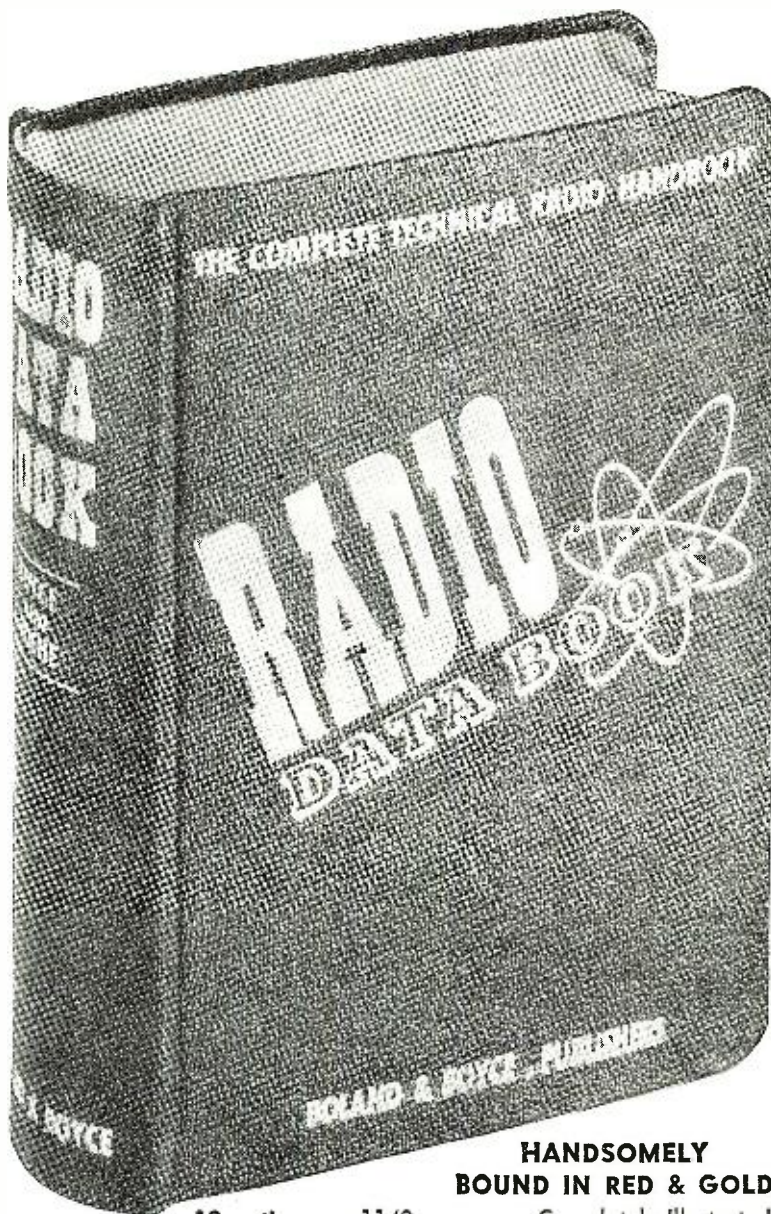

**HANDSOMELY BOUND IN RED & GOLD**

12 sections . . . 1148 pages . . . Completely illustrated

- Section 1. THE 150 BASIC CIRCUITS IN RADIO.
- Section 2. COMPLETE TEST EQUIPMENT DATA.
- Section 3. TESTING, MEASURING AND ALIGNMENT.
- Section 4. ALL ABOUT ANTENNAS.
- Section 5. SOUND SYSTEMS.
- Section 6. RECORDING.
- Section 7. COMPLETE TUBE MANUAL.
- Section 8. CHARTS, GRAPHS AND CURVES.
- Section 9. CODES, SYMBOLS AND STANDARDS.
- Section 10. 50 TESTED CIRCUITS DESIGNED FOR OPTIMUM PERFORMANCE.
- Section 11. DICTIONARY OF RADIO AND ELECTRONIC TERMS.
- Section 12. RADIO BOOK BIBLIOGRAPHY.

**12 complete books in one only \$5.00!** Less than 45¢ per book!

MAIL THIS COUPON YOUR JOBBER—OR DIRECT TO:

**BOLAND & BOYCE Inc., PUBLISHERS**

460 BLOOMFIELD AVE., MONTCLAIR, N. J.

PLEASE SEND ME:

- THE RADIO DATA BOOK AT \$5.00
- THE VIDEO HANDBOOK AT \$5.00
- BOTH BOOKS AT THE SPECIAL PRICE OF \$9.00

- I ENCLOSE FULL PAYMENT
- I ENCLOSE \$1.00 AND WILL PAY BALANCE TO POSTMAN ON DELIVERY

NAME .....  
 ADDRESS .....  
 CITY ..... ZONE.....  
 STATE .....

**BOLAND & BOYCE INC., PUBLISHERS**

# TOM ALLIANS Radio Specials

MANY OTHERS NOT LISTED

## RADIO ALTIMETER

Transmitter Receiver RT7/APN1—complete with 14 tubes: 418 to 456 meg., 27v dynamotor. Certified by CAA: cost Govt., \$2,000. Bargain ..... **\$11.95**

## BC-456B

MODULATOR UNIT, new complete with tubes, 3 relays; parts worth more than our low price of **\$3.95**

## RADIO RECEIVER BC-1023A

Ultra High Frequency, covering 62 to 80Mc range. An extremely sensitive relay, works on 4/10 of mil. Complete with 4 tubes; 12SH7, 6SQ7, 6SC7, 6U6TG. Brand New..... **\$3.95**  
Shock Mts. and instruction book included.

## BC-733D

SUPERHET RECEIVER—10 tubes, 6 xtals, 6 selector relays; operates on any one of the 6 xtal controlled frequencies; from 108.3 to 110.3Mc. Can be easily converted to 2 meter ham or mobile telephone band. Gives both visual or aural indications of position of aircraft in respect to the runway.

New..... **\$10.95**

## AIRCRAFT RECEIVER

R5/ARN-7 15 tube set. 4 bands 100-1750 KC. Easily converted to Home Broadcast. 115v-400 cycle Power Supply, Shock Mts. and schematic included. **\$9.35**  
Less Tubes, .....

15 tubes for above..... **\$10.50**

## TUBE KITS

Comes in complete sets

Each set **\$10.50**

SCR 269 R5A/ARN 7  
Bc 433 R5/ARN 7

## TUBES

65C7 .....	\$1.10	6F6 .....	60¢
6N7 .....	\$1.13	2051 .....	80¢
6K7 .....	75¢	5Z4 .....	90¢
6L7 .....	\$1.00	6J5 .....	68¢
6B8 .....	88¢		

## FIELD TELEPHONE

WE and KELLOGG

EE 3-4-5 and 8 with ringer and generator. French type handset and carrying case. Guaranteed perfect working order. **\$9.95**

## ANTENNA WIRE

On reel 300 ft. braided copper. Brand New. Each..... **\$2.50**

Write for Quantity Discounts

Prompt Delivery—Write Dept. RN6  
25% deposit Required on C.O.D. Orders  
Shipped F.O.B. New York. Minimum Order \$2.00

## T. ALLEN CO., INC.

564 Atlantic Avenue Brooklyn 17  
Tel. TRIangle 5-8241 New York

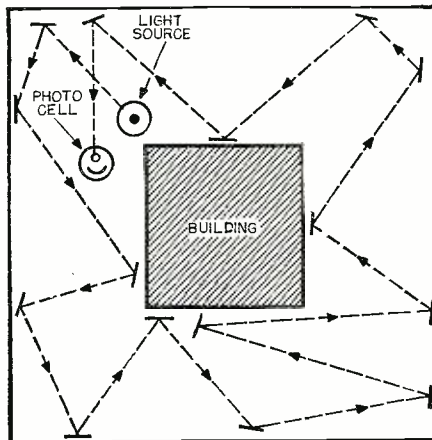

Fig. 5. A typical long-throw estate protection layout. Note that the light to the photocell actually crosses the light from the "source" and that the reflectors are not necessarily parallel to building or fence.

from sluggishness and are able to handle the complete range of audio and even ultra-audio frequencies.

A basic knowledge of light is all that is necessary in order to set up the optical requirements of a workable photoelectric device. As shown in Fig. 3A, a small light source can be kept concentrated and thus be made to operate a light-sensitive device at relatively great distances. During the last war the Germans had several fine units whereby this principle was used to transmit voice. This was "wireless" but not radio, and there was no danger of pickup by undesired persons. The light source was audio modulated and the light directed by narrow beam direct to the light-sensitive device of the authorized receiver. Now let's get back to the optical knowledge necessary to construct and install most light-sensitive devices. A positive lens (any lens that is thicker at the center than it is at the edges) will take light traveling as parallel rays and bring these rays together to form a point of light behind the lens. For our purposes, the distance from the lens to this point of convergence is the "focal length." Conversely, if we place a point source of light behind a positive lens and at a distance equal to the focal length, the light rays will become parallel after passing through the lens. These parallel rays of light can then be "re-converged" by means of another positive lens placed its focal length in front of the light-sensitive device as shown in Fig. 3A. It is also possible to utilize just one lens to direct a concentrated light beam on the cell or tube as shown in Fig. 3B. In this case, the lens is separated from the light source by a distance greater than its focal length (the exact distance should be determined by experimentation, although it is possible to arrive at it by the use of an optical formula). Now, besides the fact that for practical purposes light travels in a straight line, we only need to remember the additional rule that its "angle of reflection is always equal to its angle of incidence." (Fig. 3C)

Let's take a look at some typical installations and see the practical use of these principles. In Fig. 4 we have standard "door-opening" circuits. The same fundamental setup could be used for actuating a counting device on a moving production line simply by having the light and phototube or cell on opposite sides of the moving units to be counted. This system would therefore be ideal for use in counting vehicles passing a given spot on a highway, or pedestrians passing a store. In the latter case both the light-sensitive device and light source could be in the store window, with a mirror or other reflector mounted on a post or other support at the curb edge of the sidewalk. Naturally, as the beam would be broken twice for each passer-by the total recorded would have to be divided by two.

A similar installation, but one using many reflectors or mirrors could be made to actuate an alarm if an intruder were to enter any part of an estate or plant (see Fig. 5). For this protector or burglar alarm work it is preferable to use the non-visible light frequencies (infrared or ultraviolet) as visible light would serve to warn the intruder and might disturb residents living in or near the actual installation.

Other uses include fire-alarm installations where the presence of smoke reduces the amount of light allowed to fall on the cell or tube (also utilized to detect improper combustion when placed in smokestacks of commercial buildings). We have explained how, by the use of selective color filters, it is possible to make the cells and tubes responsive only to certain specific light frequencies. It is also possible to make a photocell or phototube apparently responsive to a light frequency to which it is not normally responsive. This is accomplished by passing the "unresponsive-frequency" light through a filter that has been dyed with the proper fluorescent material (or reflecting it from a surface coated with the same fluorescent substance). The "unresponsive-frequency" light "beats" against the fluorescent material (with a sort of heterodyne effect) and produces a light frequency to which the device is responsive.

That does it! We've shown you that photoelectric devices are of three groups, i.e., the "battery" type, the "variable resistor" type, and the "unheated diode" type. All of these components are regularly used by you in radio. We've shown you that the amplification necessary is fundamentally the same as that used by you in radio. And we have also shown you that the light wave can be made to perform like a radio wave, and even "heterodyne". With all these points of similarity you should have no hesitancy in building or servicing these devices. And remember that your imagination is the only limiting factor, because any switch that you want closed (or opened) can be actuated by a photocell or phototube!



## Single Sideband

(Continued from page 55)

any receiver thus providing the super-selectivity of Fig. 4.

Fig. 1 illustrates the commercially manufactured "805" selectivity-gainer. A drawn aluminum pan 4-15/16 inches long by 3 7/8 inches wide carries a switch to cut the "805" into or out of the circuit. On top of this pan are four special 100 kc. i.f. transformers and three new miniature tubes. Beneath the pan are mounted the resistors and condensers along with the six projecting wires for connection to the receiver.

The i.f. transformers may look rather large when compared with the size of the tubes. These units were selected deliberately as the usual small i.f. cans tend to cut down the "Q" of the i.f. coils they house and shield. When seeking the degree of selectivity shown in Fig. 4, it is necessary to use larger units. Aluminum i.f. cans measuring 1 3/4 inches square were used in order to keep their side walls far enough away from the i.f. coils so as not to impair coil "Q." However, another step was necessary in order to achieve the selectivity shown in Fig. 4.

Referring to Fig. 2, at the left appears a 6BE6 converter tube. By tapping its signal grid onto the second detector diode plate of our receiver (and retuning the last i.f. transformer secondary for loudest signal to compensate for the added capacity of the 6BE6) the 455 kc. signal is taken from the output of the receiver i.f. amplifier. The 6BE6 oscillator circuit  $L_1, C_1$  plus  $R_1, C_2$  oscillates at the receiver i.f. minus 100 kc. For a 455 kc. i.f. receiver, the powdered iron-core slug of  $L_1$  would be adjusted to tune  $L_1, C_1$  to 355 kc.

Thus we have a new i.f. in the 6BE6 plate circuit. This new, second i.f. is 100 kc. It will pass through special transformers  $T_1, T_2, T_3$ , and  $T_4$  to get the selectivity of Fig. 4. Since these are critically-coupled transformers we will lose signal voltage as the signal progresses through them, but gain tremendously in selectivity. The gain loss of the four i.f. transformers is made up, with something to spare, by the 6BA6 i.f. amplifier tube.

One of the cogent reasons for poor selectivity in almost all existing receivers is due to the low resistance loading of the diode second detector on the last i.f. transformer. This loading is usually such that the selectivity contribution of the last i.f. transformer is lost in almost all receivers. In order to avoid this loss of selectivity, the diode second detector is used across the receiver's last i.f. transformer secondary. Here it performs its original function of providing a.v.c. for the receiver and continues to allow b.f.o. injection just as usual for c.w. reception.

June, 1948

# BEST SURPLUS . . . BEST CONDITION . . . BEST APPEARANCE . . . LOWEST PRICES

## GREAT BUY!



### BRAND NEW RU-17 RECEIVER & GF-12 TRANSMITTER Made By Western Electric

• De-Luxe Equipment. Finest Made, GF-12 Xmtr. 3000-1525-Kc., and 6000-9050-Kc., with 4 plug-in Tuning Units, Tubes & RF Ammeter, also shock-mounted base. PHONE-CW. 20-Watts. Can be converted in a jiffy. Complete instructions included. **ONLY A FEW ON HAND. Brand New, \$9.95. (POWER SUPPLY KIT, \$13.90).** • **RU-17 RECEIVER** (Companion unit for GF-12). Five plug-in coil drawers included as well as remote vernier tuning dial. A GREAT receiver for hi-fi service, autos, monitoring, custom sets etc. 3 stages TRF. BFO. Shock-mounted base. Price, **WITH TUBES** and simple Conversion Diagram, \$16.95, Brand New! Plug-In Power Supply Kit for this receiver, \$9.45.

### NAVY SPARE-PARTS CHEST WITH MANY FINE PARTS

• At least \$25.00 worth of **BRAND NEW**, excellent parts, and a plywood chest, all contained in a lift-compartment, handles and hasp, at a give-away price . . . \$4.95 net! Chest contains audio xmtrs, chokes, many standard resistors, mica condensers, or condensers, coils, relay parts, wire-wound rheostats, etc., etc. **EVERYTHING BRAND NEW!** Chest 16"x9"x7". **VERY FEW ON HAND \$4.95** Air-Mail your order . . .



### CODE-PRACTICE OSCILLATOR

• Complete kit of **BRAND NEW** parts and metal case, with key, neon-blinker-lite, volume control, switch, PL Plus & Connector, selenium rectifier, resistors, condensers, etc. Wiring Diagram & Instructions included. **ONLY \$4.95 Net.** Sma'l Loud-speaker. PM-type, \$1.98 net. Sneaker Transformer to Match, \$0.98 net.



**Here it is - AT LAST**  
**SURPLUS RADIO CONVERSION MANUAL**  
115 PAGES  
**\$2.50**

**GOOD NEWS!** Here's The Book You've Asked For! Original and Conversion circuits for 529, BC-412, BC-348, BC-312, 1068/A1161A, TBV Xmtr-Revv, 274-N (453-A series), 274-N 10-meter ckts, Xmtr & VFO data for 274-N, PE-103A Dynamotor data, BC-645 IFP ckts and conversion, BC-221 ckts, etc., etc. All A/N Tube information, Amateur Frequencies, List of Commercial & FV channels, and a wealth of other timely data. Bound in a heavy cover. Really a GREAT book! \$2.50 postpaid in U.S.A.

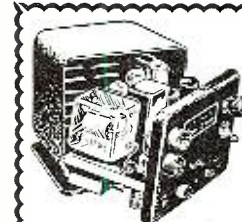

### R8/ARN-8 Modification "A" BEACON RECEIVER 75-Mc.

Here's a BUY! A 7-tube Beacon Receiver containing the following items: Three 25L6, Two 12SQ7 and Two 12SH7 tubes, a sensitive relay (12,500 ohms) and many other essential parts—completely wired and ready to operate, but less power supply. Housed in a black crackle case, approx. 7"x7"x8", complete with shock mounts. This receiver is suitable for remote control service, such as door opening devices, turning lights on and off, starting and stopping motors or machinery from remote points, etc.

**BRAND NEW—IN ORIGINAL FACTORY CARTONS . . . ONLY \$4.95 net.** complete with tubes. A complete set of special plugs for this receiver available for only \$1.44.

### POWER SUPPLY KIT For 274-N Receiver

\$7.95  
NET

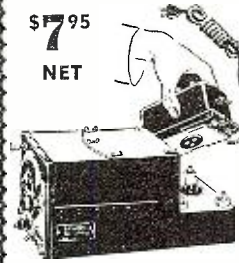

Just what you're been waiting for—a **COMPLETE** Power Supply Kit, containing A L L necessary parts for 110-volt AC conversion of A N Y 274-N type Receiver, regardless of frequency coverage. Our complete kit of parts includes wiring diagram and instructions . . . all for the **LOWEST PRICE OF ONLY \$7.95 net.** Kit includes Tuning Spline, Knobs, Plug-In Plate, black crackle metal box, filter chokes, condensers, resistors, etc., etc. Nothing else to buy. Convert your famous 274-N into a beautiful job . . . and make it work like a "million."

## Walkie-Talkie Kit



Build your own Walkie-Talkie! It's easy and simple! We supply the complete kit, including tubes and finest cradle-type telephone handset, chrome-plated telescopic antenna, all hardware and wiring diagrams. Operates from small dry cells. Frequency 144-Mc. Beautiful appearance. Everything Brand New. Black crackled aluminum case. Standard tubes supplied. **THE SET OF A THOUSAND USES** Ideal for fishing trips, camping, hunting, expeditions, autos, home use, construction projects, or any other 2-way voice services. A Real Bargain . . . **Only \$21.50 Net.** (Batteries \$3.62 additional.) **TWO KITS** for only \$41.45, less batteries. Each Kit contains Assembly and Wiring Data.



### BRAND NEW! TS-13 HANDSETS

Cradle-Type Black Bakelite Telephone Handset, with low-impedance carbon mike and 3,000-ohm earphone. 6-ft. cord and two plugs. Butterfly push-talk switch. Brand New. In Original Sealed Cartons. **LOWEST PRICE IN U.S.A. . . . Only \$2.85 net.**

**BC-221 Frequency Meter, with A-C Power Supply Kit and Modulation Kit and Circuit Diagram**

Now—AT LAST—you can get a BC-221 Frequency Meter with a complete kit of parts for an A-C Power Supply, plus another kit of parts for a Modulator, for about half the former price of a complete modulated instrument. You can convert the BC-221 Frequency Meter in a jiffy—and use it for receiver aligning, etc. Wiring diagrams are included with each kit. This may be your last chance to buy the BC-221. **PRICES:** BC-221 Frequency Meter with tubes, crystal and calibration charts, \$39.95. A-C Power Supply Kit and Diagrams, \$5.85. Modulation Kit and Diagram, \$2.50.

WRITE FOR NEW 1948  
BARGAIN CATALOG—IT'S FREE.

★ 4-HOUR MAIL-ORDER SERVICE. WE SHIP ANYWHERE.  
20% DEPOSIT MUST ACCOMPANY ALL ORDERS, BALANCE C.O.D.

## OFFENBACH & REIMUS CO.

372 ELLIS ST. SAN FRANCISCO, CALIF.

'PHONE—Ordway 3-8551

ONE STANDARD  
OF QUALITY  
ONLY...THE  
HIGHEST



DEDICATED TO  
THE CONSTANT  
BETTERMENT  
OF SOUND

1161 N. VINE ST., HOLLYWOOD 38 • 250 W. 57th ST., NEW YORK 19

## INDUSTRY WELCOMES HIGH QUALITY OF IMPROVED ALTEC LANSING LINE

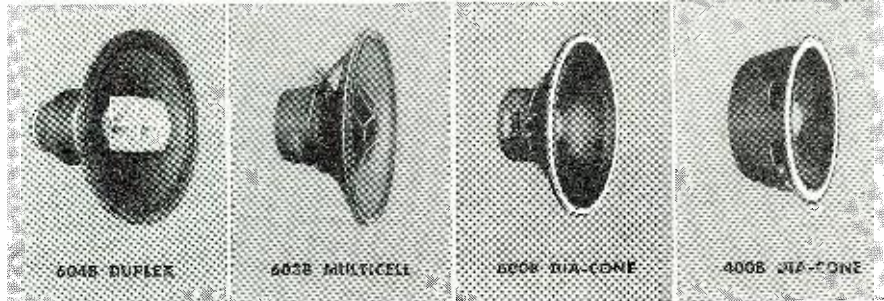

Altec Lansing scientists who developed the revolutionary new improvements in speaker design presented in the new Altec Lansing line of speakers are overwhelmed by the response of quality-conscious engineers throughout industry to the remarkable improvement in efficiency, smoothness of frequency response, and performance of the new speakers. Al-

though the consensus of industry opinion placed the previous Altec Lansing speakers in the front rank of high quality speakers, the new line of Altec Lansing speakers, basically re-engineered and fundamentally improved, has immeasurably widened the gap between Altec Lansing performance and the performance of even remotely comparable speakers.

### SEND FOR BROCHURE

An illustrated brochure describes the new line of Altec Lansing speakers in detail, shows exact, dependable, scientifically accurate frequency response curves. Use address nearest you: Altec Lansing Corporation, 250 West 57th St., New York 19, or 1161 North Vine St., Hollywood 38. Write Dept. 63.

To avoid reduction in the hard-sought selectivity we turn to the non-loading "infinite impedance" second detector, the 6C4 of Fig. 2. Transformers  $T_1$  and  $T_2$  couple the 6BE6 converter to the 6BA6 i.f. amplifier and are, in turn, coupled to each other through the 10 mmfd. condenser,  $C_4$ .  $T_3$  and  $T_4$  are similarly coupled by  $C_7$ . This is simpler than using amplifier tubes between  $T_1$ ,  $T_2$ , and  $T_3$ . Such tubes would be undesirable from a gain standpoint since almost any receiver today has ample sensitivity—it is the selectivity that is lacking. To feed output of the 6C4 detector back into the receiver a.f. amplifier we disconnect the lead of the blocking condenser between the second detector load resistor and the a.f. volume control and connect it to the junction of the two 6C4 cathode resistors,  $R_3$  and  $R_6$ .

Due to the close physical proximity of elements making up commercially practical i.f. transformers, some capacity coupling exists between primary and secondary circuits. The effect of such capacity coupling is to vitiate hard-bought selectivity. The remedy for this situation is to provide special decoupling shields between each pair of i.f. coils. These are diagrammed in Fig. 2 as a dotted line

Fig. 4. The straight-sided selectivity curve of the "805" i.f. and converter.

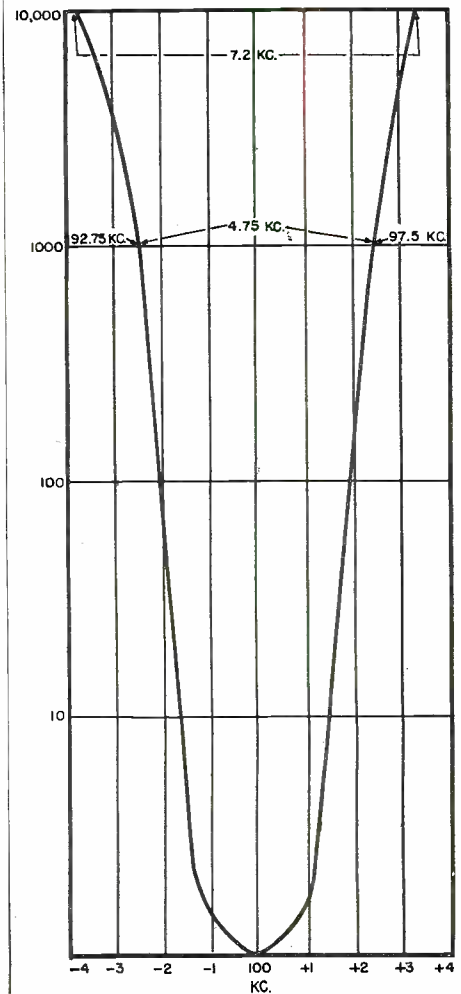

RADIO NEWS

*the best reception requires the best antenna*

INSIST ON

**Camco Featherlite**

**TELEVISION and FM ANTENNAS**

A complete line of scientifically designed antennas to provide the ultimate in reception

Send for NEW Catalog

Illustrated is Model T44

13 to 1 ALL CHANNEL Stacked Folded Dipoles and Reflectors

**CAMBURN, INC.**  
32-40 57th Street  
Woodside, N. Y.

**Miller**  
BUILDERS OF QUALITY RADIO INDUCTANCES SINCE 1924

Now Available to the Serviceman and Experimenter the Famous Franklin "AIR LOOP"

Patented construction provides highest performance and mechanical stability. Use this loop to modernize older sets and for your custom built Broadcast band receivers. "Q" in excess of 140 throughout the band.

An inductance-capacity-turns chart is packed with each loop to assist you in adjusting the loop to track with your set using any tuning condenser having a maximum of 250 to 480 uuf.

Cat. No. 703-A "Air Loop" Antenna Coil net price \$1.05. Dimensions: 5 3/8" high X 8 1/8" wide X 1/8" thick.

The "Air Loop" is distributed nationally to the Jobber only by J. W. Miller Co.

\*Mfg. by Franklin Airloop Corp. under Pat. #2,401,472

**J. W. MILLER COMPANY**  
5917 S. Main St., Los Angeles, Calif.

# JUN SPECIALS

**ARB RECEIVER** 195-9050KC, 28VDC, tubes, remote control, tuning head, manual, less cables and plugs. New.....\$49.50

**GN58 HAND CRANKED GENERATOR** 425v, 115ma; 105v, 32ma; 6.3v, 2.45amp; 1.4v, 450ma with cranks and stand .....\$5.95

## IDEAL MOBILE POWER SUPPLY

PE237 heavy duty vibrator power supply, 6, 12, or 24V input. 525V, 95ma; 105V, 42ma; 6.5V, 2amp; 6V, 500 ma; 1.3V, 450 ma; small supply 100V, 17ma; 1.35V. 450ma with spare vibrators, tubes, shock mounted—brand new.....\$29.50

7 FT. CORD CD 1086 for PE237, GN58.....\$1.95

## BC1306 SMALL COMPACT TRANSMITTER

3800-6500KC, 3A4, 2E22, less cover. Can be used with PE237, GN58. New.....\$9.95

**K-7 GUN MOUNT ASSEMBLY**, ideal mount for beam antenna, cable control. New.....\$6.95  
50 Ft. RG34U with connector NEW.....\$3.95  
250 Ft. PHOSPHOR BRONZE stranded transmitting antenna wire NEW.....\$3.95  
100 Ft. STEEL MEASURING TAPE NEW.....\$5.95  
65 Ft. GUY ROPE, pulley ring and snap.....\$.65

## BRUSH DISPLACEMENT

pickup DP-1, NEW .....\$20.00

**FT-167 FEDERAL TRANSMITTER**, 200 watts, 2 to 18 MC, tubes less power, NEW.....\$195.00  
**RA-20 POWER SUPPLY** for BC-312, N-1.....\$8.50

**GSAP 16 MM CAMERA**, f3.5 lens, converted with viewfinder, battery case. NEW.....\$67.50  
USED .....\$57.50

**ELECTRONIC MEGAPHONE**, NEW.....\$44.50  
**WESTON MODEL 45 AMMETER**, 0-15-150 D. C. amps. New.....\$59.00  
**MOBILE AMPLIFIER**—14 watts output, 12 volts input with mike. NEW.....\$44.50  
**DYNAMIC HEADSET** and mike. NEW.....\$1.95

## SCR 522 SPECIALS

Two meter transmitter-receiver with tubes, U-N \$24.95; U-1 \$17.95; U-2, \$14.95;  
**DYNAMOTOR** — SCR 522, N-1 \$3.95; Plugs for SCR 522 N-1, \$4.00 per set.  
**BC602 CONTROL BOX**, N-1.....\$1.00

**BC1206 -C SETCHELL CARLSON RECEIVER**, 28 volts D.C., 195-420 KC, 5 tubes, NEW.....\$4.95  
**BC1206A-DETROLA**, NEW.....\$4.95

**BC464 TARGET RECEIVER**, 5 channel remote control, battery case and ant. 68-73 MC-N1 . . . \$14.95

**VIBRATOR FOR PE104A**, NEW.....\$1.50  
**BC357J BEACON Receiver**, 75 MC, tubes N-1 \$3.45  
**G.E. BATTERY CHARGER**: Tungar 6RB6B17, 12 battery, 12 amp; 24 battery, 6 amp. N-1.....\$67.50  
**MN26 RADIO COMPASS RECEIVER**, tubes 150-1500 KC, U-1.....\$18.95; U-2.....\$14.95  
**SIGNAL BOX KITE**, N-1.....\$2.00

**EE-8 TELEPHONE FIELD SETS** with handset and ringer, N-1, \$15.00 ea. \$28.00 pr; U-2 \$10.00 ea., \$18.00 pr.; U-3 \$7.00 ea., \$13.00 pr.

## TUBE SPECIALS

5BP1 .....\$1.15 726 ..... 4.95 6L66 ..... 1.10  
3AP1 ..... 2.25 75TL ..... 2.50 12A6 ..... .29  
2X2 ..... .75 5BP4 ..... 2.50 4 for ..... 1.00  
9002 ..... .75 717-A ..... .69 VR150 ..... .90

**GIBSON GIRL SCR 578B** transmitter for sending distress signals from boats. Trans., complete with balloons, hydrogen gens., kite and inst. manuals. N-1 Export packed.....\$25.00  
Transmitter only, tubes .....6.95

**EXTENSION CORDS**, PL55 plug incl. N-1.....\$.40  
**HS-30 Ear Plug head set** N-1, \$.95; U-1......50  
**MATCHING TRANSFORMER**, HS-30......50

**APN-1 ALTIMETER INDICATOR** — Basic movement 0-1 m.a. 5 m.a. shunt 270° scale. An excellent basic G. E. movement for constructing your own meters, N-1.....\$1.95  
**METER RECTIFIER**, full wave midget Selenium, 10 volts, 30 MA, N-1.....\$.29

**PL-55 PLUG**, N-1, \$.29; 4 for .....\$1.00  
**AN-160 ANTENNA**, N-1, 2,000-6,000 KC; 9 insulators and jumpers 100 ft. long .....\$1.00  
.01 MFD. 300 V. MICA CAP. Ideal by-pass cond. N-1 \$.25; 7 for \$1.00; per 100.....\$6.00  
**BC733D GLIDEPATH RECEIVER**, NEW.....\$14.95  
**T-17 MIKE**, NEW \$1.50; Used.....\$.75  
**SCR-274 Remote tuning head**, 3 crank .....\$1.50

**PE-103A DYNAMOTOR** N-1.....\$12.95  
**CD-501A CABLE** for PE-103A-BC654A..... 1.95  
**FRAME MOUNTING** BC654A-PE-103A..... 4.95

**INTERPHONE AMPLIFIER** BC709, Ideal aircraft, batt. operated, N-1.....\$5.00  
**THROAT MIKE**, \$.50; **HAND KEY**, N-1.....\$.50

**BC-348 MOUNTING BASE** Postpaid.....\$2.50  
**BC-348 OUTLET PLUG** Postpaid......80  
**BC-348 MNTG. BASE & Outlet Plug**, PPD. 3.00

## \$1.00 TUBE SPECIALS

872A-1616-304TL-211: Minimum order: four tubes. NEW & CLEAN.

**DUMONT 164E Oscillograph** N-1.....\$88.00  
**DUMONT 208 Oscillograph** U-1.....\$150.00  
**DUMONT 208B Oscillograph** U-1.....\$195.00  
.25 MFD.—20,000 V. G.E. Pyrenol Cap. N-1, \$9.95  
12 In. CERAMIC insulator 1 In. Diam. N-1, \$.25  
12 In. CERAMIC spacer N-1.....\$.20  
**ALLEN BRADLEY** B-400 4 pole relay, 10 amps. 600 V.A.C., contacts, 110V-60 cycle coil N-1 \$4.95  
**T-32 DESK MIKE** — N-1, \$3.50; U-1.....\$1.95

## RG8U CONNECTORS

CHASSIS, CABLE, CABLE ELBOW, COUPLERS, TEES — \$.60 each; 10/\$4.50; 100/\$34.00

# PHOTOCON SALES

1062 North Allen Avenue Pasadena 7, Calif.

3 FT. DIAM. SIGNAL BALLOON N-1.....\$1.50  
**TEST UNIT I-135** for BC611 "Handie Talkie" U-N.....\$39.00  
**AN73, 7' ANT. TELESCOPES** to 12" N-1.....\$2.50  
U-1.....\$1.50  
**AUDIO CHOKE**—1 Henry 800 M.A. 15,000 V. Test U-1.....\$12.50  
**5 VOLT-115 Amp. Transformer** 115 V.A.C., U-1.....\$9.95  
**5 VOLT-190 Amp. Transformer** 115 V.A.C. U-1.....\$9.95  
**O-300 V.A.C. 3 In. Rd. Meter**, New.....\$2.95  
**O-800 M.A. 3 in. Sq. Meter**, New.....\$3.95  
**VARIAC O-135V 5 amps.** U-N.....\$14.50  
**SOUND POWERED CHEST SET**, N-1.....\$5.95  
**SOUND POWERED HANDSET**, TS-10, N-1 \$15.00 each; per pair .....\$25.00  
**CRANK FOR 274N RECEIVERS**.....\$.60

**PHOTOFLASH CAPACITOR**, 25 mfd., 2000 V; N-1.....\$10.00  
**6 COND. PLASTIC CABLE** for Photoflash, N-1 per foot.....\$.35

**FL-8 RANGE FILTER**, \$1.95; with cord & plugs \$2.50  
**ANTENNA KNIFE** switch, S.P.D.T.....\$1.00  
**SOLA CONSTANT VOLTAGE** transformer, 80 V.A., 60 cycle, 115 V.A.C.....\$13.50  
**PEERLESS A-4233Q** line matching transformer—50/125/200/500 ohms, NEW.....\$1.50

**BC-222 WALKIE TALKIE** transmitter-receiver 28-52 MC less tubes, batt., handset & antenna, USED.....\$6.50  
**BC-222** with tubes and handset—Used.....\$11.50

**HS-33 600 Ohm Headset**, NEW \$2.25; USED \$1.25  
**HS-23 8000 Ohm Headset**, New \$2.25; Used \$.89  
**OVERLOAD RELAY**—Potter-Brumfield, 10 MA, 5000 ohm D C trip; 115 V.A.C. 60 cy. reset—New, \$3.95  
**TRANSFORMER, CASED**: 200-0-200 at 50 M.A. 6.3 @ 3 amps., 115 V. A. C. 60 cycles NEW.....\$2.50

**SURPLUS RADIO CONVERSION MANUAL** 115 pages of circuits and data on BC221, 342, 312, 348, 412, 645, 946, 1068, SCR274, 522, TBV, PE-103, Surplus Index & VT Charis. Postpaid.....\$2.50

**5 CONDUCTOR CABLE**, rubber insulation, woven fabric overall, 60 foot roll.....\$1.95  
**SCR 610 10 METER F.M. TRANSMITTER**—receiver, tubes, 6, 12, 24 V. power supply. Used, cln.....\$19.95  
PL 68.....\$.29 ea; 4 for.....\$1.00  
**TELEPHONE PANEL JACK** for PL55.....\$.15  
**CERAMIC SOCKET** for 829/832/826, N-1.....\$.25  
**RA29A REMOTE CONTROL** and ringer for BC654A NEW.....\$6.95; USED.....\$3.95

**RM-13 REMOTE CONTROL UNIT** contains EEB, handset, 1 stage amplifier, Weston DB meter, Used, 115 V.A.C.....\$25.00

**Preamplifier FROM BC610**, modulation limiter, etc. tubes, DB meter, USED.....\$39.00  
Less Meter .....\$34.00

**CODE**: N-1—NEW; U-N, USED LIKE NEW; U-1—USED EXCELLENT COND.; U-2—USED GOOD.  
**TERMS**: F.O.B. Pasadena, unless postpaid. No C.O.D.'s under \$5.00. 25% deposit on ALL orders. All C.O.D.'s shipped by Rail Express. Send Full price with order and we will ship by fast truck, transportation collect. Minimum order \$2.00. Californians include 2 1/2% sales tax.

# 1" OSCILLOSCOPE

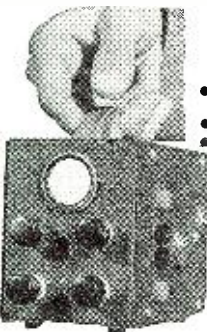

**PORTABLE!**  
**MEASURES 3"x4"x5"**  
**SPECIFICATIONS**

- Focus and Intensity Controls
- X and Y Input Controls
- Internal Sweep
- Built-In 500 V. Power Supply
- Wrinkle Finish, Red Lettering, Chrome Handle
- 110 V. AC 60 Cycle

DEALERS WRITE FOR DETAILS OF OUR 2" OSCILLOSCOPE

Oscilloscope complete, less RCA 913 C. R. tube, \$19.95 net. If you prefer to build your own 1" oscilloscope, send \$1.00 for set of plans and instructions.

**PLASTICS & ELECTRONICS COMPANY**  
272 Northland Ave., Buffalo 8, New York

# MIRACLE KIT VALUES!

**10 WATT 4 TUBE HI-GAIN 6L6 AMPLIFIER KIT**  
Separately controlled Mike & Phone inputs. All parts including drilled chassis, hardware, solder, circuit diagram, info., etc. Less Tubes.....\$6.95 ea.

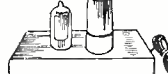
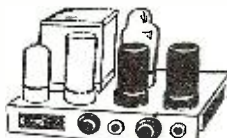

**PHONO OSCILLATOR 2 TUBE KIT**  
Hi-gain with microphone Jack and all parts including Tubes.....\$2.95

**UNIVERSAL TROUBLE SHOOTER**  
Locates every service trouble. All parts including case, test leads, plug, 3 1/4"x6"x3".....\$3.95

**PHONO-AMPLIFIER KITS**  
3 Tubes—all parts including Tubes.....\$4.25  
2 Tubes—all parts including Tubes.....\$2.95  
Pwr trans 1500 C. T., 150 ma, 6.3v 2.5a, 6.3v 1.6a, 5v 3a; 115v 50-60 cye. dri. ca.....\$5.95  
Fil trans 6.3v S2, 7,00v insul 115v. 50-60 cye.....\$2.29  
Write for lists of bargains in Radio & Electronic parts. Also free data, circuits designed by ROBT. G. HERZOG.

**Universal/general corp.**  
Dept. N  
365 Canal St., New York 13, N. Y. — WALKER 5-9642

# PRACTICAL TECHNICAL TRAINING FOR YOU

**SPECIALIZE In 6 Months to 3 Years**

## COURSES

- SERVICE**
- 6 to 12 Months
  - Electricity
  - Welding
  - Refrigeration
  - Heating
- TECHNICIAN**
- 1 to 2 Years
  - Electricity
  - Radio
  - Electronics
  - Refrigeration, Heating and Air Conditioning
- PROFESSIONAL**
- 3 Years
  - Electrical Engineering
  - Bachelor of Science Degree
  - Major in Machinery or Electronics

Train for a substantial career in industry—or a business of your own. Each 6-month course is complete in itself, yet prepares you for advanced courses. More than 35,000 former students in industries the world over. 1,538 students now enrolled from 48 states and 13 overseas countries. Faculty of 72 specialists.

Write for booklet "Career Building" and mention course interested in.

**MILWAUKEE SCHOOL OF ENGINEERING**  
"A Technical Institute" Founded 1903  
RN-648, N. Broadway and E. State, Milwaukee, Wis.

# the "NEW LOOK" in SELECTIVITY

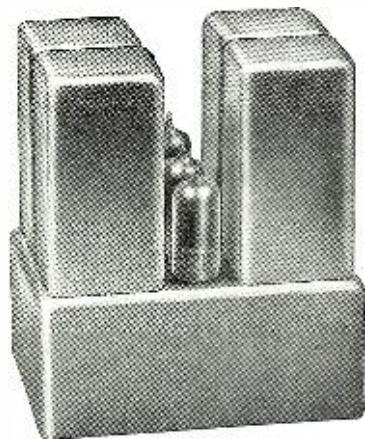

Philip Rand started a new trend to real, badly-needed receiver-selectivity with his Q-5er. Byron Goodman carried it forward with his "Lazy-Man's Q-5er". We applaud both steps, but felt that even more could be attained by special design to really give every ham super-het, new or old, the "New Look" selectivity QST advocates.

Our answer is Model 805, 100kc. I.F. Amplifier. Connect it between your last i.f. secondary and your audio volume control and you get a small boost in gain. But what you really get is single-side-band selectivity — a selectivity curve 2.4kc. wide across the flat top, skirts falling so steeply as to be only 4.7kc. broad 1000 times (60 db.) down, only 7.2kc. wide 10,000 times down! As Byron Goodman says of this new look selectivity, it will "cut thru the QRM and pull out the desired signal like nothing you ever saw or heard". Take Model 805, only 3 7/8" wide, 4 15/16" long, 5 5/8" high, make 6 simple connections to your 455/465 kc. i.f. receiver, (which can usually supply 6.3 V. ac. at 75 Amps. and 110 to 250 volts d.c. at 25 ma. to the 805) and you have that post-war receiver with the "new look"

Model 805 Price, less 1 - 6 BE6, 1 - 6 BA6, 1 - 6C4 tubes, only \$18.90\*  
Model 805K — kit complete less tubes, \$15.90\*

\*Prices slightly higher West of Rockies.

## Send for Catalog

See these and other McMurdo Silver LCET instruments at your favorite jabber.

OVER 37 YEARS OF RADIO ENGINEERING ACHIEVEMENT

*McMurdo Silver Co., Inc.*

EXECUTIVE OFFICES: 1240 MAIN ST., HARTFORD 3, CONN.  
FACTORY OFFICE: 1249 MAIN ST., HARTFORD 3, CONN.

## ONCE IN A LIFETIME... FEDERATED Values like These!

### FAMOUS MAKE CRYSTAL MIKE SPECIAL

An exceptional buy! This crystal mike (30-10,000 c.p.s.) can be used for ham work, home recordings, public address, etc. Detachable base. May be used as desk stand, hand mike, or on a floor stand. Complete with 15 foot cable. All yours for only \$4.95



### TUNGAR BULB BONANZA!

Brand new. Individually tested 2 Amp. tungar bulbs. Used in battery charges, "A" eliminators, etc. Will replace any 2 Amp. Rectigon bulb. BARGAIN PRICED AT ..... 2 for 98c

### 6" SOCKET WRENCHES

Sturdy, useful 6" spintite wrenches. Wooden handle, and hardened steel shaft. Two sizes available for either a 3/8" or 1/2" socket. Unusual 3 for 49c value at our low price of...assorted



### OUTSTANDING C.D. VALUE

Here's a hot buy! S-8-Smfd. at 450V, round aluminum can replacement electrolytic. Ideal for those good old sets still in use. 49c each

Your cost ..... JUST OPENED! NEW BRANCH!

1115 Hamilton St. ALLENTOWN, PA.  
Completely stocked warehouse and showrooms  
Drop in if you're around.  
Please include 25% Deposit with order.  
Balance C.O.D. Minimum C.O.D. Order \$5.00.  
DEPARTMENT 28-1

**Federated Purchaser**  
INCORPORATED  
distributors of RADIO - ELECTRONIC  
and SOUND EQUIPMENT  
80 PARK PLACE, N. Y. 7  
Phone: DIgby 9-3050

## SPEAKERS

T.M.C. now offers another type "Supplementary Speaker" designed to be attached to a wall or in the back of a car. The back is open on this new "Wall Model"; our Standard Model, as pictured, is entirely enclosed.

## SERVICE MEN DEALERS

Direct from Factory

ONLY \$5.75

F.O.B. Tarrytown  
Wt. 2 1/2 lbs. net

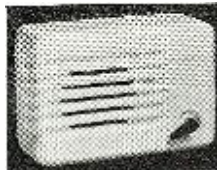

Size: 5" x 7" x 3" Deep

### FEATURES:

- Cast aluminum alloy case.
- Built in volume control.
- Best 4" P.M. Speaker.
- 7 beautiful glossy colors—Ivory, Red, Mahogany, Light Blue, Nile Green, Gray, and White. Unless otherwise specified, speakers will be shipped in Ivory.
- Very simple to install. Installation directions with each shipment. As many as 8 speakers have been connected to standard radio or television sets without altering set in any way.
- Attached ears provide easy installation.
- Fully guaranteed. If you are not satisfied, return within 30 days and your money will be refunded. DON'T FORGET OUR FULLY ENCLOSED STANDARD MODEL FOR \$6.95.

When ordering, specify Wall or Standard Model. Write for further details

Don't Delay Order Now  
25% Deposit with order, Balance C.O.D.

**TARRYTOWN METALCRAFT CORP.**  
TARRYTOWN NEW YORK

Vertical waterproof model for outdoor theatre use with L-Pad volume control and waterproof speaker. Full details on Request.

between each pair of i.f. coils. These shields work wonders in steepening the selectivity curve skirts. Permeability tuning is a "must" for all i.f. transformers since it permits the use of high-"Q" fixed i.f. tuning condensers which "stay put." Iron-core i.f. coils are also necessary in order to get maximum circuit "Q" and hence effective selectivity.

With the aid of Fig. 2, and the accompanying parts list, the home constructor should have no difficulty in building an "805." If he follows the layout of Fig. 3 he will automatically get short grid and plate leads and if parts placement and wiring correspond to Fig. 3 no trouble will develop due to instability or oscillation. Good quality parts should be employed in conjunction with the specified i.f. transformers.

Alignment of transformers  $T_1$ ,  $T_2$ ,  $T_3$  and  $T_4$  can be effected with a 100 kc. signal from any good signal generator. Tuning of  $L_1$  is accomplished after i.f. transformer alignment and after the "805" has been connected to a receiver. Then a signal is tuned in "on the nose" with switch  $S_1$  set to "Out," after which  $S_1$  is set to "In" and the signal tuned in by adjustment of the  $L_1$  core only. After that the "805" requires no operating attention or adjustment—just cut it out with  $S_1$  for local high-fidelity reception, cut it in by means of  $S_1$  for super-selective broadcast band and short-wave reception.

Almost any receiver can supply the 3/4 ampere at 6.3 volts a.c. or d.c. required for the "805" tube heaters and any good receiver can supply the 25 milliamperes plate current at 100 to 250 volts d.c. required by the three tubes in the "805." If not, a small power supply for the "805" can be assembled out of standard parts or a small filament transformer, filter choke, a couple of electrolytics, and a 100 milliamperes selenium rectifier can be mounted on the end of the "805" pan to make it completely self-powered.

Little has been said so far of the noise reduction possible with the "805." Since the most effective way to reduce noise in radio reception is to cut down the passband of the receiver, the sharper it is, the less noise. This has been proved with the "805" amplifier for with its selectivity a minimum of four times better than the average communications receiver it "slices" the noise mighty thin. This will reduce noise by a minimum of four times and, in practice, usually considerably more.

To the ham reader it has already become evident that selectivity, such as shown in Fig. 4, will provide "single-signal" c.w. reception. If the receiver b.f.o. is set to yield a 1000 cycle audio beat note, then the audio image will be 2000 cycles away. Since the "805" selectivity curve drops from "2 times

down" to "2000 times down" in no more than 1 kc. it follows that 60 db. (1000 times) audio image suppression is secured.

Substituting a balanced modulator for the 6BE6, another for the 6C4, applying a 100 kc. oscillator and output of a speech amplifier to the first tube, we can take out of the third tube a "single sideband suppressed carrier" signal for combination therein with a transmitter oscillator.

-30-

### Open Letter

(Continued from page 43)

We have found from a survey, that "B" and "C" supply defects make up 85% of radio receiver troubles. In testing supply voltages the radio technician must make the tests at the tube socket and in the majority of cases finds himself handicapped.

The radio serviceman has no special beefs about the design of the circuit, and the resultant reproduction. These are the selling points of any radio receiver. He appreciates the fact that a receiver performs no better than its alignment. In transportation and use almost anything can happen. Alignment screws can work out of adjustment. Humidity and temperature changes can add to the other maladjustments to spoil reception. For this reason the technician has purchased an r.f. test oscillator. Now he finds the chassis must be removed from the cabinet in order to permit alignment of the circuits. (a bad feature)

So, a few more suggestions to manufacturers are in order:

All adjustment screws should be accessible from the top or back of the receiver.

Convenient input points should be provided for test signal inputs on the top side. This would obviate the need for the chassis to be turned upside down when the set is aligned. Receiver i.f. and r.f. circuits should not be exposed to test wires carrying r.f. and i.f. frequencies. In many sets the calibrated dial is part of the cabinet. It should be part of the chassis.

In some service notes on alignment procedure it is stated "connect output meter to voice coil." But the notes do not tell you how without removing the output transformer.

In many sets with phonograph or record changer equipment, the record playing apparatus must be removed, with consequent loss of time, in order to get at any part of the chassis or even to remove the chassis from the cabinet. This is particularly disturbing when all that is desired is to test the tubes which cannot be removed without this extra effort.

A great many receivers have no indi-

# Free



**NEW Complete**  
*Concord*  
**RADIO CATALOG**  
**160 VALUE-PACKED PAGES**

**MAIL** the coupon below now for your copy of this great, new comprehensive Concord Catalog—a vast, complete selection of everything in Radio, Radar, Television, Test and Electronic Equipment. Featuring thousands of items . . . new, latest 1948 prices. See the new LOWER prices on finest-quality RADIO SETS, PHONO-RADIOS, RECORD CHANGERS, RECORD PLAYERS, RECORDERS—wire and disc, PORTABLES, AMPLIFIERS, COMPLETE SOUND SYSTEMS, TESTERS. See complete latest listings of all the well-known, standard, dependable lines of radio parts and equipment—all available for IMMEDIATE SHIPMENT from huge stocks in CHICAGO and ATLANTA. Whatever your needs in Radio and Electronic Parts, Supplies and Equipment—before you buy—SEE THIS GREAT NEW CONCORD CATALOG. Mail coupon for your FREE copy.

#### WE HAVE WHAT YOU WANT!

The new Concord Catalog displays the most comprehensive stock in years! All well-known, standard lines are fully represented. Equipment—accessories—parts for all radio and electronic use . . . for building, repair, maintenance . . . for engineer, amateur, serviceman, soundman, retailer . . . complete lines of tubes, instruments, tools, speakers, condensers, resistors, relays, etc. . . PLUS a complete radio set department . . . PLUS the exciting line of MULTIAMP Add-A-Unit Amplifiers offering many innovations in public address units obtainable only from Concord.

**CONCORD**  
**RADIO CORPORATION**  
CHICAGO 7 ATLANTA 3  
901 W. Jackson Blvd. 255 Peachtree St.  
Downtown Chicago Branch: 229 W. Madison  
Lafayette Radio Corp.

**RADIO PARTS**  
**RADIO SETS**  
**AMPLIFIERS**  
**TESTERS**  
**ELECTRONIC EQUIPMENT**  
**HAM GEAR**

#### Mail COUPON

CONCORD RADIO CORPORATION, Dept. 136  
901 W. Jackson Blvd., Chicago 7, Ill.

Yes, rush FREE COPY of the comprehensive new Concord Radio Catalog.

Name \_\_\_\_\_

Address \_\_\_\_\_

City \_\_\_\_\_ State \_\_\_\_\_

# VEE-D-X means VIDEO DISTANCE

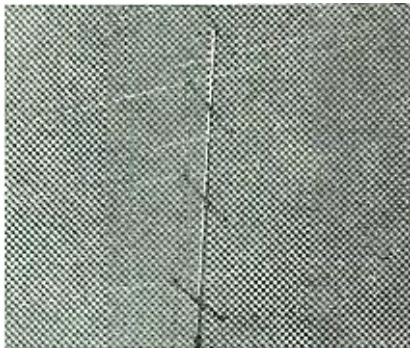

- Highest Gain of any Antenna on Market.
- Sharply Directional assuring maximum desired signal.
- Weighs less than 25 pounds—sturdily built of Duraluminum.
- Completely equipped with Matching Stubs.
- Broad Band—Model R.D.-6; for Channels 1 to 6; Model R.D. 13, for All 13 Channels.

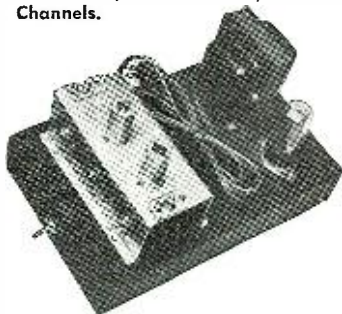

## 2-Stage Pre-Selector Model R.C.-2

- Guaranteed 5 megacycle band width. (assures quality pictures)
- Gain 40 d. b.
- Matches Impedance of Transmission line to input of Receiver.

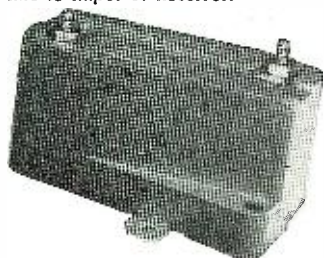

## Lightening Arrester High Frequency—Low Loss

- Designed Especially for Video and F. M.
- Unnecessary to cut Transmission line for installation.
- Unnecessary to change spacing of Transmission line.
- Does not vary impedance.
- High dielectric, low loss Plastic material.

"THERE'S MORE VISION IN TELEVISION"

See your nearest Jobber or write direct  
**La Pointe-Plascomold Corp.**  
 UNIONVILLE, CONNECTICUT

cation on the chassis itself of the model number or manufacturer. This information is frequently on a paper sticker in the cabinet or on the chassis which soon falls off from the heat and is lost. The model number and manufacturer's name should be stamped or etched right on the chassis proper.

Another source of annoyance to the radio serviceman is the use of low melting point plastic covered wire. Apart from the frequently sickening odor that is experienced when a hot soldering iron gets near the wire the insulation melts off or chars, forming a resistive path to the chassis that may be detrimental.

Some of the "spun-in" i.f. components would not be so bad if the manufacturer were to supply a can opener to get at the coils or other parts when they are defective.

With regard to the marking of com-

ponents there are some serious problems.

The i.f. frequency should be marked on each i.f. can.

The tube sockets should each be properly labelled, such as: "6H6—Discriminator." This should be stamped into the metal chassis right near the socket.

Radio servicemen are sometimes damned as worshipping the "Goddess of Destruction." Were the manufacturers of receivers to plan their sets with an eye towards the possibility of maintenance in the future they could perform the greatest service to the radio repair industry.

The radio repairman is an extremely important cog in the radio industry's machinery. He is, in fact, the direct contact between the consumer and the manufacturer of radio receivers.

-50-

## EXPERIMENTAL MULTI-CHANNEL V.H.F.

**STROMBERG-CARLSON** Company is collaborating with the General Telephone System in establishing an experimental multi-channel v.h.f. radio-telephone toll link between Johnstown and Northville, New York.

The new installation is said to be one of the first multi-channel links of its kind in the independent telephone field. Two conversations may be carried on at the same time in the experimental equipment.

The radio link covers a 26-mile stretch over rugged Adirondack mountain country. At the Johnstown end of the circuit, both the transmitting and receiving antennas are mounted atop 40 foot cedar poles on a 970 foot hill. The Northville antennas, deeper in the mountains, are located on a 1345 foot eminence. The transmitting antenna is erected on a 90 foot steel tower, the receiving antenna on a 65 foot cedar pole. The elevation of both ends of the radio link provides a direct line uninterrupted by hills or other obstacles lying between.

Low-powered wide-band FM transmitters designed by Link Radio Corporation have been installed at each end.

After completion of various transmission tests, advanced engineering models of the telephone terminal equipment are to be constructed, adopting improvements found desirable from experiments in the toll link, and incorporating circuits which will permit operation with either manual ring-down or dial trunks with full two-way supervision.

Stromberg-Carlson engineers point out that the experiment may lead to significant changes in multi-channel toll circuits for the telephone industry. Single channel radio circuits are now proving valuable in serving isolated ranches and farm houses cut off from telephone service because of the prohibitive costs of constructing land lines, or small areas separated from the central exchange by unusually rough terrain, as well as for toll service.

-30-

Topographical map of proposed multi-channel v.h.f. radio-telephone toll link.

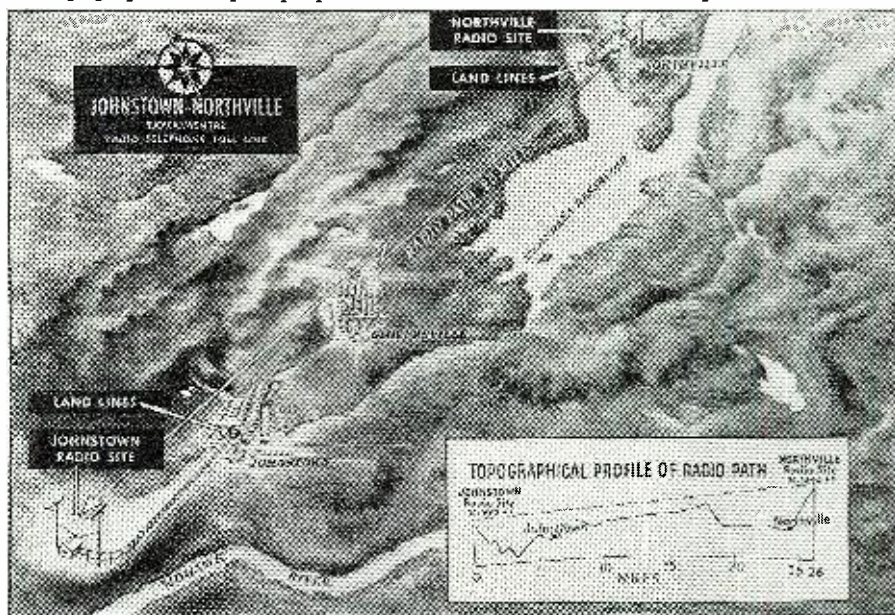

# WANTED: Sales Agents

AND WE'LL PAY THEM WELL!



## WHO WE WANT

Experienced radio servicemen — respected and well established businessmen in their communities — who can sell, install, and service two-way VHF radios. We want contacts in every locality that has a fire department or a taxicab company.



## CUSTOMERS

Your prospects are all who will be benefited by mobile radio communication—public utilities, fire departments, cab companies.



## PRODUCT

Brand new, factory rebuilt, surplus two-way radios, VHF, mobile and ground stations . . . of standard

design . . . priced at a fraction of their original cost . . . priced far below equivalent values on the market today . . . priced to stack up against all competition . . . and engineered to deliver dependable, day-in, day-out service. Quantities are limited.



## SALES HELP

We will provide names of prospects and detailed sales literature. We will provide technical advice for unusual installations.



## YOUR INCOME

An inviting commission plus installation and maintenance on every sale. Write today for full details. Only experienced, established radio servicemen need apply.

**R & M RADIO COMPANY** 1426 N. Quincy Street, Arlington, Va.

## Headquarters for ALL AUTO RADIO PARTS, and ACCESSORIES SPECIALS

### SPEAKERS!

#### Alnico Magnet PM SPEAKERS

• These speakers are of the highest grade construction. All are new and fully guaranteed.

2" . . . . . \$1.10	3" . . . . . \$1.10	4" . . . . . \$1.19
5" . . . . . \$1.39	6" . . . . . \$1.69	8" Heavy Magnet . . . \$3.59
10" Heavy Magnet . . . \$4.59	12" 16 oz. Slug . . . \$5.25	
12" PM Extra Heavy, for High Fidelity Maximum Power, 46 oz. Alnico Magnet (Nationally Known), . . . . .		<b>\$9.95</b>

#### FLUORESCENT LAMPS for DESK or BENCH

COMPLETE WITH 15 WATT LAMPS.

Shade 19"x6", White Enamel underside. Overall height 14". Attractive Brown, Wrinkle finish. Wells for pencils or pens. Bottom felt covered. . . . . Price **\$4.49**

#### STANDARD GUARANTEED 4 Prong VIBRATORS \$1.19 ea. 10 for \$9.80

40 x 40 150 volt condensers, 10 for . . . . . \$4.50  
F.P. 20-10 450 volts 25-25V condensers, 10 for . . . . . \$4.50

#### BUFFER CONDENSERS

.01 2000 volt . . . . . 10 for \$1.90  
.005 2000 volt . . . . . 10 for \$1.90

### CROWE HEADS for AUTOMOBILE RADIOS

A dial to fit any radio and car 1940 thru 1948—  
Custom Dash Mounting Dials

Under 1940—Universal Underdash Mounting Dial.	
Dealers Price . . . . .	\$3.82
Tuning Units 706-T1 up thru 720-T1. Dealers Price . . . . .	\$1.71
Tuning Units with switch 706-T2 up thru 720-T2.	
Dealers Price . . . . .	\$2.40
Volume control units 700-V1. Dealers Price . . . . .	\$0.73
Volume control units with switch, 700-V2. Dealers Price . . . . .	\$1.80
Cable kits to fit Delco-Arvin-Philco. Dealers Price . . . . .	\$1.74
When ordering, specify Make and Model of car and make and model of radio.	
Complete dial kit consists of "Head, Tuning Unit and Volume Control Unit".	
We carry a complete line of all auto radio equipment and accessories.	

### AUTO AERIALS

66" and 96" Chrome Finished Rust Proof, with Shielded Lead, Side Cowl.	
66" 3 Section . . . . .	\$1.29
96" 4 Section . . . . .	\$1.59
6½" PM Auto Speakers Alnico 5 Magnet . . . . .	\$1.69

**Radio Parts Company, 614 RANDOLPH ST., CHICAGO 6, ILL.**

# NEW RECEIVERS

## ----- on the Market

### LOW-PRICED TABLE MODEL

General Electric Company has announced production on several low-priced table model receivers.

One of the units in the new line is the Model 115. This set is available in



either an ivory or rosewood plastic cabinet. The receiver is an a.c.-d.c. superheterodyne equipped with a "Dyna-power" speaker using a GE Alnico 5 permanent magnet.

The receiver has four tubes plus rectifier and carries the Underwriters' Laboratories approval.

For further details on the Model 115 and other receivers in this new low-priced line, address inquiries to the Receiver Division, General Electric Company, Electronics Park, Syracuse, New York.

### TABLE COMBINATION

The Model 1401 is Philco Corporation's 1948 version of its popular table model radio-phonograph which plays single records automatically.

Housed in an ultra-modern cabinet of glowing ebony and mahogany, this new



table model radio-phonograph is designed to fit in with any style of furniture. It is colorfully accented by a gold-colored metal grille and a brilliantly lighted dial.

The record playing unit automatically adjusts to ten and twelve inch records. A sensitive radio circuit provides quality performance for standard broadcasts.

Five tubes, including rectifier, provide more than ample power output for both records and radio. A built-in aerial system and automatic volume control have been included.

Philco International Corporation at 50 Broadway, New York 4, New York has additional details available on the Model 1401 to those requesting them.

### EMERSON TV UNIT

Emerson Radio and Phonograph Corp. has announced production on a compact television unit which measures 16½ inches wide, 16 inches high, and 20 inches deep.

Known as the Model 571, this set contains 21 tubes plus 7 tube rectifiers and covers all channels. The new receiver boasts a 10 inch screen and sells in the moderate price class.

Further details on the Model 571 may



be secured from Emerson Radio and Phonograph Corp., 111 Eighth Avenue, New York, New York.

### AM TUNER

An advanced design standard broadcast tuning unit, with a frequency coverage of from 550 to 1700 kc. for professional use, has been developed by The Kappler Company of Los Angeles.

A unique bridge-type balanced modulator employed in the superheterodyne circuit eliminates noise ahead of the i.f. amplifier and cancels second order modulation products.

According to the company, extremely uniform sensitivity and bandpass characteristics are achieved and controlled entirely in the i.f. amplifier. The infinite impedance second detector provides a

high ratio of d.c. to a.c. load impedance which results in low distortion.

For complete details on this new AM

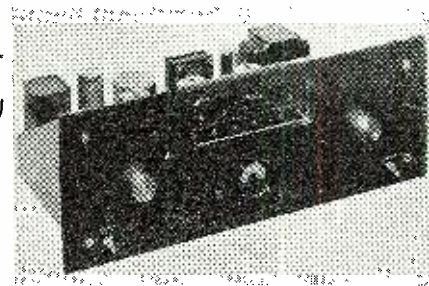

tuner write The Kappler Company, 7302 Melrose Avenue, Los Angeles 46, California.

### FM-AM TABLE MODEL

The Home Radio Division of Westinghouse Electric Corporation has developed an unusually compact FM-AM table model radio which has been designated the M-182.

Employing war-developed miniature tubes, the unit is housed in a cabinet measuring only 9 inches high, 13½ inches wide, and 7 inches deep. The circuit uses five miniature tubes and a miniature rectifier. The frequency range of the AM band is from 540 kc. to 1600 kc. and is calibrated in eight major divisions. The FM band covers the frequency range of from 88 to 108 mc., calibrated in nine major divisions.

The set is equipped with a 5 inch permanent magnet dynamic speaker with Alnico V magnet. The model gives one watt of undistorted output and has two built-in antennas with connections for two outside antennas.

Further information may be obtained from the Home Radio Division, Westinghouse Electric Corporation, Sunbury, Pa.

### TV AND FM RECEIVER

Duval Radio & Television Corp. has announced a new 15" television and FM receiver, the Model 15C.

Available as a completely wired and tested unit, less the cabinet, this receiver tunes continuously from 44 to 216 mc. A switch is provided to turn off



sweep and high voltage circuits when FM reception alone is desired.

A line of cabinets to house this re-



ceiver is now being contemplated.

The company will welcome inquiries about this unit. Write direct to the manufacturer, *Dual Radio & Television Corp.* at 423 Grove Street, Jersey City 2, New Jersey.

**AIR KING PORTABLE**

With the advent of the "portable season," *Air King Products Co., Inc.* has recently introduced the new "Pockette" portable which is tiny enough to fit in the palm of the hand.

The new 4-tube radio measures only 3 inches by 5¼ inches by 3⅝ inches and weighs one pound, eleven ounces. The portable is available in three color combinations, ebony with nickel trim, maroon with gold trim, and ivory with gold trim.

The "Pockette" turns on when the lid is opened and shuts off automatically when the lid is closed. The set utilizes two standard batteries, one an ordinary flashlight unit and the other a standard 45 volt "B" battery. The loop an-



tenna is built into the cover of the "Pockette" and the case is of polystyrene with vinylite carrying strap. The metal grille is especially treated to withstand outdoor elements.

Further information will be furnished by *Air King Products Co., Inc.*, 170 53rd Street, Brooklyn 32, New York.

**LIGHTWEIGHT PORTABLE**

*Radio Corporation of America* is currently merchandising the 1948 version of the company's popular lightweight aluminum "Globe Trotter" portable.

The unit has been restyled and features functional improvements and a lower retail price. The streamlined portable, designated the Model 8BX6, is designed for three-way operation and uses five tubes and one rectifier. The automatic lid switch turns the radio on when the lid is opened and off when it is closed.

The portable comes in aluminum and  
**June, 1948**



# TRIAL OFFER!

**TO INTRODUCE THE NEW**

## "AKRAD"

### CONDENSER

**SUPER-SEALED!**  
AKRADS are sealed in ALUMINUM TUBES, and the leads are SECURELY ANCHORED.

**TOUGH INSULATION!**  
AKRADS resist "shorts" till the cows come home. New INSULATING FILM takes voltage surges without puncturing.



POSITIVE  
**AKRAD**  
 CAP. MFD. 8 D.C.W.V. 450



**10¢**  
POST PAID

**EXCLUSIVE WITH OLSON!**  
The AKRAD Condenser is our baby, developed after years of research. Sold ONLY by OLSON Radio Warehouse!

**EXTRA VALUE!**  
AKRADS are manufactured so efficiently and in such great QUANTITY that we save on the cost, AND SO DO YOU.

**PLEASE:**  
Only ONE Akrad to a customer at this special low price. You must use the coupon. No orders outside USA. Offer expires AUG. 1, 1948.

**WHY DO WE MAKE THIS OFFER?** Well, we think the AKRAD Condenser is TERRIFIC and we think you'll agree after you try one. Watch the OVERLOADING an Akrad will take without breaking down; check the long SHELF LIFE of an Akrad. We back up every AKRAD Condenser with a 100% GUARANTEE—so get one NOW from OLSON, the Radio Parts King of America. A REAL INVESTMENT for only a DIME!

**VALUABLE COUPON!**

**SEND THIS COUPON WITH ONLY 10c TO**

## OLSON RADIO WAREHOUSE INC.

**73 E. MILL ST., DEPT. 122 AKRON, OHIO**

—and you will receive one 8 MFD 450 V. "AKRAD" CONDENSER. Hurry!  
 Offer expires AUG. 1, 1948.

NAME \_\_\_\_\_ (PLEASE PRINT)

ADDRESS \_\_\_\_\_

CITY \_\_\_\_\_ STATE \_\_\_\_\_

# PROJECTION TELEVISION!

Convert your RCA 630 or Crosley 307 to this

## OUTSTANDING TELEVISION CONVERSION OF 1948!

The gigantic picture this set is capable of projecting must be seen to be believed! One set converted by a Los Angeles company, was demonstrated at the Shriner's Temple in Los Angeles, during the Rose Bowl game. It was viewed by 4800 people at one sitting! A 12x16-foot rear projection plastic screen of our type was used.



With the use of the basic components below, diagrams and instructions, which are provided for the RCA 630 and Crosley 307, practically any 10" set can be converted to Projection Television.

### F 1.9 TELEVISION PROJECTION LENS

**Dimension—Length 7", Diameter 4 1/4"**

F 1.9 E.F. 5 in. (127.0 mm). This lens incorporates in barrel a corrective lens for use with a 5TP4 projection tube. It is easily removable for use with flat type tubes. Lens can be utilized to project picture sizes from several inches to 7x9 feet. Made by Bausch & Lomb Optical Co. **\$125.00**  
Dealers' Price.....  
Mounting ring available for above lens..Price **\$2.50**



### 30 KV RF POWER SUPPLY

**Dimensions—Length 14", Width 11", Height 11 1/4"**

This unit has a low voltage supply separate from high voltage pack. Low voltage DC supply has control which enables you to vary voltage from approximately 12 KV to 40 KV. Unit has focus control built in for use with 5TP4 projection tube. Dealers' Price, complete..... **\$99.50**



### STAND FOR PROJECTION TELEVISION SETS

**Dimensions—23" High, 25" Wide, 18 1/2" Depth.** For use with RCA 630 chassis or Crosley table model sets. Unit mounted on ball bearing soft tired wheels. Depth is designed to accommodate RF Power Supply. Open grill allows free circulation of air. This stand a natural for mounting scopes and other lab. equipment for easy mobility. Specify whether for Television use or shop. Stand as shown in top photo. Dealers' Price..... **\$31.50**

### REAR PROJECTION TELEVISION SCREENS

The screen surface consists of a conglomerate arrangement of microscopic plastic crystals that "Pin Point" the projected image providing unexcelled angular viewing with a minimum loss of projected light. It is estimated that there is a loss of approximately 10% of light viewing the image at 45 degrees off center. Light transmission percentages are controlled to obtain the maximum efficiency of the television optical projection system. The percentage of 80% of transmission has been determined as that providing maximum efficiency. Stock sheets are available from 3x4 feet down. Specify inside dimensions of screen desired. If larger sizes are required, they can be made to order. Frames can be had on request, small sizes \$5.00—large sizes \$10.00. Dealers' Price of screen, per sq. foot..... **\$4.50**

Include 25% Deposit With Order, Balance C.O.D

Pioneers in Projection Television  
**SPELLMAN TELEVISION CO., INC.**  
130 WEST 24th STREET \* NEW YORK 11, N. Y.

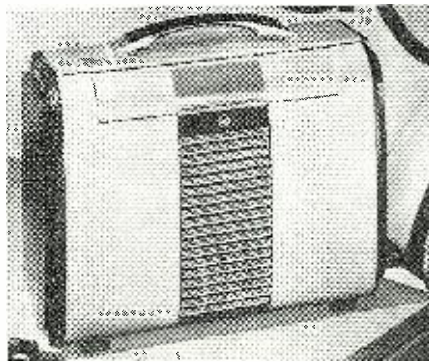

maroon and measures 10 inches high, 13 inches wide, and 5 1/2 inches deep. A deluxe traveling jacket to protect the portable is available as an accessory.

The Home Instrument Department, Radio Corporation of America, Camden, New Jersey, will supply additional details to those requesting them.

### "TELEPROJECTOR"

Lynn Television Company of Upper Darby, Pennsylvania, has announced production on a projection television unit which will provide images 9 by 12 feet in size.

Designed especially for theaters, churches, schools, auditoriums, taverns and clubs, this new unit is capable of presenting images of any size up to 9 by 12 feet using either front or rear projection.

Complete details, including prices and shipping dates, will be supplied by Lynn Television Company, 241 Fairfield Avenue, Upper Darby, Pennsylvania, to those requesting this information.

### FADA TV SET

Fada Radio and Electric Company, Inc. is currently introducing a new table model television receiver, the Model 799.

The new unit is housed in a walnut veneer cabinet which is hand rubbed to a piano finish. Picture size is 6 3/8 inches by 8 1/2 inches, providing approximately 54 square inches of material.

Special features of the Model 799 include full thirteen channel coverage

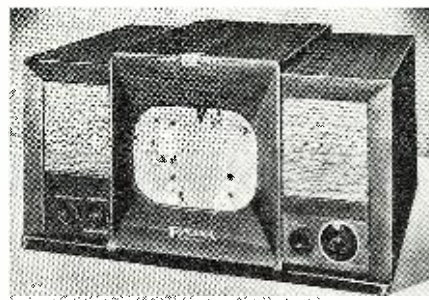

with fine tuning, FM sound system, a.f.c. horizontal hold, stabilized vertical hold, two stages of video amplification, noise saturation circuits, balanced 300-ohm antenna input circuit, and undistorted audio power output of 2.5 watts with a maximum of 4 watts.

The receiver, which operates on 117 volts a.c., uses a 5" electromagnet dynamic speaker. The cabinet measures 24 3/8 inches long, 13 3/8 inches high, and 19 1/8 inches deep.

Further information on the Model 799 and other receivers in the company's line will be furnished by Fada Radio and Electric Company, Inc., 525 Main Street, Belleville, New Jersey.

### "TRIXIE"

Jewel Radio Corporation of New York has added a three-way personal portable to its line of home receivers.

The Model 801 "Trixie" uses four tubes plus a selenium rectifier and has a PM Alnico speaker. Tuning range is from 540 to 1650 kc.

The "Trixie" is housed in a case of simulated python, alligator, or natural leather covering trimmed with saddle stitching. The interior is completely dressed with ivory plastic loop cover and dial panel.

The portable will operate with the cover open or closed and when carried is

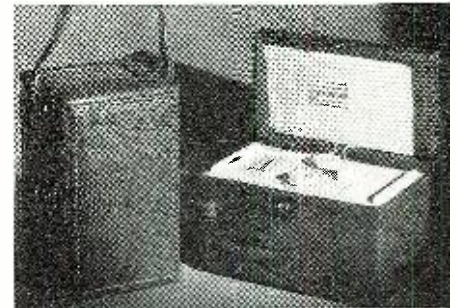

in direct line and hearing range acoustically with the ear.

The cabinet is 7 3/8 inches long, 4 3/4 inches wide and 4 3/8 inches deep. The set weighs 4 1/2 pounds with batteries.

Available in red, green, or brown python, alligator, or tan, further details on this radio will be furnished on request by Jewel Radio Corporation, 583 Avenue of the Americas, New York 11, New York.

### "MARS" TV RECEIVER

"Mars" Television, Inc. is currently making deliveries in the New York area on the new "Mars" 12 inch home television receiver.

The receiver features the company's "Dual-Tuner"—two dials performing all the tuning functions. One is the station selector for all 13 channels and the other is the sound and picture control.

Ease of servicing is another feature claimed for the new receiver. The set utilizes two separate chassis, one for the complete sound receiver and picture and the other for the complete sweep circuit. Both are connected by safety plugs and when servicing is needed, the entire chassis may be replaced in the matter of seconds. The picture tube is inde-

RADIO NEWS

## Fixing Radios the Old Hard Way?



The Feiler Stethoscope does everything but make the actual repair. And the Stethoscope does it faster, better and much easier. Thousands of radio men, many with little experience, are already fixing radios and other electronic equipment this new way.

You will find that just this one low priced unit and a few basic hand tools are all you need to fix practically any radio.

Here is the new Model TS-5 "Pocket Stethoscope" built to take out on the job. It's light, compact and rugged yet performs like the bench models. Stethoscopes are available in 4 types ranging from \$9.85 to \$34.95.



The "Inside Story" of the STETHOSCOPE—how it works—how it instantly locates trouble in any circuit—is yours for the asking. The "Inside Story," a 24 page illustrated booklet, is full of practical tips and hints on radio servicing. To get your free copy, send your name and address on a penny post card today.



"MAKES RADIO REPAIRS AUTOMATIC"

Available for Export—Choice Territories Still Open

**FEILER ENGINEERING COMPANY**

945 George St. Dept. 6H8 Chicago 14, Illinois

# COLLINS

## "Custom Built" FM-AM TUNER

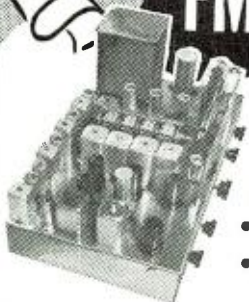

### FLAWLESS Frequency Response

- A. M. Up to 10,000 cycles without loss.
- F. M. High Fidelity 10 Tube Armstrong.

Designed for those who demand the highest possible fidelity in radio reception, the Collins FM-AM Tuner utilizes the most advanced engineering principles and finest in component parts. Two separate and distinct tuners are used having only the audio and power supply common to both. This 17-tube quality tuner features voltage stabilization; and a specially developed tuning eye in the F.M. circuit. A full line of accessories is available for the Collins Tuner.

Write today for full details.



**COLLINS Audio Products Co., Inc.**  
P. O. BOX 368 • WESTFIELD, N. J. • WE-2-4390



# TRIPLE BONUS

the **GREATEST**

Yes! the **GREATEST**

# TEST EQUIPMENT

*Story Ever Told*

1000 pieces of LATEST MODEL, Standard Brand Test Equipment to be sold this month. TUBE CHECKERS, SIGNAL GENERATORS, OSCILLOSCOPES, VTVM'S, MULTI-TESTERS, etc.

LABORATORIES, SCHOOLS, RADIO DEALERS, SERVICE MEN, HAMS, EXPERIMENTERS, STUDENTS:

Get a TRIPLE BONUS on EACH piece of equipment valued at \$40.00 or more. Just fill out the coupon below. Act now!

# Radiomart

INC.

Store  
149 Riverdale Ave.  
Yonkers  
New York

Store & Warehouse  
143 West End Ave.  
New York 23  
New York

**RADIOMART**

Dept. RN-6

149 Riverdale Ave., Yonkers, New York

I am interested in learning more about the greatest test equipment story ever told. Please send details of your great triple-bonus plan. I am particularly interested in buying the following equipment:

Name .....

Address .....

- |                                       |                                       |
|---------------------------------------|---------------------------------------|
| <input type="checkbox"/> Laboratory   | <input type="checkbox"/> Service Man  |
| <input type="checkbox"/> School       | <input type="checkbox"/> Ham          |
| <input type="checkbox"/> Radio Dealer | <input type="checkbox"/> Experimenter |

# Studio Quality AMPLIFIERS

WITH CUSTOM-BUILT FEATURES

Designers and Manufacturers  
of Broadcast Speech Equip-  
ment, School Sound Systems  
and Recording Equipment.

Designed and Fabricated by  
the Manufacturers of High  
Quality Sound and Recording  
Equipment for the Motion  
Picture Industry.



Bardwell & McAlister's new line of Commercial Amplifiers answers the great demand of sound engineers for commercial amplifiers embodying the principles used in "custom-built" units which have been successful in the sound equipment of the motion picture industry. These principles result in high fidelity reproduction at any setting of volume controls up to full rated output with less than 4% distortion, versatility of application, ease of operation and the longer life found only in Bardwell & McAlister Studio Quality Amplification Systems. Manufactured by Union Craftsmen and fully licensed.

Write for our sound equipment catalog and  
technical bulletins. Dealer inquiries invited.



ELECTRONIC DIVISION  
**BARDWELL & McALISTER, INC.**

BOX 1310, HOLLYWOOD 28, CALIFORNIA

pendently mounted and never has to be removed in case of servicing. By using three transformers for the sweep circuit, receiver, and high voltage, heat is re-

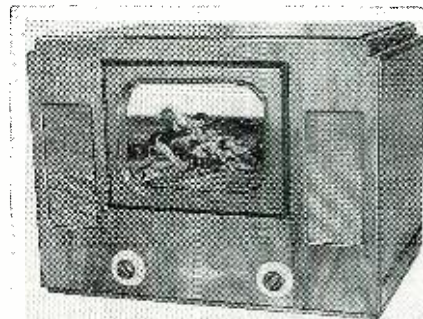

duced to a minimum as these power supplies are only extended to 75 percent of their capacity.

Further data on the new 12" receiver is available from "Mars" Television, Inc., 1441 Broadway, New York 18, New York.

## A.T. & T. FILES TV NET RATES

**A**MERICAN Telephone and Telegraph Company has filed rates with the Federal Communications Commission covering charges for television network facilities which became effective May 1st.

Under the proposed rates a television channel between two cities will cost the broadcaster \$35 a month per airline mile for eight consecutive hours each day, and \$2 a month per mile for each additional consecutive hour. For occasional or part-time service the rate will be \$1 per airline mile for the first hour of use and one-quarter of that amount for each additional consecutive 15 minutes.

For the use of terminal equipment and its maintenance, there is a charge of \$500 per month for connecting stations to the television network for eight consecutive hours daily. For stations which require only occasional service, the charge is \$200 per month plus \$10 per hour of use.

Rates now in effect for sound broadcasting will apply for the separate sound channel needed for the complete television program.

In addition to the present Eastern television network, the Bell System is now constructing 2000 miles of network channels in coaxial cables and radio relay systems in the midwest. By the end of the year the Midwestern network will be joined to the Eastern network, which will be increased and extended. At first some sharing of the available channels will be necessary on certain routes. Under these circumstances, a special schedule of rates will apply.

About 40 million people, it is estimated, live within the areas which Bell System television facilities will reach by the end of 1948.

# TUBES! NATIONALLY ADVERTISED BRANDS TUBES!

RCA — Kenrad — Sylvania — Tung-Sol — National Union — Raytheon — Philco — Hytron  
All new tubes. 100% guaranteed. Individually boxed.

TYPE	PRICE	TYPE	PRICE	TYPE	PRICE	TYPE	PRICE
OZ4	.80	6L6	.96	6ST7	.80	7Z4	.60
1A5GT	.54	6L6A	.96	6U5/6G5	.65	12A6	.54
1A7GT	.65	6N7	.80	6U7G	.54	12A8GT	.65
1D8GT	1.15	6R7G	.54	6V6GT	.65	12AT6	.54
1F4	.80	6S47GT	.54	6W7C	.65	12BA6	.54
1G4GT	.80	6SC7	.85	6X5GT	.45	12BE6	.54
1G6GT	.80	6SF5	.65	6Y7G	.80	12C8	.50
1H5GT	.54	6SF7	.65	7A4	.60	12J5GT	.45
1J8	.95	6SH7GT	.50	7A7	.60	12H6	.34
1LCR	1.15	6SJ7	.50	7B5	.60	12K8GT	.65
1LD5	1.15	6SJ7GT	.50	7E6	.60	12SA7GT	.65
1LN3	1.15	6SK7GT	.50	7E6	.60	12SC7	.65
1N5GT	.85	6SL7GT	.80	7E6	.60	12SF5	.65
1Q6GT	.85	6SN7GT	.80	7F7	.60	12SG7	.65
1R5	.60	6SQ7	.60	7H7	.60	12SJ7	.54
1S5	.60	6SQ7GT	.54	7Q7	.60	12S17GT	.54
1T4	.60	6SR7	.60	7Y4	.60	12SK7GT	.54
2A3	.85					12SL7GT	.80
2A4	.80					12SN7GT	.54
20A4	.80					12SQ7GT	.54
205GT	.72					12SR7	.50
2Y4G	.45					12Z5	1.15
5Y3GT	.40					14A7/12B7	.80
5Y4G	.45					14Q7	.80
6A3	.85					14R7	.80
6A6	.72					18	.95
6A7	.85					25L6GT	.54
6A8	.80					25Z5	.54
6AC7/1852	.75					25Z6GT	.54
6AG7	.85					26	.50
6B4G	.95					27	.45
6B7	.65					30	.65
6B8G	.72					31	.80
6C4	.80					35A5	.65
6C5	.50					35L6GT	.54
6E6	.65					35Y4	.65
6C8G	.72					35Z5GT	.45
6E5	.65					35W4	.45
6F5GT	.65					30/44	.45
6F8GT	.95					50	.65
6G6G	.80					50A5	.65
6H6	.50					50B5	.54
6H6GT	.50					50L6GT	.54
6J5	.50					50X6	.80
6J5G	.50					55	.72
6J7	.80					70L7GT	.45
6J7G	.60					77	.54
6K6GT	.45					89	.54
6K7GT	.54					117Z6GT	.96
						V90-30	1.15
						VRI50-30	.65



**ELECTRIC PORTABLE PHONOGRAPH**  
Leatherette Covered, 2 Watt Amplifier. Plays 12 inch records with cover closed. 5 inch Alnico 5 Speaker. Rim drive constant speed. Self starting motor. High fidelity pickup. Size 17"x13"x7 1/2". List Price \$29.95.

NET PRICE .....\$15.95  
LOTS OF THREE .....\$14.95

TERMS: 25% with Order—  
Balance C.O.D.—F.O.B. Chicago

ORDER TODAY FROM

**FRANKLIN ELLIS CO.** 1313 West Randolph St. Dept. R-6 Chicago 7, Ill.

## Phono System

(Continued from page 63)

lower frequencies where the diaphragm travel might be excessive.

A simple coaxial speaker may be devised merely by mounting a small three or four inch PM type speaker inside of a twelve inch speaker. However, as individual preferences differ widely, it may be found more desirable to mount the low and high frequency speakers on different sides of the room. If a number of people are listening, they may then exercise a form of personal tone control by turning their heads in the proper direction, or changing their position in the room.

For good low frequency response the low frequency speaker must be adequately baffled, the reason being that a loudspeaker produces two wave trains, one from the front, and one from the rear and if not separated or altered in some manner the low frequency wave trains will tend to cancel each other. A ten cubic foot enclosure of the bass reflex type may be constructed from plywood and two-by-fours and will give excellent results for frequencies as low as forty or fifty cycles, although speakers may be mounted in walls or ceilings and give excellent results. If a cabinet type enclosure is used, it is suggested that the record player be placed elsewhere to eliminate the possibility of acoustic coupling between the low frequency speaker and the pickup, which may cause distortion or oscillation at higher volume levels.

Although there are a number of excellent pickups available on today's market, surprising quality may be obtained from a conventional crystal such as the L-26A. As crystal pickups are capacitive devices having an internal capacitance of approximately 1500 mmfd. the high frequency response is considerably attenuated by the shunt capacitance. By using an unusually low value of load resistor of the order of ten thousand ohms, this shunt capacitance can be minimized, and several pickups treated in this manner showed nearly flat response from fifty to six thousand cycles. This provides a greatly improved clarity of tone, but also means lowered output and for this reason three stages are used in each of the amplifiers. Jewel point needles are usually best for tonal reproduction, but may introduce excessive record wear. Cactus needles, it might be noted, performed surprisingly well with increased high boost and introduced much lower wear.

The over-all electrical characteristics of the author's amplifier extend from below twenty c.p.s. to well above twenty thousand, using conventional output transformers and without inverse feed-

# Modern Hams Junk Old-Style "Cans"!



First basic improvement in headset design in 50 years

## TELEX MONOSET

- Gives clear, crisp "near as here" reception
- Blocks outside noise
- Eliminates that "top-heavy" feeling
- Ends headachy ear pressure

Man, what relief to get rid of those pressure headaches from old-style earphones!

The TELEX MONOSET swings lightly under the chin like a stethoscope—never gets in your hair! The TELEX MONOSET delivers the signal into the ears, excludes all room noise automatically. The TELEX MONOSET gives undistorted output at maximum volume... plenty of "sock" easily adjusted with the built-in volume control.

Modernize your rig with a MONOSET  
—successor to the earphone! Write  
Department BT for information.



Canadian Distributors  
Sono Film, Ltd., Winnipeg

Police

CALL FANS

HERE  
IT IS



**TUNES 152-162 MEGACYCLES**

6 Tube (miniatures) True F.M. Superhetrodyne including rectifier. 115 Volts, A.C.-D.C. 5 Inch speaker. Clear vision dial. 9 1/2 x 6 1/4 x 5 1/4 deep, walnut veneer cabinet. Shipping weight 5 1/2 lbs. Highest quality components. Schematic inside back cover. 2 stages high gain 10.7 Megacycle I.F.s. High Selectivity. Discriminator Detector. Guaranteed reception from your local F.M. Transmitters with attached antenna, from cabs, police and others. Ready to plug in and use.

**\$39<sup>95</sup>**

Excise Tax Included  
F.O.B. Indianapolis  
\$10.00 Cash With Order Rest C.O.D.

**RAC POLICALARM**

RECEIVER

**RADIO APPARATUS CO.**  
729 NORTH BANCROFT ST.  
INDIANAPOLIS (1), INDIANA

SOME CHOICE DEALERSHIPS  
STILL AVAILABLE — BE FIRST — WRITE

## A Beautiful Cabinet To Double The Value Of Your Chassis!

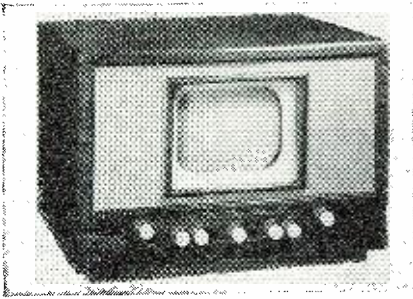

### Specially Designed For Your "Transvision" Kit (12" and 15" Standard Models)

A hand-crafted cabinet made of the best 3/4 inch walnut and mahogany, finished by expert piano polishers, for the custom-builder who seeks to give his set the advantage of commercial styling combined with exclusive construction. Dimensions; 29 1/2 inches wide, 21 inches high, 20 inches deep.

#### INCLUDES THESE BETTER FEATURES:

- 8 inch Rola P. M. speaker for natural tone
- Specially built milk-white Lucite mask, curved to fit 12" picture tube—protected with safety glass.
- Conveniently located slide switch operates concealed illumination for Lucite printed dial and jewel-covered light in base.
- English design recessed base—felt cushioned.
- Thoroughly ventilated for heat dissipation.

#### IT'S THE "NEW LOOK" FOR THE COMMERCIAL BUILDER!

This highly polished cabinet comes to you completely assembled, drilled for shafts, wired and ready for your chassis. Nothing else to buy. Furnished complete with step-by-step instructions and following kit of parts to complete installation of chassis; pin jacks, plugs, onyx catalin knobs (6 plain, 1 with pointer), special low-loss antenna block, assembly to raise CR tube, masonite back-board drilled for ventilation, heavy stack output transformer, fuse holder, strap for CR tube, caution labels, nuts, washers, bolts, screws.

12" MODEL	WALNUT OR MAHOGANY (BLOND MAH. \$10 ADD.)	15" MODEL
<b>\$79</b>	Available for both 5 and 7 shaft chassis	<b>\$89</b>

F.O.B. B'klyn, N. Y. Terms: 10% with order, balance C.O.D. Order direct or thru distributor

**TEL-CRAFT COMPANY**  
108 HAVEMEYER STREET  
BROOKLYN 11, N. Y.

**SHORT CUT** **CODE SPEED**  
*Be an Expert*

Learn to be a Telegraph or Radio Operator. Thousands of men needed. Intensely interesting work — good pay. Learn at home or wherever you are, quickly, easily, with the famous Candler Code Speed System. Qualify for Amateur or Commercial License. Book of Particulars Free.

**CANDLER SYSTEM CO.**  
Dept. 2-G, Box 928, Denver 1, Colo.

#### MOTOR GENERATORS

Brand New War Surplus Machines built by Allis Chalmers Co. to U. S. Navy Specifications.  
Input: 115 V. D.C. at 14 amps., 3600 rpm. Output: 120 V. A.C., 60 CY, 1 ph. at 10.4 amps., 1000 Watts continuous duty. Ball bearings. Splashproof. Fully enclosed. Centrifugal starter. Frequency adjustable to load. Price \$97.50.  
Same machine but for 230 V. D.C. input. Price \$125.00. Spare parts kit with extra brushes, brush-holders, field coils, bearings, etc., for either machine, \$29.50.  
All prices FOB Tuckahoe, New York  
**ELECTRONICRAFT, INC.**  
5 Waverly Place, Tuckahoe 7, New York

back. However, due to the limited power handling capabilities of loudspeakers at very low frequencies, it may be found desirable to deliberately attenuate the very low frequencies below fifty or a hundred c.p.s. to improve the clarity of the bass reproduction and to reduce speaker resonance.

Assuming that the reproducing system is in excellent shape, room acoustics may alter the character of the reproduced sound to a considerable degree. Wall reflections may do much to destroy the clarity of reproduction, especially at high volume levels. A soft rug on the floor and acoustic paneling or wall drapes may help to cut down reflections.

An excellent way to check the overall response of a phonograph system is to obtain a standard tone record which contains the range of frequencies between fifty and ten thousand cycles and, with the amplifier controls in the proper position, the entire range should be clearly reproduced. If desired the acoustic response curve of the entire system may be plotted by placing a microphone of known characteristics in front of the loudspeakers, and connecting it to a small amplifier of flat response driving an output meter. When a standard tone record is played the meter will indicate the acoustic output curve of the system. If desired the microphone may be placed in various portions of the room to determine the most favorable acoustics.

The addition of an inexpensive radio tuner will transform this system into an excellent radio phonograph, or your present console may be easily converted by the addition of another audio amplifier.

The parts cost for the entire system should run considerably less than one hundred dollars, including an automatic record changer.

Fig. 1 shows a somewhat smaller and less expensive amplifier which is especially adaptable to apartments and record booths where greater volume is not required. In either application it is desirable that a pickup with low needle talk be used, as needle chatter is quite objectionable when the amplifier is run at low levels.

—30—

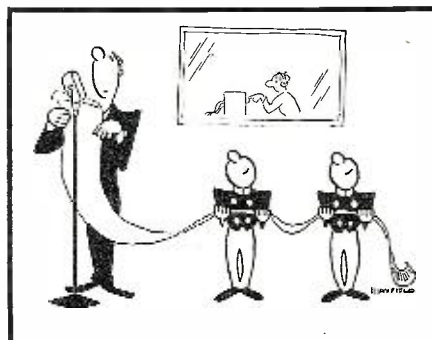

"... and now a word from our sponsor!"

now ready for  
*Immediate Delivery...*

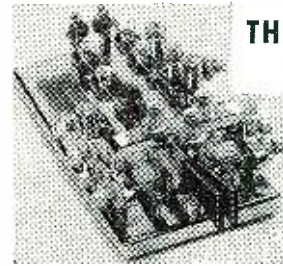

### THE MELEHAN VALIANT

DELIVERED  
PRICE  
**\$27<sup>50</sup>**

25% required on all C. O. D. merchandise. Calif. purchasers please add 2 1/2% sales tax.

"Truly, the World's Finest Telegraph Key"

#### EXCLUSIVE FEATURES OF THE MELEHAN VALIANT

- Automatic dots plus automatic dashes.
- Adjustable from fifteen to eighty words per minute.
- Massive base 4x 1/2 x 7 inches and cradle unit provide solid foundation.
- Purely mechanical in operation, self-contained and self-sufficient, no superfluous electrical forces being utilized.

Deliveries of this superior instrument have been interrupted because the manufacturer would not substitute inferior materials or in any way change the perfected design.

#### MELEHAN RADIO PRODUCTS CO.

7061 E. Monroe St. Rt. No. 1  
Anaheim California

## Industrial Teleceivers

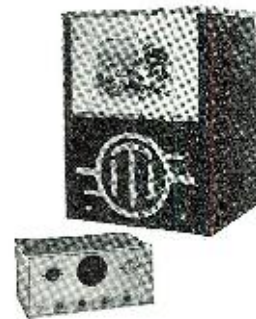

For Public Viewing in  
TAVERNS - HOTELS  
HOSPITALS - SCHOOLS  
INSTITUTIONS - CLUBS

Featuring  
**SIMPLIFIED  
CENTRAL CONTROL**  
with any number of  
viewing screens

**INDUSTRIAL TELEVISION, INC.**

359 LEXINGTON AVE., CLIFTON, N. J. - GREGORY 3-0900

Our 26th Year



Quality-Price-Dependability

**NATIONAL COMPANY COMPONENTS**

Direct Calibration Dials—5:1 Drive Ratio  
 ACN—7 1/4" W x 5" H ..... \$3.00  
 ICN—7 1/4" W x 5" H with illum'd scale ..... \$6.00  
 SCN—6 1/4" W x 4-7/16" H ..... \$3.00  
 MCN—3 3/4" W x 2 1/4" H ..... \$2.70  
 NPWO Gear Drive 20:1 Ratio; Shaft perpendicular to Panel with Microm. Dial. \$7.20  
 PWO Gear Drive 20:1 Ratio; Shaft Parallel to Panel with Micrometer Dial. \$9.00  
**We Carry a Complete Line of National Parts & Receivers**

APC-25mmf Silver Plated Air Trimmer..... 15c  
 10 for..... \$1.25  
 APC-50mmf Silver Plated Air Trimmer..... 15c  
 10 for..... \$1.25

**OIL FILLED CONDENSERS**

1 Mfd., 750VDC. Sprague ..... 15c  
 7 Mfd., 330VAC. G.E. .... 98c  
 10 Mfd., 330VAC. G.E. .... \$1.25  
 10 Mfd., 600VDC. Capacitron ..... 98c  
 16 Mfd., 400VDC. W.E. Co. .... 98c  
 2 Mfd., 1000VDC. Aerovox..... 69c  
 0.1 Mfd., 7500VDC. G.E. .... \$1.50  
 2 x 0.1 Mfd., 7000VDC. G.E. .... \$2.00  
 1 Mfd., 5000VDC. Solar ..... \$2.95  
 2 Mfd., 1000VDC. C.D. .... \$13.95

**WIRE**

No. 10 Copper Enamel 100 Ft. Lengths. Each \$1.75  
 No. 12 Copper Enamel 100 Ft. Lengths. Each \$1.25  
 No. 14 Copper Enamel 100 Ft. Lengths. Each 83c  
 300 ohm Twin Lead Plastic covered 100 ft. .... \$1.95  
 72 ohm Co-Ax Cable 7c per Ft. 100 ft. .... \$6.75  
 3 Conductor Rubber Covered Cable per Ft. .... 3c

**CS—DIFFERENTIAL RELAY—S.P.D.T.**

Dual Coil with Armature Pivoted between coils. All contacts normally open operates 220-250 volts. 8000 ohms each coil contacts Rated 2 amps @ 110VAC. Ideally suited for balanced or bridge type circuits where limited current or power is available. **95c**  
 For Only



G.E. 2500 Ohm Relay—S.P.D.T.  
 4MA D.C., 5 prong, plug in type, hermetically sealed. Brand New **95c**

**Items You May Be Looking For**

Federal Type Selenium Rectifiers 100 Ma. ea. 50c  
 De Jur W. W. 20,000 Ohm. Pot. 12 watt. .... 49c  
 ARC-5 Banana Plugs silver plated, per dozen 10c  
 PL-259 Coaxial Plugs Silver Plated. 19c ea. per 100 ..... \$15.00  
 150 Watt, 5 ohm, W. W. Rheostat 4" Diameter \$1.95

**CARDWELL VARIABLE CONDENSERS**

ET-27-AD: 27mmf split stator 15 plates per section .070 Air Gap Isolantite Insulation 1/4" Shaft ..... \$1.29  
 ER-35-AD: 35mmf split stator 11 plates per section .030 Air Gap Isolantite Insulation 1/4" Shaft ..... \$1.05  
 MP-25-GS: 25mmf-7 plate .070 Air Gap Mycalex Insulation 1/4" Shaft ..... \$1.29  
 NUV-150VS: 150mmf 35 plate, .070 Air Gap Mycalex Insulation 1/4" Shaft. .... \$1.95  
 ZO-50-AS: 50mmf-21 plate, .030 Air Gap Isolantite Insulation, Screw Driver Adj. .... 95c

**METERS**

5-0-5 Amps. D.C. Charge and Discharge Scale 2" Round ..... 69c  
 0-1 Amp. R.F. G.E. 2" Round. .... \$2.45  
 100 Amp-6 volt D.C. 3" Scale. 4 1/2" Square. Gray finish with shunt. A Swell Buy. .... \$2.95  
 0-100 MA 2" RD ..... \$1.95

**TUBES At Real Prices**

5BPI, CR Tube 5" Green Screen. New..... \$1.45  
 832A, Dual Beam Power Tetrode. New..... \$2.15  
 616, Twin Triode Miniature. New..... 50c  
 3024, Triode, 100 Watt Power Output. New, ea. 39c  
 10 for..... \$3.50

If not rated 25% with order, balance C.O.D. All prices F.O.B. our warehouse New York. No order under \$2.00. We ship to any part of the globe.

**LEEDS RADIO CO.**

Dept. RN6  
 75 VESEY STREET  
 COrtlandt 7-2612 New York City 7

**ATTENTION !!!**  
 All SCR-522 Owners:  
 Remote Control Boxes for SCR 522's, Brand New in Original Packing; Consists of 5 push button switches, 3 Western Electric Pilot Assemblies, with Pilot Bulbs and Dimmer, and lever Switch all finished in Black Crackle. Order yours today for only **\$1.25** Each  
 Antenna Plug 46-PS-1 for 522A ..... Each 15c

**STEEL CHASSIS**  
 7 x 7 x 2 ..... 63c  
 7 x 9 x 2 ..... 73c  
 7 x 11 x 2 ..... 90c  
 7 x 13 x 2 ..... 96c  
 5 x 10 x 3 ..... 87c  
 6 x 14 x 3 ..... 93c  
 10 x 14 x 3 ..... \$1.35  
 4 x 17 x 3 ..... 90c  
 7 x 17 x 3 ..... \$1.26  
 8 x 17 x 3 ..... \$1.22  
 11 x 17 x 3 ..... \$1.86  
 13 x 17 x 3 ..... \$2.22  
 All Black Wrinkle Finish

**Steel Cans and Boxes**  
 4 x 4 x 2 ..... 68c  
 4 x 5 x 3 ..... 78c  
 5 x 6 x 9 ..... \$1.41  
 6 x 6 x 6 ..... 98c  
 8 x 10 x 10 ..... \$2.06  
 12 x 7 x 6 ..... \$1.68  
 11 x 12 x 8 ..... \$2.25  
 15 x 9 x 7 ..... \$2.35  
 Sloping Front Meter Case, Cut for 3 inch Meter. Size 4 1/2 x 4 x 4 ..... 92c  
 All Black Wrinkle Finish

Dynamotor-5047-D.C. Input 27 volts @ 1.75 amps. Output 285 volts @ 0.75 amps. continuous duty Rating. Brand New. **95c**  
 DM-43 Dynamotor. Manufactured by G.E. New. Input 24v @ 23 Amps. 7500 RPM; output 515/1030/2/3v. @ 215/260 milliamperes; filtered. Special ..... \$2.95  
 Selenium Rectifier Full Wave 68VAC Input 48VDC Output .5 Amp. .... \$1.50

**Wire Wound Potentiometer**  
 100,000 ohm, precision made G.R. type, 25 watt 6" diameter. **\$1.95**  
 Brand new.....  
 Heineman Circuit Breakers, 3 amp., sizes ..... **95c**

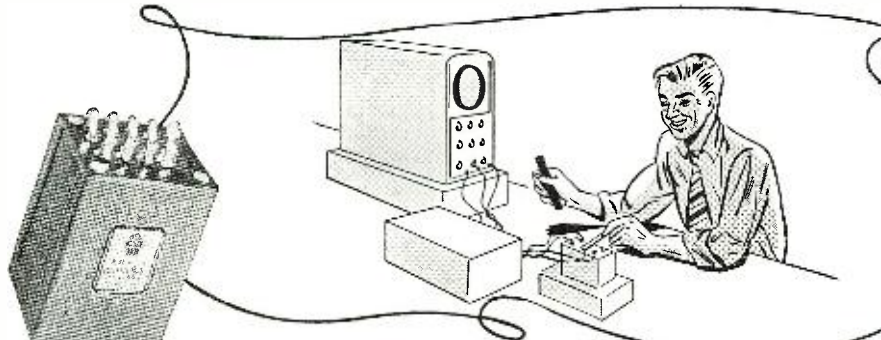

GROOMING an

**ADC AUDIO TRANSFORMER for FAULTLESS PERFORMANCE**

**3 Complete Tests to Meet Rigid ADC Specifications.**

Strict electrical tests are given each and every ADC Audio Transformer at three different stages of production. In order to give you faultless performance on the job, every transformer must come within catalog specifications on all tests. (Customer specifications on special transformers.)

**1st TEST.** After assembly of coil and laminations, each component must perform within ADC specifications on frequency response, impedance ratio, phasing, breakdown and balance tests. Any unit failing to meet all requirements is rejected.

**2nd TEST.** After impregnation, baking and casing, each transformer is re-checked for continuity breakdown and other requirements of the particular unit. This guarantees correct wiring, perfect insulation—no "shorts" or "opens."

**3rd TEST.** After cleaning, labeling, etc., a final continuity, breakdown and thorough visual check is made. This quality control test—plus the finest materials and workmanship available—assures you of faultless ADC performance on the job.

Consult your jobber about ADC Audio Transformers and other Components. Ask for Catalog 46-T.

Other ADC Components: JACKS • JACK PANELS • PLUGS • PATCH CORDS

**Audio Development Co.**  
 2833-13th Avenue So., Minneapolis, Minn.  
 Audio Develops the Finest

**Priced Far Below Wholesale Cost !!!**

**BRAND NEW  
35 WATT**



**WESTERN ELECTRIC**

- Full frequency response Driver Unit complete with projector.
- Excellent for concessions, Ball Parks, Mobile, P.A. Work.
- Stock up NOW, never again offered at this sensational price.

**\$24<sup>95</sup>**

F.O.B. N.Y.C.

**T. V. BOOSTER**

- Clarifies pictures.
- Increases signal strength.
- Helps eliminate Ghosts, external picture interference.
- Simply hook in series with Television antenna. No power supply required. Complete, self-sufficient, housed in an attractive black crackle finish metal case.

**\$9<sup>95</sup>**



**A WIRE BUY**

No. 18-7. Strand Black Plastic Vinylite Indoor or Outdoor Wiring, O.D. 1/8" on 27" reel—15,000 ft. \$270.00 Value. Lifetime Covering 100 Uses.

**YOUR PRICE \$30<sup>00</sup>**

SEND POSTCARD FOR OUR LATEST BULLETIN

ATTENTION: DEALERS—DISTRIBUTORS!

Send for our list of many other items, below wholesale cost, on your company letterhead.

All Prices F.O.B. N. Y. C.—20% deposit, Bal. C.O.D.

**MANUEL KLEIN 74 CORTLANDT STREET NEW YORK 7, N. Y.**

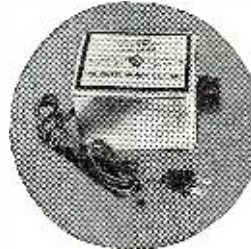
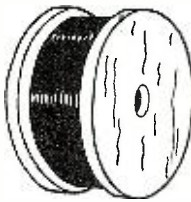

**MALLORY LINE NOISE FILTER**  
Rating 110-220 V. (AC-DC).  
\$10.00 Value.  
Your Price **\$2.95**

**TRADIO-ETTE**



Here's the **KEY** to more profits every day!

Here's one of the finest business opportunities in years. You can cash in on the fact that people like radio with their meals. That's why Tradio-ette—a small, compact coin-operated radio designed for restaurant and tavern booths—has become so nationally popular. Plays 15 minutes for 10c.

**Small Investment**

Thousands of high-yield locations are available if you get in on the ground floor. Only a small investment needed to operate this lucrative full or part-time business. Tradio is the nation's leading manufacturer of coin-operated radios.

For Complete Details . . .  
Contact Us Today!

Write Dept. P-6

**TRADIO, Inc.** ASBURY PARK NEW JERSEY

**SAVE at R. P. D.**

Write for Free Bulletin of Value

Input Transformer: Imp Ratio 100 to 2000r Max-Oper Voltage 350 volt D.C. **69c**  
EACH

**R. P. D. OIL FILLED CAPACITOR SPECIALS**

- 4—mfd 600 volt (Gudeman) Each.....55c
  - 7—mfd 600 volt (Cond-Prod) Each.....65c
  - 10—mfd 600 volt (Ineco) Each.....75c
  - 2—mfd 1000 volt (Mall-Sprague-Aer) Each.....85c
  - .25—mfd 3000 volt (Gudeman) Each.....95c
- MICAMOLD PAPER MOLDED CONDENSERS**  
ERS .01-600 Volt .50 for \$2.00 .100 for \$3.50  
Solar .1 mfd 400 volt Paper Condensers  
100 for .....\$10.00

**F. P. FABRICATED PLATE COND.**

- 100-150 Volt, 151350 Volt, 10-450 Volt, 20-450 Volt, 90-450 Volt.
- Each .....49c
- 10 for .....\$4.50

**DUAL COND.**

- 200-300-6 Volt, 20-20-25 Volt, 1000-1000-15 Volt.
- Each .....75c

**TRIPLE SECTION**

- 40-10-1000 Mfd, 450-450-6 Volt.
  - Each .....90c
- METAL PLATES FOR F. P. COND.** 3/4" x 1" x 1 1/2"  
25 for .....35c 100 for .....\$1.25

**FRACTIONAL MOTORS**

- Compound Wound 115 Volt D.C.-3/16 H.P., 2 amps. 3450 R.P.M. (18Pds) oil impregnated ball bearings. Each \$3.69 4 to a case.....\$14.00
- Leach DPST Relays 25 Volt DC-250 Ohm Res. Each .....69c
- Allied Control DPDT Relays 24 V. D.C. 10 Amp. Res. Each .....69c
- Fluted Black 1 1/2" Transm-Knobs (Metal insert) 10 for .....\$1.00
- Spaghetti Tubing, White or Black Rubber, 25 ft. lengths 3/8" inside diam. Per roll .....25c
- 3 Rolls for .....\$1.00
- Ceramic Acorn Tube Sockets 5 for .....85c
- 110 Volt Female Receptacle with Mounting Plate (2 Pole Universal) mounts in 1 3/32" hole. 10 for .....\$1.00
- 2 Prong small hard rubber AC caps to fit receptacles 30 for 85c Per 100 .....\$7.00

- 50 WATT 1000 OHM ADJUSTABLE W.W. POWER RESISTORS Each 69c Lots of 10.....\$6.00
- EDISON BASE 60 Watt 1000 Ohm Porcelain Resistors Each 59c Lots of 10.....\$5.00
- Jeff-Ect Filter Choke 40 Ma—20 Henry's metal square case 2x2 1/2x2 3/4" Each.....79c
- Jeff-Elect Dual Filter Choke 9.5-9.5 Henry 60 Ma Size 6x3x2 3/4" Each.....\$1.39

Terms: Remittance with order PLUS POSTAGE or 25% deposit, balance C.O.D.

**RADIO PARTS DISTRIBUTORS**  
925 E. 55th St., Chicago 15, Ill.

**International Short-Wave**

(Continued from page 70)

"There were but four of us present on the premises at 2130 hours when the place was stormed by a detachment armed from head to foot. They took us—two men and two women—as prisoners, without telling us what our fate might be. In the morning, they asked us to keep on working 'with' them. We refused indignantly and were rather surprised that they permitted us to return to our homes. To be quite true, I must tell you that they fetched me shortly afterwards, took me to the *Kempettain*, and took vengeance for all our past contests—I was very nearly beaten to death before they had finished with me.

"Meanwhile, their dream of transforming *Radio Saigon* into a branch of the Japanese propaganda service had come true. From March 10 to the beginning of September 1945, the station was operated by the Japs—entirely and exclusively. When the British troops came in September 1945, the Japs had turned over the station to the *Viet Minh*, who abandoned it immediately.

"We began broadcasting again on September 26, and that was indeed a great day for those among us who had devoted a large part of our activities to *Radio Saigon* for several years before the Japanese 'period.' Matters were not quite so easy as we might have wished, however, for part of our equipment had been sabotaged by either the Japs or the *Viet Minh*.

"But we made the best of it, and that lasted until April 8, 1946, another fateful date in the history of *Radio Saigon*. It was on that day that the arsenal which was just opposite our premises was blown up, the explosions lasting for some 56 hours. *Radio Saigon* was practically burned down, with all the technical equipment being utterly destroyed. The first explosion occurred at 1020, and we are proud to say that we resumed broadcasting at 1800. We borrowed whatever material we could find (from the Post Office Department), and from the Army, installed it in a private house, and simply went on!

"To the present day, we are still in that house—working under difficult conditions, but making our 'Voice' heard the world over in eight languages, 15 hours a day. Our former building is being rebuilt.

"With the gradual improvement in our equipment, the number of overseas listeners to our *English* broadcasts is increasing. We will be delighted to verify all correct reports and hope that many of you will continue to keep us posted on the reception of *Radio Saigon* in your various countries."

*Radio Saigon* is operated by Direction

**RADIO NEWS**



Federale de l'Information et du Tourisme—that is, it is under official control. Studios are located in Saigon at 198, Rue Chasseloup Laubat. The audio-frequency equipment of the emergency studios is composed of a 7-tube mixer-line amplifier, 2 dynamic microphones, 2 turntables and magnetic pick-ups, and one monitoring amplifier. The more elaborate designs in the studios are the microphone relays and announcer's warning system—working on 12-volt batteries. The line amplifier injects modulation in a 500-ohm matched telephone line which relays the station to Phu-Tho, an Annamese village about four miles from Saigon, where the transmitters are located.

Frequencies used by *Radio Saigon* are 11.78, 6.165, and 1050 kc. The 6.165 antenna is a non-directional delta-matched, and the 11.78 one is a non-directional half-wave matched. Output power is 12 kw., input power is 50 kw. Modulation is listed Class A. The 1050 kc. transmitter has an output power of 1500 watts, input power of 5 kw.

At last report, *Radio Saigon* was scheduled daily on 11.78, 6.165, and 1050 kc. at 1800\* (or 1830) to 2000; 2130-0030, and 0300-1030; *English* periods at 1945-2000, 0500-0545, 0830-0930; news 1945, 0500, 0900. The Listeners Letterbox (in *English*) is radiated on Mondays around 0540. The medium-wave channel, 1050 kc., is used also at 0030-0300.

Recently, *Radio Saigon* has been using a Post Office Department outlet, FZS, 18.388, daily at 1030-1100 for a beam to France in French ("*L'Indo-Chine Parle a la France*," consisting of messages by people in Indo-China to friends and relatives in France). This special beam may or may not be in operation by this time.

Several other outlets are reported operating from Indo-China. One is *Radio France*, 6.048, Hanoi, reported mornings to around 0900, news 0700; is officially listed at 0645-0800 with 1 kw. power; in summer may use 9.465V (which was the case last year).

Such is the *Saigon Story!*

\* \* \*

#### Radio in Japan

We are pleased this month to present this late information on radio activities in Japan (as supplied by Art Cushen, New Zealand, and Ellis Ogilvie, Washington state). Verifications are now being issued by the Broadcasting Corporation of Japan, Tokyo, by letter from R. H. Niino, vice-chief of the Liaison Section. Latest schedules are listed below (those received by Cushen and Ogilvie were *not* the same, so I have used those which appeared most logical):

(NOTE: Unless otherwise indicated, time herein is American EST; add 5 hours for GCT; "news" means in the *English* language unless otherwise stated.)



# HAS THE VALUES!



HERE ARE A FEW TYPICAL OF WHAT IS TO BE FOUND IN THE BIG NEW B-A CATALOG #481

116 BIG PAGES PACKED WITH THE LATEST DEVELOPMENTS IN RADIO AND ELECTRONICS, Sets, Supplies and Apparatus . . . For Trade—Industry—Communications—Public Utility—Experimental and Hobby Applications.

A Bargain Section Packed With **OUTSTANDING VALUES** in desirable WAR Surplus and other **SPECIAL VALUES.**

Write For Your Copy of Catalog #481 If You Did Not Receive It.

**Only \$13.88** for this Quality **RECORD CHANGER**



A fortunate purchase from an overstocked manufacturer enables us to offer these popular UTAH Model 650 Record Changers AT A BIG SAVING.

**Features:** Single post, gearless construction. Quiet and fast during change cycle. Plays 10 twelve-inch or 12 ten-inch records. Rejects any record desired. Light weight balanced tone arm with quality crystal cartridge for any standard needle.

Has heavy, die cast base plate 10 3/4" x 12 1/8". Mounting size approx. 12 1/4" x 13 3/8", extends 5 3/4" above and 2" below mounting. Operates from 110 volts, 60 cycle.

No. 40A1000 Bargain Priced, Each..... **\$13.88**

Two in Factory carton, for only..... **\$25.00**

### BIG VALUE—AC-DC Superhet

Graceful design, dependable performance anywhere. An outstanding value! Proven Superhet circuit, 5 dependable tubes (including rectifier). Full size 5" Alnico "M" PM speaker for wonderful tone. Airplane dial. Modern Plastic cabinet Ivory, finish size 10 3/8" x 5 1/2" x 6 5/8". No. 31A224, SPECIAL EACH..... **\$15.94**

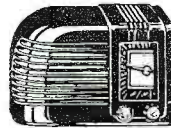

### ALUMINUM UTILITY CASE

**LIGHTWEIGHT DURABLE EYE APPEALING**

- IDEAL FOR**
- Radio Serviceman's parts and tool kit
  - Tube carrying case
  - P.A. accessory case
  - Camping, Fishing, Picnics, all family use



Life time aluminum case with bakelite handle, lock and key. Size 15" long, 11" wide, 5" deep. Weight only 3 lbs. Shipping weight approx. 5 lbs. No. 36A75—Very Handy For Everyone, NET EACH..... **\$3.65**

### 3 WAY "PERSONAL" AC.-DC. and BATTERY OPERATED PORTABLE

Superhet circuit, 4 tubes plus Selenium rectifier, 5" Alnico PM speaker. Iron core I.F. Safety switch for operation from 110 volt AC or DC electric current or from self contained batteries (1-746 "A" and 1-467 "B") available anywhere. Beautiful dual colored Polystyrene Shatter-proof molded cabinet with plastic easy grip handle. Large slide rule dial. Vernier Hi-ratio tuning. Small: only 4" wide, 8 3/8" long, 7 1/4" high. Weight only 5 1/4 lbs. with batteries. A "Money" for in the home or "on the go." No. 36A66 Less Batteries, ONLY..... **\$21.95** Set of batteries (1-746 and 1-467)..... **\$2.40**

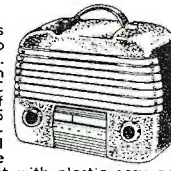

### 1000 V.—200 Ma. Power Supply FILTER KIT

Consist of Two 4 mfd. 1000 volt DC oil filled condensers size 2 1/2" x 1 1/8" x 5 1/2" high overall and One Thordarson 10 Hy.-200 Ma. filter choke fully enclosed metal case size 3 3/8" sq. x 4 5/8" H.

21T3983 ONLY..... **\$3.65**

### 2 MFD. 2500 VOLT OIL FILLED CONDENSER

Well known brand. Ceramic pillar terminals, in hermetically sealed metal case, size overall 1 3/4" x 3 3/4" x 5 1/2" high. Comes with handy removable mfg. bracket and solder lug terminals.



No. 21T3990, Special, Each..... **\$2.95**

### 12 1/2 FOOT ANTENNA TELESCOPES DOWN TO 1 FOOT 4"

"Just it" for mobile equipment, portable receivers, and transmitters. Solid Brass—Ruggedly constructed—smooth telescopic action. Base is 1/8" dia. No. 38A39, Special Each..... **\$1.95**

### WEATHERPROOF WIRE at GIVE AWAY PRICES

Stranded tinned conductors (3 copper, 4 steel) flexible, yet unusually strong to stand long runs. Conductor is rubber covered with overall weatherproof saturated braided; OD 5/32". Perfect for lead-ins, telephone, intercoms, etc. BRAND NEW in original factory wound coils.

No. 4A503, Three Conductor Per 550 Foot Coil, ONLY..... **\$4.95**

No. 4A502, As above except Single Cond. Per 900 Foot Coil, ONLY..... **\$2.95**

### "Re-Mote" REAR SEAT

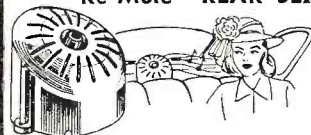

Car Radio Speaker

Easy to install in a few minutes—no cutting of holes required. Furnished complete with 17 ft. wire, fittings, resistor to match speaker to any standard Auto Radio and complete instructions. Consist of 5" quality PM speaker in beautiful marbled french gray plastic case, volume control built in. No. 14A650 Your Cost Each..... **\$6.37**

### 80, 75 and 40 Meter CRYSTALS, 10 for..... **\$3.95**

In FT 243 holders, cut from highest quality quartz, accurately ground and acid etched. Frequency marked on each within 2 KC. Sorry we must sell them in ass't. our pick of frequencies—but you can't go wrong! There are plenty of choice frequencies for 80, 75 and 40 meters or for doubling to 20 and 10 meters in each ass't. Every one guaranteed to be an active oscillator.

Stock No. 21T 3991 Assortment of TEN — ONLY..... **\$3.95**

Order direct from this ad. Our Terms: Cash With Order or C. O. D. with 20% deposit please. Radio Sets Shipped Via. Express Only.

WRITE FOR YOUR COPY OF CATALOG No. 481 IF YOU DID NOT RECEIVE IT.



# BURSTEIN-APPLEBEE

1012 MCGEE, KANSAS CITY 6, MO.

Company

# IRC PRECISION RESISTORS

Tolerance 1% or better..... **35c** each

<b>OHMS</b>	10.000	53.32
	14.460	53.96
<b>WW-1</b>	15.000	280
4.300	17.000	988
8.000	17.300	1.123
95.000	20.900	1.200
	20.520	4.000
<b>WW-3</b>	26.500	11.000
4.4	40.000	20.000
4.35	41.800	80.000
13.52	46.000	82.000
20	54.500	400.000
30	66.000	600.000
70	92.000	
105.8	109.000	<b>WW-5</b>
125	120.000	1.500
130		4.000
147.5	<b>WW-4</b>	100.000
220.4	1.563	125.000
366.6	4.3	268.000
414.3	5.1	700.000
750	12	750.000
1.000	13.333	800.000
2.200	14	1 megohm
2.230	20	
4.000	22	<b>WW-13</b>
5.000	23.29	100
7.500	33.22	40.000

Tolerance 3% or better..... **25c** each

<b>WW-3</b>	12.000	4.000
30	33.000	84.000
110	<b>WW-4</b>	250.000
235	3.94	290.000
2.500	6	<b>WW-5</b>
4.000	10	84.000
4.300	10.2	220.000

Tolerance 5% or better..... **19c** each

<b>WW-3</b>	100	<b>WW-13</b>
30	110	15.000
35	2.500	22.000
40	<b>WW-4</b>	100.000
50	250.000	110.000
70		

## 4000-6000 VOLT LOW CURRENT DC SUPPLY

These units have been designed for use with television, cathode ray, electron multiplier and other types of equipment requiring high voltage with currents up to 1 milliamper. Brand new, completely wired and tested. Ready to operate from 115 volt power line. DC output is filtered.

Price Complete ..... **\$12.50**

2000-3000 Volt DC Supply, similar to above but with lower output voltage. Ready to operate from 115 Volt power line.

Price Complete ..... **\$7.95**

## TRANSTAT VOLTAGE REGULATORS

Model #29144

Fixed Winding 115 Volts—60 cycles  
Commutators range 103-126 Volts  
Maximum output .25 KVA  
Housed in shielded case 5" x 6" x 6"

Price  
**\$6.95**

Type RH

Fixed Winding 115 Volts—400 cycles  
Commutator range 75-120 Volts  
Load — .72 KVA  
Housed in shielded case 5 1/2" x 6" x 6 1/2"

Price  
**\$1.95**

Write for free descriptive catalog R-6 listing a large variety of electronic components.

## EDLIE ELECTRONICS, INC.

131 Liberty Street, New York 6, N. Y.

Telephone: Worth 4-1169

JOAK1 — Relay station, Yamata (5 kw.), JKG, 7.257, 1455-0900 (may be from 1525).

JOAK1 — Relay station, Nazaki (5 kw.), JKF, 9.655, 1455-0245 (may be from 1725); JKF2, 4.910, 0255-0900, 1525-1715.

JOAK1 — Relay station, Kawaguchi (0.3 kw.), JO9K, 9.550, 1900-2100, 2300-0020.

JOAK2 — Relay station, Nazaki (5 kw.), JKA, 7.285, 1555-1800, 1920-2000, 2120-2200, 0255-0830.

JOAK2 — Relay station, Kawachi (5 kw.), JKG, 9.690, 1555-1800, 1920-2000, 2120-2200; JKG2, 4.930, 0255-0830.

WVTR — Relay station, Nazaki (5 kw.), JKD, 6.015, 1615-0900; AFRS programs.

WVTR — Relay station, Yamata (5 kw.), JKE, 9.605, 1615-0345; JKE2, 4.860, 0355-0900; AFRS programs.

JOAK1 — Relay station, Kawachi (7.5 kw.), JVV, 15.225, 1750-0230; JVV2, 9.505, 0255-0900.

It is explained that "short-wave broadcasts for Overseas have not yet been operated in Japan since the end of the war—except for the Japanese Repatriation Camps abroad. The short-wave broadcasts in Japan have been presented by the Broadcasting Corporation of Japan for (1) sending the programs of the Armed Forces Radio Service from WVTR, key station in Tokyo, to AFRS network stations in Japan; (2) sending BCJ programs from JOAK, key station in Tokyo, to BCJ network stations in Japan, and (3) to send BCJ programs from JOAK, key station in Tokyo, to the Japanese Repatriation Camps in the areas of Taihoku, Shanghai, Chungchun, Peiping, and Tietsin."

\* \* \*

### World Radio Handbook

The Summer Edition of *World Radio Handbook* (in English), compiled by O. Lund-Johansen, Copenhagen, Denmark, is now available for distribution. This is a valuable guide for the SWL. For further details, write me at 948 Stewartstown Road, Morgantown, West Virginia, USA.

\* \* \*

### Club Notes

*Austria*—Following is a list of 1948 officials of the Australian DX Radio Club (*South Australia*), one of the most active clubs in the world:

President, J. N. Paris; vice-presidents, E. H. Suffolk, A. W. Wright; secretary-treasurer, John Pickering, 59, Richmond Road, Westbourne Park, South Australia; competition judges (BCB and SW), J. N. Paris, J. Pickering, R. G. Gillett, (Amateur), G. Goldsmith, T. Fluck; singletons officer, A. M. Peterson; delegate to ADXBC headquarters, E. H. Tinning; DX editor, R. G. Gillett; club editor, J. N. Paris; circulation manager

J. D. Riley; publishers, J. D. Riley, M. A. Mead; auditor, Gordon L. Duffield; Victorian representative, E. H. Tinning; patrons, E. W. Paton, C. C. Wicks, K. McDonald, L. Bennett, T. P. Hoey, J. S. Larkin, Arne Skoog, Ken Boord, J. N. Paris, J. D. Riley, E. H. Suffolk, R. G. Gillett, J. Pickering, G. Goldsmith, D. G. Garratt, M. A. Mead. Regular monthly meetings of this group are held on the third Wednesday at new headquarters, Rechabite Chamber, Victoria Square, in Adelaide. Monthly house organ is *DXSA News*.

\* \* \*

### Verification Data

Polskie Radio, Noakowskiego 20, Warsaw, Poland, is now verifying by attractive card depicting colored map of Poland on one side with various transmitter locations and verie data on reverse. KZCA (*not* KOFA), Salzburg, Austria, verified by nice card, giving power of 300 watts on 7.220, and 1 kw. on 1104 kc. Duration about two months. QRA is Blue Danube Network, Radio Station KZCA, c/o T/3 Robert Graff, A.P.O. No. 541, c/o P.M., New York, N. Y., USA. TGTA, the *new* Guatemalan outlet on 6.335, verified by Spanish letter, stating schedule to be 1900-0000; relays medium-wave TGT on 1390 kc.; address, Radio Bolivar, Avenida Bolivar 13-201, Guatemala City, Guatemala; report was sent in Spanish. Radio Suisse S.A., Geneva, verified commercial reception of the Prangins transmitters, HBL, 9.345, and HBQ, 6.672, heard during the St. Moritz Olympics. The person who answered the report, strangely enough, was the technician who was in charge of the transmissions from St. Moritz, and commented that he found the report an amusing "throwback" of his conversations with New York. Data on the stations is identical since the same transmitter was used—Marconi type S.W.B. 7A, 20 kw. on modulated telegraphy (A2), 12 kw. on telephony and facsimile (A3 and A4), aerial is rhombic directed to North America. A verie was received from SAT-9, 19.425, Horby, Sweden, but no details were given other than that transmitter is single side-band, working with suppressed carrier. (Kary, Pa.)

I have received an attractive verification card (folds to form an envelope) from CQM-4, Bissau, Portuguese Guinea; card bore the notation "No. 9." Information given was power of 1000 watts; Telefunken equipment; directional antenna with reflector; frequency of 7.048 (37.76 m.), schedule 1630-1800 EST (2130-2300 GMT).

\* \* \*

### Last Minute Tips

By this time, PCJ, "The Happy Station," Hilversum, Holland, should be operating in the 21-megacycle band as well as on its previous channels.

A station is being heard on 6.170 before HER3, Berne, Switzerland, obliterates it at 0030; language is Greek; Athens? (Beck, N.Y.)

An Indonesian has been heard in California on 6,170 signing off at 1000; seems to be in dual with a station on about 7.115 which also leaves the air at 1000; the last 15 minutes seems to be in parallel; musical signature is a chorus, sounds like "Santa Lucia," but may be different. Both stations use this sign-off, which signature has also been heard on the 11.765 frequency at its 1030 closedown. The Batavia outlet on 10.365 is much better than last year, signs off 1030. (Dilg)

Swedish radio journals say Scubari, Albania, is heard on about 8.216 at 1300-1400. *Can anyone confirm?*

Leslie H. Taylor, England, sends us some data which he noted was "not contained" in the worldwide SW list (February, March R.A.D.I.O News)—4.138 is the USSR Artic distress wave; 4.185 is the common wave for all British Royal Navy ships; 4.220 is the normal USSR distress wave; call of Salisbury, Rhodesia, 3.665, is ZEA, while Bulawayo, 3,800, has the call-sign ZEB; on 6.006, Rabat, Morocco, uses 50 kw.; call of Tananarive on 6.064 is FIQA; Paris transmitters on 6.160 and 6.175 are at Allouis; XPRA, 6.404, has 1.5 kw.; Dakar on 6.917 also uses call of FCA; call of Cuecna, 7.100, is EAJ7; the French transmitter on 7.280 is at Allouis, while the 7.240 outlet is at Realtort in the south of France; he says the station listed XMAC on 7.340 should be XMNG (incidentally, Sanderson, Australia, recently mentioned hearing XMNG on this frequency at 0645 with news in Chinese); location of XMNG was not given by Taylor or Sanderson; Moscow's 7.360 outlet is RWG, call of Pointe-a-Pitre is FG8AH; call of Sofia on 7.671 is LZB, call on 9.358 is LZC; he says OTC3 call in addition to OTM2; also he reports "there seems to be some confusion with regard to GKU. This transmitter is at Portishead, near

(Continued on page 156)

*Everybody agrees  
ATR AUTO RADIO VIBRATORS  
are TOPS*



**AUTO RADIO VIBRATORS**  
*have Ceramic Stack Spacers*



New 34 page  
VIBRATOR  
GUIDE  
FREE



**A Complete Line of Vibrators . . .**

Designed for Use in Standard Vibrator-Operated Auto Radio Receivers. Built with Precision Construction, featuring Ceramic Stack Spacers for Longer Lasting Life.

Backed by more than 17 years of experience in Vibrator Design, Development, and Manufacturing--  
**ATR PIONEERED IN THE VIBRATOR FIELD.**



## KEY TO QUALITY



### The CINAXIAL Speaker

F.M. and television users *expect* quality . . . and tone quality depends on speaker.

Why limit your receiver performance by using an *ordinary* speaker? . . . The CINAXIAL Speaker covers the range from 50 to 15,000 c.p.s. . . . handles 10-watt wide-range amplifier output . . . gets the *entire* signal.

Shown above, the Model CIN 12A, list price \$27.50, for immediate delivery.

For Precision Performance . . . Specify CINAUDAGRAPH!

Write today for the CINAUDAGRAPH catalog. Dept. 149-C

# Cinaudagraph Speakers

DIVISION OF AIREON MFG. CORP.  
SALES OFFICE and FACTORY 1401 FAIRFAX TRAFFICWAY KANSAS CITY-KANSAS

### New Models





**"A" BATTERY ELIMINATORS**  
For DEMONSTRATING AND TESTING AUTO RADIOS

New Models . . . Designed for Testing D. C. Electrical Apparatus on Regular A. C. Lines. Equipped with Full-Wave Dry Disc Type Rectifier, Assuring Noiseless, Interference-Free Operation and Extreme Long Life and Reliability.

### New Models





**STANDARD AND HEAVY DUTY INVERTERS**  
For Inverting D. C. to A. C. . . .

Specially Designed for operating A. C. Radios, Television Sets, Amplifiers, Address Systems, and Radio Test Equipment from D. C. Voltages in Vehicles, Ships, Trains, Planes and in D.C. Districts.

NEW MODELS  
NEW DESIGNS  
NEW LITERATURE  
*See your jobber or write factory*

## AMERICAN TELEVISION & RADIO CO.

*Quality Products Since 1931*  
SAINT PAUL 1, MINNESOTA-U. S. A.

# New! Permanent PANEL SWITCH ↓

Mounts on console panel—Eliminates groping behind radio to turn on and off.



Model 5

## BATTERY ELIMINATORS

### A COMPLETE LINE FOR EVERY REQUIREMENT

**NEW MODEL "S" WITH SELENIUM RECTIFIER**—Operates any 1 4 volt, 4 5 or 6 tube radio from 115 volt, 60 cycle source

**MODEL "P"**—Same as MODEL "S" except with tube rectifiers at lower cost

**MODEL "F"**—Operates any 2 volt 4, 5, 6 or 7 tube radio from 115 volt, 60 cy source (0 5 amp. filament max.)

**MODEL "Q"**—Operates any 1 4 volt 4, 5, or 6 tube radio from 6 volt storage or dry battery, or Wincharger. Ideal for farms, camps, autos, boats, etc.

**MODEL "R"**—Operates 2 volt 4, 5, 6 or 7 tube radio from 6 volt storage or dry battery, or Wincharger. (0 5 amp filament max )

Models to convert dry battery radio to AC receivers—other models for use with 6 volt storage battery Costs but a few cents per hundred hours of operation Completely filtered, hum free, silent and efficient Sturdy construction with Hammerloid finish. No liquids or moving parts Operate in any position

## ELECTRO PRODUCTS LABORATORIES

Pioneer Manufacturers of Battery Eliminators

549 West Randolph Street

Chicago 6, Illinois

## CONVERSIONS and SCHEMATICS

### SCR-274-N Receivers

BC-453, BC-454, BC-455: Explanation of control and power circuits and plug terminals. Conversion of the front plug to a local control adapter with volume control, on-off and CW-MCW switch. Schematic for AC power pack. Alignment instructions. Top and bottom views showing parts location. Voltage and resistance readings. Schematic of 3-unit rack, control box, adapters and interconnection. 12 8½x11" pages. Price **\$2.00**

Conversion of BC-946-B Broadcast-Band Receiver BFO replaced by AF driver, delayed AVC added, AC power supply, speaker operation. Includes 106 step-by-step instructions, alignment, practical wiring diagram, and parts locations pictures. 12 8½x11" pages. Price **\$2.00**

1D-6A/APN-4 Loran Indicator, schematic... \$2.00  
SCR-518-A Hi-Altitude Altimeter, schematic... 2.00  
BC-375, conversion to AC, step-by-step... 1.00  
BC-645, original and conversion, fixed or mobile... 1.00

\$1.00 each **SCHEMATICS:** \$1.00 each

### SCR-274-N Transmitters, Modulator, etc.

AN/ARC-5 Transmitters (less the VHF), Push-Pull Modulator, Relay, Switching, etc.  
T-23/ARC-5, the VHF transmitter.  
ARB (CRV 46151), Alignment, etc.  
AN/ART-13A Transmitter, Control Box, etc.  
SCR-522 Receiver, Transmitter, etc.  
BC-348-J, N, or Q, plus AC Power Pack  
BC-348-H, K, L, or R, plus AC Power Pack  
R-89/ARN-5 Glide Path Receiver.  
RC-103-A, (includes BC-733-D).  
AN/APN-1, (includes RT-7/APN-1).  
MN-26-C Bendix Radio Compass Receiver.  
R-65/APN-9 Loran Receiver-Indicator.

R-5/ARN-7 AN/APT-2 RA-10  
AN/ARC-4 AN/APT-5 AN/APT-5  
DZ-1, DZ-2 BC-1206-C

### SCR-269-G (Includes BC-433-G)

PLEASE SPECIFY which you want. Remit with order. Print your name and complete address in the upper-left corner of the envelope.

R. E. GOODHEART

345½ N. Palm Drive Beverly Hills, Calif.  
Note New Address

## 1" CLEAR PILOT LIGHT



COMPLETE WITH NE-48 NEON BULB. D.C. BAYONET BASE  
OD 2¾ x 1¼  
BRAND NEW **19¢ EA**



**¼ WATT NEON BULB**  
NE-48 DOUBLE CONTACT BAYONET BASE.  
**8¢ EA**  
10 for 69¢

**OIL BURNER IGNITION TRANSFORMER GE# 56G9**  
PRI. 115V. 60 CY. SEC. 10,000V.  
23MA. UL APPROVED. ONE SIDE SEC. GROUNDED.



**\$6.95 EA**  
TAKEN FROM BRAND NEW EQUIPMENT



**GE SWITCHETTE SPDT**  
TAKEN FROM BRAND NEW EQUIPMENT  
**19¢ EA**

### DC SELSYN SYSTEM COMPLETE

OPERATES FROM 6 TO 12 VOLTS DC AT 40MA  
OPERATE FROM 110VAC WITH DROPPING RESISTOR & 75c MINIATURE SELENIUM RECTIFIER. JUST THE THING FOR BOATS, CARS, TRAILERS. CONTINUOUS DUTY & ROTATION.  
BRAND NEW COMPLETE WITH CONNECTING PLUGS & DIAGRAM.



**\$4.49 SET**



**28 VOLT BULB**  
21-21 CP FROSTED DC BAYONET BASE 58 BULB

10 FOR **39¢**  
BRAND NEW **5¢**

### 12-16 VOLT BULB

15 CP CLEAR CANDELABRA SCREW BASE 58 BULB



BRAND NEW **5¢**  
10 FOR **39¢**

ENCLOSE POSTAGE—SATISFACTION GUARANTEED OR YOUR MONEY BACK. HUNDREDS OF BARGAINS IN OUR FREE ILLUSTRATED LIST.

## DICK ROSE-ERECO

2912 HEWITT AVE. EVERETT 20, WASH.

Bristol and is 'keyed' from the station at Highbridge near Burnham-on-Sea. The line is extended at certain times to London and Abinger for 'time' at 1000 GMT (0500 EST) during January-March. GIC on 8,640 it at Seafield (may be 'Leafield'), Oxfordshire, and is 'keyed' from London, working ships between 0048-0158 GMT (1948-2058 EST). Official British Post Office news bulletins in 'morse' (c.w.) are radiated from MIJ, 7,447, GDI, 7,780, and GAH, 8,065; there is also a ships' news service at 0145 GMT (2045 EST) from GCX, 8,920, and GDB2, 6,795; and at 2145 GMT (1645 EST) from GCX, 8,920, and GIJ, 6,985."

DeMyers, Michigan, reports hearing a weak signal on approximately 5.880 that may be Praia, Cape Verde Islands, supposed to run to 1700 sign-off daily. He recently received a verification from Noumea, New Caledonia, was posted December 17, 1947, and reached him March 1, 1948; gave schedule as 1100-1200, 1830-2100 local time (presumably 16 hours ahead of EST), and frequency as 6.210.

Stockholm expects its two new 100-kw. transmitters to be delivered by British Marconi by the middle of next year. (Anderson, Calif.)

Recently, Jerusalem has been broadcasting direct to American networks instead of by landline via Cairo, on either ZNT-18, 19.210, or ZNT-19, 19.140. Heard around 0800 weekdays, around 0900 Sundays. Operated by Palestine Broadcasting Service (PBS), Postmaster's Department. (Kary, Pa.)

Best signal from *Radio Espana Independiente* lately has been on 13.035 at 1840-1852; both man and woman read the news, alternately (in Spanish); has usual "Viva Republica" and march fanfare at sign-off. (Kary, Pa.)

PPT, Amsterdam, Holland, has been heard on 21.5 at 1330. (Osterman, N.Y.)

A station believed to be *Radio Belgrade* on about 9.505, is heard in Illinois at 0300 when a bell tolls for about 45 seconds, as a sign the station is closing down; there is a short announcement in a foreign language, then station leaves the air. (Foerster)

VPO-22, Bridgetown, Barbados, has been heard on 20.590 around 0825 in contact with London. (Kary, Pa.)

HC1VT, 7,000, Ambato, Ecuador, has been heard at 2155 2300 sign-off. (Foerster, Illinois)

*Radio Budapest*, Hungary, has stated that its short-wave station has been off the air since the end of the war but that it is now planned to resume transmissions (within a year), according to a Swedish DX broadcast. Some Europeans have recently reported *Radio Budapest* heard on about 9.369 but I believe the station actually was *Radio*

RADIO NEWS

Sofia, Bulgaria, which is reported to me as operating that high these days although is listed 9.350.

XEBT, 9.625, Mexico City, appears to have a daily newscast (in English) now at 2230-2245. (Worris, Florida)

Radio Teheran, Iran, was heard some time ago around 0800 in a special broadcast directed to New York on 18.560. (Precourt, N.Y.)

A station heard on 12.395 shortly after 2100 with a good signal (in Russian language) is assumed to be Baku, Azerbaijan S.S.R. (Foerster, Illinois)

Here are late tips from our Brazilian observer, Villela: PTA, Rio de Janeiro, Central Radio of the Brazilian Army, 6.750, 10.590, 15.615, broadcasts a special army news program (Portuguese) at 1100; power is 1 kw.; later contacts chief stations of the several military districts, using any of these frequencies — 6.750, 6.825, 7.605, 7.665, 8.025, 10.120, 10.590, 10.970, 13.090, 13.330, 15.490, 15.615. PFN2, Departamento Estadual de Informacoes (DEI), Sao Paulo, 4.300, 7.635, broadcasts news to newspapers (phone). PYZ2, 9.220, Rio de Janeiro, is scheduled 1800-1840.

A new station heard with powerful signals, in clear, on 15.345 (measured 15.349) is a Greek outlet announcing as both "Radio Athens" and "The Voice of Greece." Appears to be on the air daily at 1730-1830 (may not be complete schedule); news (in English) is read by a man at 1730-1745; remainder of program is devoted to various types of Greek music; woman announces in Greek; opens and closes with Greek National Anthem. (Kary, Pa.) Heard in Illinois with good signal, in clear; asked for reports and gave QRA of 4 Rigillis Street, Athens, Greece. (Foerster) Quite a good signal here in West Virginia, no QRM noted.

The Greek Underground station which had been operating on 7.700 has lately been heard on 7.863 at 0100-0130; has slight CWQRM but is usually audible to fair; begins with Greek National Anthem, then a man talks in Greek; sometimes a woman alternates with speech. Signs off with the same Anthem. (Simonian, Mass.)

Radio Eirrean, Ireland, has informed Kary, Pa., that "at present a new 100 kw. short-wave station is in course of completion and is expected to be radiating shortly in the 16- and 48-meter bands."

Vienna, 9.666 (measured), has been logged by Kary, Pa., signing on at 2345 with march selection; announces as Radio Wien; news in German 0000; fair signals but has some QRM from BBC to 0000; afterwards two "unlisted" Russians in parallel are noted on 9.660 and 9.672; these Soviets literally "squeeze" Vienna; they carry the Soviet Home Service.

# SAVE \$ ON RADIO SURPLUS

## U.S. SIGNAL CORPS 5 METER SHORT WAVE XMTRS.

(72.2Mc) XMTRS and TUBE only, less mike, batteries and antenna. One 1 1/2 volt dry cell and 67 1/2 volts of B operate it. Just attach di-pole, key or mike, connect the batteries and it's ready to use. Signal Corps spec. wired with silvered wire, mica condensers, and precision resistors. Highly stable circuit with Lo-Loss silvered inductance. (Adjustable padding) Schematic supplied. Converts easily to walkie-talkie and Ham bands ..... \$3.25



GENUINE SIGNAL CORPS FEATHER-WEIGHT HEADPHONES WITH CORD AND PLUG 2000 OHMS—8000 OHMS IMPEDANCE ..... \$1.00

SPRAGUE—NATIONALLY KNOWN OIL FILLED FILTER CONDENSERS 1.—MF—1000 working volts. 4 for..... \$1.00

FAMOUS BRAND RECORD CUTTING HEAD These units are all Brand new and were made for a nationally advertised manufacturer to be in their quality Home Recording Radios. Size 1 3/8"x2 1/2" ready to fit your cutting arm or bracket. SPECIAL..... \$2.95

3 BAND ALL-WAVE DIAL 6" DIAMETER..... 75c  
AMPLIFIER CHASSIS, SIZE 18"x8"x2 1/2" BLUE CRACKLE FINISH DRILLED FOR CONDENSERS—TRANSFORMERS AND SOCKETS..... 65c

STROMBERG-CARLSON, 3 BAND ALL-WAVE TUNING UNIT—COMPLETE WITH TRIMMERS, BY-PASSES AND BAND SWITCH, READY TO INSTALL—DIAGRAM, etc. .... \$3.75

8 OR 9 GANG PUSH BUTTON TUNING UNIT (PLEASE SPECIFY). COMPLETE WITH BUTTONS ..... 25c

U.S. AIR FORCE RESISTOR ASST. 1/4-1/2 WATT — 100 PIECES ..... 95c

U.S. AIR FORCE MICA COND. ASST. 25 PCS. 50-100 MMFD ..... 49c

Low-Loss-Short Wave Variable Condensers 1/4" Shaft Type  
3 Plate—12-15 MMFD. .... 15c  
5 Plate—20 MMFD. .... 20c  
9 Plate—28-40 MMFD. .... 25c  
14 Plate—38-60 MMFD. .... 35c  
27 Plate—100-110 MMFD. .... 45c  
37 Plate—150 MMFD. .... 50c  
38 Plate—150-155 MMFD. .... 55c  
53 Plate—210-21 MMFD. .... 60c

Lock Type Air Trimmer Variable Condensers  
3 Plate—12-15 MMFD. .... 10c  
5 Plate—20 MMFD. .... 11c  
8 Plate—30-35 MMFD. .... 13c  
10 Plate—40 MMFD. .... 14c  
13 Plate—50 MMFD. .... 17c  
14 Plate—60 MMFD. .... 20c  
20 Plate—80-100 MMFD. .... 25c  
27 Plate—100-110 MMFD. .... 35c

3 GANG T.R.F. VARIABLE CONDENSERS .000365 Cap ..... 95c

D. P. D. T. SLIDE T O G G L E SWITCH ..... 23c

Walkie-Talkie Telescoping Aerials—extends 36" ..... 75c

AMPHENOL  
2 piece 4-pole...  
Male and Female Separable plug. Male is for panel mount. Female for Flex. cord. A steal. at only .35c per pr.

SIGNAL CORP TRAP KEYS..... 49c  
4 PRONG WAFER SOCKETS—\$1.49 per C; 3c each  
ISOLANTITE OCTAL WAFER SOCKETS—\$4.25 per C ..... 6c each  
ISOLANTITE UNDER PANEL CLAMP SOCKETS—\$4.50 per C ..... 5c each  
PHILCO 4 MF—300 V—1/4" CAN CONDENSER—\$8.00 per C ..... 10c each  
W.L.—10 W. 1,000 ohm POWER RHEOSTAT 29c ea.  
5-6 PRONG WAFER BAKELITE SOCKETS—\$2.50 per C

100 ASST. SOCKETS—4-5-6-7—OCTAL \$3.50 per C  
1 R C—1,000 OHM WIRE WOUND POTENT. .... 15c  
30 V. FILTER CHOKE SHIELDED ..... 49c  
UNSHIELDED ..... 39c  
100 ALEN BRADLEY—I WATT—1/2 MEG RESIS. .... \$1.25  
10 ERIE—I WATT—2,000 OHM RESIS. .... \$1.15  
10 WIRE WOUND RES. KIT—5-50 W. ASST. .... 49c  
2 METER RF CHOKES ..... 7c  
PHONO PICK-UP REST. RUBBER—I HOLE MTG. 6c  
YAXLEY 2,000 OHM WIRE WOUND RHEOSTATS \$1.00 per doz.

RCA-VICTOR NEEDLE CAPS—2 PIECE TOP & BOTTOM ..... 10c ea.  
CARTER WIRE WOUND C.T. VARIABLE 20 OHM RECTIFIERS ..... \$1.00 per doz.  
G. E. TAPPED VOLTAGE DIVIDER—200 WATT—230 OHM—MOUNTED ON ASBESTOS BASE—TAPPED AT 180-205 ohms ..... 25c  
RCA 6 OHM POWER RHEOSTATS ..... 39c  
RCA RUNNING BOARD AUTO AERIAL ..... 49c  
PHILCO AUTO SUPPRESSORS—\$5.00 per C; 7c ea.

Signal Corps Flex, hook-up wire asst. contains approx. 150 ft. asst. colors, glass insulation. 1 lb. .... 25c

GENERAL ELECTRIC 60 CYCLE WATT HOUR METERS, slightly used, perfect condition, same as used in your home, 110-125 volts. 5 Ampere. .... \$3.50  
10 Amps. .... \$4.50

PHILCO MAGNETIC RELAY TAP SWITCH. Operates on 6 V DC—15 V AC. When contact is made relay operates rotary contacts switch to 20 different contacts. Brand new ..... 89c

Philco rotary tap tone control, 3 position, including condensers. Only 1 wire to connect to crid of audio tube. 1/4" shaft 25c

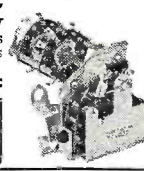

I. C. A. 30 MH RF choke..... 25c

Television or Oscilloscope power transformer for use up to 5" tubes. 117 V. pri.—60 cv. 1-2 1/2 V-25 amp. 2-5 V 2 amp., 1-470 V-10 Mt. 1-750 V-10 Mt. .... \$2.95

Grind your own crystals—Pure Brazilian Quartz, all sizes and thicknesses—1/2 lb. package..... \$1.00

National Velvet Vernier Dial Attachment—1/4" shaft—converts any dial to slow motion vernier. .... 75c

340 degree dial with 10 push button attachment—1/4" shaft—ideal for Xmtrs.—Sig Gen. or Osc. .... 49c

Yaxley Band Switches—3 gang-3 posit. 1 band..... 30c  
5 gang 5 posit. 4-5 band..... 40c

Trimmer-Padder Asst.—all isolantite—singles, dual, triples—100 asst. pieces..... \$2.25

Signal Corps V. T. I receiving tubes—\$1.00 per doz.

MAGNAVOX—12" 1,000 ohm Dynamic speakers..... \$3.95  
8"—10,000 ohm ..... 1.35

P. A. System wall speaker box. 8" diameter covering screen grille for hospital, factory or school installation. Will take up to 6" speakers. Each ..... 49c

Radio Hardware, nuts, bolts 632-832, etc., solid brass cadmium plated. \$7.00 value. 4 lbs. for..... \$1.00



Spaghetti Assortment—Approx. 75 ft..... 75c

30-WATT—6L6 BEAM POWER AMPLIFIER KIT. COMPLETE KIT OF PARTS WITH ALL NECESSARY PARTS—TUBES—READY TO ASSEMBLE AND WIRE—NOTHING ELSE TO BUY—BUT SPEAKER AND MIKE. CHASSIS—20" LONG X 8 3/4" WIDE—5" HIGH CADMIUM PLATED STEEL EXTRA HEAVY. PLATE SUPPLY—IS PROVIDED BY AN OVERSIZE EXTRA HEAVY TRANSFORMER 6" X 4 1/2" X 4"—(1) FILAMENT SUPPLIED BY AN EXTRA HEAVY TRANSFORMER FILTER, BY PASS AND FILTER CONDENSERS. SOCKETS ALL READY MOUNTED ON CHASSIS. VOLUME AND TONE CONTROLS WITH SEPARATE AC SWITCH ARE PROVIDED. CIRCUIT IS THE LATEST TYPE OF PHASE INVERTER SYSTEM USING 1-5U4, 2-6L6, 1-6C5, 1-6S17, 1-6N7. CHASSIS HAS AMPLE ROOM TO WORK ON OR ADD MORE TUBES—TERMINAL STRIPS FOR MOUNTING RESISTORS, ETC., ARE ALSO PROVIDED, AND ALL PARTS ARE SIGNAL CORPS SPEC BRAND NEW NEVER-USED BEFORE. A LARGE PICTORIAL DIAGRAM IS PROVIDED SO THAT A NOVICE MAY BE ABLE TO ASSEMBLE THIS KIT WITH EASE. MERELY BY FOLLOWING THE POINT TO POINT CONNECTIONS THAT ARE OUTLINED ON THE PRINT. COMPLETE 6L6 KIT, LESS SPEAKER AND OUTPUT TRANS..... \$17.95

TUBES—6SN7—45c; 5A—39c; 2A7—39c; 55—39c; 117L7—59c; 27—25c; #15, same as #24—20c.

DRY ELEC. FILTER COND. ASST. CONTAINS 10 PIECES ALL BRAND NEW 150-450V..... \$1.10  
6 ASST. WET ELECTROLYTIC CONDENSERS 59c

RADIO EXPERIMENTER'S SURPRISE PACKAGE—CONTAINS BY PASS & FILTER CONDENSERS, SHORT WAVE TUNING UNITS, POWER AND AUDIO TRANSFORMERS, SOCKETS, RESISTORS, CHASSIS HARDWARE, OVER 15 LBS. OF VALUABLE PARTS ..... \$4.95

## THEY'RE HERE!!! THE NEW 1948 CROP OF GENUINE EVEREADY BATTERIES

ORDER NOW THE FOLLOWING TYPES USED IN MOST PORTABLES:

Type No.	Voltage	Approx. Size	Cost
482	45V. "B"	3 1/2" x 1 3/4" x 5 1/2"	..... \$1.50
	"Min-Max"		
467	67 1/2 V. "B"	2 3/4" x 1 1/4" x 3 3/8"	..... 1.71
	"Min-Max"		
741	1 1/2 V. "A"	3 3/4" x 2 3/8" x 5 5/8"	..... 1.12
742	1 1/2 V. "A"	2 1/2" x 2 1/2" x 4"	..... .83
743	1 1/2 V. "A"	3 3/4" x 2 1/2" x 4"	..... .87
745	1 1/2 V. "A"	10 3/4" x 3 3/8" x 1 3/8"	..... 1.18
746	4 1/2 V. "A"	3 7/8" x 1 3/8" x 4 3/8"	..... .52
747	6 V. "A"	10 3/4" x 3 3/8" x 1 3/8"	..... 1.26
748	6 V. "A"	3 3/4" x 2 3/8" x 5 3/8"	..... 1.19
749	6 V. "A"	2 3/4" x 2 3/8" x 4"	..... .66
915	"AA" Penlite 1 1/2 V. Dry Cell (12 to Pkg.)		..... .05 ea.
935	"C" Medium 1 1/2 V. Dry Cell (12 to Pkg.)		..... .06 1/2 ea.
950	"D" Standard 1 1/2 V. Dry Cell (48 to Ctn.)		..... .06 1/2 ea.

## "A-B" PACK FOR 1.4 V. PORTABLES

752	9 "A", 90 "B"		
	14-1/16" x 2-11/16" x 4-1/16" ....		\$3.74
752W	9 & 1 1/2 "A", 90 "B"		
	14-1/16" x 2-11/16" x 4-1/16" ....		\$3.92
753	7 1/2 & 9 "A", 90 "B"		
	9-7/32" x 2-23/32" x 4-5/16" ....		\$3.68
754	7 1/2 & 9 "A", 90 "B"		
	10-15/32" x 3 3/4" x 4" ....		\$3.81
758	1 1/2 "A", 90 "B" (Farm)		
	10-11/16" x 4-3/16" x 6-15/16" ....		\$5.62

MINIMUM ORDER \$2.00—NO C.O.D. SHIPMENTS—PLEASE INCLUDE POSTAGE  
NEWARK SURPLUS MATERIALS CO. 324 Plane Street Dept. N Newark 1, N. J.

## DYNAMIC REPRODUCER

HS-30

### HEAD SETS

Extremely lightweight EMPLOYS SAME PRINCIPLE USED IN EXPENSIVE HEARING AIDS

LESSENS EAR DISCOMFORT

The impedance of these light-weight DYNAMIC headphones is 300 ohms, which fits most of the surplus ARMY and NAVY equipment. Phone plug not furnished, but may be used with any standard phone plug. Extra rubber ear inserts, and shirt clip for minimizing strain included in each package. Matching transformers for high impedance available; see price list below.



**BRAND NEW**

Packed in Original Army Boxes!

POSTPAID AT THESE LOW PRICES SHIPPED ANYWHERE IN THE U. S.

2 SETS FOR \$1  
12 SETS FOR \$5

Matching Transformer for High Imp. . . . .35c

## CU-24 / ART 13 LOADING CONDENSERS



\*Part of the famous ART-13 TRANSMITTER  
\*Three 25 mmf.-10,000V condensers in each set!  
\*Worth more than 10 times this low price  
\*BRAND NEW—ORIGINAL CARTONS  
Shipped anywhere in U.S.A. for 50¢

**\$395**

### BC-348 SHOCKMOUNT BASE

Dress up your "348" with a new base—fits all models—brand new in original cartons. Shipped anywhere in U.S. for 35¢. Enclose \$2.00 for each base wanted. Money Back Guarantee.

**\$165**

EACH

### Copperweld Antenna Wire \$6.95

No. 14 Stretchless Shipping Wt. 14 Lbs per M

### Strain Insulators 8 for \$1.00

3/4 x 3/4 x 5/8  
Shipped anywhere in U.S. for 40¢

### Pioneer Chassis Punches

ROUND  
5/8" ..... \$1.95  
1 1/2" ..... 2.30  
1-5/32" ..... 2.30

SQUARE  
5/8" ..... \$2.95  
3/4" ..... 3.50

Shipped anywhere in U. S. for 25c

Get On Our Mailing List  
Discounts on Larger Quantities On Request  
Mail Orders Promptly Filled—Your Satisfaction or Your Money Back

### ELECTRONIC SALES CO.

5559 W. ADAMS BOULEVARD  
LOS ANGELES 16, CALIF.

DEPT. RN-748 PHONE—WEBSTER 3-7173

Aldridge, Washington state, reports Moscow has been heard to North America around 1900 on a high frequency of 30.500, strong signal. Harmonic?

According to a DX broadcast from Stockholm, Swedish DX-ers have heard a new Jewish transmitter in Palestine using the call: "This is Palestine Calling, Haganah station;" operating on 13.890 at 0400-0420, 1700-1720, 1800-1820, and at other times. Various languages heard, including Swedish.

Recently, Bucharest, Roumania, has been heard in Sweden on approximately 11.880 in parallel with 9.252 and 6.210 from before 1500 to after 1600; asking for reports in French, English, German, and Romanian. (Holmberg, Sweden).

Miers, Germany, reports Baden-Baden, 6.237, has news in French, relayed from Paris, at 0230; latest schedule of Stuttgart, 6.180, is weekdays 0500-1800 Sundays 1200-1800. Summer Time went into effect in Central Europe on April 18.

ISWC, London, reports Armed Forces Radio Station WVG, 18.100, as located on Guam, and heard in New Zealand around 0100.

XMPA, 12.200, Nanking, now signs off 1000. (Dilg, Calif.)

Major, Western Australia, airmailed these tips: XQIO, 9.950, China, heard with fair signal 0815; XGOY, 15.17 and 9.660, Chungking, heard with news 0700; KZBU, 6.100, Cebu City, Philippines, news 1100; ZBW3, 9.525, Hong Kong, now relays BBC news 0800; Batavia, Java, now announces as *Radio Indonesia*; JKO, 9.410, Seoul, Korea, The Korean Broadcasting System, heard with good signal at 0530-0830. Also from Australia, Sanderson airmails that BFES, Singapore, 11.735, is heard with news 0445; a station heard at 0100 on about 9.35 has announced as *Radio Polskie* and is presumed to be Warsaw, interval signal of piano notes, had news in Polish.

—30—



"Sometimes I get so bored I wish I were back in radio servicing again!"

## Television Receivers

(Continued from page 78)

*Method A.* Connect a sweep generator to the input terminals of the set. (All antenna lead-in lines should be disconnected.) Connect the "hot" vertical input terminal of the oscilloscope, through a 10,000-ohm resistor, to screen-grid of the mixer. (If the mixer is a triode, connect to the plate-end of the plate bypass condenser.) Couple the output of an AM signal generator loosely to the receiver input terminals. Set the receiver to whatever channel it is desired to align and adjust the sweep generator to swing across the entire channel. The AM signal generator will act as a marker indicator producing a pip on the response curve whenever its frequency matches that of the sweep generator. By changing the frequency of the AM generator and noting the position of the pip on the response curve, we can accurately determine the extent of this curve.

With the apparatus operating, the circuit response pattern will appear on the oscilloscope screen. Adjust the input and r.f. coil adjustments for maximum amplitude, symmetry, and flat-topped appearance. The manufacturer's service bulletin will indicate which components to adjust. Determine, by changing the frequency of the AM generator, where the sound and video carriers would appear on the curve. These two points should be within 90 per-cent of the maximum amplitude of the curve. The same procedure is followed on all channels, in each instance changing the receiver selector switch and the sweep and AM generator frequencies.

*Method B.* In this method, the sweep and AM signal generator are connected as in *Method A.* The oscilloscope, however, is shifted to the output of the video second detector. (Retain the 10,000-ohm resistor.) Now, the oscilloscope screen will contain the response pattern of the video i.f. stages because whatever signal is present at the output of the r.f. section must first pass through the video i.f. amplifiers before it reaches the oscilloscope. The r.f. adjustments are then made until the video i.f. response pattern on the screen has the proper form and maximum amplitude. Just what the correct i.f. response should be will be noted in a later article.

The foregoing represent the procedures recommended by essentially all television receiver manufacturers. Some receivers however, have the front-end section pre-tuned, simplifying the alignment. *Philco*, for example, requires only a slight adjustment on Channel 10 for the input and r.f. circuits. Once these trimmers are adjusted, all other channels will possess the correct response

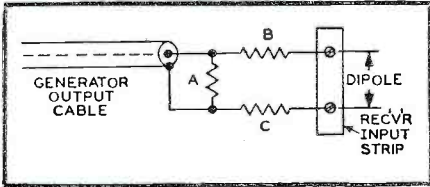
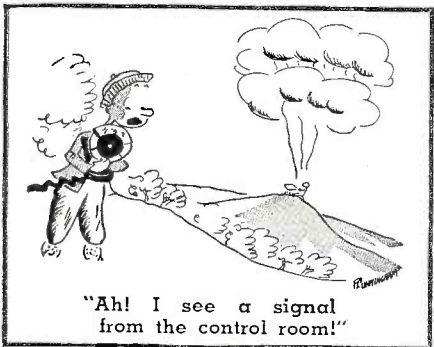

Fig. 9. Resistive matching section designed to match signal generator output impedance to the receiver input impedance.

and only the oscillator coils will require adjustment for each channel. *Du Mont* goes one step farther and eliminates all r.f. or oscillator adjustments. If the "Inductuner" goes out of alignment, they recommend that it be taken out and sent back to the factory for re-alignment. This latter instance, however, is unusual. Practically all other manufacturers indicate how their units can be set aright by the serviceman.

One final word about emergency alignments of the r.f. stages. It sometimes happens that after a set has been installed in a home, one of the r.f. tubes (r.f. amplifier, mixer, or oscillator) goes bad, necessitating replacement. Due to the high-frequency operation of these circuits, replacement of a tube can throw the circuits out of alignment. This is especially true of the oscillator. If the misalignment is slight and the job of hauling the receiver back to the shop too great, good results may often be obtained by watching the effect of any adjustments on a received test pattern. First bring in the sound by adjusting the oscillator tuning. Then adjust the input and r.f. tuning to bring in the pattern with best resolution and maximum brilliance. It is generally best not to attempt these adjustments with pictures other than test patterns. And under no circumstances should the other sections of the receiver be aligned without the proper tools and equipment. Every serviceman will learn sooner or later that although the customer may want the set in a hurry, he wants it in good operating condition. Telling him later that the temporary adjustments were made at his request will seldom excuse you for not giving him a perfect job in the first place. All a customer remembers is how badly the set operates and not why it operates so.

(To be continued)



# TUBES GREATEST SELECTION IN COUNTRY LOWEST PRICES

NEW - STANDARD BRAND - MIN. ORDER \$5.00  
QUANTITY PRICES ON REQUEST

0A4G	1.06	3C24	.69	6P55GT	.88	12F5GT	.59	50	1.56	830B	5.25
00	.50	3D6	.89	6Q5G	.59	12H6	.59	50A5	.88	832A	2.95
0Y4	.88	3E29	2.95	6Q6G/6T7G	1.06	12J5GT	.54	50B5	.72	833A	39.50
01-A	.50	3LF4	1.06	6Q7	.72	12J7GT	.72	50L6GT	.59	836	1.15
0Z4	.88	3Q4	.72	6R7	.88	12J9A	60.00	50X6	.88	837	2.50
1A3	.72	3S4	.72	6S7	.88	12K6GT	.59	50Y6GT	.59	838	4.95
1A4	1.28	4-65A	14.50	6S8GT	.88	12K8	.59	59	.88	841	.69
1A4P	1.28	4-125A	27.50	6SA7GT	.59	12Q7GT	.59	55	.72	843	.69
1A4T	.88	4-250A	37.50	6SC7	.72	12SA7	.59	56	.59	845	4.95
1A5G	.88	5BP1	1.49	6SD7GT	.72	12SC7	.72	57	.72	860	3.00
1A6	1.06	5BP4	4.95	6SF5	.59	12SF5	.59	58	.72	861	50.00
1A85	1.06	5CP1	3.95	6SF7	.72	12SF7	.72	59	1.06	864	.69
1B4	1.28	5FP7	.95	6SH7	.72	12SG7	.72	70L7GT	1.56	866A	.89
1B5/25S.	1.06	5J1	3.95	6S7	.59	12SH7	.72	71-A	.59	868	1.95
1B7G	.72	5R4GY	1.29	6SK7	.59	12SJ7	.72	75	.59	872A	.69
1B7GA	4.95	5T4	1.29	6SL7GT	.88	12SK7	.59	75TL	2.95	874	1.95
1B27	4.95	5TP4	20.00	6SN7GT	.88	12SL7GT	.88	76	.59	876	4.95
1B38	4.95	5U4G	.54	6X4	.54	12SN7GT	.88	77	.59	884	.98
1C5G	.88	5V4G	.88	6X7	.59	12SQ7	.59	78	.59	902	2.95
1C6	1.06	5X4GT	.60	6X7	.72	12SR7	.72	79	.88	920	4.95
1C7G	1.06	5Y3GT	.38	6T7	1.06	12SX	.98	80	1.28	950	1.06
1D5GT	1.28	5Y4G	.50	6U5	.72	12T3	.88	81	1.28	954	.49
1D7G	1.28	5Z3	.60	6U6GT	.72	14A5	1.56	83	.88	956	.75
1D8GT	1.28	5Z4	.88	6U7G	.59	14A7	.88	83V	.88	957	.49
1E5GP	1.56	5Z4	.88	6U7G	.59	14B7	.88	84/6Z4	.59	958A	.69
1E7G	1.28	6A3	1.06	6V6	1.06	14B7	1.10	85	.72	959	.49
1F4	.88	6A5G	1.56	6V6GT	.72	14B6	.88	89	.72	991	.50
1F5G	.88	6A7	.72	6V7G	.72	14C7	.88	90V	1.56	1613	1.75
1F6	1.28	6A8	.72	6X4	.55	14C7	.99X	91	1.56	1614	.75
1G4GT	.88	6AB5/6N5	.88	6X5	.54	14E6	.72	100TH	12.95	1616	1.39
1H4G	.72	6AB7	1.06	6Y6G	.88	14E7	.88	114A	.69	1619	.29
1H5GT	.60	6AC5GT	.88	6Z7G	1.28	14F7	.88	117L7GT	1.28	1622	1.75
1H6G	1.06	6AC7	1.06	6ZY5G	.72	14H7	1.06	117M7GT	1.28	1624	.98
1J6G	1.06	6AF6G	.88	7A4	.72	14J7	1.06	117N7GT	1.28	1625	.49
1L4	.72	6AF8	.88	7A6	.72	14K7	1.06	117P7GT	1.28	1626	.49
1LA4	1.06	6AG5	1.06	7A7	.72	14S7	1.06	117Q7GT	1.28	1627	7.95
1LB4	1.06	6AG7	1.06	7A8	.72	14T7	1.06	117R7GT	1.28	1628	.59
1LC4	1.06	6AJ5	.99	7AE7	.72	14U7	1.06	117S7GT	1.28	1629	4.95
1LC6	1.06	6AK5	.99	7AF7	.72	14V7	1.06	117T7GT	1.28	1630	4.95
1LE3	1.06	6AK6	.88	7B4	.72	14W7	1.06	117U7GT	1.28	1631	3.95
1LD5	1.06	6AL7GT	1.06	7B5	.72	14X7	1.06	117V7GT	1.28	1632	5.95
1LH4	1.06	6AQ5	.72	7B8	.72	14Y7	1.06	117W7GT	1.28	1633	10.00
1LN5	1.06	6AQ6	.72	7BP7	2.95	14Z7	1.06	117X7GT	1.28	1634	.39
1NSG	1.06	6AT6	.60	7C4	1.06	20AP4	270.00	252A	4.95	8005	4.95
1P22	11.50	6AT6	.60	7C5	.72	20AP4	270.00	252A	4.95	8005	2.95
1P5GT	.88	6AU6	.72	7C6	.72	20AP4	270.00	252A	4.95	8005	4.95
1Q5GT	.88	6BE6G	1.06	7C6	.72	20AP4	270.00	252A	4.95	8005	4.95
1R4	1.06	6B7	1.06	7C7	.72	20AP4	270.00	252A	4.95	8005	4.95
1T4	.72	6B8	1.06	7E6	1.06	20AP4	270.00	252A	4.95	8005	4.95
1T5GT	.88	6BA6	.72	7E7	.88	20AP4	270.00	252A	4.95	8005	4.95
1U4	.72	6BE6	.72	7EP4	1.75	20AP4	270.00	252A	4.95	8005	4.95
1V	.72	6BE6	2.40	7F7	.88	20AP4	270.00	252A	4.95	8005	4.95
2A3	1.06	6C4	.60	7F8	1.06	20AP4	270.00	252A	4.95	8005	4.95
2A5	.72	6C5	.60	7F9	1.06	20AP4	270.00	252A	4.95	8005	4.95
2A6	.88	6C8G	1.06	7G4	1.06	20AP4	270.00	252A	4.95	8005	4.95
2A7	.88	6D4	1.95	7J7	1.06	20AP4	270.00	252A	4.95	8005	4.95
2AP1	2.95	6D6	.60	7K7	1.06	20AP4	270.00	252A	4.95	8005	4.95
2B2	.88	6E5	.72	7L7	.88	20AP4	270.00	252A	4.95	8005	4.95
2C22	.88	6F5	.60	7N7	.88	20AP4	270.00	252A	4.95	8005	4.95
2C26A	.75	6F6G	.72	7O7	.88	20AP4	270.00	252A	4.95	8005	4.95
2C34	.98	6F7G	.72	7R7	.88	20AP4	270.00	252A	4.95	8005	4.95
2C40	2.60	6F7	1.06	7S7	1.06	20AP4	270.00	252A	4.95	8005	4.95
2C43	2.60	6F8G	1.06	7T7	1.06	20AP4	270.00	252A	4.95	8005	4.95
2C44	1.75	6G6G	.88	7W7	1.06	20AP4	270.00	252A	4.95	8005	4.95
2D21	1.69	6H6	.60	7X7	1.06	20AP4	270.00	252A	4.95	8005	4.95
2E2	1.50	6H6GT	.60	7Y7	.72	20AP4	270.00	252A	4.95	8005	4.95
2E24	4.37	6J4	3.95	7Z4	.72	20AP4	270.00	252A	4.95	8005	4.95
2E25	3.95	6J5GT	.54	10BP4	34.95	20AP4	270.00	252A	4.95	8005	4.95
2E30	2.25	6J6	1.06	10CP4	42.20	20AP4	270.00	252A	4.95	8005	4.95
2J851	4.95	617	.72	10HP4	49.50	20AP4	270.00	252A	4.95	8005	4.95
2V36	1.10	6J7GT	.72	10Y	.69	20AP4	270.00	252A	4.95	8005	4.95
2X2	.72	6J8G	1.06	12A6	.89	20AP4	270.00	252A	4.95	8005	4.95
3A8GT	1.92	6K5GT	.88	12A7	1.06	20AP4	270.00	252A	4.95	8005	4.95
3AP1	2.95	6K7	.60	12A8GT	.72	20AP4	270.00	252A	4.95	8005	4.95
3B7	1.06	6K8	.88	12A9GT	.88	20AP4	270.00	252A	4.95	8005	4.95
3B22	4.95	6L5G	.88	12AT6	.59	20AP4	270.00	252A	4.95	8005	4.95
3B23	4.95	6L6	1.29	12AU6	.72	20AP4	270.00	252A	4.95	8005	4.95
3B24	1.95	6L6G	1.06	12B6	.88	20AP4	270.00	252A	4.95	8005	4.95
3B25	.98	6L7	.88	12B6E	.72	20AP4	270.00	252A	4.95	8005	4.95
3BP1	2.95	6N7	.88	12C6	.47	20AP4	270.00	252A	4.95	8005	4.95
3C6	1.28	6N7GT	.88	12D7	14.95	20AP4	270.00	252A	4.95	8005	4.95

20% DEPOSIT WITH ALL ORDERS UNLESS RATED

ALL TYPES LISTED ABOVE IN STOCK NOW BUT SUBJECT TO PRIOR SALE

## NIAGARA RADIO SUPPLY CORP.

160 GREENWICH ST.  
NEW YORK 6, N. Y.

## "RANGE MASTER" MODEL 10-P

The 8-in-1 Service Instrument

A precision instrument for RADIO TEST-ING, Appliance Repairing, Service Calls, Amateur and Experimental Work.

- Covers these 25 ranges.
- (1) CAPACITY 001-1, 01-1, 1-10 Mfd.
  - (2) A.C. CURRENT 0-150, 0-1.5, 0-15 amps.
  - (3) A.C. VOLTAGE 1 to 10 100 500 1000 volts.
  - (4) D.C. VOLTAGE 10 100 500 1000 volts.
  - (5) D.C. CURRENT 1 to 10 100 1000 milliamps
  - (6) RESISTANCE 0 to 10,000 100,000 1 megohm
  - (7) Special High range ohmmeter to 2 megs and 20 megs.
  - (8) Sensitive A.C. microammeter to 1100 microamps.

Write for Free Catalog

If your local distributor can't supply you, write to  
Dept. R.N.

### TELEVISION SERVICE-MEN

... why guess, measure! This is the only instrument in its class that can be used as an OSCILLOSCOPE CALIBRATOR.

Available in KIT form, or assembled.

Portable Model (Illustrated) ..... \$26.95 net  
Complete KIT and Instruction ..... 17.95 net  
Bench Model (assembled) ..... 23.50 net  
Foundation Meter with 3-color scale, schematic and operating instructions ..... 7.85 net  
Test leads ..... .85

Prices 5% higher west of the Rockies  
348 Livingston Street  
Brooklyn 17, New York

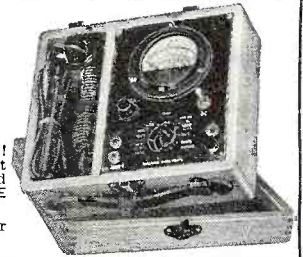

**PERMALLOY OUNCER LAMINATIONS.** Hydrogen annealed. Specifically for use in constructing TAPE RECORD-PLAYBACK HEADS. Per ounce containing laminations .40



**WHIP ANTENNA.** 9 ft., flexible, lightweight (8 oz.). 10 sections. Weather-proof finish ..... 1.25  
**RCA VICTOR POWER TRANSFORMER** for models R-32, 45, 52, or 75. Unshielded ..... 5.95

**Wire & Tape Recording Components**



**WIRE RECORD - PLAYBACK HEAD.** Precision built Triple-Coil (record, playback, erase) 4 pin plug-in type. Moulded bakelite housing (1 1/4" x 1" x 3/8"), accurately "Y" grooved for maximum fidelity & sensitivity. For replacement or new applications. **6.95**



**WIRE SPOOL HUB.** Polished aluminum. Takes standard wire spool (1 1/4" hole). 3/4" shaft hole. 3/4" deep. .39  
 Send for latest illustrated

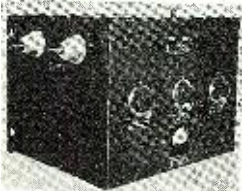

**ALNICO ERASE MAG-NET** for TAPE or WIRE. "U" shape; polished poles, 3/4" x 5/8" x 3/16" gap ..... .39  
**"ALNICO MAGNET"** supplement.

**HIGH POWER ANTENNA TUNER**

Range: 1500-7000 Kc. Pi-network matches most antennas; easily converted to higher freqs. 1 KW RF. Grey metal case contains: 20-75 mh silver-plated variometer (O.D. 4 1/2" x 8"), edge-wound with separate induct. & coupling ticklers. Hvy. duty 250 mmf 7000 V variable (4" sq. x 1 1/2"). 3" sq. Triplett 0-8 RF ammeter & thermocouple. With tech. manual. 15" x 15" x 23". **14.95**  
 Ship. wt. 50 lbs.

Essential "hard-to-get" basic parts for constructing units described in Radio News, Feb. '48. **RM-4 RECORDING MOTOR.** Heavy duty. 110 V. 60 cycles. Adaptable to WIRE, TAPE or DISC RECORD & PLAYBACK. 5/16" O.D. shaft. 3 3/4" sq. 2 3/4" deep. Less turntable, mtg. plate & reduction drive wheel. **4.95**  
 Shipping weight 6 lbs.



**MAGNET WIRE**—Sufficient to wind complete TAPE HEAD.  
 #22 P.E. .... .35  
 #28 P.E. .... .59  
 #30 S.C. .... .45  
 Kit of 3 spools ..... 1.25

Gross PerM

**PHILLIPS HEAD MACHINE SCREWS**  
 Fillister head, cadmium plated steel.  
 4/48x3/4" .35 2.20  
 4/48x5/16" .37 2.35  
 4/48x7/16" .39 2.50  
 4/48x3/4" .45 2.75  
 5/44x3/4" .45 2.75  
 5/44x7/16" .47 2.85  
 5/44x1/2" .49 3.10  
 5/44x3/4" .53 3.30  
 5/44x7/8" .56 3.50  
 5/44x1" .59 3.70

**TUBES! TUBES!**

All in perfect condition, but in unsealed cartons. Most types in stock at up to 30% off list. Every tube guaranteed 90 days.

- #20, 27 or 31... .29
- #42, 75, 77, 78, 6H6 or 6K7 .... .39
- #37, 39, 5Y4, 5U4, 6A4, 6B7, 6C5, 6F5, 6J7, 6K8, 6L7, 6SA7, 6SF5, 6SN7, 6SJ7, or 12SK7 ..... .49
- #1A7, 1H5, 1L5, 6U5, 6X3, 7A7, 7Y4, 50 or 50B5... .59

**GET ON OUR MAILING LIST**  
**ALWAYS SOMETHING NEW**  
**A BETTER CONE—BUY LEOTONE**  
**FACTORY REPAIR SERVICE ON ALL SPEAKERS**

Min. Order \$2.00—20% deposit required on COD's  
 Please add sufficient postage



**MAKERS OF CONES AND FIELD COILS**  
**65-67 DEY STREET NEW YORK 7, N.Y.**  
**WORTH 2-0284-5**  
**12,000 SQ. FT. OF RADIO PARTS**

**What's New in Radio**

(Continued from page 84)

ing marketed in the low-priced field.

The communications receiver covers all frequencies from 500 kc. to 35 mc. The unit operates from 110-120 volt a.c. or d.c. which makes it suitable for ship-board and other uses where only d.c. is available. The receiver features electrical bandwidth on all bands. An automatic noise limiter assures optimum reception under all operating conditions while a c.w. oscillator with pitch control provides exceptionally good c.w. reception.

A catalogue sheet covering the NC-33 is available on request from *National Company, Inc.*, Malden, Massachusetts.

**D.N.S. AMPLIFIER**

*The Minnesota Electronics Corporation* has added three new amplifiers to its line of *Goodell* Dynamic Noise Suppressor Amplifiers.

The new Model NSA-2 has a power output of 10 watts, with a high frequency response under dynamic operat-

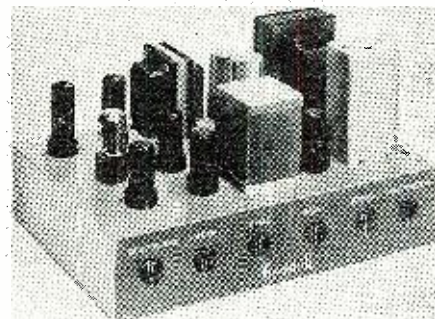

ing conditions to beyond 12,000 c.p.s. Effective reduction of objectionable noise amounts to more than 25 db. as a result of two complete high frequency reactance tube filter sections and one low frequency reactance tube.

Continuously variable treble and bass controls are provided. Both controls boost clockwise and attenuate counter-clockwise, with the center position giving flat response. Separate inputs are provided for radio and phono with a front panel switch. Power and input facilities for a magnetic pickup preamplifier are provided by means of a tube socket connection. Tube line-up is as follows; one 5U4G, three 6SJ7's, one 6H6, one 6SN7, and two 6L6's.

Further details on this amplifier and the other new units in the *Goodell* line may be secured by writing *The Minnesota Electronics Corporation*, 204 Oppenheim Building, St. Paul, Minnesota.

**CRYSTAL REPLACEMENT**

A new "Silent Sapphire Crystal Pickup" which may be used as a replacement for any of 70 different crystals

*Columbia*



**KIT OF ASSORTED WIRE**

Ten 100 foot coils of wire, assorted colors and sizes No. 18 to No. 24. Lead-in, push-back and hook up wire.

**\$4.50**  
**A REAL BUY**

**TELEPHONE WIRE**  
 Two 19 ga. solid conductors, twisted, with waxed black cotton braid overall. Ideal for inside telephone use and intercom installations. Stock up at this low price while limited quantity lasts.  
 100 foot coil, ea. .... \$1.95  
 500 foot spool, ea. .... 9.25  
 1000 foot spool, ea. .... 18.00

**OUR NEW CATALOG IS NOW AVAILABLE FOR DISTRIBUTION**  
 Write for your copy today!

**COLUMBIA WIRE & SUPPLY CO.**  
 5734 ELSTON AVE.  
 CHICAGO 30, ILLINOIS

**SENSATIONAL PRICE REDUCTION!**  
**SMALL PRECISION LATHE—110-V. A-G.**

• Cancellation of a large export order for Manson Lathes forces us to liquidate our overstock immediately. Our loss is your gain—if you order IMMEDIATELY. They won't last long at these ridiculously low prices.

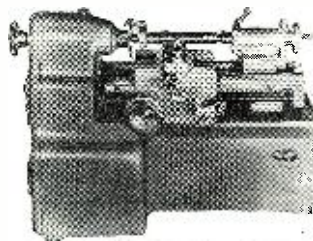

**FORMERLY SOLD FOR \$60.75**

**NEW LOW PRICE NOW \$41.50**

A small lathe for radio shops, jewelers, laboratories, dentists, hobbycrafters, model makers, machine shops, schools, etc. Automatic Feed. Work capacity 3" between centers. Swing over bed 2". Constructed of steel and cast iron. Accurately machined and finished. Fan-Cooled Motor mounted inside the base. Complete with 1 1/2" face plate, 2 lathe centers, tool post and rocker, one lathe dog, one tool-bit and test rod.

**THE MANSON LATHE KIT**

Former Price \$36.25.  
 New Low Price Only \$24.50

The Manson Lathe Kit contains the following accessories, packed in a compartment box 6" long, 4" wide, with hinged cover:

- 1—4-jaw Chuck and Wrench
- 1—Drill Chuck
- 1—Center Countersink
- 1—Drill
- 2—Tool Bits—Ground and sharpened
- 2—Lathe Dogs—Sizes 3/16" & 3/8"
- 1—1 1/2" Face Plate with 8 Drilled and Tapped holes
- 4—Collars—Sizes 1/32, 1/16", 3/32", 1/8"
- 1—Collet Chuck
- 1—Allen Wrench

Send 20% Deposit, Balance C.O.D.

**OFFENBACH & REIMUS CO.**  
 372 Ellis St., San Francisco 2, Calif.



employed in the pickup arms of a wide variety of different makes and models of phonographs, is now being marketed by the *Renewal Sales Section* of the *RCA Tube Department*.

A companion unit to the company's



"Magic Tone Cell" which replaces crystals in *RCA Victor* radio-phonographs and record players, the new pickup has similar electrical characteristics but is of smaller size to fit a wide range of record players made by other manufacturers.

The unit features a permanent jewel-point stylus which eliminates needle changing and provides excellent tonal qualities.

Further details are available from the *Renewal Sales Section, RCA Tube Department, Radio Corporation of America, Camden, New Jersey*.

#### DIRECTION FINDER

A new addition to their line of marine electronic equipment has been announced by *Applied Electronics Company* of San Francisco.

The DFR-8 Direction Finder is of the overhead mounting type and features a mechanical excellence which may be at-



tributed to the liberal use of machined bronze and aluminum castings.

The manufacturer claims exceptional

June, 1948

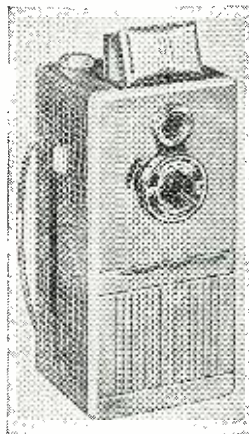

The Hottest Combination in Years!

Sensational New . . .

PORTABLE **RADIO AND CAMERA** COMBINATION

It's here . . . the Cameradio, indispensable for trips, hikes, ball games, every outdoor and vacation activity. Combines a fine Reflex Camera and a powerful Radio into one easy-to-carry unit. Order now . . . you'll double the enjoyment of every weekend!

TOM THUMB CAMERA-RADIO Combination

- Precision Built
- Excellent Tone Quality
- Full Vision Slide-Rule Dial
- The Ideal Vacation Companion
- Portable Radio, Battery Operated
- Reflex Camera, Standard # 127 Films

ONLY  
**\$28<sup>75</sup>**  
Less Batteries

ANOTHER PROGRESSIVE SPECIAL!  
AUTOMATIC

## AUTO RADIO

Tops in car radios, now at a new low price! Six-tube superheterodyne, with steady, full-toned reception. Mounting brackets included for easy installation in your car. Don't miss this big bargain!

- Six Tube Superheterodyne
- Three Gang Condenser
- Powerful Long Distance Reception
- Fits All Cars, Easy Installation
- Mounting Brackets Included

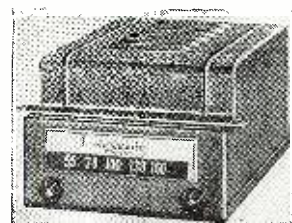

ONLY... **\$29<sup>97</sup>**

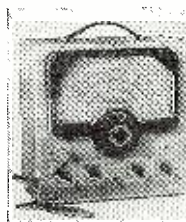

**EICO MODEL 315  
SIGNAL  
GENERATOR**  
with micro-cycle band  
spread vernier tuning

Vitaly important for tuning and aligning FM and Television receivers where tuning is very sharp and critical. The extreme wide range and accuracy afforded by the micro-

cycle vernier band spread dial assures accurate frequency adjustment for test or alignment of broadcast FM or Television receivers. Vernier dial divided into 100 divisions. Any frequency can be tuned and repeated within .02% accuracy. Spring loaded split gears eliminate back lash and play providing smooth accurate tuning. Window casing encloses and protects the lighted dial and its fine pointer from accidents and jarring out of calibration. Range 75 KC to 150 MC • Complete broadcast band from 550 KC to 1700 KC covered on one range without switching • Unused spots are automatically shorted out to eliminate dead spots and absorption • Linear dial calibration. DOES NOT CROWD UP on high frequency end of dial • Accuracy better than .5% throughout the broadcast band and 1% on the higher frequencies. • Just as accurate at high end of dial as at low end. **\$64.50**



We pay postage on prepaid orders. All C.O.D. orders shipped collect.

**PROGRESSIVE ELECTRONICS CO.**

Dept. RN-30 497 UNION AVE. • BROOKLYN 11, NEW YORK

**VACUUM  
TUBE  
VOLTMETER**

MODEL 221

A completely new and different vacuum tube voltmeter at an unusually low price. Its amazing performance sets standards of accuracy, linearity, and stability not usually found in this type of instrument. Electronic AC range is more linear and accurate than was ever possible with a copper oxide rectifier. Completely electronic so meter can not be burned out. AC and DC ranges: 0-5, 10, 100, 500 and 1000 volts. Ohmmeter measures from .2 ohm to 1,000 megohms in 5 ranges. Each instrument is **\$49.95** individually calibrated.

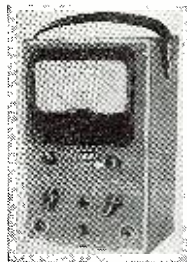

## Radio Technician and Announcers

A practical 15-month course in First Class Radiotelephone Operation and Announcing is offered by Don Martin School of Radio Arts. Most stations these days require combination men. We specialize in this type of training and maintain a placement bureau for our graduates. Serving the industry for 10 years, the School of Radio Arts can train you. Write for our catalogue outlining the courses offered. Classes can be arranged so you can do part time work on the side.

APPROVED FOR VETERANS

**DON MARTIN SCHOOL OF RADIO ARTS**  
1655 North Cherokee St. Hollywood 28, Calif.

### BARGAINS UNLIMITED

Hundreds of money-saving values at today's lowest prices—for your every need.

**FREE CATALOG** of Refrigeration, Radio, and electrical Supplies. Send for yours at once!

G. & E. Equipment Supply Co.  
Ogden at Fulton Chicago 7, Ill.



**LOOK!  
METER SALE!**

O-1 Milliammeter

Basic movement for all test equipment. 2% accuracy. 4 1/4" wide, large scale knife edge pointer. Nationally known make. Slightly used but guaranteed electrically perfect.

Order now while limited quantity lasts! A great buy!  
**\$2.75 ea.** only \$5.00 for two

### SPECIAL KITS

- (1) 100 asstd. mica condensers; pigtail and lug types .000005 to .01 mfd. \$1.95
  - (2) 40 asstd. push-on knobs for knurled shafts. Red, green, walnut, ivory \$1.29
- Orders shipped postpaid when accompanied by remittance in full. 25% deposit required on C.O.D.

**NATION WIDE RADIO**  
(The Serviceman's Supply House)  
572 W. Randolph St., Chicago 6, Illinois

*New! New!*

## CHIMNEY MOUNT ANTENNA BASE

- for TELEVISION
- FM • AMATEURS

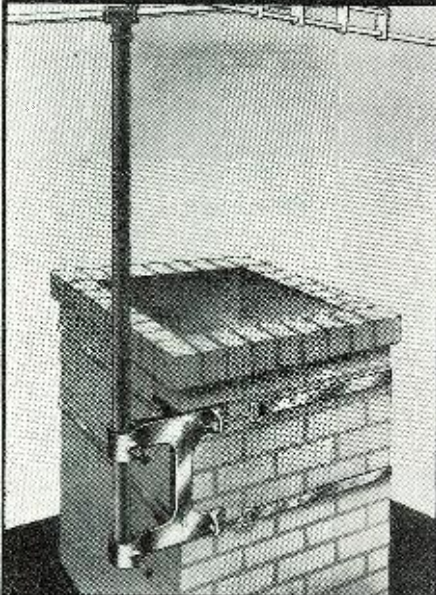

**INSTALLED IN 10 MINUTES  
PERMITS USE OF SEVERAL  
MOUNTS ON ONE CHIMNEY**

"Chimney Mount" is a brilliantly engineered new antenna base that can be installed in 10 minutes without the use of special tools or drilling of holes. Several can be strapped to one chimney—also mounts on pole, 2 x 4, side of house or to any rectangular roof extension. Fastens aerial to highest point with galvanized steel bands having a combined tensile strength of more than 3,000 pounds. Made of corrosion-resistant aircraft-type aluminum alloy. Weight: 3 lbs.

**"Chimney Mount"**

List Price, **\$7.50**

Cost to Trade, **\$4.50**

Pat.

Pending

Available Through All Leading  
Jobbers or Write to:

**South River Metal Products Co.**  
South River, New Jersey

sensitivity, selectivity, and stability for the unit through the use of powdered-iron, slug-tuned r.f. circuits and high gain miniature series tubes.

The frequency range of the DFR-8 is 130 kc. to 5600 kc. The equipment may be operated from any conventional ship supply voltages.

Additional information on the DFR-8 Direction Finder may be secured from *Applied Electronics Company*, 807 Ellis Street, San Francisco 9, California.

### VIBRATOR LINE

*American Television & Radio Co.* of St. Paul, Minnesota, is now in production on a complete line of auto radio vibrators designed for use in standard vibrator-operated auto and household radio receivers.

The new *ATR* vibrator line features ceramic stack spacers. Details of the line are included in the new 34-page *ATR* Vibrator Guide which has just been released.

A copy of the guide describing the line may be secured from *American Television & Radio Co.*, 300 East Fourth Street, St. Paul 1, Minnesota.

-30-

### SCR-274N

(Continued from page 51)

two windings add or the method will not work. A voltmeter will be of assistance in this test.

A 6X5 rectifier is used to eliminate the need for the normal rectifier winding. The use of a dual-section filter condenser provides adequate hum free d.c. from the power supply.

In the event it is desired to change over to six volt tubes, all the tubes used in these receivers have equivalents in the six volt series, with the exception of the 12A6. A 6V6 may be used in its stead with no circuit changes.

Photos of two different conversions are shown. The one in Fig. 5 includes an a.c. power supply and an "outboard" ten-meter converter. The unit shown in Fig. 1 includes a built-in speaker, ten-meter converter, a.v.c., noise limiter, and audio gain control, and is designed for use in a car, taking its power from the "B" supply in the regular auto radio. Six volt tubes are used in this version, and the b.f.o. has been changed to an added audio stage. An a.v.c. circuit has been wired in, and several resistor values changed to give improved performance. The complete circuit for this version is shown in Fig. 3. If the main operation is to be on phone it is recommended that this type of conversion be made.

In this conversion, the left hand toggle switch controls the "B" supply of the auto radio, the knob in the center is the audio gain control, and the right hand

toggle serves to place the noise limiter in or out of the circuit. The output transformer has been replaced by one of the midget universal types, to match the output tube to the two inch speaker mounted in the space formerly occupied by the dynamotor.

So far this article has dealt only with the conversion necessary to use these receivers on their original frequencies. The BC-453 and BC-946 do not have much appeal for high frequency work due to the low i.f. frequency, although they both have excellent selectivity.

The i.f. frequency of the BC-454 is 1415 kc. while the BC-455 uses an i.f. of 2830 kc. With i.f. frequencies of this order, excellent image rejection is achieved. This is especially important if the receivers are to be converted to the ten-meter band. There are two possible methods of changing the receiver frequencies. The simplest method is the re-winding of the coils to cover the ten-meter band. This method has the disadvantage of making the receiver useless on its original frequency as well as creating problems of cut and try to obtain the proper tracking over the band. While this is not too difficult if the proper equipment is on hand, few amateurs have the necessary instruments and experience to obtain optimum results.

A far more satisfactory method of using the receivers on ten meters is the use of a broad-band converter. By this means, the original calibration and tracking of the receiver is not disturbed, greater over-all stability is obtained, and considerable gain results. No added controls are necessary, and the converter may be constructed in a very limited space.

The bottom view of the receiver, Fig. 2, shows such a converter built into the space between the plug-in coils and the front panel. The construction of the converter in such a crowded space is rather difficult however, and if space permits it is recommended that the method followed in the receiver shown in Fig. 5 be used.

In this version, the entire converter is built into a cut down i.f. can and mounted at the side of the receiver. The socket for the 6J6 converter tube is mounted on the top of the can while the two screws on the side of the can are the slugs used to tune the coils in the input and oscillator circuit.

The entire converter is mounted on a bracket of aluminum which is fastened to the receiver chassis by means of short machine screws. The condenser used to tune the antenna circuit and permit matching is on the rear of the can and is not visible in the photos.

The diagram of the converter portion is shown in Fig. 6. It is essential that the antenna coil  $L_1$  be of the slug-tuned

type to permit adjustment of the inductance. This portion of the circuit will be recognized as that of the popular R9'er and has the advantage of matching the antenna or feeder impedance accurately.

A 6J6 was selected as a combined mixer and oscillator. A triode mixer has a very favorable signal-to-noise ratio, and the stability of the 6J6 as an oscillator is excellent. As the 6J6 has only one cathode, the oscillator grid leak  $R_2$  is returned directly to the cathode, while bias for the mixer portion is developed across the resistor  $R_3$  in series with the cathode tap on the oscillator coil.

The oscillator coil may be either of the slug-tuned type or wound on a piece of rod or tube. A slug-tuned coil is preferable as the bugaboo of adjusting to the proper value by spacing turns or squeezing, is eliminated. In the event an air core coil is used in this position, it will be necessary to use a variable trimmer condenser across the coil to permit setting the frequency.

The plate of the mixer portion of the 6J6 is connected directly to the stator of the trimmer condenser mounted at the left of the receiver. A 2.5 millihenry r.f. choke acts as a plate load for the mixer.

Input to the converter is through a connector of the type sold for auto radio use. This permits the use of a coaxial type feeder and allows rapid disconnection if the receiver is to be used on its original frequency.

The shielding of these receivers is excellent, and this is of the utmost importance if a converter is to be used. In one version, pickup of signals on the original range of the receiver was eliminated by removal of the antenna post. In the other version, the post was shielded by means of a small can made from a defunct electrolytic condenser. This can may be removed simply by removing one screw and the antenna connected to the post. The receiver may then be used on its original frequency.

An explanation of the operation of this type of converter is probably in order. The input circuit, consisting of  $L_1$ ,  $C_1$ ,  $C_2$ , and  $R_1$ , is broadly resonant in the band of 27 to 30 mc. The oscillator circuit is tuned to a frequency depending on the original range of the receiver. In the case of the BC-454, the oscillator is tuned to a frequency of 24 mc., while for the BC-455, the oscillator operates on 21 mc. Incoming signals in the range of 27 to 30 mc. beat with the oscillator frequency, and the regular tuning dial of the receiver is used. As the receiver in itself is selective, only a narrow band of frequencies is passed by the receiver, in the same manner in which the receiver operates by itself. The selectivity of the entire unit is exactly the same as the receiver itself. In effect the receiver

**BIGGEST SAVINGS  
IN HISTORY!**

USE THE BEST SURPLUS

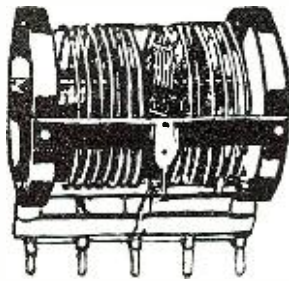

BRAND NEW! RUGGEDLY BUILT!



ATTENTION!!!

ALL SCR-522 OWNERS

Remote Control Boxes for SCR 522's. Brand New in Original Packing; Consists of 5 push button switches, 5 Western Electric Pilot Assemblies, with Pilot Bulbs and Dimmer, and Lever Switch all finished in Black Crackle. Order yours Today.

Your Cost, **79c EA**

SCOOP!

110 M.C. REC. BARGAIN  
BC-733 D Localizer Receiver

Freq. 108-110 Mc; Tube complement: 10 tubes—1-12SQ7, 2-12SR7, 1-12A6, 1-AH7GT, 2-12SG7, 3-717A. NEAR NEW CONDITION. Companion to the glide path receiver. Also

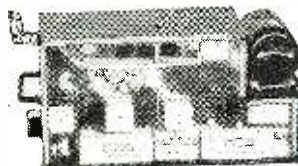

contains 90 and 150 cycle band-pass filters. Has the best AVC system yet developed; can use parts or use as a model for construction. 10 tubes, crystals, relays, etc. Schematic included. Don't pass this up! At only.....\$3.95  
**2 for \$7.50**

POWER!! POWER!!

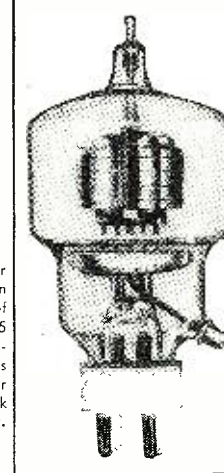

EIMAC

304TL

BRAND NEW  
JAN. INSPECTED

SUPER

VALUE

BETTER ORDER

4 OR MORE

TODAY

**90c**

EA

WHILE THEY LAST—

ANY QUANTITY

SUPER SPECIAL

BRAND NEW \$3.95

EIMAC 304TH EA

JAN. INSPECTED

Doublet Antenna Kit, Com. with  
Guys,

Hdw. **\$9.95**

used with the famous Hallicrafters BC-610, consisting of 7 steel-alloy mast sections in a handy canvas bag. Each section is 5' 6" long, 1 1/2" OD with the last 6" rolled to a smaller OD to telescope into the end of the preceding section. No taper. Assemble into mast up to 35' high or shorter by any multiple of 5'. Finished in weatherproof olive drab. Ideal for erection of FM and Television Beams! Drop your coaxial cable right through the center! Brand new, export packed.

TERMS: F.O.B. Pasadena unless postpaid. No C.O.D.'s under \$2.00. 25% deposit on ALL orders. All C.O.D.'s shipped by Rail Express. Save freight and C.O.D. fees by sending full price with order and we will ship by fast truck, transportation collect. Minimum order \$2.00. Californians include 2 1/2% sales tax.

BE SURE TO ASK FOR OUR BIG SPECIAL BULLETIN

**DOW RADIO**

1759 EAST COLORADO BLVD.  
PASADENA 4, CALIFORNIA

**RADIO ENGINEERING I**

COMPLETE radio Engineering Course. Bachelor of Science Degree. Courses also in Civil, Electrical, Mechanical, Chemical, Aeronautical Engineering, Business Administration, Accounting, Secretarial, Science. Graduates successful. 65th year. Enter Sept., Jan., March, June. Write for catalog.

TRI-STATE COLLEGE 1668 College Ave.  
ANGOLA, INDIANA

**PEN-OSCIL-LITE**

Extremely convenient test oscillator for all radio servicing; alignment • Small as a pen • Self powered • Range from 700 cycles audio to over 600 megacycles u.h.f. • Output from zero to 125 v. • Low in cost • Used by Signal Corps • Write for information.

GENERAL TEST EQUIPMENT  
38 Argyle Buffalo 9, N. Y.

**SELSYN MOTOR VALUE**

115  
Volts  
60  
Cycles



\$7.50  
Per  
Pair

From NEW gun directional control units. Excellent for rotary beam directional control and indication. No. 5 synchro Mfg. by Bendix, Diehl, Hobart, operate as transmitter and receiver. Diameter 3 1/4", length 4 1/2". Designed for direct hook-up to 115 volt, 60 cycle, A.C. supply line.

Pair (2 units), with diagram.....\$7.50

**WEBER ELECTRIC**

150 Maple Ave. Dept. 4, Hershey, Penna.

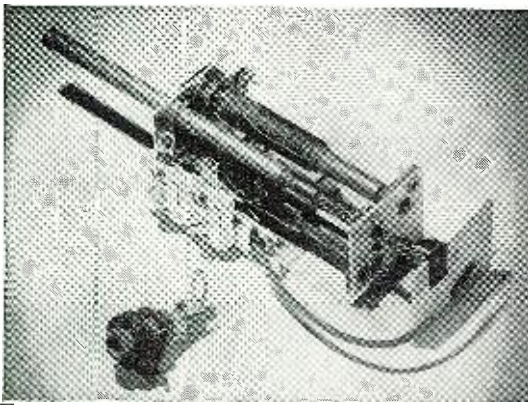

## SET-BUILDER'S SCOOP!

**Tuning Unit - -  
Newest Type,  
Permeability**

Complete, including separate iron core oscillator, tracking coil, and built-in-mica trimmers. May be used to cover the broadcast band in either AC or AC-DC receivers. Has worm gear drive for iron slugs, rigid metal frame only 1 3/4" x 1 3/4" x 3 7/8". Extra long tuning shaft. Moisture proof coils wound on plastic forms.

Nothing equal at twice the price. Full instructions included. **\$125**  
Shipped C.O.D. or postpaid with cash order within U. S. A.

**WATTERSON SALES CO.**

P. O. BOX 840

DALLAS 1, TEXAS

### Mr. Radio Service Dealer "Speed is our Motto"

One day service on all orders. None too small. Only Nationally Advertised Merchandise (No Surplus Handled). TUBES—Any quantity 50% off list.

**Mail us your orders.  
Illustrated list on request.**

*Bill Sutton's*

Fifth at Commerce

Wholesale  
Electronics  
Fort Worth, Texas

### PUSH-BACK WIRE

Brand New Solid or Stranded 20 Ga. Tinned  
5 Different Colors, in rolls of Approx. 100  
ft. Each Color, Only Per Roll..... 69c  
5 Rolls (one each color)..... \$3.25  
500 ft. Roll (one color)..... \$3.00

Send Stamped Envelope for Samples.

**ALL KINDS OF WIRE—WRITE US AND SAVE.**

**E. A. SUPPLY CO.**

687 W. Lexington Ave.

Elkhart, Ind.

acts as a tunable i.f. channel. This is essentially the same method used in the new Collins receiver. As the effective i.f. frequency is high, there is no difficulty with image response.

Determination of the received frequency is simple if it is remembered that the receiver dial will indicate this value simply by adding the frequency of the oscillator to that appearing on the dial. For example if a BC-454 is used, and the receiver dial indicates 5 mc. on a received signal, the frequency of that signal is 5 plus the converter oscillator frequency of 24 mc. or 29 mc. As the converter oscillator is fixed-tuned, it is possible to make it very stable with the result that there is no drift and the calibration does not change.

The two receivers converted were both purchased equipped with tuning cranks. Most receivers however, are sold minus these cranks, and in this event it will either be necessary to purchase these cranks in surplus, or use some other method of tuning. There are several possibilities. One is the removal of the threaded sleeve, and the use of a standard 1/4 inch shaft coupling. A piece of 1/4 inch i.d. brass or copper tubing, if squeezed slightly, will be a snug fit on the dial shaft. A piece of 1/4 inch shaft may then be placed in the free end of the tubing and soldered in place. Any type of knob may then be used.

If a.v.c. is added to the receiver, it will be necessary to provide an audio gain control, in place of the r.f. gain normally used. The wiring leading to this control should be shielded, as well as the wiring to the noise limiter switch if a noise limiter is used. The noise limiter does not introduce noticeable distortion, and the inclusion of such a switch is not absolutely necessary.

A 1N34 crystal was used as the noise limiter, but it would be preferable to use a diode such as a 6AL5 or 6H6. The disadvantage of the crystals lies in their relatively low reverse resistance, which acts as a load on the detector circuit, reducing the effectiveness of the limiter. Some crystals will be found to give considerably better performance in this circuit than others, and if several are available, the best one should be selected. If a tube is used, the cathode of the tube goes to the audio coupling condenser, C<sub>10</sub>. The point at which the limiter operates may be changed by changing the value of R<sub>11</sub>. Increasing the value of this resistor will result in greater limiting action, but the distortion will also increase.

If it is desired to use one of the fixed-tuned converters to extend the range of the receiver to the ten meter band, the input and oscillator coils should be mounted at right angles, or shielded from each other. There is sufficient coupling between the two sections of the tube to give satisfactory injection, and no

**RADIO NEWS**



## RADIO INSTITUTE Outstanding PRE-WAR Technical Training Center for

# TELEVISION & RADIO

Under the personal direction of Frank Melville, former Airlines, Merchant Marine, and Broadcast technician, you may soon qualify as:

- RADIO TECHNICIAN
- AIRLINES RADIO OFFICER
- PT. TO PT. TELEGRAPHER
- RADIO AMATEUR
- MERCHANT-MARINE RADIO OFFICER
- TELEVISION TECHNICIAN
- HOME RECEIVER REPAIRMAN
- VISUAL TELEGRAPH OPR. (SLIP TAPE)

MELVILLE RADIO INSTITUTE believes vocational training means vocational training. Thus we, like many radio schools, teach ample theory. But, unlike most schools, two-thirds of our technical students' time is spent in laboratories and shops, where, with superior equipment, they learn by doing — not memorizing.

FREE employment service is available to all MELVILLE graduates.

Visit the 10-story MELVILLE Building today as our guest and observe the school in operation.

Day and evening classes approved for veterans. Licensed by the State of New York.

**MELVILLE RADIO INSTITUTE**  
Melville Building  
15 West 46th St., N. Y. 19 • Longacre 4-0340

### MAIL THIS COUPON NOW!

MELVILLE RADIO INSTITUTE  
Melville Building  
15 West 46th St., New York 19, N. Y.

Gentlemen: Send me Free information about your school.

Name.....

Address.....

provision need be made for any adjustment of injection. Triode converters are noticeably free from a critical value of injection voltage.

If a converter is used, the adjustment is simplicity itself. When construction has been completed, the frequency of the converter oscillator should be set, by adjustment of the tuning slug if a slug-tuned coil is used, or adjustment of the padding condenser if an air core coil is used. If the receiver used is a BC-454, the oscillator should be set to 24 mc. If a BC-455, the oscillator should be placed on 21 mc. A calibrated receiver or frequency meter will be of considerable assistance in this operation.

An antenna should then be connected to the converter and the receiver tuned until a signal is heard. The station transmitter used with a dummy load, or a modulated signal generator may be used to furnish the signal in the event no stations can be heard. When the signal has been tuned in, the coil slug and antenna condenser  $C_1$  should be adjusted simultaneously for maximum signal strength.

When the adjustment has been completed, the signal may be peaked by means of the antenna trimmer on the receiver. This trimmer will require little or no adjustment in tuning over the band.

All tuning is done with the regular dial, and the converter will require no further attention or tuning unless an antenna system with a different feeder impedance is used.

Of the two receivers converted, the BC-454 gave somewhat better performance. Selectivity of this receiver is also somewhat better, being in the vicinity of 7.5 kc. at two times down.

-30-

### Recording of Sound

(Continued from page 67)

The cathode circuit effects noted are due to fluctuations in the voltage drop across the cathode resistor, occasioned by variations in the d.c. component of plate current. The current indicated by the plate-circuit milliammeter is the average value of the fluctuating "signal" plate current, is identical with the d.c. component, and is the current that produces the cathode resistor drop. These facts may be better comprehended when it is remembered that the fluctuating signal plate current (Fig. 9) is an alternating current, corresponding to the signal, superimposed upon a direct current. It will be evident from the fundamental relations of this combination that the average value of plate current, as indicated by the plate-circuit milliammeter, will be constant in the company of the alternating component under distortionless operating conditions.

June, 1948

## STAHL'S \* Star \* Studded \* Specials!!

### BC-645A 450MC X-Mitter-Receiver

#### BRAND NEW

Complete with Tubes

includes 4-7F7,

4-7H7, 2-7E6, 2-

6F6, 2-955 and 1-

WE 316A door knob.

Can be easily converted for Phone or

CW on 420-450Mc Bands.....

**\$7.95 each**

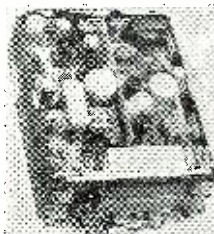

### OIL CONDENSERS

G. E.	1 Mfd	600V DC	.35
C.D.	2 "	" "	.46
Aerovox	4 "	" "	.50
	10 "	" "	.95
	15 "	" "	2.25
Bathub	1 "	1000V DC	.40
G. E.	.35 "	5000V DC	1.50
G. E.	4 "	1500V DC	1.50
G. E.	1 "	2000V DC	.95
Sprague	1 "	8000V DC	.95



5 inch Cathode Ray Type 5 B1 tubes. In their original cartons; Brand New. At this price every scope owner should buy a few, and keep in reserve. How can you go wrong for only \$1.95

SCOPE Tubes—2"—2AP1 ..... **\$1.95**

Hipower quartz Crystal units, Type CF5, 5000 KC, complete with holder ..... **\$1.95**

Jefferson step down (or step up) power circuit transformer double wound 230V input 50 - 60 cycle, to 115V output, 250KVA. Weight 17 lbs. **\$7.95**

RCA-CRV-51019 Hand Sets self contained battery operated. Uses 4 pen light batteries excellent for Television Antenna installation. Sold in pairs only ..... Pair **\$5.00**

Blank Calibration Books for BC 221-Frequency from 125KC to 20000KC printed in .10 divisions —68 pages, aluminum cover, spiral bound... **\$1.50**

Prompt Delivery—Write Dept. RN6.

25% deposit required on C.O.D. order. Shipped F.O.B. New York.

## MICHAEL STAHL, INC.

39 VESEY ST.  
NEW YORK 7, N. Y.

TELEPHONE  
WOrth 4-2882

### METERS

Roller Smith portable lab 0 to 15V D.C.

Bakelite Case with handle; 5½ x 6 x 3½ ..... **\$19.50**

Roller Smith portable lab 0 to 150 Mill. D.C.

Bakelite Case with handle; 5½ x 6 x 3½ ..... **\$19.50**

4½" Weston Panel Board flush metal case 0-5 amp. A.C. with a 0-200 amp. scale ..... **\$3.95**

3" Round Tripplit Bakelite Case 0-150 Volts A.C. .... **\$3.45**

3" Round Western Electric Bakelite Case 100-0-100 Milliamps. D.C. .... **\$3.45**

3" Square Bakelite Case Westinghouse 7.5 Volt A.C. .... **\$3.45**

2" Round Tripplit Bakelite Case 0-35 Mill D.C. in Black Wrinkle Finish. Round Metal Box. .... **\$2.25**

3" Round Western Electric 0-1000 Mill D.C. Bakelite Case ..... **\$2.25**

3" Round Beede 0-1000 Mill D.C. Bakelite Case **\$1.95**

### RAYTHEON RECTIFIER

W-3155

**\$49.50**

Supply Current at a constant voltage and supplies current to a storage battery, providing an automatic AC-DC power system. Has no moving or expendable parts — therefore no frequent adjustment or maintenance is necessary. The life of the battery increases as much as 40%. Eliminates voltage variations. Range of unit 11/12 cells, 22 to 24 volts @ 3 amp. output. Input supply source 95 to 130 volts, 60 cycles, weight 180 lbs.

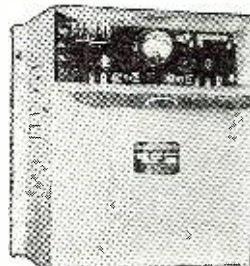

### Navy Standard

Battery (Brand New)

Made by Gould Storage Battery Corp. 6 volt 15 amp hour.

Excellent for amateurs, experimenters, radio servicemen, &c. Shipped dry, with complete instructions for charging. 4½x4½x6½ high. Shipping weight 12 lbs.

While they last **\$4.95**



### INSIDE INFO!

Get your copy today

ELEMENTS OF  
MAGNETIC TAPE  
RECORDING  
and 999  
APPLICATIONS



Available For Only **25c**

by **A. C. SHANEY** Contains schematic diagrams

**AMPLIFIER CORP. of AMERICA**

398-2 Broadway • New York 13, N. Y.

### UTICA TOOLS

PLIERS FOR EVERY NEED

TOOL NO. 654-6"

Ask Your Dealer

**UTICA DROP FORGE & TOOL CORP.**  
UTICA, 4 NEW YORK

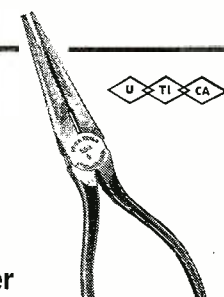

## six "firsts" in radio values



### REGAL 1107

Full size table model 6½x7x10, 4 tubes-Super-heterodyne, 5" pm speaker, built-in Regal-loop, slide rule dial, provision for outside aerial. YOUR COST **\$8.90**

### REGAL SUPER-MITE! #777

3 way portable AC-DC & Battery, powerful reception, super-sensitive pickup. Made in light-weight aluminum in several colors. Batteries extra \$2.04. Retailis \$29.95. YOUR COST **\$22.22**

Lot of 3

\$21.72

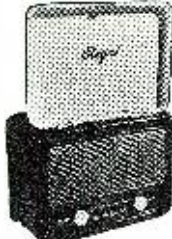

### REGAL 7251

Full size table model in walnut & ivory plastic cabinet. AC-DC super-heterodyne, built-in loop, deep rich tone, slide rule dial, excellent reception. **\$12.75**

Lot of 3

\$12.00



### AUTOMATIC M-86

6 tube car radio—3 gauge variable condenser, one piece unit, easily installed, fits any car. Retailis \$39.95. YOUR COST **\$27.97**



### TEMPLE G612

6 tube, 3 way portable superheterodyne receiver. Plays anywhere. Batteries extra \$4.04. Actual retail \$49.50. YOUR COST **\$22.22**

Lot of 3

\$21.72

### TEMPLE G415

3 way personal portable using latest octal type low drain electronic tubes. Batteries extra \$2.26. YOUR COST **\$19.50**

Lot of 3

\$18.71



At Least 10% with Order  
Balance C.O.D.

## NATIONAL RADIO DISTRIBUTORS

899 Southern Blvd., New York 59, N. Y.

LUdlow 9-6015

## HIGH PRECISION 100 Kc. CRYSTALS

Price \$3.95 each

(No C. O. D.'s. Please include 25c for postage and handling.)

Brand New Surplus at about 1/10 Gov't. cost. An ideal Frequency Standard for Amateurs, Servicemen, Laboratories, etc.

Exceptional Frequency Stability ± 15 cycles from -50° to + 80° c. (.0015)

10G Vibration Test. Calibrated at 30° c. Brand New, Mounted in Sealed Cases as Shown.

**ELECTRONICRAFT, Inc.**

5 Waverly Place

Tuckahoe, N. Y.

Fig. 9 is a graphical representation of signal plate current.  $I_{max}$  is the maximum value reached by the fluctuating plate current;  $I_0$ , the zero-signal value;  $I_{min}$ , the minimum value. From these values, it may be shown that the percent second-harmonic content (often the most troublesome distortion factor) is equal to:

$$100[\frac{1}{2}(I_{max}+I_{min})-I_0]/(I_{max}-I_{min})$$

Quantitative methods of checking distortion are *harmonic analyses*, and are concerned with measurement of the actual amount of energy present in each separate harmonic of the signal frequency (or in the total harmonic content) and establishment of percentages with respect to the fundamental frequency. The most representative methods employed in wave analysis and the apparatus necessary thereto will be described presently.

The cathode-ray oscilloscope is notably useful in the observation of wave shapes. When the horizontal plates of the ray tube are energized by a sawtooth wave sweep-oscillator-amplifier circuit to furnish the linear time base,

and a signal voltage which it is desired to observe is applied to the vertical plates through a substantially flat-response amplifier, the cathode-ray trace will be an exact reproduction of the waveform of the applied signal voltage.

An audio-frequency amplifier may be checked for distortion with the oscilloscope in the manner illustrated in Fig. 10. At the left is an audio oscillator possessing an output voltage waveform of known purity, next is the amplifier under test, and at the right is an oscilloscope having horizontal and vertical amplifiers with substantially flat frequency responses.

It is the purpose of the oscillator to supply a signal of as pure waveform as practicable to the amplifier, and that of the oscilloscope to reproduce the wave shape of the signal after it has passed through the amplifier. In order that as little distortion as possible be introduced by the instruments themselves, the oscillator used for such a test must be of exceptionally high quality and the amplifiers in the oscilloscope must possess an excellent frequency characteristic.

Fig. 7.

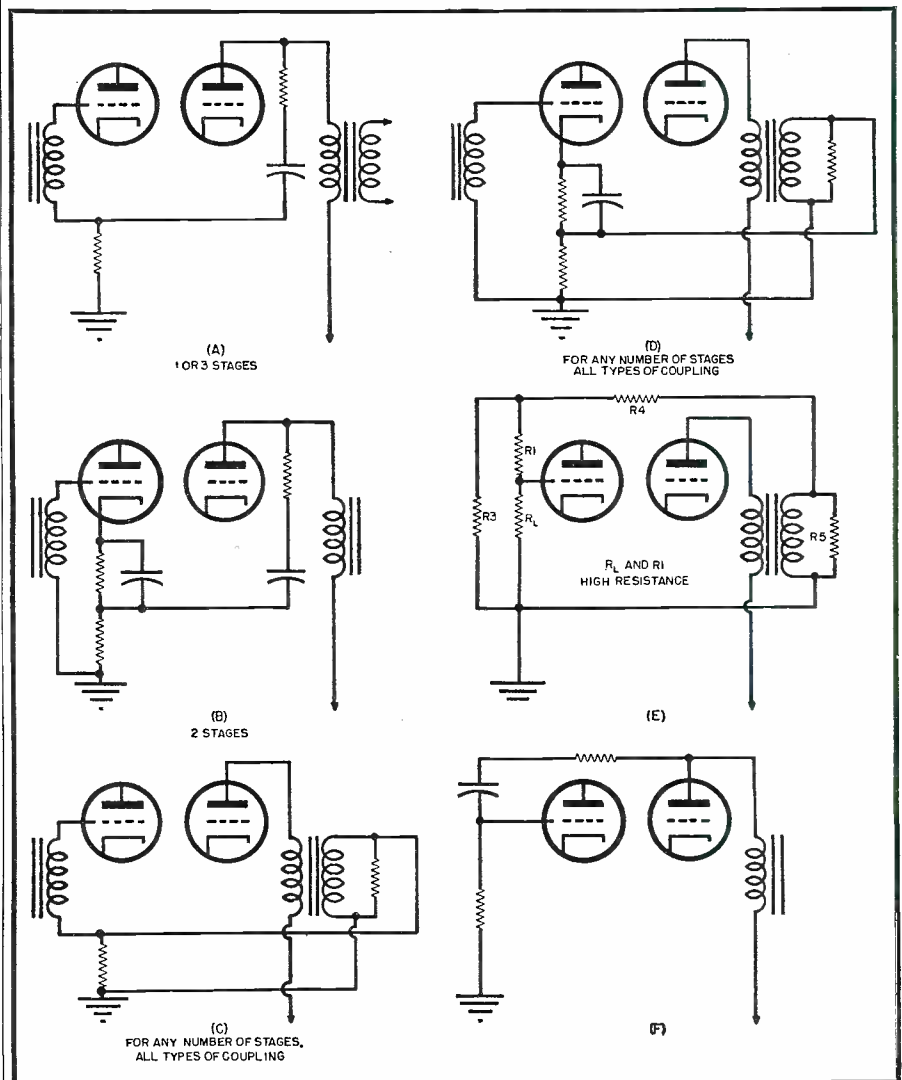

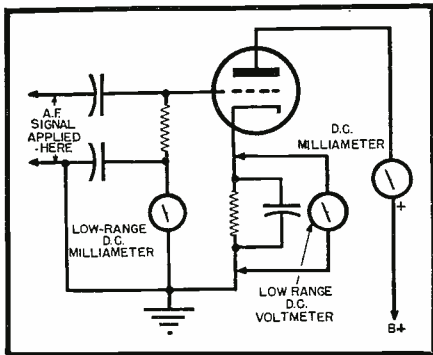

Fig. 8.

Likewise, the oscilloscope sweep circuit must be uncompromisingly linear in its characteristic.

If the amplifier had no distortion at all, the signal it delivered to the oscilloscope would be an exact reproduction of the input signal waveform. This is never encountered in practice, however, the most efficient amplifier arrangement being beset with the distortion characteristics of its tubes and other components.

For observations, a perfect sine wave (or, better still, a tracing of a single cycle from the test oscillator) might be inscribed on the transparent viewing screen of the oscilloscope, and signals from the amplifier matched to this pattern to discover variations from the original shape due to amplifier distortion. In making such a test, it would of course be necessary to adjust both oscilloscope amplifier gain controls in such a manner that the maximum amplitude and width of the signal trace coincided with those dimensions of the inscribed pattern.

With the low percentages encountered with most well-designed amplifying equipment, it will be difficult to estimate the percentage of harmonic content from the reproduced wave shape, in the oscilloscopic method, unless the operator makes use of the transparent screens furnished by some oscilloscope manufacturers for the purpose. These screens carry printed patterns of single cycles

Fig. 9.

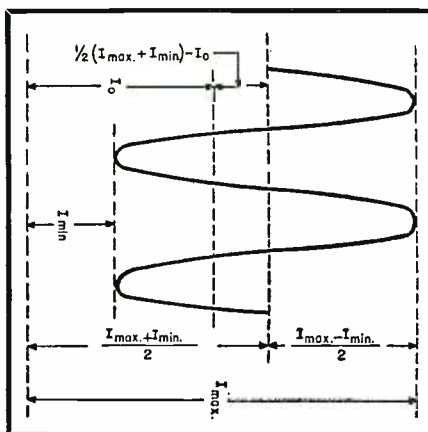

# IT PAYS To Buy Hallicrafters

From The Worlds Most Personalized

RADIO SUPPLY HOUSE

LARGE STOCKS



Hallicrafters S-53  
\$79.50  
\$15.90 Down

PROFESSIONAL PERFORMANCE

World wide domestic and short wave reception. It's sensitive, powerful, completely dependable. SIMPLIFIED control—anyone can operate the S-53. 540KC to 54.5MC—5 Tuning ranges. Electrical Band Spread-Series Noise Limiter, 2.5 watt audio output: Complete with 7 tubes and built-in speaker.



Hallicrafters SX43  
\$169.50  
\$33.90 Down

PREFERRED BY AMATEURS

Hallicrafters SX-43 is designed for the discriminating amateur and short wave fans who demand the finest reception of standard A.M., F.M., Broad. casts. AM 540 KC-55MC.—FM. 44-55 MC; 88-108MC. 6 Frequency Bands—tuned RF stage—High fidelity audio—Automatic Noise Limiter.

Hallicrafters Model No.	Your Price	Down Payment
<b>S-38</b> 540 KC to 32MC 4 bands. Self contained speaker.	47.50	9.50
<b>\$40A</b> 540 KC to 43MC 9 tubes built-in speaker.	89.50	17.80
<b>SX-42</b> 540 KC to 110MC 6 bands FM, AM, CW—15 tubes less speaker	275.00	55.00
<b>\$51</b> 140 KC to 12.0MC 4 bands complete with 9 tubes, built-in speaker	129.50	26.00
<b>HT-17</b> Crystal controlled 10 watts output, CW Xmtr	49.50	9.90
<b>HT-18</b> Variable Master Oscillator Quality AM with narrow band FM	110.00	22.00
<b>S.P. 44</b> Panoramic adapter	49.50	9.90
<b>S-47</b> New FM-AM Receiver, tunes 535 to 108 MC. Push Button Control, 12 watts output. 15 tubes—in cabinet	200.00	40.00

Leo E. Meyerson  
W0GFR



## Bigger Trade-In Allowances

Fellows—BIGGER TRADE-INS—let me know what you have to trade—use as down payment on my personalized payment plan to fit your budget. Get acquainted with me. I have a WORLD REPUTATION for square dealing and hosts of satisfied customers and friends. Ask anyone who has dealt with me—write me today for a PROMPT PERSONAL REPLY.

- Liberal Trade Ins
- Orders Filled Same Day
- Complete Parts Stock
- Ham Gear Our Specialty

Get this 68 Page Bargain Catalogue FREE!

WRITE—WIRE  
PHONE 7795

WORLD RADIO LABORATORIES  
744 West Broadway  
Council Bluffs, Iowa

Please send me:

Radio Map  Send Hallicrafters illustrated catalog

Parts Catalogue

Name.....Call Letters.....

Address.....

City.....Zone.... State.....



## Learn and Earn! TELEVISION RADIO F. M. COMMUNICATION

offer profitable occupation for both men and women. You learn by actual work, how to build and operate, and fit yourself for a higher pay job. Write for catalog.

Approved for Veterans

Hollywood Sound Institute, Inc.  
1040-A No., Kenmore Hollywood 27, Calif.

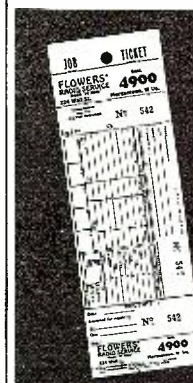

\$500  
MORE PER YEAR!

REPORTED BY  
RADIO SERVICE DEALERS  
who use

4-in-1  
JOB CARDS

Write for details  
RADIO PRESS  
MORGANTOWN, W. VA.

# QUAM *Adjust a Cone* SPEAKERS

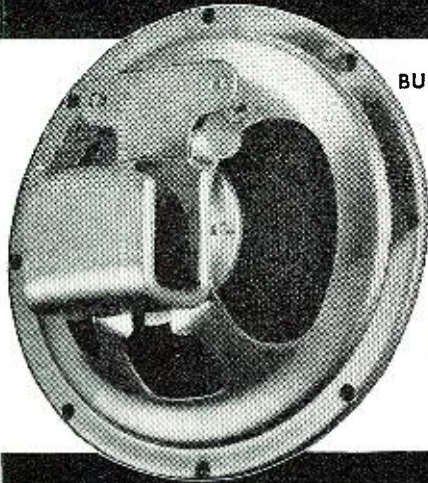

BUILDERS OF FINE SPEAKERS SINCE 1923

LOOK FOR THE  
**U-SHAPED**  
COIL POT

Electro Dynamic and P. M. Speakers in the following sizes: 3 1/2", 4", 4"x6", 5", 5 1/4", 6 1/2", 6"x9", 7", 8", 10" and 12".

*Write for Catalog...*

**QUAM-NICHOLS COMPANY, 522 East 33rd Place, Chicago 16, Ill.**

## SENSATIONAL 'MERIT' VALUE

HOTTEST ITEM OUT! Make your SCR-522 Receiver operate on 144 to 148 Mc with ONE DIAL control, in less than 1 hour! Method is completely mechanical. Tracking is adjustable for the individual receiver. Band-spread is adjustable up to about 160 degrees. Parts and instructions **\$3.00**  
(Please include 8c postage)

**MERIT RADIO SUPPLY CO.**

471 Merrick Road Lynbrook, N. Y.

## GREYLOCK

A Dependable Name in  
**RADIO TUBES**

### GT, Glass, and Miniature Types

ALL TUBES IN INDIVIDUAL CARTONS  
12SA7, 12SK7, 12SQ7, 50L6, 12AT6,  
12BA6, 12BE6, 35W4, 50B5...each 39c  
1R5, 1S5, 1T4, 3S4, 3Q4, 6AK5, 6AC5,  
6AC7, 6AQ5, 6BE6, 6BA6, 6AU6,  
6BJ6, 6X4...each 49c  
32L7, 70L7, 117L7...each 59c  
All Tubes Carry RMA 90-Day Guarantee

**PM SPEAKERS**  
4" Alnico No. 5...each \$1.19  
5" Alnico No. 5...each 1.29  
TERMS: Net C.O.D. No order accepted for less than \$5.00

Write for Bargain Catalog N-6  
**GREYLOCK ELECTRONIC SUPPLY CO.**  
30 Church Street New York 7, N. Y.

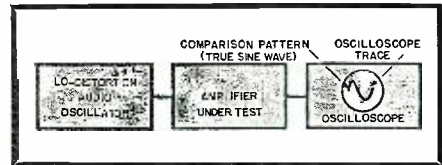

Fig. 10.

corresponding to the shapes obtained (variations from true sinusoidal) with various low percentages of distortion. Severe cases would result in images similar to Fig 11 which is an exaggerated representation of pronounced third-harmonic content.

### Frequency Bridges

Certain bridge circuits, notably the Wien bridge (see Fig. 12) can be used for the identification of frequencies in the audio-frequency spectrum. If an alternating voltage is delivered to the bridge circuit, the latter may be adjusted for a null at that particular signal frequency. The null point would not hold for the same voltage of another frequency. Thus the adjustable element of the bridge might be calibrated to read directly in cycles-per-second.

The Wien bridge in its most useful form for this purpose would have its constants so chosen that the ratio arm  $R_2$  is twice the ohmic value of  $R_1$ , the condensers  $C_1$  and  $C_2$  are equal in capacitance, and the two simultaneously adjustable resistance legs  $R_3$  and  $R_4$ , are at all positions equal. Under these conditions, the frequency of the impressed voltage at null would be equal to:

$$f = 1/2 \pi RC$$

Where:

$f$  is the frequency in cycles-per-second,

$R$  is the resistance of  $R_3$  or  $R_4$  in ohms,

$C$  is the capacitance of  $C_1$  or  $C_2$  in farads.

Since the bridge may be balanced for only one frequency at a time, it would appear that any residual voltage indicated by the vacuum-tube voltmeter  $M$ , at null would be due to some other frequency or frequencies (such as harmonics of the fundamental.) This harmonic voltage would be due to the total of harmonic voltages present. As such, the bridge might be connected, as shown in Fig. 12, to the output circuit of an audio-frequency amplifier which is passing a signal from a high-quality audio oscillator.

Fig. 11.

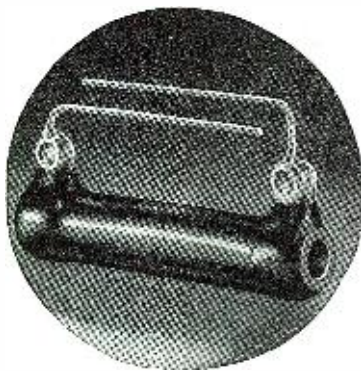
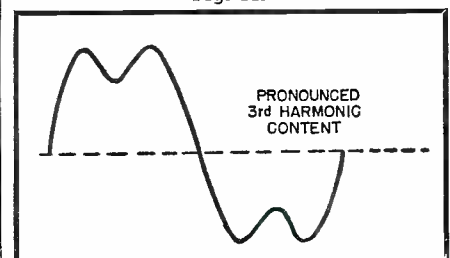

## Insist on LECTROHM when you buy 5, 10, & 25 WATT RESISTORS

Leave it to your LECTROHM dealer to take care of your Resistor needs. He knows you require the best in radio parts—that's why he carries LECTROHM. Built to exceed your specifications, LECTROHM'S 5, 10 and 25 Watt Resistors are accurately spaced, wire wound and permanently sealed in vitreous enamel for long, dependable service. Silver soldered connections assure perfect electrical bond. Today, when every penny counts, insist on the Resistors that give you more for your money—LECTROHM.

Write for Lectrohm's Catalog of valuable Resistor Data—NOW.



**LECTROHM**  
INCORPORATED

4906 WEST 25TH PLACE, CICERO 50, ILL.

Division of

National Lock Washer Company, Newark, N. J.



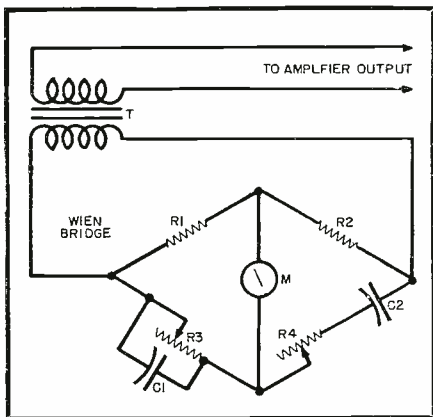

Fig. 12.

While the device might be used as shown as such a harmonic totalizer, the percentage total harmonic content with respect to the readings of the meter before and after null would not be reliable, nor would its error be uniform for all frequencies. These facts are due to the peculiar inability of the bridge to attenuate various harmonics equally.

Another popular type of bridge harmonic totalizer (developed by UTC) is shown in Fig. 13. Here, three legs of the bridge,  $R_2$ ,  $R_3$ , and  $R_1$ , contain pure resistance, while the fourth leg contains the shielded parallel resonant circuit,  $LC$ , which is resonant at the test frequency. The transformer  $T$ , like the one shown in the bridge previously described, must have an excellent frequency characteristic.

At resonant frequency of  $LC$ , the inductive reactance of the tuned circuit equals the capacitive reactance, the former is cancelled by the latter, and the bridge balances as if all four legs were pure resistance. Any voltage applied by the circuit to the vacuum-tube voltmeter is then due to harmonics of the test frequency (and it is assumed that these harmonics have been delivered to the bridge by the amplifier under measurement).

In operation, the double-pole, double-throw switch,  $S$ , is thrown to position 2 and the bridge balanced with the assistance of the vacuum-tube voltmeter,

Fig. 13.

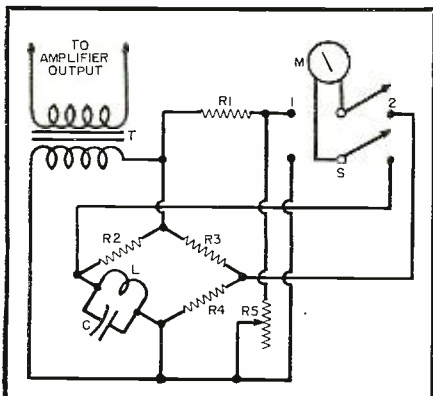

June, 1948

2 out of 3

ESPEY

need it!

The Custom-Built Chassis



According to the RMA over 18 million consoles were built BEFORE '44!

That's right! The newest are four years old, and there are more than 11 million of them that are ten years old. Of the 18 million owners, 51%, or over 9 million LIKE their cabinets—in spite of the fact that the vast majority of receivers are hopelessly obsolete, lacking such present-day essentials as FM.

Furthermore, over 90% of the console owners WANT FM, but less than 6% HAVE it. What a replacement market!

It was to fill this tremendous need that ESPEY designed its line of top-quality custom-built chassis, supplied complete and ready to operate in your customers' cabinets.

For further details about the ESPEY replacement chassis, and the opportunities in the replacement industry, we urge you to write today to Dept. A-6.

ESPEY MANUFACTURING COMPANY INC

528 EAST 72<sup>ND</sup> STREET-NEW YORK 21, N. Y.

"ESTABLISHED—1928"

## RADIO

Technician and Radio Service Courses  
**FM and TELEVISION**  
 American Radio Institute  
 101 West 63rd St., New York 23, N. Y.  
 Approved Under GI Bill of Rights  
 Licensed by New York State

## TELEVISION RECEIVER—\$1.00

Complete instructions for building your own television receiver. 16 pages—11"x17" of pictures, pictorial diagrams, clarified schematics, 17"x22" complete schematic diagram and chassis layout. Also booklet of alignment instructions, voltage and resistance tables and trouble-shooting hints.—All for \$1.00.

CERTIFIED TELEVISION LABORATORIES  
 5507-134th Ave., Brooklyn 19, N. Y.

## A LEOTONE "SPECIAL" PORTABLE D.C. AMMETER

0-15 Amperes

Unbeatable

at this Price!

Host type 515. Precision calibrated 3 1/4" mirror scale offers laboratory accuracy. Knife-edge pointer; 75 scale divisions. Moving coil D'Arsonval 50 MV. movement. For use in Laboratory, Radio-Electronics, Electrical work, etc. Complete with 36" clip type leads. In black wrinkle finish metal case (6 1/4" x 5 3/8" x 2 3/4") with hinged lid. **GUARANTEED BRAND NEW. While they last—Only \$5.95**

6 FOR \$30.00

20% DEPOSIT ON C.O.D.'s  
 GET ON OUR MAILING LIST  
 ALWAYS SOMETHING NEW

**LEOTONE RADIO CO.**  
 65 DEY ST. NEW YORK CITY

**POCKET FAST EASY**  
**EXTRA PROFITS**  
 Selling and Installing

# Autone

**AUXILIARY SPEAKER**



Sales will soar to new highs when you display the NEW AUTONE AUXILIARY SPEAKER.

More than 25 million motorists in the United States are ready prospects! They want the full, rich "Living Room" reception that an auxiliary AUTONE will give their car radios; they want the inexpensive luxury of a rear seat, separately controlled radio speaker, the pleasant, safe convenience of complete reception at low level volume. The New AUTONE is a high quality speaker. Show it in your store with our dealer aids, and it will sell itself. Your service department, too, will reap extra profits through installations of these popular units. Easily, quickly installed. Retail at \$9.95 complete with switch, cable, etc., plus installation. Long discount, big markup for you. Contact your jobber TODAY or write us direct.

**NORTHERN PRODUCTS CO.**  
 6349 N. Clark St., Chicago 26, Ill.



**CORRESPONDENCE COURSES IN**  
**RADIO and ELECTRICAL ENGINEERING**

**ELECTRICAL ENGINEERING** Get good grasp of wide electrical field. Prepare yourself at Low Cost, for secure future. Modern course. So simplified anyone can understand quickly.

**RADIO ENGINEERING** Extra fine course in radio, public address, photo-electric work. Trains you to be super-service man, real vacuum-tube technician. Servicemen needed badly. Diploma on completion. Many graduates earning big pay.

**WRITE** Send postcard for Free Copies of \$25 Course school catalog. Full details, all about deferred payment plan, experimental kits, etc. LINCOLN ENGINEERING SCHOOL, BOX 931-R114 LINCOLN 2, NEBR.

**ATTENTION RADIO DEALERS AND SERVICEMEN!**

• Are you fed up with those so-called war surplus bargains? Then call on us for standard radio parts at regular dealers discounts.  
**EL MONTE ELECTRONICS SUPPLY CO.**  
 992 East Valley Blvd., El Monte, California  
 BUdlong 8-4228

M, as a null indicator. The reading at null (due to harmonics) is recorded. The switch is then thrown to position 1 and  $R_5$  is adjusted until the meter gives the same reading (as before at null). The following calculation may be performed to determine the per-cent of total harmonics from this operation:

$$\%H = 100R_5 / (R_4 + R_5)$$

A dial indicator attached to the potentiometer  $R_5$  may be calibrated directly in these percentages.

(To be continued)

**REFERENCE**

\*"The Aerovox Research Worker", Vol. 9, Nos. 6 and 7; Vol. 12, No. 7. Aerovox Corporation.

**Receiver Design**

(Continued from page 47)

type oscillator the cathodes of the two sections are tied together or are capacitively coupled for oscillator coupling. The 7F8 and the 6J6 are the most frequently used tubes in this type of circuit. The dual-triode converter has a high input resistance and a low noise level which contributes to its popularity.

The tuning condenser is mechanically sturdy and can be tuned easily. It does rely on wiping contacts for grounding the rotor and these contacts must be kept clean and lubricated for quiet operation.

**Variable Inductance Tuner**

Another type of tuner is the *Meissner* variable inductance tuner. It is used in their Model 2961. The r.f., oscillator, and mixer stages are constructed on a separate chassis which is completely shielded. A side view of this tuner is shown in Fig. 1 with the side shield removed.

The antenna terminals are on top of the chassis directly over the antenna coil. The primary is a two-turn coil with the center tap connected to the chassis. This primary is closely coupled to the antenna coil. The input is matched to a balanced 300-ohm line.

The tuning is accomplished by inserting the "blades" between the turns of the coils. The coils consist of three turns of wire. There are two "blades" on each tuning section which slice between the turns. The "blades" are cam shaped and mounted off-center on the tuning shaft. In this type of tuning there is no connection required between the rotor and the coils. Each of the tuning sections is insulated from the other by an insulated section in the tuning shaft. This is to prevent feedback through the tuning shaft from the mixer to the input coil. A shield is placed between the mixer and r.f. stage to further lessen feedback.

The theory of operation of this tuner is that the insertion of the "blades" in the coils not only reduces the coupling

between the coils but the "blade" itself acts as a shorted turn and further reduces the inductance. With the "blade" in the coil, inductance is at a minimum and the unit is tuned to the high frequency end of the band. This is opposite of the condenser-tuned coil for the completely meshed condenser tunes to the low frequency end. There is a slight increase in capacity when the "blades" are meshed. The change in capacity is very slight as compared to the change in inductance. This slight change in capacity is due in part to the wide spacing of the "blades" from the coils and also because the tuning shaft is not connected to the chassis.

The tuning "blades" are specially designed and cut to give proper tracking. Final adjustments of tracking may be accomplished as follows: The coils are trimmed at the high frequency end with capacity trimmers. At the center of the band the center turn of the coil may be moved off its axis for tracking adjustment. At the low frequency end of the band the two outer turns are compressed or spread out, whichever is required, for proper tracking. Careful adjustment of these coils provides excellent tuner sensitivity.

The tuner uses a 6AG5 as an r.f. amplifier and another 6AG5 as a mixer. A 6C4 is used as a separate oscillator. The 6AG5 is one of the more efficient r.f. amplifier tubes at the higher frequencies. The input resistance of this tube is fairly high at FM frequencies and good gain is realized from the tube.

The oscillator is a hot cathode type. The oscillator voltage is coupled from the cathode of the oscillator, through a 10 mmfd. condenser to the cathode of the mixer which is 4700 ohms above ground. There is no shield between the oscillator coil and the r.f. coil which allows some inductive coupling between these coils.

Mechanically this type of tuner is simple and should be trouble-free. There are no wiping ground contacts and only two bearings. The tuning action is a rotary motion which enables coupling

Fig. 7. Method for spreading the short-wave bands of the "guillotine" tuner.

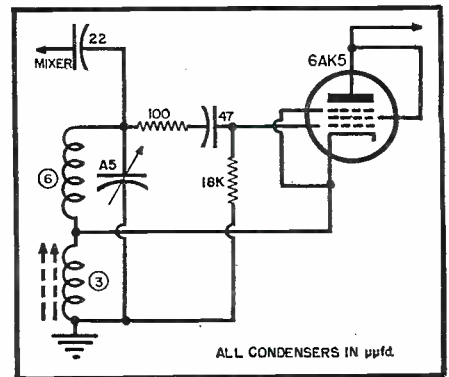

to the tuning shaft with a minimum of dial cord and pulleys.

#### The "Guillotine" Tuner

This tuner has been employed in the *General Electric FM* receivers that we have examined to date. It is used to tune both *FM* bands and to spread the short-wave bands. Although it is actually a variable inductance tuner, it receives its name "guillotine" from its peculiar physical shape.

The "coils" consist of two frames connected at their open ends. Tuning is accomplished by inserting a vane between the two frames. This reduces the mutual inductance between the two turns. The vane acts as a shorted turn and further reduces the inductance. The vane and frames are made of silverplated brass and are tool made. This makes possible positive control of tracking and calibration as the vane can be slotted to give the required change in inductance for a given change in vane motion. Both terminals extend through the chassis where direct connections can be made to the "coil." Each "coil" is mounted next to its respective tube, thus shortening the leads. This can be seen in Fig. 5. The antenna "coil" at the left of the picture is mounted at a right angle to the oscillator and r.f. "coils" to prevent feedback.

The vanes and *AM* tuning slugs are connected to the platform which is moved up and down with the tuning control. A metallic cable, seen in the center, is strung in windlass fashion to pull the platform down. A spring with the correct tension is used for raising the platform. Another version of this tuner is shown in Fig. 6. The "coils" and vanes in this unit are slightly smaller than those in the unit of Fig. 5. The insulated bar to which the vanes are connected is hinged and is raised by a cam on the tuning shaft which can be seen directly behind the tuning drum. The bar is pulled down by a spring. These units tune the high *FM* band only.

A schematic of the input circuit is shown in Fig. 2. All switching has been eliminated except that required for *FM* operation. The tuned circuit is composed of the antenna choke coil (1), condenser (A1) and the tuning coil (2). The signal is introduced across the antenna choke coil which is shunted by a 100 mmfd. condenser. The antenna trimmer (A1) has a capacity of 3-30 mmfd. When the receiver is switched to the low band *FM*, a 150 mmfd. condenser is shunted across the antenna choke coil and (A1) is shunted by (A2). (A2) has a range of 80-130 mmfd. Thus the tuner can be switched from one band to the other with a minimum of circuit changes. A 6AK5 is used as an r.f. amplifier.

Switching the oscillator from one band to the other is done with a mini-

June, 1948.

# BRAND NEW EQUIPMENT

*Available for Immediate Delivery*

Pioneer Torque Units Types 12602-1-A, 12606-1-A and 12627-1-A.  
 Pioneer Torque Unit Amplifiers Type 12073-1-A.  
 Pioneer Autosyn Motors Types AY1, AY5, AY6, AY10, AY14, AY20, AY21, AY27, AY30, AY38 and AY54.  
 Pioneer Precision Autosyn Type AY101D.  
 Pioneer Magnesyn Indicator Type 13318, dial graduated 0 to 360°, 26 volts 400 cycle.  
 Pioneer Autosyn Single Indicators Type 5907-17, dial graduated 0 to 360°, 26 volts 400 cycle.  
 Pioneer Autosyn Dual Indicators Type 6007, dial graduated 0 to 360° and other ranges, 26 volts 400 cycle.  
 Pioneer Two-Phase Low-Inertia Servo Motors Types CK1, CK2 and CK5, 400 cycle.  
 Diehl Two-Phase Low-Inertia Servo Motors Types CDA211052, 75 volts 60 cycle and FP-25-2 and FP-25-3, 20 volts 60 cycle. Will also operate on 115 volts 400 cycle.  
 Eastern Air Devices Permanent Magnet Generators Type J36A, 10 to 5000 RPM, .02 volts per revolution.  
 Eastern Air Devices Synchronous Motors Type J33, 115 volts 400 cycle, 3 phase.  
 Inverters—Three-Phase 400 cycle. Pioneer Type 12121 and 12123 and Holtzer Cabot Type 153F.  
 Inverters—Single-Phase 400 cycle. Pioneer Types 12116 and 12117. Holtzer Cabot Types 149F and 149H. General Electric Type 5D21-NJ3A. Wincharger Type MG750 PU/16 and Winco Type MG2500 PU-7.  
 Delco Permanent Magnet Field Motors Types 5069370, 5069466, 5069600, 5069230, 5067125 and Diehl Type SS-FD6-16.  
 Weston Frequency Meters Model No. 637, 350 to 450 cycle.  
 Synchros—Sizes 1F, 1CT, 5G and 5SG.  
 Pioneer and Kollsman Remote Indicating Magnesyn Compass Sets with or without 12 or 24 volt input 400 cycle inverters.  
 Gyros—Schwein Rate Types 45600D and 46800, Pioneer Servo Unit Type 12800-1-D, Sperry A4 and A5 units, Norden and Minneapolis Honeywell units.

**WRITE FOR OUR COMPLETE LISTING!**

## INSTRUMENT ASSOCIATES

40-37 172nd ST.

FLUSHING 7, N. Y.

Telephone—FL 7-8718

**Note our new address!**

### RADIO ENGINEERING DEGREE IN 27 MONTHS

Intensive, specialized course, including strong basis in mathematics and electrical engineering, advanced Radio Theory and Design. Modern laboratory. Low tuition. Self-help opportunities. Also 27-month courses in Aeronautical, Chemical, Civil, Electrical and Mechanical Engineering. Gov't approved for G.I.'s. Enter June, Sept., Dec., March. Catalogue.

#### INDIANA TECHNICAL COLLEGE

968 E. Washington Blvd., Fort Wayne 2, Indiana

#### TUNING CONTROL KNOBS For Command Set Receivers

69c ea. 3 for \$2. Postpaid in CONTINENTAL U. S. A.

BC 454, etc. series with locking sleeve. Brand new, not surplus. Makes tuning simple for fixed or mobile use.

Send for Latest Bulletin  
 ALVARADIO, Dept. RN5  
 903 S. Alvarado, Los Angeles 6, Cal

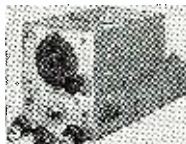

#### FOR BEST FM PERFORMANCE TROUGH-LINE FRONT END Tuned RF Amp.—Mixer—Oscillator

- High Gain
- Image Rejection 100 to 1
- Low Noise Factor
- A Quality Product
- Tunes from 75 to 120 MC

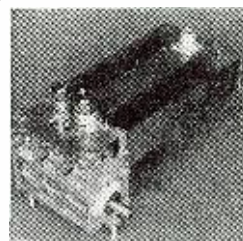

For use with any IF amp. Operating between 3 - 12 MC  
 Unwired.....\$15.95 Wired.....\$18.95

WARDELL SMITH  
 65 Glenwood Rd. Upper Montclair, N. J.

# BOOST YOUR TV SIGNAL



on all  
**13 CHANNELS**

**VIDEAMP**  
VIDEO BOOSTER  
*A 13 channel, self-powered,  
2 stage TV signal preamplifier.*

*Pretuned selector system.*

Non oscillating original circuit combination with easy matching for any antenna impedance to any tele-set input impedance.

WRITE FOR INFORMATION

List Price \$30

See Your Local Jobber

**CRYSTAL DEVICES CO.** Dept. B  
1819 BROADWAY NEW YORK 23, NEW YORK

## NOW—A REALLY HIGH-POWERED— Radio Engineering Library

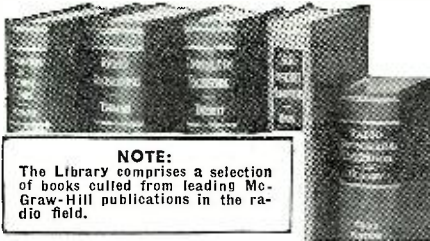

**NOTE:**  
The Library comprises a selection of books culled from leading McGraw-Hill publications in the radio field.

- especially selected by radio specialists of McGraw-Hill publications.
- to give most complete, dependable coverage of facts needed by all whose fields are grounded on radio fundamentals.
- available at a special price and on easy terms.

THESE books cover circuit phenomena, tube theory, networks, measurements, and other subjects—give specialized treatments of all fields of practical design and application. They are books of recognized position in the literature—books you will refer to and be referred to often. If you are a practical designer, researcher or engineer in any field based on radio, you want these books for the help they give on hundreds of problems throughout the whole field of radio engineering.

**5 VOLUMES, 3559 PAGES, 2558 ILLUSTRATIONS**  
1. Eastman's FUNDAMENTALS OF VACUUM TUBES

2. Terman's RADIO ENGINEERING
3. Everitt's COMMUNICATION ENGINEERING
4. Hund's HIGH FREQUENCY MEASUREMENTS
5. Henney's RADIO ENGINEERING HANDBOOK

10 days' examination. Easy terms. Special price under this offer less than books bought separately. Add these standard works to your library now; pay small monthly installments, while you use the books.

10 DAYS' FREE EXAMINATION—SEND COUPON

McGraw-Hill Book Co., Inc.

330 W. 42nd Street, New York 18, N. Y.

Send me Radio Engineering Library, 5 vols., for 10 days' examination on approval. In 10 days I will send \$2.50 plus few cents postage, and \$5.00 monthly till \$27.50 is paid, or return books postpaid. (We pay postage on orders accompanied by remittance of first installment.)

Name .....  
Address .....  
City and State.....  
Company.....  
Position..... RN-6-48

### AUTO RADIO

- Six Tube Superheterodyne
- Three Gang Condenser
- Powerful, Long-Distance Reception
- Fits All Cars, Easy Installation
- Mounting Brackets Included. Net—

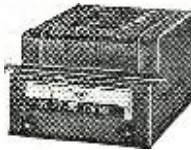

\$29.97

### TOM THUMB CAMERA RADIO

- Precision Built ● Excellent Tone Quality ● Full Vision Slide-Rule Dial ● The Ideal Vacation Companion ● A Portable Radio for Battery Operation ● A High Grade Camera with Reflex Lens ● Using Standard 127 Film

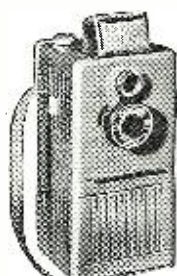

\$28.75  
Less Batteries

### FAMOUS MAKE 3 WAY PORTABLE

- Superb Styling ● Non Breakable Cabinet ● Plays Anywhere, AC, DC or Battery ● Top Notch Performance. Net—



\$21.62  
Less Batteries

### FM CONDENSER & COIL KIT (88 to 108 Mc)

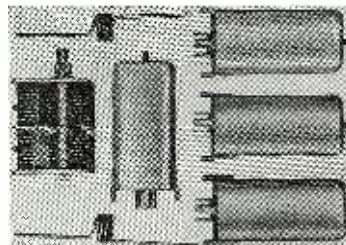

- Vital Parts For Building FM Tuner ● Variable Condenser & Matched Coils. Schematic Diagram. Instructions. Net

\$4.95

### BROOKS RADIO DIST. CORP.

30 Vesey St., Dept. B., New York 7, N. Y.

mum of switching as illustrated in Fig. 4. The tuned circuit is composed of the FM oscillator coil (3), condenser (A3) and the cathode choke (4). (A3) has a 3-30 mmfd. capacity range. When switched to the low FM band, the circuit composed of (A4), the oscillator cathode choke coil (5), the 47 mmfd. and the 56 mmfd. condensers, is shunted across the FM oscillator coil. The oscillator voltage is coupled from the oscillator cathode to the mixer grid with a 10 mmfd. condenser.

Efficient spreading of the short-wave bands is obtained as shown in Fig. 7. A short-wave oscillator loading coil (8) is connected in series with the FM tuning coil (3). (A5), having a capacity range of 475-565 mmfd., is the short-wave trimmer. The FM tuning coil is a small part of the total inductance in the circuit and can produce only a small change in the total inductance. There are no wiping contacts in this tuner and noisy tuning or microphonic howl seems unlikely.

In spite of the mass of the tuning mechanism these units seem to be smooth in tuning and the backlash on the samples we have examined is negligible.

(To be continued)

### Gang Tuning

(Continued from page 48)

the coil plus wiring and socket capacity. This must be estimated but will average 10 to 15 micromicrofarads.

To determine the values of  $L$  and  $C$  for the oscillator, the same formulas are used, except that  $K_1$  and  $K_2$  are calculated for the end frequencies of the desired oscillator range, depending upon the choice of an intermediate frequency.

As a guide in winding coils on Millen forms see Table 1.

It can be seen from this table that the slug will vary the inductance over a range of about 1.6 to 1.0 between full-in and full-out positions. If a value of  $L$  between two of the coils listed in the chart is needed, it is a simple matter to interpolate closely enough to get the desired value to fall within the range of adjustment. Inductance can also be computed from any of the standard inductance formulas, bearing in mind that the slug will increase the value in accordance with the ratio just given.

Slightly higher  $Q$  is obtained if the slug enters the form from the bottom of the form, as the brass adjusting screw tends to lower the  $Q$  slightly. The adjusting screw can be cut off and re-slotted if it projects too far for the chassis depth. The threads are a non-standard 6-40, so care should be used to avoid damaging them.

The advantages of this method of gang tuning are immediately apparent

TURNS & WIRE SIZE	SPACING	L (max.)	L (min.)
114 t. #32 en.	closewound	106	67.5
40 t. #32 en.	closewound	31	20
36 t. #28 en.	closewound	18.3	11.6
18 t. #22 en.	closewound	5.07	3
12 t. #18 en.	closewound	1.98	1.40
5 t. #22 en.	doublespaced	.81	.53

All inductances in microhenrys.

Table I

when one aligns a receiver using it. Bandspread may be varied over rather wide limits, since both inductance and the fixed to variable capacity ratio may be readily changed. Bandspread is increased by decreasing the padder value, and increasing *L* to bring the frequency range back to that desired. Alignment is not a straightforward procedure, but it should not present any serious problems, either.

Since the local oscillator frequency is the governing factor, it should be aligned first. Set up an accurate signal generator on the desired band. With the r.f. coil removed and a resistor of 20,000 to 50,000 ohms substituted for it between grid and ground of the mixer stage, tune the receiver to the high end of the band (minimum capacity). Tune the signal generator back and forth slowly until the point of response is found. If this response occurs at a higher frequency than that desired, increase the padder capacity until the response is at the desired high frequency end of the band. Check the low frequency end of the band by tuning the receiver to the low end of the band and tuning the signal generator back and forth until the response is found.

Position of the low frequency response should be shifted by tuning the coil slug. Both these adjustments should be rechecked at least five times, as there is a noticeable interaction! Once the oscillator is adjusted to cover the desired range, the r.f. coil can be replaced, and the r.f. circuit peaked by varying the padder at the high end, and the coil slug at the low end of the band, rechecking several times as before. Just a tip, if a plate tickler oscillator is used, take the injection from the plate, not the grid.

To prove his theories, the author built the receiver described by C. V. Hayes in the February, 1947, issue of RADIO NEWS, with the exception that the converter and oscillator were built according to the schematic diagram, Fig. 1. Tracking error was checked using a "resonator", a four inch piece of polystyrene tubing with a brass slug in one end and a powdered iron slug in the other. The test is conducted by inserting first one end, then the other, in the r.f. coil. If the brass gives an increase in output, the inductance is too large, while if the iron

## It's RADIONIC for everything ELECTRONIC

SERVICE QUALITY VALUE

### HICKOK MODEL 610 TELEVISION ALIGNMENT GENERATOR

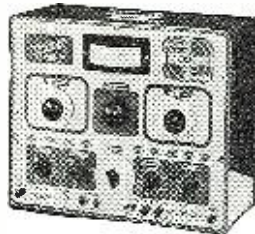

A brand new idea in radio test equipment. Instrument is directly calibrated in frequency from 10 to 250 mcs. Sweep width variable from 0 to 15 mcs. Crystal controlled — Accurate attenuation — High voltage output—Many other features hitherto not available in any instrument at any price. A "must" for the serious-minded Television serviceman. **\$159.00**

### RIDERS TELEVISION MANUAL

1000 pages of Television data: Schematics—Patterns—Alignment—Voltage and resistance tables—Chassis views—Parts Lists—Double spread and Giant pages—Standard Rider Loose-Leaf Binder. PLUS a "How-it-Works" book with explanation of antennas, channel frequencies, RF sections, sound and video, sync and sweep circuits. Complete Index. Destined to become the most popular volume on television, it is yours for ONLY..... **\$15.00**

### FAMOUS \$500.00 TELEVISION COURSE FREE WITH SAMS PHOTOFACTS

Howard W. Sams, Inc., announces a truly unique plan to aid the Serviceman in capturing profitable television repair business. Beginning with folder 38 each set of Photofacts will contain one installment of the famous Saunders Television Course ABSOLUTELY FREE. Photofacts, containing service data, detailed photos, schematics, etc., of latest receivers as released, continue

to cost you only \$1.50 per set. To insure receipt of ALL installments subscribe now for

**SAMS PHOTOFACTS**  
One Year (20 sets of Folders) **\$30.00**  
6 months (10 sets of Folders) **\$15.00**  
3 months (6 sets of Folders) **\$9.00**  
Each Set..... **\$1.50**  
Order by Number

### "TELEVISION SIMPLIFIED"

by MILTON S. KIVER

The best selling book on Television today. Newly revised, it's up-to-the-minute with complete analysis of latest circuit design and full explanation of every part of the television receiver, in a form easy to read and understand.

No mathematics. **\$5.88**

### "FM SIMPLIFIED"

Same author—Same lucid style. Covers complete FM Field. Construction and operation of receivers and transmitters—Trouble shooting—Servicing—Antennas—etc. Indispensable to the man interested in any branch of FM. .... **\$5.88**

### WEBSTER MODEL 156-27

An improved version of the famous Webster 56 Record Changer WITH the GE Variable Reluctance Pick-up. Plays 10-12" or 12-10" records at one loading. Complete with mounting hardware, template and instructions. **\$27.93**

### WEBSTER MODEL 79

Foundation unit only, as used in Model 78. Consists of wire mechanism, motor, recording head, oscillator, 15 minute spool of wire and complete instructions for building your own amplifier or for connecting to audio system of your own radio. **\$44.10**

### WEBSTER MODEL 78



Records on wire from radio or microphone. Wire can be used over and over again with automatic "erase" feature while re-recording or kept permanently for unlimited plays. Unit is complete with self-contained amplifier and speaker, cords, connectors and one 15 minute spool of wire. Full instructions **\$99.96**

**JUST RELEASED**  
**WEBSTER MODEL 81**  
Table model version of famous Webster 80. Designed for home or office use. **\$129.50**

MAIL TODAY FOR YOUR FREE CATALOG

# RADIONIC EQUIPMENT COMPANY

DEPT. 56 TRIBUNE THEATRE ENTRANCE 170 NASSAU ST., N. Y. 7, N. Y. WORTH 2-0421  
CABLE—CHANSLOB

RADIONIC EQUIPMENT CO., DEPT. 56  
170 NASSAU STREET, NEW YORK 7, N.Y.

Send at once your free catalogs, supplements and Bargain lists as published—listing products of leading manufacturers of radio—electronic parts and equipment.

NAME .....

P.O. BOX or STREET.....

TOWN..... STATE.....

### RECORD ENTHUSIASTS AND STUDIOS

Reduce distortion and increase fidelity. Finished casting makes angle arm out of any Astatic straight arm. Mounts new G.E. Variable Reluctance pick-up properly. Also mounts old cartridge.—Order now. Write for illustration.

Aluminum casting—wrinkle finish.....\$2.98  
RAYMARK PRODUCTS COMPANY  
Box 393 Wabash, Indiana

### SELSYN DRIVE MOTORS

Heavy Duty, Type C 78248—Built for Directional Gun Control—Perfect for Rotary Beam Control and Direction. Dia. 3 1/4", length 4 1/2". Mfd. by Bendix, Hobart. Operate in Pairs as Transmitter and Receiver on 115V, 60 Cycle A.C., Per pair (two units).....\$6.50  
Synchro-Differential, Type C78249, same make, size, 115V, 60 Cycle A.C., each.....\$3.50  
McCoy Sales Co., P.O. Box 335, Berea, O.

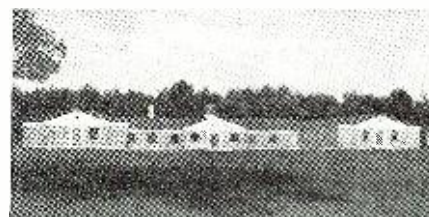

### RADIO ENGINEERING TELEVISION ELECTRONICS

Thorough training in all phases of radio and electronics, open to high school and junior college graduates. Old established school specializing in Radio training exclusively. Modern laboratories and courses. Enrollments limited. Approved veteran training.

VALPARAISO TECHNICAL INSTITUTE  
Dept. RD Valparaiso, Ind.

## TOP VALUE OFFERS

### Kit Model FM-7, a Self-Contained Table Model Frequency Modulated Radio Receiver Kit



Model FM-7 has a frequency range of 86-110 Mc., can also be used as a TUNER with a high quality amplifier. A phonojack is provided in the rear of the chassis with double pole, double throw switch for feeding signal to either the radio speaker or to the phonojack. An additional jack for connecting extra loud speaker is included. The R.F. section of the kits is pre-assembled at the factory. This kit uses 2 IF stages, 1 limiter and 1 discriminator. Miniature tubes used throughout. Complete with tubes including beautiful bakelite cabinet, ready for assembly.

### Kit Model 210, a Three Way Portable Receiver



Model 210 operates on either AC or DC or self-contained batteries... power switch conveniently located on front of set so that "battery" or "AC or DC" may be selected without opening case. Five inch Alnico 5 permanent speaker. Case covered with fine grade leatherette material. Complete with tubes, ready for assembly.

### Kit Model S-5, a One Band Receiver



Model S-5... this radio kit contains the following features: Improved superheterodyne circuit, built-in loop antenna, PM Alnico speaker, streamlined airplane dial, wide tuning range 550Kc-1600Kc, 5 tubes (including rectifier), 115V, AC-DC, 12SK7 IF, 12SA7 converter, 12SQ7 Det. and 1st audio, 50L6GT output and 35Z5GT rectifier. Complete with tubes, including beautiful bakelite cabinet, ready for assembly.

Available at

CONCORD RADIO CORP., Chicago, Ill.  
RADIO WIRE TEL., Inc., New York, N. Y.  
WALTER ASHE CO., St. Louis, Mo.  
GUARANTEE RADIO SUPPLY, Laredo, Texas  
OLSON RADIO WAREHOUSE, Cleveland, Ohio  
RADIO ELECTRIC SERVICE, Philadelphia, Pa.

Many other kit models available. Write for Catalog K

If not available at your local jobber, write directly to us.

## RADIO KITS COMPANY

120 Cedar Street New York 6, N. Y.

## TELEVISION HIGH VOLTAGE METER 0 to 30 KV

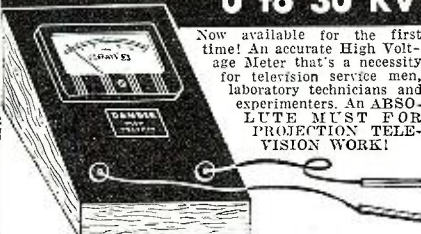

Now available for the first time! An accurate High Voltage Meter that's a necessity for television service men, laboratory technicians and experimenters. AN ABSOLUTE MUST FOR PROJECTION TELEVISION WORK!

A precision-made instrument with range from 0 to 30 KV, has 4" scale and only draws 20 microamps. Bakelite meter panel housed in solid oak cabinet. Send for FREE COMPLETE TECHNICAL INFORMATION AND DETAILS.

Pioneers in Projection Television  
**SPELLMAN TELEVISION CO., INC.**  
130 WEST 24th STREET • NEW YORK 11, N. Y.

gives an increase, the inductance is too small. If both ends cause a decrease in output, tracking is perfect at that frequency. This test was conducted at six different frequencies in the 80 meter band, and the tracking error was negligible.

In building a receiver following these ideas, it is recommended that a tuning condenser of about 50 micromicrofarads per section be used, as this will give a fairly high C/L ratio and tends to minimize drift. For the same reason, the padder condensers should be of the small zero or negative drift ceramic type. There is room enough inside the coil form shield to mount them, provided about one half inch of the coil form is cut off. A hole can be drilled in the top of the shield for access to the screw.

Another advantage not previously mentioned, is that the dial calibration can be readily reset to the desired end points, even though the i.f. frequency of the receiver may be changed somewhat. This is a decided help in dodging i.f. interference when an i.f. in the vicinity of 1600 kc. is used.

In closing, the author wishes to point out that the formulas given may be used in figuring tank circuit constants for any application where it is desired to cover a given definite range of frequencies, that is, a v.f.o. tank.

-30-

## D.C. Supply (Continued from page 69)

As a matter of fact, the improvement in all of the various characteristics discussed is brought about by one simple circuit addition. It improves stabilization, regulation, internal impedance, and hum.

First, let us look at a fault that is common to many regulated power supplies, excessive starting voltage. If the rectifier and series rheostat tubes heat up quicker than the control tube, the bias on the rheostat tube will be zero momentarily and the power supply will deliver its maximum possible voltage. This may be high enough to cause damage, either to components in the

## LOW-COST CONDENSER TESTER

By JOHN E. LOVETT

IN THE belief that many servicemen are looking for a simple and inexpensive condenser tester, I am passing along details on such a unit. The complete schematic is shown in Fig. 1. The purpose of the unit is primarily that of testing for leaks, opens, and shorts in condensers, but it may be used for the same purpose on resistors, chokes, etc. Also, by insertion of test leads in the proper jacks it is possible to obtain a fairly wide range of variable capacity, resistance, or voltage.

Condensers may be inserted directly in the circuit by placing their negative leads in the neon light jack and their positive terminals in the d.c. jack. If the condenser is good, the neon light will flash (the length of the flash depending on the capacity of the condenser), and then go out. If the condenser is open there will be no flash. If shorted, a continuous glow will indicate this condition. With a leaky condenser, the light will flicker continuously. In the case of condensers of high value, a quicker charge may be obtained by first inserting the condenser from d.c. to ground. The d.c. to ground is variable from 35 to 165 volts by means of R<sub>2</sub>.

An a.c. jack is provided for testing those condensers whose capacity is too low to show a charging flash on the neon light. By placing the positive terminal to the a.c. jack and the negative terminal to the neon light jack a continuous glow will result if the unit is not open, even on low value micas. Low value condensers will show shorts on the d.c. jack. The a.c. to ground is variable from 25 to 110 volts by means of R<sub>1</sub>.

A bell transformer was used for the filament of the rectifier. Its secondary was rated at 10 volts but when it was connected into the circuit its voltage was just about the required value. If the secondary proves to be too high, it may be regulated by means of resistors.

Parts used in this tester are not critical. Volume controls were used to control the voltage but any variable resistance might have been used in their place.

If it is not convenient to place the condenser in the jacks, test leads may be used with clips replacing the regular cord tips. These leads may also be used to place a condenser of any desired value across one in a circuit.

With the line switch in the "off" position and using the test leads, the a.c. and ground jacks furnish a variable resistance from 100 to 500,000 ohms. This is accomplished by variation of control R<sub>1</sub>.

-30-

Fig. 1.

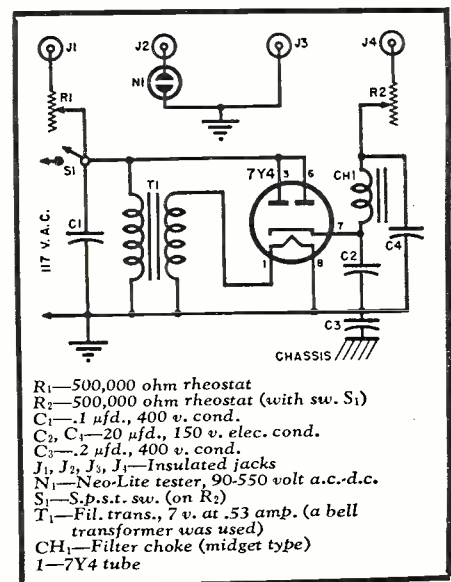

unit to which the supply is connected, or to meters connected into the circuit. A simple means will be shown which provides a time delay during this starting period and eliminates the undesirable starting surge. It is necessary to add that this time delay circuit adversely influences the characteristics discussed previously to a slight degree. This will be reviewed.

#### Circuit Change for Improved Operation

Before showing the circuit change involved, let us take a hasty glance at the conventional regulator, Fig. 2A, representing one version. Here we recognize the rheostat tube, *RT*, in series with the supply and providing the variable voltage drop. It is in effect an electronic rheostat and does the regulating. It does so by virtue of the fact that its bias is supplied by the plate current of the control tube, *CT*. The grid of the control tube is connected into the output circuit and its bias is affected by any changes in output voltage. Thus we have the usual feed-back d.c. amplifier-type voltage regulator whose action is amply covered by the references in the bibliography. Its characteristics regarding stabilization, etc. are in the order of values reviewed above.

A method which has been devised to improve the regulation so that the variations of regulated output voltage may be reduced to zero or even reversed is presented herewith. This is accomplished very simply as shown in Fig. 2B, which adds a potentiometer or resistor in the screen supply circuit. This reinforces the regulating action as described below and reduces the output voltage variations. They can be made negative if the screen voltage adjustment is run up high enough.

Suppose the load current is reduced. The output voltage tends to rise, causing the control tube grid to go in a positive direction. The regulating action carries through to keep the output voltage from rising excessively.

As this occurs, the unregulated input voltage, *E*, does rise, due to the normal regulation of the rectifier and filter. With *RS* in the circuit, the control tube screen voltage goes more positive. Since this is the same direction as the change in control grid voltage, the regulating action is reinforced or made more effective than before. It has been found that the variation in output voltage reduces as the setting of *RS* is advanced, until it runs through zero and finally becomes negative. By this simple means then, the ultimate in regulating action is achieved. In a commercial design it would be adequate to pick two resistors of proper value to accomplish this condition and use them since adjustment of this compensating action would not ordinarily be required.

June, 1948

# A New TELEVISION RECEIVING SYSTEM

## Custom-Designed for Your Area

If you want the finest television reception in a particular area—Boston, New York, Philadelphia, Cleveland, or wherever—you need a Workshop Television Receiving System.

The so-called "broad band" antennas cannot be relied upon to bring in a strong enough signal. The Workshop has been working on this problem for several years, using the finest test equipment and the most modern techniques. At the present stage of the art it appears to be practically impossible to produce a truly high-gain television antenna with consistent performance over the entire television band.

Rather than "compromise," the Workshop has designed a special "receiving system" for each television area, employing a separate high-gain, 3-element antenna for each channel. This means we have a receiving system for Boston, New York, Chicago, etc., engineered specifically to receive the maximum signal from all the stations in the particular area.

### FEATURES

- Separate antenna arrays all mounted on one mast. Universal mounting brackets supplied.
- Each array can be individually oriented to provide maximum signal strength and minimum ghosting.
- Each array is fed with a separate RG-59/U transmission line—reduces noise pickup.
- Each array is a well-matched, 3-element, high-gain antenna.
- New coaxial switch changes from one array to the other.

Please specify the channels in your area.  
Price on request

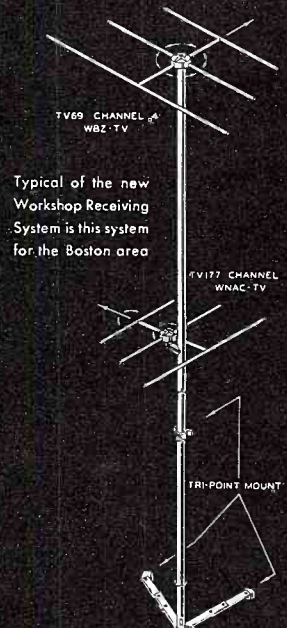

Typical of the new Workshop Receiving System is this system for the Boston area



### COAXIAL SWITCH FOR TELEVISION

This new coaxial switch for RG-59/U coaxial transmission line is designed to be used with the Workshop Television Receiving System. It provides for conveniently switching any one of four antennas to a receiver. In addition, it solves the television sales demonstration problem. By using additional switches, any number of television sets can be demonstrated from one convenient location. RG-59/U connectors available.

Model No. R-4 Four-position switch . . . . . List Price \$15.00

## THE WORKSHOP ASSOCIATES, INC.

Specialists in High-frequency Antennas

62 Needham Street, Newton Highlands 61, Mass.



DESK MODEL

with wire, power supply and instructions. Ready to Hook Up

Special Prices—

3 Phones \$20.50

4 Phones \$25.50

25% deposit required on C.O.D. orders

DUNN-WRIGHT

ELECTRIC CO.

667 6th Avenue

Brooklyn, N. Y.

### TELEPHONES

Now—Deluxe quality telephones incorporating latest improvements in design and technique. No scrap parts—but real honest to goodness first class material and finest workmanship. Lowered costs due to increased volume make possible this special low price of \$14.50 pair of either type shown complete

WALL MODEL



## SURPLUS SAVINGS!

Brand New!

9-Inch CATHODE RAY TUBES

Made by RCA. Type No. 9J1P1/1809/P1

Postpaid anywhere in U.S.A., Each . . . . . \$2.95

Guaranteed New!

"GIBSON GIRL" TRANSMITTERS (SCR 578)

Complete with all accessories—balloons, kite, parachute, Hydrogen generators, instruction book and carrying case. Prepaid by insured carrier anywhere in U.S.A.

Only . . . . . \$24.95

Send Check Or Money Order—No C.O.D.

E. M. JOHNSON COMPANY

Distributors, Radio Electronic Products

W. 615 First Ave. Spokane 8, Wash.

(Reference, Wash. Trust Bank)

## ARE YOU CONFUSED?

LET US SET YOU STRAIGHT

Cross-reference tube list—Army VT Numbers to commercial types. Price .....\$50  
Schematic diagrams for SCR274N; ART-13; BC375; BC191; BC221B, J, O, or R; BC343C; SCR269G; SCR522; BC721 Handi-Talkie; R19A/TRC-1; T14A/TRC-1; RT7/APN-1; ARB-1; RA34; BC611 Handi-Talkie; BC12N or NX; BC324N; BC314G; BC344D; BC659; BC603; BC604. Each.....\$1.00



### MIDGET HEADSET

Hearing aid type HS30. Wt. ea. unit only 3/4 oz., total wt. 6 oz. Imped. 250 ohms. diam. 7/8". Fine for miniature radios, crystal sets, all around use. Can be used as low-imped. mike. Complete with headband, rubber ear plugs and shirt clip. BRAND NEW, orig. boxes. Gov't cost \$5.

YOUR COST.....2 Sets \$1.00

Please add postage for 3 lbs. Discounts in larger quantities.

CRYSTALS. 6t FT-243 holder or octal socket; any freq. 5675 to 8650 kc (except 7025 & 7050) in steps of 25 Kc; 6 for \$5; each.....\$1.00  
COMPLETE SET of 120 xtals covering 5675 to 8650 kc in metal cabinet.....\$5.00  
ALSO: 3010, 3465, 3525, 3735, 3825, 3980, 3995, 5500, 5500 or 6335 kc, choice.....1.00  
CRYSTAL STANDARDS: 400kc, 450kc or 455.536kc.....1.95  
500,000kc.....2.50  
Get our free list for other freqs. priced at......49

### HERE'S YOUR 2-METER RIG AND RECEIVER!!

RT-19/ARC-4, 140 to 144 mc; 4 xtal controlled channels. Super-hot receiver has 13 tubes, xmitter has 7 tubes including 4 6L6's, 832A final. With all tubes, xtals, shock mount, dynamotor, control box, diagram, orig. crates.  
BRAND NEW.....\$24.95

### TRANSFORMER BARGAINS



B, 4v @ 16a. 2.5v. @ 1.75a.....\$1.88  
C, Scope 4000 vrms @ 10 ma.....\$3.65  
D, Power, 315 VDC 85 ma; 5v 3a, 6.3v 2.1a No. 1159.....\$2.15  
E, Power, 250 VDC 150 ma., 5v 3a, 6.3 5a. No. 1138 similar to "D".....\$2.65  
CHOKES, 5h 225 ma 112 ohms GE, slick.....\$1.95

### PRECISION METER



0 to 10 amps DC W'house PX-14 mirror scale.....\$10.95

### VARIABLE MIDGET

215 mmf double-bearing in shield can 1 1/4" dia. mica shaft, as used in BC-312, BC-342, etc. \$1.25

### POTENTIOMETER

500 ohm lin. WW, 1/4" shaft, 10 for.....\$2.00

### WRITE FOR FREE LIST

Postage extra. Minimum order \$2.00  
TERMS: Net Cash, 25% deposit on C.O.D.'s

## ELECTRONIC SUPPLIES

Stores in Tulsa, Okla. and Oakland, Calif.  
317-R East 2nd St. Tulsa 3, Oklahoma

### THESE SPECIALS CAN'T BE BEAT

UHF S36 27.8 to 143 meg. FM-AM 16 tube Wew.....\$149.00  
Capacitor 5000 VDC 5 MFD Cornell PFD 502-40.....\$30.00  
Capacitor 10000 VDC 4 MFD Cornell TK 10040.....\$70.00  
8 MFD 1000 VDC oil filled Cond.....\$1.65  
2 MFD 2000 VDC oil filled Cond.....\$1.95  
Test set 1-236 for AC DC Capacity Res. Spec.....\$2.95  
Amplifier BC908-B 12 tube facsimile new special.....\$15.50  
Meters RF 0-1 Simpson 0-3 Hickok 0-5 Westinghouse 0-8 Simpson all new your choice.....\$1.95  
Weston mod. 663 incase new cost \$65, our price used \$25.00  
Weston mod. 289 DC volts 0-15 0-150 DC Ambs 0-3 0-15 0-30 in leather carrying case like new.....\$14.95  
Headset Murdoch H1 imp. for 631 mil. print new.....\$2.65  
Keys 138 a rt1 buy heavy duty slightly used.....\$3.65  
Telephones E8 in leather case like new W/Bat.....\$7.75  
RA20 Pwr. sup. W/tube 110 VAC for BC348-312, etc. \$8.50  
Electronic Converter mod 502 12V DC to 110 VAC heavy duty 100 Watt new.....\$10.95  
TS 9 Q handset push to talk 6 FT. cord new.....\$2.25  
Transformer Hadley 6890 3x2 1/2 450 VCT 50 MIL Fil. 0.3 2 Amp. Fil. 5 V 2 Amp. leads color coded 117 V Pri. New.....\$2.25  
Choke T13C30 8 henry 150 mil. Reg. price \$2.90 Spec. \$1.25  
Condensers Paper Micas Electrolytics .1 .05 .25 .5 .002 .004 .005 .006, etc. once in a life time bargain 25 for \$1.50; 50 for \$2.35; 100 for \$4.00.  
Transmitting tubes 853A \$29.50, 450H \$24.50, 814 \$3.95, 813 \$5.85, 809 \$1.50, 807 \$1.20, 872 \$1.95, 865 \$1.00, 838 \$2.75, 803 \$6.95, 211 \$1.25, 2 inch RCA scope tube \$2.95, all new Battery BA38 103 1/2 volts DC for handie talkie mine det., etc., good stock and packed to keep special.....\$1.35

POSTAGE REQUIRED WITH EACH ORDER

### McCONNELL'S

3834 Germantown Ave., Philadelphia, Penna.  
RA 5-6033

Since the internal impedance of the supply is determined by dividing the voltage variation by the value of current variation which produces it, it follows then that by the addition of the compensating action described above with its attendant reduction in output voltage variations, the output impedance of the supply is correspondingly reduced. With the proper degree of compensation, the impedance is reduced to zero and may be made negative if desired.

Since the output impedance is a characteristic that may appear to have more significance in some applications than that of voltage variations, it may be well to emphasize the fact that it may thus be reduced to zero.

This arrangement also reinforces the regulating action with respect to changes of supply voltage. An increase in supply voltage tends to increase the regulated output voltage and causes the grid of the control tube to go in a positive direction. Since at the same time this increase in supply voltage causes the screen voltage to move in a positive direction, it reinforces the regulating action and the variations in output voltage may be reduced to zero by proper setting of RS.

Since hum voltages in the source may be regarded as equivalent to the existence of variations in supply voltage, the analysis of the previous paragraph may be used to show that hum in the output may be reduced to zero. It is apparent that the setting of RS that provides constant output voltage when supply voltage varies will also cancel out all hum voltages, since they are equivalent.

It should be pointed out that zero variation of output voltage with respect to load current changes will be obtained with one setting of RS whereas zero variation with respect to supply voltage changes may require another. The setting therefore would be made to satisfy the requirement. If both are desirable, the regulation of the source, E, will have to be made of proper value to bring these two settings together.

For example, assume as one extreme case that the source has very good regulation. If so, changes in load current would change E very little, and RS would have to be set high to get zero regulation in the output. Under that condition, however, the system would be highly overcompensated for supply voltage variations, since they would then affect the screen voltage a great deal. If, on the other hand, the regulation of E is very poor, changes of load current would produce large changes in E and RS would have to be set very low. The system would then be undercompensated for changes in supply voltage. A proper value of regulation in E then would enable the choice of one setting of RS or the use of fixed resistors to

accomplish perfect regulation for changes either of load current or supply voltage.

This reinforcing action may be secured by using other grids in the same general manner and will not be enlarged upon. Also, if desired, an arrangement may be used to keep the d.c. screen voltage constant on the control-tube as RS is varied. This would not ordinarily be needed and is not shown, since the usual variation will not be great enough to appreciably alter the operation of the system. The screen could readily be kept at constant d.c. potential however by connecting it in a variable divider which could be coupled to RS mechanically, such as a dual potentiometer, to drop the voltage as RS raises it. Any similar compensating arrangement will be equally effective.

### Typical Performance

A model power supply was constructed for use in a piece of special test equipment, shown in Fig. 1. The power supply is the lowest of the three panels. A voltmeter is shown at one side and the output voltage adjusting potentiometer appears immediately below it. The load milliammeter appears at the other side and its "Push to Read" unshorting switch appears below it. Other views of the power supply appear in Figs. 4 and 6, and the layout of parts and simplicity of arrangement are clearly shown. The added compensating potentiometer may be seen. Fig. 3 shows the schematic.

This power supply is rated 100 ma. at 200 to 350 volts d.c. The following performance is obtained:

1. *Stabilization:* The output was adjusted to 270 volts and was then connected through an 0-2-1/2 volt d.c. voltmeter to 270 volts of "B" batteries. By

Fig. 5. Time delay circuit RdCd has been added to the regulator shown in Fig. 3.

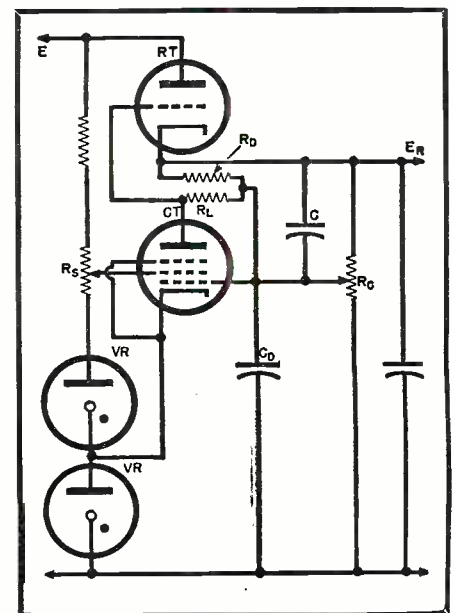



this means, a 2-1/2 volt change in output voltage would give full scale reading on the meter. The primary voltage was set at 120 volts, then the output voltage change was checked when the primary voltage was dropped to 110 volts. This was done first with no compensation (screen potentiometer set at zero), then repeated with different settings. See Table 1, "Stabilization".

The first figures given (Output Voltage Change) are the result of slow changes in primary voltage. The second row are transient changes that occur in the output when the primary voltage is dropped suddenly. Within a few seconds the voltage reaches the value given in the upper row and therefore is the same as for slow changes.

The cause of this transient condition is the time delay circuit, shown in Fig. 5. This circuit is explained in a later section. A study of the circuit will reveal that the changes in primary voltage change the plate current in the control tube. The bias on the rheostat tube, *RT*, then tends to drift while the voltage on the delay condenser, *CD*, reaches its new operating level. Thus it is impossible to set the compensating potentiometer to reduce both the steady state and transient changes in output voltage to zero.

By disconnecting *CD*, the transient condition disappears. The quick changes in primary voltage then produce precisely the same changes in output voltage as slow changes do and, at mid-range on the compensating potentiometer, the stabilization is made perfect as measured in the manner described. Thus, where perfect stabilization is the prime requirement, the time-delay circuit is not used.

2. *Regulation*: The same setup was used as before. For this test the load was increased from 50 to 75 millamperes with different degrees of adjustment on the compensating potentiometer. The performance data is given in Table 1, "Regulation".

These measurements indicate that perfect regulation is obtained with a compensating potentiometer setting of about 3/4 of maximum. With the delay circuit in use, we note that the same effect takes place as in the case of stabilization transients as explained above. Where time-delay is not needed, the time delay circuit may therefore be omitted and no transient will appear.

Whereas perfect stabilization occurs with 1/2 maximum setting of the potentiometer, we observe that 3/4 maximum setting is required in this particular power supply for perfect regulation. As pointed out previously, these two points may be brought together by choice of proper regulation in the rectifier-filter circuit. Since more compensation seems to be needed for regulation (3/4) than

# make henry your hallicrafters headquarters

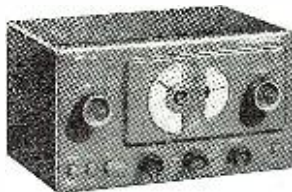

**S-38** Biggest little buy on the market. Frequency range: 540 kc to 32 Mc in 4 bands. Self-contained PM dynamic speaker. . . . . **\$47.50**

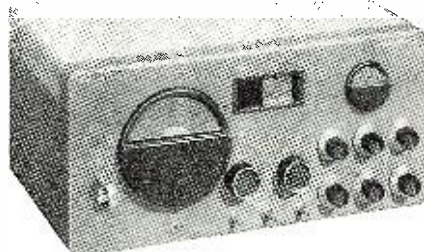

**SX-43** All essential ham frequencies from 540 kc to 108 Mc. In the band of 44 to 55 Mc, wide band FM or narrow band AM, just right for narrow band FM reception is provided. **\$169.50**

**COMPLETE STOCKS . . .** Henry has everything in the ham field.

**QUICK DELIVERY . . .** Shipments 4 hours after receipt of order.

**EASY TERMS . . .** I have the World's Best Terms because I finance the terms myself and cooperate with you. I save you time and money. Write for details.

**TEN DAY FREE TRIAL . . .** Try any receiver ten days. Return it for full refund if not satisfied.

**FREE NINETY DAY SERVICE . . .** I service everything I sell free for 90 days. At a reasonable price after 90 days.

**TRADE-INS . . .** Trade-ins solicited. Big allowances made. Other jobbers say we allow too much. Write, wire, or phone. Tell me what you want and what you have to trade.

BUTLER MISSOURI **HENRY RADIO STORES** 11240 Olympic Blvd. LOS ANGELES 25 CALIF.  
"World's Largest Distributor of Short Wave Receivers"

## HAM RECEIVER BARGAIN

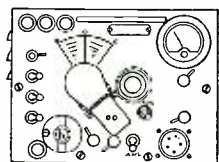

A really hot Ham Receiver. Brand new. Covers from 550 KC to 42 MC. Has crystal filter. Equivalent to the Hallicrafters SX28A. Built for the Army and Navy.

Size: 18"x8"x11" approx. For 24V DC operation but can be easily converted to 115V AC. Complete but less speaker and power supply. Has "S" meter, ANL, AVC on-off, 3 IF and 3 Xtal positions, 6 bands, Xtal phasing, Vol. Control, BFO on-off & pitch, RF gain, phone & speaker connections. R-45/ARR7 Receiver. **\$99.50**  
Brand New, FOB Denver. . . . .  
**RADIO PRODUCTS SALES CO.**  
1237—16th St. Denver 2, Colo.

## JUST CRYSTALS RELEASED

**NAVY STANDARD QUARTZ CRYSTALS**  
1000 KC ± 10 Cycles!!!

Brand New—Gov't Inspected. In original Gov't sealed boxes. Made by Bendix. AT-Cut. Only .0001%/Deg C Temperature Coefficient. Sealed in actual base metal tube envelope filled with inert gas. Used in Bendix-built Navy crystal frequency meters. Can be used also in Signal Corps BC221/SCR211 meter.

WHILE THEY LAST . . . ONLY **\$750**  
Please add 50c Shipping Charges

**AR-JAY PRODUCTS CO.**  
44 COURT STREET, BROOKLYN, N. Y.

# SUMMER SPECIALS

## PORTABLE PHONOGRAPH

Has three tube Amplifier, Tone and Volume controls, 5" Alnico P.M. Speaker, lightweight crystal pickup, Self-starting Phono-motor. A.C. operation only. Handsome luggage style carrying case. Complete, ready to operate. ONLY \$19.95  
KIT FORM .....\$17.95



## WIRELESS PHONOGRAPH

Can be used to convert any standard radio into a phonograph. No wires or connections to the radio are necessary. Just plug the phonograph into any A.C. socket and play your choice of records through any radio in your home by Wireless! Complete unit ready to operate (A.C.) ONLY.....\$15.95  
KIT FORM (A.C.) .....\$13.95



## RECORD CHANGERS

V.M.-2 Post Mixer Changer. Intermixes 10" and 12" records .....\$14.95  
Detrola Record Changer (Single Post).....\$13.95  
Milwaukee Record Changer (Single Post).....\$16.95  
G.I. Record Changer (Single Post).....\$16.95  
Maguire-2 Post Record Changer (automatic shutoff) \$11.95

## PHONO AMPLIFIER KIT

Three tube A.C.-D.C. phono-amplifier with Tone and Volume Controls. Can be used in portable and table model phonographs, Intercoms and call systems.  
KIT FORM .....\$2.35  
Wired and tested.....\$2.85  
Set of three tubes for above .....\$1.75



## PHONO OSCILLATOR

Uses two tubes and can be tuned to a clear channel on your receiver. Enables your record player to play through your radio without connecting wires. Complete ready to operate, with two tubes.....\$4.95  
5" Alnico P.M. Speaker with transformer.....\$1.95  
Astatic or Shure Crystal Pickup.....\$1.95  
Self-starting Phono-motor with 9" TT.....\$3.25  
Kit of 100 assorted resistors .....\$1.50

## TUBES ... TUBES

6K6GT	12SJ7GT	\$ .49 each
6K3GT	12SK7GT	
6V6GT	12SA7GT	10% Discount in
6SA7GT	12SQ7GT	lots of 50 or more
6SJ7GT	35L6GT	5% Discount in
6SK7GT	35Z5GT	lots of 10 to 50
6SQ7GT	50L6GT	

WRITE FOR FREE CATALOG  
ALL PRICES F.O.B. N. Y.  
25% Deposit on C.O.D. Orders  
Order direct from this ad.

**RAYTONE ELECTRONIC COMPANY**

25A Frankfort St. New York 7, N. Y.

## NOW AVAILABLE!

Amplifier for GE pickup

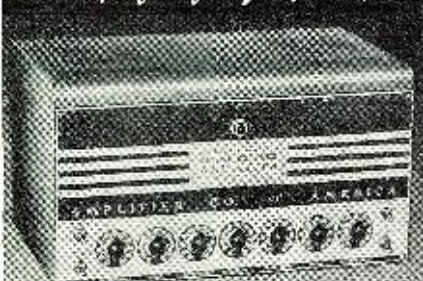

New circuits for the first time enable you to attain full benefit from the new General Electric Model DL 1RM 6C Variable Reluctance Magnetic pickup. Employs an exclusive, humless (DC on heaters) pre-equalized pre-amplifier to produce the most satisfying musical amplifier the world has ever known. If you are a perfectionist, you are the one for whom the ACA-100GE was designed. Send for technical literature.

**AMPLIFIER CORP. of AMERICA**

398-2 Broadway, New York 13, N. Y.

for stabilization (1/2), we know that increasing the voltage variation out of the filter as load is changed, which is the regulation of the rectifier-filter, will permit compensation with a lesser setting of the potentiometer. Therefore, a little poorer regulation in the rectifier-filter will bring the two settings together and permit perfect stabilization and regulation at the same setting. If necessary, a resistor may be added in the circuit to do this, and it would be placed in the rectifier-filter circuit at any convenient point.

3. *Internal Impedance:* Since the internal impedance may be calculated from the data taken on regulation, this has been done and appears in Table 1, "Internal Impedance."

A question is likely to be raised concerning the effects of using a power supply with a negative internal impedance, the fear being that motorboating or oscillation may be set up due to it. In general, it may be stated therefore that instability due to negative power supply impedance will occur only when such negative impedance is higher than the positive impedance of any load connected to it.

4. *Jitter:* Most power lines, and particularly those in industrial areas where much of our laboratory work is done, suffer from transient conditions, where the voltage jumps sharply for a few cycles from time to time. This is ironed out in the output of the regulated power supply, as in any other primary voltage variation. It is possible to make a very sensitive measurement of jitter however with a vacuum tube voltmeter since it is a transient or a.c. variation. Very sensitive vacuum tube voltmeters are in common use and these may be used. A typical measurement on the supply under consideration is as follows: Average

jitter with no compensation—20 millivolts; Average jitter with best compensation—less than 1 millivolt.

5. *Hum:* Since hum in the output is equivalent to voltage variations in the output due to input voltage (to the regulator) variations, it is reduced in like manner, as follows: Hum with no compensation—4 millivolts; Hum with best compensation—less than 0.2 millivolts.

When a regulated power supply is first turned on, the rectifier and rheostat tubes may heat up faster than the control-tube. The rheostat tube will then have zero bias, since the control-tube is not yet drawing plate current, and the regulated output will rise to its maximum attainable value. In general, this is undesirable and it may be dangerous, since regulated supplies involve rather large voltages to take care of the usual voltage drop across the rheostat tube. If the output voltage desired is rather low, the high initial d.c. may be dangerous to the equipment connected to it.

This starting surge, which will last from the time the rheostat tube begins to conduct until the control-tube has heated up, can readily be eliminated by adding the *RD-CD* delay combination shown in Fig. 5. Inspection of this circuit will show that the condenser, *CD*, holds the grid of *RT* near ground potential when the rheostat tube first begins to conduct. This puts a high bias on it and limits its initial plate current to a minute value. Of course this small current will permit *ER* to build up slowly and it will be found that the rheostat tube "lifts itself by its bootstraps," since *CD* charges up slowly and limits the speed of the rise by holding high bias on the tube. It is necessary to use an *RC* product of only one or two to get a long delay for this reason. One megohm and one microfarad will permit the output

Fig. 6. Under chassis view of power supply unit shown in Figs. 1 and 4.

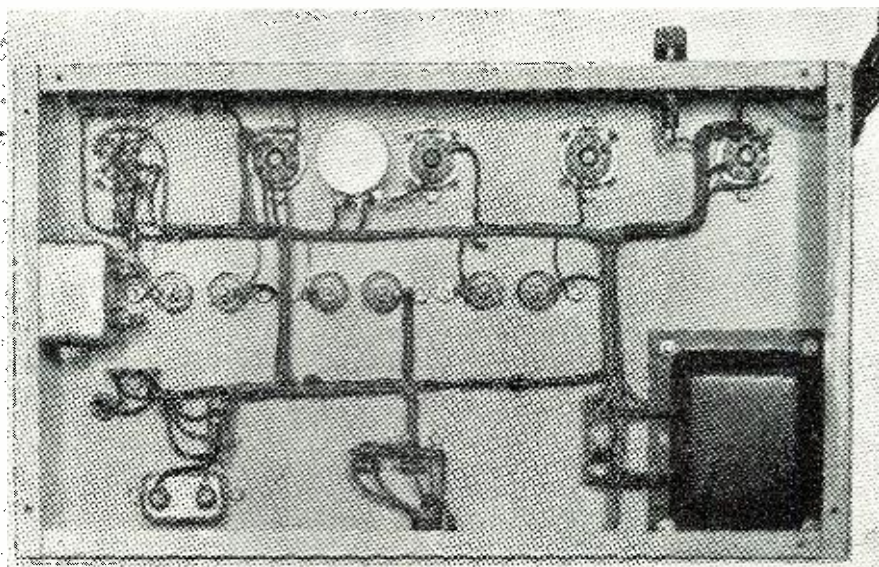

voltage to rise to half its normal maximum after a time interval of several seconds.

These values are probably sufficient for any case where the rheostat tube is indirectly heated and will not be conducting more than just a few seconds before the control-tube takes over control. If, however, the rheostat tube is a quick or direct filament type, the constants may be readily increased to provide somewhat longer time delay.

1. The regulation, stabilization, jitter, and hum reduction of a conventional regulated d.c. power supply may be made virtually perfect and the internal impedance reduced to zero by the simple change of adding a small amount of unregulated voltage to a grid of the control-tube. This requires only a potentiometer.

2. By combination of the above with a proper degree of variation of unregulated supply voltage with respect to load, the variation of regulated output may be made virtually zero both for changes of load current and supply voltage with the same setting of the potentiometer, or a resistor may be used.

3. By the addition of a condenser-resistor combination to the conventional supply, a starting time-delay is furnished to limit the speed of build up of the output voltage, thereby avoiding the high output voltage that can result with a quick heating rheostat tube and without some such protective device.

#### BIBLIOGRAPHY

- Abate, Anthony: "Basic Theory and Design of Regulated Power Supplies," *Proceedings of the I.R.E.*, Vol. 33, No. 7, Page 478, July, 1945
- Bereskin, Alexander B.: "Voltage Regulated Power Supplies," *Proceedings of the I.R.E.*, Vol. 31, No. 2, Page 47, February, 1943
- Hamilton and Maiman: "Voltage-Regulated Power Supplies," *Communications*, Vol. 25, Nos. 11 and 12, and Vol. 26, No. 1, November and December, 1945 and January, 1946
- Hill, W.R.: "Analysis of Voltage Regulator Operation," *Proceedings of the I.R.E.*, Vol. 33, No. 1, Page 38, January, 1945
- Hunt, F.V. and Hickman, R.W.: "On Electronic Voltage Stabilizers," *Review of Scientific Instruments*, Vol. 10, No. 1, Page 6, January, 1939
- Kay, M.S.: "Electronically-Regulated Power Supplies," *RADIO NEWS*, Vol. 32, No. 5, Page 38, November, 1944
- Maunter, Leonard: "Voltage-Regulated Power Supplies," *Electrical Engineering*, Vol. 66, No. 9, Page 894, September, 1947
- Terman, F.E.: "Voltage-Regulating Systems," *Radio Engineer's Handbook*, First Edition, Page 614.

## NO ONE IS "ABLE" TO BEAT "ABELL" SURPLUS VALUES

ORDER BY MAIL

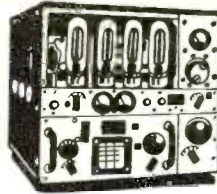

### 100 WATT TRANSMITTER

Self-contained oscillator, modulator, and P. A. Uses 4-211's and 1-10. 3-2 1/2" Meters. Requires 1000 V Plate at 350 MA and 24V A power. Or take apart for top quality transmitter parts. Less tubes and tuning unit \$13.95 With Tubes and Tuning Unit, as illustrated ... \$18.95

### ASBESTOS



**GLOVES \$1.49**  
Welders, fire fighters, etc. Can use this excellent heat proof glove.

### U. S. ARMY FLASHLIGHTS

All plastic case. Regular Army style. Low beam. 2 cell. Clip for attaching to belt. Sturdy construction for rugged use. Ideal for motorists ... sportsmen ... and handy use around home.



### Rotary Beam Gear Box

Gear train, motor mounts, enclosed in a waterproof housing. Excellent for use in constructing your new beam. Brass gears, bearings, useful hardware. Plenty of room for motor, selsyn and controls. 11 1/2 x 14 x 9". Two waterproof junction boxes also included. NEW, ridiculously low. \$7.95 All prices subject to change without notice.

Linesmen's Safety Belt and Strap, State Size ... \$5.75  
Pole Climbers and straps ... 4.50

### 7 Conductor Cable #14 Stranded

600 V insulation. Heavy duty RC. 65 feet long. Russell-Stoll plug #3880 each end. 7/8" OD. \$4.95



Almost every type of Cable used by Signal Corps in stock. 1 to 100 Conductors. Send for flyers.



### 6 VOLT DYNAMOTOR \$24.95

600 V DC @ 150 MA output. 5.6 V @ 28 Amp. input. Size 6" L by 5" D. Not an oversize brute. Ideal for the mobile rig in cars or boats. Pioneer Genemotor. 13" high Tripod. 3" Phenolic legs. Ball bearing rotating head; takes 2" shaft. Light weight, strong antenna support \$24.95

### MINE DETECTOR

SCR-625 Mine Detector ideal for locating buried metal, pipes, treasure, metallic fragments. Approximate depth of detection 6 feet, depending upon soil conditions. Supplied with batteries and tubes. Tested before shipment. Shipping weight, 70 lbs. \$49.50



### TEST CLIPS

for 98c 20 Insulation



Piercing. Shank threaded for 6/32 screw. also 6/32 thumb screw.

BARGAIN PRICES ON GAS ENGINE POWER PLANTS 110 V 60 cycle and D.C. 350 watts to 25 KW. Write for full particulars. 600 watt power unit, 110 V, 60 cycles. Reconditioned \$179.

### TELEPHONES (CRADLE DESK SETS)



Ea. \$7.95 Pr. \$15.49

Includes handset, ringer and stand. Regular 2 wire phone. Get a pair for garage, home, farm, etc. Gibson Girl, 500 KC Xmitter—hand cranked. Complete with parachute, balloons and generators, kite, kite, spare wire and manual. New ... \$24.95

### TYPEWRITERS

Standard, L. C. Smith, Remington, Underwood, Pica and elite type. Standard and Signal Corps Keyboard. Reconditioned. Satisfaction guaranteed.

\$59.50

MAST SECTIONS 5 1/2 ft. x 1 1/4" alloy tubing. 6" sleeves. Can be nested for long lengths. \$1.95

### SOUND POWERED HANDSET

No batteries required. \$12.95

MICROPHONE T-32 Desk Stand with press to talk switch and cords. NEW. \$2.95

SCR 284 CONNECTING CABLE 7 Cond with connectors, for use between PE 103 and BC 654. \$1.95

### Write Our Ham Department

Lou Bremer W3LE in charge. Nationally known DX'er and Winner 1939 DX Marathon (Phone Section).

Satisfaction guaranteed. Order By Mail. We ship C.O.D. Order today.

**ABELL**  
Distributing Company  
5 E. BIDDLE ST.—BALTIMORE 2, MD.

DEPT. No. 6



## RADIO COURSES

Preparatory, Broadcast, Marine Operating, Servicing, Aeronautical, Television, Frequency Modulation, Radar.

Classes now forming for June 1st. Entrance Exam. May 17th.

Veteran Training. Literature.

### COMMERCIAL RADIO INSTITUTE

(Founded 1920)  
38 W. Biddle St. Baltimore 1, Md.

## BRAND NEW!

Delco Constant Speed Motor Type 5069625, 120 R.P.M. Has built in reduction gearing and governor. Operates on 27 volts AC or DC. Size—over-all length 4 1/2" by 1 3/8" in diameter. Weight 7.5 ounces. Price \$4.25 each net.

### INSTRUMENT ASSOCIATES

40-37 172nd St. Flushing 7, N. Y.  
Note our new address! Phone—FL 7-8718

# RISCO HAS IT

DO YOU HAVE  
IN YOUR TELE-SET

# GHOSTS

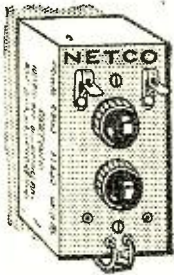

Trap it out with a NETCO Television Eliminator  
Guaranteed to eliminate FM, Amateur and all external interference in entire television spectrum (by absorbing the signals) as described in March issue pp 70. Complete! Ready to install. No soldering. Knob adjustment. From 40-120 Kc range. Instructions incl. Lists for \$10. your price \$6. Sent prepaid anywhere in U. S. A. Order yours today.

## V. M. All Changers Brand New MIXER CHANGER

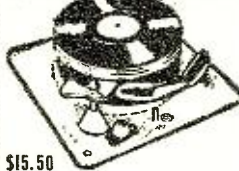

\$15.50

PLAYS 10" and 12" records at the same time \$15.50  
VM 400—\$28 prepaid  
DETROLA...\$13.75

**G. I. RECORDERS**  
Single Speed \$22  
Dual Speed \$26  
40% off on  
Recordist Recording  
Blanks.

Above Easily Attached to Any Radio  
OR CAN BE USED WITH AMPLIFIER BELOW  
ALLIANCE PHONO MOTORS 2.50  
ASTATIC L-70 or SHURE GLIDER PICKUPS 1.79

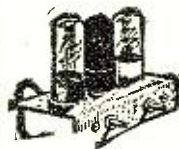

**PHONO AMPLIFIER**  
3 TUBE AC-DC  
Vol. & Tone Control \$2.75  
Uses 12SQ7, 50L6, 35Z5.  
Wired & Tested  
Set of 3 Tubes \$1.95  
Output Trans. .39  
5" Alnico Spk. 1.19

**PHONO OSC-2-TUBE**  
Wired & Tested \$2.75  
2 Tubes—\$1.20

25% on C.O.D. orders. Orders Filled as Received  
VISIT OUR NEW SHOW ROOM

Free Catalog "R6" Just Out  
We Specialize in Mail Orders

**RISCO ELECTRONICS**  
WHOLESALE DISTRIBUTORS

25 West Broadway, N. Y. 7, N. Y.

## STOP FUMBLING!

New radio special **QUICK-WEDGE SCREW-HOLDING SCREWDRIVER** HOLDS the screw, **REACHES** those impossible places, **STARTS** it and **DRIVES** it home!

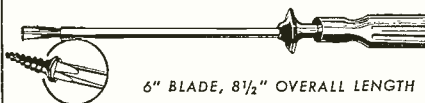

6" BLADE, 8 1/2" OVERALL LENGTH

—DOUBLE BLADE FOR EXTRA STRENGTH! BUY AT YOUR DEALER'S OR WE WILL SHIP POSTPAID UPON RECEIPT OF \$1.00.

**KEDMAN COMPANY**  
233 SO. 5TH WEST, SALT LAKE CITY 1, UTAH  
ENCLOSED FIND \$1.00—SEND ME A QUICK-WEDGE "RADIO SPECIAL" SCREWDRIVER.

NAME \_\_\_\_\_

ADDRESS \_\_\_\_\_

CITY \_\_\_\_\_

STATE \_\_\_\_\_

RN6

## TELEVISION COIL KIT

**\$2350**

Complete  
**LOOK AT THESE FEATURES!**

- Video IF Bandwidth of 4.25 MC that can operate ANY size picture tube with maximum resolution.
- Five stages Video IF permeability tuned with sound and adjacent channel rejection traps in shielded cans.
- 6 Channel RF Tuner, permeability tuned mounted on switch assembly plate.
- FM Sound Discriminator for TRUE FM.
- Detailed Construction Manual & Parts List with every kit, for 20 Tube, 7 In. Television Set.

Order Direct or Thru Local Dealer—Terms  
Shipped Parcel Post prepaid with order, or P.P. Collect on receipt of 25% deposit, balance C.O.D.

**RAY-LECTRON CO.**

706 Tenth Avenue  
180

Belmar, N. J.

# Manufacturers' Literature

## ELECTRONIC COMPONENTS

*Hugh H. Eby, Incorporated*, has announced publication of a new looseleaf catalogue covering the company's complete line of components for the electronic and electrical industries.

Printed in two colors, the 48-page catalogue contains drawings showing all pertinent dimensions of sockets, plugs, connectors, jacks, terminal strips, and a wide variety of binding posts in many models and sizes.

Of special interest are the new sockets for use with harmonic high frequency crystals, which are adapted to small-space requirements such as portable telephone and mobile radio equipment.

The catalogue is designed to have additional sheets inserted from time to time to keep it up to date. A copy of the publication may be secured by writing *Hugh H. Eby, Incorporated*, 4770 Stenton Avenue, Philadelphia, Pa.

## SOUND EQUIPMENT

An illustrated catalogue showing the newest sound equipment for custom-set builders, broadcast stations, recording studios, and high-fidelity enthusiasts is available from *Terminal Radio Corporation* of New York.

The new sound catalogue includes amplifiers, tuners, speakers, cabinets, record changers, pickups, phono cartridges, recorders, microphones, and sound accessories.

A copy of this catalogue may be secured free of charge from *Terminal Radio Corporation*, 85 Cortlandt Street, New York 7, New York.

## IDENTIFICATION BADGES

*Bud Radio, Inc.*, of Cleveland, Ohio, manufacturers of radio and electronic parts, is offering free identification badges to all members of radio clubs.

The purpose of the badges is to promote better fellowship among radio amateurs. These badges can be used at all club meetings, hamfests, and conventions.

The badge is 2 1/2 inches in diameter and is of metal and plastic. The colors are yellow and blue with call letters and name of each member of the club imprinted.

Complete information on these badges is available from local *Bud* distributors.

## SERVICE MANUAL

An up-to-the-minute compilation of all standard type radios in current use is offered in the new, 7th Edition *Clarostat* Service Manual just off the press.

The 127-page book carries information as to the set manufacturer and model number, the original part number, *Clarostat* type designation, shaft, total resistance value, how used, and special notes.

Copies of the manual are 50 cents each and may be obtained either through *Clarostat* distributors or direct from *Clarostat Mfg. Co., Inc.*, 130 Clinton Street, Brooklyn 2, New York.

## TECHNICAL BOOKS

Of interest to persons in scientific or technical fields, *Chemical Publishing Co., Inc.* is now offering a new 1948 catalogue covering technical books published by the firm.

The catalogue includes the latest books on chemistry, physics, science, technology, petroleum, engineering, metals, technical dictionaries, etc.

Conforming with the request of technical and scientific workers and librarians, the new catalogue gives the date of publication of each book as well as price, number of pages, detailed descriptions, and full table of contents.

Copies of the catalogue may be secured by writing *Chemical Publishing Co., Inc.*, 26 Court Street, Brooklyn 2, New York.

## INTERMODULATION MEASURING

Copies of *Western Electric Company's* new publication "Intermodulation Measuring Set" are now available to interested persons.

This six-page booklet discusses intermodulation, the importance of intermodulation measurement, the measurement of variable density sound tracks, and then goes on to describe the operation of the *W.E.* intermodulation measuring set. The set consists of two units, the RA-1258 signal generator and the RA-1257 analyzer. Each unit is described in some detail.

Requests for this folder should be addressed to *Electrical Research Products Division, Western Electric Company*, 233 Broadway, New York 7, New York.

## "RCA RECEIVING TUBES"

A newly revised and expanded edition of the publication "RCA Receiving Tubes for Television, FM, and Standard Broadcast" has been announced by the *Tube Department of Radio Corporation of America*.

Designed as a quick-reference aid to radio dealers, servicemen, and other tube users, the new edition includes data on the latest receiving tube types and kinescopes.

RADIO NEWS

The first pages of the booklet contain a receiving tube classification chart which groups tubes according to function and cathode voltages. All tubes announced up to the time of publication have been included in the chart.

A second section of the booklet presents the characteristics chart with tubes listed in numerical-alphabetical sequence of type designations.

The new edition, priced at 10 cents, is available from *RCA Tube Distributors* or from the *Commercial Engineering Section, Tube Department, Radio Corporation of America, Harrison, New Jersey.*

—50—

### Modulation Percentage

(Continued from page 52)

obtain modulation patterns. The .5 mfd. condenser must be mounted as close as possible to the plate terminal of the last i.f. tube socket and connected by means of a short length of shielded hookup wire to a coaxial cable connector at the rear of the receiver chassis. A length of flexible coaxial cable is plugged into this connector and is hooked at its other end to the "high" horizontal input terminal of the oscilloscope. The outer shield of the cable is connected to the "low" (ground) horizontal input terminal. A 50,000 ohm, 1 watt carbon resistor is connected by the shortest path between the "high" horizontal and vertical input terminals. The oscilloscope amplifiers must not be used, since in general they will not pass the high radio frequencies. Employ the "DIRECT" input, and switch off the linear sweep oscillator.

The stray capacitances introduced by these connections will disturb the receiver circuit somewhat, so that it may be necessary to realign the last i. f. trimmers after the connections have been completed. By employing coaxial cable, as shown in Fig. 2, the external capacitances are kept constant. If an individual operator does not care to install the coaxial connector, he may run the coaxial cable, through a hole in the rear of the receiver chassis, directly to the coupling condenser. However, this arrangement will not permit easy disconnection when desired.

To insure that alignment is preserved in the last i.f. stage when the cable and oscilloscope are disconnected from the receiver, a plug may be prepared as a substitute for the cable and oscilloscope capacitance and resistance. This plug is inserted into the coaxial chassis connector whenever the cable is removed. Such a plug is shown in Fig. 2. The capacitance of condenser *C* must equal the total capacitance of the cable and oscilloscope input circuit, and the resistance *R* must be equal to the internal resistance between the horizontal de-

June, 1948

# SURPLUS CLEARANCE

## KITS

- **FILTER CONDENSER ASSORTMENT**  
Electrolytics, paper, oil, etc., 100 to 1,000 V. DC. Assorted capacities. New...10 for \$2.69
- **BATHTUB CONDENSER KIT**  
.05 to 2 mfd. 200 to 600 W. DC. A Super Value! Assortment of 15.....98c
- **TRANSFORMER ASSORTMENT**  
Modulation, line, mic, audio, power, etc. Like new .....10 for \$4.95
- **HARDWARE ASSORTMENT**  
Contains lugs, rivets, springs, clamps, screws, shock mounts, brackets, insulators, etc. Approx. 5 lbs.....\$1.95
- **COIL ASSORTMENT**  
R.F., I.F., Osc. Ant., etc. — Shielded (some). Like-new .....10 for 98c

- **FRACTIONAL H.P. MOTORS**  
Model AD-1, 24 V. DC 1/12 h.p. 6,000 RPM. 3/4" shaft, Square End Bell for mounting with four bolts (Navy type). Size: 3" L., 2 3/4" Dia. 2 leads for intermittent duty.....\$1.49  
Model BX-1, Shunt, 5,000 RPM. 4 leads. Chrome-plated shell. Shaft 3/4" Dia., 3/4" L. Size: 2 1/2"x1 1/2". New.....\$1.49
  - **MICROPHONE JACKS**  
One circuit closed when plug is inserted. New. 3 for .....25c
  - **TRANSFORMERS**  
Filament, 4 to 30 V. @ 2 A. 60 cyc. 110 V. (pri.) Well-known Brand. Completely shielded. New.....\$2.19  
Line, 500 ohms to p.p. grids. Completely shielded. Has 4 mounting studs, 6-32 (rated at 10-15 watts), Well-known Brand. New.....\$1.49
  - **DYNAMOTORS**  
BC-77. Input: 14V. @ 40 A. Output: 1,000V. @ 350 MA. For BC-375 Transmitter. New.....\$5.95  
DM-33A. Input: 28V. Output: 540V. DC @ 250 MA. New—in original cartons. Each.....\$1.79  
PE-103. Input: 6 or 12V. DC. Output: 500V. DC @ 160 MA. Like-New. Each.....\$7.95
  - **PUSH-BUTTON TUNING ASSEMBLY**  
For BC-725 Receiver 2 to 6 Mc. 4 push-buttons. 12 Variable slug-tuned coils for R.F., Mixer and Osc. Completely assembled, wired and aligned. Overseas packed.....\$1.95
  - **ANTENNA LEAD**  
Coaxial for BC-725A Receiver. Approximately 5 ft. long. New.....59c
  - **FREQUENCY METERS**  
Vibrating Reed type. 125V. 57 to 63 cyc. All-bakelite case. New.....\$2.89
  - **HEADSETS**  
HS-30 Ear plug type. Complete. Pair.....98c  
HS-16 Standard makes (slightly used) Pair.....98c
  - **WAVE GUIDES**  
Fine milled, Silver plated. Slate gray finish. 5 foot lengths with connector at each end. Approx. 3 cm. Per foot.....75c
  - **SHOCK MOUNTS** (assorted) 8 for.....49c
- **Quantities are limited—Order now! Prices subject to change without notice.**  
● **Minimum order—\$2.00; 25% Deposit Required. Balance C.O.D. All orders shipped f.o.b. Chicago. All Foreign Shipments, Minimum order—\$50.00.**

- **MODULATOR BC 423 A.**  
Uses 955 R.F. Osc. 6J7 A.F. osc. 6J7 1st A.F. Amp., 6P6 2nd A.F. Amp. 5W4 Rec. 110V. 60 cyc. pwr supply. Variable freq. R.F. osc. in 200 Mc Range. Audio osc. variable. Complete with tubes, cabinet and ant. Size: 14 1/2"x9"x9 1/4". 1/16" Steel case. Shipping wt. approx. 60 lbs. A Real Buy! New.....\$19.95
- **TRANSITTER AND RECEIVER (SCR-529)**  
F. TRANSMITTER. BC-604C (Temperature Crystal controlled. Freq. Range: 20 to 27.9 Mc. Uses 7-1619, 1-1624 tubes. Ten preset channels controlled by push buttons. All circuits Metered. Carbon and Dynamic Mic. Input. Size: 12" H., 9" D., 18" L. Pwr. output 25 W. @ 100% Mod. RECVR BC-603C. Variable tuning; Freq. Range: 20-28 Mc. Uses 1-616, 1-6J7, 1-6V6, 3-6A(C7, 2-6SL7 tubes. Push buttons may be preset for ten channels. Calibrated dial. Built-in speaker. Squelch may be switched on or off. Size: 12" H., 7" W., 13" D.  
This complete set requires small conversion for use in 28 Mc. Ham Band. Shipped complete with tubes, 80 crystals, 2 Dynamotors, Revt and Xmitter schematic diagram.  
All sets used but in good operating condition. (made by WE) 12 or 24 volts. (Kindly specify voltage desired) Shipping weight 165 lbs. Complete. Just.....\$49.50  
May be purchased separately. Xmitter BC 604C (Less Crystals).....\$32.50  
Revt BC-603C.....19.50
- **VIBROPAK**  
PE-125 BX for SCR-223. Input: 12 or 24V. Output: 475V. @ 200 Ma. A heavy duty unit built for continuous service. Complete with 2 RK-60 Rectifier tubes, Spare vibrator, Shock Mount and Plug. Ideal for Mobile installations on cars, trucks, buses, etc. New. Ready for operation.....\$8.95
- **RL-42-B Antenna Reel Assembly**  
An ideal unit for lightweight beams. Reversible 24 V. DC. Series Motor will operate on 24V. A.C. New.....\$3.95  
Bobbin for above.....49c
- **TUNING UNITS for BC 375 or 191**  
TU-10.....\$1.95; TU-26.....\$1.79  
Cases for above.....49c  
Shipping wt. approx. 21 lbs.
- **REMOTE CONTROL UNIT (BENDIX)**  
MN-28Y Shipping Wt. Approx. 5 lbs. New.....\$1.79
- **MOUNTING RACKS** (single) for 274 Series Receivers 98c. Shock mount base for above.....59c
- **SOLDER LUGS** (assorted) 3 lbs.....\$1.00
- **ALUMINUM RIVETS** (assorted) 3 lbs.....\$1.00
- **2 CONDUCTOR CORDS** (WE)  
6 1/2 foot lengths. Each 10; 12 for.....\$1.00

### ★ Bargains Galore!!

Write for free copy of  
**UNITED SURPLUS new FLYER.**  
You'll be sure to save money.

### ★ BY POPULAR DEMAND!!

**UNITED SURPLUS' Surprise**  
"Package".....\$1.29  
More than 10 lbs. of assorted electronic units and parts.

## UNITED SURPLUS MATERIALS

3313-19 W. OGDEN AVE.

CHICAGO 23, ILL.

**WANTED**—Western Electric Carrier Telephone and Telegraph Equipment and Components. Filters, repeating coils, transformers, equalizers. Types CFI, CF2, H, C, and other carrier equipment. Telephone and telegraph repeaters.

Box 450, Radio News, 185 N. Wabash  
Chicago, Illinois

## EASY TO LEARN CODE

It is easy to learn or increase speed with an Instructograph Code Teacher. Affords the quickest and most practical method yet developed. For beginners or advanced students. Available tapes from beginner's alphabet to typical messages on all subjects. Speed range 5 to 40 WPM. Always ready—no QRM.

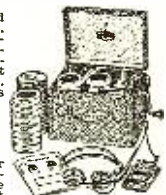

ENDORSED BY THOUSANDS!

The Instructograph Code Teacher literally takes the place of an operator-instructor and enables anyone to learn and master code without further assistance. Thousands of successful operators have "acquired the code" with the Instructograph System. Write today for convenient rental and purchase plans.

## INSTRUCTOGRAPH COMPANY

4711 SHERIDAN ROAD, CHICAGO 40, ILLINOIS

181

# WAR SURPLUS AND OTHER BARGAINS

## POWER DRIVEN ANTENNA REEL

1/2 HP, G. E. Motor—12-24V. Removable 6" Reel. Cam worm gears, bevel gear. Solenoid clutch. In gear only when current on. Operates clockwise or counter clockwise. Ideal for power fish line, opening or closing doors, auxiliary power take-off. Can be used as buffing machine or for dozen of other uses. New. Weight 6 Lbs. \$4.50 each.



CLIPS: Adel Aluminum Co., Rubber lined, hundreds of uses in any shop. Assorted sizes, all new. . . . 5 Doz. \$1. — 500 \$5.

SEND CHECK, MONEY ORDER or CASH

### VOLTAGE REGULATOR

Like new. 24 V. Carbon Pyle Type. Eclipse. Westinghouse or Leece Neville Mfr. Weight 2 1/2 Lbs. \$5.50 each.



### HIGH SPEED DRILL BITS

Like new! Original value over \$16.00. 25 assorted sizes & lengths \$2.50.



### MICROMETER

Chrome plated, precision engineered and carefully tooled to give long life

all new. 0-1" capacity, \$2.25. 1-2" capacity, \$3.50 Each. 25% DEPOSIT REQUIRED ON C.O.D. ORDERS

### TRANSFORMER: Jefferson Electric step up or step down transformer.

Input, primary 110-117 Volts A.C. Output, from 5 Volts to 650 Volts. Suitable for use with war surplus gadgets, heater relays, radio test filaments, electric trains, house chimes, etc. Weight 10 Lbs. New. \$7.95 Each.



### VASCO PETITE SOLDERING IRON

Only six inches overall length, 1/2" diameter. Small and light enough to work on most delicate instruments and reach hard-to-get-at places. Tip tapers down to needle point, and may be replaced. 25 watts. AC DC. 105-120 volts. Rubber covered cord. Weight only 3 1/2 Ozs. \$3.50 each

ALL PRICES FOR B. CULVER CITY, CALIF.



### MIDGET ELECTRICAL WRENCHES

Plomb Tool Co. and other Mfr. Set of 7—15/64", 1/4", 5/16", 11/32", 3/8", 7/16", 1/2". Angle of openings 15° and 80°. Both openings same size. Just what you want for delicate adjustments when working on magnets, filaments, radios, generators, etc. Weight 9 Ozs. Original value \$7.50 \$2.95 set

AIRBORNE SALES CO., INC. DEPT. RM 418 B. CULVER CITY, CALIF.

## PRICES SLASHED IN QUANTITY LOTS

All New, Nationally Known Brands

- CONDENSERS**—Metal encased, oil impregnated tubular, 600 VDC, .1 mfd \$8.49 per 100 \$69.00 per 1000
  - Filter Condensers—1500 VDC 1. mfd \$39.00 per 100 \$295.00 per 1000
  - DOUBLE CUP TYPE #850**—Silver Ceramic Condensers, 3000 Volts, 50 mmfd \$12.95 per 100 \$98.00 per 1000
  - PILOT LIGHT ASSEMBLY**—high grade movable lens and shutter \$11.95 per 100 \$89.00 per 1000
  - RESISTORS**—WL 10 watt, 75 ohm, adjustable \$7.49 per 100 \$49.00 per 1000
  - RESISTORS**—Wire wound cement coated 10-Watt, 10,000 Ohm \$8.49 per 100 \$69.00 per 1000
  - JACKS**—Famous make, JK34A short midget phone type \$8.95 per 100 \$79.00 per 1000
- Shipping extra—Write for circular
- ERIE SUPPLY CO.**  
P. O. Box 907 Rochester 3, N. Y.

## LEARN RADIO!

IN ONLY 10 MONTHS PREPARE FOR A GOOD JOB!  
COMMERCIAL OPERATOR (CODE)  
BROADCAST ENGINEER  
RADIO SERVICEMAN

Television Servicing—15 Months

Veterans get \$130.00 Equipment  
SEND FOR FREE LITERATURE  
**BALTIMORE TECHNICAL INSTITUTE**  
1425 EUTAW PL., DEPT. R, BALTO. 17, MD.

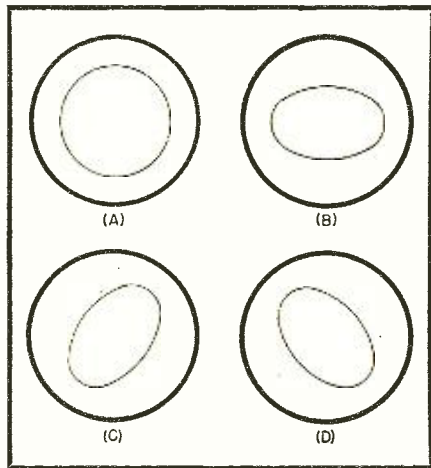

Fig. 3. Patterns obtained with various resistance-capacitance combinations.

flecting plate and ground (usually a half-megohm). These values must be chosen for an individual case. The capacitance will be determined largely by the length of the coaxial cable. Also, internal oscilloscope resistance will vary with different models. Obtain the correct resistance value by referring to the oscilloscope circuit diagram.

### Operation of the System

It is a comparatively simple matter to tune-in signals and to check modulation by the oscilloscopic method. This system is useful also for checking extraneous modulation, such as hum, noise, and parasites on c. w. signals (switch-off the beat frequency oscillator in the receiver when making the latter tests).

Naturally, most accurate results will be obtained when the received signal is

Fig. 4. Modulation patterns obtained from received signals. (A) Carrier only. (B) Under 100 per-cent modulation. (C) 100 per-cent modulation. (D) Over 100 per-cent modulation. Equations at bottom are used for calculating modulation percentage measurements on (B).

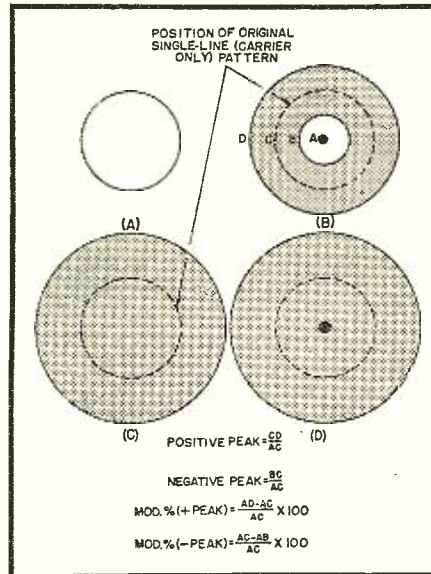

## FIDELITY PLUS

# SPEMCO

Crystal "Hi-flex" Mike Cable

### Is Back...

The one cable with all the improvements. Contains seven strands No. 31 special "SPEMCO" tinned alloy. All rubber insulation. Approximately 25 MMF. O.D. .250. Will not break under hard usage. Delivers consistently uniform response regardless of climatic conditions.

**12c PER FOOT**

SEE YOUR JOBBER TODAY

**SPECIALTIES MFG. CO.**  
4149 Cass Avenue  
DETROIT 1, MICHIGAN

## JUNE BARGAINS

Satisfaction Guaranteed

CONDENSERS	
<b>OIL FILLED - BATHUB</b>	
0.1 mfd 600 v. DCW .25	2.0 mfd 600 v. DCW .40
.75 mfd 600 v. DCW .30	3X.1 mfd 600v. DCW .49
1.0 mfd 600 v. DCW .35	.5 mfd 2000 v. 1.35
	10 mfd 25 v. .30
<b>ELECTROLYTIC</b>	
20/20 mfd 150 v. .45	.005 mfd Mica
20/20 mfd 250 v. .49	3000 v. DCW .55
12 mfd 450 v. .45	.0008 mfd Mica
	5000 v. DCW .89
TRANSFORMERS - FILTERS	
Magnetron, filament 115v. AC, 60 cycle input sec. 7v. 1.5 amp. 15,000v. insulation.....	2.55
Filament, 115v. AC, 60 cycle; Sec. #1, 27.1 @ 4.3 amp.; Sec. #2, 5.2v. @ 5A (C.T.); Sec. #3, 6.5v. @ 3A; Sec. #4, 5.2v. @ 3A (C.T.); Sec. #5, 2.6v. @ 3.5A.....	4.95
Band Pass Filters 164 K.C. w/crystal; input Z 72 ohm, output Z 3650 ohms.....	1.35
Network, oscillator, feedback patch, sealed in can	1.15
Insulators Cone type 1" high.....	.07
Insulators Lapp 1" dia., 4" high.....	.55
Resistors, vitreous type: 300, 8000, 11,500 ohms 25 W. ....	.35
Resistors, vitreous type: 2500 ohms 50 W. ....	.65
Coil Forms, porcelain, 2" dia., 5" high.....	.70
Fiberglass lagging tape 2 1/2"x.005, 150 Ft. Roll. ....	.25
Fiberglass lagging tape 4x.007, 150 Ft. Roll.....	.30
Ant. loops - small.....	.29
Ant. loops - large.....	.49
Precision resistors 1.5KV, 1.5 meg. ....	1.55
5HP4 SCOPE tube w/ shield, Mounting and Magnal socket .....	6.95
TUBES - GUARANTEED	
705A \$5.95   2X2/879.89   6Y6G .85   12A6 .60	
715A 6.25   6L6G .95   836 3.50   5U4G .60	

**WALMAR DISTRIBUTING CO.**  
3002 Virginia Ave. Baltimore 15, Md.

**TUBE SPECIALS**  
AC-DC five—50L6GT, 35Z5GT, 12SA7, K7, Q7GT. \$1.90  
Miniature five—50B5, 35W4, 12AT6, BA6, BE6. \$1.90

**TWO JUMBO ASSORTMENTS**  
40-35Z5, 20-50L6, 10 ea. 35L6, 12SA7, K7, Q7. 100 tubes.  
40-35W4, 30-50B5. 10 ea. 12AT6, BA6, BE6. 100 tubes.  
Either of the above specials at only \$34.00  
Every tube new and perfect. Guaranteed 100%.

Selenium rectifiers 100MA—ten for \$7.20  
Postage extra. 20% deposit on C.O.D. orders.  
Send for our new bargain list.

**HALLMARK ELECTRONIC CORPORATION**  
592 COMMUNIPAW AVENUE, JERSEY CITY 4, N. J.

in the clear, free from static, and not fading, and when the receiver is operating correctly. The receiver must have low hum level and all of its circuits must be correctly adjusted. It is advisable for the operator to check several signals of known modulation percentage on several carrier frequencies, in order to verify receiver performance. Any inaccuracies introduced by the receiver itself will be very small in a receiver of modern design.

-50-

### Substitution Tester

(Continued from page 53)

most commonly used as grid-bias, coupling, and for other purposes. The values of the six resistors are 400, 50,000, 100,000, 500,000 ohms and 2 and 5 meg-ohms. By the same token, seven condensers most commonly used for bypass, coupling, filter, and other purposes were selected. The seven values are; .001, .01, .05, .10, .25, 30 and 50 mfd.

The use of continuity testing is now an accepted procedure in the service profession. With this instrument, these tests do not require the use of any additional unit. A continuity tester is used in conjunction with the substitution decade. This portion of the instrument affords continuity tests of both resistors and condensers. The line plug, located at the rear of this instrument, can be inserted into any 110 volt a.c. 60-cycle line. Continuity is indicated by means of neon indicator on the front panel. If the neon indicator lights, continuity is indicated.

Leakage of condensers can also be tested by means of this neon indicator. An open condenser is indicated by the failure of the neon to light, however, if the condenser is shorted a continuous glow will result. Many present day condensers have a definite percentage of leakage, however the amount is insufficient to affect operation of a receiver. This leakage may often affect the neon by causing it to glow slightly. A leaky condenser is indicated by a series of rapid flashes, the amount of leakage being determined by the rapidity of the flashes. Resistors can be tested for continuity in the same fashion. When checking resistances, the neon indicator will glow continuously, the brilliancy of the neon varying with the amount of resistance.

This substitution tester also incorporates an output meter, a unit not often available to servicemen. An indicator of the neon type, the output meter can aid the serviceman in the efficient and rapid alignment of radio receivers. The receiver under test is aligned in the conventional manner, the brilliancy of the neon being continuously observed. Maximum brilliancy of the neon indicates correct and full alignment. Connection of

June, 1948

# REVOLUTIONARY

## THE NEW *Astatic* Magneto-Induction PICKUP



● Yes, this is it! A radically new pickup cartridge that opens broad new vistas of listening pleasure.

The Astatic Magneto-Induction Pickup represents the first clean break with traditional principles employed in the manufacture of magnetic type reproducers. Discarded now is the need for delicately spaced "air gaps," which collect lint and dust, become a prime source of trouble in other type magnetic pickups. Their elimination in the Magneto-Induction cartridge is a newly opened door to peak fidelity of reproduction that is stable and troublefree, even under the most consistent service or adverse climatic conditions.

MODEL MI-1      MODEL MI-2  
Standard Housing      Mumetal Housing\*

\*Provides increased shielding effect for maximum reduction of hum.

Also Two Equalizer-Amplifier Models

NOW AVAILABLE

Here are the OUTSTANDING FEATURES

1. No "Air Gaps."
2. No necessity for delicate handling.
3. No costly armature balancing problems.
4. Longer-lived performance without distortion or change.
5. Transcription quality reproduction.
6. Velocity response flat to 12,000 cycles.
7. Output is 100 millivolts, approximately 20 db. greater than most light-weight magnetic pickups.
8. Needle pressure, 1 oz.
9. Impedance, 7,500 ohms at 1,000 c.p.s.—110,000 ohms at 10,000 c.p.s.
10. Interchangeability: Can be employed with most standard pickup and transcription arms.



Manufactured under  
Mazda Laboratories License

## RU-16/GF-11

Introducing That Famous  
TRANSMITTER RECEIVER COMBINATION!

TRANSMITTER  
2,000 KC—9,000 KC  
RECEIVER  
200 KC—13,575 KC



RECEIVER

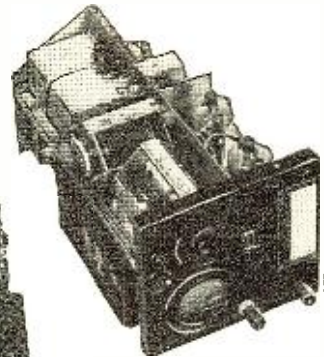

TRANSMITTER

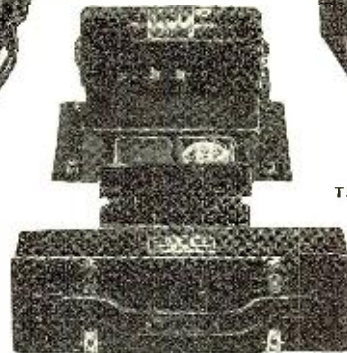

COIL DRAWER

- ★ Output on phone 15 W, much more on CW.
- ★ Band changes by single plug-in drawer; 4 included with transmitter, 10 with receiver.
- ★ Simple conversion for output also on 14 Mc, 21 Mc, 28 Mc!
- ★ Dynamotor input 12 VDC, output 435 V @ 163 ma. continuous duty.
- ★ Transmitter tube complement 89-89-837's in PP.
- ★ Includes all accessories, filter, instruction book, remote tuning, control boxes, plugs, spare tubes, shock mounts, everything.

We can't describe the superb appearance and design, so write for our detailed description and modification suggestions of a terrific double conversion receiver, and a beauty of a VFO transmitter that has no equal. You will hear plenty on the ham bands about this neat combination. Shipped in original crate 32 x 21 x 22 wt. 120 lbs.

25% deposit with order

A complete station,  
VFO operated, for  
**\$29<sup>50</sup>**  
only  
Brand new as of  
the manufacturer

**SURPLUS**  
**RADIO, INC.**

30 MUNSON ST.,  
PORT WASHINGTON, N. Y.

The Trade Mark  
of  
"Time-Tested  
Quality"



**ILLINOIS  
CONDENSERS**

belong  
IN THE BEST

**Electronic Sets**

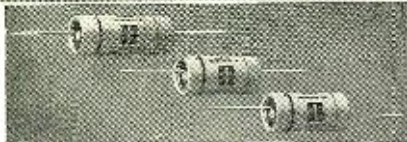
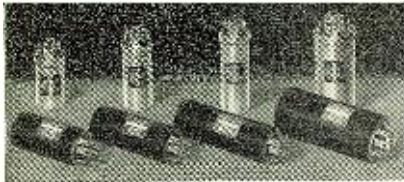

● Look to Illinois for a complete line of electrolytic capacitors for every electronic application and radio replacement use. When you need a capacitor that has superior ability to withstand extreme temperature changes, that's manufactured to exacting specifications, that's time-tested through 14 years of high quality production experience—you want an Illinois condenser!

Write for our latest catalog.



*Just off the Press!*  
**1948 Radolek RADIO PROFIT GUIDE**



**NEW  
COMPLETE  
RADIO  
PROFIT  
GUIDE  
FREE**

Radio Repair Parts • Tools  
Sound Systems • Tubes  
Phono Equipment & Supplies  
Test Instruments • Etc.

Big, new ENLARGED complete catalog showing thousands of Radio Bargains sent to you immediately. Helpful, money-saving buying information. Send coupon today!

**BIG VALUES, LARGE STOCKS,  
FAST, DEPENDABLE SERVICE.**

**FREE... SEND TODAY**

RADOLEK CO., Dept. B-068  
601 W. Randolph St., Chicago 6, Ill.  
Please send your Free Profit Guide Catalog and regular Supplements.

Name .....  
Address .....  
City.....Zone.....State.....

**SAVE AT RADOLEK**

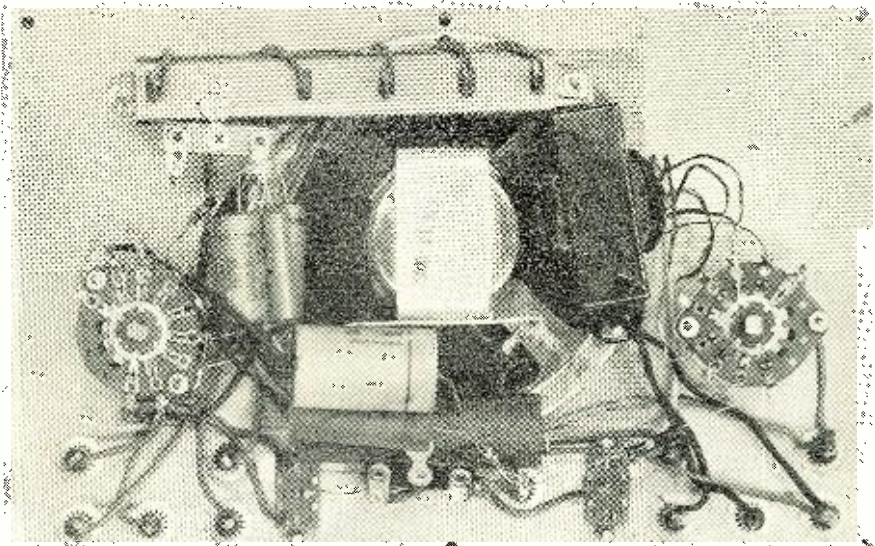

All component parts for this substitution tester are mounted on the front panel. Wafer switch at right is control "A". Tapped resistance at top of speaker is the field substitution resistor.

the output meter is made by means of input jacks 1, 2, and 3.

A complete circuit diagram of the instrument is shown in Fig. 2. The condensers are rated at 600 volts with the exception of the two electrolytics which are rated at 150 volts. The resistors are 1/2 watt units. The voice coil resistance of the speaker is 2.5 ohms. Field im-

pedances are made available by means of a heavy-duty, tapped wirewound resistor. The resistor is tapped at 500, 1000, 1500 ohms. All component parts are mounted on the front panel which is easily accessible by removal of the six panel mounting screws. The instrument is housed in a grey crackle metal cabinet measuring 10 by 7 by 5 inches.—30—

Fig. 2. Complete circuit for the commercially-built substitution tester.

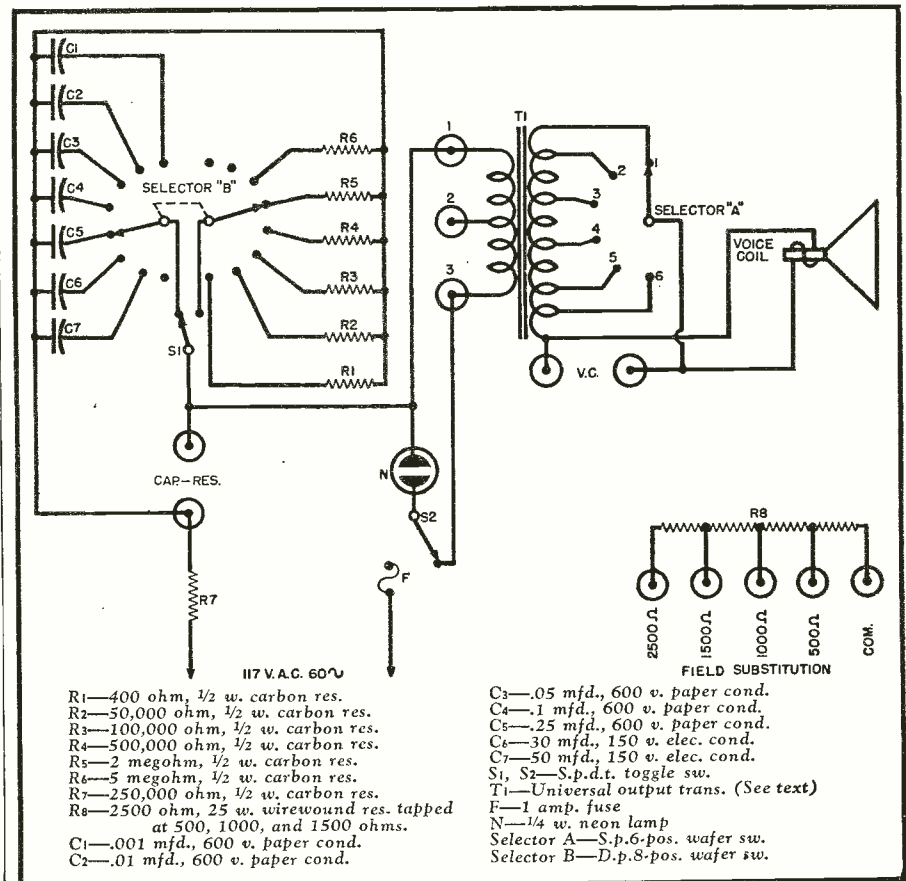



## ORDER NOW

304 TL (New in Cartons), bargain.....	\$ .90
300 ohm Amphenol.....	per C \$2.91
150 ohm Amphenol.....	per C \$2.62
75 ohm Amphenol (small).....	per C \$2.01
75 ohm Amphenol (heavy duty)....	per C \$7.20
Kilowatt 75 ohm Amphenol	
Twin Lead, per 100 ft.....	\$7.20
SCR 522 Dynamotors PE94C, New.....	\$3.95
SCR 522 Receiver Conversion Kit and Instructions (Less Dial).....	\$3.50
ACN Dial For Above.....	\$3.00
3 Gang 410 Mmfd. Per Sect. Cond. Excellent quality .....	\$2.95
Four Gang - 150 Mmfd. Variable.....	.95
4 Mfd. @ 600V - Oil - Round Can.....	.69
PL 55A Phone Plugs.....	.18
375E Tuning Units.....	\$1.95
807 - New - Boxed.....	\$1.49
2C40 Lighthouse Tube.....	.95
2" PM Speaker (Bakelite Cased) Used in Walkie Talkie.....	\$1.95
SIREN, Commercial type hand operated, very loud noise, gov't cost \$21.00. Spec.....	\$4.95
TRANSMITTING CONDENSER, 2 mfd. @ 2500 W. V. each.....	\$2.95
Vibrator, Heavy Duty 100 MA 6 Volt, 4 prong Universal.....	\$1.05
Relay Leach, 115 V-AC DPST.....	\$1.50
872A - GE Surplus, New, Boxed, 2 for.....	\$2.50
Phosphor Bronze dial cable, 42 strand, 250 ft. spool.....	.69
2051 - Tube Thyratron.....	.39
New Surplus Jones 6 and 8 prong plugs	.24
Toggle Switches SPST plus spring return	.24

### Send for Our Special Bulletin of Government Surplus Items

## DOW RADIO

1759 E. COLORADO ST., PASADENA 4, CALIF.  
Pasadena Phone - SYcamore 3-1196  
Los Angeles Phone - RYan 16683

for **QUALITY** of Reproduction...

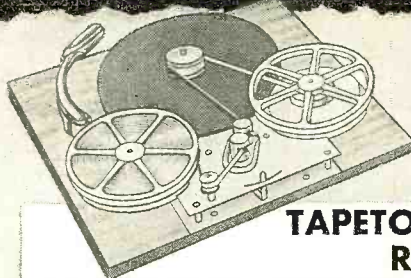

*tapetone*  
is TOPS!

## TAPETONE MAGNETIC TAPE RECORDING KIT

For Homes, Schools, Studios... Set Builders, Hams, Radio Engineers are all enthusiastic about the newly developed TAPETONE Magnetic Tape Recorder. • Records voice and music on tape. • Plays up to 12" platter records and reproduces from the records on to the tape. • Records radio reception on tape. Tape can be played back and re-recorded hundreds of times.

### THE RECORDING-PLAYBACK MECHANISM

(Illustrated above) comprises heavy duty General Industries motor mounted on rubber, and 10" 3 lb. turntable. Complete tape drive mechanism of exclusive TAPETONE design. Precision tooled with bronze bearings throughout for marvelously smooth quiet operation. Lever has Record-Play, Neutral, and rewind positions. Crystal pickup with permanent stylus. Separate Record-Play and Erase Heads, plug-in type TAPETONE exclusive design. Recording magnetic paper tape is simple to thread and can be edited more easily than home movie film. TAPETONE MAGNETIC TAPE RECORDING MECHANISM, NOW AVAILABLE SEPARATELY, includes; Recording-Playback mechanism illustrated and described above, for 115 Volt 60 cycle AC only; completely assembled plus mounting board; Amplifier wiring diagram; one 1/2 hour roll (1225 ft.) of new SCOTCH HIGH FIDELITY MAGNETIC RECORDING TAPE. Shpg. Wt. 22 lbs.

Your net cost **\$62.50**

## TAPETONE MFG. CORP.

37-06 36th St. Long Island City 1, N.Y.

Phone: STillwell 4-8380

### THE EQUALIZED AMPLIFIER

This specially-designed 6-tube recording and playback amplifier is equipped with exciter circuit for operation with mechanism above. Has high impedance microphone and phono-radio inputs with separate gain controls, permits mixing. Output connects to 4 or 8 ohm speaker components, tubes, drilled chassis, wire connectors, plugs, cables, nothing else needed - no special knowledge required to construct it. For 115 Volt 60 cycle AC only.

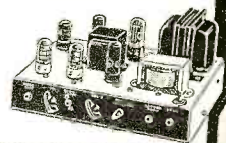

### COMPLETE TAPETONE MAGNETIC TAPE RECORDING KIT

Includes Recording-Playback Mechanism and Amplifier Kit described above, plus one 1/2 hour roll (1225 ft.) of new SCOTCH HIGH FIDELITY MAGNETIC RECORDING TAPE. Shpg. wt. 30 lbs. Express collect.

Your net cost, Complete **\$98.50**

Please include 20% deposit with C.O.D. Orders

OPTIONAL ACCESSORIES: Crystal Desk Mike with removable base and 7-ft. cable... List \$12.20. 8-inch Heavy Duty PM Speaker... List \$8.85. Additional 1/2 hour rolls Scotch Recording Tape, per roll... \$3.06 (Plus 15¢ postage when ordered separately)

# BEST WIRE BUY OF THE YEAR

## 3-Wire Outdoor Telephone Cable At Less Than 1¢ Per Foot

525 Foot Rolls - Stock No. C-561B ... Only **\$4.95** per roll.

135 Foot Rolls - Stock No. B-787B ... Only **.98** per roll.

Made to Signal Corps specifications to withstand the rigors of all climates. Each conductor consists of four #28 steel strands for added strength and three #28 copper strands for extra conductivity and flexibility. Rubber insulation with two-ply braid covering around each conductor. Conductors of 525 foot rolls are color coded at the ends.

A wonderful buy for any telephone or inter-communication use requiring 2 or 3 conductor cable.

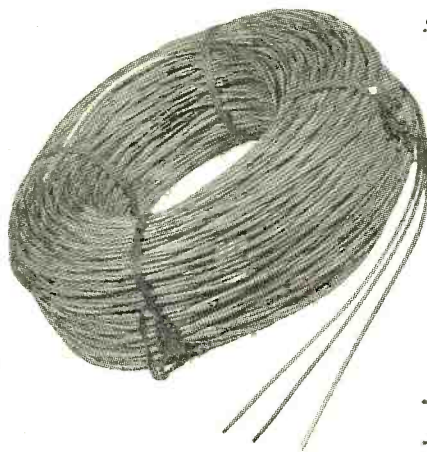

Anticipate your needs on this wire!

LAY IN A STOCK NOW! YOU WILL NEVER AGAIN BE ABLE TO DUPLICATE THIS VALUE!

# SREPCO

STANDARD RADIO & ELECTRONIC PRODUCTS CO.  
135 E. Second St. - DAYTON 2, OHIO - Tel. FULTon 2174

ALL PRICES ARE NET,  
F.O.B. DAYTON, O.

TERMS - Orders under \$3.00, cash with order; orders over \$3.00 require 20% deposit, balance C.O.D.

# JUNE SPECIAL

## RESISTOR KITS \$1.45

100 assorted carbon and wire wound resistors . . . 1/2 to 10 watt. Wide range of values. All standard items.

## CONDENSER KITS \$1.75

50 assorted paper and mica condensers . . . all new . . . good value.

### Wireless Phono Oscillator \$4.52

Operates as far as 100 ft. from radio and can be used with automatic record changer and players . . . complete with 2 tubes all wired and tested. Diagram.



### Phono Pre-Amplifier \$4.95

This unit is for G.E. Reluctance type cartridge. Completely wired, tested. Supplied with diagram, and tube 6SC7.

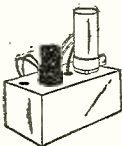

### Mike and Phono Amplifiers \$14.95

This unit sold complete with power transformer. 3 tubes and 3 controls . . . all wired and tested. Diagrams supplied.

## RADIO PARTS

G. E. Reluctance Cartridge. List \$7.95	\$4.54
4" or 5" PM Speakers	1.15
6" PM Speaker	1.55
5" 450 ohm dynamic Spk. with 50L6 output	1.95
Selenium Rectifiers—100 Ma Famous Make	.89
1/2 meg. Volume Control and Sw. long shaft	.35
Osc. Coil 12SA7	.15
6 ft. line cord	.13
Astatic Crystal Pickups	1.89
Astatic Crystal Cartridges L-70A, L-26A, L-40	1.59
Alliance Motor and Turntable	2.50

## FAMOUS MAKE CONDENSERS

50x30 150V.	\$.45	16	450V.	\$.39
20x20 150V.	.35		400V or 600V	Per 10
20x20 (10) 150V. (25)	.39	.01, .02, .05		.49
8x8 450V.	.49	.001, .002, .005		.49
25 25V.	.29	.1		.59
25 50V.	.29			

All Prices F.O.B. N.Y.C. — On C.O.D. 25% Dep.

## THE ROSE COMPANY

88 West Broadway Dept. (N) N. Y. 7, N. Y.

## Spot Radio News

(Continued from page 20)

will be a day! "For tens of thousands of radio stations around the world," as Mr. Coy points out, "it will be F-Day—when they shift to new frequencies. It will be a day of sweeping changes for stations employing long distance 'high' frequencies." He adds, with emphasis: "But I don't want to start a panic among American broadcasters or American radio listeners—let me make it as plain as a pikestaff that these changes do not affect this nation's broadcasting frequencies."

**SPEAKING OF FCC**, it's repetition to say that they are in hot water and will be for some time if not permanently. To state the problem again: How can enough room be made in the spectrum for all the services clamoring to use it? This, in Mr. Coy's view, is the toughest problem facing FCC and the industry—"a national problem in need of sound planning for the future domestically." He believes that "the most significant factor is the problem of getting the full-use of the spectrum above about 30 megacycles. Except for a certain band of frequencies that require international standardization because of their use by ships and aircraft," he points out, "this upper spectrum is free to be divided." How is another, and knotty question that Mr. Coy frankly recognizes, but thinks should be shared, not only with the industry, but with electronic engineers. If they don't do their job (as they have so far done magnificently) there is going to be trouble all along the line, especially as the air become more and more crowded. "Certainly we cannot expect to utilize this part of the spectrum," he says, "without serious restrictions on the geographic location of stations unless we wage a relentless war on spurious emissions and unwanted harmonic radiations. The suppression requirements are particularly severe for services in which the offending transmitters are adjacent to or move among the affected receivers, such as in the amateur and urban mobile services, or are of very high power, as in FM and television. I should like to impress on engineers the seriousness of this problem and ask them to consider as incomplete any transmitter design which fails to include adequate provision for such suppression. As to receiver design, it is evident that many present broadcast receivers are deficient in regard to suppression of oscillator radiations and in selectivity." As for dividing up the spectrum fairly, Mr. Coy faces the future with resolution but with full realization of the seriousness of the problem, both tomorrow and in the foreseeable future.

## HI-VOLT POWER SUPPLY (RF TYPE)

It's small and safe. New and complete for television and similar applications. Guaranteed.

3000-6000 V. supply complete	\$14.95
3000-6000 V. complete Kit	12.50
3000-6000 V. Coil with diagram	5.75
6000-10000 V. supply complete	19.95
6000-10000 V. complete Kit	16.95
6000-10000 V. Coil with diagram	7.75

## —SURPLUS—

COIL SETS for RU-16 and RU-19 equipment Receiver—single range .50, dual range .75. Xmitter Coil Sets 1.00 specify frequency. Coils are easily rewound to extend the range.	
3 MFD—4000 V. COND.	\$ 3.95
SIGNAL GENERATOR Modified BC 423 for F.M. and television RF tuning 54 to 106 MC.	19.95
BC 406 RECEIVER modify for 2 meters	19.95
TUBING quality, red, #20 wire, 1500 ft. spool	4.95
FEED-THRU INSULATORS 9" porcelain bowl	2.50
CRYSTALS—IN21 and IN23 .3 for HIGH VOLTAGE MICA COND. 500 MMF 10 KV. W.—.50; 500 MMF 20 KV. W.—\$1.00; 300 MMF 30 KV. W.	2.00
VARIABLE CERAMIC COND. dual 7—45MMF	.8 for 1.50
25% with C.O.D. orders.	
F.O.B. Hempstead — \$2.00 min. order.	

## ALGERADIO

385 Jackson Street Hempstead, N. Y.

## SEND FOR THESE SPECIALS

### ALL NEW MERCHANDISE

10.0 mfd., 600 V. Rectangle oil filled w/stand off insulators	\$ .95
2.0 mfd., 2,500 V. Rectangle oil filled w/stand off insulators	2.20
50 mmf., 32,000 V. Tubular Vacuum Telescoping antennae - AN75B,	5.95
1'—3" 7'—0" solid brass clamp on Thermo switch - Fenwall —50 +400°F. 110/220 V., 2500 watt contacts	1.25
1.60	
Sound Power Phones - Navy Type complete w/Microphone, Headset, 50' of cord	4.95
3.5 V.A.C.—1.8 V.D.C. @ 1.0 amp. full wave bridge	.75
6.5 V.A.C.—2.2 V.D.C. @ 3.0 amp. full wave center tap	1.20
Transtat 115/230 V., 50/60 Cy. nput, 0-260 V. @ 2 1/2 A.	21.50
2D21 Miniature Thyatron	.70

No Orders Under \$3.00 Please, 30% with Order—Balance C.O.D. All shipments made Express Collect. Write for additional information on above items or for Special Quantity Discounts. 1527 E. Seventh Street Los Angeles 21, California

## EPCO

Los Angeles 21, California

history-making value!

## model 8073 RCP 6-way tester

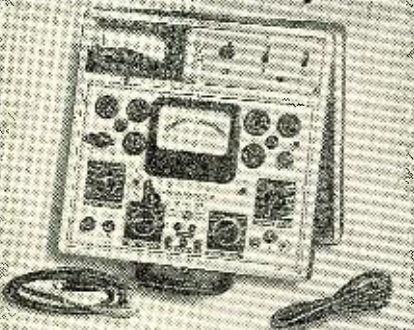

that will fill every test in the shop for only \$84.95 Complete

Boost your service earnings with this compact, flexible instrument. It's a Tube Tester, Multitester, F.M. Signal Generator, A.M. Signal Generator, Audio Oscillator and Condenser Tester—all in one! Portable, accurate, dependable—it's your complete SERVICESHOP at an amazingly low price. ORDER NOW from your dealer, or write direct.

Natural, finish carrying case, complete with all tubes, test leads, etc., ready to operate. Size: 5"x13"x9 1/2".

For the first time in history, you can buy all complete service instruments necessary for basic service work in one compact combination bench-portable instrument at the lowest price ever offered.

See RCP—Best for Every Test

## RADIO CITY PRODUCTS CO., INC.

152 West 25th St. New York 1, N. Y.

## WAR SURPLUS BARGAIN SPECIAL!

Brand New BEAM ANTENNA ROTATOR MOTOR

\$5.95



- OPERATES DIRECTLY ON 110V AC, 60 CYCLES (Requires only 12 MFD Condenser)
- NO STEP-DOWN TRANS. NEEDED
- NO LINE RESISTOR NEEDED
- HIGH TORQUE — NO FREE SWING
- APPROX. 3/4 R.P.M.
- REVERSIBLE — ONLY THREE WIRES NEEDED
- ELECTRICALLY & MECHANICALLY QUIET
- LIGHTWEIGHT, RUGGED, QUIET
- MOTOR & GEARS OIL SEALED
- NO EXPENSIVE CONVERSIONS
- FLAT MOUNTING SURFACE — FOUR TAPPED HOLES
- FB. FOR 2-6-10-LITE 20 BEAMS

## ALVARADIO SUPPLY CO.

Dept. RN4, 903 So. Alvarado Los Angeles 6, California

"It becomes increasingly evident," he says, "that the most careful planning will have to be done on a continuous basis if the objectives of the Communications Act and the desires of the American people are to be met. Planning has been done and is being done. But the point I should like to stress is that we must, from time to time, readjust our sights and make as certain as it is possible for us to do that the next generation will be able to derive the maximum benefits from the public domain we call ether."

**THIS IS NOT** to imply that everything at FCC is on a one-big-happy-family basis by a long shot. The Commission was recently accused by Senator Charles W. Tobey, of the Senate Interstate Commerce Committee, of playing along with RCA, which the Senator claims did everything it could to block FM progress. He even went so far as to claim that FCC altered the records in FM allocations, a claim also made by Prof. Edwin H. Armstrong, FM inventor. While the Tobey fireworks were exploding on the Hill, FCC faced another problem in the FM field, raised by the FM Association. FMA has asked revocation proceedings against holders of FM construction permits who are negligent in putting their stations on the air. In one of the strongest statements of the young Association's existence, FMA charged that "many broadcasters have obtained FM construction permits to keep competition out, but have not adhered to FCC regulations which require that stations be on the air eight months after construction permits are issued." A resolution, adopted unanimously by the FMA Board of Directors in behalf of the Association's 250 members, asks that FCC conduct "show cause" revocation proceedings in cases where the Commission "feels that the construction permit holders have been negligent" in putting stations on the air. FMA spokesman J. N. (Bill) Bailey, executive director of the Association, managed to get in a plug for his favorite brand of radio while fulminating against FCC. Because of the "acute shortage of FM channels in certain areas," he stated, building delays "are depriving the public of the finest aural broadcast service attainable in the present state of radio art." Statistically, FMA stated its case to FCC as follows: "There are today 442 commercial FM stations on the air. In January, 1947, Charles R. Denny, former FCC chairman, stated that 700 FM stations should be in operation by the end of that year. Mr. Denny based his prediction on the number of construction permits and conditional grants issued by FCC. But today, fourteen months after that prediction, little more than half that number are in operation. We believe the

June, 1948

# TONE QUALITY IS



with an

## American

### CRYSTAL CARTRIDGE\*

High output, wide range and a new, "locked-in" self-centered needle chuck are outstanding features of the CR-1 Crystal Cartridge.



Pin plug connectors eliminate the need for soldering and simplify assembly in the tone arm. Any type of needle will give satisfactory results, though for maximum quality reproduction, a sapphire or precious metal offset stylus should be used.

	NEEDLE FORCE IN OUNCES	OUTPUT VOLTAGE	RESPONSE	NEEDLE
CR-1	1 1/4	3.0	50-8,000	Optional
CR-2	1 1/8	1.5	50-7,000	Optional
CR-4	1 1/4	3.5	50-8,000	Optional

\*Licensed by Brush Development Company

For specifications and further details see your jobber today or write:

# American

## MICROPHONE COMPANY

DEPT. 5C • 370 SOUTH FAIR OAKS AVENUE • PASADENA 2, CALIFORNIA

## SELENIUM RECTIFIERS

FULL WAVE BRIDGE TYPES			
Input	Output	Current	Price
From 0-18 V.A.C.	From 0-14 V.D.C.	1 AMP	\$2.49
0-18 V.A.C.	0-14 V.D.C.	3 AMP	3.49
0-18 V.A.C.	0-14 V.D.C.	5 AMP	4.95
0-18 V.A.C.	0-14 V.D.C.	10 AMP	7.95
0-18 V.A.C.	0-14 V.D.C.	15 AMP	10.95
0-18 V.A.C.	0-14 V.D.C.	20 AMP	13.95
0-18 V.A.C.	0-14 V.D.C.	30 AMP	19.95

HALF WAVE TYPES*			
Input	Output	Current	Price
From 0-18 V.A.C.	From 0-7 V.D.C.	3 AMP	\$2.25
0-18 V.A.C.	0-7 V.D.C.	5 AMP	2.95
0-18 V.A.C.	0-7 V.D.C.	10 AMP	4.95
0-18 V.A.C.	0-7 V.D.C.	15 AMP	6.95
0-18 V.A.C.	0-7 V.D.C.	20 AMP	8.95
0-18 V.A.C.	0-7 V.D.C.	25 AMP	10.95

Input	Output	Current	Price
From 0-36 V.A.C.	From 0-28 V.D.C.	150 MA	\$1.25
0-36 V.A.C.	0-28 V.D.C.	2 AMP	4.95
0-36 V.A.C.	0-28 V.D.C.	5 AMP	7.95
0-36 V.A.C.	0-28 V.D.C.	10 AMP	13.95
0-36 V.A.C.	0-28 V.D.C.	15 AMP	19.95
0-36 V.A.C.	0-28 V.D.C.	20 AMP	25.95
From 0-120 V.A.C.	From 0-100 V.D.C.	2 AMP	14.95
0-120 V.A.C.	0-100 V.D.C.	5 AMP	19.95

Input	Output	Current	Price
From 0-36 V.A.C.	From 0-14 V.D.C.	3 AMP	\$2.95
0-36 V.A.C.	0-14 V.D.C.	5 AMP	4.95
0-36 V.A.C.	0-14 V.D.C.	10 AMP	7.95
0-36 V.A.C.	0-14 V.D.C.	15 AMP	10.95
0-36 V.A.C.	0-14 V.D.C.	20 AMP	13.95
0-36 V.A.C.	0-14 V.D.C.	25 AMP	16.95

\*Use with capacitor to obtain any voltage up to twice rated output.

RAYTHEON RECTIFIER CHOKES	
.03 Henry at two amperes	\$2.25
.02 Henry at five amperes	3.25

CAPACITORS	
1000 MFD., 15 V.D.C.	98c
3000 MFD., 35 V.D.C.	\$3.25
4000 MFD., 30 V.D.C.	3.25

PRIMARY	SECONDARY	TO DELIVER	CURRENT	PRICE
115 V.A.C. 60 cy.	10 V.A.C.	7 V.D.C.	18 AMP.	\$3.75
115 V.A.C. 60 cy.	15 V.A.C.	12 V.D.C.	12 AMP.	3.75

To obtain 24 V.D.C. at 12 AMPS., Use two 15 V.A.C. Transformers in series

**ALL PRICES SUBJECT TO CHANGE WITHOUT NOTICE**

It would be impossible to give a complete listing of all our rectifier types. Our engineering staff is at your service to help you work out the application of selenium rectifiers to your specific problems.

**25% Required on all C.O.D.'s—Add 10% for Parcel Post**

**OPAD GREEN COMPANY • 71 WARREN ST., Dept. 3**  
**NEW YORK 7, N. Y. • Phone: BEEKMAN 3-7385**

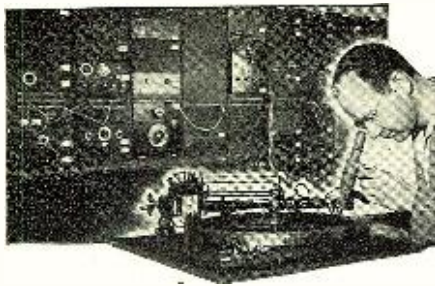

## School of SOUND RECORDING, TRANSMISSION ENGINEERING, RADIO-TELEVISION

Learn sound recording and transmission engineering techniques of the professionals, as used in Motion Picture, Broadcast, F-M, Television, and Commercial Recording Studios.

A practical engineering course, devoted to the technique of sound recording and transmission measurements. Well equipped studios, professional recorders and circuit laboratory containing latest model test equipment installed for student training. A portion of our laboratory is pictured above.



H.M. Thermoire  
Director

WRITE FOR LITERATURE

HOLLYWOOD SOUND INSTITUTE, Inc.  
1040-N No. Kenmore, Hollywood 27, Calif.

time is here for drastic action on FCC's part."

EDWIN H. (FM) ARMSTRONG, incidentally is apparently not going out of the inventing business now that his favorite brainchild has become so popular. Recently he applied to FCC for an experimental television station in the upstairs band. Mr. Armstrong wants authority to use 480-500 mc. with 50-kw. transmitter full time, plus "as much antenna gain as appears proper for the television system." Last word is that he plans to experiment in color as well as black-and-white. He plans to do his work at his laboratories at Alpine, N. J. The frequencies he wants are at the lower end of the band now set aside for television experimentation, and the band extends up to 900 mc. Desire of television stations for commercial outlets within the present low-band (ranging between 44 and 216 mc.) has already stirred concern for development of the higher area. Prof. Armstrong hasn't deserted FM by his new interest. Indeed, FM is what got him busy on television.

-30-

### The AFCA

(Continued from page 45)

tion of private industrial capacity encouraged them to maintain liaison with ten selected associations as sources of general information relating to industry-wide manufacturing capacity. Armed Forces Communications Association was one of those ten associations. Its growth during the two years since it was founded has been more than was anticipated. Americans interested in being on record as wanting to assist our country in securing and maintaining superiority in communications for our Air Force, Army and Navy are joining in increasing numbers, especially since the worsening world situation has become known to them. Membership is not restricted to former, present or future sailors, soldiers or airmen, but solely to Americans.

And in conclusion I should like to quote from a statement made recently by the Commandant of the Air University. His views seem to me most timely. He said, "The United States faces a state of insecurity in the future unparalleled in our history. Times have changed, and very much the worse for us. Time was when we could count with certainty upon a warning period measured in many months at the very least before any real damage could possibly be brought against us. Isolated, safe and secure behind our great ocean barriers, we could have watched the slow, laborious build-up of the great amphibious force and its enormous logistic train which alone could have constituted a real threat. We should have been able to mobilize and train, to de-

## NOW! After Seven Years 12B8 & 25B8 TUBES

Now Available

Composed of adapter, 1—6AT6 tube, 1—6BA6 tube, and 2 miniature sockets. The unit takes less space than the original 12B8 or 25B8 tube, and the adapter base will fit in the 12B8 or 25B8 socket perfectly. Nothing else to buy—unit is complete. Just plug in and it works!! Sold on money-back guarantee.

12B8 or 25B8 unit, complete: \$2.49 each  
10 units for \$22.50

TUBE SPECIALS: New standard brand.

5 tube kit: 50L6, 35Z5, 12SA7-K7-Q7: .....\$2.75

5 tube kit: 50B5, 35W4, 12AT6-BA6-BE6: .....\$2.75

Acorn Tubes: Nos. 954, 955, 956, 957, 958A: 49c ea. 70L7: 79c—0Z4: 89c—1LA6 \$1.09—1R5, 1S4, 1S5, 1T4, 354: 69c ea.

Scarce Tubes: 6AC5, 25A6: .....79c ea.

Send 20% Dep., Bal. C.O.D.—Min. Order \$2.00

Write for new free bargain catalog

### COMMERCIAL RADIO

36 Brattle Street

Boston 8, Mass.

## ALMO SPECIALS

Beebe 3" round panel meter  
0—1000 D.C. mils. ....\$1.49

Triplet 3" round panel meter  
0—1.2 D.C. amps. ....\$1.49

Westinghouse Rectifier Type 2" round  
panel style —10 —0 +4 D.B. meter. ....\$2.95

Full Wave Meter Rectifiers  
Conant Type M .....95¢

Universal Volt-ohmmeter Scales for  
Weston 301 and Triplet 321 Meters. ....49¢

4 tube AC/DC Bakelite cabinet radio set \$8.50

2 cell flashlights (without batteries),  
each .....49¢

3 Section Cowl antennas .....\$1.49

FREE—send us your name and address to  
receive free the ALMO BROADCASTER, na-  
tionally known monthly newspaper of news  
and new products in radio and electronics.

10%  
CASH  
WITH  
ORDERS **Covers the Globe** PHONE  
LO 3-9225

509 ARCH STREET, PHILADELPHIA 6, PENNA.



# STEADY PROFITS

YOUR OWN BUSINESS

with **CORADIO**

THE COIN OPERATED RADIO

Place these specially built radios that play 1 or 2 hours for 25c in the thousands of available hotel rooms, tourists courts, etc. They yield immediate profits and steady income. Install Coradio, the finest made Limited capital required. Send for further information. Write today.

**CORADIO** Coin Operated Radio  
Dept. R, N. 108 W. 31 Street, New York 1, N. Y.

## JUST OUT Hard-to-find New Portable 7 and 9 FT. RADIO ANTENNAS

For Homes, Boats or Autos  
Gov't Surplus as used on Army  
Tanks, Jeeps, etc. Telescopic,  
Rustproof. Tremendous Pickup.  
Eliminate Dangerous wiring. Practically insure

NOISE FREE RECEPTION

\$13.50 Val.—9 Ft. Solid  
Brass—Now \$3.45

(9 Sections) with clamps, Lug,  
Nut & wire (Postpaid)

\$12.00 Val.—9 Ft. Alumi-  
num—Now \$3.45

(8 Sections) with clamps, Lug,  
Nut & wire (Postpaid)

\$10.00 Val.—7 Ft. Solid  
Brass—Now \$2.49

(9 Sections) with Lo-Loss Lead &  
Mounting Bracket (Postpaid)

Exceptionally Rugged Sections—Handy  
for camping. Also useful for transmit-  
ting FM and Television Sets.

EASY TO INSTALL ANYWHERE  
Each Antenna comes securely packed  
ready to put up.

QUANTITY LIMITED

MAIL ORDER TODAY

Send check or M.O. State kind and size  
antenna desired. All prices postpaid.  
Mailed C.O.D. plus postage if you wish.

SPECIAL 10% DISCOUNT  
ON ANY 3 OR MORE ANTENNAS  
If ordered Now Money Back in 10 Days  
if not satisfied.

RADIO HOSPITAL  
442 East 86th St., Dept. R13  
New York 28, N. Y.

# A TERRIFIC 3 BAND RADIO



**THE WORLD AT YOUR FINGERTIPS**

- BAND I—550-1600 KC. —
- BAND II—3000-7500 KC. —
- BAND III—7.5-21.5 Mc. —

**COMPLETELY ASSEMBLED & ALIGNED**  
7 Tubes—8" Speaker—Slide Rule Dial—Phono  
Connection—Highly Sensitive—**\$30<sup>95</sup>**  
Amazing Audio Fidelity—Available For All Voltages.....

**D'ERRICO & KRISCHER INC.**  
1800 N. Humboldt Blvd. • Chicago, Ill.

## SURPLUS PLUGS & MOUNTINGS

DY21/ARC 3 Dynamotors, .....	ea. 4.50
Relay 5 volts AC SPST normally closed .....	ea. .49
6 volt dynamotor PE100A 230 volt 100 mil. output mtd on std 19" panel .....	ea. 3.35
14 volt DM21M dyn. 225v w/filter .....	ea. 1.95
P07/AP Motor Generator, used .....	ea. 7.50
T44 Dynamic mike, cord, plug & jack .....	ea. .95
BC73A Control Head w/plug .....	ea. 2.35
Plug, may be modified to fit BC348 .....	ea. .21
BC450 3-receiver head for SCR274N w/plugs ..	ea. 2.95
MC211A R/Angle Drive for SCR274N .....	ea. .75
TU7, 9, 10 & 26 Tuning Unit w/case .....	ea. 1.95
4 foot cable for BC375 w/PL61 plugs .....	ea. 2.00
UG22/U, UG23/U, UG26/U, UG100/U .....	ea. .22
AN3102-24-19S, AP 6-13 plug .....	ea. .19
PL122 plug for ARN7 and SCR 269 .....	ea. 2.00
AN/APN1, AVQ6 and R89/ARN5 plugs .....	ea. .75
FT221, FT225, FT226, FT227, FT229, FT234, FT151, FT154, FT247 used .....	ea. 2.00
FT222, FT228, FT142 used .....	ea. 1.00
MN26—23 Contact Plug .....	ea. 2.00

See our listing of tuning shafts in April Radio News  
Minimum order \$2.00—FOB Flushing, N. Y.

## LONG ISLAND RADIO CO.

36-23 164th STREET FLUSHING, NEW YORK

Bring Electrical Troubles "TO LIGHT" with

**BRACH TEST-O-LITE**

The **NEON glow** enables breaks, poor contacts, shorts, and defective electrical units to be located quickly in all circuits of 100 to 550 volts... indicates hot or grounded wires... tells AC from DC (and polarity).

Here's the ultra-convenient, time saving, modern tester for fuses, cut outs, radios, appliances, motors, outlets. Far superior to the ordinary, clumsy bulb. Operates one hundred per cent even on very minute current. The only pocket-size tester with Patented Safety Feature. Guaranteed for a lifetime.

95c at your local electrical dealer... or send \$1.00 to cover purchase price, mailing and handling.

**L. S. BRACH MFG. CORP.**  
200 Central Ave. Newark, N. J.



APPLIANCES



MOTORS



FUSES

fend against one of the most difficult and perilous of military operations—an ocean crossing with a landing and build-up on a hostile shore in the face of determined opposition. With such security no wonder we have developed into one of the least military minded nations in the world. But what a change is here!!"  
EDITORS NOTE: *The immediate need for close cooperation between the military and industry is so great at this time that RADIO NEWS has made its vast coverage available to the AFCA. Chapter notes and other association news will appear regularly in this magazine).*

More detailed information about the association may be had on request to National Headquarters, 1624 Eye Street, N.W., Washington 6, D. C.

—30—

## RADIO JOBS ABROAD

**T**HE Civilian Recruitment Office, Signal Corps Photographic Center, 35-11 35th Avenue, Long Island City 1, New York has just released a list of positions being offered with the Signal Corps in the areas indicated.

Positions are "expected" appointments on a two year basis, unless otherwise indicated. Men from 21 to 50 are acceptable for these positions. Positions in Japan include a radio engineer, a telephone repeater repairman, teletype mechanic, and ultra-high-frequency equipment repairman. Jobs on Guam, Saipan, Tinian, and Iwo-Jima (for one year appointment) include radio engineer, radio engineering aide, radio traffic control operator, electrical draftsman, radio repairman, radar repairman, radio station engineer, and instrument repairman. A signal engineer is needed in Manila while Hawaii can use an electrical engineer and a radio engineer. There is a position open in Germany for a radio engineer.

These positions are just a few of those offered and persons interested in further details regarding these jobs should contact the Civilian Recruitment Office at the above address.

—30—

## WE ARE SORRY--

Despite the fact that RADIO NEWS takes every reasonable precaution to insure the accuracy of material printed in the magazine, the release appearing in the April issue regarding the American Airlines training school is in error. American Airlines has advised us that the company is in no way connected with the school mentioned in the release and that they are not seeking applicants for radio positions, such as were involved in the item, at this time.

We sincerely regret any inconvenience we may have caused our readers or American Airlines. The item originally came to us from a source we considered completely reliable.

# PLEASE TEAR OUT THIS ADV. AS REMINDER

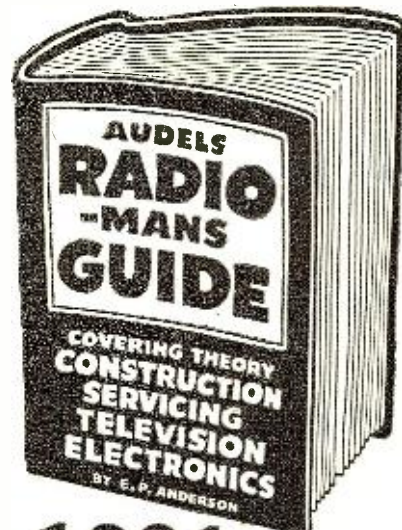

## 1001 RADIO FACTS AND FIGURES

AUDELS RADIOMANS GUIDE—914 Pages, 633 Illustrations, Photos, Wiring Diagrams, 38 Big Chapters, covering Radio Theory, Construction, Servicing, including Important Data on Developments in Television, Electronics and Frequency Modulation, Review, Questions and Answers, Calculations & Testing. Highly Endorsed—Indispensable for Ready Reference and Home Study.

**\$4 COMPLETE • PAY ONLY \$1 A MONTH**  
Step up your own skill with the facts and figures of your trade. Audels Mechanics Guides contain Practical Inside Trade Information in a handy form. Fully Illustrated and Easy to Understand. Highly Endorsed. Check the book you want for 7 days Free Examination.

Send No Money. Nothing to pay Postman.

## CUT HERE MAIL ORDER

AUDEL, Publishers, 49 W. 23 St., NEW YORK 10, N. Y.

Please send me postpaid for FREE EXAMINATION books marked (x) below. If I decide to keep them I agree to mail \$1 in 7 days on each book ordered and further mail \$1 monthly on each book until I have paid price—otherwise, I will return them.

- RADIOMANS GUIDE, 914 Pages ..... \$4
- ELECTRICIANS EXAMINATIONS, 250 Pages . . . 1
- WIRING DIAGRAMS, 210 Pages ..... 1
- ELECTRIC MOTOR GUIDE, 1000 Pages . . . . 4
- ELECTRICAL DICTIONARY, 9000 Terms . . . . 2
- ELECTRICAL POWER CALCULATIONS, 425 Pgs. . 2
- HANDY BOOK OF ELECTRICITY, 1440 Pages 4
- ELECTRONIC DEVICES, 216 Pages ..... 2
- ELECTRIC LIBRARY, 12 vol., 7000 Pgs., \$1.50 vol. 2
- OIL BURNER GUIDE, 384 Pages . . . . . 1
- REFRIGERATION & Air Conditioning, 1280 Pgs. 4
- POWER PLANT ENGINEERS Guide, 1500 Pages. 4
- PUMPS, Hydraulics & Air Compressors, 1658 Pgs. 4
- WELDERS GUIDE, 400 Pages . . . . . 1
- BLUE PRINT READING, 416 Pages . . . . . 2
- SHEET METAL WORKERS Handy Book, 388 Pgs. 1
- SHEET METAL PATTERN LAYOUTS, 1100 Pgs. 4
- AIRCRAFT WORKER, 240 Pages . . . . . 1
- MATHEMATICS & CALCULATIONS, 700 Pgs. . . 2
- MACHINISTS Handy Book, 1600 Pages . . . . 4
- MECHANICAL Dictionary, 968 Pages . . . . . 4
- AUTOMOBILE GUIDE, 1700 Pages . . . . . 4
- DIESEL ENGINE MANUAL, 400 Pages . . . . . 2
- MARINE ENGINEERS Handy Book, 1280 Pages 4
- MECHANICAL DRAWING GUIDE, 160 Pages . . 1
- MECHANICAL DRAWING & DESIGN, 480 Pgs. . 2
- MILLWRIGHTS & Mechanics Guide, 1200 Pgs. 4
- CARPENTERS & Builders Guides (4 vols.) . . 6
- PLUMBERS & Steamfitters Guides (4 vols.) . 6
- MASONRY & Builders Guides (4 vols.) . . . 6
- MASTER PAINTER & DECORATOR, 320 Pgs. 2
- GARDENERS & GROWERS GUIDES (4 vols.) . 6
- ENGINEERS and Mechanics Guides  
Nos. 1, 2, 3, 4, 5, 6, 7 and 8 complete . . . 12
- Answers on Practical ENGINEERING . . . . 1
- ENGINEERS & FIREMANS EXAMINATIONS . . 1

Name \_\_\_\_\_

Address \_\_\_\_\_

Occupation \_\_\_\_\_

Employed by \_\_\_\_\_ RN

Come to the Great  
**SHOPS OF COYNE**  
where you learn by doing



**RADIO**  
ELECTRONICS—TELEVISION  
*Quickly*

**To Succeed in Television, You Need All-Around Radio Training!**

Trained Radio men needed now. Get Radio training and be ready for a real future. Learn on actual equipment at Coyne. 49 years of training experience Not "Home Study". Free employment service to graduates. Many earn while learning. If you are short of money, ask about Student Finance Plan. Now added Training in Electric Refrigeration. G.I. Approved.

**SEND COUPON FOR FREE BOOK**

B. W. COOKE, President  
COYNE ELECTRICAL & RADIO SCHOOL  
500 S. Paulina St., Dept. A8-1K, Chicago 12, Ill.  
Send Big Free Book; also details about Coyne Part-Time Employment and Student Finance Plan.

NAME.....AGE.....  
ADDRESS.....  
CITY.....STATE.....

**SIGNAL GENERATOR**  
ONLY \$12.95

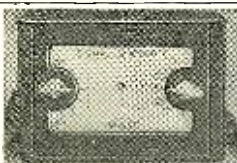

456KC—465 KC—600 KC—1400 KC

- COMPLETE WITH TUBES READY TO OPERATE
- COMPLETE CRACKLE-FINISH CABINET
- TWO OPEN CHANNELS FOR ADDITIONAL FREQS.
- INDIVIDUAL TRIMMERS FOR RECALIBRATION
- SHIELDED OUTPUT LEAD
- FULLY GUARANTEED—FULL INSTRUCTIONS

**FM TUNER KIT** \$2.95  
One tube experimental FM tuner. Amazing performance. Complete with tube, punched chassis and full instructions.

**PRE-AMPLIFIER FOR GE** \$4.75  
Reluctance pickup complete

**PHONO-AMP.** \$4.69  
Complete with tubes

**PHONO-OSC.** \$4.49  
Phono or Mike Input. Complete

WRITE FOR LITERATURE

**CONSTANT ELECTRIC**  
112 CORNELIA ST. B'way 21, N. Y.

**TELEVISION**  
A CAREER WITH A FUTURE!

- SHOP WORK • SHOP TECHNIQUES • THEORY • FULLY EQUIPPED LABORATORIES
- RADIO SERVICE & REPAIR
  - F. M. & TELEVISION
  - TRANSMITTER COURSES
- Preparing for F.C.C. LICENSES
- RADIO TECHNOLOGY
- MORNING • AFTERNOON • EVENING CLASSES • MODERATE RATES • INSTALLMENTS AVAILABLE UNDER G. I. BILL

**DELEHANTY SCHOOL OF RADIO • ELECTRONICS • TELEVISION**  
105 EAST 13th STREET, NEW YORK 3, N. Y. • DEPT. S  
LICENSED BY STATE OF NEW YORK

**RADIO COURSES**

- RADIO OPERATING
- RADIO SERVICING — ELECTRONICS
- F. M. TELEVISION
- REFRIGERATION SERVICING

Write for Catalog and Picture Brochure  
Write for Latest Trade & Technical Catalog  
Y.M.C.A. TRADE & TECHNICAL SCHOOLS  
15 W. 63rd St. (Nr. B'way) New York City

*Classified*

Rate 20c per word. Minimum 10 words.

**RADIO ENGINEERING**

RADIO Engineering Broadcasting, Aviation and Police Radio, Servicing, Marine Operating and Electronics taught thoroughly. Expenses low. Write for catalog. Valparaiso Technical Institute, Dept. N, Valparaiso, Ind.

**FOR SALE**

PANELS for any Radio News design. Gilpin, Box 638R4, Mt. Clemens, Michigan  
BC-348-R CONVERTED 110 volt 60 vac. Excellent condition with instruction manual. \$50. Garnet Frank, Route 1, Norwood, N. Y.

PUSH-BACK Wire, solid 20 ga. tinned, 6 colors; \$2.95 per 500 ft.; 69¢ per 100 ft., plus postage. Send two 3¢ stamps for 1 ft. sample each color. E A Supply Co., 887 W. Lexington Ave., Elkhart, Indiana

BC-453, 454 & 455 RECEIVER tool kits with tuning knobs, 50¢ ea. plus postage (½ lb.). E A Supply Co., 687 W. Lexington Ave., Elkhart, Indiana

FOR Sale. Hammarlund Super-Pro 400X Receiver \$300. New Machine guarantee. Elmer Westerberg, Rochester, Minn.

NEW and used Collins, Hallicrafters, National, Hammarlund, RME, Millen, Meissner, other receivers, transmitters, test equipment, amplifiers, etc. Lowest prices. World's best terms. Shipped on approval. Write. Henry Radio, Butler, Mo.

ALL new 15 watt heavy duty amplifier with 6L6 output, bass & treble tone controls, crystal & G.E. variable reluctance inputs, Seeburg record changer with G E pickup, Jensen 12" Coaxial Speaker, \$75. A.J. Magra, 8 Elizabeth St., Utica, N. Y.

TRANSFORMERS: 115/230 secondary 14/28 volts. Secondary Amps 11. Ideal for operating war surplus 28 volt motors. \$8. FOB Macon. W.R. Dorsett, Route 6, Macon Ga.

"TELEVISION Filter". A Vita-Vision filter reduces eyestrain and glare and increases contrast when used on 5, 7 & 10" television tubes. Write for details. Price \$2.39. Electron Devises, 1224 McKinley Street, Philadelphia 11, Pa.

GRILL cloth. Celanese, light and dark pieces. 1000 square inches for \$1 bill. Write for list of lowest priced national brand parts in nation. Bursma Radio, Route 5, Grand Rapids, Mich.

NEW Motorola table combination, \$119.95. Sacrifice for \$69.95 in original carton. Pilotuners two for \$50. Motorola Console, \$269.95 with FM & Record changer sacrifice for \$195. Lined Walnut finish, in carton, new Delco R705 car radio sells for \$150. Will ship to you for \$90. E/L Radio & Inter Com Walnut Cabinet complete, \$40. Kurth's Radio & Sound Service. Hutchinson, Minn.

NEW 7" Republic Kit, satisfactory performance. \$149 complete. Moy, 259 W. 21, New York, N.Y.

HALLICRAFTERS Portable S-39 with batteries for \$95. Also sx42 less speaker for \$250. Kurth's Radio and Sound Service, Hutchinson, Minn.

SELSYNS, 115V 60C, made from dynamotors. No rewinding or machine work. Instructions 50¢. Paul Hawkins, 1306 E. 27th St., Kansas City, Mo.

6V DYNAMOTOR from 12V surplus. Original output. No rewinding. Satisfaction Guaranteed. Instructions, 50¢ Paul Hawkins, 1306 E. 27th St., Kansas City, Mo.

TELEPHONES. New Army surplus field telephones with carrying cases. \$16.25 pair. Phillips, 5482 Woodlawn Ave., Chicago, Ill.

NEW Walkie Talkies, complete, each \$30. New Panadapter, \$40. E. J. Malo, 4550 Foster Ave., Chicago 30, Ill.

RME45, LATEST model, matching speaker, used about two months and McMurdo-Silver model 701 transmitter with coils, never used. Will trade or sell for best cash offer. I. Goldwasser, Louisville, Georgia. W4RD.

WIRE Recorder Magazine made for Navy KS-12009 recorder, complete with spools, wire. Has level-wind, brake control. Designed for recording with sound range 70 to 8000 cycles, instructions included, \$25. H. Jensen, Box 424, Route 3, Ogden, Utah

BUILD your own precision Volt-Ohm-Capacity meter. Complete set of plans, \$.50. See ad this issue. Bradshaw Instruments Co., 348 Livingston St., Brooklyn 17, N. Y.

HEARING Aids. Zeniths, others. All used but working. Make miniature transmitters or receivers. Complete with cords, ear piece. \$20 each. Shelby Instrument, 321 W. 7th, Long Beach, Calif.

RADIOS, Record Players, tubes, parts. Send for free bargain list. Hallmark, 592A Communipaw, Jersey City 4, New Jersey

WRITE Dept. RN18 for our free wholesale list of Radio parts & accessories. R.C. Radio Parts & Distributing Co., 731 Central Ave., Kansas City 6, Kansas

LOWEST Prices. Radio Tubes, parts. Bargain Lists 3¢. Potter, 1314 McGee, Kansas City 6, Mo.

TELEVISION components for assembly of a modern 52-square inch screen receiver using the newest circuits and tubes. The only kit on the market featuring an aluminumized cathode ray tube. A.F.C. on horizontal sync and a wired, pre-aligned r.f. tuner covering any combination from 1 to 13 television channels. Sound and Picture IF's are on one sub-chassis using new 6AH6 miniature tubes having a gm of 9000. The IF Strip and the 9000 volt RF Power Supply are sold in kit form. The main chassis is sold with all holes punched, with suggested chassis layout print. All components individually priced. Our catalog lists television components exclusively and show parts and circuits for the "hard to find items" you have been looking for. Send for it today. It's free. Television Specialties Co., 315 Madison St., Oak Park, Ill.

RADIO Tubes, bargains, National advertised radios, test equipment, etc. Address Radio Tubes, Box 108, Elizabeth City, N.C.

YOU can accurately align Superheterodyne receivers without signal generator. Complete instructions \$1. Money back guarantee. Chas. Gates, Pecos 1, Texas

NEW GE Pyranol Capacitors: 1000 WVDC, 25 mfd \$1.25; 2000 WVDC, 2 mfd \$.75; 10 mfd \$2.00 15 mfd \$2.80; Aerovox 3000 WVDC, 2 mfd \$2.95; Sprague 7500 WVDC 2 mfd \$5.50; 30 WVDC, 1500 mfd 2 for \$1; Sigma sensitive relays, 3 ma dc 3500 ohm coil \$.50 (list \$7), 1.6 ma dc 10,000 ohm coil \$.75; Tubes new cartoned, 829B \$3.00; 826 \$1.95; 838W \$3.50; 2x2 \$.75; 6Y6G, 6AC7, 6SN7, \$.25; 1824, 1825, 1641, 955, 956, 9002, 9006, \$.50; TS-15C Handsets new \$2.95. SKL Laboratory, Box 188, Lexington, 73, Mass.

V.O.M. ASSEMBLY consists of 18 wire-wound, non-inductive, precision resistors mounted and fully wired on low-loss, wafer-type, rotary switch, ready to connect to your meter to make highest grade instrument. While they last price \$2.50. Radioco, 1110 Marshall Bldg., Cleveland, Ohio

WIRE. For Webster, Sears, Air King and other Recorders, ½ hour spool, \$2.90, 1 hour \$4.95, Air King Wire Recorder, \$129.50 complete. McCoy Sales Company, P.O. Box 335, Berea, Ohio

**WANTED**

APR-5A, APR-4 RECEIVERS and Tuning Units, also other VHF Surplus equipment wanted for cash, or trade for other equipment. Charles Littell, 222 Lonsdale Avenue, Dayton 9, Ohio

OFFER \$3.00 apiece for one copy each of Jan. 1940 & 1941: Feb & Aug. 1945 Radio News. C.M. Phillips, Veterans Hospital, Gulfport, Miss.

TYPE 101B 1000/20 cycle ringers manufactured by Federal. Type 768602 Ringer-Oscillators manufactured by Western Electric. Box 461, c/o Radio News, 185 N. Wabash, Chicago, Ill.

WESTERN Electric Vacuum Tubes. Types 101F, 102F, 272A, 274A or B, 310A or B, 311A, 313C, 323A, 328A, 329A, 348A, 349A, 352A, 373A, 374A, 393A, 394A, 121A Ballast Lamps. Box 462, c/o Radio News, 185 N. Wabash, Chicago, Ill.

WE will purchase for cash small or large quantities of the following surplus items: Pioneer Torque Units, Autosyns, Servo-Amplifiers etc: Diehl A.C. Control Motors for 60 and 400 Cycles: Lear Actuators; D.C. motors; Fractional H.P.A.C. Motors; Selsyns; Synchros; Gyros; 400 Cycle Inverters, etc. Send price, quantity, condition and description to Carlson Laboratories, Box 692, Mountain View, N. J.

WANT ART-13 Autotune. Radio Station KDAL, Duluth, Minnesota

CASH for 25D8 (25Dee 8) tubes; Will pay 4 dollars for tube. Address C.W., 6043 75 Court, Argo, Ill.

MN-36A LOOPS; MN-31 Loop Director Units; MN37A Bearing Indicators, large; MP-10 Series Power Supply Units; MP-8 Series Power Supply Units. J.D. Reed Co., Inc., Municipal Airport, Hangar 8, Houston 17, Texas

**HELP WANTED**

SUB-CONTRACT work on sub-assembly of radio and electronic equipment. Write Box 463, c/o Radio News, 185 N. Wabash, Chicago 1, Ill

INSTRUCTORS in Radio-Electronics and Television. Prefer former Navy Radio Technician Instructors with Teacher Training. Must be willing to locate in Detroit, Mich. Write to Box 452, c/o Radio News, 185 N. Wabash, Chicago 1, Ill.

**PATENT ATTORNEYS**

LANCASTER, Allwine & Rommel, Registered Patent Attorneys, Patent Practice before U.S. Patent Office. Validity and Infringement Investigations and Opinions. Booklet and form "Evidence of Conception" forwarded upon request. Suite 414, 815 15th St., N. W., Washington 5, D.C.

**CORRESPONDENCE COURSES**

AMATEUR radio licenses. Complete code and theory preparation for passing amateur radio examinations. Home study courses. American Radio Institute, 101 West 63rd Street, New York 23, N. Y.

USED Correspondence Courses and Books bought, sold, rented and exchanged. Catalog Free. Lee Mountain, Pisgah, Alabama

MISCELLANEOUS

26 YEARS experience radio repairing at your fingertips I've repaired 45000 radios. Have perfected simple system you can follow step by step. No calculations or formulas. Total price, \$2 postpaid or C.O.D. Money back guarantee. Ross Radio, 14651-C Grand River, Detroit 27, Michigan

IF Low voltage gives you trouble, write for full information on low-priced voltage booster. W.R. Dorsett, Route 6, Macon, Ga.

QSL's, SWL's SAMPLES, WSFAY Press, 6118 Gollad, Dallas, Texas

ELECTRICAL, Electronic parts or products desired manufacturer. Engineering, manufacturing, shipping facilities available. Box 464, c/o Radio News, 185 N. Wabash Ave., Chicago 1, Ill.

PHOTO CREDITS

Page	Credit
39,41,42,57 (except center)	RCA
44 (top, center), 45	Acme
44 (right)	U.S. Army Signal Corps
46,47	Howard W. Sams & Co., Inc
53,184	Test-Craft Instrument Co.
54,55	McMurdo Silver Co., Inc.
56	TOCCO Div. of Ohio Crankshaft Co.
57 (center), 120	General Electric Co.
59	Allen B. DuMont Labs. Inc.
65	The Langevin Company
68,69,178	Farnsworth Tel. & Radio Corp.
70	French Broadcasting System
71	Motorola, Inc.
73 (bottom)	Belmont Radio Division
90	Bell Telephone Laboratories
130	Weston Electrical Instrument Corp.
142	Stromberg-Carlson Company

UTL SILVER-PLATING FLUID

Silverplate without batteries or generators! Simple, quick acting rub on with cloth, deposits bright coating of pure bullion silver on copper, brass, bronze. Easy, time and money saving way to silver plate radio coils, dials, switch arms, contacts, brackets, shields, etc. Hundreds of uses in shop, factory, lab. 4 oz. bottle, \$1.00, pint \$3.75 postpaid, or write for circular. Satisfaction guaranteed. Agents and Distributors wanted.

UNITED TECHNICAL LABORATORIES  
Morristown 7, N. J.

20% SAVER  
ALL MERCHANDISE BRAND NEW  
10% Discount on Orders Over \$10;  
20% Over \$25

1/2 meg. vol. controls with switch, 3" shaft.....	39
G.E. Plate Circuit Relay—10M ohms—used with 50L6—Operates on 8ma. S.P.D.T.....	.95
Willard 6v 3 cell plexiglass case miniature storage batt., 3 1/2"x1 1/2"x2 3/8"; shipped without electrolyte.....	1.95
<b>OPERATES ON A BEAM OF LIGHT</b>	
Photo-electric relay kit complete with all parts including tubes, relay, sensitivity control and simple assembly instructions.....	ONLY \$5.95
Gruen 2 1/2" meter—0-8ma. movement—scale marked 0-300.....	1.95
Weston #476-3 1/2" meter—0-8v ac.....	3.95
Weston #507-0-1.5 amps. R.F.—2% accuracy to 65mc.....	4.25
Filter chokes 10HY. @ 160ma., 150 ohms resistance.....	1.25
Westinghouse chokes 4HY. @ 90ma., 300 ohm resist.....	.69
G.E. Solenoid operated contactor #CR2820, controls 6 circuits, operates on 115V 60 cyc., 4x9, 15 amp. contacts double break each circuit—G.E. catalog price \$25.00. YOUR COST.....	5.95
U.T.C. "S-6" input Xmfr. line or mike to grid; dealer's price \$3.25; YOUR COST.....	1.25
Leach 6v DC relays, 3 pole n.o. YOUR COST.....	1.25
Selen. Rectifiers; full wave, cent. tap, 18v @ 2.5 amps.....	2.49
Rotary Switch with knob; A.H.&H. 5 pole on & off, 10 amps. @ 120v.....	.59
Send us your name — Get on our mailing list NO C.O.D. — INCLUDE POSTAGE MINIMUM ORDER \$2.00	
RADIO DEVELOPMENT & SALES CO. 323 Atlantic Ave. Brooklyn 2, N. Y.	

HARRISON SELECT SURPLUS

THE BEST IN SURPLUS AT THE LOWEST PRICES

HEAVY DUTY HIGH VOLTAGE TRANSFORMER



Primary: 115 or 230 volt, 60 cycle. Has taps which can reduce output voltages by 10% and 20%.

Secondary: 1170 volts, with center tap. Will deliver 500 volts DC at 750 ma with choke input filter, or 600 volts DC at 600 ma with condenser input (delivers 750 volts at 300 ma load). Use

duplex or branch rectifiers and/or filters for added flexibility and stability. With half-wave or bridge rectifier will give 1200 volts DC, 300 ma. TWO, with secondary windings in series will economically make available 1200 volts at 600 ma!

Excellent Regulation!—plenty of copper and a heavy, high grade core.

Compact!—6 3/4" wide x 6" high x 6 1/2" deep overall, including ceramic HV feed thru insulators. (All terminals plainly marked)

Husky!—28 3/4 lbs. unpacked!

Dependable!—made to Government specifications by a reputable manufacturer.

Sensationally Priced! Item RTP6 (add packing charge of 80c for each transformer). Send your order now! Or—send stamp for free data sheet giving circuits and full specifications.

HSS CONDENSER SUPER-VALUE

2 MFD, 1000 VOLT. Oil Filled! The popular cylindrical, upright mount type. Aluminum case 1 1/2" dia. x 4 1/2". With nut, lock washer, and lug—complete! List price \$4.75. Item ROP15

SIX OR MORE AT ONLY 49¢ EACH

SURPLUS DYNAMOTORS

It's Compact!—only 3 3/4" dia., 6 1/2" long.

It's Light!—only 6 3/4 lbs. complete!

It's Powerful!—12 volt input gives 680 volts at 210 ma; 6 volt input gives 300 volts at 210 ma or 265 volts at 300 ma.

It's Efficient!—ball bearings minimize friction loss. It's Dependable!—well constructed for U. S. Navy. Inspected, tested, original packing.

JUST the unit to power your mobile transmitter, PA amplifier or emergency rig. With built in RF hash suppressors and mounting plate—complete. Item RR05. Send for data sheet \$8.95 giving full performance curves.



THERE IS NO GUESSWORK ABOUT HSS!

FILTER CHOKE BARGAIN

15 Henry 175 MA  
200 Ohm DC Resistance

Well made, of the best materials by one of our good manufacturers. (The name plate will tell you!) Fully shielded. 3 3/4" x 4 3/4" high. 5 lbs. of high quality choke. Item RCH7. Each \$1.94

Two, or more, at \$1.69 each



NEW EQUIPMENT, TOO! Products of all top manufacturers in stock for immediate delivery—at lowest prices. Harrison Has It!



HARRISON RADIO CORPORATION

10 WEST BROADWAY • NEW YORK CITY 7

PHONE—BArdEv 7-9854 • EXPORT DEPT.—CABLE—HARRISONRAD

JAMAICA BRANCH—172-31 Hillside Ave.—REpublic 9-4102

Ceiling Unlimited!

with the new

UNIVERSITY TWEETER

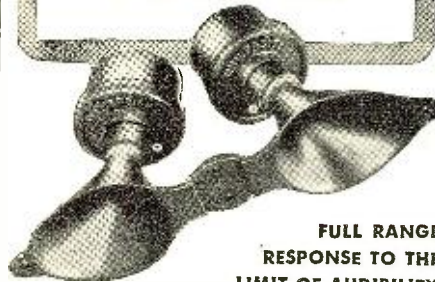

FULL RANGE RESPONSE TO THE LIMIT OF AUDIBILITY

Don't let your loudspeaker put a ceiling on the frequency response of your radio or phono equipment. Enjoy full range reproduction right up to 15,000 cycles by connecting one of these tweeters to your present cone speaker. Perfect for FM and the latest full frequency range recordings. Available in single or dual unmounted types and in walnut cabinet models. Prices from \$20.00.

UNIVERSITY LOUDSPEAKERS, INC.

80 SOUTH KENSICO AVENUE  
WHITE PLAINS, NEW YORK

University Loudspeakers

Can You Handle THESE AND SIMILAR Technical Problems

1. An FM station feeds 3 kw power into an antenna with a power gain of 4 and height of 500 feet. Find the field strength at 25 miles and a height of 30 feet.
  2. Design an H pad to match 250 ohms to 600 ohms with 15 db loss.
  3. Find the values of reactances to be used in a T network matching a 230 ohm transmission line to an antenna with impedance 100 + j85. Phase shift to be -90 degrees.
  4. Design a low-pass m-derived filter to cut off at 1000 cps and have an infinite attenuation at 1200 cps.
  5. Design a video amplifier stage to have a uniform gain of 18 db from 30 cycles to 4 megacycles.
- Prepare now for a "key job" in radio engineering. Get full information, and Sample Lesson, which shows how to add technical training to your practical experience with a genuine college-level home-study radio course.

Here's what one student says:

I am certainly glad I am taking this course. Streamlined as you have made this course, it serves to give me the grasp I have needed for years.

Wesley N. Mathews, 5660S15



MAIL TODAY!

Cleveland Institute of Radio Electronics  
RAN-6 Terminal Tower Cleveland 13, Ohio  
Send absolutely FREE Catalog A, describing Smith's Advanced Radio and Communication Engineering, and Sample Lesson. NO OBLIGATION—NO SALESMEN.

NAME .....  
ADDRESS .....  
 Veterans check for enrollment information under the G.I. Bill.

# VALUE PLUS! SURPLUS!

## 120 WATT BLEEDER

R-1 Non-Inductive

with 14" Brass Mtg. Rod and Insula-  
tors. 10000 Ohms—Individ. Boxed **3 for \$1.00**  
**Dozen \$3.00**

**Filament Transformer. Special Offering**  
**Repeated—T-23—Hypersil-Core—115V. 60cy.**



Sec. #1-6.3V-22.0 Amp.  
#2-6.3V- 2.4 "  
#3-6.3V- 2.25 "  
#4-6.3V- 0.6 "

The 22 Amp. Winding consists of  
two 11 amp. windings in Parallel.  
Simple to Re-arrange for 12 volt  
at 11 amp. Also use for 18 or 24 volts.  
New .....Each **\$2.95**

**Radar Interference Reducer #BC 736B.**  
Self contained 115 volt 60 cycle power supply,  
6 tubes. Housed in Black Crackle cabinet 8 x 11 x 12.  
Weight 20 lbs. New—Complete with fit-  
tings, Spec. sheets, Schematic ..... **\$14.95**

### Navy Cased Choke.

Porcel. Terminals.

#L-5. 20 Henry-110 Mils.  
(conserv.)230 Ohms. Brand New

**\$1.50**



**Radar Jammer**—Self contained power supply.  
British-type 3-Ref #10DB/919. Complete with  
tubes, antenna, carrying chest,  
Weight 60 lbs. operating..... **\$25.00**

**Signal Corps. Code Trainer #OAH.**  
4 tube oscillator amplifier. 7 positions. 7 keys,  
7 phones—connecting cables. Manuals. Packed in  
OD Trunk. Brand New **\$39.95** with Spare Parts.

**New Bulletin off press — write**  
**GREENWICH SALES CO.**  
59 Cortland St.  
New York 7, N. Y.

## GOOD SUPPLY OF FOLLOWING ITEMS RESERVED FOR THIS AD: REFER TO "RN-4"

- BC 639 Receiver rack complete. 100 to 156 mags.  
110 or 220 volts a.c. Olive green finish. 72"  
rack contains BC 639 as described in May Radio  
News ad. (AM rcvr, but receives standard FM  
with good fidelity also.) BC 638 Freq meter;  
control panel; speech amp. for operating Xmtr  
remote control; relay panel; Rcvr. power supply  
panel; and Auto Xfmr panel with ac meter to  
read input voltage. Complete .....**\$117.50**
- BC 639 components priced separately: Receiver  
58.50; Rcvr. Pwr Supply 8.00; Freq. Meter  
22.50; Speech Amp. 12.50; Control Panel 6.50;  
Auto Xfmr and meter panel 10.00; Relay Panel  
10.00; 72" open rack (standard) 10.00. All  
this equipment for 60 cy. a.c.
- BC 640 Xmtr. Companion to 639—Write for  
Prices
- BC 929 Indicator-fb for monitor as with 75 v.  
60 cy. .... **10.00**
- APS 15 Indicator—we're closing them out at  
..... **24.10**
- BC 221 Freq. Meter—with Xtal and Original  
calib. book ..... **45.00**
- BC 375E Xmtr. with one TU and Ant. Tuner  
..... **44.80**
- BC459 Command Xmtr. used ..... **9.50**  
Unused ..... **13.75**
- BC 458 Command Xmtr. Easy to put on 40  
..... **7.50**
- BC 457 Command Xmtr. We tune it to work 75  
& 80 mtr band ..... **11.50**
- BC 453 Lazy man's Q-fiver. A few left at. .... **12.50**
- BC 454 Excellent standby rcvr for 75 & 80—use  
it with your broadcast set as Q-5'r (IF freq 1415  
kc) ..... **6.50**
- BC 455 6 to 9.1 megs—while they last.... **7.50**
- Amertran Xfmr. 2 kva, 6200 v.c.t. at 700 mils-  
3 left ..... **55.00**
- SCR 522 Xmtr. Rcvr. unit—with set of 6 Xtals  
..... **22.50**
- APN 9 Loran Rcvr. Indicator unit—similar to APN4  
complete with 100 kc Xtal for calibration ..... **24.50**
- Motor, Beam rotating—10-30 v. ac or dc—takeoff  
1 rpm ..... **3.60**

This month's special: .01 Mica Condenser,  
1200 v.v.d.c. 13c each 10 for 1.00 postpaid

20% Deposit required for C.O.D. Orders

**S & S RADIO**  
Rochelle, Ga.  
Phone 4

# INDEX OF Advertisers

JUNE  
1948

ADVERTISER	PAGE NO.	ADVERTISER	PAGE NO.
Abell Distributing Co. . . . .	179	General Electronics Distributing Co. . . . .	115
Acorn Electronics Corp. . . . .	128	General Test Equipment. . . . .	163
Airborne Sales, Inc. . . . .	182	Goodheart, R. E. . . . .	156
Algeradio. . . . .	188	Greenlee Tool Co. . . . .	98
Allen Corp., Tom . . . . .	138	Greenwich Sales Co. . . . .	192
Allied Radio Corp. . . . .	9	Greylock Electronic Supply Co. . . . .	168
Almo Radio. . . . .	188	Hallcrafters Radio. . . . .	6
Altec Lansing. . . . .	138	Hallmark Electronics Corp. . . . .	182
Alvaradio Supply Co. . . . .	171, 186	Harrison Radio. . . . .	180
American Microphone. . . . .	187	Harvey Radio Company, Inc. . . . .	28
American Radio Institute. . . . .	169	Heath Company. . . . .	86, 87
American Sales Co. . . . .	132	Henry Radio Stores. . . . .	177
American Surplus Products Co. . . . .	95	Herbach & Radman. . . . .	110
American Television and Radio Co. . . . .	155	Hollywood Sound Institute. . . . .	167, 188
Amplifier Corp. of America. . . . .	124, 185, 178	Hytron Radio and Electronic Corp. . . . .	34
Ar-Jay Products Co. . . . .	177	Illinois Condenser Corp. . . . .	184
Arrow Sales, Inc. . . . .	92, 93	Indiana Technical College. . . . .	171
Ashe Radio Co., Walter. . . . .	108	Industrial Television, Inc. . . . .	150
Astatic Corp. . . . .	183	Instructograph Company. . . . .	181
Audel Publishers. . . . .	189	Instrument Associates. . . . .	171, 179
Audio Development Co. . . . .	151	James Vibrapower Company. . . . .	114
Baltimore Technical Institute. . . . .	182	Jensen Mfg. Co. . . . .	24
Bardwell & McAllister, Inc. . . . .	148	Johnson Company, E. F. . . . .	97
Barker & Williamson, Inc. . . . .	124	Johnson Company, E. M. . . . .	175
Bell Telephone Laboratories. . . . .	35	Joseph, Irving. . . . .	85
Berman Co., Inc., Henry O. . . . .	193	Kedman Co. . . . .	180
Bliss Electrical School. . . . .	193	Klein, Manuel. . . . .	152
Boland & Boyce Inc., Publisher. . . . .	135	LaPointe Plascomold. . . . .	142
Brach Mfg. Corp., L. S. . . . .	189	Lake Radio Sales Co. . . . .	96
Bradshaw Instruments Co. . . . .	159	Langevin Mfg. Corp. . . . .	100
Brooks Electronics Laboratories. . . . .	104	Lear Radio Co. . . . .	30, 108
Brooks Radio Distributing Corp. . . . .	172	Lectrohm, Inc. . . . .	168
Burnett Service Co. . . . .	100	Leeds Radio Co. . . . .	151
Burstein-Applebee Co. . . . .	153	Leotone Radio Co. . . . .	169, 191
Camburn, Inc. . . . .	138	Lincoln Engineering School. . . . .	170
Candler System Co. . . . .	150	Long Island Radio Co. . . . .	189
Cannon Electric Development Co. . . . .	8	Macmillan Co. . . . .	116
Capitol Radio Engineering Institute. . . . .	89	Mallory & Co., Inc., P. R. . . . .	Third Cover
Centralab, Division of Globe Union, Inc. . . . .	36, 37	Martin School of Radio Arts, Don. . . . .	161
Certified Television Laboratories. . . . .	169	Melehan Radio Products Co. . . . .	150
Chicago Industrial Instrument Co. . . . .	122	Melville Radio Institute. . . . .	164
Chicago Transformer, Division of Essex Wire Corporation. . . . .	75	Merit Coil & Transformer Corp. . . . .	20
Cinaudagraph Speakers, Division of Aireon Mfg. Corp. . . . .	155	Merit Radio Supply Co. . . . .	168
Cinex, Inc. . . . .	118	Mid-America. . . . .	76
Cleveland Institute of Radio Electronics. . . . .	38, 191	Miller Company, J. W. . . . .	138
Clippard Instrument Laboratory, Inc. . . . .	132	Milwaukee School of Engineering . . . . .	139
Collins Audio Products Co. . . . .	147	Morts Radio Shack. . . . .	98
Columbia Wire & Supply Co. . . . .	166	Moss Electronic Distributing Co. . . . .	107
Commercial Radio. . . . .	188	Murray Hill Books, Inc. . . . .	18
Commercial Radio Institute. . . . .	179	McConnell's. . . . .	178
Communications Equipment Co. . . . .	131	McCoy Sales Co. . . . .	173
Concord Radio Corp. . . . .	141	McGee Radio Company. . . . .	79, 80, 81
Constant Electric Company. . . . .	190	McGraw-Hill Book Company. . . . .	172
Coradio. . . . .	188	McMurdo Silver Company. . . . .	22, 140
Coyne Electrical & Radio School. . . . .	128, 190	National Wide Radio. . . . .	161
Crystal Devices Co. . . . .	172	National Equipment & Supply Co. . . . .	122
D'Errico & Krischer, Inc. . . . .	189	National Radio Distributors. . . . .	166
DeForest's Training, Inc. . . . .	19	National Radio Institute. . . . .	3
Delco Radio. . . . .	27	National Schools. . . . .	23
Delehanty School of Television. . . . .	190	New York YMCA. . . . .	190
Dow Radio. . . . .	163, 185	Newark Surplus Materials Co. . . . .	157
Dunn-Wright Electric Co. . . . .	175	Niagara Radio Supply Co. . . . .	105, 159
E A Supply Co. . . . .	164	Northern Products Co. . . . .	170
Editors & Engineers, Ltd. . . . .	16	Offenbach & Reimus Co. . . . .	70, 137
Eddie Electronics. . . . .	154	Ohmite Manufacturing Company. . . . .	29
El-Monte Electronic Supply Co. . . . .	170	Olin Industries, Inc. . . . .	10, 11
Electro Products Laboratory. . . . .	156	Olson Radio Warehouse. . . . .	145
Electronic Sales Co. . . . .	158	Opad & Green Company. . . . .	187
Electronic Supplies. . . . .	102, 178	Operadio Mfg. Co. . . . .	113
Electroncraft Inc. . . . .	150, 186	Peak Electronics Co. . . . .	98
Ellis Co., Franklin. . . . .	148	Photocon Sales. . . . .	139
EPCO. . . . .	186	Plastics & Electronics Company. . . . .	139
Ereco (Dick Rose). . . . .	156	Potter Radio Company . . . . .	128
Erie Supply Co. . . . .	182	Precision Apparatus Co. . . . .	78
Espey Mfg. Company, Inc. . . . .	169	Progressive Electronics Co. . . . .	112, 161
Esse Radio Company. . . . .	125	Quad Electrical Supply. . . . .	193
Fair Radio Sales. . . . .	114	Quam Nichols Company. . . . .	168
Federal Telephone & Radio Corp. . . . .	91	RCA Institutes, Inc. . . . .	112
Federated Purchaser, Inc. . . . .	140	R & M Radio Company. . . . .	99, 143
Feller Engineering Company . . . . .	147	Radiart Mfg. . . . .	32
G. & E. Equipment Supply Co. . . . .	161	Radio Apparatus Co. . . . .	149
G. & G. Radio Parts Service. . . . .	121	Radio City Products. . . . .	186
G. & M. Equipment Co., Inc. . . . .	106		
General Cement Mfg. Co. . . . .	132		
General Electric Company. . . . .	8, 21, 83, 194		



ADVERTISER PAGE NO.

Radio Cola-Matic. . . . . 98  
 Radio Corporation of America. . . . . 13, 33, 193  
 Radio Development & Sales Co. . . . . 191  
 Radio Electric Service Co. . . . . 90

Radio Ham Shack. . . . . 117  
 Radio Hospital. . . . . 188  
 Radio Kits Company. . . . . 174  
 Radio Maintenance. . . . . 120  
 Radio Parts Company. . . . . 143  
 Radio Parts Distributors. . . . . 152  
 Radio Press. . . . . 187  
 Radio Products Sales Co. . . . . 177  
 Radio Research Products. . . . . 120  
 Radio Supply & Engineering Co. . . . . 134  
 Radio Wire Television, Inc. . . . . 88  
 Radlomar, Inc. . . . . 147  
 Radionic Equipment Co. . . . . 173  
 Radolek Company. . . . . 184  
 Ravac Electronics Corp. . . . . 120  
 Ray-lectron Co. . . . . 180  
 Raymark Products Co. . . . . 173  
 Raytheon Mfg. Co. . . . . 84  
 Raytone. . . . . 178  
 Recording Devices Company. . . . . 120  
 Rider Publisher, Inc., John. . . . . 12  
 Risco Electronics Wholesale Distributors. . . . . 180  
 Rose Company. . . . . 186

Sams Company, Howard W. . . . . 26  
 Schuh's Radio Parts. . . . . 118  
 Seeburg Corp., J. P. . . . . 78  
 Senco Radio, Inc. . . . . 108  
 Servo-Tek Products Co. . . . . 127  
 Sigma Instruments Co. . . . . 119  
 Smith, Wardell. . . . . 171  
 South River Metal Products Co. . . . . 162  
 Specialties Mfg. Co. . . . . 182  
 Spellman Television. . . . . 148, 174  
 Sprayberry Academy of Radio. . . . . 7  
 Stahl, Inc., Michael. . . . . 165  
 Standard Radio & Electronic Products Co. . . . . 185  
 Standard Transformer Corp. . . . . 25  
 Stanton Radio Supply. . . . . 112  
 Star Measurements Co. . . . . 94  
 Strickland Radio Supply. . . . . 192  
 Sun Radio of Washington D. C. . . . . 77  
 Supreme Publications. . . . . 103  
 Surplus Radio, Inc. . . . . 183  
 Sutton's Wholesale Electronics, Bill. . . . . 164  
 Sylvania Electric Products, Inc. . . . . Fourth Cover

TAB. . . . . 101  
 Tape Tone Mfg. Co. . . . . 185  
 Tarrytown Metal Craft Corp. . . . . 140  
 Tec Publications. . . . . 128  
 Technical Radio Parts Co. . . . . 124  
 Tel-Craft Co. . . . . 158  
 Television Assembly Co. . . . . 31  
 Television Industries. . . . . 129  
 Telex, Inc. . . . . 149  
 Tradio, Inc. . . . . 152  
 Transvision, Inc. . . . . 111  
 Tri-State College. . . . . 163  
 Turner Company, The. . . . . 123

United Surplus Materials. . . . . 181  
 United Technical Labs. . . . . 193  
 Universal General Corp. . . . . 139  
 University Loudspeakers, Inc. . . . . 15, 191  
 Utica Drop Forge & Tool Corp. . . . . 165

V & H Radio & Electronic Supply. . . . . 120  
 Valparaiso Technical Institute . . . . . 173

Walmar Distributing Co. . . . . 182  
 Ward Products Corporation. . . . . Second Cover  
 Warren Distributors. . . . . 133  
 Watterson Radio Mfg. Co. . . . . 164  
 Weber Electric. . . . . 163  
 Weller Manufacturing Co. . . . . 118  
 Wells Sales, Inc. . . . . 14  
 Westinghouse. . . . . 17  
 Workshop Associates. . . . . 175  
 World Radio Laboratories Inc. . . . . 167  
 Wright, Inc. . . . . 112

# ELECTRICAL TRAINING

Intensive 32 weeks' residence course in fundamentals of industrial electrical engineering, including radio, electronics. Prepares for technician, engineering aides. Approved for veteran training. 54th year. Enter July 26, Nov. 22. Catalog.

**BLISS ELECTRICAL SCHOOL**  
 7698 Takoma Avenue,  
 Washington 12, D. C.

June, 1948

# KEEP POSTED ON ELECTRON TUBES

Use this convenient coupon for obtaining the RCA tube reference data you need.

RCA, Commercial Engineering,  
 Section FW60, Harrison, N. J.  
 Send me the RCA publications checked below. I am enclosing \$..... to cover cost of the books for which there is a charge.

Name \_\_\_\_\_  
 Address \_\_\_\_\_  
 City \_\_\_\_\_ Zone \_\_\_\_\_ State \_\_\_\_\_

- Quick-Reference Chart, Miniature Tubes (Free). [A]
- HB-3 Tube Handbook (\$10.00)\*. [B]
- RC-15 Receiving Tube Manual (35 cents). [C]
- Receiving Tubes for AM, FM, and Television Broadcast (10 cents). [D]
- Radiotron Designers Handbook (\$1.25). [E]
- Quick Selection Guide, Non-Receiving Types (Free). [F]
- Power and Gas Tubes for Radio and Industry (10 cents). [G]
- Phototubes, Cathode-Ray and Special Types (10 cents). [H]
- RCA Preferred Types List (Free). [I]
- Headliners for Hams (Free). [J]

\*Price applies to U. S. and possessions only.



TUBE DEPARTMENT  
**RADIO CORPORATION of AMERICA**  
 HARRISON, N. J.



**A Word to the Wise!**

War-surplus stocks are dwindling fast! So it's wise to get your radio parts and supplies at these ultra-low prices while they last. Order now. The supply of specials like those below is limited!

### C4/ARN-7 Compass Control Box

A gold mine of valuable parts for the experimenter and the amateur. Contains one 0-5 D.C. M.A. meter, band switch, 4 band dial, dial lights, knobs, jack, switches, etc. **BRAND NEW**, in original cartons ..... **\$1.25**



### SCR-274N COMPONENTS

	NEW	USED
BC-456 Modulators	\$2.00	\$1.00
BC-459 7 to 9.1 M.C. transmitter	5.50	3.50
BC-453 190 to 550 K.C. receiver		
the "Q" 5-er	7.50	6.00
BC-454 3 to 6 M.C. receiver	4.00	3.00

Modulator and receivers, less dynamotor

Spare tubes for above.

1625 15c 1626 19c 1629 19c 12A6 19c 12J5GT 39c  
 12SR7 50c 12SK7 50c 12K8 50c 12SF7 50c

Prices F.O.B. our warehouse, CHICAGO

All items subject to prior sale. Write for circular.

**QUAD ELECTRICAL SUPPLY**  
 1650 North Damen Avenue, Chicago 47, Illinois

**HOBCO**  
**JUNE**  
**SPECIALS**

### EDWARDS FIDELOTUNER

**\$31.50**  
 net

In lots of 3  
 \$28.35 each



88 to 108 MC. Connects to any radio receiver or sound amplifier for FM listening pleasure. A real FM discriminator—3 IF stages—slide rule dial—5 tubes and rectifier. Walnut cabinet 11" x 6" x 6 1/2".

### ULTRATONE Record Player

Special Price  
**\$25.45**

Lists regularly at \$49.50. Plays ten or twelve inch records, singly. Has built in amplifier—handsome cabinet.



Write for our Monthly Bulletins on Standard Radio Parts featuring Nationally Advertised Brands

### HENRY O. BERMAN CO., Inc.

10-12 E. LOMBARD STREET  
 Dept. R-7 BALTIMORE 2, MD.  
 Electronic Equipment and Replacement Parts



# TIPS DO NOT "FREEZE-IN"! CALROD SOLDERING IRONS

REMOVE the tip? With a G-E Calrod Iron it's easy because the tips *just don't "freeze-in."* The special calorization process which prevents "freezing-in" is a leading feature of these G-E irons—a feature that simplifies the care and maintenance of one of your most useful tools.

### High Efficiency—Low Heat Loss

The G-E Calrod cartridge-type element is insulated with highly compacted magnesium oxide which maintains full insulation properties. The element conducts heat so rapidly that there is little temperature drop from the resistance wire. The stainless steel barrel which encloses the element has less than half the conductivity of plain steel. Therefore the heat loss through the barrel is very low. By means of the special G-E heat reservoir the heat is efficiently conducted to the calorized conical tip seat. The calorized surfaces of the seat and tip threads retard oxidation of the heat-conducting copper parts, thereby maintaining high-heat transfer to the working tip.

### G-E Calrod—The Soldering Iron with Long Life

- The shell material, Type 18-8 stainless steel, will withstand hard usage without collapsing.
- The heater will withstand repeated jarring or rough handling, because it is embedded in highly compacted magnesium oxide.
- The life of the tip is considerably lengthened by the calorized surface. This retards corrosion during long hours of idling.
- The heater is dependably protected against grounding by the highly compacted, magnesium-oxide insulation.

### FREE—With each G-E Soldering Iron

Packed with each Calrod Soldering Iron is a booklet that contains a wealth of information about soldering, tips to make the job easier and a flux chart that will be invaluable.

For additional information on G-E Calrod Soldering Irons write: *General Electric Company, Electronics Park, Syracuse, New York.*

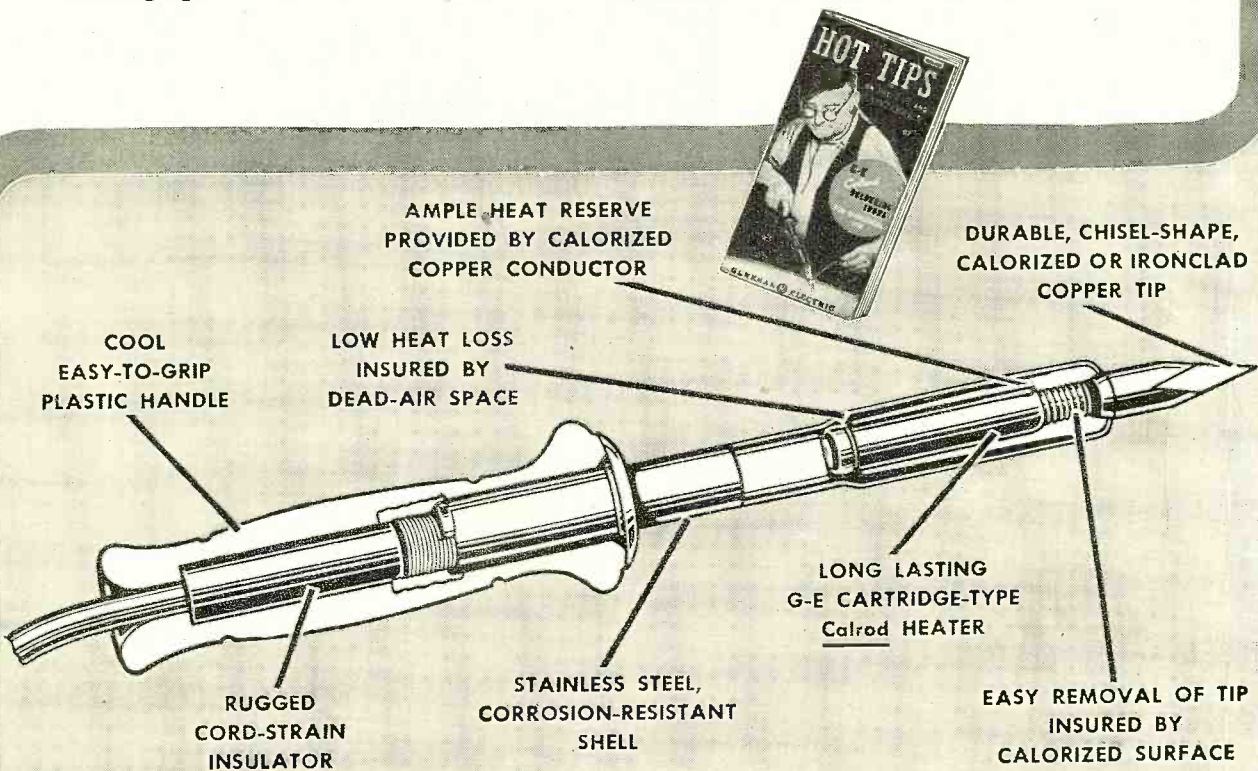

GENERAL  ELECTRIC

159-04



## EQUALLY MATCHED

Split the reed assembly of a Mallory vibrator down the middle and the two halves will match each other so accurately that no scale made will register a significant difference. This precise distribution of weight is a major factor in assuring accurate output, reliable operation and long life.

### *Mallory Vibrators Make*

#### *the Best Replacements*

Such careful manufacturing makes Mallory vibrators free of bounce and chatter and dependable in starting. More of them are used in original equipment than all other makes combined. That's convincing proof

they are the best replacement vibrators for you to stock.

In addition to assured quality, Mallory offers the most complete line in the business. Mallory standardization permits 12 basic vibrators to meet 90% of your replacement requirements. But a complete line of 52 vibrators is available to meet virtually every vibrator need.

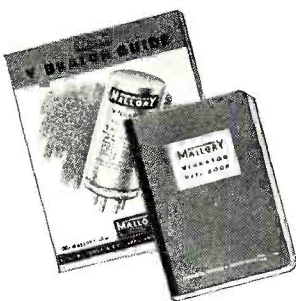

The Mallory Replacement Vibrator Guide is free. The Vibrator Data Book is \$1.00—from your distributor or by mail.

### Mallory "2448" Vibrator Deal

This deal gives you a handsome storage and display cabinet for your stock of vibrators, together with a selection of vibrators and buffer capacitors that will answer 75% of your requirements.



You pay only the service man's net price of \$24.48 for the six vibrators and twelve buffer capacitors. There is no charge for the attractive, convenient cabinet. Your Mallory distributor has them in stock for immediate delivery.

**MORE MALLORY VIBRATORS ARE IN USE THAN ALL OTHER MAKES COMBINED**

P. R. MALLORY & CO., Inc.  
**MALLORY**

CAPACITORS . . . CONTROLS . . . VIBRATORS . . .  
SWITCHES . . . RESISTORS . . . RECTIFIERS . . .  
VIBRAPACK\* POWER SUPPLIES . . . FILTERS

\*Reg. U. S. Pat. Off.

**APPROVED PRECISION PRODUCTS**

**P. R. MALLORY & CO., Inc., INDIANAPOLIS 6, INDIANA**

# Greyhound Bus improves service, saves mileage, reduces delays with *Motorola 2-way radio*

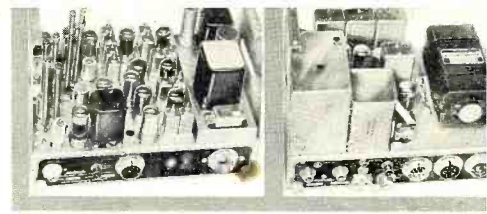

## and Sylvania Lock-In Tubes . . . . .

BY MAINTAINING 2-WAY RADIO COMMUNICATION between dispatchers and buses on the road in the Chicago area, Greyhound has effected substantial operating economies — and *at the same time* has improved quality of its service to riders! Schedules are quickly readjusted, extra sections added, runs combined — as the dispatcher works with the up-to-the-minute reports coming in from drivers.

The 2-way communication is maintained by FM equipment built by Motorola, Inc., Chicago — using Sylvania Lock-In Tubes in the mobile units. These famous tubes stay put in their sockets, no matter how rough the road. They have no soldered joints, few welded ones. Short, direct connections reduce losses. Getter is located on top; separation of getter material from leads cuts down leakage.

This electrical and mechanical superiority makes the Lock-In the ideal choice for equipment on the road, in the air, on the rails . . . for marine radar, FM, television. See Sylvania Distributors, or write Radio Tube Division, Emporium, Pa.



Dispatchers communicate directly with drivers to adjust schedules to changing load conditions.

## SYLVANIA ELECTRIC

MAKERS OF RADIO TUBES; CATHODE RAY TUBES; ELECTRONIC DEVICES; FLUORESCENT LAMPS, FIXTURES, WIRING DEVICES; ELECTRIC LIGHT BULBS



Driver can quickly report overloading or underloading, traffic conditions, weather hazards